

DOCUMENT RESUME

ED 379 510

CE 068 348

AUTHOR Scholl, Jan
 TITLE 4-H Textile Science Textile Arts Projects.
 INSTITUTION Pennsylvania State Univ., University Park.
 Cooperative Extension Service.
 PUB DATE 94
 NOTE 24p.; For related documents, see CE 068 343-347.
 PUB TYPE Guides - Classroom Use - Instructional Materials (For
 Learner) (051)

EDRS PRICE MF01/PC01 Plus Postage.
 DESCRIPTORS Clothing; Clothing Design; *Clothing Instruction;
 *Design Crafts; Elementary Secondary Education;
 Extracurricular Activities; Home Economics; *Home
 Management; *Learning Activities; *Student
 Organizations; Student Projects; *Textiles
 Instruction

IDENTIFIERS *4 H Programs; Crocheting; Knitting; Weaving

ABSTRACT

This packet contains three 4-H textile arts projects for students in the textile sciences area. The projects cover weaving, knitting, and crocheting. Each project provides an overview of what the student will learn, what materials are needed, and suggested projects for the area. Projects can be adapted for beginning, intermediate, or advanced levels of skills. A step-by-step plan for doing the project, with instruction sheets and line drawings is included. Also included are a project record, ideas for sharing the project with others, and suggestions for additional projects.
 (KC)

 * Reproductions supplied by EDRS are the best that can be made *
 * from the original document. *

4-H Textile Science Textile Arts Projects

U.S. DEPARTMENT OF EDUCATION
Office of Educational Research and Improvement
EDUCATIONAL RESOURCES INFORMATION
CENTER (ERIC)

This document has been reproduced as received from the person or organization originating it.

Minor changes have been made to improve reproduction quality.

• Points of view or opinions stated in this document do not necessarily represent official OERI position or policy.

"PERMISSION TO REPRODUCE THIS MATERIAL HAS BEEN GRANTED BY

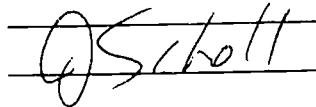

TO THE EDUCATIONAL RESOURCES INFORMATION CENTER (ERIC)."

CF 06 8 348

Weaving

4-H Textile Science



Textile Arts Project

In this project, you will learn:

- How fabrics are made
- What is meant by the "grain" of the fabric
- How to weave in two or more ways
- How to use weaving tools
- How to make and use a loom

You will make:

- A project or several small items on a loom of some type
- A woven piece of cloth or project

You will need:

- Materials to make one of the looms
- Fabric yarns to use on a loom
- Scraps of fabric, tapes, and trims
- Magnifying glass or microscope
- Parent or leader to help you

Chances are you already know something about weaving. Maybe you've woven strips of construction paper together in art class or helped a family member weave a pie crust lattice. Maybe someone gave you a simple loom as a gift once. Well, fabrics are made the very same way—by moving yarns over and under each other to hold them in place.

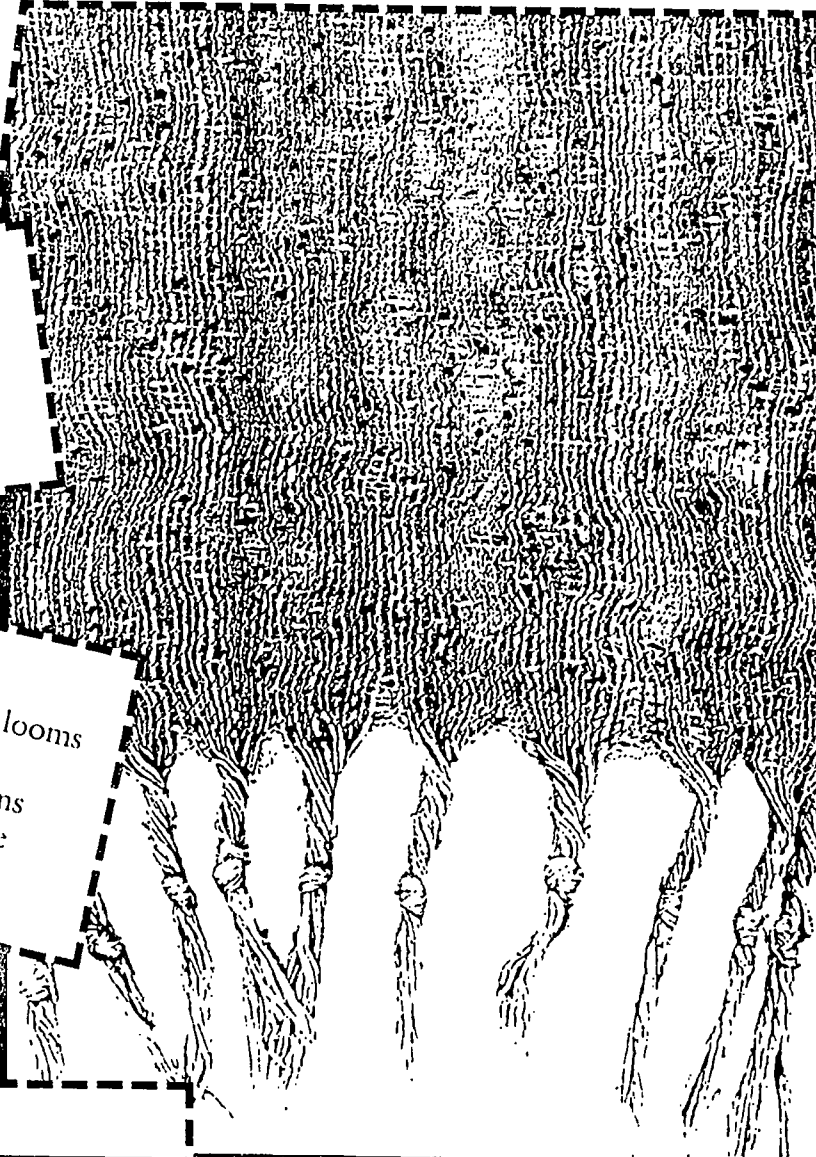

PENNSSTATE



College of
Agricultural Sciences
Cooperative Extension

How Fabrics Are Made

To make fabric, a fiber is first produced or made, then several fibers are twisted or plied together to form yarns. These yarns are woven, knitted, or matted (like felt) together. Then a finish is added.

Mount a sample of woven, knitted, and matted fabrics here:

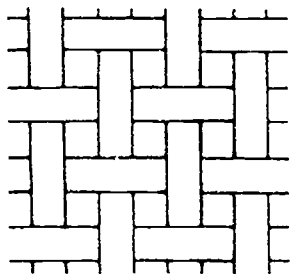

WOVEN

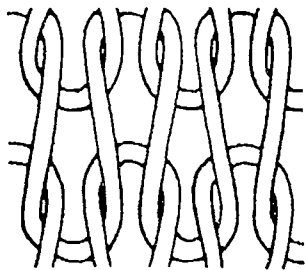

KNITTED

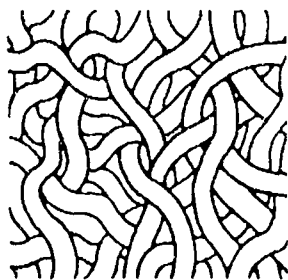

MATTED

To examine these fabrics, you'll need a magnifying glass. Look at each one. What do you see?

Pull some yarns from scraps of fabric and untwist them to find the smallest part, called a fiber. Look at the fiber under the magnifying glass. Fibers are very long compared to their width. Some are curly, while others are fuzzy, straight, or scaly.

Place the magnifying glass over your fabric and look again. Look at the weave. How are the yarns woven together? Have your leader point out the various types of grain. Lengthwise, crosswise, and true bias.

Move the magnifying glass to the selvage. The yarns lying lengthwise are called warp or woof yarns. The yarns lying crosswise are called weft or filling yarns. Sometimes the yarns in the warp and the weft are made from different fibers.

Examine a pair of jeans and a washcloth or towel. Look at both sides of a satin fabric. How are they different from your fabrics?

Look again at the lengthwise and crosswise yarns of the fabric. These yarns make the grainline of the fabric and must be straight. Some fabrics are not printed on the grain. Do not buy these fabrics because it will be very difficult to get the print to drape and not appear crooked. They usually can't be straightened.

Experiment

Pull both ways on the lengthwise, crosswise, and true bias. Do you notice any difference?

One grain follows the selvage. It is very strong and will not give.

One grain gives a little and often has yarns that are less strong.

One grain is stretchy.

Group Project

Hang weaving vertically from a wire or a tree limb in an open space. Then you can work on the project from both sides or with a group of people.

Materials for Weaving

Weaving can be done on your fingers, on paper plates, and on other common items besides regular looms. You can weave with grasses, leaves, paper, string, pie crust, cooked spaghetti, yarn, recycled fabrics, and even plastic bags! You can make a human loom, too. (See next page.)

Think about reusing or recycling materials for yarns or for your loom. For instance, you could cut strips from old T-shirts. A mesh sack that holds potatoes or onions makes a good base for weaving. So does burlap. You can pull out some of the yarns and replace them with other types of yarns.

Use a bodkin or a large needle and thread fibers, ribbons, and yarns as your filling. If you're making a wall hanging, you may want to incorporate twigs, old spoons, or other materials.

Start by doing simple construction paper weaving. You may also have a loop loom that you received long ago as a gift. Get it out and experiment!

How a Loom Works

Boredom has always forced people to find new ways to speed the weaving process and to make the woven product more beautiful! A heddle is a time saver. The heddle opens an area called the shed, making it easier to go over and under the yarns all at the same time. The yarns are carried by what is known as the shuttle and pushed together by the beater. The heddle brings up both sheds alternately up and down.

Many looms can be fitted with sheds. A popsicle stick loom is one such loom.

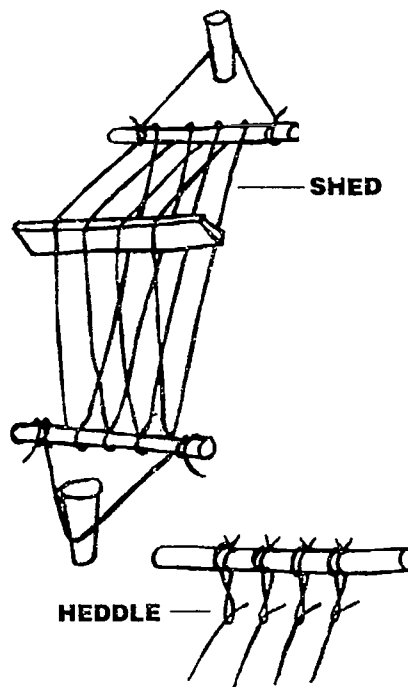

Popsicle Stick Loom

What you will need:

Tape or band six popsicle sticks together and drill a small hole in the center. Line up the sticks so there is 1/8 inch of space between each stick and the holes all line up. Glue the sticks to two other popsicle sticks, one at the top and the other at the bottom. Let dry. A power stapler may be used to secure the sticks.

Cut 11 lengths of yarn (twice the size of the project). Thread six lengths through the holes and five through the spaces. Make ends even and tie into a large knot at each end.

Tie one end to a sturdy object and the other end to the waist with a belt or a piece of extra yarn.

Make a popsicle stick shuttle by cutting a "V" in each end of the stick and sanding smooth. (You can also use a tongue depressor.) Wrap the yarn around from the inside of one "V" to the next several times.

When the heddle is raised or lowered, the yarn will move up and down, creating a space in between (called the shed). Alternate the shed by raising and lowering the popsicle heddle loom and sliding the shuttle yarn through in alternate directions. To finish, untie the original knots and retie them at the edges of the weaving. Trim leftover yarn to create a fringe.

Note: When you start, you'll want to tie some of the yarn in back so you don't have to reach so far to use the shuttle. Also try weaving both tightly and loosely to create interesting patterns in your weaving.

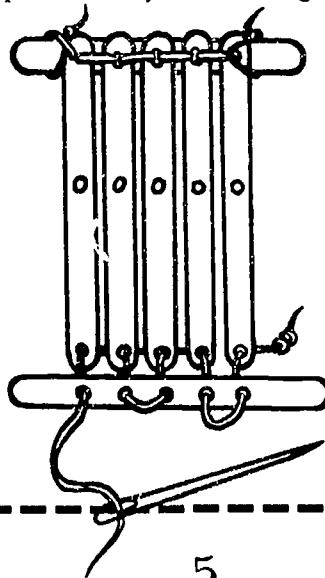

Human Loom

Fun for you and your friends! If you don't have the exact materials, improvise with what you do have.

What you need:

- 100 feet of polypropylene rope (yellow)
- 100 feet of hemp rope (natural brown) cut into seven equal lengths (about 14 feet each)
- 15 participants

What to do:

- Line up 14 participants in two rows of seven, then turn to face one another, forming seven pairs.
- Each pair is given one length of brown rope (loom warp)
- Another participant is given one end of the yellow rope (loom weft)
- Number each pair 1, 2, 1, 2, 1, 2, 1
- The #1 pairs kneel, while the #2 pairs remain standing.
- The participant with the yellow rope walks over the #2 warps and under the #1 warps.
- Continue until most of the warp space is used. The weft person may have to crawl through the last few passes.
- When finished, push the warp and weft close together to see the plain weave pattern.

Human loom activity developed by
Charlotte W. Coffman, Cornell University.

What I learned in this project (new skills, new words)

What I shared with others (presentations, helping other members, community service)

TOPIC OR SKILL	DATE	NUMBER IN AUDIENCE
<hr/>	<hr/>	<hr/>
<hr/>	<hr/>	<hr/>
<hr/>	<hr/>	<hr/>

Project story

Use this space to write about your project. What did you do? What did you enjoy doing most? Least? Tell about the type of loom you used or made and the materials you selected. Include a picture or draw a sketch of your final project.

Tell about any weaving books you read, the resource people who helped you, and the activities at your group meetings.

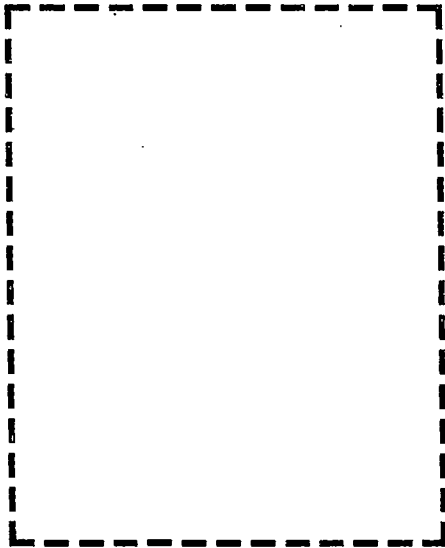

Weaving Project Record

Name _____

Address _____

Age as of January 1 _____

Club _____

Number of years in this project _____

Number of years in Textile Science projects _____

Leader's signature _____

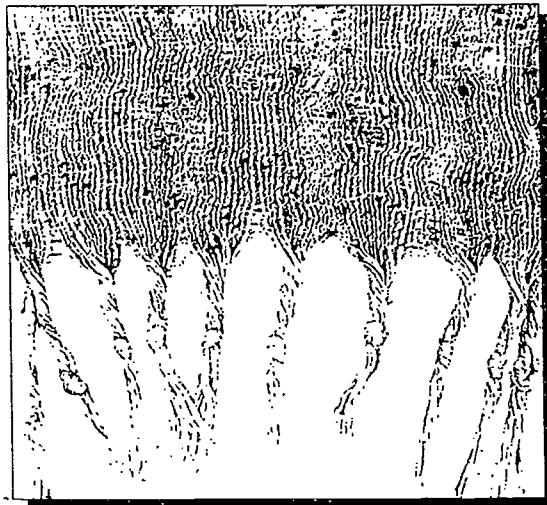
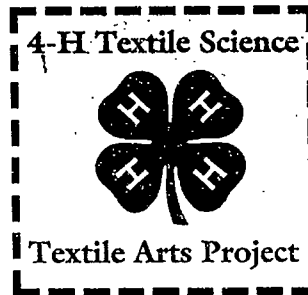

What I made for my project

ITEM	FIBER CONTENT	COST	HOURS TO MAKE
_____	_____	_____	_____
_____	_____	_____	_____
_____	_____	_____	_____
_____	_____	_____	_____
_____	_____	_____	_____

Total number of garments or articles made this year _____

People who helped me and resources I used for this project

4-H Textile Science
Weaving
Textile Arts Project

Sharing What You've Learned

Demonstrate:

- How to make a simple loom
- Parts of a loom
- How to weave
- Different types of weaves
- Fabric grain
- Fabrics printed off-grain
- Weaving projects and ideas

Fabric lingo

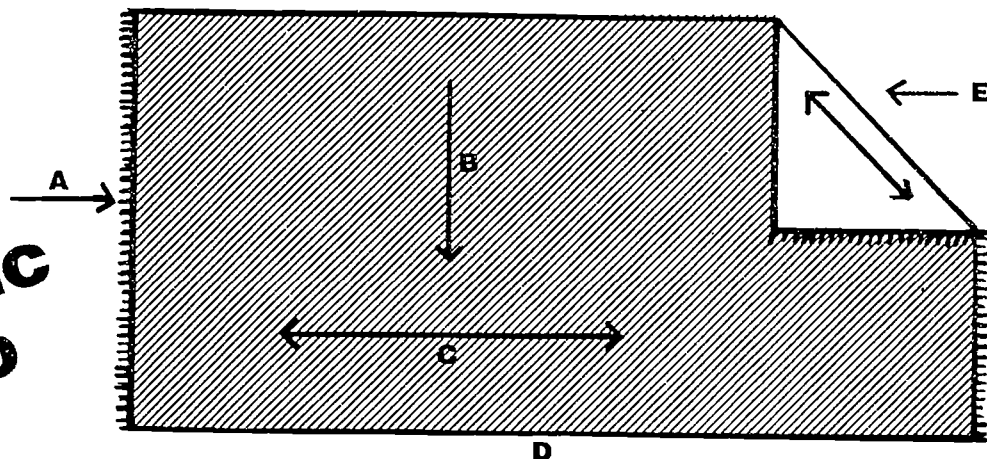

- A RAW EDGE
- B CROSSWISE YARNS
- C LENGTHWISE YARNS
- D SELVAGE
- E BIAS

Want to Know More?

There are dozens of excellent books on weaving for children and adults. Look for them at your local library. In Pennsylvania, new 4-H resource materials for the Textile Science projects are put on PENpages. Ask about PENpages at your county extension office.

Exhibits and Fashion Revue

This project was not designed to be modeled in a fashion revue unless you make a garment and have followed other fashion revue rules and regulations. Check both fashion revue and fair or roundup premium listings to know what can be entered at the county, regional, and state levels. Every piece of your work should have a hand-stitched label printed with your name, age, and county, in addition to your entry tag.

Taking the Project Again

You may want to take this project for more than one year. Make or use a different loom to help you develop new skills. You may also want to set up an exhibit of your woven projects at a local library or community center.

Name Kelly Tarve
Age 16
4-H club Socks and ties
County Snippet

Prepared by Jan Scholl, associate professor of agricultural and extension education.

Issued in furtherance of Cooperative Extension Work, Acts of Congress May 8 and June 30, 1914, in cooperation with the U.S. Department of Agriculture and the Pennsylvania Legislature. J.E. Hood, Director of Cooperative Extension, The Pennsylvania State University.

This publication is available in alternative media on request.

The Pennsylvania State University is committed to the policy that all persons shall have equal access to programs, facilities, admission, and employment without regard to personal characteristics not related to ability, performance, or qualifications as determined by University policy or by state or federal authorities. The Pennsylvania State University does not discriminate against any person because of age, ancestry, color, disability or handicap, national origin, race, religious creed, sex, sexual orientation, or veteran status. Direct all inquiries regarding the nondiscrimination policy to the Affirmative Action Director, The Pennsylvania State University, 201 Willard Building, University Park, PA 16802-2801; tel. (814) 863-0471; TDD (814) 865-3175.

© The Pennsylvania State University 1994.

Knitty Gritty

4-H Textile Science



Beginner,
Intermediate, and
Advanced Projects

Does the word “knitting” make you think of

Grandma sitting in a rocking chair? Perhaps you can picture a cozy slipper or a colorful sock in her lap and a kitten playing with a ball of yarn at her feet.

Knitting is enjoyed by men and women, boys and girls. Some form of it can be found in every country of the world!

Knitting is creative and fun. It is easy to learn, and you can use it to produce warm clothing and other useful items. Don't worry if you make mistakes at first. You will! Making mistakes is part of learning. Just keep practicing.

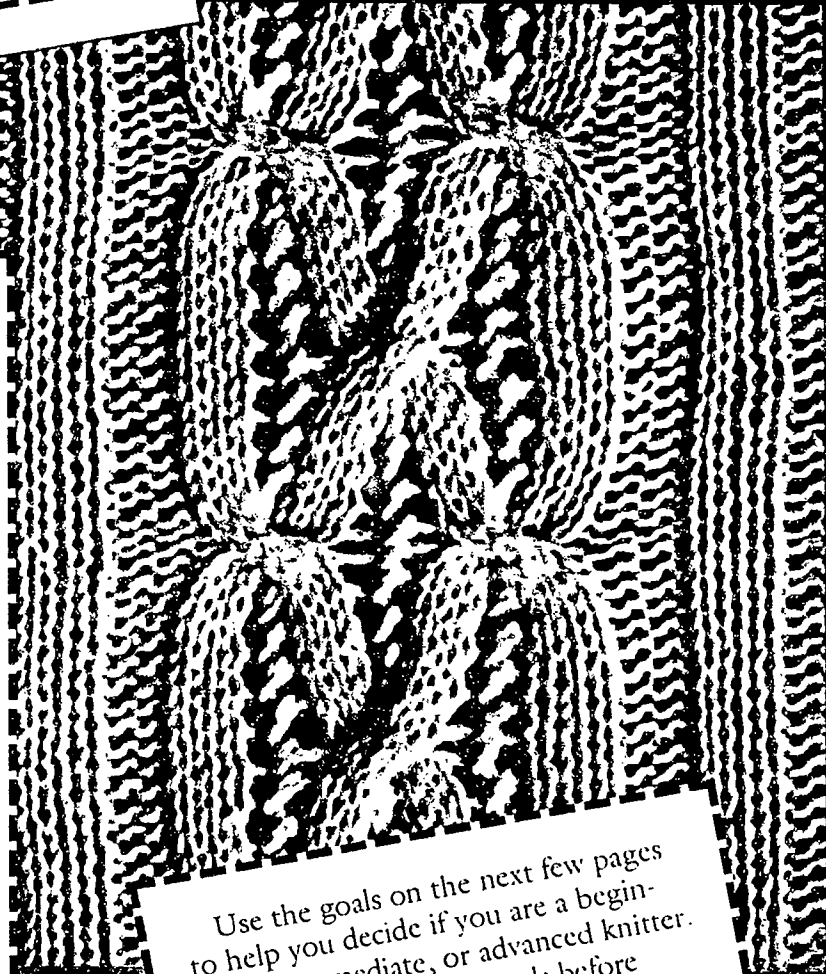

Use the goals on the next few pages to help you decide if you are a beginning, intermediate, or advanced knitter. Complete most of the goals before going to the next level. It's OK to take a project level more than once—just select new goals.

Study fair or roundup premium listings for ideas on what to exhibit. The listings are updated every year. It's also good to make several items to sharpen your skills before you start making your exhibit.

You can do it! There are many ways to knit, purl, cast on, and bind off stitches—even if you're left handed. Your leader can help you learn and locate resources to find the way that's best for you.

PENNSTATE



College of
Agricultural Sciences
Cooperative Extension

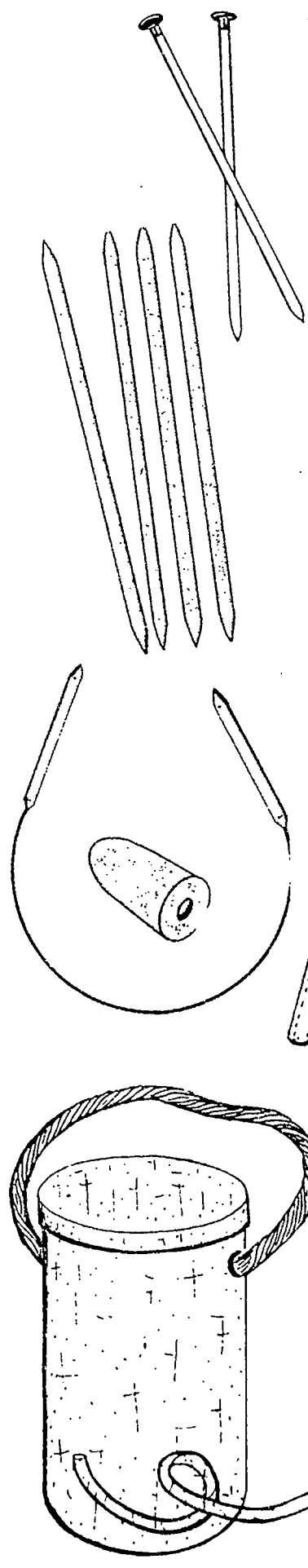

What You'll Need

- Knitting needles of correct size
- Good-quality yarn
- Small scissors
- Six-inch ruler or gauge or "knit check"
- Tapestry needle or bodkin
- Crochet hook (to correct mistakes—size G or 6 for 4-ply yarn)
- Point protectors (to protect needles and prevent dropped stitches)
- Emery board or nail file (to keep rough fingernails from snagging yarn)
- Container to hold equipment and knitting

To Complete Your Project

1. Select your skill level with your leader's help.
2. Complete at least half the goals listed in your level.
3. Knit one or more articles or garments that will help you complete your goals.
4. Give a presentation at a club meeting.
5. Exhibit a knitted garment or article.
6. Complete your 4-H record.

Here is what you'll learn!

A little ditty to help you learn to knit:
 In through the front door
 Once around the back,
 Peek through the window,
 And off jumps Jack.
 (Hansen, 1990)

To help you purl:
 Sneaking in the back door
 A lasso overhead
 Go back to check the garden
 and off to bed!

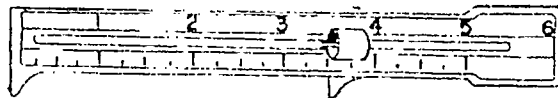

Beginner

Skills

1. Learn to cast on and bind off stitches.
2. Create a garter stitch pattern with knit stitches.
3. Create a garter stitch pattern with purl stitches.
4. Create a stockinette (stocking).
5. Make a ribbing.
6. Increase and decrease stitches.
7. Check and adjust gauge.
8. Create colorful stripes.
9. Make a pompom and a tassel.
10. Fold a sweater and store knitted items.
11. Practice cleanliness skills.
12. Read dye lot numbers and other label information.
13. Wind a ball of yarn.

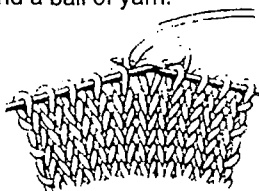

Goals

Knit two of the following articles:

- Slippers
- Headband
- Turtleneck dickey
- Leg warmers
- Bell pin
- Scarf
- Simple hat
- Simple shell
- Simple toy
- Pillow

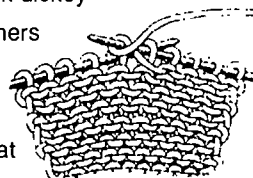

Intermediate

Skills

1. Read directions.
2. Create two or three special stitch patterns (such as moss, cable, diamond, block, or popcorn stitch).
3. Work with circular needles, jumper, and/or double pointed needles.
4. Learn at least one method of joining seams.
5. Make a buttonhole.
6. Use markers and stitch holders.
7. Pick up stitches.
8. Solve common knitting problems (such as skipped stitches, holes, and twisted stitches). Rip out a section of knitting and replace knitting on needles.
9. Hand wash and block a knitted article.
10. Visit a dry cleaner. Find out about available services and common cleaning problems.
11. Recognize the woolmark and other laundry symbols.
12. Wind yarn into a ball.

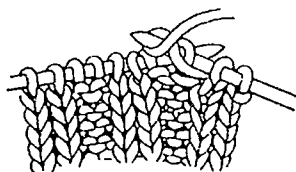

Goals

Knit one or more of the following articles:

- Mittens
- Headhugger or neck warmer
- Socks
- Stuffed animal
- Cardigan sweater
- Sweater (two colors, with or without buttonholes)
- Accessory (hat, etc.)
- Afghan
- Toy
- Wall hanging
- Baby clothes
- Vest

Advanced

Skills

1. Learn two or three additional creative stitches.
2. Use a contrasting stitch to make a conventional design (animal, landscape, etc.).
3. Combine a knitted and woven fabric in a garment.
4. Combine knit with other needlework (such as embroidery).
5. Mend a knitted garment.
6. Reclaim yarn or remake a knitted garment.
7. Use a knitting machine.
8. Create a knitted garment from start to finish: shearing, carding, spinning, dyeing, and knitting.
9. Share your knitting skills with another person.



Goals

- Article or garment using multiple colors and/or stitches
- Article or garment using a contrasting stitch
- Article or garment combining knit and woven fabric
- Article or garment combining other needlework or beadwork
- Article or garment made on a knitting machine
- Article or garment from start to finish (Goal 8)
- Notebook of samples and pictures for sharing skills
- Remade knitted garment

Abbreviations

Abbreviations are letters or symbols that make reading directions simpler. For example, "knit one, purl one" is often abbreviated "K1, P1."

Sometimes an asterisk (*) or brackets ([]) are used to let you know to do something in a series. For example, directions that say (K1, P2) four times mean that you need to do the knit 1 and purl 2 stitches four times. An asterisk means to go back to the part of the directions that are starred and repeat as the directions say.

Here are some other common knitting abbreviations. Ask your leader to show you what they mean. Practice reading directions and refer to this list.

Sometimes it's easier to follow a graph pattern when working with two or more colors.

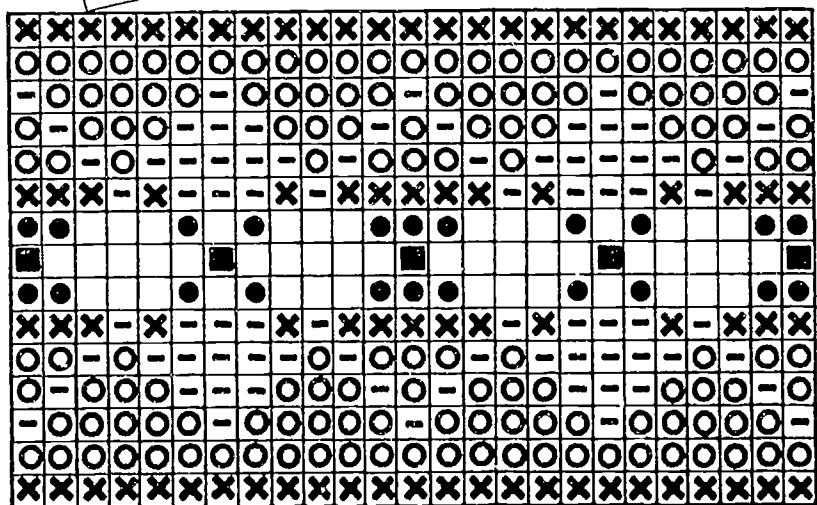

↑ End st Rep 12 sts ↗

- beg**—beginning
- CC**—contrasting color
- dec(s)**—decrease(s)
- dp**—double pointed needles
- gr**—grams
- in(s)**—inch(es)
- inc(s)**—increase(s)
- k**—knit
- MC**—main color
- oz(s)**—ounces
- pat**—pattern
- psso**—pass slip stitch over
- p**—purl
- rep**—repeat
- rnds**—round(s)
- SKP**—slip 1 stitch, knit 1, stitch, purl 1 stitch
- sk**—skip
- sl st**—slip stitch
- sl**—slip
- st(s)**—stitches
- tog**—together
- yo**—yarn over

Choosing Yarn

Yarns differ from one another in many ways. They have various twists, sizes, and textures. They may be made of one fiber (such as wool or acrylic) or may be a blend of two or more fibers. The type recommended in the directions will best suit the item you plan to make.

Yarn can't always be matched. Buy all the yarn you need at one time. Check the dye lot numbers to see that all the yarn is the same color.

Find the following information on the yarn label:

- Manufacturer's name and address
- Type of yarn (hand knitting, rug, baby, etc.)
- Fiber content (wool, acrylic, nylon, etc.)
- Word "virgin" or "reprocessed"
- Number of plies (strands in the yarn)
- Amount of yarn (by weight)
- Color name and number
- Dye lot number
- Care instructions

Reclaiming Yarn

Virgin yarn means the yarn is new. You may want to "reclaim" yarn by unraveling it from an old sweater or other article that can no longer be used.

Cut one stitch on the edge of the garment. Pull the yarn gently and wind on a back of a chair to prevent tangles. Tie the skein in four places. Dip it into warm soapy water. Rinse well in warm water and hang to dry where the air will circulate through it. After yarn is dry, rewind into a ball.

- ✕ = Blue
- = Pink
- = Red
- = Purple
- = Black
- = White

The Stretch Test

Choose quality yarns. Try the stretch test! Pull 10 inches of yarn, gently. It should reach from 1 1/2 to 3 inches. Release it and it should return back to close to the same length.

Needles

If you are starting out, select straight knitting needles in the size recommended for your pattern. Choose plastic, wooden, or aluminum needles in a color different from your yarn so that you can see your stitches.

As you advance, you will use circular and double-pointed needles. You may also want to try straight needles made from wood, bamboo, or steel.

Checking the Gauge

With the yarn and needles you plan to use for your project, cast on 25 stitches. Work for 3 inches, using the stitch given in the pattern. Bind off the stitches and block. Count the number of stitches per inch.

If your gauge has more stitches per inch than given in the directions, try the next larger size of needle. Make a new gauge. If your stitch gauge is less, try the next smaller needle. Make a new gauge. Gauge is important to the size and fit of the finished product!

Correcting Mistakes

Everyone makes mistakes. The trick is to see them and correct them early. Common mistakes are dropped stitches, holes, and twisted or split stitches. Your leader or a reference sheet can help you make corrections. A crochet hook is a useful tool to make corrections.

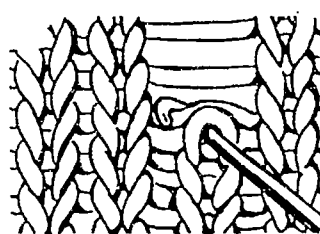

DROPPED STITCH

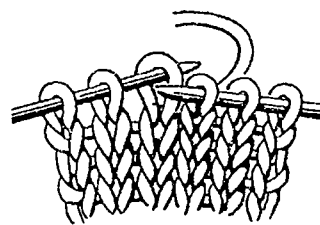
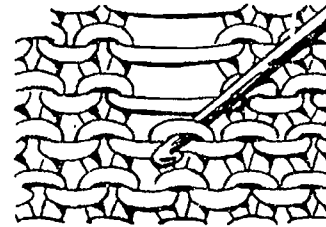

TWISTED STITCH

Seam Finishes

There are many types of seam finishes. Some common ones are woven, backstitched, and crocheted seams. You may choose one or more seam finishes. For example, in a sweater, the backstitched seam might be used in the raglan area and a woven or crocheted seam used in the side and sleeve seams.

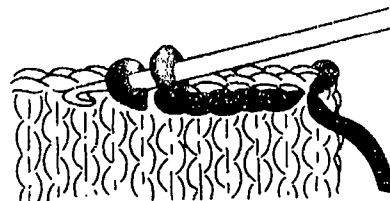

CROCHETED SEAM



WOVEN SEAM

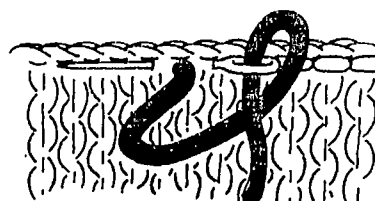

BACKSTITCHED SEAM

How to Fold a Sweater

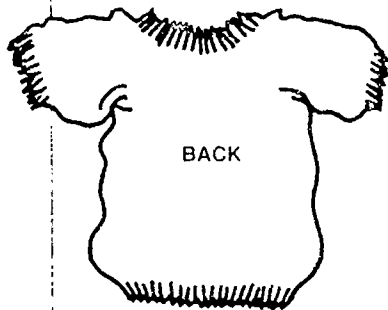

Spread sweater out, front down.

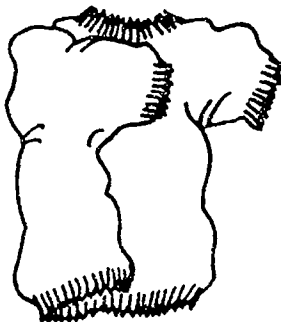

Fold back each side.

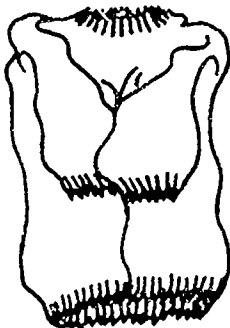

Fold the arms down.

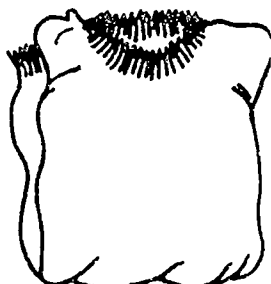

Fold up the bottom.

Cleaning, Mending, and Storing

Follow the laundry and care instructions found on most yarn labels.

Hand Washing

1. Draw an outline of the garment or article on an old sheet or heavy paper first so you can block the garment later.
2. In lukewarm water and mild detergent, saturate the garment. Work solution through garment. Soak for 2 minutes. Work solution through again, being careful not to twist or wring.
3. Fill another basin or washtub with cool water. Press water through garment, releasing suds. You may have to use several basins of water to do this. Again, be careful not to wring or twist the garment.
4. Lay the article flat between two towels and pat dry or roll up the towels. Lay down several dry, flat towels with outline of shape on top. Pat to the proper shape and air dry away from direct heat. If fabric is resilient, you can use rust-proof pins to attach the garment to the sheet or paper.

Mending and Patching

A tear or worn spot in a knitted garment can be mended with a duplicate stitch or by grafting a new piece of yarn in place.

Patches can be knit and woven over a hole using a kitchener stitch or duplicate stitch. Pull snags to the wrong side of the garment with a small crochet hook or a special mending tool. Never cut snags, because a hole will result when the yarn ends work loose.

Storage

Knitted garments should be folded for storage. Hanging causes them to pull out of shape. After wearing, air before folding and store in a drawer. Plastic containers can hold moisture that may damage the yarn or cause mold to develop. Clean the garments before long-term or seasonal storage. This will prevent insect damage and set-in stains.

Block and Dry a Sweater

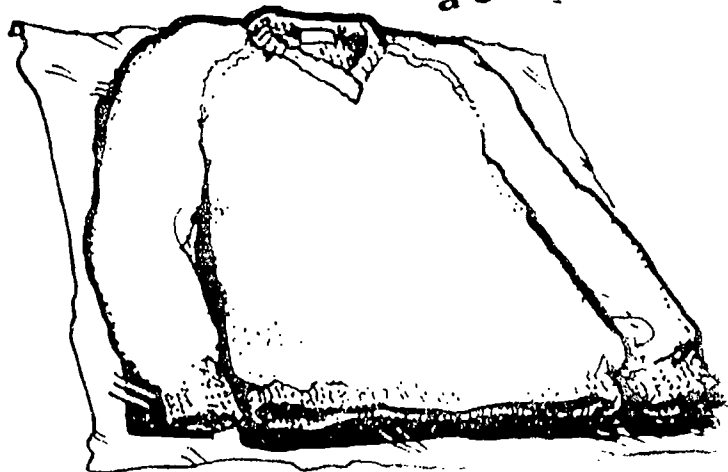

Instructions for Several Beginner Projects

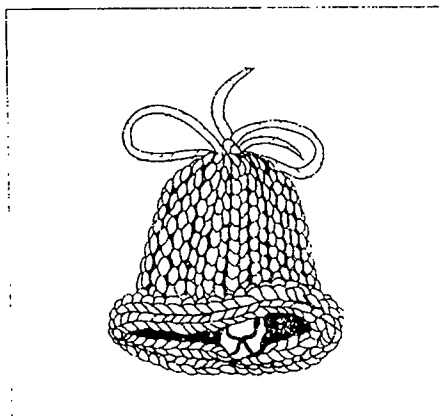

Bell

Make bells for the Christmas tree or to decorate wedding, shower, or baby gifts.

Skills:

- Casting on
- Casting off
- Knit stitch
- Purl stitch
- Sewing up a seam

Materials:

- One ball (50-gram) Sayelle yarn (makes 7 to 8 bells)
- One pair size 4 needles
- Other: bodkin or tapestry needle
- 1 small jingle bell
- 14-inch narrow ribbon

Approximate time to make:

- 1 1/2 hours

Directions:

- Cast on 14 stitches, leaving a 4-inch tail of yarn.
- Row 1: Knit 10, purl 4
- Row 2: Knit 14
- Repeat rows 1 and 2 until you have done 36 rows (count 18 ridges). End with a knit 14 row.

Cast off:

- Leave an end of yarn 12 inches long.

To finish:

Thread yarn end into the bodkin or needle and do a running stitch through every other stitch along the top, pulling up tightly. Fasten off by doing three stitches in the same spot. Use the same yarn to sew up side seam of bell, using a crochet or back stitch. Weave in yarn ends along seam.

To attach metal jingle bell:

Cut a piece of narrow ribbon or yarn 14 inches long. Thread the jingle bell onto it, positioning bell in the center of the ribbon. Poke ribbon ends through top hole of yarn bell (you may have to thread them into a large-eyed needle to do this). Pull ribbon ends up through hole until jingle bell just shows below bottom of yarn bell. Tie ribbon ends in a bow on top of the yarn bell.

To attach hanging loop (for use as a Christmas decoration):

Cut a piece of yarn 10 inches long. Thread it into a needle. On inside of bell, weave yarn into seam for about 1 inch at the top of the bell, anchor with two or three stitches just under the hole, and poke needle out top hole of yarn bell then back in again, leaving a 3-inch loop. Anchor again just under hole and weave remaining end into seam. Trim.

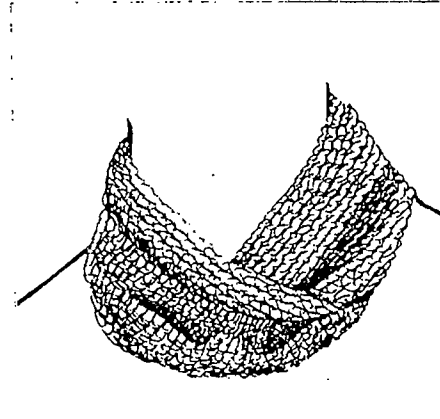

Neckwarmer

A ribbed band to wear like a turtleneck scarf.

Skills:

- Casting on
- Casting off
- Knit stitch
- Purl stitch
- Joining yarn
- Weaving in ends

Materials:

- Two balls (50 grams each)
- Shetland chunky yarn
- One #6 circular needle, 24 inches long
- Bodkin
- Circular needle

Approximate time to make:

- 4 hours

Directions:

- Cast on 80 stitches.
- Row 1: K1, P1 to end of row (ribbing)
- Row 2: Same as row 1.
- Repeat until neck warmer measures about 10 inches or desired length.

Cast off:

- Leave a 20" length of yarn to stitch seam.

Weave in yarn ends and trim.

Project goals I completed this year

Care I gave to my knit articles

Number of articles washed _____

Number of articles repaired _____

What I shared with others (presentations, helping other members, community service projects)

TOPIC OR SKILL	DATE	NUMBER IN AUDIENCE

My presentation title was _____

Project story

Use this space to write about your project. What did you do? What did you enjoy doing most? Least? Tell about the materials you selected. Include a picture or draw a sketch of your final project.

Tell about any knitting books you read, the resource people who helped you, and the activities at your club meeting.

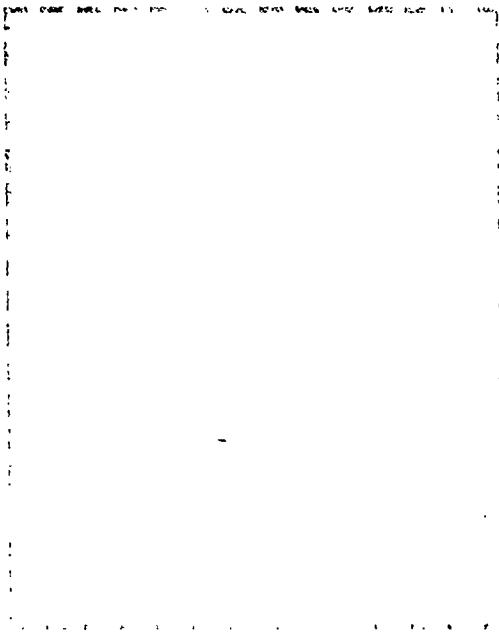

Knitty Gritty Project Record

4-H Textile Science



Beginner,
Intermediate, and
Advanced Projects

Name _____

Address _____

Age as of January 1 _____

Club _____

Project level (beginner, etc.) _____

Number of years in this project _____

Leader's signature _____

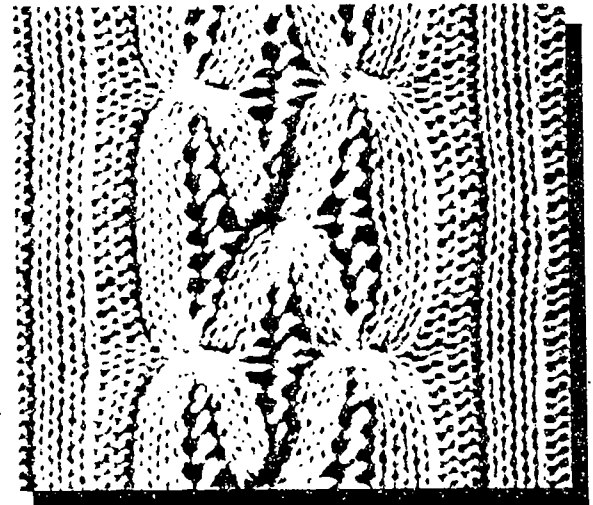

What I made for my project and what it cost

ARTICLE OR GARMENT	COST	ESTIMATED VALUE

Project goals I completed this year

Sharing What You've Learned

Demonstrate one or more of the skills listed in this project for your skill level.

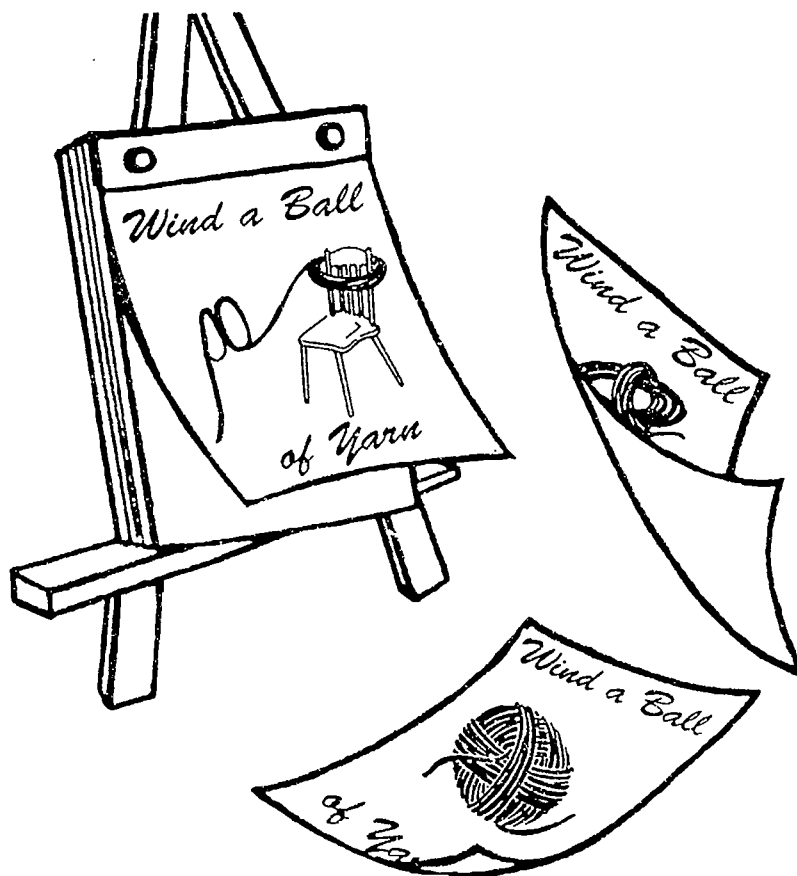

Resources and References

Ask your leader about resources and references for this project. Many are available on PENpages, at your county extension office. Don't forget to look through craft and knitting magazines at libraries, bookstores, and department stores. The magazines are packed with ideas and skills to help you.

Exhibits and Fashion Revue

Check current roundup or fair premium listings to learn what you can enter as an exhibit. Each item should have a label printed with your name, age, club, and county. You may model knitted garments and accessories at the fashion revue. Check county, regional, and state guidelines before entering.

Taking the Project Again

You can take a project over again by choosing new goals and practicing the skills you've already learned. Complete most goals before moving to the next level.

Name Kelly Tarve

Age 16

4-H club Socks and ties

County Snippet

Prepared by Jan Scholl, associate professor of agricultural and extension education.

Issued in furtherance of Cooperative Extension Work, Acts of Congress May 8 and June 30, 1914, in cooperation with the U.S. Department of Agriculture and the Pennsylvania Legislature. L.F. Hood, Director of Cooperative Extension, The Pennsylvania State University

This publication is available in alternative media on request.

The Pennsylvania State University is committed to the policy that all persons shall have equal access to programs, facilities, admission, and employment without regard to personal characteristics not related to ability, performance, or qualifications as determined by University policy or by state or federal authorities. The Pennsylvania State University does not discriminate against any person because of age, ancestry, color, disability or handicap, national origin, race, religious creed, sex, sexual orientation, or veteran status. Direct all inquiries regarding the nondiscrimination policy to the Affirmative Action Director, The Pennsylvania State University, 201 Willard Building, University Park, PA 16802-2801; tel. (814) 863-0471; TDD (814) 865-3175

© The Pennsylvania State University 1994.

Crocheting

4-H Textile Science



Beginner,
Intermediate, and
Advanced Projects

Are you ready to crochet?

This project is designed for beginning, intermediate, and advanced members. To decide where you should start, read the lists of goals on the next page. Then complete most of the goals in a list before going on to the next level. Of course, it's OK to take the project more than once. Just select new goals!

Study fair or roundup premium listings to decide what to exhibit. The listings are updated every year. It's also a good idea to make several items to strengthen your skills before beginning your exhibit.

Now here's what you'll do!

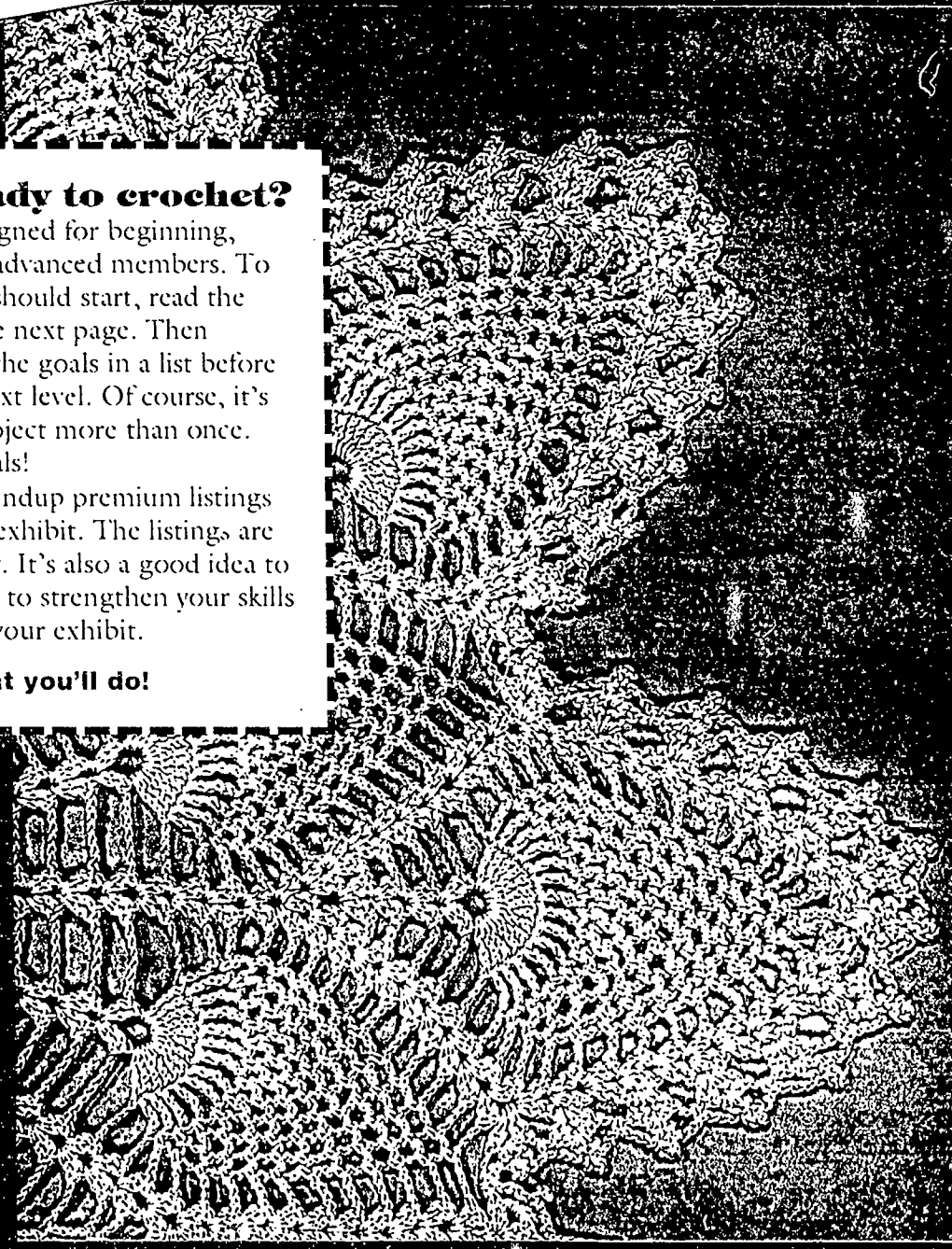

PENNSSTATE



College of
Agricultural Sciences
Cooperative Extension

Beginner

Skills

1. Select yarn or thread
2. Select crochet hooks
3. Read abbreviations
4. Check and adjust gauge
5. Make a chain
6. Make a slip stitch
7. Single crochet
8. Double crochet
9. Make rounds of single crochet
10. Use a beginner's book on crocheting
11. Wind a ball of yarn

Goals

1. Make two of the following articles:
 - Potholder
 - Bean bag
 - Coin purse
 - Belt
 - Scarf
 - Pillow
 - Purse or clutch
 - Headband
 - Hats
 - Mittens
2. Keep a record of how much materials cost.
3. Care for your crocheted garments or articles.
4. Keep work clean and organized.
5. Give a demonstration or talk at a group meeting.
6. Exhibit two articles at roundup or fair.
7. Complete the project record.



Intermediate

Skills

1. Make a half-double crochet
2. Make a treble crochet
3. Increase stitches
4. Decrease stitches
5. Make a square motif
6. Assemble motifs

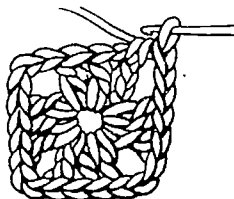

Goals

1. Crochet one or more of the following articles:
 - Vest
 - Belt
 - Purse
 - Placemat
 - Wallhanging
 - Poncho
 - Shawl
 - Scarf
 - Rug
 - Pillow
 - Toy
 - Afghan
 - Tie
 - Mittens
 - Tablecloth
 - Baby blanket
 - Christmas ornament
2. Experiment by crocheting with fabric as well as yarn.
3. Keep a record of how much materials cost.
4. Care for your crocheted garments or articles.
5. Keep work clean and organized.
6. Give a presentation or lead a discussion at a group meeting.
7. Exhibit two small articles or one large article at roundup or fair.
8. Complete the project record.

Advanced

Skills

1. Make at least four of the following stitches: shells, cluster, popcorn, puff, afghan, filet, arch, knot, loop, and bullion.
2. Make an article or garment that contains two or more colors.
3. Experiment with hook sizes and yarn types.

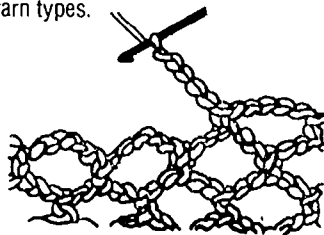

Goals

1. Crochet one or more of the following articles:
 - Sweater
 - Vest
 - Coat
 - Dress
 - Afghan
 - Gloves
 - Tie
 - Pillow
 - Socks
 - Toy
 - Tablecloth or runner
 - Bedspread
 - Hat
 - Scarf
 - Poncho
 - Baby blanket
 - Rug
2. Keep a record of how much materials cost.
3. Keep work clean and organized.
4. Give a presentation or lead a discussion at a group meeting.
5. Exhibit an article or garment made with one or more pattern stitches.
6. Complete the project record.

Helpful Hints

Rug yarn is best used for rugs and items such as hot plate mats. Lighter weight yarn is suitable for bedspreads, placemats, hats, bags, tablecloths, doilies, edgings, and accessories. It's important to think about the fiber content of the yarn, too. Wool yarn provides warmth and is flame retardant, but it is usually not machine washable.

Yarns cannot always be color-matched. Plan to buy at one time all the yarn you're going to need. Check the dye-lot numbers to make sure all skeins are the same. Crochet thread sizes vary from a 5 (heaviest) to a 30 (finest).

Crochet hooks are made of steel, nylon, plastic, or wood. Sizes range from 00 to 15. United Kingdom (U.K.) sizes are also written on the package. These sizes range from A to K. For good results, use the hook size given in the directions and check your gauge. Crochet hooks may be single- or double-ended.

Tension is controlled by the way you hold the thread as it passes through your fingers. With practice you'll learn to relax, and the flow of thread or yarn will become even. Even tension means even work. Try to make your loops and stitches just loose enough for the hook to go through easily.

"Blocking" means to press or steam material into shape; it is necessary in working with wool. Block all parts of any crocheted garment before sewing together. Doilies and fine work must also be blocked.

Gauge refers to the number of stitches per inch and rows per inch. When making an article of a certain size, you must be sure the measurements are exactly right. This means the gauge must be consistent with that given in the directions. Make a sample to determine if your gauge agrees with the one given in the instructions. If you need fewer stitches, try a larger hook. If you need more stitches, try a smaller hook.

Good crocheting instructions should contain an explanation of abbreviations. Study the abbreviations below to help you follow directions quickly and easily.

st, sts—stitch, stitches

ch—chain stitch

sc—single crochet

dc—double crochet

rnd—round

sl st—slip stitch

dec—decrease

inc—increase

An asterisk (*) means to repeat the instructions as many times as specified. Parentheses () are sometimes used instead of an asterisk to mean the same thing.

Crochet Hook Sizes

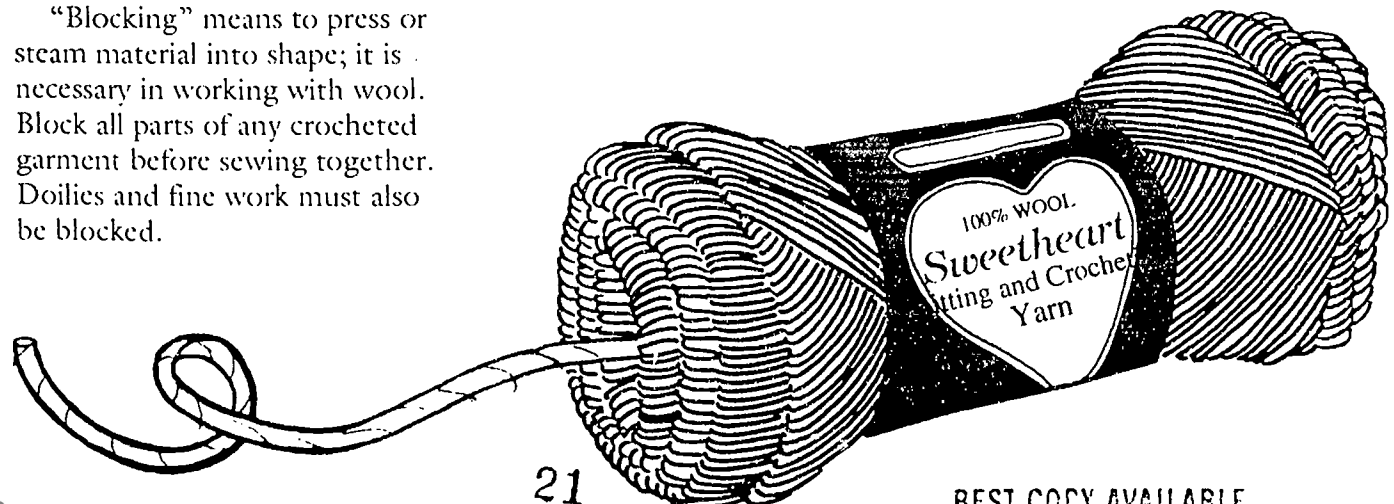
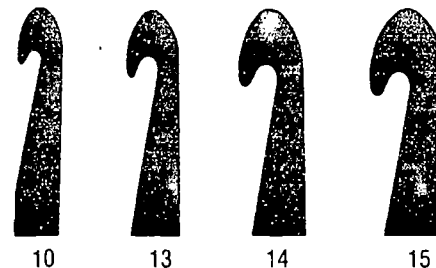
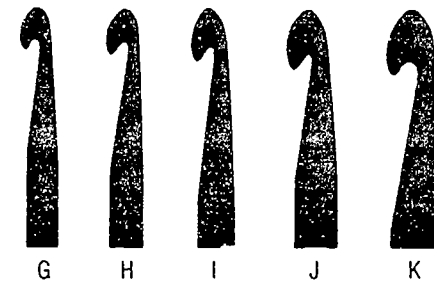
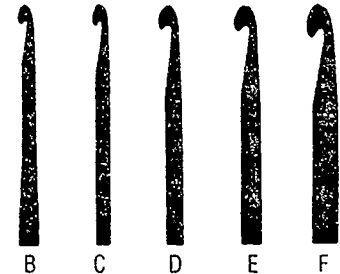
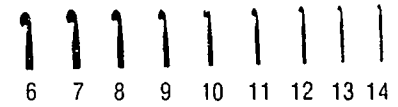
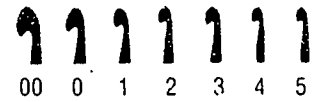

Care I gave to my crocheted articles

Number of articles washed _____

Number of articles repaired _____

What I shared with others (presentations, helping other members, community service)

TOPIC OR SKILL	DATE	NUMBER IN AUDIENCE

Project story

Use this space to write about your project. What did you do? What did you enjoy doing most? Least? Tell about the materials you selected. Include a picture or make a sketch of your final project.

Tell about any crochet books or magazines you read, people who helped you, and activities you completed at your club meetings.

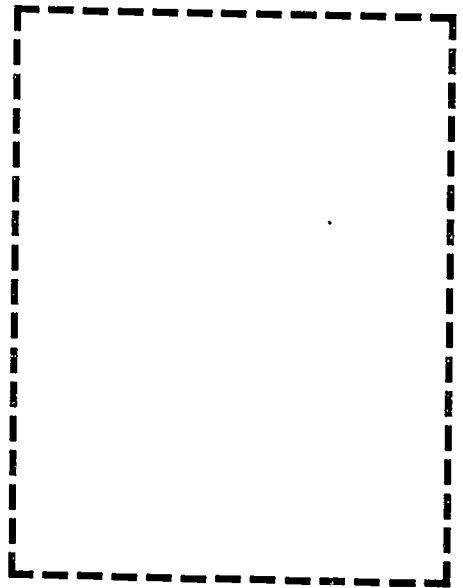

Crocheting Project Record

Name _____

Address _____

Age as of January 1 _____

Club _____

Project level (beginner, etc.) _____

Number of years in this project _____

Leader's signature _____

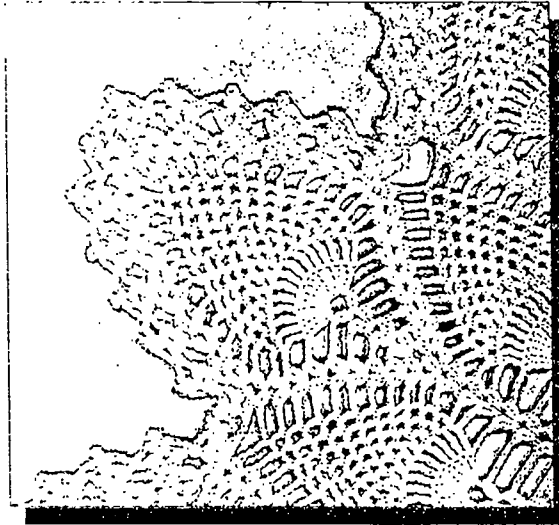
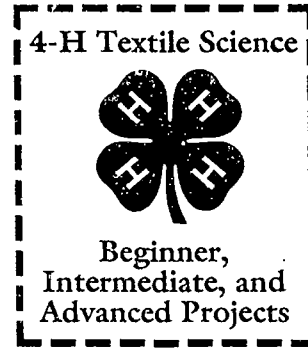

What I made for my project and what it cost

ARTICLE OR GARMENT	COST	ESTIMATED VALUE
_____	_____	_____
_____	_____	_____
_____	_____	_____
_____	_____	_____
_____	_____	_____
_____	_____	_____
_____	_____	_____
_____	_____	_____

Project goals I completed this year

4-H Textile Science
Crocheting
 Beginner, Intermediate, and Advanced Projects

Sharing What You've Learned

Demonstrate one or more of the skills listed in this project for your skill level.

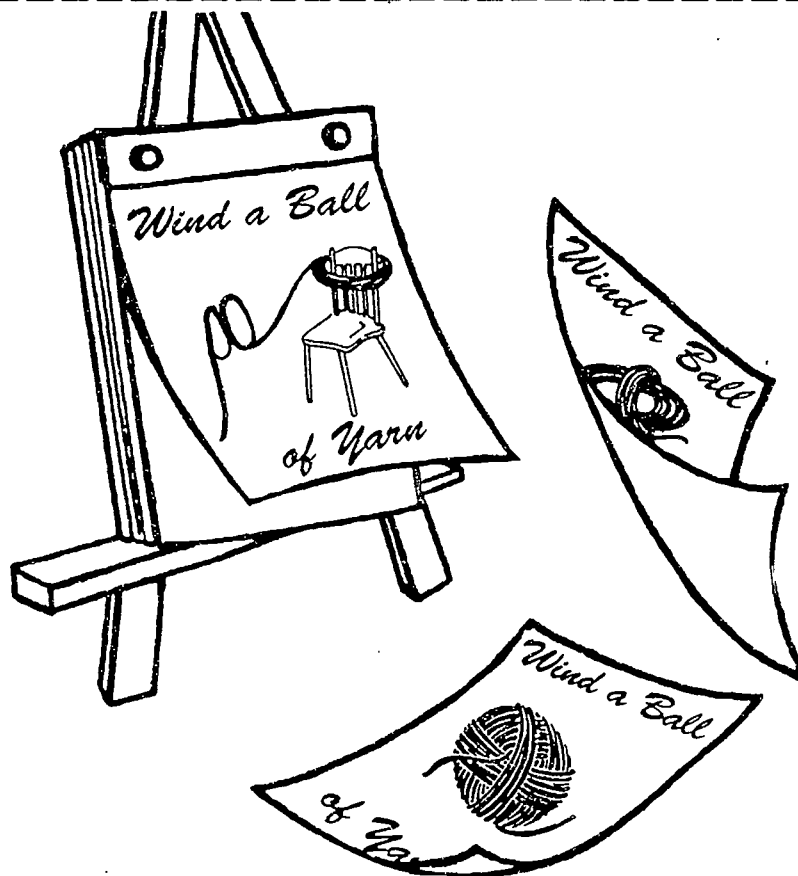

Resources and References for Your Project

Ask your leader about resources and references for this project. Many are available on PENpages, at your county extension office. Don't forget to look through craft and crochet magazines at libraries, bookstores, and department stores. The magazines are packed with ideas and skills to help you.

Exhibits and Fashion Revue

Check current roundup or fair premium listings to learn what you can enter as an exhibit. Each item should have a label printed with your name, age, club, and county. You may model crocheted garments and accessories at the fashion revue. Check county, regional, and state guidelines before entering.

Other Things You Can Do

You may take each level as many times as you'd like to learn and develop new skills. If you want to try out your own ideas, you can take the Textile Science "Create Your Own" project.

Name Kelly Tarve
Age 16
4-H club Socks and ties
County Snippet

Prepared by Jan Scholl, associate professor of agricultural and extension education.

Issued in furtherance of Cooperative Extension Work, Acts of Congress May 8 and June 30, 1914, in cooperation with the U.S. Department of Agriculture and the Pennsylvania Legislature. L.F. Hood, Director of Cooperative Extension, The Pennsylvania State University.

This publication is available in alternative media on request.

The Pennsylvania State University is committed to the policy that all persons shall have equal access to programs, facilities, admission, and employment without regard to personal characteristics not related to ability, performance, or qualifications as determined by University policy or by state or federal authorities. The Pennsylvania State University does not discriminate against any person because of age, ancestry, color, disability or handicap, national origin, race, religious creed, sex, sexual orientation, or veteran status. Direct all inquiries regarding the nondiscrimination policy to the Affirmative Action Director, The Pennsylvania State University, 201 Willard Building, University Park, PA 16802-2801; tel. (814) 863-0471; TDD (814) 865-3175

© The Pennsylvania State University 1994.