

DOCUMENT RESUME

ED 378 693

EA 026 462

TITLE The School Site: Land for Learning. Revised.
 INSTITUTION North Carolina State Dept. of Public Instruction,
 Raleigh.
 PUB DATE Oct 94
 NOTE 83p.
 PUB TYPE Guides - Non-Classroom Use (055)

EDRS PRICE MF01/PC04 Plus Postage.
 DESCRIPTORS Building Plans; *Educational Facilities Design;
 *Educational Facilities Planning; Elementary
 Secondary Education; Land Use; Playgrounds;
 Recreational Facilities; School Construction; *Site
 Analysis; *Site Development; Space Utilization;
 Statewide Planning

IDENTIFIERS *North Carolina

ABSTRACT

The selection and planning of sites appropriate for school facilities is a critical and complex undertaking. This publication describes the many factors to be considered during the process of site selection, planning, development, and use. The introduction stresses the importance of knowing the community or territory and the local school system. The second section describes the site-selection process and discusses considerations for the site-selection committee. Technical requirements include size, shape, location, topography and drainage, access and traffic, security and safety, soil conditions and plant life, noise levels, utilities, and costs. Guidelines for carrying out the site-planning process are offered in the third section. Steps for developing the site include conducting a topographic survey, learning (studying) the natural characteristics of the site, and creating a master plan of site components. These components include the buildings, transportation, pedestrians, utilities, and playgrounds. Sections 4 and 5 offer specific guidelines for designing playgrounds and recreation fields. Information on relevant North Carolina statutes and a list of North Carolina resource agencies and professions are provided. (LMI)

 * Reproductions supplied by EDRS are the best that can be made *
 * from the original document. *

ED 378 693

U.S. DEPARTMENT OF EDUCATION
Office of Educational Research and Improvement
EDUCATIONAL RESOURCES INFORMATION
CENTER (ERIC)

- This document has been reproduced as received from the person or organization originating it.
- Minor changes have been made to improve reproduction quality.

• Points of view or opinions stated in this document do not necessarily represent official OERI position or policy.

"PERMISSION TO REPRODUCE THIS
MATERIAL HAS BEEN GRANTED BY

E. Brumback

BEST COPY AVAILABLE

TO THE EDUCATIONAL RESOURCES



FOREWORD

The selection and planning of sites appropriate for school facilities is a critical and complex undertaking. School facilities are varied and complex and must be conveniently and safely adaptable for use by many school and community activities.

This publication states many factors that must be recognized during the process of site selection, site planning, site development and use. Some of these factors are the result of increased concern for environmental conservation and management; others result from the demands put on facilities by the many educational and recreational activities of entire communities.

School Planning has consistently encouraged improvements in the planning and care of school grounds. With the assistance of appropriate consultants and resource agencies, many are listed in this publication, school officials can provide communities and schools with adequate sites.

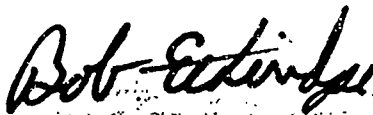

Bob Etheridge, State Superintendent
North Carolina Department of Public Instruction

NORTH CAROLINA DEPARTMENT OF PUBLIC INSTRUCTION

Bob Etheridge
State Superintendent

Dr. Charles H. Weaver
Assistant State Superintendent
Auxillary Services

Tom O'Kelley
Director
School Facility Services

Dr. Karen S. Gulledge
Chief Consultant
School Planning

PUBLICATION STAFF

Marjorie L. Acker, Architect
Gerald H. Knott, Architect
James M. Lora, Architect
Steven Taynton, Architect
Long Chang, Engineer
Ronald C. Harrell, Engineer
Andre Johnson, Architectural Intern

TABLE OF CONTENTS

| INTRODUCTION | PAGE |
|---|-----------|
| The School Site: Land for Learning | 1 |
| Knowing The Community or Territory | 2 |
| Knowing The Local School System | 3 |
| Sites and Buildings in Historic Districts | 4 |
| | |
| SITE SELECTION PROCESS | 5 |
| Selecting A School Site | 6 - 7 |
| Technical Requirements | 8 - 12 |
| Size; Shape; Location; | |
| Topography and Drainage; | |
| Access and Traffic; | |
| Security and Safety; | |
| Soil Conditions and Plant Life; | |
| Noise Levels; Utilities; Costs | |
| Worksheet for Prioritizing Sites | 13 |
| | |
| SITE PLANNING PROCESS | 15 |
| Developing The School Site | 16 - 17 |
| Components of a School Site | 18 - 25 |
| Buildings and Landscaping; Buses; | |
| Private Vehicles; Service Vehicles; | |
| Pedestrians; Utilities; Playgrounds | |
| General Vehicle Information | 26 - 32 |
| | |
| PLAYGROUNDS | 33 |
| Planning A Playground | 34 - 35 |
| Playground Equipment | 36 - 43 |
| Ladders and Platforms; Slides; Swings; | |
| Merry-Go-Rounds; Climbing Equipment; | |
| Protective Fall Zones | |
| | |
| RECREATION AND ATHLETIC FIELDS | 45 |
| Athletic Field Layouts | 46 - 61 |
| 400 Meter Track; Field Events; | |
| Football Fields; Soccer Fields; | |
| Field Hockey Fields; Baseball Fields; | |
| Softball Fields; Basketball Courts; | |
| Tennis Courts; Volleyball Courts | |
| | |
| STATE AGENCIES AND STATUTES | |
| Resource Agencies and Professions | 63 - 66 |
| N.C. Statutes Relating to School Sites | 67 - 68 |
| References | 69 |

INTRODUCTION

THE SCHOOL SITE: LAND FOR LEARNING

The School Site: Land for Learning is the property and physical location usually known as the school. The school is a separate, distinctive place intended primarily as a setting for the nurturing and training of youth. A piece of property with sheltering buildings considered as the place for learning.

The school site is linked to other places in the community by transportation and communication. In many communities, school facilities are customarily used for purposes other than those directly related to the learning activities of students; such as: adult education, public assembly, recreation, election polling places, meetings that require food services, etc. There is a trend toward increasing this multi-use function of school facilities. Some schools are based on the idea of the community school that are now being built as a part of a larger complex of community service facilities: recreation grounds and parks, health and social service centers, libraries and cultural centers.

No school system ever completely or permanently solves all of the problems relating to school sites. Even if it does not need to buy new land, the school system needs to operate and maintain existing sites: it is very likely that all school grounds continually need to be replanned, renewed or otherwise improved to meet changing requirements.

In an area where population and educational changes are taking place, finding and developing a new site may be a continuing process. Even in small, stable communities there is a constant need to improve and upgrade school programs and facilities. This may require abandoning obsolete schools and relocating them on new land or acquiring additional land at an existing school site.

School officials, patrons and students are becoming more concerned about improving the sites and grounds for public schools. In addition, increasing emphasis on conserving, preserving and restoring our physical environment has led to actions such as these:

- greater control over the soil sedimentation that results from construction projects and poor soil management practices
- higher standards for water quality and for disposal of waste material
- efforts to minimize damage to humans that can result from air pollution and noise pollution
- energy conservation measures

Furthermore, official steps are being taken to provide more agreeable accommodations in the manmade environment. Some examples are:

- legislation that requires higher standards for safety of employees in commerce and industry that also affects school owned facilities.
- more stringent building codes to provide for physically disabled persons' access to public facilities.

KNOWING THE COMMUNITY OR TERRITORY

Selecting, planning and developing school sites should be an organized and rational process which is based on adequate and accurate information. Information should include facts about the community or territory and data about schools under the responsibility of the local administrative unit.

The local administrative unit is directly responsible for the school services which are provided by their public schools. These school services do not only pertain to the educational benefits provided to the students, but also on how the public schools interact with the community and other agencies such as: parks and recreation, health and social services, entertainment, cultural arts and adult education.

School officials should maintain adequate and current information on their local administrative unit's community or territory regarding the following areas:

GEOGRAPHICAL:

This information should include a set of maps and other forms of data that describes the boundaries of the county and administrative units. These maps should include major roads, utilities, land ownerships, hospitals, industries, cultural centers, parks, etc.

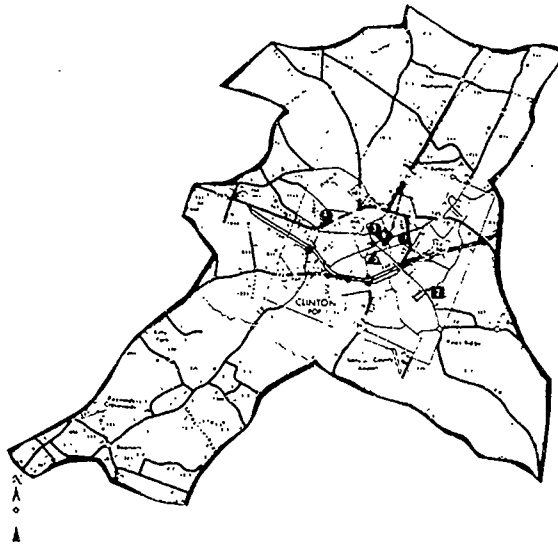

EDUCATIONAL:

The public school system is not the only educational agency in a community. Public schools are affected by non-public schools in terms of enrollments, public attitudes and support. School officials should know about all local institutions of education.

SOCIOLOGICAL:

This should include information about the general characteristics of all inhabitants of the administrative unit, such as: community history, ethnic origin, educational levels, economic status, employment, cultural opportunities, population, crime patterns, religious bodies, institutions and educational services.

CULTURAL ARTS:

Cultural services and activities in the community can effect and influence public education and can be a rich resource for education purposes such as: museums, concert halls, galleries, music, artists and performers in visual arts, film, etc.

RECREATIONAL:

Since public schools will increasingly interact with and provide some of the recreational services in the community, school officials must be aware of the recreational agencies, services and places used by the citizens.

FINANCIAL BASE:

Schools need money. School officials must know about the availability and use of tax funds and other financial resources for educational purposes. Information should be gathered about the characteristics of industrial and commercial enterprises and their development programs, as well as, local transportation and communications services.

KNOWING THE LOCAL SCHOOL SYSTEM

Each school within an administrative unit is an institution by itself serving one or more communities. There can be more than one educational institution serving different age groups within a community, such as: elementary schools (grades K-5), middle schools (grades 6-8) and high schools (grades 9-12). School officials should maintain adequate and current information on each school facility within their administrative unit regarding the following areas:

PERSONNEL SERVICES:

Since the basic purpose of the school system is to serve the students, school officials need current and historical data about the students. Educational services, teaching and administrative personnel must be chosen and organized to meet the educational requirements of the students. Information should include: student membership, staffing, local board of education, administrative organization, and central office staff.

COMMUNICATIONS:

Schools are including more extensive use of media, especially electronic, which may reduce the need for physical facilities at school sites. Media broadcast services (audio and visual) are having a major impact on education within schools today.

EDUCATIONAL PROGRAM:

Statements about the educational programs of the schools in the administrative unit will be useful in selecting and planning a school site. The educational programs should identify experiences and activities which can take place outside the school buildings both on the school grounds and off campus.

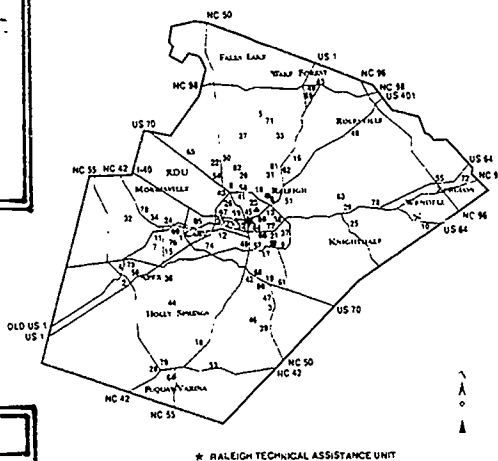

FINANCE:

A clear and concise analysis of school finance will identify costs related to sites. Total school costs should include purchasing, planning, developing and maintaining school site costs. Studies of financing practices may result in appropriate schedule of site purchase and development.

TRANSPORTATION:

A study of transportation practices may help determine optimum locations for school sites. Helpful information will include recent and/or current transportation maps, routes and statistics.

PHYSICAL FACILITIES:

Obviously the information base should include accurate and complete information about all existing property owned by the local board of education. A complete system of property accounting should include: complete floor plans of all buildings, construction dates, site plans of all campuses, and a description of construction including the mechanical, plumbing and electrical system within each building.

SITES AND BUILDINGS IN HISTORIC DISTRICTS

Be especially cautious when considering a new site or planning for construction at an existing location that involves an old building or historic district. Projects being contemplated must be approved by the State Superintendent of Public Instruction in regards to safety, sanitation and functional adequacy of the site; as well as, the facility. Opposition to replacing an old building or making an addition to an old building that requires obtaining adequate land in a historic district may adversely affect the approval of the project. Prior to issuing a Certificate of Approval, School Planning may require documentation that projects involving historical preservation will not be contested by local interest groups or any state or federal agency. The demolition of an old building that has been placed on the Historic Register must follow the procedures required by the U.S. Department of the Interior.

A "Feasibility and Cost Analysis" form is available from School Planning in order to assist local school units in the evaluation of existing facilities and sites regarding the advisability of renovating or replacing an old building. The form must be submitted to the State Superintendent through School Planning if an old building is to be replaced with a new facility. The "Feasibility and Cost Analysis" is also valuable for evaluating the desirability of renovating an existing school as opposed to replacing it.

SITE SELECTION PROCESS

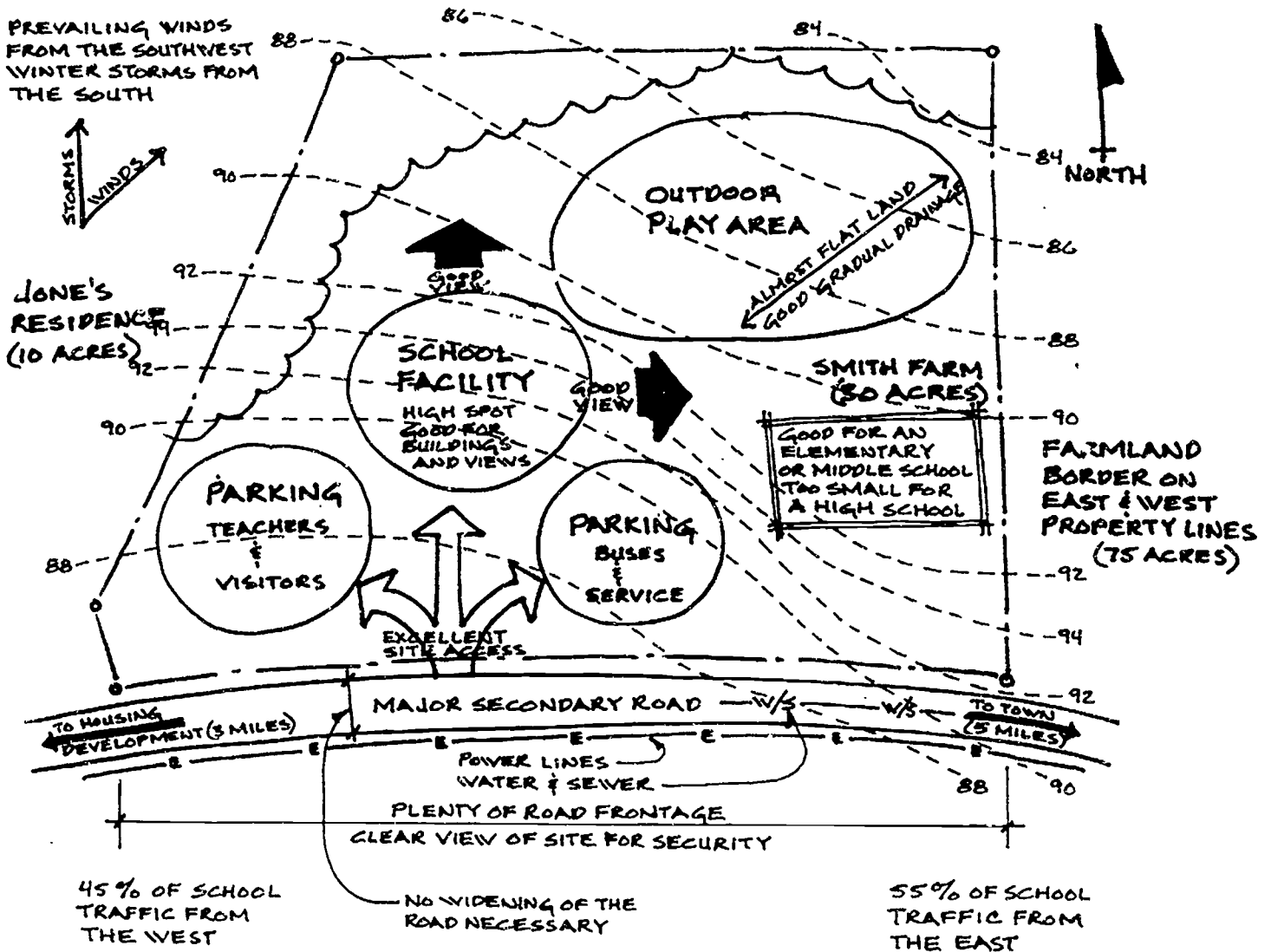

SELECTING A SCHOOL SITE

The primary purposes of a school site is to provide a place and an environment that are conducive to the learning/teaching experiences that benefit the youth who attend the schools.

When a new school site is needed, the school system should set up a committee of school board members and administrative personnel who will be responsible for selecting potential sites. This committee should then take the following five steps:

STEP NO. 1: EDUCATIONAL PROGRAM

Prepare an educational program for the site that identifies experiences and activities that will take place outside the school buildings both on the school grounds and off campus. The following areas and activities should be discussed in relation to the proposed site selection:

- physical educational and athletic programs
- nature and conservation education
- "after hours" educational use of facilities
- use of "off-campus" facilities for educational purposes

STEP NO. 2: TECHNICAL REQUIREMENTS

Prepare a list of technical requirements or general criteria regarding the features and characteristics that are desirable for almost all school sites. The criteria together with the educational program for the site are a set of "standards" or "desirable characteristics" against which potential sites can be evaluated and selected. General criteria should include the following types of topics:

- | | | |
|-----------------------|------------------------------|-------------|
| ■ size | ■ access/traffic | ■ utilities |
| ■ shape | ■ security/safety | ■ costs |
| ■ location | ■ noise levels | |
| ■ topography/drainage | ■ soil conditions/plant life | |

Each topic listed above is defined in more detail on pages 8 to 12.

STEP NO. 3: SITE SELECTION

The committee should choose a general area within the county where the school should ideally be placed. Then the committee should consider several tracts of land within this general area that appear acceptable based on the educational program and technical requirements. Each tract of land should be analyzed equally and thoroughly with a prepared list of questions that cover all potential site concerns.

The committee may also decide to obtain the services of an architect, landscape architect and/or engineer to help in this selection process or request the assistance of School Planning.

STEP NO. 4: PRIORITIES

The next step is to rank all potential sites in order of priority. Then make a final decision on one site to be purchased. Before purchasing this site it is wise to invest some extra money and time in having **soil boring tests** made to avoid possible costly surprises later. It is also good to consult with the officials of the appropriate government agencies where on-site water supply and sewage disposal systems will be required and the Department of Transportation or municipal street officials to obtain assurance that adequate and safe access to the proposed site is feasible. If the chosen site presents potential costly unforeseen problems it may be wise for the committee to select the second choice site and perform a new set of soil boring tests until a suitable site is found.

STEP NO. 5: ACQUISITION

The final step in the site selection process is to begin negotiations on the chosen site and make an offer to purchase. Although the purchase price and/or costs of a new piece of school property may involve many thousands of dollars, the cost must be related to the total cost of purchasing the land, developing it, building on it, operating and maintaining it. If the purchase price is seen in this context, the site with the lowest per acre purchase price may not necessarily be the best buy. After careful scrutiny by the school officials and the site selection committee, legal counsel should take legal steps to get title to the selected property.

TECHNICAL REQUIREMENTS

SIZE: Good judgement beyond the mere application of minimum standards is needed to determine the appropriate size for a site. **The Council of Educational Facility Planners**, a national organization of school planners, says that while it recognizes that for many schools larger sites are preferred, it suggests the following areas as minimum acreage of *usable* land:

Site Size In Acres Of Land By Grade

| | |
|------|----------------|
| K-6 | 10 + 1/100 ADM |
| 5-8 | 15 + 1/100 ADM |
| 7-9 | 20 + 1/100 ADM |
| 9-12 | 30 + 1/100 ADM |

The diagram above shows the site size in acres of land by grade level. As an example: a Jr. High School (grades 7-9) with 800 students (ADM) would require a minimum of 20 acres plus 1 acre per 100 ADM or 8 acres for a total of 28 acres.

The site for *usable* land should be large enough to hold the necessary building(s) and space for outdoor instruction, recreation, parking, and any future expansion to the building(s) and play areas.

- For schools in densely populated areas and in other locations where land costs are extremely high, the recommended areas shown above may be unrealistic.
- For schools in open country or sparsely settled areas, acreage may justifiably exceed those recommended above.
- For schools located immediately adjacent to park and recreation lands, acreage of school-owned land may be modified.
- For schools requiring on-site water or sewer, substantial additional acreage may be needed.
- A high school may need an additional 10 acres or more if a stadium and spectator parking are anticipated.

Usable land is often significantly less than the total site size. When estimating needed site sizes, make allowances for such special restrictions such as:

- Zoning setbacks and vegetative buffers around the perimeter of the site.
- Future road Right-of-Way increases due to heavier traffic.
- Wetlands, creeks and drainage ways or slopes too steep to build upon.
- Adequate land for parking of buses and queuing space for parent pickup.
- Additional land for location of temporary classrooms or future expansions.

SHAPE: Sites with shapes almost rectangular in form are usually easiest to plan. As a very general rule-of-thumb, an efficient plan can be achieved on a rectangular site with dimensions in a ratio of approximately three to five.

- suitable for efficient use of land that does not restrict any phase of the educational program
- adequate to accommodate outdoor areas such as playgrounds, physical education and athletic fields, recreation spaces and buildings

LOCATION: The location of a school is a very important factor, but it must not dominate if too many other desirable features are sacrificed.

- Convenient and readily accessible to the present and/or future school population to be served and to the public for community use educationally or recreationally.
- Possibility for interrelationships and joint planning with other public facilities such as parks, libraries, museums, etc.
- Accessible at reasonable cost to public roads that are adequate to accommodate the added traffic generated by the school.
- In a community that is safe and readily accessible to students, utilities, and services, but free from noise, air pollution and other disturbing elements. Industrial areas and transportation service areas such as railroad, truck or air terminals are not suitable for school locations.
- Where bus transportation is involved, the maximum travel time for elementary students should rarely exceed seventy-five minutes and ninety minutes should be the limit for middle school and high school students.

TOPOGRAPHY AND DRAINAGE: Inadequate drainage or excessive earthmoving can cause continuing problems.

- Ideally, the site is gently sloping with an elevation and contour which will insure good drainage.
- The site should be adaptable to intended use without massive and costly Earthmoving activities or destruction of desirable land characteristics.
- The site should have a type of subsoil that provides a good base for building footings and foundations. Surfaces and subsoil that have been filled with debris are generally unstable.
- The site should be tolerable for modifications without destroying all existing desirable features to accommodate proposed use of land.
- Appropriate to allow for natural gravity flow of sewage on or from site, preferably without use of pumps.
- Provide an adequate amount of level area for physical education, some uneven and wooded areas with a variety of tree and plant life, and some water area for use in various parts of the educational program.
- Check all sites for wetlands and/or flood plains before purchasing.

ACCESS AND TRAFFIC: Ready, safe and economical access to the school site is basic.

- Accessible at reasonable cost to public roads and/or streets that are adequate or made adequate to hold the added traffic generated by the school.
- Adequate frontage to provide safe access from roads or streets approved by the Division of Highways of the N.C. Department of Transportation or by the local street departments.
- Adjacent to or readily accessible to modes of transport useful to students and staff: school buses, private vehicles, public transportation, bicycles and/or pedestrians.
- Not too close to congested traffic arteries or highways that are noisy and will cause delays or special hazards for school traffic.
- Adequate to handle peak load traffic at beginning and end of school day and after-hours public assembly activities without undue delay or hazards.
- Avoid locations near manufacturing plants with large employee work forces.

SECURITY AND SAFETY: Local conditions may demand special attention to this factor.

- Location where regular periodic inspections by police authorities are possible.
- Convenient to a fire station, police station, hospital and/or rescue squad.
- Adequate site lighting to discourage mischief and/or vandalism and fencing around play areas to give students a sense of security, especially in elementary schools.
- No student should have to cross any roadway to get to playgrounds, buildings or other campus facilities.
- Avoid locations near neighborhood social hazards, such as high incidence of crime and drug or alcohol abuse.
- Locate away from industrial and manufacturing plants due to bad air quality problems, such as: odor, dust, noise, etc.

SOIL CONDITIONS AND PLANT LIFE: A careful investigation of what is below and above the surface of the land is necessary before purchase of a site. Adverse soil conditions such as rock, poor bearing soils, high water levels and soils impervious to water will usually cause difficulties and increase development and perhaps operation costs.

- Sub-surface soil conditions that provide adequate drainage and support for structures at a moderate cost.
- Soil capable of growing at reasonable cost and treatment, the necessary and desirable turf and a good variety of other plant materials. Vegetation is an excellent absorber of both sound and heat and can also beautify the environment.
- Suitable for on-site sewage waste disposal systems, if necessary.
- Soils that permit proper percolation will make lawns, playgrounds and athletic facilities easier and less expensive to maintain.

NOISE LEVELS: Noise generated by modern technological devices may exceed desirable conditions for schools.

- Not serious enough to cause interference with communications.
 - Site far enough removed from air traffic and high speed vehicular traffic (especially trucks, buses) and noisy industrial or commercial enterprises.
-

UTILITIES: Water, sewer, and electrical services must be available to all sites. Community cable television and piped gas may also be available.

- Water supply and sewage waste disposal services from municipal or district systems are preferred to on-site systems.
- If on-site problems for water supply and sewage disposal are needed, they must comply with requirements of appropriate health and environmental agencies.
- Electrical service of adequate capacity should be available at reasonable installation cost.
- Select sites that do not have electric power transmission line easements that cross or border the property. If the chosen site does have power transmission lines the following limits should be considered:
 - 100 feet from edge of easement for 100-110 kv line
 - 150 feet from edge of easement for 220-230 kv line
 - 250 feet from edge of easement for 345 kv line

These limits are based on an electric field strength graph developed by the Southern California Edison Company.

COSTS: Besides the purchase price, the cost of planning, developing, operating and maintaining a site must be considered to determine the true cost of a site.

- Initial purchase price in line with current costs of similar property.
- A site should be available at a cost that is not exorbitant which reflects desirable aesthetic qualities.
- Administrative costs: fees for consultants in site selection and planning processes, and fees for legal services associated with procedures for acquisition.
- Development costs: clearing, grubbing, demolition, grading, paving, erosion control, storm drainage, rock removal, soil analyses and treatment, plant materials and their installation, transportation cost difference, access to and/or installation of waste disposal systems and other utilities.
- Operating costs: regular tending, cleaning, mowing, gardening, pruning, waste disposal system.
- Maintenance costs: erosion control measures, repairs to paving and walks, reestablishing turf, restoring trees and shrubs, repair of outdoor equipment.

WORKSHEET FOR PRIORITIZING SITES

Site Identification: _____ Grade Level: _____

Site Location: _____

Total Acres: _____ Estimated Value: _____

| SITE SELECTION FACTORS | 0 | 1 | 2 | 3 | 4 | 5 | TOTAL |
|---|---|---|---|---|---|---|-------|
| Size of Site (Inadequate to Adequate) | | | | | | | |
| Shape of Site (Inadequate to Adequate) | | | | | | | |
| Location of Site (Remote to Convenient) | | | | | | | |
| Topography and Drainage (Unsuitable to Suitable) | | | | | | | |
| Accessibility and Traffic (Obstructed to Accessible) | | | | | | | |
| Security and Safety (Dangerous to Safe) | | | | | | | |
| Soil Conditions and Plant Life (Unsuitable to Suitable) | | | | | | | |
| Noise Levels (Unsuitable to Suitable) | | | | | | | |
| Utilities (Unavailable to Available) | | | | | | | |
| Costs (Expensive to Economical) | | | | | | | |
| Total Points x 2 (100 points possible) | | | | | | | |

SITE PLANNING PROCESS

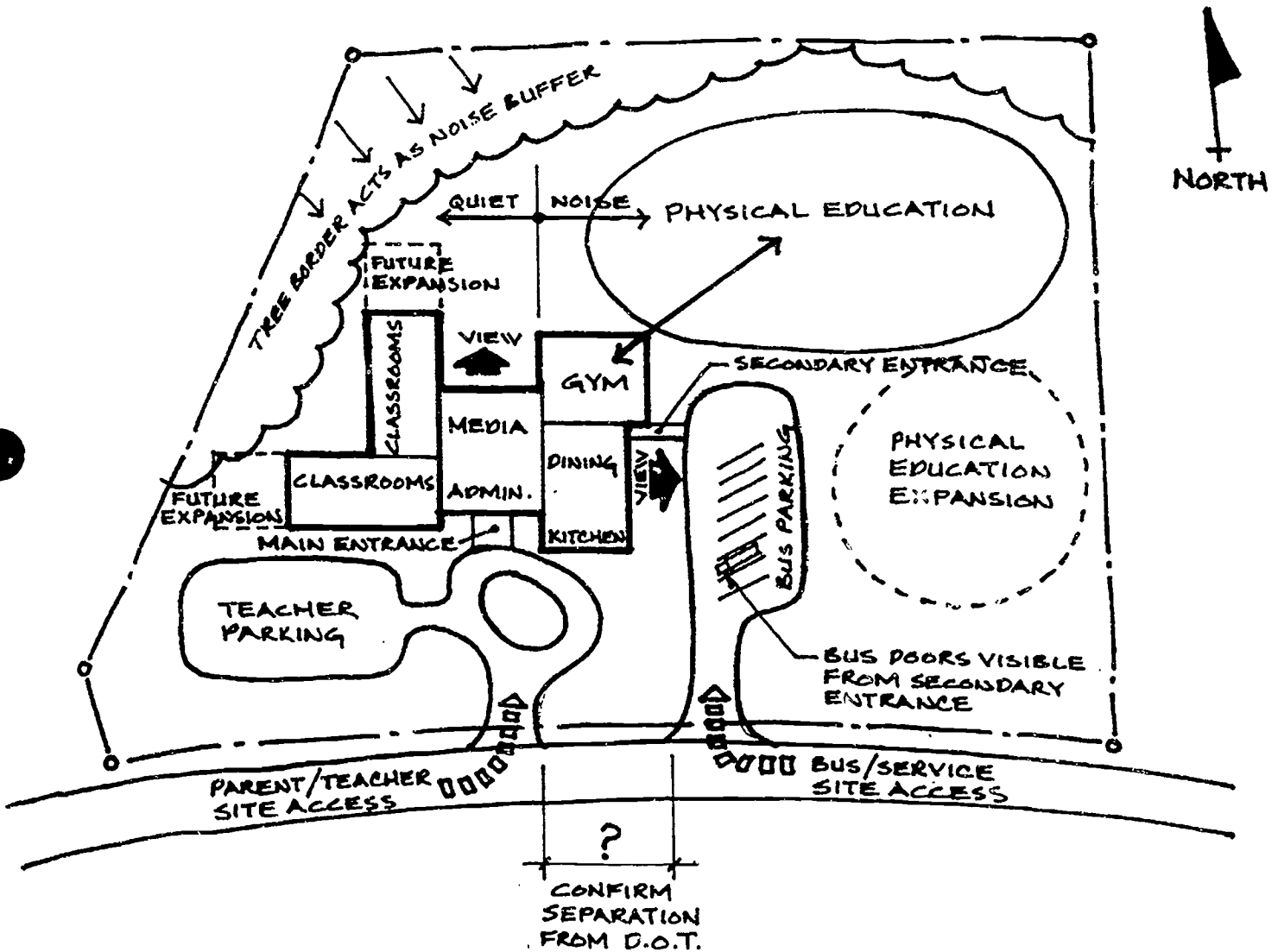

DEVELOPING THE SCHOOL SITE

To a community, the appearance of the school site often determines the perceived quality and care for education. Beautiful, functional buildings placed on adequate grounds in an attractive environment help to create in children an appreciation for schools and in adults an added civic interest and respect for the dignity of education.

Site planning is based on a thorough analysis of the site, determination of human needs, determination of requirements for other uses, provisions for transportation, communications and utilities. Site planning establishes immediate and long term uses of the site. When planning a school site the following steps should be taken:

STEP NO. 1: TOPOGRAPHIC SURVEY

A good boundary line and topographic survey of the chosen site should be obtained with an agreement between the owner and the design professionals that clearly defines the site information to be recorded. Site surveys should include information such as:

- title of survey, property location, certification and date
- scale and compass orientation
- tract boundary lines, courses and distances
- names of abutting property owners
- topographic contours and bench marks with assumed elevations
- names and locations of all existing road right-of-ways and easements.
- location, size and names of significant plant life and trees
- existing use of land and of adjoining land
- existing structures and other site improvements
- existing utilities or closest connections
- zoning designation, setbacks, buffers and acreage
- location and size of wetlands
- indication of flood plains

STEP NO. 2: LEARNING THE SITE

While the survey is being prepared, the site needs to be studied by an architect and engineer for the feeling of the site's natural characteristics and for the functional design of the site in relation to the users' requirements. The site needs to be considered not only from the functional aspect but also the human needs, the artistic aspects, the desirable pleasantness of the landscape and other important ingredients of the site. Consider the visual and spatial experiences encountered in the processes of approaching the school, entering the grounds, moving between buildings, parking areas, play areas and nature preserves. The architect can begin preparing diagrammatic sketches based on all collected data and an understanding of the site.

STEP NO. 3: SITE COMPONENTS

Once the topographic survey is completed, a more refined master plan for the site can be developed. The master plan establishes a basic order or process to the site by following basic principles that establish immediate and long term uses of the site. **Always give paramount emphasis to life safety with the encounters between people and vehicles.** There are seven major components on a school site that are all interrelated with each other:

- The buildings and landscaping
- Bus traffic
- Private vehicle traffic
- Service vehicle traffic
- Pedestrian traffic and provisions for the physically disabled
- Utilities, sedimentation control, and storm water drainage
- Playgrounds, athletic fields, and recreation areas

Each of these components are defined in more detail on pages 18 to 25.

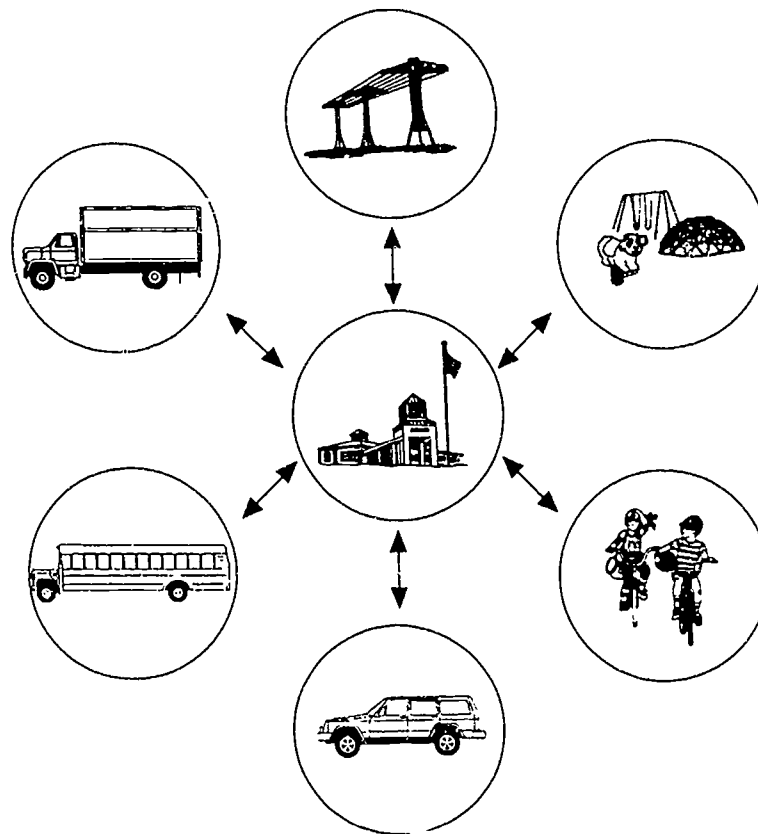

COMPONENTS OF A SCHOOL SITE

A school site is made-up of seven components which are all interrelated with each other. These components are as follows:

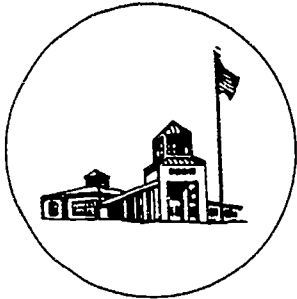

Buildings are any permanent or temporary structures that are located on the school site.

Buses are used at all schools to transport students to and from the school site, this also includes activity buses and handicap buses.

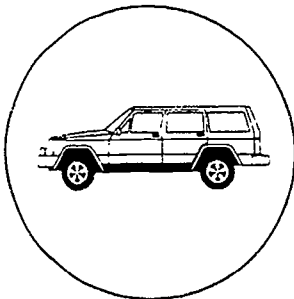
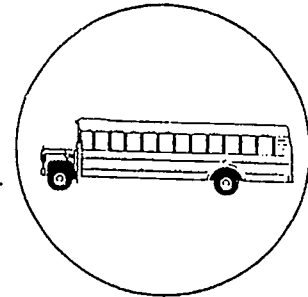

Private vehicles include three categories of vehicles: visitors, staff and parents that pick-up or drop-off children at school.

Service vehicles usually come once or twice a week to deliver food to the kitchen, pick-up trash and to deliver cleaning supplies.

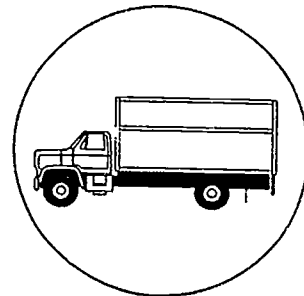

Pedestrians include visitors, staff, parents, and students.

Utilities include public service items such as electric power, gas, water, telephone, cable television, etc.

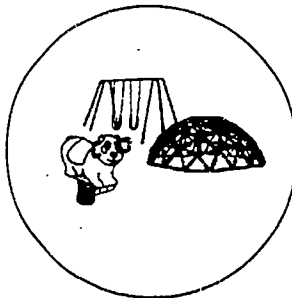
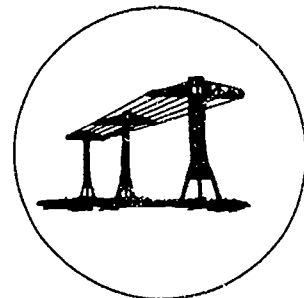

Playgrounds are areas on the school site designated for outdoor games and recreation which include football fields, baseball fields, running tracks, etc.

BUILDINGS AND LANDSCAPING

PLANNING AND DESIGN GUIDELINES

RECOMMENDED

- Locate buildings sufficiently away from roads and streets to minimize traffic noises and hazards.
- Design buildings that can accept changing educational programs and future expansions.
- Plan buildings and sites as one unit with service drives near kitchens, shops, stages and storage areas; place bus loading/unloading near large group core facilities; locate vehicular parking near athletic areas, etc.
- Provide drives that are well illuminated and defined with curbs, gutters, and signs directing traffic.
- Provide creative functional grading of the site to improve the appearance of the building and provide screening from noise, wind and other climatic elements. Use vegetation to discourage erosion, mark boundaries, provide shade and shelter, channel pedestrian traffic, provide visual and aural screening and provide a noise buffer.
- The site planning and building orientation should be designed to minimize use of conventionally powered heating, cooling and lighting by using natural energy available at the site.

AVOID

- Avoid buildings that are not sensitive to the scale of its user or in keeping with the neighborhood.
- Avoid steep slopes, low spots and barren areas in the landscaping.
- Avoid plants and landscaping that blocks the vision of vehicular drivers accessing or leaving the school site.
- Avoid sites that are too small to meet the educational needs.
- Avoid hazardous entrances off main thoroughfares.
- Avoid cars parked parallel to curbing. This can cause traffic congestion and create a serious safety problem if students should step into traffic.
- Students approaching the buildings on foot should not have to cross main traffic arteries.
- Avoid buildings with screen walls and/or retaining walls that provide easy access to children climbing on to the roof.

BUSES

PLANNING AND DESIGN GUIDELINES

RECOMMENDED

- Provide separate driveways and parking lots for buses and cars.
- Place bus entrance near core facilities such as the gymnasium, multi-purpose room, cafeteria, or media center.
- Park buses in a single row facing the building at an angle between 45 and 90 degrees so the doors are visible for supervision.
- Provide an adequate turning radius (45'-0" min. outside & 26'-0" min. inside) within parking lot.
- Provide a covered walkway for students to use during inclement weather.
- Locate bus parking lots near after-hours athletic events for additional vehicular parking.

AVOID

- Avoid mixing parent drop-off driveways with bus driveways.
- Avoid unloading bus students into narrow classroom corridors.
- Don't park buses in two rows behind each other.
- Don't park buses so they have to back up to turn or park.
- Don't load or unload students where they have to cross a vehicular path on foot before entering the building.
- Avoid landscaping that blocks or interferes with the bus driver's vision at intersections to the school.

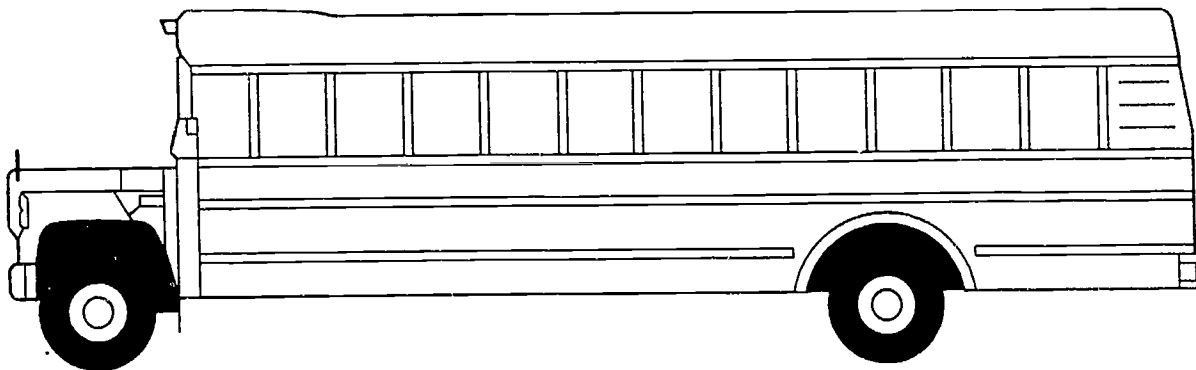

SERVICE VEHICLES

PLANNING AND DESIGN GUIDELINES

RECOMMENDED

- Service vehicles can share the same driveway and parking lot with buses.
- Locate dumpsters at the end of a driveway where the trash truck can easily empty the dumpster and provide adequate paving area for the trash truck to turn around.
- Provide adequate paving area for trash trucks and delivery trucks to access the loading dock and to turn around. Remember: Delivery trucks have to turn and back-up to the dock and the trash truck has to drive up to the dock and back out to turn before leaving.
- Provide adequate fencing, railings and/or bollards to protect the buildings and the pedestrians from service vehicular movement.

AVOID

- Don't circle school buildings or campuses with service drives that children have to cross to access the playgrounds.
- Avoid placing dumpsters in remote locations away from the buildings. Usually dumpsters are best located near loading docks for the kitchen.
- Avoid screen walls that have small entrances or a tight turning radius. Provide plenty of paving within the screen wall area or delete the screen wall. Do not install gates for they are very rarely used and are left open.
- Avoid screen walls that obstruct the vision of the drivers or the pedestrians crossing the driveway.

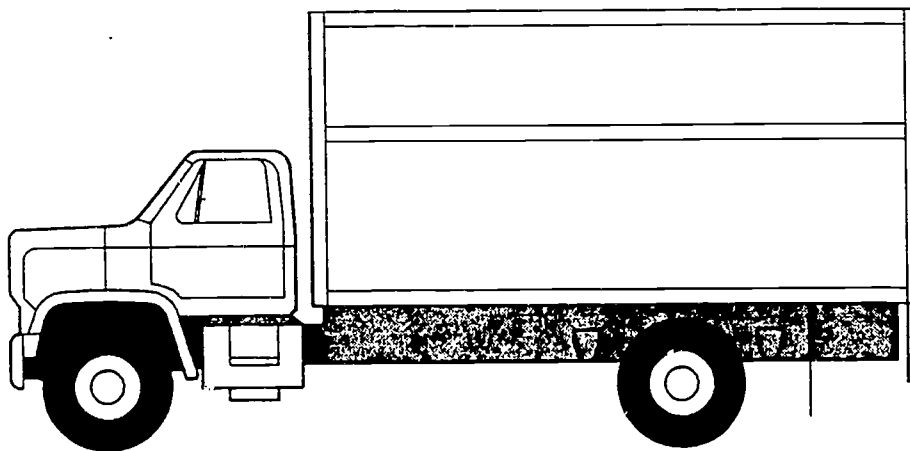

PRIVATE VEHICLES

PLANNING AND DESIGN GUIDELINES

RECOMMENDED

- Provide separate driveways and parking lots for cars and buses.
- Provide an adequate driveway for lining up cars on site that are waiting to drop-off or pick-up students with two lanes heading in the same direction.
- Locate the student drop-off area near the administration office and main entrance. Provide a covered walkway for use during inclement weather.
- Provide separate parking lots for teachers and students. Combine visitor's parking with the parent drop-off driveway located near the main entrance and administration office.
- Designate parking spaces for disabled persons and visitors close to the main school entrance.

AVOID

- Avoid sharing the same entrance drive with buses.
- Avoid driveways with two-way traffic where children may cross the path of a moving vehicle.
- Avoid driveways that allow parents to take short cuts through parking lots to drop-off or pick-up students. This type of parking layout encourages students to cross vehicular paths.
- Avoid landscaping that blocks or interferes with the driver's vision at intersections to the school or on the site.

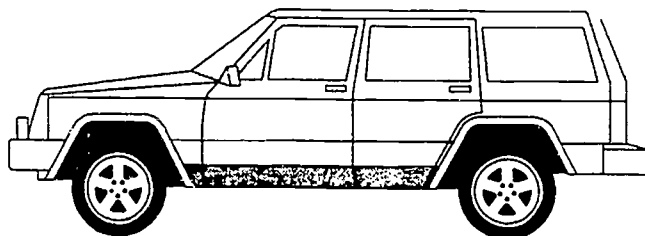

PEDESTRIAN TRAFFIC

PLANNING AND DESIGN GUIDELINES

RECOMMENDED

- The site should be designed with respect for the safety and convenience of users.
- Layout sidewalks by following the lines of least resistance and connecting the buildings with short, direct walkways.
- At all changes in direction or sidewalk intersections, flare the sidewalk corners sufficiently to prevent walking on grass.
- Design wide sidewalks to meet the needs of the pedestrians using them. Use a minimum width of 5 feet and increase width in high volume areas.
- Provide adequate lighting at entrances, steps and along sidewalks to promote safety and enhance the appearance and security of the building.
- Provide paved student gathering areas in convenient locations that are adequate in size, well lit and easily supervised.

AVOID

- Avoid or minimize road crossings by the students and staff.
- Avoid single step trip hazards on sidewalks, provide a minimum of three steps and illuminate.
- Avoid 90-degree intersections on sidewalks.
- Avoid narrow sidewalks, people do not normally walk single-file.
- Avoid sidewalks that have shallow steps, hollow cracks, deterioration, or areas that pond water. Make sure sidewalks drain well.
- Avoid dark alcoves and deep recesses along the building perimeter. These areas are hard to police.



UTILITIES

PLANNING AND DESIGN GUIDELINES

RECOMMENDED

- Install fire hydrants around the building and site with easy access by fire trucks.
- Provide enough ground width around the building for easy fire truck service and police surveillance.
- Provide adequate water supply with good pressure (30 to 40 psi).
- Try to select sites that have access to municipal water supply and sewer waste disposal systems and piped natural gas.
- Locate in an area with good TV reception or with cable access.

AVOID

- Avoid paved driveways around the building.
- Avoid overhead power lines or cables on the school site wherever possible.
- Avoid sites with any utility easements that divide the site into parcels.
- Avoid sites that require long runs for access to municipal utilities.

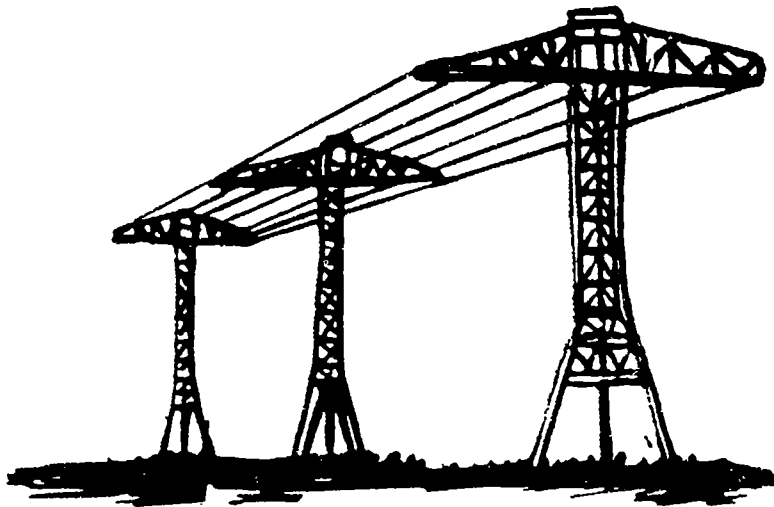

PLAYGROUNDS

PLANNING AND DESIGN GUIDELINES

RECOMMENDED

- Keep playgrounds separate from streets and parking lots.
- Kindergarten and first grade classes should have separate playgrounds fenced in for safety and supervision. This is required for Pre-Kindergarten.
- Playgrounds should be well drained, free of holes, debris, poison ivy, rocks, and other hazards which may lead to accidents. Plan for maximum safety.
- Locate playgrounds and athletic fields near the gym or buildings for safe/easy access by the students, but not so close that it disrupts the classrooms.
- Provide good separation between quiet and active play, as well as, separation between play for different age groups.
- Arrange playgrounds and athletic fields with easy access by maintenance trucks, spectators and/or community use.

AVOID

- Avoid playgrounds that children must cross a vehicular path to access.
- Avoid playground equipment with sharp edges, hazardous projections and rough surfaces that may cause injury or entangle children's clothing.
- Avoid grading level surfaces too flat. 2% grade (2' per 100') is desirable.
- Avoid locating the playgrounds and athletic fields too close to highways or streets. Install fencing around the property for security and safety.
- Avoid laying out playgrounds that become throughways to other areas.
- Avoid crowding play equipment or children. Provide plenty of room for jumps or falls.

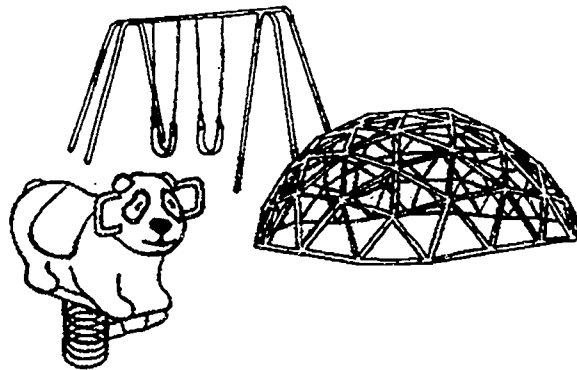

TRANSPORTATION

There are several types of vehicles that may use a school site. Each vehicle has its own dimensions and minimum turning radius. The following diagrams and charts are included for quick reference.

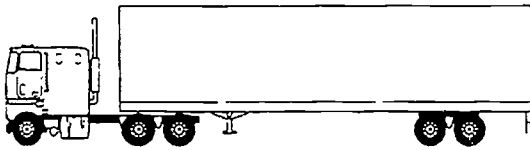

SEMI-TRAILER

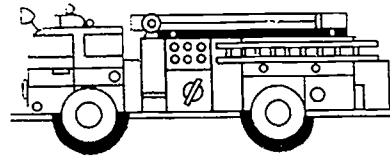

FIRE TRUCK

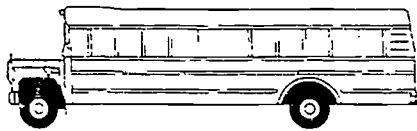

SCHOOL BUS

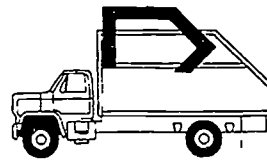

TRASH TRUCK

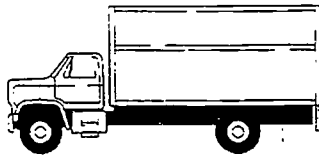

FREIGHT TRUCK

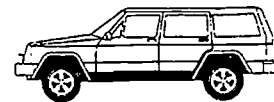

CARS

GENERAL VEHICLE INFORMATION

| Vehicle Type | Length (L) | Width (W) | Height (H) | Turning Radius (min) |
|---------------|------------|-----------|------------|----------------------|
| Semi-Trailer | 60'-0" | 8'-0" | 13'-6" | 50'-0" |
| School Bus | 39'-6" | 8'-0" | 8'-6" | 45'-0" |
| Freight Truck | 35'-0" | 8'-0" | 13'-6" | 45'-0" |
| Fire Truck | 32'-0" | 8'-0" | 9'-8" | 48'-0" |
| Trash Truck | 28'-2" | 8'-0" | 11'-0" | 32'-0" |
| Large Car | 18'-5" | 6'-6" | 4'-9" | 23'-0" |
| Compact Car | 14'-9" | 5'-8" | 4'-5" | 21'-6" |

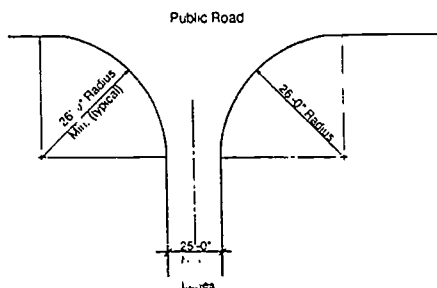

TYPICAL "T-INTERSECTION" FOR BUSES

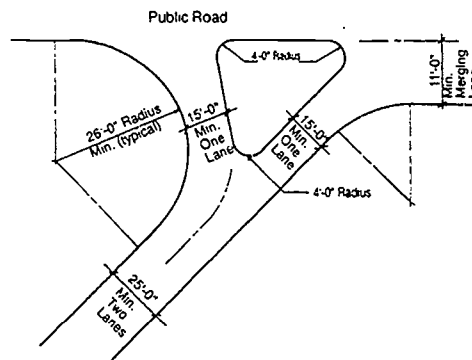

TYPICAL "Y-INTERSECTION" FOR BUSES

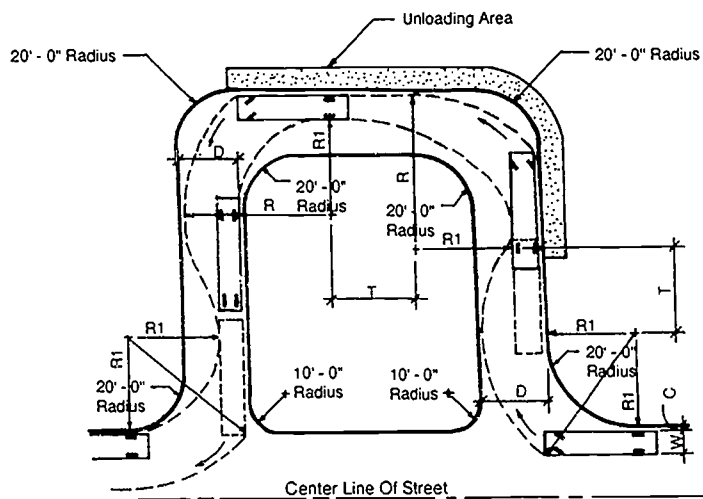

"U" DRIVE AND VEHICLE TURNING DIMENSIONS

| Vehicle | R | RI | T | D | C |
|--------------|--------|--------|--------|--------|-------|
| Standard Car | 22'-5" | 12'-7" | 15'-0" | 11'-2" | 8" |
| School Bus | 43'-6" | 26'-0" | 30'-0" | 19'-5" | 1'-0" |
| Trash Truck | 32'-0" | 18'-0" | 20'-0" | 16'-0" | 1'-0" |
| Fire Truck | 48'-0" | 34'-4" | 30'-0" | 15'-8" | 1'-0" |

BUS PARKING (BP1)

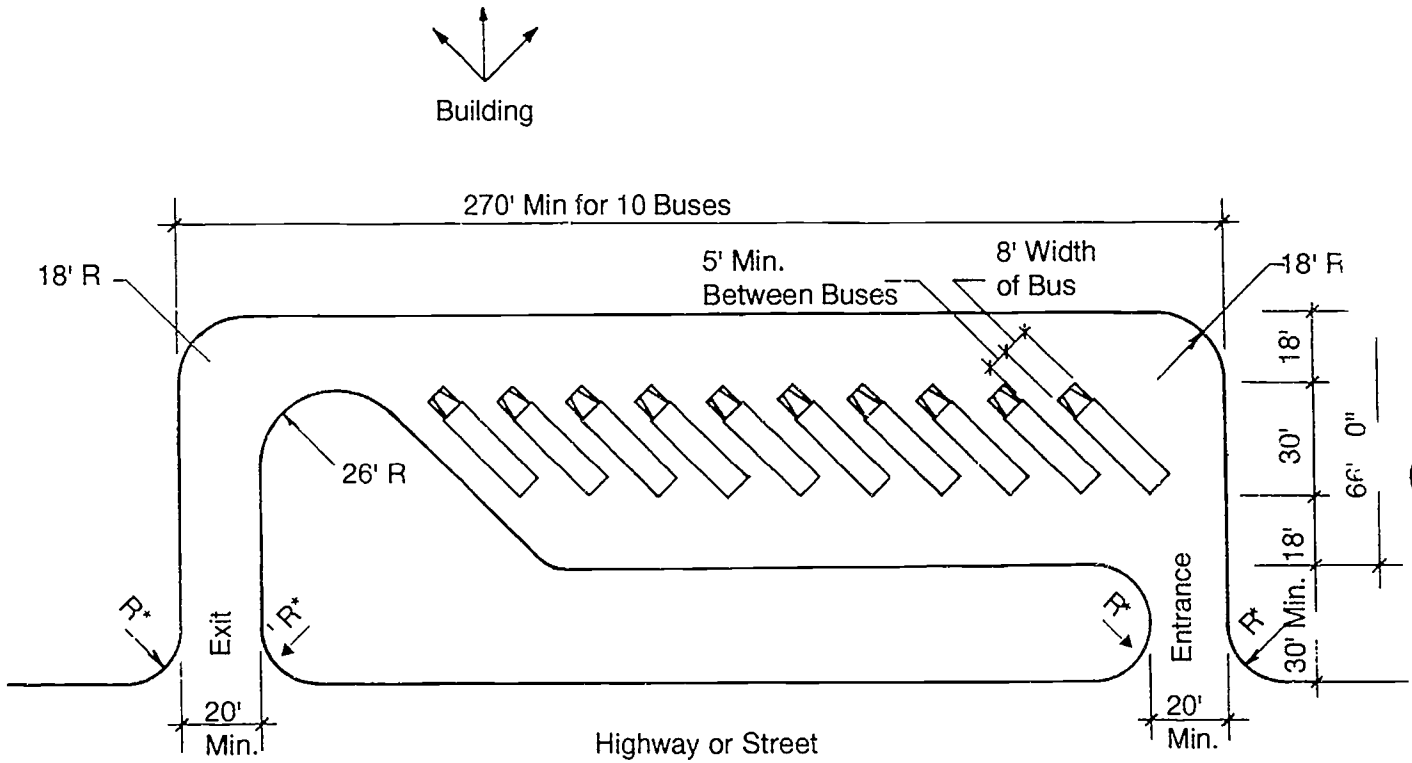

Bus Parking Layout

*26' Minimum Radius

BUS PARKING (BP2)

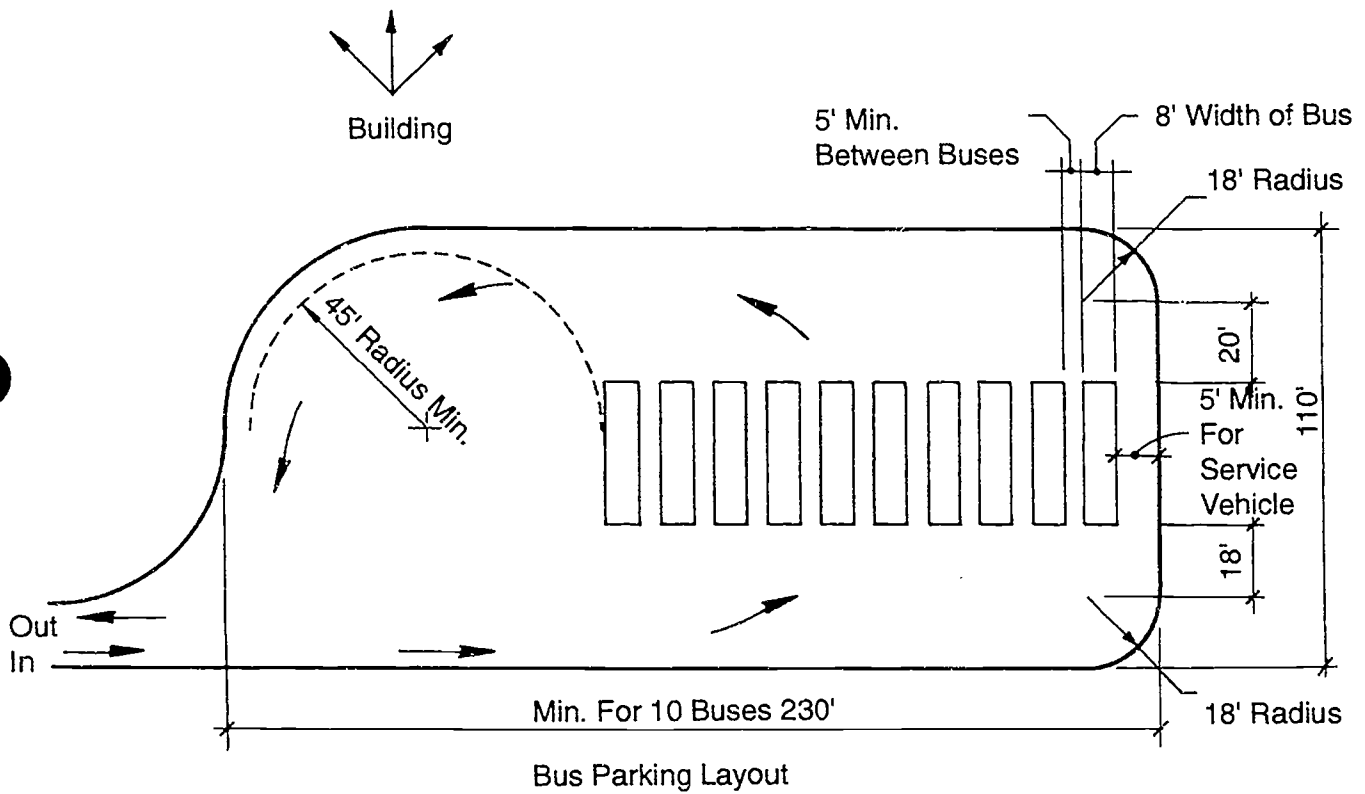

BUS PARKING (BP3)

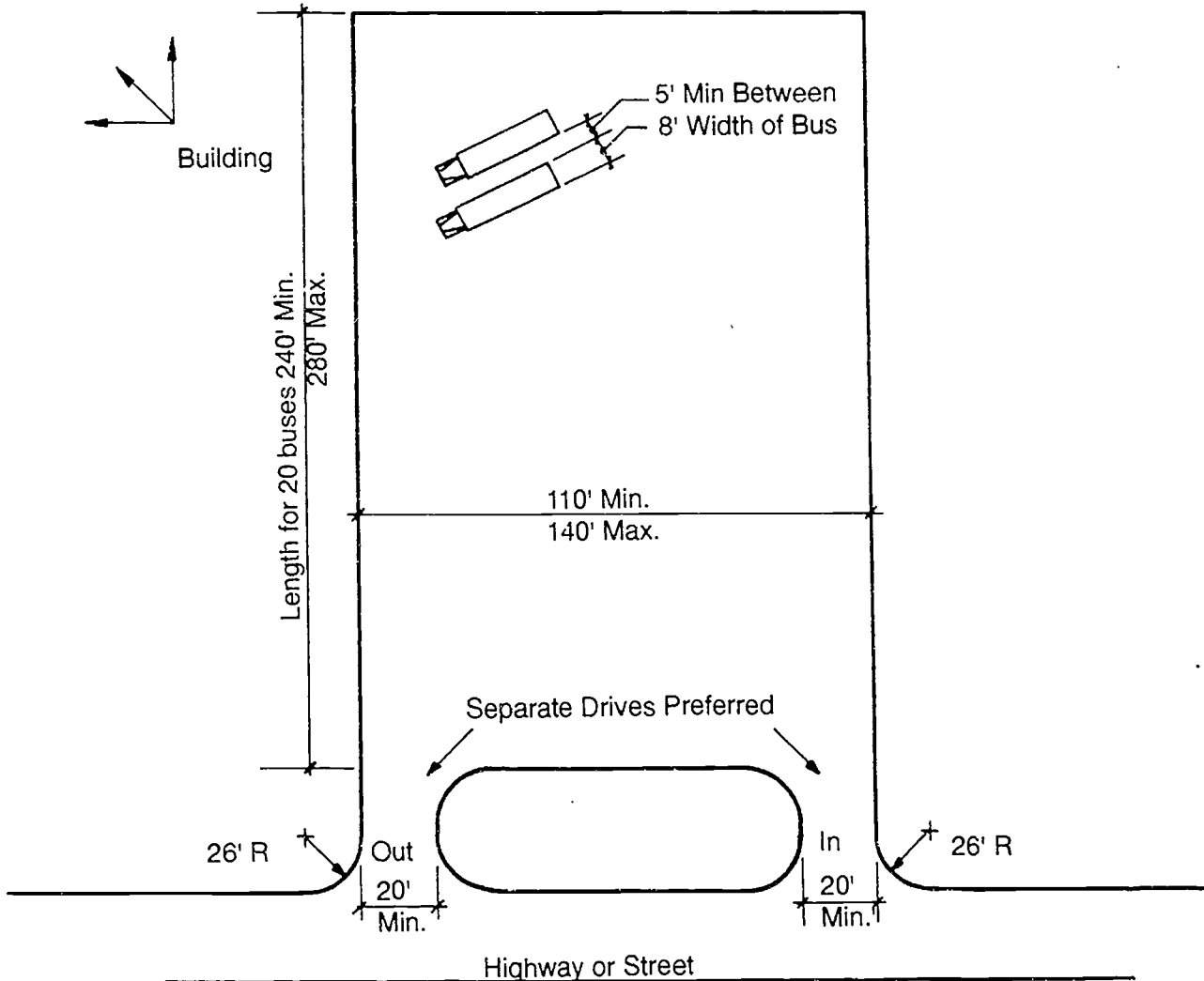

Bus Parking Layout

PRIVATE VEHICLE PARKING (P1)

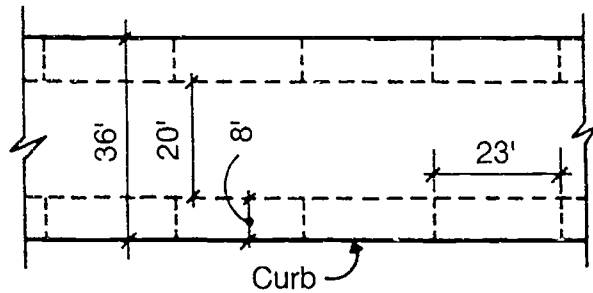

Typical Two Lane Drive Parallel Parking Each Side

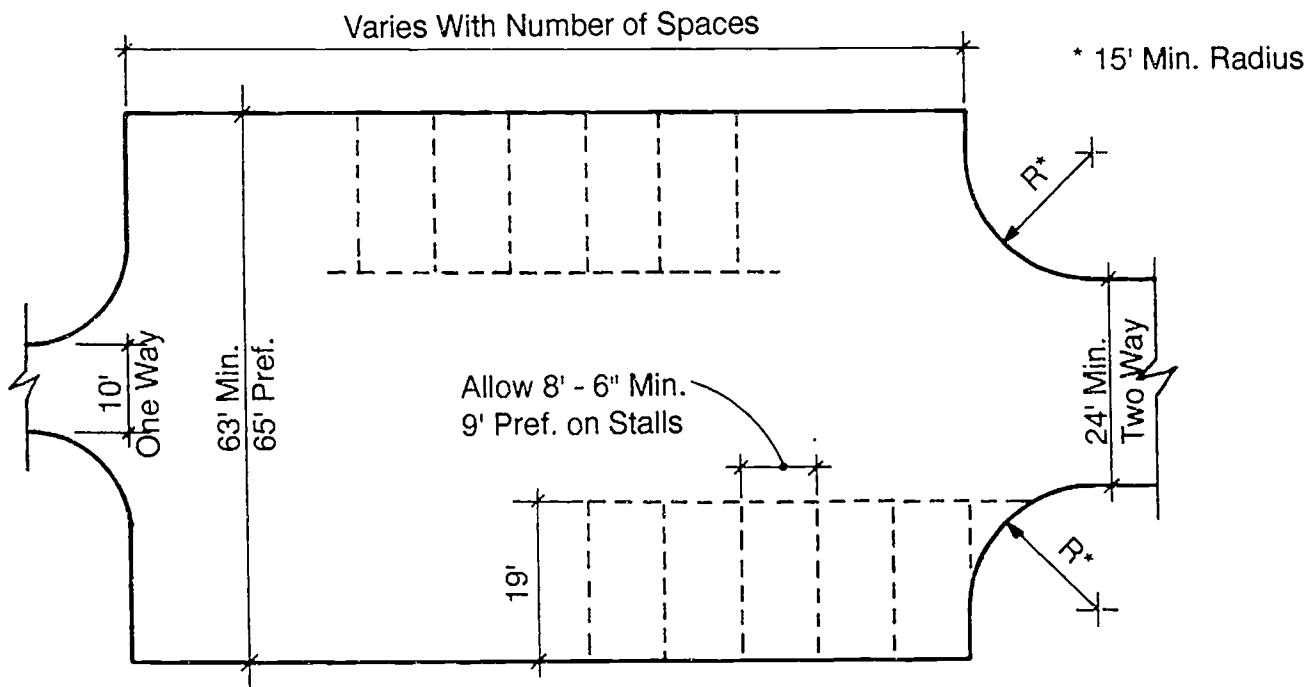

Typical Parking Bay 19' Parking Each Side

PRIVATE VEHICLE PARKING (P2)

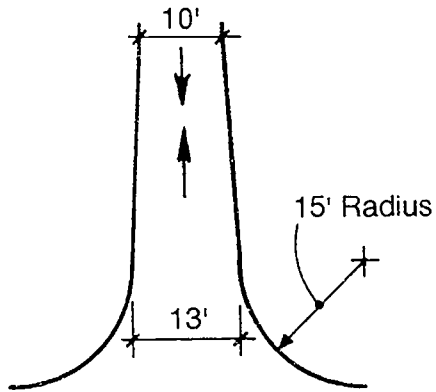

One Way Single Lane Entrance - Exit

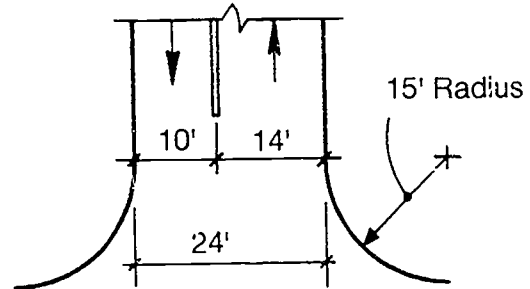

Two Way Entrance - Exit

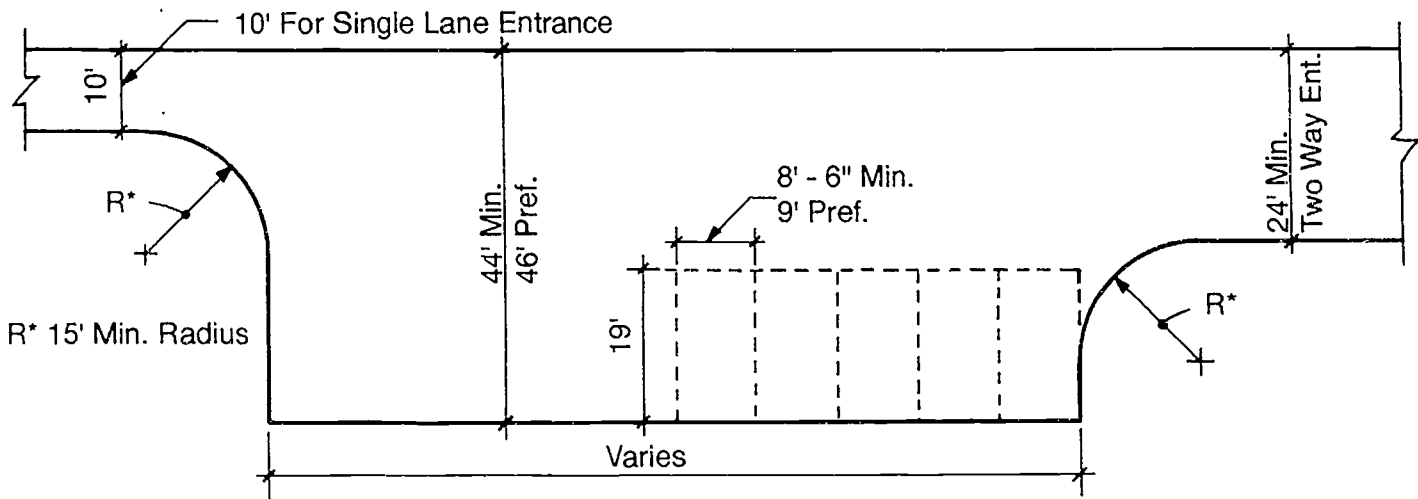

PLAYGROUNDS

PLAYGROUNDS

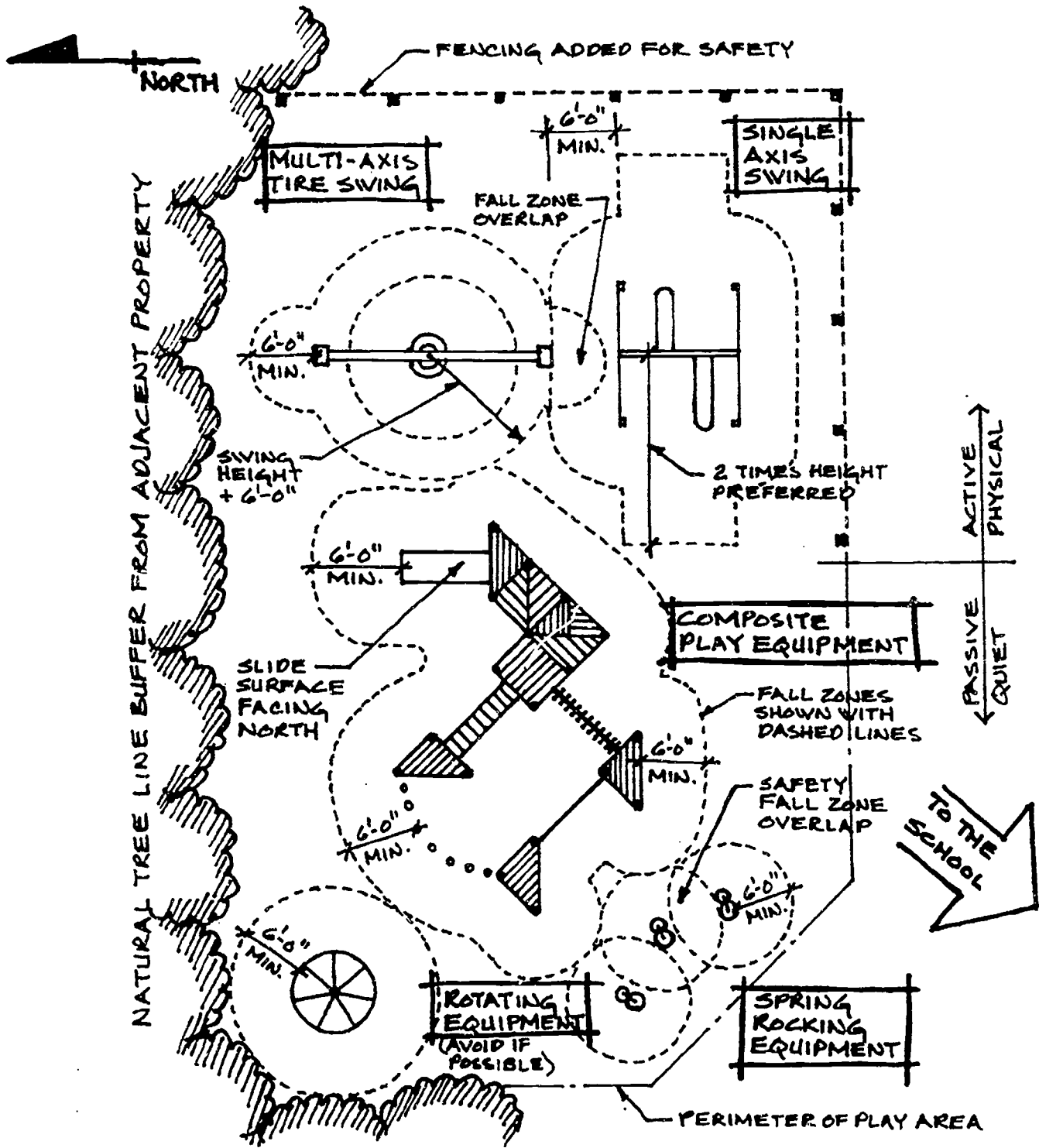

PLANNING A PLAYGROUND

School Planning recommends more open playgrounds for group activity games than playgrounds with fixed equipment. Group activities are safer and help teach team playing and good sportsmanship. Playground equipment presents too much liability to the school system with the increasing number of equipment-related injuries and deaths.

The **Consumer Product Safety Commission** published the results of a study on playground equipment-related injuries and deaths, in April 1990. The results of the study showed that there were approximately 170,200 playground equipment-related injuries treated in U.S. hospital emergency rooms in 1988. Approximately 70 percent of all incidents involved equipment in public locations. Most of the incidents on public equipment occurred in school yards and public parks, each accounting for about 40 percent of all injuries. These equipment-related injuries continue to increase each year.

Planning A Playground

The most important thing to remember in planning a playground is the safety of the children. All playground equipment must be well maintained regularly and the playground area kept clean of any broken glass or other dangerous debris.

Locating a Playground On a School Site:

- Consider areas that are free from hazards or obstacles to children traveling to and from the playground.
- Surround the playground with plants or fencing to prevent small children from inadvertently running into a street or leaving the playground unsupervised.
- Locate a fenced-in playground for Pre-Kindergarten children next to their classroom.
- Locate a fenced-in playground for Kindergarten and first graders close to their classrooms wing and away from the playground area for older children.
- Keep vehicular traffic away from areas designated for playgrounds.
- Locate playgrounds and athletic fields close to the multi-purpose rooms and gymnasiums.
- Keep playgrounds and athletic fields away from on-site sewage waste disposal systems and nitrification fields.

Important Tips on Locating Playground Equipment:

- Separate active/physical activities from passive/quiet activities.
 - Keep clear sight lines over the entire playground for supervision.
 - Disperse popular or heavy-use equipment to avoid crowding.
 - Locate moving equipment such as swings and merry-go-rounds to a corner or edge.
 - Locate exits to slides in a non-congested area.
 - Provide separation of equipment by age groups:
Preschool (4 to 5 years old) and School-age (6 to 12 years old)
-

General Hazards to Avoid Related to Playground Equipment:

- Avoid sharp points, corners or edges, provide rounded edges with a minimum radius of curvature of 1/4 inch.
- All wood should be smooth and free of splinters.
- All wood should be insect-resistant or treated to avoid deterioration. Inorganic arsenical is the most common wood treatment substance. **Do not use** creosote, pentachlorophenol, tributyl tin oxide or pesticide containing finishes because they are too toxic or irritating to the skin.
- All ferrous metals should be painted or galvanized to prevent rust.
- Protrusions or projections should resist entanglement of clothing. Restrict all protrusions and projections to 1/8 inch maximum.
- Avoid accessible pinch, crush or shearing points.
- Avoid openings that could trap a child's head or body. An opening may present an entrapment hazard if the distance between any interior opposing surface is greater than 3.5 inches and less than 9 inches.
- Avoid angles of any vertex less than 55-degrees to one leg horizontal.
- Bury all anchoring devices below playing surfaces to eliminate tripping.
- Keep area clean of broken glass or other hazardous debris.
- Retaining walls should be highly visible and elevation changes obvious.
- Avoid cables, wires, ropes or flexible components in high traffic areas.
- All fasteners, connecting, and covering devices should not loosen or be removable without the use of tools and have a corrosion-resistant coating.
- All bearings in moving joints should be easy to lubricate or self-lubricating.
- Avoid bare or painted metal surfaces unless they can be located out of the direct rays of the sun.
- Avoid rung ladders and climbing components as the sole means of access.
- Do not attach a single-axis swing to composite playground structures.
- Fall zones of adjacent pieces of equipment should not overlap.
- Platforms over 6 feet high should provide an intermediate landing.

Four Key Elements of Playground Safety

1. **Removing equipment that is too tall.**
2. **Installing resilient surfacing under all equipment.**
3. **Removing hazards such as debris or broken equipment.**
4. **Supervising children's play.**

It is up to parents, teachers and individuals in the community to demand safer play areas and to provide proper supervision for children's play.

LADDERS AND PLATFORMS

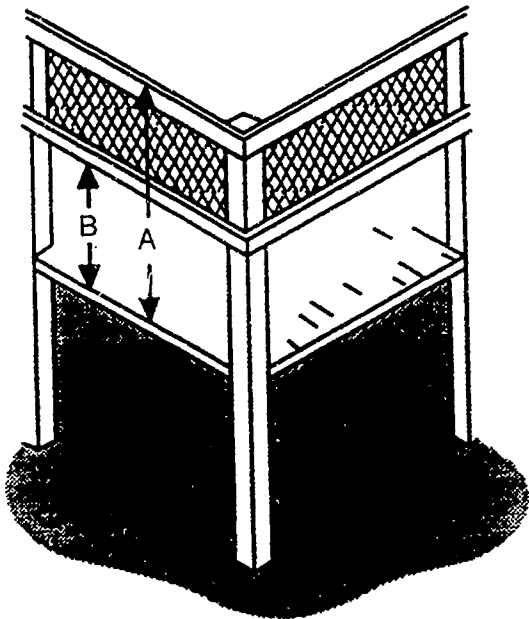

A = 38" minimum for older children

or

29" minimum for younger children

B = 26" maximum for older children

or

23" maximum for younger children

Design Recommendations for Ladders and Platforms

Step/ Ladder Design: Provide evenly spaced steps or rungs. Close in risers that are between 3.5 and 9 inches in height. Flexible climbing devices, such as net, chain or tire climbers **shall not** be the sole means of access to other components of equipment.

Handrail Design: Handrail heights should be between 22 and 38 inches. Avoid horizontal railings for protective barriers use vertical railings to minimize the likelihood of climbing. Continuous handrails shall be provided on both sides of stairs and ladders.

Platform Design: Slope platforms within 2-degrees of the horizontal plane. Provide openings for drainage on all platforms.

- **Preschool:** Provide a guardrail on platforms \geq 20-inches in height and a protective barrier on platforms \geq 30 inches in height. The top surface of guardrails shall be at least 29 inches and the lower edge should be no more than 23 inches above the platform. The maximum height between stepped platforms is 12-inches.
- **School-age:** Provide a guardrail on platforms \geq 30-inches in height and a protective barrier on platforms \geq 48-inches in height. The top surface of guardrails shall be at least 38 inches and the lower edge should be no more than 26 inches above the platform. The maximum height between stepped platforms is 18-inches.

SLIDES

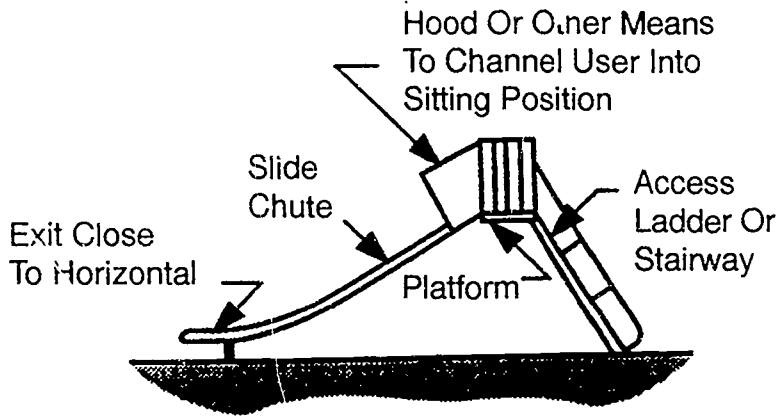

Design Recommendations for Slide Components:

Platform Design: Minimum length of 22-inches.
 Width equal to width of slide.
 Surround platform with guardrails and barriers.
 No gap between the platform and sliding surface.
 Handholds should be provided at the entrance to all slides.
 Add a hood or chute to channel user into a sitting position.

Sliding Surface: Average incline should not exceed 30-degrees.
 Slope changes should not allow a child to lose contact with surfaces.
 Straight slides should have sides 4-inches minimum in height.
Metal slides should be located in the shade or facing north.
 Tube slides should be no less than 23-inches in diameter.

Exit Regions: Minimum length of 11-inches.
 Slide exit edges should be rounded or curved.
 Essentially horizontal and parallel with the ground with a slope between 0-degrees and -4 degrees to the ground.
 The slide exit radius of curvature shall be 30 inches or greater.
 All slide exits should be located in uncongested areas.
 Allow a 6'-0" minimum fall zone on all sides of the slide.

| | | |
|--------------|----|-----------------------|
| Slide Height | vs | Exit Region Height |
| ≤ 4'-0" | | ≤ 11-inches |
| > 4'-0" | | 7-inches to 15-inches |

| | | | |
|---------------------|---|--------------------|--|
| Recommended: | Embankment Slides Low Free-standing Slides Spiral Slides Tube Slides | Do Not Use: | Roller Slides High Free-standing Slides |
|---------------------|---|--------------------|--|

SWINGS

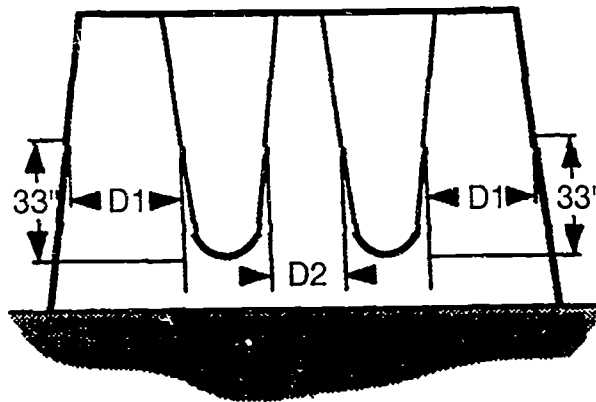

D1 = Minimum 30"
D2 = Minimum 24"

Design Recommendations for Swing Components

Swing Structure: Use support hardware that requires a tool for removal. S-hooks should be pinched closed as tightly as possible. A-frame support structures should not have horizontal crossbars. Install only two single axis swings in each swing structure bay or install only one multi-axis tire swing in each swing structure bay. Do not attach single or multi-axis swings to composite structures. Install swing hangers wider apart than the swing seat. Use 30-inch minimum clearance between seat and swing structure. Use 24-inch minimum clearance between adjacent swing seats. Allow a fall zone of twice the swing's height in the front and back.

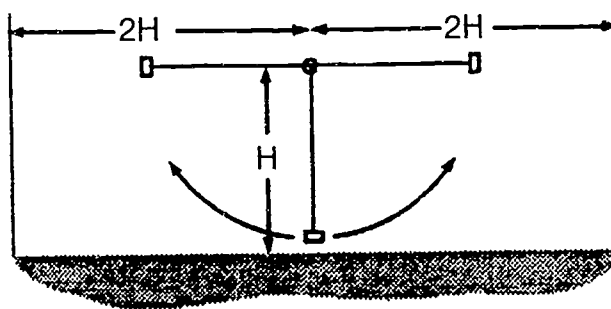

Seat Design: Swing seats should hold no more than one child. Plastic seats are recommended, do not use wood or metal. Seats should have a smooth finish and rounded edges.

| | | | |
|---------------------|--------------------------------------|--------------------|---|
| Recommended: | Tot Swings Multi-axis Tire Swings | Do Not Use: | Multiple Occupancy Swings Rope Swings Animal Figure Swings Swinging Exercise Rings Trapeze Bars Large Single Axis Swings |
|---------------------|--------------------------------------|--------------------|---|

MERRY-GO-ROUNDS

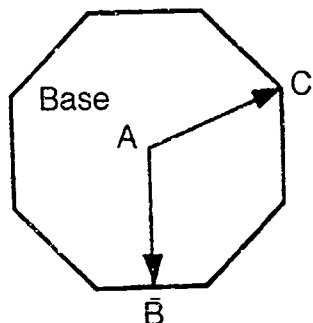

A = Axis of Rotation
AB = Minimum Radius
AC = Maximum Radius

Design Recommendations for Merry-Go-Rounds

Platform Design: The rotating platform should be continuous and almost circular. No component or handrail should extend past the outer perimeter. The platform should have no sharp edges. Openings in the platform should not be over 5/16-inch in diameter. Maximize peripheral speed of rotation to 13 ft/sec. if possible. Do not include an oscillatory (up and down) motion. The difference between platform radii should not exceed 2'-0".

Do Not Use: Merry-go-rounds in preschool age playgrounds.
* **Recommended to avoid elsewhere.**

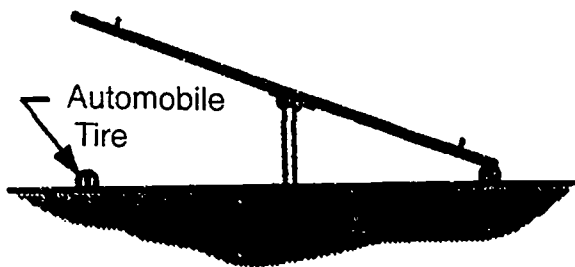

Fulcrum Seesaw

Seesaws should be securely anchored to a central fulcrum and mounted over shock-absorbing material imbedded in the ground below the seats to minimize impact with the ground. The maximum attainable angle to the horizontal is 25-degrees and the maximum attainable seat height is 5 feet.

* **Recommended to avoid elsewhere.**



Spring Rocking Equipment

The springs of rocking equipment should minimize the possibility of children pinching either their hands or their feet between coils or between the spring and a part of the rocker. Each seat should have handgrips and footrests. The height of the seat while at rest shall not be less than 14 inches and not more than 28 inches above the ground.

CLIMBING EQUIPMENT

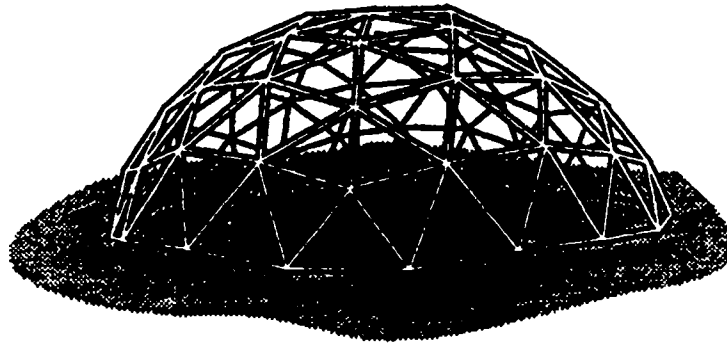

Design Recommendations For Climbing Equipment

General Safety:

Climbers should not have any other structural component in the interior or below the structure to be climbed.
Climbing equipment should allow children to descend as easily as they ascend.
Climbing equipment for Pre-K children should offer an easy out.
Flexible grid climbing devices providing access to platforms should be securely anchored at both ends.
Rung ladders and climbing components should not be used as the sole means of access.

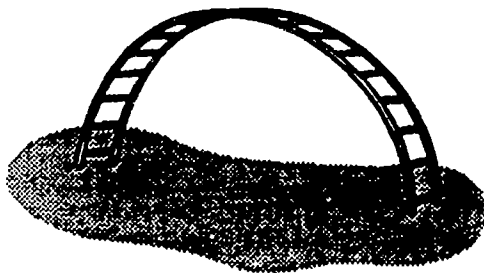

Arch Climbers

These climbers may be free standing or provided as a more challenging means of access to other equipment. However, they should not be used as the sole means of access. The slope should be between 75 - 90 degrees, vertical rise (tread to tread) should be less than or equal to 12", and the rung width should be greater than or equal to 16" with a 1" to 1.67" diameter.

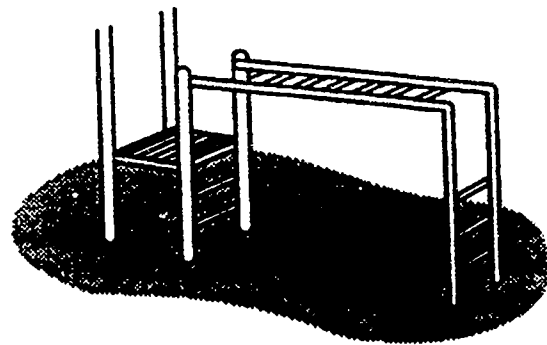

Horizontal Ladders & Overhead Rings

The space between adjacent rungs should be greater than 9" and the center-to-center spacing of horizontal rungs should not exceed 15" (overhead rings should include the arc of the swinging motion). The first handhold on either end should not be placed directly above the platform or climbing rung used for mount or dismount.

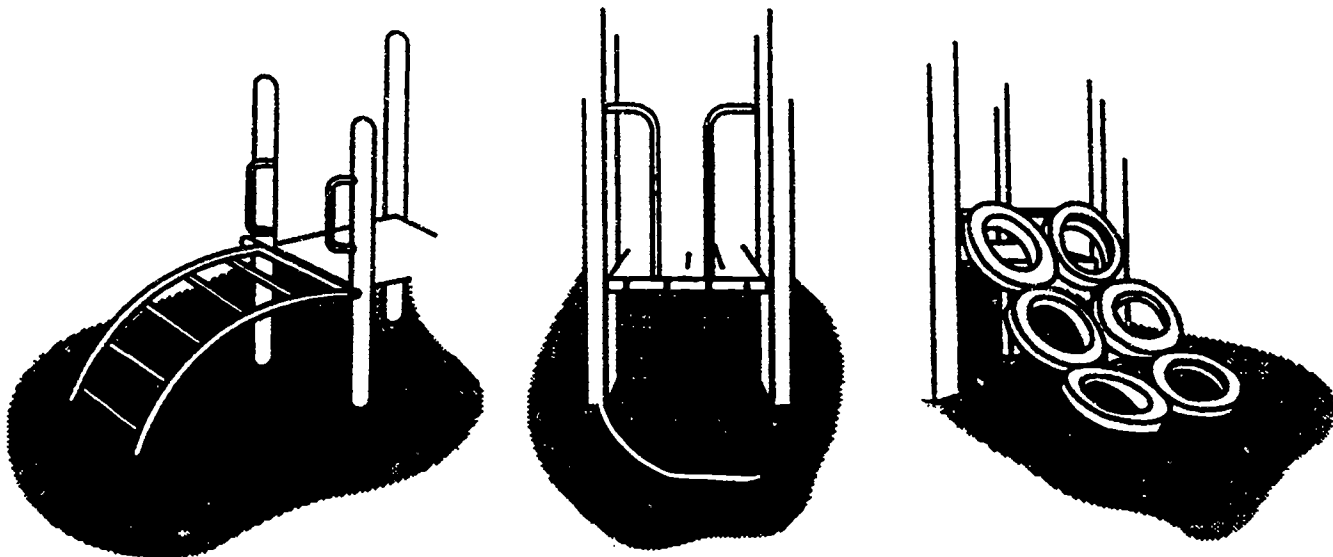

Combining Climbing Equipment With Composite Structure Platforms

Climbing equipment is designed to present a greater degree of physical challenge than other playground equipment. Physical skills necessary for certain climbing activities are balance, coordination, and upper body strength. Climbers include a wide variety of equipment, such as: arch climbers, sliding poles, chain or net climbers, overhead horizontal ladders, overhead rings, dome climbers, parallel bars, balance beams, cable walks, suspension bridges, and spiral climbers. These climbing devices can also be linked to platforms on composite structures. Older children tend to use climbing equipment more frequently and proficiently than younger children.

Balance Beams: To avoid groin injuries during falls, balance beams should be no higher than 12" off the ground.

Climbing Ropes: Recommended only if the ropes are securely anchored to a footing at the lower end to prevent the rope from being looped back on itself and forming a noose.

Sliding Poles: Vertical sliding poles require upper body strength and coordination. Poles should be continuous with no protruding welds or seams. Poles should be continuously straight with no change in direction. Horizontal distance between a sliding pole and the edge of the access platform should be at least 18" but not more than 20". The sliding pole should extend at least 38" above the level of the access platform. The diameter of the sliding pole should be no greater than 1.9".

PROTECTIVE FALL ZONE DIMENSIONS

All playground equipment should have a protective fall zone surrounding the equipment for unexpected falls. This area should be kept separate from pedestrian walkways and fall zones for adjacent play equipment. The recommended minimum dimensions are:

- Stationary Equipment:** Extend fall zone 6'-0" minimum in all directions.
- Slides:** Extend fall zone 6'-0" minimum on each side and the ladder access side. The slide exit should have a minimum of 6 feet from the end of the slide or a distance of the slide height from ground to platform plus 4'-0" whichever is greater.
- Single Axis Swing:
or
Multi-Axis Tire Swing:** Extend fall zone in front and back a minimum distance of 6'-0" plus the length of the suspending members. The sides should have a 6'-0" fall zone that can overlap with another swing structure.
- Rotating Equipment:** Extend fall zone a minimum of 6'-0" from perimeter.
- Spring Rocking Equip:** Extend fall zone a minimum of 6'-0" from the "at rest" perimeter. Adjacent spring rockers can share fall zones if the maximum seat height is 24 inches.
- Composite Equipment:** The fall zone shall be composed of the fall zones stated above for individual pieces of play equipment.

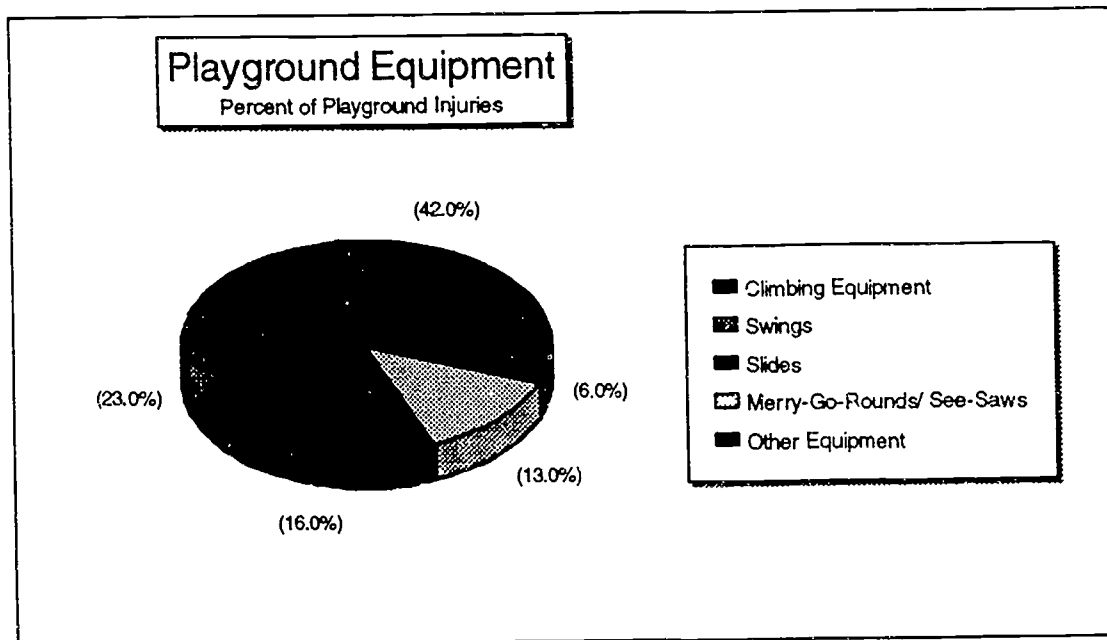

FALL ZONE SURFACE MATERIALS

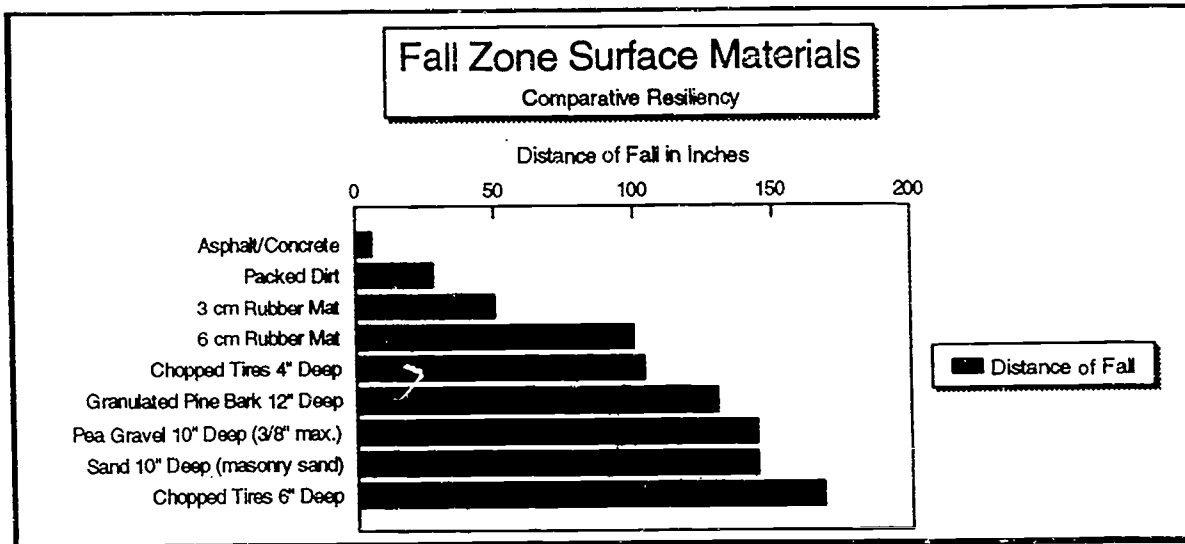

Three Types of Surface Materials for Under and Around Playground Equipment:

1. Unitary synthetic materials, such as rubber mats, foam mats, etc.
2. Organic loose-fill materials, such as wood chips, bark mulch, etc.
3. Inorganic loose-fill material, such as sand and gravel.

| | Unitary Synthetic Materials | Organic Loose-fill Materials | Inorganic Loose Material |
|-----------------------------|---|---|--|
| Installation Maintenance | Can be laid directly on hard surfaces when other materials may require undersurface preparation and installation. Requires no containment. Requires min. maintenance. | Do not install over hard surfaces. Requires containment. Requires good drainage. Requires periodic renewal or replacement and maintenance. | Do not install over hard surfaces. Requires drainage, containment and replacement. Sand needs loosening. Gravel needs breaking up. |
| Advantages | Low maintenance. Easy to clean. Consistent shock absorbency. Material does not displace. Low life cycle costs. Good footing material. Harbor few foreign objects. No retaining edges needed. Accessible to handicapped. | Low initial cost. Ease of installation. Good drainage. Less abrasive than sand. Less attractive to cats and dogs compared to sand. Attractive appearance. Readily available. | Low initial cost. Easy of installation. Does not pulverize. Not ideal for microbial growth. Nonflammable. Materials are readily available. Not susceptible to vandalism. Gravel is less attractive to animals than sand. |
| Disadvantages | Initial cost relatively high. Undersurfacing required for thin materials. Needs level uniform surface. May be flammable. Subject to vandalism. Rubber tiles may curl up and cause tripping. May be susceptible to frost damage. | Decomposes over time. Can be blown or thrown. Subject to microbial growth. Conceals animal excrement and trash. Spreads easily outside of containment area. Can be flammable. Subject to theft by neighborhood residents for mulch. | May be blown or thrown. May be swallowed. Conceals animal excrement and trash. Spreads easily outside of containment area. Sand adheres to clothing. Gravel is difficult to walk on. Gravel could cause hazards if displaced in other areas. |

RECREATION AND ATHLETIC FIELDS

TRACK AND FIELD EVENTS COMBINATION

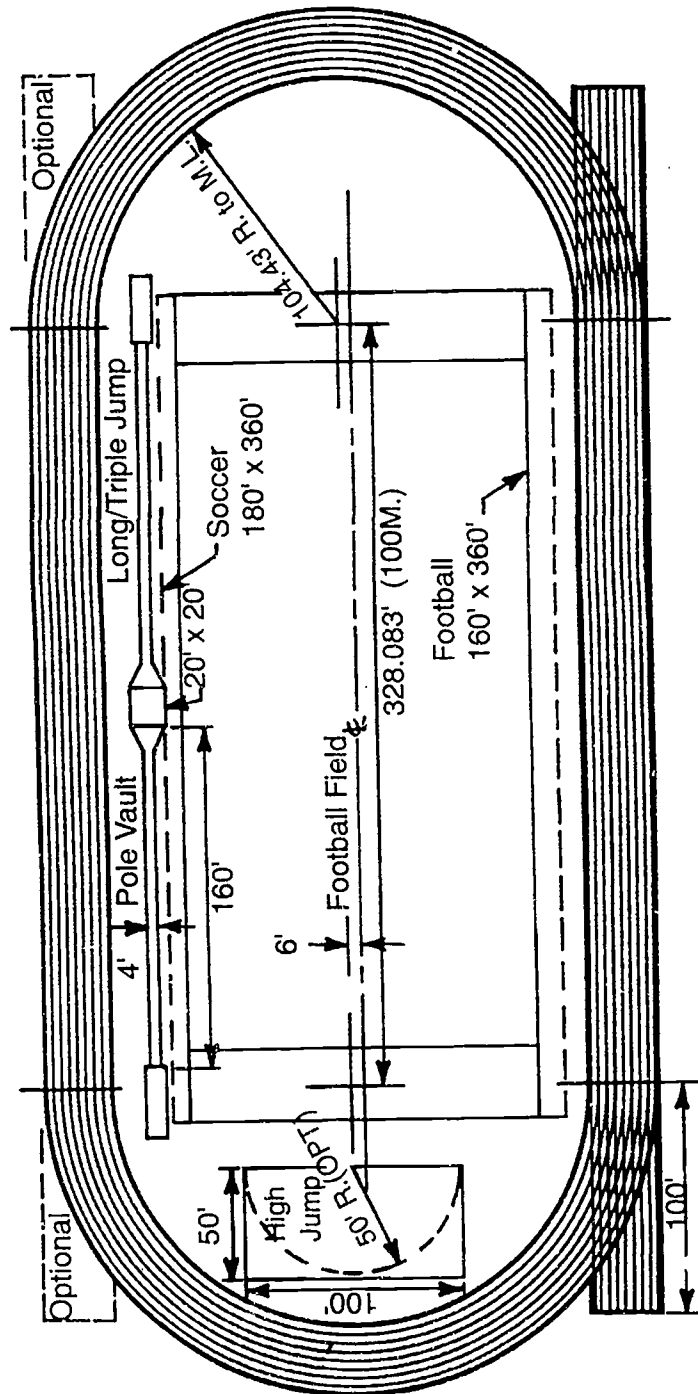

400 METER TRACK

Specifications for High Schools

GOVERNING BODY: National Federation of State High School Association (NFSHSA)

SITE STANDARDS: 400 Meter Standard Track (For equal quadrant facilities)

| | Width (East/West) | Length (North/South) |
|---------|--------------------------|-----------------------------|
| 8 Lanes | 82 meters (268'-0") | 182 Meters (596'-0") |
| 6 Lanes | 77 meters (252'-0") | 177 Meters (580'-0") |

LANE WIDTHS: Minimum 1.067 meters (42-inch). The 5 cm (2-inch) wide right hand lane line is included in the width of the lane.

INCLINATIONS: Lateral Direction 2:100 Maximum
Running Direction 1:1000 Maximum

CURB DIMENSIONS: 5 cm (2-inch) in height with a rounded top, use a 5 cm painted line if no curb is used.

GENERAL RECOMMENDATIONS: 400 meter track with a common finish line for all events within 20 meters of the juncture of the straight and curve. Direction of running the straight races should be with the prevailing wind. Direction of running around the 400 meter race course is counter clockwise i.e., inside lane boundary to runner's left.

CRITERIA FOR TRACK SURFACES: There are two types of track surfaces natural materials and all-weather systems. Each needs to be considered for the following surface features:

| | |
|--|---------------------|
| Porosity | Resiliency/cushion |
| Maintenance characteristics | Durability |
| Performance (wet and dry) | Cost |
| Spike tear | Abrasion resistance |
| Hardness | Cosmetic retention |
| Appearance | Adhesion |
| Consistency through temperature changes (40-degrees to 80-degrees) | |

TWO TYPES OF TRACK SURFACES:

Natural Materials

Cinders
Fired Clay
Crushed Brick
Expanded Shale
Decomposed Granite
Natural Clay

All-weather Systems

Cold Cushion
Hot Cushion
Field Mix Synthetic Systems
Pre-manufactured Systems

400 METER TRACK

400 METER EVENT MARKINGS LAYOUT

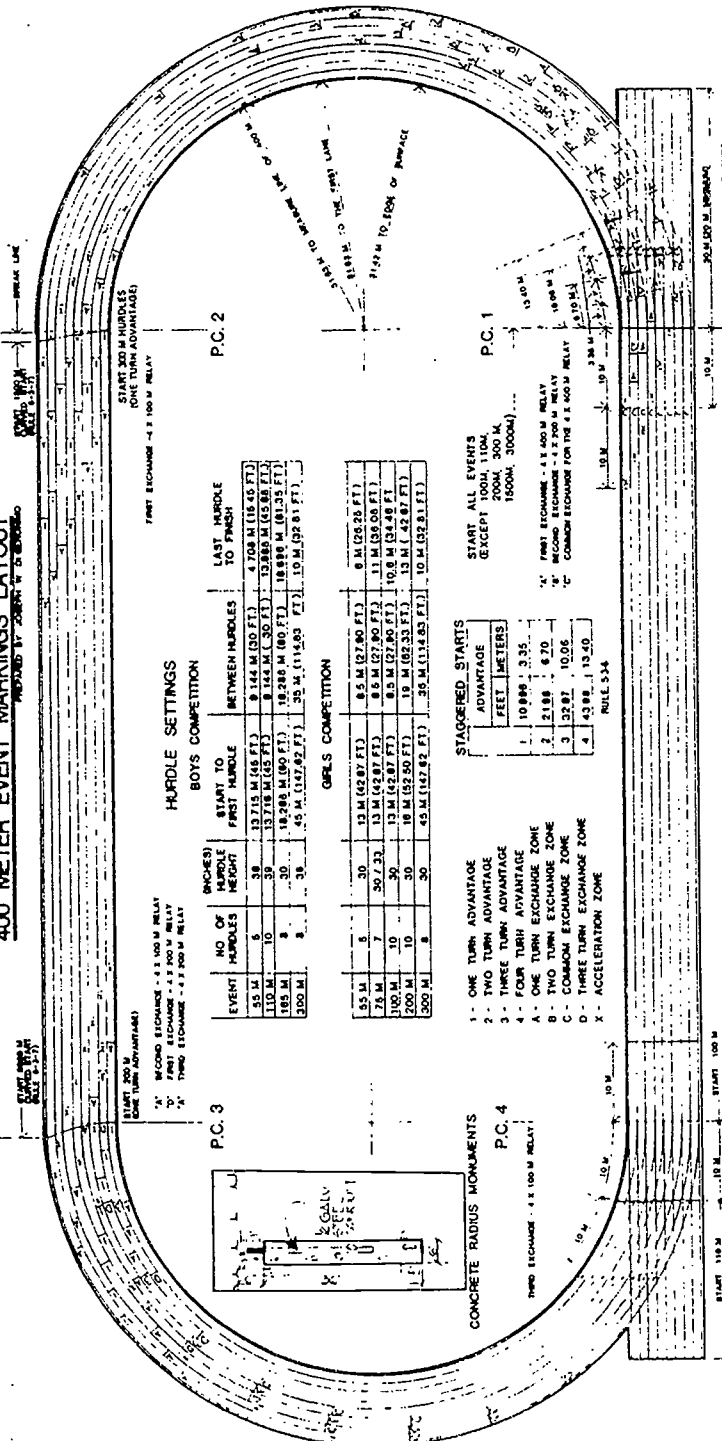

NOTE: FOR A RUSED CURB ON THE INSIDE EDGE IN LIEU OF A PAINTED LINE THE DISTANCE TO THE MEASURE LINE IS 30 CM FOR LANE NO. 1 ONLY



Copied From:
 The National Federation
 Court And Field
 Diagram Guide

FIELD EVENTS

High Jump

Runway: The high jump approach area should provide 22 meters of level surface (21.3 meters required by rule) from any angle within an arc of 150 degrees. The arc should be of synthetic material, usually the same as the track. The high jump pit must be a minimum of 4 x 5 meters and of a composition to provide a safe landing (no bottom out).

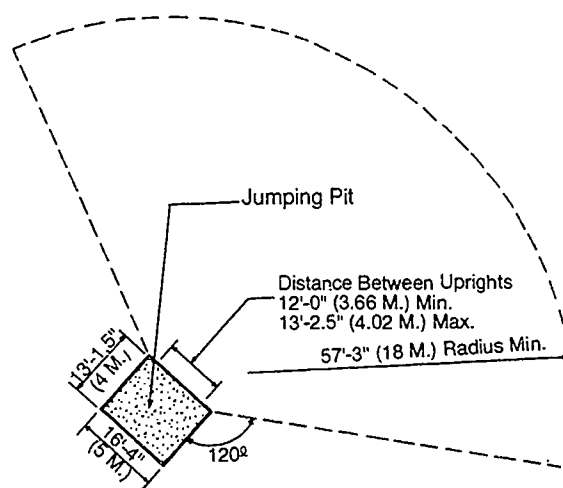

Shot Put and Discus Throw

Circumference: Shall be marked with a metal, wood or plastic band which shall not rise more than 1.9 cm (3/4-inch) above the level of the circle. If the circle has a surface of asphalt, concrete, wood or other hard material, a painted line 5 cm (2-inches) wide may be substituted for the band. Maximum lateral inclination 2:100 (2%); maximum inclination in the throwing direction is 1:1000 (0.1%). A concrete surface with a 1 mm (1/64-inch) roughness is recommended for shot put.

| | | |
|-----------------------------|-----------|-------------------------|
| Circle Measurements: | Shot Put: | Inside Diameter 2.135 m |
| | Discus: | Inside Diameter 2.50 m |

Shot Put Stopboard: The board shall be made of concrete, fiberglass, metal, wood or other hard-surfaced material in the shape of an arc, so that the inner edge coincides with the inner edge of the circle. It shall be firmly fixed in this position. The board shall measure 1.22 m long on the inside, 11.4 cm wide and 10 cm high.

Landing Area: For the shot put the sector shall be formed by lines from the center of the throwing circle extended through the extremities of the stopboard. For the discus, the sector is 60-degrees. No sector is specified for the hammer. Maximum lateral inclinations is 2:100 (2%); maximum inclination in the throwing direction is 1:100.

FIELD EVENTS

A throwing cage is recommended for the discus and shot put throwing events.

The cage should be "C" shaped in plan. The diameter being 22'-11 1/2" (7 m) with the opening thru which the throw is made being 19'-8 1/4" (6 m) wide.

The height of the cage should be 13'-1 1/2" (4 m).

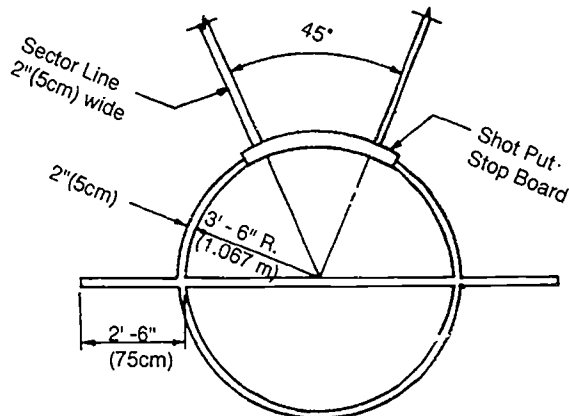

SECTOR LAYOUT - SHOT PUT

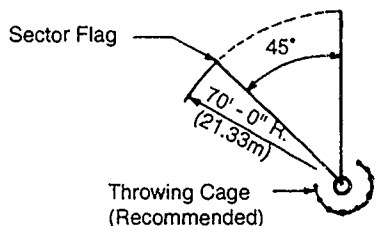

SHOT PUT THROW CIRCLE

Throwing circles to be formed of band iron or steel 1/4" (6 mm) thick and 3" (76 mm) high sunk flush with the ground outside.

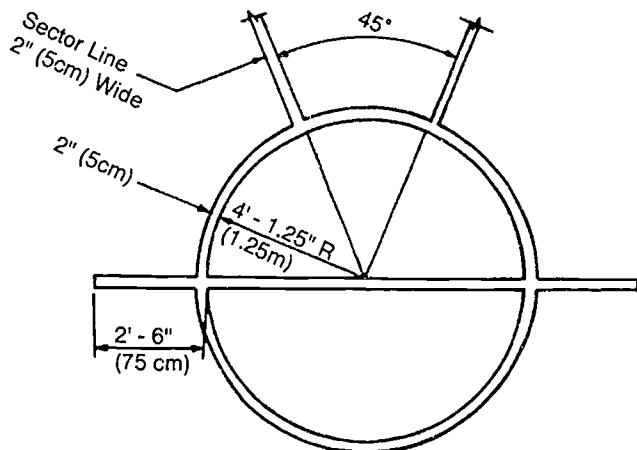

DISCUS THROW CIRCLE

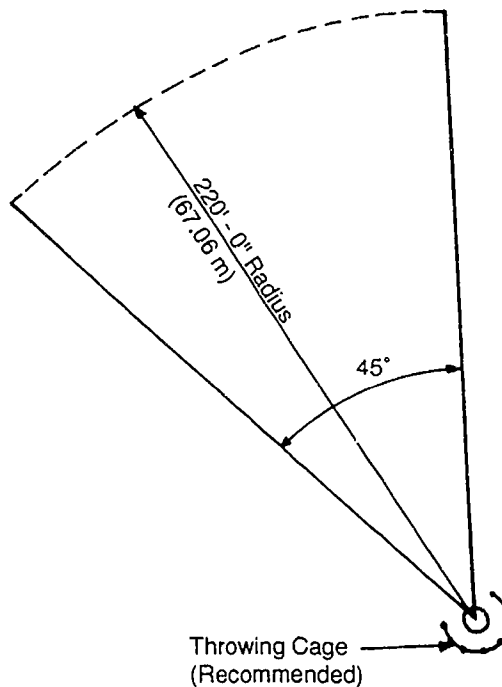

SECTOR LAYOUT - DISCUS THROW

FIELD EVENTS

Pole Vault

Runway: Length unlimited; minimum length 39.63 m (130'-0"); recommended length 44.96 m (147'-6"). Recommended width of 1.067 m (42-inch). Maximum lateral inclination of 2:100 (2%) and maximum downward inclination in the direction of running of 1:1000. Locate the pole vault so that the prevailing wind will be at the vaulters' backs.

Crossbar: The upright standards that support the crossbar shall not be less than 12'-0" or more than 14'-2" apart and the standards must include pins or holes for supporting the crossbar. The crossbar shall not be less than 12'-0" or more than 14'-10" in length, with uniform thickness and a weight of not more than 5 pounds.

Planting Box: The planting box shall be constructed of some suitable rigid material, use a steel liner for wooden boxes. The length of the box at ground level and the depth of the stopboard will depend upon the angle formed between the base and stopboard which shall be 105-degrees. The box should be constructed in such a manner that the sides slope outwards and end next to the stopboard at an angle of approximately 120-degrees to the base. See diagrams A and B for dimensions.

Landing Pad: The pole vault pad measured beyond the vertical plane of the stopboard shall be a minimum of 16 feet wide and 12 feet deep. The material in the pad will be high enough and of a composition that will provide a safe landing. A front pad of 4 feet is attached to the main landing pad with an area cut out for the planting box. See diagram C for dimensions.

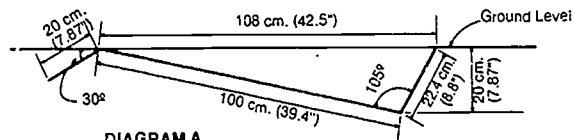

DIAGRAM A

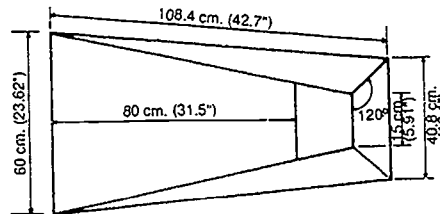

DIAGRAM B

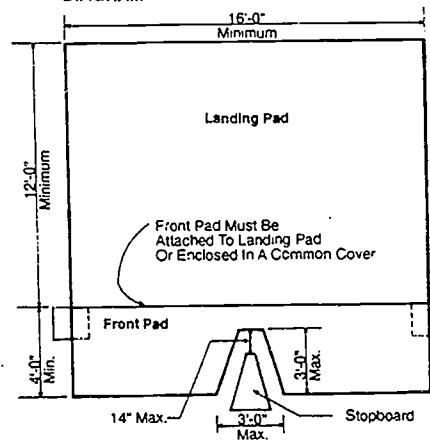
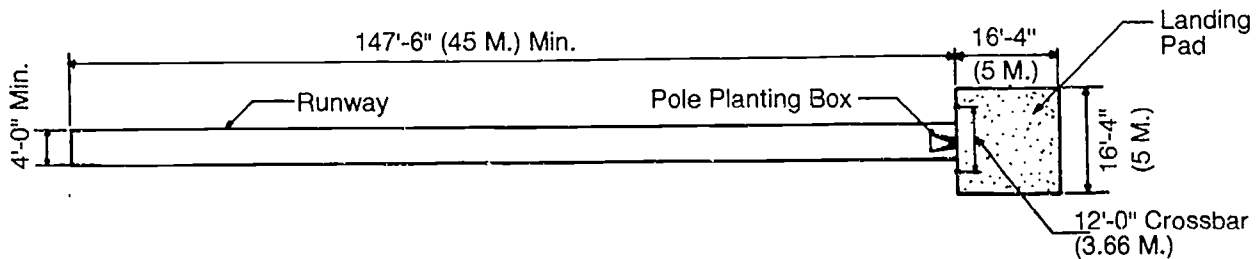
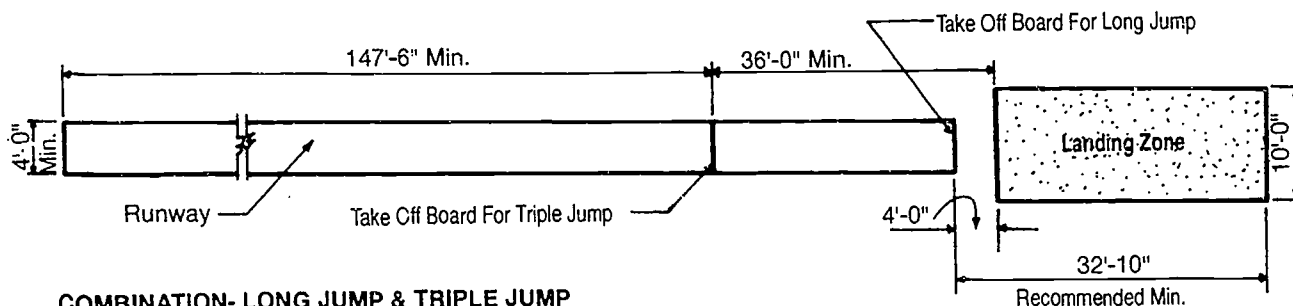

DIAGRAM C



FIELD EVENTS



COMBINATION- LONG JUMP & TRIPLE JUMP

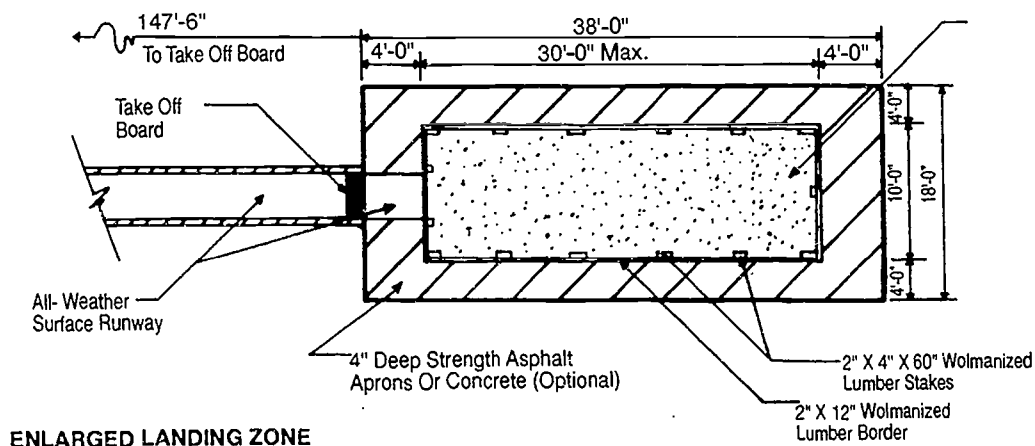

ENLARGED LANDING ZONE

Long and Triple Jump

Runway: Same as the runway for pole vaulting. Make provisions to place a platicine foul-indicator board in runway adjacent to takeoff boards on the side nearer the landing pit.

Takeoff Board: A wood or synthetic rectangular board a minimum of 1.22 m (4'-0") long and 20 cm (8-inches) to 61 cm (24-inches) wide set firmly in the ground level with the runway. For the long jump and triple jump set lines on the synthetic runways at a distance of:

| Event | Boys | Girls |
|-------------|--------|--------|
| Long Jump | 12'-0" | 8'-0" |
| Triple Jump | 32'-0" | 24'-0" |

Landing Pit: Minimum width 2.74 m (9'-0") and minimum length 4.57 m (15'-0"). Sand, sawdust or other soft material may be used and must be at the same level as the top surface of the takeoff board or the painted takeoff line (on synthetic runways).

FOOTBALL FIELDS

Required Area: The football field is a level area 360 feet long and 160 feet wide.

Orientation: If games are played during daylight hours or the field is used for practices, it should be oriented so that play is in a north (northwest) and south (southeast) direction to insure that the sun does not shine directly into the eyes of the contestants.

Drainage: For a stadium football field, a 12-inch crown down the longitudinal axis on the middle of the field or a 1/4-inch per foot slope from the center to the sidelines is recommended. A one-percent slope is recommended as maximum for turf areas.

Field Markings: White lines, called yard lines, run across the width of the field every five yards, and lines called sidelines, run down the length of each side. End lines, sidelines and yard lines should be 4-inches wide. The goal lines run at each end of the width of the field at 100 yards apart, with the end zones extending 10 yards beyond each goal line. The yard lines are numbered at 10-yard intervals from the goal lines to midfield. Two broken lines, called inbounds lines, or hash marks, run parallel to the sidelines. Inbound lines should be 24-inches long and 4-inches wide.

Goal Posts: In high school football, two goal posts, each a minimum of 20 feet high, stand 10 yards behind each goal line. A crossbar connects them 10 feet from above the ground. The posts are 23'-4" apart. See sketch for details.

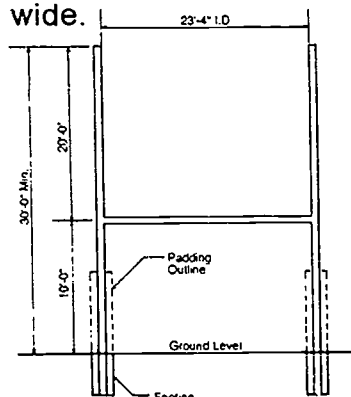

Team Boxes: Both team boxes may be on one side between the two 45 and 20 yard lines. The area between the team boxes and sidelines should be solid white or marked with diagonal lines.

Support Facilities: Facilities should be provided for the press and radio along with the public address system, scoreboard operators, spotters, scouts and other officials. The press box should be located opposite the 50-yard line, high in the west stand to eliminate direct sun glare.

Bleacher Seating: The North Carolina High School Athletic Association has the following minimum seating requirements by classification:

| Classification | Host Seating | Visitor Seating |
|----------------|--------------|-----------------|
| Class 1A | 1000 | 500 |
| Class 2A | 1450 | 750 |
| Class 3A | 2000 | 1000 |
| Class 4A | 2500 | 1500 |

FOOTBALL FIELDS

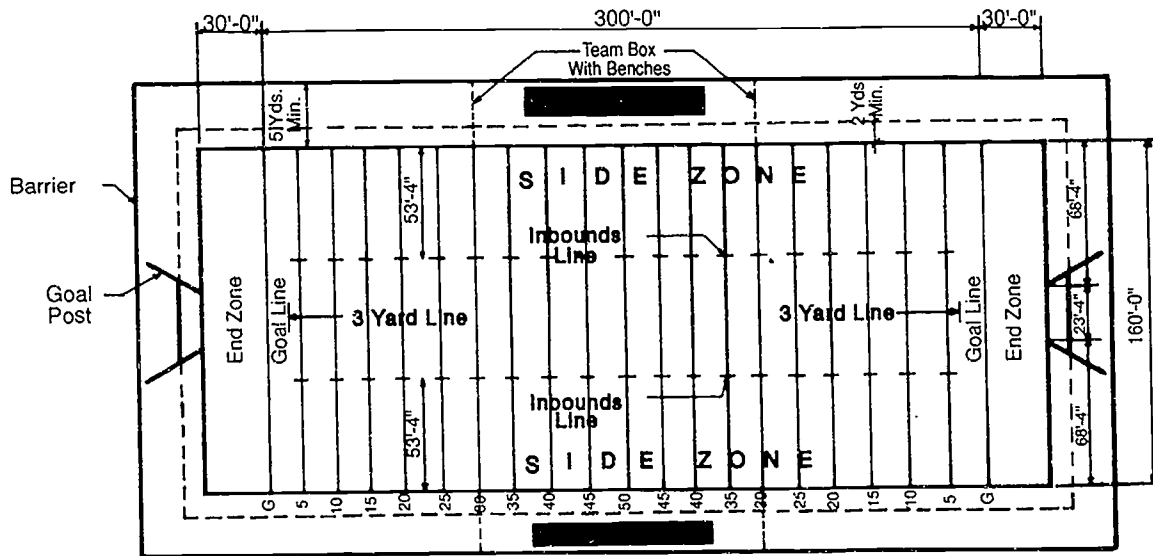
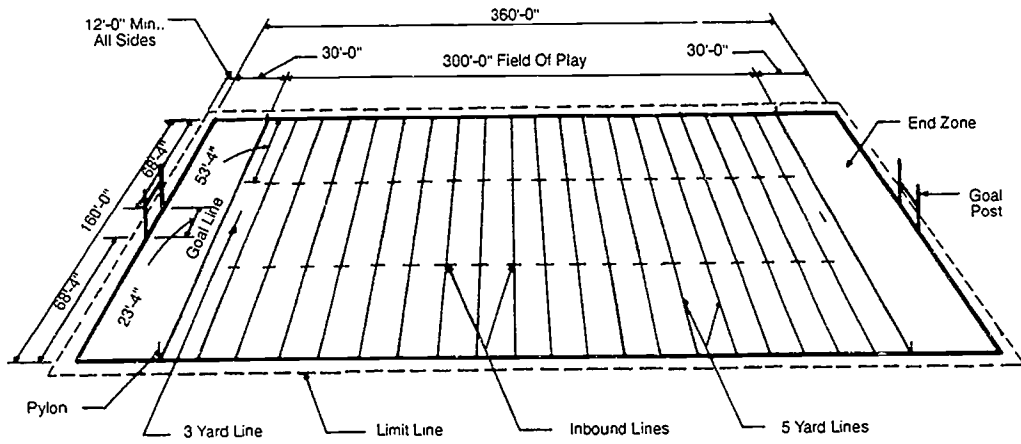

SOCCKER FIELDS

Required Area: The soccer field should be laid out on the most level area of land available. The rules state that the field of play must be rectangular and not more than 120 yards in length or less than 100 yards. The width not more than 75 yards or less than 65 yards. In most high schools, the football field is used for soccer games by using portable goals.

Orientation: The orientation of the length of the field should be in the north (northwest) and south (southeast) direction.

Drainage: The preferred drainage is a longitudinal crown with a one percent (1%) slope from center to each side.

Field Markings: All lines are to be white and 2-inches wide, except the centerline, which is 5-inches wide. The side boundaries are called the touchlines, which are 114 yards (105m) long. A centerline divides the playing field in half with a 10 yard (9 m) radius center circle. Each end of the field has two rectangular areas immediately in front of the goals. The goal area is the smaller of the two zones: 20 yards (18.3 m) by 6 yards (5.4 m). The penalty area is the larger of the two zones: 44 yards (40 m) by 18 yards (16.4 m).

Goal Posts: The goal posts and crossbar shall not exceed 5-inches nor be less than 4-inches wide and shall present a flat surface to the playing field. The net must be attached to the ground, goal posts, and crossbar. The net must also extend back and level with the crossbar for two feet.

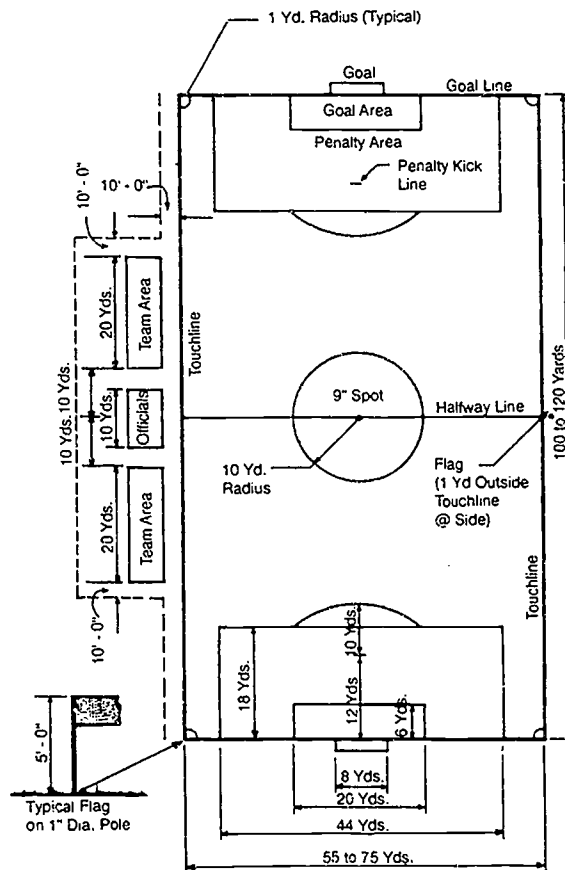
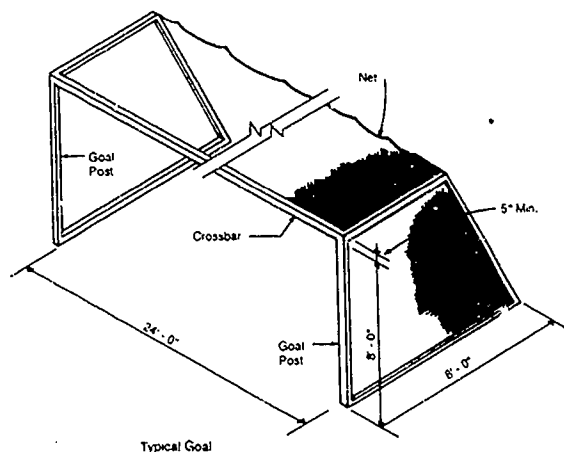

FIELD HOCKEY FIELDS

Required Area: The dimensions of the field are 300 feet (100 yards) long and 180 feet (60 yards) wide with an additional 10 foot safety zone recommended on all sides. A smaller field of 255 feet by 135 feet can be used for younger players.

Orientation: The field should be oriented so that play is in the north (northwest) and south (southeast) direction.

Drainage: The playing surface should be a multi-purpose turf or loam that is crowned down the center, sloping one-fourth inch per foot or 1% slope toward the sidelines.

Field Markings: The field should be marked with 2-inch white lines. There should be four lines across the width of the field that divides the length of the field into four equal parts 25 yards apart. Parallel to and five yards from each side line, is a broken 5-yard line, this area is called the alley. At each end of the field is a striking circle which is 48 feet (16 yards) from each goal post out to the side. The penalty corners are marked 30 feet to the side of each goal post on the goal line. These penalty lines run 12 inches from the goal line into the field. The goal is 12 feet wide.

Goal Posts: The goal posts should be two-by-three inches and painted white. The goal posts are 12 feet apart joined by a crossbar 7 feet above the ground. Six feet behind the goal line are two 6 foot posts. The sides, back and top are enclosed by netting or wire mesh.

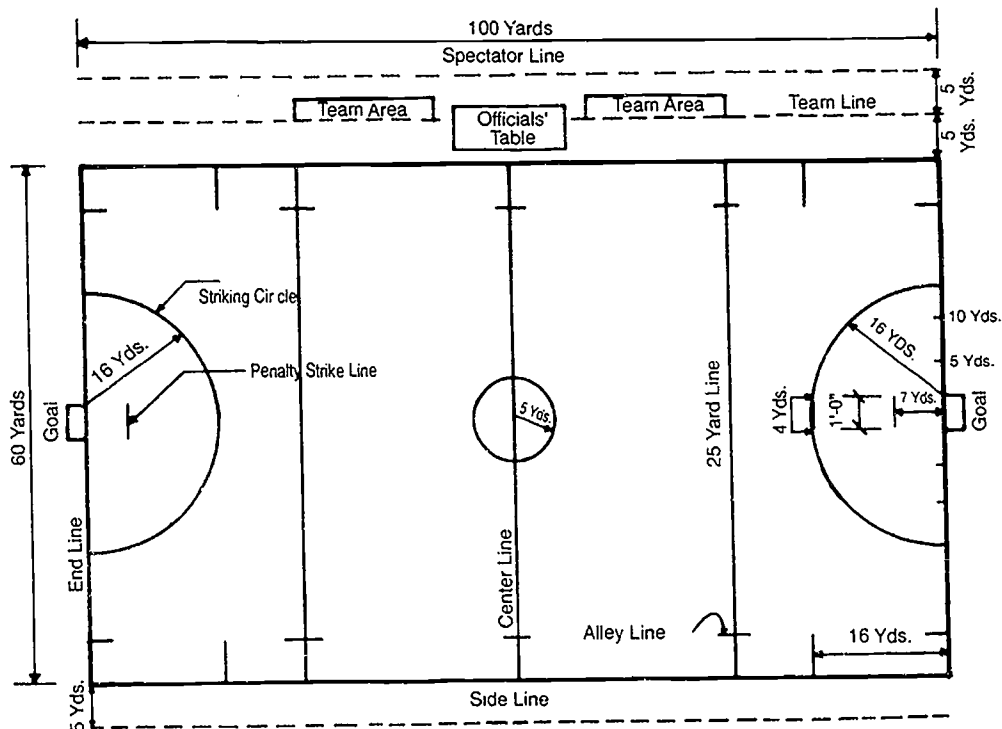

BASEBALL FIELDS

Required Area: An area of approximately three acres (400 feet by 400 feet) is required. This will allow for dugouts and bleachers as well as the playing area.

Orientation: If possible, the back point of home plate should be set to point due south to southwest. Another check is to have the baseline from home plate to first base run easterly.

Diamond Area: The official diamond is 90 feet on a side, with the dimensions across the diamond 127 feet 3-3/8 inches. There should be a minimum of 60 feet from home plate, down the foul lines to the outfield fence, the distance varies but the minimum should be 320 feet.

Backstop: A large frame backstop should be located 60 feet behind home plate. This backstop should be a minimum of 20 feet high. Attached to each end of the backstop should be a fence at least four feet high, 60 feet from the nearer foul line, and extending to the outfield fence where they join in foul territory at least 45 feet from the foul line. The outfield fence should be eight feet high for maximum safety.

Fencing: Woven wire fencing of the chain-link type (minimum thickness - 11 gauge), using H-type or circular line posts. Chain-link fencing is available in the standard galvanized steel and also in aluminum-coated steel, plastic-coated steel and aluminum alloy mesh. The new plastic coatings are smoother to the touch and come in a variety of colors, with forest green being the most common color since it blends well with grass and shrubs.

Drainage: The pitcher's box should be elevated 10 inches above the base lines and home plate. The slope from the pitcher's box to home plate and to all base lines should be gradual. A one-percent (1.0%) drainage grade for the outfield is recommended.

Junior Baseball: Facilities are similar to regular baseball, except that the playing area may be reduced, depending on the age of the participants. See the Little League and Babe Ruth League diagrams on the next page. Middle Schools are using the Babe Ruth Field layouts.

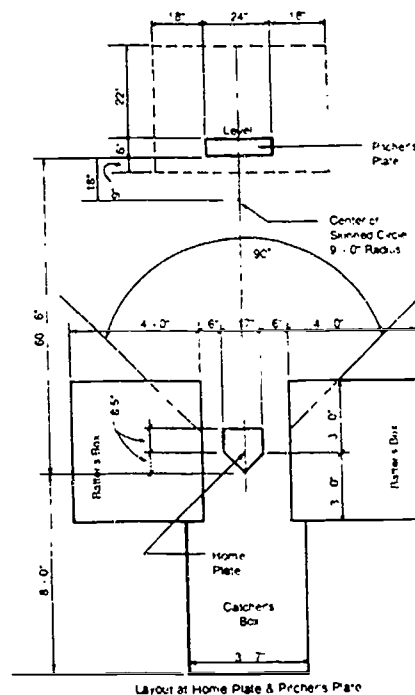

BASEBALL FIELDS

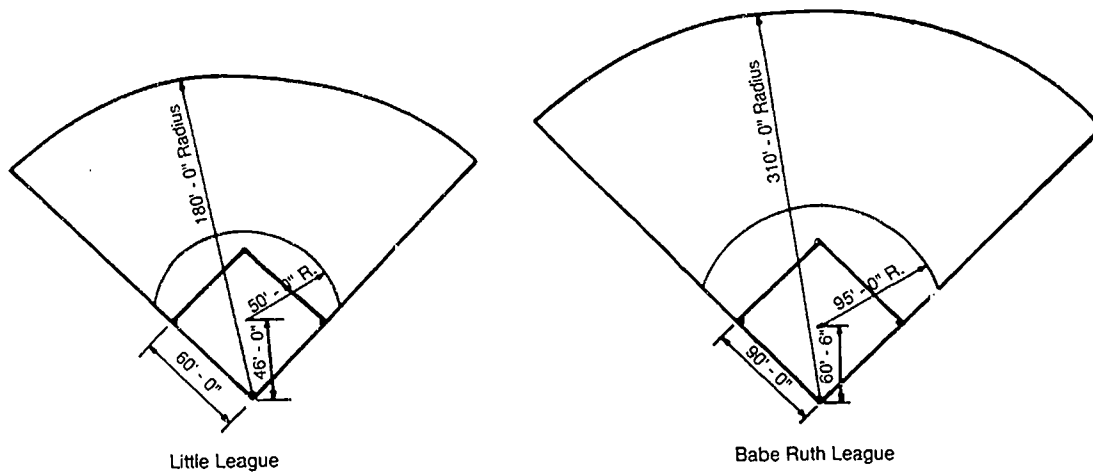
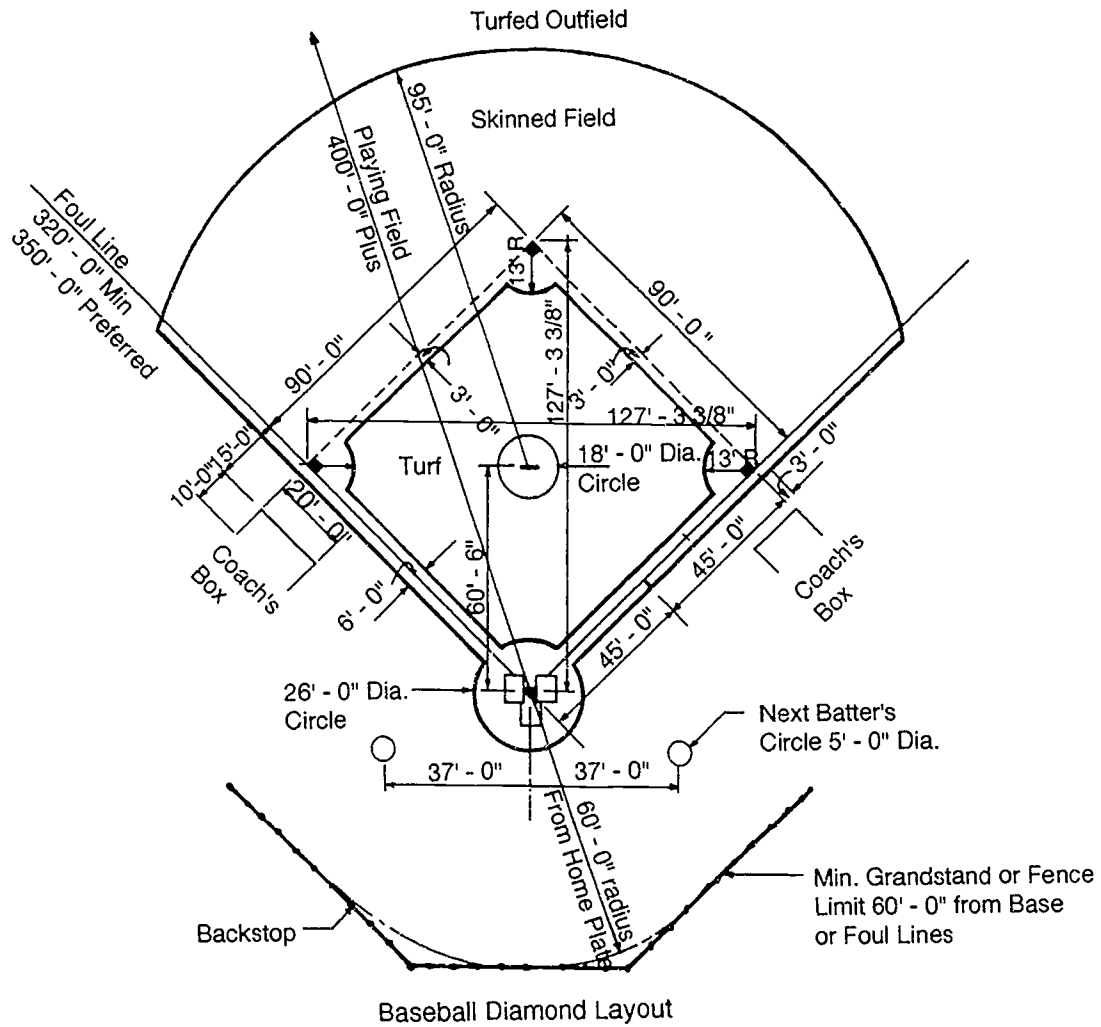

SOFTBALL FIELDS

Required Area: Softball fields are a little smaller than baseball fields due to the outfield being shorter in distance to the fence. There is fast pitch and slow pitch softball for both women and men. The field sizes are as follows:

| | |
|--------------------|---------|
| Women's Fast Pitch | 225'-0" |
| Men's Fast Pitch | 225'-0" |
| Women's Slow Pitch | 250'-0" |
| Men's Slow Pitch | 275'-0" |

Orientation: The best orientation is to point the line from home plate through second base north-northeast.

Diamond Area: The official diamond should have 60 foot base lines with pitching distances as follows:

| | |
|--------------------|--------|
| Women's Fast Pitch | 40'-0" |
| Men's Fast Pitch | 46'-0" |
| Women's Slow Pitch | 46'-0" |
| Men's Slow Pitch | 46'-0" |

Backstop: The field must have a backstop erected not less than 25 feet behind home plate. The backstop should consist of three panels 12 feet wide; one panel centered on home plate, with the other two panels on each end flaring out at an angle of 30 degrees with the center panel. Each panel should be 18 to 20 feet in height. The wire mesh should be 1-1/2 inch galvanized.

Drainage: The baselines should be level, but if pitched the average slope shall be 2% from first base to third base. The slope for drainage on turf areas outside the skinned area is 1% minimum with adequate subsoil drainage and 2.5% maximum.

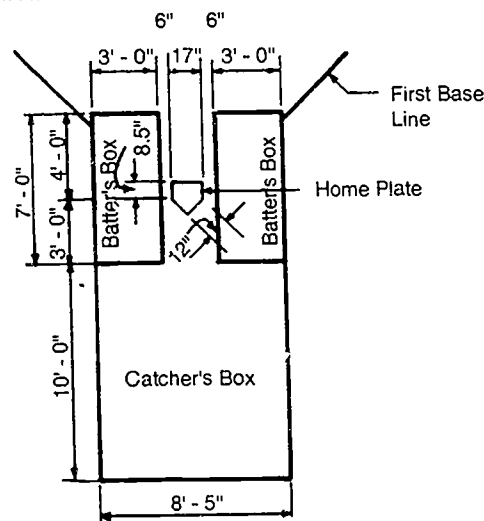
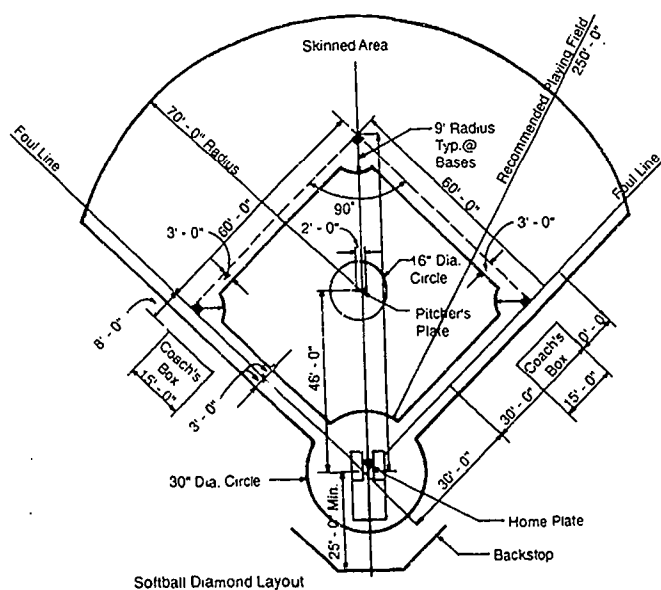

Layout at Home Plate

BASKETBALL COURTS

Required Area: A single court can vary in size in accordance with the age group:

| Type | School Grades | Court Size |
|---------------|---------------|-----------------|
| Elementary | K-5 | 40'-0" x 60'-0" |
| Middle School | 6-8 | 42'-0" x 74'-0" |
| High School | 9-12 | 50'-0" x 84'-0" |

Orientation: A true north-south orientation is recommended for the longitudinal direction.

Drainage: Drainage should always slope in a true plane: side to side, end to end, or corner to corner; never up the middle of the court. Hard court surfaces should slope 1-inch over 10 feet.

Court Markings: All end lines, sidelines and other court markings should be 2-inches wide. See the sketch below for the dimensions of the center circle and the free throw lane.

Backboard and Goal: High school backboards are either transparent rectangular or fan shaped. The goal rim itself is mounted 10'-0" above the court for high school students. The goal can be lowered to satisfy different age groups.

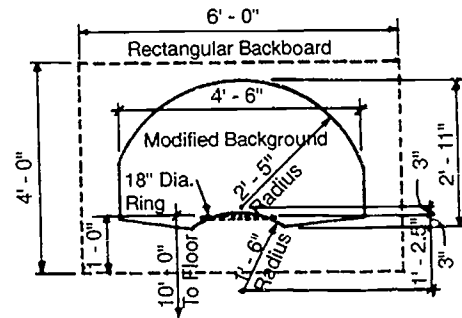

Backboard Detail

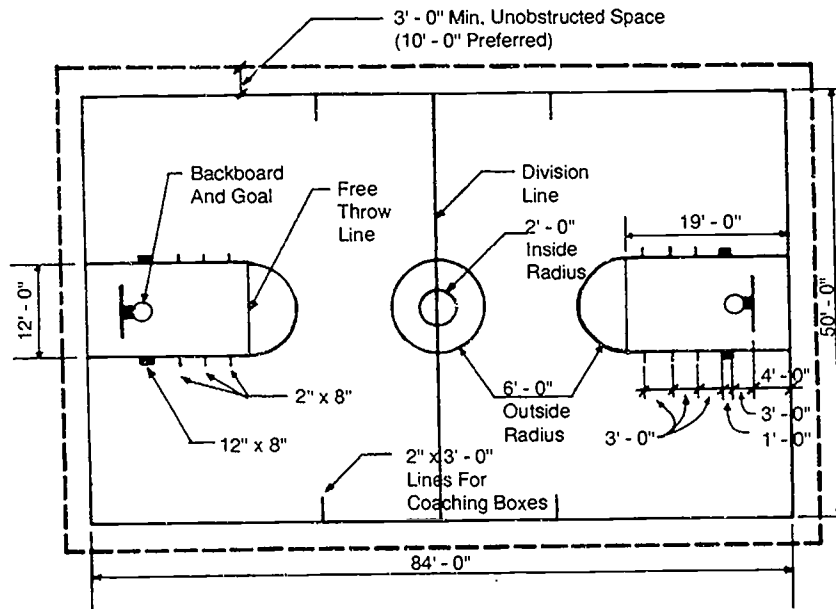

Note: Typical High School Basketball Court Shown Above

TENNIS COURTS

Required Area: A single, double court is 36 feet by 78 feet. There should always be 12 feet of clearance on each side of the court between the side screen or side line of the adjacent court. There should always be 21 feet of clearance between the base line and the back screen. This makes the total required area per court 60 feet by 120 feet.

Orientation: A true north-south orientation is recommended for the longitudinal direction.

Drainage: There are over 100 available finishes suitable for tennis courts. Drainage should always slope in a true plane: side to side, end to end, or corner to corner; never up the middle of the court. Surface drainage varies with court surfaces:

| | |
|---|---------------------------|
| Hard Surfaces | 1-inch over 10 feet |
| Porous Courts | 1-inch over 20 to 30 feet |
| Porous Courts (with underground watering system) | 1-inch over 40 feet |

Center Net: The center net is constructed of a 3 mm net system fastened to 11 GA. galvanized steel or heavy GA. aluminum 2-7/8 inch minimum O.D. painted high gloss or vinyl coated posts set in ground sleeves. The posts are set at 3'-6" on the outside with a center anchor strap in the middle.

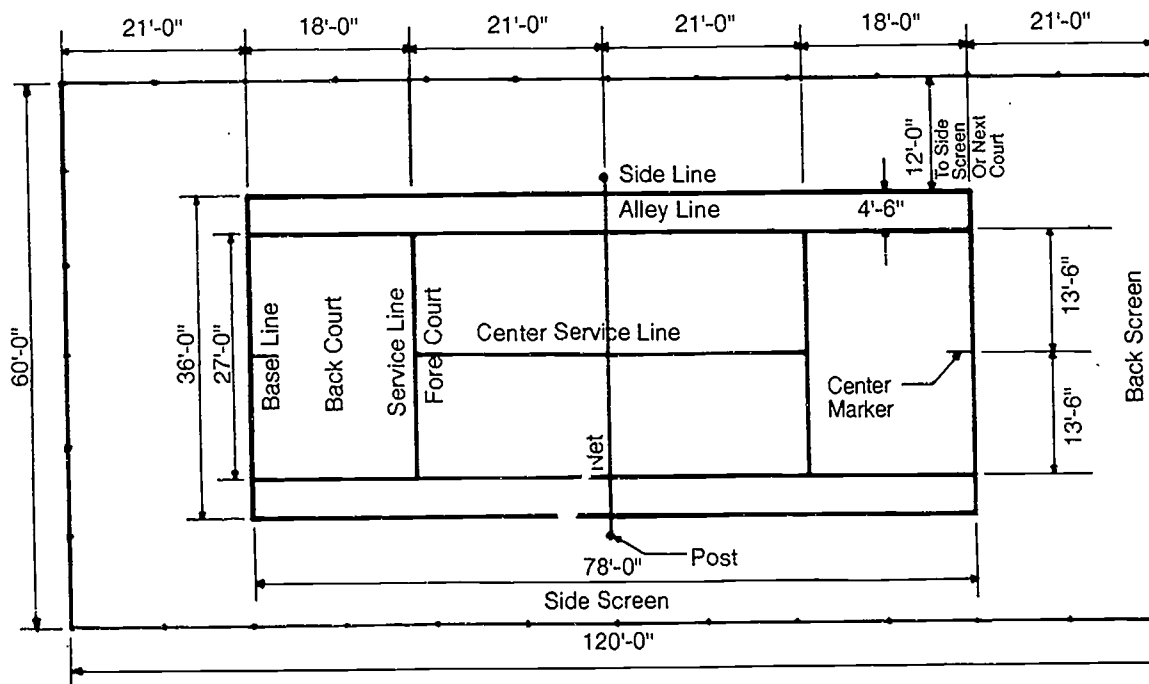

VOLLEYBALL COURTS

Required Area: A standard volleyball court is 30 feet wide by 60 feet long. A 6'-0" minimum clearance is needed around all sides of the court. Sometimes 12 to 15 feet is allowed behind the end lines for competitive serving.

Orientation: North-south orientation is recommended for the longitudinal direction.

Drainage: There are several different types of court surfaces. Drainage should always slope in a true plane: side to side, end to end, or corner to corner; never up the middle of the court. Surface drainage varies with court surfaces:

| Surfaces | Slope |
|----------|---------------------------|
| Hard | 1-inch over 10 feet |
| Porous | 1-inch over 20 to 30 feet |

Center Net: The center net is mounted on two posts set 3 feet minimum off the side lines of the court. The mounting height of the net from the ground or court is as follows:

| | |
|--------------------|-------|
| Elementary Schools | 6'-6" |
| High Schools | 7'-0" |

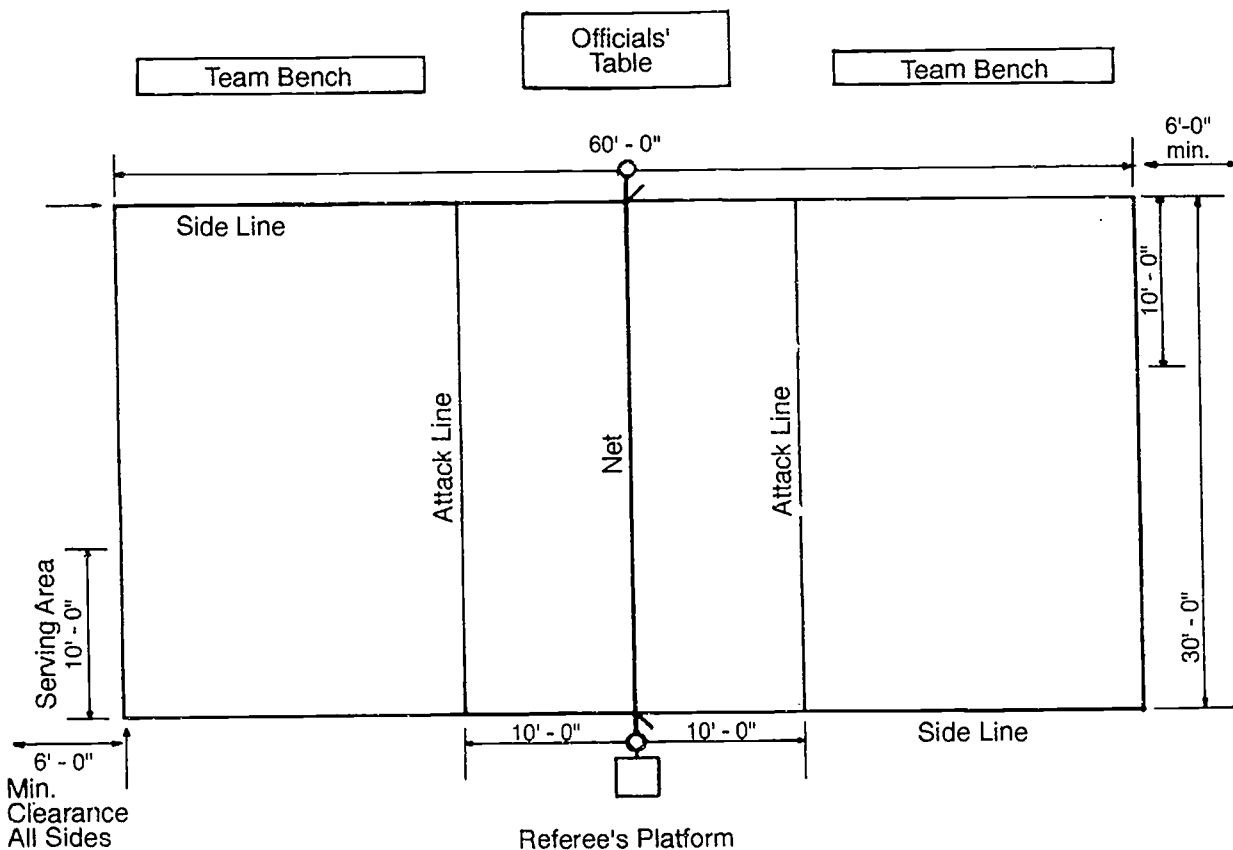

RESOURCE AGENCIES AND PROFESSIONS

In dealing with matters relating to all aspects of the school site, school officials need the services of agencies and professionals who have special information, resources and skills. In the public sector many agencies and offices can provide assistance and advice at no special cost to the school administration. Some of these agencies are listed below along with the services they can provide.

U.S. or N.C. Department of Agriculture Soil Conservation Service Local Conservation District

Provides and interprets general soil maps that show the major soils and describes their suitability for buildings, playgrounds, waste disposal systems, etc. Determines water problems at specific sites and gives counsel and recommendation regarding flooding, excessive wetness or Runoff erosion, identifies existing and possible future soil erosion difficulties and provides recommendations to reduce or eliminate erosion problems. Appraises existing plant materials and provides service to protect useful plant materials and improve vegetation. Provides advice regarding pond development, nature trail, and other outdoor learning areas. Provides service and counsel regarding maintenance of natural resources and site improvements.

N.C. Department of Transportation Division of Highways

Provides maps and aerial photographs at cost (not available for entire state). Makes traffic studies at or near existing or proposed school sites. Provides roads, bus parking areas according to state statutes and furnish additional roadways and parking areas in accordance with Division of Highways' policies. Evaluates proposed school sites in terms of traffic patterns, approves driveway permits.

N.C. Department of Environment, Health, and Natural Resources (EHNR) Environmental Health Division Public Water Supply Section

Provides consultant services relating to present and future school-owned water supply system. Evaluates quality and adequacy of water supply systems.

**N.C. Department of Environment, Health, and Natural Resources (EHNR)
Division of Environmental Management
Air Quality Section**

Provides information about air quality for old and new school sites. Issues rules and regulations regarding smoke abatement and open burning of waste materials.

Water Quality Section

Provides inspection and advisory services regarding sewage waste disposal services to all schools and recommends and approves installation for sewage waste disposal systems.

**N.C. Department of Environment, Health, and Natural Resources (EHNR)
Land Resource Division
Land Quality Section**

Provides advice and issues permits regarding appropriate soil sedimentation and erosion control at all schools with special emphasis on building construction and site improvements.

**N.C. Department of Environment, Health, and Natural Resources (EHNR)
Division of Parks and Recreation
Design Development Section**

Provides consultation service to school system and related agencies regarding community wide recreation needs, programs and assistance. Distributes information and availability of federal assistance for recreation programs. Promote recreation planning for cities, counties, and communities. Make studies of existing and needed recreation programs. Coordinates recreation services of a variety of public and non-public agencies.

**N.C. Department of Environment, Health, and Natural Resources (EHNR)
Wildlife Resources Commission**

Provides information regarding conservation, preservation and development of areas and school sites for wildlife.

**N.C. Department of Public Instruction
School Facilities Services
School Planning**

Offer recommendations regarding proper procedures for site selection, acquisition, development utilization and evaluation. Provides consultant services for preparation of User Requirements for school property. Offers consultant services in selection of school sites. Reviews, evaluates and makes recommendations regarding site planning and site improvements.

**N.C. Department of Public Instruction
School Services
Transportation**

Offer recommendations regarding school bus transportation routes and parking arrangements on school sites.

**WUNC-TV
Engineering Division**

Provides consulting services to school systems in testing and evaluating television signal strength at proposed school sites and in recommending television antenna design for specific locations on sites.

Regional, County, or City Planning Agencies

Provide varying degrees of services regarding general placement of schools with advice regarding zoning, traffic, coordination with other public agencies.

Regional, County, or City Engineering Services

Provide information and advice regarding existing and proposed water supply, sewer lines, street and other locally owned and operated utility services.

Regional, County, or City Police and Property Protection Services

Provide advice and recommendations regarding planning which will simplify and improve police and fire protection services for school properties.

Utilities (telephone, electrical and gas)

Provide information regarding existing and proposed extensions of utility services where existing and future schools may be located. Provide information about proposed business, industrial, residential or institutional development of communities.

Landscape Architects

Concerned with sites in relation to neighboring land and with planning development of specific sites for appropriate uses, including optional uses of site, traffic, erosion control, building settings and plants.

Civil Engineers and Land Surveyors

Concerned with measuring and documenting characteristics of existing land. Provide boundary and contour maps of the site which offer insight into building placement and site development.

Real Estate Consultants

Can judge if the cost of the site is reasonable. A real estate appraisal is particularly important when an educational institution initiates condemnation proceedings in an attempt to acquire a site. When the right of eminent domain is exercised, the appraiser submits evidence on property value to the court.

Architects and Engineers

Concerned with future uses and development of school property for education and related purposes, and their relationship to utilities, transportation and communication services.

Educational Consultants

Concerned with educational program to accommodate and with services needed to support/enhance learning experiences; help in preparing User Requirements.

Acoustical Consultant

Concerned with assessing acoustical conditions at schools and providing consultant services to preserve satisfactory or improve unsatisfactory noise pollution at school sites.

N.C. STATUTES RELATING TO SCHOOL SITES

The General Statutes of North Carolina state the duties and responsibilities of local school boards and their administration regarding school sites. The accompanying list identifies selected sections from several chapters of the General Statutes that deal with these matters:

| | |
|----------------------|---|
| Chapter 14. | CRIMINAL LAW |
| Section 14-68. | Failure of owner of property to comply with orders of public authorities. |
| 14-132. | Disorderly conduct in and injuries to public buildings and facilities. |
| 14-236. | Acting as agent for those furnishing supplies for schools and other state institutions. |
| | |
| Chapter 40A. | EMINENT DOMAIN |
| Article 2 | Condemnation Proceedings |
| | |
| Chapter 113A. | POLLUTION CONTROL AND ENVIRONMENT |
| Article 4 | Sedimentation Pollution Control Act of 1973 |
| | |
| Chapter 115C. | ELEMENTARY AND SECONDARY EDUCATION |
| Section 115C-47. | Powers and duties of county and city boards generally. |
| 115C-71. | Districts formed from portions of contiguous counties. |
| 115C-72. | Consolidation of districts and discontinuance of schools. |
| 115C-241. | Assignment of school buses to schools. |
| 115C-426(f). | Uniform budget format. |
| 115C-509. | Conveyance of school property upon enlargement of city administrative unit. |
| 115C-517. | Acquisition of sites. |
| 115C-518. | Disposition of school property; easements and rights-of-ways. |
| 115C-519. | Deeds to property. |
| 115C-521. | Erection of school buildings. |
| 115C-522. | Provisions of equipment for buildings. |
| 115C-524. | Repair of school property; use of buildings for other than school purposes. |

Chapter 130A.

Section 130A-236.
130A-237.
130A-317.

130A-320.
130A-335.

Chapter 136.

Section 136-181(17).

PUBLIC HEALTH

Regulation of sanitation in schools.
Inspection, reports, corrective action.
Department to provide advice; submission and approval of public water system plans.
Sanitation of watersheds; rules, inspection.
Sanitary sewage collection, treatment and disposal; rules.

ROADS AND HIGHWAYS

Powers of Department of Transportation.

Chapter 143.

Section 143-138.

Article 3
Article 21

STATE DEPARTMENTS, ETC.

North Carolina State Building Code,
Department of Insurance.
Department of Human Resources.
Department of Natural Resources and
Community Development.

Chapter 159.

Section 159-18.

LOCAL GOVERNMENT FINANCE

Capitol reserve funds.

Chapter 160A.

Section 160A-274.

CITIES AND TOWNS

Sales, lease exchange and joint use of governmental property.

REFERENCES

- Administrator's Handbook for School Transportation*
Division of Transportation Controller's Office
North Carolina Department of Public Education
- Architectural GRAPHIC Standards, Ninth Edition*
The American Institute of Architects
- FACILITY PLANNING for Physical Education, Recreation, and Athletics*
American Alliance for Health, Physical Education, Recreation and Dance, 1993
- Guide for Planning Educational Facilities*
The Council of Educational Facility Planners, International, 1991
- Handbook for Public Playground Safety*
U.S. Consumer Product Safety Commission, Washington, D.C., 1991
- National Federation Court and Field Diagram Guide*
National Federation of State High School Associations, June, 1993
- North Carolina Public Schools FACILITY STANDARDS*
A Guide for Planning School Facilities
School Planning, North Carolina Department of Public Instruction, February 1994
- Public School Laws of North Carolina*
The State Board of Education, 1993
- School Site Problems and Solutions*
Volume 31, Number 6, 1993
The Council of Educational Facility Planners, International
- SCHOOL SITES Selection, Development, and Utilization*
Special Publication No. 7, 1958
U.S. Department of Health, Education, and Welfare,
- SCHOOL SITES: Selection, Development and Utilization*
Educational Facilities Series, A Guide to Planning
New Jersey State Department of Education, 1973
- Site Design Graphics*
Michael S. Kerndall, 1989
- Standard Consumer Safety Performance Specification for
Playground Equipment for Public Use*
American Society for Testing and Materials, Designation: F 1487 - 93
- The Secretary of the Interior's Standards for Rehabilitation and Guidelines for
Rehabilitating Historic Buildings*
U.S. Department of the Interior, National Park Service, 1990
-

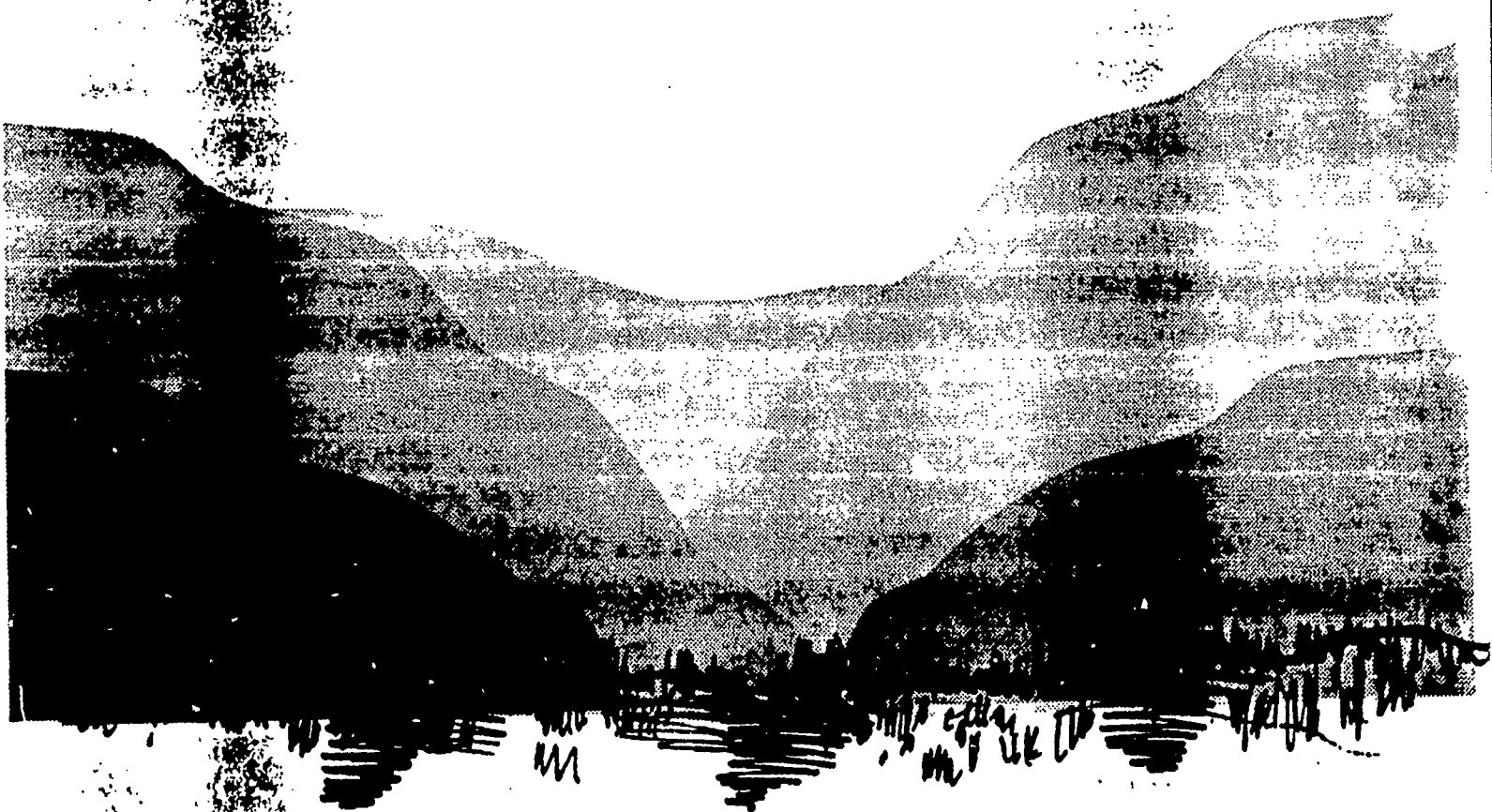

REVISED - OCTOBER, 1994
SCHOOL PLANNING
DIVISION OF SCHOOL FACILITY SERVICES, AUXILIARY SERVICES
NORTH CAROLINA DEPARTMENT OF PUBLIC INSTRUCTION