

DOCUMENT RESUME

ED 377 406

CE 067 957

TITLE Occupational Opportunities in the Private Sector (OOPS).

INSTITUTION Tennessee State Dept. of Education, Nashville. Div. of Vocational-Technical Education.; Tennessee State Dept. of Employment Security, Nashville.; Tennessee State Occupational Information Coordinating Committee, Nashville.

PUB DATE Mar 93

NOTE 822p.; For a related document, see CE 067 958.

PUB TYPE Guides - Classroom Use - Teaching Guides (For Teacher) (052)

EDRS PRICE MF05/PC33 Plus Postage.

DESCRIPTORS *Career Choice; *Course Content; Demand Occupations; *Educational Needs; *Employment Projections; High Schools; *Labor Market; Occupational Clusters; *Occupational Information; Private Sector; State Curriculum Guides; Statewide Planning

IDENTIFIERS *Tennessee

ABSTRACT

This curriculum guide was developed to provide high school students in Tennessee with an overview of various occupations, including educational requirements, expected labor supply and demand, wages, and job duties. In the first section, the guide describes the types of jobs in 13 career clusters: art, design, and communications; business and office; construction; education and related occupations; health; industrial production and related occupations; mechanics and repairers; plants and animals; sales; science; service; social science; and transportation. The guide then describes high school academic and vocational courses and lists graduation requirements. The major part of the guide consists of overviews--statewide and then for 14 service delivery areas--of the outlooks for occupations requiring 4 or more years of college. The occupational areas are listed and indexed in the guide's appendix. (KC)

 * Reproductions supplied by EDRS are the best that can be made *
 * from the original document. *



Acknowledgments

The Tennessee Department of Employment Security
Research and Statistics

Roger Broach
Cherri Cooper
Jean Harrington
Dawn Kilpatrick
Martha Wettemann
Carol Hughes, Graphic Art

The Tennessee Department of Education
Division of Vocational - Technical Education

Tennessee Occupational Information Coordinating Committee
(TOICC)

U.S. DEPARTMENT OF EDUCATION
EDUCATIONAL RESOURCES INFORMATION
CENTER (ERIC)
 This document has been reproduced as
received from the person or organization
that originated it.
 Minor corrections have been made to
improve reproduction quality.
• For more information, contact the ERIC
Full Text Provided by ERIC

PERMISSION TO REPRODUCE THIS
MATERIAL HAS BEEN GRANTED BY

P. Cochran

TO THE EDUCATIONAL RESOURCES
INFORMATION CENTER (ERIC)

BEST COPY AVAILABLE

51 067 957

OOPS
ALL SERVICE DELIVERY AREAS
TABLE OF CONTENTS

EMPLOYER TIPS	1
CAREER CLUSTERS	3
ACADEMIC COURSES	11
Language Arts	13
Fine Arts	21
Computer Technology	24
Mathematics	26
Science	32
Social Studies	36
Physical and Health Education	40
Automobile Driver Education	42
R. O. T. C. Military Science	42
VOCATIONAL COURSES	45
General Education Exploratory	47
Agricultural Education	49
Business Education	54
Office Education	59
Health Occupations	63
Home Economics Education	66
Technology Education	71
Technology Preparation	74
Marketing Education/Cooperative Education	76
Trade and Industrial Education	80
GRADUATION REQUIREMENTS	89
HOW TO USE OOPS	93
OCCUPATIONAL AREAS	95
Occupations Requiring Four or More Years of College - Statewide Outlook Statewide	- 1
Service Delivery Area 1	1-1
Service Delivery Area 2	2-1
Service Delivery Area 3	3-1
Service Delivery Area 4	4-1
Service Delivery Area 5	5-1
Service Delivery Area 6	6-1
Service Delivery Area 7	7-1
Service Delivery Area 8	8-1
Service Delivery Area 9	9-1
Service Delivery Area 10	10-1
Service Delivery Area 11	11-1
Service Delivery Area 12	12-1
Service Delivery Area 13	13-1
Service Delivery Area 14	14-1
ALPHABETICAL LISTING OF OCCUPATIONAL AREAS	A-1
ALPHABETICAL INDEX OF OCCUPATIONAL AREAS	A-3

EMPLOYER TIPS

Stay in School
Good Attitude
Willingness to Listen
Hard Work
Math and English Skills
Be an Achiever
Good Communication Skills
Good Attendance
Willingness to Accept Responsibility
Leadership
Imagination
Flexibility
Competitiveness

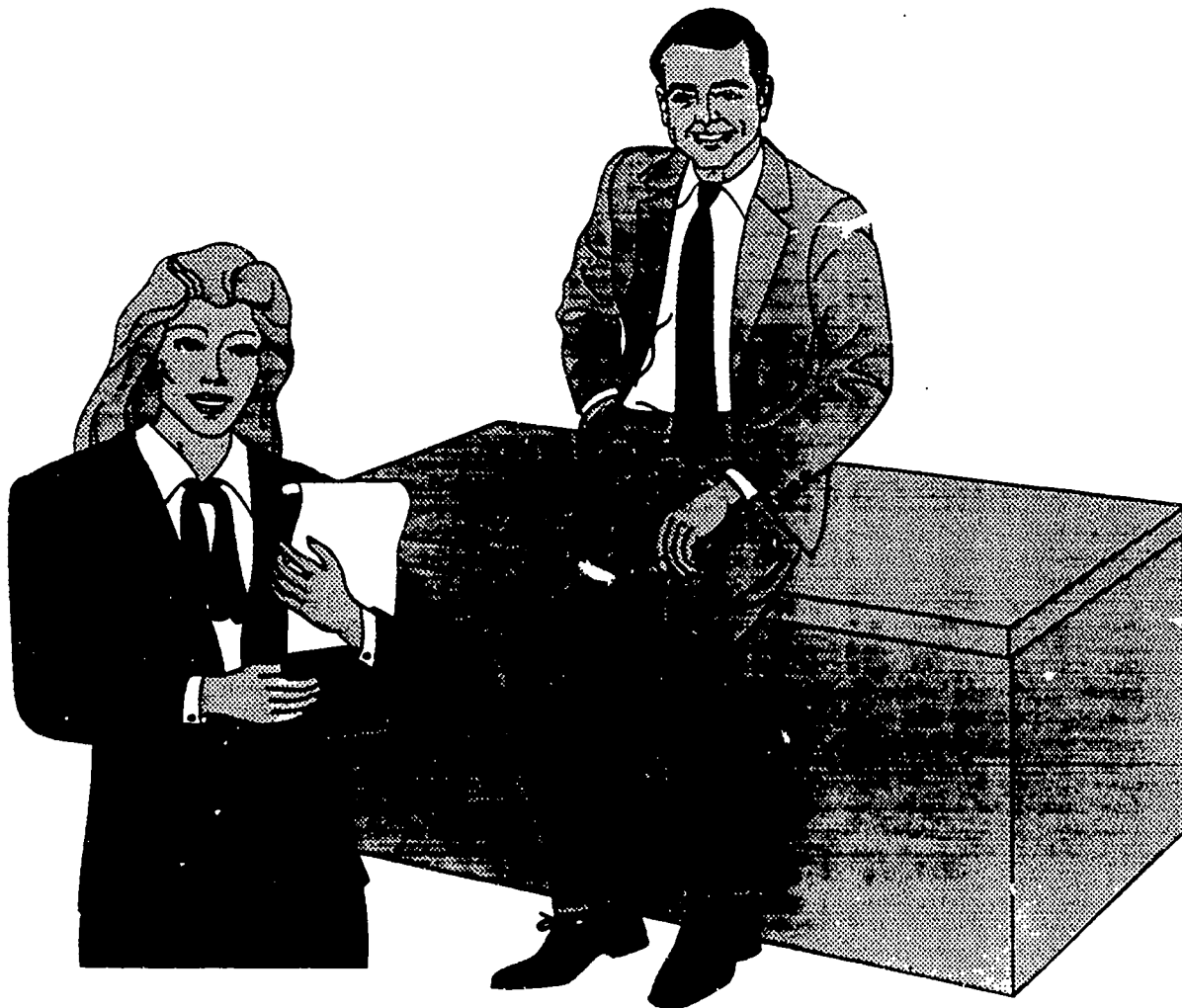

Career Clusters

ART, DESIGN AND COMMUNICATION

People who work in these fields should be creative and be able to express thoughts and emotions and to communicate ideas to others. Occupations that require these talents are the performing arts--actors, dancers, musicians, and singers; the design occupations--architects, commercial artists, designers, and photographers; and communications related occupations--newspaper reporters, technical writers, and radio and television announcers.

Those employed in the performing arts may work in the theatre, TV or radio or as teachers. Architectural and designing firms, builders, printing, and publishing firms employ people in the design occupations. Those in communications related occupations work for newspapers, TV, radio, government, and private industry.

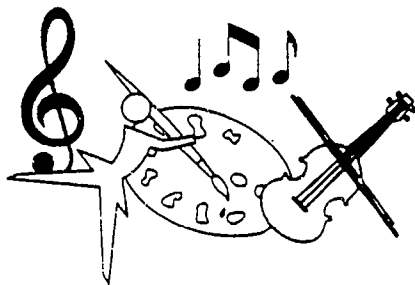

BUSINESS AND OFFICE

Workers in business and office occupations perform the many different jobs necessary to keep organizations running on a daily basis. These jobs range from bookkeeping, typing, and operating business machines to solving problems and devising ways to provide better service. Administrative assistants, bookkeepers, accountants, receptionists, and typists are a few example occupations. The largest occupations are secretaries and typists.

These workers are employed by banks, insurance companies, department stores, government offices, and businesses and organizations of all types and sizes. Demand will be particularly strong in banks, insurance companies, manufacturing firms, and professional service organizations. Because of the great influx of computer technology into the office place, knowing how to use a computer is a definite plus. Secretaries and typists rely heavily on word processors. Getting along with people is another quality that will help anyone aspiring to a business and office job.

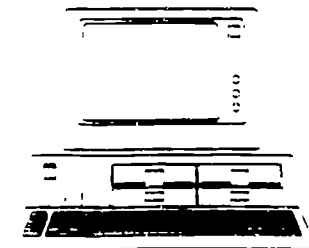

CONSTRUCTION

Workers in construction trades build, repair, and modernize homes and buildings. They also work on highways, airports, and military installations. Construction work may be divided into three categories: structural work (fabricating and erecting structural metals used in the construction of buildings, bridges, dams, etc.); finishing work on structures and buildings (including painting, trimming, and decorating); and mechanical work (the actual earth breaking and hauling, paving of highways and parking lots, cement pouring and mixing, etc.). The largest trades are carpenter, painter, plumber, and electrician. Most jobs are with contractors in the construction industry. Other industries such as mining and manufacturing employ workers for maintenance and repair work. Government agencies employ workers to maintain highways, buildings, and sanitation systems.

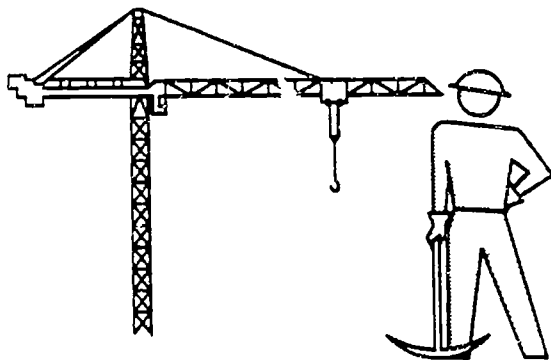

EDUCATION AND RELATED OCCUPATIONS

People who work in education and related occupations should have the desire to work with people and the ability to motivate students and to relate knowledge to them. They play an important role in the education of people of all ages. These occupations include librarian, teacher, school administrator, counselor, and teacher aide.



HEALTH

People who are employed in health occupations provide care for the sick and injured and help people maintain their health. This field offers a great variety of occupations from service oriented to technical and administrative positions. Besides doctors, nurses, and dentists, there are lab technicians, administrators, and aides. The largest occupation fields are registered nurses, nurse's aides, and licensed practical nurses.

Hospitals employ about half of all health workers. Others work in clinics, laboratories, pharmacies, nursing homes, mental health centers, and other public and private agencies. Because of the increase in aging population and the move away from hospital to home-based health care, we can expect to see more physician's assistants, nurses, and nurse's aides/orderlies working out of the home setting.



INDUSTRIAL PRODUCTION AND RELATED OCCUPATIONS

Both skilled and semi-skilled workers are employed in industrial production. Most work in the mass production of goods. Workers in the machining and foundry occupations produce tools, dies, cores, and molds. Assemblers work to put together parts to make airplanes, computers, and many other products. Other workers not directly involved in production engage in supporting the production process. The largest occupations are assemblers, welders, and machinists.

As industrial worksites become highly automated and computerized, industrial workers need to be able to read, write and do simple arithmetic. Changing technology also requires these workers to go through frequent retraining programs to help them master new production processes.

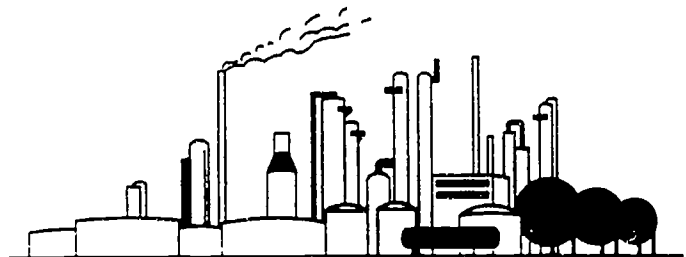

MECHANICS AND REPAIRERS

Mechanics and repairers keep mechanical equipment and machinery running and in good working order. They work as automobile, truck, or bus mechanics; automobile body repairers; airplane mechanics; and television and radio service technicians. Other related occupations are maintenance electrician, telephone craftworker, and watch repairer.

Many mechanics and repairers work in manufacturing industries -- in most plants that produce goods such as steel, automobiles, and aircrafts. Others work in retail trade, mainly in firms that sell and service automobiles, appliances, farm implements, and other mechanical equipment. Some work in shops that service equipment for transportation, construction, and public utility industries. Computer service technicians and office machine repairers often work on customers' business sites, which can be a factory, office building, laboratory, etc.

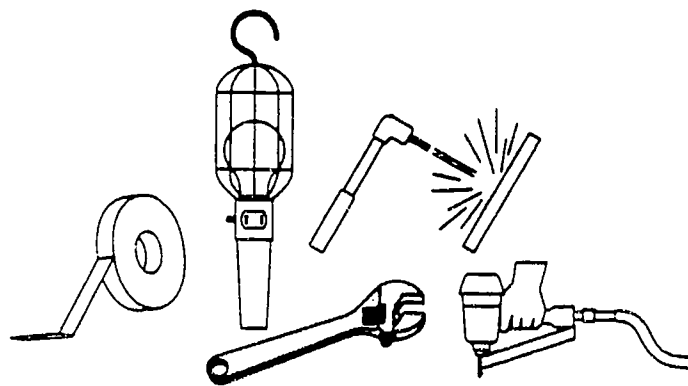

PLANTS AND ANIMALS

Plants and animal workers operate or manage farming, fishing, forestry, and horticultural service businesses of many kinds. Some breed specialty plants and animals. Others provide services to increase production or beautify land areas. Many work in rural or woodland areas on farms, ranches, forest preserves, commercial nurseries, landscaping firms, business services, or government agencies located in large and small communities all over the country.



SALES

People employed in these occupations sell merchandise and services. In almost all sales work except retail trade, salesworkers take initiative to find prospective customers and to plan work schedules. Sales occupations include insurance sales, retail sales, real estate agents, and a variety of other jobs.

Workers in these jobs may sell for manufacturers, service firms, wholesalers, or retailers or run their own business.



SCIENCE

Workers in science and technical occupations improve many areas of life by developing new products, working on environmental protection, and improving the country's defense capabilities. They work as engineers, scientists, statisticians, technicians, drafters, and surveyors.

Most engineers work in private industry, mainly in industries manufacturing machinery, electrical equipment, and aircraft and in firms providing engineering services. Scientists work in private industries or in colleges and universities teaching and doing research. Technicians and technical assistants work with scientists and engineers in industry, education, and governmental agencies.

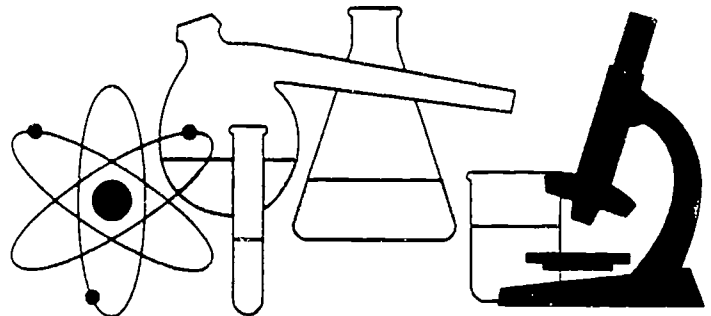

SERVICE

Service occupations offer a variety of jobs ranging from fighting fires to cutting hair. The major groups of service occupations are food, cleaning, personal, private household, education, health, and protective and related services. Necessary training and skills differ greatly. Some need special vocational training. For others, personality traits and special abilities are most important. The ability to deal with people is a necessity.

A large group of service workers are employed in the food service occupations. Restaurants, hospitals, schools, government agencies, hotels, and many others employ service workers.



SOCIAL SCIENCE

Occupations found in this group include social scientists such as anthropologists and sociologists who study human behavior, social workers who help people in various ways, religious workers, and lawyers.

People in this group are employed in government agencies, research and consulting firms, hospitals, law firms, business firms of all kinds, and colleges and universities. Religious workers are employed in church settings as priests, pastors, ministers, rabbis, social workers and counselors. The schools are another large employer of these occupations. Many social workers are also employed by voluntary organizations such as crisis counseling centers.

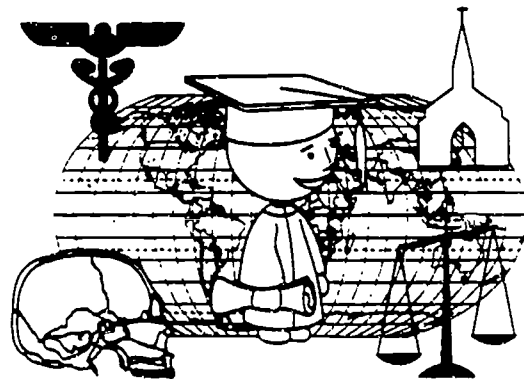

TRANSPORTATION

Transportation industries offer many career opportunities. Workers provide transportation by flying aircraft; operating trains and ships; and driving buses, trucks, and taxicabs. The largest occupation is truck driver.

Most workers are employed by trucking companies, airlines, railroads, and public and private transit systems.

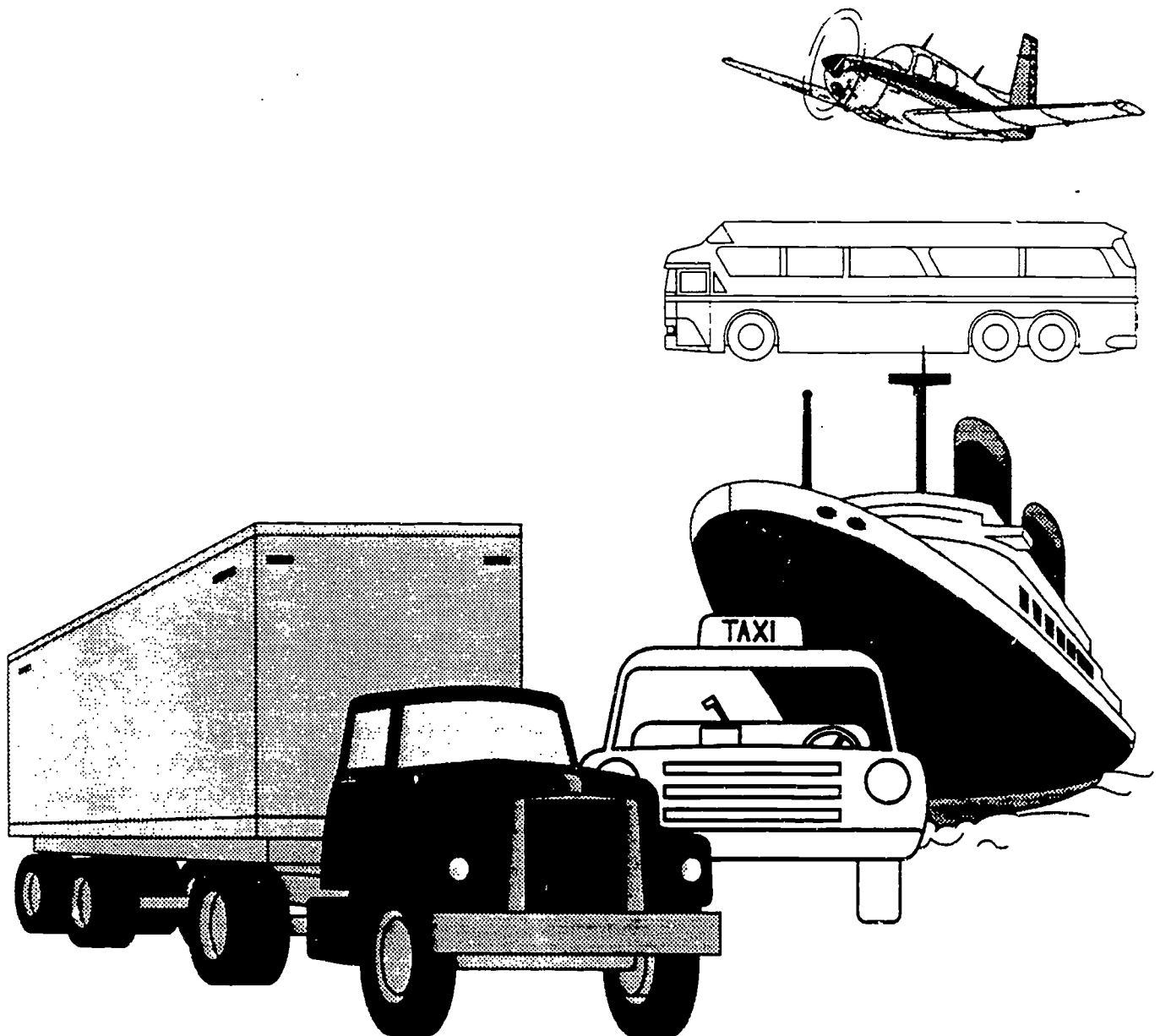



Academic Courses

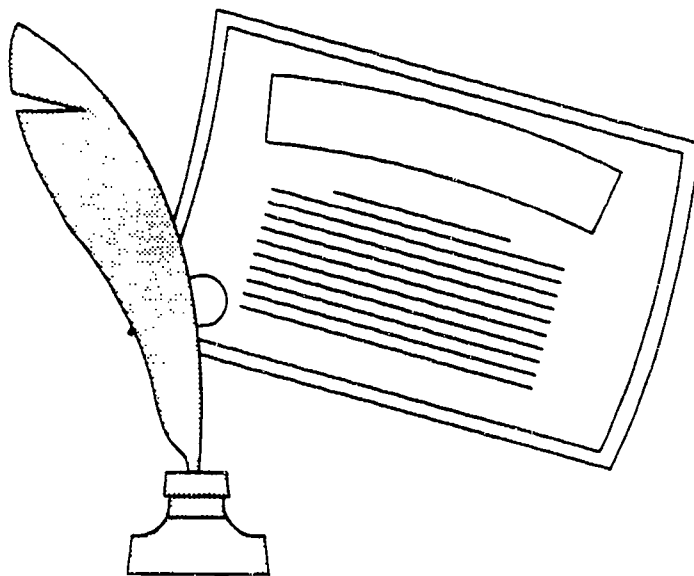

LANGUAGE ARTS

English I, II, III, IV

Speech

Journalism

FOREIGN LANGUAGES

Latin I, II, III, IV
French I, II, III, IV
German I, II, III, IV
Spanish I, II, III, IV
Russian I, II, III, IV
Japanese I, II, III, IV

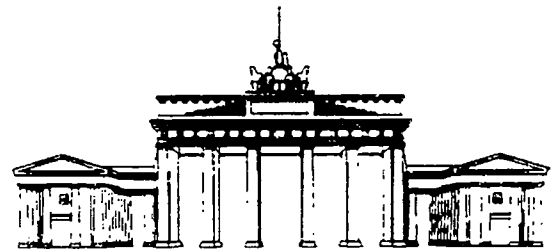
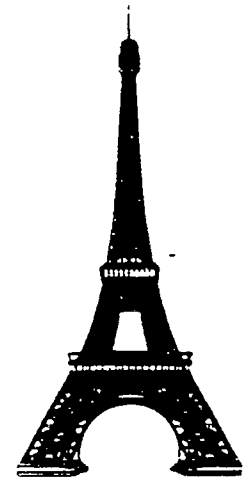
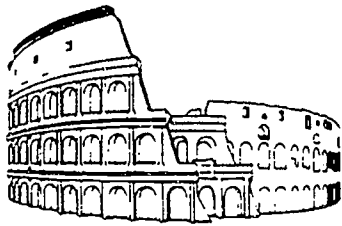

LANGUAGE ARTS

ENGLISH COURSES

English I

1 Credit

Students study parts of speech and parts of a sentence. Special consideration will be given to verb usage, pronoun usage, and capitalization. Composition assignments will involve developing topic sentences into short paragraphs. Spelling will be an ongoing activity. Students will be introduced to examples of literature from each of the major genres: short stories, non-fiction, poetry, drama, and novels. Students will read, discuss, and learn specific vocabulary which will help to analyze assignments.

English I - Honors

1 Credit

Students will review all aspects of grammar concerning parts of speech, parts of the sentence, mechanics, and usage. Composition assignments will involve development of topic sentences into paragraphs and the use of complex sentences and transitional expressions. Vocabulary will include derivation of meaning from context, and selection of the proper word to give precise meaning and expression. Students will read at least one book each six weeks. Students will study assignments involving all the major genres: short stories, non-fiction, poetry, drama, and novels. Students will learn related literary terms from glossary in textbooks. Vocabulary study will involve analysis of word choice and word emphasis by the authors and poets. Composition assignments will be extensive.

English II

1 Credit

Students will be taught a unit of library usage and skills. The composition course is designed to develop proficiency in writing paragraphs. Literature assignments include a short story and its elements. Students will have a comprehensive study course in vocabulary building. Recognition, spelling, and definition will be emphasized. Course includes literature assignments.

English II - Honors

1 Credit

Students will study advanced composition and a unit on library usage and skills. Students will be trained in the use of both formal and informal styles of composition. Several novels will be read. A series of advanced vocabularies relating to several fields of interest will be studied. Students will develop their analytical skills by studying the development of a classic novel. Literature assignments will include several novels.

English III

1 Credit

Students will study the development of American literature from the seventeenth century until the present. They will study poetry, essays, short stories, novels, and drama of American writers. Appropriate vocabulary assignments will be included. Students will begin work on research techniques and research projects that will culminate in the writing of a research paper at the end of one of the two semesters.

English III - Honors

1 Credit

Students will study the development of American literature from the seventeenth century until the present. A balanced study of poetry, essays, short stories, novels, and drama of American writers will be included. Composition topics will be related to material being considered. Advanced vocabulary training is also included. Students will begin work on research techniques and research projects that will culminate in the writing of a research paper at the end of one of the two semesters. Students will read at least six books by American authors.

English IV

1 Credit

Students will study the history of the English language. Origins of roots as well as prefixes and suffixes will be included. Reasons for current English spelling, verb forms, and pronunciations will also be studied. Students will write short essays on a variety of subjects. Paragraph development will be stressed with correct spelling and punctuation. Students will study the development of literature from Shakespeare through the twentieth century. Students will read six selected books during the year.

English IV - Honors

1 Credit

Students will begin a detailed study of the development of the English language. Preparation for college level composition will be included. Literature studies will include several novels. Students will study English literature from Shakespeare through the twentieth century. Advanced study in genre identification, drama, and fiction will be included. Students will read six English novels during the year.

English - Advanced Placement

1 Credit

This course places emphasis on a rigorous critical examination of classical, English, and American literature and on composition skills.

Speech I

**1/2 Credit
or 1 Credit**

This course is designed to teach students the basics of public speaking in informative speeches, visual aid speeches, and formal debate. Concurrently the student works in oral interpretation of prose, poetry, and dramatic literature.

Speech II

1/2 Credit

An instructional program that describes strategies for improving competence in speaking and listening and the application of forms of argument to testing ideas or reaching decisions.

Journalism

**1/2 Credit
or 1 Credit**

An instructional program that describes the principles and methods of gathering, processing, evaluating, and disseminating through mass media.

FOREIGN LANGUAGES

Latin I

1 Credit

Introduction to the basic sound system, vocabulary, and grammar of Latin. Emphasis is placed on oral response and understanding with simple reading and writing.

Latin II

1 Credit
Prerequisite: Latin I

Deals with grammatical construction and places more emphasis on the cultures of Latin-speaking countries..

Latin III

1 Credit
Prerequisite: Latin II

More advanced conversation and vocabulary emphasized. Detailed Latin history and culture will be included in this course.

Latin IV

1 Credit
Prerequisite: Latin III

Students are expected to use the skills they learned in Latin I, II, and III. Literary works of major periods will be read. Special independent research work will be required.

French I

1 Credit

This course is an introduction to the speaking, writing, and understanding of basic French. Emphasis will be placed on conversational and modern French as it is used in France today.

French II

1 Credit
Prerequisite: French I

The development of intermediate skills in speaking, writing, and understanding French will be stressed. Emphasis is placed on pronunciation, grammar, and introduction to French culture.

French III

1 Credit
Prerequisite: French II

This course includes conversation, advanced French grammar, and composition. Emphasis is placed on French history and culture with an introduction to French literature.

French IV

1 Credit
Prerequisite: French III

Students will be expected to use skills they developed in French I, II, and III. Literary works of major periods will be read. Students will also study, in depth, French history and culture and will develop further oral and written skills.

German I**1 Credit**

Communication skills in modern German will be introduced in this course. Speaking and essential reading and grammar will be emphasized. A study of the German people and their culture will be included.

German II**1 Credit****Prerequisite: German I**

Intermediate skills in speaking, writing, and understanding German will be the focus of this class. Students will increase their knowledge of German history, culture, and the correct use of the language.

German III**1 Credit****Prerequisite: German II**

Conversation, advanced German grammar, and composition will be emphasized. A more detailed emphasis of German history and culture will be included in this course. German literature will be studied, and students will pursue independent work on German related topics.

German IV**1 Credit****Prerequisite: German III**

Students will be expected to use the skills they developed in German I, II, and III. Study of literary works of major periods will be included in this course. Also, in-depth study of German history and culture and a development of further oral and written skills will be required.

Russian I**1 Credit**

An introduction to the speaking, writing, and understanding of basic Russian. Emphasis is placed on conversational and modern Russian as it is used in Russia today.

Russian II**1 Credit****Prerequisite: Russian I**

Developing skills in speaking, writing, and understanding Russian will be stressed. Emphasis is placed on pronunciation, grammar, and introduction to Russian culture.

Russian III

1 Credit
Prerequisite: Russian II

This course includes conversation, advanced Russian grammar, and composition. Emphasis is placed on Russian history and culture with an introduction to Russian literature.

Russian IV

1 Credit
Prerequisite: Russian III

Students will be expected to use skills developed in Russian I, II, and III. Also, students will study, in depth, Russian history and culture. Literary works of major periods will be read.

Japanese I

1 Credit

Communication skills in modern Japanese will be introduced in this course. Speaking, reading, and grammar will be emphasized. A study of their people and culture will be included.

Japanese II

1 Credit
Prerequisite: Japanese I

Skills in speaking, writing, and understanding Japanese will be the focus of this class. Students increase their knowledge of Japanese history, culture, and the correct use of the language.

Japanese III

1 Credit
Prerequisite: Japanese II

Conversation, advanced Japanese grammar, and composition are emphasized. More detailed emphasis on Japanese history and culture will be included in this course. Japanese literature will be introduced.

Japanese IV

1 Credit
Prerequisite: Japanese III

Students are expected to use skills developed in Japanese I, II, and III. Literary works of major periods will be read. Students will also study, in depth, Japanese history and culture and develop further oral and written skills.

Spanish I

1 Credit

Spanish I is an introduction to the basic sound system, vocabulary, and grammar of Spanish. Emphasis is placed on oral response and understanding with simple reading and writing also included.

Spanish II

1 Credit

Prerequisite: Spanish I

Spanish in the second year deals mainly with grammatical construction and places more emphasis on the cultures of Spanish-speaking countries.

Spanish III

1 Credit

Prerequisite: Spanish II

The course deals principally with literary selections in Spanish. Also, more advanced conversation and vocabulary will be emphasized. Fables, novels, plays, short stories, and poetry will be studied.

Spanish IV

1 Credit

Prerequisite: Spanish III

This course is a continuation of Spanish III. Special independent research work will be required.

FINE ARTS

VISUAL ART
ART HISTORY
GENERAL MUSIC
VOCAL MUSIC
INSTRUMENTAL MUSIC
THEORY AND HARMONY
MUSIC HISTORY
THEATRE ARTS

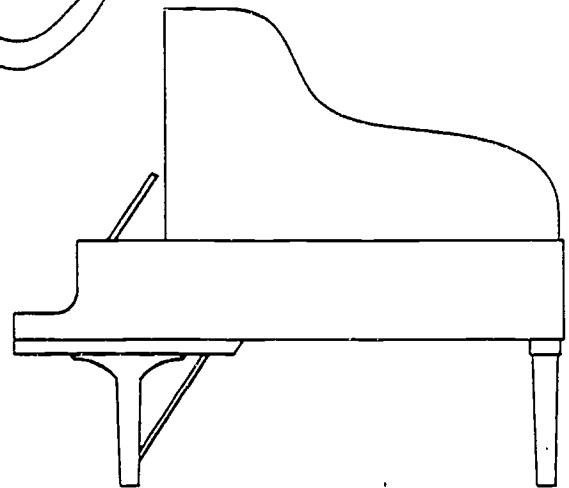
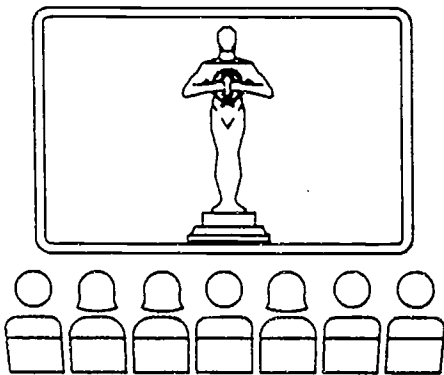

FINE ARTS

Visual Arts

1 Credit

An instructional program that generally describes the historic development, aesthetic qualities, and creative processes of two or more of the visual and performing arts.

Art History

1 Credit

An instructional program that describes art and its relationship to concurrent events, the evaluation of artistic styles, the lives of artists, and the role of art in human affairs, including contemporary times.

General Music

1 Credit

An instructional program that generally describes music history and appreciation, music performance, and music theory and composition, and the study of the performance of musical instruments.

Vocal Music

1 Credit

An instructional program whereby students learn the fundamentals of choral music. Students learn to read and understand musical notation by singing. Proper singing techniques will be emphasized.

Instrumental Music

1 Credit

An instructional program that describes the applied study of, and performance on, musical instruments.

Theory and Harmony

1 Credit

An instructional program that describes the principles, forms, and foundations of music as well as the techniques of creating and arranging tonal combinations and sequences.

Music History

1 Credit

An instructional program that describes music and its relationship to concurrent events, the evolution of musical styles, the lives of musicians, and the role of music in human affairs, including contemporary times.

An instructional program that describes the development, theory and processes of creating live performances through human expressive modalities.



COMPUTER TECHNOLOGY

DATA STRUCTURES & LANGUAGE ORGANIZATION (PASCAL I, II)

DATA STRUCTURES & LANGUAGE ORGANIZATION (FORTRAN)

DATA STRUCTURES & LANGUAGE ORGANIZATION (LOGO)

ADVANCED PLACEMENT COMPUTER SCIENCE

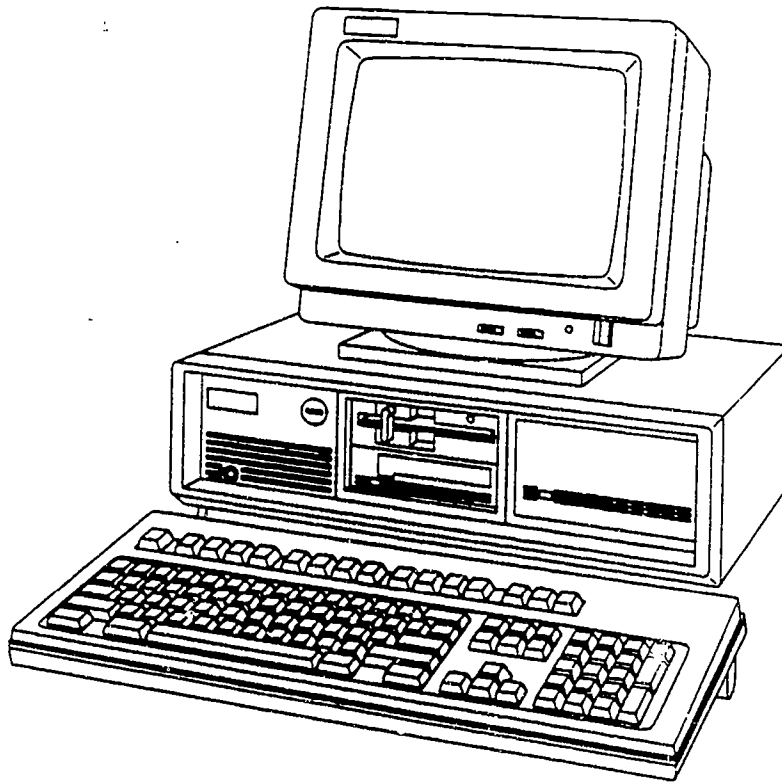

COMPUTER TECHNOLOGY

Data Structures & Language Organization **1 Credit**
PASCAL I, II **Each**
FORTRAN
LOGO

Instructional programs that describe the coding, processing, and storage of data through repetitious and highly complex mathematical operations at high speed, and in accordance with strictly defined systems and procedures.

Advanced Placement Computer Science **1 Credit**

An instructional program that describes the principles and techniques involved in the design of large-scale computer programs. Includes instruction in modeling, flow charting, data organization, and the impact of the programs on organizational objectives.

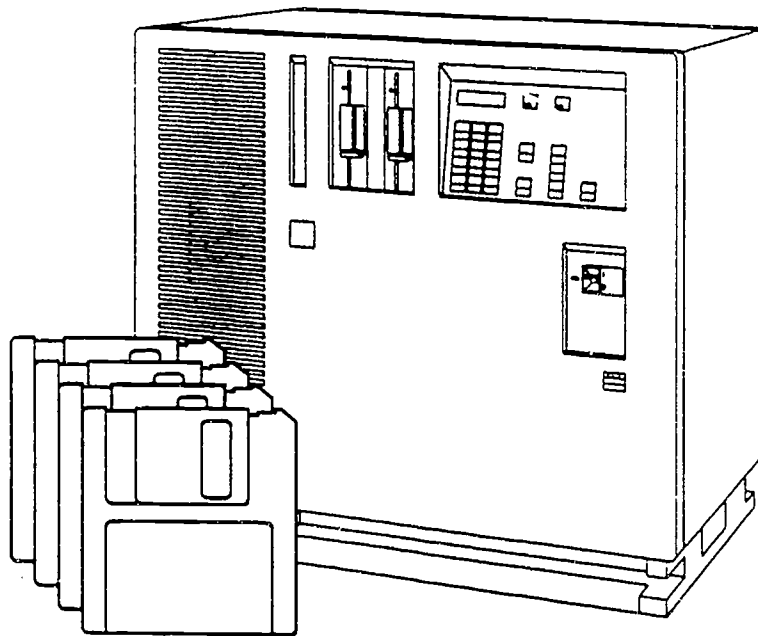

MATHEMATICS

ARITHMETIC

APPLIED MATH I, II

PRE-ALGEBRA

ALGEBRA I, II

UNIFIED GEOMETRY

ADVANCED ALGEBRA - TRIGONOMETRY

MATH IV

ANALYTICAL GEOMETRY - PRE-CALCULUS

CALCULUS

PROBABILITY AND STATISTICS

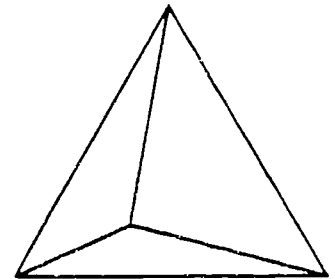
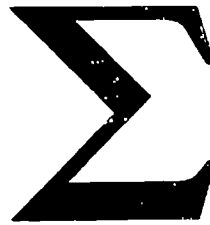
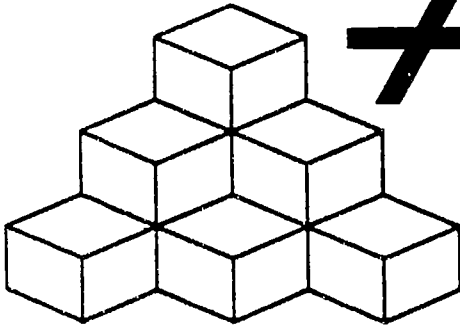
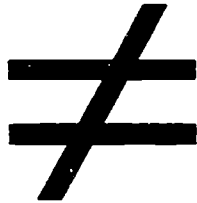
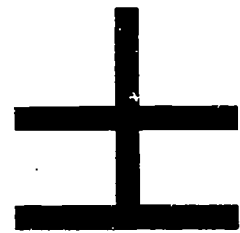
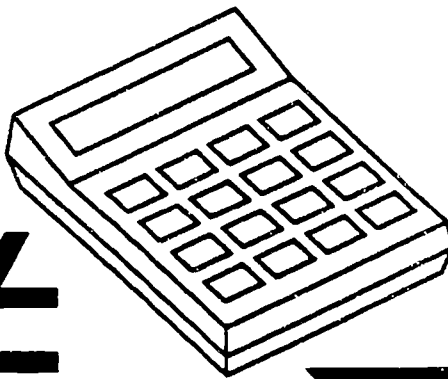
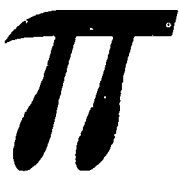
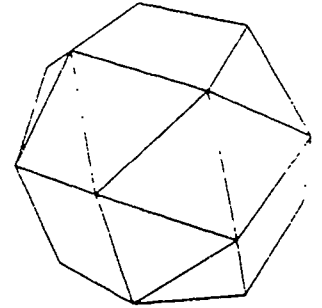
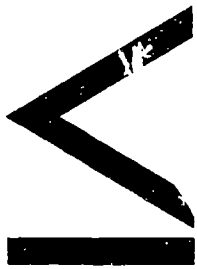

MATHEMATICS

Arithmetic 9

1 Credit

This course is designed only for those students who need intensive work in basic arithmetic skills. Focus is on the skills and concepts of the Proficiency Test. Additional topics are included in this course to provide proper preparation for further mathematics coursework.

Applied Mathematics I

1 Credit

This course is designed to develop essential mathematics and problem solving skills. It is also designed to provide skills reinforcement through practical applications. Begins the development of applications of mathematical topics necessary to function in today's technological society.

Applied Mathematics II

1 Credit

Prerequisite: Applied Mathematics I or Pre-Algebra

This course is designed to meet the mathematical needs of students who are pursuing vocational/technical education. The course covers precision instruments, multiple line graphs and statistical measurements. Emphasis is placed on using calculators to solve applied mathematical problems. This course also includes fundamentals of Applied Algebra, Geometry and Trigonometry.

Pre-Algebra

1 Credit

The content of this course includes topics traditionally addressed to bridge the gap between arithmetic concepts and algebra. The course focuses on an introduction to the use of equations, algebraic notation, use of variables, and an extension of measurement concepts.

Algebra I

1 Credit

The course consists of a review and extension of basic math skills learned in previous math courses. These skills will be incorporated into new concepts, such as factoring polynomials, solving of linear equations in one variable, solving of quadratic equations by factoring, solving systems of linear equations in more than one variable, solving linear inequalities, introducing irrational numbers, and working with elementary linear and quadratic functions.

Algebra I - Advanced Placement**1 Credit**

A student enrolling in this course should have a thorough understanding of basic math concepts and pre-algebra. Students will be expected to do more independent study than is required in regular class. The course covers algebraic concepts, such as solving linear equations in more than one variable, graphing linear equations, solving and graphing linear inequalities, implying irrational numbers, and working with linear and quadratic functions.

Algebra I - Honors**1 Credit**

A student enrolling in this course should have demonstrated a better-than-average understanding of basic math concepts presented in the eighth grade. This course covers algebraic concepts such as solving linear equations in one variable, factoring polynomials, solving quadratic equations by factoring, solving linear equations, graphing and solving linear inequalities, and simplifying irrational numbers.

Algebra II**1 Credit****Prerequisite: Algebra I**

This course provides more practice at solving algebraic sentences and expands many of the concepts of Algebra I. Students will be expected to work more practical problems in order to achieve mastery. The concept of functions is introduced and studied in-depth. The real number system is expanded to include the complex number system. The student is introduced to ideas of more complex math involving quadratic equations, matrices, and determinants.

Algebra II**1 Credit****Prerequisite: Algebra I**

Provides more practice at solving algebraic sentences and expands many of the concepts presented in Algebra I. Emphasis on an introduction to probability and statistics. The real number system is expanded to include the complex number system, and the student is introduced to ideas of more complex math involving trigonometry, vector analysis, matrices, determinants, sequences and series and probability.

Algebra II - Advanced Placement**1 Credit**

A student desiring to take this course must have a thorough understanding of Algebra I and Geometry. Students will be expected to do more independent study than is required in regular math classes. Any student completing this course successfully should be prepared to take the advanced placement course as a senior, thus laying the ground work for a subsequent study of calculus. An introduction to Trigonometry will be included in this course. Emphasis will be placed on the construction of logical and valid proofs throughout the entire course.

Unified Geometry**1 Credit****Prerequisite: Algebra I**

The course includes an emphasis on two- and three-dimensional concepts. Increased attention to coordinate and transformation approaches, the development of short sequences of theorems, deductive arguments expressed orally and in sentence or paragraph form, and to real work applications and modeling. The content of the course includes understanding elements of geometry, lines and planes, polygons and polyhedra, congruency, similarity, right triangles, circles, cones, cylinders and spheres, coordinate geometry, formal proofs, and problem solving strands.

Unified Geometry - Honors**1 Credit****Prerequisite: Algebra I**

This course is for the college-bound students who plan to enter a field related to math, science or engineering. Students will learn to utilize inductive and deductive reasoning in problem solving. Areas of study will include properties of geometric figures, Pythagorean Theorem, the basic trigonometric functions and coordinate geometry.

Unified Geometry - Advanced Placement**1 Credit**

Students enrolled in this course will be expected to do more independent study than is required in regular math classes. Strong emphasis will be given to logical development of concepts and rigorous proofs.

Trigonometry

1/2 Credit

Prerequisite: Algebra I, Algebra II, Unified Geometry

This is a college preparatory course emphasizing circular functions and graphing of trigonometric functions. Students will understand identities, equations, inequalities, applications of trigonometric functions, vectors, polar coordinates and complex numbers.

Math IV

1 Credit

Prerequisite: Algebra I, Algebra II, Unified Geometry

This course is designed for students who have completed Algebra I, II and Unified Geometry. These students may not be ready for the sophistication of the other college preparatory courses, or may be entering fields which require mathematics but not necessarily calculus. The content of the course includes understanding relations and functions, exponents and logarithms, polynomial functions, triangle trigonometry, matrices, probability and statistics, linear programming and coordinate geometry.

Pre-Calculus - Analytical Geometry

1/2 Credit

Prerequisite: Algebra I, Algebra II, Unified Geometry, Trigonometry

This course includes the content of a college preparatory course in analytical geometry and functions. Students will understand functions, algebraic and transcendental functions, conic sections, and sequences and series. The content includes the connections among a problem situation, its model as a function in symbolic form, and the graph of that function.

Calculus

1 Credit

Prerequisite: Pre-calculus & Trigonometry

This course gives special emphasis to logical methods of proof; thus, analysis is more abstract logic, the real number system is developed; ideas and concepts of sequences and series will be used to develop the completeness property -- the final characterization of the real number field. Algebraic polynomials of two variables will be studied in some detail; it is here that the concepts of limits, derivatives, and complex numbers is introduced. The study of trigonometric functions and their applications is an integral part and statistics are covered as well as work in two-dimensional vectors and the analytic geometry of lines, planes, and the conic sections. Limited work is done with determinants and matrices.

Probability and Statistics

1/2 Credit

Prerequisite: Algebra I, Algebra II, Unified Geometry

This course is a more thorough development of the terms, relationships and applications of probability and statistics. Students understand data analysis, data interpretation, systematic counting, and probability.

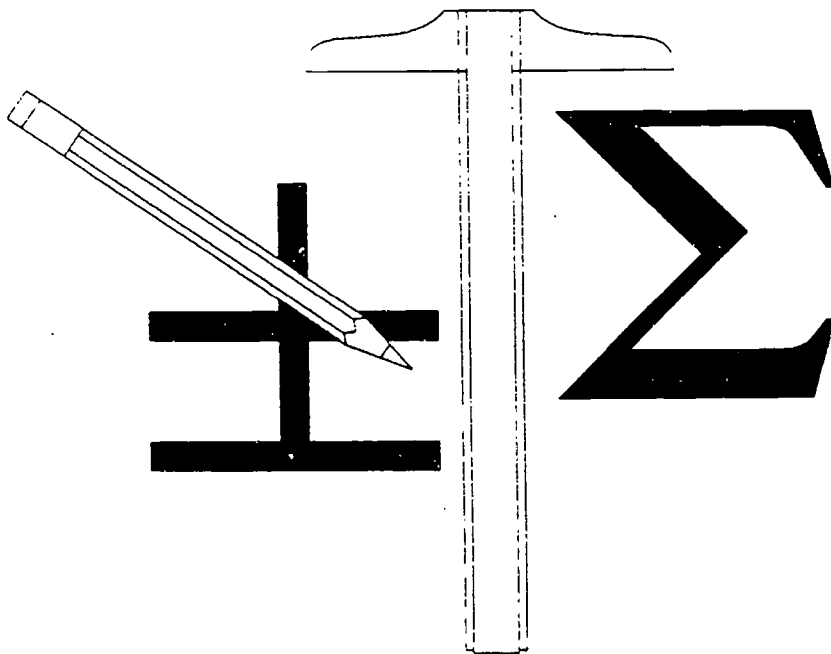

SCIENCE

Biology I, II

Chemistry I, II

Earth Science

Ecology and the Conservation of Natural Resources

Geology

Life Science

Physical Science

Physics

Physiology

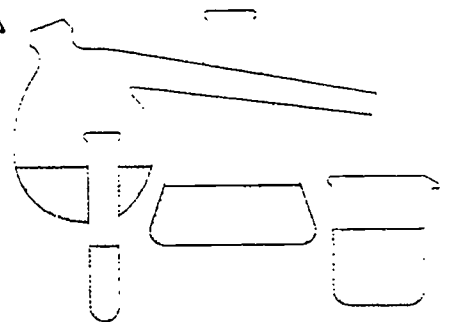
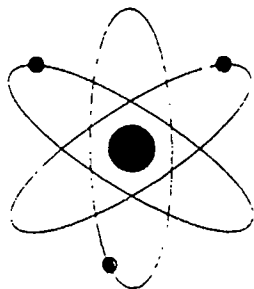
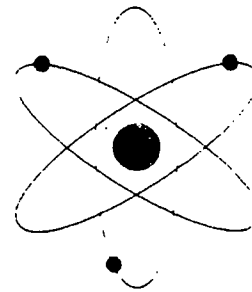
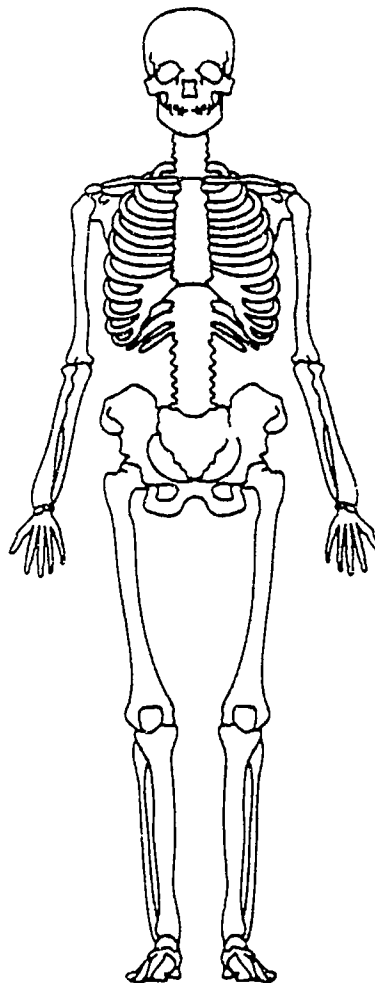

SCIENCE

Biology I

1 Credit

This course is designed to develop an understanding of the diversity and unity in living things. The content includes how all organisms interact with their physical environment; a knowledge of the substances composing our world is essential to an understanding of life processes; the transfer of energy is necessary for the functioning of organisms; an understanding of cell structure and function is fundamental to the study of living things; how both continuity and change in living things can be explained through genetics; to understand a person's place in the biosphere and the origin of life.

Biology I - Honors

1 Credit

An instructional program that generally describes life forms, including the structure, function, reproduction, growth, heredity, evolution, behavior, and distribution of living organisms.

Biology II

1 Credit

Prerequisite: Biology I & Chemistry I

This course is designed to develop an understanding and an appreciation of the unity underlying the diversity of living things. The content includes the molecular and cellular structures and functions of organisms that control the organisms' life processes; genetic principles and reproductive processes control continuity and change in living organisms; microorganisms are a major part of an ecosystem; a study of the anatomy and physiology of animals and plants; and interactions between abiotic and biotic factors.

Chemistry I

1 Credit

This course is designed to develop an understanding of chemistry as it relates to standards of living, career choices and current issues in science and technology. The content includes: Chemistry is the science of matter, its properties and its structures. Chemical calculations are useful in developing logical thinking skills and in fostering a fundamental understanding of the quantitative relationships in chemistry as illustrated in chemical equations. Compound and molecule formation are a function of electron

configuration. A knowledge of descriptive chemistry allows one to predict chemical reactions. The basic principles and theories of the states of matter. Chemical principles explain the rate of reactions, the energy of reactions, and the stability of molecules.

Chemistry II 1 Credit
Prerequisite: Algebra I & Chemistry I

This course is designed to develop an understanding of the properties of matter and the interactions of matter and energy. The content includes the explanation of chemical and physical properties; a knowledge of descriptive chemistry; development of logical thinking skills and quantitative relationships; the magnitude of the intermolecular attractions and the kinetic energy of a system's particles denote its physical state; quantitative relationships between substances involved in reactions, and the stoichiometric interpretation is based on the mole concept; concept of equilibrium, P_H and its applications; factors affecting reaction rates; oxidation-reduction reactions and their application to electrochemistry; and the laws of thermodynamics.

Earth Science 1 Credit

This course is designed to develop an understanding of the materials of the earth, the universality of change and the relevance of the earth's resources to our quality of life. The content includes a study of the earth, oceans and atmosphere.

Ecology and the Conservation of Natural Resources 1 Credit

This course is designed to develop an understanding of the interdependence of all organisms and the need for conserving natural resources. The content includes the history of the environmental movement; factors that cause ecosystems to be different, organisms habitat; similarities within different ecosystems; characteristics of populations, ecological relationships among different populations within an ecosystem; differences between adaptation and speciation; primary and secondary succession; theory of plate tectonics; earth's biosphere; and the quality of life on earth.

Geology

1 Credit

This course is designed to develop an understanding of earth materials, earth processes, both past and present, the historical development of the earth and life on earth.

Life Science

1 Credit

This course is designed to develop an understanding of the growth and development of living things. The content includes a study of the organization of life; a knowledge of the human body; and the interaction of all organisms.

Physical Science

1 Credit

This course is designed to develop an understanding of matter and energy relationships in order to enable a scientifically literate population to apply those principles in creative problem solving. The content includes concepts, processes, and interrelationships of non-living matter and associated phenomena.

Physics

1 Credit

Prerequisite: Algebra I

This course is designed to develop an understanding of the relationship of man and the physical world. The content includes the description of physical properties and interactions of matter and energy, including equilibrium power, wave phenomena, mechanics, heat, electricity, magnetism, sound, light, special relativity and the particular nature of matter.

Physiology

1 Credit

Prerequisite: Biology I & Chemistry I

This course is designed to develop an understanding of the functioning of the human body. The content includes a description of human and animal functions which include processes of respiration, circulation, digestion, excretion, and reproduction.

social studies

ancient history

modern history

united states history

world history

world geography

civics

united states government*

economics**

sociology

psychology

anthropology

contemporary issues

*The United States History, United States Government and Economics requirements for graduation may be fulfilled by a two-unit course combining these subjects or by separate courses.

**The Economics requirement for graduation may be satisfied by one semester of Economics, two semesters of Marketing Education, or out-of-school experiences through Junior Achievement.

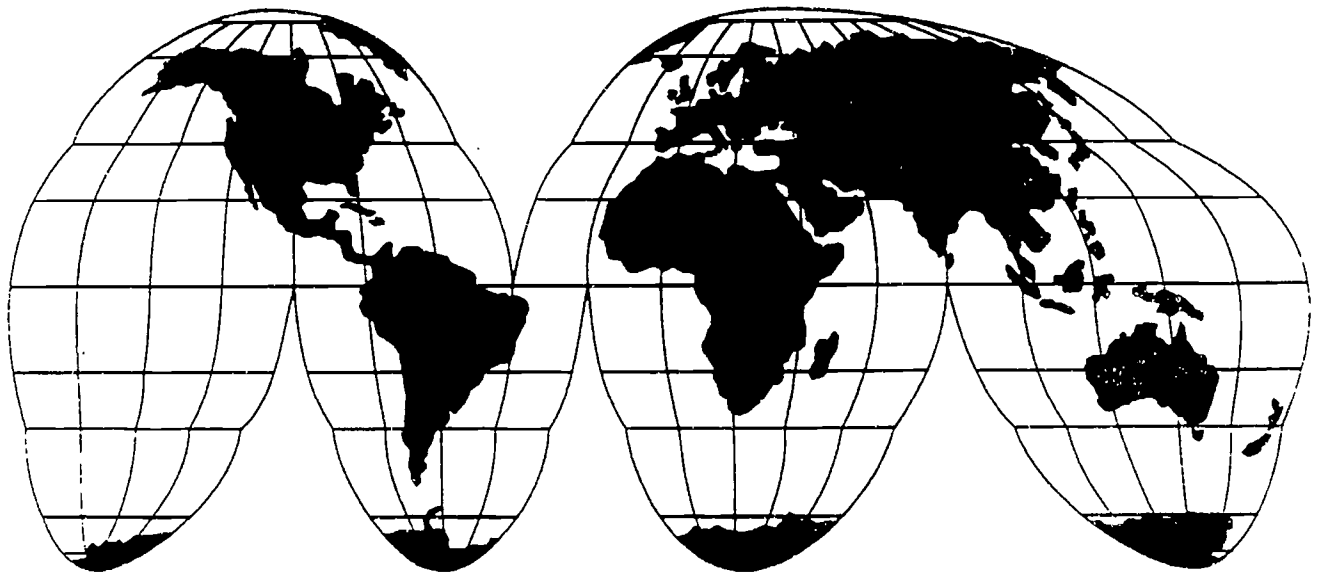

SOCIAL STUDIES

Ancient History

1/2 Credit or
1 Credit

An instructional program that describes the past, including the recording, gathering, criticizing, synthesizing, and interpreting evidence about past events.

Modern History

1/2 Credit or
1 Credit

An instructional program that promotes the understanding of historical turning points and cause and effect, the development of the modern world, understanding past societies; understanding the causes and consequences of World Wars; understanding the impact of economic and technological change on both western and non-western societies.

United States History

1 Credit

An instructional program whereby students understand that the culture of the United States is characterized and enriched by geographic, racial and ethnic diversity; the development of the United States within its geographical context, the economic growth and development from an agrarian society to an industrial and technological nation; the democratic principles found in the Constitution; and the study of U. S. History.

UNITED States History - Honors

1 Credit

The aforementioned material will also apply to honor class with the following additions: (1) outside work such as reports (written and oral); (2) independent study of topics selected by the student after conferring with the instructor; and (3) individual study or group study on topics pertaining to either current events or continuing "threads" (trends) in our nation's history.

United States - Advanced Placement **1 Credit**

This course is designed to provide students with both factual information about U. S. history and the interpretive and analytical skills necessary to assess historical documents and other materials. Emphasis is placed on writing and research, and students must pass a placement exam in order to register for this course. Students will take the Advanced Placement Examination upon completion of this course.

World History **1/2 Credit or
1 Credit**

An instructional program that provides students the opportunity to go beyond learning about the past, broaden their perspectives by studying the world's different cultures and societies; confront various historical interpretations and discover causes of present issues.

World Geography **1/2 Credit or
1 Credit**

An instructional program that describes the earth and its life; the land, sea, and air; and the distribution of plant and animal life, human beings and industries.

Civics **1/2 Credit or
1 Credit**

An instructional program that describes and analyzes political institutions and processes, including the origin, development, geographical units, forms, sources of authority, powers, purposes, functions, and operations of government.

United States Government **1/2 Credit**

An instructional program that describes government's role in society; the rights and responsibilities of citizens living in a democratic society; the United States' Constitution in principle and practice; the relationship between government and the economy; the differences and similarities of the U. S. Government with governments of other nations.

Economics

1/2 Credit

This course includes the study of supply and demand, profit motives, and the principles of production and cost. Other areas of importance that will be studied are uses of monetary and fiscal policy, an overview of international trade and finance, the macroeconomic concepts of unemployment and inflation and the operation of the market system.

Sociology

1/2 Credit or
1 Credit

An instructional program that describes the human society, social institutions, and social relationships, including the development, purposes, structures, and functions of human groups.

Psychology

1/2 Credit or
1 Credit

An instructional program that studies how humans learn, think, feel and behave; that human development and behavior are influenced by heredity and environment; the relationship between the brain and behavior; understanding mental illness, mental health and the treatment of mental disorders.

Anthropology

1/2 Credit or
1 Credit

An instructional program that describes the historic and prehistoric origins of man, his physical and cultural development, racial characteristics, social customs and beliefs.

Contemporary Issues

1/2 Credit

An instructional program that describes the substantive portions of behavior, past and present activities, interactions, and organizations of people associated together for religious, benevolent, cultural, scientific, political, patriotic or other purposes.

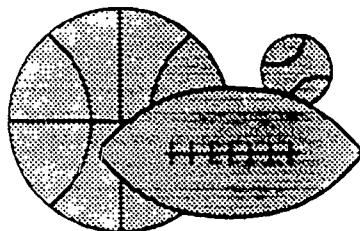

PHYSICAL AND HEALTH EDUCATION

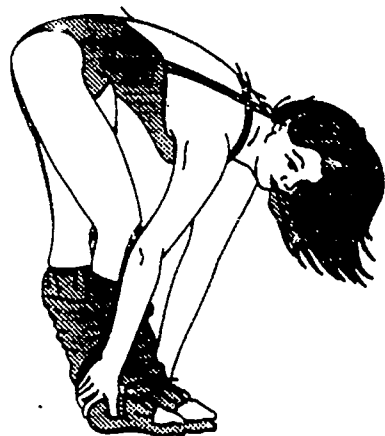

Physical Education*

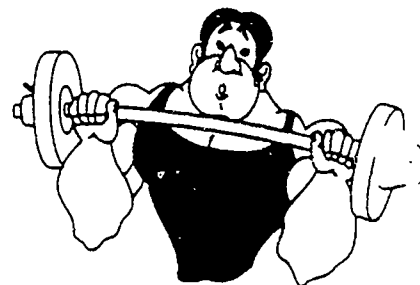

Health Education

*Participation in inter-scholastic athletics and marching band may be substituted for the physical education graduation requirement during the period of participation.

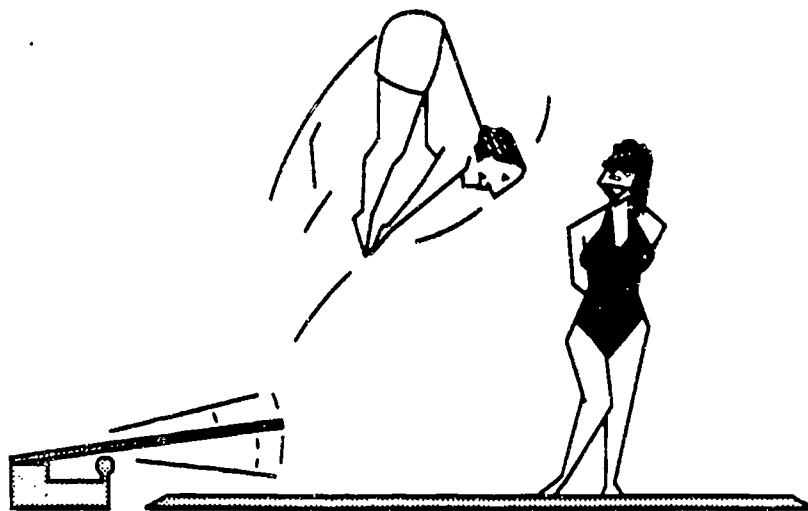

PHYSICAL & HEALTH EDUCATION

Physical Education

1 Credit

An instructional program that describes how to increase one's ability to engage in a particular recreational activity that generally requires physical exertion.

Health Education

1/2 Credit

An instructional program that describes the need for community health, consumer health, disease control, environmental health, family life, mental health, nutrition, personal health, safety and first aid; and the prevention of substance abuse and HIV/AIDS.



Automobile Driver Education

R.O.T.C. Military Science

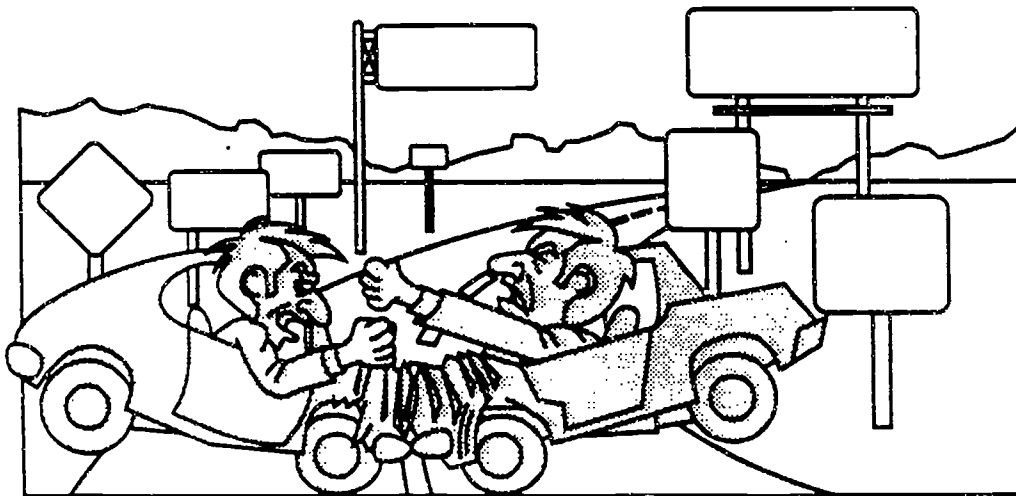
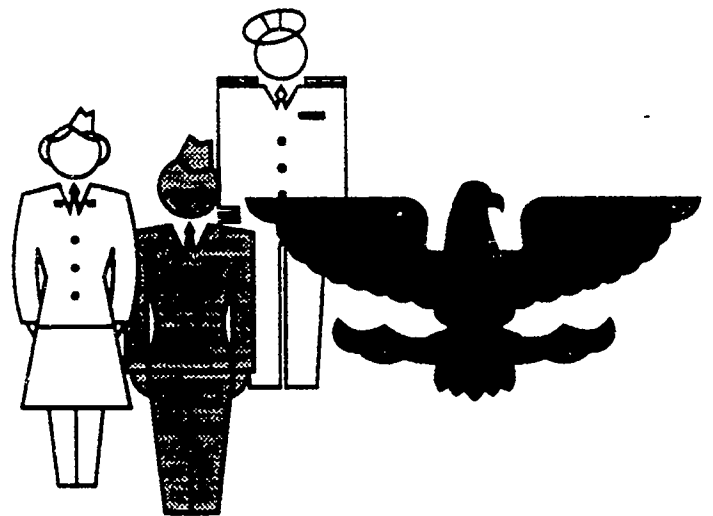

Automobile Driver Education

1/2 Credit

Students will understand attitudes, strategies, skills and maneuvers necessary for safe and efficient operation of vehicles on our traffic ways. The course includes understanding driving tasks, alcohol and drugs as they relate to traffic safety, natural law, man-made laws, coping with hazardous driving situations, decision making and problem solving skills as related to driving, vehicle operation and maintenance, principles of vehicular consumerism, and physical skills that are basic to driving.

R. O. T. C. Military Science*

1 Credit

Instructional program that describes the causative factors and tactical principles of warfare, armed conflict and defense.

*Credit earned for R. O. T. C. may substitute for physical education required for graduation.

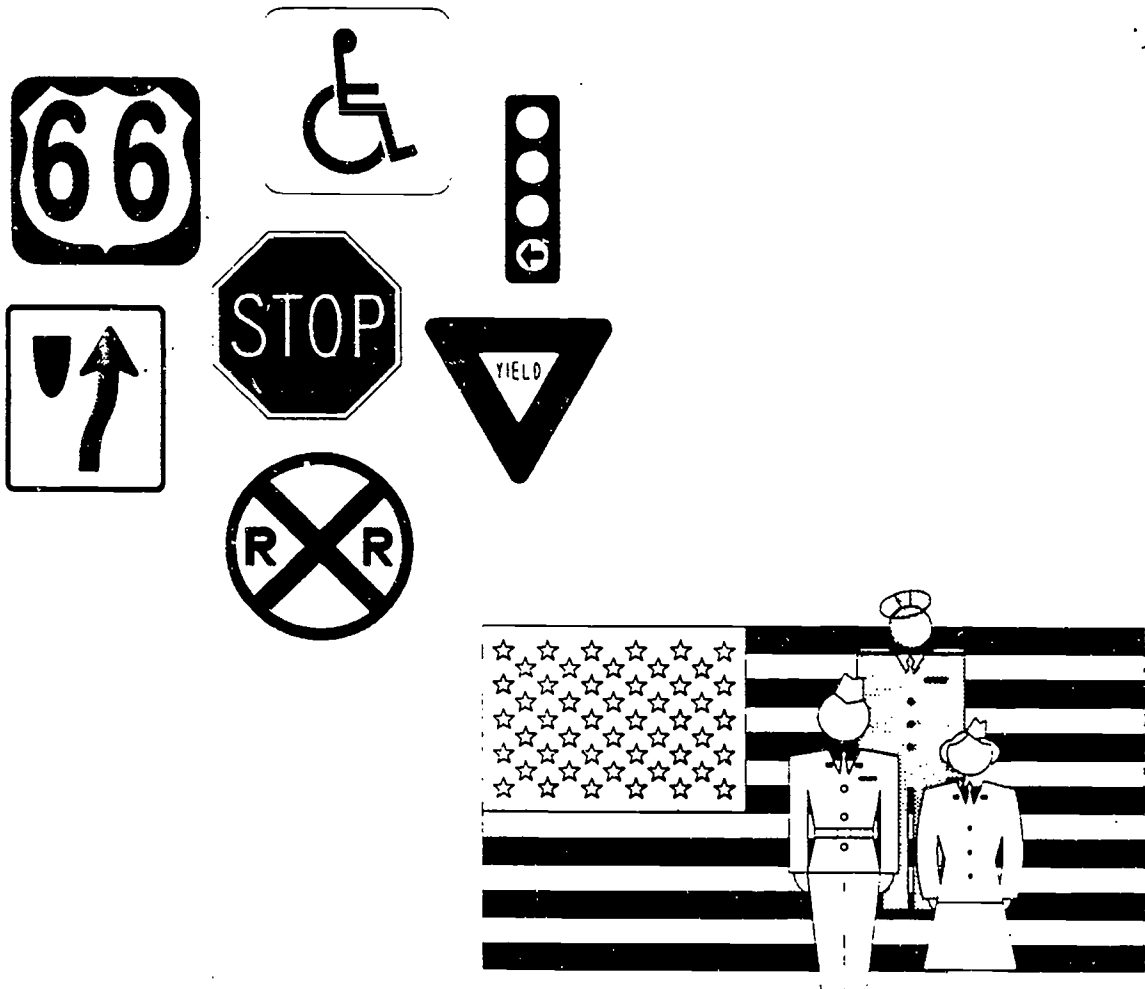

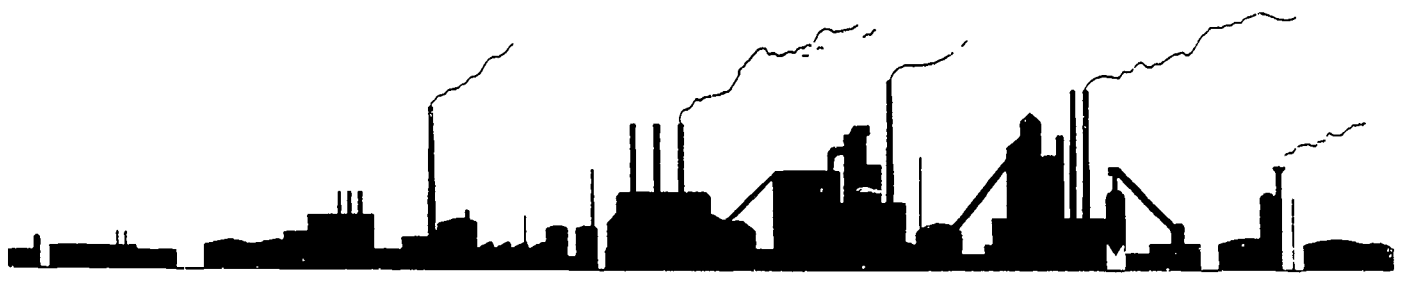

GENERAL EDUCATION EXPLORATORY

General Agriculture

General Home Economics

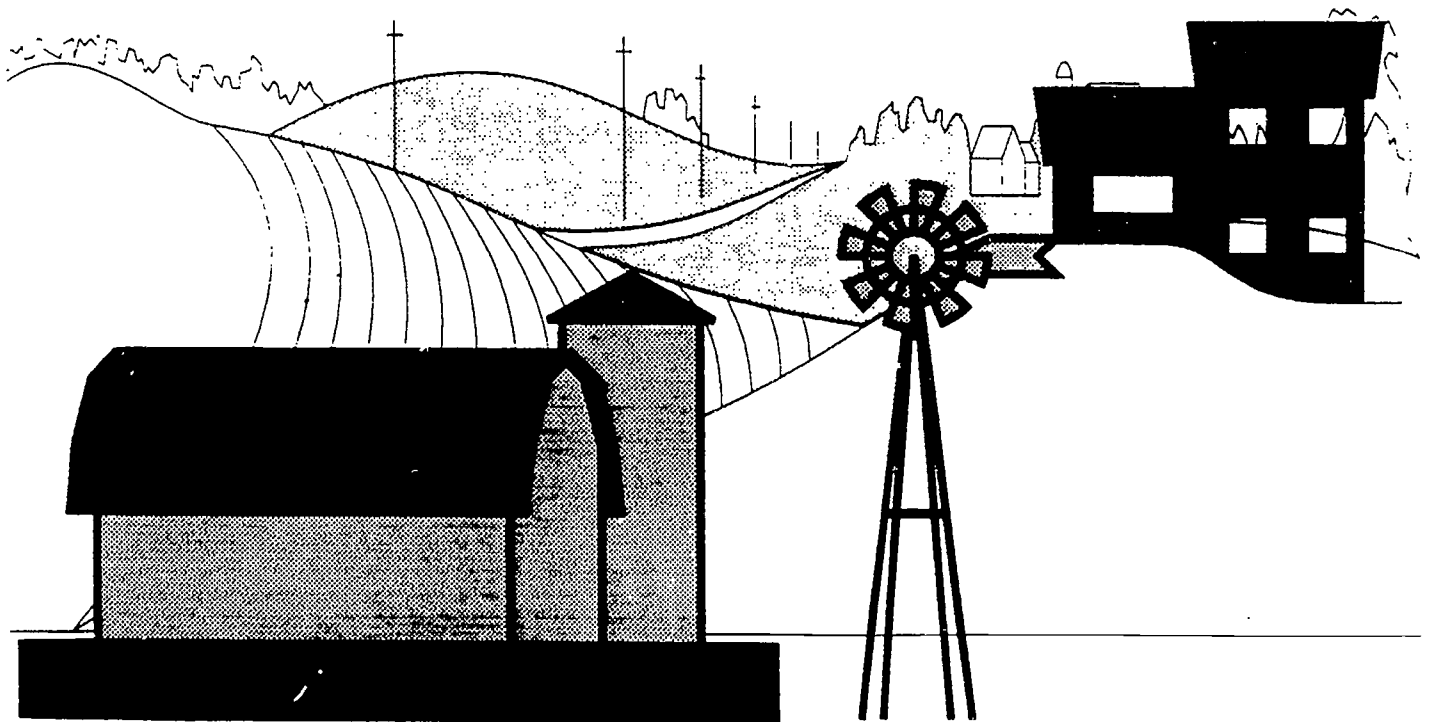

GENERAL EDUCATION EXPLORATORY

General Agriculture

1 Credit

An instructional program that generally describes the production, processing and distribution of food and fiber.

General Home Economics

1 Credit

An instructional program that generally describes the understanding of the relationship between the physical, social, emotional and intellectual environment and the well-being of individuals and families.

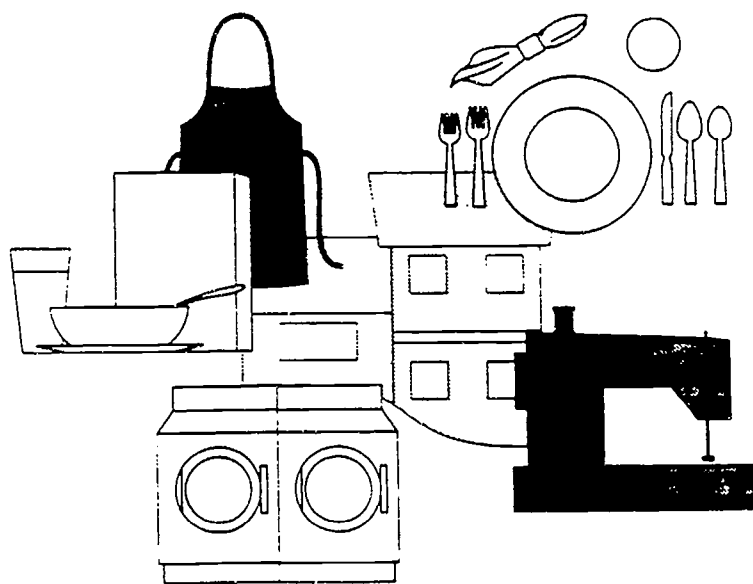
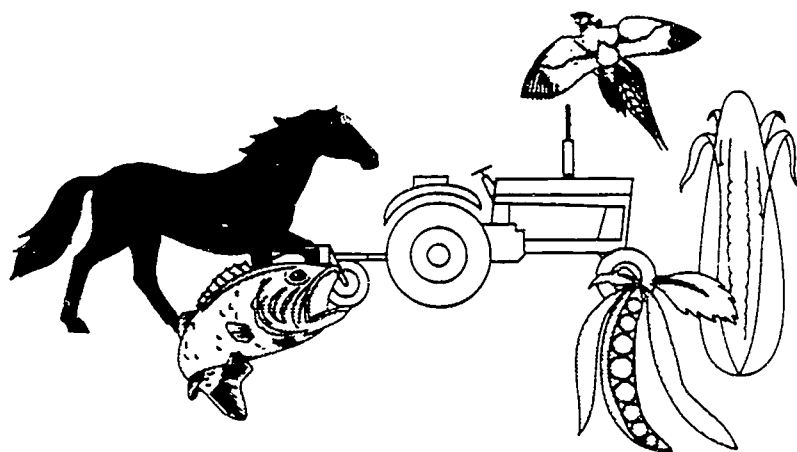

AGRICULTURAL EDUCATION*

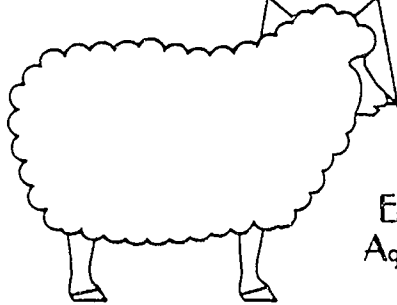
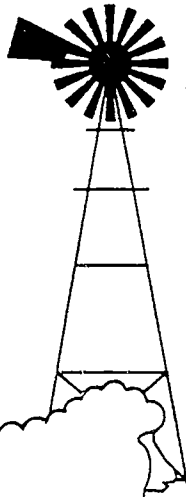
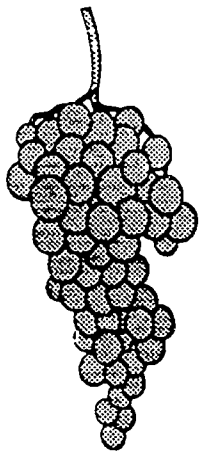

Science 1A (Agriscience)**
 Agricultural Science I
 Agricultural Science II
 Animal Production
 Crop Production
 Food Processing Science
 Fruit, Berry and Vegetable
 Alternative/Specialty Agriculture
 Agricultural Mechanics and Maintenance
 Agricultural Power and Equipment
 Small Animal Care
 Agricultural Technologies
 Aquaculture
 Horse Science
 Exterior and Interior Landscaping
 Nursery Production
 Greenhouse Management
 Floriculture
 Turfgrass and Grounds Maintenance
 Forestry
 Wildlife Management and Recreation
 Environmental Agriculture and Conservation
 Agricultural Economics, Marketing and Finance
 Agricultural Sales and Service
 Leadership Development

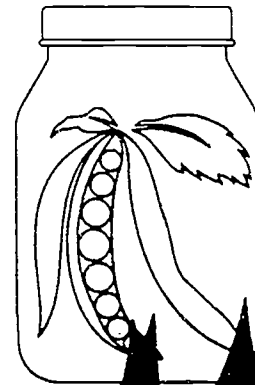
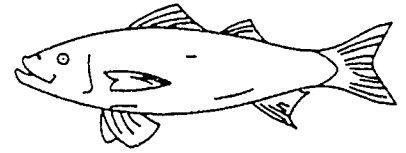

*A student who completes an approved supervised occupational education program consisting of at least 180 hours will be given one-half unit of credit as an out-of-school experience.

**This course satisfies one of the science credits required for graduation or it may be offered for one vocational credit.

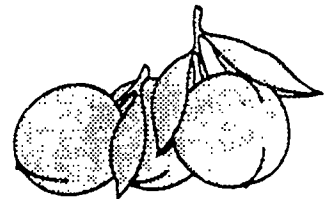
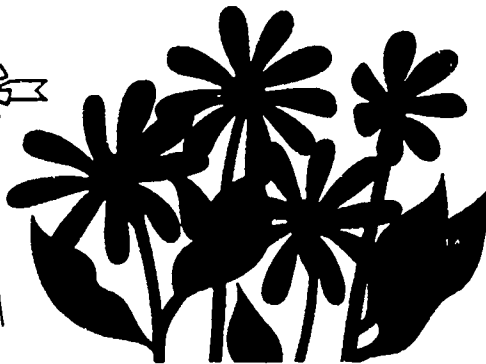
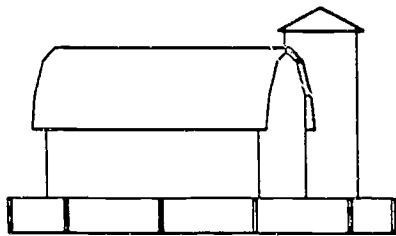

AGRICULTURAL EDUCATION

Science IA (Agriscience)

1 Credit

An instructional program that describes the science, art and business of cultivating the soil, producing crops, and raising livestock. Students will learn to apply the latest principles in science and biotechnology.

Agricultural Science I

1 Credit

This course is designed for the student with or without any agriculture experience or background. The content of the course is to provide a broad, but in-depth, study of the agriculture/agribusiness industry; agriculture orientation, animal science, plant science, agriculture mechanics and various leadership skills.

Agricultural Science II

1 Credit

Prerequisite: Agriculture Science I

This course is designed to prepare for both farm and non-farm industry. Students will learn the latest science technology, biotechnology, and computer technology within the field of agriculture.

Animal Production

1 Credit

An instructional program that prepares students to operate animal production enterprises by developing competencies concerning the selection, breeding, physiology, nutrition, health, housing, feeding, and marketing of animals such as dairy cattle, beef cattle, horses, swine, sheep, poultry, bees, rabbits, cats, dogs, and earthworms.

Crop Production

1 Credit

An instructional program that prepares students to operate enterprises concerned with the production of cereal grain, fiber, forage, oil seed, tree fruits and nuts, small fruits, vegetables, and other crops. Includes instructions in soils, plant nutrition, plant and seed identification, genetics, physiology, entomology, plant pathology, plant disease, and pest control, including insecticides, fungicides, herbicides, non-chemical controls, and plant genetic resistance.

Food Processing Science

1 Credit

An instructional program that describes the principles and practices involved in converting agriculture products to forms suitable for direct human consumption or for storage.

Fruit, Berry and Vegetable Production

1 Credit

An instructional program that prepares students for activities dealing with processing produce for sale and consumption.

Alternative/Specialty Agriculture

1 Credit

An instructional program that prepares students to apply scientific knowledge and methods, and technical skills in support of agribusiness and agricultural activities concerned with the management of agricultural enterprises, production and propagation of crops and animals, supplies and services, mechanics, products processing and marketing, and horticulture.

Agricultural Mechanics and Maintenance

1 Credit

An instructional program that prepares students to select, safely use, and maintain hand and power tools and arc and acetylene welding equipment.

Agricultural Power and Equipment

1 Credit

An instructional program that prepares students to select, operate, service, maintain, and repair a variety of agricultural power units and agricultural machinery and equipment. Includes instruction in gas, diesel, and electric units; welding; refrigeration; and hydraulics and other power systems.

Small Animal Care

1 Credit

An instructional program that describes the environment, drugs, antibiotics, vaccinations, blood tests, and other factors that affect the prevention and control of diseases.

Agricultural Technologies

1 Credit

An instructional program that prepares students to apply scientific knowledge, methods and technical skills. The course includes measurement, analysis of quality, testing and processing.

Aquaculture

1 Credit

An instructional program that prepares students for fish farming and marine plant production and harvesting. Includes instruction in feeding, culturing, protecting, and propagating commercially produced marine food products and seaweed, and the uses of marine foods.

Horse Science

1 Credit

An instructional program that describes the theories, principles, and applications of appropriate technical skills that apply to production and management.

Exterior and Interior Landscaping

1 Credit

An instructional program that describes the processes, procedures, observations, and techniques essential to the development of designs for exterior and interior environments. The content includes preparing students to locate, plant and maintain turf, plants, shrubs or devices for the beautification of grounds for human habitation.

Nursery Production

1 Credit

An instructional program that prepares students to produce turf, plants, shrubs, and/or trees for the purpose of transplanting or propagation.

Greenhouse Management

1 Credit

An instructional program that prepares students to produce plants under glass and in other artificial environments.

Floriculture

1 Credit

An instructional program that generally describes the theories and principles of science and practices involved in the production and management of plants for food, feed, fiber and soil conservation.

Turfgrass and Grounds Maintenance

1 Credit

An instructional program that prepares students to establish, manage, and maintain grassed areas for ornamental and/or recreational purposes.

Forestry**1 Credit**

An instructional program that prepares students in a general way to produce, protect, and manage timber and specialty forest crops; maintain, operate and repair related equipment and machinery; harvest and transport trees as a crop and select, grade, and market forest raw materials for converting into a variety of consumer goods, and to use the forest for multiple purposes such as game preserves and recreation.

Wildlife Management and Recreation**1 Credit**

An instructional program that prepares students in the principles and practices used in the production and improvement of wildlife resources for aesthetic, ecological, and recreational uses of public and private lands.

Environmental Agriculture and Conservation 1 Credit

An instructional program that prepares students to engage in activities concerned with the preservation, protection, and regulation of renewable natural resources.

Agricultural Economics, Marketing, and Finance 1 Credit

An instructional program that prepares students to apply business and economic principles relating to the purchasing, selling, producing, and marketing of agricultural products and services for maximizing profit. Students also learn the principles relating to the allocation of resources to the production and marketing of agricultural products and services in the domestic and international markets.

Agricultural Sales and Service**1 Credit**

An instructional program that generally prepares students to sell supplies for agricultural production; provide agricultural services; and purchase, grade, store, market, and transport agricultural products. Includes instruction in animal breeding, horseshoeing and small animal services.

Leadership Development**1 Credit**

An instructional program that generally describes how to effectively live and interact with others, social organization, being a congenial friend and companion, establishing courses of action for others, and influencing others to follow.

BUSINESS EDUCATION

Accounting I, II, III

Business Communications

Business Law

Business Machines

Business Management Principles

Business Mathematics

General Business

Keyboarding

Office Procedures/Office Management

Microcomputer Applications

Recordkeeping

Shorthand I, II

Typewriting I, II

Personal Computing

Software Tools

Basic I, II

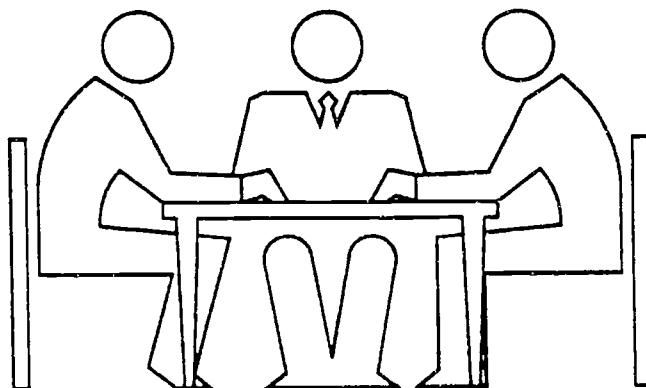
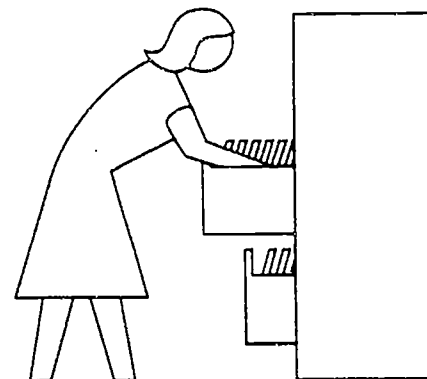
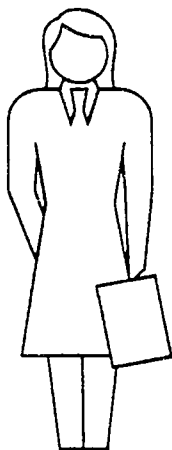

BUSINESS EDUCATION

Accounting I

1 Credit

This course provides a study of the complete accounting cycle for small businesses. The essential procedures for adequate accounting will include the use of journals, ledgers, and financial statements. Other areas studied include banking activities, collectible accounts, notes and interest, and other areas.

Accounting II

1 Credit

Prerequisite: Accounting I

This course reviews the accounting cycle and covers partnership accounting, departmental accounting, accounting control systems, accounting for taxes, notes, drafts, corporation accounting, and automated accounting systems, with actual hands-on experience using a computer.

Accounting III

1 Credit

Prerequisite: Accounting II

This course reviews the entire accounting cycle. Special emphasis placed on cost accounting. Several business simulations for small business and corporations will be used.

Business Communications

1 Credit

An instructional program that describes the creation, transmission, and evaluation of messages.

Business Law

1 Credit

This course deals with important rules of conduct relating to the economic activities of American citizens. These economic activities concern themselves with earning a livelihood and with acquiring essential goods and services. A knowledge of legal principles is beneficial to every individual in their daily affairs. Case-problems illustrating the legal highlights of mutual assent are presented.

Business Machines

1 Credit

An instructional program that prepares students to utilize office machines for billing, posting, calculating, adding, listing, and mechanizing data.

Business Management Principles

1 Credit

An instructional program that generally describes the processes of purchasing, selling, producing, and interchanging of goods, commodities, and services in profit-making and non-profit public and private institutions and agencies.

Business Mathematics

1 Credit

An instructional program that generally describes the sciences of logical symbolic language and their applications.

General Business

1 Credit

This course provides information needed for appreciation of the American free enterprise system, trains consumers to be wise and skillful in selecting and using goods and services, and gives practical application to help develop competent and efficient consumers who can manage their own personal, business and financial affairs. Topics covered include managing money, using banking services, using credit wisely, attaining and maintaining insurance, investing, and being a wise consumer.

Keyboarding

1 Credit

An introduction to basic skills in operating the keyboard. Students study typewriter and computer keyboards and develop skills in speed and accuracy.

Office Procedures/Office Management

1 Credit

Prerequisite: Typewriting/Keyboard

An instructional program that prepares students to supervise employees; budget, analysis, and coordinate clerical and other activities; evaluate, organize, and/or revise office operations and procedures to establish uniformity in handling correspondence, records, and other materials; design various office layouts to facilitate maximum production and efficiency; evaluate employee records.

Microcomputer Applications

1 Credit

An instructional program that prepares students to develop microcomputer systems and application packages for particular uses, e.g., accounts receivable, accounts payable, inventory control, time management.

Includes concepts and capabilities of microcomputers, programming, and design and implementation of disk-operating systems.

Recordkeeping

1 Credit

An instructional program that prepares students to record, duplicate, and retrieve data, including classifying, sorting, and filing correspondence, records and other data.

Shorthand I

1 Credit

Prerequisite: Typewriting or Keyboard

This course is designed to cover the complete theory of shorthand developing a reasonable writing skill on material encountered in business situations and the ability to transcribe this material in mailable form. Emphasis placed on the improvement of English, spelling and punctuation, as well as the qualities needed for success in a business office.

Shorthand II

1 Credit

Prerequisite: Shorthand I

This course stresses speed building and transcription. Records and tapes are used extensively. The course includes building shorthand vocabulary, developing speed in taking dictation, developing short cuts, and transcribing material into mailable form.

Typewriting I

1 Credit

This course includes basic typing skills (keyboard by touch, correct techniques for maximum efficiency) and basic application such as tabulation, composition, centering, reports and manuscripts, personal business application and office production.

Typewriting II

1 Credit

Prerequisite: Typewriting I

This course stresses speed building and accuracy. Extensive typing of manuscripts, reports and tables with columns will be included.

Personal Computing

1 Credit

Prerequisite: Typewriting or Keyboard

An instructional program that describes computers and computer programming.

Software Tools

1 Credit

An instructional program that describes the methods of creating, organizing, storing and accessing organized fields of information.

Basic I

1 Credit

This course includes a brief history of computers, introduction to computers, hardware and software, data entry concepts and skills, flowcharting/programming, and introductory applications for word processing/data base/spreadsheet.

Basic II

1 Credit

Prerequisite: Basic I

This course will extend knowledge learned in Basic I and will include advanced data processing skills, extended flowcharting/programming, and advanced application of word processing/data base management/spreadsheet theory.



OFFICE EDUCATION

INTRODUCTION TO VOCATIONAL OFFICE EDUCATION (VOE)

INTRODUCTION TO DATA PROCESSING

VOE STENOGRAPHY

VOE WORD PROCESSING

VOE AUTOMATED ACCOUNTING

VOCATIONAL OFFICE EDUCATION:

I. VOE I, II - Office Technology

II. VOE I - Accounting

III. VOE - Data Processing

IV. VOE - Data Processing &
Computer Programming

V. VOE I, II - Management

VI. VOE II - Cooperative Education

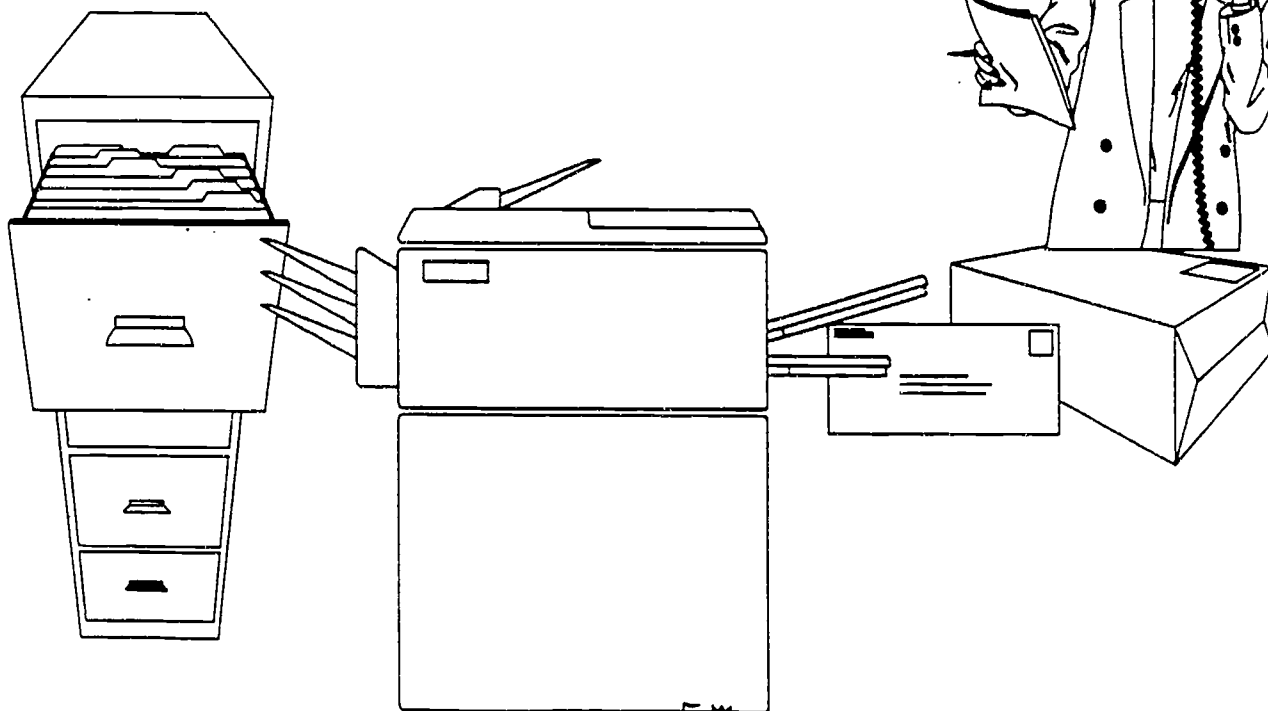
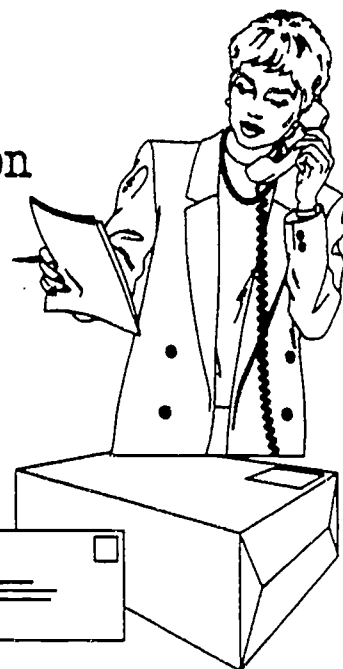
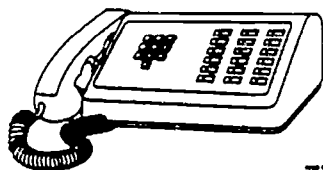

OFFICE EDUCATION

Introduction to Vocational Office Education 1 Credit (VOE)

An instructional program that prepares students for a variety of activities in planning, organizing, directing, and controlling all business office systems and procedures. Includes instruction in preparing, transcribing, systematizing, and preserving written communications and records; preparing and analyzing financial records; collecting accounts and receiving and disbursing money; gathering, processing and distributing information and mail; operating office machines and electronic data processing equipment, storing, distributing and accounting for inventories of materials; operating telephone switchboards and delivering messages; and performing other business office duties.

Introduction to Data Processing 1 Credit

An instructional program that generally prepares students to analyze and design data processing system configurations; write, test, monitor, debug, and maintain data processing programs; maintain data processing programs; and operate computers and peripheral and data entry equipment.

VOE Stenography 1 Credit

An instructional program that prepares students to take direct dictation of correspondence, reports, and other materials, by hand or machine and to transcribe dictated materials.

VOE Word Processing 1 Credit

An instructional program that prepares students to operate computer-based equipment to prepare correspondence, reports, statistical tables, forms, and other printed materials by keying and sorting text or data in the equipment memory and/or magnetic media for subsequent revision and editing, using coded commands to enter, store, edit, retrieve and delete information, and to format and print the information to obtain a finished copy.

VOE Automated Accounting

1 Credit

An instructional program that prepares students to organize, design, and compute numerical and financial data; obtaining final records of financial activities, and preparing other financial statistical reports and information.

VOE I Office Technology

1 Credit

Prerequisite: Typewriting or Keyboard

This course includes electronic typewriting and initial training in the following related office skills: electronic calculating machines, filing, proofreading/editing, formatting skills, reprographics, record keeping, transcribing, introduction to word processing, and data entry on the computer.

VOE II Office Technology

1 Credit

Prerequisite: VOE I Office Technology

Prepares students for entry-level office occupations. Students are taught the skills, knowledge, and attitudes necessary to obtain employment. The course includes intensive training in advanced typewriting, business machines, and related skills taught through a simulated laboratory. Also included are electronic calculator, reprographics, business filing, mailing procedures, word processing, data entry on the computer, machine transcription, statistical typewriting, payroll record keeping, and office communications.

VOE I Accounting

1 Credit

An instructional program that prepares students to systematize information about transactions and activities into accounts and quantitative records, verify accuracy of data by applying auditing principles, prepare budgets and financial reports, operate bookkeeping machines, and pay and receive money.

VOE I Data Processing

1 Credit

An instructional program that describes computers and computer programming, also, analyzing and designing data processing system configurations.

VOE II Data Processing & Computer Programming 1 Credit
Prerequisite: VOE I Data Processing

An instructional program that describes the methods and procedures used in flow charting and writing instructions in computer language for the direction of computer operation in the solution of a problem.

VOE I Management 1 Credit

An instructional program that prepares students to supervise employees; budget, analyze, and coordinate clerical and other activities; evaluate, organize, and/or revise office operations and procedures to establish uniformity in handling correspondence, records, and other materials; design various office layouts to facilitate maximum production and efficiency; evaluate employee records; and coordinate activities of clerical department and workers.

VOE II Management 1 Credit
Prerequisite: VOE I Management

This course allows students to extend their training to include practical work experience by working in the school's administrative office.

VOE II Cooperative Education 1 Credit

An instructional program that prepares students for occupations directed toward the flow of industrial and consumer goods in channels of trade, or the provision of services to consumers or users. Prepares students to perform one or more of the marketing functions such as selling, buying, pricing, promoting, financing, transporting, storing, market research and management. Also, technical knowledge of products or services marketed, related communication and computation skills, and abilities associated with human relations and private enterprise.



HEALTH OCCUPATIONS*

Introduction to Health Occupations
Health Occupations I, II
Wellness: The Steps to a Healthy Life
Nursing/Geriatric Nursing Assistant
Allied Health Careers
Introduction to Physical Therapy
Introduction to Sports/Physical Fitness
Clinical Internship

*Two semesters in health occupations satisfies the health education requirement for graduation.

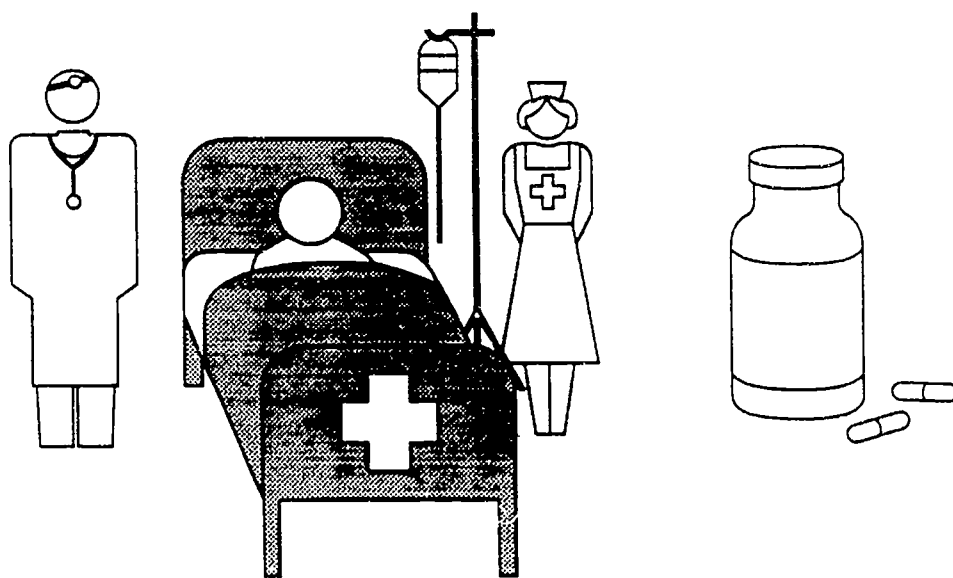
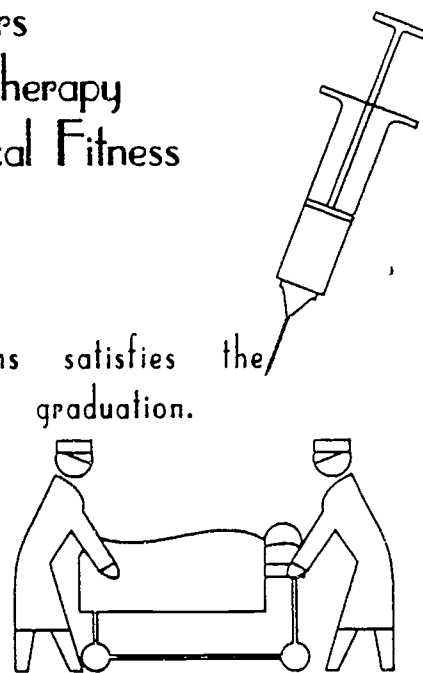
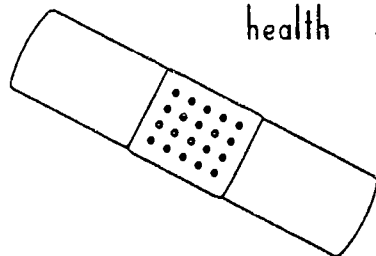

HEALTH OCCUPATIONS

Introduction to Health Occupations 1 Credit

This course contains information on the requirements and responsibilities for entry into various health occupations, both medical and paramedical areas, such as: nursing, medicine, dentistry, rehabilitation, medical laboratory, and others. Introductory units will be given in vocational relations, bacteriology, first aid, anatomy and physiology, personal and community health, skills basic to nursing and allied fields, and medical terminology.

Health Occupations I 1 Credit

This course is for students who do not take Introduction to Health Occupations. It includes the information described in Introduction to Health Occupations. In addition, field trips to various health agencies and occupational guest speakers are correlated with the core curriculum in order to foster meaningful learning experiences.

Health Occupations II 2 Credits
Prerequisite: Health Occupations I

This course consists of both classroom activities and clinical experience in a health agency. The content of the course includes advanced studies in the Introduction to conditions of illnesses, basic nutrition, growth and development, rehabilitation, introductory bacteriology, advanced skills in nursing and allied fields, and related medical terminology. Field trips are essential part of the course work. This course will prepare students for employment at the assistant level in a health occupation of their choice.

Wellness: The Steps to a Healthy Life 1 Credit

An instructional program that generally describes the promotion of the health of individuals. Also describes the principles, techniques, and methods by which individuals can improve their overall physical well-being.

Nursing/Geriatric Nursing Assistant 1 Credit

An instructional program that prepares students to perform tasks involved in providing nursing and personal care to elderly patients under the supervision

of qualified nursing staff members. Emphasis is on the maintenance of daily living activities of these patients.

Allied Health Careers

1 Credit

An instructional program that prepares students to assist qualified health professionals in providing diagnostic, therapeutic, preventive, restorative, and rehabilitative services to patients in health care facilities, the home, and the community.

Introduction to Medical Clerical/Medical Records

1 Credit

An instructional program that prepares students to manage the administration and business aspects of a medical practice or group medical practices. The course includes developing statistical reports, code diseases and operations, and maintain indexes according to accepted procedures; take records to court; handle requests for medical information; record minutes of medical staff committee meetings; and supervise filing areas and activities of medical clerks.

Introduction to Physical Therapy

1 Credit

An instructional program that prepares students to use the principles and techniques of treating disease, bodily weakness, or physical defects by physical remedies, including massage and gymnastics.

Introduction to Sports/Physical Fitness

1 Credit

An instructional program that describes athletic injuries and the techniques and procedures for treating them with special emphasis on care and rehabilitation.

Clinical Internship

1 Credit

An instructional program that describes the bodily structures and functions of humans, the principles and techniques of identifying and classifying diseases which affect them, and the foundation of scientific knowledge that is essential to the restoration and preservation of health.

Home Economics Education

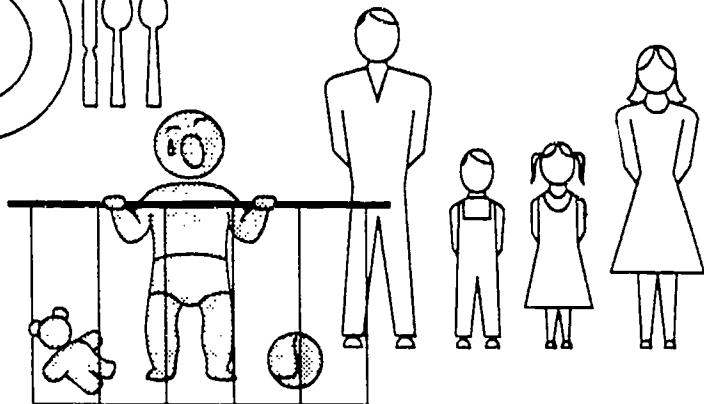
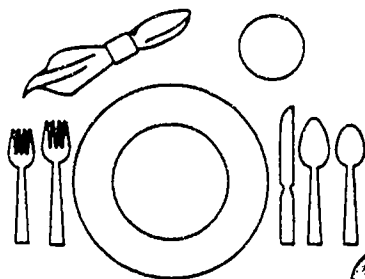
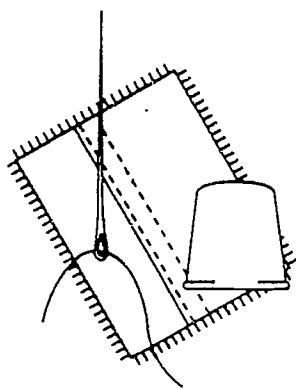
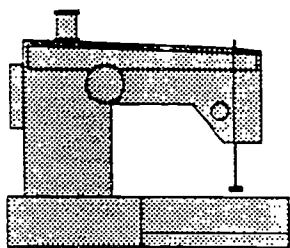

- Adult Living
- Consumer Homemaking 1, 2
- Child Development
- Consumer Economics & Management Strategies
- Family and Individual Health*
- Family and Parenting Education
- Housing and Interiors
- Interpersonal Relationships
- Nutrition and Food 1, 2
- Teen Parenting
- Textiles and Clothing
- Occupational Home Economics
- Occupational Child Care Services
- Occupational Fashion and Fabric Services
- Occupational Food Services
- Occupational Institutional and Home Services
- Occupational Multi-Area Home Economics
(Composed of two or more of the above)

*One semester of Family and Individual Health satisfies the health education requirements for graduation.

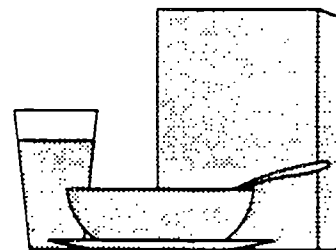
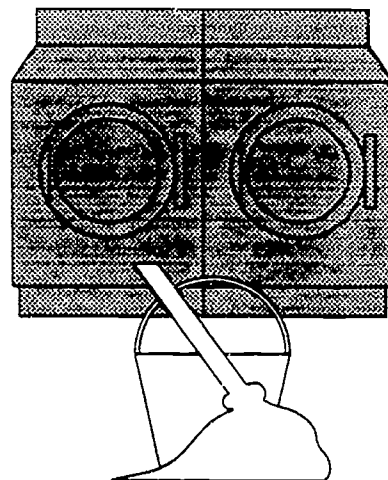
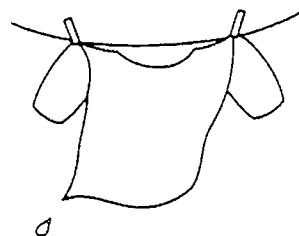

HOME ECONOMICS EDUCATION

Adult Living

1/2 Credit

This course is designed to study the functions of the family with an emphasis on family life, marriage, and parenthood. The development of personal qualities that are essential for living effectively with others is also emphasized.

Consumer Homemaking I

1 Credit

This course is designed to provide classroom instruction and laboratory work in all areas of home economics such as; foods and nutrition, consumer education and home management, clothing and textiles and personal and family relationships. The course will provide the student with skills relevant to personal, home, and family life.

Consumer Homemaking II

1 Credit

Prerequisite: Consumer Homemaking I

This is a comprehensive course which includes instruction in all home economics subject areas. It also provides experiences in the multiple roles of homemaker and wage earner. Also included are craft projects; stenciling, soft fabric frames, pillows, and counted cross stitch.

Child Development

1/2 Credit

This course includes parental care, birth and infant care with further study of the young child's social, emotional, intellectual, and physical development. Parenting skills are taught along with child care.

Consumer Economics & Management Strategies

1 Credit

An instructional program that describes the concepts, skills, and processes through which decisions about the use of resources are directed to enhance individual and family well-being; also involved is an understanding of goal setting and management functions and processes through which the household and financial activities of individuals families are accomplished.

Family and Individual Health

1 Credit

An instructional program that prepares students to understand the related aspects of health in family living with special emphasis on nutrition, emotional health, and physical health; the relationship of the

health of an individual to the well-being of the family; the prevention of illness; and the basic care of the ill and convalescent in the home, including the elderly, the young child, and the handicapped.

Family and Parenting Education

1 Credit

An instructional program that prepares students to understand the nature, function, and significance of human relationships within the family/individual units. Includes instruction in the concepts and principles related to various family living conditions; the establishment and maintenance of relationships; and the preparation for marriage, parenthood, and family life. Instruction emphasizes the uniqueness of families and individuals, the development and socialization of the individuals, and meeting the needs and interests of individuals and family members.

Housing and Interiors

1 Credit

An instructional program that prepares students to understand the physical, psychological, and social influences pertaining to complex housing decisions required for creating a desirable living environment. Includes instruction in human and environmental factors influencing the form and use of housing; the varied types of housing; costs; exterior and interior design; home furnishings and equipment; and the selection, use, and care of available resources for achieving improved living space to meet individual and family needs.

Interpersonal Relationships

1 Credit

An instructional program that describes how to increase one's ability to establish and develop mutually satisfactory ties with other human beings.

Nutrition and Food I

1/2 Credit

An instructional program that prepares students to understand the principles of nutrition; the relationship of nutrition to health and well-being; the selection, preparation, and care of food; meal management to meet individual and family food needs and patterns of living; good economics and ecology; and optimal use of the food dollar.

Nutrition and Food II

1/2 Credit

Prerequisite: Nutrition and Food I

This course is an advanced study of techniques in preparing food products for holiday seasons and for special occasions such as teas, showers, birthdays, and for parties. Skills in comparative shopping through grocery research projects with emphasis on quality and economy will be learned. Also food safety and sanitation principles will be studied.

Teen Parenting

1 Credit

An instructional program that prepares students to understand the nature, function and significance of human relationships within the family/individual units. Instruction includes the preparation for marriage, parenthood and family life. It also prepares an individual to understand children's physical, mental, emotional and social growth and development, as well as their care and guidance.

Textiles and Clothing

1 Credit

An instructional program that generally prepares students for occupations concerned with the entire spectrum of clothing, apparel, and textiles management, production and services, including but not limited to construction, fabric and fabric care, pattern design, principles in clothing construction and selection, fitting and alterations of ready-to-wear garments, custom tailoring, clothing maintenance and textiles testing.

OCCUPATIONAL HOME ECONOMICS EDUCATION

Occupational Child Care Services

2 Credits

Prerequisite: Child Development

An instructional program that prepares students to assist with the care and guidance of infants and young children under the supervision of professional personnel. Includes instruction in planning, organizing, and conducting activities which promote physical, interpersonal, motor, mental and social growth and development of acceptable behavior, cleanliness, eating, playing, resting, and toilet habits. Prepares individuals as child care assistants to assume major responsibilities for caring and guiding the development of young children.

Occupational Fashion & Fabric Services 2 Credits
Prerequisite: Textiles and Clothing

An instructional program that prepares students to assist in coordinating garments for various occasions. Includes instruction in fashion design, trends, characteristic styles, and merchandising; describing to customers the garment construction, quality, and fiber content, care and durability; selecting current fashion for figure types, fitting garments on customers; planning and presenting fashion shows; developing fashion displays; assisting home sewers with construction techniques; advising on quantity of fabric needed; measuring and cutting fabric; ordering, receiving, and displaying fabric and merchandise; keeping shop and store clean and orderly; and taking inventory and replenishing stock.

Occupational Food Services 1 Credit

An instructional program that prepares students to select, purchase, prepare, or produce food in quantities; preserve nutritive value of foods, follow standard recipes for quality control; prepare and serve quantity foods; receive, store, and issue foods and supplies; select and use commercial equipment for production and services; observe safety precautions and sanitation regulations; store and handle food and equipment; clean food preparation and service areas; take inventories; and work in food-service establishments.

Occupational Institutional & Home Services 1 Credit

An instructional program that prepares students for occupations in institutional/executive housekeeping; hotel/motel housekeeping; commercial cleaning; provision of services to the aged in their homes and in institutions; assistance in the management of household tasks; and assistance to consumers in decision making in relation to housing, food, clothing, community resources, and other homemaking concerns.

Occupational Multi-Area Home Economics 1 Credit

An instructional program that emphasizes the acquisition of competencies needed for securing and holding paid employment at the entry and advanced levels, and/or preparing for advancement in occupations utilizing home economics education knowledge and skills. The program is developed from home economics education subject matter areas to meet the unique requirements of the specific vocations.

TECHNOLOGY EDUCATION

EXPLORING TECHNOLOGY I, II
COMMUNICATION AND MEDIA TECHNOLOGIES I, II
MATERIALS AND PROCESSES TECHNOLOGIES I, II
POWER, ENERGY, TRANSPORTATION TECHNOLOGIES I, II

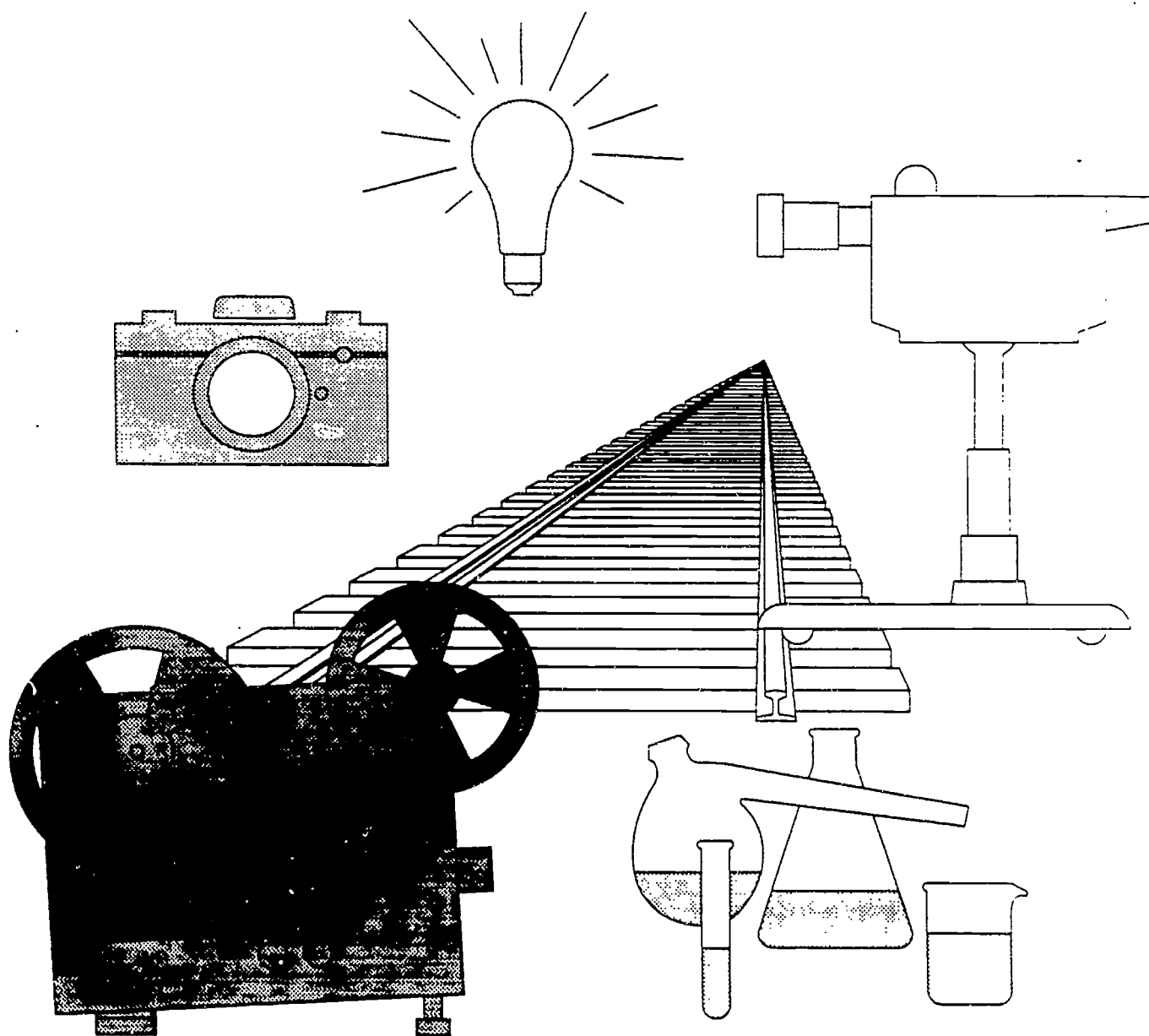

TECHNOLOGY EDUCATION

Exploring Technology I

1 Credit

An instructional program that provides students with knowledge that pertains to the body of related subject matter or related courses, organized for the development of understanding about all aspects of industry and technology, including learning experiences involving activities such as; experiments, designating, constructing, evaluating, and using tools, machines, materials, and processes. It also assists individuals in making informed and meaningful occupational choices or which prepare for entry into advanced trade and industrial or technical education programs.

Exploring Technology II

1 Credit

Prerequisite: Exploring Technology I

This course gives instruction in using tools, equipment, materials, and products associated with industry and technology; role playing in simulated enterprises associated with a number of career areas; studying and analyzing the materials, products, processes, problems, uses, developments, and contributions of many of the elements in a specific career area; studying the organization of an industry and business; researching, planning, designing, constructing, evaluating and generalizing in association with problems and projects related to a specific career.

Communication & Media Technologies I

1 Credit

An instructional program that prepares students to support and assist communication professionals and skilled communication workers. The course stresses specialized, practical knowledge related to the mechanical, scientific, or technical aspects of communication. Includes instruction in construction of equipment; the procedures, processes and techniques for making overhead projection materials, photographic slides, graphs, charts, tables, or other projectable materials.

Communication & Media Technologies II

1 Credit

Prerequisite: Communication & Media Technologies I

This course includes preparation for operating, adjusting, and making minor repairs for and diagnosing major difficulties in audiovisual devices, equipment,

and systems used in communication applications, loudspeaker systems, slides, movie film, or overhead projection equipment and tape-recording equipment. Includes the administration of equipment acquisition, storage, servicing, controlling, and packing for transportation, cost, and maintenance.

Materials and Processes Technologies I 1 Credit

An instructional program that prepares students for enrollment in advanced vocational education programs and includes operational and basic technical information and laboratory experiences directly related to the processes used by industry.

Materials and Processes Technologies II 1 Credit
Prerequisite: Materials & Processes Technologies I

An instructional program that focuses on the study of the information and basic skills concerned with industrial-technical materials and processes, including their properties and utilization as they are fabricated into usable products. Activities involve hand and machine processes for the fabrication, analysis or testing of metals, woods, and plastics.

Power, Energy, & Transportation Technologies I 1 Credit

An instructional program that prepares students for understanding the energy, power, and transportation industries and occupations by utilizing exploratory experiences and laboratory activities.

Power, Energy & Transportation Technologies II 1 Credit

An instructional program that focuses on the theory, maintenance, and servicing of machines and devices with emphasis on energy sources, small gas engines, basic electricity, and methods of transmitting power.

TECHNOLOGY PREPARATION

PRINCIPLES OF TECHNOLOGY I

MATH FOR TECHNOLOGY I--

APPLIED COMMUNICATION/ENGLISH III OR IV---

*This course satisfies one of the science credits required for graduation or it may be offered for one vocational credit.

**This course satisfies one of the mathematics credits required for graduation.

***This course satisfies the English III or English IV credit required for graduation.

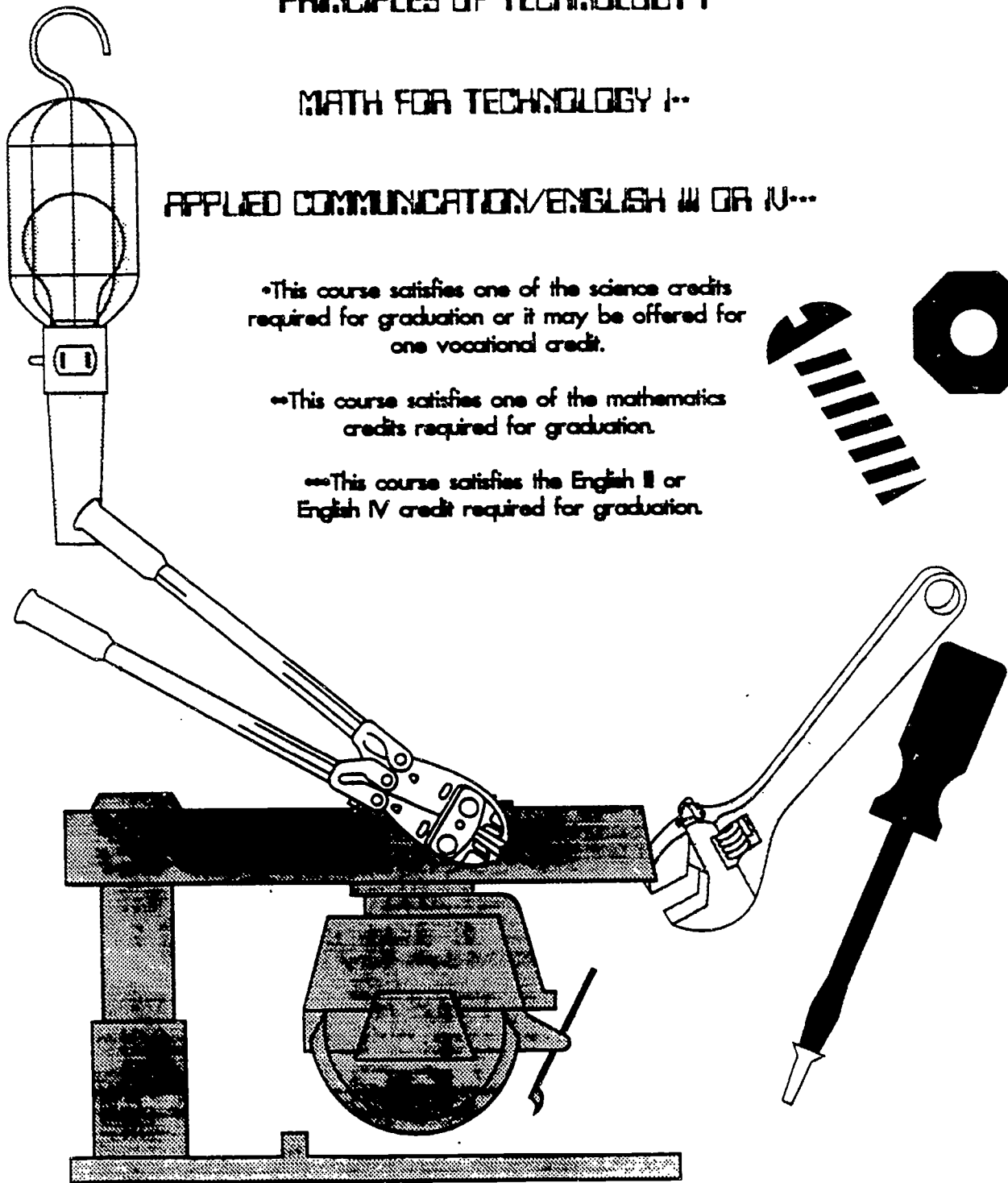

TECHNOLOGY PREPARATION

Principles of Technology I

1 Credit

An instructional program that provides students with knowledge about all aspects of industry and technology, including learning experiences involving activities such as experiments, designating, constructing, evaluating, and using tools, machines, materials, and processes. It also assists students in making informed and meaningful occupational choices or prepares them for entry into advanced trade education programs.

Math for Technology I

1 Credit

An instructional program that describes the theories, methods, and techniques of mathematical technology. It assists students in making informed and meaningful occupational choices or prepare for entry into advanced trade education programs.

Applied Communication/English III or IV

1 Credit

An instructional program that prepares students to support and assist communication professionals and skilled communication workers. Course stresses specialized, practical knowledge related to the mechanical, scientific or technical aspects of communication.

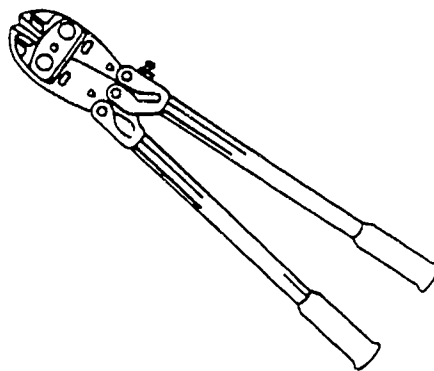

MARKETING EDUCATION/COOPERATIVE EDUCATION

Marketing I, II
Fashion Merchandising
Tourism and Lodging
Business & Personal Services Marketing
Entrepreneurship
Marketing Finance
Food Marketing
Insurance Marketing
Transportation Marketing
International Marketing
Advertising and Promotion
Sales
Wholesaling
Real Estate
Retailing
Entertainment Marketing
Automotive Parts Marketing

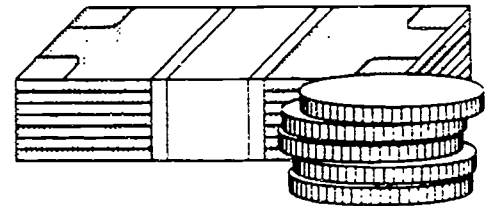
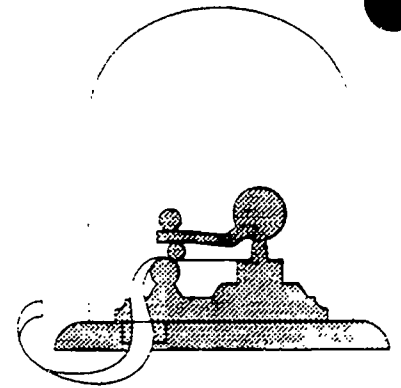
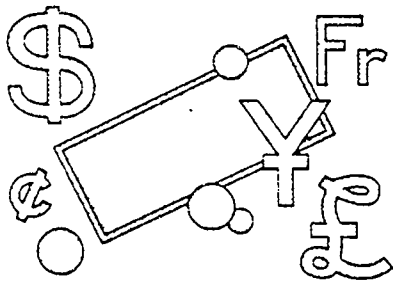

•Two semesters in marketing education satisfies the economics requirement for graduation.

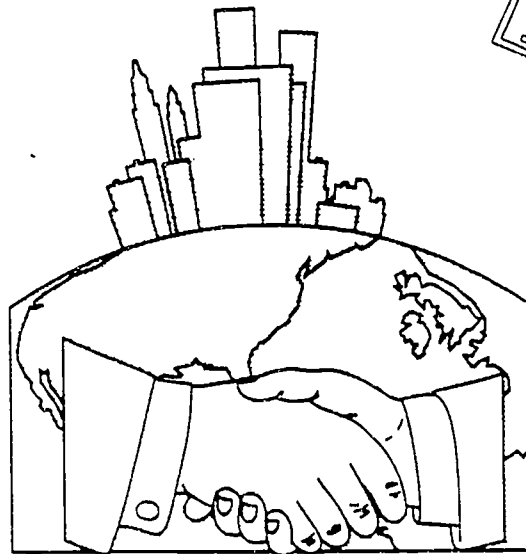
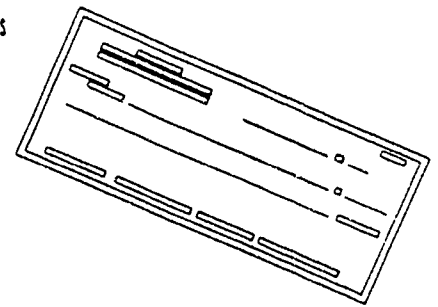

MARKETING EDUCATION/COOPERATIVE EDUCATION

Marketing I

1 Credit

This course includes instruction in the basic skills of marketing, merchandising, and product management. Involves classroom and laboratory activities relating to: development of human relations skills, job interviews, cash register operation, free enterprise system, small and large business management and merchandising.

Marketing II

3 Credits

Prerequisite: Marketing I

Students will be employed in a cooperative work experience program with two credits given for the work experience and one credit for the classroom work. Students will study marketing from a supervisory standpoint with emphasis on employee/employer relations, management principles and quality control standards.

Fashion Merchandising

1/2 Credit

An instructional program that prepares students to engage in the marketing of apparel and accessories, with particular emphasis given to fashion selling and buying, fashion cycles, fashion coordination, and specialized consulting services.

Tourism and Lodging

1/2 Credit

An instructional program that prepares students to assume initiatives in any business, agency or institution for attracting and serving the travelling public, with the objective of stimulating the local, state or national economy.

Business & Personal Services Marketing

1 Credit

An instructional program that prepares students to perform marketing functions and tasks in two types of enterprises: those primarily engaged in providing services to businesses on a fee or contract basis and those providing services to consumers. This program places emphasis on the marketing activities involved in such enterprises and not on the development of manual or procedural skills that are required to perform a particular service or task. Includes instruction in preparing individuals to perform advertising and merchandise display functions as a part of the operation of any enterprise.

Entrepreneurship 1 Credit

An instructional program that prepares students to perform marketing and management functions and tasks associated with owning and operating a business.

Marketing Finance 1 Credit

An instructional program that prepares students to perform marketing functions and tasks in financial institutions such as; savings and loan associations, credit agencies, credit unions, collection agencies, security and commodity brokerages, and credit departments of business enterprises.

Food Marketing 1 Credit

An instructional program that generally prepares students to perform marketing functions and tasks in retail and wholesale establishments, and in food processing and manufacturing firms that deal primarily with food and beverage products for either home preparation and consumption, or for use in commercial and institutional food service installations.

Insurance Marketing 1 Credit

An instructional program that prepares students to perform marketing functions and tasks related to the sale and placement of insurance contracts with carriers.

Transportation Marketing 1 Credit

An instructional program that prepares students to facilitate the provision of any form of transport used for the physical movement of raw materials, products, people, and personal effects.

International Marketing 1 Credit

An instructional program that prepares students to perform marketing activities in enterprises primarily engaged in exporting or importing industrial and consumer goods in world markets.

Advertising and Promotion 1 Credit

An instructional program that describes the creation, execution, transmission and evaluation of commercial messages concerned with the promotion and sale of products and services.

Sales

1 Credit

An instructional program that prepares students to apply marketing skills in a selling capacity in any industry, or to advance to more specialized training in marketing.

Wholesaling

1 Credit

An instructional program that prepares students to apply marketing skills in wholesale establishments, or to advance to more specialized training in marketing.

Real Estate

1 Credit

An instructional program that describes the theories and techniques of buying, selling, appraising, renting, managing and leasing real property.

Retailing

1 Credit

An instructional program that prepares students to apply marketing skills in retail establishments, or to advance to more specialized training in marketing.

Entertainment Marketing

1 Credit

An instructional program that prepares students to perform a variety of services related to the sale of food, beverages, and entertainment.

Automotive Parts Marketing

1 Credit

An instructional program that prepares students to engage in the marketing of new and used cars, vans, truck, and related parts.

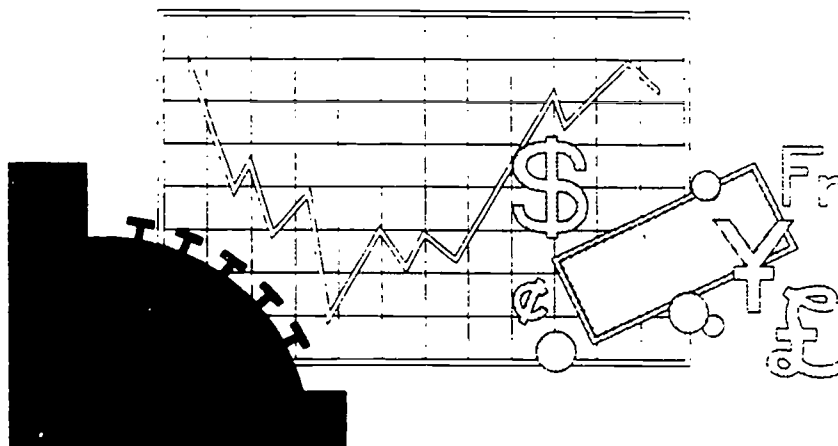

TRADE AND INDUSTRIAL EDUCATION*

- Air-Cooled Engines
- Aircraft Mechanics
- Appliance Repair
- Automotive Mechanics
- Building Maintenance
- Building Trades
- Cabinet Making and Millwork
- Carpentry
- Cast Metals
- Commercial Art
- Commercial Food Service
- Consumer Electronics Repair
- Cosmetology
- Diesel Mechanics
- Drafting
- Dry Cleaning
- Electricity/Electronics
- Electricity/Electronics Technology
- Electronic Recording
- Electronics
- General Cooperative Education
- Graphic Arts
- Heating, Air Conditioning and Refrigeration
- Industrial Cooperative Education
- Industrial Electricity
- Machine Shop
- Masonry
- Metals Technology
- Photography
- Plastics
- Plumbing and Pipefitting
- Printing
- Radio and Television Broadcasting
- Sheet Metal
- Shoe Repair
- Tailoring
- Upholstering
- Welding

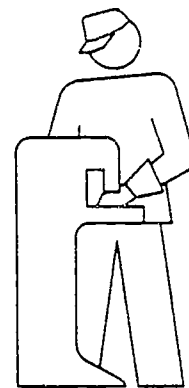
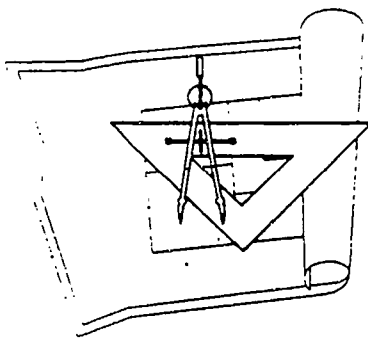
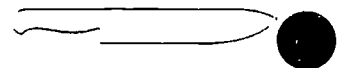
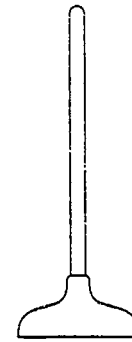
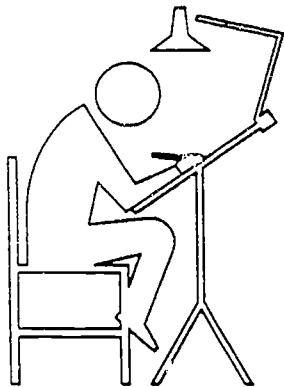
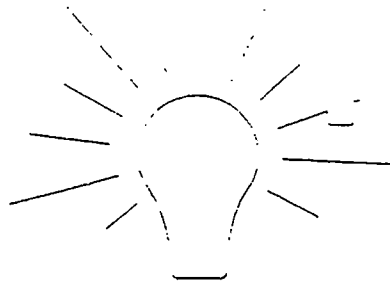
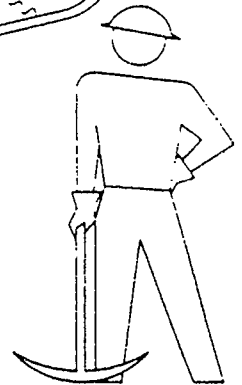
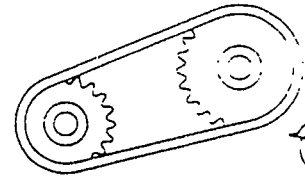
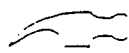
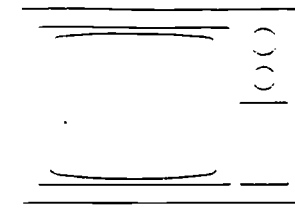

*Every local Board of Education shall develop a policy regarding the minimum and maximum units in any course or subject area for which a student may earn credit toward graduation.

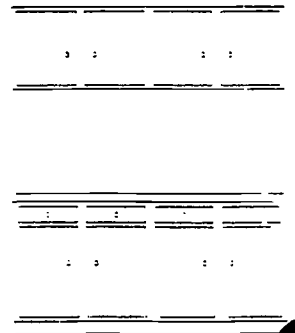

TRADE AND INDUSTRIAL EDUCATION

Air-Cooled Engines

2 or 3 Credits

An instructional program that prepares students to maintain and repair engines in vehicles and engines in mobile equipment.

Aircraft Mechanics

2 or 3 Credits

An instructional program that prepares students to inspect, repair and maintain all airplane parts other than engines, propellers and instruments. Includes layout and fabrication of sheet metals, fabric skin, and other materials into structural members, parts, and fittings, and replacement of damaged or worn parts such as control cables and hydraulic units.

Appliance Repair

2 or 3 Credits

An instructional program that prepares students to repair, install, service major gas, electric and microwave consumer appliances such as; stoves, refrigerators, dryers, water heaters, washers, dishwashers, and commercial units such as ice makers and coffee makers.

Autobody Repair

2 or 3 Credits

An instructional program that prepares students in automobile body and fender repair. Includes body preparation for painting and finishing.

Automotive Mechanics

2 or 3 Credits

An instructional program that prepares students to engage in the servicing and maintenance of all types of automobiles. Includes instruction in the diagnosis of malfunctions in and repair of engines; fuel, electrical, cooling and brake systems; and drive train and suspension systems. Also includes instruction in the adjustment and repair of individual components and systems such as radiators, transmissions and carburetors.

Building Maintenance

2 or 3 Credits

An instructional program that prepares students to keep buildings functioning, and service a variety of structures including commercial and industrial

buildings and mobile homes. Includes basic maintenance and repair skills related to the air conditioning, heating, plumbing, electrical, and other mechanical systems.

Building Trades

2 or 3 Credits

An instructional program that prepares students to erect, install, maintain, and repair buildings, highways, airports, missile sites, and other structures using materials such as metal, wood, stone, brick, glass, concrete, and composition substances. Includes instruction in costs estimating, cutting, fastening, and fitting various materials; the use of hand and power tools; and in following technical specifications and blueprints.

Cabinet Making and Millwork

2 or 3 Credits

An instructional program that prepares students to engage in the mass production of such articles as window frames, molding, trim and panels; and such products as store fixtures, kitchen cabinets and office equipment. Includes instruction in cutting, shaping, assembling and refinishing articles; installing hinges, catches, drawer pulls, and other hardware; and planning and drafting layouts.

Carpentry

2 or 3 Credits

An instructional program that prepares students to lay out, fabricate, erect, install and repair structures and fixtures using hand and power tools. Includes instruction in common systems of framing, construction materials, estimating and blueprint reading.

Cast Metals

2 or 3 Credits

An instructional program that prepares students to plan, manufacture, assemble, test, and repair parts, mechanisms, machines, and structures in which materials are cast, formed, shaped, molded, heat treated, cut, twisted, pressed, fused, stamped or otherwise worked upon.

Commercial Art

2 or 3 Credits

An instructional program that generally prepares students to design and execute layouts and make illustrations for advertising displays and

instructional manuals. Includes instruction in the preparation of; copy, lettering, poster, package, and product design; fashion illustration; silk screening; air-brushing; and inks and color dynamics.

Commercial Food Services

2 or 3 Credits

An instructional program that prepares students to select, purchase, prepare, or produce food in quantities; preserve nutritive value of foods; follow standard recipes for quality control; prepare and serve quantity foods; receive, store and issue foods and supplies; select and use commercial equipment for production and services; observe safety precautions and sanitation regulations; store and handle food and equipment; clean food preparation and service areas; take inventories; and work in or manage food-service establishments.

Consumer Electronics Repair

2 or 3 Credits

An instructional program that prepares students to operate, maintain, and repair business machines, communications equipment, major and small appliances, commercial vending machines, and related equipment. Includes instruction in electrical circuitry, simple gearing, linkages and lubrication of machines and appliances, and the use of testing equipment.

Cosmetology

2 or 3 Credits

An instructional program that prepares students to care for and beautify hair, complexions and hands by giving shampoos, rinses, and scalp treatments, styling, setting, cutting, dyeing, tinting, permanent waving, and bleaching hair; and giving facials, manicures, and hand and arm massages, with emphasis on hygiene, sanitation, customer relations and salon management.

Diesel Mechanics

2 or 3 Credits

An instructional program that prepares students to repair diesel engines in vehicles such as buses, ships, trucks, railroad locomotives, and construction equipment, and to repair stationary diesel engines in electrical generators and related equipment. Includes instruction in diagnosing malfunctions; disassembling

engines and replacing parts; and in repairing and adjusting fuel-injection systems, oil and water pumps, generators, governors, auxiliary and accompanying power units, controls, and transmissions, using a variety of tools, testing and diagnostic equipment.

Drafting

2 or 3 Credits

An instructional program that prepares students to plan, prepare, and interpret mechanical, architectural, structural, pneumatic, marines, electric/electronic, topographical, and other sketches; to use reproduction materials equipment, and processes, to develop, plan, and process charts and drawings; to develop models; and to prepare reports and data sheets for writing specifications; and to use computer assisted design equipment and materials.

Dry Cleaning

2 or 3 Credits

An instructional program that prepares individuals to operate and manage dry cleaning and laundering plants. Includes instruction in receiving and inspecting garments; identifying fabrics; identifying spots and using cleaning agents; washing and dry and wet cleaning; drying and bleaching; ironing, pressing, sorting, folding, and wrapping household furnishings, wearing apparel and accessories; making minor alterations and repair of articles; and use a variety of hand and power tools and equipment.

Electricity/Electronics

2 or 3 Credits

An instructional program that prepares students for enrollment in advanced vocational programs and includes occupational and basic technical information and laboratory experiences directly related to electricity and electronics. Includes the fundamentals of the theory, measurement, control, and applications of electrical energy. Activities include reading instructions, interpreting schematics, setting up experimental apparatus, making measurements, testing circuits and recording results.

Electricity/Electronics Technology 2 or 3 Credits

An instructional program that prepares students to work to support and assist electrical and electronic engineers, and other engineers and scientists concerned with the development of lasers. Program stresses specialized, practical knowledge related to the mechanical, mathematical, scientific, or technical aspects of electrical engineering, electronic engineering, and laser development.

Electronic Recording 2 or 3 Credits

An instructional program that prepares students to assist in the design, development, and testing of electronic devices and systems. Includes instruction in assisting with feasibility testing or engineering concepts; systems analysis and the preparation of written reports and test results.

Electronics 2 or 3 Credits

An instructional program that prepares students in the design, development, modification and testing of electronic circuits, devices, and systems. Includes instruction in practical circuit feasibility; prototype development and testing; system analysis, including design, selection, installation, calibration and testing; solid-state and micro-miniature circuits; and the application of data to specific problems in the electronics field.

General Cooperative Education 2 or 3 Credits

Program which places students in entry level jobs in business/industry for the purpose of training.

Graphic Arts 2 or 3 Credits

An instructional program that prepares students for exploratory experiences and laboratory activities related to graphic arts. Program focuses on the fundamentals of graphic arts, including study of information and skills concerned with graphic reproduction using the tools, materials and processes of the printing industry. Experience includes designing, composing, printing, and evaluating reproduction techniques.

Heating, Air Conditioning & Refrigeration

2 or 3 Credits

An instructional program that generally prepares students to install, repair, and maintain the operating condition of heating, air conditioning and refrigeration systems.

Industrial Cooperative Education

2 or 3 Credits

Program which places students in entry level jobs in industry for the purpose of training.

Industrial Electricity

2 or 3 Credits

An instructional program that prepares students to assemble, install, operate, maintain and repair electrical equipment used in industry and manufacturing. Includes instruction in using actual equipment such as: power supplies, amplifiers, motors, controls, digital and computer circuitry, synchro and servomechanisms, mechanical power transfer systems, pneumatics, hydraulic systems, and three-phase A.C., and control circuitry.

Machine Shop

2 or 3 Credits

An instructional program that prepares students in the adjustment, maintenance, part replacement, and repair of tools, equipment, and machines.

Masonry

2 or 3 Credits

An instructional program that prepares students to lay brick, concrete block, hard tile, marble and related materials using trowels, levels, hammers, chisels, and other hand tools.

Metals Technology

2 or 3 Credits

An instructional program that prepares students to plan, manufacture, assemble, test and repair parts, mechanisms, machines, and structures in which materials are cast, formed, shaped, molded, heat treated, cut, twisted, pressed, fused, stamped, or otherwise worked upon.

Photography 2 or 3 Credits

An instructional program that describes the historic development, aesthetic qualities, theories, techniques, and creative processes of producing images on photographic film or plates.

Plastics 2 or 3 Credits

An instructional program that prepares students to mold and cast parts, patterns, and prototype parts; fit, fabricate, and repair internal carving; finish plastic parts; and assemble plastic components into products.

Plumbing and Pipefitting 2 or 3 Credits

An instructional program that prepares students to lay out, assemble, install and maintain piping fixtures, and piping systems for hot water, heating, cooling, drainage, lubricating, sprinkling, and industrial processing systems. Includes material selection and use of tools to cut, bend, join, and weld pipes.

Printing 2 or 3 Credits

An instructional program that describes all phases of offset printing, layout, composition, presswork, and binding, flexography, lithography and photoengraving. Prepares students to make ready, operate, and maintain printing presses.

Radio and Television Broadcasting 2 or 3 Credits

An instructional program that prepares students in the production of materials and the production and broadcasting of materials or programs. Instruction includes equipment, processes, and procedures used in producing and making radio or television broadcast operations; electronic communication, both radio and television; script and program preparation; photographic and audio recording of material to be broadcast.

Sheet Metal 2 or 3 Credits

An instructional program that prepares students to lay out, fabricate, erect or install, and maintain items made of steel, copper, stainless steel, and aluminum, using hand tools and machines such as cornice brakes, forming rolls, and squaring sheets.

Shoe Repair

2 or 3 Credits

An instructional program that prepares students to repair all types of footwear, including replacement and mending of worn parts; repairing orthopaedic footwear, refinishing and dyeing leather; and repairing other leather goods such as handbags, belts and luggage.

Tailoring

2 or 3 Credits

An instructional program that prepares students to construct, alter, and repair men's, women's and children's garments. Includes instruction in selection of design, fabric, and notions to customer specifications; taking measurements and fitting; preparing patterns; cutting, sewing and altering by hand; and/or finishing of garments.

Upholstering

2 or 3 Credits

An instructional program that prepares students to engage in all aspects of upholstering furniture, automobile seats, caskets, mattresses, and bedsprings. Includes installing, repairing, arranging, and securing springs, filler, padding, and covering material of mattresses and bedsprings; cutting, sewing, and trimming; cushion filling, tufting, and buttoning; and wood refinishing.

Welding

2 or 3 Credits

An instructional program that prepares students to use any welding and cutting processes according to diagrams, blueprints, or written specifications, and may include robotic applications.

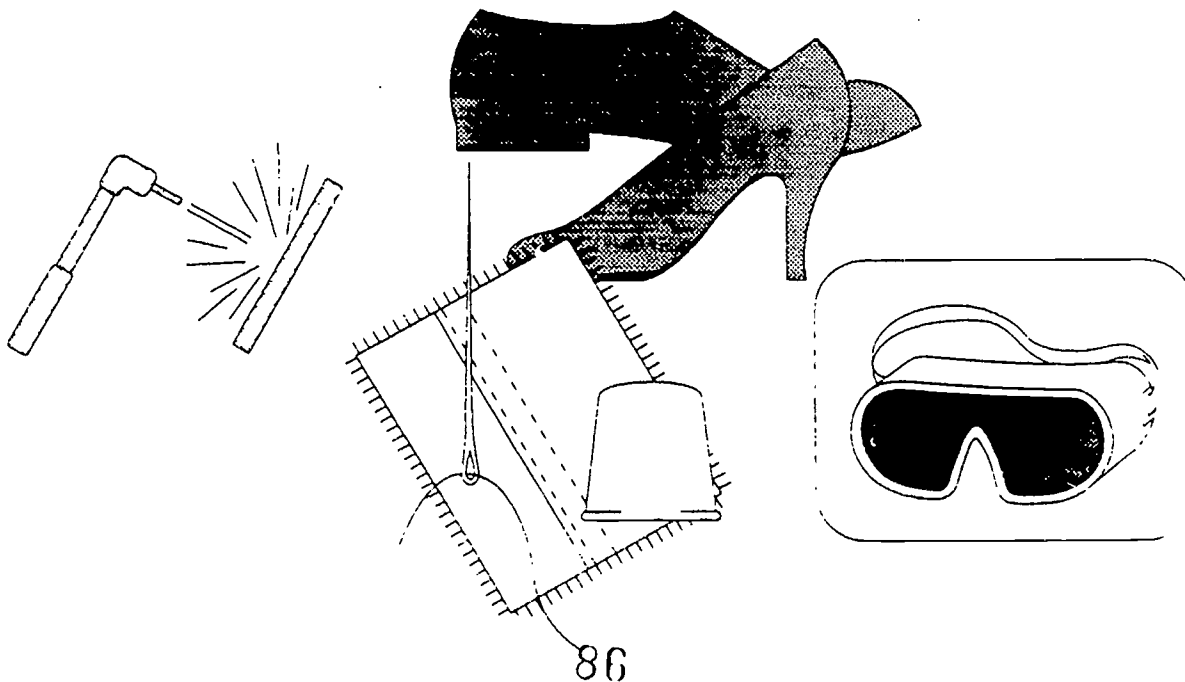



Graduation Requirements

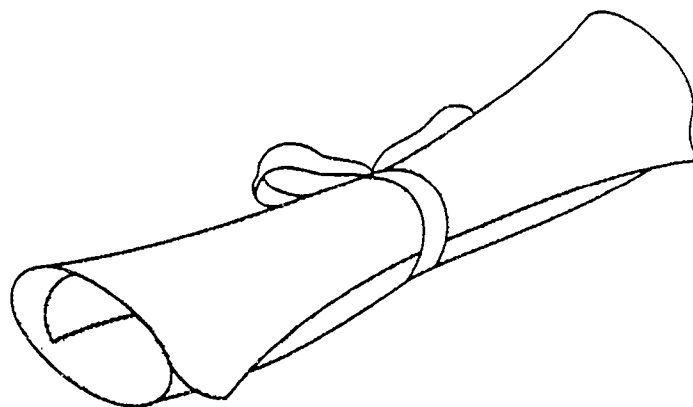

87

GRADUATION REQUIREMENTS

REGULAR DIPLOMA (1993-94 School Year)

<u>COURSES</u>	<u>UNITS</u>
English Language Arts	4
Mathematics	2
Science	2
United States History	1
Economics	1/2
Physical Education	1
Health Education	1/2
Electives	9
TOTAL	20

REGULAR DIPLOMA (1994-95 School Year)

<u>COURSES</u>	<u>UNITS</u>
English Language Arts	4
Mathematics	2
Science	2
United States History	1
United States Government	1/2
Economics	1/2
Additional courses in Mathematics, Science, or World History, World Geography, Ancient History, Modern History, or European History	1 1/2
Physical Education	1
Health Education	1/2
Electives	7
TOTAL	20

HONORS DIPLOMA

GENERAL CORE COURSES

	<u>Credits</u>
English (Honors level, if offered)	4
Mathematics (Algebra I, Algebra II and Geometry or Advanced Math	3
Science	3
Social Studies (United States History, Economics, and 1 1/2 additional units)	3
Physical Education	1
Health Education	1/2

General Education or

Vocational Education

Foreign Language	2
Fine Arts	1
Electives	3

Vocational Education	4
Electives	2

Total 20 1/2

Total 20 1/2

HOW TO USE GOOPS

Shows the largest occupations and those with the most openings.

This area describes the major duties of the occupation or group of occupations.

ADMINISTRATIVE SUPPORT: ACCOUNTING

Persons employed in this group of occupations provide clerical and administrative support to accountants and auditors. Most of these jobs require only a high school diploma for entry.

The largest occupations, which also have the greatest number of job openings annually, are:

- Bookkeeping, accounting, and auditing clerks
- Payroll and timekeeping clerks

These occupations may have a generally favorable outlook for the future. Overall, the number of these jobs shows little change. Large numbers of job openings are expected over the next four or five years. Recently, there have been fewer new trainees than job openings. If this trend continues, job opportunities should be good.

Hourly wages include:

- \$8.69 Bookkeeping, accounting, and auditing clerks
- \$8.96 Payroll and timekeeping clerks

High school programs preparing for these occupations are:

- 07.0101 Accounting and bookkeeping

Related postsecondary programs at state-supported institutions in this area are:

- 07.0601 Secretarial and related programs
- 07.0606 Secretarial and office administration
- 07.9999 Business and Office

Describes the job outlook for the occupations within the service delivery area.

Shows related education and training at public high schools and/or postsecondary schools.

Lists hourly wages for these occupations within the service delivery area.

STATEWIDE JOB OUTLOOK

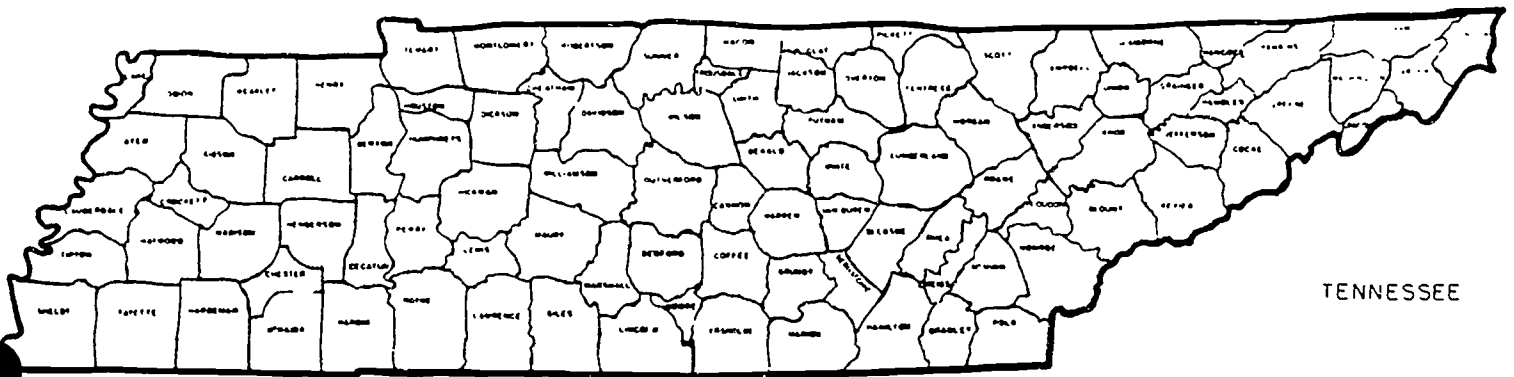

FOR OCCUPATIONS REQUIRING
FOUR YEARS OR MORE
OF COLLEGE

ARCHITECTURAL DESIGN

Architects provide a variety of professional services to individuals and organizations planning building projects. They are often involved in all phases of a project, from initial discussions through construction. Tasks include making drawings to present ideas and to show construction details, assisting in the preparation of construction contracts, and overseeing the construction process to ensure the contractor is following the plan and meeting all regulations.

This occupation may not have a favorable outlook for the future. Overall, the number of these jobs is growing. A moderate number of job openings are expected over the next four or five years. Recently, there have been many more state college graduates than job openings. If this trend continues, job seekers can expect to face keen competition.

Related postsecondary programs at state-supported institutions in Tennessee are:

04.0201 Architecture

Licensing may be required. Contact: TENNESSEE STATE BOARD OF ARCHITECTURAL AND ENGINEERING EXAMINERS, 615-741-3221.

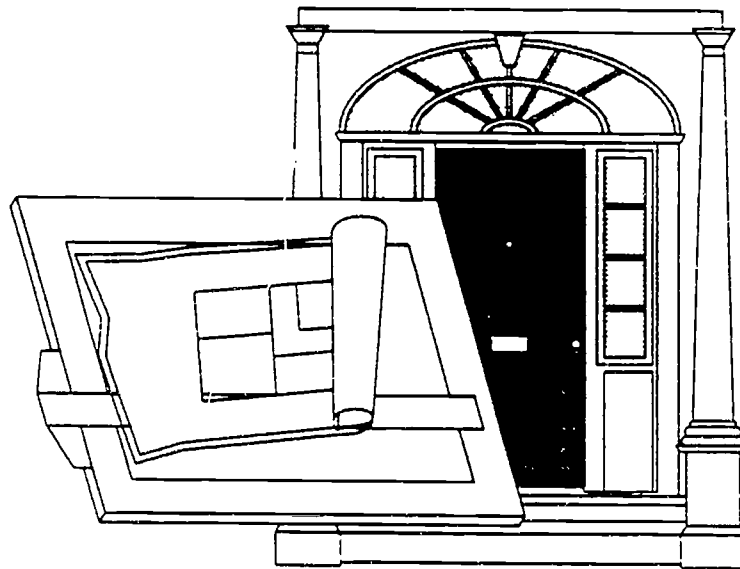

AUDIOLOGY AND SPEECH PATHOLOGY

Speech pathologists assess and treat persons with speech, language, voice, and fluency disorders, while audiologists assess and treat those with hearing and related disorders.

This occupation may not have a favorable outlook for the future. Overall, the number of these jobs is growing rapidly. A moderate number of job openings are expected over the next four or five years. Recently, there have been many more state college graduates than job openings. If this trend continues, job seekers can expect to face keen competition.

Related postsecondary programs at state-supported institutions in Tennessee are:

- 51.0202 Audiology and hearing sciences
- 51.0203 Speech-language pathology
- 51.0204 Audiology and speech pathology

Licensing may be required. Contact: TENNESSEE STATE BOARD OF EXAMINERS FOR SPEECH PATHOLOGY, 615-367-6243.

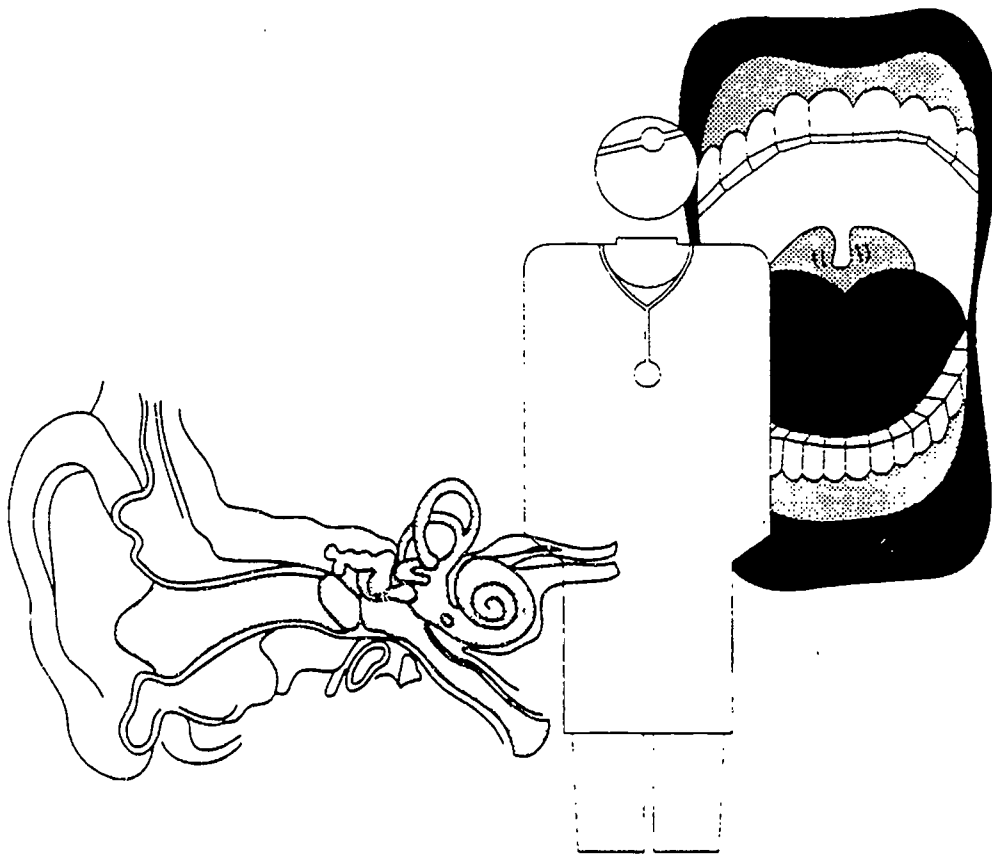

CHEMICAL ENGINEERING

Chemical engineers apply the principles of chemistry and engineering to solve problems. Many work in the production of chemicals and chemical products. They design equipment and develop processes for manufacturing chemicals in chemical plants, develop methods for quality control testing, and supervise production.

This occupation may have a generally favorable outlook for the future. Overall, the number of these jobs is growing. A moderate number of job openings are expected over the next four or five years. Recently, there have been more state college graduates than job openings. If this trend continues, job seekers can expect to face some competition.

Average hourly wages are \$23.92

Related postsecondary programs at state-supported institutions in Tennessee are:

14.0701 Chemical engineering

Licensing may be required. Contact: TENNESSEE STATE BOARD OF ARCHITECTURAL AND ENGINEERING EXAMINERS, 615-741-3221.

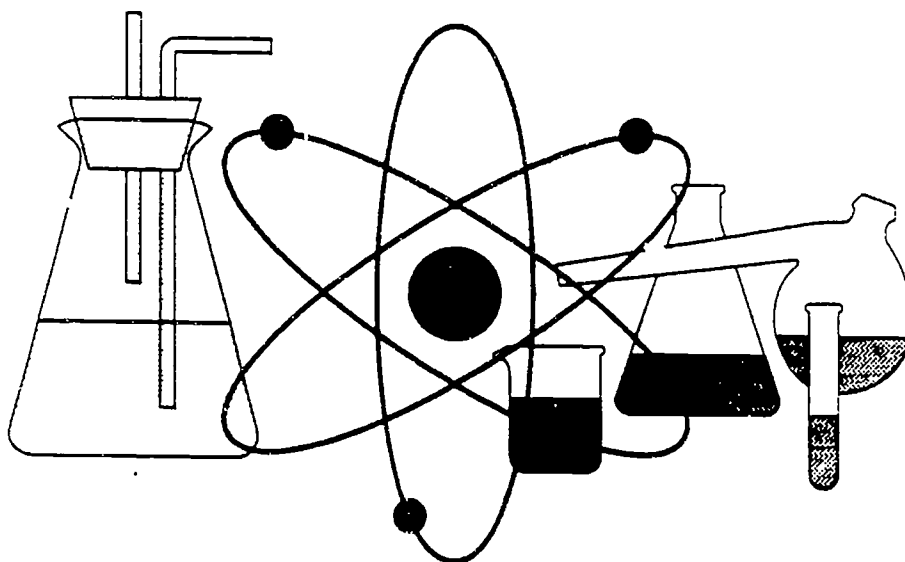

CHEMISTRY

Chemists research and put to practical use new knowledge about chemicals. They usually work in research and development for private industry, government agencies, or academic institutions. Areas of specialty include organic chemistry, inorganic chemistry, physical chemistry, and biochemistry.

The largest occupations, which also have the greatest number of job openings annually, are:

- Chemists, except biochemists
- Chemistry teachers

These occupations may not have a favorable outlook for the future. Overall, the number of these jobs is growing. A moderate number of job openings are expected over the next four or five years. Recently, there have been many more state college graduates than job openings. If this trend continues, job seekers can expect to face keen competition.

Hourly wages include:

\$16.38 Chemists, except biochemists

Related postsecondary programs at state-supported institutions in Tennessee are:

- 40.0501 Chemistry
- 40.0505 Medical, pharmaceutical chemistry

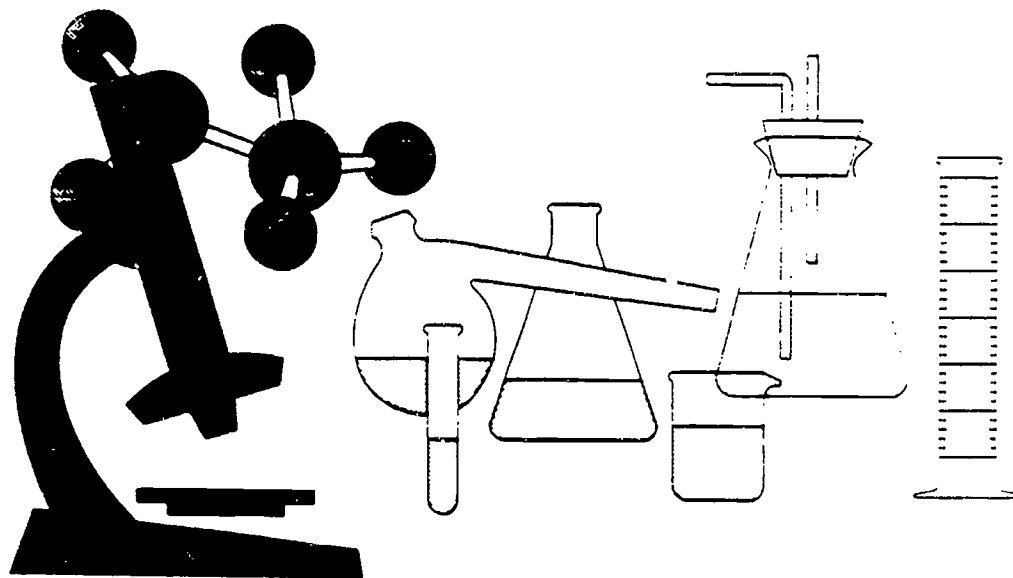

CIVIL ENGINEERING

Civil engineers plan, design, and oversee construction and maintenance of structures and facilities such as roads, railroads, bridges, airports, dams, power plants, water and sewage systems, and waste disposal units. A bachelor's degree in engineering with a heavy emphasis on mathematics is the accepted educational requirement to enter the field. Civil engineers may work for engineering firms, construction companies, governmental agencies, public utilities, railroads, or manufacturing firms.

This occupation may have a generally favorable outlook for the future. Overall, the number of these jobs is growing. A moderate number of job openings are expected over the next four or five years. Recently, there have been more state college graduates than job openings. If this trend continues, job seekers can expect to face some competition.

Average hourly wages are \$19.26

Related postsecondary programs at state-supported institutions in Tennessee are:

14.0801 Civil engineering

Licensing may be required. Contact: TENNESSEE STATE BOARD OF ARCHITECTURAL AND ENGINEERING EXAMINERS, 615-741-3221.

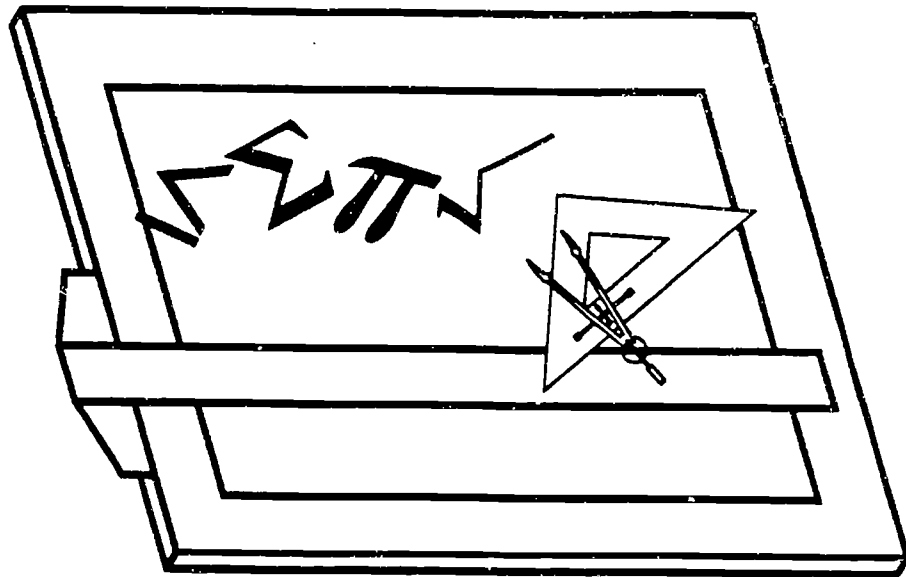

DENTISTRY

Dentists examine, diagnose, and treat diseases, injuries, and disorders of the mouth. They take X-rays, fill cavities, and perform corrective surgery. Dentists may specialize in one of several areas; all require a license. Training beyond the baccalaureate degree is required.

This occupation may have a generally favorable outlook for the future. Overall, the number of these jobs is growing. A moderate number of job openings are expected over the next four or five years. Although private colleges may also provide training, there have been fewer state college graduates than job openings recently. If this trend continues, job opportunities should be good.

Related postsecondary programs at state-supported institutions in Tennessee are:

51.0401 Dentistry (D.D.S., D.M.D.)

Licensing may be required. Contact: TENNESSEE BOARD OF DENTISTRY, 615-367-6228.

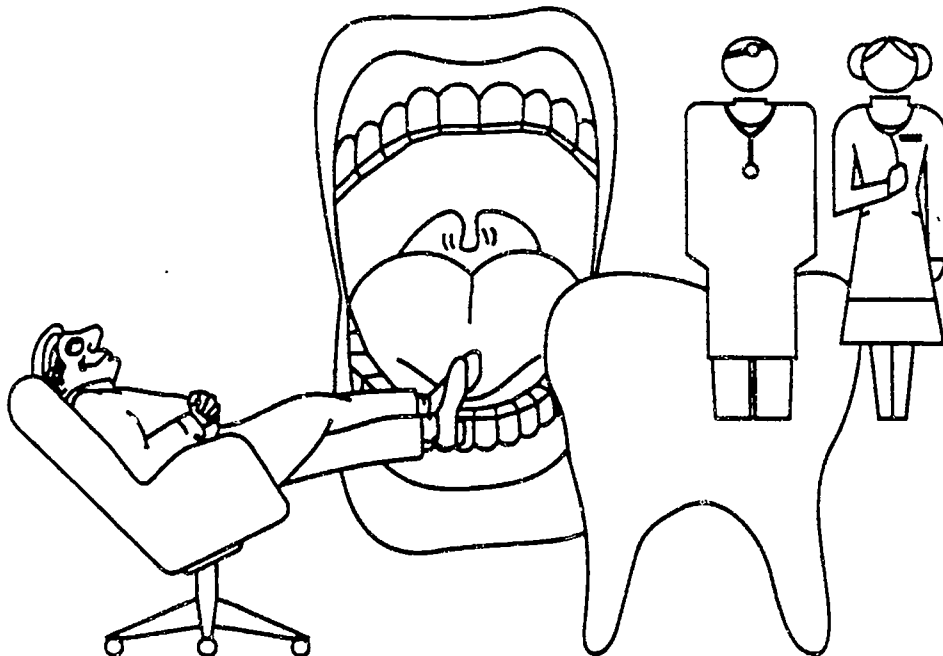

DRAMATIC ARTS

Actors, directors, and producers entertain and communicate with people through the creation and marketing of performances. They may create a visual and/or audio image for film, television, radio, or other medium, to provide entertainment and information.

These occupations may not have a favorable outlook for the future. Overall, the number of these jobs is growing rapidly. A moderate number of job openings are expected over the next four or five years. Recently, there have been many more state college graduates than job openings. If this trend continues, job seekers can expect to face keen competition.

Related postsecondary programs at state-supported institutions in Tennessee are:

50.0501 Drama and theater arts



ELECTRICAL AND ELECTRONIC ENGINEERING

This area of engineering is only one of several specialties workers can pursue. These engineers design, develop, produce, install, operate, maintain, and repair computer, electrical, and electronic equipment. Such engineers find work in manufacturing, government, public utilities, and engineering firms.

The largest occupations, which also have the greatest number of job openings annually, are:

- Electrical and electronic engineers
- Computer engineers

These occupations may have a generally favorable outlook for the future. Overall, the number of these jobs is growing rapidly. A moderate number of job openings are expected over the next four or five years. Although private colleges may also provide training, there have been about as many state college graduates as job openings recently. If this trend continues, job seekers can expect to face some competition.

Hourly wages include:

\$18.90 Electrical and electronic engineers

Related postsecondary programs at state-supported institutions in Tennessee are:

14.1001 Electrical, electronics, and communications engineering

Licensing may be required. Contact: TENNESSEE STATE BOARD OF ARCHITECTURAL AND ENGINEERING EXAMINERS, 615-741-3221.

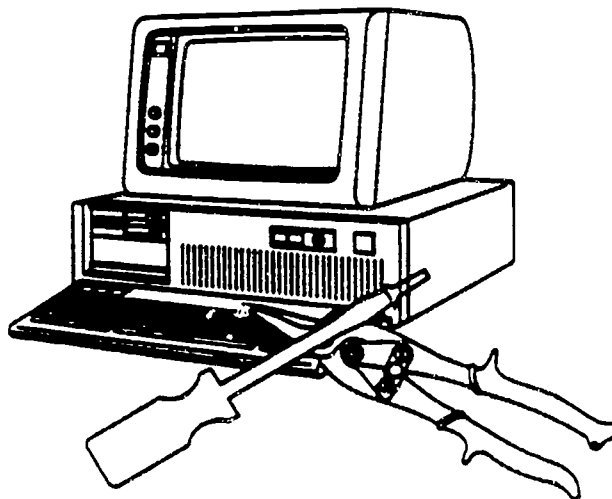

ELEMENTARY TEACHING

Elementary school teachers plan the learning experiences of children in first through the sixth grades, using many different types of learning tools. They help each student develop physically, emotionally, mentally, and socially. The scope of the teacher's job depends largely on the type of program employed by the individual school, whether it be the traditional self-contained classroom, team teaching, or non-graded concept of teaching.

This occupation may have a generally favorable outlook for the future. Overall, the number of these jobs is growing. Large numbers of job openings are expected over the next four or five years. Although private colleges may also provide training, there have been fewer state college graduates than job openings recently. If this trend continues, job opportunities should be good.

Related postsecondary programs at state-supported institutions in Tennessee are:

13.1202 Elementary education

Licensing may be required. Contact: OFFICE OF TEACHER LICENSING AND CAREER LADDER CERTIFICATION, 615-741-1644.

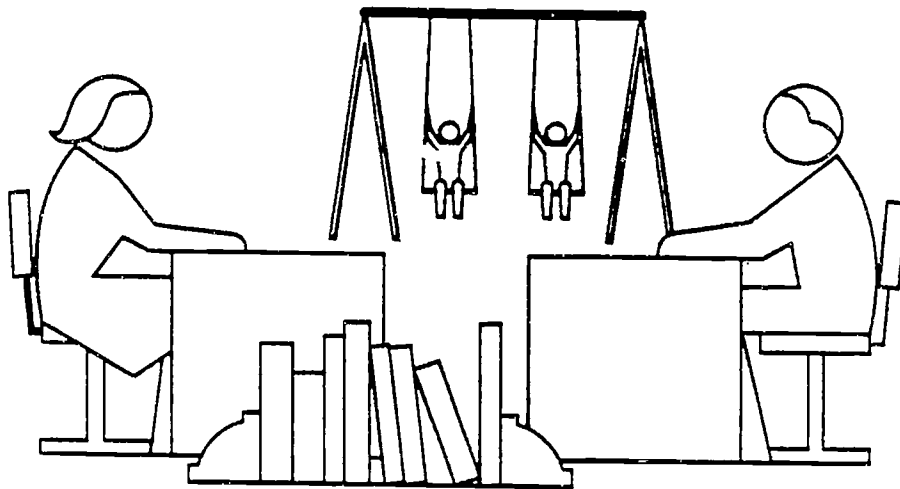

INDUSTRIAL ENGINEERING

Industrial engineers determine the most efficient and economical methods of using people, machines, and materials in a variety of industrial settings. They plan equipment layout, work flow, and accident prevention measures to best utilize plant facilities. They also plan and oversee work, study, and training programs to better utilize the worker. Industrial engineers develop and oversee quality control, inventory control, and production record systems.

This occupation may have a generally favorable outlook for the future. Overall, the number of these jobs is growing rapidly. A moderate number of job openings are expected over the next four or five years. Recently, there have been more state college graduates than job openings. If this trend continues, job seekers can expect to face some competition.

Average hourly wages are \$12.63

Related postsecondary programs at state-supported institutions in Tennessee are:

14.1701 Industrial engineering

Licensing may be required. Contact: TENNESSEE STATE BOARD OF ARCHITECTURAL AND ENGINEERING EXAMINERS, 615-741-3221.



LABORATORY TECHNOLOGY

Laboratory technologists perform a critical role in the detection, diagnosis, and treatment of diseases through the complex testing they perform of body fluids, tissue, and other substances. Included are workers who teach and supervise others performing the same types of tasks.

This occupation may have a generally favorable outlook for the future. Overall, the number of these jobs is growing rapidly. A moderate number of job openings are expected over the next four or five years. Although private colleges may also provide training, there have been fewer state college graduates than job openings recently. If this trend continues, job opportunities should be good.

Related postsecondary programs at state-supported institutions in Tennessee are:

- 51.1002 Cytotechnologist
- 51.1005 Medical technology

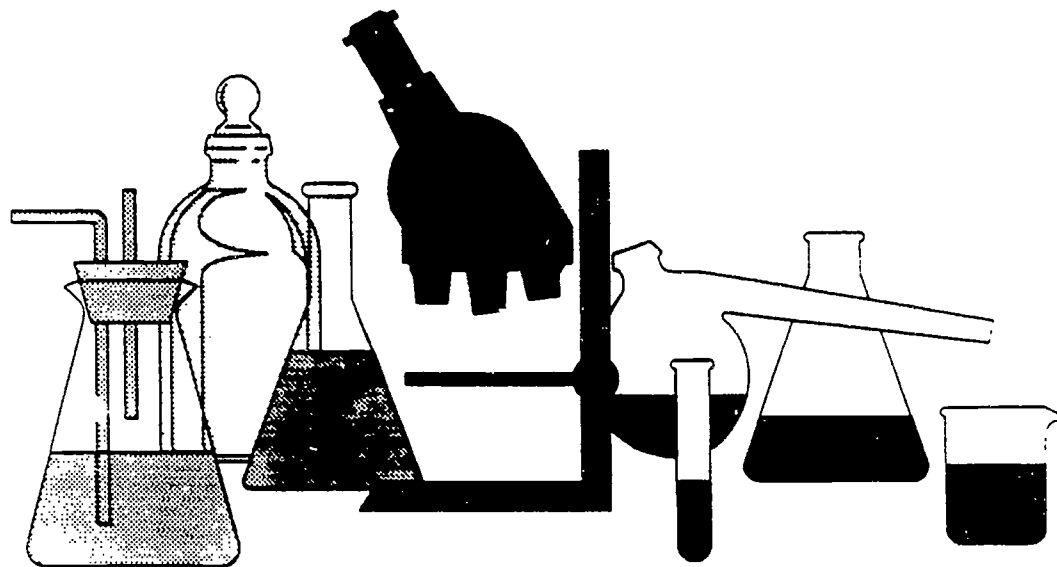

LAW

Lawyers research and interpret law to advise clients of their rights and responsibilities in legal matters. They conduct criminal cases and civil lawsuits, draft legal documents, and often represent the client in court or before administrative hearing officers. Lawyers may engage in private practice, or work for law firms, government, or non-profit groups or corporations. Training beyond the baccalaureate degree is required.

The largest occupations, which also have the greatest number of job openings annually, are:

- Adjudicators, hearings officers, and judicial reviewers
- Lawyers

These occupations may have a generally favorable outlook for the future. Overall, the number of these jobs is growing slowly. A moderate number of job openings are expected over the next four or five years. Although private colleges may also provide training, there have been about as many state college graduates as job openings recently. If this trend continues, job seekers can expect to face some competition.

Related postsecondary programs at state-supported institutions in Tennessee are:

22.0101 Law (LLB., J.D.)

Licensing may be required. Contact: BOARD OF PROFESSIONAL RESPONSIBILITY, 615-361-7500.

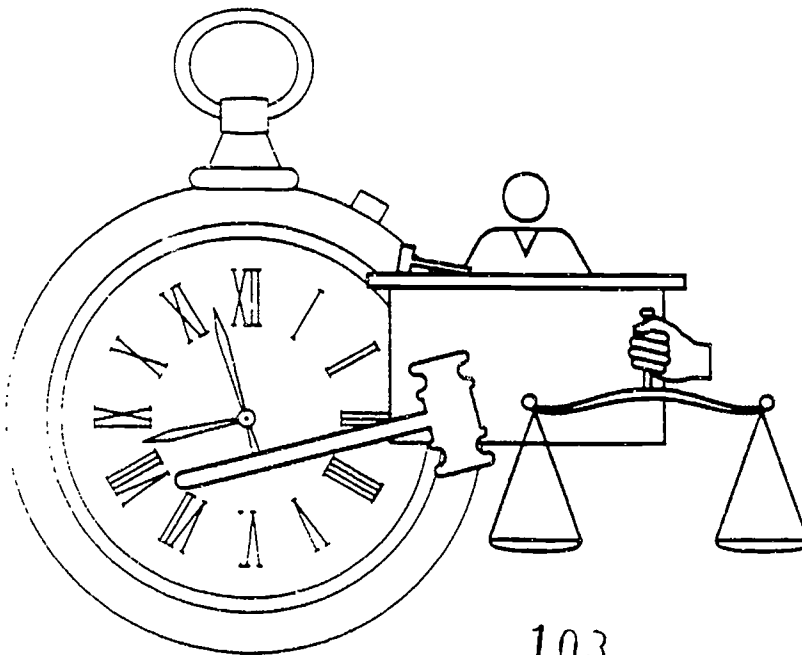

LIBRARY SCIENCE

Librarians obtain, organize, lend, and care for books, periodicals, audio and videotapes, and other educational reference materials. Places of work include public or school libraries and state departments of education.

This occupation may have a generally favorable outlook for the future. Overall, the number of these jobs is growing. A moderate number of job openings are expected over the next four or five years. Although private colleges may also provide training, there have been fewer state college graduates than job openings recently. If this trend continues, job opportunities should be good.

Related postsecondary programs at state-supported institutions in Tennessee are:

25.0101 Library science, librarianship

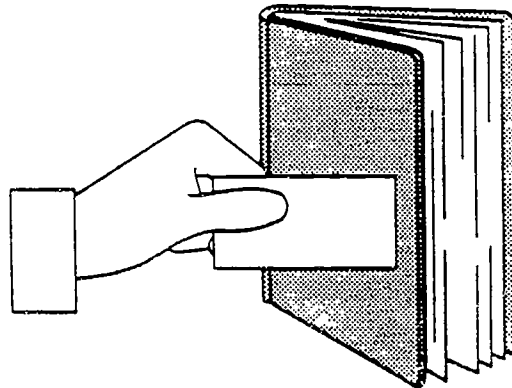

MARKETING, ADVERTISING, AND PUBLIC RELATIONS

Workers whose objectives are to market a product, service, or image of their firm or organization so that the public or consumers receive the best possible image are involved in these occupations. They use a variety of media and techniques to express the attributes of the organization they represent, including print, radio, television or outdoor advertisement.

The largest occupations, which also have the greatest number of job openings annually, are:

- Marketing, advertising, and public relations managers
- Sales agents of advertising

These occupations may have a generally favorable outlook for the future. Overall, the number of these jobs is growing rapidly. Large numbers of job openings are expected over the next four or five years. Although private colleges may also provide training, there have been fewer state college graduates than job openings recently. If this trend continues, job opportunities should be good.

Hourly wages include:

\$14.09 Public relations specialists and publicity writers

Related postsecondary programs at state-supported institutions in Tennessee are:

09.0201 Advertising
52.1401 Business marketing and marketing management

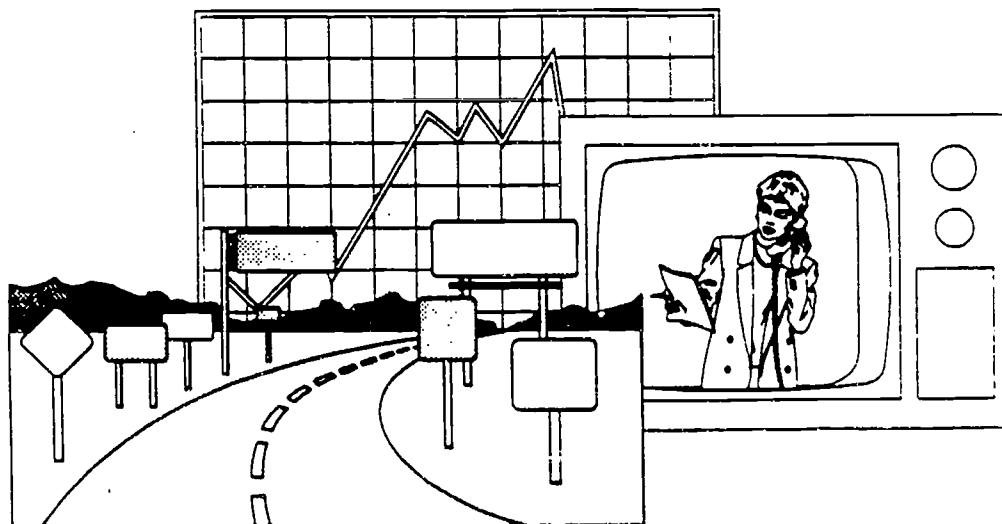

MECHANICAL ENGINEERING

Mechanical engineers are concerned with the design, production, installation, operation, and maintenance of tools, machines, engines and mechanical equipment which produce and use power. They may specialize in areas such as motor vehicles, marine equipment, or rocket engines. Many mechanical engineers work in research, development, sales, or maintenance.

This occupation may have a generally favorable outlook for the future. Overall, the number of these jobs is growing rapidly. A moderate number of job openings are expected over the next four or five years. Although private colleges may also provide training, there have been about as many state college graduates as job openings recently. If this trend continues, job seekers can expect to face some competition.

Average hourly wages are \$20.54

Related postsecondary programs at state-supported institutions in Tennessee are:

14.1901 Mechanical engineering

Licensing may be required. Contact: TENNESSEE STATE BOARD OF ARCHITECTURAL AND ENGINEERING EXAMINERS, 615-741-3221.

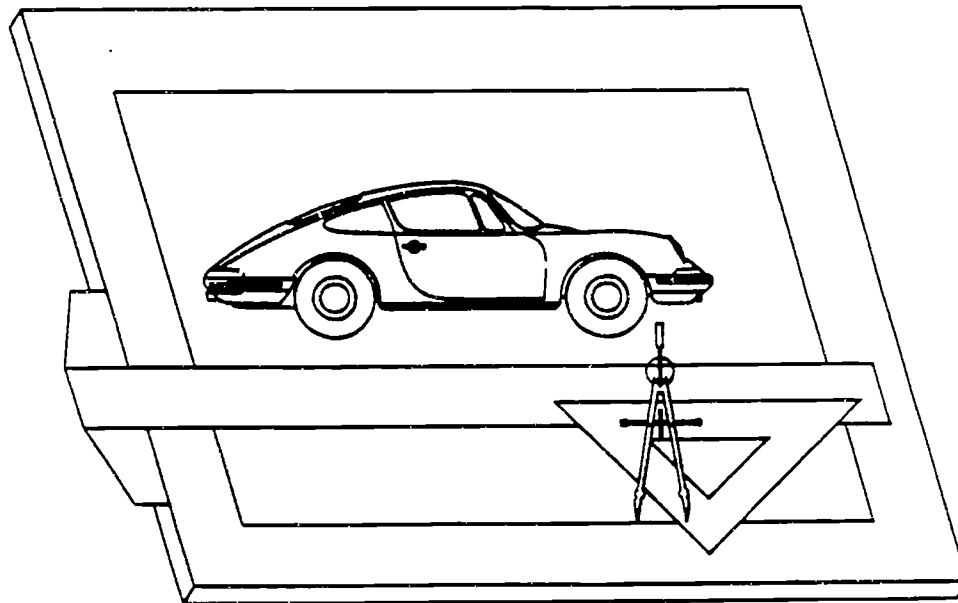

PHARMACISTS

Pharmacists measure, count, mix, and dispense drugs and medicines prescribed by physicians, dentists, and podiatrists. They must have a good understanding of the use, composition, and effects of drugs and how they are tested for purity and strength. Pharmacists work for pharmacies, drug stores, or drug departments of stores and supermarkets. They also work for hospitals, nursing homes, or clinics.

This occupation may have a generally favorable outlook for the future. Overall, the number of these jobs is growing. A moderate number of job openings are expected over the next four or five years. Although private colleges may also provide training, there have been fewer state college graduates than job openings recently. If this trend continues, job opportunities should be good.

Related postsecondary programs at state-supported institutions in Tennessee are:

51.2001 Pharmacy

Licensing may be required. Contact: TENNESSEE BOARD OF PHARMACY, 615-741-2718.



PHYSICAL THERAPY

Physical therapists develop programs of treatment and exercise to rehabilitate patients disabled due to illness or injury. They use heat, light, water, electricity, massage, sound therapeutic exercises, and mobilization to treat patients. Physical therapists often specialize in the type of patient they treat, such as children, the severely disabled, or the elderly.

This occupation may have a generally favorable outlook for the future. Overall, the number of these jobs is growing rapidly. A moderate number of job openings are expected over the next four or five years. Although private colleges may also provide training, there have been fewer state college graduates than job openings recently. If this trend continues, job opportunities should be good.

Average hourly wages are \$18.68

Related postsecondary programs at state-supported institutions in Tennessee are:

51.2308 Physical therapy

Licensing may be required. Contact: TENNESSEE STATE BOARD OF OCCUPATIONAL AND PHYSICAL THERAPY, 615-367-6243.

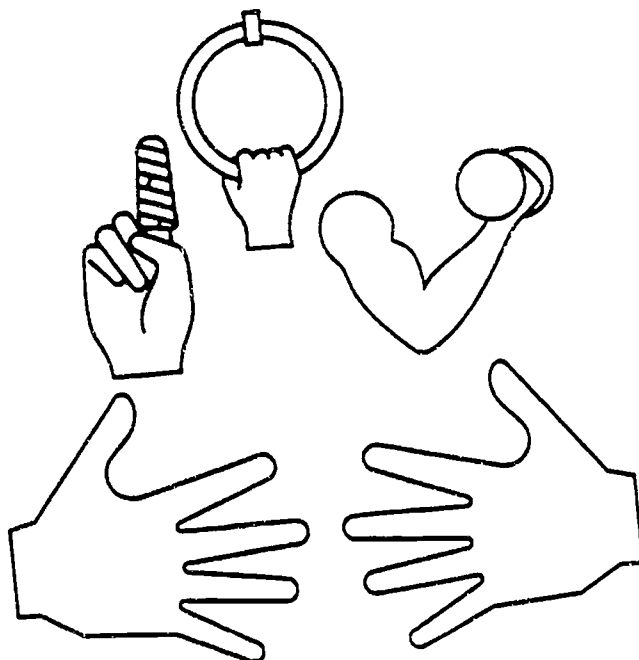

PHYSICIANS AND SURGEONS

Physicians and surgeons examine, diagnose, and treat illnesses and injuries of the human body as well as practicing preventive medicine. Others in the field may treat mental disorders. Many specialize in one area such as surgery, obstetrics, or family practice. Some combine medical practice with research or teaching. Training beyond the baccalaureate degree is required.

This occupation may have a generally favorable outlook for the future. Overall, the number of these jobs is growing rapidly. Large numbers of job openings are expected over the next four or five years. Although private colleges may also provide training, there have been fewer state college graduates than job openings recently. If this trend continues, job opportunities should be good.

Related postsecondary programs at state-supported institutions in Tennessee are:

51.1201 Medicine (M.D.)

Licensing may be required. Contact: TENNESSEE BOARD OF MEDICAL EXAMINERS, 615-367-6231.

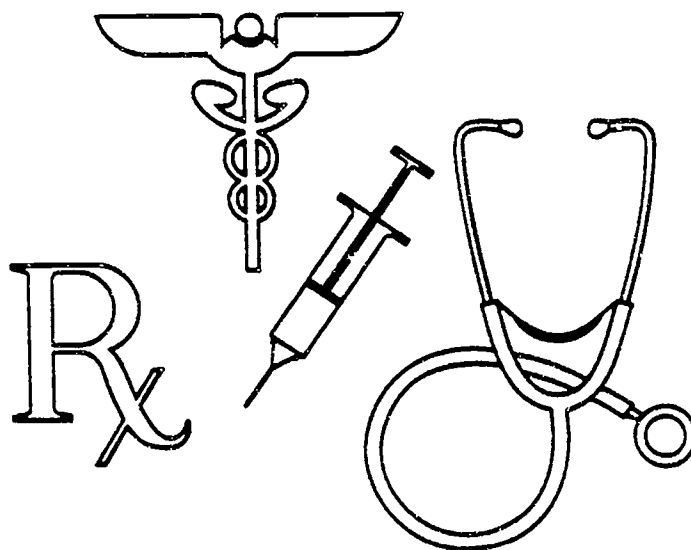

PRESCHOOL AND KINDERGARTEN TEACHING

Kindergarten and preschool teachers work with children up to six years of age in public, private, or church sponsored schools, teaching them elemental, physical, mental, and developmental skills. Using a wide variety of teaching methods and equipment, they may introduce students to subjects such as science, numbers, and language. Teachers closely communicate with parents to give the student a positive image of the educational system and a firm foundation for continued learning.

These occupations may have a generally favorable outlook for the future. Overall, the number of these jobs is growing rapidly. Large numbers of job openings are expected over the next four or five years. Although private colleges may also provide training, there have been fewer state college graduates than job openings recently. If this trend continues, job opportunities should be good.

Related postsecondary programs at state-supported institutions in Tennessee are:

13.1204 Pre-elementary education

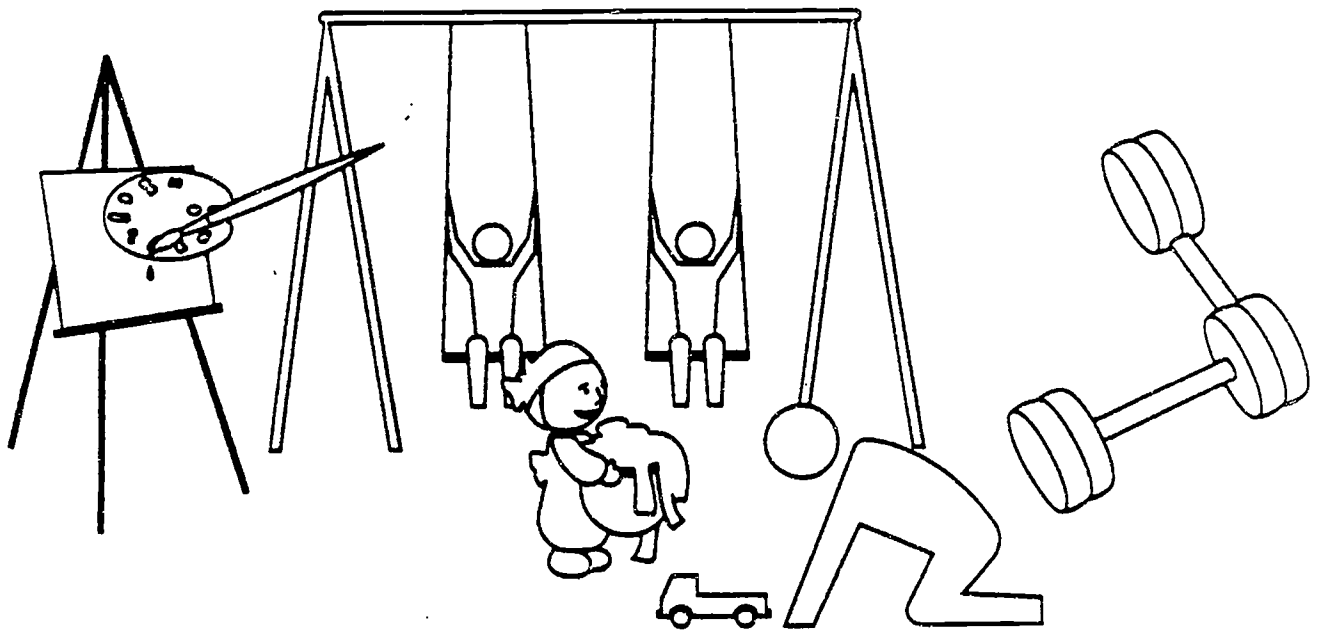

PSYCHOLOGY

Psychologists are employed in a variety of work environments including government, hospitals, research and consulting firms, and academic institutions. Psychologists study human behavior and mental processes to understand, explain, and change people's behavior. They typically collect and interpret scientific data through controlled laboratory experiments or through testing, observing, or surveying individuals. Training beyond the baccalaureate degree is usually required.

This occupation may not have a favorable outlook for the future. Overall, the number of these jobs is growing rapidly. A moderate number of job openings are expected over the next four or five years. Recently, there have been many more state college graduates than job openings. If this trend continues, job seekers can expect to face keen competition.

Related postsecondary programs at state-supported institutions in Tennessee are:

13.0802	Educational psychology
42.0101	Psychology
42.0901	Industrial and organizational psychology
42.1701	School psychology

Licensing may be required. Contact: BOARD OF EXAMINERS IN PSYCHOLOGY, 615-367-6291.

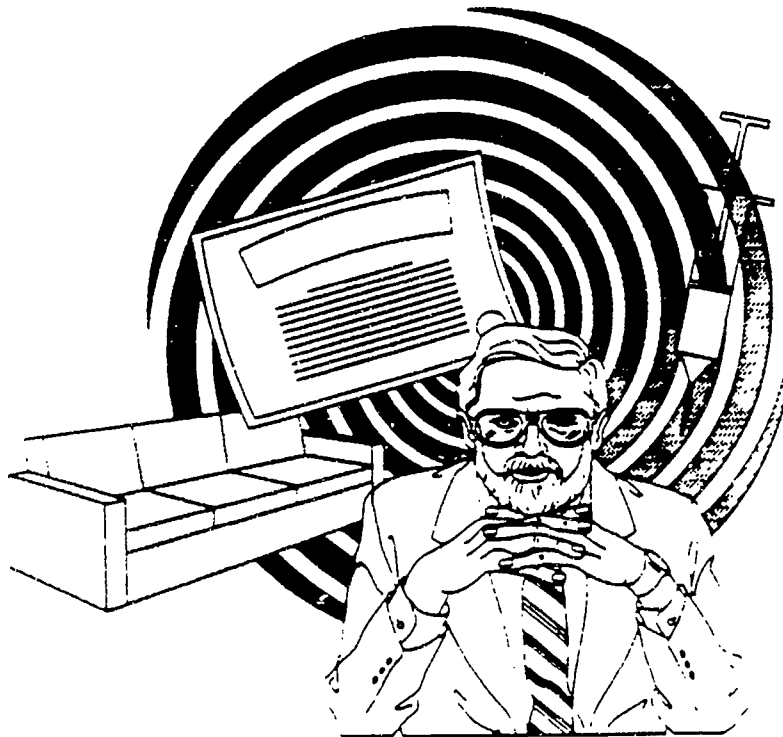

SOCIAL SCIENCES

The majority of individuals working in this field are postsecondary teachers. Courses taught include sociology, history, and political science. The majority of these subjects pertain to human society, economic and social relations, and scientific data relating to human behavior. Training beyond the baccalaureate degree is usually required.

The largest occupations, which also have the greatest number of job openings annually, are:

- Social scientists, except economists, planners, and psychologists
- Social science teachers in colleges and universities

These occupations may have a generally favorable outlook for the future. Overall, the number of these jobs is growing. A moderate number of job openings are expected over the next four or five years. Although private colleges may also provide training, there have been fewer state college graduates than job openings recently. If this trend continues, job opportunities should be good.

Related postsecondary programs at state-supported institutions in Tennessee are:

- | | |
|---------|----------------------------------|
| 45.0201 | Anthropology |
| 45.0701 | Geography |
| 45.0801 | History |
| 45.1001 | Political science and government |
| 45.1101 | Sociology |

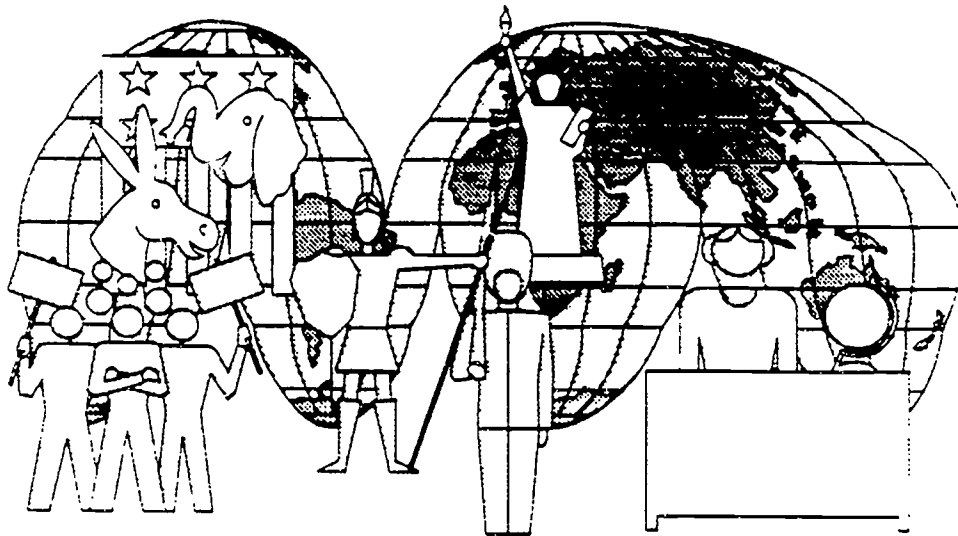

SOCIAL WORK

Social workers are employed in a variety of work environments including government, hospitals, and human service agencies. Social workers counsel individuals and groups with problems dealing with poverty, illness, family, anti-social behavior, financial mismanagement, and inadequate housing. Caseworkers usually specialize in such fields as child welfare, family services, and medical, psychiatric, or public assistance.

The largest occupations, which also have the greatest number of job openings annually, are:

- Medical and psychiatric social workers
- Social workers, except medical and psychiatric social workers

These occupations may have a generally favorable outlook for the future. Overall, the number of these jobs is growing. A moderate number of job openings are expected over the next four or five years. Although private colleges may also provide training, there have been about as many state college graduates as job openings recently. If this trend continues, job seekers can expect to face some competition.

Hourly wages include:

\$9.95 Social workers, except medical and psychiatric

Related postsecondary programs at state-supported institutions in Tennessee are:

44.0701 Social work

Licensing may be required. Contact: BOARD OF SOCIAL WORKERS CERTIFICATION AND LICENSURE, 615-367-6207.



113

SPECIAL EDUCATION TEACHING

Special education teachers work with physically or learning disabled students in elementary and secondary schools. They observe and evaluate students in order to plan and carry out academic and recreational programs that will result in maximum progress for the student.

This occupation may have a generally favorable outlook for the future. Overall, the number of these jobs is growing rapidly. A moderate number of job openings are expected over the next four or five years. Although private colleges may also provide training, there have been fewer state college graduates than job openings recently. If this trend continues, job opportunities should be good.

Related postsecondary programs at state-supported institutions in Tennessee are:

13.1001 Special education

Licensing may be required. Contact: OFFICE OF TEACHER LICENSING AND CAREER LADDER CERTIFICATION, 615-741-1644.

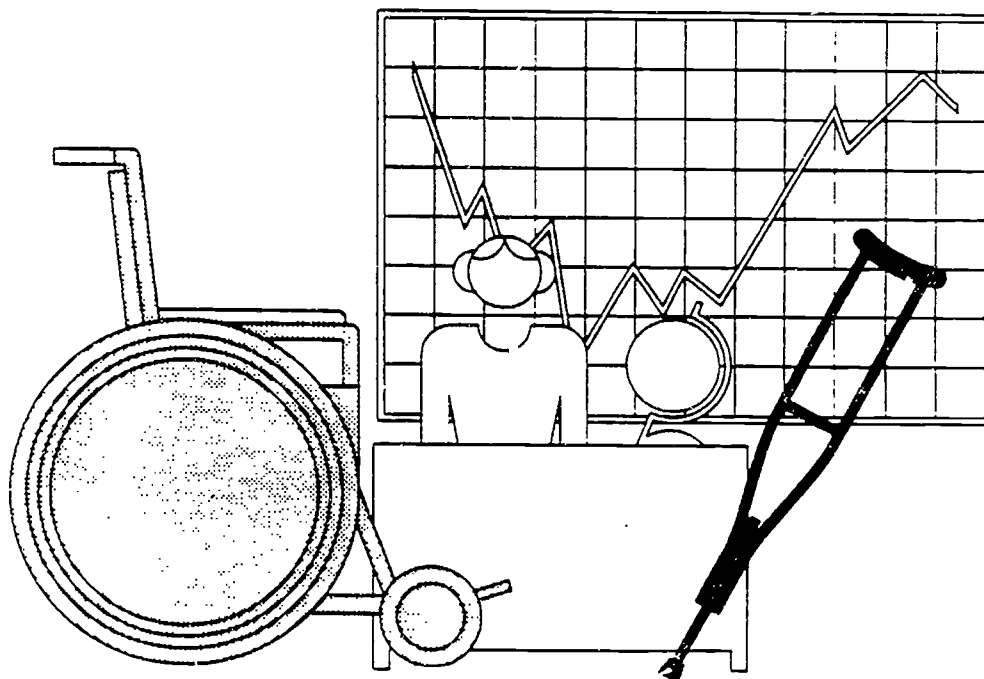

VETERINARY MEDICINE

Veterinarians are concerned with the prevention, diagnosis, and treatment of illness or injury to animals. They can administer both medical and surgical treatment.

This occupation may not have a favorable outlook for the future. Overall, the number of these jobs is growing slowly. Few job openings are expected over the next four or five years. Recently, there have been many more state college graduates than job openings. If this trend continues, job seekers can expect to face keen competition.

Related postsecondary programs at state-supported institutions in Tennessee are:

51.2401 Veterinary medicine

Licensing may be required. Contact: STATE BOARD OF VETERINARY MEDICINE, 615-367-6225.

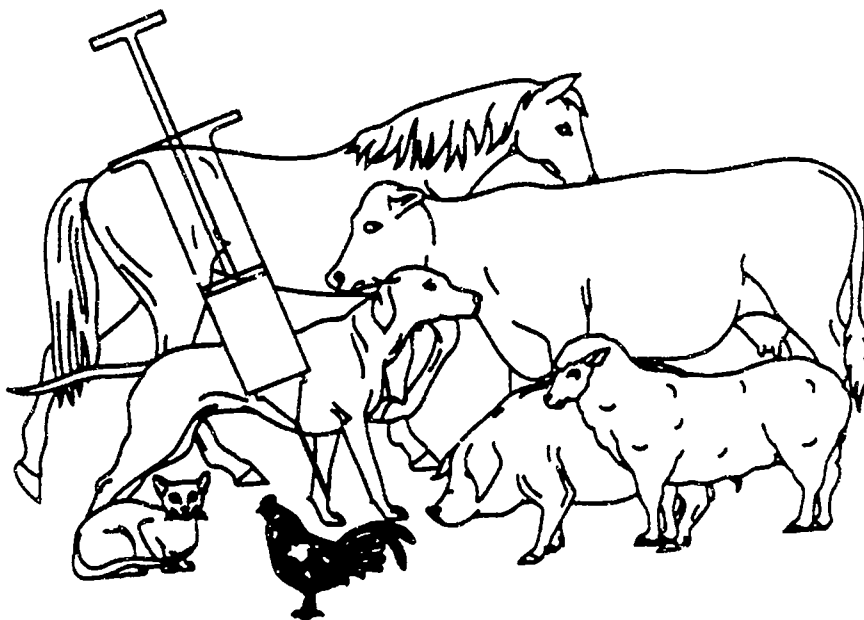

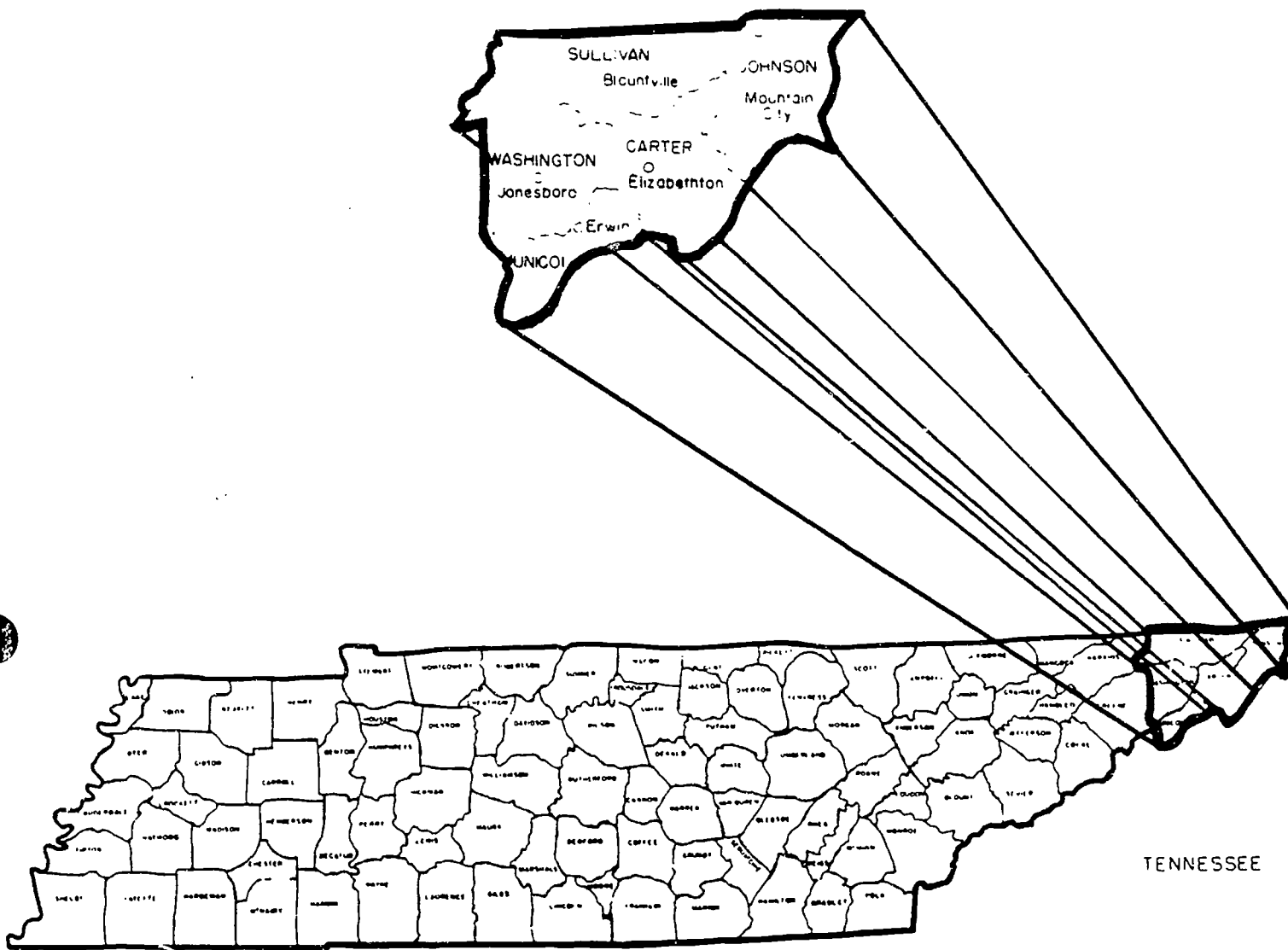

Service Delivery Area 1

ACCOUNTING AND FINANCIAL MANAGEMENT

Many individuals in this group are accountants and auditors who prepare and analyze business records and financial reports which are needed for effective management of any organization. Financial managers, another occupation in this group, typically plan, organize, control, or coordinate the financial activities of an organization.

The largest occupations, which also have the greatest number of job openings annually, are:

- Financial managers
- Accountants and auditors

These occupations may not have a favorable outlook for the future. Overall, the number of these jobs is growing. Large numbers of job openings are expected over the next four or five years. Recently, there have been many more new trainees than job openings. If this trend continues, job seekers can expect to face keen competition.

Hourly wages include:

\$13.09 Accountants and auditors
\$22.53 Financial managers

Related postsecondary programs at state-supported institutions in this area are:

52.0301 Accounting
52.0801 Finance

Licensing may be required. Contact: TENNESSEE BOARD OF ACCOUNTANCY, 615-741-2250.



SDA 1 - 1

ADMINISTRATIVE SUPPORT: ACCOUNTING

Persons employed in this group of occupations provide clerical and administrative support to accountants and auditors. Most of these jobs require only a high school diploma for entry.

The two largest occupations are:

- Bookkeeping, accounting, and auditing clerks
- Payroll and timekeeping clerks

The occupations expected to have the most job openings annually are:

- Bookkeeping, accounting, and auditing clerks
- Billing, posting, and calculating machine operators

These occupations may have a generally favorable outlook for the future. Overall, the number of these jobs shows little change. A moderate number of job openings are expected over the next four or five years. Recently, there have been fewer new trainees than job openings. If this trend continues, job opportunities should be good. Placement rates at area vocational technical schools, community colleges, and/or technical institutes have been good recently.

Hourly wages include:

- \$8.69 Bookkeeping, accounting, and auditing clerks
- \$8.96 Payroll and timekeeping clerks

Related postsecondary programs at state-supported institutions in this area are:

07.0101 Accounting and bookkeeping

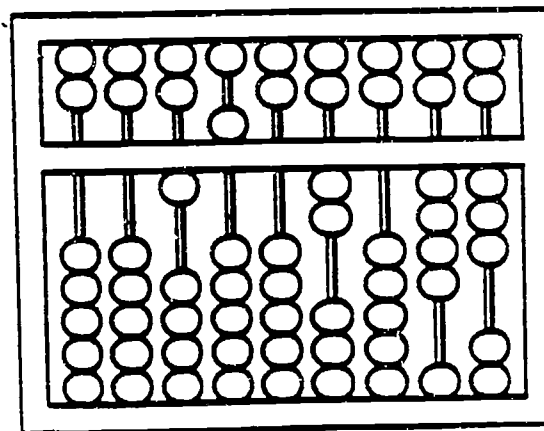
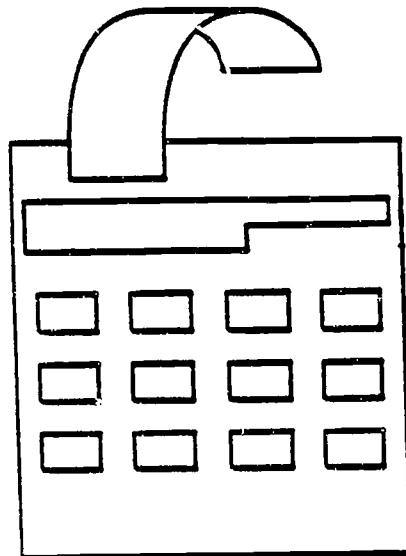

ADMINISTRATIVE SUPPORT: FINANCE AND INSURANCE

Workers provide clerical and general administrative support to the banking and finance industry. Workers receive and pay out money, keep records of money and negotiable instruments, interview applicants for credit, locate and notify customers of delinquent accounts, examine insurance claims, and process a variety of paperwork.

The largest occupations, which also have the greatest number of job openings annually, are:

- Tellers
- Bill and account collectors

These occupations may have a generally favorable outlook for the future. Overall, the number of these jobs shows little change. Few job openings are expected over the next four or five years. Recently, there have been fewer new trainees than job openings. Placement rates at area vocational technical schools, community colleges, and/or technical institutes have been good recently.

Hourly wages include:

\$6.40 Bill and account collectors

Related postsecondary programs at state-supported institutions in this area are:

07.0201 Banking and finance

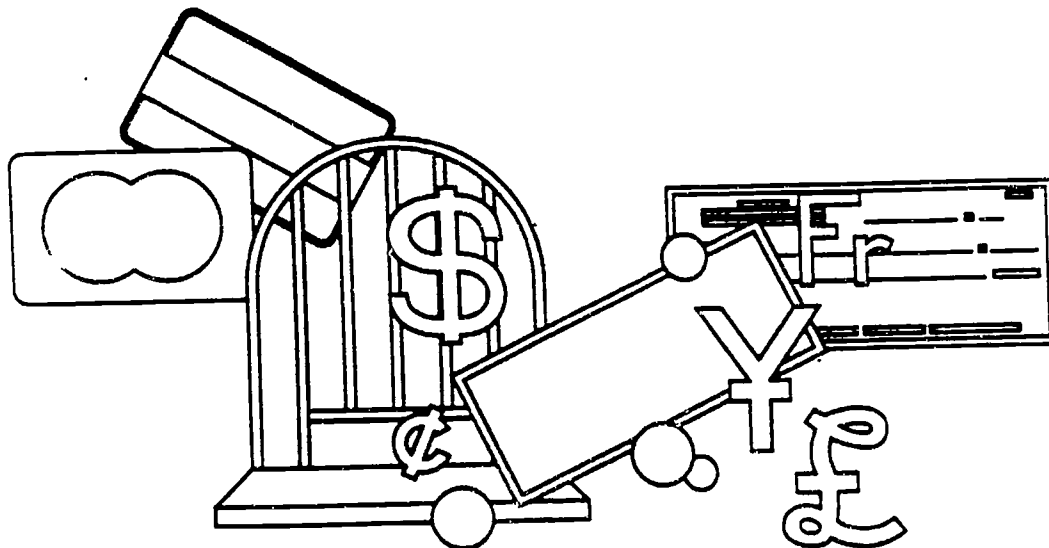

ADMINISTRATIVE SUPPORT: GENERAL

The job duties in this group of occupations are very diverse and are determined by the type of firm. For example, workers may schedule appointments, give information to callers, take dictation, type correspondence, read and route incoming mail, file correspondence and other records, and supervise and coordinate the activities of subordinate clerical workers.

The largest occupations, which also have the greatest number of job openings annually, are:

- Secretaries, except legal and medical secretaries
- General office clerks

These occupations may have a generally favorable outlook for the future. Overall, the number of these jobs is growing. Large numbers of job openings are expected over the next four or five years. Recently, there have been more new trainees than job openings. If this trend continues, job seekers can expect to face some competition. Placement rates at area vocational technical schools, community colleges, and/or technical institutes have been fair recently.

Hourly wages include:

\$4.93	File clerks
\$6.09	Data entry keyers, except composing
\$7.13	General office clerks
\$7.45	Receptionists and information clerks
\$7.46	Order clerks- materials, merchandise, and service
\$7.62	Secretaries, ex. legal and medical
\$7.94	Medical secretaries
\$8.12	Typists including word processing
\$8.27	Legal secretaries
\$12.09	First line supervisors and manager/supervisors- clerical and administrative support occupations

High school programs preparing for these occupations are:

07.0601	Secretarial and related programs
07.0701	Typing, general office and related programs
07.0799	Miscellaneous typing, general office, and related programs

Related postsecondary programs at state-supported institutions in this area are:

07.0606	Secretarial and office administration
07.9999	Miscellaneous business administrative support
52.0401	Administrative assistant and secretarial science

AGRICULTURAL PRODUCTION

Workers in this field plan and economically use facilities, land, water, machinery, chemicals, finance, and labor in the production of plant and animal products.

The largest occupations, which also have the greatest number of job openings annually, are:

- Farm managers
- Farm workers

These occupations may not have a favorable outlook for the future. Overall, the number of these jobs shows little change. Few job openings are expected over the next four or five years. Recently, there have been many more new trainees than job openings.

High school programs preparing for these occupations are:

01.0301 Agricultural production

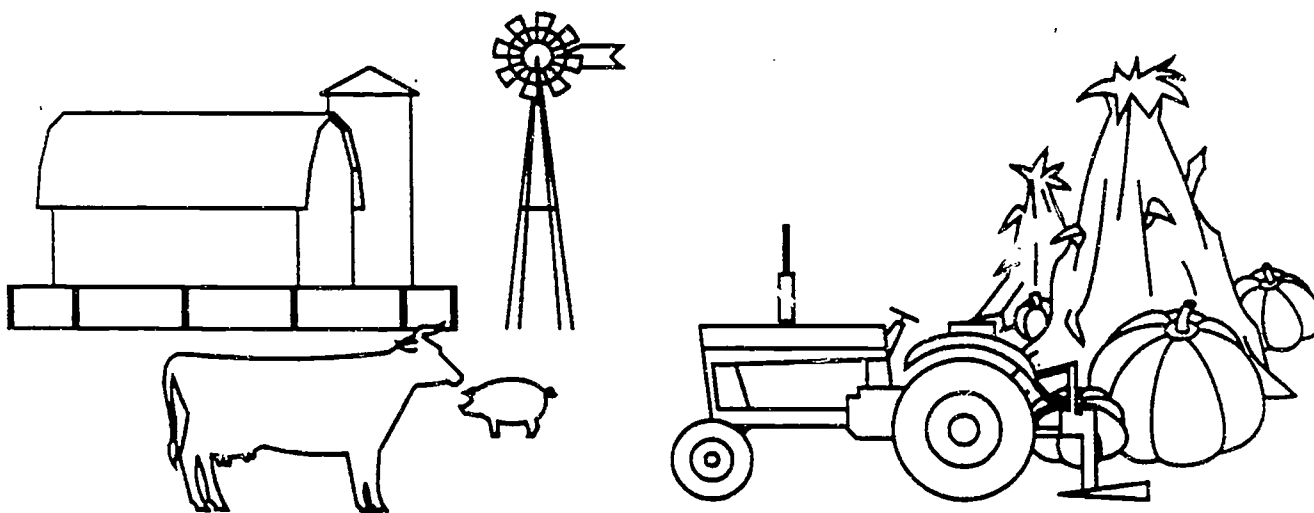

APPLIANCE AND EQUIPMENT REPAIR

Individuals in these occupations repair, adjust, maintain, and install all types of electrical motors and electrical and gas home appliances. Types of equipment used include test instruments, gauges, and hand, bench, and power tools.

The two largest occupations are:

- Electric home appliance and power tool repairers
- Electric motor, transformer, and related repairers

The occupations expected to have the most job openings annually are:

- Coin and vending machine servicers and repairers
- Gas appliance repairers

These occupations may not have a favorable outlook for the future. Overall, the number of these jobs shows little change. Very few job openings are expected over the next four or five years. Recently, there have been many more new trainees than job openings. Placement rates at area vocational technical schools, community colleges, and/or technical institutes have been good recently.

High school programs preparing for these occupations are:

47.0101 Electrical and electronics technology

Related postsecondary programs at state-supported institutions in this area are:

47.0101 Electrical and electronics technology

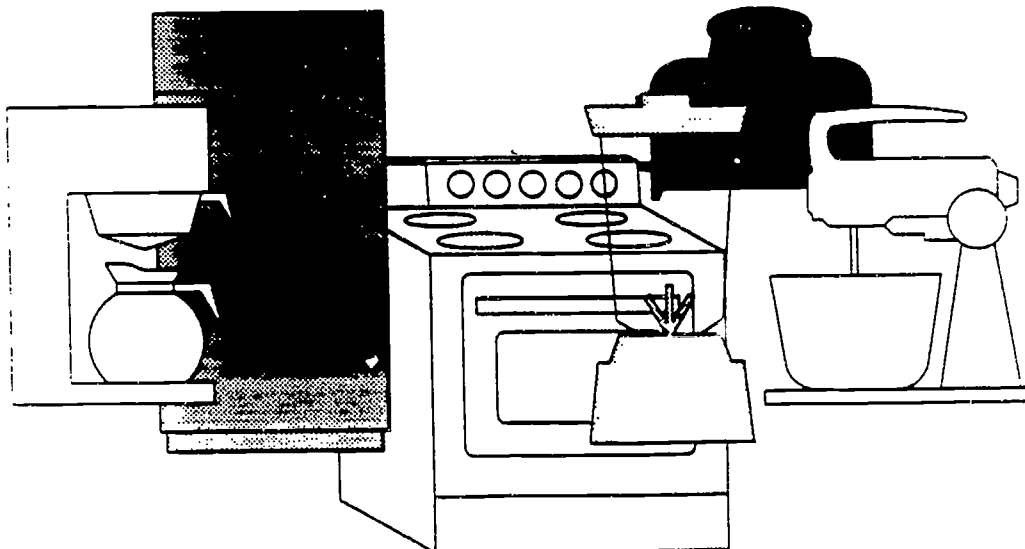

AUTOMOTIVE BODY REPAIR

Thousands of motor vehicles are damaged in traffic accidents every day. The workers in this field straighten bent frames, remove dents, and replace crumpled parts that are beyond repair so that those vehicles look and drive like new.

The largest occupations, which also have the greatest number of job openings annually, are:

- Automotive body and related repairers
- Painters of transportation equipment

These occupations may not have a favorable outlook for the future. Overall, the number of these jobs shows little change. Few job openings are expected over the next four or five years. Recently, there have been many more new trainees than job openings.

High school programs preparing for these occupations are:

- 47.J603 Automotive body repair

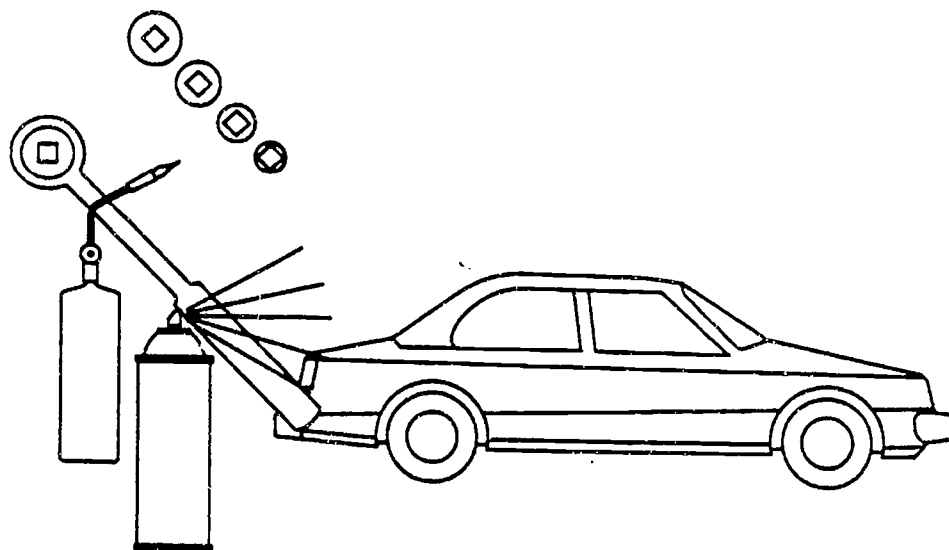

AUTOMOTIVE SERVICE TECHNOLOGY

These occupations include jobs concerned with parking, cleaning, polishing, lubricating, repairing, and refueling trucks, buses, and automobiles, and related servicing activities. The primary occupation, automotive mechanic, is concerned with repair and service of motor vehicles.

The largest occupations, which also have the greatest number of job openings annually, are:

- Automotive mechanics
- Tire repairers and changers

These occupations may have a generally favorable outlook for the future. Overall, the number of these jobs is growing slowly. A moderate number of job openings are expected over the next four or five years. Recently, there have been many more new trainees than job openings. If this trend continues, job seekers can expect to face keen competition. Placement rates at area vocational technical schools, community colleges, and/or technical institutes have been very good recently.

Hourly wages include:

\$7.42 Automotive mechanics

High school programs preparing for these occupations are:

47.0604 Automotive mechanics
47.0699 Miscellaneous vehicle and mobile equipment mechanics and repairers

Related postsecondary programs at state-supported institutions in this area are:

15.0803 Automotive technology
47.0604 Automotive mechanics

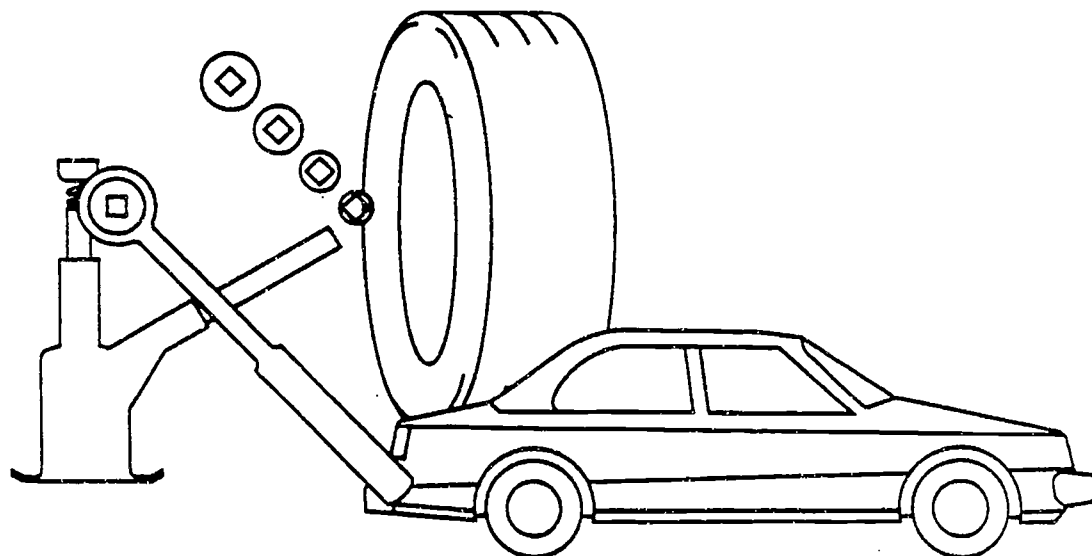

BUILDING MAINTENANCE

Persons in building maintenance occupations perform work involving several maintenance skills to keep the structure of an establishment in repair. Duties may involve pipefitting, boilermaking, carpentry, and electrical work as well as repairing buildings, floors, or stairs.

The two largest occupations are:

- General utility maintenance repairers
- Boiler operators and tenders of low pressure boilers

The occupations expected to have the most job openings annually are:

- General utility maintenance repairers
- Stationary engineers

These occupations may have a generally favorable outlook for the future. Overall, the number of these jobs is growing. A moderate number of job openings are expected over the next four or five years. Recently, no training has been reported. Job opportunities should be good.

Hourly wages include:

\$8.10 Maintenance repairers, general utility

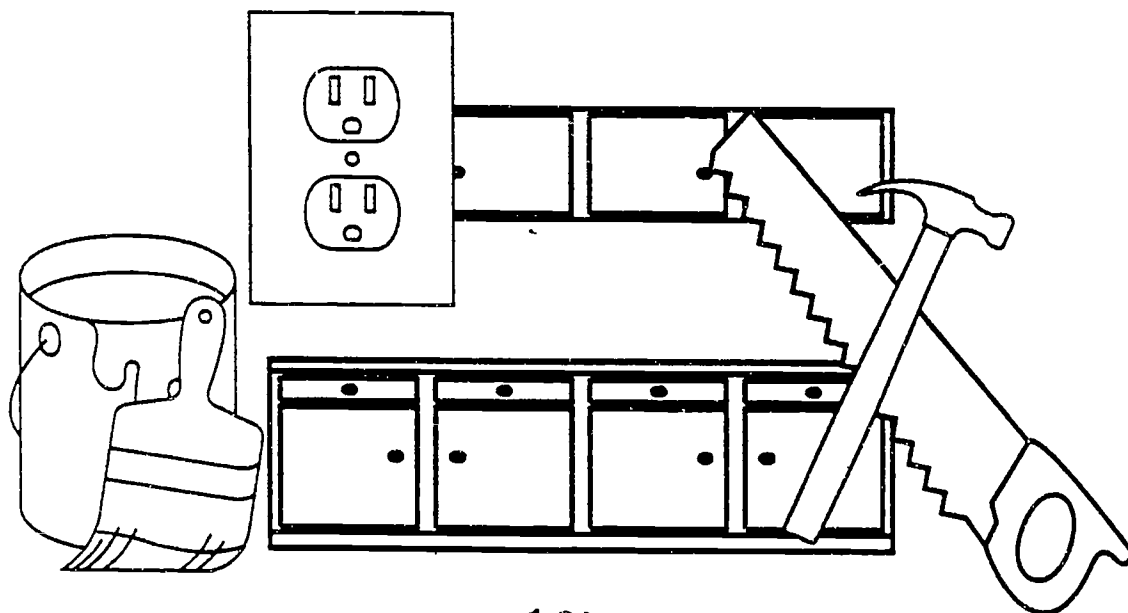

CARPENTRY

Almost all construction projects employ carpenters, the largest group of building trades workers. Carpenters perform a variety of jobs. Their duties will vary by type of construction, type of company, skill of the carpenter, and size of the community. A carpenter employed by a special trade contractor, for example, may specialize in laying hardwood floors, while one who is employed by a general building contractor may build wall frames and install paneling.

The largest occupations, which also have the greatest number of job openings annually, are:

- Carpenters
- Ceiling tile installers and acoustical carpenters

These occupations may have a generally favorable outlook for the future. Overall, the number of these jobs is growing slowly. A moderate number of job openings are expected over the next four or five years. Recently, there have been fewer new trainees than job openings. If this trend continues, job opportunities should be good.

Hourly wages include:

\$10.28 Carpenters

High school programs preparing for these occupations are:

46.0201 Carpentry

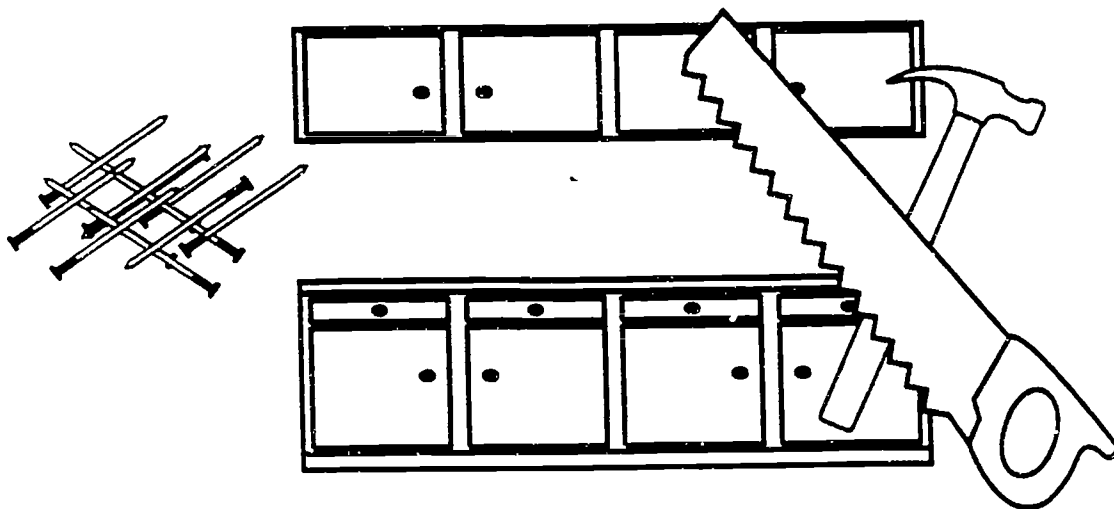

CHEMICAL TECHNOLOGY

Chemical technology workers either research and monitor chemical processes or are directly involved in operating equipment or control boards to create chemical reactions and processes in industrial settings. Technicians work with chemists or chemical engineers, setting up and conducting experiments and collecting and analyzing data.

The two largest occupations are:

- Chemical equipment controllers and operators
- Chemical (except health) technicians and technologists

The occupations expected to have the most job openings annually are:

- Chemical (except health) technicians and technologists
- Chemical plant and system operators

These occupations may have a generally favorable outlook for the future. Overall, the number of these jobs is declining. A moderate number of job openings are expected over the next four or five years. Recently, there have been fewer new trainees than job openings. If this trend continues, job opportunities should be good. Placement rates at area vocational technical schools, community colleges, and/or technical institutes have been very good recently.

Related postsecondary programs at state-supported institutions in this area are:

41.0301 Chemical technology

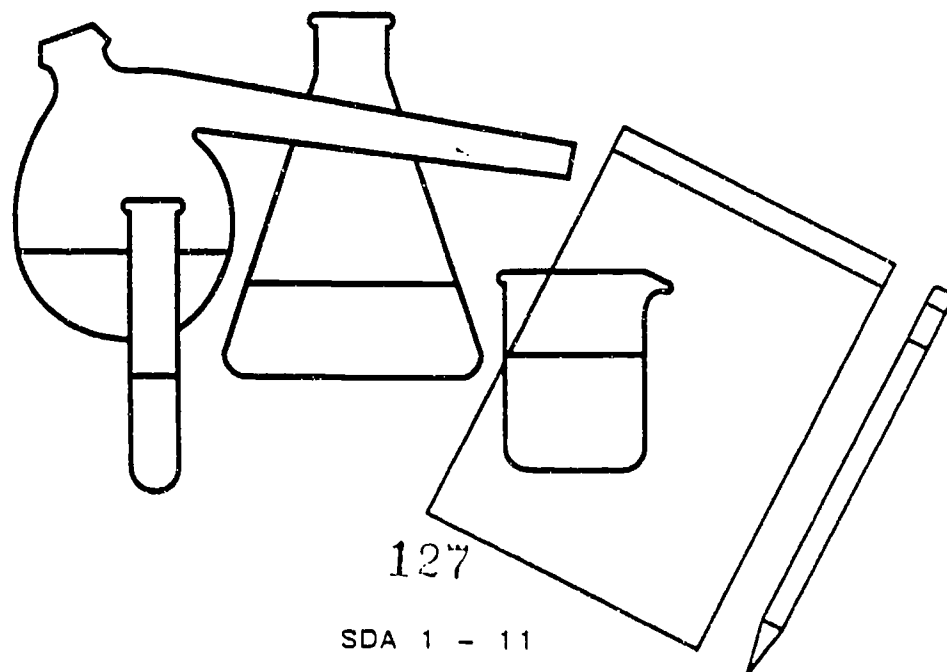

127

SDA 1 - 11

COMMERCIAL ART AND DESIGN

The majority of workers in this field design or arrange objects and materials in an artistic or decorative manner. Additional tasks may include the creation or drawing of designs for items such as furniture and machinery (product design).

The largest occupations, which also have the greatest number of job openings annually, are:

- Artists and related workers
- Designers, except interior designers

These occupations may have a generally favorable outlook for the future. Overall, the number of these jobs is growing. A moderate number of job openings are expected over the next four or five years. Recently, no training has been reported.

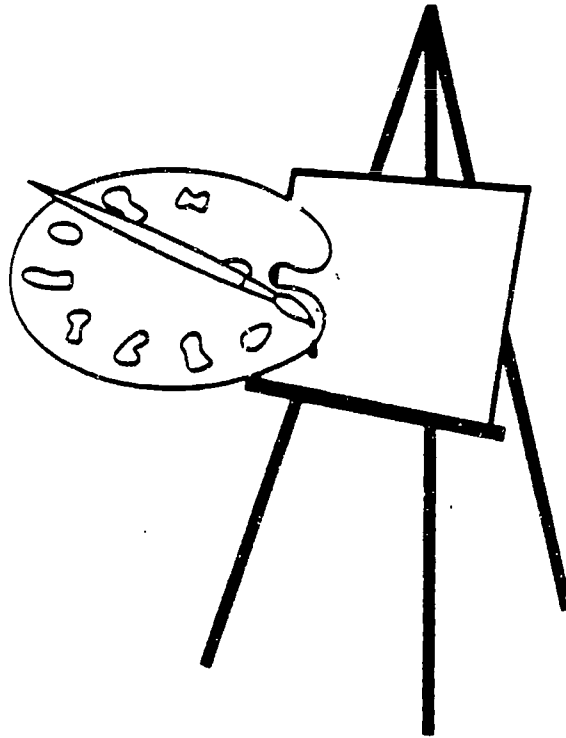

COMMUNICATIONS, JOURNALISM, AND BROADCASTING

Individuals who work in these fields are concerned with communicating ideas and information to individuals for their education and entertainment. The methods utilized are varied and may include the written word, radio, and television.

The two largest occupations are:

- Writers and editors
- Reporters and correspondents

The occupations expected to have the most job openings annually are:

- Writers and editors
- Radio and television announcers

These occupations may not have a favorable outlook for the future. Overall, the number of these jobs is growing rapidly. A moderate number of job openings are expected over the next four or five years. Recently, there have been many more new trainees than job openings.

High school programs preparing for these occupations are:

- 09.0601 Radio and television news broadcasting
- 09.0701 Radio and television broadcasting

Related postsecondary programs at state-supported institutions in this area are:

- 09.C403 Mass communication

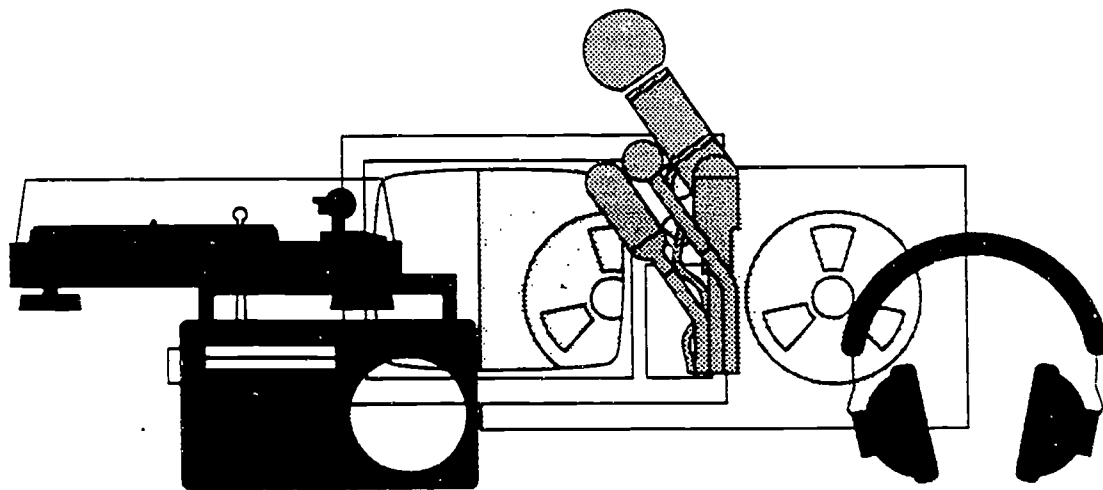

COMPUTER, ELECTRICAL, AND ELECTRONICS TECHNOLOGY

The majority of workers in this field are electrical and electronic engineering technicians and technologists. They apply electrical and related knowledge to design, build, test, and repair electrical equipment in industrial or commercial settings for subsequent use by engineering personnel.

This occupation may have a generally favorable outlook for the future. Few job openings are expected over the next four or five years. Recently, there have been many more new trainees than job openings. Placement rates at area vocational technical schools, community colleges, and/or technical institutes have been very good recently.

Average hourly wages are \$13.94

Related postsecondary programs at state-supported institutions in this area are:

- 15.0301 Computer engineering technology
- 15.0302 Electrical technology
- 15.0303 Electronic technology

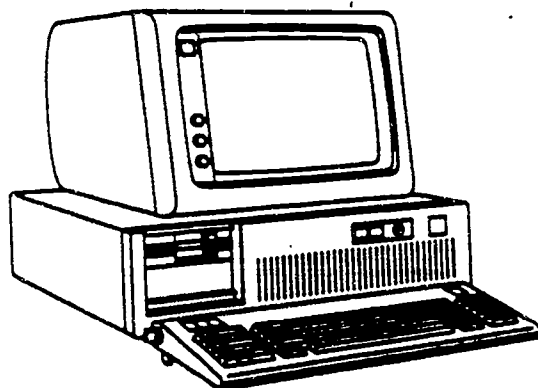

COMPUTER SYSTEMS

Workers in these computer occupations develop and write computer programs to store, locate, and retrieve specific documents, data, and information. They may also analyze business, scientific, and technical problems for application to electronic data processing systems. These careers generally require specialized training.

The largest occupations, which also have the greatest number of job openings annually, are:

- Systems analysts, electronic data processing
- Computer programmers

These occupations may not have a favorable outlook for the future. Overall, the number of these jobs is growing rapidly. A moderate number of job openings are expected over the next four or five years. Recently, there have been many more new trainees than job openings. If this trend continues, job seekers can expect to face keen competition. Placement rates at area vocational technical schools, community colleges, and/or technical institutes have been good recently.

Hourly wages include:

- \$14.97 Computer programmers
- \$16.46 Systems analysts, electronic data processing

High school programs preparing for these occupations are:

- 11.0101 Computer and information sciences
- 11.0201 Computer programming
- 11.9999 Miscellaneous computer and information sciences

Related postsecondary programs at state-supported institutions in this area are:

- 07.0301 Electronic data processing, computer science
- 11.0101 Computer and information sciences

COSMETOLOGY

Cosmetologists and related workers provide beauty services for customers. These may include cutting and styling hair, treating hair and scalp, applying makeup, dressing wigs, or removing hair by electrolysis, as well as cleaning, shaping, and polishing a customer's fingernails and toenails.

The two largest occupations are:

- Hairdressers, hairstylists, and cosmetologists
- Manicurists

The occupations expected to have the most job openings annually are:

- Hairdressers, hairstylists, and cosmetologists
- Shampooers

These occupations may not have a favorable outlook for the future. Overall, the number of these jobs is growing. A moderate number of job openings are expected over the next four or five years. Recently, there have been many more new trainees than job openings. If this trend continues, job seekers can expect to face keen competition.

High school programs preparing for these occupations are:

12.0403 Cosmetology

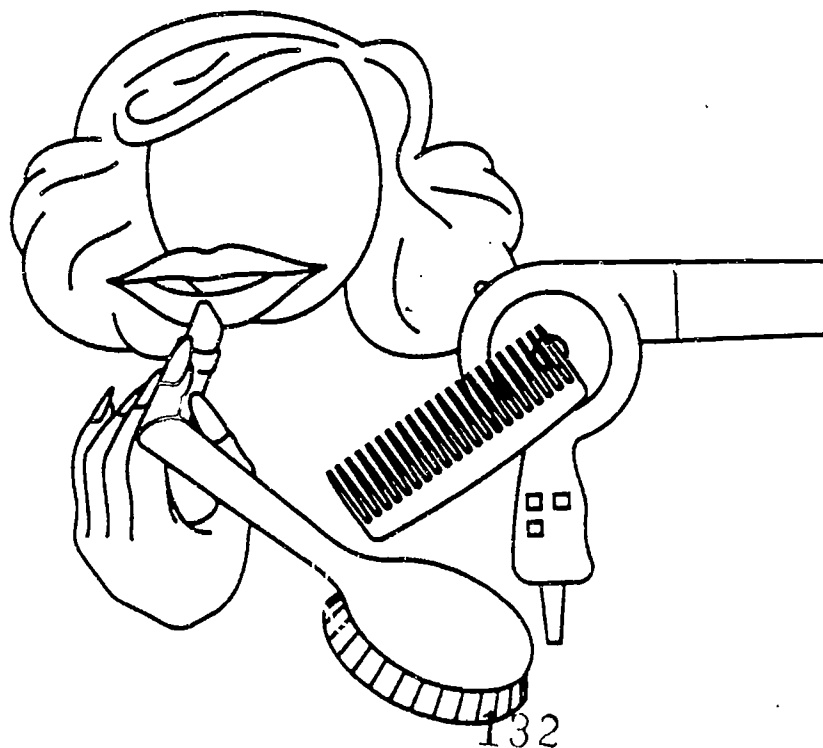

DENTAL ASSISTING

Dental assistants may perform a wide variety of clinical, office, and laboratory duties, depending on the size of the dental practice. Typically, assistants seat patients in the dental chair, prepare them for the dentist's treatment, and work with the dentist during examination and treatment.

This occupation may have a generally favorable outlook for the future. Overall, the number of these jobs is growing. Few job openings are expected over the next four or five years. Recently, there have been more new trainees than job openings.

Related postsecondary programs at state-supported institutions in this area are:

51.0601 Dental assistant

Licensing may be required. Contact: TENNESSEE BOARD OF DENTISTRY, 615-367-6228.

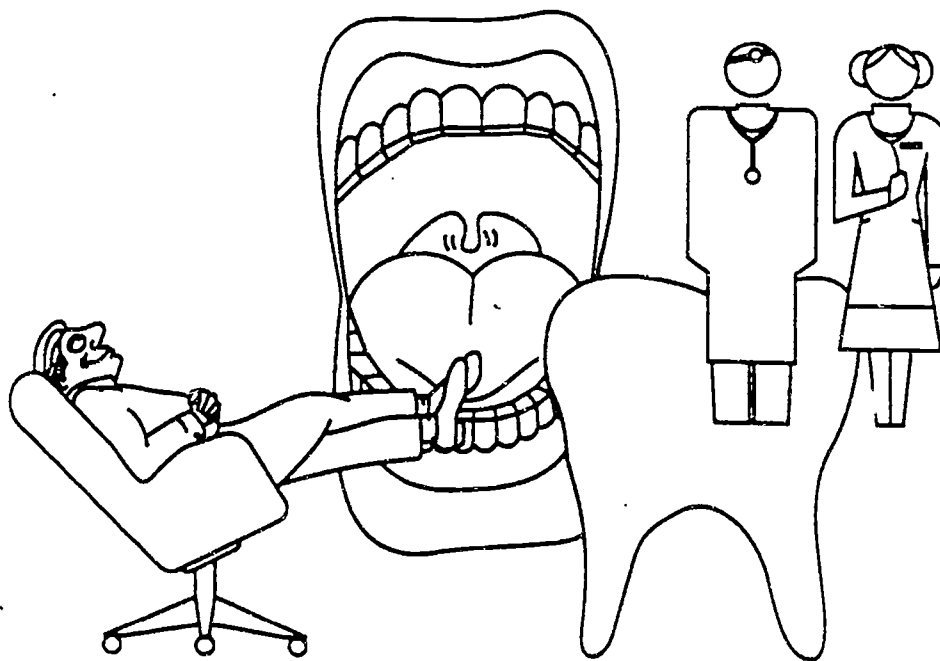

DENTAL HYGIENE

Dental hygienists provide preventive dental care and encourage patients to develop good oral health skills. They evaluate patients' dental health; remove calculus, stain, and plaque from above and below the gumline; expose and develop dental x-rays; and instruct patients on plaque control.

This occupation may not have a favorable outlook for the future. Few job openings are expected over the next four or five years. Recently, there have been more new trainees than job openings.

Related postsecondary programs at state-supported institutions in this area are:

51.0602 Dental hygienist

Licensing may be required. Contact: TENNESSEE BOARD OF DENTISTRY, 615-367-6228.

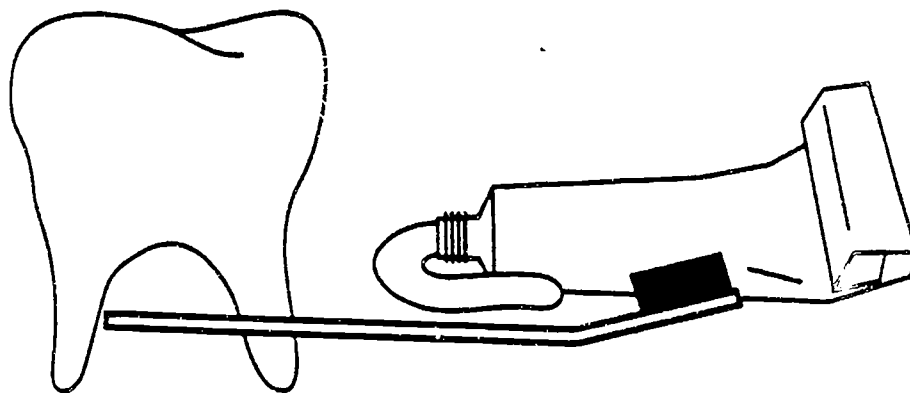

DRAFTING AND DESIGN TECHNOLOGY

Persons in drafting and design technology prepare clear, complete, and accurate working plans and detail drawings from rough or detailed sketches or notes for engineering or manufacturing purposes according to specified dimensions. Workers need to have knowledge of various machines, engineering practices, mathematics, building materials, and other physical sciences to complete drawings. Computer-assisted design (CAD) equipment may be used by some workers.

The largest occupations, which also have the greatest number of job openings annually, are:

- Cost estimators
- Drafters

These occupations may not have a favorable outlook for the future. Overall, the number of these jobs is growing. Few job openings are expected over the next four or five years. Recently, there have been many more new trainees than job openings. Placement rates at area vocational technical schools, community colleges, and/or technical institutes have been good recently.

Hourly wages include:

\$11.63 Drafters

High school programs preparing for these occupations are:

48.0101 Drafting
48.0199 Drafting

Related postsecondary programs at state-supported institutions in this area are:

15.0202 Drafting and design technology

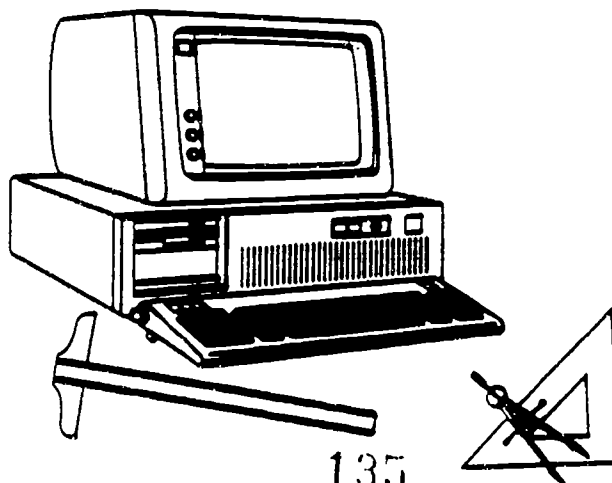

135

DRYCLEANING

Workers in these occupations operate washing and drying machines to clean and dry clean commercial, industrial, or household articles; use pressing machines to press and shape articles; and identify stains and apply chemical solutions to remove them.

The largest occupations, which also have the greatest number of job openings annually, are:

- Laundry and drycleaning machine operators and tenders, except of pressing machines
- Operators and tenders of machines pressing textiles, garments, and related materials

These occupations may have a generally favorable outlook for the future. Overall, the number of these jobs is growing. Few job openings are expected over the next four or five years. Recently, no training has been reported.

Hourly wages include:

\$6.07 Laundry and drycleaning machine operators and tenders, except pressing

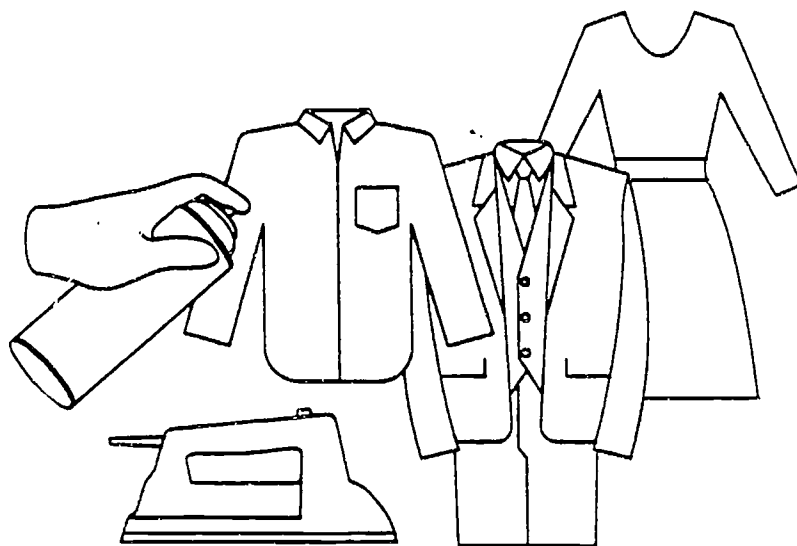

EARLY CHILDHOOD EDUCATION

Child care workers and managers of child care centers assume responsibility for the safety, physical care, and emotional, social, and intellectual growth of preschool children and infants while parents are at work or are unavailable for other reasons. Some work in residential institutions for young children. Teacher aides assist teachers by handling routine paperwork or by working directly with children.

The largest occupations, which also have the greatest number of job openings annually, are:

- Teacher aides, paraprofessional
- Child care workers

These occupations may have a generally favorable outlook for the future. Overall, the number of these jobs is growing rapidly. Large numbers of job openings are expected over the next four or five years. Recently, there have been fewer new trainees than job openings. If this trend continues, job opportunities should be good.

High school programs preparing for these occupations are:

- 20.0102 Child development, care, and guidance
- 20.0201 Child care and guidance management services

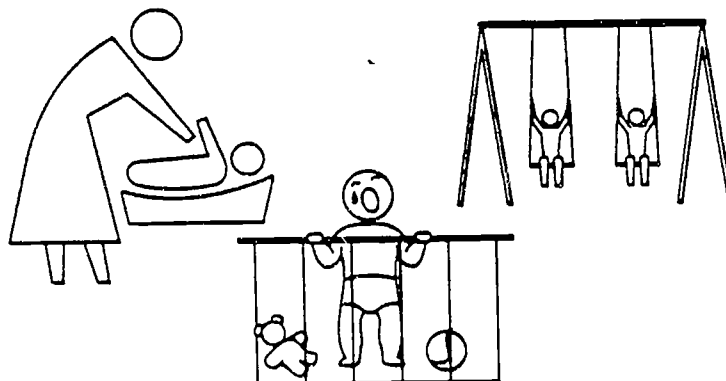

ELECTRICIAN OCCUPATIONS

Workers in the electrical field install, maintain, and repair wiring, electrical equipment, and fixtures or assist in such activities. These workers insure that work is in accordance with the relevant codes. A high school education is usually required and a five-year apprenticeship program is recommended.

The largest occupations, which also have the greatest number of job openings annually, are:

- Electricians
- Helpers of electricians and powerline transmission installers

These occupations may have a generally favorable outlook for the future. Overall, the number of these jobs is growing. A moderate number of job openings are expected over the next four or five years. Recently, no training has been reported. Job opportunities should be good.

Hourly wages include:

\$13.05 Electricians

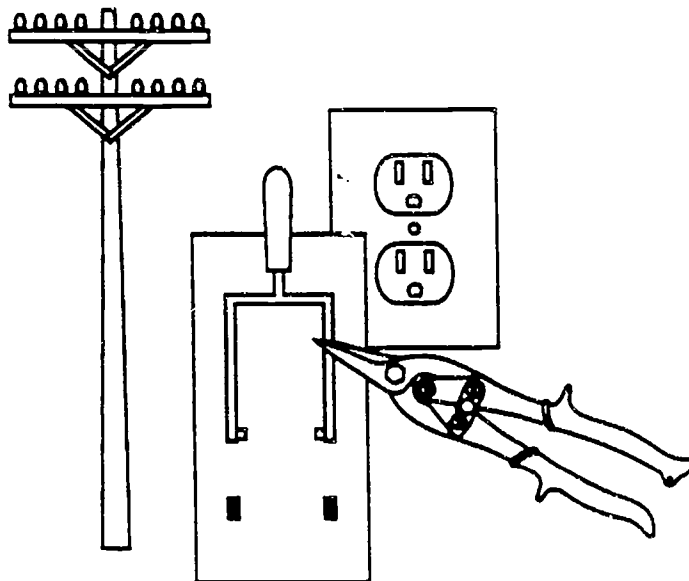

FOOD PREPARATION AND SERVICES

The majority of workers in these occupations prepare and serve food and beverages in restaurants, fast food establishments, catering firms, hotels, clubs, factories, school cafeterias, or hospitals, or supervise those providing food services. Others are factory machine operators involved in the preparation of food products. Dietetic technicians teach principles of food nutrition and provide dietary counseling to patients.

The largest occupations, which also have the greatest number of job openings annually, are:

- Food preparation workers
- Combined food preparation and service workers

These occupations may have a generally favorable outlook for the future. Overall, the number of these jobs is growing. Large numbers of job openings are expected over the next four or five years. Recently, there have been fewer new trainees than job openings. If this trend continues, job opportunities should be good.

Hourly wages include:

\$4.24	Bartenders
\$4.48	Cooks, specialty fast food
\$4.91	Food preparation workers
\$5.87	Cooks, restaurant

High school programs preparing for these occupations are:

20.0401	Food production, management, and services
---------	---

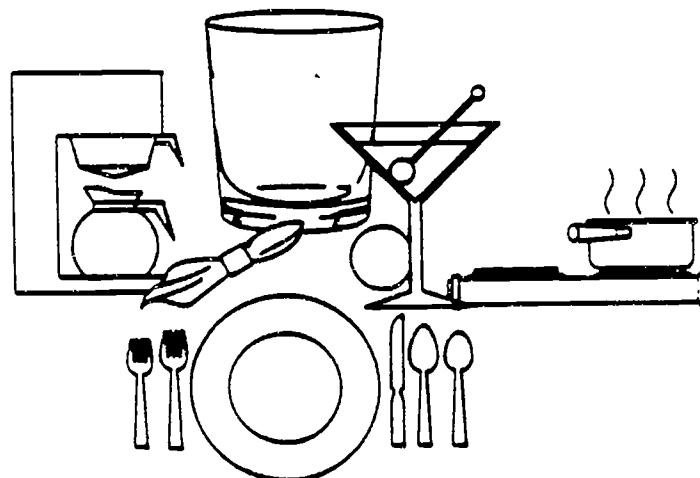

GENERAL BUSINESS AND MANAGEMENT

Workers in the general business and management occupations plan, organize, direct, control, or coordinate activities in all types of fields. Many occupations involve analysis of productivity and financial soundness. General managers and top executives usually have very diverse duties and responsibilities and work through departmental or subordinate executives.

The largest occupations, which also have the greatest number of job openings annually, are:

- Industrial production managers
- General managers and top executives

These occupations may have a generally favorable outlook for the future. Overall, the number of these jobs is growing. Large numbers of job openings are expected over the next four or five years. Recently, there have been fewer new trainees than job openings. If this trend continues, job opportunities should be good. Placement rates at area vocational technical schools, community colleges, and/or technical institutes have been very good recently.

Hourly wages include:

- \$17.20 Purchasing managers
- \$18.12 Industrial production managers

Related postsecondary programs at state-supported institutions in this area are:

- 07.9998 Business management technology
- 52.0201 General business administration and management



SDA 1 - 24

GENERAL WOODWORKING

Woodworkers are in occupations concerned with the complete cycle of cutting, shaping, and assembling parts of complex wood products. The occupations are primarily concerned with one or a limited number of machine functions according to their speciality.

The two largest occupations are:

- Assemblers and fabricators, except machine, electrical, electronic, and precision assembly
- Cabinetmakers and bench carpenters

The occupations expected to have the most job openings annually are:

- Assemblers and fabricators, except machine, electrical, electronic, and precision assembly
- Sawing machine operators and tenders

These occupations may have a generally favorable outlook for the future. Overall, the number of these jobs shows little change. A moderate number of job openings are expected over the next four or five years. Recently, there have been fewer new trainees than job openings.

High school programs preparing for these occupations are:

48.0701 Woodworking

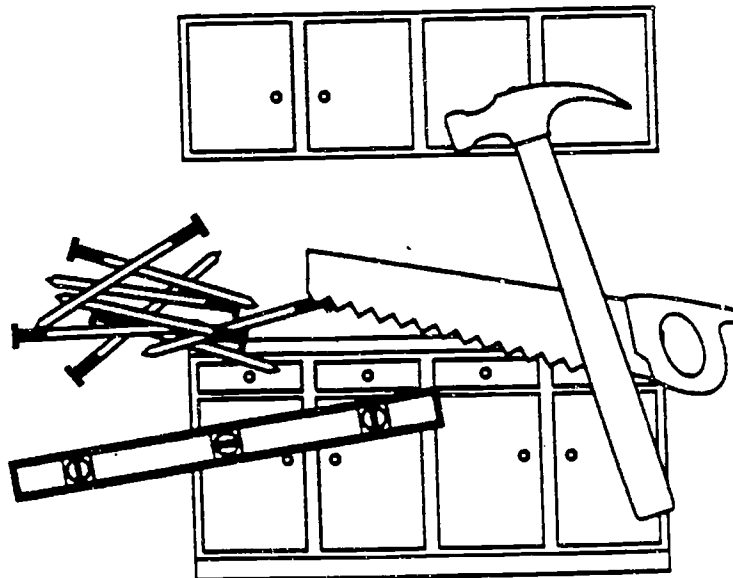

GRAPHIC ARTS

A majority of workers in this field are involved in offset printing. In this process the material to be printed is photographed and a printing plate is made from the film. This process has been advanced by the use of computers and lasers.

The largest occupations, which also have the greatest number of job openings annually, are:

- Offset lithographic press setters and set-up operators
- Printing press machine operators and tenders

These occupations may not have a favorable outlook for the future. Overall, the number of these jobs is growing. A moderate number of job openings are expected over the next four or five years. Recently, there have been many more new trainees than job openings.

High school programs preparing for these occupations are:

- 48.0201 Graphic and printing communications
- 48.0299 Miscellaneous graphic and printing communication

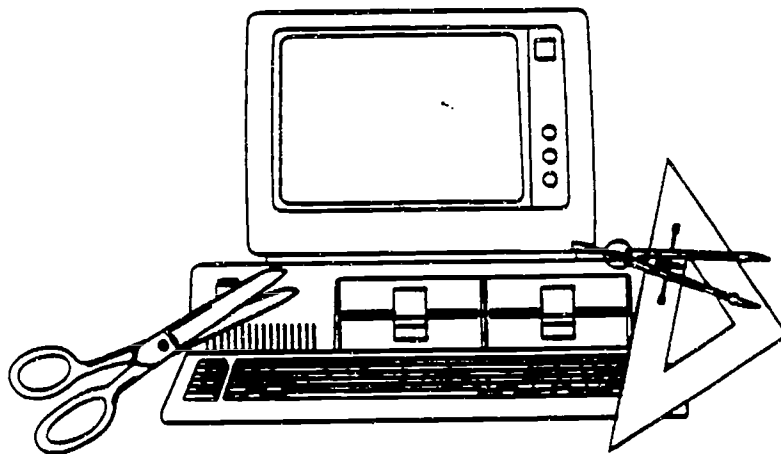

HEATING AND AIR CONDITIONING

Workers in this field install and repair heating, air conditioning, and refrigeration systems. They may install and repair oil burners, hot-air furnaces, and heating stoves in homes and businesses. They may also install and repair air conditioning systems, or install sheet metal ducts for the heating and cooling systems.

The largest occupations, which also have the greatest number of job openings annually, are:

- Heating, air conditioning, and refrigeration mechanics and installers
- Sheet metal duct installers

These occupations may not have a favorable outlook for the future. Overall, the number of these jobs is growing. Few job openings are expected over the next four or five years. Recently, there have been many more new trainees than job openings. Placement rates at area vocational technical schools, community colleges, and/or technical institutes have been fair recently.

Hourly wages include:

\$11.59 Heating, air conditioning, and refrigeration mechanics and installers

High school programs preparing for these occupations are:

47.0201 Heating, air conditioning, and refrigeration mechanics

Related postsecondary programs at state-supported institutions in this area are:

47.0201 Heating, air conditioning, and refrigeration mechanics

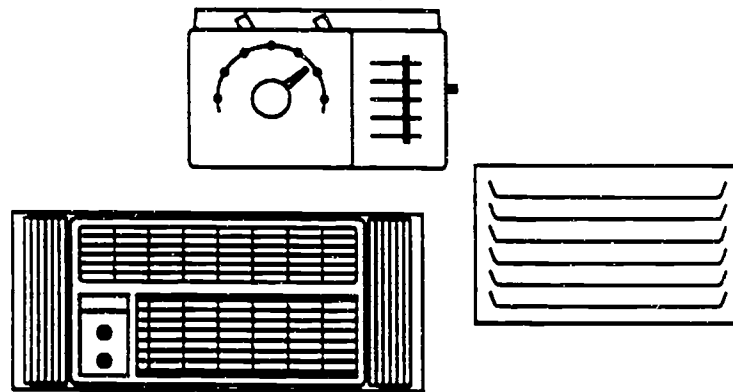

HEAVY TRUCK MAINTENANCE

Persons in heavy truck maintenance repair and maintain the operating condition of trucks, buses, and all types of diesel engines. This also includes mechanics working primarily with automobile diesel engines.

This occupation may have a generally favorable outlook for the future. Overall, the number of these jobs is growing. Few job openings are expected over the next four or five years. Recently, there have been about as many new trainees as job openings. Placement rates at area vocational technical schools, community colleges, and/or technical institutes have been excellent recently.

Average hourly wages are \$9.23

High school programs preparing for these occupations are:

47.0605 Diesel engine mechanics

Related postsecondary programs at state-supported institutions in this area are:

47.0601 Heavy truck and diesel maintenance

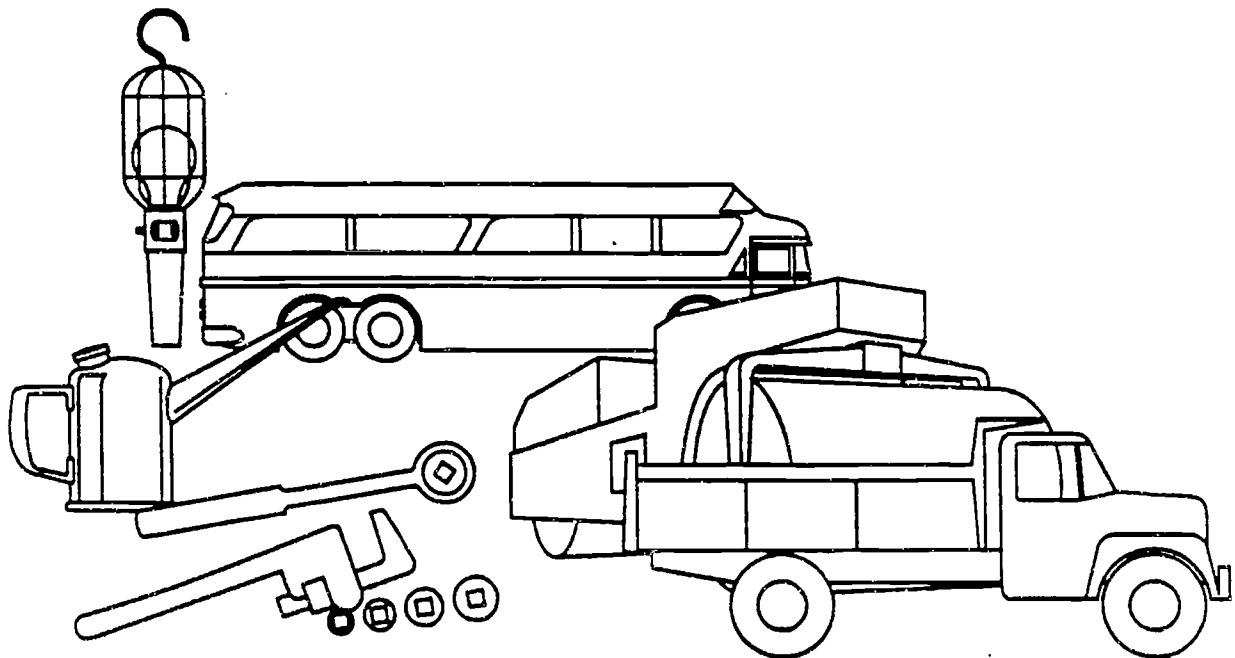

HORTICULTURE AND LANDSCAPING

The largest group of workers in these occupations, gardeners and groundskeepers, maintain the grounds of public and private property. Duties may include mowing, trimming, planting, and watering plants, shrubs, and grass.

The largest occupations, which also have the greatest number of job openings annually, are:

- Nursery workers
- Gardeners and groundskeepers, except farm workers

These occupations may not have a favorable outlook for the future. Overall, the number of these jobs is growing. A moderate number of job openings are expected over the next four or five years. Recently, there have been many more new trainees than job openings.

Hourly wages include:

\$6.28 Gardeners and groundskeepers, except farm

High school programs preparing for these occupations are:

01.0601 Horticulture

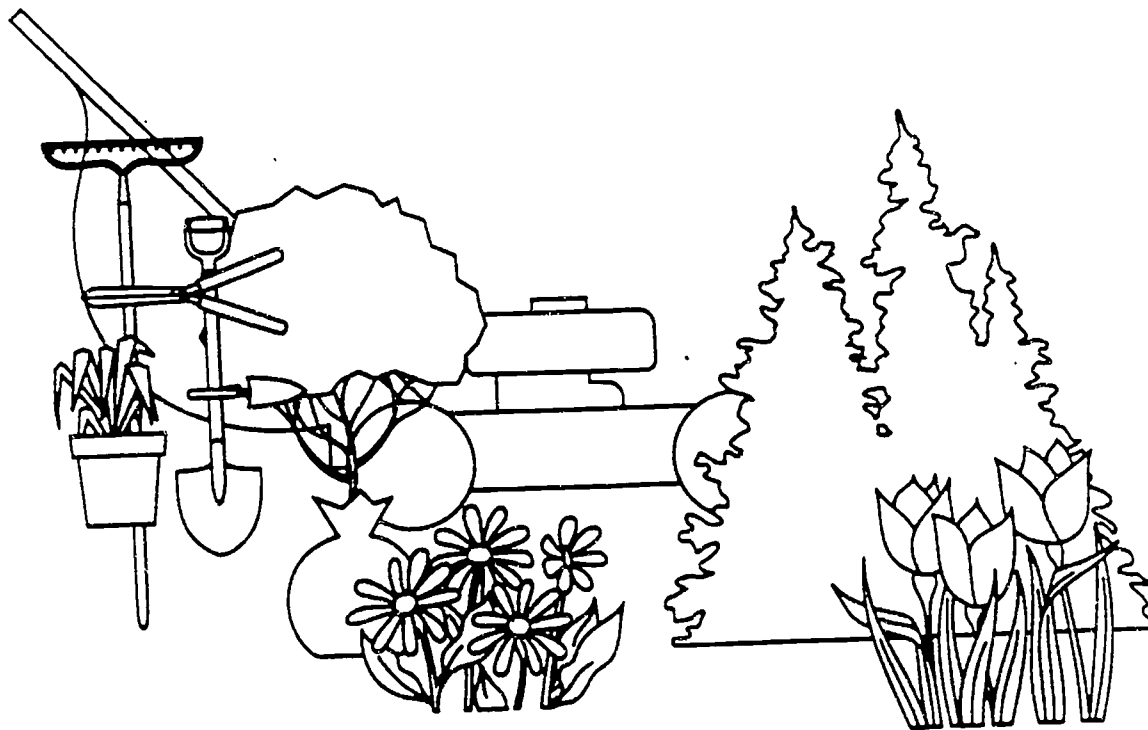

HOTEL AND RESTAURANT MANAGEMENT

Food service and lodging managers supervise the profitable operation of restaurants, hotels, and motels. Workers direct the varied activities of these businesses with the goal of pleasing people and providing good service to their customers.

This occupation may have a generally favorable outlook for the future. Overall, the number of these jobs is growing rapidly. A moderate number of job openings are expected over the next four or five years. Recently, no training has been reported. Job opportunities should be good.

Average hourly wages are \$8.75

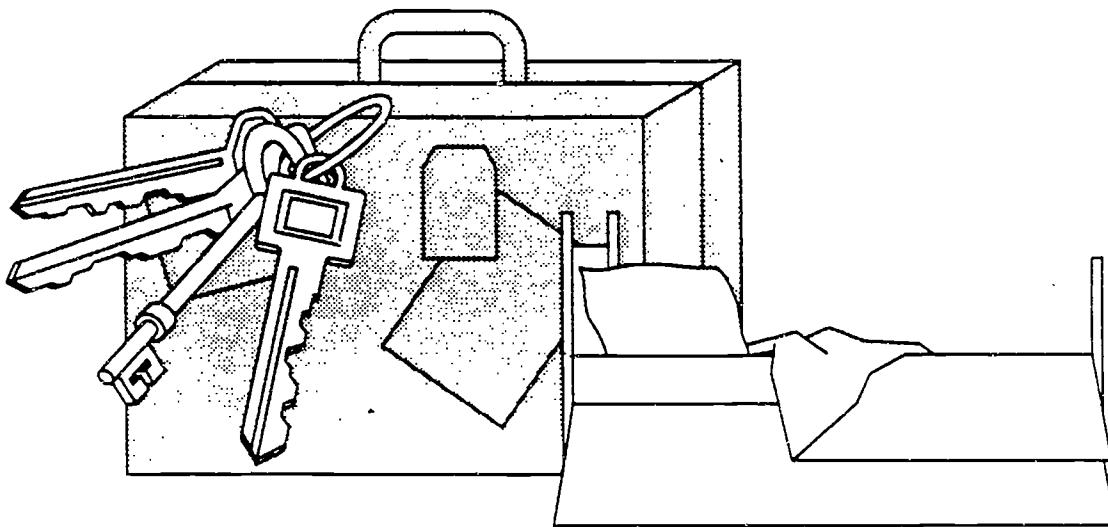

INDUSTRIAL MAINTENANCE TECHNOLOGY

Workers prevent costly waste of raw materials and the idling of human resources in a plant or factory by making industrial machinery repairs as quickly as possible. Maintenance mechanics spend considerable time doing preventive maintenance, including keeping machines well oiled and greased, and periodically cleaning parts.

The two largest occupations are:

- Maintenance mechanics for industrial machinery
- Textile machine setters and set-up operators

The occupations expected to have the most job openings annually are:

- Maintenance mechanics for industrial machinery
- Millwrights

These occupations may have a generally favorable outlook for the future. Overall, the number of these jobs shows little change. A moderate number of job openings are expected over the next four or five years. Recently, there have been fewer new trainees than job openings. If this trend continues, job opportunities should be good. Placement rates at area vocational technical schools, community colleges, and/or technical institutes have been very good recently.

Hourly wages include:

\$10.78 Machinery maintenance mechanics

Related postsecondary programs at state-supported institutions in this area are:

47.0303 Industrial mechanics technology

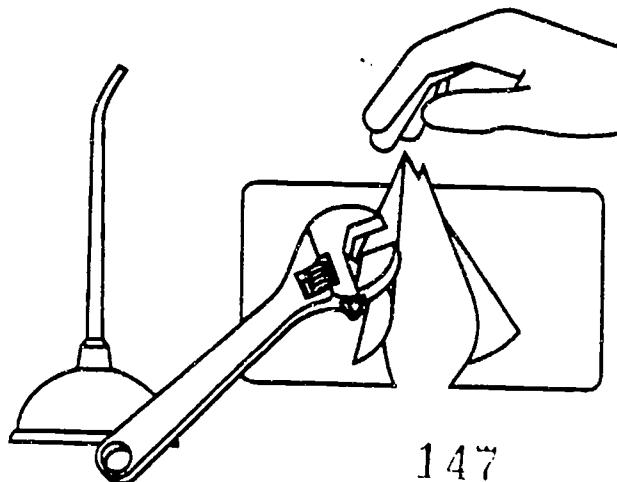

INSTITUTIONAL HOME MANAGEMENT AND SUPPORTING SERVICES

These workers make sure that all public buildings, offices, hospitals, stores, and apartment houses are kept clean and in good condition for the comfort and safety of the people who work or live there. Generally, no special education is required for occupations in this field, with most skills learned on the job.

The largest occupations, which also have the greatest number of job openings annually, are:

- Maids and housekeeping cleaners
- Janitors and cleaners, except maids and housekeeping cleaners

These occupations may have a generally favorable outlook for the future. Overall, the number of these jobs is growing. Large numbers of job openings are expected over the next four or five years. Recently, no training has been reported. Job opportunities should be good.

Hourly wages include:

- \$5.54 Maids and housekeeping cleaners
- \$5.80 Janitors and cleaners, except maids and housekeeping cleaners
- \$6.55 Housekeepers

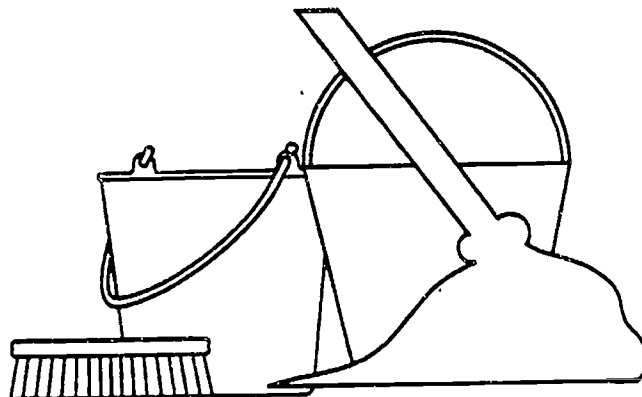

LABORATORY TECHNICIAN

Medical and clinical laboratory technicians perform routine laboratory tests for use in the treatment and diagnosis of disease; prepare vaccines, biologicals, and serums for prevention of disease; and prepare tissue samples, take blood samples, and execute laboratory tests including urinalyses and blood counts.

This occupation may have a generally favorable outlook for the future. Few job openings are expected over the next four or five years. Recently, there have been more new trainees than job openings.

Average hourly wages are \$14.84

Related postsecondary programs at state-supported institutions in this area are:

51.1004 Medical laboratory technician

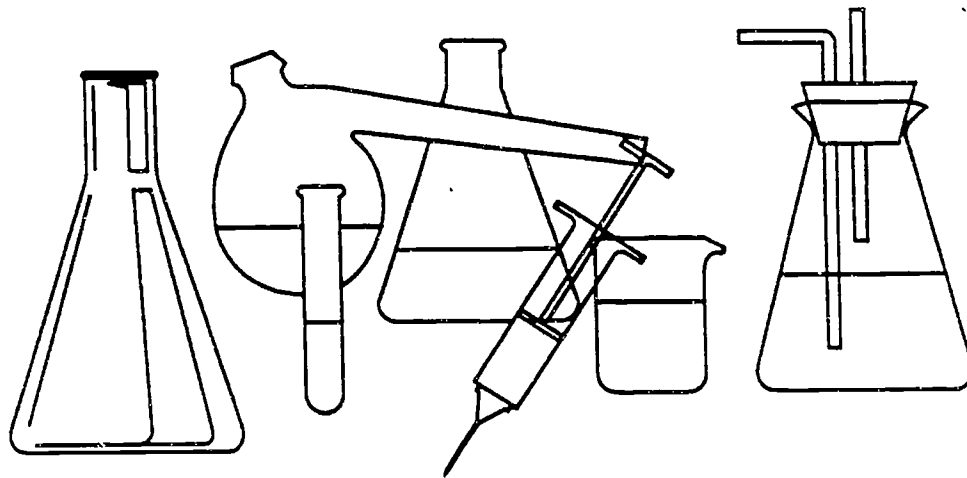

LAW ENFORCEMENT

People working at these occupations are responsible for the safety of Tennessee cities, towns, and highways. Their responsibilities range from controlling traffic to preventing and investigating crimes. Whether on or off duty, they are expected to exercise their authority whenever necessary.

The largest occupations, which also have the greatest number of job openings annually, are:

- Police patrol officers
- Sheriffs and deputy sheriffs

These occupations may have a generally favorable outlook for the future. Overall, the number of these jobs is growing. A moderate number of job openings are expected over the next four or five years. Recently, there have been fewer new trainees than job openings. If this trend continues, job opportunities should be good.

Hourly wages include:

\$9.99 Police patrol officers

Related postsecondary programs at state-supported institutions in this area are:

43.0107 Law enforcement and police science

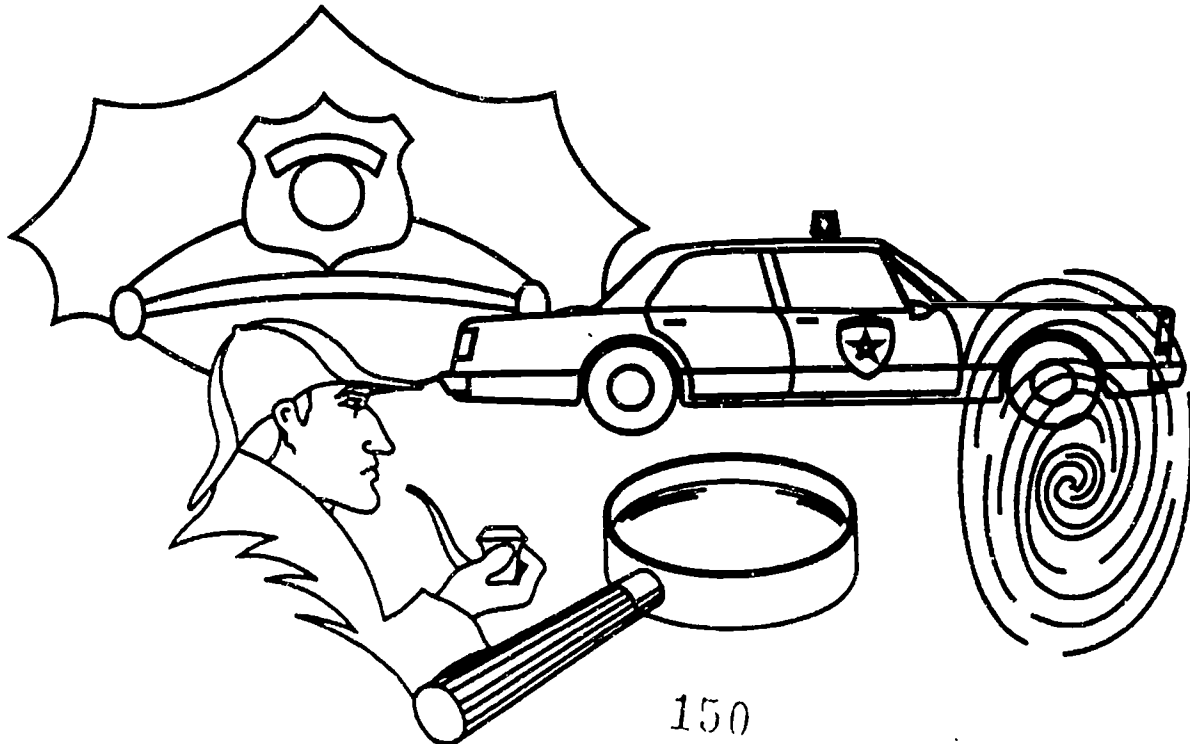

MACHINE TOOL TECHNOLOGY

Workers in these occupations make or set up and operate machine tools or repair metal parts. Machinists and tool-and-die makers create highly specialized precision tools, molds, and metal parts. Often they use blueprints to develop prototypes for tools or machines to be used in manufacturing.

The two largest occupations are:

- Machinists
- First line supervisors and manager/supervisors of production

The occupations expected to have the most job openings annually are:

- Machinists
- Tool and die makers

These occupations may have a generally favorable outlook for the future. Overall, the number of these jobs is growing. Large numbers of job openings are expected over the next four or five years. Recently, there have been fewer new trainees than job openings. If this trend continues, job opportunities should be good. Placement rates at area vocational technical schools, community colleges, and/or technical institutes have been excellent recently.

Hourly wages include:

- \$8.57 Combination machine tool operators and tenders, metal and plastic
- \$9.42 Lathe and turning machine tool setters and set-up operators, metal and plastic
- \$10.40 Machinists
- \$10.73 Tool and die makers
- \$11.89 Numerical control machine tool operators and tenders, metal and plastic

High school programs preparing for these occupations are:

- 48.0503 Machine tool operation and machine shop technology

Related postsecondary programs at state-supported institutions in this area are:

- 48.0503 Machine tool operation and machine shop technology

MEDICAL ASSISTING

Medical assistants perform a wide variety of clinical and administrative duties under the direction of physicians. Clinical duties may include taking and recording patients' vital signs and medical histories, preparing patients for examination by physicians, and explaining treatment procedures to patients.

In small physicians' offices they may keep medical records, schedule appointments, and order supplies. Electrocardiograph (EKG) technicians operate the EKG machines which provide graphic tracings of heartbeats.

The largest occupations, which also have the greatest number of job openings annually, are:

- Electrocardiograph technicians
- Medical assistants

These occupations may have a generally favorable outlook for the future. Few job openings are expected over the next four or five years. Recently, there have been fewer new trainees than job openings.

Hourly wages include:

\$7.06 Medical assistants

Related postsecondary programs at state-supported institutions in this area are:

51.0801 Medical assistant

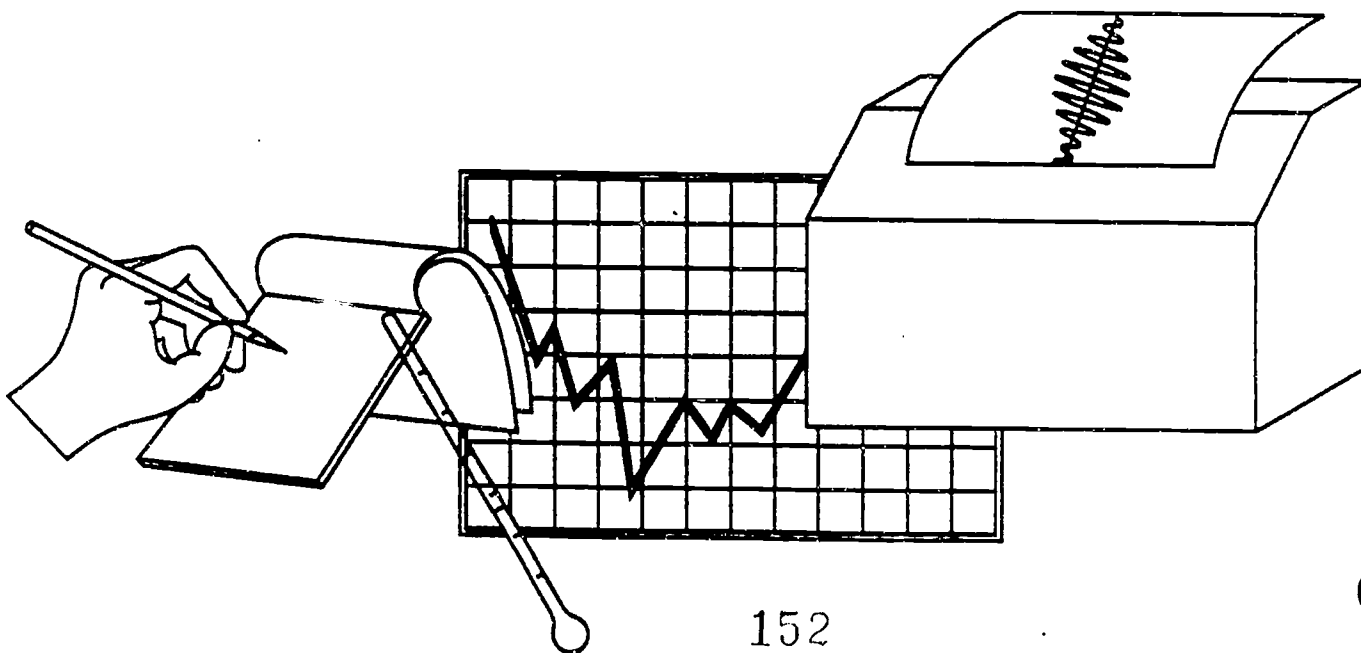

MEDICAL RECORDS TECHNOLOGY

Medical records technicians compile and maintain medical records of hospital and clinic patients. Such work is becoming increasingly important as this background information is used for medicare and medicaid insurance reimbursements.

This occupation may not have a favorable outlook for the future. Few job openings are expected over the next four or five years. Recently, no training has been reported.

Average hourly wages are \$7.41

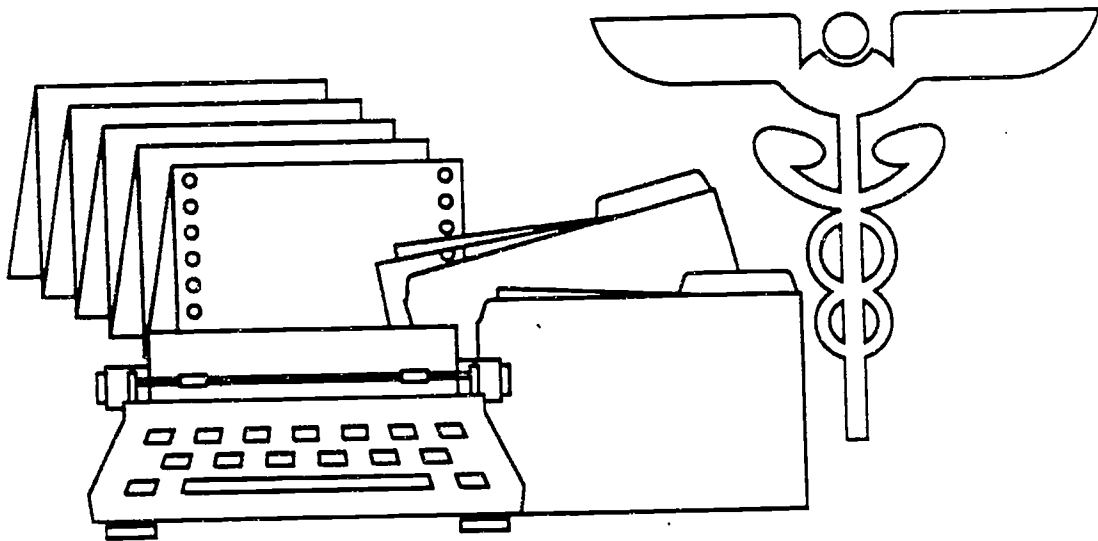

NURSING ASSISTANT

Nursing aides and orderlies work under the general direction of nursing or medical staff. In hospitals, they may answer patients' call bells, serve and collect food trays, feed patients, or set up equipment. In nursing homes, they are expected to sustain ongoing relations with patients.

The largest occupations, which also have the greatest number of job openings annually, are:

- Nursing aides, orderlies, and attendants
- Home health aides

These occupations may have a generally favorable outlook for the future. Overall, the number of these jobs is growing rapidly. Large numbers of job openings are expected over the next four or five years. Recently, there have been fewer new trainees than job openings. If this trend continues, job opportunities should be good.

Hourly wages include:

- \$5.56 Home health aides
- \$5.99 Nursing aides, orderlies, and attendants

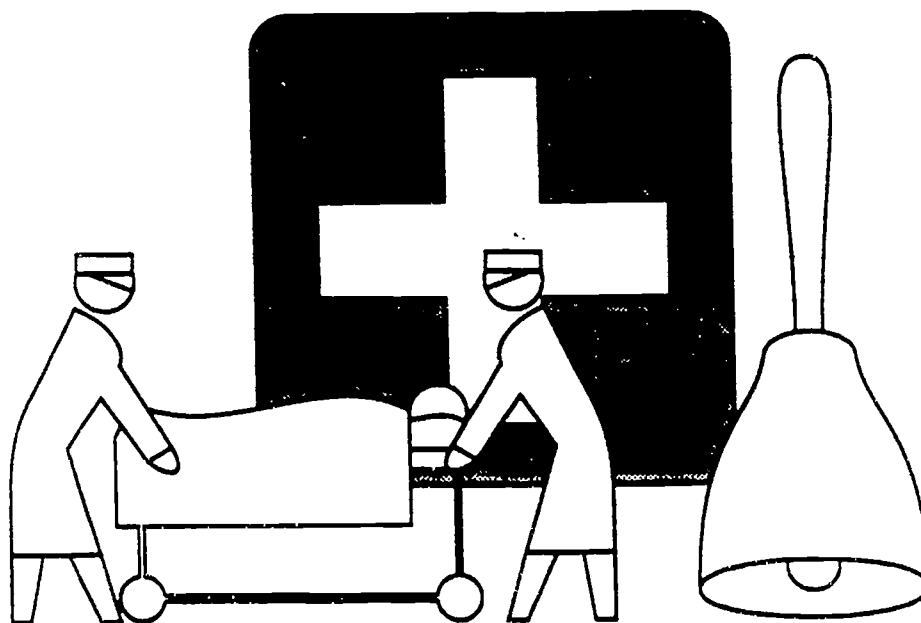

PLUMBING AND PIPEFITTING

Plumbers and pipefitters install and maintain the complex system of pipes that connect to the master system that runs underground. Although plumbing and pipefitting are sometimes considered a single trade, workers may specialize in either craft. Plumbers build and repair the water, waste disposal, drainage, and gas systems in homes and commercial/industrial buildings. Pipefitters build and repair both high and low pressure pipe.

The largest occupations, which also have the greatest number of job openings annually, are:

- Plumbers, pipefitters, and steamfitters
- Pipelayers

These occupations may have a generally favorable outlook for the future. Overall, the number of these jobs is growing slowly. Few job openings are expected over the next four or five years. Recently, there have been fewer new trainees than job openings.

Hourly wages include:

\$9.52 Plumbers, pipefitters, and steamfitters

High school programs preparing for these occupations are:

46.0501 Plumbing, pipefitting, and steamfitting

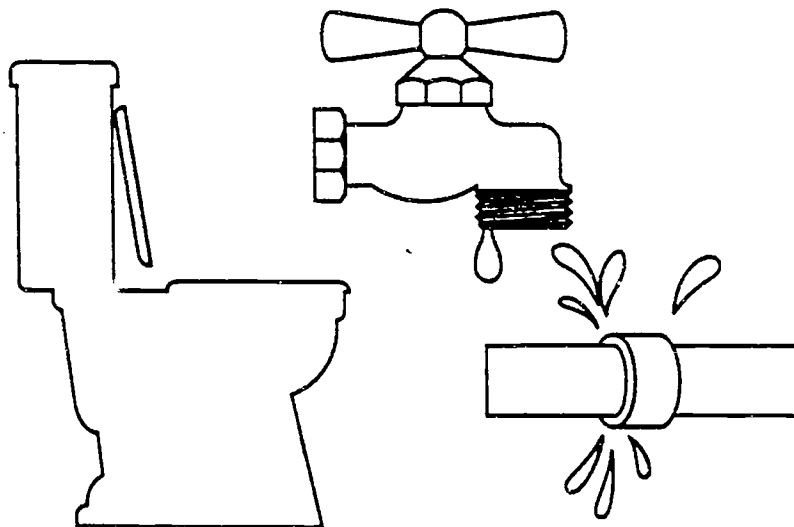

PRACTICAL NURSING

Licensed practical nurses (LPNs) work under the supervision of physicians and/or registered nurses to provide nursing care that requires technical knowledge but not the professional training of a registered nurse. They provide bedside care, administer certain medications, and assist in patient examinations.

This occupation may have a generally favorable outlook for the future. Overall, the number of these jobs is growing rapidly. Large numbers of job openings are expected over the next four or five years. Recently, there have been many more new trainees than job openings. If this trend continues, job seekers can expect to face keen competition. Placement rates at area vocational technical schools, community colleges, and/or technical institutes have been very good recently.

Average hourly wages are \$9.00

Related postsecondary programs at state-supported institutions in this area are:

17.0605 Practical nursing

Licensing may be required. Contact: TENNESSEE BOARD OF NURSING, 615-367-6232.

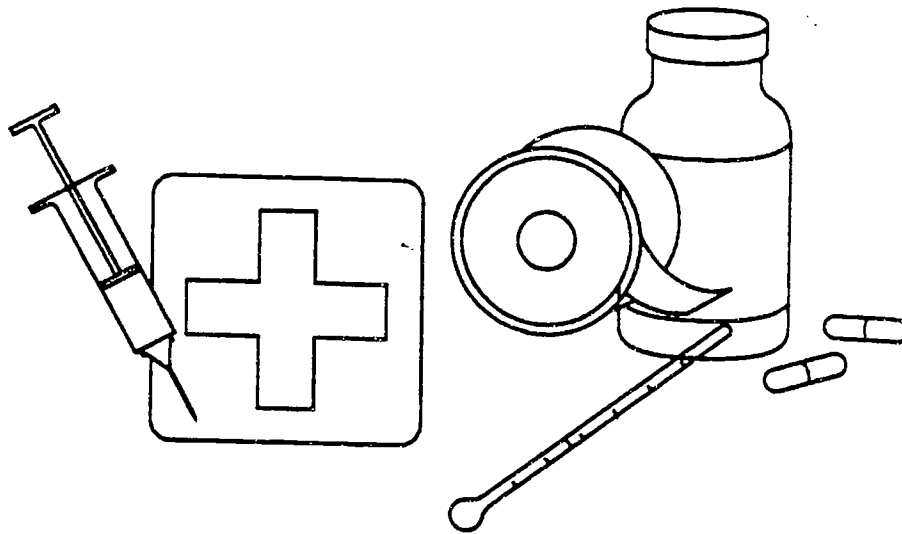

PROFESSIONAL NURSING

Registered Nurses (R.N.'s), the largest occupational group in this field, are primarily employed in hospitals and nursing homes, where they provide skilled bedside care and may supervise licensed practical nurses, nursing aides, and orderlies. Working under the direction of a licensed "supervising physician," physician assistants elicit detailed patient histories, perform physical examinations, and prescribe appropriate treatments.

The largest occupations, which also have the greatest number of job openings annually, are:

- Registered nurses
- Physician's assistants

These occupations may have a generally favorable outlook for the future. Overall, the number of these jobs is growing rapidly. Large numbers of job openings are expected over the next four or five years. Recently, there have been more new trainees than job openings. If this trend continues, job seekers can expect to face some competition.

Hourly wages include:

\$14.15 Registered nurses

Related postsecondary programs at state-supported institutions in this area are:

51.1601 Nursing (R.N. training)

Licensing may be required. Contact: TENNESSEE BOARD OF MEDICAL EXAMINERS-COMMITTEE ON PHYSICIAN ASSISTANTS, 615-367-6250.

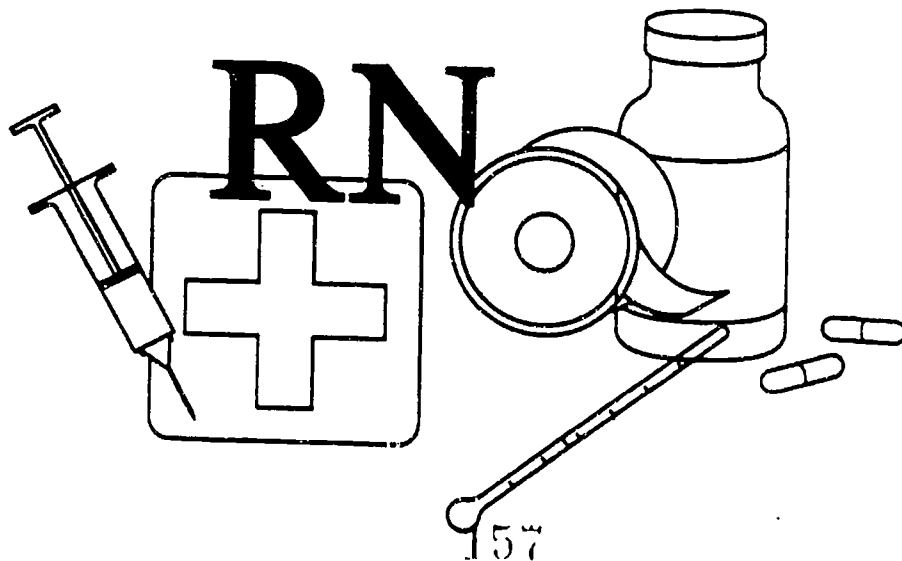

157

PUBLIC ADMINISTRATION

Individuals in this field are responsible for the management of diverse areas of governmental organizations. These managers usually work through departmental executives or subordinates in coordinating the various activities and groups they control. Public administration chief executives, legislators, and general administrators establish government policy and develop federal, state, or local regulations, rules, and laws.

The two largest occupations are:

- General managers and top executives
- Public administration chief executives, legislators, and general administrators

The occupations expected to have the most job openings annually are:

- Management analysts
- General managers and top executives

These occupations may not have a favorable outlook for the future. Overall, the number of these jobs shows little change. Very few job openings are expected over the next four or five years. Recently, there have been many more new trainees than job openings.

Related postsecondary programs at state-supported institutions in this area are:

43.0103 Criminal justice and law enforcement administration



RADIOGRAPHIC MEDICAL TECHNOLOGY

Workers in this field operate equipment including x-ray machines, fluoroscopes, ultrasonic scanners, computed tomography (CP) scanners, and nuclear magnetic resonance (MCI) machines for diagnostic imagery of the human body or for therapy.

The largest occupations, which also have the greatest number of job openings annually, are:

- Radiologic technologists
- Radiologic technicians

These occupations may not have a favorable outlook for the future. Few job openings are expected over the next four or five years. Recently, there have been many more new trainees than job openings.

Related postsecondary programs at state-supported institutions in this area are:

51.0907 Medical radiologic technology and technician

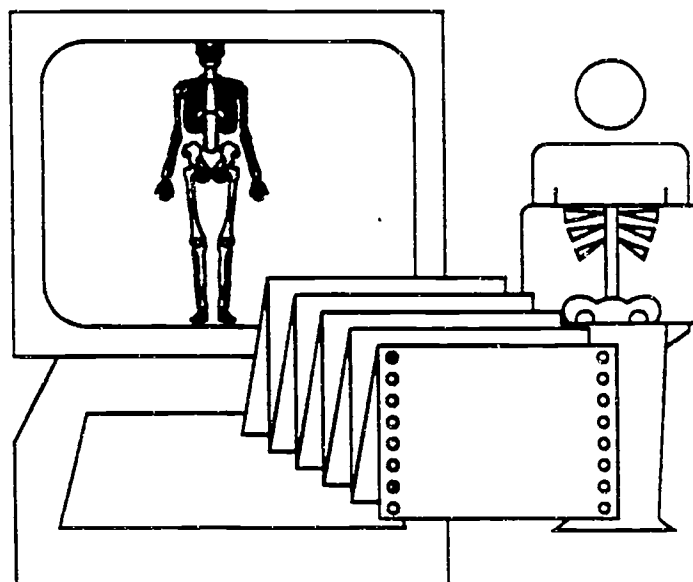

RECREATIONAL LEADERSHIP

Workers in recreational leadership occupations conduct recreational activities with groups, consider the interests of participants, and organize and promote activities. A large proportion of recreational workers are employed in city recreation departments and in state and national parks.

This occupation may have a generally favorable outlook for the future. Overall, the number of these jobs is growing. Few job openings are expected over the next four or five years. Recently, no training has been reported.



SALES AND MERCHANDISING

Workers in sales and merchandising occupations promote and sell a wide variety of merchandise and services. They also receive, store, display, and inventory products to be sold.

The largest occupations, which also have the greatest number of job openings annually, are:

- Salespersons in retail establishments
- Cashiers

These occupations may have a generally favorable outlook for the future. Overall, the number of these jobs is growing. Large numbers of job openings are expected over the next four or five years. Recently, there have been about as many new trainees as job openings. If this trend continues, job seekers can expect to face some competition.

Hourly wages include:

- \$4.56 Cashiers
- \$5.63 Salespersons, retail
- \$11.60 Customer service representatives, utilities
- \$14.46 Purchasing agents- except wholesale, retail, and farm products

High school programs preparing for these occupations are:

- 08.0700 General marketing
- 08.0799 Miscellaneous general marketing
- 08.9999 Miscellaneous marketing and distribution

Licensing may be required. Contact: TENNESSEE DEPARTMENT OF COMMERCE AND INSURANCE, 615-741-2693.

SECURITY SERVICES

Security guards, the largest occupation in this field, patrol and inspect property to protect it against fire, theft, vandalism, and illegal entry. Guards and doorkeepers usually are uniformed and often carry a nightstick and a weapon; correctional officers and jailers maintain order in correctional institutions, enforce institutional rules and regulations, and may supplement the counseling inmates receive from mental health professionals.

The largest occupations, which also have the greatest number of job openings annually, are:

- Correction officers and jailers
- Guards and watch guards

These occupations may have a generally favorable outlook for the future. Overall, the number of these jobs is growing. A moderate number of job openings are expected over the next four or five years. Recently, no training has been reported. Job opportunities should be good.

Hourly wages include:

\$7.39 Guards and watch guards

Licensing may be required. Contact: COUNTY COURT CLERK'S OFFICE.

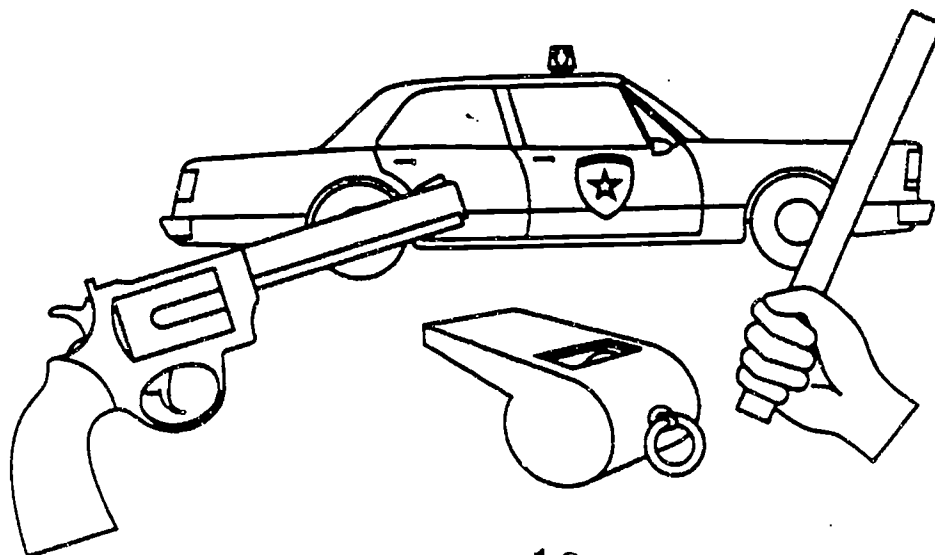

SHEET METAL

Sheet metal workers make, install, and maintain a variety of sheet metal products for home, commercial, and industrial buildings. These products include ducts for air conditioning, heating, and ventilating and pollution control systems, kitchen equipment, roofs, siding, rain gutters, skylights, and outdoor signs. Other workers use a variety of machines in the mass production of sheet-metal products.

The two largest occupations are:

- Machine forming operators and tenders of metal and plastic
- Assemblers and fabricators, except machine, electrical, electronic, and precision assembly

The occupations expected to have the most job openings annually are:

- Machine forming operators and tenders of metal and plastic
- Sheet metal workers

These occupations may have a generally favorable outlook for the future. Overall, the number of these jobs shows little change. A moderate number of job openings are expected over the next four or five years. Recently, there have been fewer new trainees than job openings. If this trend continues, job opportunities should be good.

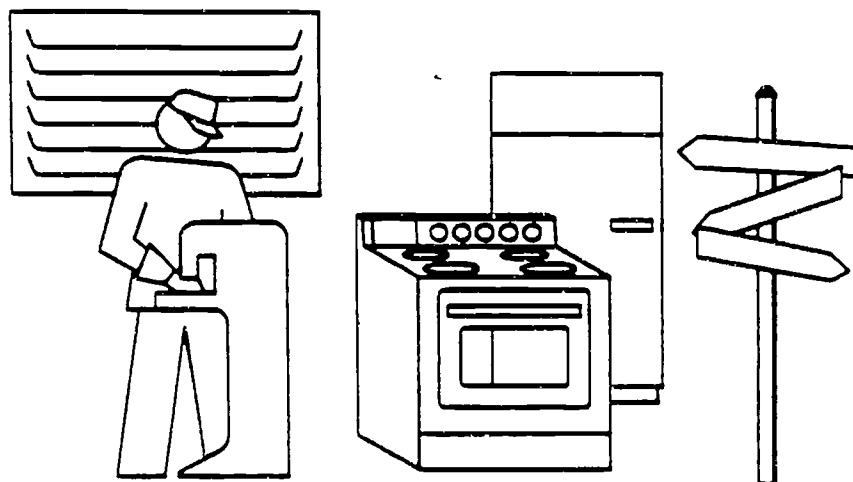

SMALL ENGINE REPAIR

Persons working in these occupations repair and service motorcycles, other small vehicles, and equipment with small gasoline engines. The ability to make quick and accurate diagnoses is one of the mechanic's most valuable skills. In fact, many mechanics consider diagnosing "hard to find" troubles one of their most challenging and satisfying duties.

This occupation may not have a favorable outlook for the future. Overall, the number of these jobs shows little change. Very few job openings are expected over the next four or five years. Recently, there have been many more new trainees than job openings.

High school programs preparing for these occupations are:

47.0606 Small engine repair

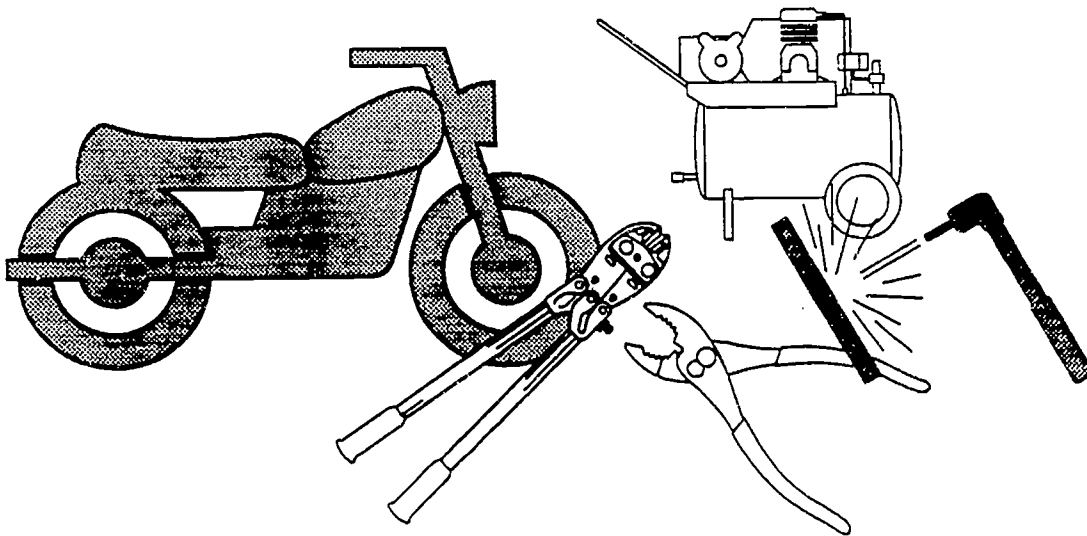

TRUCK, BUS, AND HEAVY EQUIPMENT OPERATION

These occupations include truck drivers who transport goods, bus drivers who transport passengers, and heavy equipment operators who use machinery to move construction materials and other goods over short distances--around a factory, construction site or loading dock.

The largest occupations, which also have the greatest number of job openings annually, are:

- Truck drivers of heavy or tractor trailer trucks
- School bus drivers

These occupations may have a generally favorable outlook for the future. Overall, the number of these jobs is growing. Large numbers of job openings are expected over the next four or five years. Recently, there have been fewer new trainees than job openings. If this trend continues, job opportunities should be good.

Hourly wages include:

- \$8.89 Grader, dozer, and scraper operators
- \$9.93 Truck drivers, heavy or tractor trailer

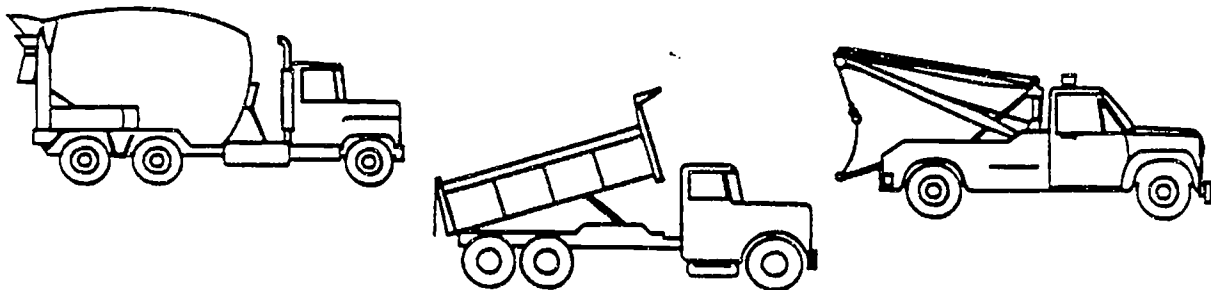

WELDING TECHNOLOGY

Welding is the most common way of permanently joining metal parts. Typically, heat is applied to the metal pieces to be joined; the parts are melted and fused to form a permanent bond. Welding is used to construct and repair parts of ships, automobiles, spacecraft, and thousands of products. It can also be used to join beams and steel reinforcing rods in buildings, bridges, and highways.

The two largest occupations are:

- Welders and cutters
- Welding machine setters and set-up operators

The occupations expected to have the most job openings annually are:

- Welders and cutters
- Welding machine operators and tenders

These occupations may have a generally favorable outlook for the future. Overall, the number of these jobs is growing. A moderate number of job openings are expected over the next four or five years. Recently, there have been many more new trainees than job openings. Placement rates at area vocational technical schools, community colleges, and/or technical institutes have been very good recently.

Hourly wages include:

\$10.67 Welders and cutters

High school programs preparing for these occupations are:

48.0508 Welding, brazing, and soldering

Related postsecondary programs at state-supported institutions in this area are:

15.0610 Combination welder and welding technology

48.0508 Welding, brazing, and soldering

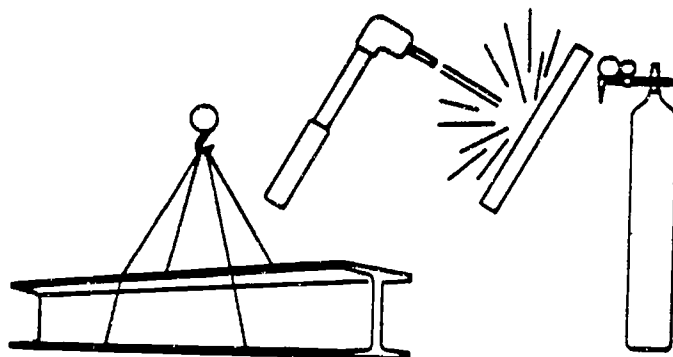

ACCOUNTING AND FINANCIAL MANAGEMENT

Many individuals in this group are accountants and auditors who prepare and analyze business records and financial reports which are needed for effective management of any organization. Financial managers, another occupation in this group, typically plan, organize, control, or coordinate the financial activities of an organization.

The largest occupations, which also have the greatest number of job openings annually, are:

- Financial managers
- Accountants and auditors

These occupations may have a generally favorable outlook for the future. Overall, the number of these jobs is growing. A moderate number of job openings are expected over the next four or five years. Recently, no training has been reported. Job opportunities should be good.

Hourly wages include:

\$12.63 Accountants and auditors
\$22.49 Financial managers

Licensing may be required. Contact: TENNESSEE BOARD OF ACCOUNTANCY, 615-741-2250.



SDA 2 - 1

ADMINISTRATIVE SUPPORT: ACCOUNTING

Persons employed in this group of occupations provide clerical and administrative support to accountants and auditors. Most of these jobs require only a high school diploma for entry.

The largest occupations, which also have the greatest number of job openings annually, are:

- Bookkeeping, accounting, and auditing clerks
- Payroll and timekeeping clerks

These occupations may have a generally favorable outlook for the future. Overall, the number of these jobs shows little change. A moderate number of job openings are expected over the next four or five years. Recently, there have been fewer new trainees than job openings. If this trend continues, job opportunities should be good.

Hourly wages include:

- \$7.96 Bookkeeping, accounting, and auditing clerks
- \$8.08 Payroll and timekeeping clerks

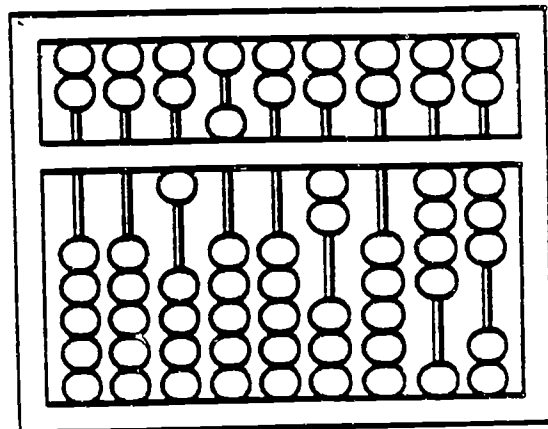
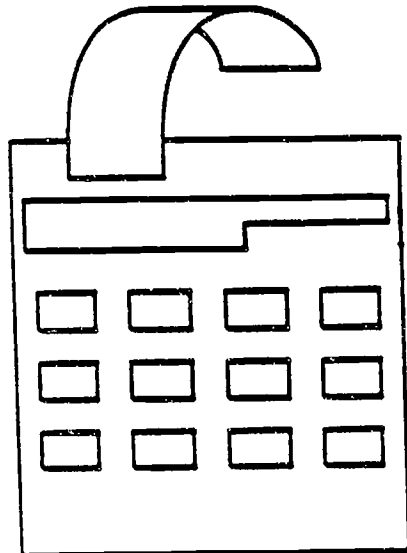

ADMINISTRATIVE SUPPORT: FINANCE AND INSURANCE

Workers provide clerical and general administrative support to the banking and finance industry. Workers receive and pay out money, keep records of money and negotiable instruments, interview applicants for credit, locate and notify customers of delinquent accounts, examine insurance claims, and process a variety of paperwork.

The two largest occupations are:

- Tellers
- Loan and credit clerks

The occupations expected to have the most job openings annually are:

- Tellers
- Bill and account collectors

These occupations may have a generally favorable outlook for the future. Overall, the number of these jobs is declining. Few job openings are expected over the next four or five years. Recently, there have been fewer new trainees than job openings.

Hourly wages include:

- \$5.82 Tellers
- \$6.71 New accounts clerks
- \$7.42 Bill and account collectors
- \$9.01 Loan and credit clerks

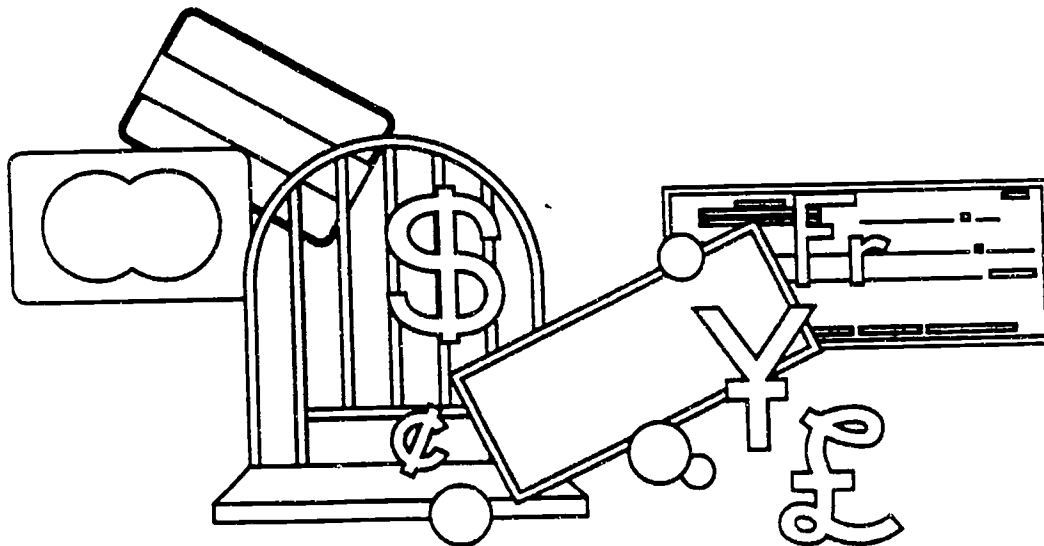

ADMINISTRATIVE SUPPORT: GENERAL

The job duties in this group of occupations are very diverse and are determined by the type of firm. For example, workers may schedule appointments, give information to callers, take dictation, type correspondence, read and route incoming mail, file correspondence and other records, and supervise and coordinate the activities of subordinate clerical workers.

The largest occupations, which also have the greatest number of job openings annually, are:

- Secretaries, except legal and medical secretaries
- General office clerks

These occupations may have a generally favorable outlook for the future. Overall, the number of these jobs is growing. Large numbers of job openings are expected over the next four or five years. Recently, there have been more new trainees than job openings. If this trend continues, job seekers can expect to face some competition. Placement rates at area vocational technical schools, community colleges, and/or technical institutes have been good recently.

Hourly wages include:

\$6.04	File clerks
\$6.23	Receptionists and information clerks
\$6.84	General office clerks
\$6.91	Typists including word processing
\$6.95	Data entry keyers, except composing
\$7.65	Secretaries, ex. legal and medical
\$8.48	Order clerks- materials, merchandise, and service
\$11.07	First line supervisors and manager/supervisors- clerical and administrative support occupations

High school programs preparing for these occupations are:

07.0601	Secretarial and related programs
07.0701	Typing, general office and related programs
07.9999	Miscellaneous business administrative support

Related postsecondary programs at state-supported institutions in this area are:

07.0606	Secretarial and office administration
07.0701	Typing, general office and related programs
07.9999	Miscellaneous business administrative support

AGRICULTURAL PRODUCTION

Workers in this field plan and economically use facilities, land, water, machinery, chemicals, finance, and labor in the production of plant and animal products.

The largest occupations, which also have the greatest number of job openings annually, are:

- Farm managers
- Farm workers

These occupations may not have a favorable outlook for the future. Overall, the number of these jobs shows little change. A moderate number of job openings are expected over the next four or five years. Recently, there have been many more new trainees than job openings. If this trend continues, job seekers can expect to face keen competition.

High school programs preparing for these occupations are:

- 01.0101 Agricultural technology
- 01.0301 Agricultural production
- 01.0399 Miscellaneous agricultural production

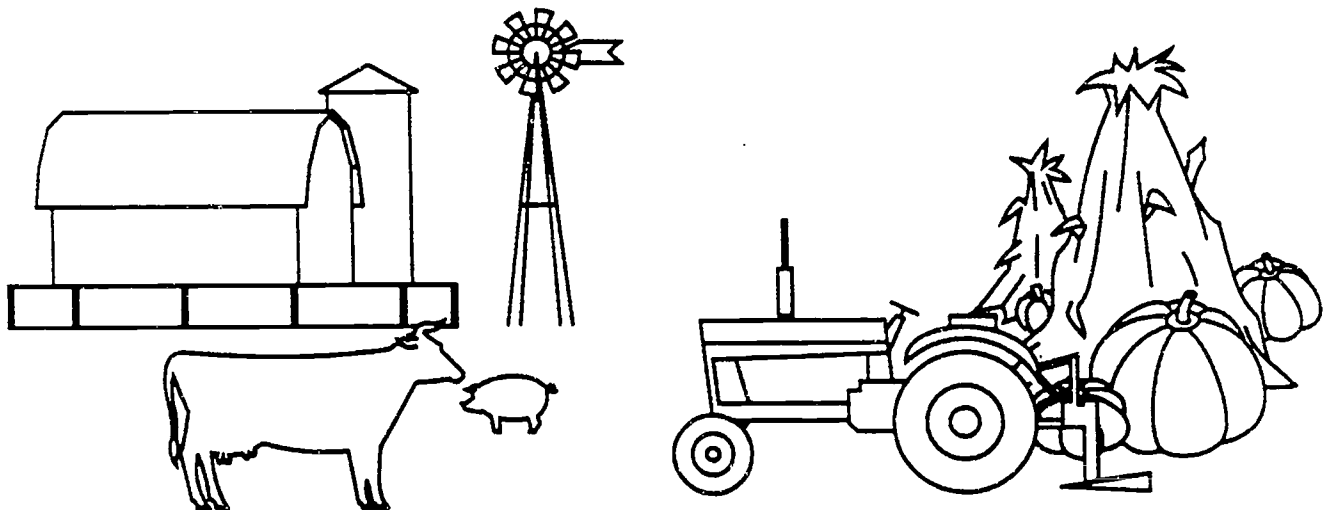

APPLIANCE AND EQUIPMENT REPAIR

Individuals in these occupations repair, adjust, maintain, and install all types of electrical motors and electrical and gas home appliances. Types of equipment used include test instruments, gauges, and hand, bench, and power tools.

The two largest occupations are:

- Electric home appliance and power tool repairers
- Electric motor, transformer, and related repairers

The occupations expected to have the most job openings annually are:

- Coin and vending machine servicers and repairers
- Gas appliance repairers

These occupations may not have a favorable outlook for the future. Overall, the number of these jobs shows little change. Very few job openings are expected over the next four or five years. Recently, there have been many more new trainees than job openings.

High school programs preparing for these occupations are:

47.0101 Electrical and electronics technology

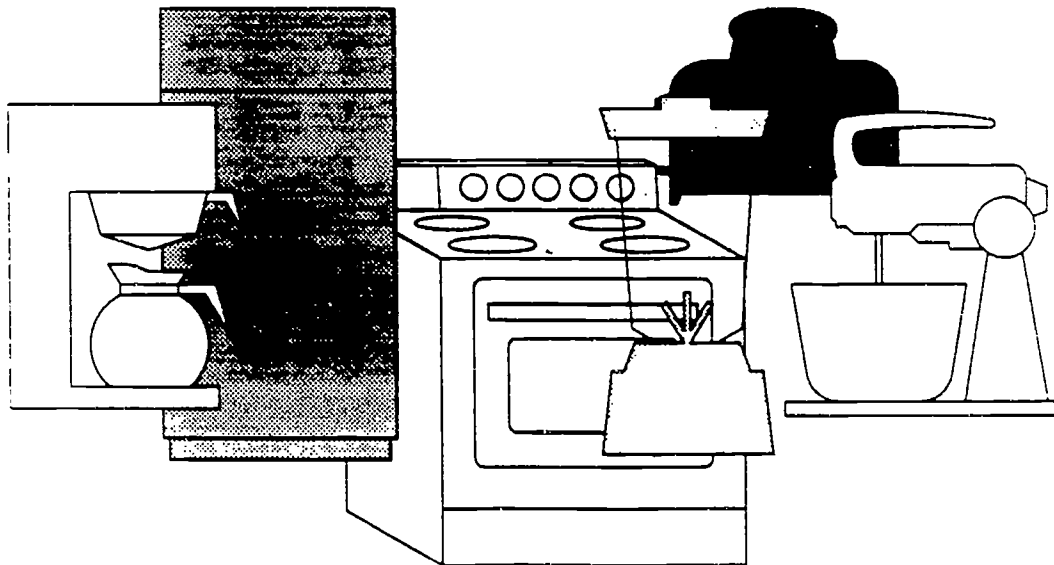

AUTOMOTIVE BODY REPAIR

Thousands of motor vehicles are damaged in traffic accidents every day. The workers in this field straighten bent frames, remove dents, and replace crumpled parts that are beyond repair so that those vehicles look and drive like new.

The largest occupations, which also have the greatest number of job openings annually, are:

- Automotive body and related repairers
- Painters of transportation equipment

These occupations may not have a favorable outlook for the future. Overall, the number of these jobs shows little change. Few job openings are expected over the next four or five years. Recently, there have been many more new trainees than job openings. Placement rates at area vocational technical schools, community colleges, and/or technical institutes have been fair recently.

High school programs preparing for these occupations are:

47.0603 Automotive body repair

Related postsecondary programs at state-supported institutions in this area are:

47.0603 Automotive body repair

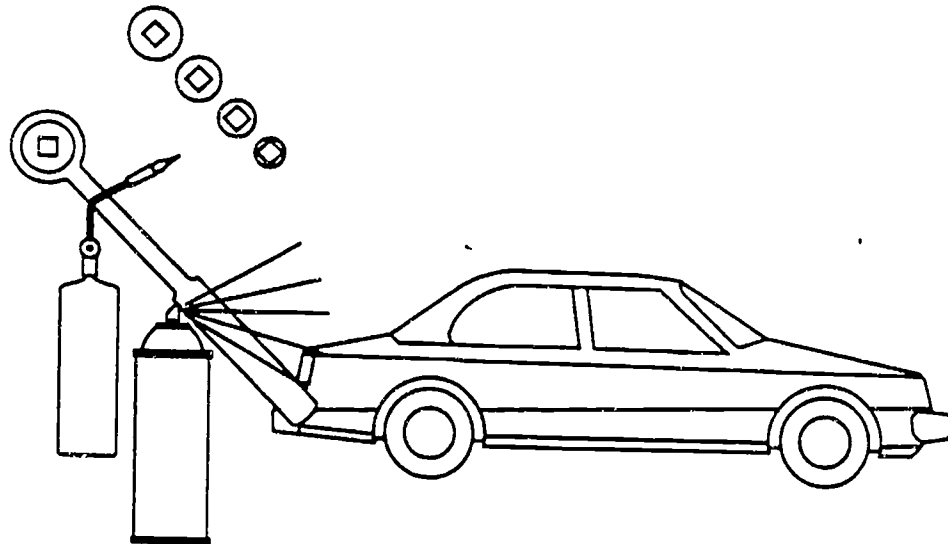

174

AUTOMOTIVE SERVICE TECHNOLOGY

These occupations include jobs concerned with parking, cleaning, polishing, lubricating, repairing, and refueling trucks, buses, and automobiles, and related servicing activities. The primary occupation, automotive mechanic, is concerned with repair and service of motor vehicles.

The largest occupations, which also have the greatest number of job openings annually, are:

- Automotive mechanics
- Tire repairers and changers

These occupations may not have a favorable outlook for the future. Overall, the number of these jobs is growing slowly. A moderate number of job openings are expected over the next four or five years. Recently, there have been many more new trainees than job openings. If this trend continues, job seekers can expect to face keen competition. Placement rates at area vocational technical schools, community colleges, and/or technical institutes have been fair recently.

High school programs preparing for these occupations are:

47.0604 Automotive mechanics

Related postsecondary programs at state-supported institutions in this area are:

15.0803 Automotive technology

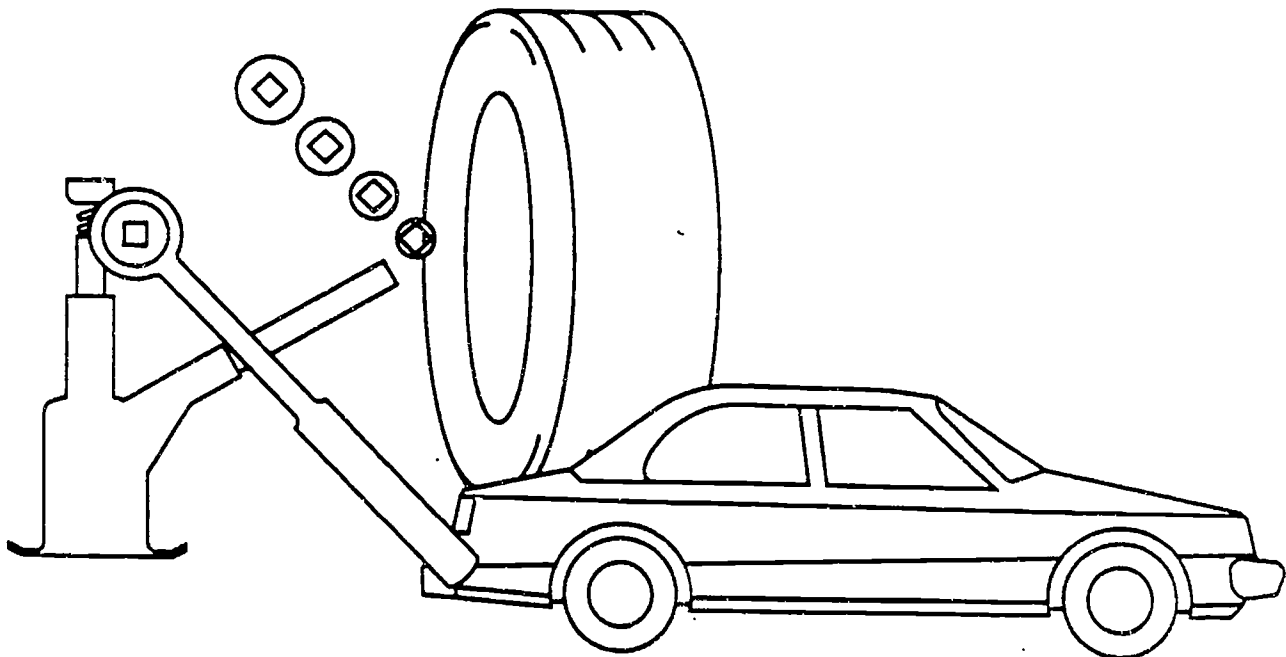

BRICK, BLOCK, AND STONEMASONRY

Workers are involved in trades producing attractive, durable surfaces. Bricklayers build walls, floors, partitions, fireplaces, and other structures with brick, cinder, or concrete block and other masonry materials. Stone masons build stone walls as well as set stone exteriors and floors. Both natural and artificial stones are used.

This occupation may not have a favorable outlook for the future. Overall, the number of these jobs shows little change. Very few job openings are expected over the next four or five years. Recently, there have been many more new trainees than job openings. Placement rates at area vocational technical schools, community colleges, and/or technical institutes have been good recently.

High school programs preparing for these occupations are:

- 46.0101 Brickmasonry, stonemasonry, and tilesetting
- 46.0102 Brick, block, and stonemasonry

Related postsecondary programs at state-supported institutions in this area are:

- 46.0102 Brick, block, and stonemasonry

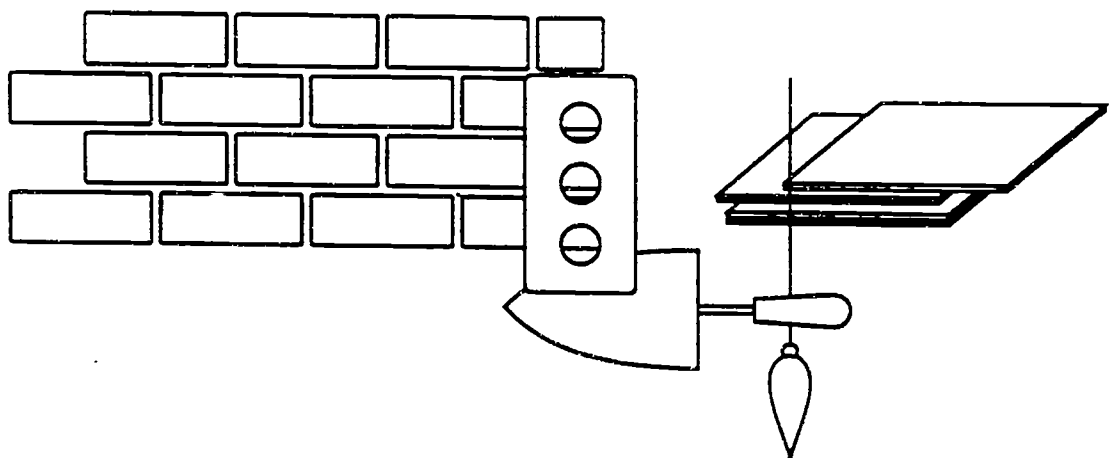

BUILDING MAINTENANCE

Persons in building maintenance occupations perform work involving several maintenance skills to keep the structure of an establishment in repair. Duties may involve pipefitting, boilermaking, carpentry, and electrical work as well as repairing buildings, floors, or stairs.

The two largest occupations are:

- General utility maintenance repairers
- Boiler operators and tenders of low pressure boilers

The occupations expected to have the most job openings annually are:

- General utility maintenance repairers
- Stationary engineers

These occupations may have a generally favorable outlook for the future. Overall, the number of these jobs is growing. A moderate number of job openings are expected over the next four or five years. Recently, there have been fewer new trainees than job openings. If this trend continues, job opportunities should be good.

Hourly wages include:

\$6.08 Maintenance repairers, general utility

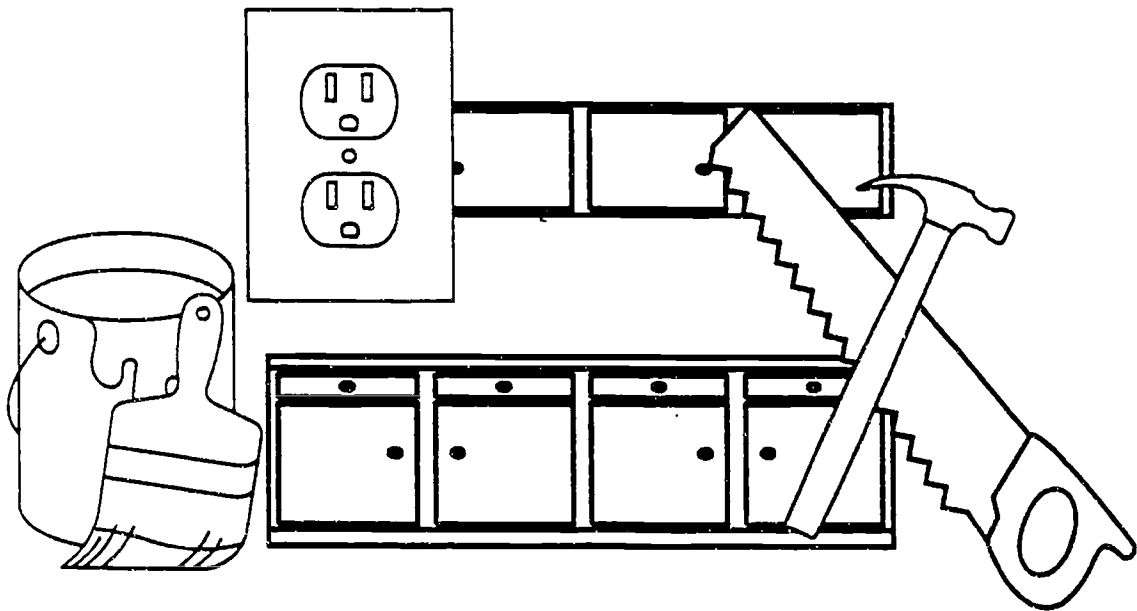

CARPENTRY

Almost all construction projects employ carpenters, the largest group of building trades workers. Carpenters perform a variety of jobs. Their duties will vary by type of construction, type of company, skill of the carpenter, and size of the community. A carpenter employed by a special trade contractor, for example, may specialize in laying hardwood floors, while one who is employed by a general building contractor may build wall frames and install paneling.

The largest occupations, which also have the greatest number of job openings annually, are:

- Carpenters
- Ceiling tile installers and acoustical carpenters

These occupations may have a generally favorable outlook for the future. Overall, the number of these jobs is growing. A moderate number of job openings are expected over the next four or five years. Recently, there have been about as many new trainees as job openings. If this trend continues, job seekers can expect to face some competition.

Hourly wages include:

\$9.11 Carpenters

High school programs preparing for these occupations are:

46.0201 Carpentry

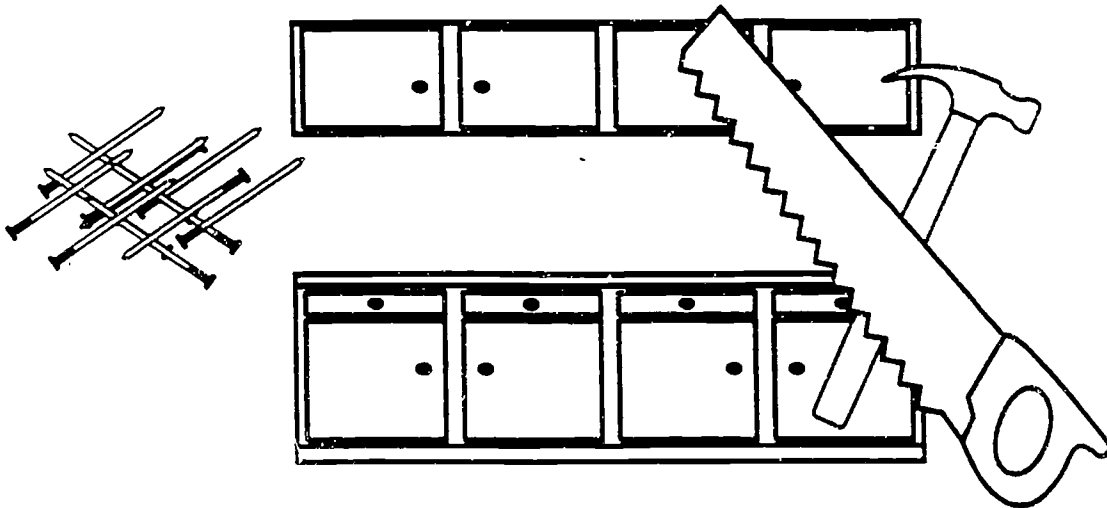

CHEMICAL TECHNOLOGY

Chemical technology workers either research and monitor chemical processes or are directly involved in operating equipment or control boards to create chemical reactions and processes in industrial settings. Technicians work with chemists or chemical engineers, setting up and conducting experiments and collecting and analyzing data.

The two largest occupations are:

- Chemical equipment controllers and operators
- Chemical (except health) technicians and technologists

The occupations expected to have the most job openings annually are:

- Chemical plant and system operators
- Chemical (except health) technicians and technologists

These occupations may have a generally favorable outlook for the future. Overall, the number of these jobs is declining. Few job openings are expected over the next four or five years. Recently, no training has been reported.

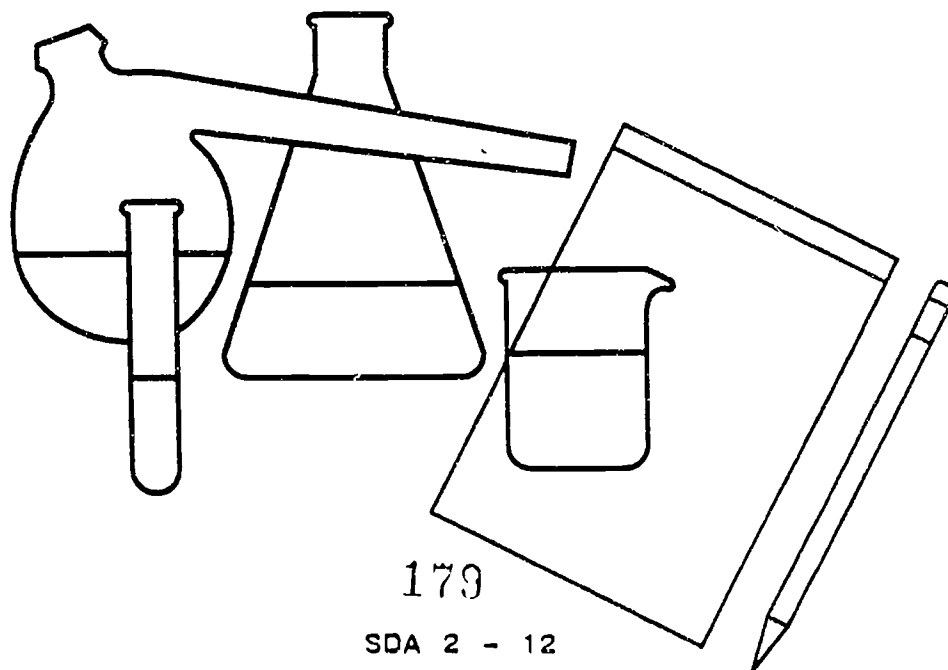

179

SDA 2 - 12

COMMERCIAL ART AND DESIGN

The majority of workers in this field design or arrange objects and materials in an artistic or decorative manner. Additional tasks may include the creation or drawing of designs for items such as furniture and machinery (product design).

The largest occupations, which also have the greatest number of job openings annually, are:

- Artists and related workers
- Designers, except interior designers

These occupations may have a generally favorable outlook for the future. Overall, the number of these jobs is growing. Few job openings are expected over the next four or five years. Recently, there have been fewer new trainees than job openings.

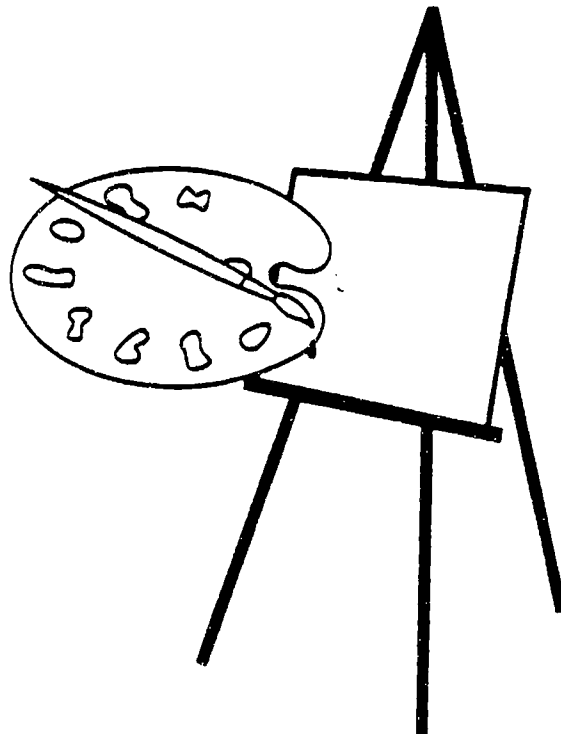

SDA 2¹⁰⁰-13

COMPUTER AND BUSINESS MACHINE PRODUCTION AND REPAIR

Workers in these fields install, service, maintain, and repair mechanical and electronic equipment, such as computers, word processing systems, radar systems, and office machines. Repairers may work in various locations doing a variety of tasks.

The two largest occupations are:

- Precision inspectors, testers, and graders
- Electrical and electronic assemblers

The occupations expected to have the most job openings annually are:

- Electrical and electronic assemblers
- Office machine and cash register servicers

These occupations may not have a favorable outlook for the future. Overall, the number of these jobs shows little change. Very few job openings are expected over the next four or five years. Recently, there have been more new trainees than job openings. Placement rates at area vocational technical schools, community colleges, and/or technical institutes have been poor recently.

Related postsecondary programs at state-supported institutions in this area are:

47.0105 Industrial electronics

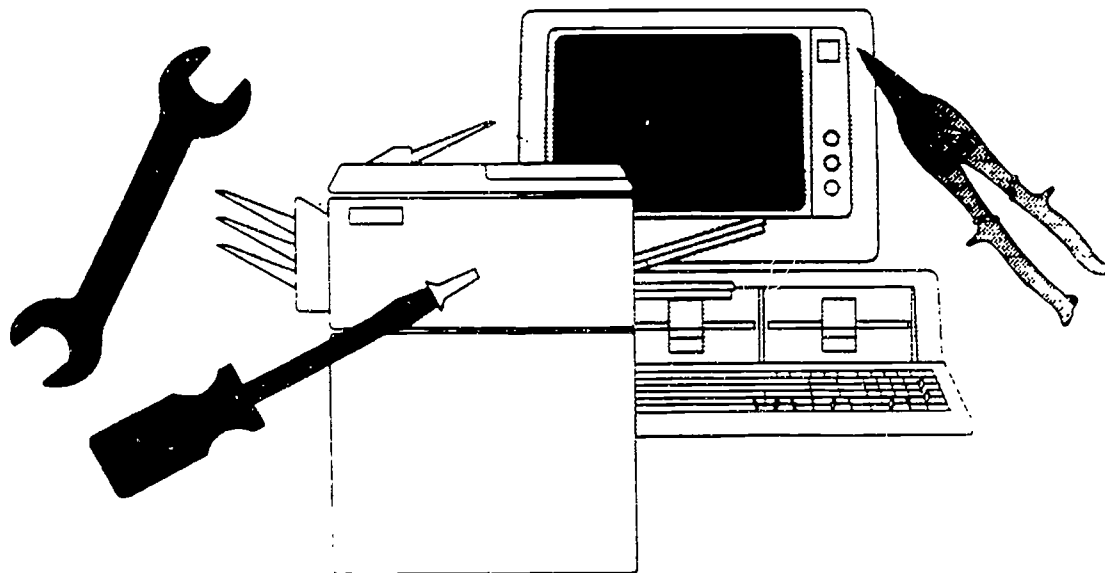

SDA 2 - 14 181

COMPUTER, ELECTRICAL, AND ELECTRONICS TECHNOLOGY

The majority of workers in this field are electrical and electronic engineering technicians and technologists. They apply electrical and related knowledge to design, build, test, and repair electrical equipment in industrial or commercial settings for subsequent use by engineering personnel.

This occupation may not have a favorable outlook for the future. Few job openings are expected over the next four or five years. Recently, there have been more new trainees than job openings.

Average hourly wages are \$11.83

High school programs preparing for these occupations are:

15.0303 Electronic technology

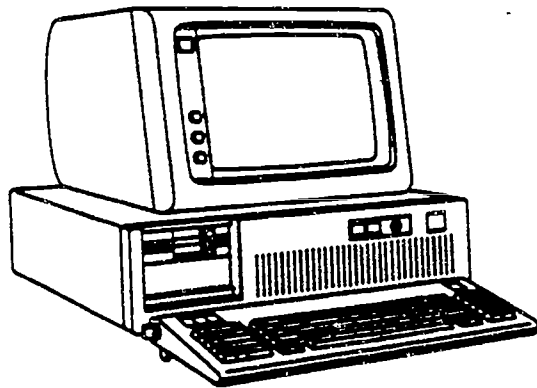

COMPUTER SYSTEMS

Workers in these computer occupations develop and write computer programs to store, locate, and retrieve specific documents, data, and information. They may also analyze business, scientific, and technical problems for application to electronic data processing systems. These careers generally require specialized training.

The largest occupations, which also have the greatest number of job openings annually, are:

- Systems analysts, electronic data processing
- Computer programmers

These occupations may not have a favorable outlook for the future. Overall, the number of these jobs is growing rapidly. A moderate number of job openings are expected over the next four or five years. Recently, there have been many more new trainees than job openings. If this trend continues, job seekers can expect to face keen competition. Placement rates at area vocational technical schools, community colleges, and/or technical institutes have been good recently.

Hourly wages include:

\$13.06 Computer programmers

High school programs preparing for these occupations are:

- 11.0101 Computer and information sciences
- 11.0201 Computer programming

Related postsecondary programs at state-supported institutions in this area are:

- 07.0301 Electronic data processing, computer science

COSMETOLOGY

Cosmetologists and related workers provide beauty services for customers. These may include cutting and styling hair, treating hair and scalp, applying makeup, dressing wigs, or removing hair by electrolysis, as well as cleaning, shaping, and polishing a customer's fingernails and toenails.

This occupation may not have a favorable outlook for the future. Overall, the number of these jobs is growing. Few job openings are expected over the next four or five years. Recently, there have been many more new trainees than job openings.

High school programs preparing for these occupations are:

12.0403 Cosmetology

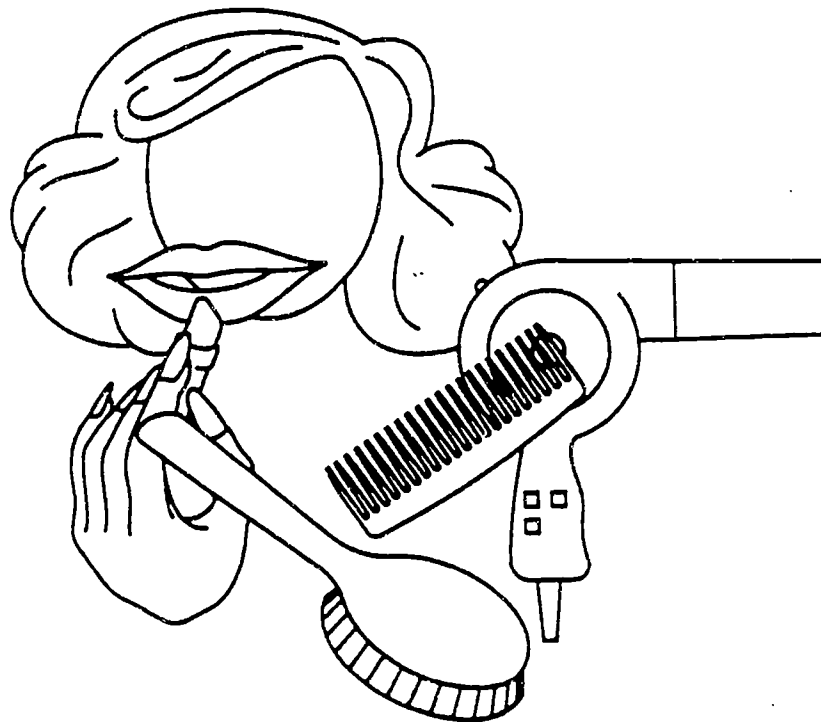

SDA 2 - 17

CUSTOM UPHOLSTERY

Upholsterers recondition sofas, chairs, and other upholstered furniture by replacing worn and damaged fabrics, springs, and padding. Upholsterers combine a knowledge of fabrics and other materials with artistic flair and manual skill. Upholsterers should have manual dexterity, good coordination, and be able to do occasional heavy lifting.

The largest occupations, which also have the greatest number of job openings annually, are:

- Upholsterers
- Sewing machine operators manufacturing items other than garments

These occupations may have a generally favorable outlook for the future. Overall, the number of these jobs shows little change. A moderate number of job openings are expected over the next four or five years. Recently, there have been fewer new trainees than job openings. If this trend continues, job opportunities should be good.

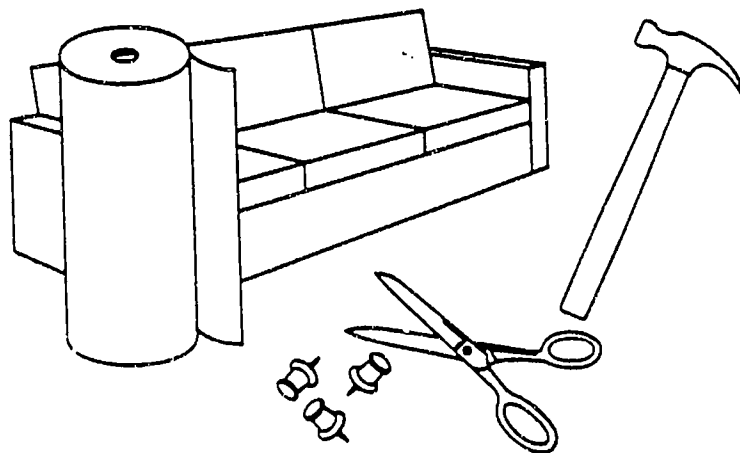

DRAFTING AND DESIGN TECHNOLOGY

Persons in drafting and design technology prepare clear, complete, and accurate working plans and detail drawings from rough or detailed sketches or notes for engineering or manufacturing purposes according to specified dimensions. Workers need to have knowledge of various machines, engineering practices, mathematics, building materials, and other physical sciences to complete drawings. Computer-assisted design (CAD) equipment may be used by some workers.

The largest occupations, which also have the greatest number of job openings annually, are:

- Cost estimators
- Drafters

These occupations may not have a favorable outlook for the future. Overall, the number of these jobs shows little change. Few job openings are expected over the next four or five years. Recently, there have been many more new trainees than job openings. Placement rates at area vocational technical schools, community colleges, and/or technical institutes have been poor recently.

High school programs preparing for these occupations are:

48.0101 Drafting

Related postsecondary programs at state-supported institutions in this area are:

48.0101 Drafting

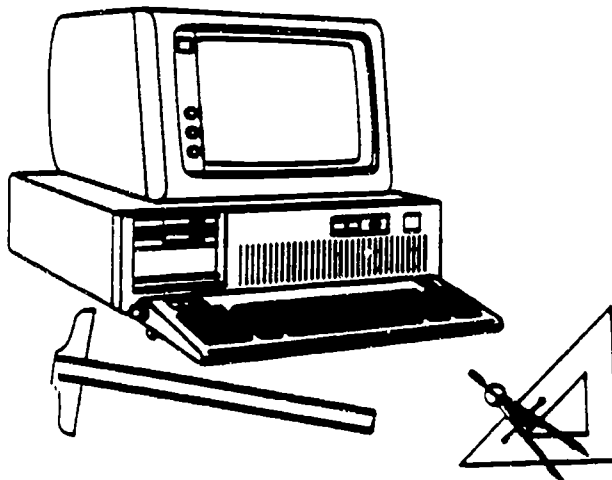

DRYCLEANING

Workers in these occupations operate washing and drying machines to clean and dry clean commercial, industrial, or household articles; use pressing machines to press and shape articles; and identify stains and apply chemical solutions to remove them.

The largest occupations, which also have the greatest number of job openings annually, are:

- Laundry and drycleaning machine operators and tenders, except of pressing machines
- Operators and tenders of machines pressing textiles, garments, and related materials

These occupations may have a generally favorable outlook for the future. Overall, the number of these jobs is growing. Few job openings are expected over the next four or five years. Recently, no training has been reported.

Hourly wages include:

\$4.65 Laundry and drycleaning machine operators and tenders, except pressing

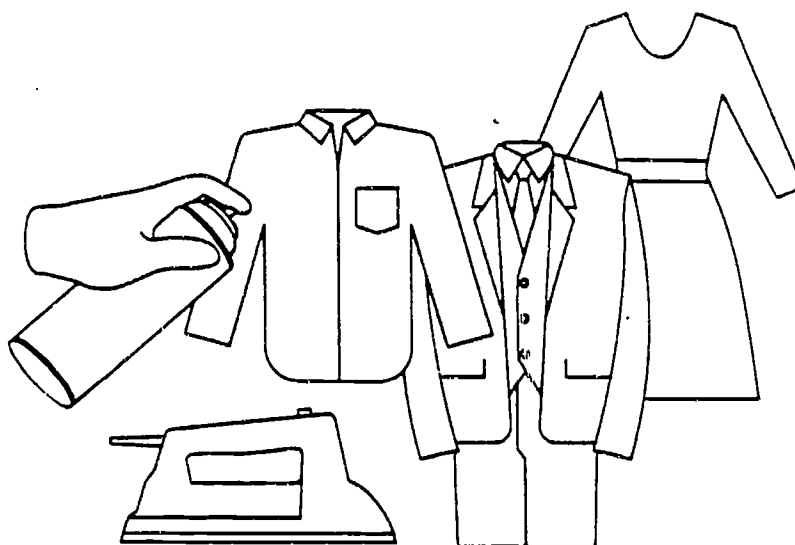

EARLY CHILDHOOD EDUCATION

Child care workers and managers of child care centers assume responsibility for the safety, physical care, and emotional, social, and intellectual growth of preschool children and infants while parents are at work or are unavailable for other reasons. Some work in residential institutions for young children. Teacher aides assist teachers by handling routine paperwork or by working directly with children.

The largest occupations, which also have the greatest number of job openings annually, are:

- Teacher aides, paraprofessional
- Child care workers

These occupations may have a generally favorable outlook for the future. Overall, the number of these jobs is growing rapidly. Large numbers of job openings are expected over the next four or five years. Recently, there have been fewer new trainees than job openings. If this trend continues, job opportunities should be good. Placement rates at area vocational technical schools, community colleges, and/or technical institutes have been excellent recently.

High school programs preparing for these occupations are:

- 20.0102 Child development, care, and guidance
- 20.0201 Child care and guidance management services

Related postsecondary programs at state-supported institutions in this area are:

- 20.0201 Child care and guidance management services

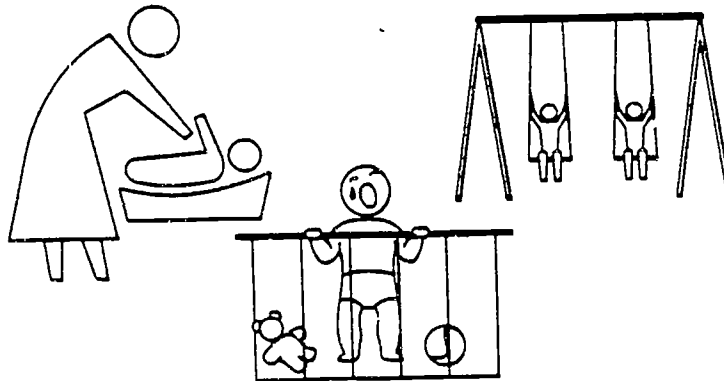

ELECTRICIAN OCCUPATIONS

Workers in the electrical field install, maintain, and repair wiring, electrical equipment, and fixtures or assist in such activities. These workers insure that work is in accordance with the relevant codes. A high school education is usually required and a five-year apprenticeship program is recommended.

The largest occupations, which also have the greatest number of job openings annually, are:

- Electricians
- Helpers of electricians and powerline transmission installers

These occupations may have a generally favorable outlook for the future. Overall, the number of these jobs is growing. A moderate number of job openings are expected over the next four or five years. Recently, no training has been reported. Job opportunities should be good.

Hourly wages include:

\$9.21 Electricians

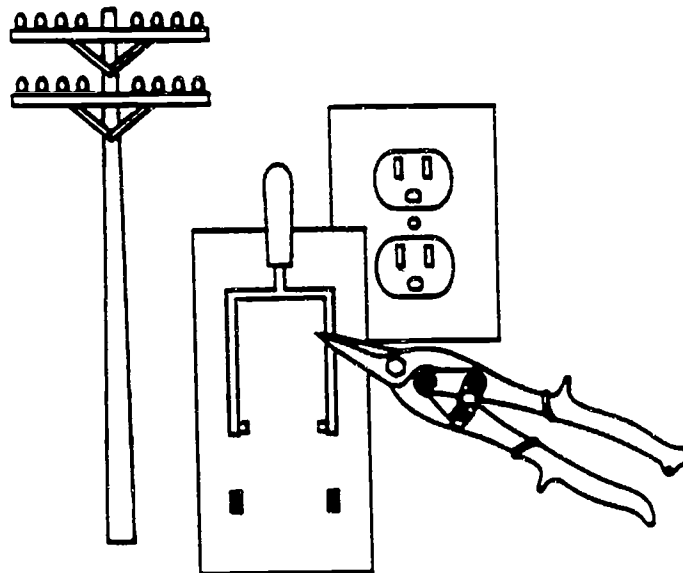

FOOD PREPARATION AND SERVICES

The majority of workers in these occupations prepare and serve food and beverages in restaurants, fast food establishments, catering firms, hotels, clubs, factories, school cafeterias, or hospitals, or supervise those providing food services. Others are factory machine operators involved in the preparation of food products. Dietetic technicians teach principles of food nutrition and provide dietary counseling to patients.

The largest occupations, which also have the greatest number of job openings annually, are:

- Food preparation workers
- Combined food preparation and service workers

These occupations may have a generally favorable outlook for the future. Overall, the number of these jobs is growing. Large numbers of job openings are expected over the next four or five years. Recently, there have been fewer new trainees than job openings. If this trend continues, job opportunities should be good. Placement rates at area vocational technical schools, community colleges, and/or technical institutes have been fair recently.

Hourly wages include:

- \$4.42 Cooks, specialty fast food
- \$4.49 Food preparation workers
- \$5.28 Bartenders
- \$5.34 Cooks, restaurant

High school programs preparing for these occupations are:

- 20.0401 Food production, management, and services
- 46.1111 Food occupations

Related postsecondary programs at state-supported institutions in this area are:

- 20.0401 Food production, management, and services

GENERAL BUSINESS AND MANAGEMENT

Workers in the general business and management occupations plan, organize, direct, control, or coordinate activities in all types of fields. Many occupations involve analysis of productivity and financial soundness. General managers and top executives usually have very diverse duties and responsibilities and work through departmental or subordinate executives.

The largest occupations, which also have the greatest number of job openings annually, are:

- Industrial production managers
- General managers and top executives

These occupations may have a generally favorable outlook for the future. Overall, the number of these jobs is growing. Large numbers of job openings are expected over the next four or five years. Recently, there have been fewer new trainees than job openings. If this trend continues, job opportunities should be good. Placement rates at area vocational technical schools, community colleges, and/or technical institutes have been excellent recently.

Hourly wages include:

- \$16.78 Purchasing managers
- \$19.59 Industrial production managers

Related postsecondary programs at state-supported institutions in this area are:

06.0401 Business administration and management



SDA 2 - 24

GENERAL WOODWORKING

Woodworkers are in occupations concerned with the complete cycle of cutting, shaping, and assembling parts of complex wood products. The occupations are primarily concerned with one or a limited number of machine functions according to their speciality.

The two largest occupations are:

- Assemblers and fabricators, except machine, electrical, electronic, and precision assembly
- Sawing machine operators and tenders

The occupations expected to have the most job openings annually are:

- Woodworking machine operators and tenders, except of sawing machines
- Sawing machine operators and tenders

These occupations may have a generally favorable outlook for the future. Overall, the number of these jobs shows little change. Large numbers of job openings are expected over the next four or five years. Recently, there have been fewer new trainees than job openings. If this trend continues, job opportunities should be good.

High school programs preparing for these occupations are:

- 48.0701 Woodworking
- 48.0799 Miscellaneous woodworking

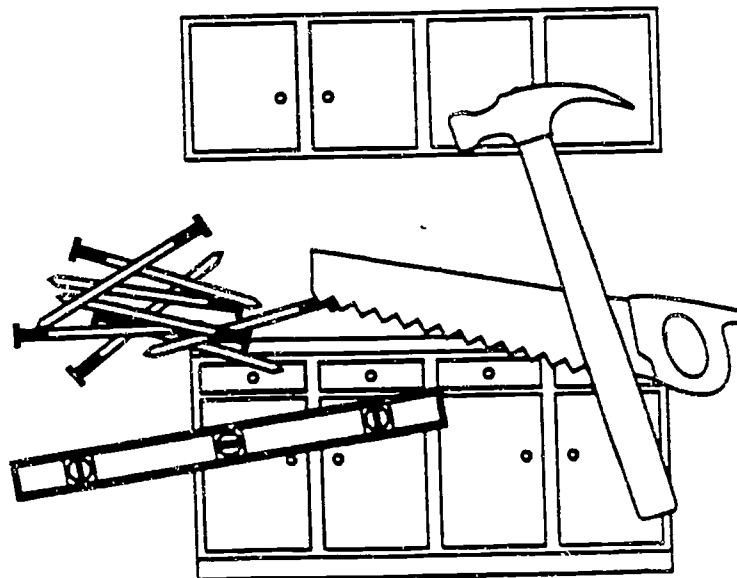

GRAPHIC ARTS

A majority of workers in this field are involved in offset printing. In this process the material to be printed is photographed and a printing plate is made from the film. This process has been advanced by the use of computers and lasers.

The two largest occupations are:

- Printing press machine operators and tenders
- Offset lithographic press setters and set-up operators

The occupations expected to have the most job openings annually are:

- Printing press machine operators and tenders
- Bindery machine operators

These occupations may not have a favorable outlook for the future. Overall, the number of these jobs is growing slowly. Few job openings are expected over the next four or five years. Recently, there have been many more new trainees than job openings. Placement rates at area vocational technical schools, community colleges, and/or technical institutes have been fair recently.

Hourly wages include:

\$10.11 Offset lithographic press setters & set-up operators, sheet or web fed

High school programs preparing for these occupations are:

48.0201 Graphic and printing communications

Related postsecondary programs at state-supported institutions in this area are:

48.0201 Graphic and printing communications

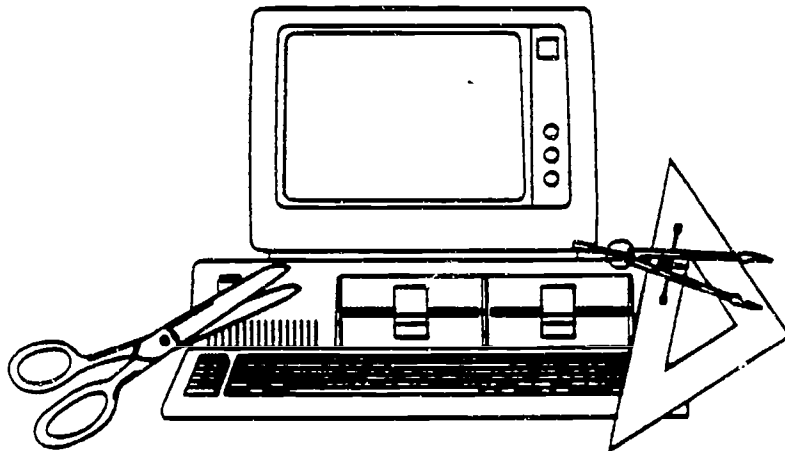

HEATING AND AIR CONDITIONING

Workers in this field install and repair heating, air conditioning, and refrigeration systems. They may install and repair oil burners, hot-air furnaces, and heating stoves in homes and businesses. They may also install and repair air conditioning systems, or install sheet metal ducts for the heating and cooling systems.

The largest occupations, which also have the greatest number of job openings annually, are:

- Heating, air conditioning, and refrigeration mechanics and installers
- Sheet metal duct installers

These occupations may not have a favorable outlook for the future. Overall, the number of these jobs is growing. Few job openings are expected over the next four or five years. Recently, there have been more new trainees than job openings. Placement rates at area vocational technical schools, community colleges, and/or technical institutes have been fair recently.

Hourly wages include:

\$8.65 Heating, air conditioning, and refrigeration mechanics and installers

High school programs preparing for these occupations are:

47.0201 Heating, air conditioning, and refrigeration mechanics

Related postsecondary programs at state-supported institutions in this area are:

47.0201 Heating, air conditioning, and refrigeration mechanics

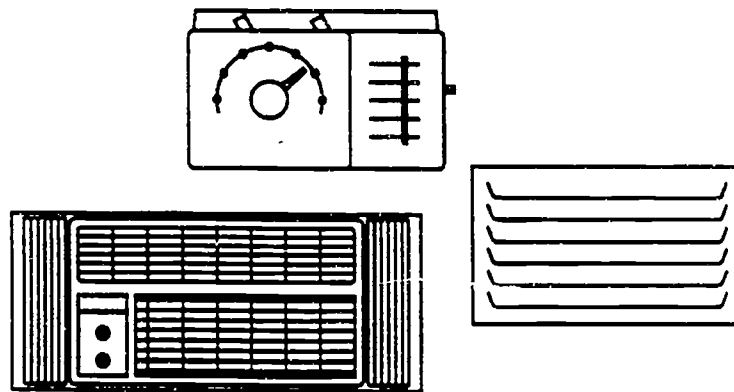

HEAVY TRUCK MAINTENANCE

Persons in heavy truck maintenance repair and maintain the operating condition of trucks, buses, and all types of diesel engines. This also includes mechanics working primarily with automobile diesel engines.

This occupation may have a generally favorable outlook for the future. Overall, the number of these jobs is growing. Few job openings are expected over the next four or five years. Recently, no training has been reported.

Average hourly wages are \$8.05

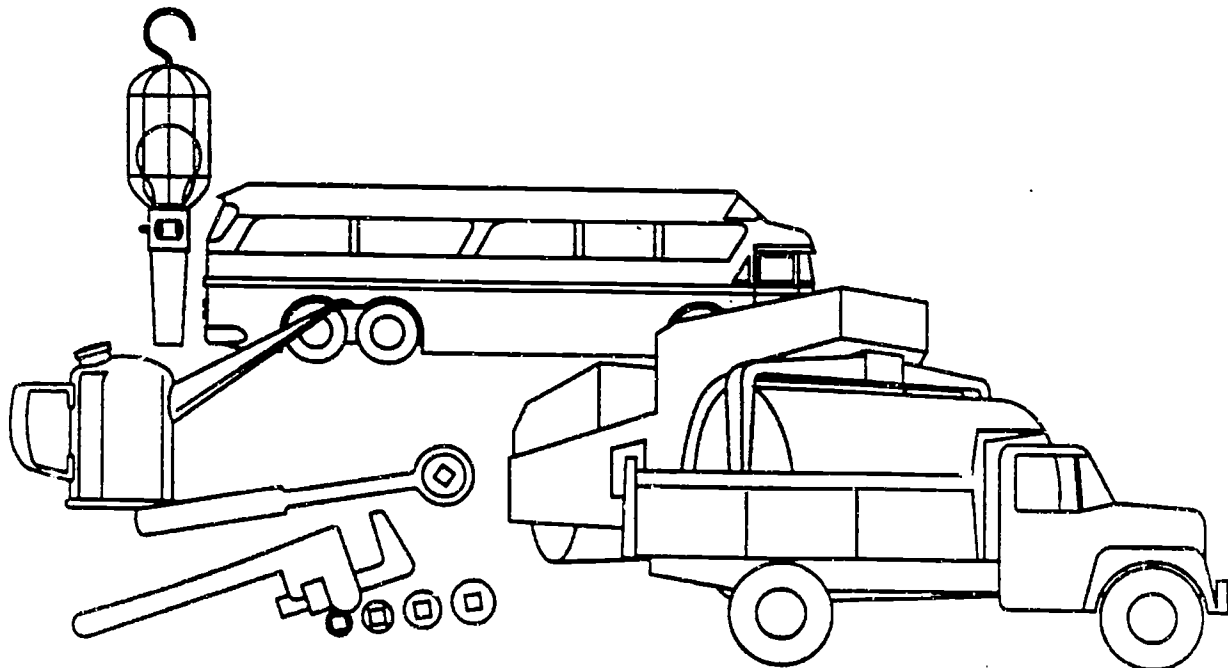

HORTICULTURE AND LANDSCAPING

The largest group of workers in these occupations, gardeners and groundskeepers, maintain the grounds of public and private property. Duties may include mowing, trimming, planting, and watering plants, shrubs, and grass.

The largest occupations, which also have the greatest number of job openings annually, are:

- Nursery workers
- Gardeners and groundskeepers, except farm workers

These occupations may have a generally favorable outlook for the future. Overall, the number of these jobs is growing. Few job openings are expected over the next four or five years. Recently, there have been many more new trainees than job openings. Placement rates at area vocational technical schools, community colleges, and/or technical institutes have been excellent recently.

Hourly wages include:

\$6.88 Gardeners and groundskeepers, except farm

High school programs preparing for these occupations are:

01.0601 Horticulture

Related postsecondary programs at state-supported institutions in this area are:

01.0603 Ornamental horticulture

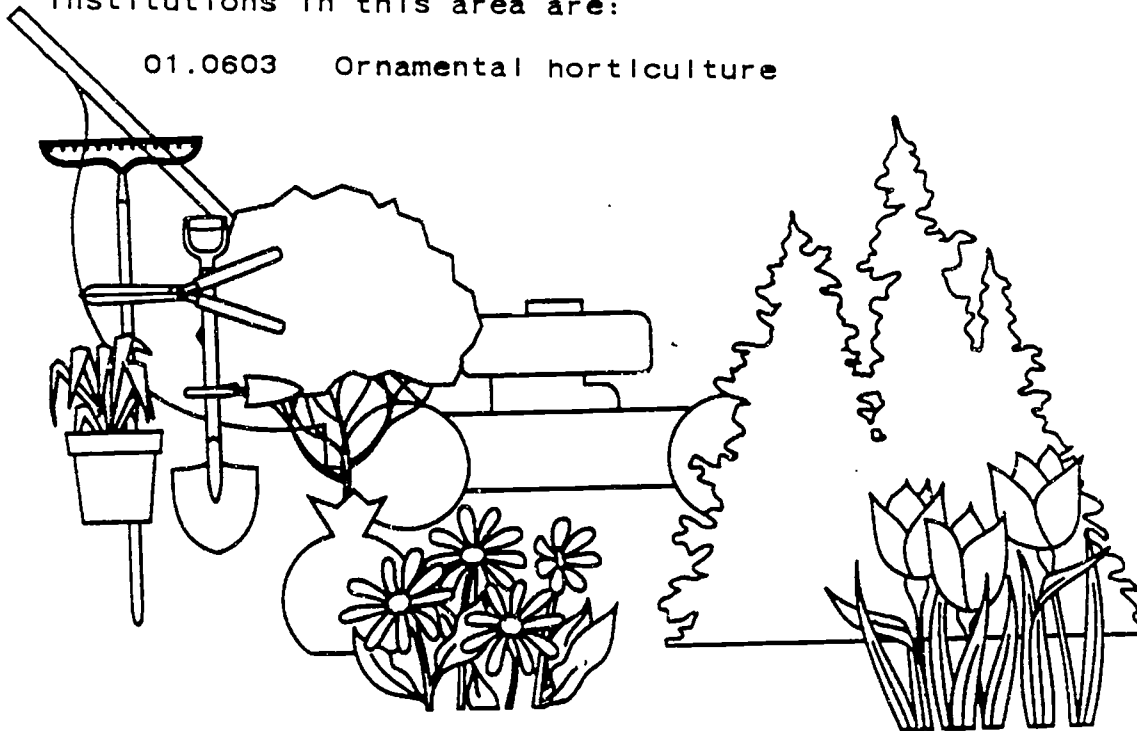

HOTEL AND RESTAURANT MANAGEMENT

Food service and lodging managers supervise the profitable operation of restaurants, hotels, and motels. Workers direct the varied activities of these businesses with the goal of pleasing people and providing good service to their customers.

- This occupation may have a generally favorable outlook for the future. Overall, the number of these jobs is growing. A moderate number of job openings are expected over the next four or five years. Recently, there have been fewer new trainees than job openings. If this trend continues, job opportunities should be good.

Average hourly wages are \$7.96

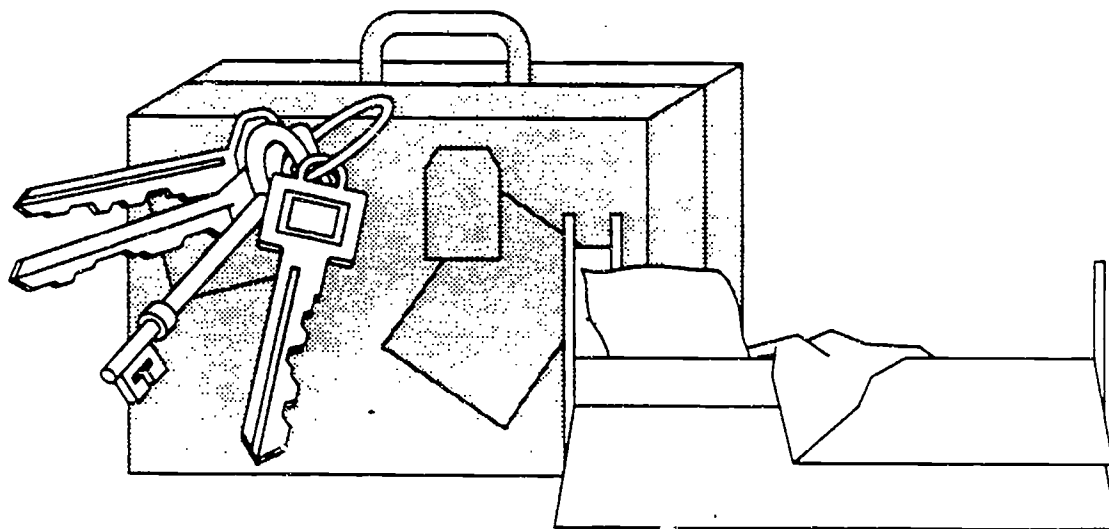

INDUSTRIAL MAINTENANCE TECHNOLOGY

Workers prevent costly waste of raw materials and the idling of human resources in a plant or factory by making industrial machinery repairs as quickly as possible. Maintenance mechanics spend considerable time doing preventive maintenance, including keeping machines well oiled and greased, and periodically cleaning parts.

The two largest occupations are:

- Maintenance mechanics for industrial machinery
- Textile machine setters and set-up operators

The occupations expected to have the most job openings annually are:

- Maintenance mechanics for industrial machinery
- Millwrights

These occupations may have a generally favorable outlook for the future. Overall, the number of these jobs shows little change. A moderate number of job openings are expected over the next four or five years. Recently, there have been fewer new trainees than job openings. If this trend continues, job opportunities should be good. Placement rates at area vocational technical schools, community colleges, and/or technical institutes have been excellent recently.

Hourly wages include:

\$9.72 Machinery maintenance mechanics

Related postsecondary programs at state-supported institutions in this area are:

15.0603 Industrial technology

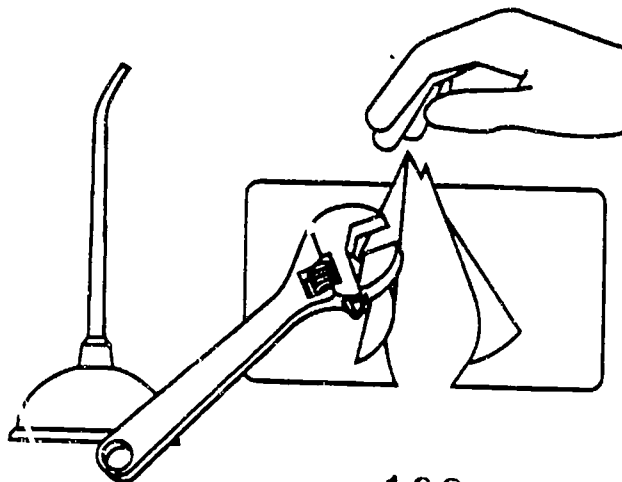

INSTITUTIONAL HOME MANAGEMENT AND SUPPORTING SERVICES

These workers make sure that all public buildings, offices, hospitals, stores, and apartment houses are kept clean and in good condition for the comfort and safety of the people who work or live there. Generally, no special education is required for occupations in this field, with most skills learned on the job.

The largest occupations, which also have the greatest number of job openings annually, are:

- Maids and housekeeping cleaners
- Janitors and cleaners, except maids and housekeeping cleaners

These occupations may have a generally favorable outlook for the future. Overall, the number of these jobs is growing. Large numbers of job openings are expected over the next four or five years. Recently, there have been fewer new trainees than job openings. If this trend continues, job opportunities should be good.

Hourly wages include:

- \$5.02 Maids and housekeeping cleaners
- \$5.07 Housekeepers
- \$5.46 Janitors and cleaners, except maids and housekeeping cleaners

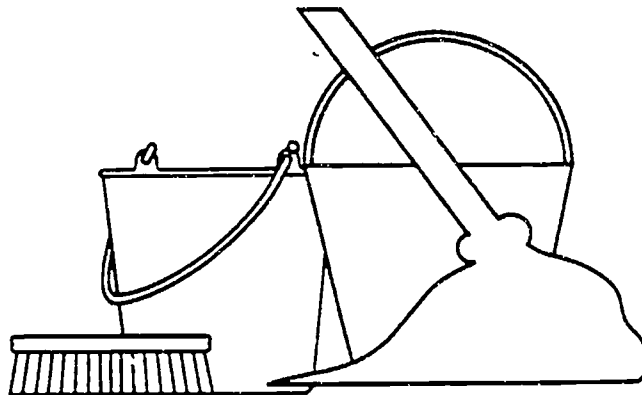

LAW ENFORCEMENT

People working at these occupations are responsible for the safety of Tennessee cities, towns, and highways. Their responsibilities range from controlling traffic to preventing and investigating crimes. Whether on or off duty, they are expected to exercise their authority whenever necessary.

The largest occupations, which also have the greatest number of job openings annually, are:

- Police and detective supervisors
- Police patrol officers

These occupations may have a generally favorable outlook for the future. Overall, the number of these jobs is growing. Few job openings are expected over the next four or five years. Recently, there have been more new trainees than job openings. Placement rates at area vocational technical schools, community colleges, and/or technical institutes have been good recently.

Hourly wages include:

\$9.96 Police patrol officers

Related postsecondary programs at state-supported institutions in this area are:

43.0107 Law enforcement and police science



200

SDA 2 - 33

MACHINE TOOL TECHNOLOGY

Workers in these occupations make or set up and operate machine tools or repair metal parts. Machinists and tool-and-die makers create highly specialized precision tools, molds, and metal parts. Often they use blueprints to develop prototypes for tools or machines to be used in manufacturing.

The two largest occupations are:

- Machinists
- Machine tool cutting operators and tenders of metal and plastic

The occupations expected to have the most job openings annually are:

- Machinists
- Press and press brake machine setters and set-up operators for metal and plastic

These occupations may have a generally favorable outlook for the future. Overall, the number of these jobs is growing. Large numbers of job openings are expected over the next four or five years. Recently, there have been about as many new trainees as job openings. If this trend continues, job seekers can expect to face some competition. Placement rates at area vocational technical schools, community colleges, and/or technical institutes have been good recently.

Hourly wages include:

- \$6.42 Lathe and turning machine tool setters and set-up operators, metal and plastic
- \$9.59 Machinists
- \$10.08 Combination machine tool operators and tenders, metal and plastic
- \$11.87 Numerical control machine tool operators and tenders, metal and plastic
- \$12.13 Tool and die makers

High school programs preparing for these occupations are:

- 48.0503 Machine tool operation and machine shop technology

Related postsecondary programs at state-supported institutions in this area are:

- 48.0503 Machine tool operation and machine shop technology

MEDICAL ASSISTING

Medical assistants perform a wide variety of clinical and administrative duties under the direction of physicians. Clinical duties may include taking and recording patients' vital signs and medical histories, preparing patients for examination by physicians, and explaining treatment procedures to patients.

In small physicians' offices they may keep medical records, schedule appointments, and order supplies. Electrocardiograph (EKG) technicians operate the EKG machines which provide graphic tracings of heartbeats.

This occupation may have a generally favorable outlook for the future. Few job openings are expected over the next four or five years. Recently, no training has been reported.

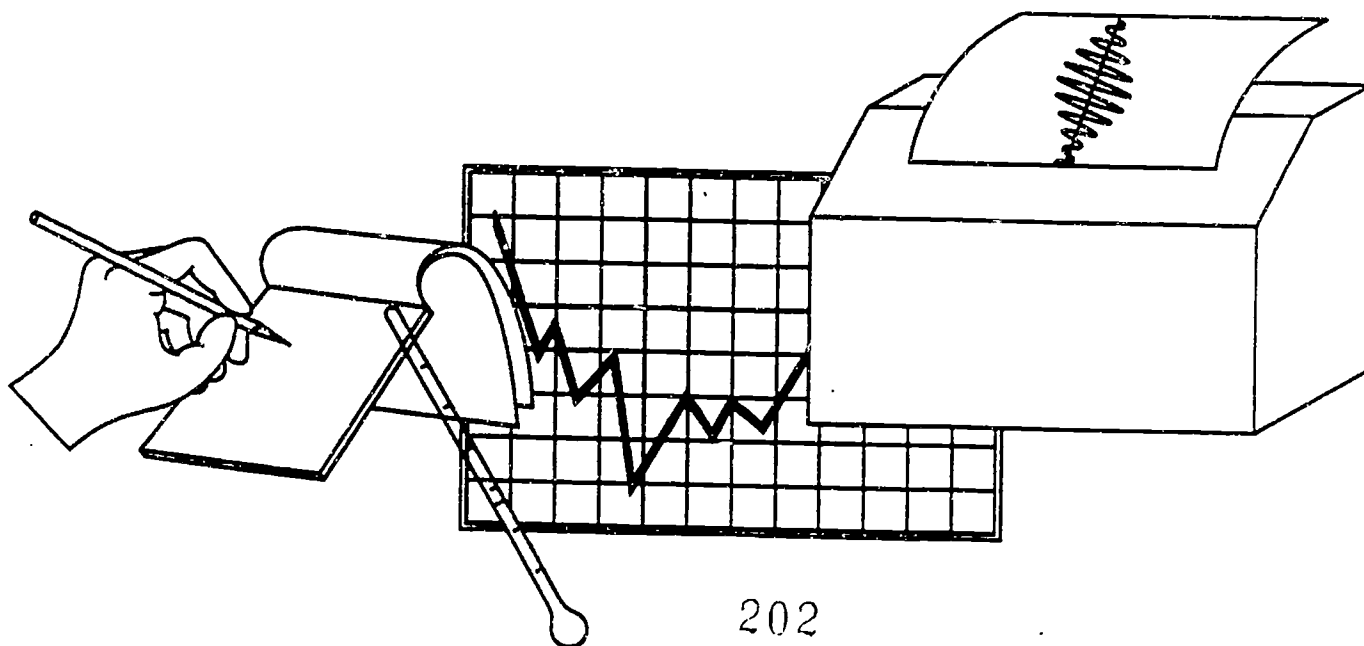

MEDICAL RECORDS TECHNOLOGY

Medical records technicians compile and maintain medical records of hospital and clinic patients. Such work is becoming increasingly important as this background information is used for medicare and medical insurance reimbursements.

This occupation may not have a favorable outlook for the future. Overall, the number of these jobs shows little change. Very few job openings are expected over the next four or five years. Recently, no training has been reported.

Average hourly wages are \$6.13

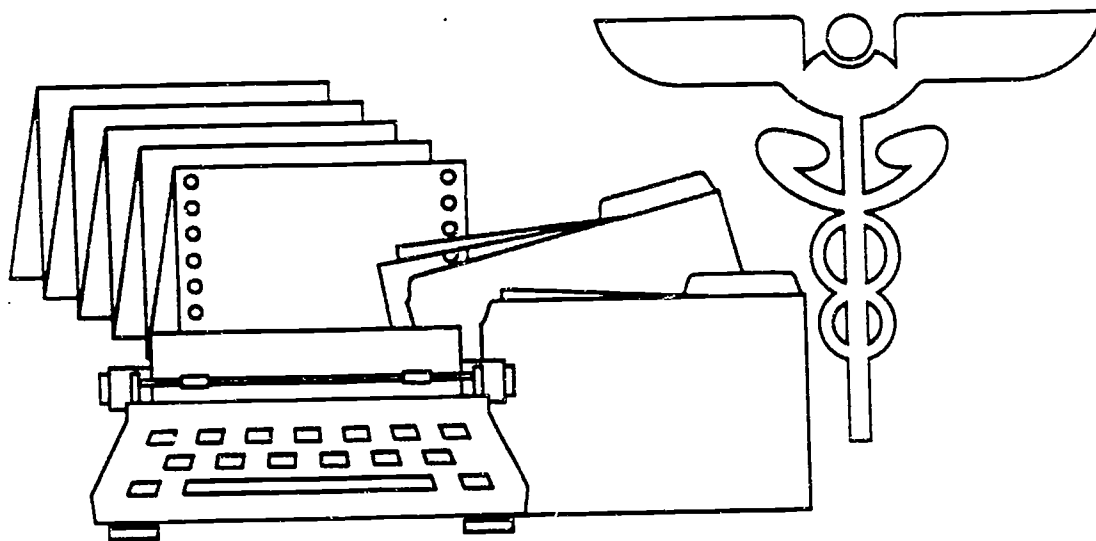

NURSING ASSISTANT

Nursing aides and orderlies work under the general direction of nursing or medical staff. In hospitals, they may answer patients' call bells, serve and collect food trays, feed patients, or set up equipment. In nursing homes, they are expected to sustain ongoing relations with patients.

The largest occupations, which also have the greatest number of job openings annually, are:

- Nursing aides, orderlies, and attendants
- Home health aides

These occupations may have a generally favorable outlook for the future. Overall, the number of these jobs is growing rapidly. A moderate number of job openings are expected over the next four or five years. Recently, there have been fewer new trainees than job openings. If this trend continues, job opportunities should be good.

Hourly wages include:

- \$5.26 Nursing aides, orderlies, and attendants
- \$6.56 Home health aides

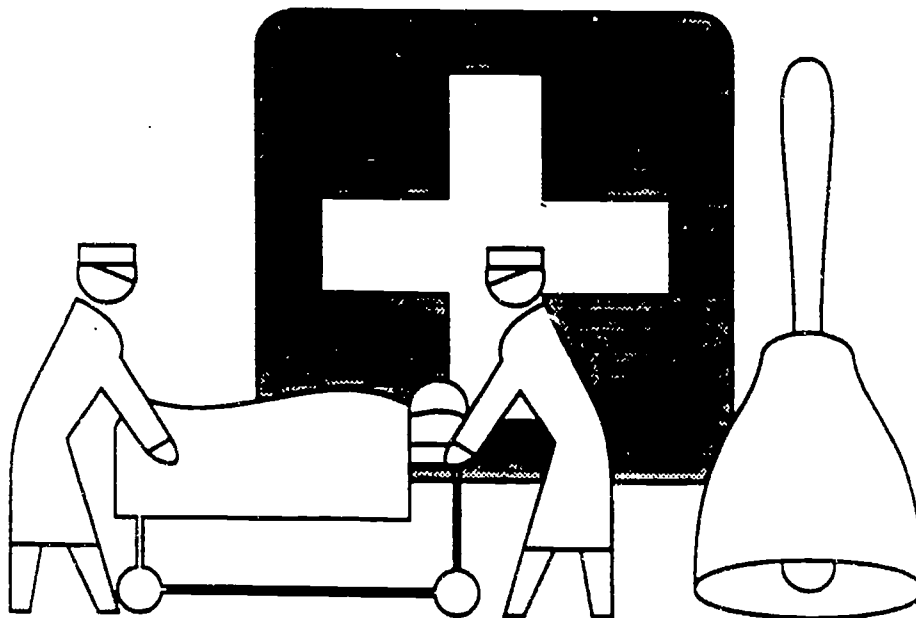

SDA 2 - 37201

PLUMBING AND PIPEFITTING

Plumbers and pipefitters install and maintain the complex system of pipes that connect to the master system that runs underground. Although plumbing and pipefitting are sometimes considered a single trade, workers may specialize in either craft. Plumbers build and repair the water, waste disposal, drainage, and gas systems in homes and commercial/industrial buildings. Pipefitters build and repair both high and low pressure pipe.

The largest occupations, which also have the greatest number of job openings annually, are:

- Plumbers, pipefitters, and steamfitters
- Pipelayers

These occupations may not have a favorable outlook for the future. Overall, the number of these jobs is growing. Few job openings are expected over the next four or five years. Recently, there have been more new trainees than job openings.

Hourly wages include:

\$10.91 Plumbers, pipefitters, and steamfitters

High school programs preparing for these occupations are:

46.0501 Plumbing, pipefitting, and steamfitting

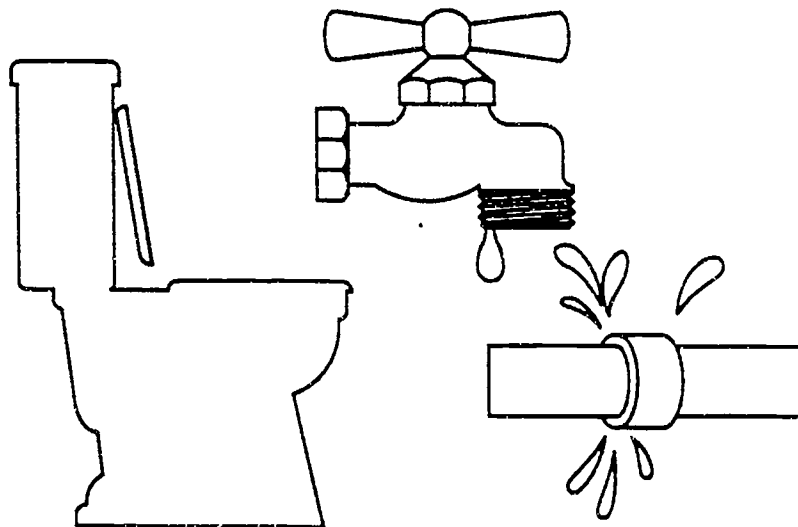

PRACTICAL NURSING

Licensed practical nurses (LPNs) work under the supervision of physicians and/or registered nurses to provide nursing care that requires technical knowledge but not the professional training of a registered nurse. They provide bedside care, administer certain medications, and assist in patient examinations.

This occupation may have a generally favorable outlook for the future. Overall, the number of these jobs is growing rapidly. A moderate number of job openings are expected over the next four or five years. Recently, there have been more new trainees than job openings. If this trend continues, job seekers can expect to face some competition. Placement rates at area vocational technical schools, community colleges, and/or technical institutes have been excellent recently.

Average hourly wages are \$8.64

Related postsecondary programs at state-supported institutions in this area are:

17.0605 Practical nursing

Licensing may be required. Contact: TENNESSEE BOARD OF NURSING, 615-367-6232.

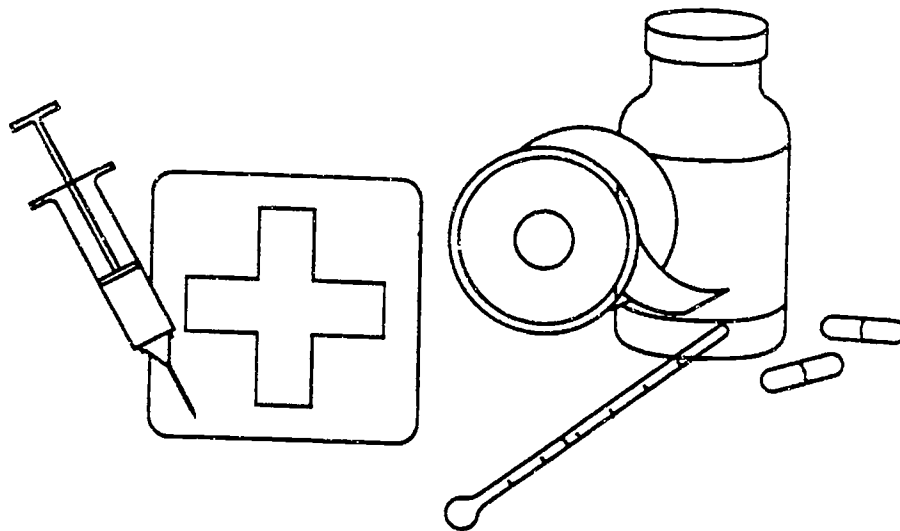

PROFESSIONAL NURSING

Registered Nurses (R.N.'s), the largest occupational group in this field, are primarily employed in hospitals and nursing homes, where they provide skilled bedside care and may supervise licensed practical nurses, nursing aides, and orderlies. Working under the direction of a licensed "supervising physician," physician assistants elicit detailed patient histories, perform physical examinations, and prescribe appropriate treatments.

The largest occupations, which also have the greatest number of job openings annually, are:

- Registered nurses
- Physician's assistants

These occupations may have a generally favorable outlook for the future. Overall, the number of these jobs is growing rapidly. Large numbers of job openings are expected over the next four or five years. Recently, there have been many more new trainees than job openings. If this trend continues, job seekers can expect to face keen competition. Placement rates at area vocational technical schools, community colleges, and/or technical institutes have been excellent recently.

Hourly wages include:

\$14.16 Registered nurses

Related postsecondary programs at state-supported institutions in this area are:

18.1101 Nursing

Licensing may be required. Contact: TENNESSEE BOARD OF MEDICAL EXAMINERS-COMMITTEE ON PHYSICIAN ASSISTANTS, 615-367-6250.

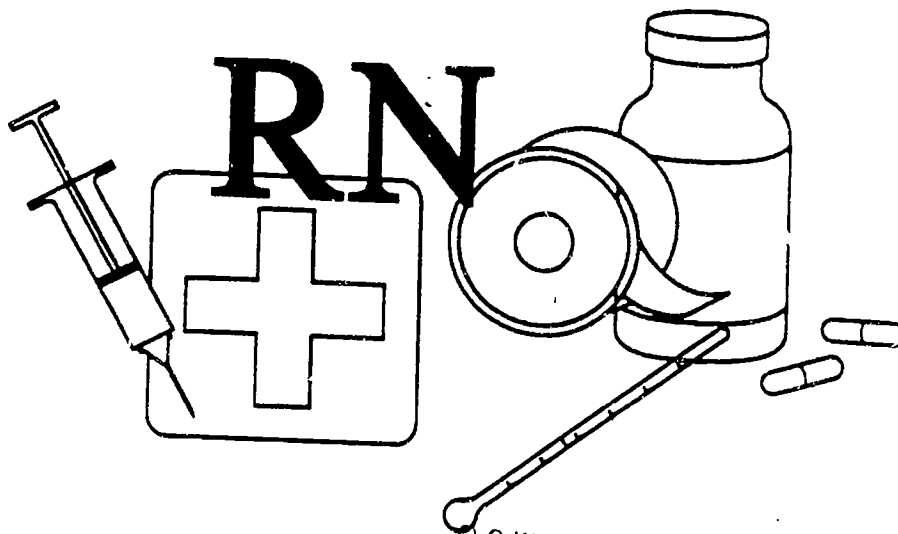

RADIOGRAPHIC MEDICAL TECHNOLOGY

Workers in this field operate equipment including x-ray machines, fluoroscopes, ultrasonic scanners, computed tomography (CP) scanners, and nuclear magnetic resonance (MCI) machines for diagnostic imagery of the human body or for therapy.

The largest occupations, which also have the greatest number of job openings annually, are:

- Radiologic technologists
- Radiologic technicians

These occupations may have a generally favorable outlook for the future. Few job openings are expected over the next four or five years. Recently, no training has been reported.

Hourly wages include:

\$9.98 Radiologic technicians

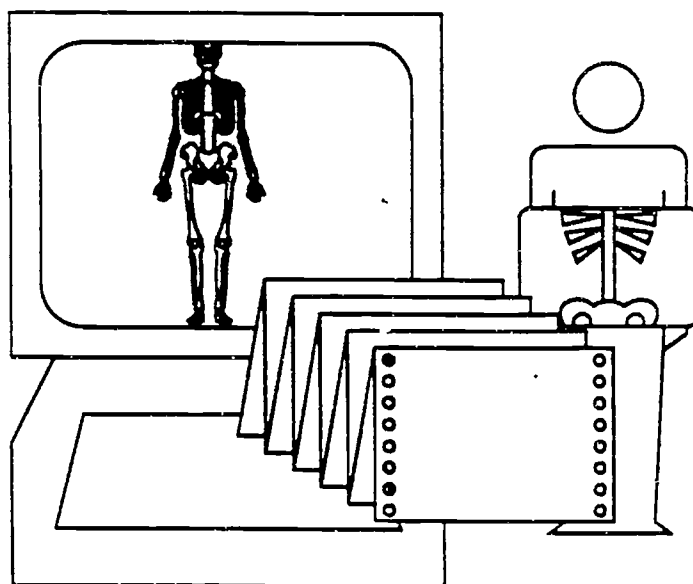

208

SALES AND MERCHANDISING

Workers in sales and merchandising occupations promote and sell a wide variety of merchandise and services. They also receive, store, display, and inventory products to be sold.

The largest occupations, which also have the greatest number of job openings annually, are:

- Salespersons in retail establishments
- Cashiers

These occupations may have a generally favorable outlook for the future. Overall, the number of these jobs is growing. Large numbers of job openings are expected over the next four or five years. Recently, there have been more new trainees than job openings. If this trend continues, job seekers can expect to face some competition.

Hourly wages include:

\$4.62	Cashiers
\$5.41	Salespersons, retail
\$8.98	Customer service representatives, utilities
\$14.80	Purchasing agents- except wholesale, retail, and farm products

High school programs preparing for these occupations are:

08.0700	General marketing
08.0799	Miscellaneous general marketing

Licensing may be required. Contact: TENNESSEE DEPARTMENT OF COMMERCE AND INSURANCE, 615-741-2693.

SECURITY SERVICES

Security guards, the largest occupation in this field, patrol and inspect property to protect it against fire, theft, vandalism, and illegal entry. Guards and doorkeepers usually are uniformed and often carry a nightstick and a weapon; correctional officers and jailers maintain order in correctional institutions, enforce institutional rules and regulations, and may supplement the counseling inmates receive from mental health professionals.

The largest occupations, which also have the greatest number of job openings annually, are:

- Correction officers and jailers
- Guards and watch guards

These occupations may have a generally favorable outlook for the future. Overall, the number of these jobs is growing. A moderate number of job openings are expected over the next four or five years. Recently, no training has been reported. Job opportunities should be good.

Hourly wages include:

\$5.38 Guards and watch guards

Licensing may be required. Contact: COUNTY COURT CLERK'S OFFICE.

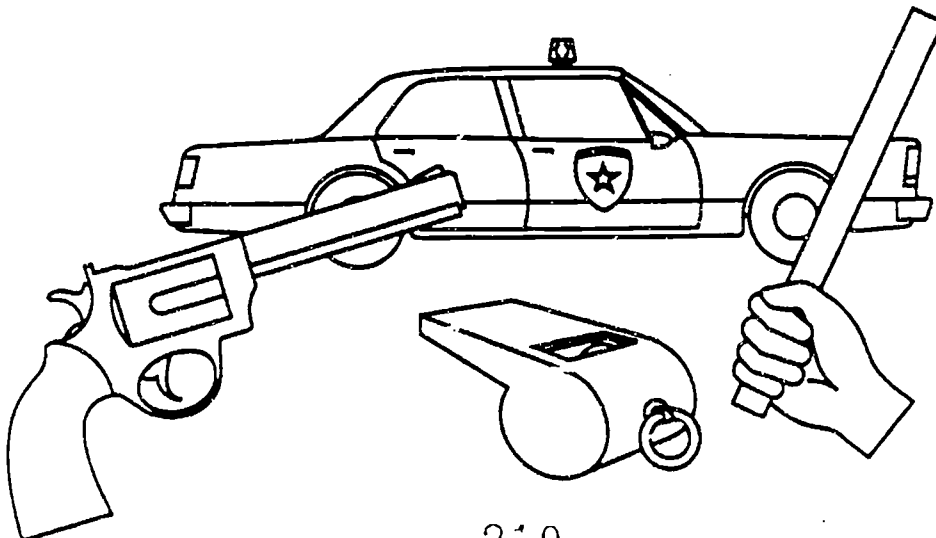

SDA 2 - 43²¹⁰

SHEET METAL

Sheet metal workers make, install, and maintain a variety of sheet metal products for home, commercial, and industrial buildings. These products include ducts for air conditioning, heating, and ventilating and pollution control systems, kitchen equipment, roofs, siding, rain gutters, skylights, and outdoor signs. Other workers use a variety of machines in the mass production of sheet-metal products.

The largest occupations, which also have the greatest number of job openings annually, are:

- Machine forming operators and tenders of metal and plastic
- Assemblers and fabricators, except machine, electrical, electronic, and precision assembly

These occupations may not have a favorable outlook for the future. Overall, the number of these jobs shows little change. A moderate number of job openings are expected over the next four or five years. Recently, there have been many more new trainees than job openings. If this trend continues, job seekers can expect to face keen competition.

Hourly wages include:

\$8.53 Sheet metal workers

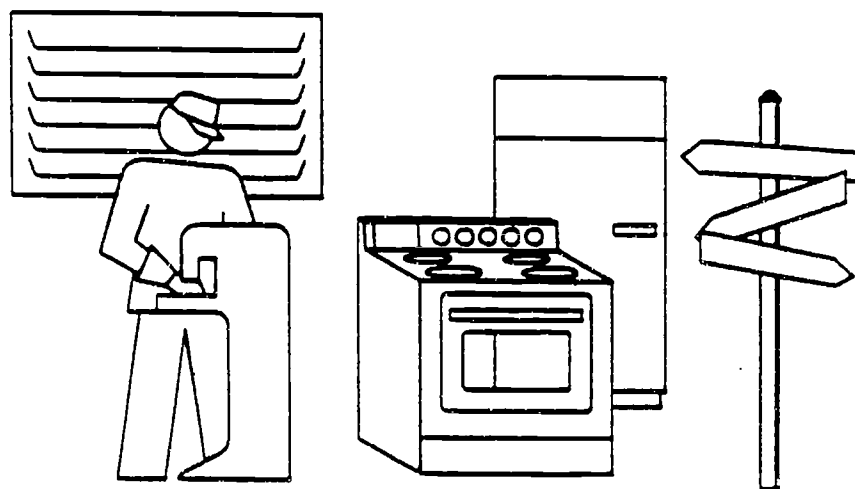

TRAVEL SERVICES

These workers assist people with all facets of their travel. Planning and budgeting a trip, purchasing tickets, selling travel insurance, obtaining passports and visas, and even ticket taking are all done by these employees.

The largest occupations, which also have the greatest number of job openings annually, are:

- Reservation and transportation ticket agents
- Guides

These occupations may not have a favorable outlook for the future. Overall, the number of these jobs shows little change. Very few job openings are expected over the next four or five years. Recently, there have been many more new trainees than job openings.

High school programs preparing for these occupations are:

08.1101 Transportation and travel marketing

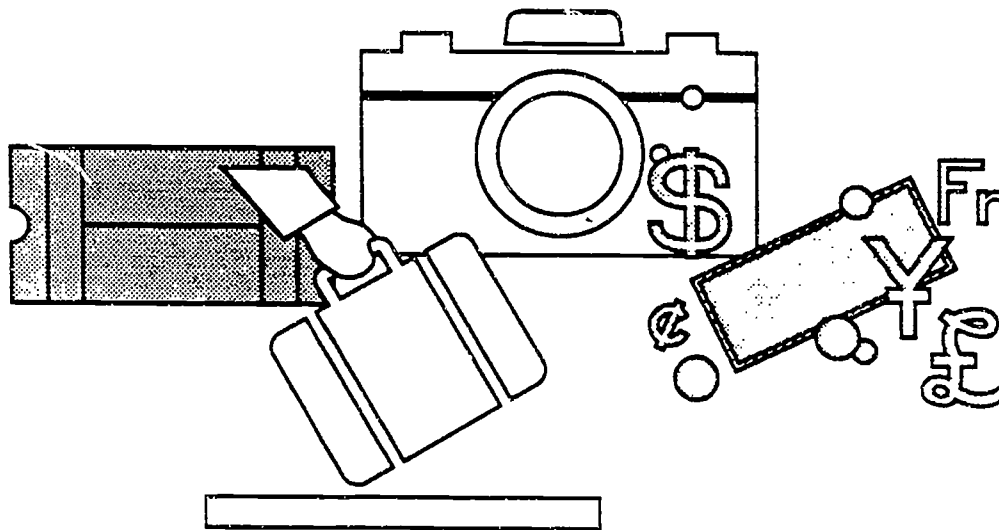

TRUCK, BUS, AND HEAVY EQUIPMENT OPERATION

These occupations include truck drivers who transport goods, bus drivers who transport passengers, and heavy equipment operators who use machinery to move construction materials and other goods over short distances--around a factory, construction site or loading dock.

The largest occupations, which also have the greatest number of job openings annually, are:

- Truck drivers of heavy or tractor trailer trucks
- School bus drivers

These occupations may have a generally favorable outlook for the future. Overall, the number of these jobs is growing. Large numbers of job openings are expected over the next four or five years. Recently, there have been fewer new trainees than job openings. If this trend continues, job opportunities should be good. Placement rates at area vocational technical schools, community colleges, and/or technical institutes have been very good recently.

Hourly wages include:

- \$6.92 Truck drivers, heavy or tractor trailer
- \$8.58 Grader, dozer, and scraper operators

Related postsecondary programs at state-supported institutions in this area are:

- 49.0205 Truck and bus driving

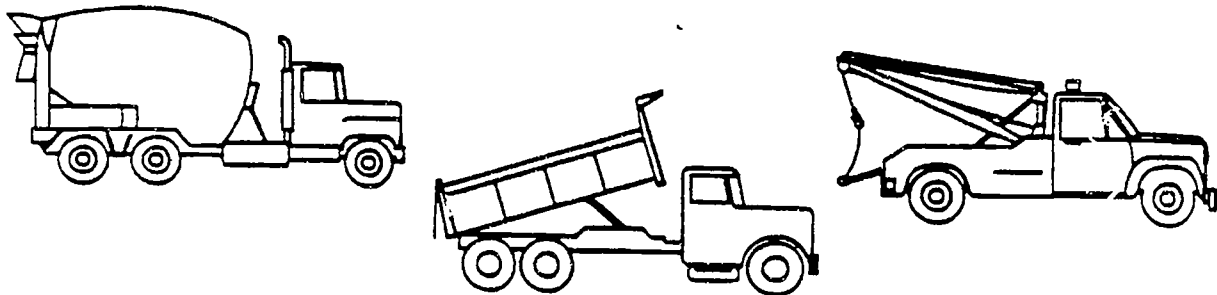

WELDING TECHNOLOGY

Welding is the most common way of permanently joining metal parts. Typically, heat is applied to the metal pieces to be joined; the parts are melted and fused to form a permanent bond. Welding is used to construct and repair parts of ships, automobiles, spacecraft, and thousands of products. It can also be used to join beams and steel reinforcing rods in buildings, bridges, and highways.

The two largest occupations are:

- Welders and cutters
- Welding machine setters and set-up operators

The occupations expected to have the most job openings annually are:

- Welders and cutters
- Welding machine operators and tenders

These occupations may have a generally favorable outlook for the future. Overall, the number of these jobs is growing. A moderate number of job openings are expected over the next four or five years. Recently, there have been more new trainees than job openings. If this trend continues, job seekers can expect to face some competition. Placement rates at area vocational technical schools, community colleges, and/or technical institutes have been good recently.

Hourly wages include:

\$7.95 Welders and cutters

High school programs preparing for these occupations are:

48.0508 Welding, brazing, and soldering

Related post-secondary programs at state-supported institutions in this area are:

48.0508 Welding, brazing, and soldering

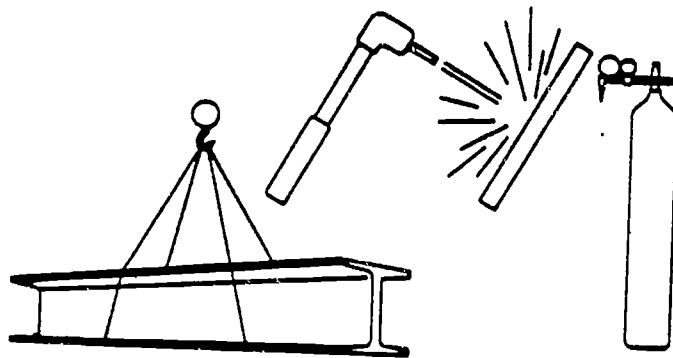

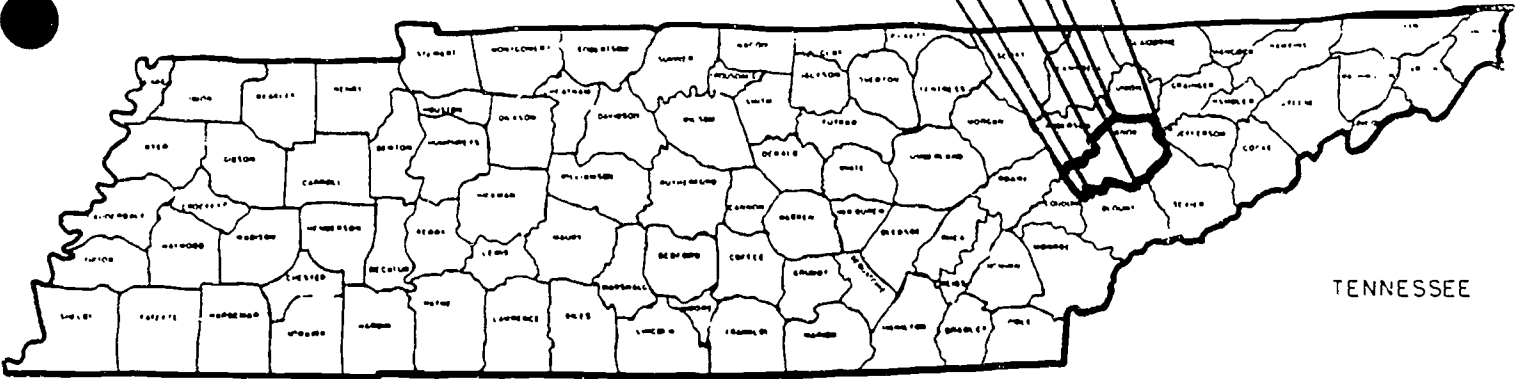

Service Delivery Area 3

ACCOUNTING AND FINANCIAL MANAGEMENT

Many individuals in this group are accountants and auditors who prepare and analyze business records and financial reports which are needed for effective management of any organization. Financial managers, another occupation in this group, typically plan, organize, control, or coordinate the financial activities of an organization.

The largest occupations, which also have the greatest number of job openings annually, are:

- Financial managers
- Accountants and auditors

These occupations may not have a favorable outlook for the future. Overall, the number of these jobs is growing. Large numbers of job openings are expected over the next four or five years. Recently, there have been many more new trainees than job openings. If this trend continues, job seekers can expect to face keen competition.

Hourly wages include:

\$14.85 Accountants and auditors
\$23.40 Financial managers

Related postsecondary programs at state-supported institutions in this area are:

52.0301 Accounting
52.0801 Finance

Licensing may be required. Contact: TENNESSEE BOARD OF ACCOUNTANCY, 615-741-2250.



ADMINISTRATIVE SUPPORT: ACCOUNTING

Persons employed in this group of occupations provide clerical and administrative support to accountants and auditors. Most of these jobs require only a high school diploma for entry.

The two largest occupations are:

- Bookkeeping, accounting, and auditing clerks
- Payroll and timekeeping clerks

The occupations expected to have the most job openings annually are:

- Bookkeeping, accounting, and auditing clerks
- Billing, posting, and calculating machine operators

These occupations may have a generally favorable outlook for the future. Overall, the number of these jobs shows little change. Large numbers of job openings are expected over the next four or five years. Recently, there have been fewer new trainees than job openings. If this trend continues, job opportunities should be good. Placement rates at area vocational technical schools, community colleges, and/or technical institutes have been good recently.

Hourly wages include:

- \$7.84 Bookkeeping, accounting, and auditing clerks
- \$8.30 Payroll and timekeeping clerks

Related postsecondary programs at state-supported institutions in this area are:

07.0102 Accounting and computing

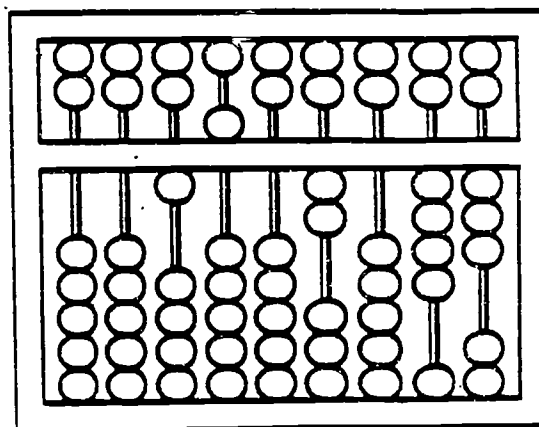
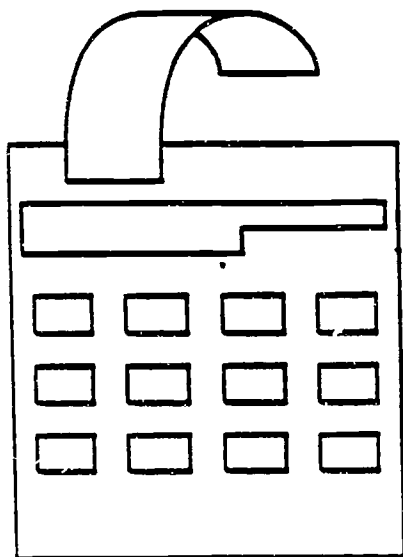

ADMINISTRATIVE SUPPORT: FINANCE AND INSURANCE

Workers provide clerical and general administrative support to the banking and finance industry. Workers receive and pay out money, keep records of money and negotiable instruments, interview applicants for credit, locate and notify customers of delinquent accounts, examine insurance claims, and process a variety of paperwork.

The largest occupations, which also have the greatest number of job openings annually, are:

- Tellers
- Bill and account collectors

These occupations may have a generally favorable outlook for the future. Overall, the number of these jobs is growing slowly. A moderate number of job openings are expected over the next four or five years. Recently, there have been fewer new trainees than job openings. If this trend continues, job opportunities should be good. Placement rates at area vocational technical schools, community colleges, and/or technical institutes have been excellent recently.

Hourly wages include:

- \$5.95 Tellers
- \$7.45 Loan and credit clerks
- \$7.74 New accounts clerks
- \$9.86 Bill and account collectors

Related postsecondary programs at state-supported institutions in this area are:

07.0201 Banking and finance

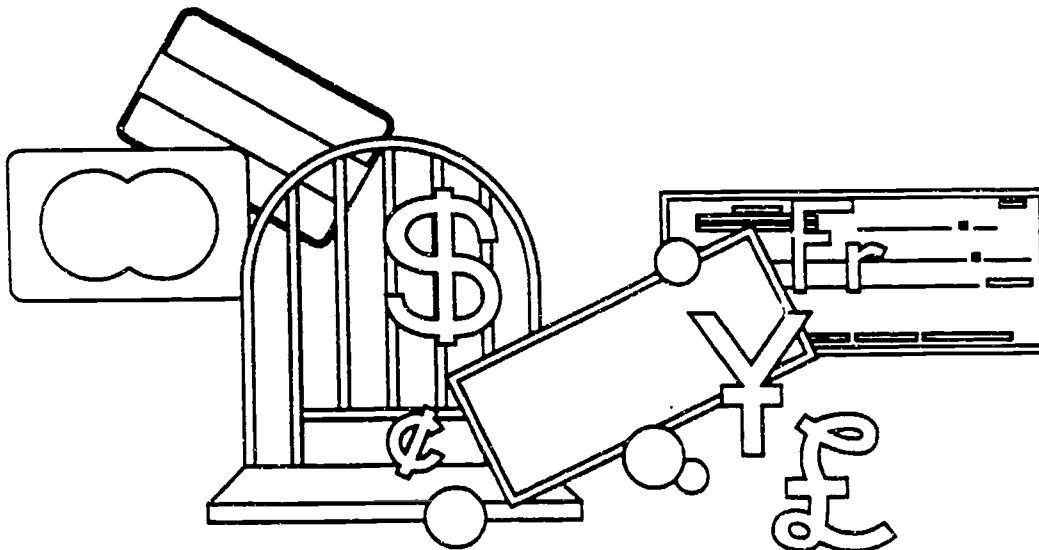

ADMINISTRATIVE SUPPORT: GENERAL

The job duties in this group of occupations are very diverse and are determined by the type of firm. For example, workers may schedule appointments, give information to callers, take dictation, type correspondence, read and route incoming mail, file correspondence and other records, and supervise and coordinate the activities of subordinate clerical workers.

The largest occupations, which also have the greatest number of job openings annually, are:

- Secretaries, except legal and medical secretaries
- General office clerks

These occupations may have a generally favorable outlook for the future. Overall, the number of these jobs is growing. Large numbers of job openings are expected over the next four or five years. Recently, there have been fewer new trainees than job openings. If this trend continues, job opportunities should be good. Placement rates at area vocational technical schools, community colleges, and/or technical institutes have been fair recently.

Hourly wages include:

\$5.54	Adjustment clerks
\$5.73	File clerks
\$6.35	Receptionists and information clerks
\$6.71	Data entry keyers, except composing
\$7.05	General office clerks
\$7.10	Typists including word processing
\$8.29	Order clerks- materials, merchandise, and service
\$8.31	Secretaries, ex. legal and medical
\$8.33	Medical secretaries
\$10.18	Legal secretaries
\$12.58	First line supervisors and manager/supervisors- clerical and administrative support occupations

High school programs preparing for these occupations are:

07.0601	Secretarial and related programs
07.0701	Typing, general office and related programs

Related postsecondary programs at state-supported institutions in this area are:

07.0699	Miscellaneous secretarial and related programs
07.9999	Miscellaneous business administrative support

AGRICULTURAL PRODUCTION

Workers in this field plan and economically use facilities, land, water, machinery, chemicals, finance, and labor in the production of plant and animal products.

The largest occupations, which also have the greatest number of job openings annually, are:

- Farm managers
- Farm workers

These occupations may have a generally favorable outlook for the future. Overall, the number of these jobs shows little change. Few job openings are expected over the next four or five years. Recently, no training has been reported.

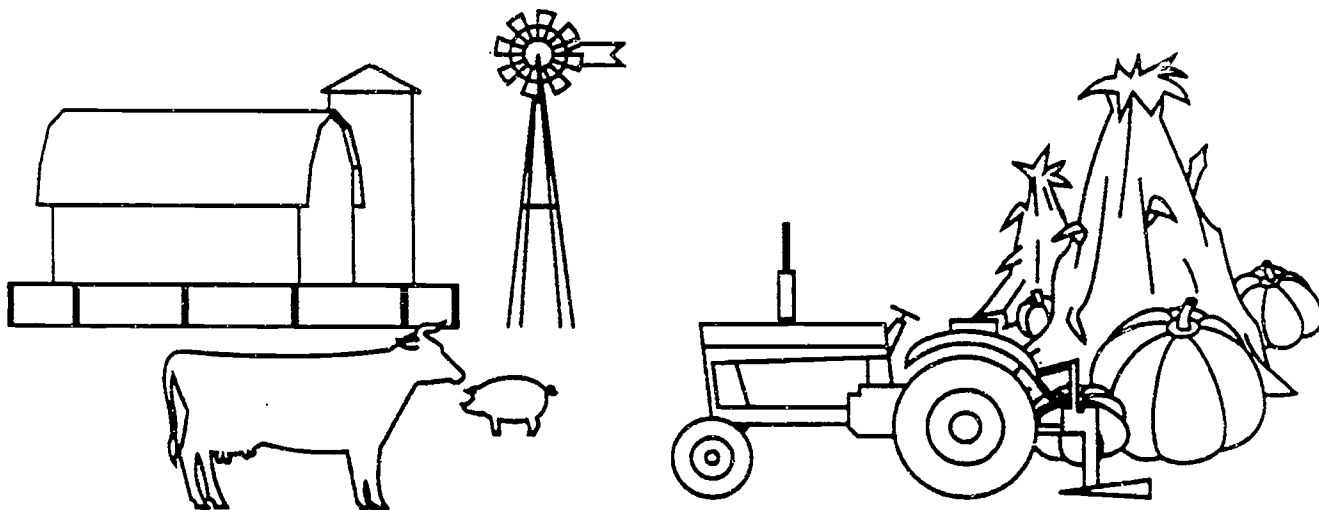

APPLIANCE AND EQUIPMENT REPAIR

Individuals in these occupations repair, adjust, maintain, and install all types of electrical motors and electrical and gas home appliances. Types of equipment used include test instruments, gauges, and hand, bench, and power tools.

The largest occupations, which also have the greatest number of job openings annually, are:

- Electric home appliance and power tool repairers
- Coin and vending machine servicers and repairers

These occupations may not have a favorable outlook for the future. Overall, the number of these jobs shows little change. Few job openings are expected over the next four or five years. Recently, there have been many more new trainees than job openings.

High school programs preparing for these occupations are:

47.0101 Electrical and electronics technology

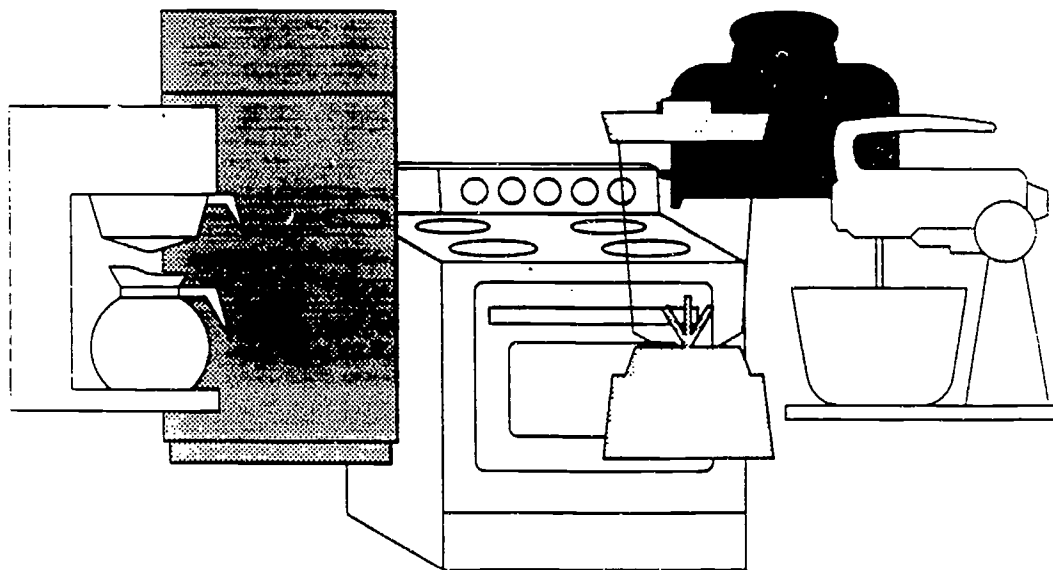

AUTOMOTIVE BODY REPAIR

Thousands of motor vehicles are damaged in traffic accidents every day. The workers in this field straighten bent frames, remove dents, and replace crumpled parts that are beyond repair so that those vehicles look and drive like new.

The largest occupations, which also have the greatest number of job openings annually, are:

- Automotive body and related repairers
- Painters of transportation equipment

These occupations may not have a favorable outlook for the future. Overall, the number of these jobs is growing. Few job openings are expected over the next four or five years. Recently, there have been many more new trainees than job openings. Placement rates at area vocational technical schools, community colleges, and/or technical institutes have been fair recently.

High school programs preparing for these occupations are:

47.0603 Automotive body repair

Related postsecondary programs at state-supported institutions in this area are:

47.0603 Automotive body repair

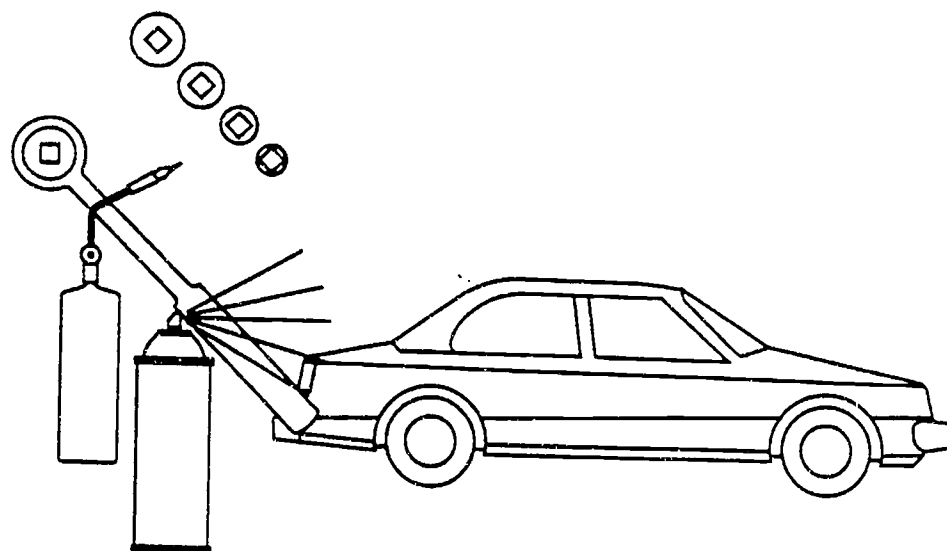

AUTOMOTIVE SERVICE TECHNOLOGY

These occupations include jobs concerned with parking, cleaning, polishing, lubricating, repairing, and refueling trucks, buses, and automobiles, and related servicing activities. The primary occupation, automotive mechanic, is concerned with repair and service of motor vehicles.

The largest occupations, which also have the greatest number of job openings annually, are:

- Automotive mechanics
- Tire repairers and changers

These occupations may have a generally favorable outlook for the future. Overall, the number of these jobs is growing. Large numbers of job openings are expected over the next four or five years. Recently, there have been many more new trainees than job openings. If this trend continues, job seekers can expect to face keen competition. Placement rates at area vocational technical schools, community colleges, and/or technical institutes have been very good recently.

Hourly wages include:

\$9.89 Automotive mechanics

High school programs preparing for these occupations are:

47.0604 Automotive mechanics

Related postsecondary programs at state-supported institutions in this area are:

15.0803 Automotive technology

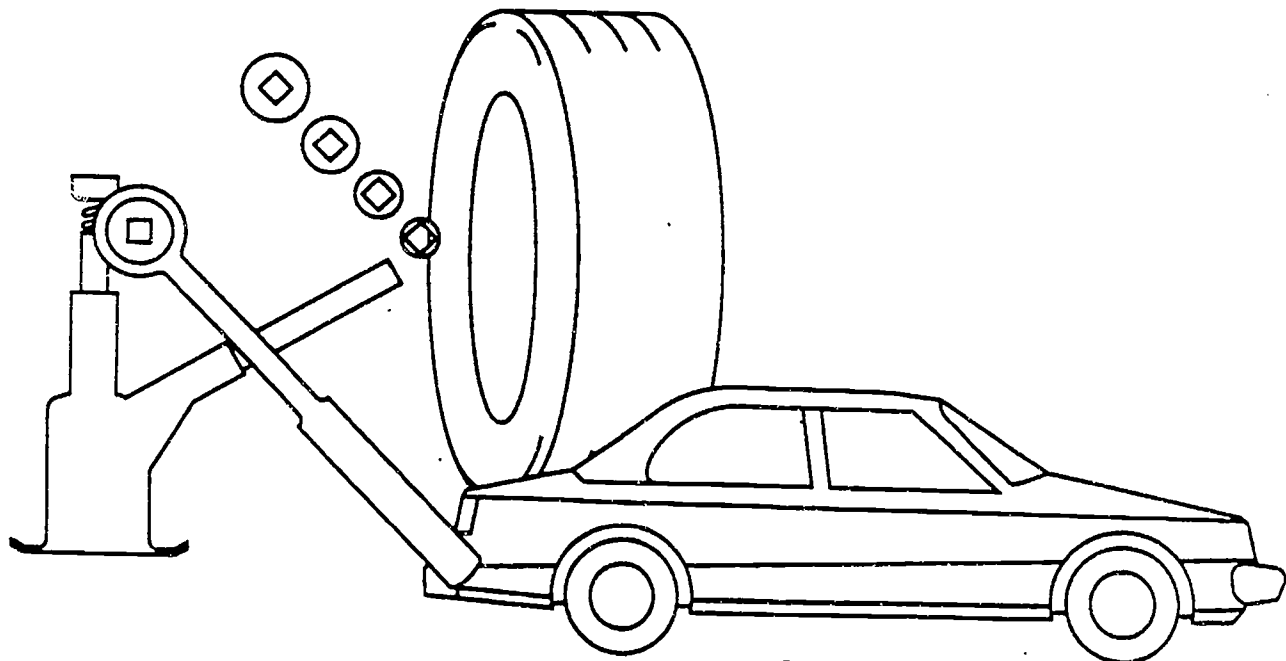

BAKING OCCUPATIONS

The workers in this group of jobs mix and bake ingredients according to recipes to produce breads, pastries, doughnuts, and other baked goods. These workers must be proficient in cleaning and maintaining the equipment used in preparing baked goods from raw materials.

The largest occupations, which also have the greatest number of job openings annually, are:

- Bakers of bread and pastry
- Bakers in manufacturing plants

These occupations may have a generally favorable outlook for the future. Overall, the number of these jobs is growing. Few job openings are expected over the next four or five years. Recently, no training has been reported.

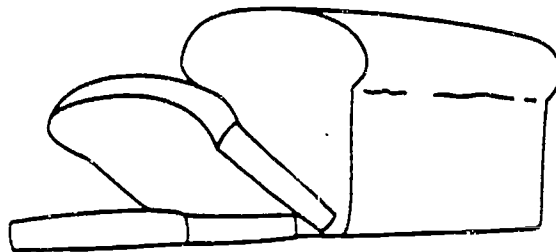

BUILDING MAINTENANCE

Persons in building maintenance occupations perform work involving several maintenance skills to keep the structure of an establishment in repair. Duties may involve pipefitting, boilermaking, carpentry, and electrical work as well as repairing buildings, floors, or stairs.

The two largest occupations are:

- General utility maintenance repairers
- Installers and repairers of manufactured buildings, mobile homes, and travel trailers

The occupations expected to have the most job openings annually are:

- General utility maintenance repairers
- Stationary engineers

These occupations may have a generally favorable outlook for the future. Overall, the number of these jobs is growing. Large numbers of job openings are expected over the next four or five years. Recently, there have been fewer new trainees than job openings. If this trend continues, job opportunities should be good.

Hourly wages include:

\$6.86 Maintenance repairers, general utility

High school programs preparing for these occupations are:

46.0401 Building maintenance

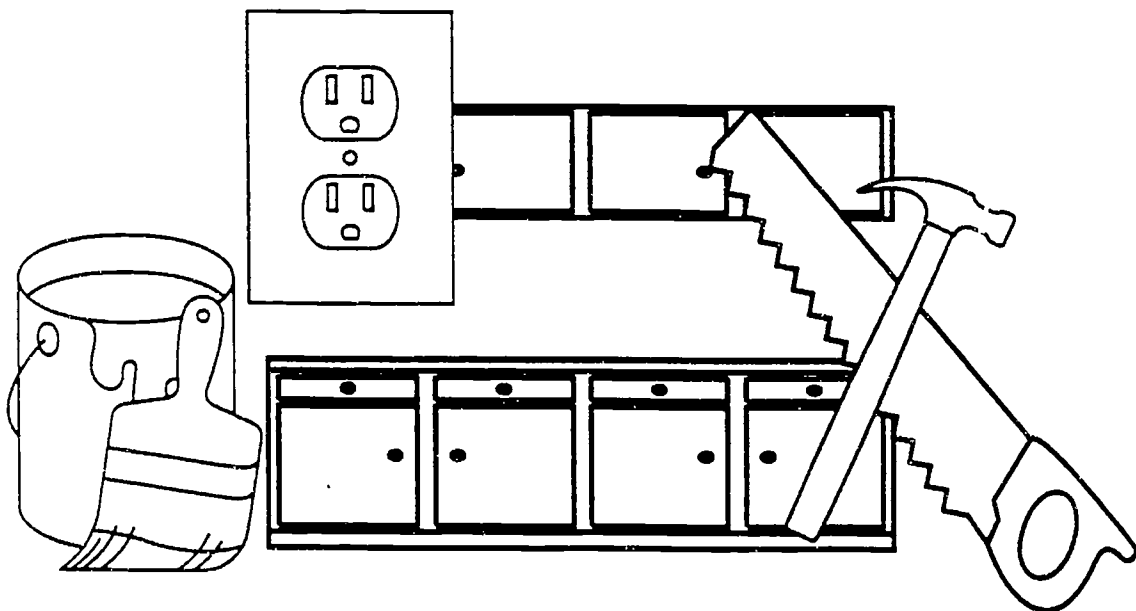

CARPENTRY

Almost all construction projects employ carpenters, the largest group of building trades workers. Carpenters perform a variety of jobs. Their duties will vary by type of construction, type of company, skill of the carpenter, and size of the community. A carpenter employed by a special trade contractor, for example, may specialize in laying hardwood floors, while one who is employed by a general building contractor may build wall frames and install paneling.

The largest occupations, which also have the greatest number of job openings annually, are:

- Carpenters
- Ceiling tile installers and acoustical carpenters

These occupations may have a generally favorable outlook for the future. Overall, the number of these jobs is growing slowly. A moderate number of job openings are expected over the next four or five years. Recently, there have been fewer new trainees than job openings. If this trend continues, job opportunities should be good.

Hourly wages include:

\$9.65 Carpenters

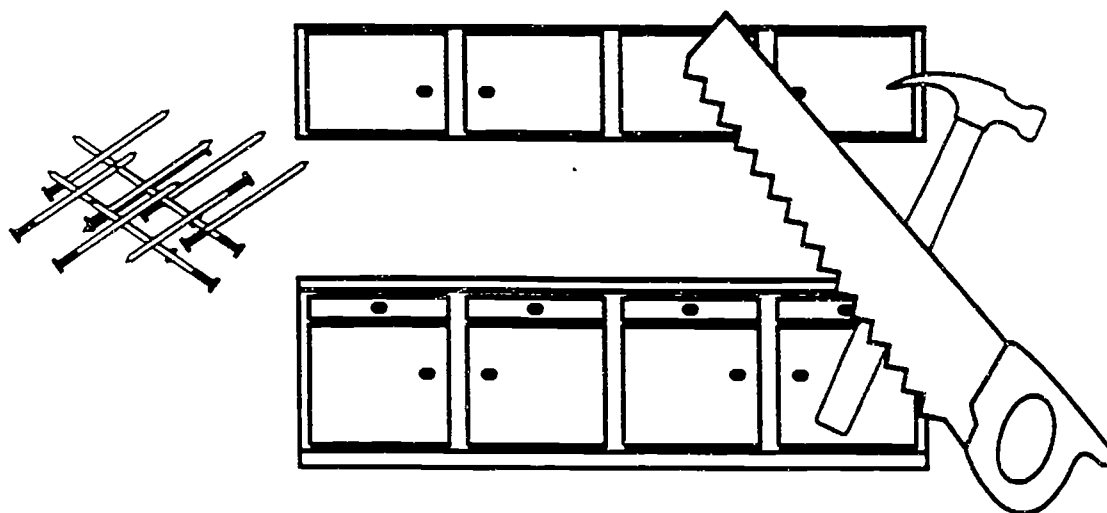

COMMERCIAL ART AND DESIGN

The majority of workers in this field design or arrange objects and materials in an artistic or decorative manner. Additional tasks may include the creation or drawing of designs for items such as furniture and machinery (product design).

The largest occupations, which also have the greatest number of job openings annually, are:

- Artists and related workers
- Designers, except interior designers

These occupations may not have a favorable outlook for the future. Overall, the number of these jobs is growing. A moderate number of job openings are expected over the next four or five years. Recently, there have been many more new trainees than job openings. If this trend continues, job seekers can expect to face keen competition.

High school programs preparing for these occupations are:

48.0203 Commercial art

Related postsecondary programs at state-supported institutions in this area are:

50.0402 Graphic design, commercial art and illustration

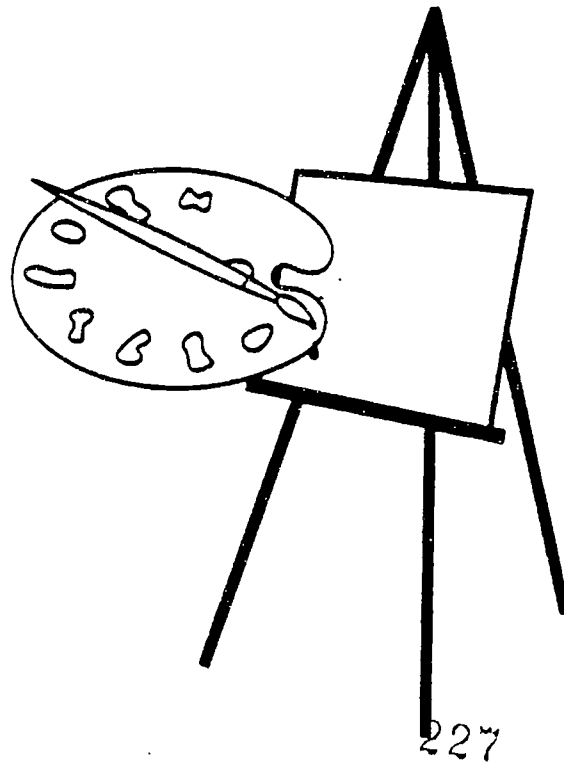

227

COMMUNICATIONS, JOURNALISM, AND BROADCASTING

Individuals who work in these fields are concerned with communicating ideas and information to individuals for their education and entertainment. The methods utilized are varied and may include the written word, radio, and television.

The two largest occupations are:

- Writers and editors
- Reporters and correspondents

The occupations expected to have the most job openings annually are:

- Writers and editors
- Radio and television announcers

These occupations may not have a favorable outlook for the future. Overall, the number of these jobs is growing rapidly. A moderate number of job openings are expected over the next four or five years. Recently, there have been many more new trainees than job openings.

High school programs preparing for these occupations are:

09.0601 Radio and television news broadcasting

Related postsecondary programs at state-supported institutions in this area are:

09.0101 General communications
09.0401 Journalism
09.0701 Radio and television broadcasting

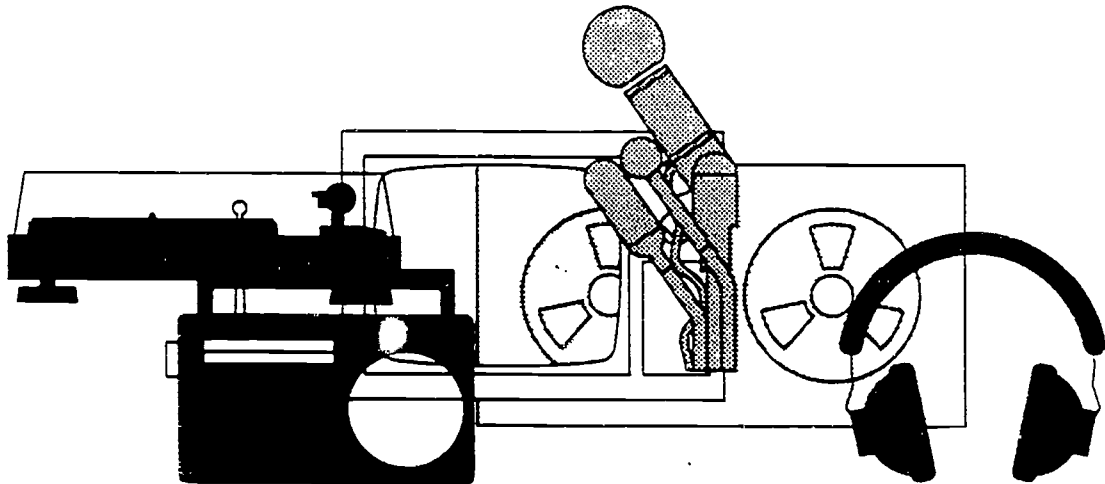

COMPUTER AND BUSINESS MACHINE PRODUCTION AND REPAIR

Workers in these fields install, service, maintain, and repair mechanical and electronic equipment, such as computers, word processing systems, radar systems, and office machines. Repairers may work in various locations doing a variety of tasks.

The largest occupations, which also have the greatest number of job openings annually, are:

- Data processing equipment repairers
- Office machine and cash register servicers

These occupations may have a generally favorable outlook for the future. Overall, the number of these jobs is growing. Few job openings are expected over the next four or five years. Recently, there have been about as many new trainees as job openings. Placement rates at area vocational technical schools, community colleges, and/or technical institutes have been excellent recently.

Related postsecondary programs at state-supported institutions in this area are:

47.0105 Industrial electronics

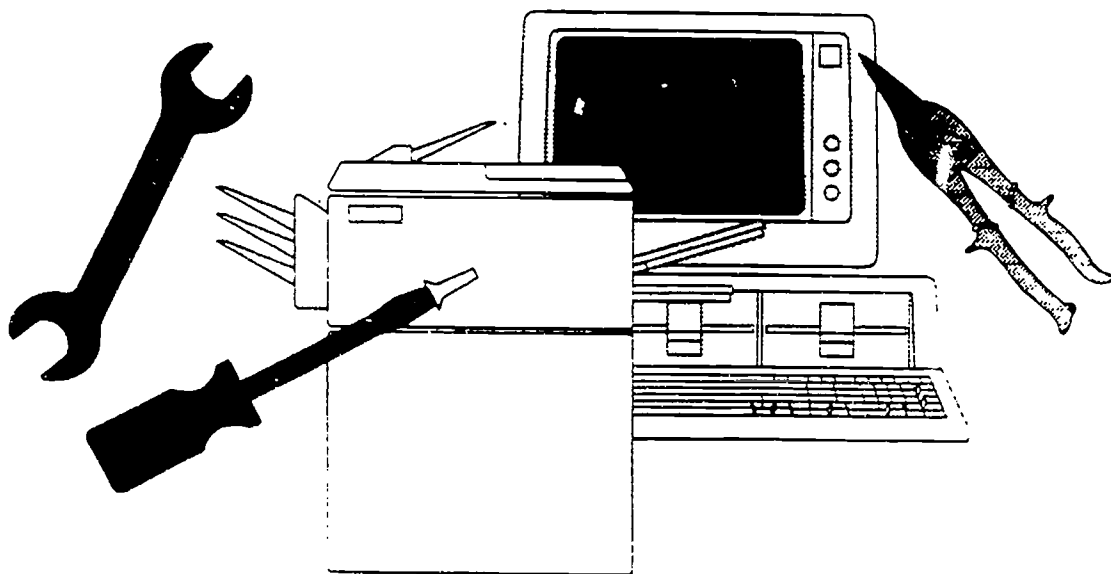

SDA 3 - 14 229

COMPUTER, ELECTRICAL, AND ELECTRONICS TECHNOLOGY

The majority of workers in this field are electrical and electronic engineering technicians and technologists. They apply electrical and related knowledge to design, build, test, and repair electrical equipment in industrial or commercial settings for subsequent use by engineering personnel.

This occupation may have a generally favorable outlook for the future. Overall, the number of these jobs is growing rapidly. A moderate number of job openings are expected over the next four or five years. Recently, there have been more new trainees than job openings. Placement rates at area vocational technical schools, community colleges, and/or technical institutes have been very good recently.

Average hourly wages are \$11.69

Related postsecondary programs at state-supported institutions in this area are:

15.0399 . Miscellaneous electrical and electronic engineering-related technologies

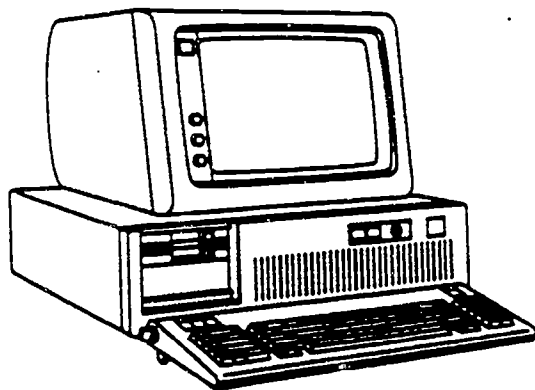

COMPUTER SYSTEMS

Workers in these computer occupations develop and write computer programs to store, locate, and retrieve specific documents, data, and information. They may also analyze business, scientific, and technical problems for application to electronic data processing systems. These careers generally require specialized training.

The largest occupations, which also have the greatest number of job openings annually, are:

- Systems analysts, electronic data processing
- Computer programmers

These occupations may have a generally favorable outlook for the future. Overall, the number of these jobs is growing rapidly. Large numbers of job openings are expected over the next four or five years. Recently, there have been about as many new trainees as job openings. If this trend continues, job seekers can expect to face some competition. Placement rates at area vocational technical schools, community colleges, and/or technical institutes have been good recently.

Hourly wages include:

- \$14.22 Computer programmers
- \$22.36 Systems analysts, electronic data processing

Related postsecondary programs at state-supported institutions in this area are:

- 07.0301 Electronic data processing, computer science
- 11.0701 Computer science

COSMETOLOGY

Cosmetologists and related workers provide beauty services for customers. These may include cutting and styling hair, treating hair and scalp, applying makeup, dressing wigs, or removing hair by electrolysis, as well as cleaning, shaping, and polishing a customer's fingernails and toenails.

The two largest occupations are:

- Hairdressers, hairstylists, and cosmetologists
- Manicurists

The occupations expected to have the most job openings annually are:

- Hairdressers, hairstylists, and cosmetologists
- Shampooers

These occupations may not have a favorable outlook for the future. Overall, the number of these jobs is growing. A moderate number of job openings are expected over the next four or five years. Recently, there have been many more new trainees than job openings. If this trend continues, job seekers can expect to face keen competition. Placement rates at area vocational technical schools, community colleges, and/or technical institutes have been good recently.

High school programs preparing for these occupations are:

12.0403 Cosmetology

Related postsecondary programs at state-supported institutions in this area are:

12.0403 Cosmetology

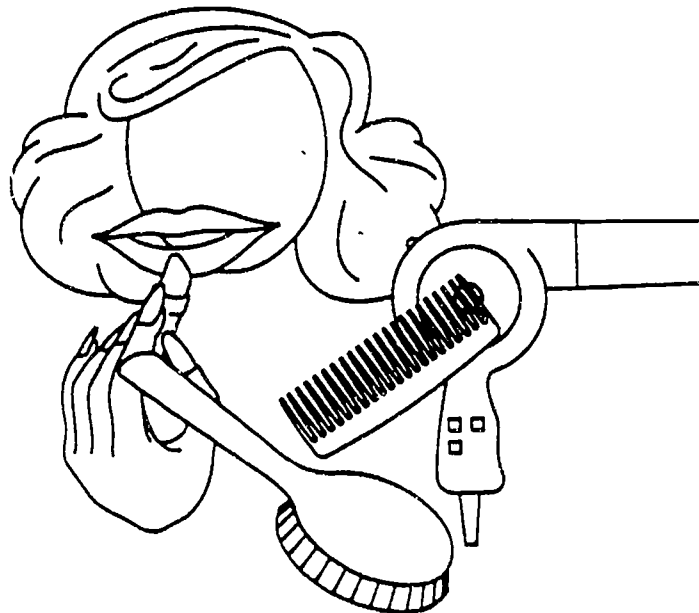

DENTAL ASSISTING

Dental assistants may perform a wide variety of clinical, office, and laboratory duties, depending on the size of the dental practice. Typically, assistants seat patients in the dental chair, prepare them for the dentist's treatment, and work with the dentist during examination and treatment.

This occupation may have a generally favorable outlook for the future. Few job openings are expected over the next four or five years. Recently, there have been about as many new trainees as job openings. Placement rates at area vocational technical schools, community colleges, and/or technical institutes have been good recently.

Related postsecondary programs at state-supported institutions in this area are:

17.0101 Dental assisting

Licensing may be required. Contact: TENNESSEE BOARD OF DENTISTRY, 615-367-6228.

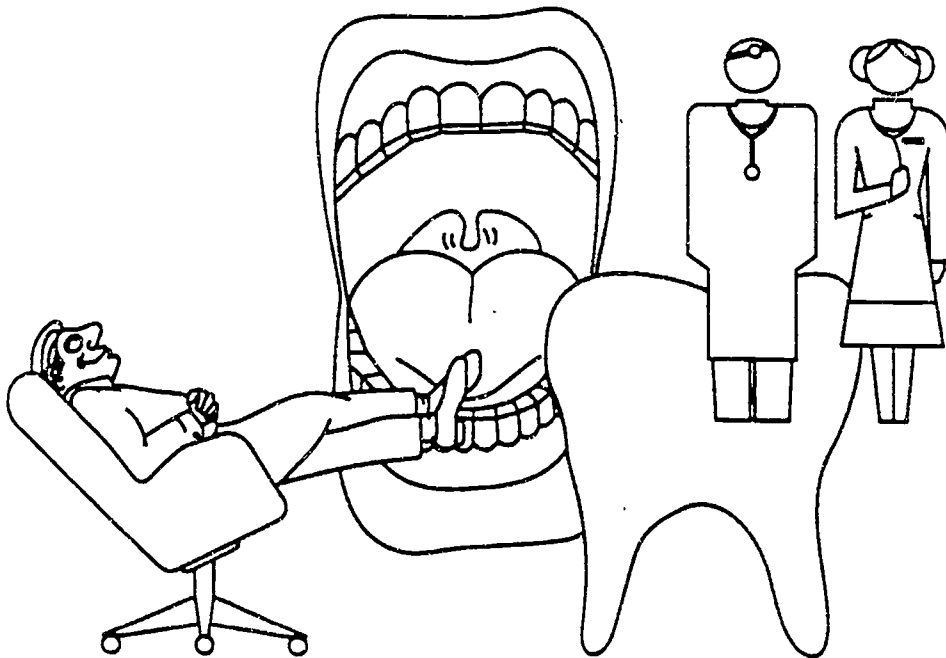

DENTAL HYGIENE

Dental hygienists provide preventive dental care and encourage patients to develop good oral health skills. They evaluate patients' dental health; remove calculus, stain, and plaque from above and below the gumline; expose and develop dental x-rays; and instruct patients on plaque control.

This occupation may have a generally favorable outlook for the future. Few job openings are expected over the next four or five years. Recently, no training has been reported.

Licensing may be required. Contact: TENNESSEE BOARD OF DENTISTRY, 615-367-6228.

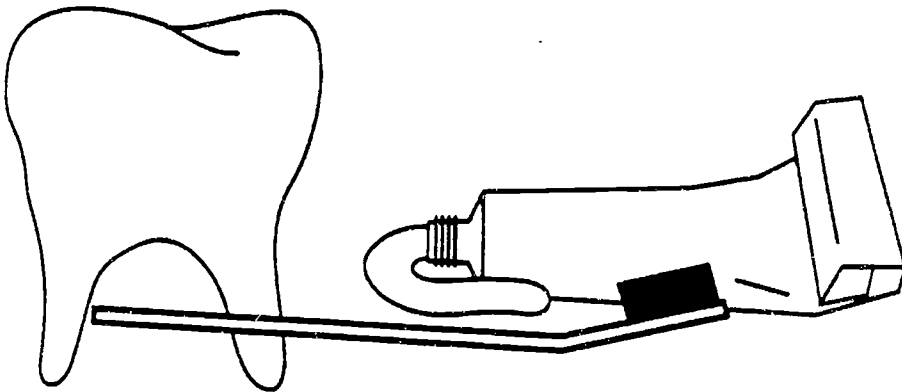

231

SDA 3 - 19

DRAFTING AND DESIGN TECHNOLOGY

Persons in drafting and design technology prepare clear, complete, and accurate working plans and detail drawings from rough or detailed sketches or notes for engineering or manufacturing purposes according to specified dimensions. Workers need to have knowledge of various machines, engineering practices, mathematics, building materials, and other physical sciences to complete drawings. Computer-assisted design (CAD) equipment may be used by some workers.

The largest occupations, which also have the greatest number of job openings annually, are:

- Cost estimators
- Drafters

These occupations may not have a favorable outlook for the future. Overall, the number of these jobs is growing. A moderate number of job openings are expected over the next four or five years. Recently, there have been many more new trainees than job openings. Placement rates at area vocational technical schools, community colleges, and/or technical institutes have been good recently.

Hourly wages include:

\$11.73 Drafters

High school programs preparing for these occupations are:

48.0101 Drafting

Related postsecondary programs at state-supported institutions in this area are:

15.0202 Drafting and design technology
48.0101 Drafting

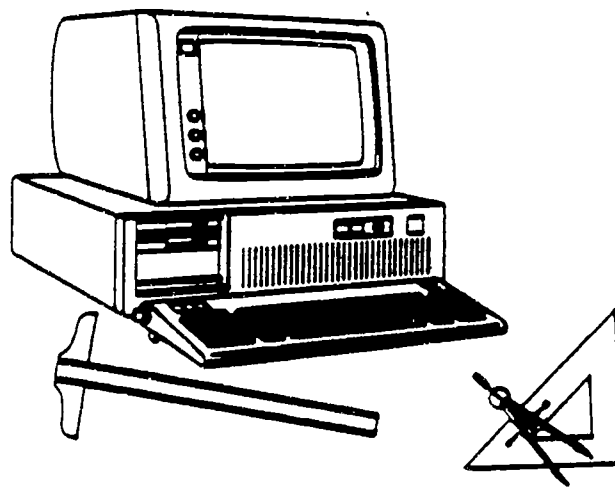

DRYCLEANING

Workers in these occupations operate washing and drying machines to clean and dry clean commercial, industrial, or household articles; use pressing machines to press and shape articles; and identify stains and apply chemical solutions to remove them.

The largest occupations, which also have the greatest number of job openings annually, are:

- Laundry and drycleaning machine operators and tenders, except of pressing machines
- Operators and tenders of machines pressing textiles, garments, and related materials

These occupations may have a generally favorable outlook for the future. Overall, the number of these jobs is growing slowly. Few job openings are expected over the next four or five years. Recently, no training has been reported.

Hourly wages include:

\$4.51 Laundry and drycleaning machine operators and tenders, except pressing

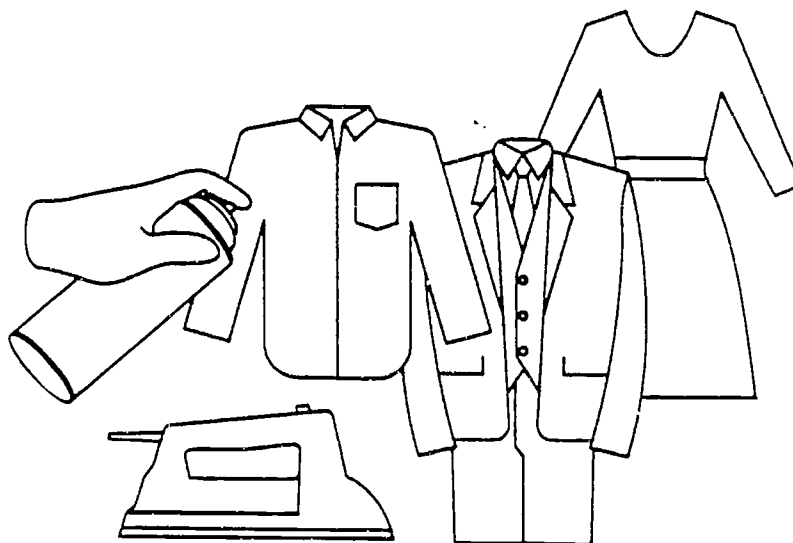

EARLY CHILDHOOD EDUCATION

Child care workers and managers of child care centers assume responsibility for the safety, physical care, and emotional, social, and intellectual growth of preschool children and infants while parents are at work or are unavailable for other reasons. Some work in residential institutions for young children. Teacher aides assist teachers by handling routine paperwork or by working directly with children.

The largest occupations, which also have the greatest number of job openings annually, are:

- Teacher aides, paraprofessional
- Child care workers

These occupations may have a generally favorable outlook for the future. Overall, the number of these jobs is growing rapidly. Large numbers of job openings are expected over the next four or five years. Recently, there have been fewer new trainees than job openings. If this trend continues, job opportunities should be good.

High school programs preparing for these occupations are:

20.0201 Child care and guidance management services

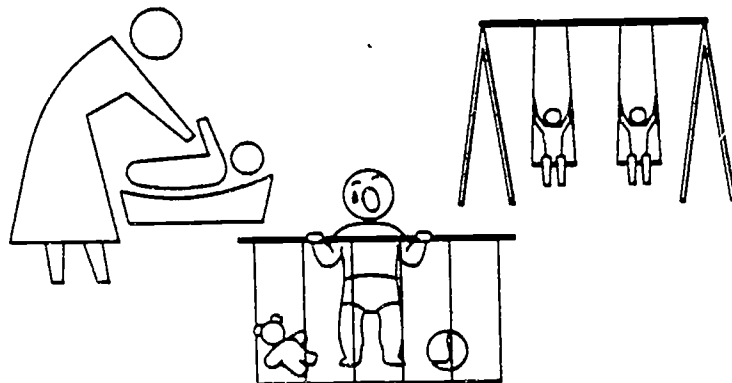

ELECTRICIAN OCCUPATIONS

Workers in the electrical field install, maintain, and repair wiring, electrical equipment, and fixtures or assist in such activities. These workers insure that work is in accordance with the relevant codes. A high school education is usually required and a five-year apprenticeship program is recommended.

The largest occupations, which also have the greatest number of job openings annually, are:

- Electricians
- Helpers of electricians and powerline transmission installers

These occupations may have a generally favorable outlook for the future. Overall, the number of these jobs is growing. A moderate number of job openings are expected over the next four or five years. Recently, there have been fewer new trainees than job openings. If this trend continues, job opportunities should be good. Placement rates at area vocational technical schools, community colleges, and/or technical institutes have been excellent recently.

Hourly wages include:

\$10.99 Electricians

Related postsecondary programs at state-supported institutions in this area are:

46.0302 Electrician

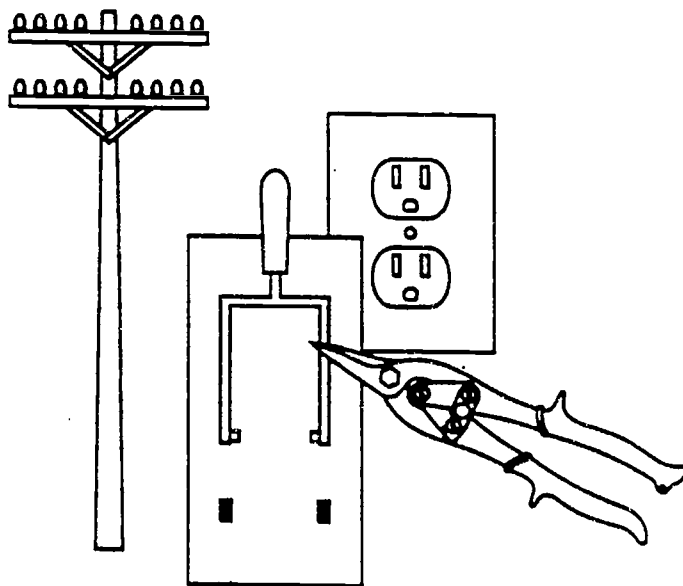

238

SDA 3 - 23

FIRE CONTROL AND SAFETY TECHNOLOGY

Workers in these positions help protect the public against the danger to their lives and property by fire. Firefighters must be prepared to respond to a fire and handle any emergency, including medical, that arises. Some firefighters operate fire apparatus, ambulances, emergency rescue vehicles, and fireboats. Most fire departments also are responsible for fire prevention.

The largest occupations, which also have the greatest number of job openings annually, are:

- Fire fighting and prevention supervisors
- Fire fighters

These occupations may have a generally favorable outlook for the future. Overall, the number of these jobs is growing. A moderate number of job openings are expected over the next four or five years. Recently, no training has been reported.

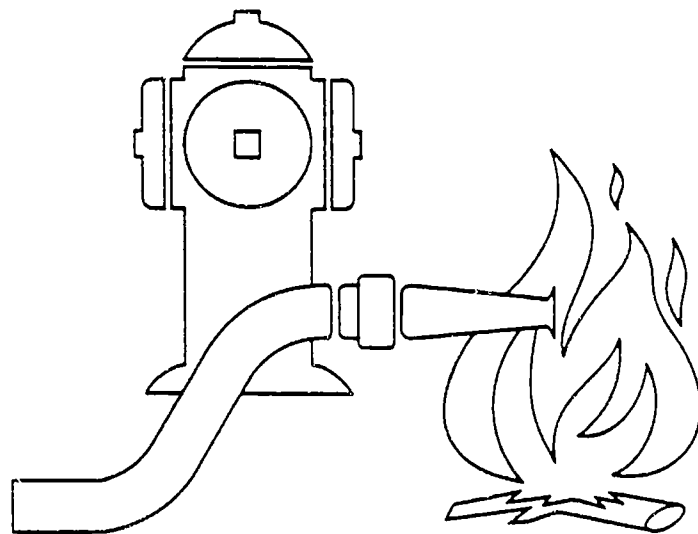

233

FOOD PREPARATION AND SERVICES

The majority of workers in these occupations prepare and serve food and beverages in restaurants, fast food establishments, catering firms, hotels, clubs, factories, school cafeterias, or hospitals, or supervise those providing food services. Others are factory machine operators involved in the preparation of food products. Dietetic technicians teach principles of food nutrition and provide dietary counseling to patients.

The largest occupations, which also have the greatest number of job openings annually, are:

- Food preparation workers
- Combined food preparation and service workers

These occupations may have a generally favorable outlook for the future. Overall, the number of these jobs is growing. Large numbers of job openings are expected over the next four or five years. Recently, there have been fewer new trainees than job openings. If this trend continues, job opportunities should be good.

Hourly wages include:

\$4.53	Food preparation workers
\$4.56	Cooks, specialty fast food
\$5.40	Bartenders
\$5.85	Cooks, restaurant

High school programs preparing for these occupations are:

20.0401	Food production, management, and services
46.1111	Food occupations

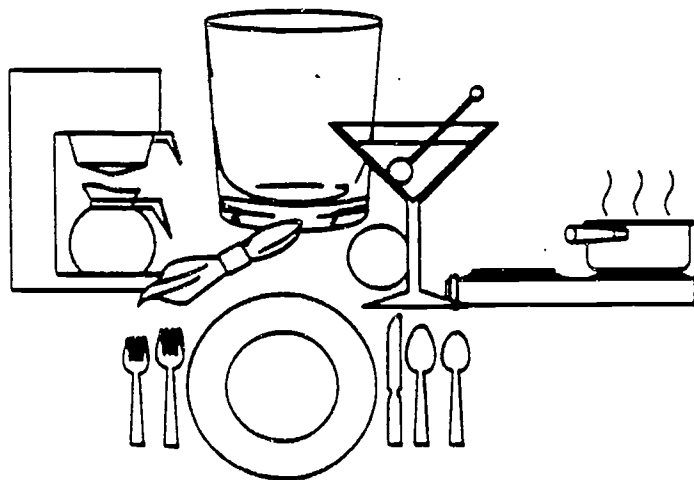

GENERAL BUSINESS AND MANAGEMENT

Workers in the general business and management occupations plan, organize, direct, control, or coordinate activities in all types of fields. Many occupations involve analysis of productivity and financial soundness. General managers and top executives usually have very diverse duties and responsibilities and work through departmental or subordinate executives.

The two largest occupations are:

- General managers and top executives
- Purchasing managers

The occupations expected to have the most job openings annually are:

- General managers and top executives
- Communications, transportation, and utilities operations managers

These occupations may have a generally favorable outlook for the future. Overall, the number of these jobs is growing. Large numbers of job openings are expected over the next four or five years. Recently, there have been more new trainees than job openings. If this trend continues, job seekers can expect to face some competition. Placement rates at area vocational technical schools, community colleges, and/or technical institutes have been very good recently.

Hourly wages include:

- \$18.94 Purchasing managers
- \$20.87 Industrial production managers

Related postsecondary programs at state-supported institutions in this area are:

- 06.0401 Business administration and management
- 06.9999 Miscellaneous business management
- 31.0301 Parks, recreation and leisure facilities management
- 52.0101 General business
- 52.0201 General business administration and management
- 52.0203 Logistics and materials management

GENERAL WOODWORKING

Woodworkers are in occupations concerned with the complete cycle of cutting, shaping, and assembling parts of complex wood products. The occupations are primarily concerned with one or a limited number of machine functions according to their speciality.

The largest occupations, which also have the greatest number of job openings annually, are:

- Cabinetmakers and bench carpenters
- Assemblers and fabricators, except machine, electrical, electronic, and precision assembly

These occupations may have a generally favorable outlook for the future. Overall, the number of these jobs shows little change. Few job openings are expected over the next four or five years. Recently, there have been fewer new trainees than job openings.

High school programs preparing for these occupations are:

48.0701 Woodworking

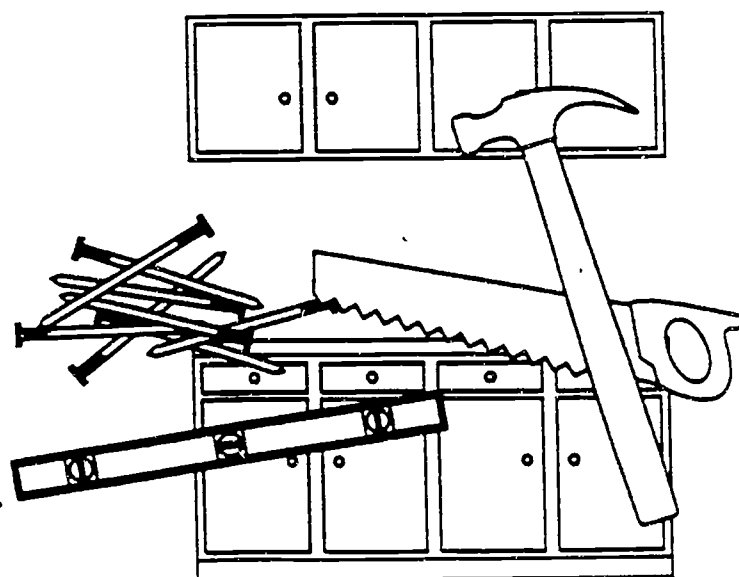

242

GRAPHIC ARTS

A majority of workers in this field are involved in offset printing. In this process the material to be printed is photographed and a printing plate is made from the film. This process has been advanced by the use of computers and lasers.

The largest occupations, which also have the greatest number of job openings annually, are:

- Offset lithographic press setters and set-up operators
- Printing press machine operators and tenders

These occupations may have a generally favorable outlook for the future. Overall, the number of these jobs is growing slowly. Few job openings are expected over the next four or five years. Recently, there have been many more new trainees than job openings. Placement rates at area vocational technical schools, community colleges, and/or technical institutes have been very good recently.

Hourly wages include:

\$10.06 Offset lithographic press setters & set-up operators, sheet or web fed

High school programs preparing for these occupations are:

48.0201 Graphic and printing communications

Related postsecondary programs at state-supported institutions in this area are:

48.0201 Graphic and printing communications

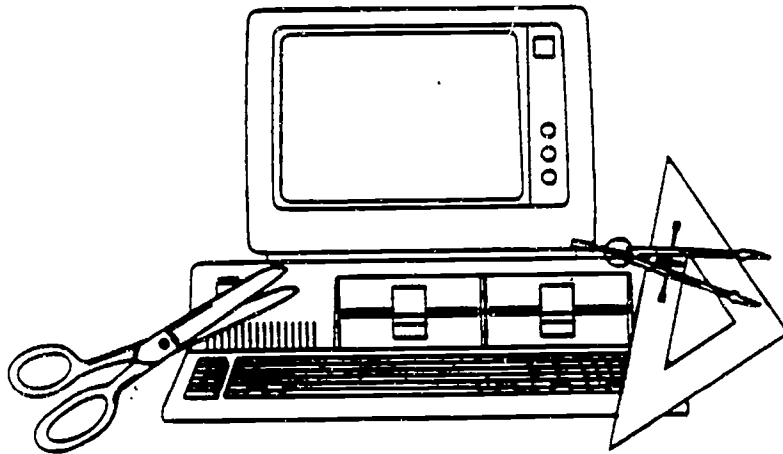

HEATING AND AIR CONDITIONING

Workers in this field install and repair heating, air conditioning, and refrigeration systems. They may install and repair oil burners, hot-air furnaces, and heating stoves in homes and businesses. They may also install and repair air conditioning systems, or install sheet metal ducts for the heating and cooling systems.

The largest occupations, which also have the greatest number of job openings annually, are:

- Heating, air conditioning, and refrigeration mechanics and installers
- Sheet metal duct installers

These occupations may not have a favorable outlook for the future. Overall, the number of these jobs is growing slowly. Few job openings are expected over the next four or five years. Recently, there have been many more new trainees than job openings. Placement rates at area vocational technical schools, community colleges, and/or technical institutes have been fair recently.

Hourly wages include:

\$8.97 Heating, air conditioning, and refrigeration mechanics and installers

High school programs preparing for these occupations are:

47.0201 Heating, air conditioning, and refrigeration mechanics

Related postsecondary programs at state-supported institutions in this area are:

47.0201 Heating, air conditioning, and refrigeration mechanics

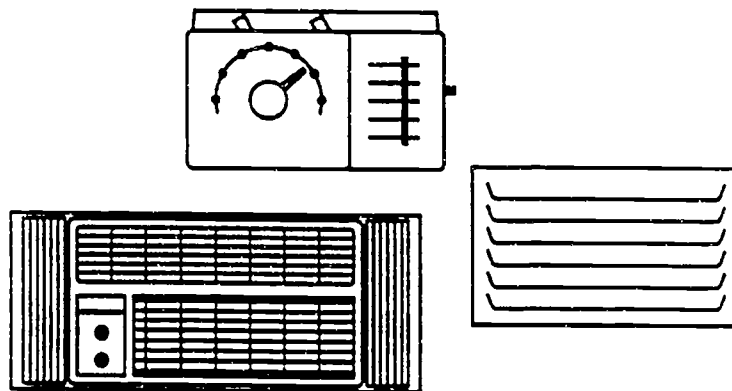

HEAVY TRUCK MAINTENANCE

Persons in heavy truck maintenance repair and maintain the operating condition of trucks, buses, and all types of diesel engines. This also includes mechanics working primarily with automobile diesel engines.

This occupation may have a generally favorable outlook for the future. Overall, the number of these jobs is growing. A moderate number of job openings are expected over the next four or five years. Recently, there have been fewer new trainees than job openings. If this trend continues, job opportunities should be good. Placement rates at area vocational technical schools, community colleges, and/or technical institutes have been fair recently.

Average hourly wages are \$9.48

Related postsecondary programs at state-supported institutions in this area are:

47.0605 Diesel engine mechanics

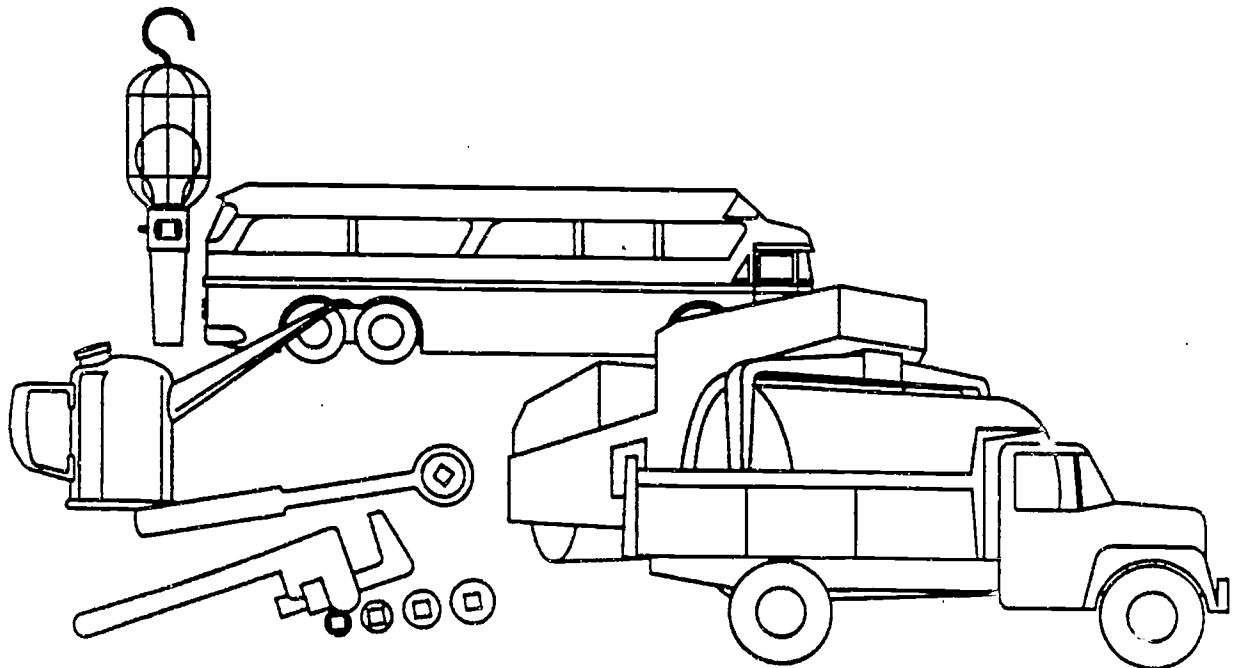

HORTICULTURE AND LANDSCAPING

The largest group of workers in these occupations, gardeners and groundskeepers, maintain the grounds of public and private property. Duties may include mowing, trimming, planting, and watering plants, shrubs, and grass.

The largest occupations, which also have the greatest number of job openings annually, are:

- Nursery workers
- Gardeners and groundskeepers, except farm workers

These occupations may not have a favorable outlook for the future. Overall, the number of these jobs is growing. A moderate number of job openings are expected over the next four or five years. Recently, there have been many more new trainees than job openings. If this trend continues, job seekers can expect to face keen competition.

Hourly wages include:

\$6.27 Gardeners and groundskeepers, except farm

High school programs preparing for these occupations are:

01.0601 Horticulture

Related postsecondary programs at state-supported institutions in this area are:

01.0603 Ornamental horticulture

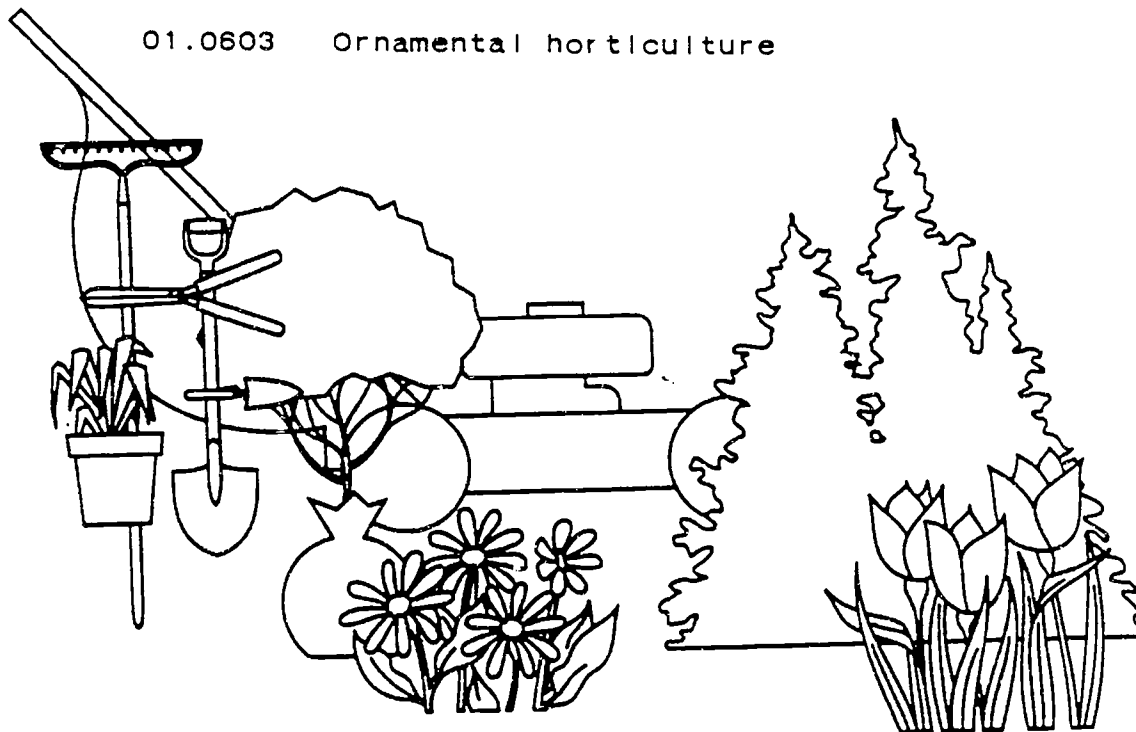

HOTEL AND RESTAURANT MANAGEMENT

Food service and lodging managers supervise the profitable operation of restaurants, hotels, and motels. Workers direct the varied activities of these businesses with the goal of pleasing people and providing good service to their customers.

This occupation may have a generally favorable outlook for the future. Overall, the number of these jobs is growing. A moderate number of job openings are expected over the next four or five years. Recently, there have been about as many new trainees as job openings. If this trend continues, job seekers can expect to face some competition.

Average hourly wages are \$8.26

Related postsecondary programs at state-supported institutions in this area are:

52.0902 Hotel, motel and restaurant management

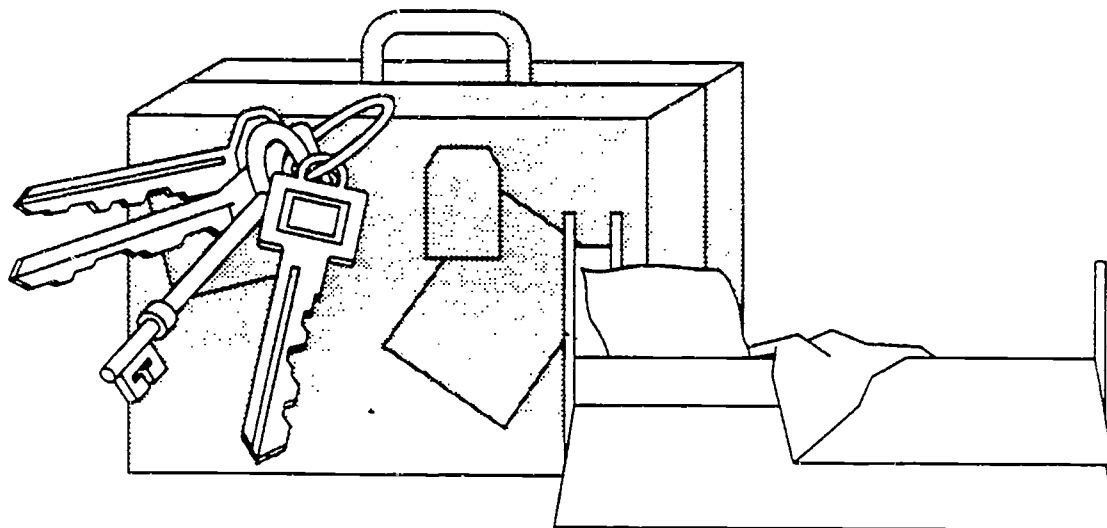

INDUSTRIAL MAINTENANCE TECHNOLOGY

Workers prevent costly waste of raw materials and the idling of human resources in a plant or factory by making industrial machinery repairs as quickly as possible. Maintenance mechanics spend considerable time doing preventive maintenance, including keeping machines well oiled and greased, and periodically cleaning parts.

The largest occupations, which also have the greatest number of job openings annually, are:

- Maintenance mechanics for industrial machinery
- Millwrights

These occupations may have a generally favorable outlook for the future. Overall, the number of these jobs is growing. A moderate number of job openings are expected over the next four or five years. Recently, no training has been reported.

Hourly wages include:

\$10.78 Machinery maintenance mechanics

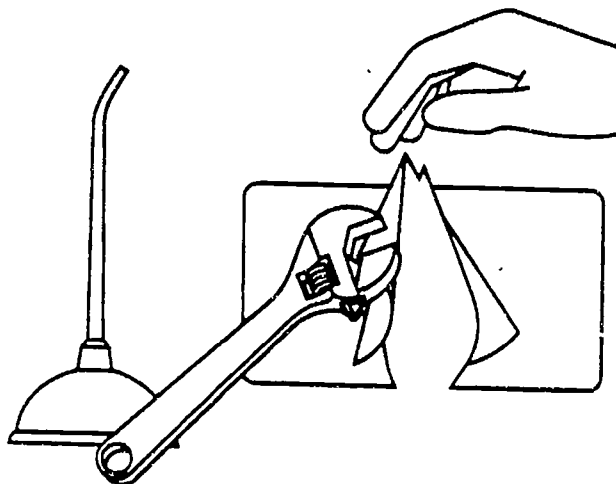

248

INSTITUTIONAL HOME MANAGEMENT AND SUPPORTING SERVICES

These workers make sure that all public buildings, offices, hospitals, stores, and apartment houses are kept clean and in good condition for the comfort and safety of the people who work or live there. Generally, no special education is required for occupations in this field, with most skills learned on the job.

The largest occupations, which also have the greatest number of job openings annually, are:

- Maids and housekeeping cleaners
- Janitors and cleaners, except maids and housekeeping cleaners

These occupations may have a generally favorable outlook for the future. Overall, the number of these jobs is growing. Large numbers of job openings are expected over the next four or five years. Recently, there have been fewer new trainees than job openings. If this trend continues, job opportunities should be good.

Hourly wages include:

- \$4.57 Maids and housekeeping cleaners
- \$5.34 Janitors and cleaners, except maids and housekeeping cleaners
- \$6.64 Housekeepers

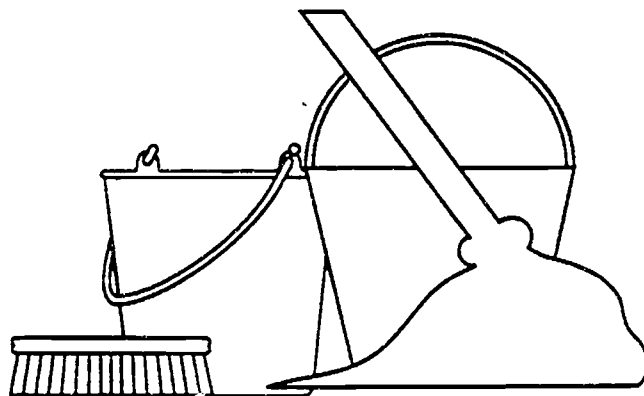

LABORATORY TECHNICIAN

Medical and clinical laboratory technicians perform routine laboratory tests for use in the treatment and diagnosis of disease; prepare vaccines, biologicals, and serums for prevention of disease; and prepare tissue samples, take blood samples, and execute laboratory tests including urinalyses and blood counts.

This occupation may have a generally favorable outlook for the future. Overall, the number of these jobs is growing. Few job openings are expected over the next four or five years. Recently, no training has been reported.

Average hourly wages are \$9.98

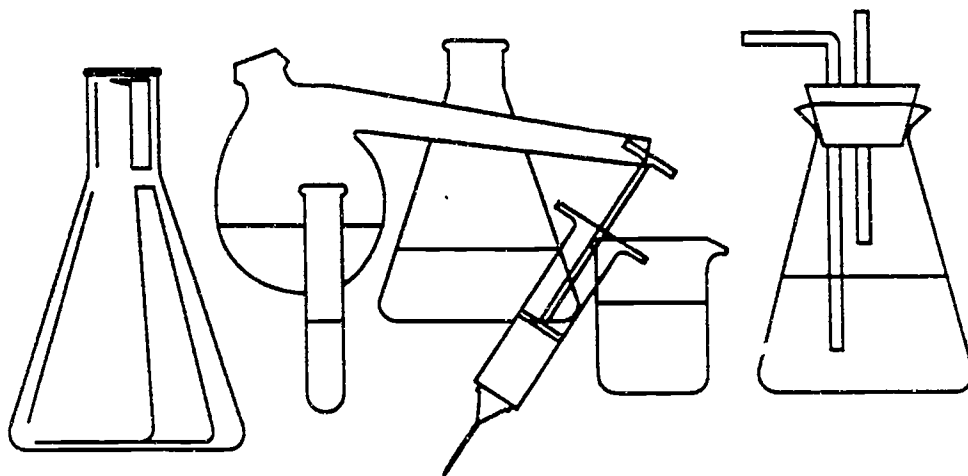

LAW ENFORCEMENT

People working at these occupations are responsible for the safety of Tennessee cities, towns, and highways. Their responsibilities range from controlling traffic to preventing and investigating crimes. Whether on or off duty, they are expected to exercise their authority whenever necessary.

The largest occupations, which also have the greatest number of job openings annually, are:

- Police patrol officers
- Sheriffs and deputy sheriffs

These occupations may have a generally favorable outlook for the future. Overall, the number of these jobs is growing slowly. A moderate number of job openings are expected over the next four or five years. Recently, no training has been reported. Job opportunities should be good.

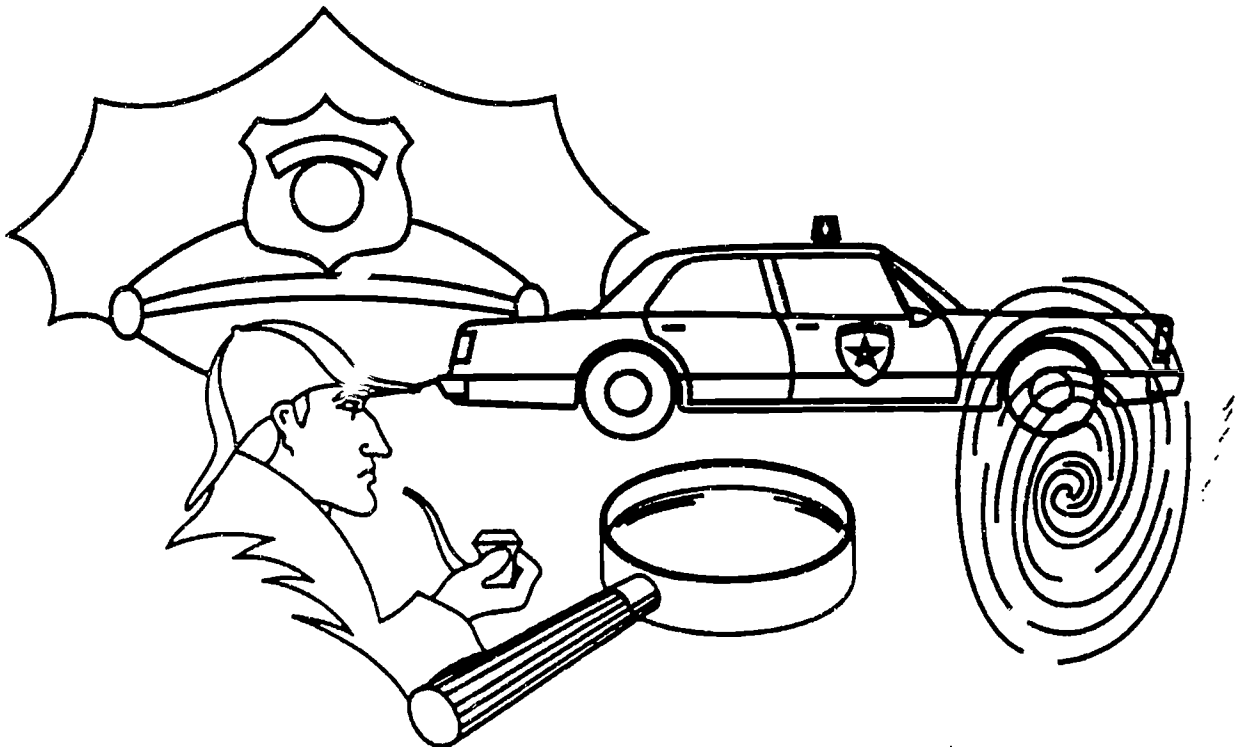

LEGAL ASSISTING

Under the direct supervision of a lawyer, workers employed in paralegal occupations do research for the preparation of lawsuits and legal documents; gather information for use as evidence in trials; draft documents such as mortgages, deeds, and contracts; and search titles to determine if a title deed is correct. Most paralegal personnel work for private law firms.

This occupation may not have a favorable outlook for the future. Few job openings are expected over the next four or five years. Recently, there have been more new trainees than job openings. Placement rates at area vocational technical schools, community colleges, and/or technical institutes have been very good recently.

Average hourly wages are \$10.29

Related postsecondary programs at state-supported institutions in this area are:

22.0103 Paralegal, legal assisting

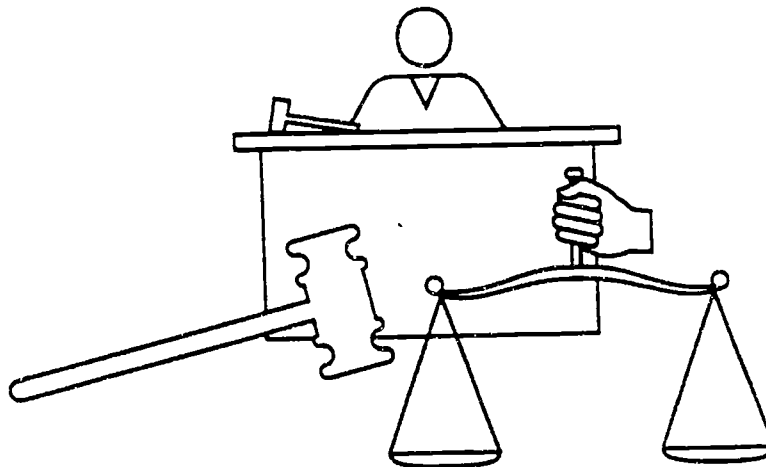

MACHINE TOOL TECHNOLOGY

Workers in these occupations make or set up and operate machine tools or repair metal parts. Machinists and tool-and-die makers create highly specialized precision tools, molds, and metal parts. Often they use blueprints to develop prototypes for tools or machines to be used in manufacturing.

The two largest occupations are:

- Machinists
- Machine tool cutting operators and tenders of metal and plastic

The occupations expected to have the most job openings annually are:

- Machinists
- Tool and die makers

These occupations may have a generally favorable outlook for the future. Overall, the number of these jobs is growing. A moderate number of job openings are expected over the next four or five years. Recently, there have been fewer new trainees than job openings. If this trend continues, job opportunities should be good. Placement rates at area vocational technical schools, community colleges, and/or technical institutes have been very good recently.

Hourly wages include:

- \$8.66 Combination machine tool operators and tenders, metal and plastic
- \$9.64 Machinists
- \$10.61 Numerical control machine tool operators and tenders, metal and plastic

High school programs preparing for these occupations are:

- 48.0503 Machine tool operation and machine shop technology

Related postsecondary programs at state-supported institutions in this area are:

- 48.0503 Machine tool operation and machine shop technology

MEDICAL ASSISTING

Medical assistants perform a wide variety of clinical and administrative duties under the direction of physicians. Clinical duties may include taking and recording patients' vital signs and medical histories, preparing patients for examination by physicians, and explaining treatment procedures to patients.

In small physicians' offices they may keep medical records, schedule appointments, and order supplies. Electrocardiograph (EKG) technicians operate the EKG machines which provide graphic tracings of heartbeats.

The largest occupations, which also have the greatest number of job openings annually, are:

- Electrocardiograph technicians
- Medical assistants

These occupations may have a generally favorable outlook for the future. Overall, the number of these jobs is growing rapidly. A moderate number of job openings are expected over the next four or five years. Recently, no training has been reported. Job opportunities should be good.

Hourly wages include:

\$7.79 Medical assistants

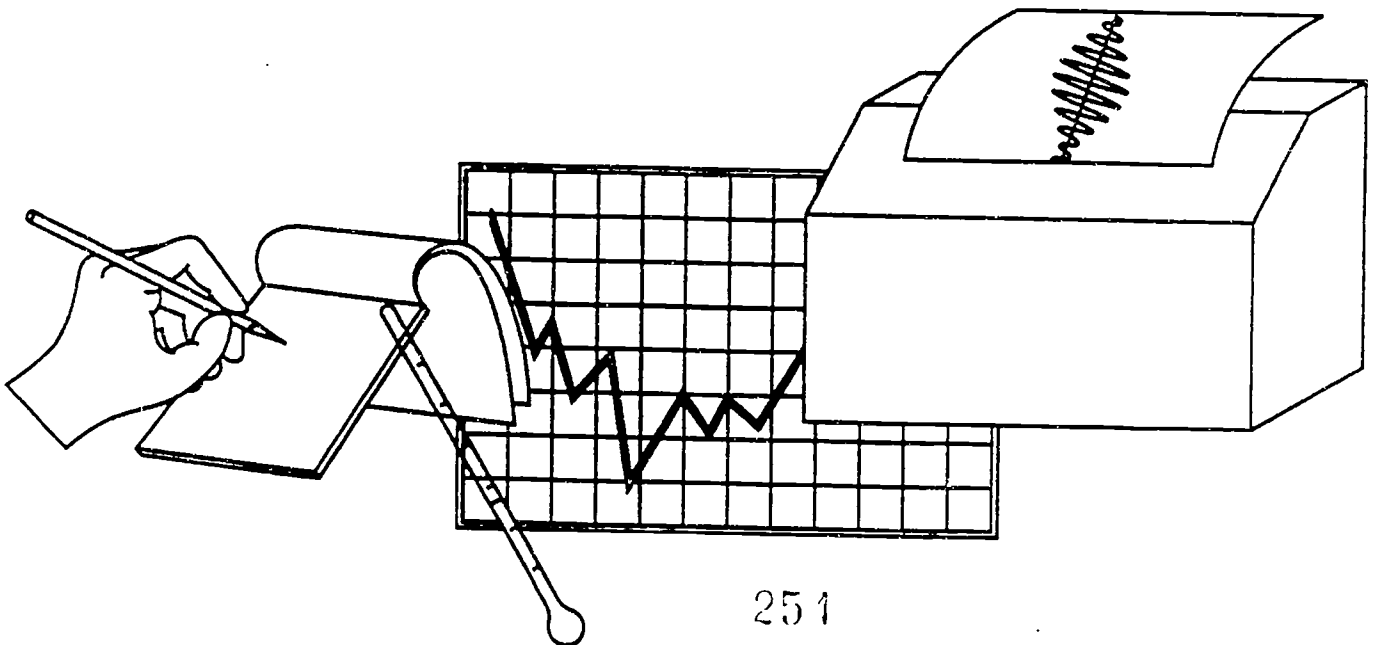

MEDICAL RECORDS TECHNOLOGY

Medical records technicians compile and maintain medical records of hospital and clinic patients. Such work is becoming increasingly important as this background information is used for medicare and medical insurance reimbursements.

This occupation may not have a favorable outlook for the future. Few job openings are expected over the next four or five years. Recently, no training has been reported.

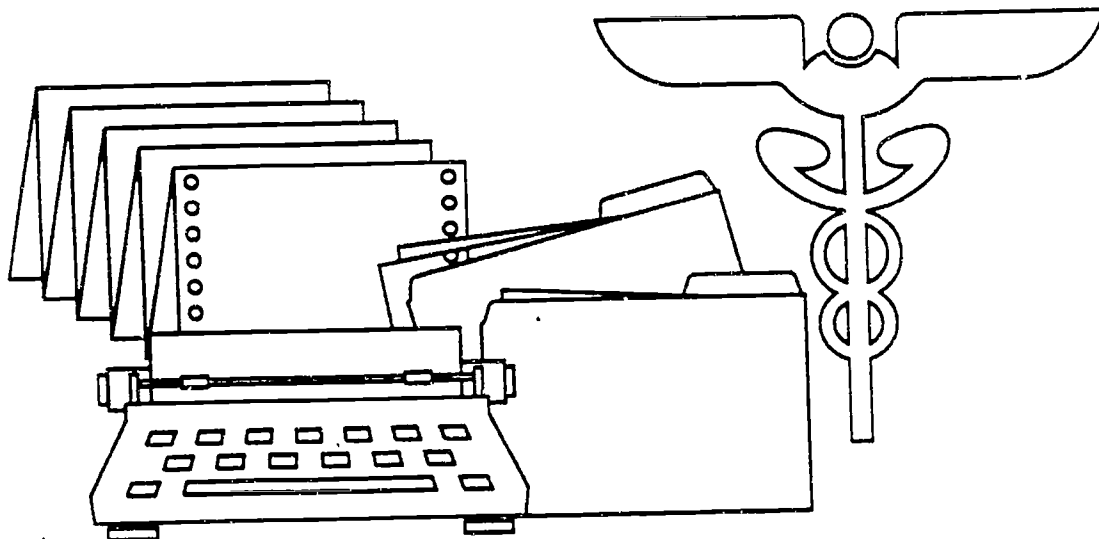

NURSING ASSISTANT

Nursing aides and orderlies work under the general direction of nursing or medical staff. In hospitals, they may answer patients' call bells, serve and collect food trays, feed patients, or set up equipment. In nursing homes, they are expected to sustain ongoing relations with patients.

The largest occupations, which also have the greatest number of job openings annually, are:

- Nursing aides, orderlies, and attendants
- Home health aides

These occupations may have a generally favorable outlook for the future. Overall, the number of these jobs is growing rapidly. Large numbers of job openings are expected over the next four or five years. Recently, there have been fewer new trainees than job openings. If this trend continues, job opportunities should be good.

Hourly wages include:

- \$5.46 Home health aides
- \$5.68 Nursing aides, orderlies, and attendants

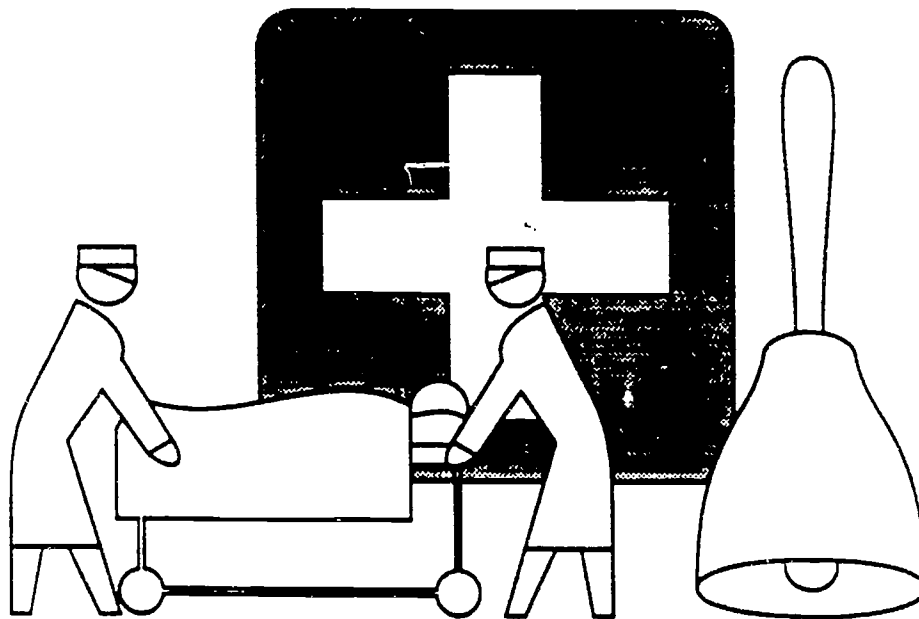

PHOTOGRAPHIC TECHNOLOGY

Workers in this cluster use their cameras and film to portray people, places, and events much as a writer uses words. Those who are skillful can capture the personality of individuals or the mood of the scenes which they photograph. Photographers specializing in scientific, medical, or engineering photography expose worlds normally hidden from our view.

The two largest occupations are:

- Photographers
- Photographic processing machine operators and tenders

The occupations expected to have the most job openings annually are:

- Photographic processing machine operators and tenders
- Precision photographic process workers

These occupations may have a generally favorable outlook for the future. Overall, the number of these jobs shows little change. Few job openings are expected over the next four or five years. Recently, there have been more new trainees than job openings.

High school programs preparing for these occupations are:

48.0204 Commercial photography

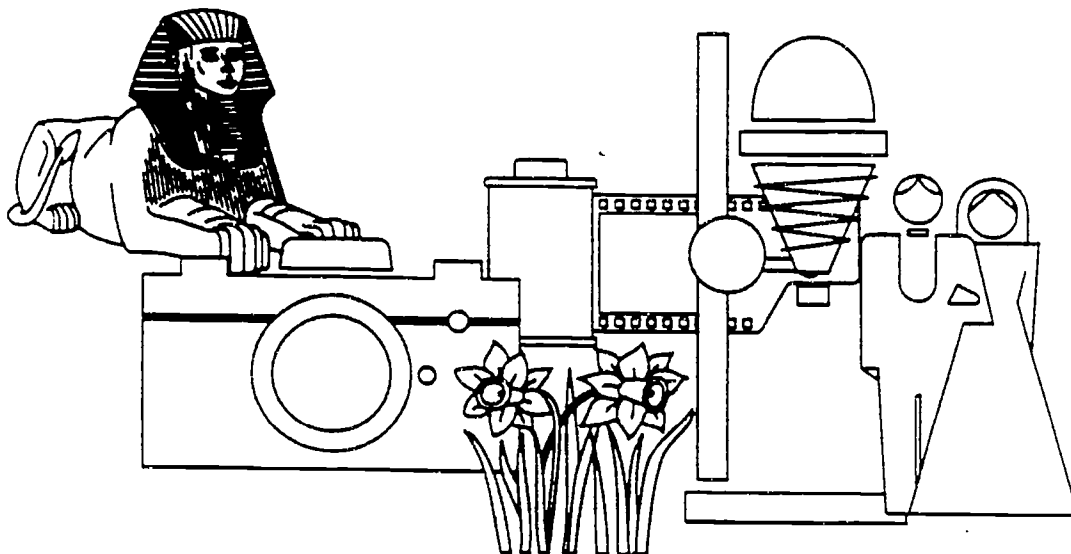

PLUMBING AND PIPEFITTING

Plumbers and pipefitters install and maintain the complex system of pipes that connect to the master system that runs underground. Although plumbing and pipefitting are sometimes considered a single trade, workers may specialize in either craft. Plumbers build and repair the water, waste disposal, drainage, and gas systems in homes and commercial/industrial buildings. Pipefitters build and repair both high and low pressure pipe.

The largest occupations, which also have the greatest number of job openings annually, are:

- Plumbers, pipefitters, and steamfitters
- Pipelayers

These occupations may have a generally favorable outlook for the future. Overall, the number of these jobs is growing. A moderate number of job openings are expected over the next four or five years. Recently, no training has been reported. Job opportunities should be good.

Hourly wages include:

\$11.26 Plumbers, pipefitters, and steamfitters

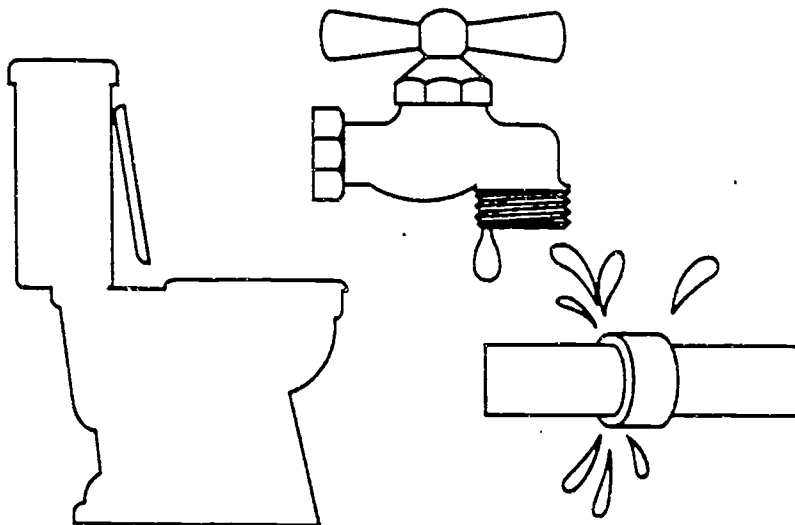

258

PRACTICAL NURSING

Licensed practical nurses (LPNs) work under the supervision of physicians and/or registered nurses to provide nursing care that requires technical knowledge but not the professional training of a registered nurse. They provide bedside care, administer certain medications, and assist in patient examinations.

This occupation may have a generally favorable outlook for the future. Overall, the number of these jobs is growing rapidly. Large numbers of job openings are expected over the next four or five years. Recently, there have been fewer new trainees than job openings. If this trend continues, job opportunities should be good. Placement rates at area vocational technical schools, community colleges, and/or technical institutes have been excellent recently.

Average hourly wages are \$9.23

Related postsecondary programs at state-supported institutions in this area are:

17.0605 Practical nursing

Licensing may be required. Contact: TENNESSEE BOARD OF NURSING, 615-367-6232.

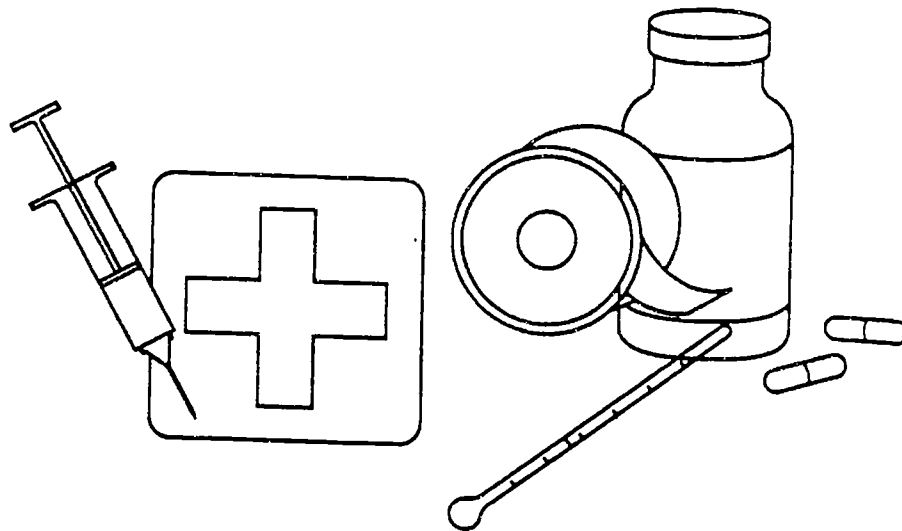

259

PROFESSIONAL NURSING

Registered Nurses (R.N.'s), the largest occupational group in this field, are primarily employed in hospitals and nursing homes, where they provide skilled bedside care and may supervise licensed practical nurses, nursing aides, and orderlies. Working under the direction of a licensed "supervising physician," physician assistants elicit detailed patient histories, perform physical examinations, and prescribe appropriate treatments.

The largest occupations, which also have the greatest number of job openings annually, are:

- Registered nurses
- Physician's assistants

These occupations may have a generally favorable outlook for the future. Overall, the number of these jobs is growing rapidly. Large numbers of job openings are expected over the next four or five years. Recently, there have been fewer new trainees than job openings. If this trend continues, job opportunities should be good.

Hourly wages include:

\$14.41 Registered nurses

Related postsecondary programs at state-supported institutions in this area are:

- 51.1601 Nursing (R.N. training)
- 51.1608 Nursing science (post R.N.)

Licensing may be required. Contact: TENNESSEE BOARD OF MEDICAL EXAMINERS-COMMITTEE ON PHYSICIAN ASSISTANTS, 615-367-6250.

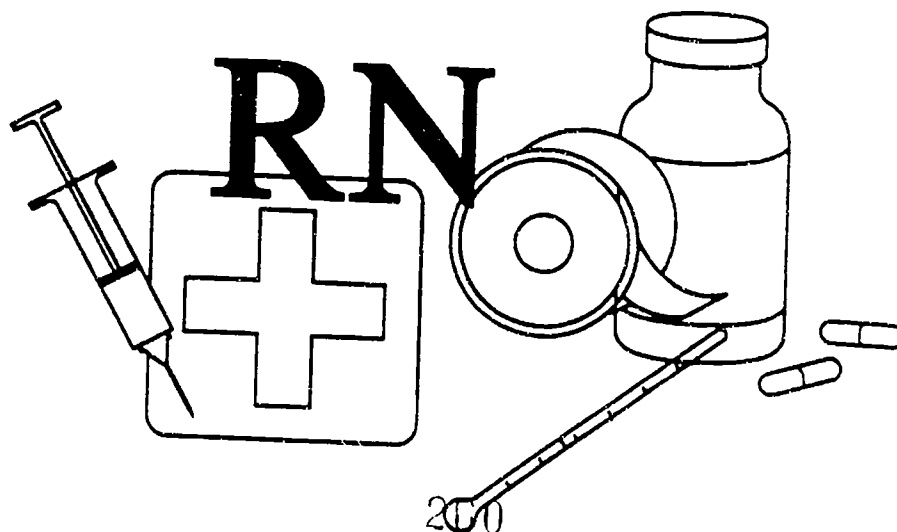

PUBLIC ADMINISTRATION

Individuals in this field are responsible for the management of diverse areas of governmental organizations. These managers usually work through departmental executives or subordinates in coordinating the various activities and groups they control. Public administration chief executives, legislators, and general administrators establish government policy and develop federal, state, or local regulations, rules, and laws.

The two largest occupations are:

- General managers and top executives
- Public administration chief executives, legislators, and general administrators

The occupations expected to have the most job openings annually are:

- Management analysts
- General managers and top executives

These occupations may not have a favorable outlook for the future. Overall, the number of these jobs is growing. Few job openings are expected over the next four or five years. Recently, there have been many more new trainees than job openings.

Related postsecondary programs at state-supported institutions in this area are:

- 44.0201 Community organization, resources and services
- 44.0401 Public administration



RADIOGRAPHIC MEDICAL TECHNOLOGY

Workers in this field operate equipment including x-ray machines, fluoroscopes, ultrasonic scanners, computed tomography (CP) scanners, and nuclear magnetic resonance (MCI) machines for diagnostic imagery of the human body or for therapy.

The largest occupations, which also have the greatest number of job openings annually, are:

- Radiologic technologists
- Radiologic technicians

These occupations may have a generally favorable outlook for the future. Overall, the number of these jobs is growing rapidly. A moderate number of job openings are expected over the next four or five years. Recently, no training has been reported. Job opportunities should be good.

Hourly wages include:

\$13.06 Radiologic technicians

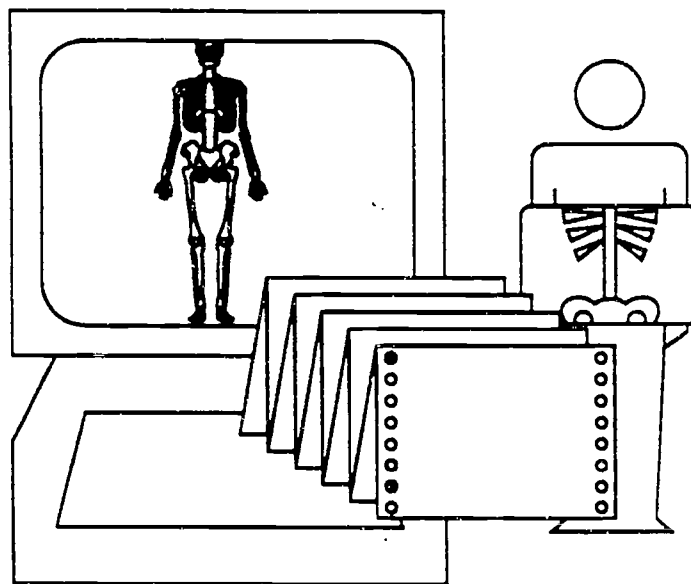

262

RECREATIONAL LEADERSHIP

Workers in recreational leadership occupations conduct recreational activities with groups, consider the interests of participants, and organize and promote activities. A large proportion of recreational workers are employed in city recreation departments and in state and national parks.

This occupation may have a generally favorable outlook for the future. Overall, the number of these jobs is growing. Few job openings are expected over the next four or five years. Recently, no training has been reported.



RESPIRATORY THERAPY

Respiratory therapists treat patients with breathing problems ranging from chronic asthma and emphysema to heart failure, stroke, or drowning emergencies. Respiratory care may involve administering oxygen; delivering medication or humidity through aerosol mists; administering chest physical therapy; or setting up and operating mechanical ventilators.

This occupation may have a generally favorable outlook for the future. Few job openings are expected over the next four or five years. Recently, no training has been reported.

Licensing may be required. Contact: BOARD OF MEDICAL EXAMINERS-COUNCIL ON RESPIRATORY CARE, 615-367-6393.

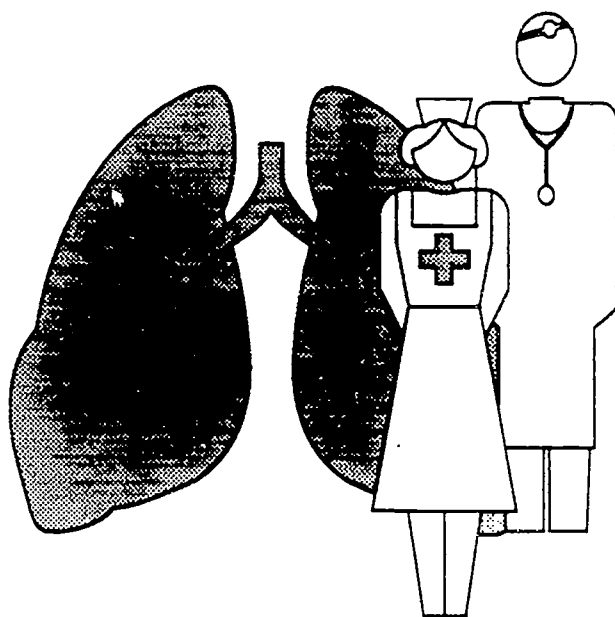

SALES AND MERCHANDISING

Workers in sales and merchandising occupations promote and sell a wide variety of merchandise and services. They also receive, store, display, and inventory products to be sold.

The largest occupations, which also have the greatest number of job openings annually, are:

- Salespersons in retail establishments
- Cashiers

These occupations may have a generally favorable outlook for the future. Overall, the number of these jobs is growing. Large numbers of job openings are expected over the next four or five years. Recently, there have been fewer new trainees than job openings. If this trend continues, job opportunities should be good. Placement rates at area vocational technical schools, community colleges, and/or technical institutes have been good recently.

Hourly wages include:

\$4.73	Cashiers
\$5.65	Counter and rental clerks
\$6.48	Salespersons, retail
\$7.07	Customer service representatives, utilities
\$11.17	Driver/sales workers
\$13.71	Purchasing agents- except wholesale, retail, and farm products
\$15.62	Wholesale and retail buyers, except farm products

High school programs preparing for these occupations are:

08.0700 General marketing

Related postsecondary programs at state-supported institutions in this area are:

08.0799 Miscellaneous general marketing

Licensing may be required. Contact: TENNESSEE DEPARTMENT OF COMMERCE AND INSURANCE, 615-741-2693.

SECURITY SERVICES

Security guards, the largest occupation in this field, patrol and inspect property to protect it against fire, theft, vandalism, and illegal entry. Guards and doorkeepers usually are uniformed and often carry a nightstick and a weapon; correctional officers and jailers maintain order in correctional institutions, enforce institutional rules and regulations, and may supplement the counseling inmates receive from mental health professionals.

The largest occupations, which also have the greatest number of job openings annually, are:

- Correction officers and jailers
- Guards and watch guards

These occupations may have a generally favorable outlook for the future. Overall, the number of these jobs is growing. Large numbers of job openings are expected over the next four or five years. Recently, no training has been reported. Job opportunities should be good.

Hourly wages include:

\$4.89 Guards and watch guards

Licensing may be required. Contact: COUNTY COURT CLERK'S OFFICE.

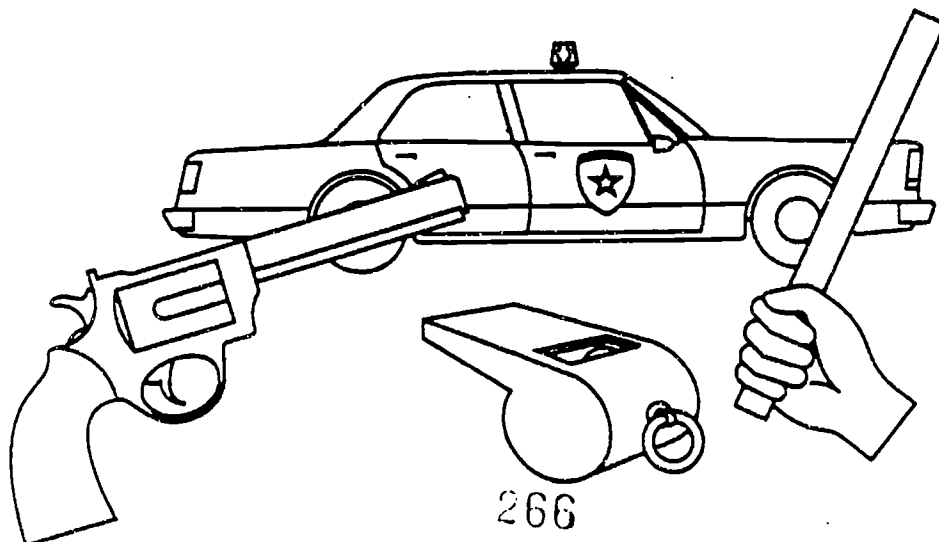

266

SHEET METAL

Sheet metal workers make, install, and maintain a variety of sheet metal products for home, commercial, and industrial buildings. These products include ducts for air conditioning, heating, and ventilating and pollution control systems, kitchen equipment, roofs, siding, rain gutters, skylights, and outdoor signs. Other workers use a variety of machines in the mass production of sheet-metal products.

The largest occupations, which also have the greatest number of job openings annually, are:

- Sheet metal workers
- Machine forming operators and tenders of metal and plastic

These occupations may have a generally favorable outlook for the future. Overall, the number of these jobs shows little change. A moderate number of job openings are expected over the next four or five years. Recently, no training has been reported. Job opportunities should be good.

Hourly wages include:

\$8.34 Sheet metal workers

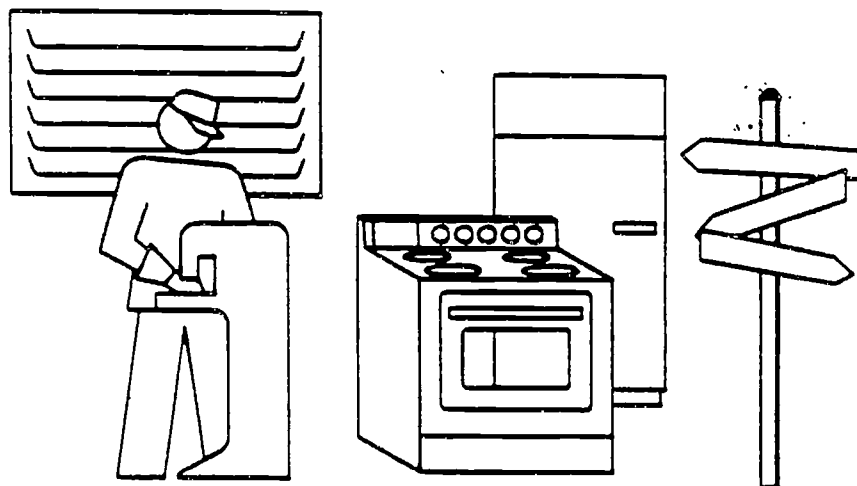

SMALL ENGINE REPAIR

Persons working in these occupations repair and service motorcycles, other small vehicles, and equipment with small gasoline engines. The ability to make quick and accurate diagnoses is one of the mechanic's most valuable skills. In fact, many mechanics consider diagnosing "hard to find" troubles one of their most challenging and satisfying duties.

The largest occupations, which also have the greatest number of job openings annually, are:

- Motorcycle repairers
- Small engine specialists

These occupations may not have a favorable outlook for the future. Overall, the number of these jobs shows little change. Very few job openings are expected over the next four or five years. Recently, there have been many more new trainees than job openings. Placement rates at area vocational technical schools, community colleges, and/or technical institutes have been very good recently.

High school programs preparing for these occupations are:

47.0606 Small engine repair

Related postsecondary programs at state-supported institutions in this area are:

47.0606 Small engine repair

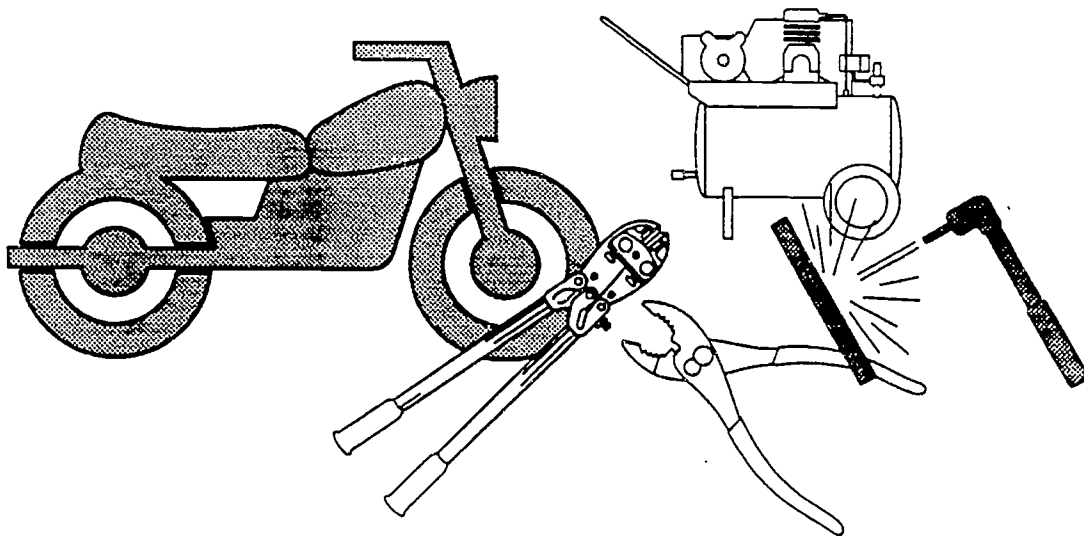

SURGICAL TECHNOLOGY

Surgical technicians, also called operating room technicians, work in hospitals under the direct supervision of surgeons and registered nurses. They help set up the operating room with surgical instruments and supplies, help prepare patients for surgery, and may pass instruments and supplies to surgeons.

This occupation may not have a favorable outlook for the future. Few job openings are expected over the next four or five years. Recently, there have been many more new trainees than job openings. Placement rates at area vocational technical schools, community colleges, and/or technical institutes have been good recently.

Related postsecondary programs at state-supported institutions in this area are:

17.0211 Surgical technology

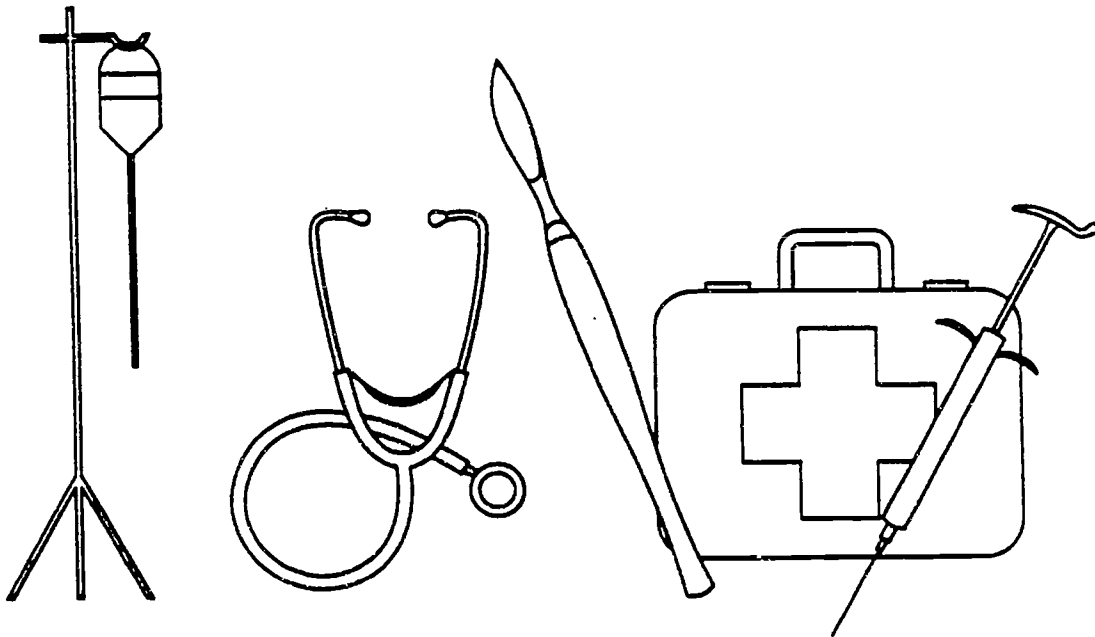

269

TRAVEL SERVICES

These workers assist people with all facets of their travel. Planning and budgeting a trip, purchasing tickets, selling travel insurance, obtaining passports and visas, and even ticket taking are all done by these employees.

The two largest occupations are:

- Travel agents
- Reservation and transportation ticket agents

The occupations expected to have the most job openings annually are:

- Travel agents
- Guides

These occupations may have a generally favorable outlook for the future. Overall, the number of these jobs is growing. Few job openings are expected over the next four or five years. Recently, no training has been reported.

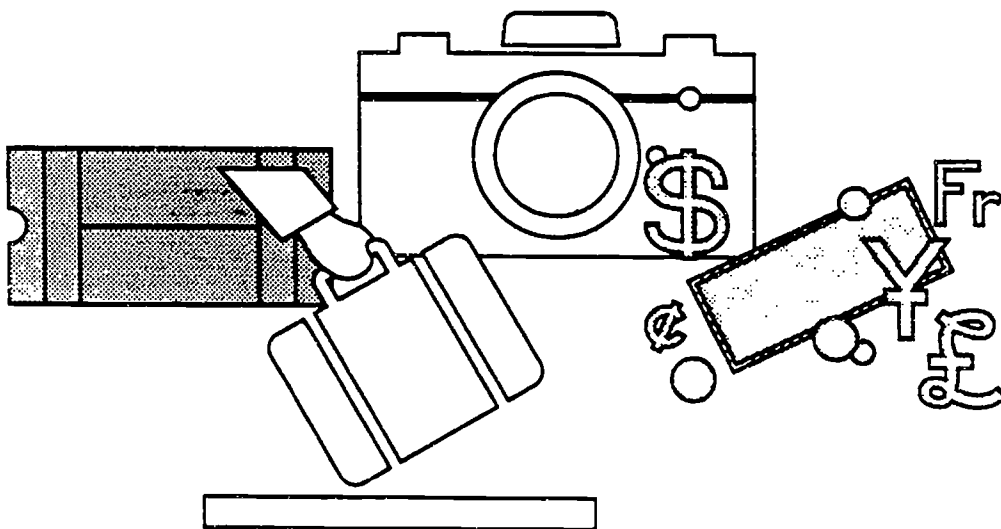

TRUCK, BUS, AND HEAVY EQUIPMENT OPERATION

These occupations include truck drivers who transport goods, bus drivers who transport passengers, and heavy equipment operators who use machinery to move construction materials and other goods over short distances--around a factory, construction site or loading dock.

The largest occupations, which also have the greatest number of job openings annually, are:

- Truck drivers of heavy or tractor trailer trucks
- School bus drivers

These occupations may have a generally favorable outlook for the future. Overall, the number of these jobs is growing. Large numbers of job openings are expected over the next four or five years. Recently, there have been fewer new trainees than job openings. If this trend continues, job opportunities should be good. Placement rates at area vocational technical schools, community colleges, and/or technical institutes have been very good recently.

Hourly wages include:

- \$8.62 Grader, dozer, and scraper operators
- \$10.93 Truck drivers, heavy or tractor trailer

Related postsecondary programs at state-supported institutions in this area are:

- 49.0205 Truck and bus driving

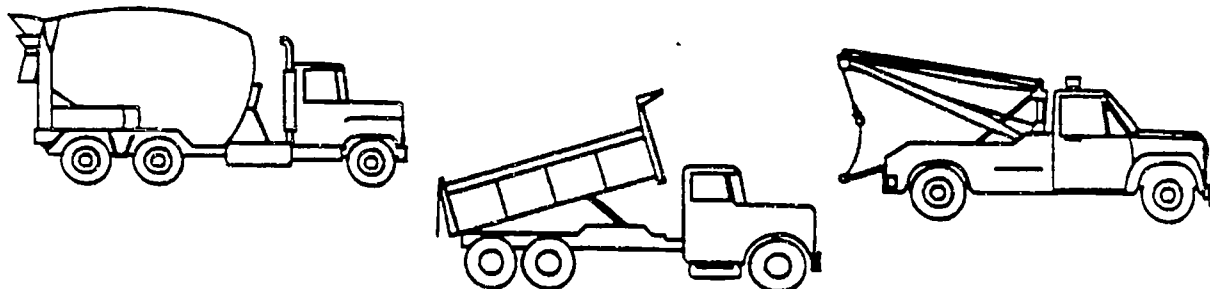

WELDING TECHNOLOGY

Welding is the most common way of permanently joining metal parts. Typically, heat is applied to the metal pieces to be joined; the parts are melted and fused to form a permanent bond. Welding is used to construct and repair parts of ships, automobiles, spacecraft, and thousands of products. It can also be used to join beams and steel reinforcing rods in buildings, bridges, and highways.

The two largest occupations are:

- Welders and cutters
- Welding machine setters and set-up operators

The occupations expected to have the most job openings annually are:

- Welders and cutters
- Solderers and brazers

These occupations may not have a favorable outlook for the future. Overall, the number of these jobs is growing. Few job openings are expected over the next four or five years. Recently, there have been many more new trainees than job openings. Placement rates at area vocational technical schools, community colleges, and/or technical institutes have been good recently.

Hourly wages include:

\$10.85 Welders and cutters

High school programs preparing for these occupations are:

48.0508 Welding, brazing, and soldering

Related postsecondary programs at state-supported institutions in this area are:

48.0508 Welding, brazing, and soldering

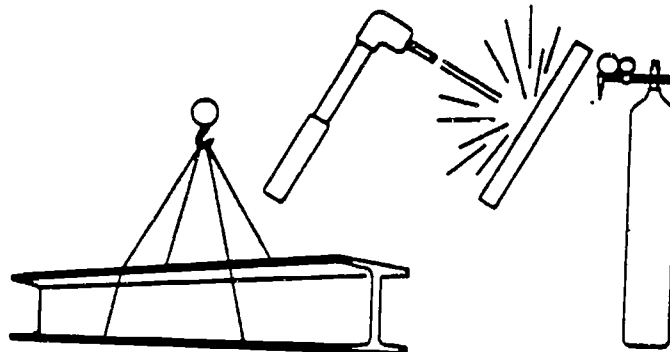

272

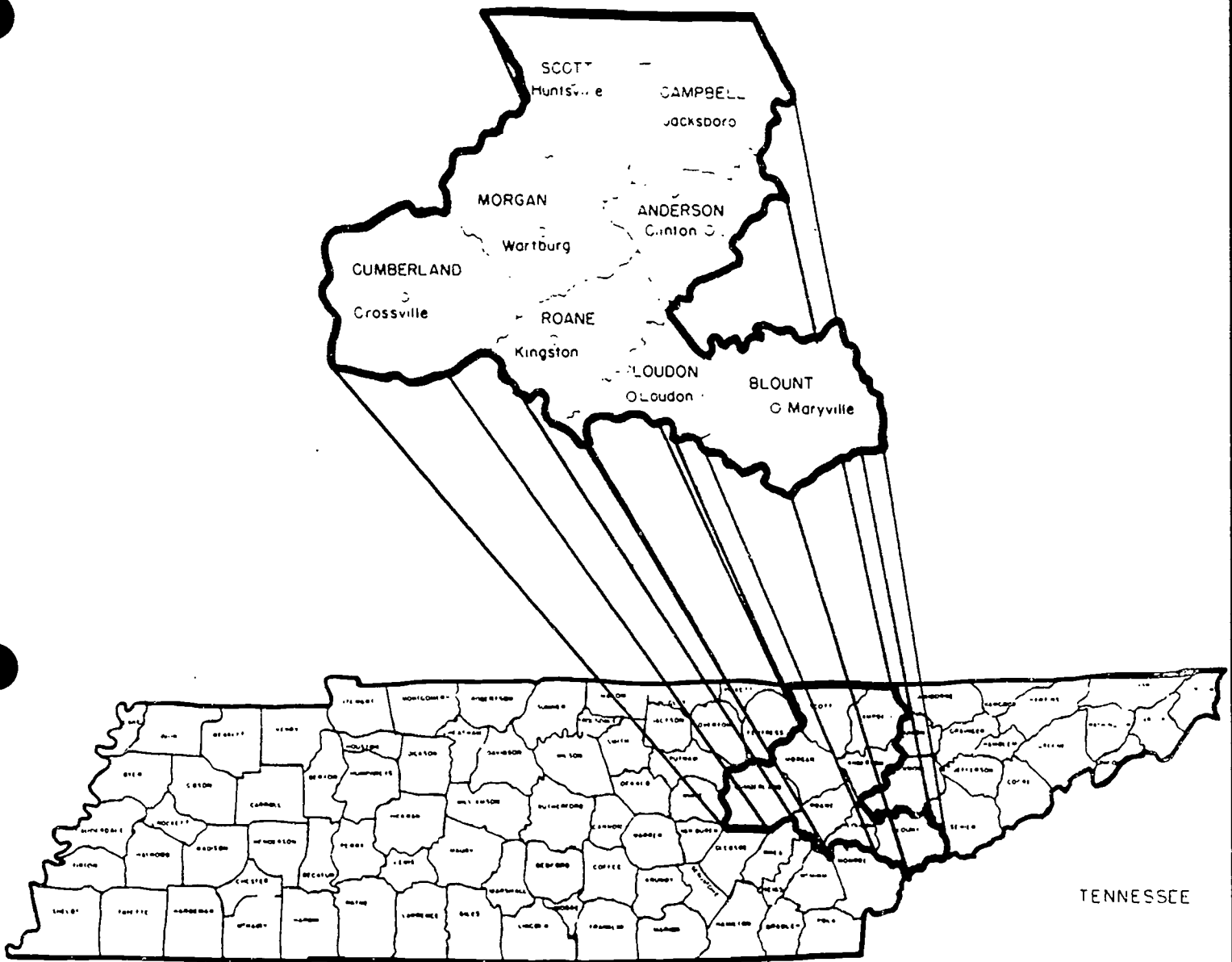

Service Delivery Area 4

ACCOUNTING AND FINANCIAL MANAGEMENT

Many individuals in this group are accountants and auditors who prepare and analyze business records and financial reports which are needed for effective management of any organization. Financial managers, another occupation in this group, typically plan, organize, control, or coordinate the financial activities of an organization.

The largest occupations, which also have the greatest number of job openings annually, are:

- Financial managers
- Accountants and auditors

These occupations may have a generally favorable outlook for the future. Overall, the number of these jobs is growing. Large numbers of job openings are expected over the next four or five years. Recently, no training has been reported. Job opportunities should be good.

Hourly wages include:

\$15.53 Accountants and auditors
\$16.58 Financial managers

Licensing may be required. Contact: TENNESSEE BOARD OF ACCOUNTANCY, 615-741-2250.



274

ADMINISTRATIVE SUPPORT: ACCOUNTING

Persons employed in this group of occupations provide clerical and administrative support to accountants and auditors. Most of these jobs require only a high school diploma for entry.

The largest occupations, which also have the greatest number of job openings annually, are:

- Bookkeeping, accounting, and auditing clerks
- Payroll and timekeeping clerks

These occupations may have a generally favorable outlook for the future. Overall, the number of these jobs shows little change. A moderate number of job openings are expected over the next four or five years. Recently, there have been fewer new trainees than job openings. If this trend continues, job opportunities should be good.

Hourly wages include:

- \$8.13 Bookkeeping, accounting, and auditing clerks
- \$8.60 Payroll and timekeeping clerks

High school programs preparing for these occupations are:

- 07.0101 Accounting and bookkeeping

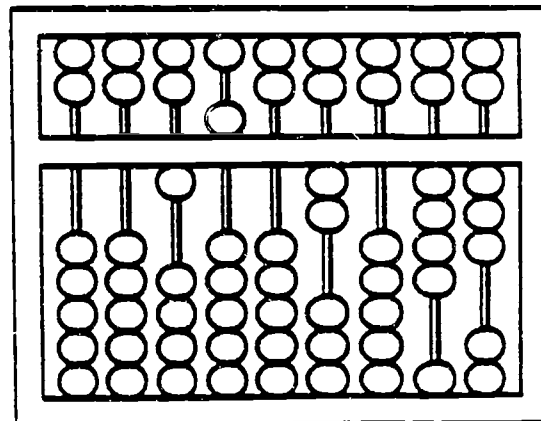
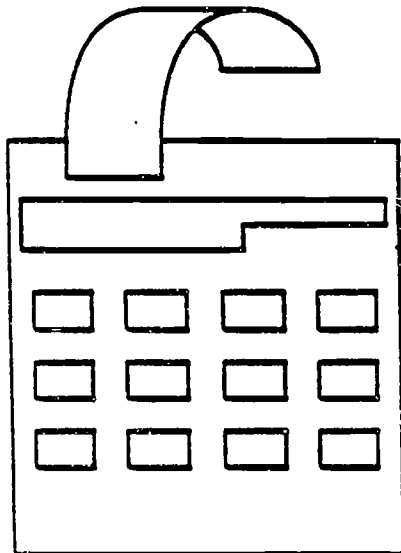

ADMINISTRATIVE SUPPORT: FINANCE AND INSURANCE

Workers provide clerical and general administrative support to the banking and finance industry. Workers receive and pay out money, keep records of money and negotiable instruments, interview applicants for credit, locate and notify customers of delinquent accounts, examine insurance claims, and process a variety of paperwork.

The largest occupations, which also have the greatest number of job openings annually, are:

- Tellers
- Bill and account collectors

These occupations may have a generally favorable outlook for the future. Overall, the number of these jobs shows little change. A moderate number of job openings are expected over the next four or five years. Recently, there have been fewer new trainees than job openings. If this trend continues, job opportunities should be good.

Hourly wages include:

- \$5.57 Tellers
- \$7.16 Bill and account collectors
- \$7.29 Loan and credit clerks
- \$7.55 New accounts clerks

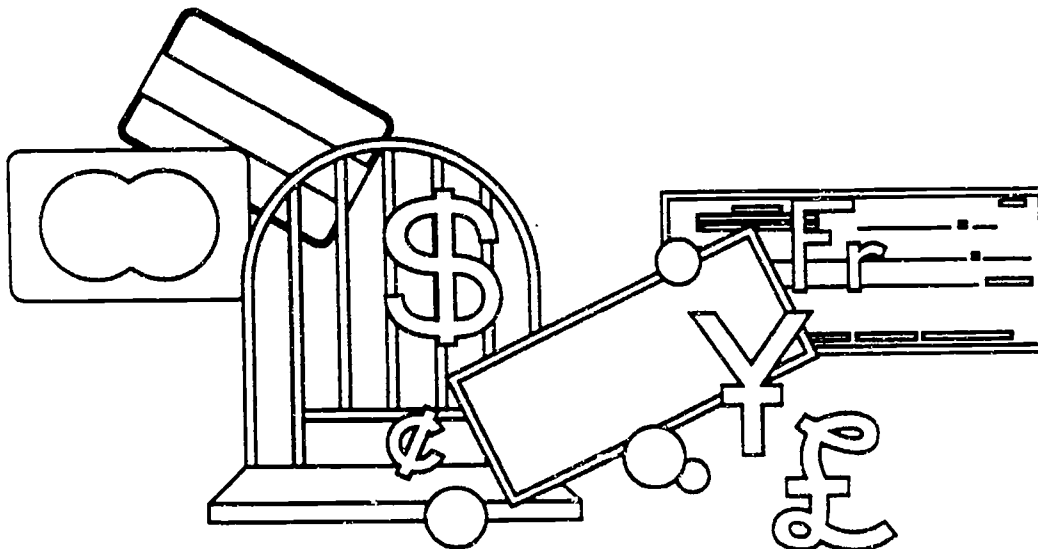

ADMINISTRATIVE SUPPORT: GENERAL

The job duties in this group of occupations are very diverse and are determined by the type of firm. For example, workers may schedule appointments, give information to callers, take dictation, type correspondence, read and route incoming mail, file correspondence and other records, and supervise and coordinate the activities of subordinate clerical workers.

The largest occupations, which also have the greatest number of job openings annually, are:

- Secretaries, except legal and medical secretaries
- General office clerks

These occupations may not have a favorable outlook for the future. Overall, the number of these jobs is growing. Large numbers of job openings are expected over the next four or five years. Recently, there have been many more new trainees than job openings. If this trend continues, job seekers can expect to face keen competition. Placement rates at area vocational technical schools, community colleges, and/or technical institutes have been good recently.

Hourly wages include:

\$5.77	Adjustment clerks
\$6.79	Receptionists and information clerks
\$6.80	Medical secretaries
\$7.36	General office clerks
\$8.55	Order clerks- materials, merchandise, and service
\$8.55	Data entry keyers, except composing
\$8.72	Typists including word processing
\$9.06	File clerks
\$9.87	Secretaries, ex. legal and medical
\$12.32	First line supervisors and manager/supervisors- clerical and administrative support occupations

High school programs preparing for these occupations are:

07.0401	Office supervision and management
07.0601	Secretarial and related programs
07.0701	Typing, general office and related programs

Related postsecondary programs at state-supported institutions in this area are:

07.0605	Medical secretarial
07.0606	Secretarial and office administration
07.9999	Miscellaneous business administrative support

AGRICULTURAL PRODUCTION

Workers in this field plan and economically use facilities, land, water, machinery, chemicals, finance, and labor in the production of plant and animal products.

The largest occupations, which also have the greatest number of job openings annually, are:

- Farm managers
- Farm workers

These occupations may not have a favorable outlook for the future. Overall, the number of these jobs shows little change. A moderate number of job openings are expected over the next four or five years. Recently, there have been many more new trainees than job openings. If this trend continues, job seekers can expect to face keen competition.

High school programs preparing for these occupations are:

01.0301 Agricultural production

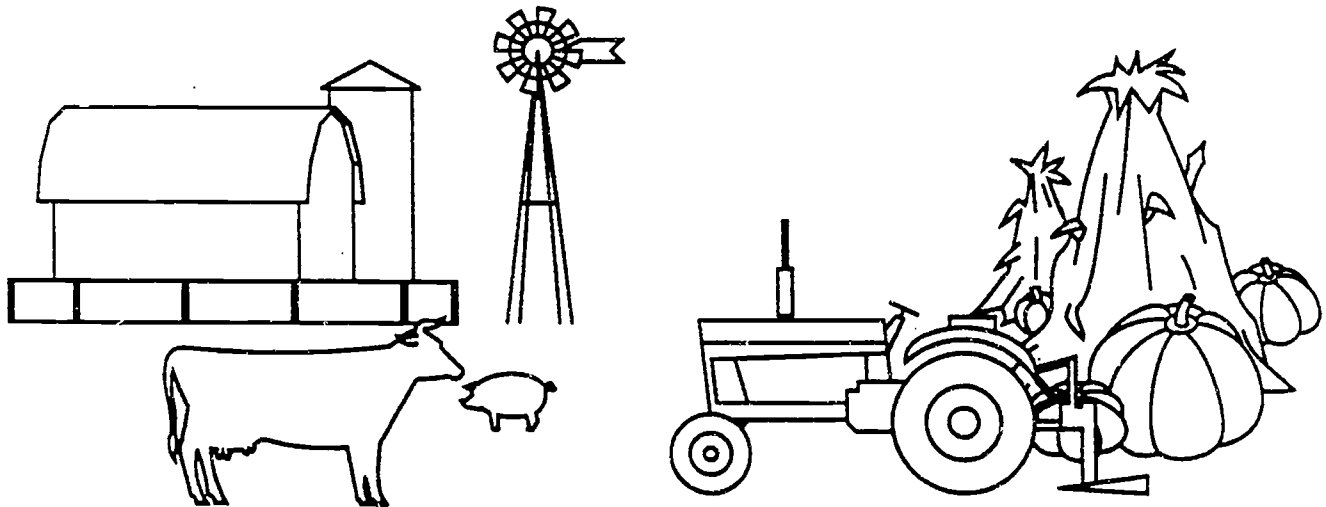

APPLIANCE AND EQUIPMENT REPAIR

Individuals in these occupations repair, adjust, maintain, and install all types of electrical motors and electrical and gas home appliances. Types of equipment used include test instruments, gauges, and hand, bench, and power tools.

The largest occupations, which also have the greatest number of job openings annually, are:

- Electric home appliance and power tool repairers
- Gas appliance repairers

These occupations may not have a favorable outlook for the future. Overall, the number of these jobs shows little change. Very few job openings are expected over the next four or five years. Recently, there have been more new trainees than job openings. Placement rates at area vocational technical schools, community colleges, and/or technical institutes have been good recently.

Related postsecondary programs at state-supported institutions in this area are:

47.0101 Electrical and electronics technology

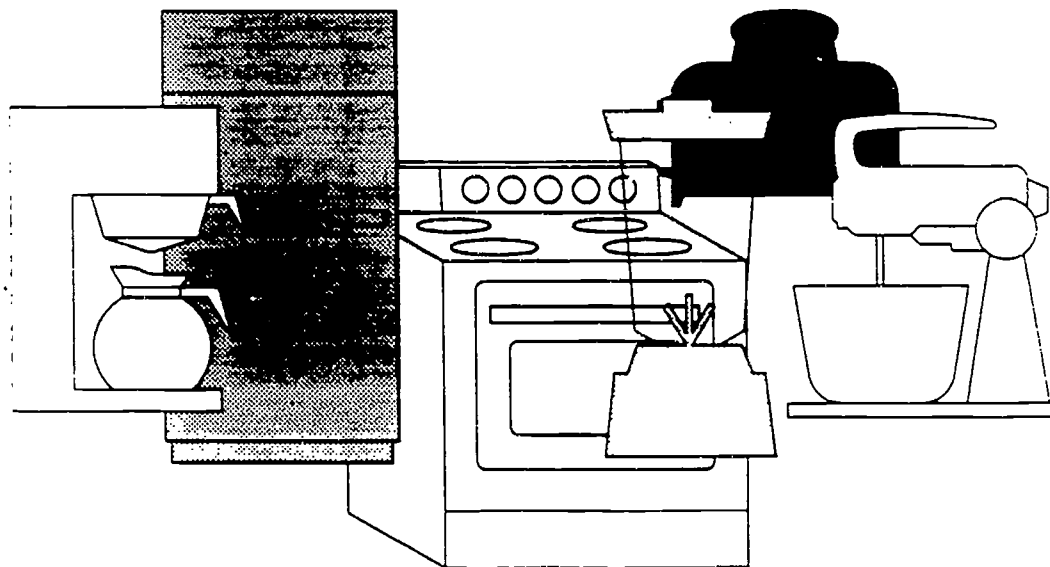

AUTOMOTIVE BODY REPAIR

Thousands of motor vehicles are damaged in traffic accidents every day. The workers in this field straighten bent frames, remove dents, and replace crumpled parts that are beyond repair so that those vehicles look and drive like new.

The largest occupations, which also have the greatest number of job openings annually, are:

- Automotive body and related repairers
- Painters of transportation equipment

These occupations may not have a favorable outlook for the future. Overall, the number of these jobs shows little change. Few job openings are expected over the next four or five years. Recently, there have been many more new trainees than job openings. Placement rates at area vocational technical schools, community colleges, and/or technical institutes have been excellent recently.

High school programs preparing for these occupations are:

47.0603 Automotive body repair

Related postsecondary programs at state-supported institutions in this area are:

47.0603 Automotive body repair

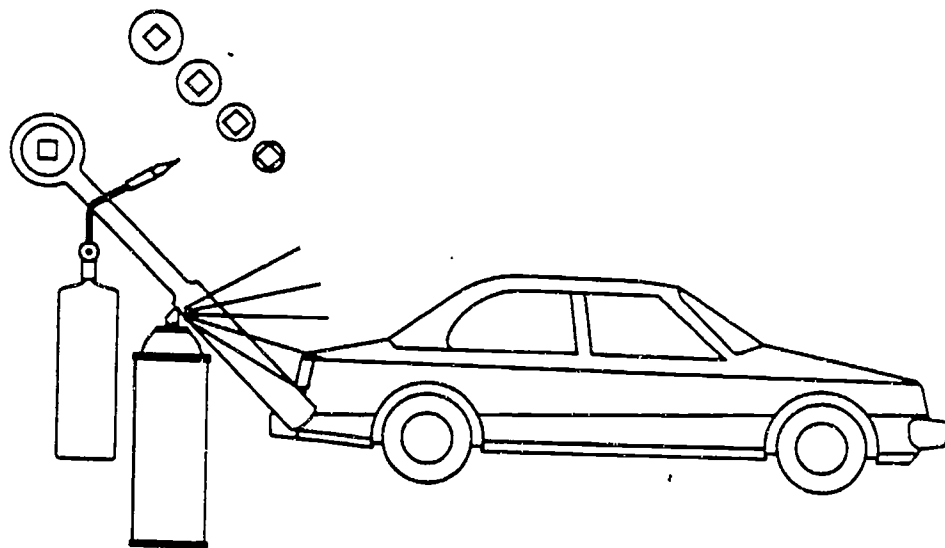

200

AUTOMOTIVE SERVICE TECHNOLOGY

These occupations include jobs concerned with parking, cleaning, polishing, lubricating, repairing, and refueling trucks, buses, and automobiles, and related servicing activities. The primary occupation, automotive mechanic, is concerned with repair and service of motor vehicles.

The largest occupations, which also have the greatest number of job openings annually, are:

- Automotive mechanics
- Tire repairers and changers

These occupations may not have a favorable outlook for the future. Overall, the number of these jobs is growing slowly. A moderate number of job openings are expected over the next four or five years. Recently, there have been many more new trainees than job openings. If this trend continues, job seekers can expect to face keen competition. Placement rates at area vocational technical schools, community colleges, and/or technical institutes have been good recently.

Hourly wages include:

\$11.07 Automotive mechanics

High school programs preparing for these occupations are:

47.0604 Automotive mechanics

Related postsecondary programs at state-supported institutions in this area are:

15.0803 Automotive technology

47.0604 Automotive mechanics

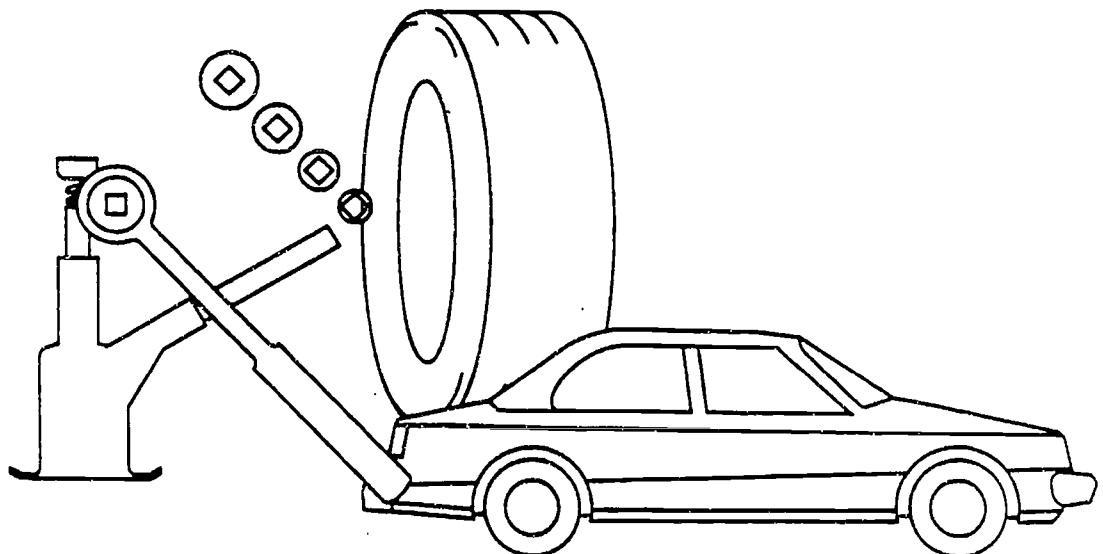

BUILDING MAINTENANCE

Persons in building maintenance occupations perform work involving several maintenance skills to keep the structure of an establishment in repair. Duties may involve pipefitting, boilermaking, carpentry, and electrical work as well as repairing buildings, floors, or stairs.

The largest occupations, which also have the greatest number of job openings annually, are:

- General utility maintenance repairers
- Stationary engineers

These occupations may have a generally favorable outlook for the future. Overall, the number of these jobs is growing. A moderate number of job openings are expected over the next four or five years. Recently, no training has been reported. Job opportunities should be good.

Hourly wages include:

\$7.31 Maintenance repairers, general utility

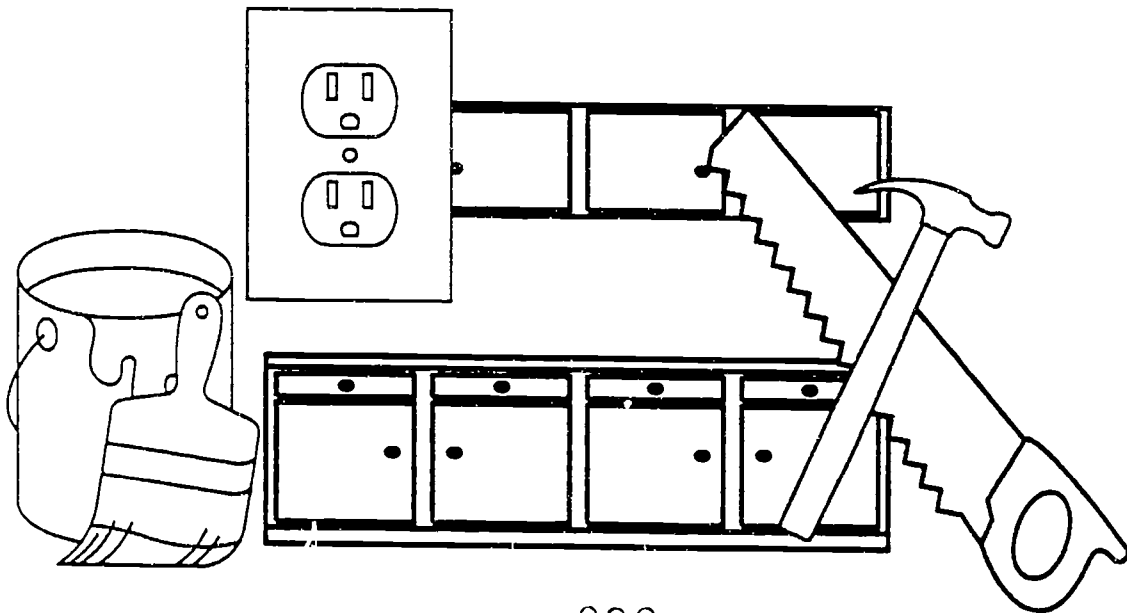

CARPENTRY

Almost all construction projects employ carpenters, the largest group of building trades workers. Carpenters perform a variety of jobs. Their duties will vary by type of construction, type of company, skill of the carpenter, and size of the community. A carpenter employed by a special trade contractor, for example, may specialize in laying hardwood floors, while one who is employed by a general building contractor may build wall frames and install paneling.

The largest occupations, which also have the greatest number of job openings annually, are:

- Carpenters
- Ceiling tile installers and acoustical carpenters

These occupations may have a generally favorable outlook for the future. Overall, the number of these jobs is growing slowly. A moderate number of job openings are expected over the next four or five years. Recently, no training has been reported. Job opportunities should be good.

Hourly wages include:

\$14.61 Carpenters

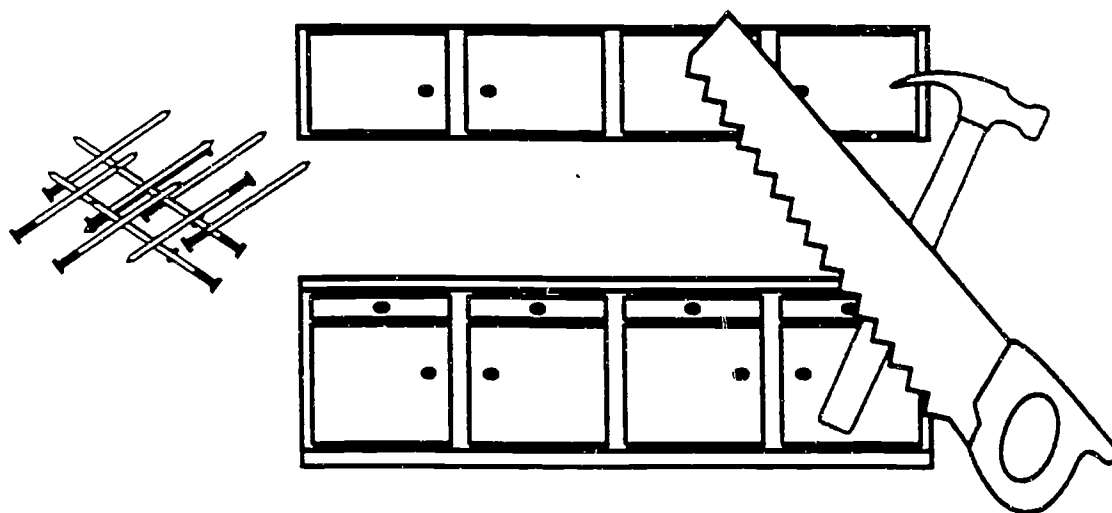

283

CHEMICAL TECHNOLOGY

Chemical technology workers either research and monitor chemical processes or are directly involved in operating equipment or control boards to create chemical reactions and processes in industrial settings. Technicians work with chemists or chemical engineers, setting up and conducting experiments and collecting and analyzing data.

The two largest occupations are:

- Chemical (except health) technicians and technologists
- Chemical equipment controllers and operators

The occupations expected to have the most job openings annually are:

- Chemical (except health) technicians and technologists
- Chemical plant and system operators

These occupations may have a generally favorable outlook for the future. Overall, the number of these jobs is growing slowly. A moderate number of job openings are expected over the next four or five years. Recently, no training has been reported. Job opportunities should be good.

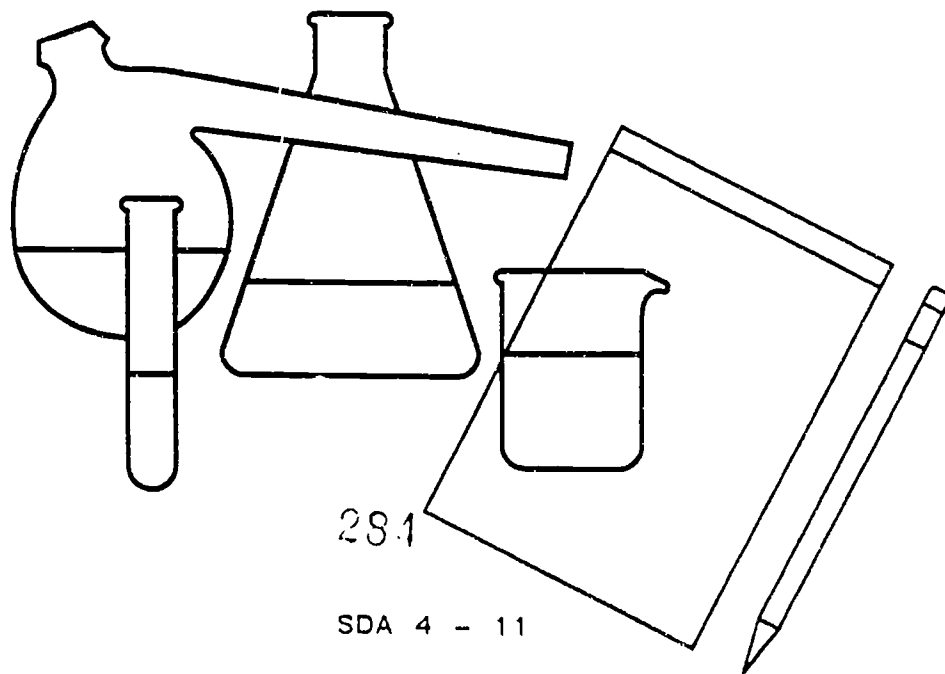

28.1

SDA 4 - 11

COMMERCIAL ART AND DESIGN

The majority of workers in this field design or arrange objects and materials in an artistic or decorative manner. Additional tasks may include the creation or drawing of designs for items such as furniture and machinery (product design).

The largest occupations, which also have the greatest number of job openings annually, are:

- Artists and related workers
- Designers, except interior designers

These occupations may have a generally favorable outlook for the future. Overall, the number of these jobs is growing. A moderate number of job openings are expected over the next four or five years. Recently, no training has been reported. Job opportunities should be good.

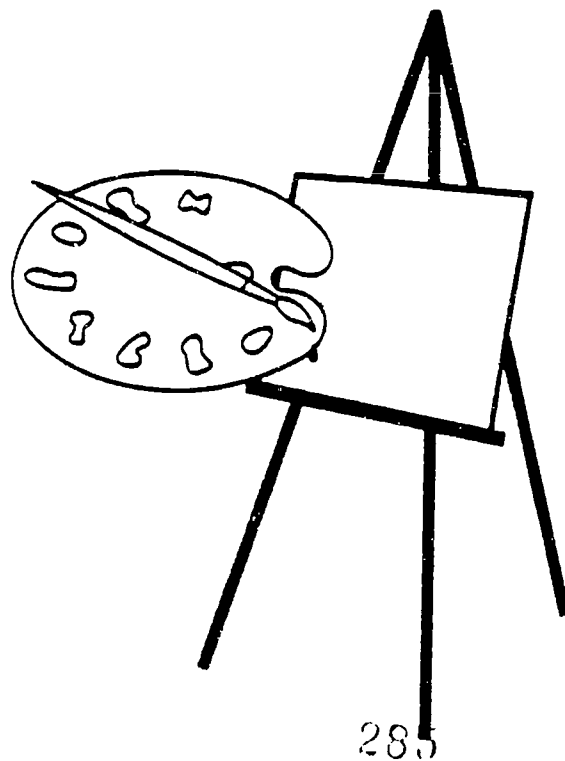

285

SDA 4 - 12

COMMUNICATIONS, JOURNALISM, AND BROADCASTING

Individuals who work in these fields are concerned with communicating ideas and information to individuals for their education and entertainment. The methods utilized are varied and may include the written word, radio, and television.

The two largest occupations are:

- Writers and editors
- Technical writers

The occupations expected to have the most job openings annually are:

- Radio and television announcers
- Reporters and correspondents

These occupations may not have a favorable outlook for the future. Overall, the number of these jobs shows little change. Very few job openings are expected over the next four or five years. Recently, there have been more new trainees than job openings.

Hourly wages include:

\$10.55 Writers and editors

High school programs preparing for these occupations are:

09.0701 Radio and television broadcasting

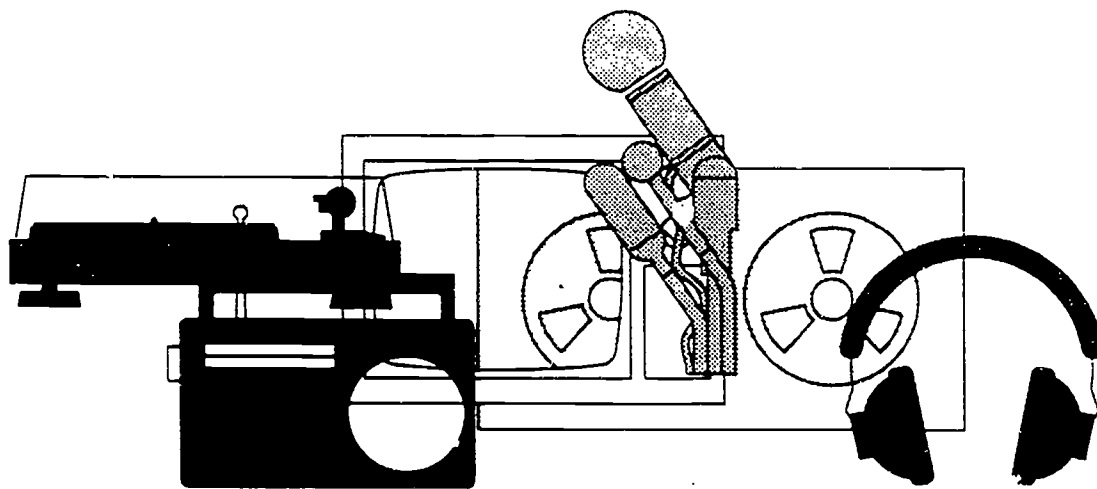

COMPUTER, ELECTRICAL, AND ELECTRONICS TECHNOLOGY

The majority of workers in this field are electrical and electronic engineering technicians and technologists. They apply electrical and related knowledge to design, build, test, and repair electrical equipment in industrial or commercial settings for subsequent use by engineering personnel.

This occupation may have a generally favorable outlook for the future. Few job openings are expected over the next four or five years. Recently, no training has been reported.

Average hourly wages are \$10.83

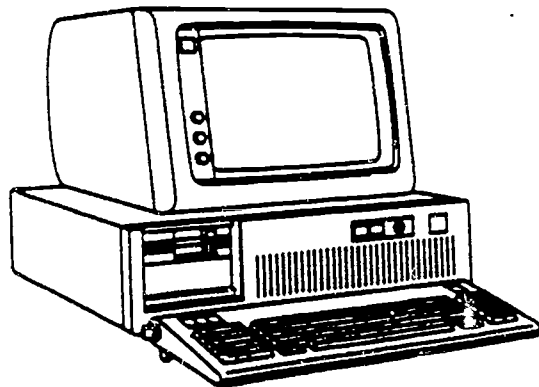

COMPUTER SYSTEMS

Workers in these computer occupations develop and write computer programs to store, locate, and retrieve specific documents, data, and information. They may also analyze business, scientific, and technical problems for application to electronic data processing systems. These careers generally require specialized training.

The largest occupations, which also have the greatest number of job openings annually, are:

- Systems analysts, electronic data processing
- Computer programmers

These occupations may have a generally favorable outlook for the future. Overall, the number of these jobs is growing rapidly. A moderate number of job openings are expected over the next four or five years. Recently, there have been fewer new trainees than job openings. If this trend continues, job opportunities should be good.

Hourly wages include:

- \$14.60 Computer programmers
- \$18.54 Systems analysts, electronic data processing

High school programs preparing for these occupations are:

- 07.0399 Miscellaneous business data processing
- 11.0101 Computer and information sciences

COSMETOLOGY

Cosmetologists and related workers provide beauty services for customers. These may include cutting and styling hair, treating hair and scalp, applying makeup, dressing wigs, or removing hair by electrolysis, as well as cleaning, shaping, and polishing a customer's fingernails and toenails.

This occupation may not have a favorable outlook for the future. Overall, the number of these jobs is growing. Few job openings are expected over the next four or five years. Recently, there have been many more new trainees than job openings.

High school programs preparing for these occupations are:

12.0403 Cosmetology

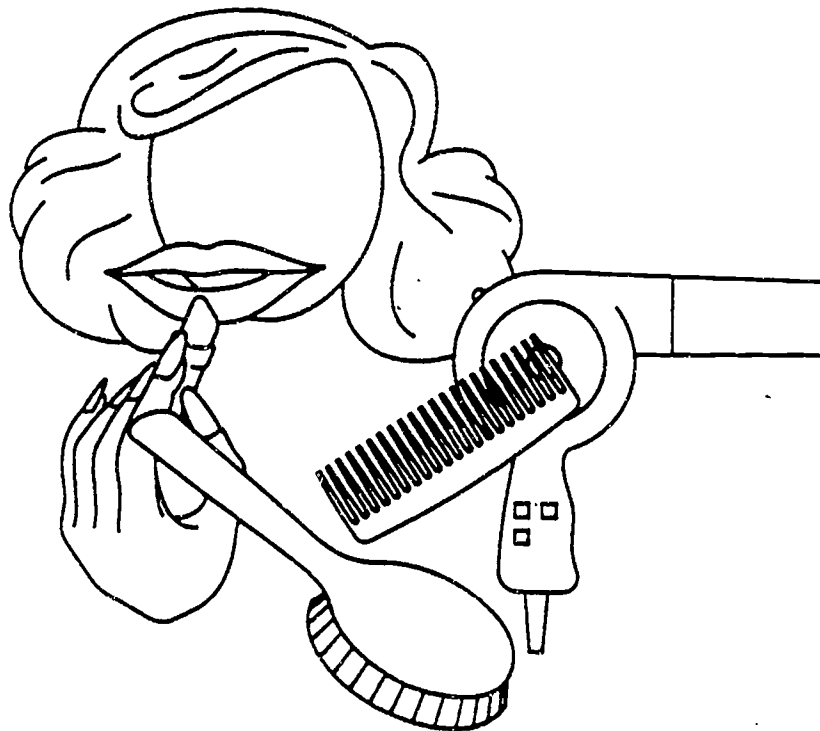

DENTAL ASSISTING

Dental assistants may perform a wide variety of clinical, office, and laboratory duties, depending on the size of the dental practice. Typically, assistants seat patients in the dental chair, prepare them for the dentist's treatment, and work with the dentist during examination and treatment.

This occupation may have a generally favorable outlook for the future. Few job openings are expected over the next four or five years. Recently, no training has been reported.

Licensing may be required. Contact: TENNESSEE BOARD OF DENTISTRY, 615-367-6228.

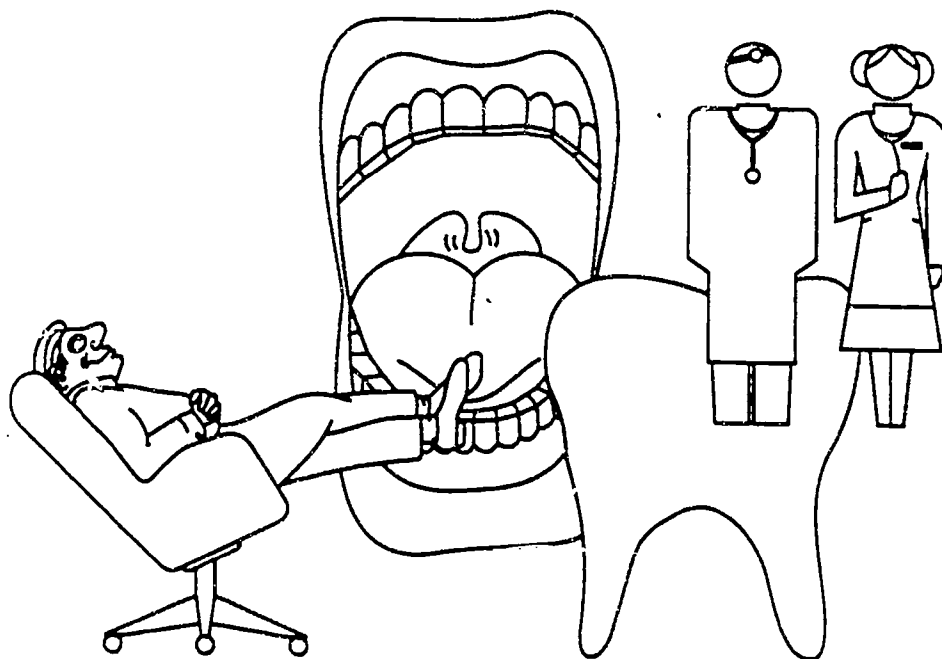

230

SDA 4 - 17

DRAFTING AND DESIGN TECHNOLOGY

Persons in drafting and design technology prepare clear, complete, and accurate working plans and detail drawings from rough or detailed sketches or notes for engineering or manufacturing purposes according to specified dimensions. Workers need to have knowledge of various machines, engineering practices, mathematics, building materials, and other physical sciences to complete drawings. Computer-assisted design (CAD) equipment may be used by some workers.

The largest occupations, which also have the greatest number of job openings annually, are:

- Cost estimators
- Drafters

These occupations may not have a favorable outlook for the future. Overall, the number of these jobs is growing rapidly. A moderate number of job openings are expected over the next four or five years. Recently, there have been many more new trainees than job openings. If this trend continues, job seekers can expect to face keen competition. Placement rates at area vocational technical schools, community colleges, and/or technical institutes have been poor recently.

Hourly wages include:

\$17.83 Drafters

High school programs preparing for these occupations are:

48.0101 Drafting

Related postsecondary programs at state-supported institutions in this area are:

48.0101 Drafting

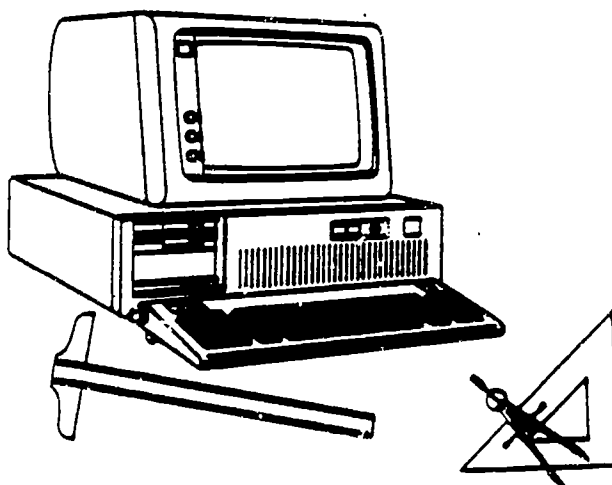

EARLY CHILDHOOD EDUCATION

Child care workers and managers of child care centers assume responsibility for the safety, physical care, and emotional, social, and intellectual growth of preschool children and infants while parents are at work or are unavailable for other reasons. Some work in residential institutions for young children. Teacher aides assist teachers by handling routine paperwork or by working directly with children.

The largest occupations, which also have the greatest number of job openings annually, are:

- Teacher aides, paraprofessional
- Child care workers

These occupations may have a generally favorable outlook for the future. Overall, the number of these jobs is growing rapidly. Large numbers of job openings are expected over the next four or five years. Recently, there have been about as many new trainees as job openings. If this trend continues, job seekers can expect to face some competition.

High school programs preparing for these occupations are:

20.0201 Child care and guidance management services

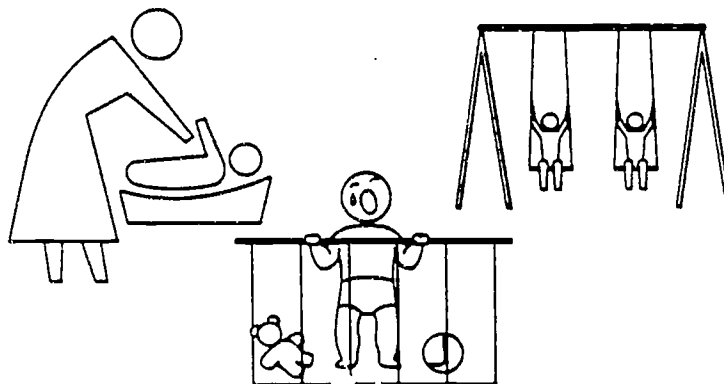

ELECTRICIAN OCCUPATIONS

Workers in the electrical field install, maintain, and repair wiring, electrical equipment, and fixtures or assist in such activities. These workers insure that work is in accordance with the relevant codes. A high school education is usually required and a five-year apprenticeship program is recommended.

The largest occupations, which also have the greatest number of job openings annually, are:

- Electricians
- Helpers of electricians and powerline transmission installers

These occupations may have a generally favorable outlook for the future. Overall, the number of these jobs is growing. A moderate number of job openings are expected over the next four or five years. Recently, no training has been reported. Job opportunities should be good.

Hourly wages include:

\$16.08 Electricians

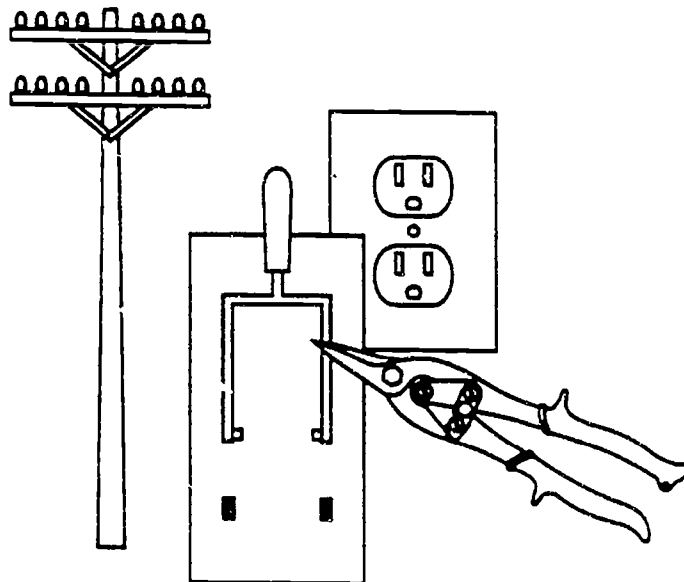

FOOD PREPARATION AND SERVICES

The majority of workers in these occupations prepare and serve food and beverages in restaurants, fast food establishments, catering firms, hotels, clubs, factories, school cafeterias, or hospitals, or supervise those providing food services. Others are factory machine operators involved in the preparation of food products. Dietetic technicians teach principles of food nutrition and provide dietary counseling to patients.

The largest occupations, which also have the greatest number of job openings annually, are:

- Food preparation workers
- Combined food preparation and service workers

These occupations may have a generally favorable outlook for the future. Overall, the number of these jobs is growing. Large numbers of job openings are expected over the next four or five years. Recently, there have been fewer new trainees than job openings. If this trend continues, job opportunities should be good.

Hourly wages include:

- \$4.45 Food preparation workers
- \$4.50 Cooks, specialty fast food
- \$4.72 Bartenders
- \$5.46 Cooks, restaurant

High school programs preparing for these occupations are:

- 20.0401 Food production, management, and services
- 46.1111 Food occupations

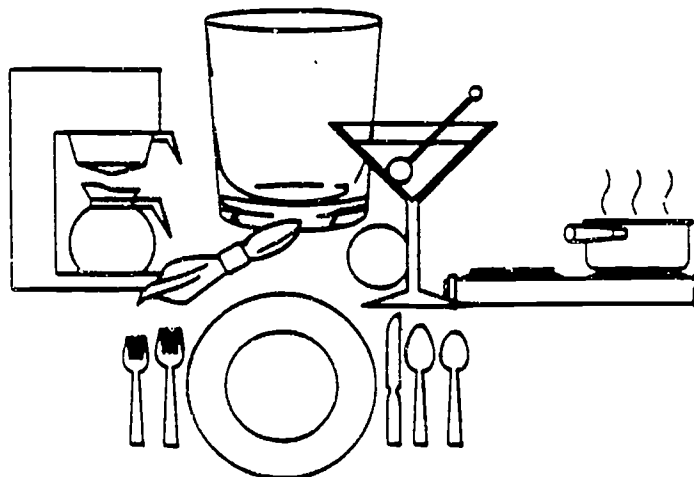

GENERAL BUSINESS AND MANAGEMENT

Workers in the general business and management occupations plan, organize, direct, control, or coordinate activities in all types of fields. Many occupations involve analysis of productivity and financial soundness. General managers and top executives usually have very diverse duties and responsibilities and work through departmental or subordinate executives.

The largest occupations, which also have the greatest number of job openings annually, are:

- Engineering, mathematical, and natural sciences managers
- General managers and top executives

These occupations may have a generally favorable outlook for the future. Overall, the number of these jobs is growing. Large numbers of job openings are expected over the next four or five years. Recently, there have been fewer new trainees than job openings. If this trend continues, job opportunities should be good. Placement rates at area vocational technical schools, community colleges, and/or technical institutes have been good recently.

Hourly wages include:

- \$16.07 Purchasing managers
- \$18.81 Industrial production managers

Related postsecondary programs at state-supported institutions in this area are:

- 06.0401 Business administration and management



SDA 4 - 22

295

GENERAL WOODWORKING

Woodworkers are in occupations concerned with the complete cycle of cutting, shaping, and assembling parts of complex wood products. The occupations are primarily concerned with one or a limited number of machine functions according to their speciality.

The two largest occupations are:

- Assemblers and fabricators, except machine, electrical, electronic, and precision assembly
- Cabinetmakers and bench carpenters

The occupations expected to have the most job openings annually are:

- Assemblers and fabricators, except machine, electrical, electronic, and precision assembly
- Sawing machine operators and tenders

These occupations may have a generally favorable outlook for the future. Overall, the number of these jobs shows little change. A moderate number of job openings are expected over the next four or five years. Recently, there have been about as many new trainees as job openings. If this trend continues, job seekers can expect to face some competition.

High school programs preparing for these occupations are:

48.0701 Woodworking

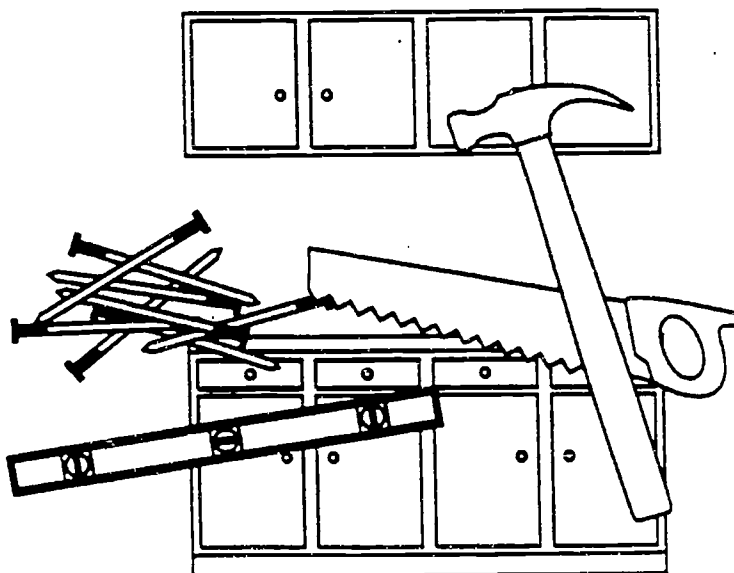

GRAPHIC ARTS

A majority of workers in this field are involved in offset printing. In this process the material to be printed is photographed and a printing plate is made from the film. This process has been advanced by the use of computers and lasers.

The two largest occupations are:

- Printing press machine operators and tenders
- Screen printing machine setters and set-up operators

The occupations expected to have the most job openings annually are:

- Bindery machine operators
- Printing press machine operators and tenders

These occupations may not have a favorable outlook for the future. Overall, the number of these jobs shows little change. Very few job openings are expected over the next four or five years. Recently, there have been more new trainees than job openings.

High school programs preparing for these occupations are:

48.0201 Graphic and printing communications

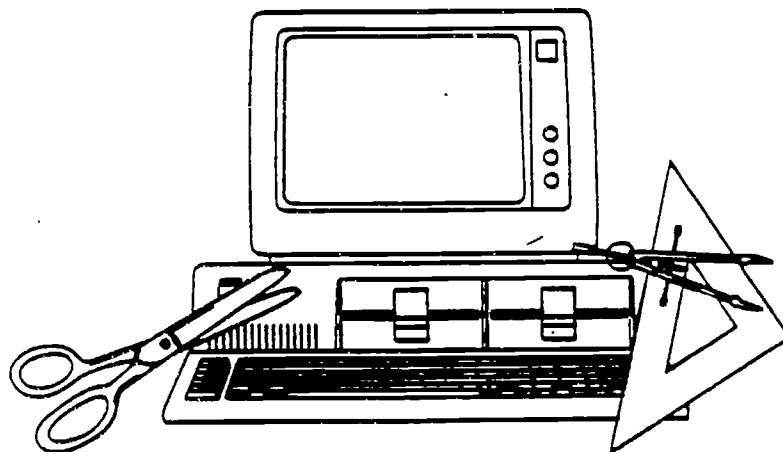

HEATING AND AIR CONDITIONING

Workers in this field install and repair heating, air conditioning, and refrigeration systems. They may install and repair oil burners, hot-air furnaces, and heating stoves in homes and businesses. They may also install and repair air conditioning systems, or install sheet metal ducts for the heating and cooling systems.

The largest occupations, which also have the greatest number of job openings annually, are:

- Heating, air conditioning, and refrigeration mechanics and installers
- Sheet metal duct installers

These occupations may not have a favorable outlook for the future. Overall, the number of these jobs shows little change. Very few job openings are expected over the next four or five years. Recently, there have been many more new trainees than job openings. Placement rates at area vocational technical schools, community colleges, and/or technical institutes have been very good recently.

Hourly wages include:

\$13.43 Heating, air conditioning, and refrigeration mechanics and installers

High school programs preparing for these occupations are:

47.0201 Heating, air conditioning, and refrigeration mechanics

Related postsecondary programs at state-supported institutions in this area are:

47.0201 Heating, air conditioning, and refrigeration mechanics

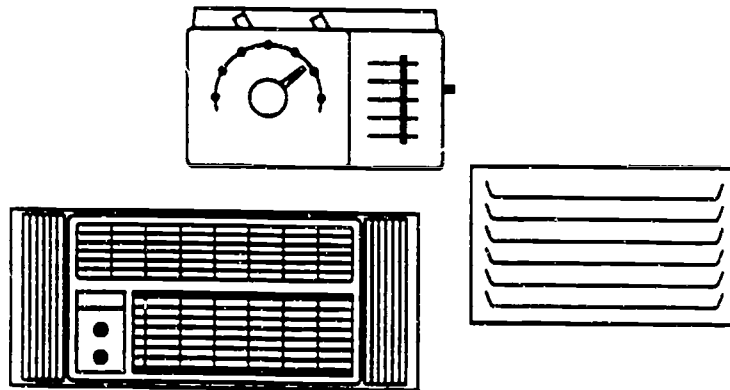

HEAVY TRUCK MAINTENANCE

Persons in heavy truck maintenance repair and maintain the operating condition of trucks, buses, and all types of diesel engines. This also includes mechanics working primarily with automobile diesel engines.

This occupation may have a generally favorable outlook for the future. Overall, the number of these jobs is growing. Few job openings are expected over the next four or five years. Recently, there have been about as many new trainees as job openings. Placement rates at area vocational technical schools, community colleges, and/or technical institutes have been excellent recently.

Average hourly wages are \$9.45

Related postsecondary programs at state-supported institutions in this area are:

47.0605 Diesel engine mechanics

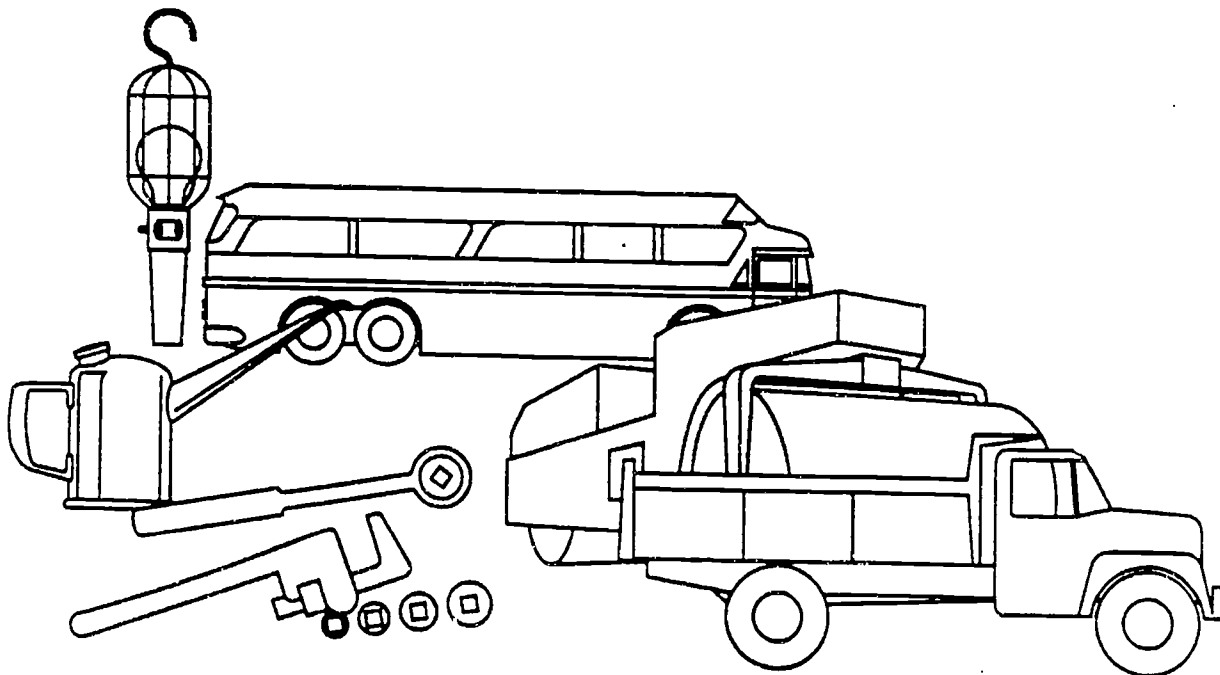

HORTICULTURE AND LANDSCAPING

The largest group of workers in these occupations, gardeners and groundskeepers, maintain the grounds of public and private property. Duties may include mowing, trimming, planting, and watering plants, shrubs, and grass.

The largest occupations, which also have the greatest number of job openings annually, are:

- Nursery workers
- Gardeners and groundskeepers, except farm workers

These occupations may not have a favorable outlook for the future. Overall, the number of these jobs is growing. Few job openings are expected over the next four or five years. Recently, there have been many more new trainees than job openings.

Hourly wages include:

\$9.73 Gardeners and groundskeepers, except farm

High school programs preparing for these occupations are:

01.0601 Horticulture

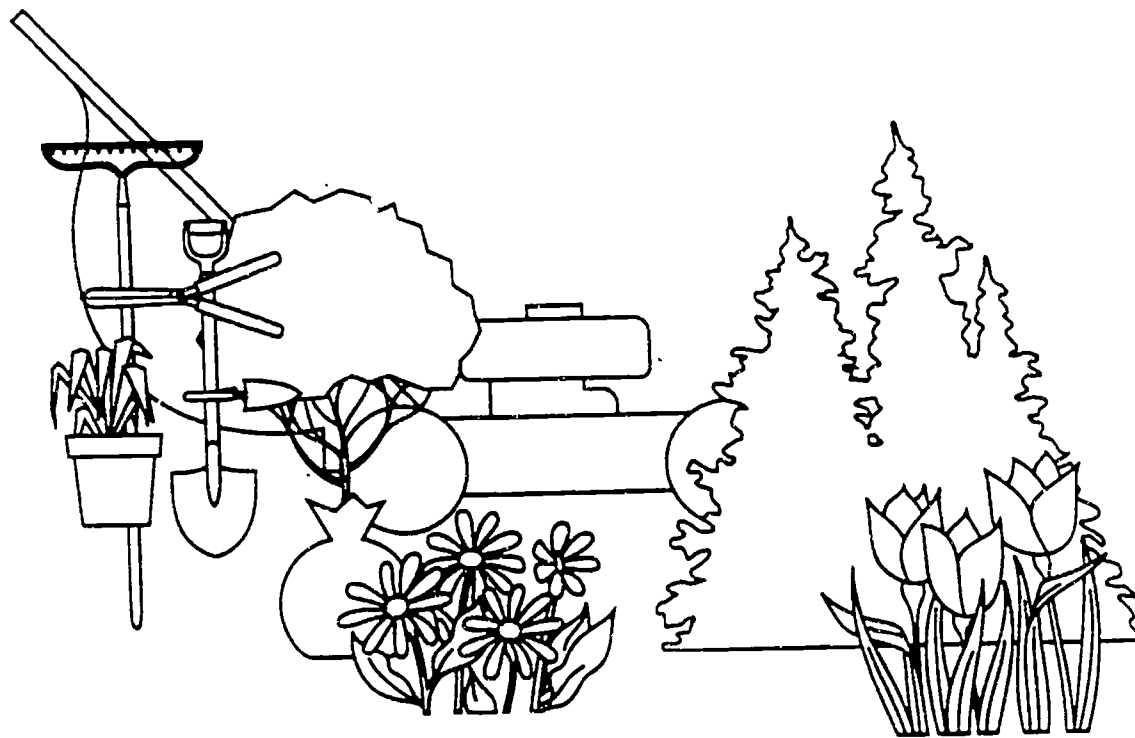

HOTEL AND RESTAURANT MANAGEMENT

Food service and lodging managers supervise the profitable operation of restaurants, hotels, and motels. Workers direct the varied activities of these businesses with the goal of pleasing people and providing good service to their customers.

This occupation may have a generally favorable outlook for the future. Overall, the number of these jobs is growing. A moderate number of job openings are expected over the next four or five years. Recently, no training has been reported. Job opportunities should be good.

Average hourly wages are \$8.86

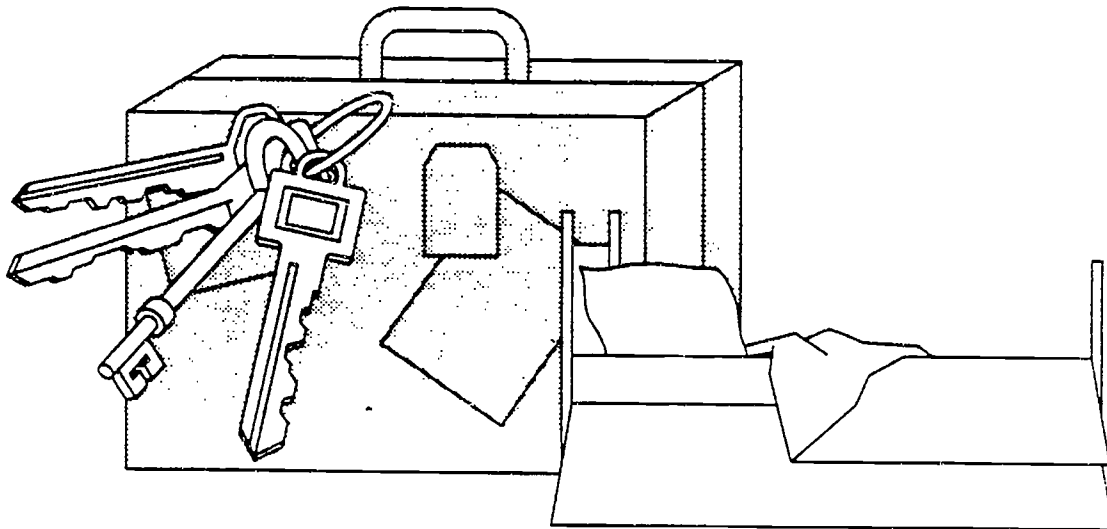

301

INDUSTRIAL MAINTENANCE TECHNOLOGY

Workers prevent costly waste of raw materials and the idling of human resources in a plant or factory by making industrial machinery repairs as quickly as possible. Maintenance mechanics spend considerable time doing preventive maintenance, including keeping machines well oiled and greased, and periodically cleaning parts.

The largest occupations, which also have the greatest number of job openings annually, are:

- Maintenance mechanics for industrial machinery
- Textile machine setters and set-up operators

These occupations may have a generally favorable outlook for the future. Overall, the number of these jobs is growing slowly. A moderate number of job openings are expected over the next four or five years. Recently, no training has been reported. Job opportunities should be good.

Hourly wages include:

\$11.38 Machinery maintenance mechanics

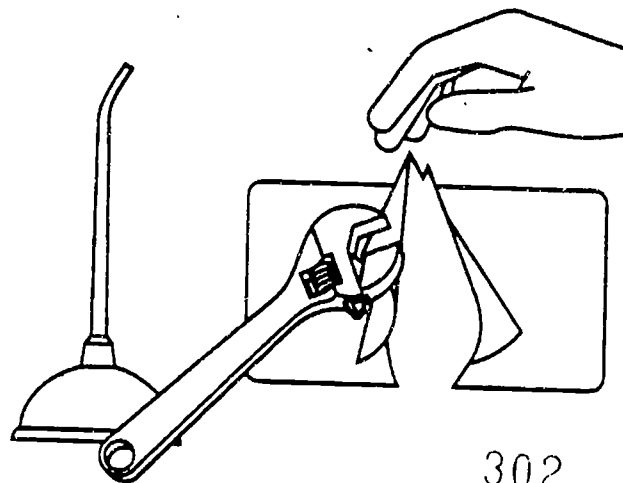

INSTITUTIONAL HOME MANAGEMENT AND SUPPORTING SERVICES

These workers make sure that all public buildings, offices, hospitals, stores, and apartment houses are kept clean and in good condition for the comfort and safety of the people who work or live there. Generally, no special education is required for occupations in this field, with most skills learned on the job.

The largest occupations, which also have the greatest number of job openings annually, are:

- Maids and housekeeping cleaners
- Janitors and cleaners, except maids and housekeeping cleaners

These occupations may have a generally favorable outlook for the future. Overall, the number of these jobs is growing. Large numbers of job openings are expected over the next four or five years. Recently, there have been fewer new trainees than job openings. If this trend continues, job opportunities should be good.

Hourly wages include:

- \$4.84 Maids and housekeeping cleaners
- \$6.00 Housekeepers
- \$8.28 Janitors and cleaners, except maids and housekeeping cleaners

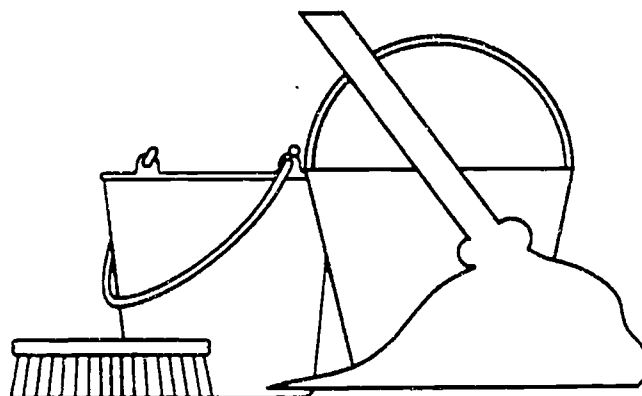

LABORATORY TECHNICIAN

Medical and clinical laboratory technicians perform routine laboratory tests for use in the treatment and diagnosis of disease; prepare vaccines, biologicals, and serums for prevention of disease; and prepare tissue samples, take blood samples, and execute laboratory tests including urinalyses and blood counts.

This occupation may have a generally favorable outlook for the future. Few job openings are expected over the next four or five years. Recently, there have been more new trainees than job openings. Placement rates at area vocational technical schools, community colleges, and/or technical institutes have been very good recently.

Average hourly wages are \$10.80

Related postsecondary programs at state-supported institutions in this area are:

- 17.0301 Blood bank technology
- 17.0309 Medical laboratory technology

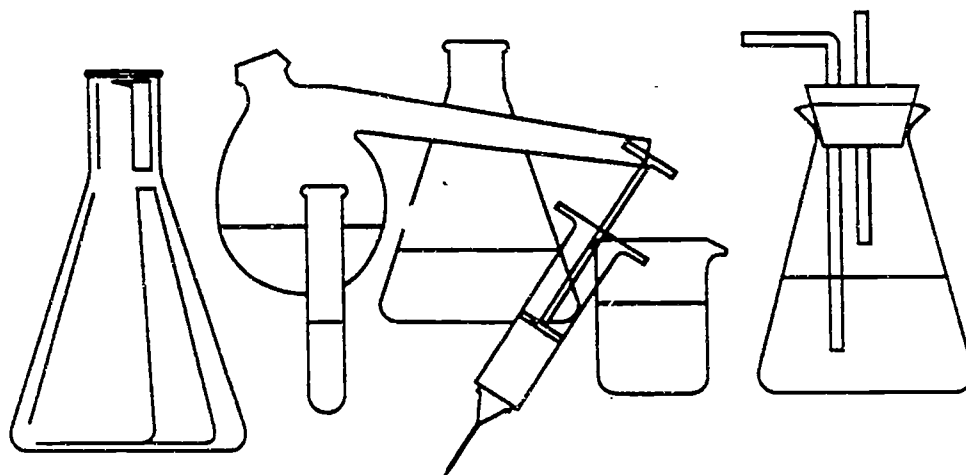

LAW ENFORCEMENT

People working at these occupations are responsible for the safety of Tennessee cities, towns, and highways. Their responsibilities range from controlling traffic to preventing and investigating crimes. Whether on or off duty, they are expected to exercise their authority whenever necessary.

The two largest occupations are:

- Police patrol officers
- Sheriffs and deputy sheriffs

The occupations expected to have the most job openings annually are:

- Police patrol officers
- Police and detective supervisors

These occupations may have a generally favorable outlook for the future. Overall, the number of these jobs is growing. A moderate number of job openings are expected over the next four or five years. Recently, there have been fewer new trainees than job openings. If this trend continues, job opportunities should be good. Placement rates at area vocational technical schools, community colleges, and/or technical institutes have been very good recently.

Hourly wages include:

\$10.63 Police patrol officers

Related postsecondary programs at state-supported institutions in this area are:

43.0107 Law enforcement and police science

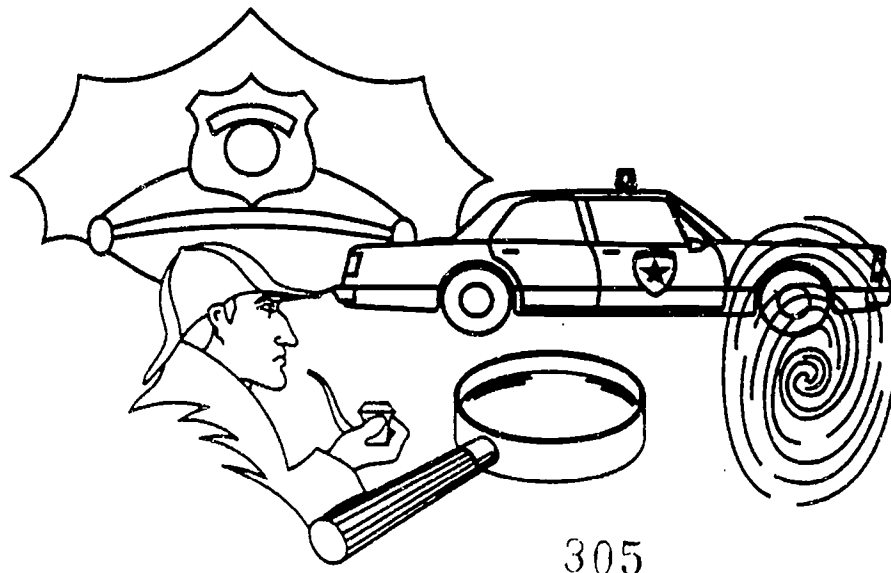

MACHINE TOOL TECHNOLOGY

Workers in these occupations make or set up and operate machine tools or repair metal parts. Machinists and tool-and-die makers create highly specialized precision tools, molds, and metal parts. Often they use blueprints to develop prototypes for tools or machines to be used in manufacturing.

The two largest occupations are:

- Machinists
- Machine tool cutting operators and tenders of metal and plastic

The occupations expected to have the most job openings annually are:

- Machinists
- Tool and die makers

These occupations may have a generally favorable outlook for the future. Overall, the number of these jobs is growing. Large numbers of job openings are expected over the next four or five years. Recently, there have been fewer new trainees than job openings. If this trend continues, job opportunities should be good. Placement rates at area vocational technical schools, community colleges, and/or technical institutes have been good recently.

Hourly wages include:

- \$6.94 Combination machine tool operators and tenders, metal and plastic
- \$14.18 Tool and die makers
- \$15.21 Machinists

High school programs preparing for these occupations are:

- 48.0501 Precision metal work
- 48.0503 Machine tool operation and machine shop technology

Related postsecondary programs at state-supported institutions in this area are:

- 48.0503 Machine tool operation and machine shop technology

MEDICAL ASSISTING

Medical assistants perform a wide variety of clinical and administrative duties under the direction of physicians. Clinical duties may include taking and recording patients' vital signs and medical histories, preparing patients for examination by physicians, and explaining treatment procedures to patients.

In small physicians' offices they may keep medical records, schedule appointments, and order supplies. Electrocardiograph (EKG) technicians operate the EKG machines which provide graphic tracings of heartbeats.

This occupation may have a generally favorable outlook for the future. Few job openings are expected over the next four or five years. Recently, no training has been reported.

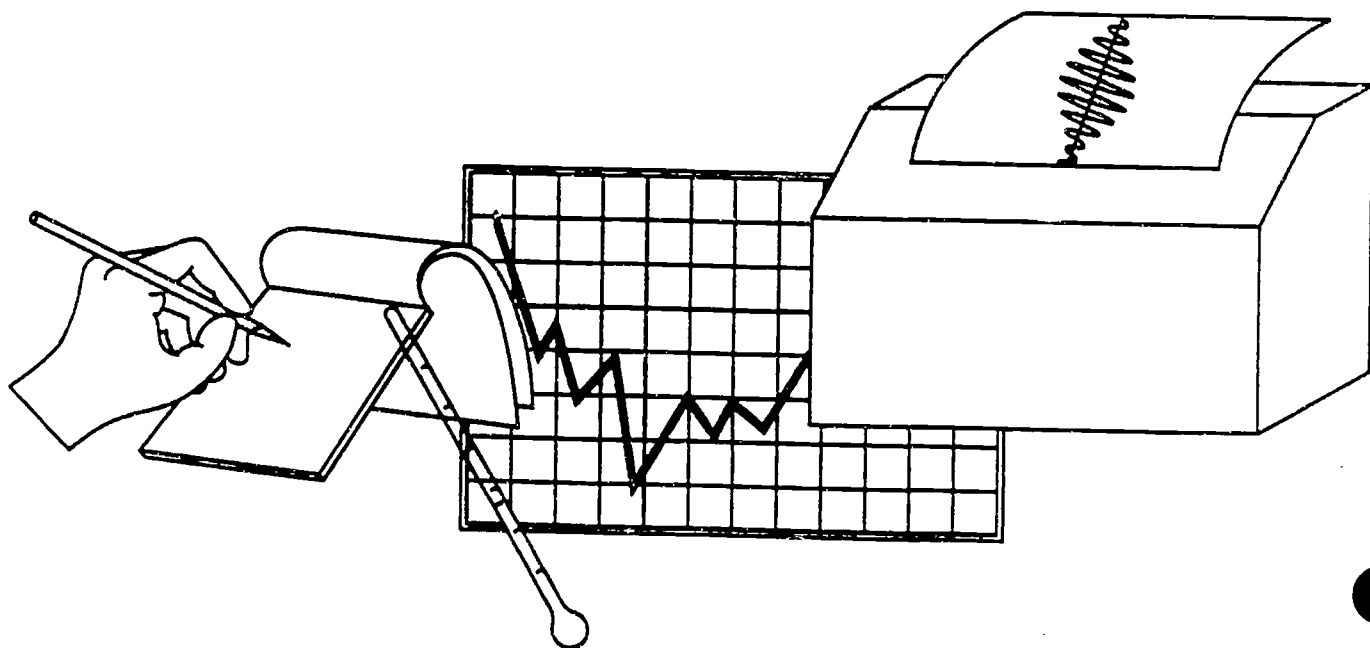

MEDICAL RECORDS TECHNOLOGY

Medical records technicians compile and maintain medical records of hospital and clinic patients. Such work is becoming increasingly important as this background information is used for medicare and medicaid insurance reimbursements.

This occupation may not have a favorable outlook for the future. Few job openings are expected over the next four or five years. Recently, there have been more new trainees than job openings. Placement rates at area vocational technical schools, community colleges, and/or technical institutes have been very good recently.

Average hourly wages are \$6.82

Related postsecondary programs at state-supported institutions in this area are:

17.0506 Medical records technology

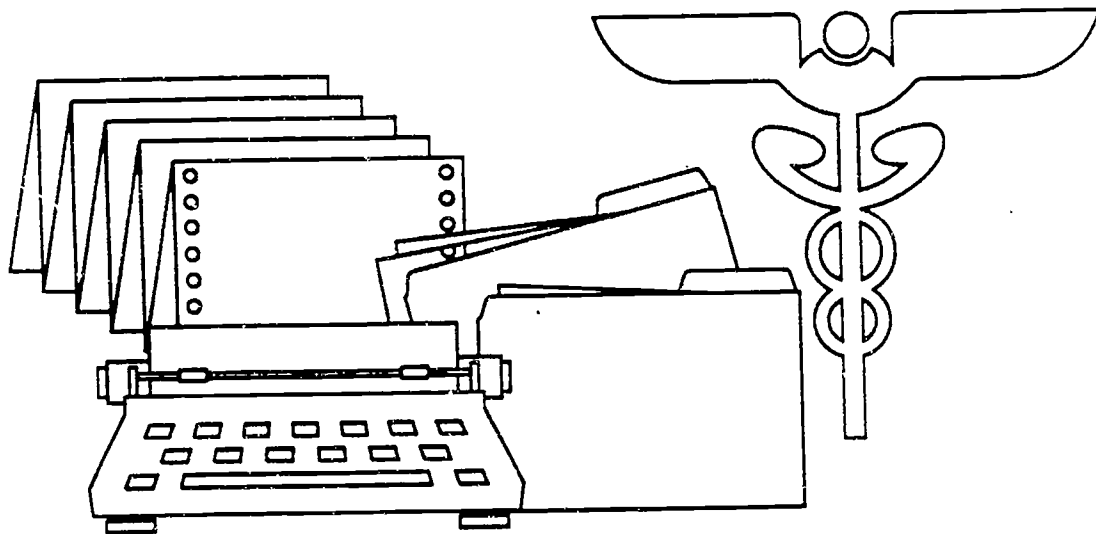

NURSING ASSISTANT

Nursing aides and orderlies work under the general direction of nursing or medical staff. In hospitals, they may answer patients' call bells, serve and collect food trays, feed patients, or set up equipment. In nursing homes, they are expected to sustain ongoing relations with patients.

The largest occupations, which also have the greatest number of job openings annually, are:

- Nursing aides, orderlies, and attendants
- Home health aides

These occupations may have a generally favorable outlook for the future. Overall, the number of these jobs is growing rapidly. Large numbers of job openings are expected over the next four or five years. Recently, there have been fewer new trainees than job openings. If this trend continues, job opportunities should be good.

Hourly wages include:

- \$5.00 Nursing aides, orderlies, and attendants
- \$5.71 Home health aides

High school programs preparing for these occupations are:

- 17.0602 Nursing assisting

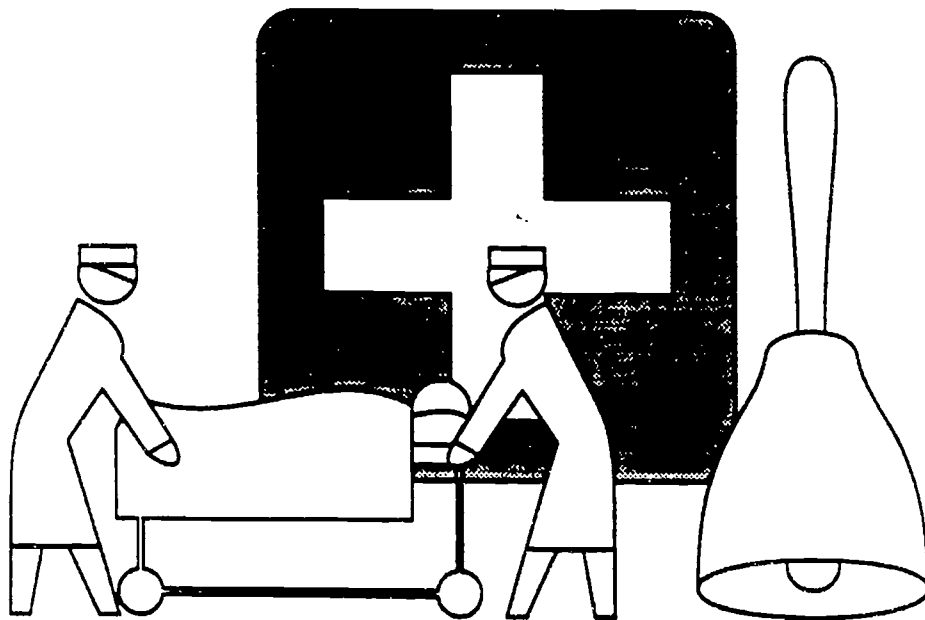

PLUMBING AND PIPEFITTING

Plumbers and pipefitters install and maintain the complex system of pipes that connect to the master system that runs underground. Although plumbing and pipefitting are sometimes considered a single trade, workers may specialize in either craft. Plumbers build and repair the water, waste disposal, drainage, and gas systems in homes and commercial/industrial buildings. Pipefitters build and repair both high and low pressure pipe.

The largest occupations, which also have the greatest number of job openings annually, are:

- Plumbers, pipefitters, and steamfitters
- Pipelayers

These occupations may have a generally favorable outlook for the future. Overall, the number of these jobs is growing. Few job openings are expected over the next four or five years. Recently, there have been fewer new trainees than job openings.

Hourly wages include:

\$17.48 Plumbers, pipefitters, and steamfitters

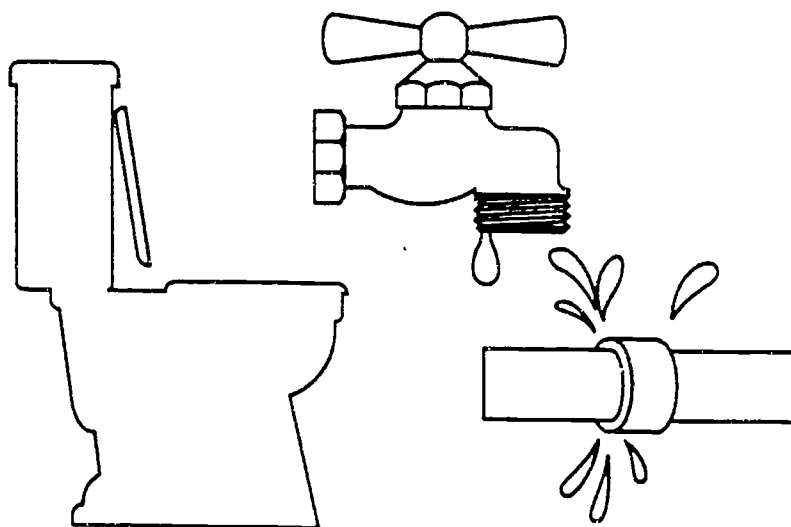

PRACTICAL NURSING

Licensed practical nurses (LPNs) work under the supervision of physicians and/or registered nurses to provide nursing care that requires technical knowledge but not the professional training of a registered nurse. They provide bedside care, administer certain medications, and assist in patient examinations.

This occupation may have a generally favorable outlook for the future. Overall, the number of these jobs is growing rapidly. A moderate number of job openings are expected over the next four or five years. Recently, there have been many more new trainees than job openings. If this trend continues, job seekers can expect to face keen competition. Placement rates at area vocational technical schools, community colleges, and/or technical institutes have been excellent recently.

Average hourly wages are \$8.61

Related postsecondary programs at state-supported institutions in this area are:

17.0605 Practical nursing

Licensing may be required. Contact: TENNESSEE BOARD OF NURSING, 615-367-6232.

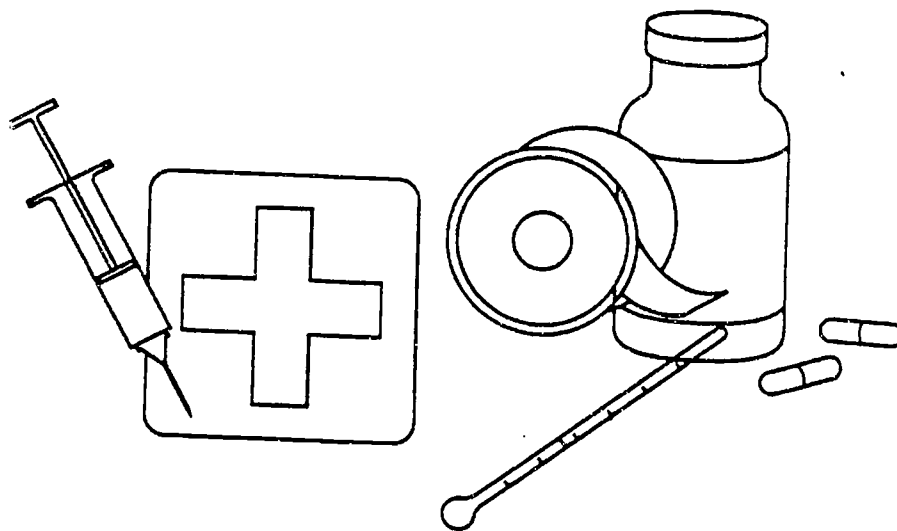

311

PROFESSIONAL NURSING

Registered Nurses (R.N.'s), the largest occupational group in this field, are primarily employed in hospitals and nursing homes, where they provide skilled bedside care and may supervise licensed practical nurses, nursing aides, and orderlies. Working under the direction of a licensed "supervising physician," physician assistants elicit detailed patient histories, perform physical examinations, and prescribe appropriate treatments.

The largest occupations, which also have the greatest number of job openings annually, are:

- Registered nurses
- Physician's assistants

These occupations may have a generally favorable outlook for the future. Overall, the number of these jobs is growing rapidly. Large numbers of job openings are expected over the next four or five years. Recently, there have been fewer new trainees than job openings. If this trend continues, job opportunities should be good. Placement rates at area vocational technical schools, community colleges, and/or technical institutes have been very good recently.

Hourly wages include:

\$13.74 Registered nurses

Related postsecondary programs at state-supported institutions in this area are:

18.1101 Nursing

Licensing may be required. Contact: TENNESSEE BOARD OF MEDICAL EXAMINERS-COMMITTEE ON PHYSICIAN ASSISTANTS, 615-367-6250.

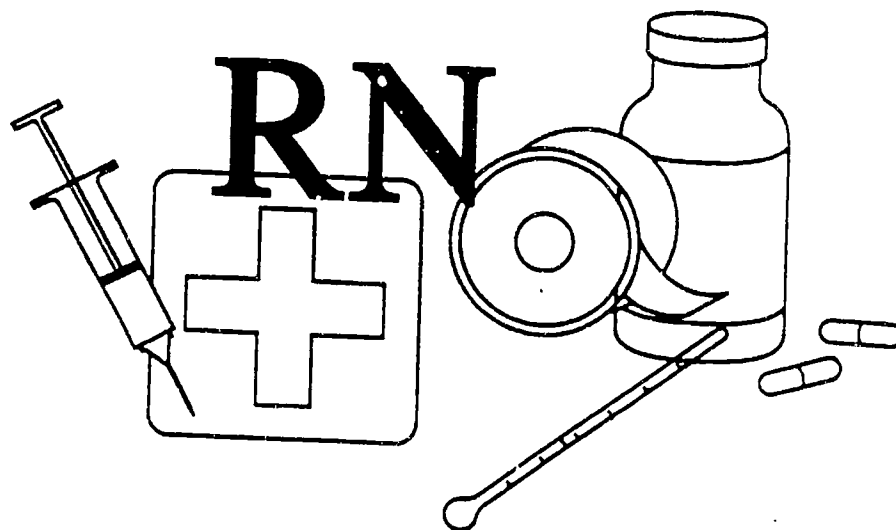

RADIOGRAPHIC MEDICAL TECHNOLOGY

Workers in this field operate equipment including x-ray machines, fluoroscopes, ultrasonic scanners, computed tomography (CT) scanners, and nuclear magnetic resonance (MRI) machines for diagnostic imaging of the human body or for therapy.

The largest occupations, which also have the greatest number of job openings annually, are:

- Radiologic technologists
- Radiologic technicians

These occupations may have a generally favorable outlook for the future. Few job openings are expected over the next four or five years. Recently, there have been more new trainees than job openings. Placement rates at area vocational technical schools, community colleges, and/or technical institutes have been excellent recently.

Hourly wages include:

\$10.57 Radiologic technicians

Related postsecondary programs at state-supported institutions in this area are:

17.0209 Radiologic medical technology

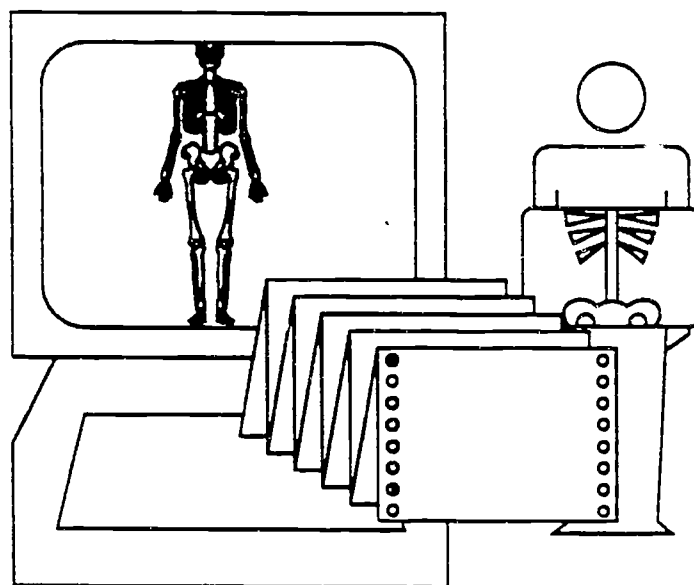

RECREATIONAL LEADERSHIP

Workers in recreational leadership occupations conduct recreational activities with groups, consider the interests of participants, and organize and promote activities. A large proportion of recreational workers are employed in city recreation departments and in state and national parks.

This occupation may have a generally favorable outlook for the future. Overall, the number of these jobs is growing. Few job openings are expected over the next four or five years. Recently, no training has been reported.



RESPIRATORY THERAPY

Respiratory therapists treat patients with breathing problems ranging from chronic asthma and emphysema to heart failure, stroke, or drowning emergencies. Respiratory care may involve administering oxygen; delivering medication or humidity through aerosol mists; administering chest physical therapy; or setting up and operating mechanical ventilators.

This occupation may not have a favorable outlook for the future. Few job openings are expected over the next four or five years. Recently, there have been more new trainees than job openings. Placement rates at area vocational technical schools, community colleges, and/or technical institutes have been excellent recently.

Average hourly wages are \$11.96

Related postsecondary programs at state-supported institutions in this area are:

17.0210 Respiratory therapy technology

Licensing may be required. Contact: BOARD OF MEDICAL EXAMINERS-COUNCIL ON RESPIRATORY CARE, 615-367-6393.

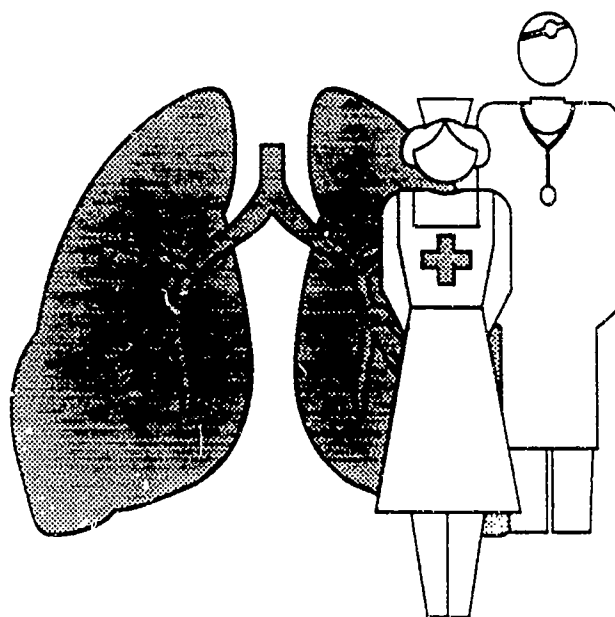

SALES AND MERCHANDISING

Workers in sales and merchandising occupations promote and sell a wide variety of merchandise and services. They also receive, store, display, and inventory products to be sold.

The largest occupations, which also have the greatest number of job openings annually, are:

- Salespersons in retail establishments
- Cashiers

These occupations may have a generally favorable outlook for the future. Overall, the number of these jobs is growing. Large numbers of job openings are expected over the next four or five years. Recently, there have been about as many new trainees as job openings. If this trend continues, job seekers can expect to face some competition.

Hourly wages include:

\$4.72	Cashiers
\$4.80	Salespersons, retail
\$5.40	Counter and rental clerks
\$9.58	Customer service representatives, utilities
\$12.93	Purchasing agents- except wholesale, retail, and farm products

High school programs preparing for these occupations are:

08.0700	General marketing
08.0799	Miscellaneous general marketing

Licensing may be required. Contact: TENNESSEE DEPARTMENT OF COMMERCE AND INSURANCE, 615-741-2693.

SECURITY SERVICES

Security guards, the largest occupation in this field, patrol and inspect property to protect it against fire, theft, vandalism, and illegal entry. Guards and doorkeepers usually are uniformed and often carry a nightstick and a weapon; correctional officers and jailers maintain order in correctional institutions, enforce institutional rules and regulations, and may supplement the counseling inmates receive from mental health professionals.

The largest occupations, which also have the greatest number of job openings annually, are:

- Correction officers and jailers
- Guards and watch guards

These occupations may have a generally favorable outlook for the future. Overall, the number of these jobs is growing. A moderate number of job openings are expected over the next four or five years. Recently, there have been fewer new trainees than job openings. If this trend continues, job opportunities should be good. Placement rates at area vocational technical schools, community colleges, and/or technical institutes have been excellent recently.

Hourly wages include:

\$7.20 Guards and watch guards

Related postsecondary programs at state-supported institutions in this area are:

43.0109 Private and correction technology

Licensing may be required. Contact: COUNTY COURT CLERK'S OFFICE.

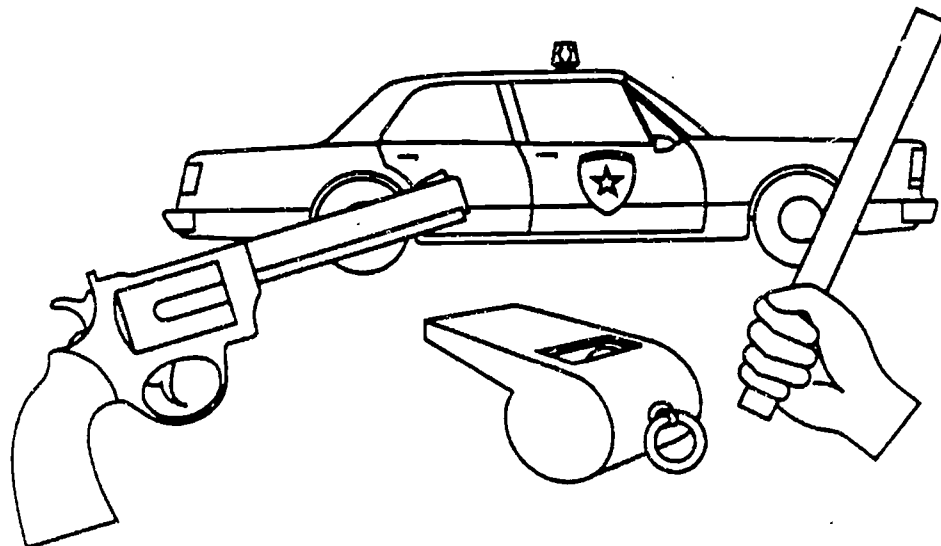

SHEET METAL

Sheet metal workers make, install, and maintain a variety of sheet metal products for home, commercial, and industrial buildings. These products include ducts for air conditioning, heating, and ventilating and pollution control systems, kitchen equipment, roofs, siding, rain gutters, skylights, and outdoor signs. Other workers use a variety of machines in the mass production of sheet-metal products.

The largest occupations, which also have the greatest number of job openings annually, are:

- Sheet metal workers
- Machine forming operators and tenders of metal and plastic

These occupations may have a generally favorable outlook for the future. Overall, the number of these jobs is growing slowly. Large numbers of job openings are expected over the next four or five years. Recently, no training has been reported. Job opportunities should be good.

Hourly wages include:

\$15.36 Sheet metal workers

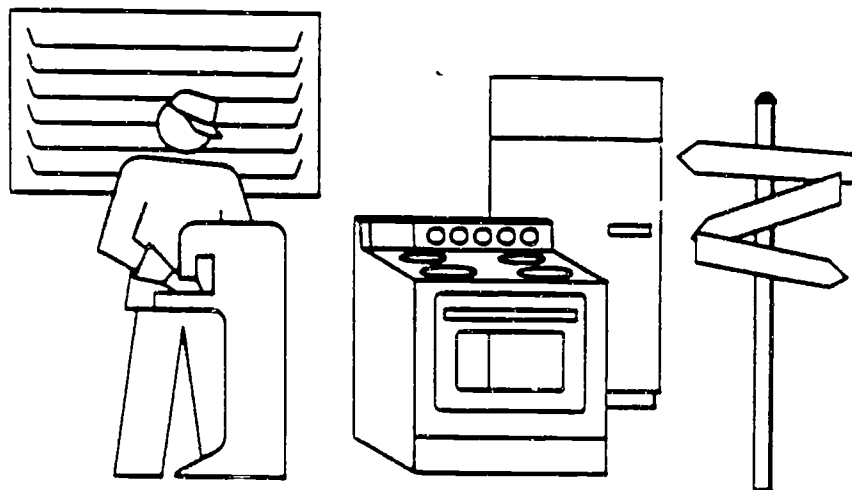

SURVEYING AND CIVIL TECHNOLOGY

Workers establish official land boundaries, with descriptions of land to satisfy legal requirements, and then plan, design, and construct structures and facilities on these tracts of land. The structures can include buildings, bridges, roads, harbors, airfields, dams, tunnels, or water supply and sewage systems.

The largest occupations, which also have the greatest number of job openings annually, are:

- Civil engineering technicians and technologists
- Surveying and mapping technicians and technologists

These occupations may have a generally favorable outlook for the future. Overall, the number of these jobs is growing. Few job openings are expected over the next four or five years. Recently, no training has been reported.

Licensing may be required. Contact: TENNESSEE STATE BOARD OF EXAMINERS FOR LAND SURVEYING, 615-741-3611.

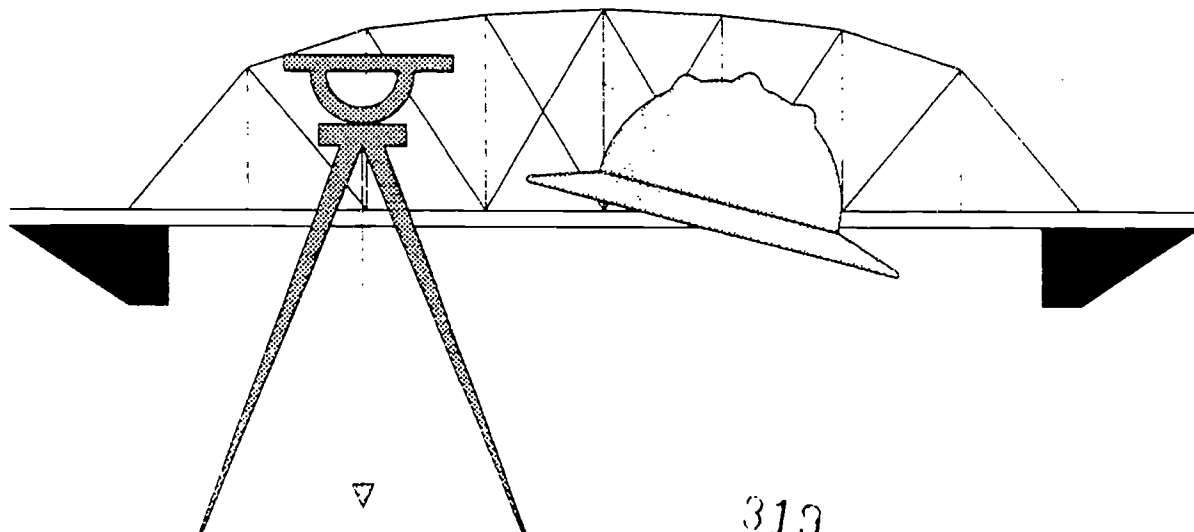

SDA 4 - 46

TRUCK, BUS, AND HEAVY EQUIPMENT OPERATION

These occupations include truck drivers who transport goods, bus drivers who transport passengers, and heavy equipment operators who use machinery to move construction materials and other goods over short distances--around a factory, construction site or loading dock.

The largest occupations, which also have the greatest number of job openings annually, are:

- Truck drivers of heavy or tractor trailer trucks
- School bus drivers

These occupations may have a generally favorable outlook for the future. Overall, the number of these jobs is growing. Large numbers of job openings are expected over the next four or five years. Recently, no training has been reported. Job opportunities should be good.

Hourly wages include:

\$10.00 Truck drivers, heavy or tractor trailer

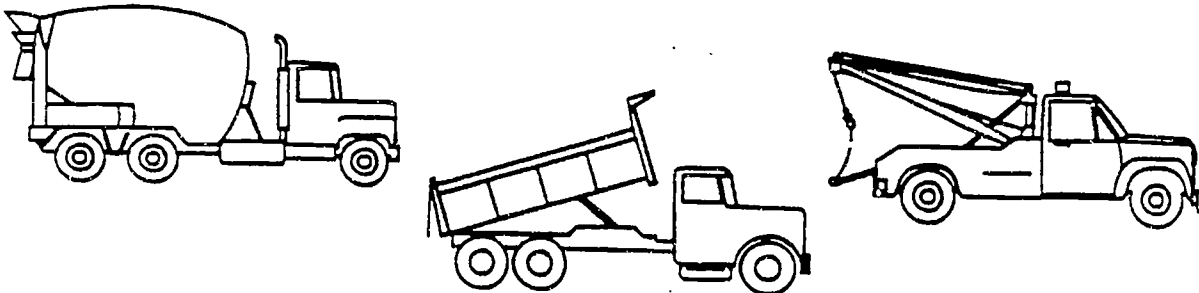

WELDING TECHNOLOGY

Welding is the most common way of permanently joining metal parts. Typically, heat is applied to the metal pieces to be joined; the parts are melted and fused to form a permanent bond. Welding is used to construct and repair parts of ships, automobiles, spacecraft, and thousands of products. It can also be used to join beams and steel reinforcing rods in buildings, bridges, and highways.

The largest occupations, which also have the greatest number of job openings annually, are:

- Welding machine operators and tenders
- Welders and cutters

These occupations may not have a favorable outlook for the future. Overall, the number of these jobs is growing. A moderate number of job openings are expected over the next four or five years. Recently, there have been many more new trainees than job openings. If this trend continues, job seekers can expect to face keen competition. Placement rates at area vocational technical schools, community colleges, and/or technical institutes have been good recently.

Hourly wages include:

\$15.02 Welders and cutters

High school programs preparing for these occupations are:

48.0508 Welding, brazing, and soldering

Related postsecondary programs at state-supported institutions in this area are:

48.0508 Welding, brazing, and soldering

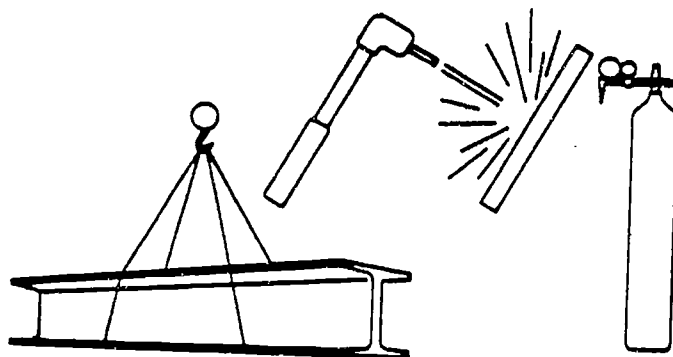

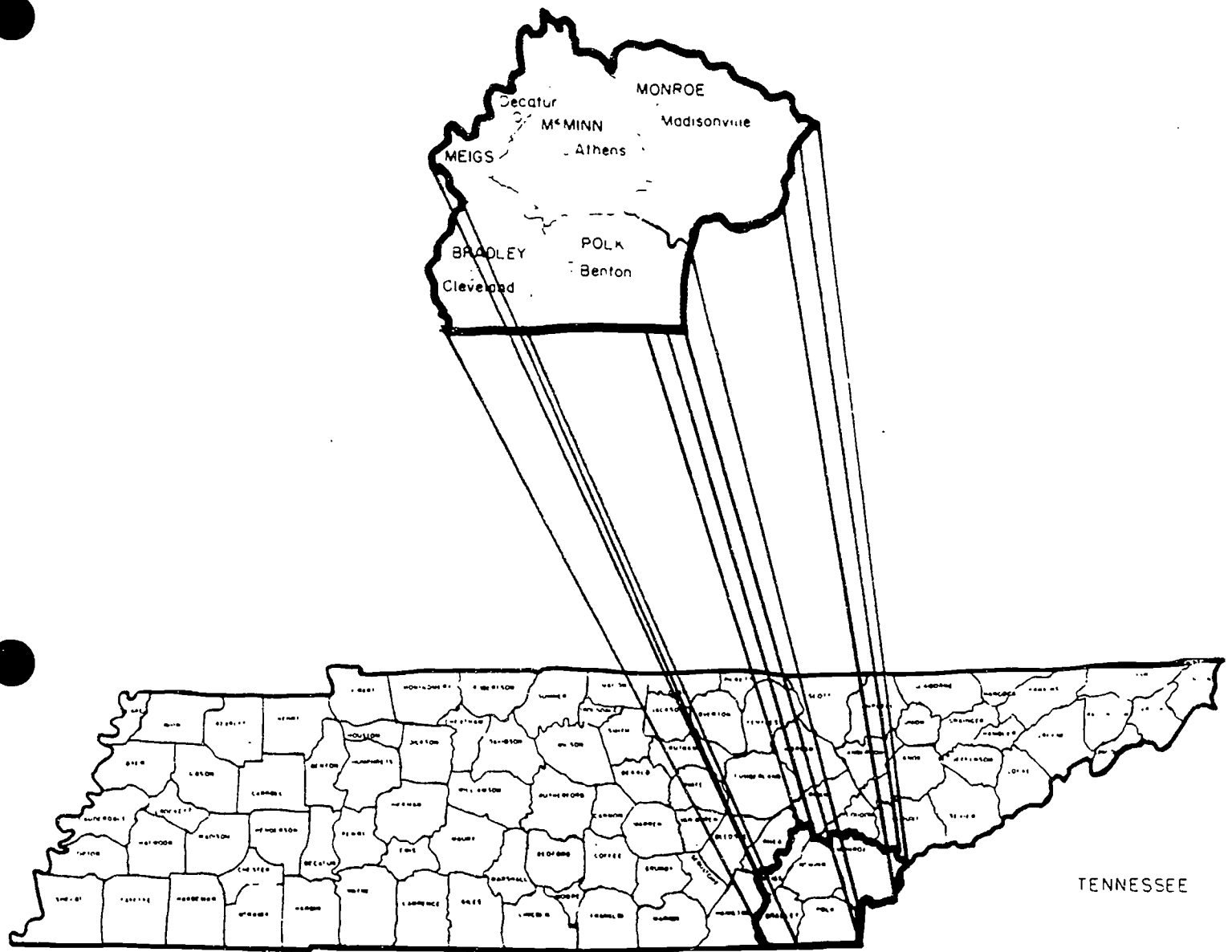

Service Delivery Area 5

ACCOUNTING AND FINANCIAL MANAGEMENT

Many individuals in this group are accountants and auditors who prepare and analyze business records and financial reports which are needed for effective management of any organization. Financial managers, another occupation in this group, typically plan, organize, control, or coordinate the financial activities of an organization.

The largest occupations, which also have the greatest number of job openings annually, are:

- Financial managers
- Accountants and auditors

These occupations may have a generally favorable outlook for the future. Overall, the number of these jobs is growing. A moderate number of job openings are expected over the next four or five years. Recently, no training has been reported. Job opportunities should be good.

Hourly wages include:

\$13.60 Accountants and auditors
\$23.71 Financial managers

Licensing may be required. Contact: TENNESSEE BOARD OF ACCOUNTANCY, 615-741-2250.



ADMINISTRATIVE SUPPORT: ACCOUNTING

Persons employed in this group of occupations provide clerical and administrative support to accountants and auditors. Most of these jobs require only a high school diploma for entry.

The largest occupations, which also have the greatest number of job openings annually, are:

- Bookkeeping, accounting, and auditing clerks
- Payroll and timekeeping clerks

These occupations may have a generally favorable outlook for the future. Overall, the number of these jobs shows little change. A moderate number of job openings are expected over the next four or five years. Recently, there have been fewer new trainees than job openings. If this trend continues, job opportunities should be good. Placement rates at area vocational technical schools, community colleges, and/or technical institutes have been excellent recently.

Hourly wages include:

- \$7.89 Bookkeeping, accounting, and auditing clerks
- \$8.07 Payroll and timekeeping clerks

Related postsecondary programs at state-supported institutions in this area are:

- 07.0101 Accounting and bookkeeping

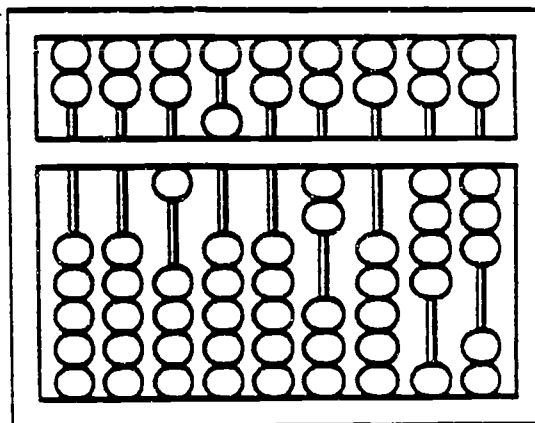
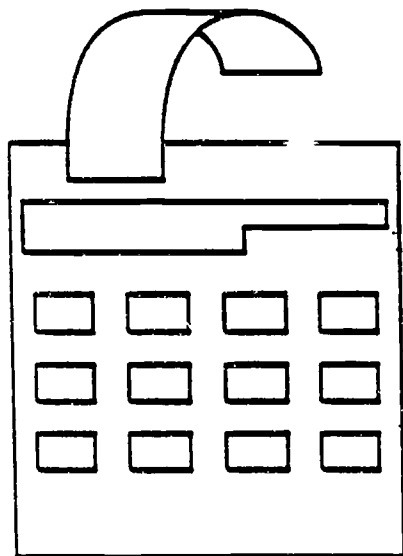

ADMINISTRATIVE SUPPORT: FINANCE AND INSURANCE

Workers provide clerical and general administrative support to the banking and finance industry. Workers receive and pay out money, keep records of money and negotiable instruments, interview applicants for credit, locate and notify customers of delinquent accounts, examine insurance claims, and process a variety of paperwork.

The largest occupations, which also have the greatest number of job openings annually, are:

- Tellers
- Bill and account collectors

These occupations may have a generally favorable outlook for the future. Overall, the number of these jobs shows little change. Few job openings are expected over the next four or five years. Recently, there have been fewer new trainees than job openings. Placement rates at area vocational technical schools, community colleges, and/or technical institutes have been excellent recently.

Hourly wages include:

- \$5.84 Tellers
- \$7.27 New accounts clerks
- \$7.68 Loan and credit clerks
- \$8.04 Bill and account collectors

Related postsecondary programs at state-supported institutions in this area are:

- 07.0201 Banking and finance

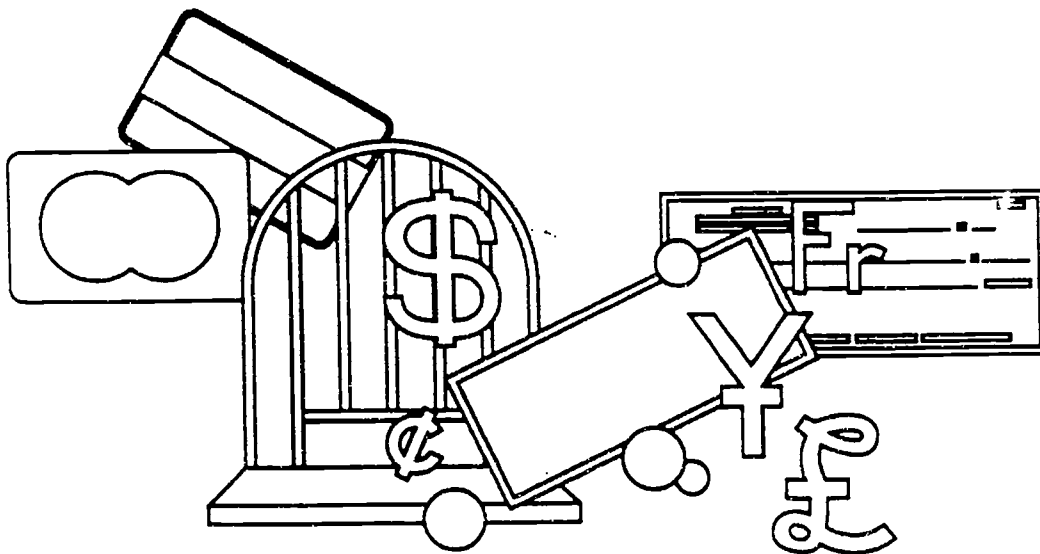

ADMINISTRATIVE SUPPORT: GENERAL

The job duties in this group of occupations are very diverse and are determined by the type of firm. For example, workers may schedule appointments, give information to callers, take dictation, type correspondence, read and route incoming mail, file correspondence and other records, and supervise and coordinate the activities of subordinate clerical workers.

The largest occupations, which also have the greatest number of job openings annually, are:

- Secretaries, except legal and medical secretaries
- General office clerks

These occupations may not have a favorable outlook for the future. Overall, the number of these jobs is growing. Large numbers of job openings are expected over the next four or five years. Recently, there have been many more new trainees than job openings. If this trend continues, job seekers can expect to face keen competition. Placement rates at area vocational technical schools, community colleges, and/or technical institutes have been good recently.

Hourly wages include:

\$5.87	Medical secretaries
\$6.05	Order clerks- materials, merchandise, and service
\$6.08	File clerks
\$6.60	Receptionists and information clerks
\$6.64	Data entry keyers, except composing
\$7.09	General office clerks
\$8.32	Secretaries, ex. legal and medical
\$13.02	First line supervisors and manager/supervisors- clerical and administrative support occupations

High school programs preparing for these occupations are:

07.0601	Secretarial and related programs
07.0701	Typing, general office and related programs
07.0801	Word processing

Related postsecondary programs at state-supported institutions in this area are:

07.0606	Secretarial and office administration
07.9999	Miscellaneous business administrative support

AGRICULTURAL PRODUCTION

Workers in this field plan and economically use facilities, land, water, machinery, chemicals, finance, and labor in the production of plant and animal products.

The largest occupations, which also have the greatest number of job openings annually, are:

- Farm managers
- Farm workers

These occupations may not have a favorable outlook for the future. Overall, the number of these jobs shows little change. Few job openings are expected over the next four or five years. Recently, there have been many more new trainees than job openings.

High school programs preparing for these occupations are:

01.0301 Agricultural production

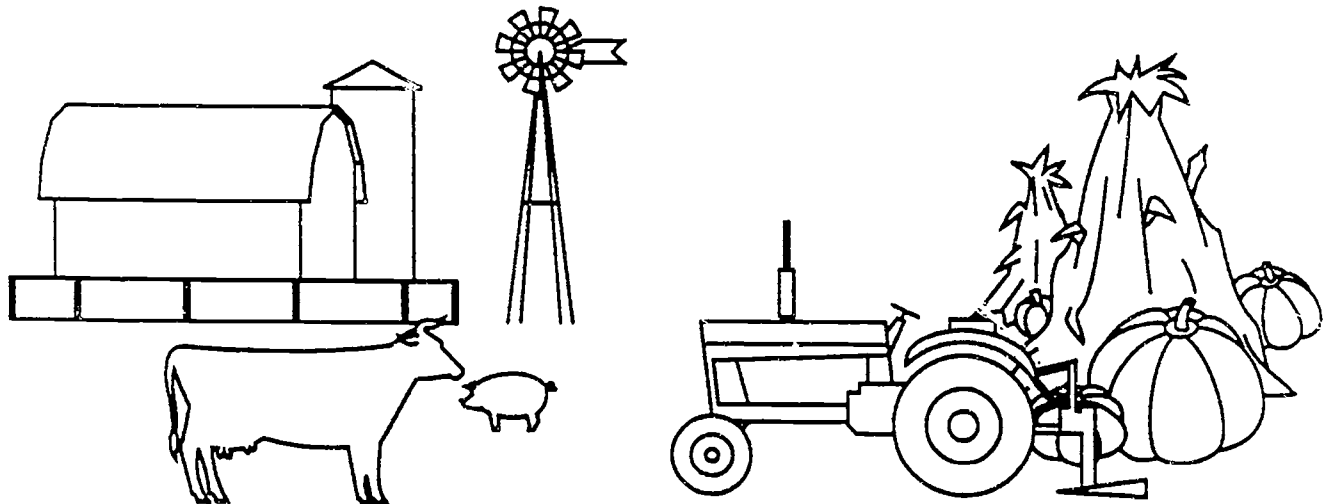

APPLIANCE AND EQUIPMENT REPAIR

Individuals in these occupations repair, adjust, maintain, and install all types of electrical motors and electrical and gas home appliances. Types of equipment used include test instruments, gauges, and hand, bench, and power tools.

This occupation may not have a favorable outlook for the future. Overall, the number of these jobs shows little change. Very few job openings are expected over the next four or five years. Recently, there have been many more new trainees than job openings. Placement rates at area vocational technical schools, community colleges, and/or technical institutes have been poor recently.

High school programs preparing for these occupations are:

47.0101 Electrical and electronics technology

Related postsecondary programs at state-supported institutions in this area are:

47.0101 Electrical and electronics technology

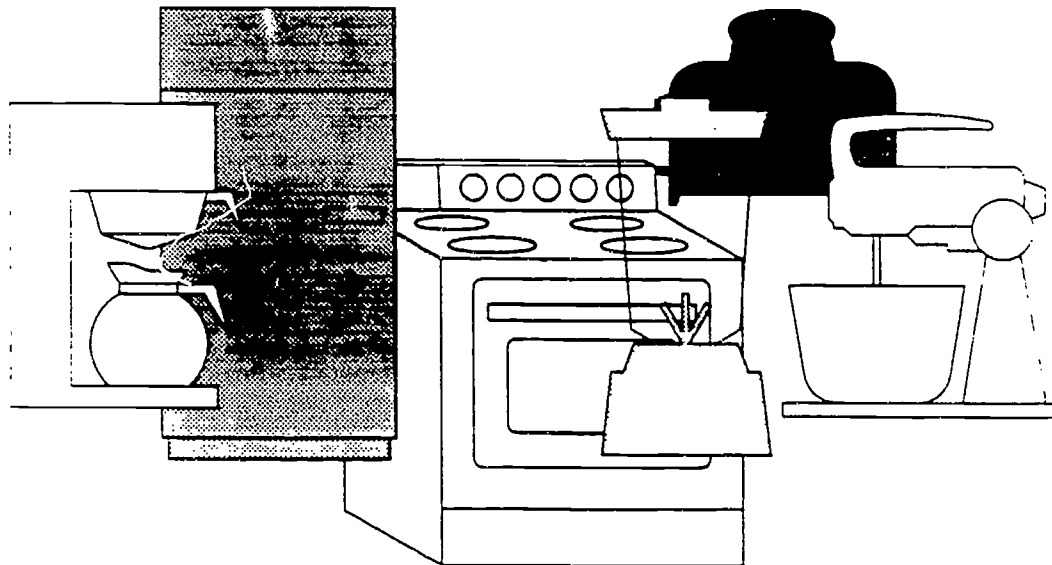

AUTOMOTIVE BODY REPAIR

Thousands of motor vehicles are damaged in traffic accidents every day. The workers in this field straighten bent frames, remove dents, and replace crumpled parts that are beyond repair so that those vehicles look and drive like new.

The largest occupations, which also have the greatest number of job openings annually, are:

- Automotive body and related repairers
- Painters of transportation equipment

These occupations may not have a favorable outlook for the future. Overall, the number of these jobs shows little change. Very few job openings are expected over the next four or five years. Recently, there have been many more new trainees than job openings. Placement rates at area vocational technical schools, community colleges, and/or technical institutes have been good recently.

High school programs preparing for these occupations are:

47.0603 Automotive body repair

Related postsecondary programs at state-supported institutions in this area are:

47.0603 Automotive body repair

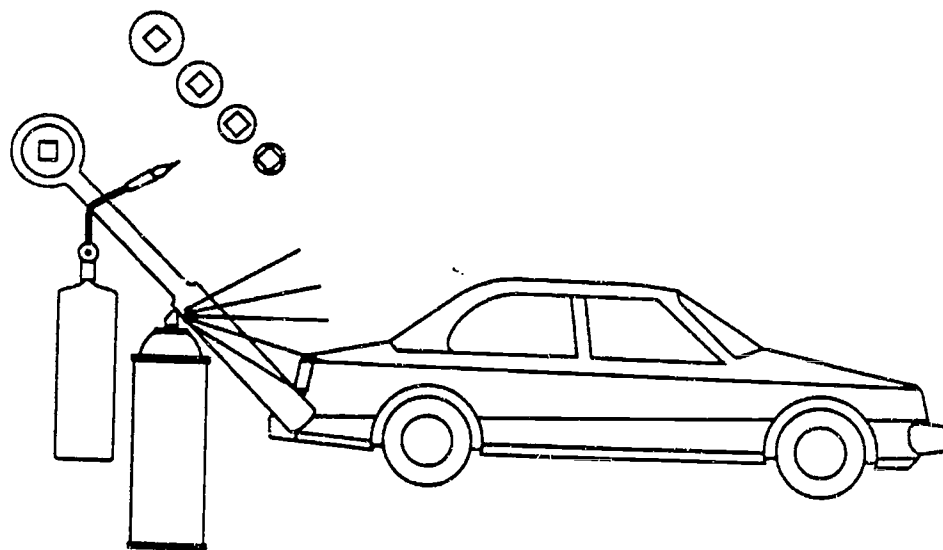

AUTOMOTIVE SERVICE TECHNOLOGY

These occupations include jobs concerned with parking, cleaning, polishing, lubricating, repairing, and refueling trucks, buses, and automobiles, and related servicing activities. The primary occupation, automotive mechanic, is concerned with repair and service of motor vehicles.

The largest occupations, which also have the greatest number of job openings annually, are:

- Automotive mechanics
- Tire repairers and changers

These occupations may have a generally favorable outlook for the future. Overall, the number of these jobs is growing. Few job openings are expected over the next four or five years. Recently, there have been many more new trainees than job openings. Placement rates at area vocational technical schools, community colleges, and/or technical institutes have been excellent recently.

Hourly wages include:

\$10.15 Automotive mechanics

High school programs preparing for these occupations are:

47.0604 Automotive mechanics

Related postsecondary programs at state-supported institutions in this area are:

15.0803 Automotive technology

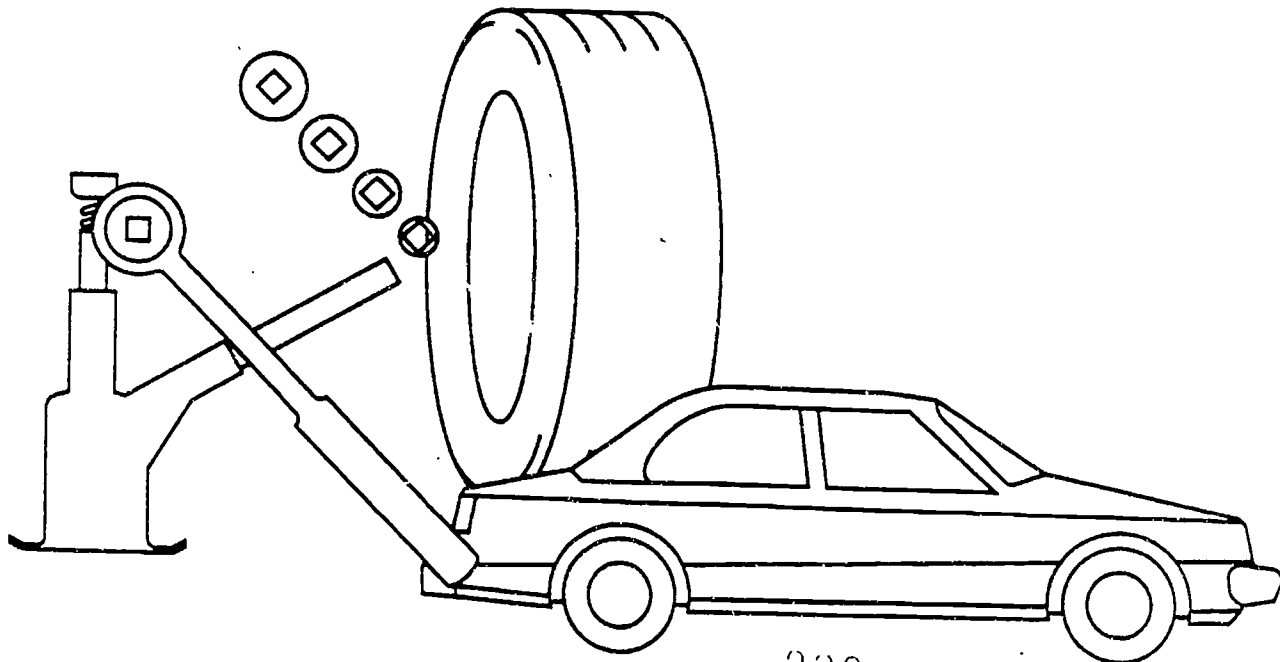

330

BUILDING MAINTENANCE

Persons in building maintenance occupations perform work involving several maintenance skills to keep the structure of an establishment in repair. Duties may involve pipefitting, boilermaking, carpentry, and electrical work as well as repairing buildings, floors, or stairs.

The largest occupations, which also have the greatest number of job openings annually, are:

- General utility maintenance repairers
- Boiler operators and tenders of low pressure boilers

These occupations may have a generally favorable outlook for the future. Overall, the number of these jobs is growing. A moderate number of job openings are expected over the next four or five years. Recently, there have been fewer new trainees than job openings. If this trend continues, job opportunities should be good.

Hourly wages include:

\$7.79 Maintenance repairers, general utility

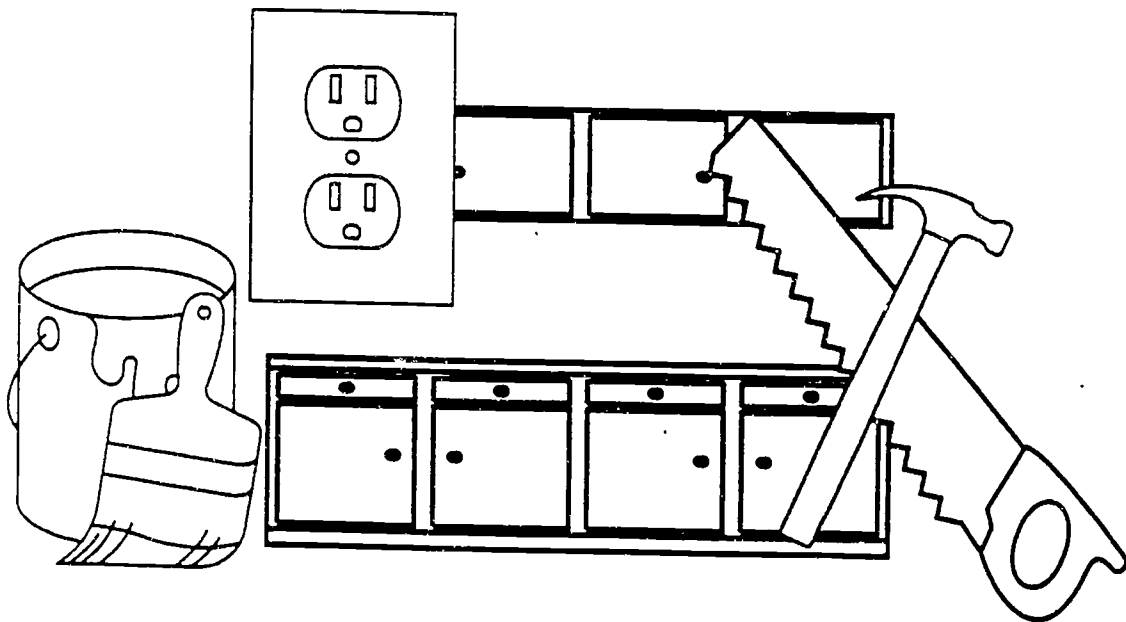

CARPENTRY

Almost all construction projects employ carpenters, the largest group of building trades workers. Carpenters perform a variety of jobs. Their duties will vary by type of construction, type of company, skill of the carpenter, and size of the community. A carpenter employed by a special trade contractor, for example, may specialize in laying hardwood floors, while one who is employed by a general building contractor may build wall frames and install paneling.

This occupation may have a generally favorable outlook for the future. Overall, the number of these jobs is growing. Few job openings are expected over the next four or five years. Recently, no training has been reported.

Average hourly wages are \$8.70

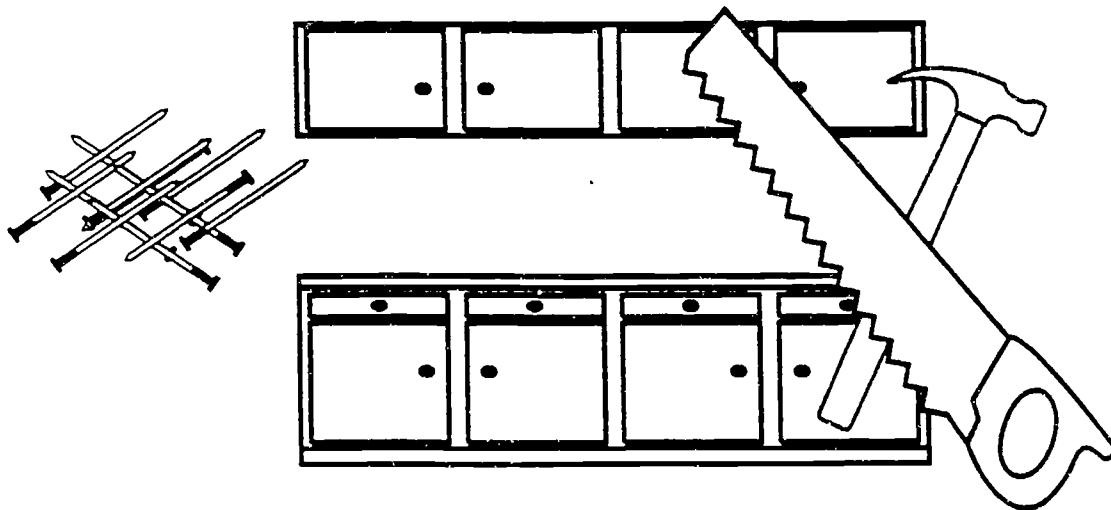

COMPUTER SYSTEMS

Workers in these computer occupations develop and write computer programs to store, locate, and retrieve specific documents, data, and information. They may also analyze business, scientific, and technical problems for application to electronic data processing systems. These careers generally require specialized training.

The largest occupations, which also have the greatest number of job openings annually, are:

- Systems analysts, electronic data processing
- Computer programmers

These occupations may not have a favorable outlook for the future. Overall, the number of these jobs is growing rapidly. A moderate number of job openings are expected over the next four or five years. Recently, there have been many more new trainees than job openings. If this trend continues, job seekers can expect to face keen competition.

Hourly wages include:

- \$14.39 Systems analysts, electronic data processing
- \$14.45 Computer programmers

High school programs preparing for these occupations are:

- 07.0399 Miscellaneous business data processing
- 11.0201 Computer programming

COSMETOLOGY

Cosmetologists and related workers provide beauty services for customers. These may include cutting and styling hair, treating hair and scalp, applying makeup, dressing wigs, or removing hair by electrolysis, as well as cleaning, shaping, and polishing a customer's fingernails and toenails.

This occupation may not have a favorable outlook for the future. Overall, the number of these jobs is growing. Few job openings are expected over the next four or five years. Recently, there have been many more new trainees than job openings.

High school programs preparing for these occupations are:

12.0403 Cosmetology

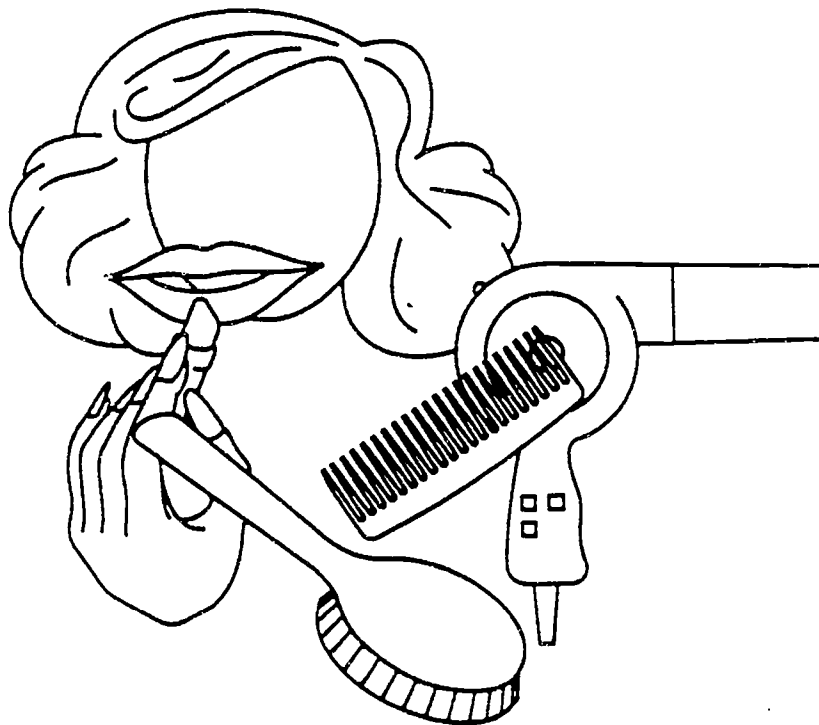

CUSTOM UPHOLSTERY

Upholsterers recondition sofas, chairs, and other upholstered furniture by replacing worn and damaged fabrics, springs, and padding. Upholsterers combine a knowledge of fabrics and other materials with artistic flair and manual skill. Upholsterers should have manual dexterity, good coordination, and be able to do occasional heavy lifting.

The largest occupations, which also have the greatest number of job openings annually, are:

- Upholsterers
- Sewing machine operators manufacturing items other than garments

These occupations may have a generally favorable outlook for the future. Overall, the number of these jobs shows little change. Few job openings are expected over the next four or five years. Recently, no training has been reported.

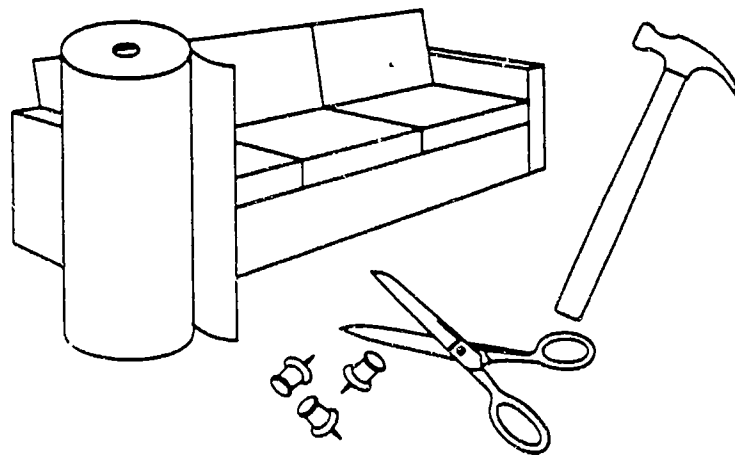

DRAFTING AND DESIGN TECHNOLOGY

Persons in drafting and design technology prepare clear, complete, and accurate working plans and detail drawings from rough or detailed sketches or notes for engineering or manufacturing purposes according to specified dimensions. Workers need to have knowledge of various machines, engineering practices, mathematics, building materials, and other physical sciences to complete drawings. Computer-assisted design (CAD) equipment may be used by some workers.

The largest occupations, which also have the greatest number of job openings annually, are:

- Cost estimators
- Drafters

These occupations may not have a favorable outlook for the future. Overall, the number of these jobs shows little change. Few job openings are expected over the next four or five years. Recently, there have been many more new trainees than job openings. Placement rates at area vocational technical schools, community colleges, and/or technical institutes have been fair recently.

Hourly wages include:

\$18.51 Drafters

High school programs preparing for these occupations are:

48.0101 Drafting

Related postsecondary programs at state-supported institutions in this area are:

15.0101 Architectural engineering technology
48.0101 Drafting

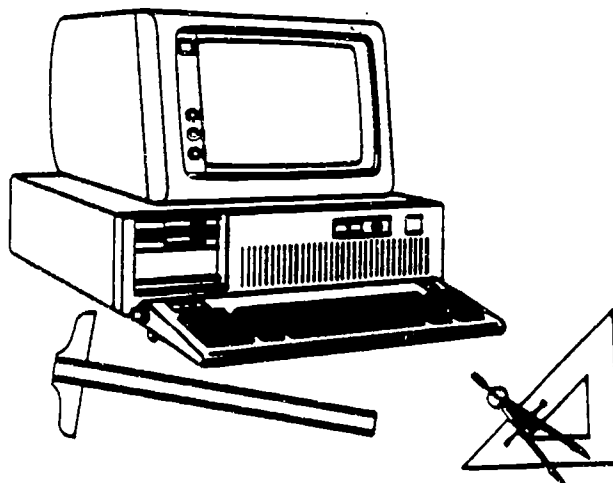

EARLY CHILDHOOD EDUCATION

Child care workers and managers of child care centers assume responsibility for the safety, physical care, and emotional, social, and intellectual growth of preschool children and infants while parents are at work or are unavailable for other reasons. Some work in residential institutions for young children. Teacher aides assist teachers by handling routine paperwork or by working directly with children.

The largest occupations, which also have the greatest number of job openings annually, are:

- Teacher aides, paraprofessional
- Child care workers

These occupations may have a generally favorable outlook for the future. Overall, the number of these jobs is growing rapidly. A moderate number of job openings are expected over the next four or five years. Recently, there have been fewer new trainees than job openings. If this trend continues, job opportunities should be good.

High school programs preparing for these occupations are:

20.0201 Child care and guidance management services

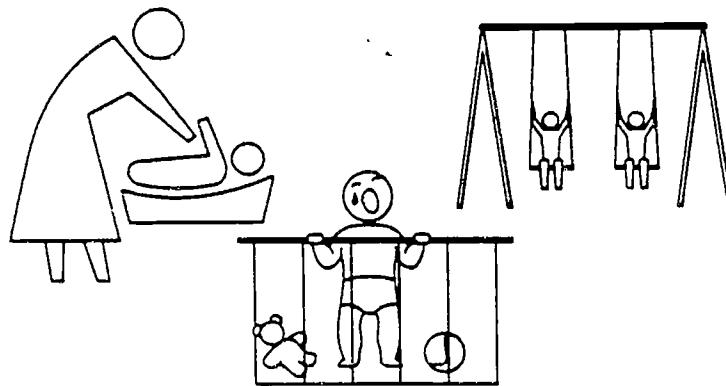

ELECTRICIAN OCCUPATIONS

Workers in the electrical field install, maintain, and repair wiring, electrical equipment, and fixtures or assist in such activities. These workers insure that work is in accordance with the relevant codes. A high school education is usually required and a five-year apprenticeship program is recommended.

The largest occupations, which also have the greatest number of job openings annually, are:

- Electricians
- Helpers of electricians and powerline transmission installers

These occupations may have a generally favorable outlook for the future. Overall, the number of these jobs is growing. Few job openings are expected over the next four or five years. Recently, no training has been reported.

Hourly wages include:

\$17.47 Electricians

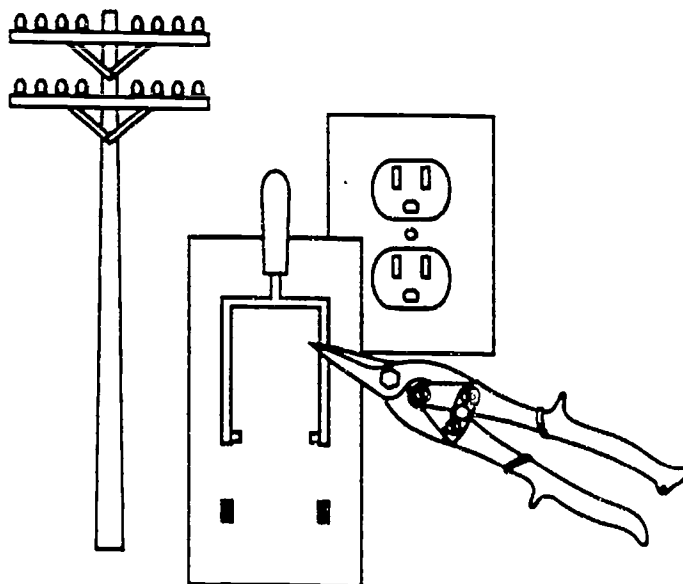

FOOD PREPARATION AND SERVICES

The majority of workers in these occupations prepare and serve food and beverages in restaurants, fast food establishments, catering firms, hotels, clubs, factories, school cafeterias, or hospitals, or supervise those providing food services. Others are factory machine operators involved in the preparation of food products. Dietetic technicians teach principles of food nutrition and provide dietary counseling to patients.

The largest occupations, which also have the greatest number of job openings annually, are:

- Food preparation workers
- Combined food preparation and service workers

These occupations may have a generally favorable outlook for the future. Overall, the number of these jobs is growing. Large numbers of job openings are expected over the next four or five years. Recently, there have been fewer new trainees than job openings. If this trend continues, job opportunities should be good.

Hourly wages include:

- \$4.38 Cooks, specialty fast food
- \$6.13 Cooks, restaurant

High school programs preparing for these occupations are:

- 20.0401 Food production, management, and services

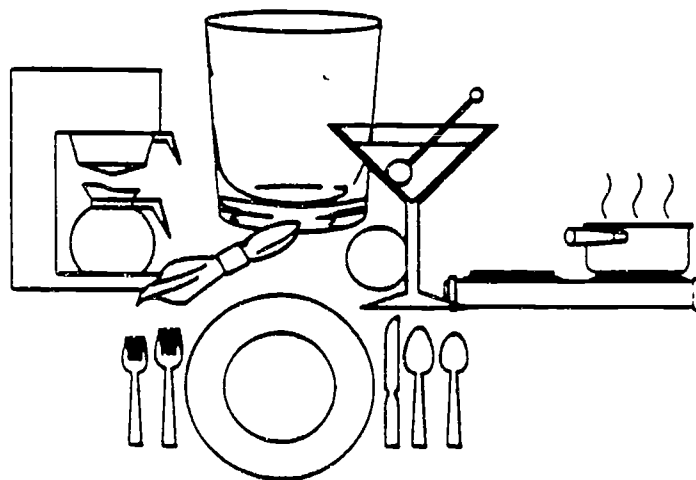

GENERAL BUSINESS AND MANAGEMENT

Workers in the general business and management occupations plan, organize, direct, control, or coordinate activities in all types of fields. Many occupations involve analysis of productivity and financial soundness. General managers and top executives usually have very diverse duties and responsibilities and work through departmental or subordinate executives.

The largest occupations, which also have the greatest number of job openings annually, are:

- Industrial production managers
- General managers and top executives

These occupations may have a generally favorable outlook for the future. Overall, the number of these jobs is growing. Large numbers of job openings are expected over the next four or five years. Recently, there have been fewer new trainees than job openings. If this trend continues, job opportunities should be good. Placement rates at area vocational technical schools, community colleges, and/or technical institutes have been good recently.

Hourly wages include:

- \$16.13 Purchasing managers
- \$16.38 Industrial production managers

Related postsecondary programs at state-supported institutions in this area are:

- 06.0401 Business administration and management
- 06.9999 Miscellaneous business management
- 07.9998 Business management technology



GENERAL WOODWORKING

Woodworkers are in occupations concerned with the complete cycle of cutting, shaping, and assembling parts of complex wood products. The occupations are primarily concerned with one or a limited number of machine functions according to their speciality.

The two largest occupations are:

- Assemblers and fabricators, except machine, electrical, electronic, and precision assembly
- Sawing machine operators and tenders

The occupations expected to have the most job openings annually are:

- Assemblers and fabricators, except machine, electrical, electronic, and precision assembly
- Woodworking machine operators and tenders, except of sawing machines

These occupations may have a generally favorable outlook for the future. Overall, the number of these jobs shows little change. A moderate number of job openings are expected over the next four or five years. Recently, there have been about as many new trainees as job openings. If this trend continues, job seekers can expect to face some competition.

High school programs preparing for these occupations are:

48.0701 Woodworking

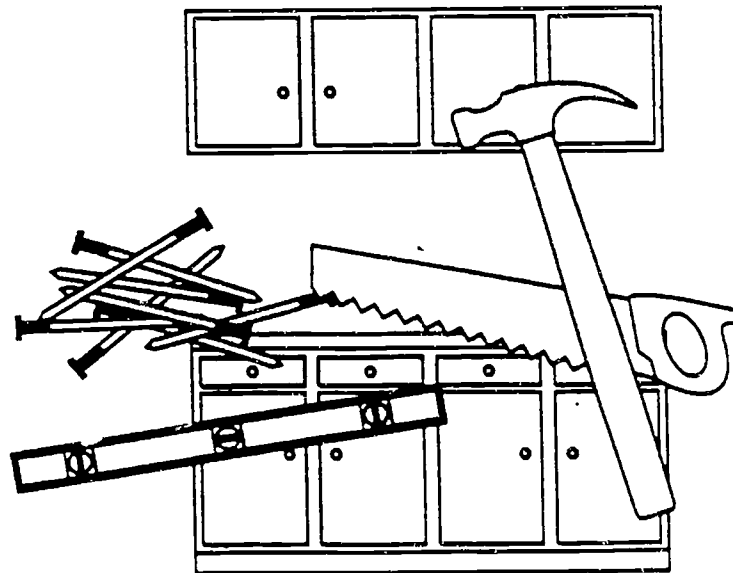

HORTICULTURE AND LANDSCAPING

The largest group of workers in these occupations, gardeners and groundskeepers, maintain the grounds of public and private property. Duties may include mowing, trimming, planting, and watering plants, shrubs, and grass.

The largest occupations, which also have the greatest number of job openings annually, are:

- Nursery workers
- Gardeners and groundskeepers, except farm workers

These occupations may not have a favorable outlook for the future. Overall, the number of these jobs is growing. Few job openings are expected over the next four or five years. Recently, there have been many more new trainees than job openings.

Hourly wages include:

\$8.03 Gardeners and groundskeepers, except farm

High school programs preparing for these occupations are:

01.0601 Horticulture

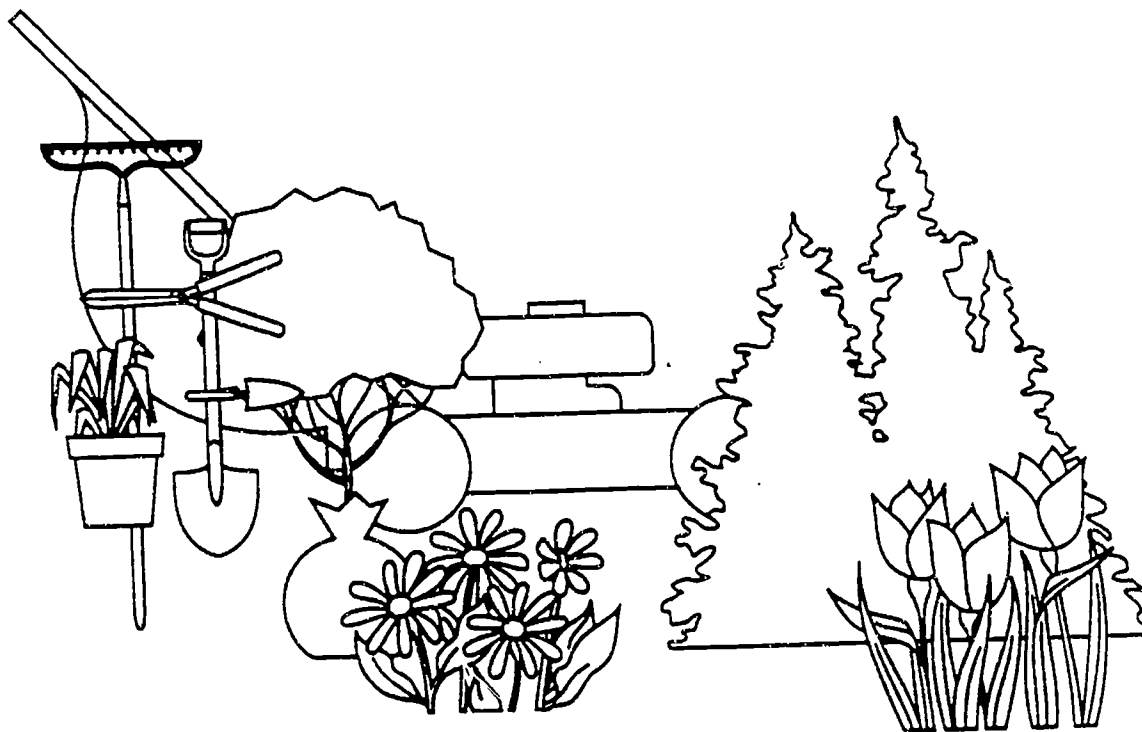

HOTEL AND RESTAURANT MANAGEMENT

Food service and lodging managers supervise the profitable operation of restaurants, hotels, and motels. Workers direct the varied activities of these businesses with the goal of pleasing people and providing good service to their customers.

This occupation may have a generally favorable outlook for the future. Overall, the number of these jobs is growing. Few job openings are expected over the next four or five years. Recently, there have been fewer new trainees than job openings.

Average hourly wages are \$8.96

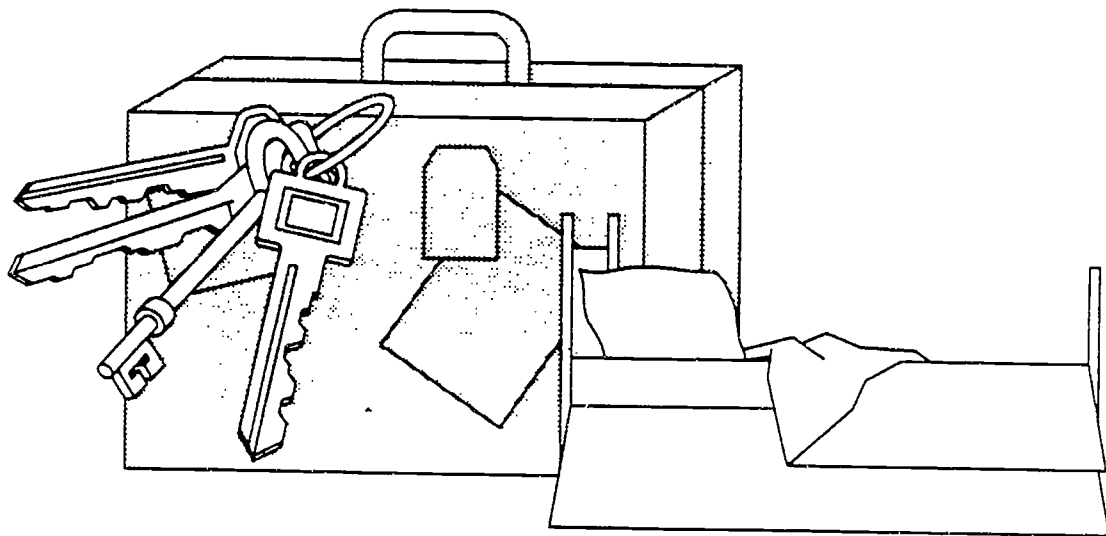

INDUSTRIAL MAINTENANCE TECHNOLOGY

Workers prevent costly waste of raw materials and the idling of human resources in a plant or factory by making industrial machinery repairs as quickly as possible. Maintenance mechanics spend considerable time doing preventive maintenance, including keeping machines well oiled and greased, and periodically cleaning parts.

The largest occupations, which also have the greatest number of job openings annually, are:

- Maintenance mechanics for industrial machinery
- Textile machine setters and set-up operators

These occupations may have a generally favorable outlook for the future. Overall, the number of these jobs is growing slowly. A moderate number of job openings are expected over the next four or five years. Recently, there have been fewer new trainees than job openings. If this trend continues, job opportunities should be good. Placement rates at area vocational technical schools, community colleges, and/or technical institutes have been very good recently.

Hourly wages include:

\$12.44 Machinery maintenance mechanics

Related postsecondary programs at state-supported institutions in this area are:

15.0603 Industrial technology

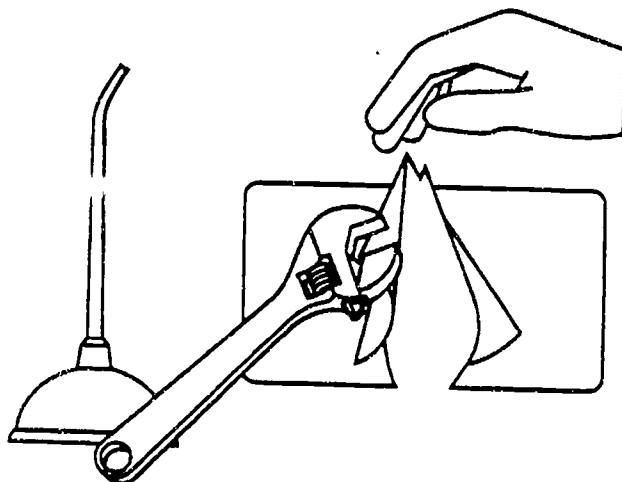

INSTITUTIONAL HOME MANAGEMENT AND SUPPORTING SERVICES

These workers make sure that all public buildings, offices, hospitals, stores, and apartment houses are kept clean and in good condition for the comfort and safety of the people who work or live there. Generally, no special education is required for occupations in this field, with most skills learned on the job.

The largest occupations, which also have the greatest number of job openings annually, are:

- Maids and housekeeping cleaners
- Janitors and cleaners, except maids and housekeeping cleaners

These occupations may have a generally favorable outlook for the future. Overall, the number of these jobs is growing. Large numbers of job openings are expected over the next four or five years. Recently, there have been fewer new trainees than job openings. If this trend continues, job opportunities should be good.

Hourly wages include:

- \$5.31 Housekeepers
- \$5.48 Maids and housekeeping cleaners
- \$6.61 Janitors and cleaners, except maids and housekeeping cleaners

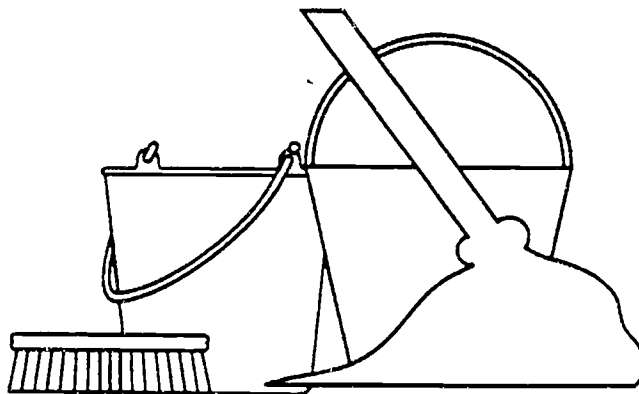

LEGAL ASSISTING

Under the direct supervision of a lawyer, workers employed in paralegal occupations do research for the preparation of lawsuits and legal documents; gather information for use as evidence in trials; draft documents such as mortgages, deeds, and contracts; and search titles to determine if a title deed is correct. Most paralegal personnel work for private law firms.

These occupations may not have a favorable outlook for the future. Overall, the number of these jobs shows little change. Very few job openings are expected over the next four or five years. Recently, there have been more new trainees than job openings. Placement rates at area vocational technical schools, community colleges, and/or technical institutes have been good recently.

Related postsecondary programs at state-supported institutions in this area are:

22.0103 Paralegal, legal assisting

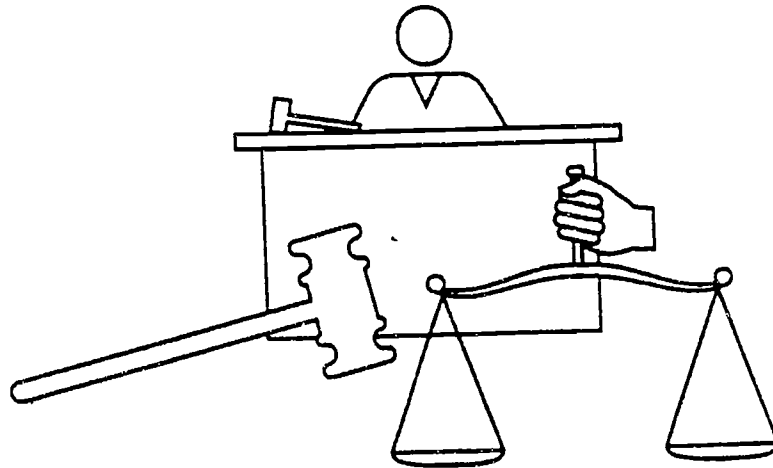

MACHINE TOOL TECHNOLOGY

Workers in these occupations make or set up and operate machine tools or repair metal parts. Machinists and tool-and-die makers create highly specialized precision tools, molds, and metal parts. Often they use blueprints to develop prototypes for tools or machines to be used in manufacturing.

The largest occupations, which also have the greatest number of job openings annually, are:

- Tool and die makers
- Machinists

These occupations may have a generally favorable outlook for the future. Overall, the number of these jobs is growing slowly. A moderate number of job openings are expected over the next four or five years. Recently, there have been fewer new trainees than job openings. If this trend continues, job opportunities should be good. Placement rates at area vocational technical schools, community colleges, and/or technical institutes have been very good recently.

Hourly wages include:

\$13.26 Machinists

Related postsecondary programs at state-supported institutions in this area are:

48.0503 Machine tool operation and machine shop technology

MEDICAL RECORDS TECHNOLOGY

Medical records technicians compile and maintain medical records of hospital and clinic patients. Such work is becoming increasingly important as this background information is used for medicare and medicaid insurance reimbursements.

This occupation may not have a favorable outlook for the future. Overall, the number of these jobs shows little change. Very few job openings are expected over the next four or five years. Recently, no training has been reported.

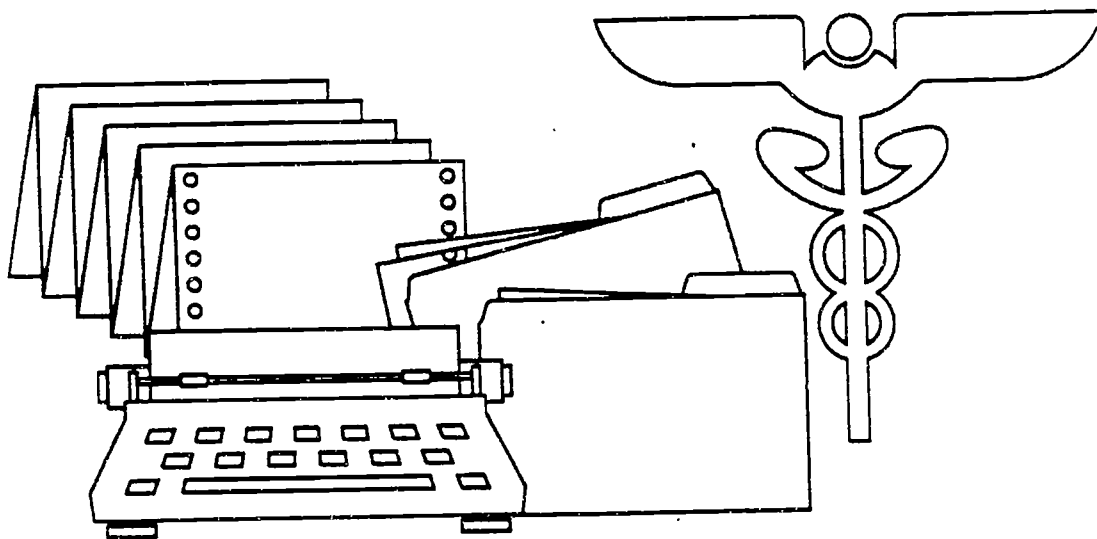

NURSING ASSISTANT

Nursing aides and orderlies work under the general direction of nursing or medical staff. In hospitals, they may answer patients' call bells, serve and collect food trays, feed patients, or set up equipment. In nursing homes, they are expected to sustain ongoing relations with patients.

The largest occupations, which also have the greatest number of job openings annually, are:

- Nursing aides, orderlies, and attendants
- Home health aides

These occupations may have a generally favorable outlook for the future. Overall, the number of these jobs is growing rapidly. A moderate number of job openings are expected over the next four or five years. Recently, there have been fewer new trainees than job openings. If this trend continues, job opportunities should be good.

Hourly wages include:

- \$5.05 Nursing aides, orderlies, and attendants
- \$6.31 Home health aides

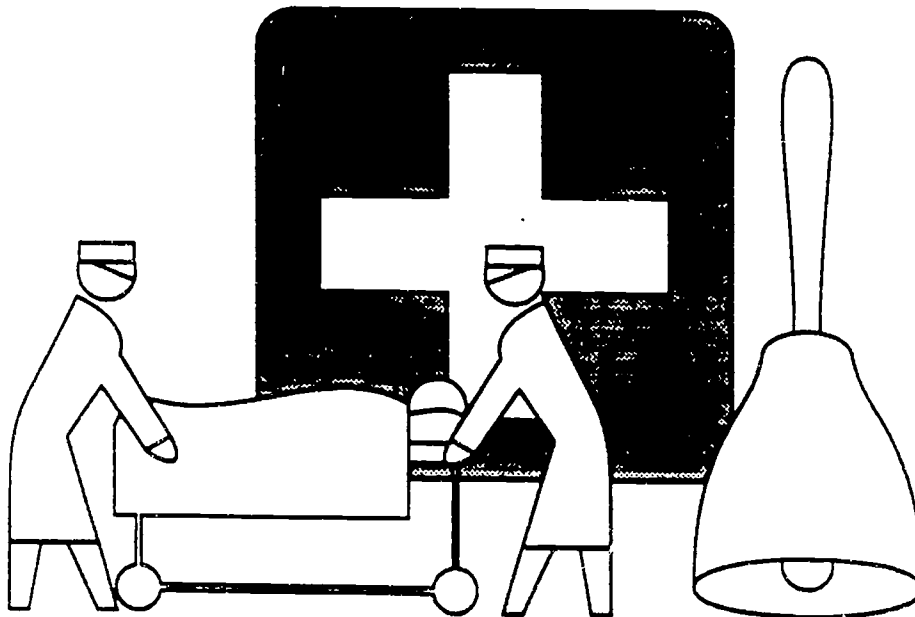

PRACTICAL NURSING

Licensed practical nurses (LPNs) work under the supervision of physicians and/or registered nurses to provide nursing care that requires technical knowledge but not the professional training of a registered nurse. They provide bedside care, administer certain medications, and assist in patient examinations.

This occupation may have a generally favorable outlook for the future. Overall, the number of these jobs is growing rapidly. A moderate number of job openings are expected over the next four or five years. Recently, there have been more new trainees than job openings. If this trend continues, job seekers can expect to face some competition. Placement rates at area vocational technical schools, community colleges, and/or technical institutes have been very good recently.

Average hourly wages are \$8.79

Related postsecondary programs at state-supported institutions in this area are:

17.0605 Practical nursing

Licensing may be required. Contact: TENNESSEE BOARD OF NURSING, 615-367-6232.

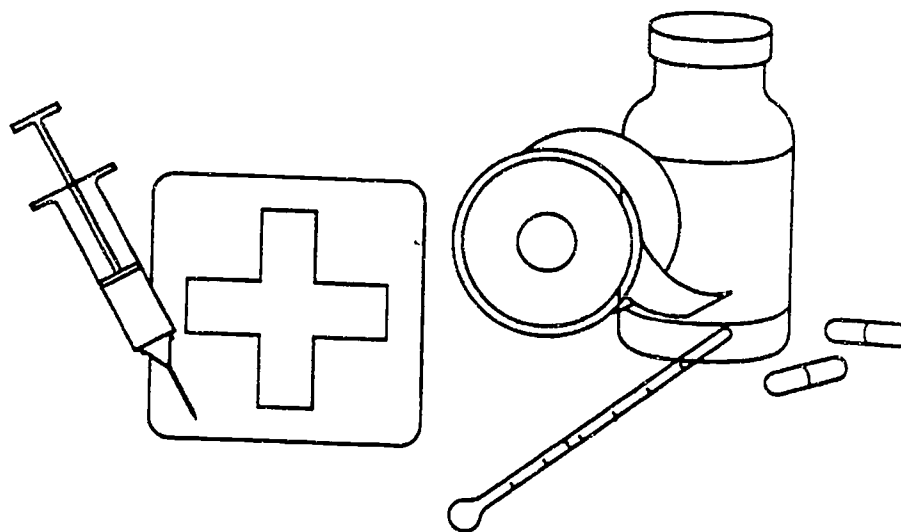

350

PROFESSIONAL NURSING

Registered Nurses (R.N.'s), the largest occupational group in this field, are primarily employed in hospitals and nursing homes, where they provide skilled bedside care and may supervise licensed practical nurses, nursing aides, and orderlies. Working under the direction of a licensed "supervising physician," physician assistants elicit detailed patient histories, perform physical examinations, and prescribe appropriate treatments.

The largest occupations, which also have the greatest number of job openings annually, are:

- Registered nurses
- Physician's assistants

These occupations may have a generally favorable outlook for the future. Overall, the number of these jobs is growing rapidly. A moderate number of job openings are expected over the next four or five years. Recently, there have been more new trainees than job openings. If this trend continues, job seekers can expect to face some competition. Placement rates at area vocational technical schools, community colleges, and/or technical institutes have been very good recently.

Hourly wages include:

\$13.60 Registered nurses

Related postsecondary programs at state-supported institutions in this area are:

18.1101 Nursing

Licensing may be required. Contact: TENNESSEE BOARD OF MEDICAL EXAMINERS-COMMITTEE ON PHYSICIAN ASSISTANTS, 615-367-6250.

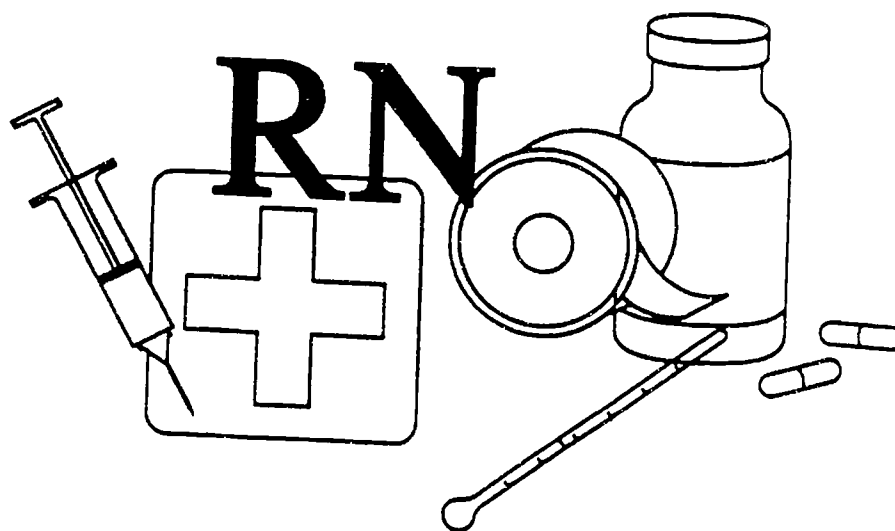

SALES AND MERCHANDISING

Workers in sales and merchandising occupations promote and sell a wide variety of merchandise and services. They also receive, store, display, and inventory products to be sold.

The largest occupations, which also have the greatest number of job openings annually, are:

- Salespersons in retail establishments
- Cashiers

These occupations may have a generally favorable outlook for the future. Overall, the number of these jobs is growing. Large numbers of job openings are expected over the next four or five years. Recently, there have been about as many new trainees as job openings. If this trend continues, job seekers can expect to face some competition.

Hourly wages include:

\$4.60 Cashiers
\$6.26 Salespersons, retail
\$18.42 Purchasing agents- except wholesale, retail, and farm products

High school programs preparing for these occupations are:

08.0700 General marketing
08.0799 Miscellaneous general marketing

Licensing may be required. Contact: TENNESSEE DEPARTMENT OF COMMERCE AND INSURANCE, 615-741-2693.

SECURITY SERVICES

Security guards, the largest occupation in this field, patrol and inspect property to protect it against fire, theft, vandalism, and illegal entry. Guards and doorkeepers usually are uniformed and often carry a nightstick and a weapon; correctional officers and jailers maintain order in correctional institutions, enforce institutional rules and regulations, and may supplement the counseling inmates receive from mental health professionals.

The largest occupations, which also have the greatest number of job openings annually, are:

- Correction officers and jailers
- Guards and watch guards

These occupations may have a generally favorable outlook for the future. Overall, the number of these jobs is growing rapidly. A moderate number of job openings are expected over the next four or five years. Recently, there have been fewer new trainees than job openings. If this trend continues, job opportunities should be good.

Hourly wages include:

\$9.26 Guards and watch guards

Licensing may be required. Contact: COUNTY COURT CLERK'S OFFICE.

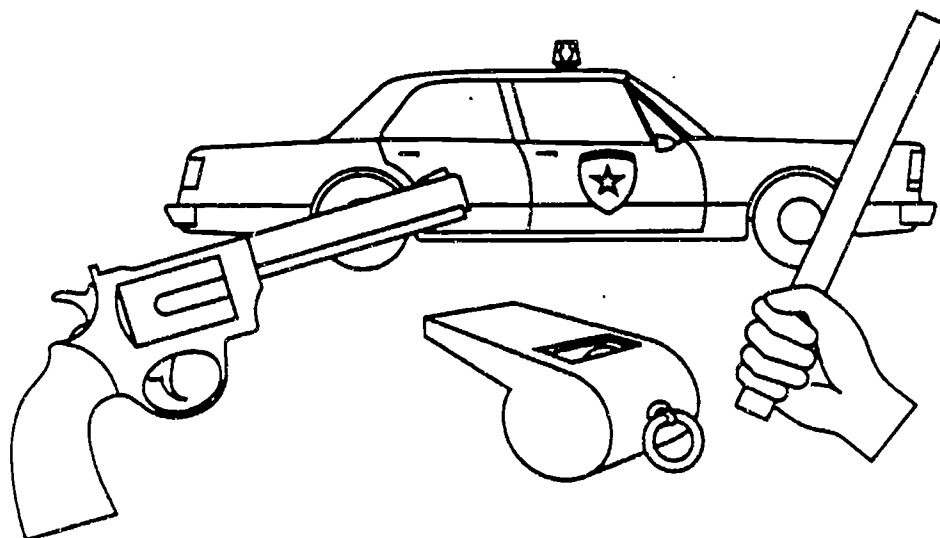

SHEET METAL

Sheet metal workers make, install, and maintain a variety of sheet metal products for home, commercial, and industrial buildings. These products include ducts for air conditioning, heating, and ventilating and pollution control systems, kitchen equipment, roofs, siding, rain gutters, skylights, and outdoor signs. Other workers use a variety of machines in the mass production of sheet-metal products.

The largest occupations, which also have the greatest number of job openings annually, are:

- Machine forming operators and tenders of metal and plastic
- Assemblers and fabricators, except machine, electrical, electronic, and precision assembly

These occupations may have a generally favorable outlook for the future. Overall, the number of these jobs shows little change. A moderate number of job openings are expected over the next four or five years. Recently, there have been about as many new trainees as job openings. If this trend continues, job seekers can expect to face some competition.

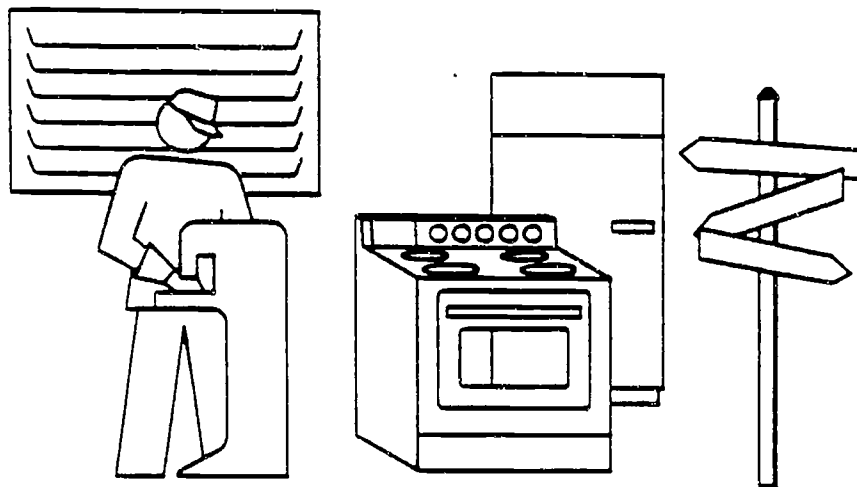

TRUCK, BUS, AND HEAVY EQUIPMENT OPERATION

These occupations include truck drivers who transport goods, bus drivers who transport passengers, and heavy equipment operators who use machinery to move construction materials and other goods over short distances--around a factory, construction site or loading dock.

The largest occupations, which also have the greatest number of job openings annually, are:

- Truck drivers of heavy or tractor trailer trucks
- School bus drivers

These occupations may have a generally favorable outlook for the future. Overall, the number of these jobs is growing. Large numbers of job openings are expected over the next four or five years. Recently, no training has been reported. Job opportunities should be good.

Hourly wages include:

\$11.00 Truck drivers, heavy or tractor trailer

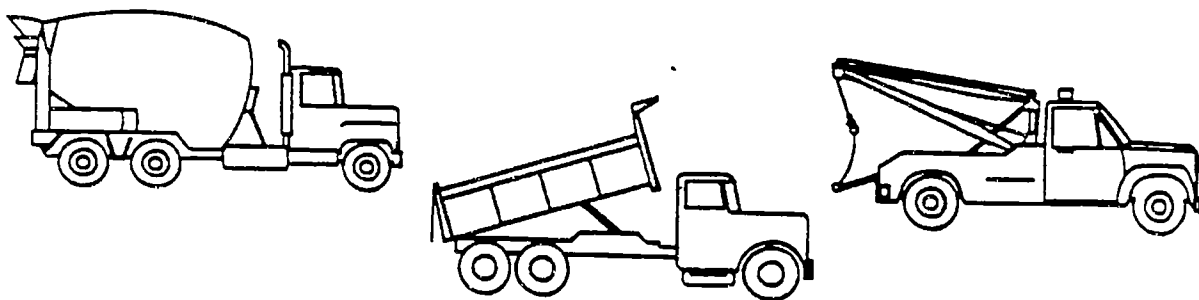

WELDING TECHNOLOGY

Welding is the most common way of permanently joining metal parts. Typically, heat is applied to the metal pieces to be joined; the parts are melted and fused to form a permanent bond. Welding is used to construct and repair parts of ships, automobiles, spacecraft, and thousands of products. It can also be used to join beams and steel reinforcing rods in buildings, bridges, and highways.

The largest occupations, which also have the greatest number of job openings annually, are:

- Welding machine setters and set-up operators
- Welders and cutters

These occupations may have a generally favorable outlook for the future. Overall, the number of these jobs is growing. Few job openings are expected over the next four or five years. Recently, there have been more new trainees than job openings. Placement rates at area vocational technical schools, community colleges, and/or technical institutes have been good recently.

Hourly wages include:

\$8.90 Welders and cutters

High school programs preparing for these occupations are:

48.0508 Welding, brazing, and soldering

Related postsecondary programs at state-supported institutions in this area are:

48.0508 Welding, brazing, and soldering

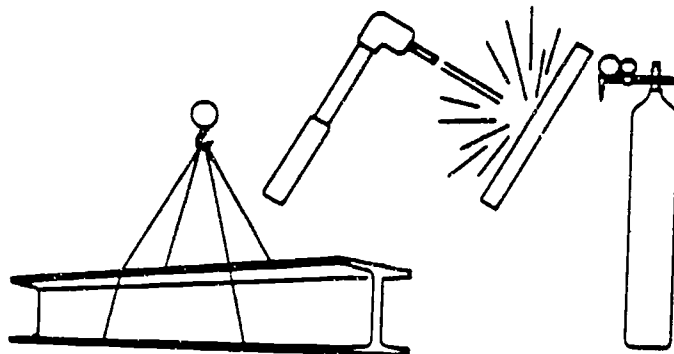

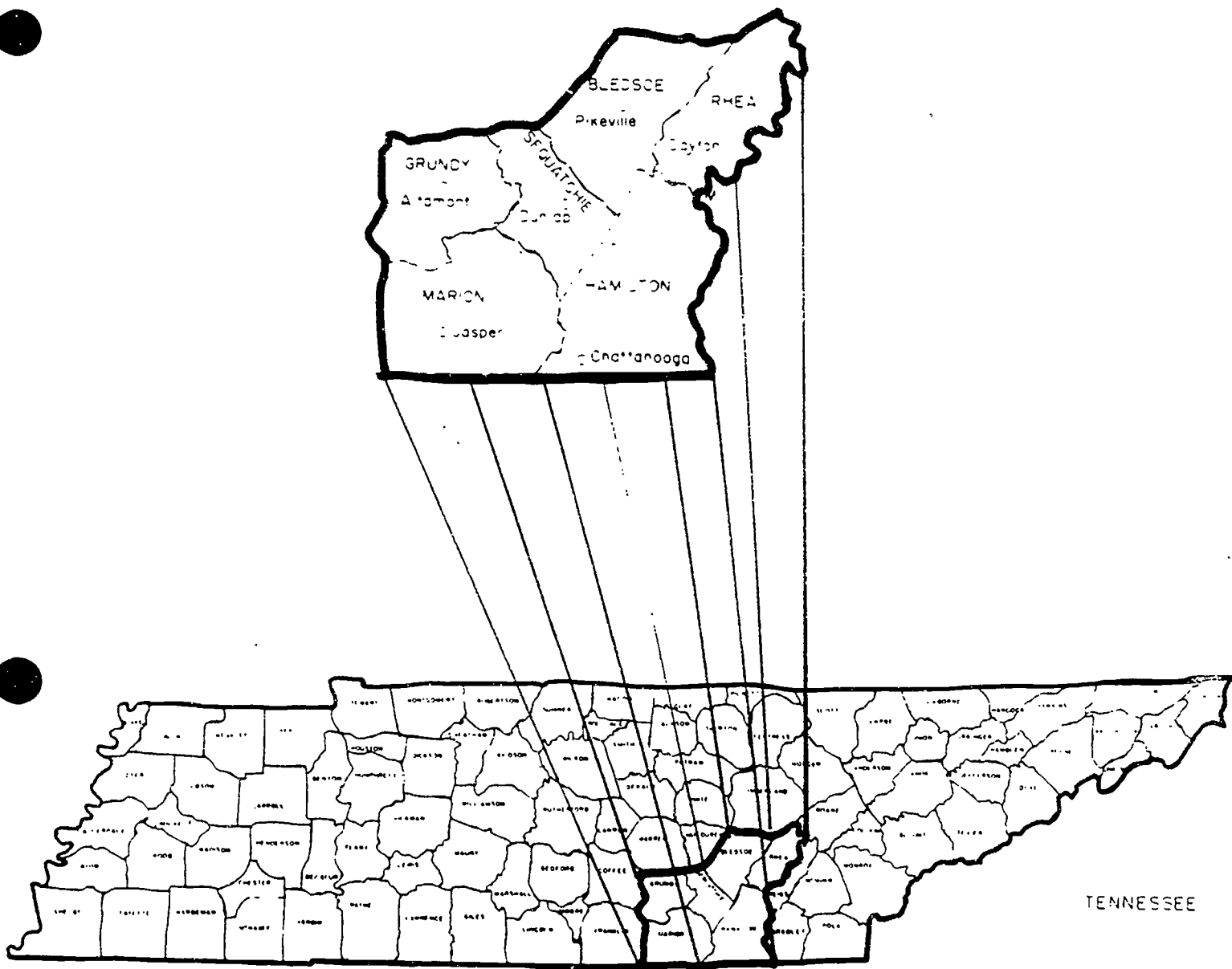

Service Delivery Area 6

ACCOUNTING AND FINANCIAL MANAGEMENT

Many individuals in this group are accountants and auditors who prepare and analyze business records and financial reports which are needed for effective management of any organization. Financial managers, another occupation in this group, typically plan, organize, control, or coordinate the financial activities of an organization.

The largest occupations, which also have the greatest number of job openings annually, are:

- Financial managers
- Accountants and auditors

These occupations may have a generally favorable outlook for the future. Overall, the number of these jobs is growing. Large numbers of job openings are expected over the next four or five years. Recently, there have been fewer new trainees than job openings. If this trend continues, job opportunities should be good.

Hourly wages include:

- \$14.30 Accountants and auditors
- \$19.53 Financial managers

Licensing may be required. Contact: TENNESSEE BOARD OF ACCOUNTANCY, 615-741-2250.



ADMINISTRATIVE SUPPORT: ACCOUNTING

Persons employed in this group of occupations provide clerical and administrative support to accountants and auditors. Most of these jobs require only a high school diploma for entry.

The largest occupations, which also have the greatest number of job openings annually, are:

- Bookkeeping, accounting, and auditing clerks
- Payroll and timekeeping clerks

These occupations may have a generally favorable outlook for the future. Overall, the number of these jobs shows little change. A moderate number of job openings are expected over the next four or five years. Recently, there have been fewer new trainees than job openings. If this trend continues, job opportunities should be good. Placement rates at area vocational technical schools, community colleges, and/or technical institutes have been very good recently.

Hourly wages include:

\$8.17 Payroll and timekeeping clerks

\$8.30 Bookkeeping, accounting, and auditing clerks

Related postsecondary programs at state-supported institutions in this area are:

07.0101 Accounting and bookkeeping

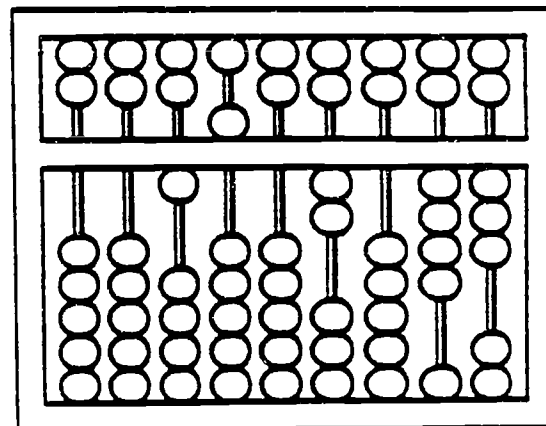
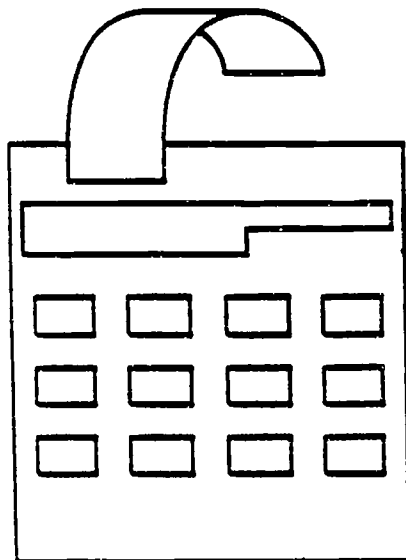

ADMINISTRATIVE SUPPORT: FINANCE AND INSURANCE

Workers provide clerical and general administrative support to the banking and finance industry. Workers receive and pay out money, keep records of money and negotiable instruments, interview applicants for credit, locate and notify customers of delinquent accounts, examine insurance claims, and process a variety of paperwork.

The two largest occupations are:

- Insurance adjusters, examiners, and investigators
- Tellers

The occupations expected to have the most job openings annually are:

- Tellers
- Bill and account collectors

These occupations may have a generally favorable outlook for the future. Overall, the number of these jobs is growing slowly. Large numbers of job openings are expected over the next four or five years. Recently, there have been fewer new trainees than job openings. If this trend continues, job opportunities should be good.

Hourly wages include:

\$5.89	Tellers
\$7.24	New accounts clerks
\$8.24	Bill and account collectors
\$8.94	Loan and credit clerks

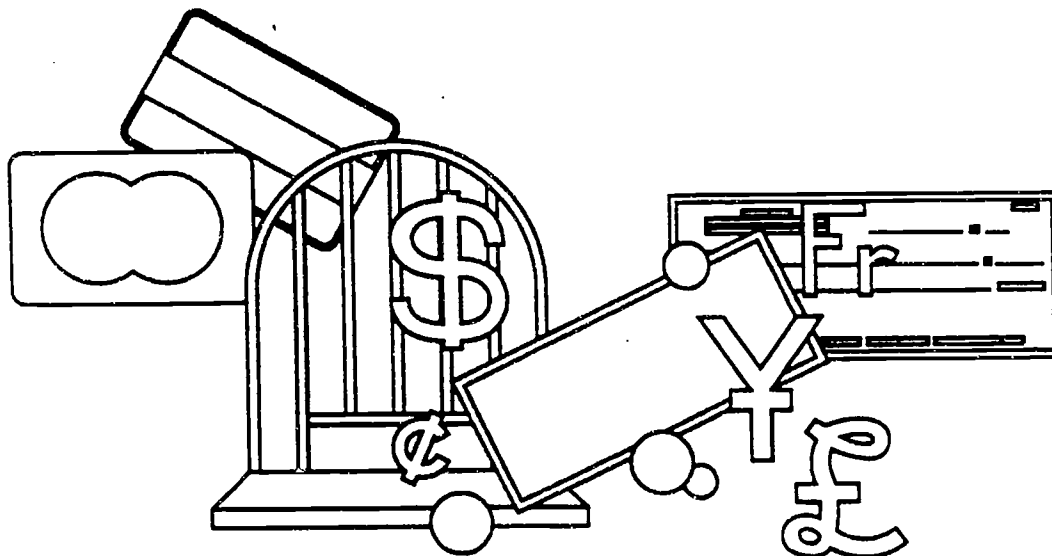

ADMINISTRATIVE SUPPORT: GENERAL

The job duties in this group of occupations are very diverse and are determined by the type of firm. For example, workers may schedule appointments, give information to callers, take dictation, type correspondence, read and route incoming mail, file correspondence and other records, and supervise and coordinate the activities of subordinate clerical workers.

The largest occupations, which also have the greatest number of job openings annually, are:

- Secretaries, except legal and medical secretaries
- General office clerks

These occupations may have a generally favorable outlook for the future. Overall, the number of these jobs is growing. Large numbers of job openings are expected over the next four or five years. Recently, there have been about as many new trainees as job openings. If this trend continues, job seekers can expect to face some competition. Placement rates at area vocational technical schools, community colleges, and/or technical institutes have been very good recently.

Hourly wages include:

\$5.85	File clerks
\$6.00	Order clerks- materials, merchandise, and service
\$6.75	Medical secretaries
\$6.82	Data entry keyers, except composing
\$6.90	General office clerks
\$6.96	Receptionists and information clerks
\$7.77	Typists including word processing
\$7.85	Adjustment clerks
\$8.37	Secretaries, ex. legal and medical
\$9.49	Legal secretaries
\$14.13	First line supervisors and manager/supervisors- clerical and administrative support occupations

High school programs preparing for these occupations are:

07.0601	Secretarial and related programs
07.0701	Typing, general office and related programs
07.9999	Miscellaneous business administrative support

Related postsecondary programs at state-supported institutions in this area are:

07.0606	Secretarial and office administration
17.0505	Medical office management
52.0401	Administrative assistant and secretarial science

AGRICULTURAL PRODUCTION

Workers in this field plan and economically use facilities, land, water, machinery, chemicals, finance, and labor in the production of plant and animal products.

The largest occupations, which also have the greatest number of job openings annually, are:

- Farm managers
- Farm workers

These occupations may have a generally favorable outlook for the future. Overall, the number of these jobs shows little change. A moderate number of job openings are expected over the next four or five years. Recently, there have been fewer new trainees than job openings.

High school programs preparing for these occupations are:

01.0301 Agricultural production

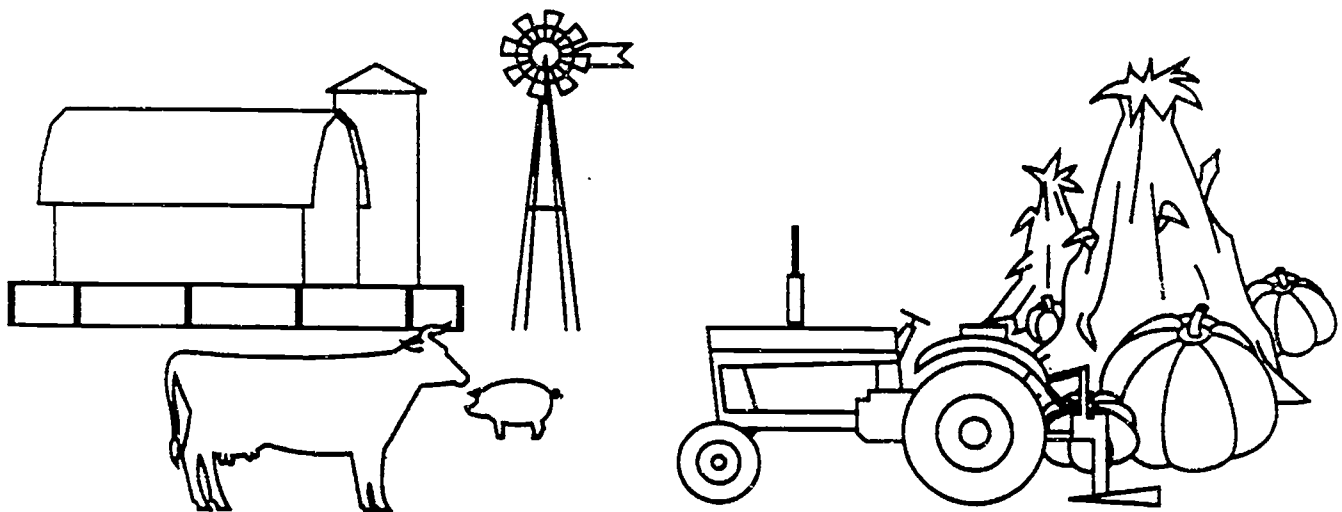

APPLIANCE AND EQUIPMENT REPAIR

Individuals in these occupations repair, adjust, maintain, and install all types of electrical motors and electrical and gas home appliances. Types of equipment used include test instruments, gauges, and hand, bench, and power tools.

The largest occupations, which also have the greatest number of job openings annually, are:

- Electric home appliance and power tool repairers
- Coin and vending machine servicers and repairers

These occupations may not have a favorable outlook for the future. Overall, the number of these jobs shows little change. Few job openings are expected over the next four or five years. Recently, there have been more new trainees than job openings. Placement rates at area vocational technical schools, community colleges, and/or technical institutes have been excellent recently.

Related postsecondary programs at state-supported institutions in this area are:

47.0101 Electrical and electronics technology

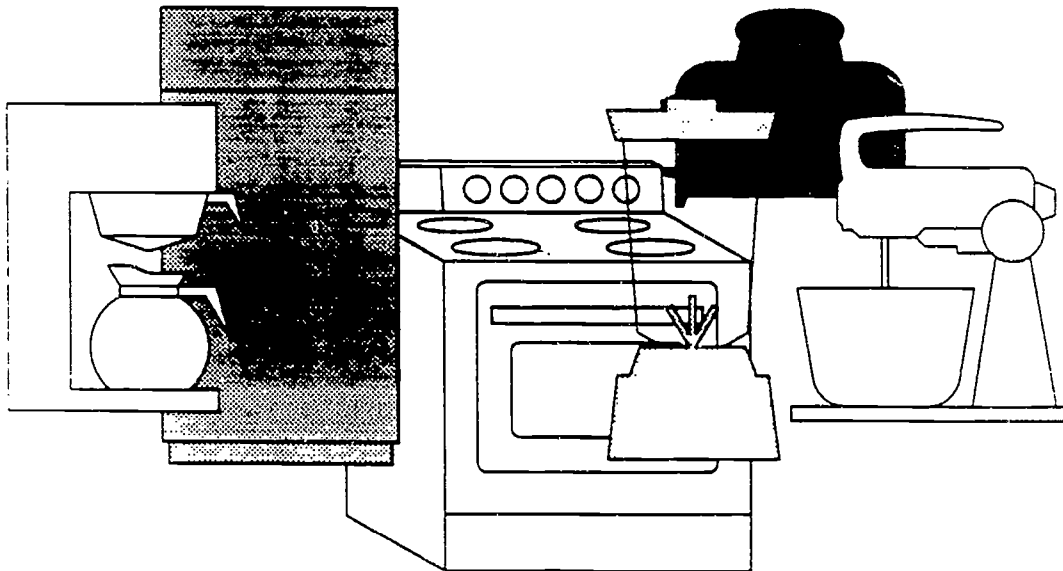

AUTOMOTIVE BODY REPAIR

Thousands of motor vehicles are damaged in traffic accidents every day. The workers in this field straighten bent frames, remove dents, and replace crumpled parts that are beyond repair so that those vehicles look and drive like new.

The largest occupations, which also have the greatest number of job openings annually, are:

- Automotive body and related repairers
- Painters of transportation equipment

These occupations may have a generally favorable outlook for the future. Overall, the number of these jobs is growing. Few job openings are expected over the next four or five years. Recently, there have been many more new trainees than job openings. Placement rates at area vocational technical schools, community colleges, and/or technical institutes have been excellent recently.

High school programs preparing for these occupations are:

47.0603 Automotive body repair

Related postsecondary programs at state-supported institutions in this area are:

47.0603 Automotive body repair

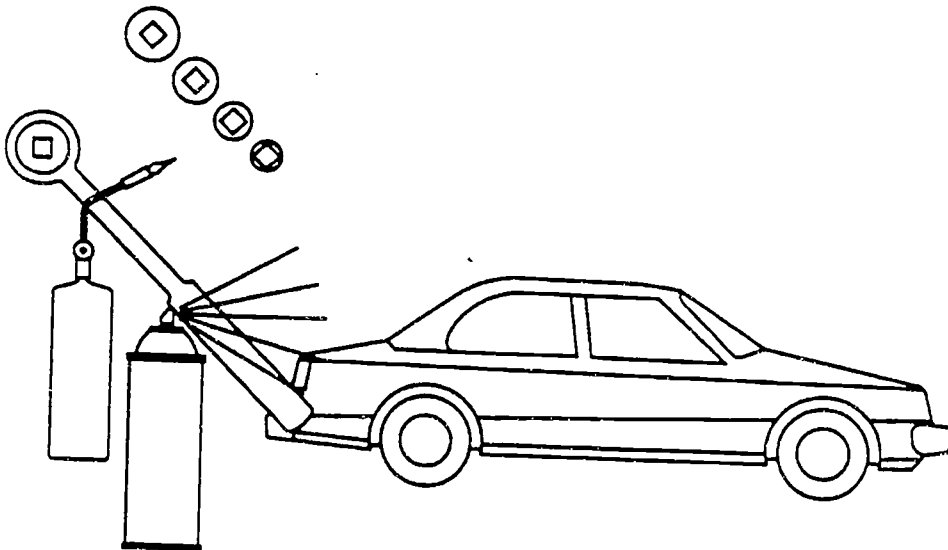

AUTOMOTIVE SERVICE TECHNOLOGY

These occupations include jobs concerned with parking, cleaning, polishing, lubricating, repairing, and refueling trucks, buses, and automobiles, and related servicing activities. The primary occupation, automotive mechanic, is concerned with repair and service of motor vehicles.

The largest occupations, which also have the greatest number of job openings annually, are:

- Automotive mechanics
- Tire repairers and changers

These occupations may not have a favorable outlook for the future. Overall, the number of these jobs is growing slowly. A moderate number of job openings are expected over the next four or five years. Recently, there have been many more new trainees than job openings. If this trend continues, job seekers can expect to face keen competition. Placement rates at area vocational technical schools, community colleges, and/or technical institutes have been good recently.

Hourly wages include:

\$10.43 Automotive mechanics

High school programs preparing for these occupations are:

47.0604 Automotive mechanics

Related postsecondary programs at state-supported institutions in this area are:

15.0803 Automotive technology

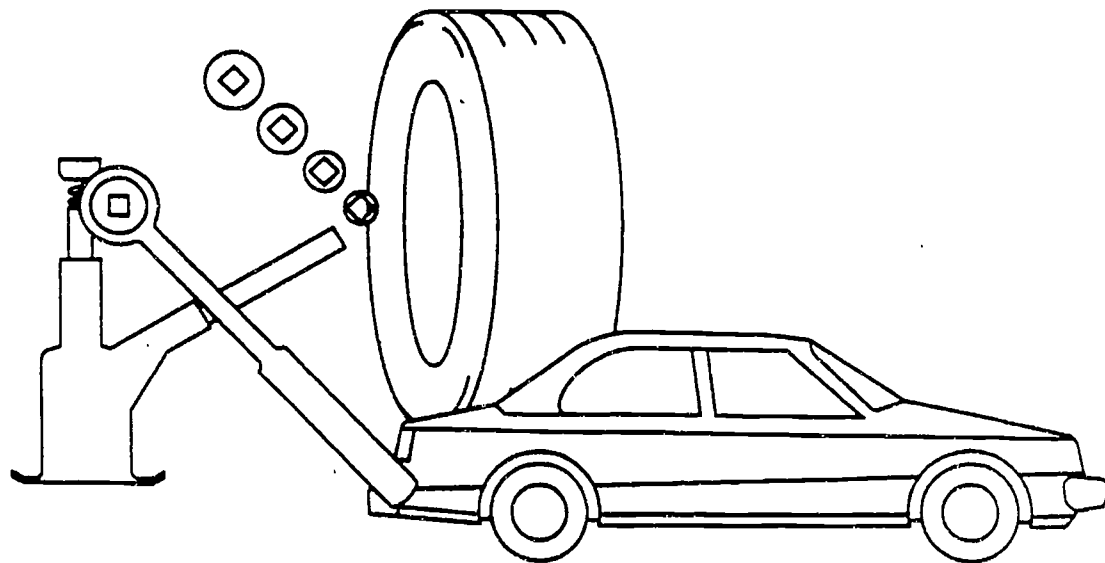

SDA 6 - 8

365

BAKING OCCUPATIONS

The workers in this group of jobs mix and bake ingredients according to recipes to produce breads, pastries, doughnuts, and other baked goods. These workers must be proficient in cleaning and maintaining the equipment used in preparing baked goods from raw materials.

The largest occupations, which also have the greatest number of job openings annually, are:

- Bakers of bread and pastry
- Bakers in manufacturing plants

These occupations may have a generally favorable outlook for the future. Overall, the number of these jobs is growing. Few job openings are expected over the next four or five years. Recently, no training has been reported.

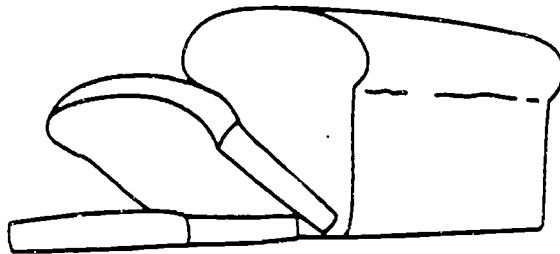

BUILDING MAINTENANCE

Persons in building maintenance occupations perform work involving several maintenance skills to keep the structure of an establishment in repair. Duties may involve pipefitting, boilermaking, carpentry, and electrical work as well as repairing buildings, floors, or stairs.

The largest occupations, which also have the greatest number of job openings annually, are:

- General utility maintenance repairers
- Stationary engineers

These occupations may have a generally favorable outlook for the future. Overall, the number of these jobs is growing. A moderate number of job openings are expected over the next four or five years. Recently, there have been fewer new trainees than job openings. If this trend continues, job opportunities should be good.

Hourly wages include:

\$7.59 Maintenance repairers, general utility

High school programs preparing for these occupations are:

46.0401 Building maintenance

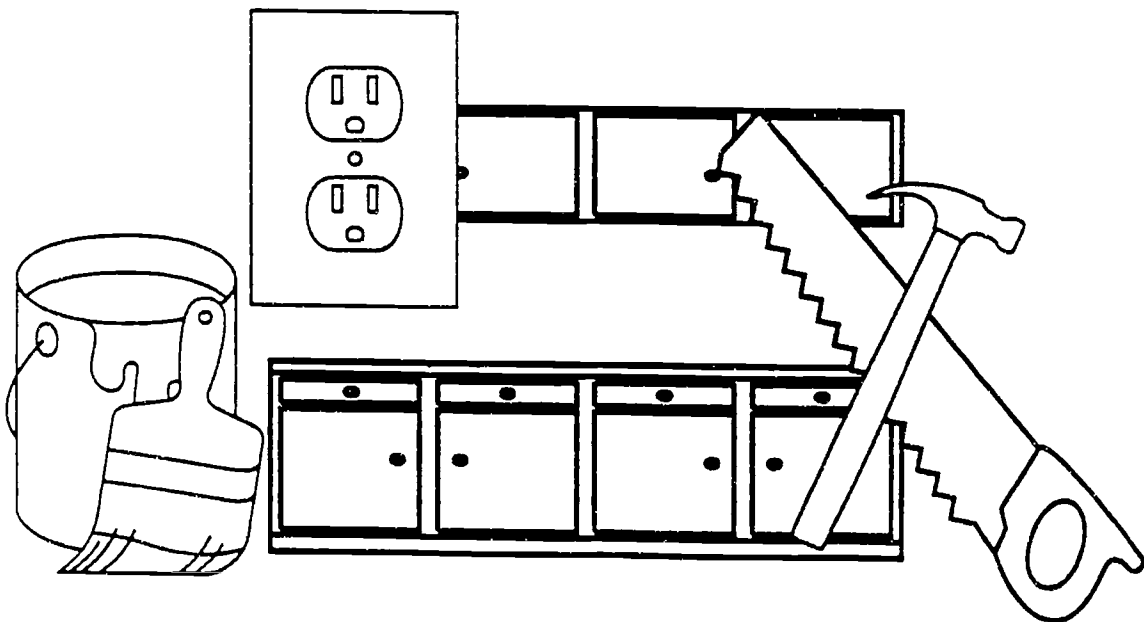

367

CARPENTRY

Almost all construction projects employ carpenters, the largest group of building trades workers. Carpenters perform a variety of jobs. Their duties will vary by type of construction, type of company, skill of the carpenter, and size of the community. A carpenter employed by a special trade contractor, for example, may specialize in laying hardwood floors, while one who is employed by a general building contractor may build wall frames and install paneling.

The largest occupations, which also have the greatest number of job openings annually, are:

- Carpenters
- Ceiling tile installers and acoustical carpenters

These occupations may have a generally favorable outlook for the future. Overall, the number of these jobs is growing slowly. A moderate number of job openings are expected over the next four or five years. Recently, there have been fewer new trainees than job openings. If this trend continues, job opportunities should be good.

Hourly wages include:

\$11.72 Carpenters

High school programs preparing for these occupations are:

46.0201 Carpentry

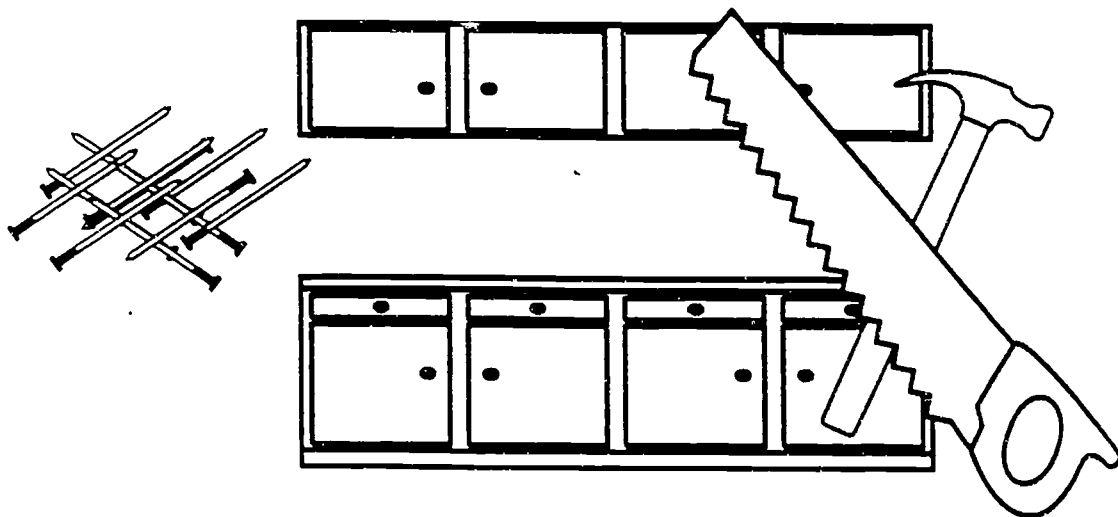

CHEMICAL TECHNOLOGY

Chemical technology workers either research and monitor chemical processes or are directly involved in operating equipment or control boards to create chemical reactions and processes in industrial settings. Technicians work with chemists or chemical engineers, setting up and conducting experiments and collecting and analyzing data.

The two largest occupations are:

- Chemical (except health) technicians and technologists
- Chemical equipment controllers and operators

The occupations expected to have the most job openings annually are:

- Chemical plant and system operators
- Chemical equipment controllers and operators

These occupations may have a generally favorable outlook for the future. Overall, the number of these jobs shows little change. Few job openings are expected over the next four or five years. Recently, there have been fewer new trainees than job openings.

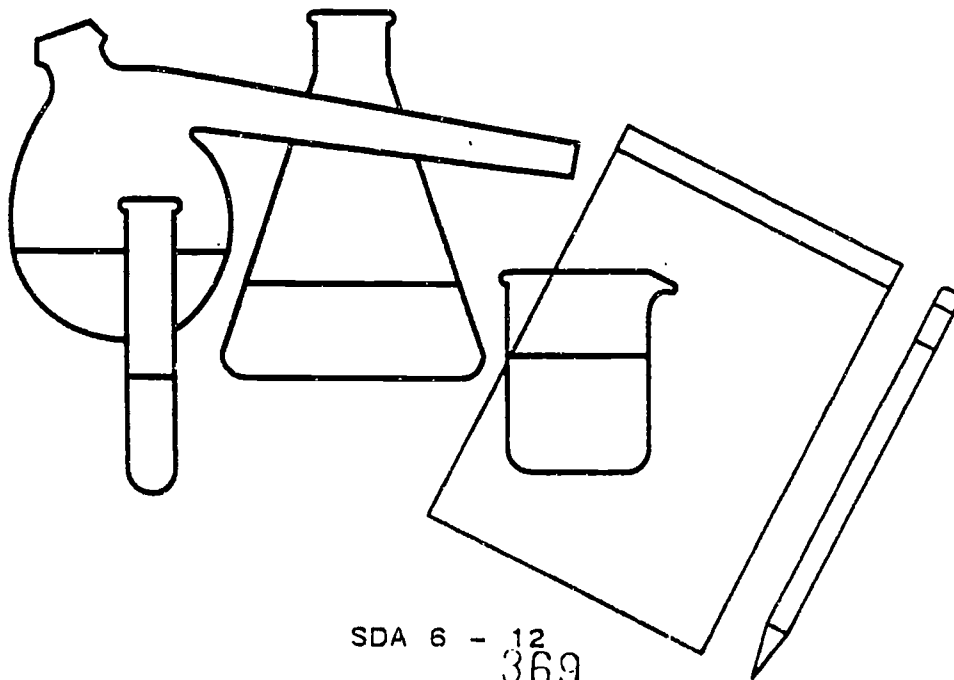

COMMERCIAL ART AND DESIGN

The majority of workers in this field design or arrange objects and materials in an artistic or decorative manner. Additional tasks may include the creation or drawing of designs for items such as furniture and machinery (product design).

The largest occupations, which also have the greatest number of job openings annually, are:

- Artists and related workers
- Designers, except interior designers

These occupations may have a generally favorable outlook for the future. Overall, the number of these jobs is growing. A moderate number of job openings are expected over the next four or five years. Recently, there have been fewer new trainees than job openings. If this trend continues, job opportunities should be good.

High school programs preparing for these occupations are:

48.0203 Commercial art

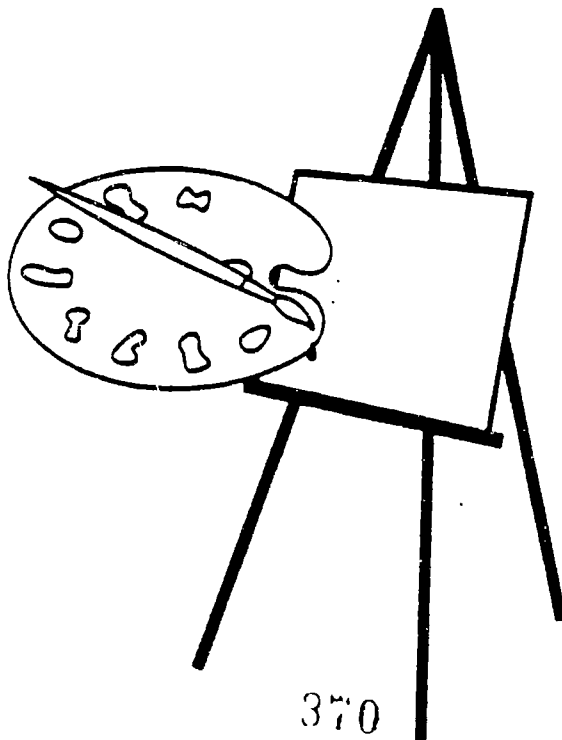

370

COMMUNICATIONS, JOURNALISM, AND BROADCASTING

Individuals who work in these fields are concerned with communicating ideas and information to individuals for their education and entertainment. The methods utilized are varied and may include the written word, radio, and television.

The two largest occupations are:

- Writers and editors
- Reporters and correspondents

The occupations expected to have the most job openings annually are:

- Writers and editors
- Radio and television announcers

These occupations may have a generally favorable outlook for the future. Overall, the number of these jobs is growing. Few job openings are expected over the next four or five years. Recently, there have been many more new trainees than job openings. Placement rates at area vocational technical schools, community colleges, and/or technical institutes have been excellent recently.

Hourly wages include:

\$14.84 Writers and editors

Related postsecondary programs at state-supported institutions in this area are:

09.0101 General communications
23.1101 Technical and business writing

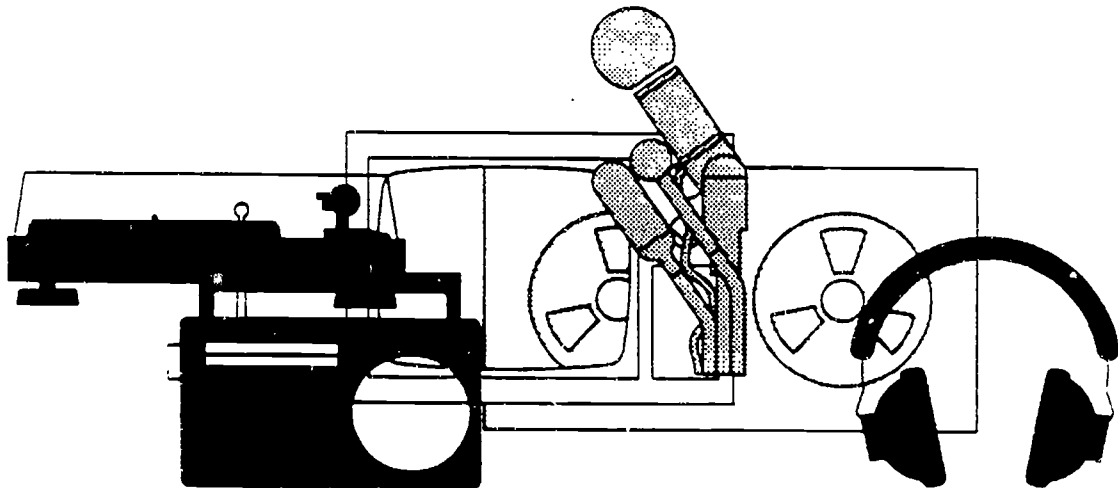

COMPUTER, ELECTRICAL, AND ELECTRONICS TECHNOLOGY

The majority of workers in this field are electrical and electronic engineering technicians and technologists. They apply electrical and related knowledge to design, build, test, and repair electrical equipment in industrial or commercial settings for subsequent use by engineering personnel.

This occupation may not have a favorable outlook for the future. Few job openings are expected over the next four or five years. Recently, there have been many more new trainees than job openings. Placement rates at area vocational technical schools, community colleges, and/or technical institutes have been good recently.

Average hourly wages are \$11.81

Related postsecondary programs at state-supported institutions in this area are:

15.0399 Miscellaneous electrical and electronic engineering-related technologies

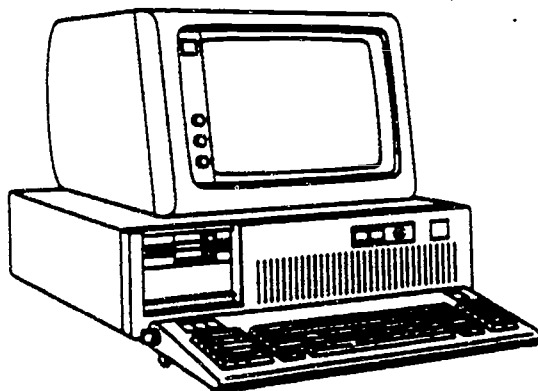

COMPUTER SYSTEMS

Workers in these computer occupations develop and write computer programs to store, locate, and retrieve specific documents, data, and information. They may also analyze business, scientific, and technical problems for application to electronic data processing systems. These careers generally require specialized training.

The largest occupations, which also have the greatest number of job openings annually, are:

- Systems analysts, electronic data processing
- Computer programmers

These occupations may have a generally favorable outlook for the future. Overall, the number of these jobs is growing rapidly. Large numbers of job openings are expected over the next four or five years. Recently, there have been more new trainees than job openings. If this trend continues, job seekers can expect to face some competition. Placement rates at area vocational technical schools, community colleges, and/or technical institutes have been good recently.

Hourly wages include:

- \$14.64 Computer programmers
- \$20.19 Systems analysts, electronic data processing

High school programs preparing for these occupations are:

- 07.0399 Miscellaneous business data processing

Related postsecondary programs at state-supported institutions in this area are:

- 11.0401 Information systems technology
- 11.0701 Computer science

COSMETOLOGY

Cosmetologists and related workers provide beauty services for customers. These may include cutting and styling hair, treating hair and scalp, applying makeup, dressing wigs, or removing hair by electrolysis, as well as cleaning, shaping, and polishing a customer's fingernails and toenails.

The two largest occupations are:

- Hairdressers, hairstylists, and cosmetologists
- Manicurists

The occupations expected to have the most job openings annually are:

- Hairdressers, hairstylists, and cosmetologists
- Shampooers

These occupations may have a generally favorable outlook for the future. Overall, the number of these jobs is growing. A moderate number of job openings are expected over the next four or five years. Recently, there have been many more new trainees than job openings. If this trend continues, job seekers can expect to face keen competition. Placement rates at area vocational technical schools, community colleges, and/or technical institutes have been excellent recently.

High school programs preparing for these occupations are:

12.0403 Cosmetology

Related postsecondary programs at state-supported institutions in this area are:

12.0403 Cosmetology

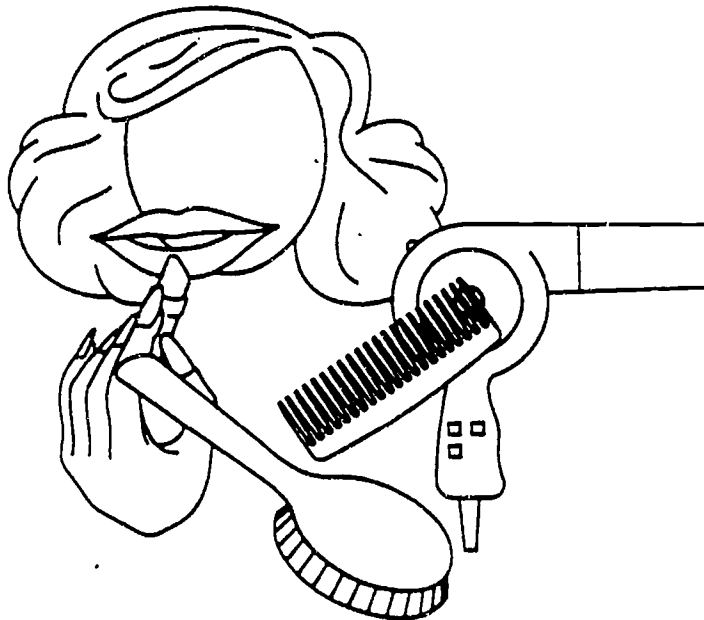

DENTAL ASSISTING

Dental assistants may perform a wide variety of clinical, office, and laboratory duties, depending on the size of the dental practice. Typically, assistants seat patients in the dental chair, prepare them for the dentist's treatment, and work with the dentist during examination and treatment.

This occupation may not have a favorable outlook for the future. Few job openings are expected over the next four or five years. Recently, there have been many more new trainees than job openings. Placement rates at area vocational technical schools, community colleges, and/or technical institutes have been good recently.

Related postsecondary programs at state-supported institutions in this area are:

17.0101 Dental assisting

Licensing may be required. Contact: TENNESSEE BOARD OF DENTISTRY, 615-367-6228.

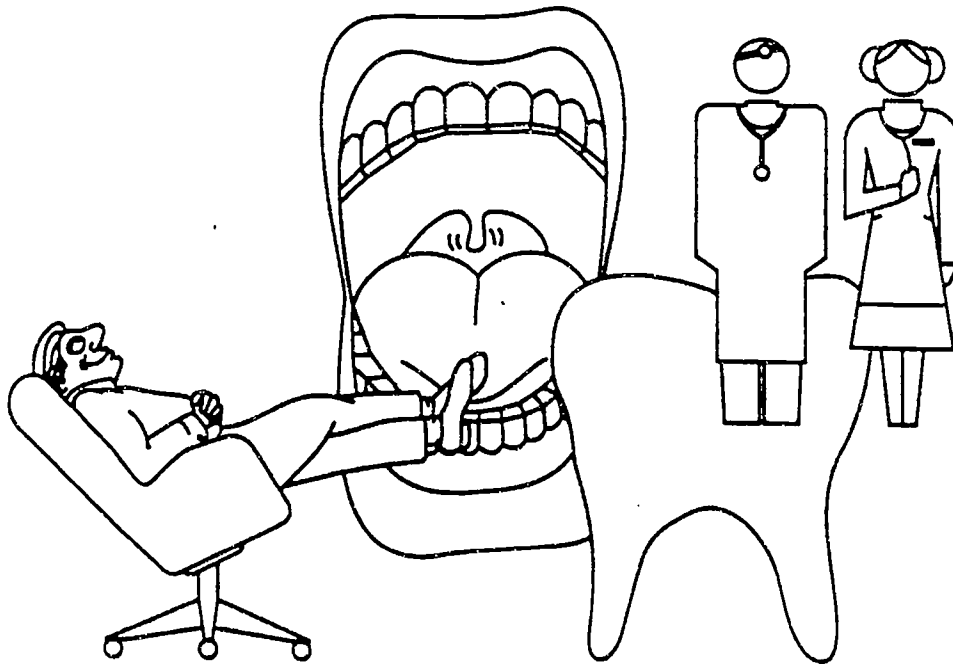

DENTAL HYGIENE

Dental hygienists provide preventive dental care and encourage patients to develop good oral health skills. They evaluate patients' dental health; remove calculus, stain, and plaque from above and below the gumline; expose and develop dental x-rays; and instruct patients on plaque control.

This occupation may have a generally favorable outlook for the future. Few job openings are expected over the next four or five years. Recently, there have been more new trainees than job openings. Placement rates at area vocational technical schools, community colleges, and/or technical institutes have been excellent recently.

Related postsecondary programs at state-supported institutions in this area are:

17.0102 Dental hygiene

Licensing may be required. Contact: TENNESSEE BOARD OF DENTISTRY, 615-367-6228.

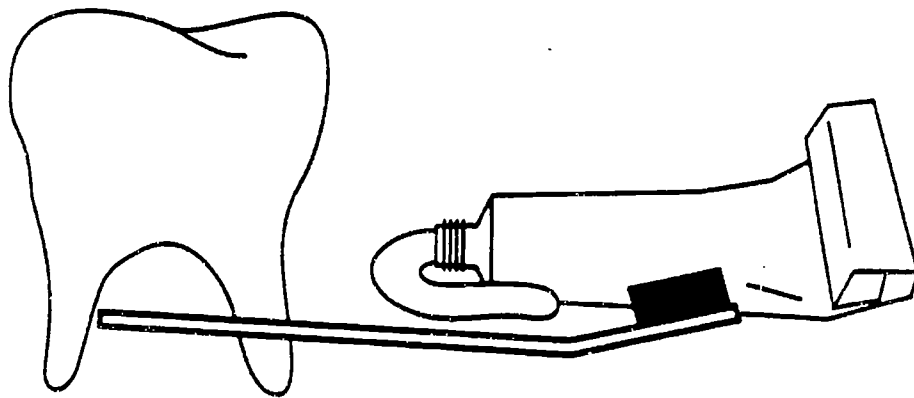

376

SDA 6 - 19

DRAFTING AND DESIGN TECHNOLOGY

Persons in drafting and design technology prepare clear, complete, and accurate working plans and detail drawings from rough or detailed sketches or notes for engineering or manufacturing purposes according to specified dimensions. Workers need to have knowledge of various machines, engineering practices, mathematics, building materials, and other physical sciences to complete drawings. Computer-assisted design (CAD) equipment may be used by some workers.

The largest occupations, which also have the greatest number of job openings annually, are:

- Cost estimators
- Drafters

These occupations may have a generally favorable outlook for the future. Overall, the number of these jobs is growing. A moderate number of job openings are expected over the next four or five years. Recently, there have been many more new trainees than job openings. Placement rates at area vocational technical schools, community colleges, and/or technical institutes have been very good recently.

Hourly wages include:

\$9.29 Drafters

High school programs preparing for these occupations are:

48.0101 Drafting

Related postsecondary programs at state-supported institutions in this area are:

15.0202 Drafting and design technology

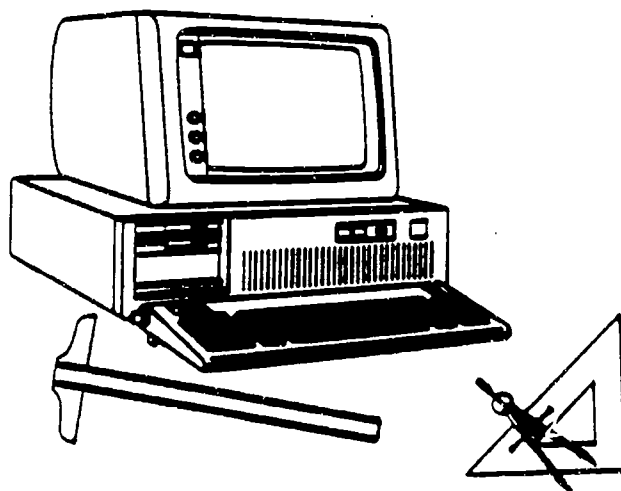

SDA 6 - 20

377

DRYCLEANING

Workers in these occupations operate washing and drying machines to clean and dry clean commercial, industrial, or household articles; use pressing machines to press and shape articles; and identify stains and apply chemical solutions to remove them.

The largest occupations, which also have the greatest number of job openings annually, are:

- Laundry and drycleaning machine operators and tenders, except of pressing machines
- Operators and tenders of machines pressing textiles, garments, and related materials

These occupations may have a generally favorable outlook for the future. Overall, the number of these jobs is growing slowly. Few job openings are expected over the next four or five years. Recently, no training has been reported.

Hourly wages include:

\$4.78 Laundry and drycleaning machine operators and tenders, except pressing

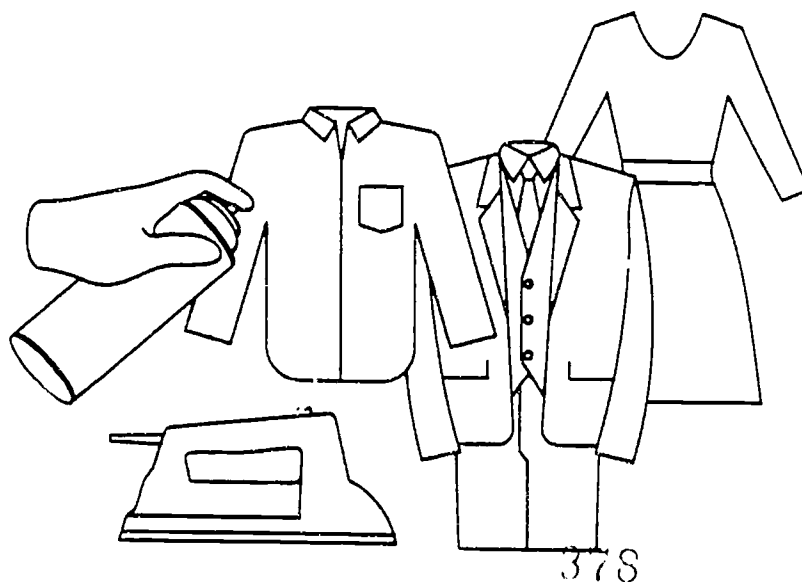

EARLY CHILDHOOD EDUCATION

Child care workers and managers of child care centers assume responsibility for the safety, physical care, and emotional, social, and intellectual growth of preschool children and infants while parents are at work or are unavailable for other reasons. Some work in residential institutions for young children. Teacher aides assist teachers by handling routine paperwork or by working directly with children.

The largest occupations, which also have the greatest number of job openings annually, are:

- Teacher aides, paraprofessional
- Child care workers

These occupations may have a generally favorable outlook for the future. Overall, the number of these jobs is growing rapidly. Large numbers of job openings are expected over the next four or five years. Recently, there have been fewer new trainees than job openings. If this trend continues, job opportunities should be good. Placement rates at area vocational technical schools, community colleges, and/or technical institutes have been good recently.

Hourly wages include:

\$5.28 Child care workers

High school programs preparing for these occupations are:

20.0201 Child care and guidance management services

Related postsecondary programs at state-supported institutions in this area are:

20.0201 Child care and guidance management services

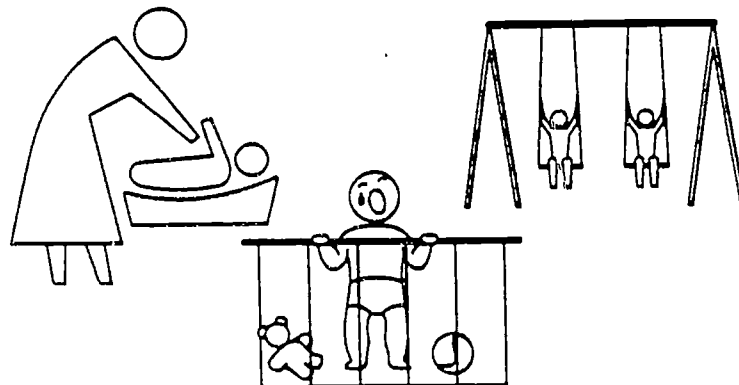

ELECTRICIAN OCCUPATIONS

Workers in the electrical field install, maintain, and repair wiring, electrical equipment, and fixtures or assist in such activities. These workers insure that work is in accordance with the relevant codes. A high school education is usually required and a five-year apprenticeship program is recommended.

The largest occupations, which also have the greatest number of job openings annually, are:

- Electricians
- Helpers of electricians and powerline transmission installers

These occupations may have a generally favorable outlook for the future. Overall, the number of these jobs is growing. A moderate number of job openings are expected over the next four or five years. Recently, no training has been reported. Job opportunities should be good.

Hourly wages include:

\$15.13 Electricians

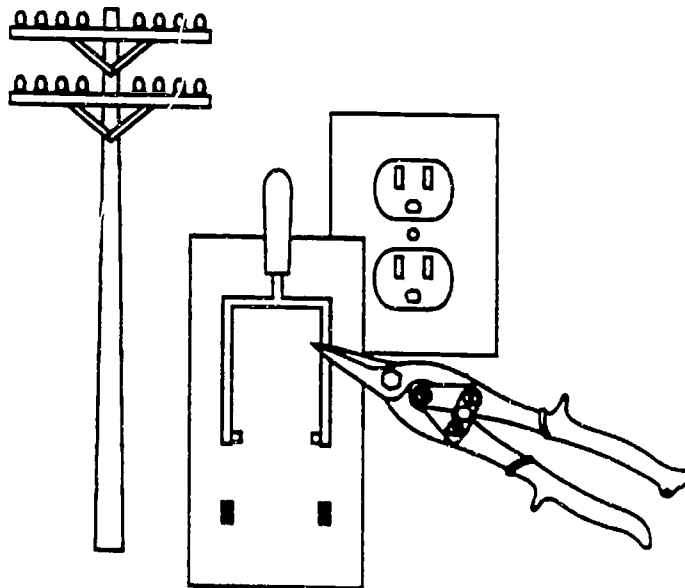

SDA 6 - 23

350

FIRE CONTROL AND SAFETY TECHNOLOGY

Workers in these positions help protect the public against the danger to their lives and property by fire. Firefighters must be prepared to respond to a fire and handle any emergency, including medical, that arises. Some firefighters operate fire apparatus, ambulances, emergency rescue vehicles, and fireboats. Most fire departments also are responsible for fire prevention.

The largest occupations, which also have the greatest number of job openings annually, are:

- Fire fighting and prevention supervisors
- Fire fighters

These occupations may have a generally favorable outlook for the future. Overall, the number of these jobs is growing. A moderate number of job openings are expected over the next four or five years. Recently, there have been fewer new trainees than job openings. Placement rates at area vocational technical schools, community colleges, and/or technical institutes have been good recently.

Related postsecondary programs at state-supported institutions in this area are:

43.0201 Fire control and safety technology

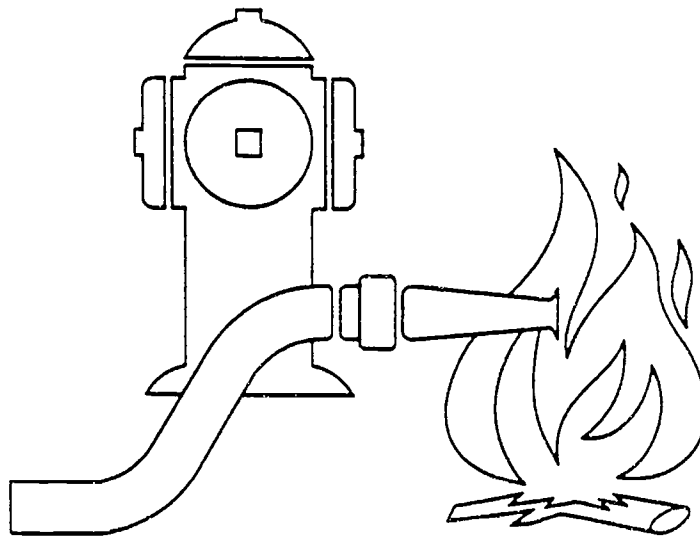

FOOD PREPARATION AND SERVICES

The majority of workers in these occupations prepare and serve food and beverages in restaurants, fast food establishments, catering firms, hotels, clubs, factories, school cafeterias, or hospitals, or supervise those providing food services. Others are factory machine operators involved in the preparation of food products. Dietetic technicians teach principles of food nutrition and provide dietary counseling to patients.

The largest occupations, which also have the greatest number of job openings annually, are:

- Food preparation workers
- Combined food preparation and service workers

These occupations may have a generally favorable outlook for the future. Overall, the number of these jobs is growing. Large numbers of job openings are expected over the next four or five years. Recently, there have been fewer new trainees than job openings. If this trend continues, job opportunities should be good.

Hourly wages include:

- \$4.12 Bartenders
- \$4.50 Cooks, specialty fast food
- \$4.63 Food preparation workers
- \$6.24 Cooks, restaurant

High school programs preparing for these occupations are:

- 46.1111 Food occupations

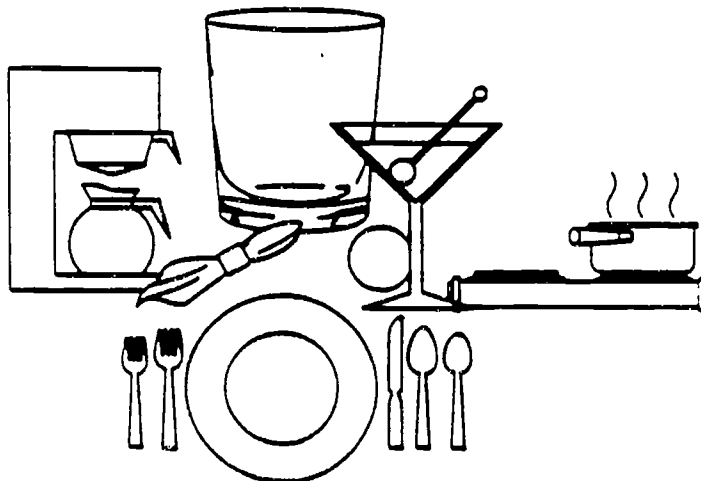

GENERAL BUSINESS AND MANAGEMENT

Workers in the general business and management occupations plan, organize, direct, control, or coordinate activities in all types of fields. Many occupations involve analysis of productivity and financial soundness. General managers and top executives usually have very diverse duties and responsibilities and work through departmental or subordinate executives.

The two largest occupations are:

- General managers and top executives
- Engineering, mathematical, and natural sciences managers

The occupations expected to have the most job openings annually are:

- General managers and top executives
- Industrial production managers

These occupations may have a generally favorable outlook for the future. Overall, the number of these jobs is growing. Large numbers of job openings are expected over the next four or five years. Recently, there have been about as many new trainees as job openings. If this trend continues, job seekers can expect to face some competition. Placement rates at area vocational technical schools, community colleges, and/or technical institutes have been good recently.

Hourly wages include:

- \$18.10 Purchasing managers
- \$19.77 Industrial production managers

Related postsecondary programs at state-supported institutions in this area are:

- 06.0401 Business administration and management
- 14.3001 Engineering management
- 52.0201 General business administration and management



GENERAL WOODWORKING

Woodworkers are in occupations concerned with the complete cycle of cutting, shaping, and assembling parts of complex wood products. The occupations are primarily concerned with one or a limited number of machine functions according to their speciality.

The two largest occupations are:

- Assemblers and fabricators, except machine, electrical, electronic, and precision assembly
- Cabinetmakers and bench carpenters

The occupations expected to have the most job openings annually are:

- Assemblers and fabricators, except machine, electrical, electronic, and precision assembly
- Sawing machine operators and tenders

These occupations may have a generally favorable outlook for the future. Overall, the number of these jobs shows little change. A moderate number of job openings are expected over the next four or five years. Recently, there have been fewer new trainees than job openings.

High school programs preparing for these occupations are:

48.0701 Woodworking

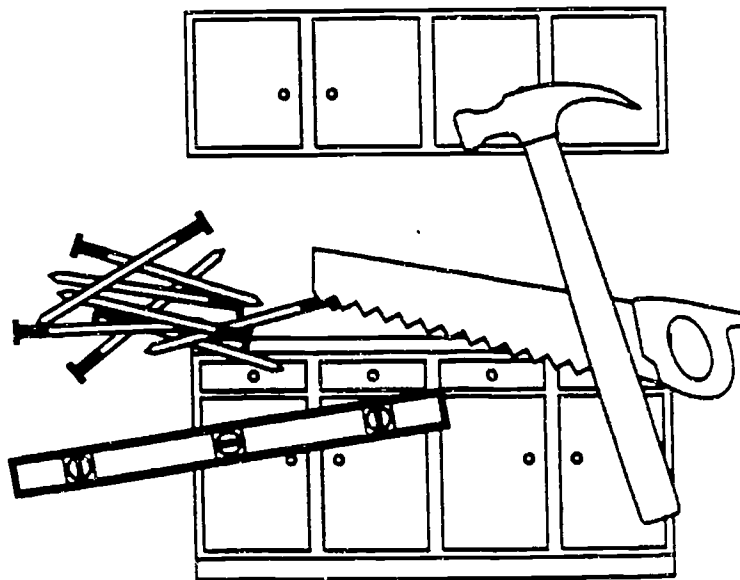

GRAPHIC ARTS

A majority of workers in this field are involved in offset printing. In this process the material to be printed is photographed and a printing plate is made from the film. This process has been advanced by the use of computers and lasers.

The largest occupations, which also have the greatest number of job openings annually, are:

- Offset lithographic press setters and set-up operators
- Printing press machine operators and tenders

These occupations may not have a favorable outlook for the future. Overall, the number of these jobs is growing. Few job openings are expected over the next four or five years. Recently, there have been many more new trainees than job openings. Placement rates at area vocational technical schools, community colleges, and/or technical institutes have been good recently.

Hourly wages include:

\$11.00 Offset lithographic press setters & set-up operators, sheet or web fed

High school programs preparing for these occupations are:

48.0201 Graphic and printing communications

Related postsecondary programs at state-supported institutions in this area are:

48.0201 Graphic and printing communications

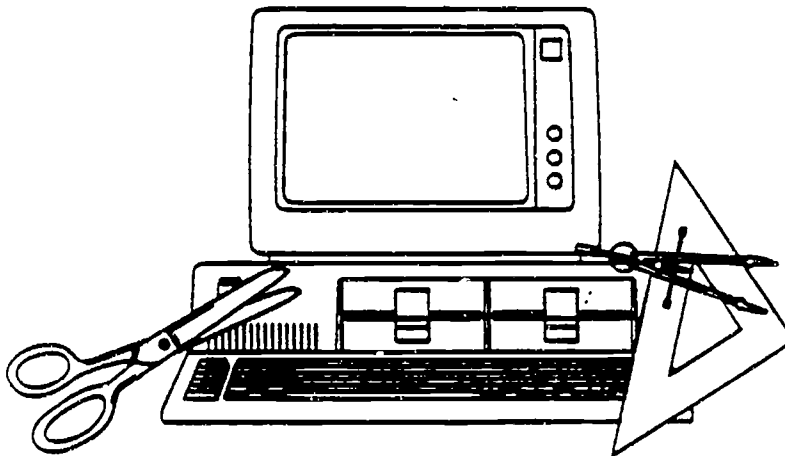

HEATING AND AIR CONDITIONING

Workers in this field install and repair heating, air conditioning, and refrigeration systems. They may install and repair oil burners, hot-air furnaces, and heating stoves in homes and businesses. They may also install and repair air conditioning systems, or install sheet metal ducts for the heating and cooling systems.

The largest occupations, which also have the greatest number of job openings annually, are:

- Heating, air conditioning, and refrigeration mechanics and installers
- Sheet metal duct installers

These occupations may have a generally favorable outlook for the future. Overall, the number of these jobs is growing. Few job openings are expected over the next four or five years. Recently, there have been many more new trainees than job openings. Placement rates at area vocational technical schools, community colleges, and/or technical institutes have been excellent recently.

Hourly wages include:

\$10.43 Heating, air conditioning, and refrigeration mechanics and installers

High school programs preparing for these occupations are:

47.0201 Heating, air conditioning, and refrigeration mechanics

Related postsecondary programs at state-supported institutions in this area are:

47.0201 Heating, air conditioning, and refrigeration mechanics

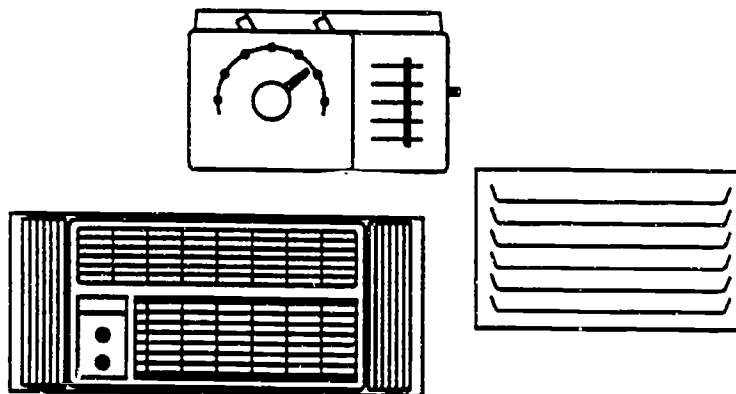

386

SDA 6 - 29

HEAVY TRUCK MAINTENANCE

Persons in heavy truck maintenance repair and maintain the operating condition of trucks, buses, and all types of diesel engines. This also includes mechanics working primarily with automobile diesel engines.

This occupation may have a generally favorable outlook for the future. Overall, the number of these jobs is growing. A moderate number of job openings are expected over the next four or five years. Recently, there have been fewer new trainees than job openings. Placement rates at area vocational technical schools, community colleges, and/or technical institutes have been good recently.

Average hourly wages are \$9.60

High school programs preparing for these occupations are:

47.0605 Diesel engine mechanics

Related postsecondary programs at state-supported institutions in this area are:

47.0605 Diesel engine mechanics

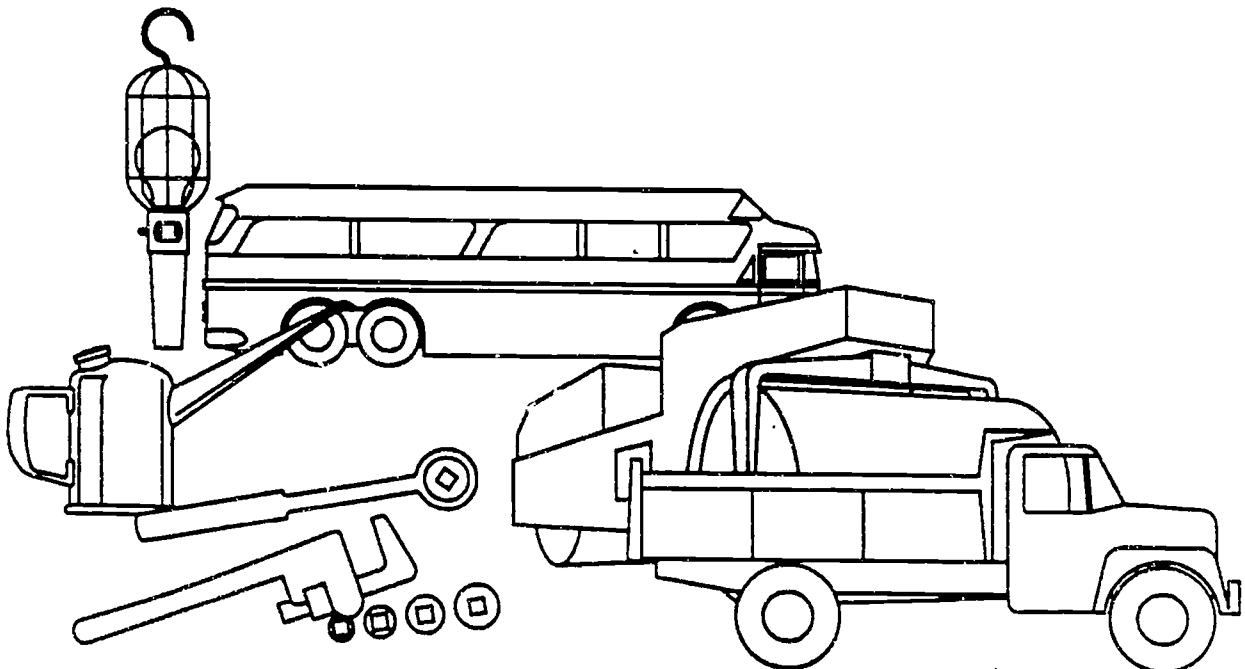

HORTICULTURE AND LANDSCAPING

The largest group of workers in these occupations, gardeners and groundskeepers, maintain the grounds of public and private property. Duties may include mowing, trimming, planting, and watering plants, shrubs, and grass.

The largest occupations, which also have the greatest number of job openings annually, are:

- Nursery workers
- Gardeners and groundskeepers, except farm workers

These occupations may have a generally favorable outlook for the future. Overall, the number of these jobs is growing. A moderate number of job openings are expected over the next four or five years. Recently, there have been many more new trainees than job openings. If this trend continues, job seekers can expect to face keen competition. Placement rates at area vocational technical schools, community colleges, and/or technical institutes have been excellent recently.

Hourly wages include:

\$6.32 Gardeners and groundskeepers, except farm

High school programs preparing for these occupations are:

01.0601 Horticulture

Related postsecondary programs at state-supported institutions in this area are:

01.0601 Horticulture

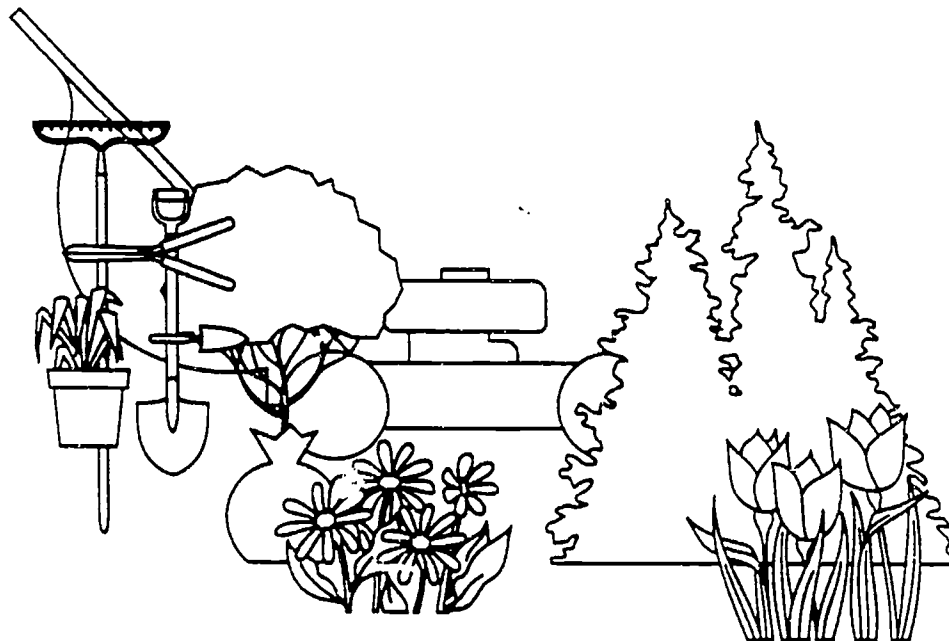

HOTEL AND RESTAURANT MANAGEMENT

Food service and lodging managers supervise the profitable operation of restaurants, hotels, and motels. Workers direct the varied activities of these businesses with the goal of pleasing people and providing good service to their customers.

This occupation may have a generally favorable outlook for the future. Overall, the number of these jobs is growing rapidly. Large numbers of job openings are expected over the next four or five years. Recently, no training has been reported. Job opportunities should be good.

Average hourly wages are \$10.43

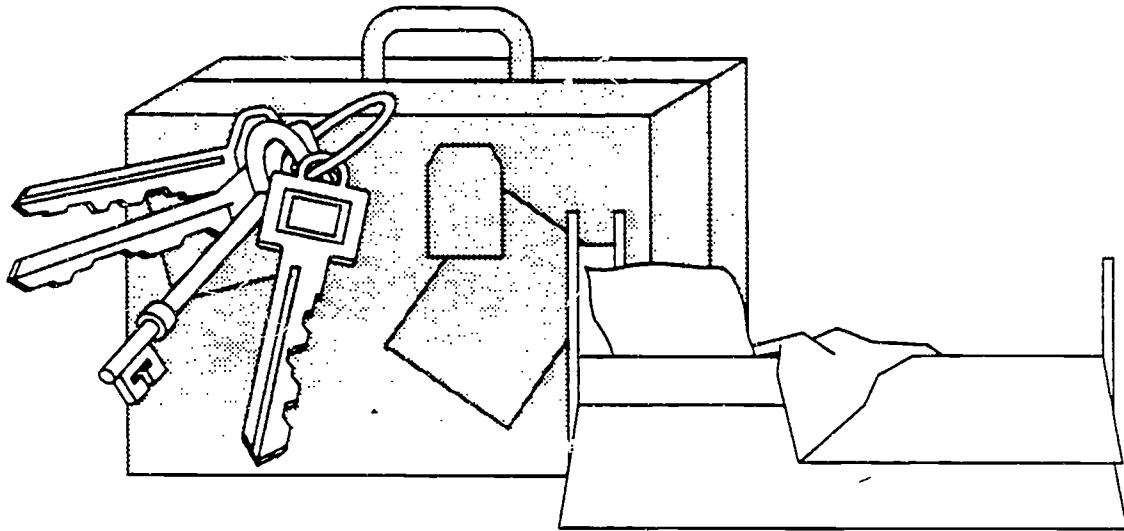

INDUSTRIAL MAINTENANCE TECHNOLOGY

Workers prevent costly waste of raw materials and the idling of human resources in a plant or factory by making industrial machinery repairs as quickly as possible. Maintenance mechanics spend considerable time doing preventive maintenance, including keeping machines well oiled and greased, and periodically cleaning parts.

The two largest occupations are:

- Maintenance mechanics for industrial machinery
- Textile machine setters and set-up operators

The occupations expected to have the most job openings annually are:

- Maintenance mechanics for industrial machinery
- Millwrights

These occupations may have a generally favorable outlook for the future. Overall, the number of these jobs shows little change. A moderate number of job openings are expected over the next four or five years. Recently, there have been about as many new trainees as job openings. If this trend continues, job seekers can expect to face some competition. Placement rates at area vocational technical schools, community colleges, and/or technical institutes have been excellent recently.

Hourly wages include:

\$10.97 Machinery maintenance mechanics

Related postsecondary programs at state-supported institutions in this area are:

47.0303 Industrial mechanics technology

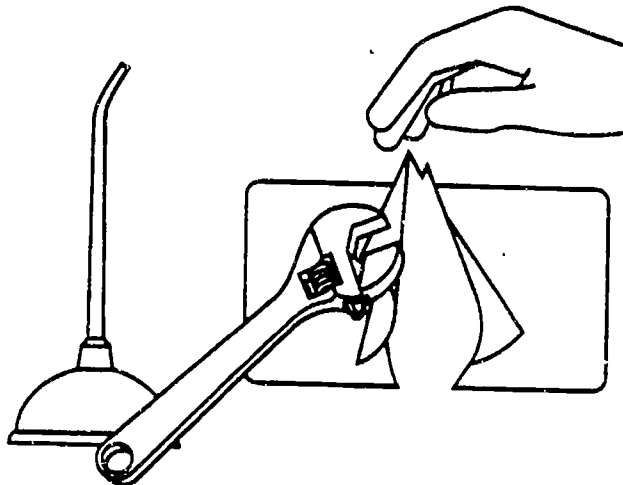

SDA 6 - 330

INSTITUTIONAL HOME MANAGEMENT AND SUPPORTING SERVICES

These workers make sure that all public buildings, offices, hospitals, stores, and apartment houses are kept clean and in good condition for the comfort and safety of the people who work or live there. Generally, no special education is required for occupations in this field, with most skills learned on the job.

The largest occupations, which also have the greatest number of job openings annually, are:

- Maids and housekeeping cleaners
- Janitors and cleaners, except maids and housekeeping cleaners

These occupations may have a generally favorable outlook for the future. Overall, the number of these jobs is growing. Large numbers of job openings are expected over the next four or five years. Recently, there have been fewer new trainees than job openings. If this trend continues, job opportunities should be good.

Hourly wages include:

- \$4.39 Maids and housekeeping cleaners
- \$5.41 Housekeepers
- \$5.57 Janitors and cleaners, except maids and housekeeping cleaners

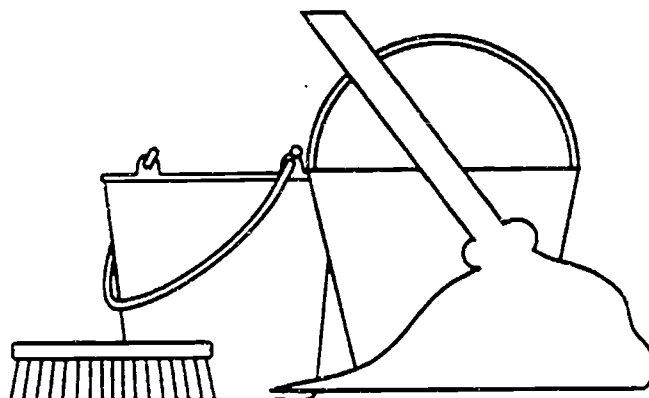

LABORATORY TECHNICIAN

Medical and clinical laboratory technicians perform routine laboratory tests for use in the treatment and diagnosis of disease; prepare vaccines, biologicals, and serums for prevention of disease; and prepare tissue samples, take blood samples, and execute laboratory tests including urinalyses and blood counts.

This occupation may have a generally favorable outlook for the future. Overall, the number of these jobs is growing. Few job openings are expected over the next four or five years. Recently, no training has been reported.

Average hourly wages are \$11.68

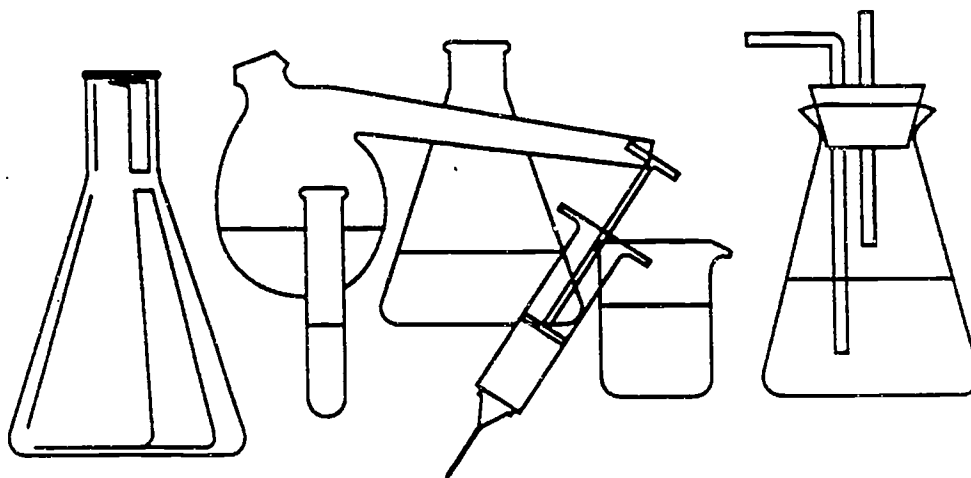

LAW ENFORCEMENT

People working at these occupations are responsible for the safety of Tennessee cities, towns, and highways. Their responsibilities range from controlling traffic to preventing and investigating crimes. Whether on or off duty, they are expected to exercise their authority whenever necessary.

The largest occupations, which also have the greatest number of job openings annually, are:

- Police patrol officers
- Sheriffs and deputy sheriffs

These occupations may have a generally favorable outlook for the future. Overall, the number of these jobs is growing slowly. A moderate number of job openings are expected over the next four or five years. Recently, no training has been reported.. Job opportunities should be good.

Hourly wages include:

\$9.15 Police patrol officers

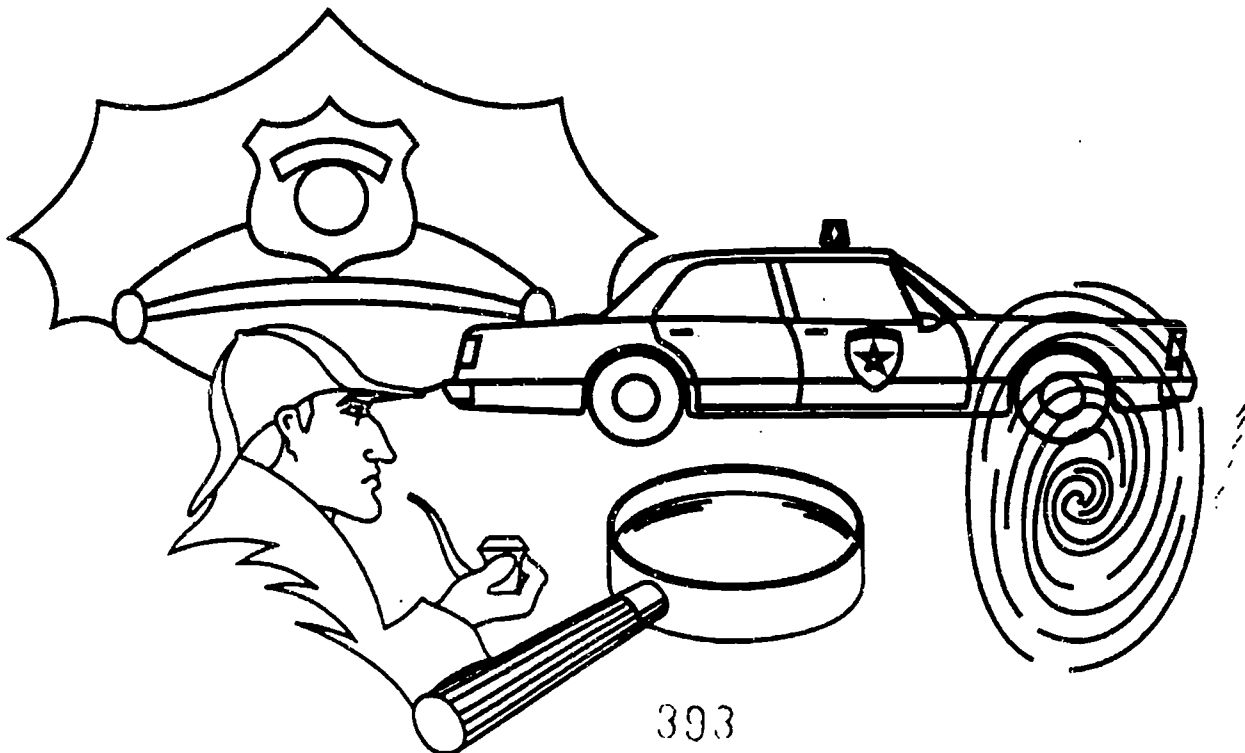

393

LEGAL ASSISTING

Under the direct supervision of a lawyer, workers employed in paralegal occupations do research for the preparation of lawsuits and legal documents; gather information for use as evidence in trials; draft documents such as mortgages, deeds, and contracts; and search titles to determine if a title deed is correct. Most paralegal personnel work for private law firms.

The largest occupations, which also have the greatest number of job openings annually, are:

- Paralegal personnel
- Title examiners and abstractors

These occupations may not have a favorable outlook for the future. Overall, the number of these jobs is growing. Few job openings are expected over the next four or five years. Recently, there have been more new trainees than job openings. Placement rates at area vocational technical schools, community colleges, and/or technical institutes have been fair recently.

Related postsecondary programs at state-supported institutions in this area are:

22.0103 Paralegal, legal assisting

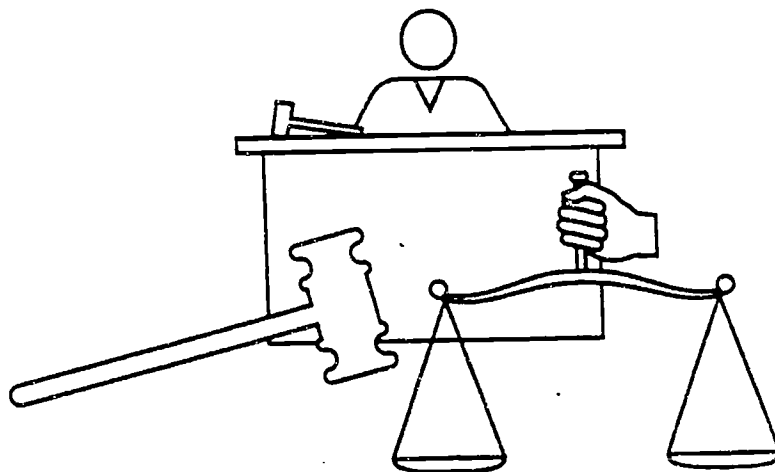

MACHINE TOOL TECHNOLOGY

Workers in these occupations make or set up and operate machine tools or repair metal parts. Machinists and tool-and-die makers create highly specialized precision tools, molds, and metal parts. Often they use blueprints to develop prototypes for tools or machines to be used in manufacturing.

The two largest occupations are:

- Machinists
- Machine tool cutting operators and tenders of metal and plastic

The occupations expected to have the most job openings annually are:

- Machinists
- Tool and die makers

These occupations may have a generally favorable outlook for the future. Overall, the number of these jobs is growing. Large numbers of job openings are expected over the next four or five years. Recently, there have been fewer new trainees than job openings. If this trend continues, job opportunities should be good. Placement rates at area vocational technical schools, community colleges, and/or technical institutes have been very good recently.

Hourly wages include:

- \$9.25 Combination machine tool operators and tenders, metal and plastic
- \$10.20 Lathe and turning machine tool setters and set-up operators, metal and plastic
- \$10.90 Numerical control machine tool operators and tenders, metal and plastic
- \$11.28 Tool and die makers
- \$11.46 Machinists

High school programs preparing for these occupations are:

- 48.0503 Machine tool operation and machine shop technology

Related postsecondary programs at state-supported institutions in this area are:

- 15.0698 Machine tool technology (Chattanooga AVTS 15.0699.01)

MEDICAL ASSISTING

Medical assistants perform a wide variety of clinical and administrative duties under the direction of physicians. Clinical duties may include taking and recording patients' vital signs and medical histories, preparing patients for examination by physicians, and explaining treatment procedures to patients.

In small physicians' offices they may keep medical records, schedule appointments, and order supplies. Electrocardiograph (EKG) technicians operate the EKG machines which provide graphic tracings of heartbeats.

The largest occupations, which also have the greatest number of job openings annually, are:

- Electrocardiograph technicians
- Medical assistants

These occupations may have a generally favorable outlook for the future. Overall, the number of these jobs is growing rapidly. A moderate number of job openings are expected over the next four or five years. Recently, no training has been reported.

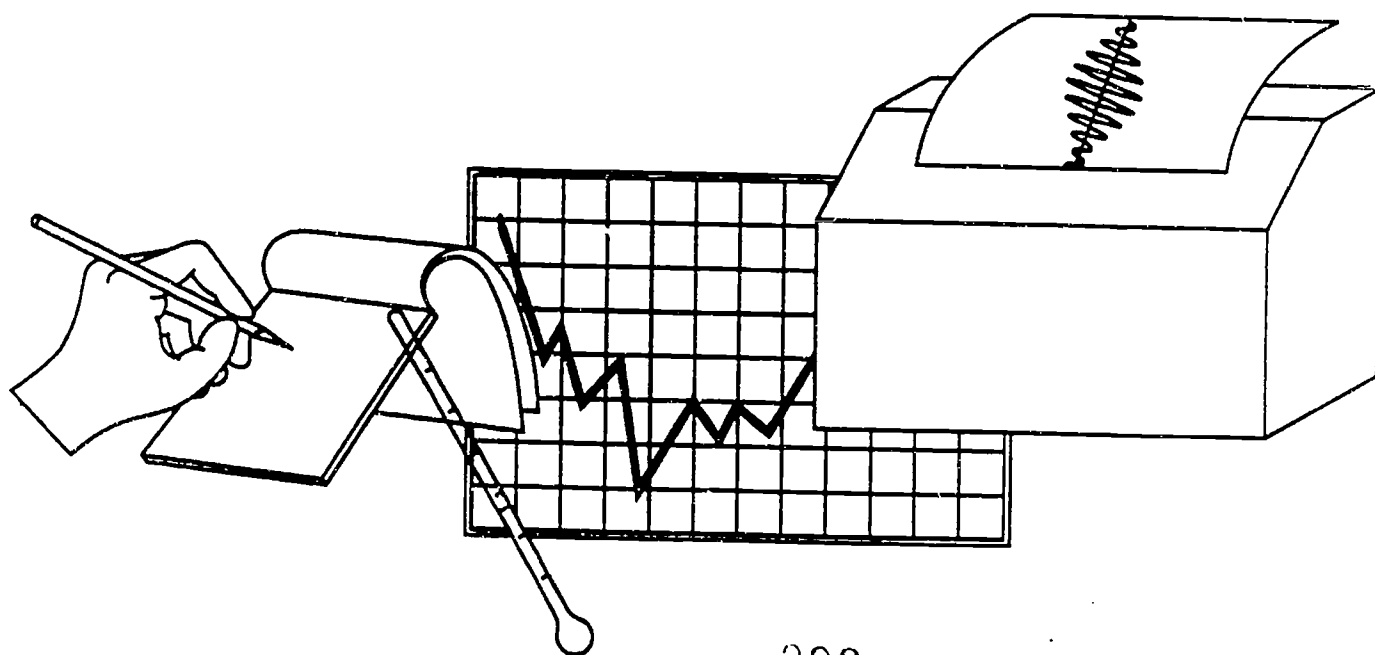

MEDICAL RECORDS TECHNOLOGY

Medical records technicians compile and maintain medical records of hospital and clinic patients. Such work is becoming increasingly important as this background information is used for medicare and medicaid insurance reimbursements.

This occupation may not have a favorable outlook for the future. Few job openings are expected over the next four or five years. Recently, there have been more new trainees than job openings. Placement rates at area vocational technical schools, community colleges, and/or technical institutes have been very good recently.

Average hourly wages are \$7.68

Related postsecondary programs at state-supported institutions in this area are:

17.0506 Medical records technology

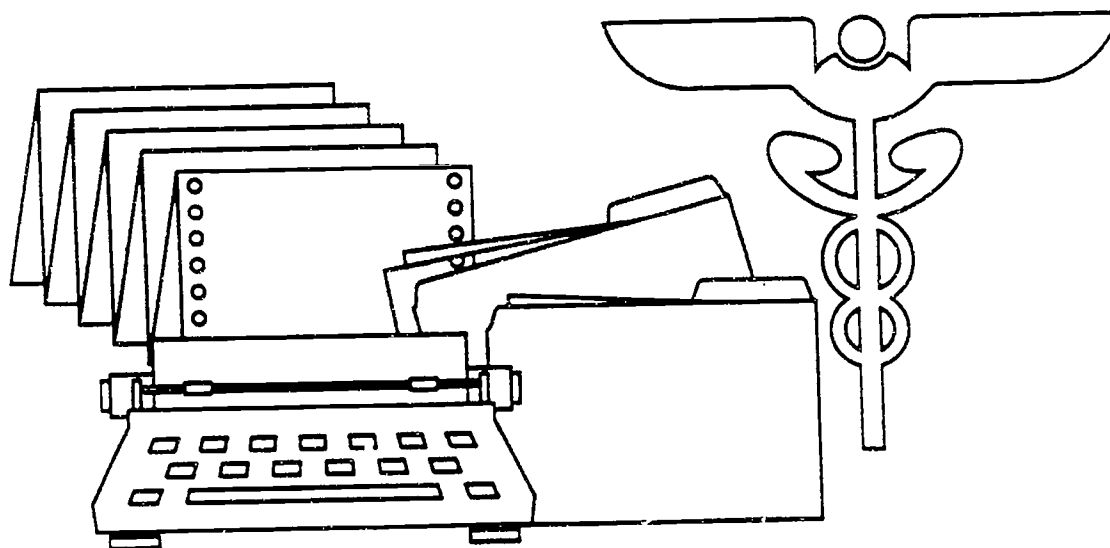

NURSING ASSISTANT

Nursing aides and orderlies work under the general direction of nursing or medical staff. In hospitals, they may answer patients' call bells, serve and collect food trays, feed patients, or set up equipment. In nursing homes, they are expected to sustain ongoing relations with patients.

The largest occupations, which also have the greatest number of job openings annually, are:

- Nursing aides, orderlies, and attendants
- Home health aides

These occupations may have a generally favorable outlook for the future. Overall, the number of these jobs is growing rapidly. Large numbers of job openings are expected over the next four or five years. Recently, there have been fewer new trainees than job openings. If this trend continues, job opportunities should be good.

Hourly wages include:

\$5.47 Nursing aides, orderlies, and attendants

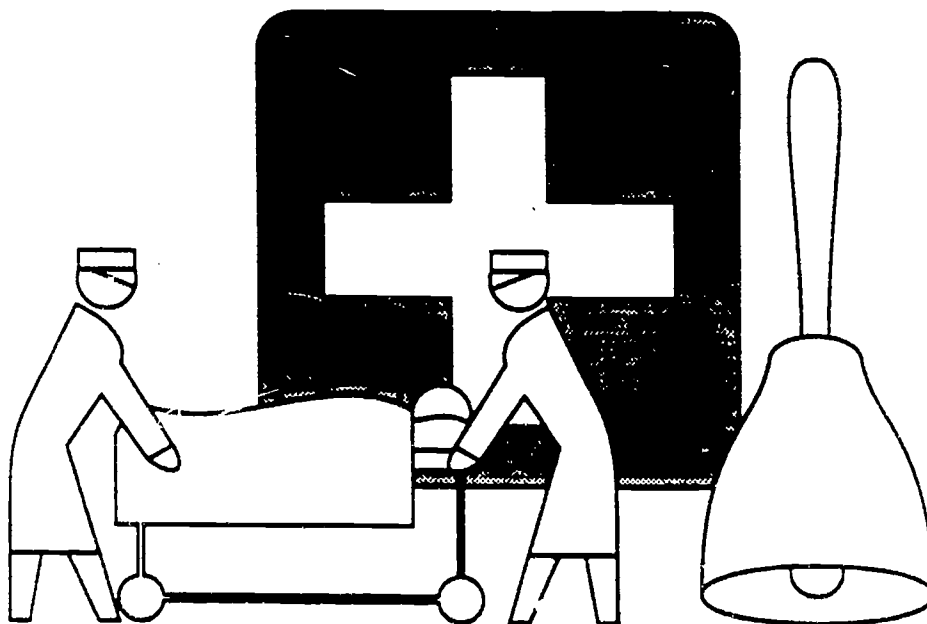

SDA 6 - 41 398

PHOTOGRAPHIC TECHNOLOGY

Workers in this cluster use their cameras and film to portray people, places, and events much as a writer uses words. Those who are skillful can capture the personality of individuals or the mood of the scenes which they photograph. Photographers specializing in scientific, medical, or engineering photography expose worlds normally hidden from our view.

The two largest occupations are:

- Photographers
- Photographic processing machine operators and tenders

The occupations expected to have the most job openings annually are:

- Photographic processing machine operators and tenders
- Precision photographic process workers

These occupations may have a generally favorable outlook for the future. Overall, the number of these jobs shows little change. Few job openings are expected over the next four or five years. Recently, no training has been reported.

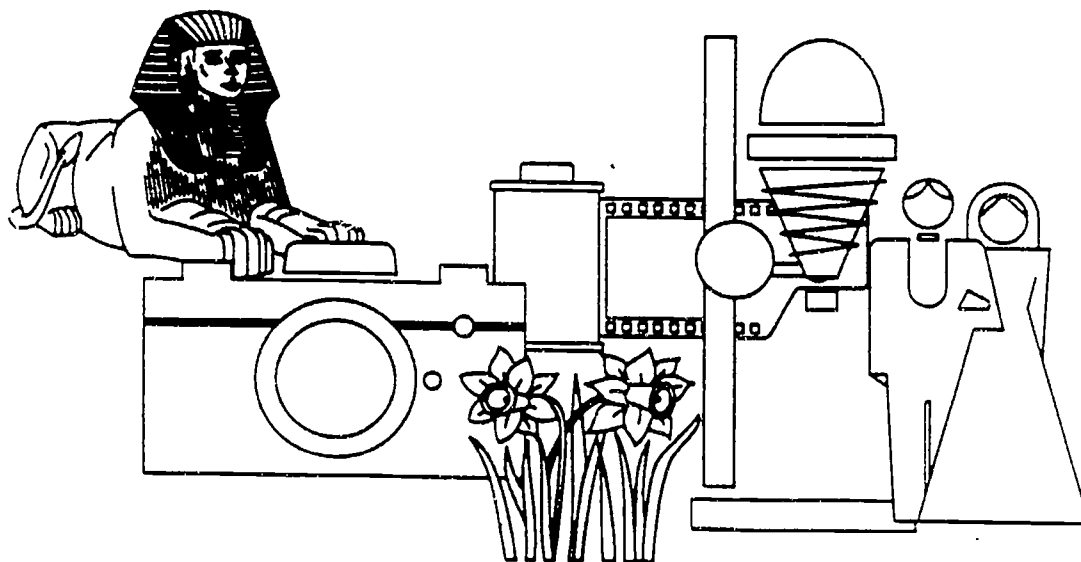

PHYSICAL THERAPY ASSISTING

Workers in this occupation, under the direction of a physical therapist, prepare patients for and/or administer physical therapy treatment, such as massages, heat, light and sound treatment, and traction. They also instruct, motivate, and assist patients with learning and improving functional activities.

This occupation may not have a favorable outlook for the future. Few job openings are expected over the next four or five years. Recently, there have been more new trainees than job openings. Placement rates at area vocational technical schools, community colleges, and/or technical institutes have been excellent recently.

Related postsecondary programs at state-supported institutions in this area are:

17.0815 Physical therapy assisting

Licensing may be required. Contact: TENNESSEE STATE BOARD OF OCCUPATIONAL AND PHYSICAL THERAPY, 615-367-6243.

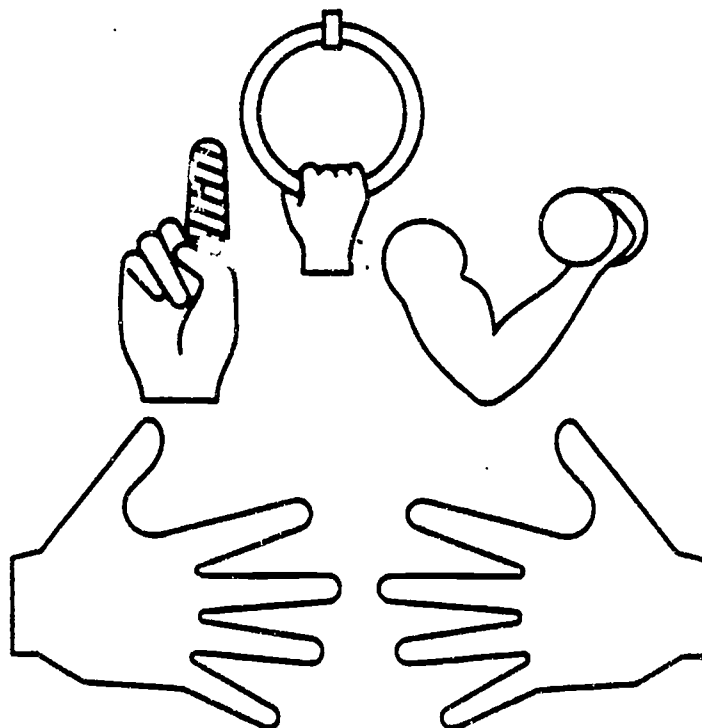

SDA 6 - 43 100

PLUMBING AND PIPEFITTING

Plumbers and pipefitters install and maintain the complex system of pipes that connect to the master system that runs underground. Although plumbing and pipefitting are sometimes considered a single trade, workers may specialize in either craft. Plumbers build and repair the water, waste disposal, drainage, and gas systems in homes and commercial/industrial buildings. Pipefitters build and repair both high and low pressure pipe.

The largest occupations, which also have the greatest number of job openings annually, are:

- Plumbers, pipefitters, and steamfitters
- Pipelayers

These occupations may have a generally favorable outlook for the future. Overall, the number of these jobs is growing slowly. A moderate number of job openings are expected over the next four or five years. Recently, there have been fewer new trainees than job openings.

Hourly wages include:

\$12.03 Plumbers, pipefitters, and steamfitters

High school programs preparing for these occupations are:

46.0501 Plumbing, pipefitting, and steamfitting

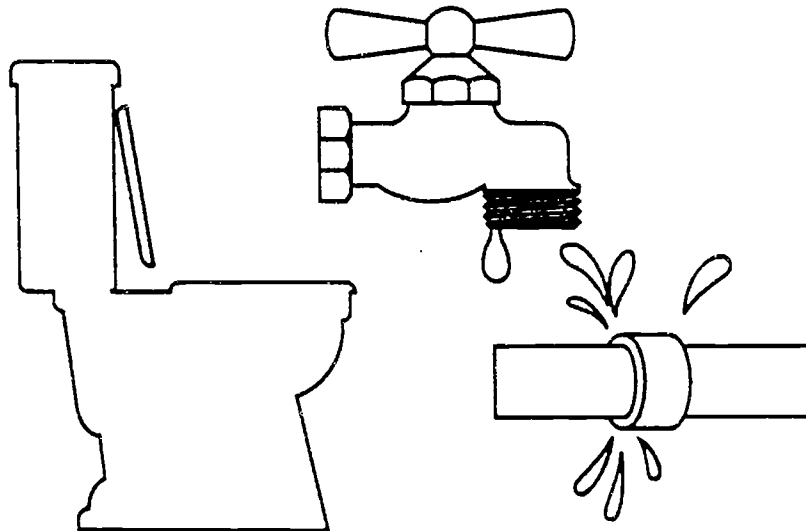

PRACTICAL NURSING

Licensed practical nurses (LPNs) work under the supervision of physicians and/or registered nurses to provide nursing care that requires technical knowledge but not the professional training of a registered nurse. They provide bedside care, administer certain medications, and assist in patient examinations.

This occupation may have a generally favorable outlook for the future. Overall, the number of these jobs is growing rapidly. Large numbers of job openings are expected over the next four or five years. Recently, there have been fewer new trainees than job openings. If this trend continues, job opportunities should be good. Placement rates at area vocational technical schools, community colleges, and/or technical institutes have been excellent recently.

Average hourly wages are \$8.75

High school programs preparing for these occupations are:

17.0605 Practical nursing

Related postsecondary programs at state-supported institutions in this area are:

17.0605 Practical nursing

Licensing may be required. Contact: TENNESSEE BOARD OF NURSING, 615-367-6232.

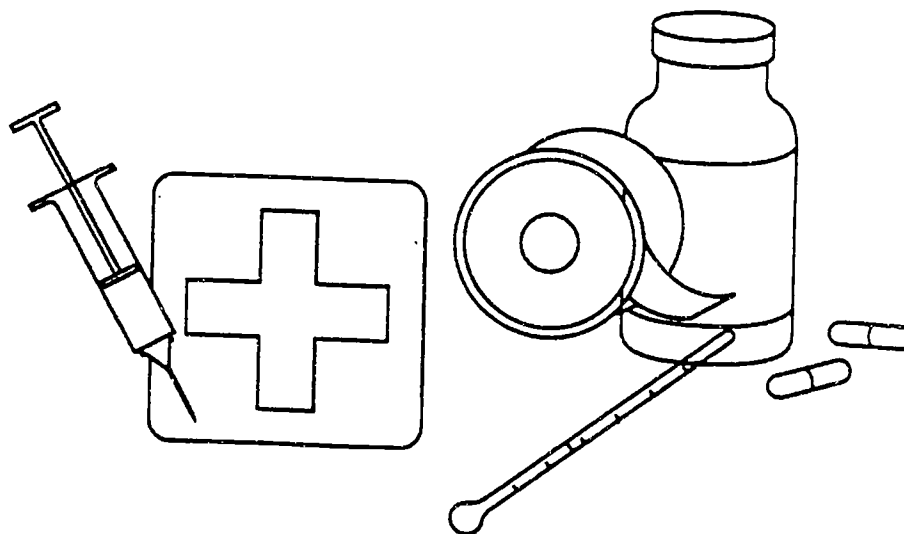

PROFESSIONAL NURSING

Registered Nurses (R.N.'s), the largest occupational group in this field, are primarily employed in hospitals and nursing homes, where they provide skilled bedside care and may supervise licensed practical nurses, nursing aides, and orderlies. Working under the direction of a licensed "supervising physician," physician assistants elicit detailed patient histories, perform physical examinations, and prescribe appropriate treatments.

The largest occupations, which also have the greatest number of job openings annually, are:

- Registered nurses
- Physician's assistants

These occupations may have a generally favorable outlook for the future. Overall, the number of these jobs is growing rapidly. Large numbers of job openings are expected over the next four or five years. Recently, there have been about as many new trainees as job openings. If this trend continues, job seekers can expect to face some competition. Placement rates at area vocational technical schools, community colleges, and/or technical institutes have been excellent recently.

Hourly wages include:

\$14.60 Registered nurses

Related postsecondary programs at state-supported institutions in this area are:

- 18.1101 Nursing
- 51.1601 Nursing (R.N. training)

Licensing may be required. Contact: TENNESSEE BOARD OF MEDICAL EXAMINERS-COMMITTEE ON PHYSICIAN ASSISTANTS, 615-367-6250.

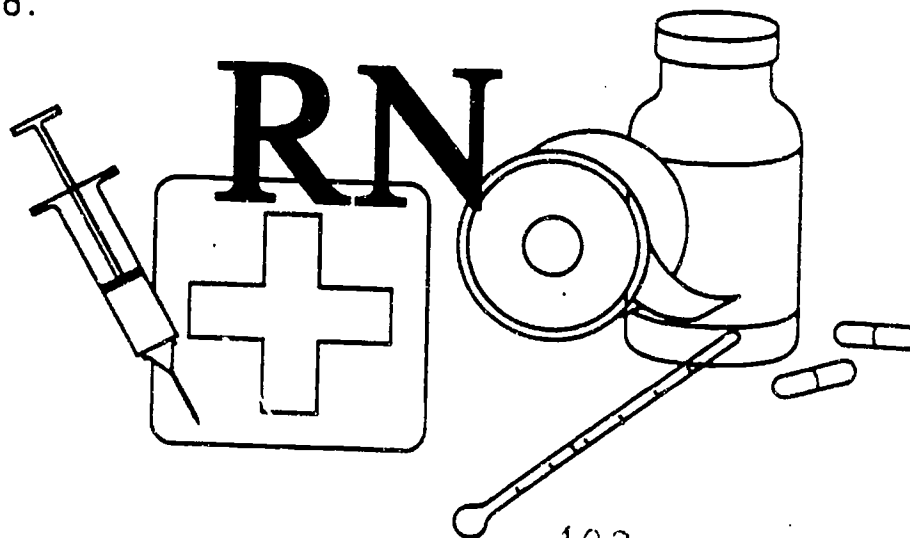

403

SDA 6 - 46

PUBLIC ADMINISTRATION

Individuals in this field are responsible for the management of diverse areas of governmental organizations. These managers usually work through departmental executives or subordinates in coordinating the various activities and groups they control. Public administration chief executives, legislators, and general administrators establish government policy and develop federal, state, or local regulations, rules, and laws.

The two largest occupations are:

- Public administration chief executives, legislators, and general administrators
- General managers and top executives

The occupations expected to have the most job openings annually are:

- Management analysts
- General managers and top executives

These occupations may not have a favorable outlook for the future. Overall, the number of these jobs is growing. Few job openings are expected over the next four or five years. Recently, there have been many more new trainees than job openings.

Related postsecondary programs at state-supported institutions in this area are:

- 43.0103 Criminal justice and law enforcement administration
- 44.0201 Community organization, resources and services
- 44.0401 Public administration



RADIOGRAPHIC MEDICAL TECHNOLOGY

Workers in this field operate equipment including x-ray machines, fluoroscopes, ultrasonic scanners, computed tomography (CT) scanners, and nuclear magnetic resonance (MRI) machines for diagnostic imagery of the human body or for therapy.

The largest occupations, which also have the greatest number of job openings annually, are:

- Radiologic technologists
- Radiologic technicians

These occupations may have a generally favorable outlook for the future. Overall, the number of these jobs is growing rapidly. A moderate number of job openings are expected over the next four or five years. Recently, there have been fewer new trainees than job openings. Placement rates at area vocational technical schools, community colleges, and/or technical institutes have been excellent recently.

Related postsecondary programs at state-supported institutions in this area are:

17.0209 Radiologic medical technology

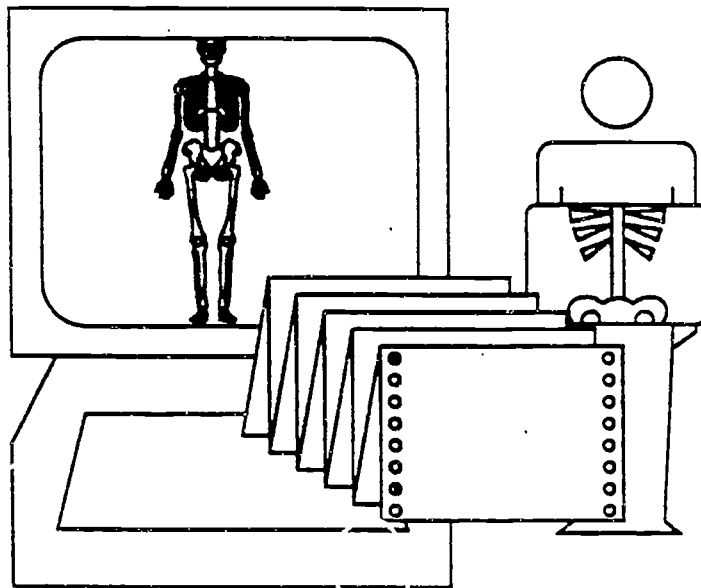

405

RECREATIONAL LEADERSHIP

Workers in recreational leadership occupations conduct recreational activities with groups, consider the interests of participants, and organize and promote activities. A large proportion of recreational workers are employed in city recreation departments and in state and national parks.

This occupation may have a generally favorable outlook for the future. Overall, the number of these jobs is growing. Few job openings are expected over the next four or five years. Recently, no training has been reported.



RESPIRATORY THERAPY

Respiratory therapists treat patients with breathing problems ranging from chronic asthma and emphysema to heart failure, stroke, or drowning emergencies. Respiratory care may involve administering oxygen; delivering medication or humidity through aerosol mists; administering chest physical therapy; or setting up and operating mechanical ventilators.

This occupation may have a generally favorable outlook for the future. Few job openings are expected over the next four or five years. Recently, there have been more new trainees than job openings. Placement rates at area vocational technical schools, community colleges, and/or technical institutes have been excellent recently.

Related postsecondary programs at state-supported institutions in this area are:

17.0210 Respiratory therapy technology

Licensing may be required. Contact: BOARD OF MEDICAL EXAMINERS-COUNCIL ON RESPIRATORY CARE, 615-367-6393.

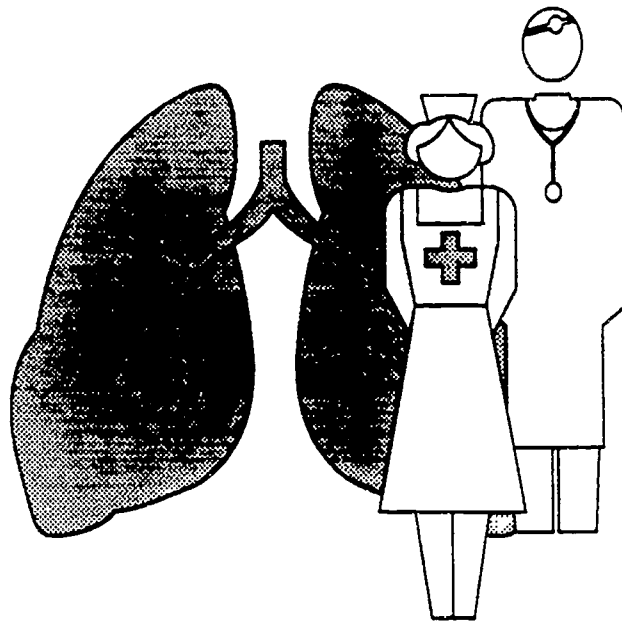

SALES AND MERCHANDISING

Workers in sales and merchandising occupations promote and sell a wide variety of merchandise and services. They also receive, store, display, and inventory products to be sold.

The largest occupations, which also have the greatest number of job openings annually, are:

- Salespersons in retail establishments
- Cashiers

These occupations may have a generally favorable outlook for the future. Overall, the number of these jobs is growing. Large numbers of job openings are expected over the next four or five years. Recently, there have been fewer new trainees than job openings. If this trend continues, job opportunities should be good.

Hourly wages include:

\$4.69	Cashiers
\$5.17	Counter and rental clerks
\$6.67	Salespersons, retail
\$8.74	Customer service representatives, utilities
\$13.41	Purchasing agents— except wholesale, retail, and farm products

High school programs preparing for these occupations are:

08.0700	General marketing
08.0799	Miscellaneous general marketing

Licensing may be required. Contact: TENNESSEE DEPARTMENT OF COMMERCE AND INSURANCE, 615-741-2693.

SECURITY SERVICES

Security guards, the largest occupation in this field, patrol and inspect property to protect it against fire, theft, vandalism, and illegal entry. Guards and doorkeepers usually are ununiformed and often carry a nightstick and a weapon; correctional officers and jailers maintain order in correctional institutions, enforce institutional rules and regulations, and may supplement the counseling inmates receive from mental health professionals.

The largest occupations, which also have the greatest number of job openings annually, are:

- Correction officers and jailers
- Guards and watch guards

These occupations may have a generally favorable outlook for the future. Overall, the number of these jobs is growing. Large numbers of job openings are expected over the next four or five years. Recently, no training has been reported. Job opportunities should be good.

Hourly wages include:

\$4.84 Guards and watch guards

Licensing may be required. Contact: COUNTY COURT CLERK'S OFFICE.

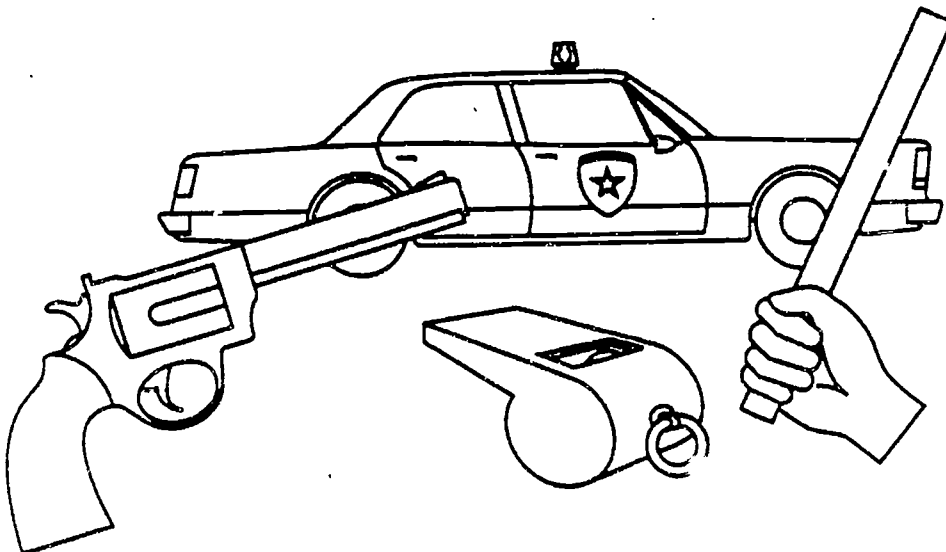

SHEET METAL

Sheet metal workers make, install, and maintain a variety of sheet metal products for home, commercial, and industrial buildings. These products include ducts for air conditioning, heating, and ventilating and pollution control systems, kitchen equipment, roofs, siding, rain gutters, skylights, and outdoor signs. Other workers use a variety of machines in the mass production of sheet-metal products.

The largest occupations, which also have the greatest number of job openings annually, are:

- Sheet metal workers
- Machine forming operators and tenders of metal and plastic

These occupations may have a generally favorable outlook for the future. Overall, the number of these jobs shows little change. A moderate number of job openings are expected over the next four or five years. Recently, there have been fewer new trainees than job openings. If this trend continues, job opportunities should be good.

Hourly wages include:

\$10.64 Sheet metal workers

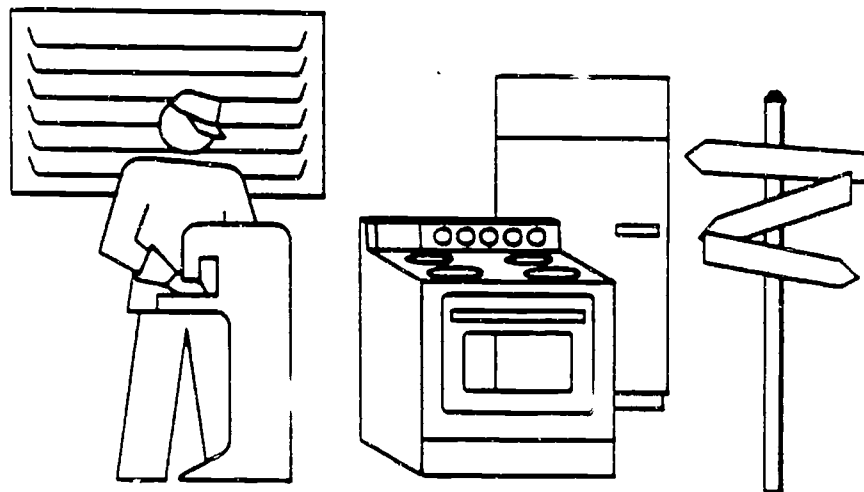

TRUCK, BUS, AND HEAVY EQUIPMENT OPERATION

These occupations include truck drivers who transport goods, bus drivers who transport passengers, and heavy equipment operators who use machinery to move construction materials and other goods over short distances--around a factory, construction site or loading dock.

The largest occupations, which also have the greatest number of job openings annually, are:

- Truck drivers of heavy or tractor trailer trucks
- School bus drivers

These occupations may have a generally favorable outlook for the future. Overall, the number of these jobs is growing. Large numbers of job openings are expected over the next four or five years. Recently, there have been fewer new trainees than job openings. If this trend continues, job opportunities should be good. Placement rates at area vocational technical schools, community colleges, and/or technical institutes have been excellent recently.

Hourly wages include:

- \$9.71 Grader, dozer, and scraper operators
- \$10.93 Truck drivers, heavy or tractor trailer

Related postsecondary programs at state-supported institutions in this area are:

- 49.0205 Truck and bus driving

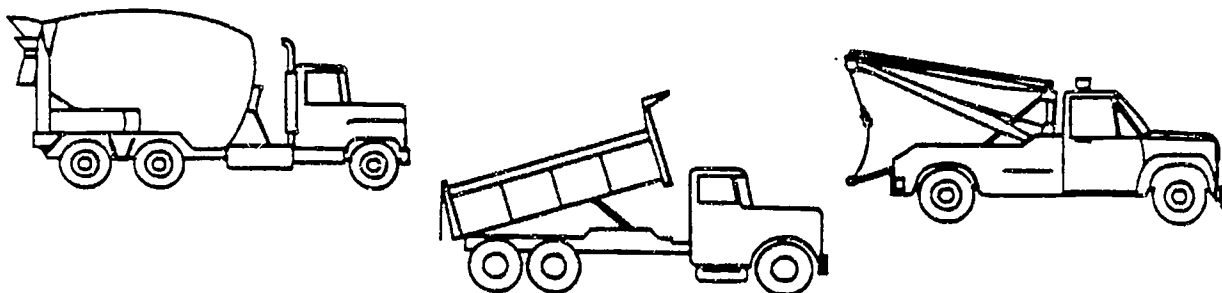

WELDING TECHNOLOGY

Welding is the most common way of permanently joining metal parts. Typically, heat is applied to the metal pieces to be joined; the parts are melted and fused to form a permanent bond. Welding is used to construct and repair parts of ships, automobiles, spacecraft, and thousands of products. It can also be used to join beams and steel reinforcing rods in buildings, bridges, and highways.

The two largest occupations are:

- Welders and cutters
- Welding machine setters and set-up operators

The occupations expected to have the most job openings annually are:

- Welders and cutters
- Welding machine operators and tenders

These occupations may not have a favorable outlook for the future. Overall, the number of these jobs is growing. A moderate number of job openings are expected over the next four or five years. Recently, there have been many more new trainees than job openings. If this trend continues, job seekers can expect to face keen competition. Placement rates at area vocational technical schools, community colleges, and/or technical institutes have been good recently.

Hourly wages include:

\$10.34 Welders and cutters

High school programs preparing for these occupations are:

48.0508 Welding, brazing, and soldering

Related postsecondary programs at state-supported institutions in this area are:

48.0508 Welding, brazing, and soldering

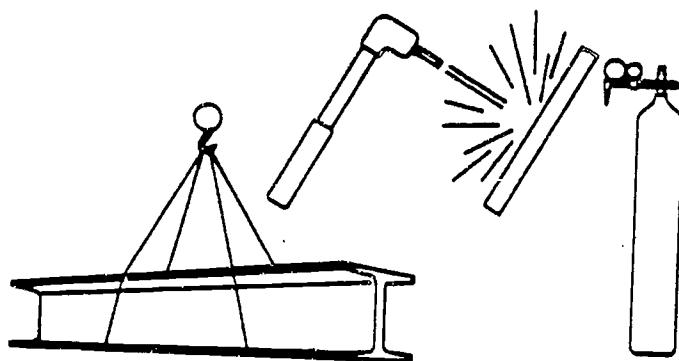

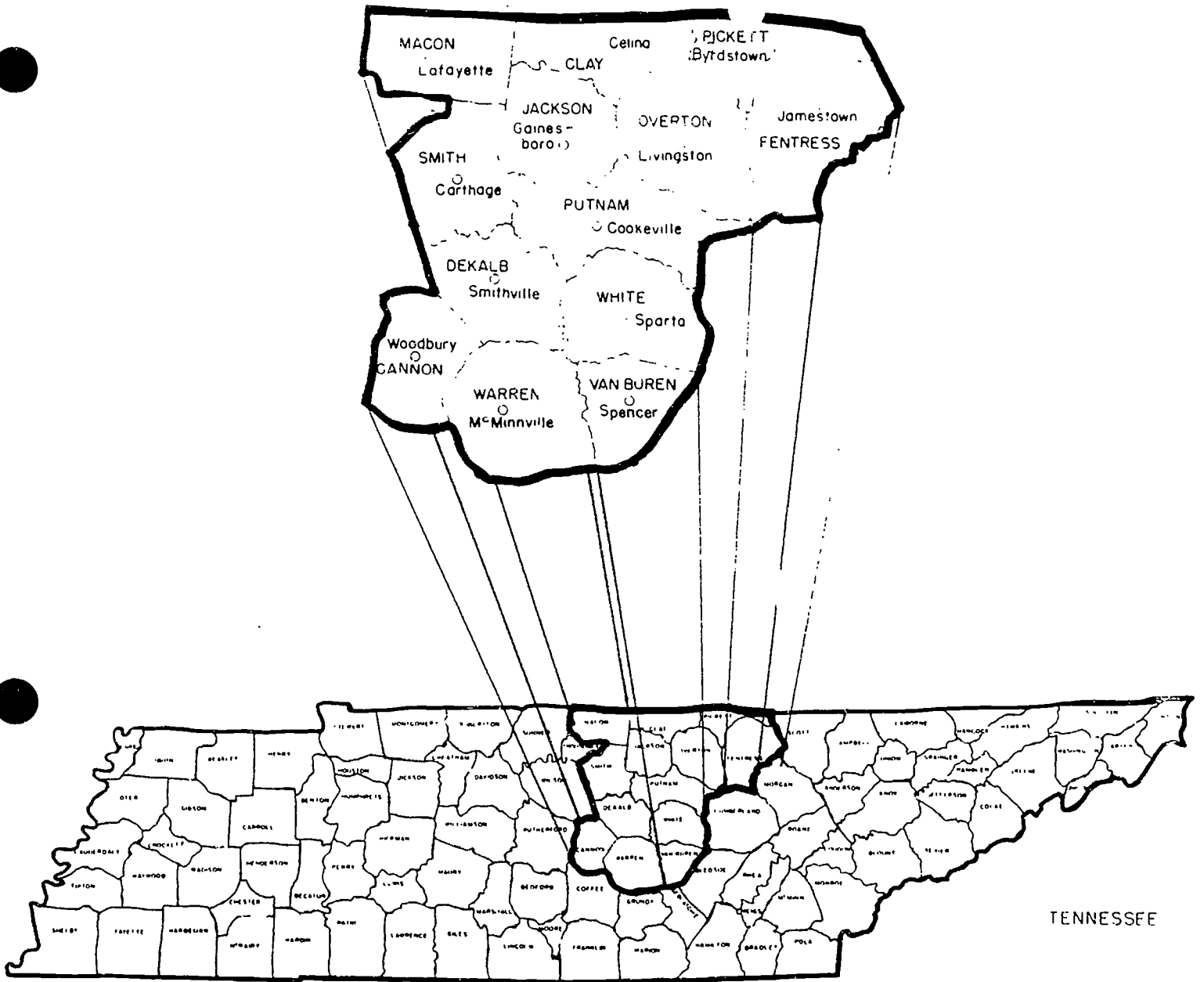

Service Delivery Area 7

ACCOUNTING AND FINANCIAL MANAGEMENT

Many individuals in this group are accountants and auditors who prepare and analyze business records and financial reports which are needed for effective management of any organization. Financial managers, another occupation in this group, typically plan, organize, control, or coordinate the financial activities of an organization.

The largest occupations, which also have the greatest number of job openings annually, are:

- Financial managers
- Accountants and auditors

These occupations may not have a favorable outlook for the future. Overall, the number of these jobs is growing. A moderate number of job openings are expected over the next four or five years. Recently, there have been many more new trainees than job openings. If this trend continues, job seekers can expect to face keen competition.

Hourly wages include:

\$13.00 Accountants and auditors
\$22.13 Financial managers

Related postsecondary programs at state-supported institutions in this area are:

52.0301 Accounting
52.0801 Finance

Licensing may be required. Contact: TENNESSEE BOARD OF ACCOUNTANCY, 615-741-2250.



SDA 7 - 1

ADMINISTRATIVE SUPPORT: ACCOUNTING

Persons employed in this group of occupations provide clerical and administrative support to accountants and auditors. Most of these jobs require only a high school diploma for entry.

The largest occupations, which also have the greatest number of job openings annually, are:

- Bookkeeping, accounting, and auditing clerks
- Payroll and timekeeping clerks

These occupations may have a generally favorable outlook for the future. Overall, the number of these jobs shows little change. A moderate number of job openings are expected over the next four or five years. Recently, there have been fewer new trainees than job openings. If this trend continues, job opportunities should be good.

Hourly wages include:

- \$8.07 Payroll and timekeeping clerks
- \$8.54 Bookkeeping, accounting, and auditing clerks

High school programs preparing for these occupations are:

- 07.0101 Accounting and bookkeeping

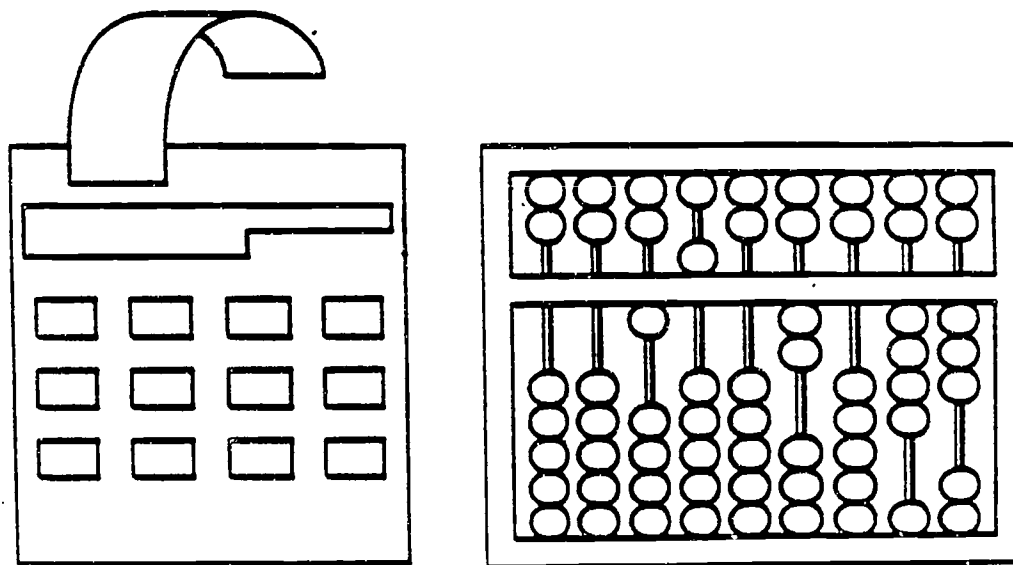

ADMINISTRATIVE SUPPORT: FINANCE AND INSURANCE

Workers provide clerical and general administrative support to the banking and finance industry. Workers receive and pay out money, keep records of money and negotiable instruments, interview applicants for credit, locate and notify customers of delinquent accounts, examine insurance claims, and process a variety of paperwork.

The largest occupations, which also have the greatest number of job openings annually, are:

- Tellers
- Bill and account collectors

These occupations may have a generally favorable outlook for the future. Overall, the number of these jobs shows little change. Few job openings are expected over the next four or five years. Recently, no training has been reported.

Hourly wages include:

- \$5.59 Tellers
- \$6.77 Bill and account collectors
- \$8.69 Loan and credit clerks

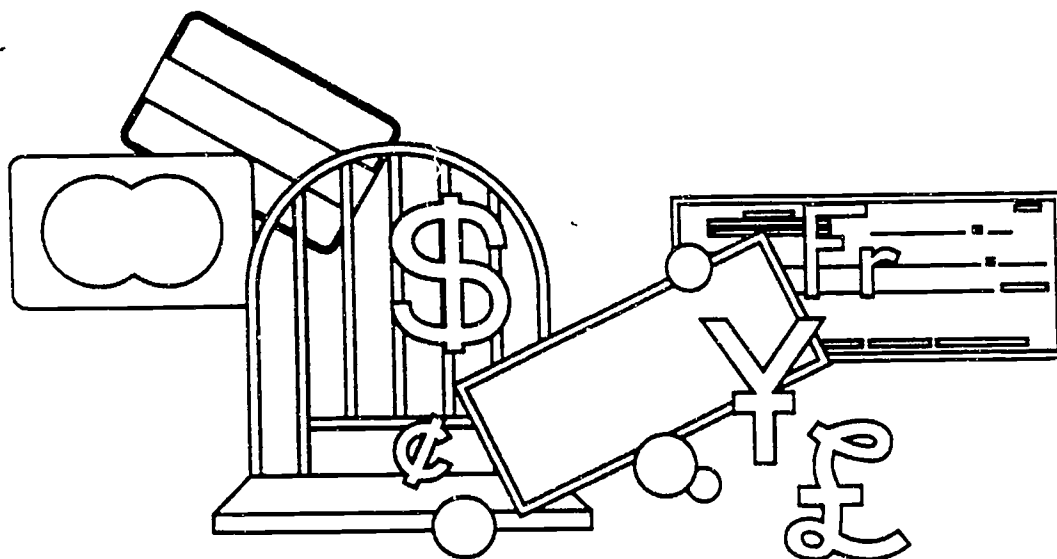

ADMINISTRATIVE SUPPORT: GENERAL

The job duties in this group of occupations are very diverse and are determined by the type of firm. For example, workers may schedule appointments, give information to callers, take dictation, type correspondence, read and route incoming mail, file correspondence and other records, and supervise and coordinate the activities of subordinate clerical workers.

The largest occupations, which also have the greatest number of job openings annually, are:

- Secretaries, except legal and medical secretaries
- General office clerks

These occupations may not have a favorable outlook for the future. Overall, the number of these jobs is growing. Large numbers of job openings are expected over the next four or five years. Recently, there have been many more new trainees than job openings. If this trend continues, job seekers can expect to face keen competition. Placement rates at area vocational technical schools, community colleges, and/or technical institutes have been good recently.

Hourly wages include:

\$6.26	Receptionists and information clerks
\$6.91	File clerks
\$7.04	Data entry keyers, except composing
\$7.17	Medical secretaries
\$7.19	General office clerks
\$7.53	Order clerks- materials, merchandise, and service
\$7.64	Typists including word processing
\$7.82	Secretaries, ex. legal and medical
\$13.45	First line supervisors and manager/supervisors- clerical and administrative support occupations

High school programs preparing for these occupations are:

- 07.0601 Secretarial and related programs
- 07.0701 Typing, general office and related programs

Related postsecondary programs at state-supported institutions in this area are:

- 07.9999 Miscellaneous business administrative support

AGRICULTURAL PRODUCTION

Workers in this field plan and economically use facilities, land, water, machinery, chemicals, finance, and labor in the production of plant and animal products.

The largest occupations, which also have the greatest number of job openings annually, are:

- Farm managers
- Farm workers

These occupations may not have a favorable outlook for the future. Overall, the number of these jobs shows little change. A moderate number of job openings are expected over the next four or five years. Recently, there have been many more new trainees than job openings. If this trend continues, job seekers can expect to face keen competition.

High school programs preparing for these occupations are:

01.0301 Agricultural production

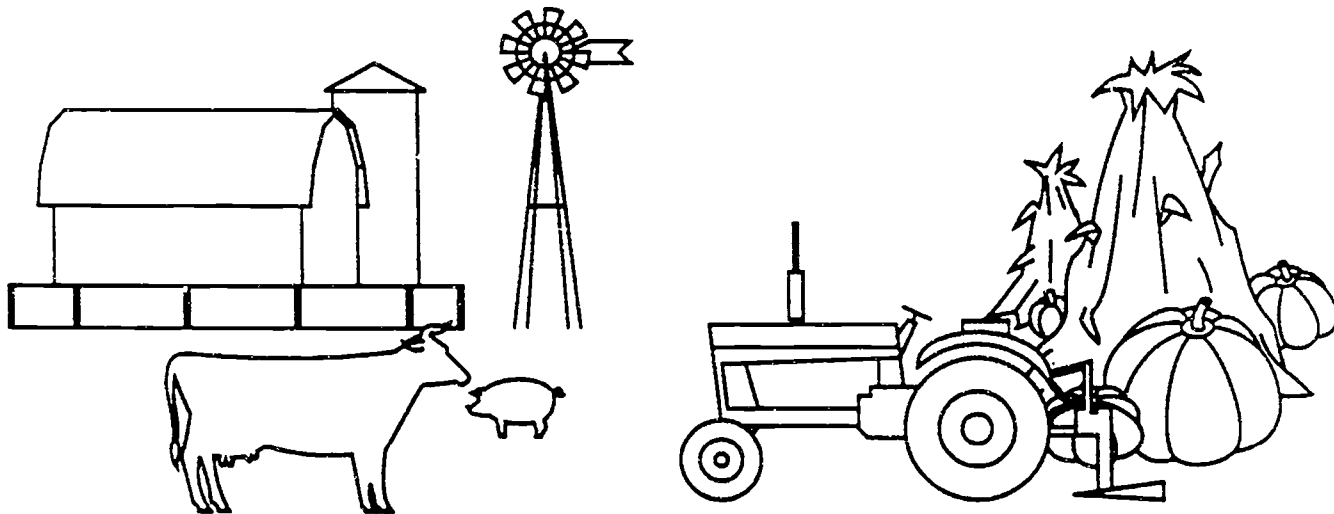

APPLIANCE AND EQUIPMENT REPAIR

Individuals in these occupations repair, adjust, maintain, and install all types of electrical motors and electrical and gas home appliances. Types of equipment used include test instruments, gauges, and hand, bench, and power tools.

The largest occupations, which also have the greatest number of job openings annually, are:

- Electric home appliance and power tool repairers
- Gas appliance repairers

These occupations may not have a favorable outlook for the future. Overall, the number of these jobs shows little change. Very few job openings are expected over the next four or five years. Recently, there have been many more new trainees than job openings. Placement rates at area vocational technical schools, community colleges, and/or technical institutes have been good recently.

High school programs preparing for these occupations are:

47.0101 Electrical and electronics technology

Related postsecondary programs at state-supported institutions in this area are:

47.0101 Electrical and electronics technology

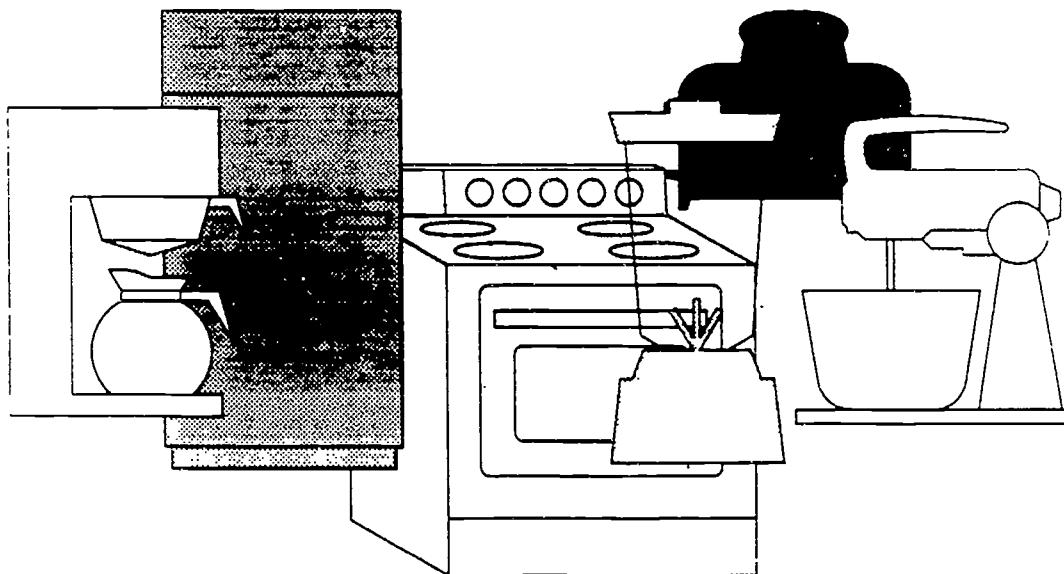

419

AUTOMOTIVE BODY REPAIR

Thousands of motor vehicles are damaged in traffic accidents every day. The workers in this field straighten bent frames, remove dents, and replace crumpled parts that are beyond repair so that those vehicles look and drive like new.

The largest occupations, which also have the greatest number of job openings annually, are:

- Automotive body and related repairers
- Painters of transportation equipment

These occupations may not have a favorable outlook for the future. Overall, the number of these jobs shows little change. Very few job openings are expected over the next four or five years. Recently, there have been many more new trainees than job openings. Placement rates at area vocational technical schools, community colleges, and/or technical institutes have been excellent recently.

High school programs preparing for these occupations are:

47.0603 Automotive body repair

Related postsecondary programs at state-supported institutions in this area are:

47.0603 Automotive body repair

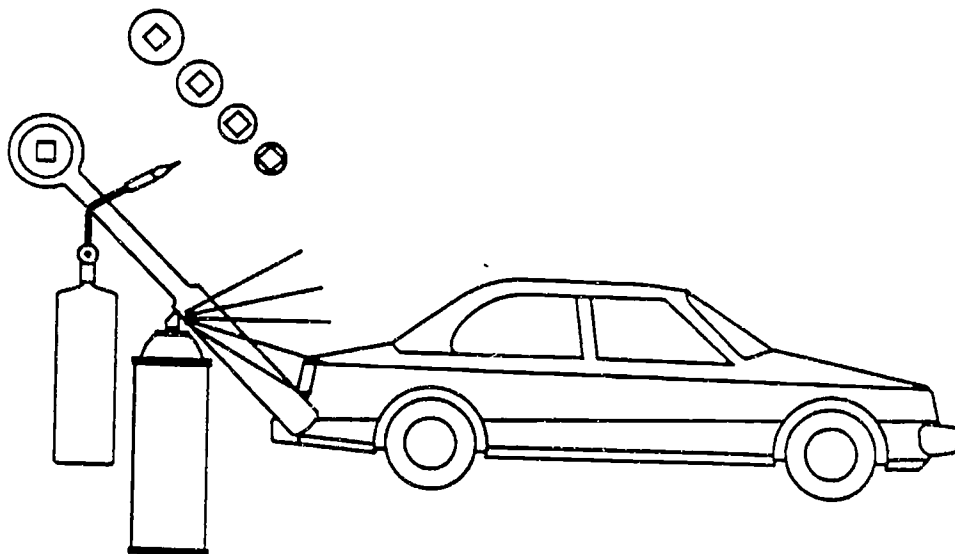

AUTOMOTIVE SERVICE TECHNOLOGY

These occupations include jobs concerned with parking, cleaning, polishing, lubricating, repairing, and refueling trucks, buses, and automobiles, and related servicing activities. The primary occupation, automotive mechanic, is concerned with repair and service of motor vehicles.

The largest occupations, which also have the greatest number of job openings annually, are:

- Automotive mechanics
- Tire repairers and changers

These occupations may not have a favorable outlook for the future. Overall, the number of these jobs is growing. Few job openings are expected over the next four or five years. Recently, there have been many more new trainees than job openings. Placement rates at area vocational technical schools, community colleges, and/or technical institutes have been good recently.

Hourly wages include:

\$7.76 Automotive mechanics

High school programs preparing for these occupations are:

47.0604 Automotive mechanics

Related postsecondary programs at state-supported institutions in this area are:

15.0803 Automotive technology
47.0604 Automotive mechanics

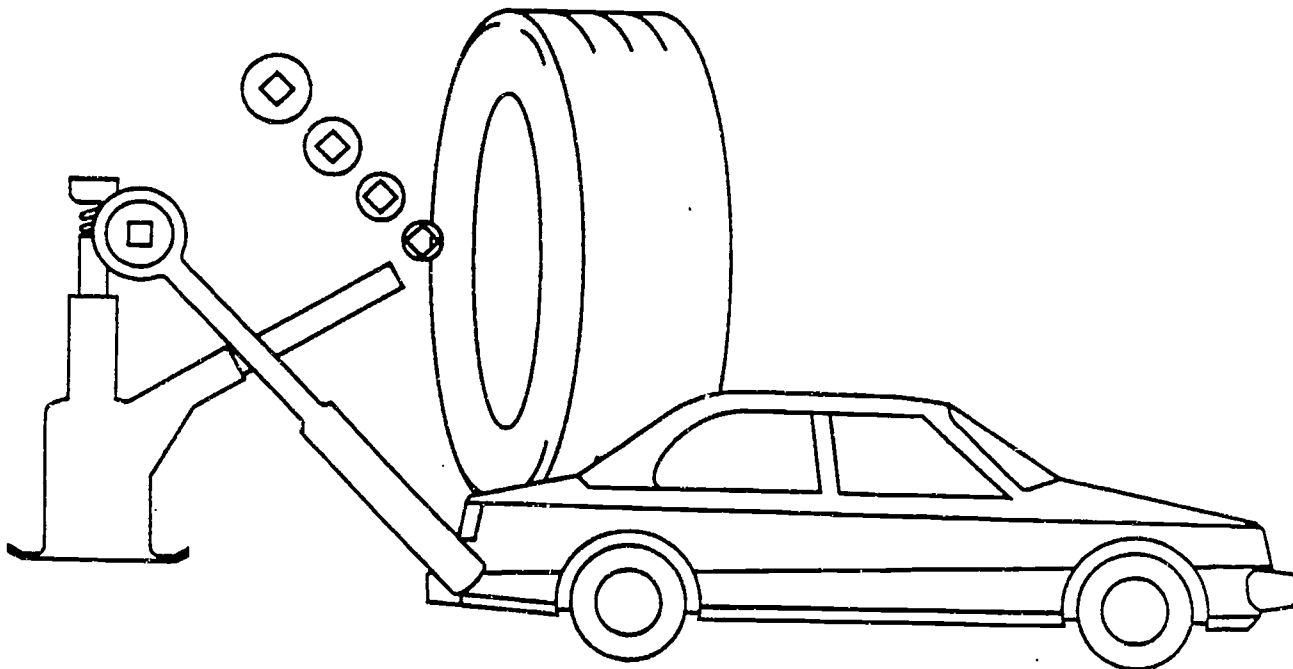

BUILDING MAINTENANCE

Persons in building maintenance occupations perform work involving several maintenance skills to keep the structure of an establishment in repair. Duties may involve pipefitting, boilermaking, carpentry, and electrical work as well as repairing buildings, floors, or stairs.

The largest occupations, which also have the greatest number of job openings annually, are:

- General utility maintenance repairers
- Boiler operators and tenders of low pressure boilers

These occupations may have a generally favorable outlook for the future. Overall, the number of these jobs is growing. A moderate number of job openings are expected over the next four or five years. Recently, no training has been reported. Job opportunities should be good.

Hourly wages include:

\$7.79 Maintenance repairers, general utility

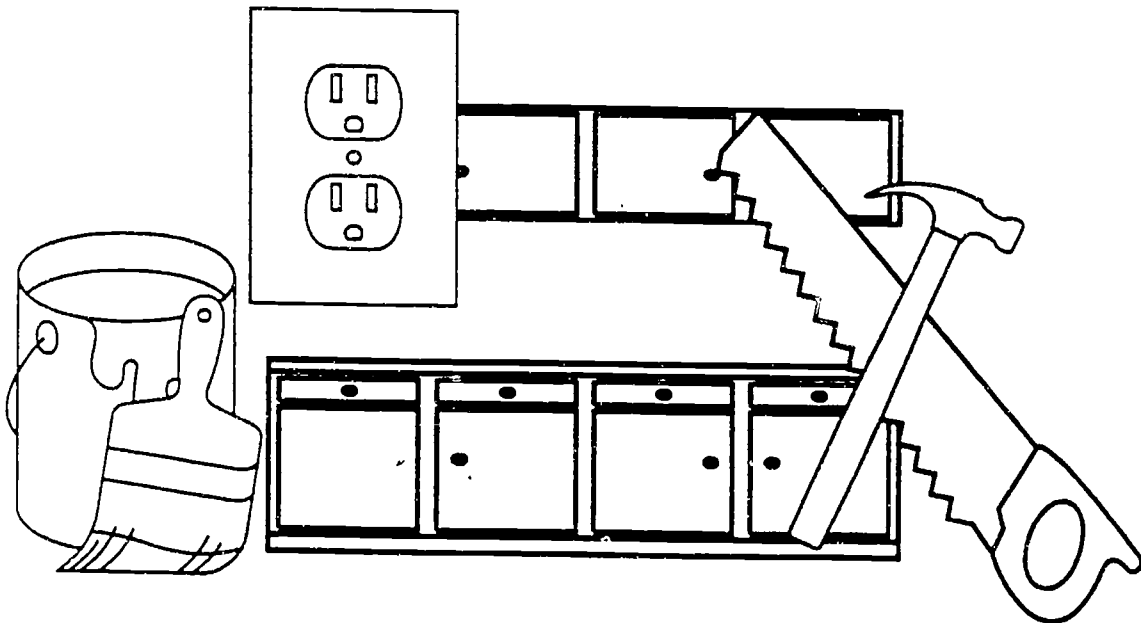

CARPENTRY

Almost all construction projects employ carpenters, the largest group of building trades workers. Carpenters perform a variety of jobs. Their duties will vary by type of construction, type of company, skill of the carpenter, and size of the community. A carpenter employed by a special trade contractor, for example, may specialize in laying hardwood floors, while one who is employed by a general building contractor may build wall frames and install paneling.

This occupation may not have a favorable outlook for the future. Overall, the number of these jobs is growing slowly. Few job openings are expected over the next four or five years. Recently, there have been many more new trainees than job openings.

High school programs preparing for these occupations are:

46.0201 Carpentry

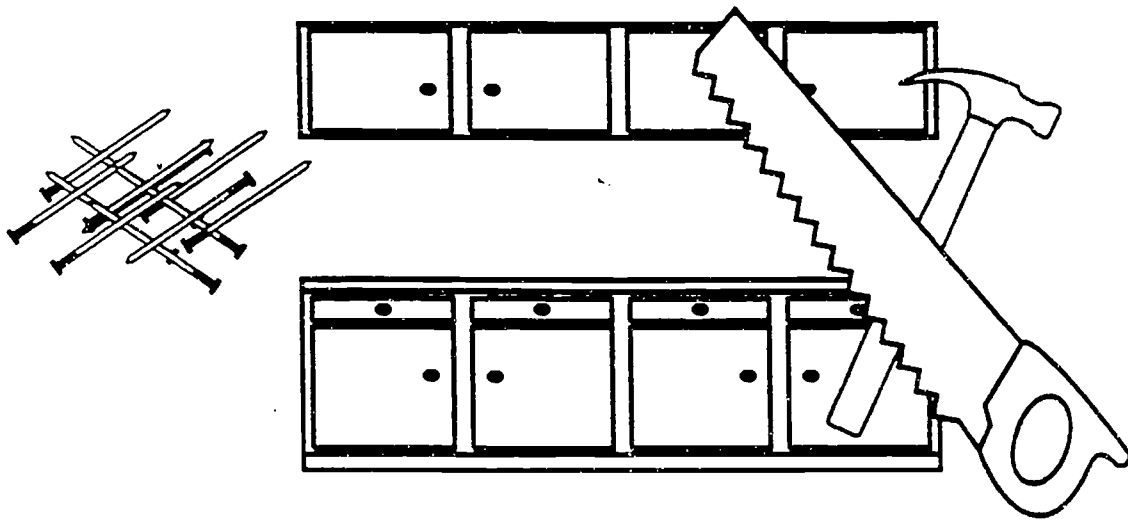

COMMUNICATIONS, JOURNALISM, AND BROADCASTING

Individuals who work in these fields are concerned with communicating ideas and information to individuals for their education and entertainment. The methods utilized are varied and may include the written word, radio, and television.

The two largest occupations are:

- Writers and editors
- Radio and television announcers

The occupations expected to have the most job openings annually are:

- Radio and television announcers
- Reporters and correspondents

These occupations may not have a favorable outlook for the future. Overall, the number of these jobs shows little change. Very few job openings are expected over the next four or five years. Recently, there have been more new trainees than job openings.

Related postsecondary programs at state-supported institutions in this area are:

- 09.0401 Journalism
- 23.1101 Technical and business writing

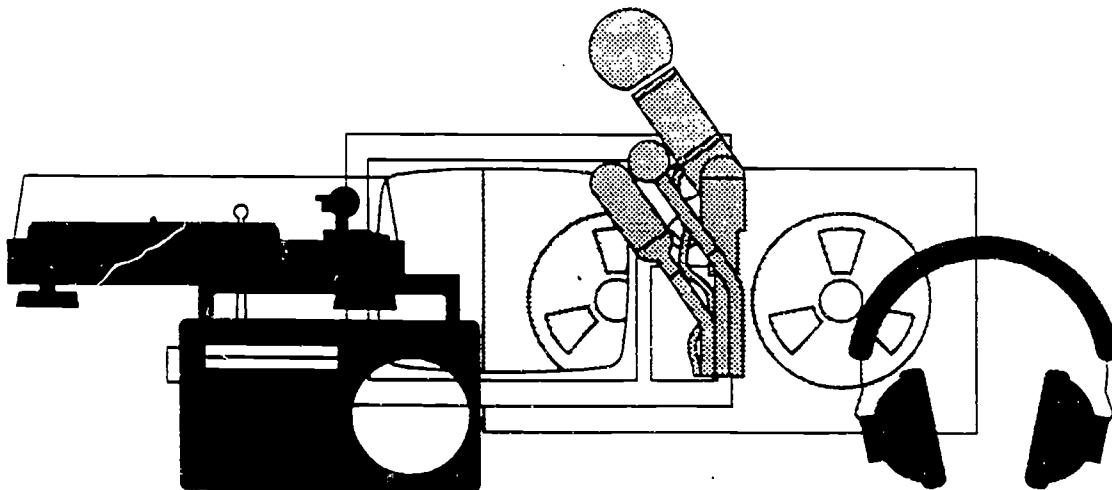

COMPUTER SYSTEMS

Workers in these computer occupations develop and write computer programs to store, locate, and retrieve specific documents, data, and information. They may also analyze business, scientific, and technical problems for application to electronic data processing systems. These careers generally require specialized training.

The largest occupations, which also have the greatest number of job openings annually, are:

- Systems analysts, electronic data processing
- Computer programmers

These occupations may have a generally favorable outlook for the future. Few job openings are expected over the next four or five years. Recently, there have been more new trainees than job openings.

Hourly wages include:

- \$14.96 Computer programmers
- \$17.97 Systems analysts, electronic data processing

Related postsecondary programs at state-supported institutions in this area are:

- 11.0701 Computer science

COSMETOLOGY

Cosmetologists and related workers provide beauty services for customers. These may include cutting and styling hair, treating hair and scalp, applying makeup, dressing wigs, or removing hair by electrolysis, as well as cleaning, shaping, and polishing a customer's fingernails and toenails.

This occupation may not have a favorable outlook for the future. Overall, the number of these jobs is growing. Few job openings are expected over the next four or five years. Recently, there have been many more new trainees than job openings. Placement rates at area vocational technical schools, community colleges, and/or technical institutes have been good recently.

High school programs preparing for these occupations are:

12.0403 Cosmetology

Related postsecondary programs at state-supported institutions in this area are:

12.0403 Cosmetology

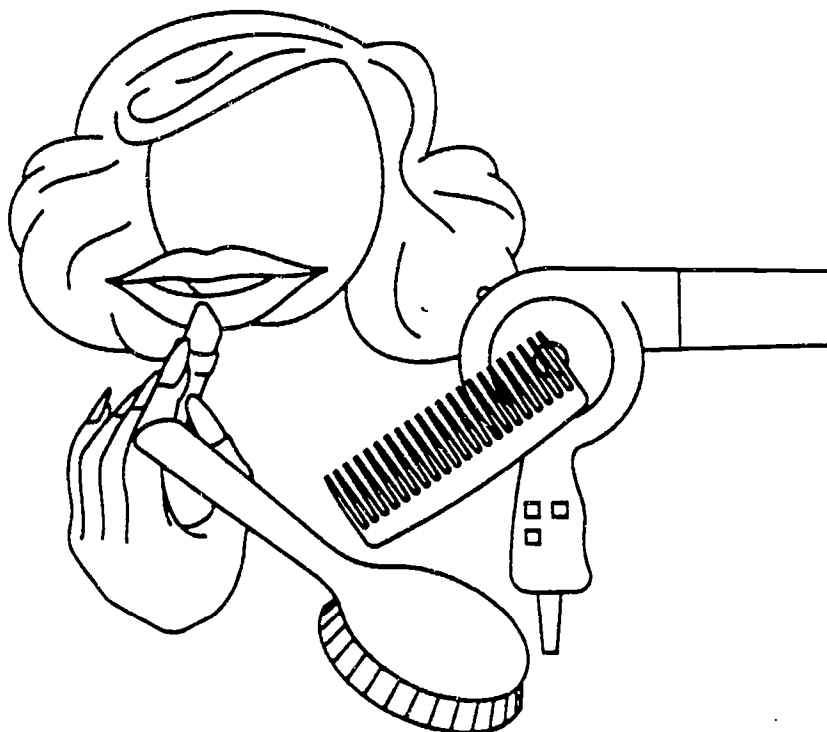

DRAFTING AND DESIGN TECHNOLOGY

Persons in drafting and design technology prepare clear, complete, and accurate working plans and detail drawings from rough or detailed sketches or notes for engineering or manufacturing purposes according to specified dimensions. Workers need to have knowledge of various machines, engineering practices, mathematics, building materials, and other physical sciences to complete drawings. Computer-assisted design (CAD) equipment may be used by some workers.

The largest occupations, which also have the greatest number of job openings annually, are:

- Cost estimators
- Drafters

These occupations may not have a favorable outlook for the future. Overall, the number of these jobs shows little change. Few job openings are expected over the next four or five years. Recently, there have been many more new trainees than job openings. Placement rates at area vocational technical schools, community colleges, and/or technical institutes have been poor recently.

High school programs preparing for these occupations are:

- 48.0101 Drafting
- 48.0199 Drafting

Related postsecondary programs at state-supported institutions in this area are:

- 48.0101 Drafting

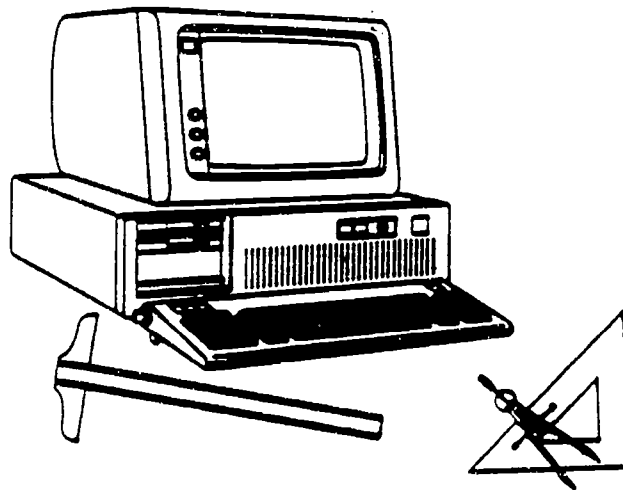

SDA 7 - 427

EARLY CHILDHOOD EDUCATION

Child care workers and managers of child care centers assume responsibility for the safety, physical care, and emotional, social, and intellectual growth of preschool children and infants while parents are at work or are unavailable for other reasons. Some work in residential institutions for young children. Teacher aides assist teachers by handling routine paperwork or by working directly with children.

The two largest occupations are:

- Teacher aides, paraprofessional
- Teacher aides and educational assistants, clerical

The occupations expected to have the most job openings annually are:

- Teacher aides, paraprofessional
- Child care workers

These occupations may not have a favorable outlook for the future. Overall, the number of these jobs is growing rapidly. A moderate number of job openings are expected over the next four or five years. Recently, there have been many more new trainees than job openings. If this trend continues, job seekers can expect to face keen competition.

High school programs preparing for these occupations are:

- 20.0102 Child development, care, and guidance
- 20.0201 Child care and guidance management services

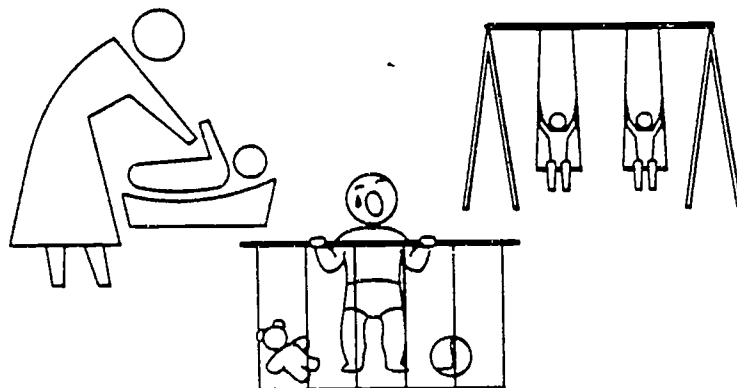

ELECTRICIAN OCCUPATIONS

Workers in the electrical field install, maintain, and repair wiring, electrical equipment, and fixtures or assist in such activities. These workers insure that work is in accordance with the relevant codes. A high school education is usually required and a five-year apprenticeship program is recommended.

The largest occupations, which also have the greatest number of job openings annually, are:

- Electricians
- Helpers of electricians and powerline transmission installers

These occupations may have a generally favorable outlook for the future. Overall, the number of these jobs is growing. Few job openings are expected over the next four or five years. Recently, no training has been reported.

Hourly wages include:

\$10.79 Electricians

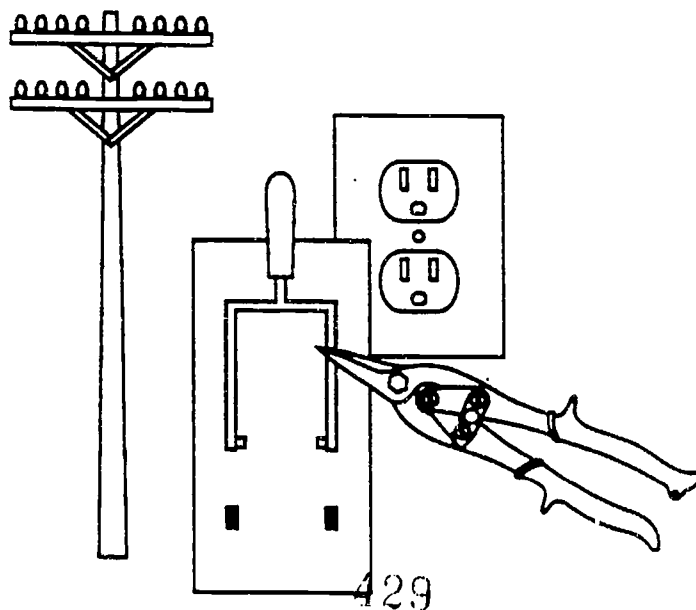

FOOD PREPARATION AND SERVICES

The majority of workers in these occupations prepare and serve food and beverages in restaurants, fast food establishments, catering firms, hotels, clubs, factories, school cafeterias, or hospitals, or supervise those providing food services. Others are factory machine operators involved in the preparation of food products. Dietetic technicians teach principles of food nutrition and provide dietary counseling to patients.

The two largest occupations are:

- Food preparation workers
- Cooks in institutions and cafeterias

The occupations expected to have the most job openings annually are:

- Food preparation workers
- Combined food preparation and service workers

These occupations may have a generally favorable outlook for the future. Overall, the number of these jobs is growing. Large numbers of job openings are expected over the next four or five years. Recently, there have been fewer new trainees than job openings. If this trend continues, job opportunities should be good.

Hourly wages include:

- \$4.42 Food preparation workers
- \$4.70 Cooks, specialty fast food

High school programs preparing for these occupations are:

- 20.0401 Food production, management, and services

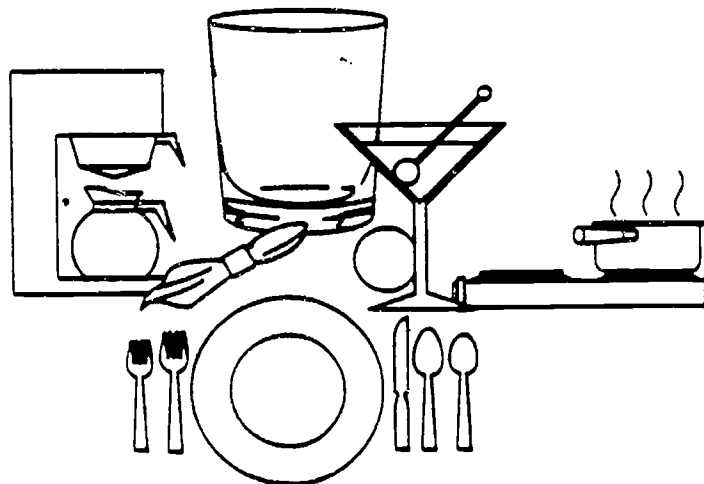

SDA 7 - 17⁴³⁰

GENERAL BUSINESS AND MANAGEMENT

Workers in the general business and management occupations plan, organize, direct, control, or coordinate activities in all types of fields. Many occupations involve analysis of productivity and financial soundness. General managers and top executives usually have very diverse duties and responsibilities and work through departmental or subordinate executives.

The largest occupations, which also have the greatest number of job openings annually, are:

- Industrial production managers
- General managers and top executives

These occupations may have a generally favorable outlook for the future. Overall, the number of these jobs is growing. Large numbers of job openings are expected over the next four or five years. Recently, there have been more new trainees than job openings. If this trend continues, job seekers can expect to face some competition.

Hourly wages include:

- \$15.36 Industrial production managers
- \$16.61 Purchasing managers

Related postsecondary programs at state-supported institutions in this area are:

- 52.0201 General business administration and management



SDA 7 - 18 431

GENERAL WOODWORKING

Woodworkers are in occupations concerned with the complete cycle of cutting, shaping, and assembling parts of complex wood products. The occupations are primarily concerned with one or a limited number of machine functions according to their speciality.

The largest occupations, which also have the greatest number of job openings annually, are:

- Cabinetmakers and bench carpenters
- Assemblers and fabricators, except machine, electrical, electronic, and precision assembly

These occupations may have a generally favorable outlook for the future. Overall, the number of these jobs shows little change. A moderate number of job openings are expected over the next four or five years. Recently, there have been about as many new trainees as job openings. If this trend continues, job seekers can expect to face some competition.

High school programs preparing for these occupations are:

48.0701 Woodworking

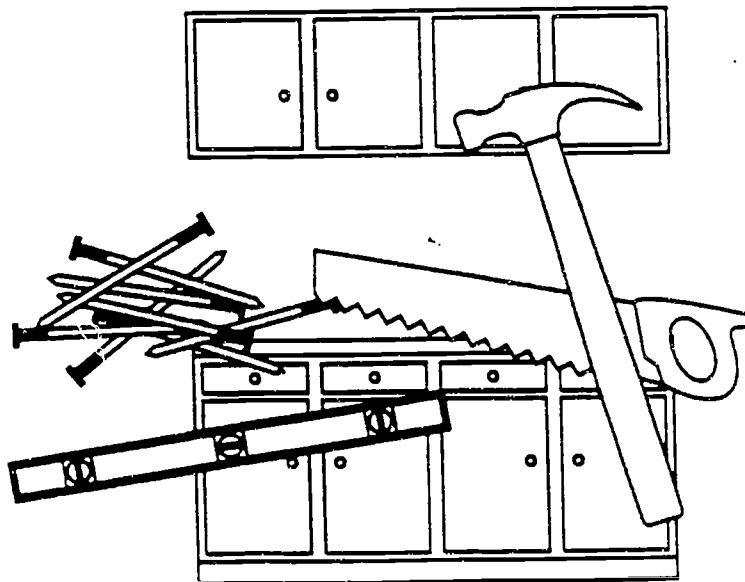

HEATING AND AIR CONDITIONING

Workers in this field install and repair heating, air conditioning, and refrigeration systems. They may install and repair oil burners, hot-air furnaces, and heating stoves in homes and businesses. They may also install and repair air conditioning systems, or install sheet metal ducts for the heating and cooling systems.

The largest occupations, which also have the greatest number of job openings annually, are:

- Heating, air conditioning, and refrigeration mechanics and installers
- Sheet metal duct installers

These occupations may not have a favorable outlook for the future. Overall, the number of these jobs shows little change. Very few job openings are expected over the next four or five years. Recently, there have been many more new trainees than job openings. Placement rates at area vocational technical schools, community colleges, and/or technical institutes have been fair recently.

Hourly wages include:

\$8.31 Heating, air conditioning, and refrigeration mechanics and installers

High school programs preparing for these occupations are:

47.0201 Heating, air conditioning, and refrigeration mechanics

Related postsecondary programs at state-supported institutions in this area are:

47.0201 Heating, air conditioning, and refrigeration mechanics

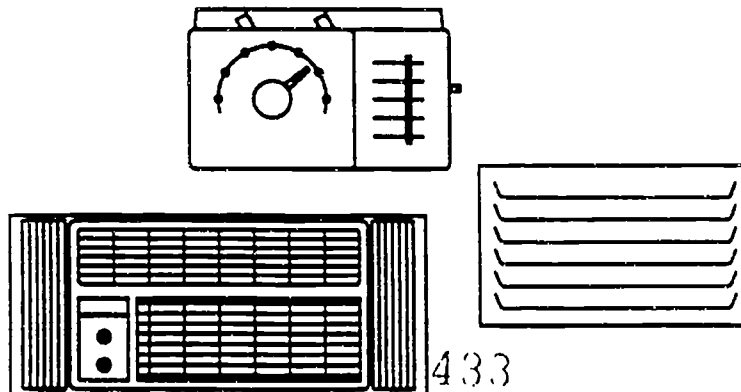

HEAVY TRUCK MAINTENANCE

Persons in heavy truck maintenance repair and maintain the operating condition of trucks, buses, and all types of diesel engines. This also includes mechanics working primarily with automobile diesel engines.

This occupation may have a generally favorable outlook for the future. Few job openings are expected over the next four or five years. Recently, no training has been reported.

Average hourly wages are \$8.23

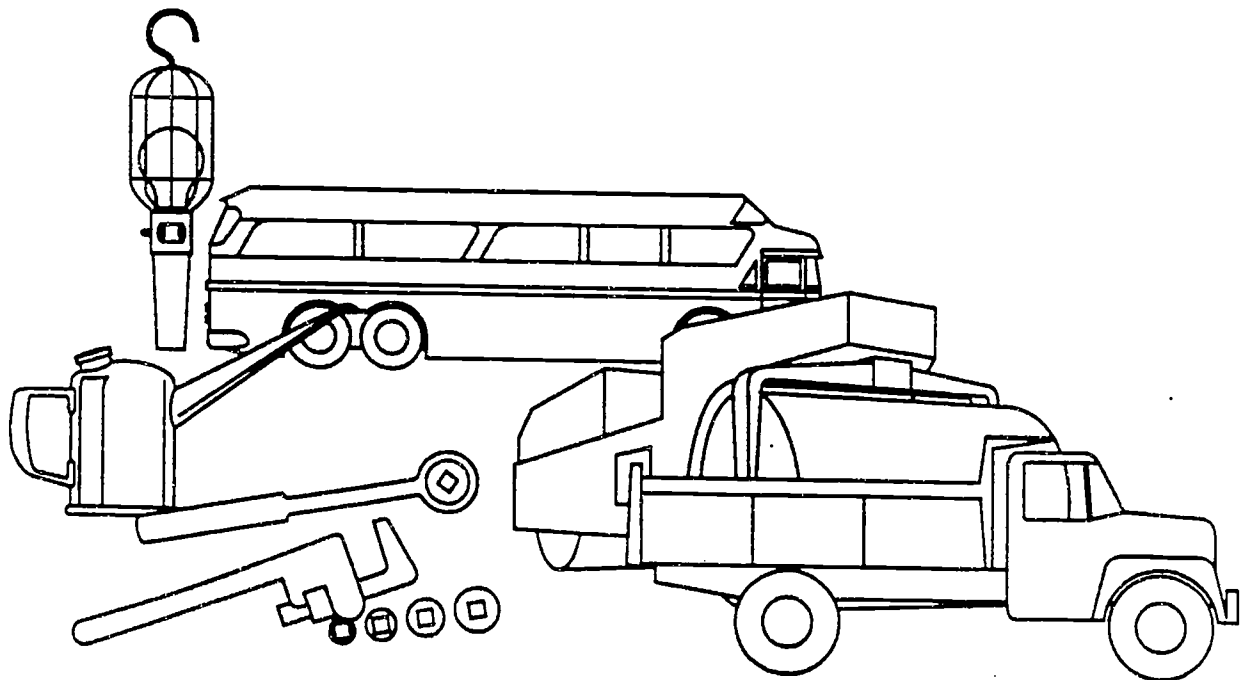

SDA 7 - 2431

HORTICULTURE AND LANDSCAPING

The largest group of workers in these occupations, gardeners and groundskeepers, maintain the grounds of public and private property. Duties may include mowing, trimming, planting, and watering plants, shrubs, and grass.

The largest occupations, which also have the greatest number of job openings annually, are:

- Nursery workers
- Gardeners and groundskeepers, except farm workers

These occupations may not have a favorable outlook for the future. Overall, the number of these jobs is growing. Few job openings are expected over the next four or five years. Recently, there have been many more new trainees than job openings.

Hourly wages include:

\$6.86 Gardeners and groundskeepers, except farm

High school programs preparing for these occupations are:

01.0601 Horticulture

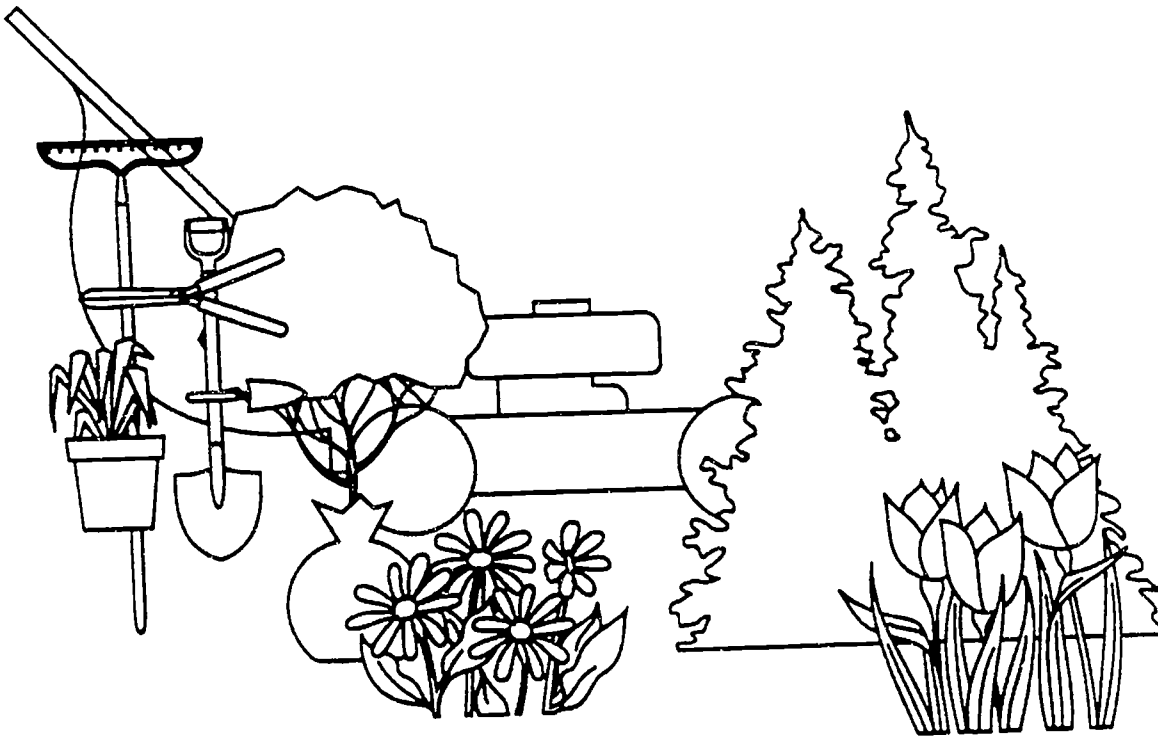

HOTEL AND RESTAURANT MANAGEMENT

Food service and lodging managers supervise the profitable operation of restaurants, hotels, and motels. Workers direct the varied activities of these businesses with the goal of pleasing people and providing good service to their customers.

This occupation may have a generally favorable outlook for the future. Overall, the number of these jobs is growing. Few job openings are expected over the next four or five years. Recently, no training has been reported.

Average hourly wages are \$7.74

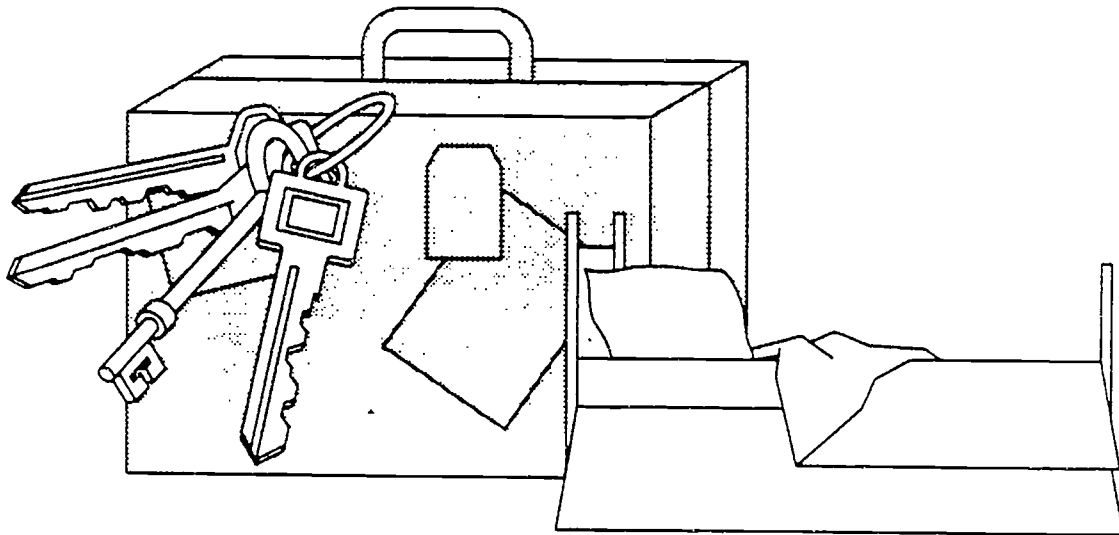

436

SDA 7 - 23

INDUSTRIAL MAINTENANCE TECHNOLOGY

Workers prevent costly waste of raw materials and the idling of human resources in a plant or factory by making industrial machinery repairs as quickly as possible. Maintenance mechanics spend considerable time doing preventive maintenance, including keeping machines well oiled and greased, and periodically cleaning parts.

The largest occupations, which also have the greatest number of job openings annually, are:

- Maintenance mechanics for industrial machinery
- Maintenance mechanics for sewing machines

These occupations may have a generally favorable outlook for the future. Overall, the number of these jobs is growing. A moderate number of job openings are expected over the next four or five years. Recently, there have been many more new trainees than job openings. If this trend continues, job seekers can expect to face keen competition. Placement rates at area vocational technical schools, community colleges, and/or technical institutes have been very good recently.

Hourly wages include:

\$9.64 Machinery maintenance mechanics

Related postsecondary programs at state-supported institutions in this area are:

15.0603 Industrial technology
47.0303 Industrial mechanics technology

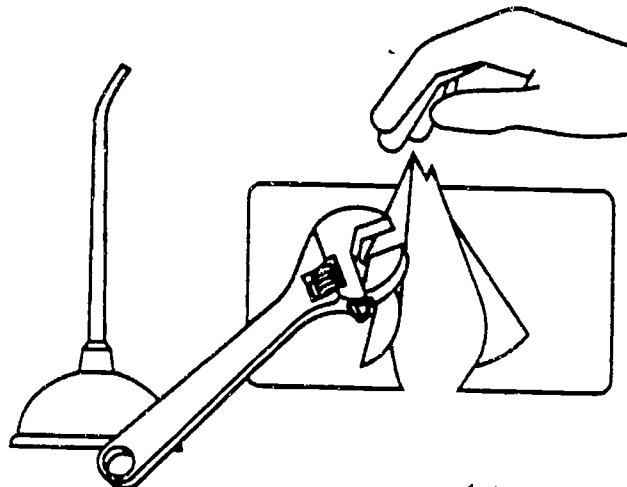

437

SDA 7 - 24

INSTITUTIONAL HOME MANAGEMENT AND SUPPORTING SERVICES

These workers make sure that all public buildings, offices, hospitals, stores, and apartment houses are kept clean and in good condition for the comfort and safety of the people who work or live there. Generally, no special education is required for occupations in this field, with most skills learned on the job.

The largest occupations, which also have the greatest number of job openings annually, are:

- Maids and housekeeping cleaners
- Janitors and cleaners, except maids and housekeeping cleaners

These occupations may have a generally favorable outlook for the future. Overall, the number of these jobs is growing. A moderate number of job openings are expected over the next four or five years. Recently, no training has been reported. Job opportunities should be good.

Hourly wages include:

- \$4.66 Housekeepers
- \$4.79 Maids and housekeeping cleaners
- \$5.77 Janitors and cleaners, except maids and housekeeping cleaners

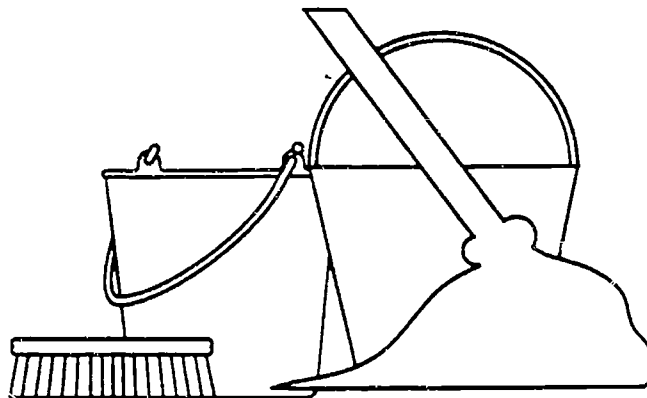

LAW ENFORCEMENT

People working at these occupations are responsible for the safety of Tennessee cities, towns, and highways. Their responsibilities range from controlling traffic to preventing and investigating crimes. Whether on or off duty, they are expected to exercise their authority whenever necessary.

The largest occupations, which also have the greatest number of job openings annually, are:

- Police patrol officers
- Sheriffs and deputy sheriffs

These occupations may not have a favorable outlook for the future. Overall, the number of these jobs is growing. Few job openings are expected over the next four or five years. Recently, there have been many more new trainees than job openings.

Hourly wages include:

\$9.03 Police patrol officers

Related postsecondary programs at state-supported institutions in this area are:

43.0107 Law enforcement and police science

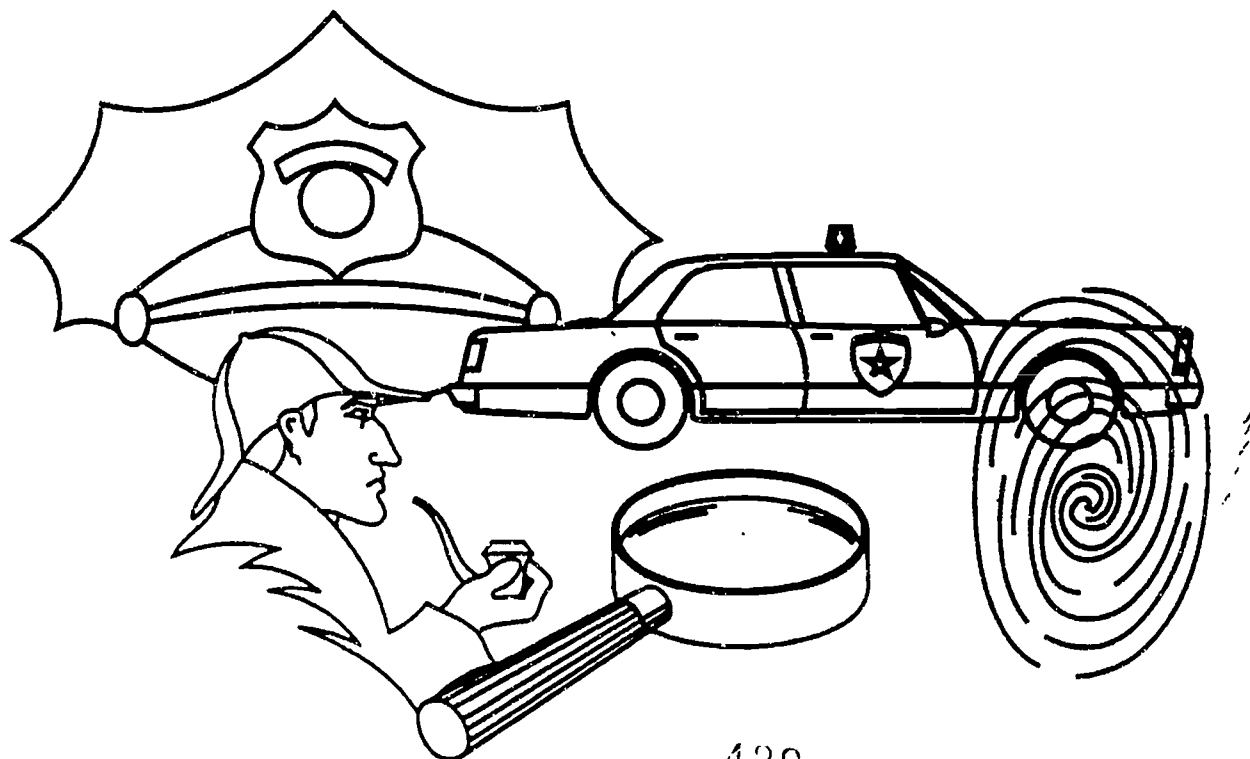

439

MACHINE TOOL TECHNOLOGY

Workers in these occupations make or set up and operate machine tools or repair metal parts. Machinists and tool-and-die makers create highly specialized precision tools, molds, and metal parts. Often they use blueprints to develop prototypes for tools or machines to be used in manufacturing.

The two largest occupations are:

- Machinists
- Machine tool cutting operators and tenders of metal and plastic

The occupations expected to have the most job openings annually are:

- Machinists
- Press and press brake machine setters and set-up operators for metal and plastic

These occupations may have a generally favorable outlook for the future. Overall, the number of these jobs is growing. Large numbers of job openings are expected over the next four or five years. Recently, there have been about as many new trainees as job openings. If this trend continues, job seekers can expect to face some competition. Placement rates at area vocational technical schools, community colleges, and/or technical institutes have been good recently.

Hourly wages include:

- \$8.35 Numerical control machine tool operators and tenders, metal and plastic
- \$8.63 Combination machine tool operators and tenders, metal and plastic
- \$8.98 Lathe and turning machine tool setters and set-up operators, metal and plastic
- \$10.20 Machinists
- \$11.98 Tool and die makers

High school programs preparing for these occupations are:

- 48.0500 Machine tool operation and machine shop technology

Related postsecondary programs at state-supported institutions in this area are:

- 48.0503 Machine tool operation and machine shop technology

MEDICAL RECORDS TECHNOLOGY

Medical records technicians compile and maintain medical records of hospital and clinic patients. Such work is becoming increasingly important as this background information is used for medicare and medicaid insurance reimbursements.

This occupation may not have a favorable outlook for the future. Overall, the number of these jobs shows little change. Very few job openings are expected over the next four or five years. Recently, no training has been reported.

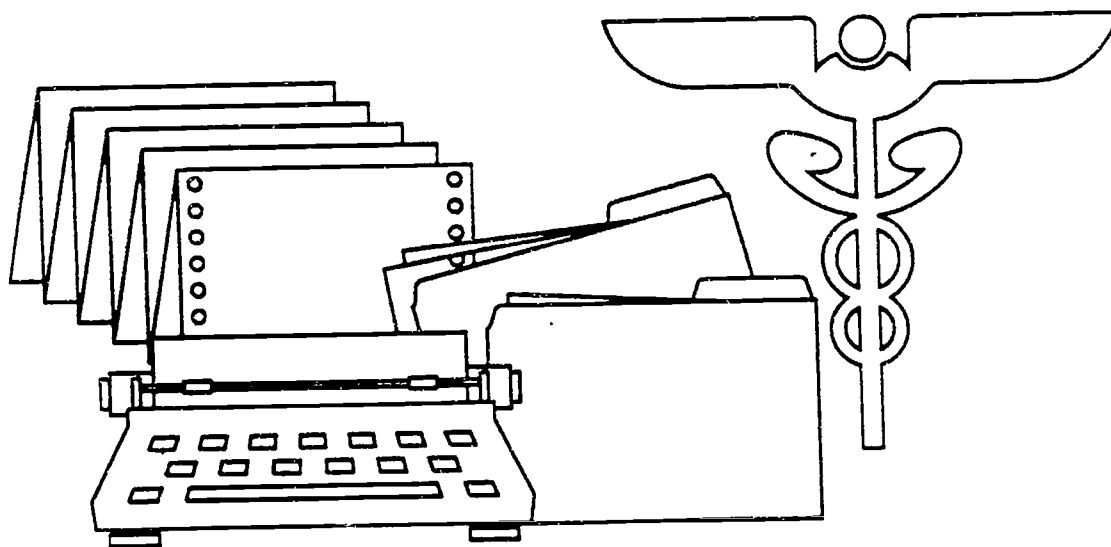

NURSING ASSISTANT

Nursing aides and orderlies work under the general direction of nursing or medical staff. In hospitals, they may answer patients' call bells, serve and collect food trays, feed patients, or set up equipment. In nursing homes, they are expected to sustain ongoing relations with patients.

The largest occupations, which also have the greatest number of job openings annually, are:

- Nursing aides, orderlies, and attendants
- Home health aides

These occupations may have a generally favorable outlook for the future. Overall, the number of these jobs is growing rapidly. A moderate number of job openings are expected over the next four or five years. Recently, there have been fewer new trainees than job openings. If this trend continues, job opportunities should be good.

Hourly wages include:

- \$4.43 Nursing aides, orderlies, and attendants
- \$5.63 Home health aides

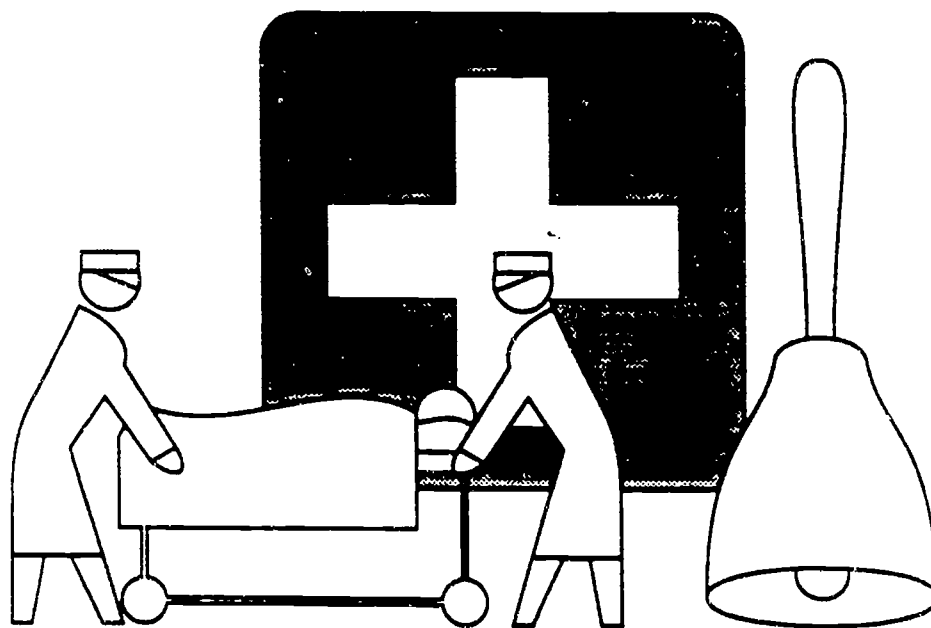

PLUMBING AND PIPEFITTING

Plumbers and pipefitters install and maintain the complex system of pipes that connect to the master system that runs underground. Although plumbing and pipefitting are sometimes considered a single trade, workers may specialize in either craft. Plumbers build and repair the water, waste disposal, drainage, and gas systems in homes and commercial/industrial buildings. Pipefitters build and repair both high and low pressure pipe.

The largest occupations, which also have the greatest number of job openings annually, are:

- Plumbers, pipefitters, and steamfitters
- Pipelayers

These occupations may have a generally favorable outlook for the future. Overall, the number of these jobs is growing. Few job openings are expected over the next four or five years. Recently, no training has been reported.

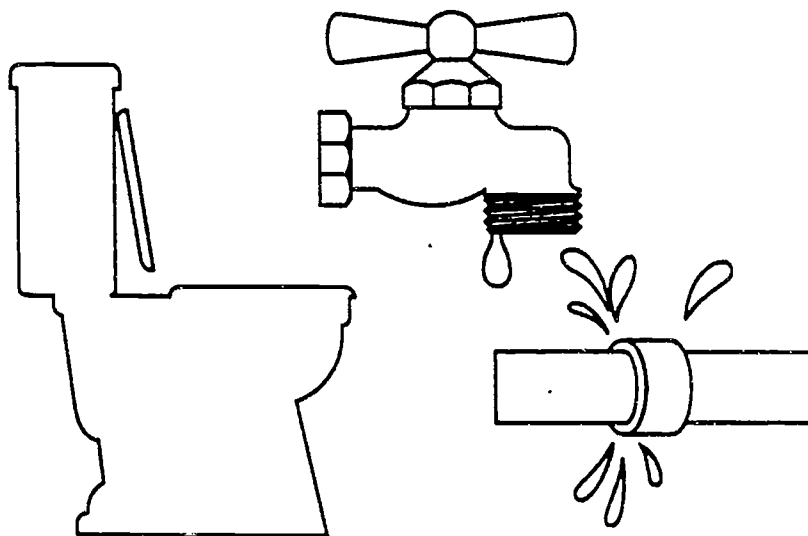

443

PRACTICAL NURSING

Licensed practical nurses (LPNs) work under the supervision of physicians and/or registered nurses to provide nursing care that requires technical knowledge but not the professional training of a registered nurse. They provide bedside care, administer certain medications, and assist in patient examinations.

This occupation may have a generally favorable outlook for the future. Overall, the number of these jobs is growing rapidly. A moderate number of job openings are expected over the next four or five years. Recently, there have been many more new trainees than job openings. If this trend continues, job seekers can expect to face keen competition. Placement rates at area vocational technical schools, community colleges, and/or technical institutes have been excellent recently.

Average hourly wages are \$7.92

Related postsecondary programs at state-supported institutions in this area are:

17.0605 Practical nursing

Licensing may be required. Contact: TENNESSEE BOARD OF NURSING, 615-367-6232.

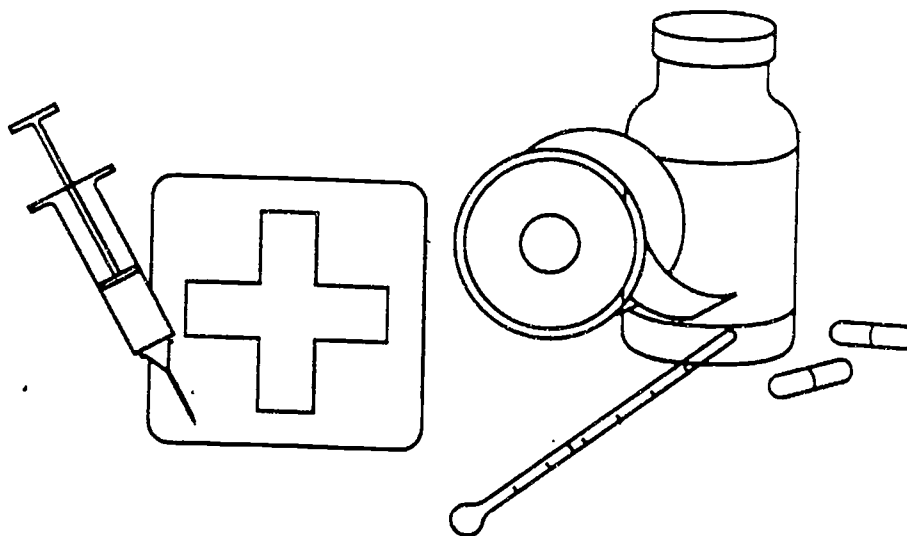

PROFESSIONAL NURSING

Registered Nurses (R.N.'s), the largest occupational group in this field, are primarily employed in hospitals and nursing homes, where they provide skilled bedside care and may supervise licensed practical nurses, nursing aides, and orderlies. Working under the direction of a licensed "supervising physician," physician assistants elicit detailed patient histories, perform physical examinations, and prescribe appropriate treatments.

The largest occupations, which also have the greatest number of job openings annually, are:

- Registered nurses
- Physician's assistants

These occupations may have a generally favorable outlook for the future. Overall, the number of these jobs is growing rapidly. Large numbers of job openings are expected over the next four or five years. Recently, there have been fewer new trainees than job openings. If this trend continues, job opportunities should be good.

Hourly wages include:

\$14.79 Registered nurses

Related postsecondary programs at state-supported institutions in this area are:

51.1601 Nursing (R.N. training)

Licensing may be required. Contact: TENNESSEE BOARD OF MEDICAL EXAMINERS-COMMITTEE ON PHYSICIAN ASSISTANTS, 615-367-6250.

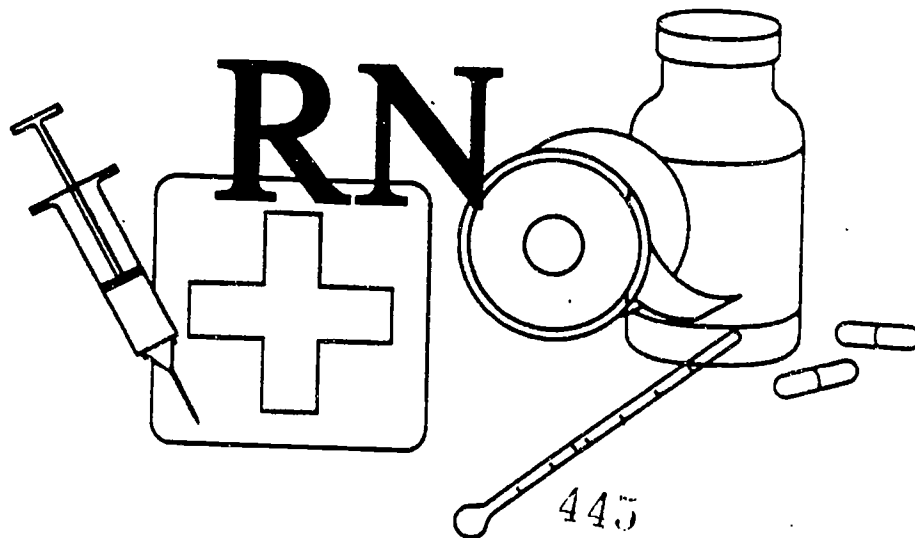

SALES AND MERCHANDISING

Workers in sales and merchandising occupations promote and sell a wide variety of merchandise and services. They also receive, store, display, and inventory products to be sold.

The largest occupations, which also have the greatest number of job openings annually, are:

- Salespersons in retail establishments
- Cashiers

These occupations may have a generally favorable outlook for the future. Overall, the number of these jobs is growing. Large numbers of job openings are expected over the next four or five years. Recently, there have been fewer new trainees than job openings. If this trend continues, job opportunities should be good.

Hourly wages include:

- \$4.46 Cashiers
- \$5.30 Salespersons, retail
- \$9.65 Customer service representatives, utilities
- \$12.87 Purchasing agents- except wholesale, retail, and farm products
- \$15.28 Driver/sales workers

High school programs preparing for these occupations are:

- 08.0700 General marketing
- 08.0799 Miscellaneous general marketing

Licensing may be required. Contact: TENNESSEE DEPARTMENT OF COMMERCE AND INSURANCE, 615-741-2693.

SECURITY SERVICES

Security guards, the largest occupation in this field, patrol and inspect property to protect it against fire, theft, vandalism, and illegal entry. Guards and doorkeepers usually are uniformed and often carry a nightstick and a weapon; correctional officers and jailers maintain order in correctional institutions, enforce institutional rules and regulations, and may supplement the counseling inmates receive from mental health professionals.

The largest occupations, which also have the greatest number of job openings annually, are:

- Correction officers and jailers
- Guards and watch guards

These occupations may have a generally favorable outlook for the future. Overall, the number of these jobs is growing. Few job openings are expected over the next four or five years. Recently, no training has been reported.

Hourly wages include:

- \$5.87 Guards and watch guards
- \$7.52 Correction officers and jailers

Licensing may be required. Contact: COUNTY COURT CLERK'S OFFICE.

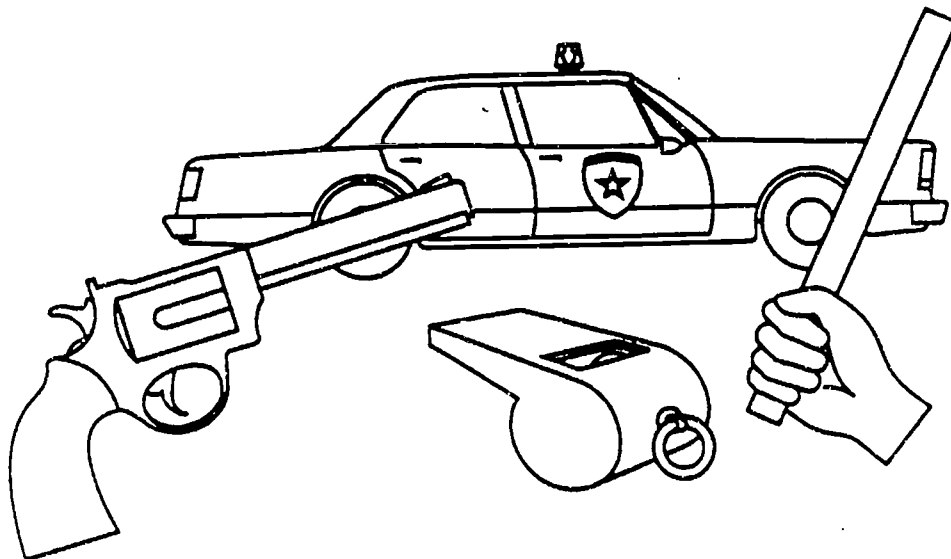

SHEET METAL

Sheet metal workers make, install, and maintain a variety of sheet metal products for home, commercial, and industrial buildings. These products include ducts for air conditioning, heating, and ventilating and pollution control systems, kitchen equipment, roofs, siding, rain gutters, skylights, and outdoor signs. Other workers use a variety of machines in the mass production of sheet-metal products.

The two largest occupations are:

- Machine forming operators and tenders of metal and plastic
- Assemblers and fabricators, except machine, electrical, electronic, and precision assembly

The occupations expected to have the most job openings annually are:

- Machine forming operators and tenders of metal and plastic
- Sheet metal workers

These occupations may have a generally favorable outlook for the future. Overall, the number of these jobs shows little change. A moderate number of job openings are expected over the next four or five years. Recently, there have been fewer new trainees than job openings. If this trend continues, job opportunities should be good.

Hourly wages include:

\$8.82 Sheet metal workers

High school programs preparing for these occupations are:

48.0506 Sheet metal

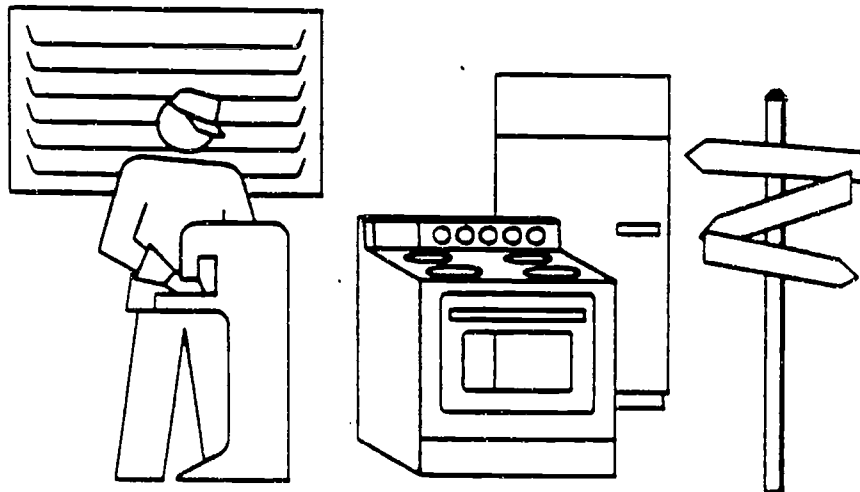

TRUCK, BUS, AND HEAVY EQUIPMENT OPERATION

These occupations include truck drivers who transport goods, bus drivers who transport passengers, and heavy equipment operators who use machinery to move construction materials and other goods over short distances--around a factory, construction site or loading dock.

The largest occupations, which also have the greatest number of job openings annually, are:

- Truck drivers of heavy or tractor trailer trucks
- School bus drivers

These occupations may have a generally favorable outlook for the future. Overall, the number of these jobs is growing. Large numbers of job openings are expected over the next four or five years. Recently, no training has been reported. Job opportunities should be good.

Hourly wages include:

\$7.93 Truck drivers, heavy or tractor trailer

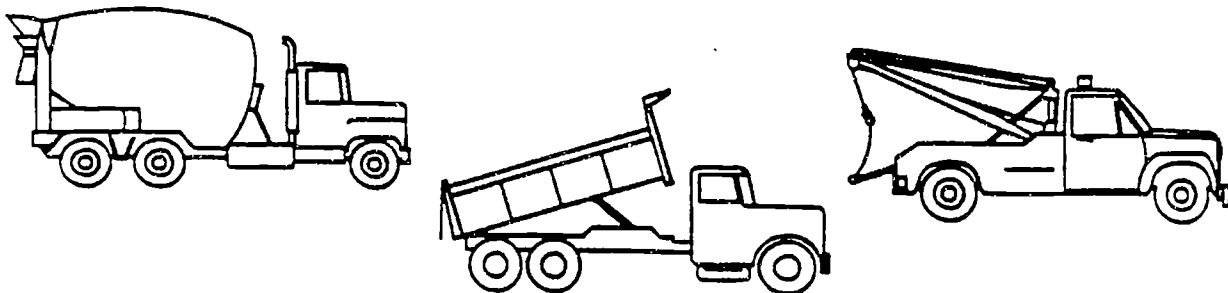

WELDING TECHNOLOGY

Welding is the most common way of permanently joining metal parts. Typically, heat is applied to the metal pieces to be joined; the parts are melted and fused to form a permanent bond. Welding is used to construct and repair parts of ships, automobiles, spacecraft, and thousands of products. It can also be used to join beams and steel reinforcing rods in buildings, bridges, and highways.

The largest occupations, which also have the greatest number of job openings annually, are:

- Welding machine setters and set-up operators
- Welders and cutters

These occupations may not have a favorable outlook for the future. Overall, the number of these jobs is growing rapidly. A moderate number of job openings are expected over the next four or five years. Recently, there have been many more new trainees than job openings. If this trend continues, job seekers can expect to face keen competition. Placement rates at area vocational technical schools, community colleges, and/or technical institutes have been fair recently.

Hourly wages include:

\$8.36 Welders and cutters

High school programs preparing for these occupations are:

48.0508 Welding, brazing, and soldering

Related postsecondary programs at state-supported institutions in this area are:

48.0508 Welding, brazing, and soldering

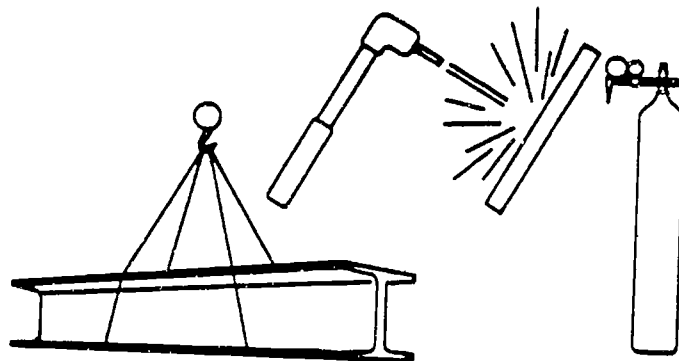

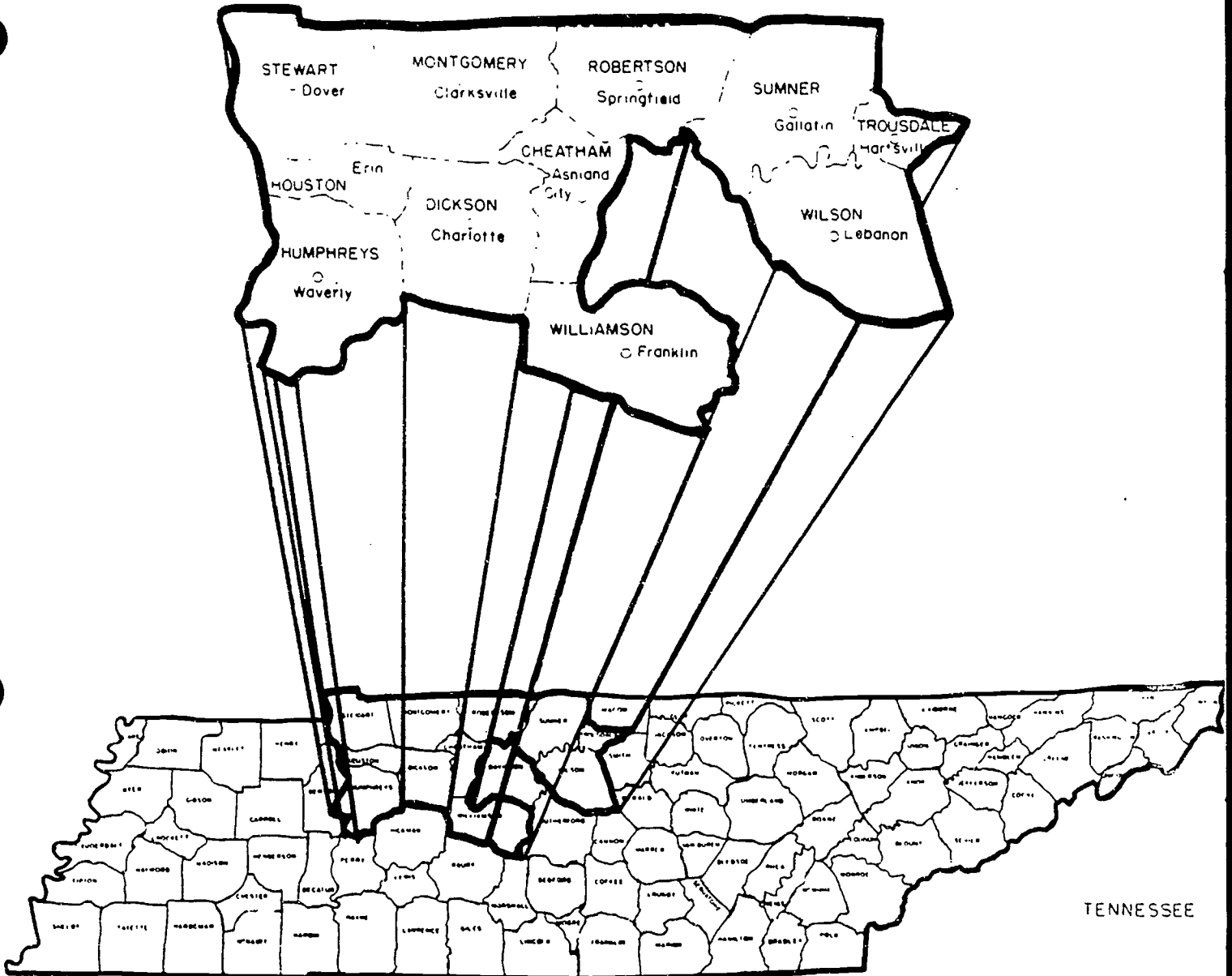

Service Delivery Area 8

ACCOUNTING AND FINANCIAL MANAGEMENT

Many individuals in this group are accountants and auditors who prepare and analyze business records and financial reports which are needed for effective management of any organization. Financial managers, another occupation in this group, typically plan, organize, control, or coordinate the financial activities of an organization.

The largest occupations, which also have the greatest number of job openings annually, are:

- Financial managers
- Accountants and auditors

These occupations may have a generally favorable outlook for the future. Overall, the number of these jobs is growing. A moderate number of job openings are expected over the next four or five years. Recently, there have been fewer new trainees than job openings. If this trend continues, job opportunities should be good.

Hourly wages include:

\$14.30 Accountants and auditors
\$19.77 Financial managers

Licensing may be required. Contact: TENNESSEE BOARD OF ACCOUNTANCY, 615-741-2250.



ADMINISTRATIVE SUPPORT: ACCOUNTING

Persons employed in this group of occupations provide clerical and administrative support to accountants and auditors. Most of these jobs require only a high school diploma for entry.

The largest occupations, which also have the greatest number of job openings annually, are:

- Bookkeeping, accounting, and auditing clerks
- Payroll and timekeeping clerks

These occupations may not have a favorable outlook for the future. Overall, the number of these jobs shows little change. Large numbers of job openings are expected over the next four or five years. Recently, there have been many more new trainees than job openings. If this trend continues, job seekers can expect to face keen competition.

Hourly wages include:

- \$8.42 Bookkeeping, accounting, and auditing clerks
- \$8.53 Payroll and timekeeping clerks

High school programs preparing for these occupations are:

- 07.0101 Accounting and bookkeeping

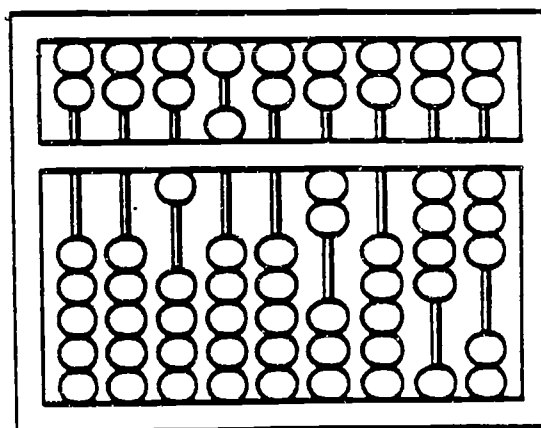
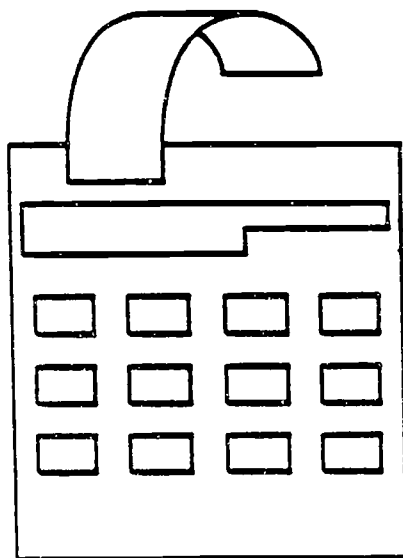

ADMINISTRATIVE SUPPORT: FINANCE AND INSURANCE

Workers provide clerical and general administrative support to the banking and finance industry. Workers receive and pay out money, keep records of money and negotiable instruments, interview applicants for credit, locate and notify customers of delinquent accounts, examine insurance claims, and process a variety of paperwork.

The largest occupations, which also have the greatest number of job openings annually, are:

- Tellers
- Bill and account collectors

These occupations may have a generally favorable outlook for the future. Overall, the number of these jobs shows little change. A moderate number of job openings are expected over the next four or five years. Recently, no training has been reported. Job opportunities should be good.

Hourly wages include:

- \$6.32 Tellers
- \$6.83 Bill and account collectors

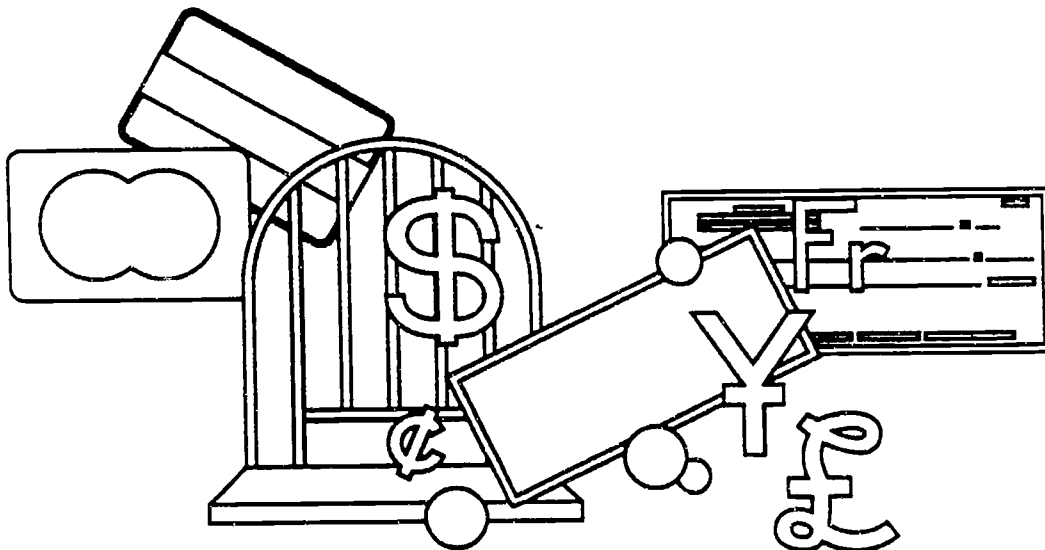

ADMINISTRATIVE SUPPORT: GENERAL

The job duties in this group of occupations are very diverse and are determined by the type of firm. For example, workers may schedule appointments, give information to callers, take dictation, type correspondence, read and route incoming mail, file correspondence and other records, and supervise and coordinate the activities of subordinate clerical workers.

The largest occupations, which also have the greatest number of job openings annually, are:

- Secretaries, except legal and medical secretaries
- General office clerks

These occupations may not have a favorable outlook for the future. Overall, the number of these jobs is growing. Large numbers of job openings are expected over the next four or five years. Recently, there have been many more new trainees than job openings. If this trend continues, job seekers can expect to face keen competition. Placement rates at area vocational technical schools, community colleges, and/or technical institutes have been good recently.

Hourly wages include:

\$6.00	Receptionists and information clerks
\$7.22	Data entry keyers, except composing
\$7.51	Typists including word processing
\$7.73	File clerks
\$7.77	Order clerks- materials, merchandise, and service
\$7.98	Secretaries, ex. legal and medical
\$8.15	General office clerks
\$11.91	First line supervisors and manager/supervisors- clerical and administrative support occupations

High school programs preparing for these occupations are:

07.0601	Secretarial and related programs
07.0701	Typing, general office and related programs

Related postsecondary programs at state-supported institutions in this area are:

07.9999	Miscellaneous business administrative support
52.0401	Administrative assistant and secretarial science

AGRICULTURAL PRODUCTION

Workers in this field plan and economically use facilities, land, water, machinery, chemicals, finance, and labor in the production of plant and animal products.

The largest occupations, which also have the greatest number of job openings annually, are:

- Farm managers
- Farm workers

These occupations may not have a favorable outlook for the future. Overall, the number of these jobs shows little change. A moderate number of job openings are expected over the next four or five years. Recently, there have been many more new trainees than job openings. If this trend continues, job seekers can expect to face keen competition.

High school programs preparing for these occupations are:

01.0301 Agricultural production

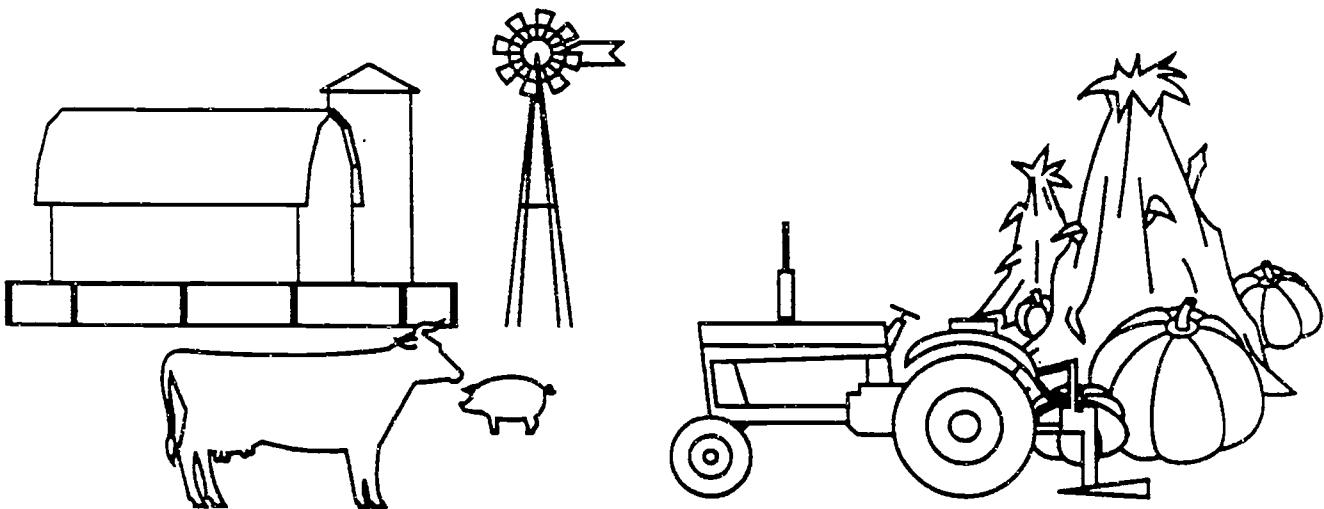

APPLIANCE AND EQUIPMENT REPAIR

Individuals in these occupations repair, adjust, maintain, and install all types of electrical motors and electrical and gas home appliances. Types of equipment used include test instruments, gauges, and hand, bench, and power tools.

The two largest occupations are:

- Electric home appliance and power tool repairers
- Gas appliance repairers

The occupations expected to have the most job openings annually are:

- Coin and vending machine servicers and repairers
- Gas appliance repairers

These occupations may not have a favorable outlook for the future. Overall, the number of these jobs shows little change. Very few job openings are expected over the next four or five years. Recently, there have been many more new trainees than job openings.

High school programs preparing for these occupations are:

47.0101 Electrical and electronics technology

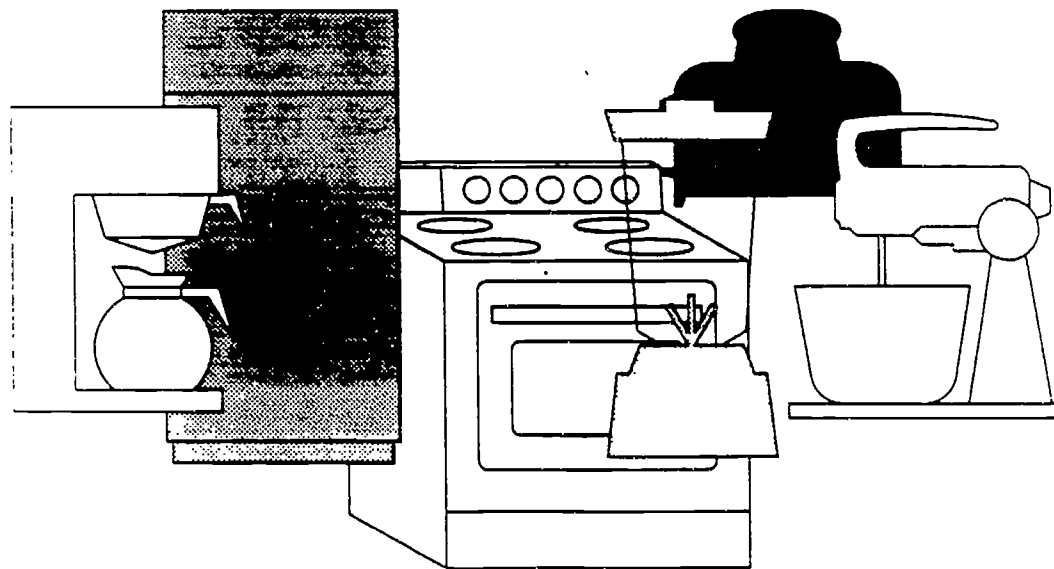

AUTOMOTIVE BODY REPAIR

Thousands of motor vehicles are damaged in traffic accidents every day. The workers in this field straighten bent frames, remove dents, and replace crumpled parts that are beyond repair so that those vehicles look and drive like new.

The largest occupations, which also have the greatest number of job openings annually, are:

- Automotive body and related repairers
- Painters of transportation equipment

These occupations may not have a favorable outlook for the future. Overall, the number of these jobs is growing. Few job openings are expected over the next four or five years. Recently, there have been many more new trainees than job openings.

High school programs preparing for these occupations are:

47.0603 Automotive body repair

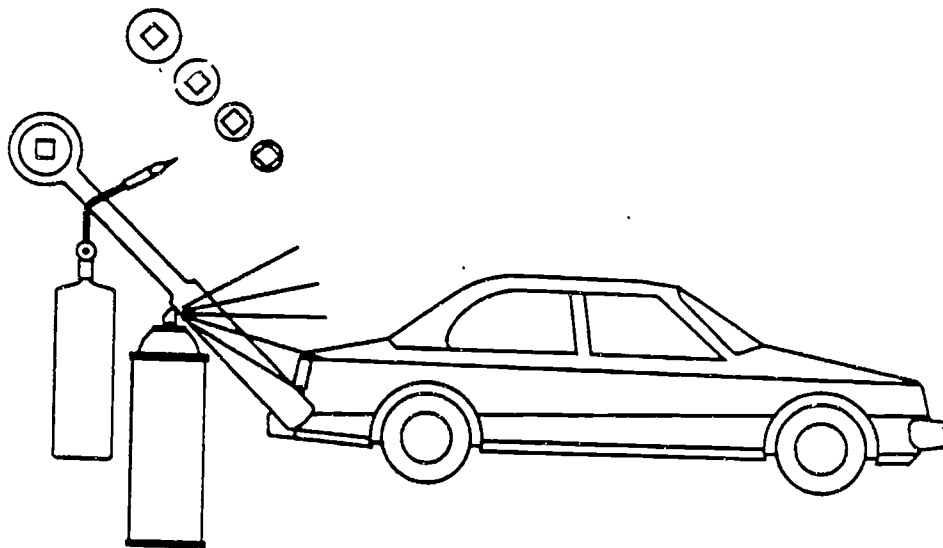

458

SDA 8 - 7

AUTOMOTIVE SERVICE TECHNOLOGY

These occupations include jobs concerned with parking, cleaning, polishing, lubricating, repairing, and refueling trucks, buses, and automobiles, and related servicing activities. The primary occupation, automotive mechanic, is concerned with repair and service of motor vehicles.

The largest occupations, which also have the greatest number of job openings annually, are:

- Automotive mechanics
- Tire repairers and changers

These occupations may not have a favorable outlook for the future. Overall, the number of these jobs is growing slowly. A moderate number of job openings are expected over the next four or five years. Recently, there have been many more new trainees than job openings. If this trend continues, job seekers can expect to face keen competition. Placement rates at area vocational technical schools, community colleges, and/or technical institutes have been fair recently.

Hourly wages include:

\$10.61 Automotive mechanics

High school programs preparing for these occupations are:

47.0604 Automotive mechanics

Related postsecondary programs at state-supported institutions in this area are:

15.0803 Automotive technology
47.0604 Automotive mechanics

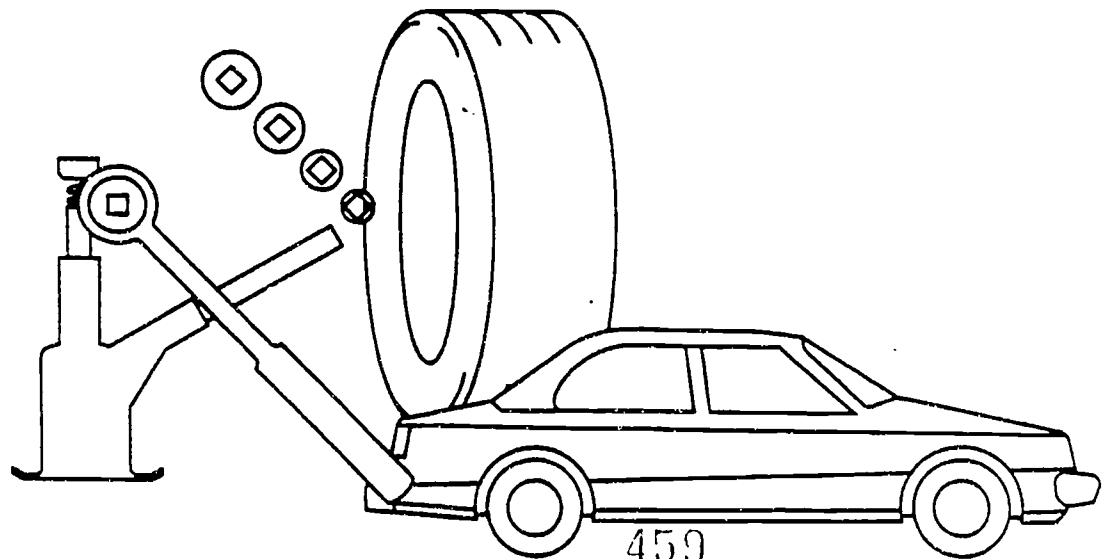

BRICK, BLOCK, AND STONEMASONRY

Workers are involved in trades producing attractive, durable surfaces. Bricklayers build walls, floors, partitions, fireplaces, and other structures with brick, cinder, or concrete block and other masonry materials. Stone masons build stone walls as well as set stone exteriors and floors. Both natural and artificial stones are used.

The largest occupations, which also have the greatest number of job openings annually, are:

- Brick masons
- Hard tile setters

These occupations may not have a favorable outlook for the future. Overall, the number of these jobs shows little change. Few job openings are expected over the next four or five years. Recently, there have been more new trainees than job openings.

High school programs preparing for these occupations are:

46.0102 Brick, block, and stonemasonry

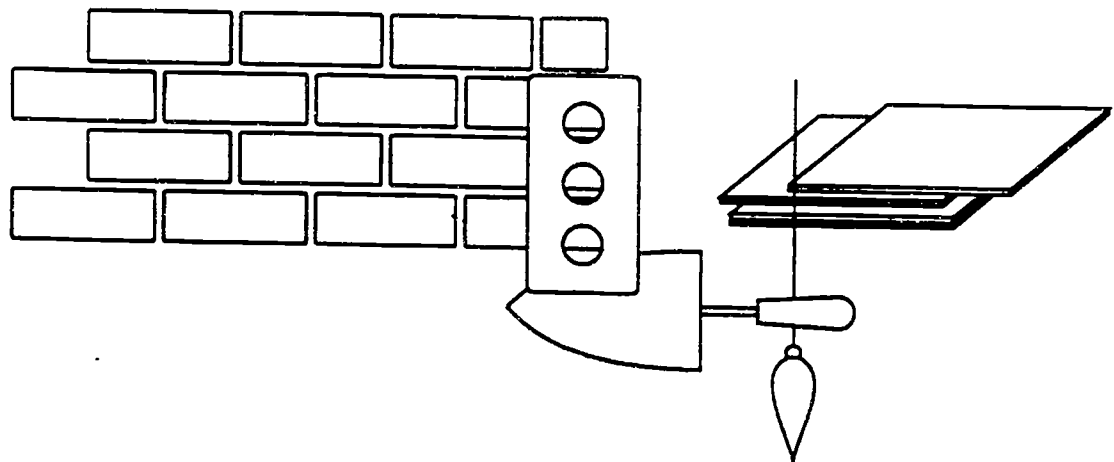

400

BUILDING MAINTENANCE

Persons in building maintenance occupations perform work involving several maintenance skills to keep the structure of an establishment in repair. Duties may involve pipefitting, boilermaking, carpentry, and electrical work as well as repairing buildings, floors, or stairs.

The two largest occupations are:

- General utility maintenance repairers
- Installers and repairers of manufactured buildings, mobile homes, and travel trailers

The occupations expected to have the most job openings annually are:

- General utility maintenance repairers
- Stationary engineers

These occupations may have a generally favorable outlook for the future. Overall, the number of these jobs is growing. Large numbers of job openings are expected over the next four or five years. Recently, there have been fewer new trainees than job openings. If this trend continues, job opportunities should be good.

Hourly wages include:

\$8.89 Maintenance repairers, general utility

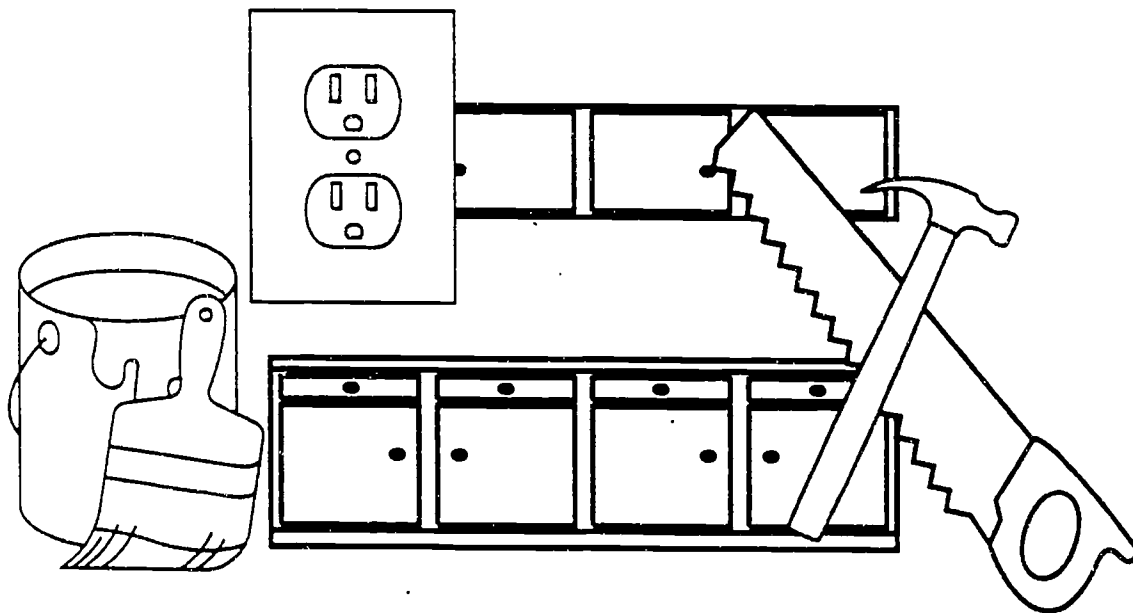

CARPENTRY

Almost all construction projects employ carpenters, the largest group of building trades workers. Carpenters perform a variety of jobs. Their duties will vary by type of construction, type of company, skill of the carpenter, and size of the community. A carpenter employed by a special trade contractor, for example, may specialize in laying hardwood floors, while one who is employed by a general building contractor may build wall frames and install paneling.

The largest occupations, which also have the greatest number of job openings annually, are:

- Carpenters
- Ceiling tile installers and acoustical carpenters

These occupations may have a generally favorable outlook for the future. Overall, the number of these jobs is growing slowly. A moderate number of job openings are expected over the next four or five years. Recently, there have been fewer new trainees than job openings. If this trend continues, job opportunities should be good.

Hourly wages include:

\$9.42 Carpenters

High school programs preparing for these occupations are:

46.0201 Carpentry

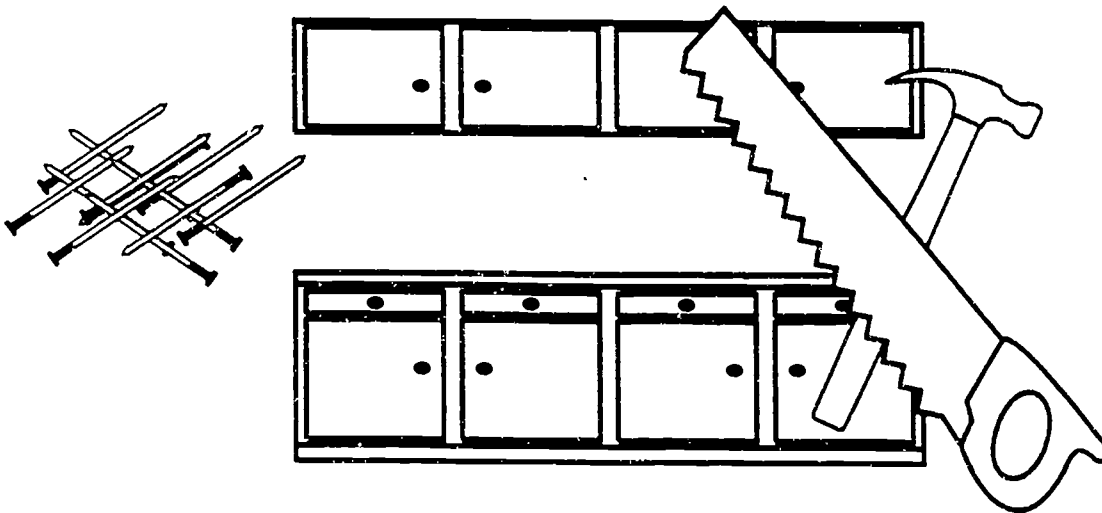

COMMERCIAL ART AND DESIGN

The majority of workers in this field design or arrange objects and materials in an artistic or decorative manner. Additional tasks may include the creation or drawing of designs for items such as furniture and machinery (product design).

The largest occupations, which also have the greatest number of job openings annually, are:

- Artists and related workers
- Designers, except interior designers

These occupations may have a generally favorable outlook for the future. Overall, the number of these jobs is growing. A moderate number of job openings are expected over the next four or five years. Recently, there have been fewer new trainees than job openings. If this trend continues, job opportunities should be good.

High school programs preparing for these occupations are:

48.0203 Commercial art

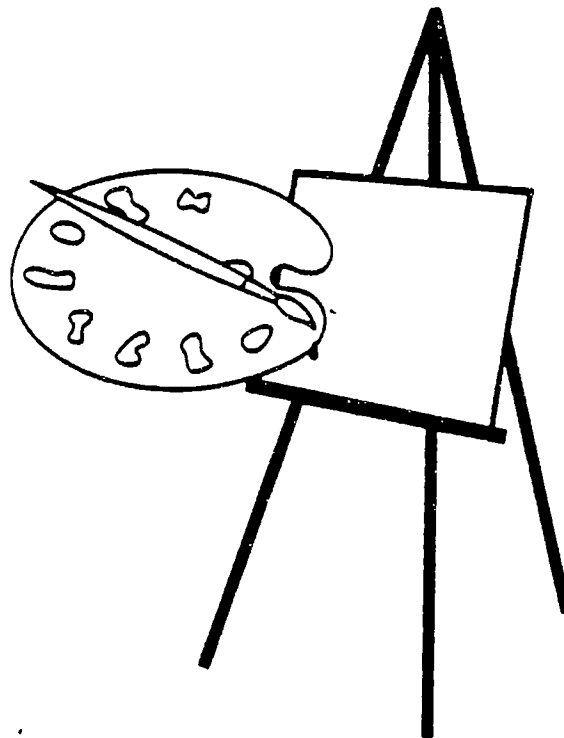

COMMUNICATIONS, JOURNALISM, AND BROADCASTING

Individuals who work in these fields are concerned with communicating ideas and information to individuals for their education and entertainment. The methods utilized are varied and may include the written word, radio, and television.

The largest occupations, which also have the greatest number of job openings annually, are:

- Writers and editors
- Reporters and correspondents

These occupations may not have a favorable outlook for the future. Overall, the number of these jobs is growing. Few job openings are expected over the next four or five years. Recently, there have been many more new trainees than job openings.

High school programs preparing for these occupations are:

09.0601 Radio and television news broadcasting

Related postsecondary programs at state-supported institutions in this area are:

09.0403 Mass communication

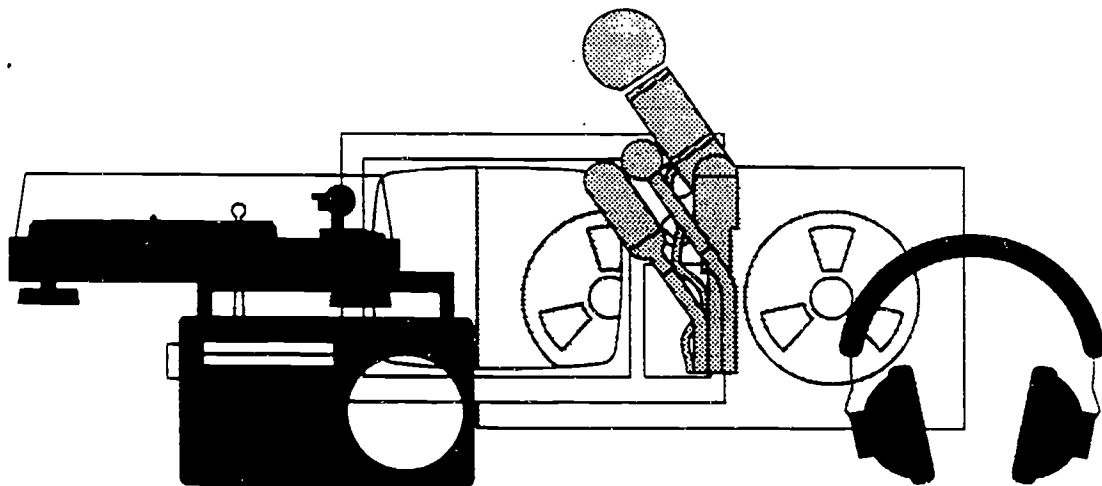

COMPUTER AND BUSINESS MACHINE PRODUCTION AND REPAIR

Workers in these fields install, service, maintain, and repair mechanical and electronic equipment, such as computers, word processing systems, radar systems, and office machines. Repairers may work in various locations doing a variety of tasks.

The two largest occupations are:

- Precision inspectors, testers, and graders
- Data processing equipment repairers

The occupations expected to have the most job openings annually are:

- Electrical and electronic assemblers
- Office machine and cash register servicers

These occupations may not have a favorable outlook for the future. Overall, the number of these jobs shows little change. Very few job openings are expected over the next four or five years. Recently, there have been many more new trainees than job openings. Placement rates at area vocational technical schools, community colleges, and/or technical institutes have been fair recently.

High school programs preparing for these occupations are:

47.0105 Industrial electronics

Related postsecondary programs at state-supported institutions in this area are:

47.0105 Industrial electronics

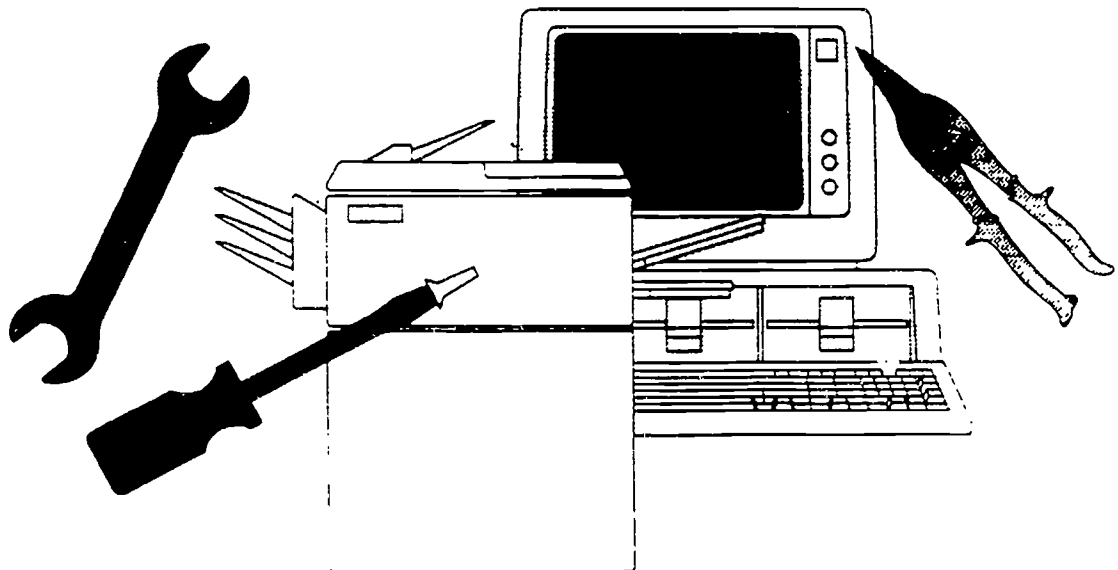

The majority of workers in this field are electrical and electronic engineering technicians and technologists. They apply electrical and related knowledge to design, build, test, and repair electrical equipment in industrial or commercial settings for subsequent use by engineering personnel.

This occupation may have a generally favorable outlook for the future. Overall, the number of these jobs is growing. Few job openings are expected over the next four or five years. Recently, there have been more new trainees than job openings.

Average hourly wages are \$12.07

High school programs preparing for these occupations are:

15.0303 Electronic technology

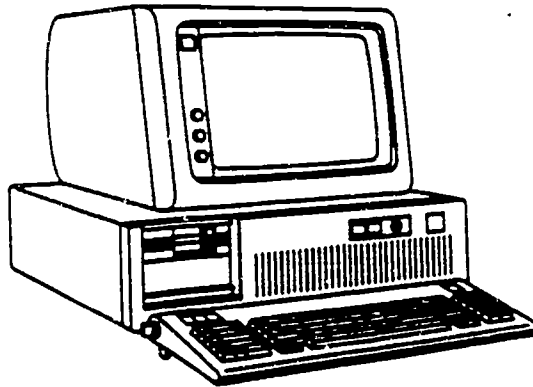

COMPUTER SYSTEMS

Workers in these computer occupations develop and write computer programs to store, locate, and retrieve specific documents, data, and information. They may also analyze business, scientific, and technical problems for application to electronic data processing systems. These careers generally require specialized training.

The largest occupations, which also have the greatest number of job openings annually, are:

- Systems analysts, electronic data processing
- Computer programmers

These occupations may not have a favorable outlook for the future. Overall, the number of these jobs is growing rapidly. A moderate number of job openings are expected over the next four or five years. Recently, there have been many more new trainees than job openings. If this trend continues, job seekers can expect to face keen competition.

Hourly wages include:

- \$13.46 Systems analysts, electronic data processing
- \$14.42 Computer programmers

High school programs preparing for these occupations are:

- 07.0301 Electronic data processing, computer science
- 07.0305 Business data programming

Related postsecondary programs at state-supported institutions in this area are:

- 52.1201 Management information systems and business data processing

COSMETOLOGY

Cosmetologists and related workers provide beauty services for customers. These may include cutting and styling hair, treating hair and scalp, applying makeup, dressing wigs, or removing hair by electrolysis, as well as cleaning, shaping, and polishing a customer's fingernails and toenails.

The largest occupations, which also have the greatest number of job openings annually, are:

- Hairdressers, hairstylists, and cosmetologists
- Manicurists

These occupations may have a generally favorable outlook for the future. Overall, the number of these jobs is growing. A moderate number of job openings are expected over the next four or five years. Recently, there have been many more new trainees than job openings. If this trend continues, job seekers can expect to face keen competition. Placement rates at area vocational technical schools, community colleges, and/or technical institutes have been very good recently.

High school programs preparing for these occupations are:

12.0403 Cosmetology

Related postsecondary programs at state-supported institutions in this area are:

12.0403 Cosmetology

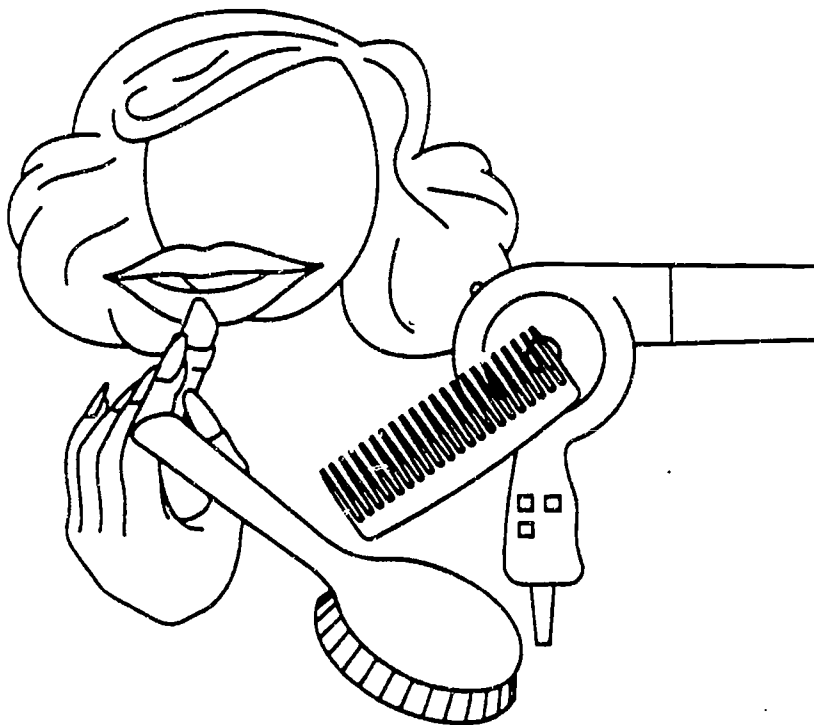

CUSTOM UPHOLSTERY

Upholsterers recondition sofas, chairs, and other upholstered furniture by replacing worn and damaged fabrics, springs, and padding. Upholsterers combine a knowledge of fabrics and other materials with artistic flair and manual skill. Upholsterers should have manual dexterity, good coordination, and be able to do occasional heavy lifting.

The two largest occupations are:

- Upholsterers
- Sewing machine operators manufacturing items other than garments

The occupations expected to have the most job openings annually are:

- Upholsterers
- Assemblers and fabricators, except machine, electrical, electronic, and precision assembly

These occupations may have a generally favorable outlook for the future. Overall, the number of these jobs shows little change. Few job openings are expected over the next four or five years. Recently, no training has been reported.

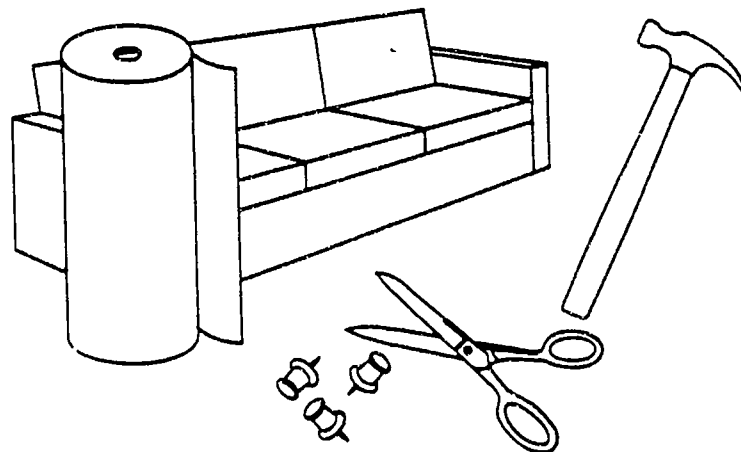

463

DENTAL ASSISTING

Dental assistants may perform a wide variety of clinical, office, and laboratory duties, depending on the size of the dental practice. Typically, assistants seat patients in the dental chair, prepare them for the dentist's treatment, and work with the dentist during examination and treatment.

This occupation may have a generally favorable outlook for the future. Few job openings are expected over the next four or five years. Recently, there have been about as many new trainees as job openings. Placement rates at area vocational technical schools, community colleges, and/or technical institutes have been excellent recently.

Related postsecondary programs at state-supported institutions in this area are:

17.0101 Dental assisting

Licensing may be required. Contact: TENNESSEE BOARD OF DENTISTRY, 615-367-6228.

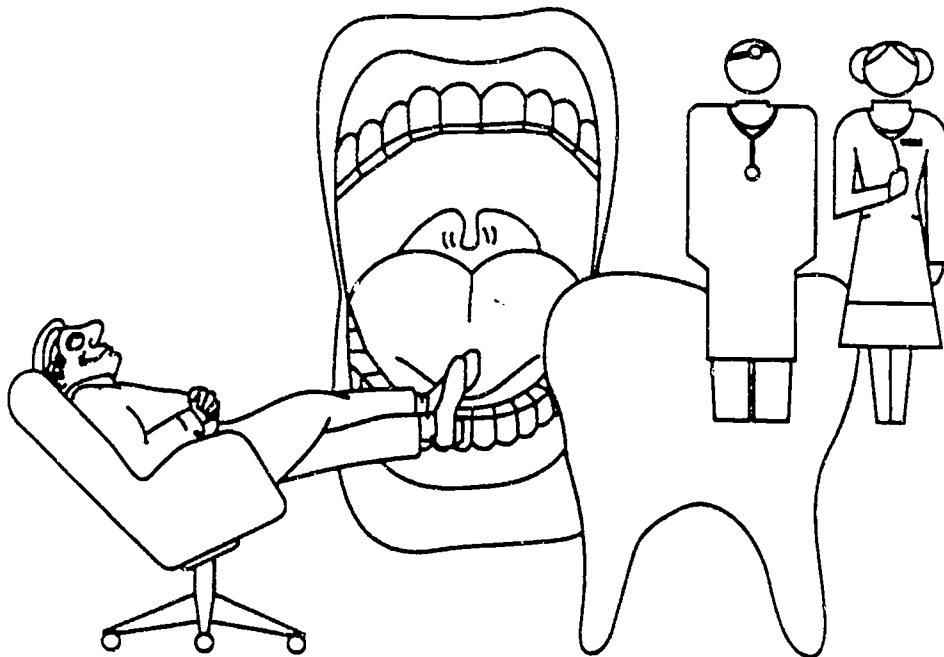

470

DRAFTING AND DESIGN TECHNOLOGY

Persons in drafting and design technology prepare clear, complete, and accurate working plans and detail drawings from rough or detailed sketches or notes for engineering or manufacturing purposes according to specified dimensions. Workers need to have knowledge of various machines, engineering practices, mathematics, building materials, and other physical sciences to complete drawings. Computer-assisted design (CAD) equipment may be used by some workers.

The largest occupations, which also have the greatest number of job openings annually, are:

- Cost estimators
- Drafters

These occupations may not have a favorable outlook for the future. Overall, the number of these jobs is growing. A moderate number of job openings are expected over the next four or five years. Recently, there have been many more new trainees than job openings. If this trend continues, job seekers can expect to face keen competition. Placement rates at area vocational technical schools, community colleges, and/or technical institutes have been good recently.

Hourly wages include:

\$11.85 Drafters

High school programs preparing for these occupations are:

48.0101 Drafting

Related postsecondary programs at state-supported institutions in this area are:

48.0101 Drafting

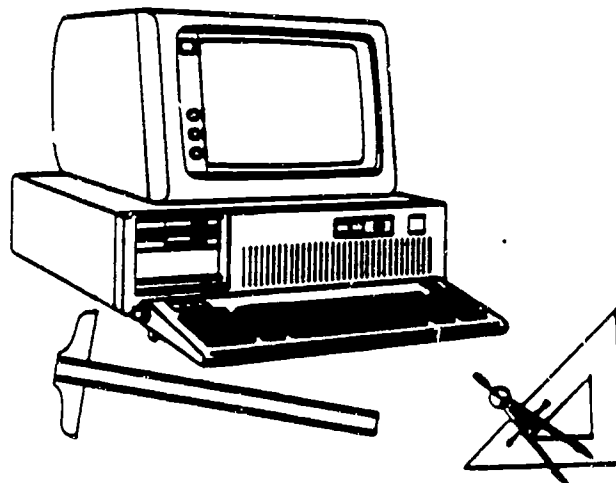

DRYCLEANING

Workers in these occupations operate washing and drying machines to clean and dry clean commercial, industrial, or household articles; use pressing machines to press and shape articles; and identify stains and apply chemical solutions to remove them.

The largest occupations, which also have the greatest number of job openings annually, are:

- Laundry and drycleaning machine operators and tenders, except of pressing machines
- Operators and tenders of machines pressing textiles, garments, and related materials

These occupations may have a generally favorable outlook for the future. Overall, the number of these jobs is growing. Few job openings are expected over the next four or five years. Recently, no training has been reported.

Hourly wages include:

\$4.64 Laundry and drycleaning machine operators and tenders, except pressing

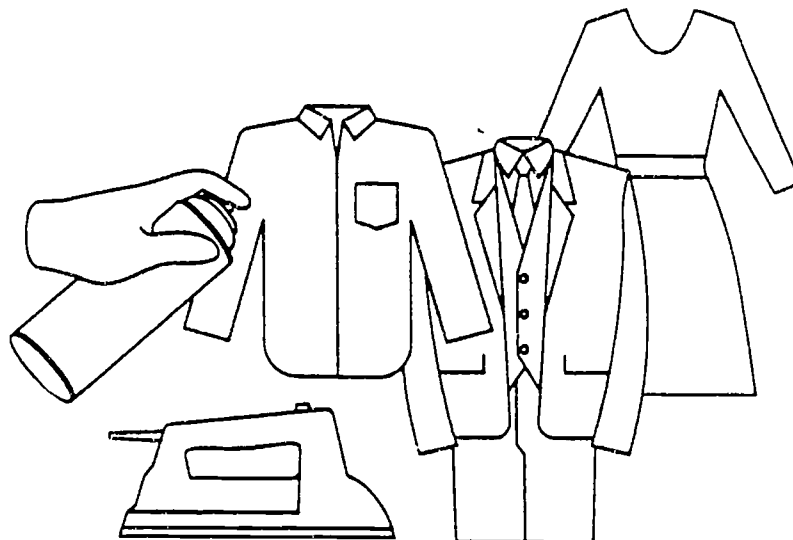

EARLY CHILDHOOD EDUCATION

Child care workers and managers of child care centers assume responsibility for the safety, physical care, and emotional, social, and intellectual growth of preschool children and infants while parents are at work or are unavailable for other reasons. Some work in residential institutions for young children. Teacher aides assist teachers by handling routine paperwork or by working directly with children.

The largest occupations, which also have the greatest number of job openings annually, are:

- Teacher aides, paraprofessional
- Child care workers

These occupations may have a generally favorable outlook for the future. Overall, the number of these jobs is growing rapidly. Large numbers of job openings are expected over the next four or five years. Recently, there have been fewer new trainees than job openings. If this trend continues, job opportunities should be good.

High school programs preparing for these occupations are:

20.0201 Child care and guidance management services

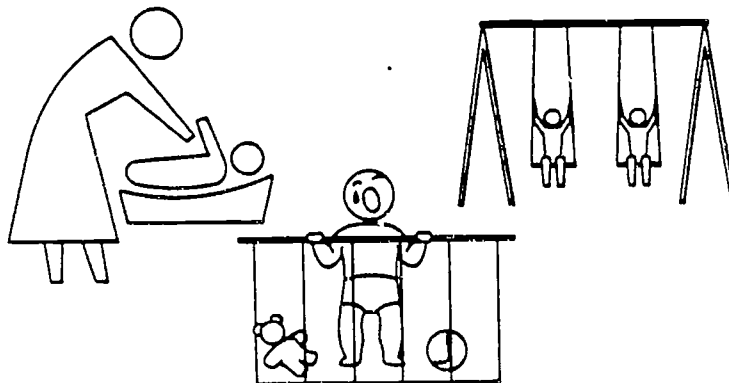

ELECTRICIAN OCCUPATIONS

Workers in the electrical field install, maintain, and repair wiring, electrical equipment, and fixtures or assist in such activities. These workers insure that work is in accordance with the relevant codes. A high school education is usually required and a five-year apprenticeship program is recommended.

The largest occupations, which also have the greatest number of job openings annually, are:

- Electricians
- Helpers of electricians and powerline transmission installers

These occupations may have a generally favorable outlook for the future. Overall, the number of these jobs is growing. A moderate number of job openings are expected over the next four or five years. Recently, there have been more new trainees than job openings. If this trend continues, job seekers can expect to face some competition.

Hourly wages include:

\$15.29 Electricians

High school programs preparing for these occupations are:

46.0302 Electrician

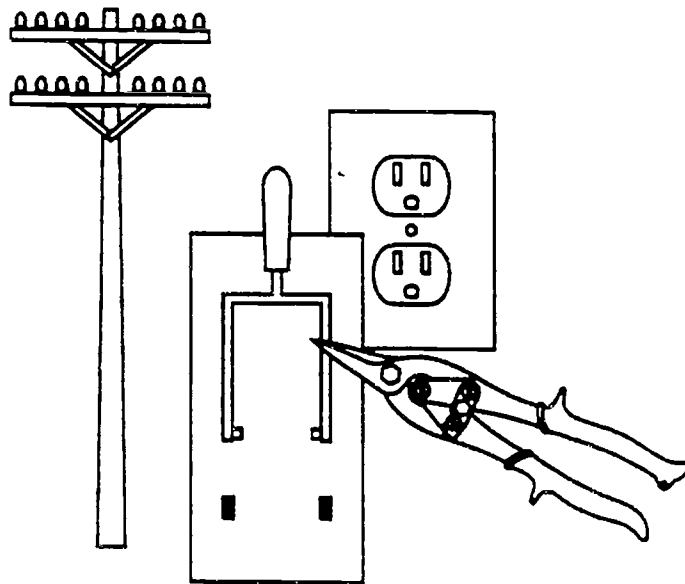

FIRE CONTROL AND SAFETY TECHNOLOGY

Workers in these positions help protect the public against the danger to their lives and property by fire. Firefighters must be prepared to respond to a fire and handle any emergency, including medical, that arises. Some firefighters operate fire apparatus, ambulances, emergency rescue vehicles, and fireboats. Most fire departments also are responsible for fire prevention.

The largest occupations, which also have the greatest number of job openings annually, are:

- Fire fighting and prevention supervisors
- Fire fighters

These occupations may have a generally favorable outlook for the future. Overall, the number of these jobs is growing. A moderate number of job openings are expected over the next four or five years. Recently, no training has been reported. Job opportunities should be good.

Hourly wages include:

\$9.78 Fire fighters

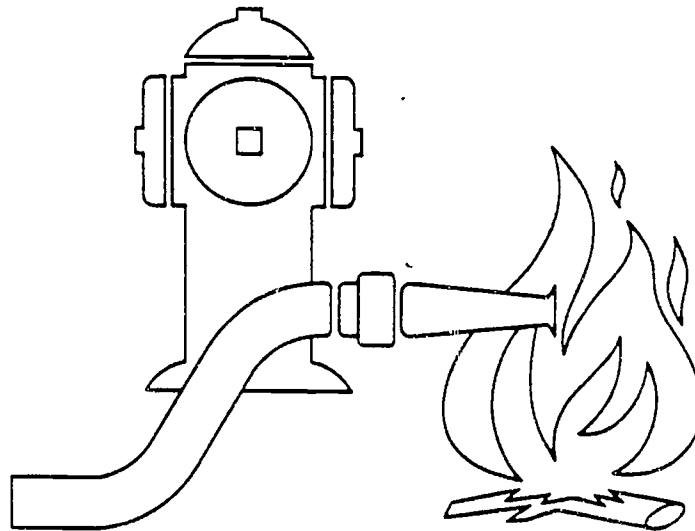

FOOD PREPARATION AND SERVICES

The majority of workers in these occupations prepare and serve food and beverages in restaurants, fast food establishments, catering firms, hotels, clubs, factories, school cafeterias, or hospitals, or supervise those providing food services. Others are factory machine operators involved in the preparation of food products. Dietetic technicians teach principles of food nutrition and provide dietary counseling to patients.

The largest occupations, which also have the greatest number of job openings annually, are:

- Food preparation workers
- Combined food preparation and service workers

These occupations may have a generally favorable outlook for the future. Overall, the number of these jobs is growing. Large numbers of job openings are expected over the next four or five years. Recently, there have been fewer new trainees than job openings. If this trend continues, job opportunities should be good.

Hourly wages include:

- \$4.48 Food preparation workers
- \$4.53 Cooks, specialty fast food
- \$5.24 Cooks, restaurant

High school programs preparing for these occupations are:

- 20.0401 Food production, management, and services
- 46.1111 Food occupations

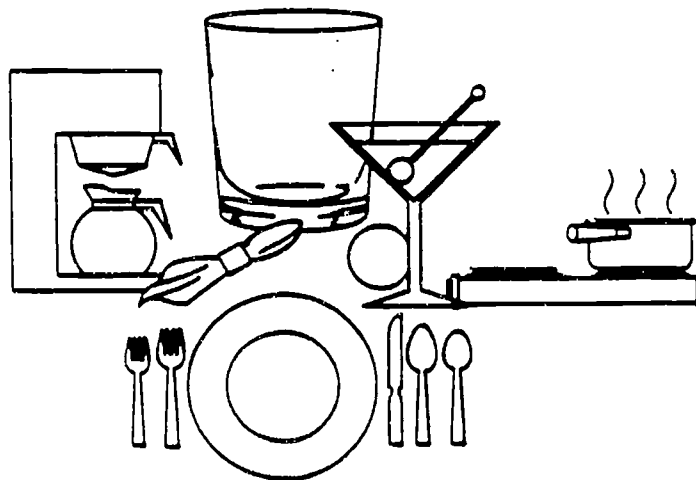

GENERAL BUSINESS AND MANAGEMENT

Workers in the general business and management occupations plan, organize, direct, control, or coordinate activities in all types of fields. Many occupations involve analysis of productivity and financial soundness. General managers and top executives usually have very diverse duties and responsibilities and work through departmental or subordinate executives.

The largest occupations, which also have the greatest number of job openings annually, are:

- Industrial production managers
- General managers and top executives

These occupations may have a generally favorable outlook for the future. Overall, the number of these jobs is growing. Large numbers of job openings are expected over the next four or five years. Recently, there have been fewer new trainees than job openings. If this trend continues, job opportunities should be good. Placement rates at area vocational technical schools, community colleges, and/or technical institutes have been good recently.

Hourly wages include:

- \$17.23 Purchasing managers
- \$18.79 Industrial production managers

Related postsecondary programs at state-supported institutions in this area are:

- 07.9998 Business management technology
- 52.0101 General business
- 52.0201 General business administration and management



GENERAL WOODWORKING

Woodworkers are in occupations concerned with the complete cycle of cutting, shaping, and assembling parts of complex wood products. The occupations are primarily concerned with one or a limited number of machine functions according to their speciality.

The two largest occupations are:

- Assemblers and fabricators, except machine, electrical, electronic, and precision assembly
- Sawing machine operators and tenders

The occupations expected to have the most job openings annually are:

- Assemblers and fabricators, except machine, electrical, electronic, and precision assembly
- Woodworking machine operators and tenders, except of sawing machines

These occupations may have a generally favorable outlook for the future. Overall, the number of these jobs shows little change. A moderate number of job openings are expected over the next four or five years. Recently, there have been more new trainees than job openings. If this trend continues, job seekers can expect to face some competition.

High school programs preparing for these occupations are:

48.0703 Millwork and cabinetmaking

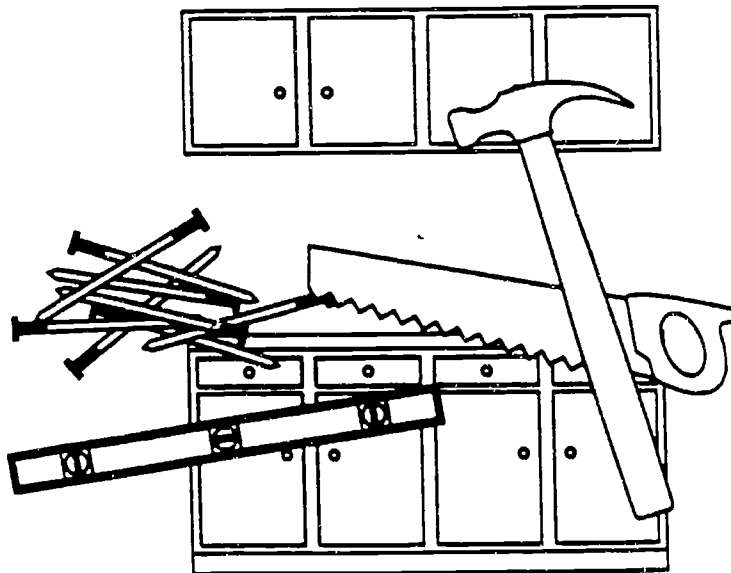

473

GRAPHIC ARTS

A majority of workers in this field are involved in offset printing. In this process the material to be printed is photographed and a printing plate is made from the film. This process has been advanced by the use of computers and lasers.

The two largest occupations are:

- Printing press machine operators and tenders
- Offset lithographic press setters and set-up operators

The occupations expected to have the most job openings annually are:

- Printing press machine operators and tenders
- Bindery machine operators

These occupations may not have a favorable outlook for the future. Overall, the number of these jobs is growing. A moderate number of job openings are expected over the next four or five years. Recently, there have been many more new trainees than job openings. If this trend continues, job seekers can expect to face keen competition.

Hourly wages include:

\$7.37 Offset lithographic press setters & set-up operators, sheet or web fed

High school programs preparing for these occupations are:

48.0201 Graphic and printing communications

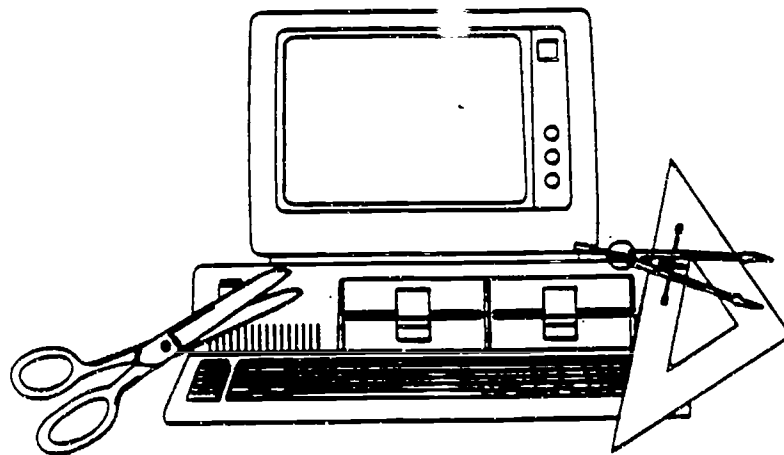

479

HEATING AND AIR CONDITIONING

Workers in this field install and repair heating, air conditioning, and refrigeration systems. They may install and repair oil burners, hot-air furnaces, and heating stoves in homes and businesses. They may also install and repair air conditioning systems, or install sheet metal ducts for the heating and cooling systems.

The largest occupations, which also have the greatest number of job openings annually, are:

- Heating, air conditioning, and refrigeration mechanics and installers
- Sheet metal duct installers

These occupations may not have a favorable outlook for the future. Overall, the number of these jobs is growing. Few job openings are expected over the next four or five years. Recently, there have been more new trainees than job openings. Placement rates at area vocational technical schools, community colleges, and/or technical institutes have been good recently.

Hourly wages include:

\$9.63 Heating, air conditioning, and refrigeration mechanics and installers

Related postsecondary programs at state-supported institutions in this area are:

47.0201 Heating, air conditioning, and refrigeration mechanics

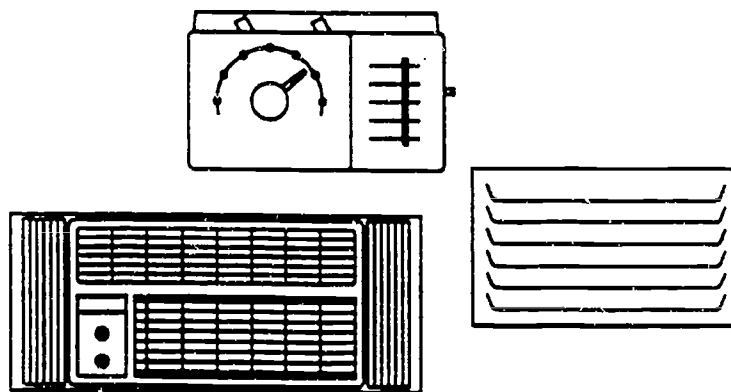

HEAVY TRUCK MAINTENANCE

Persons in heavy truck maintenance repair and maintain the operating condition of trucks, buses, and all types of diesel engines. This also includes mechanics working primarily with automobile diesel engines.

This occupation may have a generally favorable outlook for the future. Overall, the number of these jobs is growing. Few job openings are expected over the next four or five years. Recently, there have been fewer new trainees than job openings. Placement rates at area vocational technical schools, community colleges, and/or technical institutes have been excellent recently.

Average hourly wages are \$10.93

Related postsecondary programs at state-supported institutions in this area are:

47.0302 Heavy equipment maintenance and repair

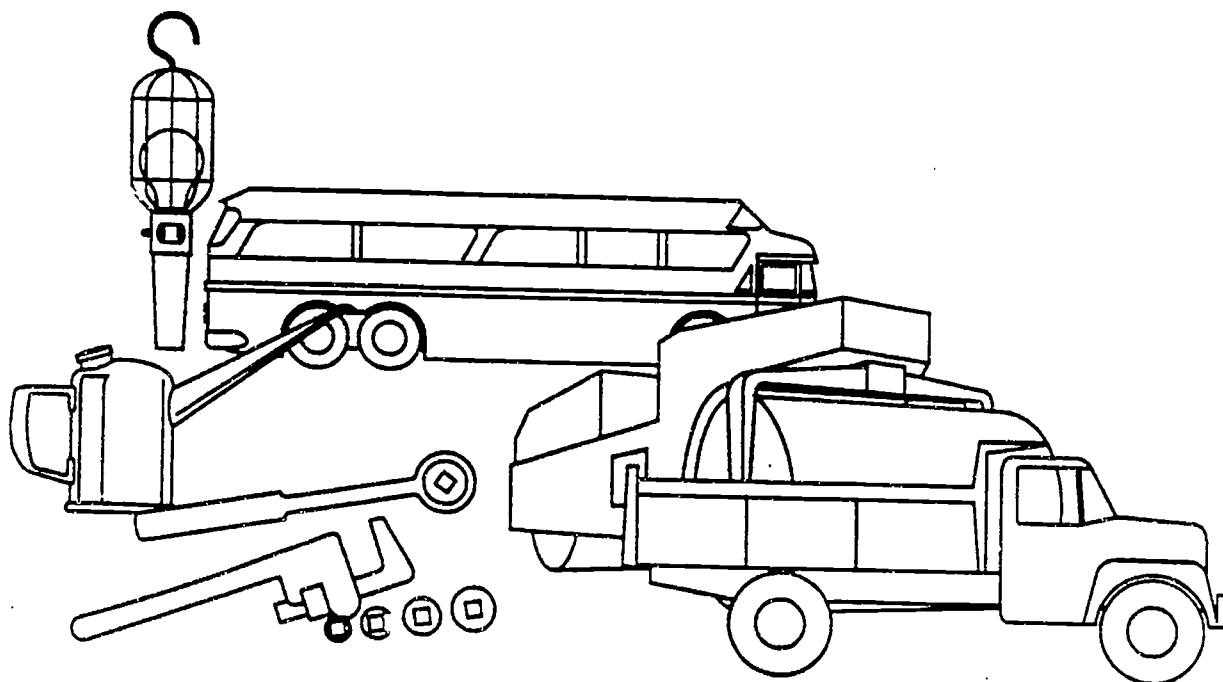

SDA 8 - 30481

HORTICULTURE AND LANDSCAPING

The largest group of workers in these occupations, gardeners and groundskeepers, maintain the grounds of public and private property. Duties may include mowing, trimming, planting, and watering plants, shrubs, and grass.

The largest occupations, which also have the greatest number of job openings annually, are:

- Nursery workers
- Gardeners and groundskeepers, except farm workers

These occupations may not have a favorable outlook for the future. Overall, the number of these jobs is growing. A moderate number of job openings are expected over the next four or five years. Recently, there have been many more new trainees than job openings. If this trend continues, job seekers can expect to face keen competition.

Hourly wages include:

\$6.55 Gardeners and groundskeepers, except farm

High school programs preparing for these occupations are:

01.0601 Horticulture

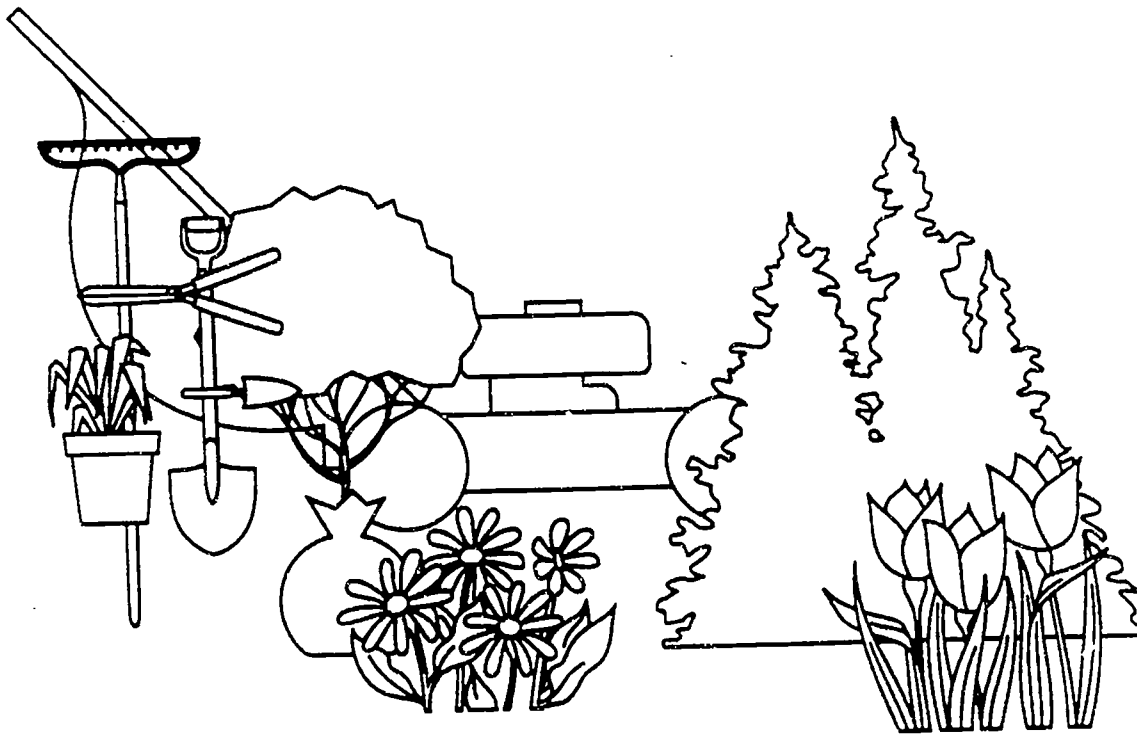

HOTEL AND RESTAURANT MANAGEMENT

Food service and lodging managers supervise the profitable operation of restaurants, hotels, and motels. Workers direct the varied activities of these businesses with the goal of pleasing people and providing good service to their customers.

This occupation may have a generally favorable outlook for the future. Overall, the number of these jobs is growing. A moderate number of job openings are expected over the next four or five years. Recently, no training has been reported. Job opportunities should be good.

Average hourly wages are \$9.00

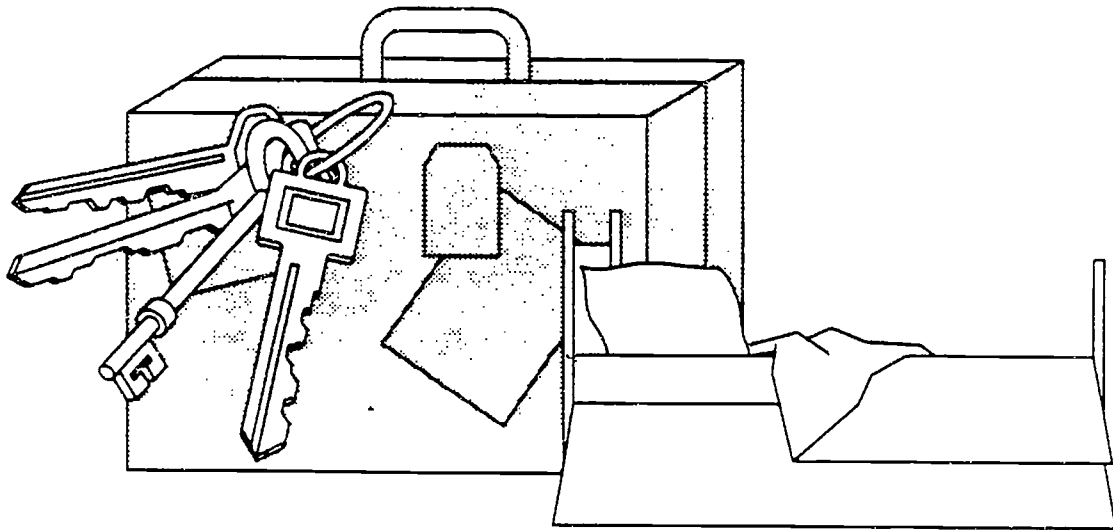

INDUSTRIAL MAINTENANCE TECHNOLOGY

Workers prevent costly waste of raw materials and the idling of human resources in a plant or factory by making industrial machinery repairs as quickly as possible. Maintenance mechanics spend considerable time doing preventive maintenance, including keeping machines well oiled and greased, and periodically cleaning parts.

The largest occupations, which also have the greatest number of job openings annually, are:

- Maintenance mechanics for industrial machinery
- Millwrights

These occupations may have a generally favorable outlook for the future. Overall, the number of these jobs is growing. A moderate number of job openings are expected over the next four or five years. Recently, there have been about as many new trainees as job openings. If this trend continues, job seekers can expect to face some competition. Placement rates at area vocational technical schools, community colleges, and/or technical institutes have been very good recently.

Hourly wages include:

\$14.41 Machinery maintenance mechanics

Related postsecondary programs at state-supported institutions in this area are:

- 15.0603 Industrial technology
- 47.0303 Industrial mechanics technology

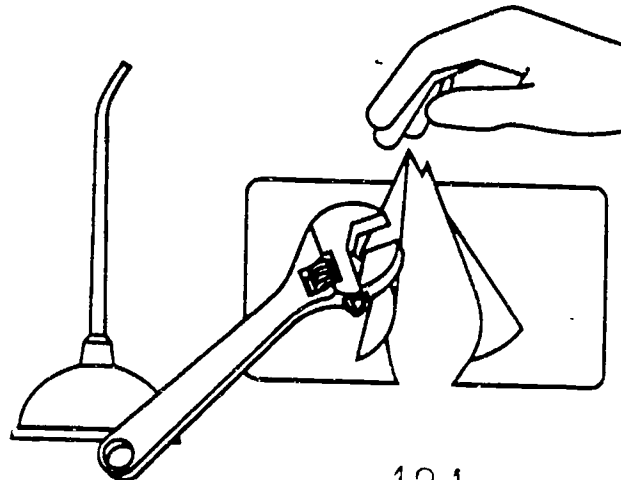

484

INSTITUTIONAL HOME MANAGEMENT AND SUPPORTING SERVICES

These workers make sure that all public buildings, offices, hospitals, stores, and apartment houses are kept clean and in good condition for the comfort and safety of the people who work or live there. Generally, no special education is required for occupations in this field, with most skills learned on the job.

The largest occupations, which also have the greatest number of job openings annually, are:

- Maids and housekeeping cleaners
- Janitors and cleaners, except maids and housekeeping cleaners

These occupations may have a generally favorable outlook for the future. Overall, the number of these jobs is growing. Large numbers of job openings are expected over the next four or five years. Recently, there have been fewer new trainees than job openings. If this trend continues, job opportunities should be good.

Hourly wages include:

- \$4.92 Maids and housekeeping cleaners
- \$4.96 Housekeepers
- \$6.35 Janitors and cleaners, except maids and housekeeping cleaners

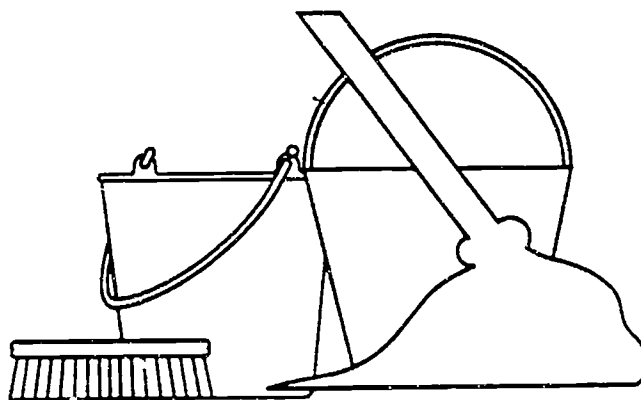

LABORATORY TECHNICIAN

Medical and clinical laboratory technicians perform routine laboratory tests for use in the treatment and diagnosis of disease; prepare vaccines, biologicals, and serums for prevention of disease; and prepare tissue samples, take blood samples, and execute laboratory tests including urinalyses and blood counts.

This occupation may have a generally favorable outlook for the future. Few job openings are expected over the next four or five years. Recently, no training has been reported.

Average hourly wages are \$13.07

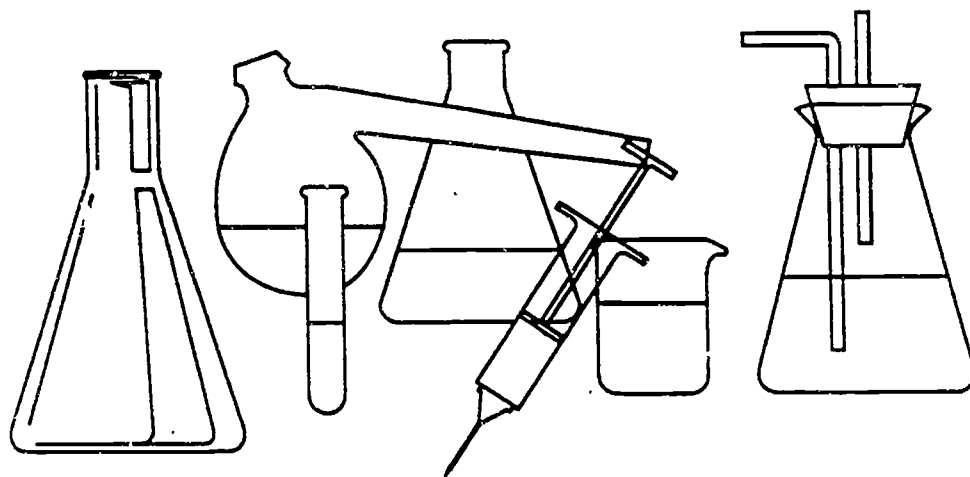

486

SDA 8 - 35

LAW ENFORCEMENT

People working at these occupations are responsible for the safety of Tennessee cities, towns, and highways. Their responsibilities range from controlling traffic to preventing and investigating crimes. Whether on or off duty, they are expected to exercise their authority whenever necessary.

The largest occupations, which also have the greatest number of job openings annually, are:

- Police patrol officers
- Sheriffs and deputy sheriffs

These occupations may have a generally favorable outlook for the future. Overall, the number of these jobs is growing slowly. A moderate number of job openings are expected over the next four or five years. Recently, no training has been reported. Job opportunities should be good

Hourly wages include:

\$10.22 Police patrol officers

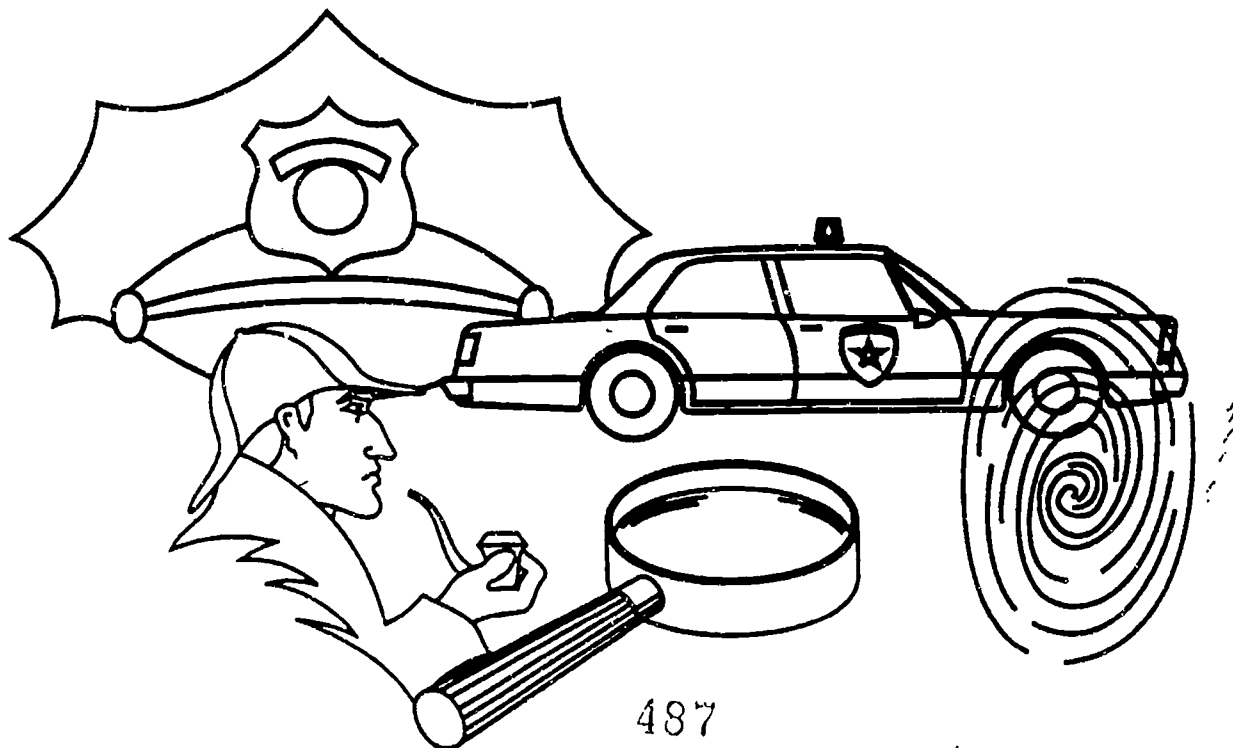

MACHINE TOOL TECHNOLOGY

Workers in these occupations make or set up and operate machine tools or repair metal parts. Machinists and tool-and-die makers create highly specialized precision tools, molds, and metal parts. Often they use blueprints to develop prototypes for tools or machines to be used in manufacturing.

The two largest occupations are:

- Machinists
- Machine tool cutting operators and tenders of metal and plastic

The occupations expected to have the most job openings annually are:

- Machinists
- Tool and die makers

These occupations may have a generally favorable outlook for the future. Overall, the number of these jobs is growing. Large numbers of job openings are expected over the next four or five years. Recently, there have been fewer new trainees than job openings. If this trend continues, job opportunities should be good. Placement rates at area vocational technical schools, community colleges, and/or technical institutes have been good recently.

Hourly wages include:

- \$8.46 Combination machine tool operators and tenders, metal and plastic
- \$8.88 Lathe and turning machine tool setters and set-up operators, metal and plastic
- \$11.60 Machinists
- \$13.32 Tool and die makers

High school programs preparing for these occupations are:

- 48.0501 Precision metal work
- 48.0503 Machine tool operation and machine shop technology

Related postsecondary programs at state-supported institutions in this area are:

- 48.0503 Machine tool operation and machine shop technology

MEDICAL ASSISTING

Medical assistants perform a wide variety of clinical and administrative duties under the direction of physicians. Clinical duties may include taking and recording patients' vital signs and medical histories, preparing patients for examination by physicians, and explaining treatment procedures to patients.

In small physicians' offices they may keep medical records, schedule appointments, and order supplies. Electrocardiograph (EKG) technicians operate the EKG machines which provide graphic tracings of heartbeats.

The largest occupations, which also have the greatest number of job openings annually, are:

- Electrocardiograph technicians
- Medical assistants

These occupations may have a generally favorable outlook for the future. Few job openings are expected over the next four or five years. Recently, there have been about as many new trainees as job openings.

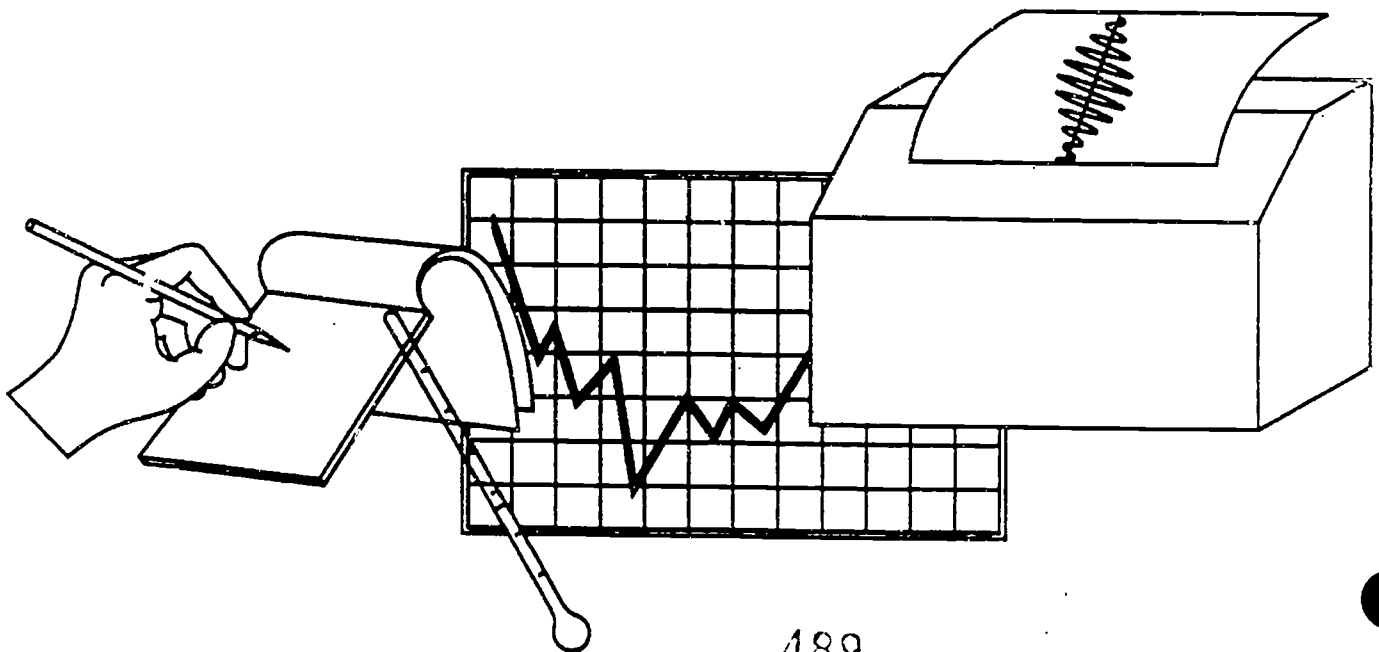

MEDICAL RECORDS TECHNOLOGY

Medical records technicians compile and maintain medical records of hospital and clinic patients. Such work is becoming increasingly important as this background information is used for medicare and medical insurance reimbursements.

This occupation may not have a favorable outlook for the future. Few job openings are expected over the next four or five years. Recently, there have been more new trainees than job openings. Placement rates at area vocational technical schools, community colleges, and/or technical institutes have been very good recently.

Average hourly wages are \$7.24

Related postsecondary programs at state-supported institutions in this area are:

17.0506 Medical records technology

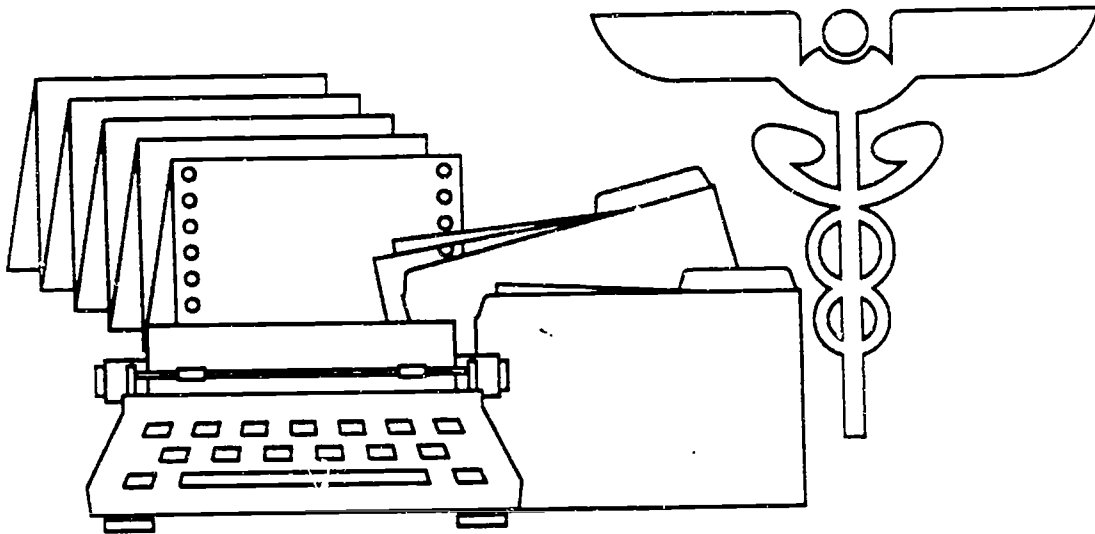

NURSING ASSISTANT

Nursing aides and orderlies work under the general direction of nursing or medical staff. In hospitals, they may answer patients' call bells, serve and collect food trays, feed patients, or set up equipment. In nursing homes, they are expected to sustain ongoing relations with patients.

The largest occupations, which also have the greatest number of job openings annually, are:

- Nursing aides, orderlies, and attendants
- Home health aides

These occupations may have a generally favorable outlook for the future. Overall, the number of these jobs is growing rapidly. Large numbers of job openings are expected over the next four or five years. Recently, there have been fewer new trainees than job openings. If this trend continues, job opportunities should be good.

Hourly wages include:

\$4.98 Nursing aides, orderlies, and attendants

High school programs preparing for these occupations are:

17.0602 Nursing assisting

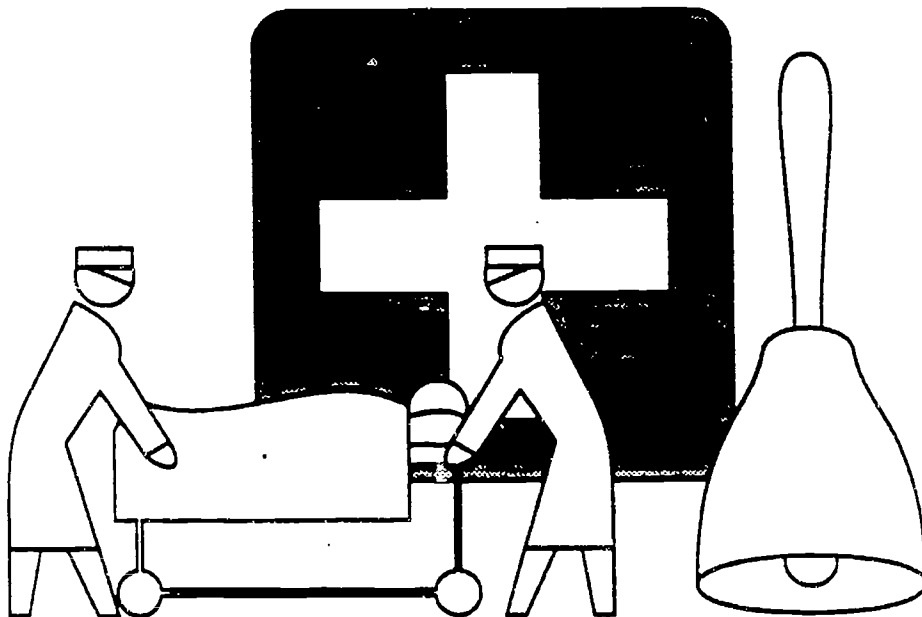

PHYSICAL THERAPY ASSISTING

Workers in this occupation, under the direction of a physical therapist, prepare patients for and/or administer physical therapy treatment, such as massages, heat, light and sound treatment, and traction. They also instruct, motivate, and assist patients with learning and improving functional activities.

This occupation may not have a favorable outlook for the future. Few job openings are expected over the next four or five years. Recently, there have been many more new trainees than job openings. Placement rates at area vocational technical schools, community colleges, and/or technical institutes have been excellent recently.

Related postsecondary programs at state-supported institutions in this area are:

17.0815. Physical therapy assisting

Licensing may be required. Contact: TENNESSEE STATE BOARD OF OCCUPATIONAL AND PHYSICAL THERAPY, 615-367-6243.

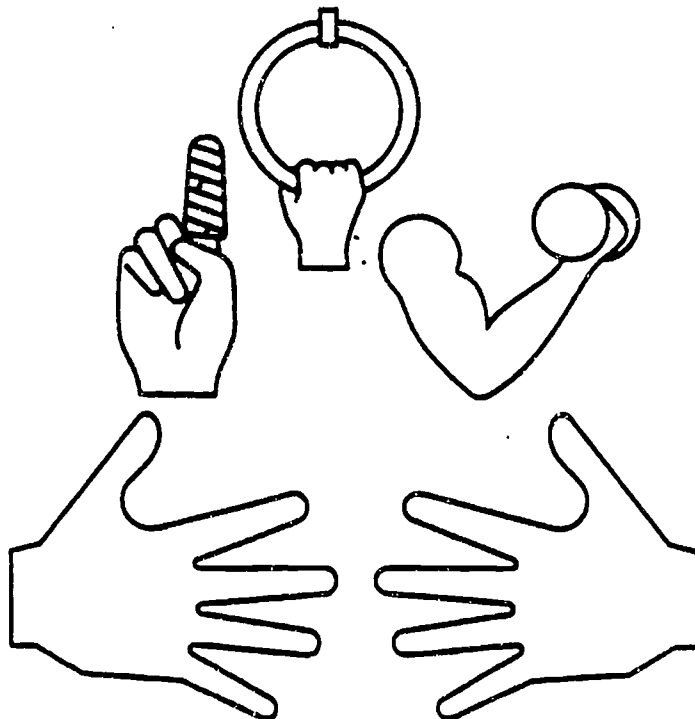

SDA 8 - 492

PLUMBING AND PIPEFITTING

Plumbers and pipefitters install and maintain the complex system of pipes that connect to the master system that runs underground. Although plumbing and pipefitting are sometimes considered a single trade, workers may specialize in either craft. Plumbers build and repair the water, waste disposal, drainage, and gas systems in homes and commercial/industrial buildings. Pipefitters build and repair both high and low pressure pipe.

The largest occupations, which also have the greatest number of job openings annually, are:

- Plumbers, pipefitters, and steamfitters
- Pipelayers

These occupations may have a generally favorable outlook for the future. Overall, the number of these jobs is growing slowly. Few job openings are expected over the next four or five years. Recently, no training has been reported.

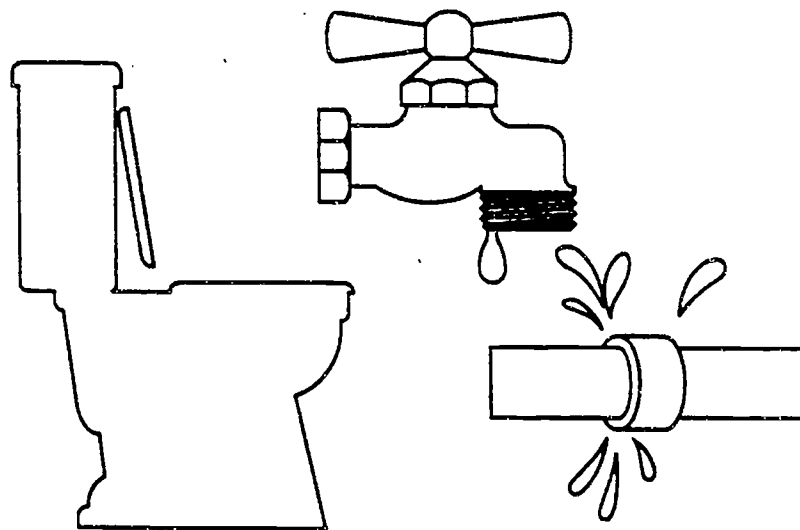

493

PRACTICAL NURSING

Licensed practical nurses (LPNs) work under the supervision of physicians and/or registered nurses to provide nursing care that requires technical knowledge but not the professional training of a registered nurse. They provide bedside care, administer certain medications, and assist in patient examinations.

This occupation may have a generally favorable outlook for the future. Overall, the number of these jobs is growing rapidly. Large numbers of job openings are expected over the next four or five years. Recently, there have been fewer new trainees than job openings. If this trend continues, job opportunities should be good. Placement rates at area vocational technical schools, community colleges, and/or technical institutes have been excellent recently.

Average hourly wages are \$9.54

Related postsecondary programs at state-supported institutions in this area are:

17.0605 Practical nursing

Licensing may be required. Contact: TENNESSEE BOARD OF NURSING, 615-367-6232.

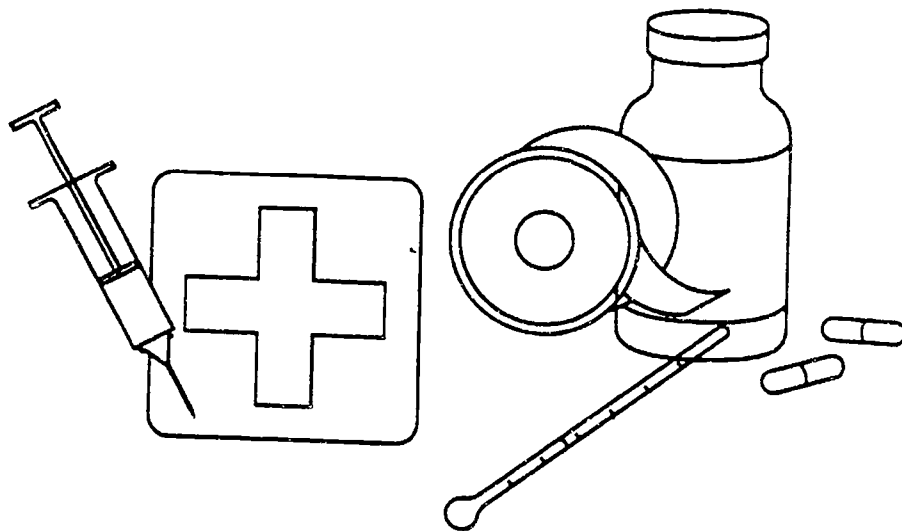

PROFESSIONAL NURSING

Registered Nurses (R.N.'s), the largest occupational group in this field, are primarily employed in hospitals and nursing homes, where they provide skilled bedside care and may supervise licensed practical nurses, nursing aides, and orderlies. Working under the direction of a licensed "supervising physician," physician assistants elicit detailed patient histories, perform physical examinations, and prescribe appropriate treatments.

The largest occupations, which also have the greatest number of job openings annually, are:

- Registered nurses
- Physician's assistants

These occupations may have a generally favorable outlook for the future. Overall, the number of these jobs is growing rapidly. Large numbers of job openings are expected over the next four or five years. Recently, there have been fewer new trainees than job openings. If this trend continues, job opportunities should be good.

Hourly wages include:

\$13.76 Registered nurses

Related postsecondary programs at state-supported institutions in this area are:

51.1601 Nursing (R.N. training)

Licensing may be required. Contact: TENNESSEE BOARD OF MEDICAL EXAMINERS-COMMITTEE ON PHYSICIAN ASSISTANTS, 615-367-6250.

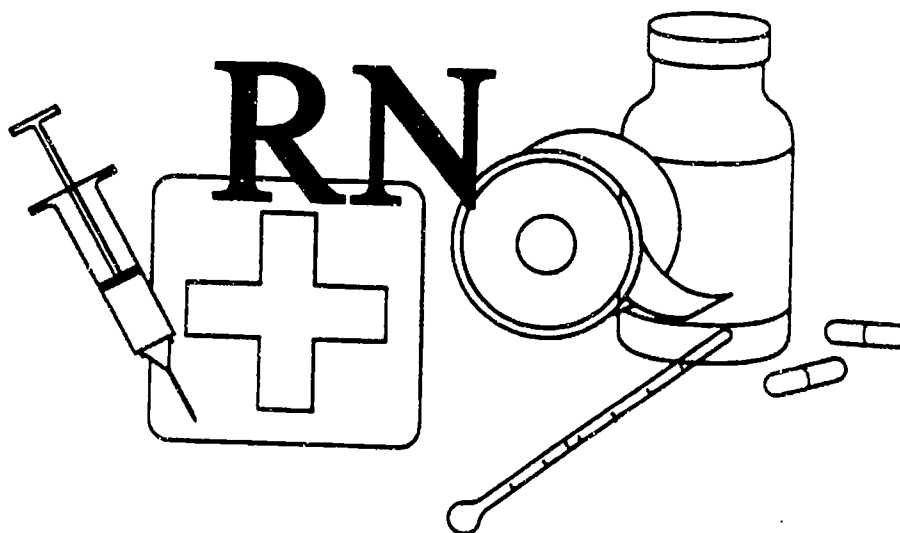

PUBLIC ADMINISTRATION

Individuals in this field are responsible for the management of diverse areas of governmental organizations. These managers usually work through departmental executives or subordinates in coordinating the various activities and groups they control. Public administration chief executives, legislators, and general administrators establish government policy and develop federal, state, or local regulations, rules, and laws.

The two largest occupations are:

- Public administration chief executives, legislators, and general administrators
- General managers and top executives

The occupations expected to have the most job openings annually are:

- Management analysts
- General managers and top executives

These occupations may not have a favorable outlook for the future. Overall, the number of these jobs shows little change. Very few job openings are expected over the next four or five years. Recently, there have been many more new trainees than job openings.

Related postsecondary programs at state-supported institutions in this area are:

52.0206 Non-profit and public management

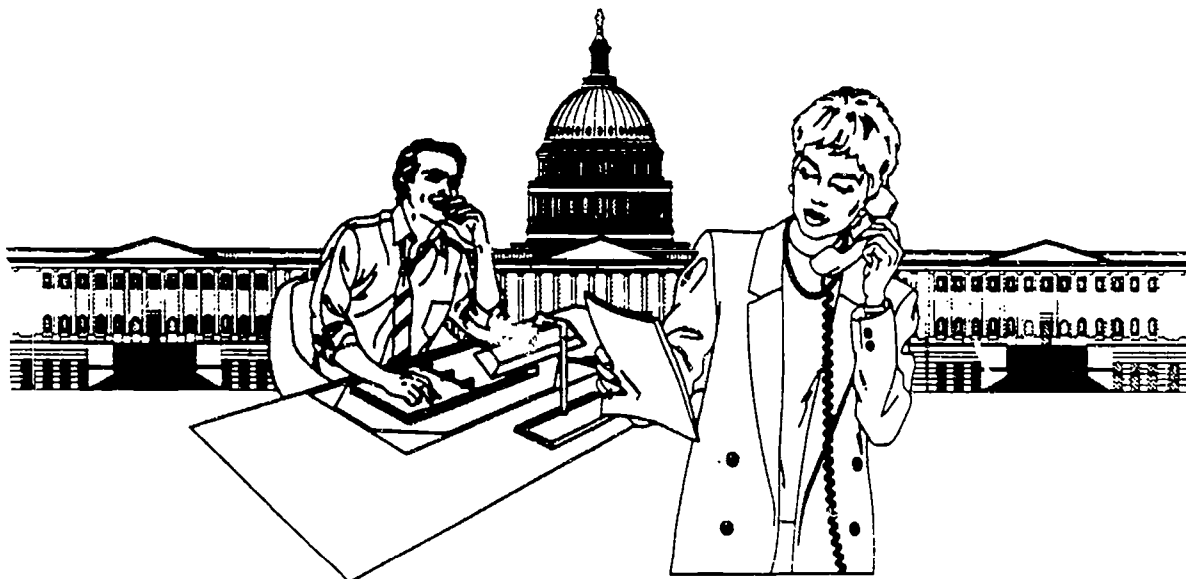

RADIOGRAPHIC MEDICAL TECHNOLOGY

Workers in this field operate equipment including x-ray machines, fluoroscopes, ultrasonic scanners, computed tomography (CT) scanners, and nuclear magnetic resonance (MRI) machines for diagnostic imagery of the human body or for therapy.

The largest occupations, which also have the greatest number of job openings annually, are:

- Radiologic technologists
- Radiologic technicians

These occupations may have a generally favorable outlook for the future. Few job openings are expected over the next four or five years. Recently, no training has been reported.

Hourly wages include:

\$12.59 Radiologic technicians

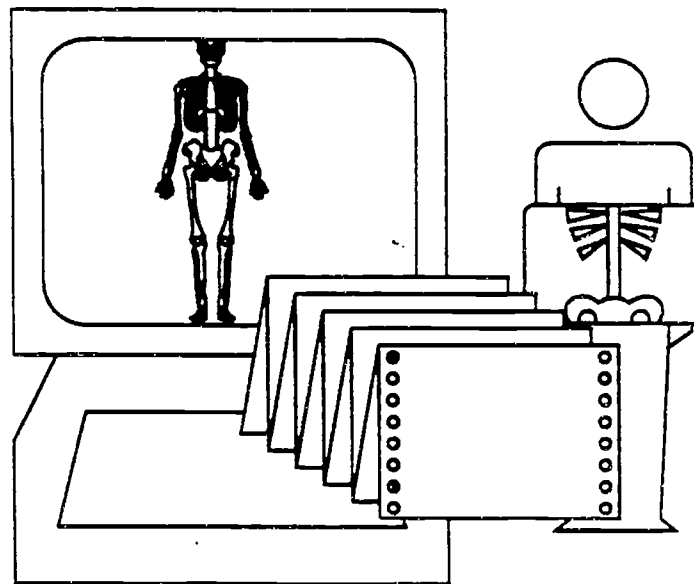

497

SALES AND MERCHANDISING

Workers in sales and merchandising occupations promote and sell a wide variety of merchandise and services. They also receive, store, display, and inventory products to be sold.

The largest occupations, which also have the greatest number of job openings annually, are:

- Salespersons in retail establishments
- Cashiers

These occupations may have a generally favorable outlook for the future. Overall, the number of these jobs is growing. Large numbers of job openings are expected over the next four or five years. Recently, there have been fewer new trainees than job openings. If this trend continues, job opportunities should be good.

Hourly wages include:

\$4.92	Cashiers
\$6.69	Salespersons, retail
\$8.19	Customer service representatives, utilities
\$10.60	Driver, sales workers
\$13.79	Purchasing agents- except wholesale, retail, and farm products

High school programs preparing for these occupations are:

08.0700	General marketing
08.0799	Miscellaneous general marketing

Licensing may be required. Contact: TENNESSEE DEPARTMENT OF COMMERCE AND INSURANCE, 615-741-2693.

SECURITY SERVICES

Security guards, the largest occupation in this field, patrol and inspect property to protect it against fire, theft, vandalism, and illegal entry. Guards and doorkeepers usually are uniformed and often carry a nightstick and a weapon; correctional officers and jailers maintain order in correctional institutions, enforce institutional rules and regulations, and may supplement the counseling inmates receive from mental health professionals.

The largest occupations, which also have the greatest number of job openings annually, are:

- Correction officers and jailers
- Guards and watch guards

These occupations may have a generally favorable outlook for the future. Overall, the number of these jobs is growing. A moderate number of job openings are expected over the next four or five years. Recently, there have been fewer new trainees than job openings. If this trend continues, job opportunities should be good.

Hourly wages include:

- ‡ .36 Guards and watch guards

Licensing may be required. Contact: COUNTY COURT CLERK'S OFFICE.

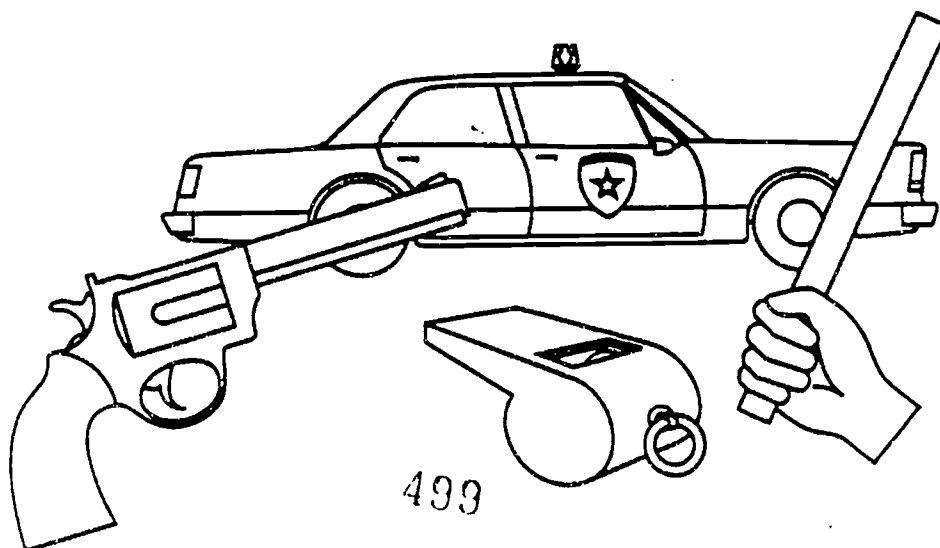

SHEET METAL

Sheet metal workers make, install, and maintain a variety of sheet metal products for home, commercial, and industrial buildings. These products include ducts for air conditioning, heating, and ventilating and pollution control systems, kitchen equipment, roofs, siding, rain gutters, skylights, and outdoor signs. Other workers use a variety of machines in the mass production of sheet-metal products.

The two largest occupations are:

- Machine forming operators and tenders of metal and plastic
- Assemblers and fabricators, except machine, electrical, electronic, and precision assembly

The occupations expected to have the most job openings annually are:

- Machine forming operators and tenders of metal and plastic
- Sheet metal workers

These occupations may have a generally favorable outlook for the future. Overall, the number of these jobs shows little change. Large numbers of job openings are expected over the next four or five years. Recently, there have been fewer new trainees than job openings. If this trend continues, job opportunities should be good.

Hourly wages include:

\$8.13 Sheet metal workers

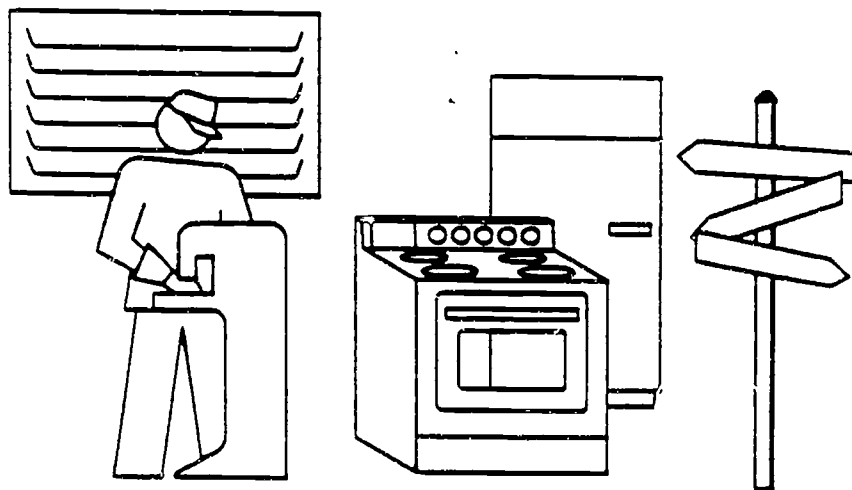

SMALL ENGINE REPAIR

Persons working in these occupations repair and service motorcycles, other small vehicles, and equipment with small gasoline engines. The ability to make quick and accurate diagnoses is one of the mechanic's most valuable skills. In fact, many mechanics consider diagnosing "hard to find" troubles one of their most challenging and satisfying duties.

The largest occupations, which also have the greatest number of job openings annually, are:

- Motorcycle repairers
- Small engine specialists

These occupations may not have a favorable outlook for the future. Overall, the number of these jobs shows little change. Very few job openings are expected over the next four or five years. Recently, there have been more new trainees than job openings.

High school programs preparing for these occupations are:

47.0606 Small engine repair

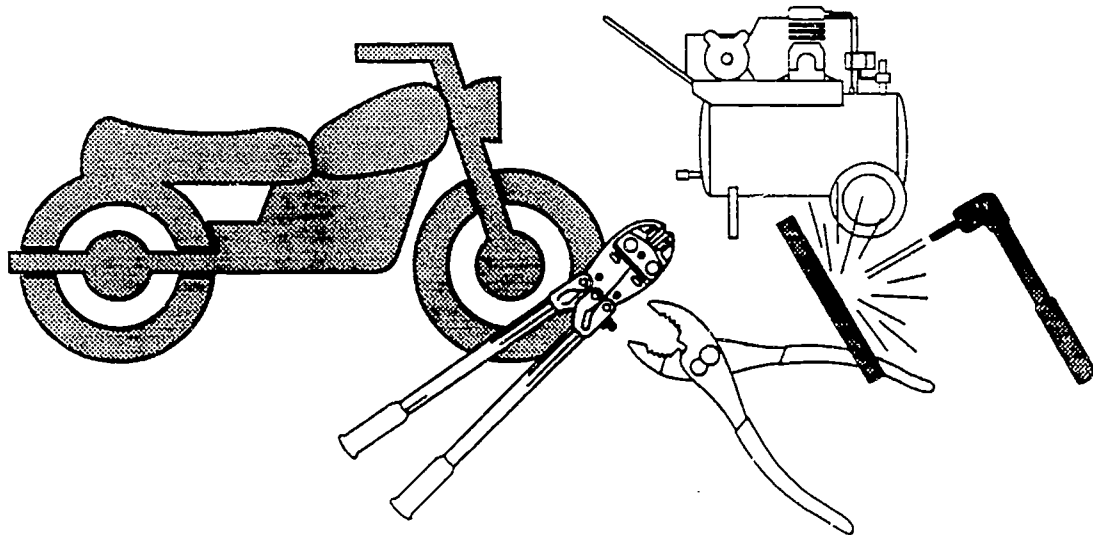

TRUCK, BUS, AND HEAVY EQUIPMENT OPERATION

These occupations include truck drivers who transport goods, bus drivers who transport passengers, and heavy equipment operators who use machinery to move construction materials and other goods over short distances--around a factory, construction site or loading dock.

The largest occupations, which also have the greatest number of job openings annually, are:

- Truck drivers of heavy or tractor trailer trucks
- School bus drivers

These occupations may have a generally favorable outlook for the future. Overall, the number of these jobs is growing. Large numbers of job openings are expected over the next four or five years. Recently, there have been fewer new trainees than job openings. If this trend continues, job opportunities should be good.

Hourly wages include:

- \$9.01 Grader, dozer, and scraper operators
- \$9.20 Truck drivers, heavy or tractor trailer

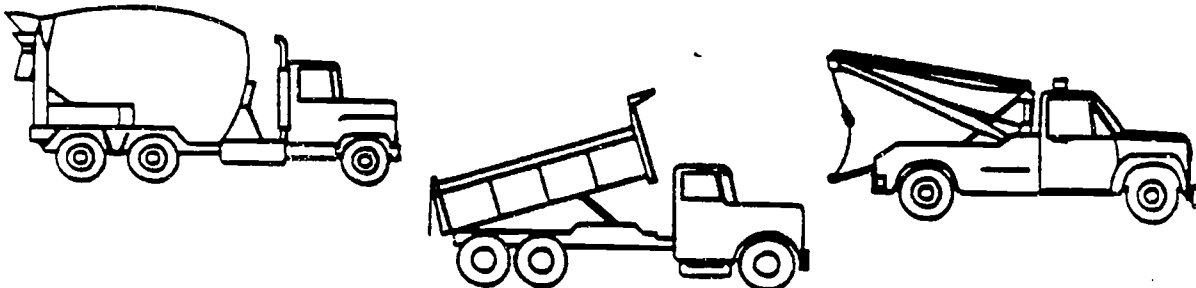

WELDING TECHNOLOGY

Welding is the most common way of permanently joining metal parts. Typically, heat is applied to the metal pieces to be joined; the parts are melted and fused to form a permanent bond. Welding is used to construct and repair parts of ships, automobiles, spacecraft, and thousands of products. It can also be used to join beams and steel reinforcing rods in buildings, bridges, and highways.

The two largest occupations are:

- Welders and cutters
- Welding machine setters and set-up operators

The occupations expected to have the most job openings annually are:

- Welders and cutters
- Welding machine operators and tenders

These occupations may have a generally favorable outlook for the future. Overall, the number of these jobs is growing. A moderate number of job openings are expected over the next four or five years. Recently, there have been fewer new trainees than job openings. If this trend continues, job opportunities should be good. Placement rates at area vocational technical schools, community colleges, and/or technical institutes have been good recently.

Hourly wages include:

\$13.01 Welders and cutters

High school programs preparing for these occupations are:

48.0508 Welding, brazing, and soldering

Related postsecondary programs at state-supported institutions in this area are:

48.0508 Welding, brazing, and soldering

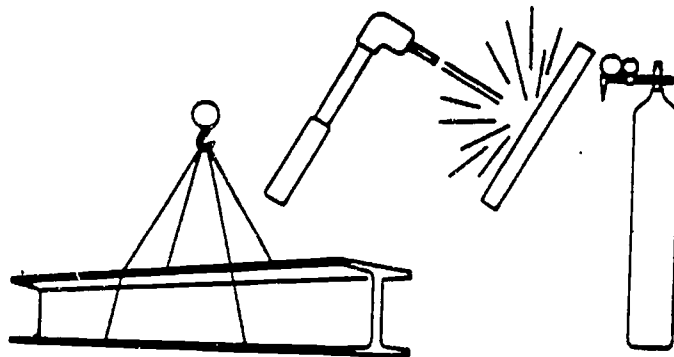

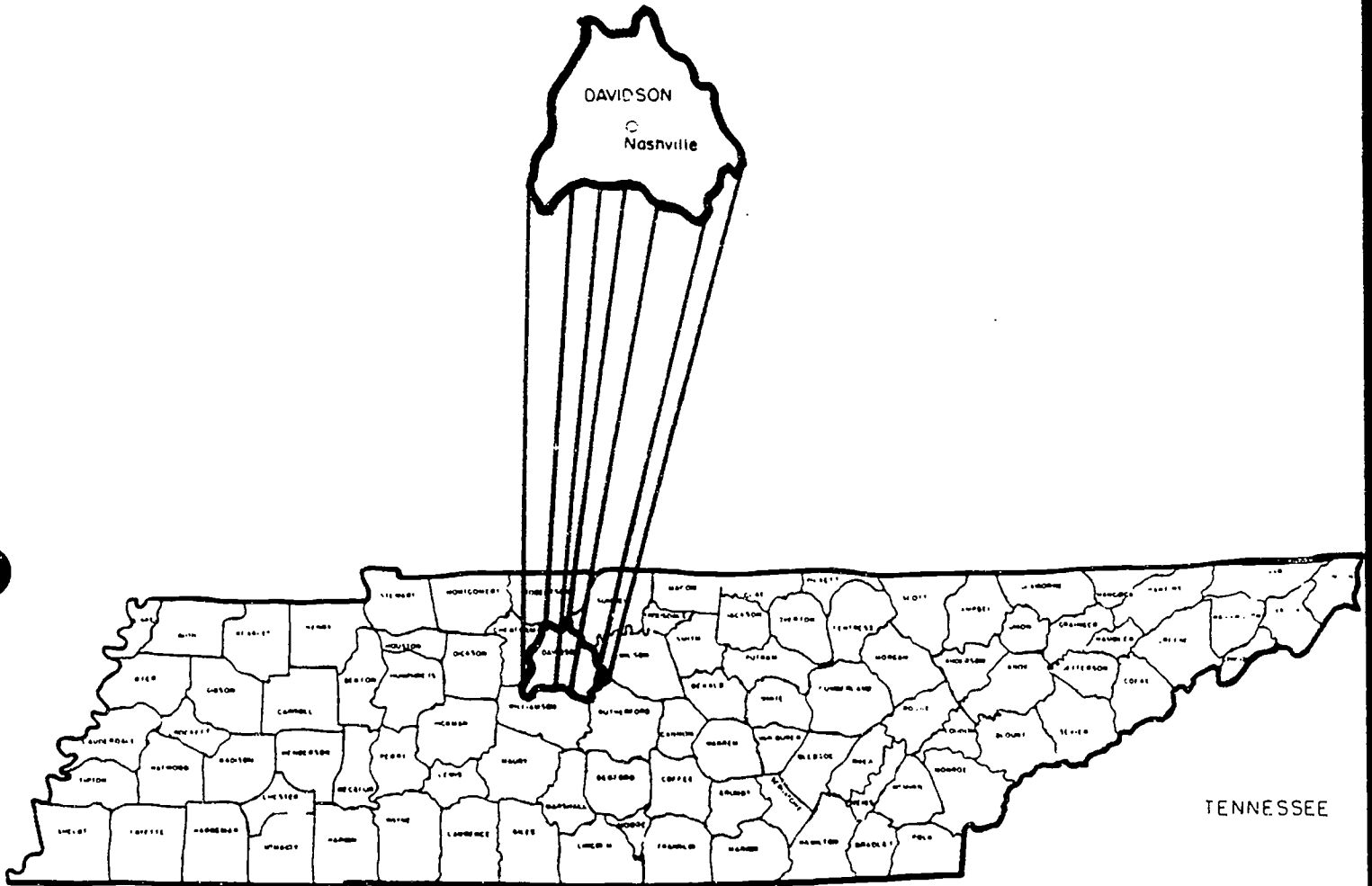

Service Delivery Area 9

ACCOUNTING AND FINANCIAL MANAGEMENT

Many individuals in this group are accountants and auditors who prepare and analyze business records and financial reports which are needed for effective management of any organization. Financial managers, another occupation in this group, typically plan, organize, control, or coordinate the financial activities of an organization.

The largest occupations, which also have the greatest number of job openings annually, are:

- Financial managers
- Accountants and auditors

These occupations may have a generally favorable outlook for the future. Overall, the number of these jobs is growing. Large numbers of job openings are expected over the next four or five years. Recently, there have been fewer new trainees than job openings. If this trend continues, job opportunities should be good.

Hourly wages include:

\$15.30 Accountants and auditors
\$22.53 Financial managers

Related postsecondary programs at state-supported institutions in this area are:

52.0301 Accounting

Licensing may be required. Contact: TENNESSEE BOARD OF ACCOUNTANCY, 615-741-2250.



SDA 9 - 1505

ADMINISTRATIVE SUPPORT: ACCOUNTING

Persons employed in this group of occupations provide clerical and administrative support to accountants and auditors. Most of these jobs require only a high school diploma for entry.

The largest occupations, which also have the greatest number of job openings annually, are:

- Bookkeeping, accounting, and auditing clerks
- Payroll and timekeeping clerks

These occupations may not have a favorable outlook for the future. Overall, the number of these jobs shows little change. Large numbers of job openings are expected over the next four or five years. Recently, there have been many more new trainees than job openings. If this trend continues, job seekers can expect to face keen competition. Placement rates at area vocational technical schools, community colleges, and/or technical institutes have been good recently.

Hourly wages include:

- \$9.30 Bookkeeping, accounting, and auditing clerks
- \$10.11 Payroll and timekeeping clerks

High school programs preparing for these occupations are:

- 07.0101 Accounting and bookkeeping
- 07.0102 Accounting and computing

Related postsecondary programs at state-supported institutions in this area are:

- 07.0102 Accounting and computing

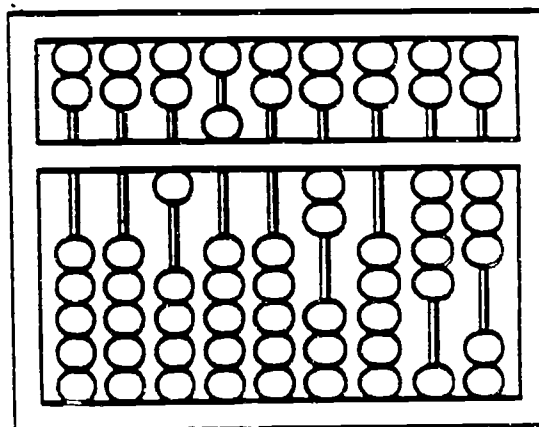
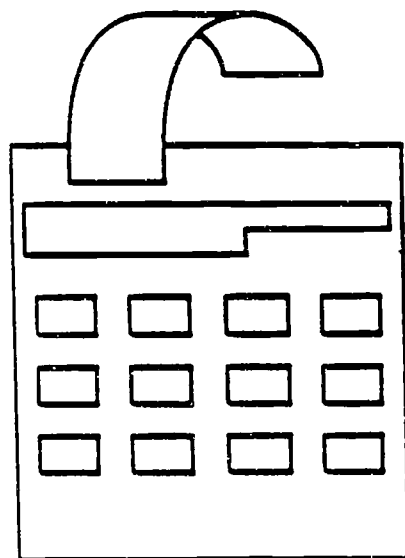

ADMINISTRATIVE SUPPORT: FINANCE AND INSURANCE

Workers provide clerical and general administrative support to the banking and finance industry. Workers receive and pay out money, keep records of money and negotiable instruments, interview applicants for credit, locate and notify customers of delinquent accounts, examine insurance claims, and process a variety of paperwork.

The two largest occupations are:

- Tellers
- Insurance adjusters, examiners, and investigators

The occupations expected to have the most job openings annually are:

- Tellers
- Bill and account collectors

These occupations may have a generally favorable outlook for the future. Overall, the number of these jobs is growing slowly. Large numbers of job openings are expected over the next four or five years. Recently, no training has been reported. Job opportunities should be good.

Hourly wages include:

\$6.56	Tellers
\$7.48	New accounts clerks
\$7.89	Insurance claims clerks
\$9.15	Bill and account collectors
\$9.73	Loan and credit clerks

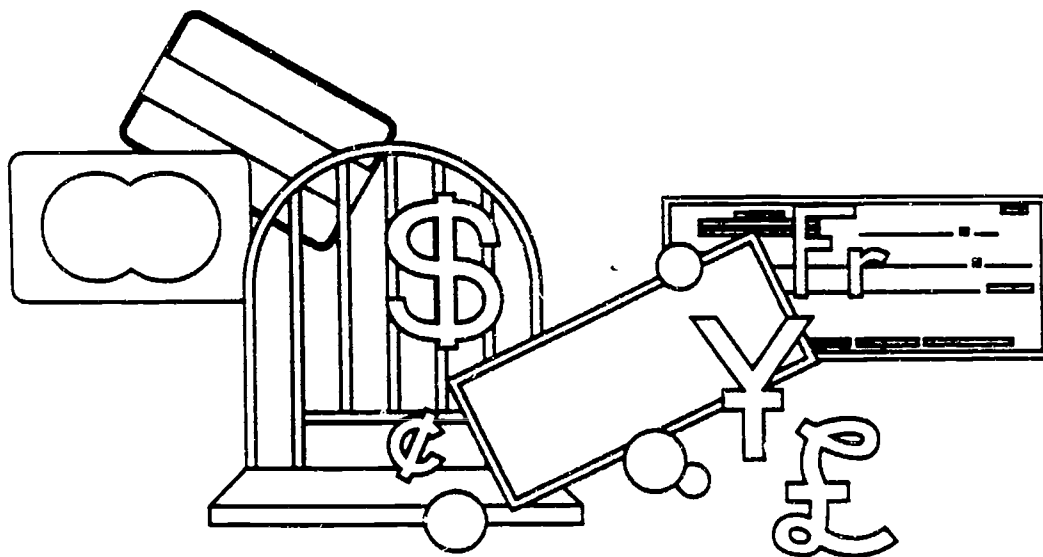

507

ADMINISTRATIVE SUPPORT: GENERAL

The job duties in this group of occupations are very diverse and are determined by the type of firm. For example, workers may schedule appointments, give information to callers, take dictation, type correspondence, read and route incoming mail, file correspondence and other records, and supervise and coordinate the activities of subordinate clerical workers.

The largest occupations, which also have the greatest number of job openings annually, are:

- Secretaries, except legal and medical secretaries
- General office clerks

These occupations may have a generally favorable outlook for the future. Overall, the number of these jobs is growing. Large numbers of job openings are expected over the next four or five years. Recently, there have been fewer new trainees than job openings. If this trend continues, job opportunities should be good. Placement rates at area vocational technical schools, community colleges, and/or technical institutes have been good recently.

Hourly wages include:

\$6.15	File clerks
\$7.15	Adjustment clerks
\$7.31	Receptionists and information clerks
\$7.96	Data entry keyers, except composing
\$8.16	General office clerks
\$8.78	Typists including word processing
\$9.05	Order clerks- materials, merchandise, and service
\$9.16	Medical secretaries
\$9.53	Secretaries, ex. legal and medical
\$11.82	Legal secretaries
\$13.17	First line supervisors and manager/supervisors- clerical and administrative support occupations

High school programs preparing for these occupations are:

07.0401	Office supervision and management
07.0606	Secretarial and office administration
07.0701	Typing, general office and related programs
07.0799	Miscellaneous typing, general office, and related programs
07.9999	Miscellaneous business administrative support

Related postsecondary programs at state-supported institutions in this area are:

07.0606	Secretarial and office administration
07.9999	Miscellaneous business administrative support
17.0513	Health unit coordinating
52.0401	Administrative assistant and secretarial science

508

AGRICULTURAL PRODUCTION

Workers in this field plan and economically use facilities, land, water, machinery, chemicals, finance, and labor in the production of plant and animal products.

The largest occupations, which also have the greatest number of job openings annually, are:

- Farm managers
- Farm workers

These occupations may have a generally favorable outlook for the future. Overall, the number of these jobs shows little change. A moderate number of job openings are expected over the next four or five years. Recently, there have been fewer new trainees than job openings.

High school programs preparing for these occupations are:

01.0301 Agricultural production

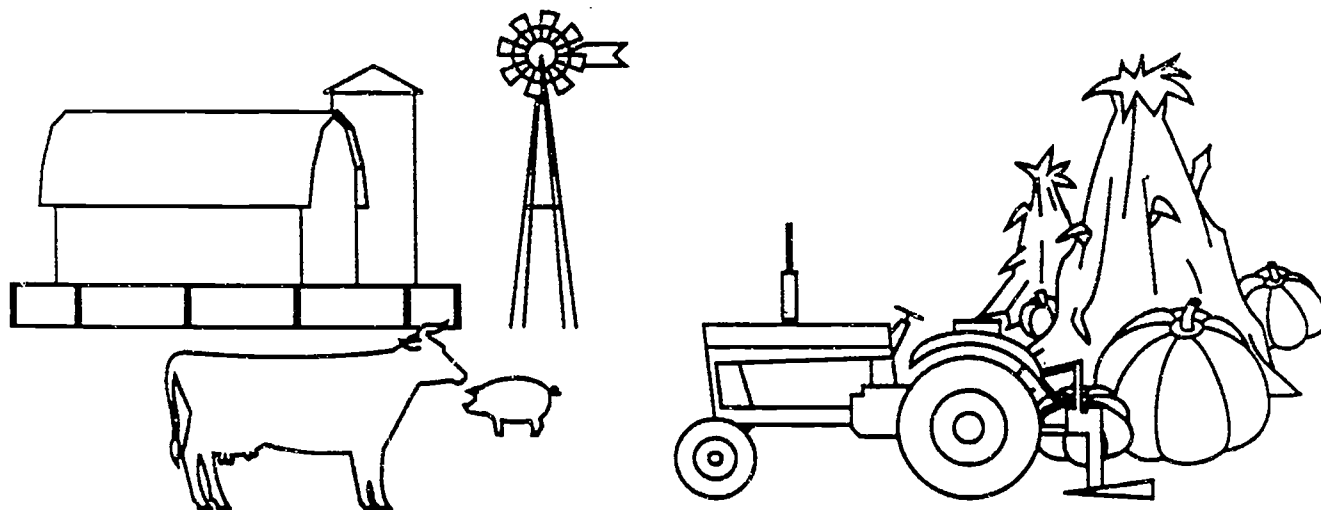

AIRCRAFT MECHANICS

To keep an aircraft in top operating condition, workers must perform scheduled maintenance, make repairs, and complete inspections required by the Federal Aviation Administration (FAA). Mechanics inspect the engines, landing gear, instruments, and other parts of the aircraft and do necessary maintenance.

The two largest occupations are:

- Aircraft mechanics
- Aircraft engine specialists

The occupations expected to have the most job openings annually are:

- Aircraft structure, surfaces, rigging, and systems assemblers- precision
- Electrical installers and repairers, transportation equipment

These occupations may not have a favorable outlook for the future. Overall, the number of these jobs is growing. Few job openings are expected over the next four or five years. Recently, there have been more new trainees than job openings. Placement rates at area vocational technical schools, community colleges, and/or technical institutes have been poor recently.

High school programs preparing for these occupations are:

47.0602 Aircraft mechanics

Related postsecondary programs at state-supported institutions in this area are:

47.0608 Aircraft mechanics, powerplant

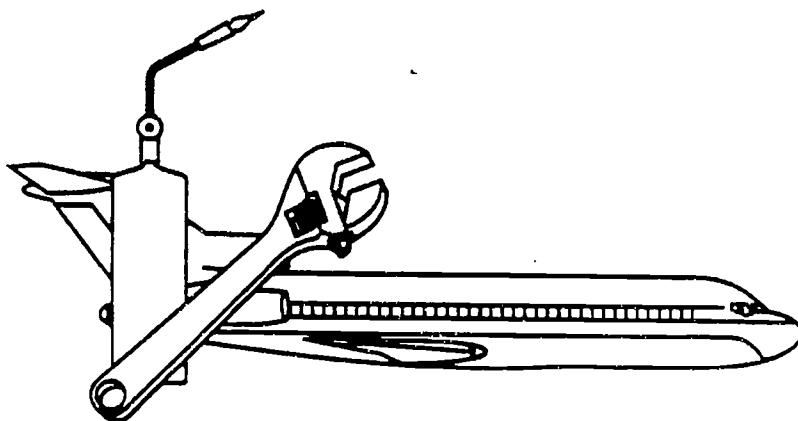

510

APPLIANCE AND EQUIPMENT REPAIR

Individuals in these occupations repair, adjust, maintain, and install all types of electrical motors and electrical and gas home appliances. Types of equipment used include test instruments, gauges, and hand, bench, and power tools.

The two largest occupations are:

- Electric home appliance and power tool repairers
- Electric motor, transformer, and related repairers

The occupations expected to have the most job openings annually are:

- Electric home appliance and power tool repairers
- Coin and vending machine servicers and repairers

These occupations may not have a favorable outlook for the future. Overall, the number of these jobs shows little change. Few job openings are expected over the next four or five years. Recently, there have been many more new trainees than job openings.

High school programs preparing for these occupations are:

- 47.0101 Electrical and electronics technology

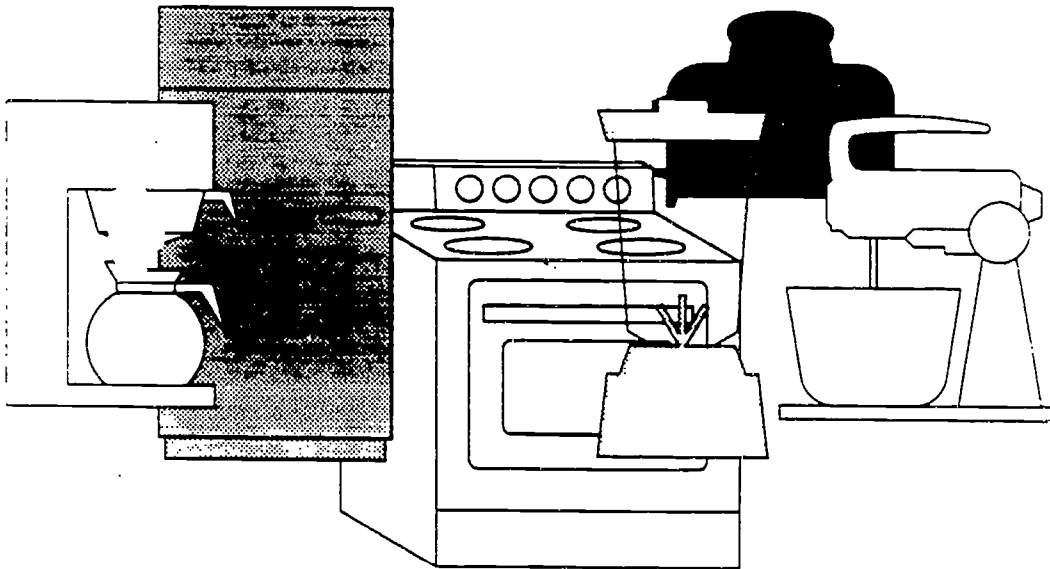

AUTOMOTIVE BODY REPAIR

Thousands of motor vehicles are damaged in traffic accidents every day. The workers in this field straighten bent frames, remove dents, and replace crumpled parts that are beyond repair so that those vehicles look and drive like new.

The largest occupations, which also have the greatest number of job openings annually, are:

- Automotive body and related repairers
- Painters of transportation equipment

These occupations may not have a favorable outlook for the future. Overall, the number of these jobs is growing. A moderate number of job openings are expected over the next four or five years. Recently, there have been many more new trainees than job openings. If this trend continues, job seekers can expect to face keen competition. Placement rates at area vocational technical schools, community colleges, and/or technical institutes have been fair recently.

High school programs preparing for these occupations are:

47.0603 Automotive body repair

Related postsecondary programs at state-supported institutions in this area are:

47.0603 Automotive body repair

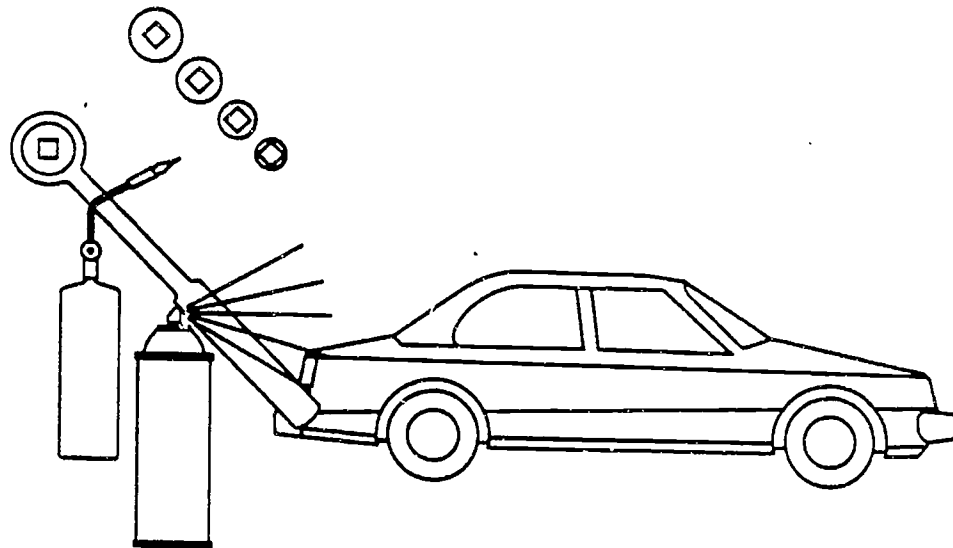

512

AUTOMOTIVE SERVICE TECHNOLOGY

These occupations include jobs concerned with parking, cleaning, polishing, lubricating, repairing, and refueling trucks, buses, and automobiles, and related servicing activities. The primary occupation, automotive mechanic, is concerned with repair and service of motor vehicles.

The largest occupations, which also have the greatest number of job openings annually, are:

- Automotive mechanics
- Tire repairers and changers

These occupations may have a generally favorable outlook for the future. Overall, the number of these jobs is growing. Large numbers of job openings are expected over the next four or five years. Recently, there have been about as many new trainees as job openings. If this trend continues, job seekers can expect to face some competition. Placement rates at area vocational technical schools, community colleges, and/or technical institutes have been good recently.

Hourly wages include:

\$13.14 Automotive mechanics

High school programs preparing for these occupations are:

47.0604 Automotive mechanics

Related postsecondary programs at state-supported institutions in this area are:

15.0803 Automotive technology

47.0604 Automotive mechanics

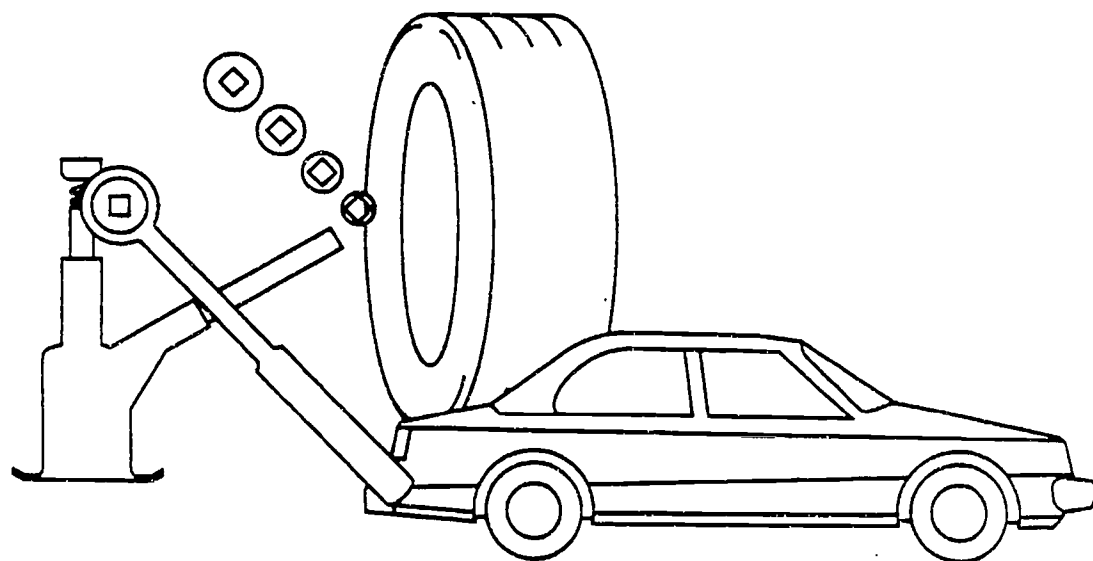

SDA 9 - 9 513

BAKING OCCUPATIONS

The workers in this group of jobs mix and bake ingredients according to recipes to produce breads, pastries, doughnuts, and other baked goods. These workers must be proficient in cleaning and maintaining the equipment used in preparing baked goods from raw materials.

The largest occupations, which also have the greatest number of job openings annually, are:

- Bakers of bread and pastry
- Bakers in manufacturing plants

These occupations may have a generally favorable outlook for the future. Overall, the number of these jobs is growing. A moderate number of job openings are expected over the next four or five years. Recently, there have been about as many new trainees as job openings.

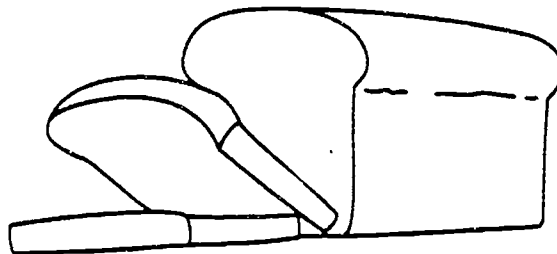

BRICK, BLOCK, AND STONEMASONRY

Workers are involved in trades producing attractive, durable surfaces. Bricklayers build walls, floors, partitions, fireplaces, and other structures with brick, cinder, or concrete block and other masonry materials. Stone masons build stone walls as well as set stone exteriors and floors. Both natural and artificial stones are used.

The largest occupations, which also have the greatest number of job openings annually, are:

- Brick masons
- Hard tile setters

These occupations may have a generally favorable outlook for the future. Overall, the number of these jobs is growing. Few job openings are expected over the next four or five years. Recently, no training has been reported.

Hourly wages include:

\$11.57 Brick masons

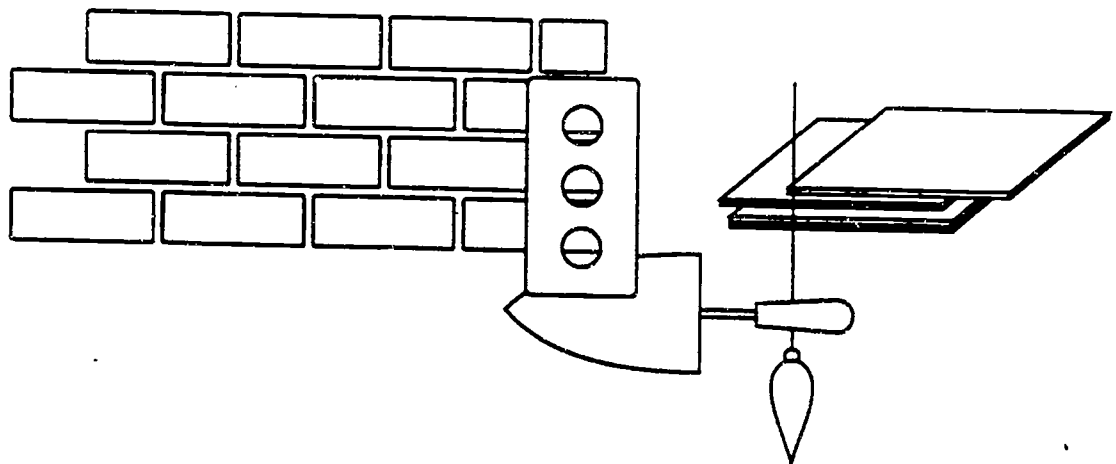

BUILDING MAINTENANCE

Persons in building maintenance occupations perform work involving several maintenance skills to keep the structure of an establishment in repair. Duties may involve pipefitting, boilermaking, carpentry, and electrical work as well as repairing buildings, floors, or stairs.

The largest occupations, which also have the greatest number of job openings annually, are:

- General utility maintenance repairers
- Stationary engineers

These occupations may have a generally favorable outlook for the future. Overall, the number of these jobs is growing. Large numbers of job openings are expected over the next four or five years. Recently, there have been fewer new trainees than job openings. If this trend continues, job opportunities should be good.

Hourly wages include:

\$8.62 Maintenance repairers, general utility

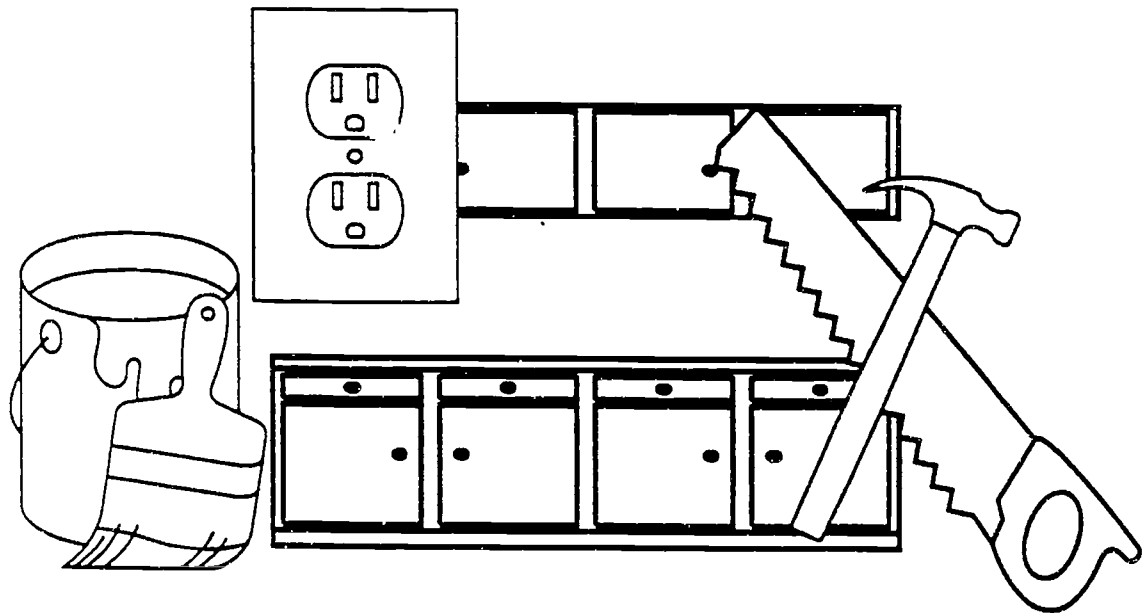

CARPENTRY

Almost all construction projects employ carpenters, the largest group of building trades workers. Carpenters perform a variety of jobs. Their duties will vary by type of construction, type of company, skill of the carpenter, and size of the community. A carpenter employed by a special trade contractor, for example, may specialize in laying hardwood floors, while one who is employed by a general building contractor may build wall frames and install paneling.

The largest occupations, which also have the greatest number of job openings annually, are:

- Carpenters
- Ceiling tile installers and acoustical carpenters

These occupations may have a generally favorable outlook for the future. Overall, the number of these jobs is growing slowly. A moderate number of job openings are expected over the next four or five years. Recently, no training has been reported. Job opportunities should be good.

Hourly wages include:

\$10.88 Carpenters

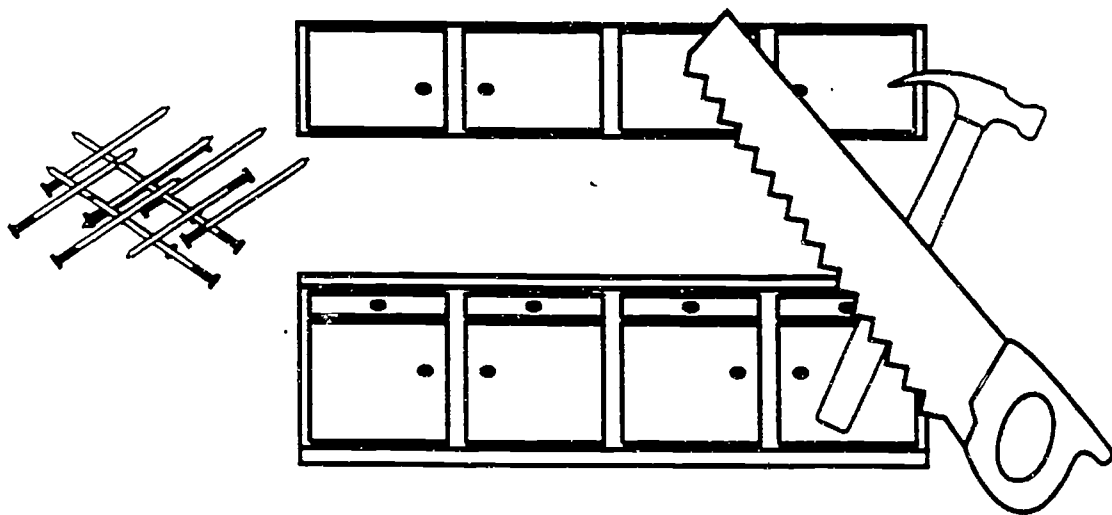

CHEMICAL TECHNOLOGY

Chemical technology workers either research and monitor chemical processes or are directly involved in operating equipment or control boards to create chemical reactions and processes in industrial settings. Technicians work with chemists or chemical engineers, setting up and conducting experiments and collecting and analyzing data.

The largest occupations, which also have the greatest number of job openings annually, are:

- Chemical (except health) technicians and technologists
- Chemical equipment controllers and operators

These occupations may have a generally favorable outlook for the future. Overall, the number of these jobs is growing. Few job openings are expected over the next four or five years. Recently, no training has been reported.

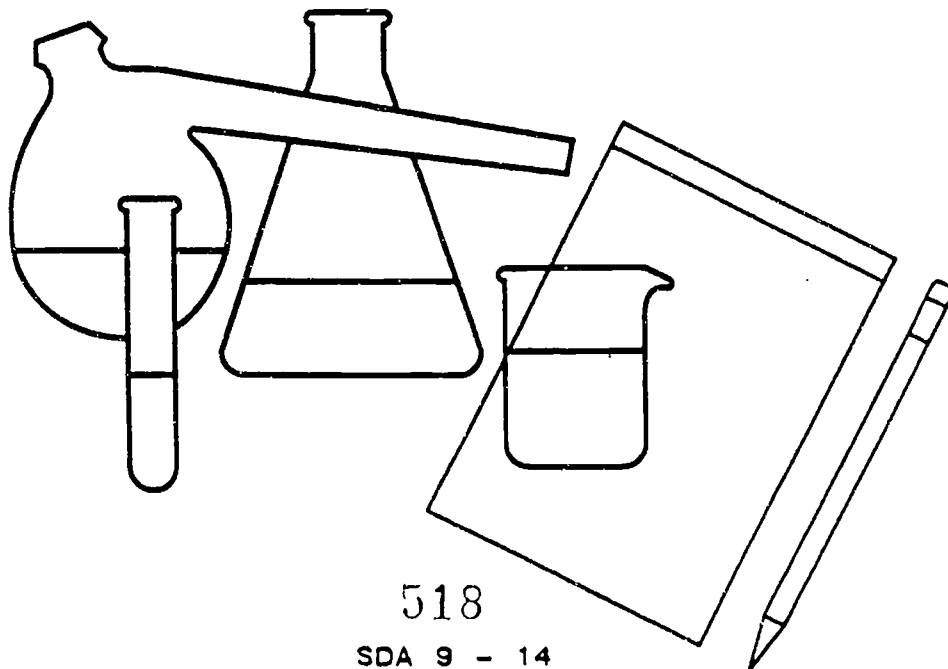

518

SDA 9 - 14

COMMERCIAL ART AND DESIGN

The majority of workers in this field design or arrange objects and materials in an artistic or decorative manner. Additional tasks may include the creation or drawing of designs for items such as furniture and machinery (product design).

The largest occupations, which also have the greatest number of job openings annually, are:

- Artists and related workers
- Designers, except interior designers

These occupations may not have a favorable outlook for the future. Overall, the number of these jobs is growing. A moderate number of job openings are expected over the next four or five years. Recently, there have been many more new trainees than job openings. If this trend continues, job seekers can expect to face keen competition.

High school programs preparing for these occupations are:

48.0203 Commercial art

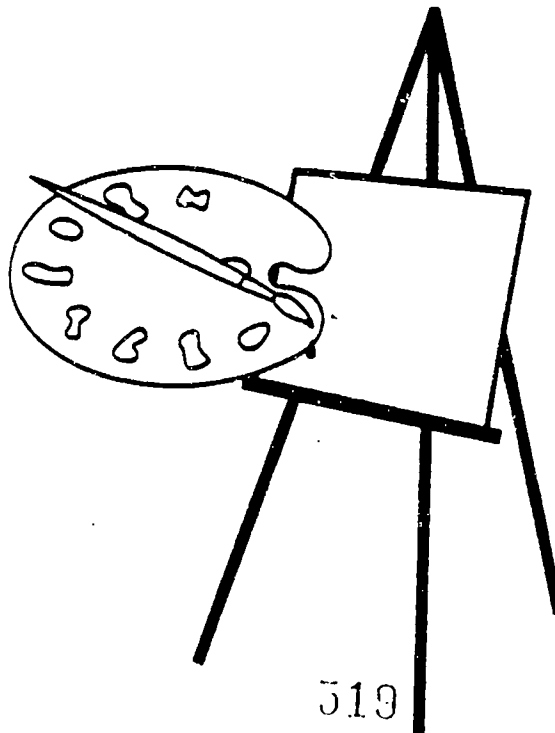

319

COMMUNICATIONS, JOURNALISM, AND BROADCASTING

Individuals who work in these fields are concerned with communicating ideas and information to individuals for their education and entertainment. The methods utilized are varied and may include the written word, radio, and television.

The two largest occupations are:

- Writers and editors
- Reporters and correspondents

The occupations expected to have the most job openings annually are:

- Writers and editors
- Radio and television announcers

These occupations may have a generally favorable outlook for the future. Overall, the number of these jobs is growing. A moderate number of job openings are expected over the next four or five years. Recently, no training has been reported. Job opportunities should be good.

Hourly wages include:

\$18.04 Writers and editors

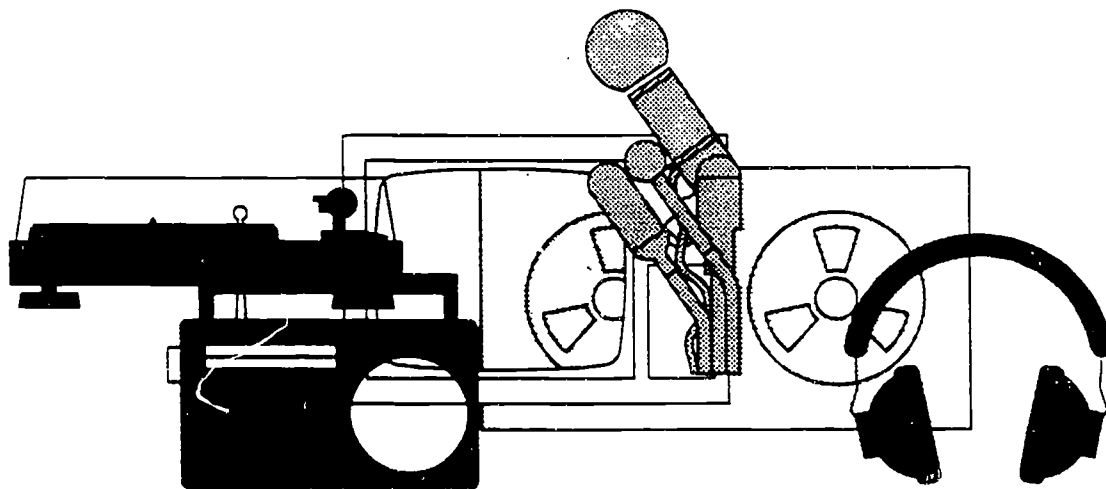

COMMUNICATIONS TECHNOLOGY

Workers operate and maintain the electronic equipment used to record and transmit radio and television programs. They work with microphones, sound and videotape recorders, light and sound effects, television cameras, transmitters, and other equipment.

The largest occupations, which also have the greatest number of job openings annually, are:

- Television and motion picture camera operators
- Broadcast technicians

These occupations may have a generally favorable outlook for the future. Few job openings are expected over the next four or five years. Recently, there have been about as many new trainees as job openings. Placement rates at area vocational technical schools, community colleges, and/or technical institutes have been fair recently.

Related postsecondary programs at state-supported institutions in this area are:

- 10.0101 Educational media technology
- 10.0103 Photography

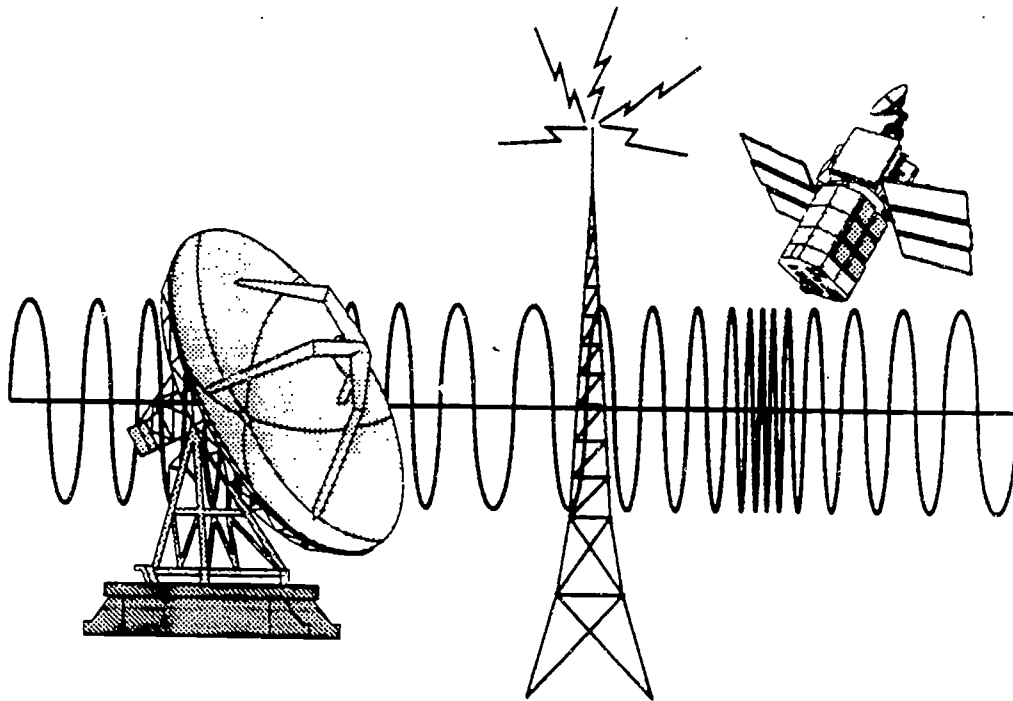

521

COMPUTER AND BUSINESS MACHINE PRODUCTION AND REPAIR

Workers in these fields install, service, maintain, and repair mechanical and electronic equipment, such as computers, word processing systems, radar systems, and office machines. Repairers may work in various locations doing a variety of tasks.

The two largest occupations are:

- Data processing equipment repairers
- Office machine and cash register servicers

The occupations expected to have the most job openings annually are:

- Data processing equipment repairers
- Electronics repairers, commercial and industrial equipment

These occupations may have a generally favorable outlook for the future. Overall, the number of these jobs is growing. A moderate number of job openings are expected over the next four or five years. Recently, there have been about as many new trainees as job openings. If this trend continues, job seekers can expect to face some competition. Placement rates at area vocational technical schools, community colleges, and/or technical institutes have been good recently.

Related postsecondary programs at state-supported institutions in this area are:

- 15.0402 Computer servicing technology
- 47.0104 Computer electronics

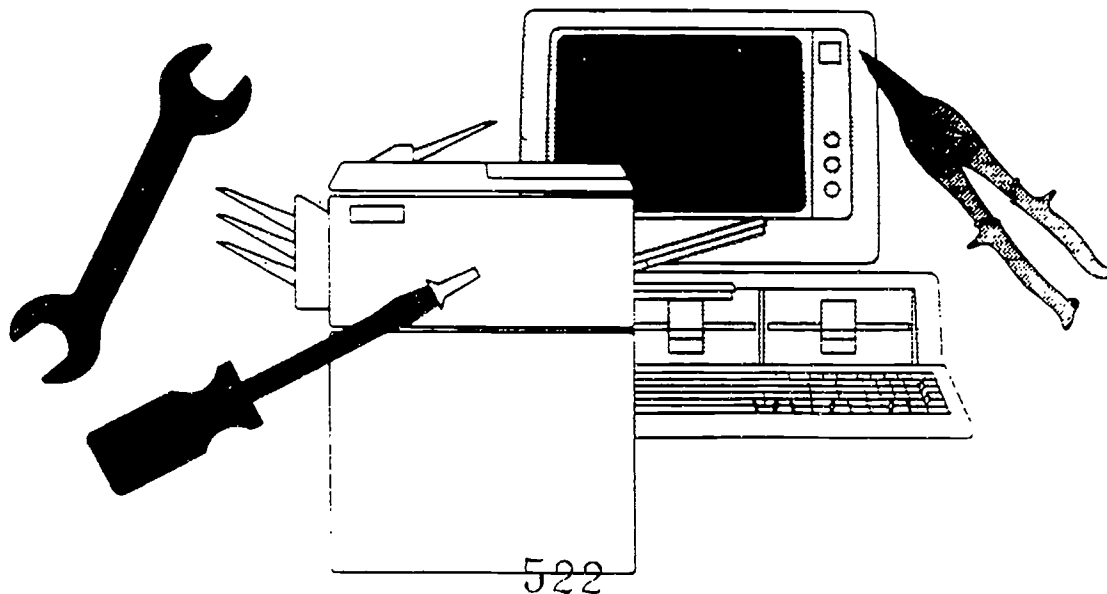

The majority of workers in this field are electrical and electronic engineering technicians and technologists. They apply electrical and related knowledge to design, build, test, and repair electrical equipment in industrial or commercial settings for subsequent use by engineering personnel.

This occupation may have a generally favorable outlook for the future. Overall, the number of these jobs is growing rapidly. A moderate number of job openings are expected over the next four or five years. Recently, there have been fewer new trainees than job openings. If this trend continues, job opportunities should be good. Placement rates at area vocational technical schools, community colleges, and/or technical institutes have been fair recently.

Average hourly wages are \$13.14

Related postsecondary programs at state-supported institutions in this area are:

- 15.0302 Electrical technology
- 15.0303 Electronic technology

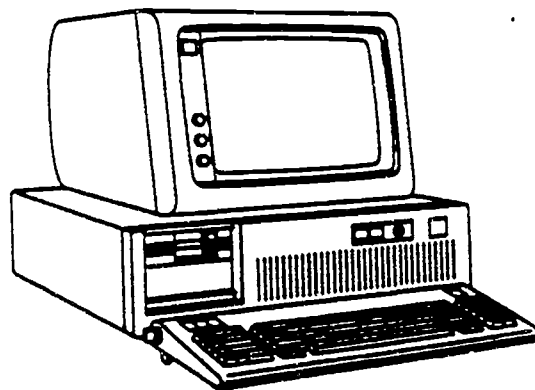

COMPUTER SYSTEMS

Workers in these computer occupations develop and write computer programs to store, locate, and retrieve specific documents, data, and information. They may also analyze business, scientific, and technical problems for application to electronic data processing systems. These careers generally require specialized training.

The largest occupations, which also have the greatest number of job openings annually, are:

- Systems analysts, electronic data processing
- Computer programmers

These occupations may not have a favorable outlook for the future. Overall, the number of these jobs is growing rapidly. Large numbers of job openings are expected over the next four or five years. Recently, there have been many more new trainees than job openings. If this trend continues, job seekers can expect to face keen competition. Placement rates at area vocational technical schools, community colleges, and/or technical institutes have been good recently.

Hourly wages include:

- \$14.51 Computer programmers
- \$18.86 Systems analysts, electronic data processing

High school programs preparing for these occupations are:

- 07.0301 Electronic data processing, computer science
- 07.0305 Business data programming
- 07.0399 Miscellaneous business data processing

Related postsecondary programs at state-supported institutions in this area are:

- 07.0301 Electronic data processing, computer science
- 11.0701 Computer science

COSMETOLOGY

Cosmetologists and related workers provide beauty services for customers. These may include cutting and styling hair, treating hair and scalp, applying makeup, dressing wigs, or removing hair by electrolysis, as well as cleaning, shaping, and polishing a customer's fingernails and toenails.

The two largest occupations are:

- Hairdressers, hairstylists, and cosmetologists
- Manicurists

The occupations expected to have the most job openings annually are:

- Hairdressers, hairstylists, and cosmetologists
- Shampooers

These occupations may not have a favorable outlook for the future. Overall, the number of these jobs is growing. A moderate number of job openings are expected over the next four or five years. Recently, there have been many more new trainees than job openings. If this trend continues, job seekers can expect to face keen competition. Placement rates at area vocational technical schools, community colleges, and/or technical institutes have been fair recently.

High school programs preparing for these occupations are:

12.0403 Cosmetology

Related postsecondary programs at state-supported institutions in this area are:

12.0403 Cosmetology

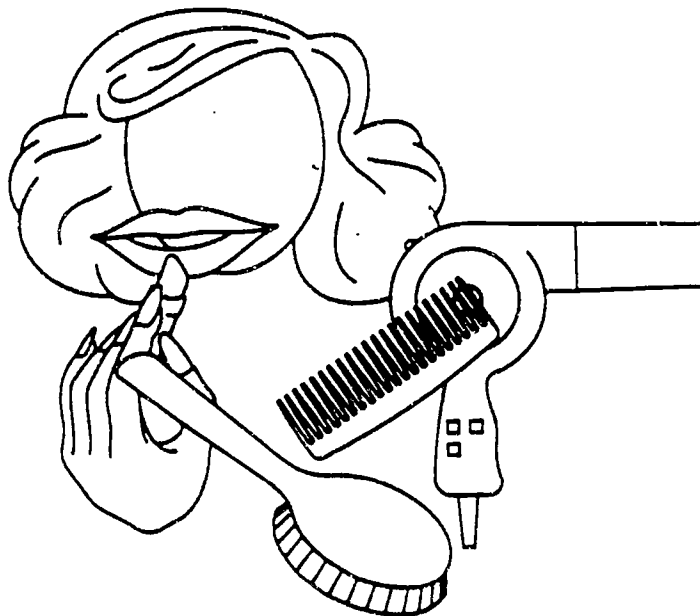

DENTAL ASSISTING

Dental assistants may perform a wide variety of clinical, office, and laboratory duties, depending on the size of the dental practice. Typically, assistants seat patients in the dental chair, prepare them for the dentist's treatment, and work with the dentist during examination and treatment.

This occupation may have a generally favorable outlook for the future. Overall, the number of these jobs is growing rapidly. A moderate number of job openings are expected over the next four or five years. Recently, no training has been reported. Job opportunities should be good.

Licensing may be required. Contact: TENNESSEE BOARD OF DENTISTRY, 615-367-6228.

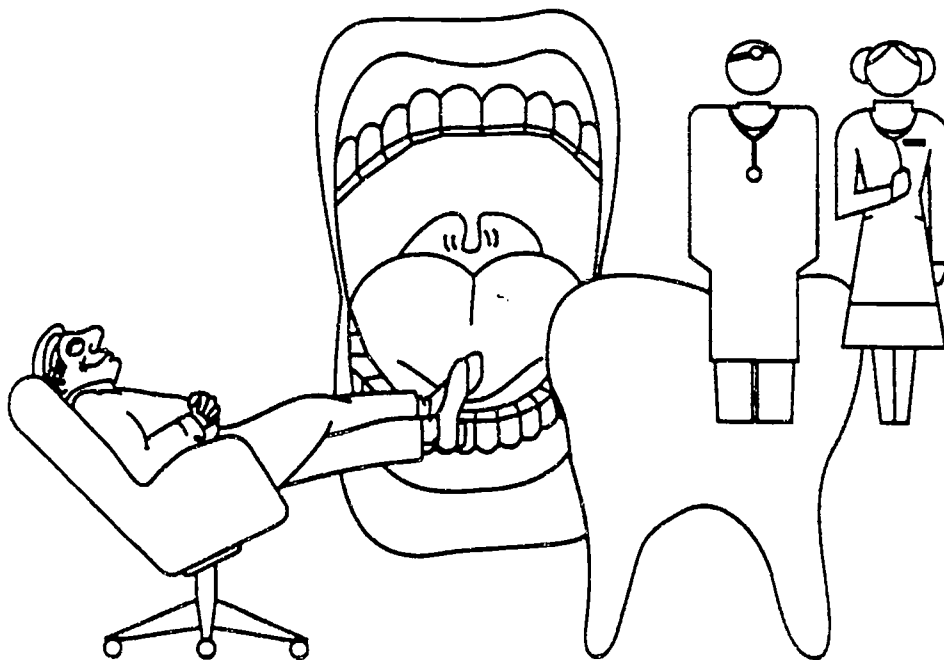

526

DENTAL HYGIENE

Dental hygienists provide preventive dental care and encourage patients to develop good oral health skills. They evaluate patients' dental health; remove calculus, stain, and plaque from above and below the gumline; expose and develop dental x-rays; and instruct patients on plaque control.

This occupation may have a generally favorable outlook for the future. Overall, the number of these jobs is growing rapidly. A moderate number of job openings are expected over the next four or five years. Recently, there have been more new trainees than job openings.

Related postsecondary programs at state-supported institutions in this area are:

51.0602 Dental hygienist

Licensing may be required. Contact: TENNESSEE BOARD OF DENTISTRY, 615-367-6228.

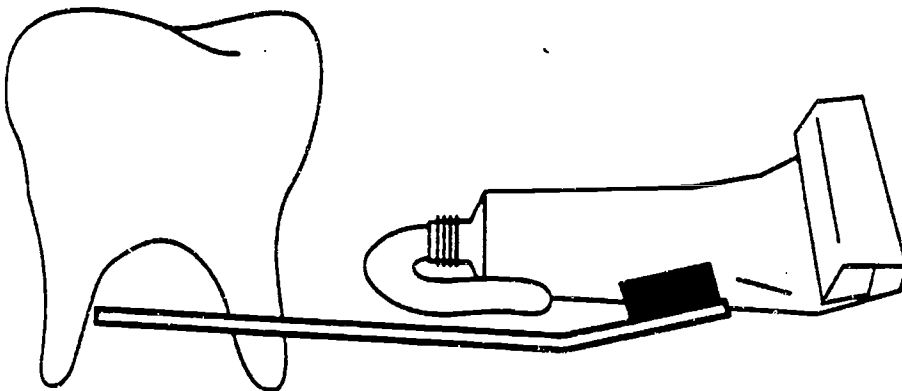

527

SDA 9 - 23

DRAFTING AND DESIGN TECHNOLOGY

Persons in drafting and design technology prepare clear, complete, and accurate working plans and detail drawings from rough or detailed sketches or notes for engineering or manufacturing purposes according to specified dimensions. Workers need to have knowledge of various machines, engineering practices, mathematics, building materials, and other physical sciences to complete drawings. Computer-assisted design (CAD) equipment may be used by some workers.

The largest occupations, which also have the greatest number of job openings annually, are:

- Cost estimators
- Drafters

These occupations may not have a favorable outlook for the future. Overall, the number of these jobs is growing. A moderate number of job openings are expected over the next four or five years. Recently, there have been many more new trainees than job openings. If this trend continues, job seekers can expect to face keen competition. Placement rates at area vocational technical schools, community colleges, and/or technical institutes have been fair recently.

Hourly wages include:

\$11.59 Drafters

High school programs preparing for these occupations are:

48.0101 Drafting

Related postsecondary programs at state-supported institutions in this area are:

15.0101 Architectural engineering technology
48.0101 Drafting

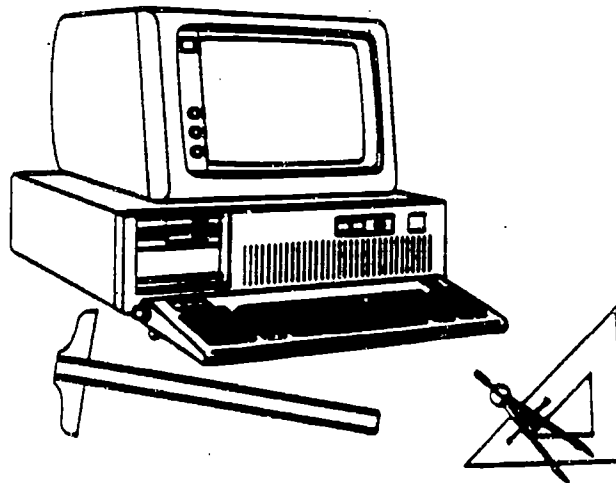

DRYCLEANING

Workers in these occupations operate washing and drying machines to clean and dry clean commercial, industrial, or household articles; use pressing machines to press and shape articles; and identify stains and apply chemical solutions to remove them.

The largest occupations, which also have the greatest number of job openings annually, are:

- Laundry and drycleaning machine operators and tenders, except of pressing machines
- Operators and tenders of machines pressing textiles, garments, and related materials

These occupations may have a generally favorable outlook for the future. Overall, the number of these jobs is growing. A moderate number of job openings are expected over the next four or five years. Recently, no training has been reported. Job opportunities should be good.

Hourly wages include:

\$5.04 Laundry and drycleaning machine operators and tenders, except pressing

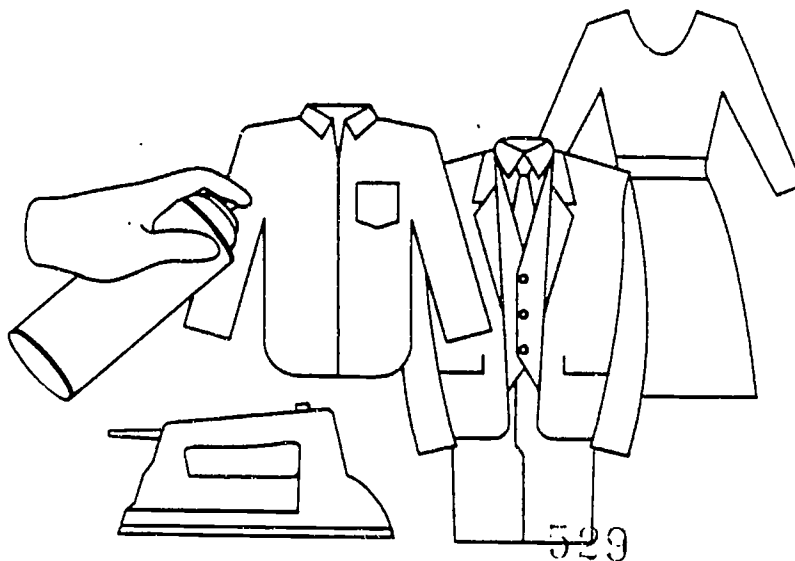

EARLY CHILDHOOD EDUCATION

Child care workers and managers of child care centers assume responsibility for the safety, physical care, and emotional, social, and intellectual growth of preschool children and infants while parents are at work or are unavailable for other reasons. Some work in residential institutions for young children. Teacher aides assist teachers by handling routine paperwork or by working directly with children.

The largest occupations, which also have the greatest number of job openings annually, are:

- Teacher aides, paraprofessional
- Child care workers

These occupations may have a generally favorable outlook for the future. Overall, the number of these jobs is growing rapidly. Large numbers of job openings are expected over the next four or five years. Recently, there have been many more new trainees than job openings. If this trend continues, job seekers can expect to face keen competition. Placement rates at area vocational technical schools, community colleges, and/or technical institutes have been excellent recently.

Hourly wages include:

\$4.72 Child care workers

High school programs preparing for these occupations are:

- 20.0102 Child development, care, and guidance
- 20.0201 Child care and guidance management services

Related postsecondary programs at state-supported institutions in this area are:

- 20.0201 Child care and guidance management services

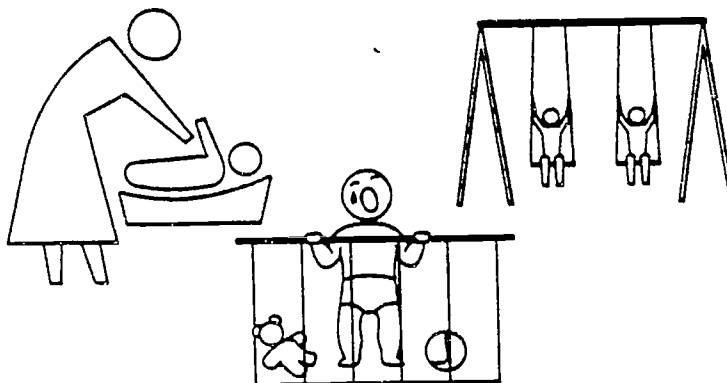

530

ELECTRICIAN OCCUPATIONS

Workers in the electrical field install, maintain, and repair wiring, electrical equipment, and fixtures or assist in such activities. These workers insure that work is in accordance with the relevant codes. A high school education is usually required and a five-year apprenticeship program is recommended.

The largest occupations, which also have the greatest number of job openings annually, are:

- Electricians
- Helpers of electricians and powerline transmission installers

These occupations may have a generally favorable outlook for the future. Overall, the number of these jobs is growing. Large numbers of job openings are expected over the next four or five years. Recently, there have been fewer new trainees than job openings. If this trend continues, job opportunities should be good. Placement rates at area vocational technical schools, community colleges, and/or technical institutes have been fair recently.

Hourly wages include:

\$13.72 Electricians

Related postsecondary programs at state-supported institutions in this area are:

46.0302 Electrician

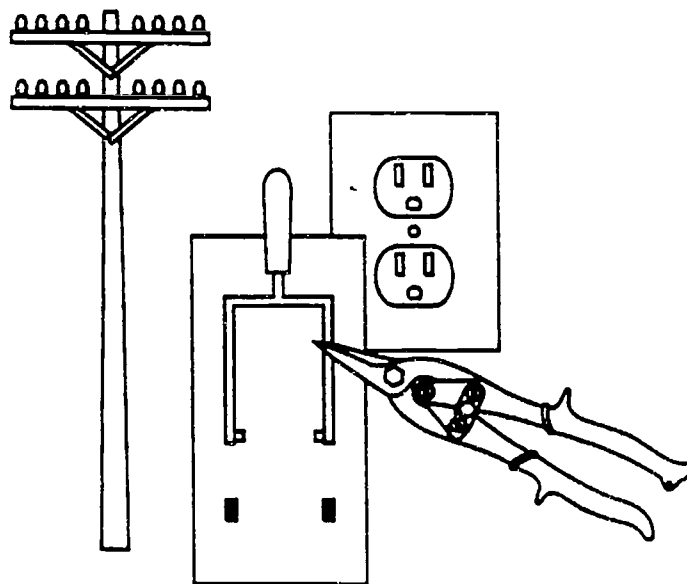

531

SDA 9 - 27

FIRE CONTROL AND SAFETY TECHNOLOGY

Workers in these positions help protect the public against the danger to their lives and property by fire. Firefighters must be prepared to respond to a fire and handle any emergency, including medical, that arises. Some firefighters operate fire apparatus, ambulances, emergency rescue vehicles, and fireboats. Most fire departments also are responsible for fire prevention.

The largest occupations, which also have the greatest number of job openings annually, are:

- Fire fighting and prevention supervisors
- Fire fighters

These occupations may have a generally favorable outlook for the future. Overall, the number of these jobs is growing slowly. A moderate number of job openings are expected over the next four or five years. Recently, there have been fewer new trainees than job openings. If this trend continues, job opportunities should be good.

Related postsecondary programs at state-supported institutions in this area are:

43.0203 Fire science and firefighting

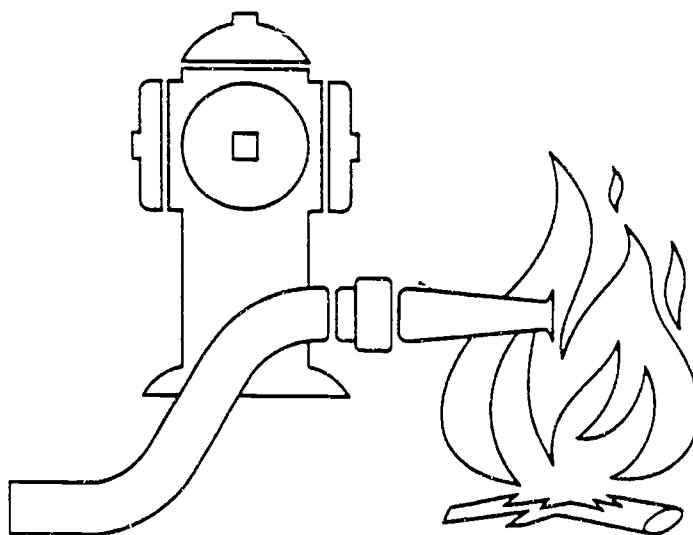

532

FOOD PREPARATION AND SERVICES

The majority of workers in these occupations prepare and serve food and beverages in restaurants, fast food establishments, catering firms, hotels, clubs, factories, school cafeterias, or hospitals, or supervise those providing food services. Others are factory machine operators involved in the preparation of food products. Dietetic technicians teach principles of food nutrition and provide dietary counseling to patients.

The largest occupations, which also have the greatest number of job openings annually, are:

- Food preparation workers
- Combined food preparation and service workers

These occupations may have a generally favorable outlook for the future. Overall, the number of these jobs is growing. Large numbers of job openings are expected over the next four or five years. Recently, there have been fewer new trainees than job openings. If this trend continues, job opportunities should be good.

Hourly wages include:

\$4.86	Cooks, specialty fast food
\$5.30	Bartenders
\$5.81	Food preparation workers
\$6.49	Cooks, restaurant

High school programs preparing for these occupations are:

46.1111	Food occupations
---------	------------------

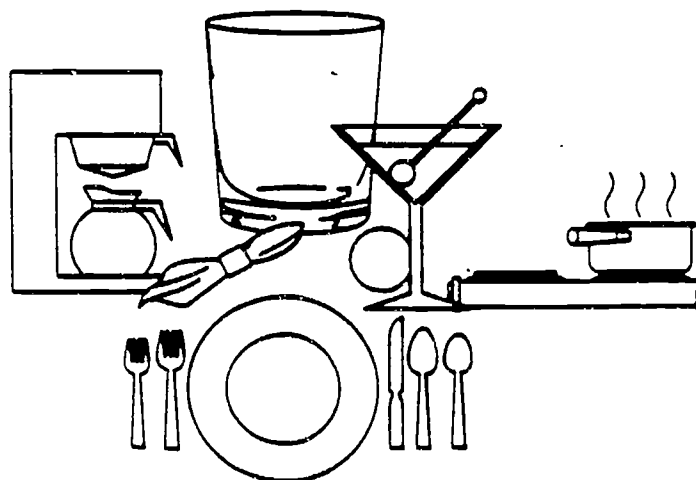

GENERAL BUSINESS AND MANAGEMENT

Workers in the general business and management occupations plan, organize, direct, control, or coordinate activities in all types of fields. Many occupations involve analysis of productivity and financial soundness. General managers and top executives usually have very diverse duties and responsibilities and work through departmental or subordinate executives.

The two largest occupations are:

- General managers and top executives
- Purchasing managers

The occupations expected to have the most job openings annually are:

- General managers and top executives
- Communications, transportation, and utilities operations managers

These occupations may have a generally favorable outlook for the future. Overall, the number of these jobs is growing. Large numbers of job openings are expected over the next four or five years. Recently, there have been fewer new trainees than job openings. If this trend continues, job opportunities should be good. Placement rates at area vocational technical schools, community colleges, and/or technical institutes have been fair recently.

Hourly wages include:

- \$18.76 Industrial production managers
- \$18.87 Purchasing managers

Related postsecondary programs at state-supported institutions in this area are:

- 06.0401 Business administration and management
- 31.0301 Parks, recreation and leisure facilities management
- 51.0701 Health systems and services administration
- 52.0201 General business administration and management



SDA 9 - 30534

GENERAL WOODWORKING

Woodworkers are in occupations concerned with the complete cycle of cutting, shaping, and assembling parts of complex wood products. The occupations are primarily concerned with one or a limited number of machine functions according to their speciality.

The two largest occupations are:

- Assemblers and fabricators, except machine, electrical, electronic, and precision assembly
- Cabinetmakers and bench carpenters

The occupations expected to have the most job openings annually are:

- Assemblers and fabricators, except machine, electrical, electronic, and precision assembly
- Sawing machine operators and tenders

These occupations may have a generally favorable outlook for the future. Overall, the number of these jobs shows little change. A moderate number of job openings are expected over the next four or five years. Recently, there have been about as many new trainees as job openings.

High school programs preparing for these occupations are:

48.0703 Millwork and cabinetmaking

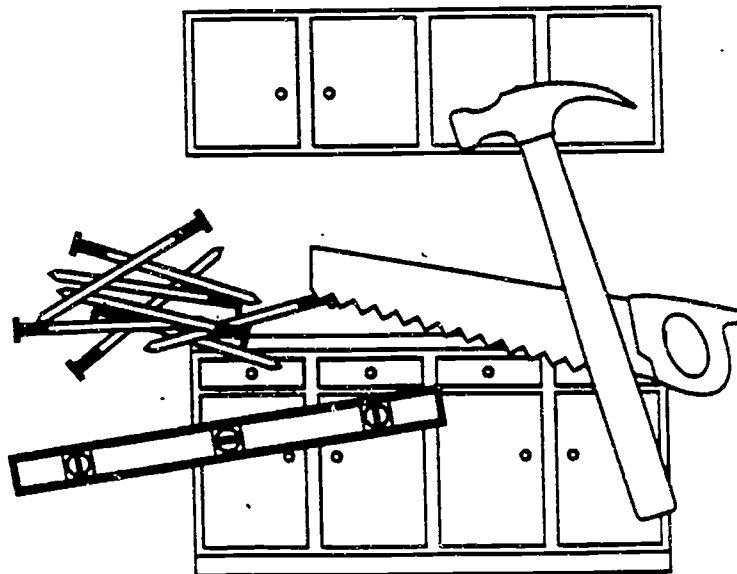

GRAPHIC ARTS

A majority of workers in this field are involved in offset printing. In this process the material to be printed is photographed and a printing plate is made from the film. This process has been advanced by the use of computers and lasers.

The largest occupations, which also have the greatest number of job openings annually, are:

- Offset lithographic press setters and set-up operators
- Printing press machine operators and tenders

These occupations may have a generally favorable outlook for the future. Overall, the number of these jobs is growing. Large numbers of job openings are expected over the next four or five years. Recently, there have been about as many new trainees as job openings. If this trend continues, job seekers can expect to face some competition. Placement rates at area vocational technical schools, community colleges, and/or technical institutes have been good recently.

Hourly wages include:

\$11.88 Offset lithographic press setters & set-up operators, sheet or web fed

High school programs preparing for these occupations are:

48.0201 Graphic and printing communications

Related postsecondary programs at state-supported institutions in this area are:

48.0299 Miscellaneous graphic and printing communication

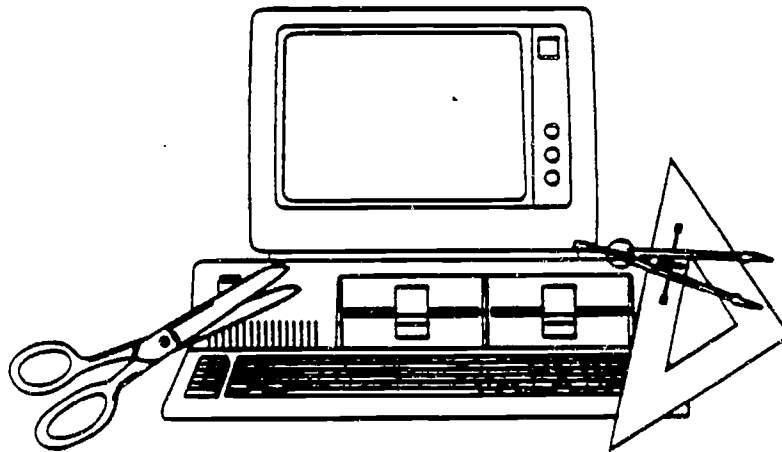

536

HEATING AND AIR CONDITIONING

Workers in this field install and repair heating, air conditioning, and refrigeration systems. They may install and repair oil burners, hot-air furnaces, and heating stoves in homes and businesses. They may also install and repair air conditioning systems, or install sheet metal ducts for the heating and cooling systems.

The largest occupations, which also have the greatest number of job openings annually, are:

- Heating, air conditioning, and refrigeration mechanics and installers
- Sheet metal duct installers

These occupations may have a generally favorable outlook for the future. Overall, the number of these jobs is growing slowly. A moderate number of job openings are expected over the next four or five years. Recently, there have been many more new trainees than job openings. If this trend continues, job seekers can expect to face keen competition. Placement rates at area vocational technical schools, community colleges, and/or technical institutes have been very good recently.

Hourly wages include:

\$12.33 Heating, air conditioning, and refrigeration mechanics and installers

High school programs preparing for these occupations are:

47.0201 Heating, air conditioning, and refrigeration mechanics

Related postsecondary programs at state-supported institutions in this area are:

47.0201 Heating, air conditioning, and refrigeration mechanics

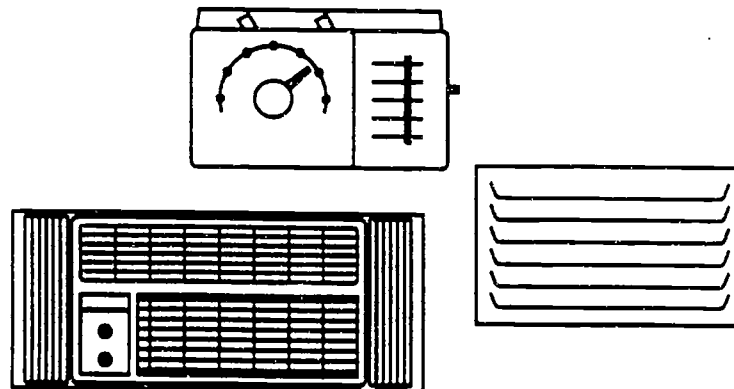

HEAVY TRUCK MAINTENANCE

Persons in heavy truck maintenance repair and maintain the operating condition of trucks, buses, and all types of diesel engines. This also includes mechanics working primarily with automobile diesel engines.

This occupation may have a generally favorable outlook for the future. Overall, the number of these jobs is growing. A moderate number of job openings are expected over the next four or five years. Recently, no training has been reported. Job opportunities should be good.

Average hourly wages are \$11.32

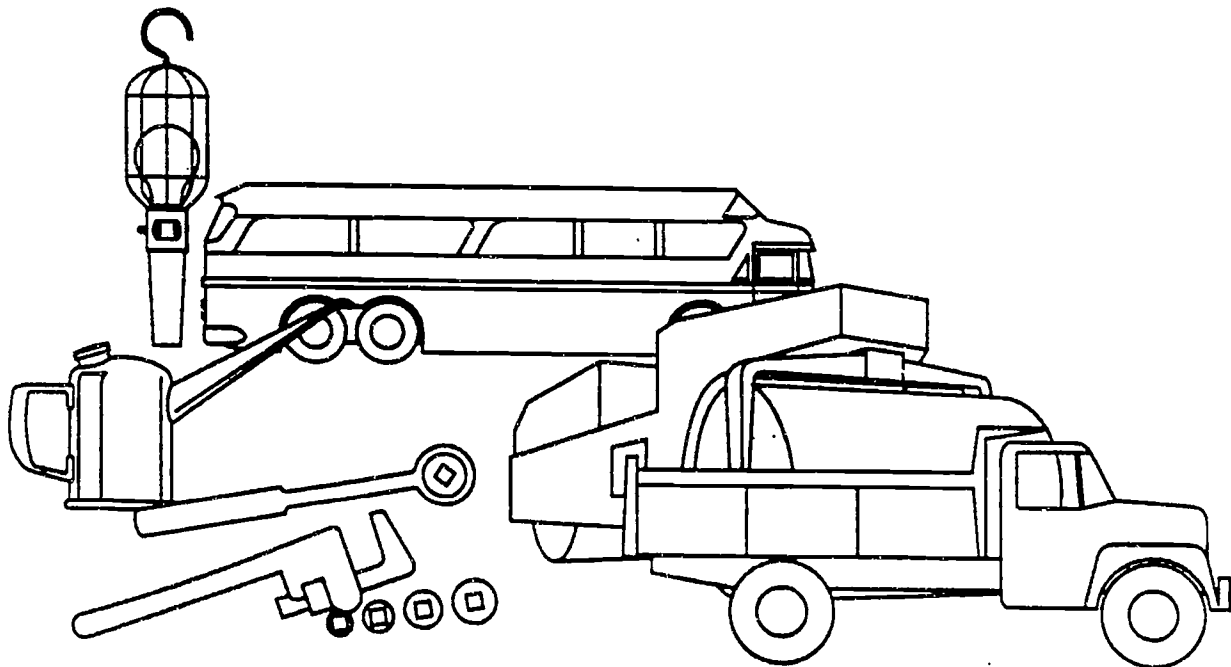

HORTICULTURE AND LANDSCAPING

The largest group of workers in these occupations, gardeners and groundskeepers, maintain the grounds of public and private property. Duties may include mowing, trimming, planting, and watering plants, shrubs, and grass.

The largest occupations, which also have the greatest number of job openings annually, are:

- Nursery workers
- Gardeners and groundskeepers, except farm workers

These occupations may have a generally favorable outlook for the future. Overall, the number of these jobs is growing. Large numbers of job openings are expected over the next four or five years. Recently, there have been about as many new trainees as job openings. If this trend continues, job seekers can expect to face some competition.

Hourly wages include:

\$7.03 Gardeners and groundskeepers, except farm

High school programs preparing for these occupations are:

01.0601 Horticulture

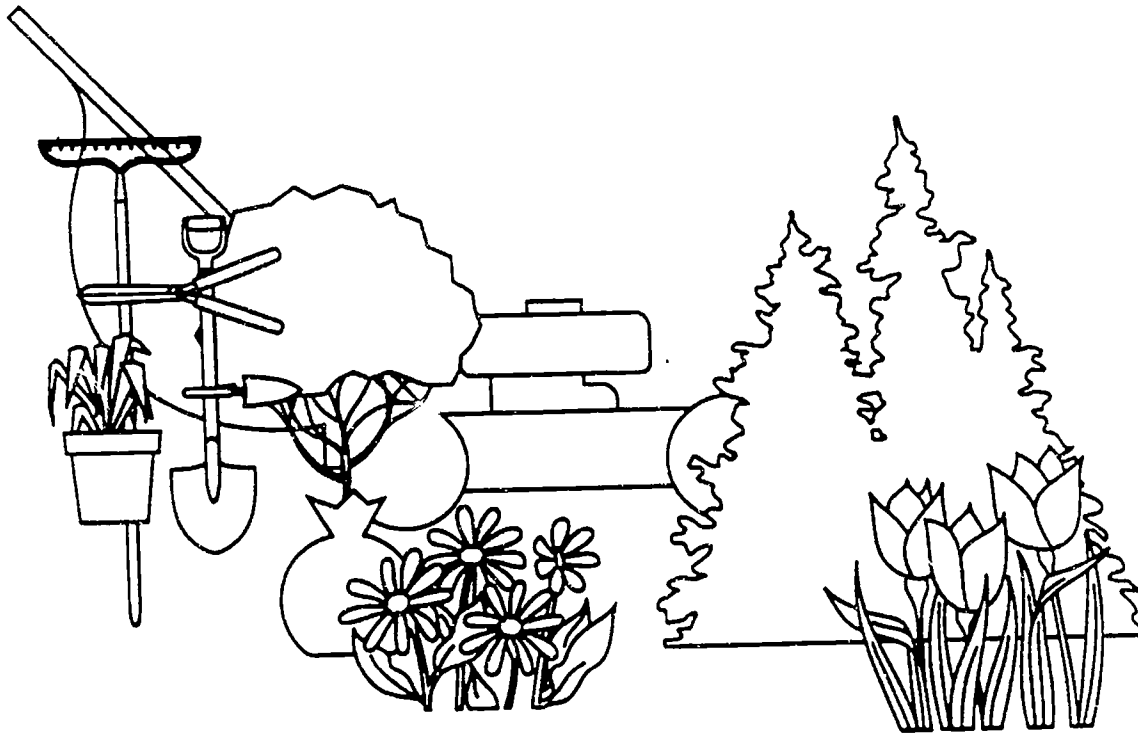

HOTEL AND RESTAURANT MANAGEMENT

Food service and lodging managers supervise the profitable operation of restaurants, hotels, and motels. Workers direct the varied activities of these businesses with the goal of pleasing people and providing good service to their customers.

This occupation may have a generally favorable outlook for the future. Overall, the number of these jobs is growing. Large numbers of job openings are expected over the next four or five years. Recently, no training has been reported. Job opportunities should be good.

Average hourly wages are \$12.37

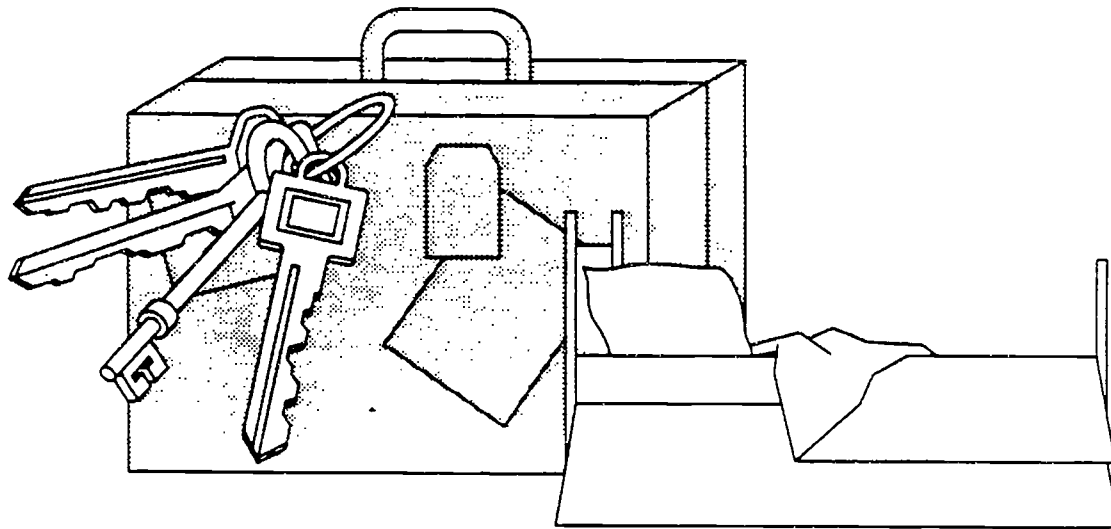

HUMAN SERVICES

Human services workers assist social group workers and caseworkers with developing, organizing, and conducting programs to prevent and resolve problems relevant to substance abuse and human relationships. They help families and clients obtain information on the use of social and community services.

This occupation may have a generally favorable outlook for the future. Few job openings are expected over the next four or five years. Recently, no training has been reported.

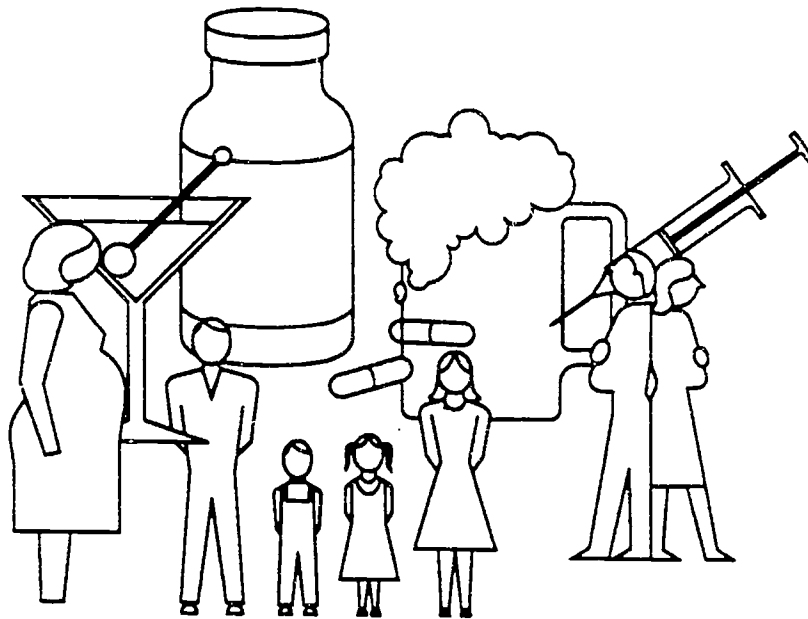

541

INDUSTRIAL MAINTENANCE TECHNOLOGY

Workers prevent costly waste of raw materials and the idling of human resources in a plant or factory by making industrial machinery repairs as quickly as possible. Maintenance mechanics spend considerable time doing preventive maintenance, including keeping machines well oiled and greased, and periodically cleaning parts.

The largest occupations, which also have the greatest number of job openings annually, are:

- Maintenance mechanics for industrial machinery
- Millwrights

These occupations may have a generally favorable outlook for the future. Overall, the number of these jobs is growing. A moderate number of job openings are expected over the next four or five years. Recently, there have been fewer new trainees than job openings. If this trend continues, job opportunities should be good. Placement rates at area vocational technical schools, community colleges, and/or technical institutes have been fair recently.

Hourly wages include:

\$13.74 Machinery maintenance mechanics

Related postsecondary programs at state-supported institutions in this area are:

15.0603 Industrial technology

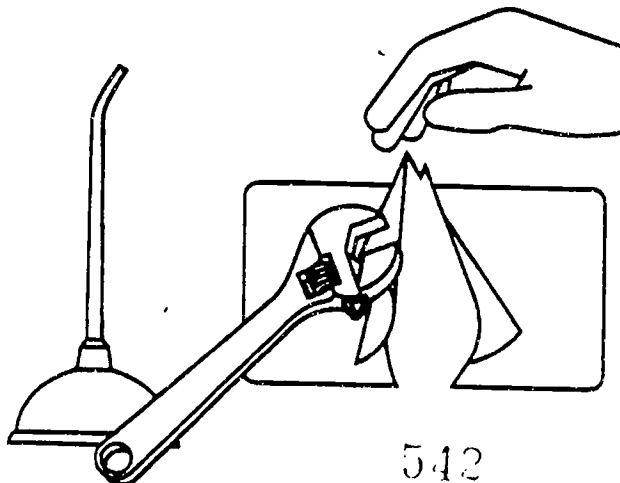

542

INSTITUTIONAL HOME MANAGEMENT AND SUPPORTING SERVICES

These workers make sure that all public buildings, offices, hospitals, stores, and apartment houses are kept clean and in good condition for the comfort and safety of the people who work or live there. Generally, no special education is required for occupations in this field, with most skills learned on the job.

The largest occupations, which also have the greatest number of job openings annually, are:

- Maids and housekeeping cleaners
- Janitors and cleaners, except maids and housekeeping cleaners

These occupations may have a generally favorable outlook for the future. Overall, the number of these jobs is growing. Large numbers of job openings are expected over the next four or five years. Recently, no training has been reported. Job opportunities should be good.

Hourly wages include:

- \$4.89 Maids and housekeeping cleaners
- \$5.43 Housekeepers
- \$7.26 Janitors and cleaners, except maids and housekeeping cleaners

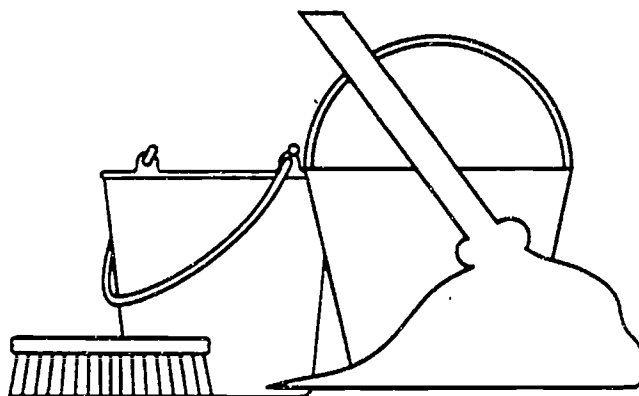

543

LABORATORY TECHNICIAN

Medical and clinical laboratory technicians perform routine laboratory tests for use in the treatment and diagnosis of disease; prepare vaccines, biologicals, and serums for prevention of disease; and prepare tissue samples, take blood samples, and execute laboratory tests including urinalyses and blood counts.

This occupation may have a generally favorable outlook for the future. Overall, the number of these jobs is growing. A moderate number of job openings are expected over the next four or five years. Recently, there have been more new trainees than job openings. If this trend continues, job seekers can expect to face some competition. Placement rates at area vocational technical schools, community colleges, and/or technical institutes have been very good recently.

Average hourly wages are \$10.72

Related postsecondary programs at state-supported institutions in this area are:

17.0398 Phlebotomy (Nashville AVTS 17.0399)

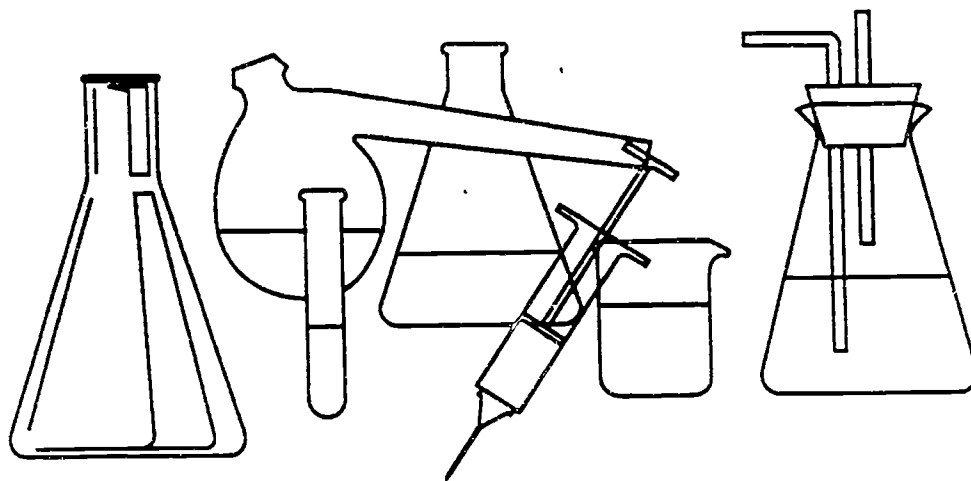

544

LAW ENFORCEMENT

People working at these occupations are responsible for the safety of Tennessee cities, towns, and highways. Their responsibilities range from controlling traffic to preventing and investigating crimes. Whether on or off duty, they are expected to exercise their authority whenever necessary.

The largest occupations, which also have the greatest number of job openings annually, are:

- Police and detective supervisors
- Police patrol officers

These occupations may have a generally favorable outlook for the future. Overall, the number of these jobs shows little change. Large numbers of job openings are expected over the next four or five years. Recently, no training has been reported. Job opportunities should be good.

Hourly wages include:

\$11.01 Police patrol officers

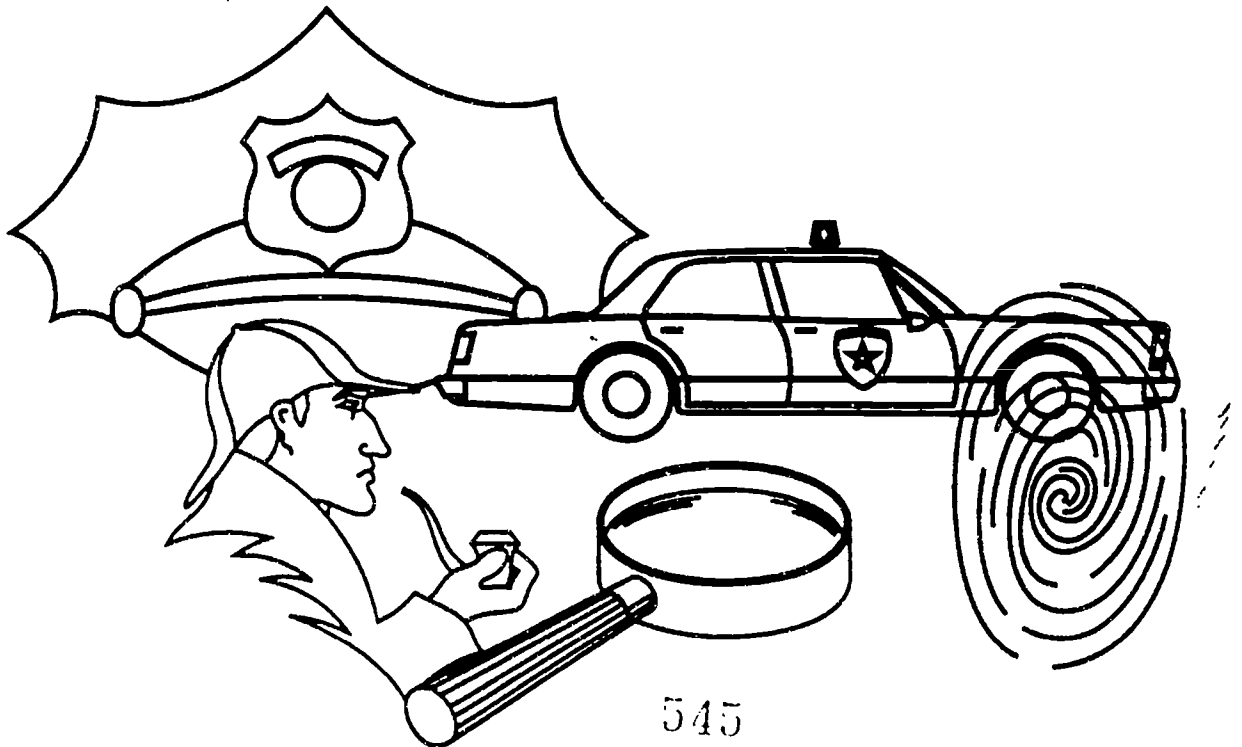

LEGAL ASSISTING

Under the direct supervision of a lawyer, workers employed in paralegal occupations do research for the preparation of lawsuits and legal documents; gather information for use as evidence in trials; draft documents such as mortgages, deeds, and contracts; and search titles to determine if a title deed is correct. Most paralegal personnel work for private law firms.

The largest occupations, which also have the greatest number of job openings annually, are:

- Paralegal personnel
- Title examiners and abstractors

These occupations may have a generally favorable outlook for the future. Few job openings are expected over the next four or five years. Recently, no training has been reported.

Hourly wages include:

\$12.52 Paralegal personnel

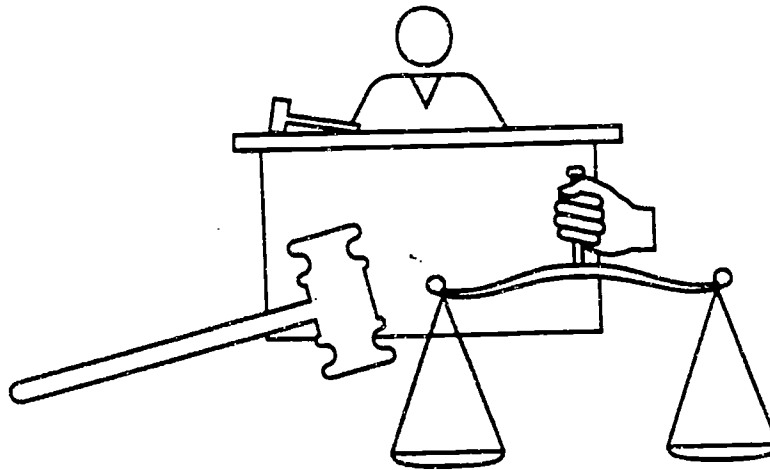

MACHINE TOOL TECHNOLOGY

Workers in these occupations make or set up and operate machine tools or repair metal parts. Machinists and tool-and-die makers create highly specialized precision tools, molds, and metal parts. Often they use blueprints to develop prototypes for tools or machines to be used in manufacturing.

The two largest occupations are:

- Machinists
- Machine tool cutting operators and tenders of metal and plastic

The occupations expected to have the most job openings annually are:

- Machinists
- Numerical control machine tool operators and tenders for metal and plastic

Overall, the number of these jobs is growing. Large numbers of job openings are expected over the next four or five years. Recently, there have been fewer new trainees than job openings. If this trend continues, job opportunities should be good. Placement rates at area vocational technical schools, community colleges, and/or technical institutes have been poor recently.

Hourly wages include:

- \$7.72 Combination machine tool operators and tenders, metal and plastic
- \$13.90 Machinists
- \$14.34 Tool and die makers
- \$15.70 Numerical control machine tool operators and tenders, metal and plastic

High school programs preparing for these occupations are:

- 48.0503 Machine tool operation and machine shop technology

Related postsecondary programs at state-supported institutions in this area are:

- 48.0503 Machine tool operation and machine shop technology

MEDICAL ASSISTING

Medical assistants perform a wide variety of clinical and administrative duties under the direction of physicians. Clinical duties may include taking and recording patients' vital signs and medical histories, preparing patients for examination by physicians, and explaining treatment procedures to patients.

In small physicians' offices they may keep medical records, schedule appointments, and order supplies. Electrocardiograph (EKG) technicians operate the EKG machines which provide graphic tracings of heartbeats.

The largest occupations, which also have the greatest number of job openings annually, are:

- Electrocardiograph technicians
- Medical assistants

These occupations may have a generally favorable outlook for the future. Overall, the number of these jobs is growing rapidly. A moderate number of job openings are expected over the next four or five years. Recently, no training has been reported. Job opportunities should be good.

Hourly wages include:

\$8.52 Medical assistants

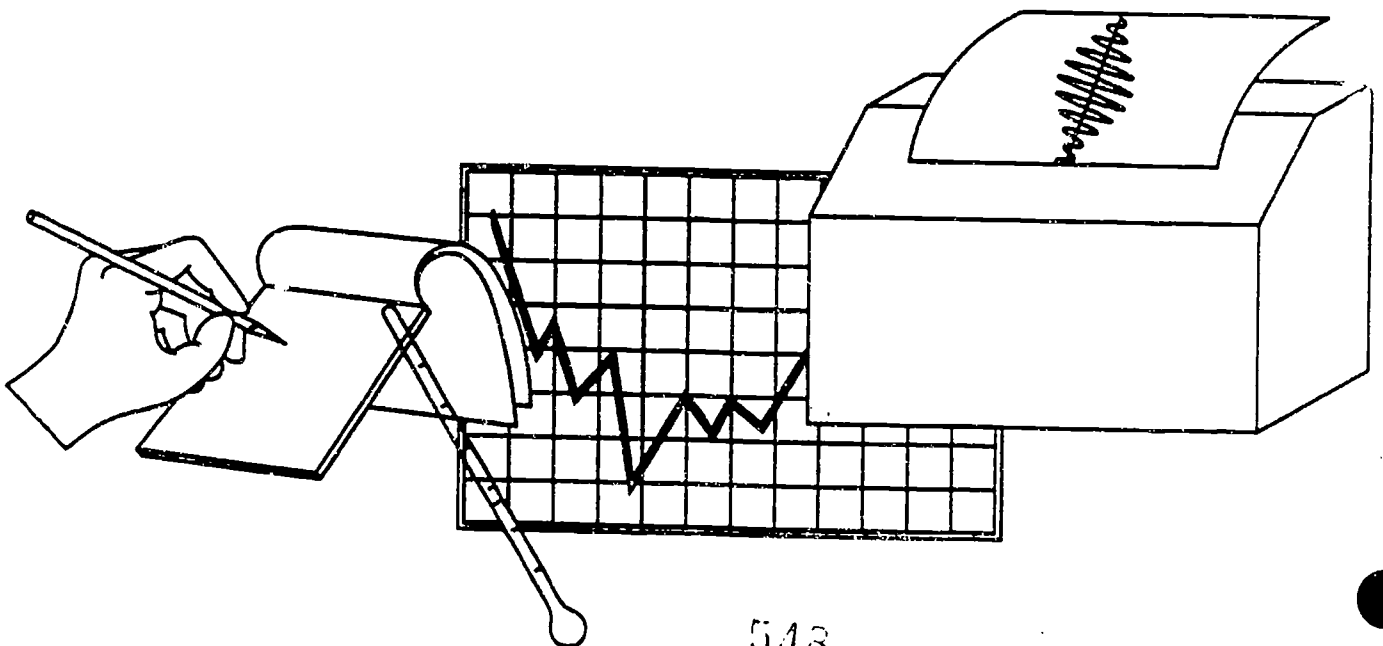

548

MEDICAL RECORDS TECHNOLOGY

Medical records technicians compile and maintain medical records of hospital and clinic patients. Such work is becoming increasingly important as this background information is used for medicare and medical insurance reimbursements.

This occupation may have a generally favorable outlook for the future. Few job openings are expected over the next four or five years. Recently, there have been fewer new trainees than job openings.

Average hourly wages are \$6.97

Related postsecondary programs at state-supported institutions in this area are:

51.0707 Medical records technology and technician

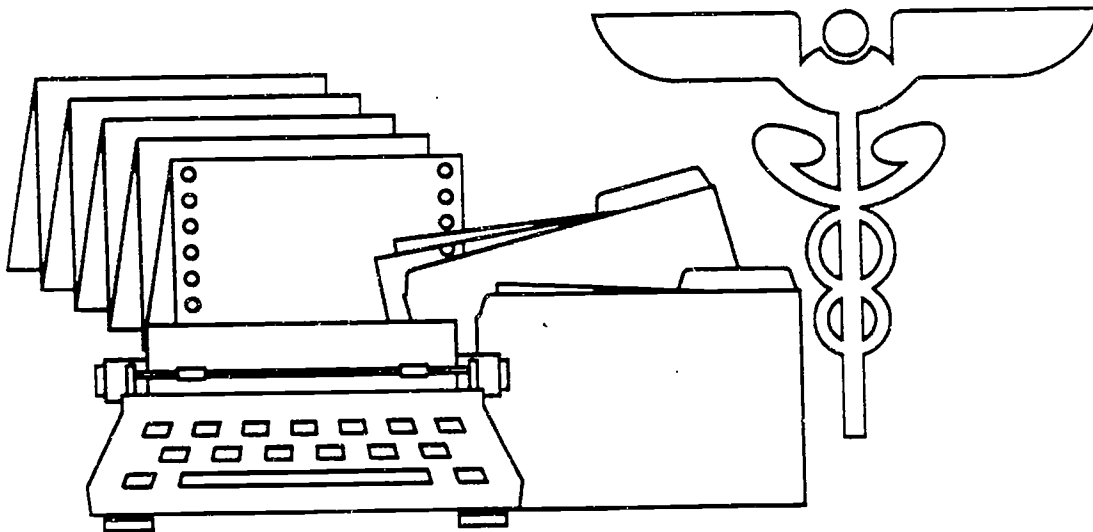

NURSING ASSISTANT

Nursing aides and orderlies work under the general direction of nursing or medical staff. In hospitals, they may answer patients' call bells, serve and collect food trays, feed patients, or set up equipment. In nursing homes, they are expected to sustain ongoing relations with patients.

The largest occupations, which also have the greatest number of job openings annually, are:

- Nursing aides, orderlies, and attendants
- Home health aides

These occupations may have a generally favorable outlook for the future. Overall, the number of these jobs is growing rapidly. Large numbers of job openings are expected over the next four or five years. Recently, there have been fewer new trainees than job openings. If this trend continues, job opportunities should be good.

Hourly wages include:

- \$5.71 Nursing aides, orderlies, and attendants
- \$6.50 Home health aides

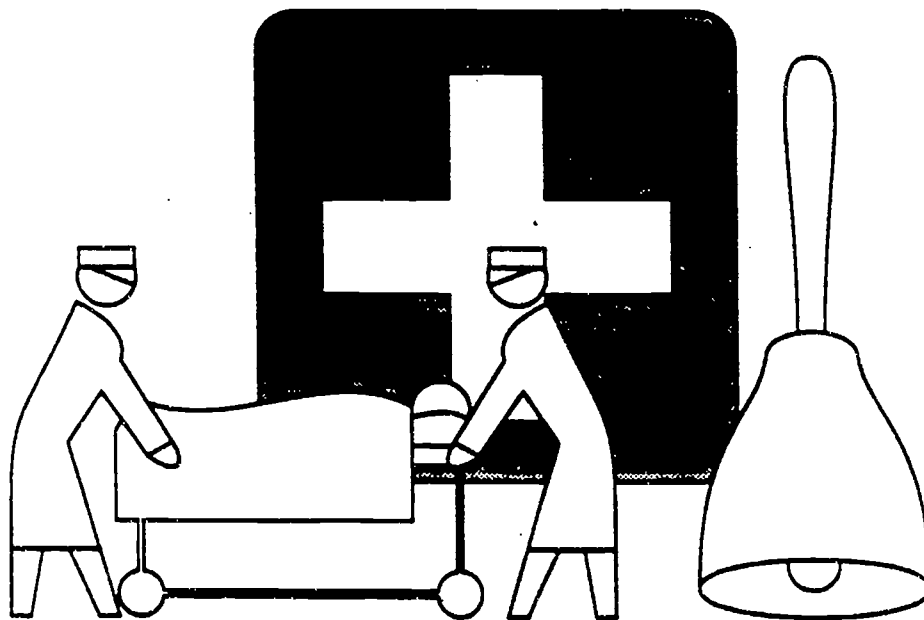

PHOTOGRAPHIC TECHNOLOGY

Workers in this cluster use their cameras and film to portray people, places, and events much as a writer uses words. Those who are skillful can capture the personality of individuals or the mood of the scenes which they photograph. Photographers specializing in scientific, medical, or engineering photography expose worlds normally hidden from our view.

The largest occupations, which also have the greatest number of job openings annually, are:

- Photographers
- Photographic processing machine operators and tenders

These occupations may have a generally favorable outlook for the future. Overall, the number of these jobs is growing slowly. A moderate number of job openings are expected over the next four or five years. Recently, there have been fewer new trainees than job openings. If this trend continues, job opportunities should be good.

High school programs preparing for these occupations are:

48.0204 Commercial photography

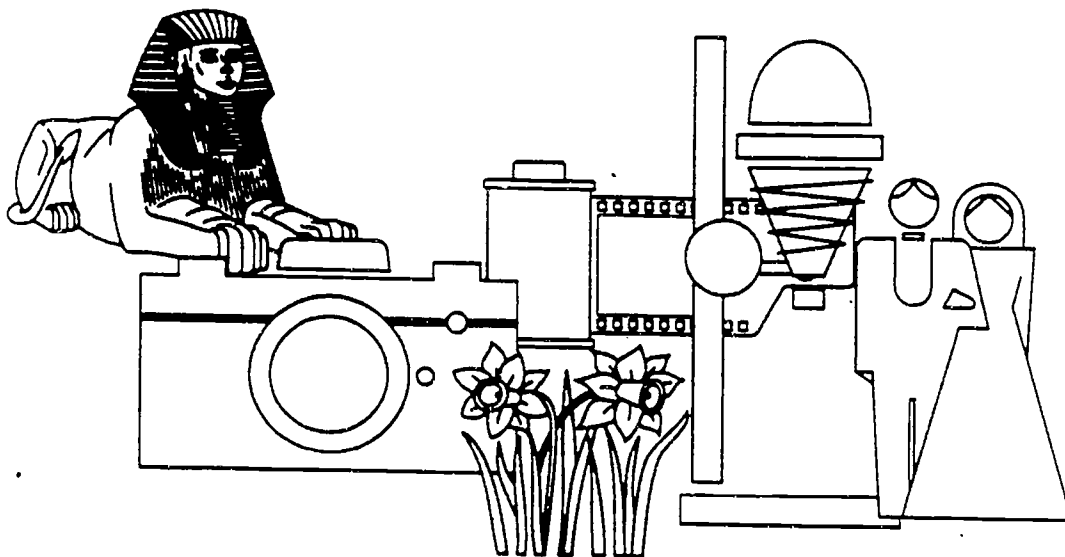

551

SDA 9 - 47

PHYSICAL THERAPY ASSISTING

Workers in this occupation, under the direction of a physical therapist, prepare patients for and/or administer physical therapy treatment, such as massages, heat, light and sound treatment, and traction. They also instruct, motivate, and assist patients with learning and improving functional activities.

This occupation may have a generally favorable outlook for the future. Few job openings are expected over the next four or five years. Recently, no training has been reported.

Licensing may be required. Contact: TENNESSEE STATE BOARD OF OCCUPATIONAL AND PHYSICAL THERAPY, 615-367-6243.

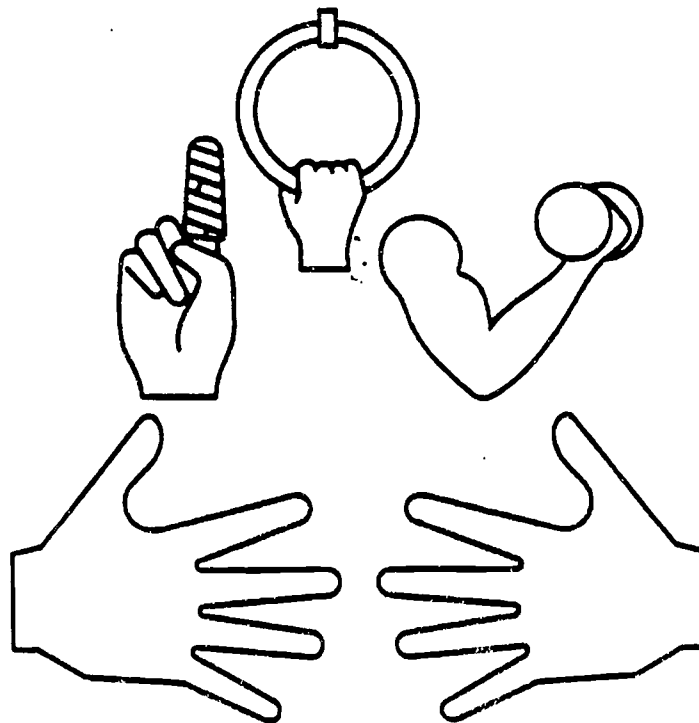

PLUMBING AND PIPEFITTING

Plumbers and pipefitters install and maintain the complex system of pipes that connect to the master system that runs underground. Although plumbing and pipefitting are sometimes considered a single trade, workers may specialize in either craft. Plumbers build and repair the water, waste disposal, drainage, and gas systems in homes and commercial/industrial buildings. Pipefitters build and repair both high and low pressure pipe.

The largest occupations, which also have the greatest number of job openings annually, are:

- Plumbers, pipefitters, and steamfitters
- Pipelayers

These occupations may have a generally favorable outlook for the future. Overall, the number of these jobs is growing. A moderate number of job openings are expected over the next four or five years. Recently, no training has been reported. Job opportunities should be good.

Hourly wages include:

\$13.64 Plumbers, pipefitters, and steamfitters

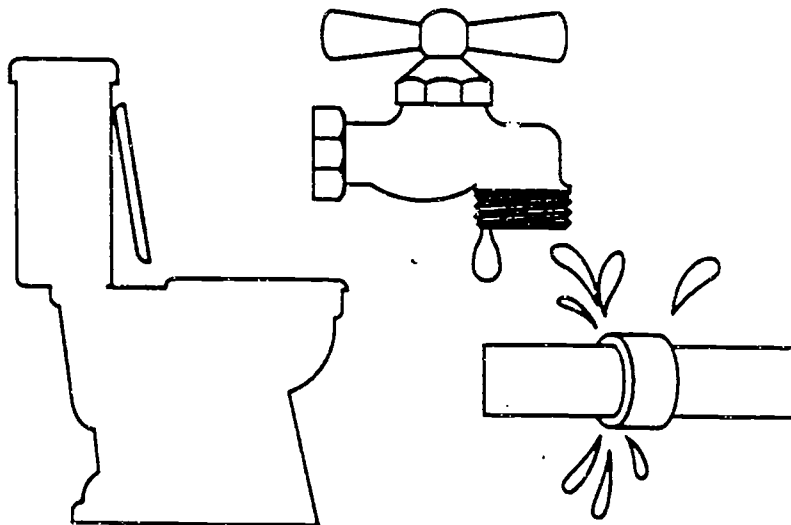

553

PRACTICAL NURSING

Licensed practical nurses (LPNs) work under the supervision of physicians and/or registered nurses to provide nursing care that requires technical knowledge but not the professional training of a registered nurse. They provide bedside care, administer certain medications, and assist in patient examinations.

This occupation may have a generally favorable outlook for the future. Overall, the number of these jobs is growing rapidly. Large numbers of job openings are expected over the next four or five years. Recently, there have been fewer new trainees than job openings. If this trend continues, job opportunities should be good. Placement rates at area vocational technical schools, community colleges, and/or technical institutes have been excellent recently.

Average hourly wages are \$12.34

Related postsecondary programs at state-supported institutions in this area are:

17.0605 Practical nursing

Licensing may be required. Contact: TENNESSEE BOARD OF NURSING, 615-367-6232.

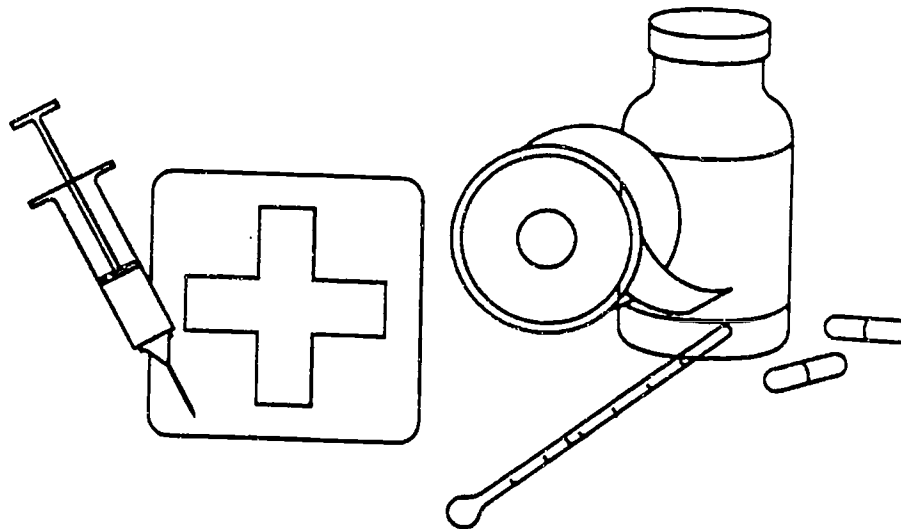

PROFESSIONAL NURSING

Registered Nurses (R.N.'s), the largest occupational group in this field, are primarily employed in hospitals and nursing homes, where they provide skilled bedside care and may supervise licensed practical nurses, nursing aides, and orderlies. Working under the direction of a licensed "supervising physician," physician assistants elicit detailed patient histories, perform physical examinations, and prescribe appropriate treatments.

The largest occupations, which also have the greatest number of job openings annually, are:

- Registered nurses
- Physician's assistants

These occupations may have a generally favorable outlook for the future. Overall, the number of these jobs is growing rapidly. Large numbers of job openings are expected over the next four or five years. Recently, there have been fewer new trainees than job openings. If this trend continues, job opportunities should be good.

Hourly wages include:

\$15.96 Registered nurses

Related postsecondary programs at state-supported institutions in this area are:

51.1601 Nursing (R.N. training)

Licensing may be required. Contact: TENNESSEE BOARD OF MEDICAL EXAMINERS-COMMITTEE ON PHYSICIAN ASSISTANTS, 615-367-6250.

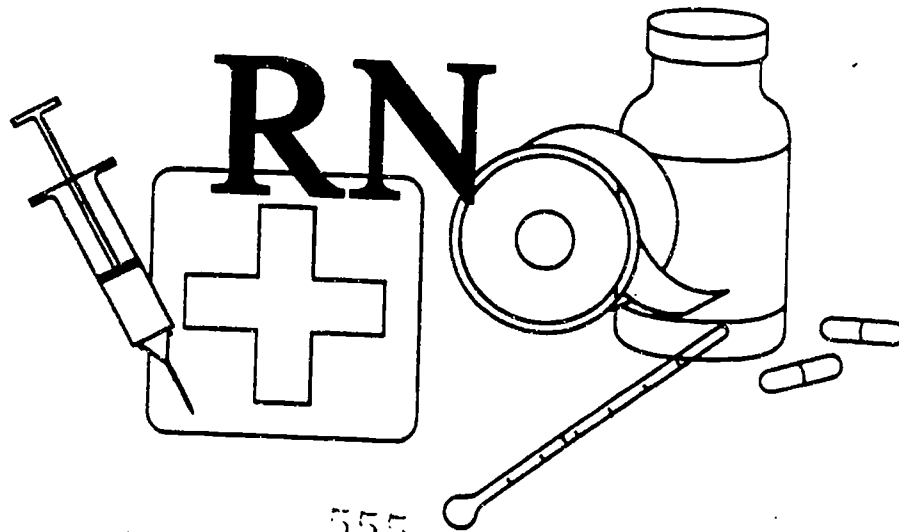

555

PUBLIC ADMINISTRATION

Individuals in this field are responsible for the management of diverse areas of governmental organizations. These managers usually work through departmental executives or subordinates in coordinating the various activities and groups they control. Public administration chief executives, legislators, and general administrators establish government policy and develop federal, state, or local regulations, rules, and laws.

The largest occupations, which also have the greatest number of job openings annually, are:

- Public administration chief executives, legislators, and general administrators
- General managers and top executives

These occupations may have a generally favorable outlook for the future. Overall, the number of these jobs shows little change. A moderate number of job openings are expected over the next four or five years. Recently, there have been more new trainees than job openings. If this trend continues, job seekers can expect to face some competition.

Related postsecondary programs at state-supported institutions in this area are:

- 43.0103 Criminal justice and law enforcement administration
- 44.0401 Public administration



RADIOGRAPHIC MEDICAL TECHNOLOGY

Workers in this field operate equipment including x-ray machines, fluoroscopes, ultrasonic scanners, computed tomography (CP) scanners, and nuclear magnetic resonance (MCI) machines for diagnostic imagery of the human body or for therapy.

The largest occupations, which also have the greatest number of job openings annually, are:

- Radiologic technologists
- Radiologic technicians

These occupations may have a generally favorable outlook for the future. Overall, the number of these jobs is growing rapidly. A moderate number of job openings are expected over the next four or five years. Recently, no training has been reported. Job opportunities should be good.

Hourly wages include:

\$12.55 Radiologic technicians

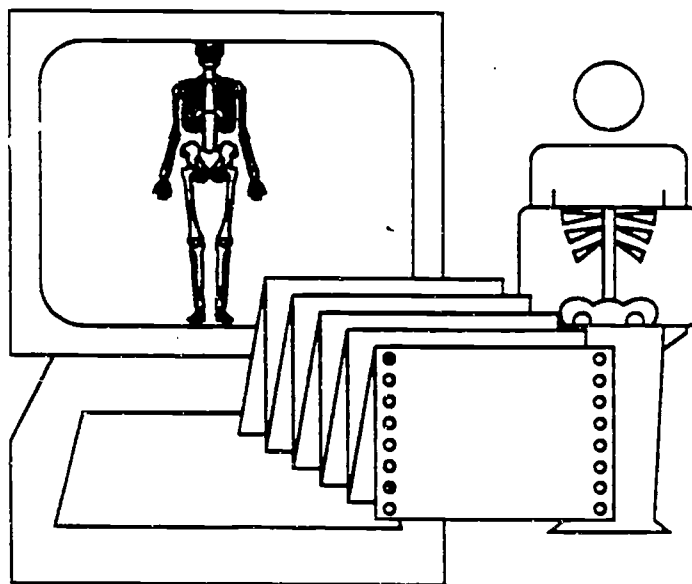

RECREATIONAL LEADERSHIP

Workers in recreational leadership occupations conduct recreational activities with groups, consider the interests of participants, and organize and promote activities. A large proportion of recreational workers are employed in city recreation departments and in state and national parks.

This occupation may have a generally favorable outlook for the future. Overall, the number of these jobs is growing. A moderate number of job openings are expected over the next four or five years. Recently, no training has been reported.



RESPIRATORY THERAPY

Respiratory therapists treat patients with breathing problems ranging from chronic asthma and emphysema to heart failure, stroke, or drowning emergencies. Respiratory care may involve administering oxygen; delivering medication or humidity through aerosol mists; administering chest physical therapy; or setting up and operating mechanical ventilators.

This occupation may have a generally favorable outlook for the future. Few job openings are expected over the next four or five years. Recently, there have been fewer new trainees than job openings.

Related postsecondary programs at state-supported institutions in this area are:

51.0908 Respiratory therapy technician

Licensing may be required. Contact: BOARD OF MEDICAL EXAMINERS-COUNCIL ON RESPIRATORY CARE, 615-367-3393.

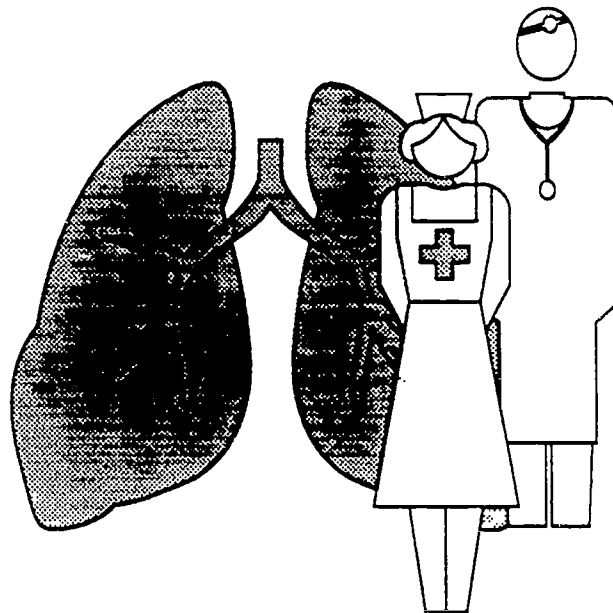

559

SDA 9 - 55

SALES AND MERCHANDISING

Workers in sales and merchandising occupations promote and sell a wide variety of merchandise and services. They also receive, store, display, and inventory products to be sold.

The largest occupations, which also have the greatest number of job openings annually, are:

- Salespersons in retail establishments
- Cashiers

These occupations may have a generally favorable outlook for the future. Overall, the number of these jobs is growing. Large numbers of job openings are expected over the next four or five years. Recently, there have been fewer new trainees than job openings. If this trend continues, job opportunities should be good.

Hourly wages include:

\$5.15	Cashiers
\$6.10	Counter and rental clerks
\$6.87	Salespersons, retail
\$9.19	Driver/sales workers
\$10.97	Customer service representatives, utilities
\$13.44	Wholesale and retail buyers, except farm products
\$15.73	Purchasing agents- except wholesale, retail, and farm products

High school programs preparing for these occupations are:

08.0700 General marketing

Licensing may be required. Contact: TENNESSEE DEPARTMENT OF COMMERCE AND INSURANCE, 615-741-2693.

SECURITY SERVICES

Security guards, the largest occupation in this field, patrol and inspect property to protect it against fire, theft, vandalism, and illegal entry. Guards and doorkeepers usually are uniformed and often carry a nightstick and a weapon; correctional officers and jailers maintain order in correctional institutions, enforce institutional rules and regulations, and may supplement the counseling inmates receive from mental health professionals.

The largest occupations, which also have the greatest number of job openings annually, are:

- Correction officers and jailers
- Guards and watch guards

These occupations may have a generally favorable outlook for the future. Overall, the number of these jobs is growing. Large numbers of job openings are expected over the next four or five years. Recently, there have been fewer new trainees than job openings. If this trend continues, job opportunities should be good.

Hourly wages include:

\$7.09 Guards and watch guards

Licensing may be required. Contact: COUNTY COURT CLERK'S OFFICE.

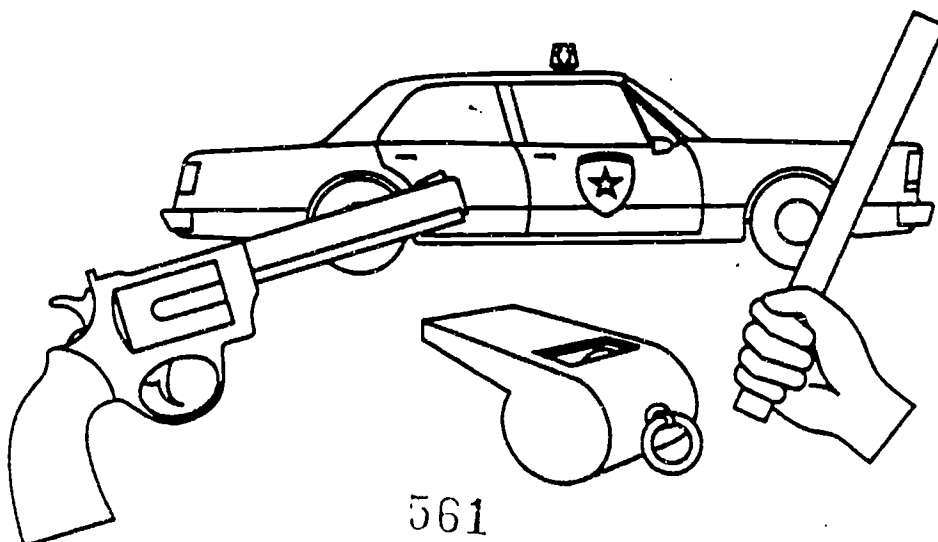

561

SHEET METAL

Sheet metal workers make, install, and maintain a variety of sheet metal products for home, commercial, and industrial buildings. These products include ducts for air conditioning, heating, and ventilating and pollution control systems, kitchen equipment, roofs, siding, rain gutters, skylights, and outdoor signs. Other workers use a variety of machines in the mass production of sheet-metal products.

The largest occupations, which also have the greatest number of job openings annually, are:

- Sheet metal workers
- Machine forming operators and tenders of metal and plastic

These occupations may have a generally favorable outlook for the future. Overall, the number of these jobs shows little change. A moderate number of job openings are expected over the next four or five years. Recently, no training has been reported. Job opportunities should be good.

Hourly wages include:

\$11.81 Sheet metal workers

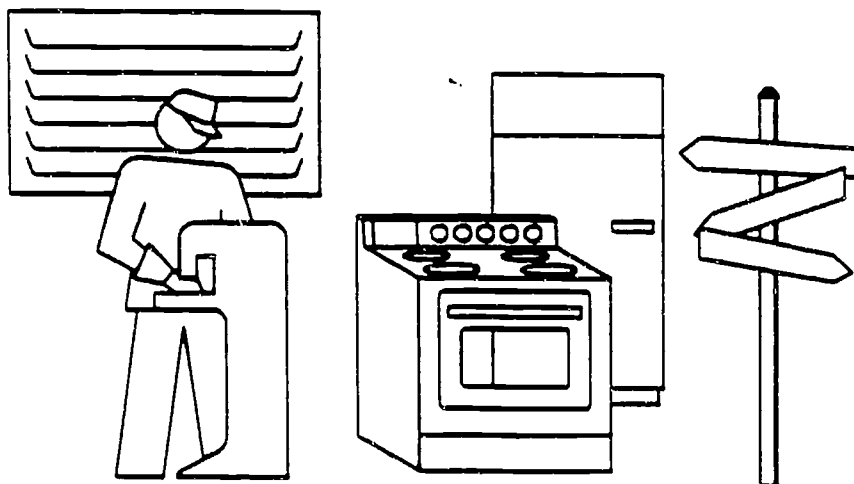

560

SURGICAL TECHNOLOGY

Surgical technicians, also called operating room technicians, work in hospitals under the direct supervision of surgeons and registered nurses. They help set up the operating room with surgical instruments and supplies, help prepare patients for surgery, and may pass instruments and supplies to surgeons.

This occupation may have a generally favorable outlook for the future. Overall, the number of these jobs is growing rapidly. A moderate number of job openings are expected over the next four or five years. Recently, there have been fewer new trainees than job openings. Placement rates at area vocational technical schools, community colleges, and/or technical institutes have been very good recently.

Related postsecondary programs at state-supported institutions in this area are:

17.0211 Surgical technology

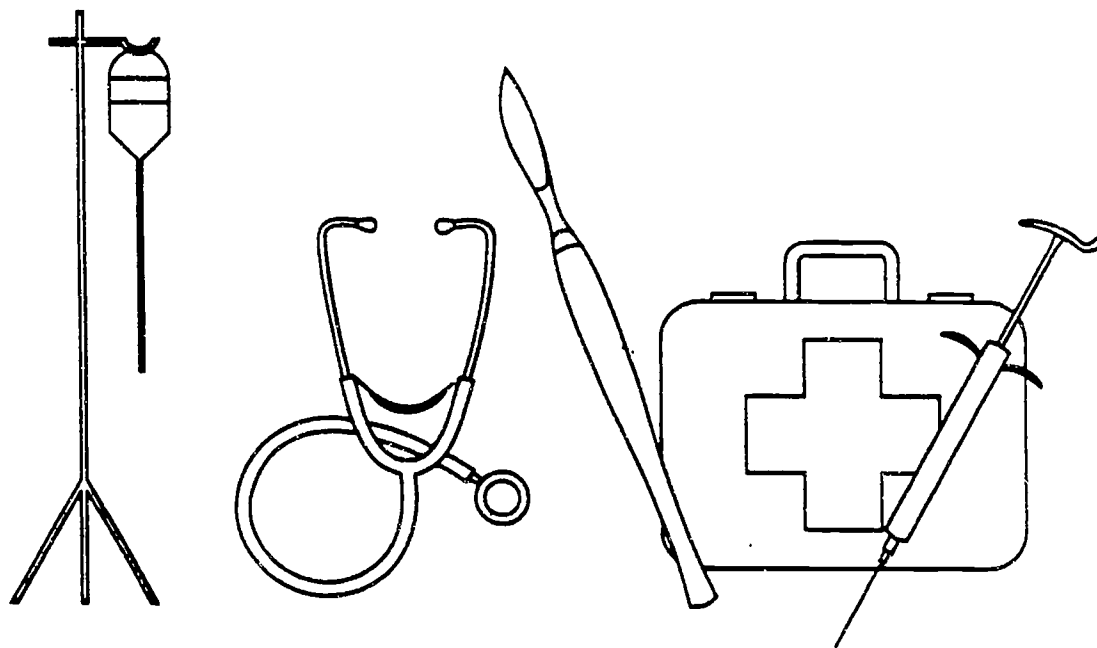

563

SURVEYING AND CIVIL TECHNOLOGY

Workers establish official land boundaries, with descriptions of land to satisfy legal requirements, and then plan, design, and construct structures and facilities on these tracts of land. The structures can include buildings, bridges, roads, harbors, airfields, dams, tunnels, or water supply and sewage systems.

The largest occupations, which also have the greatest number of job openings annually, are:

- Civil engineering technicians and technologists
- Surveying and mapping technicians and technologists

These occupations may have a generally favorable outlook for the future. Overall, the number of these jobs is growing. Few job openings are expected over the next four or five years. Recently, there have been fewer new trainees than job openings. Placement rates at area vocational technical schools, community colleges, and/or technical institutes have been very good recently.

Related postsecondary programs at state-supported institutions in this area are:

15.0201 Civil engineering and technology

Licensing may be required. Contact: TENNESSEE STATE BOARD OF EXAMINERS FOR LAND SURVEYING, 615-741-3611.

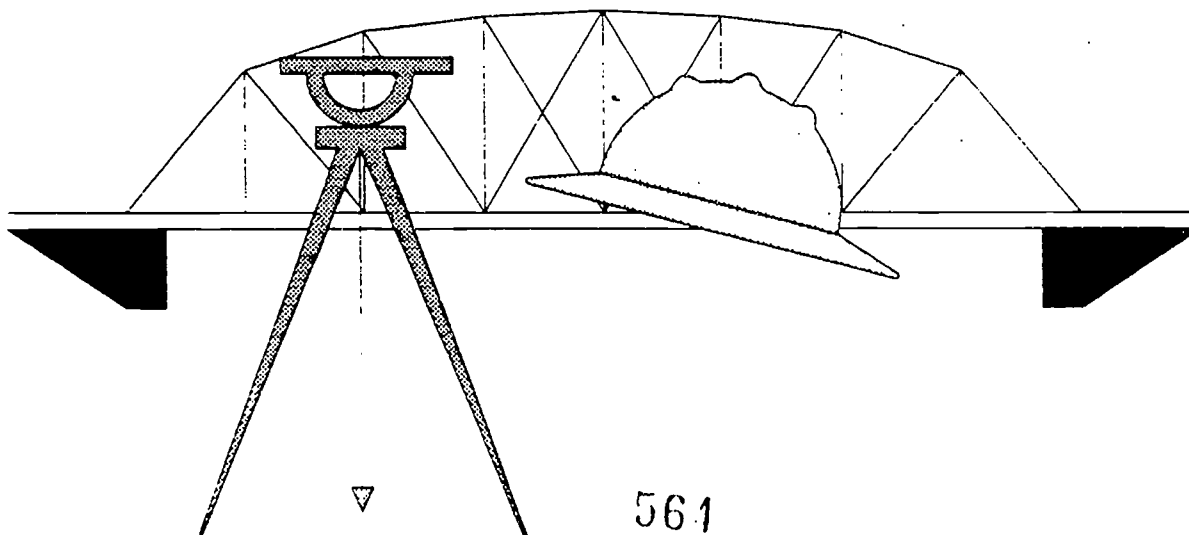

TRAVEL SERVICES

These workers assist people with all facets of their travel. Planning and budgeting a trip, purchasing tickets, selling travel insurance, obtaining passports and visas, and even ticket taking are all done by these employees.

The two largest occupations are:

- Travel agents
- Reservation and transportation ticket agents

The occupations expected to have the most job openings annually are:

- Travel agents
- Guides

These occupations may have a generally favorable outlook for the future. Overall, the number of these jobs is growing rapidly. A moderate number of job openings are expected over the next four or five years. Recently, no training has been reported. Job opportunities should be good.

Hourly wages include:

\$8.25 Travel agents

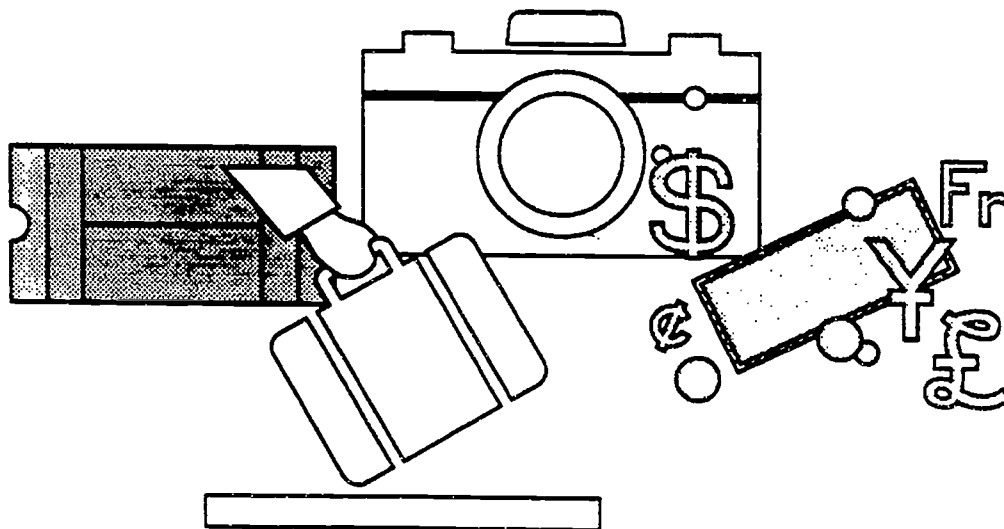

TRUCK, BUS, AND HEAVY EQUIPMENT OPERATION

These occupations include truck drivers who transport goods, bus drivers who transport passengers, and heavy equipment operators who use machinery to move construction materials and other goods over short distances--around a factory, construction site or loading dock.

The largest occupations, which also have the greatest number of job openings annually, are:

- Truck drivers of heavy or tractor trailer trucks
- School bus drivers

These occupations may have a generally favorable outlook for the future. Overall, the number of these jobs is growing. Large numbers of job openings are expected over the next four or five years. Recently, there have been fewer new trainees than job openings. If this trend continues, job opportunities should be good. Placement rates at area vocational technical schools, community colleges, and/or technical institutes have been good recently.

Hourly wages include:

- \$10.25 Grader, dozer, and scraper operators
- \$11.20 Truck drivers, heavy or tractor trailer

Related postsecondary programs at state-supported institutions in this area are:

- 49.0205 Truck and bus driving

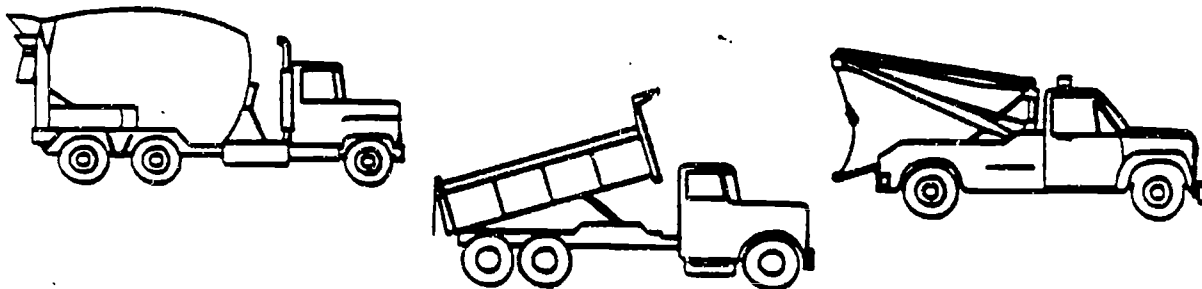

WELDING TECHNOLOGY

Welding is the most common way of permanently joining metal parts. Typically, heat is applied to the metal pieces to be joined; the parts are melted and fused to form a permanent bond. Welding is used to construct and repair parts of ships, automobiles, spacecraft, and thousands of products. It can also be used to join beams and steel reinforcing rods in buildings, bridges, and highways.

The largest occupations, which also have the greatest number of job openings annually, are:

- Welding machine operators and tenders
- Welders and cutters

These occupations may have a generally favorable outlook for the future. Overall, the number of these jobs is growing. A moderate number of job openings are expected over the next four or five years. Recently, there have been fewer new trainees than job openings. If this trend continues, job opportunities should be good. Placement rates at area vocational technical schools, community colleges, and/or technical institutes have been good recently.

Hourly wages include:

\$11.41 Welders and cutters

High school programs preparing for these occupations are:

48.0508 Welding, brazing, and soldering

Related postsecondary programs at state-supported institutions in this area are:

48.0508 Welding, brazing, and soldering

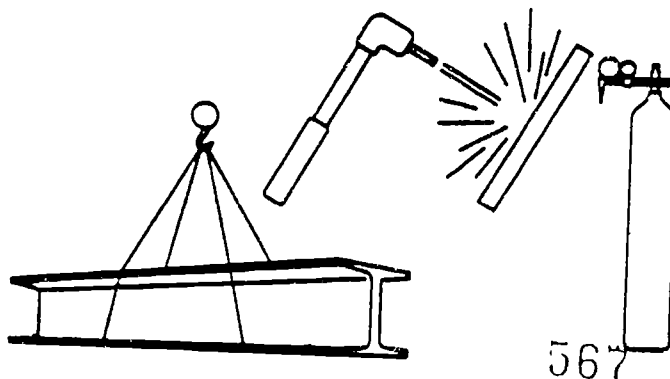

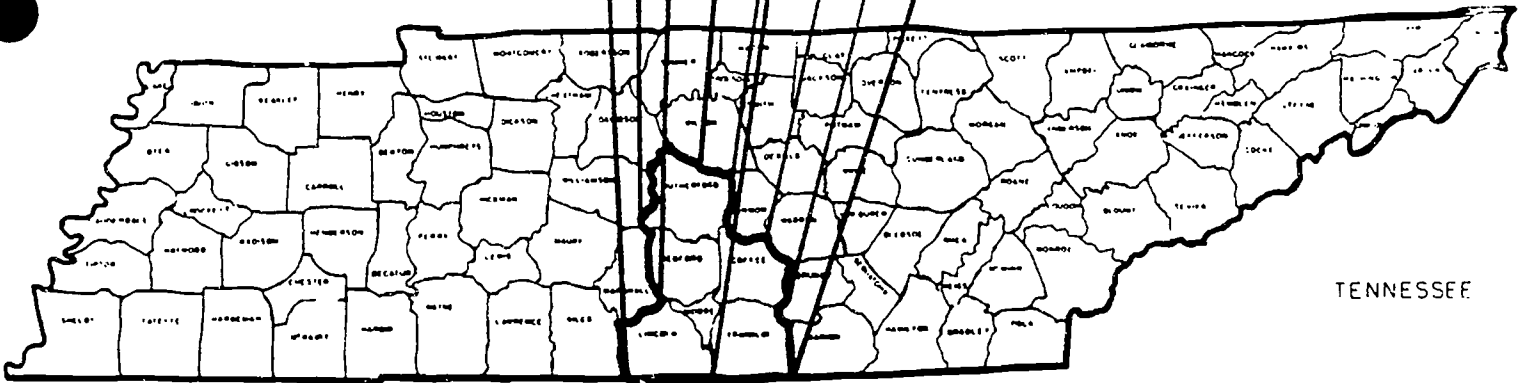
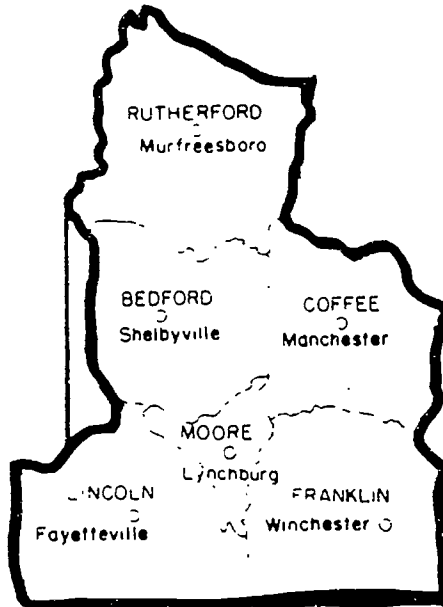

Service Delivery Area 10

ACCOUNTING AND FINANCIAL MANAGEMENT

Many individuals in this group are accountants and auditors who prepare and analyze business records and financial reports which are needed for effective management of any organization. Financial managers, another occupation in this group, typically plan, organize, control, or coordinate the financial activities of an organization.

The largest occupations, which also have the greatest number of job openings annually, are:

- Financial managers
- Accountants and auditors

These occupations may not have a favorable outlook for the future. Overall, the number of these jobs is growing. Large numbers of job openings are expected over the next four or five years. Recently, there have been many more new trainees than job openings. If this trend continues, job seekers can expect to face keen competition.

Hourly wages include:

\$13.86 Accountants and auditors
\$20.29 Financial managers

Related postsecondary programs at state-supported institutions in this area are:

52.0301 Accounting
52.0398 Accounting and information systems (MTSU
52.0399)
52.0801 Finance

Licensing may be required. Contact: TENNESSEE BOARD OF ACCOUNTANCY, 615-741-2250.



ADMINISTRATIVE SUPPORT: ACCOUNTING

Persons employed in this group of occupations provide clerical and administrative support to accountants and auditors. Most of these jobs require only a high school diploma for entry.

The largest occupations, which also have the greatest number of job openings annually, are:

- Bookkeeping, accounting, and auditing clerks
- Payroll and timekeeping clerks

These occupations may have a generally favorable outlook for the future. Overall, the number of these jobs shows little change. A moderate number of job openings are expected over the next four or five years. Recently, no training has been reported. Job opportunities should be good.

Hourly wages include:

- \$8.05 Bookkeeping, accounting, and auditing clerks
- \$8.59 Payroll and timekeeping clerks

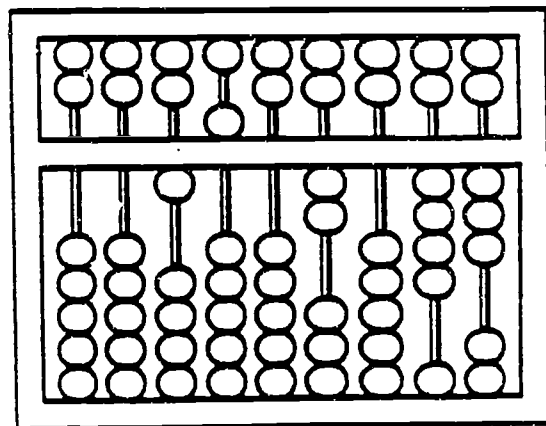
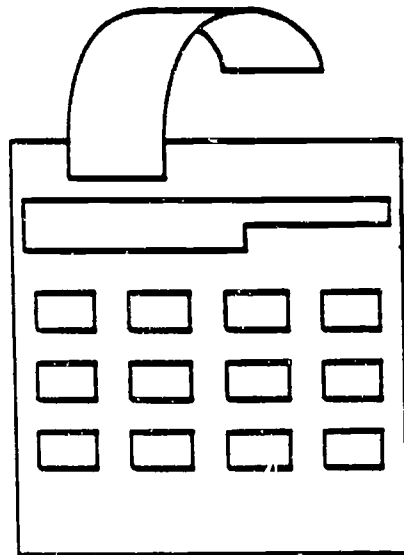

570

ADMINISTRATIVE SUPPORT: FINANCE AND INSURANCE

Workers provide clerical and general administrative support to the banking and finance industry. Workers receive and pay out money, keep records of money and negotiable instruments, interview applicants for credit, locate and notify customers of delinquent accounts, examine insurance claims, and process a variety of paperwork.

The two largest occupations are:

- Tellers
- Insurance adjusters, examiners, and investigators

The occupations expected to have the most job openings annually are:

- Tellers
- Bill and account collectors

These occupations may have a generally favorable outlook for the future. Overall, the number of these jobs shows little change. A moderate number of job openings are expected over the next four or five years. Recently, no training has been reported. Job opportunities should be good.

Hourly wages include:

- \$6.15 Tellers
- \$7.35 Bill and account collectors
- \$7.77 Loan and credit clerks
- \$8.15 New accounts clerks

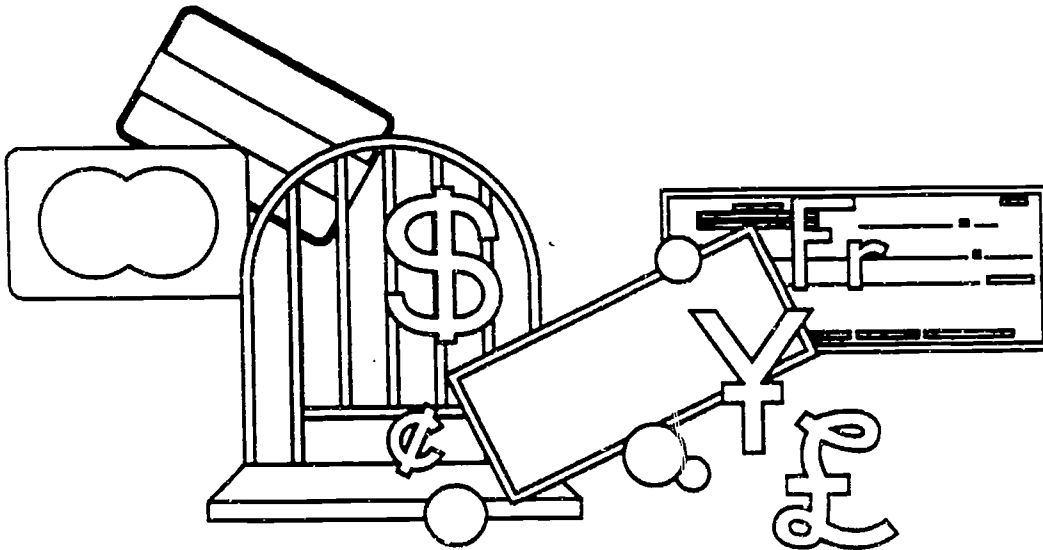

ADMINISTRATIVE SUPPORT: GENERAL

The job duties in this group of occupations are very diverse and are determined by the type of firm. For example, workers may schedule appointments, give information to callers, take dictation, type correspondence, read and route incoming mail, file correspondence and other records, and supervise and coordinate the activities of subordinate clerical workers.

The largest occupations, which also have the greatest number of job openings annually, are:

- Secretaries, except legal and medical secretaries
- General office clerks

These occupations may not have a favorable outlook for the future. Overall, the number of these jobs is growing. Large numbers of job openings are expected over the next four or five years. Recently, there have been many more new trainees than job openings. If this trend continues, job seekers can expect to face keen competition. Placement rates at area vocational technical schools, community colleges, and/or technical institutes have been good recently.

Hourly wages include:

\$5.90	File clerks
\$6.44	Receptionists and information clerks
\$6.57	Order clerks- materials, merchandise, and service
\$6.71	General office clerks
\$7.14	Data entry keyers, except composing
\$7.27	Typists including word processing
\$8.85	Secretaries, ex. legal and medical
\$12.38	First line supervisors and manager/supervisors- clerical and administrative support occupations

High school programs preparing for these occupations are:

07.0601	Secretarial and related programs
07.0701	Typing, general office and related programs

Related postsecondary programs at state-supported institutions in this area are:

07.0606	Secretarial and office administration
07.9999	Miscellaneous business administrative support
52.0204	Office supervision and management
52.0401	Administrative assistant and secretarial science

AGRICULTURAL PRODUCTION

Workers in this field plan and economically use facilities, land, water, machinery, chemicals, finance, and labor in the production of plant and animal products.

The largest occupations, which also have the greatest number of job openings annually, are:

- Farm managers
- Farm workers

These occupations may not have a favorable outlook for the future. Overall, the number of these jobs shows little change. A moderate number of job openings are expected over the next four or five years. Recently, there have been many more new trainees than job openings. If this trend continues, job seekers can expect to face keen competition.

High school programs preparing for these occupations are:

01.0301 Agricultural production

Related postsecondary programs at state-supported institutions in this area are:

01.0102 Agricultural business

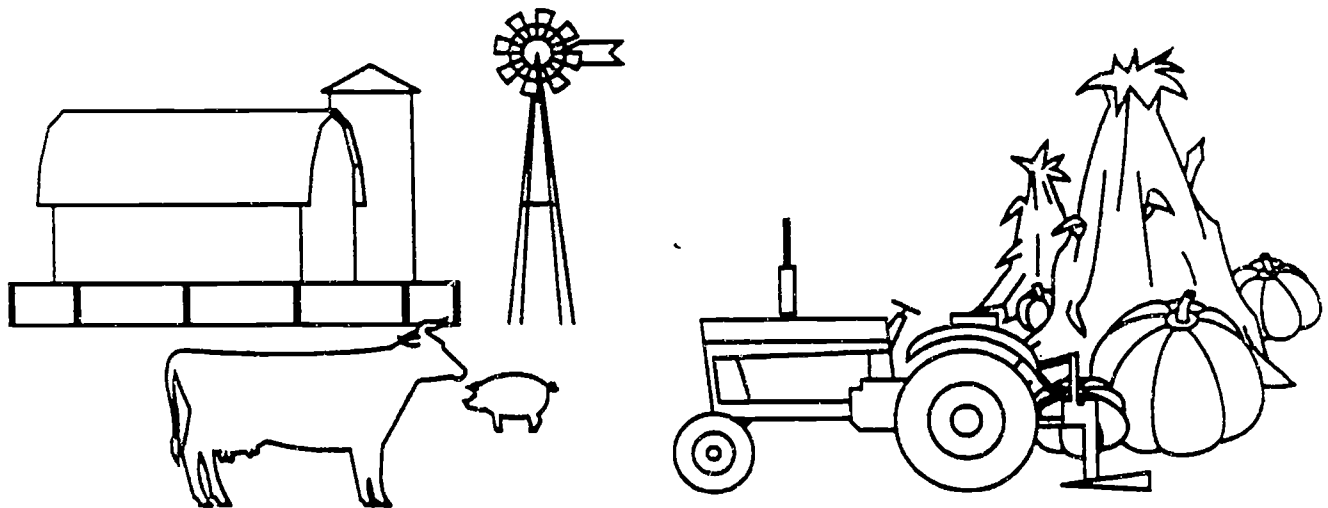

AIRCRAFT MECHANICS

To keep an aircraft in top operating condition, workers must perform scheduled maintenance, make repairs, and complete inspections required by the Federal Aviation Administration (FAA). Mechanics inspect the engines, landing gear, instruments, and other parts of the aircraft and do necessary maintenance.

The largest occupations, which also have the greatest number of job openings annually, are:

- Aircraft mechanics
- Aircraft structure, surfaces, rigging, and systems assemblers- precision

These occupations may not have a favorable outlook for the future. Few job openings are expected over the next four or five years. Recently, there have been many more new trainees than job openings.

Related postsecondary programs at state-supported institutions in this area are:

49.0101 Aviation and airway science

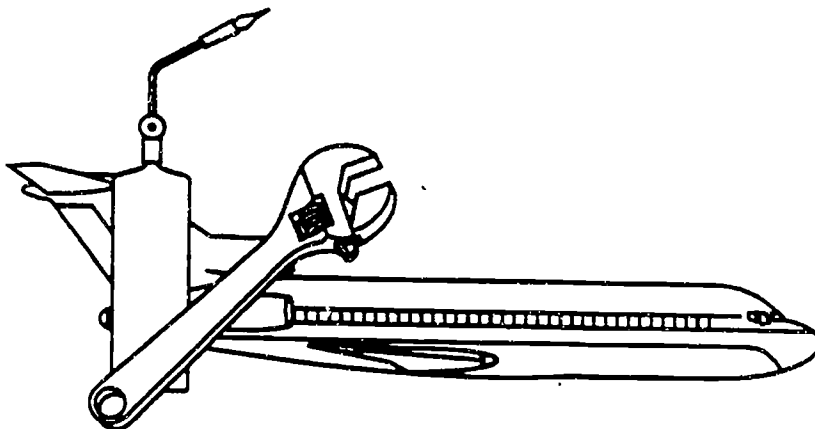

574

APPLIANCE AND EQUIPMENT REPAIR

Individuals in these occupations repair, adjust, maintain, and install all types of electrical motors and electrical and gas home appliances. Types of equipment used include test instruments, gauges, and hand, bench, and power tools.

The two largest occupations are:

- Electric home appliance and power tool repairers
- Coin and vending machine servicers and repairers

The occupations expected to have the most job openings annually are:

- Coin and vending machine servicers and repairers
- Gas appliance repairers

These occupations may not have a favorable outlook for the future. Overall, the number of these jobs shows little change. Very few job openings are expected over the next four or five years. Recently, there have been many more new trainees than job openings. Placement rates at area vocational technical schools, community colleges, and/or technical institutes have been very good recently.

High school programs preparing for these occupations are:

- 47.0101 Electrical and electronics technology
- 47.0108 Small appliance repair

Related postsecondary programs at state-supported institutions in this area are:

- 47.0101 Electrical and electronics technology

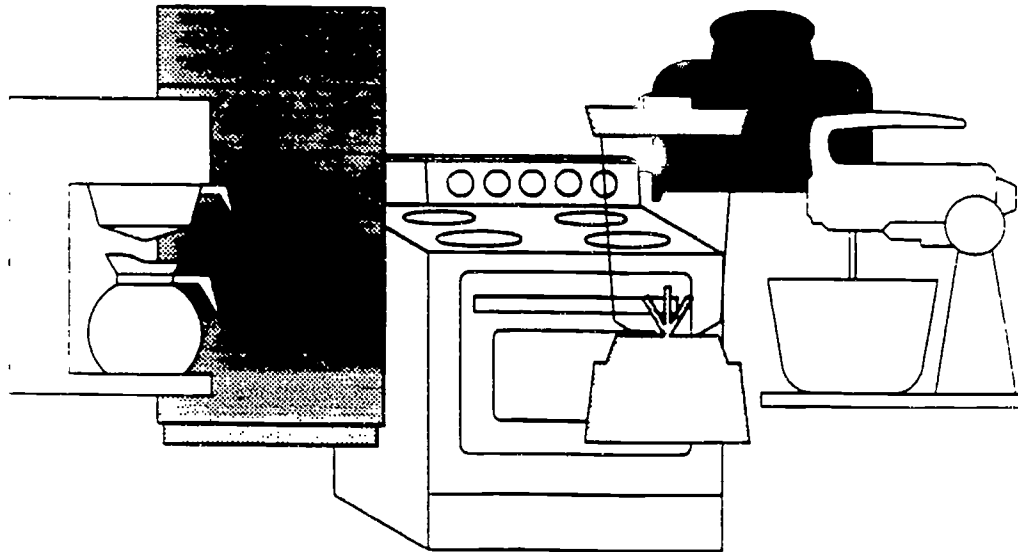

575

SDA 10 - 7

AUTOMOTIVE BODY REPAIR

Thousands of motor vehicles are damaged in traffic accidents every day. The workers in this field straighten bent frames, remove dents, and replace crumpled parts that are beyond repair so that those vehicles look and drive like new.

The largest occupations, which also have the greatest number of job openings annually, are:

- Automotive body and related repairers
- Painters of transportation equipment

These occupations may not have a favorable outlook for the future. Overall, the number of these jobs shows little change. Few job openings are expected over the next four or five years. Recently, there have been many more new trainees than job openings. Placement rates at area vocational technical schools, community colleges, and/or technical institutes have been very good recently.

High school programs preparing for these occupations are:

47.0603 Automotive body repair

Related postsecondary programs at state-supported institutions in this area are:

47.0603 Automotive body repair

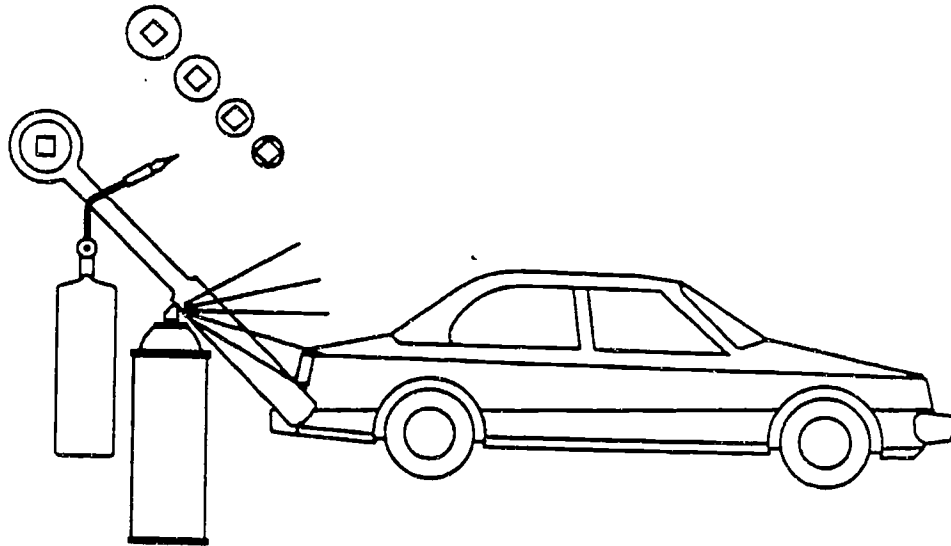

576

AUTOMOTIVE SERVICE TECHNOLOGY

These occupations include jobs concerned with parking, cleaning, polishing, lubricating, repairing, and refueling trucks, buses, and automobiles, and related servicing activities. The primary occupation, automotive mechanic, is concerned with repair and service of motor vehicles.

The largest occupations, which also have the greatest number of job openings annually, are:

- Automotive mechanics
- Tire repairers and changers

These occupations may not have a favorable outlook for the future. Overall, the number of these jobs is growing slowly. A moderate number of job openings are expected over the next four or five years. Recently, there have been many more new trainees than job openings. If this trend continues, job seekers can expect to face keen competition. Placement rates at area vocational technical schools, community colleges, and/or technical institutes have been fair recently.

Hourly wages include:

\$9.59 Automotive mechanics

High school programs preparing for these occupations are:

47.0604 Automotive mechanics

Related postsecondary programs at state-supported institutions in this area are:

15.0803 Automotive technology
47.0604 Automotive mechanics

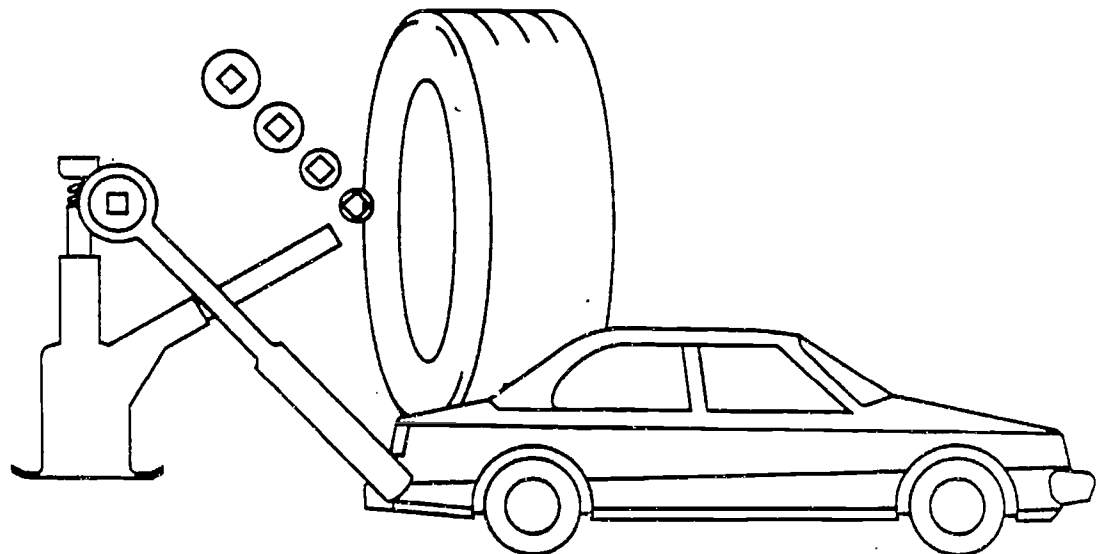

SDA 105-779

BUILDING MAINTENANCE

Persons in building maintenance occupations perform work involving several maintenance skills to keep the structure of an establishment in repair. Duties may involve pipefitting, boilermaking, carpentry, and electrical work as well as repairing buildings, floors, or stairs.

The largest occupations, which also have the greatest number of job openings annually, are:

- General utility maintenance repairers
- Boiler operators and tenders of low pressure boilers

These occupations may have a generally favorable outlook for the future. Overall, the number of these jobs is growing. A moderate number of job openings are expected over the next four or five years. Recently, no training has been reported. Job opportunities should be good.

Hourly wages include:

\$9.16 Maintenance repairers, general utility

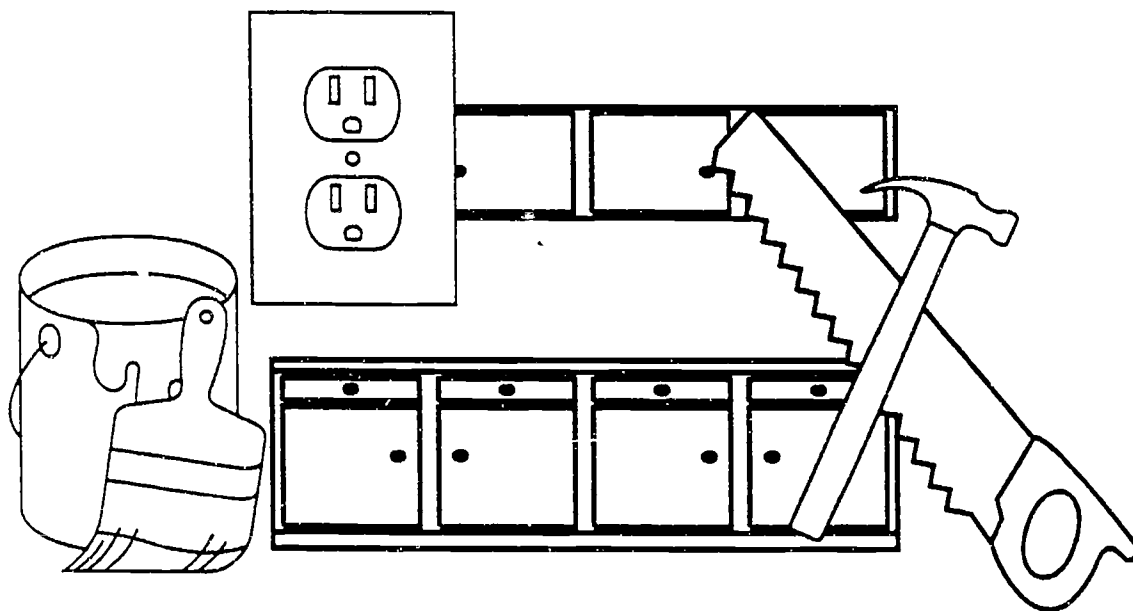

578

CARPENTRY

Almost all construction projects employ carpenters, the largest group of building trades workers. Carpenters perform a variety of jobs. Their duties will vary by type of construction, type of company, skill of the carpenter, and size of the community. A carpenter employed by a special trade contractor, for example, may specialize in laying hardwood floors, while one who is employed by a general building contractor may build wall frames and install paneling.

The largest occupations, which also have the greatest number of job openings annually, are:

- Carpenters
- Ceiling tile installers and acoustical carpenters

These occupations may have a generally favorable outlook for the future. Overall, the number of these jobs is growing. A moderate number of job openings are expected over the next four or five years. Recently, there have been fewer new trainees than job openings. If this trend continues, job opportunities should be good.

Hourly wages include:

\$11.05 Carpenters

High school programs preparing for these occupations are:

46.0201 Carpentry

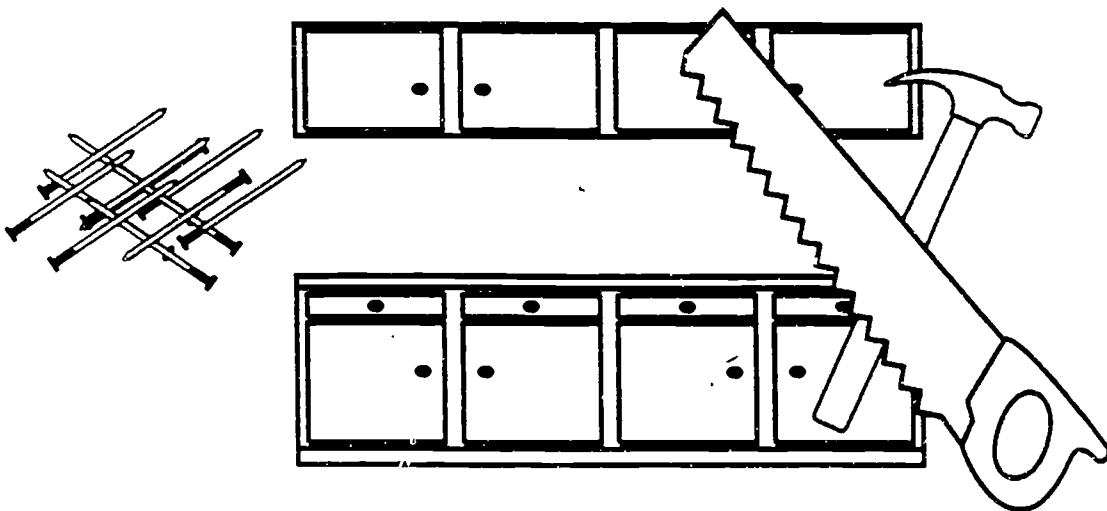

579

COMMERCIAL ART AND DESIGN

The majority of workers in this field design or arrange objects and materials in an artistic or decorative manner. Additional tasks may include the creation or drawing of designs for items such as furniture and machinery (product design).

The largest occupations, which also have the greatest number of job openings annually, are:

- Artists and related workers
- Designers, except interior designers

These occupations may have a generally favorable outlook for the future. Overall, the number of these jobs is growing. A moderate number of job openings are expected over the next four or five years. Recently, no training has been reported. Job opportunities should be good.

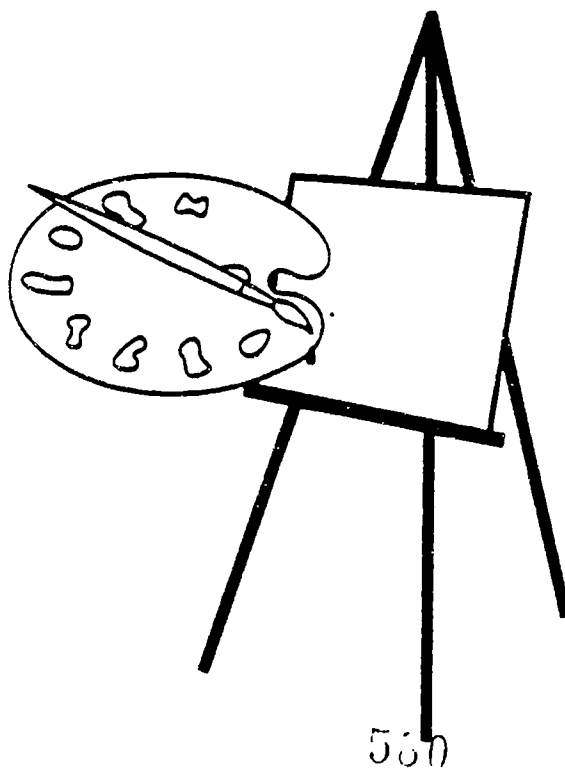

COMMUNICATIONS, JOURNALISM, AND BROADCASTING

Individuals who work in these fields are concerned with communicating ideas and information to individuals for their education and entertainment. The methods utilized are varied and may include the written word, radio, and television.

The two largest occupations are:

- Writers and editors
- Reporters and correspondents

The occupations expected to have the most job openings annually are:

- Writers and editors
- Radio and television announcers

These occupations may not have a favorable outlook for the future. Overall, the number of these jobs is growing. Few job openings are expected over the next four or five years. Recently, there have been many more new trainees than job openings.

Hourly wages include:

\$11.28 Writers and editors

Related postsecondary programs at state-supported institutions in this area are:

09.0403 Mass communication

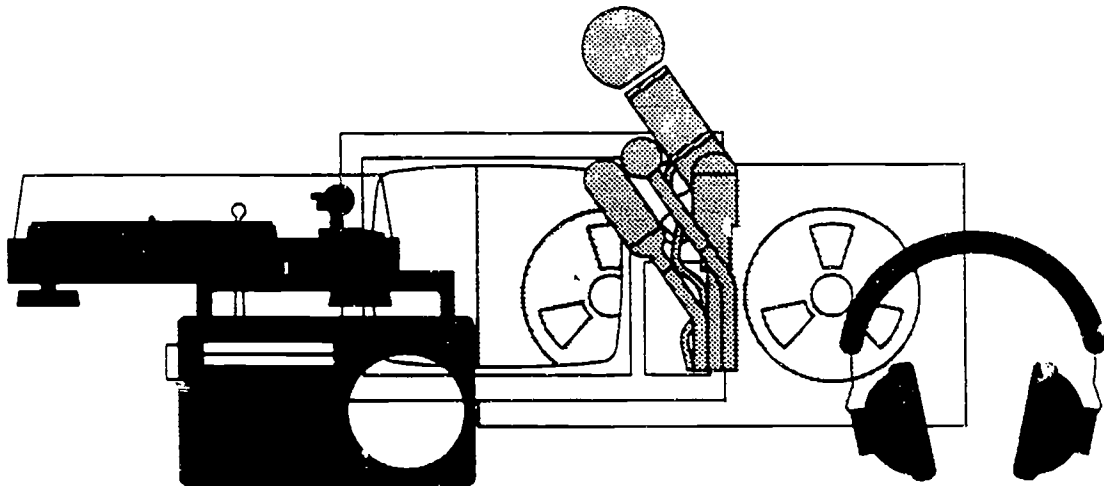

COMPUTER, ELECTRICAL, AND ELECTRONICS TECHNOLOGY

The majority of workers in this field are electrical and electronic engineering technicians and technologists. They apply electrical and related knowledge to design, build, test, and repair electrical equipment in industrial or commercial settings for subsequent use by engineering personnel.

This occupation may have a generally favorable outlook for the future. Few job openings are expected over the next four or five years. Recently, no training has been reported.

Average hourly wages are \$14.79

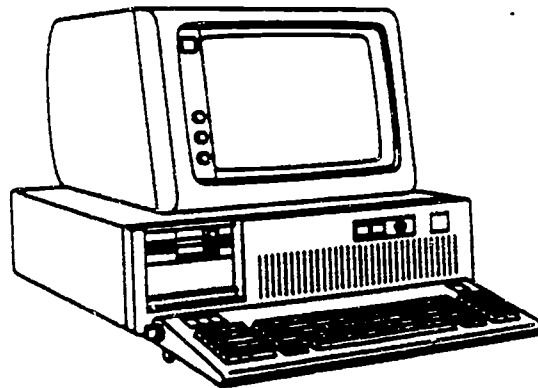

COMPUTER SYSTEMS

Workers in these computer occupations develop and write computer programs to store, locate, and retrieve specific documents, data, and information. They may also analyze business, scientific, and technical problems for application to electronic data processing systems. These careers generally require specialized training.

The largest occupations, which also have the greatest number of job openings annually, are:

- Systems analysts, electronic data processing
- Computer programmers

These occupations may not have a favorable outlook for the future. Overall, the number of these jobs is growing rapidly. A moderate number of job openings are expected over the next four or five years. Recently, there have been many more new trainees than job openings. If this trend continues, job seekers can expect to face keen competition. Placement rates at area vocational technical schools, community colleges, and/or technical institutes have been good recently.

Hourly wages include:

- \$16.36 Systems analysts, electronic data processing
- \$16.80 Computer programmers

High school programs preparing for these occupations are:

- 07.0301 Electronic data processing, computer science

Related postsecondary programs at state-supported institutions in this area are:

- 11.0301 Data processing technology
- 11.0701 Computer science
- 52.1201 Management information systems and business data processing

COSMETOLOGY

Cosmetologists and related workers provide beauty services for customers. These may include cutting and styling hair, treating hair and scalp, applying makeup, dressing wigs, or removing hair by electrolysis, as well as cleaning, shaping, and polishing a customer's fingernails and toenails.

This occupation may not have a favorable outlook for the future. Overall, the number of these jobs is growing. Few job openings are expected over the next four or five years. Recently, there have been many more new trainees than job openings.

High school programs preparing for these occupations are:

12.0403 Cosmetology

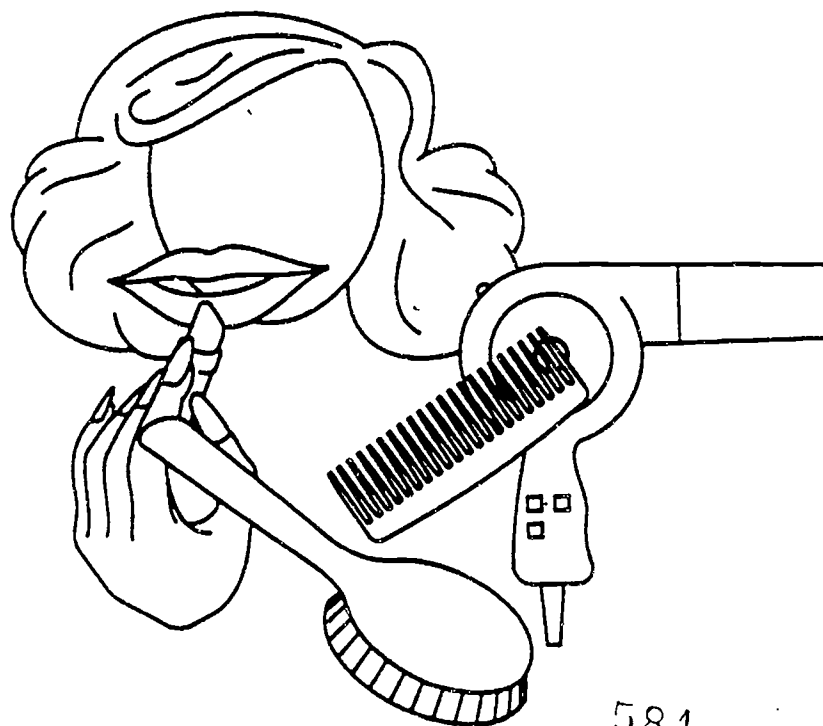

DRAFTING AND DESIGN TECHNOLOGY

Persons in drafting and design technology prepare clear, complete, and accurate working plans and detail drawings from rough or detailed sketches or notes for engineering or manufacturing purposes according to specified dimensions. Workers need to have knowledge of various machines, engineering practices, mathematics, building materials, and other physical sciences to complete drawings. Computer-assisted design (CAD) equipment may be used by some workers.

The largest occupations, which also have the greatest number of job openings annually, are:

- Cost estimators
- Drafters

These occupations may not have a favorable outlook for the future. Overall, the number of these jobs is growing. A moderate number of job openings are expected over the next four or five years. Recently, there have been many more new trainees than job openings. If this trend continues, job seekers can expect to face keen competition. Placement rates at area vocational technical schools, community colleges, and/or technical institutes have been fair recently.

High school programs preparing for these occupations are:

48.0101 Drafting

Related postsecondary programs at state-supported institutions in this area are:

48.0101 Drafting

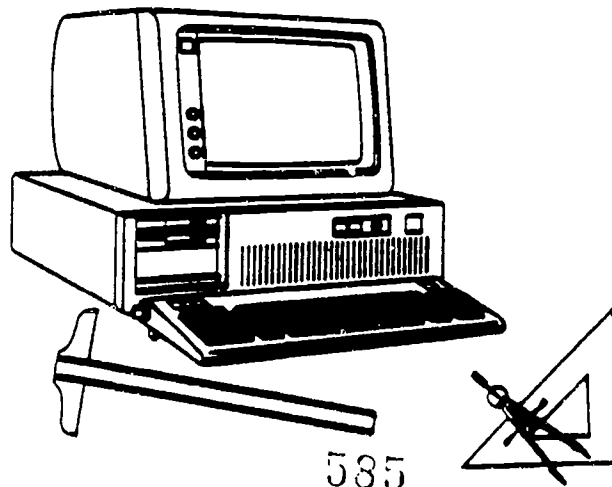

EARLY CHILDHOOD EDUCATION

Child care workers and managers of child care centers assume responsibility for the safety, physical care, and emotional, social, and intellectual growth of preschool children and infants while parents are at work or are unavailable for other reasons. Some work in residential institutions for young children. Teacher aides assist teachers by handling routine paperwork or by working directly with children.

The two largest occupations are:

- Teacher aides, paraprofessional
- Teacher aides and educational assistants, clerical

The occupations expected to have the most job openings annually are:

- Teacher aides, paraprofessional
- Child care workers

These occupations may not have a favorable outlook for the future. Overall, the number of these jobs is growing rapidly. Large numbers of job openings are expected over the next four or five years. Recently, there have been many more new trainees than job openings. If this trend continues, job seekers can expect to face keen competition.

High school programs preparing for these occupations are:

20.0201 Child care and guidance management services

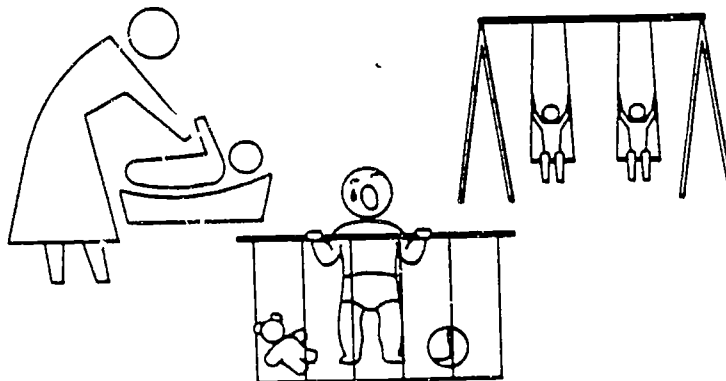

ELECTRICIAN OCCUPATIONS

Workers in the electrical field install, maintain, and repair wiring, electrical equipment, and fixtures or assist in such activities. These workers insure that work is in accordance with the relevant codes. A high school education is usually required and a five-year apprenticeship program is recommended.

The largest occupations, which also have the greatest number of job openings annually, are:

- Electricians
- Helpers of electricians and powerline transmission installers

These occupations may have a generally favorable outlook for the future. Overall, the number of these jobs is growing. A moderate number of job openings are expected over the next four or five years. Recently, no training has been reported. Job opportunities should be good.

Hourly wages include:

\$12.85 Electricians

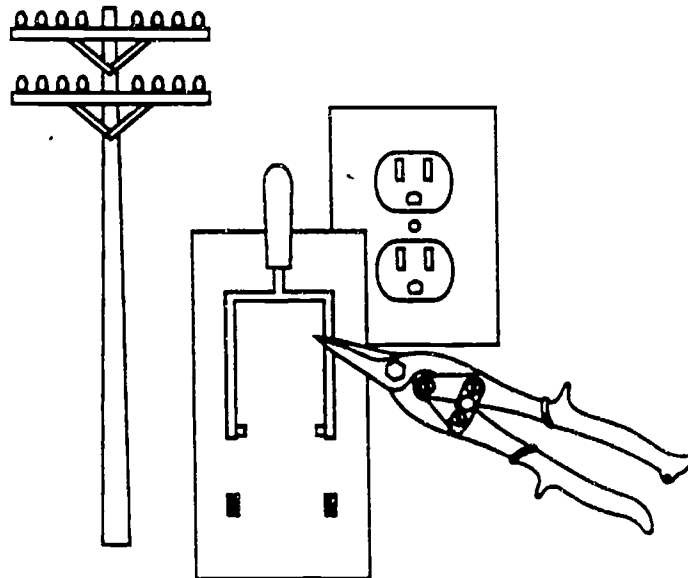

587

SDA 10 - 19

FOOD PREPARATION AND SERVICES

The majority of workers in these occupations prepare and serve food and beverages in restaurants, fast food establishments, catering firms, hotels, clubs, factories, school cafeterias, or hospitals, or supervise those providing food services. Others are factory machine operators involved in the preparation of food products. Dietetic technicians teach principles of food nutrition and provide dietary counseling to patients.

The largest occupations, which also have the greatest number of job openings annually, are:

- Food preparation workers
- Combined food preparation and service workers

These occupations may have a generally favorable outlook for the future. Overall, the number of these jobs is growing. Large numbers of job openings are expected over the next four or five years. Recently, there have been fewer new trainees than job openings. If this trend continues, job opportunities should be good.

Hourly wages include:

- \$4.45 Food preparation workers
- \$4.63 Cooks, specialty fast food
- \$5.13 Cooks, restaurant

High school programs preparing for these occupations are:

- 20.0401 Food production, management, and services
- 46.1111 Food occupations

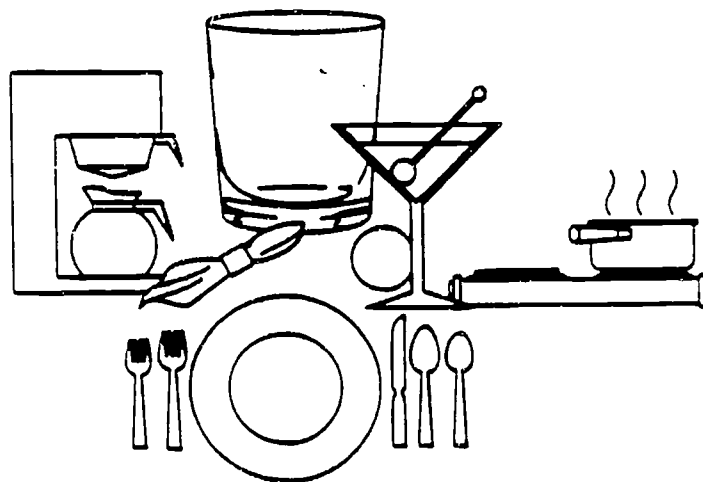

GENERAL BUSINESS AND MANAGEMENT

Workers in the general business and management occupations plan, organize, direct, control, or coordinate activities in all types of fields. Many occupations involve analysis of productivity and financial soundness. General managers and top executives usually have very diverse duties and responsibilities and work through departmental or subordinate executives.

The largest occupations, which also have the greatest number of job openings annually, are:

- Industrial production managers
- General managers and top executives

These occupations may not have a favorable outlook for the future. Overall, the number of these jobs is growing. Large numbers of job openings are expected over the next four or five years. Recently, there have been many more new trainees than job openings. If this trend continues, job seekers can expect to face keen competition. Placement rates at area vocational technical schools, community colleges, and/or technical institutes have been good recently.

Hourly wages include:

- \$15.99 Purchasing managers
- \$20.70 Industrial production managers

Related postsecondary programs at state-supported institutions in this area are:

- 07.9998 Business management technology
- 31.0301 Parks, recreation and leisure facilities management
- 50.0909 Music business management and merchandising
- 52.0201 General business administration and management



GENERAL WOODWORKING

Woodworkers are in occupations concerned with the complete cycle of cutting, shaping, and assembling parts of complex wood products. The occupations are primarily concerned with one or a limited number of machine functions according to their speciality.

The largest occupations, which also have the greatest number of job openings annually, are:

- Cabinetmakers and bench carpenters
- Assemblers and fabricators, except machine, electrical, electronic, and precision assembly

These occupations may not have a favorable outlook for the future. Overall, the number of these jobs shows little change. Few job openings are expected over the next four or five years. Recently, there have been more new trainees than job openings.

High school programs preparing for these occupations are:

- 48.0701 Woodworking
- 48.0703 Millwork and cabinetmaking

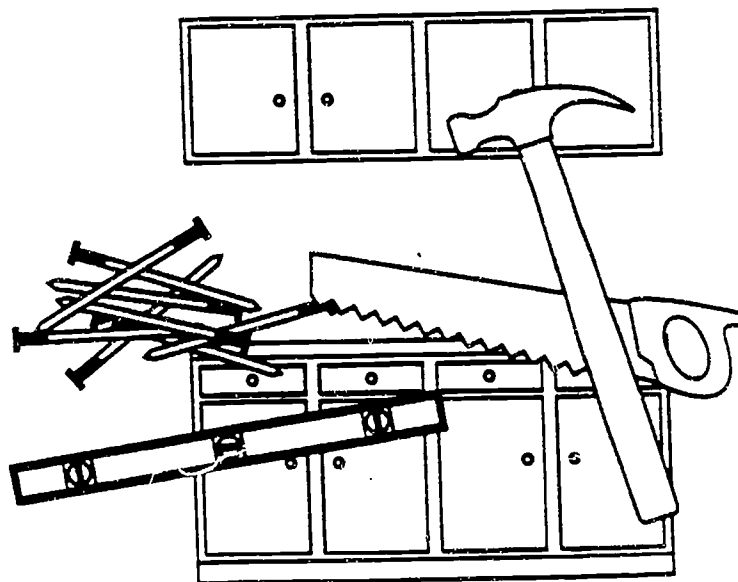

590

GRAPHIC ARTS

A majority of workers in this field are involved in offset printing. In this process the material to be printed is photographed and a printing plate is made from the film. This process has been advanced by the use of computers and lasers.

The two largest occupations are:

- Printing press machine operators and tenders
- Screen printing machine setters and set-up operators

The occupations expected to have the most job openings annually are:

- Printing press machine operators and tenders
- Bindery machine operators

These occupations may not have a favorable outlook for the future. Overall, the number of these jobs is growing slowly. Few job openings are expected over the next four or five years. Recently, there have been many more new trainees than job openings.

Hourly wages include:

\$7.90 Offset lithographic press setters & set-up operators, sheet or web fed

High school programs preparing for these occupations are:

48.0201 Graphic and printing communications

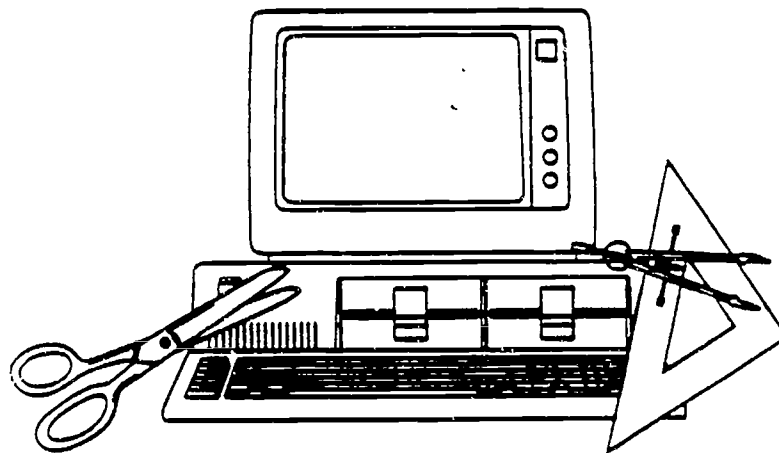

HEATING AND AIR CONDITIONING

Workers in this field install and repair heating, air conditioning, and refrigeration systems. They may install and repair oil burners, hot-air furnaces, and heating stoves in homes and businesses. They may also install and repair air conditioning systems, or install sheet metal ducts for the heating and cooling systems.

The largest occupations, which also have the greatest number of job openings annually, are:

- Heating, air conditioning, and refrigeration mechanics and installers
- Sheet metal duct installers

These occupations may not have a favorable outlook for the future. Overall, the number of these jobs shows little change. Very few job openings are expected over the next four or five years. Recently, there have been many more new trainees than job openings. Placement rates at area vocational technical schools, community colleges, and/or technical institutes have been very good recently.

Hourly wages include:

\$11.97 Heating, air conditioning, and refrigeration mechanics and installers

High school programs preparing for these occupations are:

47.0201 Heating, air conditioning, and refrigeration mechanics

Related postsecondary programs at state-supported institutions in this area are:

47.0201 Heating, air conditioning, and refrigeration mechanics

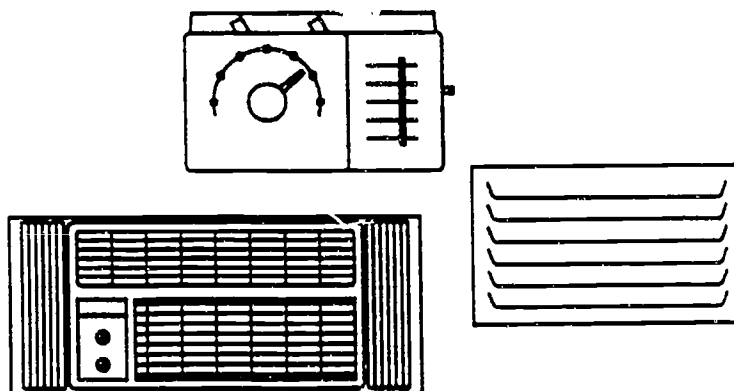

592

HEAVY TRUCK MAINTENANCE

Persons in heavy truck maintenance repair and maintain the operating condition of trucks, buses, and all types of diesel engines. This also includes mechanics working primarily with automobile diesel engines.

This occupation may have a generally favorable outlook for the future. Few job openings are expected over the next four or five years. Recently, no training has been reported.

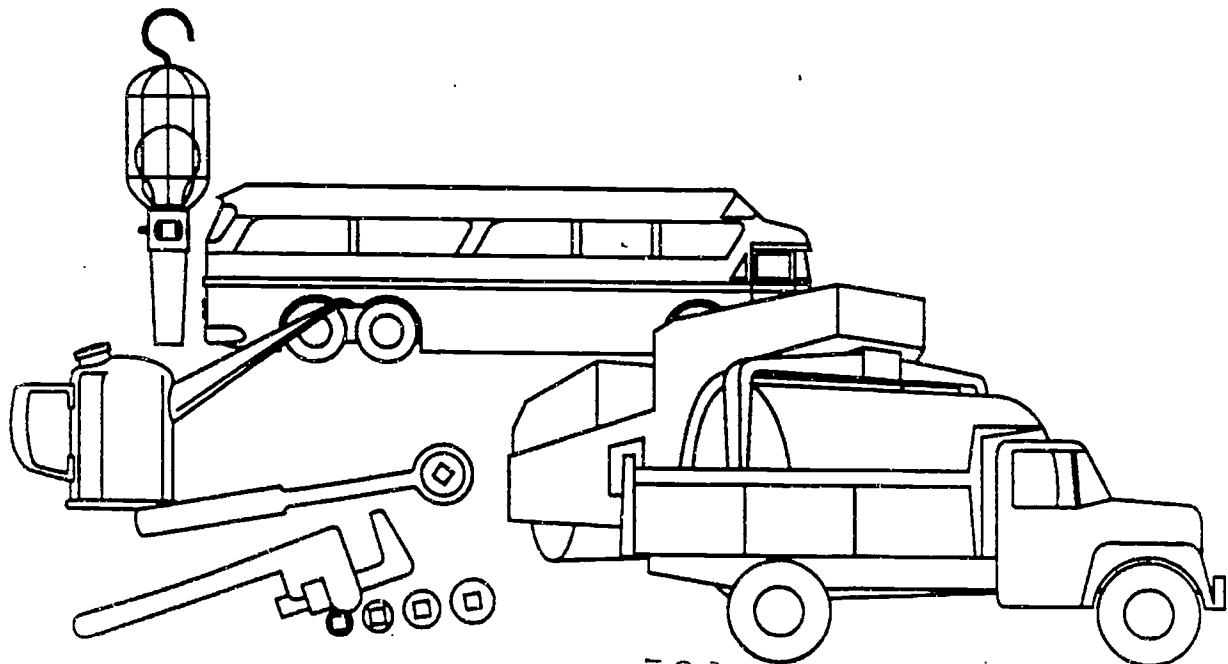

593

HORTICULTURE AND LANDSCAPING

The largest group of workers in these occupations, gardeners and groundskeepers, maintain the grounds of public and private property. Duties may include mowing, trimming, planting, and watering plants, shrubs, and grass.

The largest occupations, which also have the greatest number of job openings annually, are:

- Nursery workers
- Gardeners and groundskeepers, except farm workers

These occupations may not have a favorable outlook for the future. Overall, the number of these jobs is growing. Few job openings are expected over the next four or five years. Recently, there have been many more new trainees than job openings.

Hourly wages include:

\$7.73 Gardeners and groundskeepers, except farm

High school programs preparing for these occupations are:

01.0601 Horticulture

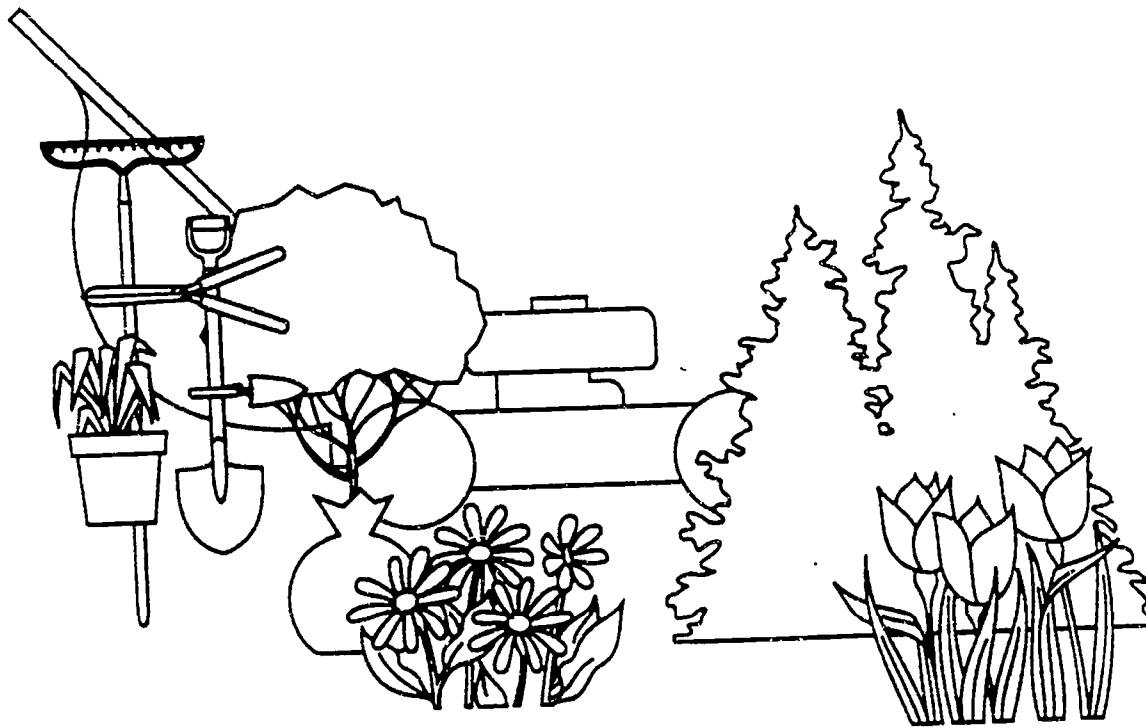

HOTEL AND RESTAURANT MANAGEMENT

Food service and lodging managers supervise the profitable operation of restaurants, hotels, and motels. Workers direct the varied activities of these businesses with the goal of pleasing people and providing good service to their customers.

This occupation may have a generally favorable outlook for the future. Overall, the number of these jobs is growing. A moderate number of job openings are expected over the next four or five years. Recently, no training has been reported. Job opportunities should be good.

Average hourly wages are \$8.66

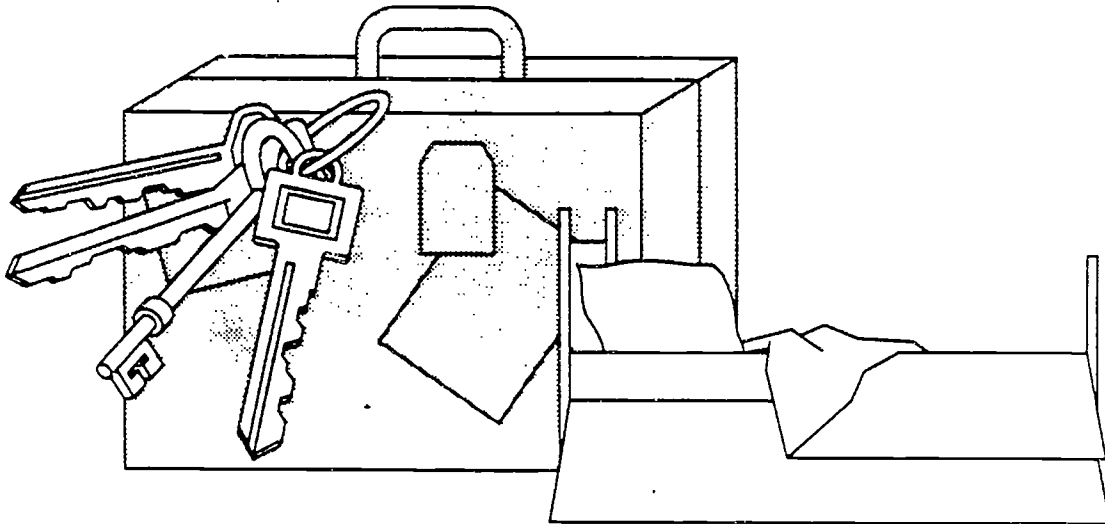

INDUSTRIAL MAINTENANCE TECHNOLOGY

Workers prevent costly waste of raw materials and the idling of human resources in a plant or factory by making industrial machinery repairs as quickly as possible. Maintenance mechanics spend considerable time doing preventive maintenance, including keeping machines well oiled and greased, and periodically cleaning parts.

The largest occupations, which also have the greatest number of job openings annually, are:

- Maintenance mechanics for industrial machinery
- Machine builders and other precision machine assemblers

These occupations may have a generally favorable outlook for the future. Overall, the number of these jobs is growing. A moderate number of job openings are expected over the next four or five years. Recently, there have been about as many new trainees as job openings. If this trend continues, job seekers can expect to face some competition. Placement rates at area vocational technical schools, community colleges, and/or technical institutes have been good recently.

Hourly wages include:

\$11.65 Machinery maintenance mechanics

Related postsecondary programs at state-supported institutions in this area are:

15.0603	Industrial technology
30.9998	General technology
47.0303	Industrial mechanics technology

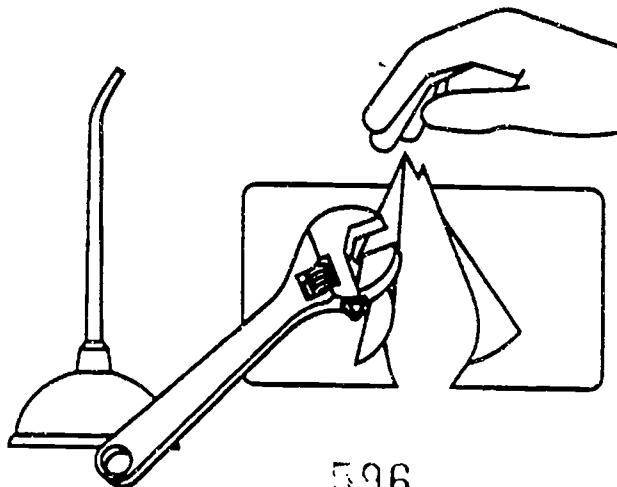

INSTITUTIONAL HOME MANAGEMENT AND SUPPORTING SERVICES

These workers make sure that all public buildings, offices, hospitals, stores, and apartment houses are kept clean and in good condition for the comfort and safety of the people who work or live there. Generally, no special education is required for occupations in this field, with most skills learned on the job.

The largest occupations, which also have the greatest number of job openings annually, are:

- Maids and housekeeping cleaners
- Janitors and cleaners, except maids and housekeeping cleaners

These occupations may have a generally favorable outlook for the future. Overall, the number of these jobs is growing. Large numbers of job openings are expected over the next four or five years. Recently, there have been fewer new trainees than job openings. If this trend continues, job opportunities should be good.

Hourly wages include:

- \$4.50 Maids and housekeeping cleaners
- \$4.65 Housekeepers
- \$6.46 Janitors and cleaners, except maids and housekeeping cleaners

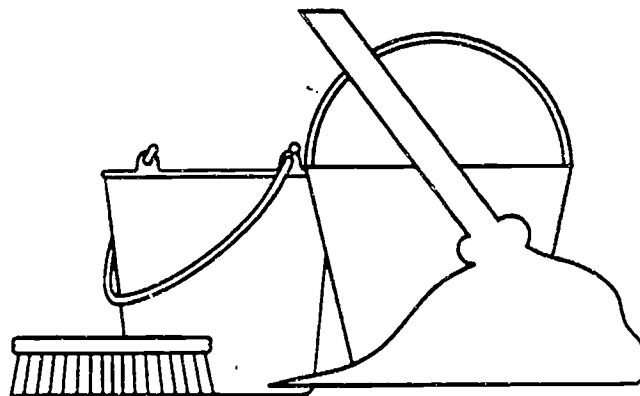

597

LAW ENFORCEMENT

People working at these occupations are responsible for the safety of Tennessee cities, towns, and highways. Their responsibilities range from controlling traffic to preventing and investigating crimes. Whether on or off duty, they are expected to exercise their authority whenever necessary.

The largest occupations, which also have the greatest number of job openings annually, are:

- Police patrol officers
Sheriffs and deputy sheriffs

These occupations may have a generally favorable outlook for the future. Overall, the number of these jobs is growing. Few job openings are expected over the next four or five years. Recently, there have been fewer new trainees than job openings.

Hourly wages include:

\$9.43 Police patrol officers

Related postsecondary programs at state-supported institutions in this area are:

43.0107 Law enforcement and police science

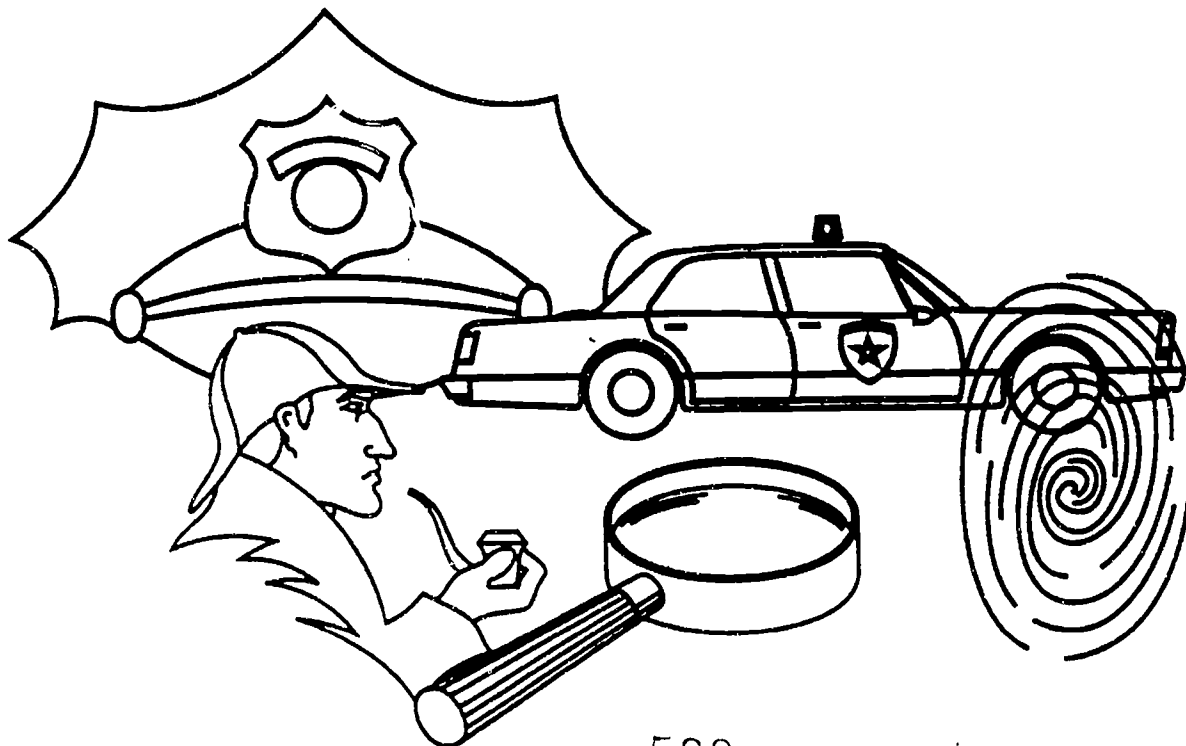

598

MACHINE TOOL TECHNOLOGY

Workers in these occupations make or set up and operate machine tools or repair metal parts. Machinists and tool-and-die makers create highly specialized precision tools, molds, and metal parts. Often they use blueprints to develop prototypes for tools or machines to be used in manufacturing.

The two largest occupations are:

- Machinists
- Machine tool cutting operators and tenders of metal and plastic

The occupations expected to have the most job openings annually are:

- Machinists
- Numerical control machine tool operators and tenders for metal and plastic

These occupations may have a generally favorable outlook for the future. Overall, the number of these jobs is growing. Large numbers of job openings are expected over the next four or five years. Recently, there have been fewer new trainees than job openings. If this trend continues, job opportunities should be good. Placement rates at area vocational technical schools, community colleges, and/or technical institutes have been very good recently.

Hourly wages include:

- \$8.11 Combination machine tool operators and tenders, metal and plastic
- \$9.54 Numerical control machine tool operators and tenders, metal and plastic
- \$12.10 Machinists
- \$13.54 Tool and die makers

High school programs preparing for these occupations are:

- 48.0503 Machine tool operation and machine shop technology

Related postsecondary programs at state-supported institutions in this area are:

- 48.0503 Machine tool operation and machine shop technology

MEDICAL ASSISTING

Medical assistants perform a wide variety of clinical and administrative duties under the direction of physicians. Clinical duties may include taking and recording patients' vital signs and medical histories, preparing patients for examination by physicians, and explaining treatment procedures to patients.

In small physicians' offices they may keep medical records, schedule appointments, and order supplies. Electrocardiograph (EKG) technicians operate the EKG machines which provide graphic tracings of heartbeats.

This occupation may have a generally favorable outlook for the future. Few job openings are expected over the next four or five years. Recently, no training has been reported.

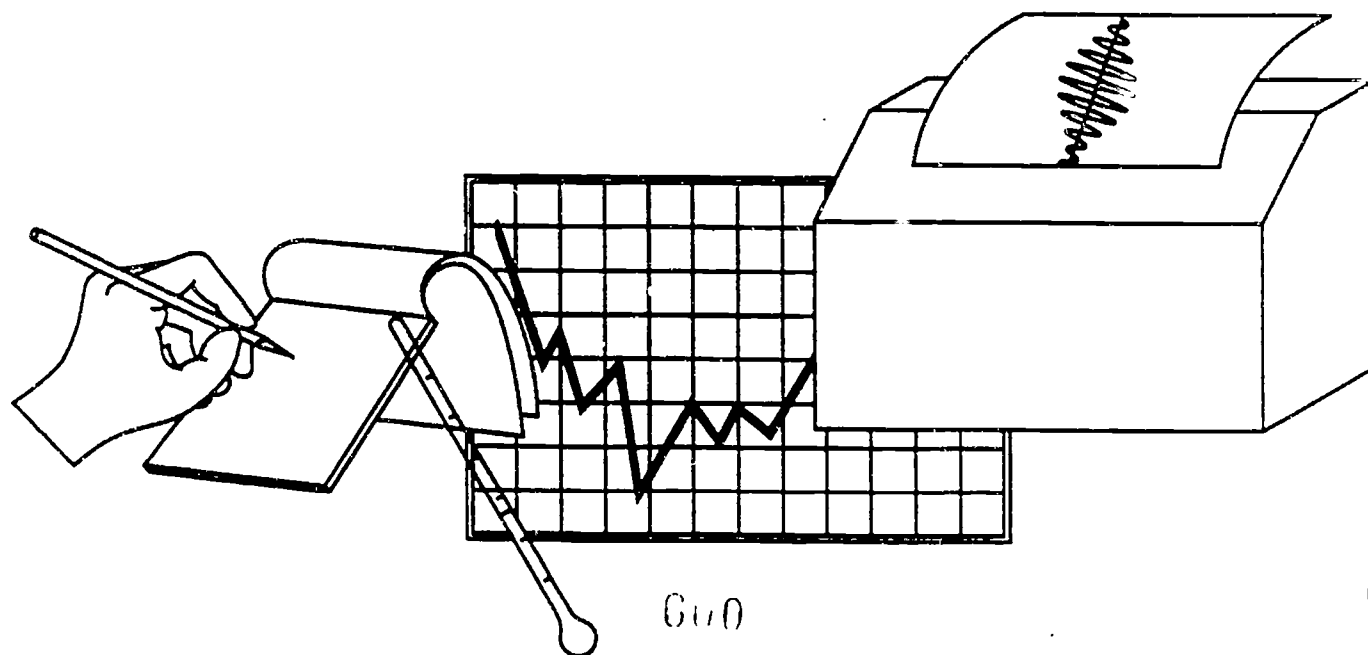

MEDICAL RECORDS TECHNOLOGY

Medical records technicians compile and maintain medical records of hospital and clinic patients. Such work is becoming increasingly important as this background information is used for medicare and medicaid insurance reimbursements.

This occupation may not have a favorable outlook for the future. Overall, the number of these jobs shows little change. Very few job openings are expected over the next four or five years. Recently, no training has been reported.

Average hourly wages are \$7.49

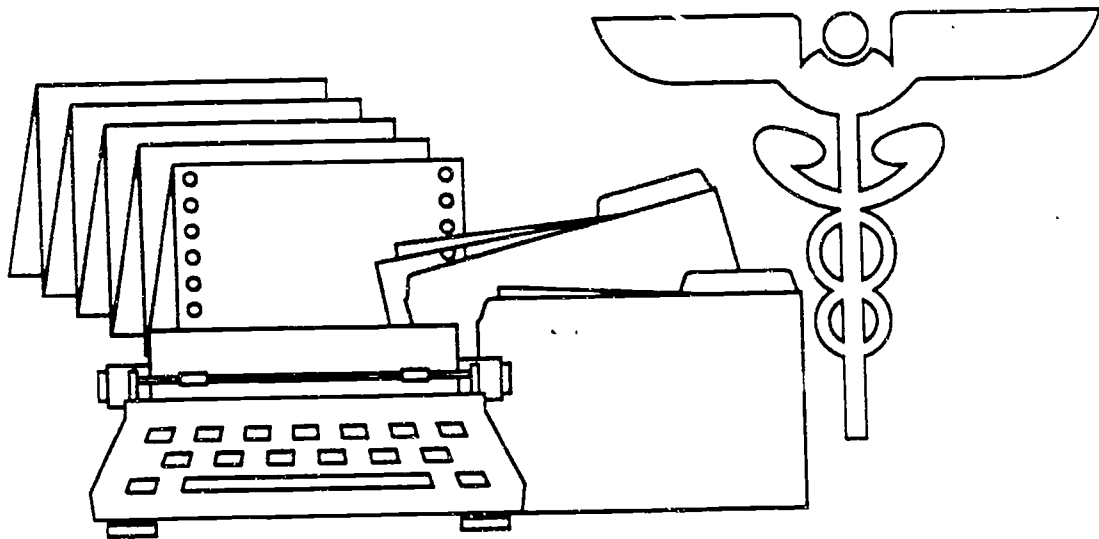

601

NURSING ASSISTANT

Nursing aides and orderlies work under the general direction of nursing or medical staff. In hospitals, they may answer patients' call bells, serve and collect food trays, feed patients, or set up equipment. In nursing homes, they are expected to sustain ongoing relations with patients.

The largest occupations, which also have the greatest number of job openings annually, are:

- Nursing aides, orderlies, and attendants
- Home health aides

These occupations may have a generally favorable outlook for the future. Overall, the number of these jobs is growing rapidly. A moderate number of job openings are expected over the next four or five years. Recently, no training has been reported. Job opportunities should be good.

Hourly wages include:

- \$4.72 Nursing aides, orderlies, and attendants
- \$5.72 Home health aides

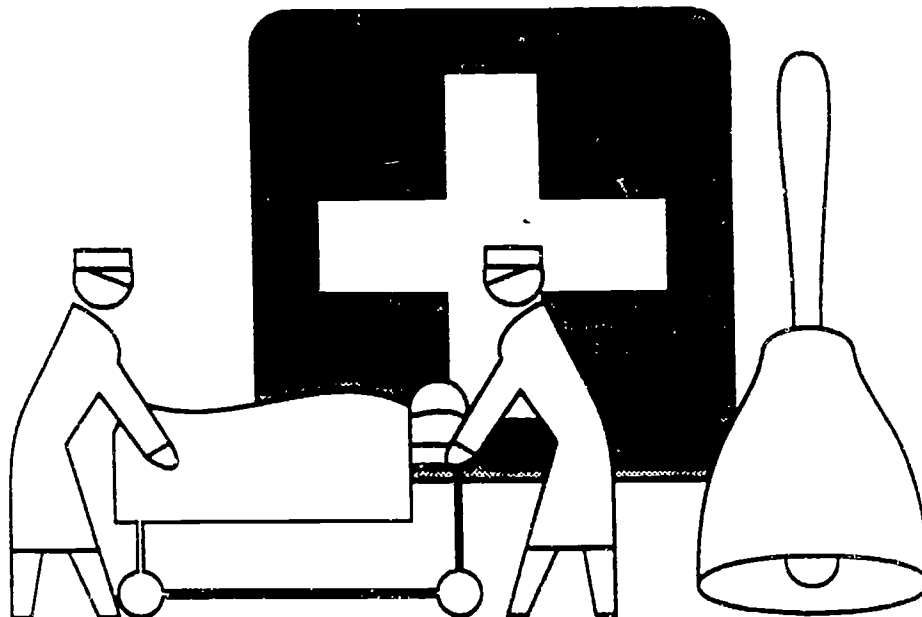

602

SDA 10 - 34

PLUMBING AND PIPEFITTING

Plumbers and pipefitters install and maintain the complex system of pipes that connect to the master system that runs underground. Although plumbing and pipefitting are sometimes considered a single trade, workers may specialize in either craft. Plumbers build and repair the water, waste disposal, drainage, and gas systems in homes and commercial/industrial buildings. Pipefitters build and repair both high and low pressure pipe.

The largest occupations, which also have the greatest number of job openings annually, are:

- Plumbers, pipefitters, and steamfitters
- Pipelayers

These occupations may have a generally favorable outlook for the future. Overall, the number of these jobs is growing. Few job openings are expected over the next four or five years. Recently, no training has been reported.

Hourly wages include:

\$13.61 Plumbers, pipefitters, and steamfitters

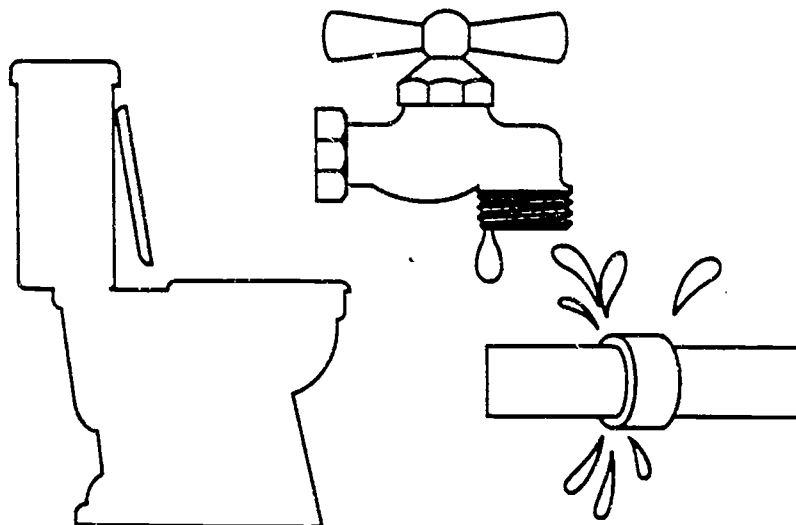

PRACTICAL NURSING

Licensed practical nurses (LPNs) work under the supervision of physicians and/or registered nurses to provide nursing care that requires technical knowledge but not the professional training of a registered nurse. They provide bedside care, administer certain medications, and assist in patient examinations.

This occupation may have a generally favorable outlook for the future. Overall, the number of these jobs is growing rapidly. A moderate number of job openings are expected over the next four or five years. Recently, there have been fewer new trainees than job openings. If this trend continues, job opportunities should be good. Placement rates at area vocational technical schools, community colleges, and/or technical institutes have been excellent recently.

Average hourly wages are \$9.90

Related postsecondary programs at state-supported institutions in this area are:

17.0605 Practical nursing

Licensing may be required. Contact: TENNESSEE BOARD OF NURSING, 615-367-6232.

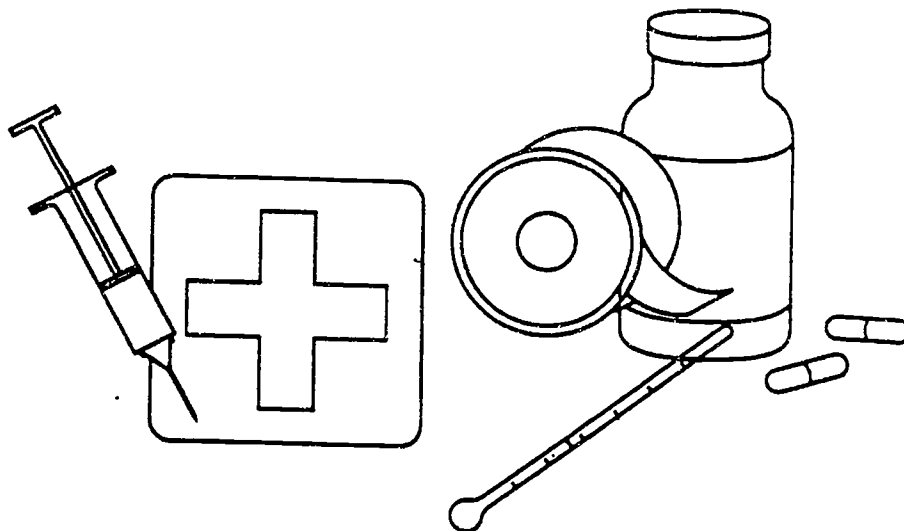

PROFESSIONAL NURSING

Registered Nurses (R.N.'s), the largest occupational group in this field, are primarily employed in hospitals and nursing homes, where they provide skilled bedside care and may supervise licensed practical nurses, nursing aides, and orderlies. Working under the direction of a licensed "supervising physician," physician assistants elicit detailed patient histories, perform physical examinations, and prescribe appropriate treatments.

The largest occupations, which also have the greatest number of job openings annually, are:

- Registered nurses
- Physician's assistants

These occupations may have a generally favorable outlook for the future. Overall, the number of these jobs is growing rapidly. Large numbers of job openings are expected over the next four or five years. Recently, there have been more new trainees than job openings. If this trend continues, job seekers can expect to face some competition. Placement rates at area vocational technical schools, community colleges, and/or technical institutes have been excellent recently.

Hourly wages include:

\$14.33 Registered nurses

Related postsecondary programs at state-supported institutions in this area are:

18.1101 Nursing
51.1601 Nursing (R.N. training)

Licensing may be required. Contact: TENNESSEE BOARD OF MEDICAL EXAMINERS-COMMITTEE ON PHYSICIAN ASSISTANTS, 615-367-6250.

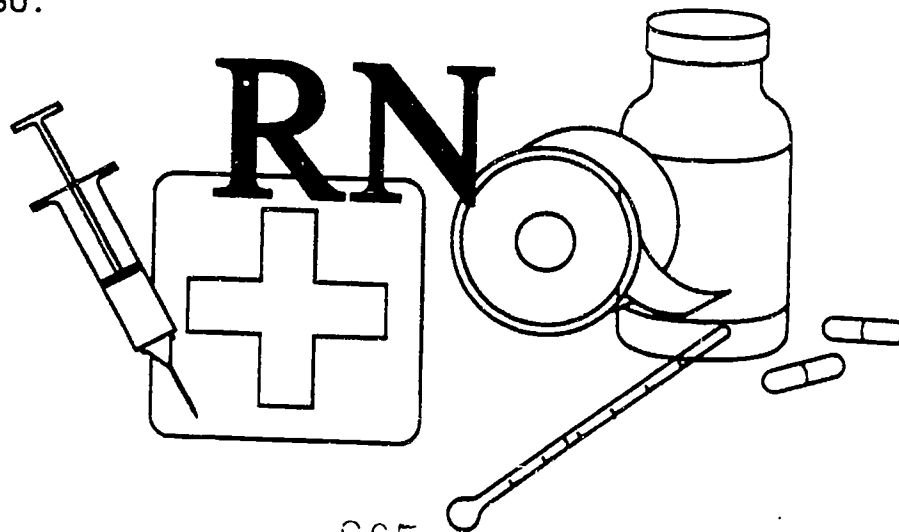

605

PUBLIC ADMINISTRATION

Individuals in this field are responsible for the management of diverse areas of governmental organizations. These managers usually work through departmental executives or subordinates in coordinating the various activities and groups they control. Public administration chief executives, legislators, and general administrators establish government policy and develop federal, state, or local regulations, rules, and laws.

The two largest occupations are:

- Public administration chief executives, legislators, and general administrators
- General managers and top executives

The occupations expected to have the most job openings annually are:

- Management analysts
- General managers and top executives

These occupations may not have a favorable outlook for the future. Overall, the number of these jobs shows little change. Very few job openings are expected over the next four or five years. Recently, there have been many more new trainees than job openings.

Related postsecondary programs at state-supported institutions in this area are:

43.0103 Criminal justice and law enforcement administration

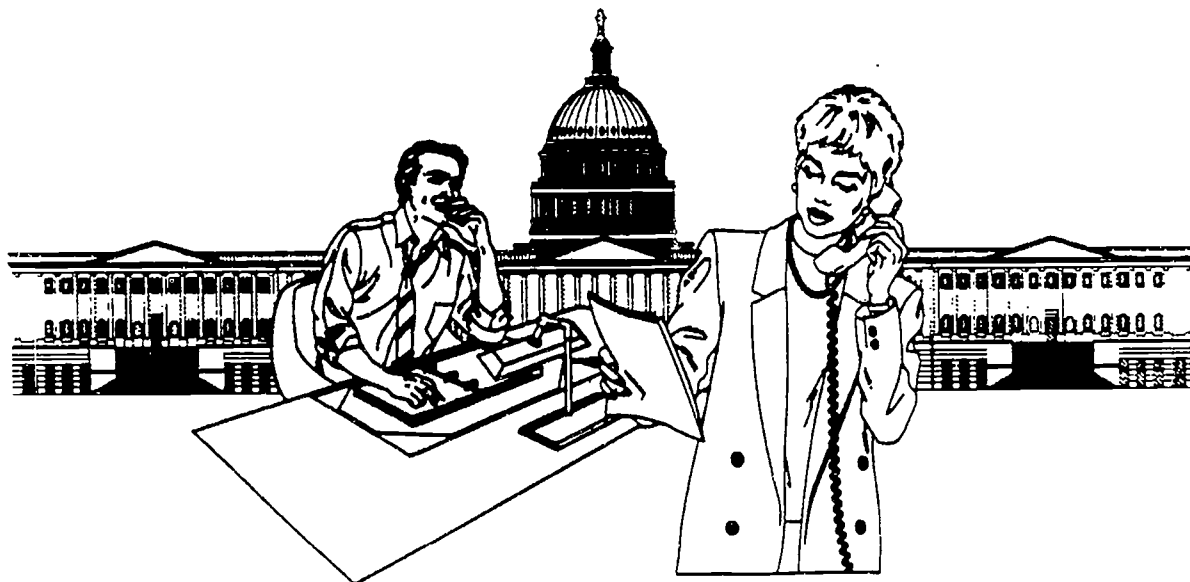

SALES AND MERCHANDISING

Workers in sales and merchandising occupations promote and sell a wide variety of merchandise and services. They also receive, store, display, and inventory products to be sold.

The largest occupations, which also have the greatest number of job openings annually, are:

- Salespersons in retail establishments
- Cashiers

These occupations may have a generally favorable outlook for the future. Overall, the number of these jobs is growing. Large numbers of job openings are expected over the next four or five years. Recently, there have been about as many new trainees as job openings. If this trend continues, job seekers can expect to face some competition.

Hourly wages include:

\$4.58	Cashiers
\$5.47	Salespersons, retail
\$7.65	Customer service representatives, utilities
\$12.73	Purchasing agents- except wholesale, retail, and farm products
\$13.09	Driver/sales workers

High school programs preparing for these occupations are:

08.0700	General marketing
08.0799	Miscellaneous general marketing

Related postsecondary programs at state-supported institutions in this area are:

08.0102	Apparel and accessories marketing operations
---------	--

Licensing may be required. Contact: TENNESSEE DEPARTMENT OF COMMERCE AND INSURANCE, 615-741-2693.

SECURITY SERVICES

Security guards, the largest occupation in this field, patrol and inspect property to protect it against fire, theft, vandalism, and illegal entry. Guards and doorkeepers usually are uniformed and often carry a nightstick and a weapon; correctional officers and jailers maintain order in correctional institutions, enforce institutional rules and regulations, and may supplement the counseling inmates receive from mental health professionals.

The largest occupations, which also have the greatest number of job openings annually, are:

- Correction officers and jailers
- Guards and watch guards

These occupations may have a generally favorable outlook for the future. Overall, the number of these jobs is growing. A moderate number of job openings are expected over the next four or five years. Recently, no training has been reported. Job opportunities should be good.

Hourly wages include:

\$9.94 Guards and watch guards

Licensing may be required. Contact: COUNTY COURT CLERK'S OFFICE.

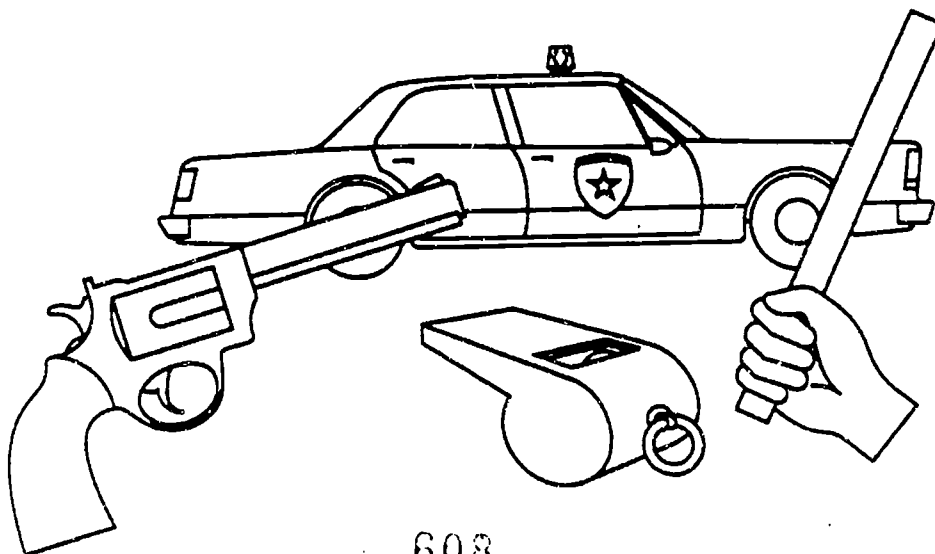

608

SHEET METAL

Sheet metal workers make, install, and maintain a variety of sheet metal products for home, commercial, and industrial buildings. These products include ducts for air conditioning, heating, and ventilating and pollution control systems, kitchen equipment, roofs, siding, rain gutters, skylights, and outdoor signs. Other workers use a variety of machines in the mass production of sheet-metal products.

The two largest occupations are:

- Machine forming operators and tenders of metal and plastic
- Assemblers and fabricators, except machine, electrical, electronic, and precision assembly

The occupations expected to have the most job openings annually are:

- Machine forming operators and tenders of metal and plastic
- Sheet metal workers

These occupations may have a generally favorable outlook for the future. Overall, the number of these jobs shows little change. A moderate number of job openings are expected over the next four or five years. Recently, there have been fewer new trainees than job openings. If this trend continues, job opportunities should be good.

Hourly wages include:

\$5.44 Sheet metal workers

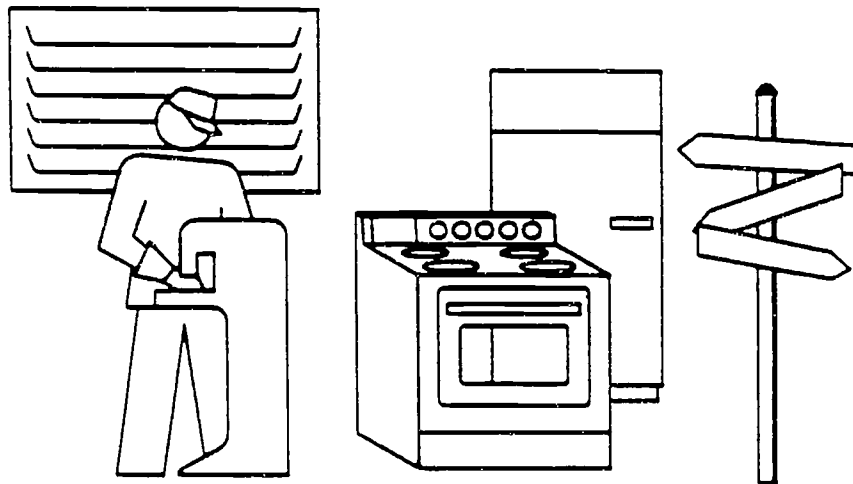

609

SMALL ENGINE REPAIR

Persons working in these occupations repair and service motorcycles, other small vehicles, and equipment with small gasoline engines. The ability to make quick and accurate diagnoses is one of the mechanic's most valuable skills. In fact, many mechanics consider diagnosing "hard to find" troubles one of their most challenging and satisfying duties.

This occupation may not have a favorable outlook for the future. Overall, the number of these jobs shows little change. Very few job openings are expected over the next four or five years. Recently, there have been more new trainees than job openings.

High school programs preparing for these occupations are:

47.0606 Small engine repair

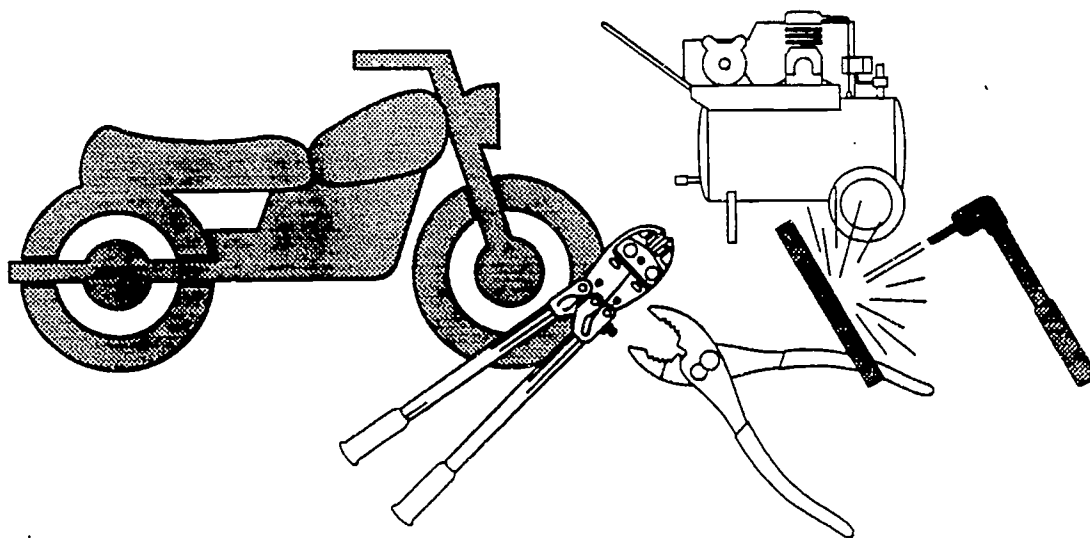

SURVEYING AND CIVIL TECHNOLOGY

Workers establish official land boundaries, with descriptions of land to satisfy legal requirements, and then plan, design, and construct structures and facilities on these tracts of land. The structures can include buildings, bridges, roads, harbors, airfields, dams, tunnels, or water supply and sewage systems.

The largest occupations, which also have the greatest number of job openings annually, are:

- Civil engineering technicians and technologists
- Surveying and mapping technicians and technologists

These occupations may have a generally favorable outlook for the future. Overall, the number of these jobs is growing. Few job openings are expected over the next four or five years. Recently, no training has been reported.

Licensing may be required. Contact: TENNESSEE STATE BOARD OF EXAMINERS FOR LAND SURVEYING, 615-741-3611.

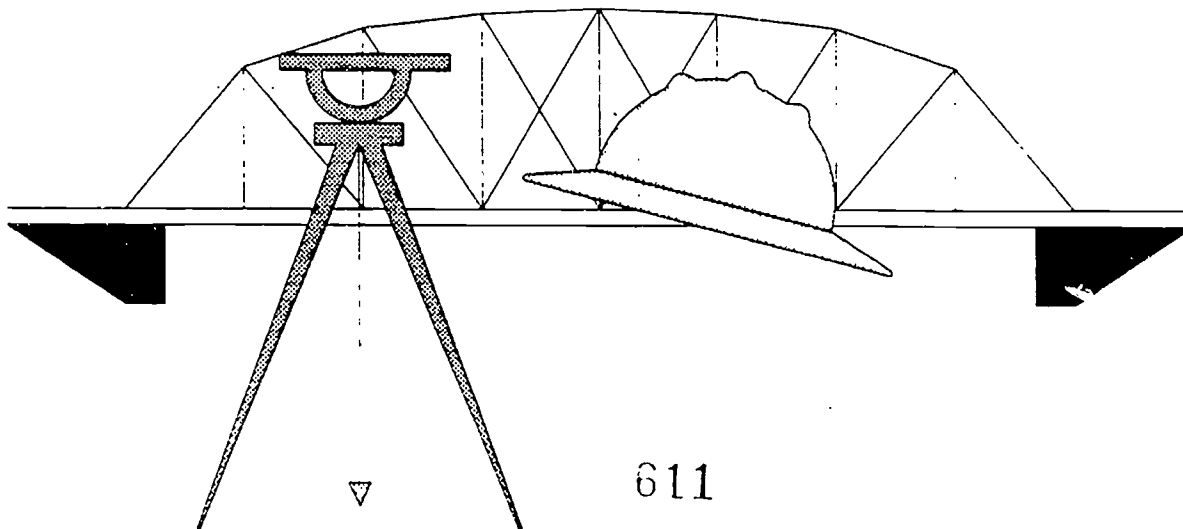

TRUCK, BUS, AND HEAVY EQUIPMENT OPERATION

These occupations include truck drivers who transport goods, bus drivers who transport passengers, and heavy equipment operators who use machinery to move construction materials and other goods over short distances--around a factory, construction site or loading dock.

The largest occupations, which also have the greatest number of job openings annually, are:

- Truck drivers of heavy or tractor trailer trucks
- School bus drivers

These occupations may have a generally favorable outlook for the future. Overall, the number of these jobs is growing. Large numbers of job openings are expected over the next four or five years. Recently, no training has been reported. Job opportunities should be good.

Hourly wages include:

- \$8.59 Grader, dozer, and scraper operators
- \$9.21 Truck drivers, heavy or tractor trailer

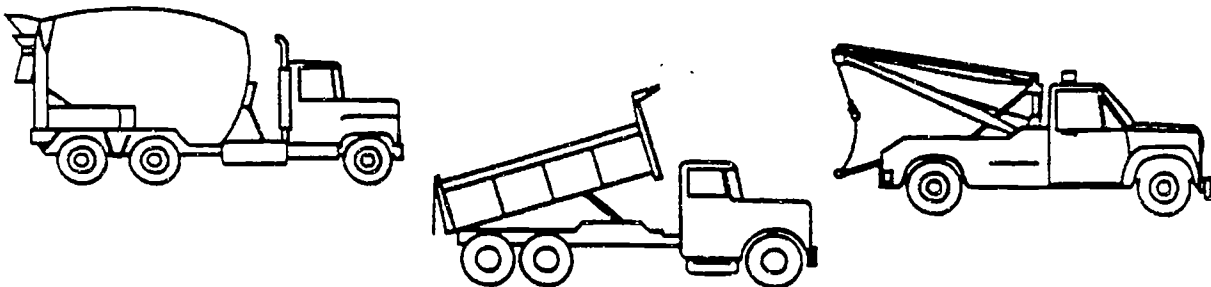

612

WELDING TECHNOLOGY

Welding is the most common way of permanently joining metal parts. Typically, heat is applied to the metal pieces to be joined; the parts are melted and fused to form a permanent bond. Welding is used to construct and repair parts of ships, automobiles, spacecraft, and thousands of products. It can also be used to join beams and steel reinforcing rods in buildings, bridges, and highways.

The largest occupations, which also have the greatest number of job openings annually, are:

- Welding machine operators and tenders
- Welders and cutters

These occupations may have a generally favorable outlook for the future. Overall, the number of these jobs is growing. A moderate number of job openings are expected over the next four or five years. Recently, there have been fewer new trainees than job openings. If this trend continues, job opportunities should be good. Placement rates at area vocational technical schools, community colleges, and/or technical institutes have been good recently.

Hourly wages include:

\$11.09 Welders and cutters

High school programs preparing for these occupations are:

48.0508 Welding, brazing, and soldering

Related postsecondary programs at state-supported institutions in this area are:

48.0508 Welding, brazing, and soldering

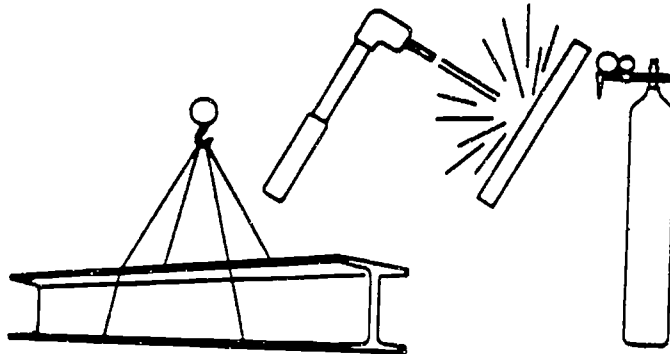

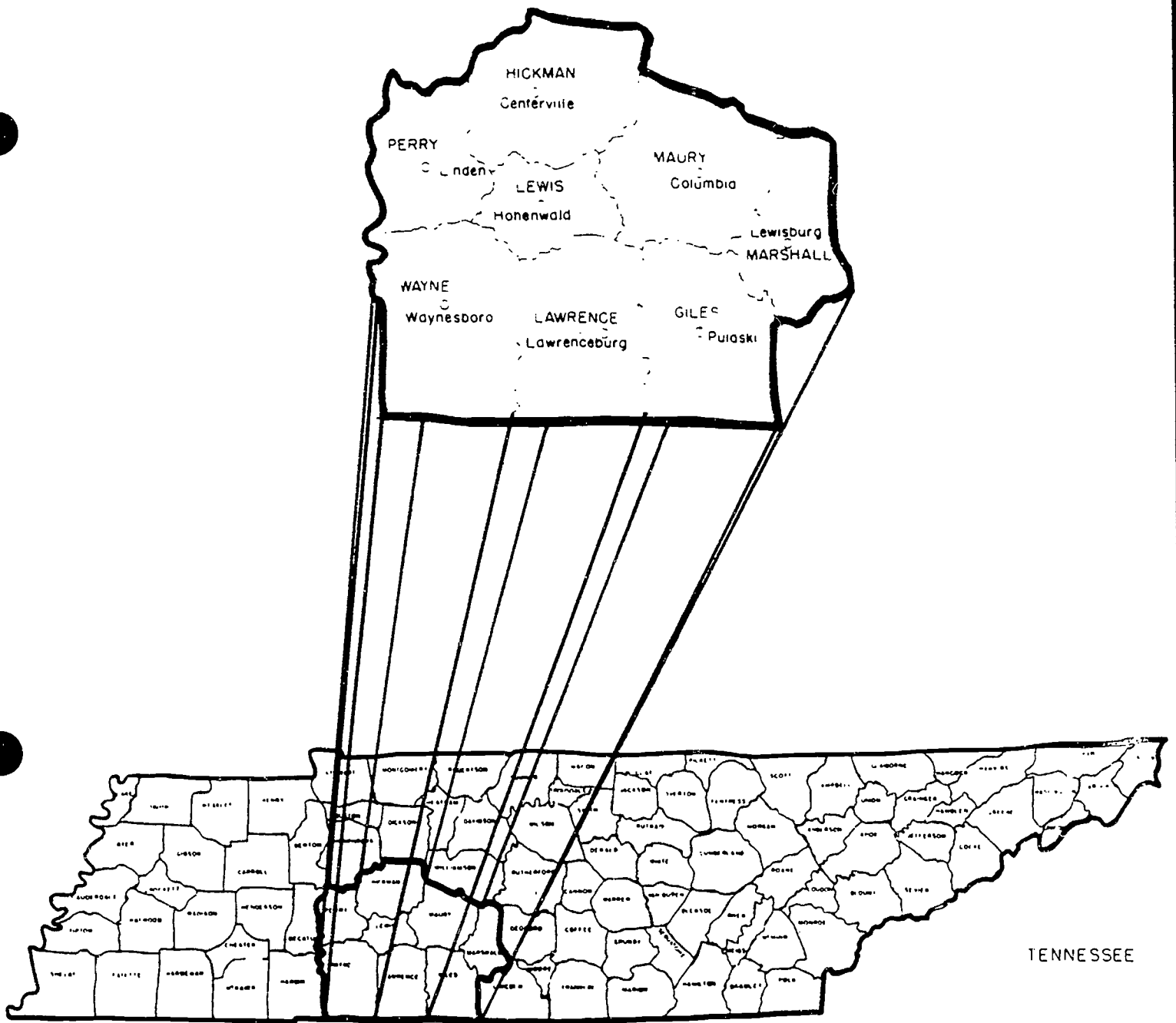

Service Delivery Area 11

ACCOUNTING AND FINANCIAL MANAGEMENT

Many individuals in this group are accountants and auditors who prepare and analyze business records and financial reports which are needed for effective management of any organization. Financial managers, another occupation in this group, typically plan, organize, control, or coordinate the financial activities of an organization.

The largest occupations, which also have the greatest number of job openings annually, are:

- Financial managers
- Accountants and auditors

These occupations may have a generally favorable outlook for the future. Overall, the number of these jobs is growing. A moderate number of job openings are expected over the next four or five years. Recently, there have been fewer new trainees than job openings. If this trend continues, job opportunities should be good. Placement rates at area vocational technical schools, community colleges, and/or technical institutes have been excellent recently.

Hourly wages include:

\$15.16 Accountants and auditors
\$19.23 Financial managers

Related postsecondary programs at state-supported institutions in this area are:

06.0301 Banking and finance

Licensing may be required. Contact: TENNESSEE BOARD OF ACCOUNTANCY, 615-741-2250.



615

ADMINISTRATIVE SUPPORT: ACCOUNTING

Persons employed in this group of occupations provide clerical and administrative support to accountants and auditors. Most of these jobs require only a high school diploma for entry.

The largest occupations, which also have the greatest number of job openings annually, are:

- Bookkeeping, accounting, and auditing clerks
- Payroll and timekeeping clerks

These occupations may have a generally favorable outlook for the future. Overall, the number of these jobs shows little change. A moderate number of job openings are expected over the next four or five years. Recently, there have been fewer new trainees than job openings. If this trend continues, job opportunities should be good. Placement rates at area vocational technical schools, community colleges, and/or technical institutes have been good recently.

Hourly wages include:

- \$7.86 Payroll and timekeeping clerks
- \$8.17 Bookkeeping, accounting, and auditing clerks

Related postsecondary programs at state-supported institutions in this area are:

- 07.0101 Accounting and bookkeeping

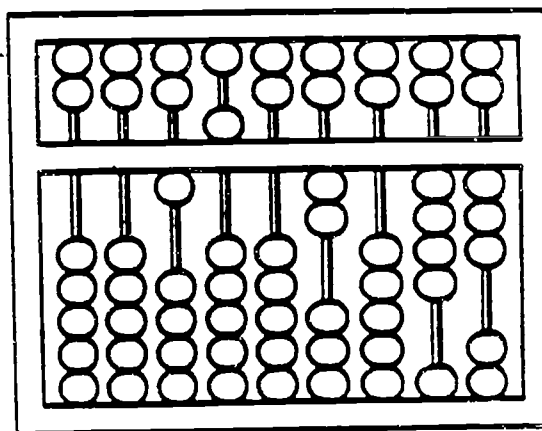
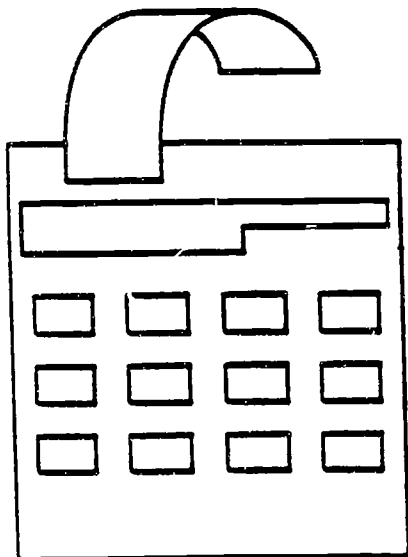

ADMINISTRATIVE SUPPORT: FINANCE AND INSURANCE

Workers provide clerical and general administrative support to the banking and finance industry. Workers receive and pay out money, keep records of money and negotiable instruments, interview applicants for credit, locate and notify customers of delinquent accounts, examine insurance claims, and process a variety of paperwork.

The largest occupations, which also have the greatest number of job openings annually, are:

- Tellers
- Bill and account collectors

These occupations may have a generally favorable outlook for the future. Overall, the number of these jobs shows little change. Few job openings are expected over the next four or five years. Recently, no training has been reported.

Hourly wages include:

- \$5.83 Tellers
- \$6.77 Loan and credit clerks
- \$8.06 Bill and account collectors

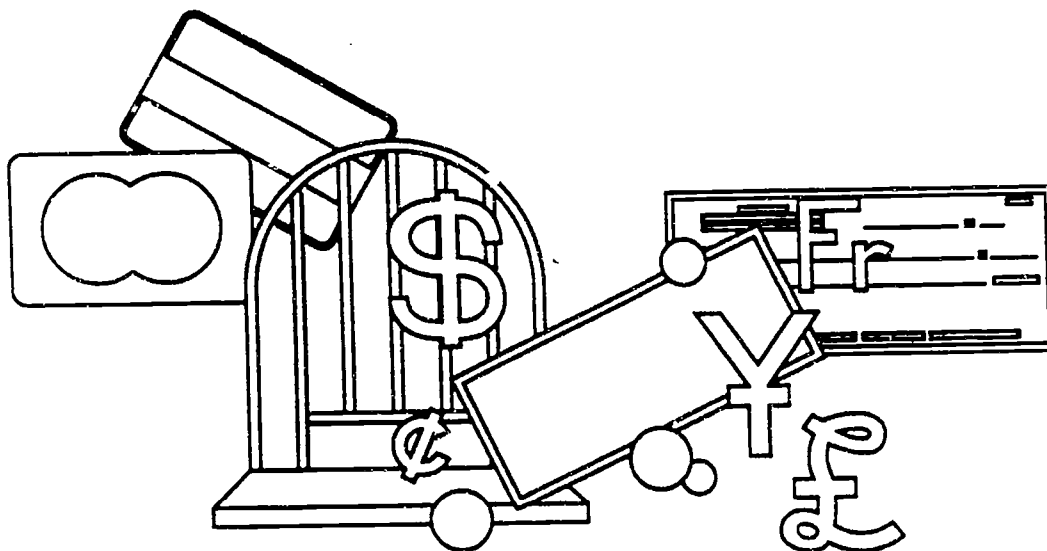

ADMINISTRATIVE SUPPORT: GENERAL

The job duties in this group of occupations are very diverse and are determined by the type of firm. For example, workers may schedule appointments, give information to callers, take dictation, type correspondence, read and route incoming mail, file correspondence and other records, and supervise and coordinate the activities of subordinate clerical workers.

The largest occupations, which also have the greatest number of job openings annually, are:

- Secretaries, except legal and medical secretaries
- General office clerks

These occupations may not have a favorable outlook for the future. Overall, the number of these jobs is growing. Large numbers of job openings are expected over the next four or five years. Recently, there have been many more new trainees than job openings. If this trend continues, job seekers can expect to face keen competition. Placement rates at area vocational technical schools, community colleges, and/or technical institutes have been good recently.

Hourly wages include:

\$5.28	File clerks
\$6.44	Receptionists and information clerks
\$6.46	Data entry keyers, except composing
\$7.00	General office clerks
\$7.63	Order clerks- materials, merchandise, and service
\$8.42	Secretaries, ex. legal and medical
\$13.64	First line supervisors and manager/supervisors- clerical and administrative support occupations

High school programs preparing for these occupations are:

07.0401	Office supervision and management
07.0601	Secretarial and related programs
07.0701	Typing, general office and related programs
07.0801	Word processing

Related postsecondary programs at state-supported institutions in this area are:

07.0606	Secretarial and office administration
07.9999	Miscellaneous business administrative support

AGRICULTURAL PRODUCTION

Workers in this field plan and economically use facilities, land, water, machinery, chemicals, finance, and labor in the production of plant and animal products.

The largest occupations, which also have the greatest number of job openings annually, are:

- Farm managers
- Farm workers

These occupations may not have a favorable outlook for the future. Overall, the number of these jobs shows little change. Few job openings are expected over the next four or five years. Recently, there have been many more new trainees than job openings.

High school programs preparing for these occupations are:

01.0301 Agricultural production

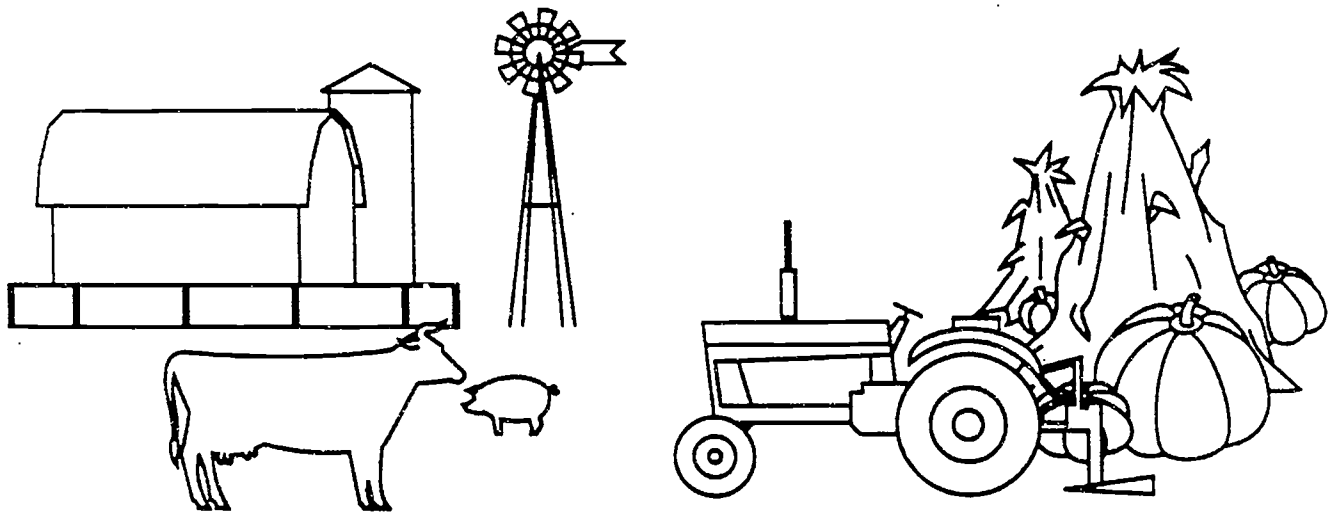

APPLIANCE AND EQUIPMENT REPAIR

Individuals in these occupations repair, adjust, maintain, and install all types of electrical motors and electrical and gas home appliances. Types of equipment used include test instruments, gauges, and hand, bench, and power tools.

This occupation may not have a favorable outlook for the future. Overall, the number of these jobs shows little change. Very few job openings are expected over the next four or five years. Recently, there have been many more new trainees than job openings.

High school programs preparing for these occupations are:

47.0101 Electrical and electronics technology

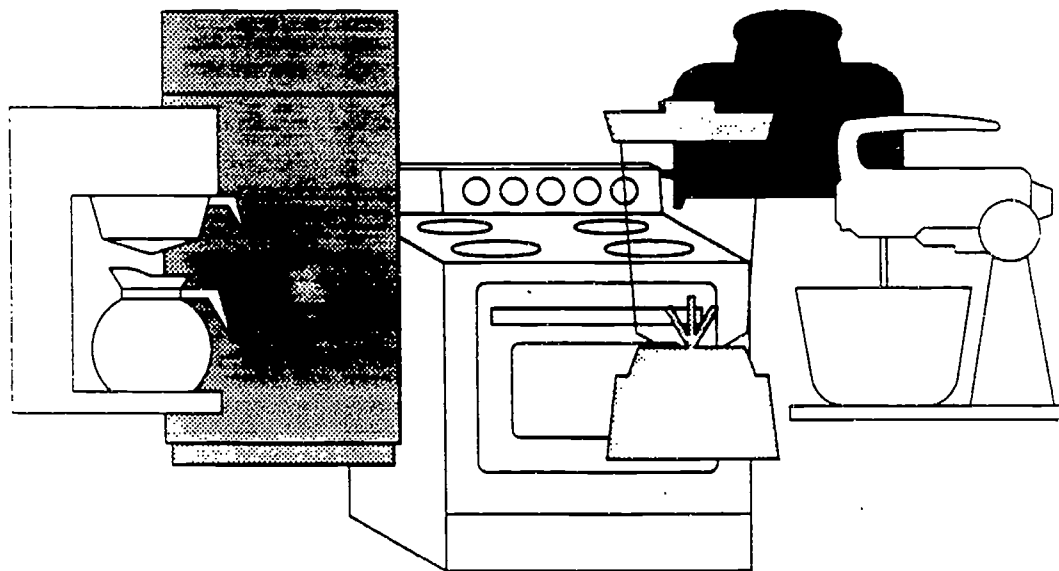

620

AUTOMOTIVE BODY REPAIR

Thousands of motor vehicles are damaged in traffic accidents every day. The workers in this field straighten bent frames, remove dents, and replace crumpled parts that are beyond repair so that those vehicles look and drive like new.

The largest occupations, which also have the greatest number of job openings annually, are:

- Automotive body and related repairers
- Painters of transportation equipment

These occupations may not have a favorable outlook for the future. Overall, the number of these jobs shows little change. Very few job openings are expected over the next four or five years. Recently, there have been more new trainees than job openings.

High school programs preparing for these occupations are:

47.0603 Automotive body repair

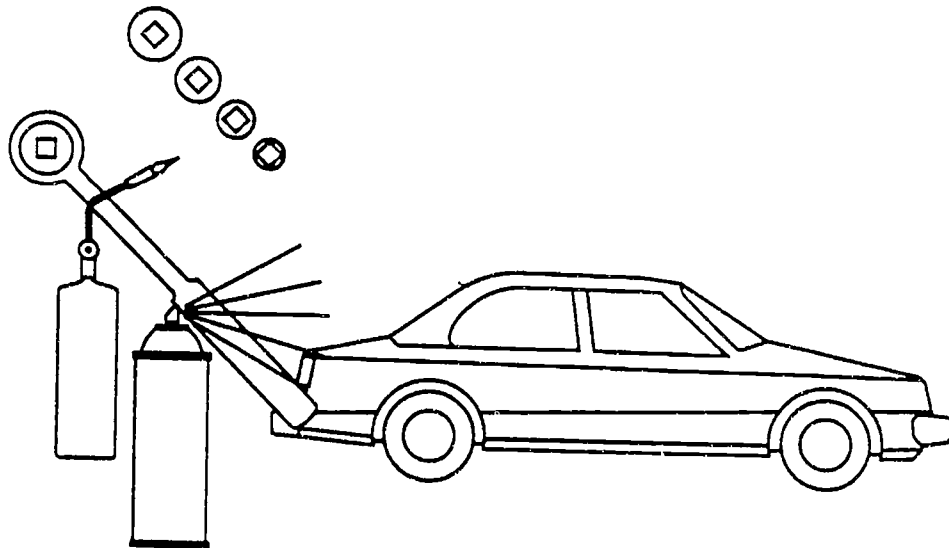

621

AUTOMOTIVE SERVICE TECHNOLOGY

These occupations include jobs concerned with parking, cleaning, polishing, lubricating, repairing, and refueling trucks, buses, and automobiles, and related servicing activities. The primary occupation, automotive mechanic, is concerned with repair and service of motor vehicles.

The largest occupations, which also have the greatest number of job openings annually, are:

- Automotive mechanics
- Tire repairers and changers

These occupations may not have a favorable outlook for the future. Overall, the number of these jobs is growing. Few job openings are expected over the next four or five years. Recently, there have been many more new trainees than job openings. Placement rates at area vocational technical schools, community colleges, and/or technical institutes have been poor recently.

Hourly wages include:

\$6.89 Automotive mechanics

High school programs preparing for these occupations are:

47.0604 Automotive mechanics

Related postsecondary programs at state-supported institutions in this area are:

15.0803 Automotive technology
47.0604 Automotive mechanics

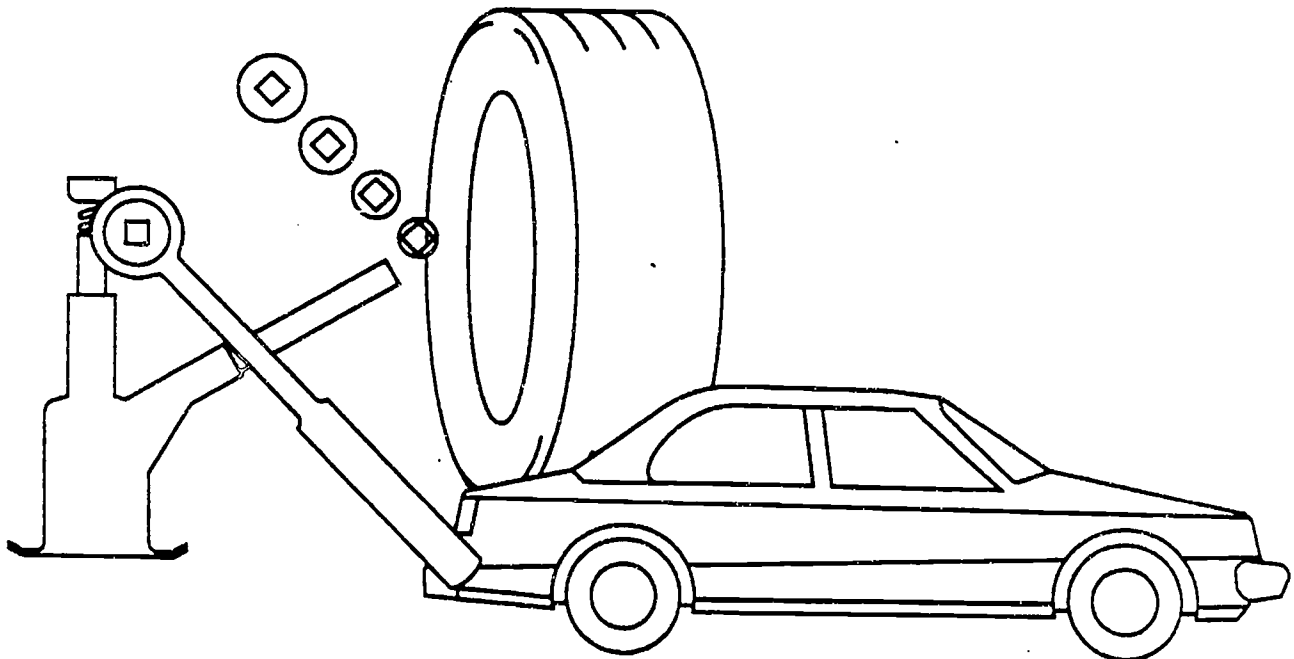

622

BUILDING MAINTENANCE

Persons in building maintenance occupations perform work involving several maintenance skills to keep the structure of an establishment in repair. Duties may involve pipefitting, boilermaking, carpentry, and electrical work as well as repairing buildings, floors, or stairs.

The two largest occupations are:

- General utility maintenance repairers
- Boiler operators and tenders of low pressure boilers

The occupations expected to have the most job openings annually are:

- General utility maintenance repairers
- Stationary engineers

These occupations may have a generally favorable outlook for the future. Overall, the number of these jobs is growing. A moderate number of job openings are expected over the next four or five years. Recently, no training has been reported. Job opportunities should be good.

Hourly wages include:

\$8.74 Maintenance repairers, general utility

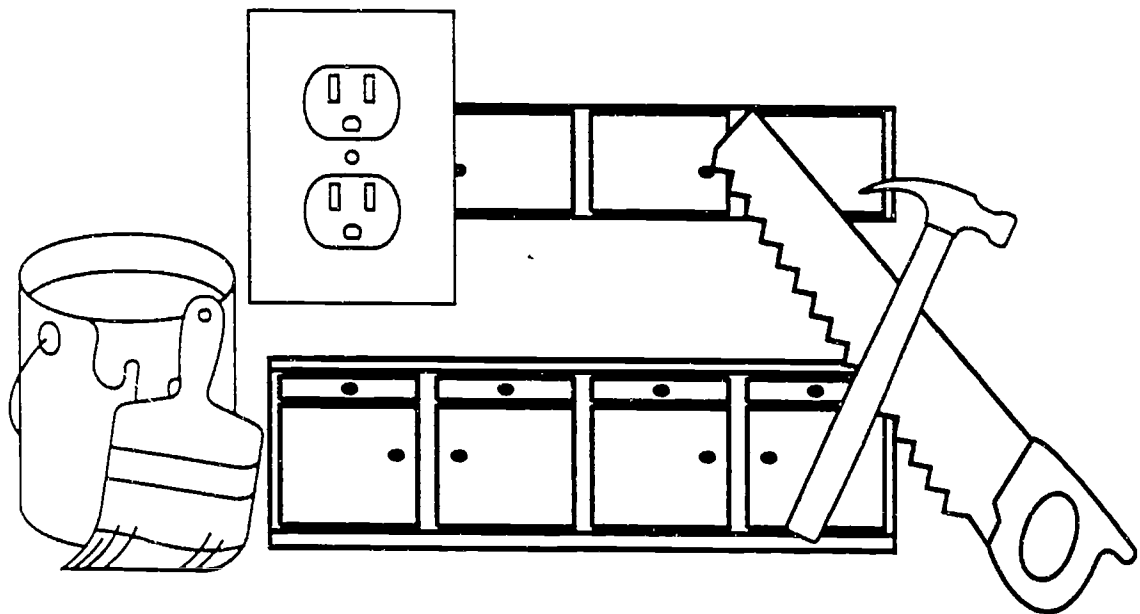

CARPENTRY

Almost all construction projects employ carpenters, the largest group of building trades workers. Carpenters perform a variety of jobs. Their duties will vary by type of construction, type of company, skill of the carpenter, and size of the community. A carpenter employed by a special trade contractor, for example, may specialize in laying hardwood floors, while one who is employed by a general building contractor may build wall frames and install paneling.

This occupation may have a generally favorable outlook for the future. Overall, the number of these jobs is growing slowly. A moderate number of job openings are expected over the next four or five years. Recently, there have been fewer new trainees than job openings. If this trend continues, job opportunities should be good.

Average hourly wages are \$11.89

High school programs preparing for these occupations are:

46.0201 Carpentry

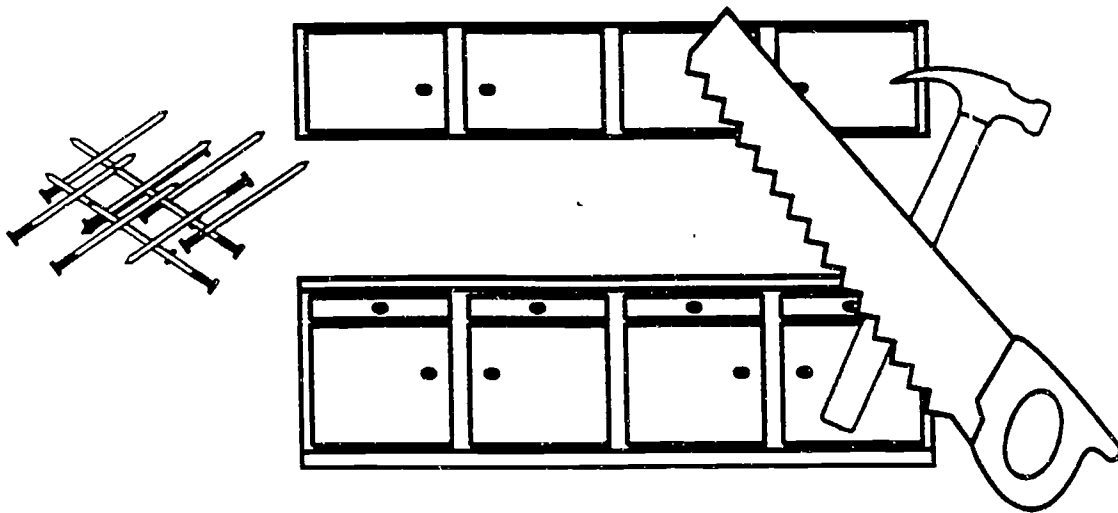

COMPUTER AND BUSINESS MACHINE PRODUCTION AND REPAIR

Workers in these fields install, service, maintain, and repair mechanical and electronic equipment, such as computers, word processing systems, radar systems, and office machines. Repairers may work in various locations doing a variety of tasks.

The two largest occupations are:

- Precision inspectors, testers, and graders
- Electrical and electronic assemblers

The occupations expected to have the most job openings annually are:

- Electrical and electronic assemblers
- Electronics repairers, commercial and industrial equipment

These occupations may not have a favorable outlook for the future. Overall, the number of these jobs shows little change. Very few job openings are expected over the next four or five years. Recently, there have been many more new trainees than job openings. Placement rates at area vocational technical schools, community colleges, and/or technical institutes have been fair recently.

High school programs preparing for these occupations are:

47.0105 Industrial electronics

Related postsecondary programs at state-supported institutions in this area are:

47.0105 Industrial electronics

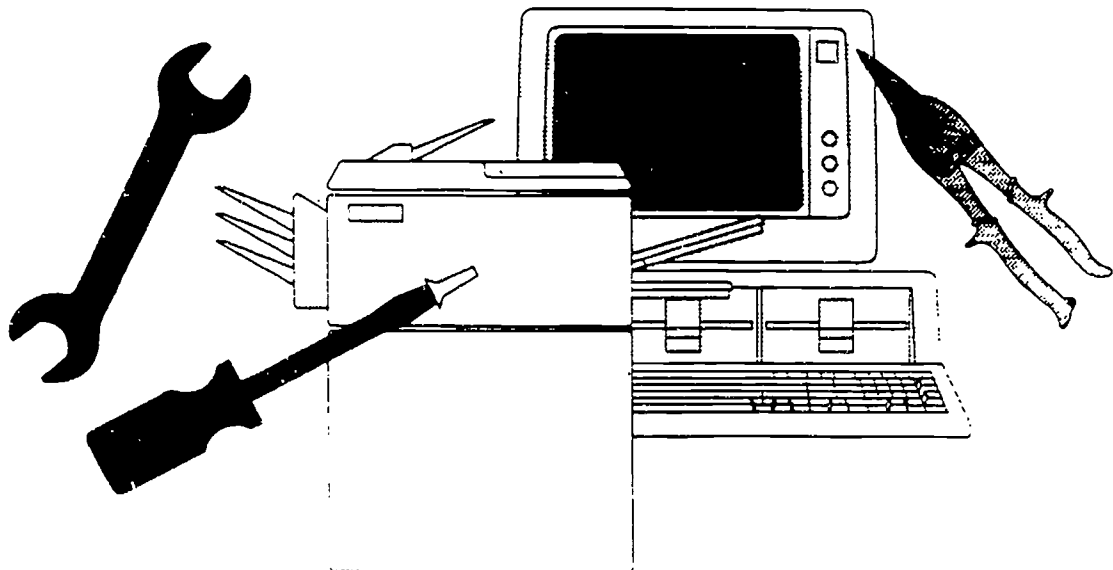

625

SDA 11 - 11

The majority of workers in this field are electrical and electronic engineering technicians and technologists. They apply electrical and related knowledge to design, build, test, and repair electrical equipment in industrial or commercial settings for subsequent use by engineering personnel.

This occupation may not have a favorable outlook for the future. Overall, the number of these jobs shows little change. Very few job openings are expected over the next four or five years. Recently, there have been more new trainees than job openings. Placement rates at area vocational technical schools, community colleges, and/or technical institutes have been excellent recently.

High school programs preparing for these occupations are:

15.0303 Electronic technology

Related postsecondary programs at state-supported institutions in this area are:

15.0303 Electronic technology

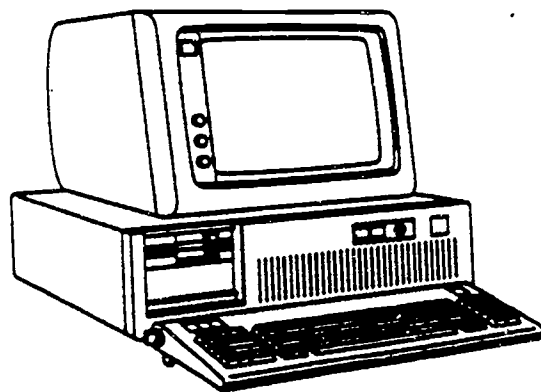

COMPUTER SYSTEMS

Workers in these computer occupations develop and write computer programs to store, locate, and retrieve specific documents, data, and information. They may also analyze business, scientific, and technical problems for application to electronic data processing systems. These careers generally require specialized training.

The largest occupations, which also have the greatest number of job openings annually, are:

- Systems analysts, electronic data processing
- Computer programmers

These occupations may have a generally favorable outlook for the future. Overall, the number of these jobs is growing rapidly. A moderate number of job openings are expected over the next four or five years. Recently, there have been many more new trainees than job openings. If this trend continues, job seekers can expect to face keen competition. Placement rates at area vocational technical schools, community colleges, and/or technical institutes have been excellent recently.

High school programs preparing for these occupations are:

07.0399 Miscellaneous business data processing

Related postsecondary programs at state-supported institutions in this area are:

11.0301 Data processing technology

COSMETOLOGY

Cosmetologists and related workers provide beauty services for customers. These may include cutting and styling hair, treating hair and scalp, applying makeup, dressing wigs, or removing hair by electrolysis, as well as cleaning, shaping, and polishing a customer's fingernails and toenails.

This occupation may not have a favorable outlook for the future. Overall, the number of these jobs is growing. Few job openings are expected over the next four or five years. Recently, there have been many more new trainees than job openings. Placement rates at area vocational technical schools, community colleges, and/or technical institutes have been fair recently.

High school programs preparing for these occupations are:

12.0403 Cosmetology

Related postsecondary programs at state-supported institutions in this area are:

12.0403 Cosmetology

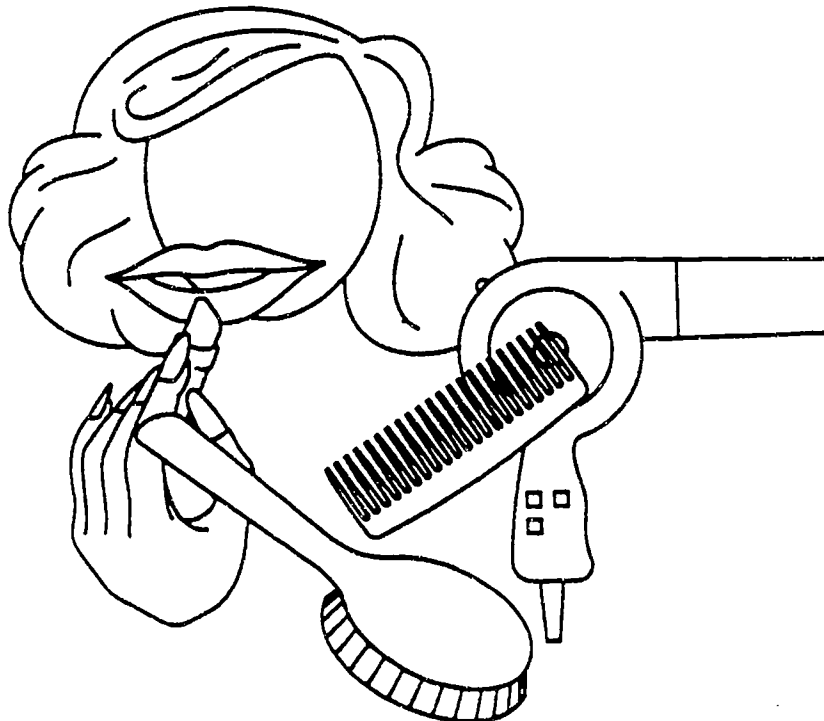

628

DRAFTING AND DESIGN TECHNOLOGY

Persons in drafting and design technology prepare clear, complete, and accurate working plans and detail drawings from rough or detailed sketches or notes for engineering or manufacturing purposes according to specified dimensions. Workers need to have knowledge of various machines, engineering practices, mathematics, building materials, and other physical sciences to complete drawings. Computer-assisted design (CAD) equipment may be used by some workers.

The largest occupations, which also have the greatest number of job openings annually, are:

- Cost estimators
- Drafters

These occupations may not have a favorable outlook for the future. Overall, the number of these jobs shows little change. Few job openings are expected over the next four or five years. Recently, there have been many more new trainees than job openings. Placement rates at area vocational technical schools, community colleges, and/or technical institutes have been fair recently.

High school programs preparing for these occupations are:

48.0101 Drafting

Related postsecondary programs at state-supported institutions in this area are:

48.0101 Drafting

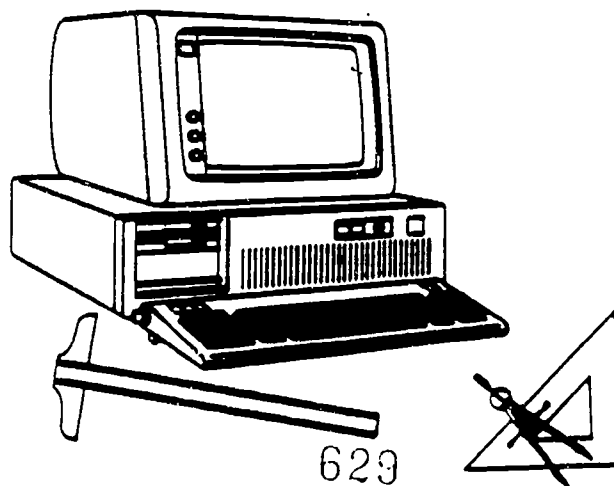

EARLY CHILDHOOD EDUCATION

Child care workers and managers of child care centers assume responsibility for the safety, physical care, and emotional, social, and intellectual growth of preschool children and infants while parents are at work or are unavailable for other reasons. Some work in residential institutions for young children. Teacher aides assist teachers by handling routine paperwork or by working directly with children.

The two largest occupations are:

- Child care workers
- Teacher aides, paraprofessional

The occupations expected to have the most job openings annually are:

- Child care workers
- Teacher aides and educational assistants, clerical

These occupations may have a generally favorable outlook for the future. Overall, the number of these jobs is growing rapidly. A moderate number of job openings are expected over the next four or five years. Recently, no training has been reported. Job opportunities should be good.

Hourly wages include:

\$5.09 Child care workers

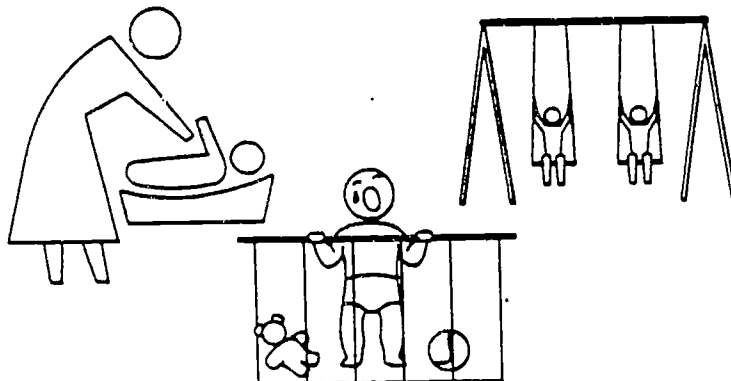

ELECTRICIAN OCCUPATIONS

Workers in the electrical field install, maintain, and repair wiring, electrical equipment, and fixtures or assist in such activities. These workers insure that work is in accordance with the relevant codes. A high school education is usually required and a five-year apprenticeship program is recommended.

The largest occupations, which also have the greatest number of job openings annually, are:

- Electricians
- Helpers of electricians and powerline transmission installers

These occupations may have a generally favorable outlook for the future. Overall, the number of these jobs is growing. A moderate number of job openings are expected over the next four or five years. Recently, there have been fewer new trainees than job openings. If this trend continues, job opportunities should be good.

Hourly wages include:

\$11.40 Electricians

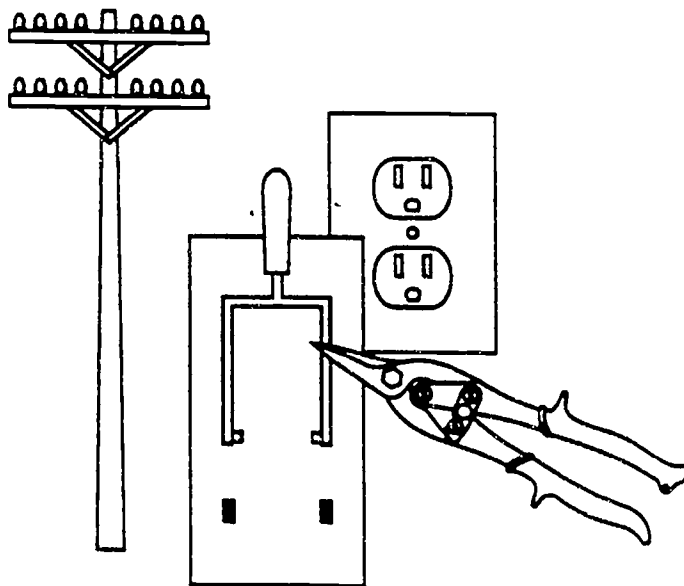

631

SDA 11 - 17

FOOD PREPARATION AND SERVICES

The majority of workers in these occupations prepare and serve food and beverages in restaurants, fast food establishments, catering firms, hotels, clubs, factories, school cafeterias, or hospitals, or supervise those providing food services. Others are factory machine operators involved in the preparation of food products. Dietetic technicians teach principles of food nutrition and provide dietary counseling to patients.

The largest occupations, which also have the greatest number of job openings annually, are:

- Food preparation workers
- Combined food preparation and service workers

These occupations may have a generally favorable outlook for the future. Overall, the number of these jobs is growing. Large numbers of job openings are expected over the next four or five years. Recently, there have been fewer new trainees than job openings. If this trend continues, job opportunities should be good.

Hourly wages include:

- \$4.51 Cooks, specialty fast food
- \$4.58 Cooks, restaurant

High school programs preparing for these occupations are:

- 20.0401 Food production, management, and services

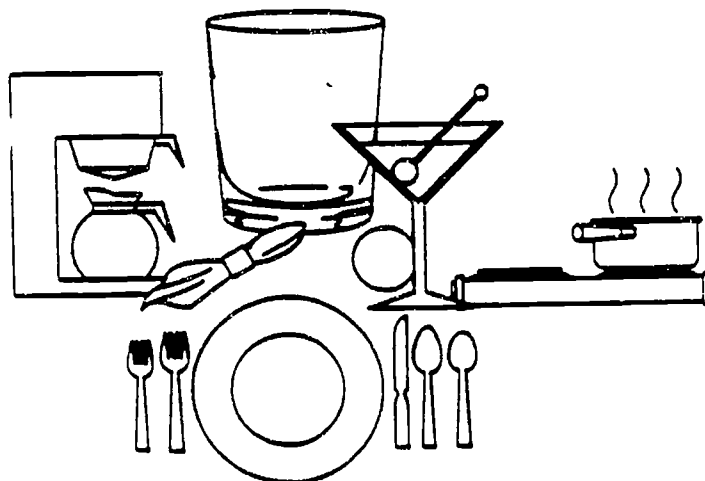

632

SDA 11 - 18

GENERAL BUSINESS AND MANAGEMENT

Workers in the general business and management occupations plan, organize, direct, control, or coordinate activities in all types of fields. Many occupations involve analysis of productivity and financial soundness. General managers and top executives usually have very diverse duties and responsibilities and work through departmental or subordinate executives.

The largest occupations, which also have the greatest number of job openings annually, are:

- Industrial production managers
- General managers and top executives

These occupations may have a generally favorable outlook for the future. Overall, the number of these jobs is growing. Large numbers of job openings are expected over the next four or five years. Recently, there have been fewer new trainees than job openings. If this trend continues, job opportunities should be good. Placement rates at area vocational technical schools, community colleges, and/or technical institutes have been excellent recently.

Hourly wages include:

- \$16.55 Industrial production managers
- \$17.26 Purchasing managers

Related postsecondary programs at state-supported institutions in this area are:

- 06.0401 Business administration and management



633

GENERAL WOODWORKING

Woodworkers are in occupations concerned with the complete cycle of cutting, shaping, and assembling parts of complex wood products. The occupations are primarily concerned with one or a limited number of machine functions according to their speciality.

The two largest occupations are:

- Assemblers and fabricators, except machine, electrical, electronic, and precision assembly
- Cabinetmakers and bench carpenters

The occupations expected to have the most job openings annually are:

- Assemblers and fabricators, except machine, electrical, electronic, and precision assembly
- Sawing machine operators and tenders

These occupations may have a generally favorable outlook for the future. Overall, the number of these jobs shows little change. Few job openings are expected over the next four or five years. Recently, there have been fewer new trainees than job openings.

High school programs preparing for these occupations are:

48.0703 Millwork and cabinetmaking

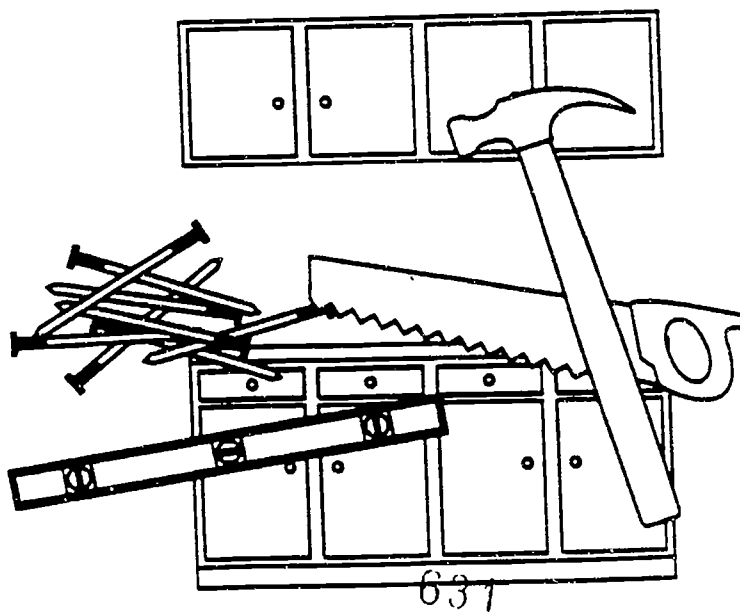

GRAPHIC ARTS

A majority of workers in this field are involved in offset printing. In this process the material to be printed is photographed and a printing plate is made from the film. This process has been advanced by the use of computers and lasers.

The largest occupations, which also have the greatest number of job openings annually, are:

- Screen printing machine setters and set-up operators
- Printing press machine operators and tenders

These occupations may not have a favorable outlook for the future. Overall, the number of these jobs shows little change. Very few job openings are expected over the next four or five years. Recently, there have been many more new trainees than job openings.

High school programs preparing for these occupations are:

48.0201 Graphic and printing communications

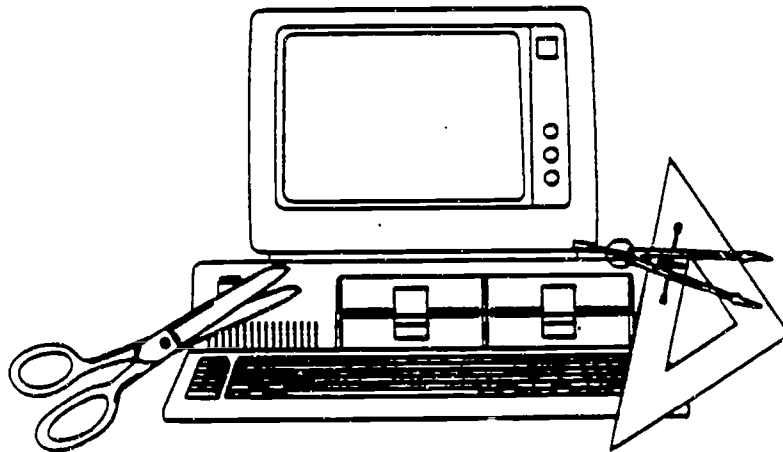

635

HEATING AND AIR CONDITIONING

Workers in this field install and repair heating, air conditioning, and refrigeration systems. They may install and repair oil burners, hot-air furnaces, and heating stoves in homes and businesses. They may also install and repair air conditioning systems, or install sheet metal ducts for the heating and cooling systems.

The largest occupations, which also have the greatest number of job openings annually, are:

- Heating, air conditioning, and refrigeration mechanics and installers
- Sheet metal duct installers

These occupations may not have a favorable outlook for the future. Overall, the number of these jobs shows little change. Very few job openings are expected over the next four or five years. Recently, there have been many more new trainees than job openings.

Hourly wages include:

\$9.63 Heating, air conditioning, and refrigeration mechanics and installers

High school programs preparing for these occupations are:

47.0201 Heating, air conditioning, and refrigeration mechanics

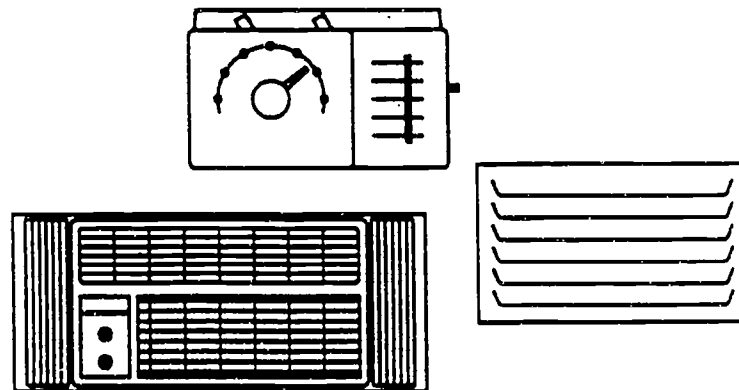

636

HORTICULTURE AND LANDSCAPING

The largest group of workers in these occupations, gardeners and groundskeepers, maintain the grounds of public and private property. Duties may include mowing, trimming, planting, and watering plants, shrubs, and grass.

The largest occupations, which also have the greatest number of job openings annually, are:

- Nursery workers
- Gardeners and groundskeepers, except farm workers

These occupations may not have a favorable outlook for the future. Overall, the number of these jobs is growing. Few job openings are expected over the next four or five years. Recently, there have been many more new trainees than job openings.

Hourly wages include:

\$6.46 Gardeners and groundskeepers, except farm

High school programs preparing for these occupations are:

01.0601 Horticulture

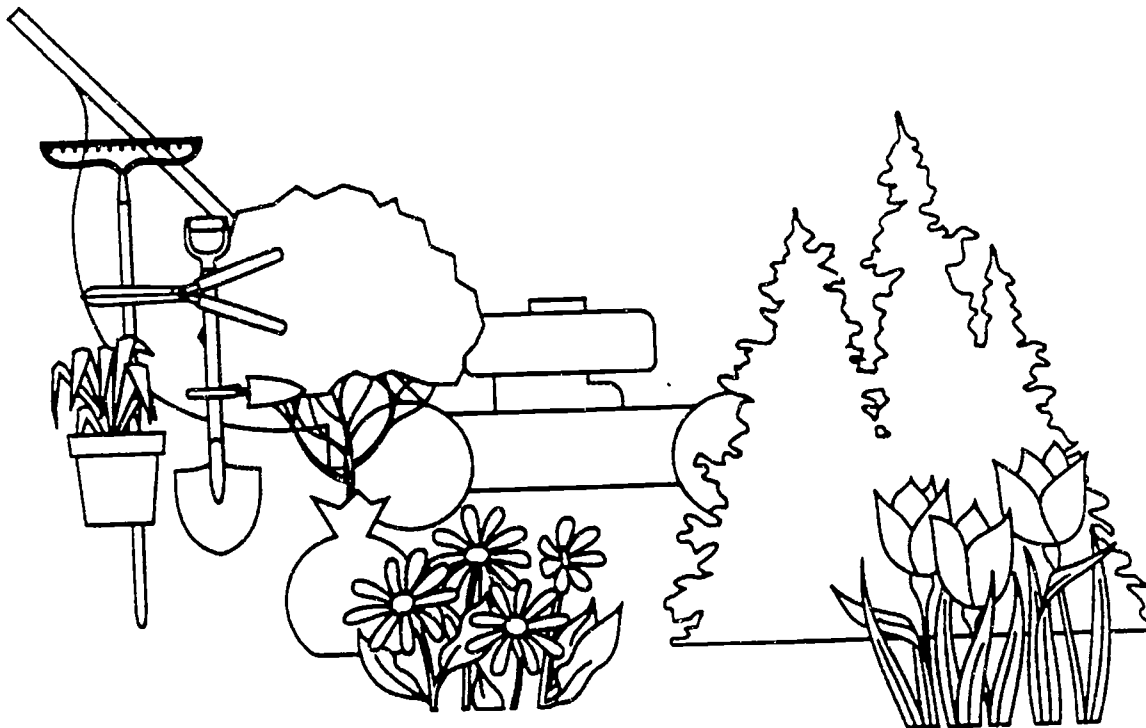

637

HOTEL AND RESTAURANT MANAGEMENT

Food service and lodging managers supervise the profitable operation of restaurants, hotels, and motels. Workers direct the varied activities of these businesses with the goal of pleasing people and providing good service to their customers.

This occupation may have a generally favorable outlook for the future. Overall, the number of these jobs is growing. Few job openings are expected over the next four or five years. Recently, no training has been reported.

Average hourly wages are \$8.82

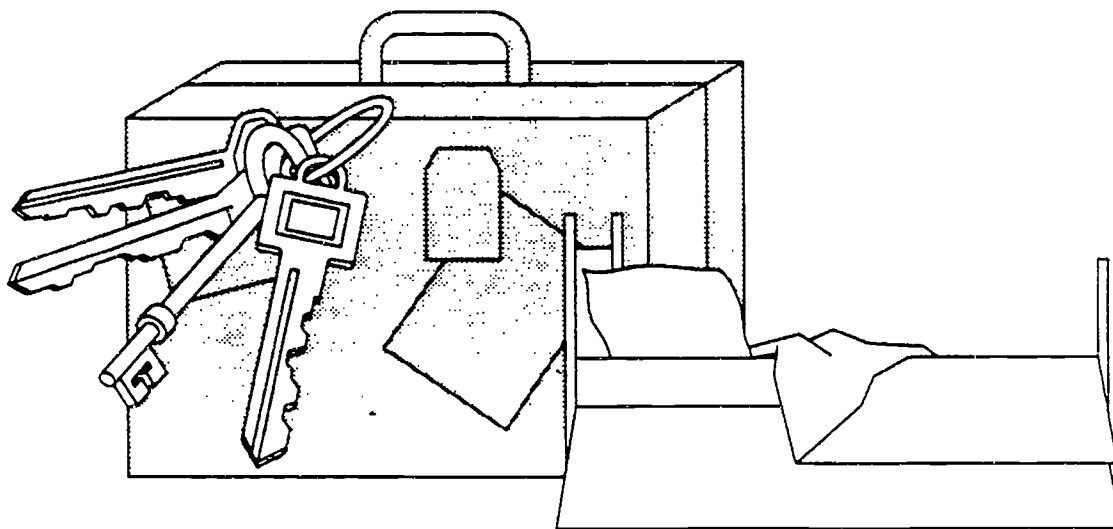

INDUSTRIAL MAINTENANCE TECHNOLOGY

Workers prevent costly waste of raw materials and the idling of human resources in a plant or factory by making industrial machinery repairs as quickly as possible. Maintenance mechanics spend considerable time doing preventive maintenance, including keeping machines well oiled and greased, and periodically cleaning parts.

The two largest occupations are:

- Maintenance mechanics for industrial machinery
- Millwrights

The occupations expected to have the most job openings annually are:

- Maintenance mechanics for industrial machinery
- Machine builders and other precision machine assemblers

These occupations may have a generally favorable outlook for the future. Overall, the number of these jobs is growing. A moderate number of job openings are expected over the next four or five years. Recently, there have been fewer new trainees than job openings. If this trend continues, job opportunities should be good. Placement rates at area vocational technical schools, community colleges, and/or technical institutes have been good recently.

Hourly wages include:

\$10.76 Machinery maintenance mechanics

Related postsecondary programs at state-supported institutions in this area are:

15.0603 Industrial technology
47.0303 Industrial mechanics technology

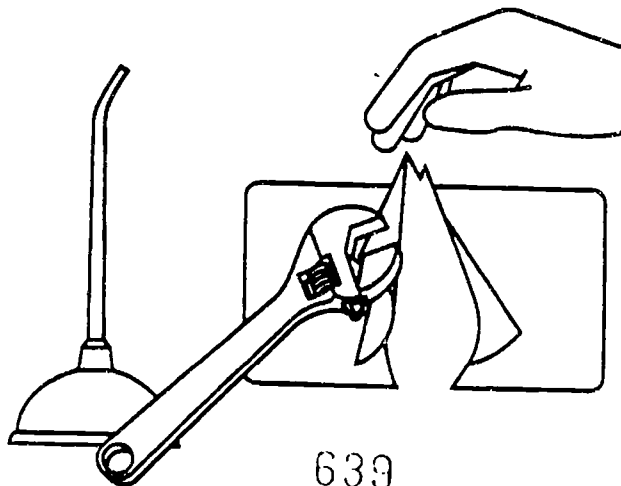

INSTITUTIONAL HOME MANAGEMENT AND SUPPORTING SERVICES

These workers make sure that all public buildings, offices, hospitals, stores, and apartment houses are kept clean and in good condition for the comfort and safety of the people who work or live there. Generally, no special education is required for occupations in this field, with most skills learned on the job.

The largest occupations, which also have the greatest number of job openings annually, are:

- Maids and housekeeping cleaners
- Janitors and cleaners, except maids and housekeeping cleaners

These occupations may have a generally favorable outlook for the future. Overall, the number of these jobs is growing. Large numbers of job openings are expected over the next four or five years. Recently, there have been fewer new trainees than job openings. If this trend continues, job opportunities should be good.

Hourly wages include:

- \$5.19 Maids and housekeeping cleaners
- \$6.48 Janitors and cleaners, except maids and housekeeping cleaners

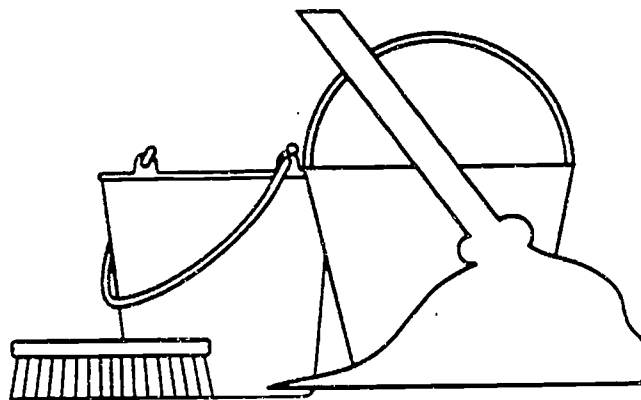

LAW ENFORCEMENT

People working at these occupations are responsible for the safety of Tennessee cities, towns, and highways. Their responsibilities range from controlling traffic to preventing and investigating crimes. Whether on or off duty, they are expected to exercise their authority whenever necessary.

The largest occupations, which also have the greatest number of job openings annually, are:

- Police patrol officers
- Sheriffs and deputy sheriffs

These occupations may have a generally favorable outlook for the future. Overall, the number of these jobs is growing. Few job openings are expected over the next four or five years. Recently, no training has been reported.

Hourly wages include:

\$10.25 Police patrol officers

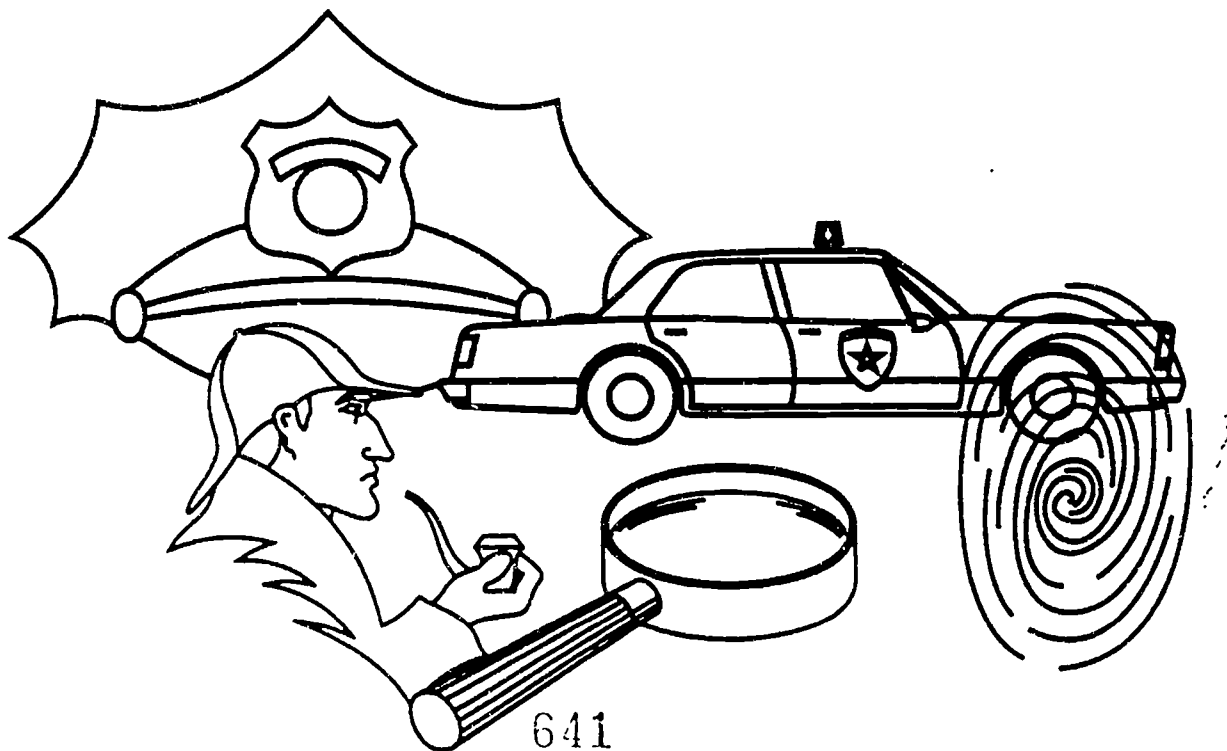

641

MACHINE TOOL TECHNOLOGY

Workers in these occupations make or set up and operate machine tools or repair metal parts. Machinists and tool-and-die makers create highly specialized precision tools, molds, and metal parts. Often they use blueprints to develop prototypes for tools or machines to be used in manufacturing.

The two largest occupations are:

- Machinists
- Machine tool cutting operators and tenders of metal and plastic

The occupations expected to have the most job openings annually are:

- Machinists
- Tool and die makers

These occupations may have a generally favorable outlook for the future. Overall, the number of these jobs is growing. Large numbers of job openings are expected over the next four or five years. Recently, there have been fewer new trainees than job openings. If this trend continues, job opportunities should be good. Placement rates at area vocational technical schools, community colleges, and/or technical institutes have been good recently.

Hourly wages include:

- \$7.48 Lathe and turning machine tool setters and set-up operators, metal and plastic
- \$9.14 Combination machine tool operators and tenders, metal and plastic
- \$9.79 Machinists
- \$11.44 Tool and die makers

High school programs preparing for these occupations are:

- 48.0503 Machine tool operation and machine shop technology

Related postsecondary programs at state-supported institutions in this area are:

- 48.0503 Machine tool operation and machine shop technology

MEDICAL RECORDS TECHNOLOGY

Medical records technicians compile and maintain medical records of hospital and clinic patients. Such work is becoming increasingly important as this background information is used for medicare and medicaid insurance reimbursements.

This occupation may not have a favorable outlook for the future. Overall, the number of these jobs shows little change. Very few job openings are expected over the next four or five years. Recently, no training has been reported.

Average hourly wages are \$6.37

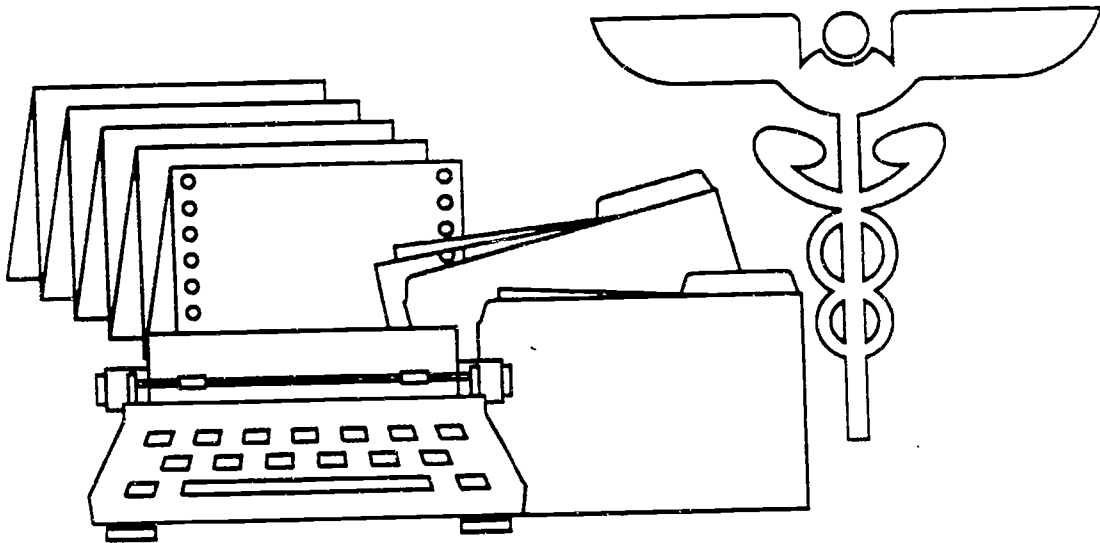

NURSING ASSISTANT

Nursing aides and orderlies work under the general direction of nursing or medical staff. In hospitals, they may answer patients' call bells, serve and collect food trays, feed patients, or set up equipment. In nursing homes, they are expected to sustain ongoing relations with patients.

The largest occupations, which also have the greatest number of job openings annually, are:

- Nursing aides, orderlies, and attendants
- Home health aides

These occupations may have a generally favorable outlook for the future. Overall, the number of these jobs is growing rapidly. A moderate number of job openings are expected over the next four or five years. Recently, there have been fewer new trainees than job openings. If this trend continues, job opportunities should be good.

Hourly wages include:

\$5.07 Nursing aides, orderlies, and attendants

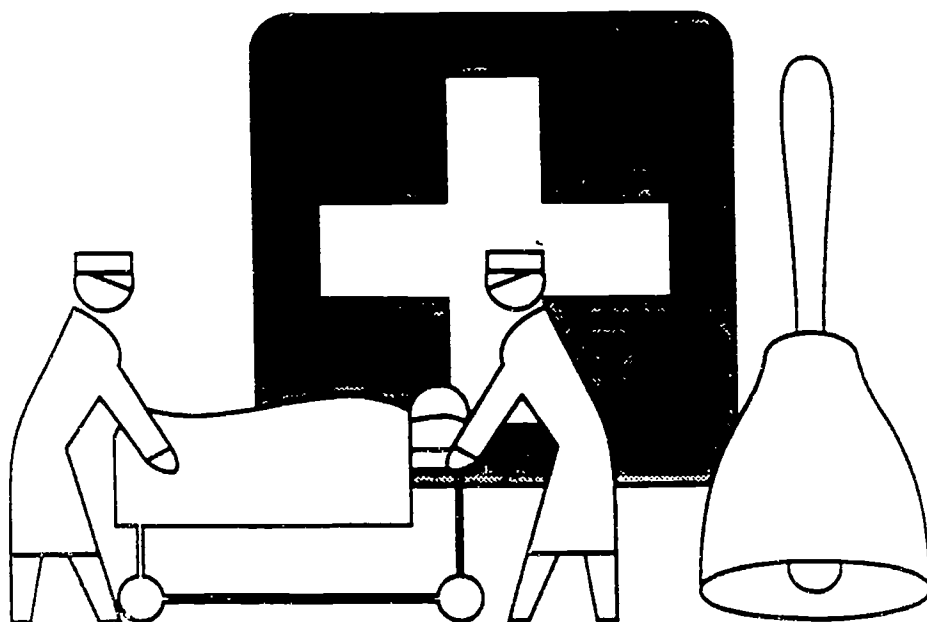

PLUMBING AND PIPEFITTING

Plumbers and pipefitters install and maintain the complex system of pipes that connect to the master system that runs underground. Although plumbing and pipefitting are sometimes considered a single trade, workers may specialize in either craft. Plumbers build and repair the water, waste disposal, drainage, and gas systems in homes and commercial/industrial buildings. Pipefitters build and repair both high and low pressure pipe.

The largest occupations, which also have the greatest number of job openings annually, are:

- Plumbers, pipefitters, and steamfitters
- Pipelayers

These occupations may have a generally favorable outlook for the future. Overall, the number of these jobs is growing. Few job openings are expected over the next four or five years. Recently, no training has been reported.

Hourly wages include:

\$12.34 Plumbers, pipefitters, and steamfitters

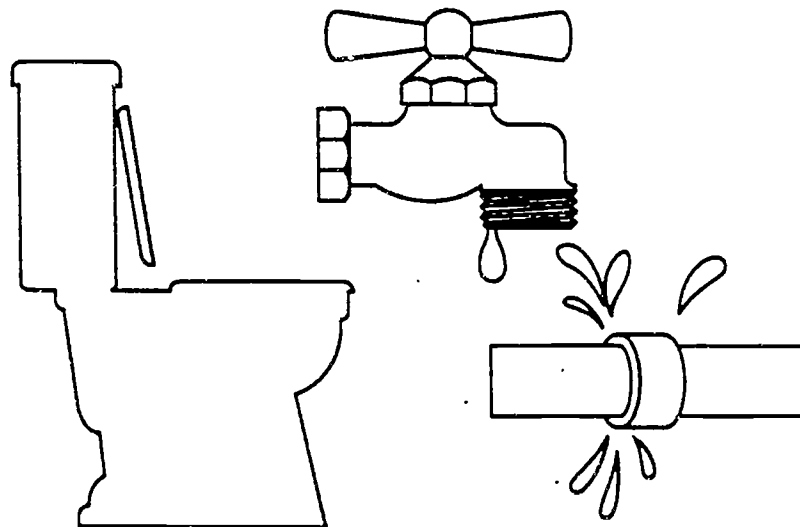

PRACTICAL NURSING

Licensed practical nurses (LPNs) work under the supervision of physicians and/or registered nurses to provide nursing care that requires technical knowledge but not the professional training of a registered nurse. They provide bedside care, administer certain medications, and assist in patient examinations.

This occupation may have a generally favorable outlook for the future. Overall, the number of these jobs is growing rapidly. A moderate number of job openings are expected over the next four or five years. Recently, there have been fewer new trainees than job openings. If this trend continues, job opportunities should be good. Placement rates at area vocational technical schools, community colleges, and/or technical institutes have been excellent recently.

Average hourly wages are \$8.64

Related postsecondary programs at state-supported institutions in this area are:

17.0605 Practical nursing

Licensing may be required. Contact: TENNESSEE BOARD OF NURSING, 615-367-6232.

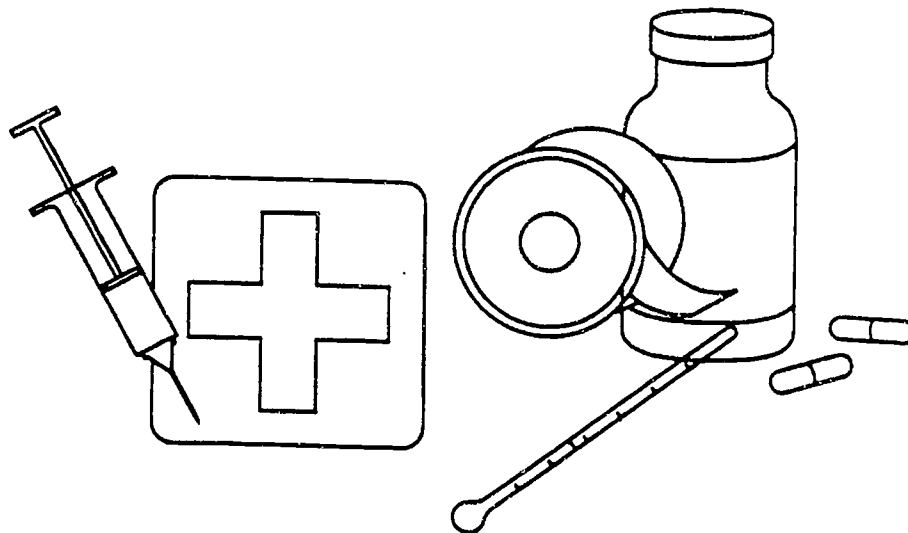

PROFESSIONAL NURSING

Registered Nurses (R.N.'s), the largest occupational group in this field, are primarily employed in hospitals and nursing homes, where they provide skilled bedside care and may supervise licensed practical nurses, nursing aides, and orderlies. Working under the direction of a licensed "supervising physician," physician assistants elicit detailed patient histories, perform physical examinations, and prescribe appropriate treatments.

The largest occupations, which also have the greatest number of job openings annually, are:

- Registered nurses
- Physician's assistants

These occupations may have a generally favorable outlook for the future. Overall, the number of these jobs is growing rapidly. Large numbers of job openings are expected over the next four or five years. Recently, there have been many more new trainees than job openings. If this trend continues, job seekers can expect to face keen competition. Placement rates at area vocational technical schools, community colleges, and/or technical institutes have been excellent recently.

Hourly wages include:

\$13.23 Registered nurses

High school programs preparing for these occupations are:

18.1101 Nursing

Related postsecondary programs at state-supported institutions in this area are:

18.1101 Nursing

Licensing may be required. Contact: TENNESSEE BOARD OF MEDICAL EXAMINERS-COMMITTEE ON PHYSICIAN ASSISTANTS, 615-367-6250.

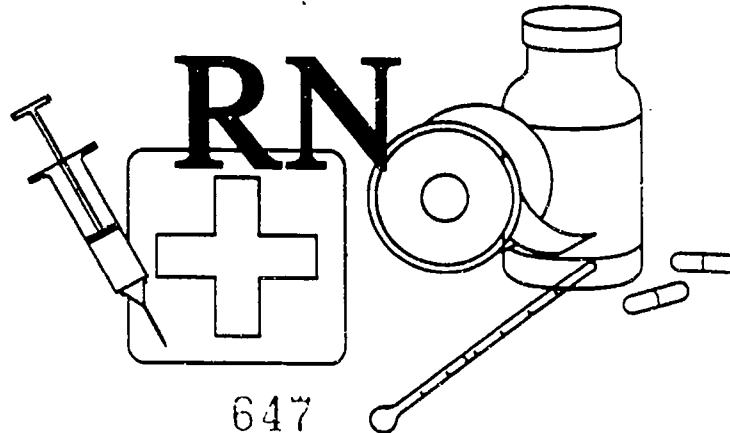

647

PUBLIC ADMINISTRATION

Individuals in this field are responsible for the management of diverse areas of governmental organizations. These managers usually work through departmental executives or subordinates in coordinating the various activities and groups they control. Public administration chief executives, legislators, and general administrators establish government policy and develop federal, state, or local regulations, rules, and laws.

The largest occupations, which also have the greatest number of job openings annually, are:

- Public administration chief executives, legislators, and general administrators
- General managers and top executives

These occupations may not have a favorable outlook for the future. Overall, the number of these jobs shows little change. Very few job openings are expected over the next four or five years. Recently, there have been more new trainees than job openings.

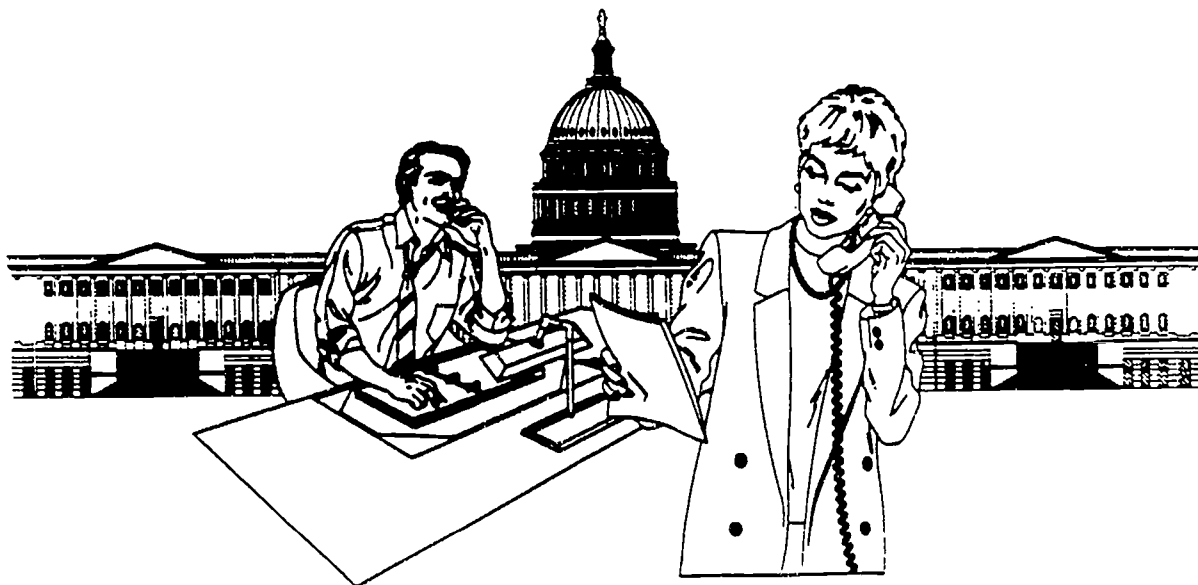

RADIOGRAPHIC MEDICAL TECHNOLOGY

Workers in this field operate equipment including x-ray machines, fluoroscopes, ultrasonic scanners, computed tomography (CP) scanners, and nuclear magnetic resonance (MCI) machines for diagnostic imagery of the human body or for therapy.

The largest occupations, which also have the greatest number of job openings annually, are:

- Radiologic technologists
- Radiologic technicians

These occupations may not have a favorable outlook for the future. Few job openings are expected over the next four or five years. Recently, there have been more new trainees than job openings. Placement rates at area vocational technical schools, community colleges, and/or technical institutes have been excellent recently.

Related postsecondary programs at state-supported institutions in this area are:

17.0209 Radiologic medical technology

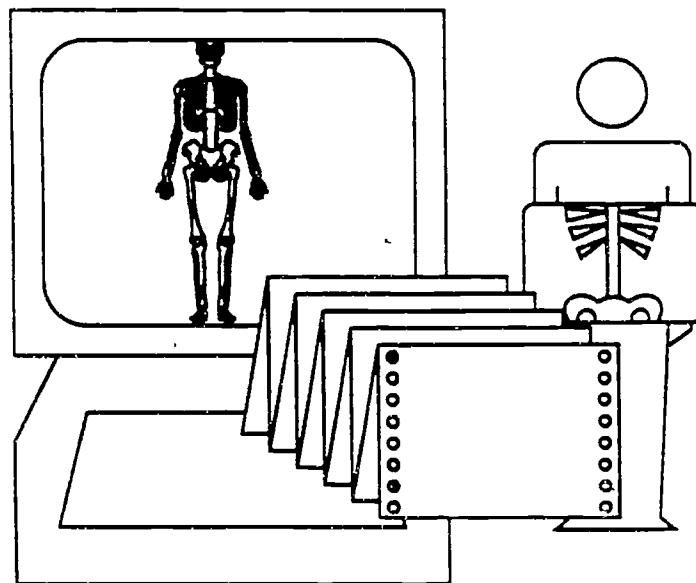

649

SALES AND MERCHANDISING

Workers in sales and merchandising occupations promote and sell a wide variety of merchandise and services. They also receive, store, display, and inventory products to be sold.

The largest occupations, which also have the greatest number of job openings annually, are:

- Salespersons in retail establishments
- Cashiers

These occupations may not have a favorable outlook for the future. Overall, the number of these jobs is growing. Large numbers of job openings are expected over the next four or five years. Recently, there have been about as many new trainees as job openings. If this trend continues, job seekers can expect to face some competition. Placement rates at area vocational technical schools, community colleges, and/or technical institutes have been poor recently.

Hourly wages include:

\$4.70 Cashiers
\$7.96 Salespersons, retail
\$14.19 Purchasing agents- except wholesale, retail, and farm products

High school programs preparing for these occupations are:

08.0700 General marketing
08.0799 Miscellaneous general marketing
08.9999 Miscellaneous marketing and distribution

Related postsecondary programs at state-supported institutions in this area are:

08.0799 Miscellaneous general marketing

Licensing may be required. Contact: TENNESSEE DEPARTMENT OF COMMERCE AND INSURANCE, 615-741-2693.

650

SECURITY SERVICES

Security guards, the largest occupation in this field, patrol and inspect property to protect it against fire, theft, vandalism, and illegal entry. Guards and doorkeepers usually are uniformed and often carry a nightstick and a weapon; correctional officers and jailers maintain order in correctional institutions, enforce institutional rules and regulations, and may supplement the counseling inmates receive from mental health professionals.

The largest occupations, which also have the greatest number of job openings annually, are:

- Correction officers and jailers
- Guards and watch guards

These occupations may have a generally favorable outlook for the future. Overall, the number of these jobs is growing rapidly. A moderate number of job openings are expected over the next four or five years. Recently, no training has been reported. Job opportunities should be good.

Hourly wages include:

\$6.87 Guards and watch guards

Licensing may be required. Contact: COUNTY COURT CLERK'S OFFICE.

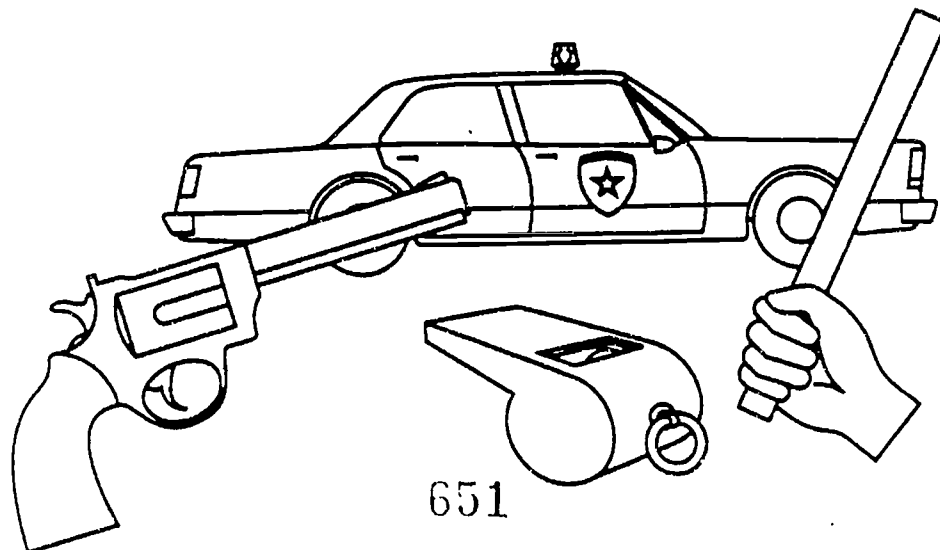

SHEET METAL

Sheet metal workers make, install, and maintain a variety of sheet metal products for home, commercial, and industrial buildings. These products include ducts for air conditioning, heating, and ventilating and pollution control systems, kitchen equipment, roofs, siding, rain gutters, skylights, and outdoor signs. Other workers use a variety of machines in the mass production of sheet-metal products.

The two largest occupations are:

- Machine forming operators and tenders of metal and plastic
- Assemblers and fabricators, except machine, electrical, electronic, and precision assembly

The occupations expected to have the most job openings annually are:

- Machine forming operators and tenders of metal and plastic
- Sheet metal workers

These occupations may have a generally favorable outlook for the future. Overall, the number of these jobs shows little change. A moderate number of job openings are expected over the next four or five years. Recently, no training has been reported. Job opportunities should be good.

Hourly wages include:

\$10.96 Sheet metal workers

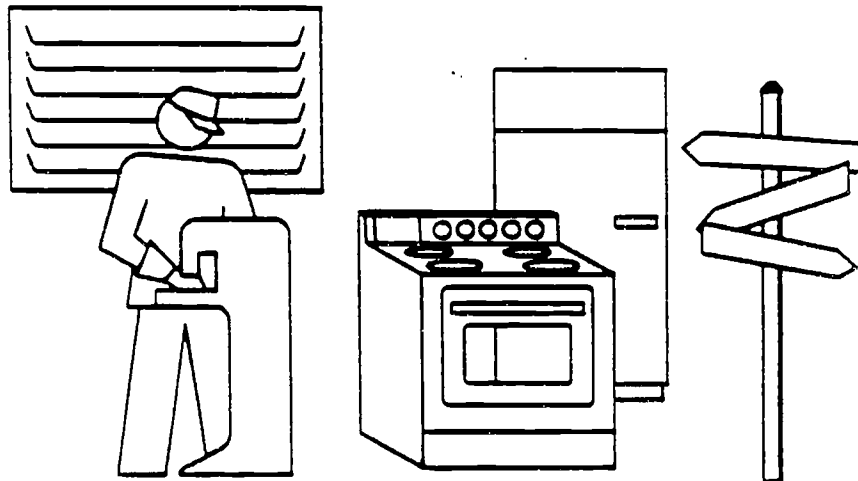

TRUCK, BUS, AND HEAVY EQUIPMENT OPERATION

These occupations include truck drivers who transport goods, bus drivers who transport passengers, and heavy equipment operators who use machinery to move construction materials and other goods over short distances--around a factory, construction site or loading dock.

The largest occupations, which also have the greatest number of job openings annually, are:

- Truck drivers of heavy or tractor trailer trucks
- School bus drivers

These occupations may have a generally favorable outlook for the future. Overall, the number of these jobs is growing. Large numbers of job openings are expected over the next four or five years. Recently, no training has been reported. Job opportunities should be good.

Hourly wages include:

\$9.67 Truck drivers, heavy or tractor trailer

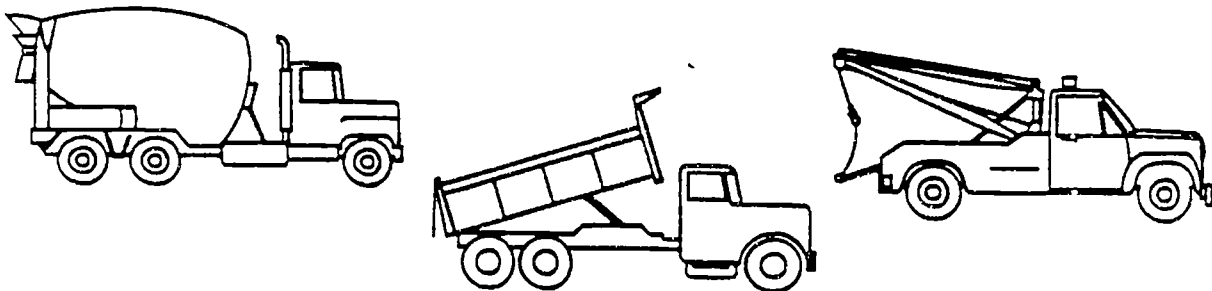

WELDING TECHNOLOGY

Welding is the most common way of permanently joining metal parts. Typically, heat is applied to the metal pieces to be joined; the parts are melted and fused to form a permanent bond. Welding is used to construct and repair parts of ships, automobiles, spacecraft, and thousands of products. It can also be used to join beams and steel reinforcing rods in buildings, bridges, and highways.

The largest occupations, which also have the greatest number of job openings annually, are:

- Welding machine operators and tenders
- Welders and cutters

These occupations may have a generally favorable outlook for the future. Overall, the number of these jobs is growing. A moderate number of job openings are expected over the next four or five years. Recently, there have been about as many new trainees as job openings. If this trend continues, job seekers can expect to face some competition. Placement rates at area vocational technical schools, community colleges, and/or technical institutes have been excellent recently.

High school programs preparing for these occupations are:

48.0508 Welding, brazing, and soldering

Related postsecondary programs at state-supported institutions in this area are:

48.0508 Welding, brazing, and soldering

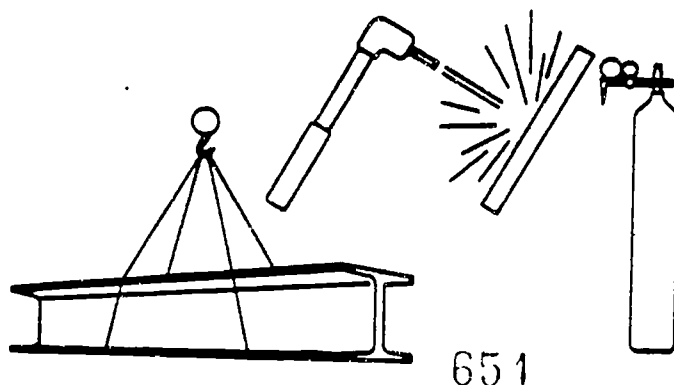

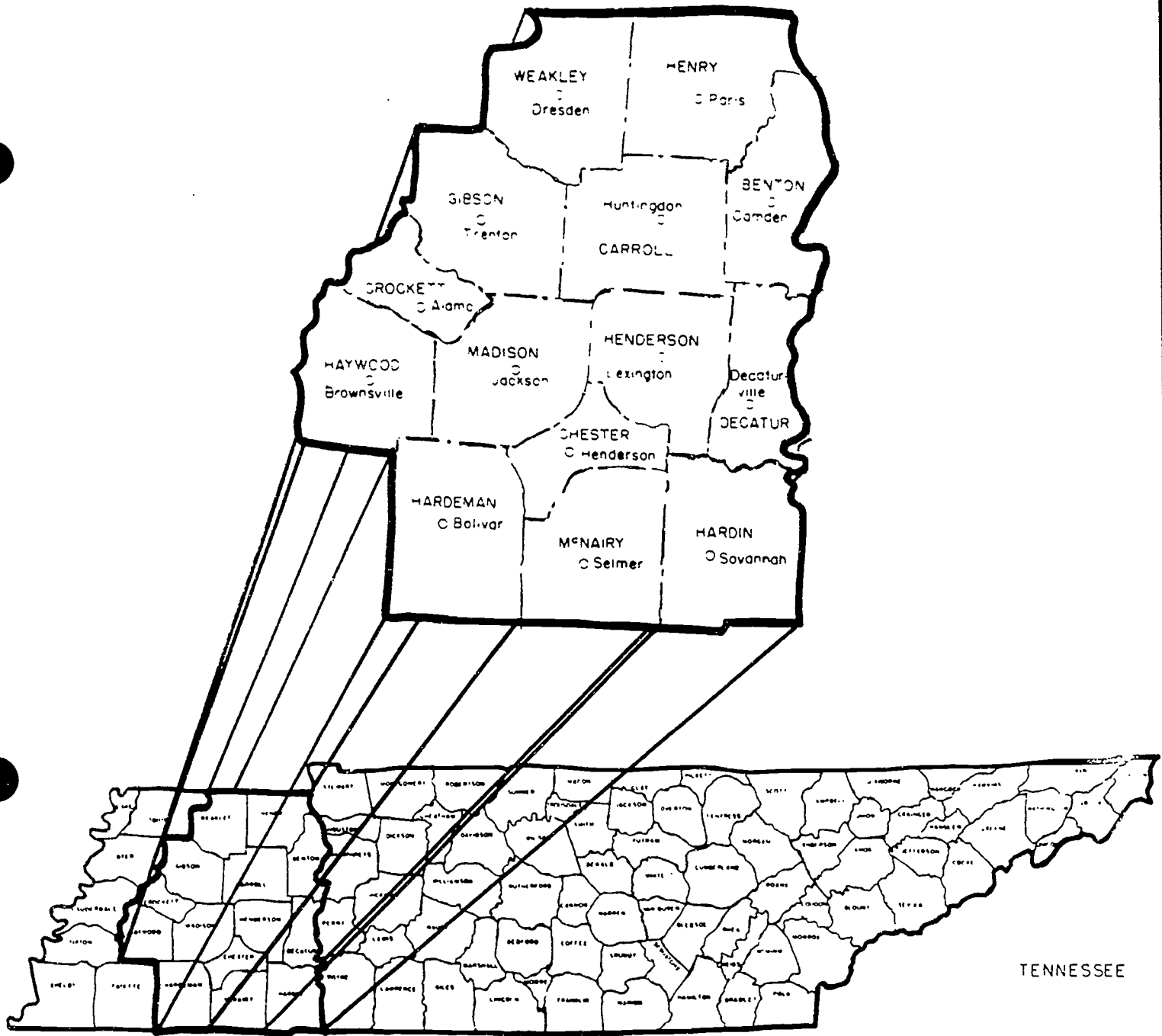

Service Delivery Area 12

ACCOUNTING AND FINANCIAL MANAGEMENT

Many individuals in this group are accountants and auditors who prepare and analyze business records and financial reports which are needed for effective management of any organization. Financial managers, another occupation in this group, typically plan, organize, control, or coordinate the financial activities of an organization.

The largest occupations, which also have the greatest number of job openings annually, are:

- Financial managers
- Accountants and auditors

These occupations may have a generally favorable outlook for the future. Overall, the number of these jobs is growing. A moderate number of job openings are expected over the next four or five years. Recently, there have been fewer new trainees than job openings. If this trend continues, job opportunities should be good.

Hourly wages include:

\$13.50 Accountants and auditors
\$22.35 Financial managers

Related postsecondary programs at state-supported institutions in this area are:

52.0301 Accounting

Licensing may be required. Contact: TENNESSEE BOARD OF ACCOUNTANCY, 615-741-2250.



SDA 12 - 1 656

ADMINISTRATIVE SUPPORT: ACCOUNTING

Persons employed in this group of occupations provide clerical and administrative support to accountants and auditors. Most of these jobs require only a high school diploma for entry.

The largest occupations, which also have the greatest number of job openings annually, are:

- Bookkeeping, accounting, and auditing clerks
- Payroll and timekeeping clerks

These occupations may have a generally favorable outlook for the future. Overall, the number of these jobs shows little change. A moderate number of job openings are expected over the next four or five years. Recently, there have been fewer new trainees than job openings. If this trend continues, job opportunities should be good.

Hourly wages include:

- \$7.98 Payroll and timekeeping clerks
- \$8.17 Bookkeeping, accounting, and auditing clerks

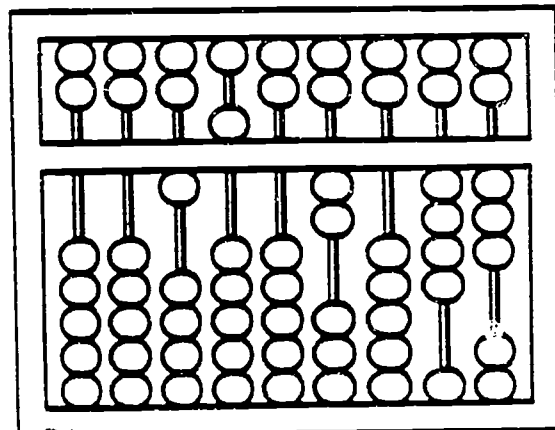
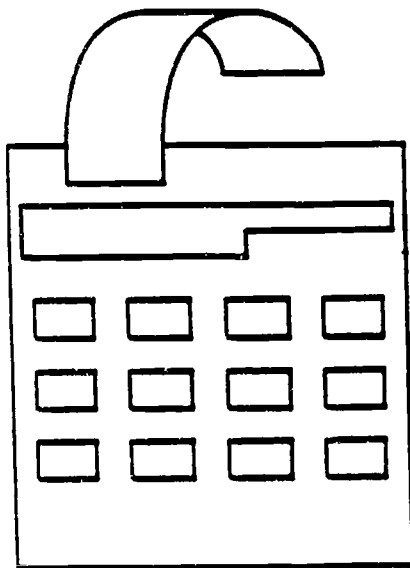

057

ADMINISTRATIVE SUPPORT: FINANCE AND INSURANCE

Workers provide clerical and general administrative support to the banking and finance industry. Workers receive and pay out money, keep records of money and negotiable instruments, interview applicants for credit, locate and notify customers of delinquent accounts, examine insurance claims, and process a variety of paperwork.

The largest occupations, which also have the greatest number of job openings annually, are:

- Tellers
- Bill and account collectors

These occupations may have a generally favorable outlook for the future. Overall, the number of these jobs shows little change. A moderate number of job openings are expected over the next four or five years. Recently, there have been fewer new trainees than job openings. If this trend continues, job opportunities should be good.

Hourly wages include:

\$6.02	Tellers
\$6.68	New accounts clerks
\$6.77	Loan and credit clerks
\$7.18	Bill and account collectors

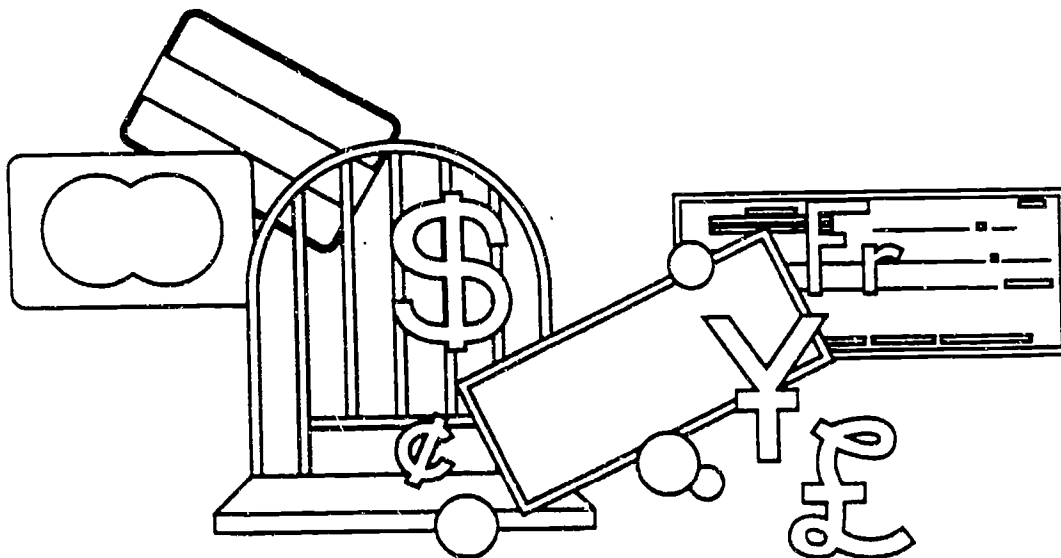

658

ADMINISTRATIVE SUPPORT: GENERAL

The job duties in this group of occupations are very diverse and are determined by the type of firm. For example, workers may schedule appointments, give information to callers, take dictation, type correspondence, read and route incoming mail, file correspondence and other records, and supervise and coordinate the activities of subordinate clerical workers.

The largest occupations, which also have the greatest number of job openings annually, are:

- Secretaries, except legal and medical secretaries
- General office clerks

These occupations may not have a favorable outlook for the future. Overall, the number of these jobs is growing. Large numbers of job openings are expected over the next four or five years. Recently, there have been many more new trainees than job openings. If this trend continues, job seekers can expect to face keen competition. Placement rates at area vocational technical schools, community colleges, and/or technical institutes have been good recently.

Hourly wages include:

\$6.06	File clerks
\$6.42	Receptionists and information clerks
\$6.92	Data entry keyers, except composing
\$6.94	General office clerks
\$7.03	Medical secretaries
\$7.55	Secretaries, ex. legal and medical
\$7.90	Typists including word processing
\$8.29	Order clerks- materials, merchandise, and service
\$12.19	First line supervisors and manager/supervisors-- clerical and administrative support occupations

High school programs preparing for these occupations are:

07.0601	Secretarial and related programs
07.0701	Typing, general office and related programs
07.9999	Miscellaneous business administrative support

Related postsecondary programs at state-supported institutions in this area are:

07.0606	Secretarial and office administration
07.9999	Miscellaneous business administrative support
52.0401	Administrative assistant and secretarial science

AGRICULTURAL PRODUCTION

Workers in this field plan and economically use facilities, land, water, machinery, chemicals, finance, and labor in the production of plant and animal products.

The largest occupations, which also have the greatest number of job openings annually, are:

- Farm managers
- Farm workers

These occupations may have a generally favorable outlook for the future. Overall, the number of these jobs shows little change. A moderate number of job openings are expected over the next four or five years. Recently, there have been many more new trainees than job openings. If this trend continues, job seekers can expect to face keen competition. Placement rates at area vocational technical schools, community colleges, and/or technical institutes have been excellent recently.

High school programs preparing for these occupations are:

01.0301 Agricultural production

Related postsecondary programs at state-supported institutions in this area are:

01.0101 Agricultural technology

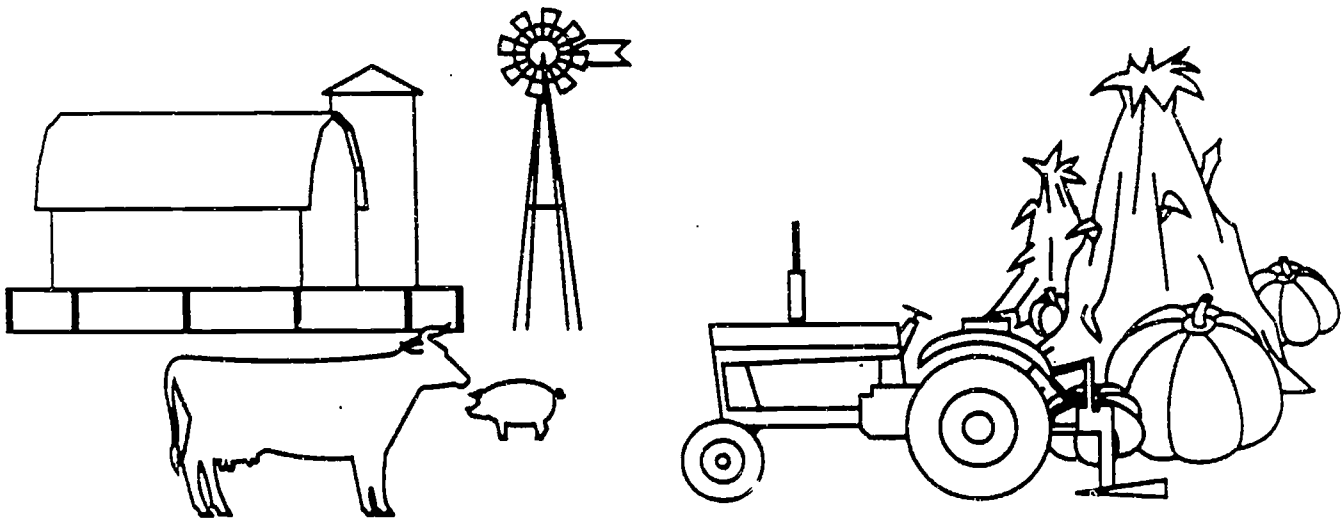

600

APPLIANCE AND EQUIPMENT REPAIR

Individuals in these occupations repair, adjust, maintain, and install all types of electrical motors and electrical and gas home appliances. Types of equipment used include test instruments, gauges, and hand, bench, and power tools.

The two largest occupations are:

- Electric home appliance and power tool repairers
- Coin and vending machine servicers and repairers

The occupations expected to have the most job openings annually are:

- Coin and vending machine servicers and repairers
- Gas appliance repairers

These occupations may not have a favorable outlook for the future. Overall, the number of these jobs shows little change. Very few job openings are expected over the next four or five years. Recently, there have been many more new trainees than job openings. Placement rates at area vocational technical schools, community colleges, and/or technical institutes have been fair recently.

High school programs preparing for these occupations are:

- 47.0101 Electrical and electronics technology
- 47.0108 Small appliance repair

Related postsecondary programs at state-supported institutions in this area are:

- 47.0101 Electrical and electronics technology

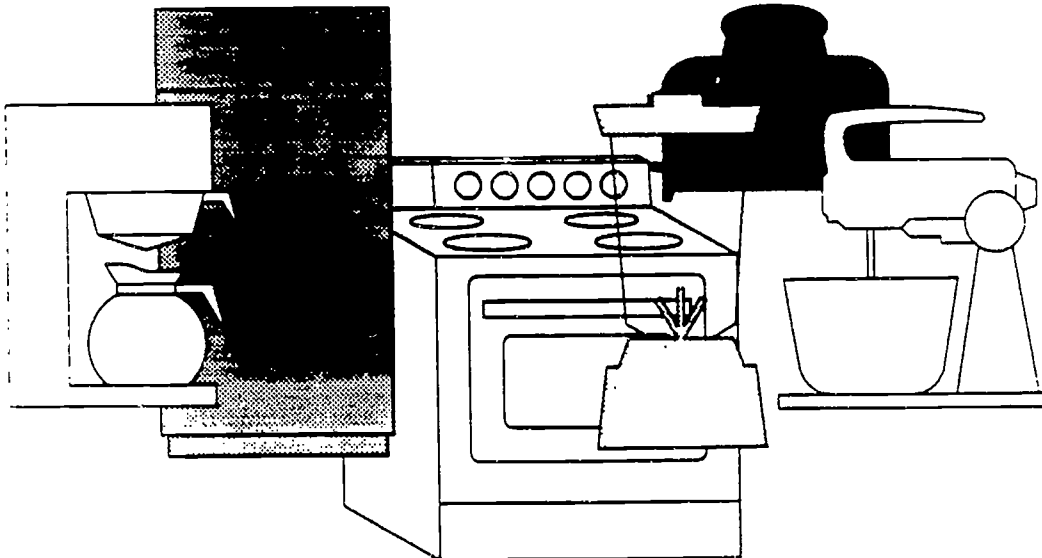

661

SDA 12 - 6

AUTOMOTIVE BODY REPAIR

Thousands of motor vehicles are damaged in traffic accidents every day. The workers in this field straighten bent frames, remove dents, and replace crumpled parts that are beyond repair so that those vehicles look and drive like new.

The largest occupations, which also have the greatest number of job openings annually, are:

- Automotive body and related repairers
- Painters of transportation equipment

These occupations may not have a favorable outlook for the future. Overall, the number of these jobs shows little change. Few job openings are expected over the next four or five years. Recently, there have been many more new trainees than job openings. Placement rates at area vocational technical schools, community colleges, and/or technical institutes have been good recently.

High school programs preparing for these occupations are:

47.0603 Automotive body repair

Related postsecondary programs at state-supported institutions in this area are:

47.0603 Automotive body repair

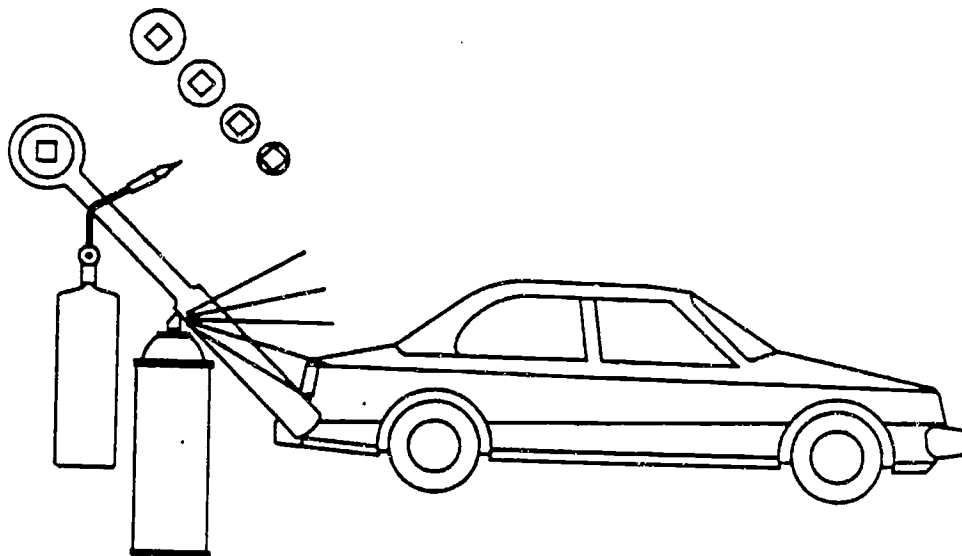

662

AUTOMOTIVE SERVICE TECHNOLOGY

These occupations include jobs concerned with parking, cleaning, polishing, lubricating, repairing, and refueling trucks, buses, and automobiles, and related servicing activities. The primary occupation, automotive mechanic, is concerned with repair and service of motor vehicles.

The largest occupations, which also have the greatest number of job openings annually, are:

- Automotive mechanics
- Tire repairers and changers

These occupations may not have a favorable outlook for the future. Overall, the number of these jobs is growing slowly. A moderate number of job openings are expected over the next four or five years. Recently, there have been many more new trainees than job openings. If this trend continues, job seekers can expect to face keen competition. Placement rates at area vocational technical schools, community colleges, and/or technical institutes have been fair recently.

Hourly wages include:

\$9.41 Automotive mechanics

High school programs preparing for these occupations are:

47.0604 Automotive mechanics

Related postsecondary programs at state-supported institutions in this area are:

15.0803 Automotive technology

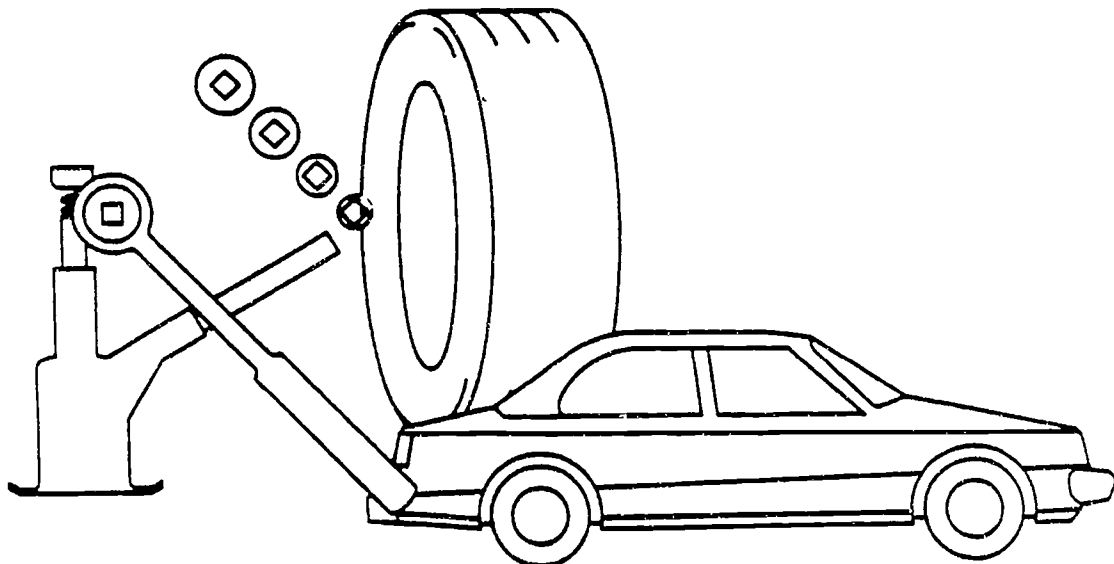

SDA 12 - 8663

BUILDING MAINTENANCE

Persons in building maintenance occupations perform work involving several maintenance skills to keep the structure of an establishment in repair. Duties may involve pipefitting, boilermaking, carpentry, and electrical work as well as repairing buildings, floors, or stairs.

The two largest occupations are:

- General utility maintenance repairers
- Boiler operators and tenders of low pressure boilers

The occupations expected to have the most job openings annually are:

- General utility maintenance repairers
- Stationary engineers

These occupations may have a generally favorable outlook for the future. Overall, the number of these jobs is growing. A moderate number of job openings are expected over the next four or five years. Recently, there have been fewer new trainees than job openings. If this trend continues, job opportunities should be good.

Hourly wages include:

\$8.57 Maintenance repairers, general utility

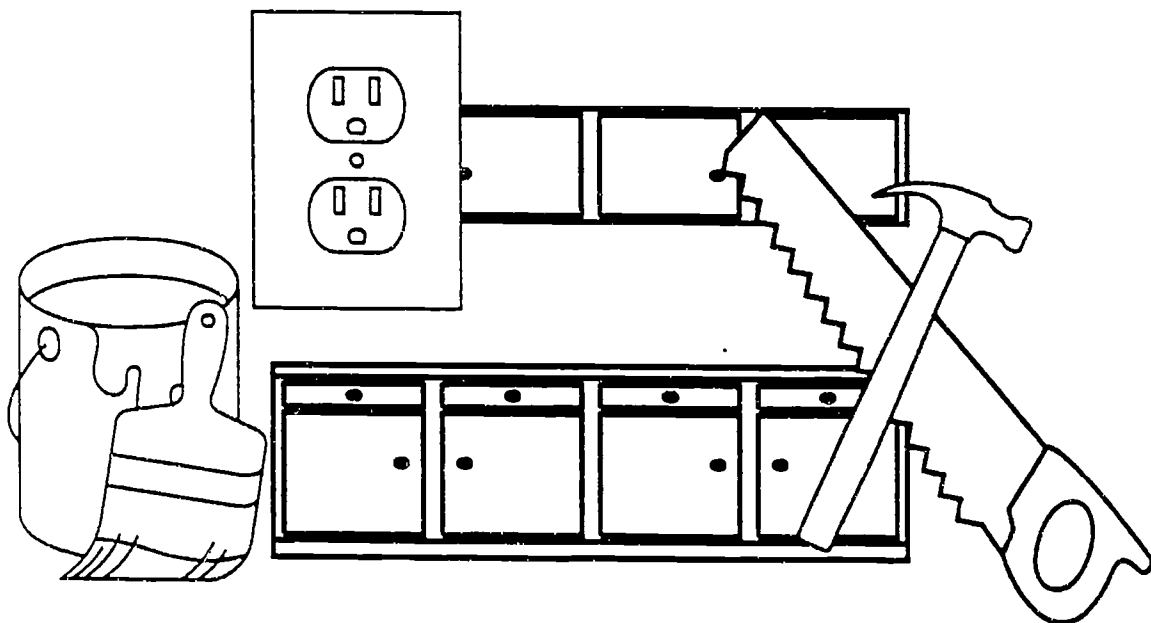

CARPENTRY

Almost all construction projects employ carpenters, the largest group of building trades workers. Carpenters perform a variety of jobs. Their duties will vary by type of construction, type of company, skill of the carpenter, and size of the community. A carpenter employed by a special trade contractor, for example, may specialize in laying hardwood floors, while one who is employed by a general building contractor may build wall frames and install paneling.

The largest occupations, which also have the greatest number of job openings annually, are:

- Carpenters
- Ceiling tile installers and acoustical carpenters

These occupations may have a generally favorable outlook for the future. Overall, the number of these jobs is growing slowly. A moderate number of job openings are expected over the next four or five years. Recently, there have been fewer new trainees than job openings. If this trend continues, job opportunities should be good.

Hourly wages include:

\$10.23 Carpenters

High school programs preparing for these occupations are:

46.0201 Carpentry

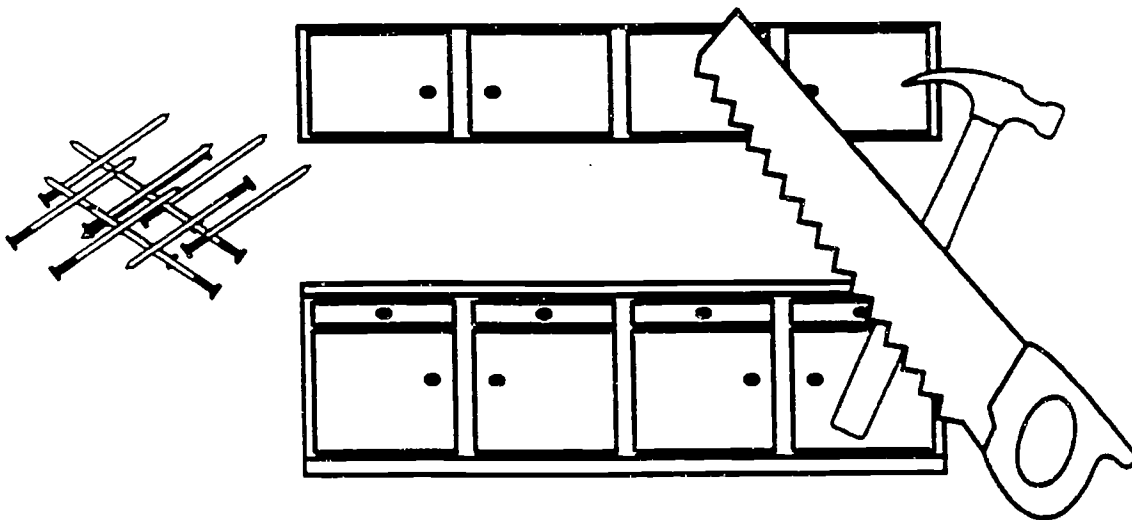

665

COMMERCIAL ART AND DESIGN

The majority of workers in this field design or arrange objects and materials in an artistic or decorative manner. Additional tasks may include the creation or drawing of designs for items such as furniture and machinery (product design).

The largest occupations, which also have the greatest number of job openings annually, are:

- Artists and related workers
- Designers, except interior designers

These occupations may have a generally favorable outlook for the future. Overall, the number of these jobs is growing. A moderate number of job openings are expected over the next four or five years. Recently, there have been fewer new trainees than job openings. If this trend continues, job opportunities should be good.

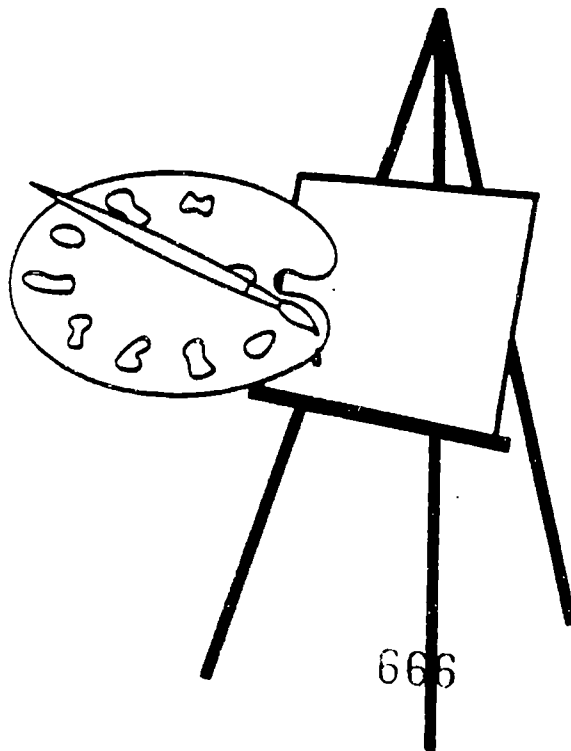

666

COMMUNICATIONS, JOURNALISM, AND BROADCASTING

Individuals who work in these fields are concerned with communicating ideas and information to individuals for their education and entertainment. The methods utilized are varied and may include the written word, radio, and television.

The two largest occupations are:

- Writers and editors
- Reporters and correspondents

The occupations expected to have the most job openings annually are:

- Writers and editors
- Radio and television announcers

These occupations may not have a favorable outlook for the future. Overall, the number of these jobs is growing. Few job openings are expected over the next four or five years. Recently, there have been many more new trainees than job openings.

Hourly wages include:

\$10.35 Writers and editors

Related postsecondary programs at state-supported institutions in this area are:

09.0101 General communications

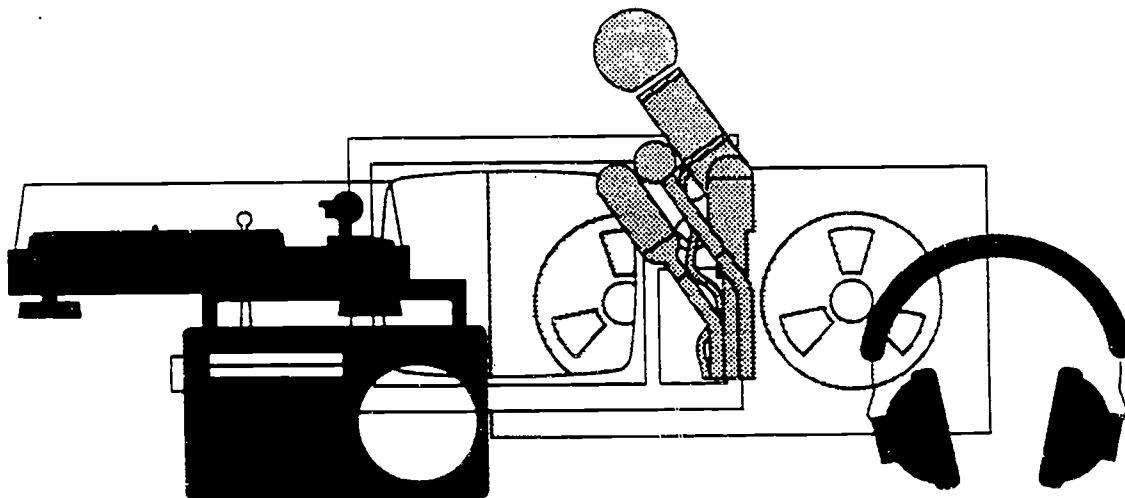

667

COMPUTER SYSTEMS

Workers in these computer occupations develop and write computer programs to store, locate, and retrieve specific documents, data, and information. They may also analyze business, scientific, and technical problems for application to electronic data processing systems. These careers generally require specialized training.

The largest occupations, which also have the greatest number of job openings annually, are:

- Systems analysts, electronic data processing
- Computer programmers

These occupations may not have a favorable outlook for the future. Overall, the number of these jobs is growing rapidly. A moderate number of job openings are expected over the next four or five years. Recently, there have been many more new trainees than job openings. If this trend continues, job seekers can expect to face keen competition. Placement rates at area vocational technical schools, community colleges, and/or technical institutes have been fair recently.

Hourly wages include:

- \$15.38 Computer programmers
- \$16.23 Systems analysts, electronic data processing

High school programs preparing for these occupations are:

- 07.0399 Miscellaneous business data processing

Related postsecondary programs at state-supported institutions in this area are:

- 07.0301 Electronic data processing, computer science
- 11.0701 Computer science

COSMETOLOGY

Cosmetologists and related workers provide beauty services for customers. These may include cutting and styling hair, treating hair and scalp, applying makeup, dressing wigs, or removing hair by electrolysis, as well as cleaning, shaping, and polishing a customer's fingernails and toenails.

The largest occupations, which also have the greatest number of job openings annually, are:

- Hairdressers, hairstylists, and cosmetologists
- Manicurists

These occupations may have a generally favorable outlook for the future. Overall, the number of these jobs is growing. Few job openings are expected over the next four or five years. Recently, there have been many more new trainees than job openings. Placement rates at area vocational technical schools, community colleges, and/or technical institutes have been very good recently.

High school programs preparing for these occupations are:

12.0403 Cosmetology

Related postsecondary programs at state-supported institutions in this area are:

12.0403 Cosmetology

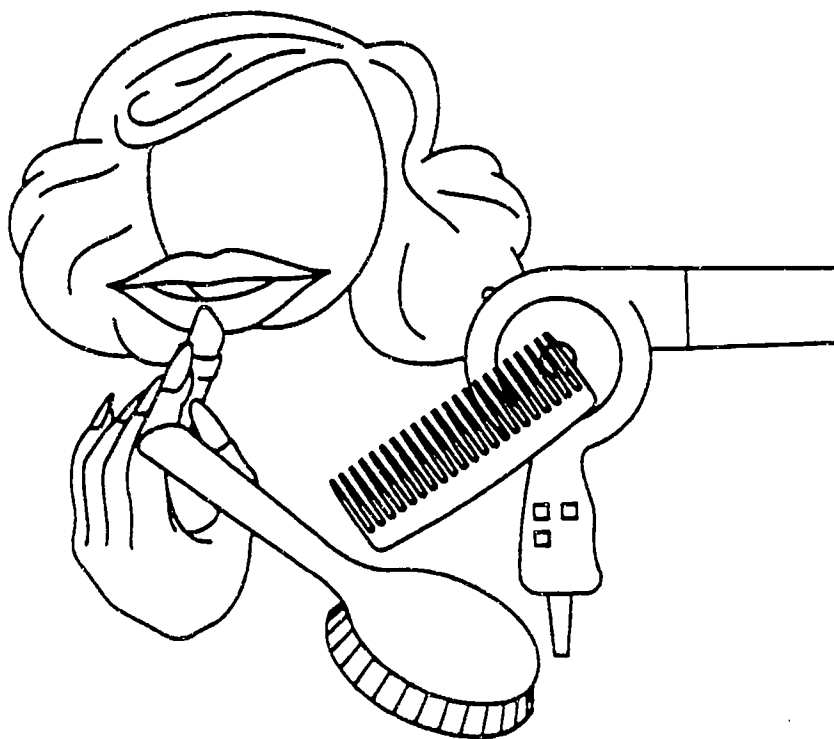

DENTAL ASSISTING

Dental assistants may perform a wide variety of clinical, office, and laboratory duties, depending on the size of the dental practice. Typically, assistants seat patients in the dental chair, prepare them for the dentist's treatment, and work with the dentist during examination and treatment.

This occupation may have a generally favorable outlook for the future. Few job openings are expected over the next four or five years. Recently, no training has been reported.

Licensing may be required. Contact: TENNESSEE BOARD OF DENTISTRY, 615-367-6228.

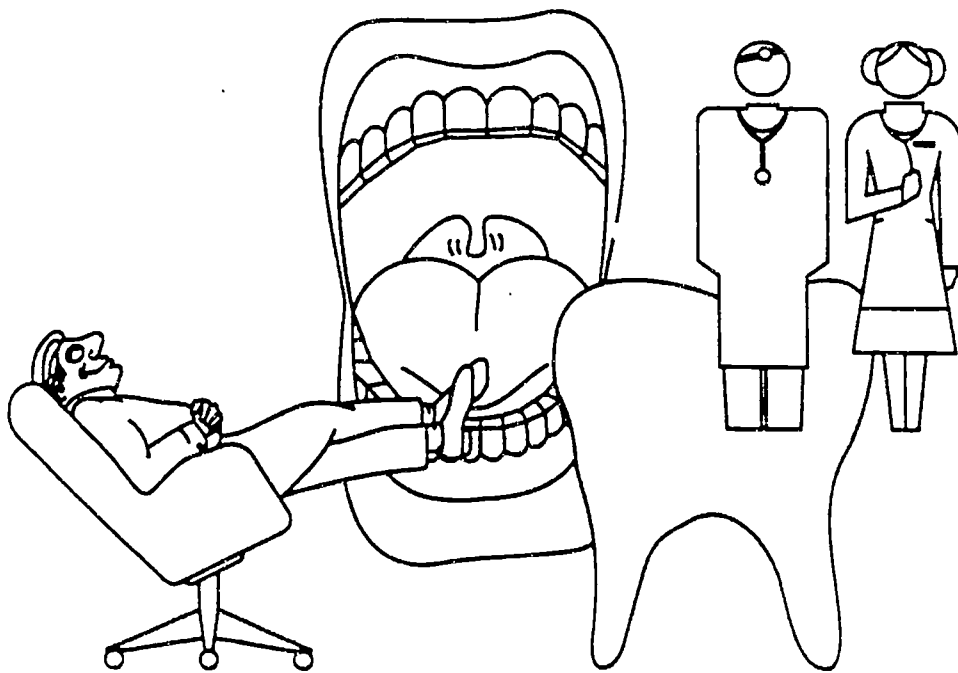

670

SDA 12 - 15

DRAFTING AND DESIGN TECHNOLOGY

Persons in drafting and design technology prepare clear, complete, and accurate working plans and detail drawings from rough or detailed sketches or notes for engineering or manufacturing purposes according to specified dimensions. Workers need to have knowledge of various machines, engineering practices, mathematics, building materials, and other physical sciences to complete drawings. Computer-assisted design (CAD) equipment may be used by some workers.

The largest occupations, which also have the greatest number of job openings annually, are:

- Cost estimators
- Drafters

These occupations may not have a favorable outlook for the future. Overall, the number of these jobs shows little change. Few job openings are expected over the next four or five years. Recently, there have been many more new trainees than job openings. Placement rates at area vocational technical schools, community colleges, and/or technical institutes have been fair recently.

Hourly wages include:

\$11.46 Drafters

High school programs preparing for these occupations are:

48.0101 Drafting

Related postsecondary programs at state-supported institutions in this area are:

48.0101 Drafting

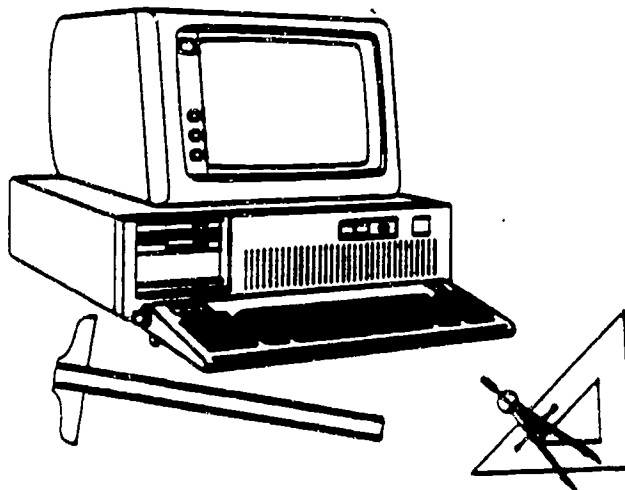

SDA 12 - 1671

DRYCLEANING

Workers in these occupations operate washing and drying machines to clean and dry clean commercial, industrial, or household articles; use pressing machines to press and shape articles; and identify stains and apply chemical solutions to remove them.

The largest occupations, which also have the greatest number of job openings annually, are:

- Laundry and drycleaning machine operators and tenders, except of pressing machines
- Operators and tenders of machines pressing textiles, garments, and related materials

These occupations may have a generally favorable outlook for the future. Overall, the number of these jobs is growing. Few job openings are expected over the next four or five years. Recently, no training has been reported.

Hourly wages include:

\$4.75 Laundry and drycleaning machine operators and tenders, except pressing

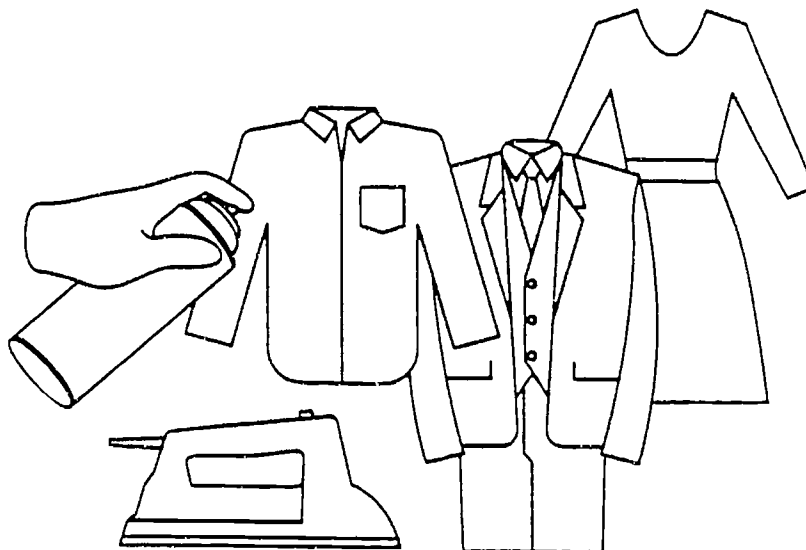

SDA 12 - 17⁶⁷²

EARLY CHILDHOOD EDUCATION

Child care workers and managers of child care centers assume responsibility for the safety, physical care, and emotional, social, and intellectual growth of preschool children and infants while parents are at work or are unavailable for other reasons. Some work in residential institutions for young children. Teacher aides assist teachers by handling routine paperwork or by working directly with children.

The largest occupations, which also have the greatest number of job openings annually, are:

- Teacher aides, paraprofessional
- Child care workers

These occupations may have a generally favorable outlook for the future. Overall, the number of these jobs is growing rapidly. Large numbers of job openings are expected over the next four or five years. Recently, there have been about as many new trainees as job openings. If this trend continues, job seekers can expect to face some competition. Placement rates at area vocational technical schools, community colleges, and/or technical institutes have been excellent recently.

High school programs preparing for these occupations are:

- 20.0201 Child care and guidance management services

Related postsecondary programs at state-supported institutions in this area are:

- 20.0201 Child care and guidance management services

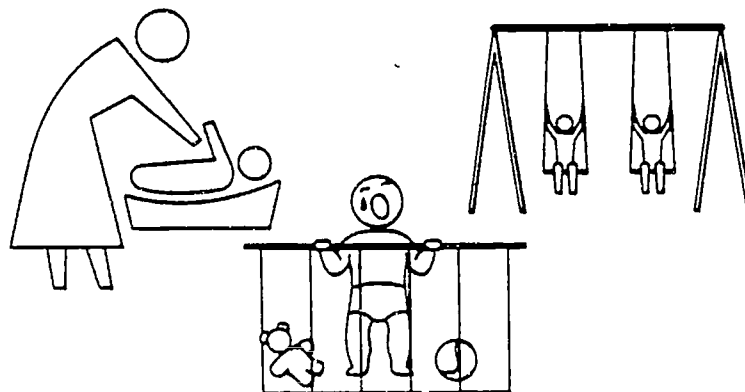

673

ELECTRICIAN OCCUPATIONS

Workers in the electrical field install, maintain, and repair wiring, electrical equipment, and fixtures or assist in such activities. These workers insure that work is in accordance with the relevant codes. A high school education is usually required and a five-year apprenticeship program is recommended.

The largest occupations, which also have the greatest number of job openings annually, are:

- Electricians
- Helpers of electricians and powerline transmission installers

These occupations may have a generally favorable outlook for the future. Overall, the number of these jobs is growing. A moderate number of job openings are expected over the next four or five years. Recently, there have been fewer new trainees than job openings. If this trend continues, job opportunities should be good.

Hourly wages include:

\$12.08 Electricians

High school programs preparing for these occupations are:

46.0302 Electrician

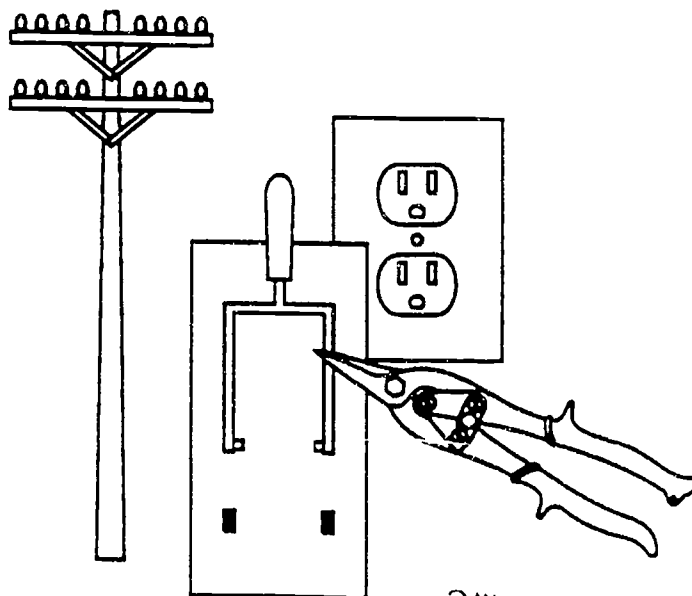

FIRE CONTROL AND SAFETY TECHNOLOGY

Workers in these positions help protect the public against the danger to their lives and property by fire. Firefighters must be prepared to respond to a fire and handle any emergency, including medical, that arises. Some firefighters operate fire apparatus, ambulances, emergency rescue vehicles, and fireboats. Most fire departments also are responsible for fire prevention.

The largest occupations, which also have the greatest number of job openings annually, are:

- Fire fighting and prevention supervisors
- Fire fighters

These occupations may have a generally favorable outlook for the future. Overall, the number of these jobs is growing. A moderate number of job openings are expected over the next four or five years. Recently, no training has been reported. Job opportunities should be good.

Hourly wages include:

\$9.13 Fire fighters

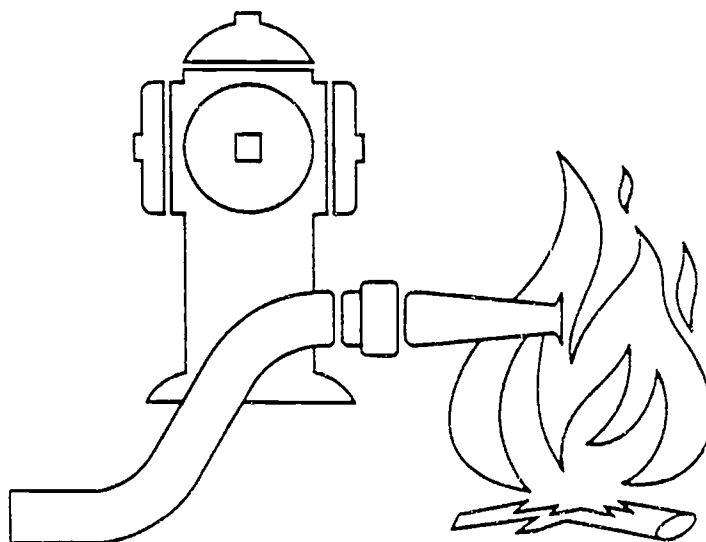

675

FOOD PREPARATION AND SERVICES

The majority of workers in these occupations prepare and serve food and beverages in restaurants, fast food establishments, catering firms, hotels, clubs, factories, school cafeterias, or hospitals, or supervise those providing food services. Others are factory machine operators involved in the preparation of food products. Dietetic technicians teach principles of food nutrition and provide dietary counseling to patients.

The largest occupations, which also have the greatest number of job openings annually, are:

- Food preparation workers
- Combined food preparation and service workers

These occupations may have a generally favorable outlook for the future. Overall, the number of these jobs is growing. Large numbers of job openings are expected over the next four or five years. Recently, there have been fewer new trainees than job openings. If this trend continues, job opportunities should be good. Placement rates at area vocational technical schools, community colleges, and/or technical institutes have been fair recently.

Hourly wages include:

- \$4.37 Cooks, specialty fast food
- \$4.82 Food preparation workers
- \$4.95 Cooks, restaurant

High school programs preparing for these occupations are:

- 20.0401 Food production, management, and services

Related postsecondary programs at state-supported institutions in this area are:

- 20.0401 Food production, management, and services

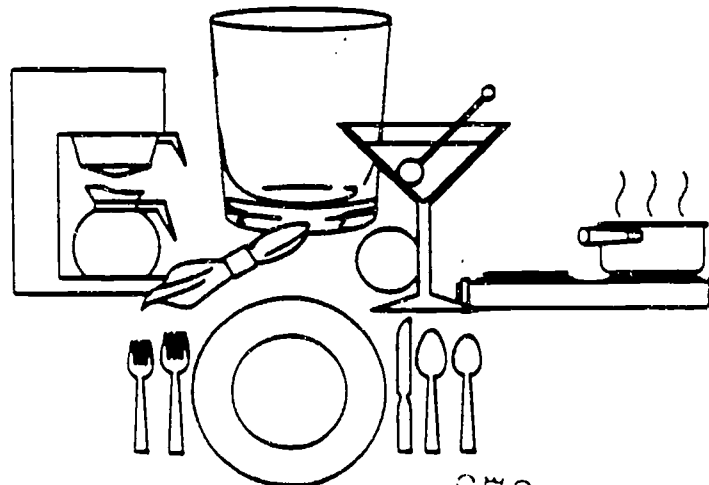

676

GENERAL BUSINESS AND MANAGEMENT

Workers in the general business and management occupations plan, organize, direct, control, or coordinate activities in all types of fields. Many occupations involve analysis of productivity and financial soundness. General managers and top executives usually have very diverse duties and responsibilities and work through departmental or subordinate executives.

The largest occupations, which also have the greatest number of job openings annually, are:

- Industrial production managers
- General managers and top executives

These occupations may not have a favorable outlook for the future. Overall, the number of these jobs is growing. Large numbers of job openings are expected over the next four or five years. Recently, there have been fewer new trainees than job openings. If this trend continues, job opportunities should be good. Placement rates at area vocational technical schools, community colleges, and/or technical institutes have been poor recently.

Hourly wages include:

- \$16.64 Purchasing managers
- \$16.99 Industrial production managers

Related postsecondary programs at state-supported institutions in this area are:

- 06.0401 Business administration and management
- 52.0201 General business administration and management



GENERAL WOODWORKING

Woodworkers are in occupations concerned with the complete cycle of cutting, shaping, and assembling parts of complex wood products. The occupations are primarily concerned with one or a limited number of machine functions according to their speciality.

The two largest occupations are:

- Assemblers and fabricators, except machine, electrical, electronic, and precision assembly
- Cabinetmakers and bench carpenters

The occupations expected to have the most job openings annually are:

- Assemblers and fabricators, except machine, electrical, electronic, and precision assembly
- Sawing machine operators and tenders

These occupations may have a generally favorable outlook for the future. Overall, the number of these jobs shows little change. A moderate number of job openings are expected over the next four or five years. Recently, there have been more new trainees than job openings. If this trend continues, job seekers can expect to face some competition.

High school programs preparing for these occupations are:

48.0701 Woodworking

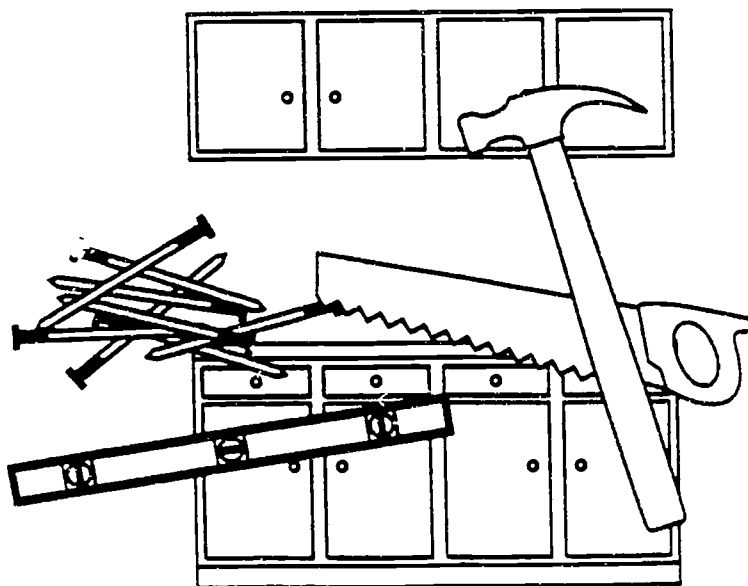

678

GRAPHIC ARTS

A majority of workers in this field are involved in offset printing. In this process the material to be printed is photographed and a printing plate is made from the film. This process has been advanced by the use of computers and lasers.

The two largest occupations are:

- Printing press machine operators and tenders
- Screen printing machine setters and set-up operators

The occupations expected to have the most job openings annually are:

- Printing press machine operators and tenders
- Bindery machine operators

These occupations may have a generally favorable outlook for the future. Overall, the number of these jobs is growing slowly. Few job openings are expected over the next four or five years. Recently, no training has been reported.

Hourly wages include:

\$7.39 Offset lithographic press, setters & set-up operators, sheet or web fed

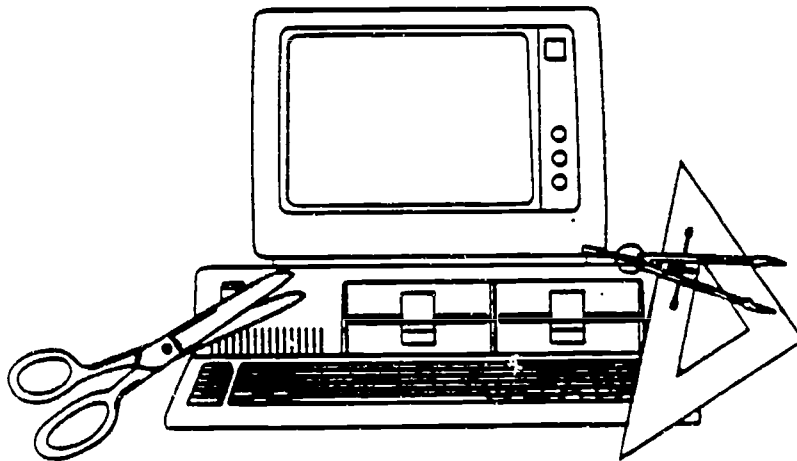

679

HEATING AND AIR CONDITIONING

Workers in this field install and repair heating, air conditioning, and refrigeration systems. They may install and repair oil burners, hot-air furnaces, and heating stoves in homes and businesses. They may also install and repair air conditioning systems, or install sheet metal ducts for the heating and cooling systems.

The largest occupations, which also have the greatest number of job openings annually, are:

- Heating, air conditioning, and refrigeration mechanics and installers
- Sheet metal duct installers

These occupations may not have a favorable outlook for the future. Overall, the number of these jobs is growing. Few job openings are expected over the next four or five years. Recently, there have been many more new trainees than job openings. Placement rates at area vocational technical schools, community colleges, and/or technical institutes have been good recently.

Hourly wages include:

\$11.58 Heating, air conditioning, and refrigeration mechanics and installers

High school programs preparing for these occupations are:

47.0201 Heating, air conditioning, and refrigeration mechanics

Related postsecondary programs at state-supported institutions in this area are:

47.0201 Heating, air conditioning, and refrigeration mechanics

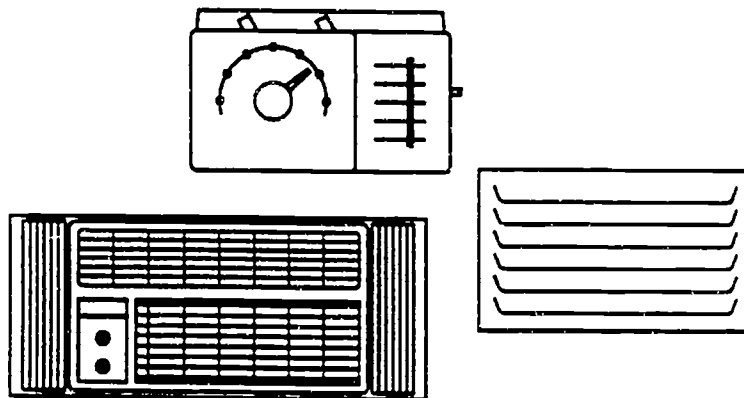

HEAVY TRUCK MAINTENANCE

Persons in heavy truck maintenance repair and maintain the operating condition of trucks, buses, and all types of diesel engines. This also includes mechanics working primarily with automobile diesel engines.

This occupation may have a generally favorable outlook for the future. Overall, the number of these jobs is growing. Few job openings are expected over the next four or five years. Recently, there have been fewer new trainees than job openings. Placement rates at area vocational technical schools, community colleges, and/or technical institutes have been good recently.

Average hourly wages are \$10.96

High school programs preparing for these occupations are:

47.0605 Diesel engine mechanics

Related postsecondary programs at state-supported institutions in this area are:

47.0302 Heavy equipment maintenance and repair

47.0605 Diesel engine mechanics

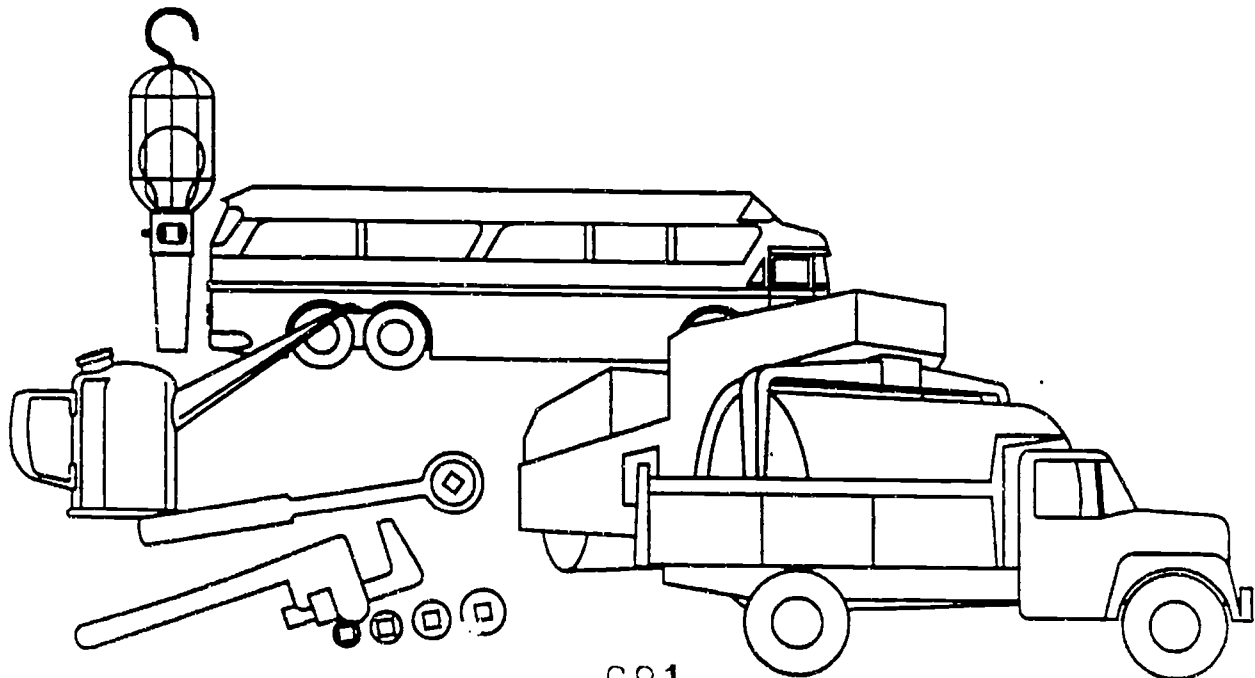

681

HORTICULTURE AND LANDSCAPING

The largest group of workers in these occupations, gardeners and groundskeepers, maintain the grounds of public and private property. Duties may include mowing, trimming, planting, and watering plants, shrubs, and grass.

The largest occupations, which also have the greatest number of job openings annually, are:

- Nursery workers
- Gardeners and groundskeepers, except farm workers

These occupations may not have a favorable outlook for the future. Overall, the number of these jobs is growing. A moderate number of job openings are expected over the next four or five years. Recently, there have been many more new trainees than job openings. If this trend continues, job seekers can expect to face keen competition.

Hourly wages include:

\$6.35 Gardeners and groundskeepers, except farm

High school programs preparing for these occupations are:

01.0601 Horticulture

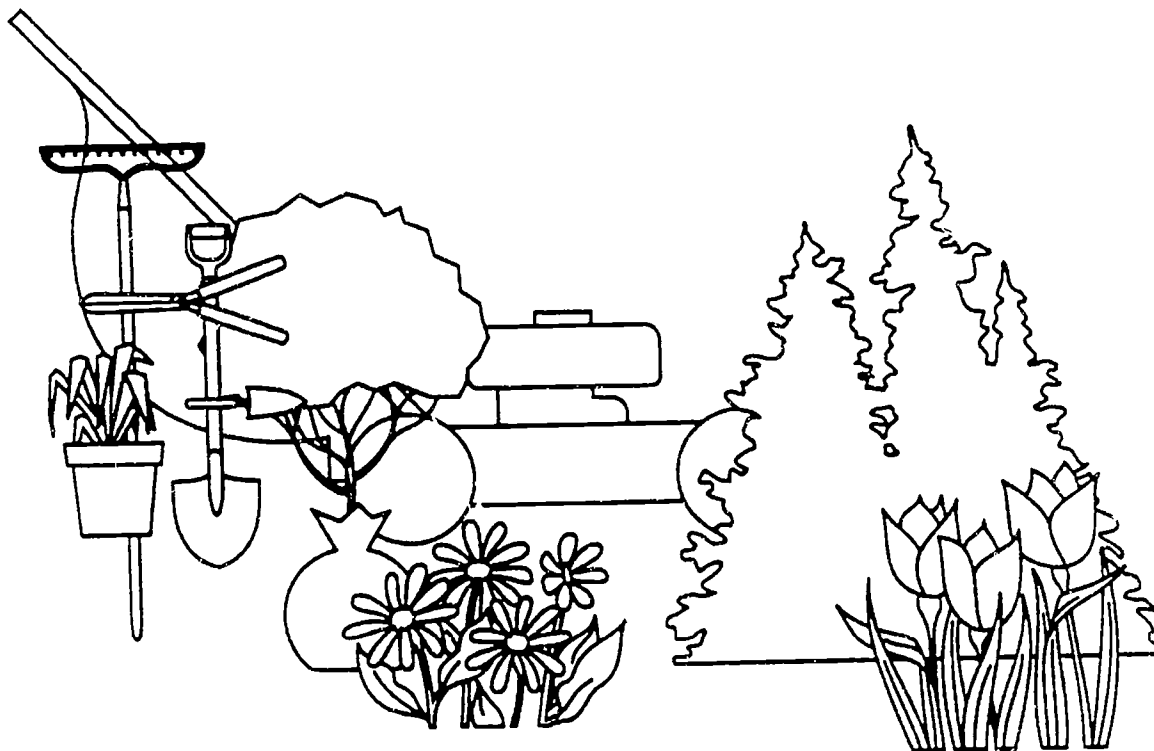

HOTEL AND RESTAURANT MANAGEMENT

Food service and lodging managers supervise the profitable operation of restaurants, hotels, and motels. Workers direct the varied activities of these businesses with the goal of pleasing people and providing good service to their customers.

This occupation may have a generally favorable outlook for the future. Overall, the number of these jobs is growing. A moderate number of job openings are expected over the next four or five years. Recently, no training has been reported. Job opportunities should be good.

Average hourly wages are \$8.59

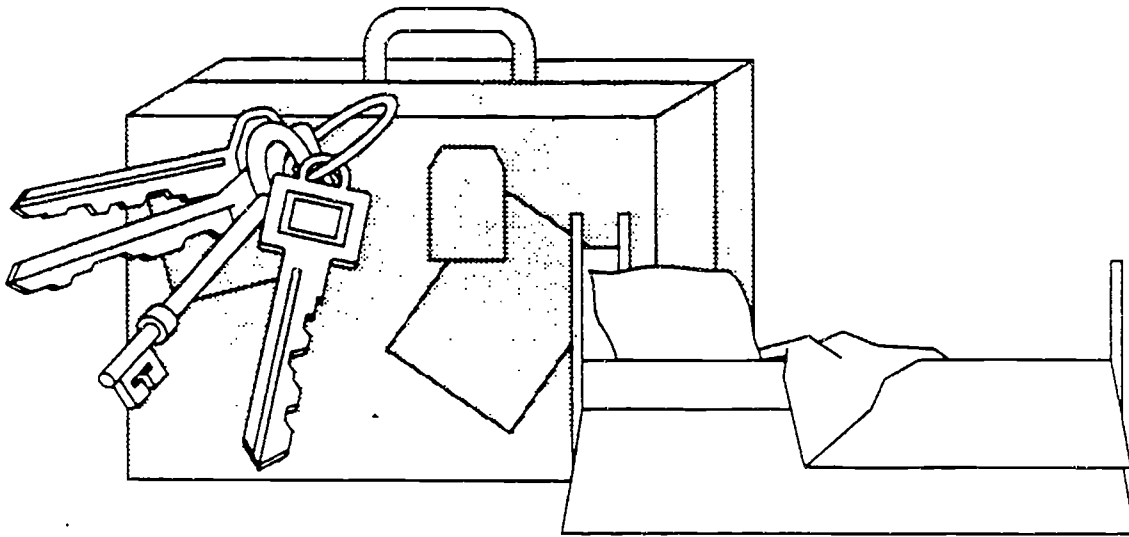

683

INDUSTRIAL MAINTENANCE TECHNOLOGY

Workers prevent costly waste of raw materials and the idling of human resources in a plant or factory by making industrial machinery repairs as quickly as possible. Maintenance mechanics spend considerable time doing preventive maintenance, including keeping machines well oiled and greased, and periodically cleaning parts.

The largest occupations, which also have the greatest number of job openings annually, are:

- Maintenance mechanics for industrial machinery
- Millwrights

These occupations may have a generally favorable outlook for the future. Overall, the number of these jobs is growing. A moderate number of job openings are expected over the next four or five years. Recently, there have been fewer new trainees than job openings. If this trend continues, job opportunities should be good. Placement rates at area vocational technical schools, community colleges, and/or technical institutes have been very good recently.

Hourly wages include:

\$10.68 Machinery maintenance mechanics

Related postsecondary programs at state-supported institutions in this area are:

47.0303 Industrial mechanics technology

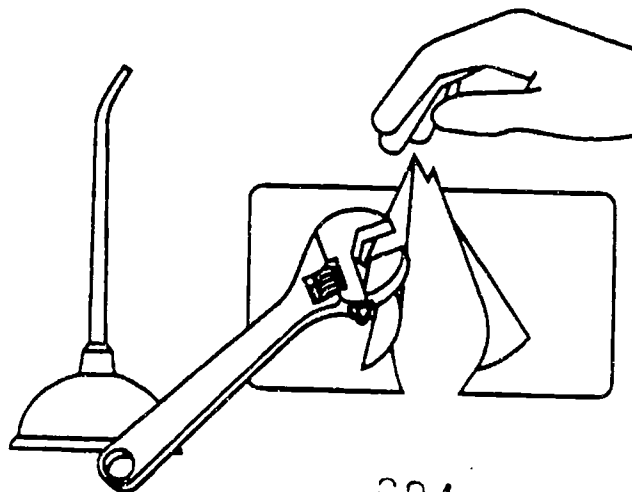

684

SDA 12 - 29

INSTITUTIONAL HOME MANAGEMENT AND SUPPORTING SERVICES

These workers make sure that all public buildings, offices, hospitals, stores, and apartment houses are kept clean and in good condition for the comfort and safety of the people who work or live there. Generally, no special education is required for occupations in this field, with most skills learned on the job.

The largest occupations, which also have the greatest number of job openings annually, are:

- Maids and housekeeping cleaners
- Janitors and cleaners, except maids and housekeeping cleaners

These occupations may have a generally favorable outlook for the future. Overall, the number of these jobs is growing. Large numbers of job openings are expected over the next four or five years. Recently, there have been fewer new trainees than job openings. If this trend continues, job opportunities should be good.

Hourly wages include:

- \$4.41 Maids and housekeeping cleaners
- \$5.87 Housekeepers
- \$6.10 Janitors and cleaners, except maids and housekeeping cleaners

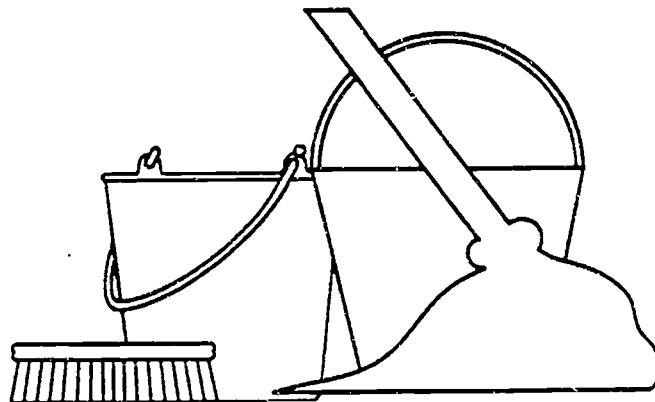

LABORATORY TECHNICIAN

Medical and clinical laboratory technicians perform routine laboratory tests for use in the treatment and diagnosis of disease; prepare vaccines, biologicals, and serums for prevention of disease; and prepare tissue samples, take blood samples, and execute laboratory tests including urinalyses and blood counts.

This occupation may have a generally favorable outlook for the future. Few job openings are expected over the next four or five years. Recently, there have been about as many new trainees as job openings. Placement rates at area vocational technical schools, community colleges, and/or technical institutes have been excellent recently.

Average hourly wages are \$10.94

Related postsecondary programs at state-supported institutions in this area are:

17.0309 Medical laboratory technology

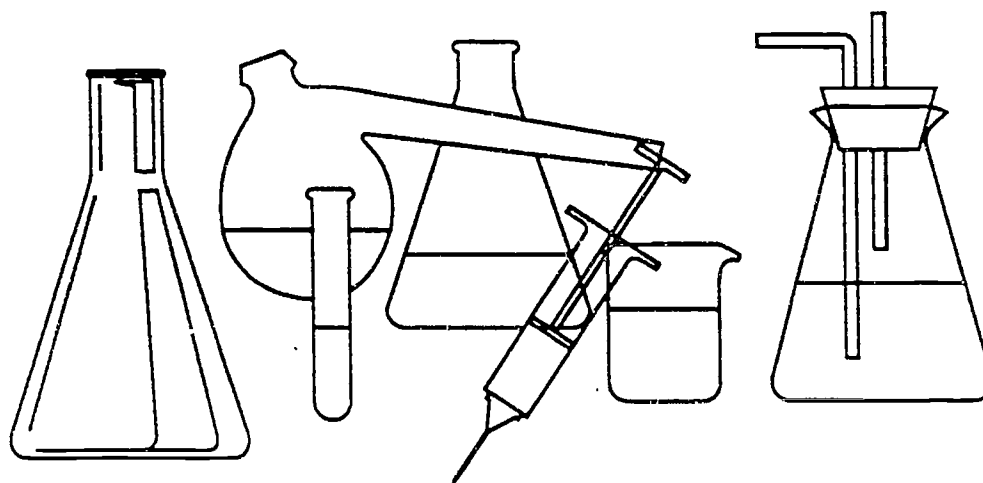

LAW ENFORCEMENT

People working at these occupations are responsible for the safety of Tennessee cities, towns, and highways. Their responsibilities range from controlling traffic to preventing and investigating crimes. Whether on or off duty, they are expected to exercise their authority whenever necessary.

The largest occupations, which also have the greatest number of job openings annually, are:

- Police patrol officers
- Sheriffs and deputy sheriffs

These occupations may have a generally favorable outlook for the future. Overall, the number of these jobs is growing slowly. A moderate number of job openings are expected over the next four or five years. Recently, there have been fewer new trainees than job openings. If this trend continues, job opportunities should be good.

Hourly wages include:

\$9.54 Police patrol officers

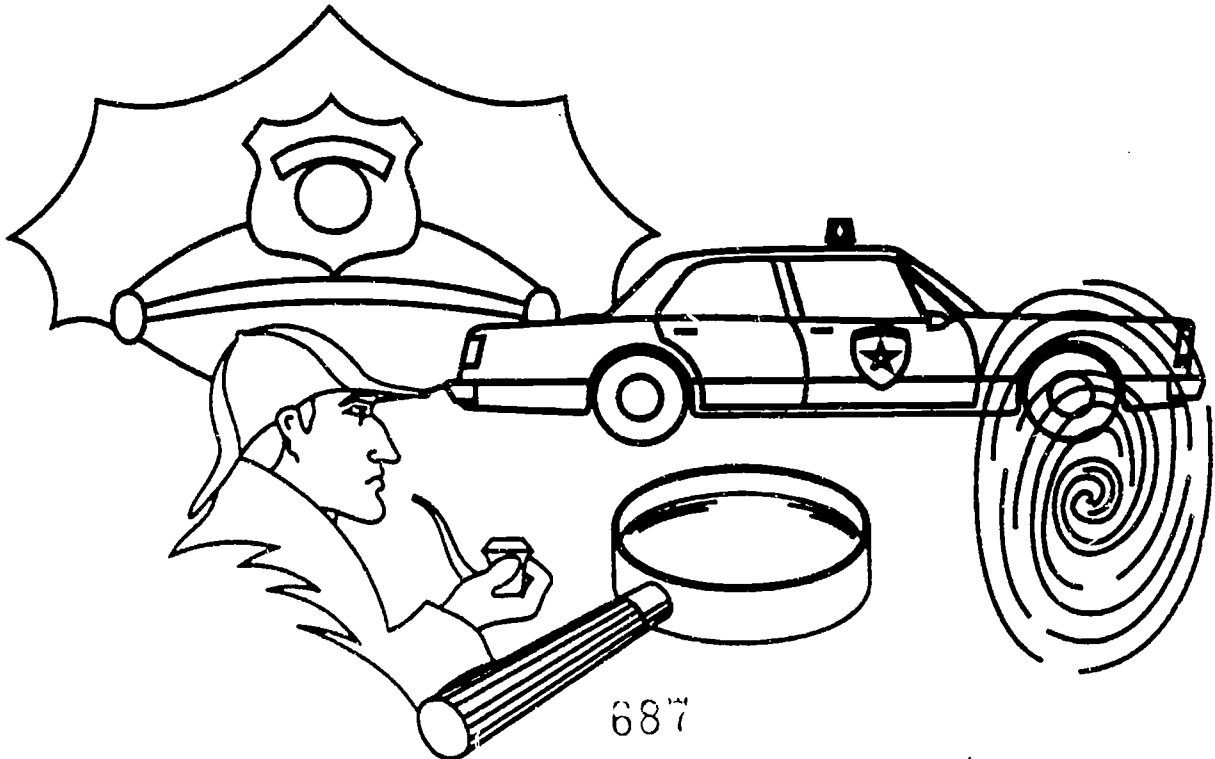

687

MACHINE TOOL TECHNOLOGY

Workers in these occupations make or set up and operate machine tools or repair metal parts. Machinists and tool-and-die makers create highly specialized precision tools, molds, and metal parts. Often they use blueprints to develop prototypes for tools or machines to be used in manufacturing.

The two largest occupations are:

- Machinists
- Machine tool cutting operators and tenders of metal and plastic

The occupations expected to have the most job openings annually are:

- Machinists
- Tool and die makers

These occupations may have a generally favorable outlook for the future. Overall, the number of these jobs is growing. Large numbers of job openings are expected over the next four or five years. Recently, there have been more new trainees than job openings. If this trend continues, job seekers can expect to face some competition. Placement rates at area vocational technical schools, community colleges, and/or technical institutes have been very good recently.

Hourly wages include:

- \$8.56 Combination machine tool operators and tenders, metal and plastic
- \$9.41 Machinists
- \$10.70 Numerical control machine tool operators and tenders, metal and plastic
- \$12.02 Tool and die makers

High school programs preparing for these occupations are:

- 48.0503 Machine tool operation and machine shop technology

Related postsecondary programs at state-supported institutions in this area are:

- 48.0501 Precision metal work
- 48.0503 Machine tool operation and machine shop technology
- 48.0507 Tool and die making

MEDICAL ASSISTING

Medical assistants perform a wide variety of clinical and administrative duties under the direction of physicians. Clinical duties may include taking and recording patients' vital signs and medical histories, preparing patients for examination by physicians, and explaining treatment procedures to patients.

In small physicians' offices they may keep medical records, schedule appointments, and order supplies. Electrocardiograph (EKG) technicians operate the EKG machines which provide graphic tracings of heartbeats.

The largest occupations, which also have the greatest number of job openings annually, are:

- Electrocardiograph technicians
- Medical assistants

These occupations may have a generally favorable outlook for the future. Few job openings are expected over the next four or five years. Recently, no training has been reported.

Hourly wages include:

\$6.86 Medical assistants

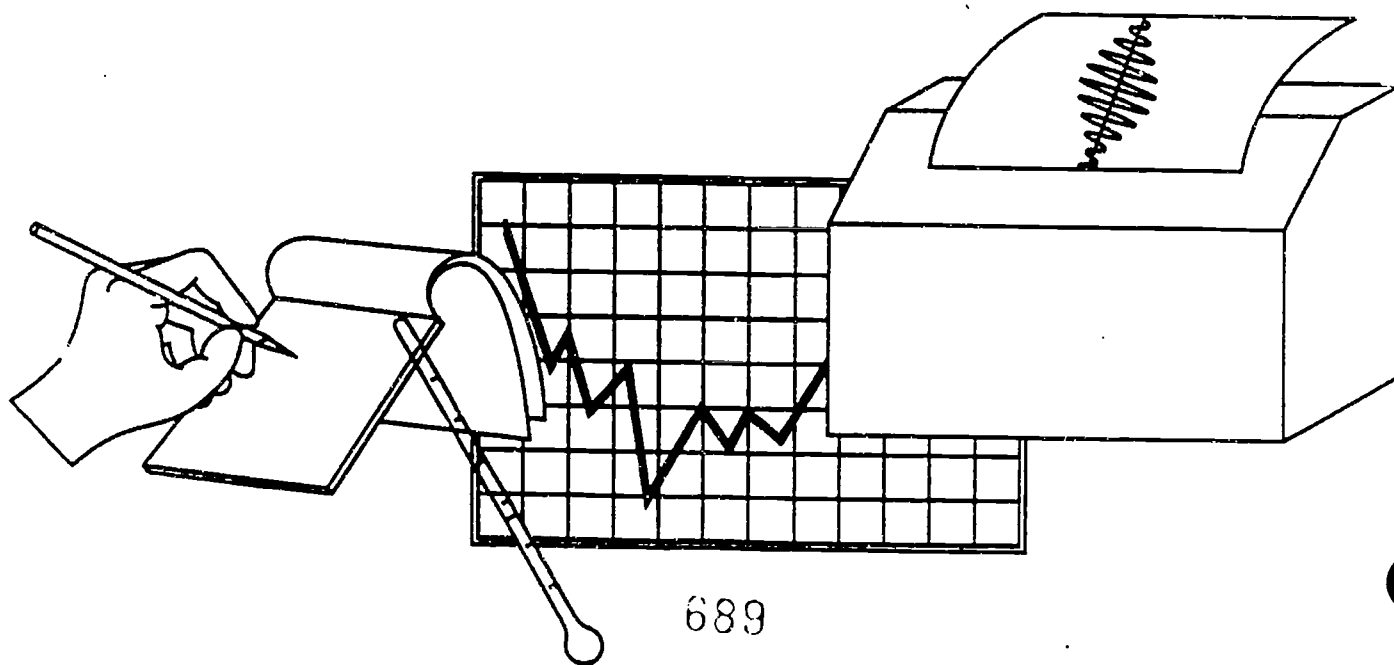

689

MEDICAL RECORDS TECHNOLOGY

Medical records technicians compile and maintain medical records of hospital and clinic patients. Such work is becoming increasingly important as this background information is used for medicare and medical insurance reimbursements.

This occupation may not have a favorable outlook for the future. Few job openings are expected over the next four or five years. Recently, no training has been reported.

Average hourly wages are \$6.28

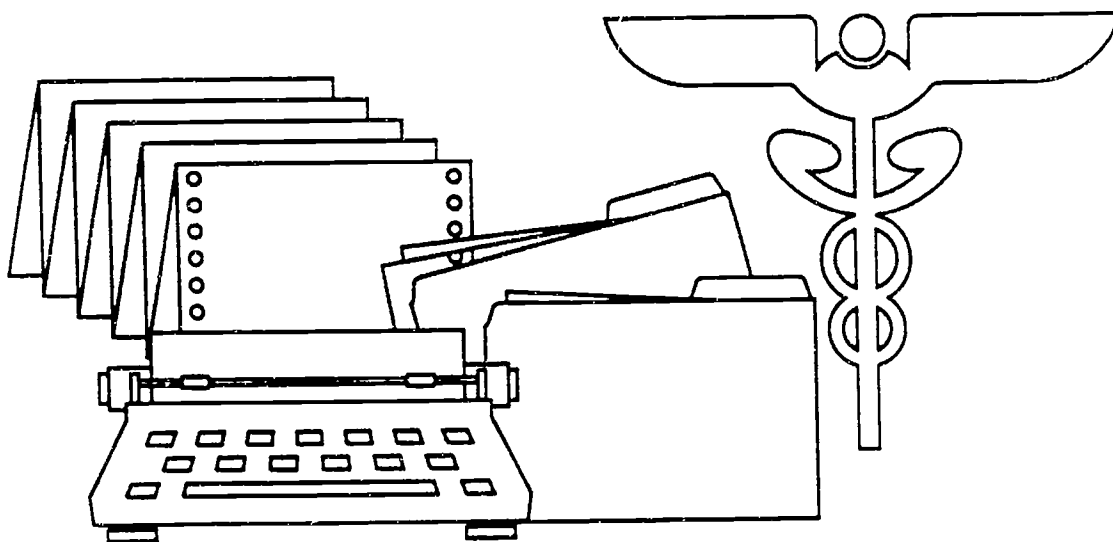

690

NURSING ASSISTANT

Nursing aides and orderlies work under the general direction of nursing or medical staff. In hospitals, they may answer patients' call bells, serve and collect food trays, feed patients, or set up equipment. In nursing homes, they are expected to sustain ongoing relations with patients.

The largest occupations, which also have the greatest number of job openings annually, are:

- Nursing aides, orderlies, and attendants
- Home health aides

These occupations may have a generally favorable outlook for the future. Overall, the number of these jobs is growing rapidly. Large numbers of job openings are expected over the next four or five years. Recently, there have been about as many new trainees as job openings. If this trend continues, job seekers can expect to face some competition. Placement rates at area vocational technical schools, community colleges, and/or technical institutes have been good recently.

Hourly wages include:

- \$4.73 Nursing aides, orderlies, and attendants
- \$7.62 Home health aides

High school programs preparing for these occupations are:

17.0602 Nursing assisting

Related postsecondary programs at state-supported institutions in this area are:

17.0602 Nursing assisting

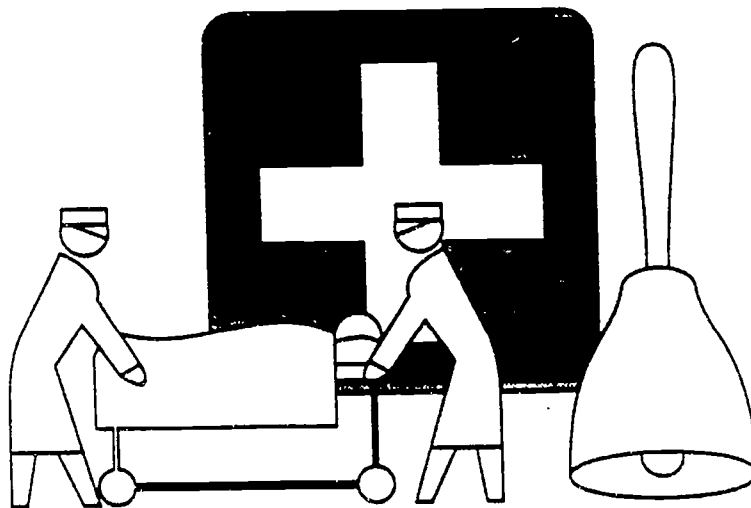

PLUMBING AND PIPEFITTING

Plumbers and pipefitters install and maintain the complex system of pipes that connect to the master system that runs underground. Although plumbing and pipefitting are sometimes considered a single trade, workers may specialize in either craft. Plumbers build and repair the water, waste disposal, drainage, and gas systems in homes and commercial/industrial buildings. Pipefitters build and repair both high and low pressure pipe.

The largest occupations, which also have the greatest number of job openings annually, are:

- Plumbers, pipefitters, and steamfitters
- Pipelayers

These occupations may have a generally favorable outlook for the future. Overall, the number of these jobs is growing slowly. Few job openings are expected over the next four or five years. Recently, there have been fewer new trainees than job openings. Placement rates at area vocational technical schools, community colleges, and/or technical institutes have been good recently.

Hourly wages include:

\$13.37 Plumbers, pipefitters, and steamfitters

Related postsecondary programs at state-supported institutions in this area are:

46.0501 Plumbing, pipefitting, and steamfitting
46.0503 Plumbing

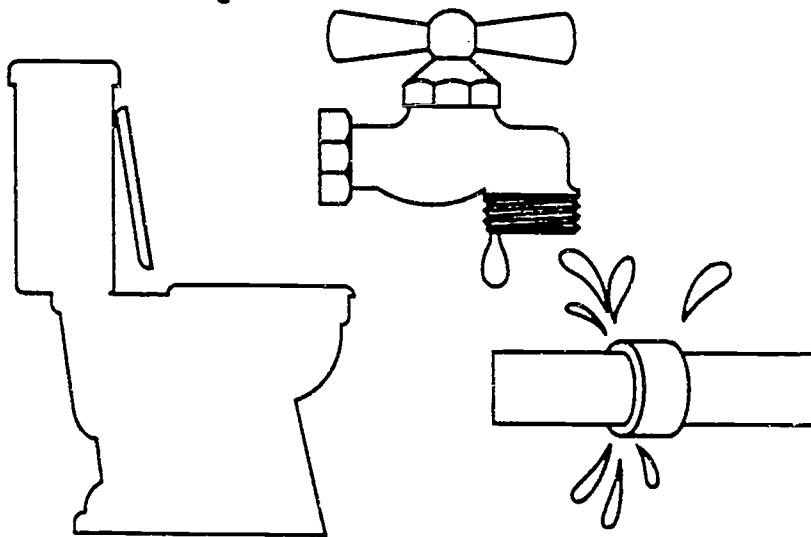

PRACTICAL NURSING

Licensed practical nurses (LPNs) work under the supervision of physicians and/or registered nurses to provide nursing care that requires technical knowledge but not the professional training of a registered nurse. They provide bedside care, administer certain medications, and assist in patient examinations.

This occupation may have a generally favorable outlook for the future. Overall, the number of these jobs is growing rapidly. A moderate number of job openings are expected over the next four or five years. Recently, there have been many more new trainees than job openings. If this trend continues, job seekers can expect to face keen competition. Placement rates at area vocational technical schools, community colleges, and/or technical institutes have been excellent recently.

Average hourly wages are \$8.69

Related postsecondary programs at state-supported institutions in this area are:

17.0605 Practical nursing

Licensing may be required. Contact: TENNESSEE BOARD OF NURSING, 615-367-6232.

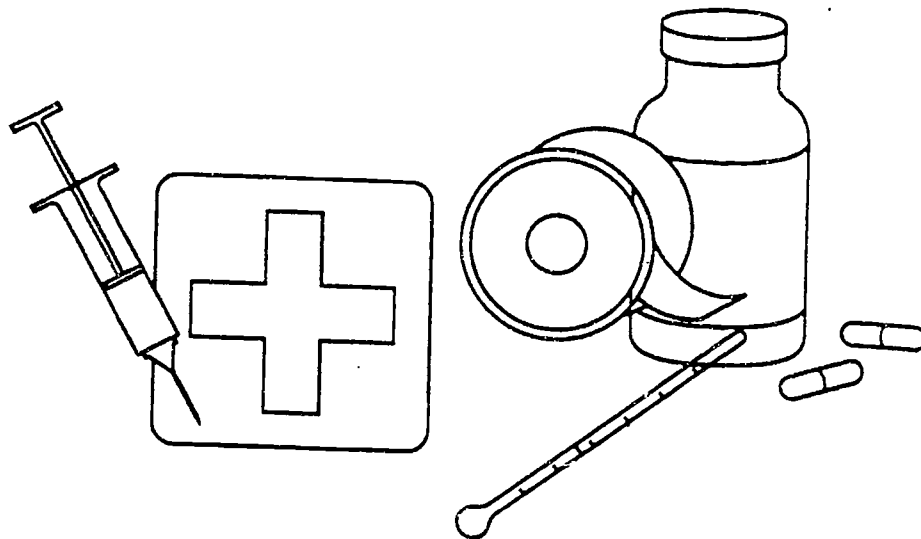

693

PROFESSIONAL NURSING

Registered Nurses (R.N.'s), the largest occupational group in this field, are primarily employed in hospitals and nursing homes, where they provide skilled bedside care and may supervise licensed practical nurses, nursing aides, and orderlies. Working under the direction of a licensed "supervising physician," physician assistants elicit detailed patient histories, perform physical examinations, and prescribe appropriate treatments.

The largest occupations, which also have the greatest number of job openings annually, are:

- Registered nurses
- Physician's assistants

These occupations may have a generally favorable outlook for the future. Overall, the number of these jobs is growing rapidly. Large numbers of job openings are expected over the next four or five years. Recently, there have been fewer new trainees than job openings. If this trend continues, job opportunities should be good.

Hourly wages include:

\$13.44 Registered nurses

Related postsecondary programs at state-supported institutions in this area are:

51.1601 Nursing (R.N. training)

Licensing may be required. Contact: TENNESSEE BOARD OF MEDICAL EXAMINERS-COMMITTEE ON PHYSICIAN ASSISTANTS, 615-367-6250.

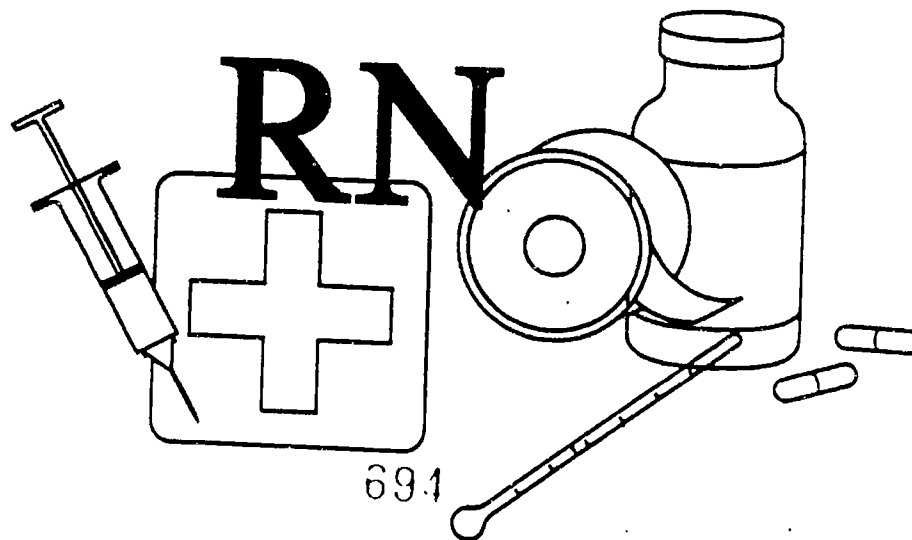

694

PUBLIC ADMINISTRATION

Individuals in this field are responsible for the management of diverse areas of governmental organizations. These managers usually work through departmental executives or subordinates in coordinating the various activities and groups they control. Public administration chief executives, legislators, and general administrators establish government policy and develop federal, state, or local regulations, rules, and laws.

The two largest occupations are:

- Public administration chief executives, legislators, and general administrators
- General managers and top executives

The occupations expected to have the most job openings annually are:

- Public administration chief executives, legislators, and general administrators
- Management analysts

These occupations may not have a favorable outlook for the future. Overall, the number of these jobs shows little change. Few job openings are expected over the next four or five years. Recently, there have been many more new trainees than job openings.

High school programs preparing for these occupations are:

43.0103 Criminal justice and law enforcement administration

Related postsecondary programs at state-supported institutions in this area are:

43.0103 Criminal justice and law enforcement administration

44.0401 Public administration



695

RADIOGRAPHIC MEDICAL TECHNOLOGY

Workers in this field operate equipment including x-ray machines, fluoroscopes, ultrasonic scanners, computed tomography (CT) scanners, and nuclear magnetic resonance (MRI) machines for diagnostic imagery of the human body or for therapy.

The largest occupations, which also have the greatest number of job openings annually, are:

- Radiologic technologists
- Radiologic technicians

These occupations may have a generally favorable outlook for the future. Few job openings are expected over the next four or five years. Recently, there have been more new trainees than job openings. Placement rates at area vocational technical schools, community colleges, and/or technical institutes have been excellent recently.

Hourly wages include:

\$11.27 Radiologic technicians

Related postsecondary programs at state-supported institutions in this area are:

17.0209 Radiologic medical technology

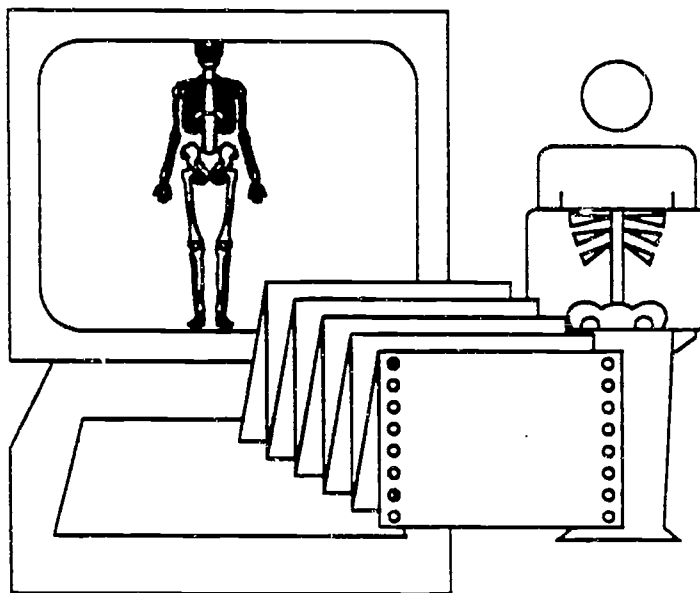

696

RECREATIONAL LEADERSHIP

Workers in recreational leadership occupations conduct recreational activities with groups, consider the interests of participants, and organize and promote activities. A large proportion of recreational workers are employed in city recreation departments and in state and national parks.

This occupation may have a generally favorable outlook for the future. Overall, the number of these jobs is growing. Few job openings are expected over the next four or five years. Recently, no training has been reported.



SALES AND MERCHANDISING

Workers in sales and merchandising occupations promote and sell a wide variety of merchandise and services. They also receive, store, display, and inventory products to be sold.

The largest occupations, which also have the greatest number of job openings annually, are:

- Salespersons in retail establishments
- Cashiers

These occupations may have a generally favorable outlook for the future. Overall, the number of these jobs is growing. Large numbers of job openings are expected over the next four or five years. Recently, there have been fewer new trainees than job openings. If this trend continues, job opportunities should be good.

Hourly wages include:

\$4.92	Cashiers
\$5.57	Counter and rental clerks
\$5.69	Salespersons, retail
\$9.86	Customer service representatives, utilities
\$10.96	Wholesale and retail buyers, except farm products
\$11.72	Driver/sales workers
\$15.46	Purchasing agents- except wholesale, retail, and farm products

High school programs preparing for these occupations are:

08.0700 General marketing

Licensing may be required. Contact: TENNESSEE DEPARTMENT OF COMMERCE AND INSURANCE, 615-741-2693.

SECURITY SERVICES

Security guards, the largest occupation in this field, patrol and inspect property to protect it against fire, theft, vandalism, and illegal entry. Guards and doorkeepers usually are uniformed and often carry a nightstick and a weapon; correctional officers and jailers maintain order in correctional institutions, enforce institutional rules and regulations, and may supplement the counseling inmates receive from mental health professionals.

The largest occupations, which also have the greatest number of job openings annually, are:

- Correction officers and jailers
- Guards and watch guards

These occupations may have a generally favorable outlook for the future. Overall, the number of these jobs is growing. A moderate number of job openings are expected over the next four or five years. Recently, there have been more new trainees than job openings. If this trend continues, job seekers can expect to face some competition.

Hourly wages include:

- \$7.48 Correction officers and jailers
- \$8.05 Guards and watch guards

High school programs preparing for these occupations are:

- 43.0105 Criminal justice technology

Licensing may be required. Contact: COUNTY COURT CLERK'S OFFICE.

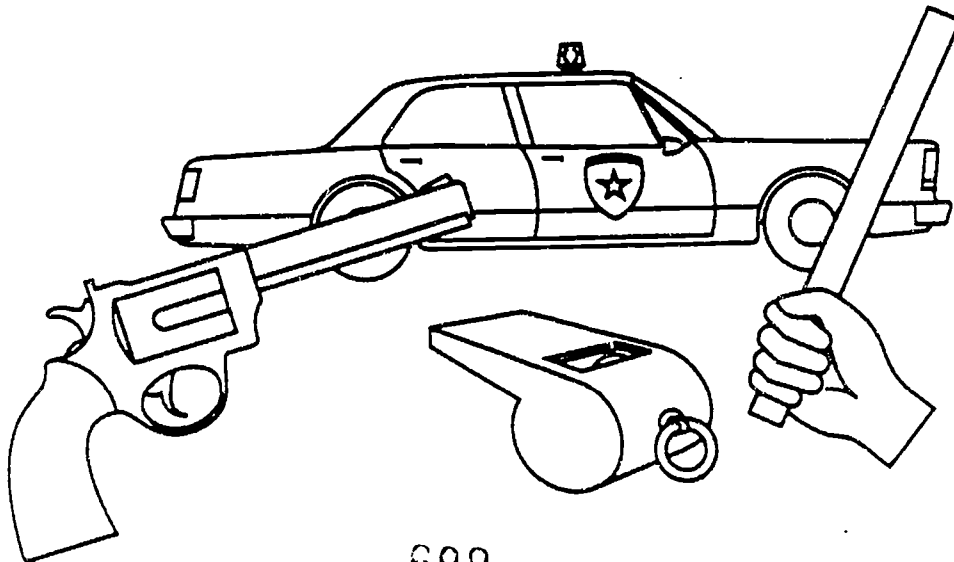

SHEET METAL

Sheet metal workers make, install, and maintain a variety of sheet metal products for home, commercial, and industrial buildings. These products include ducts for air conditioning, heating, and ventilating and pollution control systems, kitchen equipment, roofs, siding, rain gutters, skylights, and outdoor signs. Other workers use a variety of machines in the mass production of sheet-metal products.

The two largest occupations are:

- Machine forming operators and tenders of metal and plastic
- Assemblers and fabricators, except machine, electrical, electronic, and precision assembly

The occupations expected to have the most job openings annually are:

- Machine forming operators and tenders of metal and plastic
- Sheet metal workers

These occupations may have a generally favorable outlook for the future. Overall, the number of these jobs shows little change. A moderate number of job openings are expected over the next four or five years. Recently, there have been fewer new trainees than job openings. If this trend continues, job opportunities should be good.

Hourly wages include:

\$9.92 Sheet metal workers

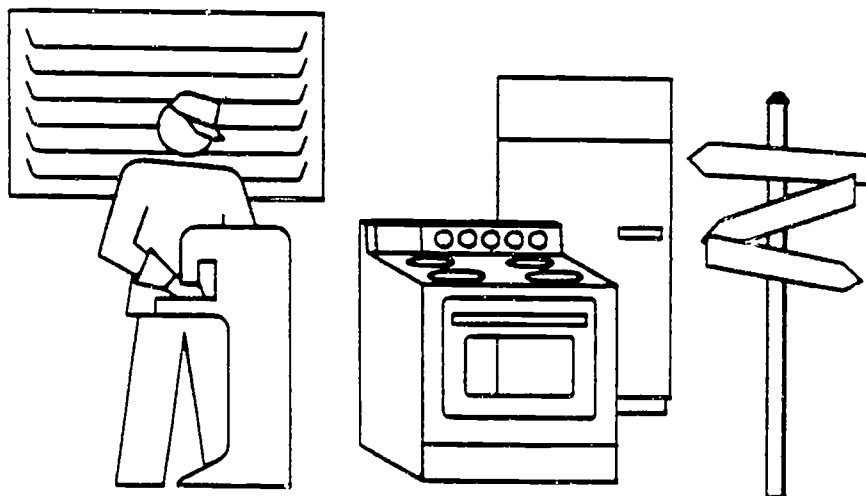

700
SDA 12 - 45

TRUCK, BUS, AND HEAVY EQUIPMENT OPERATION

These occupations include truck drivers who transport goods, bus drivers who transport passengers, and heavy equipment operators who use machinery to move construction materials and other goods over short distances--around a factory, construction site or loading dock.

The largest occupations, which also have the greatest number of job openings annually, are:

- Truck drivers of heavy or tractor trailer trucks
- School bus drivers

These occupations may have a generally favorable outlook for the future. Overall, the number of these jobs is growing. Large numbers of job openings are expected over the next four or five years. Recently, there have been fewer new trainees than job openings. If this trend continues, job opportunities should be good. Placement rates at area vocational technical schools, community colleges, and/or technical institutes have been fair recently.

Hourly wages include:

- \$8.99 Truck drivers, heavy or tractor trailer
- \$9.08 Grader, dozer, and scraper operators

Related postsecondary programs at state-supported institutions in this area are:

- 49.0205 Truck and bus driving

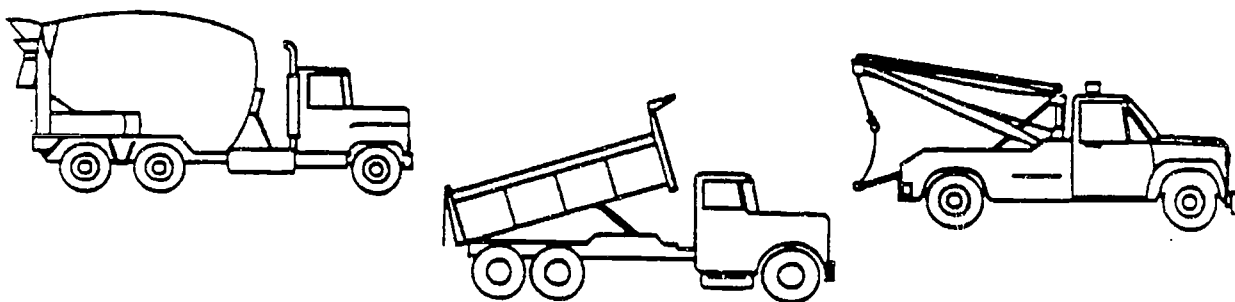

WELDING TECHNOLOGY

Welding is the most common way of permanently joining metal parts. Typically, heat is applied to the metal pieces to be joined; the parts are melted and fused to form a permanent bond. Welding is used to construct and repair parts of ships, automobiles, spacecraft, and thousands of products. It can also be used to join beams and steel reinforcing rods in buildings, bridges, and highways.

The two largest occupations are:

- Welders and cutters
- Welding machine setters and set-up operators

The occupations expected to have the most job openings annually are:

- Welders and cutters
- Welding machine operators and tenders

These occupations may not have a favorable outlook for the future. Overall, the number of these jobs is growing. A moderate number of job openings are expected over the next four or five years. Recently, there have been many more new trainees than job openings. If this trend continues, job seekers can expect to face keen competition. Placement rates at area vocational technical schools, community colleges, and/or technical institutes have been good recently.

Hourly wages include:

\$10.47 Welders and cutters

High school programs preparing for these occupations are:

48.0508 Welding, brazing, and soldering

Related postsecondary programs at state-supported institutions in this area are:

48.0508 Welding, brazing, and soldering

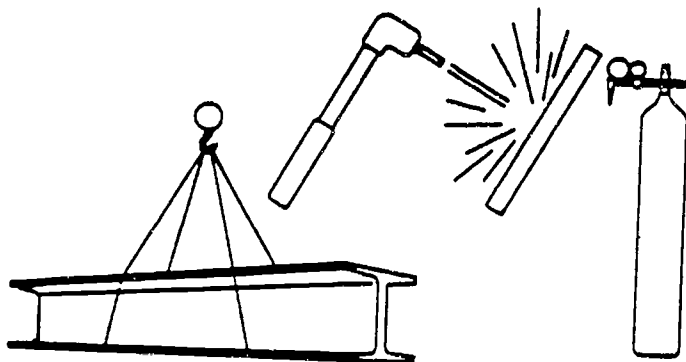

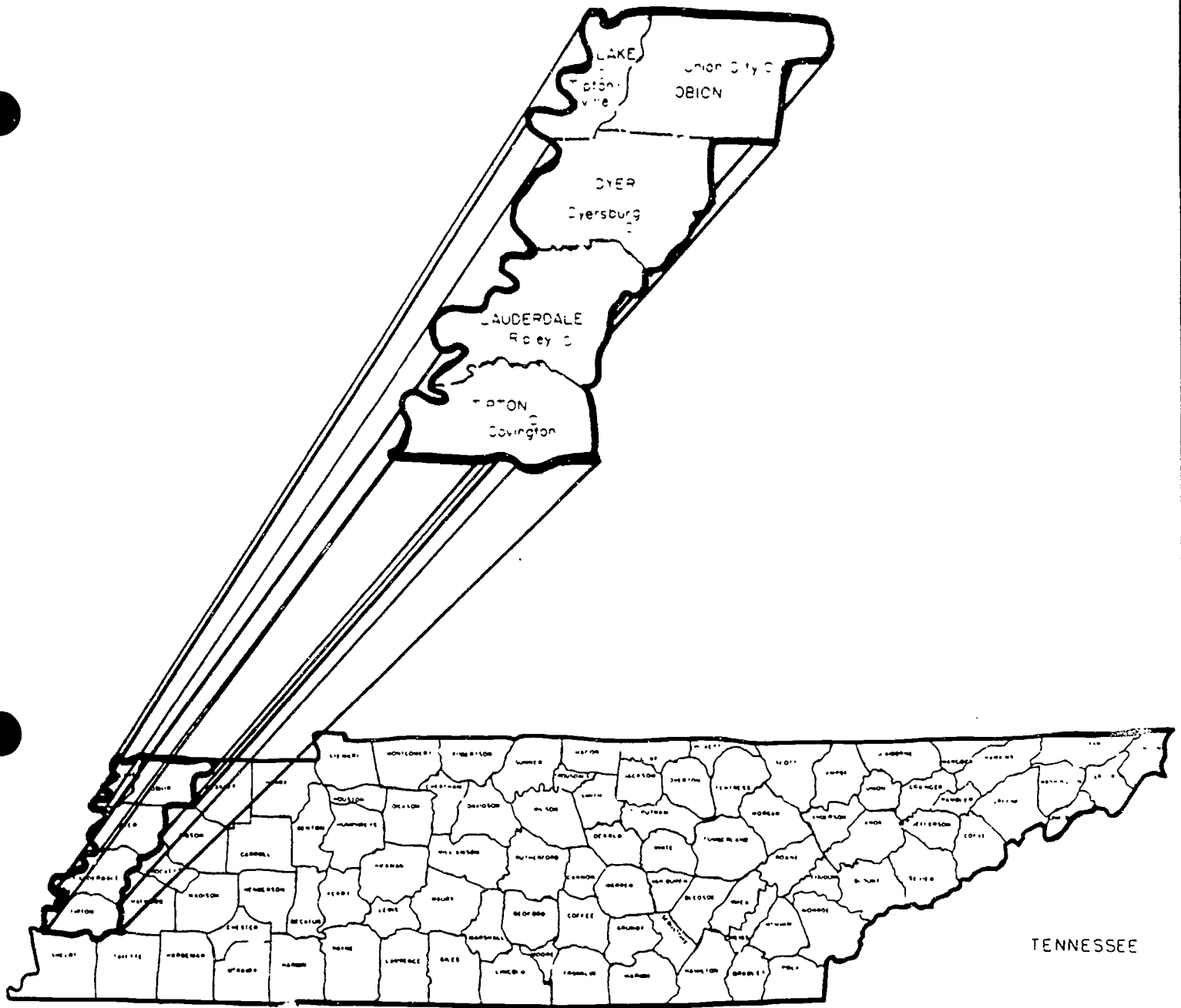

Service Delivery Area 13

ACCOUNTING AND FINANCIAL MANAGEMENT

Many individuals in this group are accountants and auditors who prepare and analyze business records and financial reports which are needed for effective management of any organization. Financial managers, another occupation in this group, typically plan, organize, control, or coordinate the financial activities of an organization.

The largest occupations, which also have the greatest number of job openings annually, are:

- Financial managers
- Accountants and auditors

These occupations may have a generally favorable outlook for the future. Overall, the number of these jobs is growing. A moderate number of job openings are expected over the next four or five years. Recently, no training has been reported. Job opportunities should be good.

Hourly wages include:

\$11.13 Accountants and auditors
\$19.60 Financial managers

Licensing may be required. Contact: TENNESSEE BOARD OF ACCOUNTANCY, 615-741-2250.

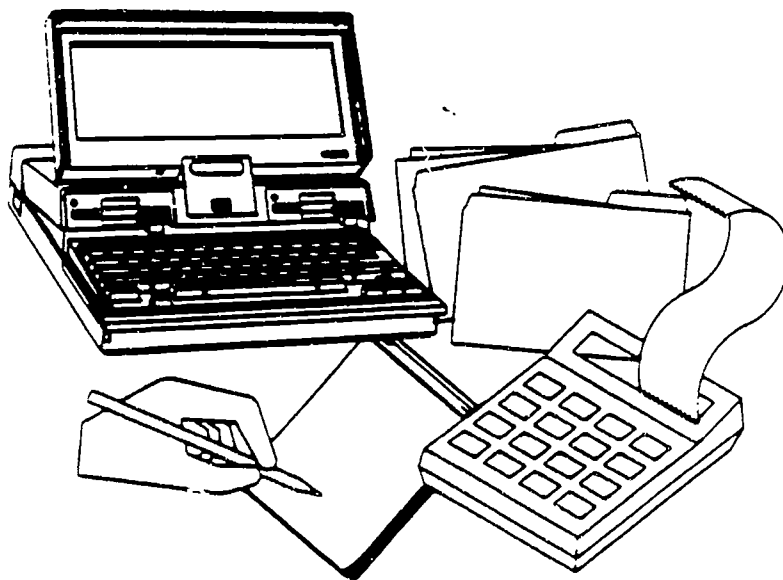

SDA 13 - 704

ADMINISTRATIVE SUPPORT: ACCOUNTING

Persons employed in this group of occupations provide clerical and administrative support to accountants and auditors. Most of these jobs require only a high school diploma for entry.

The largest occupations, which also have the greatest number of job openings annually, are:

- Bookkeeping, accounting, and auditing clerks
- Payroll and timekeeping clerks

These occupations may have a generally favorable outlook for the future. Overall, the number of these jobs is declining. Few job openings are expected over the next four or five years. Recently, no training has been reported.

Hourly wages include:

- \$7.85 Payroll and timekeeping clerks
- \$8.01 Bookkeeping, accounting, and auditing clerks

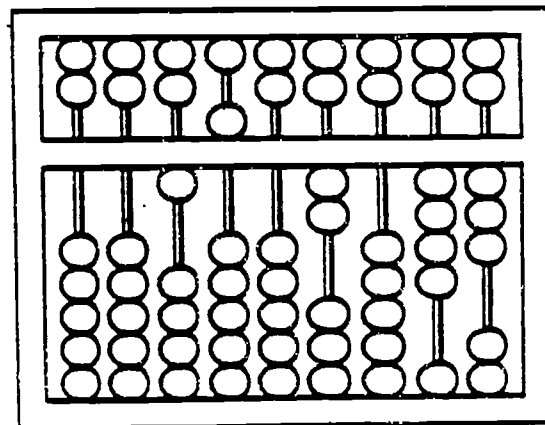
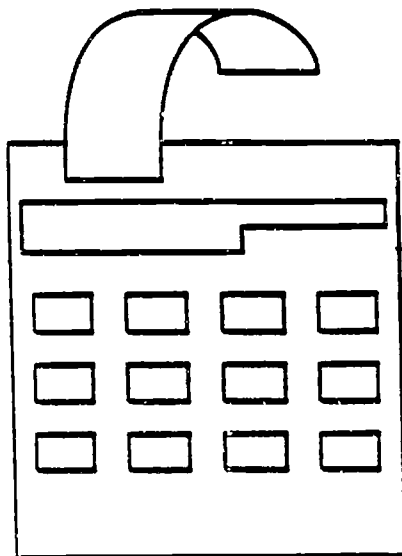

(11)

ADMINISTRATIVE SUPPORT: FINANCE AND INSURANCE

Workers provide clerical and general administrative support to the banking and finance industry. Workers receive and pay out money, keep records of money and negotiable instruments, interview applicants for credit, locate and notify customers of delinquent accounts, examine insurance claims, and process a variety of paperwork.

The two largest occupations are:

- Tellers
- Loan and credit clerks

The occupations expected to have the most job openings annually are:

- Tellers
- Bill and account collectors

These occupations may have a generally favorable outlook for the future. Overall, the number of these jobs shows little change. Few job openings are expected over the next four or five years. Recently, no training has been reported.

Hourly wages include:

- \$5.59 Tellers
- \$11.32 Loan and credit clerks

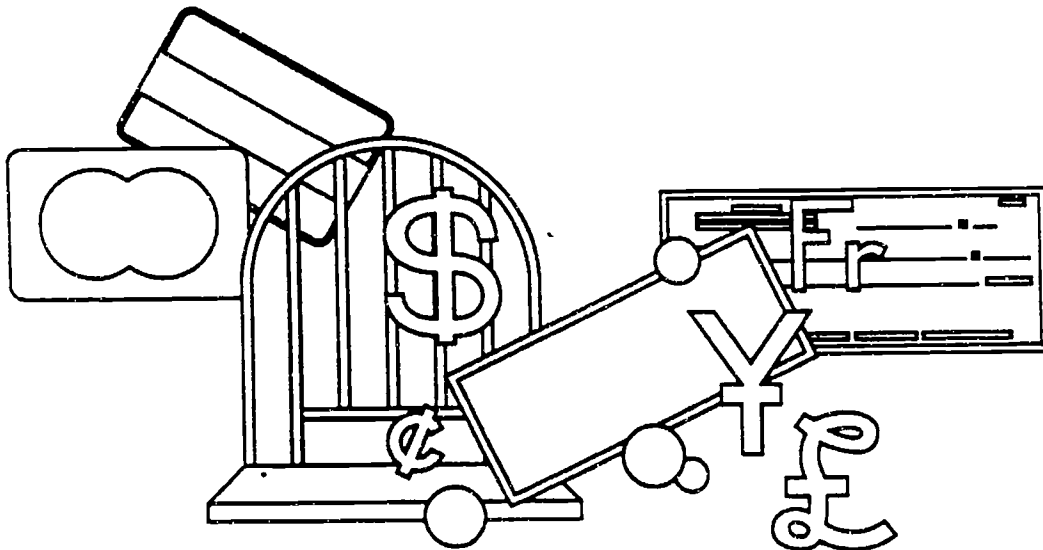

706

ADMINISTRATIVE SUPPORT: GENERAL

The job duties in this group of occupations are very diverse and are determined by the type of firm. For example, workers may schedule appointments, give information to callers, take dictation, type correspondence, read and route incoming mail, file correspondence and other records, and supervise and coordinate the activities of subordinate clerical workers.

The largest occupations, which also have the greatest number of job openings annually, are:

- Secretaries, except legal and medical secretaries
- General office clerks

These occupations may not have a favorable outlook for the future. Overall, the number of these jobs is growing. Large numbers of job openings are expected over the next four or five years. Recently, there have been many more new trainees than job openings. If this trend continues, job seekers can expect to face keen competition. Placement rates at area vocational technical schools, community colleges, and/or technical institutes have been good recently.

Hourly wages include:

- \$5.40 File clerks
- \$6.23 Receptionists and information clerks
- \$6.29 Data entry keyers, except composing
- \$6.67 General office clerks
- \$7.34 Order clerks- materials, merchandise, and service
- \$8.21 Secretaries, ex. legal and medical
- \$8.52 Medical secretaries
- \$14.73 First line supervisors and manager/supervisors- clerical and administrative support occupations

High school programs preparing for these occupations are:

- 07.0601 Secretarial and related programs
- 07.0701 Typing, general office and related programs

Related postsecondary programs at state-supported institutions in this area are:

- 07.9999 Miscellaneous business administrative support

AGRICULTURAL PRODUCTION

Workers in this field plan and economically use facilities, land, water, machinery, chemicals, finance, and labor in the production of plant and animal products.

The largest occupations, which also have the greatest number of job openings annually, are:

- Farm managers
- Farm workers

These occupations may not have a favorable outlook for the future. Overall, the number of these jobs shows little change. Few job openings are expected over the next four or five years. Recently, there have been many more new trainees than job openings.

High school programs preparing for these occupations are:

01.0301 Agricultural production

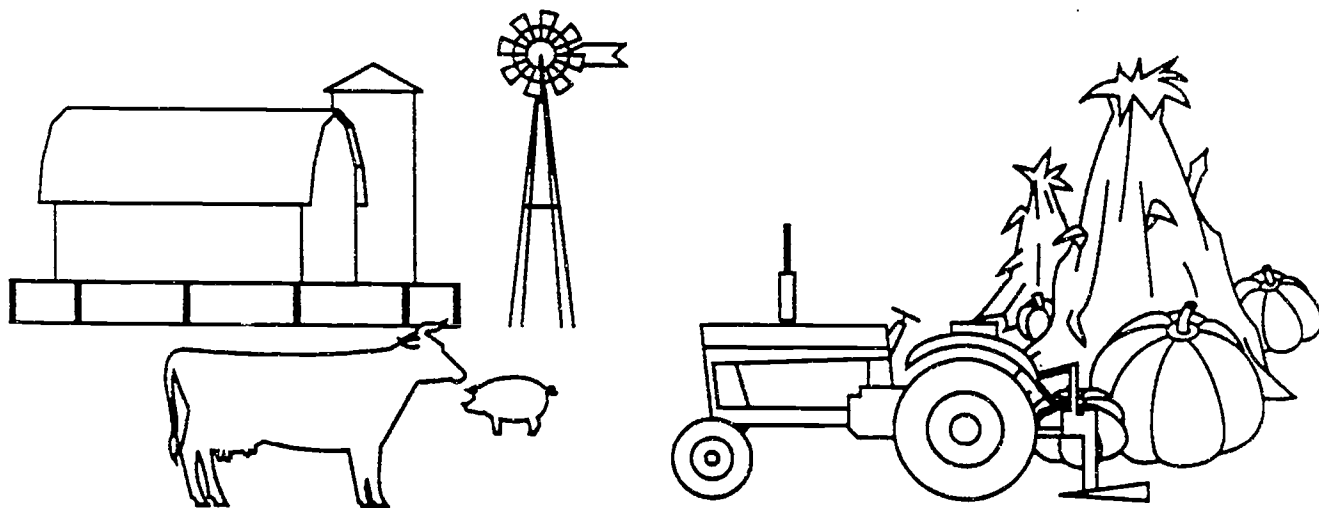

APPLIANCE AND EQUIPMENT REPAIR

Individuals in these occupations repair, adjust, maintain, and install all types of electrical motors and electrical and gas home appliances. Types of equipment used include test instruments, gauges, and hand, bench, and power tools.

This occupation may not have a favorable outlook for the future. Overall, the number of these jobs shows little change. Very few job openings are expected over the next four or five years. Recently, there have been more new trainees than job openings. Placement rates at area vocational technical schools, community colleges, and/or technical institutes have been fair recently.

Related postsecondary programs at state-supported institutions in this area are:

47.0101 Electrical and electronics technology

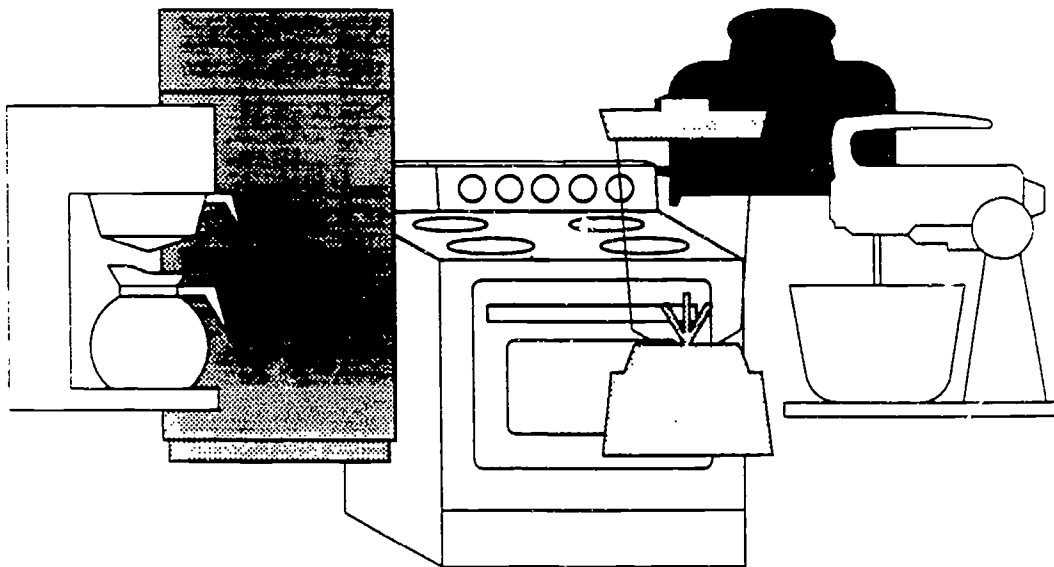

709

AUTOMOTIVE SERVICE TECHNOLOGY

These occupations include jobs concerned with parking, cleaning, polishing, lubricating, repairing, and refueling trucks, buses, and automobiles, and related servicing activities. The primary occupation, automotive mechanic, is concerned with repair and service of motor vehicles.

The largest occupations, which also have the greatest number of job openings annually, are:

- Automotive mechanics
- Tire repairers and changers

These occupations may have a generally favorable outlook for the future. Overall, the number of these jobs is growing. Few job openings are expected over the next four or five years. Recently, there have been many more new trainees than job openings. Placement rates at area vocational technical schools, community colleges, and/or technical institutes have been very good recently.

Hourly wages include:

\$9.63 Automotive mechanics

High school programs preparing for these occupations are:

47.0604 Automotive mechanics

Related postsecondary programs at state-supported institutions in this area are:

47.0604 Automotive mechanics

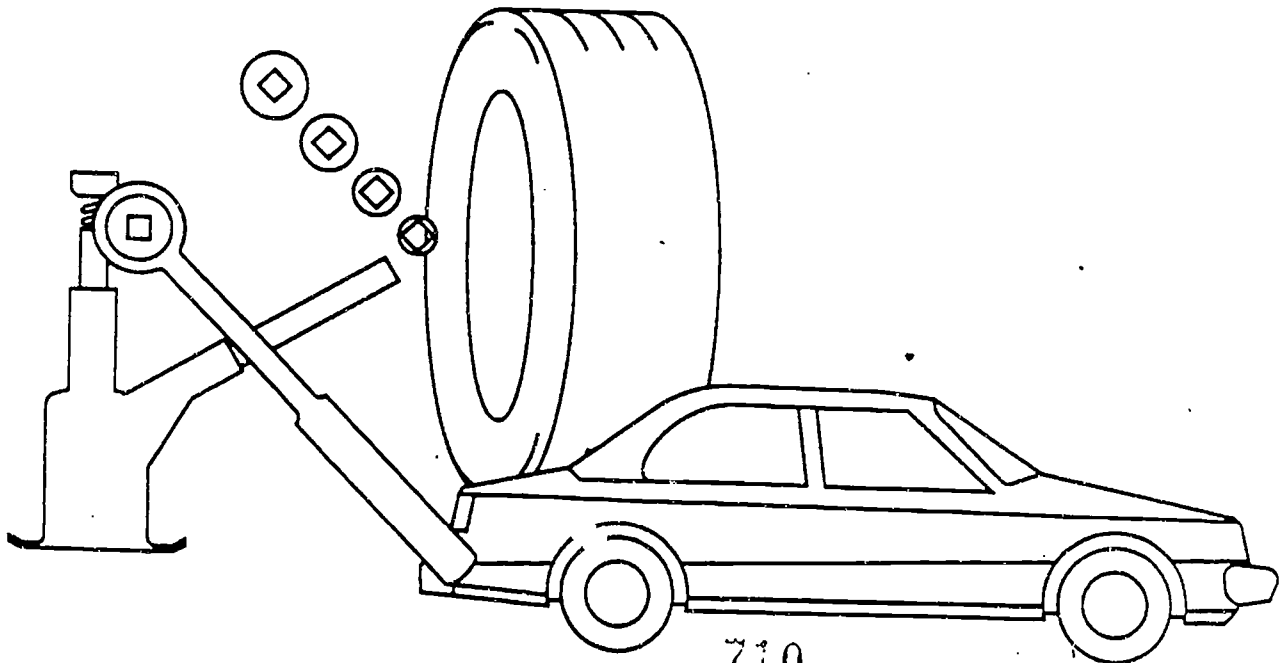

BUILDING MAINTENANCE

Persons in building maintenance occupations perform work involving several maintenance skills to keep the structure of an establishment in repair. Duties may involve pipefitting, boilermaking, carpentry, and electrical work as well as repairing buildings, floors, or stairs.

This occupation may have a generally favorable outlook for the future. Overall, the number of these jobs is growing. A moderate number of job openings are expected over the next four or five years. Recently, no training has been reported. Job opportunities should be good.

Average hourly wages are \$8.17

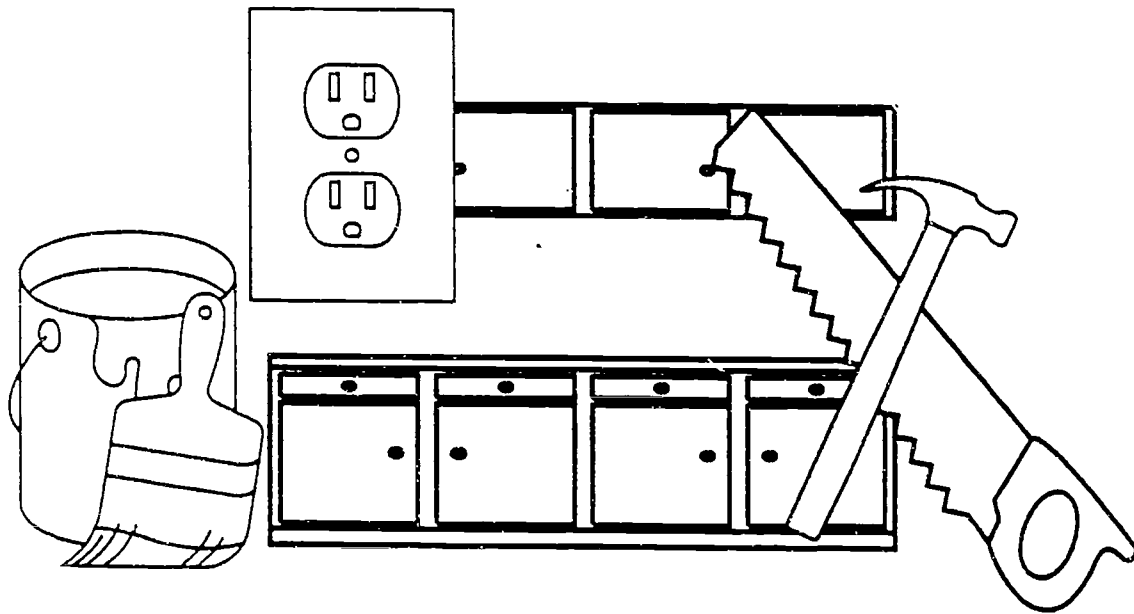

711

CARPENTRY

Almost all construction projects employ carpenters, the largest group of building trades workers. Carpenters perform a variety of jobs. Their duties will vary by type of construction, type of company, skill of the carpenter, and size of the community. A carpenter employed by a special trade contractor, for example, may specialize in laying hardwood floors, while one who is employed by a general building contractor may build wall frames and install paneling.

This occupation may have a generally favorable outlook for the future. Overall, the number of these jobs is growing. Few job openings are expected over the next four or five years. Recently, no training has been reported.

Average hourly wages are \$9.61

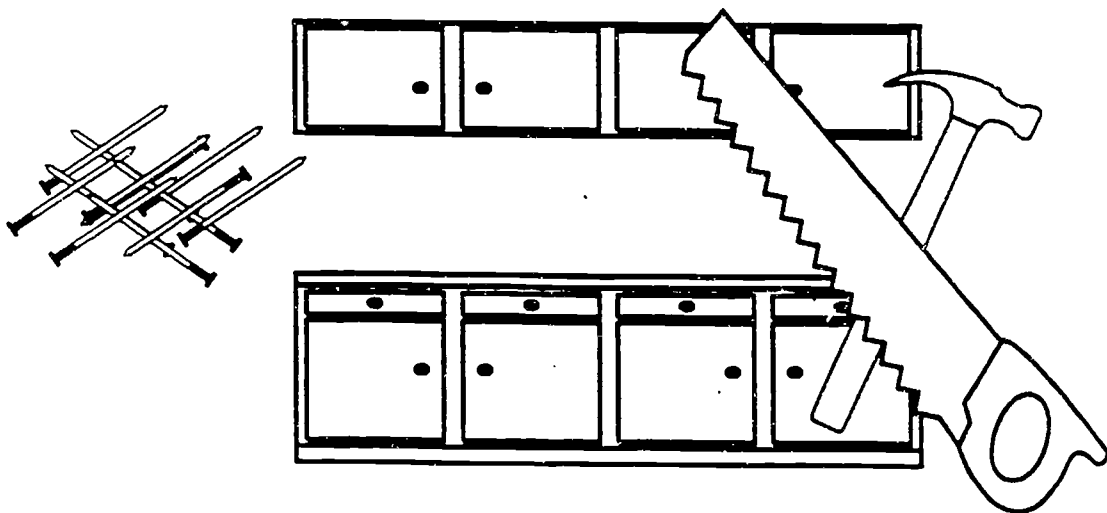

COMMERCIAL ART AND DESIGN

The majority of workers in this field design or arrange objects and materials in an artistic or decorative manner. Additional tasks may include the creation or drawing of designs for items such as furniture and machinery (product design).

The largest occupations, which also have the greatest number of job openings annually, are:

- Artists and related workers
- Designers, except interior designers

These occupations may not have a favorable outlook for the future. Few job openings are expected over the next four or five years. Recently, there have been many more new trainees than job openings.

High school programs preparing for these occupations are:

48.0203 Commercial art

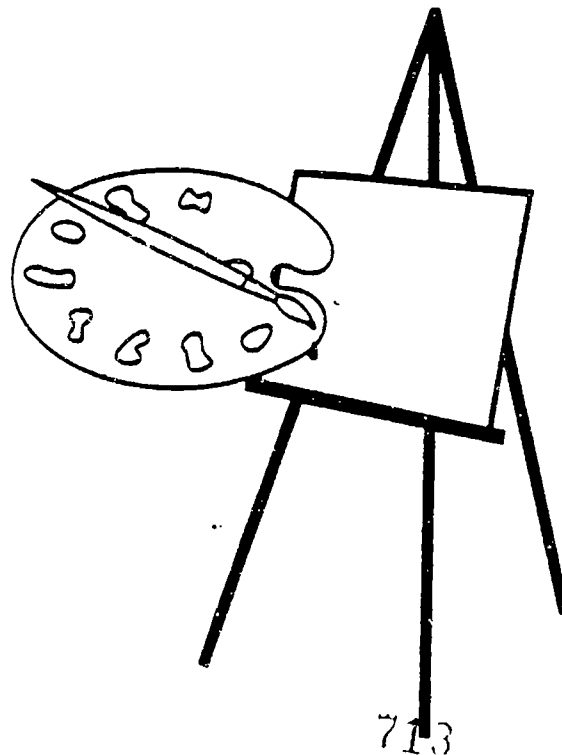

713

COMPUTER SYSTEMS

Workers in these computer occupations develop and write computer programs to store, locate, and retrieve specific documents, data, and information. They may also analyze business, scientific, and technical problems for application to electronic data processing systems. These careers generally require specialized training.

The largest occupations, which also have the greatest number of job openings annually, are:

- Systems analysts, electronic data processing
- Computer programmers

These occupations may have a generally favorable outlook for the future. Few job openings are expected over the next four or five years. Recently, no training has been reported.

COSMETOLOGY

Cosmetologists and related workers provide beauty services for customers. These may include cutting and styling hair, treating hair and scalp, applying makeup, dressing wigs, or removing hair by electrolysis, as well as cleaning, shaping, and polishing a customer's fingernails and toenails.

This occupation may not have a favorable outlook for the future. Overall, the number of these jobs is growing. Few job openings are expected over the next four or five years. Recently, there have been many more new trainees than job openings.

High school programs preparing for these occupations are:

12.0403 Cosmetology

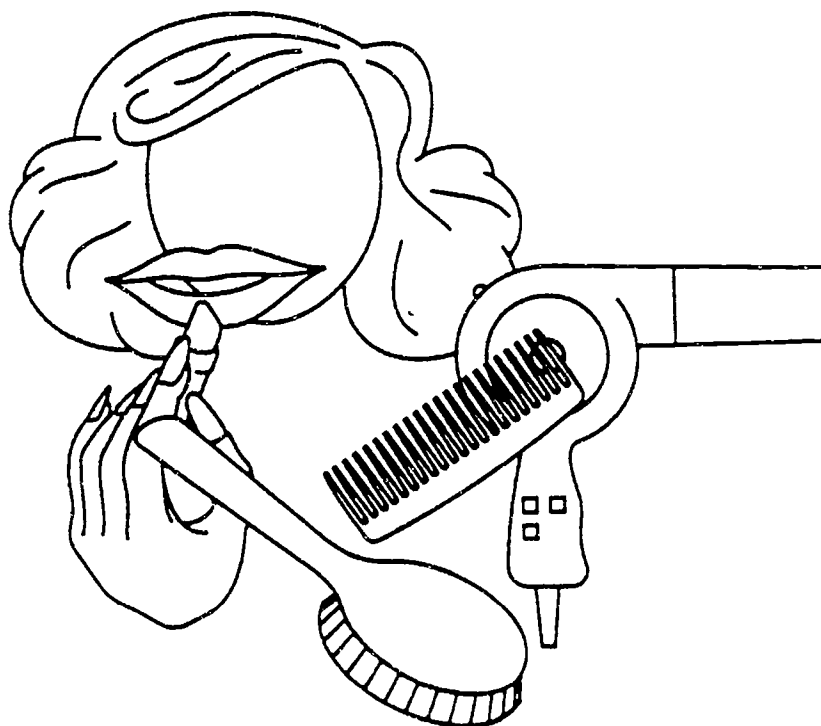

SDA 13 - 12715

DRAFTING AND DESIGN TECHNOLOGY

Persons in drafting and design technology prepare clear, complete, and accurate working plans and detail drawings from rough or detailed sketches or notes for engineering or manufacturing purposes according to specified dimensions. Workers need to have knowledge of various machines, engineering practices, mathematics, building materials, and other physical sciences to complete drawings. Computer-assisted design (CAD) equipment may be used by some workers.

The largest occupations, which also have the greatest number of job openings annually, are:

- Cost estimators
- Drafters

These occupations may not have a favorable outlook for the future. Overall, the number of these jobs shows little change. Very few job openings are expected over the next four or five years. Recently, there have been many more new trainees than job openings. Placement rates at area vocational technical schools, community colleges, and/or technical institutes have been poor recently.

High school programs preparing for these occupations are:

48.0101 Drafting

Related postsecondary programs at state-supported institutions in this area are:

48.0101 Drafting

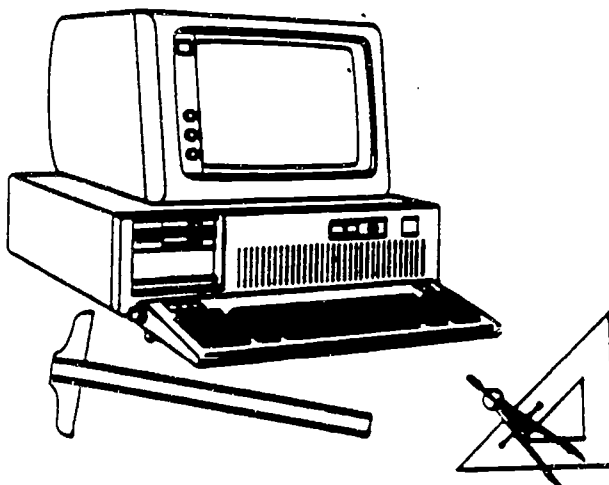

716

EARLY CHILDHOOD EDUCATION

Child care workers and managers of child care centers assume responsibility for the safety, physical care, and emotional, social, and intellectual growth of preschool children and infants while parents are at work or are unavailable for other reasons. Some work in residential institutions for young children. Teacher aides assist teachers by handling routine paperwork or by working directly with children.

The largest occupations, which also have the greatest number of job openings annually, are:

- Teacher aides, paraprofessional
- Teacher aides and educational assistants, clerical

These occupations may have a generally favorable outlook for the future. Overall, the number of these jobs is growing rapidly. A moderate number of job openings are expected over the next four or five years. Recently, no training has been reported. Job opportunities should be good.

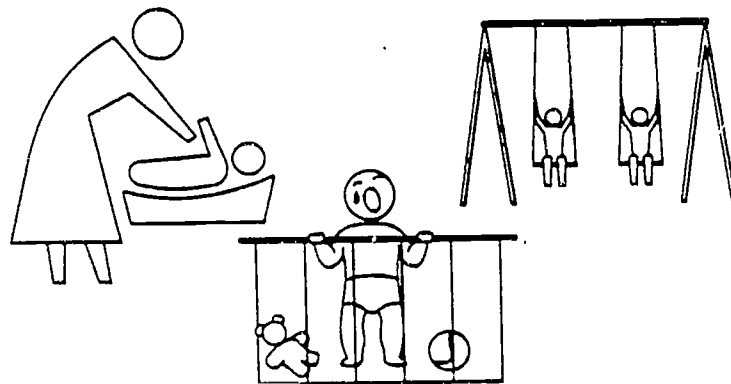

717

ELECTRICIAN OCCUPATIONS

Workers in the electrical field install, maintain, and repair wiring, electrical equipment, and fixtures or assist in such activities. These workers insure that work is in accordance with the relevant codes. A high school education is usually required and a five-year apprenticeship program is recommended.

The largest occupations, which also have the greatest number of job openings annually, are:

- Electricians
- Helpers of electricians and powerline transmission installers

These occupations may have a generally favorable outlook for the future. Overall, the number of these jobs is growing. Few job openings are expected over the next four or five years. Recently, no training has been reported.

Hourly wages include:

\$10.94 Electricians

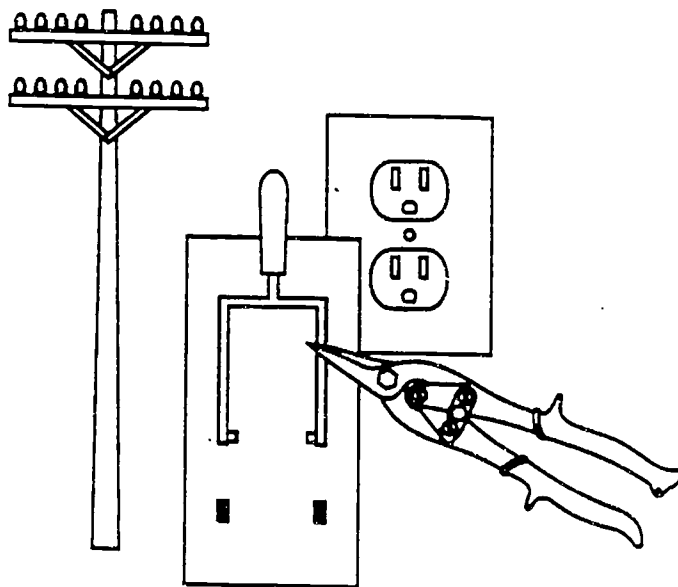

718

SDA 13 - 15

FOOD PREPARATION AND SERVICES

The majority of workers in these occupations prepare and serve food and beverages in restaurants, fast food establishments, catering firms, hotels, clubs, factories, school cafeterias, or hospitals, or supervise those providing food services. Others are factory machine operators involved in the preparation of food products. Dietetic technicians teach principles of food nutrition and provide dietary counseling to patients.

The largest occupations, which also have the greatest number of job openings annually, are:

- Food preparation workers
- Combined food preparation and service workers

These occupations may have a generally favorable outlook for the future. Overall, the number of these jobs is growing. Large numbers of job openings are expected over the next four or five years. Recently, no training has been reported. Job opportunities should be good.

Hourly wages include:

- \$4.31 Food preparation workers
- \$4.45 Cooks, specialty fast food
- \$4.63 Cooks, restaurant

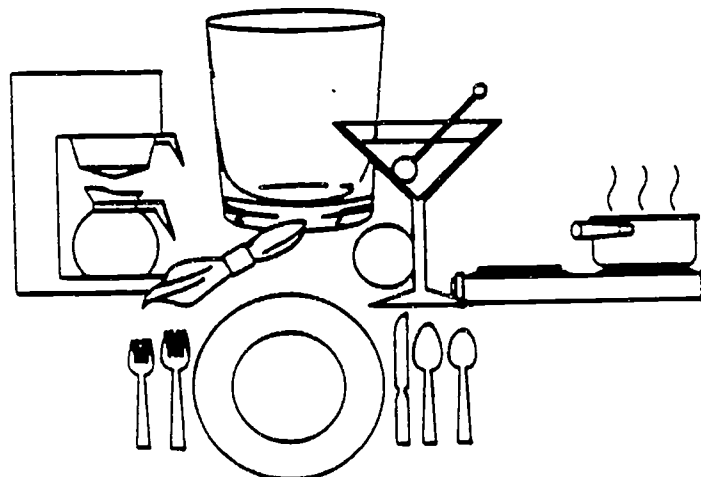

713

GENERAL BUSINESS AND MANAGEMENT

Workers in the general business and management occupations plan, organize, direct, control, or coordinate activities in all types of fields. Many occupations involve analysis of productivity and financial soundness. General managers and top executives usually have very diverse duties and responsibilities and work through departmental or subordinate executives.

The largest occupations, which also have the greatest number of job openings annually, are:

- Industrial production managers
- General managers and top executives

These occupations may have a generally favorable outlook for the future. Overall, the number of these jobs is growing. Large numbers of job openings are expected over the next four or five years. Recently, there have been fewer new trainees than job openings. If this trend continues, job opportunities should be good. Placement rates at area vocational technical schools, community colleges, and/or technical institutes have been good recently.

Hourly wages include:

\$22.24 Industrial production managers

Related postsecondary programs at state-supported institutions in this area are:

07.9998 Business management technology



SDA 13 - 1720

GRAPHIC ARTS

A majority of workers in this field are involved in offset printing. In this process the material to be printed is photographed and a printing plate is made from the film. This process has been advanced by the use of computers and lasers.

The two largest occupations are:

- Printing press machine operators and tenders
- Offset lithographic press setters and set-up operators

The occupations expected to have the most job openings annually are:

- Printing press machine operators and tenders
- Bindery machine operators

These occupations may have a generally favorable outlook for the future. Overall, the number of these jobs is growing slowly. Few job openings are expected over the next four or five years. Recently, no training has been reported.

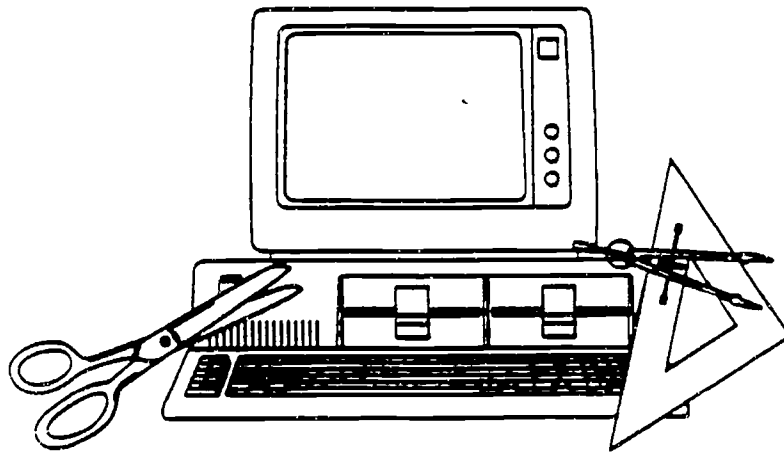

721

HEATING AND AIR CONDITIONING

Workers in this field install and repair heating, air conditioning, and refrigeration systems. They may install and repair oil burners, hot-air furnaces, and heating stoves in homes and businesses. They may also install and repair air conditioning systems, or install sheet metal ducts for the heating and cooling systems.

The largest occupations, which also have the greatest number of job openings annually, are:

- Heating, air conditioning, and refrigeration mechanics and installers
- Sheet metal duct installers

These occupations may not have a favorable outlook for the future. Overall, the number of these jobs shows little change. Very few job openings are expected over the next four or five years. Recently, there have been many more new trainees than job openings. Placement rates at area vocational technical schools, community colleges, and/or technical institutes have been fair recently.

High school programs preparing for these occupations are:

47.0201 Heating, air conditioning, and refrigeration mechanics

Related postsecondary programs at state-supported institutions in this area are:

47.0201 Heating, air conditioning, and refrigeration mechanics

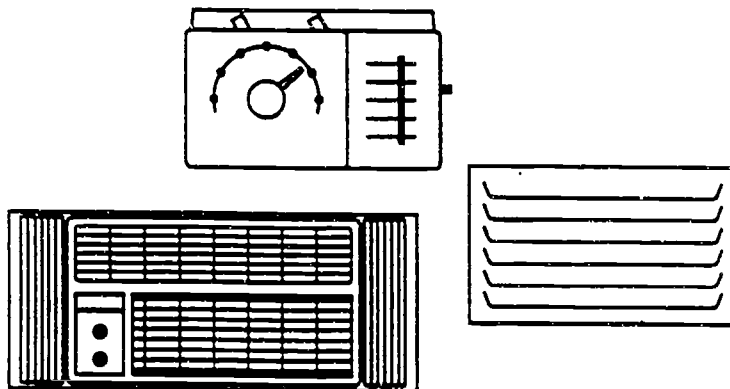

HOTEL AND RESTAURANT MANAGEMENT

Food service and lodging managers supervise the profitable operation of restaurants, hotels, and motels. Workers direct the varied activities of these businesses with the goal of pleasing people and providing good service to their customers.

This occupation may have a generally favorable outlook for the future. Overall, the number of these jobs is growing. Few job openings are expected over the next four or five years. Recently, there have been fewer new trainees than job openings.

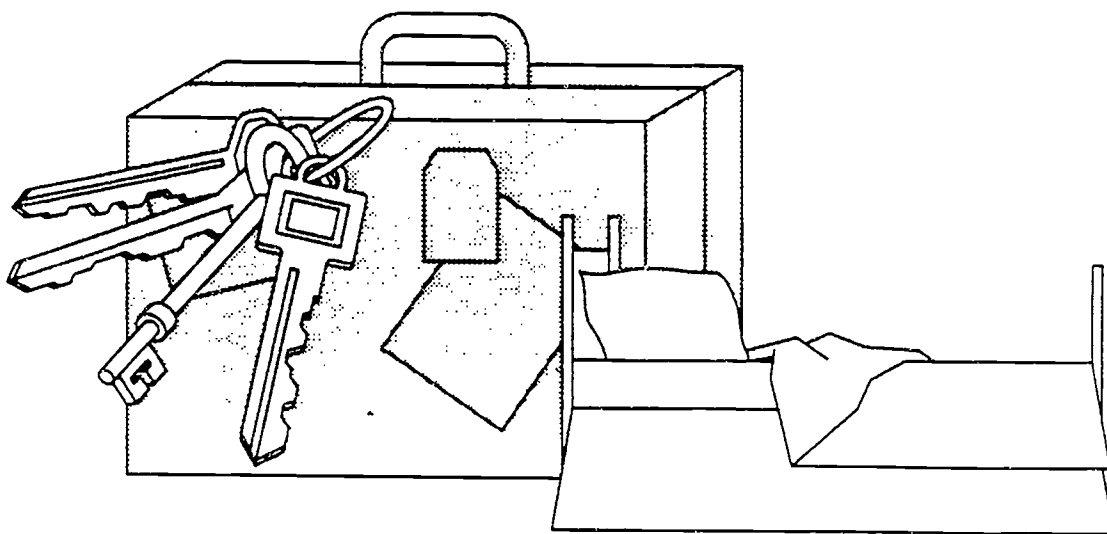

723

INDUSTRIAL MAINTENANCE TECHNOLOGY

Workers prevent costly waste of raw materials and the idling of human resources in a plant or factory by making industrial machinery repairs as quickly as possible. Maintenance mechanics spend considerable time doing preventive maintenance, including keeping machines well oiled and greased, and periodically cleaning parts.

The two largest occupations are:

- Maintenance mechanics for industrial machinery
- Textile machine setters and set-up operators

The occupations expected to have the most job openings annually are:

- Maintenance mechanics for industrial machinery
- Machine builders and other precision machine assemblers

These occupations may not have a favorable outlook for the future. Overall, the number of these jobs is growing slowly. Few job openings are expected over the next four or five years. Recently, there have been many more new trainees than job openings. Placement rates at area vocational technical schools, community colleges, and/or technical institutes have been good recently.

Hourly wages include:

\$10.18 Machinery maintenance mechanics

Related postsecondary programs at state-supported institutions in this area are:

47.0303 Industrial mechanics technology

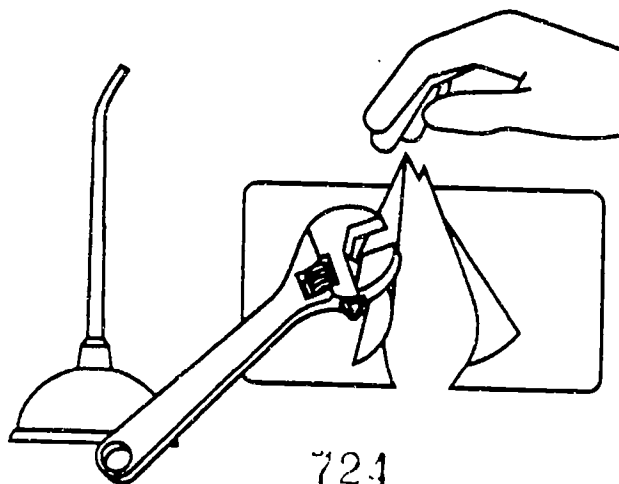

INSTITUTIONAL HOME MANAGEMENT AND SUPPORTING SERVICES

These workers make sure that all public buildings, offices, hospitals, stores, and apartment houses are kept clean and in good condition for the comfort and safety of the people who work or live there. Generally, no special education is required for occupations in this field, with most skills learned on the job.

The largest occupations, which also have the greatest number of job openings annually, are:

- Maids and housekeeping cleaners
- Janitors and cleaners, except maids and housekeeping cleaners

These occupations may have a generally favorable outlook for the future. Overall, the number of these jobs is growing. Large numbers of job openings are expected over the next four or five years. Recently, no training has been reported. Job opportunities should be good.

Hourly wages include:

- \$4.73 Maids and housekeeping cleaners
- \$5.11 Housekeepers
- \$5.91 Janitors and cleaners, except maids and housekeeping cleaners

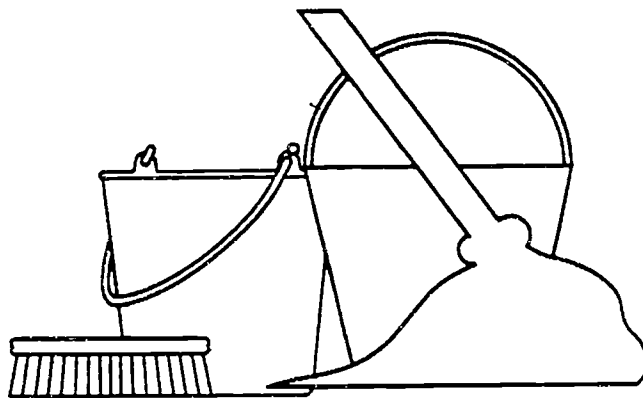

725

MACHINE TOOL TECHNOLOGY

Workers in these occupations make or set up and operate machine tools or repair metal parts. Machinists and tool-and-die makers create highly specialized precision tools, molds, and metal parts. Often they use blueprints to develop prototypes for tools or machines to be used in manufacturing.

The two largest occupations are:

- Machinists
- Tool and die makers

The occupations expected to have the most job openings annually are:

- Plastic molding and casting machine setters and set-up operators
- Machinists

These occupations may have a generally favorable outlook for the future. Overall, the number of these jobs is growing. Large numbers of job openings are expected over the next four or five years. Recently, there have been about as many new trainees as job openings. If this trend continues, job seekers can expect to face some competition. Placement rates at area vocational technical schools, community colleges, and/or technical institutes have been good recently.

Hourly wages include:

- \$9.30 Machinists
- \$9.62 Lathe and turning machine tool setters and set-up operators, metal and plastic
- \$11.46 Tool and die makers

High school programs preparing for these occupations are:

- 48.0503 Machine tool operation and machine shop technology

Related postsecondary programs at state-supported institutions in this area are:

- 48.0503 Machine tool operation and machine shop technology

MEDICAL RECORDS TECHNOLOGY

Medical records technicians compile and maintain medical records of hospital and clinic patients. Such work is becoming increasingly important as this background information is used for medicare and medicaid insurance reimbursements.

This occupation may not have a favorable outlook for the future. Overall, the number of these jobs shows little change. Very few job openings are expected over the next four or five years. Recently, no training has been reported.

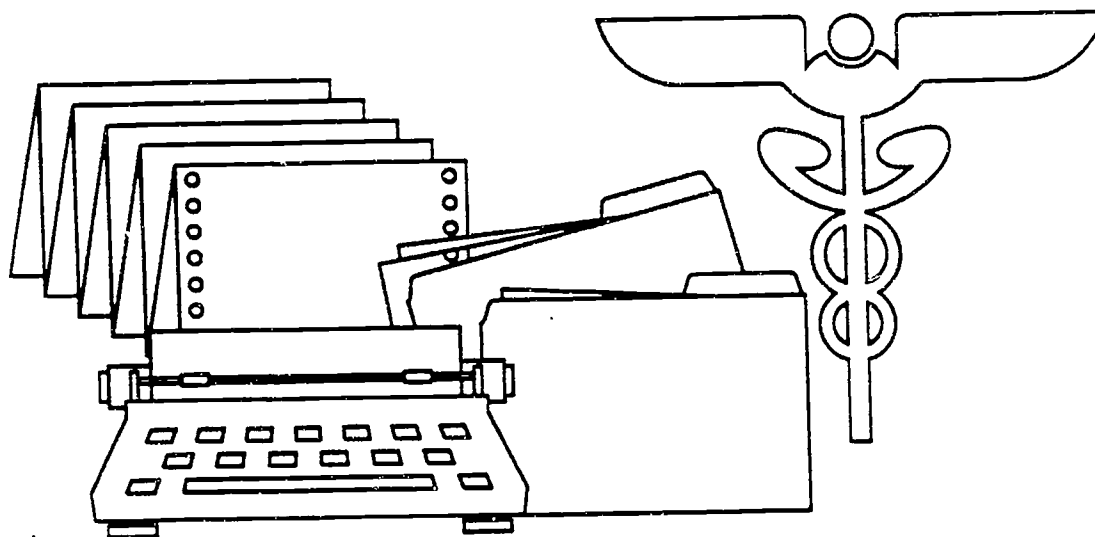

NURSING ASSISTANT

Nursing aides and orderlies work under the general direction of nursing or medical staff. In hospitals, they may answer patients' call bells, serve and collect food trays, feed patients, or set up equipment. In nursing homes, they are expected to sustain ongoing relations with patients.

The largest occupations, which also have the greatest number of job openings annually, are:

- Nursing aides, orderlies, and attendants
- Home health aides

These occupations may have a generally favorable outlook for the future. Overall, the number of these jobs is growing rapidly. A moderate number of job openings are expected over the next four or five years. Recently, there have been fewer new trainees than job openings. If this trend continues, job opportunities should be good.

Hourly wages include:

\$4.69 Nursing aides, orderlies, and attendants

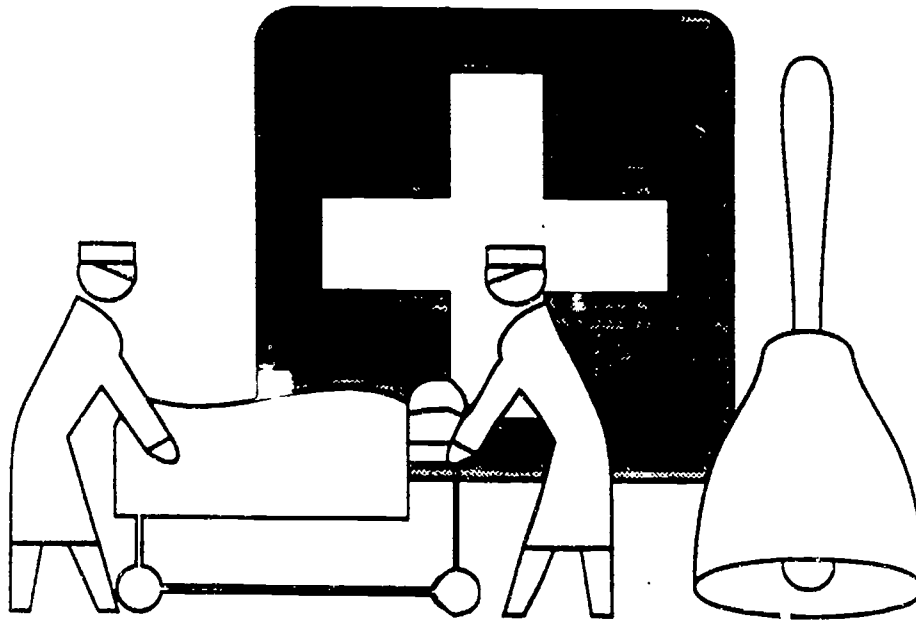

PRACTICAL NURSING

Licensed practical nurses (LPNs) work under the supervision of physicians and/or registered nurses to provide nursing care that requires technical knowledge but not the professional training of a registered nurse. They provide bedside care, administer certain medications, and assist in patient examinations.

This occupation may have a generally favorable outlook for the future. Few job openings are expected over the next four or five years. Recently, there have been many more new trainees than job openings. Placement rates at area vocational technical schools, community colleges, and/or technical institutes have been very good recently.

Average hourly wages are \$8.12

Related postsecondary programs at state-supported institutions in this area are:

17.0605 Practical nursing

Licensing may be required. Contact: TENNESSEE BOARD OF NURSING, 615-367-6232.

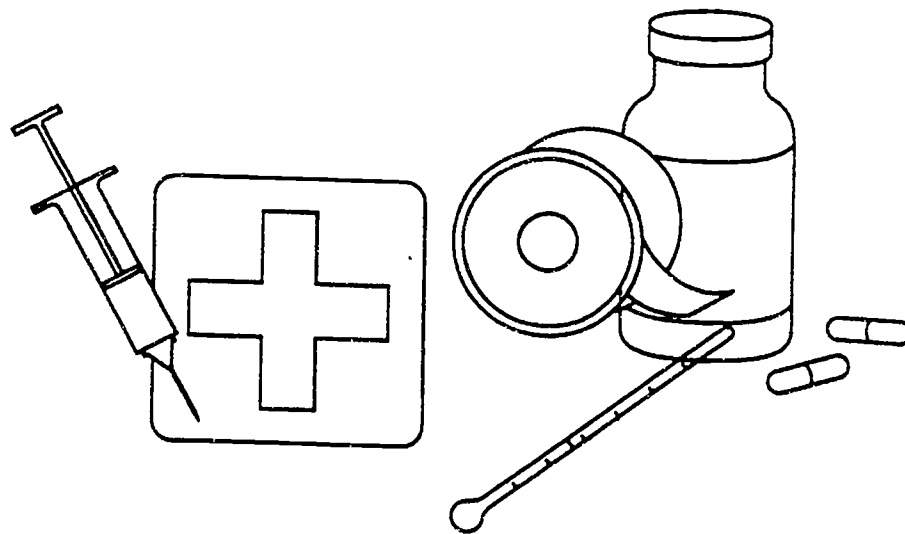

729

PROFESSIONAL NURSING

Registered Nurses (R.N.'s), the largest occupational group in this field, are primarily employed in hospitals and nursing homes, where they provide skilled bedside care and may supervise licensed practical nurses, nursing aides, and orderlies. Working under the direction of a licensed "supervising physician," physician assistants elicit detailed patient histories, perform physical examinations, and prescribe appropriate treatments.

The largest occupations, which also have the greatest number of job openings annually, are:

- Registered nurses
- Physician's assistants

These occupations may have a generally favorable outlook for the future. Overall, the number of these jobs is growing rapidly. A moderate number of job openings are expected over the next four or five years. Recently, there have been fewer new trainees than job openings. If this trend continues, job opportunities should be good. Placement rates at area vocational technical schools, community colleges, and/or technical institutes have been excellent recently.

Hourly wages include:

\$12.88 Registered nurses

Related postsecondary programs at state-supported institutions in this area are:

18.1101 Nursing

Licensing may be required. Contact: TENNESSEE BOARD OF MEDICAL EXAMINERS-COMMITTEE ON PHYSICIAN ASSISTANTS, 615-367-6250.

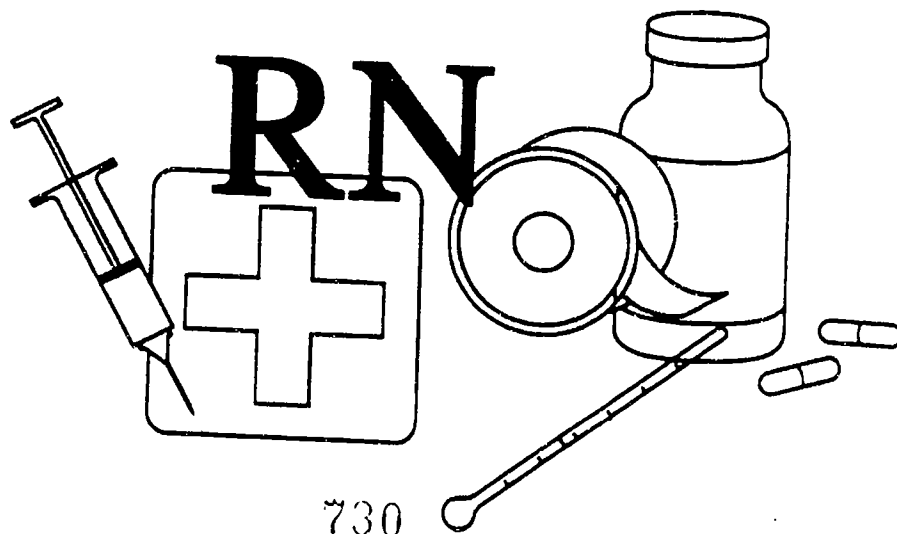

730

SALES AND MERCHANDISING

Workers in sales and merchandising occupations promote and sell a wide variety of merchandise and services. They also receive, store, display, and inventory products to be sold.

The largest occupations, which also have the greatest number of job openings annually, are:

- Salespersons in retail establishments
- Cashiers

These occupations may have a generally favorable outlook for the future. Overall, the number of these jobs is growing. Large numbers of job openings are expected over the next four or five years. Recently, there have been about as many new trainees as job openings. If this trend continues, job seekers can expect to face some competition.

Hourly wages include:

\$4.63 Cashiers
\$8.46 Salespersons, retail
\$11.13 Driver/sales workers

High school programs preparing for these occupations are:

08.0700 General marketing
08.0799 Miscellaneous general marketing

Licensing may be required. Contact: TENNESSEE DEPARTMENT OF COMMERCE AND INSURANCE, 615-741-2693.

731

SECURITY SERVICES

Security guards, the largest occupation in this field, patrol and inspect property to protect it against fire, theft, vandalism, and illegal entry. Guards and doorkeepers usually are uniformed and often carry a nightstick and a weapon; correctional officers and jailers maintain order in correctional institutions, enforce institutional rules and regulations, and may supplement the counseling inmates receive from mental health professionals.

The largest occupations, which also have the greatest number of job openings annually, are:

- Correction officers and jailers
- Guards and watch guards

These occupations may have a generally favorable outlook for the future. Few job openings are expected over the next four or five years. Recently, no training has been reported.

Hourly wages include:

\$5.59 Guards and watch guards

Licensing may be required. Contact: COUNTY COURT CLERK'S OFFICE.

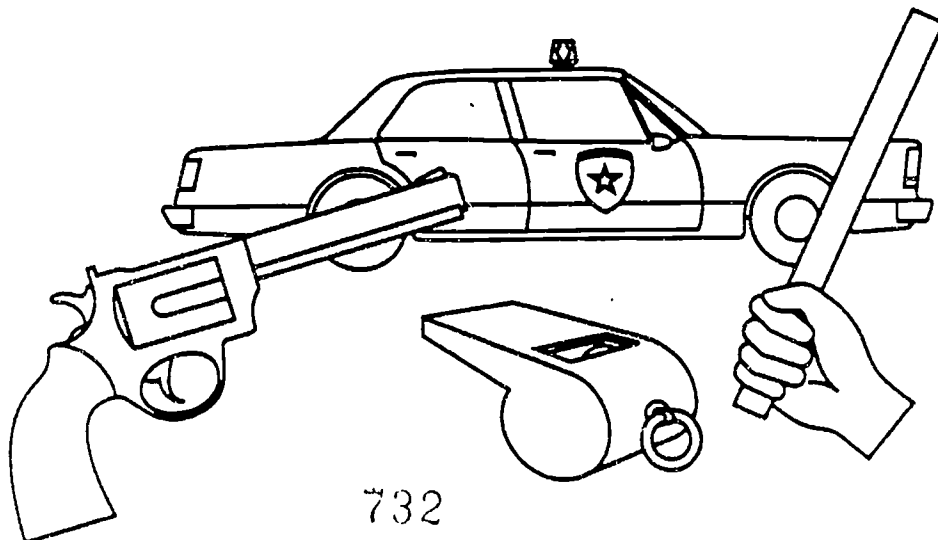

732

SHEET METAL

Sheet metal workers make, install, and maintain a variety of sheet metal products for home, commercial, and industrial buildings. These products include ducts for air conditioning, heating, and ventilating and pollution control systems, kitchen equipment, roofs, siding, rain gutters, skylights, and outdoor signs. Other workers use a variety of machines in the mass production of sheet-metal products.

The two largest occupations are:

- Machine forming operators and tenders of metal and plastic
- Assemblers and fabricators, except machine, electrical, electronic, and precision assembly

The occupations expected to have the most job openings annually are:

- Machine forming operators and tenders of metal and plastic
- Sheet metal workers

These occupations may have a generally favorable outlook for the future. Overall, the number of these jobs shows little change. Few job openings are expected over the next four or five years. Recently, there have been fewer new trainees than job openings. Placement rates at area vocational technical schools, community colleges, and/or technical institutes have been good recently.

Related postsecondary programs at state-supported institutions in this area are:

48.0504 Metal fabrication

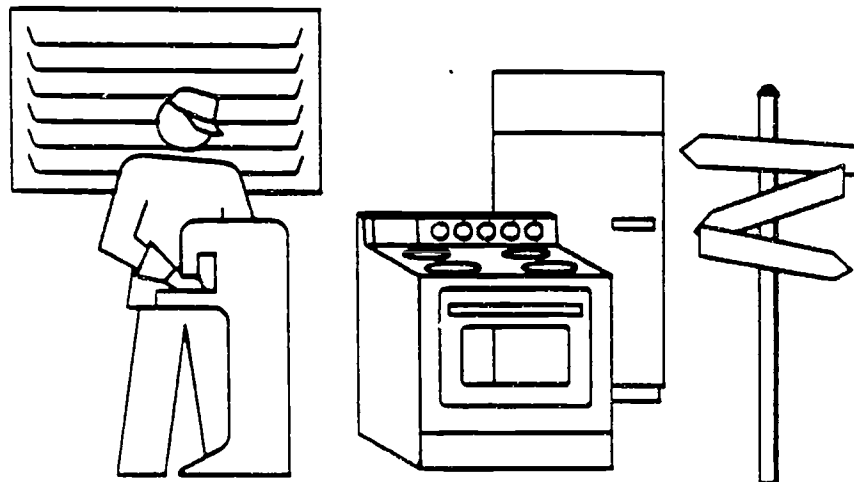

733

TRUCK, BUS, AND HEAVY EQUIPMENT OPERATION

These occupations include truck drivers who transport goods, bus drivers who transport passengers, and heavy equipment operators who use machinery to move construction materials and other goods over short distances--around a factory, construction site or loading dock.

The largest occupations, which also have the greatest number of job openings annually, are:

- Truck drivers of heavy or tractor trailer trucks
- School bus drivers

These occupations may have a generally favorable outlook for the future. Overall, the number of these jobs is growing. Large numbers of job openings are expected over the next four or five years. Recently, no training has been reported. Job opportunities should be good.

Hourly wages include:

\$9.18 Truck drivers, heavy or tractor trailer

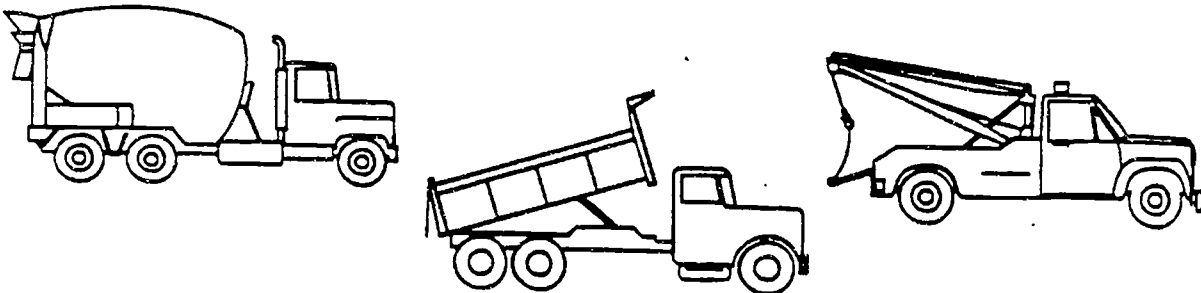

WELDING TECHNOLOGY

Welding is the most common way of permanently joining metal parts. Typically, heat is applied to the metal pieces to be joined; the parts are melted and fused to form a permanent bond. Welding is used to construct and repair parts of ships, automobiles, spacecraft, and thousands of products. It can also be used to join beams and steel reinforcing rods in buildings, bridges, and highways.

The two largest occupations are:

- Welders and cutters
- Welding machine setters and set-up operators

The occupations expected to have the most job openings annually are:

- Welders and cutters
- Welding machine operators and tenders

These occupations may not have a favorable outlook for the future. Overall, the number of these jobs is growing. Few job openings are expected over the next four or five years. Recently, there have been about as many new trainees as job openings. Placement rates at area vocational technical schools, community colleges, and/or technical institutes have been poor recently.

Hourly wages include:

\$10.67 Welders and cutters

High school programs preparing for these occupations are:

48.0508 Welding, brazing, and soldering

Related postsecondary programs at state-supported institutions in this area are:

48.0508 Welding, brazing, and soldering

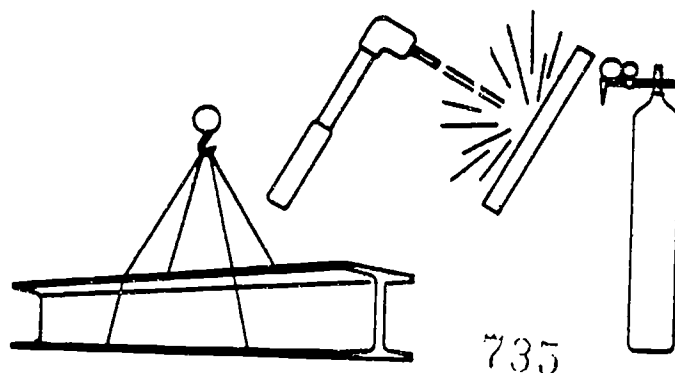

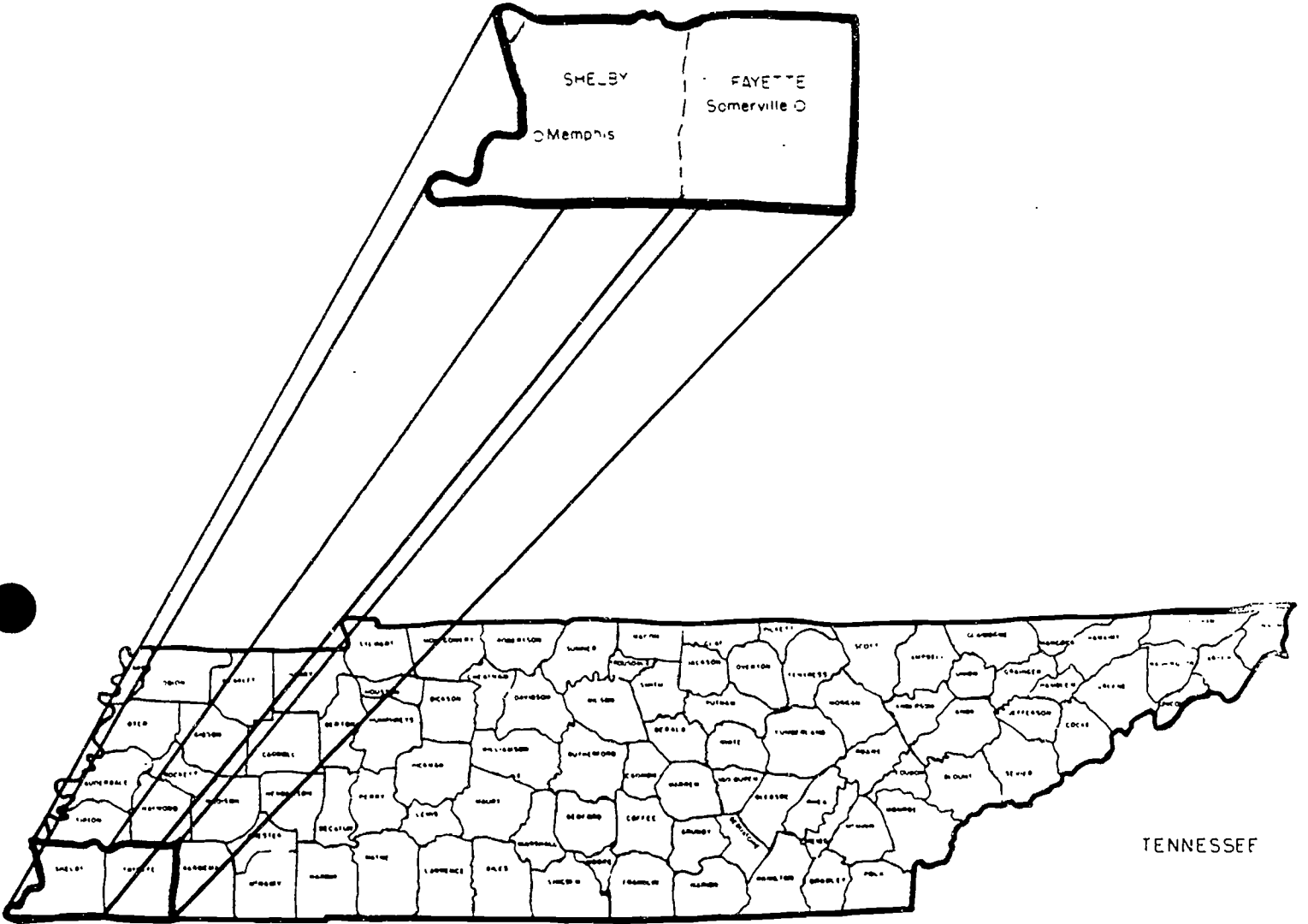

Service Delivery Area 14

ACCOUNTING AND FINANCIAL MANAGEMENT

Many individuals in this group are accountants and auditors who prepare and analyze business records and financial reports which are needed for effective management of any organization. Financial managers, another occupation in this group, typically plan, organize, control, or coordinate the financial activities of an organization.

The largest occupations, which also have the greatest number of job openings annually, are:

- Financial managers
- Accountants and auditors

These occupations may have a generally favorable outlook for the future. Overall, the number of these jobs is growing. Large numbers of job openings are expected over the next four or five years. Recently, there have been about as many new trainees as job openings. If this trend continues, job seekers can expect to face some competition.

Hourly wages include:

\$16.65 Accountants and auditors
\$23.61 Financial managers

Related postsecondary programs at state-supported institutions in this area are:

52.0301 Accounting
52.0801 Finance

Licensing may be required. Contact: TENNESSEE BOARD OF ACCOUNTANCY, 615-741-2250.



ADMINISTRATIVE SUPPORT: ACCOUNTING

Persons employed in this group of occupations provide clerical and administrative support to accountants and auditors. Most of these jobs require only a high school diploma for entry.

The largest occupations, which also have the greatest number of job openings annually, are:

- Bookkeeping, accounting, and auditing clerks
- Payroll and timekeeping clerks

These occupations may have a generally favorable outlook for the future. Overall, the number of these jobs shows little change. Large numbers of job openings are expected over the next four or five years. Recently, there have been many more new trainees than job openings. If this trend continues, job seekers can expect to face keen competition. Placement rates at area vocational technical schools, community colleges, and/or technical institutes have been very good recently.

Hourly wages include:

- \$8.87 Bookkeeping, accounting, and auditing clerks
- \$9.15 Payroll and timekeeping clerks

High school programs preparing for these occupations are:

- 07.0101 Accounting and bookkeeping

Related postsecondary programs at state-supported institutions in this area are:

- 07.0101 Accounting and bookkeeping
- 07.0102 Accounting and computing

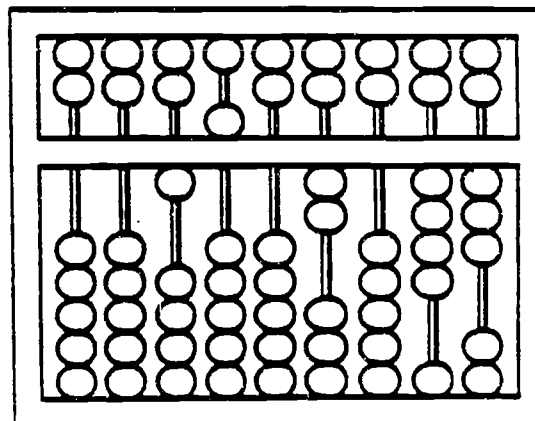
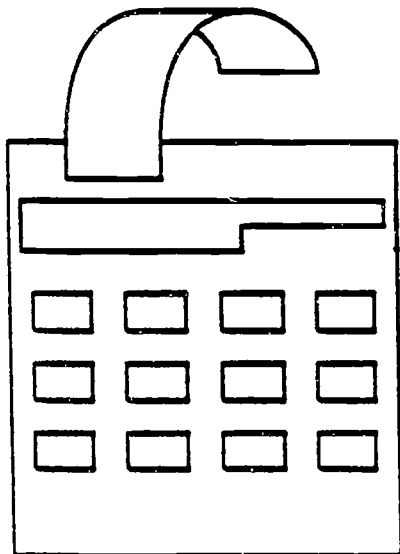

ADMINISTRATIVE SUPPORT: FINANCE AND INSURANCE

Workers provide clerical and general administrative support to the banking and finance industry. Workers receive and pay out money, keep records of money and negotiable instruments, interview applicants for credit, locate and notify customers of delinquent accounts, examine insurance claims, and process a variety of paperwork.

The largest occupations, which also have the greatest number of job openings annually, are:

- Tellers
- Bill and account collectors

These occupations may have a generally favorable outlook for the future. Overall, the number of these jobs is growing slowly. Large numbers of job openings are expected over the next four or five years. Recently, there have been fewer new trainees than job openings. If this trend continues, job opportunities should be good.

Hourly wages include:

\$6.74	Tellers
\$6.98	New accounts clerks
\$7.81	Bill and account collectors
\$8.63	Loan and credit clerks
\$9.28	Insurance claims clerks

Related postsecondary programs at state-supported institutions in this area are:

52.0803 Banking and financial support services

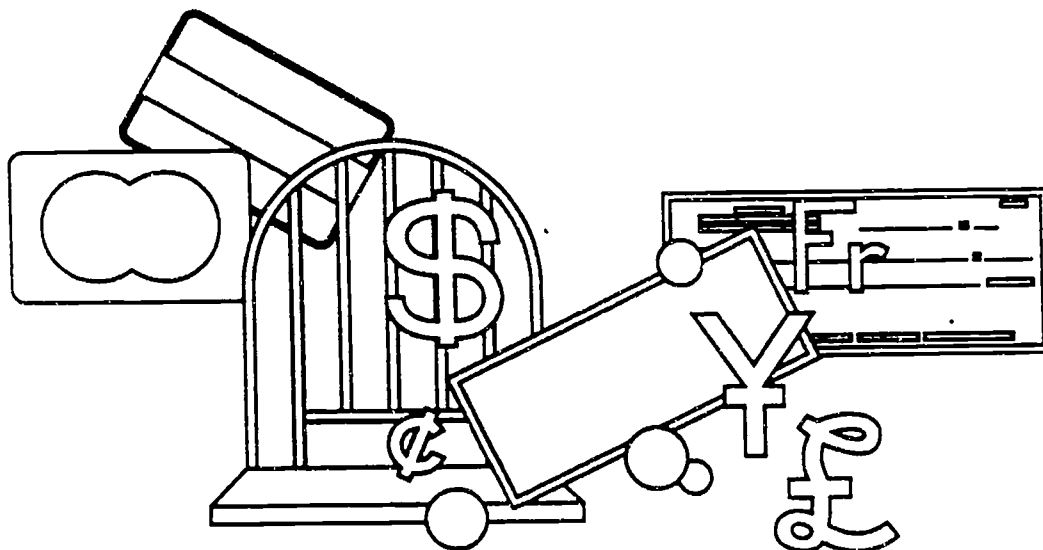

739

ADMINISTRATIVE SUPPORT: GENERAL

The job duties in this group of occupations are very diverse and are determined by the type of firm. For example, workers may schedule appointments, give information to callers, take dictation, type correspondence, read and route incoming mail, file correspondence and other records, and supervise and coordinate the activities of subordinate clerical workers.

The largest occupations, which also have the greatest number of job openings annually, are:

- Secretaries, except legal and medical secretaries
- General office clerks

These occupations may have a generally favorable outlook for the future. Overall, the number of these jobs is growing. Large numbers of job openings are expected over the next four or five years. Recently, there have been about as many new trainees as job openings. If this trend continues, job seekers can expect to face some competition. Placement rates at area vocational technical schools, community colleges, and/or technical institutes have been fair recently.

Hourly wages include:

\$5.64	File clerks
\$6.93	Receptionists and information clerks
\$7.68	General office clerks
\$7.76	Data entry keyers, except composing
\$8.21	Adjustment clerks
\$8.52	Typists including word processing
\$8.65	Order clerks- materials, merchandise, and service
\$9.00	Medical secretaries
\$9.34	Secretaries, ex. legal and medical
\$10.55	Legal secretaries
\$13.77	First line supervisors and manager/supervisors- clerical and administrative support occupations

High school programs preparing for these occupations are:

07.0701 Typing, general office and related programs

Related postsecondary programs at state-supported institutions in this area are:

07.0606 Secretarial and office administration
07.9999 Miscellaneous business administrative support
52.0401 Administrative assistant and secretarial science

AGRICULTURAL PRODUCTION

Workers in this field plan and economically use facilities, land, water, machinery, chemicals, finance, and labor in the production of plant and animal products.

The largest occupations, which also have the greatest number of job openings annually, are:

- Farm managers
- Farm workers

These occupations may have a generally favorable outlook for the future. Overall, the number of these jobs shows little change. A moderate number of job openings are expected over the next four or five years. Recently, there have been fewer new trainees than job openings.

High school programs preparing for these occupations are:

01.0301 Agricultural production

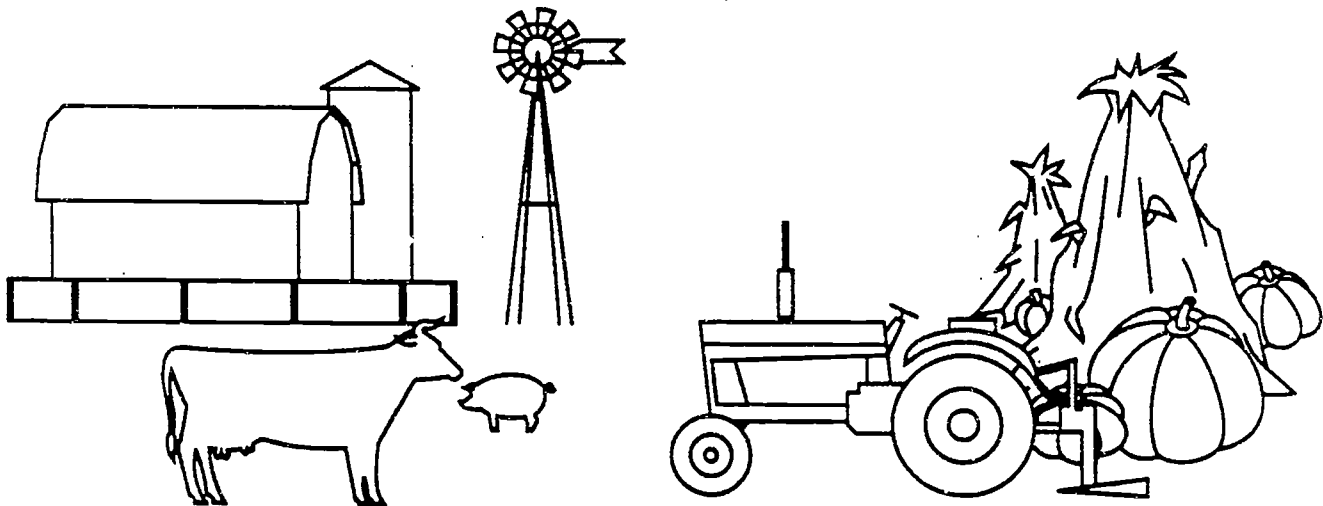

AIRCRAFT MECHANICS

To keep an aircraft in top operating condition, workers must perform scheduled maintenance, make repairs, and complete inspections required by the Federal Aviation Administration (FAA). Mechanics inspect the engines, landing gear, instruments, and other parts of the aircraft and do necessary maintenance.

The largest occupations, which also have the greatest number of job openings annually, are:

- Aircraft mechanics
- Aircraft engine specialists

These occupations may not have a favorable outlook for the future. Overall, the number of these jobs is growing rapidly. A moderate number of job openings are expected over the next four or five years. Recently, there have been about as many new trainees as job openings. If this trend continues, job seekers can expect to face some competition. Placement rates at area vocational technical schools, community colleges, and/or technical institutes have been poor recently.

High school programs preparing for these occupations are:

49.0101 Aviation and airway science

Related postsecondary programs at state-supported institutions in this area are:

47.0608 Aircraft mechanics, powerplant

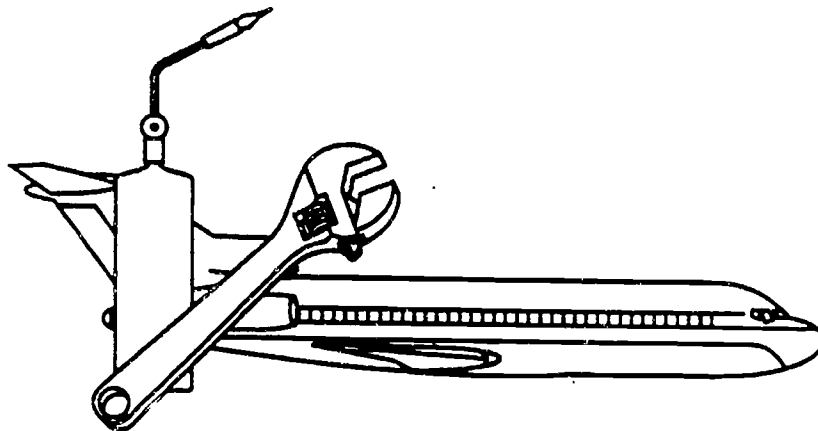

742

APPLIANCE AND EQUIPMENT REPAIR

Individuals in these occupations repair, adjust, maintain, and install all types of electrical motors and electrical and gas home appliances. Types of equipment used include test instruments, gauges, and hand, bench, and power tools.

The largest occupations, which also have the greatest number of job openings annually, are:

- Electric home appliance and power tool repairers
- Coin and vending machine servicers and repairers

These occupations may not have a favorable outlook for the future. Overall, the number of these jobs shows little change. Few job openings are expected over the next four or five years. Recently, there have been many more new trainees than job openings. Placement rates at area vocational technical schools, community colleges, and/or technical institutes have been good recently.

High school programs preparing for these occupations are:

- 47.0101 Electrical and electronics technology
- 47.0108 Small appliance repair

Related postsecondary programs at state-supported institutions in this area are:

- 47.0101 Electrical and electronics technology

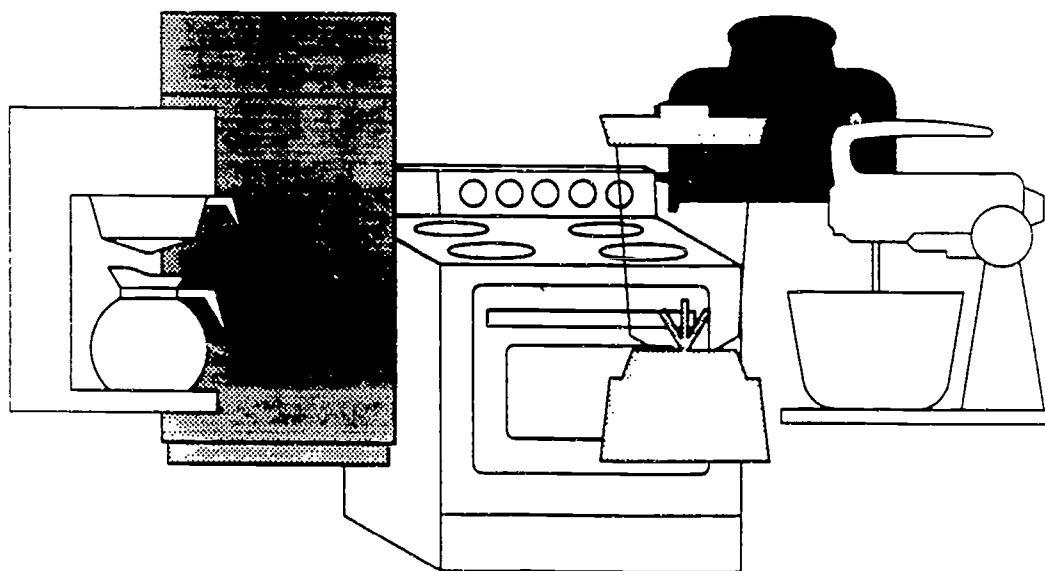

AUTOMOTIVE BODY REPAIR

Thousands of motor vehicles are damaged in traffic accidents every day. The workers in this field straighten bent frames, remove dents, and replace crumpled parts that are beyond repair so that those vehicles look and drive like new.

The largest occupations, which also have the greatest number of job openings annually, are:

- Automotive body and related repairers
- Painters of transportation equipment

These occupations may not have a favorable outlook for the future. Overall, the number of these jobs is growing. A moderate number of job openings are expected over the next four or five years. Recently, there have been many more new trainees than job openings. If this trend continues, job seekers can expect to face keen competition. Placement rates at area vocational technical schools, community colleges, and/or technical institutes have been good recently.

High school programs preparing for these occupations are:

47.0603 Automotive body repair

Related postsecondary programs at state-supported institutions in this area are:

47.0603 Automotive body repair

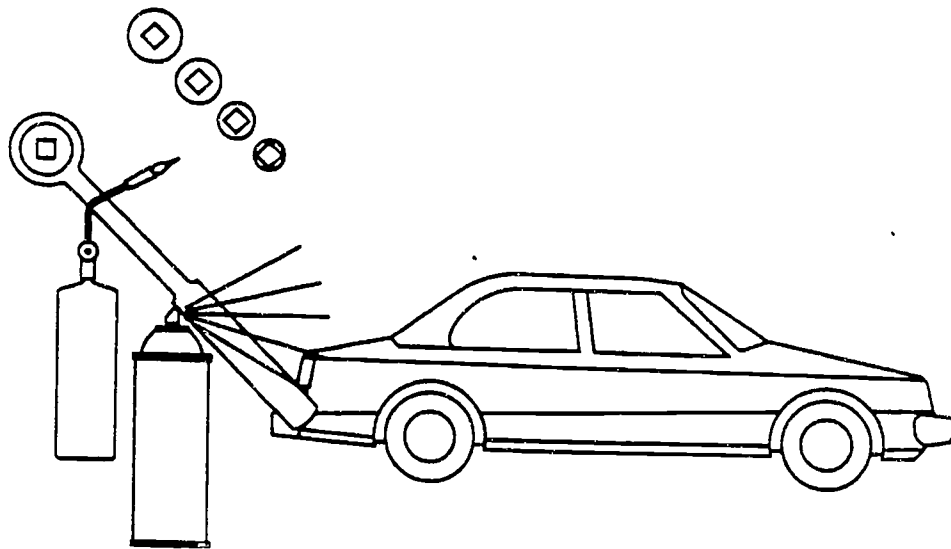

741

AUTOMOTIVE SERVICE TECHNOLOGY

These occupations include jobs concerned with parking, cleaning, polishing, lubricating, repairing, and refueling trucks, buses, and automobiles, and related servicing activities. The primary occupation, automotive mechanic, is concerned with repair and service of motor vehicles.

The largest occupations, which also have the greatest number of job openings annually, are:

- Automotive mechanics
- Tire repairers and changers

These occupations may have a generally favorable outlook for the future. Overall, the number of these jobs is growing. Large numbers of job openings are expected over the next four or five years. Recently, there have been more new trainees than job openings. If this trend continues, job seekers can expect to face some competition. Placement rates at area vocational technical schools, community colleges, and/or technical institutes have been fair recently.

Hourly wages include:

\$9.62 Automotive mechanics.

High school programs preparing for these occupations are:

47.0604 Automotive mechanics

Related postsecondary programs at state-supported institutions in this area are:

47.0604 Automotive mechanics

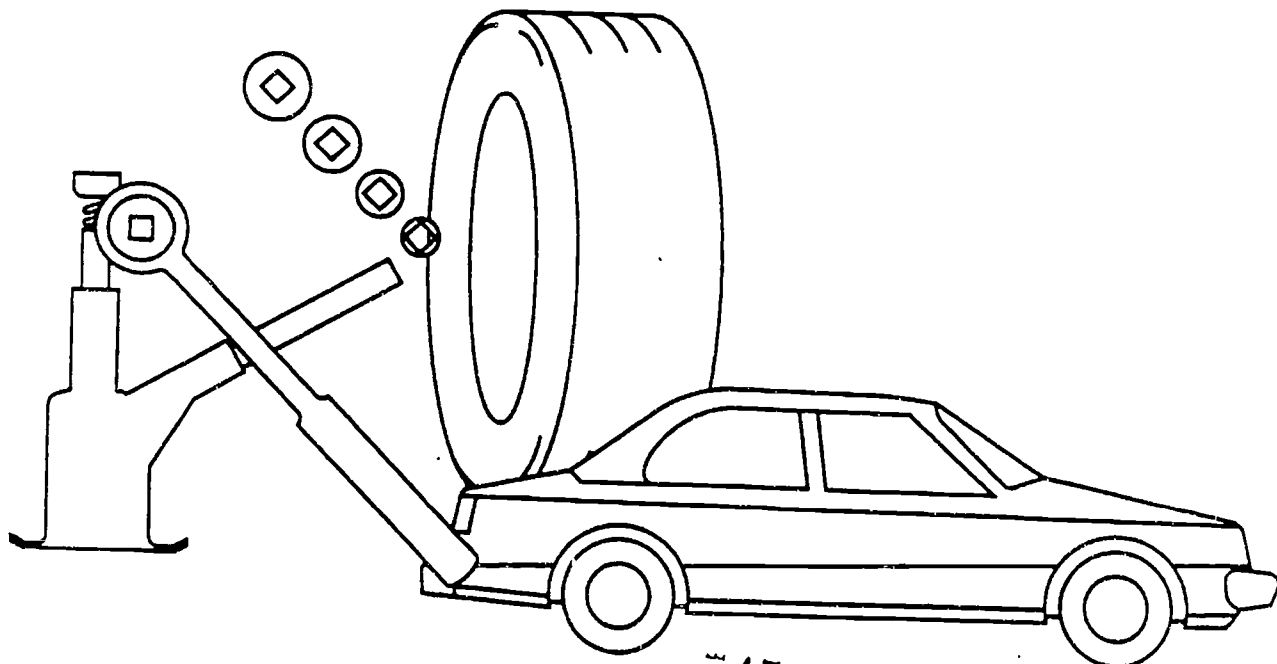

745

BAKING OCCUPATIONS

The workers in this group of jobs mix and bake ingredients according to recipes to produce breads, pastries, doughnuts, and other baked goods. These workers must be proficient in cleaning and maintaining the equipment used in preparing baked goods from raw materials.

The largest occupations, which also have the greatest number of job openings annually, are:

- Bakers of bread and pastry
- Bakers in manufacturing plants

These occupations may have a generally favorable outlook for the future. Overall, the number of these jobs is growing. A moderate number of job openings are expected over the next four or five years. Recently, no training has been reported.

Hourly wages include:

\$5.17 Bakers, bread and pastry

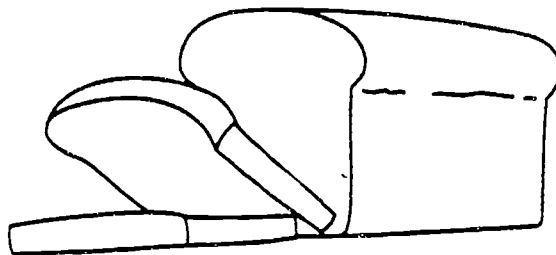

BRICK, BLOCK, AND STONEMASONRY

Workers are involved in trades producing attractive, durable surfaces. Bricklayers build walls, floors, partitions, fireplaces, and other structures with brick, cinder, or concrete block and other masonry materials. Stone masons build stone walls as well as set stone exteriors and floors. Both natural and artificial stones are used.

The largest occupations, which also have the greatest number of job openings annually, are:

- Brick masons
- Hard tile setters

These occupations may have a generally favorable outlook for the future. Overall, the number of these jobs is growing slowly. Few job openings are expected over the next four or five years. Recently, there have been fewer new trainees than job openings.

Hourly wages include:

\$12.66 Brick masons

High school programs preparing for these occupations are:

46.0102 Brick, block, and stonemasonry

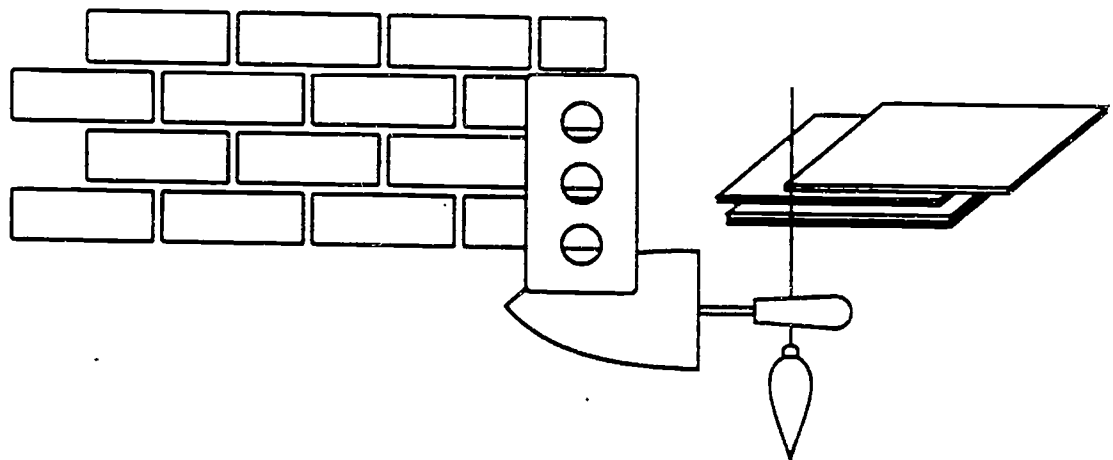

BUILDING MAINTENANCE

Persons in building maintenance occupations perform work involving several maintenance skills to keep the structure of an establishment in repair. Duties may involve pipefitting, boilermaking, carpentry, and electrical work as well as repairing buildings, floors, or stairs.

The largest occupations, which also have the greatest number of job openings annually, are:

- General utility maintenance repairers
- Boiler operators and tenders of low pressure boilers

These occupations may have a generally favorable outlook for the future. Overall, the number of these jobs is growing. Large numbers of job openings are expected over the next four or five years. Recently, there have been fewer new trainees than job openings. If this trend continues, job opportunities should be good.

Hourly wages include:

\$8.06 Maintenance repairers, general utility

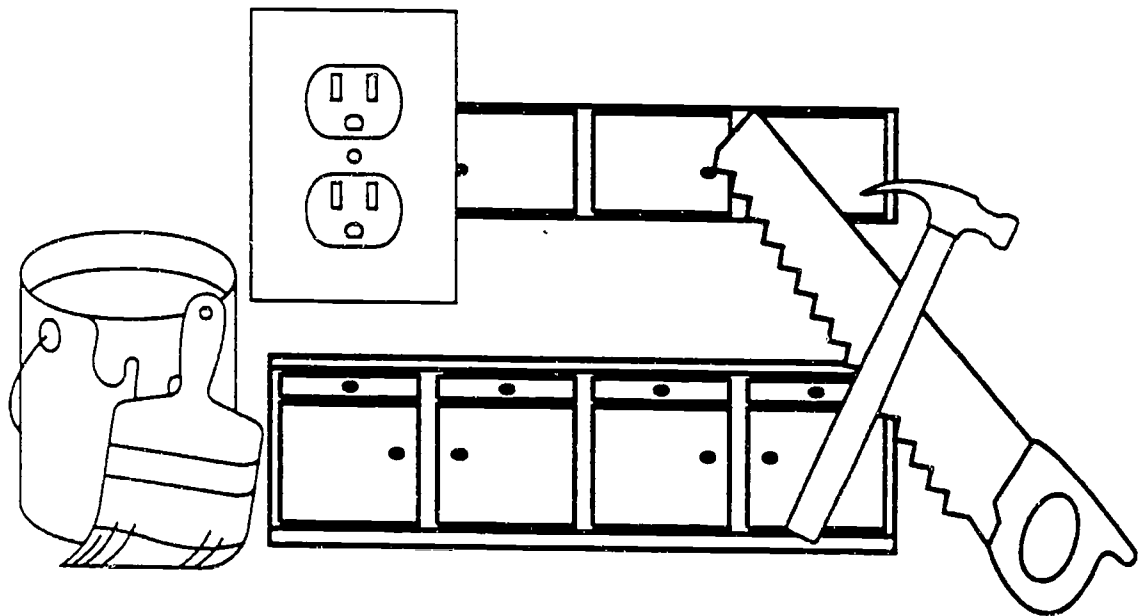

748

CARPENTRY

Almost all construction projects employ carpenters, the largest group of building trades workers. Carpenters perform a variety of jobs. Their duties will vary by type of construction, type of company, skill of the carpenter, and size of the community. A carpenter employed by a special trade contractor, for example, may specialize in laying hardwood floors, while one who is employed by a general building contractor may build wall frames and install paneling.

The largest occupations, which also have the greatest number of job openings annually, are:

- Carpenters
- Ceiling tile installers and acoustical carpenters

These occupations may have a generally favorable outlook for the future. Overall, the number of these jobs is growing slowly. A moderate number of job openings are expected over the next four or five years. Recently, there have been fewer new trainees than job openings. If this trend continues, job opportunities should be good.

Hourly wages include:

\$12.85 Carpenters

High school programs preparing for these occupations are:

46.0201 Carpentry

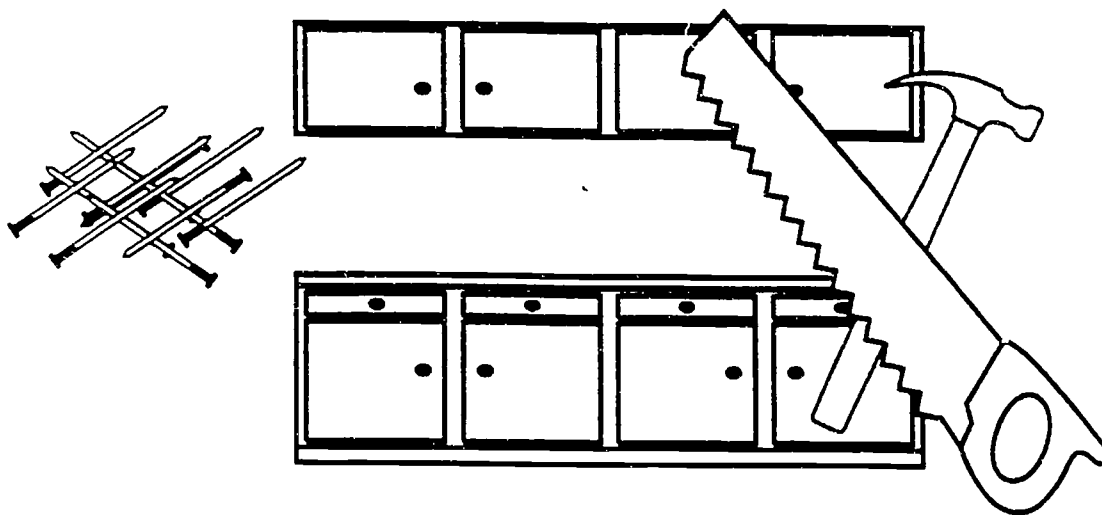

CHEMICAL TECHNOLOGY

Chemical technology workers either research and monitor chemical processes or are directly involved in operating equipment or control boards to create chemical reactions and processes in industrial settings. Technicians work with chemists or chemical engineers, setting up and conducting experiments and collecting and analyzing data.

The two largest occupations are:

- Chemical equipment controllers and operators
- Chemical (except health) technicians and technologists

The occupations expected to have the most job openings annually are:

- Chemical (except health) technicians and technologists
- Chemical plant and system operators

These occupations may have a generally favorable outlook for the future. Overall, the number of these jobs shows little change. A moderate number of job openings are expected over the next four or five years. Recently, there have been fewer new trainees than job openings. If this trend continues, job opportunities should be good..

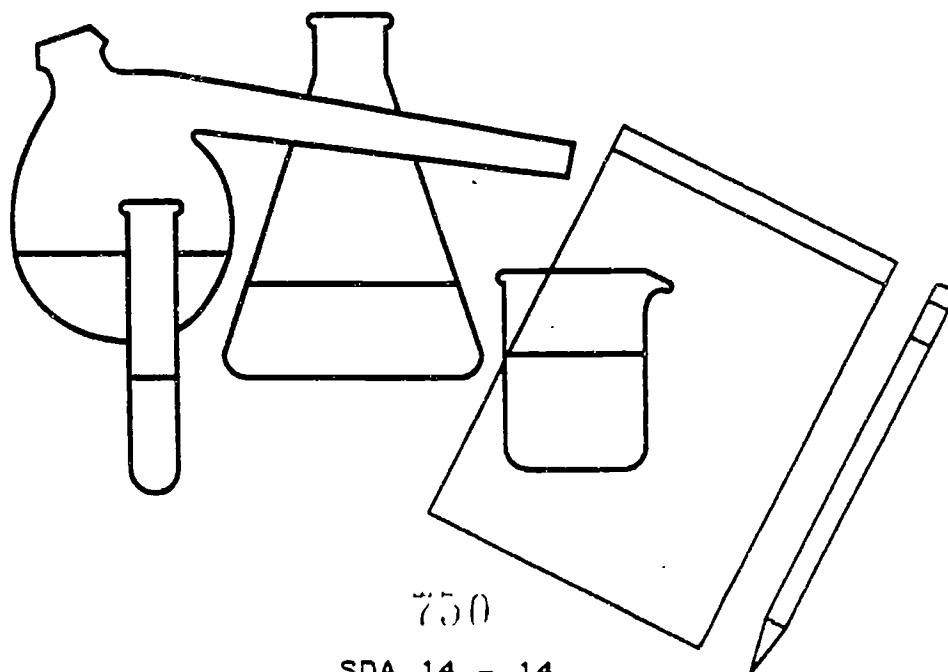

750

COMMERCIAL ART AND DESIGN

The majority of workers in this field design or arrange objects and materials in an artistic or decorative manner. Additional tasks may include the creation or drawing of designs for items such as furniture and machinery (product design).

The largest occupations, which also have the greatest number of job openings annually, are:

- Artists and related workers
- Designers, except interior designers

These occupations may have a generally favorable outlook for the future. Overall, the number of these jobs is growing. A moderate number of job openings are expected over the next four or five years. Recently, there have been fewer new trainees than job openings. If this trend continues, job opportunities should be good. Placement rates at area vocational technical schools, community colleges, and/or technical institutes have been fair recently.

High school programs preparing for these occupations are:

48.0203 Commercial art

Related postsecondary programs at state-supported institutions in this area are:

48.0203 Commercial art

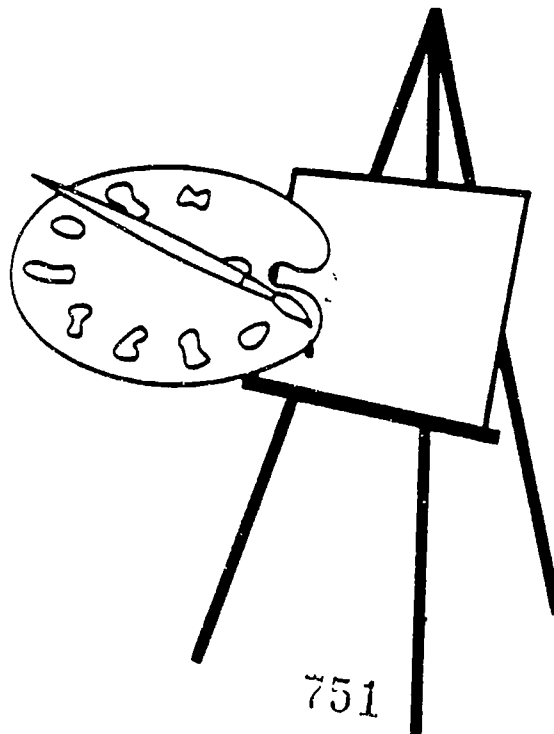

COMMUNICATIONS, JOURNALISM, AND BROADCASTING

Individuals who work in these fields are concerned with communicating ideas and information to individuals for their education and entertainment. The methods utilized are varied and may include the written word, radio, and television.

The two largest occupations are:

- Writers and editors
- Reporters and correspondents

The occupations expected to have the most job openings annually are:

- Writers and editors
- Radio and television announcers

These occupations may not have a favorable outlook for the future. Overall, the number of these jobs is growing. A moderate number of job openings are expected over the next four or five years. Recently, there have been many more new trainees than job openings. If this trend continues, job seekers can expect to face keen competition.

Hourly wages include:

\$13.59 Writers and editors

High school programs preparing for these occupations are:

09.0701 Radio and television broadcasting

Related postsecondary programs at state-supported institutions in this area are:

09.0401 Journalism
09.0403 Mass communication
23.0501 Creative writing

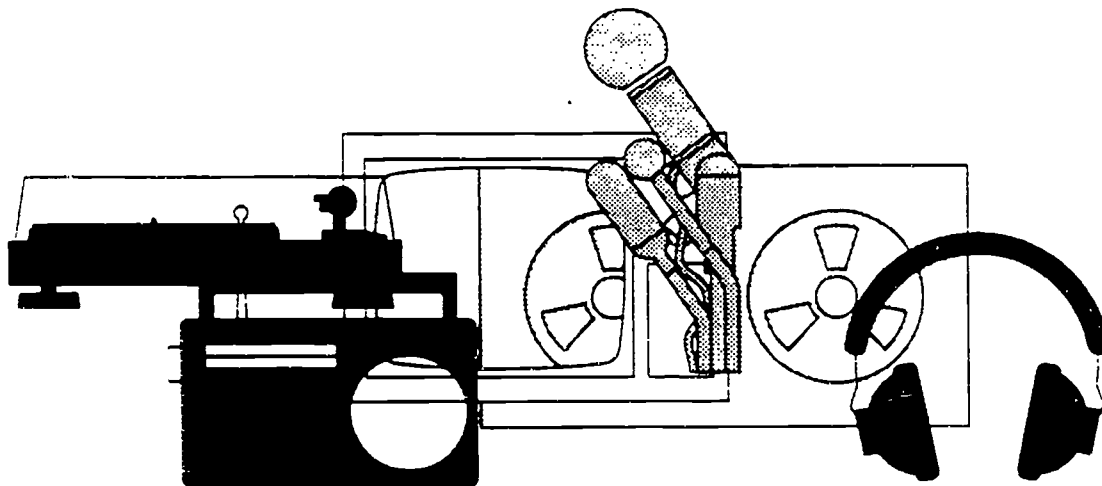

752

COMPUTER AND BUSINESS MACHINE PRODUCTION AND REPAIR

Workers in these fields install, service, maintain, and repair mechanical and electronic equipment, such as computers, word processing systems, radar systems, and office machines. Repairers may work in various locations doing a variety of tasks.

The two largest occupations are:

- Data processing equipment repairers
- Office machine and cash register servicers

The occupations expected to have the most job openings annually are:

- Data processing equipment repairers
- Electronics repairers, commercial and industrial equipment

These occupations may have a generally favorable outlook for the future. Overall, the number of these jobs is growing. A moderate number of job openings are expected over the next four or five years. Recently, there have been fewer new trainees than job openings. If this trend continues, job opportunities should be good.

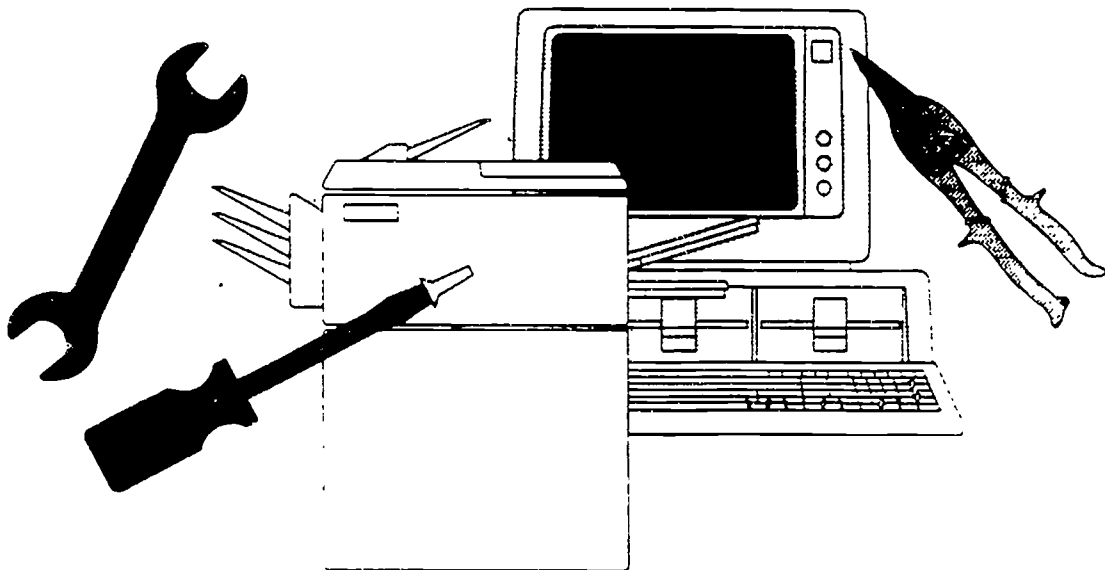

COMPUTER, ELECTRICAL, AND ELECTRONICS TECHNOLOGY

The majority of workers in this field are electrical and electronic engineering technicians and technologists. They apply electrical and related knowledge to design, build, test, and repair electrical equipment in industrial or commercial settings for subsequent use by engineering personnel.

This occupation may not have a favorable outlook for the future. Overall, the number of these jobs is growing rapidly. A moderate number of job openings are expected over the next four or five years. Recently, there have been many more new trainees than job openings. If this trend continues, job seekers can expect to face keen competition. Placement rates at area vocational technical schools, community colleges, and/or technical institutes have been good recently.

Average hourly wages are \$14.48

Related postsecondary programs at state-supported institutions in this area are:

- 15.0301 Computer engineering technology
- 15.0302 Electrical technology
- 15.0303 Electronic technology
- 15.0399 Miscellaneous electrical and electronic engineering-related technologies

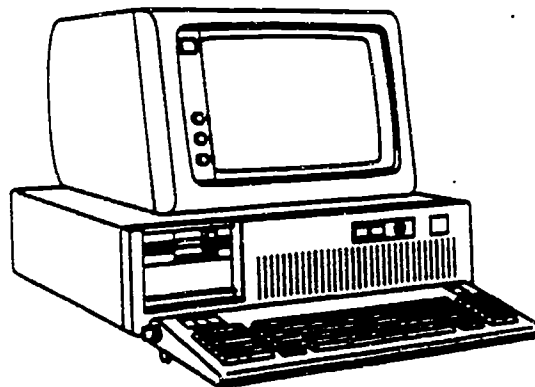

COMPUTER SYSTEMS

Workers in these computer occupations develop and write computer programs to store, locate, and retrieve specific documents, data, and information. They may also analyze business, scientific, and technical problems for application to electronic data processing systems. These careers generally require specialized training.

The largest occupations, which also have the greatest number of job openings annually, are:

- Systems analysts, electronic data processing
- Computer programmers

These occupations may have a generally favorable outlook for the future. Overall, the number of these jobs is growing rapidly. Large numbers of job openings are expected over the next four or five years. Recently, there have been about as many new trainees as job openings. If this trend continues, job seekers can expect to face some competition. Placement rates at area vocational technical schools, community colleges, and/or technical institutes have been good recently.

Hourly wages include:

- \$15.68 Computer programmers
- \$18.05 Systems analysts, electronic data processing

High school programs preparing for these occupations are:

- 07.0305 Business data programming
- 07.0399 Miscellaneous business data processing

Related postsecondary programs at state-supported institutions in this area are:

- 07.0301 Electronic data processing, computer science
- 11.0301 Data processing technology
- 11.0701 Computer science
- 52.1201 Management information systems and business data processing

COSMETOLOGY

Cosmetologists and related workers provide beauty services for customers. These may include cutting and styling hair, treating hair and scalp, applying makeup, dressing wigs, or removing hair by electrolysis, as well as cleaning, shaping, and polishing a customer's fingernails and toenails.

The two largest occupations are:

- Hairdressers, hairstylists, and cosmetologists
- Manicurists

The occupations expected to have the most job openings annually are:

- Hairdressers, hairstylists, and cosmetologists
- Shampooers

These occupations may not have a favorable outlook for the future. Overall, the number of these jobs is growing. A moderate number of job openings are expected over the next four or five years. Recently, there have been many more new trainees than job openings. If this trend continues, job seekers can expect to face keen competition. Placement rates at area vocational technical schools, community colleges, and/or technical institutes have been good recently.

High school programs preparing for these occupations are:

12.0403 Cosmetology

Related postsecondary programs at state-supported institutions in this area are:

12.0403 Cosmetology

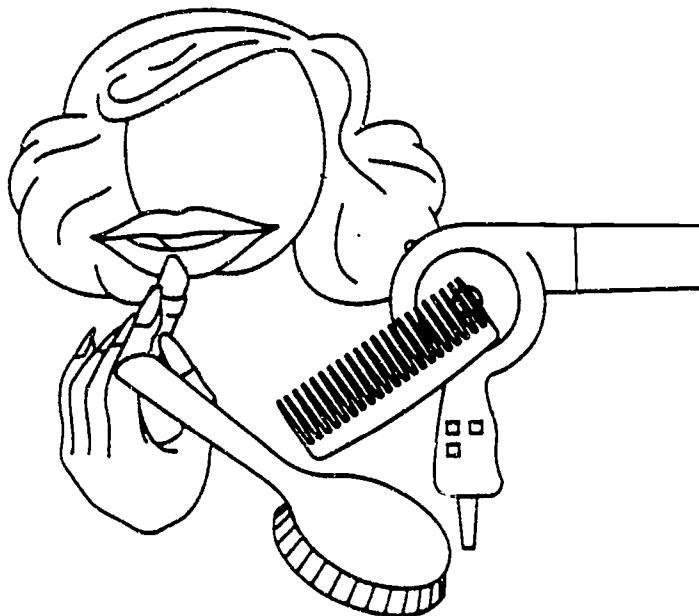

CUSTOM UPHOLSTERY

Upholsterers recondition sofas, chairs, and other upholstered furniture by replacing worn and damaged fabrics, springs, and padding. Upholsterers combine a knowledge of fabrics and other materials with artistic flair and manual skill. Upholsterers should have manual dexterity, good coordination, and be able to do occasional heavy lifting.

The two largest occupations are:

- Upholsterers
- Sewing machine operators manufacturing items other than garments

The occupations expected to have the most job openings annually are:

- Upholsterers
- Assemblers and fabricators, except machine, electrical, electronic, and precision assembly

These occupations may not have a favorable outlook for the future. Overall, the number of these jobs shows little change. Few job openings are expected over the next four or five years. Recently, there have been many more new trainees than job openings. Placement rates at area vocational technical schools, community colleges, and/or technical institutes have been fair recently.

High school programs preparing for these occupations are:

48.0303 Upholstery

Related postsecondary programs at state-supported institutions in this area are:

48.0303 Upholstery

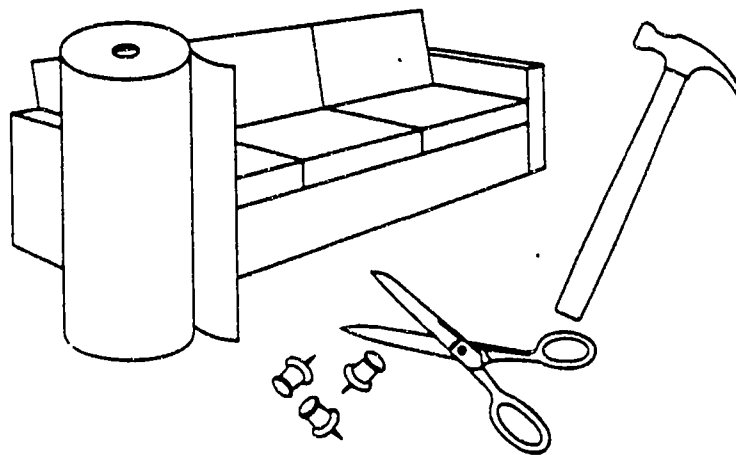

757

DENTAL ASSISTING

Dental assistants may perform a wide variety of clinical, office, and laboratory duties, depending on the size of the dental practice. Typically, assistants seat patients in the dental chair, prepare them for the dentist's treatment, and work with the dentist during examination and treatment.

This occupation may have a generally favorable outlook for the future. Overall, the number of these jobs is growing rapidly. A moderate number of job openings are expected over the next four or five years. Recently, there have been fewer new trainees than job openings. If this trend continues, job opportunities should be good. Placement rates at area vocational technical schools, community colleges, and/or technical institutes have been very good recently.

Related postsecondary programs at state-supported institutions in this area are:

17.0101. Dental assisting

Licensing may be required. Contact: TENNESSEE BOARD OF DENTISTRY, 615-367-6228.

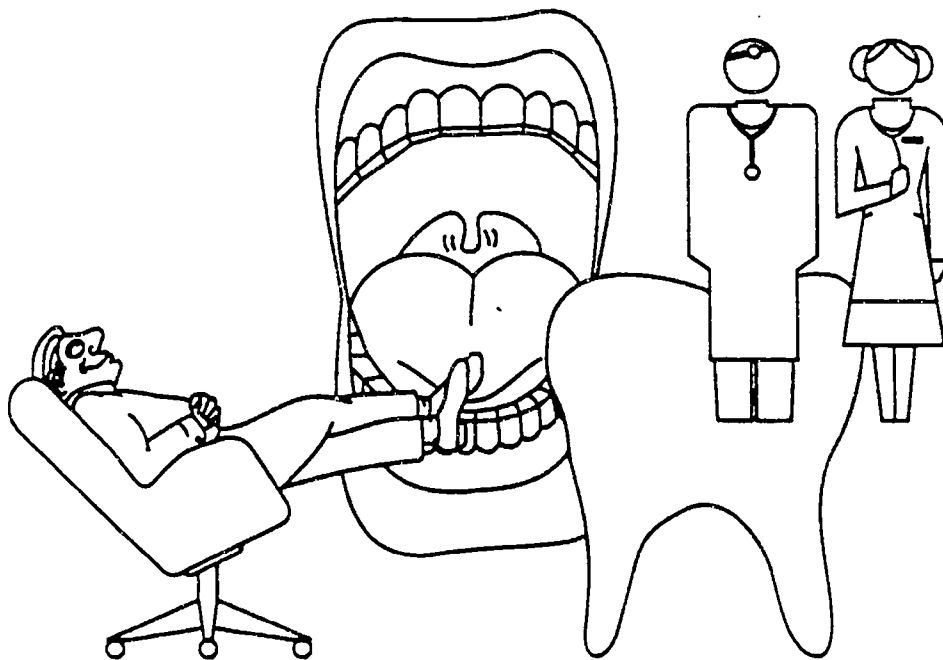

753

DENTAL HYGIENE

Dental hygienists provide preventive dental care and encourage patients to develop good oral health skills. They evaluate patients' dental health; remove calculus, stain, and plaque from above and below the gumline; expose and develop dental x-rays; and instruct patients on plaque control.

This occupation may have a generally favorable outlook for the future. Overall, the number of these jobs is growing rapidly. A moderate number of job openings are expected over the next four or five years. Recently, there have been about as many new trainees as job openings.

Related postsecondary programs at state-supported institutions in this area are:

51.0602 Dental hygienist

Licensing may be required. Contact: TENNESSEE BOARD OF DENTISTRY, 615-367-6228.

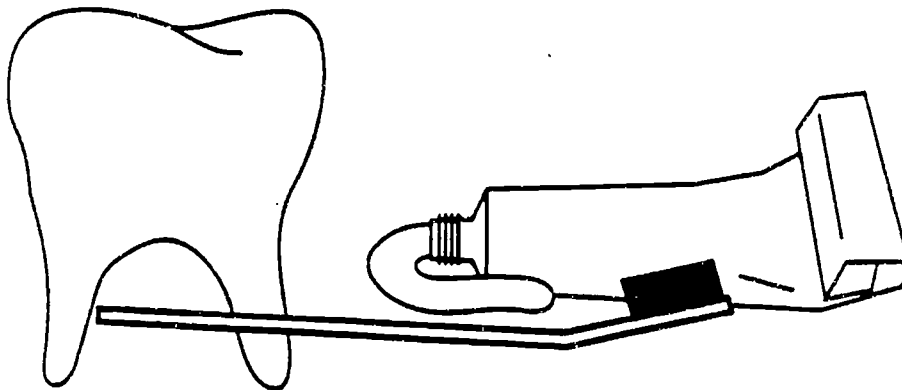

759

DRAFTING AND DESIGN TECHNOLOGY

Persons in drafting and design technology prepare clear, complete, and accurate working plans and detail drawings from rough or detailed sketches or notes for engineering or manufacturing purposes according to specified dimensions. Workers need to have knowledge of various machines, engineering practices, mathematics, building materials, and other physical sciences to complete drawings. Computer-assisted design (CAD) equipment may be used by some workers.

The largest occupations, which also have the greatest number of job openings annually, are:

- Cost estimators
- Drafters

These occupations may have a generally favorable outlook for the future. Overall, the number of these jobs is growing. A moderate number of job openings are expected over the next four or five years. Recently, there have been many more new trainees than job openings. If this trend continues, job seekers can expect to face keen competition. Placement rates at area vocational technical schools, community colleges, and/or technical institutes have been very good recently.

Hourly wages include:

\$13.20 Drafters

High school programs preparing for these occupations are:

48.0101 Drafting

Related postsecondary programs at state-supported institutions in this area are:

15.0101 Architectural engineering technology
48.0101 Drafting

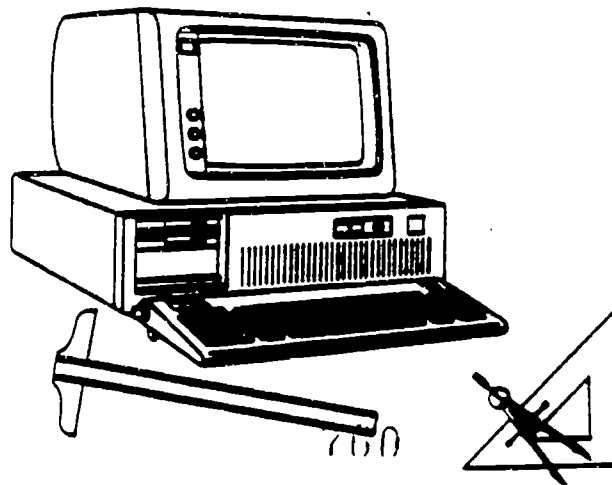

DRYCLEANING

Workers in these occupations operate washing and drying machines to clean and dry clean commercial, industrial, or household articles; use pressing machines to press and shape articles; and identify stains and apply chemical solutions to remove them.

The largest occupations, which also have the greatest number of job openings annually, are:

- Laundry and drycleaning machine operators and tenders, except of pressing machines
- Operators and tenders of machines pressing textiles, garments, and related materials

These occupations may have a generally favorable outlook for the future. Overall, the number of these jobs is growing: A moderate number of job openings are expected over the next four or five years. Recently, there have been fewer new trainees than job openings. If this trend continues, job opportunities should be good. Placement rates at area vocational technical schools, community colleges, and/or technical institutes have been good recently.

Hourly wages include:

\$5.99 Laundry and drycleaning machine operators and tenders, except pressing

High school programs preparing for these occupations are:

12.0102 Drycleaning

Related postsecondary programs at state-supported institutions in this area are:

12.0101 Drycleaning and laundering services



EARLY CHILDHOOD EDUCATION

Child care workers and managers of child care centers assume responsibility for the safety, physical care, and emotional, social, and intellectual growth of preschool children and infants while parents are at work or are unavailable for other reasons. Some work in residential institutions for young children. Teacher aides assist teachers by handling routine paperwork or by working directly with children.

The largest occupations, which also have the greatest number of job openings annually, are:

- Teacher aides, paraprofessional
- Child care workers

These occupations may have a generally favorable outlook for the future. Overall, the number of these jobs is growing rapidly. Large numbers of job openings are expected over the next four or five years. Recently, there have been many more new trainees than job openings. If this trend continues, job seekers can expect to face keen competition. Placement rates at area vocational technical schools, community colleges, and/or technical institutes have been excellent recently.

Hourly wages include:

\$4.97 Child care workers

High school programs preparing for these occupations are:

- 20.0102 Child development, care, and guidance
- 20.0201 Child care and guidance management services

Related postsecondary programs at state-supported institutions in this area are:

- 20.0201 Child care and guidance management services

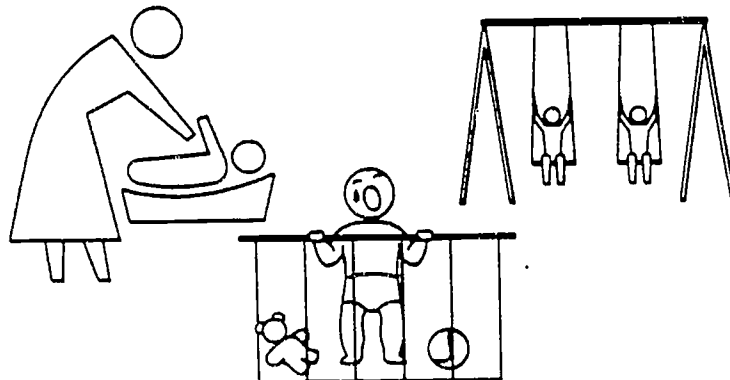

ELECTRICIAN OCCUPATIONS

Workers in the electrical field install, maintain, and repair wiring, electrical equipment, and fixtures or assist in such activities. These workers insure that work is in accordance with the relevant codes. A high school education is usually required and a five-year apprenticeship program is recommended.

The largest occupations, which also have the greatest number of job openings annually, are:

- Electricians
- Helpers of electricians and powerline transmission installers

These occupations may have a generally favorable outlook for the future. Overall, the number of these jobs is growing. Large numbers of job openings are expected over the next four or five years. Recently, there have been fewer new trainees than job openings. If this trend continues, job opportunities should be good.

Hourly wages include:

\$12.88 Electricians

High school programs preparing for these occupations are:

46.0302 Electrician

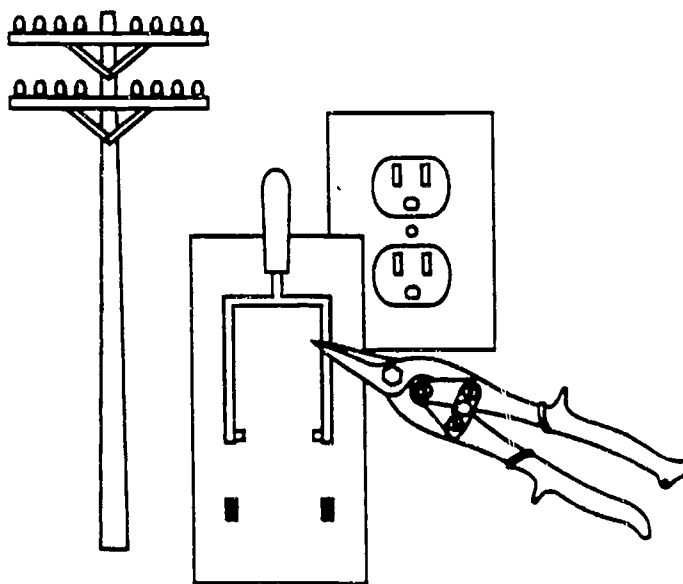

SDA 14 - 2763

ELECTROMECHANICAL INSTRUMENT PRODUCTION AND REPAIR

Workers in this group fabricate, modify, or repair mechanical instruments or mechanical assemblies of electrical instruments. They may install, test, repair, maintain, and make adjustments to recording, telemetering, and controlling instruments.

The largest occupations, which also have the greatest number of job openings annually, are:

- Precision instrument repairers
- Mechanical control and valve installers and repairers

These occupations may have a generally favorable outlook for the future. Overall, the number of these jobs is growing slowly. A moderate number of job openings are expected over the next four or five years. Recently, there have been fewer new trainees than job openings.

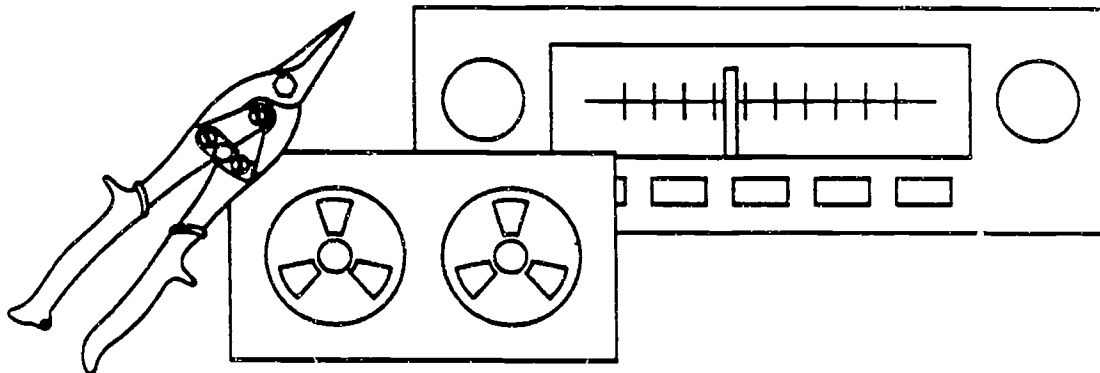

761

FIRE CONTROL AND SAFETY TECHNOLOGY

Workers in these positions help protect the public against the danger to their lives and property by fire. Firefighters must be prepared to respond to a fire and handle any emergency, including medical, that arises. Some firefighters operate fire apparatus, ambulances, emergency rescue vehicles, and fireboats. Most fire departments also are responsible for fire prevention.

The largest occupations, which also have the greatest number of job openings annually, are:

- Fire fighting and prevention supervisors
- Fire fighters

These occupations may have a generally favorable outlook for the future. Overall, the number of these jobs is growing. A moderate number of job openings are expected over the next four or five years. Recently, no training has been reported. Job opportunities should be good.

Hourly wages include:

\$7.98 Fire fighters

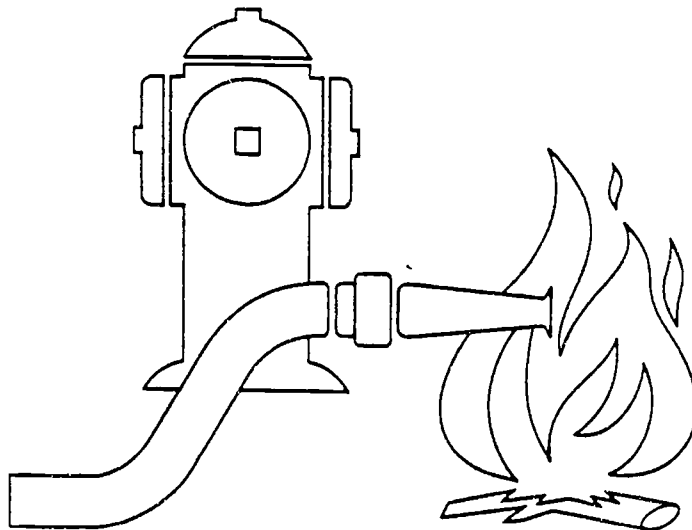

FOOD PREPARATION AND SERVICES

The majority of workers in these occupations prepare and serve food and beverages in restaurants, fast food establishments, catering firms, hotels, clubs, factories, school cafeterias, or hospitals, or supervise those providing food services. Others are factory machine operators involved in the preparation of food products. Dietetic technicians teach principles of food nutrition and provide dietary counseling to patients.

The largest occupations, which also have the greatest number of job openings annually, are:

- Food preparation workers
- Combined food preparation and service workers

These occupations may have a generally favorable outlook for the future. Overall, the number of these jobs is growing. Large numbers of job openings are expected over the next four or five years. Recently, there have been fewer new trainees than job openings. If this trend continues, job opportunities should be good. Placement rates at area vocational technical schools, community colleges, and/or technical institutes have been good recently.

Hourly wages include:

- \$4.22 Bartenders
- \$4.51 Cooks, specialty fast food
- \$4.83 Food preparation workers
- \$5.77 Cooks, restaurant

High school programs preparing for these occupations are:

- 20.0401 Food production, management, and services

Related postsecondary programs at state-supported institutions in this area are:

- 20.0401 Food production, management, and services

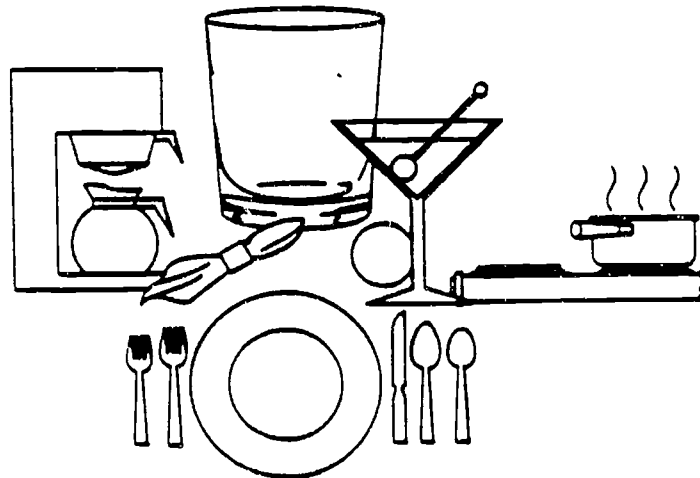

GENERAL BUSINESS AND MANAGEMENT

Workers in the general business and management occupations plan, organize, direct, control, or coordinate activities in all types of fields. Many occupations involve analysis of productivity and financial soundness. General managers and top executives usually have very diverse duties and responsibilities and work through departmental or subordinate executives.

The largest occupations, which also have the greatest number of job openings annually, are:

- Communications, transportation, and utilities operations managers
- General managers and top executives

These occupations may have a generally favorable outlook for the future. Overall, the number of these jobs is growing. Large numbers of job openings are expected over the next four or five years. Recently, there have been fewer new trainees than job openings. If this trend continues, job opportunities should be good. Placement rates at area vocational technical schools, community colleges, and/or technical institutes have been very good recently.

Hourly wages include:

- \$15.15 Underwriters
- \$19.94 Purchasing managers
- \$20.74 Industrial production managers

Related postsecondary programs at state-supported institutions in this area are:

- 06.0101 Business and management
- 06.0401 Business administration and management
- 07.9998 Business management technology
- 31.0301 Parks, recreation and leisure facilities management
- 52.0201 General business administration and management
- 52.0203 Logistics and materials management
- 52.0805 Insurance and risk management
- 52.1101 International business



GENERAL WOODWORKING

Woodworkers are in occupations concerned with the complete cycle of cutting, shaping, and assembling parts of complex wood products. The occupations are primarily concerned with one or a limited number of machine functions according to their speciality.

The largest occupations, which also have the greatest number of job openings annually, are:

- Cabinetmakers and bench carpenters
- Assemblers and fabricators, except machine, electrical, electronic, and precision assembly

These occupations may have a generally favorable outlook for the future. Overall, the number of these jobs shows little change. A moderate number of job openings are expected over the next four or five years. Recently, there have been fewer new trainees than job openings. If this trend continues, job opportunities should be good.

High school programs preparing for these occupations are:

48.0701 Woodworking

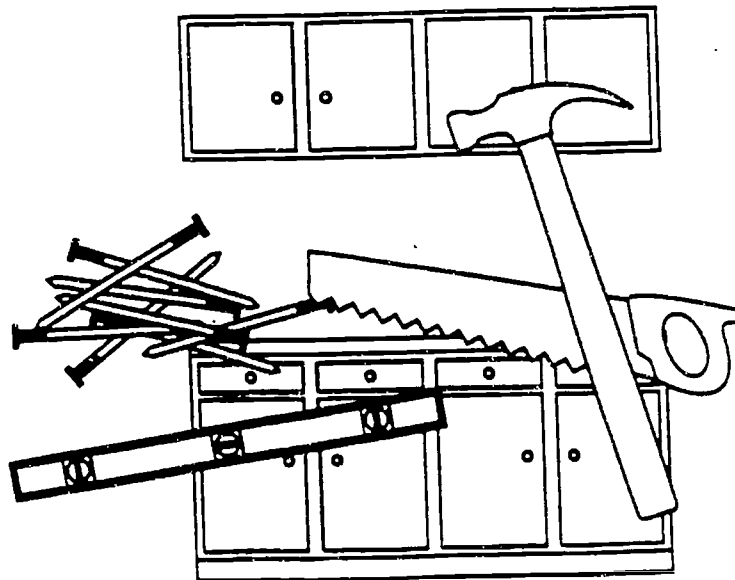

768

GRAPHIC ARTS

A majority of workers in this field are involved in offset printing. In this process the material to be printed is photographed and a printing plate is made from the film. This process has been advanced by the use of computers and lasers.

The largest occupations, which also have the greatest number of job openings annually, are:

- Printing press machine operators and tenders
- Bindery machine operators

These occupations may not have a favorable outlook for the future. Overall, the number of these jobs is growing. A moderate number of job openings are expected over the next four or five years. Recently, there have been many more new trainees than job openings. If this trend continues, job seekers can expect to face keen competition. Placement rates at area vocational technical schools, community colleges, and/or technical institutes have been good recently.

Hourly wages include:

- \$10.04 Letterpress setters and set-up operators, sheet or web fed
- \$13.81 Offset lithographic press setters & set-up operators, sheet or web fed

High school programs preparing for these occupations are:

- 48.0201 Graphic and printing communications

Related postsecondary programs at state-supported institutions in this area are:

- 48.0201 Graphic and printing communications
- 48.0205 Composition, makeup, and typesetting

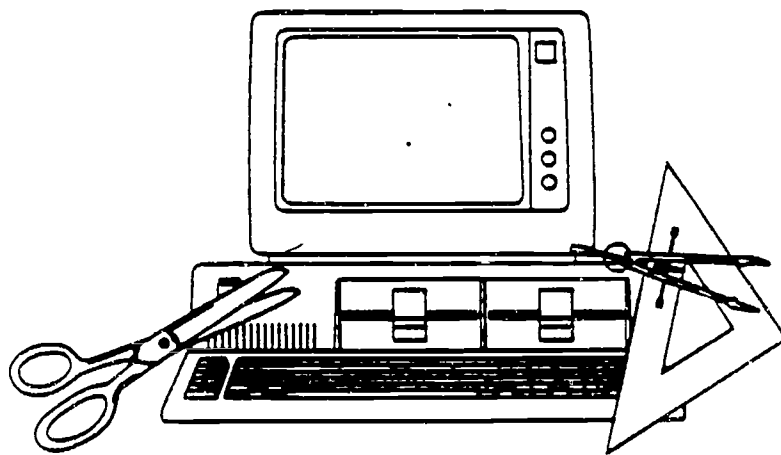

763

HEATING AND AIR CONDITIONING

Workers in this field install and repair heating, air conditioning, and refrigeration systems. They may install and repair oil burners, hot-air furnaces, and heating stoves in homes and businesses. They may also install and repair air conditioning systems, or install sheet metal ducts for the heating and cooling systems.

The largest occupations, which also have the greatest number of job openings annually, are:

- Heating, air conditioning, and refrigeration mechanics and installers
- Sheet metal duct installers

These occupations may have a generally favorable outlook for the future. Overall, the number of these jobs is growing. A moderate number of job openings are expected over the next four or five years. Recently, there have been about as many new trainees as job openings. If this trend continues, job seekers can expect to face some competition. Placement rates at area vocational technical schools, community colleges, and/or technical institutes have been fair recently.

Hourly wages include:

\$14.09 Heating, air conditioning, and refrigeration mechanics and installers

High school programs preparing for these occupations are:

47.0201 Heating, air conditioning, and refrigeration mechanics

Related postsecondary programs at state-supported institutions in this area are:

47.0201 Heating, air conditioning, and refrigeration mechanics

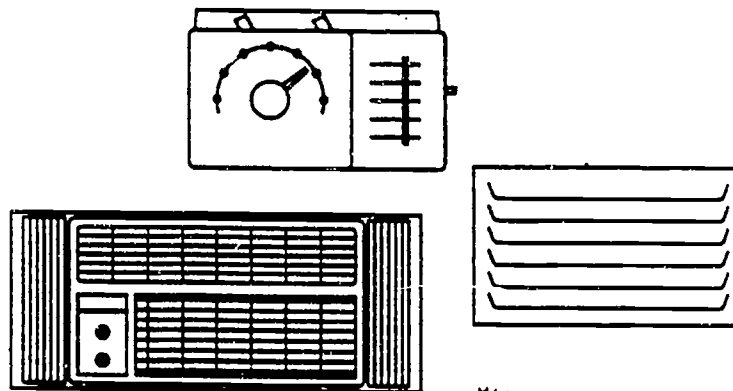

770

HEAVY TRUCK MAINTENANCE

Persons in heavy truck maintenance repair and maintain the operating condition of trucks, buses, and all types of diesel engines. This also includes mechanics working primarily with automobile diesel engines.

This occupation may have a generally favorable outlook for the future. Overall, the number of these jobs is growing. A moderate number of job openings are expected over the next four or five years. Recently, there have been fewer new trainees than job openings. If this trend continues, job opportunities should be good. Placement rates at area vocational technical schools, community colleges, and/or technical institutes have been fair recently.

Average hourly wages are \$11.50

High school programs preparing for these occupations are:

- 47.0601 Heavy truck and diesel maintenance
- 47.0605 Diesel engine mechanics

Related postsecondary programs at state-supported institutions in this area are:

- 47.0605 Diesel engine mechanics

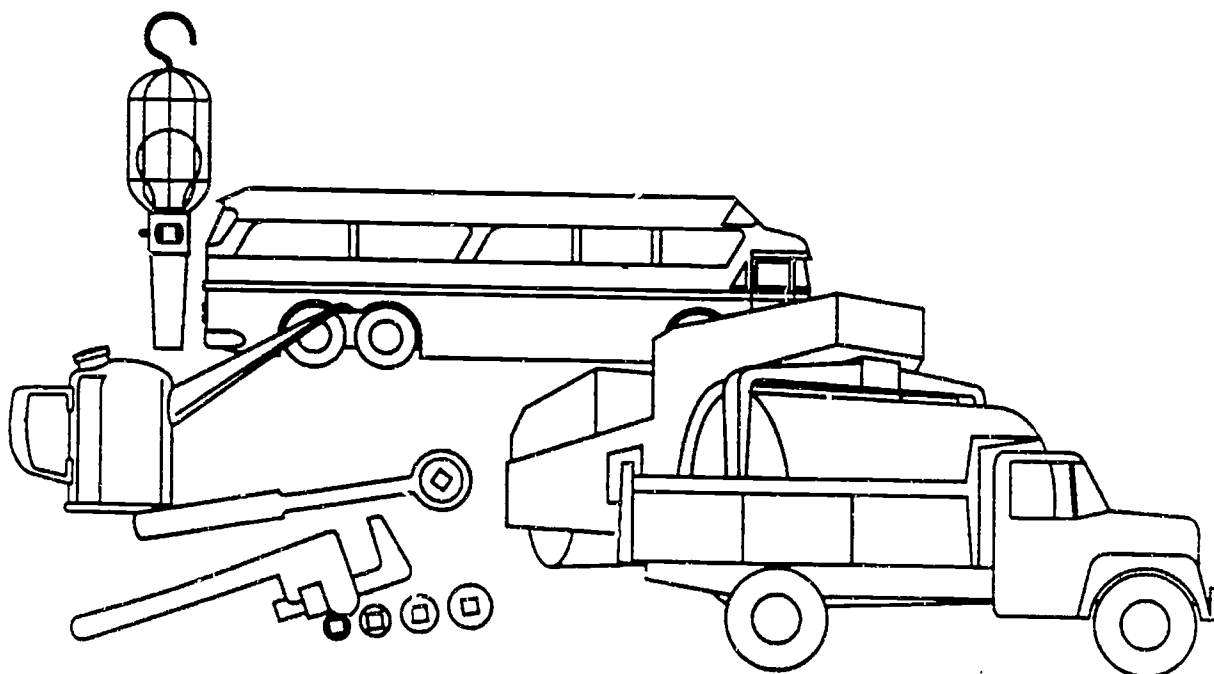

771

HORTICULTURE AND LANDSCAPING

The largest group of workers in these occupations, gardeners and groundskeepers, maintain the grounds of public and private property. Duties may include mowing, trimming, planting, and watering plants, shrubs, and grass.

The largest occupations, which also have the greatest number of job openings annually, are:

- Nursery workers
- Gardeners and groundskeepers, except farm workers

These occupations may have a generally favorable outlook for the future. Overall, the number of these jobs is growing. Large numbers of job openings are expected over the next four or five years. Recently, there have been fewer new trainees than job openings. If this trend continues, job opportunities should be good.

Hourly wages include:

\$7.39 Gardeners and groundskeepers, except farm

High school programs preparing for these occupations are:

01.0601 Horticulture

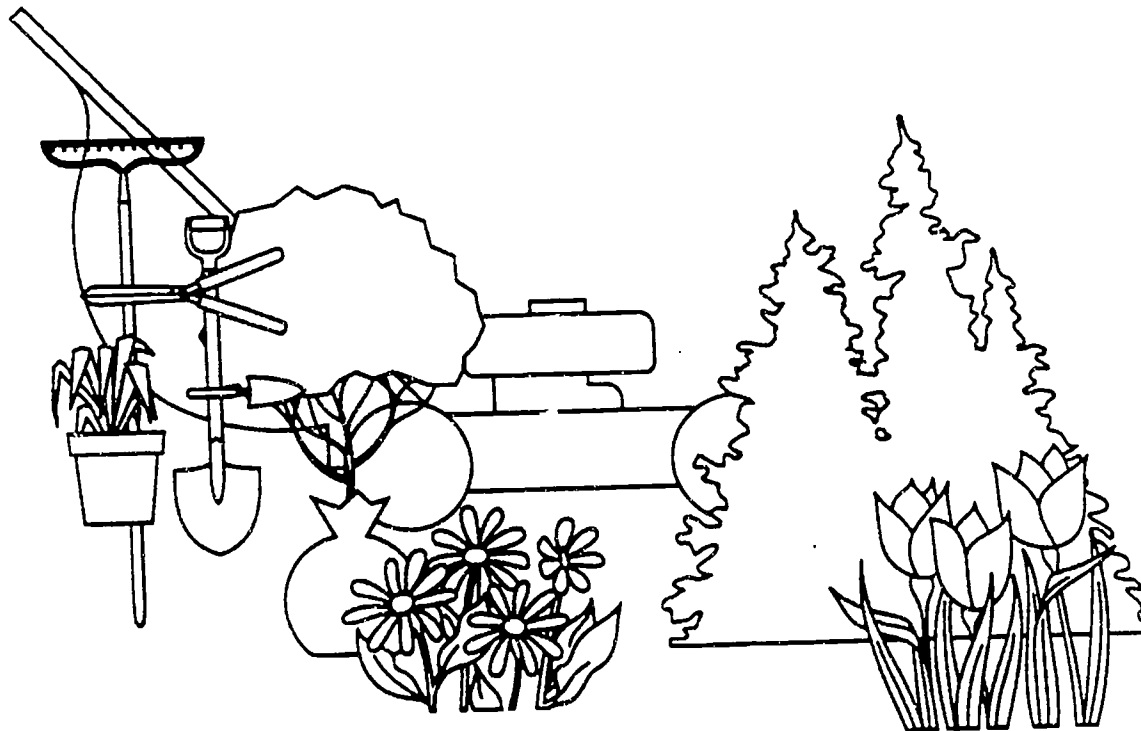

772

HOTEL AND RESTAURANT MANAGEMENT

Food service and lodging managers supervise the profitable operation of restaurants, hotels, and motels. Workers direct the varied activities of these businesses with the goal of pleasing people and providing good service to their customers.

This occupation may have a generally favorable outlook for the future. Overall, the number of these jobs is growing. Large numbers of job openings are expected over the next four or five years. Recently, there have been fewer new trainees than job openings. If this trend continues, job opportunities should be good. Placement rates at area vocational technical schools, community colleges, and/or technical institutes have been excellent recently.

Average hourly wages are \$11.25

Related postsecondary programs at state-supported institutions in this area are:

06.0701 Hotel and motel management

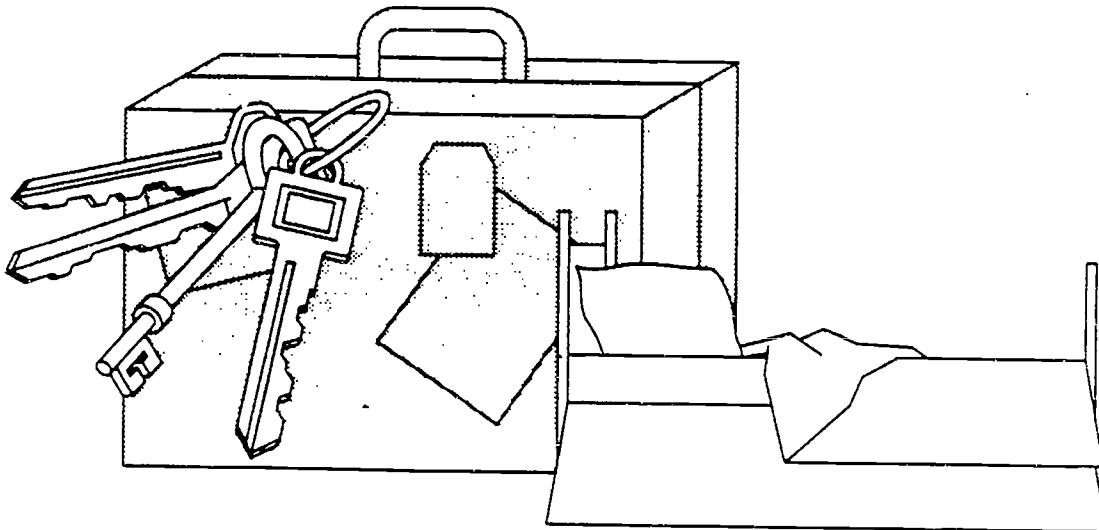

HUMAN SERVICES

Human services workers assist social group workers and caseworkers with developing, organizing, and conducting programs to prevent and resolve problems relevant to substance abuse and human relationships. They help families and clients obtain information on the use of social and community services.

This occupation may have a generally favorable outlook for the future. Overall, the number of these jobs is growing rapidly. A moderate number of job openings are expected over the next four or five years. Recently, there have been fewer new trainees than job openings. Placement rates at area vocational technical schools, community colleges, and/or technical institutes have been excellent recently.

Related postsecondary programs at state-supported institutions in this area are:

19.0301 Family and community services

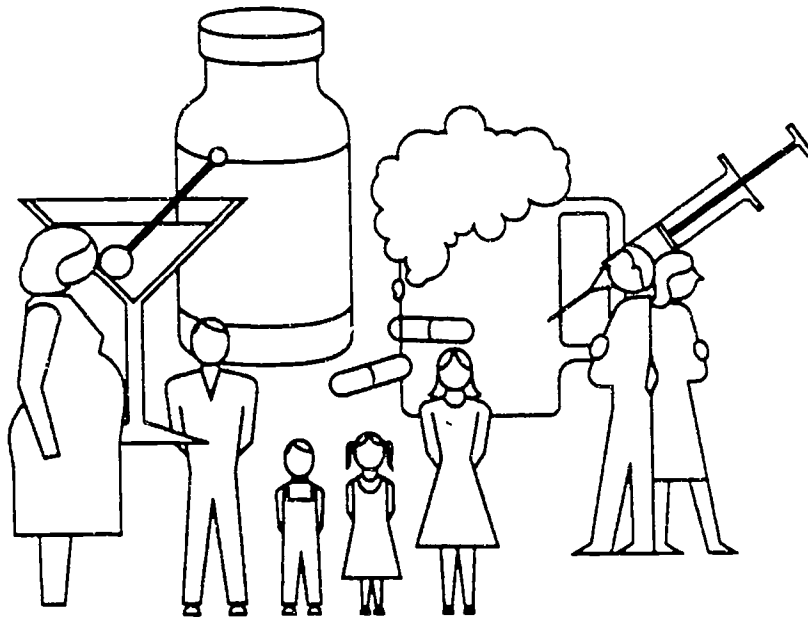

771

INDUSTRIAL MAINTENANCE TECHNOLOGY

Workers prevent costly waste of raw materials and the idling of human resources in a plant or factory by making industrial machinery repairs as quickly as possible. Maintenance mechanics spend considerable time doing preventive maintenance, including keeping machines well oiled and greased, and periodically cleaning parts.

The largest occupations, which also have the greatest number of job openings annually, are:

- Maintenance mechanics for industrial machinery
- Millwrights

These occupations may have a generally favorable outlook for the future. Overall, the number of these jobs is growing. A moderate number of job openings are expected over the next four or five years. Recently, there have been about as many new trainees as job openings. If this trend continues, job seekers can expect to face some competition. Placement rates at area vocational technical schools, community colleges, and/or technical institutes have been very good recently.

Hourly wages include:

\$11.73 Machinery maintenance mechanics

High school programs preparing for these occupations are:

15.0603 Industrial technology

Related postsecondary programs at state-supported institutions in this area are:

15.0603 Industrial technology

47.0303 Industrial mechanics technology

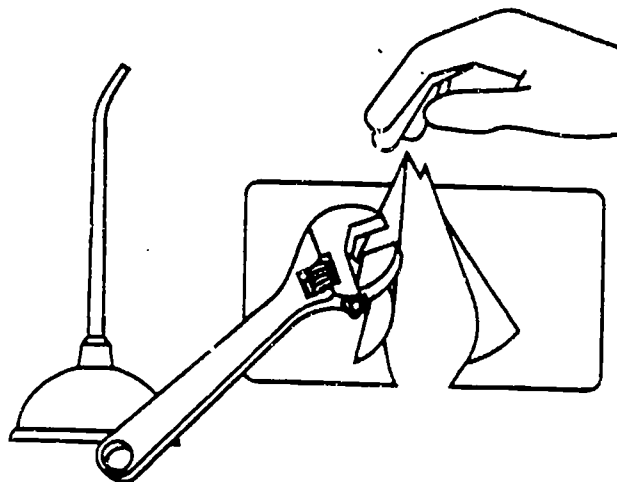

INSTITUTIONAL HOME MANAGEMENT AND SUPPORTING SERVICES

These workers make sure that all public buildings, offices, hospitals, stores, and apartment houses are kept clean and in good condition for the comfort and safety of the people who work or live there. Generally, no special education is required for occupations in this field, with most skills learned on the job.

The largest occupations, which also have the greatest number of job openings annually, are:

- Maids and housekeeping cleaners
- Janitors and cleaners, except maids and housekeeping cleaners

These occupations may have a generally favorable outlook for the future. Overall, the number of these jobs is growing. Large numbers of job openings are expected over the next four or five years. Recently, there have been fewer new trainees than job openings. If this trend continues, job opportunities should be good.

Hourly wages include:

- \$4.93 Maids and housekeeping cleaners
- \$6.08 Janitors and cleaners, except maids and housekeeping cleaners
- \$6.30 Housekeepers

High school programs preparing for these occupations are:

- 20.0601 Institutional, home management, and supporting services

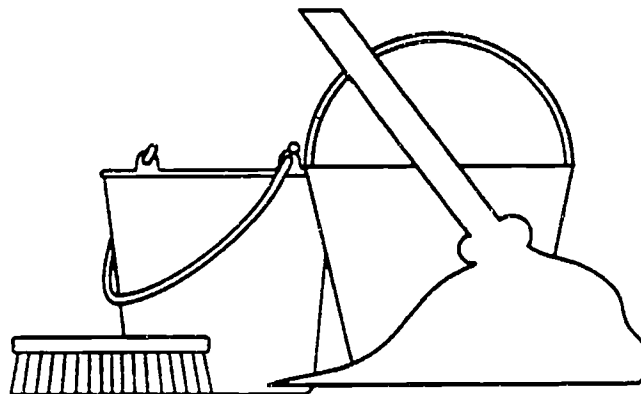

LABORATORY TECHNICIAN

Medical and clinical laboratory technicians perform routine laboratory tests for use in the treatment and diagnosis of disease; prepare vaccines, biologicals, and serums for prevention of disease; and prepare tissue samples, take blood samples, and execute laboratory tests including urinalyses and blood counts.

This occupation may have a generally favorable outlook for the future. Overall, the number of these jobs is growing. A moderate number of job openings are expected over the next four or five years. Recently, there have been fewer new trainees than job openings. If this trend continues, job opportunities should be good. Placement rates at area vocational technical schools, community colleges, and/or technical institutes have been excellent recently.

Average hourly wages are \$10.62

High school programs preparing for these occupations are:

17.0302 Chemistry technology

Related postsecondary programs at state-supported institutions in this area are:

17.0309 Medical laboratory technology

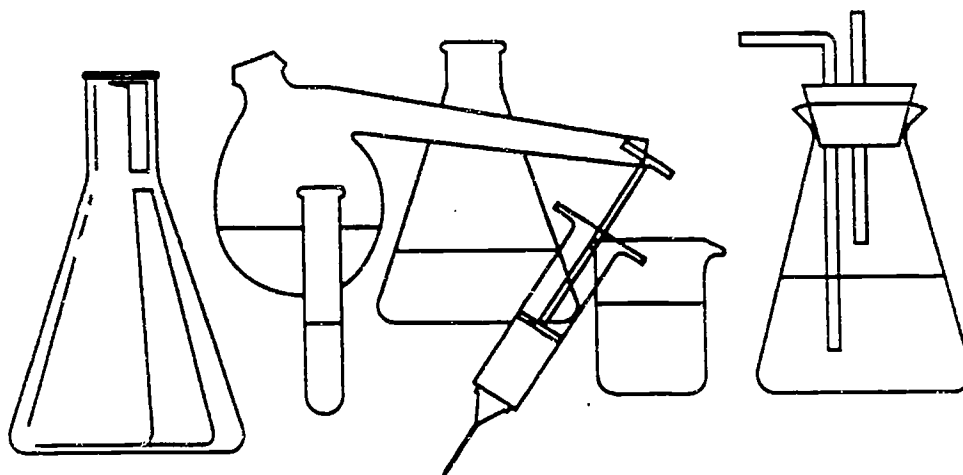

777

LAW ENFORCEMENT

People working at these occupations are responsible for the safety of Tennessee cities, towns, and highways. Their responsibilities range from controlling traffic to preventing and investigating crimes. Whether on or off duty, they are expected to exercise their authority whenever necessary.

The two largest occupations are:

- Police patrol officers
- Sheriffs and deputy sheriffs

The occupations expected to have the most job openings annually are:

- Police patrol officers
- Police and detective supervisors

These occupations may have a generally favorable outlook for the future. Overall, the number of these jobs is growing. A moderate number of job openings are expected over the next four or five years. Recently, there have been fewer new trainees than job openings. If this trend continues, job opportunities should be good. Placement rates at area vocational technical schools, community colleges, and/or technical institutes have been good recently.

Hourly wages include:

\$11.02 Police patrol officers

Related postsecondary programs at state-supported institutions in this area are:

43.0107 Law enforcement and police science

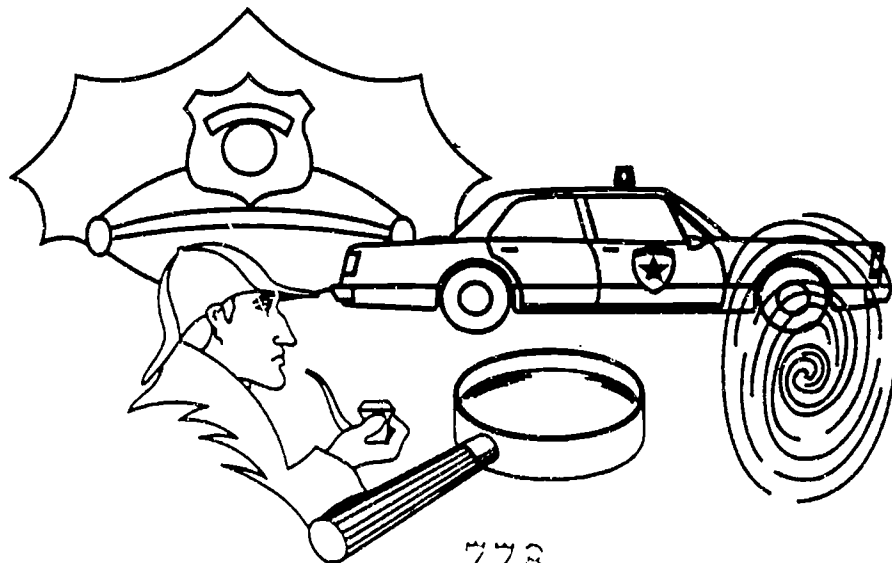

778

LEGAL ASSISTING

Under the direct supervision of a lawyer, workers employed in paralegal occupations do research for the preparation of lawsuits and legal documents; gather information for use as evidence in trials; draft documents such as mortgages, deeds, and contracts; and search titles to determine if a title deed is correct. Most paralegal personnel work for private law firms.

The two largest occupations are:

- Paralegal personnel
- Title searchers

The occupations expected to have the most job openings annually are:

- Paralegal personnel
- Title examiners and abstractors

These occupations may not have a favorable outlook for the future. Few job openings are expected over the next four or five years. Recently, there have been many more new trainees than job openings.

Related postsecondary programs at state-supported institutions in this area are:

22.0103 Paralegal, legal assisting

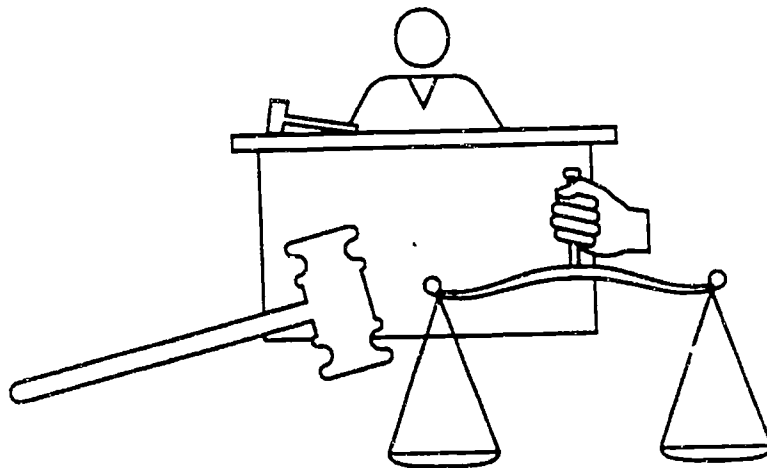

779

MACHINE TOOL TECHNOLOGY

Workers in these occupations make or set up and operate machine tools or repair metal parts. Machinists and tool-and-die makers create highly specialized precision tools, molds, and metal parts. Often they use blueprints to develop prototypes for tools or machines to be used in manufacturing.

The two largest occupations are:

- Machinists
- Machine tool cutting operators and tenders of metal and plastic

The occupations expected to have the most job openings annually are:

- Machinists
- Tool and die makers

These occupations may have a generally favorable outlook for the future. Overall, the number of these jobs is growing. Large numbers of job openings are expected over the next four or five years. Recently, there have been fewer new trainees than job openings. If this trend continues, job opportunities should be good. Placement rates at area vocational technical schools, community colleges, and/or technical institutes have been good recently.

Hourly wages include:

- \$8.89 Combination machine tool operators and tenders, metal and plastic
- \$9.01 Numerical control machine tool operators and tenders, metal and plastic
- \$9.13 Lathe and turning machine tool setters and set-up operators, metal and plastic
- \$11.00 Machinists
- \$13.18 Tool and die makers

High school programs preparing for these occupations are:

- 48.0503 Machine tool operation and machine shop technology

Related postsecondary programs at state-supported institutions in this area are:

- 48.0503 Machine tool operation and machine shop technology

MEDICAL ASSISTING

Medical assistants perform a wide variety of clinical and administrative duties under the direction of physicians. Clinical duties may include taking and recording patients' vital signs and medical histories, preparing patients for examination by physicians, and explaining treatment procedures to patients.

In small physicians' offices they may keep medical records, schedule appointments, and order supplies. Electrocardiograph (EKG) technicians operate the EKG machines which provide graphic tracings of heartbeats.

The two largest occupations are:

- Medical assistants
- Electrocardiograph technicians

The occupations expected to have the most job openings annually are:

- Medical assistants
- Cardiology technologists

These occupations may have a generally favorable outlook for the future. Overall, the number of these jobs is growing rapidly. A moderate number of job openings are expected over the next four or five years. Recently, no training has been reported. Job opportunities should be good.

Hourly wages include:

\$7.32 Medical assistants

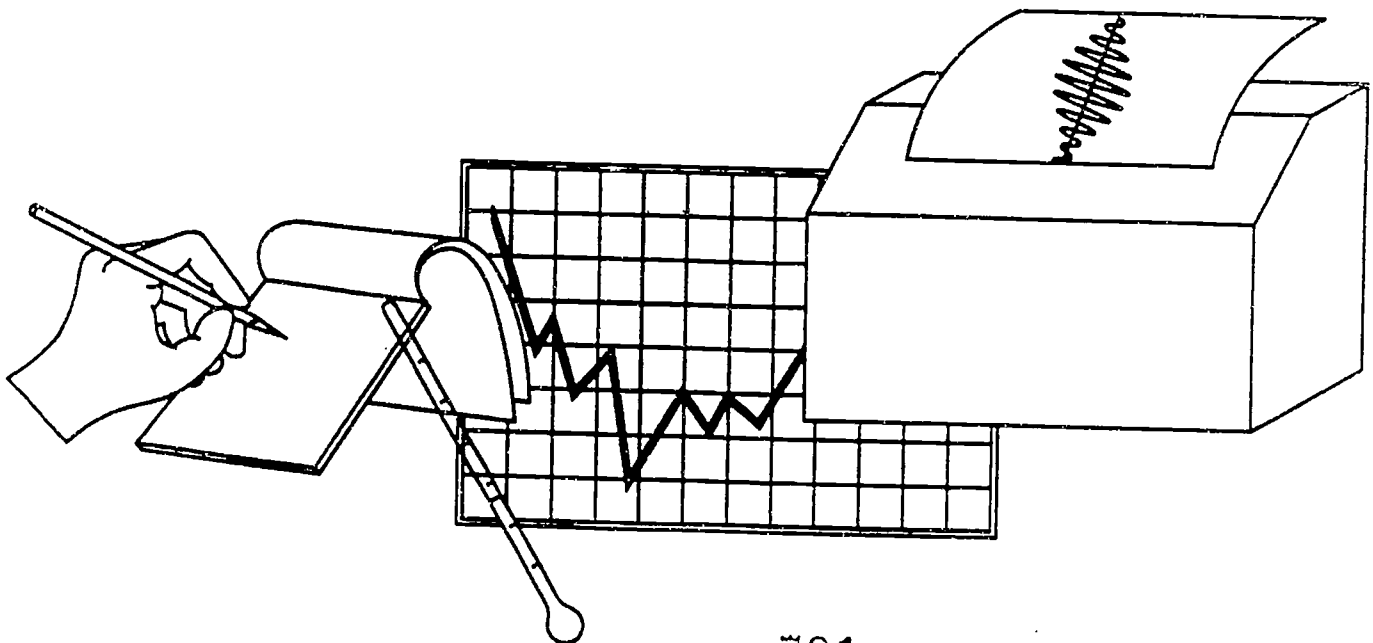

781

SDA 14 - 45

MEDICAL RECORDS TECHNOLOGY

Medical records technicians compile and maintain medical records of hospital and clinic patients. Such work is becoming increasingly important as this background information is used for medicare and medical insurance reimbursements.

This occupation may have a generally favorable outlook for the future. Overall, the number of these jobs is growing rapidly. A moderate number of job openings are expected over the next four or five years. Recently, there have been about as many new trainees as job openings.

Average hourly wages are \$7.50

Related postsecondary programs at state-supported institutions in this area are:

51.0707 Medical records technology and technician

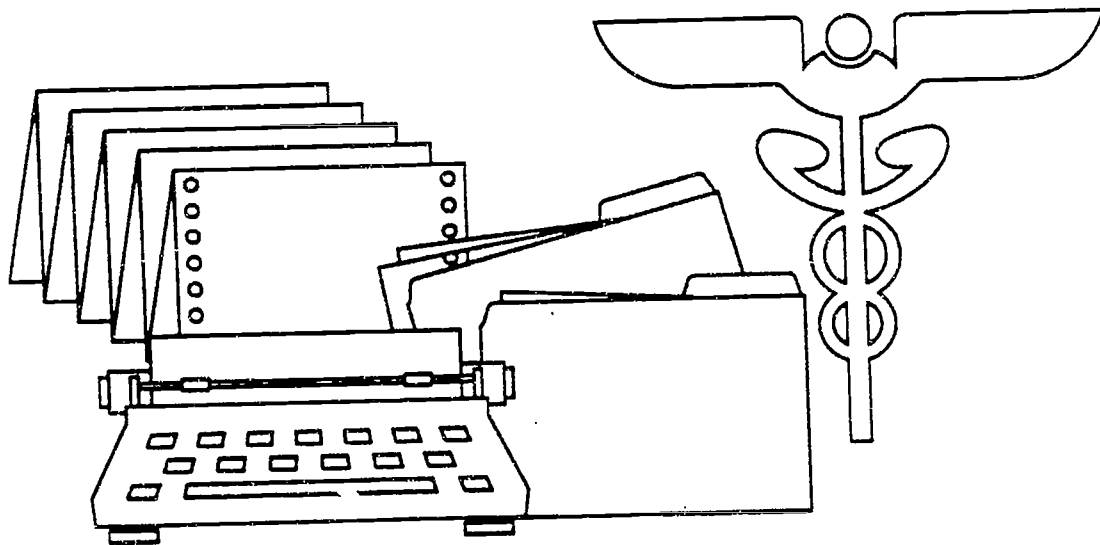

782

SDA 14 - 46

NURSING ASSISTANT

Nursing aides and orderlies work under the general direction of nursing or medical staff. In hospitals, they may answer patients' call bells, serve and collect food trays, feed patients, or set up equipment. In nursing homes, they are expected to sustain ongoing relations with patients.

The largest occupations, which also have the greatest number of job openings annually, are:

- Nursing aides, orderlies, and attendants
- Home health aides

These occupations may not have a favorable outlook for the future. Overall, the number of these jobs is growing rapidly. Large numbers of job openings are expected over the next four or five years. Recently, there have been fewer new trainees than job openings. If this trend continues, job opportunities should be good. Placement rates at area vocational technical schools, community colleges, and/or technical institutes have been poor recently.

Hourly wages include:

- \$5.35 Home health aides
- \$6.79 Nursing aides, orderlies, and attendants

Related postsecondary programs at state-supported institutions in this area are:

- 17.0602 Nursing assisting

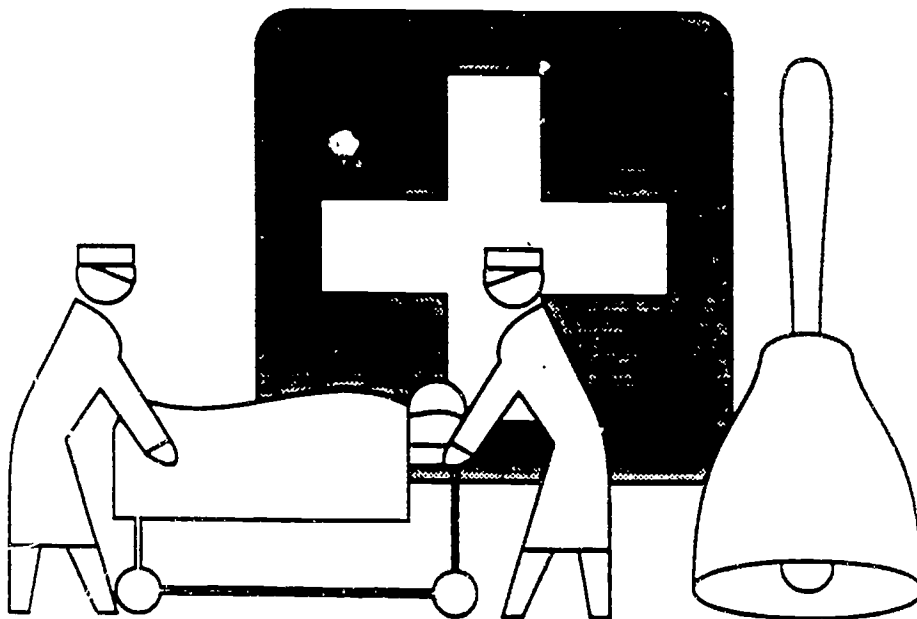

783

PHOTOGRAPHIC TECHNOLOGY

Workers in this cluster use their cameras and film to portray people, places, and events much as a writer uses words. Those who are skillful can capture the personality of individuals or the mood of the scenes which they photograph. Photographers specializing in scientific, medical, or engineering photography expose worlds normally hidden from our view.

The largest occupations, which also have the greatest number of job openings annually, are:

- Photographers
- Photographic processing machine operators and tenders

These occupations may have a generally favorable outlook for the future. Overall, the number of these jobs is growing slowly. A moderate number of job openings are expected over the next four or five years. Recently, there have been more new trainees than job openings. If this trend continues, job seekers can expect to face some competition.

High school programs preparing for these occupations are:

48.0204 Commercial photography

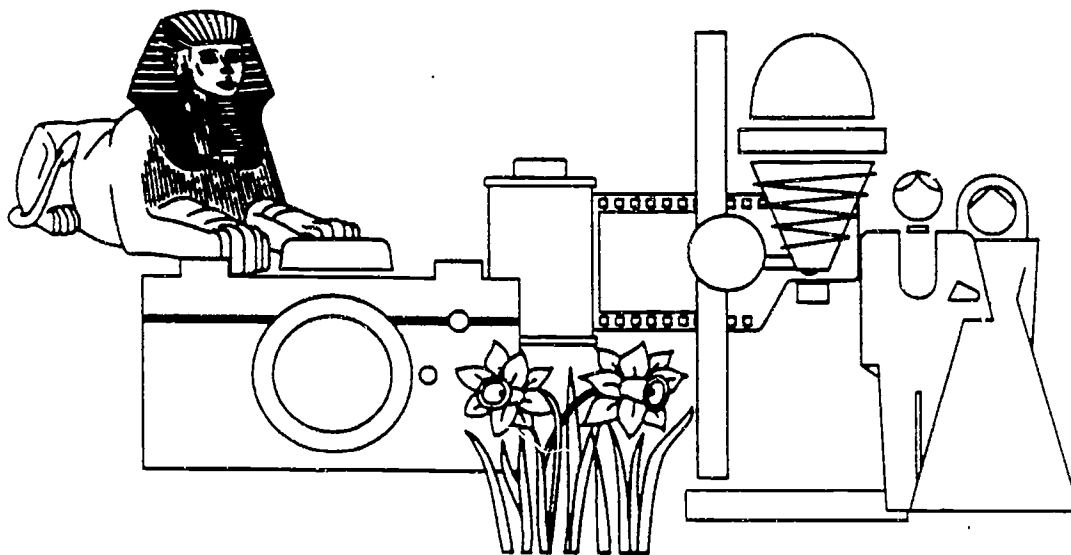

781

PHYSICAL THERAPY ASSISTING

Workers in this occupation, under the direction of a physical therapist, prepare patients for and/or administer physical therapy treatment, such as massages, heat, light and sound treatment, and traction. They also instruct, motivate, and assist patients with learning and improving functional activities.

This occupation may have a generally favorable outlook for the future. Few job openings are expected over the next four or five years. Recently, there have been more new trainees than job openings. Placement rates at area vocational technical schools, community colleges, and/or technical institutes have been excellent recently.

Related postsecondary programs at state-supported institutions in this area are:

17.0815 Physical therapy assisting

Licensing may be required. Contact: TENNESSEE STATE BOARD OF OCCUPATIONAL AND PHYSICAL THERAPY, 615-367-6243.

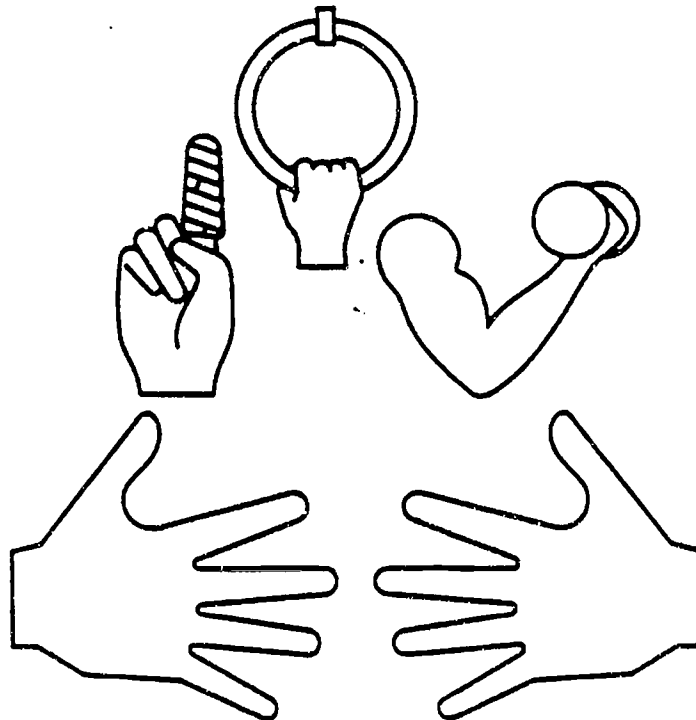

PLUMBING AND PIPEFITTING

Plumbers and pipefitters install and maintain the complex system of pipes that connect to the master system that runs underground. Although plumbing and pipefitting are sometimes considered a single trade, workers may specialize in either craft. Plumbers build and repair the water, waste disposal, drainage, and gas systems in homes and commercial/industrial buildings. Pipefitters build and repair both high and low pressure pipe.

The largest occupations, which also have the greatest number of job openings annually, are:

- Plumbers, pipefitters, and steamfitters
- Pipelayers

These occupations may have a generally favorable outlook for the future. Overall, the number of these jobs is growing. A moderate number of job openings are expected over the next four or five years. Recently, there have been fewer new trainees than job openings. If this trend continues, job opportunities should be good.

Hourly wages include:

\$14.56 Plumbers, pipefitters, and steamfitters

High school programs preparing for these occupations are:

46.0501 Plumbing, pipefitting, and steamfitting

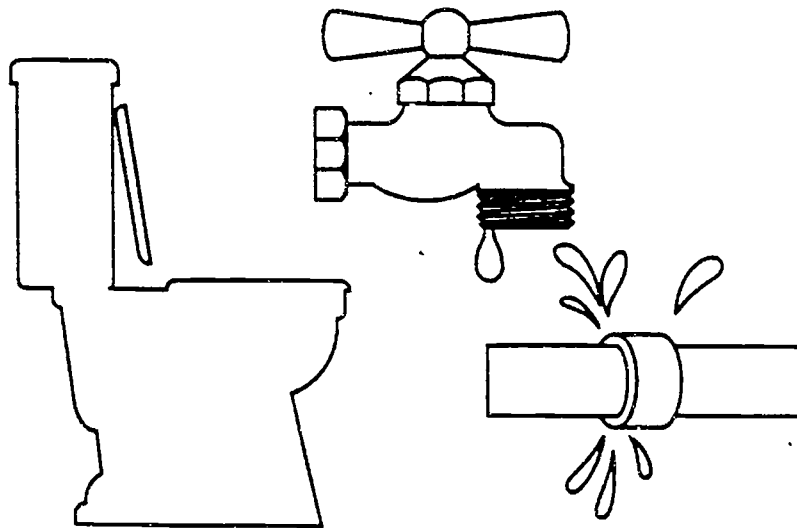

786

PRACTICAL NURSING

Licensed practical nurses (LPNs) work under the supervision of physicians and/or registered nurses to provide nursing care that requires technical knowledge but not the professional training of a registered nurse. They provide bedside care, administer certain medications, and assist in patient examinations.

This occupation may have a generally favorable outlook for the future. Overall, the number of these jobs is growing rapidly. Large numbers of job openings are expected over the next four or five years. Recently, there have been fewer new trainees than job openings. If this trend continues, job opportunities should be good. Placement rates at area vocational technical schools, community colleges, and/or technical institutes have been excellent recently.

Average hourly wages are \$10.21

Related postsecondary programs at state-supported institutions in this area are:

17.0605 Practical nursing

Licensing may be required. Contact: TENNESSEE BOARD OF NURSING, 615-367-6232.

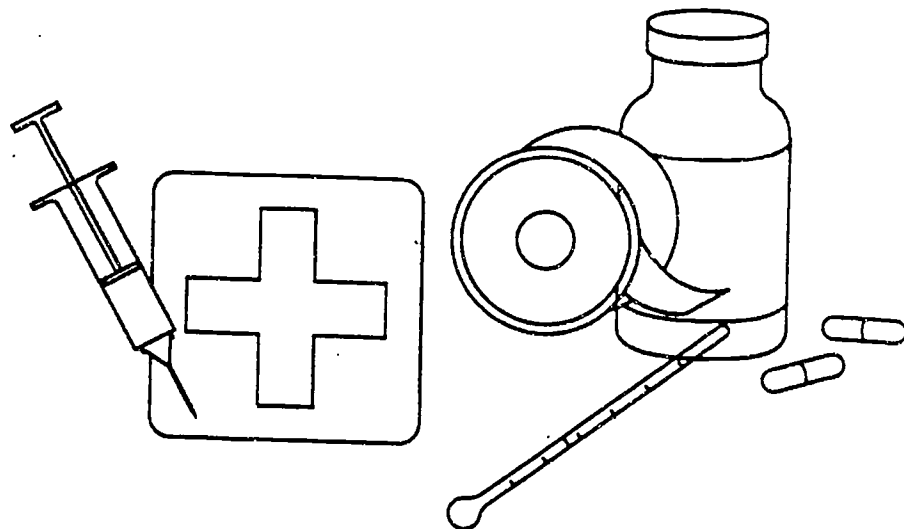

787

PROFESSIONAL NURSING

Registered Nurses (R.N.'s), the largest occupational group in this field, are primarily employed in hospitals and nursing homes, where they provide skilled bedside care and may supervise licensed practical nurses, nursing aides, and orderlies. Working under the direction of a licensed "supervising physician," physician assistants elicit detailed patient histories, perform physical examinations, and prescribe appropriate treatments.

The largest occupations, which also have the greatest number of job openings annually, are:

- Registered nurses
- Physician's assistants

These occupations may have a generally favorable outlook for the future. Overall, the number of these jobs is growing rapidly. Large numbers of job openings are expected over the next four or five years. Recently, there have been fewer new trainees than job openings. If this trend continues, job opportunities should be good. Placement rates at area vocational technical schools, community colleges, and/or technical institutes have been excellent recently.

Hourly wages include:

\$15.12 Registered nurses

Related postsecondary programs at state-supported institutions in this area are:

- 18.1101 Nursing
- 51.1601 Nursing (R.N. training)
- 51.1608 Nursing science (post R.N.)

Licensing may be required. Contact: TENNESSEE BOARD OF MEDICAL EXAMINERS-COMMITTEE ON PHYSICIAN ASSISTANTS, 615-367-6250.

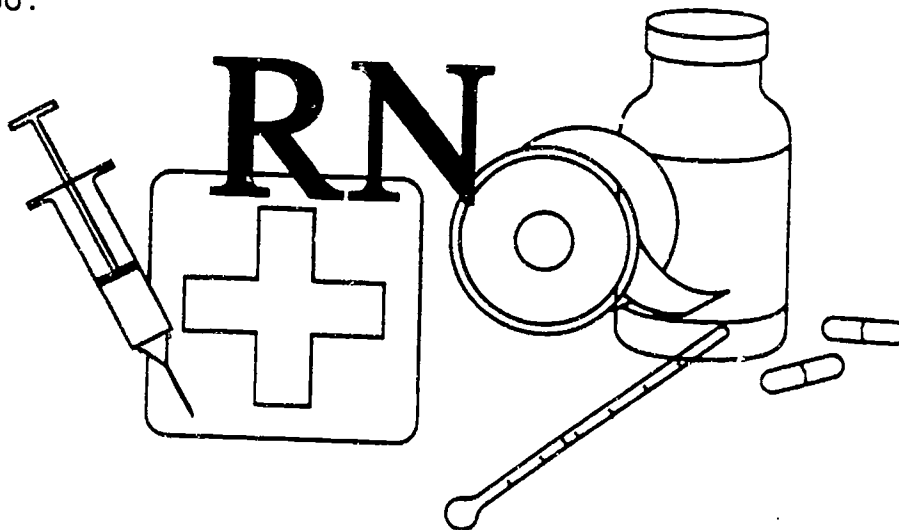

788

PUBLIC ADMINISTRATION

Individuals in this field are responsible for the management of diverse areas of governmental organizations. These managers usually work through departmental executives or subordinates in coordinating the various activities and groups they control. Public administration chief executives, legislators, and general administrators establish government policy and develop federal, state, or local regulations, rules, and laws.

The largest occupations, which also have the greatest number of job openings annually, are:

- Public administration chief executives, legislators, and general administrators
- General managers and top executives

These occupations may not have a favorable outlook for the future. Overall, the number of these jobs is growing. A moderate number of job openings are expected over the next four or five years. Recently, there have been many more new trainees than job openings. If this trend continues, job seekers can expect to face keen competition.

Related postsecondary programs at state-supported institutions in this area are:

- 43.0103 Criminal justice and law enforcement administration
- 44.0401 Public administration



RADIOGRAPHIC MEDICAL TECHNOLOGY

Workers in this field operate equipment including x-ray machines, fluoroscopes, ultrasonic scanners, computed tomography (CT) scanners, and nuclear magnetic resonance (MRI) machines for diagnostic imagery of the human body or for therapy.

The largest occupations, which also have the greatest number of job openings annually, are:

- Radiologic technologists
- Radiologic technicians

These occupations may have a generally favorable outlook for the future. Overall, the number of these jobs is growing rapidly. A moderate number of job openings are expected over the next four or five years. Recently, there have been fewer new trainees than job openings. If this trend continues, job opportunities should be good. Placement rates at area vocational technical schools, community colleges, and/or technical institutes have been excellent recently.

Hourly wages include:

\$12.61 Radiologic technicians

Related postsecondary programs at state-supported institutions in this area are:

17.0209 Radiologic medical technology

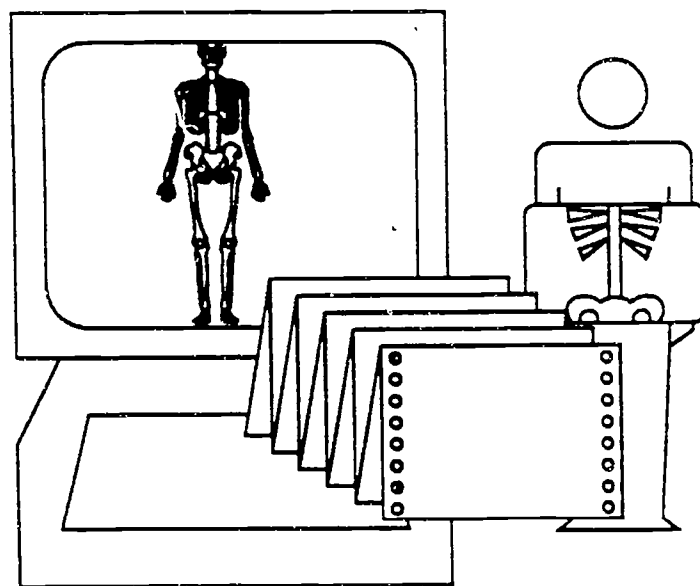

790

RECREATIONAL LEADERSHIP

Workers in recreational leadership occupations conduct recreational activities with groups, consider the interests of participants, and organize and promote activities. A large proportion of recreational workers are employed in city recreation departments and in state and national parks.

This occupation may have a generally favorable outlook for the future. Overall, the number of these jobs is growing. A moderate number of job openings are expected over the next four or five years. Recently, no training has been reported.



RESPIRATORY THERAPY

Respiratory therapists treat patients with breathing problems ranging from chronic asthma and emphysema to heart failure, stroke, or drowning emergencies. Respiratory care may involve administering oxygen; delivering medication or humidity through aerosol mists; administering chest physical therapy; or setting up and operating mechanical ventilators.

This occupation may have a generally favorable outlook for the future. Overall, the number of these jobs is growing rapidly. A moderate number of job openings are expected over the next four or five years. Recently, there have been more new trainees than job openings. Placement rates at area vocational technical schools, community colleges, and/or technical institutes have been good recently.

Average hourly wages are \$11.32

Related postsecondary programs at state-supported institutions in this area are:

17.0210 Respiratory therapy technology

Licensing may be required. Contact: BOARD OF MEDICAL EXAMINERS-COUNCIL ON RESPIRATORY CARE, 615-367-6393.

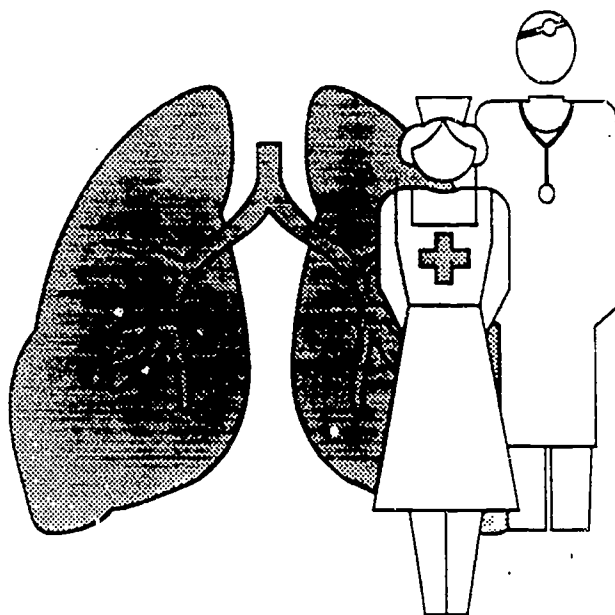

792

SALES AND MERCHANDISING

Workers in sales and merchandising occupations promote and sell a wide variety of merchandise and services. They also receive, store, display, and inventory products to be sold.

The largest occupations, which also have the greatest number of job openings annually, are:

- Salespersons in retail establishments
- Cashiers

These occupations may have a generally favorable outlook for the future. Overall, the number of these jobs is growing. Large numbers of job openings are expected over the next four or five years. Recently, there have been fewer new trainees than job openings. If this trend continues, job opportunities should be good. Placement rates at area vocational technical schools, community colleges, and/or technical institutes have been fair recently.

Hourly wages include:

\$5.44	Cashiers
\$5.51	Counter and rental clerks
\$6.26	Salespersons, retail
\$9.89	Driver/sales workers
\$11.26	Customer service representatives, utilities
\$13.43	Purchasing agents- except wholesale, retail, and farm products
\$14.86	Wholesale and retail buyers, except farm products

High school programs preparing for these occupations are:

08.0700	General marketing
08.0799	Miscellaneous general marketing

Related postsecondary programs at state-supported institutions in this area are:

08.0102	Apparel and accessories marketing operations
08.0706	General selling skills and sales operations

Licensing may be required. Contact: TENNESSEE DEPARTMENT OF COMMERCE AND INSURANCE, 615-741-2693.

SECURITY SERVICES

Security guards, the largest occupation in this field, patrol and inspect property to protect it against fire, theft, vandalism, and illegal entry. Guards and doorkeepers usually are uniformed and often carry a nightstick and a weapon; correctional officers and jailers maintain order in correctional institutions, enforce institutional rules and regulations, and may supplement the counseling inmates receive from mental health professionals.

The largest occupations, which also have the greatest number of job openings annually, are:

- Correction officers and jailers
- Guards and watch guards

These occupations may have a generally favorable outlook for the future. Overall, the number of these jobs is growing rapidly. Large numbers of job openings are expected over the next four or five years. Recently, there have been fewer new trainees than job openings. If this trend continues, job opportunities should be good.

Hourly wages include:

\$6.43 Guards and watch guards

Licensing may be required. Contact: COUNTY COURT CLERK'S OFFICE.

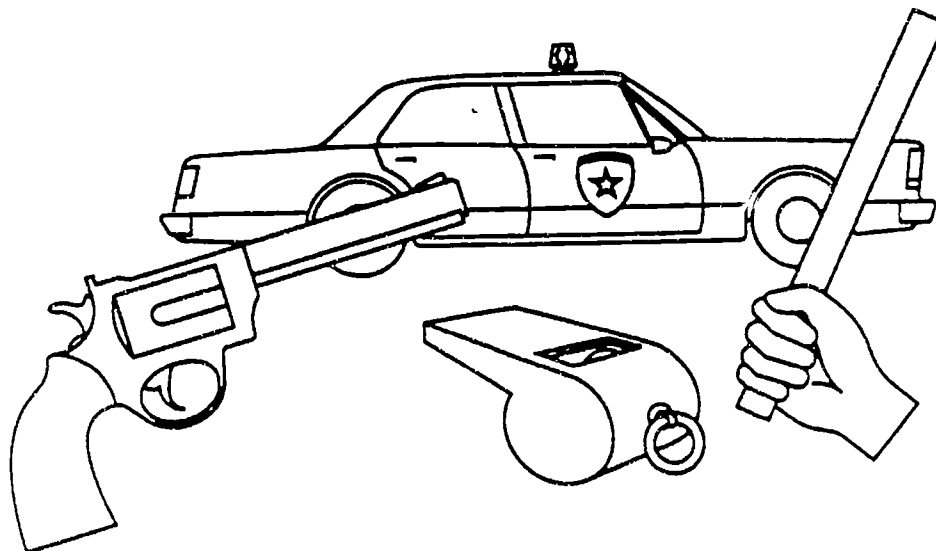

SHEET METAL

Sheet metal workers make, install, and maintain a variety of sheet metal products for home, commercial, and industrial buildings. These products include ducts for air conditioning, heating, and ventilating and pollution control systems, kitchen equipment, roofs, siding, rain gutters, skylights, and outdoor signs. Other workers use a variety of machines in the mass production of sheet-metal products.

The largest occupations, which also have the greatest number of job openings annually, are:

- Sheet metal workers
- Machine forming operators and tenders of metal and plastic

These occupations may have a generally favorable outlook for the future. Overall, the number of these jobs shows little change. A moderate number of job openings are expected over the next four or five years. Recently, there have been fewer new trainees than job openings. If this trend continues, job opportunities should be good.

Hourly wages include:

\$8.95 Sheet metal workers

High school programs preparing for these occupations are:

48.0506 Sheet metal

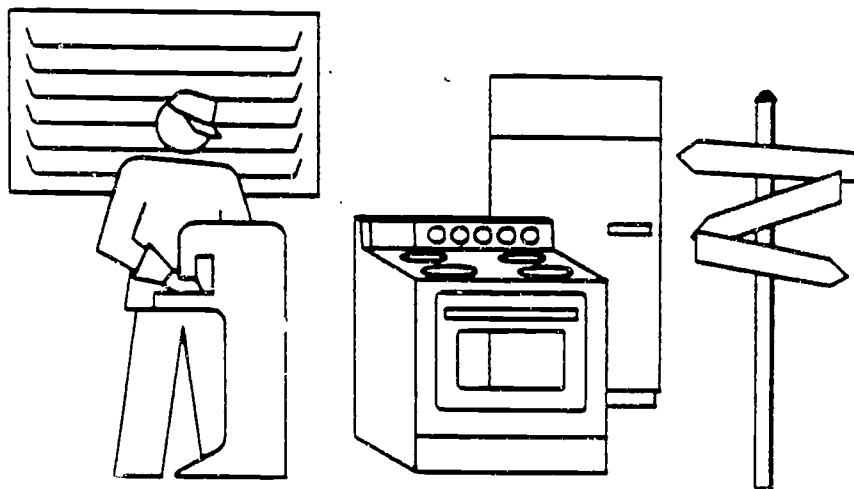

SMALL ENGINE REPAIR

Persons working in these occupations repair and service motorcycles, other small vehicles, and equipment with small gasoline engines. The ability to make quick and accurate diagnoses is one of the mechanic's most valuable skills. In fact, many mechanics consider diagnosing "hard to find" troubles one of their most challenging and satisfying duties.

The largest occupations, which also have the greatest number of job openings annually, are:

- Motorcycle repairers
- Small engine specialists

These occupations may not have a favorable outlook for the future. Overall, the number of these jobs shows little change. Few job openings are expected over the next four or five years. Recently, there have been many more new trainees than job openings.

High school programs preparing for these occupations are:

47.0606 Small engine repair

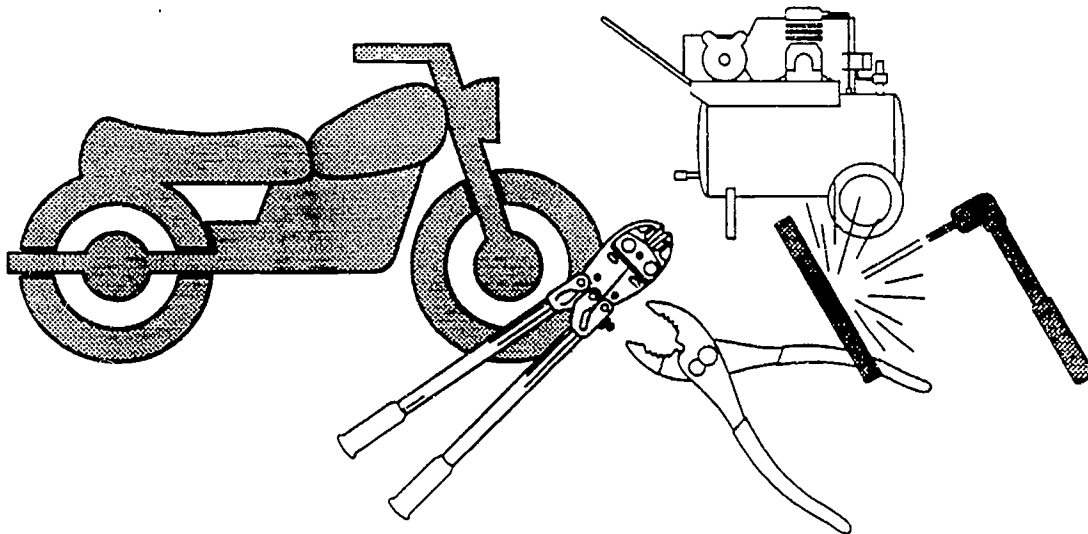

796

SURGICAL TECHNOLOGY

Surgical technicians, also called operating room technicians, work in hospitals under the direct supervision of surgeons and registered nurses. They help set up the operating room with surgical instruments and supplies, help prepare patients for surgery, and may pass instruments and supplies to surgeons.

This occupation may have a generally favorable outlook for the future. Overall, the number of these jobs is growing rapidly. A moderate number of job openings are expected over the next four or five years. Recently, there have been fewer new trainees than job openings. If this trend continues, job opportunities should be good. Placement rates at area vocational technical schools, community colleges, and/or technical institutes have been excellent recently.

Average hourly wages are \$9.53

Related postsecondary programs at state-supported institutions in this area are:

17.0211 Surgical technology

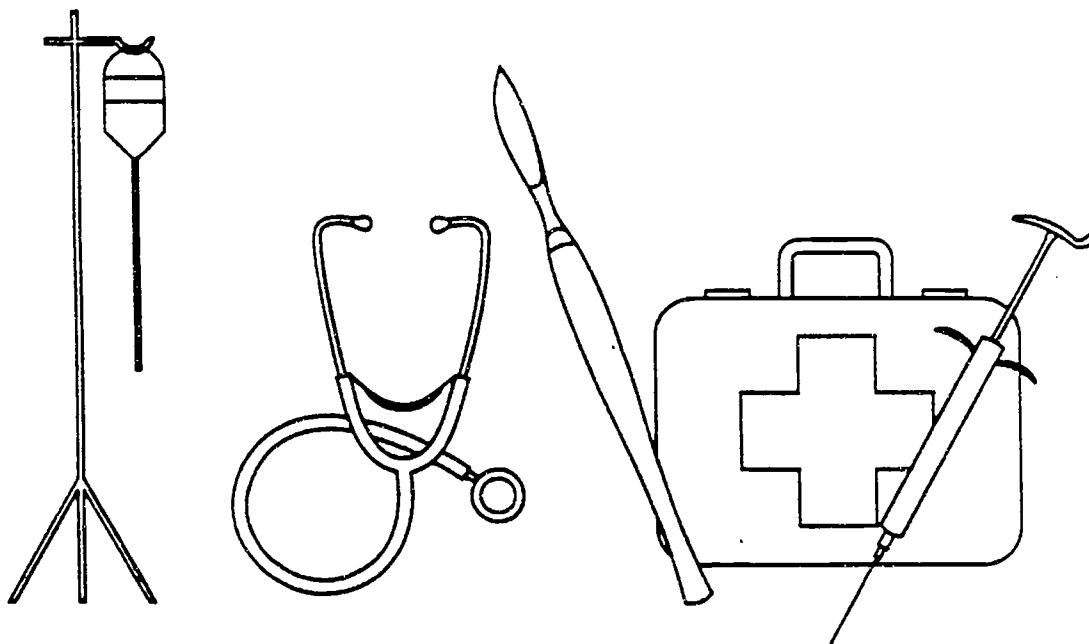

797

SDA 14 - 61

SURVEYING AND CIVIL TECHNOLOGY

Workers establish official land boundaries, with descriptions of land to satisfy legal requirements, and then plan, design, and construct structures and facilities on these tracts of land. The structures can include buildings, bridges, roads, harbors, airfields, dams, tunnels, or water supply and sewage systems.

The largest occupations, which also have the greatest number of job openings annually, are:

- Civil engineering technicians and technologists
- Surveying and mapping technicians and technologists

These occupations may have a generally favorable outlook for the future. Overall, the number of these jobs is growing. Few job openings are expected over the next four or five years. Recently, there have been fewer new trainees than job openings. Placement rates at area vocational technical schools, community colleges, and/or technical institutes have been good recently.

Related postsecondary programs at state-supported institutions in this area are:

15.0201 Civil engineering and technology

Licensing may be required. Contact: TENNESSEE STATE BOARD OF EXAMINERS FOR LAND SURVEYING, 615-741-3611.

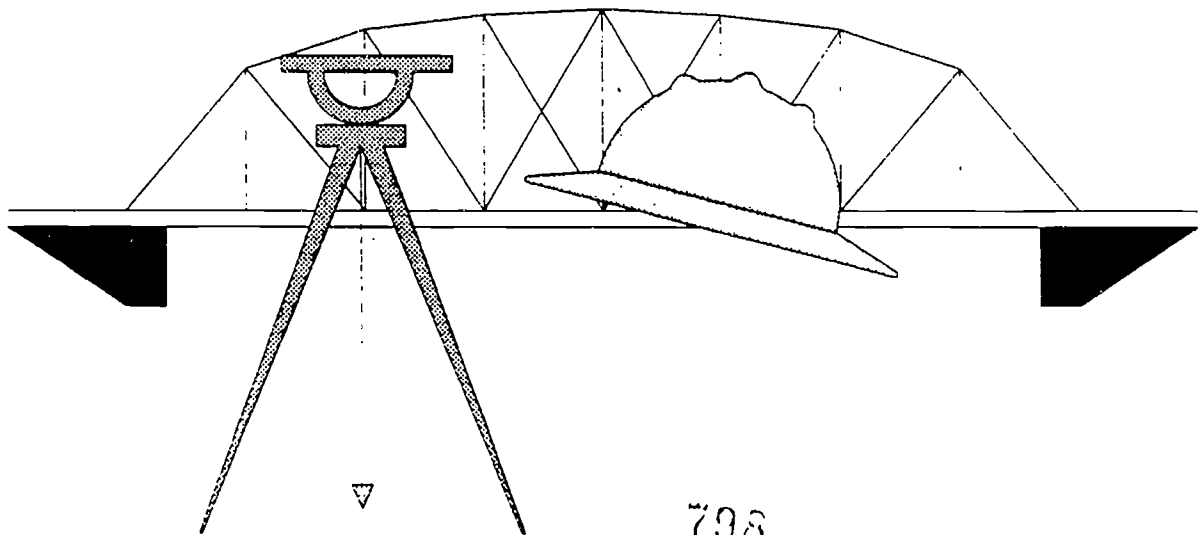

798

TRAVEL SERVICES

These workers assist people with all facets of their travel. Planning and budgeting a trip, purchasing tickets, selling travel insurance, obtaining passports and visas, and even ticket taking are all done by these employees.

The largest occupations, which also have the greatest number of job openings annually, are:

- Travel agents
- Reservation and transportation ticket agents

These occupations may have a generally favorable outlook for the future. Overall, the number of these jobs is growing rapidly. Large numbers of job openings are expected over the next four or five years. Recently, there have been fewer new trainees than job openings. If this trend continues, job opportunities should be good.

High school programs preparing for these occupations are:

08.1104 Tourism

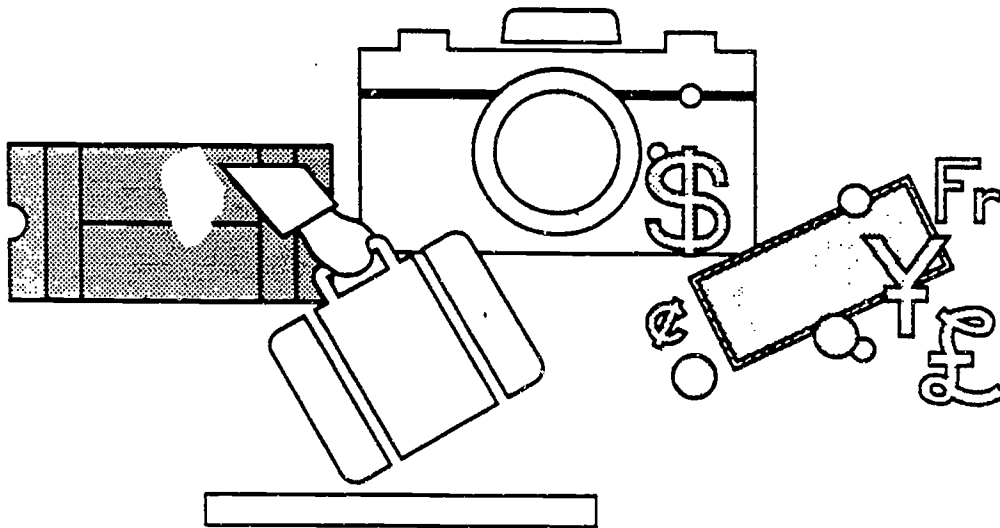

799

TRUCK, BUS, AND HEAVY EQUIPMENT OPERATION

These occupations include truck drivers who transport goods, bus drivers who transport passengers, and heavy equipment operators who use machinery to move construction materials and other goods over short distances--around a factory, construction site or loading dock.

The largest occupations, which also have the greatest number of job openings annually, are:

- Truck drivers of heavy or tractor trailer trucks
- School bus drivers

These occupations may have a generally favorable outlook for the future. Overall, the number of these jobs is growing. Large numbers of job openings are expected over the next four or five years. Recently, there have been fewer new trainees than job openings. If this trend continues, job opportunities should be good. Placement rates at area vocational technical schools, community colleges, and/or technical institutes have been good recently.

Hourly wages include:

- \$10.52 Truck drivers, heavy or tractor trailer
- \$10.53 Grader, dozer, and scraper operators

Related postsecondary programs at state-supported institutions in this area are:

- 49.0205 Truck and bus driving

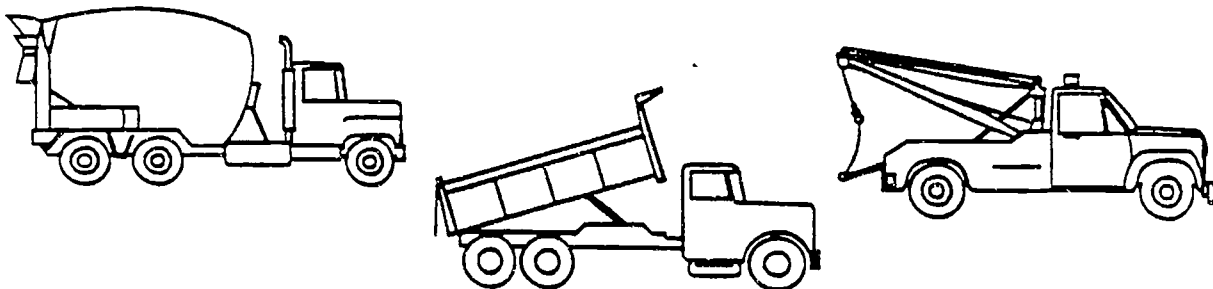

560

WELDING TECHNOLOGY

Welding is the most common way of permanently joining metal parts. Typically, heat is applied to the metal pieces to be joined; the parts are melted and fused to form a permanent bond. Welding is used to construct and repair parts of ships, automobiles, spacecraft, and thousands of products. It can also be used to join beams and steel reinforcing rods in buildings, bridges, and highways.

The two largest occupations are:

- Welders and cutters
- Welding machine setters and set-up operators

The occupations expected to have the most job openings annually are:

- Welders and cutters
- Welding machine operators and tenders

These occupations may have a generally favorable outlook for the future. Overall, the number of these jobs is growing. A moderate number of job openings are expected over the next four or five years. Recently, there have been about as many new trainees as job openings. If this trend continues, job seekers can expect to face some competition. Placement rates at area vocational technical schools, community colleges, and/or technical institutes have been very good recently.

Hourly wages include:

\$9.53 Welders and cutters

High school programs preparing for these occupations are:

48.0508 Welding, brazing, and soldering

Related postsecondary programs at state-supported institutions in this area are:

48.0508 Welding, brazing, and soldering

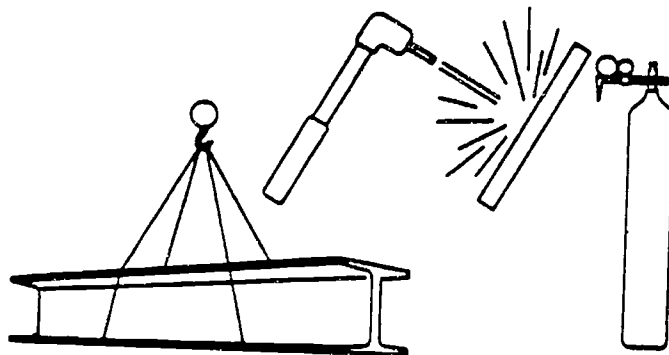

ALPHABETICAL LISTING OF OCCUPATIONAL AREAS
ALL AREAS

Accounting and Financial Management
Administrative Support: Accounting
Administrative Support: Finance and Insurance
Administrative Support: General
Agricultural Production
Aircraft Mechanics
Appliance and Equipment Repair
Architectural Design
Audiology and Speech Pathology
Automotive Body Repair
Automotive Service Technology
Baking Occupations
Brick, Block and Stonemasonry
Building Maintenance
Carpentry
Chemical Engineering
Chemical Technology
Chemistry
Civil Engineering
Commercial Art and Design
Communications, Journalism, and Broadcasting
Communications Technology
Computer and Business Machine Production and Repair
Computer, Electrical, and Electronics Technology
Computer Systems
Cosmetology
Custom Upholstery
Dental Assisting
Dental Hygiene
Dentistry
Drafting and Design Technology
Dramatic Arts
Drycleaning
Early Childhood Education
Electrical and Electronic Engineering
Electrician Occupations
Electromechanical Instrument Production and Repair
Elementary Teaching
Fire Control and Safety Technology
Food Preparation and Services
General Business and Management
General Woodworking
Graphic Arts
Heating and Air Conditioning
Heavy Truck Maintenance
Horticulture and Landscaping
Hotel and Restaurant Management
Human Services
Industrial Engineering
Industrial Maintenance Technology

ALPHABETICAL LISTING OF OCCUPATIONAL AREAS
ALL AREAS

Institutional Home Management and Supporting Services
Laboratory Technician
Laboratory Technology
Law
Law Enforcement
Legal Assisting
Library Science
Machine Tool Technology
Marketing, Advertising, and Public Relations
Mechanical Engineering
Medical Assisting
Medical Records Technology
Nursing Assistant
Pharmacists
Photographic Technology
Physical Therapy
Physical Therapy Assisting
Physicians and Surgeons
Plumbing and Pipefitting
Practical Nursing
Preschool and Kindergarten Teaching
Professional Nursing
Psychology
Public Administration
Radiographic Medical Technology
Recreational Leadership
Respiratory Therapy
Sales and Merchandising
Security Services
Sheet Metal
Small Engine Repair
Social Sciences
Social Work
Special Education Teaching
Surgical Technology
Surveying and Civil Technology
Travel Services
Truck, Bus, and Heavy Equipment Operation
Veterinary Medicine
Welding Technology

803

ALPHABETICAL INDEX OF OCCUPATIONAL AREAS
ALL AREAS

Accounting and Financial Management	1- 1
	2- 1
	3- 1
	4- 1
	5- 1
	6- 1
	7- 1
	8- 1
	9- 1
	10- 1
	11- 1
	12- 1
	13- 1
	14- 1
Administrative Support: Accounting	1- 2
	2- 2
	3- 2
	4- 2
	5- 2
	6- 2
	7- 2
	8- 2
	9- 2
	10- 2
	11- 2
	12- 2
	13- 2
	14- 2
Administrative Support: Finance and Insurance	1- 3
	2- 3
	3- 3
	4- 3
	5- 3
	6- 3
	7- 3
	8- 3
	9- 3
	10- 3
	11- 3
	12- 3
	13- 3
	14- 3

ALPHABETICAL INDEX OF OCCUPATIONAL AREAS
ALL AREAS

Administrative Support: General	1- 4
	2- 4
	3- 4
	4- 4
	5- 4
	6- 4
	7- 4
	8- 4
	9- 4
	10- 4
	11- 4
	12- 4
	13- 4
	14- 4
Agricultural Production	1- 5
	2- 5
	3- 5
	4- 5
	5- 5
	6- 5
	7- 5
	8- 5
	9- 5
	10- 5
	11- 5
	12- 5
	13- 5
	14- 5
Aircraft Mechanics	9- 6
	10- 6
	14- 6
Appliance and Equipment Repair	1- 6
	2- 6
	3- 6
	4- 6
	5- 6
	6- 6
	7- 6
	8- 6
	9- 7
	10- 7
	11- 6
	12- 6
	13- 6
	14- 7

ALPHABETICAL INDEX OF OCCUPATIONAL AREAS
ALL AREAS

Architectural Design	Statewide- 1
Audiology and Speech Pathology	Statewide- 2
Automotive Body Repair	1- 7
	2- 7
	3- 7
	4- 7
	5- 7
	6- 7
	7- 7
	8- 7
	9- 8
	10- 8
	11- 7
	12- 7
	14- 8
Automotive Service Technology	1- 8
	2- 8
	3- 8
	4- 8
	5- 8
	6- 8
	7- 8
	8- 8
	9- 9
	10- 9
	11- 8
	12- 8
	13- 7
	14- 9
Baking Occupations	3- 9
	6- 9
	9-10
	14-10
Brick, Block and Stonemasonry	2- 9
	8- 9
	9-11
	14-11

ALPHABETICAL INDEX OF OCCUPATIONAL AREAS
ALL AREAS

Building Maintenance	1- 9 2-10 3-10 4- 9 5- 9 6-10 7- 9 8-10 9-12 10-10 11- 9 12- 9 13- 8 14-12
Carpentry	1-10 2-11 3-11 4-10 5-10 6-11 7-10 8-11 9-13 10-11 11-10 12-10 13- 9 14-13
Chemical Engineering	Statewide- 3
Chemical Technology	1-11 2-12 4-11 6-12 9-14 14-14
Chemistry	Statewide- 4
Civil Engineering	Statewide- 5

ALPHABETICAL INDEX OF OCCUPATIONAL AREAS
ALL AREAS

Commercial Art and Design	1-12 2-13 3-12 4-12 6-13 8-12 9-15 10-12 12-11 13-10 14-15
Communications, Journalism, and Broadcasting	1-13 3-13 4-13 6-14 7-11 8-13 9-16 10-13 12-12 14-16
Communications Technology	9-17
Computer and Business Machine Production and Repair	2-14 3-14 8-14 9-18 11-11 14-17
Computer, Electrical, and Electronics Technology	1-14 2-15 3-13 4-14 6-15 8-15 9-19 10-14 11-12 14-18

308

ALPHABETICAL INDEX OF OCCUPATIONAL AREAS
ALL AREAS

Computer Systems	1-15 2-16 3-16 4-15 5-11 6-16 7-12 8-16 9-20 10-15 11-13 12-13 13-11 14-19
Cosmetology	1-16 2-17 3-17 4-16 5-12 6-17 7-13 8-17 9-21 10-16 11-14 12-14 13-12 14-20
Custom Upholstery	2-18 5-13 8-18 14-21
Dental Assisting	1-17 3-18 4-17 6-18 8-19 9-22 12-15 14-22
Dental Hygiene	1-18 3-19 6-19 9-23 14-23

ALPHABETICAL INDEX OF OCCUPATIONAL AREAS
ALL AREAS

Dentistry	Statewide- 6
Drafting and Design Technology	1-19
	2-19
	3-20
	4-18
	5-14
	6-20
	7-14
	8-20
	9-24
	10-17
	11-15
	12-16
	13-13
	14-24
Dramatic Arts	Statewide- 7
Drycleaning	1-20
	2-20
	3-21
	6-21
	8-21
	9-25
	12-17
	14-25
Early Childhood Education	1-21
	2-21
	3-22
	4-19
	5-15
	6-22
	7-15
	8-22
	9-26
	10-18
	11-16
	12-18
	13-14
	14-26
Electrical and Electronic Engineering	Statewide- 8

ALPHABETICAL INDEX OF OCCUPATIONAL AREAS
ALL AREAS

Electrician Occupations	1-22 2-22 3-23 4-20 5-16 6-23 7-16 8-23 9-27 10-19 11-17 12-19 13-15 14-27
Electromechanical Instrument Production and Repair . .	14-28
Elementary Teaching	Statewide- 9
Fire Control and Safety Technology	3-24 6-24 8-24 9-28 12-20 14-29
Food Preparation and Services	1-23 2-23 3-25 4-21 5-17 6-25 7-17 8-25 9-29 10-20 11-18 12-21 13-16 14-30

ALPHABETICAL INDEX OF OCCUPATIONAL AREAS
ALL AREAS

General Business and Management	1-24 2-24 3-26 4-22 5-18 6-26 7-18 8-26 9-30 10-21 11-19 12-22 13-17 14-31
General Woodworking	1-25 2-25 3-27 4-23 5-19 6-27 7-19 8-27 9-31 10-22 11-20 12-23 14-32
Graphic Arts	1-26 2-26 3-28 4-24 6-28 8-28 9-32 10-23 11-21 12-24 13-18 14-33

ALPHABETICAL INDEX OF OCCUPATIONAL AREAS
ALL AREAS

Heating and Air Conditioning	1-27 2-27 3-29 4-25 6-29 7-20 8-29 9-33 10-24 11-22 12-25 13-19 14-34
Heavy Truck Maintenance	1-28 2-28 3-30 4-26 6-30 7-21 8-30 9-34 10-25 12-26 14-35
Horticulture and Landscaping	1-29 2-29 3-31 4-27 5-20 6-31 7-22 8-31 9-35 10-26 11-23 12-27 14-36

ALPHABETICAL INDEX OF OCCUPATIONAL AREAS
ALL AREAS

Hotel and Restaurant Management	1-30 2-30 3-32 4-28 5-21 6-32 7-23 8-32 9-36 10-27 11-24 12-28 13-20 14-37
Human Services	9-37 14-38
Industrial Engineering	Statewide-10
Industrial Maintenance Technology	1-31 2-31 3-33 4-29 5-22 6-33 7-24 8-33 9-38 10-28 11-25 12-29 13-21 14-39
Institutional Home Management and Supporting Services .	1-32 2-32 3-34 4-30 5-23 6-34 7-25 8-34 9-39 10-29 11-26 12-30 13-22 14-40

ALPHABETICAL INDEX OF OCCUPATIONAL AREAS
ALL AREAS

Laboratory Technician	1-33 3-35 4-31 6-35 8-35 9-40 12-31 14-41
Laboratory Technology	Statewide-11
Law	Statewide-12
Law Enforcement	1-34 2-33 3-36 4-32 6-36 7-26 8-36 9-41 10-30 11-27 12-32 14-42
Legal Assisting	3-37 5-24 6-37 9-42 14-43
Library Science	Statewide-13
Machine Tool Technology	1-35 2-34 3-38 4-33 5-25 6-38 7-27 8-37 9-43 10-31 11-28 12-33 13-23 14-44

ALPHABETICAL INDEX OF OCCUPATIONAL AREAS
ALL AREAS

Marketing, Advertising, and Public Relations . . .	Statewide-14
Mechanical Engineering	Statewide-15
Medical Assisting	1-36
	2-35
	3-39
	4-34
	6-39
	8-38
	9-44
	10-32
	12-34
	14-45
Medical Records Technology	1-37
	2-36
	3-40
	4-35
	5-26
	6-40
	7-28
	8-39
	9-45
	10-33
	11-29
	12-35
	13-24
	14-46
Nursing Assistant	1-38
	2-37
	3-41
	4-36
	5-27
	6-41
	7-29
	8-40
	9-46
	10-34
	11-30
	12-36
	13-25
	14-47
Pharmacists	Statewide-16

ALPHABETICAL INDEX OF OCCUPATIONAL AREAS
ALL AREAS

Photographic Technology	3-42 6-42 9-47 14-48
Physical Therapy	Statewide-17
Physical Therapy Assisting	6-43 8-41 9-48 14-49
Physicians and Surgeons	Statewide-18
Plumbing and Pipefitting	1-39 2-38 3-43 4-37 6-44 7-30 8-42 9-49 10-35 11-31 12-37 14-50
Practical Nursing	1-40 2-39 3-44 4-38 5-28 6-45 7-31 8-43 9-50 10-36 11-32 12-38 13-26 14-51
Preschool and Kindergarten Teaching	Statewide-19

ALPHABETICAL INDEX OF OCCUPATIONAL AREAS
ALL AREAS

Professional Nursing	1-41 2-40 3-45 4-39 5-29 6-46 7-32 8-44 9-51 10-37 11-33 12-39 13-27 14-52
Psychology	Statewide-20
Public Administration	1-42 3-46 6-47 8-45 9-52 10-38 11-34 12-40 14-53
Radiographic Medical Technology	1-43 2-41 3-47 4-40 6-48 8-46 9-53 11-35 12-41 14-54
Recreational Leadership	1-44 3-48 4-41 6-49 9-54 12-42 14-55

ALPHABETICAL INDEX OF OCCUPATIONAL AREAS
ALL AREAS

Respiratory Therapy	3-49 4-42 6-50 9-55 14-56
Sales and Merchandising	1-45 2-42 3-50 4-43 5-30 6-51 7-33 8-47 9-56 10-39 11-36 12-43 13-28 14-57
Security Services	1-46 2-43 3-51 4-44 5-31 6-52 7-34 8-48 9-57 10-40 11-37 12-44 13-29 14-58
Sheet Metal	1-47 2-44 3-52 4-45 5-32 6-53 7-35 8-49 9-58 10-41 11-38 12-45 13-30 14-59

ALPHABETICAL INDEX OF OCCUPATIONAL AREAS
ALL AREAS

Small Engine Repair	1-48 3-53 8-50 10-42 14-60
Social Sciences	Statewide-21
Social Work	Statewide-22
Special Education Teaching	Statewide-23
Surgical Technology	3-54 9-59 14-61
Surveying and Civil Technology	4-46 9-60 10-43 14-62
Travel Services	2-45 3-55 9-61 14-63
Truck, Bus, and Heavy Equipment Operation	1-49 2-46 3-56 4-47 5-33 6-54 7-36 8-51 9-62 10-44 11-39 12-46 13-31 14-64
Veterinary Medicine	Statewide-24

ALPHABETICAL INDEX OF OCCUPATIONAL AREAS
ALL AREAS

Welding Technology	1-50
	2-47
	3-57
	4-48
	5-34
	6-55
	7-37
	8-52
	9-63
	10-45
	11-40
	12-47
	13-32
	14-65

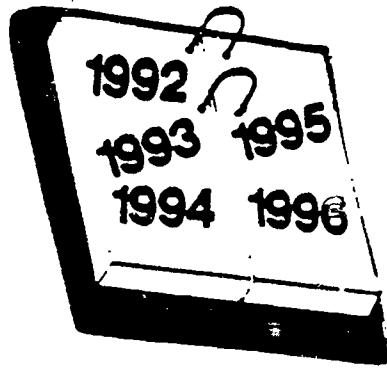

Department of Employment Security, March 1993, Authorization Number 333250; 100 copies.
This public document was promulgated at a cost of \$29.15 per copy.