

TITLE Key Statistics on Technical Education and Training
1992.

INSTITUTION Institute of Technical Education (Singapore).

REPORT NO ISSN-0218-4753

PUB DATE 93

NOTE 83p.; For the 1991 edition, see ED 357 168.

PUB TYPE Statistical Data (110)

EDRS PRICE MF01/PC04 Plus Postage.

DESCRIPTORS *Apprenticeships; *Continuing Education; Educational
Certificates; Foreign Countries; Postsecondary
Education; Statistics; Student Certification; Student
Characteristics; *Technical Education; Technical
Institutes

IDENTIFIERS *Singapore

ABSTRACT

This publication documents important statistical data on the technical education and training activities under the purview of the Institute of Technical Education, Singapore. Section I on technical education and training in Singapore highlights major developments in 1992 and provides flowcharts of the former vocational training system and the new technical training system. Section II offers statistics on full-time institutional training, including the following: intake by level, level and sex, and level and race; average enrollment by level, level and sex, qualification, level and race, and technical institute; cumulative output by level and sex and by sector, trade cluster, and sex; output by level and race; and output of courses. Section III offers these statistics on apprenticeship: apprenticeships (1983-92); intake of apprentices by sector and trade cluster, level and race, and qualification; and apprentices completed training in 1992 by sector and trade cluster. Section IV provides these statistics: training places taken under continuing skills training and education (1988-92) and under the continuing skills training and continuing education courses by level. Section V contains statistics on worker education: training places taken by participants in Basic Education for Skills Training (BEST) and Worker Improvement through Secondary Education (WISE) by level and type of center and examination results of BEST and WISE participants. Section VI on trade testing and certification offers these statistics: candidature by type of test and course level; distribution of candidatures and passes by type of test; and number certified through the institutional, public, and modular trade test. Section VII provides miscellaneous statistics. (YLB)

* Reproductions supplied by EDRS are the best that can be made *
* from the original document. *

1992

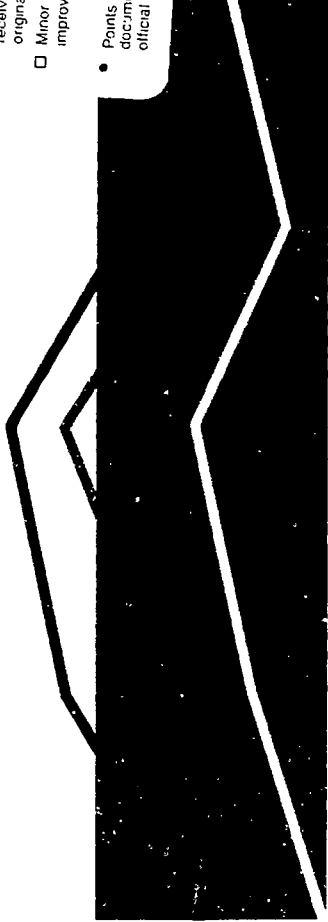
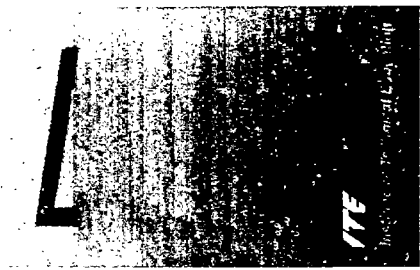

KEY STATISTICS ON TECHNICAL EDUCATION AND TRAINING

U.S. DEPARTMENT OF EDUCATION
Office of Educational Research and Improvement
EDUCATIONAL RESOURCES INFORMATION
CENTER (ERIC)

- This document has been reproduced as received from the person or organization originating it.
- Minor changes have been made to improve reproduction quality.

- Points of view or opinions stated in this document do not necessarily represent official OERI position or policy.



BEST COPY AVAILABLE

"PERMISSION TO REPRODUCE THIS MATERIAL HAS BEEN GRANTED BY

the U.S. Dept. of Education

TO THE EDUCATIONAL RESOURCES INFORMATION CENTER (ERIC)."

**KEY STATISTICS
ON
TECHNICAL EDUCATION & TRAINING
1992**

Institute of Technical Education, Singapore

PREFACE

KEY STATISTICS ON TECHNICAL EDUCATION & TRAINING document's important statistical data on the technical education & training activities under the purview of the Institute of Technical Education, Singapore (ITE). The ITE was established on 1 Apr 92 to take over the functions of the former Vocational & Industrial Training Board.

KEY STATISTICS ON TECHNICAL EDUCATION & TRAINING is an annual publication of ITE. It was previously known as the "Key statistics on Vocational Training". Data for 1986 and subsequent years have been compiled on a Calendar Year basis while Data for years prior to 1986 are on a Financial Year basis.

For clarification of any data in this publication, please contact the Corporate Planning Department, Institute of Technical Education, Singapore on telephone number 7720864.

CONTENTS

Preface	3
Abbreviations Used	8
Nomenclature	10
Section I — Technical Education & Training in Singapore	
Major Developments in 1992	13
Former Vocational Training System	14
New Technical Training System	15
Section II — Full-Time Institutional Training	
Intake by Level (1983 — 1992)	19
Intake by Level and Sex — 1992	21
Intake by Level and Race — 1992	23
Intake by Qualification — 1992	25
Average Enrolment by Level (1983 — 1992)	27
Average Enrolment by Level and Sex — 1992	29
Average Enrolment by Qualification — 1992	31
Average Enrolment by Level and Race — 1992	32
Average Enrolment by Technical Institute — 1992	33
Cumulative Output by Level and Sex Up to 1992	35
Cumulative Output by Sector, Trade Cluster and Sex	36

CONTENTS (Cont'd)

Output by Level and Race — 1992	37
Output of Courses	38
Section III — Apprenticeship	45
Apprenticeship (1983 — 1992)	47
Intake of Apprentices by Sector and Trade Cluster — 1992	48
Intake of Apprentices by Level and Race — 1992	49
Intake of Apprentices by Qualification — 1992	50
Apprentices Completed Training in 1992 by Sector and Trade Cluster	
Section IV — Continuing Education and Training	53
Training Places taken up under Continuing Skills Training and Education (1988 — 1992)	54
Training Places taken up under the Continuing Skills Training and Continuing Education Courses by Level — 1992	
Section V — Worker Education	57
Training Places taken up by BEST Participants by Level (1983 — 1992)	58
Training Places taken up by BEST Participants by Type of Centre (1983 — 1992)	59
Examination Results of BEST Participants (1983 — 1992)	61
Training Places taken up by WISE Participants by Level (1987 — 1992)	62
Training Places taken up by WISE Participants by Type of Centre (1987 — 1992)	63
Examination Results of WISE Participants (1988 — 1992)	

CONTENTS (Cont'd)

Section VI — Trade Testing and Certification

Candidature by Type of Test/Exam (1983 — 1992)

68

Candidature by Course Level (1983 — 1992)

69

Distribution of Candidatures and Passes by Type of Test/Exam — 1992

71

Number Certified through the Institutional, Public and Modular Trade Test — 1992

72

Section VII — Miscellaneous

List of On-going Full-Time Courses (as at 1992)

74

List of On-going Full-Time Courses by Sector and Trade Cluster (as at 1992)

76

List of On-going Apprenticeship Courses by Sector and Trade Cluster (as at 1992)

78

List of Discontinued Full-Time Courses (as at 1992)

80

Cost of Training per trainee per year (FY87 — FY91)

86

Expenditure in the ITE Ordinary Budget (FY87 — FY91)

87

ABBREVIATIONS USED

Abbreviation	Explanation
BEST	Basic Education for Skills Training
BM4	BEST Module 4
BST	Basic Skills Training
BVT	Basic Vocational Training
CBS	Certificate in Business Studies
CoC	Certificate of Competency
COS	Certificate in Office Skills
CoVT	Certificate of Vocational Training
Diploma	Diploma in Applied Arts
ITC	Industrial Technician Certificate
MOST	Modular Skills Training

ABBREVIATIONS USED (Cont'd)

Abbreviation	Explanation
NTC-1	National Technical Certificate Grade 1
NTC-2	National Technical Certificate Grade 2
NTC-3	National Technical Certificate Grade 3
PCBS	Preliminary Certificate in Business Studies
PTT	Public Trade Test
PVT	Pre-Vocational Training
TIME	Training Initiative for Mature Employees
WISE	Worker Improvement through Secondary Education

NOMENCLATURE

Term	Definition
Intake	Intake refers to the total number of trainees admitted to a course at a specific intake exercise.
Average Enrolment	Enrolment refers to the total number of trainees at a particular point in time when the count is taken. Average Enrolment refers to the mean of enrolment for a given period.
Output	Output refers to the number of trainees who have completed training.
Pass Rate	Pass Rate refers to the number of candidates who passed as against the number of candidates. ie Pass Rate = $\frac{\text{Number of candidates who passed the examination}}{\text{Number of candidates who took the examination}} \times 100\%$

SECTION I

TECHNICAL EDUCATION & TRAINING IN SINGAPORE

MAJOR DEVELOPMENTS IN 1992

1 FORMATION OF THE INSTITUTE OF TECHNICAL EDUCATION

The Institute of Technical Education (ITE) was established on 1 Apr 92 to take over the functions of the former Vocational & Industrial Training Board (VITB). ITE is now a post-secondary institution offering higher-level technical training courses for secondary school leavers and Continuing Education & Training programmes for workers.

2 REVISED CERTIFICATION AND COURSE TITLES FOR NTC COURSES

With effect from 1 Apr 92, the "National Trade Certificate" certification title has been replaced by the "National Technical Certificate" title. The National Trade Certificate issued by the former VITB are considered as equivalent to the new National Technical Certificate issued by ITE. In addition, the titles of some of the NTC courses have been revised to better reflect the current occupational and technical terminologies.

3 HYBRID MODEL OF APPRENTICESHIP TRAINING LAUNCHED

A hybrid model of apprenticeship training was introduced in Jul 92. The hybrid model comprises a period of block-release full-time training followed by day-release training. It enables the apprentice to be equipped with broad-based basic skills before he undertakes on-the-job training in a company. The hybrid model of apprenticeship training will meet the needs of small-and-medium sized enterprises (SMEs) that are unable to provide the required range of basic skills due to the specialized nature of their operations.

4 ADULT CO-OPERATIVE TRAINING SCHEME (ACTS)

The Adult Co-operative Training Scheme (ACTS) was launched in Nov 92. The scheme aims to upgrade the skills of workers between the ages of 20 and 40 with below GCE 'O' qualification. ACTS is apprenticeship-based. Workers who enrolled under ACTS must be fully sponsored by employers. Workers received both the on-the-job and off-the-job training during the company's time.

FORMER VOCATIONAL TRAINING SYSTEM

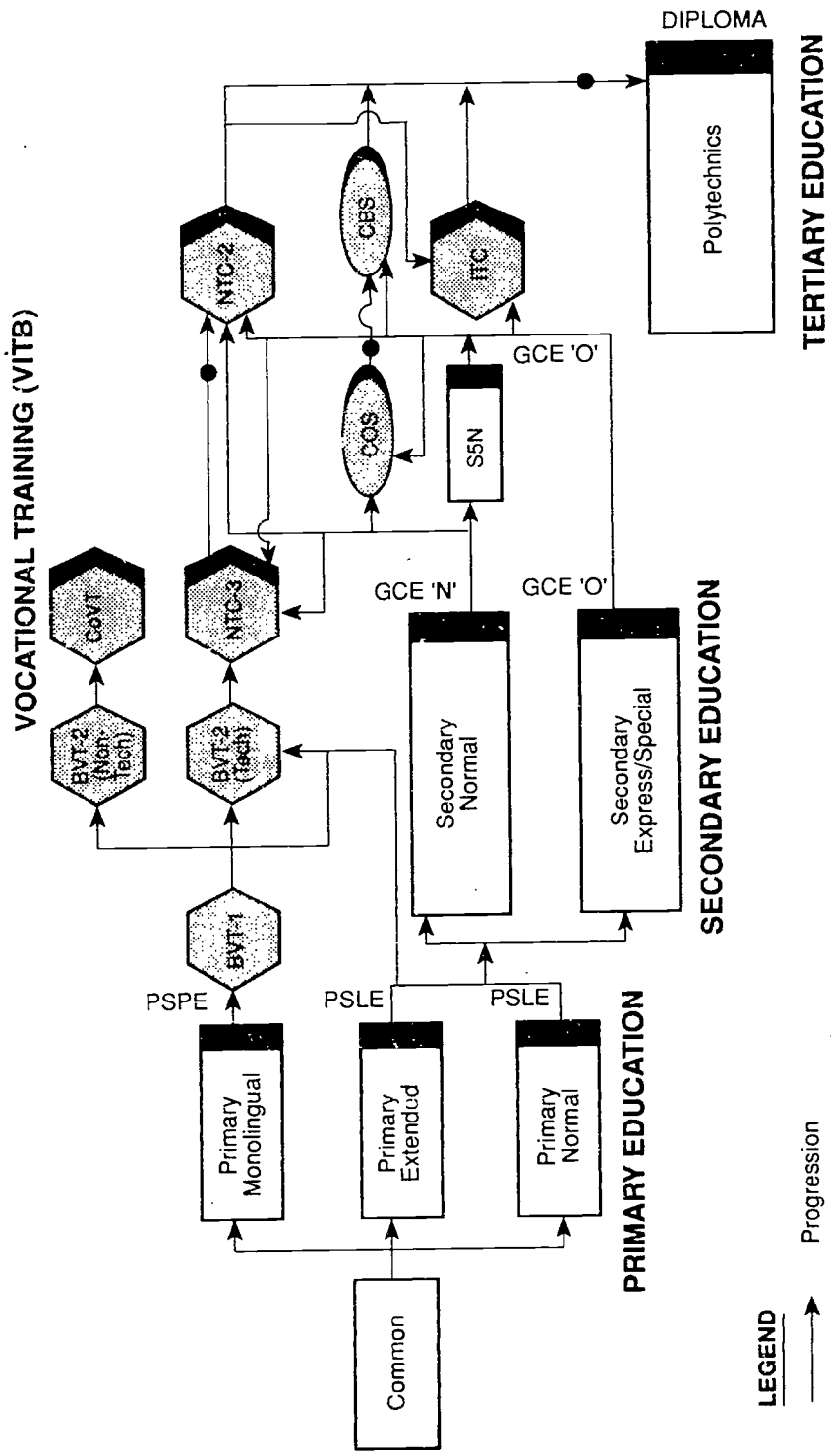

NEW TECHNICAL TRAINING SYSTEM

TECHNICAL TRAINING (ITE)

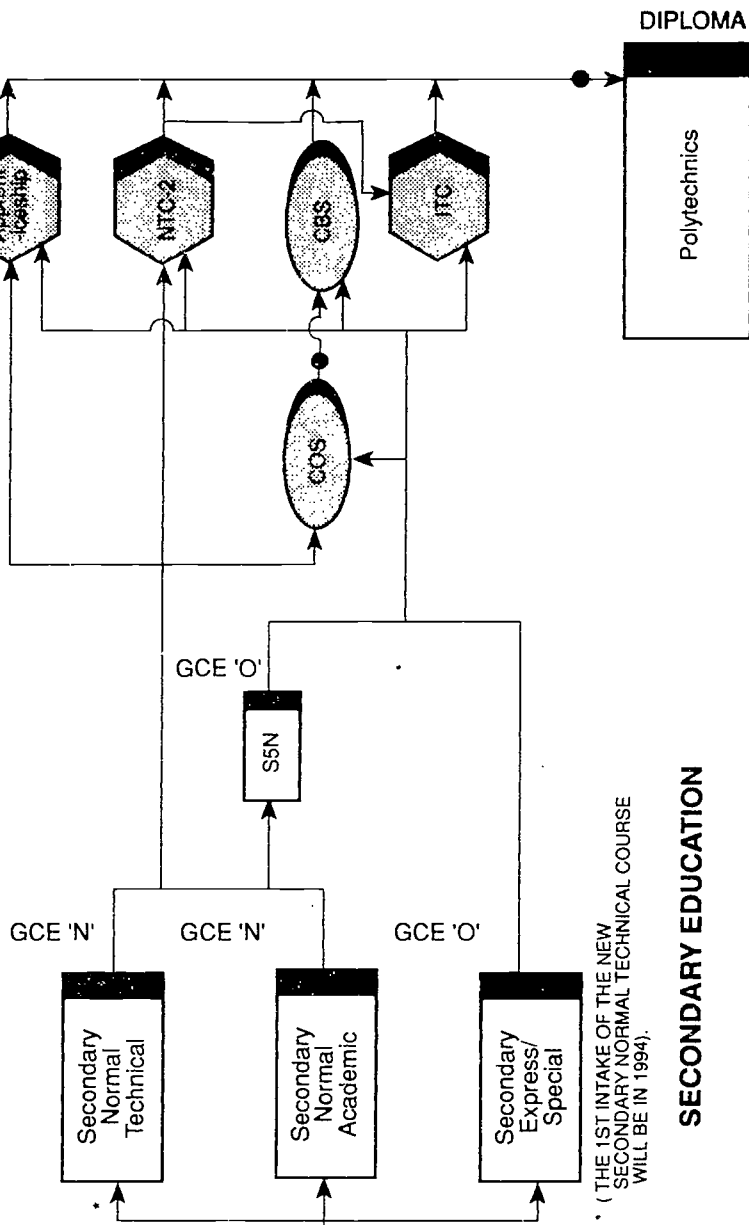

* (THE 1ST INTAKE OF THE NEW SECONDARY NORMAL TECHNICAL COURSE WILL BE IN 1994).

SECONDARY EDUCATION

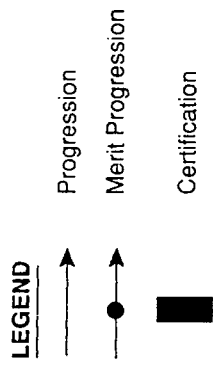

14

SECTION II

FULL-TIME INSTITUTIONAL TRAINING

INTAKE (1983 - 1992)

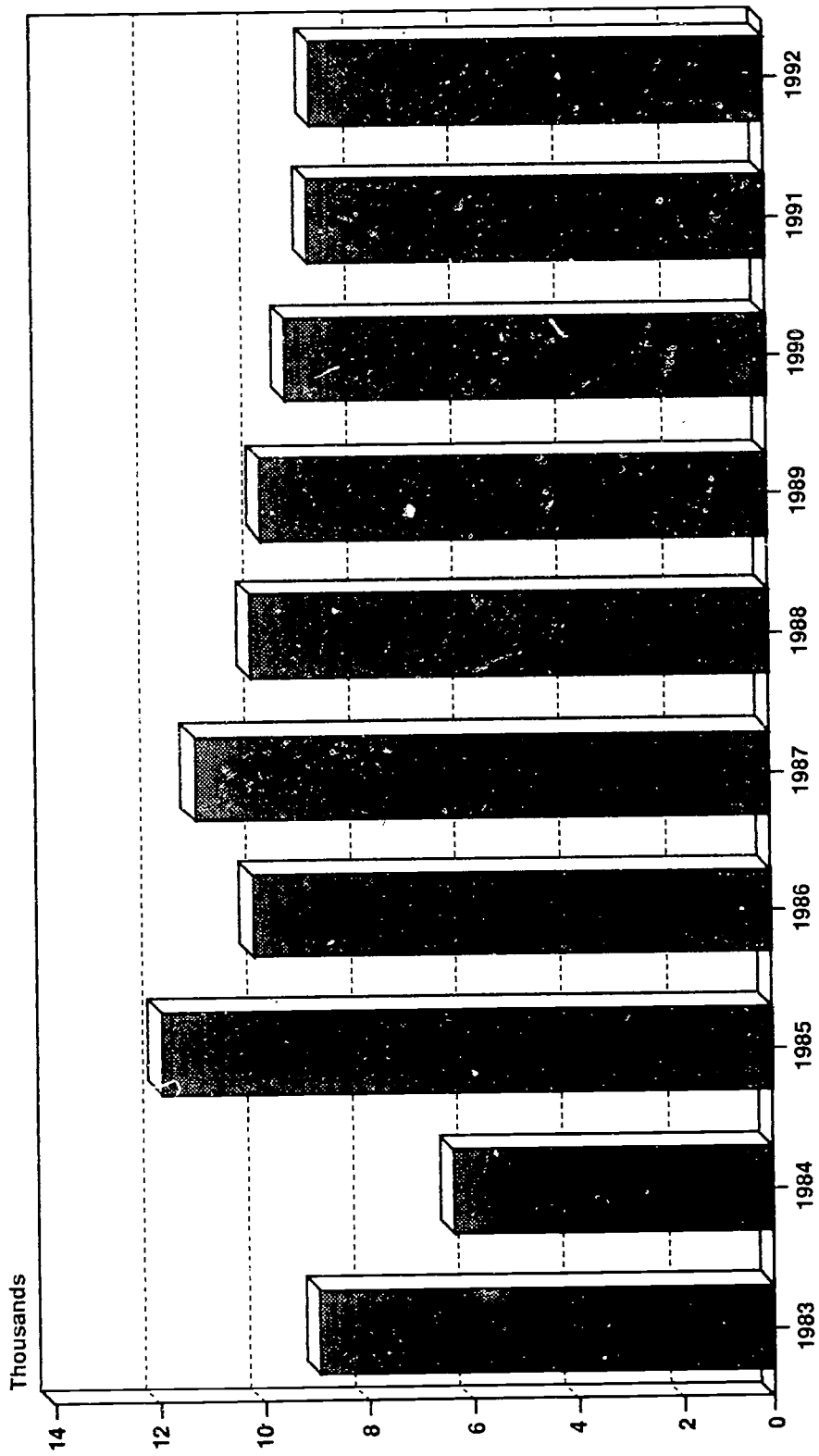

INTAKE BY LEVEL (1983 — 1992)

Course Level	1983	1984	1985	1986	1987	1988	1989	1990	1991	1992
Total	8,881	6,426	11,891	10,291	11,573	10,294	9,982	9,221	8,969	8,743
Diploma #	67	65	95	88	82	108	106	—	—	—
ITC	799	656	885	905	1,168	1,336	1,343	1,410	1,326	1,404
CBS	462	596	531	869	902	1,040	1,098	1,077	1,135	1,104
NTC-2	545	762	1,076	752	1,241	1,346	1,301	1,370	1,289	1,290
PCBS/COS *	901	914	851	1,464	1,775	1,529	1,418	1,367	1,219	1,204
NTC-3	2,142	1,363	2,732	1,216	842	646	828	613	592	506
BST/BVT-2 *	2,274	1,625	3,290	2,182	2,305	1,845	1,951	1,850	1,721	1,458
PVT/BVT-1 *	—	142	2,406	2,768	3,247	2,428	1,937	1,534	1,687	1,777
CoC	1,428	224	12	44	—	—	—	—	—	—
Others	263	79	13	3	11	16	—	—	—	—

#The Diploma courses were transferred to Temasek Polytechnic with effect from July 1990.

*The PCBS course was renamed COS with effect from July 1989.

The BST course was renamed BVT-2 with effect from January 1989.

The PVT course was renamed BVT-1 with effect from January 1989.

INTAKE BY LEVEL AND SEX 1992

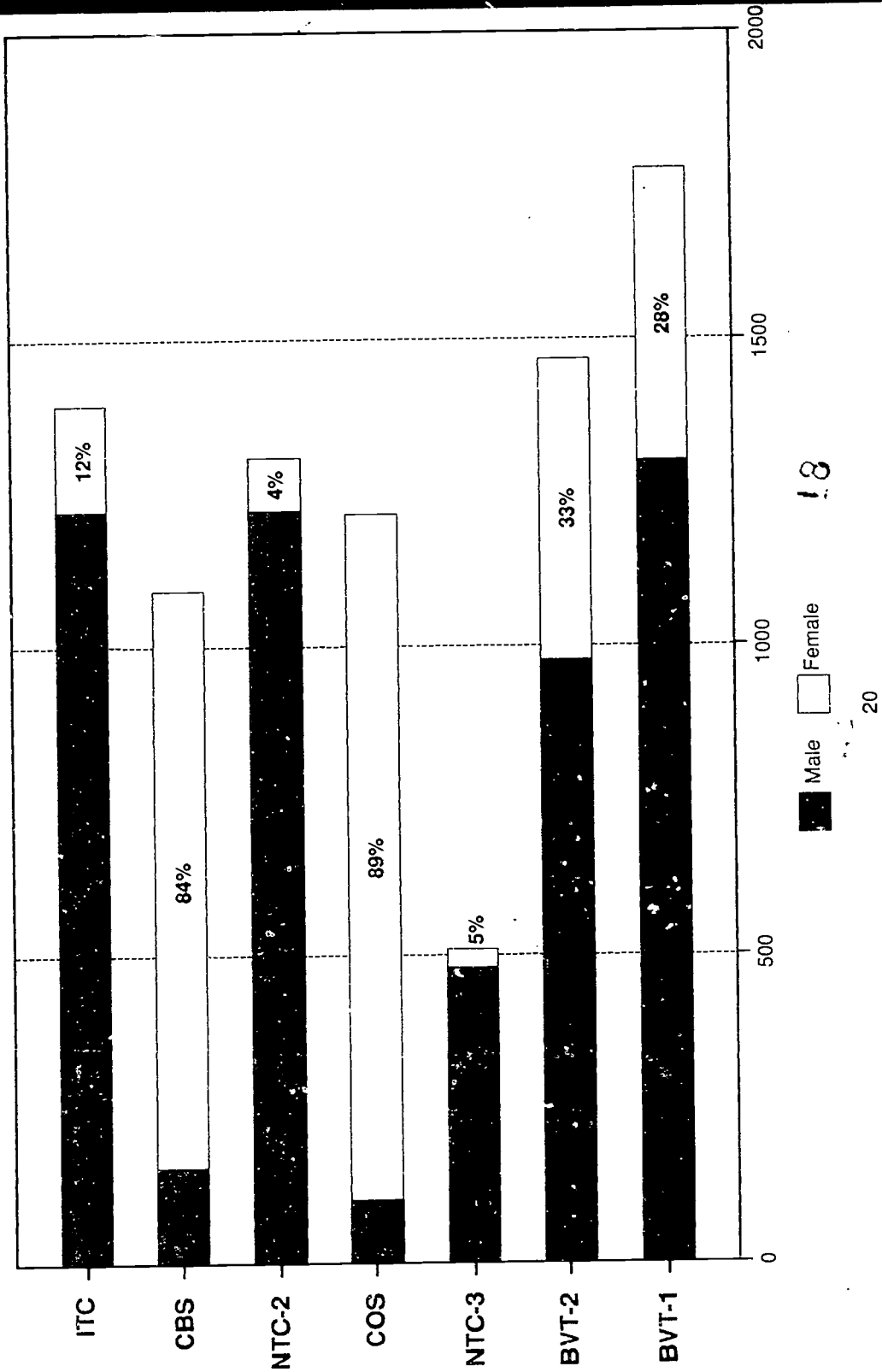

INTAKE BY LEVEL AND SEX
1992

Course Level	Total	Male	Female
Total	8,743	5,516	3,227
ITC	1,404	1,232	172
CBS	1,104	177	927
NTC-2	1,290	1,235	55
COS	1,204	127	1,077
NTC-3	506	483	23
BVT-2	1,458	983	475
BVT-1	1,777	1,279	498

INTAKE BY RACE 1992



INTAKE BY LEVEL AND RACE
1992

Course Level	Total	Chinese	Malay	Indian	Others
Total	8,743	5,780	1,948	639	376
ITC	1,404	1,159	204	36	5
CBS	1,104	910	128	51	15
NTC-2	1,290	711	440	109	30
COS	1,204	856	278	56	14
NTC-3	506	232	201	58	15
BVT-2	1,458	831	350	144	133
BVT-1	1,777	1,081	347	185	164

INTAKE BY QUALIFICATION
1992

Secondary & Above School Leavers
59%

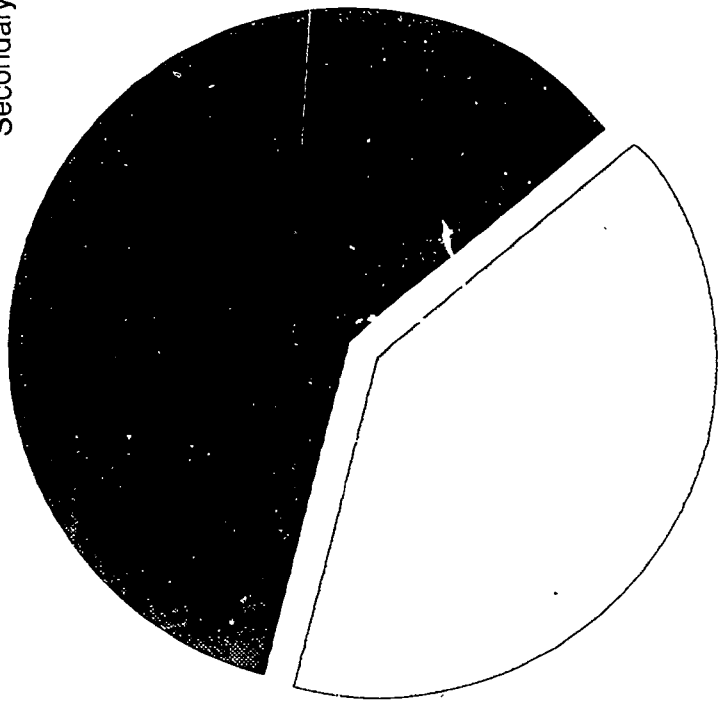

41%
Primary & Premature Secondary School Leavers

22

24

INTAKE BY QUALIFICATION 1992

Educational Qualification	Total	Male	Female
Total	8,743	5,516	3,227
Below Primary 6	27	26	1
BM4	2	2	—
P8M	1,841	1,341	500
P8E/P6N	1,328	864	464
S1 - S3	356	335	21
S4/GCE 'N'	658	400	258
GCE 'O'	4,529	2,546	1,983
GCE 'A'	2	2	—

AVERAGE ENROLMENT (1983 - 1992)

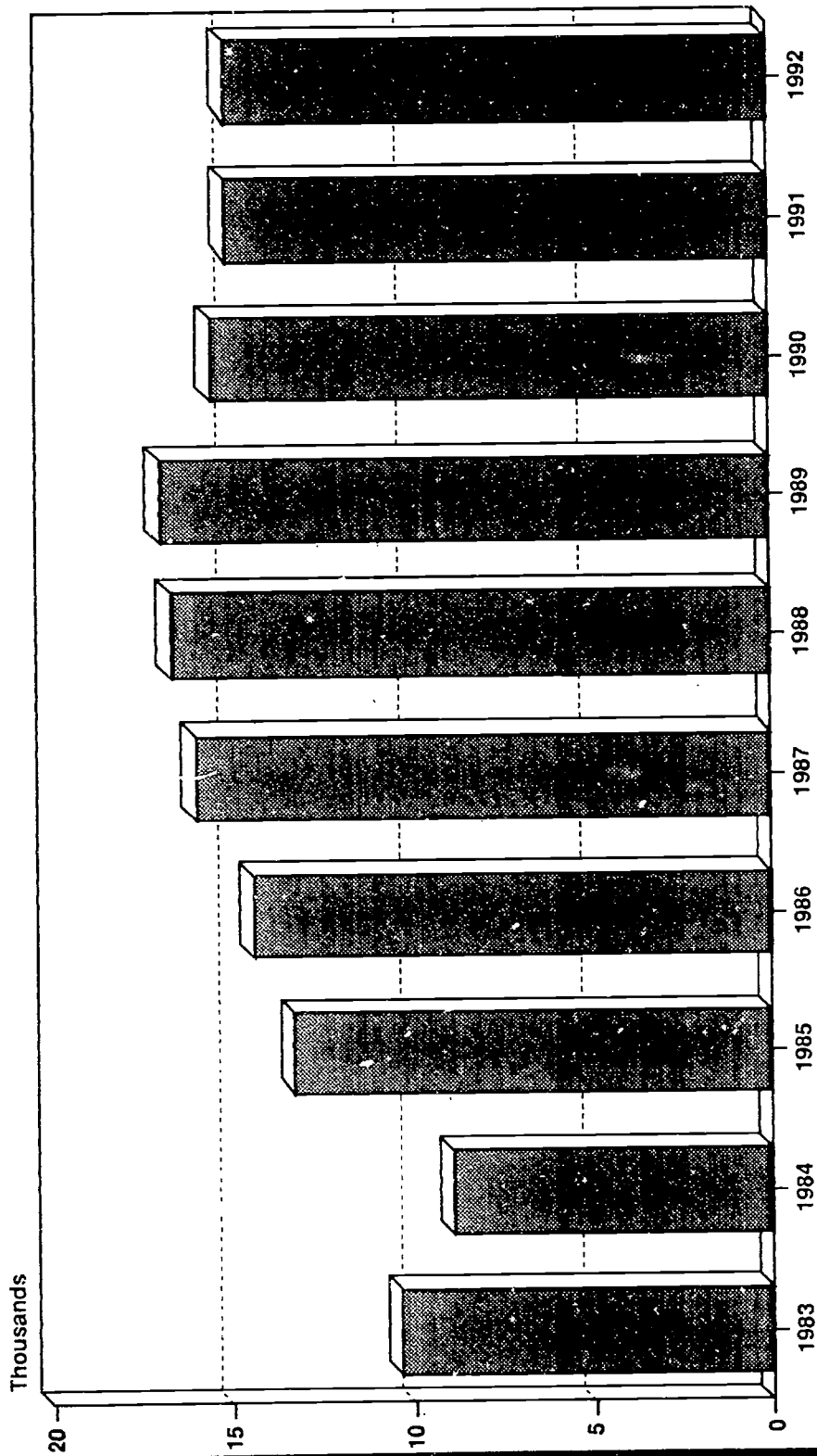

24

26

AVERAGE ENROLMENT BY LEVEL (1983 — 1992)

Course Level	1983	1984	1985	1986	1987	1988	1989	1990	1991	1992
Total	10,508	9,036	13,404	14,496	16,166	16,999	17,133	15,769	15,181	15,117
Diploma #	152	167	191	211	238	255	275	—	—	—
ITC	1,573	1,366	1,244	1,396	1,664	2,029	2,256	2,319	2,323	2,343
CBS	909	853	860	1,080	1,380	1,579	1,698	1,811	1,899	2,008
NTC-2	632	901	1,243	1,629	1,711	2,131	2,434	2,463	2,556	2,690
PCBS/COS *	597	840	876	1,289	1,448	1,472	1,394	1,296	1,191	1,142
NTC-3	4,042	3,175	3,849	3,396	3,004	3,511	3,679	2,955	2,610	2,404
CoVT	—	—	—	—	—	—	—	422	240	264
BST:/BVT-2 *	2,158	1,497	2,958	2,889	3,723	3,722	3,603	3,059	2,782	2,612
PVT/BVT-1 *	—	136	2,160	2,581	2,983	2,277	1,794	1,444	1,580	1,654
CoC	357	56	3	11	—	—	—	—	—	—
Others	88	45	20	14	15	23	—	—	—	—

#The Diploma courses were transferred to Temasek Polytechnic with effect from July 1990.

*The PCBS course was renamed COS with effect from July 1989.

The BST course was renamed BVT-2 with effect from January 1989.

The PVT course was renamed BVT-1 with effect from January 1989.

AVERAGE ENROLMENT BY LEVEL AND SEX 1992

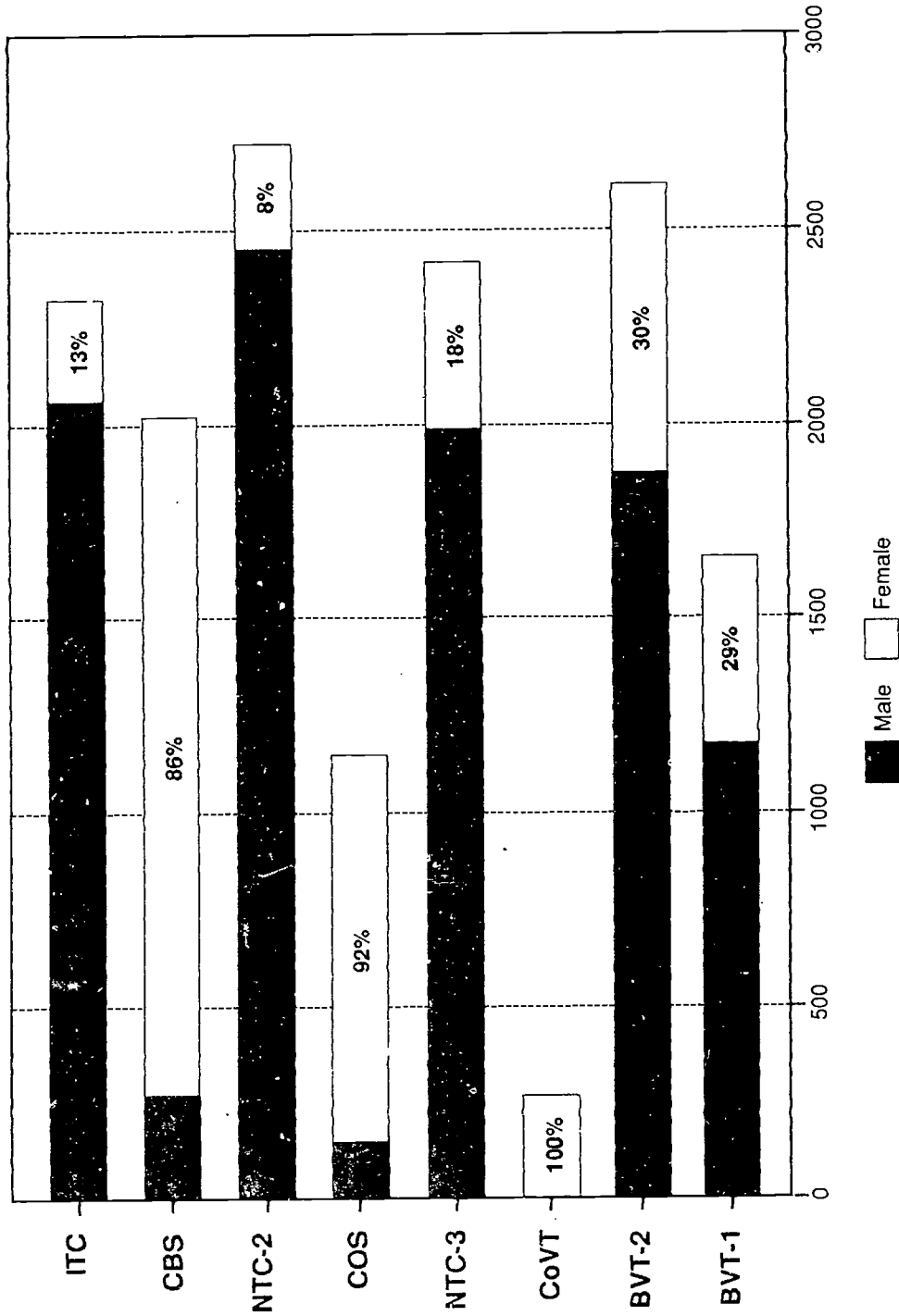

AVERAGE ENROLMENT BY LEVEL AND SEX
1992

Course Level	Total	Male	Female
Total	15,117	9,882	5,235
ITC	2,343	2,041	302
CBS	2,008	276	1,732
NTC-2	2,690	2,483	207
COS	1,142	95	1,047
NTC-3	2,404	1,982	422
CoVT	264	—	264
BVT-2	2,612	1,826	786
BVT-1	1,654	1,179	475

**AVERAGE ENROLMENT BY QUALIFICATION
1992**

Secondary & Above School Leavers
52%

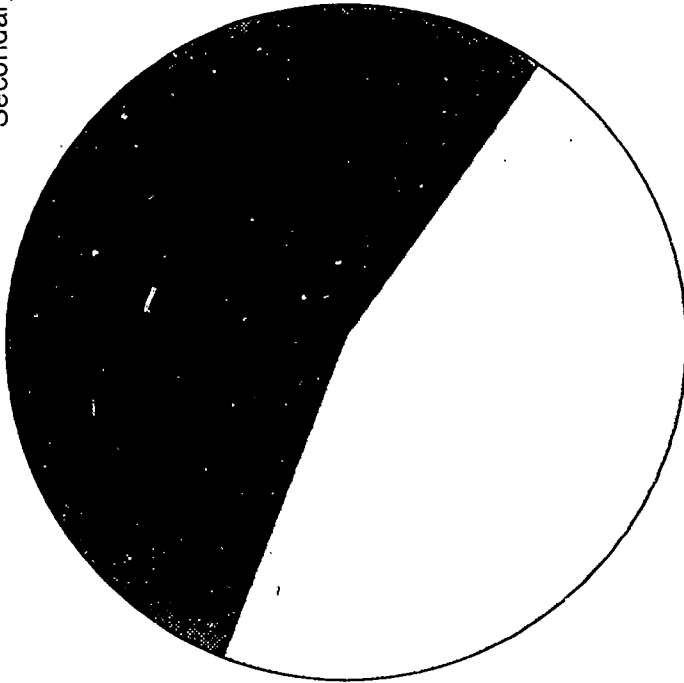

48%
Primary & Premature Secondary School Leavers

28

30

AVERAGE ENROLMENT BY QUALIFICATION 1992

Educational Qualification.	Total	Male	Female
Total	15,117	9,882	5,235
Below Primary 6	35	34	1
BM4	4	4	0
P8M	4,241	3,125	1,116
P8E/P6N	2,420	1,549	871
S1 - S3	488	456	32
S4/GCE 'N'	754	505	249
GCE 'O'	7,169	4,204	2,965
GCE 'A'	6	5	1

AVERAGE ENROLMENT BY LEVEL AND RACE 1992

Course Level	Total	Chinese	Malay	Indiash	Others
Total	15,117	10,380	2,915	996	826
ITC	2,343	1,937	267	68	71
CBS	2,008	1,661	204	80	63
NTC-2	2,690	1,634	731	184	141
COS	1,142	811	243	52	36
NTC-3	2,404	1,525	558	188	133
CoVT	264	166	54	22	22
BVT-2	2,612	1,636	537	231	208
BVT-1	1,654	1,010	321	171	152

**AVERAGE ENROLMENT BY TECHNICAL INSTITUTE
1992**

Technical Institute	Total	Male	Female
Total	15,117	9,882	5,235
ITE Ang Mo Kio	1,778	1,284	494
ITE Bedok	1,770	1,268	502
ITE Bukit Merah	900	864	36
ITE Balestier	1,507	1,120	387
ITE Bishan	1,615	164	1,451
ITE Clementi	1,535	207	1,328
ITE Geylang Serai	414	378	36
ITE Jurong	1,375	1,154	221
ITE MacPherson	2,343	2,041	302
ITE Pasir Panjang	1,415	937	478
Boy's Town Vocational Institute	465	465	0

CUMULATIVE OUTPUT BY LEVEL AND SEX UP TO 1992

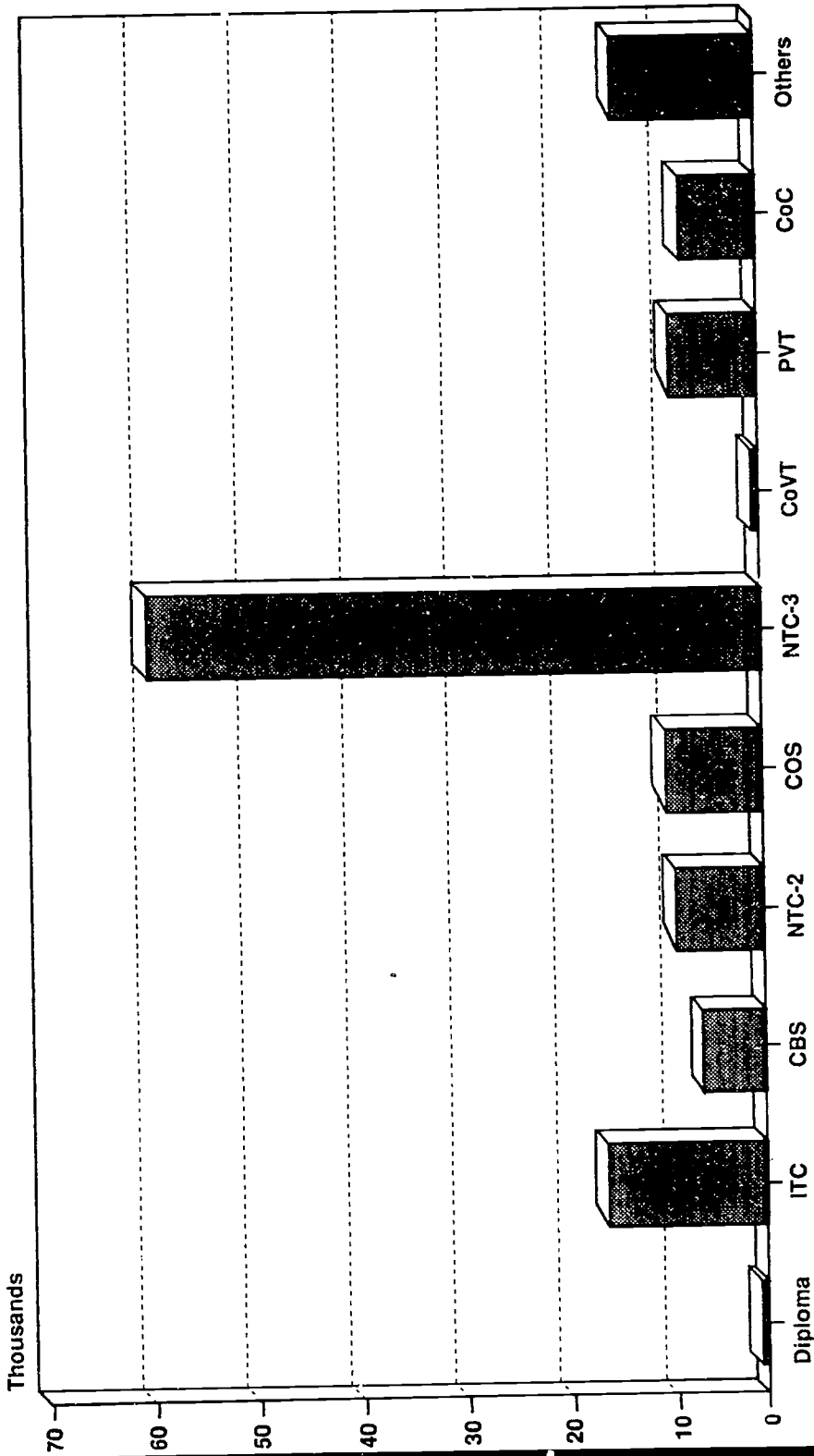

CUMULATIVE OUTPUT BY LEVEL AND SEX UP TO 1992

Course Level	Total	Male	Female
Total	133,159	91,135	42,024
Diploma	493	175	318
ITC	14,822	12,812	2,010
CBS	5,673	888	4,785
NTC-2	9,506	8,474	1,032
COS	11,154	1,085	10,069
NTC-3	60,440	52,546	7,894
CoVT	854	—	854
PVT	9,382	7,295	2,087
CoC	7,078	6,761	317
Other Commercial Courses	13,757	1,099	12,658

CUMULATIVE OUTPUT BY SECTOR, TRADE CLUSTER AND SEX

Sector/Trade Cluster	Output in 1992			Cumulative Output Up to 1992		
	Total	Male	Female	Total	Male	Female
	MANUFACTURING					
Automation	189	183	6	772	749	23
Electrical	472	447	25	12,852	12,304	548
Electronics	866	762	104	12,763	11,217	1,546
Precision Engineering	1,177	978	199	16,916	14,387	2,529
Printing	139	111	28	2,015	1,564	451
Woodbased	49	37	12	5,006	4,230	776
Subtotal	2,892	2,518	374	50,324	44,451	5,873
TECHNICAL SUPPORT						
Automotive	593	588	5	9,061	9,008	53
Drafting & Building Servicing	305	228	77	5,422	4,250	1,172
Marine & Fabrication	132	130	2	9,519	9,294	225
Mechanical & Maintenance	594	504	90	12,131	11,045	1,086
Subtotal	1,624	1,450	174	36,133	33,597	2,536
FINANCE & BUSINESS						
Business Studies	1,962	174	1,788	30,584	3,072	27,512
Subtotal	1,962	174	1,788	30,584	3,072	27,512
SERVICE						
Garments/Textiles	148	7	141	2,004	388	1,616
Hairstyling	76	1	75	1,038	97	941
Hotel/Catering	28	0	28	608	254	354
Retail Sales	180	0	180	569	0	569
Subtotal	432	8	424	4,219	739	3,480
OTHERS *	—	—	—	11,899	9,276	2,623
TOTAL	6,910	4,150	2,760	133,159	91,135	42,024

* Include the Diploma in Applied Arts courses which were formerly conducted by VITB before they were transferred to the Temasek Polytechnic and other discontinued courses that are not classified in the trade clusters above

** Refer to page 76 for the list of full-time courses by sector and trade cluster.

OUTPUT BY LEVEL AND RACE
1992

Course Level	Total	Chinese	Malay	Indian	Others
Total	6,910	4,945	1,257	381	327
ITC	1,047	888	102	28	29
CBS	859	725	72	31	31
NTC-2	1,449	958	339	83	69
COS	1,103	782	212	50	59
NTC-3	2,209	1,435	483	171	120
CoVT	243	157	49	18	19

OUTPUT OF COURSES

Course	Output in 1992		Cumulative Output Up to 1992			
	Total	Male	Female	Total	Male	Female
On-Going Courses as at 1992						
ITC						
Electrical Engineering	225	200	25	4,333	4,001	332
Electronics Engineering	368	307	61	4,605	3,903	702
Electro-Mechanical Engineering	85	80	5	213	197	16
Mechanical Engineering	237	226	11	2,327	2,210	117
Mechanical & Electrical Drafting & Design	132	81	51	1,623	1,103	520
Subtotal (ITC)	1,047	894	153	13,101	11,414	1,687
CBS						
Certificate in Business Studies - Accounting	559	99	460	3,880	862	3,018
Certificate in Business Studies - Secretarial Practice	300	6	294	1,793	26	1,767
Subtotal (CBS)	859	105	754	5,673	888	4,785
NTC - 2						
Air-Conditioning & Refrigeration	61	60	1	502	493	9
Architectural Drafting	65	53	12	492	321	171
Civil/Structural Drafting	23	14	9	257	167	90

OUTPUT OF COURSES

Course	Output In 1982			Cumulative Output Up to 1982		
	Total	Male	Female	Total	Male	Female
Diesel Engine Mechanics	22	22	0	182	181	1
Electrical Installation & Servicing	148	148	0	981	977	4
Electrical Power & Machines	41	41	0	264	258	6
Electronics Servicing (Digital Equipment)	288	277	11	1,221	1,136	85
Electronics Servicing (Electronics Instrumentation)	42	39	3	270	252	18
Electronics Servicing (Video Technology)	66	64	2	625	587	38
Electro-Mechanical Servicing	104	103	1	552	546	6
Fashion Garment	58	7	51	343	31	312
Mechanical Servicing	76	65	11	351	330	21
Motor Vehicle Mechanics	116	116	0	909	904	5
Precision Machining	148	125	23	1,200	1,079	121
Precision Tooling (Injection Mould)	74	60	14	387	362	25
Precision Tooling (Press Tool)	66	52	14	339	312	27
Day Release Courses*						
Graphic Reproduction	19	9	10	102	56	46
Offset Printing	32	32	0	139	138	1
Subtotal (NTC-2)	1,449	1,287	162	9,116	8,130	986

BEST COPY AVAILABLE

3937

OUTPUT OF COURSES

Course	Output in 1992			Cumulative Output Up to 1992		
	Total	Male	Female	Total	Male	Female
COS	1,103	69	1,034	11,154	1,085	10,069
<u>NTC-3</u>						
Air-Conditioning & Refrigeration	60	55	5	1,269	1,220	49
Building Drafting	21	19	2	1,264	935	329
Building Servicing	64	61	3	534	499	35
Diesel Engine Mechanics	126	126	0	2,635	2,633	2
Electrical Installation & Servicing	58	58	0	6,440	6,240	200
Electronics Servicing	77	75	2	5,854	5,308	546
Fashion Garment	80	0	80	1,003	7	996
Furniture Production	38	31	7	948	605	343
General Welding	40	39	1	4,297	4,211	86
Graphic Reproduction	4	4	0	281	198	83
Hairstyling	76	1	75	991	77	914
Marine Mechanics	92	91	1	1,209	1,197	12

OUTPUT OF COURSES

Course	Output in 1992			Cumulative Output Up to 1992		
	Total	Male	Female	Total	Male	Female
Mechanical Servicing	397	324	73	8,982	8,095	887
Motor Vehicle Mechanics	329	324	5	4,884	4,846	38
Offset Printing	22	22	0	478	446	32
Precision Machining	652	515	137	12,663	10,424	2,239
Upholstery	11	6	5	360	119	241
Day Release Courses*						
Graphic Reproduction	35	18	17	167	90	77
Offset Printing	27	26	1	213	208	5
Subtotal (NTC-3)	2,209	1,795	414	54,472	47,358	7,114
CoVT	243	0	243	854	0	854
Other Discontinued Courses**	—	—	—	38,789	22,260	16,529
Total	6,910	4,150	2,760	133,159	91,135	42,024

* These courses were launched in 1979. They were part-time day-release courses until 1988 when they were captured under full-time statistics as they were conducted using full-time resources and facilities. Cumulative figures reflected were cumulative output from 1988.

** Readers who are interested in the discontinued courses can refer to page 80 on the list of courses.

SECTION III

APPRENTICESHIP

40

43

INTAKE OF APPRENTICES (1983 — 1992)

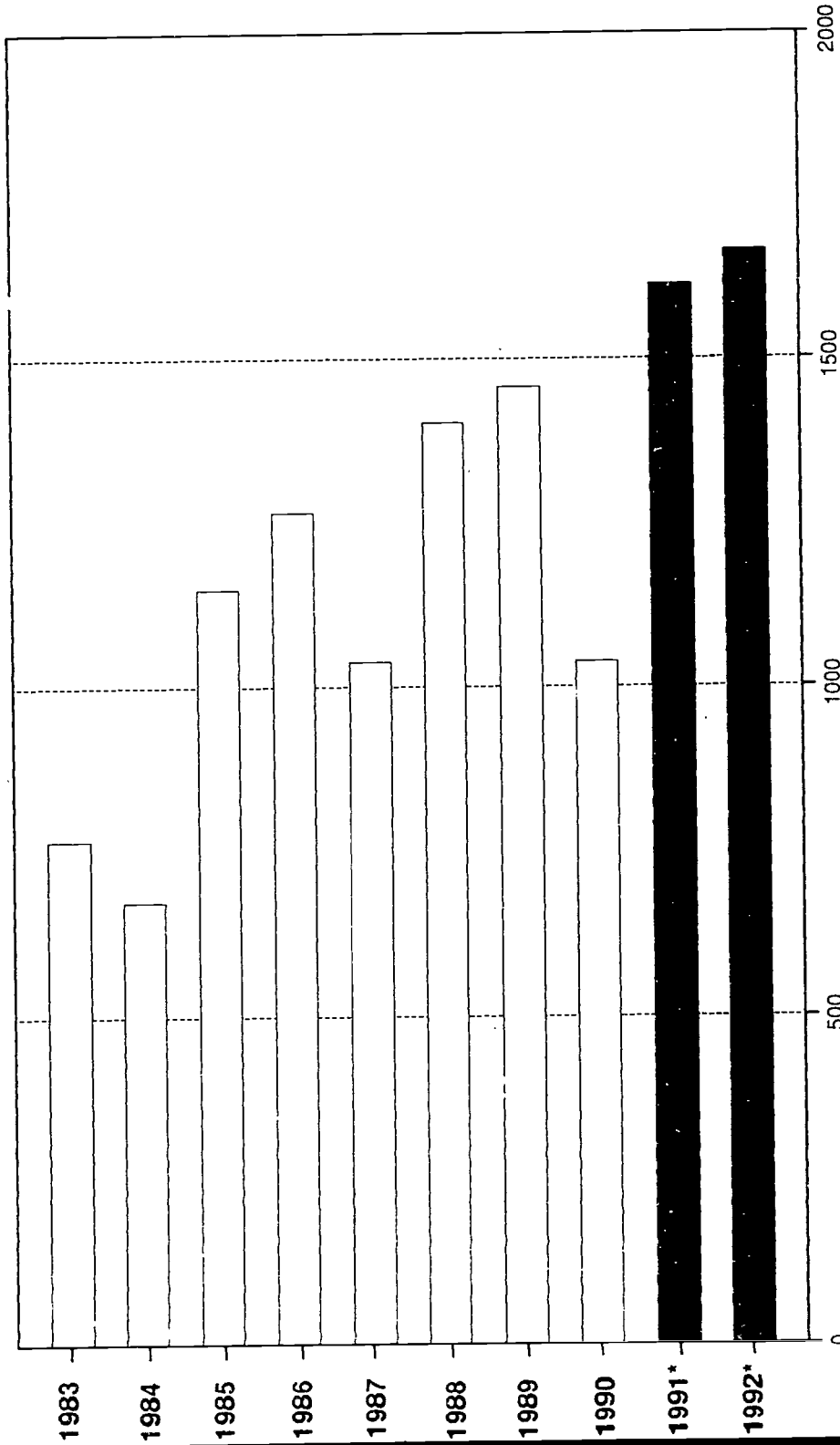

* Intake of Apprentices under the New Apprenticeship System

41

APPRENTICESHIP (1983 — 1992)

Apprenticeship Indicator	1983	1984	1985	1986	1987	1988	1989	1990	1991	1992
Firms participated in apprenticeship as at year end	242	173	177	160	192	181	182	209	202	288
Intake of apprentices	752	694	1,157	1,285	1,020	1,404	1,486	1,019	1,594	1,661
Apprentices completed training during the year	1,428	1,386	891	966	1,171	1,177	1,214	1,071	1,081	1,263
Apprentices in training as at year end	2,849	2,271	2,078	2,272	1,961	2,152	2,550	2,287	2,134	2,275

The New Apprenticeship System was launched in October 1990. The new system is attractive to school leavers who prefer to earn as they learn and employers who have the ability to train their own workers. Key features of the new system are: the need for pedagogic qualified industry trainers, increased level of Skills Development Funds (SDF) training subsidies to employers, and continuing education for apprentices without adequate academic qualification.

Prior to 1991, apprentices include self-sponsored trainees. With the launching of the New Apprenticeship System, all apprentices should be sponsored. Thus, self-sponsored trainees were excluded from the apprenticeship statistics from 1991 onwards.

BEST COPY AVAILABLE

42

INTAKE OF APPRENTICES BY SECTOR

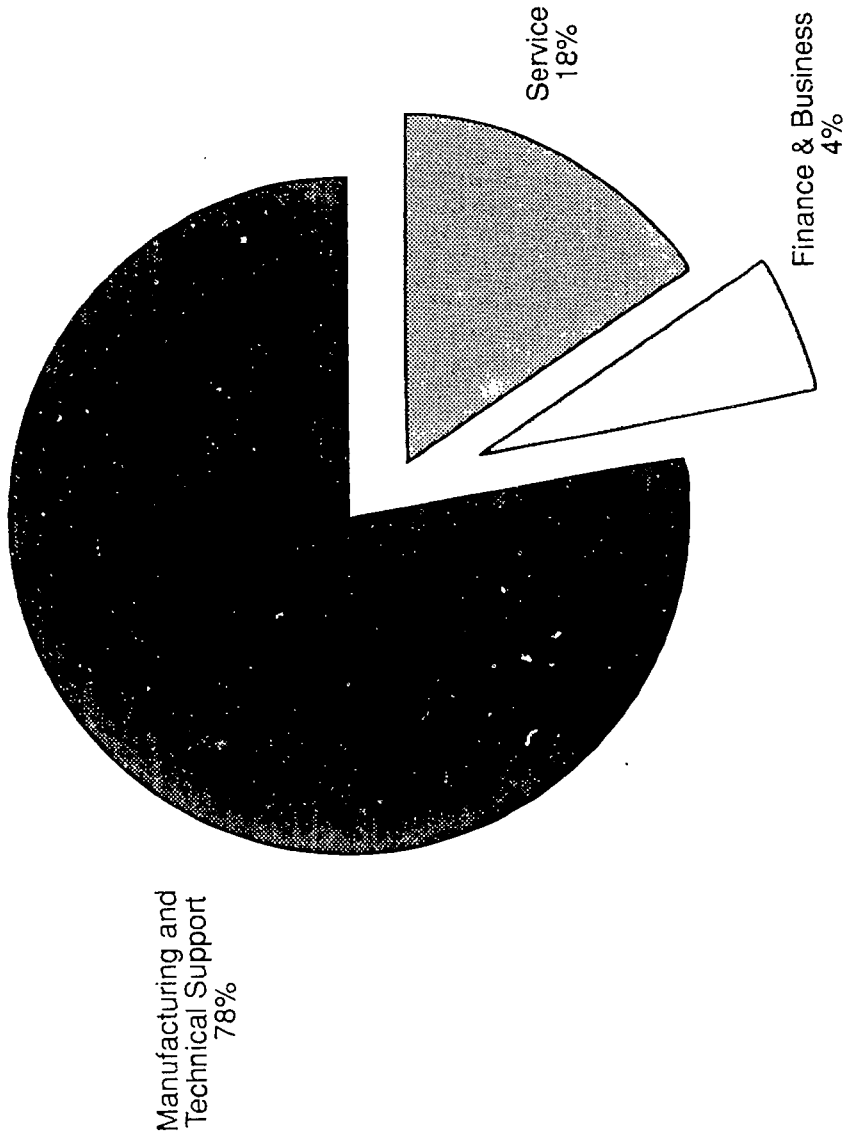

43

46

INTAKE OF APPRENTICES BY SECTOR AND TRADE CLUSTER — 1992

Sector	Trade Cluster	Intake
MANUFACTURING	Automation	36
	Chemicals	12
	Electrical	67
	Electronics	143
	Precision Engineering	106
	Printing	168
	Woodbased	12
	Subtotal	544
TECHNICAL SUPPORT	Aerospace	186
	Automotive	199
	Drafting & Building Servicing	8
	Marine & Fabrication	285
	Mechanical & Maintenance	79
	Subtotal	757
FINANCE & BUSINESS	Business Studies	57
	Subtotal	57
SERVICE	Garments/Textiles	23
	Hairstyling	29
	Hotel/Catering	105
	Medical Services	20
	Retail Sales	48
	Travel	78
		Subtotal
	Total	1,661

Refer to page 78 for the list of Apprenticeship courses by sector and trade cluster

INTAKE OF APPRENTICES BY LEVEL AND RACE
1992

Course Level	Total	Chinese	Malay	Indian	Others
Total	1,661	1,030	362	227	42
NTC-2	1,027	641	232	126	28
NTC-3	430	263	74	83	10
COS	57	18	31	6	2
CoC	1	1	0	0	0
Certificate in Service Skills	146	107	25	12	2

INTAKE OF APPRENTICES BY QUALIFICATION
1992

Educational Qualification	Total	Male	Female
Total	1,661	1,240	421
BM4	34	29	5
P8M	129	123	6
P8E/P6N/PSLE	226	189	37
S1 - S3	190	147	43
S4/S5/GCE 'N'	290	214	76
GCE 'O'	743	510	233
GCE 'A'	49	28	21

APPRENTICES COMPLETED TRAINING IN 1992 BY SECTOR AND TRADE CLUSTER

Sector	Trade Cluster	Number Completed
MANUFACTURING	Electrical	70
	Electronics	19
	Precision Engineering	173
	Printing	122
	Woodbased	14
	Subtotal	398
TECHNICAL SUPPORT	Aerospace	259
	Automotive	82
	Marine & Fabrication	273
	Mechanical & Maintenance	38
	Subtotal	652
FINANCE & BUSINESS	Business Studies	21
	Subtotal	21
SERVICE	Garments/Textiles	6
	Hairstyling	6
	Hotel/Catering	126
	Retail Sales	6
	Travel	48
	Subtotal	192
	Total	1,263

47

SECTION IV

CONTINUING EDUCATION AND TRAINING

49

51

TRAINING PLACES TAKEN UP UNDER
CONTINUING SKILLS TRAINING AND EDUCATION (1988 - 1992)

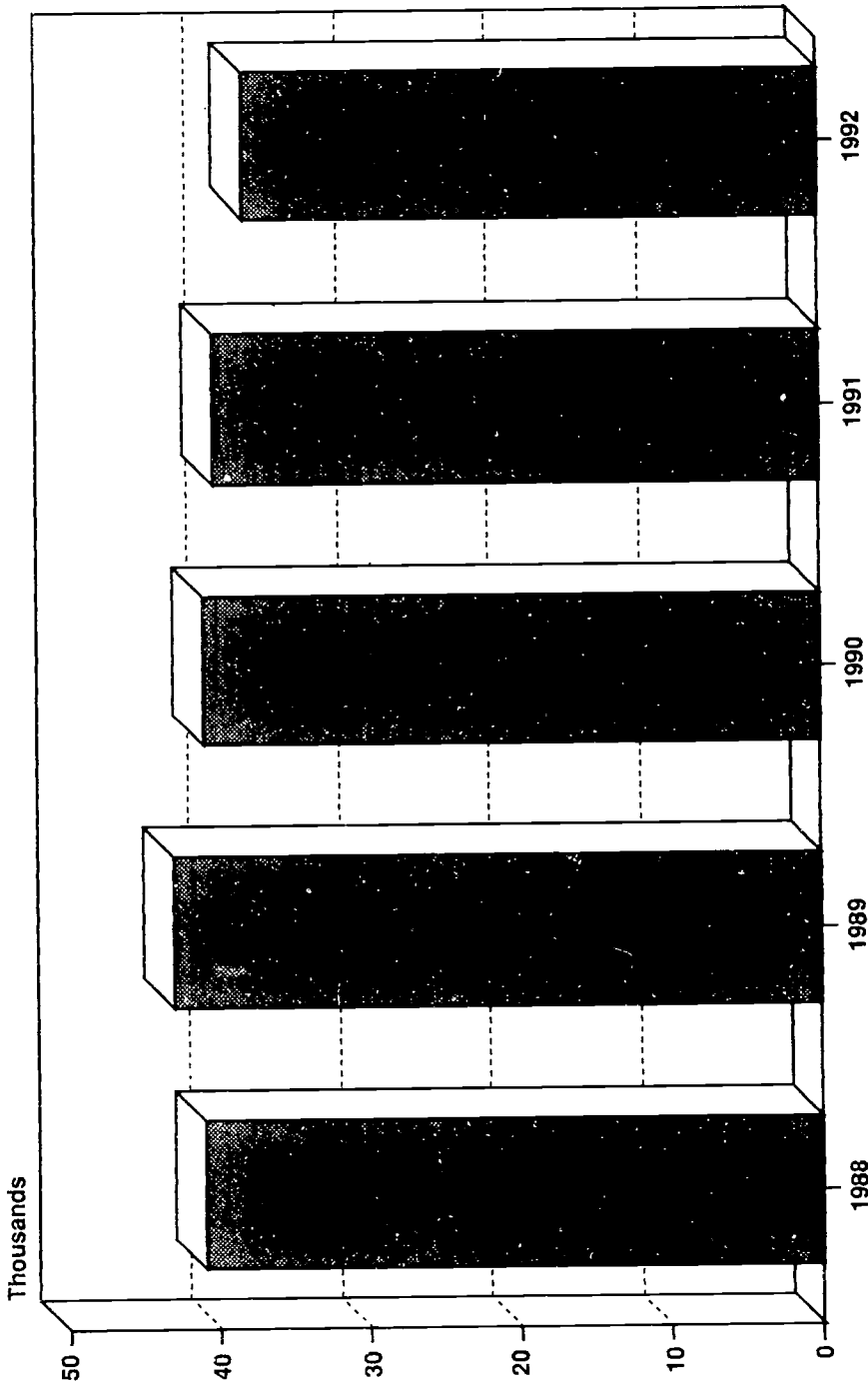

TRAINING PLACES TAKEN UP UNDER CONTINUING SKILLS TRAINING AND EDUCATION*

(1988 — 1992)

Programme	1988	1989	1990	1991	1992
Total	41,324	44,479	41,685	40,197	38,228
Continuing Skills Training	17,371	19,456	20,573	21,043	20,359
Continuing Education	23,953	25,023	21,112	19,154	17,869

* Training Places taken up indicate the number of modules and subjects taken up by participants under the 'MOST' and 'TIME' Schemes, and continuing education courses. It is not equivalent to headcount.

**TRAINING PLACES TAKEN UP
UNDER THE CONTINUING SKILLS TRAINING AND CONTINUING EDUCATION COURSES BY LEVEL
1992**

Continuing Skills Training	
Level	Training Places
Total	20,359
ITC	523
NTC-2	4,674
NTC-3	14,534
CoC	289
Other Skills Courses	339

Continuing Education	
Level	Training Places
Total	17,869
Secondary 1N	1,790
Secondary 2N	1,380
Secondary 3N	1,861
Secondary 4N	3,548
Secondary 5N (Including GCE 'O' Revision)	4,431
Pre-University 1	1,975
Pre-University 2 (Including GCE 'A' Revision)	2,884

SECTION V

WORKER EDUCATION

00 02
55

TRAINING PLACES TAKEN UP BY BEST PARTICIPANTS (1983 - 1992)

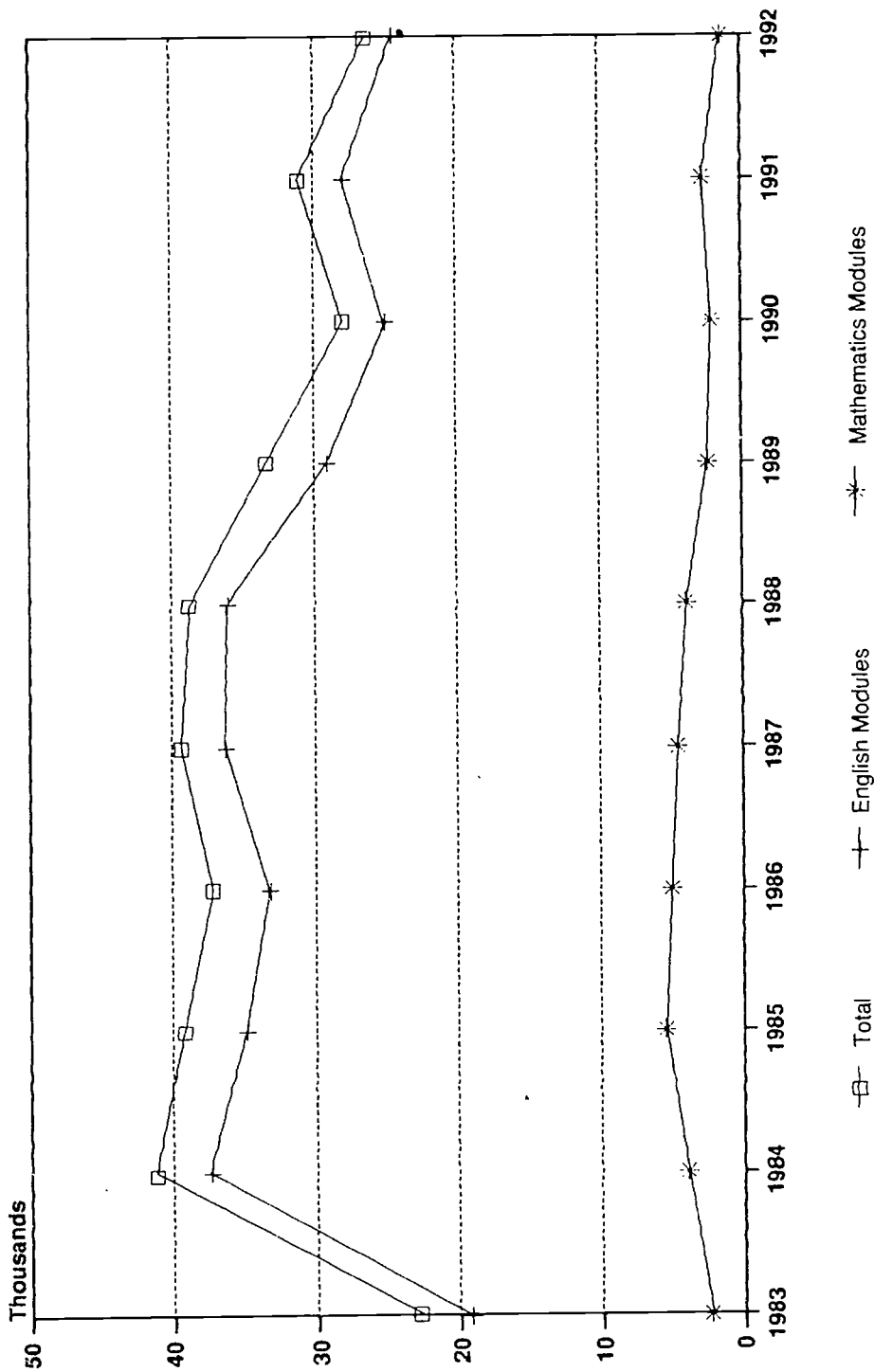

TRAINING PLACES TAKEN UP BY BEST PARTICIPANTS BY LEVEL (1983 ~ 1992)

Module and Level	1983	1984	1985	1986	1987	1988	1989	1990	1991	1992
Total	22,247	40,958	33,998	37,059	39,501	38,694	32,787	28,320	30,956	26,875
ENGLISH MODULES	19,079	36,824	33,880	32,016	34,755	34,556	29,669	25,273	27,766	24,395
Module 1	9,018	10,910	7,674	12,326	9,725	11,574	7,564	7,036	7,774	6,384
Module 2	4,322	9,584	7,278	6,980	9,429	7,699	6,242	5,898	6,529	5,849
Module 3	1,680	7,144	8,427	5,682	7,333	6,326	6,597	5,185	5,579	5,020
Module 4	4,059	9,186	10,501	7,028	8,268	8,957	9,266	7,154	7,884	7,142
MATHEMATICS MODULES	3,168	4,134	5,118	5,043	4,746	4,138	3,118	3,047	3,190	2,480
Module 1	1,377	1,002	829	882	541	662	1,074	472	552	290
Module 2	524	689	1,345	866	838	604	572	543	446	396
Module 3	282	856	1,156	1,148	1,216	842	361	525	598	404
Module 4	985	1,587	1,788	2,147	2,151	2,030	1,111	1,507	1,594	1,390

TRAINING PLACES TAKEN UP BY BEST PARTICIPANTS BY TYPE OF CENTRE (1983 — 1992)

Module and Centre	1983	1984	1985	1986	1987	1988	1989	1990	1991	1992
Total	22,247	40,958	38,998	37,059	39,501	38,694	32,787	28,320	30,956	26,875
ENGLISH MODULES	19,079	36,824	33,880	32,016	34,755	34,556	29,669	25,273	27,766	24,395
Companies	9,794	15,175	11,429	12,403	14,947	13,721	10,443	9,317	9,313	7,162
ITE	1,692	2,444	3,561	3,161	4,503	6,747	7,185	7,832	10,329	10,389
Ministry of Defence	2,216	6,149	5,142	4,352	3,841	3,063	2,831	1,532	1,487	1,164
NTUC/PAP	5,377	13,056	13,748	12,100	11,464	11,025	9,210	6,592	6,637	5,680
MATHEMATICS MODULES	3,168	4,134	5,118	5,043	4,746	4,138	3,118	3,047	3,190	2,480
Companies	1,553	1,967	2,350	2,448	1,965	1,460	1,065	1,170	1,342	972
ITE	691	905	778	815	1,358	1,726	1,459	1,577	1,506	1,290
NTUC/PAP	924	1,262	1,990	1,780	1,423	952	594	300	342	218

EXAMINATION RESULTS OF BEST PARTICIPANTS (1983 -- 1992)

BEST Programme	1983	1984	1985	1986	1987	1988	1989	1990	1991	1992
ENGLISH MODULES										
Number registered for examination	15,183	30,377	29,343	28,056	30,575	31,503	28,693	25,373	26,506	24,288
Number took examination	12,418	22,313	18,824	17,655	18,448	18,695	17,089	16,547	16,404	14,435
Number passed examination	11,595	20,542	16,046	14,892	16,128	15,705	14,165	13,458	14,403	11,448
Pass Rate	93%	92%	85%	84%	87%	84%	83%	81%	88%	79%
MATHEMATICS MODULES										
Number registered for examination	2,035	3,499	4,344	4,431	3,840	3,762	2,961	2,968	3,163	2,471
Number took examination	1,639	2,422	2,943	3,066	2,612	2,401	2,043	2,242	2,214	1,707
Number passed examination	1,382	1,984	2,584	2,750	2,241	1,994	1,575	1,761	1,647	1,102
Pass Rate	84%	82%	88%	90%	86%	83%	77%	79%	74%	65%

BEST COPY AVAILABLE

56

TRAINING PLACES TAKEN UP BY WISE PARTICIPANTS (1987 - 1992)

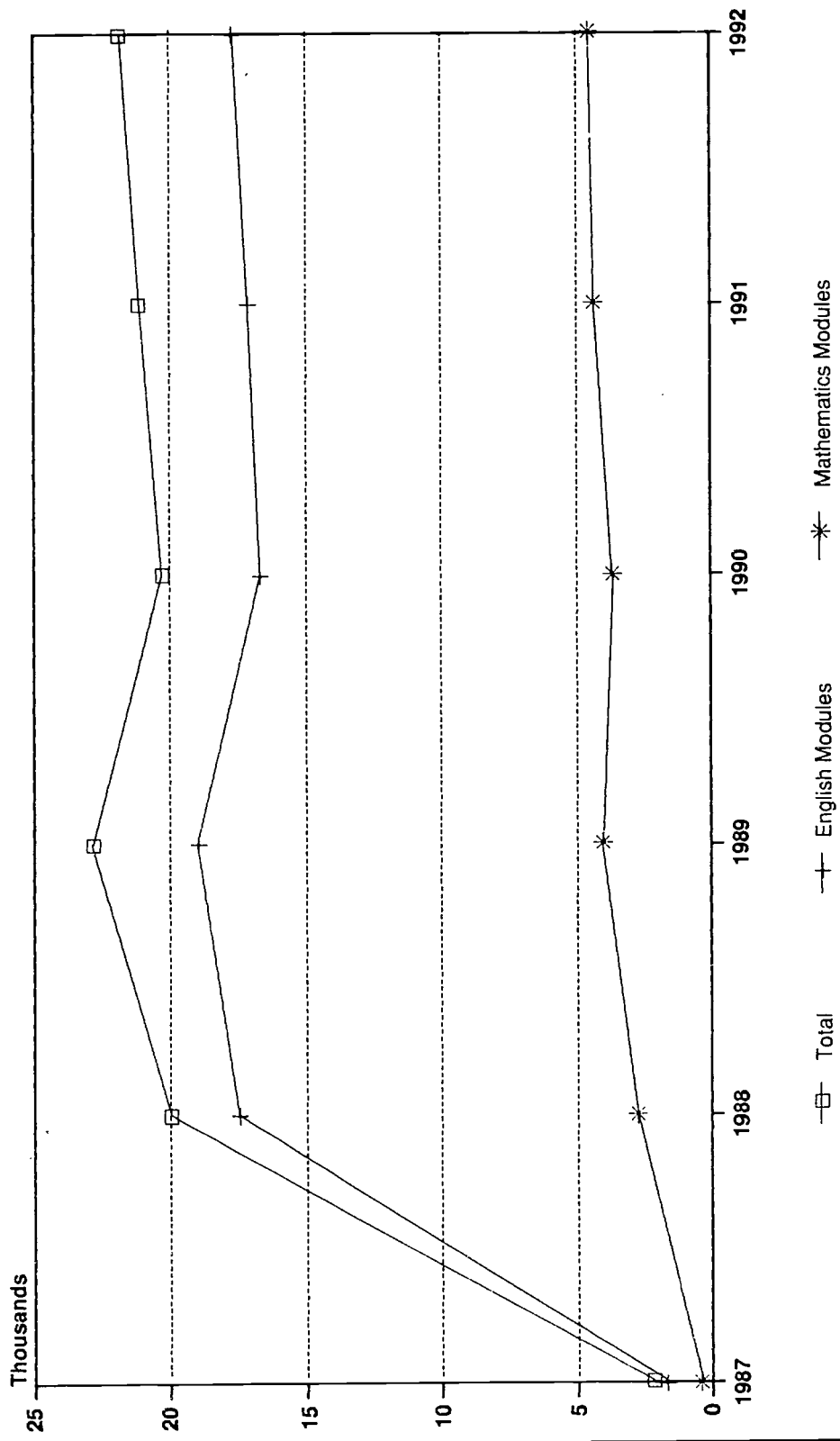

TRAINING PLACES TAKEN UP BY WISE PARTICIPANTS BY LEVEL (1987 - 1992)

Module and Level	1987	1988	1989	1990	1991	1992
Total	1,643	20,041	22,652	20,178	21,148	21,738
ENGLISH MODULES	1,407	16,935	18,928	16,748	16,899	17,328
Module 1	1,215	9,089	5,176	5,761	5,905	5,623
Module 2	192	5,211	4,565	3,905	4,501	4,533
Module 3	—	2,130	5,422	3,749	3,756	4,027
Module 4	—	505	3,765	3,333	2,737	3,045
MATHEMATICS MODULES	236	3,106	3,724	3,430	4,249	4,510
Module 1	210	1,707	1,250	1,204	1,550	1,517
Module 2	26	992	820	880	1,194	1,147
Module 3	—	353	1,018	766	878	1,079
Module 4	—	54	636	580	627	767

TRAINING PLACES TAKEN UP BY WISE PARTICIPANTS BY TYPE OF CENTRE (1987 - 1992)

Module and Centre	1987	1988	1989	1990	1991	1992
Total	1,643	20,041	22,652	20,178	21,148	21,738
ENGLISH MODULES	1,407	16,935	18,928	16,748	16,899	17,228
Companies	622	8,103	8,409	6,968	6,031	6,098
ITE	373	5,815	6,871	6,859	7,961	8,416
Ministry of Defence*	72	—	—	—	—	—
NTUC/PAP	340	3,017	3,648	2,921	2,907	2,714
MATHEMATICS MODULES	236	3,106	3,724	3,430	4,249	4,510
Companies	49	956	1,075	896	830	801
ITE	156	1,907	2,337	2,317	3,113	3,347
NTUC/PAP	31	243	312	217	306	362

* From 1988, data on training places under the Ministry of Defence is subsumed under company centres.

EXAMINATION RESULTS OF WISE PARTICIPANTS (1988 – 1992)

WISE Programme	1988	1989	1990	1991	1992
ENGLISH MODULES					
Number registered for examination	8,624	16,213	12,897	13,666	14,309
Number took examination	5,633	11,054	8,586	8,803	9,653
Number passed examination	5,512	10,127	7,591	7,550	7,679
Pass Rate	98%	92%	88%	86%	80%
MATHEMATICS MODULES					
Number registered for examination	1,640	3,174	2,803	3,265	4,000
Number took examination	1,096	2,158	1,898	2,270	2,671
Number passed examination	872	1,725	1,365	1,608	1,713
Pass Rate	80%	80%	72%	71%	64%

CO

SECTION VI

TRADE TESTING AND CERTIFICATION

61

65

CANDIDATURE FOR EXAMINATION AND TRADE TESTING (1983 - 1992)

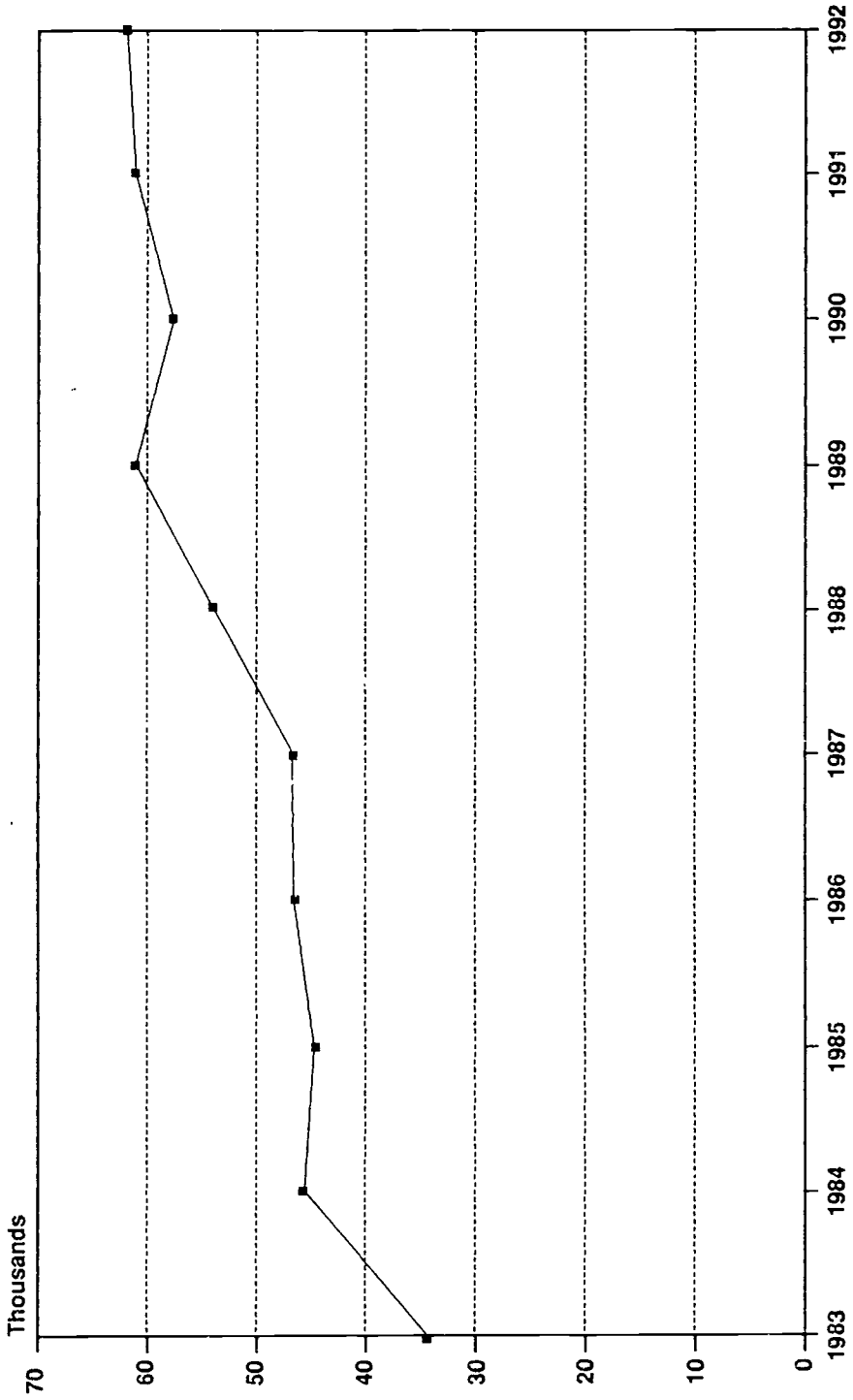

CANDIDATURE BY TYPE OF TEST/EXAM (1983 — 1992)

Type of Test/Exam	1983	1984	1985	1986	1987	1988	1989	1990	1991	1992
Total	33,978	46,369	45,445	47,369	47,396	54,227	60,646	57,909	61,164	61,816
Institutional+	7,476	7,839	10,326	12,215	11,789	11,160	9,531	9,793	9,218	9,588
Public Trade Test	7,545	6,431	5,414	4,396	4,425	4,321	4,771	3,631	5,330	5,027
Modular Trade Test	2,121	4,142	4,598	7,038	8,359	9,491	12,777	14,000	15,247	16,672
BEST	14,057	24,735	21,767	20,721	21,060	21,096	19,132	18,789	18,618	16,142
WISE	—	—	—	—	—	6,729	13,212	10,484	11,073	12,324
Academic (S1 - S3)	2,359	2,768	2,880	2,779	1,634	1,399	1,203	1,132	1,067	1,142
Industry Trainers	—	—	—	—	—	—	—	—	592	899
Certificate in Vocational Education (CVE)	310	247	321	184	82	10	6	7	—	—
Professional Certificate in Vocational Administration (PCVA)	—	—	—	—	—	—	—	7	—	—
Others	110	207	139	36	47	21	14	66	19	22

+Includes candidates from the Government Training Centres and Approved Training Centres.

CANDIDATURE BY COURSE LEVEL (1983 — 1992)

Course Level	1983	1984	1985	1986	1987	1988	1989	1990	1991	1992
Total	33,978	46,369	45,445	47,369	47,396	54,227	60,646	57,909	61,164	61,816
Diploma	37	33	65	68	66	80	81	85	—	—
NTC-1	—	—	—	—	—	14	21	19	28	27
ITC	827	824	764	901	1,420	1,357	1,556	1,709	1,418	1,421
CBS	370	548	536	537	469	762	729	802	831	858
NTC-2	3,246	3,153	2,613	2,876	3,531	3,269	3,711	3,511	3,425	3,487
NTC-2 (Modular)	—	—	—	—	—	155	1,198	1,417	2,165	3,530
PCBS/COS	210	970	921	1,250	1,355	1,542	1,435	1,279	1,200	1,236
NTC-3	9,583	7,887	8,538	8,193	6,258	6,130	6,538	5,436	7,082	6,852
NTC-3 (Modular)	2,121	4,142	4,598	7,038	8,359	9,336	11,500	12,497	13,028	13,001
CoVT	—	—	—	—	—	—	—	394	217	242
PVT	—	112	1,885	2,362	2,719	2,105	—	—	—	—
CoC	748	743	418	424	396	222	231	189	221	269
CoC (Modular)	—	—	—	—	—	—	79	86	54	141
BEST	14,057	24,735	21,767	20,721	21,060	21,096	19,132	18,789	8,618	16,142
WISE	—	—	—	—	—	6,729	13,212	10,484	11,073	12,324
Academic (S1 - S3)	2,359	2,768	2,880	2,779	1,634	1,399	1,203	1,132	1,067	1,142
Industry Trainers	—	—	—	—	—	—	—	—	592	899
Certificate in Vocational Education (CVE)	310	247	321	184	82	10	6	7	—	—
Professional Certificate in Vocational Administration (PCVA)	—	—	—	—	—	—	—	7	—	—
Certificate in Travel Services (General)	—	—	—	—	—	—	—	—	29	56
Certificate in Retailing (Sales & Customer Service)	—	—	—	—	—	—	—	—	97	147
Certificate in Health Care (Outpatient)	—	—	—	—	—	—	—	—	—	20
Others	110	207	139	36	47	21	14	66	19	22

CANDIDATURES AND PASSES BY TYPE OF TEST/EXAM

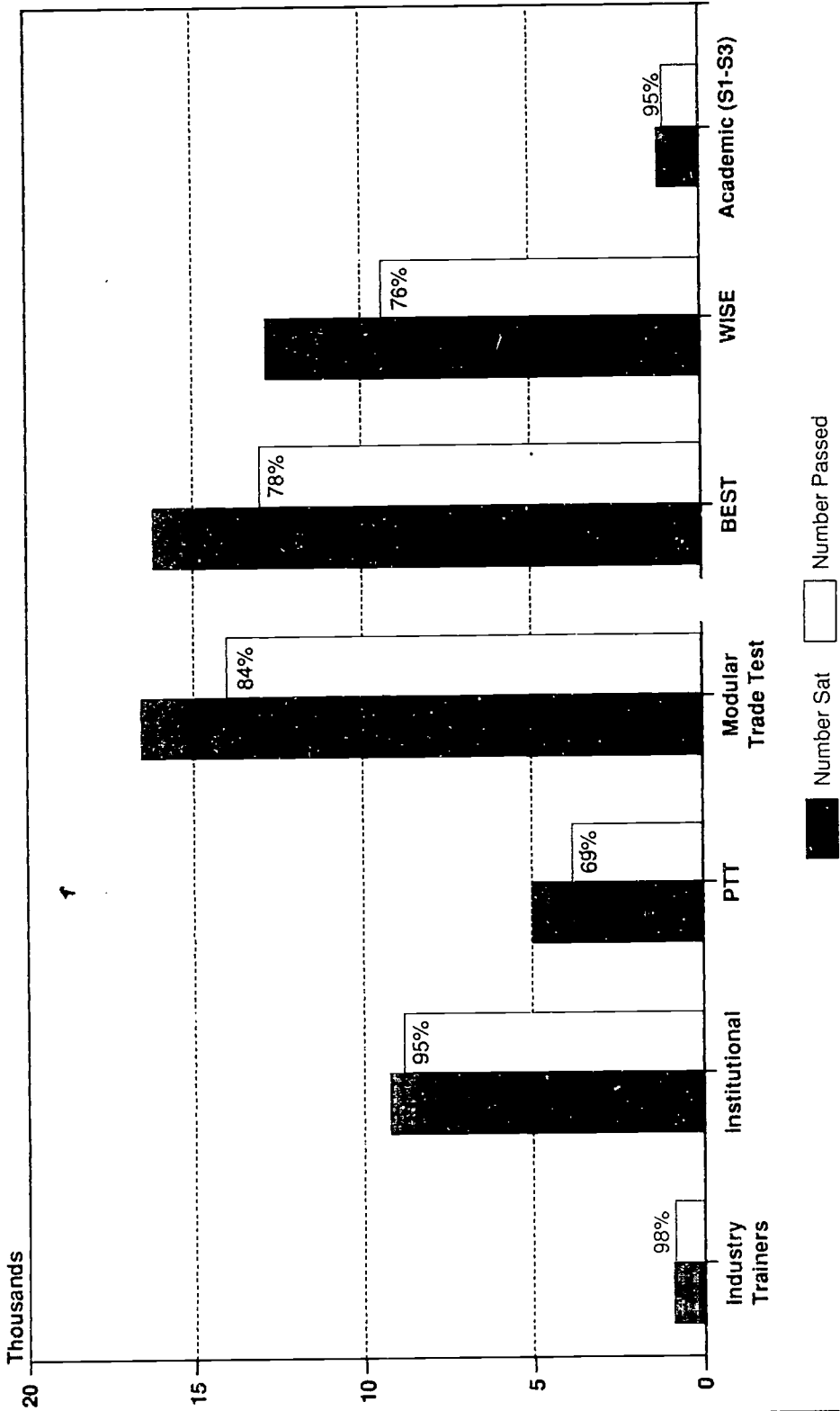

DISTRIBUTION OF CANDIDATURES AND PASSES BY TYPE OF TEST/EXAM — 1992

Type of Test/Exam	No Sat (Candidature)	No Passed*	Percent Passed
Total	61,816	50,447	82%
Institutional +	9,588	9,099	95%
Public Trade Test	5,027	3,444	69%
Modular Trade Test	16,672	13,985	84%
BEST	16,142	12,550	78%
WISE	12,324	9,392	76%
Academic (S1 - S3)	1,142	1,080	95%
Industry Trainers	899	877	98%
Others	22	20	91%

Note : * 'Number Passed' refers to candidates issued with certificates (on passing practical and theory or practical only) as well as those issued with statements (i.e. passed theory only)

+ Includes candidates from the Government Training Centres and Approved Training Centres.

NUMBER CERTIFIED THROUGH THE INSTITUTIONAL, PUBLIC AND MODULAR TRADE TESTS 1992

Course Level	Total	Institutional+	Public	Modular*
Total	26,528	9,099	3,444	13,985
NTC-1	27	27	—	—
ITC	1,352	1,352	—	—
CBS	718	718	—	—
NTC-2	5,909	2,652	474	2,783
COS	1,049	1,049	—	—
NTC-3	16,682	2,880	2,737	11,065
CoVT	222	222	—	—
CoC	364	63	164	137
Certificate in Travel Services (General)	52	52	—	—
Certificate in Retailing (Sales & Customer Service)	133	64	69	—
Certificate in Health Care (Outpatient)	20	20	—	—

+ Includes candidates from the Government Training Centres and Approved Training Centres.

* 'Number certified' through the Modular Trade Tests is not by 'headcount'. A person is counted twice if he has obtained two Module certificates.

SECTION VII

MISCELLANEOUS

68

73

LIST OF ON-GOING FULL-TIME COURSES (AS AT 1992)

Level /Course	Year of Launching	Year of First Output
Industrial Technician Certificate Courses		
Electrical Engineering	1971	1973
Electronics Engineering	1969	1971
Electro-Mechanical Engineering	1988	1990
Mechanical Engineering	1969	1971
Mechanical & Electrical Drafting & Design	1971	1973
Business Studies Courses		
Certificate in Business Studies – Accounting	1981	1983
Certificate in Business Studies – Secretarial Practice	1981	1983
Certificate in Office Skills	1981	1981
National Technical Certificate Grade 2 Courses		
Air-Conditioning & Refrigeration	1981	1981
Architectural Drafting	1981	1981
Civil/Structural Drafting	1982	1982
Diesel Engine Mechanics	1985	1987
Electrical Installation & Servicing	1981	1981
Electrical Power & Machines	1984	1985
Electronics Servicing (Digital Equipment)	1980	1982
Electronics Servicing (Electronics Instrumentation)	1987	1989
Electronics Servicing (Video Technology)	1983	1984
Electro-Mechanical Servicing	1985	1987
Fashion Garment	1986	1987
Mechanical Servicing	1985	1987
Motor Vehicle Mechanics	1980	1981
Precision Machining	1980	1980

LIST OF ON-GOING FULL-TIME COURSES (AS AT 1992)

Level / Course	Year of Launching	Year of First Output
Precision Tooling (Injection Mould)	1980	1981
Precision Tooling (Press Tool)	1981	1982
National Technical Certificate Grade 3 Courses		
Air-Conditioning & Refrigeration	1974	1975
Building Drafting	1974	1974
Building Servicing	1986	1986
Diesel Engine Mechanics	1974	1974
Electrical Installation & Servicing	1974	1974
Electronics Servicing	1974	1974
Fashion Garment	1975	1976
Furniture Production	1982	1983
General Welding	1974	1974
Graphic Reproduction	1979	1980
Hairstyling	1979	1979
Marine Mechanics	1975	1975
Mechanical Servicing	1974	1974
Motor Vehicle Mechanics	1974	1974
Offset Printing	1974	1974
Precision Machining	1974	1974
Upholstery	1975	1976
Basic Vocational Training Programmes		
Basic Vocational Training 1st year	1984	1984
Basic Vocational Training 2nd Year	1980	1981

LIST OF ON-GOING FULL-TIME COURSES BY SECTOR AND TRADE CLUSTER (AS AT 1992)

Sector	Trade Cluster	Course
MANUFACTURING	AUTOMATION	ITC Electro-Mechanical Engineering NTC-2 Electro-Mechanical Servicing
	ELECTRICAL	ITC Electrical Engineering NTC-2/3 Electrical Installation & Servicing NTC-2 Electrical Power & Machines
	ELECTRONICS	ITC Electronics Engineering NTC-2 Electronics Servicing (Digital Equipment) NTC-2 Electronics Servicing (Electronics Instrumentation) NTC-2 Electronics Servicing (Video Technology) NTC-3 Electronics Servicing Certificate of Vocational Training
	PRECISION ENGINEERING	ITC Mechanical Engineering NTC-2 Precision Machining NTC-2 Precision Tooling (Injection Mould) NTC-2 Precision Tooling (Press Tool) NTC-3 Precision Machining
	PRINTING	NTC-2/3 Graphic Reproduction NTC-2/3 Offset Printing
	WOODBASED	NTC-3 Furniture Production NTC-3 Upholstery

LIST OF ON-GOING FULL-TIME COURSES BY SECTOR AND TRADE CLUSTER (AS AT 1992)

Sector	Trade Cluster	Course
TECHNICAL SUPPORT	AUTOMOTIVE	NTC-2/3 Diesel Engine Mechanics NTC-2/3 Motor Vehicle Mechanics
	DRAFTING & BUILDING SERVICING	ITC Mechanical & Electrical Drafting & Design NTC-2 Architectural Drafting NTC-2 Civil & Structural Drafting NTC-3 Building Drafting NTC-3 Building Servicing
	MARINE & FABRICATION	NTC-3 General Welding NTC-3 Marine Mechanics
	MECHANICAL & MAINTENANCE	NTC-2/3 Air-Conditioning & Refrigeration NTC-2/3 Mechanical Servicing
FINANCE & BUSINESS	BUSINESS STUDIES	CBS (Accounting) CBS (Secretarial Practice) Certificate in Office Skills
SERVICE	GARMENTS/TEXTILES	NTC-2/3 Fashion Garment Certificate of Vocational Training
	HAIRSTYLING	NTC-3 Hairstyling
	HOTEL/CATERING	Certificate of Vocational Training
	RETAIL SALES	Certificate of Vocational Training

72

LIST OF ON-GOING APPRENTICESHIP COURSES BY SECTOR AND TRADE CLUSTER (AS AT 1992)

Sector	Trade Cluster	Course	
MANUFACTURING	AUTOMATION	NTC-2 Electro-Mechanical Maintenance Fitting NTC-2 Electro-Mechanical Servicing	
	CHEMICALS	NTC-2 Process Operation & Control	
	ELECTRICAL	NTC-2/3 Electrical Installation & Servicing NTC-2 Electrical Power & Machines	
	ELECTRONICS	NTC-2 Electronics Servicing (Digital Equipment) NTC-2 Electronics Servicing (Video Technology) NTC-3 Electronics Servicing	
	PRECISION ENGINEERING	NTC-2 Precision Machining NTC-2/3 Precision Optics CoC Die-Casting Machine Setting CoC Heat Treatment	
	PRINTING	NTC-2/3 Graphic Reproduction NTC-2/3 Offset Printing	
	WOODBASED	NTC-2/3 Furniture Production CoC Woodworking Machine Operations	
	TECHNICAL SUPPORT	AEROSPACE	NTC-2/3 Aircraft Mechanics (Airframe & Engines) NTC-2 Aircraft Mechanics (Electrical & Instruments) NTC-2 Aircraft Mechanics (Radar & Communication) NTC-3 Aircraft Mechanics (Sheetmetal)
		AUTOMOTIVE	NTC-2 Diesel Engine Mechanics NTC-2 Motor Vehicle Mechanics

LIST OF ON-GOING APPRENTICESHIP COURSES BY SECTOR AND TRADE CLUSTER (AS AT 1992)

Sector	Trade Cluster	Course
TECHNICAL SUPPORT	DRAFTING & BUILDING SERVICING	NTC-2 Architectural Drafting NTC-2 Civil/Structural Drafting
	MARINE & FABRICATION	NTC-2/3 Marine Mechanics NTC-2 Welding NTC-3 Boiler/Pipe Fitting & Servicing NTC-3 General Welding NTC-3 Marine Steelwork
	MECHANICAL & MAINTENANCE	NTC-2 Air-Conditioning & Refrigeration NTC-2/3 Mechanical Servicing
FINANCE & BUSINESS	BUSINESS STUDIES	Certificate in Office Skills
SERVICE	GARMENTS/TEXTILES	NTC-2/3 Fashion Garment
	HAIRSTYLING	NTC-3 Hairstyling
	HOTEL/CATERING	NTC-2/3 Food & Beverage Service NTC-2 Food Preparation NTC-2 Front Office Operations
	MEDICAL SERVICES	Certificate in Health Care (In-patient)
	RETAIL SALES	Certificate in Retailing
	TRAVEL	Certificate in Travel Services

LIST OF DISCONTINUED FULL-TIME COURSES (AS AT 1992)

Level / Course	Year of Final Output
Diploma in Applied Arts Courses*	
Graphic Design	1990
Interior Design	1990
Product Design	N. A.
Industrial Technician Certificate Courses	
Air-Conditioning & Refrigeration Engineering	1984
Automotive Engineering	1984
Furniture Design & Production	1984
Industrial Plant Engineering	1982
Three-Dimensional Design	1982
Advertising Arts	1981
Auto/Industrial Plant Engineering	1980
Interior Design	1980
Printing Technology (Press Work)	1980
Printing Technology (Pre-Press)	1980
Offset Litho Printing Processes	1978
Fashion Arts	1977
Letterpress Printing Processes	1976

LIST OF DISCONTINUED FULL-TIME COURSES (AS AT 1992)

Level / Course	Year of Final Output
National Trade Certificate Grade 2 Courses	
Hairdressing	1991
Arc Welding	1986
Pattern Making	1984
Plumbing & Pipe Fitting	1984
Electrical Drafting	1982
Electronics Servicing (TV)	1982
National Trade Certificate Grade 3 Courses	
Men's Tailoring	1990
Metal Fabrication	1990
Furniture Making	1987
Lift & Escalator Mechanics	1986
Boiler Pipe Fitting & Servicing	1984
Marine Steelwork	1984
Plumbing & Pipe Fitting	1984
Sheetmetal / Metal Fabrication	1983
Accommodation Operations	1982
Letterpress Printing	1982
Mechanical Drafting	1982
Offset Presswork/Printing Presswork	1982
Offset Reproduction	1982
Pattern Making	1982

76

LIST OF DISCONTINUED FULL-TIME COURSES (AS AT 1992)

Level / Course	Year of Final Output
Watch Repairing	1982
Food & Beverage	1981
Machine Woodworking/Woodmachining	1981
Metal Shipwright/Hull Fabrication/Marine Steelwork	1980
Composing/Composer's Work	1979
Marine Pipe Fitting	1979
Fine Jewellery	1977
Steelwork Fabrication	1977
Carpentry	1976
Electricity	1976
Lithotype and Work Composing	1976
Shipwright/Marine Fitting	1976
Steelwork/Welding	1976
Advertising Arts	1975
Applied Sculpture	1975
Binding & Finishing/Bindery	1975
Fabric Design & Printing	1975
Fabric Design & Silkscreen Work	1975
Fashion Arts	1975
Marine Pipe Fitting/Boiler Work	1975

LIST OF DISCONTINUED FULL-TIME COURSES (AS AT 1992)

Level / Course	Year of Final Output
Offset Plate Making	1975
Shipbuilding Fabrication	1975
Ceramics Art	1974
Interior Design	1974
Reproduction Photography	1974
Business Studies Courses	
Certificate in Accounting (2nd Year)	1982
Certificate in Clerical Practice	1981
Private Secretary's Certificate	1981
Accounts Clerk	1980
Commercial Practice	1980
Advanced Accounts Clerk	1979
Certificate In Accounting (1st year)	1979
School Certificate of Commercial Education	1976
Secretarial Training	1974
Certificate of Competency Courses	
Woodworking Machine Operation	1986
Electrical Wiring	1985
Barbending	1984
Binding & Finishing/Bindery	1984
Bricklaying	1984

LIST OF DISCONTINUED FULL-TIME COURSES (AS AT 1392)

Level / Course	Year of Final Output
Building Carpentry	1984
Painting & Decorating	1984
Pipe Fitting	1984
Plastering	1984
Tiling	1984
Industrial Sewing Machine Mechanics	1982
Basic Joinery	1980
Masonry	1980
Electrical Fitting & Installation	1979
Cane Furniture	1978
Offset Platemaking	1977
Panel Beating	1977
Sheetmetal/Metal Fabrication	1977
Spray Painting	1977
Trouser Making	1977
Welding	1977
Woodcarving	1977
Ceramic Arts	1976
Sewing Assistant	1976

LIST OF DISCONTINUED FULL-TIME COURSES (AS AT 1992)

Level / Course	Year of Final Output
Dressmaking	1975
Arc Welding	1974
Bricklaying & Plastering	1974
Cane Wickerwork	1974
Cane/Rattanwork	1974
Carpentry Formwork	1974
Carpentry Joinery	1974
Doll & Flowermaking	1974
Furniture Upholstery	1974
Shellcraft	1974

* The Diploma in Applied Arts courses were transferred to the Temasek Polytechnic with effect from July 1990. The Product Design course was launched in 1988. The first output was in 1991 at the Temasek Polytechnic.

COST OF TRAINING PER TRAINEE PER YEAR (FY87 - FY91)*

Course Level	FY87	FY88	FY89	FY90	FY91
Overall	\$3,863	\$4,052	\$4,560	\$5,141	\$5,438
Diploma	\$5,510	\$6,550	\$7,038	—	—
ITC	\$4,420	\$4,333	\$4,697	\$5,149	\$5,725
CBS	\$2,884	\$2,910	\$3,135	\$3,541	\$3,608
NTC-2	\$5,063	\$5,033	\$5,519	\$6,411	\$6,888
PCBS/COS +	\$2,696	\$2,877	\$3,173	\$3,416	\$3,720
NTC-3	\$5,171	\$5,000	\$5,637	\$6,376	\$6,554
BST/BVT-2 +	\$3,009	\$3,184	\$3,700	\$4,517	\$4,848
PVT/BVT-1 +	\$3,492	\$4,167	\$4,900	\$5,541	\$5,568

* Excludes depreciation

+ The PCBS course was renamed COS wef July 1989.

The BST course was renamed BVT-2 wef January 1989

The PVT course was renamed BVT-1 wef January 1989.

EXPENDITURE IN THE ITE ORDINARY BUDGET (FY87 - FY91)

Type of Expenditure	FY87	FY88	FY89	FY90	FY91
Total	\$74,378,924	\$80,884,387	\$88,515,949	\$92,363,094	\$97,109,000
Expenditure on Manpower	\$59,299,726	\$66,450,741	\$72,572,585	\$78,971,965	\$81,537,000
Other Operating Expenditure	\$15,079,198	\$14,433,646	\$15,943,364	\$13,391,129	\$15,572,000

BEST COPY AVAILABLE