

DOCUMENT RESUME

ED 372 016

SO 024 251

TITLE China: Tradition and Transformation. Curriculum Projects. 1993 Fulbright Hays Seminar Abroad Program.

INSTITUTION National Committee on United States-China Relations, New York, N.Y.

SPONS AGENCY Department of Education, Washington, DC.

PUB DATE Apr 94

NOTE 499p.; Some pages may not reproduce well.

PUB TYPE Guides - Classroom Use - Teaching Guides (For Teacher) (052)

EDRS PRICE MF02/PC20 Plus Postage.

DESCRIPTORS Area Studies; Comparative Education; *Cross Cultural Studies; Cultural Background; Cultural Influences; Cultural Traits; *Curriculum Design; *Curriculum Development; Elementary Secondary Education; Folk Culture; Foreign Countries; Global Approach; Instructional Materials; Postsecondary Education; Social Studies; *Teaching Guides

IDENTIFIERS *China; Fulbright Hays Seminars Abroad Program; Global Education

ABSTRACT

Sixteen participants in the 1993 Fulbright Hays Seminar Abroad Program present curriculum projects that focus on tradition and transformation in China. The curriculum projects highlight the diversity of interests and disciplines of the participants and offer ideas for various educational levels. The projects include: (1) "Beijing Bicycle" (Sylvia Brown); (2) "Chinese Philosophy and Religion: Buddhism; An Experiential Approach" (Daniel A. Camilli, Jr.); (3) "Employing the Creative Arts in the Instruction of the Learning Disordered Child" (Richard Lance Corey); (4) "Jiaoshu Yuren 'Teach Knowledge, Form Human Character': Moral Education in the People's Republic of China" (Helen A. Finken); (5) "Chinese Studies" (Mary Ellis-Hansen); (6) "Cultural Contexts of Population Management Policies" (Barbara Liddell); (7) "China: Transitions and Transformation" (Joann Malone); (8) "Money: Dollar vs. Yuan" (Mel Miller); (9) "China, Hong Kong, Taiwan: Tradition and Transformation" (Peggy R. Moring); (10) "China/U.S.A., Beijing/Washington D.C.: A Sense of China" (Diane Naegeli); (11) "China: Across the Globe and Across the Curriculum" (Julia Olvera); (12) "China Studies: Issues of Law and International Relations" (Fran O'Malley); (13) "Chinese Economics--Overview" (Arnold J. Rosenberg); (14) "Chinese (Peking Style) Opera, European Opera, Role of Tradition" (Carol Gisela Schmidt); (15) "Obstacles to Economic Development: China as an Example" (Sarah W. Turner); and (16) "The History and Culture of Han China: A Fulbright Curriculum Project" (Bonnie Volkman). (CK)

 * Reproductions supplied by EDRS are the best that can be made *
 * from the original document. *

ED 372 016

U.S. DEPARTMENT OF EDUCATION
Office of Educational Research and Improvement
EDUCATIONAL RESOURCES INFORMATION
CENTER (ERIC)

- This document has been reproduced as received from the person or organization originating it
- Minor changes have been made to improve reproduction quality
- Points of view or opinions stated in this document do not necessarily represent official OERI position or policy

"PERMISSION TO REPRODUCE THIS MATERIAL HAS BEEN GRANTED BY

1993 FULBRIGHT HAYS SEMINAR ABROAD PROGRAM

ELIZABETH D. KOWAL

China: Tradition and Transformation

TO THE EDUCATIONAL RESOURCES INFORMATION CENTER (ERIC)."

Curriculum Projects

50 024 251

Compiled by the National Committee on U.S.-China Relations on behalf of the United States Department of Education in fulfillment of Fulbright Hays requirements.

Table of Contents

Sylvia Brown	"Beijing Bicycle"
Daniel A. Camilli, Jr.	"Chinese Philosophy and Religion: Buddhism; An Experiential Approach"
Richard Lance Corey	"Employing the Creative Arts in the Instruction of the Learning Disordered Child"
Helen A. Finken	"Jiaoshu Yuren 'Teach Knowledge, Form Human Character': Moral Education in the People's Republic of China"
Mary Ellis-Hansen	"Chinese Studies"
Barbara Liddell	"Cultural Contexts of Population Management Policies"
Joann Malone	"China: Transition & Transformation"
Mel Miller	"Money: Dollar vs. Yuan"
Peggy R. Moring	"China, Hong Kong, Taiwan: Tradition and Transformation"
Diane Naegeli	"China/U.S.A., Beijing/Washington D.C.: A Sense of China"
Julia Olvera	"China: Across the Globe and Across the Curriculum"
Fran O'Malley	"China Studies: Issues of Law and International Relations"
Arnold J. Rosenberg	"Chinese Economics - Overview"
Carol Gisela Schmidt	"Chinese (Peking Style) Opera, European Opera, Role of Tradition"
Sarah W. Turner	"Obstacles to Economic Development: China as an Example"
Bonnie Volkman	"The History and Culture of Han China: A Fulbright Curriculum Project"

SYLVIA BROWN
928 Greenfield Rd.
Woodmere, NY 11598

LAWRENCE MIDDLE SCHOOL
195 Broadway
Lawrence, NY 11559

Fulbright Project: Designed for a Sixth Grade Class
in a Middle School but can be adapted
to other grade levels.

DURATION: Two weeks (Periods are 42 minutes)

OVERVIEW: Class has been reading a novel entitled
In the Year of the Boar and Jackie
Robinson by Lord. The book is about
a Chinese child who comes to the U. S.
Many different topics are part of this
interdisciplinary project and the
following is just one of the topics.

SUBJECT: BEIJING BICYCLE

GENERAL LEARNING OBJECTIVE: Upon completion of a many unit
Chinese studies, students will be able to understand the
importance of a bicycle within Beijing and other areas of
the People's Republic of China.

1. Identify the main means of transportation in Beijing
and the People's Republic of China
2. Describe how this means of transportation is used for
moving goods and people
3. Compare and contrast the movement of goods in PRC with
the state of New York (Bicycle laws)
4. Justify the use of bicycles as the most important means
of transportation of this population

GENERAL OBJECTIVE: Students will be able to demonstrate an
understanding of how to adapt the design of a bike to
meet the needs of a particular society.

1. Adapt the bicycle to meet a particular need
2. Design a bicycle for a particular use
3. Explain the design using overhead
4. Justify the design

MATERIALS AND INSTRUCTIONAL SUPPLIES NEEDED:

1. Overhead for facts sheet and presentations by students
2. Slides of transportation in China
3. Encyclopedias
4. Maps
5. Videos
6. Bicycle magazines

STUDENTS SUPPLIED WITH THE FOLLOWING:

1. Form for Journal
2. Pens and pencils
3. Art supplies, paper
4. Photos
5. Transparency paper for their design presentations

PROCEDURE: MOTIVATING ACTIVITIES

1. Slides
2. Pictures
3. Postcards
4. Story telling
5. Would you believe . . .
6. Did you know . . .
7. Brainstorming activities
8. Why do you own a bike in New York?
9. Discussion
10. Debate
11. Bicycle use log
12. Create a design for a bike to be used in a new way
13. Research the history of the bicycle
14. Essay: How important is your bicycle to you?

DIRECT INSTRUCTION:

1. Slide Presentation and lecture
2. Overhead transparency - Facts
3. Cooperative learning
4. Demonstrating the culture box

HAND OUT:

Bicycle Log for students to record how they use a bicycle and for how long a period of time.
Log should also be made into a transparency for use in modeling for class.

HOMEWORK:

1. Bicycle Log
2. Think about a design for a bicycle which can be used for another purpose.

PROCEDURE:

1. Briefly ask about how the Bike Logs are going
2. Cooperative learning groups of four students in each group to design a bicycle with another use
3. Transparencies of their designs
4. Groups report on designs
5. Would it be useful in New York? Beijing?

HELPFUL INFORMATION:

1. The average car costs over \$33,000 dollars
2. The number of bikes in PRC is about 1/3 the total of population
3. One liter of gas costs 2.5 yuan
4. An average new bicycle costs 250 yuan, the best bike costs 800 yuan, used bikes cost about 20 yuan
5. The favorite bike, the Fenghuang, is manufactured in Shanghai
6. There are special lanes on the street for bikes
7. A license must be obtained - 5 yuan per year
8. You must have your bike license card with you
9. There are fines for operating the bike illegally.
i. e. For riding two on a bike there is a fine of five or ten yuan, an illegally parked bike can cost 10-20 yuan, not riding in the bike lane can cost 20 yuan
10. All bikes must have a bell

11. To have a flat fixed would cost about one yuan
12. To park a bike in a bicycle parking lot costs two fen
13. Beijing has the largest bike population in the world (nearly 3 million)
14. Bicycles offer freedom, and mobility, allowing you to explore back roads, villages, temples
15. Population of Beijing - 10,819,407
Density - 360 people per square kilometer

REFERENCES:

1. Personal interviews with guides and interpreters in Beijing, Shanghai, Gullin
2. Slides taken by Sylvia Brown while in China
3. Photos taken by Sylvia Brown while in China
4. China's Population (Pamphlet), Beijing, China, New Star Publishers, 1992
5. Kaplan, Fredric and Sobin, Julian, deKeijzer, China, 1989 Guidebook, Eurasia Press, New Jersey, 1989
6. Videos
7. Encyclopedias

BICYCLE LOG

Name _____ Grade _____

Date _____ # _____

Reason for using bike: (check as many as needed)

Recreational _____

Sports activity _____

Paper route _____

Visit someone _____

School _____

Job _____

Transport goods _____

Other _____ Explain:

Time of bike use: From _____ To _____

Totals: _____ hours _____ minutes

(Check one):

My bike is my most important means of
transportation. _____

My bike is not my most important means of
transportation. _____

BIKES IN USE IN CHINA



BICYCLE USED AS A FLATBED



BICYCLE TO TRANSPORT A PASSENGER



BIKES BEING CONFISCATED FOR LACK OF LICENSE



TRANSPORTING GOODS BY BIKE

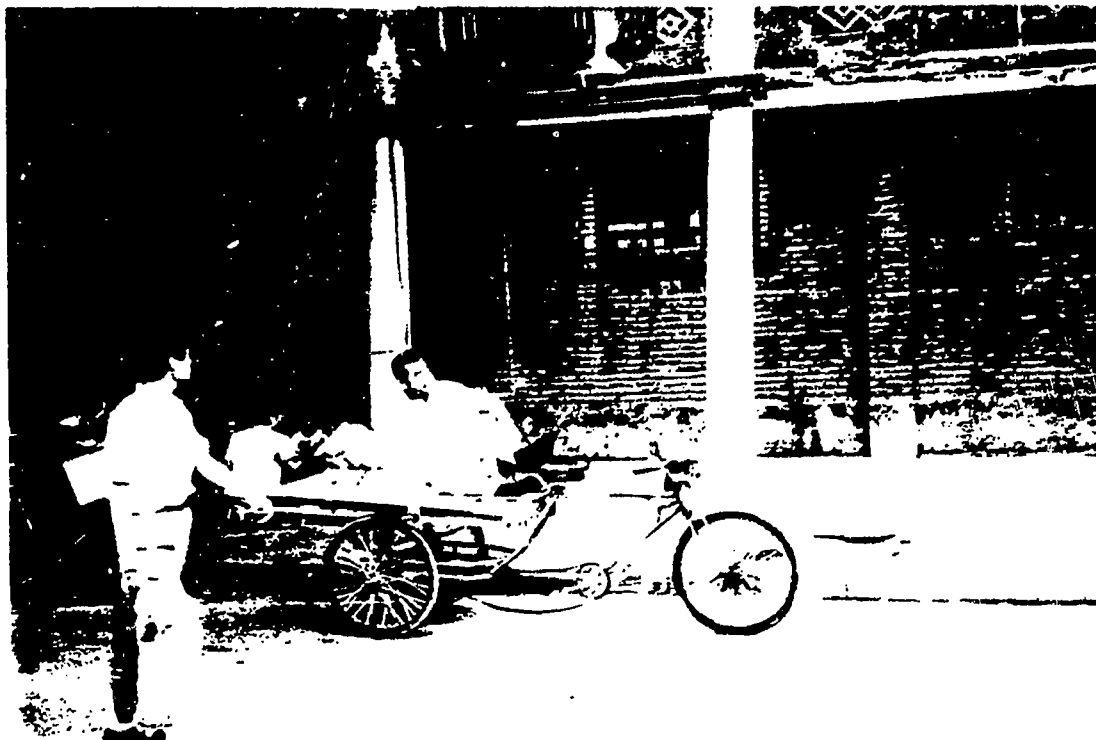

BICYCLE USED AS A FLATBED

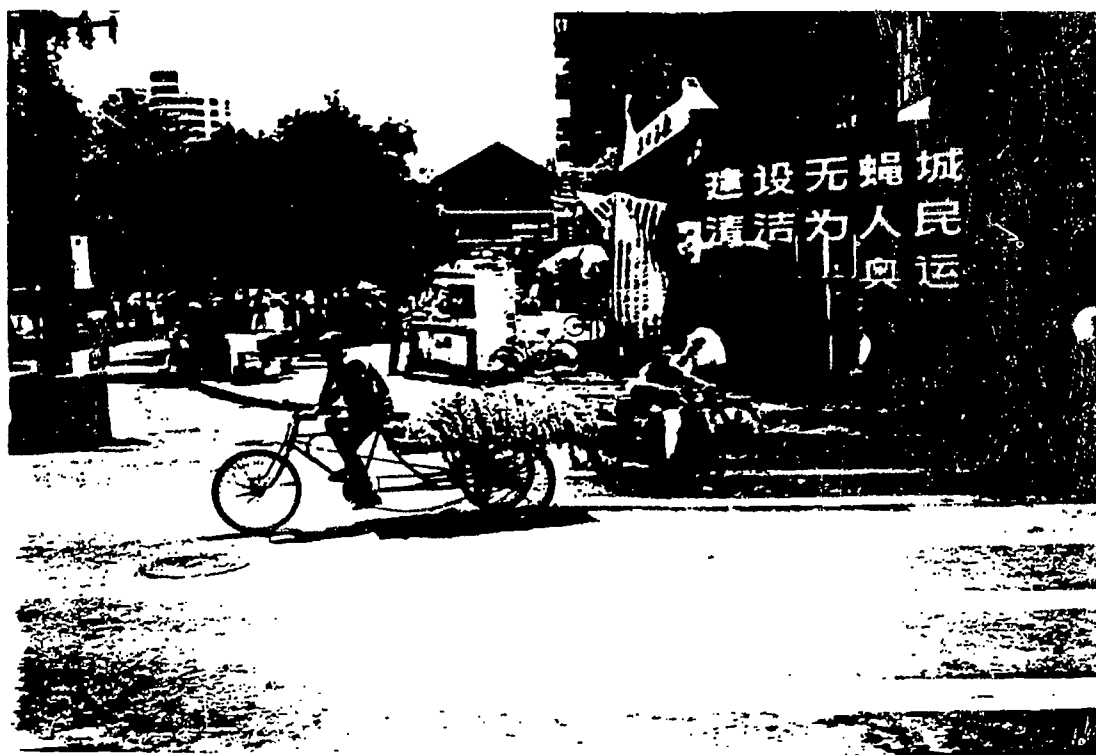

BICYCLE TRANSPORTING GOODS

CHINESE PHILOSOPHY AND RELIGION: BUDDHISM; AN EXPERIENTIAL APPROACH

By

Daniel A. Camilli, Jr.

Arlington Catholic High School
Arlington, MA

Chinese Philosophy and Religion: Buddhism; An Experiential Approach.

An Introductory Unit Assignment and Related Instructional Materials.

by Daniel A. Camilli, Jr. M.A., M.Ed..

Introduction

The educational philosophy and methods presented in this unit were inspired by my Global Perspectives course . I created the Global Perspectives course in an attempt to provide high school students with an experiential approach to the cultures of Asia, Africa and Latin America. Although many of the materials and slides, etc. were acquired during my Fulbright travels in China, Hong Kong and Taiwan, I have attempted wherever possible to provide explanations or alternative sources for instructional materials used. Books, articles and other materials are listed in the reference section. In any event, the single most important aspect of this unit is the method not the materials. The central purpose, at all times is to provide students with an alternative cultural experience which is personal and hopefully transformative. The Buddha himself provides the Global Perspectives creed:

Copyright © 1994 by D.A. Camilli, Jr.. All Rights Reserved.

"Do not accept anything simply because it has been said by your teacher, Or because it has been written in your sacred book, Or because it has been believed by many, Or because it has been handed down by your ancestors. Accept and live only according to what will enable you to see truth face to face."

Buddha

Although any aspect of this unit may be used individually such as the sections on Buddhism , my experience has been that there is a cumulative effect upon students when the unit is incorporated and experienced as a whole. The initial sections on meditation presented here along with some additional materials regarding Buddhism and Chinese folk customs seem to help some students break out of their culturally learned understanding of experience and serve to prepare them for the more complex and abstract principles of Buddhism, Taoism etc.. Regardless of how you may choose to use this unit assignment I wish you success.

Part One: Introduction to Meditation

Purpose: To introduce students to the Chinese and , indeed, Eastern perspective on the "inner world" of the mind and consciousness. This very simple introduction to meditation provides many students with their first "interior" experience; coming face to face with the stream of consciousness as they make an initial attempt to stop its flow and experience inner stillness.

Method: The form of meditation which I use to introduce students to the "inner world" is called Vipassana; a mindfulness or insight method of Buddhist meditation. Although almost any other meditation technique may be applicable, I have found this simple approach to be the best starting point for those new to meditation. I introduce other techniques later in the course as students become more comfortable with the process .

Technique: Students are seated comfortably in a softly or naturally lit room. A quiet, peaceful setting seems to be essential in the introductory stages. They are then asked to straighten their backs and sit in an upright position; gently close their eyes; let their jaw open slightly and take a deep breath in through the mouth and out through the nose. Students

should be guided through this process with soft , gentle almost monotone directions. The teacher should say "Follow your breath in through the mouth and out through the nose.....in and out ...feel the peace as you breath in through the mouth and out through the nose... if you have any passing thoughts view them as clouds blowing across the sky and gently return your attention to the breath flowing in through the mouth and out through the nose...in and out...in and out...in and out."

The first few experiences should last at least three but no more than five minutes. When time is up say:" At the count of three gently open your eyes and reorient yourself to this space. One....two...three. Leave the lights dim and allow some time for students to "take in" the experience then ask for feedback. Do NOT call on people but gently allow them to volunteer information. Remember that this is an extremely personal experience and some may not wish to share or may need time to process. It helps if the teacher can relate personal experiences with this or other kinds of meditation.

Another interesting thing to call attention to is the "feeling" in the room... What does it feel like?...How is it different than before the meditation? Usually the room feels more peaceful and still after a group meditation and calling students attention to this can be a valuable aspect in developing the awareness process.

Meditation and Journal Keeping

This meditation process should be done each day at the start of class and students should be expected to meditate for at least three minutes a day on their own as "homework" keeping a personal journal of experiences, feelings emotions etc.. The journal is NOT to be passed in or graded but is a personal record with which students may reflect on possibly instructive patterns and themes in their meditative experiences. Students may be asked to share journal entries with the class voluntarily.

The voluntary sharing of journal entries can be one of the most rewarding aspects of this introduction to meditation as all kinds of experiences are usually related to the class. Some students will be more excited about this process than others and it is important for the teacher to point out that there are many different kinds of meditation designed to address the needs of different personality types. Just as no two people may learn in the same way; so may they meditate in different ways as well.

The critical aspect of this process is that students become aware of this inner world and begin to understand its importance to so many of the people of China and Asia. It is also hoped, of course that they might use this as a form of self examination and personal growth and , in my experience over the past five years, many have.

As students become more comfortable with the process the teacher can add incense (preferably sandalwood which is said to be "the smell of Buddhism") and meditative music. There are many excellent tapes with an Eastern feeling available for this purpose such as "Music for Zen Meditation" or "Bell Ringing In An Empty Sky". Check local music stores and/or Buddhist Temples and centers for ideas.

Now that students have some personal experience with "what it's all about", they are ready to explore the basic premises of Buddhism. I find that using the meditation as an introduction to Buddhism serves to make many students more receptive to the often more unfamiliar ideas and tenents of the belief system.

Outline of Basic Buddhist Principles

(As presented in Global Insights: People and Cultures by Hantula, Flickema et al. Merrill Publishing Company Columbus, Oh. 1987.)

Origin: Imported from India and based upon teachings of Siddhartha Gautama (the Buddha).

Major Beliefs: Life is suffering. Suffering is caused by desire for things to be as they are not. Suffering, however, has an end. The means to the end are the Middle Way of moderation and the Eightfold Path-Right Views, Right Intentions, Right Speech, Right Action, Right Occupation, Right Effort, Right Concentration and Right Meditation.

Characteristic: Has split into several branches, virtually extinct in India by the 12th century AD, although influential

in China and Japan.

A critical aspect in this explanation which I believe is overlooked in some high school texts , including this one, is the concept of reincarnation. The idea that the world is like a big classroom and that all people are here to work out the lessons that they need in order to attain enlightenment- and that we continue to come back or reincarnate again and again until we get it right. Please see reference section for additional books on Buddhism and meditation.

Buddhism in China

Buddhist influence can be seen in Chinese literature, art, scholarship and architecture by the 300's AD. Each of these areas are explored in other sections of this unit.

In this section I show students slides of the various Buddhist temples which I visited during my trip. Due to the limitations of the ERIC system, I am not able to reproduce slides here. However, slides or photos of more famous temples may be available at your local library or Buddhist temple/center.

As with virtually all religions , Buddhism incorporated many of the beliefs and customs of local people as it spread throughout China and Asia. One of the ways in which Buddhism has adopted local folk customs in some areas of China is through the burning of "Spirit Money". Spirit money is burned as part of the worship ritual for a variety of purposes ranging from wishing for a good harvest to asking the spirits for a baby boy or girl. I have enclosed copies of spirit money with explanations of their purpose for classroom use.

Still another aspect of folk culture which has found its way into some Chinese Buddhist practices is the use of a "Pu". The "Pu" consists of two half moon shaped pieces of wood. The

wooden (sometimes plastic) pieces are painted red (an auspicious color in China) and have a flat side and a rounded side. When they are held together on their flat sides they form a crescent shape. The practitioner holds the pieces together in such a fashion and , bowing three times towards the Buddha statue, asks the spirit world to hear his/her prayer or request then tosses the "Pu" in the air allowing it to land on the ground.

If the "Pu" sections fall either both flat side up or down it signifies that the spirit world will now grant a hearing. If it should land one on its flat side and the other on the round the spirits will hear" you some other time".

I have also enclosed a photocopy of a Pu. Some students or classes might wish to make a pu out of pine, balsa or some other soft wood and demonstrate their use to the class.

Buddhist Hermits in China:

In order to introduce students to one of the many different lifestyles inspired by Buddhism, I have also included a copy of "Finding Hermit Heaven" by Bill Porter as published in Silkroad Magazine, June/July 1993. From his book Road To Heaven published by Mercury House, San Francisco. 1993.

References: A short list of books about Buddhism/Chinese Buddhism and Meditation which I use in my course(with brief commentary).

Gautama, Sidhartha (The Buddha). The Dharmmapada. Translated by Juan Mascaro'. A collection of 423 aphorisms which illustrate the Buddhist dhamma or Dharma (moral system)." In the Dharmapada

we can hear the voice of the Buddha" says Mascaro. Viking Penguin, Inc. , 40 West 23rd St. New York, New York. 1973.

Goddard, Dwight. A Buddhist Bible. Introduction by Huston Smith. A classic compilation of major works of Buddhist scripture including several selections from Chinese sources. Beacon Press, Boston, Ma. 1970

Han, Shan. Cold Mountain Poems. Classic collection of Buddhist inspired poetry by Chinese Buddhist hermit. Shambala Pocket Classics Series (also available in several other editions from a number of publishers.) Shambala Books, Boston, Ma. 1993.

Levine, Stephen. A Gradual Awakening. Excellent explanation of Vipassana Meditation in clear straight-forward language. Includes a number of exercises and guided meditations. Anchor Books Anchor Press/Doubleday, Garden City, New York. 1979.

Marshall, George N., Buddha: The Quest For Serenity. Introduction by Huston Smith. A biography of the Buddha. Beacon Press, Boston, Ma. 1978.

Rahula, Walpola. What The Buddha Taught. "A lucid and faithful account of the Buddha's teachings", says the Journal of The Buddhist Society. Grove Press, Inc. New York, New York. 1974.

Ross, Nancy Wilson. Buddhism: A Way Of Life And Thought. Classic explanation and description of general teaching and practice as well as specific approaches to Theraveda, Tibetan and Zen Buddhism. Vintage Books, New York, New York. 1980.

June-July, 1993

Silkroad Magazine. June-July, 1993

FINDING hermit heaven

*Radio raconteur and writer
Bill Porter searches for China's
Buddhist hermits in his new book
Road to Heaven, published by
Mercury House, San Francisco*

Throughout Chinese history, there have always been people who preferred to spend their lives in the mountains, getting by on less, sleeping under thatch, wearing old clothes, working the higher slopes, talking little, writing even less — maybe a few poems. Out of touch with the times but not with the seasons, they cultivated roots of the spirit, trading flatland dust for mountain mist. Distant and insignificant, they were the most respected men and women in the world's oldest society.

No explanation has ever been offered or demanded for the admiration the Chinese have had for hermits. Hermits were simply there: beyond city walls, in the mountains, lone columns of smoke after a snowfall. As far back as records go, there were always hermits in China.

My own acquaintance with China's hermit tradition began in 1972, when I left the United States and moved to China's island province of Taiwan. I lived in a Buddhist monastery: up before dawn to chant sutras, song of the bell at night, three vegetarian meals a day, a room, a bed, a mosquito net, no bill. When my legs got too sore or my mind too restless for meditation, I read.

My favourite stories were Confucian and Taoist tales about hermits in the hills of ancient China. I could understand someone wanting nothing more than to live a simpler life inside a cloud, under a pine tree, somewhere out of town, surviving on moonlight, taro, and hemp. Other than a mountain, they didn't need much: a little mud, some thatch, a patch of melons, a row of tea bushes, a trellis of chrysanthemums, a break in the weather.

Since the Yellow Emperor's time [some five thousand years ago], there must have been a million hermits in China. But reading about them only made me wonder if they could have survived the twentieth century. Whenever I asked the monks in Taiwan, they assured me that China's hermits no longer existed. After a century of revolution, war, and oppression, how could they? Still, I wondered.

In the spring of 1989, after the government in Taiwan lifted its ban on travel to the Chinese mainland, I decided to go there with American photographer Steve Johnson. I had no idea where we would find hermits but assumed that if any were left they would be in the mountains. But which mountains? And even if we happened to find the right one, how would we find the right trail, much less the hut? And would they welcome a couple of foreigners brandishing a tape recorder and a camera?

We headed southwest of Beijing for Wutaishan, the ancient residence of Manjusri, Bodhisatva of Wisdom, and the northernmost of four mountains selected for special veneration by Buddhists in China. But the abbots in the area said, as far as they knew, there were no hermits on Wutaishan or on any other mountain in China.

I stopped an old monk who was helping reconstruct one of the buildings damaged by the Red Guards during the Cultural Revolution. When I repeated my standard question, he said, "Of course there are still hermits in China." My heart stopped. Then he added, "But when you meet them, you won't know them. You won't find them, unless they want to be found." He laughed and returned to his work. That night I lay wondering how we would find people who didn't want to be found.

We headed south from Beijing to Sian and beyond to the Tsaotang Temple, a two-hour drive further southwest. This is where Kumarajiva stayed 1,600 years ago when he produced his transcendently beautiful translations of Buddhist sutras.

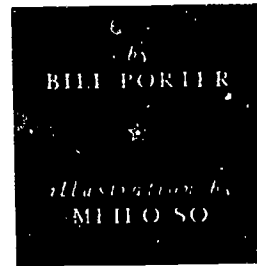

At a mountaintop pagoda near the temple, the view was one of endless serrated ridges, cloud-wrapped peaks, and turquoise streams. It looked like the perfect place for hermits. The trail led past the mud walls of an old temple. We could hear voices, and our guide knocked on the door. It opened, and five young monks ushered us through a courtyard and into a room that contained a table and five stools. We sat, and they poured us cups of hot water and added something like presweetened orange Kool-Aid.

Refreshed, I asked our hosts: "Are there any hermits in these mountains?" One of the monks answered, "Of course. Which hermits do you want to know about?" Over the next hour, we drank hot Kool-Aid and listened. Some had been in the mountains for only one winter; others hadn't been down in forty years. Apparently, we had found Hermit Heaven. One of the monks said: "These are the Chungnan Mountains. This is where monks and nuns come who are sincere about their practice."

We sought out a nun by the name of Yuan-chao (who I'd met on a previous trip) who now lived in an adobe hut on a plateau beneath Kuanyinshan peak in the mountains. Another nun led us to Yuan-chao's hut. She was sitting cross-legged on her *k'ang*, an adobe bed with a built-in oven, common throughout northern China. As I walked in, she said, "You're back. Good. Now we can talk. Last time I wasn't sure. Now I know you've come for the Dharma [ideal truth]."

I was glad I had made the effort to visit her again. She was 88, but I've seldom talked with anyone as alert. She was born in Chilin Province in northeast China into a family of six generations of doctors. Her grandfather was a Buddhist monk, and her father also became a monk. She became a novice at 16 and graduated from the Buddhist academy in Peking. Afterward, she returned to the northeast where she established four Buddhist academies herself.

Yuan-chao had taught Buddhism to so many students for so many years, I think she had her lectures memorized, or at least her quotes, which she chanted. From my bag, I took out a sheet of calligraphy paper and asked if she would write down for me the essence of Buddhist practice. She put the paper aside and I didn't raise the subject again. Two months later, back in Taiwan, I received the sheet of paper in the mail with four words: goodwill, compassion, joy, detachment. Her calligraphy was as strong and clear as her mind.

On another quest for hermits, we visited Tailaoshan, a mountain just inside the northwest tip of Fujian Province. A Buddhist layman we met on the trail led us to a cave where an 85-year-old monk had been living for the past fifty years. In the course of our conversation, the monk asked me who this Chairman Mao was that I kept mentioning. He said he had moved into the cave in 1939 after the spirits of the mountain appeared to him in a dream and asked him to become the mountain's protector. He hadn't been down the mountain since then.

Disciples and local villagers brought him the few things he needed. And he didn't need much: flour, cooking oil, salt, and once every five years or so a new blanket or set of robes. His practice was [reciting] the name of the Buddha: Amitabha, Buddha of the Infinite. After so many mountains searching for hermits, we were finally feeling at home with the Infinite. ◀

I asked if she would write down for me the essence of Buddhist practice. Two months later, I received the sheet of paper in the mail with four words: goodwill, compassion, joy, detachment.

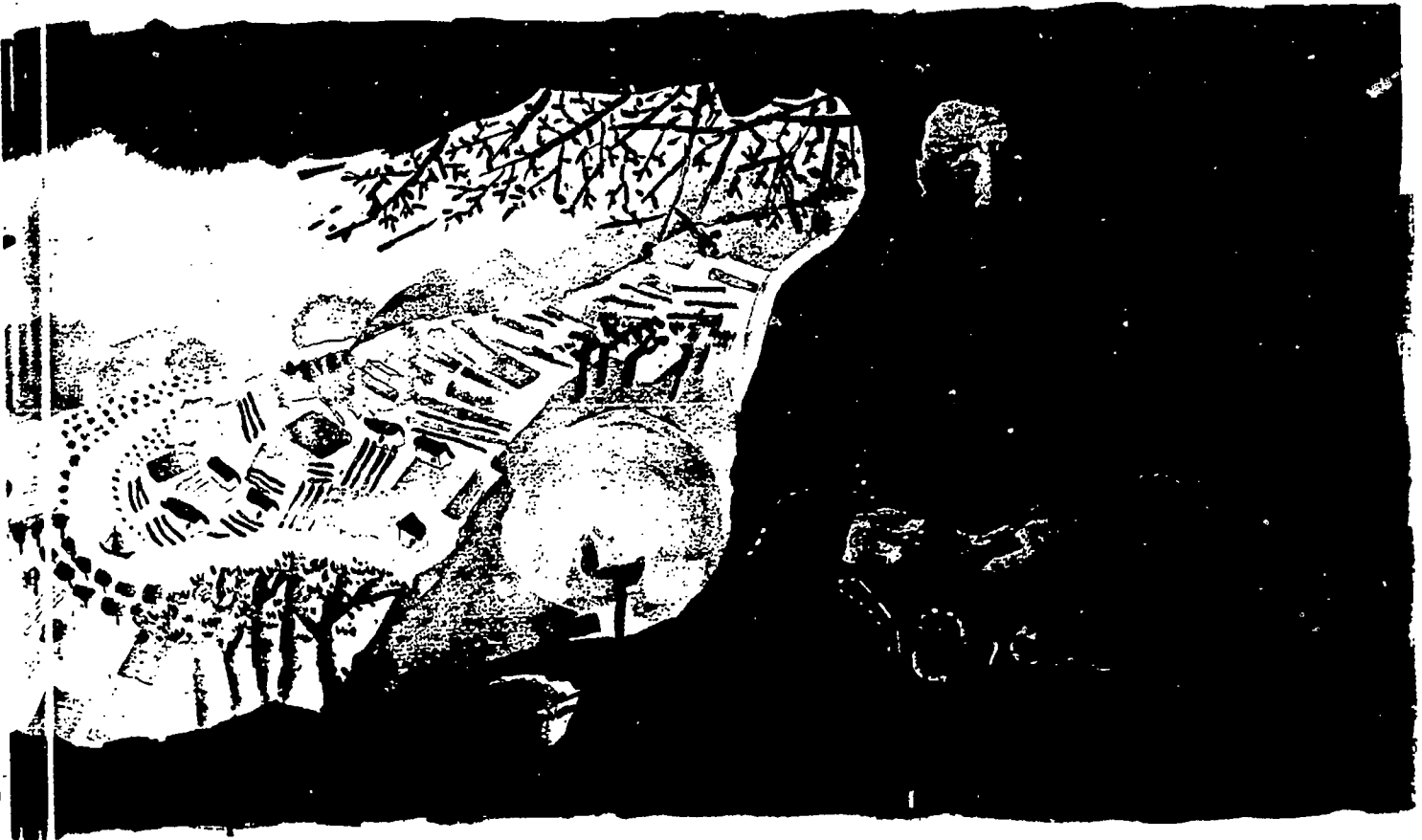

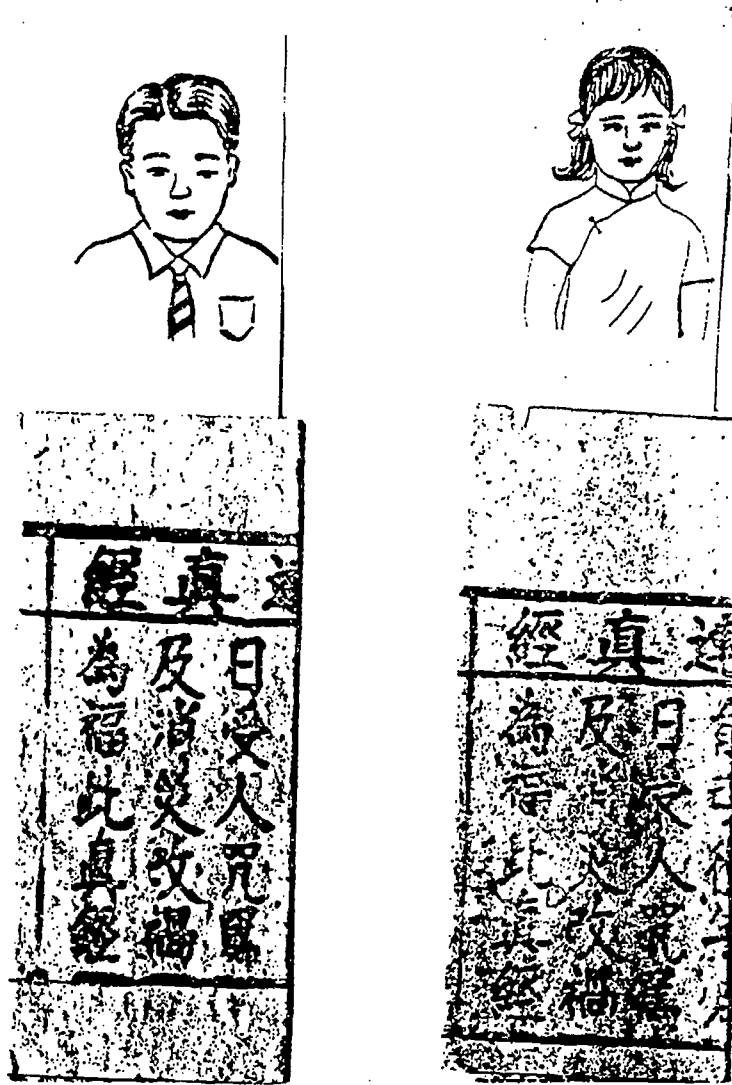

Spirit Money : Burned when praying for a girl or boy.

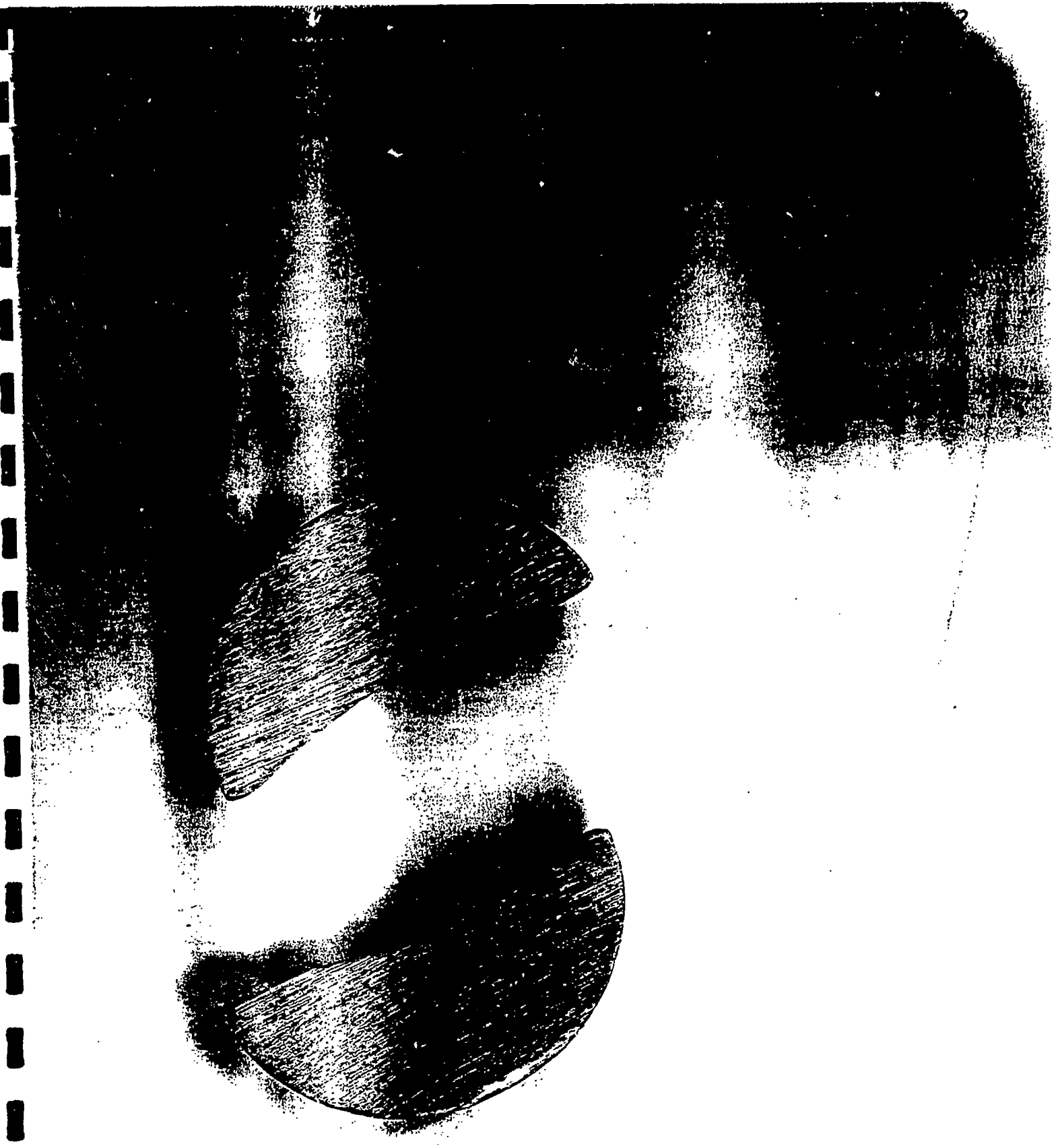

PU: (Flat side up) Used when asking spirits to hear your prayers.

BEST COPY AVAILABLE



PU: (Concave Edge up) Used when the
to a wire

National Committee for US-China Relations
1993 Fulbright-Hays Summer Seminar in China:
Tradition & Transformation

Curriculum Project: Employing
the Creative Arts in the Instruction
of the Learning Disordered Child

Submitted by: Richard Lance Corey
January 13, 1994

The enclosed unit of lessons on China employs a variety of creative skills and media varying the learning environment, activities and mediums involving the full range of senses for the Learning Disordered Child.

While these lessons are not intended to be all inclusive, they do provide a sampling of the many possibilities available in teaching this subject to the L.D. child.

The class in question consists of 30 to 36 9th Grade Global Studies students, ages 14 to 17. Among these are anywhere from one (1) to seven (7) mainstreamed Special Education students with learning disorders (that have been diagnosed). Their learning disabilities range from the organic -- Dyslexia, brain damage, impaired acuity, hunger and related deficiencies, developmental lag, and drug addiction -- to the inorganic -- language barriers, school environment and home environment -- and any combination of the above.

Tariq is typical of the mainstreamed L.D. child. While his math skills are at the 9th grade Regents level, his reading skills are those of a 3rd grader. Specifically, Tariq needs to improve decoding what he reads. Kevin, yet to be diagnosed, comes from a seriously dysfunctional family; he has poor work habits and has great difficulty completing assignments.

These lessons are designed with flexibility in mind. If three (3) days are necessary to complete a lesson, it's acceptable to do that. We must always remember that our primary goal is to instill in the students a love and desire for knowledge. Stimulating the pace by which they arrive there is our challenge.

- Lance Corney

Unit Objectives:

The students will . . .

1. Understand the main geographical features of China.
2. Appreciate that China has one of the oldest continuous civilizations, whose culture and traditions were established centuries ago.
3. Understand the effect of Imperialism on China and why China underwent revolution.
4. See how ways of life are undergoing changes.
5. Appreciate the depth of Chinese culture and its contribution to world culture.
6. Learn to identify and appraise the main ideas in reading materials.
7. Learn to highlight main ideas, and to reorganize and classify main ideas into outline format.
8. Learn to observe visual materials (videos, slides) and describe what is seen.
9. Learn to locate and identify important geographic features on maps.
10. Analyze and synthesize conclusions based on observations and prior knowledge.
11. Learn to work as a member of a team in cooperative efforts at completing assigned tasks.
12. Acquire vocabulary.
13. Enhance decoding skills.
14. Detect similarities and differences, and evaluate advantages and disadvantages.
15. Express inspiration and impressions either visually, verbally, or kinetically.
16. Infer cultural values.
17. Reorganize and simplify their experiences into a coherent structure.
18. Improve reading and writing skills.
19. Increase openness and sensitivity to others.
20. Enjoy themselves lost in thought.
21. Ask for more.

Lesson #1 -- What is life like in China? An Introduction.

Objectives: The students will . . .

1. Describe what they see in the video,
2. Analyze the slice of Chinese history shown in the video, and draw some conclusions based on their observations.

Materials: VCR, TV, video - The Heart of the Dragon, Episode 1 - "Remembering."

Method:

1. Students are to write down their general observations and impressions based on the video.
2. Students should list what we are able to learn from China's memories.
3. Students should note questions they wish answered in class discussion.

Homework: Students are to read handout material on China's Geography from pages 144 & 145 in Mastering Global Studies (reprinted with prior permission); students are to highlight the main ideas and facts with a yellow magic marker, and they are to make an outline of the highlighted passages. (See attached)

Lesson #2 -- How have Geography, Location, and Climate influenced China?

Objectives: The students will . . .

1. Identify and appraise "Main Ideas;"
2. Organize and classify "Main Ideas" into outline form.

Materials: Overhead projector, screen, extension cord, pointer

Method:

1. Review handout on China's geographic features using an overhead projector and a pointer to guide students in appraising which ideas and facts to highlight.
2. Develop a blackboard outline utilizing student responses.

Homework: Students are to enter into their notebooks the first three (3) of "Ten Keys to Knowing China" on page 534 of our textbook: Geography - Our Changing World. Students are also to examine and study the Physical Map and the Population Map on pages 532 & 533 and answer: Where is China's population most dense? Why do they live where they do?



In this section you will read about the major geographic features of China, and how these features have affected its people and history.

THINK ABOUT IT

Look at the map of China on page 145. Where do you think the majority of China's population lives? _____

Why? _____

Important Terms: As you read this section, look for the following terms:

◆ Hwang Ho / Yangtze

◆ Ethnocentrism

SIZE AND LOCATION

China is one of the largest countries in the world. It occupies most of the mainland of East Asia, covering 3.7 million square miles. The map below shows that China is slightly larger than the United States. China's neighbors to the north and west are Russia and Mongolia. To the east lies the Pacific Ocean.

MAJOR GEOGRAPHIC FEATURES AND THEIR EFFECTS

MOUNTAINS

On the southern and western borders of China are some of the world's high mountains, including the **Himalayas**, the highest in the world. These mountains have protected and isolated China from other nations. Cut off from the outside world, China's people developed a unified culture. This helped promote **ethnocentrism** (*the belief that one's culture is superior to all other cultures*) among the Chinese.

DESERTS

Much of western China is made up of deserts; the Gobi Desert is the largest. Because of this geographic feature, a high **population density** exists in the eastern part of the country (*the greater the number of people, the higher the population density*).

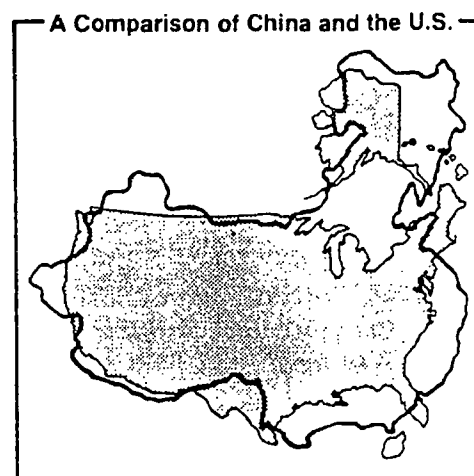

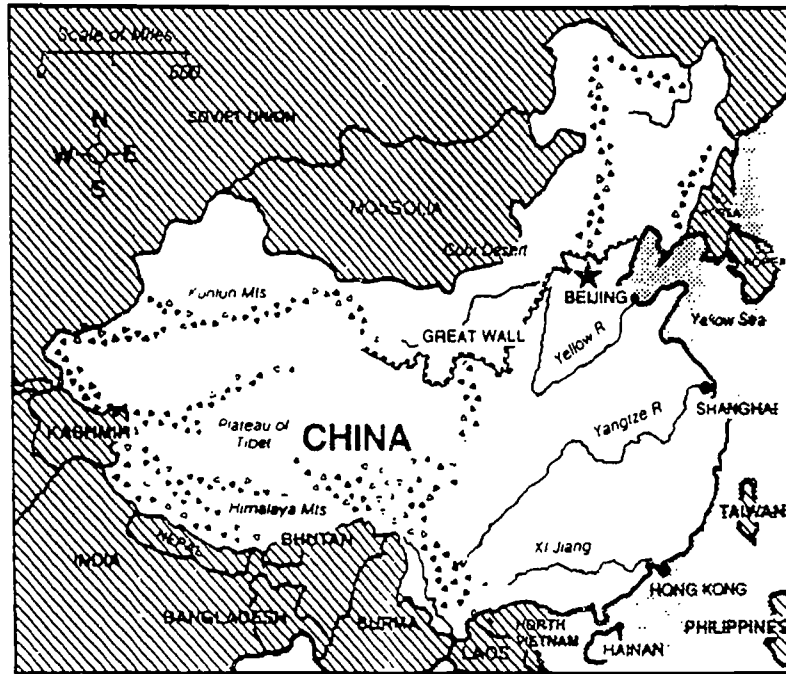

RIVERS AND RIVER VALLEYS

Like other ancient civilizations (*the Egyptians along the Nile and the Indians along the Indus River*) the Chinese developed their earliest civilization in river valleys. River valleys such as the **Hwang Ho** (*Yellow River*) and the **Yangtze** have been very important to China, providing water for transportation and agriculture. ◆◆

CLIMATE

Because of its large size, China's climate varies greatly from one part of the country to another. Most Chinese live in the eastern part of the nation where the most fertile soil is found. The southeast part of China receives plenty of rainfall from monsoons, making it easier to grow rice and other crops.

SUMMING UP: GEOGRAPHY

China, located in eastern Asia, is one of the largest countries in the world. Mountains have played an important role in China's history, allowing it to develop apart from the rest of the world.

THINKING IT OVER

Were you correct in locating the most populated area of China? _____

What might you now answer? _____

Why? _____

Lesson #3 -- What does geographic China look like?

Objectives: The students will . . .

1. Locate and identify the major geographic features of China,
2. Position and reconstruct those features using a clay model,
3. Label those features using a color code.

Materials: Topographic map of China on display, clay, paints, brushes, cardboard or masonite

Method: 1. Using map display, handouts and textbook maps as guides . . .

Day 1 - 2. Students will create a sculpture of China complete with mountains, river valleys, and coastal plains.

Day 2 - 1. Students will color code their maps to indicate elevation, rivers, deserts, oceans & seas.

2. Students will label the Great Wall and major cities such as Beijing, X'ian, Shanghai, and Hong Kong.

Homework: Students will examine and study the political, physical, and population maps of China located on pages 531 to 533 of their text, Geography. Study for "Team Test" of map-reading skills.

Lesson #4 -- Team Test of our geographic knowledge.

Objectives: The students will . . .

1. Locate, identify, gather and cite geographic features in China,
2. Discover the rewards of cooperation and teamwork in successfully completing this exam at their own pace.

Materials: Topographic map of China on display, World map on display, a class set of Hammond's Basic Map Skills, ten (10) pairs of chopsticks, 36 fortune cookies, and China map questionnaire

Method: 1. Students are to team-up into teams of twos (2s).
2. All teams are competing to complete the map questionnaire (see attached).
3. Students may use wall displays, Basic Map Skills, their textbooks, and/or notes to complete the questionnaire.
4. The first five (5) teams to complete the test correctly will receive chopsticks; all contestants will receive a fortune cookie.

Homework: Students will read "The Growth of the Chinese Empire" on pages 536 to 539 in Geography; They will answer Review Questions 1-3 and Thought Questions 1&2 on page 539.

Team Members: _____ + _____

- ①. Your plane lands at 40° North Latitude, 117° East Longitude. Where are you? _____.
- ②. You travel West North West for 600 miles. This places you smack in the middle of _____.
- ③. What is your approximate elevation in feet or meters? _____
- ④. Heading for a more productive area you discover that 4 major cereals grown in China are _____, _____, _____, and _____.
- ⑤. Through your observations you also notice that the Chang Jiang is also known as the _____ river and the Huang He is known as the _____ river.
- ⑥. Which of the above rivers would take you to the Tibetan plateau if you travel up-river? _____
- ⑦. If you chose to go South from there, you would need to cross _____ to reach Nepal and India.
- ⑧. But your interest lies in two peninsulas in Northeast China. They are known as _____ and _____.
- ⑨. From here you hop a boat on the _____ canal to make your way to the city at the mouth of the Yangtze. That city is
- ⑩. known as _____.

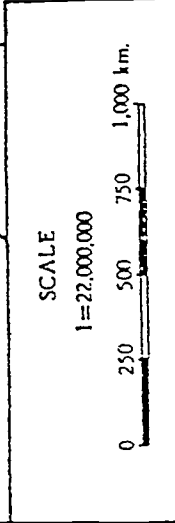
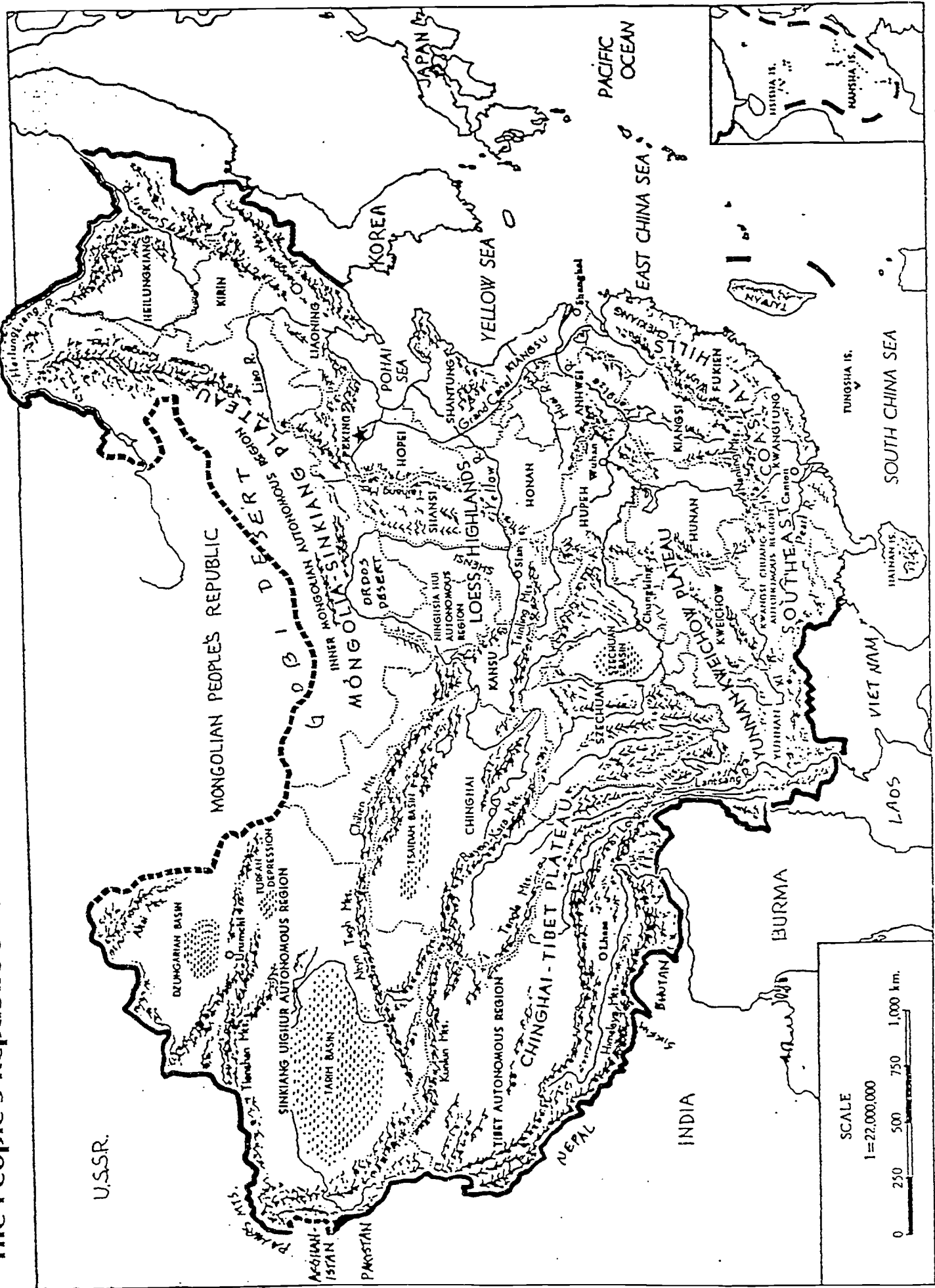

Lesson #5 -- Is China's history visible in China today?

Objectives: The students will . . .

1. Enter and organize in their notebooks their visual and auditory observations based on a slide presentation and teacher's commentary,
2. Continue working as teams by comparing notes and observations.

Materials: Slide projector, screen, extension cord, pointer, and slides of China (with particular emphasis on the Forbidden City, X'ian and the Terra Cotta Warriors, the Great Wall, and Shanghai's Bund)

Method: 1. Students are to take notes based on slides viewed and on commentary.
2. Teammates are encouraged to compare notes and share their observations.

Homework: Students will read, highlight, and outline handout on "Chinese Civilization" from pages 147 & 148 in Mastering Global Studies. Students will also read "The System Falls Under Outside Pressure," pages 542 & 543 in Geography; and answer Review Questions 1-3 and Thought Questions 1&2 on page 543.

Lesson #6 -- Why was there Revolution in China?

Objectives: The students will . . .

1. Take notes while observing a documentary video,
2. Evaluate and appraise the reception received by the Communists upon entering Beijing in 1949,
3. Continue working as teams by comparing notes and observations.

Materials: VCR, TV, Video - The Great Wall Of Iron, Episode 2 - "Peoples' War."

Method: 1. Students are to take notes based on video presentation.
2. In addition to general observations, students are to answer: - Why were the Japanese so hated?
- Why did many nationalists join the Communists?
- Why were the Communists greeted with cheers?
- How does the music make you feel about what you are seeing?
3. Consult with teammate.

Homework: Read, highlight, and outline handout on "China Under Mao" from page 149 in Mastering Global Studies. Also read, highlight, and outline handout on "Major Ideas of Communism," from page 153.

Lesson #7 -- Why was Communism in its extreme form destructive?

Objectives: The students will . . .

1. Enhance their reading comprehension and decoding skills,
2. Enter vocabulary into notes,
3. Select events, facts and observations to enter into notes,
4. consult with teammate.

Materials: Reading selection from Life and Death in Shanghai by Nien Chang, excerpted in TIME, June 8, 1987 (reprinted with prior permission), plain white paper, envelopes, waste basket, matches

Method: 1. Students and teacher will read together, out-loud (by volunteers) for discussion.
2. Students will highlight key passages, statements, ideas, events, and facts of personal interest ... to be entered into notes.
3. Students will write a letter to the spirit of Mao Zedong, and send the letter off to him through the act of burning it.

Homework: Students will read, highlight, and outline handout material on "China Under Deng," from page 150 in Mastering Global Studies; Students will also read "Communist Pathways to Modernization," pages 563 to 568 in Geography, and answer Review Questions 1-3 and Thought Questions 1&2 on page 565 and Review Questions 1-4 and Thought Questions 1&2 on page 568.

Lesson #8 -- How successfully is China modernizing?

Objectives: The students will . . .

1. Assemble and organize notes based on visual and auditory observations,
2. continue to consult with teammate.

Materials: Slide projector, screen, extension cord, pointer, a "Collage of China Today" wall display, and slides of "modern" China (with particular emphasis on buildings, street vendors, modes of transport, beggars and "fluid" population at the train terminals, as well as the new urban "yuppie")

Method: 1. Students are to take notes based on slides viewed and on commentary.
2. Teammate consultations continue.

Homework: Using American magazines, newspapers, and family photos - students are to assemble photos for a "Collage" that reflects life in the United States.

Lesson #9 -- How similar is life in (urban) China to life in (urban) America?

Objectives: The students will . . .

1. Detect similarities and differences in the urban lifestyles of Chinese and Americans,
2. Evaluate those lifestyles, and their relative advantages and disadvantages,
3. While continuing to work in teams of two (2).

Materials: Stacks of BEIJING REVIEW, CHINA TODAY, and CHINA RECONSTRUCTS; oaktag &/or cardboard, scissors, glue, and adhesive tape

Method: 1. Students, in teams of two (2), are to select photos of life in urban China that reflects modern life today.
2. Students are to note similarities and differences in lifestyles and environments of China and the U.S.
3. Team members are to discuss the relative advantages & disadvantages of living in either or both countries, and prepare to defend their selections.

Homework: Students will read, highlight, and outline handout material on "Chinese Society and the Arts," from pages 154 & 155 in Mastering Global Studies.

Lesson #10 -- How similar/different is Chinese music from American?

Objectives: The students will . . .

1. Allow their imaginations to flow with the music to
2. Give expression to their impressions by "just doing" a poem, a drawing, or whatever moves them,
3. And evaluate (and experience?) the undercurrents underlying Chinese music, art, and culture.

Materials: Audio cassette player, audio cassette of American urban hip-hop rap, audio cassette of Chinese instrumentals, blank white paper, number two pencils

Method: 1. Students are to first listen to American urban hip-hop rap and, using it as a springboard, draw an image with pencil or with words of what comes to mind.
2. Students next listen to Chinese instrumentals and, using it as a springboard, draw an image with pencil or with words of whatever comes to mind.

Homework: Students are to finish their drawings and/or compose a poem using their earlier images as springboards.

Lesson #11 -- How does China's art reflect her cultural values?

Objectives: The students will . . .

1. Evaluate the differences contrasting the arts of China with those of the U.S.,
2. Infer cultural values underlying Chinese arts.

Materials: Assorted samples of Chinese arts and artifacts (ie.-- Statues of the Buddha, of Quan Lin - the Goddess of Mercy, and of a Terra Cotta warrior; paintings of poets and of nature; calligraphy; harmony balls; et.al.), an audio cassette player, and audio cassettes of Chinese music and Buddhist chants

Method:

1. Evaluate previous night's homework assignment
2. Contrast/complement with samples of Chinese art, music, poetry, and artifacts.
3. Note observations and conclusions arrived at from hands-on analysis and discussion.

Homework: Write-out the post card from China as instructed in the handout (attached) telling friends of what you've seen during your journey to China. Also study for Unit Exam.

Texts --

Geography: Our Changing World by English, Schule, & Lindoo,
West Publishing Company, St. Paul, Minnesota

Mastering Global Studies, by Killoran, Zimmer, & Jarrett,
Jarrett Publishing Company, New York and California

Basic Map Skills, by Graham & Thomas,
Hammond Incorporated, New Jersey

Pretend you are a young traveler and X'ian is your last stop on a trip around China. Write a postcard back to your family or friends that describes what you have seen there, and what you have bought to take back with you.

The image shows a rectangular box representing a postcard template. On the left side, there is a vertical dotted line. In the top right corner, there is a horizontal dotted line. In the bottom right corner, there are three horizontal solid lines, suggesting a space for an address or a return address.

Jiaoshu Yuren

"TEACH KNOWLEDGE, FORM HUMAN CHARACTER"
Moral Education in the People's Republic of China

Helen A. Finken
Iowa City High School
Iowa City, Iowa

Jiaoshu Yuren, meaning 'teach knowledge, form human character,' is the term Chinese educators often use to refer to education because it acknowledges the pervasiveness of moral education as a goal in the educational program.

The purpose of this lesson is to provide teacher background and student activities about moral education in Greater China: the People's Republic of China, Taiwan and Hong Kong. The materials and observations were gathered from an on-site study tour to Beijing, Xian, Guilin, Shanghai, Hong Kong and Taiwan sponsored by the Fulbright-Hayes Seminar Abroad Program in 1993 and through follow-up research. The work and advice of Dr. Stanley Rosen, Fulbright Academic Escort, Dr. Gerard Postiglione, University of Hong Kong, and Dr. Jeffrey Meyer, University of South Carolina, are reflected in this lesson.

On-Site Observations

A variety of components of moral education were observed and discussed during the Fulbright-Hayes Seminar:

The Chinese schools visited by the Fulbright delegation displayed several portraits in their hallways to serve as models for students: Stalin, Lenin, Albert Einstein, Madame Curie and famous Chinese scientists. Inspirational inscriptions were placed on blackboards at school doorways. Pictures of one-child families were hung in nursery school rooms, and Young Pioneers wore their uniforms with red kerchiefs. In Guilin, a small shop in the main shopping area, sold posters of Mao Zedong, English workbooks, children's storybooks, and the "Rules for Daily Behavior" posters which are displayed in primary and middle schools. When we questioned school officials about the content of the moral education program, they most frequently mentioned 'civics' or 'law-related' courses.

Moral education is not just the province of the schools. The Shanghai Women's Federation discussed their attempt to teach the 'Five Goods' to the general population, a program that has been in effect since 1983:

THE FIVE GOODS

1. Everyone should work hard.
2. Parents of the older generation should educate their young.
3. Respect the old; love the young.
4. Be a good neighbor.
5. Practice good family planning.

The Women's Federation sponsors 'festivals' to show families 'healthy' ways of behaving—sharing books, activities, and conversations. They advocate equality between husbands and wives. The Women's Federation also sponsors five-day camps for youth where students are expected to help with daily chores.

In the Republic of China, the Ministry of Culture promotes and teaches Chinese culture throughout the country. The schools and society promote Confucian ideals. Teachers remarked that individual students are like a "blade of grass," and it is their goal to create a "luxurious lawn." Family days are planned at culture centers where traditional arts

and crafts can be experienced. There is strong support for traditional performing artists and traditional artisans. In Hong Kong the approach to moral education has been to focus on acceptable social behaviors, again using the Confucian model.

Instructional Objectives

By the end of the lesson, the students will be able to:

1. Define moral education as instruction about what is 'right' and 'wrong' within a particular cultural context.
2. Compare and contrast moral education in the People's Republic of China, Hong Kong and Taiwan.
3. Discuss the advantages and disadvantages (for individuals and institutions) of teaching moral education.
4. Describe the historical and contemporary goals of moral education in the People's Republic of China.
5. Design future models for moral education in China based upon current social trends, economic conditions and belief systems.

Rationale

Each society, whether it is a small hunting and gathering band such as the Bushmen of the Kalahari Desert or a multi-ethnic population comprised of millions of people, establishes ideals of acceptable behavior and devises ways to teach them to its progeny. Sometimes the responsibility to teach the behaviors and values are the sole responsibility of the family. But more frequently, religious institutions, youth groups, civic groups, and the state, particularly through its schools, are involved.

It will be helpful to discuss the nature of moral education in America as part of the introduction to this topic. Students will probably suggest that there is no consensus in America about how to teach 'right' and 'wrong.' Debates over censored books, R-rated films and prayer-in-the-schools exemplify our diverse opinions in this area. The fact that these issues are openly debated reflects our Constitutional principles of the freedom of speech and the separation of church and state. The practice of local school control also impacts the nature of moral education in this country. Disagreements about the content of moral education occur in authoritarian societies as well, primarily because moral education is seen as a means through which the state can obtain order and stability.

TEACHER BACKGROUND

Hong Kong

Historically, moral education had a distinctly Confucian flavor. Guidelines published in 1981 stated that schools were to 'develop a moral sensibility, to promote character formation and training, to encourage correct attitudes towards life, school and community.' Very little mention was made about China though students were taught about how the government of Hong Kong worked and their rights and responsibilities as citizens. The content of the

1989 social studies syllabus mentions the Basic Law and the joint agreement with Great Britain. As of 1993, there is an increasing attempt to teach about Chinese culture and the PRC. Lessons include studying the biography of Mao Zedong, the value of central planning, and the development and structure of the Chinese Communist party. Prior to 1982, these activities could have resulted in the closure of a Hong Kong school, the dismissal of a teacher or the withdrawal of government financial support since they were related to a political party.

Hong Kong's impending change of status in 1997 will continue to impact the content of moral and political education of Hong Kong students. According to Dr. Stanley Rosen, Fulbright Academic Escort, teachers in Hong Kong are using self-censorship and avoiding political subjects. The curriculum is changing to reflect a more neutral or Chinese perspective on historical events instead of a British view. Some social studies teachers are switching to teaching English; changes in 1997 may bring into question their opinions and political positions.

Republic of China

Moral education in the Republic of China has three main themes: filial piety, patriotism and diligent study (in contrast to manual labor promoted in the PRC). The approach is distinctly Confucian. Filial piety is by far the most important, as reflected in the frequency of lessons which emphasize that value. If a student respects his/her parents, the belief is that teachers, classmates, the elderly and the general public will also be treated well and that order will be maintained.

These Confucian beliefs are taught through models such as Lai-tzu, a 70 year-old man who still serves his parents. He dresses to please them, prepares their favorite foods and entertains them to raise their spirits. Authority figures such as teachers, school principals, government leaders and parents are models, too. There is additional instruction in how to behave in interpersonal relations. Developing an appreciation of nature and living harmoniously with it is an important aspect of education as well.

People's Republic of China

From 1949 until 1980, moral education in the People's Republic of China reflected the political, social, and economic goals of building a 'new society.' There was an emphasis on self-sacrifice for the good of the society, manual work (schools often had small factories attached to them up through the Cultural Revolution), the family as it related to the 'national family,' and the Young Pioneers and the Community Youth League were positive ways for youth to help build the country. The authority figures included political leaders, self-sacrificing heroes such as Lei Feng, and peasant, workers and soldiers. The Confucian ideals were actively refuted and teachers, who were seen as heirs of Confucius, were criticized during the Cultural Revolution. Agricultural and rural life were portrayed as honorable and desirable. "Learn from the peasants, workers and soldiers!" became a popular slogan.

The attitude towards nature was that it was to

be conquered and applied to China's development (i.e. Anti-Sparrow Campaign). The purpose of education was to help a person become productive, not just learned. Therefore, moral education was 'institution centered' rather than 'people centered.' During the Cultural Revolution, the country was in chaos. Schools, when open, promoted students on their class background rather than on their abilities. Grades and examinations were eliminated. The emphasis was on how 'red' a person's beliefs were rather than on how 'expert' their skills were. The entire country underwent political re-education based on Mao Zedong's leftist beliefs.

With the introduction of the Four Modernizations (army, science and technology, agriculture and industry) by Premier Deng Xiaoping, the pendulum has swung toward economic reform. Beginning in 1985, nine years of schooling became compulsory. Current moral education themes are reflected in the forty "Rules for Daily Behavior" and the politics and law classes. There is emphasis on the Four Basic Principles (adherence to socialism, the dictatorship of the proletariat, rule by the communist party, and Marxism-Leninism-Mao Zedong thought). Since the student demonstrations at Tiananmen Square in 1989, the government has made efforts, particularly at the university level, to do political re-education work. There is a strong concern about establishing societal stability so that economic reforms can continue without disruption from demands for political reforms.

As the Chinese are trying to adjust to economic reforms and ideas from the West, there is a confusion in social values. In traditional and Communist China, model citizens were used to teach values. Now that strategy is questioned because the models do not meet contemporary problems and their promotion results in very little change. Some Chinese and outside observers suggest that instead of relying on the virtues of individual models, there should be a stronger legal code that establishes the standard for behavior.

Currently, five types of education are promoted in Chinese schools: intellectual, moral, physical, aesthetic, and labor (teaching the value of productive work, appreciation for workers and their contributions to society, group spirit and cooperation). Moral education is found in all aspects of the educational program. It is taught through textbooks, bi-weekly moral education classes, weekly class meetings, bi-weekly meetings of the Young Pioneers (through age 13) or Communist Youth League (14 up), annual celebrations, contests and family education programs. The media broadcasts moral education programs as well. Community members from business, politics, and the military are involved, when possible, in moral education classes.

This lesson will challenge students to think about the purposes and forms moral education has taken in Greater China and how moral education might be used to help the People's Republic of China meet its contemporary needs.

Jiaoshu Yuren

TEACHING SEQUENCE

This lesson is designed to be flexible so that each instructor may adapt the concepts and materials about moral education to their student's needs. It is assumed that the students will have studied the historical development of the People's Republic of China before participating in this activity. A suggested teaching sequence that includes all the materials follows:

INTRODUCTION

Use Overhead (OHT) #1—Introduction to Moral Education—to elicit student ideas about moral education and citizenship education.

LESSON DEVELOPMENT

Using the background materials provided with the lesson, **prepare an overview** of moral education in the People's Republic of China. Use OHT's #2-#7 and the handout on China's 'model citizen,' Lei Feng, to illustrate the points you want to make about the form and substance of moral education in China since 1949. It is suggested that the students clap out the Three Character Songs in pairs. Discuss role models in America: Who are they? What values do they represent? What is the role of the government/school in promoting role models? What is the role of popular culture in creating role models? Who should be role models for young people?

Examine the junior middle school "Rules for Daily Behavior." Have the students analyze the values they represent. Look for similarities with values commonly taught in the United States. Where are these values taught in America? What role should schools play in teaching moral values? Are there any rules which are unique to China? What overall message do these rules give to the junior middle school students?

Introduce the ROLE PLAY: JIAOSHU YUREN. You may do this activity in a 'jigsaw' format by first having all the students playing similar roles meet to clarify their positions. Then they can break into groups of three and work through the issues involved in creating a moral education program for China in the late 1990s. Students will complete their action plans in this group of three.

Debrief the role play by discussing the dilemmas China is facing and summarizing the creative options the students formulated.

EVALUATION

Have students write a response to this essay question:

What challenges does the People's Republic of China face as it approaches the 21st century and how might JIAOSHU YUREN (moral education) help them meet those challenges? Include advantages and disadvantages of at least two moral education approaches the Chinese might use to meet their goals.

ADDITIONAL ACTIVITIES

With the increased use of automobiles in the PRC, and the need to provide more funding for schools, there is an opportunity for a new school-based enterprise: the creation, printing and sale of bumper stickers. This is a common practice in the United States where you often see bumper stickers that read "Proud Parent of a (school name) Honor Student" or "All-State Music Parent." These stickers promote good study habits and music proficiency. Discuss the criteria that bumper stickers must meet in order to be appropriate for the moral education goals of the PRC. Students should write the slogans, design the stickers, post them for display and discuss their appropriateness for current goals of the PRC.

Students could also design a game to teach values. In India, the traditional game 'Snakes and Ladders' is used to teach values. The American version is 'Chutes and Ladders.' Prior to 1980, schools in the PRC taught a version of tug-of-war that emphasized working hard but keeping each team equal. The strongest children were placed at the head of each side of the rope; the smaller children were at the ends. As each team struggled to pull the other side across the line, the smaller children ran between the teams to keep each side equal! Pose this challenge to your students: What game could be designed for children in China that would teach current moral education goals?

RULES FOR DAILY BEHAVIOR

(People's Republic of China - Junior Middle School)

SELF-RESPECT

1. Sit, stand, walk, read, and write correctly.
2. What you wear should be simple and clean, including your school uniforms. Males should not have long hair; females should not have permanents or make-up, jewelry or high heels.
3. Cultivate good hygiene habits—do not spit on the floor, do not throw fruit skins or paper. No smoking, no drinking.
4. Behave like a proper person. Do not fight, curse or use foul language. Do not gamble. Do not take part in feudalistic superstitious activities.
5. Do not look at or propagate bad books and videos about pornography, murder or superstition. Do not sing or listen to songs that are not good for you.
6. Do not enter commercial dance halls, bars or music tea houses.
7. Do not pocket money that you find. Do not cheat someone with money. Cherish your reputation. Do not lose your dignity. Be concerned about what others think about you rather than financial gain.
8. Maintain the country's integrity and honor when you meet a foreign guest. Do not demean China; be polite.

HOW TO TREAT PEOPLE POLITELY AND THE TRUE MEANING OF FRIENDSHIP AND LOVE

9. Use polite language. Use language appropriate to the circumstances. Pay attention to the situation and use harmonious language. Use common speech (Mandarin, the national language, rather than local dialect).
10. Respect others. Respect their personalities, religions and nationality customs. Respect the elderly and love the very young. Respect women and help disabled people. Be modest and courteous.
11. Respect all the teachers, staff members and workers. When you meet them, actively ask about their welfare. When you answer teacher's questions or speak, stand up. When someone hands you something, stand up and take it with both hands. When you have an opinion for the teacher your attitude should be very sincere and earnest.
12. Among your classmates, you should be united and give mutual help with normal interactions.

You should not use insulting behavior or language; don't tease or take advantage of weaker classmates. When contradictions develop, you should engage in your own self-criticism (i.e. look for your own faults, do not put the blame on others).

13. When you take guests around, do it enthusiastically. When guests come in, stand up and also see them out. When those in adjacent seats have difficulties, you should be actively concerned and help them.
14. If you are not permitted to enter person's room, do not enter. Do not use their things, do not look at what they have written on their writing paper and do not read their diaries.
15. Do not interrupt other people's conversation as you please; do not disturb other people when they are studying, working, resting. When you disturb other people, apologize for it.
16. Keep your promises. Be punctual. When you promise to do something, do it by the time you say you will do it. If you cannot do it by the time you said, you should apologize. When you borrow money or someone's things, you should return them in a timely fashion.

OBEYING DISCIPLINE AND STUDYING HARD

17. When the flag is raised, or the national anthem is sung or played, stand in a solemn way. Take off your hat, look at the flag directly and salute. Young Pioneers should salute the flag in groups as part of their team/brigade.
18. When you are on duty for the day, be very serious about it. Maintain the proper order of the school and the classroom. Maintain the quiet of the library and the reading room. Do not make a lot of noise in the classrooms or the halls.
19. Love and protect the school grounds and all of the things that publicly belong to the school. On the blackboard, walls desks, public bulletin boards and other public spaces, do not deface them or carve pictures. When you borrow books or magazines, make sure you return them on time. If you lose or destroy something, you should pay compensation.
20. Come to school on time. Before going to class, prepare the items you will need for studying. When you come to class and leave the class, stand up and convey your respect to the teacher. When you leave the class, please allow

the teacher to leave first.

21. When you come to class, listen with attention and when you speak give all your attention to the class. Do not hesitate to ask questions. Dare to express your views. Actively respond when the teacher asks questions.
22. Earnestly review your lessons. Accomplish all your work independently and on time. Do not cheat on exams. Fully recognize the value of time. Plan your classroom activities.
23. Observe the order of the dormitory and canteen (cafeteria). Cherish the food. Save water and electricity. Obey the regulations.
24. Participate in all kinds of assemblies and arrive punctually. Be quiet when people are speaking. Do not do anything that isn't related to the meeting taking place.

**BE DILIGENT, THRIFTY, SIMPLE
AND RESPECT YOUR PARENTS.**

25. In your life you should follow a code and rest and work at the proper times.
26. Learn well how to manage your own personal life so you can arrange your clothing and other personal effects. Be attentive to where you put things and do not scatter them around.
27. Be actively responsible for cleaning up your room, for washing your clothes, for cooking, washing and cleaning up the house and other labor activities.
28. Be frugal in your life; do not flaunt your wealth; do not waste money without thinking; do not ask your parents for things that go beyond what the household economic conditions can provide.
29. Respect the teachings and guidance of your parents. Tell your parents often about your life, your studies and your thoughts.
30. When you go in and out of the house, inform your parents. Do not spend the night away without the approval of your parents.
31. Help your parents in a considerate way. Respect both sets of grandparents. Be attentive to the older generation as well as brothers and sisters.

32. If you have some disagreement with someone in an older generation, raise the objection in a polite way. Do not become angry; you should yield to them.

**OBSERVE PUBLIC MORALITY AND HAVE STRICT
PERSONAL DISCIPLINE**

33. Observe traffic regulations; pay attention to traffic safety. When riding a bike, do not violate any of the regulations and cross at the pedestrian walk.
34. When riding on a public bus or tram, ask for a ticket. Let people go through, give up a seat to the elderly, the very young, the ill, the disabled, pregnant women or a teacher. Do not fight for a seat.
35. Observe public order. In buying things, do it in a suitable way. Be courteous to sales people in a store.
36. Love and protect public facilities, historical monuments and scenic spots.
37. When you visit museums or memorial halls, you should do it in an orderly way. When you view the tombs or mausoleums of martyrs, you should do it silently and in a somber way.
38. When you watch a performance or sporting match, you should behave like a civilized audience. Do not be too raucous when the performance or match is over. Show your appreciation by applauding.
39. Show respect to people coming from different areas. When they ask directions, seriously point out the direction.
40. When you see social behavior that violates public morality, you should boldly persuade people not to do it.

ROLE PLAY

Jiaoshu Yuren

TEACH KNOWLEDGE,
FORM HUMAN CHARACTER

The place is the People's Republic of China. The time period is the mid-1990s. The problem is: How should Chinese youth be taught the difference between 'right' and 'wrong' in order to develop citizens who can help fulfill China's goals for the 21st century?

China in the mid-1990s is undergoing the most rapid economic transformation in its history. After 1979, Premier Deng Xiaoping introduced reforms to move China toward 'market socialism.' He declared that: "It doesn't matter if the cat is black or white as long as it catches mice," and that "To get rich is glorious!" The change in economic direction produced enterprises which changed the landscape of the country, increased the living standard of the people and boosted economic growth to over 10% a year.

However, the economic changes have brought new problems: inflation, unequal economic growth between rural and urban areas, a push for political reform (as evidenced in 1989 at Tiananmen Square), and a change in values. There is also concern that the central government has lost control at the local and provincial levels.

The Associate Director of the National Education Commission has said that reports from throughout the country show that students are no longer interested in serving society; instead they are striving for personal gain. Most students are unwilling to study hard and there is a growing dropout problem among elementary and junior middle school students. Furthermore, the Director stated "Students have an inadequate appreciation of the value of labor and do not exhibit a spirit of thrift or hard struggle."

Educators are concerned that children of one-child families are lazy and selfish. Many students are not public-spirited and they do not know how to act according to rules of civilized behavior and courtesy. Particularly alarming is that the average age of students involved with the law is getting lower, while the number of incidents increases.

There is mounting evidence that students are 'infected with capitalist ideas' and that they worship everything Western. Bad reading materials, frivolous television programs and movies, corruption and 'money worship' are seen as reasons for the changes. Role models are often Hong Kong and Taiwanese performers rather than revolutionary heroes.

One teacher gave an example: A family she knew had two young boys in school. The elder boy did poorly, the younger did well and was the 'favorite.' But when the elder brother dropped out of school and began making money, he soon took over as the 'favorite.' The younger brother then began to

study less and was also considering dropping out of school.

HOW SHOULD CHINA USE MORAL EDUCATION TO SOLVE THESE PROBLEMS?

Jiaoshu Yuren

YOUR TASKS:

As a member of the National Education Commission, you are responsible for revising the moral education program that will be used in China's schools as it begins the 21st century.

1. **Read** the background statement about your views; add other ideas that are consistent with your role.

2. **Listen** to the views of your colleagues. Their views will require you to consider China's history and current goals and to examine possible ideas from 'Greater China' (Hong Kong, Taiwan). **Question** the other commissioners. Ask them to clarify, justify, or add to their views.

3. **Present** your views according to the role you are fulfilling. Answer the questions of the other commissioners.

4. **Discuss** the direction China should take in moral education. Write your JIAOSHU YUREN ACTION PLAN. Be very specific about the RATIONALE and the ACTIONS you propose.

5. **Send** a representative to the National Education Commission (NEC) and present your plan. Be prepared to explain and defend it to the entire commission (class).

6. **Collaborate** on a final JIAOSHU YUREN ACTION PLAN with the class.

EVALUATION

At the conclusion of Jiaoshu Yuren, be prepared to write a response to this essay question:

What challenges does the People's Republic of China face as it approaches the 21st century and how might JIAOSHU YUREN help them meet those challenges? Include advantages and disadvantages of at least two moral education approaches the Chinese could use to meet their goals.

ROLE PLAY:

Jiaoshu Yuren

ROLE: NATIONAL EDUCATION
COMMISSIONER 'A'

You have just returned from a trip throughout China. You were overwhelmed by the tremendous economic changes China is experiencing as a result of the economic reforms begun by Deng Xiaoping. Construction is occurring everywhere, joint ventures have brought foreign goods and ideas into the country, and people are able to purchase more consumer products with their increased wages. However, you are deeply troubled by some of the effects these changes are having on young people.

Young people seem to be learning their values from the music that originates in Hong Kong and Taiwan or from 'bad reading materials' from the West. Their major interest seems to be to pursue economic gain. Teachers complain that students are less willing to study hard, with the exception of key high school students who anticipate gaining entrance into a top university or going overseas. Families are placing less emphasis on studying since they see that their family's economic status is often improved when children drop out of school and work.

You are worried that young people will not gain the training they need to become 'experts' at technical skills. You feel individuals need to develop initiative, enterprise, self-respect and self-confidence. People who are willing to take risks and assume responsibility are critical for China's continuing economic momentum.

You were especially upset about a report in a recent *Wall Street Journal* that told about the poor quality of Chinese workers. Employees were observed spitting on the floor, falling asleep on the job, playing poker and jeering at people who actually try to get something done. You realize that many Chinese workers are not ambitious because in the past all jobs were dead-end and all work was treated the same. The 'iron rice bowl' mentality, where people assume the government will pay their wages and benefits forever—no matter what type of job they do—is a major obstacle to change. You have been aware of these problems for years, but now the poor quality of Chinese workers is becoming an issue that could keep foreign companies from investing in China.

You know developing better work skills and attitudes in students will be difficult. Children are being pushed in quite different directions. At school, they are urged to be frugal, but from TV they learn that happiness can come from consumer products and that to get rich is glorious. They are told to serve the collective, yet their parents want them to stay close to home and work for the benefit of the family. Where, you ask, are they learning the manners of the workplace and the attitudes that inspire them to 'climb the ladder' and 'go places?' You know that old models such as Lei Feng are disregarded and derided by many students. You hope to find better models for the new economic times.

You think the National Education Commission should consider teaching work-related attitudes as part of their moral education program. This is not just teaching about the value of labor for labor's sake. It is about teaching students the skills and attitudes necessary to survive in the modern world of work.

ROLE PLAY:

Jiaoshu Yuren

ROLE: NATIONAL EDUCATION
COMMISSIONER 'B'

You work in the section of the education commission that is responsible for keeping track of the statistics about China's pupils: how many students enter school, how many drop out, how many schools are at capacity, and so forth. You work closely with population experts because you rely upon their census reports for projecting the number of teachers that need to be hired, how many students will be at each grade level, and how many textbooks will need to be printed.

One aspect of your job that has interested you in recent years is the progress of the "Little Emperors" and "Little Empresses" as they have entered the school system. These are the names given to the only children born under the 'one-child' population policy. Though this policy will help alleviate China's population crisis, there are unanticipated social and schooling problems that are related to the only children.

You have heard several reports that the only children are spoiled and selfish. They are used to receiving an abundance of material objects because there are six adults who give them gifts and indulge their wishes. Furthermore, the children are receiving mixed messages. From school they are taught to be frugal, while from television they learn that happiness can come from consumer products and that to get rich is glorious. They are told to serve the collective, yet their parents often do everything for them such as washing their clothing.

As you look at the demographic information for the future, you realize that this generation of only children will be responsible for the care of their aging parents. You are concerned that they have become so selfish that they will not want to help their parents in their old age.

To remedy this problem, you think that China should strengthen the teaching of Confucian ideals - particularly filial piety. This respect for elders would have the added benefit of improving student respect for teachers. You know that in Taiwan the schools emphasize filial piety, patriotism, and diligent study more than any other moral values.

Even though you disagree with their political beliefs, you admire the fact that the Republic of China is a stable society and that their citizens have been successful at modernizing the country. You think more emphasis on Confucian beliefs in the schools could help guide young people. You will remind the other commissioners that Confucius advocated cherishing the teacher and valuing knowledge. He worked to improve relations between social classes which is important now, too, since some people are getting rich faster than others. Confucian ideas are truly Chinese and could serve as a 'buffer' to the new ideas and values coming from the West. The Communist Party is no longer teaching against Confucius as it did during Mao's time, so it is politically safe to promote his ideas. You think an improved attitude toward teachers would help attract more qualified people to education.

You are also convinced that the changes that need to be made in China's moral education program cannot be made by the schools alone. You will suggest to the other commissioners that programs for the family, the workplace and the media be planned.

ROLE PLAY:

Jiaoshu Yuren

ROLE: NATIONAL EDUCATION
COMMISSIONER 'C'

Your grandparents grew up during the Century of Humiliation when China was in political and economic chaos. You remember their stories about the exploitation and control of China by foreigners. During your own youth, you experienced the Civil War with the Nationalists and the triumph of Mao Zedong and the Communist Party. You saw the improvement Mao brought to China: more food, better health care, land reform and a unified country. Though you recognize the abuses that occurred during the Cultural Revolution when Mao's policies were carried to extremes and education suffered because schools were closed, you believe there are some ideals and themes that can still be beneficial for today's students. After all, China is NOT undergoing political reform! You think developing loyalty to the state will contribute to China's #1 priority: stability. While the quest for economic modernization must be maintained, there must be no more demonstrations such as the 1989 Tiananmen Square Incident.

You realize that with a growing population of only children and the idea of individualism from the West, there is a tendency for young people to be self-

centered. You believe moral education should help students gain respect for their country and acquire an appreciation for groups such as the neighborhood, work unit, and school class. You think the values of hard work, thriftiness, and self-sacrifice are still important to China's future. You know that good manners are necessary for the smooth functioning of society.

Recently, you heard that a monument for young heroes was dedicated at the Scientific Children's Park in Beijing. You think this is a good sign since the children it honors can serve as models for other youngsters. Han Yujian, a girl who died while saving a drowning child, was one of the heroes commemorated. You think more emphasis on the model of Lei Feng, the Young Pioneers and the Communist Youth League would benefit students.

This generation has little understanding of Mao Zedong's life and goals. The men and women who gained China's liberation are very elderly. You think it would 'serve the people' if the young people learned about Mao, visited revolutionary sites, read *The Quotations of Chairman Mao*, and did manual labor. There needs to be a core of beliefs that will give Chinese citizens a sense of unity. You think these core values should come from the historical experiences and leaders of the Chinese Communist Party. After all, it is the work of the Party and the peasants, workers and soldiers who have made the current prosperity possible. These are lessons all Chinese students should learn.

Jiaoshu Yuren

ACTION PLAN

Commissioner

Names _____

1. Identify and describe the top three problems you will try and solve through the new moral education program.

Problem #1

Description of the Problem

Problem #2

Description of the Problem

Problem #3

Description of the Problem

2. Prioritize and defend the ACTIONS you will recommend for the SCHOOLS:

3. Prioritize and defend the ACTIONS you will recommend the Chinese Communist Party take within SOCIETY:

4. Prioritize and defend the ACTIONS you will encourage the Women's Federations to direct towards FAMILIES:

LEI FENG: A MORAL EDUCATION MODEL

Lei Feng: For Three Decades The Face of Altruism

(Chen Quiping, Staff Reporter, Adapted from *Beijing Review*, March 29-April 4, 1993)

One day in April 1961, a young People's Liberation Army (PLA) soldier named Lei Feng set off for Liaoning Province on business. When an elderly woman could not find a seat on the crowded train, Lei offered to let her take his without hesitation, then volunteered to clean the car and fill hot water bottles for the passengers.

"You need a break, son," said a grandmother when she saw the sweat running down Lei's face.

"Oh, I am doing just fine," he replied.

Lei was happy to be able to do things for others, and did such altruistic deeds throughout his short life of 22 years. He is famous for his statement, "Life's short, but the cause of serving others is infinitely good. I have resolved to devote my limited life to serving the people." He kept his words.

On March 5, 1963, the late Chairman Mao Zedong wrote an inscription which read "Learn from Comrade Lei Feng." Other Party and state leaders followed suit. Lei Feng has been a role model for the Chinese people ever since, especially those of the younger generations.

A National Hero

Lei Feng was born on December 18, 1940, into a poor peasant family in Wangcheng County, Hunan Province. Orphaned and homeless at seven, he made a living by cutting firewood for others. The poor life lasted until 1949 when New China was founded. With the assistance of the local government, Lei received a primary school education. After graduation he was given a job by the local government. The sharp contrast with his early childhood instilled loyalty to the Communist Party of China, and he devoted himself to socialist construction. Lei worked in a Party office, a factory and on a farm, and was chosen as a model worker at each place. In 1960 he joined the PLA and became a squad leader of a transport company. He died in an accident at his post in August, 1962.

Lei Feng was not a legendary figure. His greatness lies in the selflessness he showed doing plain everyday work—helping save cement at a factory from a sudden downpour, lending a helping hand to farmers during his time off, secretly contributing his savings to a people's commune, and being always ready to help his co-workers and fellow soldiers in their duties. He was the embodiment of traditional Chinese virtues—simple, honest and kindhearted. His philosophy of life was "to be useful to others," and he insisted that a person's worth "lies fundamentally in labor, creation and making greater



Lei Feng

contributions to society." These qualities have won him national admiration, and emulation by many. Soon after his premature death, Lei became known throughout the country. In Fushun City, Liaoning Province, where Lei Feng's transport company was stationed, nearly 100,000 mourners took part in his funeral procession. The name Lei Feng has since become synonymous with socialist ethics, which extol complete devotion to the revolution and wholehearted service to the people. Learning from Lei Feng became a nationwide campaign.

The campaign to keep alive Lei's memory has seen peaks and valleys during the last three decades, and the spirit of Lei Feng has faced many challenges. Yet he is still held in high esteem. The people need, care for, love and help each other through the various problems they confront, and they want to cultivate better interpersonal relationships and morals.

In the early 1960s, natural disasters hit China for several years in a row. This greatly increased the need for mutual support. It was against this background that Mao and other state leaders called on the Chinese people to learn from Lei Feng.

However, during the chaotic "cultural revolution" (1966-1976), such activities were suspended and replaced by infighting. Lei Feng was then regarded as a product of revisionism. "How can you help a person without knowing his or her political attitude? some would say. "And how do you know the little old lady you helped cross the street is not a

landlady?"

Individualism blossomed in the 1980s, when people began putting money and their own interests first. During this period, morality suffered as people began to pay more attention to the role of money in social relations. Profit-motivated behavior was no longer an isolated phenomenon.

For example, dozens of people in Henan Province tried to flag down a car to carry a seriously injured man to a hospital. No one stopped. The young man died from excessive blood loss. When faced with such a situation, people are likely to conclude that "Uncle Lei Feng has disappeared."

A New Campaign

These days the Chinese leaders are once again advocating the spirit of Lei Feng, as they believe it can benefit the policy of reform and opening to the outside world. They say a new Lei Feng campaign will help promote cultural advances and socialist ideology and help foster hard work and plain living. It may also combat the negative aspects of economic development and reform.

The campaign is being carried out vigorously, and more outstanding collectives and individuals with fine ethical qualities are emerging.

At a March 4 mass rally in Beijing marking the 30th anniversary of the late Chairman Mao's call on the whole nation to learn from Lei Feng, senior Party leader Hu Jintao said the arduous and important tasks being undertaken during this great time of change require a spirit of devotion to hard work and of mutual respect and support. "Therefore," Hu said, "it is still essential for us to carry forward the spirit of Lei Feng to make progress."

With the nation switching over to a market economy, some people think the spirit of Lei Feng out-dated and his ideas old-fashioned. The relationship between a market economy and altruism is now a hot topic.

In a talk to some workers and students from various localities, Zhu Boru, a national pact-setter in "learning from Lei Feng," said that to learn from Lei Feng and perform voluntary services for the people belong to a category very different from that of economic activities. "Stressing exchange at equal value and paid services will never make Lei Feng's ideology obsolete. The more the economy develops, the more people need understanding, friendship and mutual assistance," Zhu added.

But Zhu noted that one should not completely disregard personal interests and family. "To learn from Lei Feng is to learn not to be selfish and to integrate individual interests with the overall interests of the society and people. It is wrong to set these against each other," he said.

At present, the ordinary Chinese people, especially young people, have complex attitudes about the campaign... Quite a number make fun of the campaign, yet wish more people would follow in the footsteps of Lei Feng when they witness selfish behavior.

The fact that Lei Feng remains in people's memory during this period of reevaluation shows the ideas he symbolizes still carry weight. More than 7 million people have visited the Lei Feng Museum since it was built in his hometown in 1968. A businessman who brought his child to the museum once said, "I need a moral base while earning money, otherwise I feel uneasy."

Questions

1. What qualities made Lei Feng a model citizen?

2. Could Lei Feng be used as a model for China in the 1990s? Why or why not?

OHT #1

Jiaoshu Yuren

WHAT IS A 'MORAL PERSON?'

WHAT IS A 'MODEL CITIZEN'?

WHAT IS THE DIFFERENCE BETWEEN MORAL
EDUCATION AND CITIZENSHIP EDUCATION? WHO
SHOULD BE RESPONSIBLE FOR EACH?

Jiaoshu Yuren

MORAL EDUCATION THEMES (Elementary School)

- Patriotism
- Respect for authorities: parents, teachers, etc.
- Love and consideration for others
- Courtesy, orderly public behavior
- Honesty and sincerity
- Thrift and frugality
- Neatness, cleanliness, health
- Regular exercise and good posture
- Responsibility, love of labor
- Safety
- Respect for environment and public property
- Smoking, drinking, gambling prohibited
- Good reading materials
- Against feudal 'superstitions'
- Report bad characters and illegal behavior

Jiaoshu Yuren

THREE CHARACTER SONGS (Sanzige)

There are 46 Sanzige couplets used to teach moral education ideas.

Sanzige are 3 syllable sayings, chanted in a group or with a partner.

In a pair, each person claps their own hands together, then claps their right hand to their partner's right hand, claps their own hands again and then claps their left hand to their partner's left hand.

Examples:

Study hard, don't come late,
Good and bad discriminate.

When you speak, use your brain,
Cleanliness do not disdain.

At your desk, keep things neat.
Every task, do complete.

Jiaoshu Yuren

What VALUES does this reading present? WHEN would it have been used to teach moral education?

WHAT WILL I BE WHEN I GROW UP?
(Grade One)

When I grow up, I will be a peasant.
And I will build new villages for my motherland.

When I grow up, I will make machines,
And I will send them to the villages.

When I grow up, I will join the Army,
To protect our motherland and fight our enemies.

Workers, peasants, and soldiers are very important
and very revolutionary,
When we grow up, we will be workers, peasants,
and soldiers.

Jiaoshu Yuren

What VALUES does this reading present? WHEN would it have been used to teach moral education?

CHAIRMAN MAO SEES A PLAY (Grade Two)

Once a theatrical company was putting on a performance at Yen-an. Many people had come to the hall to see the play.

As the curtain was about to open, Chairman Mao arrived. When he saw that all the seats in front were taken, he found an empty place at the back and sat down. The people sitting in front saw that Chairman Mao had come, and everyone stood up, each wanting to give his place to him. Chairman Mao rose hastily and said: "Everyone sit in your own seat. Once you move, order will be destroyed."

Everyone still wanted to invite Chairman Mao to sit down front.

Chairman Mao saw that no one was willing to sit down. He then walked to the front and sat in the seat of a little boy. Chairman Mao picked the little boy up and let him sit on his lap.

The play began, and Chairman Mao and his little friend watched it together. During intermission they chatted like close friends.

OHT #6

Jiaoshu Yuren

What VALUES does this poem present? WHEN would it have been used to teach moral education?

A RED SUN BLAZING LIKE A FIRE (Grade Five)

A red sun is blazing like a fire;
The rice in the fields is half withered and scorched.
The farmer's heart is like boiling soup;
Gentlemen and descendents of princes wave their fans.

Jiaoshu Yuren

MORAL EDUCATION (Junior Middle School)

In addition to the forty 'Rules of Daily Behavior' for middle school students, there are lessons and classes on moral education:

Textbook lessons for **First Year** of Junior Middle School:

1. Patriotism—the greatness of China and the Revolution
2. Love of the People, the 'backbone' of the Revolution
3. Love the Communist Party
4. Honor science, study hard, reject superstition.
5. Honor labor and public property (the result of labor).
6. The collective comes before the individual.
7. Respect teachers, parents, elders.
8. Observe public order, be courteous, civilized.
9. Importance of Communist Ideals.
10. Discriminate true from false, ugly from beautiful.
11. Nourish good interests and hobbies.
12. Have an eager, positive attitude toward life.
13. Be modest and sincere.
14. Be diligent and simple in life style.
15. Train your will and determination.
16. Manifest revolutionary heroism.

Second Year: Study of the Marxist view of the development of history and society (emphasis on the economic causes for social development.)

Third Year: Civics course about fundamental laws of China, the socialist political system, the rights and duties of citizenship, penal and criminal law, structure of the government.



CHINESE STUDIES

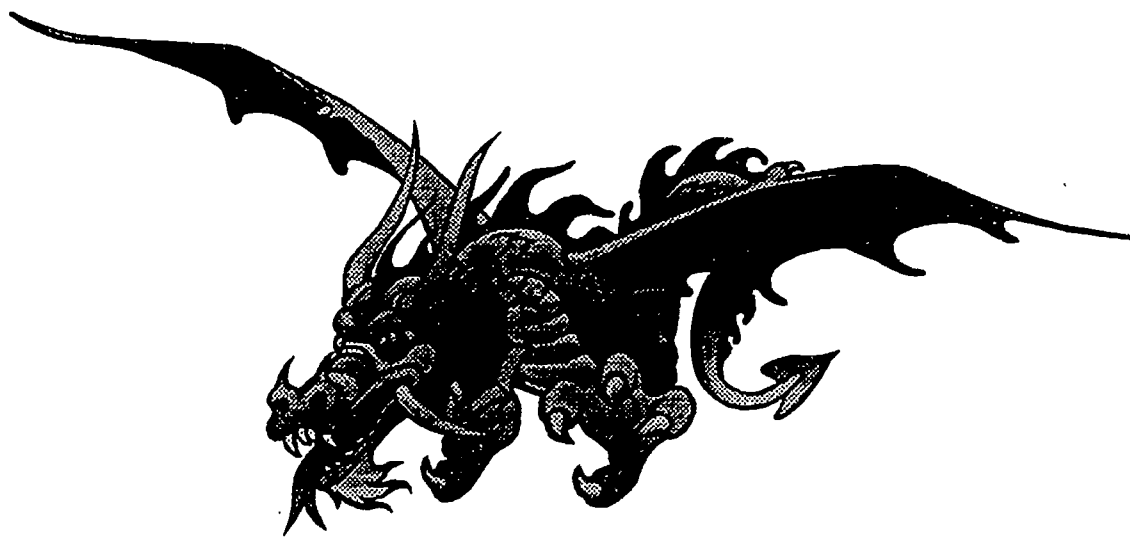

Mary Ellis-Hansen

**Baldwin County Public Schools
Daphne High School
300 East Lawson Road
Daphne, Alabama 36526**

TABLE OF CONTENTS

Chinese Culture in Daphne, Alabama	1
Ethnic Minorities in the People's Republic of China	4
Chinese Cuisine	16



MARY ELLIS-HANSEN
BALDWIN COUNTY PUBLIC SCHOOL SYSTEMS
Daphne High School
300 East Lawson Road
Daphne, AL 36526
{205} 626-8787



SUBJECT: Social Studies {World Geography, World Cultures, Consumer Economics, Economics}

AUDIENCE: Ninth, Tenth, Eleventh, or Twelfth Grades

UNIT: *CHINESE STUDIES*

LESSON: Enrichment Activity {*Chinese Culture in Daphne, AL*}

OBJECTIVES: Upon completion of Enrichment Activity, students will be able to:

- recognize differences that exist between Chinese and American cultures
- describe five (5) differences in an essay
- use interviewing skills to gather information
- catalogue evidence found in the classroom and the community
- construct bulletin board *Chinese Culture in Daphne, AL*

INSTRUCTIONAL SUPPLIES NEEDED. Chalkboard, bulletin board, note cards, *VIDEO(S)*: (filmed in Beijing and Shanghai, China, Hong Kong, and Taiwan Summer 1993).

STUDENT SUPPLIES NEEDED. Student Journal to document interviews and note cards.

TIME FRAME: 2-3 Days

TODAY'S LESSON: Identify evidence of a Chinese Culture realm in Daphne, Alabama. (Evidence may appear as newspaper articles, businesses, people or products.)



Chinese Culture in Daphne, AL

PROCEDURE:

Write on the chalkboard "*Chinese Culture in Daphne, Alabama.*"

ACTIVITY. LARGE GROUPS

Inventory the classroom and students for Chinese products such as: clothing, bookbags, pens, shoes, wallets, purses, jewelry, classroom furniture and equipment.

- A. List inventory items in chart form on the chalk board. {Listing items on the board will be done by students.}

QUESTIONS AND ANSWERS

- B. Call on various students to name of the items they found in the classroom that point to Chinese culture.
- [1] Why are there so many products with labels "Made in China?" Taiwan? Hong Kong?
 - [2] Compare the cost of a shirt made in the U.S. with a shirt made in China, Hong Kong, or Taiwan.
 - a. Is the cost the same? If not, why is the cost differently? List reasons given by the students on the chalkboard.
 - [3] Answers will vary.

STEP TWO. VIDEOS. Show students Chinese at work and play. Videos were filmed in *Beijing and Shanghai, PRC, Hong Kong, and Taiwan*. {Approximate eight minutes of each video.

- A. Discuss differences in Chinese and American culture as evident in videos.
- B. Have students name Chinese customs, etc. that they recognize in the videos that they see around them.



Chinese Culture in Daphne, AL

INDEPENDENT PRACTICE. Assignment

Look for Chinese Culture in Daphne, Alabama.

- a. Interview someone who has visited China, Hong Kong, or Taiwan this afternoon or tonight. {Our PTSA president, Mrs. Dube, lived in China for several years. She has a daughter in Daphne High. She is a senior.}
- b. Other means by which you can complete this assignment:
 1. Visit the grocery store, check the news paper, evening news {radio and television}, interview people in the community, call your State Senator and Representatives, Chamber of Commerce, and get your parents involved with this assignment.

SECOND DAY.

Have students go to the board and list their findings. After their findings (and articles) have been listed and discussed:

- Use the note cards to list evidence of *Chinese Culture* in Daphne, Alabama.
- Have student's construct a bulletin board using note cards and other evidence gathered.

EVALUATION TECHNIQUE: Observation and check list for the bulletin board.

Essay. Describe five differences in Chinese and Daphne, Alabama's culture.

SUPPLEMENTARY MATERIALS

MEDIA

Ellis-Hansen, Mary. Videos: { *Beijing and Shanghai, China*. June 28-July 25, 1992} { *Hong Kong* July 26-27, 1993}. { *Taiwan* July 28-August 3, 1993}.

Fulbright-Hays Seminar Abroad Program. *China: Tradition and Transformation*. Videos were filmed during summer program abroad.



元春



Mary Ellis-Hansen
BALDWIN COUNTY PUBLIC SCHOOLS
Daphne High School
300 East Lawson Road
Daphne , AL 36526
{205} 626-8787



SUBJECT: Social Studies {World Geography, World Cultures, Sociology, World History}

AUDIENCE: Ninth, Tenth, Eleventh, or Twelfth Grades

UNIT: *Chinese Studies*

LESSON: Ethnic Minorities in the People's Republic of China

OBJECTIVES: Upon completion of today's lesson, *Ethnic Minorities in the People's Republic of China*, students will be able to:

- identify the largest ethnic group
- explain how ethnic diversity shapes the PRC'S history
- describe lifestyles and customs of five of the fifty-six ethnic groups
- compare ethnic problems in the PRC with those in the U.S.

INSTRUCTIONAL SUPPLIES NEEDED: Lesson plan, textbook, overhead projector, outline map of Asia and the People's Republic of China, List of minorities, slides, pictures, and video of minorities, minority clothing.

PURPOSE . In order to understand the challenges facing the Chinese people, it is necessary to learn about them. Today, you will learn about ethnic groups in the PRC.

SET INDUCTION: *WHAT DOES THE TERM "ETHNIC MINORITY" MEAN?*

1. **Brainstorm.** As students give clues to the definition of *Ethnic Minority*, write their answers on the board.

[4]



2. Students will use the list of clues on the chalkboard to formulate a working definition for the term *ethnic minority*.

Answers will vary.

A group of people living within a country that differs from the population.

A group of people that share the same customs and traditions that give them a feeling of identity. Often, they have the same language, religion, and ancestry.

FOCUSING ACTIVITY.

1. Ask students to name some *ethnic minorities* in the United States. List the minorities on the board.
 - a. Have students identify some tensions or problems among these groups.
 - b. Discuss national and local problems with *ethnic minorities*. Students should be encouraged to name tensions/problems and state causes.
 1. Last, they should state solutions to the tensions and/or problems.
2. Explain that fifty-six minorities live in the People's Republic of China.

PRESENTATION.

Use the overhead projector to show the class a list of the ethnic minorities living within the most populous country in the world.

a. **DIRECT INSTRUCTION.**

1. Background Notes combined with transparencies, slides, pictures, videos, and Yao Ethnic Minority clothing.

COOPERATIVE LEARNING.

Activity: Research *Ethnic Minorities* in the People's Republic of China
Grouping: {Five heterogeneous groups}
Purpose: To research assigned ethnic minority. Have each group pool findings and prepare a report explaining the customs of their minority and how the customs and life styles differ among the Chinese people.

[5]



- Roles:** Assign each group a scribe and a leader.
- Outcome:** Have each group present its report to the class. Display the reports and any illustrations they show.
- Closure:** Remind students that their group's findings will help the class get a closer look at the various minorities in the PRC
- Assessment:** Group
-

Background Notes: CHINA'S NATIONAL ETHNIC MINORITIES

- I. The PRC is a multi-national country
 - A. Fifty-six ethnic groups live in the PRC
 - 1. Largest ethnic group is the Han nationality
 - a. accounts for 91.98 percent of the total population
 - b. has own spoken and written language
 - (1) used throughout the PRC
 - (2) working language of the United Nations
 - c. Han found in all parts of the country
 - 2. Other 55 nationalities represent 8.04 percent of the total population of the country
 - a. live in compact communities
 - (1) live within the border regions of the north, northeast, northwest, and southwest
 - b. fifty-three ethnic groups use their own spoken language
 - c. twenty-three minorities have their own written language
- II. Regional Autonomy for Minority Peoples
 - A. National Autonomy for minority peoples
 - 1. Allows minority peoples living in compact communities to establish self-government and direct their own affairs
 - 2. Each minority has:
 - a. its own customs
 - 3. National minorities are represented in the National People's Congress
 - a. 439 deputies represents the 55 minorities
 - (1) 14.74 percent of the whole assembly



4. Five Autonomus Regions
 - a. Inner Mongolia Autonomous Region
 - b. Ningxia Hui Autonomous Region
 - c. Xinjiang Uygur Autonomous Region
 - d. Guangxi Zhuang Autonomous Region
 - e. Tibet Autonomous Region
5. Thirty autonomous prefectures and 124 autonomous counties have been established in the country

Use a transparency: *Map of the People's Republic of China.* {1} *Locate each autonomous region.* {2} *Label each region.*

III. Life Styles

- A. Customs and habits of minorities are influenced by environment, social and economic conditions {**Examples follow:**}
 1. South China-----rice is eaten
 2. North China-----noodles is choice
 3. Inner Mongolia Autonomous Region
 - a. millet stir-fried in butter, fried sheep tail and tea with milk
 - b. wear robes and riding boots
 - c. live in yurts (beehive-shaped tents)
 - d. traditional festival-----*Nadam Fair*
 - e. religious preference-----*Lamaist*
- B. Other life styles
 1. Koreans
 - a. likes sticky rice cakes, cold noodles, and kimchi {pickled vegetables}
 - b. wear boat-shaped rubber overshoes
 2. Tibetans
 - a. wear Tibetan robes
 - b. women wear gold or silver ornaments
 - c. majority of Tibetans are believers of Tibetan Buddhism
 - d. Lamaist is another popular religion practiced in Tibet
 - e. festivals
 - f. Tibetan New Year and Onghor {expecting good harvest} Festival

[7]



3. Li's, Jing's and Dai's
 - a. chew betel nut palms
 4. Ugyurs
 - a. wear embroidered skull caps
 5. Dai's, Zhuang's and Bouyei's
 - a. live in the ganlan {balustrade} style storeyed houses
- C. All 55 ethnic groups have their own traditions for engagement. The most distinctive are the following:
1. Va and Blang
 - a. engagement is indicated by couples sleeping together
 2. Pumi
 - a. engagement means a lasting tie
 - b. engagement can not be broken as long as a woman's fiance is alive
 - (1) if her fiance is too poor to afford a wedding, she remains in her mothers house
 - c. Yao
 - (1) women will cut a hole in the wall of their room
 - (2) men come to the hole with a stick late at night and thrust into the hole
 - (3) if woman likes him, she will talk to him through the hole
 - (a) if she doesn't like him, she pretends to be asleep
 - (4) Yao men woo by climbing walls
 - (a) girls age 13-14 live alone in a house with a balcony right above the roadside
 - i) men climb the wall to talk to the girl
 - ii) he climbs alone and the girl will help him
 - iii) once she has chosen one of the men, the others must give up
 - (5) Lahu
 - (a) Labour test

[8]



- b. prerequisite for marriage is being a hard worker
 - (1) women must be keen and quick
 - (a) be able to weave and sew
 - (b) men must be skilled as a farmer and woodcutter
 - (c) appearance is secondary and family wealth is of little importance
 - (d) after engagement, both of them go to work in the other's home
 - (e) if one of them is incapable or lazy, the other will break the engagement

5. Hanı

- a. one party goes to other party's home to spend a period of time farming and living together
 - (1) if both satisfied, he or she will return home to prepare for wedding
 - (a) if one is not satisfied
 - (b) remunerated and leave for good

D. Marriage Ceremonies

1. Jing bride

- a. walks to groom's home at a slow pace
 - (1) tip of the toe touching the heel of the other foot
 - (2) must avoid passing religious temples and ancestral halls
 - (3) passersby make way for her, including local officials

2. Li bride

- a. walks to bridegroom's home
 - (1) if brides encounters a snake on the way, must return to inform parents
 - (a) parents ask a sorcerer to expel the evil before letting her go again
 - (2) will be warmly welcomed at the door by the groom, his parents, and relatives
 - (3) wizard follows bride
 - (a) murmuring incantations, wielding a pair of scissors and spreading rice

[9]

3. Mongolian weddings

a. permeated with song

- (1) have songs for meeting the bride
- (2) songs for the wedding ceremony
- (3) departing from her mother
- (4) bride sings song to show her reluctance to leave



4. Tu Wedding

a. wedding with a series of songs

- (1) songs asking the man's family questions on the origin of the universe and reasons for meeting the bride
 - (a) bridegroom's family must answer
- (2) traditional dance
- (3) bride complains of her reluctance to leave family's home
- (4) arrival of bride at the groom's home
- (5) bride's escorts sing about the hardships they have suffered along the way
 - (a) demand a gift of *hada* {a piece of silk used as a gift among the Tibetans and Mongolians and a drink of wine}
 - (b) groom's family gives them out one by one as they sing
- (6) Tujia
 - (a) women sing *Song of Weeping Over Marriage*
 - (b) bride chants weeping songs in Tujia dialect for parents, brothers, sisters-in-law, matchmaker, etc.
 - (c) weeps 7-10 days for own distress and misery, but sometimes as long as a month
 - (d) weeps until mouth and tongue becomes dry and she loses her voice and consciousness
 - i) considered a capable woman at this point
- (7) Jing
 - (a) bride must weep and sing 3-7 days before the wedding

[10]



- A. Weddings on Foot
1. Jing Bride
 - a. walks to her groom's home at a slow pace
 - (1) tip of the toe touching the heel of the other foot
 - (2) must avoid passing religious temples and ancestral halls
 - (3) passersby make way for her, even local officials
 2. Li Bride
 - a. walks to the bridegroom's home
 - b. if she should run into a snake on the way, must return to her parents
 - (1) parents ask a sorcerer to expel the evil
 - c. welcomed at the door by groom, his parents and relatives
 - d. wizard follows the bride
 - (1) murmuring incantations, wielding a pair of scissors and spreading rice
 - (a) beats a fresh egg with scissors to expel ghosts and this ensures the bride of a peaceful future
- B. Weddings Held at both Families
1. Kirgiz Weddings
 - a. usually held twice
 - (1) first time at the bride's home and second at the groom's home
 - b. bride must jump over a bonfire while someone chants scriptures when she arrives at the groom's home
 - c. an imam presides at the wedding
 - (1) imam recites Islamic scripture and prays
 - (2) pronounces man and wife
- C. Marrying off the Bridegroom
1. Lahu
 - a. wedding is held at the brides's home
 - b. bridegroom removes his personal objects and several farm tools to the brides home
 - (1) groom gives parent-in-laws a bamboo tube of clear water
 - (a) sign of respect



- D. Separate Life from Husband
1. Popular among the Miao, Bouyei, Dong, Li, Shui, Maonan, Yao, and Jingpo people
 - a. *Miao*
 - (1) newlyweds do not go through a ceremony
 - (2) do not sleep together
 - (a) symbol of their union
 - (b) does not indicate the beginning of family life
 - (c) bride returns to her home afterwards
 - i) stays with husband during the Spring Festival and on festival occasions and significant days of the husband's family
 - ii) forbidden to touch any cooking utensils
 - (d) separate life lasts for one to two years
 - i) in some cases five to six years
 - (3) separate life ends when she is pregnant, or is old enough
 - (a) becomes a member of the groom's family
 - b. *Bouyei*
 - (1) bride and groom abstain from sexual relations on their wedding night
 - (2) bride's pigtail changed to a married woman's chignon and then a fan-shaped hat is worn
 - (a) signifies the bride's new life and is conducted within 1-2 years after the wedding
 - i) status change from girl to woman
- E. Education
1. Article 2: Law of the People's Republic of China on Compulsory Education
 - a. nine (9) years' compulsory education for all Chinese people {applies to minorities as well}
 - (1) China has a competitive exam to get into a university
 - (2) minorities have fewer chances to make required score
 - (3) government gives minority children a chance
 2. Quality of Education
 - a. minority children are given 10 points to add to their exam score

[12]



- 3. Agricultural society
 - a. students spend time helping with farm work
- 4. Teachers
 - a. government offers higher salaries to teachers in the minority school
 - (1) most teachers in the minority schools are from the minority areas

V. Government Policy: Population Control

A. Since the 1970's, the government regards family planning and population control and the improvement of population quality as long term and basic national policy.

- 1. One couple---One child
 - a. National minorities
 - (1) encourage couples to have only one child
 - (2) three or more children are common
 - (a) one child policy is difficult to enforce in the rural areas, especially among the minorities

NATIONAL ETHNIC MINORITIES IN THE PRC

<i>HAN</i>	Jing	Orogen	Yugur
Achang	Jingpo	Ozek	Zhuang
Bai	Jino	Pumi	
Blang	Kazak	Qiang	
Bonan	Kirgiz	Russian	
Bouyei	Korean	Salar	
Daur	Lahu	She	
Deang	Lhoba	Shui	
Dai	Li	Tajik	
Dong	Lisu	Tatar	
Dongxiang	Manchu	Tibetan	
Drung	Maona	Tu	
Ewenki	Miao	Tujia	
Gaosham	Moinba	Uygur	
Gelo	Mongolian	Va	
Hani	Mulam	Xibe	
Hazhen	Naxi	Yao	
Hui	Nu	Yi	

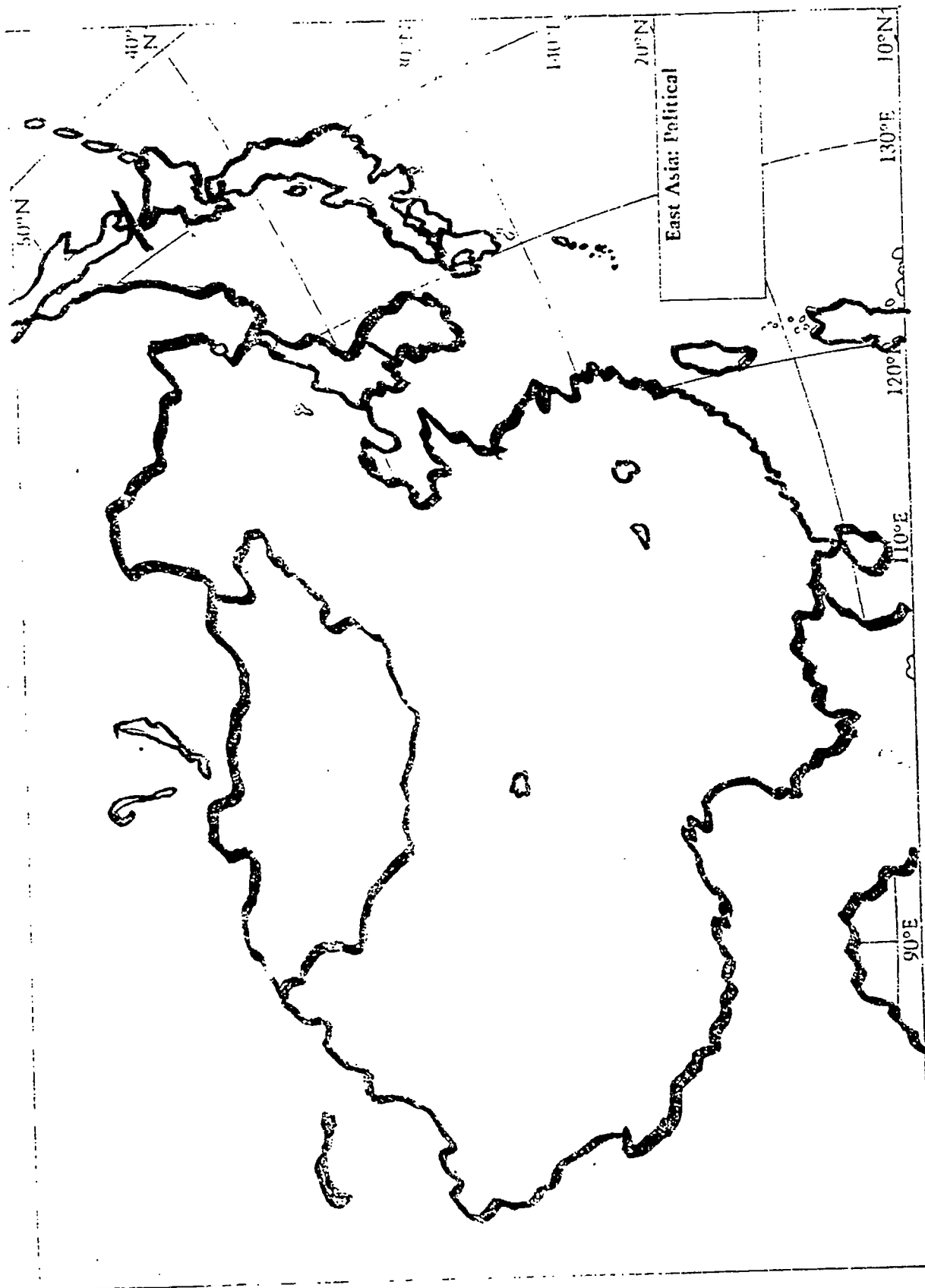

Political Map

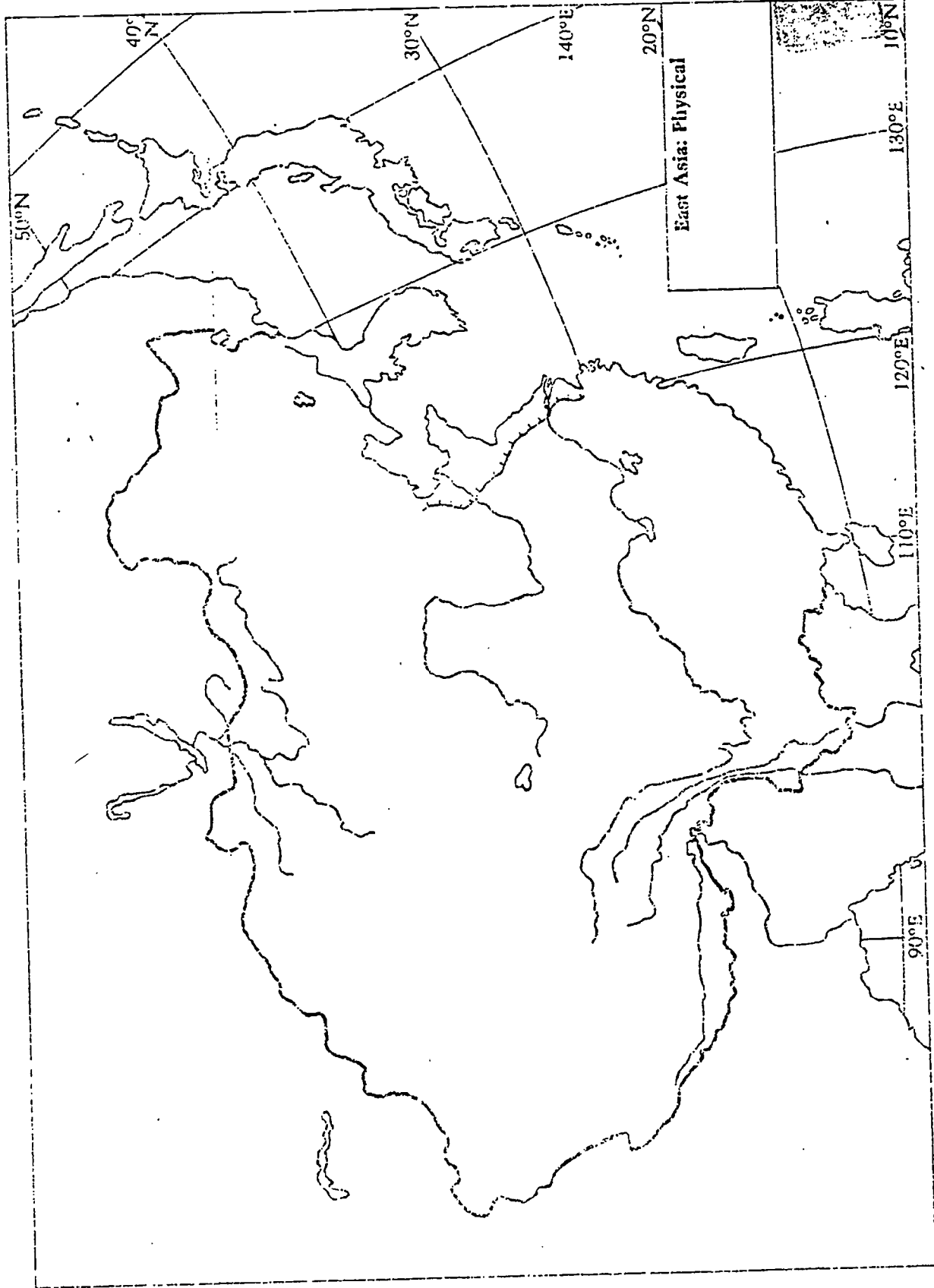

— Physical Map:
— People's Republic of China

JOKER



族 居住在
巴西亞的亞
各二萬人口

HERKOL

2 ♠



族 主要分佈
在吉林延吉
人口約一百九
朝十萬

♥ 2

3 ♠



族 居住在
北的松花江
人口約四
赫百

♥ 2

JOKER



族 居住在
南西北滿江
人口約五
萬八千

HERKOL

A ♠



族 人口約
四百八十萬
人分佈在
滿全疆各地

♥ A

4 ♠



族 居住在內
蒙古草原上
人口約四百八
十萬

♥ 4

♥ 3



族 居住在
北的松花江
人口約四
赫百

♥ 3

♥ 4



族 分佈在
蒙古草原上
人口約四
百八十萬

♥ 4

Ethnic Minorities

3 ♠



赫哲族
居住在北的松花江
人口約四萬
赫哲

♥ 3

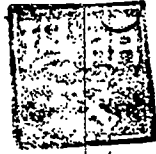

英蘭

A ♠



滿族
人口約
四百八十萬
人，分佈在
滿全國各地。

♥ A

Ethnic Minorities



Chinese National Ethnic Minorities. The chart on page 13 can be use to make a transparency.

East Asia: Political Map. Outline included.

East Asia: Physical Map. Outline included.

Handout: Chinese Minorities: These sheets may be duplicated and/or used to make a transparency.

Photographs, brochures, slides, and Videos.
Fulbright-Hays Seminars Abroad Program.
China: Tradition and Transformation. Summer 1993.

REFERENCE MATERIALS

China--Facts and Figures. China's Population and Religious Policy. Beijing, China: New Star Publishers. 1992.

China--Facts and Figures. Marriage Customs of Chinese Ethnic Minorities. Beijing, China: New Star Publishers. 1992.

China--Facts and Figures. China's Population. Beijing, China: New Star Publishers. 1992.

Zheng, Lan. *Travels Through Xishuangbanna. China's Subtropical Home of Many Nationalities.* Beijing, China: Foreign Language Press. 1981.



LECTURE NOTES.

Beijing Normal University, Beijing, China.

- July 3, 1993. *Woman and Family in China.* Professor Pang Lijuan.
July 5, 1993. *Chinese Education.* Professor Wang Yingjie.
July 8, 1993. *Chinese Folklore.* Professor Li Defang.
July 10, 1993. *Population and Nationality in China.* Professor Feng Jiaping.

United States Embassy. Beijing, China.

- June 30, 1993. *Introduction and Overview of the People's Republic of China.* Frank W. Scotton.

Xian, People's Republic of China.

- July 12, 1993. *History of Shannxi.* Associate Professor: Hushi Qin.
Shannxi Normal University.

Guilin, People's Republic of China. {Guangxi Autonomous Region}

- July 14, 1993. *Minorities.* Quinyan Huan. Director of Local Minorities:
Guilin.

VIDEOS

Guilin Minority Museum. Permission was given to video exhibits in the
Museum. July 16, 1993.

Visit to a Yao Villiage. Guangxi Autonomous Region. Filmed and
produced by Mary Ellis-Hansen. July 18, 1993.

OTHER MATERIALS.

Yao Clothing.



熙
風



Shanghai cuisine

Seafood is an outstanding feature of Shanghai cuisine. Fried green crab with red beans, braised carp head in sweet brown sauce, and braised superior abalone, to name a few, are famous Shanghai dishes. Shanghai dishes are actually refined combinations of delicious dishes from neighboring provinces. They often consist of dishes cooked with brown sauce and steamed or stewed seafood with heavy seasoning. Beggar's chicken and eight treasure duck as well as preserved foods such as salted fish, dried bamboo shoots and mushrooms, are also popular Shanghai dishes.

Szechuan cuisine

Szechuan cuisine is distinguished by the clever use of spices. Star anise, fennel seed, chili and coriander are very often applied to the hot dishes of Szechuan, such as squid rolls with dried pepper. Chicken, pork, river fish and shellfish are popular, and a specialty of this region is smoked duck. In terms of technique, Szechuan dishes often employ multiple processes, smoked duck, for instance, is flavored with pepper-corns, ginger, cinnamon, orange peel and coriander, marinated for 24 hours, steamed for two hours, and finally smoked over a charcoal fire to which camphor wood and tea leaves are added.



Chaochou cuisine

Chaochou, though a district within Canton province, has its unique style of cuisine quite different from Cantonese food. Chaochou food is described as gutsy and hearty, and chefs pride themselves on their skills in vegetable carving. The lively designs of flowers, birds and dragons make a magnificent decoration for the banquet table. A Chaochou meal begins with a small cup of Tieh Kwun Yin tea to clean the palate and stimulate the taste buds. Famous shellfish dishes, shark's fin soup, steamed goose in soy sauce may follow. Chaochou restaurants usually stay open until the small hours.

Cantonese cuisine

Cantonese dishes are known for their great variety. In addition to the roasted or stir-fried dishes, Cantonese dimsum (pastry) and seafood are also favored by gourmets. A real Cantonese meal can range from a quick snack to an elaborate 12-course banquet featuring delicacies such as abalone, shark's fin or swallow's nest soup. Cantonese food is less spicy and more colorful than other styles. Roast suckling pig, braised shark's fin with greens and deep-fried prawn pauquette are popular dishes in a banquet, while a snack with dimsum and Chinese tea can also be a delightful experience in Cantonese food.

Chinese Cuisine

Mongolian barbecue
 Mongolian barbecue originated among the nomads of Mongolia, and has been refined to a new level of excellence in Taiwan. Mongolian barbecue consists of meat, poultry and vegetables for patrons to fill their bowls with to be broiled on a big grill. In winter, hotpot is also served in Mongolian barbecue restaurants. Frozen beancurd, bean flour noodle, beef and mutton are cooked in a hot pot together with many other ingredients and condiments.

Taiwanese cuisine
 Taiwanese cuisine is dominated by seafood and noted for its large variety of soups. Since the Taiwanese have their origins in Fukien, this mainland province has a profound influence on Taiwanese food. Many Taiwanese restaurants feature large tanks of live shrimps, lobsters, crabs and fish, from which gourmets may choose their favorite. Taiwanese soups feature mostly seafood, including turtle, shark's fin and clams. Seasonings are mild and sweet compared with other regional cuisines. Steamed rice with crab and shellfish wrapped around pickles are among the most famous dishes.



Peking cuisine
 Peking was the Chinese capital through several dynasties in Chinese history, and Peking cuisine is famous for its freshness and tenderness. Though the cooking style is plain, many materials are used. Dishes, such as celestial beef and baked beancurd are normally mild and without heavy seasoning. The best known and most typical dish is Peking duck, marinated roast duck fattened specially for the table, roasted in a special oven, and served with pancakes, spring onions or leeks, and sweet bean sauce. Noodles and dumplings are also popular food in northern China, represented by Peking cuisine.

Hunan cuisine
 Hunan cuisine is either spicy and hot or sweet and sour. It is comparable to Szechuan cuisine, but oilier. The banquet dishes are often delicately seasoned. Steamed dishes are particularly popular, such as minced pork in cantaloupe cup. Pork and scallops minced and seasoned placed in a cantaloupe cup, and steamed before they are served. Honey ham with dates is another famous Hunan steamed dish. Raw ham slices are steamed with honey and black dates, cut into pieces, steamed again with the addition of sugar, and served with bread.

Mary Ellis-Hansen



Baldwin County Public Schools
Daphne High School
300 East Lawson Road
Daphne, AL 36526

SUBJECT: Social Studies, Home Economics, World Cultures, Health and
and Nutrition, Enrichment Programs and/or Activities

AUDIENCE: Ninth, Tenth, Eleventh, or Twelfth Grades

UNIT: *Chinese Studies*

LESSON: Chinese Cuisine

OBJECTIVES: Upon completion of lesson, *Chinese Cuisine*, the students
should be able to:

- categorize Chinese Cuisine as either northern or southern
- relate cooking styles with geographic location
- compare and contrast Chinese Cuisine with local cooking
- demonstrate basic skills in preparing Chinese Cuisine
- Explain nutrition and medical value in Chinese foods

INSTRUCTIONAL SUPPLIES NEEDED:

Chinese cookbooks, magazines and cookbooks featuring
American cuisine, pictures of Chinese food, lazy-Susan,
chopsticks, soup spoon, dishes, wok, ingredients for Chinese
dishes, overhead projector and transparencies showing the
Chinese cooking utensils and how to use chopsticks.
Photographs, slides and videos: Chinese Cuisine.

TIME FRAME: 2-3 days for the content. One day for cooking activity.

LESSON OVERVIEW: Chinese food varies from province to province
[16]



in China. However, it can be categorized either *northern* or *southern*.

Northern dishes are typically oily, flavored strongly with vinegar and garlic. Noodles and dumplings play an important role. Peking, Tientsin, and Shantung are the best known *northern styles*.

Southern dishes include the spicy Szechwan and Hunan food, emphasizing freshness and tender ingredients.

Chinese cooking emphasizes not only flavor, but also color and aroma.

Nutrition is another guideline to ensure harmony in foods.

Medical value is also valued by the Chinese in the belief that food and medicine share the same origin.

MOTIVATING TECHNIQUES:

Ask students if they have eaten Chinese food.
Have volunteers describe this food.

Discuss how this food differs from traditional American food.
{Predominate use of rice, variety of vegetables, less meat, and no dairy products}

Write observations on the board and then ask why these differences exist. Tell students to look for answers while they study the Chinese and their food supply.

MOTIVATE FOR LEARNING:

Ask the students *did you know*.....

According to nutritionist, Xie Guizhen, an individual eats several thousand times his weight in food during a lifetime.



In all, water will account for over 75 tons, carbohydrates over 17 tons, protein more than 2.5 tons, and fat more than 1.3 tons. {*Chinese Cooking*. p. 9}

Did you know that among Chinese it is acceptable to:

- put bones on the table next to the plate
- slurp the soup
- burp gently
- use a toothpick at dinner parties with one hand over the mouth while the other maneuvers the pick {*Briefing Book*. p. 5}

Did you know that the Chinese have rules and Customs associated with eating such as:

- meals must be taken while seated
- set order of who may be seated among men, women, old, and young
- main course must be eaten with chopsticks
- soup must be eaten with soup spoon
- arrival of fruit on the table is the signal that the meal has reached its conclusion

FOCUS ACTIVITY:

Tell students Chinese food emphasizes flavor, color, aroma, nutrition and medical value.

The basic skills in preparing Chinese dishes include braising, mixed boiling, stir-frying, frying, steamed, stewed, smoked, and roasted.

Cutting techniques can be witnessed in the unusual arrangements of cold dishes.

SLIDE PRESENTATION:

Ten Slides. Show the class various dishes and arrangement of dishes on the table. Point out the importance of color and the

[18]

III. Culinary Arts



- A. has gone through thousands of years of refinement and development
- B. the secret to Chinese cooking lies in the fire
 - 1. example: cooking a fried dish is very quick, taking 10-15 minutes at the most
- C. Chinese food appeals to the senses through color, shape, aroma, and taste
- D. to achieve perfection in Chinese cooking, one must understand the techniques underlying the art
 - 1. Cutting
 - a. shape depends on cutting
 - b. color, aroma, and taste affected by cutting
 - c. improper cutting makes food unattractive and causes an unevenness in color and taste
 - 2. Flavoring
 - a. proper use of seasonings and spice is important
 - b. many tastes---salty, sweet, sour, pungent, and fragrant
 - c. salty predominant
 - (1) improves flavor
 - (2) eliminates fishy or gamy flavors
 - d. sugars sweetens and can dissolve fats and eliminate or offset bitter flavors
 - e. vinegar dissolves calcium and cuts the greasiness of a dish
 - 3. Regional styles
 - a. variety of regional styles and dishes is enormous
 - (1) depends on natural resources available

IV. Health and Diet

- A. the human body takes in seven basic substances from food: carbohydrates, fat, protein, vitamins, inorganic salts, cellulose and water {*Chinese Cooking*. p.9}
 - 1. carbohydrates and fats
 - a. major source of heat energy calories
 - b. grains and tubers rich in carbohydrates
 - 2. protein
 - a. source of energy in the human body

[19]



- b. exist in all forms of animal and plant tissue
 - (1) egg, milk, meats, grains, {rice, wheat, corn} soya bean, potato
- 3. vitamins
 - a. vitamin A promotes the growth of tissue and maintenance of normal eyesight
 - b. Beriberi is caused by insufficient amount of vitamin B1
 - c. Scurvy is caused by insufficient intake of vitamin C
- 4. cellulose
 - a. lowers serum cholesterol and vegetables, has shown effectiveness in preventing cancer {*Chinese Cooking*. p. 12}
- B. Chinese medicine has historically used certain foods, their nutrients, and their pharmaceutical qualities to treat certain conditions and diseases {*Chinese Cooking*. p. 12}
 - 1. Garlic
 - a. used against infections
 - b. treatment of carbuncles and inflammations
 - c. effective in getting rid of worms and parasites in the intestinal tract
 - 2. Scallions
 - a. used in the treatment of colds and influenza
 - b. eating raw scallions improve blood circulation
 - c. scallion bulbs and watercress are good for the brain
 - 3. Radishes
 - a. reduce phlegm and relieve coughing
 - 4. Bean milk and beancurd
 - a. prevents fevers
 - 5. Ginger
 - a. stimulates many activities in the body, e.g. gastric secretion, blood circulation, and perspiration
 - 6. Raw peanuts, dates, and walnuts
 - a. good for bone marrow
 - b. serves a function in the production of red blood cells and platelets

[20]

- 
- c. prevents and used to treat anaemia
 7. Black edible fungi
 - a. clears the villi in the stomach, intestines, and lungs
 8. Spring Onions
 - a. can stimulate and improve digestion
 - b. has the ability to ward off the common cold
 9. Chili Peppers
 - a. excellent stimulant of the appetite, nerves, blood circulation, and perspiration
 10. Chinese White Cabbage
 - a. aids digestion
 - b. ability to reduce heat in three of the major internal organs {lungs, stomach, liver}
 11. Leeks
 - a. can warm and stimulate digestion
 - b. raw leeks able to cleanse the intestines of infections {e.g. dysentery, parasites}
 12. Black Dates and Dried Persimmons
 - a. used to cleanse the breath
 13. Garland Chrysanthemum
 - a. ability to warm and "harmonize" the stomach
 - b. served primarily in the winter
 - c. used fresh to garnish snake dishes or dried in tea and herbal medicines
 14. Long Bean {Americans have named "string bean"}
 - a. has a neutral energy and is believed to tonify both the stomach and kidneys
 15. Bean Curd {tofu}
 - a. calming effect on metabolism
 - b. can stimulates the thyroid
 16. Winter Melon {common name "wax gourd"}
 - a. promotes urination
 - b. chemical analysis shows exceptionally high amounts of sodium, a vital electrolyte excreted in perspiration
 - (1) winter melon soup can restore electrolyte balance, help cleanse the kidneys
 17. Squash {known as pumpkin in the Americas}
 - a. stimulates the spleen and stomach

[21]

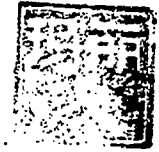

18. Bell Pepper
 - a. stimulates blood circulation
19. Green Papaya
 - a. good for the stomach and digestion
20. Celery
 - a. considered to be neutral
 - b. powerful in its calming effect on the liver
 - c. is a home tonic for lowering blood pressure and cholesterol

GUIDED PRACTICE:

Use vegetables and/or pictures of vegetables for a review of Chinese concepts of nutrition and medicine.

Example: Show the students a *bell pepper*

Response: Stimulates blood circulation

- V. Foods Eaten on Special Occasions{s}
- A. Celery {considered a lucky charm}
 1. served in vegetarian dishes during the Chinese Lunar New Year
 - a. will enable one to be diligent and have the strength to work hard throughout the coming year
 - B. Lettuce
 1. served to the family on birthdays, New Year's Day, graduation days, and other festive occasions
 - C. Snow Peas
 1. eaten occasionally and especially on festive occasions
 - D. Lotus Root
 1. slices of lotus root are candied and served as snacks during the Lunar New Year season
 1. at other special times, whole roots are stuffed with glutinous rice and braised in sugar syrup
 - A. Sweet dumplings {yuan xiao}
 1. customary to eat for the Lantern Festival



- a. round balls made of glutinous rice flour stuffed with sugar fillings
- B. Zongzi
 - 1. glutinous rice wrapped in a pyramid shape using bamboo or reed
 - 2. is the traditional food for the Dragon Boat Festival

TEACHER LED DISCUSSION:

What you might expect to find in a Chinese kitchen.

- A. Use transparency *Basic Kitchen Equipment {1 and 2}*
Ask students to identify basic equipment for a Chinese kitchen.

GUIDED PRACTICE.

- A. Compare and contrast Basic Kitchen Equipment in Chinese and American kitchens.
 - 1. {microwave, electric and/or gas stove, electric knife, electric tea maker, toaster, etc.}
- B. Identify foods one might expect to find in a Chinese market.
 - large tanks of live shrimps, lobsters, crabs, and fish
 - live rabbits, chickens, frogs, quail, turtle, ducks, pigeons, guinea pigs, pork, beef, mutton and snake
 - Variety of vegetables: alfalfa shoots, bamboo shoots, bamboo, mustard cabbage, bean curd, bean sprouts, long beans, bell peppers, bitter melon, cabbage, caltrops, celery, chestnuts, chili peppers, chinese box thorn, chrysanthemum, cucumber, fuzzy melon, eggplant, garlic, ginger, gourd, honey peas, kale, leek,

[23]

kohlrabi, lettuce, lotus root, luffa, mushrooms, onions, papaya,
parsley, pea shoots, pea pods, snow peas, sugar peas.



CULMINATING ACTIVITY:

- Divide the class into groups of 4-5 students
—create a Chinese dinner menu, using authentic Chinese Cookbooks
1. prepare shopping list
 2. locate items at local stores
 - a. find substitutions for items not available
 3. Each group will prepare an authentic Chinese dinner
 4. Identify each Chinese Dish with a note card and/or index card
 - a. display recipe for each dish
 1. organize recipes in a folder and/or book

EXAMPLE OF RECIPE NOTE CARD

Title of Recipe

Ingredients: _____

From: recipe book, magazine, etc.

Directions: _____

Servings: _____

Additional Comments: _____

[24]



This cooking activity can be done during class, but is most effective as an evening activity with the parents participating.

{Parents get involved with school activities when the teacher telephones and explains the activity. The teacher encourages the parent{s} to attend.

In class activity or evening activity

... Items needed

- a. paper plates
- b. chop sticks
- c. napkins
- d. cups for tea
- e. table cloths {white flat sheet are excellent}
- f. lazy susans
{use the top of press wood round tables and place on a regular lazy susan base. . . works great}
- g. serving plates
{each group responsible for providing serving utensils}
- h. Guest Book

EVENING ACTIVITY

Use the school cafeteria for the Chinese Dinner
{gives you access to the kitchen}

Group Responsibility

Divide tasks among the group
... items needed

[25]



EVALUATION TECHNIQUES:

- Essay. Compare and contrast an American Kitchen with a Chinese kitchen.
- Essay. Chinese cooking emphasizes not only flavor, but color, and aroma. Explain.
- Essay. List five foods and describe the medical value of foods.
- Group: Chinese Dinner
Observation/check-list

OBSERVATION/CHECK-LIST

- Cooperative _____
- shows respect for classmates _____
- Contributes in planning menu _____
- Shares ideas with group _____
- Shares cooking with members of group _____
- Volunteers for committee work _____
- Brings items needed for activity _____
- Helps set up for Cooking activity _____
- Cleans up after activity _____
- other _____

FUNDING

- Sources: Partners In Education
- Grocery stores for contribution
- School Administrator
- Civic Organizations
- Parents
- Grant Money

BASIC EQUIPMENT FOR A CHINESE HOME KITCHEN

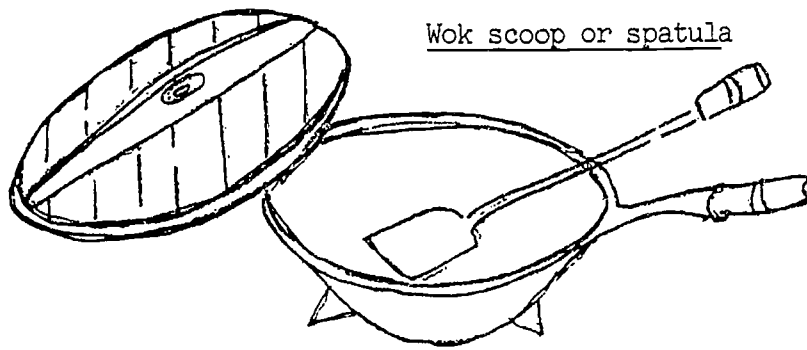

Wok scoop or spatula

Wok or skillet

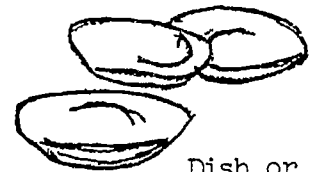

Dish or saucer



Wok spoon

Soup Spoon

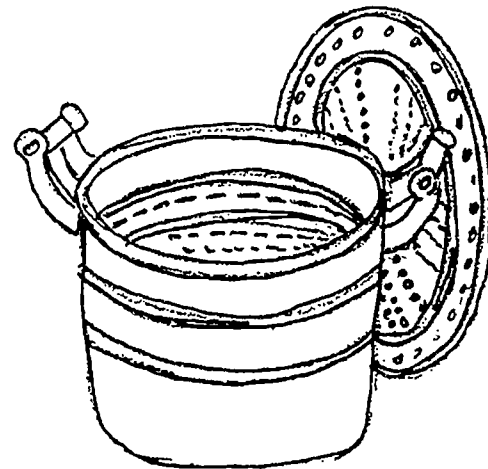

Bamboo steamer or assembled metal steamer

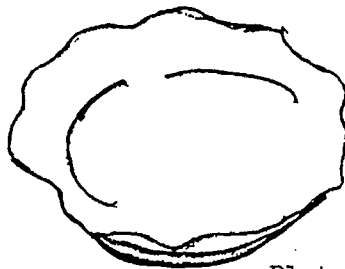
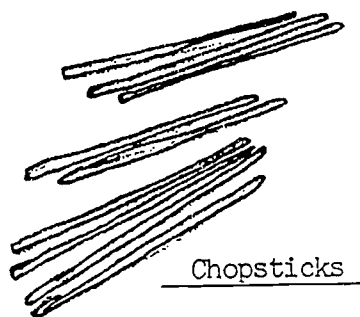
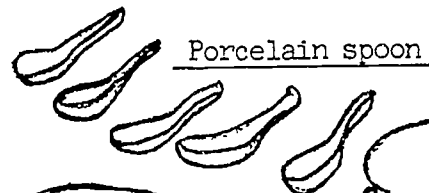

Plate and platter



Chopsticks



Porcelain spoon



Dish

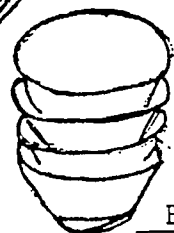

Bowl

BASIC EQUIPMENT FOR A CHINESE HOME KITCHEN



Bamboo strainer



Perforated spoon

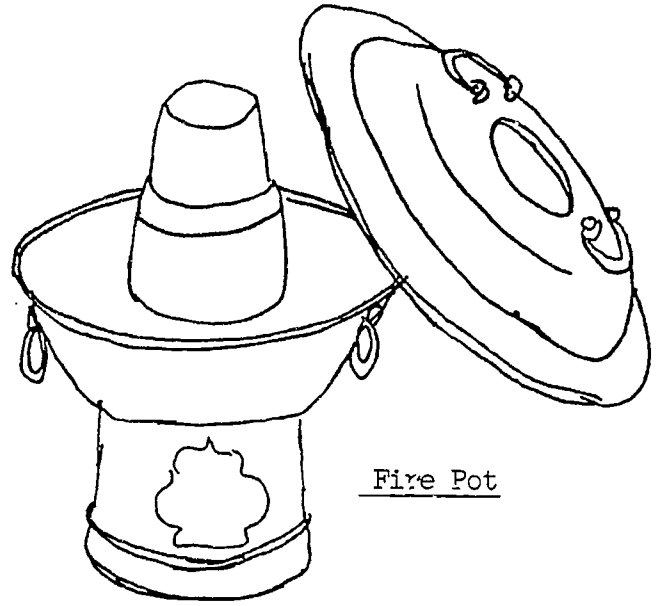

Fire Pot



Earthenware casserole

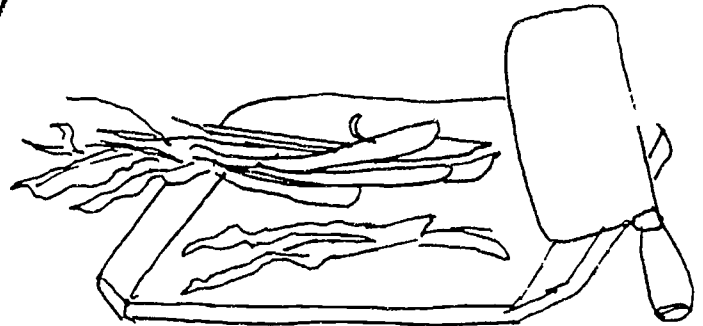

Chopping Board and cleaver

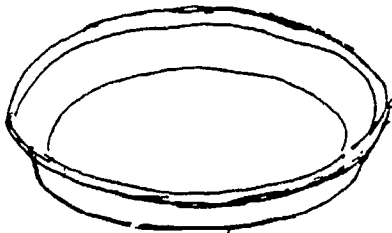

Pan

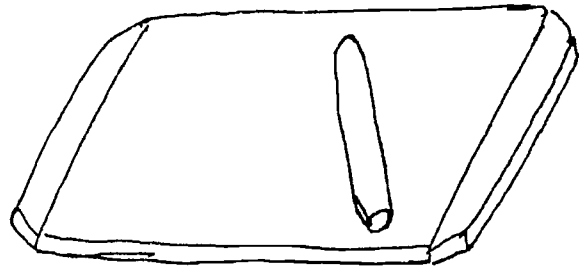

Pastry board and rolling pin

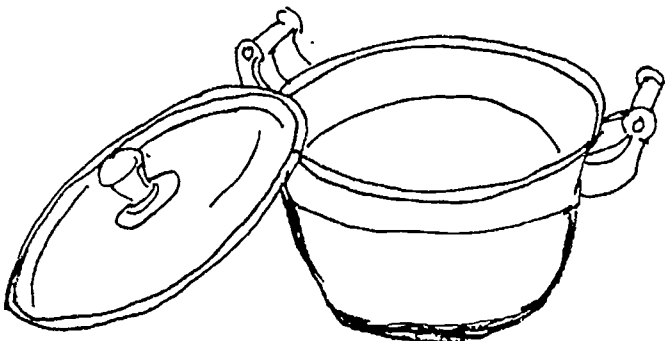

Saucerpan

Chopsticks

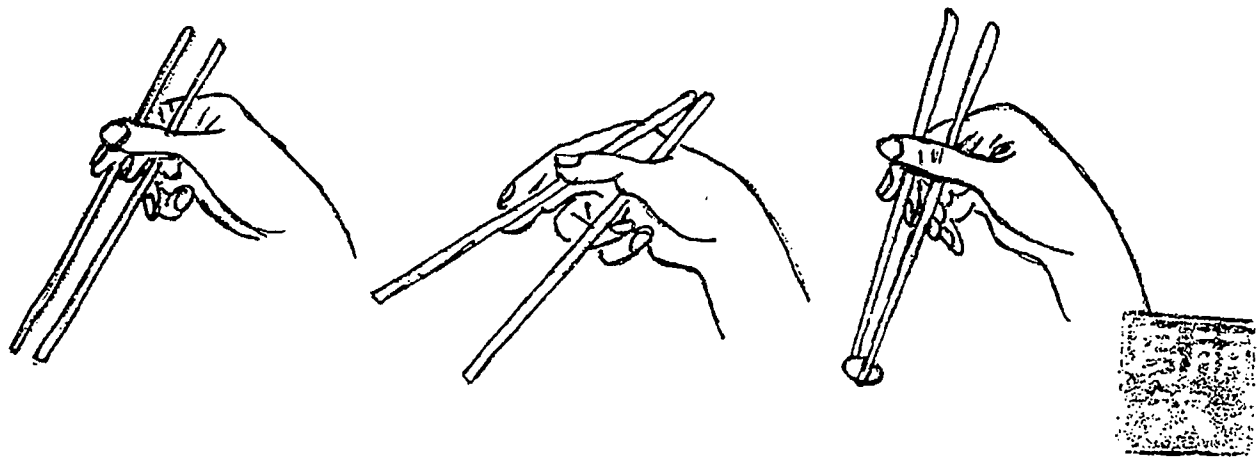

To learn to use chopsticks, perch them between the thumb, first, middle, and ring fingers so that they lie parallel to each other.

The lower chopstick rests on the inside tip of the ring finger which keeps it stationary, while the thumb, first and middle fingers manoeuvre the upper chopstick in a pincer movement to pick up the food.

Holiday Inn Breakfast Menu

Guilin



ood

AMERICAN BREAKFAST

Choice of chilled juices or season fruits

Cornflakes, all grain rice crispies or hot oatmeal with milk or cream

Two eggs any style with ham, bacon or sausage

Choice of croissant, danish pastries, toast, muffins, rolls or banana bread

Coffee or tea

BUFFET BREAKFAST

自助早餐

\$55.00

EGGS AND OMELETTES

Two fresh farm eggs any style \$2.00

with ham, bacon or sausage \$6.00

Plan omelette \$7.00

with cheese \$8.00

CONTINENTAL BREAKFAST

歐陸式早餐

Choice of chilled juices

任選一杯果汁或鮮果

Choice of croissant, danish pastries, toast, muffins, rolls or banana bread

任選一種麵包配黃油和果醬牛角飽、丹麥飽、早餐飽、多士、小松糕或香煎餅

Coffee or tea

\$2.00

FRESH FROM OUR BAKERY

各式麵包

Croissant or danish pastries \$2.00

牛角飽、丹麥麥飽

Muffins, soft rolls or

小松糕、小餐包或

Banana bread

香蕉飽

香煎餅

Holiday Inn Breakfast Menu

Guilin

Morning

HOT OR COLD CEREALS

食物類	FECS
Oatmeal 麥片粥	14.00
Corn flakes, rice crispies 粟米片, 脆米	12.00
All bran or shredded wheat 什錦乾麥片	12.00

BREAKFAST FAVOURITES

早餐精選	FECS
Breakfast steak with toast Topped with Fried Egg 早餐牛扒配多士加煎蛋	33.00
Corned beef with grilled tomato Freshly brewed coffee Topped with Fried Egg 咸牛肉配紅柿豆加煎蛋	30.00
Assorted cold-cuts and cheese 什錦冷肉和奶酪	24.00
Chicken or pork congee Served with Fresh Egg 雞肉或豬肉粥加鮮雞蛋	24.00



All prices are subject to 15% Service Charge
加收15%附加費

Holiday Inn
林氏酒店

JUICES & FRUITS

果汁和鮮果	FECS
Chilled fruit juices Orange, pineapple, grapefruit or tomato 各式果汁 橙子汁、菠蘿汁、西柚汁、蕃茄汁	12.00
Fresh fruit in season with yogurt 鮮奶鮮果	14.00
Stewed fruit or compote 水果盆	10.00
Fruit cocktail 水果乾啤	10.00

BEVERAGES

飲料	FECS
Freshly brewed coffee 香濃咖啡	8.00
Decaffeinated coffee 無咖啡因之咖啡	9.00
Chinese tea 英式紅茶	6.00
English tea 中國茶	8.00
Hot or cold milk 熱或冷牛奶	8.00
Hot chocolate 熱巧克力	10.00
Mineral water 礦泉水	10.00



今日菜单

冷菜类 COLD DISHES:

1、双味拼盘	Mixed cold dish	18.00
2、麻辣肚条	Cold tripe slices with hot sauce	15.00
3、凉拌鸭掌	Cold duck web	17.00
4、白切嫩鸡	Poached chicken	20.00
5、麻辣牛健	Saute beef with hot pepper	17.00
6、煮花生	Peanuts of brine	3.00
7、泡菜	Pickle vegetable	3.00

汤菜类 SOUPS:

1、蛤蚧炖全鸡	Steamed lizards with whole chicken	173.00
2、川汤鸡	Delicious chicken soup	21.00
3、三丝金菇汤	Golden with mushroom, bamboo chicken soup	17.00
4、荔芋羹(咸、甜)	Guilin taro thick soup (sweet, salt) (每碗)	5.00
5、榕湖牛肉羹	Ronghu beef thick soup	14.00
6、鱼头豆腐汤	Fish head with bean curd soup	14.00
7、粟米羹(咸、甜)		每碗 5.00

面食类 RICE AND NOODLES:

1、馒头(半打)	Steamed bun	每个0.70
2、烙饼	Pan cakes	每个1.20
3、水饺(一打)	Dumplings	每个0.30
4、米饭(碗)	Fresh rice	0.60
5、桂花炒饭	Fried rice "Guilin" style	6.00
6、肉丝炒粉	Fried rice noodles with shredded pork	7.00
7、三鲜拌面	Noodle with pork soup	12.00

TODAY'S MENU

热菜类 (地方风味) LOCAL FLAVOUR:

1、干笋焖肉	Braised diced pork with bamboo shoots	14.00
2、荔芋扣肉	Braised pork slices with taro(Guilin style)	21.00
3、生爆兔块	Fried rabbits	20.00
4、美味田螺	Delicious li river snail	12.00
5、爆炒鸭	Fried duck	17.00
6、豆瓣鲤鱼	Bean paste with carp	21.00
7、五香鹌鹑	Flavour spiced quails	(每只) 6.00
8、铁板豉汁鸡	Grilled chicken with preserved bean	29.00
9、铁板扒牛排	Grilled beef	23.00
10、铁板烹鹌鹑	Grilled quails	21.00
11、砂煲鳝鱼	Boil eels by earthen pot	21.00
12、腰果鸡丁	Diced chicken with cashew-nuts	29.00
13、酸炒牛肉	Fried shredded beef with pickled vegetable	16.00
14、酸炒肚片	Fried pig's tripe slice with pickled vegetable	17.00
15、脆炸牛脑	Deep-fried ox brain in bread-crumbs	16.00
16、清蒸鲈鱼	Steamed catfish	29.00
17、脆皮马蹄夹	Deep-fried water-chasnrts with mince pork	17.00
18、素油炒时菜	Fried vegetable heart	6.00
19、素油烧双冬	Fried mushroom with bamboo shoots	9.00
20、山水豆腐	Steamed bean-curd "Guilin" style	12.00
21、双冬水鱼	Braised turtle with mushroom and bamboo shoots	92.00
22、紫盅水鱼	Turtle soup (Ronghu style)	17.00
23、蚝油牛肉	Shredded beef in oyster sauce	17.00
24、清蒸漓江鱼	Steamed river fish	21.00
25、青椒炒牛鞭		17.00
26、素油烧腐竹	Saute bean-curd sheet roots	9.00
27、红烧豆腐	Red-cooked bean curd	7.00
28、铁板兔	Grilled rabbit	29.00

Chinese and English

八	丹	龙	荷	杜	椒	薯	红	西	美	水
味	珠	须	花	丹	榄	汁	灯	湖	点	果
小	虾	珠	龙	蟹	川	脆	鸡	明	双	拼
碟	仁	笋	眼	粉	蒜	鳝	片	月	辉	盆

龙 华 迎 宾 馆

菜 单

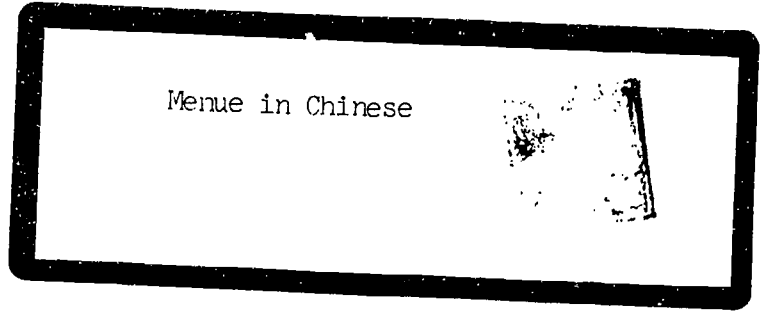



REFERENCES

Briefing Book on the People's Republic of China. New York: National committee on United States-China Relations. 1993.

Chinese Cooking. Beijing, China: Morning Glory Publishers. 1990.

Dahlen, Martha. *A Cook's Guide to Chinese Vegetables.* Hong Kong: Pacific Publishers Limited. 1992.

Jinhuai, Wang and Yuan, Xue. *Chinese Home-Style Cooking.* Beijing, China: Foreign Language Press. 1990.

The Chinese Art of Food and Drink. Traditional Chinese Culture in Taiwan. Taipei, ROC: Kwang Hwa Publishing Company. 1991.

Two weeks Delicious Dishes. Hong Kong: Food Paradise Publishing Company. 1991.

Zhu, Zhang Shi. *Album of Chinese Delicacies.* Shanghai, China: Xvelin Publishing House. 1993.

Media

Phonographs, slides, and videos. *Chinese Cuisine. China, Hong Kong, and Taiwan.* {Fulbright-Hays Seminars Abroad Program. China: Tradition and Transformation} June 28-August 3, 1993.

REFERENCES



Briefing Book on the People's Republic of China. New York: National committee on United States-China Relations. 1993.

Chinese Cooking. Beijing, China: Morning Glory Publishers. 1990.

Dahlen, Martha. *A Cook's Guide to Chinese Vegetables.* Hong Kong: Pacific Publishers Limited. 1992.

Jinhuai, Wang and Yuan, Xue. *Chinese Home-Style Cooking.* Beijing, China: Foreign Language Press. 1990.

The Chinese Art of Food and Drink. Traditional Chinese Culture in Taiwan. Taipei, ROC: Kwang Hwa Publishing Company. 1991.

Two weeks Delicious Dishes. Hong Kong: Food Paradise Publishing Company. 1991.

Zhu, Zhang Shi. *Album of Chinese Delicacies.* Shanghai, China: Xvelin Publishing House. 1993.

Media

Phonographs, slides, and videos. *Chinese Cuisine. China, Hong Kong, and Taiwan.* {Fulbright-Hays Seminars Abroad Program. China: Tradition and Transformation} June 28-August 3, 1993.

CULTURAL CONTEXTS OF POPULATION MANAGEMENT POLICIES



CHINA AND THE ONE-CHILD POLICY

Submitted by
Barbara Liddell
January 1994

CULTURAL CONTEXTS OF POPULATION MANAGEMENT POLICIES

CHINA AND THE ONE-CHILD POLICY

These lessons are designed to be incorporated into a Contemporary World History or Global Studies course. They can fit into a larger unit on China or into a unit focused on global problems. In this packet, they are written to fit a unit on Contemporary China.

KNOWLEDGE:

- Students will know that worldwide population growth presents enormous political, economic, social, and environmental challenges.
- Students will know what forces have caused population growth to dramatically increase in the last 100 years.
- Using China as an example, students will understand that culture influences attitudes toward and responses to efforts to control population.
 - ▶ Students will know how China has managed to slow population growth in the last 20 years.
 - ▶ Students will know what social and economic forces are at work to make the one-child policy less than a complete success.

SKILLS:

- Students will gain facility in analyzing data displayed in graphs and tables.
- Students will draw conclusions about population growth worldwide and about China in particular.
- Using multiple perspectives, students will evaluate the one-child policy.

ATTITUDES:

- Students will recognize that events occurring on other continents can have serious global implications and that nations and individuals must act responsibly to help resolve global problems.
- Students will credit China with acting responsibly and with some success in resolving its population problem.
- Students will acknowledge the challenges inherent in implementing policy that challenges traditional attitudes and practices.

BACKGROUND FOR THE TEACHER:

Every three years enough people are added to the earth to equal the population of the United States. This growth rate has accelerated in the last half of this century as a result of improved international health standards, which lowered infant mortality rates, and increased longevity. Nowhere is this pattern more true than in China, where the trend was also accelerated by improved farming methods and the production of new grain crops, notably corn, both of which contributed to improved nutrition.

Given current growth rates, worldwide population will double by the year 2020, causing food shortages and vast migrations from poorer to richer countries, which will in turn cause additional shortages in shelter, education and ability to earn a living.

Twenty-five percent of the world's population lives in China. Since 1949, population has grown from 540 million to over 1.1 billion in 1990. China is approximately the same size as the United States and the British Isles combined. The United States had a population of 250 million in 1990. In both countries, arable land is limited (7% of total area in China, 28% in the United States), and the populations are unevenly distributed. The city of Shanghai, which is approximately the same size as San Francisco, has 6 million people within the city limits, while San Francisco has 730 thousand. The western provinces of Xinjiang and Qinghai, on the other hand, are comparable in population per square mile to our own sparsely inhabited regions such as Nevada, the Dakotas and Montana.

In the early 1970's, the Chinese government adopted a family planning policy to control population growth. Family planning agencies run by local governments have been established to promote family planning policy. Elements of the policy are late marriages and late childbirth, and two children per couple. Later this was changed to one child per couple. Free contraception and medical sources were made available to assist its implementation. This policy, plus improved socioeconomic conditions, have combined to slow China's population growth to less than one percent per year.

However, a number of factors interfere with full or consistent implementation – the need for manual labor in rural areas where farming is still labor intensive; no social insurance in rural areas, meaning that children are expected to care for elderly parents; a policy to increase ethnic minorities that are disappearing; and traditional thinking – a high value placed on large families (the more children, the greater happiness) and a higher value for boys than girls, often causing a relaxation of the rules for families who have a first girl, or under-reporting of female births. China's current population growth rate and age structure may prevent realization of the country's population planning goal of 1.2 billion for the year 2000. Even if current planning measures are strictly implemented, the fertility rate will be 1.6, adding 17 million people per year and resulting in a population of 1.3 billion.

This look at China's population policy is one example of the role of culture in the success or failure of such policies. This study can be extended to India, Japan, Germany, and Singapore – examples of countries whose governments, for different reasons, are trying to manage population growth.

World Population Growth: 1750-2100

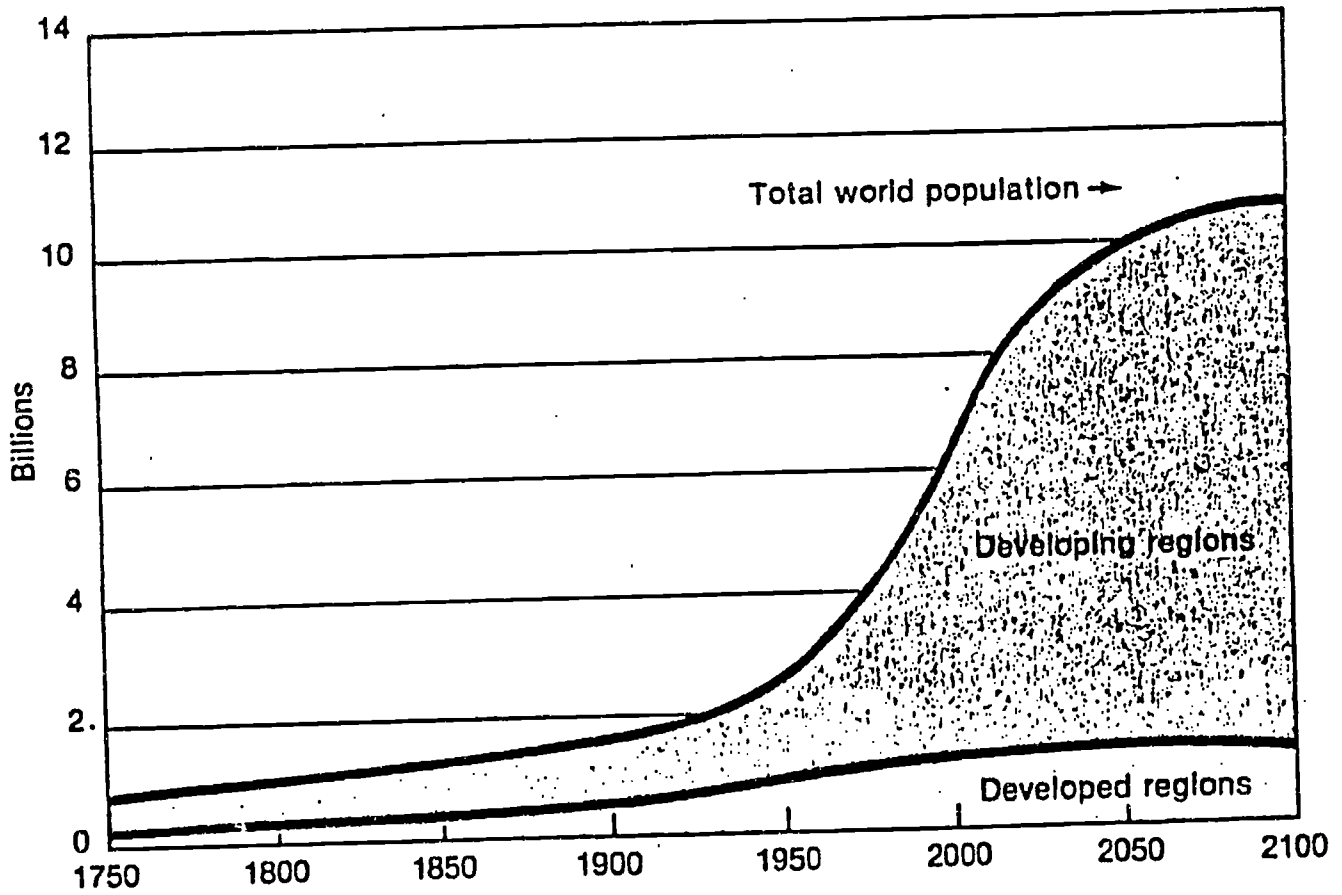

* World Population Facts

	Past Population 1950	Current Population 1992	Future Population 2025 (projection)	No. of Children Per Family	Percent Urban ¹	No. of Children Out of 100 Born Who Die Before Age 5	Percent of Population Under Age 15	Percent of Population 65 and Older	Enough Food Daily? ²	Wealth (per person in 1990) ³
WORLD	2,516,443,000	5,420,391,000	8,545,297,000	3	43	11	33	6	—	\$ 3,790
AFRICA	221,984,000	654,218,000	1,539,583,000	6	30	15	45	3	—	630
Egypt	20,330,000	55,680,000	103,115,000	4	45	11	41	4	Yes+	600
Kenya	6,265,000	24,164,000	62,275,000	7	22	9	49	2	No	370
Sahel Region	16,502,000	44,028,000	109,957,000	7	25	—	46	3	—	375
Burkina Faso	3,654,000	9,567,000	26,006,000	7	18	19	48	4	No	330
Mali	3,520,000	8,538,000	21,665,000	7	22	19	47	4	No	270
ASIA	1,377,259,000	3,207,402,000	4,997,621,000	3	31	9	33	5	—	1,680
Bangladesh	41,783,000	111,445,000	221,625,000	5	14	18	44	3	No	200
China	554,760,000	1,165,771,000	1,590,783,000	2	26	4	28	6	Yes	370
India	357,561,000	882,575,000	1,383,115,000	4	26	13	36	4	No	350
LATIN AMERICA	165,880,000	452,784,000	728,769,000	3	70	8	36	5	—	2,170
Brazil	53,444,000	150,794,000	237,172,000	3	74	9	35	5	Yes+	2,880
Mexico	28,012,000	87,715,000	143,287,000	4	71	6	38	4	Yes+	2,490
Peru	7,632,000	22,454,000	37,350,000	4	70	11	39	4	No	1,160
NORTH AMERICA	166,075,000	283,046,000	362,647,000	2	75	<1	21	12	—	21,580
United States	151,326,000	255,570,000	327,489,000	2	75	<1	22	13	Yes+	21,700
EUROPE*	—	511,040,000	515,862,000	2	75	<1	20	14	—	12,990
Germany	68,376,000	80,556,000	73,701,000	1	90	<1	16	15	Yes+	16,200
AUSTRALIA	8,219,000	17,782,000	23,900,000	2	85	<1	22	11	Yes+	17,080

* Includes newly independent Bahre states.

— Data not available

¹Percent Urban = Percent of population living in areas termed urban by that country.

²Enough Food Daily = Based on the per capita calorie supply. Yes means that most people get about the number of calories necessary to sustain a person at normal levels of activity and health. No means that most people do not get enough calories daily.

Yes+ means that they get more than enough.

³Wealth = The gross national product (GNP) per capita for 1990.

*Crews, Kimberly A., Making Connections, Linking Population and the Environment, Section VIII.

LESSON ONE – ESTABLISHING THE CONTEXT

STUDENT OUTCOMES:

- Students will know that China has acknowledged a responsibility for population reduction since the early 1960s.
- Students will become familiar with the size of world population, its growth rate and the pattern of growth.
- Students will demonstrate the relationships between births and deaths.
- Students will interpret age and sex distribution table.

TEACHER:

“One of the major problems facing China is how to control its population. It is important to China as a nation, but also of importance to all of us because approximately 20% of the world’s population is in China. The earth has about 5 billion inhabitants (5.3 billion in 1990). China has 1.1 billion. The United States has a quarter of a billion. China is the most populous nation in the world. The United States is fourth, as of 1991. How much is a billion? Work in groups of two (or three) to figure these problems out. (Half of the groups can do each problem.) Share answers and discuss.

- a. A stack of U.S. paper currency one inch high will contain 233 bills. If you had a million dollars in thousand dollar bills, how high would the stack of bills be? (4.29 inches high)*
If you had a billion dollars in thousand dollar bills, how high would the stack be? (357 feet or almost the length of a football field)*
- b. How old would you be if you were a million seconds old? (11.6 days)*
A billion second old? (31.7 years)*

- Show the film, “World Population” (See Resources, p. 7) six minutes long. Discussion.
and/or

- Show *World Population Growth Chart* on an overhead projector.

Ask students questions to assist in interpretation, such as:

- ▶ When did world population reach 1 billion?
- ▶ What population is projected for the year 2000?
- ▶ What is a ‘less developed’ region as opposed to a ‘more developed’ region? (See Glossary of Terms, p. 6)
 - What parts of the world are in each region?
- ▶ What are the implications for such rapid growth in these regions?

What causes population to grow so fast? (More people being born than dying.)

Why has growth accelerated so much in recent history? (Improved health care, better farming methods yielding more crops per acre.)

HOMEWORK:

Analyze the data on the *World Population Facts Chart* and answer the following questions:

1. Is China’s number of children per family above or below the world average?
2. How does China’s child mortality rate compare with other countries in the developing regions? In the developed regions?
3. Do most people in China get *enough, more than enough, or less than enough* calories to sustain normal activity and health? How do you know?
4. Draw two diagrams representing the data in the two columns ‘Percent of Population Under Age 15’ and ‘Percent of Population 65 or Older’ for North America, Europe and Australia and another for Asia and Latin America. How are they different?

Read the article “*Continuing Questions in China*” in preparation for tomorrow’s activities.

* *Connections*, Teacher’s Guide, Crewes, Kimberly A., Cancellier, Patricia, eds., Washington, Population Reference Bureau, 1991, p. 14.

CONTINUING QUESTIONS IN CHINA

With a population of 1.1 billion—roughly equivalent to the combined populations of North America, South America, and Europe—China is a necessary focal point in the effort to curb population pressures on the global environment. Indeed, even after two decades of a controversial family planning campaign, China's population is still projected to increase by another half billion people by the year 2050, adding almost another Europe to worldwide levels before stabilizing.

This increase does not mean that China's program has not seen results. To the contrary, Chinese fertility rates have dropped by more than 50 percent in the past 20 years, and recent figures indicate that China might have already reached below-replacement birth rates.

But while China has worked to slow its rapid growth, continuing allegations have arisen regarding human rights abuses within its family planning program, including forced abortion and sterilization. Much of the attention and criticism is centered on the one-child-per-couple policy.

Since the early 1970s, the Chinese government has made a sustained effort to stabilize population growth by reducing the average family size. The long-term goal of this effort has been to stabilize the Chinese population at approximately 1.5 billion by the middle of the next century. Although several different initiatives have been attempted, the main components of the program include the wide distribution of contraceptives and abortion services, the promotion of a small family ideal, an increase in the average age at which Chinese marry, and a heightening of the status of women in Chinese society.

In order to fairly judge China's poli-

Further decrease the birth rate. With increased pressure to meet specific birth targets, Chinese family planning officials required that all births be registered and previously authorized. Also, financial rewards were granted to couples who limited their families to one child, while penalties were imposed upon families with additional children.



- One out of every five people on the planet is Chinese.
- China has only 7 percent of the world's arable land.
- By the year 2000, Beijing is projected to have a shortfall of 500,000 cubic meters of water a day—the equivalent to 250 olympic-size swimming pools.
- The level of cultivated land per person in China has dropped 43 percent since 1949.
- One-third of China's timber consumption is used for household cooking and heating.

doubled to more than 800 million by the mid-1970s, growing at a pace that would have doubled the population again by the year 2000. Struggling with efforts to modernize their economy and facing burgeoning costs related to their expanding population, China's leaders recognized, albeit a bit late, that their hopes for breaking into the ranks of the developed world would hinge on their ability to manage their population growth.

Thus, in 1970, the government initiated its first sustained effort at family planning. But despite tremendous drops in the fertility rate during the next 10 years, population levels continued to soar as record numbers of Chinese entered their peak reproductive years. Recognizing the long-term threat that continued growth posed to their economic development, China's leaders implemented the one-child policy in 1980 in an effort to

many cases of abuses going unpunished and largely unrecognized by the government.

While experts caution against attributing the recent drops in fertility to coercion, they acknowledge that the tremendous pressure to meet specific demographic targets has led to abuses by some local officials.

Another frequent charge is that the one-child policy has led to female infanticide. China does, in fact, have an unusually high ratio of male to female reported births.

Again, experts contend that one should not conclude that female infanticide is widespread. While there is a clear preference for sons in Chinese society, particularly in rural areas where they are seen as a means of old age security, much of the demographic disparity is probably due to the high rate of unreported female births. Especially during the first years of the one-child policy, some Chinese couples would hide the birth of a girl, so that they would be able to try again to have a son. This was one reason why the policy was relaxed in the late 1980s, specifically allowing rural Chinese to have a second child if the first was a girl. Rumors of female infanticide have been of great concern to the government, and there have been efforts to heighten the status of women within Chinese society by improving educational and professional opportunities for women.

The Chinese approach to family planning is without question extreme, born as it was out of extreme circumstances. While birth rates have dropped, many problems in the program remain, involving both the occurrence of abuses and the viability of a system which is essentially non-voluntary. Whether China will be able to solve these problems remains to be seen. But if the world is to be successful at stabilizing population growth in a humane manner, China will continue to be of central concern.

The one-child-per-couple policy, however, drew more criticism than success, and the steep declines in fertility which had been achieved in the previous decade stabilized during the 1980s. By the end of the decade, the policy had been greatly relaxed, allowing most rural Chinese to have two children.

The most common charges of abuse do not involve the policy itself, but rather how the policy has been implemented. Indeed, the major question today is whether or not coercive measures, such as forced abortion or sterilization, are used to meet policy goals.

Officially, China's leaders strongly condemn any form of physical coercion, and the Chinese media has reported several cases of overzealous family planning officials being punished by the government for abuses. But at the same time, the Western media has reported at least as

LESSON TWO – IDENTIFYING THE POLICY ISSUES

STUDENT OUTCOMES:

- Using the article *"Continuing Questions in China,"* students will evaluate the merits of the one-child policy and its implication for individuals, the Chinese nation, the world, and construct a policy recommendation.
- Students will analyze age and sex distribution tables.

TEACHER / ACTIVITY:

Divide class into four or five discussion groups. Choose a facilitator and a recorder.

- Facilitator leads a review of the homework questions on China (questions 1-3). Have them reach a conclusion about China's success in promoting health and nutrition and in reducing population growth. How has that been accomplished?
- Using the information from *"Continuing Questions in China,"* have students analyze the one-child policy.
 - ▶ What tradeoffs has China required of its citizens in order to reduce population?
 - ▶ What traditions have interfered with implementation of the one-child policy?
 - ▶ Is 'success' the only criteria by which a policy should be judged? What other criteria should be considered?
 - ▶ If your group were able to advise China's leaders, what advice would you give them?
- Prepare a brief written statement which begins – "We believe that China should . . ."

HOMEWORK:

Analyze the two charts titled 'Age and Sex Distribution' and 'China's Age Composition' to answer the following questions in writing:

1. Explain what might produce different age-sex profiles in more and less developed countries.
2. How is China's profile different and why? What might account for the relatively small population between the ages of 20 and 30?

Age and Sex Distribution, 1990

More Developed Countries

Less Developed Countries

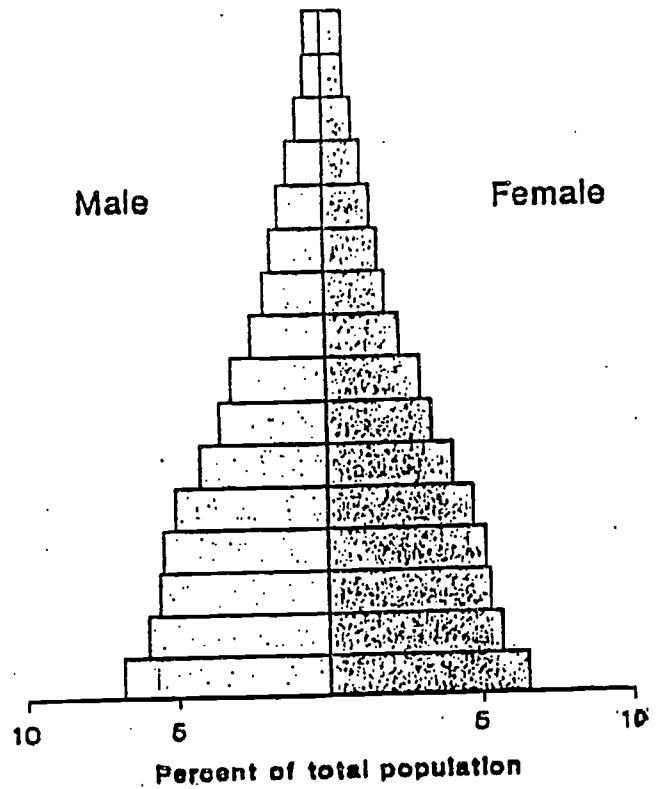
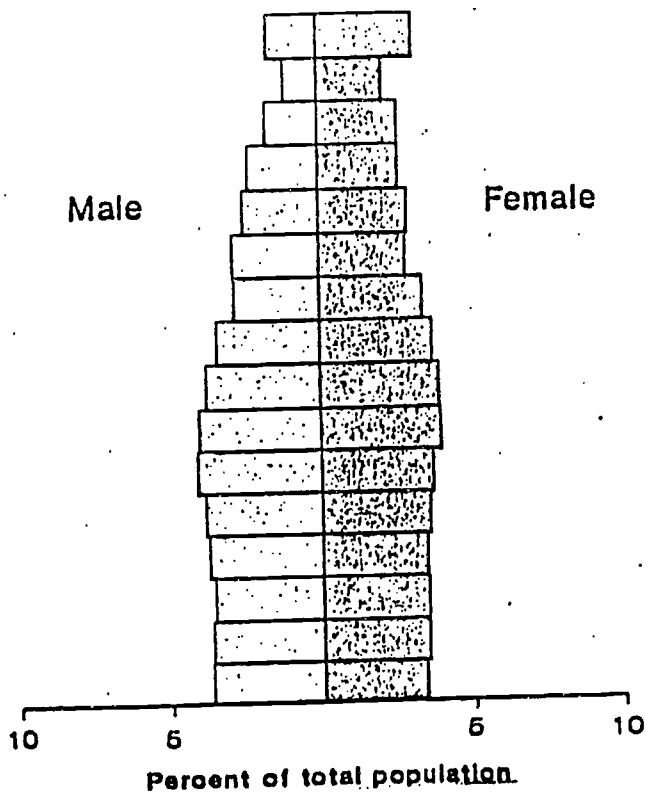

- 75+
- 70-74
- 65-69
- 60-64
- 55-59
- 50-54
- 45-49
- 40-44
- 35-39
- 30-34
- 25-29
- 20-24
- 15-19
- 10-14
- 5-9
- 0-4

Source: World Bank

China's Age Composition in 1987

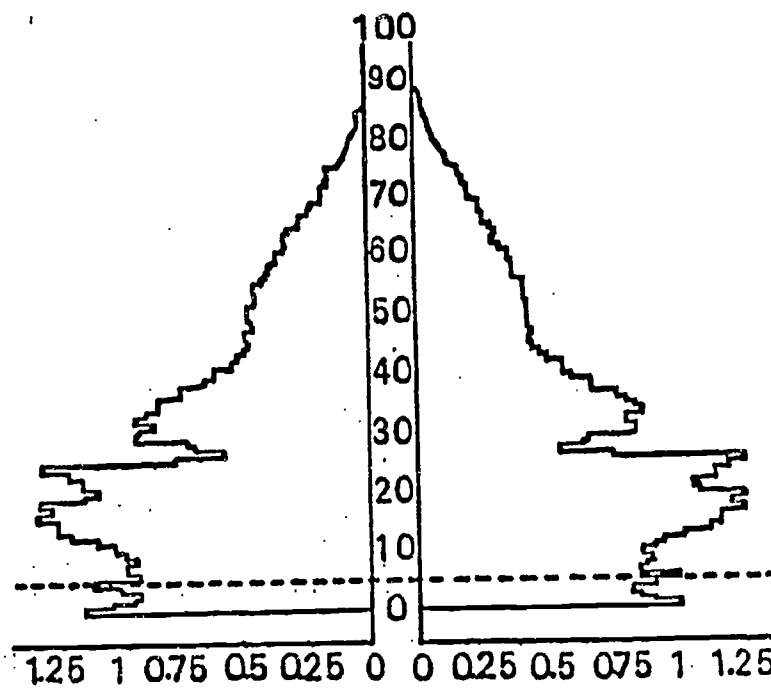

LESSON THREE – UNDERSTANDING THE ISSUES FROM A HUMAN VIEWPOINT

STUDENT OUTCOMES:

- Students will know what social and economic forces conspire to prevent China from reaching its population goals.
- Students will acknowledge the challenges posed by traditional practices when they clash with modern needs.

TEACHER / ACTIVITY:

Review homework by displaying tables on an overhead projector and discussing student responses.

1. High fertility rate / high mortality rate in less developed countries. Note 'Baby Boom' bulge in 30-44 year population, greater female longevity in more developed countries.
2. Famine as a result of 'Great Leap Forward' policies account for low population in age 20-30 population. Table shows recent rise in births--a failure to achieve one-child policy goal in rural areas. What might account for that failure?

Show excerpts from "*Small Happiness*," a film about women in rural China (See Resources, p. 7).

Recommend first 38 minutes, up to point where woman washing clothes says, "In our day, that wouldn't do."

TEACHER:

"Watch this film through the eyes of an anthropologist. What does it tell you about the social, economic traditions of rural life in China? Look for issues that might have an influence on the one-child policy. Find answers to the following questions:

1. What traditions have shaped the lives of peasant women?
 - male/female roles*
 - family structure
 - marriage customs – "Weddings are times when men get together and have a good time."
 - farming methods/role assignments
2. What influences do family structure and marriage traditions have on the one-child policy?
 - daughter not family, only a relative – raised for someone else
 - need sons to do farm labor
 - tradition of male dominance exemplified by foot binding
 - women bear all the health risks of 'family planning'
3. What effects did the revolution of 1949 have on women's circumstances?
 - some say in choosing a husband
 - could initiate a divorce
 - eliminated the worst poverty
 - improved health care
 - gave women the words to name their oppression
4. What does the term 'feudal' refer to?
 - authoritarian family relationships
5. Having seen this film, would you change your policy recommendation?
6. Did the film raise troubling issues?"

Because of time constraints, it will probably be necessary to debrief the film the next day, or postpone reviewing the homework assignment. Use whatever strategy best leads into your following lesson(s).

* Responses .

GLOSSARY

Age Structure. Proportion of the population, or the number of people of each sex, at each age level in a population.

Birth Rate (or Crude Birth Rate). The number of births per 1,000 population in a given year.

Development. Meeting the basic needs (economic, health, and so forth) of people, and improving the standard of living in a society.

Less Developed Country (LDC) also called Developing or Third World. A country that has low levels of average wealth, industrialization and modernization and often high levels of population growth and people employed in agriculture. Most are located in the tropical (low) latitudes in Africa, Asia and Latin America.

Life Expectancy. The average number of years a person can expect to live at the time of birth.

More Developed Country (MDC) also called Developed or Industrialized. Countries that have higher levels of per capita income, industrialization and modernization. They usually have lower levels of population growth. The "more developed" region of the world according to the United Nations includes Europe, Canada, the United States, Australia, Japan, New Zealand and the Soviet Union.

Population Explosion. A phrase used to describe rapid population growth in this century. This is caused by the world birth rate being much higher than the world death rate.

Population Growth Rate. The rate at which a population is increasing (or decreasing) in a given time period, expressed as a percentage of the base population.

RESOURCES

BOOKS:

Li Chengrui, "A Study of China's Population," Beijing, Foreign Language Press, 1992.

BULLETINS:

Tien, H, Yuan, et. al., "China's Demographic Dilemmas," *Population Bulletin*, Vol. 47, No. 1, Washington, D. C., Population Reference Bureau, Inc., June, 1992.

McFalls, Joseph A., "Population: A Lively Introduction," *Population Bulletin*, Vol. 46, No. 2, Washington, D. C., Population Reference Bureau, Inc., June, 1992.

DEMOGRAPHIC DATA:

World Population Prospects, The 1992 Revision, Department for Economic and Social Information and Policy Analysis, New York, United Nations, 1993.

World Population Data Sheet of the Population Reference Bureau, Inc.

FILMS:

World Population, 1990, 6 minutes, VHS and 16mm, \$32.95

Obtain from: Zero Population Growth, 1400 16th Street NW, Suite 320, Washington, D. C. 20036

Small Happiness, 1984, 58 minutes, VHS, \$60 rental

Obtain from: Long Bow Film Library, 22-D Hollywood Avenue, Ho-Ho-Kus, New Jersey 07423

CURRICULUM GUIDES:

Crews, Kimberly A. and Cancellier, Patricia, "Connections, Linking Population and the Environment," Washington, D. C., Population Reference Bureau, Inc., 1991.

Crews, Kimberly A., "Making Connections, Linking Population and the Environment," Washington, D. C., Population Reference Bureau, Inc., 1991.

Fulbright Curriculum: China: Transition & Transformation

Joann Malone
AP Comparative Govt
Woodrow Wilson SHS
Chesapeake & Nebraska Ave.
Washington, D.C. 20016
August 24, 1993

OBJECTIVES:

Content:

1. To analyze the present economic changes in China in relation to revolutionary history and political philosophy.
2. To compare and contrast the economic development of the People's Republic of China with that of Hong Kong and Taiwan.
3. To relate economic changes in mainland China since 1978 to changes in the political power structure and the CCP.
4. To examine the impact of economic changes on the various cleavages in China: rural/urban, male/female, poor/elite, old/young, agricultural/industrial, macro vs. micro economic needs.
5. To compare and contrast the economic and political changes in China to those in the Commonwealth of Independent States, Britain and France.

Skill:

6. To use comprehension of material as a vehicle for critical thinking, reasoning and effective argument.
7. To sharpen skills of differentiating fact and opinion, detecting cultural and political bias and determining the accuracy and completeness of information presented.
8. To develop skills of comparison and contrasting in specific areas of political science and to make logical projections based on present and past trends.

STRATEGIES:

1. List the student questions about China (in comparison to Britain, France and Russia's economic and political changes).
2. Brainstorm student impressions of China from previous study, news media and personal experience.
3. Organize brainstorming into categories of impressions and examine stereotypes and prejudices.
4. Use current news from different sources (including Chinese publications) to compare factual information to biased opinion. (Students will have completed summer assignment to collect, read and analyze news articles on the five countries to be compared.)

5. Analyze the political viewpoints and factual information in text (Theen and Wilson), readings from Deng Xiaoping, Mao Zedong, the Soe readings and novels students read during the summer.

6. Observe the slide presentation based on Fulbright study and travel, looking for images of China that contrast with stereotypes, especially in the areas of economic development.

7. Constantly update list of questions and determine methods of finding answers.

8. Make use of Washington, D.C. sources for speakers from the Chinese Embassy, Chinese student organizers studying at local universities (American University, University of Maryland, George Washington, Georgetown U, Howard U., etc.) and parents and associates of Chinese students at Wilson SHS.

9. Use student reports on the "themes for comparison" to analyze Chinese political systems, political process, institutions and public policy and political change.

10. Construct a comparison chart on these themes to show likenesses and differences among the five countries studied. Students will also construct a chart of economic comparisons within China focusing on comparisons with Hong Kong and Taiwan.

MATERIALS:

Books:

Theen, Rolf H. and Frank L. Wilson, Comparative Politics: An Introduction to Seven Countries. NJ: Prentice-Hall, 1992.

Almond, Gabriel A. and G. Bingham Powell, Jr., Comparative Politics Today: A World View. NY: Harper Collins, 1992.

Curtis, Michael, et al. Introduction to Comparative Government. NY: Harper Collins, 1993.

Soe, Christian, ed. Comparative Politics 93/94 ("Annual Editions"). NY: Harper & Row, 1993.

Deng Xiaoping. Selected Works of Deng Xiaoping (1975-1982). Beijing: Foreign Languages Press, 1983.

Cheng, Nien. Life and Death in Shanghai. New York: Penguin Books, 1986.

Hinton, William. Fanshen: A Documentary of Revolution in a Chinese Village. NY: Vintage Books, 1966.

Liang, Heng and Judith Shapiro. Son of the Revolution. NY: Vintage Books, 1984.

Lao, She. Rickshaw: The Novel of Lo-t'lo Hsiang Tzu. Translated by Jean M. James. Honolulu: University of Hawaii Press, 1979.

Snow, Edgar. Red Star over China. NY: Grove Press, 1938.

Gargan, Edward. China's Fate: A People's Turbulent Struggle with Reform and Repression. NY: Doubleday, 1991.

Chang, Jung. Wild Swans: Three Daughters of China. NY: Simon & Schuster, 1991.

Articles:

Mao Zedong, Selections from writings, including "On Contradictions," "On Theory and Practice," and "The Mass Line."

Tyson, Ann Scott and James L., "Deng Struggles to Set Reform Back on Track," *The Christian Science Monitor*, February 26, 1992.

Bachman, David, "Preparing for the Succession," *Current History*, September 1991.

Southerland, Daniel, "How China's Economy Left Its Comrade Behind," *The Washington Post National Weekly Edition*, September 2-8, 1991.

Barnett, A. Doak, "After Deng, What?: Will China follow the USSR?" *The Foreign Policy Institute Papers: New World-New Directions*, 1991.

Also current articles from *China Daily* and *Beijing Review*.

Primary Sources:

Interviews with Jin Zhong Liang of China People's University,
Cui Song and Ma Lei of Beijing Normal
Tsai Chu-Wai of Shanghai
Michael Malik, Dow Jones Report, Hong Kong
Zhou Li Fang, Xinhua School of Journalism
Tang Bowen, Poet/Translator, Beijing
and numerous other high school teachers,
university professors, businessmen and
government officials (especially in Taiwan).

Over 500 personal slide photographs of sites, schools, urban and rural development, etc.

Notes from lectures at Beijing Normal University on "Chinese Political System and Human Rights in China," "Chinese History," "Woman and the Family in China," "Chinese Education," "Economic Structural Reform in China," "Chinese Folklore," "Chinese Geography and Environment," and "Population and Nationality in China."

Notes from U.S. Embassy briefings in Beijing and Hong Kong

Notes from lecture on education in Hong Kong

Notes from the ROC Ministry of Education, the China Youth Corps, the Council for Cultural Planning and Development, Ministry of Economic Affairs and the Straits Exchange.

Artifacts and notes from the Yao Village in Guangxi Province and numerous other sites in the People's Republic of China, Hong Kong and Taiwan.

III. QUESTIONS

Since the focus for my Fulbright curriculum project was my very real AP course on Comparative Govt and Politics, I came to the 1993 Fulbright Summer Seminar in China, Hong Kong and Taiwan prepared with years of study of Marxism-Leninism, a history of political activism in relation to China, a long-term fascination with Chinese culture, religion, history and art, recent reading on education, political and economic changes in China and a list of questions from my students.

Some of the questions:

Govt/Leaders/Political Change:

1. Who is in charge? Deng? Jiang Zemin? Is Rong Yiren's new role as vice-president of state signaling a shift directly to "capitalism" rather than Deng's "Socialism with Chinese characteristics"? Who are Deng's allies? Political opponents? Political following and power of each? Who will emerge as principal leader when Deng dies?
2. How stable is the govt? Is stability a major political priority for the people?
3. How does ideology function in maintaining political power today? How large are CCP forces? Do they follow Deng ideologically? Any old Mao holdouts? How is Mao regarded? How important is ideology? Communism? Socialism? Capitalism?
4. What is the democracy movement? What are its roots? Are there certain areas of the country in which it is/was most powerful? Has it been crushed? Pushed outside the country? Intellectuals? Tied to overseas Chinese, Hong Kong, Taiwan? Are there developments of democratic socialism? Modeled on any other countries or systems? What is the theory of economics of the democracy movement? What changes would people in the democracy movement make in Deng's economic policies?
5. How do the Chinese people regard the govt? Leaders? Ideology? Tian'anmen? Economic changes? Political changes? Relationships with other countries?
6. Political parties? Are there real, vital political parties outside the CCP? Are the seven parties who "take leadership" from the CCP real? What interests, elite, historical groups do they represent? Are there signs of new parties?

Are there parties in Taiwan or Hong Kong which may have influence in the mainland, esp after 1997?

Economics:

1. Are Deng's economic policies really benefiting the majority of people in China? What are the policies? How do they affect people outside the Special Economic Zones? Inside?
2. How have economic changes affected the Chinese govt's relationships with Japan, U.S., Taiwan, Hong Kong, etc.?
3. Is there really any socialism in China? Is it becoming a capitalist system with a socialist veneer? How much is this process of adoption of capitalist relations of production to the history of the Soviet economic changes?

IV. BACKGROUND NOTES

After about two weeks in China, I began to realize that I was not going to get direct answers to many of these questions for various reasons: 1) my own lack of Chinese language skills to question the people to whom I needed to speak; 2) the blank looks I usually got from almost anyone to whom I asked such questions (ignorance, lack of interest, strange or impolite question, misunderstanding, fear, decision not to discuss such topics????); and 3) that perhaps the questions were not going to be answered primarily by a trip of this sort which was not meant to be "political" and during which I would probably not be introduced purposely to people qualified to answer many of the questions. Perhaps most of my questions would even seem rude to hosts who represented the very government which was subsidizing my room, board, transportation and guide services.

I began to analyze what I was learning about China, what it was that my Chinese hosts most wanted us to learn and take back to the U.S. educational institutions and tried to change my focus somewhat.

What misconceptions had I come with from my own political education and background that might not fit the real situation in China? What stereotyped images of China from the news media and U.S. textbooks and political analysis kept me from seeing things as they truly are in China?

1) My early 1970's, somewhat "romantic" and "idealistic" view of socialism in China needed to be given a dose of realism. Apparently Deng Xiao Ping's decision to make economic changes before liberalizing the political system was working. I couldn't see anything of "evidence of socialism" in the sense of the old slogans, cooperative nurseries, agricultural and industrial cooperatives, people "serving the people."

From the lectures at the U.S. Embassy and at Beijing Normal (especially on Human Rights, Education, Women's Rights, Economy and Population and Minorities), I began to see that China's priorities were economic ("very Marxist, really") -- subsistence of the 1.2 billion people, control of that enormous population (40% under age 19), food, trade, development of new economic forms.

If there were traces of romanticism about the period of the Cultural Revolution, no one seemed to share them. There were a few old people in old blue Mao jackets, Mao hats with buttons were sold to tourists, the memory of Mao himself is still held in high regard. Most of the tourists I saw at Mao's Mausoleum laying flowers in his honor were Chinese. But everyone I asked saw the Cultural Revolution as a serious error full of suffering. I read Nien Cheng's Life and Death in Shanghai on the trip, a vivid account of a wealthy woman's suffering during that period.

However, I also saw no evidence of a heavy-handed government -- no armies, tanks, hardly any police except a few men in uniform loading food onto trucks and one bike arrest in Guilin. The heavily armed guards were in the Taipei Airport! Certainly this would not be the image most Americans carry from news coverage of Tian'anmen!

2) There were so many ways in which I could see the economic development before my eyes! The energy, the flow of traffic, the construction everywhere in Beijing of apartment complexes, new industries, hotels, highways, the sophisticated hotels, shops, subway system, satellite dishes on many a roof. Of course, once I reached Hong Kong and Taiwan, there were models of even more advanced levels of communications, availability of goods to more high-income people, etc. According to Frank Scotten of the U.S. Embassy, the Chinese economy grew 12.8% last year! Nothing to snort at! Food seemed abundant everywhere we went, especially in rural Guilin (which had suffered recent flooding and landslides).

3) Our hosts and guides in the PRC very genuinely wanted to show us what they could in limited time of the culture, history and successes of China. They wanted to impress us with China's tremendous potential for progress, its success at bringing itself from occupation and devastating poverty to economic independence, its desire for openness to the rest of the world and to trade with other countries. My conclusion is that the discussion of government did not seem the most relevant question to many educated Chinese. Although there are govt restrictions and regulations about housing, movement from job to job and the arrangement of joint ventures, economic, educational and cultural progress and communication with the peoples of the world seemed very important to the people I met.

4) What were some of the conclusions I drew? (given that my brain hasn't had much time to sort through all the experiences and notes). Perhaps these points will form the basis of my themes for the curriculum project:

a) Any country or international system that would try to ignore China and its needs would be extremely foolish. This country with over 1/5th of the world's population is very important to know and understand realistically.

b) Individuals and groups can learn almost whatever they want to about China with language and good resources. The governmental processes are different from ours, come from a different historical and cultural viewpoint; but China wants trade with the U.S. and other countries and will be opening more and more to whatever is necessary to progress economically.

c) The Chinese people are as varied and wonderful as any people on earth. Any generalizations about them pale before the reality of diversity within a vast and complex culture and society. The people I came to know best were warm, open, friendly, extremely helpful, honest, perceptive, intelligent, funny, "down to earth." I found I had much more in common with my new friends than I had differences.

d) Perhaps what our Chinese exchange teacher at Wilson said in preparing me for the trip was one of the real truths I saw - that all people need and want some of the same basic things: family, work, food and shelter, education, peace. Why shouldn't the people of China, many of whom have suffered great poverty for so long, share the same goods and services that we have in the U.S.? Who are we to say that they should do this "our way" or the "socialist" way or any other way than the one that works for them and avoids harming their neighbors.

e) Very few people were looking for "handouts" from us Americans. There were some miserable beggars in Xi'an, though not as many as in D.C. Lots of people wanted to sell us things, show us their cousin's art studio, etc., but no one asked for money or expected us to sponsor them in the U.S. How much does our foreign policy demean the independence and autonomy of governments such as China?

Do I still have questions? Yes. Did I get some answers? Many more than I realized at first...and ways to get more answers. Perhaps the most promising is the arrangement I made with a teacher at China People's University to exchange surveys among our high school students. He is interested in the value systems of our U.S. youth.

I have a similar interest in Chinese youth - and also in their assessments of the future of Chinese economic and political development. I can also continue to write to other friends I made in China, Hong Kong and Taiwan. I can find some answers in further research from people who had more time, language skills and contacts than I started with on this trip. The future is hopeful! Change is inevitable - in China and here. But the people are solid, eager to learn, grow, advance. Hope I will be doing the same. I am extremely grateful for the opportunity to learn all I have learned and to have a way to share it with U.S. students!

V. EVALUATION

A. The summer reading (including some of the books listed above, in addition to books on Britain, France, CIS and Mexico) is evaluated by a comparative essay due the second week of class. Students compare and contrast the books on two of the five countries studied focusing on what the books reveal about the history, culture, political and economic problems of the country.

B. The "news notebook" is due the fourth day of class. It is a collection done during the summer of news articles from U.S. newspapers and magazines - at least 10 articles on each of the five countries studied. (Some students who studied abroad will include news from a variety of countries.) Students clip and organize the articles in a notebook according to country and also include

articles on issues (such as "Is Socialism Dead?"). They include a brief summary of each article and their commentary on the article.

C. Since the AP class is not a "contest" between students and teacher for grades but a collective effort of teacher and students to help all of us learn as much as we can to "beat" the test in May, students are also teachers in this class. Each student takes responsibility for at least one of the areas on the "Themes" list (see attached). That student becomes our expert for the class on her topic giving a report on each country studied, being responsible for that topic on the giant comparison chart we construct at the end of the course and bringing in articles, news items and updated information on the topic throughout the course. (This technique must have helped us achieve our high scores on the exam in 1993, my first year of teaching the course. Only one student received a "2" or non-passing grade.)

D. Students summarize and "report" on chapters in the text or supplementary reading. They are responsible for being able to answer questions from other students and to make connections between text and supplementary readings and news reports. (In highly motivated classes such as AP, peer evaluation is much sharper and more critical than that of teachers.

E. Objective tests are administered on each chapter in the text (we usually cover a chapter every one or two class periods).

F. Students are responsible for several essays on each unit - at least one on their "area of expertise" and one topic given to the whole class. We also do numerous "thesis statements" on 4x6 cards with brief outlines of how the essay would be developed if written in full form. (This method makes it easier for the teacher to grade more "essays" in a semester).

G. Students are responsible for keeping notes on chapters from the text, news articles and class discussions and their test results and essays. This notebook is checked periodically by the teacher and graded. (They hate this but are grateful when review time comes in May.)

H. The most real, ongoing evaluation of level of understanding, further questioning, skill level in comparison of the countries is the class discussion. When we had time in '92-'93, we invited in experts from the Russian Embassy or our resident Chinese exchange teacher to speak and answer questions. However, the best discussions were usually those begun by students bursting into the room with "Wow, that Communist Manifesto was dynamite! How much of it was put into practice in China?"

ADVANCED PLACEMENT COMPARATIVE GOVERNMENTS

Course Outline

OBJECTIVES:

Comparative Governments is a one-semester college-level survey course on comparative methods of studying various state systems. Five model countries will be studied: Great Britain, France, Mexico, The Commonwealth of Independent States and China. Throughout the study of each country, the following themes will be emphasized for comparison:

1. Political Systems: Political socialization, culture, value systems, social cleavages, geography and the historical source of political power. (College Board topics #1 and 2 and Then & Wilson #1 and 2).
2. The Political Process: Voting, citizen participation, interest groups, representation, political parties. (CB #3 and T&W #4).
3. Political Institutions: Their structure, framework, and political leaders (CB #3 and T&W #3 and 5).
4. Public Policy, Political Performance, and Political Change. (CB #5 and T&W #6).

The skills of critical thinking, analysis of challenging material, comparison of systems, thesis statement and essay writing will prepare the student to gain college credit in the Advanced Placement exam to be given in May, 1994.

PROCEDURES:

1. Students are to have completed summer assignments to collect, read and analyze 50 articles on the five countries and to read (at least) two books on the summer reading list.
2. Students are responsible for reading, taking notes and analyzing all assigned materials BEFORE discussion in class. Students are encouraged to read as much supplemental material as possible, especially daily newspapers and news periodicals.
3. Thorough notes must be taken on class lectures, student and guest presentations, discussions and all assigned reading. These notes should be kept in an organized notebook subject to review by the teacher at any time.
4. Students will polish writing and verbal analysis skills in book reviews, essays, analytical papers, class discussions and weekly seminars.
5. Quizzes, unit and teacher final exams will include objective and essay questions. Pre-testing from previous AP exams will be offered.

6. Grading will be based on exams, daily homework, reading and writing assignments, participation in discussions and seminars and presentation of individual and group research projects and papers. Weighted grades are given for this course.

TEXT: Theen, Rolf H. and Frank L. Wilson, Comparative Politics: An Introduction to Seven Countries. NJ: Prentice-Hall, 1992.

SUGGESTED PURCHASE:

Soe, Christian, ed. Comparative Politics 93/94 ("Annual Editions"). NY: Harper & Row, 1993.

Riding, Alan. Distant Neighbors: A Portrait of the Mexicans. NY: Vintage, 1989.

Lenin, V.I. State and Revolution (any edition, but Foreign Language Press, Peking, 1970 will be the one used in class)

Marx, Karl and Frederick Engels, The Communist Manifesto (any edition).

COURSE OUTLINE:

Unit I: Introduction and Methods of Comparative Politics (week 1-2)

- A. Why study and compare different political systems?
- B. Themes for Comparison defined
 - 1. Political Systems
 - 2. Political Process
 - 3. Political Institutions
 - 4. Public Policy and Political Change
- C. Cross-cultural methods of Analysis

Readings: Theen & Wilson, pp 1-25.
AP Course Description, p. 25-29
C.W. Mills, Selections from The Power Elite
Kohl's, Multicultural Communication
Current news articles on cultural clashes between countries and summer news notebook.

Unit II: Great Britain (weeks 3-4)

- A. Political Culture and History
- B. Political Process: Class and Social Divisions and the Relationship of Citizens to the Political Process
- C. Political Institutions:
 - 1. Why the Monarchy?
 - 2. How Parliament and Parties Function.
- D. How will the E.C. change European nations?

Readings: Theen & Wilson, p. 27-103.
Soe, "How British Politics Has Changed" and "United We Stand"

Soe, "Having Outwitted the Seers, Tories Wax Conciliatory."

Film: A Very British Coup

*****EXAM on Units I and II*****

Unit III: France (weels 5-6)

- A. Revolution: Effects on Class and Political Culture
- B. Political Process: Social Cleavages as they affect Interest Group and Political Parties
- C. Political Institutions
 - 1. Power of the Presidency
 - 2. Role of Bureaucracy
- D. Public Policy: Immigration, EEC, Economics

Readings: Then & Wilson, p. 104-182.

- "What we Know about Women Voters in Britain, France and West Germany."
- Soe, "France's Fifth Republic: Sure-Footed"
- Walsh, "The New France"

Film: The Battle of Algiers

Unit IV: Mexico: (Development in a Shrinking World) Weeks 7-9

- A. Political Culture and History: From Aztec Rule to European Conquest to Revolution
- B. Political Process: Role of Church, Parties, Business and Military
- C. Political Institutions: Why the President and PRI have so much power.
- D. Public Policy and Political Change: Trade as it influences Mexican economy.

Readings:

(No chapter in text)

- Mahler, "The Mexican Political System"
- Needler, "The Government of Mexico" (in Curtis, Introduction to Comparative Government)
- Riding, Distant Neighbors, Chapter 1
- Miller & Darling, "Mexico: Progress and Promise"

Slide Show: Aztec Influence on Mestizo Political Institutions

Unit V: The Commonwealth of Independent States and Former Soviet Republics (weeks 10-12)

- A. Political Systems: History and Political Philosophy of Socialism as institutionalized in the Soviet Union
- B. Political Process: How citizens are organized into the political process

- C. Political Institutions: How and why the Communist Party lost power
- D. Public Policy and Political Change
 - 1. The Effects of Foreign Policy on the Economy
 - 2. Rise of Ethnic/Religious Nationalism

Readings: Theen & Wilson, p. 289-387

- The Communist Manifesto
- Lenin, The State and Revolution
- Stalin, The National Question
- Soe, "End of the Soviet Empire."
- Cohen, "What's Really Happening in Russia?"
- Malia, "The Yeltsin Revolution".

Unit VI: China (week 13-15)

- A. Political Systems: The Differences between Soviet and Chinese Political Philosophy, Culture, History, and Revolution.
- B. Political Process: Mass Organizations and other means of political participation
- C. Political Institutions: The Party and the People's Revolutionary Army
- D. Public Policy and Political Change:
 - 1. Deng's Economic Development: "Socialism with Chinese Characteristics"
 - 2. Self-Reliance vs. International Trade and Development
 - 3. Tiananmen Square and the Aftermath of the Democracy Movement
 - 4. Who will succeed the "Eight Old Men"?

Readings: Theen & Wilson, p. 461-545.

- Mao, "On Contradictions"
- "On Theory and Practice:
"The Mass Line" and other Essays on Philosophy
- Readings from Selected Works of Deng Xiaoping and the Beijing Review
- Soe: Tyson, "Deng Struggles to Set Reform Back on Track"
- Southerland, "How China's Economy Left Its Comrade Behind"

Unit VII: Methods of Comparing and Contrasting the Five Countries (weeks 15-17)

- A. Presentation of Student Panel on 5 countries/4 themes
- B. Essay Question Focus
- C. Review of Material

Week 18: Final Exam

We are hoping to visit embassies and hear experts on the five countries as time and need permit. Clearly this is a challenging amount of work for a short period of time. DO NOT FALL BEHIND IN YOUR READING! Better to be ahead than behind. Studying with fellow students is encouraged. We will also set up a special review in May during the week of CTBS testing. Buena suerte!

A.P. Comparative Governments - Themes/ Issue to Compare

Each student should choose one of the topics below as an area of expertise for the class on all the countries we study. Also choose one of the "democratic" countries (GB or France), one "socialist" (CIS or China) and one "developing" (Mexico or Nigeria) in which you will be an expert.

J. Malone

I. Political Systems:

1. Differences in history, political culture, value systems
2. Demographic and economic differences (geography, classes, population, resources, level of poverty, etc.)
3. Cleavages: religious, class, ethnic, regional, language
4. Sources of Political Authority & Legitimacy (including constitutionality and separation of powers)
5. Differences in Political Ideology

II. The Political Process:

6. Level and type of citizen participation
7. Political parties (number, type, leadership, philosophy, level of power, relationship to interest groups)
8. Elections (who votes, how they are held, level of democracy)
9. Role of business and other interest groups in government

III. Political Institutions:

10. Forms of government (monarchy, democratic, socialist, authoritarian, military dictatorship, unitary, federalist)
11. Structure of government (parliamentary, presidential, etc.)
12. Leadership (type and recruitment of political elites)
13. Forms of legislature and methods of law-making
14. Forms of executive office and level of executive power
15. Type and level of power of bureaucracy/ civil service

IV. Public Policy and Political Change:

16. Forces producing social and political change
17. Economic changes within the countries as they relate to worldwide economic changes and problems
18. Evaluation of political leadership and level of stability of government

Joann Malone
Woodrow Wilson SHS
October 17, 1993

Notes for Orientation to China in preparation for Joy Luck Club

1. Have students brainstorm words they associate with "China."
2. Ask what experience people in the room actually have with China... anyone traveled there? have family there? have Chinese friends? Do you want to go to China? Know Chinese people?
3. Do you confuse Chinese culture with any others? Which? Anyone come from another culture and experience people in the U.S. not understanding your culture?
4. Look at the brainstorming words for stereotypes, inaccuracies... What is true?
5. Has anyone finished Joy Luck Club or seen the movie?
6. Are there issues, events or attitudes that are confusing?

?????

Some areas you will need background on to more fully understand the Joy Luck Club:

Geography - show map (action takes place in mainland China and San Francisco)... "Chungking" now Chongqing in Sichuan Province... karst mountains.

In the slides and the film, look for different examples of how geography affects the lives of the people especially the lives of women, their work, the conditions of homes, clothing, economic well-being.

History - Can you tell the period of time by clothing (there are lots of flashbacks in the film... look for cars, western influence, lifestyle, differences in time periods or place that affect the ways women act... What period of history are you seeing?--pre-revolution? WW II? The Cultural Revolution? Post-Mao era?

Philosophy and Chinese value system: Confucianism/Daoism

Buddhism

What examples do you see of respect for authority, reverence for order, balance, harmony of the individual with society, worship, the importance of the state and family? How important is education? Obedience?

The Role of the Family

Who is most important in the family? How does the family fit into the rest of society? Why? What relationships do you see between the role of the head of the family and the head of government? What role do the ancestors (living and dead) play in people's daily lives?

The Role of Women

Are women equals to men? What is their role in the family, in relation to work, to the state? To their children? Do you see changes in the roles women

play as mother, wife, daughter, concubine, worker, artist, homemaker as changes take place in Chinese history? As the women immigrate to the U.S.?

Economic Changes

China has gone through tremendous economic changes, especially in the last 12 years or so. These changes have been encouraged by the Chinese Communist Party under the leadership of Deng Xiaoping. China is the fastest growing economy in the world with the largest population in the world (1.2 billion people). What role does economic change have in the transformations in government, in work relations, in the family structure, in the role of women, in relations between generations of women? Why could survival be considered a "human right"?

&&&&&&&&&&

A little history:

I. Ancient: Yuanmon Man - 1.7 million years old

Peking Man

Lantian Man (600,000-4000 B.C.)

Neanderthal Man 200,000 B.C.

II. Dynasties:

Xia (2205-1766 B.C.)

Shang (1766-1122 B.C.)

Zhou (1122-249 B.C.)...iron, warring states, merchant class

Qin (221-207 BC)...1st emperor 246-210 B.C.

Han (207 BC - 220 AD)...paper, compass, Buddhism, civil service exams

Three Kingdoms (Wei, Shu Han, and Wu) 220-280 AD...Rise of Taoism and Buddhism

Jin (265-420 AD)

Southern and Northern (386-581 AD)

Sui (590-618)

Tang (618-907)

5 Dynasties (907-960 AD)...footbinding, warlords, paper currency

Song (960-1279 AD)

Yuan (Mongol) 1271-1368 AD...Genghis Kubla Khan, Marco Polo

Ming (1386-1644 AD)...Jesuits

Qing (Manchu) 1644-1911...Opium Wars

III. Modern:

1900 Boxer Rebellion (war against foreign domination)

1905 Sun Yat Sen forms the Tung Meng Hui, forerunner of the Kuomintang (KMT or GMT, the Nationalist Party which now rules in Taiwan)

1911 Revolution overthrows the Qing Dynasty

1919 May 4th Student Movement

1921 Chinese Communist Party formed (Mao Zedong one of the

- founding members)
- 1923 CCP and KMT collaborate to unify the country, now largely controlled by warlords.
- 1925 Sun Yat Sen dies; factionalism of KMT
- 1926 General Chiang Kai-shek launches expedition with aid of CCP advisors
- 1928 Chiang Kai-shek leader assumes leadership of KMT and Chinese govt, establishes capital in Nanjing
- 1931 Japanese invade Manchuria and set up puppet govt under the "Last Emperor" Pu Yi
- 1934 Long March of Mao's forces retreating from KMT
- 1937 Sino-Japanese War begins...Massacre of Nanjing (400,000 killed Chinese killed in 6 weeks, 57,000 in one day)
- 1939-1945 World War II...civil war follows the defeat of Japanese
- 1949 CCP defeats the KMT...People's Republic of China established
- 1956-57 Hundred Flowers Campaign
- 1958 Great Leap Forward (economic disaster-30 million die)
- 1966-76 Great Proletarian Cultural Revolution
- 1971 People's Republic voted a member of the U.N.
- 1972 Nixon visits China and pledges to normalize relations with U.S.
- 1976 Chairman Mao Zedong and Zhou Enlai die
- 1977 Deng Xiaoping initiates economic reforms (dismantling commune system and increasing privatization in rural areas)
- 1988 Pro-independence movement in Tibet
- 1989 Tien'Anmen Square occupied by students...several hundred students and soldiers killed...1500 arrested
- 1991 Massive flooding...1st time China requests disaster aid
- 1993 China bids for and loses 2000 Olympic site

&&&&&&&&&&&&&&&&&&&&&&&

Fulbright-Hays Summer Seminar, 1993

Eighteen Social Studies teachers and administrators from around the U.S. were chosen from a competitive application process. We traveled, together with a scholar/advisor, Dr. Stanley Rosen of USC,

to

- Beijing, the capital of the People's Republic of China, (2 weeks),
- Xi'an, ancient capital, location of the Terra Cotta warriors
- Guilin, in southern China, next to Vietnam (Yao people)
- Shanghai
- Hong Kong (to be united with China in 1997)
- and Taiwan (where we were based in the capital Taipei).

In addition to extensive visits to famous sites like the Great Wall, the Terra Cotta Warriors, the karst mountain area of southern China and numerous Buddhist temples, we also visited schools, met with government officials, and had lectures in each location on many aspects of Chinese life, history and culture.

&&&&&&&&&&&&&&&&&&&&&&&

Some additional books you might like to read to understand China better:

Wild Swans: Three Daughters of China by Jung Chang

Son of the Revolution by Liang Heng and Judith Shapiro

Life and Death in Shanghai by Nien Cheng

MONEY:

Dollar vs. Yuan

**A Curriculum Project
for
The National Committee on United States - China Relations**

October, 1993

by

**Mel Miller
Social Studies Consultant
Macomb Intermediate School District
44001 Garfield Road
Clinton Township, MI 48038**

(313) 228-3465

**Fulbright-Hays Seminar
China: Tradition and Transformation
Summer, 1993**

MONEY: Dollar vs. Yuan

GOAL -

Students will become acquainted with Chinese money and its exchange rate to U.S. currency.

OBJECTIVES - Students will:

- * recognize the currency of the People's Republic of China.
- * convert Chinese money to U.S. money.
- * determine value of Chinese purchases in terms of comparative U.S. currency.

MATERIALS -

Background Information sheet, "Checking Out Chinese Currency and Coin" sheet, Chinese currency/coin sheets, McDonald's Menu, "Lunch at McDonald's — Beijing Style!" activity sheet, McDonald's menu.

VOCABULARY -

Currency, yuan, jiao, fen, Renminbi (RMB), Foreign Exchange Certificates (FEC), emblem, dollar, black market, exchange rate

BACKGROUND INFORMATION -

The basic unit of Chinese currency is the *yuan* (Y). The *yuan* is divided into *jiao* and *fen*. Chinese yuan might be thought of as their "dollar", the *jiao* as their "dime", and the *fen* as their "penny". Therefore, ten *fen* would equal one *jiao* and ten *jiao* would equal one *yuan*. There are two types of currency in use in China: Renminbi (RMB) and Foreign Exchange Certificates (FEC).

Renminbi (RMB) -

Renminbi or "People's Money" is issued by the Bank of China. Paper notes are issued in denominations of one, two, five, and ten yuan; one, two and five jiao; and one, two and five fen. Coins are in denominations of one yuan; one and five jiao; and one, two, and five fen. The one-fen note is small and yellow, the two-fen note is blue, and the five-fen note is small and green.

RMB is not supposed to be taken out of the country and you cannot legally exchange RMB when you leave China. Therefore, tourists try to spend all of their RMB before leaving China.

Various Chinese minority people are pictured on many of the RMB currency. Others picture scenes of workers and machinery.

The state emblem can also be found on Chinese currency and coins. In the emblem, the large star represents the leadership of the Communist Party. The four small stars stand for groups of workers. Also shown is the Gate of Heavenly Peace in Beijing framed by grains of rice and wheat and a cogwheel that represents industry.

There are five languages spoken in China --- Mongolian, Tibetan, Uighur, Zhuang, and the official language Madarin. Samples of these languages can be found on many RMB.

Foreign Exchange Certificates (FEC) -

China is one of the few countries with two currencies. Foreign Exchange Certificates, or "tourist money", is issued in China for use by foreigners and for compatriots from Hong Kong, Macau and Taiwan.

FEC creates numerous hassles. FEC and RMB are supposed to be worth the same, but in fact they are not. FEC is worth more.

FEC comes in seven denominations: 100 yuan, 50 yuan, 10 yuan, five yuan, one yuan, five jiao and one jiao. There are no FEC coins. FEC currency usually pictures landscape scenes from China.

You are meant to use FEC for all hotels, rail and air transportation, as well as international telephone calls. The government does not require that you pay for buses, taxis, postage stamps or food in FEC.

Some shops and hotels operate an interesting "price differential". You may be asked if you want to pay a given price in FEC or pay about 50% more in RMB. Some stores and hotels simply do not accept payment in RMB. On the other hand, in smaller towns and in the countryside, where few foreigners go you will probably find that the locals have never seen FEC, and you will have to pay in RMB.

Changing Money -

Foreign currency and traveler's checks can be changed at the main centers of the Bank of China, the tourists hotels, some Friendship (tourist) Stores, and some big department stores. You will be issued FEC when exchanging money in these places.

Black Market -

The words "Hello, change money" has become a popular phrase in China. Many people on the streets will try to exchange foreign money into RMB. This is called the "black market" and is considered illegal in the eyes of the government. Tourists are recommended to exchange money only at banks, hotels and stores with official exchange counters.

Exchange Rates -

The exchange rate between U.S. dollars and Chinese yuan changes periodically. In the summer of 1993, the average exchange rate was one U.S. dollar equaled 5.72 yuan. One yuan equaled 17.5 U.S. cents.

The following exchange rate equations were used:

$$\text{Chinese yuan} = \text{U.S. dollar} \times 5.72$$

example I:	5.72 yuan	=	\$ 1 U.S.	X	5.72
example II:	286 yuan	=	\$50 U.S.	X	5.72

$$\text{Chinese jiao} = \text{U.S. dollar} \times .572$$

example I:	57.2 jiao	=	\$ 1 U.S.	X	57.2
example II:	2860 jiao	=	\$ 50 U.S.	X	57.2

$$\text{Chinese fen} = \text{U.S. dollar} \times 572.$$

example I:	572 fen	=	\$ 1 U.S.	X	572.
example II:	28,600 fen	=	\$ 50 U.S.	X	572.

$$\text{U.S. dollar} = \text{Chinese yuan} \times .175$$

example I:	\$.175 U.S.	=	1 yuan	X	.175
example II:	\$ 8.75 U.S.	=	50 yuan	X	.175

$$\text{U.S. dollar} = \text{Chinese jiao} \times .0175$$

example I:	\$.0175 U.S.	=	1 jiao	X	.0175
example II:	\$.875 U.S.	=	50 jiao	X	.0175

$$\text{U.S. dollar} = \text{Chinese fen} \times .00175$$

example I:	\$.00175 U.S.	=	1 fen	X	.00175
example II:	\$.0875 U.S.	=	50 fen	X	.00175

CHECKING OUT CHINESE CURRENCY AND COIN !

1. Study the examples of Chinese money on the following pages. Identify each piece and tell what it is called (yuan, jiao or fen)
2. What are some of the noticeable pictures on these pieces of currency ?
3. Locate the state emblem on each piece of currency and coin. Note the symbolism of this emblem.
4. Locate examples of the five languages of China on the currency notes.
5. Using the exchange rate equations provided for you on the background sheet, calculate how much each Chinese currency note and coin would be worth in U.S. dollars and cents.

Ten Yuan = \$

Five Yuan = \$

One Yuan = \$

Five Jiao = \$

Two Jiao = \$

One Jiao = \$

Ten Fen = \$

Five Fen = \$

Two Fen = \$

One Fen = \$

Further Activities:

1. Study examples of U.S. currency and coin. What pictures and symbols do you notice on them? Are there any similarities between Chinese and U.S. currency and coins?
2. Bring in other foreign currencies and coins that you might have at home. Locate the areas from which they are from on a world map. Examine the symbols on each and discuss what it tells about that country's culture.



Two Yuan (RMB)

Side One

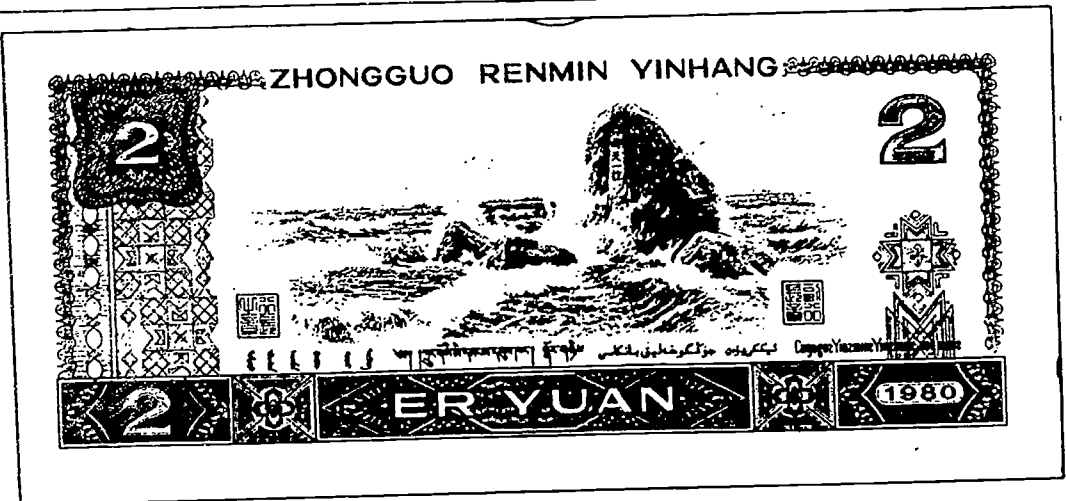

Two Yuan (RMB)

Side Two

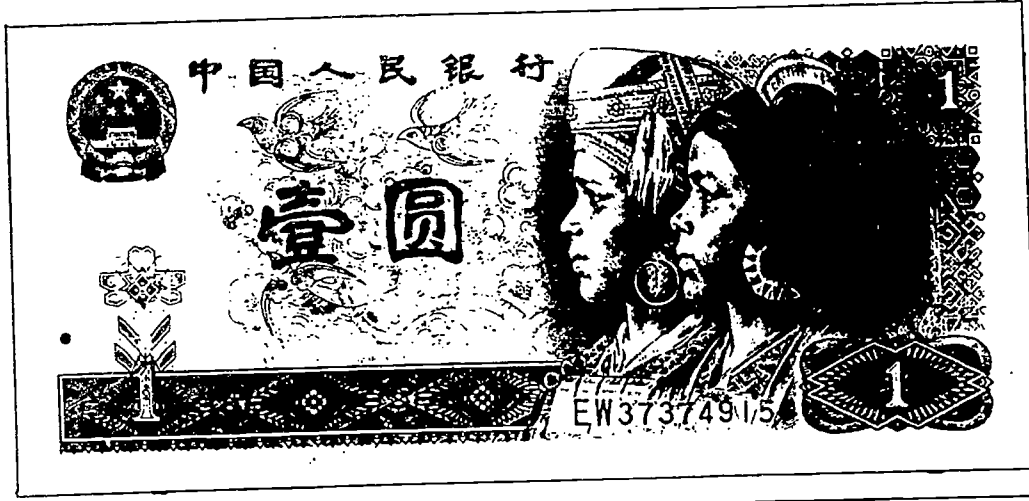

One Yuan (RMB)

Side One



One Yuan (RMB)

Side Two



One Yuan (RMB)

Side One

One Yuan (RMB)

Side Two



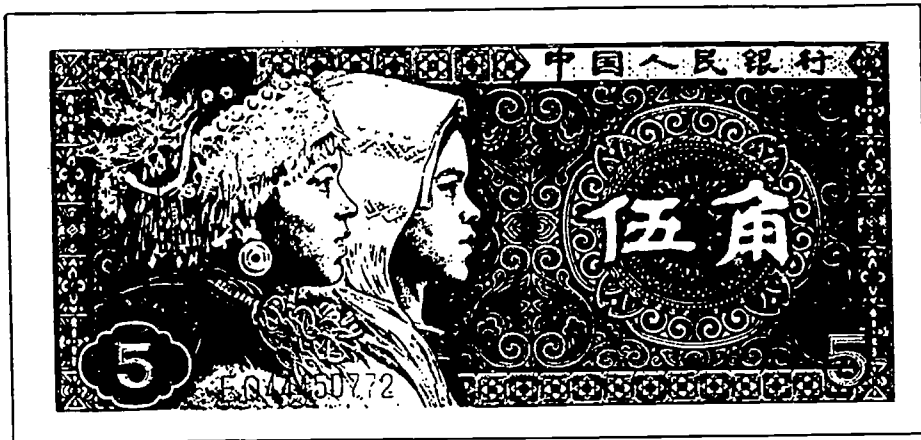

Five Jiao (RMB)

Side One

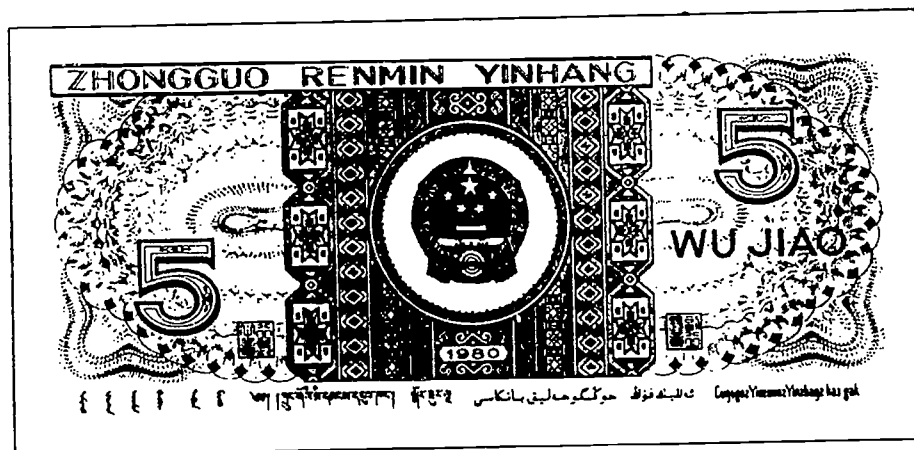

Five Jiao (RMB)

Side Two

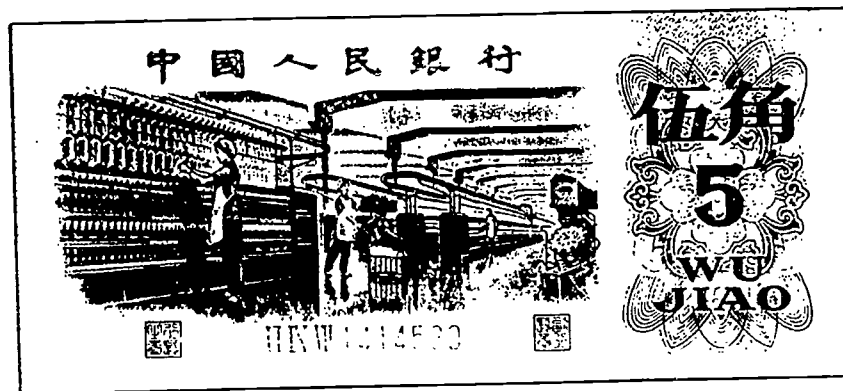

Five Jiao (RMB)

Side One



Five Jiao (RMB)

Side Two



Two Jiao (RMB)

Side One

Two Jiao (RMB)

Side Two

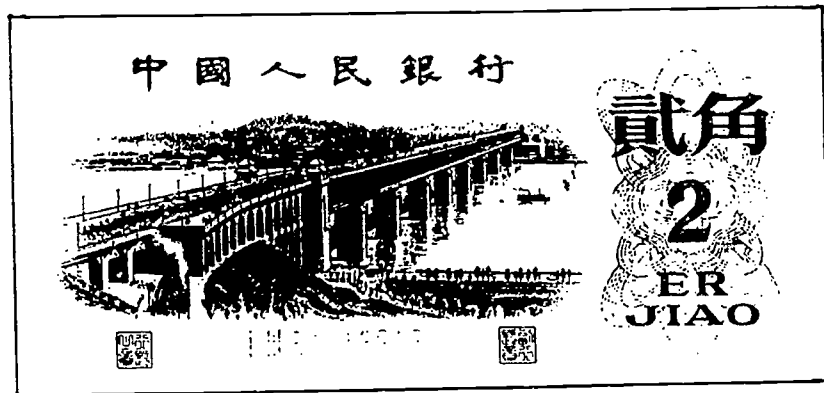
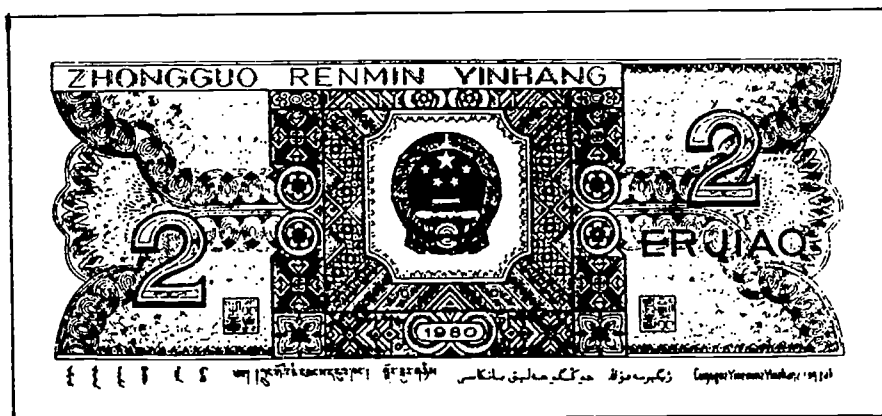

Two Jiao (RMB)

Side One

Two Jiao (RMB)

Side Two





One Jiao (RMB)

Side One



One Jiao (RMB)

Side Two

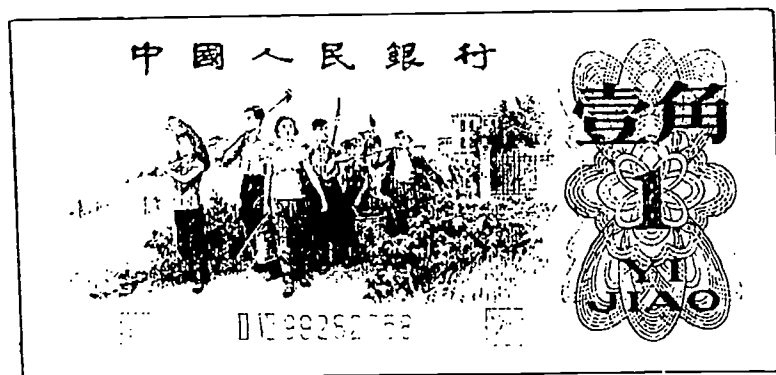

One Jiao (RMB)

Side One



One Jiao (RMB)

Side Two



Five Fen (RMB)

Side One

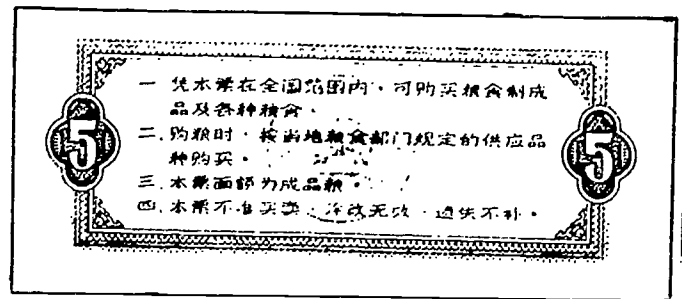

Five Fen (RMB)

Side Two

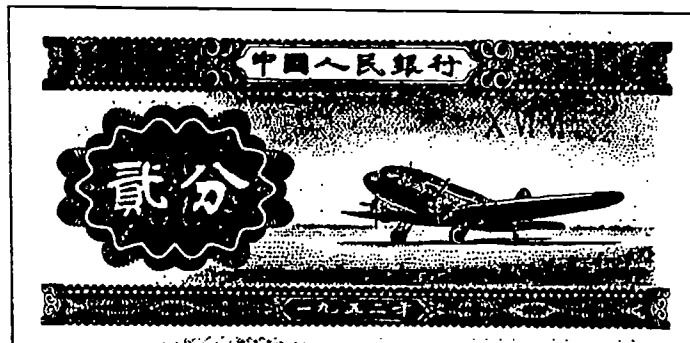

Two Fen (RMB)

Side One

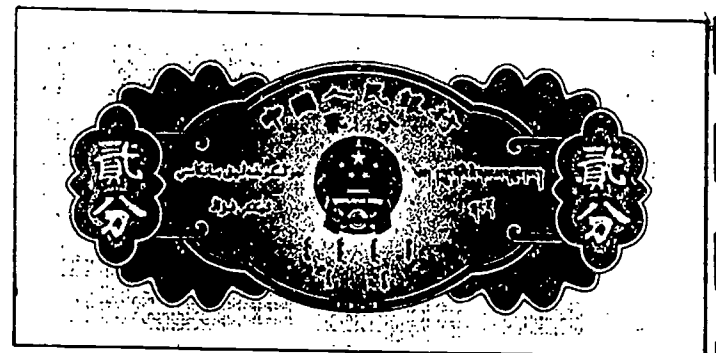

Two Fen (RMB)

Side Two



One Fen (RMB)

Side One



One Fen (RMB)

Side Two



One Yuan - Coin (RMB)



Five Jiao - Coin (RMB)



One Jiao - Coin (RMB)



Five Fen - Coin (RMB)



Two Fen - Coin (RMB)



One Fen - Coin (RMB)

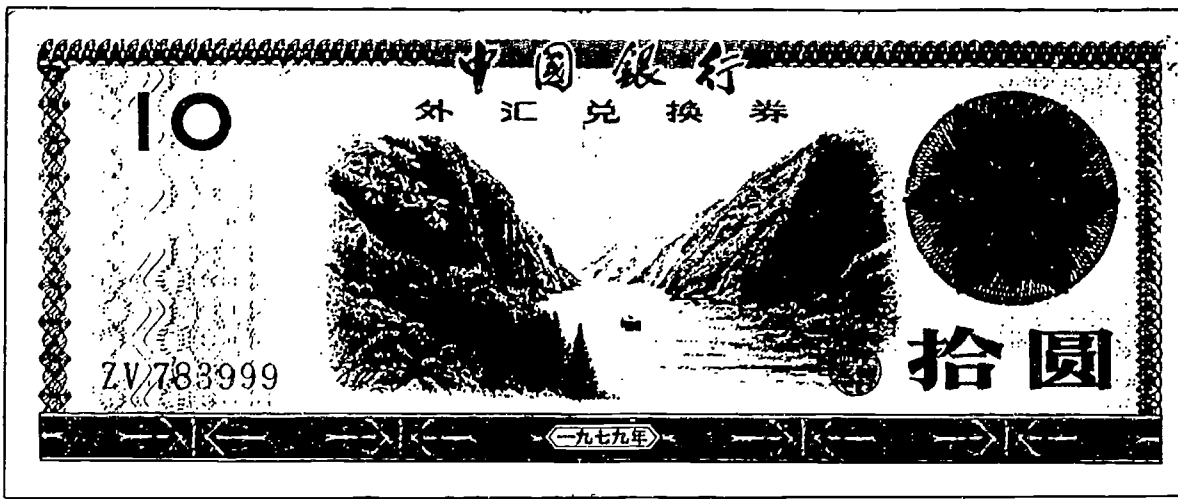

Ten Yuan (FEC)

Side One



Ten Yuan (FEC)

Side Two



Five Yuan (FEC)

Side One



Five Yuan (FEC)

Side Two

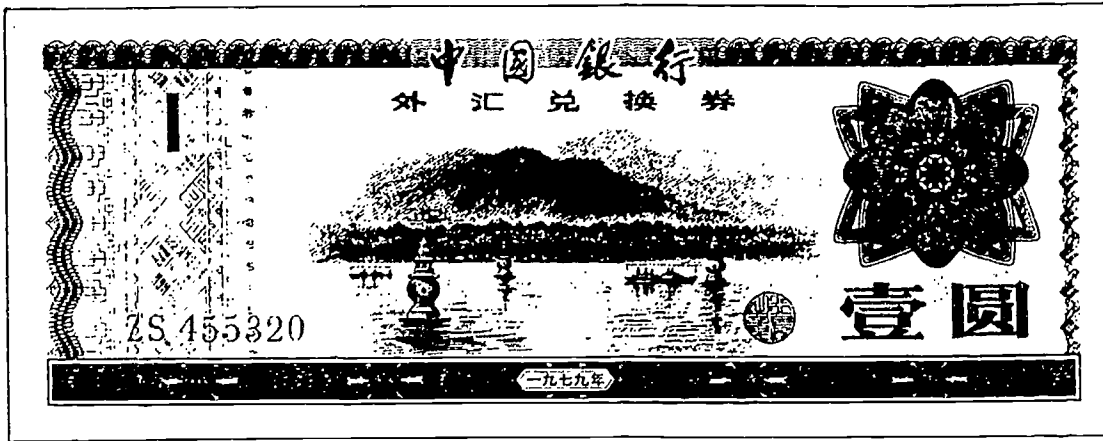

One Yuan (FEC)

Side One



One Yuan (FEC)

Side Two

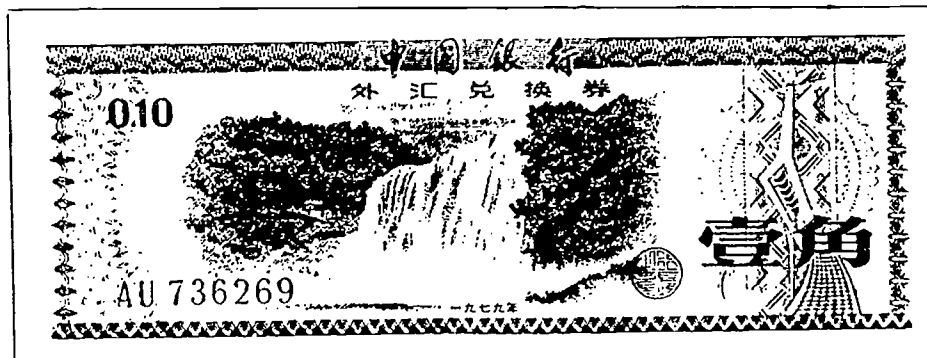

Ten Fen (FEC)

Side One



Ten Fen (FEC)

Side Two

Lunch at McDonald's -- Beijing Style !

The menu that accompanies this activity sheet is from the largest McDonald's in the world — in downtown Beijing in the People's Republic of China. It is a very popular eating spot for the Chinese as their culture becomes more westernized. You will notice many familiar choices on this menu. The taste and quality of the Chinese McDonald's food is the same as what you would find in the United States. For many Americans visiting or working in Beijing, this McDonald's has become a bit of "home away from home".

Using the exchange rate equations on the background sheet, calculate what the price would be in U.S. dollars for the items on this menu:

1.	Large drink	(3.50 Y)	=	\$
2.	Regular drink	(3.00 Y)	=	\$
3.	Chocolate shake	(5.50 Y)	=	\$
4.	Hamburger	(3.50 Y)	=	\$
5.	Cheeseburger	(4.00 Y)	=	\$
6.	Double Hamburger	(7.00 Y)	=	\$
7.	Double Cheeseburger	(8.00 Y)	=	\$
8.	Big Mac	(8.50 Y)	=	\$
9.	Filet-O-Fish	(7.50 Y)	=	\$
10.	McChicken Sandwich	(8.00 Y)	=	\$
11.	Large Fries	(5.00 Y)	=	\$
12.	Regular Fries	(3.50 Y)	=	\$
13.	Chocolate Sundae	(4.50 Y)	=	\$
14.	Apple Pie	(4.50 Y)	=	\$
15.	Large Orange Juice	(5.00 Y)	=	\$
16.	Regular Orange Juice	(3.50 Y)	=	\$
17.	Milk	(3.00 Y)	=	\$
18.	Hot Tea	(2.00 Y)	=	\$
19.	Hot Chocolate	(3.50 Y)	=	\$
20.	Coffee	(2.50 Y)	=	\$
21.	Cheeseburger and Shake	(9.50 Y)	=	\$
22.	Hamburger, Regular Fries, Regular Drink Combo.	(10.00 Y)	=	\$
23.	What Chinese symbol is used for "yuan" ?			
24.	What Chinese symbols are used for "hamburger" ?			
25.	What Chinese symbols are used for "chocolate" ?			

Further Activity:

Go to a local McDonald's and compare these converted prices to prices of these same items in your community. What similarities and differences did you find? Why do you think there might be a price difference?

麦当劳餐厅

(北京分为麦当劳)

不一样的享受 就在麦当劳

六款统一口味好

不过十元那里找

3.50元
大份软饮
Large Drink
15 盎司
Regular Drink

3.00元
15 盎司
软饮, 可乐
Soft Drink, Cola

5.50元
草莓奶昔
Strawberry
Shake

3.50元
巧克力奶昔
Chocolate Shake

3.50元
汉堡
Hamburger

4.00元
芝士汉堡
Cheeseburger

7.00元
双层汉堡
Double Hamburger

8.00元
双层芝士汉堡
Double Cheeseburger

8.50元
巨无霸
Big Mac

7.50元
麦香鱼
Filet-O-Fish

8.00元
麦香鸡
McChicken Sandwich

10.00元
2个汉堡、标准冷饮
2 Hamburgers, Regular Drink

10.00元
2个芝士汉堡、热红茶
2 Cheeseburgers, Hot Tea

10.00元
2个汉堡、标准热饮
2 Hamburgers, Regular Drink

10.00元
2个芝士汉堡、热红茶
2 Cheeseburgers, Hot Tea

10.00元
2个汉堡、标准冷饮
2 Hamburgers, Regular Drink

10.00元
2个芝士汉堡、热红茶
2 Cheeseburgers, Hot Tea

10.00元
2个汉堡、标准热饮
2 Hamburgers, Regular Drink

2.90元
大份软饮
Large Drink
15 盎司
Regular Drink

2.50元
15 盎司
软饮, 巧克力
Soft Drink, Chocolate

5.00元
巧克力奶昔
Chocolate Shake

3.50元
巧克力奶昔
Chocolate Shake

3.50元
苹果派
Apple Pie

4.50元
巧克力派
Chocolate Sundae

5.00元
大薯条
Large Fries

5.50元
标准薯条
Regular Fries

5.50元
巧克力奶昔
Chocolate Shake

3.50元
汉堡
Hamburger

4.00元
芝士汉堡
Cheeseburger

7.00元
双层汉堡
Double Hamburger

8.00元
双层芝士汉堡
Double Cheeseburger

8.50元
巨无霸
Big Mac

7.50元
麦香鱼
Filet-O-Fish

8.00元
麦香鸡
McChicken Sandwich

10.00元
2个汉堡、标准冷饮
2 Hamburgers, Regular Drink

10.00元
2个芝士汉堡、热红茶
2 Cheeseburgers, Hot Tea

10.00元
2个汉堡、标准热饮
2 Hamburgers, Regular Drink

10.00元
2个芝士汉堡、热红茶
2 Cheeseburgers, Hot Tea

10.00元
2个汉堡、标准冷饮
2 Hamburgers, Regular Drink

10.00元
2个芝士汉堡、热红茶
2 Cheeseburgers, Hot Tea

10.00元
2个汉堡、标准热饮
2 Hamburgers, Regular Drink

10.00元
2个芝士汉堡、热红茶
2 Cheeseburgers, Hot Tea

10.00元
2个汉堡、标准冷饮
2 Hamburgers, Regular Drink

10.00元
2个芝士汉堡、热红茶
2 Cheeseburgers, Hot Tea

10.00元
2个汉堡、标准热饮
2 Hamburgers, Regular Drink

10.00元
2个芝士汉堡、热红茶
2 Cheeseburgers, Hot Tea

10.00元
2个汉堡、标准冷饮
2 Hamburgers, Regular Drink

10.00元
2个芝士汉堡、热红茶
2 Cheeseburgers, Hot Tea

10.00元
2个汉堡、标准热饮
2 Hamburgers, Regular Drink

10.00元
2个芝士汉堡、热红茶
2 Cheeseburgers, Hot Tea

10.00元
2个汉堡、标准冷饮
2 Hamburgers, Regular Drink

10.00元
2个芝士汉堡、热红茶
2 Cheeseburgers, Hot Tea

10.00元
2个汉堡、标准热饮
2 Hamburgers, Regular Drink

10.00元
2个芝士汉堡、热红茶
2 Cheeseburgers, Hot Tea

10.00元
2个汉堡、标准冷饮
2 Hamburgers, Regular Drink

10.00元
2个芝士汉堡、热红茶
2 Cheeseburgers, Hot Tea

10.00元
2个汉堡、标准热饮
2 Hamburgers, Regular Drink

10.00元
2个芝士汉堡、热红茶
2 Cheeseburgers, Hot Tea

10.00元
2个汉堡、标准冷饮
2 Hamburgers, Regular Drink

10.00元
2个芝士汉堡、热红茶
2 Cheeseburgers, Hot Tea

10.00元
2个汉堡、标准热饮
2 Hamburgers, Regular Drink

10.00元
2个芝士汉堡、热红茶
2 Cheeseburgers, Hot Tea

10.00元
2个汉堡、标准冷饮
2 Hamburgers, Regular Drink

10.00元
2个芝士汉堡、热红茶
2 Cheeseburgers, Hot Tea

10.00元
2个汉堡、标准热饮
2 Hamburgers, Regular Drink

10.00元
2个芝士汉堡、热红茶
2 Cheeseburgers, Hot Tea

10.00元
2个汉堡、标准冷饮
2 Hamburgers, Regular Drink

10.00元
2个芝士汉堡、热红茶
2 Cheeseburgers, Hot Tea

10.00元
2个汉堡、标准热饮
2 Hamburgers, Regular Drink

10.00元
2个芝士汉堡、热红茶
2 Cheeseburgers, Hot Tea

10.00元
2个汉堡、标准冷饮
2 Hamburgers, Regular Drink

10.00元
2个芝士汉堡、热红茶
2 Cheeseburgers, Hot Tea

10.00元
2个汉堡、标准热饮
2 Hamburgers, Regular Drink

5.50元
巧克力奶昔
Chocolate Shake

3.50元
汉堡
Hamburger

4.00元
芝士汉堡
Cheeseburger

7.00元
双层汉堡
Double Hamburger

8.00元
双层芝士汉堡
Double Cheeseburger

8.50元
巨无霸
Big Mac

7.50元
麦香鱼
Filet-O-Fish

8.00元
麦香鸡
McChicken Sandwich

10.00元
2个汉堡、标准冷饮
2 Hamburgers, Regular Drink

10.00元
2个芝士汉堡、热红茶
2 Cheeseburgers, Hot Tea

10.00元
2个汉堡、标准热饮
2 Hamburgers, Regular Drink

10.00元
2个芝士汉堡、热红茶
2 Cheeseburgers, Hot Tea

10.00元
2个汉堡、标准冷饮
2 Hamburgers, Regular Drink

10.00元
2个芝士汉堡、热红茶
2 Cheeseburgers, Hot Tea

10.00元
2个汉堡、标准热饮
2 Hamburgers, Regular Drink

10.00元
2个芝士汉堡、热红茶
2 Cheeseburgers, Hot Tea

10.00元
2个汉堡、标准冷饮
2 Hamburgers, Regular Drink

10.00元
2个芝士汉堡、热红茶
2 Cheeseburgers, Hot Tea

10.00元
2个汉堡、标准热饮
2 Hamburgers, Regular Drink

10.00元
2个芝士汉堡、热红茶
2 Cheeseburgers, Hot Tea

10.00元
2个汉堡、标准冷饮
2 Hamburgers, Regular Drink

10.00元
2个芝士汉堡、热红茶
2 Cheeseburgers, Hot Tea

10.00元
2个汉堡、标准热饮
2 Hamburgers, Regular Drink

10.00元
2个芝士汉堡、热红茶
2 Cheeseburgers, Hot Tea

10.00元
2个汉堡、标准冷饮
2 Hamburgers, Regular Drink

10.00元
2个芝士汉堡、热红茶
2 Cheeseburgers, Hot Tea

10.00元
2个汉堡、标准热饮
2 Hamburgers, Regular Drink

10.00元
2个芝士汉堡、热红茶
2 Cheeseburgers, Hot Tea

10.00元
2个汉堡、标准冷饮
2 Hamburgers, Regular Drink

10.00元
2个芝士汉堡、热红茶
2 Cheeseburgers, Hot Tea

10.00元
2个汉堡、标准热饮
2 Hamburgers, Regular Drink

10.00元
2个芝士汉堡、热红茶
2 Cheeseburgers, Hot Tea

10.00元
2个汉堡、标准冷饮
2 Hamburgers, Regular Drink

10.00元
2个芝士汉堡、热红茶
2 Cheeseburgers, Hot Tea

10.00元
2个汉堡、标准热饮
2 Hamburgers, Regular Drink

10.00元
2个芝士汉堡、热红茶
2 Cheeseburgers, Hot Tea

10.00元
2个汉堡、标准冷饮
2 Hamburgers, Regular Drink

10.00元
2个芝士汉堡、热红茶
2 Cheeseburgers, Hot Tea

10.00元
2个汉堡、标准热饮
2 Hamburgers, Regular Drink

10.00元
2个芝士汉堡、热红茶
2 Cheeseburgers, Hot Tea

10.00元
2个汉堡、标准冷饮
2 Hamburgers, Regular Drink

10.00元
2个芝士汉堡、热红茶
2 Cheeseburgers, Hot Tea

10.00元
2个汉堡、标准热饮
2 Hamburgers, Regular Drink

10.00元
2个芝士汉堡、热红茶
2 Cheeseburgers, Hot Tea

10.00元
2个汉堡、标准冷饮
2 Hamburgers, Regular Drink

10.00元
2个芝士汉堡、热红茶
2 Cheeseburgers, Hot Tea

10.00元
2个汉堡、标准热饮
2 Hamburgers, Regular Drink

10.00元
2个芝士汉堡、热红茶
2 Cheeseburgers, Hot Tea

10.00元
2个汉堡、标准冷饮
2 Hamburgers, Regular Drink

10.00元
2个芝士汉堡、热红茶
2 Cheeseburgers, Hot Tea

10.00元
2个汉堡、标准热饮
2 Hamburgers, Regular Drink

5.50元
巧克力奶昔
Chocolate Shake

3.50元
汉堡
Hamburger

4.00元
芝士汉堡
Cheeseburger

7.00元
双层汉堡
Double Hamburger

8.00元
双层芝士汉堡
Double Cheeseburger

8.50元
巨无霸
Big Mac

7.50元
麦香鱼
Filet-O-Fish

8.00元
麦香鸡
McChicken Sandwich

10.00元
2个汉堡、标准冷饮
2 Hamburgers, Regular Drink

10.00元
2个芝士汉堡、热红茶
2 Cheeseburgers, Hot Tea

10.00元
2个汉堡、标准热饮
2 Hamburgers, Regular Drink

10.00元
2个芝士汉堡、热红茶
2 Cheeseburgers, Hot Tea

10.00元
2个汉堡、标准冷饮
2 Hamburgers, Regular Drink

10.00元
2个芝士汉堡、热红茶
2 Cheeseburgers, Hot Tea

10.00元
2个汉堡、标准热饮
2 Hamburgers, Regular Drink

10.00元
2个芝士汉堡、热红茶
2 Cheeseburgers, Hot Tea

10.00元
2个汉堡、标准冷饮
2 Hamburgers, Regular Drink

10.00元
2个芝士汉堡、热红茶
2 Cheeseburgers, Hot Tea

10.00元
2个汉堡、标准热饮
2 Hamburgers, Regular Drink

10.00元
2个芝士汉堡、热红茶
2 Cheeseburgers, Hot Tea

10.00元
2个汉堡、标准冷饮
2 Hamburgers, Regular Drink

10.00元
2个芝士汉堡、热红茶
2 Cheeseburgers, Hot Tea

10.00元
2个汉堡、标准热饮
2 Hamburgers, Regular Drink

10.00元
2个芝士汉堡、热红茶
2 Cheeseburgers, Hot Tea

10.00元
2个汉堡、标准冷饮
2 Hamburgers, Regular Drink

10.00元
2个芝士汉堡、热红茶
2 Cheeseburgers, Hot Tea

10.00元
2个汉堡、标准热饮
2 Hamburgers, Regular Drink

10.00元
2个芝士汉堡、热红茶
2 Cheeseburgers, Hot Tea

10.00元
2个汉堡、标准冷饮
2 Hamburgers, Regular Drink

10.00元
2个芝士汉堡、热红茶
2 Cheeseburgers, Hot Tea

10.00元
2个汉堡、标准热饮
2 Hamburgers, Regular Drink

10.00元
2个芝士汉堡、热红茶
2 Cheeseburgers, Hot Tea

10.00元
2个汉堡、标准冷饮
2 Hamburgers, Regular Drink

10.00元
2个芝士汉堡、热红茶
2 Cheeseburgers, Hot Tea

10.00元
2个汉堡、标准热饮
2 Hamburgers, Regular Drink

10.00元
2个芝士汉堡、热红茶
2 Cheeseburgers, Hot Tea

10.00元
2个汉堡、标准冷饮
2 Hamburgers, Regular Drink

10.00元
2个芝士汉堡、热红茶
2 Cheeseburgers, Hot Tea

10.00元
2个汉堡、标准热饮
2 Hamburgers, Regular Drink

10.00元
2个芝士汉堡、热红茶
2 Cheeseburgers, Hot Tea

10.00元
2个汉堡、标准冷饮
2 Hamburgers, Regular Drink

10.00元
2个芝士汉堡、热红茶
2 Cheeseburgers, Hot Tea

10.00元
2个汉堡、标准热饮
2 Hamburgers, Regular Drink

10.00元
2个芝士汉堡、热红茶
2 Cheeseburgers, Hot Tea

10.00元
2个汉堡、标准冷饮
2 Hamburgers, Regular Drink

10.00元
2个芝士汉堡、热红茶
2 Cheeseburgers, Hot Tea

10.00元
2个汉堡、标准热饮
2 Hamburgers, Regular Drink

10.00元
2个芝士汉堡、热红茶
2 Cheeseburgers, Hot Tea

10.00元
2个汉堡、标准冷饮
2 Hamburgers, Regular Drink

10.00元
2个芝士汉堡、热红茶
2 Cheeseburgers, Hot Tea

10.00元
2个汉堡、标准热饮
2 Hamburgers, Regular Drink

麦当劳的四大承诺

品质高：麦当劳的每一份食品都经过严格的质量控制，由经验丰富的厨师精心制作，确保每一份食品都符合麦当劳的高品质标准。

服务好：麦当劳的员工都经过专业的培训，能够提供热情、快捷、友好的服务，让每一位顾客都能感受到麦当劳的温暖。

环境好：麦当劳的餐厅环境干净整洁，明亮舒适，为顾客提供了一个理想的用餐场所。

价格好：麦当劳提供丰富多样的食品选择，满足不同顾客的需求，同时保持合理的价格，让每一位顾客都能享受到高品质的食品。

环境清洁、工作热情、与顾客互动、使用先进的技术、员工具备良好的素质是麦当劳成功的关键。麦当劳的每一份食品都经过严格的质量控制，由经验丰富的厨师精心制作，确保每一份食品都符合麦当劳的高品质标准。

麦当劳的每一份食品都经过严格的质量控制，由经验丰富的厨师精心制作，确保每一份食品都符合麦当劳的高品质标准。麦当劳的每一份食品都经过严格的质量控制，由经验丰富的厨师精心制作，确保每一份食品都符合麦当劳的高品质标准。

地址：王府井大街南口北京饭店东座4层
电话：512 2189



欢聚麦当劳 共享家庭乐

The Fulbright-Hays Seminars Abroad Program

Summer 1993

CHINA, HONG KONG AND TAIWAN
Tradition and Transformation

by

Peggy R. Moring

Daleville, Alabama

The yen to learn about China escalated when Marco Polo returned from the Orient with astounding stories of remarkable achievements. His accounts inspired man to embark upon ventures overland and by sea to explore the mysteries of this foreign land. As a more open China welcomes tourism and trade, the global community can learn much by investigating the traditions and transformation of this nation. For China, one of the oldest civilizations, continues to survive though it is overpopulated and limited in natural resources.

Artifacts, relics and products made in China abound as China opens its doors to the world and expands its market economy. Many tourists and teachers are traveling to China and returning with items that range from antiques to garbage. Teachers who are unable to travel to China can prepare their own culture box by purchasing products made in China from local stores, consulting travel agents for brochures and posters, visiting an Asian grocery or restaurant, and substituting pictures for the items you are unable to find.

Purpose:

To develop a culture box with related activities which gives students an opportunity to see, touch, research, question and to form hypothesis about artifacts from China.

Objectives:

- To develop an artifact and memorabilia box.
- To learn to ask informative questions.
- To enhance the imagination.
- To examine artifacts as an approach to understanding cultures.

Materials:

Artifacts and memorabilia box composed of items from China.
Category label strips: NATURAL RESOURCES, HANDICRAFTS, ARTS,
AGRICULTURE, TOURISM, COMMUNICATION, RELIGION, CLOTHING,
TRANSPORTATION, ENTERTAINMENT, TECHNOLOGY.
Chinese Zodiac Calendar.
Flower Month and Season Chart.
Four-inch circles.

Procedure:

CHINESE CULTURE BOX.
INQUIRING ABOUT CHINESE CULTURE.
CATEGORIES OF CHINESE ARTIFACTS AND MEMORABILIA.
CHINESE ZODIAC FAMILY TREE.
FLOWERY CHINA.
CHINA'S MOVERS AND SHAKERS.

CHINESE CULTURE BOX

Purpose:

To set up a Chinese Culture Box.

Objectives:

To collect a varied array of artifacts and memorabilia for introductory lessons to a Chinese culture.

Materials:

Items from China are collected. Below is a partial listing which can be amended as needed.

- | | |
|------------------------|--------------------------------|
| parasol | kimono |
| papercuts | bamboo items |
| good luck symbol | fan |
| Mao button | chops, ink |
| ankle stockings | longevity symbol |
| paper money, coins | minority clothing |
| art | language cassettes |
| fortune cookies | ping pong game book |
| Chinese checkers | pick up sticks |
| prayer beads | red guard hat |
| China music cassette | match box with advertisement |
| city maps | subway maps |
| newspapers | opera program |
| McDonald's placemat | hotel items: shampoo, tea bags |
| ticket stubs | sugar, toothpaste, stationary |
| luggage tags | passport |
| money exchange receipt | coke label |
| ice cream label | T.V. Guide |
| business cards | peasant paintings |
| abacus | lantern |
| noodles | woven slippers |
| silk table cloth | terra cotta warrior cards |
| chopsticks | baby clothes |
| budda image | incense |
| travel posters | tea |
| tea pot | Little Red Book |
| water chestnuts | inventions |
| folk tales | rice paper |
| Zodiac symbols | sniff bottle |
| harmony balls | tangram |
| carry bag | airline note pad, ticket |
| pen | pencil |
| calendar | calligraphy brushes |

ye ye's
cloissne

ink
flower poster

Procedure:

Do not label any item. Arrange items collected by teacher and students in a random manner on a large table or in a box.

Evaluation:

student product.

BEST COPY AVAILABLE

INQUIRING ABOUT CHINESE CULTURE

Purpose:

To develop a curiosity about artifacts.

Objective:

To learn to ask good questions.

To develop the use of the imagination.

To recognize that uses of items vary from culture to culture.

Materials:

Items from the culture box.

Procedure:

Give students an opportunity to browse and look at the artifacts.

Divide students into groups of five.

The teacher chooses an artifact at random for each round of the activity.

Each group will be given an opportunity to ask one question about the item that can be answered with yes or no. Answers will be sequential. If a group passes or answers incorrectly, the next group will be given the chance to answer.

Proceed to the next item, beginning with group 2 for round 2, group 3 for round 3, etc.

Evaluation:

The artifacts correctly identified will be placed on the table of the group that answered correctly.

CATEGORIES OF CHINESE ARTIFACTS AND MEMORABILIA

Purpose:

To examine artifacts as an approach to understanding a new culture.

Objective:

The student will make hypotheses, deductions and assumptions about artifacts that will determine the artifacts placement in particular categories.

Materials:

Artifacts and memorabilia from Culture Center.

Category cards: NATURAL RESOURCES, COMMUNICATION, TOURISM
TRANSPORTATION, AGRICULTURE, ART, HANDICRAFTS, CLOTHING
RELIGION, MANUFACTURING, ENTERTAINMENT, TECHNOLOGY.

Items used for one activity:

1. Eggshell porcelain
2. Matchbox from hotel
3. Woven shoes
4. Postcard showing Mao's Tomb
5. Coke or Sprite label
6. Plastic bag with advertising label
7. McDonald's place mat
8. Calendar
9. Subway ticket
10. Newspaper
11. Business card
12. Stamps
13. Hotel folder
14. Coins
15. Luggage tag
16. Prayer Beads
17. Cassette of Bell Tower
18. Postcard showing Great Wall
19. Ice cream package
20. Cloisne
21. Bamboo whistle
22. Money exchange receipt
23. Bag of rice
24. Bag of rice

- 25. Peasant paintings
- 26. Yogurt bottle
- 27. Terra cotta warrior cards
- 28. Bicycle bell
- 29. Zodiac placemat

Procedures:

1. Use category labels and masking tape to create a table of categories (Chart 1).
2. Give each student one object. Put the extras on a table. Give the students time to examine the object and formulate questions about the object (What it is made of? What language is represented? What does it tell about the people that used it?) and answer the questions. The students will then place the object on the table under a specific category. Items can often fit under more than one category.

Evaluation:

student product and response.

BEST COPY AVAILABLE

Chart 1. Categories of artifact- and memorabilia.

Natural Resources	Communication	Tourism
Art	Transportation	Religion
Handicraft	Manufacturing	Technology
Clothing	Entertainment	Agriculture

CHINESE ZODIAC FAMILY TREE

The Chinese zodiac is based on a twelve-year cycle. Each year is represented by an animal and personality traits and predictions. The traditional Chinese belief is that a person's birth year influences his character, health and prosperity.

Purpose:

To stimulate the students interest in Chinese culture.

Objectives:

To use a Chinese zodiac to create a family tree.

To use library research.

Background Activity:

Before beginning the activity, have students record and return to class family data which includes birth year of fraternal and maternal grandparents, parents and siblings.

Materials:

Family data sheet.

Chinese zodiac information sheet.

Optional research materials about the Chinese zodiac.

Chinese zodiac activity sheet (Chart 2).

Procedures:

Use the information from the Chinese zodiac sheet, research from the library and family data to create a Chinese Zodiac Family Tree or mobile.

- A. Record in the data about fraternal and maternal grandparents on row 1. Include names, year born, a positive trait, a negative trait, the zodiac symbol.

Moring 10

- B. Record the same information about parents on row 2.
- C. Record the same information about siblings and self on row 3.

Evaluation:

Student product.

CHINESE ZODIAC FAMILY TREE

INSTRUCTIONS: Begin the family tree by filling in the data about the fraternal and maternal grandparents on row one, parents on row two, and siblings and yourself on row three. Include names, year born, and a positive and negative trait about each member. Draw the zodiac symbol in the box.

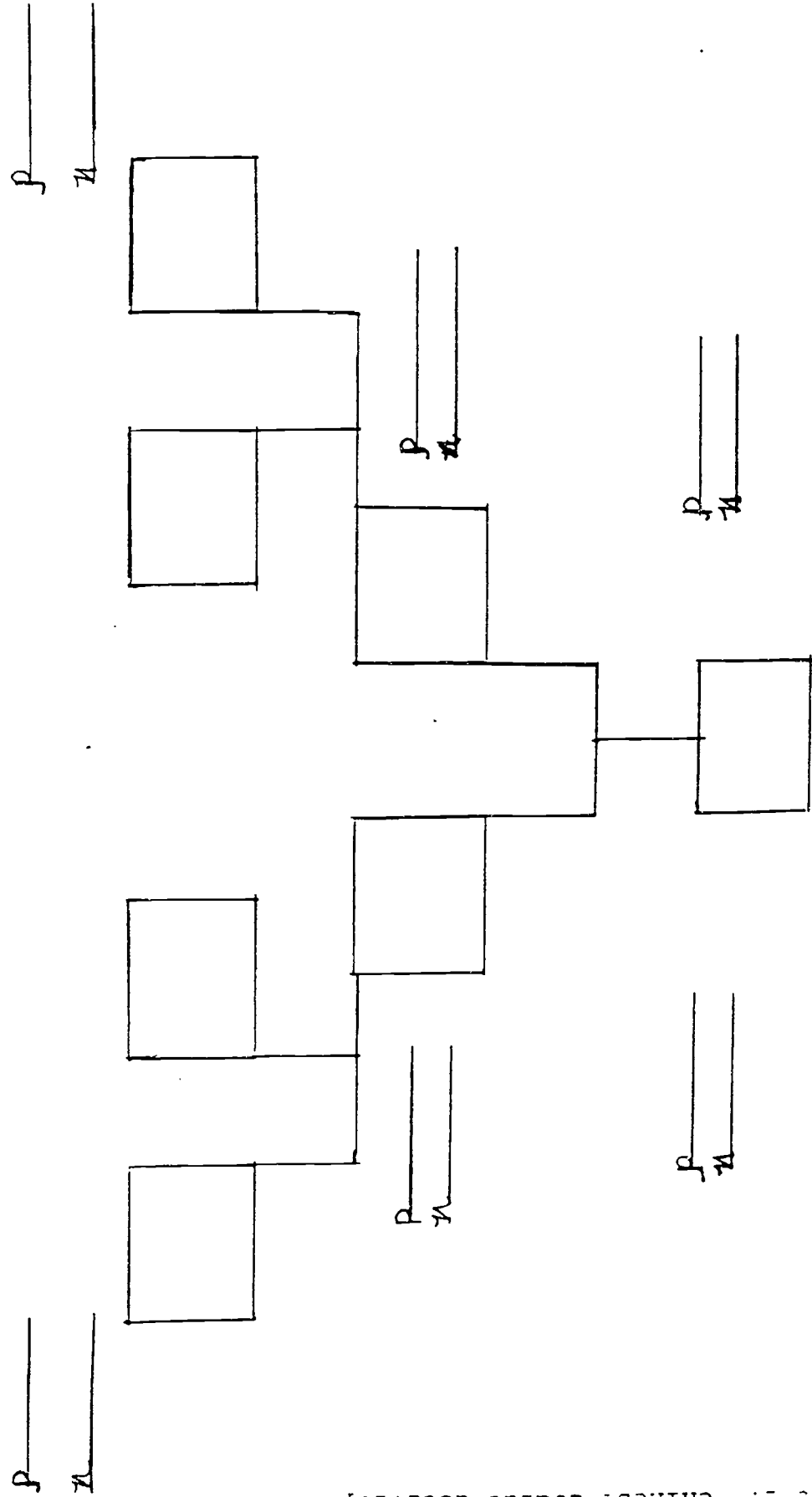
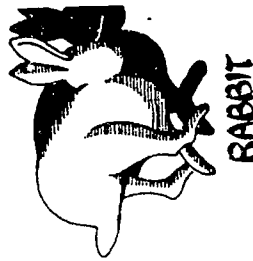

Chart 2. Chinese zodiac activity chart.



RABBIT

1915 • 27 • 38 • 51 • 63 • 75 • 87
You are the kind of person that people like to be around — affectionate, obliging, always pleasant. You have a loyalty tough to get too sentimental and seem superficial.



DRAGON

1916 • 28 • 40 • 52 • 64 • 76 • 88
Full of vitality and enthusiasm, the Dragon is a popular individual even with the reputation of being boisterous and a "big mouth" at times. You are intelligent, polite, and a perfectionist.



HORSE

1919 • 30 • 42 • 54 • 66 • 78 • 90
Your capacity for hard work is amazing. You are your own person — very independent. While realistic and friendly, you have a strong streak of self-interest and sheep cunning.



SNAKE

1917 • 29 • 41 • 53 • 65 • 77 • 89
Rich in wisdom and charm, you are romantic and deep feeling and your intuition guides you. Avoid procrastination and your shrewd attitude brings in money. Keep your sense of humor!

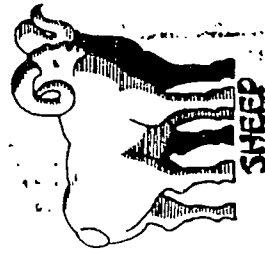

SHEEP

1919 • 31 • 43 • 55 • 67 • 79 • 91
Though you're always peering off to the wrong foot, you are charming company. Sheep are elegant and artistic, but always find to complain.



MONKEY

1920 • 32 • 44 • 56 • 68 • 80 • 92
Monkeys are smart and have a clever wit. You have a strong nature and may react personally. Avoid being cooperative and distrustful of others.



Chinese Zodiac

Charming, Witty, Gallant, Wise — Recognize Yourself? Stingy, Selfish, Cunning (must be somebody else!)

The Chinese Zodiac is based on a twelve year cycle — each year is represented by an animal. Traditional Chinese beliefs are that a person's year of birth holds the key to their life-long character and well-being. Find the year you were born to determine your own sign.

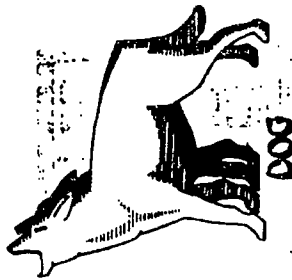

DOG

1910 • 22 • 34 • 46 • 58 • 70 • 82
The Dog will never let you down. Born under the sign you are honest, and faithful to those you love. You are prepared by constant worry, a sharp tongue, and a tendency to be a fault finder.



COCK

1921 • 23 • 45 • 57 • 69 • 81 • 93
The Cock is a hard worker, shrewd and deliberate in decision making, often speaking his mind. Because of this, you tend to seem bossy to others. You are a cleaner and neatfreak.



BOAR

1911 • 25 • 37 • 49 • 61 • 73 • 85
You are a spirited competitor, in particular with a very strong need to set difficult goals. You are serious, tolerant, and honest but by expecting the same from others, you are naive.



RAT

1912 • 24 • 36 • 48 • 60 • 72 • 84
You are imaginative, charming, and truly generous to the person you love. However, you have a tendency to be quick-tempered and overly critical. You are also inclined to be an opportunist.



OX

1913 • 26 • 38 • 50 • 62 • 74 • 86
You are a born leader, inspiring confidence from all others. On an occasion, you are firm and good with their hands. Avoid being obsessive and demanding.



TIGER

1914 • 27 • 39 • 51 • 63 • 75 • 87
Tigers are sensitive, emotional, and possess great love. However, you get carried away with what you think is right a rat.

© 1988
© Entertainment

FLOWERY CHINA

China is often called the "flowery land." Flowers have been an inspiration to artists, poets and writers. They are used in cooking, making drugs, medicinal products, perfumes and for their products (fruits, nuts and vegetables). Chinese gardeners have a way of arranging the rocks, trees and flowers so that the results seems almost like paradise. Each month and season has its own flower.

January - Prunus (plum)

February - Peach

March - Peony

April - Cherry

May - Magnolia

June - Pomegranate

July - Lotus

August - Pear

September - Mallow

October - Chrysanthemum

November - Gardenia

December - Poppy

Spring - Tree Peony

Summer - Lotus

Autumn - Chrysanthemum

Winter - Prunus (plum)

BEST COPY AVAILABLE

Purpose:

To develop an understanding of cultural traits of other countries.

Objectives:

To identify and use sources in a library.

To introduce facts about flowers.

To use Chinese cultural traits in a classroom activity.

Materials:

Field Guide to Flowers by Herbert Zim

World Book Encyclopedia

Magic markers

Bulletin board

Procedure:

1. Have each student research his birth month flower and season flower.
2. Each student will draw the birth month flower and the season flower on a four-inch circle.
3. The class will prepare a bulletin board that graphs the students' birthdays by month and by season, using the student-prepared circles.

Evaluation:

Classroom product.

Initiate a classroom discussion on products used to represent the birth month in other countries.

CHINA'S MOVERS AND SHAKERS

The people of China have created a remarkable culture. People who influence culture are movers and shakers of that society.

Purpose:

To stimulate student interest in the culture of China.

Objectives:

To use research skills with various library sources.

To prepare an informative presentation about the movers and shakers of Chinese culture.

Materials:

Time line plaque.

List of movers and shakers for student research cards.

Qin Shji Huangdi	Cheng Ho
Wuer Kaixi	Mattes Ricci
Princess Tou War	Ghengis Khan
Mao Zedong	Dalai Lama
Confucius	Ts'ao Chan and Kao E
Empress Wu	Soong Ching-ling
Laoten	Soong Ching-Ai-ling
Marco Polo	Scong May-Lin
Budde	Hong Xiuquan
Chaing-Kai-shek	Li Hong-zhang
Sun-Yat-sen	Menicus
Deng Xiaoping	Chou-Wen-chu
Jiang Qin	Tung Yuan
Cixi Empress Dowager	Yang Mo
Laozi or Laotzu	Tien Ana
Zhou Enlai	Tsai Te hon chen
Richard Nixon	Lu Ho'un
P'u Sung-ling	Han Kan
Kublai Khan	

Procedures:

Use encyclopedias, world history books, magazines, movies, biographies and autobiographies in the library to research the mover or shaker.

Use a separate research card for each source.

Research cards should include: name of mover or shaker, date lived, general area and time in history. Write several sentences about his accomplishments and personality traits.

Create props or a costume for use with the mover or shaker. Place a button on the left shoulder.

Make a time line showing the dates of the mover.

Arrange the information in an entertaining format.

Learn the information.

The student will assume the identity of the person on the date the class choses to present the Movers and Shakers Living Wax Museum. Students will dress in costume and makeup. Students will be arranged in a sequential time line at various points of the place chosen to house the museum. When a student visits the museum, he must press the button on the character's left shoulder. The mover or shaker recites information about his character.

Evaluation:

student product.

BEST COPY AVAILABLE

Diane Naegeli
Chico Un. Sch. Dist.
Chico, Ca. 95926
(916) 345-6816

December 1993

Audience: 4-12
(combinations)
(5/6;7/8)

CHINA/U.S.A.
Beijing - Wash.D.C.
"A Sense of China"

Purpose: to develop "a sense of China!" and suggest an approach for integrating the study of China with that of U.S. History. The activities presented in this paper will work very well for multi-graded classes (5/6,7/8) or High School classes where World History and U.S. History must be combined, or in a regular classroom. They may be used as introductory, enrichment, or mini-lessons, and this concept may be expanded to other CHINA/USA units.

All five themes of geography--1 Location, 2 Place, 3 Human-Interaction Environment, 4 Movement, and 5 Regions--are present in these activities. They coincide with the California State Social Studies Framework and will adapt easily to other courses of study.

NOTE: The concept of teaching CHINA and USA simultaneously will be especially helpful to 5/6th grade teachers for the following reason: The 6th grade California curriculum spans 3 1/2 million years BC to 500 AD, and includes the major world religions. The 5th grade California curriculum spans only the Pre-Columbian Period to the Civil War, approximately 400 years! Due to time constraints, 6th grade China studies are often skipped; which in the 90's may be a loss of valuable background information which students need to develop-- "a sense of China!"

Lesson Objective: to compare and contrast the mystical places and events of CHINA with the more familiar places and events of the U.S.A.--the capitol cities: Beijing vs Washington--

Materials: (select from the list below.)

1. Large physical/political map of both CHINA/USA
2. Tourist map of Beijing/D.C.
3. Student atlases (laminated desktop maps of Asia optional)
4. A Variety of slides, videos, photos, post cards, pictures of CHINA--Beijing: Imperial Palace, Mao Memorial, Great Hall

of the People, Statues/Monument to the Peoples Heroes,
Museum, Great Wall, street scenes (bikes, etc)

5. Teacher overhead/students copies of Tianmen Square and
Capitol Mall

6. White drawing paper (12x18), colored pencils, felt pens,
5x8 cards, binder paper, etc;

7. Outline maps of China and provinces - overlay materials
for extension lessons (size, population, minorities, etc)

SET: Ask Geographic "quick review" questions from list
below, while students work as partners. One student will use
an atlas of the USA, and the other student will use an atlas
of CHINA. Laminated desktop maps of Asia (or the World) are
an excellent way to stimulate interest in this activity.

Allocated time depends upon the grade level and prior
knowledge of the class. Shorter segments of the "quick
review" could be used prior to each lesson on CHINA.

NOTE: Many variations and games can be created with the use
of laminated maps and atlases. Example: As one student looks
for and marks the answer on the laminated map; the other
student uses the atlas to find good questions, or check the
answers. (may keep score)

--FIND AND COMPARE EACH LOCATION--(find USA 1st/CHINA 2nd)

1. On what hemisphere is the country?
2. On what continent is the country?
3. What are the country's northern borders?
4. What are the country's southern borders?
5. What is the country's eastern border?
6. What borders the country to the west?
7. Name the country's large deserts?
8. Name the country's largest mountain range.
9. Name a major eastern mountain range.
10. The longest river? The muddyist river?
11. Major city near the mouth of the longest river?
12. Name the national capitol.
13. Nearest sea or bay to the east of the capitol.
14. What states or provinces border the capitol?
15. Other plateau, plains, farmlands, forests, canyons,
ETC;

(USA=answers: Western, North America, Canada, Mexico,
Atlantic, Pacific, Mojave/Sonoran, Rocky, Appalachian,
Mississippi, Colorado, New Orleans, Washington DC, East
Coast, Chesapeake, Maryland and Virginia)

(CHINA=answers:

1. Eastern
2. Asia
3. Mongolia/Russia
4. Vietnam/Laos/Burma/Bangladesh/India
5. Pacific
6. Gobi/TaklaMakan
7. Himalayas
8. Da Himggan Ling
9. Yantsze/Yellow
10. Shanghai
11. Beijing (Peking)
12. East Coast
13. Bo Hai/Yellow Sea
14. HEBEI - Tianjin, Shanxi, Nei Monggol, Liaoning **
15. Tibetan, steppe, southeast, northern, karst, etc;
(** see KEY--Sample China Map)

Extension Activity--give a homework or class assignment to label above items on outline maps of USA/CHINA. Pass out outline maps showing province/state and country borders.

Procedure:

1. Ask if there could there be other similarities between our capitol city Washington D.C. and China's capitol city, Beijing?
2. Have students list on binder paper the important things that they remember when they think of Washington D.C.

USA

1. White House
2. Capitol
3. Washington Monument
4. Smithsonian Institute
5. Jefferson Memorial
6. Vietnam Wall Statues
7. Government Buildings
8. Kennedy Performing Arts
9. Arlington Cemetery
10. Mall Design
11. Parks (recreation?)
12. Lincoln (other)

CHINA

1. Imperial Palace
2. Great Hall of the People
3. Mon. to the Peoples Heroes
4. History Museum
5. Chairman Mao Mem. Hall
6. Peoples Heroes Statues
7. Government Buildings
8. Beijing Opera (acrobat)
9. Cremation Beliefs
10. Tian Square Design
11. Parks (recreation?)
12. (other)

3. If they finish early, have them sketch on back of their notes, where they think the above places are located around the capital Mall.

4. Display overhead of Capitol Mall (2=see samples from World Book; 2=see samples Weekly Reader), or tourist map--compare.

3.

5. Get "A Feeling of Beijing" by showing slides, photos, video clips, postcards of Beijing and Tiananmen Square. (personal experiences, background information, etc; helpful)

6. During slide viewing have students jot on a separate sheet of paper, 10 to 12 things they observe on their Arm-Chair Tour of Beijing in #5.

7. Have students copy a large rectangle on the back of their slide notes and briefly jot down brief shapes, names, and placement of Tiananmen Square Landmarks. While drawing ask-- what do the CHINESE call their White House? their Smithsonian? their Capital? their Jefferson Memorial? what would be in the center of Square where the Washington Monument is located? etc?

Compare to Tiananmen Square overhead (2=see samples)

8. FOCUS SLIDE (or large visual) on each of the major Tiananmen Square Landmarks. while class "sketches" landmarks on 5x8 cards, discuss and share information and questions about the area. Discuss similarities and differences in USA/CHINA--grassy vs.cement; architectural styles; French designer, layout; and other aspects of each place. (see EXTENSION below)

9. After most 5x8 sketches are roughed in, have students fold 12x18 art paper into fourths; and take time to make a quality, labeled diagram of Tiananmen Square placing completed, colorfully enhanced landmark cards at each side. (Continue using visuals, color pencils, pens--SAMPLE-A)

10. Students finishing early could may draw a large free hand black outline map of China on the back of diagram. Then impose four different impressions of Beijing in each quadrant with an informational caption below each picture. (suggestions: A)Summer Palace B)Great Wall C)Temple of Heaven D)Chinese Flag; or A)Fisherman B)Opera Mask C)Bicycle Cart D)Tai Chi) (see sample B)

EXTENSION: COOPERATIVE GROUPS may study landmark places in more depth. Let students pool their resources and formulate "questions" on Beijing, China's capitol city.

"Quick Research Idea List"

- 6th grade explore CHINA (compare/contrast USA)
 - 5th grade explore USA (compare/contrast-CHINA)
- Focus slides on various Beijing Landmarks below:

Imperial Palace

- moat
- architectural style
- vast size, number of buildings
- when built, by whom,
- last emperor living there, dates, why left, etc;

- who lives there now; (national museum)
- residence of present leader
- title of China's head-of-state (king, queen, premier, sultan, president, shaw, prime minister, etc)
- Rest and Relaxation, Beihai Lake/Hill, walking, etc;
(see SUMMER PALACE)

* VIDEO Last Emperor (first half)

Great Hall of the People

- was Beijing the first capitol, dates built, etc;
- name other cities that were capitols, dates, etc;
- is there a large room or area for each province
- art work for each province
- number of provinces ____ (** see KEY-China Map)
- Architecture - communistic principles - "Stalinistic"
square lines, gray, slab construction
- democratic principles - Greek columns,
Roman domes, etc;

Monument to the Peoples Heroes

- tanks upon speaking platform
- Freedom of Speech, Right to Assemble
- T. Square Massacre-1989, why, happened before?
- (MLK March, other causes, etc);
- does obelisk honor a special leader, or group
- feeling tone around area (design/cement, pond, grass,)

History Museum

- difficult to enjoy unless read Mandarin
- interpret in English, foreign language tours
- most spoken language in the world (Mandarin)
- writing Chinese symbols, number _____; (USA 26 letters)

Chairman Mao's Memorial (Mausoleum)

- live person vs statue
- when did Mao die; peoples party ideals; results;
- leaders: how elected, removed, etc;
first emperor, last emperor, etc;
Dr. Sun Yet-sen, revolution; Chiang Kai-shek, civil war;
- shortest term, longest term,
(who were our Presidents related to the above)
- present leaders, names/titles, etc;
- head of state _____
- leaders' religion
- LEADER TIME LINE
- * see film: Farewell My Concubine (teacher only)

Statues to the Peoples Heroes

- common man, statesmen, leaders, minorities, etc;
- WAR heroes? (Vietnam Wall, Iwo Jima, soldier statuary)
- WAR TIME LINE

Summer Palace (Recreation)

- Rest/Relaxation (Camp David, San Clemente, Maine)
- Meditation/Religion (beheaded Buddhas incident)
- Park scenes (gift giving--BEAN ART--SCENES)
- Parks--pet birds, kites, tai chi, swing dance, fishing, feeding ducks, haircuts, board games, etc;
(USA--picnic, read, kites, physical games)
- * VIDEO Iron and Silk (customs, beliefs, daily life)

Temple of Heaven (Religion)

- Meditation/Religion, sacrifices, etc;

Beijing Bikes (Transportation)

- BEIJING BIKES! subway, bus, cab, auto, jet, etc;
(D.C., AUTOS subway, bus, cab, JET, bikes)

THREE MINI-LESSONS

Abacus (Business) -easy activity for Math--place value
Materials: 1 abacus(or more), paragraph, ditto, beans,
overhead

- Chinese use an ABACUS in shops to check calculators.
- Display an abacus; ask if any one knows how it works.
- Pre-teach 2 or 3 students. (use paragraph in World Book)
- Student reads directions to class and allows volunteers to come try it on the abacus--give them an easy number.
- Partners use ABACUS ditto/beans to challenge each other.
(Make teacher overhead to help students--see sample)

Bean Art (Recreation) -easy activity for Math/Art-
Materials: construction paper(red,yellow,white), glue,
scissors,pencil,colored pens,beans variety

- Students fold and cut one red/one yellow construction paper to make two square boxes. Make one a bit smaller, so they fit together as a box should (about 4/5 inches in size).
- Cut white construction paper to fit inside box bottom.
- Students draw recreational or traditional Chinese scenes. Plan the sketch around any "type" of bean or beans. Use the bean/beans as the face,body,etc; of the sketch. CAUTION students to use only 1-4 beans at the most. Keep it simple. (example: glue ONE large bean head--draw on eye; sketch graceful body and beak)
- Glue bean sketch into the box, 1st display and then give to a friend.

Reflections on Beijing -easy activity for Language Arts-
Materials: paper and pencil

- Brainstorm topics for China on board
- Students select only topics on Beijing and MAP it adding more of their own ideas (STUDENT sample)
- Write 1-3 paragraphs on one topic; OR write 3 paragraphs 3 topics; title the work; illustrate if time allows

CULMINATION ACTIVITY --Great Wall Art--

SET: Show "Big Blue Marble Earth Poster"; kids love to tell about the astronauts seeing The Great Wall from space. Show slides, post cards, pictures; and let the students share what they know about The Wall. (Genghis Khan, Mongols, brutal border WARS, Great Emperors, etc.)

Materials: Visuals above; pencil; 12x18 white art paper; blue, green, black crayons and watercolors (or tempera).

1. Have students chose 1 or 2 favorite slides of The Wall and leave picture books open. Discuss how artists project their own ideas and feelings to draw and create a more personal and individual version of commonly photographed places. Exact likeness is seldom the goal of a good artist.

2. ONE RULE - student Walls may twist and turn, but must go completely across the page; and end in the middle of both sides. For elementary students I have them pencil in the Wall; when they like it, they outline it in dark black crayon. Draw in hills outline in dark green crayon. The rest is sky; then they use watercolors (green, blue, and light black-gray). (see sample F)

When finished students may read "Meng-Jiang Nyu" from Traditional Chinese Folk tales by Yin-lien Chin, Yetta Carter, and Mildred Ross. (see sample)

3. Display Wall Art in wavy hill-like fashion all around the classroom from top edge of ceilings through middle of bulletin boards. Surprise! All pictures will join near the center side edges. One student commented, "Wow, we don't have to go to CHINA to see The GREAT WALL. We have it RIGHT HERE in our classroom!!"

Students are excited about CHINA. One boy came as an Emperor in velvet on Halloween; one designed a Forbidden City that opened on his binder; one said, "If I ask my folks any more questions about CHINA, they're going to kill me."; and the whole class keeps chanting: "When can we see more slides? When do we go to XIAN?"

Could it be we've begun to develop - "a Sense of China". . .

--ENJOY--

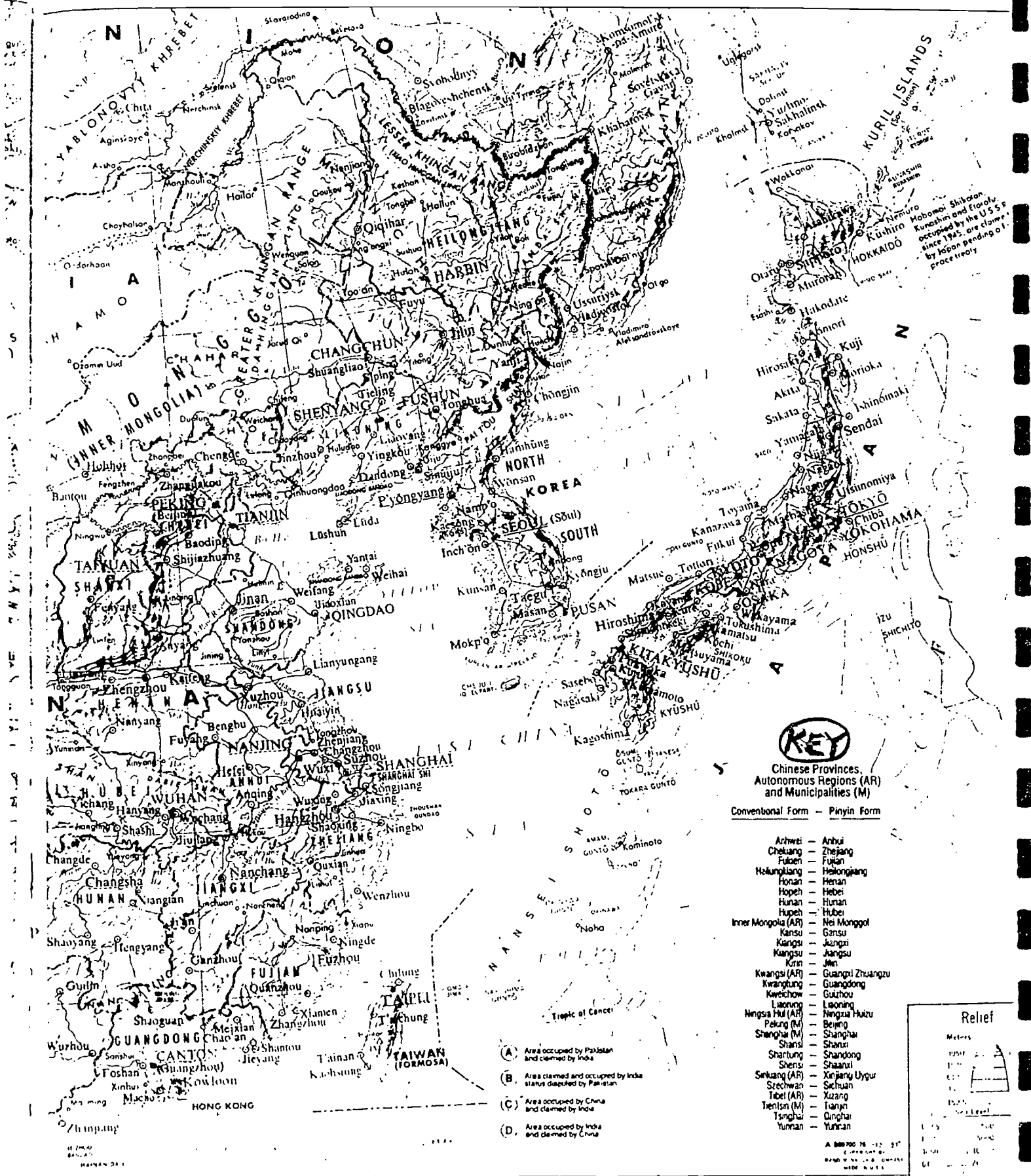

Chinese Provinces, Autonomous Regions (AR) and Municipalities (M)

Conventional Form - Pinyin Form

Arwei	-	Anhui
Chekung	-	Zhejiang
Futen	-	Fujian
Helungkiang	-	Heilongjiang
Honan	-	Henan
Hopeh	-	Hebei
Hunan	-	Hunan
Hupeh	-	Hubei
Inner Mongolia (AR)	-	Nei Monggol
Kansu	-	Gansu
Kangsu	-	Jiangxi
Kangsu	-	Jiangsu
Kirin	-	Jilin
Kwangsi (AR)	-	Guangxi Zhuangzu
Kwangtung	-	Guangdong
Kweichow	-	Guizhou
Laoning	-	Laoning
Ningsia Hui (AR)	-	Ningxia Huizu
Peking (M)	-	Beijing
Shanghai (M)	-	Shanghai
Shansi	-	Shanxi
Shantung	-	Shandong
Shensi	-	Shaanxi
Sinkiang (AR)	-	Xinjiang Uygur
Stechwan	-	Sichuan
Tabei (AR)	-	Xizang
Tientsin (M)	-	Tianjin
Tsinghai	-	Qinghai
Tunnan	-	Yunnan

- (A) Area occupied by Pakistan and claimed by India
- (B) Area claimed and occupied by India status disputed by Pakistan
- (C) Area occupied by China and claimed by India
- (D) Area occupied by India and claimed by China

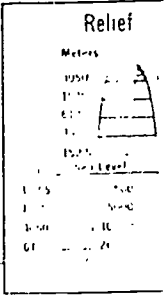

BEST COPY AVAILABLE

Cities and Towns 0 to 500 500,000 to 1,000,000 1,000,000 to 2,000,000

Continued on pages 2, 6, 23



Scale 1:10,000,000 (one inch to 200 miles). Data and Prop. U.S. Geological Survey, 1950. Reprinted by permission of the U.S. Government Printing Office.

WASHINGTON D.C.

Washington, D.C., covers 67 square miles on the eastern bank of the Potomac River. Its location, once a part of Maryland, was chosen during George Washington's first administration. A famous French military engineer and architect, Major Pierre Charles L'Enfant, drew up the plans for the city. With amazing foresight, he planned a great capital with broad streets, grand avenues, and sweeping park areas, which could grow with the new nation.

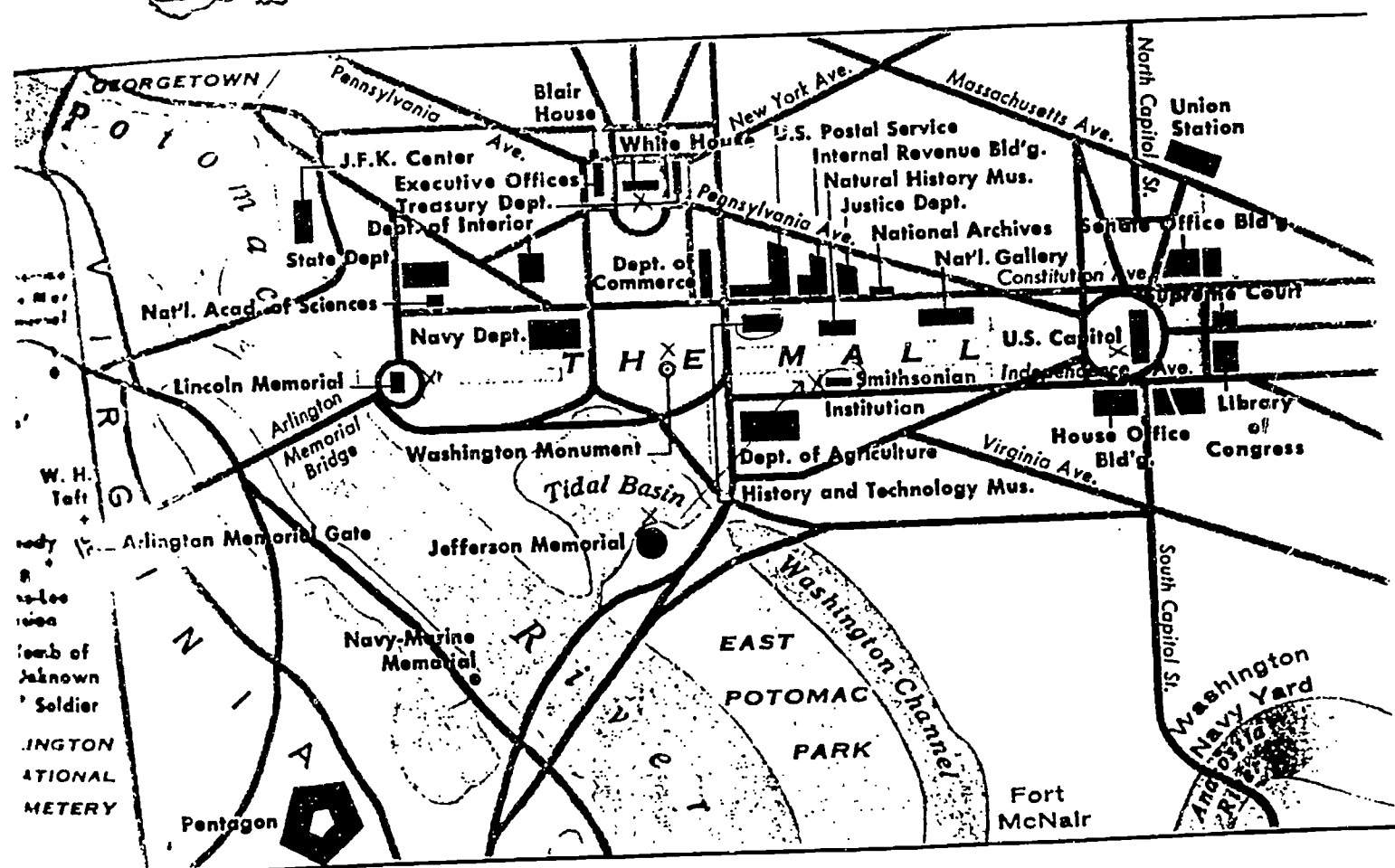
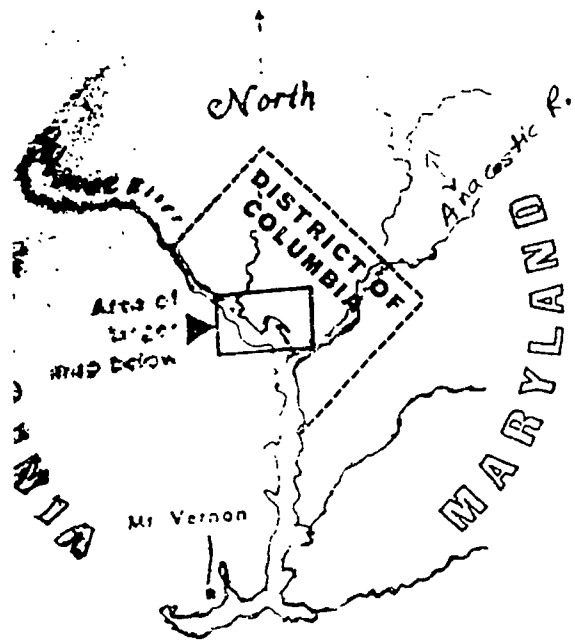

(World Book)

The National Archives Building houses official United States government documents and records.



The Heart of Washington is the United States Capitol, below, number 2. From the Capitol, wide avenues branch across the city. Pennsylvania Avenue runs northwest from the Capitol past the White House. The Mall, a long stretch of green parkway, extends westward from the Capitol.

1. The Mall
2. United States Capitol
3. Supreme Court Building
4. Library of Congress
5. United States Botanic Garden
6. House Office Buildings
7. Department of Health, Education, and Welfare
8. Food and Drug Administration
9. Department of Transportation
10. Department of Housing and Urban Development
11. Jefferson Memorial
12. Tidal Basin
13. Bureau of Engraving and Printing
14. Department of Agriculture
15. Forrestal Building
16. Federal Aviation Building
17. Smithsonian Building
18. Lincoln Memorial
19. Washington Monument
20. Arlington Memorial Bridge
21. Navy Department
22. Museum of History and Technology
23. Natural History Museum
24. National Gallery of Art
25. National Science Foundation
26. John F. Kennedy Center for the Performing Arts
27. Department of State
28. Department of the Interior
29. Constitution Hall
30. Federal Triangle
 Department of Commerce
 Postal Service
 Bureau of Internal Revenue
 Department of Justice
 National Archives
 Federal Trade Commission
31. Executive Office Building
32. White House
33. Department of the Treasury
34. United States Court House
35. Senate Office Buildings
36. Constitution Avenue
37. Pennsylvania Avenue
38. Maryland Avenue
39. Independence Avenue



WORLD BOOK photo by U.S. News Service

(World Book)

The Smithsonian Building houses the administrative offices of the Smithsonian Institution, an organization founded for scientific learning and research more than 100 years ago. Its building is of unusual design with numerous towers, turrets, and pinnacles.

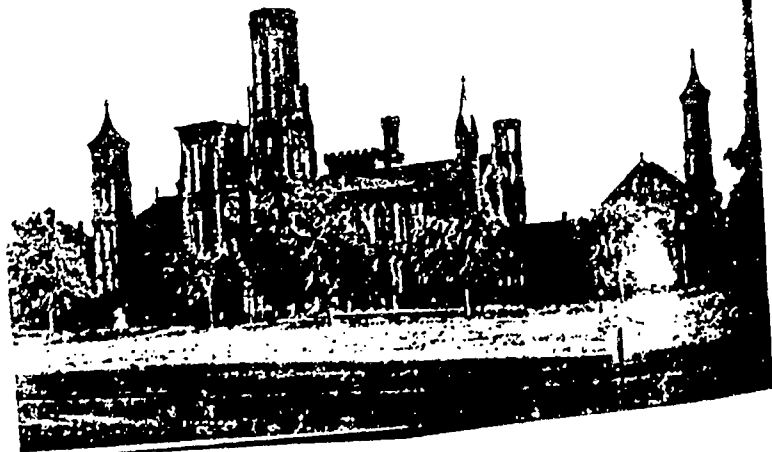

U.S. Capitol Celebration

One of the most important places in the United States is the U.S. Capitol building in Washington, D.C. It is the place where our laws are made and our country is governed. The Capitol building is a symbol of our democracy and our freedom.

Major Andrew Ellicott designed Washington, D.C., and placed the Capitol in the heart of the city on Jenkins Hill. It later remained Capital Hill. He described the site as "a pedestal waiting for a monument."

It took seven years to finish the first

U.S. Capitol building. The House of Representatives and the Senate met in the building from 1800 to 1857. The building was destroyed by fire in 1864. It was rebuilt and enlarged to make room for lawmakers from the states that entered the union in the 1800s.

Despite those changes, the Capitol still looks much the same as it did when it was first completed. Its famous dome remains a symbol of our democratic government.

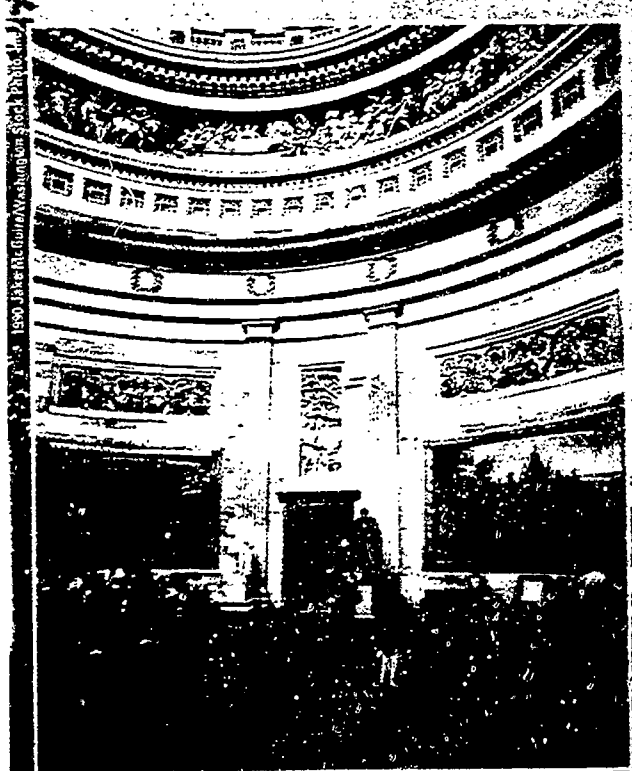

Tourists visit the Capitol Rotunda, where the largest fresco in the nation is located. The painting measures 4,664 square feet.

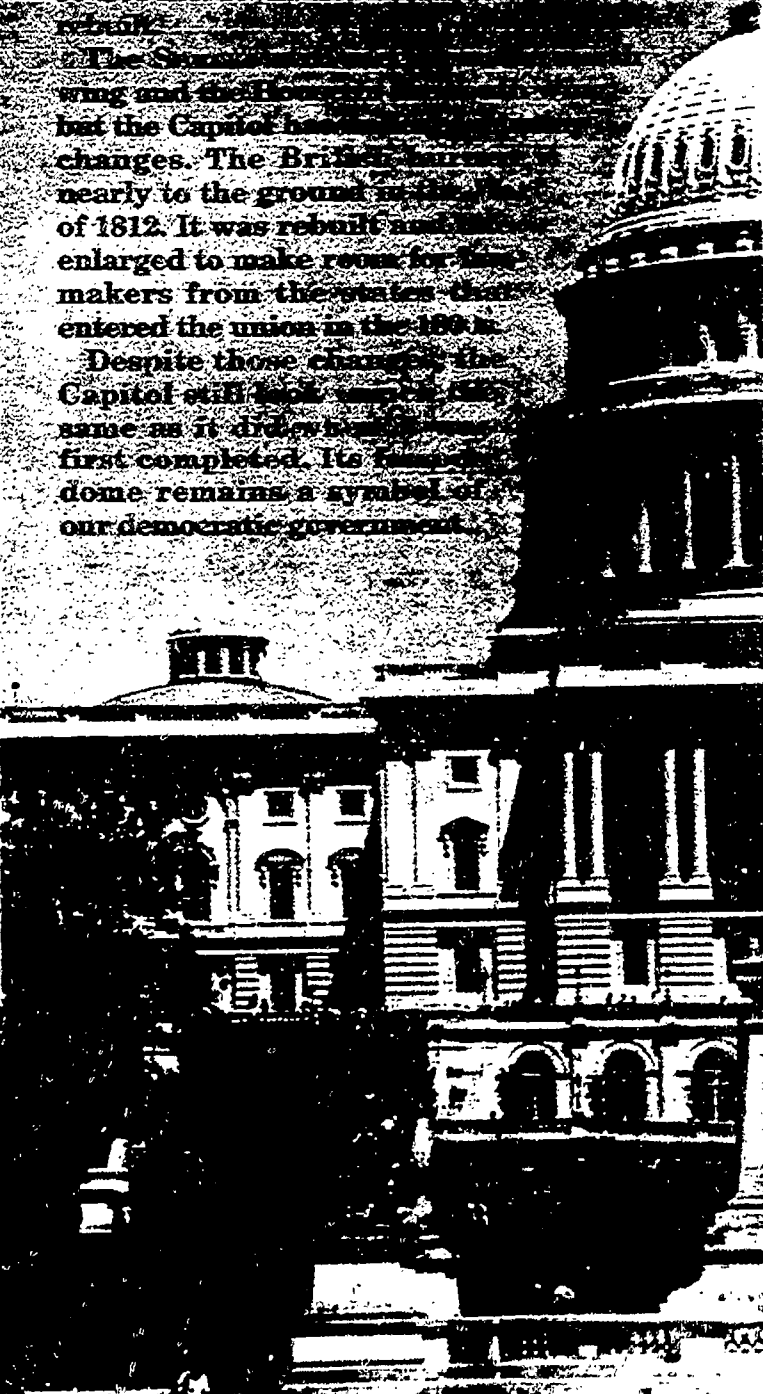

Sample type of articles can be used on different layouts

es Bicentennial

Lady Freedom Gets a Bath

The Statue of Freedom is finally getting a bath. After all, it hasn't had one—except for rain showers—since it was first placed atop the U.S. Capitol dome in 1863.

Last spring, a helicopter lifted the 15,000-pound statue from the 268-foot-high dome and lowered it to the ground. For months, specially trained workers have been cleaning Freedom's surface with high-powered hoses.

Before the 197-foot-tall bronze statue is returned to its perch, it will receive a special coating to protect it against rain, snow, and pollution.



CAPITOL FACTS

- The Senate got its first ladies' room this year, after the number of female senators doubled, bringing the total to six.
- Ten million people visit the U.S. Capitol each year.
- The Capitol has the largest cast-iron dome in the nation. The dome weighs 9 million pounds.
- During the Civil War, the Capitol served as a hospital for soldiers wounded in battle.

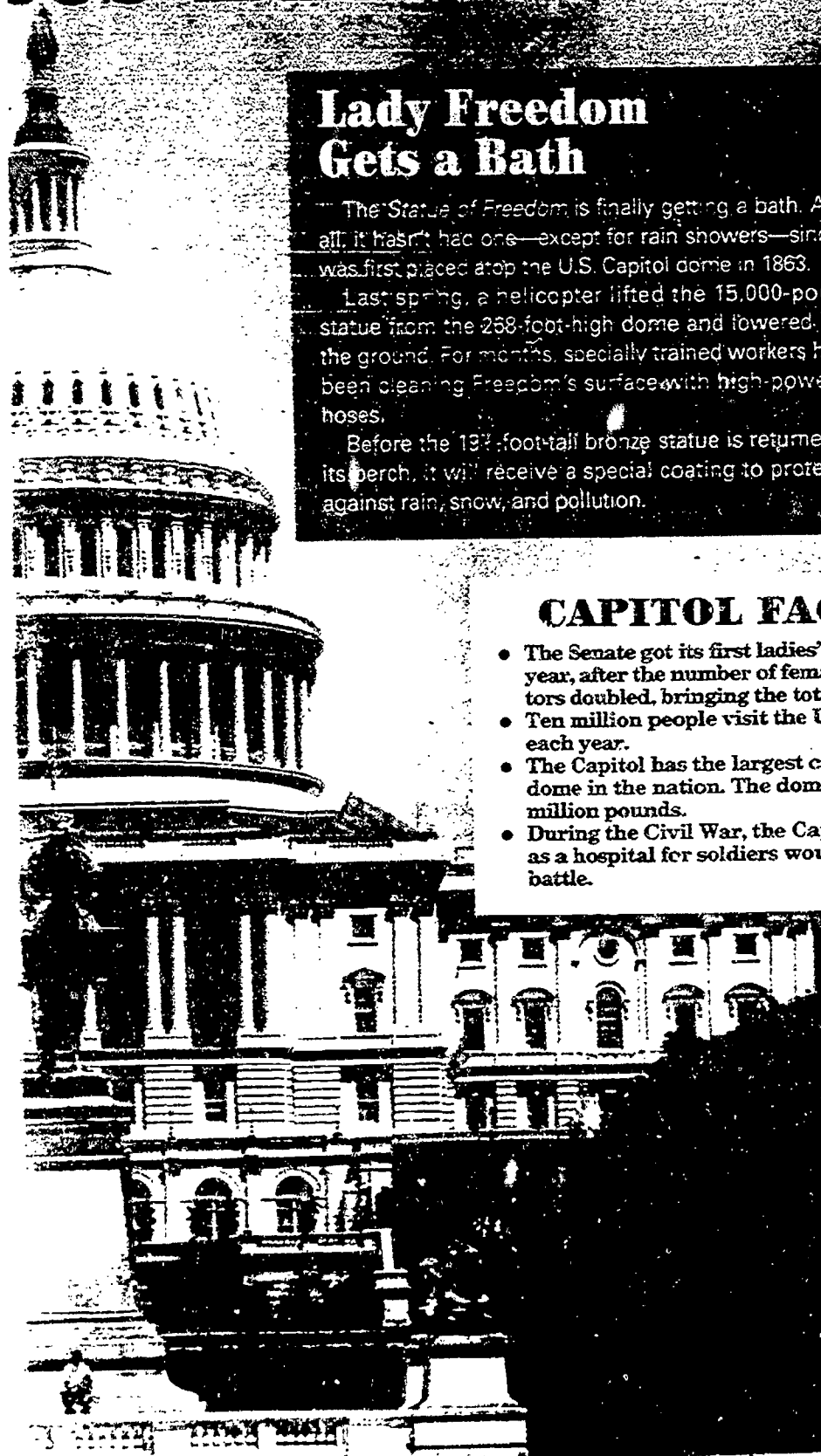

© 1993 John N. Gray & Associates, Inc. Photo: AP/Wide World

Weekly Reader 1993

Brief to the Scenic Spots in Beijing

北京景點簡要介紹

Tian'anmen Square Tian'anmen Square was formerly an imperial square in front of the Forbidden City. Large scale expansion after 1919 has turned it into the biggest square in the world. North of the square stands Tian'anmen, the main gate of the Forbidden City of Ming and Qing dynasties. Towering on the square is the Monument to the People's Heroes. In the due south of the square, just inside zhengyanmen stands the majestic Memorial Hall to Chairman Mao. Flanking the square are the Museum of Chinese History and the Great Hall of the People on the west side. Northwest of the square is the Zhongshan Park. Northeast of the square is the Cultural Palace of Labouring People. Which used to be the ancestral temple of the Ming and Qing rulers.

Palace Museum The Imperial Palace of 21 emperors of the Ming and Qing dynasties, known as the Forbidden City, is the largest and best preserved palace complex still in existence in China, and also the largest museum in this country. Started to be built in the 4th year (1406) of Yongle reign in the Ming dynasty, consisting of about 9000 rooms. The Palace complex is divided into the outer and inner part. The outer part consists of three main halls - Taihe Hall, Zhonghe Hall and Baohe Hall. Which are laid out in a line along the central axis of the part. Wenhuadian and Wuyingdian are on both sides of axis as wings. The inner part of the palace complex consists of Qianqing Hall, Jiaotai Hall, Kunming Hall, Six Eastern Hall, Six Western Hall and the Imperial Garden. The eastern halls are now used for displaying antiques, it collects more than 90000 pieces of court and the treasures in all dynasties in China. The western Halls are used for showing reconstructions of former rooms.

The Great Wall at Badaling The Great Wall was first built about 2500 years ago, during the Warring States period, and then extended and fortified in the Qin, Han and Ming dynasties. Typicality of the Great Wall is the section at Badaling. This section, once a component part of the northern defence system of Ming dynasty, having a height of 6.7m and a width great enough for five horses to march abreast. Scenic spots near the Juyong Pass are Guancheng of Ming dynasty and Yuntai of the Yuan dynasty, which are known for their stone carvings.

The Great Wall at Mutianyu The Mutianyu section of the Great Wall, is located the mountainous region of Huairou County. Also a important part of the defence system of the capital during the Ming Dynasty and is known as the "Second Badaling" for its scenery. This section has a large number of guard towers, there are 22 beacon towers spread along a length of 2km, where the convergence of three walls and juxtaposition of three beacon towers. A footpath has been built for climbers and a cable car service is available.

Beihai Park The Beihai Park was originally a palace constructed by Liao emperors in the 10th century for short stays away from the Capital, during the Jin, Yuan, Ming and Qing dynasties, it was an imperial garden. Half of which is occupied by waters. The Jade Glowery Islet, located at the park's center. On the islet, besides towers the White Dogoba, also the Yungansi, the waterside long corridor, and the Yilantang. Other scenic spots in the park include the Jingsinzhai, the Haopujian, the Huafangzhai, the Five-dragon Pavilion, the Nine Dragon screen and the Round city.

Summer Palace (Yiheyan) The Summer Palace is the most magnificent and the best preserved of all existing royal gardens in China. Started to be built in Jin dynasty about more than 800 years ago. It was expansion in Ming and Qing dynasties, and then destroyed by the joint force of Britain and France. In the 14th years of the Guangxu reign period (1888), Empress Dowager reconstructed the garden with fund originally intended for building the Chinese Navy, and named it Yiheyuan, with a land to waters ratio of 1:3. There are in the park over 3060 halls, chief among them are Renshoudian, Yulantang the Theatre, Painted long corridor, Panyundian, Luxiangge, Marble Boat, Bronze cattle, 17-arch Bridge, and Garden of harmonious interest, etc. The major halls are all furnished as they were during the late Qing dynasty. Hence the name "the Museum Park".

Ming Tombs There are altogether tombs for 13 emperors of the Ming Dynasty. The area is entered by a huge stone gateway. Leading from the gateway is a 750m long path flanked by stela pavilions and 18 Pairs of stone statues. Changling, the tomb for the Ming emperor Yongle and his wife, consisting of the Ling'en Hall, Minglou, Baocheng and the underground Palace. Dinglin, the burial place of the 13th Ming emperor, Zhu Yijun, and his two wives. It was excavated, unearthed from this tomb were more than 3000 precious cultural relics, including gold crowns and dragon decorated robes. Southeast of the tomb area is a newly developed scenic spot, the Shisanling Reservoir.

Zhoukudian The relic of the "Peking Man", it is over 50km. Southwest of Beijing. About 578000 years ago, here in the limestone cavern on Mt. Longgu, the "Peking Man" lived in. Moreover, the relic of the "Upper Cave Man", the primitive yellow man of 18000 years ago, have been found in a cave about the "Beijing Man" Cavern. Now, the Place is a research center of paleontology and paleoanthropology and set up an exhibition hall here.

The Temple of Heaven The Temple of Heaven used to be the place where emperors of Ming and Qing dynasties offered sacrifices to heaven. It is the largest existing architectural complex for imperial sacrificial ceremonies in China. It was built in the 18th year (1420) of Yunle reign in the Ming dynasty. The complex consists of the Qiniandian, the Circular Altar, and the zhongong. The Qiniandian, 38m tall, is supported by pillars standing in three rings representing respectively the four seasons, the twelve months and the twelve two-hours periods. The Circular Altar, the sacrificial ceremony was held, the Triple-sound stones and the Echo Wall of the Imperial Vault of Heaven symbolize that a dialogue was going on between the emperor and the heaven.

Lama Temple the largest lamasery in Beijing. It was constructed in the 33rd year of the Kangxi reign period of the Qing Dynasty (1694), and was the mansion house of prince Yongzheng originally. In the 9th year of Emperor qianlong (1744), turned into a lamasery. It comprise five major halls, taken in every styles of Han, Man, Monglian and Tibetan nationalities. There is a rich store of religious here. Chief among them are the statue of Maitreya Carved out of a 26m long single piece of sandal wood, the Buddha niche of nanmu and the 500 arhats made of five metals -- gold, silver, bronze, iron and tin, as called "Three consummate arts". In the west nearby region there are the Temple of Confucius and the Imperial College (Guozijian).

Great Bell Temple Because in it there is a big Bell, so named. The bell is 6.5m in height and 16.5 tons in weight. When it is struck, its sound can travel 10-20km and lingers in the air for two minutes. So it may be rated as the "King of bells in the world". In the temple, there is an Ancient Bells Mussum.

Grand View Garden It is a famous cultural garden which is a reconstruction of the Grand View Garden in the Chinese famous novel 《A dream of the Red Mansion》.

Temple of Reclining Buddha It is located in the north of the Fragrant Hills. In this temple a giant sleeping Buddha, 3.2m in length, was laid in the hall of the Hall of the Reclining Buddha, altogether 250 tons of bronze was used for cast the statue. The Buddha surrounded his twelve disciples, this is the scene before Sakyamuni's death.

Fragrant Hills Park and Biyun Temple The Fragrant Hills Park boasts a long history and is famous for its wooded mountains. During the Jin, Yuan, ming and Qing dynasties, all the emperors put up the villas here. Covering an area of more than 1.5 million m². The Park has many scenic spots, there are the zhaomiao, the Glazed Pagoda, the Jianxinzhai, the Yuhuashanzhaung, the "White Snow Under the Sun at the Western Hills", the Senyuhu, the ruins of Fragrant Hills Temple, and the Shuangqing Villa, etc. The Park is indeed a place where people can view red leaves in autumn. Outside the North Gate of the park, here is the Biyun Temple. In this Temple, there is Dr. Sun Yat sen Memorial Hall.

天安門廣場 天安門廣場為北京皇城的正門廣場。1919年這裡曾發生過五四運動，面積達1萬多平方米。成為可容納百萬人的當今世界最大的廣場。廣場正北的天安門，是明朝、清皇城的正門，廣場中盤立著人民英雄紀念碑，中國革命歷史博物館和人民大會堂分列廣場東西兩側，廣場南面是傳聞內皇宮主殿乾清宮。廣場西面有中國人民大會堂、北京人民大會堂、皇宮後門即正門，現在則是人民總和文藝活動之地。

故宮 故宮舊稱紫禁城，是明、清兩朝24位皇帝的皇宮，是中國現存最大、最完整的帝王宮殿，也是國內最大的博物館。始建於明永樂四年(1406年)，現在殿、門、宮、堂9000多間，面積720000平方米。建築有前中後三朝和內廷外朝之分，中軸線、中殿、後殿、大殿為中軸，文華殿、武英殿為兩翼，此外還有乾清宮、交泰宮、坤寧宮、西六宮如寧壽宮等。宮內主要作為博物館，藏有中國歷代珍品和宮廷文物90多萬件，宮內則以宮廷博覽館為主。

八達嶺長城 萬里長城是世界上最偉大的奇蹟之一，始建於2500多年前戰國時期，秦、漢、明等朝多次加以修繕。八達嶺長城是其北段最壯麗的一段，是長城沿線中規模最大、保存最完好的一段，是長城沿線中規模最大、保存最完好的一段，是長城沿線中規模最大、保存最完好的一段。

慕田峪長城 在懷柔縣，距北京70公里，是明初修築的長城，是長城沿線中規模最大、保存最完好的一段，是長城沿線中規模最大、保存最完好的一段。

北海公園 位於北京皇宮北側，是10世紀時建成的，是長城沿線中規模最大、保存最完好的一段，是長城沿線中規模最大、保存最完好的一段。



Jianguomen Sz	C6	Nanishulu Sz.	C3	Xijiekou Gb.	D4-E4
Jianxiang GB	F1	Paris & Telecom		Suzhenen GB.	D4
Yan GB.	F3 E4	Communications Centre	F5	Xizhimen Sz.	D4

十三陵
神道
建築
皇宮
園林
廟宇
天壇
皇極殿
正陽門
正陽門城樓
正陽門箭樓
正陽門城牆
正陽門城基
正陽門城礎
正陽門城臺
正陽門城階
正陽門城欄
正陽門城門
正陽門城扉
正陽門城扇
正陽門城楔
正陽門城釘
正陽門城鎖
正陽門城鑰
正陽門城匙
正陽門城符
正陽門城咒
正陽門城術
正陽門城法
正陽門城術
正陽門城法

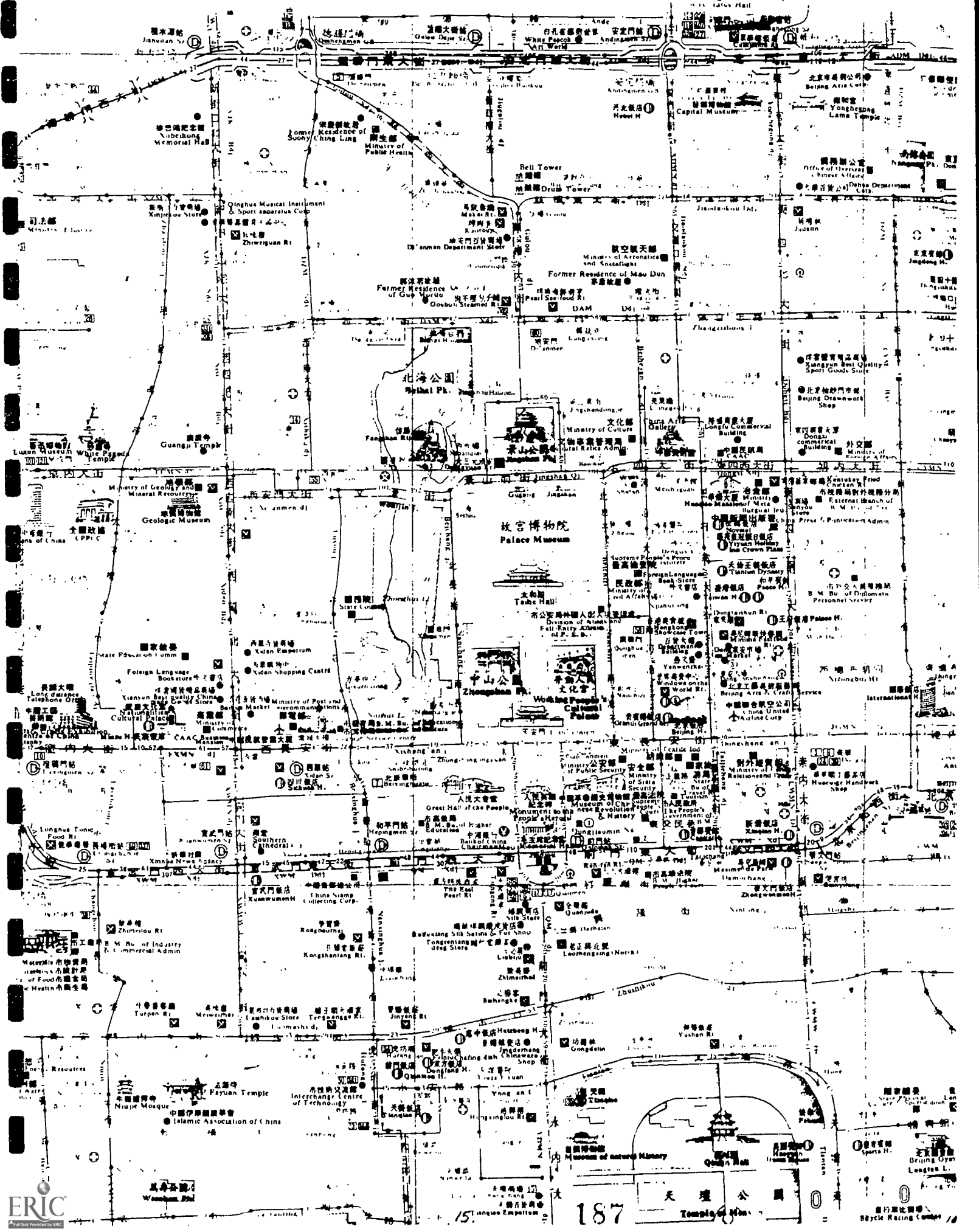
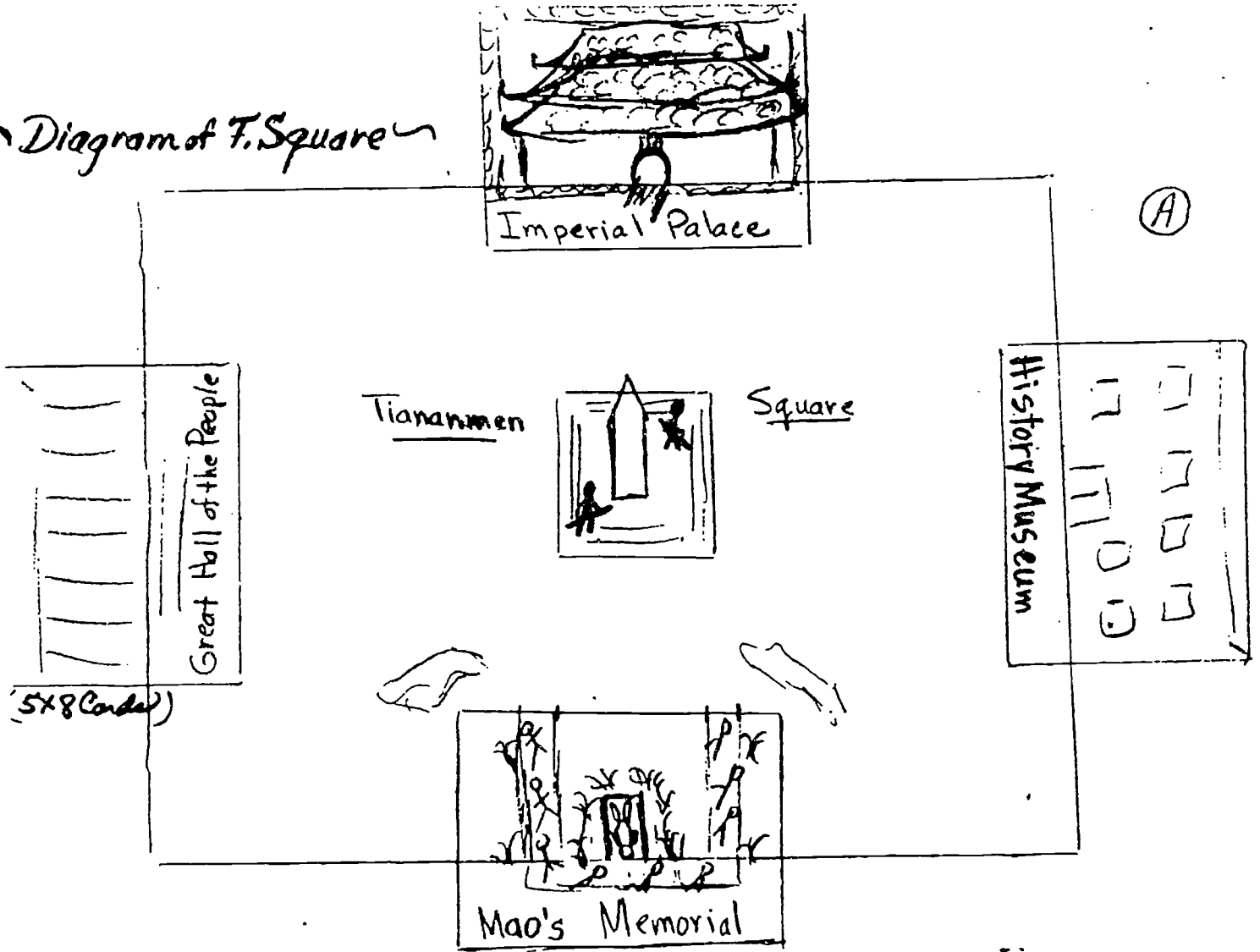
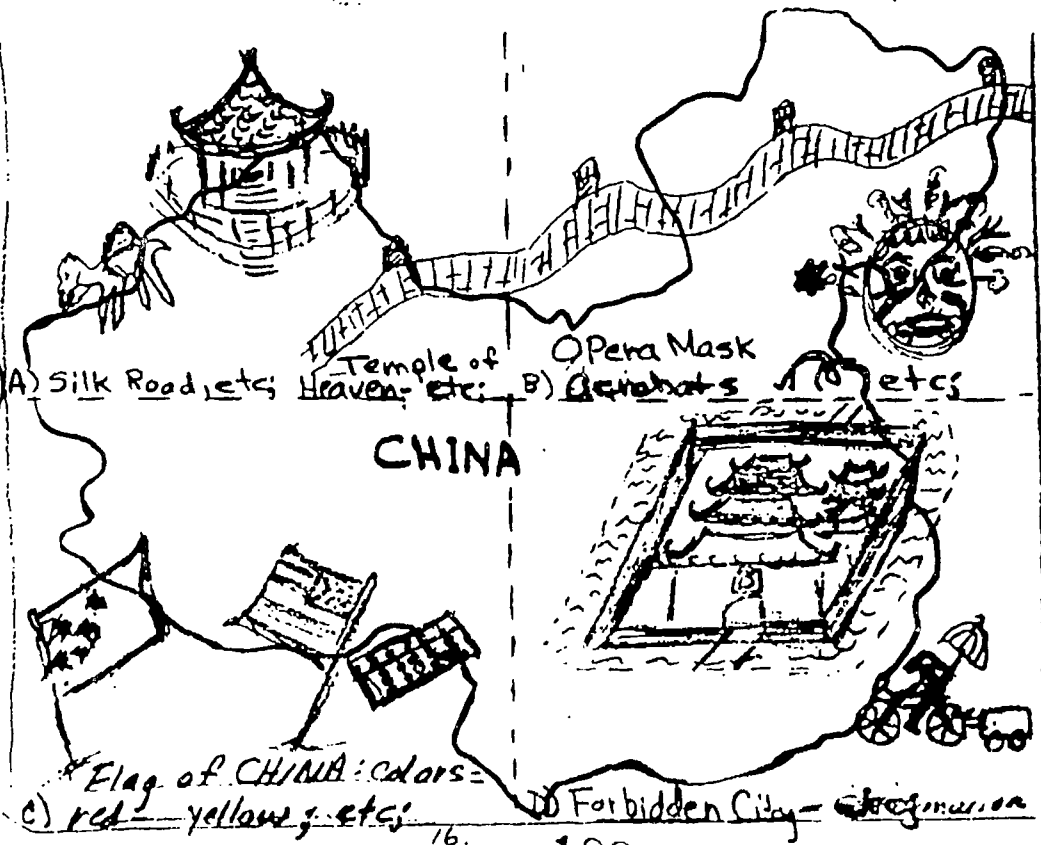

Diagram of T. Square



Freehand China Outline MAP

(4 sections) of Impressions of CHINA



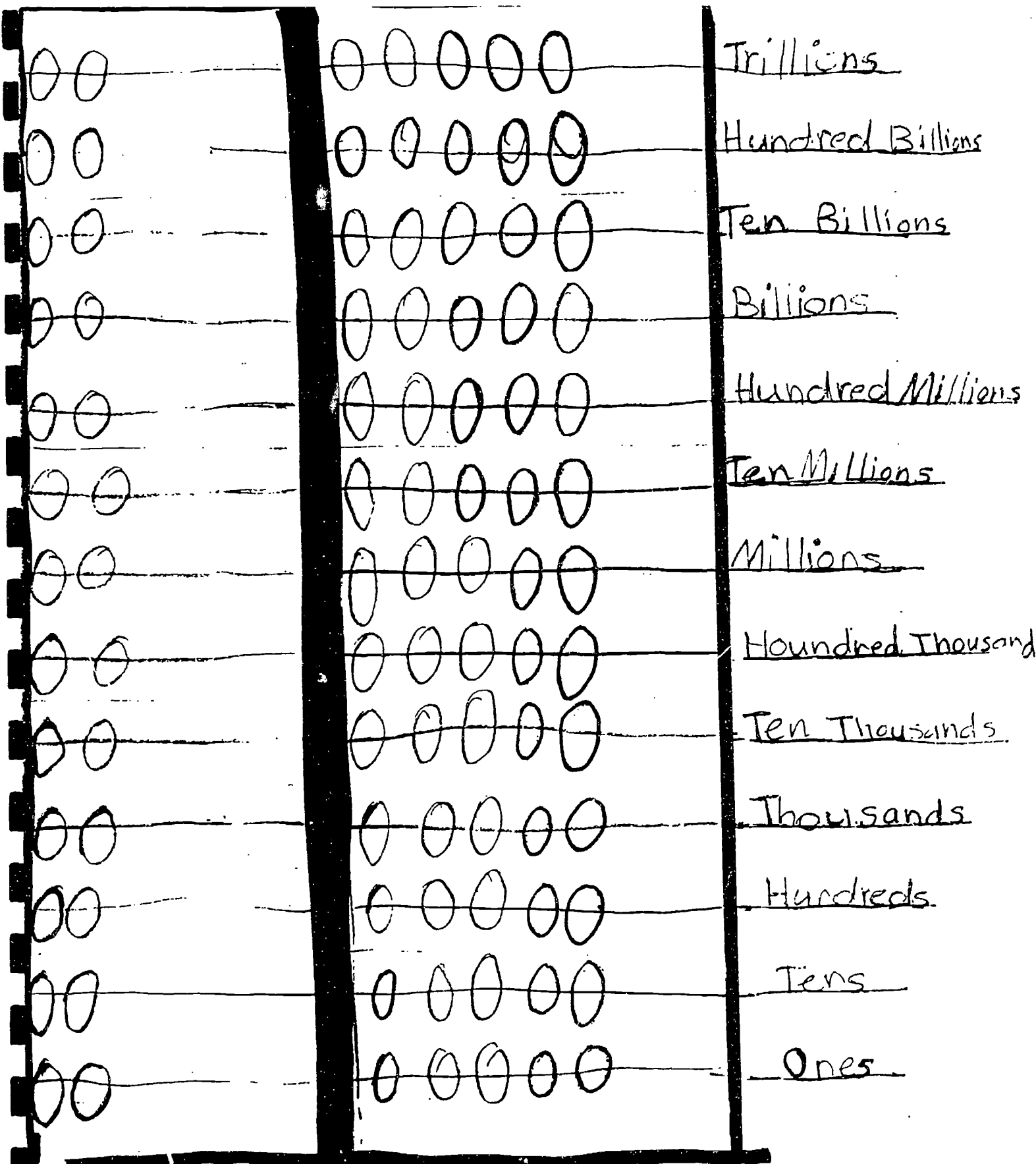

(Make teacher Overhead) CHINESE ABACUS

Use beans - follow directions, as student reads from "World Book"

(Student work)
NAME

REFLECTIONS on BEIJING

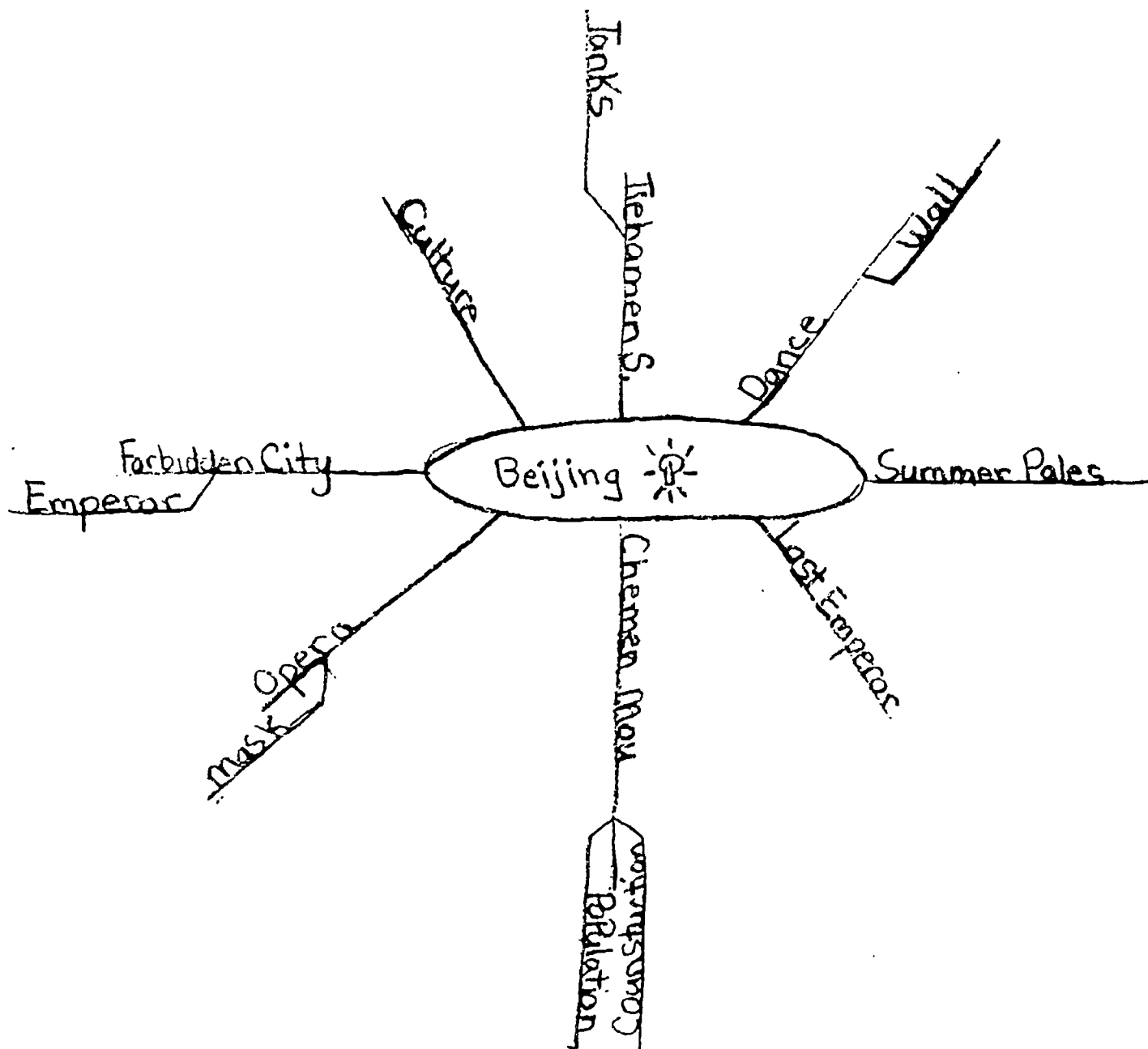



Wall Art

(3 colors)

- dark black crayon outlines wall
- dark green crayon outlines hills
- Water color wash (blue, green, gray, green)

INTRODUCE

The story "Meng-Jiang Nyu" is taken from the book *Traditional Chinese Folktales* written by Yin-lien C. Chin, Yetta S. Center, and Mildred Ross. The selection serves as an introduction to Chapter 9 by giving students a glimpse into the hardships of life in ancient China.

READ AND RESPOND

"Meng-Jiang Nyu" is a long reading, and you may want to assign it in segments. Most students can probably read the story independently if you break it down into two or three assignments. After reading a segment, ask students to retell that part of the story.

As students read, have them consider these questions: What kind of person was Meng-Jiang Nyu? What does this story tell us about the early emperors of China?

Words that students may need to know are *impenetrable*, cannot be broken through; *severe*, intense; *unceasingly*, without stopping; *banished*, told to leave; *millet*, a type of grain; *indistinguishable*, not recognizable; *relentless*, harsh; and *laden*, loaded or burdened.

In Lesson 3 you will learn about the history of the Great Wall of China.

Meng-Jiang Nyu
(muhng jyahng nyoo)
Wan Chi-liang
(wan chy lyahng)

conscripting forcing people to enlist in the army

LITERATURE

Meng-Jiang Nyu

Yin-lien C. Chin, Yetta S. Center, and Mildred Ross

The Great Wall of China, which spans 1,500 miles, was built to prevent invasion from the north. But the construction itself cost thousands of Chinese lives. This selection from *Traditional Chinese Folktales* tells how the Great Wall project affected the lives of an ordinary Chinese man and woman.

Meng-Jiang Nyu was eighteen on the day of her marriage to Wan Chi-liang. Everyone delighted in the lovely couple. She, dainty as a flower in her red wedding dress, glowed with happiness. And Chi-liang in his new, belted tunic was a handsome groom. The entire village was invited to witness the ceremony and partake of the feast that lasted for several days. The festivities over, the young bride and groom settled down to the routines of village life. They thought of themselves as truly fortunate, for they never felt hunger nor suffered from the cold. Deeply in love with his wife, Chu-liang found pleasure in fulfilling her every wish.

Their peaceful life was shattered one late summer day. Barely moments after they had come in from the fields, a stranger appeared at their door. He was dressed in an official's gown, and behind him stood two men in army uniform. With no word of explanation, he commanded his soldiers to seize Chi-liang and take him outside. Meng-Jiang Nyu, a look of bewilderment on her face, watched them push her husband toward the milling crowd assembled in the center of the village road.

The younger men from the neighboring cottages had all been rounded up, and they stood in a tight knot ringed by armed guards. Women, children, and older people had been ordered to remain at some distance.

Meng-Jiang Nyu's pounding heart made it difficult for her to breathe. As she approached the villagers, she heard a woman ask, "Could the emperor be conscripting men again? How well I remember when they took my father. I was just a young girl. I never saw him again."

Grandfather Hu, a village elder who was respected by all, offered his opinion. "The emperor has probably been convinced by his advisers to undertake another one of his foolish projects. No

Thematic Connections

Social Studies
Geography/Human-environment interactions

Houghton Mifflin Literary Readers: Building a Nation

Background

Construction of the Great Wall of China was ordered by the emperor Qin in about 214 B.C. Completed in 204 B.C., the wall wound like a caterpillar, covering about 2,500 miles. In most places it was about 30 feet high. The wall's thickness was 25 feet at the base and 15 feet at the top. A road upon which Chinese soldiers could travel ran along the top of the wall. The wall contained 40,000 watch towers that were built about 750 feet apart. The

tremendous task of building this wall, which at one time was the largest in the world, is even more astounding in light of the lack of technology and tools in the ancient world. As the story tells, many men lost their lives to the cruel hardships inflicted on them by the building of the wall.

(Houghton-Mifflin)
"Message of Ancient Days" - CA Text

good can come of this."

Children fidgeted and cried, while the restlessness of the bystanders increased as their anxiety mounted.

"Silence!" shouted the official. "I bring an order from the emperor." The murmuring ceased. "Wild horsemen are attacking from the north. These barbarians are looting and killing, burning whole villages to the ground. The emperor has issued a call for all able-bodied men to build a great wall, the highest and thickest wall ever built by men. The enemy will never be able to break through its impenetrable defense, and our people will be able to live in peace. It is the duty of every man to obey the emperor's summons. Anyone who refuses does so on pain of death."

"Forward!" he commanded. Lined up three abreast, the men were marched off. Soldiers carrying spears walked along the sides of the column. Escape was impossible.

Tearful parents, wives, and children were left behind to fend for themselves. An old farmer leaning on a cane shook his head sadly.

"Heaven alone knows if I shall ever see my son before my life is over," he said in a hoarse whisper.

Only a few months had passed since that terrifying day, but for Meng-Jiang Nyu it seemed like ages. Without her husband at her side, time dragged interminably. In her fervent prayers she asked that he be kept from hunger and thirst. The winter would bring its bitter winds that blow unceasingly from the mountains. How was Chi-liang going to survive in so hostile a climate without a warm jacket and cotton quilted shoes?

The last days of autumn were drawing to an end. It was the time of year when the dusk came early, but Meng-Jiang Nyu would not stop until darkness forced her to lay aside her sewing. Her needle flew ever faster as she layered fabric with cotton padding, fashioning a comfortable outer garment. She took particular care to design thick-soled shoes, sewing them with extra strong thread. Time was her enemy as she worked to finish the task she had set for herself.

Meng-Jiang Nyu swore a solemn oath. Chi-liang would not do without winter clothes. This she vowed. No matter how perilous the journey, she would take them to him herself. A woman traveling alone might encounter unexpected dangers, and she wondered if she would endure the long trek on foot. But she banished the troubling thoughts from her mind.

The evening before her departure, she prepared a small bag of rice and another of millet, only the barest necessities to sustain her along the way. On a large cloth square she placed Chi-liang's jacket and shoes. By tying the opposite corners of the square together, she made a bundle to carry over her arm.

Before daybreak she left her home. No one was yet awake,

impenetrable can't be entered or crossed

interminably without end; tiresomely long

◀ Could a young man escape conscription? (Maybe.) If so, how? (If he were not able-bodied.)

757

Access Strategy

Students need to understand two issues in this story. The first is the enormous size of the wall and the cost in human lives to build it. The second issue is the loyalty of Meng-Jiang Nyu. Deal with the first by helping students imagine the size of the wall. Show them a picture if possible. Compare the distance from coast to coast in the United States with the length of the wall. Then make comparisons to illustrate the dimensions of the wall (for example, the wall was as high as three

classrooms stacked on top of one another.)

Now discuss Meng-Jiang Nyu's loyalty. What can make someone so loyal? Ask students to give examples of people or animals that exhibit loyalty.

► If Meng-Jiang Nyu had realized how far her journey would take her, do you think she would have started it? Why or why not? (*She probably would have because of her devotion to her husband.*)

doggedly stubbornly

and the narrow streets of the village were deserted. It was still quite dark. In the east, Meng-Jiang Nyu saw a rosy glow that nounced the beginning of a new day. "A good omen," she mu-
Word had come back to the village that the section of the wall where Chi-liang was working lay at a great distance. If it snows came early, there was no telling how long it would take to get there. Meng-Jiang Nyu had learned that she must travel in a northwesterly direction, but beyond that she did not even know for certain where she would find her husband.

Never having traveled more than a few miles from her village she could not imagine the vastness that lay beyond it. Nor could she conceive, in her wildest flight of fancy, the size and length of the wall that the emperor had planned. Neither could she picture a wall three thousand miles long that would climb over mountains, descend into deep valleys, and cross forbidding deserts. But the grandeur of the emperor's ambitious undertaking meant nothing to her. She only knew she must plod ahead for as long as it would take her to join Chi-liang.

As the days wore on, Meng-Jiang Nyu found she had to rest more and more frequently. Often, as she passed through little villages, she begged for food. She had finished her rice and millet long ago. People who spoke to her and learned where she was bound praised her devotion but shook their heads in disbelief.

Once she heard a woman lamenting loudly to a friend. "Our sons are gone, our daughters widowed, and the pile of dead grows ever larger at the foot of the emperor's great wall." Meng-Jiang Nyu shuddered.

From sunrise to sunset she doggedly trudged on. When darkness fell, she looked for a place to lay her head. Many a night her bed was just a pile of scratchy straw.

The day Meng-Jiang Nyu reached the Yellow River, her strength was beginning to fail. At the point where she stood, the river was wide and the current of its silt-laden water, swift. For the peasants who lived along its banks it was life-sustaining, but for Meng-Jiang Nyu it was yet another obstacle that had to be overcome. Except for a lone shepherd grazing his flock of sheep, there was not a soul in sight.

"I have not come this far in vain," she thought. "I will not turn back!"

With determination born of despair, she walked into the water, holding Chi-liang's clothes over her head to keep them dry. A few yards out from the shore her feet could no longer touch bottom and she tried to swim. The effort to keep afloat was beyond her endurance. Finally she gave up the struggle and let the river claim her. The cold water dragged her toward the murky bottom—down, down into an inky blackness.

Meng-Jiang Nyu's distress did not go unnoticed. A river god

Investigation

The sad story of Meng-Jiang Nyu would never have taken place if not for the building of the Great Wall of China. Ask students to find out more about the Great Wall. For example, they might find out about Qin, the emperor who ordered the building of the wall; the wall itself and how it was built; how much of the wall still exists; what the wall was used for and what it is used for today. Have students share the facts they have found.

came to her rescue, plucking her from the deep and carrying her to the opposite shore.

When Meng-Jiang Nyu opened her eyes, a shadowy specter was hovering over her.

specter a ghost;
phantom

"My brave child, do not abandon hope," it soothed. "All the spirits along the way will help you to the end of your journey." The shadow drifted away and melted into the air. Meng-Jiang Nyu was alone. She had no recollection of how she had reached the other side of the river. Nor was she sure she had heard the encouraging promise of help.

Wearily, she picked up her bundle. Everything was wet through. Before moving on she would have to wait for the clothes to dry. She wrung out Chi-liang's jacket and spread it on the ground. When she reached for his shoes, a miracle occurred. Spellbound, she saw the shoes turn into two blackbirds. From then on, never ceasing their shrill chatter, the blackbirds led her day after day in a northerly direction. Whenever she tired, they alighted on the ground near her and waited until she had regained her strength. At night they roosted in a nearby tree while she slept. One morning, Meng-Jiang Nyu awoke, trembling with cold. Her fingers and toes were numb and she ached all over. Reaching to pick up her bundle, she was surprised to see Chi-liang's shoes standing neatly, side by side. The blackbirds, her guides and constant companions, were gone. They had fulfilled their mission, for they had led Meng-Jiang Nyu close to her destination.

Meng-Jiang Nyu dragged her swollen, painful feet along a dusty road. At first the road was flat; then it began to climb steeply. When she reached high ground, her eyes took in an incredible scene. The figures she saw moving about resembled a scurrying swarm of ants. She quickened her pace. Now she could see more clearly. Files of men, backs bent under the weight of heavy stones, were struggling to the top of the unfinished wall. Others were lugging buckets of mortar to fill the spaces between the rocks. Covered from head to foot by the dry, brown sand, they were indistinguishable, one from the other. How could she ever find Chi-liang among that multitude?

With unaccustomed boldness, she approached a small group of men who were attempting to warm their hands over a smoldering fire. Timidly she explained, "I am looking for my husband. He is called Chi-liang." She told them the name of their village and the day on which he was conscripted, but they only looked at her with pity.

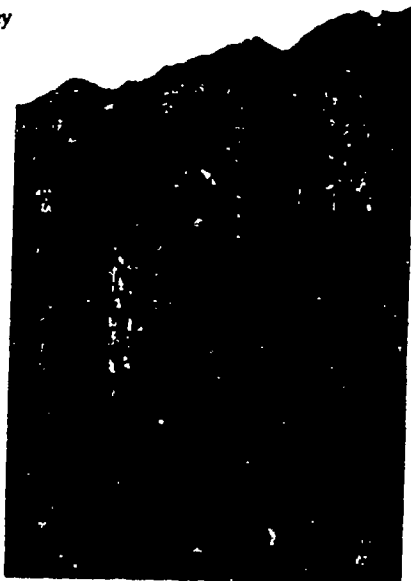

Writing a Letter

Wan Chi-liang and Meng-Jiang Nyu were very happy together. After his conscription by the Chinese troops, Wán Chi-liang probably would have liked to communicate with his wife. Discuss with the students the kinds of things that Wán Chi-liang might have included in a letter home. Make a list of these on the board. Have students imagine they are Wán Chi-liang and write a letter to Meng-Jiang Nyu (before she started her journey). Encourage students to include many details

about the nature of the work Wán Chi-liang was doing and the conditions under which he was living. Students can include whatever information they want, choosing from the list on the board and adding anything else they desire. Ask volunteers to share their letters with the class when they are finished.

BEST COPY AVAILABLE

► What does he mean "no beginning and no end?" (*The wall is very long. To the workers, it seems to go on forever.*)

plundering: stealing;
taking by force

"I am sorry I cannot help you," said one of the men. "This wall has no beginning and no end. The wind batters us, the snow blinds us, we have little food and no warm clothing. There is only toil without rest. Every day we see good comrades fall, and many more will die of exhaustion. Hundreds are already buried inside the wall. We admire your loyalty to your husband but you should not endanger your own life trying to do the impossible. Better that you return home. You will never find him."

But Meng-jiang Nyu could not be discouraged. Bravely she continued to search. Wherever she went she asked for Chi-liang. The relentless wind tore at her clothing, her face and hands became rough and red from exposure. She ate very little and slept hardly a wink. At last, fatigue conquered her, and Meng-jiang Nyu fell asleep on the frozen ground. She did not know how much time had passed before she became aware of someone prodding her. "You must not lie here or you will freeze to death," a man warned.

Shaking uncontrollably, she managed to say, "I am looking for my husband. He bears the name Chi-liang." Once again, she recited the name of their village and the date on which he was taken.

"Yes, I knew your husband," the stranger responded. "I remember him well. We were assigned the task of making bricks and he was the best worker in the section. It pains me to tell you that we found him one morning covered by newly fallen snow, lifeless. With many others he lies buried within the wall."

Meng-jiang Nyu could not hold back the flood of salty tears that stung her cold cheeks. She blamed herself for Chi-liang's death. She had come too late to save him.

"How can it be that so gentle a husband has perished so young? The Great Wall takes more lives than the plundering enemy."

A wife's devotion can sometimes move mountains. Wailing bitterly, Meng-jiang Nyu cried out to heaven. The sun vanished behind threatening clouds. A violent tempest churned up the powdery sand, and rain fell in icy sheets. Bolts of lightning streaked through the sky. With a deafening clap of thunder, a section of the wall collapsed, bricks and stones spilling out together with human bones and skulls.

"Do not be alarmed, brave wife of Chi-liang. Heaven has witnessed your sorrow. You will seek out your husband's bones from among all the others." The words were sharp and clear, but there was not a soul in sight. Meng-jiang Nyu stood transfixed amid the pile of rubble.

"But how will I know which among the many are his?"

"Have no fear. You will succeed, for when love is sincere and true, two people become as one. They share thoughts, hopes,

260

Writing/Persuasion

The task of building the Great Wall of China was monumental. The huge wall took ten years and many lives to build. Emperor Qin must have had good reasons for undertaking such an enormous project. Have students take the role of the emperor and argue that the wall was worth the sacrifice because the future of the country depended on it.

Have students make notes of their thoughts and prepare rough drafts of their arguments. Then have them write final drafts.

24-197

BEST COPY AVAILABLE

feelings. Their blood, their bones, their very tissues mingle. Do not despair, you will find a way."

"Alas," moaned Meng-jiang Nyu. "In this jumble lying here, strewn this way and that, are the bones of Chi-liang. Oh mountains, hills, desert of yellow sands," she pleaded, "favor me, and give me a sign that I may recognize those that belong to him. I cannot choose for I cannot tell one from another." Unaware of what she was doing, she bit down on her thumb until she drew blood. She watched a drop fall upon a bone, slide off the surface, and reach the ground. Suddenly the words she had just heard took on meaning.

"If the bones are Chi-liang's, my blood will mingle with his and sink into them. If the bones belong to others, the blood will remain apart."

This time, with determination, she bit down harder and then shook her hand, spattering the blood about. What she hoped for did not happen. Again, and still again, she tried. Each time her blood slid quickly off the bones. "One last time," she told herself. Though the pain brought tears to her eyes, she bit down with all her might. The blood flowed freely and she flung it as far and as wide as she could. One quivering red dot landed on a bone lying apart from the others. At once the blood sank into its chalky whiteness. This bone must belong to Chi-liang. Of this she was certain. Feverishly she continued to search, and soon she recovered the rest. Chi-liang's bones would receive a proper burial, and his soul would not have to wander aimlessly in search of peace.

Laden with the heavy blow fate had dealt her, Meng-jiang Nyu turned to the south and began her sad journey homeward.

Further Reading

China Homecoming. Jean Fritz. In this book Jean Fritz returns to the country where she spent her childhood.

Heaven's Reward: Fairy Tales from China. Catherine Edwards. These six fairy tales present Confucian and Taoist philosophies.

Homesick: My Own Story. Jean Fritz. The author describes her experiences as the child of American missionary parents in China.

Young Fu of the Upper Yangtze. Elizabeth Lewis. A teenage country boy travels to the city of Chongqing to become a coppersmith's apprentice in the 1930s.

◀ Do you like the ending of this story? Why or why not? If not, how would you like the story to end?

EXTEND

Supply students with an outline map of China. With the help of encyclopedias or other reference books, have them map the route taken by the Great Wall from Shanhaikwan on the Gulf of Liaotung to the province of Kansu.

26

Further Reading

You may want to have your students look for more books to read on this topic in the school or local library.

BEST COPY AVAILABLE

198

CHINA: ACROSS THE GLOBE AND ACROSS THE CURRICULUM

By Julia Olvera
Fulda American High School
Department of Defense Dependents Schools

TABLE OF CONTENTS

Introduction..... 1a-1b
Mathematics.....2a-2m
Science.....3a-3d
Social Studies.....4a-4p
English.....5a-5i
Home Economics.....6a-6l
Music.....7a-7d
Physical Education.....8a-8b
Art.....9a-9j

THIS UNIT ON CHINA IS INTENDED TO BE AN ACROSS THE CURRICULUM UNIT AT THE SEVENTH GRADE LEVEL. IT IS HOPED THAT TEACHERS WILL WORK TOGETHER TO PROVIDE THE STUDENTS WITH FUN, BUT CONTENT ORIENTED, LESSONS DESIGNED TO TEACH THEM ABOUT CHINA.

THE INDIVIDUAL LESSONS CONTAIN A LIST OF OBJECTIVES, A LIST OF NEEDED MATERIALS, AND STEP BY STEP INSTRUCTIONS ON HOW TO COMPLETE THE LESSON. HOPEFULLY, TEACHERS WILL FIND THAT THE PREPARATION TIME NEEDED FOR EACH LESSON IS MINIMAL. IT IS IMPORTANT, HOWEVER, THAT TEACHERS READ THE INFORMATION IN THE PACKET PRIOR TO USING THE LESSON WITH STUDENTS. THIS IS DUE TO THE COMPLEXITY OF THE INSTRUCTIONS FOR SOME LESSONS. I BELIEVE THAT ALTHOUGH THE PROCEDURES MAY SEEM COMPLICATED AT FIRST, ONCE INDIVIDUAL TEACHERS HAVE TRIED THE VARIOUS ACTIVITIES THEMSELVES, THEY WILL FIND THAT IT IS MUCH EASIER TO GIVE CLEAR EXPLANATIONS TO THEIR STUDENTS.

HAVING SCHOOLS DESIGNATE A PARTICULAR WEEK FOR THE STUDY OF CHINA THROUGHOUT THE SEVENTH GRADE CURRICULUM IS ONE OF MY MAJOR OBJECTIVES IN WRITING THIS UNIT. UNFORTUNATELY, ALL LESSONS CANNOT POSSIBLY BE COMPLETED IN THE SAME AMOUNT OF TIME. THEREFORE, THE TEACHERS INVOLVED WITH THE UNIT SHOULD CHOOSE A STARTING DATE FOR THE TEACHING OF THIS UNIT. THIS WILL GUARANTEE THAT ALL SEVENTH GRADE STUDENTS WILL BE STUDYING CHINA IN EVERY CLASS FOR AT LEAST ONE DAY, IF NOT LONGER. SOME LESSONS MAY TAKE UP TO A WEEK TO COMPLETE, BUT MOST WILL TAKE ABOUT THREE DAYS FOR COMPLETION.

THE LESSONS INCLUDED FOR A SOCIAL STUDIES CLASS ONLY

INCLUDE THE STUDY OF TOPOGRAPHY AND TEMPERATURE. IT IS NOT INTENDED THAT THIS BE THE ENTIRE UNIT FOR A SOCIAL STUDIES CLASS. I CONCENTRATED MY EFFORTS ON WRITING LESSONS FOR OTHER DISCIPLINES, SINCE MATERIALS FOR THE STUDY OF CHINA WHICH INCLUDE SOCIAL STUDIES CONCEPTS ARE PLENTIFUL. THE SOCIAL STUDIES TEACHER(S) SHOULD CONCENTRATE ON INTEGRATING INFORMATION NOT CONTAINED IN THIS UNIT INTO THEIR CLASS(ES). THIS WOULD INCLUDE TOPICS SUCH AS POPULATION, HISTORY, RELIGION, AND GOVERNMENT. IT WOULD BE BEST IF THE STUDENTS BEGAN STUDYING THESE TOPICS A COUPLE OF WEEKS BEFORE THE AGREED STARTING DATE FOR THE ACROSS THE CURRICULUM UNIT. THEN, STUDENTS WOULD HAVE SOME KNOWLEDGE OF THE THINGS THAT SHAPE CHINESE LIFE. THIS WILL HELP THEM UNDERSTAND HOW THE LESSONS IN THEIR OTHER SUBJECT AREAS FIT INTO THEIR STUDY OF CHINA.

Mathematics

BEST COPY AVAILABLE

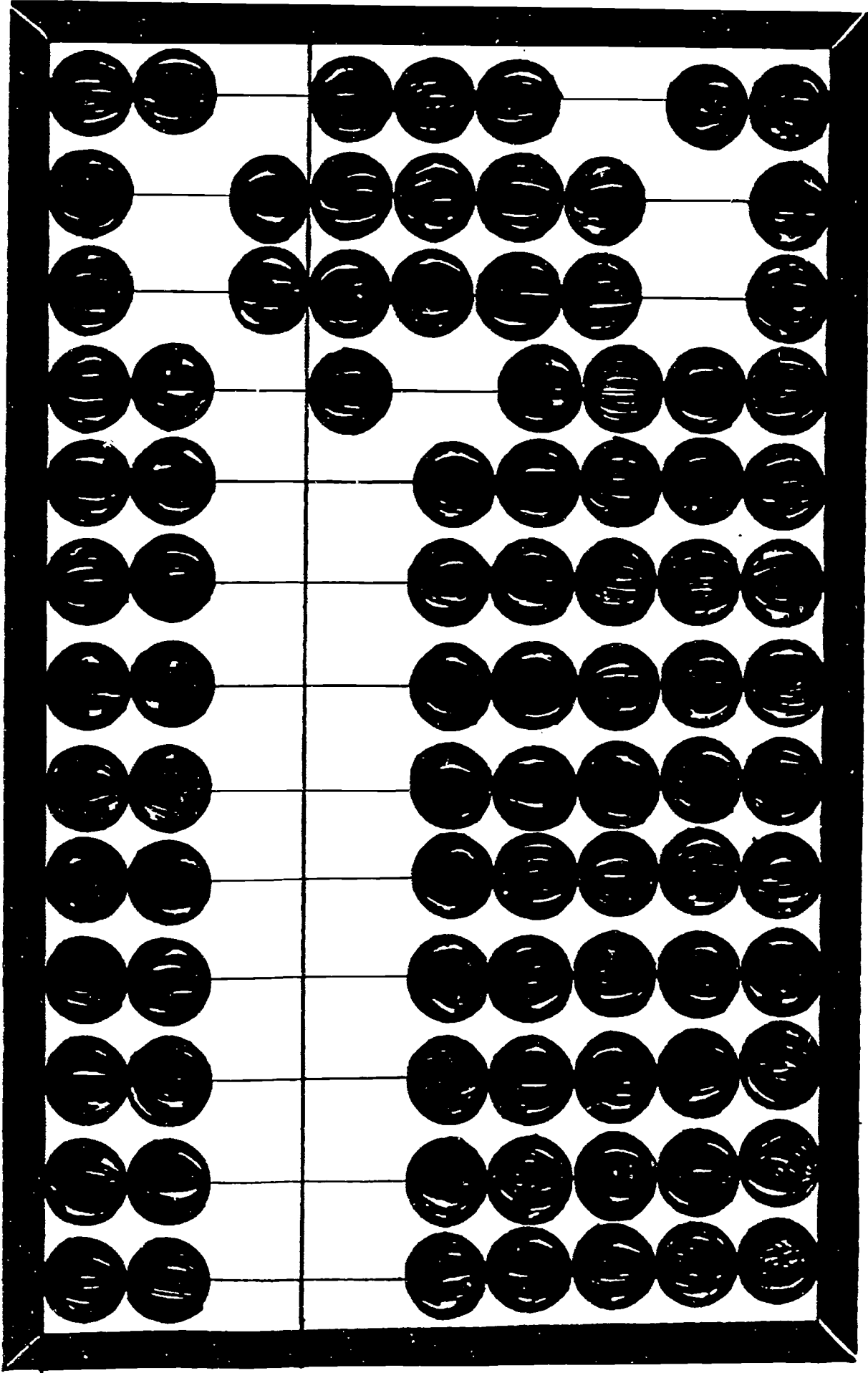

FOR CENTURIES, THE CHINESE HAVE USED THE ABACUS TO CALCULATE. USING THE ABACUS IS A FAIRLY SIMPLE PROCESS WHICH PROVIDES ACCURATE ANSWERS QUICKLY (ONCE YOU HAVE LEARNED THE PROPER USAGE!).

OBJECTIVES:

1. Students will be able to give the place value of any number through trillions.
2. Students will be able to calculate addition and subtraction problems with 90% accuracy by using the abacus.
3. Students will understand the importance of the abacus in Chinese culture.

MATERIALS NEEDED:

1 packet of handouts on the use of the abacus for each student
cardboard (one piece per abacus-approximately 13" x 6")
yarn or string
scissors
84 beads for each abacus

PROCEDURES:

1. Have the students make abacuses. You can have each student make an abacus, or you may want to have the students work in pairs if your supplies are limited.

Students should use the scissors to make twelve evenly spaced notches on one side (a long side) of the cardboard.

Now, directly across from those twelve notches, students should make twelve more notches.

On each of the remaining sides (short sides) of the cardboard, cut one notch approximately 2" from the top of the cardboard.

Before stringing the cardboard, it should look similar to the illustration below.

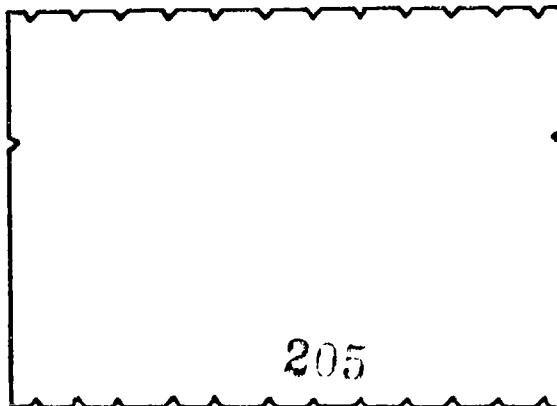

Once the notches have been cut, use string or yarn to form columns for your beads. The beads will need to be strung as you are forming each column with the string. Each column must have seven beads.

Now, push two beads from each column towards the top of the abacus. Push the remaining five beads in each column towards the bottom of the abacus.

Students should then use the string to make a horizontal "bar" extending across the abacus.

2. Use the information in the packet to review place values.
3. Have students complete the missing place values on the illustration.
4. Read and discuss with the students the information regarding the use of the abacus.
5. Have students write the numbers each of the six abacuses show.
6. Give numbers to each of the students to show using their abacuses.
7. Have students use their abacuses to follow the steps on adding.
8. Give students sample problems to work.
9. Have students use their abacuses to follow the steps on subtraction.
10. Give students sample problems to work.
11. Use the last page of the packet as problems to be solved in a race. Teams or individuals can compete to see who is the fastest. NO PENCILS!

***THE ABACUS MUST BE LYING FLAT TO BE USED. IT CANNOT BE UPRIGHT.

ON AN ABACUS, EACH COLUMN OF BEADS REPRESENTS A PLACE VALUE. THE COLUMN ON THE FAR RIGHT SIDE OF THE ABACUS REPRESENTS ONES; THE NEXT COLUMN REPRESENTS TENS; TO THE LEFT OF THE TENS COLUMN IS THE HUNDREDS COLUMN; NEXT IS THE THOUSANDS COLUMN, ETC.

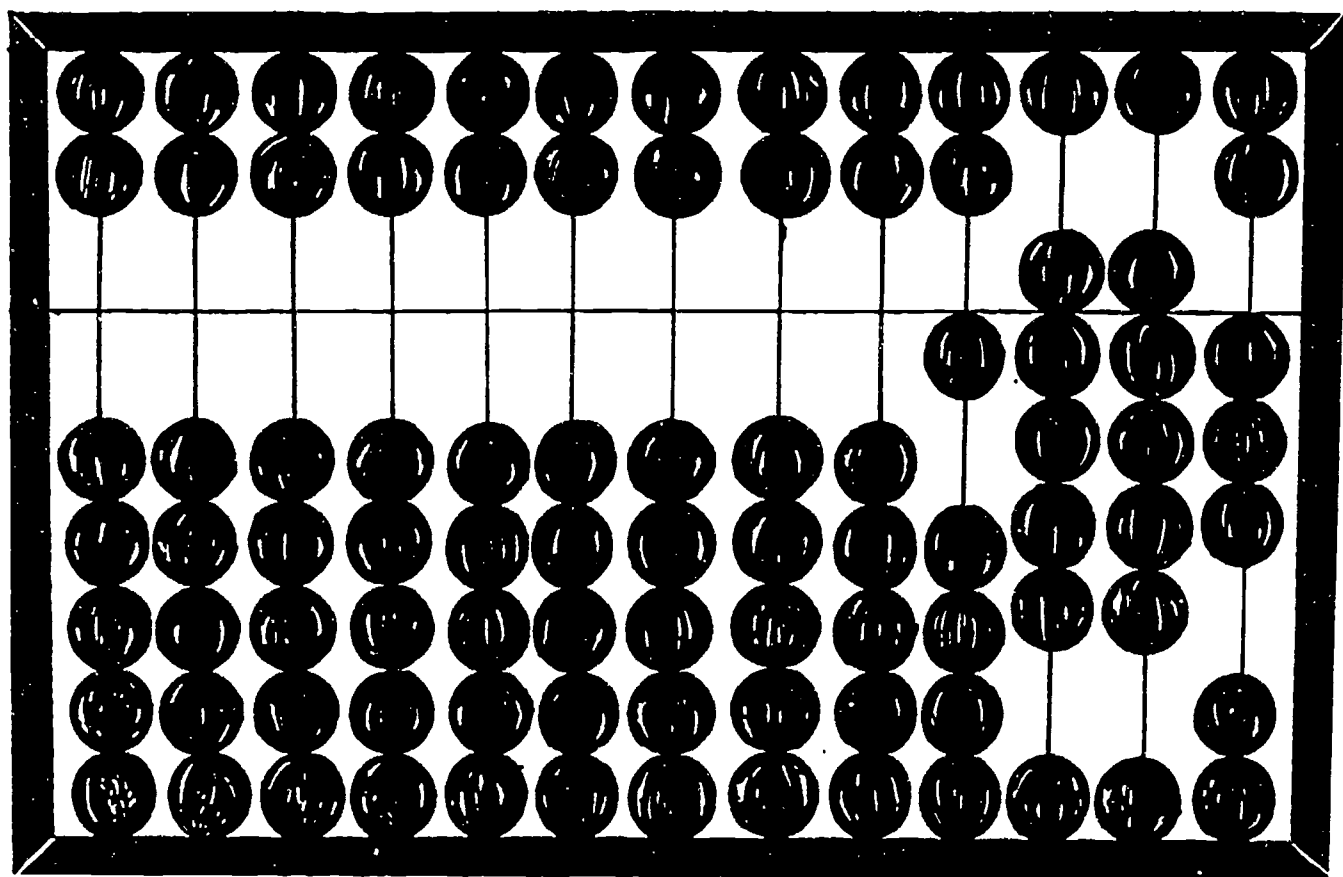

ones
tens
hundreds
thousands
ten-thousands
hundred-thousands
millions
ten-millions
hundred-millions
billions
ten-billions
hundred-billions
trillions

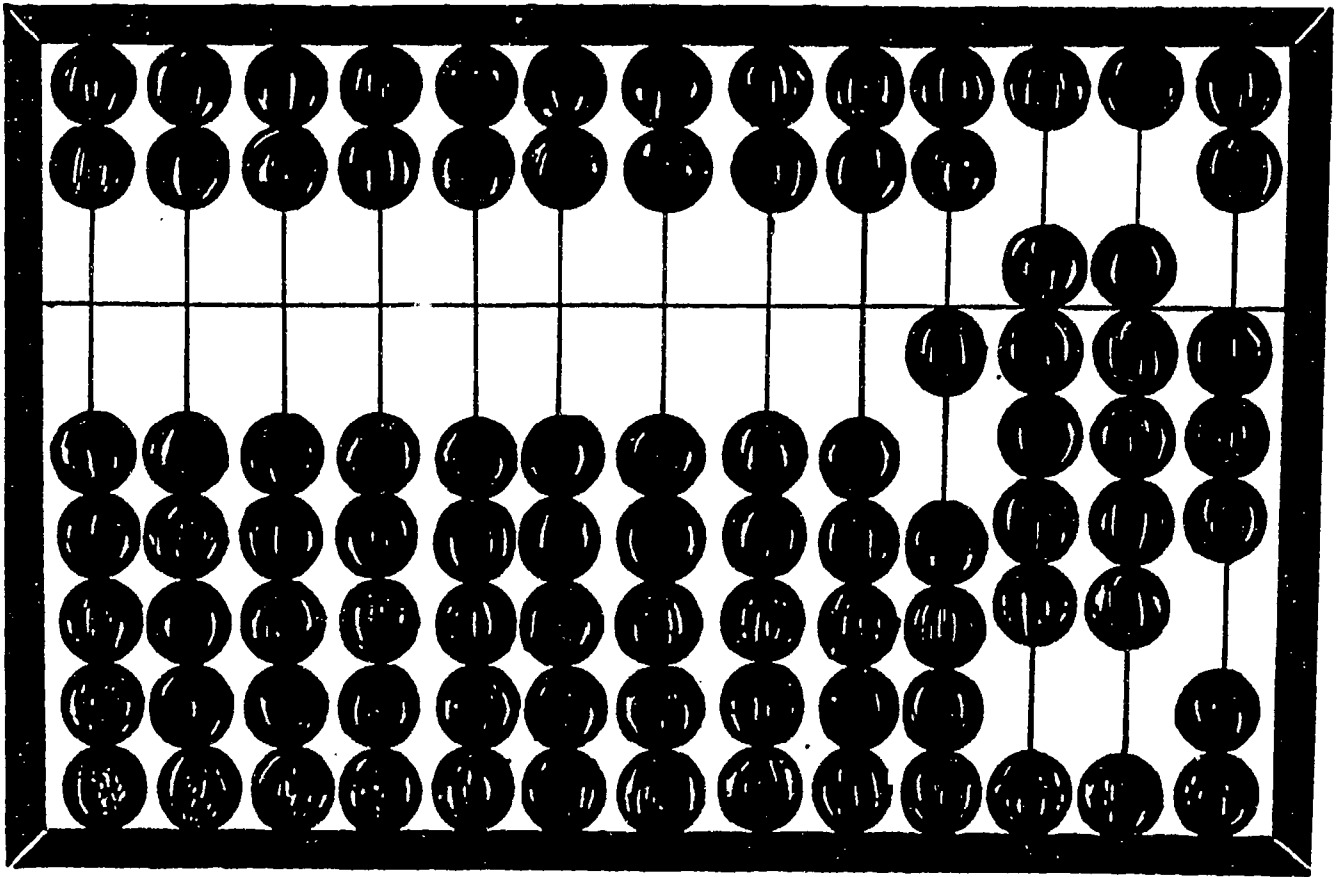

_____ ones
 _____ tens
 _____ thousands
 _____ hundred-thousands
 _____ millions
 _____ billions
 _____ hundred-billions

FILL IN THE MISSING PLACE VALUES ABOVE.

USING AN ABACUS

PUSHING FOUR BEADS UP TO THE HORIZONTAL BAR IN THE FIRST COLUMN REPRESENTS THE NUMBER 4.

PUSHING FOUR BEADS UP TO THE HORIZONTAL BAR IN THE SECOND COLUMN REPRESENTS THE NUMBER 40.

PUSHING FOUR BEADS UP TO THE HORIZONTAL BAR IN THE THIRD COLUMN REPRESENTS THE NUMBER 400.

EACH BEAD IN THE UPPER PORTION OF THE ABACUS REPRESENTS THE PLACE VALUE MULTIPLIED BY FIVE. THEREFORE, PUSHING ONE BEAD DOWN TO THE HORIZONTAL BAR IN THE FIRST COLUMN REPRESENTS THE NUMBER 5.

PUSHING ONE BEAD DOWN TO THE HORIZONTAL BAR IN THE SECOND COLUMN REPRESENTS THE NUMBER 50.

PUSHING ONE BEAD DOWN TO THE HORIZONTAL BAR IN THE THIRD COLUMN REPRESENTS THE NUMBER 500.

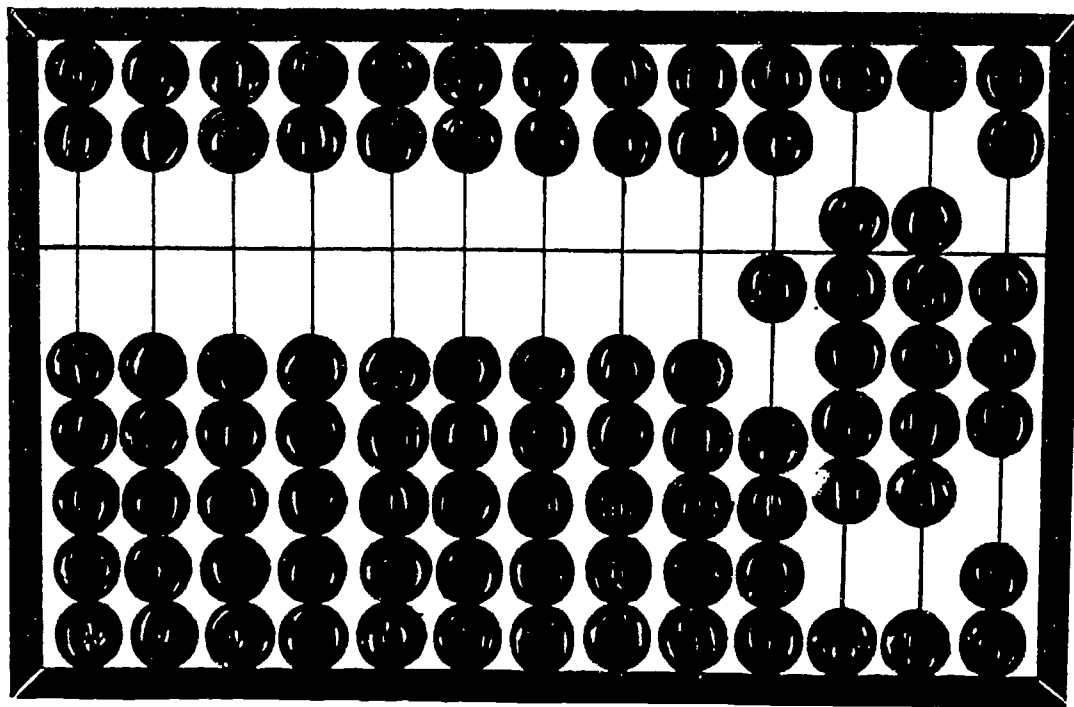

What number is represented by this abacus?

THE ABACUS ON THE PREVIOUS PAGE REPRESENTS THE NUMBER 1,993.

In the thousands column, one bead is pushed up. This represents 1,000.

In the hundreds column, one bead is pushed down, representing the number 500. Four beads are pushed up, representing the number 400. Added together, there is a total of 900.

In the tens column, one bead is pushed down, representing the number 50. Four beads are pushed up, representing the number 40. Added together, there is a total of 90.

In the ones column, three beads are pushed up, representing the number three.

$$1,000 + 900 + 90 + 3 = 1,993$$

WRITE THE NUMBER SHOWN ON EACH ABACUS.

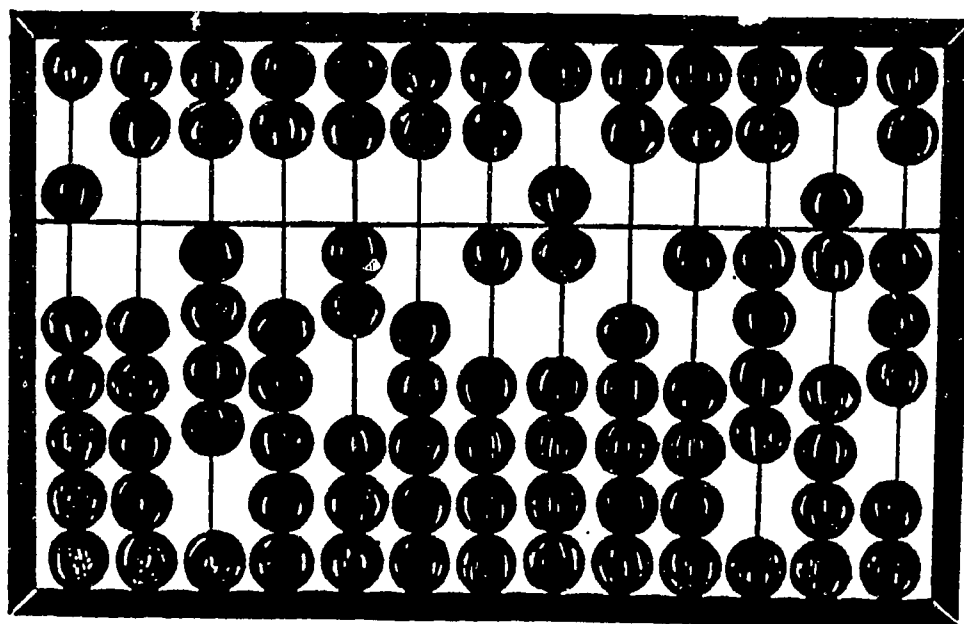

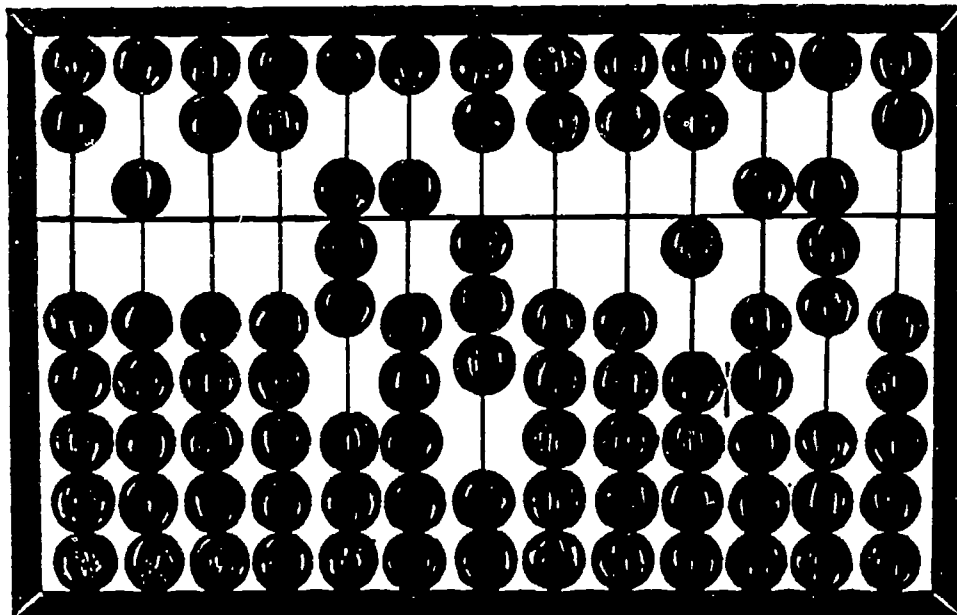
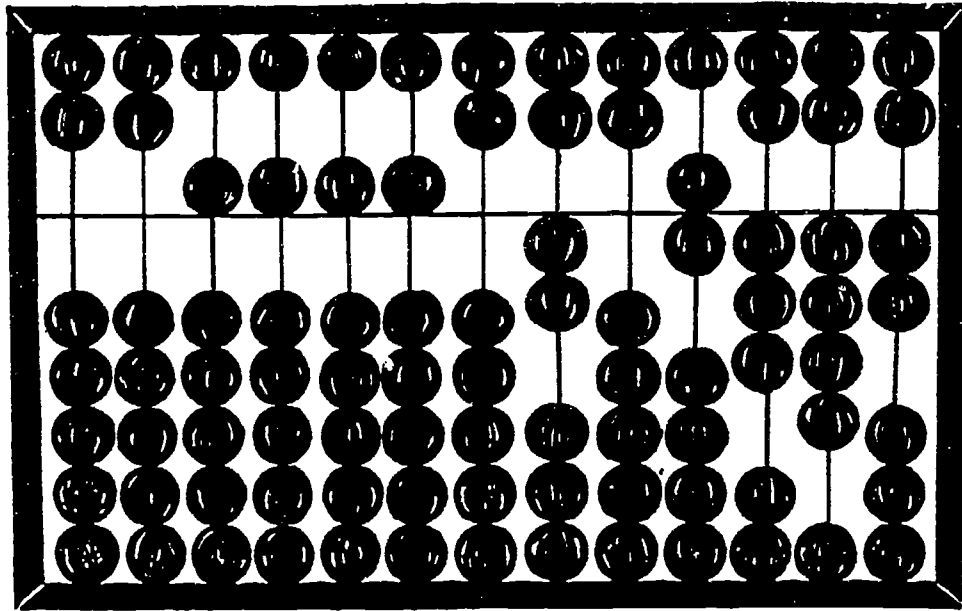

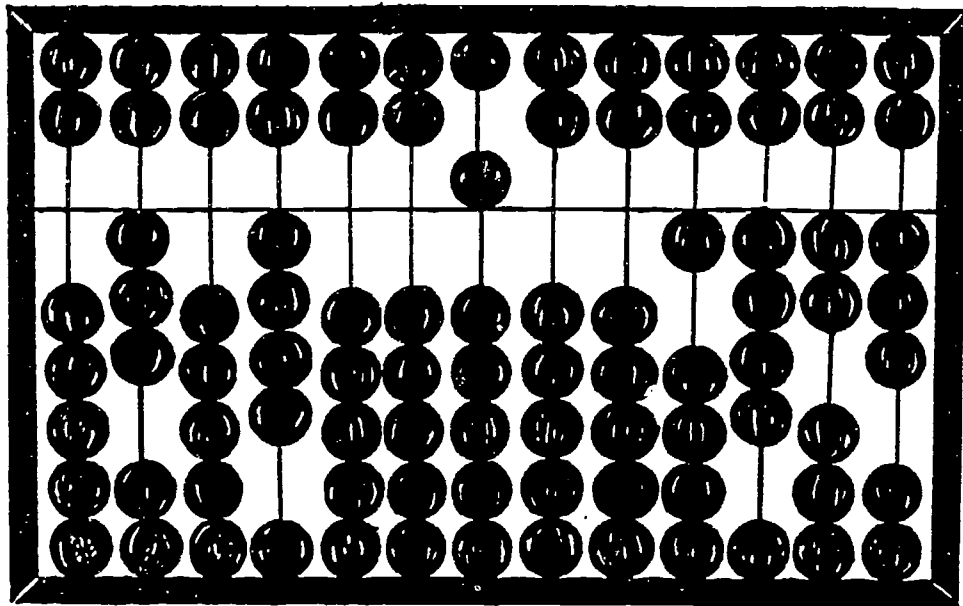

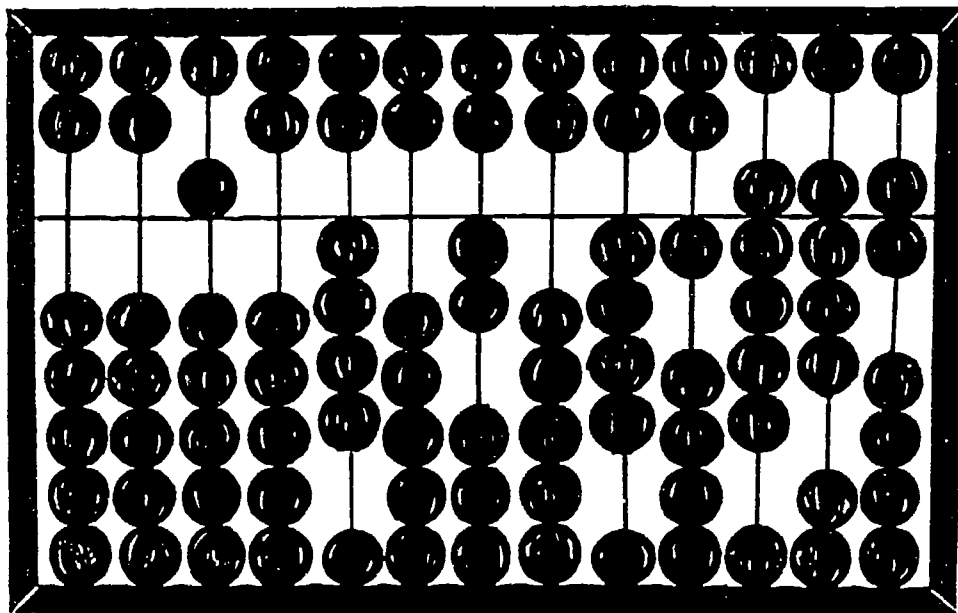

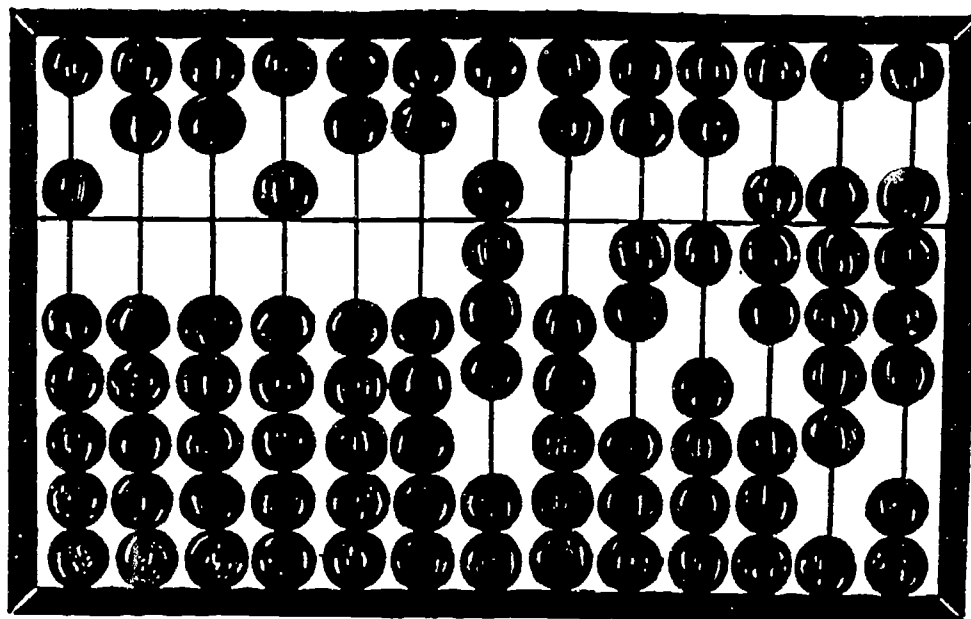

ADDING ON AN ABACUS IS NOT DIFFICULT. TRY THE FOLLOWING SIMPLE ADDITION PROBLEMS.

$$23 + 12$$

1. Make sure all beads are pushed away from the horizontal bar.
2. Push two beads up in the tens column. (represents 20)
3. Push three beads up in the ones column. (represents 3)
4. Push one bead up in the tens column. (represents 10)
5. Push two beads up in the ones column. (represents 2)
6. Count the beads in each column.

YOU SHOULD HAVE THREE BEADS PUSHED UP IN THE TENS COLUMN, REPRESENTING THE NUMBER 30.

YOU SHOULD HAVE FIVE BEADS PUSHED UP IN THE ONES COLUMN, REPRESENTING THE NUMBER 5.

NOW ADD THE 30 AND THE 5. YOUR ANSWER SHOULD BE 35.

$$115 + 1,322$$

2k

1. Make sure all beads are pushed away from the horizontal bar.
2. Push one bead up in the hundreds column. (represents 100)
3. Push one bead up in the tens column. (represents 10)
4. Push one bead down in the ones column. (represents 5)
5. Push one bead up in the thousands column. (represents 1,000)
6. Push three beads up in the hundreds column. (represents 300)
7. Push two beads up in the tens column. (represents 20)
8. Push two beads up in the ones column. (represents 2)

YOU SHOULD HAVE ONE BEAD PUSHED UP IN THE THOUSANDS COLUMN, REPRESENTING THE NUMBER 1,000.

YOU SHOULD HAVE FOUR BEADS PUSHED UP IN THE HUNDREDS COLUMN, REPRESENTING THE NUMBER 400.

YOU SHOULD HAVE THREE BEADS PUSHED UP IN THE TENS COLUMN, REPRESENTING THE NUMBER 30.

YOU SHOULD HAVE ONE BEAD PUSHED DOWN IN THE ONES COLUMN, REPRESENTING THE NUMBER 5.

YOU SHOULD HAVE TWO BEADS PUSHED UP IN THE ONES COLUMN, REPRESENTING THE NUMBER 2.

NOW ADD $1,000 + 400 + 30 + 5 + 2$. YOUR ANSWER SHOULD BE 1,437.

AN ABACUS CAN ALSO BE USED TO SOLVE SUBTRACTION PROBLEMS.

$$34 - 14$$

1. Make sure all beads are pushed away from the horizontal bar.
2. Push three beads up in the tens column. (represents 30)
3. Push four beads up in the ones column. (represents 4)
4. Push one bead down in the tens column. (represents 10)
5. Push four beads down in the ones column. (represents 4)
6. Count the beads in each column.

YOU SHOULD HAVE TWO BEADS PUSHED UP IN THE TENS COLUMN, REPRESENTING THE NUMBER 20.

YOU SHOULD HAVE ZERO BEADS PUSHED UP IN THE ONES COLUMN, REPRESENTING THE NUMBER 0.

NOW ADD 20 AND 0. YOUR ANSWER SHOULD BE 20.

9,654 - 3,013

1. Make sure all beads are pushed away from the horizontal bar.
2. Push one bead down in the thousands column. (represents 5,000)
3. Push four beads up in the thousands column. (represents 4,000)
4. Push one bead down in the hundreds column. (represents 500)
5. Push one bead up in the hundreds column. (represents 100)
6. Push one bead down in the tens column. (represents 50)
7. Push four beads up in the ones column. (represents 4)

NOW, TO SUBTRACT, YOU WILL BE MOVING THE BEADS THAT WERE PREVIOUSLY MOVED TOWARD THE HORIZONTAL BAR AWAY FROM THE HORIZONTAL BAR.

8. Push three beads down in the thousands column. (represents 3,000)

IN THE TENS COLUMN, ONLY ONE BEAD (REPRESENTING 50) WAS MOVED TOWARDS THE HORIZONTAL BAR. EXCHANGE THIS BEAD FOR FIVE BEADS FROM THE LOWER PORTION OF THE ABACUS. TO DO THIS, FIRST, MOVE THE BEAD REPRESENTING 50 AWAY FROM THE HORIZONTAL BAR. NEXT, PUSH FIVE BEADS UP TO THE HORIZONTAL BAR.

9. Push one bead down in the tens column. (represents 10)
10. Push three beads down in the ones column. (represents 3)
11. Count the beads in each column.

YOU SHOULD HAVE ONE BEAD PUSHED DOWN IN THE THOUSANDS COLUMN, REPRESENTING THE NUMBER 5,000.

YOU SHOULD HAVE ONE BEAD PUSHED UP IN THE THOUSANDS COLUMN, REPRESENTING THE NUMBER 1,000.

YOU SHOULD HAVE ONE BEAD PUSHED DOWN IN THE HUNDREDS COLUMN, REPRESENTING THE NUMBER 500.

YOU SHOULD HAVE ONE BEAD PUSHED UP IN THE HUNDREDS COLUMN, REPRESENTING THE NUMBER 100.

YOU SHOULD HAVE FOUR BEADS PUSHED UP IN THE TENS COLUMN, REPRESENTING THE NUMBER 40.

YOU SHOULD HAVE ONE BEAD PUSHED UP IN THE ONES COLUMN, REPRESENTING THE NUMBER 1.

NOW ADD $5,000 + 1,000 + 500 + 100 + 40 + 1$ ANSWER: 6,641

USE AN ABACUS TO SHOW THE FOLLOWING NUMBERS.

24	98	104	38,776
48	5	365	145,689
16	0	4,290	7,654,321
88	67	9,999	4,567,413,098
76	75	21,444	623,972,004

ADD:

84 + 11	617 + 381	9,657 + 1,322
65 + 43	264 + 634	97,624,452 + 2,374,000
21 + 88	822 + 76	777,854 + 5,232
79 + 70	44 + 915	1,692 + 16
36 + 22	35 + 414	432,987,654 + 321

SUBTRACT:

77 - 26	478 - 363	641,789,021 - 320,578,000
89 - 33	972 - 751	7,438,662 - 3,261
65 - 54	884 - 751	555,130 - 430,010
98 - 36	156 - 41	62,963,002 - 2,001
67 - 55	764 - 102	542,989 - 763



Science

FOR THE TEACHER:

CHINA'S TERRAIN AND CLIMATE VARY TREMENDOUSLY. THERE ARE SIX DIFFERENT TYPES OF ECOSYSTEMS ON MAINLAND CHINA. THIS UNIT EXPLORES THE VARIOUS ECOSYSTEMS.

IT IS IMPORTANT TO NOTE THAT DIFFERENT SOURCES USE DIFFERENT TERMINOLOGY WHEN REFERRING TO THE ECOLOGICAL ZONES. FOR EXAMPLE, WHAT SOME REFER TO AS STEPPE IS CALLED TEMPERATE GRASSLANDS BY OTHERS. THEREFORE, YOU MAY NEED TO ADJUST THE TERMS INCLUDED IN THIS UNIT TO CORRELATE WITH YOUR PARTICULAR TEXTBOOK.

OBJECTIVES:

1. Students will be able to define the term "ecosystem".
2. Students will be able to list the ecosystems of mainland China.
3. Students will be able to list characteristics of each of China's ecosystems.
4. Students will be able to define the term "food chain".
5. Students will be able to give an example of a food chain within the ecosystem in which they are currently living.
6. Students will be able to give an example of a food chain for each of the six ecosystems of China.

MATERIALS NEEDED:

map of China's ecosystems
opaque projector or overhead projector with a means to make transparencies
colored chalk, pastels, colored pencils, colored markers
scissors
resource materials from the media center
large rolls of various colors of bulletin board paper

PROCEDURES:

1. Discuss the meaning of the term "ecosystem" and the various types of ecosystems in the world.
2. Have students list characteristics of the various ecosystems of the world.

3. Have the students discuss characteristics of the ecosystem in which they live and decide what type of ecosystem they live in.
4. Have students complete the map of China's ecosystems. Remind students to complete the key.
5. Discuss the meaning of the term "food chain".
6. Have students think of examples of food chains within the ecosystem in which they are living.
7. Divide the class into six groups. Assign each group one of the six ecosystems found in China.
8. Each group will research the particular ecosystem that it was assigned. Students must find out the types of animals found in their ecosystem and be able to develop a correct food chain for that ecosystem.
9. Once the students have completed their research, they will draw pictures of these animals or plants. The pictures must be life-sized or larger. Encourage students to use projectors to enlarge pictures from books if they are not artistic. The projector will help them draw the basic shape. Students can then fill in the detailing themselves.
10. The colored pencils, chalk, pastels, etc. will be used for the detailing. Encourage students to make their animals appear as life-like as possible.
11. After the animals have been completed, they should be cut out so that there is no extra background paper, just the animals.
12. Have the students make paper chains to link their animals in the correct order and to symbolize the linkage between their animals on the food chain.
13. Hang the animals on a large wall when they are completed, and have the class determine the ecosystem that each food chain represents.

THE ECOSYSTEMS OF CHINA



- steppe
- broadleaf forest
- mountain
- desert
- needleleaf forest
- rainforest

227

Social Studies

228

FOR THE TEACHER:

FROM PAST EXPERIENCE, I HAVE FOUND THAT STUDENTS OFTEN HAVE DIFFICULTY UNDERSTANDING THE RELATIONSHIP BETWEEN COLOR ON A TOPOGRAPHICAL MAP AND ELEVATION. BY BUILDING A MODEL, I BELIEVE, STUDENTS WILL BETTER UNDERSTAND THIS CONCEPT.

OBJECTIVES:

1. Students will be able to state the colors most frequently used to show elevation on a relief map.
2. Students will understand the correlation between colors used on relief maps and actual elevation.
3. Students will be able to locate, on a map, areas of China with high elevation.
4. Students will be able to locate, on a map, areas of China with low elevation.

MATERIALS NEEDED:

cardboard
construction paper (dark green, light green, yellow, orange, red, brown (white may be substituted for brown))
an Xacto knife for each student
glue
set of seven patterns for each student

PROCEDURES:

1. Students will need a piece of cardboard large enough to fit pattern number one on.
2. Have students glue a dark green sheet of construction paper to the top side of the cardboard.
3. Students should now place pattern number one on top of the paper covered cardboard.
4. Now, have students use an Xacto knife to cut on the black pattern line (Both the pattern and the piece of cardboard should be cut.).
5. Students should discard the scraps of cardboard and pattern pieces.

6. Have students repeat this process with pattern number two, except that light green construction paper will be substituted for the dark green used previously.
7. Now, use pattern number seven as a guide to help determine the proper placement of the light green covered cardboard pieces on top of the dark green piece.
8. Use glue to secure the light green pieces to the dark green piece of cardboard.
9. This process should be continued until all of the pattern pieces have been used and are secured in their proper places. (Each pattern states the correct color of construction paper that should be used for that/those piece(s).)

*DIFFERENT COLORS OF CONSTRUCTION PAPER SHOULD NOT BE USED. IN ORDER FOR STUDENTS TO ACTUALLY SEE THE RELATIONSHIP BETWEEN THE COLORS USED ON TOPOGRAPHICAL MAPS AND ELEVATION, NO SUBSTITUTIONS SHOULD BE MADE.

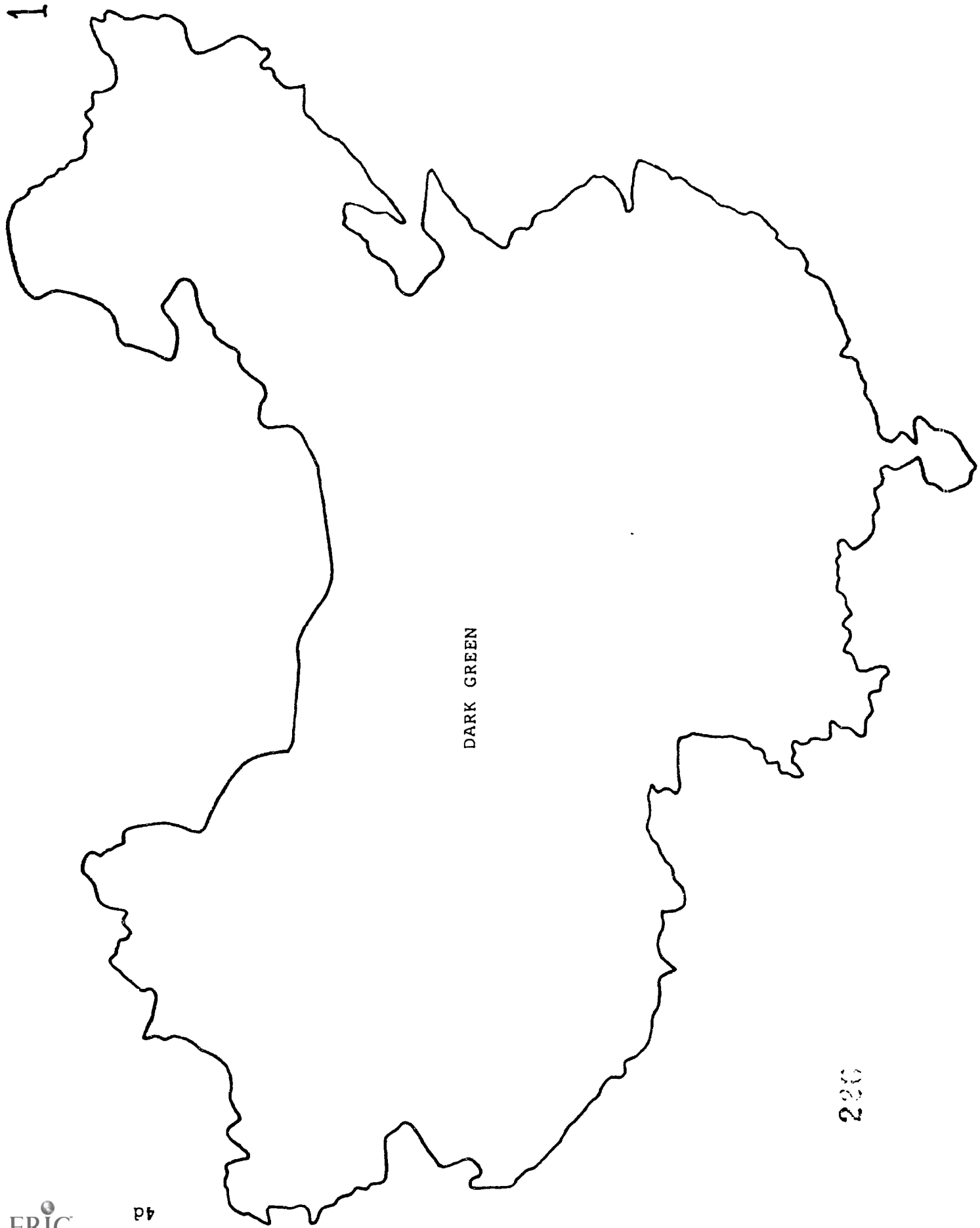

DARK GREEN



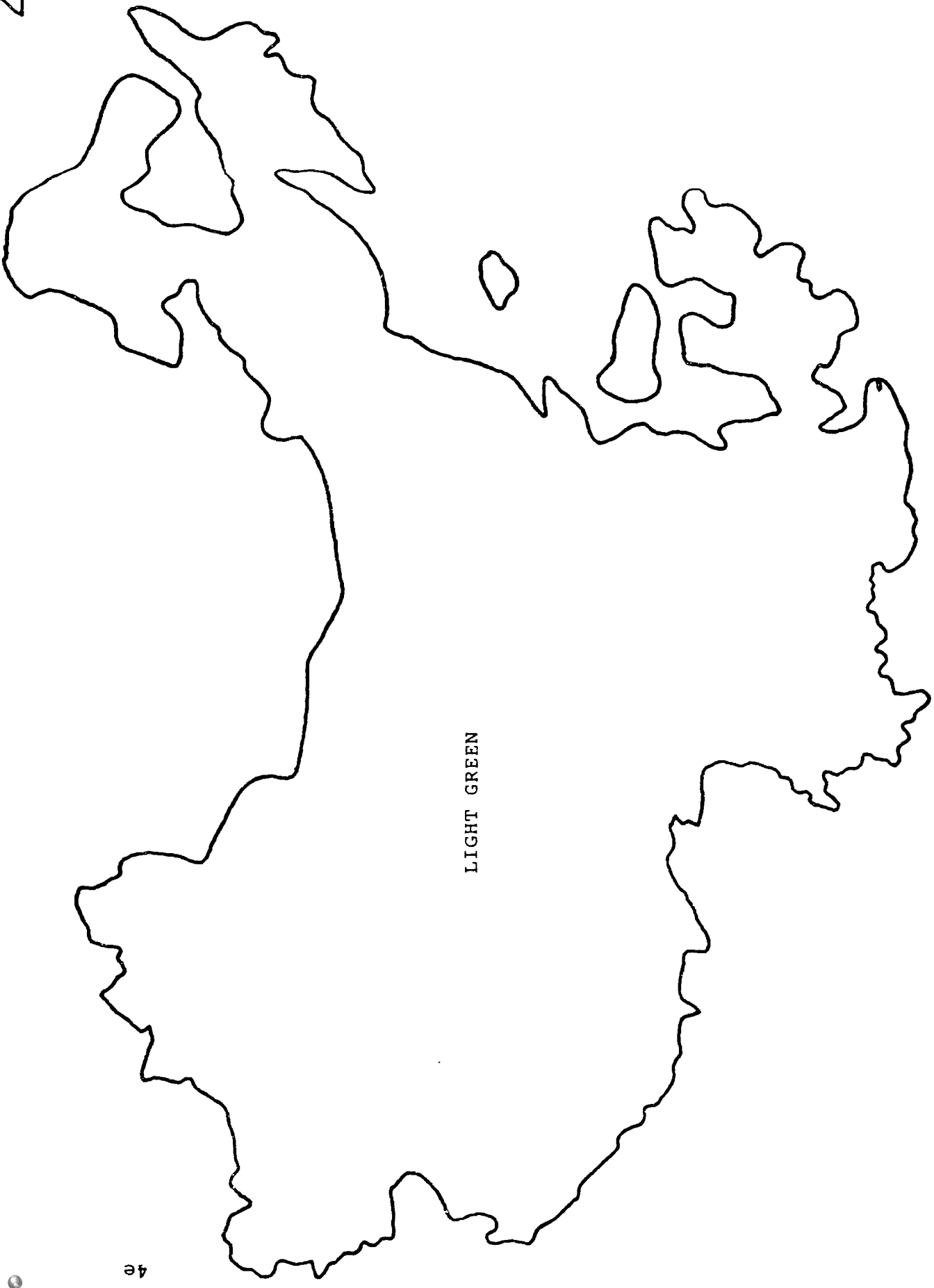

LIGHT GREEN

3

231

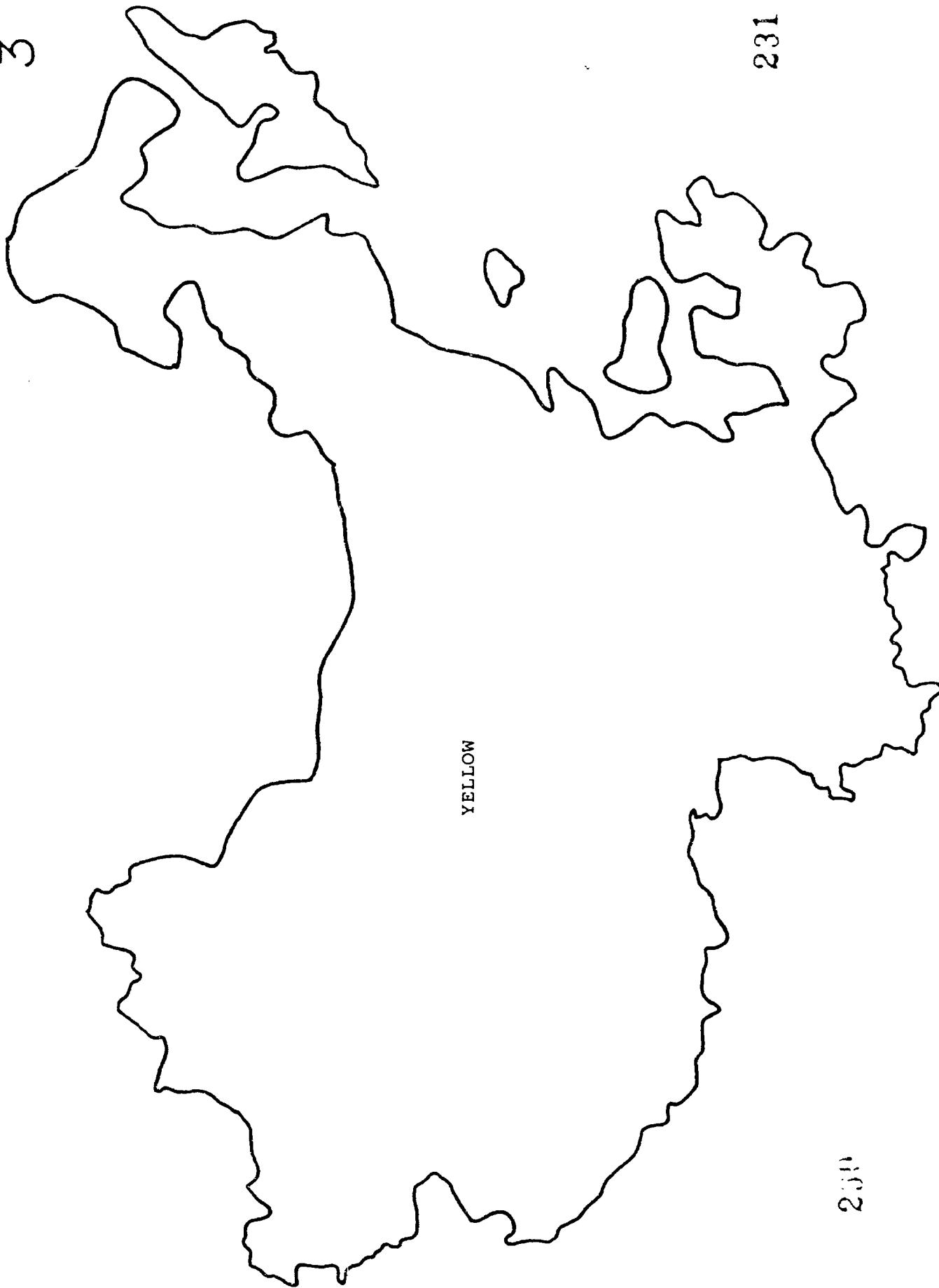

YELLOW

231

4E

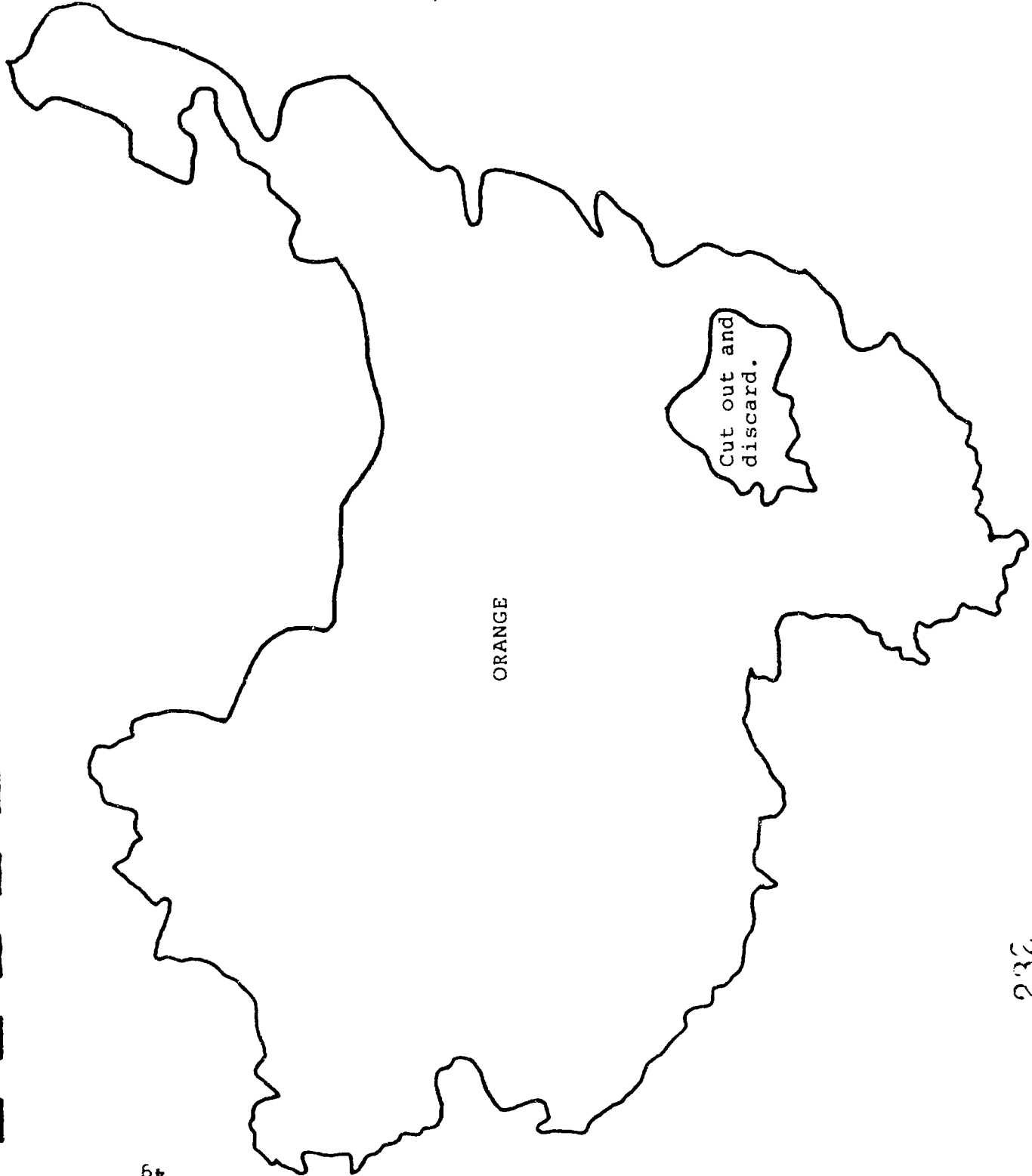

ORANGE

Cut out and
discard.

235

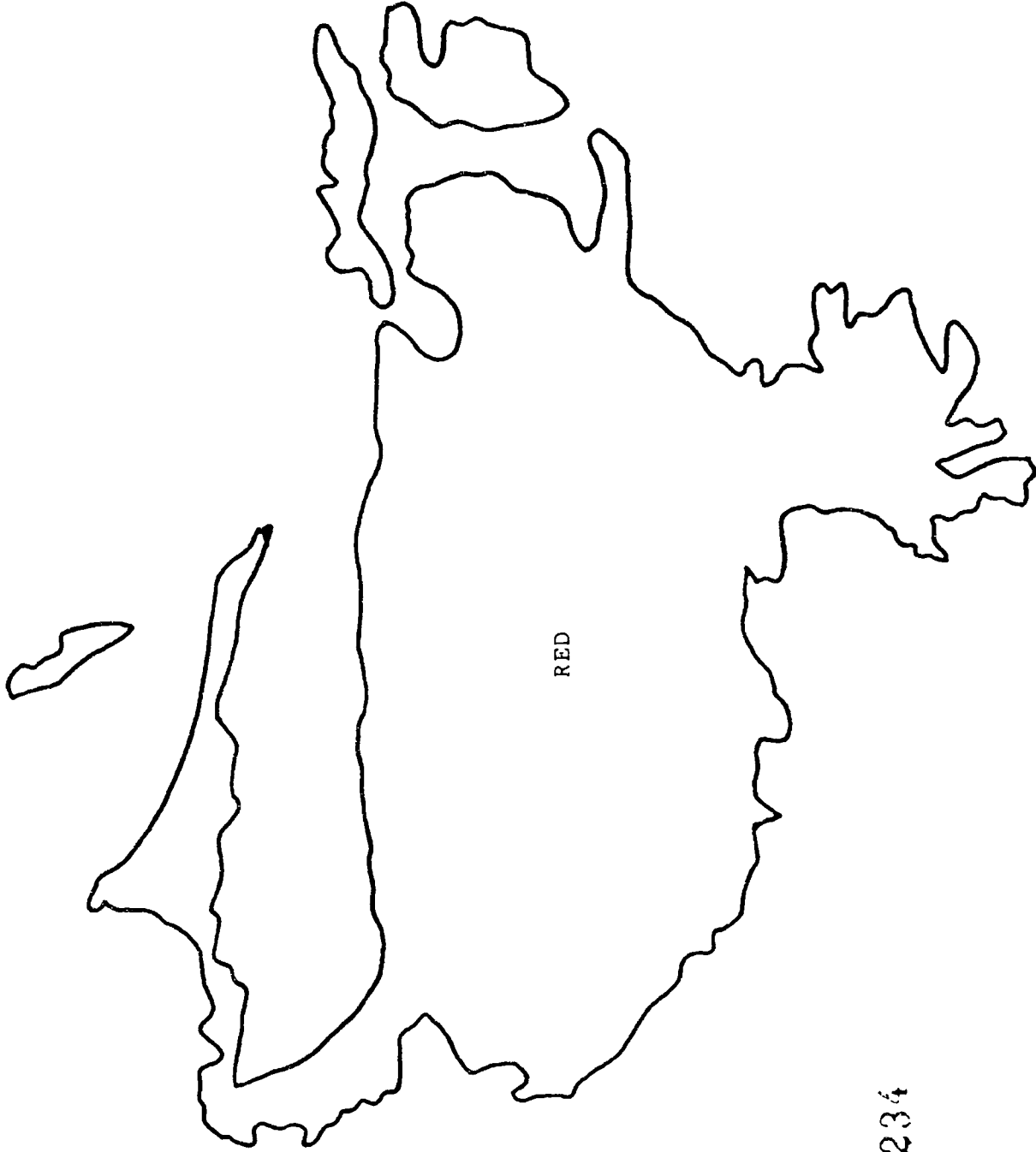

234

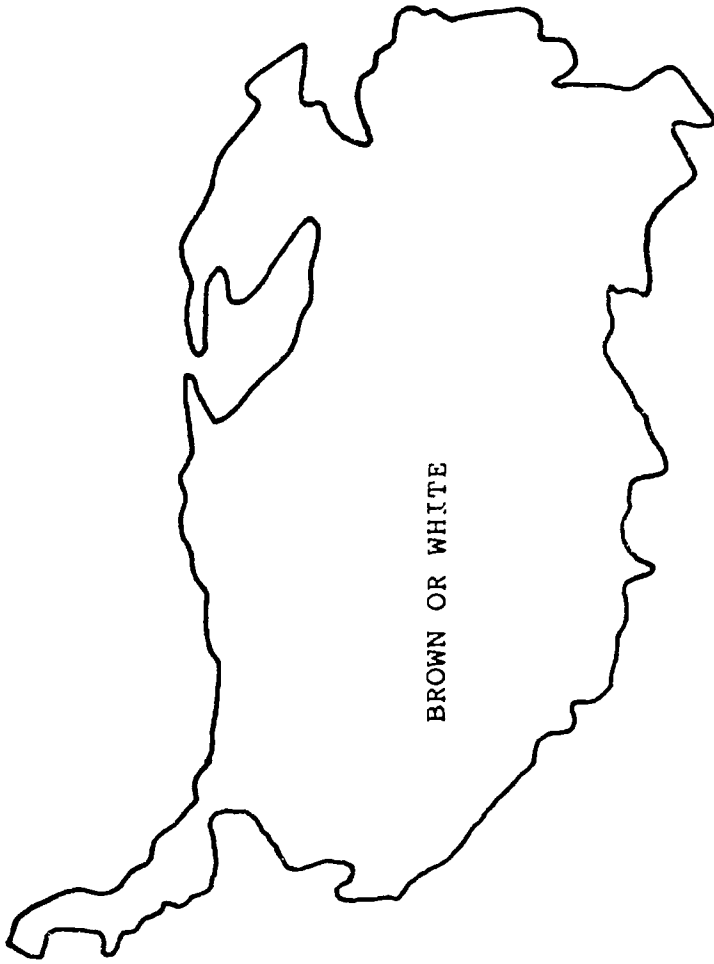

237

236

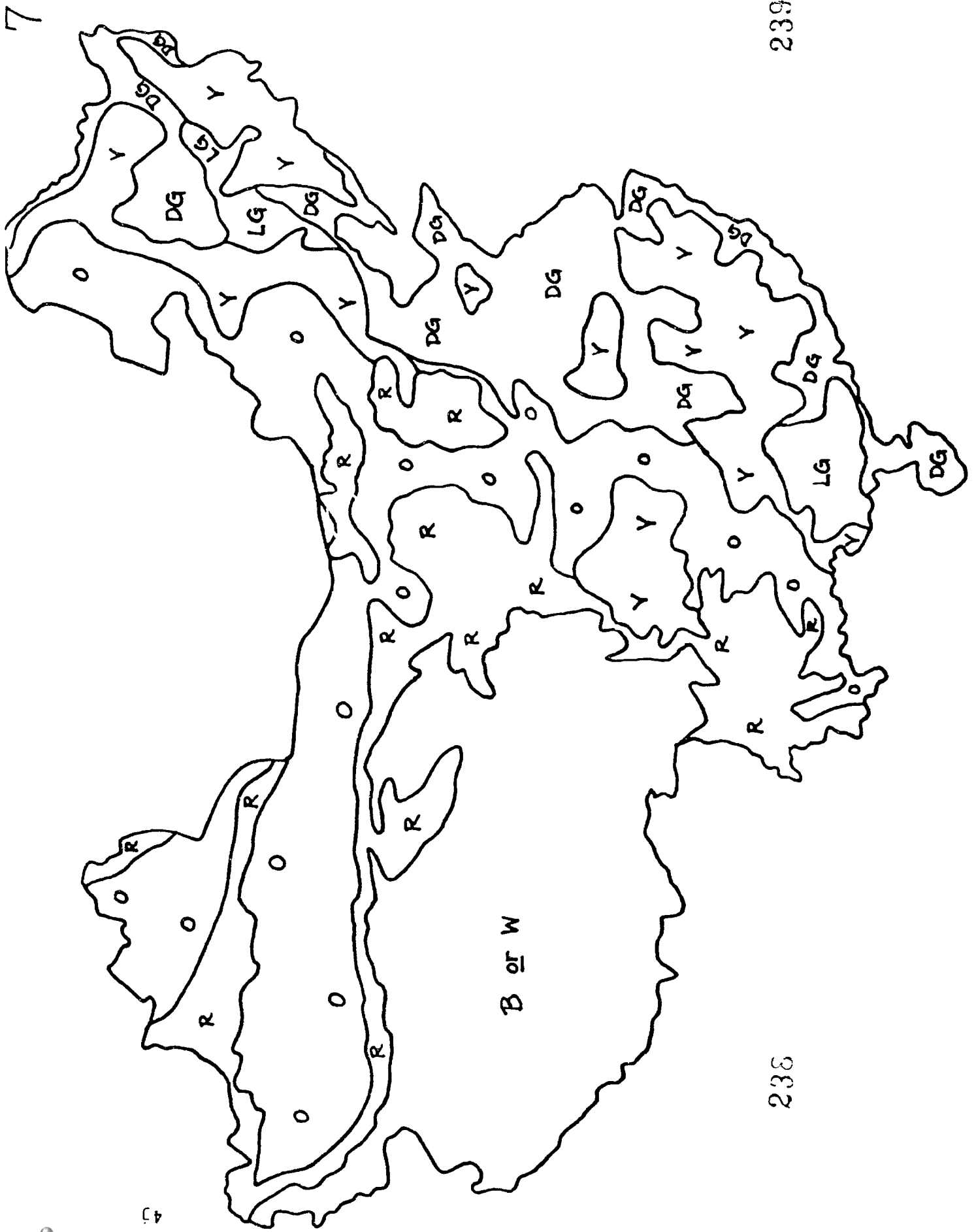

4J

238

239

FOR THE TEACHER:

STUDENTS SHOULD UNDERSTAND THAT A COUNTRY'S CLIMATE IS DIRECTLY RELATED TO ITS TERRAIN AND LOCATION. THE FOLLOWING LESSON IS DESIGNED TO FAMILIARIZE STUDENTS WITH CHINA'S TEMPERATURE PATTERNS. THEN, STUDENTS WILL BE ASKED TO DRAW SOME CONCLUSIONS ABOUT TEMPERATURE BY COMPARING THEIR MAP OF TEMPERATURE BANDS WITH THEIR MODEL OF CHINA'S ELEVATION.

OBJECTIVES:

1. Students will be able to analyze data on temperature.
2. Students will be able to use given data to prepare an accurate map of temperature bands.
3. Students will be able to interpret a map of temperature bands.
4. Students will recognize various temperature bands throughout China.
5. Students will be able to make comparisons between temperature and elevation.

MATERIALS NEEDED:

set of colored pencils for each student
data sheet for each student
map for each student
directions for the completion of the map for each student

PROCEDURES:

1. Hand out each of the materials needed to the students.
2. Discuss the instructions for the map with the students.
3. Have students complete the map according to the directions
4. When the students have completed their maps, have them look at their elevation models and their temperature maps and see if they can spot any relationship between elevation and temperature.
5. Discuss other things that affect temperature such as ocean currents and latitude. How do these affect China's temperature?

DATA SHEET FOR TEMPERATURE PROFILE

CITY	HIGH TEMPERATURE (JULY 9,1993)
Nanjing	93
Beijing	81
Hefei	97
Harbin	77
Hangzhou	95
Changchun	79
Nanchang	91
Tianjin	81
Wuhan	95
Yinchuan	91
Changsha	90
Lanzhou	82
Fuzhou	97
Xian	97
Nanning	93
Xining	72
Macau	91
Lhasa	75
Guangzhou	91
Kunming	81
Hong Kong	90
Chengdu	90
Xiamen	93
Guiyang	86
Ningbo	91
Taiyuan	81
Shantou	91
Jinan	86
Lianyungang	91
Shijiazhuang	84
Zhengzhou	97
Shanghai	95
Zhanjiang	100





TEMPERATURE PROFILE

Directions:

1. Use tape to join the two halves of your map of China. (TAPE THE BACK SIDE OF YOUR MAP!)
2. For each city on the large map of China, enter the high temperature for July 9, 1993, in the circle next to the name of the city.
3. Your next task is to draw a series of unbroken lines across the map so that each line will separate the temperatures into sections of 10 degrees (such as 70 to 79, 80 to 89, and so on).

HERE'S AN EXAMPLE:

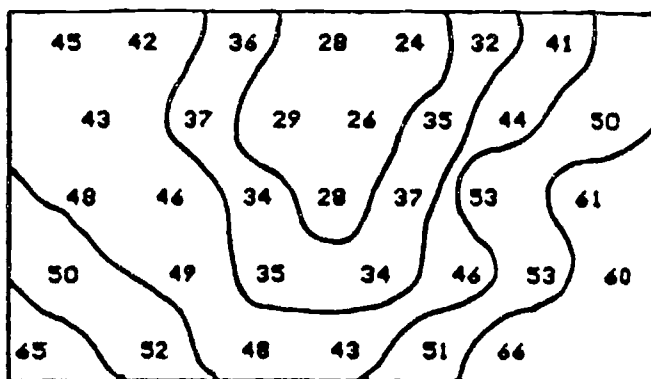

4. Draw your lines so that they separate your map into bands of ten degrees.
5. Color each band so that it can be easily seen. Color the bands the following colors:
 - 70-79 degrees=yellow
 - 80-89 degrees=orange
 - 90-99 degrees=red
 - 100 degrees and above=white

DISCUSSION QUESTIONS:

1. Describe any patterns that you see on your map. What parts of the country are the warmest? the coldest? Compare the coasts to the interior of China.
2. Compare your temperature band map to your model of China's elevations. What effect does elevation have on temperature? Give some specific examples of areas that show the relationship between elevation and temperature.
3. Why do you suppose that northern China is generally cooler than southern China?
4. Why do you suppose the coastal areas of China are warmer than areas farther inland?

STUDENTS' MAPS SHOULD LOOK LIKE THIS MAP BEFORE THEY COLOR THEM.

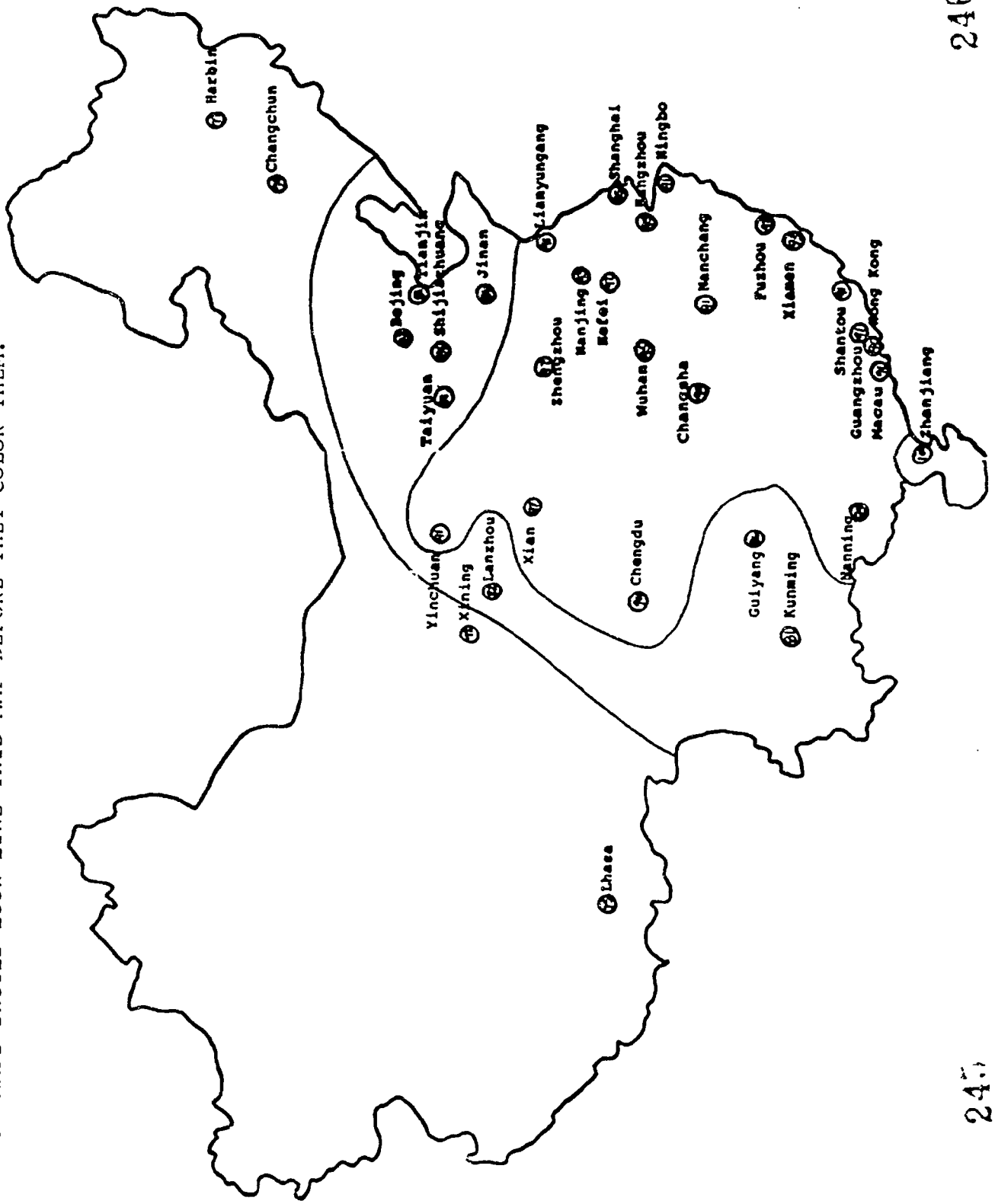

English,
 One-Minute,
 English One-Minute,
 English One-Minute Sto
 English One-Minute Stories
 English

5a

English
 English
 One-Minute
 One-Minute
 English
 English
 One-Minute
 One-Minute
 English

FOR THE TEACHER:

ONE-MINUTE STORIES HAVE BEEN PART OF CHINESE LITERATURE FOR CENTURIES. THEY CAN BE TRACED BACK AS FAR AS 770 B.C. IN THE 1980'S, THERE WAS A REVIVAL OF THE ONE-MINUTE STORY AS AN ART FORM IN CHINA. THE SHANGHAI-BASED LITERARY MAGAZINE, REALM OF FICTION, BEGAN PUBLISHING ONE-MINUTE STORIES, AND READERS IMMEDIATELY LIKED THEM.

THERE ARE FOUR DEFINING CHARACTERISTICS OF THE ONE-MINUTE STORY. THESE ARE:

1. ITS FLUID STYLE
2. ITS CONCISENESS
3. ITS UNEXPECTED TWISTS
4. ITS SENSITIVITY TO NUANCE

OBJECTIVES:

1. Students will be introduced to foreign literature.
2. Students will be able to state the author's motive for writing "Fashionable Summer Yellow".
3. Students will be introduced to a new genre of literature.
4. Students will improve their vocabulary skills.
5. Students will improve their skills at understanding the meanings of words through reading them in context.
6. Students will be able to relate "Fashionable Summer Yellow" to their own personal experiences.
7. Students will improve their writing skills.

MATERIALS NEEDED:

one copy of "Fashionable Summer Yellow" for each student
 one copy of "Understanding the Meaning Through Context" for each student

PROCEDURES:

1. Present a brief lesson on the one-minute story genre to the students.
2. Have the students complete "Understanding the Meaning Through Context" WITHOUT the use of dictionaries.

3. Either have students hand in their papers or discuss the worksheet together in class.
4. Have the students look up the vocabulary words from "Understanding the Meaning Through Context" in the dictionary and write their correct meanings.
5. Have students read "Fashionable Summer Yellow".
6. Discuss "Fashionable Summer Yellow" with the students.
7. Assign the writing assignment.

Fashionable Summer Yellow

Liu Xinwu

IT is so easy to be unfashionable.

After browsing through several street markets, Shanshan finally found what she wanted at the one on East Xiushui Street — a deep yellow dress. She wore it to meet her boyfriend that evening.

“I hardly recognized you!” he said, looking her up and down with raised eyebrows.

“I bet you never thought you’d see me in a dress like this!” she said, then added with a sigh, “When I was ill those last few weeks I lost touch with the fashions. By the time I got better and could take a look in the streets, I found that deep yellow was suddenly in vogue! What do you think? Do you like it?”

“Uh-huh.” Her boyfriend muttered noncommittally. The expression on his face showed he had no idea of what was in fashion.

She wore her new dress to work, and the moment she stepped through the door, she was surrounded by her female colleagues.

“Hey, that’s not the right colour. The fashion now is bright yellow, not that deep yellow!” opined Wu Shuli, narrowing her high almond-shaped eyes.

Han also expressed a view. “Nowadays girls all want to wear the colours of an empress. In the old

Fashionable Summer Yellow

days only the royal family could wear that particular yellow."

Shanshan couldn't care less about Han's remarks, but Shuli's words bothered her.

"Why are you throwing away your brand-new dress after only two days?" asked her mother in astonishment.

"Can't you see?" came the bitter reply. "It's not the right yellow!"

Her mother shrugged. These days girls were not afraid to walk around wearing yellow. When she had been young, the word yellow alone meant something scandalous. If you called someone "yellow", you were saying they had loose morals.

The next time Shanshan went to meet her boyfriend she had on a new dress. She twirled to show it off. "It's pure bright yellow, make no mistake."

She pointed to the passing girls in their yellow dresses. "Look, that colour is wrong. So is that one. All of them are just off. Deep yellow looks vulgar; light yellow is unsophisticated; brownish yellow looks old-fashioned!"

In an attempt to assert a modicum of independent thought her boyfriend ventured that he thought lemon yellow "not bad".

"Lemon yellow?! Thank God you didn't say orange yellow!"

No sooner had Shanshan walked — not without a certain smugness — into the finance office in her new dress than Wu Shuli rushed over. "The new fashion! Hey, you look really stylish! A blouse and skirt is so much nicer and more modern than a one-piece."

Shanshan smiled broadly. Shuli came up and felt the

skirt between her fingers. "Oh!" exclaimed the latter, her slanted almond eyes widening in surprise. "The material's not right! It should be soft and shiny satin but this...."

Shanshan's smile froze.

The next time she went to meet her boyfriend she found him searching the crowds, neck outstretched, eyes wide. She had to reach out and pat him on the back before he realized she was there. "Who are you looking for?" she asked.

"Oh," he said, turning around and looking at her. "I thought you'd wear the bright yellow dress. It was so hard to find you. Bright yellow is everywhere now!"

Shanshan was wearing mauve.

FASHIONABLE SUMMER YELLOW

UNDERSTANDING THE MEANING THROUGH CONTEXT

Sometimes when you are reading, you will encounter an unfamiliar word. You can sometimes figure out the meaning of a word by its context, or the way it is used in the sentence. This is a skill that becomes very handy when a dictionary is unavailable.

The following passages are from "Fashionable Summer Yellow". Read each passage. Then, using context clues, determine the meaning of the underlined word. Write your definition on the line below the passage.

1. "By the time I got better and could take a look in the streets, I found that deep yellow was suddenly in voque!"

2. "'Uh-huh.' Her boyfriend muttered noncommittally."

3. "She wore her new dress to work, and the moment she stepped through the door, she was surrounded by her female colleagues."

4. "'Hey, that's not the right colour. The fashion now is bright yellow, not that deep yellow!' opined Wu Shuli, narrowing her high almond-shaped eyes."

5. "When she had been young, the word yellow alone meant something scandalous."

6. "'All of them are just off. Deep yellow looks vulgar; light yellow is unsophisticated; brownish yellow looks old-fashioned!'"

7. "'All of them are just off. Deep yellow looks vulgar; light yellow is unsophisticated; brownish yellow looks old-fashioned!'"

8. "In an attempt to assert a modicum of independent thought her boyfriend ventured that he thought lemon yellow 'not bad'."
-
9. "No sooner had Shanshan walked--not without a certain smugness--into the finance office in her new dress than Wu Shuli rushed over."
-
10. "Shanshan was wearing mauve."
-

FASHIONABLE SUMMER YELLOW

ANALYZING LITERATURE

Discuss the following questions with the students.

1. What lesson is to be learned from this story?
2. What is conformity?
3. What is materialism?
4. What is peer pressure?
5. Why do you think that having a yellow dress was so important to Shanshan?
6. Shanshan was so proud of her deep yellow dress; however, she is disappointed to find out that deep yellow is not in style. Have you ever experienced this before (trying to fit in with others only to find out that you are still a little different)?
7. What does this story tell you about Chinese society and values?

COMPOSITION

Pre-writing: Provide class time for students to discuss personal experiences similar to this story.

Writing: Allow time for students to write a first draft of a composition using this story as a basis but changing the details to reflect personal experiences.

Revising: Provide time for students to make revisions in their compositions. Encourage them to proofread carefully. Have students make sure that the theme of "Fashionable Summer Yellow" is evident in their stories.

Home Economics



25⁴

FOR THE TEACHER:

CHINESE COOKING IS UNIQUE IN MANY WAYS. THIS UNIT EXPLORES CHINESE FOODS, TECHNIQUES OF FOOD PREPARATION, AND CHINESE TABLE SETTINGS.

OBJECTIVES:

1. Students will be able to list ten ingredients commonly found in Chinese foods.
2. Students will be able to demonstrate the proper technique for using a wok.
3. Students will gain a new appreciation of foreign foods.
4. Students will be able to demonstrate the proper technique for using a food processor.
5. Students will be able to demonstrate the proper technique for using a rice steamer.
6. Students will gain an understanding of the nutritional value of Chinese foods and Chinese methods of cooking.
7. Students will be able to construct an attractive table setting based on Chinese customs and traditions.
8. Students will improve their fine motor skills by learning to use chopsticks (or they'll go hungry!).
9. Students will improve their math computation skills by learning to increase serving sizes.

MATERIALS NEEDED:

ingredients for selected dishes
 food processor (optional)
 rice steamer
 * lazy-Susan (approximately 3' in diameter)
 chop sticks (enough for each student)
 small bowls (one for each place setting)
 salad plates (one for each place setting)
 recipes (copy for each student)
 wok (having several would enable the groups to cook simultaneously)
 various cooking utensils for chopping, stirring, and measuring
 1 jar of peanuts

PROCEDURES:

1. Discuss Chinese cooking traditions with the students. Some basic information can be found in this packet.

* YOU MAY BE ABLE TO GET YOUR INDUSTRIAL ARTS TEACHER TO MAKE A COUPLE OF LAZY-SUSANS FOR YOU.

2. Select recipes for preparation. This should include at least two entrees, one vegetable dish, one type of soup, and rice.
3. Discuss with the students the process for increasing the serving size of a recipe. Make sure that you mention that it is not always necessary to increase the amount of every ingredient. Discuss which types of ingredients do not always need to be increased at the same ratio as other ingredients. This would include ingredients such as oil, when it is used for stir frying purposes, and some other ingredients such as salt.
4. Have students complete the chart for increasing the serving sizes of recipes. Before students begin working, discuss which of the ingredients, if any, will not need to be increased or will be increased at a different ratio than the other ingredients. Have students circle these ingredients on the chart so that they will remember not to increase their amounts in the same proportions as the other ingredients. (You may want to enlist the help of the math teacher to see if the students can work on this and discuss the various measurements in their math class.)
5. Discuss the charts with the students once they have been completed. Have students make corrections if necessary.
6. Have students prepare a list of necessary ingredients for the recipe(s) they will be preparing. The quantities needed of each ingredient should also be listed.
7. Purchase the necessary ingredients.
8. Demonstrate the proper use of the food processor, rice steamer, and wok.
9. Review the following terms with the students: pinch, sift, beat, dice, stir-fry, blanched
10. Have the students cook their assigned food according to the recipe.
11. Since the groups will finish preparing their foods at different times, have those who finish early prepare the table setting according to Chinese tradition.
12. When the food is ready to be eaten and the table has been set, have the students sit down at the table. Give them a brief lesson on the use of chopsticks and table manners.

*YOU MAY WANT TO INVITE ANY STUDENTS WHO ARE PARTICIPATING IN THIS ACROSS THE CURRICULUM UNIT, BUT WHO DO NOT HAVE A HOME ECONOMICS CLASS, TO JOIN YOUR STUDENTS. OTHER TEACHERS PARTICIPATING IN THIS UNIT WOULD PROBABLY ENJOY THE INVITATION ALSO.

WORKSHEET FOR INCREASING THE SERVING SIZES OF RECIPES

6d

CHICKEN WITH BEAN SPROUTS AND CRISPY NOODLES (Gai see jar min)			
Ingredient	Single Recipe	Double Recipe	Triple Recipe
chicken breast	1½ oz.		
slice ham	1		
medium Chinese mushroom	1		
small spring onion	1		
peanut oil	1½ pints		
bean sprouts	1 oz.		
monosodium glutamate	½ teaspoon		
chicken stock	½ pint		
cornflour	½ teaspoon		
water	1 tablespoon		
Chuka soba	1 round		

CHICKEN WITH ALMONDS (Hung yen gai)			
Ingredient	Single Recipe	Double Recipe	Triple Recipe
chicken meat	7 oz.		
bamboo shoots	2 oz.		
water chestnuts	2 oz.		
cucumber	1 oz.		
egg white	1		
sherry	1 teaspoon		
salt	1 pinch		
monosodium glutamate	½ teaspoon		
peanut oil	4 tablespoons		
almonds	2 oz.		
sugar	1 pinch		
soy sauce	2 teaspoons		
cornflour	1 teaspoon		
water	1 tablespoon		

CHINESE FOODS VARY FROM ONE AREA OF THE COUNTRY TO ANOTHER. GENERALLY, BECAUSE WHEAT IS A MAJOR CROP OF NORTHERN CHINA, NORTHERN MEALS INCLUDE NOODLES, DUMPLINGS, STEAMED BUNS AND BREADS. IN THE SOUTH, A RICE GROWING REGION, RICE, RICE CAKES, AND RICE NOODLES ARE FREQUENTLY SERVED.

FLAVOR, AROMA, AND COLOR ALL PLAY AN IMPORTANT PART IN CHINESE COOKING. NORMALLY, ONE ENTREE WILL COMBINE THREE TO FIVE COLORS. CONTRAST IN COLOR IS IMPORTANT IN CHINESE COOKING. USUALLY, A DISH CONSISTS OF ONE MAIN INGREDIENT AND TWO OR THREE SECONDARY INGREDIENTS OF CONTRASTING COLORS. THIS MAKES THE DISH APPEALING TO THE EYE.

THE AROMA OF CHINESE FOODS IS A RESULT OF THE USE OF INGREDIENTS SUCH AS GINGER ROOT, GARLIC, SESAME OIL, STICK CINNAMON, PEPPER, AND SCALLIONS. IT IS IMPORTANT TO REMOVE FISHY ODORS FROM DISHES CONTAINING SEAFOODS. WHILE IN THE UNITED STATES LEMON IS USED FOR THIS PURPOSE, IN CHINA GINGER AND SCALLIONS SERVE THIS PURPOSE.

THE NATURAL FLAVORS OF THE INGREDIENTS OF CHINESE ENTREES MUST NOT BE COVERED UP. EACH CHINESE ENTREE SHOULD SATISFY ALL PALATES WHETHER ONE PREFERS SWEET, HOT, OR RICH FLAVORS.

THE TABLE SETTING FOR A CHINESE MEAL IS VERY DIFFERENT FROM A TYPICAL WESTERN TABLE SETTING. IN THE CENTER OF THE TABLE, ONE USUALLY FINDS A LARGE LAZY-SUSAN. THE NUMEROUS ENTREES WILL BE PLACED ON THE LAZY-SUSAN TO ENABLE EVERYONE TO REACH THE VARIOUS DISHES EASILY. INDIVIDUALS WILL EACH HAVE A PLACE SETTING CONSISTING OF A RICE BOWL, A SMALL PLATE, CHOPSTICKS, A CHINA SPOON, AND A CUP FOR TEA OR A GLASS FOR OTHER TYPES OF BEVERAGES.

CHINESE TABLE MANNERS ARE QUITE DIFFERENT FROM WESTERN CUSTOMS. FOR INSTANCE, WHEN EATING SOUP, IT IS CONSIDERED POLITE FOR ONE TO RAISE HIS BOWL UP CLOSE TO HIS FACE. ONE IS ALSO PERMITTED TO PLACE BONES DIRECTLY ON THE TABLE NEXT TO HIS PLATE. BIRPING LOULDLY IS ALSO OKAY. IF THERE ARE GUESTS AT THE MEAL, THE HOST IS REQUIRED TO SERVE HIS GUESTS. GUESTS SHOULD NOT TURN DOWN AN OFFER OF FOOD FROM THE HOST, AS THIS IS CONSIDERED VERY IMPOLITE.

Chicken with bean sprouts and crispy noodles

Gai see jar min

Preparation time 5 minutes
Cooking time 5-6 minutes
To serve 1-2

You will need

1½ oz. chicken breast
 few snow peas
 1 slice ham
 1 medium size Chinese mushroom (soaked)
 1 small spring onion
 1½ pints peanut oil for frying
 1 round Chuka soba (Chinese noodle) or home made egg noodles*
 1 oz. bean sprouts
 ½ teaspoon monosodium glutamate
 ¼ pint chicken stock
 ½ teaspoon cornflour mixed with 1 tablespoon water
 salt

Shred chicken breast, snow peas, ham, mushroom, and spring onion. Put 1½ pints of peanut oil in a large pan on the stove, have oil hot, then add noodles. Fry until brown and crisp, remove from the pan and drain on kitchen paper first, then set on a heated plate. Heat 2 table-
 spoons peanut oil in a pan, fry the chicken, snow peas, ham, mushroom, spring onion and bean sprouts all at once for 2 minutes. Add monosodium glutamate, chicken stock and cornflour mixture, bring to the boil, and boil for 1 minute. Add salt to taste. Pour the mixture on the top of the noodles, and serve at once.

*Home made egg noodles:

Beat 6 eggs lightly. Add a pinch of salt and sift in enough flour to make a soft dough. Roll the dough very thinly (much thinner than pie pastry). Sprinkle flour on the surface to prevent it sticking. Let it remain on the table to dry for 30 minutes, then slice it into very fine strips. You can use these egg noodles for soup noodles (noodles with a little soup) or noodle soup (soup with a few noodles) or fried noodles.

Chicken with almonds

Hung yen gai

Preparation time 8 minutes
Cooking time 5 minutes
To serve 4

You will need

7 oz. chicken meat
 2 oz. bamboo shoots
 2 oz. water chestnuts
 1 oz. cucumber
 1 egg white
 1 teaspoon sherry
 pinch salt
 ½ teaspoon monosodium glutamate
 4 tablespoons peanut oil
 about 2 oz. blanched almonds
 pinch sugar
 2 teaspoons soy sauce
 1 teaspoon cornflour mixed with 1 tablespoon water

Dice chicken meat, bamboo shoots, water chestnuts and cucumber. Add egg white, sherry, pinch salt and ¼ teaspoon monosodium glutamate to chicken and mix well. Heat peanut oil in a pan, add almonds and fry quickly until lightly browned. Remove and drain on kitchen paper. Fry chicken in same pan and remove when cooked. Put bamboo shoots, water chestnuts and cucumber in the pan and cook for 2 minutes. Add chicken, pinch of sugar, ¼ teaspoon monosodium glutamate and soy sauce. Add mixed cornflour and stir until mixture thickens. Add almonds, stir all well together and remove to a heated dish. Serve hot.

Sweet-sour pork**Gu lo yuk**

Preparation time 20 minutes
Cooking time 15 minutes
To serve 4

You will need

7 oz. lean leg of pork
 1 teaspoon sherry
 ½ teaspoon salt
 ¼ teaspoon pepper
 ¼ teaspoon monosodium glutamate
 1 small carrot
 ½ small onion
 1 green pepper
 2 pieces of canned pineapple
 1 clove garlic
 1 egg
 1 tablespoon flour
 3 tablespoons cornflour
 1 pint peanut oil
 3 tablespoons tomato ketchup
 1 teaspoon soy sauce
 3 tablespoons vinegar
 3 tablespoons sugar
 ¼ pint water

Cut pork into 1-inch squares, sprinkle with sherry, salt, pepper and monosodium glutamate, set aside. Boil carrot until almost tender and cut into 1-inch squares. Cut onion, green pepper and pineapple into same size, chop the garlic. Beat egg and mix with the flour and 2 tablespoons cornflour. Coat pork with the mixture.

Heat peanut oil in saucepan. Drop pork squares one by one into the pan, and deep fry them until well done and crisp outside. Remove from oil and drain. Add carrots, onion and green pepper to the same oil, fry 1 minute.

Remove from pan and drain. Mix tomato ketchup, soy sauce, vinegar, sugar, remaining cornflour and water well together. Heat 4 tablespoons oil in the pan, cook the mixture until boiling and thick. Place the pork, vegetables and pineapple into the mixture and mix well. Serve hot.

Rump steak with bean sprouts**Ngow yuk ngar choy**

Preparation time 6 minutes
Cooking time 4 minutes
To serve 4

You will need

1 oz. bamboo shoots
 1 green pepper
 3-inch piece leek or spring onion
 5 oz. beef (rump steak)
 salt
 ½ teaspoon monosodium glutamate
 white pepper
 1 tablespoon sherry
 1 egg white
 1 teaspoon cornflour
 4 oz. bean sprouts
 4 tablespoons peanut oil
 1 crushed clove garlic
 1 tablespoon soy sauce
 ¼ teaspoon sugar

Shred bamboo shoots, green pepper, leek and rump steak. Sprinkle the steak with pinch salt, ¼ teaspoon monosodium glutamate, pinch of pepper and 1 teaspoon sherry. Mix with the egg white and cornflour and set aside. Wash the bean sprouts and drain. Heat 2 tablespoons peanut oil in the pan, and add ½ teaspoon salt, fry the shredded bamboo shoots, green pepper, the onion and the bean sprouts for 2 minutes. Move from the pan. Again add 2 tablespoons peanut oil into the same pan. Add garlic and beef, stir well. When the beef changes colour, add cooked vegetables to the pan, and add soy sauce, remaining sherry, sugar, ¼ teaspoon monosodium glutamate and pinch of white pepper. Cook for 1 minute, remove to a heated dish and serve immediately.

BEST COPY AVAILABLE

Sprouting broccoli

Choy far lui

<i>Preparation time</i>	5 minutes
<i>Cooking time</i>	10 minutes
<i>To serve</i>	4

You will need

10 oz. broccoli
 few carrots
 few bamboo shoots
 ½ teaspoon salt
 2 tablespoons vinegar
 2½ tablespoons sugar
 1 tablespoon soy sauce
 ¼ teaspoon monosodium glutamate
 1 teaspoon cornflour
 1 tablespoon water
 3 tablespoons peanut oil
 1 teaspoon sherry

Cut the broccoli from the stem end into flowerets about 1½-inches long and 1 inch wide. Cut carrots and bamboo shoots as the photograph (however, slicing will be suitable). Put the broccoli in boiling water with ½ teaspoon salt, and cook for 4 minutes, drain well. Put the carrots and bamboo shoots into the same boiling water, cook for 2 minutes and drain well too. Mix vinegar, sugar, soy sauce, monosodium glutamate, cornflour and water together. Heat oil in the pan. Add broccoli and bamboo shoots, fry for 2 minutes. Add carrots and sherry and cook for 2 minutes. Add vinegar mixture to the pan, stir until thick, turn into a heated dish and serve.

Bean sprouts with spring onions

Chen chow ngar choy

<i>Preparation time</i>	4 minutes
<i>Cooking time</i>	3 minutes
<i>To serve</i>	4

You will need

10 oz. bean sprouts
 2-3 spring onions
 2 tablespoons peanut oil
 ½ teaspoon salt
 ¼ teaspoon monosodium glutamate
 Pick and wash the bean sprouts, discarding any seeds, drain well. Cut the spring onions into same length as the bean sprouts. Heat 2 tablespoons peanut oil in the pan, add ½ teaspoon salt and fry the spring onion for ½ minute. Add bean sprouts, stirring for 2 minutes over a strong heat. Sprinkle with monosodium glutamate, turn into a heated dish and serve.

Note This dish may be eaten cold.

Celery in cream sauce

Lai yow kan choy

<i>Preparation time</i>	20 minutes
<i>Cooking time</i>	15 minutes
<i>To serve</i>	4

You will need

1 egg
 ¾ lb. celery
 ½ pint water
 6 tablespoons chicken stock
 ¼ teaspoon salt
 ½ teaspoon monosodium glutamate
 ½ pint milk
 1 teaspoon cornflour mixed with 1 tablespoon water
 Boil the egg for 15 minutes, remove shell and crumble the yolk. Remove the rough part of celery and use the inner part, but not the heart. Slice the celery into strips about 2-inches long and ¼-inch wide. Bring the water to boil and add the celery, cook for 3-4 minutes, drain. Place the chicken stock into the pan, add celery and bring to the boil, add salt, and monosodium glutamate, and cook for 2 minutes. Lower heat and add milk. Add cornflour mixed with the water, bring to the boil and cook until creamy. Turn into the heated dish, sprinkle the egg yolk on the top and serve hot.

Rice cooked in chicken stock**Gai tong fan**

Preparation time 10 minutes
Cooking time 30 minutes
To serve 4

You will need

6 oz. long grained rice
 2 tablespoons oil
 1/4 tomato
 1/4 cucumber
 1 chicken leg
 1 pint chicken stock
 1/2 teaspoon salt
 1/4 teaspoon monosodium glutamate

Wash rice 2-3 times, rubbing gently between the hands, and drain very well. Heat the oil in the pan until it becomes brown, add rice and toss it about to coat with oil. Cut tomato, cucumber and chicken leg into small pieces. Cook the chicken meat in chicken stock for 5 minutes. Mix the rice, chicken meat and stock together. Add salt and monosodium glutamate. Bring to the boil and simmer until the stock has almost been absorbed by the rice, lower the heat and continue to cook until the rice is dry. Remove the rice to a bowl and garnish with tomato and cucumber as the photograph shows.

Egg drop soup**Dan far tong**

Preparation time 7 minutes
Cooking time 4 minutes
To serve 4

You will need

1 tomato
 few bamboo shoots
 3 French mushrooms (champignons de Paris)
 2 eggs
 1 1/4 pints chicken soup
 pinch salt
 1/2 teaspoon monosodium glutamate
 2 tablespoons cooked green peas
 1 teaspoon gingelly oil

Slice the tomato, bamboo shoots and French mushrooms. Beat the eggs. Boil the chicken soup, add bamboo shoots, mushrooms and tomato. Cook for 1 minute. Add salt and monosodium glutamate, bring to boil again, drop the beaten eggs gently into the soup, and cook for another 2 minutes. Add green peas, gingelly oil. Pour into the soup bowl. Serve hot.

Pork and leek soup**Yuk pin tong**

Preparation time 7-8 minutes
Cooking time 5 minutes
To serve 4

You will need

1 oz. pork
 few bamboo shoots
 1/2 small leek
 1 large Chinese mushroom
 8 snow peas
 1 1/4 pints chicken soup
 1 teaspoon sherry
 pinch salt
 1/2 teaspoon monosodium glutamate
 1 teaspoon gingelly oil

Slice pork, bamboo shoots, leek and mushroom soaked in warm water for 20-30 minutes and drained. Cut both ends off snow peas. Bring the chicken soup to boil, add sliced pork, leek and sherry, cook for 2 minutes. Add bamboo shoots, mushroom and snow peas, cook for another 2 minutes. Add salt and monosodium glutamate. Bring to boil again and add gingelly oil. Place in the bowl or tureen. Serve hot.

Chicken noodle soup

Gai see min tong

Preparation time 5 minutes
Cooking time 9 minutes
To serve 2

You will need

1½ oz. chicken meat
 little hot Chinese cabbage (pickled)
 few bamboo shoots
 1 oz. ham
 1 medium size Chinese mushroom
 few snow peas
 5-inch leek (Cut it into half and slice each half lengthwise.)
 1 oz. round egg noodles (Chuka-soba)
 1¼ pints chicken stock
 ¼ teaspoon salt
 ½ teaspoon monosodium glutamate

Shred the chicken meat, Chinese cabbage, bamboo shoots, ham, soaked mushroom, snow peas and leek. Drop the noodles into boiling water and boil for 5-6 minutes. Drain, rinse and drain again, set aside. Bring the chicken stock to boiling point, separate the chicken meat, add with the Chinese cabbage, bamboo shoots, ham, mushroom, snow peas and leek to the stock, cook for 2 minutes. Add salt, monosodium glutamate and cooked noodles and boil for 1 minute, remove to the tureen or soup bowl, serve immediately.

Note If this is not served immediately, the noodles will be soaked by the soup.

Sweet corn and chicken soup

Gai yong shok mei tong

Preparation time 3 minutes
Cooking time 3 minutes
To serve 4

You will need

2 oz. chicken meat
 1 tablespoon sherry
 ¾ pint chicken stock
 11½ oz. can sweet corn
 2 eggs
 ¼ teaspoon salt
 ½ teaspoon monosodium glutamate
 1 teaspoon cornflour
 1 tablespoon water
 1 tablespoon chopped ham
 1 teaspoon chopped parsley

Chop chicken meat and mix together with the sherry. Put chicken stock into the saucepan, add sweet corn, and bring to the boil. Beat eggs and drop into the pan, add chicken meat and mix well. Add salt, monosodium glutamate and 1 teaspoon cornflour mixed with 1 tablespoon water, cook this for 1 minute, but do not stir. Turn the soup into a heated bowl. Sprinkle the chopped ham and parsley on the top and serve hot.

How to use chopsticks:

(1) Tuck one chopstick under thumb and hold firmly.

(2) Add second chopstick and hold it as you would a pencil.

(3) Hold first chopstick in original position, move the second one up and down. Now you can pick up anything!

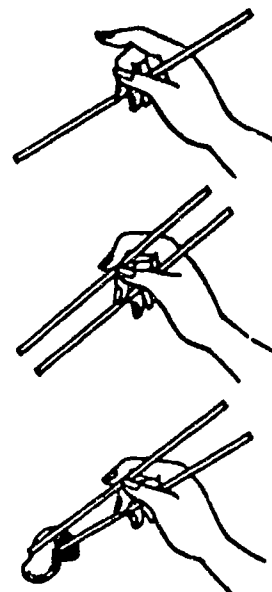

*ONCE YOU HAVE LEARNED HOW TO USE CHOPSTICKS, HOLD A RELAY RACE TO SEE WHO CAN PICK UP THE MOST PEANUTS USING YOUR CHOPSTICKS IN A CERTAIN AMOUNT OF TIME.

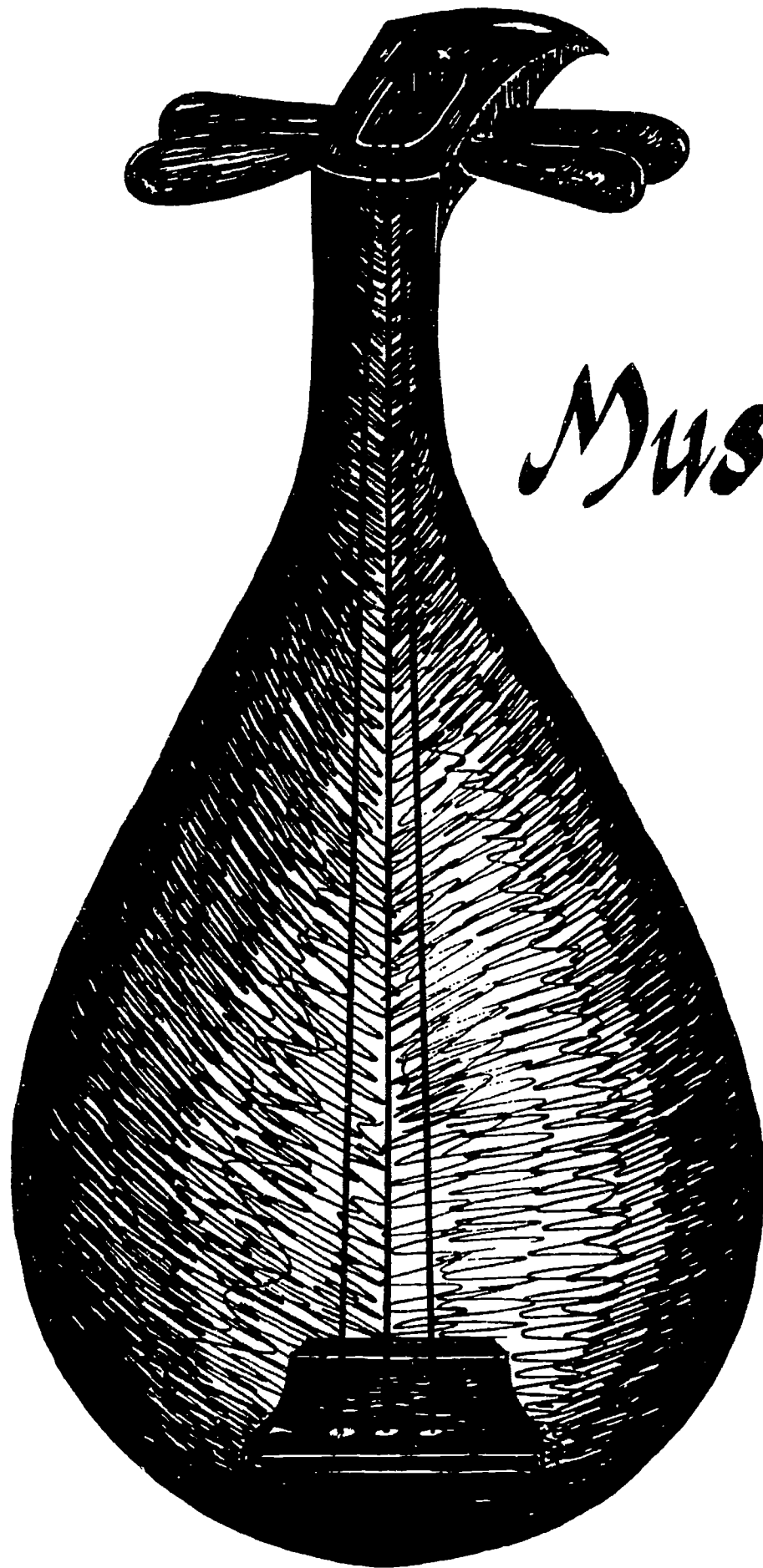

MUSIC

FOR THE TEACHER:

ORIENTAL MUSIC HAS A SOUND THAT IS UNFAMILIAR TO MOST AMERICAN STUDENTS. IN THIS UNIT, STUDENTS WILL EXPLORE THE USE OF THE PENTATONIC SCALE AND ORIENTAL MUSICAL INSTRUMENTS.

OBJECTIVES:

1. Students will be able to recognize a pentatonic scale.
2. Students will gain an appreciation of Oriental music.
3. Students will be able to sing a pentatonic scale or play a pentatonic scale on a musical instrument.
4. Students will be able to identify types of Chinese musical instruments.

MATERIALS NEEDED:

a tape or record of traditional Chinese music
a piano or keyboard
drums or bongoes

PROCEDURES:

1. Review the basic elements of music with the students.
 - melody-succession of notes (It is linear.)
 - harmony-more than one note played at the same time (It is vertical.)
 - rhythm-pulse of the music-rhythm of long and short notes
 - form-how music is formally organized
 - timbre-tone colors-different instruments and voices
2. Play a recording of Chinese music for students to listen to. Have them think of each of the elements of music as they listen. Does Chinese music contain each of these elements?
3. Write the word "pentatonic" on the chalkboard. Have students figure out its literal meaning.
 - penta = five
 - tonic = tone
4. Explain to the students that today they will be learning about the pentatonic scale, as opposed to the diatonic scale (seven notes plus the first note

repeated --an octave).

5. Play some familiar songs that use a pentatonic scale on the piano. Some examples are "Mary Had A Little Lamb", "Born In the U.S.A.", "Old McDonald", and "Auld Lang Sine".
6. Explain to the students that playing a pentatonic scale is like playing the black keys on a piano.
7. Give students examples of the most common pentatonic scales.

F# G# A# C# D# F#

C# D# F# G# A# C#

8. Have students practice singing a pentatonic scale by singing the following:

do	re	mi	sol	la	do
1	2	3	5	6	8

OR

do	re	fa	sol	la	do
1	2	4	5	6	8

(IF STUDENTS HAVE ACCESS TO INSTRUMENTS, HAVE THEM PLAY THESE SCALES ON THEIR INSTRUMENTS.)

9. Now, play the recording of Chinese music, and have students listen to the rhythm of the music. Have students join in by playing the rhythm of the music on drums or bongoes.
10. Mention to the students that a 19 tone scale is also used in Chinese music.
11. Show students pictures of Chinese instruments if any are available.
12. Discuss the various Chinese instruments.

CHINESE MUSICAL INSTRUMENTS FALL INTO ONE OF FOUR CATAGORIES BASED ON HOW THEY ARE PLAYED. THESE ARE: BLOWN, BOWED, PLUCKED, AND STRUCK. ONE OF THE MOST POPULAR OF THE "BLOWN" INSTRUMENTS IS THE TI, A WOODEN HORIZONTAL FLUTE. ONE OF THE MOST ANCIENT CHINESE MUSICAL INSTRUMENTS IS THE CHINESE PAN FLUTE, OR P'AI-HSIAO.

SOFT TONES CAN BE ACHIEVED BY THE USE OF CHINESE VIOLINS CALLED HU-CH'IN. THESE INSTRUMENTS ARE AS IMPORTANT IN CHINESE MUSIC AS THE VIOLIN IS IN A WESTERN ORCHESTRA. CHINESE VIOLINS HAVE TWO STRINGS WITH A BOW THAT IS PERMANENTLY CAUGHT BETWEEN THEM.

WHEREAS THERE ARE VERY FEW PLUCKED STRING INSTRUMENTS IN A WESTERN ORCHESTRA, THE CHINESE HAVE NUMEROUS INSTRUMENTS OF THIS TYPE. THE P'I-P'A IS AN EXAMPLE OF THIS TYPE OF INSTRUMENT.

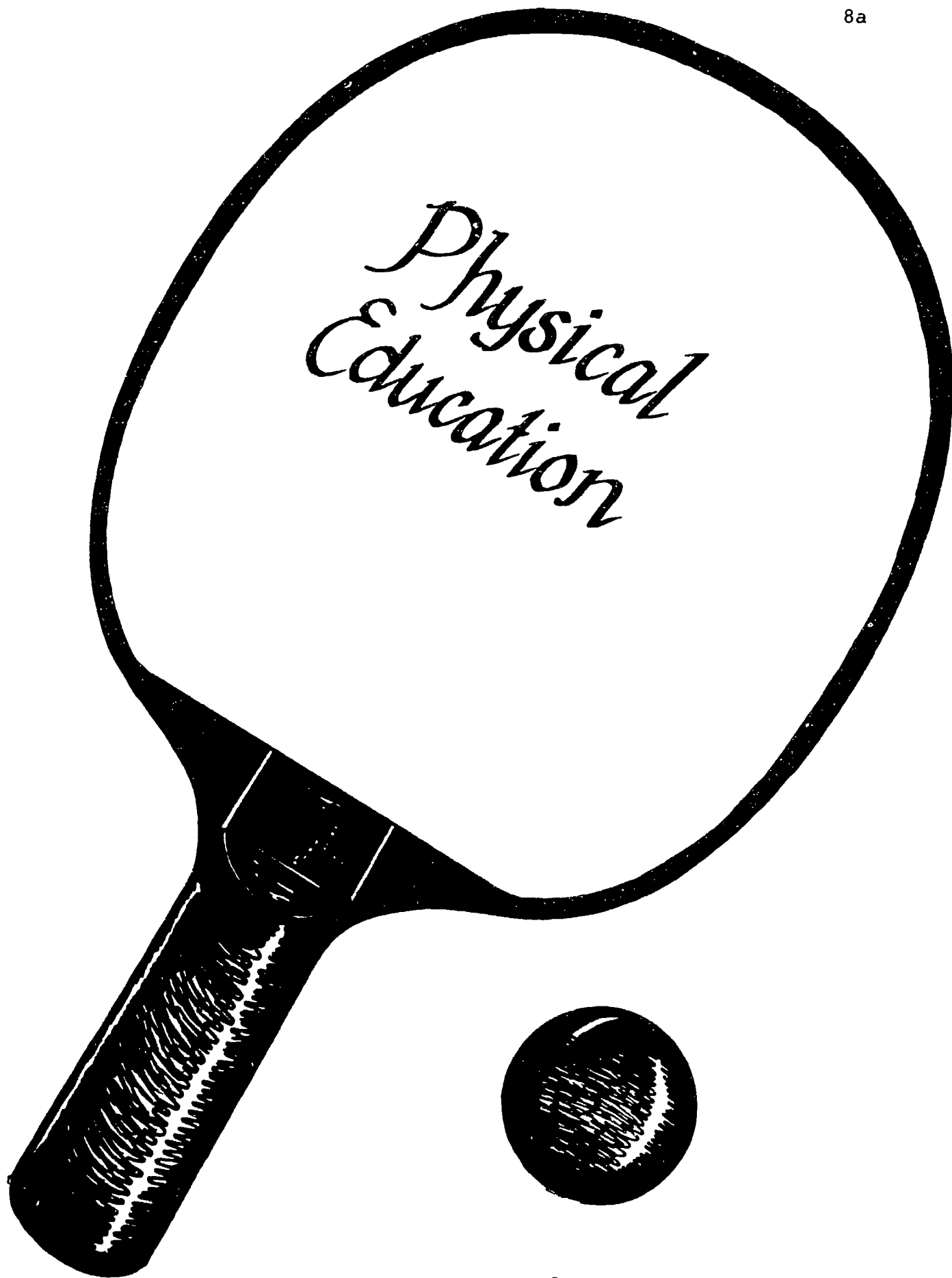

FOR THE TEACHER:

PING-PONG IS A POPULAR GAME IN CHINA. IT IS A GAME THAT IS SIMPLE TO LEARN AND ENJOYED BY PEOPLE OF ALL AGES.

OBJECTIVES:

1. Students will improve their eye-hand coordination.
2. Students will be able to list the equipment necessary to play ping-pong.
3. Students will be able to demonstrate their knowledge of the basic rules of the game.
4. Students will be able to demonstrate the proper techniques and skills necessary to play ping-pong.
5. Students will demonstrate their ability to keep score properly.
6. Students will be able to demonstrate their knowledge of the terminology associated with the game of ping-pong.

MATERIALS NEEDED:

ping-pong tables with nets
ping-pong balls
ping-pong rackets (paddles)

PROCEDURES:

1. Students should be introduced to the equipment that is needed in order to play ping-pong.
2. Discuss the rules of the game with the students.
3. Demonstrate the various skills and techniques needed to play ping-pong. The proper grip, strokes, and serves should be demonstrated.
4. Allow students to practice each of the skills and techniques before actually playing a game of ping-pong.
5. Hold a ping-pong tournament.

FOR SPECIFIC INFORMATION ABOUT THE GAME OF PING-PONG, THE FOLLOWING BOOK IS A GREAT SOURCE:

Seaton, Don C. Physical Education Handbook, 7th ed.
Englewood Cliffs, New Jersey: Prentice-Hall, Inc.,
1983.



Art

FOR THE TEACHER:

PAPER CUTTING IS A TRADITIONAL CHINESE ART FORM WHICH IS EASY ENOUGH FOR YOUR STUDENTS TO TRY. TRADITIONAL SYMBOLS CAN BE VERY SIMPLISTIC OR EXTREMELY COMPLEX.

THE FOLLOWING UNIT IS BASED ON VARIATIONS OF THE CHINESE SYMBOL FOR DOUBLE HAPPINESS, COMMONLY FOUND THROUGHOUT THE CULTURE.

OBJECTIVES:

1. Students will improve their fine motor skills.
2. Students will recognize the importance of symmetry in Chinese art and culture.
3. Students will recognize the importance of the primary color red in Chinese society.
4. Students will improve their ability to follow oral instructions.

MATERIALS NEEDED:

brightly colored paper such as origami paper (red is especially important)
 scissors or an Xacto knife for each student
 patterns for paper cutouts

PROCEDURES:

1. Give each student a copy of pattern number 1 and one brightly colored piece of paper.
2. Give the students step by step oral instructions on folding their papers properly. Have them refer to figures 1 and 2.
3. Now, have students use figure 3 as a guide for cutting their papers.
4. Have students unfold their papers and compare them to figure 4. This is the Chinese symbol for happiness.

NOW, STUDENTS ARE READY TO ADVANCE TO A MORE DIFFICULT PATTERN. YOU MAY CHOOSE ONE OF THE TWO METHODS FROM BELOW.

METHOD 1

1. For patterns 2 through 5, students can fold their

patterns and colored paper in half.

2. Have students lay the folded pattern on top of the folded colored paper. The folds should be aligned with each other.
3. Now, students should cut out the black areas.
4. Once the black areas have been cut out, the colored paper should be unfolded to reveal the double happiness symbol.

METHOD 2

1. Using a photocopying machine, print the patterns directly on the colored paper (If using origami paper, print the pattern on the WHITE side of the paper.).
2. Have students use an Xacto knife to cut out the patterns.

NOW THAT YOUR STUDENTS ARE EXPERTS AT THE ART OF CHINESE PAPER CUTTING, HAVE THEM CUT A MORE INTRICATE DESIGN SHOWN ON PATTERN 6. THE USE OF AN XACTO KNIFE IS RECOMMENDED.

*ONCE STUDENTS HAVE COMPLETED THEIR PAPER CUTOUTS, HAVE THEM MAT THEIR CUTOUTS ON COLORED PAPER OF CONTRASTING COLORS.

①

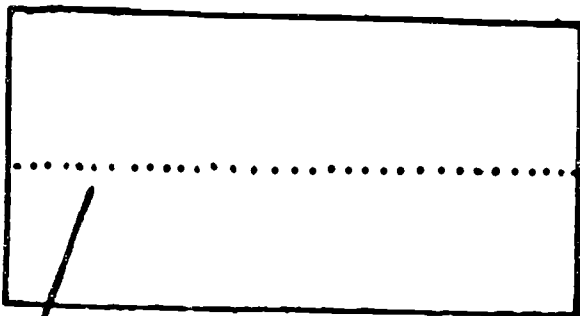

②

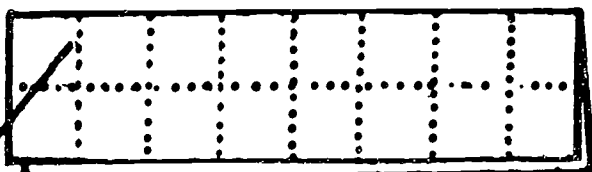

③



④

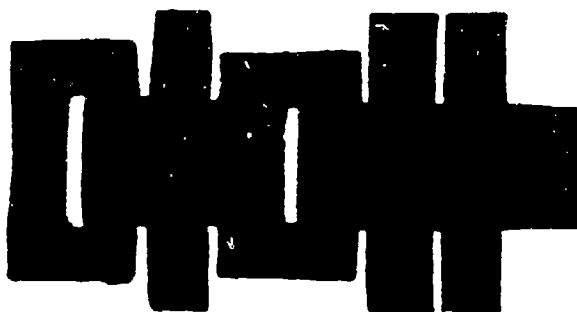

FOLD ON DOTTED LINES

CUT ON DASHED LINES

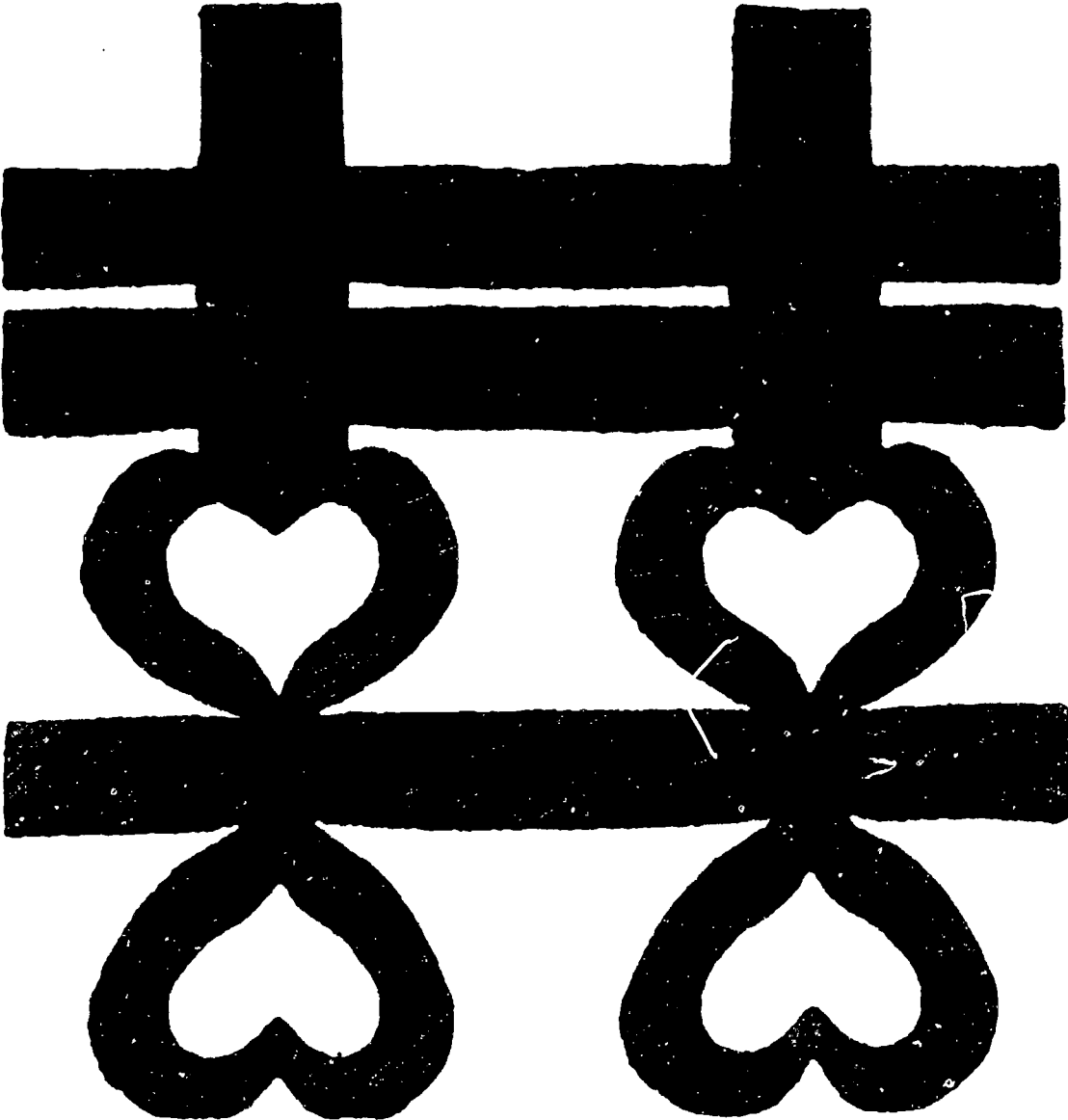



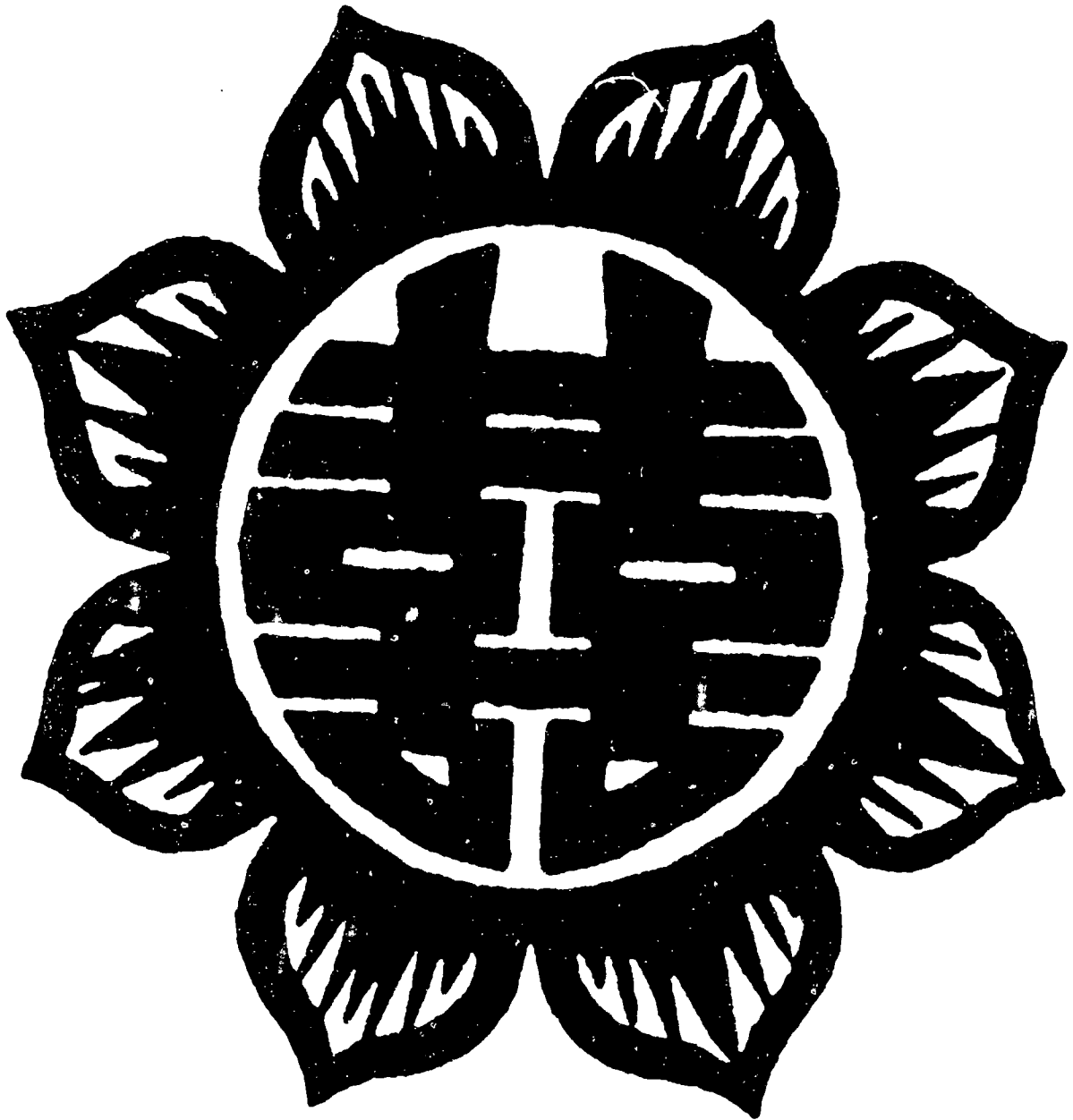

PATTERN 5

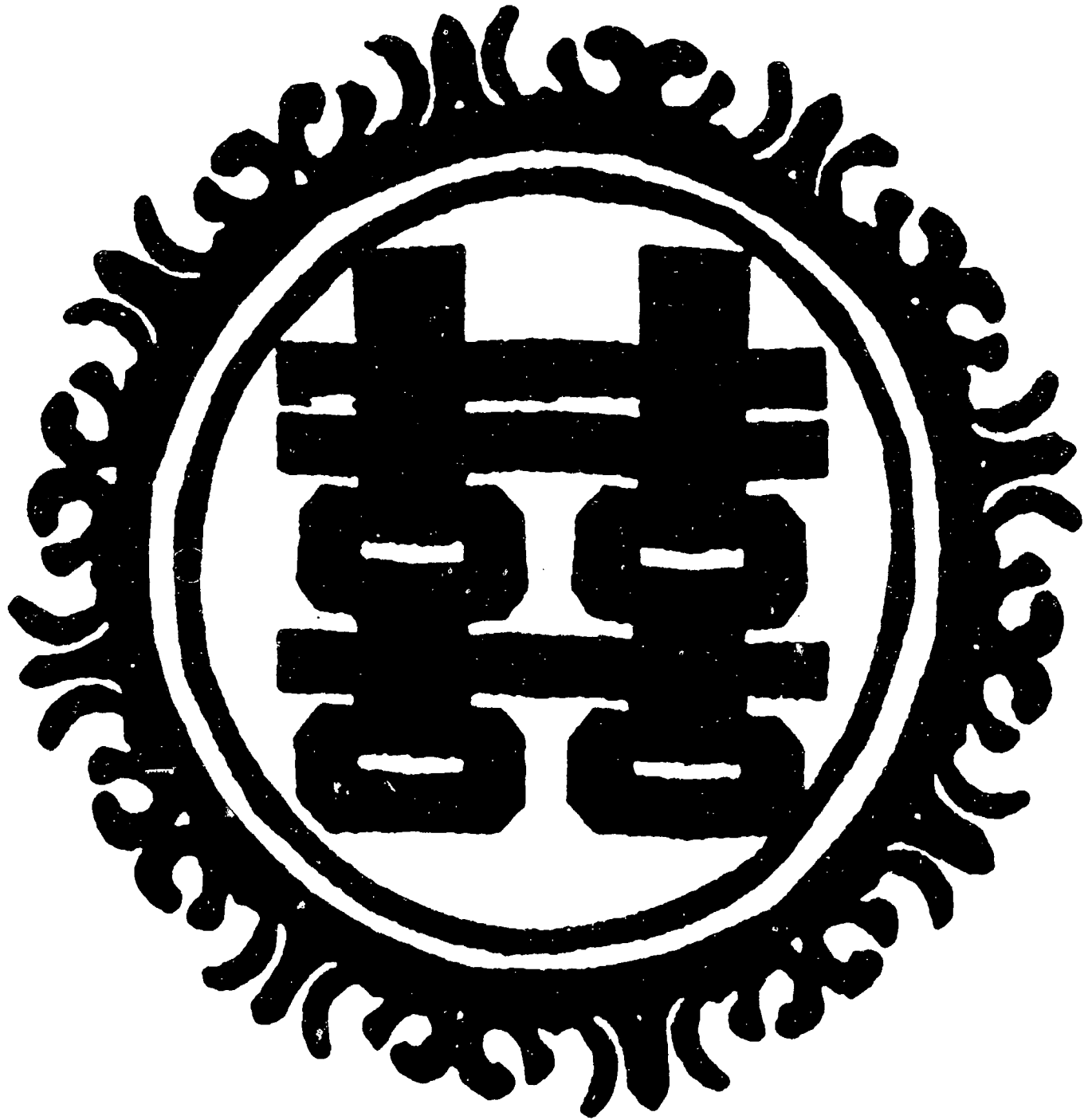

PATTERN 6
METHOD 1

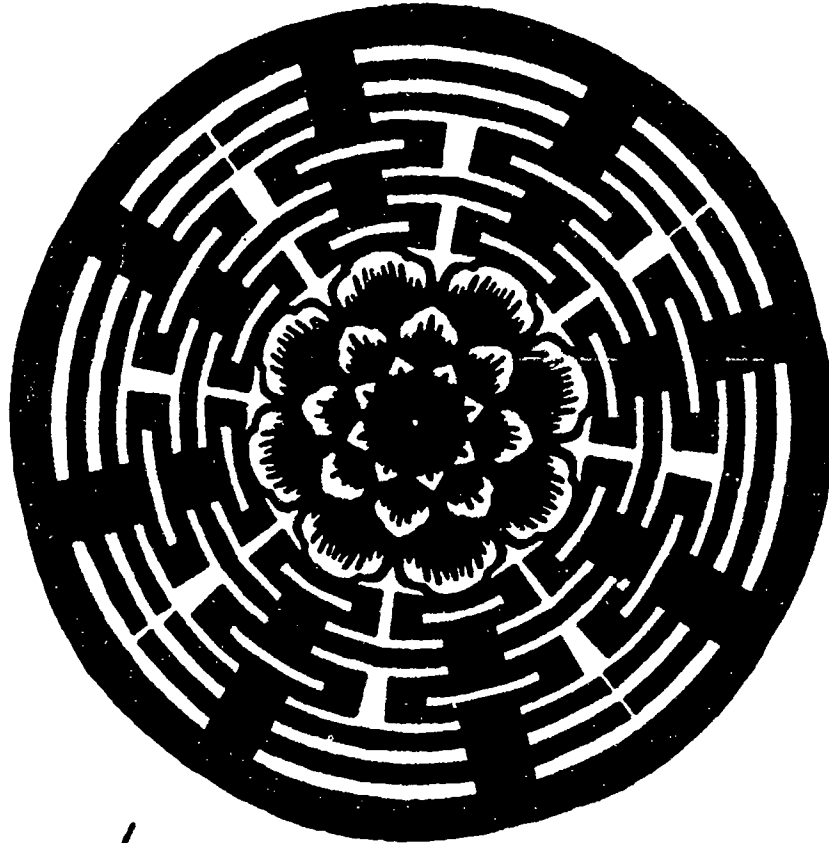

CUT DARKENED AREAS

USE AN $8\frac{1}{2}$ " SQUARE PIECE OF COLORED PAPER.

FOLD THE PAPER ACCORDING TO THE DIAGRAM BELOW. THEN, USE THE WEDGE SHAPED PATTERN ABOVE TO CUT THE PAPER.

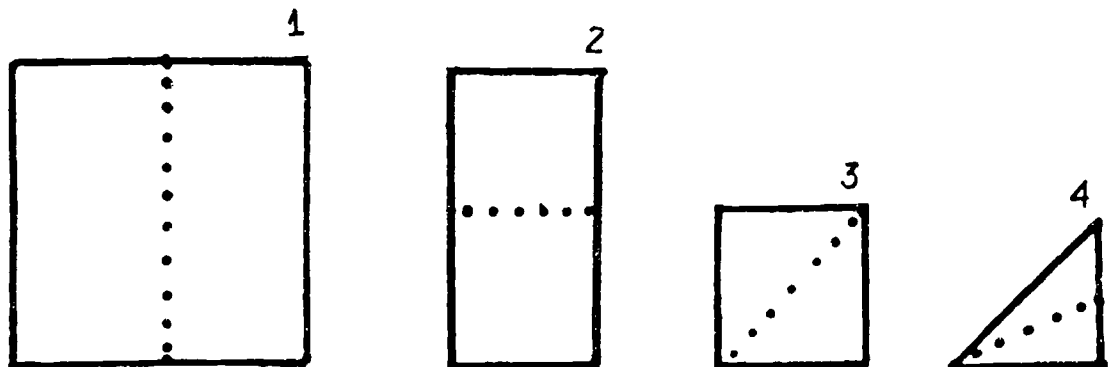

PATTERN 6
METHOD 2

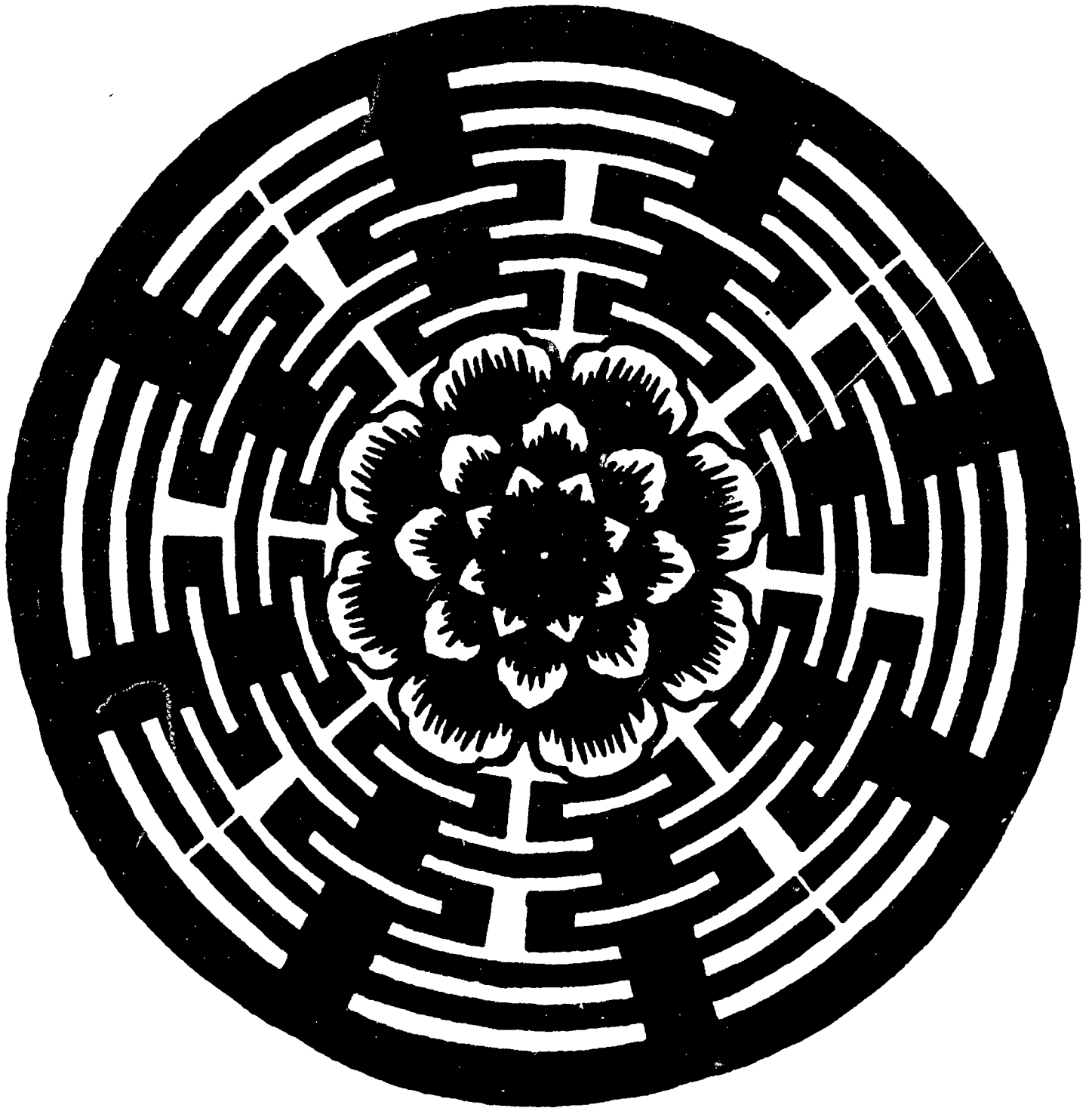

1993
Fulbright-Hays Summer Seminars Abroad Program
"China: Transformation and Change"

China Studies: Issues of Law

and

International Relations



Mr. Fran O'Malley
Brandywine School District
Wilmington, Delaware

Contents

- I. Unit Introduction** page *i*
- II. Lesson 1: Mock Trial - Chinese Request Asylum in the U.S.** page *2*
- III. Lesson 2: Model United Nations Simulation - Should Taiwan Be Admitted to the United Nations?** page *26*
- IV. Lesson 3: Mock Congressional Debate - Should "Most Favored Nation" Status Be Extended to China?** page *38*
- V. Lesson 4: Role Play - Selecting a Site for the Olympic Games** page *46*
- VI. Supplemental Documents** page *50*

PROJECT INTRODUCTION

The lessons contained in the following pages are the outcomes of a curriculum project developed as part of my involvement with the 1993 Fulbright-Hays Summer Seminars Abroad Program. The title of the seminar was "China: Transformation and Change." For six weeks, a group of 17 teachers from across the United States toured and studied in the People's Republic, Hong Kong and Taiwan. The lessons represent an attempt to share a selected few insights into the "Chinese experience."

The unit also represents an attempt to highlight some of the ways in which events in China impact on international relations and law in the United States. The lessons contained in this unit will involve students actively in the simulated affairs and operations of U.S. and international governing institutions.

The first lesson was designed to introduce students to the growing issue of Chinese immigration. Students will learn about some of the major causes of Chinese immigration and will be invited to reflect upon the nature of a communist society. The focus of this lesson is on our judicial system. Students will engage in a mock asylum hearing to learn about trial processes and U.S. immigration law.

Information for this lesson was derived from a wide variety of sources including the Immigration and Naturalization Service, the U.S. State Department, the Nationalities Service Center in Philadelphia and attorneys who are representing asylees from the "Golden Venture."

The third lesson features the debate over whether "Most Favored Nation" status should be extended to the People's Republic. In this lesson, students will engage in a mock congressional debate. Information in this lesson was derived mainly from discussions with Senator Joseph Biden's (Delaware) staff and from the "President's Report" to Congress "on MFN Status for China."

Lessons two and four broaden the perspective of student studies by focusing on major international organizations. Lesson two asks students to assume roles as delegates to the United Nations. In this role play, students will learn about the "two China" dispute as they debate the merits of admitting Taiwan as a parallel member of the United Nations.

The final lesson picks up on the recent competition to host future Olympics. In this lesson, students will design campaigns to lure the 2004 Olympics to prospective cities including Beijing, which recently lost in its bid to be the site for the year 2000. As the lesson proceeds, students will learn something about the International Olympic Committee and China's less developed status.

As an addendum, I have included some of the documents which were used in the development of the lessons. They can be used as supplements or as springboards for future lessons.

Feel free to duplicate any of the lessons for classroom use. It is my hope that they will prove useful in helping students understand some aspects of the Chinese experience through the perspectives of law and international affairs.

INTEGRATING THE FIVE CONCEPTS OF GLOBAL EDUCATION

The Stanford Program on International and Cross-Cultural Education (SPICE) has developed the "Five Concepts of Global Education." The Five Concepts are listed and described below. As you go through this unit, ask your students to identify ways in which each lesson illustrates one or more of the Five Concepts.

Global Education Concepts

(1) Context Setting

Every event, situation, or problem occurs within a particular context. Context can be defined by different dimensions such as geography, history, politics, economics, language, and culture. The context helps to define the boundaries and limitations of an event. An understanding of situational context can help in the analysis, decision making, and problem solving of contemporary world issues.

(2) Multiple Perspectives

Individuals bring their own perspectives to examining and analyzing situations and world issues and problems. Individuals need to recognize and examine their own viewpoints as well as other perspectives on the same issue or event. The development of multiple perspectives is essential in understanding and analyzing world problems and appreciating the complexities of an interconnected, interdependent world.

(3) Interdependence

We live in an interconnected, interdependent global system. Events in different world regions are affected by various global systems—economic, political, social, technological, ecological, and others. These systems are interdependent and operate on a global level. Problems such as environmental pollution, resource use and management, and economic and political competition cannot be solved by any single entity. Students need to understand interdependence, its benefits and its costs, and be able to deal with its attendant conflicts.

(4) Conflict

To ignore conflict as a natural part of the human experience and as a social force worthy of recognition in an educational setting is an unrealistic view of how human destinies have been shaped. Conflict may be the most powerful force structuring the world today. Students should realize that violent and non-violent means of conflict management and resolution are available to participants in conflicts. Students should understand that conflicts can have both positive and negative consequences. It is important for students to develop skills in creating and using alternative approaches to conflict resolution and management through communication and critical thinking.

(5) Change

People, communities, and nations are continually undergoing change. Sometimes there is agreement on whether the change was positive or negative. At other times, change may represent something positive for one person (community or nation) and something negative for another. By examining contexts where change takes place, students will learn about the complexities and values involved in this process as well as strategies for influencing the direction of change.

© SPICE

Lesson 1

Mock Trial: Chinese Request Asylum in the United States.

Mock Asylum Hearings: Chinese Claim Persecution

In this lesson students will apply U.S. immigration law to three cases in which illegal Chinese immigrants seek asylum in the United States on the basis of alleged persecution. This lesson will highlight claims of persecution in the People's Republic of China based on religious, political and family planning reasons.

AUDIENCE: Students in grades 7-12.

TIME TO COMPLETE: Two or three class periods. Preparation will take longer.

RATIONALE/PURPOSE: This lesson is designed to help student understand the fundamentals of U.S. immigration law, the steps in an asylum hearing, and some of the bases upon which illegal Chinese immigrants are claiming persecution in their native country.

GOALS: At the conclusion of this lesson, students will be able to

1. explain the steps in an asylum hearing
2. list the grounds for establishing a valid legal claim of persecution in the United States
3. describe three reasons why Chinese emigrants are seeking asylum in the United States

MATERIALS: Students will need copies of all "Handouts."

PROCEDURES:

1. Distribute Handout #1 ("Illegal Chinese Immigration")
Have students read the background information on the current wave of illegal immigrants coming from the People's Republic of China.
2. Explain to students that they will be engaging in a mock asylum hearing involving three cases of individuals from China who are claiming that they are being persecuted in their native country. On the basis of these claims, the three asylees are asking to be admitted into the United States.
3. Assign Roles - the success of mock legal hearings often depends on the talents and work ethics of students who are asked to play the roles. It is suggested that the teacher select students who exhibit quality in both areas. Because there will be three hearings, you will be able to involve as many as 21 individuals. The roles include
 - a. Judge(s) - if this is your first mock legal hearing, I would strongly suggest that the teacher assume this role. Teachers are far better equipped to maintain order and keep the proceedings moving. Remember...in asylum hearings, the judge decides the case (not a jury). For purposes of student involvement, though, you may want to make this a jury hearing.
 - b. Clerk/Bailiff/Timekeeper - this role is an

- optional one. This individual will swear in the witness and keep time if the teacher decides that it is best to establish time limits for each phase of the proceeding.
- c. Attorneys - you can use as many as 3 per side. The attorneys have three major responsibilities. They must give opening and closing statements and engage the asylee in direct and cross examination. If you decide to use 3 attorneys per side, one should give the opening and closing statements, one should engage in direct examination, and the third should engage in cross-examination.
 - d. Witnesses - you will need one student to play the role of the asylee in each hearing. The witnesses are the most important persons in the mock legal proceedings. Be sure to choose a talented student for this part.
4. Distribute copies of the witness statements to the appropriate persons. The witness and each attorney for a specific case will need copies. The groups selected for each of the three trials will need the different witness statements.
 5. Distribute Handout #2 ("Steps in a Mock Asylum Hearing"). All of the attorneys, witnesses and judges will need copies of this handout. Review the steps with the students.
 6. Distribute Handout #3 ("Legal Considerations"). This reading reviews the important legal considerations which arise during an asylum hearing. This information must be reviewed carefully along with the teacher. Many of the attorneys arguments should be based on these considerations. Every attorney and judge must receive copies of this handout.
 4. Give the students ample time to prepare for the activity. On the day that roles are assigned, you will need to give the students class time to organize their responsibilities and read over the witness statements. After that
 5. On the day of the trial, arrange the room in the shape of a typical courtroom and follow the steps outlined in Handout 2.

EVALUATION: A typical evaluation form which is used in statewide and national mock trial competitions is included in this packet.

TIPS FROM THE TEACHER: Be sure to videotape the hearing. Students can learn a lot about the areas in which they need to improve their public speaking skills. Besides, they love to watch themselves on the big screen. The tapes can also be used for workshop presentations, teacher evaluations and parent-teacher events.

INTRODUCTION

At 2 o'clock in the morning of 6 June 1993, a ship named the "Golden Venture" was grounded on a sandbar just outside of New York City. The ship was carrying nearly 300 illegal Chinese immigrants who, for one reason or another, left their homeland in search of a better life. Conflicting reports indicate that between six and ten of them died trying to swim to shore in 53 degree waters. They never got to see "meiguo" - the beautiful country. Seven months later, the survivors of the Golden Venture were still sitting in detention centers in five states awaiting the outcomes of their asylum hearings.

The landing of the Golden Venture and the plight of those on board drew national attention to the issue of illegal Chinese immigration in the United States. Investigation into this problem reveals an amazing story. According to the estimates of the Immigration and Naturalization Service (INS), somewhere between 50-80,000 Chinese are illegally smuggled into the United States each year. Most of them come on boats which are little more than floating rustbuckets. Between January and June of 1993, the U.S. Coastguard intercepted more than a dozen ships carrying 1,959 Chinese immigrants. Since 1991, 40 vessels have been spotted. Twenty four were intercepted.

The smuggling of Chinese into the United States is part of a highly sophisticated and organized operation which involves an international crime syndicate. The immigrants, many of whom come from coastal provinces in southeastern China, pay as much as \$35,000 for services which include illegal documents, transportation, employment arrangements and legal services. Ruthless Chinese crime gangs, known as triads, control these multimillion dollar schemes. They are run by "snakeheads" who force the immigrants into modern day indentured servitude to pay off the debts which carry interest rates as high as 36%. In many cases, the immigrants are forced into prostitution, slave labor, gambling, loan sharking and drug operations.

Notably, the wave of immigrants is expected to rise in the near future for a variety of reasons. In recent years, China has been relaxing its travel restrictions within the country thereby making it easier to sneak out. Also, as the time draws near for Hong Kong (1997) and Macau (1999) to be returned to China, many are expected to flee the inevitable communist takeover.

Why Are People Leaving China

Visitors to China are quick to realize the complexity of the People's Republic. One is quick to notice the differences between rural and urban life, between the north and the south, between mainland China and Taiwan, and between the areas where economic experiments are underway and the areas where the communist command economy is still intact. The reasons for Chinese emigration can be found at every level. Yet, the aspect of Chinese society which seems to be at the root of the problem is the one which separates the visible China, which is proudly displayed for all to

see, from the one which is carefully guarded from outside observers.

The causes of Chinese migration can be found at both the visible and less visible levels of Chinese society. At the visible level, it is poverty and a lower standard of living which is pushing people out. The average per capita income in the People's Republic is less than US\$400 per year. Images of great jobs, large houses and lots of land fill the minds of aspiring people. At the less visible level of Chinese society, lurk the repressions which have characterized communist China and have identified her as somewhat of a pariah in the free world. Descriptions of the brutal repression of democracy advocates, one-child policy opponents and religious dissidents fill the pages of asylum applications in the United States. Some are true, some are pretexts for those who seek a way around a U.S. immigration policy which offers limited refuge for those seeking to escape poverty. The unenviable task of U.S. Immigration and Naturalization officers is to attempt to accurately distinguish those who deserve asylum from those whom the United States has decided it cannot help.

The lesson contained in the next few pages is designed to introduce you to the legal and illegal migration of people from China to the United States. In the process, students will become acquainted with the actual stories of people who claim to be victims of Chinese persecution and with the fundamentals of a changing U.S. immigration policy. After involving yourself in this lesson, it is hoped that you will learn that the laws and ideals which the United States has adopted for itself, are directly affected by events which happen halfway around the globe.

The story presented here is unfinished. China's emigration policy is still somewhat of a mystery. Requests for information from their embassy and consulate have yielded no response. Unnamed officials at the China desk of the U.S. State Department will say only that the P.R.C. allows anyone to emigrate but that restrictive immigration policies in other countries make it very difficult for the numerous applicants to obtain visas. In recent reports to Congress, Presidents Bush and Clinton accept this State Department assessment. Yet, conversations with Chinese citizens in and out of the United States have produced unambiguous assertions that, with relatively few exceptions, China does not permit emigration that is intended to result in a permanent departure from the country. The mysteries of the "less visible" China seem to mount with each investigation.

What is the Nature of U.S. Immigration Policy

Generally speaking, U.S. immigration policy allows a limited number of people to enter the United States. From now until the end of the 1994 fiscal year, 700,000 immigrant visas are available annually and, after this, 675,000 visas will be available each year. Once that limit is reached, those who wish to immigrate to the United States must meet very specific criteria which have been designed for humanitarian purposes.

The Immigration Act of 1990 is designed to admit three major categories of people: those who wish to be reunited with their families, those who can bring special skills or money into the marketplace, and those who will add to the diversity of America's population.

In fiscal year 1992, the U.S. numerical limitation for legal immigrants from China was fully met as was the case in 1991. A total of 26,711 immigrant visas were issued in the People's Republic of China in FY92. If the INS estimates are correct, this means that 2/3rds of the Chinese people who are coming to the United States each year are entering illegally. One can only imagine the number waiting to come.

For some of the "illegals", our immigration policy provides an open door. In an attempt to preserve our standard of living and keep jobs open to U.S. citizens, U.S. immigration policy does not allow exceptions to the immigration limits on the basis of economic hardship. Individuals who wish to immigrate once the yearly limit is reached must be able to convince U.S. officials that they are victims of persecution in the country from which they are fleeing. If U.S. officials accept one's claim of persecution, then the individual can be granted asylum regardless of whether the visa limit has been reached.

Persons who are not yet in the United States and request entrance into the United States are called refugees. Individuals who are already in the United States (illegally) and claim persecution are called asylees. Each year, the President of the United States determines the number of refugees who will be admitted into the United States and the regions from which they will be selected. Refugees must be able to substantiate a claim of persecution basis on race, religion, nationality, political opinions, or membership in a particular group. Asylees are subject to the same eligibility criteria but are not subject to an annual numerical quota. Another important difference between refugees and asylees is that asylees do not have to have financial sponsorship before being considered for admittance.

Although asylum seekers account for only 10% of those who come into the United States each year, most of the Chinese who are arriving illegally do seek asylum.

The New Wave of Immigrants Is Creating a Backlash

Developments within China in 1989 impacted dramatically on U.S. immigration policy. In reaction to the "brutal" suppression of the Tiananmen Square pro-democracy movement, President George Bush issued Executive Order 12711 in 1990. The Order directed the Attorney General and INS officials to grant "enhanced consideration" to those seeking asylum who were involved in the Tiananmen movement and to those who are suffering under China's "one child" family planning policy. The combination of China's reactionary crackdown and news of the altered U.S. immigration policy produced a new wave of Chinese immigrants arriving on America's shores.

It did not take long for word of the new U.S. policy to reach China. Those longing to flee a hard life recognized new opportunities. Smugglers, who stand to profit if clients make it to the United States, are now coaching future emigrants in the finer points of U.S. immigration law. The

special treatment granted to those who claim persecution on the grounds of China's one child policy is being used by thousands as a basis for requesting asylum. While claims of persecution in some cases are unquestionably valid, others are not. The large number of immigrants who are abusing the system merely to escape economic hardship have led U.S. officials to reconsider Bush's 1990 directive.

Twelve days after the the Golden Venture ran aground, President Clinton issued a call for tougher measures to stop the smuggling of illegal immigrants. The new process not only speeds up the process of granting and denying asylum, it also requires that the illegals be held in detention until asylum decisions are completed. Most of those who came over on the Golden Venture were still being held as the New Year (1994) arrived. The prolonged detentions have resulted in hunger strikes and 16 suicide threats. The immigrants making the threats speak of punishments from the government and snakeheads which they will encounter upon their return to China. Punishments include imprisonment, beatings and heavy fines that amount to as much as a year's salary. Attorneys for the asylees have stated that China has destroyed the homes or removed the household doors of some of the returnees who failed paid their fines.

Additionally, asylum appeals have been filed claiming the existence of an unreleased executive directive designed to counteract Bush's 1990 Executive Order. Statistics reveal that asylum requests are being denied in larger numbers. In 1992, 84% of the Chinese who requested asylum were granted it. To date, only 6% of those who arrived on the Golden Venture have had the same success. Lawyers are now suing for the details of the suspected new policy.

During the first week of January in 1994, a federal judge in Pennsylvania dealt a major blow to the Chinese immigrants when he dismissed a class action suit which would have recognized China's restrictive policies on family size as a general ground for asylum.

As of December 21, 1993, twenty of the Golden Venture crew had been granted asylum. The INS is now appealing in 7 of those cases. More than 160 of the 284 immigrants have been denied asylum and can now be deported. They can appeal, however.

Problems Encountered at Asylum Hearings

The problems faced by Chinese asylees deserve special attention. Some of these problems are directly related to the apparent backlash which has been caused by the increasing numbers of illegal immigrants coming to the United States. Other problems are caused by the uniqueness of the culture from which the Chinese come.

On the one hand, information about the activities of China's organized smugglers has convinced INS officials that many of the illegals lie on their applications. The numerous, implausible claims of one child persecution have aroused considerable suspicion on the part of immigration officers. Additionally, it has been argued that, even if the truth is told, it is beyond the capacity of the United States to accept the potentially millions of Chinese who could be granted asylum on the basis of the one child persecution.

On the other hand, the relative uniqueness of the Chinese culture has also handicapped the asylees. Unfortunately, differences in language often cause the strength of an appeal to get lost in translation. Interpreters struggle to convey the passion contained in the stories of the truly persecuted. Additionally, the fears and suspicion of government officials that become imbedded in communist societies often lead asylees to become so distrustful of other legal cultures that they are hesitant to be completely candid in explaining their stories at asylum hearings. If this is not enough to ruin chances for successful appeals, the problems are compounded for those who hope to escape the wrath of the snakeheads to whom they are indebted. In such cases, the asylees are fearful of giving the details of their family life back in China for fear of reprisals against their relatives. Such tactics are common within triad circles. Unfortunately, the success of an asylee's claim often rests on the details of experiences back home.

Another problem the asylees face is the frequent inability to produce corroborative evidence. Physical evidence such as letters from relatives, photographs and government documents are important in supporting claims of persecution. Unfortunately, many of the asylees cannot produce such evidence. Reports from human rights organizations can be of limited help. INS attorneys cite the lack of evidence in their efforts to disprove claims of persecution.

It should also be pointed out that the new immigration policies which have been designed to speed up asylum processes are leading volunteer defense attorneys to argue that they have insufficient time to prepare adequate defenses. This is especially true when the attorneys have to work around the barriers described above. Thirty volunteer attorneys and paralegals are currently handling the cases of the 110 asylees detained at the federal prison in Allentown, Pennsylvania. Their caseload has become overwhelming.

In spite of the allegations of false claims, it is difficult not to feel tremendous sympathy for those who have suffered so much in pursuit of a life of freedom and better opportunity. Needless to say, the job of an U.S. immigration officer is not always an enviable one either. In this lesson, you will get the chance to act out their difficult lives.

The Cases in This Lesson

The cases described in this lesson are based on those which have actually been reported in recent months. In two cases, the names were changed to avoid any problems which may arise as a result of identification. Very minor changes were also made in two of the cases to make it easier for the mock witnesses to play their roles.

Although there were other cases to choose from, these were selected partly because they present three different reasons why some Chinese are migrating illegally. Two were also selected because of the fact that their stories have only recently been publicized. The third is based on an actual appeal case which occurred in 1988. The final reason for selecting the cases was to illustrate a variety of ways in which illegals are entering the United States.

Case 1

The case of "Li Jin-Lai" is based on an appeals hearing which was decided in 1988. It suggests a pattern of persecution based on past association with the Chinese Nationalists (Kuomintang - KMT). The case is reported as it was described in the appeals briefing.

Case 2

The case of "Fang Cheng" is based on the actual claims of one of the survivors of the Golden Venture. He is currently being held in a detention center in southeastern Pennsylvania. Fang's case helps to illustrate claims of persecution based on China's "one child" policy.

Information about "Fang" was gathered from articles which have appeared in the Philadelphia Inquirer and from interviews with attorneys working on the cases of the Golden Venture immigrants. Fang's case is pending.

Case 3

The case of Zhang Lezhi is based on an actual account which has been reported in an Amnesty International "Appeal" dated June 1993. Zhang (his real name), who was tried in December of 1992 and sentenced to three years of "reform through labour," is apparently still being held. His case was modified in the lesson to give him the appearance of an illegal immigrant.

All of the information regarding his case is described as reported except the section which describes his escape and arrival in the United States.

HANDOUT 2

Steps in the Mock Asylum Hearing

Step 1 Judge's Introduction

The clerk/balliff should announce the arrival of the judge in the courtroom ("All rise..."). The judge should provide the class with a brief and impartial description of the purpose of the hearing so that the mindset for the lesson is established from the outset. This introduction is especially important if you have invited guests into the classroom or if you are planning to videotape the activity for future viewing at workshops, parent meetings or classroom observations.

Step 2 The Opening Statements

In the opening statement, each attorney must briefly

- summarize the facts in the case which are most favorable to your client
- explain to the judge or jury what it is that you are trying to prove (e.g. there is or is not a well-grounded fear of persecution, that the asylee's case does or does not meet the legal requirements for granting asylum, or that the U.S. would be overburdened if it granted asylum to all persons in a position similar to the asylee).
- ask the judge to reach the decision which you want him to reach (i.e. grant or not grant asylum).

Step 3 Direct Examination by the Asylee's Attorney

In this stage of the hearing, the asylee's attorney asks questions of the asylee which will bring out the evidence that supports his or her request for asylum. The questions that are asked should be designed to show that all or the legal requirements for granting asylum are met.

***RULE** - you may not ask "leading questions" during direct examination. Leading questions are ones which put answers in the witnesses mouth. Leading questions often require a simple yes or no answer. (Example - "Is it not true that you were repeatedly beaten while in police custody?" In direct examination, this question must be phrased to allow the witness to tell the story - "What happened to you while you were in police custody?") Questions which require narrative answers must be asked during direct examination.

Step 4 Cross-Examination by the INS Attorney

During this phase of the hearing, the INS attorney must ask questions which show that the person seeking asylum does not meet all of the legal requirements for asylum or that the asylee has not presented enough evidence to support his or her claims of persecution.

On cross-examination, the attorney is permitted to ask leading questions.

Step 5 Re-Direct Examination by the Asylee's Attorney

The asylee's attorney now has the option to ask question of the asylee which will help to rebuild any aspects of the case which have been discredited during cross-examination.

*RULE - you are limited to asking questions on matters which were brought up during cross-examination.

Step 6 Re-Cross Examination by the INS Attorney

Lastly, the INS attorney may ask questions which restore the credibility of his or her case. Again, questions are limited to the testimony which was given during re-direct examination.

Step 7 Closing Statements

Both sides now have the opportunity to argue to the judge that he or she should reach a particular decision. The asylee's attorney wants asylum granted, the INS official does not if the asylee has not demonstrated the need for it. In closing, you should

- a. explain how the testimony met or did not meet the requirements for granting asylum
- b. try to fill-in any "holes" in your case. If you overlook them, it will look as if you did not have a satisfactory response.
- b. always conclude by asking the judge or jury to decide in your favor.

Step 8 Deliberations, Decision and Debriefing

At this point the judge or jury must be given some time to arrive at a decision based on the evidence presented at the hearing. Once a decision is made, the judge should re-enter the room and announce it to the class. Give students some time at the end to share their thoughts on the process and the activity.

Mock Trial Competitions
Simplified Rules of Evidence

Direct Examination

A. Form of Questions

Witnesses may not be asked leading questions by the attorney who calls them. A leading question is one that suggests to the witness the answer desired by the examiner, and often suggests a "yes" or "no" answer. A leading question often has the answer included as part of the question (e.g. "Isn't it true that you were in Padua's parking lot on the night in question?")

Direct questions (permitted) generally are phrased to evoke a narrative answer (e.g. "Where were you on the night in question?")

B. Scope of Witness Examination

A witness may not testify to any matter of which she has no personal knowledge. (e.g. If Jessica has never seen Angela with the baby, Jessica would not be able to say, "Angela is a terrible mother.")

C. Character

Evidence about the character of a individual may not be introduced unless the person's character is an issue in the case. (e.g. whether one spouse has been unfaithful to another is a relevant issue in a civil trial for divorce, but is not an issue in a criminal trial for larceny. Similarly, a person's violent temper may be relevant in a criminal trial for assault, but is not an issue in a trial for breach of contract.)

D. Refreshing Recollection

If a witness is unable to recall a statement made in the affidavit, or if the witness contradicts the affidavit, the attorney on direct may seek to introduce that portion of the affidavit that will help the witness remember.

Cross-Examination

A. Form of Questions

An attorney may ask leading questions when cross examining the opponent's witnesses. Questions tending to evoke a narrative answer should be avoided.

B. Scope of Witness Examination

Attorneys may only ask questions that relate to matters brought out by the other side on direct examination, or to matters relating to the credibility of the witness. (e.g. if the plaintiff in a car accident case never mentions damages to the car, then the defense cannot ask questions on cross-examination about the repair costs.)

C. Impeachment

On cross-examination, the attorney may want to show the court that the witness should not be believed. This is called "impeaching the witness." Impeachment may be done by introducing the witness affidavit, and asking the witness whether he or she has contradicted something which was stated in the affidavit. It may be done by asking questions about prior conduct that makes the witness truth-telling ability doubtful. Other times, it may be done by asking about evidence of certain types of criminal conviction

Re-direct Examination

If the credibility or reputation of the witness has been attacked on cross examination, the attorney whose witness has been damaged may wish to ask several more questions. These questions should be limited to the damage the attorney thinks has been done and should be phrased so as to try to "save" the witness' truth telling image in the eyes of the court. Re-direct examination is usually limited to issues raised by the attorney on cross examination.

Inadmissible Evidence

Grounds for Objections

An attorney can object any time the opposing attorneys have violated the rules of evidence. The attorney wishing to object should stand up and do so at the time of the violation. When an objection is made, the judge will ask the reason for it. Then the judge will turn to the attorney who asked the question, and that attorney will have a chance to explain why the objection should not be accepted ("sustained") by the judge.

- A. Hearsay - is secondhand evidence that is not admissible (there are exceptions). It is testimony a witness provides that is not based on personal knowledge but is repetition of what another has allegedly said. (e.g. my brother told me he saw Bob enter the store that evening). Hearsay evidence is not admissible because it is impossible to test its truthfulness.
- B. Irrelevant Evidence - To be admissible, evidence must be relevant; there must be a valid reason for introducing the statement, object, or testimony. Evidence not related to an issue at trial is termed immaterial or irrelevant.
- C. Witness Opinions - As a general rule, witnesses may not give opinions unless they are logical deductions of the facts (and are relevant to the case). Certain witnesses who have special qualifications may be qualified as "experts." Before an expert can be asked an expert opinion, the questioning attorney must bring out the expert's qualifications and experience.
- D. Leading Questions - leading questions may be asked during cross examination only.
- E. Beyond the Scope of Direct Examination - remember, during cross-examination the questioning attorney must restrict his questions to issues or facts that came up during direct examination.
- F. Lack of Personal Knowledge - witnesses cannot be expected to answer questions on matters about which they have no personal knowledge.
- G. Badgering the Witness - attorneys may not use forceful or threatening language in an attempt to extract information which otherwise may not be given.

Introduction of Physical Evidence

Below are the basic steps to use when introducing a physical object or document into evidence in a court.

1. "Your honor, I ask that this (letter, report etc.) be marked for identification as Petitioner's Exhibit A." (Show letter and hand to bailiff for marking.)
2. Show letter, report etc. to opposing counsel who may make an objection to the offering.
3. Show letter to witness. "Miss _____, do you recognize this document which is marked Petitioner's Exhibit A for identification?" (The witness explains what it is.)
4. "Your honor, I offer this document for admission into evidence as Petitioner's Exhibit A, and ask the court to so admit it."

Seeking Asylum In the United States
Legal Considerations

An asylum hearing is similar to a regular trial in that the procedures which are followed resemble one another closely. In the asylum hearing, the burden of proof falls entirely on the individual who is seeking asylum (i.e. "asylee"). The steps in the hearing are identical to a trial proceeding. Attorneys for the Immigration and Naturalization Service (INS) are pitted against the asylee and his or her attorney. Most of the Chinese immigrants who are seeking asylum lack sufficient funds and do not speak English well enough to work through the legal processes. In such cases, attorneys often donate their time to represent the asylees. Volunteer groups work with the attorneys to arrange for interpreters.

The proceeding begins with opening statements which are followed by direct and cross-examination. After each side has presented their witnesses, the closing arguments are given. Sometimes witnesses are called to corroborate the testimony given. For example, an anthropologist may be called on to corroborate testimony given about the treatment of a particular minority group in China. Experts in Chinese culture or politics may provide testimony which support or refute the testimony of the asylee.

It is also possible that other types of evidence may be admitted. For example, depositions from relatives in China may be considered as well as photographs or documents which corroborate testimony. Additionally, information from such groups as Amnesty International may be introduced to support allegations made by the asylee.

It should also be pointed out that asylum hearings are what may be described as bench hearings. That is, the final decision as to whether asylum is granted or denied rests with the judge in the case as opposed to a jury. Appeals from the asylee may be granted, however.

In virtually every asylum hearing, certain criteria must be met in order for the two sides to adequately substantiate their claims. The more important legal considerations which surface in asylum hearings are briefly described below.

I. Standard of Proof

- A. Fear of Persecution - Asylum seekers must be able to substantiate a claim that they are being persecuted on account of their race, religion, nationality political opinions, or membership in a particular group, and for this reason, they are unable or unwilling to return to their country of last residence.

The fear of persecution must be "well-founded" and must be supported by a "preponderance of the evidence." It should be noted that an alien's own testimony in an asylum case may be sufficient, without corroborative evidence, to prove a well-founded fear of persecution where that testimony is believable, consistent, and sufficiently

detailed to provide a plausible and coherent account of the basis for one's fear. Obviously, though, it is to the asylee's benefit if he or she has corroborative evidence to present.

In order to succeed at an asylum hearing, the asylee has to convince the Judge that there is a "reasonable possibility" that the asylee faces persecution if returned home. At one time asylees were held to a tougher "reasonable probability" standard.

B. Definition of Persecution

To persecute is defined as: "to pursue, harass in a manner designed to injure, grieve or afflict; to oppress; specifically to cause to suffer or put to death because of belief."

C. Establishing a Well-Rounded Fear of Persecution

The evidence must establish that

1. the alien possesses a belief or characteristic which a persecutor seeks to overcome in others by means of punishment of some sort;
2. the persecutor is already aware, or could become aware, that the alien possesses this belief or characteristic;
3. the persecutor has the capability of punishing the alien; and
4. the persecutor has the inclination to punish the alien.

D. Fear of Future Persecution

People who have not suffered past persecution in a country are still eligible as asylees if they have a genuine belief that they will be subject to persecution in the future.

E. Membership in a Group

If a person belongs to a group and a pattern or practice exists of persecuting people who belong to similar groups, this constitutes grounds for acceptance by the United States. In other words, the asylee does not have to prove that he or she is being singled out for persecution.

II. Financial Sponsorship

Unlike refugees who are not yet in the country, asylum seekers do not have to have financial sponsors in the United States as a prerequisite for the granting of asylum.

III. Executive Order 12711

Executive Order 12711, which was issued by President Bush in 1990, directs that forced abortion, forced sterilization, and other persecution for resistance to coercive population control programs shall be treated as persecution on account of political opinion.

Executive Order 12711 directed the Secretary of

State and the Attorney General to provide for "enhanced consideration under the immigration laws for individuals from any country who express a fear of persecution upon return to that country related to that country's policy of forced abortion or coerced sterilization." The Executive Order did not define "enhanced consideration."

As the attorneys for the INS and the asylee work through their case, they build their arguments around the criteria which is described above. In preparing for the role-play, students should seek to present their evidence in a manner which builds upon this legal criteria.

USEFUL INFORMATION ON IMMIGRATION CASES

China's One Child Policy

To control its burgeoning population of nearly 1.3 billion, China adopted an official family planning policy of one child per family in the late 1970s. This policy is implemented through wage incentives and social pressures. Minorities and remote rural communities are exempted. Compliance has been relatively high in the cities, but not in the countryside, where the new economic reform policies inadvertently also provide incentives for families to have more children in order to put more hands to work.

Evidence seems to support the contention that considerable pressure to adhere to family planning targets is applied by central authorities. Coercive measures have been used to meet these targets. Sterilization for couples with two or more children, abortion for unauthorized pregnancies, and the absolute prohibition of third and higher order births continue. The evidence on coercion is fragmentary due to the practice of cloaking directives behind the cover of euphemisms such as "advice," "remedial measures," "remedies," "technical services," and "long term contraceptive measures." Nevertheless, the evidence is considerable.

Just recently, China elaborated and proposed an expansion of its family planning policy. Under draft legislation entitled, "On Eugenics and Health Protection," the National People's Congress has been asked to consider the use of abortions, sterilization and marriage bans to "avoid new births of inferior quality and heighten the standards of the whole population." The legislation, which was submitted in December of 1993, proposes that people who are diagnosed with reproductive diseases, hereditary diseases "that lead to seriously sick or disabled children," severe mental illness and/or acute infectious diseases, be ordered to postpone marriage until they are well, or be barred from having children.

The official Xinhua News Agency stated that the "law will serve to prevent or reduce the number of births of seriously sick and disabled children and improve the quality of the Chinese population."

China has insisted that the stringent measures are needed in a country of nearly 1.3 billion people so that population growth does not outstrip the nation's economy. The government has noted that China has 22% of the world's population but only 7% of its arable land.

*Sources

"Briefing Book on the People's Republic of China." Prepared by the National Committee on U.S.-China Relations.
Wilmington News Journal, December 22, 1993. p A2.
Philadelphia Inquirer, December 23, 1993.

Religion in China

The Chinese constitution guarantees religious freedom for each of the five officially recognized religions - Buddhism, Taoism, Islam, Catholicism and Protestantism. But each is controlled and ruled by a "patriotic association" accountable to the government. Underground churches, or "house" churches, which do not register with the government and do not take orders from it, are illegal.

The Puebla Institute, a human rights organization in Washington, reports that 19 Catholic bishops, 41 priests and 23 Catholic lay people are currently imprisoned in China (as of November 1993). Additionally, 31 Protestant leaders and lay people are in prison or under house arrest for such crimes as attending illegal services or distributing religious literature.

Last year (1992), China's minister of public security called religion one of six "hostile forces" that could undermine the Chinese government. Chinese leaders have been especially alarmed at the power of religion since observing its influence on democratization trends in eastern Europe. "If China does not want such a scene to be repeated in its land," the state run press said in 1992, "it must strangle the baby while it is still in the manger."

*Source - Philadelphia Inquirer, November 23, 1993. p A18.

The Case of Li Jin-Lai

My name is Li Jin Lai. I am 27 years old, single and a citizen and native of the People's Republic of China. I arrived in the United States without a visa at Seattle, Washington on March 13, 1992.

Prior to 1949, my father was a policeman for the Nationalist (Kuomintang - KMT) government. After the 1949 revolution, my father was imprisoned by the communists for 3 years until 1952. Upon his release, my father was sent to a steel factory to work. He was employed there until the Cultural Revolution. At least 3 times between 1966 and 1968, my father was paraded in the street with an anti-revolutionary sign around his neck and a dunce hat on his head. Later, in 1968, my father was imprisoned at Wong Wa, a political prisoner's camp in Guangzhou (formerly Canton), and remained there for 12 years until his death in 1980. I was not permitted to visit my father in prison.

I attended school between 1967 and 1977, but was discriminated against in many ways. For example, I was not permitted to participate in school celebrations. I was constantly criticized because of my family's background. And I was repeatedly interrogated regarding my family's connections with the Republic of China (Taiwan). After graduating from high school, I was not permitted to take the college entrance examination and was sent to a farm in a rural area for "re-education." Worst of all, I was often required to stand in front of my peers and denounce and condemn my father for his work with the Kuomintang.

I remained on the farm for approximately 5 months from September 1977 until I escaped in February 1978. I was caught within a few days and sent to prison, a youth detention center, for 6 months. While in prison, I was beaten and kicked, accused of being a spy, and interrogated to determine if I had assisted my cousin in escaping from China in 1971. In the early Spring of 1978, I was sent back to the "farm" until April of 1979 when I was released and sent to work at a factory as a replacement for my mother. During my time at the factory, I was interrogated at least 3 times a year and was again accused of being a spy. The interrogations lasted from 2-3 days during which time I was held by government officials. In 1984, I was laid off after I asked for a raise and argued with government officials. Following the arguments, a letter was put in my file which prevented me from applying for another job. Thereafter, I was unemployed from 1984 until September of 1986 when I obtained a job as a salesman with a private employer. While on this job, I was questioned by police at least 3 times per year regarding demonstrations as well as criminal offenses but was not arrested.

In December of 1986, I participated in a student demonstration. A few days later, the police came to my home and arrested me. While in prison, I was interrogated and beaten. I was also told that I would be executed. One night,

when the guards were not watching. I climbed out of a window and escaped and immediately began making plans to leave China. I contacted my cousin who arranged with a smuggler to get me out of China. My family helped me raise the \$5,000 down payment for the smuggler's services. I promised to pay the remaining \$20,000 once I got a job in America. The smuggler arranged for false documents and the itinerary which took me from China through Tibet, Nepal, Thailand and Malaysia before arriving in Seattle. Our plan was to fly from Seattle to Canada where I would seek asylum.

While awaiting my flight in Seattle, I tried to ask people in the airport where I was to go to catch my connecting plane to Vancouver. Because I knew very little English, I tried to communicate through sign language. At one point, two airport officials came up to me and took me to a room where they questioned me. After inspecting my passport, which I later acknowledged was false, they took me into custody where I have been held ever since.

My mother, brother and 3 sisters still live in China. My mother has not worked since 1979 when she became ill. Because of my father's background, my older brother and sisters were not permitted to attend school. All of them were sent to a farm to work with my aunt. In 1979, my brother and sisters began working for a construction company that is owned by the government. Because they worked on the farm, they have never been imprisoned. However, whenever demonstrations or other revolutionary activities have occurred in China, they have had to attend "re-education" classes.

The Case of Fang Cheng

My name is Fang Cheng and I am a 22 year old electrician from the city of Chang-Le in Fujian Province of the People's Republic of China. I am a native and citizen of the People's Republic. I fled China in late January of 1993 right after I had been detained by my town's family planning committee. For 6 days I was beaten with sticks and flashlights, and threatened with sterilization.

My sister became pregnant with her second child in May of 1992. She already had a three year old daughter named Zhaoquan and her second pregnancy was a violation of China's "one-child policy." The pregnancy was not planned. It just happened. In early December, the authorities discovered that my sister was pregnant. The family planning committee began to pressure her to have an abortion. My sister wanted to have another child and hoped that it would be a boy. She did everything she could to conceal the pregnancy and by the time the family planning committee discovered her pregnancy, she was already 8 months pregnant. She refused to have the abortion especially because they are so dangerous at late stages of pregnancy.

As January arrived, the committee stepped up their pressure on my sister. She received visits from family planning committee members throughout the day and into the evening. Finally, she went into hiding. During the time when she was being pressured by the family planning committee, I decided to protest my country's one child policy. I put up posters in Chang-Le which asked, "Is it a crime to give birth to a child?"

Shortly after I put up the posters, the authorities took me into custody and seized the hardware store that me and my brother operated. While in custody, committee members beat me in the chest and in the back. Their faces were very grim. One night when the guards were not looking, I managed to climb out a window and escaped.

It was at this point that I finally decided to flee China. My friends were able to put me in touch with one of the "snakeheads" who was able to arrange my trip out of China. With the help of friends and family members, I was able to scrape together \$4,000. The total cost of the snakehead's services was \$30,000. I had to sign an agreement to repay the balance once I got to "meiguo," the beautiful country (United States) and found work.

My journey to America began in late January (1993). We were told that we would need nothing except a change of clothes. The snakehead told us that everything would be provided.

As soon as I boarded the ship, named the "Golden Venture," I knew that I had been deceived. The ship was rusty and we were put into a large, empty storage space with only a blanket on the floor. We left from Hong Kong then sailed from Bangkok, Thailand to Singapore and then to Mombasa, Kenya. In Singapore the ship picked up 90 passengers and in Kenya, another 200 of my countrymen whose ship had stranded were brought on board. Our last stop was in South Africa.

The conditions on board the ship were terrible. There was barely enough room to lie down. There were no showers and only one toilet for 300 people. Because we had to wash

ourselves and brush our teeth with salt water. we developed rashes. Meals were limited to rice and vegetables which were served once a day. We were told that the trip would last only 20 days. It lasted 4 months.

On 6 June 1993. our ship ran aground just off the coast of New York. I had had enough and decided to try to swim ashore. Although the water was very cold and the waves were as high as 6 feet. I decided that I would rather die than return to China. Fortunately. I made it. As many as 10 others did not. We were met by many authorities and taken into custody. Since that time. I have been held in a detention center in York. Pennsylvania awaiting my asylum hearing.

If I get sent back to China. I will be fined at least a year's salary and possibly be sent to a labor camp. I have not heard from my family back in China and I am fearful of what may happen to them. I have no visa and the passport which I was carrying was a false one. It was provided by the snakehead who arranged my trip. At this time. I am being held in a federal detention facility in eastern Pennsylvania and am seeking asylum in the United States as a victim of persecution in the People's Republic of China.

I will kill myself before I will allow myself to be sent back to China.

309

The Case of Zhang Lezhi

My name is Zhang Lezhi. I am a 32 year old tradesman from Shandong Province in the People's Republic of China, where I am a native and citizen.

On the evening of 8 September 1992. I was at my market stall in Nine Lanes Village in Shouguang County where I sell household goods. Nine Lanes Village is located approximately 200 kilometers from Jinan, which is the provincial capital of Shandong. A gentleman approached me and asked me if I would come with him to discuss some business which he suggested would increase my profits. I did not realize that he was a plain clothes policeman. As I approached his jeep, several other officers surrounded me. I was handcuffed, tied-up and taken to the police station at Belluo.

At the police station, I remained bound as the police beat and interrogated me. They asked me about my involvement with the New Testament Church - a small Protestant congregation in Shandong Province. I have been a Christian for several years but have had to keep my involvement with the New Testament Church quiet because it has been banned by authorities in various areas within China. In 1989, I was imprisoned for 2 years along with Yan Peizhi and Xu Zhihe for preaching the Gospel. When we were released, we quietly resumed our peaceful religious meetings. I am very ashamed that I had to give the police the names of 7 other members of my church for I feared that the police would kill me. On September 9th, the seven church members who I identified were taken into custody. Yan and Xu were among those arrested.

On September 10th, the eight of us were transferred to Shouguang City Detention Center. We were accused of engaging in illegal religious activities and of restoring and expanding the New Testament Church.

While in detention, we were beaten and mistreated. After I protested my innocence, my arms and feet were manacled together with heavy chains and I was assaulted by two policemen with an electric baton. I was beaten and chained in this position repeatedly for three months without the chains ever being removed, even for eating and sleeping. When the weather became cold, I requested permission to remove the chains so that I could buy on more clothes. My request was denied.

At the same time, one of my fellow church members who had been arrested was forced to sit for a whole day in the "anquan yi" (security chair) which had spikes on the side. Zhu was beaten while on the chair and had food forced into his mouth. Each time he moved, the spikes opened wounds in Zhu's side.

Five of us were held without charges for periods of one to three months. Three others were tried in December of 1992 and sentenced to three years of "reform through labor." They were sent to carry out their sentences at the Chang Le "Re-Education Through Labor" camp which is located 40 kilometers south of Shouguang.

After I got out in December, I was able to contact a cousin in Guangdong Province who told me that he would be able to put me in contact with someone who could make arrangements for me to get out of China. With the help of friends and relatives in Shandong Province, I was able to

raise \$4,000 and transportation to Guongdong. The remaining \$21,000 I promised to pay once I found work in the United States.

In Guongdong, I was given false documents and was placed aboard a boat. The conditions on the boat were terrible. We were given very little food and were forced to remain in the hull for most of the journey. I never knew where we were.

Many weeks after we had departed, our ship landed in Mexico. We were hidden in the secret compartment of a small truck in which we were smuggled into the United States. Shortly after we crossed the border, U.S. officials stopped our truck and discovered our presence. We immediately requested asylum and were taken into custody.

Lesson 2

Model United Nations
Simulation:
Should Taiwan Be
Admitted into the
United Nations?

"Model United Nations Debate: Taiwan Requests Membership in the United Nations"

In this lesson, students will role play delegates to the United Nations who must decide whether to admit Taiwan into the United Nations.

AUDIENCE: Students in grades 7-12.

TIME TO COMPLETE: One or two class periods.

RATIONALE/PURPOSE: This lesson is designed to familiarize students with the operations of the United Nations and to help them to develop an understanding of the "two Chinas" problem in international affairs. Participation in this lesson will also help students to refine their public speaking and debating skills.

GOALS: At the conclusion of this lesson, students will be able to

1. describe the process which is used to admit states into membership in the United Nations
2. list at least two reasons why Taiwan's request for U.N. membership has been blocked
3. explain the debating process which is followed in the United Nations
4. list the five nations which have veto powers in the Security Council

MATERIALS NEEDED: The teacher will need to provide class copies of

- Handout 1 - "Chapter II of the U.N. Charter"
- Handout 2 - "Background Information"
- Handout 3 - "Guidelines for Model U.N. Debates"
- Handout 4 - "Resolution Recommending Taiwan's Admittance to the UN"

In preparation for the debates, the teacher may want students to design placards and flags for each country ("state") which will participate in the debates.

PROCEDURES:

1. Distribute copies of handouts 1-4 to the class. Tell them that they will be involved in a classroom role-play in which they will act as delegates to the United Nations Security Council. Tell them that they will be asked to decide whether or not to recommend that Taiwan be admitted as a member to the United Nations.
2. Ask student to read Handouts 2 and 4. Answer any questions which they may have regarding the issue.
3. Ask students to read Handout 1. This section of the U.N. Charter describes the process which is used to admit members into the organization. Highlight the fact that the Security Council must recommend membership before the General Assembly admits a new state.
4. Assign Roles - depending on the size of your class, delegations may consist of 1-2 students per country. You may wish to assign roles based on the

actual current make-up of the United Nations or spice-up the debates by creating a list of 10 non-permanent Security Council members.

At this point you must inform the students that there are 15 members of the Security Council. The five permanent members ("Big Five") have an absolute veto power on all substantive motions. The "Big Five" include the United States, United Kingdom, Russia, France and the PEOPLE'S REPUBLIC OF CHINA! The 10 non-permanent members are elected by the General Assembly for 2 year terms. Non-permanent members do not possess the veto power.

NOTE - although the outcome of this debate should be well known (since the PRC holds the veto power) you should tell the delegates from the PRC to refrain from threatening a veto until the debates have been exhausted and a vote is taken. At voting time, it is expected that the PRC will veto any recommendation for admission which is proposed on behalf of Taiwan.

The veto power cannot be used on procedural motions such as changing agendas, amending resolutions, proposing recesses or ending debates.

It is also recommended that you grant Taiwan "Observer Status" at the debates. Observer states may participate in the debates but may not vote. Taiwan's presence at the debates helps to insure greater balance in the discussions.

4. Distribute copies of Handout 3 "Guidelines for Model U.N. Debates." Review the guidelines for debates and clarify any points of confusion. It is strongly recommended that you spend some time practicing for the debates. Choose a general topic for discussion and allow the students time to debate the topic using parliamentary procedure. School related proposals serve this purpose well. You may offer a resolution such as "Suggestive attire may not be worn in school." This topic lends itself to heated discussion and provides obvious opportunity for proposed amendments.

EVALUATION: Methods for evaluating students vary for this type of activity. Students should be graded on the quality and frequency of their participation in the debates. One method is suggested below

1. Create a list of countries which are participating. Place a slash mark next to the country each time a positive contribution is made. The teacher should serve as recorder.
2. The various types of contributions are weighted. For example, speeches can earn as many as 5 points. Questions and procedural motions facilitate debates can earn one point. Responses to questions, proposed amendments and leadership during caucusing can earn as many as 3 points.

Whichever system you use, be sure that the students are made aware of it before the debates begin. Otherwise, you may end up with some very unhappy students should they earn

- low grades.
3. Grading scales are usually determined at the end of the debates.

TIPS FROM THE TEACHER: You may want to schedule this activity far in advance so that students have the opportunity to write to embassies or consulates requesting their countries' policies regarding the admission of Taiwan into the United Nations. Most countries are more than willing to send information provided that requests are brief, specific and placed on school letterhead. Be sure to mention that the information will be used for a Model United Nations debate.

Secondly, it is advised that the teacher serve as chairperson for the debates. The chair may not vote or become involved in the discussions other than to explain and enforce the procedures.

HANDOUT 1

Charter of the United Nations Chapter II: Membership

Article 3

"The original members of the United Nations shall be the states which, having participated in the United Nations Conference on International Organization at San Francisco, or having previously signed the Declaration by United Nations of 1 January 1942, sign the present Charter and ratify it in accordance with *Article 110.

Article 4

1. Membership in the United Nations is open to all other peace-loving nations which accept the obligations contained in the present Charter and, in the judgement of the Organization, are able and willing to carry out these obligations.

2. The admission of any such state to membership in the United Nations will be effected by a decision of the General Assembly upon the recommendation of the Security Council.

Article 5

A Member of the United Nations against which preventative or enforcement action has been taken by the Security Council may be suspended from the exercise of the rights and privileges of membership by the General Assembly upon the recommendation of the Security Council. The exercise of these rights and privileges may be restored by the Security Council.

Article 6

A Member of the United Nations which has persistently violated the Principles contained in the present Charter may be expelled from the Organization by the General Assembly upon the recommendation of the Security Council."

*Endnote

Article 110 simply outlines the procedures which must be followed for ratification of the Charter. Its most important clause states that "The present Charter shall be ratified by the signatory states in accordance with their respective constitutional processes."

HANDOUT 2

Background Information: China's Seat in the United Nations

In the late 1920s, a power struggle erupted in China pitting the Nationalist forces under Chiang Kai-shek against the communist force led by Mao Tse-tung. When Japan invaded China at the outset of World War II, the two sides agreed to a temporary truce and united against their common enemy. After Japan's defeat in 1945, a four year civil war between Communist and Nationalist forces resulted in a communist victory and Chiang Kai-shek's retreat to the Island of Taiwan in 1949. From there, Chiang's followers set up what amounted to a de facto second Chinese seat of government. Taiwan adopted the name - Republic of China (ROC).

Since 1949, the international community has been troubled by the alleged existence of two Chinas. The governments of the Communist controlled mainland and the Nationalist controlled Taiwan both claimed to be the legitimate representative of the Chinese people. Both sides refused to recognize the legitimacy of the other and expected the world community to do the same. The conflicting claims forced the international community to decide which "China" it would be granted diplomatic recognition. Cold War tensions were reflected in the world community's division over which China deserved the recognition. Although relations between the "two Chinas" have evolved into a state of relatively peaceful coexistence, the conflict over which is the legitimate China still permeates Chinese and international affairs.

From 1949 until 1971, China's seat in the United Nations was held by the Republic of China (Taiwan). Cold War tensions between the United States and the communist controlled "People's Republic of China" (the mainland) caused the United States and its allies to prevent the PRC from achieving official recognition within the world body. By 1971, however, the dynamics of international affairs had changed significantly. From the perspective of the United States, the expansionist desires of the Soviet Union became an area of far greater concern than the threat of communist China. In fact, officials within the United States were coming to realize that the Chinese, who were also suspicious of the Soviets intentions in Asia, might be used as a countercheck to Soviet hegemony in the region.

Coupled with the growing recognition of China's emerging influence in international affairs, the desire to work with the PRC in checking the Soviets led to dramatic developments in the 1970s. It became increasingly difficult for the nations of the world to ignore a nation which was home to one-fifth of the world's people. High level contacts between the United States and the PRC developed. Then, on 25 October 1971, the UN General Assembly passed Resolution 2758 (see p. 62) which granted China's UN seat to the People's Republic of China. The resolution passed by a margin of 76 in favor, 35 against and 17 abstentions. The General Assembly recognized that "the representatives of the Chinese People's Republic are the sole legal representatives of China in the United Nations and that the Chinese People's Republic is one of the five permanent members of the Security Council."

The Assembly then resolved "to exclude the representatives of Chiang Kai-shek from their illegally held seat in the United Nations and from all organizations connected with the United Nations." Needless to say, the people of Taiwan were devastated. One year later, the United States and the PRC agreed to establish normal diplomatic relations and in 1979, official diplomatic recognition was cemented with the exchange of embassies. The People's Republic of (mainland) China replaced the Republic of China (Taiwan) in the United Nations as the officially recognized China. Taiwan lost its seat and considerable international standing.

Considering the fact that neither the PRC nor the ROC can agree to a common definition of the relationship between the two, it is understandable that international observers have been left somewhat tongue-tied in their efforts to explain the current relationship between the PRC and the ROC.

Currently, Beijing firmly states that there is only one China - the PRC. It refuses to consider explanations which fall under the titles of "Two Chinas", "One China, One Taiwan", "Taiwan Independence", or "One Country, Two Governments." Since 1984, Beijing has entitled their approach "One country, Two Systems" which suggests that Taiwan is somewhat of a stray province of the PRC which exercises local authority. In essence, Taiwan is viewed as a "special administrative region" of the People's Republic. If the international community decided to take steps affecting the status of Taiwan, Beijing argues, this would represent an unlawful interference in the "internal affairs" of the PRC.

On the other hand, Taipei's current policy is officially described as "One China, Two Areas." In other words, Taipei and Beijing are two political entities that control the Taiwan area and mainland China respectively. Beijing flatly rejects any suggestions of Taipei's political independence.

In both cases, their ultimate goal is to achieve national unification. Whereas Taiwan's official policy embraces a peaceful and democratic unification, the PRC has not ruled out the possibility of using force. In fact, the PRC has threatened an all out war if Taiwan declares its independence.

Beijing asserts that the recognition of Taiwan as a separate political entity is the first step towards a permanent breakup of China. From a PRC perspective, this is totally unacceptable. Taipei, on the other hand, emphasizes that recognition of its separate political status does not rule out possibilities for the eventual unification of China. It cites the German experience as evidence. At one time, Taipei contends, two Germanies were recognized and both held seats in the United Nations. Now there is one Germany and one German seat in the UN.

It has been 23 years since the ROC lost its seat in the United Nations. In that time, it has risen to the status of one of the world's emerging economic powers. It holds claims to holding the world's second highest foreign exchange reserves, ranking as the 14th largest trading nation and placing 25th in per capita income. With 21 million people, Taiwan is larger than 2/3rds of the 184 member countries of

the United Nations. Additionally, Taiwan has cited recent steps which it has taken to establish a more democratic form of government as arguments for granting it "parallel membership" in the United Nations. They include the holding of "free and open elections regularly," the establishment of a "multiparty system" and the introduction of a "vigorous free press."

On 6 August 1993, seven Central American nations - El Salvador, Guatemala, Nicaragua, Costa Rica, Honduras, Panama and Belize - jointly forwarded a letter to UN Secretary-General Boutros Boutros-Ghali asking the United Nations to seriously consider parallel representation in the UN for Taiwan. They requested the establishment of an ad hoc committee to consider the matter and make recommendations in 1994.

In the Fall of 1993, the Philadelphia Inquirer reported that "Without so much as a vote, China and a legion of supporters quashed Taiwan's bid to rejoin the United Nations after a 22 year absence.

In an angry speech, China's ambassador, Li Zhaoxing, said admitting Taiwan to the United Nations would be an 'abominable precedent' and would interfere in China's internal affairs (see p. 38a).

After similar speeches from nine other countries backing China, the General Committee of the 184 member General Assembly refused to put the issue on the agenda."

Nevertheless, the issue of parallel Chinese representation in the United Nations is certainly not a dead one. Barring the unification of the the "two Chinas" in the very near future, one can expect that the world community will revisit the question of Taiwan's membership in the not too distant future. In the meantime, it remains an interesting educational topic of debate in a Model United Nations forum.

HANDOUT 3

GUIDELINES FOR MODEL U.N. DEBATES

- I. Room Arrangement- arrange desks in a circle so that the room takes on the appearance of the actual Security Council. Delegations should have a flag and a placard to identify the countries which they represent. The placards should be raised to indicate a desire to be recognized for speaking by the chairperson and to show voting preference during voting procedures.
- II. Procedures
 - A. Establish the Agenda-in most Model U.N. debates, a variety of resolutions will be submitted. The resolutions contain proposals for a course of action. The first step in the debates is to decide which resolution will be discussed first. Some teachers may want the students to write their own resolutions. In this case, a 2/3rds majority decides which resolution will be discussed. Since there is only one resolution for this activity, go on to the next step.
 - B. Create a Speakers List - ask delegates to raise their placards if they wish to speak to the topic. The chair should create a list of speakers. List the order of speakers on the board so that it is visible to all. This allows those who are at the bottom of the list to get "yields" from those at the top of the list.

"Yields" may be granted by the speaker whose turn it is to speak. The main speaker is usually given anywhere from 3-5 minutes for his or her speech. If there is time left over, the time is yielded to whomever the speaker has identified at the beginning of the speech. The desire to yield must be indicated at the beginning of the speech. Otherwise, the chair should not recognize it.
 - C. Speeches Begin - go through the list until the speakers list has been exhausted or a motion to end debate is approved. Each speaker should be permitted to entertain 3-5 questions from other delegates. State sovereignty is recognized during Model U.N. debates. Therefore, one country may refuse to yield to a question from a particular country. For example, the PRC may refuse to yield to a question from Taiwan since it does not recognize its independent status.
 - D. Caucusing - occurs frequently in Model United Nations. Caucuses are used to lobby votes, to get yields, to arrange support for amendments etc. The chairperson should allow motions for short recesses so that caucusing can take place.
 - E. Voting-once debate has been ended, the room enters into voting procedure. There should be no talking

during voting procedure. Students should be allowed to motion for a particular type of vote (e.g. voice vote, raising of placards or roll call). Roll call votes may be desirable because they allow students to ask for a "right of explanation" at the end of the vote. This gives delegates a final opportunity to explain why they voted as they did.

After "rights of explanation" are exercised, the chair may ask for any changes in votes. Once the offer for changes is made, the votes should be counted and announced. At this point, the debate is over.

III. Modified Parliamentary Procedure - the rules of debate.

-all motions must be seconded before discussions begin. All motions are addressed to the chair.

- A. Motion to Change Agenda - requires a 2/3rds majority
- B. Motion to Recess - is often used to initiate a caucus. This motion requires a simple majority.
- C. Point of Personal Privilege - is used when a delegate is inconvenienced in some way and wishes to have the situation corrected. For example, the room is too noisy or the speaker cannot be heard. The chairperson decides what course of action should be taken.
- D. Point of Order - is used when the chair or another delegate is not following the rules of procedures. Points of order reflect attempts to draw attention to the violation in procedures so that the violation may be corrected. For example, a delegate gives a speech instead of asking a question. Or, a fourth question is asked when a limit of 3 has been set.
- E. Motion to Table a Proposal - such as a resolution or amendment. These motions are often made when a proposal is offered at an inappropriate or illogical time. The motion to "table" is actually a request to set something aside for the time being. Motions to table are sometimes used by shrewd delegates in an effort to block or delay a vote on a "unfriendly" proposal.
- F. Motion to Amend a Proposal - may only be made at the beginning of a speech. If the sponsor of the resolution which is being discussed accepts the amendment, it is considered a "friendly" amendment and becomes part of the resolution without a vote. If the sponsor of the resolution rejects the amendment, it is considered an unfriendly amendment and must be voted upon. Amendments require the support of 2/3rds of those present.

Motions to amend must be dispensed with

before any other action can be taken on the main resolution.

G. Motion for a "Right of Reply" - Is used when a delegate feels that his or her country has been unduly insulted. It is up to the chair to decide whether the delegate gets has been insulted and deserves a right to reply.

H. Motion to End Debate - since this is a very serious motion which will end all discussion on the resolution. this motion requires a 2/3rds majority. Motions to end debate should be followed by one speaker in favor of the motion and one speaker against.

If the motion is approved. the room enters immediately into voting procedure.

HANDOUT 4

Resolution Recommending Taiwan's Membership in the UN

SECURITY COUNCIL

SUBJECT: Admission of Taiwan to the United Nations

SUBMITTED BY:

- (1) Noting with regret the expulsion of the Republic of
- (2) China from the United Nations in 1971 and the decades
- (3) of semi-isolation imposed on the people of Taiwan.

- (4) Aware that the Chinese communists are not entitled
- (5) to represent the Republic of China on Taiwan and its
- (6) 21 million people.

- (7) Recognizing that the Universal Declaration of Human
- (8) Rights, the International Covenant on Civil and
- (9) Political Rights, and the International Covenant
- (10) on Economic, Social and Cultural Rights emphasize
- (11) that every person is entitled to participate in
- (12) political, cultural, and economic activities.

- (13) Noting the emergence of the Republic of China
- (14) as a strong democracy with one of the world's
- (15) most prosperous economies.

- (16) Further noting the will and the wherewithal of
- (17) the Republic of China to pay back the international
- (18) community for its help in the past.

- (19) Hoping that the United Nations can build upon the
- (20) "Taiwan experience" to promote economic development
- (21) in the Third World.

- (22) Further recognizing that the Republic of China's
- (23) participation in the United Nations would be conduc-
- (24) tive to the eventual unification of China and to
- (25) peace and stability in the Asia-Pacific region.

- (26) Citing the German and Korean precedents for
- (27) parallel representation in the United Nations.

- (29) Reaffirming the United Nations' principle of
- (30) universality and its relevance to the people of
- (31) Taiwan.

- (32) Noting further that the Republic of China's
- (33) participation in the UN will help the United Nations
- (34) to establish a completely neutral position for
- (35) itself in the new world order.

- (36) 1. Strongly urges the Security Council to
- (37) recommend to the General Assembly that the
- (38) Republic of China on Taiwan be admitted as
- (39) a full voting member of the United Nations.

PRC'S POSITION ON TAIWAN MEMBERSHIP IN THE U.N.

The following excerpt is taken from "The Taiwan Question and Reunification of China" which was released by the Taiwan Affairs & Information Office of the State Council of the People's Republic of China in August of 1993.

"Relations between international organizations and Taiwan"

"The sovereignty of each state is an integral whole which is indivisible and unsharable. The Government of the People's Republic of China, as the sole legal government of China, has the right and obligation to exercise state sovereignty and represent the whole of China in international organizations. The Taiwan authorities' lobbying for a formula of "one country, two seats" in international organizations whose membership is confined to sovereign states is a manoeuvre to create "two Chinas." The Chinese Government is firmly opposed to such an attempt. Its principled position fully conforms to the fundamental interests of the entire Chinese people including Taiwan compatriots and overseas Chinese. Only on the premise of adhering to the principle of one China and in light of the nature and statutes of the international organizations concerned as well as the specific circumstances, can the Chinese Government consider the question of Taiwan's participation in the activities of such organizations and in a manner agreeable and acceptable to the Chinese Government.

All the specialized agencies and organizations of the United Nations system are inter-governmental organizations composed of sovereign states. After the restoration of the lawful rights of the People's Republic of China in the United Nations, all the specialized agencies and organizations of the U.N. system have formally adopted resolutions restoring to the People's Republic of China its lawful seat and expelling the "representatives" of the Taiwan authorities. Since then the issue of China's representation in the U.N. system has been resolved once and for all and Taiwan's re-entry is out of the question. However, it should be pointed out that recently some elements of the Taiwan authorities have been clamouring for "returning to the United Nations". Apparently, this is an attempt to split state sovereignty, which is devoid of any legal or practical basis. The Chinese Government is convinced that all governments and organizations of the U.N. system will be alert to this scheme and refrain from doing anything prejudicial to China's sovereignty."

The document continues to state that "...Taiwan may participate in the activities of those [regional economic] organizations only as a region of China under the designation of Taipei, China (in the Asian Development Bank) or Chinese Taipei (in the Asia-Pacific Economic Cooperation)."



PEOPLE'S REPUBLIC OF CHINA
MISSION TO THE UNITED NATIONS

155 WEST 66th STREET, NEW YORK, N.Y. 10023

PRESS RELEASE

Remarks by the Spokesman of the Chinese
Ministry of Foreign Affairs Concerning Taiwan's Attempt
to "Return to the United Nations"

Recently, the Taiwan authorities have repeatedly made clamours for its "return to the United Nations" and urged a small number of countries to raise to the United Nations the issue of "parallel representation of separated states", which were designed to confuse the international community and fish in troubled waters.

The United Nations is an inter-governmental international organization consisting of sovereign states. As a province of China, Taiwan is not qualified to be a member. Resolution 2758 adopted by the U.N. General Assembly in 1971 recognizes the representatives of the Government of the People's Republic of China as the sole legal representatives of China in the United Nations, decides to restore to the People's Republic of China all its rights in the United Nations and expels forthwith the representatives of the Taiwan authorities from the U.N. and all its specialized agencies and organizations. China's representation in the United Nations has, therefore, long been settled in political, legal and procedural terms. Taiwan's "return to the United Nations" is simply out of the question. But under the incitement of the Taiwan authorities, a few countries, ignoring history, have openly raised the question of "Taiwan's representation" with the U.N. General Assembly. This constitutes a gross interference in China's internal affairs. And we are resolutely opposed to it.

The attempt of the Taiwan authorities to create "two Chinas", "one China, one Taiwan" or "one country, two seats" runs counter to the fundamental interests of the Chinese people and goes against the historical trend. It comes under the resolute opposition by all the Chinese people including the people in Taiwan, neither will it get any support from the international community. So it is doomed to failure.

Lesson 3

Mock Congressional Debate:

Should Most Favored
Nation Status Be
Extended to China?

Should the United States Extend Most Favored Nation Status to China: A Mock Congressional Debate

In this lesson, students will assume roles as members of the United States Senate and debate whether "Most Favored Nation" status should be granted to the People's Republic of China.

AUDIENCE: Students in grades 7-12.

TIME TO COMPLETE: One or two class periods.

RATIONALE/PURPOSE: This lesson is designed to help students understand the complexities of dealing with a nation that is accused of numerous human rights violations but which is also vital to the economic and geopolitical interests of the United States.

By asking students to resolve a national dilemma, it is hoped that they will acquire or develop skills which will better enable them to deal with disputes.

GOALS: At the conclusion of this lesson, students will be able to

1. describe the procedures which are followed in the United States for extending "Most Favored Nation" status
2. explain some of the benefits associated with "Most Favored Nation" status
3. list reasons for and against the extension of "Most Favored Nation" status to the People's Republic of China
4. write a letter to their Senators explaining why they would or would not want the United States to grant "Most Favored Nation" status to China.

MATERIALS: You will need to provide students with class copies of the handout entitled "Background Information: Most Favored Nation Debate." Depending on the size of your class, you will also need copies of the arguments for and against extension of MFN status.

PROCEDURES:

1. Have students read the handout entitled "Background Information: Most Favored Nation Debate." Once they have completed the reading, ask them
 - a. What is "Most Favored Nation" status?
 - b. What is the nature of the dilemma which the President will face when he has to decide whether to extend MFN status to the PRC?
2. Explain to the students that they are going to engage in a simulated Congressional debate. Tell them that they will be assigned roles as supporters, opponents and neutrals in the debates. It will be their responsibility to decide how to advise the President in his decision regarding the extension of MFN status to the PRC.
3. You can choose from one of two possible ways to approach role assignments. If you prepare well enough in advance, you can have your students write

to their senators asking them to provide information regarding their position on MFN extension. If this approach is taken, students can be assigned the role of actual senators.

- Otherwise, you may want to divide the class into three groups - supporters, opponents and "undecided"
4. Distribute copies of the appropriate arguments to each group of students. The "undecideds" should get copies of both sets of arguments so that they have the opportunity to make-up their own minds based on their reading and the debates.
 5. Have students prepare speeches reflecting their points of view.
 6. Follow the debating procedures outlined in the Model U.N. lesson which is contained in this unit.
 7. Following the debates, take a class vote on the question. Then, have the students write a letter to their Senator, the President, or a local newspaper in which they encourage the reader to follow a recommended course of action.

EVALUATION: In a lesson such as this, it is recommended that the students should be evaluated on the bases of four activities which share equal weight. A breakdown of the evaluations is suggested below:

Speeches - 25%

Contributions During the Debates - 25%

Letters to Editor, Senator or President - 25%

Quiz Which Assesses Knowledge of Content - 25%

TIPS FROM THE TEACHER: Contact one of your Senators to find out when the MFN debates are scheduled. Be sure to plan this lesson before the debates take place. This way, the students can follow them in the news and realize that their voices were heard prior to the making of the decision.

BACKGROUND INFORMATION: MOST FAVORED NATION DEBATE

In June of 1993, President Clinton informed Congress of his decision to extend "Most Favored Nation" (MFN) status to the People's Republic of China. The extension applies for a twelve month period and is scheduled to expire on July 3rd. Although, by law, only the President may extend or revoke MFN status, it has become customary for the President to seek the "advice and consent" of the Senate prior to making his decision. The Senate is scheduled to take up the debate in the Spring of 1994.

The debate promises to be a heated one. Well documented charges of serious human rights violations by China have led many to oppose an extension of MFN status. China's brutal suppression of the Tiananmen Square democracy movement of 1989 resulted in the deaths of at least 1,000 people and the arrest of thousands more. International media coverage of the "massacre" confirmed worldwide charges of the worst type of human rights violations. The continued arrests and trials of those associated with the movement and continued reports of other types of human rights violations have made it difficult to support proposals for the extension of privileges to the Chinese government. Human Rights organizations such as Amnesty International, Asia Watch and Freedom House place China's government among the most repressive in the world.

Still, the economic and strategic importance of China to the United States cannot be easily dismissed. A nation which is home to 22% of the world's population cannot be sanctioned without the expectation of significant risks. Its overpopulation problems have caused the Chinese government to argue that its human rights policies must be judged in light of its own history and culture. Many disagree.

In essence, Americans face a serious dilemma. On the one hand, there are those who would argue that the United States is supposed to stand for human rights and should not reward a nation like China which blatantly disregards them. On the other hand, there are those who argue that our economic and strategic interests far outweigh any results which may come from revoking China's MFN status. Besides, they would argue, China has recognized some of its past mistakes and has initiated significant reforms since 1989. To revoke MFN would jeopardize the continuation of those reforms.

"Most Favored Nation" status entitles a country to economic preferences that the U.S. grants only to its closest allies and trading partners. This status allows those partners to bring merchandise into the United States with the lowest possible taxes. Should the United States place China among the ranks of its "Most Favored Nations?"

In this lesson, students will confront the very difficult decision which the President and Congress will have to make in the Spring. In the process, it is hoped that you will come to realize that decisions regarding international affairs are often complicated by unavoidable dilemmas which force you to exchange a gain for a loss. You will also learn the one thing about China that even the experts have come to understand i.e. dealing with China tends to be a very complex endeavor.

ARGUMENTS AGAINST THE EXTENSION OF MOST FAVORED NATION STATUS TO THE PEOPLE'S REPUBLIC OF CHINA

A list of the most significant reasons why some people are opposed to the extension of "Most Favored Nation" status to the People's Republic of China is presented below. Do not consider this to be a complete list.

1. China's restrictive emigration policy denies many the opportunity to leave China. Most frequently identified are those who have relatives abroad who are engaged in "unacceptable" political activities.
2. China has been accused of punishing individuals who return to China after illegally leaving the country.
3. China uses forced abortions and sterilizations to enforce its "one child policy."
4. China sharply restricts fundamental human rights such as freedom of speech, assembly, association and religion. International rights organizations contend that China imprisons and tortures critics of the government.
5. China has denied requests to allow inspections of its prisons by international humanitarian organizations.
6. According to official Chinese figures, over 800 people have been convicted by Beijing courts on charges stemming from the 1989 Tiananmen protests.
7. China has been accused of using prison labor to produce exportable goods.
8. China has used heavy handed tactics to suppress political and pro-independence demonstrations in Tibet. "Several hundred" persons are currently incarcerated for what appear to be only nonviolent political activities.
9. Recent allegations of China's attempt to dilute the Tibetan population by encouraging involuntary migration and marriages of Han Chinese in the Tibetan Autonomous Region have been filed.
10. China continues to violate non-proliferation agreements by selling sensitive military equipment and technology to nations such as Pakistan.
11. China maintains multiple barriers to imports in order to protect state owned industries. Since June of 1989, the U.S. trade deficit with China has grown to \$40 billion.
12. China has yet to fully implement the 1992 "Intellectual Property Rights" agreement which protects patent and copyrights granted in other nations.
13. China continues to censor international radio and television broadcasts into China (e.g. "Voice of America").
14. Chinese diplomats have been accused of threatening Chinese students residing in the United States.
15. China continues to try and imprison individuals connected with the 1989 Tiananmen movement for "counterrevolutionary crimes."
16. China has recently announced its opposition to the thought of applying sanctions to North Korea should North Korea refuse international inspections of its nuclear facility.

17. In January of 1994, the Clinton Administration publicly charged the Chinese with attempts to get around American limits on imports by shipping goods into the United States through other nations. U.S. officials contend that at least 25 other countries are re-labeling goods to read "Made in _____ (the 3rd country)". Cited as evidence were the 3.6 million sweaters shipped from China to neighboring Macau, a steamy Portugese territory next to Hong Kong with a population of only 475,000. In another case, 625 million rags used to clean industrial machinery were made in China and then shipped to Honduras. U.S. trade representative, Mickey Kantor, argued that "given the limited number of heavy manufacturing industries in this country, obviously it would take decades for this volume of shop towels to actually be used in Honduras."

*Source - New York Times. January 7, 1994. p A1.

18. Draft legislation which has been introduced in the People's National Congress proposes to reduce births of disabled or diseased babies through abortion, sterilization and marriage bans. Entitled, "On Eugenics and Health Protection," the legislation is being described by some as a "Nazi-like eugenics campaign."

**ARGUMENTS IN FAVOR OF EXTENDING MOST FAVORED
NATION STATUS TO THE PEOPLE'S REPUBLIC OF CHINA**

1. In 1992, trade between China and the United States topped \$33 billion, including \$7.5 billion in U.S. exports. U.S. exports to China rose by 19%, thereby making China our fastest growing market in Asia.
2. China is a developing country and home to 1/5th of the world's population. The United States must look to the future and recognize the importance of the Chinese market for U.S. exports.
3. The market access agreement which was signed on 10 October 1992 will phase out 70-80% of China's non-tariff trade barriers within the next four years if implemented.
4. At least 8 Chinese delegations have been or will soon be dispatched to the U.S. with orders to "buy American." These missions have the potential to generate billions of dollars worth of exports involving aircraft, autos, satellites, oil drilling equipment, aviation electronics, wheat fertilizer and other U.S. products.
5. There have been significant improvements in China's emigration policies. In Fiscal Year 1992, the numerical limitation for immigrants from China was fully met. In the President's Report to Congress which was released in June of 1993, it was reported that "the principal restraint on increased immigration continues to be the capacity and willingness of other nations to absorb Chinese immigrants, not Chinese policy.
6. With the exception of student activist Shen Tong, the U.S. government is not aware of any case in which Chinese living in the United States who returned to China for visits after the Tiananmen demonstrations in 1989 were prevented from leaving again. Shen was detained in September 1992 and then expelled two months later for trying to establish a Beijing chapter of his Fund for Chinese Democracy.
7. No part of China is now subject to martial law.
8. China has provided some information on human rights cases when it was requested by U.S. officials. China has recently released, prior to the completion of their sentences, several prominent dissidents whom the U.S. had identified on lists to them. In November of 1991, Secretary of State James Baker was given the names of 133 who were released.
9. In 1991 the Chinese promised that all Chinese, regardless of their political views, have the right to travel abroad. The only exceptions are those who are imprisoned, have criminal proceedings pending against them, or have received court notices concerning civil cases.
10. China has recently hosted human rights delegations from France, Australia, the United Kingdom and Germany for discussions on the subject of human rights.
11. China has admitted some foreign observers to Tibet and to the main Lhasa prison. Diplomatic reports state that the Chinese government is providing funds for rebuilding Tibetan monasteries and that monks are now provided more leeway in their religious practices.
12. The United States government has found no evidence to

- date of a Chinese policy designed to dilute the Tibetan population.
13. China now is a party to all of the leading nonproliferation agreements including the Nuclear Non-Proliferation Treaty (1992) and the Chemical Weapons Convention of 1993.
 14. China officially banned the export of products produced by prison labor in October 1991. U.S. officials have been permitted to visit 3 suspect prisons and have standing requests to visit 5 others. Additionally, the Chinese government has reported back to the U.S. on 16 alleged cases of prison labor. China has admitted to 4 violations and maintains that the facilities have either stopped exporting or have removed prisoners from production lines.
 15. If MFN status were withdrawn, China would probably retaliate by erecting high barriers to U.S. exports. America's economic competitors are likely to take advantage and replace U.S. exports.
 16. Loss of MFN status would mean that American consumers would have to pay higher prices for Chinese imports such as toys, clothing and footwear.
 17. The extension of MFN would serve to promote reform in China. Open markets permit access to new ideas and higher standards of living.
 18. The withdraw of MFN status would create new hostilities between the U.S. and China. The United States cannot afford to alienate a nation like China which has a permanent seat and veto power in the United Nations Security Council.

China has done much to promote the interests of the United States recently. It allowed all of the UN Persian Gulf resolutions to pass. It has been instrumental in arranging the Cambodian peace agreement. And, China has been instrumental in reducing tensions on the Korean Peninsula.

Update

Treasury Secretary Lloyd Bentsen and U.S. Congressional officials returned from visits to Beijing in mid-January (1994) with news of three major agreements which had been reached with the Chinese government. The agreements were timed to stem U.S. warnings of the fact that a renewal of MFN status was in jeopardy unless certain conditions were met.

A textile agreement provides for U.S. inspections of Chinese factories suspected of making illegal shipments and allows the U.S. to cut import quotas if repeated violations occur. The agreement was a three-year renewal of a U.S.-China pact that had expired on December 31, 1993.

Concerning jail exports, China and the U.S. reached an agreement to reopen Chinese prisons to American customs officers to insure that their factories are not making products for export into the United States. American law prohibits prison imports. An earlier agreement on this same subject had fallen apart after only two American inspections.

The final agreement will allow foreign banks to conduct business in the Chinese currency.

Lesson 4

Role Play:
Selecting a Site
for the
2004 Olympics.

CHOOSING AN OLYMPIC SITE

In this lesson, students will assume the roles of national Olympic promotional committees and try to convince the International Olympic Committee to select their nation as the site for the Olympics in the year 2004.

TITLE: Choosing the Olympic Site: Is China Deserving?

AUDIENCE: Junior and Senior High School Students

TIME TO COMPLETE: 2-3 Class Periods

RATIONALE/PURPOSE: On 23 September 1993, the International Olympic Committee took four rounds of voting before selecting Sydney, Australia as the site for the 2000 Olympics. Anyone who visited China in the months preceding the vote, was manifestly aware of the PRC's intense desire to be selected as the site.

Although the process is supposed to be devoid of political considerations, in reality, a host of political concerns complicated the lobbying which surrounded the decision. This lesson provides students with an opportunity to consider the practical, economic, cultural and political issues which went into the 2000 Olympic decision.

GOAL: The goal of this lesson is to provide students with a lively and thought provoking means by which they can compare and contrast the qualifications of 4 cities which are likely to compete for the 2004 Olympics. While improving their thinking and debating skills, it is hoped that students will learn more about the countries which they represent and the dynamics of international rivalry.

To quote an article which appeared in Sports Illustrated the week before the IOC's decision was announced, "Beijing appears to have the inside track to host the Summer Olympics in 2000." It is hoped that students will develop a deeper understanding of the PRC as they investigate the reasons why Beijing lost in its bid.

PROCEDURES:

1. Tell students that they are going to be assigned roles as members of national Olympic committees which have submitted bids to host the Summer Olympics in the year 2004. Their assignment is to prepare a proposal in which they highlight the reasons why their city should be selected as the host and the reasons why their competitors should not.

Further explain to them that they will be asked to make public presentations of their proposals to a mock International Olympic Committee which, after hearing all of the proposals, will select the host for the games.

2. Assign 4 groups of students to play the roles of

the Olympic Committees from China (Beijing), Germany (Berlin), Great Britain (Manchester), and Turkey (Istanbul). Sydney, Australia was the other major contender but since it has been awarded the Olympics in 2000, the decision may be made to exclude them from this role-play

3. Brainstorm with your students. Ask them to think of a list of city/country attributes which would attract an event as sizeable as the Olympics. Then, ask them to think of a list of attributes which might prove unfavorable to the IOC selection committee. This information will provide the students with a springboard from which they will begin their research.
4. Students who are placed in the 4 city groups must research information regarding the attributes of their city/country which will attract votes from the IOC. If time permits, they should also seek to uncover information which may prove unfavorable to the other candidate cities.
5. Assign the group the responsibility of playing the role of the International Olympic Committee (IOC). The "IOC" group has responsibility for researching how the IOC actually operates in its site selection function. At the conclusion of the 4 city presentations, they must vote on a site for the Olympics in the year 2004.

TIPS FROM THE TEACHER: Encourage students to liven up their presentations with posters, maps, music etc. You may also encourage them to write to the embassies or the country that they are representing asking for information on the cities and their Olympic bid.

OLYMPICS 2000: HOW THE I.O.C. VOTED

The chart below illustrates the number of votes which each city received from the International Olympic Committee in its September 1993 decision to grant the 2000 Olympics to the city of Sydney, Australia. The top five contenders were considered in the first round. The city receiving the least number of votes was eliminated in each round of voting. Notice that Beijing received more votes than any other city in the first round of voting.

How the Vote Went

Round-by-round voting:

First round: Beijing, 32. Sydney, 30. Manchester, 11. Berlin, 9. Istanbul, 7. (eliminated).

Second round: Beijing, 37. Sydney, 30. Manchester, 13. Berlin, 9. (eliminated).

Third round: Beijing, 40. Sydney, 37. Manchester, 11 (eliminated). (One voter did not cast a ballot.)

Fourth round: Sydney, 45. Beijing, 43. (One voter did not cast a ballot.)

SOURCE: Associated Press

Supplemental

Documents

DOCUMENTS CONTAINED IN THIS SECTION

- I. REQUEST FOR ASYLUM IN THE UNITED STATES (Application) page 51
- II. AMNESTY INTERNATIONAL'S "PERSECUTION OF CHRISTIANS IN CHINA:" Appeal for Zhang Lezhi, Yan Peizhi and Xu Zhihe page 57
- III. BEIJING NORMAL UNIVERSITY LECTURE NOTES: "BASIC POSITIONS AND PRACTICE OF CHINA ON HUMAN RIGHTS." page 60
- IV. PRESIDENT BUSH'S EXECUTIVE ORDER 12711: "Policy Implementation With Respect to Nationals of the People's Republic of China." page 61
- V. U.N. GENERAL ASSEMBLY RESOLUTION: Restoration of the Lawful Rights of the People's Republic of China in the United Nations." 25 April 1971 page 62
- VI. TRANSCRIPT OF PRESIDENT CARTER'S STATEMENT ON NORMALIZATION OF RELATIONS WITH CHINA. page 63
- VII. PRESIDENT BUSH'S "REPORT ON MFN STATUS FOR CHINA." May 29, 1991. page 64
- VIII. PRESIDENT CLINTON'S "REPORT TO CONGRESS CONCERNING EXTENSION OF WAIVER AUTHORITY FOR THE PEOPLE'S REPUBLIC OF CHINA" page 67

INSTRUCTIONS

READ ALL INSTRUCTIONS CAREFULLY BEFORE COMPLETING THIS FORM

1. General:

Use typewriter or print legibly in block letters with ballpoint pen.

DO NOT LEAVE ANY QUESTIONS UNANSWERED. Where appropriate insert "none" or "not applicable". If you need more space to fully answer any question, use a separate sheet of paper this size and identify each answer with the number of the corresponding question. One form may include an entire family (husband, wife, and children if they are also applying for asylum) except children over age 21 or married, who must file a separate form.

Each applicant age 14 or older must complete the Biographic Information Form G-325A and Fingerprint Chart FD-258.

2. SUBMISSION OF FORM:

Be sure to sign, mail or take this form to the Immigration and Naturalization Service having jurisdiction over your place of residence.

3. FINGERPRINTS:

Fingerprint cards with instructions for their completion are available at the office of the Immigration and Naturalization Service where you intend to file your application. You may have your fingerprints recorded on Form FD-258 at an office of the Immigration and Naturalization Service, other Law Enforcement Offices, Immigration and Naturalization Service Outreach Centers, Charitable and Voluntary Agencies. The card must be signed by you in the presence of the individual taking your prints, who must then sign his name and enter the date in the spaces provided. It is important to furnish all the information called for on the card.

4. PASSPORT INFORMATION:

You will be notified to appear for an interview with an Immigration Officer within 45 days after your form is received. You must bring your passport with you to this interview. If other members of your family are included in your form, they must also appear for the interview and bring their passports.

An immigration officer will interview you regarding asylum and make an evaluation of the propriety of the claim.

You may remain in the United States until a final decision is made on your case (or you are notified otherwise by this Service).

5. UNITED NATIONS:

You may, if you wish, forward a copy of your form and other supporting documents to the: Regional Representative of the United Nations, High Commissioner for Refugees, United Nations, 1718 Connecticut Ave., N.W., Suite 200, Washington, D.C. 20009

6. SUPPORTING DOCUMENTS:

Background materials, such as newspaper articles, affidavits of witnesses or experts, periodicals, journals, books, photographs, official documents, your own statements, etc., must include explanations from you of their relevance to your personal case and situation. Give full citation of your sources, dates, pages, etc.

The burden of proof is upon you to establish that you have a wellfounded fear of persecution on account of your race, religion, nationality, membership in a particular social group or political opinion, and for this reason you are unwilling or unable to return to your country of last residence. To persecute is defined as: "to pursue; to harass in a manner designed to injure, grieve or afflict; to oppress; specifically, to cause to suffer or put to death because of belief".

Answer all questions on this form as to "when", "where", "how", "who", and "why" relating to your claim of persecution.

Attach as many sheets and explanations as necessary to fully explain the basis of your claim.

7. TRANSLATION:

Any document in a foreign language must be accompanied by a translation in English. The translator must certify that he or she is competent to translate and that the translation is accurate.

340

BEST COPY AVAILABLE

(over)

8. WORK AUTHORIZATION:

You may request permission to work while your asylum form is pending. submit a written statement with this form explaining your reasons and include the original Form I-94, ARRIVAL AND DEPARTURE RECORD of each person seeking work.

Generally, work authorization, if granted, will be valid during the pendency of the form.

9. PENALTY:

Title 18, United States Code, section 1546, provides, "Whoever knowingly makes under oath any false statement with respect to a material fact in any application, affidavit, or other document required by the immigration laws or regulations prescribed thereunder, or knowingly presents any such application, affidavit or other document containing any such false statement, shall be fined not more than \$2,000 or imprisoned not more than 5 years or both."

10. REPORTING BURDEN:

Public reporting burden for this collection of information is estimated to average 1 hour per response, including the time for reviewing instructions, searching existing data sources, gathering and maintaining the data needed, and completing and reviewing the collection of information. Send comments regarding this burden estimate or any other aspect of this collection of information, including suggestions for reducing this burden to: U.S. Department of Justice, Immigration and Naturalization Service (Room 2011), Washington, DC 20536; and to the Office of Management and Budget, Paperwork Reduction Project: OMB No. 1115-0086, Washington, DC 20503.

REQUEST FOR ASYLUM IN THE UNITED STATES

INS Office
Date

1 Family Name		First	Middle Name		2 A number (if any or known)	
All other names used at any time (include maiden name if married)					3 Sex	4 Marital status
					<input type="checkbox"/> Male	<input type="checkbox"/> Single <input type="checkbox"/> Divorced
					<input type="checkbox"/> Female	<input type="checkbox"/> Married <input type="checkbox"/> Widowed
I was born		(Month)	(Day)	(Year)	in (Town or City)	(State or Province) (Country)
Nationality — at birth		At present		Other nationalities		
5 If stateless, how did you become stateless?						
6 Ethnic group		7 Religion		8 Languages spoken		
9 Address in United States (In care of, C/O, if appropriate)					10 Telephone number	
(Number and street)		(Apt. No.)	(City or town)	(State)	(Zip Code)	(include area code)
11 Address abroad prior to coming to the United States						
(Number and street)		(City)	(Province)	(Country)		
12 My last arrival in the U.S. occurred on (Mo./Day/Yr)				As a <input type="checkbox"/> Visitor <input type="checkbox"/> Student <input type="checkbox"/> Seaman <input type="checkbox"/> Crewman		
				<input type="checkbox"/> Other (Specify)		
At the port of (City/State)				Means of arrival (Name of vessel or airline and flight number, etc.)		
<input type="checkbox"/> I was <input type="checkbox"/> was not inspected				Date authorized stay expires (Mo./Day/Yr)		
13 My nonimmigrant visa number is _____, it was issued by the U.S. Consul on _____						
(If none, state "none") (Mo./Day/Yr)						
at _____						
(City, County)						
14 Name and location of schools attended		Type of school	From Mo./Yr	To Mo./Yr	Highest grade completed	Title of degree or certification
15 What specific skills do you have?					16 Social Security No (if any)	
17 Name of husband or wife (wife's maiden name)						
18 My husband or wife resides <input type="checkbox"/> with me <input type="checkbox"/> apart from me (if apart, explain why)						
Address (Apt. No.)		(No. and street)	(Town or city)	(Province or state)	(Country)	

RECEIVED	TRANS IN	RET'D TRANS OLT	COMPLETED

3423-

19. If in the U.S. is your spouse included in your request for asylum? Yes No (If not, explain why)

20. If in the U.S. is spouse making separate application for asylum? Yes No (If not, explain why)

21. If in the U.S. are children included in your request for asylum? Yes No (If not, explain why)

22. I have _____ sons or daughters as follows: (Complete all columns as to each son or daughter. If living with you state "with me" in last column; otherwise give city and state or foreign country of son's or daughter's residence.)

Name	Sex	Place of birth	Date of birth	Now living at

23. Relatives in U.S. other than immediate family		Relationship	Immigration status
Name	Address		

24. Other relatives who are refugees but outside the U.S.		Relationship	Country where presently located
Name			

25. List all travel or identity documents such as national passport, refugee convention travel document or national identity card

Document type	Document number	Issuing country or authority	Date of issue	Date of expiration	Cost	Obtained by whom

26. Why did you obtain a U.S. visa?

27. If you did not apply for a U.S. visa, explain why not?

28. Date of departure from your country of nationality (Mo/Day/Yr)	29. Was exit permission required to leave your country? <input type="checkbox"/> Yes <input type="checkbox"/> No (If so, did you obtain exit permission <input type="checkbox"/> Yes <input type="checkbox"/> No (If not, explain why)
--	--



30. Are you entitled to return to country of issuance of your passport . Yes No Travel document Yes No Or other document Yes No (If not, explain why)

31. What do you think would happen to you if you returned? (Explain)

32. When you left your home country, to what country did you intend to go?

33. Would you return to your home country? Yes No (Explain)

34. Have you or any member of your immediate family ever belonged to any organization in your home country? Yes No. (If yes, provide the following information relating to each organization: Name of organization, date of membership or affiliation, purpose of the organization, what, if any, were your official duties or responsibilities, and are you still an active member. (If not, explain)

35. Have you taken any action that you believe will result in persecution in your home country? Yes No (If yes, explain)

36. Have you ever been detained interrogated convicted and sentenced imprisoned in any country? Yes No (If yes, specify for each instance: what occurred and the circumstances, date, location, duration of the detention or imprisonment, reason for the detention or conviction, what formal charges were placed against you, reasons for the release, names and addresses of persons who could verify these statements. Attach documents referring to these incidents, if any).

37. If you base your claim for asylum on current conditions in your country, do these conditions affect your freedom more than the rest of that country's population? Yes No (If yes, explain)

38. Have you, or any member of your immediate family, ever been mistreated by the authorities of your home country/country of nationality Yes No. If yes, was it mistreatment because of Race Religion Nationality Political opinion or Membership of a particular social group? Specify for each instance: what occurred and the circumstances, date, exact location, who took such action against you and what was his/her position in the government, reason why the incident occurred, names and addresses of people who witnessed these actions and who could verify these statements. Attach documents referring to these incidents.

39. After leaving your home country, have you traveled through (other than in transit) or resided in any other country before entering the U.S.? Yes No (If yes, identify each country, length of stay, purpose of stay, address, and reason for leaving, and whether you are entitled to return to that country for residence purposes.

40. Why did you continue traveling to the U.S.?

41. Did you apply for asylum in any other country? Yes -- Give details No -- Explain why not

BEST COPY AVAILABLE

42 Have you been recognized as a refugee by another country or by the United Nations High Commissioner for Refugees? Yes No (If yes, where and when)

43 Are you registered with a consulate or any other authority of your home country abroad? Yes—Give details No—Explain why not

44 Is there any additional information not covered by the above questions? (If yes, explain)

45 Under penalties of perjury, I declare that the above and all accompanying documents are true and correct to the best of my knowledge and belief

(Signature of Applicant)

(Date)

(Interviewing Officer)

ACTION BY ADJUDICATING OFFICER

(Adjudicating Officer)

Advisory opinion requested

(Date)

(Date)

(Date of Interview)

GRANTED DENIED

amnesty international

Persecution of Christians in China

Appeal for Zhang Lezhi, Yan Peizhi and Xu Zhihe

JUNE 1993

AI INDEX: ASA 17/23/93

DISTR: SC/CO/GR

According to information recently received by Amnesty International, eight Christians arrested last September in Shandong province, east China, were ill-treated in detention and three of them sentenced to terms of three years' imprisonment for their involvement in peaceful religious activities. One of them, Zhang Lezhi, was reportedly chained in a painful position continuously for three months, with his hands and feet tied together.

The eight Christians, most of them farmers, were members of a local group of the New Testament Church, a Protestant congregation which has been banned by authorities in various areas in China. They were arrested on 8 and 9 September 1992 in several villages of Shouguang county, located some 200 kilometres east of Jinan, the provincial capital of Shandong.



Seven of those detained have been identified. They were: Zhang Lezhi, a 32 year-old tradesman; Yan Peizhi, a 35 year-old farmer, and his wife, Zheng Yulian, aged 23; Xu Zhihe, a 50 year-old farmer, and his wife, Guo Ruiping; Zhu Zizheng, aged 30, and Hu Jinting, aged 38, both of them farmers.

According to a detailed report received by Amnesty International, Zhang Lezhi was arrested in the evening of 8 September in Nine Lanes village, Shouguang county, after a plainclothes policeman led him away from his market stall under the pretext of discussing a business matter. He was bundled into a jeep in which other police officers were waiting, handcuffed and taken to a local police station. The following day, the other Christians were arrested in various places and taken to the police station at Beiluo, Shouguang county. On 10 September, Zhang Lezhi and the seven other detainees were transferred to the Shouguang City Detention Centre.

They were accused of engaging in "illegal" religious activities and of "restoring and expanding" the New Testament Church. Three of them had previously been detained or imprisoned for preaching: Zhang Lezhi for two years and Yan Peizhi and Xu Zhihe each for two months. Their homes were searched by police and private belongings confiscated, including Bibles, religious publications, personal letters and cassette tapes and recorders.

The eight Christians were reportedly beaten in detention and ill-treated in other ways. According to the report, shortly after his arrest, Zhang Lezhi protested that he was innocent and was assaulted by two police officers with an electric baton. After he was beaten, his legs were manacled with fetters weighing nine kilograms. His hands were also handcuffed and the handcuffs and fetters were tied together with a short chain so that Zhang Lezhi had to bend at a 180 degree angle. The beatings reportedly continued while he was thus chained and an additional fetter was later added to his legs, bringing the total weight to 13 kilograms. According to the report, he was chained in this painful position day and night for three months without the chains ever being removed, even for sleeping or eating. When the weather became cold, he reportedly requested permission to have the chains removed so as to put on additional clothes, but this was also denied.

Another of the detainees, Zhu Zizheng, was reportedly forced to sit for a whole day on a so-called "security chair" (*anquan yi*) which had spikes on the sides. This chair is reportedly used at the detention centre for punishing inmates and any movement on the chair causes severe pain. Zhu Zizheng was reportedly beaten while he was sitting on the chair and had food forced into his mouth.

Five of the detainees were held without charge for periods varying from one to three months and then released. The three others, Zhang Lezhi, Yan Peizhi and Xu Zhihe, were tried in December 1992 by Shouguang county court and sentenced each to three years of "reform through labour". The exact charges against them are not known.

They were sent to carry out their sentences at the Chang Le "Re-education Through Labour" camp, in Chang Le county, some 40 kilometres south of Shouguang. There, they have reportedly been abused by common criminal prisoners and assigned to carry out the dirtiest and most exhausting jobs.

Amnesty International has no further details about the trial of the three Christians, but it is concerned that they are reported to be jailed for their involvement in peaceful religious activities. It is also concerned about the allegations that they and the other Christians detained were subjected to torture and ill-treatment in police custody. Amnesty International is calling on the Chinese authorities to launch a public and impartial investigation into the allegations and to take all appropriate measures to ensure the victims' safety.

Many other incidents of harassment, arrest and ill-treatment of Christians have been reported in various provinces during the past year. For further information about such incidents, see Amnesty International's reports, *China: Update on Torture* (ASA 17/12/93, March 1993), *China: Gross Violations of Human Rights Continue* (Weekly

Update of 27 May 1993. ASA 17/WU 05/93). and Urgent Action 149/93 PRC: *Lai Manping and other Christians* (ASA 17/18/93. 10 May 1993).

Please send telexes/express or airmail letters either in English or in your own language:

- ◆ Expressing concern that Zhang Lezhi, Yan Peizhi and Xu Zhihe, three Christians from Shouguang county in Shandong province, are reported to have been sentenced in December 1992 to three years' imprisonment for their involvement in peaceful religious activities. Urge that they be released unconditionally if they have not been charged with recognizably criminal offences in accordance with international human rights standards;
- ◆ Expressing concern that the three men and five other Christians are reported to have been severely ill-treated in police custody after their arrest in Shouguang county in September 1992. Urge the authorities to launch without delay an impartial investigation into the allegations, the result of which should be made public, and to take all appropriate measures to ensure the safety of the alleged victims against any reprisals or ill-treatment in detention.

Please send appeals to:

Minister of Justice of the People's Republic of China

XIAO Yang Buzhang Telexes: 210070 FMPC CN or 22478 MFERT CN
Sifabu (Please forward to Xiao Yang Buzhang)
Xiaguangli Faxes: - 861 467 7351
Beijingshi 100016 Telegram: Justice Minister Xiao Yang, Beijing, China
People's Republic of China Salutation: Your Excellency

Procurator-General of the Supreme People's Procuratorate of the PRC

ZHANG Siqing Jianchazhang Telexes: 210070 FMPC CN or 22478 MFERT CN
Zuigao Renmin Jianchayuan (Please forward to Zhang Siqing Jianchazhang)
147 Beiheyuan Dajie Faxes: - 861 512 6655 ext.1053
Donganmen Telegram: Procurator-General Zhang Siqing, Beijing, China
Dongchengqu Salutation: Dear Procurator-General
Beijingshi 100726
People's Republic of China

Governor of the Shandong Provincial People's Government

ZHAO Zhihao Shengzhang
Shandongsheng Renmin Zhengfu
193 Jinger Lu Telegram: Governor Zhao Zhihao, Jinan,
Jinanshi Shandong province, China
Shandongsheng
People's Republic of China

KEYWORDS: RELIGIOUS GROUPS · PROTESTANTS · TORTURE · ILL-TREATMENT
RESTRAINTS · DETENTION WITHOUT TRIAL · DETENTION FOR RE-EDUCATION
FARMERS · TRADERS · WOMEN · POLICE · RELIGIOUS INTOLERANCE · RELEASE

INTERNATIONAL SECRETARIAT · 1 EASTON STREET, LONDON WC1X 8DJ, UNITED KINGDOM

The information presented below is a duplicate copy of the handout given to the 1993 Fulbright-Hays Summer Seminar participants at our lecture on China's Human Rights policy. The handout was intended as an outline for the lecture. The lecture was given by the Vice-President of Beijing Normal University at BNU in July of 1993.

BASIC POSITIONS AND PRACTICE OF CHINA ON HUMAN RIGHTS ISSUES

The development of human rights status is restricted by the history, society, economy and culture in different countries and is a process of historical development. The Chinese people, based on their own history, national conditions and long-term practice, have formed their own viewpoints and policies towards human rights issues.

1. The right to subsistence is the foremost human right the Chinese people long fight for [sic].
2. The Chinese people have gained extensive political rights. National People's Congress is the fundamental political system of China. The Chinese Communist Party is the ruling party of socialist China. China has been attaching great importance to the construction of democracy.
3. The Chinese people enjoy economic, cultural, and social rights. China has eradicated the system of exploitation. Cultural, educational enterprises and health care has been developing very fast. Women's rights have been guaranteed.
4. China attaches importance to the guarantee of human rights in judicial work. Citizens are equal before the law. China has a very low crime rate. Humanitarian and scientific administration are carried out in Chinese prisons and reformatories.
5. China is a united country with many nationalities. All nationalities enjoy equal rights.

China is an ancient and young country. A long time work of the government of China is to continuously enhance the development of human rights and try to meet the targets required by socialism.

EXECUTIVE ORDERS

No. 12711

Executive Order 12711 of April 11, 1990

Policy Implementation With Respect to Nationals of the People's Republic of China

15 F.R. 13897

By the authority vested in me as President by the Constitution and laws of the United States of America, the Attorney General and the Secretary of State are hereby ordered to exercise their authority, including that under the Immigration and Nationality Act (8 U.S.C. 1101-1857), as follows:

Section 1. The Attorney General is directed to take any steps necessary to defer until January 1, 1994, the enforced departure of all nationals of the People's Republic of China (PRC) and their dependents who were in the United States on or after June 8, 1989, up to and including the date of this order hereinafter "such PRC nationals").

Sec. 2. The Secretary of State and the Attorney General are directed to take all steps necessary with respect to such PRC nationals (a) to waive through January 1, 1994, the requirement of a valid passport and (b) to process and provide necessary documents, both within the United States and at U.S. consulates overseas, to facilitate travel across the borders of other nations and reentry into the United States in the same status such PRC nationals had upon departure.

Sec. 3. The Secretary of State and the Attorney General are directed to provide the following protections:

(a) irrevocable waiver of the 2-year home country residence requirement that may be exercised until January 1, 1994, for such PRC nationals;

(b) maintenance of lawful status for purposes of adjustment of status or change of nonimmigrant status for such PRC nationals who were in lawful status at any time on or after June 8, 1989, up to and including the date of this order;

(c) authorization for employment of such PRC nationals through January 1, 1994; and

(d) notice of expiration of nonimmigrant status (if applicable) rather than the institution of deportation proceedings, and explanation of options available for such PRC nationals eligible for deferral of enforced departure whose nonimmigrant status has expired.

Sec. 4. The Secretary of State and the Attorney General are directed to provide for enhanced consideration under the immigration laws for individuals from any country who express a fear of persecution upon return to their country related to that country's policy of forced abortion or coerced sterilization, as implemented by the Attorney General's regulation effective January 28, 1990.

Sec. 5. The Attorney General is directed to ensure that the Immigration and Naturalization Service finalizes and makes public its position on the issue of training for individuals in F-1 visa status and on the issue of reinstatement into lawful nonimmigrant status of such PRC nationals who have withdrawn their applications for asylum.

Sec. 6. The Departments of Justice and State are directed to consider other steps to assist such PRC nationals in their efforts to utilize the protections that I have extended pursuant to this order.

Sec. 7. This order shall be effective immediately.

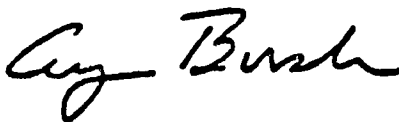

THE WHITE HOUSE,

April 11, 1990.

-61- 350

BEST COPY AVAILABLE

**2758 (XXVI). Restoration of the lawful rights of
the People's Republic of China in the United
Nations**

The General Assembly,

*Recalling the principles of the Charter of the United
Nations,*

*Considering that the restoration of the lawful rights
of the People's Republic of China is essential both for
the protection of the Charter of the United Nations
and for the cause that the United Nations must serve
under the Charter,*

*Recognizing that the representatives of the Govern-
ment of the People's Republic of China are the only
lawful representatives of China to the United Nations
and that the People's Republic of China is one of the
five permanent members of the Security Council,*

*Decides to restore all its rights to the People's Re-
public of China and to recognize the representatives
of its Government as the only legitimate representa-
tives of China to the United Nations, and to expel
forthwith the representatives of Chiang Kai-shek from
the place which they unlawfully occupy at the United
Nations and in all the organizations related to it.*

*1976th plenary meeting,
25 October 1971.*

PRESIDENT CARTER'S STATEMENT ON NORMALIZATION OF RELATIONS WITH CHINA

Following is the transcript of President Carter's statement in Washington on normalizing relations with China, as recorded by *The New York Times* through the facilities of ABC News:

Good evening. I would like to read a joint communiqué which is being simultaneously issued in Peking at this very moment by the leaders of the People's Republic of China:

"A Joint Communiqué on the Establishment of Diplomatic Relations Between the United States of America and the People's Republic of China, Jan. 1, 1979.

"The United States of America and the People's Republic of China have agreed to recognize each other and to establish diplomatic relations as of Jan. 1, 1979.

"The United States recognizes the Government of the People's Republic of China as the sole legal Government of China. Within this context the people of the United States will maintain cultural, commercial and other unofficial relations with the people of Taiwan.

"The United States of America and the People's Republic of China reaffirm the principles agreed on by the two sides in the Shanghai Communiqué of 1972 and emphasize once again that both sides wish to reduce the danger of international military conflict. Neither should seek hegemony — that is the dominance of one nation over others — in the Asia-Pacific region or in any other region of the world and each is opposed to efforts by any other country or group of countries to establish such hegemony.

"Neither is prepared to negotiate on behalf of any other third party or to enter into agreements or understandings with the other directed at other states.

"The Government of the United States of America acknowledges the Chinese position that there is but one China and Taiwan is part of China.

"Both believe that normalization of Sino-American relations is not only in the interest of the Chinese and American people but also contributes to the cause of peace in Asia and in the world.

"The United States of America and the People's Republic of China will exchange ambassadors and establish embassies on March 1, 1979."

Yesterday, our country and the People's Republic of China reached this final historic agreement. On Jan. 1, 1979, a little more than two weeks from now, our two Governments will implement full normalization of diplomatic relations.

As a nation of gifted people who comprise about one-fourth of the total population of the Earth, China plays, already, an important role in world affairs — a role that can only grow more important in the years ahead.

We do not undertake this important step for transient tactical or expedient reasons. In recognizing the People's Republic of China — that it is a single Government of China, we're recognizing simple reality. But far more is involved in this decision than just the recognition of a fact.

"Long History of Friendship"

Before the estrangement of recent decades, the American and the Chinese people had a long history of friendship. We've already begun to rebuild some of the previous ties.

Now our rapidly expanding relationship requires a kind of structure that only full diplomatic relations will make possible.

The change that I'm announcing tonight will be of great long-term benefit to the peoples of both our country and China and I believe for all the peoples of the world.

Normalization and expanded commercial and cultural relations that it will bring will contribute to the well-being of our nation to our own national interest. And it will also enhance the stability of Asia.

These more positive relations with China can beneficially affect the world in which we live and the world in which our children will live.

Special Message to Taiwan

We have already begun to inform our allies and other nations and the members of the Congress of the details of our intended action, but I wish also tonight to convey a special message to the people of Taiwan.

I have already communicated with the leaders in Taiwan, with whom the American people have had, and will have, extensive, close and friendly relations. This is important between our two peoples. As the United States

asserted in the Shanghai Communiqué of 1972, issued on President Nixon's historic visit, we will continue to have an interest in the peaceful resolution of the Taiwan issue.

I have paid special attention to insuring that normalization of relations between our country and the People's Republic will not jeopardize the well-being of the people of Taiwan.

Broad Ties With Taiwan Pledged

The people of our country will maintain our current commercial, cultural, trade and other relations with Taiwan through nongovernmental means. Many other countries of the world are already successfully doing this.

These decisions and these actions open a new and important chapter in our country's history and also in world affairs. To strengthen and to expedite the benefits of this new relationship between China and the United States, I am pleased to announce that Vice Premier Teng has accepted my invitation and will visit Washington at the end of January. His visit will give our Governments the opportunity to consult with each other on global issues and to begin working together to enhance the cause of world peace.

Negotiations Begun by Nixon

These events are the final result of long and serious negotiations begun by President Nixon in 1972 and continued under the leadership of President Ford. The results bear witness to the steady, determined, bipartisan effort of our own country to build a world in which peace will be the goal and the responsibility of all nations.

The normalization of relations between the United States and China has no other purpose than the advancement of peace. It is in this spirit, at this season of peace, that I take special pride in sharing this good news with you tonight.

Thank you very much.

enhance their ability to realize their essential national security objectives.

4. The resulting sense of equal security amongst the members of the Alliance, regardless of differences in their circumstances or in their national military capabilities relative to each other, contributes to overall stability within Europe and thus to the creation of conditions conducive to increased cooperation both among Alliance members and with others. It is on this basis that members of the Alliance, together with other nations, are able to pursue the development of cooperative structures of security for a Europe whole and free.

The Fundamental Tasks of the Alliance

5. The means by which the Alliance pursues its security policy to preserve the peace will continue to include the maintenance of a military capability sufficient to prevent war and to provide for effective defence; an overall capability to manage successfully crises affecting the security of its members; and the pursuit of political efforts favouring dialogue with other nations and the active search for a cooperative approach to European security, including in the field of arms control and disarmament.

6. To achieve its essential purpose, the Alliance performs the following fundamental security tasks:

I. To provide one of the indispensable foundations for a stable security environment in Europe, based on the growth of democratic institutions and commitment to the peaceful resolution of disputes, in which no country would be able to intimidate or coerce any European nation or impose hegemony through the threat or use of force.

II. To serve, as provided for in Article IV of the North Atlantic Treaty, as a transatlantic forum for Allied consultations on any issues that affect their vital interests, including possible developments posing risks for members' security, and for appropriate coordination of their efforts in fields of common concern.

III. To deter and defend against any threat of aggression against the territory of any NATO member state.

President's Report on MFN Status for China

Following is the text of the President's Report to Congress Concerning Extension of Waiver Authority for the People's Republic of China, released by the White House, May 29, 1991.

Pursuant to Subsection 402 (d) (1) of the Trade Act of 1974 (hereinafter "the Act"), having determined that further extension of the waiver authority granted by Subsection 402 (c) of the Act for twelve months will substantially promote the objectives of Section 402, I have today determined that continuation of the waiver currently applicable to China will also substantially promote the objectives of Section 402 of the Act. My determination [No. 91-36] is attached and is incorporated herein.

Freedom of Emigration Determination

China's relatively free emigration policies have continued during the past twelve months. In FY 1990, 16,751 US immigrant visas were issued in China. The US numerical limitation for immigrants from China was fully met. The principal restraint on increased emigration continues to be the capacity and willingness of other nations to absorb Chinese immigrants, not Chinese policy. After considering all the relevant information, I have

concluded that continuing the MFN waiver will preserve the gains already achieved on freedom of emigration and encourage further progress.

Chinese Foreign Travel Policies

China continues to adhere to a relatively open foreign travel policy. According to Chinese officials, issuance of passports for private travel has increased more than threefold since 1986. US diplomatic posts in China issued 60,687 non-immigrant visas in FY 1990. In FY 1990, 33,800 visas were issued worldwide to student and tourists from China, a 19 percent increase over FY 1989 and an 84 percent increase over FY 1988.

Chinese officials report that several thousand students have returned from overseas for visits after June 1989 and have been allowed to depart again under expedited procedures. We cannot verify these figures, but we are not aware of any cases in which Chinese living in the US who returned to China for visits after June 1989 were prevented from leaving again.

Foreign travel officially sponsored by the Chinese Government, mainly involving businessmen and state-sponsored scholars, continued to decline in FY 1990, this reflects the effects of economic austerity measures and, in the case of scholars, concern

IV. To preserve the strategic balance within Europe.

7. Other European institutions such as the EC, WEU and CSCE also have roles to play, in accordance with their respective responsibilities and purposes, in these fields. The creation of a European identity in security and defence will underline the preparedness of the Europeans to take a greater share of responsibility for their security and will help to reinforce transatlantic solidarity. However the extent of its membership and of its capabilities gives NATO a particular

position in that it can perform all four core security functions. NATO is the essential forum for consultation among the Allies and the forum for agreement on policies bearing on the security and defence commitments of its members under the Washington Treaty.

In defining the core functions of the Alliance in the terms set out above, member states confirm that the scope of the Alliance as well as their rights and obligations as provided for in the Washington Treaty remain unchanged. ■

about extended delays in their return to China. In February 1990, China issued a new directive requiring recent college graduates and fourth-year undergraduates to work for five years before applying for overseas study, with some exceptions. The directive most likely has forced some students to defer their plans for overseas study, but its full impact is unclear since student visa applications and issuances continue to increase. We are aware of a small number of individuals who have had difficulty in obtaining permission to travel abroad, apparently because of the political activities of their relatives in the US. We have discussed these cases with Chinese authorities, who have indicated a willingness to address the issue.

Overall Human Rights Climate

In addition to the emigration considerations of Section 402, we are continuing to monitor closely the overall human rights climate in China and press our concerns vigorously at all levels of the Chinese Government. Beijing has taken a number of steps on human rights issues that we have urged since June 1989. No part of China is now subject to martial law. The vast majority of those detained in the wake of the 1989 demonstrations have been released. Over 1,000 prisoners were released since the beginning of 1990. Prominent dissident Fang Lizhi and his family were permitted to leave China in June 1990, and most relatives of Chinese citizens in the US who sought to join them have been allowed to do so. Chinese diplomats have ceased threatening Chinese students residing in the US. Authorities in Tibet have avoided violence in quelling demonstrations since March 1989. Foreign officials and journalists are again able to visit the region, and even to tour the main prison in Lhasa.

Beijing hosted an unprecedented visit by Assistant Secretary [of State for Human Rights and Humanitarian Affairs Richard] Schifter in December 1990. The Chinese have agreed to receive additional human rights delegations from the Congress, Australia and France later this year. The

Schifter visit inaugurated a more formal human rights dialogue than we have ever had with China. In recent weeks, Chinese officials have begun to respond to some of our key questions on the status of cases against the detainees, the judicial process, religious repression and family planning. They have also provided assurances that China's prohibition on prison exports would be enforced, and that no special restrictions would be placed on people wishing to join dissident relatives abroad.

I nonetheless still have serious concerns about the human rights situation in China. According to official Chinese figures, 813 persons have been convicted by courts in Beijing on charges stemming from the 1989 protests, including 26 so far this year. Most were charged with crimes against persons or property but nearly 100 of these were tried for "counterrevolutionary crimes" (e.g., instigation or organizing rebellious activities) that apparently involved nothing other than nonviolent political actions. At least scores if not more have been convicted elsewhere in China. Since 1989, others, probably including peaceful demonstrators, have been sent to labor reeducation camps for up to three years after administrative hearings. Freedom of expression, religion, the press, and association remain tightly constrained. The Chinese continue to jam the Mandarin language service of Voice of America.

In Tibet, participants in ongoing pro-independence activities continue to be subject to legal prosecution. Several hundred persons are currently incarcerated for what appear to be only nonviolent political activities.

Impact of MFN on Other US Interests

The granting of MFN tariff status to China was a key element in the normalization of our diplomatic relations and provided a framework for a major expansion of our economic and commercial relations. Maintaining non-discriminatory tariff status is fundamental for strong bilateral trade

relations with China. In 1990, bilateral trade totaled \$20 billion, with Chinese exports of \$15.2 billion and US exports of \$4.8 billion. The United States is China's largest export market, absorbing 25 percent of China's total exports.

If MFN were withdrawn, China would reciprocate by applying its own higher non-MFN tariffs to US products and possibly erect other trade barriers as well. With US companies placed at a disadvantage, competitors from Japan and Europe would quickly move to replace US exports in our largest markets in China—grain, aircraft and aerospace equipment, industrial machinery, steel products, chemicals, fertilizers and computers. US joint ventures in China would pay higher duties on imported components from the US, and their exports to the US would be subject to non-MFN tariffs, jeopardizing their continued operations. Loss of MFN would lead to higher prices for US consumers of products made in China, including toys, apparel and footwear.

Maintaining MFN is essential for promoting reform in China. The opening of China and expansion of bilateral commercial relations made possible by MFN have contributed significantly to improving living standards, introducing progressive ideas and further integrating China into the world community as it continues its drive to modernize. Withdrawing MFN would most hurt the dynamic coastal provinces in China which have gone the farthest in introducing market-oriented economic reforms. It would further isolate those in China who look to the US for support in their effort to liberalize Chinese society.

Withdrawing MFN would have a major impact on Hong Kong's free enterprise economy, which depends heavily on US-China trade and the health of export industries in South China. The economic disruption which followed MFN withdrawal would further undermine confidence in Hong Kong's future.

While US-China relations still cannot return to normal under current circumstances, withdrawing China's

CSCE—One of the Building Blocks of a New Europe

Vice President Quayle

Remarks at the CSCE Symposium on Cultural Heritage,
Krakow, Poland, June 6, 1991

Mr. Chairman, representatives of the Conference on Security and Cooperation in Europe, officials and citizens of Krakow: This is the Quayle family's first visit to Poland, and we are pleased that it is a visit to a free Poland. We look forward to revisiting free Poland many times in the future.

I am especially honored to visit Krakow, one of the great intellectual centers of Europe. Its former Archbishop is now the Bishop of Rome and the Church Universal. It is not by chance that Poland achieved independence when John Paul II resided in the Holy See.

Poland's freedom and the growth of liberty throughout Central and Eastern Europe are due in no small part to the CSCE. For a generation, CSCE has been a beacon of hope to a troubled and divided continent; it has served as an ongoing vigil, held by those who enjoyed the blessings of freedom, on behalf of those who did not.

Now, with the Cold War behind us, CSCE offers new avenues of cooperation. The United States will continue

to play an active role in CSCE. We fully support the CSCE process and its institutions. CSCE is one of the building blocks of a new Europe. A Europe, as President Bush has described it, whole and free.

Poland's freedom and the growth of liberty throughout Central and Eastern Europe are due in no small part to the CSCE.

My friends, as you know, there are dates that resonate down through the centuries of European history. These dates mark revolutions that have permanently transformed the lives of generations of Europeans. After the revolution of 1789, Europe—and, indeed, the world—were never the same again. Similarly, the forces let loose in 1848 eventually reshaped the continent of Europe.

Today's gathering provides an opportunity to reflect on yet another

major turning point in the history of Europe—the revolutions of 1989-90.

The events of the last 2 years, like those of 1848 and 1789, will shape the course of history. Communism, thank God, is disappearing into the dust bin of history. Central and Eastern Europe's nightmare of totalitarianism is over. Democracy's triumph is at hand.

However, we cannot merely celebrate the revolutions of 1989—and the great courage and strength of the peoples of Europe who made those events possible, we need to defend and build on yesterday's victories.

I am here to tell you that the government and people of the United States of America are committed to helping the people of Central and Eastern Europe achieve their goals. We see your democratic revolutions as affirming the principles underlying our own national identity. As a nation of immigrants—so many from this very region—the United States has always felt that our freedom is enhanced by the advance of freedom elsewhere. For the peoples of Central and Eastern Europe especially. Your long wait was our long wait. Your freedom is our success. And your success is our success.

As President Bush said in Prague last November, "We will not fail you in this decisive moment." We want to help build on the successes that the new democracies have already achieved—to help overcome the legacy of the dictators and to encourage their integration into the commonwealth of freedom.

Make no mistake about it. There have already been monumental successes. But despite these successes, the region faces major challenges. The old system was not kind to the peoples of Central and Eastern Europe. It scarred their land and fouled their water and air. Despite your energy and genius, it retarded the development of modern industry.

The remains of the old system are still a burden. But your resolve is strong; your course is set. You have been called upon to create the future, to provide the models for other societies in transition to democracy. You are blessed with an abundance of skilled workers and talented entrepreneurs. This region's human potential—long

Continued from previous page

MFN status would harm vital US interests. On a variety of global and regional issues, China has an important and sometimes crucial influence. As a permanent member of the UN Security Council, China voted for twelve resolutions on the Persian Gulf and abstained on two others, enabling all to pass. China's cooperation is also important for other US foreign policy objectives, such as seeking peace in Cambodia, reducing tensions on the Korean peninsula, and restricting

transfers of nuclear, CBW [chemical and biological weapons] and missile equipment and technology.

In summary, maintaining non-discriminatory trade status gives China an incentive to stay engaged on issues of vital concern to the US, including human rights, non-proliferation, global and regional affairs and trade. I hope to work with the Congress to achieve these shared objectives. ■

REPORT TO CONGRESS CONCERNING EXTENSION OF WAIVER
AUTHORITY FOR THE PEOPLE'S REPUBLIC OF CHINA

Pursuant to section 402(d)(1) of the Trade Act of 1974 (hereinafter "the Act"), having determined that further extension of the waiver authority granted by section 402(c) of the Act for the twelve-month period beginning July 3, 1993 will substantially promote the objectives of section 402, I have today determined that continuation of the waiver currently applicable to China will also substantially promote the objectives of section 402 of the Act. My determination is attached and is incorporated herein.

Freedom of Emigration Determination

In FY 1992, 26,711 U.S. immigrant visas were issued in China. The U.S. numerical limitation for immigrants from China was fully met. The principal restraint on increased emigration continues to be the capacity and willingness of other nations to absorb Chinese immigrants, not Chinese policy. After considering all the relevant information, I have concluded that continuing the MFN waiver will preserve the gains already achieved on freedom of emigration and encourage further progress. There, thus, continues to be progress in freedom of emigration from China; we will continue to urge more progress.

Chinese Foreign Travel Policies

In FY 1992, 75,758 U.S. visas were issued worldwide to tourists and business visitors from China, a 35 percent increase over FY 1991 and a 76 percent increase over FY 1988. Foreign travel by Chinese-government sponsored businessmen alone increased by 48 percent in FY 1992, reflecting Deng Xiaoping's policies of accelerating China's opening to the outside world.

In FY 1992, 18,908 student visas (including exchange students) were issued, a decline from FY 1991 of 14 percent but still 8 percent greater than FY 1988. The decline was probably the result in part of a recent new directive requiring Chinese college graduates educated at state expense to work for five years before applying for privately-funded overseas study. A drop in funding from recession-strapped U.S. schools and relatives may also have played a role.

Chinese students continue to return from overseas for visits without any apparent problem. With the exception of student activist Shen Tong, we are not aware of any case in which Chinese living in the U.S. who returned to China for visits after June 1989 were prevented from leaving again. Shen was detained in September 1992 and then expelled from China two months later for trying to establish a Beijing chapter of his Fund for Chinese Democracy.

Human Rights Issues

As detailed in the Department's annual human rights report, China's human rights practices remain repressive and fall far short of internationally-accepted norms. Freedoms of speech, assembly, association, and religion are sharply restricted.

China understands that the Clinton Administration has made human rights a cornerstone of our foreign policy. We have already repeatedly raised our concerns with the Chinese authorities and we intend to press at every opportunity for observance of internationally accepted standards of human rights practice.

We have made numerous requests for information on specific human rights cases. China has provided information on some of these cases but further and more complete responses are necessary. The Chinese recently released, prior to completion of their sentences, several prominent dissidents whom we had identified on lists provided to them. These included not only Tiananmen-era demonstrators but also Democracy Wall (circa 1979) activists. We hope this is the first step toward a broad and general amnesty for all prisoners of conscience.

The Chinese promised then Secretary Baker in 1991 that all Chinese citizens, regardless of their political views, have the right to travel abroad. The only exceptions are citizens who are imprisoned, have criminal proceedings pending against them, or have received court notices concerning civil cases. A number of prominent dissidents, despite long delays, have been able to leave China. Some others have not. Those who have been able to obtain exit permits in the past year include labor leader Han Dongfang, writers Wang Ruowang and Bai Hua, scientist Wen Yuankai, journalists Wang Ruoshui, Zhang Weiguo, and Zhu Xingqing, and scholar Liu Qing. Others, like Hou Xiaotian, Yu Haicheng, and Li Honglin, continue to face difficulties in obtaining exit permission, although the Chinese have informed us Hou Xiaotian will soon receive an exit visa. We continue to press the Chinese on these and other cases.

Our goal is the release of all those held solely for the peaceful expression of their political and religious views. In November 1991, the Chinese confirmed to Secretary Baker the release of 133 prisoners on a list presented them earlier in June of that year. Since then, the Chinese have released additional political prisoners, including Xu Wanli, Han Dongfang, Wang Youcai, Luo Haixing, Xiong Yan, Yang Wei, Wang Zhixin, Zhang Weiguo, Wang Dan, Wang Xizhe, Gao Shan, Bao Zunxin, and a number of Catholic clergy and lesser known activists. We continue to press for a general amnesty and for permission for international humanitarian organizations to have access to Chinese prisons. We have also pressed for improvement in the conditions of those in Chinese

3

China has publicly acknowledged that domestic human rights policies are a legitimate topic of international discussion. China has hosted human rights delegations from France, Australia, the U.K., and Germany. China sent several delegations to the U.S. and Europe, as well as Southeast Asia, to study foreign human rights practices and issued a "white paper" maintaining that basic human rights are observed in China and arguing that a country's human rights record should be viewed in light of its own history and culture. We reject this limited definition of human rights but believe it is a significant step forward that China is willing to debate human rights issues with its international critics.

The U.S. continually raises with the Chinese government the need for protection of Tibet's distinctive religion and culture. We are concerned about China's heavy-handed suppression of political demonstrations in the Tibetan Autonomous Region. Demonstrations continue to result in instances of brutal beatings and long detentions. China has admitted some foreign observers to Tibet and to the main Lhasa prison. Diplomatic reports state that the Chinese Government is providing funds for rebuilding monasteries and that monks are now provided more leeway in their religious practices. In recent years, an increasing number of Han Chinese have moved to the Tibetan Autonomous Region in search of economic opportunity. We will continue to monitor closely reports that the PRC is encouraging involuntary emigration to areas traditionally settled by Tibetans. So far, we have found no evidence of a Chinese government policy to this effect. This is, however, an area of considerable concern given the relatively small Tibetan population. We join many others in urging the Chinese government to establish conditions under which the unique Tibetan culture and religion will be protected.

Nonproliferation Issues

China's support for global nonproliferation initiatives has increased substantially since the beginning of 1992. In March 1992, China acceded to the Nuclear Non-Proliferation Treaty (NPT) and adhered to the Missile Technology Control Regime (MTCR) guidelines and parameters. In January 1993, Beijing became an original signatory to the Chemical Weapons Convention (CWC). China now is a party to all of the leading nonproliferation agreements. These commitments have influenced Chinese behavior: Beijing has refrained from selling certain sensitive items because of proliferation concerns, and nonproliferation as an issue appears to receive more senior consideration in Chinese policy-making circles.

At the same time, certain sensitive Chinese exports raise questions about PRC compliance with these commitments. At present, the greatest concern involves reports that China in

November 1992 transferred MTCR-class M-11 missiles or related equipment to Pakistan. Such a transfer would violate China's MTCR commitment and trigger powerful sanctions under U.S. missile proliferation law. There also are reports that China is exercising inadequate control over sensitive nuclear, chemical, and missile technology exports to countries of proliferation concern. Even if these sales do not violate PRC obligations, they raise questions about China's appreciation of the importance of preventing the proliferation of weapons of mass destruction and their ballistic missile delivery systems.

We are also concerned that China has withdrawn from the Middle East arms control (ACME) talks. The U.S. holds that, as a permanent member of the UN Security Council, China has a special responsibility to continue in these talks.

Seeking full Chinese compliance with multilateral obligations and support for international nonproliferation goals is a top Administration priority. The U.S. is prepared to employ the resources under U.S. law and executive determinations -- including the imposition of sanctions -- if the PRC engages in irresponsible transfers that violate its commitments.

Trade Issues, Including Prison Labor

Reciprocal granting of MFN tariff status was a key element cementing the normalization of Sino-U.S. relations by providing a framework for major expansion of our economic and trade relations. In 1992, bilateral trade topped \$33 billion, with Chinese exports of \$25.8 billion and U.S. exports of \$7.5 billion. China was our fastest growing export market in Asia in 1992 as U.S. exports to China rose by 19 percent. In turn, the United States remains China's largest export market, absorbing about 30 percent of China's total exports.

China maintains multiple, overlapping barriers to imports in an effort to protect non-competitive, state-owned industries. China also has recognized that its development goals cannot be achieved without gradually reducing protection and opening its domestic market to the stimulus for change brought by import competition.

Our market access agreement, signed October 10, 1992, if implemented by the PRC, will increase opportunities for U.S. exports by phasing-out 70 to 80 percent of China's non-tariff trade barriers over the next four years. The regular consultation process required by this agreement allows us to monitor implementation and take appropriate action should China violate its commitments. Progress has been made in opening the market to U.S. products but we still need to resolve several issues regarding implementation.



Recently, the Chinese have indicated an interest in doing more business with U.S. companies. As U.S. corporate executives are arriving in droves to explore new commercial opportunities in Beijing, at least eight Chinese delegations have been or will soon be dispatched to the U.S. with orders to "buy American". These missions have the potential to generate billions of dollars of exports of aircraft, autos, satellites, oil drilling equipment, aviation electronics, wheat, fertilizer, and other U.S. products.

Still, the large and growing U.S.-China trade deficit is unacceptable. The over \$40 billion trade surplus China has accumulated with the United States since June 1989 has been very destructive to American industries, particularly the textile and footwear sectors, resulting in the loss of American jobs. It is therefore essential that the PRC implement the market access agreement we have negotiated, which would produce a much greater equilibrium and fairness in Sino-American trade. It is also important that China liberalize its foreign exchange regime, including a market-determined exchange rate. Regarding the 1992 Intellectual Property Rights (IPR) agreement, the Chinese government has carried out the great bulk of its commitments, although there are some problems that have arisen in implementation.

Prison Labor

China officially banned the export of products produced by prison labor in October 1991. In August 1992, we signed a Memorandum of Understanding under which the Chinese agreed to investigate cases we presented and to allow U.S. officials access to suspect facilities in China.

The U.S. has presented the Chinese government information on 16 cases of alleged use of prison labor. The Chinese have reported back on all 16 cases, admitting that four of the facilities involved have used prison labor for export production in the past. The Chinese maintain that the factories either have ceased exporting, or have removed prisoners from the production line. U.S. officials have visited three prisons and have standing requests to visit five others, including a revisit to one facility.

In the past two years, U.S. Customs has aggressively expanded its enforcement of U.S. laws banning the import of prison labor products. Customs has issued twenty orders banning suspected Chinese goods from entering the U.S., achieved one court conviction of a U.S. company for importing prison made machine tools and detained suspected equipment in another case. We are actively looking into recent allegations of violations of the prison labor MOU. Talks with China will continue on the full enforcement of the provisions of this agreement.

6

Conditions for Renewal in 1994

China has made progress in recent years in the areas of human rights, nonproliferation, and trade. Nevertheless, I believe more progress is necessary and possible in each of these three areas. In considering the optimal method of encouraging further progress on these issues, I have decided to issue the attached Executive Order which outlines the areas in the field of human rights with respect to which China, in order to receive positive consideration for a renewal of MFN in 1994, will have to make overall, significant progress in the next twelve months.

In considering extension of MFN, we will take into account Chinese actions with respect to the following:

- Respecting the fundamental human rights recognized in the Universal Declaration of Human Rights.
- Complying with China's commitment to allow its citizens, regardless of their political views, freedom to emigrate and travel abroad (excepting those who are imprisoned, have criminal proceedings pending against them, or have received court notices concerning civil cases).
- Providing an acceptable accounting for and release of Chinese citizens imprisoned or detained for the peaceful expression of their political views, including Democracy Wall and Tiananmen activists.
- Taking effective steps to ensure that forced abortion and sterilization are not used to implement China's family planning policies.
- Ceasing religious persecution, particularly by releasing leaders and members of religious groups detained or imprisoned for expression of their religious beliefs.
- Taking effective actions to ensure that prisoners are not being mistreated and are receiving necessary medical treatment, such as by granting access to Chinese prisons by international humanitarian organizations.
- Seeking to resume dialogue with the Dalai Lama or his representatives, and taking measures to protect Tibet's distinctive religious and cultural heritage.
- Continuing cooperation concerning U.S. military personnel who are listed as prisoners of war or missing in action.
- Ceasing the jamming of Voice of America broadcasts.

7

The Administration will also use tools under existing legislation and executive determinations to encourage further progress in human rights.

In addition, I wish to make clear my continuing and strong determination to pursue objectives in the areas of nonproliferation and trade, utilizing other instruments available, including appropriate legislation and executive determinations. For example, various provisions of U.S. law contain strong measures against irresponsible proliferation of weapons of mass destruction and nuclear weapons technology. These include missile proliferation sanctions under the National Defense Authorization Act. Using these tools as necessary, we will continue to press China to implement its commitments to abide by international standards and agreements in the nonproliferation area.

In the area of trade, the Clinton Administration will continue to press for full and faithful implementation of bilateral agreements with China on market access, intellectual property rights, and prison labor. Section 301 of the 1974 Trade Act is a powerful instrument to ensure our interests are protected and advanced in the areas of market access and intellectual property rights. The Administration will also continue to implement vigorously the provisions of the Tariff Act of 1930 to prevent importation of goods made by forced labor.

EXECUTIVE ORDER

- - - - -
CONDITIONS FOR RENEWAL OF
MOST FAVORED NATION STATUS FOR THE
PEOPLE'S REPUBLIC OF CHINA IN 1994

WHEREAS, the Congress and the American people have expressed deep concern about the appropriateness of unconditional most-favored-nation (MFN) trading status for the People's Republic of China (China);

WHEREAS, I share the concerns of the Congress and the American people regarding this important issue, particularly with respect to China's record on human rights, nuclear nonproliferation, and trade;

WHEREAS, I have carefully weighed the advisability of conditioning China's MFN status as a means of achieving progress in these areas;

WHEREAS, I have concluded that the public interest would be served by a continuation of the waiver of the application of sections 402 (a) and (b) of the Trade Act of 1974 (19 U.S.C. 2432(a) and 2432(b)) (Act) on China's MFN status for an additional 12 months with renewal thereafter subject to the conditions below;

NOW, THEREFORE, by the authority vested in me as President by the Constitution and the laws of the United States of America, it is hereby ordered as follows:

Section 1. The Secretary of State (Secretary) shall make a recommendation to the President to extend or not to extend MFN status to China for the 12-month period beginning July 3, 1994.

(a) In making this recommendation the Secretary shall not recommend extension unless he determines that:

2

- extension will substantially promote the freedom of emigration objectives of section 402 of the Act; and
- China is complying with the 1992 bilateral agreement between the United States and China concerning prison labor.

(b) In making this recommendation the Secretary shall also determine whether China has made overall, significant progress with respect to the following:

- taking steps to begin adhering to the Universal Declaration of Human Rights;
- releasing and providing an acceptable accounting for Chinese citizens imprisoned or detained for the non-violent expression of their political and religious beliefs, including such expression of beliefs in connection with the Democracy Wall and Tiananmen Square movements;
- ensuring humane treatment of prisoners, such as by allowing access to prisons by international humanitarian and human rights organizations;
- protecting Tibet's distinctive religious and cultural heritage; and
- permitting international radio and television broadcasts into China.

364

-75-

BEST COPY AVAILABLE

3

Sec. 2. The Secretary shall submit his recommendation to the President before June 3, 1994.

Sec. 3. The Secretary, and other appropriate officials of the United States, shall pursue resolutely all legislative and executive actions to ensure that China abides by its commitments to follow fair, nondiscriminatory trade practices in dealing with U.S. businesses, and adheres to the Nuclear Non-Proliferation Treaty, the Missile Technology Control Regime guidelines and parameters, and other nonproliferation commitments.

Sec. 4. This order does not create any right or benefit, substantive or procedural, enforceable by any person or entity against the United States, its officers, or employees.

THE WHITE HOUSE,

365

-76-

CHINESE ECONOMICS - OVERVIEW

By

Arnold J. Rosenberg

Quince Orchard High School
Gaithersburg, MD

CHINESE ECONOMICS - OVERVIEW
From Lectures at Beijing Normal University - July 1993

- . 1992 increase - 12%
- . Bankrupt & backward prior to 1949. Average life expectancy - 35 years.
- . Achievements since 1949
 1. Large scale industrial development
 2. Scientific & technological level raised
 3. Increase in marketing and production
 4. Telecommunication
 5. Rise in S of L.
- . Main deficits
 1. Subordination of industry to central authority
 2. Mandatory planning from above
 3. Unified distribution of income; guaranteed employment; iron rice bowl.
 4. Inefficiency & lack of responsibility.
- . December 1978 - beginning of shift toward modernization. Reduced scope of mandatory planning.
- . Reforms
 - Rural responsibility system - Commune, brigade, team. Work point system. In 1978 the group contract system permitted products exceeding quota to belong to contractor. 1979 - household contract system - contract with collectives. Well received by peasants. Services provided by the collective. Single grain production changed.
 - Urban - Relatively independent units - contract system. In 1978 - 88.8% state owned; 19% collective. 1990 - 55% state owned; 35.6% collective; 9.5% other.
 - Shareholding system - 3000 by end of 1991
 1. Stocks within enterprises
 2. Stocks held by other companies
 3. Stocks on the market - Shanghai & Shenzhen
 4. Foreigners may buy stocks
- . Socialist market economy since 1992. 363 more shareholding enterprises.
- . Economic reform must precede political reform.
- . Market economy is merely a means of distributing revenue so it doesn't belong to any political system.

Arnold J. Rosenberg

Economic Reforms in China
From China Daily Newspaper &
other U.S. newspapers

July 5, 1993 - Increasing concern about glaring economic problems, especially in the money market. One of the knotty problems is that the economy is suffering double-digit inflation. Cost of living increased to 16.7% in the first five months of this year. Retail prices in the countryside rose 11.7% in April.

Out of control capital spending ploughed into real estate and stocks. Banking reform is regarded as key issue.

The People's Construction Bank of China will be China's first specialized bank to set up an office in Hong Kong.

Overseas-funded enterprises in Beijing now have access to duty-free foreign-made automobiles following establishment of a bonded warehouse.

July 7, 1993 - Central and provincial authorities are set to adopt specific reform measures designed to push China's more than 13,000 large and medium sized State-owned enterprises into market competition within three to five years. To date, about 9,812 different kinds of enterprises in 17 provinces, autonomous regions and municipalities, including State-owned industries, are experimenting with new ways to transfer their operational mechanisms to suit the change to a "socialist market economy" from the highly centralized planned economy.

In Northeast China's Heilongjiang Province, 18 State-owned enterprises have gone bankrupt since the implementation of the regulation last year. while 103 have been merged and 68 firms have closed.

With the approval of the central government, seven large Sino-foreign joint venture commercial retail enterprises will be set up in Shanghai, Beijing, Tianjin, Qingdao and Dalian. They are expected to become operational after 1995.

July 10, 1993 - Chinese Vice-Premier Zhou Rongji said it was not necessary to launch a comprehensive austerity program at this time. Zhu was named as the new governor of the People's Bank of China. He said that problems can be solved through the speeding up and deepening of reforms. He ordered bank officials to observe the following three basic provisions:

1. To stop immediately interbank lending in violation of State regulations and to recall such outstanding loans within a prescribed time.
2. No financial institutions will be allowed to raise their interest rates independently. They are also prohibited from receiving or raising commissions on bank loans.

3. All banks must cut off their links with business firms run by the banks and must not offer credit to those firms. Zhou added that offenders would be severely punished. The reform goal is to balance social demand and supply and stabilize the country's currency

July 4-10 Business Weekly - The China Investment Bank is preparing to issue \$50 million worth of foreign-exchange bonds to domestic citizens for the first time.

The Chinese government is determined to abolish the dual-rate monetary system within five years, but has found that difficult to achieve when the gap between swap-market rate and official rate is so big. The yuan closed last Friday at 10.52 in Foreign Exchange Swap Market. China's official exchange rate has remained steady at 5.74 for buying and 5.77 for selling.

August 29, 1993 - Washington Post - The bank's low interest rates are essential to the survival of many struggling state-owned enterprises. The numerous local bank branches owe more loyalty to provincial officials than to Beijing.

Questions for Students

1. Explain the three basic provisions of the new head of China's central bank.
2. Why is double-digit inflation a knotty problem for China?
3. What do you think is meant by a "socialist market economy"?
4. Why have state-owned enterprises gone bankrupt?
5. How are foreign exchange bonds expected to benefit China?
6. Why is the dual-rate monetary system a problem for China?
7. Why are low interest bank rates essential to state-owned enterprises?

Enter At Your Own Risk

Companies face myriad problems investing in China

Country Risks

- Political instability
- Social instability
- Changes in economic policies
- Bureaucracy
- Insufficiency and negligence of the legal system



Contract Risks

- Negotiations for long-term and complicated contracts
- Difficulties of feasibility studies
- Demand for a foreign exchange balance
- China's shortages of funds/ overvaluation of capital in kind
- Demand for technology transfer
- Insufficient knowledge of a market economy on the Chinese side

Operation Risks

- Complexity and delay in the approval procedure
- Difficulty with procurement of raw materials and parts
- Underdeveloped infrastructure
- Difficulty in labour management
- Increases in wages and land-use charges
- Shortages of funds
- Difficulty in quality control
- Difficulty in domestic sales/ export obligations

Source: Nomura Research Institute

From Far Eastern Economic Review
September 1993

1. Why is this chart headed "Enter At Your Own Risk"?
2. What is political and social instability?
3. Why is bureaucracy shown as a country risk?
4. What is the meaning of "negligence of the legal system"?
5. Explain each of the contract risks.
6. Explain each of the operation risks.
7. Which three risks do you think present the biggest problems for foreign investors? Why?

CHINA STOCK LISTING

A shares priced in RMB yuan; B shares in US dollars
Shenzhen Securities Exchange

June 28 - July 2, 1993

Stock	Last week			Change %	volume (10,000)
	close	high	low		
An Da Industry	16.65	17.05	15.70	-1.48	99.51
Bao'an Enterprise (Group)	17.10	17.20	16.00	0.59	325.69
Chemical Fibre	10.10	10.30	9.45	-0.98	64.86
China Bicycles	17.90	18.30	16.90	-0.56	58.38
China Merchant Port	11.60	11.75	10.90	0.43	97.46
Chiwan Wharf	11.70	11.70	10.80	1.30	71.08
Development Bank	26.20	27.15	25.25	-3.14	343.34
Fiyta	13.55	13.65	12.80	1.50	28.10
Fuhua	12.00	12.10	11.15	0.42	405.03
HK & Macao Properties	15.55	15.85	14.65	-1.27	109.89
Huafa Industry	10.10	10.15	9.30	2.54	42.66
Huayuan Industry	15.80	16.75	15.50	-4.24	96.22
Jinju	14.05	14.10	13.10	1.44	417.55
Jintian Industry	21.30	21.95	20.10	-2.74	141.00
Jinxing Development & Service	12.70	12.70	11.75	0.79	61.83
Konka Electronic (Group)	14.15	14.20	13.00	2.17	103.96
Minyuan	23.70	24.50	22.80	-2.27	243.25
New Energy	19.70	20.20	18.60	-1.99	124.04
Pearl River	20.00	20.60	19.20	-2.44	136.59
Petrochemical (Holdings)	12.75	13.00	11.90	-0.78	63.35
Properties & Resources (Group)	18.00	18.80	17.20	-3.74	108.97
Salt Chemical	9.75	9.90	9.20	0.00	709.47
Shenbao	10.50	10.30	9.90	-2.78	75.23
Southern Glass	15.50	15.80	14.70	-0.96	122.15
Tiandi	13.00	13.00	12.00	0.78	41.25
Tiange Garment	14.70	14.90	13.90	2.08	176.97
Vanke	16.80	17.10	15.70	-3.25	122.93
Victor Onward Textiles Industry	11.25	11.25	9.60	5.13	93.88
Wuhan Store	12.90	13.00	12.20	-0.77	257.47
Zhenye	21.40	21.95	20.10	-2.28	104.50
Zhongchu	20.10	20.20	18.80	-0.50	105.20
China Bicycle B	8.85	10.00	8.80	-10.15	39.60
China Merchant Port B	3.20	3.20	2.65	25.49	174.40
Chiwan Wharf B	3.05	3.10	2.95	-1.61	63.80
Fiyta B	3.10	—	—	0.00	0.00
Huafa Electronic B	4.20	—	—	—	—
Konka Electronic B	5.55	5.60	5.55	-1.77	20.00
Petrochemical B	5.00	5.00	4.90	-0.99	3.40
Properties & Resources B	7.55	7.55	7.50	-0.66	1.80
Shengbao B	2.50	2.60	2.50	-5.66	19.60
Southern Glass B	6.40	6.80	6.40	-5.88	4.60
Vanke B	7.30	8.30	5.50	36.45	11.80
Victor Onward Textiles B	5.40	5.50	4.80	9.09	24.20
Zhongchu B	5.40	5.50	4.80	9.09	24.20

1. What does this listing reveal about China's economy?
2. What is a B share?
3. Which company made the greatest gains in the week shown?
4. How did the China Bicycle B Company do during the week shown?
5. Where is this securities exchange?

BEST COPY AVAILABLE

The last time the Chinese economy overheated, it catalyzed the protests that led to the 1989 crackdown in Tiananmen. "The question [now] is whether rapid growth and accelerating inflation will lead to another economic crisis—and if so, what the political ramifications will be. . . . Retrenchment could work again, but the reins are not as tight as they once were. [And a] failed clampdown might be as politically dangerous as a successful one. . . ."

The Economy in Overdrive: Will It Crash?

BY PENELOPE B. PRIME

Last fall, delegates to the Chinese Communist party's fourteenth congress proclaimed that China's "planned commodity economy" was now a "socialist market economy." What is the significance of this change in terminology? In practice as well as rhetoric, markets have replaced planning. China still plans, of course, but recent years have seen a significant reduction in the extent to which the government determines the economy's course. Market mechanisms have expanded from consumer goods to include producer goods, raw materials, and even stocks and bonds. The party's removal of the word "planning" from its label for China's economic system signals an ideological acceptance of markets and the likelihood that reforms will continue.

The introduction of the market has, however, created boom and bust cycles. The economy experienced serious inflation and imbalance in 1985, and again in 1988 and 1989. The last bout of overheating contributed to the pro-democracy protests in Beijing's Tiananmen Square in June 1989. Following the bloody suppression of the movement, many thought the government would curtail economic reform. While this did occur, it turned out to be a surprisingly brief effort followed by a strong rebound. Growth was so rapid in 1992 and the first quarter of this year that overheating again appears inevitable. Foreign investment and trade have risen even faster than in the past. The question for 1993 and 1994 is whether rapid growth and accelerating inflation will lead to another economic crisis—and if so, what the political ramifications will be.¹

PENELOPE B. PRIME is an associate professor of economics at Kennesaw State College. She is currently an analyst with the China Branch at the Center for International Research at the United States Bureau of the Census. The author would like to thank Tina Harbaugh for her assistance with data collection and Jong-Heum Park for his comments on an earlier draft.

¹Unless otherwise noted, all figures are from China's annual statistical yearbooks, *Beijing Review*, and the Foreign Broadcast Information Service

STOCK FRENZY AND SOFT DRINKS

Two developments last year significantly influenced the operation of the Chinese economy and expectations about future growth. These were the rapid extension of securities markets and a flood of foreign investment into the country.

The establishment of securities exchanges enhances the economy's marketization and benefits the economy's reform in several ways. Through stock or bond issues enterprises have the opportunity to raise capital, which may eventually wean them from the state budget. The country's political leaders are eager to revitalize large enterprises through market pressure, but without truly privatizing. (True privatization has been circumvented by limiting the number of shares sold to individuals: most shares are owned by other state enterprises or the government agencies that managed them in the past.) Another benefit of the exchanges stems from the fact the populace now holds large amounts of cash. Purchasing shares absorbs this money, channeling it into production and lowering demand for consumer goods.

There are currently two stock exchanges in China. The one in Shanghai started up in December 1990. The Shenzhen special economic zone (SEZ) in southern China opened the second exchange in July 1991, after experimenting with shareholding systems as early as 1987. Numerous other cities and provinces have been lobbying Beijing for authorization to set up their own stock exchanges—so far without success. There are dozens of other securities markets throughout China, but these handle treasury bonds only; in Shanghai and Shenzhen alone both stocks and bonds are traded.

The two exchanges are small but growing quickly. As of late 1992 the two combined had issued the shares of approximately 30 companies; by early this year the number had jumped to 70. Nearly 4,000 other enterprises in China are internal shareholding companies, in which the corporation in conjunction with employees holds shares. Many of these firms someday hope to go public.

The stock exchanges issue two types of shares: "A" shares, issued only to citizens, companies, or institutions

China's Foreign Trade and Investment

	1986	1987	1988	1989	1990	1991	1992	1993
Foreign Investment								
Contracted	11.74	12.14	16.00	13.48	12.09	19.58	48.53	NA
Utilized	7.26	8.45	10.23	10.04	10.29	11.55	18.03	NA
International Trade								
Exports	30.94	39.43	47.51	52.53	42.09	71.91	84.99	37.15
Imports	42.90	43.21	55.26	59.14	53.34	43.79	40.40	46.49
Trade Balance	-11.96	-3.78	-7.75	-6.61	8.75	28.12	44.59	-9.34

Note: The figures for 1993 are for the first six months.

in China, and "B" shares, issued only to foreigners. The B shares are denominated in yuan but must be paid for with United States or Hong Kong dollars. Since they are a risky investment, foreign interest has primarily been expressed through trading in shares in Hong Kong companies that do business with China. Foreign houses have set up numerous mutual funds for foreign investors, including Paine Webber's Greater China Fund, James Capel & Company's China Fund, and the Jardine Fleming China Region Fund. Last year the New York Stock Exchange listed its first Chinese company, China Brilliance Automotive Corporation, and plans to list a number of mainland corporations on the Hong Kong exchange are in the works.

Stocks have caught the interest of the people of China as well. New issues have attracted large crowds. Disappointed citizens rioted last fall in Shenzhen when the forms that must be used to apply to purchase shares ran out. Many people bring substantial savings to invest if they are among the lucky ones granted a chance to buy. Because of the intense demand for shares, prices have been inflated and at times have fluctuated wildly, and a second market flourishes on the steps of the official exchange. Investing has helped reduce the demand for consumer goods, easing the pressure on these prices. If people think hyperinflation is just around the corner, they may pull money out of investments and savings accounts and go on a buying spree. Since savings totaled the equivalent of \$200 billion at the end of last year, such a spree would surely fuel inflation.

Along with the securities market, capital has also been generated through foreign investment. Businesses from around the world continue to see China as potentially, if not currently, a profitable venture. In 1992 alone new foreign investment totaled almost \$19 billion—a phenomenal 63 percent increase over new foreign investment the previous year—and this figure does not include contracts worth billions of dollars signed that year.

The inflow appears to be more than just a rebound from the slowing of investment following the repression of the democracy movement in 1989. Several new considerations in the minds of investors may be fueling it. Although the

yuan technically is still not convertible, foreign currency exchange centers, or swap markets, are common in major Chinese cities and seem to be functioning well. In early June all controls on the value of the yuan were lifted in these markets. Use of foreign exchange within China has also gained marginal acceptance. In Fujian province, for example, the Taiwan dollar is widely used, as is Hong Kong currency in Guangdong. This year, for the first time, China plans to offer a bond denominated in United States dollars; leaders obviously believe people hold enough dollars that such an issue will attract investors.

Prospects for foreign sales in China's domestic market have also brightened. Incomes and savings are beginning to reach levels that allow citizens to satisfy a taste for quality and variety by buying goods from abroad. Restrictions on foreign companies and joint venture sales in the domestic market are easing. One can find soft drinks such as Pepsi-Cola not only in the cities but also in the far corners of southwestern Yunnan province and other remote areas. More important, foreign products are increasingly sold in Chinese shops (brought to the shelves by Chinese distribution networks) and not just in hotels and restaurants catering to visitors to the country. The domestic demand for computers, machinery, and other inputs into production continues to grow as Chinese enterprises increasingly make more of their own investment decisions. Production for China's domestic market rather than for export to third-country markets may be attracting companies that had been watching China from afar. Some foreign companies producing goods in China have actually exported less than they expected because of their ability to sell domestically.

Another driving force behind the surge in foreign investment has been the rising cost of manufacturing in Hong Kong and Taiwan. For Hong Kong, which will become part of China in 1997, the decision to move production makes sense. For Taiwan, investment in the mainland is more of an issue politically. The Taiwanese government has been leery of having too much of its citizens' and corporations' funds invested in China, but has not stopped the flow of capital. In a significant development, nongovernmental

Selected Economic Indicators

	1986	1987	1988	1989	1990	1991	1992	1993
Gross National Product (annual growth)	8.1	10.9	11.3	4.4	4.1	7.7	12.8	15.0
Currency in circulation (annual growth)	23.3	19.4	46.7	9.8	12.8	20.2	36.4	45.0
Domestic Budget (billion yuan)	-7.1	-8.0	-7.9	-9.2	-14.0	-21.1	-23.7	NA
Cost of Living (annual growth)	7.0	8.8	20.7	16.3	1.3	5.1	6.4	10.3
General Retail Price Index (annual growth)	6.0	7.3	18.5	17.8	2.1	2.9	5.4	16.0
Investment in Fixed Assets (billion yuan)								
State firms	197.9	229.8	276.3	253.5	291.9	353.8	510.6	58.8
Collectives	39.2	54.7	71.2	57.0	52.9	62.9	123.3	NA
Total Retail Sales (annual growth)	15.0	17.6	27.8	8.9	2.4	13.4	15.7	27.0

Note: The figures for 1993 are for the first quarter, except for the cost of living, which is for January. GNP and retail sales figures are for the first five months of 1993. The figures for 1992 and first quarter 1993 GNP were reported as gross domestic product.

groups from Taiwan and China met for the first time this spring in Singapore to discuss increasing exchanges and communications across the straits.

Over the decade, foreign investment provided China with raw materials through imports, transferred new technology, and earned foreign exchange through exports. While these benefits will continue, something new appears to be happening as well. The latest wave of investment seems to cover a broader area geographically, reaching inland regions as well as the traditional coastal zones. As a result, foreign companies want to use China's raw materials, energy sources, and infrastructure more than they did in the past, which increases the already high demand for them. These companies also have the financial resources to offer higher prices for the inputs they need. So while foreign investment is supplying additional capital, it is also contributing to rapid growth and the resultant overheating of the economy.

A REPEAT PERFORMANCE?

With expected annual growth rates for real gross national product well over 10 percent, will 1993 and 1994 see a repeat of the creeping inflation of 1987 followed by the hyperinflation of 1988 that caused leaders to force the economy into retrenchment? There are indeed many similarities between trends during the earlier period and those unfolding in the Chinese economy now.

Growth, inflation, and the money supply were all high by 1988. After respectable growth of 8 percent in real GNP in 1986, the figure jumped to 11 percent in both 1987 and

1988. Inflation, as measured by China's official cost of living index, was 7 percent in 1986 and 9 percent in 1987, and skyrocketed to 21 percent in 1988. Currency in circulation increased 19 percent in 1987 and jumped to 48 percent the next year. Finally, rapid income growth raised imports and depressed exports, resulting in trade deficits throughout the late 1980s.

In 1992 and early 1993, a similar pattern developed, but with even higher growth. Real GNP increased 13 percent in 1992 and at an annual rate of 15 percent during the first five months of this year; this compares with 8 percent in 1991 and only 4 percent in 1990. The cost of living went up 5 percent in 1991; last year this index advanced only 1 percentage point, but in January 1993 it rose at an annual rate of 10 percent. The urban cost of living index reportedly was up almost 20 percent by May 1993 compared with a year earlier. Other reports on inflation for early 1993 put it as high as 25 percent above the level the previous year. Cash in circulation increased 36 percent in 1992, compared with 20 percent in 1991, but jumped to a 45 percent annualized rate in the first quarter of 1993. After posting trade surpluses for three years, beginning with the last quarter of 1992 China once again registered trade deficits. The deficit for the first six months of 1993 was over \$3 billion, more than doubling in May and June alone.²

These trends have raised concerns both at home and abroad. In May interest rates in China were raised for the first time in a year in an attempt to attract savings and discourage loans; the small hike, however, had little apparent effect. Plans to tighten credit discussed by Chinese leaders last fall seem to have fallen by the wayside. The 1993 Plan for National Economic and Social Development discussed, in general terms, maintaining the economy's balance and reform of the banking system. But concern over the potential problems associated with overheating is more muted than in the past.

²Figures on cash in circulation are from "Banking on Zhu," *The Economist*, July 3, 1993, p. 33; trade deficit statistics are from "China's Trade Deficit Doubled in 2 Months," *The New York Times*, July 6, 1993, p. C8.

any economists in China argue that major differences between the current picture and the situation in the late 1980s mean drastic action may not be necessary this time.³ The difference cited is that inflation in the 1990s is due primarily to price adjustments and increases in costs, rather than the severe imbalances between demand and supply that occurred in the previous decade. Demand is high, but supply for investment goods and consumer goods. The supply of consumer goods, they argue, has kept up with demand. Further, peoples' incomes rose faster than inflation during 1992, in contrast to 1987 and 1988. Finally, the optimistic analysts acknowledge the money supply is increasing rapidly—too rapidly—but say that at least it is going into productive, long-term investment rather than subsidizing unproductive enterprises.

These economists correctly contend that the economy has developed and been reformed in the four years since the 1980s, but all arguments that minimize the potential need for retrenchment can be disputed. While price reform has pushed prices up, property speculation has meant higher rents and a higher price index. Demand may not be as imbalanced as in 1988, but the enormous amount of savings held by individuals could at any time be withdrawn, quickly creating serious imbalance. With the high inflation in the first quarter, savings accounts were earning negative rates of interest; in fact, in March total individual deposits fell for the first time since 1988.

The optimists also argue that incomes have kept ahead of inflation in today's economy, unlike during the latter 1980s. But this was while annual inflation was under 10 percent. If inflation continues to escalate toward 20 percent and beyond, real income growth will no longer be sustainable. As real incomes fall, people may be even more sensitive to negative interest rates, and put their money into consumer durables rather than saving it. This of course would push inflation even higher.

Finally, while productivity has improved in China, there are still many failing state-owned enterprises that formerly relied on subsidies through the state budget. Although the subsidies have reportedly been cut back, essentially unprofitable state enterprises continue to be subsidized through a new channel. When they need money, they are virtually guaranteed bank credit, with little or no questioning of how the funds will be used. In addition, more money has become available through foreign sources, securities issues, and underground credit channels. Some of these funds are no doubt going into profitable ventures, but whether these are necessarily the more productive projects, as the optimists argue, is difficult to determine because many prices are still distorted.

But along with the positive—albeit weak—factors that

contribute to the optimism of some in China, other indications strongly suggest the economy is overheating. Last year China registered a budget deficit of more than 90 billion yuan, the highest in the history of the People's Republic. Approximately 67 billion yuan was covered by domestic bonds and foreign loans, but over 23 billion yuan was left to be covered by printing new money. It is thus not surprising that China's measure of currency in circulation has increased. The recent pattern has been for currency in circulation to decline in the first quarter of a new year and then grow relatively quickly in the last quarter. This happened even in 1988. But this year the pattern has been broken. The July 3 *Economist* reported that currency actually increased 45 percent in the first quarter of 1993. If the money supply cannot be controlled at the beginning of the year, there is little hope that currency growth this year will be less than in 1992. Nonetheless, banks, especially in rural areas, reportedly were short of cash by midyear. Inflation had already increased substantially as well, even by the conservative, annualized measure used by China's official statistical agencies. If currency expands throughout the year as usual, inflation can be expected to accelerate quickly.

Poor agricultural performance can also contribute to potential overheating. Last year was not a stellar one for two key crops, grain and cotton. Grain production inched up less than 2 percent over 1991, and the cotton harvest was down 20 percent. In contrast, the flourishing industrial and service sectors in rural China registered 37 percent gains in output value over 1991. These nonagricultural sectors in the countryside compete with urban areas for farm products, contributing to rising prices and shortages.

Cash-poor rural banks have had difficulty paying for crops, exposing a critical weakness in the system. Under the reformed system established in the early 1980s, households contract with the state to deliver a certain amount of a crop that the state purchases at a set price. (A household can keep or sell at market prices anything produced beyond the contracted amount.) The government uses the rural banking system to make these purchases. According to Hong Kong newspapers, peasant protests occurred late last year and early this year when the government offered promissory notes instead of cash for the winter harvest. The summer crop will be brought in amid reports that banks are even more strapped for cash than they were earlier. Under these circumstances, government officials are likely to allow increased credit, which would push inflation higher.

Construction and investment in fixed assets also indicate that the economy is growing too rapidly. Last year the construction industry grew 18 percent in terms of the value of business it did. Completed projects rose 38 percent over 1991, and investment in projects under construction increased 49 percent. In the first quarter of this year investment took off. The State Statistical Bureau in Beijing reported that investment in fixed assets in state-owned enterprises rose 71 percent, and investment in local enterprises 81 percent. According to the economic plan, the total

³See, for example, Gong Yong, "1988 nian yanzhong tonghuo pengzhang de lishi" [The history of serious inflation in 1988], *Jiage yuekan* [Price monthly], March 1993, pp. 8-9.

investment growth target is not to exceed 30 percent this year. Local leaders across the country have also established industrial development zones. Citing incomplete official statistics, the May 30 *China Focus* reported that as of last September there were 1,951 economic development zones in China. Not all have been successful at attracting investment, and leaders in the central government are considering closing many of them.

To sum up, there are many signs that China will experience an even bigger boom in 1993 than in 1992, with more rapid growth in real GNP than in the late 1980s. At the same time, by the first quarter of this year inflation was already the highest it had been since the crisis in 1989, with many overt and latent pressures for still further increases.

FINE-TUNE OR STEP ON THE BRAKES?

The attitude of many officials and academics in China appears to be that markets have been established, and that these can be adjusted through indirect means such as interest rates and tax rates. In other words, "fine tuning" the economy is now an option, whereas in 1988 it was not. Without the tools to adjust demand and supply, severe credit and import quotas were necessary to bring the economy back under control. Lacking credit or inputs, many enterprises had to stop production, halt construction projects, or even close. All this also brought the inflation rate down to 2 percent in 1990.

Many foreign analysts argue that China in fact still does not have the ability to fine tune. Some new institutions appropriate for a market economy are in place, but they exercise insufficient power over key variables, these voices say. For example, the May increase in the interest rate did little to attract savings or decrease the demand for loans. The central bank has in principle the authority to control the amount of loans local banks issue. In practice, however, it is in the interest of local banks to heed local party leaders who want to keep their enterprises running. Further, the numerous nonbank financial institutions that have been set up by the government are not even under the jurisdiction of the central bank.

If the newly reformed system is not yet strong enough to fine tune the economy, does Beijing still have the choice of applying the brakes? In the past, leaders simply ordered a halt on credit in certain sectors or enterprises, and inflation would immediately slow; painful as such a step can be, it has worked. Retrenchment could do the trick again, but the reins are not as tight as they once were. A failed clampdown might be as politically dangerous as a successful one, pointing up the weakness of the central government.

Another political consideration has colored debate on this issue. Paramount leader Deng Xiaoping's strong endorsement of reform early last year has been interpreted to mean that rapid growth should not be criticized. In the

past, Chinese leaders used inflation as the bellwether of policy. If inflation became too high, reformers and conservatives generally agreed that growth and imports or other variables had to be sacrificed. The working assumption through mid-1993—at least by some at the top level—has been growth at any cost. Some localities, including Guangdong province in southern China, also prefer to accept inflation as a cost of growth.

Accepting inflation is a new development. Such a strategy might be feasible if prices rise at some reasonable, albeit high, rate. If, however, they begin to increase at an annual pace of 50 percent or more, China will face a much altered future. Inflation at this level would sap or even reverse the strengths the country has been able to exploit throughout most of the reform of the economy. Savings have been high and rising, but severe inflation would cause people to spend instead. Real income for everyone but a few elites would fail to keep up with price hikes. Capital flows could easily turn into net outflows. Finally, the corruption that is endemic in China and is already destabilizing would multiply in the face of expected sustained high inflation.

The peculiar nature of inflation in China poses yet another dilemma. When inflation begins to rise in the country, it tends to accelerate quickly. While adjusting to high inflation would be a challenge, dealing with high but accelerating inflation would be even more difficult. Part of the problem has been an inability to adjust the money supply in increments—an inability that has yet to be overcome.

Some attempt on the part of central officials to slow the economy seems inevitable. In late June, deputy prime minister Zhu Rongji was appointed temporary head of the central bank. His public statements clearly indicated a concern with China's financial situation, and a Hong Kong paper reported a new austerity program targeting imports and credit was being readied. Whether it will work is another question. Since some leaders are against pulling back, any such policy will already have one strike against it.

The course of China's economic transition could be altered by what happens in the next few years. The truly conservative leaders who favor a major shift in China's path will have to act soon. The longer Deng lives, the less political legitimacy they have. Further, if they use the failure of reform as their rationale, they will need to offer alternatives that work, and coming up with these will be difficult. However, most of the devoted socialists may already have bought into the benefits of economic reform available to them from their seats of power. In this case, marketization is likely to go forward, eventually gaining an ability to influence business cycles through interest rates, exchange rates, and the money supply. But even in this optimistic scenario, progress could be derailed if one of the boom-bust cycles is too extreme. The pressure from unpaid farmers and state workers could be too great even for Deng. ■

CHINESE (PEKING STYLE) OPERA, EUROPEAN OPERA, ROLE OF TRADITION

By

Carol Gisela Schmidt

International School
Bellevue, WA

Lesson: Chinese(Peking Style) Opera, European Opera, Role of Tradition

Students: 8 - 12th grades(with adjustments for experience level)

Subject areas: Humanities, Social Studies, Music

Time: 1 - 3 week lessons depending on number of activities

Materials:

Peking Opera by Rewi Alley, New World Press: Beijing, 1984

Stories of the Great Operas by John W. Freeman, W.W. Norton and Co: New York, 1984

Peking opera as a European sees it by Marie-Luise Latsch, New World Press, Beijing, 1980.

Peking opera: a short guide by Elizabeth Halson, Oxford University Press, Hong Kong: 1966.

Videos from local library of Western style opera productions, especially from the Metropolitan Opera. Also excellent are filmed versions of Carmen and Don Giovanni. Both of these have terrific themes for young audiences to grasp: loyalty to family and country and sexual morality. Both films were filmed on location and in traditional costumes.

If you are studying the epic nature of these operas, The Ring series is excellent but it requires knowledgeable and serious students.

I have not found a good introduction to Western opera video or film for high school students, if anyone knows of a source--please let me know. Opera with Henry Butler: Introduction to the Performing Arts Series is the most recent opera film in our district(1970).

Films of Chinese Opera are more difficult to find. The Seattle office of the Coordination Council for North American Affairs does mail films to schools(206-441-4586 ask for Linda or Steve)

Good introductory films from the Council are:

What is Chinese Opera? (#073)

Heritage of Chinese Opera (#39)

Both of these films were produced in Taiwan and have a good overview of training, style of singing, role, costuming, instrumentation, action and make-up.

The best of all worlds: contact your local opera society and arrange either student tickets to regular productions or rehearsal nights(those are free here in Seattle). Lecture and discussion sessions are sometimes available through the opera's education outreach program.

Also check entertainment listings to see if a Peking Opera troupe or Kabuki Theater group is coming to your city.

If your students are also studying Japan, Kabuki is an excellent add-in to the study of classical forms of entertainment.

Activities:

1. Have students view the Peking Opera films and short clips from European operas and complete the attached worksheet.
2. If your students are younger, they may wish to color or draw Peking opera masks. There is a rather old but useful source for this. Peking opera make-up: an album of cut-outs by Kuang-yu Chang, Foreign Languages Press, Beijing: 1959. Or I have attached two of my own coloring worksheets

Colors: Red- loyal brave and heroic
White- treacherous
Black- honest
Blue- ferocious
Gold/Silver- supernatural
Multi-colored- violent
Off-centered- crooked, robber

3. Choose one Peking opera and one European opera. Discuss the story of each opera: main characters, plot, climax, costuming and theme. You may wish to have readings from opera guides, history of opera books and from librettos.
4. I like the theme of filial piety or loyalty to family and country. My students have written and discussed the virtues of large families (extended living in the same housing unit) and small nuclear families, loyalty to family versus individual ambition. The students have read The Family by Pa Chin and Spring Moon by Bette Bao Lord and they are also familiar with Shakespeare's Julius Caesar and are reading a number of novels in their Humanities class with theme discussions of loyalty and ambition. I have the students write short essay papers on a variety of these themes.
5. Another good discussion point is the role of heroes and heroines in opera. If your students are making a longer serious study of opera, they may wish to make a brainstorm list of the types of heroes present in the operas they have seen. Peking opera is much more active in its staging of battles and fights. Women and celestial beings often participate. Such is rare in Western style opera with a notable exception being Wagner's epics or Verdi's Aida. Parts of these operas are accessible to the young listener and would make excellent comparisons about the value of traditional staging and costuming. Even Peking opera has modern forms. Students may discuss the value of staying with tradition.
6. Go to a performance, visit with the singers or education directors-- this will really involve even the most disinterested student.

Carol Gisela Schmidt
International School
Bellevue, Washington

European Opera

Peking Opera

Role: Male

Female

Clowns

Other-worldly
beings

Painted Faces

Action

Singing

Instruments

Scenery

Costumes

Training

Carol Gisela Schmidt, International School, Bellevue, WA



Carol Gisela Schmidt, International School, Bellevue, WA



A TRADITIONAL CHINESE ART

Beijing is now a great world city, the hub of a vast transportation system that reaches out to many parts of the world. The tourist trade has expanded and now an increasing number of people come in from many lands. Among them are those who want to catch a glimpse of Peking Opera which through all the years of change continues with its age-old forms, simply perfecting them, and remaining high in the affection of the Chinese people. For those who do go to see Peking Opera, this book may be of use in making for a deeper understanding of so powerful an artistic form.

Beijing people who love their opera talk about going to hear an opera, rather than see it. But those who have not yet gained some background of understanding may find it a little difficult at first. If they have been provided with a general outline of the theme of the opera they go to see, it will help them a great deal. Still they will not be able to follow the words, and the high notes in which it is sung may, in the beginning, be too unfamiliar to be fully appreciated. They may return, perhaps, to their hotels saying, "Yes, the costumes were certainly gorgeous, and the battle scenes with those magnificent acrobats — simply terrific!" or those who take a special delight in the human form may say, "The hand and leg movements were most expressive, graceful and artistic." Yet in all this they will have only touched the fringe of the manifold artistry that goes to make up a classical opera performance.

Artistically, Peking Opera is perhaps the most perfect thing of its kind existing in our world today. Its influence is deep in the hearts of the Chinese people, and it is as intensely popular in this living present as it was centuries ago. A knowledge of it is one beginning in the adventure of understanding this quarter of the world's population.

The classical Peking Opera is amazing in that it combines so many forms which, in the Western drama, are separated. It is grand opera, ballet, an acrobatic display and an historical play rolled into one changing and exciting panorama. It definitely sets

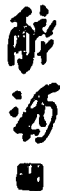

The drunken beauty Yang Yubuan
by Ma De

..from: Peking Opera by Rewi Alley, Beijing: New World Press, 1984

out to be something different from ordinary life, yet on the other hand it remains intensely human. Its great figures, for instance, are human — its gods, its spirits, its generals and emperors, even its monks and nuns. The fiery old Queen of the Western Heavens, the immortals who drink wine together, hate and love as do the legendary and historical characters whose exploits form so many of the plots. Moral rather than material values predominate: filial piety, love of country, the fidelity of comrades-in-arms find equal place with the love stories common to all peoples at all times. Naturally, the customs and thought are those of the day in which the stories were written, but some very modern conceptions can be found tucked away in the old tales. Today's directors have been very skillful in bringing these to the fore.

Just as folk legend and familiar stories colour so much of the drama of the West, so in China many themes for classical opera are ancient tales that have been handed down until they have become part of the people's thinking. Classical opera may offer many new clues to those who would add to their knowledge and understanding of China and of the Chinese people.

To the sophisticated viewer of p'ays, Peking Opera may seem at first rather stylized and formal in many of its aspects — though in these times of change, variety is increasing along with all the changes society is undergoing. Yet so rich is the old content that it is only by visiting the theatre very often that a proper appreciation of its subtleties can be gained. Many Chinese people themselves feel this.

In spite of the formalism, however, there is great scope left for the individual actor to carry off a traditional scene in a way that impresses all with his/her genius. The name of Tan Xinpei, the greatest actor in the early 20th century, is better known to the people than are the names of the various warlords who strutted on and off the political stage in those hectic times. His mantle fell on the shoulders of Mei Lanfang, whose name was a household word

秋
江
圖



Autumn Rider



by Mo De



Wu Song drinks deeply before killing a tiger.
by Ma De

all over China. Others such as Zhou Xinfang were as well known in the big cities as was any Hollywood star in America.

The Chinese theatre, with its tradition of selecting the colourful and meaningful from the past, may perhaps be expected in the next great creative age of China to seek new material and new themes. People who do things — make new bridges, climb over mountains, lead vital lives — will in this new age look for these things in operatic themes and music. But the old favourites will not be lost; they are too much a part of the people for that. Themes from the times when Han pioneers threw themselves against terrific obstacles in Central Asia, when the talent and wealth of the world flowed down the Old Silk Road during the Tang dynasty, will continue. Even if they adopt changed forms, they will continue to maintain the hold that the old opera has had on Chinese society in the past.

One can see in the operatic programmes picked for many an evening's entertainment something of this already. It is common for extracts from several operas to be selected — four or five of them — to make up the programme. These dramatic selections show how the interest of the people is increasingly drawn to those human situations which come into most people's lives rather than those which reflect the personal heroism of some very great figure of the past.

There are, of course, many operas as well as many forms of opera. It would require a long, concentrated study to know them all. Further, it is not likely that any visitor to China will become as familiar with Chinese tradition as, for example, the native of Beijing who has been brought up from childhood on stories from the theatre related by his elders. Such a person will naturally be immediately familiar with almost any kind of situation that may develop in any opera. But this need not discourage the visitor, whose best way is to ask and then keep on asking, until one gets into the swing of the thing and the opera begins to exert its fascinating hold.

SOME NOTES ON ORIGINS

From the earliest recorded times the Chinese people, like all others, have expressed themselves in song and dance, from the magical fertility dances to those that expressed their hope for a good harvest or their joy in the result of their toil. Dance and song very early became a part of court ritual. We know that in Zhou times they were considered things that every child should learn. State music was composed for emperors, to which dancers moved holding in their hands various ritual ornaments. Blind people were trained as musicians and, because of this, had an honoured place in the society of that day.

Some promotion of opera from the song and dance of early times seems to have taken place in the imperial courts where rulers demanded amusement from acrobats, jesters and story-tellers. But the dramatic expression of course came from the people as their own creation. Music, narrative and dance began to be integrated into the precursor of opera as we have it today. Historical incidents, especially those which caught a popular trend of thought, naturally became favourite themes. Chinese poetry, always composed to be sung or chanted, could be used freely in such an entertainment.

Practically every dynasty has left some record of the state of the drama in its day, if only of that which was confined to the court. We know too that when the great merchants' and craftsmen's guilds spread over the country they carried stages with them for the production of plays. In an early account of the workers' life in Jingdezhen, the great pottery centre in Jiangxi, it is noted that the kiln managers were to be fined for not keeping their agreement to pay for the staging of operas for the workers on a stipulated number of days in the year. There are many country places, especially along the "Old Silk Road" in the northwest, where it can still be seen that almost every ancient temple had a stage opposite its gate where drama in its operatic form was sung on people's festivals in bygone times.



◁ Coloured paper-cuts on pages 34 through 41 from Weixian County, Shandong Province

The Yuan period (1279-1368) is considered the golden age of the classical opera, though in various forms it dates back as far as the Zhou. In Western Han times the "hundred plays" (*bai xi*) were a very popular, largely acrobatic form of people's drama which spread over the whole land. But it was in the Yuan period — the Mongol dynasty of which Kublai Khan was the first emperor — that the opera underwent certain changes. By then north China had already had a period of overlordship by the Jin and Liao tribesmen who had begun to be absorbed as Chinese. The Mongols conquered both the Jin empire and that of the Southern Song with its beautiful capital at Hangzhou in Zhejiang and ousted the old ruling bureaucracy. No longer did the examination system carry the poor but brilliant student into high office. So among the intellectuals there was a great striving for self-expression. At the same time, the foreign superstructure itself began to be absorbed. Though the Yuan drama was an evolution of that of Song which had preceded it, there were innovations in line with the new integration of peoples. The great hero with a huge voice shouting his defiant song began to replace earlier forms in which there were choruses of sweeter and more rhythmic voices.

It was in the Yuan period that many of the stories handed down by oral tradition, which were later incorporated into such popular novels as *The Three Kingdoms* and the *Outlaws of the Marsh* and others, began to be used as themes for the opera. They could be played because they placed the desire for change in a historical setting and were woven around legendary or historical happenings from that part of Chinese history (in the case of the Three Kingdoms) that came after the end of the Han dynasty. *The Three Kingdoms* is set in the 3rd century A.D., when China was divided into three kingdoms, each struggling for ascendancy over the other. The story of the struggles between these three, with its plot and counterplot, has so captured the imagination of succeeding generations of people that today almost everyone knows something of these tales.

Outlaws of the Marsh is a very long story, telling of what was actually a peasant revolt against the bureaucracy and decadence of the Northern Song dynasty. The heroes, all of whom are people who have offended the government in some way, collect together gradually in one band under Song Jiang in the Liangshan Hills. From here they sally forth in the manner of Robin Hood to relieve the distressed. Before their final defeat they succeed in bringing together armies of considerable proportions which acutely tax the strength of the Northern Song dynasty. Among the many vivid tales told of this band of brothers are stories of success, of treason and betrayal, of intense loyalty and devotion to their fighting group. Among the most lovable characters is the rash Black Li Kui, who makes many mistakes because of his impulsiveness; but who nevertheless is warm of heart.

There was a very widespread use of drama in the Song periods when the official plays were known as *guan ben* and the ones in



private homes as *yuan ben*. After the Song dynasty was driven south of the Changjiang (Yangtze River), considerable development took place around Wenzhou in east Zhejiang. There, Gao Zecheng wrote the *Tale of the Lute (Pi Pa Ji)* which has been a famous opera ever since it was produced in 1347 during the Yuan dynasty.

In the Ming period (1368-1644) some very fine operatic music was created, much of it based on earlier forms. The *ku qu* form of opera came into great favour and the music of Huizhou, a lovely old city in southern Anhui Province, became popular, as did that of Yiyang in Jiangxi.

With the coming of the Manchu (Qing) dynasty in 1644, many dramatic writers, especially Hong Sheng, tried to express in their works some of the feelings of the people. Hong Sheng used stories of an ancient period — that of the Tang dynasty — to illustrate his criticism of the present, and he was in consequence persecuted. His work is strongly appreciated even today: he was commemorated in the new Beijing in 1954, on the 200th anniversary of his death.

An English translation of his opera, *The Palace of Eternal Youth (Chang Sheng Dian)*, was made in 1955 and should be read with the understanding that the real purpose of the plot is to denounce those traitors who turned to serve what was at that time a foreign regime.

*Yet those rotten courtiers, those good-for-nothing curs,
Who talked so much of loyalty and piety,
As soon as disaster came just turned their coats
To grab at wealth and position.
They fawn and cringe when they accept new titles,
Taking their deadly foe as their benefactor.
Have they no sense of shame?**

Though the setting is in the Tang dynasty and the protest is against other foreign conquerors, this must have hit home. This opera, though political in intent, also appeals to the human side, for all people are interested in love stories. Here is the prologue to the play:

*Since ancient times how few lovers
Have really remained constant to the end;
But those who were true have come together at last,
Even though thousands of miles apart,
Even though torn from each other by death. And all
Who curse their unhappy fate are simply those
Lacking in love. True love moves heaven and earth,
Metal and stone, shines like the sun and lights
The pages of old histories....*

It is no wonder that the Manchu rulers did their best to stamp out the kind of opera where strong opposition to feudal rule or

* Hong Sheng, *The Palace of Eternal Youth*, p. 171. Foreign Languages Press, Beijing.



sentiments of national feeling were expressed. Moreover, they set up a commission in Yangzhou, northern Jiangsu Province, where many rich merchants and others lived who patronized the disliked forms of opera. The duty of this commission was to delete from the old opera the offending passages and bring it into line, in form and content, with the type the Manchu overlords approved of. This was in 1777 during the Qian Long period; and the result of this action was that in the end many popular operas which had had great influence with the people were either revised, banned or completely lost.

At the time of the revolution against the Manchus, 1911-1912, many members of the imperial household, who till then had been amateurs, went on the stage as professionals. The onslaught of Western imperialism made the patriotic operas more and more popular and in time they began to be used as an interpretation of the wishes and feelings of the people.

So it is interesting to see how the Yuan drama, the basis for most of the modern Peking Opera, was an expression of popular feeling by the Chinese people in a time of foreign domination. It flowered again at the time of the domination of the Manchus and afterwards during the period of foreign imperialist control. At all these periods, the bringing back of the stories of old, with their struggles and their heroes, their brilliance and their patriotism, brought hope to the people.

The first Chinese opera ever to come to the West was the one called *Search for and Rescue of the Orphan* written by a Yuan playwright Ji Junxiang who lived somewhere about the middle of the 14th century. Since it is not easy to sing, it is not performed much in China today. Set in the Spring and Autumn Period of the Zhou dynasty the story is about a civil war, in which a military leader tries to kill all the members of the ruling house but misses one child who is saved by a loyal servant. It was called *The Zhao Family Orphan* in the West and no less than five adaptations of it were made. In England the play was converted into a political one attacking the corrupt Walpole government; it departed widely from its original. Hatcher, the English playwright who adapted it, makes one of his characters say:

*Are we not likewise prey'd upon like carrion,
By locust place-men and by martial drones?
Are we not up to th' chin in debts and taxes?
Trick'd where we trust and bated where we love?
By foe and by ally, alike despis'd?
Are we not drain'd by ev'ry state catbarrick,
By costly peaces and expensive wars?*

A French version in which Voltaire propounded his ideas of the triumph of reason also existed, and it is said by a biographer that Goethe also based his play *Elpenor* on *The Zhao Family Orphan*.

The role of the classical Chinese opera in sustaining the morale of the common people during the terrible century before liberation



is certainly very considerable. The chief figures are beings from another world, from the ancient periods of China's history. But it is a world which the people loved to enter because it recalled the heroic struggles of the past. The common man, seeing the ancient heroes fighting mightily to overthrow foreign rule, would say to himself: "Soon we shall do it again!" He would see and admire the righteous Judge Bao, who never failed to find the absolute truth in every case — so different from the justice which the people then met in daily life. He would see quick swords raised in defence of righteous causes, and great, pompous officials topple down before the brothers of Liangshan or Sun, the Monkey King.

The Monkey is truly a popular hero, for nothing is too big or too pompous for him to take on — not even the whole court of heaven, the Pearly Emperor included. Some of his exploits are familiar to readers of English in Arthur Waley's *Monkey*, a selection of episodes from the novel *Journey to the West (Xi You Ji)*, a full translation of which is being published by the Foreign Languages Press. The book, an old classic in China, is a parody on the Tang dynasty account of Xuan Zhuang's long journey to India in search of the Buddhist scriptures. The Monkey is a very resourceful character, a puller-down of anything he feels like pulling down. Many episodes from the story have been dramatized in the opera, and Monkey's antics are a never-ending source of delight to audiences. In the minds of the Chinese people he has always represented the common man, scoring some of the victories which the people would like to score, against all the forces that were arrayed against him.

From the time China's Red Army was organized, and through the formation of a series of resistance bases, the problem of education of the people and the army itself was naturally a great one. As small drama groups grew into bigger ones and as technique was perfected and folk music adapted, so did the revolutionary theatre develop.

An entirely new form of opera arose. This evolved in a series of stages during the fight against Japan, in the liberated areas of the country, in the War of Liberation that followed the Japanese defeat. It was spread mainly by the drama groups of the People's Liberation Army and it told stories of the everyday life of the people and their struggles in an absolutely electrifying way. The performances in thousands of towns and villages by the army drama groups in the period immediately following liberation opened the eyes of the people in a way nothing else could have done. They saw their own struggles enacted before their eyes; all the bitterness caused by the landlords and their armies was there in living reality. They saw that change had come and that power was really in their hands. In form, this new type of opera was something closer to those more familiar to the rest of the world, though the music was based on folk songs and the instruments used were often classical Chinese instruments. It too played to crowded houses whenever it was brought to the stage. It had a deep real-



ism which people recognized as their own experience and a philosophy which was right down to earth.

Although these new liberation operas will live long and will be accorded an honoured position in the permanent operatic tradition of China, they have in no way taken, or ever would seem likely to take, the place of the classical Peking Opera. The two are entirely different.

Peking Opera has a lasting fascination and a definite and expanding role to play in the mighty new land that has so swiftly and so brilliantly emerged from the ruins of the old. Many of the operatic plots, with little or no adaptation, still have that ageless freshness of appeal to the people. Naturally, the actors, in line with their new political understanding and as people's artists, place a new emphasis on some of the parts played.

One old and very popular opera still currently being played in Beijing, for example, is *Iron Faced and Unselfish*, the story of an event around a flood disaster in the Song dynasty. All the officials concerned — magistrate, prefect, imperial commissioner — are grasping and corrupt and share the extra levies for flood relief among themselves, instead of using them for the people. But at court there is the righteous judge, Bao Gong, who works for justice. With the help of the emperor's uncle he foils their greedy plans and sets the situation right. Many people who see this opera must recall personal experiences of the great floods of past days, such as the disasters of 1931 when corrupt officials and traders of that day rushed to the scene to use their power to gain profit from the situation. They must rejoice when they see this ancient drama, knowing that now corruption has gone for good and their country is united in one whole to fight and guard against whatever natural disaster may come.

Another successful recent presentation is a story from *Outlaws of the Marsh* which tells of the killing of a tiger by some hunters. The tiger in its death struggle falls from the mountainside and lands in the grounds of a rich landlord, whose men seize it and carry it off to collect the reward which has been offered. When the hunters arrive at the landlord's home to demand the rightful spoils of their chase, the landlord falsely accuses them of being bandits and attempting armed assault on him. It is worthwhile having a good seat for a performance of this kind for the actors, especially when they are facing such scenes as those depicting torture and imprisonment at the hands of the corrupt magistrate and the landlord, play their part with a tremendously realistic brilliance and strength, shown so well in their facial expressions.

Today, whether it be the White Snake, the heroine Hua Mulan, the tribal princess Mu Guiying, or the brave fisherman and his beautiful daughter who took revenge for the wrongs perpetrated against them, the old stories are taking on a new richness. They become part of the new life of a people who have themselves struggled against aggression and have given birth to countless new heroes and heroines, worthy inheritors of the glories of past struggles.



These old stories too are a natural background for the newer heroic ones that come from the great events of today — the conservancy projects on the Huai and Yellow rivers, the Wuhan cities defending themselves against flood, the vast endeavours of industrialization and continued resistance against aggression.

More and more new drama will be written and will become part of that vast store which is the Chinese people's heritage. Already stories of the Taipings, the revolutionary peasants of the 19th century, of the tragic life of Qu Yuan, the great poet of the 4th century B.C., have been made into impressive operas. In November 1955 they commemorated in Guangzhou the actor Li Wenmao who had died a hero's death just one hundred years before. He had a group of players to fight alongside the peasants of the Taiping revolution against Manchu imperial oppression.

How many people see the opera every day? Surely more than ten million of them! Local operas exist in a tremendous variety of forms, but the form and influence of the Peking Opera has penetrated every corner of the land and adds to the delight and sets standards for the opera everywhere. The great dramatic festivals which have been held in Beijing and other places have brought to light a store of talent that has hitherto gone unregarded. Actors now take their rightful places as truly national figures, loved and admired by the millions who are cheered and inspired by their art.

Before leaving this brief introduction to a very great Chinese institution, a little more might be said on what steps are being taken to see that all which has been evolved so carefully through the generations is not lost. Today there are many training centres for young actors and actresses, and one remembers well going to a performance where the performers were all students of ages from ten to twenty. They played very well indeed, but one could better appreciate the immense perfection of the popular actors on the adult stage when one watched the portrayal of these talented beginners. They could not quite co-ordinate the completely motionless outstretched hand with intricate leg movements... not quite attain the magnificent poise and complete control over each bodily action of the finished actor.

In this demonstration of learners was all the life and freshness that only youngsters can give. It was another proof, if any proof is needed, that most Chinese are born actors, for they so evidently loved and lived the parts they were playing.

After attending this performance, it was good to go and see at one of the bigger Beijing theatres a presentation made by graduate student actors of the National School of Peking Opera. The ladies came on with a polish and professional charming glide while the great generals entered with a most convincing and terrific swagger, their back flags fluttering and the bright red pompon on their head-dresses all a-quivering. Especially good was the much-loved scene of Sun, the Monkey King, defeating the cohorts of Heaven. The whole act was a breathless storm of dance and acrobatics with the old folktale running through, brought out in a clear and delightful



manner. There is certainly a rising generation of actors coming on to fill the places of their elders, who will do credit to them.

The tradition of training for opera in China is a very ancient one. For instance, in the 8th century A.D. after the capital at Chang'an in the Tang dynasty had been sacked and the existing court driven away, the great Tang poet Du Fu wrote longingly from Kweifu in Sichuan. After listening to a southern revival of old opera in which some of the players were trained in the old Chang'an, he thought back on the magnificence of the other day. A translation of his lines is as follows:

*Where the strain from stringed instruments
stirs the hearts of older officials; where
the beauties of the scene are enough to sway
even spirits or immortals; now in this southern court
songs of Kai Yuan times are sung by pupils
of the Pear Garden; and as they sing,
the sweetness of their song spreads through
the palace, tears flow from eyes, and lips
move in sympathy.*

Now, all the bigger industrial centres that are coming into being have permanent Peking Opera companies playing in the theatres that have been erected among the new homes of the working people there. Indeed, one can see the revived Peking Opera all over China today. In its new form, it is a theatre superbly costumed and magnificently played, resting on the most solid base of all, that of the love and appreciation of the people. Its organization runs parallel and interlinks with other people's organizations in the collective way that all such operate in. The genius of the Chinese people is their ability to work in the group, and the new order now gives additional responsibility and strength to all such that operate for the common good.

In China today there is not only the great work which is being carried out in the training of new actors for the people, but also there is painstaking and widespread research being done into the whole operatic tradition of the country. Wherever survivals of old forms are found, they are closely investigated, and especially in the realm of music where much is being discovered and preserved for all time. The old musical instruments and the melodies played on them become familiar again.

In consequence of all of this, it may be safely said that the creative side of future operatic development will be in line with the best Chinese tradition. Surely there will be change, for with industrialization the people change. For instance, there is now the demand that more scenery be used and that this be of the highest quality. This need is one that is being experimented with very successfully in some of the new productions now being staged.

In conclusion one may say that the people of China today, although they warmly receive the diversity of theatre that is developing, will certainly not forget their first love, the Peking Opera.



OBSTACLES TO ECONOMIC DEVELOPMENT:
CHINA AS AN EXAMPLE

SUBJECT AREA: ECONOMICS

Sarah W. Turner
Puerto Rico
1993

INTRODUCTION

The welfare of underdeveloped nations is a matter of concern to our own economy. Many of these countries supply us with vital raw materials upon which our industry relies. It is essential to us that supplies of these items not be cut off. Also experience has shown that poor countries are poor customers, while healthy economies are good customers. We may expect that as the underdeveloped nations become more affluent, they will buy more of our products. Assisting these poor countries may therefore be regarded as "good business."

China has one of the world's fastest growing economies. The years of development have, nonetheless, left China with inflation, strong pressures of the population on the land, a poorly educated labor force, and an income distribution with inequalities typical of the world's most backward and under developed nations. Persistent and growing deficits is the current account of the balance of payments and foreign public debt. Foreign firms have become conspicuously important in the export of manufactures, and Chinese firms had been paying large annual sums for the use of foreign technology.

Opening up to the outside world is the current strategy of china for economic progress. This plan involves building special economic zones and opening other regions economically by reforming the system of foreign trade. All of these make full use of foreign capital and advanced technology to serve the economic change in China.

New economic policies are being implemented that Chinese leaders predict will make the country one of the world's leading economic powers in the 21st century. The opportunities are enormous. So are the problems. The potential is great. So are the economic hurdles that have to be overcome.

Because the benefits of economic growth have been so inequitably distributed, China exhibits some of the shrpest indexes of underdevelopment - a per capita GNP of \$360, nearly one-half of the population subsist on a margin of nutrition, nearly one-half have no schooling and the disparity in income between the richest and the poorest approaches forty times.

No matter what policies are laid down, despite the emergence of Guangzhou as one of the most vital manufacturing cities on earth and Shanghai as the powerhouse to generate industry for half a continent, down in the countryside, Chinese life remains basically uninterrupted. (Kevin Sinclair)

OBJECTIVES

1. List the four general obstacles to economic development.
2. Describe an example for each obstacle to economic development as related to the P.R. China.
3. Describe problems created by economic development in China.
4. Analyze each problem and state a possible solution to each of the problems.
5. Devise economic policies which might be implemented by the Chinese government to solve its economic problems related to development.
6. Appraise the consequences of the policies if implemented.
7. Evaluate the consequences of foreign aid and investment as a means of economic development with the possible result of economic dependency.

MOTIVATIONAL ACTIVITIES

1. Before presentation of this unit, make sure students have an understanding of underdeveloped and developing economies and the usual resulting problems.
2. Prepare a bulletin board showing a map of China and products produced and exported.
3. Use charts and graphs to illustrate the ideas presented in the lesson. Several are included in the unit.
4. Have students make a list of the imports their family uses on a regular basis. Review the lists deciding which items probably came from China.
5. Locate major transportation routes, agricultural areas, energy distribution centers, and manufacturing areas in China.
6. Follow current developments in China through television and newspaper sources.
7. Read the China Daily articles included in this unit.

SEQUENTIAL ACTIVITIES

1. Have students list the four obstacles to economic development as: people's attitudes, rapid population growth, misuse of natural or human resources and trade restrictions. Students will brainstorm all the possible consequences of these obstacles.
2. Read the article, "Petrochemicals crucial to every economic sector," (China Daily, July 9, 1993). Choose one example from it to illustrate each of the four obstacles to economic development. then work with another person to determine as many different examples as possible to illustrate other problems which could occur in each of those four areas. Return to large group to make a group composite list of possible example problems in obstacle areas.
3. Provide students with the collection of China Daily news articles related to economic development. Then have students brainstorm in small groups to construct a list of the problems of economic development specific to China.
4. Have students return to their groups to analyze each problem. They should list a possible solution for each, devise an economic policy which could be implemented by the Chinese government to correspond to each solution, state the possible negative and positive consequences of each policy, and determine which would be the best policies to actually implement.
5. Describe how you (the student) would justify the negative consequences of these policies if implemented by you as the leader of China. Participate in a debate on this topic.
6. Using the reaction guide for sorting activities, draw a conclusion about the following statement:
Despite reports by the IMF citing China as an economic power, it is still a low-income developing country.
7. One of the major problems confronting underdeveloped nation is how to amass the capital goods necessary to increase productive output. Capital formation may be financed through personal savings, taxation, deficit financing, or aid from abroad. (1) With reference to three of the listed items, explain how they would serve to finance capital formation. (2) Summarize the problems that China has in seeking to amass capital, as it applies to each of the methods listed.

8. In seeking solutions to the problems of the underdeveloped nations, economists have focused on the following four areas: (1) population growth, (2) land reform, (3) foreign aid, (4) technical assistance. Describe how each of the four items listed above is related to the problems in China.
9. React to this statement: "Because it is necessary for them to engage in extensive economic planning in order to industrialize, China can be expected to remain under the control of a Communist dictatorship."
Do you agree with this statement? Give reasons to defend your answer..
10. Incorporate China into a lesson on economic geography by using the enclosed worksheet format for a cooperative exercise on foreign investment decisions.

China Daily

Petrochemicals crucial to every economic sector

China will make machinery, electronics, petrochemicals, auto-making and construction the most important industries, according to the First Session of the Eighth National People's Congress.

Sheng Huaren, director of the China National Petrochemical Industrial Corporation, which is in charge of the country's petrochemical industry, told Outlook magazine how his industry should try to reach the goal. Excerpts follow:

The State has listed the petrochemical industry as one of the most important industries because in today's world each sector of the national economy is inseparable from petrochemical products.

With a population of more than 1 billion, China has only 100 million hectares of cultivated land. Feeding 20 per cent of the world's population from only 7 per cent of its arable land requires China to make effective use of natural resources, including land and forestry.

The petrochemical industry's most important products — synthetic materials — can save land, raise agricultural output and replace some natural materials, such as cotton, hemp and timber.

When farmers had to rely on manpower and animals to plant crops, a

farmer in the United States could feed only four people. In the era of mechanization, one American farmer could feed seven people. Now, with the wide application of chemical fertilizers and pesticides, the chemical era has arrived. In this era, an American farmer can feed 50 to 60 people.

Petrochemical industrial products can provide energy and raw materials for the military, textile, light industry, chemical, and transportation and communications sectors.

Plastics can replace timber, steel, aluminium, copper and other alloys in machinery, electronics, auto-making and construction.

Petrochemicals are technology-intensive. The industry operates under high temperatures, high pressures, extreme cold, and inflammable, explosive and corrosive conditions. So the containers, meters, high-speed rotors, centrifugal compressors and computerized controls that it requires must be reliable.

This requires industries, such as metallurgy, machinery and electronics, to keep improving their equipment.

To satisfy the need for petrochemi-

cal products, the industry also has to adopt new technology. This has boosted the development of the auto, aircraft, railway and shipbuilding industries, whose products rely on the internal-combustion engine for power.

The petrochemical industry has good economic returns and can accumulate capital rapidly. The postwar economic prosperity of the United States, the economic revival of Western Europe, and the economic transformation of Japan and South Korea were to a great extent due to the rapid development of their petrochemical industries.

After more than 40 years of development, China's petrochemical industry has laid a firm foundation. Last year, China's crude oil processing capacity ranked fourth in the world and its ethylene production capacity ranked eighth.

But China's petrochemical industry lags behind those of the advanced world.

China's population accounts for one-fifth of the world's total. But the amount of crude oil each Chinese processes represents only 3.7 per cent of the global total. China produces only 3 per cent of the world's ethylene, 2.9 per cent of its plastic, 8.6 per cent of its synthetic fibre and 3.6 per cent of its synthetic rubber. This is incompatible with China's status as a large country.

Several factors hinder the development of China's petrochemical industry.

Production needs advanced technology, precision equipment and a high degree of automation. But most of the technology and equipment in China's industry are backward.

The supply of crude oil has hindered the development of the petrochemical industry. China's crude oil and natural gas resources cannot meet the needs of the developing petrochemical industry

The industry is also short of money and talent, especially personnel skilled in marketing, finance and accounting.

Two steps ought to be taken to build the petrochemical industry into a pillar of the national economy.

First, by the year 2000 China should annually process about 200 million tons of crude oil, about 5 million tons of ethylene, 7 million to 8 million tons of synthetic resin, 3.5 million to 3.7 million tons of synthetic fibre, and 700,000 to 1 million tons of synthetic rubber.

Second, by the year 2010 China's annual crude oil output should reach 300 million to 350 million tons and its ethylene output 8 million to 10 million tons to be compatible with its status as a major nation.

To achieve the goal, China ought to use advanced technology to set up new factories and renovate its old ones.

It should introduce advanced foreign technology and management methods so it can produce more with less manpower and investment.

It must also raise capital both at home and abroad to boost the development of the petrochemical industry. It should also attract foreign businesses to set up factories in China.

ECONOMIC DECISION MAKING

Possible Solutions

Consequences

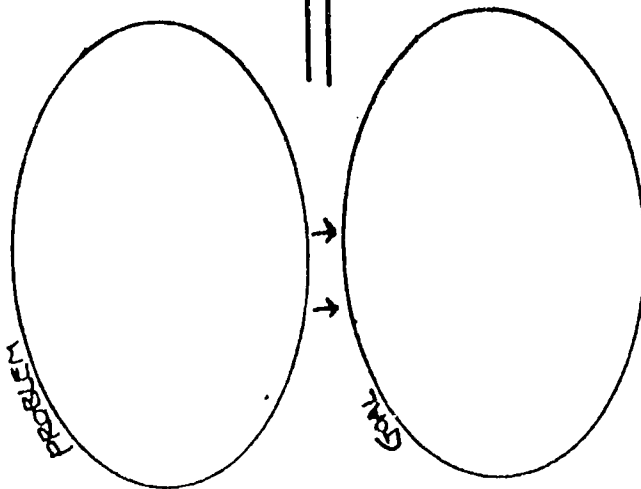
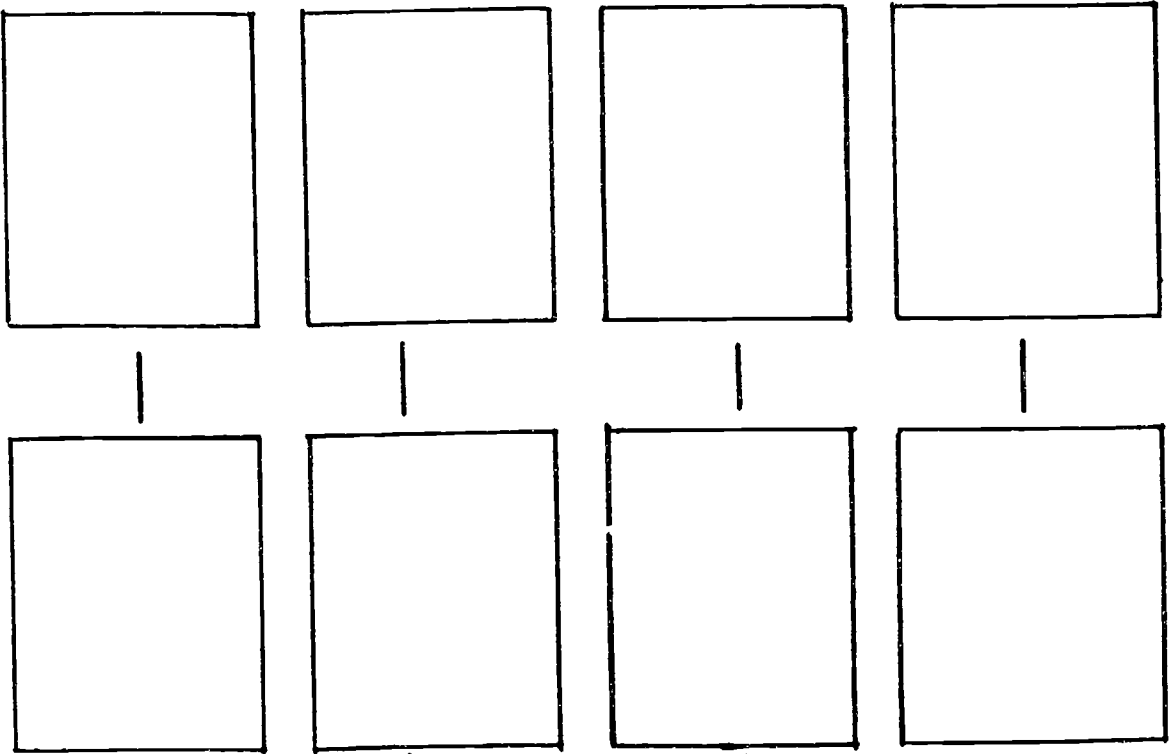

WHAT IS THE BEST SOLUTION

A large, empty rectangular box intended for the student to write their chosen best solution.

WHY DID YOU CHOOSE THIS?
 WHAT WERE THE TRADE-OFFS?
 HOW DID IT MEET YOUR GOAL?

CLASSIFICATION FORMAT REACTION GUIDE

The three best policies are:

1. _____
2. _____
3. _____

Good consequences likely to follow from the adoption of these policies are:

Bad consequences likely to follow from the adoption of these policies are:

Suppose someone asked your group to justify risking the bad consequences you have identified. If this occurred, what basis would you use to argue that your decision is a good one?

REACTION GUIDE FOR SORTING ACTIVITIES

The generalization is: _____

List data consistent with the generalization:

List data inconsistent with the generalization:

As a group, we believe the generalization is:

_____ Accurate _____ Inaccurate

because _____

ECONOMIC GEOGRAPHY







PROBLEM: You are a Swiss manufacturer producing inexpensive (\$25 to \$40) and medium priced (\$100 or more) watches. Due to import duties placed on your product by foreign governments, you have decided that you would like to open up a new factory in some foreign country. For a variety of reasons, you have narrowed your choice to P.R. China, Republic of China, or Hong Kong.

1. List the many factors (both natural and human resources and other problems) that you must investigate before you decide where to build your factory.
2. What advantages would there be for your company in the location of your choice?
3. What disadvantages or problems would you think that you would find in the location of your choice?
4. What advantages would there be for your company if you decided to locate in the other locations listed?
5. What disadvantages would there be in the other locations listed for your company?
6. Which location have you chosen in which to locate?
7. Where in the location chosen will you locate? Why?
8. Would your overall decision regarding selection have been the same for the following industries? If not, which of the other two locations would you choose and why?
steel, winemaking, textiles, perfume, chemicals, toys, sailboats

BASIC STATISTICS OF CHINA'S ECONOMY

INDICATORS	UNIT	1952	1978	1985	1990	1991
GNP	billion yuan	--	358.8	855.8	1768.6	1975.9
National income	billion yuan	58.9	301	702	1442.9	1602
Total value of agricultural output	billion yuan	46.1	139.7	361.9	766.2	815.7
Total value of industrial output	billion yuan	34.9	423.7	871.6	2382.4	2822.5
Total value of import and export	billion dollar	1.94	20.64	69.6	115.44	135.7
Per capita consumption	RMB yuan	76	175	403	714	798
Overall price indexes (preceding year = 100)	%	99.6	100.7	108.8	102.1	







Vital Signs

	 People per tel	 Pop (m.)	 Pop. growth	 Infant mortality	 Literacy rate	 People per doctor
Switzerland	1.1	6.9	0.2%	7	100.0%	238.0
Canada	1.3	27.8	1.5%	7	99.0%	501
U.S.	1.3	256.3	0.7%	9	95.5%	420
New Zealand	1.4	3.5	1.0%	7	99.8%	332
Australia	1.5	17.7	1.3%	7	99.5%	333
France	1.5	57.5	0.4%	7	98.8%	350
Japan	1.5	124.9	0.4%	5	100.0%	609
Hongkong.	1.6	5.9	0.9%	6	88.1%	933
Germany.	1.8	80.2	0.8%	7	100.0%	564
Britain	1.9	57.8	0.2%	7	100.0%	611
Italy	1.9	57.9	0.2%	8	97.0%	210
Singapore	2.0	3.1	2.0%	5	91.0%	711
Taiwan	2.4	20.9	1.2%	5	91.7%	381
Macau	2.9	0.4	4.7%	7	61.3%	667
South Korea	3.2	44.1	0.9%	16	96.0%	1,071
Brunei	3.8	0.3	2.8%	8	85.1%	1,323
Turkey	6.6	59.6	1.9%	58	81.0%	1,169
South Africa	6.9	37.7	2.2%	54	79.3%	1,750
Mexico	7.6	84.7	1.9%	27	90.3%	600
Saudi Arabia	8.5	17.5	3.8%	32	62.0%	660
Malaysia	8.8	18.8	2.6%	13	78.5%	2,656
Brazil	10.0	159.5	1.9%	57	81.0%	684
Fiji	10.3	0.8	1.5%	20	85.5%	2,028
Maldives	19.5	0.2	3.4%	31	98.2%	6,034
Egypt	23.8	57.2	2.2%	59	48.5%	1,320
Thailand	28.5	58.6	1.4%	27	93.0%	4,361
Mongolia	32.8	2.4	2.7%	60	89.5%	390
P.N. Guinea	49.0	3.9	2.3%	55	52.0%	6,070
Philippines	52.5	64.2	2.3%	41	93.5%	1,019
Kenya	62.7	27.4	3.7%	67	69.0%	10,130
China	76.9	1,181.8	1.4%	38	73.3%	724
Pakistan	89.3	122.8	2.9%	97	35.0%	2,111
Sri Lanka	100.0	17.7	1.0%	18	88.5%	7,143
Indonesia	107.7	188.4	1.7%	60	81.5%	11,641
Nigeria	125.0	92.9	3.2%	85	51.0%	6,650
India	126.6	884.6	2.1%	90	52.1%	2,460
Nepal	196.0	20.4	2.3%	101	26.0%	16,830
Bhutan	285.0	0.6	2.3%	118	38.0%	3,738
Afghanistan	417.0	17.7	6.7%	162	29.4%	9,091
Vietnam	435.0	71.8	2.2%	43	88.0%	2,857
Bangladesh	455.0	123.4	2.7%	103	35.3%	6,650
Burma	476.0	44.3	2.1%	65	81.0%	12,500
Laos	588.0	4.3	2.9%	100	83.9%	4,380
Cambodia	1,429.0	8.7	2.2%	116	48.0%	25,000

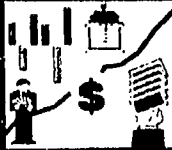
These figures are the latest available from national and multilateral sources. Population growth is the percentage increase in population over the last year, and includes births, deaths and net immigration. († Afghanistan figure includes returning refugees.) Infant mortality is the number of babies per 1,000 who die within one year, and does not count stillborns. Standards may differ, but generally means the ability to read and write a short, simple statement about everyday life. Literacy rates refer to the percentage of population over fifteen years († ten years). People per doctor counts only those physicians and medical practitioners who meet World Health Organization standards. It does not include nurses.

Asia week 7/28/93
405

The Bottom Line

	 GDP per cap	 GDP growth	 Exports 12 mths	 Surp/Def cur. a/c	 Foreign debt	 Inflation CPI
Switzerland	\$36,650	-1.1%	\$65.6b.	\$15.60b.	05	3.1%
Japan	\$29,500	2.7%	\$349.0b	\$127.51b	08	1.0%
U.S.	\$23,500	0.9%	\$448.2b.	-\$81.56b.	\$611.5b.	3.8%
Germany	\$23,000	2.9%	\$422.3b.	\$25.09b	08	4.3%
France	\$22,400	-0.5%	\$235.8b.	\$2.90b.	05	2.0%
Canada	\$19,936	3.8%	\$130.3b	\$28.60b.	\$237.0b	1.8%
Italy	\$19,511	0.9%	\$172.2b.	-\$25.40b.	\$107.0b.	4.0%
Britain	\$17,738	0.7%	\$190.0b.	\$20.70b.	08	2.8%
Brunei	\$17,500	3.0%	\$2.6b.	\$1.50b.	05	2.5%
Hongkong	\$16,382	5.1%	\$126.0b.	\$1.30b.	08	8.5%
Australia	\$16,310	2.5%	\$42.8b.	-\$10.83b.	\$112.3b.	1.2%
Singapore	\$15,200	7.1%	\$63.4b.	\$2.99b.	08	2.1%
Macau	\$13,527	12.1%	\$1.8b.	n.a.	05	7.4%
New Zealand	\$11,500	2.8%	\$9.9b.	\$0.78b	\$35.0b.	1.3%
Taiwan	\$10,215	3.2%	\$83.9b.	\$7.23b.	05	4.3%
Saudi Arabia	\$7,150	3.0%	\$78.2b.	-\$25.74b.	\$16.7b.	2.6%
South Korea	\$6,635	3.9%	\$78.0b.	-\$1.73b.	\$42.5b.	4.6%
Mexico	\$3,950	2.6%	\$27.5b.	\$22.80b	\$75.7b.	9.8%
South Africa	\$2,970	0.8%	\$24.0b.	\$1.50b.	\$0.8b.	9.7%
Malaysia	\$2,965	8.1%	\$42.5b.	-\$1.70b.	\$15.8b	3.7%
Brazil	\$2,800	-0.9%	\$33.7b.	\$6.58b.	\$111.2b.	1,055%
Fiji	\$1,945	3.0%	\$0.5b.	\$0.05b.	\$0.4b.	6.2%
Turkey	\$1,910	5.3%	\$14.8b.	-\$0.94b.	\$41.4b.	70.1%
Thailand	\$1,660	7.4%	\$33.2b.	-\$7.33b.	\$37.4b.	4.5%
P.N. Guinea	\$1,115	9.0%	\$2.1b.	-\$0.18b.	\$2.4b.	5.5%
Philippines	\$835	0.2%	\$10.0b.	\$1.07b.	\$32.0b.	6.7%
Egypt	\$700	0.7%	\$3.9b.	\$1.90b.	\$38.4b.	10.4%
Indonesia	\$645	5.8%	\$33.9b.	\$4.00b	\$73.6b	9.5%
Sri Lanka	\$550	4.3%	\$2.4b.	-\$0.50b.	\$5.4b.	11.4%
Maldives	\$470	6.3%	\$0.4b	\$0.02b.	\$1.1b	17.2%
Pakistan	\$425	3.0%	\$7.4b.	-\$2.50b.	\$18.4b.	10.0%
Bhutan	\$415	5.0%	\$0.1b.	\$0.06b.	\$0.1b	13.0%
China	\$360	13.9%	\$86.6b.	\$10.42b.	\$69.3b.	10.5%
Kenya	\$340	2.0%	\$1.1b.	\$0.48b.	\$6.4b	35.6%
Nigeria	\$315	4.6%	\$12.3b.	\$1.20b.	\$33.0b.	45.2%
India	\$310	4.2%	\$19.0b	\$6.03b.	\$73.5b	6.1%
Burma	\$250*	1.2%	\$0.6b.	-\$0.14b.	\$4.8b.	30.0%
Laos	\$230	7.3%	\$0.2b	\$0.04b.	\$0.4b.	9.8%
Bangladesh	\$220	4.0%	\$1.9b.	\$0.21b.	\$14.8b.	5.0%
Vietnam	\$220	8.3%	\$2.5b.	\$0.21b.	\$15.4b.	37.7%
Cambodia	\$200	7.0%	\$0.3b.	-\$0.03b.	\$1.6b.	75.0%
Nepal	\$180	3.1%	\$0.3b.	\$0.24b.	\$1.9b.	17.0%
Afghanistan	\$150*	0.8%*	\$0.9b.	-\$0.14b.	\$1.6b.	56.7%
Mongolia	\$100*	-7.6%	\$0.4b.	-\$0.05b.	\$7.1b.	321.1%

Compiled from the latest available data. Gross Domestic Product (GDP) is the value of all goods and services produced in one year. Gross National Product (GNP) is GDP plus payments from abroad from investments, labour, etc., and minus similar payments to foreigners. As an indication of living standards, GNP per capita is only a rough guide. It includes some output that is not universal, such as home heating. It does not take into account purchasing power. Per capita GNP is converted to U.S. dollars using an average exchange rate. The CPI (Consumer Price Index) measures one year's price changes in the goods and services bought by a typical household. n.a. Not available. † Not creditor. * Best estimate.

China pushes ahead with reform

Premier Li calls for rapid economic growth despite inflation

By KATHY WILHELM
The Associated Press

BEIJING — Premier Li Peng urged China's legislature Monday to push ahead with market reforms and high-speed economic growth, as the country prepares to enter a new era of leadership without revolutionary elders.

But he made it clear that the communist Party has no plans to ease its authoritarian rule, and denounced efforts to expand democracy in Hong Kong before it reverts to Chinese rule in 1997.

Li, known as cautious, was uncharacteristically bullish on economic development in his speech to the National People's Congress. He called it the nation's central task.

"We should seize every opportunity that presents itself for our development," Li told nearly 3,000 delegates assembled in the Great Hall of the People for the congress' annual meeting.

"We must never allow ourselves to be distracted from economic development," he said, stressing that social and political stability are essential in that pursuit.

His annual report, which serves as a statement of official policy on numerous subjects, made it clear the congress will be devoted to endorsing the leadership's economic reforms.

During its two-week session, the congress also will ratify a new lineup of top government leaders that for the first time will not include any old revolutionaries from Mao Tse-tung's era.

Official news reports have confirmed that President Yang Shangkun, 85, and congress Chairman Wan Li, 77, will retire

and be replaced by younger party leaders. Even out of office, they will continue to wield influence based on their seniority.

Li, who is expected to stay on for a second five-year term as premier, sprinkled his two-hour speech with calls to "blaze new trails" and "emancipate our minds." Those phrases were coined by China's 88-year-old senior leader Deng Xiaoping, who wants to finish dismantling the Maoist state-planned economy

before he dies.

Li said the economy should grow 8 percent to 9 percent annually or even faster. In fact, it grew 12.8 percent last year during a time of worldwide recession, prompting some economists to warn of overheating inflation. High prices helped send protesters into the streets in 1989.

Li acknowledged that the reforms have benefited some more than others and that there is a "constant threat of inflation." He urged more rational investment and greater efforts to develop sectors that lag behind, such as agriculture and transportation.

He said jobs and wages should be determined by market need and state companies should be forced to become profitable — reforms that could put millions out of work.

"The socialist market economy is a new invention. We still have to find our way forward through practice," he said.

Li also proposed a 25 percent cut in the government work force of 34 million, and a reorganization of ministries that used to run the planned economy. Past efforts to streamline government have failed, however.

Li read most of his speech in a near monotone, standing on a stage draped with huge crimson flags.

Li said relations with the West were gradually improving, but rejected Western criticism of China's human rights record.

Warm applause also greeted Li's call to combat corruption within government, which has become endemic. However, he offered no new cleanup plan.

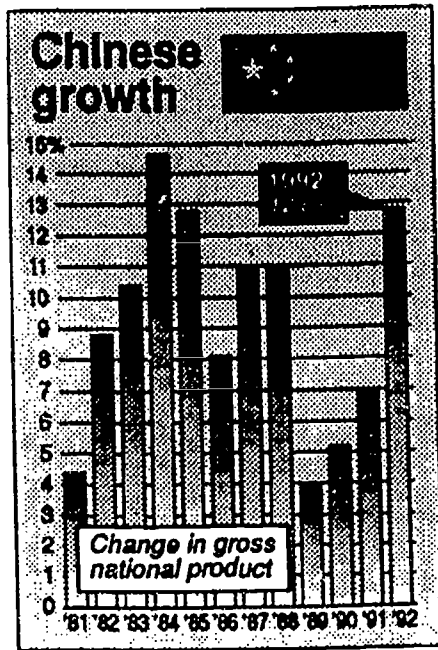

AP

San Juan Star 3/16/93

7/20/93

China Daily

Per capita income outpaces inflation, government says

by our staff reporter
Wu Yunhe

Urban and rural income rose faster than inflation in the first six months of the year, the State Statistics Bureau (SSB) says.

Per capita urban income increased 28 per cent in the first six months of the year, and rural income rose 16 per cent per person, SSB spokesman Zhang Zhongji said yesterday at a news conference.

Inflation for the first six months of 1993 rose 12.5 per cent over the same period last year, Zhang said.

However, the country's cost of living index, in June, chalked up a year-on-year increase of 14 per cent, and 21.6 per cent in 35 large- and medium-sized cities.

The government's new macro-economic policies to curb inflation would slow down China's gross domestic product (GDP) growth rate — from the 13.9 per cent seen in the first half of this year — to an expected yearly average of 12 per cent by the end of 1993, he said.

China's GDP hit a record 1,264.7 billion yuan (\$218.1 billion) in the first six months of 1993.

Zhang said the slowdown is necessary because unbridled investment in fixed assets is feeding inflation.

Investment in fixed assets reached 354.2 billion yuan (\$61.1 billion) during the first six months of this year, representing an increase of 61 per cent over the same period a year ago.

During the first six months of 1993, the fixed assets investment by State units accounted for 219 billion yuan (\$37.8 billion), up 70.7 per cent.

Zhang urged every region to fully observe the government's new policies to keep inflation at bay, describing them as crucial to regaining control over some economic sectors.

The first six months this year saw a continued economic boom, with capital investment and industrial growth showing particular progress, Zhang said.

During the first six months, the country's industrial production saw

an increase of 25.1 per cent compared with the same period last year.

He said that the individually-run and foreign-invested companies took the lead in industrial production, with a growth rate of 68.7 per cent during the first six months of this year.

Industrial production for State and collectively-owned companies was reported to have grown 10 per cent and 45 per cent, respectively.

By the end of June, 31.1 per cent of the country's State industrial firms suffered operational losses, but the number of firms that lost money decreased 0.9 per cent from the same period a year ago.

Agriculture, the sector that has grown the most as a result of the 14-year-old economic reform, showed a bumper harvest this summer, with an estimated output of 107.98 million tons, an increase of 4.7 million tons over the same period a year ago.

During the first six months, output of pork, beef and mutton saw an increase of 9 per cent from the same period last year to total more than 14.4 million tons. This was achieved despite a decrease of rural crop-growing land, soaring production-material prices and arbitrary levies on farmers.

Retail sales in the first six months reached 639.6 billion yuan (\$110.3 billion), up 21.6 per cent from the same period in 1992.

The dramatic increase in retail sales was, to some extent, attributed to the increase in per capita income to 1,116 yuan (\$200) for the first six months of the year for the urban residents.

The per capita income for the rural residents during the six-month period amounted to 423 yuan (\$74.5), an increase of 18 per cent, or only 7 per cent allowing for inflation.

China Daily

State must get basics right to boost economy

by Liu Li

China's industrial policy must focus on developing infrastructure and basic industries.

If it fails to do so, the country will miss an opportunity to realize the fruits of its economic take-off in the rest of the 20th century.

Industrial policy is one means for a government to guide the country's industrial development over a long period, but it must have a clear focus.

Vague industrial policy was one of the major reasons for the Chinese economy experiencing great ups and downs in the last decade.

But even when the policy was clear, there were some instances in which it could not be implemented.

China reaffirmed at the end of the 1980s that industrial policy centred on the development of agriculture, infrastructure and basic industry.

But the policy was overshadowed by the rapid development of processing industry.

Generally speaking, infrastructure means transport, highways, telecommunications, harbours, railway stations and airports. Basic industry includes mining, raw materials and energy.

These industries usually determine whether a country's economy can develop robustly and healthily.

The 14th National Congress of the Communist Party of China, held at

the end of last year, was the springboard for promoting economic development and reform, particularly in infrastructure and basic industry.

Some people, however, argue that the country should opt for high economic growth as its basic focus. They reason that supplies of energy and raw materials can be met in international markets.

This argument runs counter to the national situation.

Haste will make waste.

From 1989-91, when the country launched a retrenchment programme aimed at curbing double-digit inflation, the government called for a readjustment of industrial structure. Most economists believed it was time for readjustment because demand was sluggish and the pressure on basic industry was reduced.

However, infrastructure and basic industry were still developing slowly.

Basic industry advanced 23.6 per cent from 1989-91, 4.6 percentage points lower than the average industrial growth rate.

Why were opportunities for industrial readjustment missed?

First, investment in infrastructure and basic industry was too low.

Funds in fixed assets in the basic industrial sector increased 66.9 per cent from 1989-91, but that was only 4.9 percentage points higher than the growth of new investment in fixed assets in the whole of Chinese industry.

The margin was too small to stimu-

late high growth in basic industry.

Second, prices of basic industrial products were too low, compared with those of consumer goods, and the situation still exists.

It is a historical problem, as China has adopted a policy of low prices for capital goods to support its heavy industry since the founding of the New Republic.

Due to the irrational price pattern, some basic industries such as coal mining suffered losses in 1991 and the situation has yet to improve.

Third, the criteria to assess the achievements of local authorities, which were set under the planned economy, still focus on growth of local economies, ignoring profits, technological improvements and innovation.

The criteria have inevitably led local governments to spur production in the more swiftly profitable processing sector, resulting in more and more duplicate production projects across the country.

The proposed industrial policy depends on the principle of resources being allocated by the market.

Resources will continue to be the major bottleneck of China's economic development. We should avoid the go-for-speed policy, which will drain the country's limited resources.

At the same time, the government should keep some necessary administrative methods to minimize the risks brought by any short-term behaviour under a market economy.

For example, the overheated real estate industry and wild enclosing of development areas attracted capital in opposition to the country's industrial policy in 1992 and early this year.

Such behaviour has diverted funds that should have gone to basic industry and agriculture.

Accelerating reform — to establish an efficient economic system — can create a good environment for the implementation of industrial policy.

Meanwhile, more investment should be made in infrastructure and basic industry, otherwise industrial policy will amount to nothing.

In addition, it is necessary to maintain a moderate economic growth.

A stagnated economic development will blur the implementation of industrial policy, as was the case from 1989-91.

If the economy develops faster ahead of basic industry, the target of economic efforts will have to be the high inflation which will result.

Also, the implementation of industrial policy will be overshadowed.

China should learn the overheating lesson of 1992.

(The author is an industrial analyst with the State Statistics Bureau)

Rise in unemployment seen

Cool-down of economy main reason

Reuter

Beijing, July 28 — Joblessness in mainland China, already rising as the socialist lifetime-employment system is dismantled, will surge as Beijing puts the brakes on its overheating economy, the China Daily reported on Wednesday.

A crackdown ordered this month on speculative real estate deals and loose credit would hit the roaring construction and manufacturing industries, throwing unknown numbers of laborers out of work, the newspaper said.

Authorities expect the official unemployment rate to swell beyond the current 2.3 percent and have pledged new efforts to create jobs in the second half of 1993.

The number of mainland Chinese officially "waiting for work" reached 3.6 million at the end of June, a 9.1 percent increase over the same date in 1992, official statistics show.

The number of urban jobs is shrinking, standing at 146.8 million at the end of June, down 1.14 million, or 0.7 percent, from December.

Beijing's deliberate slowing of the overheating econo-

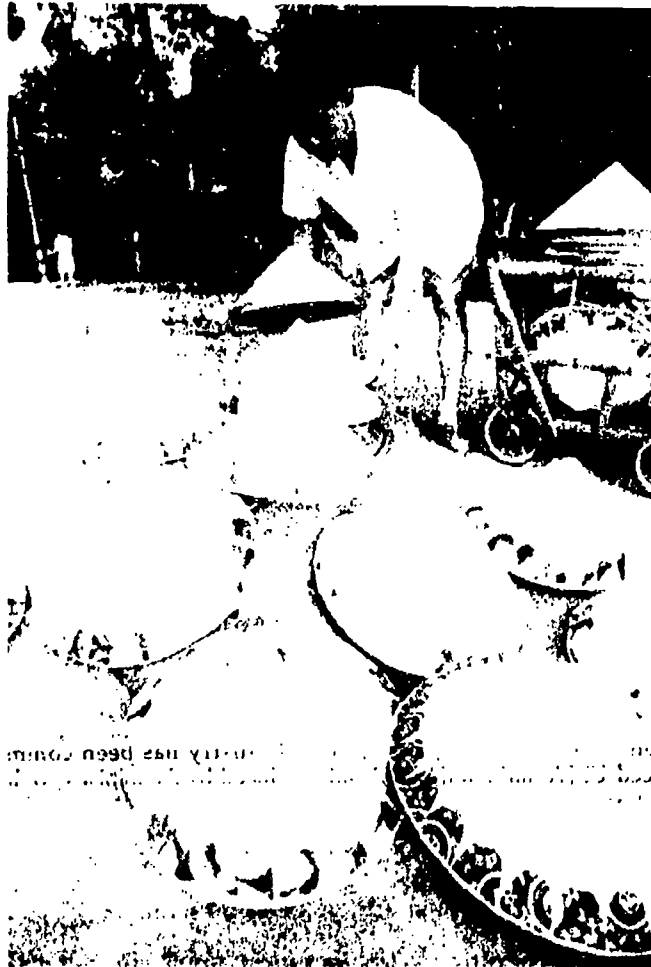

— Greg Baker, Associated Press

A mainland Chinese man displays cone-shaped straw hats on a Beijing sidewalk Sunday. The hats, which have become popular in Beijing this summer, sell for 2 yuan (35 U.S. cents) each.

my would exacerbate the labor crunch, the China Daily said.

The new measures would include "market oriented mechanisms like (those used)

in developed countries," labor ministry official Zhang Xiaojian was quoted as saying.

The ministry vowed to give preferential treatment — presumably financial and technical assistance — to businesses in a position to create the largest number of jobs, Zhang said.

The labor market has become increasingly chaotic after measures to "smash the iron rice bowl" of lifetime employment left millions of urban workers out of a job.

Growing population pressures in the land-scarce countryside have propelled millions of peasants into booming cities in search of work.

This huge floating population — seen queuing up at streetcorner job marts or idling in railway stations — goes uncounted in official unemployment statistics.

Vibrant economic growth has spurred private-sector job creation and absorbed many surplus workers.

But mounting concerns that growth, now at about 14 percent a year, is spinning out of control have prompted officials to try to slow things down with a sharp tightening of credit and administrative measures to curb property development.

China Post 7/29/93

Foreign funds boost exports

China Daily 7/7/93

by our staff reporter
Wang Yong

Enterprises funded by foreigners are becoming a main force in China's export drive.

The news came yesterday from a meeting held in Beijing by the China Foreign-invested Enterprises Association for awarding 1,117 such enterprises.

The award-winning enterprises, mostly manufacturers, each generated at least \$2 million in exports and 1 million yuan (\$172,000) in pre-tax profits last year.

Each posted per capita exports of more than \$10,000 and 10,000 yuan (\$1,724) in pre-tax profits.

The 1,117 companies had a combined export income of nearly \$8 billion, 46 per cent of that from China's more than 110,000 foreign-funded enterprises.

Of the 1,117, the top 10 exporters pulled in some \$1.1 billion in export income.

The top 10 foreign-funded businesses in the categories of business turnover and per capita profits were also given awards.

The highest per capita profits of the top 10 (including taxes) last year came to 2.34 million yuan (\$403,000).

The meeting's award ceremony put in the limelight China's foreign-funded enterprises, which have posted a faster export growth rate

than China's State-run exporters.

In the first four months this year, foreign-funded enterprises saw their exports jump by more than 60 per cent, while their State-owned counterparts lost ground.

In 1992, the industrial output of foreign-funded enterprises nationwide reached 250 billion yuan (\$43 billion), about 8.5 per cent of China's overall industrial production.

The foreign-funded enterprises include foreign wholly-owned firms, Sino-foreign joint ventures and cooperative businesses.

The foreign-funded companies' export volume was \$17.3 billion or 20 per cent of the country's total, and they paid more than 10 billion yuan

(\$1.72 billion) in taxes, excluding tariffs.

In the first four months of 1993, China approved the establishment of 23,000 foreign-invested enterprises, up 270 per cent over the same period of last year.

The promised foreign investment was \$32.9 billion, up 310 per cent.

In another development, the Bank of China, China's major foreign exchange bank, praised 210 foreign-funded enterprises at the same meeting, which it deems its "best customers."

By 1992, the bank had loaned more than \$10 billion and 93 billion yuan (\$16 billion) to China's foreign-funded enterprises.

Foreign firms in China hit record

In case there were doubts over the fast-growing importance of China in the global economy, consider this:

The number of foreign-owned or foreign-funded companies in China reached a record high of 130,000 by the end of June, up 54 percent from one year earlier, the official Xinhua News Agency reported from Beijing.

Foreign-based companies invested a total \$114.45 billion in China in the first half of the year, 4.5 times the amount for the first half of 1992.

The huge increase in investment in part reflects new efforts by the Chinese government to allow foreign companies more access to the domestic market, Xinhua reported.

However, the total also is swelled by growing numbers of Chinese companies that have set up Hong Kong subsidiaries, which in turn invest back in the mainland. That's because foreign-funded companies often are eligible for tax breaks and enjoy more autonomy in hiring and firing than wholly Chinese-owned companies.

San Juan Star 8/10/93

July 4 - 10, 1993

Cross-border capital to revive barter trade

By Wang Yong

Has Sino-Russian border trade, tartly billed as "exchanging soap for awls," reached its peak already?

This comment from a senior Russian trade official earlier this month gives credence to growing doubts about the future of border trade across the Heilongjiang River, currently overshadowed by a cash shortage.

The bulk of the border trade so far has been barter. China sells its foodstuffs, textiles and other consumer products to Russia and other countries of the Commonwealth of Independent States (CIS). In turn, it gets heavy machinery and raw materials.

The barter business as such has made China's Heihe and Russia's Blagoveshchensk, which face each other across the Heilongjiang River, boom towns.

Signboards in Russian are popular in Heihe, which covers nearly 70,000

square kilometres of land (including suburbs and forested areas) and is abundant in natural resources like gold and coal.

These days when you roam through the city of Heihe you'll still encounter the effects of the hot border trade.

But local officials, like their Russian counterparts, fear that given the low-value barter business, the fast growth of border trade cannot be sustained.

One major reason is that Russia has hefted its import and export tariffs, while capping the outflow of its raw materials.

This has driven up the costs of what China buys from Russia and also what it sells, says Wang Shuquan, an official in charge of Heihe's border trade.

"In 1993, two-way border trade allows no optimism," he told Business Weekly.

His words may sit uneasy in Heihe, which has earned 100 million yuan (\$17.2 million) since 1987 from its border trade with Russia.

But Chinese officials have another trump card to bolster border trade: Enhancing cross-border investment.

Heihe and Blagoveshchensk are planning to set up a free trade zone at either end of a bridge across the Heilongjiang River, which is to be completed in three to five years.

"The twin zones will lubricate the flow of capital and people between the two countries," says Wang.

Details of the programme will be hammered out later this year when the two sides meet again.

In a parallel move, Heihe, which shares 358 kilometres of border with Russia, is building a development zone that will total 8.5 square kilometres by 2010.

With investment projected at about 1 billion yuan (\$172 million), the zone will become Heihe's commercial centre when it is finally operating at full steam.

"The establishment of our zone meshes well with Russia's strategy of shifting its economic focus to the

Far East," says Huo Qingxian, a senior researcher with the Heihe Development Zone.

He says the zone will endeavour to attract investment both from the CIS and Southeast Asia. Many Chinese investors have shown growing interest in the zone.

"Heihe's strong point lies in its abundant natural reserves," he says.

Its precious rocks, copper, coal, gold and forests are well-known throughout the country.

Besides, it has power supply aplenty, in sharp contrast to China's coastal areas where power shortages are unsettling.

Potential investors here can either deliver what they have manufactured to other parts of the country, or directly to Russia and other CIS nations.

"We will spruce up our airport, railways, roads and build the Heilongjiang bridge linking Heihe with Blagoveshchensk in four years to prepare for large-scale foreign investment," Huo says.

State lures foreign funds to its companies

6/28/93

China Daily

by our staff reporter
Xiao Xie

China is studying a package of preferential policies to attract overseas investment in State-owned companies with outmoded technology.

An official with the State Council Economic and Trade Office declined to give any details, saying that the procedures are still being worked out by the relevant government ministries.

Nation set to fight disasters

by our staff reporter

China assured an international conference in Beijing that it would fully co-operate in the world effort to reduce losses caused by natural disasters.

The one-day International Conference on Disaster Management on Friday was organized to provide a forum to discuss worldwide co-operation.

President Jiang Zemin said China would enhance international exchanges and co-operation, as well as make contributions to the world disaster relief.

China, which is frequently battered by disasters, is preparing to open a State Centre for Disaster Reduction, according to Dojie Cairang, Minister of Civil Affairs.

The centre is expected to collate information on natural disasters, provide training courses on disaster management and conduct research.

The United Nations Development Programme (UNDP) representative and local co-ordinator, Arthur Holcombe, said his organization could aid co-ordination within the international community, help human resource development in disaster mitigation and preparedness and advise on disaster mitigation planning and management.

"To bring together these elements of aid co-ordination, training and advisory services, UNDP is prepared to provide \$250,000 as seed money to initiate a new programme in China," Holcombe said.

Most foreign investors are interested in the economic development zones which have sprung up throughout the country, and only a small number of them are interested in State firms.

State-owned enterprises used at the most 20 per cent of the total overseas investment in China last year, and the percentage is dropping.

State companies play an important role in China's economy, but their poor economic performance has long been a headache for the government.

China's more than 10,000 large and medium-sized State businesses, which comprise only 2.5 per cent of the number of the country's industrial enterprises, contributed about 60 per cent of the nation's tax revenues and turned out about 46 per cent of the country's aggregate industrial output. However, about one-third of the State businesses are operating in the red.

China's industrial enterprises last year suffered a total of 441.2 billion yuan (\$76 billion) in operational losses, the same as the previous year, the State Statistics Bureau said.

The Chinese Government is working hard to reform its large and medium-sized companies. Both officials and economists agree that increasing the State enterprises' competitiveness will mean more management autonomy and more funds for development.

According to an overseas edition of People's Daily, Ministry of Foreign Trade and Economic Co-operation officials have said that the government has been urged to direct foreign investors toward State companies that work with raw materials, energy, fuel and the transportation sector.

The government has been urged to be more flexible in using foreign investment money to reform the State companies.

These measures will include allowing the State-owned companies to set up joint ventures or establish limited liability companies with their foreign counterparts. Foreigners would be able to contract for or lease the old enterprises.

Sources from the Ministry of Post and Telecommunications have said that the ministry has a total of 28 large manufacturing enterprises, which need foreign investment to upgrade their production facilities in order to be competitive.

Economic clout overestimated, official says

by our staff reporter
Wu Yunhe

Referring to recent international reports citing the country as an economic power, China said yesterday that it is still a low-income developing country.

Zhang Zhongji, spokesman of the State Statistics Bureau, said a new calculating method based on purchasing power parity (PPP) has some inadequacies in measuring economic strength, especially in the developing countries.

Using the PPP method, the International Monetary Fund (IMF) rated China as the "third economic power" right behind the United States and Japan.

Zhang said the new calculation showed that China's gross domestic product (GDP) was much higher than that drawn from the traditional accounting, which converts output into US dollars at the official rate of exchange.

The PPP method calls for "accurate GDP-related statistical materials" for measurement of a nation's economy, including more than 151 kinds of expense items and a wide variety of price statistics.

The major flaw in the calculation is that China is not in a position to supply such updated and detailed information of expenditures and price changes, as its statistical system is backward, Zhang said.

As a result, Zhang noted that China has not qualified for participation in the United Nations' International Comparative Project (ICP), which was established in 1968.

The GDP is a major comprehensive economic indicator to weigh a nation's economic strength, he said.

But, he added, more and more economists in the world have acknowledged that, in addition to the GDP, more factors need to be considered in measuring a nation's economy.

Social, cultural and environmental conditions should also be included in such an assessment to obtain a more realistic result, Zhang said.

According to the bureau's statistics, China has successfully fed its more than 1.1 billion population. In addition, its 14-year-old economic reform is coming along.

"But as we consider not only the economic background but also the scientific, technological, social, cultural and environmental development, it is easy to see that the country is still a developing country, with a relatively small per capita income," he added.

China's per capita GDP was still below \$400 in 1992, far behind that in the developed countries — despite the fact that the country's total GDP reached 2,393.8 billion yuan or \$458.6 billion last year, ranking 10th in the world.

Agriculture is still a major component in China's GDP. And agricultural output mainly is affected by weather.

The industrial output amounted to only 27.2 per cent of the country's GDP, 14 per cent lower than the world average.

Other factors that put China at the level of a low income nation are such factors as food structure, literacy and education, and per capita living space.

Furthermore, 520 of the country's 1,903 counties are considered poverty-stricken areas, where the people's average per capita income is below 200 yuan (\$34.5), the official said.

China Daily 7/8/93

Quick action needed to curb inflation

By Zhang Yu'an

A market analyst has predicted nationwide inflation will soar to about 10 per cent this year.

Zhang Xuhong, an analyst with the China Market Development Institute, said the government must pay particular attention and take effective measures to avoid sharp price rises.

But he added the country's current inflation is still within the limit that can be controlled and endured. He told Business Weekly in an interview last week that "potential inflationary pressures have started to work" caused by the rapid growth of the national economy and increasing prices throughout the country.

Statistics show the national inflation level was 8.4 per cent in January, 8.7 per cent in February, 10.2 per cent in March and 10.9 per cent in April.

In the country's 35 large and medium cities, living costs rose by 16.7 per cent in the January-May period, already close to the 18.5 inflation figure in 1988, which led to a three-year austerity and tight-credit programme.

Viewed from the present economic

situation, inflation still can be kept within an "endurable limit" if effective macro-control measures are taken, he said. Otherwise, inflation will probably become "quite serious" this year, he said.

He noted that experience shows inflation, once it starts, will accelerate and is impossible to stop unless macro-measures are used. If the measures come late, the cost will be great.

The 1988 high inflation caused a nationwide buying spree and bank run.

To avoid serious inflation, he suggested relevant departments do the following work:

- Enhance macro-control to avoid a full-scale overheating of the economy. At present, there are already signs of overheating in some places:
- Avoid blind growth and let the market and resources decide the economic growth:
- Limit investment size, especially for projects already under construction. Both administrative and legal measures should be taken to draft a regulation on management of investment in different places:
- Improve currency management and introduce a quota system for issuing bank loans.

China Daily 7/14/93

Dispute over Hong Kong intensifies

China accuses Britain of blocking unification

Sun Jan Star
3/16/93

By NICHOLAS D. KRISTOF
New York Times News Service

BEIJING — Prime Minister Li Peng has accused Britain of "perfidiously" trying to create disorder in Hong Kong and trying to impede the territory's smooth return to China.

Li used the occasion of a two-hour policy address Monday morning, opening the annual session of the National People's Congress, to step up the attack on Britain's proposals to increase democracy in Hong Kong. His voice rising in outrage, Li departed from the advance text of his speech to warn that China would hold Britain fully responsible for the consequences of the dispute.

The speech also indirectly accused the United States and France of "having deliberately created obstacles to China's peaceful unification" by selling weapons to Taiwan. While Li specifically referred only to "certain foreign elements" it was clear that he meant Washington and Paris.

Li also warned that China was ready to take "strong measures" — apparently meaning full military force — to prevent Taiwan from proclaiming itself an independent country separate from China.

Communist Party leaders have worked together for several months on the speech, which is equivalent to a state-of-the-nation address. It thus represents the views of the entire leadership, not just those of Li, and as such it is one of the best indications available of what vision the party has for China's future.

While the speech affirmed China's current economic course, it did not appear to signal any hastening or slowing of the pace. Instead, the lack of vision underscored the extent to which the initiative in economic policy has passed from the central government to the provinces.

At a party Monday evening attended by many Chinese officials and business people, none of those questioned had bothered to watch the speech on television or listen to the radio broadcast. "Frankly, no one really cares," a businessman said, before changing the topic.

The denunciation of Britain comes after the governor of Hong Kong, Christopher Patten, announced on Friday that he would present legislation for democratic change to the territory's legislature. China will inherit Hong Kong in July 1997 and is outraged by Patten's proposals.

"The governor of Hong Kong perfidiously and unilaterally proposed a program for major changes in the current political system in the territory," Li declared. He asserted that the dispute was not over democracy but about adherence to the Basic Law, which China has established for Hong Kong after 1997.

"In essence, the action taken by the British authorities in Hong Kong against the Basic Law is designed to create disorder and to impede the smooth transfer of power, so it is not a question of democracy," Li said.

**The History and Culture of Han China:
A Fulbright Curriculum Project**

Bonnie Volkman
Fulbright China Group, 1993
Curriculum Project
January 15, 1994

Mills High School
400 Murchison Dr.
Millbrae, Ca, 94030
(415) 697-3344

Background Information on Teaching Situation:

I teach at Mills High School, a suburban school in a middle class, educationally focused community called Millbrae on the San Francisco peninsula. The school has a student body of approximately 1500 students who are ethnically diverse with Asian and Caucasian students predominating. The largest group of Asian students is Chinese; our Chinese students come mostly from Taiwan and Hong Kong although in recent years, we have more and more students coming from the Mainland. I taught this unit on ancient China in World History, a sophomore level, academic elective course. I teach the only two sections of this class and so have control over the curriculum. My department head has been supportive of my curricular revision as we both recognize the need to change the course content from a traditional western civilization survey course to a multi-cultural survey to better met the diverse needs and interests of our student body.

Another piece of background information necessary to the reader of this unit is the knowledge that Mills H.S. is currently in the third year of a restructuring project aimed at improving education for all students. I have worked on school teams involved in revising instructional strategies, writing integrated curricula, and implementing authentic assessment. I was a mentor teacher with a project in all of these areas from Spring, 1992 to the Fall semester, 1993. Faculty and administrators at Mills encourage experimentation aimed at developing higher level critical thinking skills, cooperative learning strategies, and authentic assessment instruments. Thus, I have taught this unit in a school situation that was receptive to experimentation. The introduction of a new curricular unit on Chinese history and culture was easy for me to accomplish although I believe that this unit could fit into any World History course.

The Philosophy of this Unit:

I planned this unit on ancient China with the intention of having my students read and discuss as many Han dynasty primary sources as possible. The primary sources that I selected were mythological, Confucian, Taoist and Legalist texts (the texts used are included at the end of this document as well as a bibliography of resource texts). I wanted to focus on the Han Dynasty as the formative period of Chinese culture; it is interesting to note that the Chinese still refer to themselves as the "Han people".

While the Han was the focus, instruction included background information about the development of Chinese culture from the Neolithic period through the early dynasties. The central questions that directed our study were:

1. What were the social and intellectual beliefs and cultural traditions established during the Han Dynasty?
2. What were the central philosophical and ethical principles underlying Han beliefs and traditions?
3. Why were the Han paradigms so stable?

The Contents of the Unit:

To answer these questions, I began by teaching background information about the geography of China, the time frame of the dynasties, and the cultural history of China up to and including the Han. As a foundation for an in depth discussion of the thought of Han China, we studied the earlier dynasties in the content of the development of civilization, the key concept that linked this unit to the larger scope of the course. We investigated the unique, as well as the common elements shared by all early river valley civilizations and took a fieldtrip to the Asian Art Museum in San Francisco to see the art produced in China, India, and Teotihuacan, during this formative period of their histories. I also showed slides of Banpo neolithic village located outside Xi'an that I had taken during my Fulbright trip last summer. Background information on political and economic history came from a reading assignment in the class text, Ricker, John and John Saywell. The Emergence of Europe. Toronto: Clarke, Irwin & Co. Ltd, 1976.

Another part of this unit was the introduction to history as a discipline and to historical methodology. I assigned my students a research paper on a topic of their choice related to the Han Dynasty. My instruction on this writing assignment was designed to aid students in formulating an original thesis about one aspect of Han Chinese culture, researching the topic, and presenting a supported argument defending the thesis. This paper was the major assessment tool for the unit.

My instructional strategies relied heavily on reading and discussing primary

sources; after grappling with philosophy, I designed cooperative group work assignments to give students the opportunity to demonstrate their understanding of the abstract concepts. For example, following the discussion of Confucian and Taoist principles, student groups produced a visual including a metaphor and a poem that illuminated one commonality between the two philosophical systems. We ended the unit with a celebration of Chinese culture that included traditional music (tapes that I had purchased during the summer), food, and slides of my Fulbright trip.

After receiving a two month extension of the due date of this curricular package, I decided to continue the parallel study of western and Chinese history into the Middle Ages of both civilizations. I designed the China portion of this last unit of the semester as a performance final exam (see heading **Final Exam**). I have suggested to the students that they consider peer teaching their lesson to my senior honors Humanities class at the beginning of the second semester as a way of sharing their knowledge with other Mills students. Finally, I told my students from the beginning that they were going to be involved in a teaching project that was going to result in a published curricular unit that would be available to teachers nation-wide over the ERIC system. I had each student write an evaluation of the unit and offered extra credit to those who would allow their essays to be submitted as part of my project. A representative sampling of those essays is included following the readings and assignment sheets.

Lesson Plans for Han Dynasty Unit:

- Day 1: introduction and overview of unit emphasizing the focus questions
-brief video on ancient Chinese history
-assignment of textbook reading for homework (spread over two weeks)
- Day 2: map emphasizing physical geography, early settlement sites, and early kingdoms
- Days 3-4: presentation and discussion of the timeline through the Han dynasty using transparencies
- Day 5: film on the history of ancient China to visualize the timeline and introduction of the research paper assignment*

- Day 6: library day to select topic and begin research
- Day 7: discussion of the Pan Gu creation myth**
- Day 8: discussion of Nu Wa and the creation of human beings; comparison of Chinese myths to western creation myths
- Day 9: lecture introducing historical period and brief biography of Confucius
- Day 10: discussion of Confucian texts
- Day 11: lecture on the impact and institutionalization of Confucian teachings in both education and government service
- Day 12: library day for conferencing and research
- Day 13: discussion of Confucian idea of filial piety and the five relationships
- Day 14: lecture on imperial government and the concept of the Mandate of Heaven- political implications for the peasantry, revolt against the dynasties, the "life cycle" of dynasties
- Day 15: video-- *Heart of the Dragon: Beliefs* (PBS series) on religious/philosophical belief systems to introduce Taoism in comparison to Confucianism
- Day 16: discussion of Taoism
- Day 17: test on primary source readings
- Day 18-19: group work to create visual and poem comparing, contrasting or meshing Confucian and Taoist ideas
- Day 20: presentation of visuals and poems to the class (peer teaching)
- Day 21: discussion of Legalist texts emphasizing comparison to Confucian and Taoist texts
- Day 22-23: lecture and slides on Chinese art from the neolithic through the Han
- Day 24: essay evaluation on choice of topic:
~How do Confucian values still impact modern Chinese attitudes and behaviors especially in the family?
~How do Taoist values compliment modern attitudes toward nature?
- Day 25: Chinese Cultural Celebration (essay evaluating unit due)

*the research paper was due one week after I completed teaching the unit; during that week, the students peer edited their papers, revised their rough drafts and conferenced with me as this was the first "long" thesis paper (five pages typed) that many of them had written

**all texts to be discussed were read for homework

The Performance Final--Medieval China:

I gave this assignment three weeks before final exams are scheduled and have allotted four (4) days for students to work together in the library during class. Students picked the people they wanted to work with and then the group selected the dynasty (the Six Dynasties, the Song, the Tang or the Yuan) they wanted to research. There are four groups of approximately seven (7) students each; their task is to create an illustrated timeline noting events that occurred in Chinese politics, economics, social system, science and technology, art, and religion during their dynasty. During the two hour final exam testing period, students will take a brief objective test on the western Middle Ages, and will then teach their classmates about their dynasty emphasizing the unique contributions made during that era of Chinese history. The final grade will include credit for both the timeline and the teaching, as well as a possibility for extra credit points based on creativity in either area.

Bibliography:

A Chronological Table of Chinese and World Cultures. National Palace Museum; Taipei, 1985.

Ebrey, Patricia Buckley. Chinese Civilization: A Sourcebook 1993.

Fairbank, John King. China: A New History. 1992.

Morton, W. Scott. China: Its History and Culture. 1982.

Chang Po-Tuan. The Inner Teachings of Taoism. Translated by Thomas Cleary. 1986.

Schwartz, Benjamin I.. The World of Thought in Ancient China. 1985.

Stories From Chinese Mythology. Translated by Ke Wen-li and Hou Mei-xue. n.d.g.

China: Timeline

- 1709,000 Yüan-mou Man - Earliest known species of MAN found in China
- 600,000 - 500,000 Lan-t'ien Homo Erectus / Peking Man
- 16,000 Shan-t'ing-tung Man (modern)
(carving, marriage rites) (Advanced tools)
- 10,000 Shen-nung (trad.) invented ploughing tools and taught people how to farm - Also, founder of medicine.
- Fu Hsi (trad.) invented the net, domestic animals and institution of marriage

Neolithic Period

- ceramic ware with fish, human, motifs & geometric designs

4000

- 3000 - silkworm cocoon found in neolithic village
- work in jade

- Huang-ti (trad.) Ancestor of Chinese race - writing, MA palaces, clothes, etc.

- 2333 - 2233 Reign of Emperor Yao

- 2231 - 2183 Reign of Emperor Shun

Hsia dynasty

- 2183 - 2176 Hsia Yu - irrigation system to control floods; 1st court

- 1819 - 1720 Yi Yin - prime minister

Shang dynasty

- c. 1500 bronze weapons and vessels
- 1400 - 1300 oracle bone writing
- c. 1300 evidence of astronomy (star chart)

Shang, cont

- c. 1500 writing brushes; earliest books
- c. 1325 Chou-p'i - SUAN-CHING - EARLIEST text on
ASTRONOMICAL MATH and Geometry
- 1177 - first record of an earthquake

Western Chou

- 1171-1121 King Wen - composed I Ching
- King Wu - overthrew last Shang ruler and est'd
Chou dynasty
- 1100 Chou Kung - model for governance in Chou
dynasty

Spring and Autumn Period

- 770 BCE King Ping moved Chou capital E. to LoYang -
ruled for 40 years
- c. 685-645 Kuan-tzu, minister tried to hold China
together as a unified nation
- 687 1st record of fall of meteorite
- 1st recorded appearance of a comet
- 580-480 Lao-tzu Author of Tao-te Ching
- 551-479 Confucius, Analects, emphasized music and
rites as foundation of Chinese civilization
- 500-400 BCE San-hai Ching, world's oldest treatise on
geology

Warring States Period

- c. 430 currency (state of Chi'u)
- c. 410 bronze bells - EARLIEST large set of musical instruments
- c. 460-390 Mo-tzu, Book of Mo-tzu; simplicity basic approach
to life, universal love
- c. 372-289 Meng-tzu (Mencius) follower of Confucius;
man's basic nature is good / advocated benevolent gov't
- 400-300 Shih Shen and Kan Te produced EARLIEST ASTRONOM-
ICAL instruments and stellar diagrams

Warring States Period, cont.

- 315-286 BCE Hsun-tzu, theory that man's basic nature is evil but could be rectified with discipline and adherence to tradition
- 369-286 Chuang-tzu, phil. of transcendence (Taoist)
- Mo Ching, physics text, 1st to use decimal system
c 400-300
- Nei Ching, medical text (oldest known), beginning of veterinary medicine

Ch'in Dynasty

- c. 215 Terracotta warriors in Emperor's tomb
- Great Wall expanded by 1st Ch'in Emperor, Shih Huang Ti
- unified measuring systems; adopted decimal system

Western Han

- 206-191 BCE Liu Pang 1st Han Emperor
- Emperor Hsin Wu-ti
- 179-104 BCE Tung Chung-shu, influenced Wu-ti and contributed to ascendancy of Confucian phil.
- 145-86 Ssu-ma Ch'ien wrote 1st systematic history of China
- advanced drilling techniques allowed deep mining of salt
- bronze cross-bow
- stone sundial
- opening of the Silk Road
- selective breeding of plants to improve grain harvest
- jade burial suit, tomb of King Chung-shan Ching

Eastern Han 25CE

- paper manufacture
- Tu Shih invented blast furnace for smelting metals
- c 100CE Shen Nung, Materia Medica, earliest pharmacological work
- 27-100CE Wang Ch'ung, Lun-heng, principles of sound waves
- 112 sword of refined steel
- 126 Chang Heng, 78-139CE, armillary sphere with water-powered movements like clock-drive
- 132 Chang Heng devised seismograph
- 181-234 Chu-ko Liang, statesman, philosopher, inventor

1. PAN GU, CREATOR OF THE UNIVERSE

Long, long ago, when heaven and earth were still united, the face of nature, a chaotic mass in the pervading gloom, was in the shape of a huge egg.

A giant in stature and strength, Pan Gu, forefather of the human race, was born in the midst of the egg wherein he grew up and slumbered soundly for eighteen thousand years.

One day, he awoke suddenly. When he opened his eyes, he found himself in an impenetrable darkness which made him feel quite smothered.

Exasperated at the annoying situation, he snatched a broad axe from somewhere and wielded it with a vengeance in the darkness. Out of the blue came an ear-splitting explosion; the colossal "egg" had cracked, the light and clear part of which rose to become heaven while the heavy and cloudy substance fell to become earth.

Where heaven was still linked with earth, Pan

Gu, chisel in his left hand and broad axe in his right, cleaved and chipped away with preternatural might and unremitting effort. By and by, heaven and earth finally came apart and the state of chaos ceased to exist.

After heaven and earth were separated, Pan Gu, for fear of their possible reunion, stood in between with his head against the heavens and his feet on the earth. He changed his form many a time each and every day as heaven and earth changed.

Each day, just as the heavens went up a *Jiang*¹ higher and the earth became a *Jiang* thicker, so Pan Gu grew taller in the same measure. Another eighteen thousand years later, the heavens were to become extremely high, the earth was to become immensely thick and Pan Gu phenomenally tall.

What in heaven's name was the height of Pan Gu? He was speculated to be ninety thousand *li*² in height. Like a never ending column, the heaven kissing colossus stood erect between heaven and earth, leaving the two no chance of meeting again.

There stood Pan Gu in loneliness, engaging himself in such laborious work. After no one knows how many ages had elapsed and heaven and earth solidi

16

fied, Pan Gu decided there was no longer a need to worry about their reunion. Completely fatigued and exhausted, he felt a great urge for a comfortable respite and, like other mortals, dropped dead at last.

When he was breathing his last, a dramatic change came over his whole body. His breath became winds and clouds and his voice, roaring thunder; his left eye was turned into the sun and his right one into the moon; his upper and lower extremities and his physique were transformed into the ends of the universe and the five famous mountains³; his blood was metamorphosed into rivers and streams; his tendons and veins into roads across the land; his flesh into the fields; his hair and beard into multitudinous stars that dotted the sky; the skin and the fine hair on his body into grass and trees; his teeth and bones into metallic minerals and rocks; his semen and marrow into pearls and jade; even his very perspiration was transmogrified into rain and dew that moistened all in the universe. By the sacrifice of his whole body, Pan Gu, the earliest ancestor of human beings lent beauty and splendour to the newly-born world.

1. A Chinese unit of length = $3\frac{1}{3}$ metres.

2. A Chinese unit of length = $\frac{1}{2}$ kilometre.

3. The Five Mountains were said to be the sacred abodes of mountain gods and were deified and worshipped by emperors and kings of past successive, feudal dynasties. They now refer to: Taishan Mountain (泰山) in Shandong Province, Hengshan Mountain (衡山) in Hunan Province, Huashan Mountain (华山) in Shaanxi Province, Hengshan Mountain (恒山) in Shanxi Province and Songshan Mountain (嵩山) in Henan Province.

2. NU WA, CREATOR OF HUMAN BEINGS

At one time, this myth tells us, the sun, the moon and the stars in the heavens, and mountains, rivers, trees, and grass on earth existed. There were even birds, beasts, insects and fish. But there were no human beings at all, which in a sense rendered the whole universe somewhat desolate and lonely.

In time there appeared a goddess known as Nu Wa. She was said to be able to change her form seventy times a day. One day, Nu Wa was strolling on the vast plains. At the sight of the surroundings overgrown with luxuriant grass and shrubs, a sense of utter loneliness overcame her. She felt that something needed to be added to the universe to make it thrive and prosper.

What was to be added, then?

Nu Wa sauntered on and on. She felt a little bit tired as she knelt down beside a pond. Her face and figure were mirrored in the water: she smiled and was

smiled back to; she pretended to be angry and her reflection did likewise. At this moment she had a bright idea: since there were already beings of all descriptions on earth except for ones like herself, why not create some beings in her image to live in the world?

So thinking, she dug a handful of clay from the brink of the pond and mixed it with water. She rolled the clay into a ball in her hand and moulded the first ball into a little thing like a baby.

Nu Wa put it on the ground. Curiously, the little creature had no sooner touched the ground than it came to life and shouted: "Mama!"

Then it started jumping and cheering, expressing its great joy in life.

Seeing the clever, beautiful little being she had created and hearing herself called "Mama!", Nu Wa was all smiles.

She gave her dear child a name "Human Being".

Small as the baby was, its appearance and manner, because it was created by the goddess, bore some resemblance to her. Altogether different either from flying birds in the air or from crawling beasts of the fields, it looked as if it possessed an extraordinary

20

432

courage to preside over the universe.

Nu Wa was much gratified with her production. She therefore went on with her work, creating many more little human beings that could walk and speak. These little creatures gambolled, danced and cheered around her, giving her great comfort and enlivening her spirits a great deal. From then on, Nu Wa no longer felt solitary and lonely.

She worked and worked until nightfall. As the night settled in, she slept briefly with her head pillowed on a cliff. She hurried to resume her work the next day when dawn was beginning to break.

Nu Wa had been bent on producing more such agile little beings to spread over the land. But the land was so vast that although she had been working for a long time, she could not fulfil her aspiration before she had exhausted herself.

At last she thought up an ingenious way of creating human beings. She pulled a dry rattan from a cliff and dipped it into the pond stirring it into the muddy sludge. Lifting the rattan she shook it and, lo and behold, there sprang up many living human beings where the sludge from the rattan splashed. These little creatures, jumping and dancing, calling "Ma-

21

433

ma, Mama" from here and from there, were exactly like the ones Nü Wa had previously moulded with tawny clay.

Her method was certainly simple and easy. She merely shook the rattan and many human beings would appear. Before long, the land was covered with the human race.

Man began to live on the earth, yet Nü Wa did not cease working. She was contemplating another problem, human beings are mortal; must I create another group after their death? That would be too troublesome. How, then, can I make them continue to exist year after year, century after century?

Later she found a solution to the problem; these little beings were to be divided into men and women; let each man match with a woman so that together they would create future generations and shoulder the responsibility of bringing up their own children. Thus the human race has continued from generation to generation and the population has been growing ever since.

3. NU WA REPAIRING THE SKY

Since the creation of human beings by Nu Wa, it had been uneventful for many years and people on the earth had lived a blissful life.

Who could have imagined that in one year, a great and sudden change somehow took place in the universe. It was either because of an enormous chaos in the kingdom of gods or because of the instability of the newly created heavens and earth.

Behold! half the sky had collapsed, revealing huge openings. The vast land cracked open leaving deep black chasms. Quenchless flames raged far and wide in the forests and immense flood waters gushed out from under the ground turning the land into oceans, their white caps kissing the sky. Beasts of prey driven by fire rushed out of the forests to devour good and innocent people and birds of prey hovered about in the blue, ready to swoop down on the old and the weak. What a hard time to survive!

It pained her heart when Nu Wa saw her chil-

dren suffer so terrible a disaster. Leaving the causes of the calamities for others to ponder, she set about repairing the sky all by herself.

This was indeed no small task. For the sake of her children's happiness, however, Nü Wa feared neither difficulties nor hardships, facing alone the challenge of this big job.

She selected multicoloured stones from rivers and streams, built a fire and smelted them into a sticky liquid with which to fill the holes in the heavens. Examined closely, the sky was somewhat different from its former shape; seen from afar, it looked as good as ever.

Fearing that the heavens might fall again, she cut off the four legs of a giant turtle, which, in place of the celestial pillars, were to stand in the four corners of the earth to prop up the sky as if they were supporting a huge tent. The pillars proved to be so strong that the sky was never again in danger of falling.

At that time, in the Yellow River Valley, there was a vicious black dragon which caused a lot of trouble to the people by stirring up floods. To rescue the people, the goddess slew it and at the same time drove

away all varieties of beasts and birds of prey which brought a world of harm to the people.

Now there remained only the floods left to be tamed. Nü Wa burnt the reeds on the river and massed the ashes with which she finally stopped the floods.

These universal calamities, the causes of which no one knows, were eventually brought under control by Nü Wa herself; her dear children with her divine assistance survived the catastrophes by a narrow escape.

Now the land again presented a scene of prosperity. Spring, summer, autumn and winter came in turn. The whole universe was in perfect order; the four seasons followed one after the other regularly. There were no beasts, birds, insects or serpents but that concealed their paws and claws and ceased to discharge their poisons. They became tame and submissive without vicious hearts to do harm to the human race. Food plants grew everywhere on the plains. With little effort, man could support himself. Free from care, people on the "central plains" of China lived an easy, blissful life.

Nü Wa was overjoyed to see her children live

happily. It was said that she created a sort of musical instrument called *shenghuang* made of calabash with thirteen pipes inserted in it in the shape of a phoenix's tail. This wind instrument, which she gave to her children as a gift, could produce dulcet tones. From that day forward human beings began to live a happier life than ever.

Having restored the heavens, Nu Wa contributed all she could to the human race and at length took a lasting rest. Her last repose was called "death", but her death was not extinction. As in the case of Pan Gu, so Nu Wa was also turned into a myriad things on the earth. West of the Great Wasteland, there was a stretch of plain called Liguang Plain where ten demigods, referred to as "Intestine of Nu Wa", stood abreast, blocking the path and guarding the plain. They were none other than those that were transformed from Nu Wa's intestine. Just consider how many amazing things Nu Wa's body could be metamorphosed into if one of her intestines alone could be turned into ten demigods!

Another version of the story says that Nu Wa did not die. After she had accomplished her work, she drove a thunder chariot enveloped in yellow clouds

and drawn by a winged-dragon in the middle and hornless dragons on either flank. Preceded by a white dragon and followed by a footless flying dragon, Nu Wa, propitious rarities in hand, was sitting on a matress specially made of tendrils. Guiding the ghosts and spirits from all parts of the universe, she floated leisurely and carelessly in the clouds.

After she ascended to the Ninth Heaven, she entered the abodes of gods to have an audience with God the Supreme and report her work to him. Then she took a good rest, peaceful and modest. She neither boasted of her achievements nor tried to make her renown felt, concealing behind a truly virtuous demeanour her prowess and great art so as to abide by the law of nature. Such was the magnitude of Nu Wa.

Confucius

September 28 is a national holiday in free China. It is Confucius' birthday, designated Teacher's Day by the government of the Republic of China.

Few civilizations of the ancient world had any scholastic or historical figure comparable to Confucius. If anyone were asked to characterize in one word the Chinese way of life for the last 2,000 years or more, the word would be Confucian. Just how it became so is not easy to explain. Confucius and his teachings were little respected and rarely practiced by the people of his day. Only some 300 years later was Confucianism declared the official creed of the country, and the classics became the principal study of all scholars and statesmen.

From the 2nd century B.C. to the present day, Confucianism has been synonymous with learning in China. Confucius was revered by the illiterate millions who could not read his classics but nonetheless practiced what he stood for. He was referred to as *ta cheng chih sheng hsien shih*, "the all-encompassing, supremely sagacious late master." His temple can be found in every one of China's 2,000 counties.

Who was Confucius and what did he teach?

Confucius is the Latinized name of Kung-futzu—his surname being "Kung" and "futzu" meaning master. He came from the state of Lu, in today's Shantung province, in the Spring and Autumn Period (722-481 B. C.), when the Chou



dynasty had lost its control over the feudal lords who each held a part of the country. Born on the 27th day of the Tenth Moon in the 22nd year of Duke Hsiang of Lu (551 B. C.), he was given the name of Chiu, meaning a hill, because there was a noticeable protuberance on his head. His literary name was Chung-ni.

His father died when Confucius was only three years old, and the boy was brought up by his mother. Confucius matured early. From childhood, he liked to play at performing sacrificial ceremonies and offerings as adults did. At 15, he made up his mind to become a scholar. Confucius used these formative years to learn from everyone and about everything. When he got a job as a clerk in the memorial temple of the Duke of Chou, he attended all the ceremonies and would ask tirelessly about every detail of the

ritual. Soon he acquired a reputation as an expert in ancient rituals, and disciples started to flock around him.

Confucius' preoccupation with rituals requires explanation. The original word for "ritual" is *li*, which means a sense of propriety, the order of things. Some translate it as "moral and religious institutions (of the Three Dynasties)." In fact, Confucianism has been known in China through the centuries as *li chiao*, "the religion of *li*, or ritual". This conception of *li*, meaning much more than mere ritualism, is Confucius' central theme for an ideal social order. Throughout his life, he sought to restore a social order based on love for one's kind and respect for authority, of which the social rites of public worship and festivities in ritual and music should be the outward symbols.

Confucius attributed all the ills of his day to the fact that the leaders of society had neglected the old rites, were performing them incorrectly, or usurping rites and ceremonies to which they were not entitled. He believed that the neglect and abuse of the rites reflected a deepening moral chaos and the beginning of spiritual darkness. Such was the state of affairs in his native place of Lu.

Only when he had reached the age of 50 was he able to put his ideals into practice. In 502 B.C. he was made *ssu kou*, the secretary of justice and one of the six highest ranking official positions. In 497 B.C. he was promoted to be the prime minister. He was then 55 years old.

When signs of neglect and moral chaos again appeared, Confucius quit, and started on travels which took him and his disciples to many states for the next 14 years.

The wandering years bespoke better than anything else the character of Confucius. He was not only a scholar, but a man of positive political ideals and a burning desire to see them materialize.

Many rulers sought his service, yet he would rather spurn their offer than grasp at any opportunity.

The record of the itinerary of Confucius during these years is scanty and sometimes contradictory. He had little success in his search for the ideal ruler under whom he could put his political theories into practice. When he was 68, he packed up his political aspirations and went home to Lu.

For the next five years, he devoted himself to teaching and editing the classics.

Before Confucius' time, education was a privilege of the aristocracy. Advocating that "where education took root, class distinction would not exist," Confucius was the first person to bring the knowledge previously reserved for the temples of the ruling class to the market place of the common men. He had taught, over a period of 40 years, some 3,000 pupils, of whom 72 had mastered the "six arts"—ritual, music, archery, driving of chariot, history and mathematics. They came from all over China, not just the state of Lu, but from Wei, Chi, Chin, Cheng, Tsin, Sung, Wu and Yueh. It was something unheard of before him, and the popularization of learning produced the unexpected effect of cultural unity for China, coming some 300 years before Chin Shih Huang united the country in the first Chinese empire.

For use in teaching, Confucius edited the "six classics." They were:

Shih Ching (Book of Odes), a collection of 305 songs and sacred anthems, said to be chosen from more than 3,000.

Li Chi (Book of Rites), allegedly a record of government system and rituals of the early Chou dynasty.

Shu Ching (Book of History), composed of early historic documents, chiefly kings' proclamations, the earliest of Chinese documents and most archaic in style of all the classics.

Chun Chiu (Annals of Spring and Autumn), written by Confucius, a chronicle of events from 722 to 481 B.C., based on the history of the state of Lu. The only work attributed to him.

I Ching (Book of Changes), the philosophy of mutations in human events, originally a divination system based on changing arrangements of the lines of an octogram, but which developed into a full philosophy for human conduct in varying circumstances.

Yueh Ching (Book of Music), a book which has been completely lost.

With the Book of Music no longer existing, the six classics became only five. Later on, two chapters were taken from the Book of Rites and became two independent books: *Tu Hsueh* (The Great Learning) and *Chung Yung* (The Golden Mean). But the most popular of all was *Lun Yu* (Analects of Confucius), a collection of the master's sayings recorded by his disciples. A century later, Confucianism found its most effective spokesman in Mencius (372-289 B.C.), who since has been regarded by the Chinese as their "second sage." His disciples collected his sayings into a book called

Mencius. Together, these volumes form the treasure of Confucian teachings as well as classical Chinese learning, and are known as the "Four Books and Five Classics."

In 479 B.C. Confucius died at 72. He was buried in Lu, in the present city of Chufu. His disciples all observed the traditional mourning of three years by living in huts beside his grave. Endless dynasties in 25 centuries added to the buildings and the surrounding garden, so that today it has become one of the most imposing temples and tourist attractions in China.

What are the essences of Confucianism? According to Lin Yu-tang, there are five:

Confucius identified politics with ethics. His definition of "ritual and music" embodied the entire aim of the Confucian social order. He was aiming at the moral basis for peace in society, out of which political peace should naturally ensue. His idea of government was: "Guide the people by governmental measures and regulate them by the threat of punishment, and the people will try to keep out of jail but will have no sense of honor or shame. Guide the people by virtue and regulate them by *li* (sense of propriety), and the people will have a sense of honor and respect."

Confucius was trying to restore a social order, particularly a rationalized feudal order, which was breaking down in his day. His means were ritual and music. He also insisted on the recti-

fication of names, i.e., calling a spade a spade.

Once Tzu Lu asked him: "If the ruler of Wei should put you in power, how would you begin?"

"I would begin with the rectification of names," Confucius answered.

"Do you really mean it?" asked Tzu Lu. "How old and impractical you are! What do you want to do it for?"

"Ah, you are simple-minded indeed," Confucius replied. "If the name is not rectified, then the whole style of one's speech falls out of form; if one's speech is not in form, then orders cannot be carried out; if orders are not carried out, then the proper forms of worship and social intercourse (in ritual and music) cannot be restored; if the proper forms of worship and social intercourse are not restored, then legal justice in the country will fail; when legal justice fails, then the people are at a loss to know what to do or what not to do."

Confucius advocated humanism. He recognized that "the measure of man is man." The central tenet of Confucian teaching is *jen*: humanity, benevolence, perfect virtue, or "the moral sense," which is probably closest to it. The other tenet is *shu*: tolerance or reciprocity. Confucius repeatedly said: "Do not do unto others what you would not have others do unto you." In explaining *jen*, Confucius listed five virtues: "Courtesy, magnanimity, good faith, diligence, and kindness. He who is courteous is not humiliated, he who is magnanimous wins the multitude, he

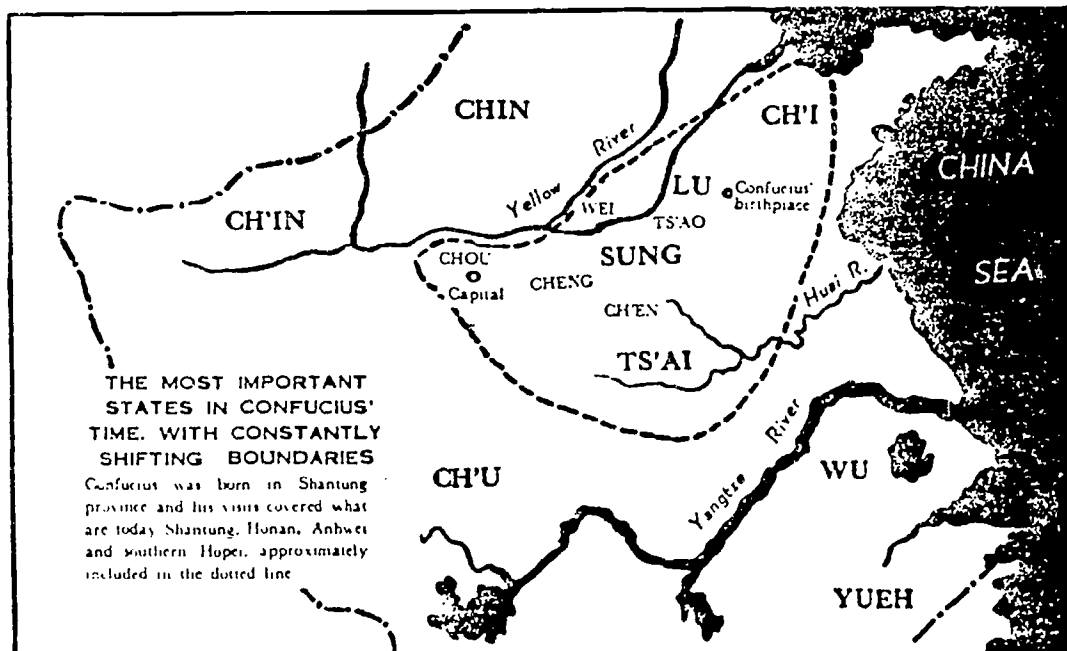

who is of good faith is trusted by the people, he who is diligent attains his objective, and he who is kind can get service from the people," On another occasion, when asked about the meaning of *jen*, he replied in two words: "Love men."

Confucius stressed personal cultivation as the basis of a world order. *Hsiao*, or filial piety, is the basis of this. For having acquired the habits of love and respect in the home, one could not but extend this mental attitude of love and respect to other people's parents and elder brothers and to the authorities of the state. The idea is best expressed by the opening chapter of *Ta Hsueh* (The Great Learning): "The ancients who wished to preserve the fresh or clear character of the people of the world would first set about ordering their national life. Those who wished to order their national life would first set about regulating their family life. Those who wished to regulate their family life would first set about cultivating their personal life. Those who wished to cultivate their personal life would first set about setting their hearts right. Those who wished to set their hearts right would first set about making their wills sincere."

Confucius' ideal man is the *chün tzu*, or gentleman. He is not an aristocrat, but merely

a kind and gentle man of moral principles. He is a man who loves learning, who is calm himself and perfectly at ease and constantly careful of his own conduct, believing that by example he has great influence over society in general. He is also perfectly at ease in his own station of life and has a certain contempt for the mere luxuries of living. Confucius said: "The gentleman makes demands on himself; the inferior man makes demands on others."

These ideas of Confucius have dictated the development of Chinese history for the last 25 centuries. They not only exerted a vital influence on the Chinese way of life, but also on those of Korea, Japan, the Ryukyus and Vietnam. For the last 800 years, the Confucian classics have been the basic text in Chinese education, known to every school-age boy or girl. As a political system aiming at the restoration of a feudal order, Confucianism is long out of date. But as a system of humanist culture, as a fundamental viewpoint concerning the conduct of life and of society, and above all, as a way of life which has proved its value after 2,500 years, there is no doubt that it is still very much alive, and dear to the heart of every Chinese.

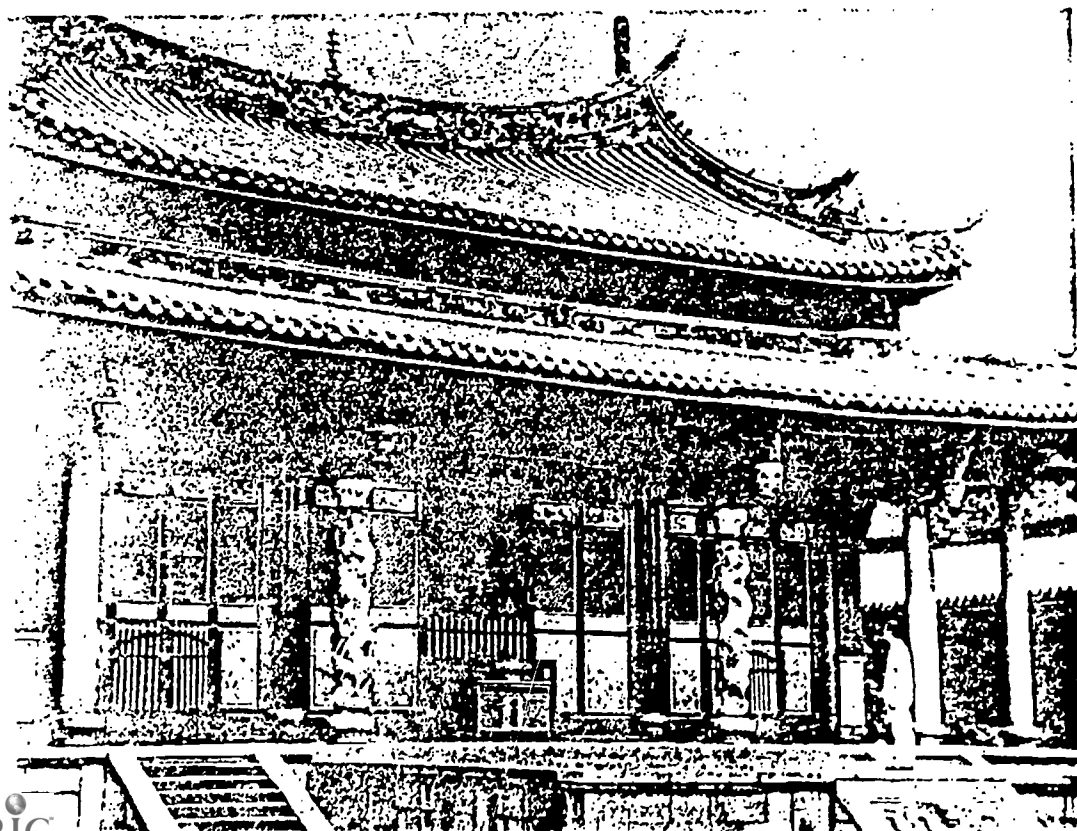

Confucian
Temple in
Taipei

PREPARED BY
China Publishing Co.
P.O. BOX 337
TAIPEI, TAIWAN, CHINA
OCTOBER 1965

6

CONFUCIAN TEACHINGS

Confucius (traditional dates, 551–479 B.C.) was a man of no particular distinction in his own day who exerted a profound influence on the development of Chinese culture through his teachings. He tried in vain to gain a high office, traveling from state to state with his disciples in search of a ruler who would listen to him. He talked repeatedly of an ideal age in the early Zhou, revealing his vision of a more perfect society in which rulers and subjects, nobles and commoners, parents and children, men and women would all wholeheartedly accept the parts assigned to them, devoting themselves to their responsibilities to others. Confucius revered tradition and taught his disciples the traditional arts—music, rituals, the Book of Songs and Book of Documents—while continually holding up for them high moral standards.

Confucius's ideas are known to us primarily through the sayings recorded by his disciples in the Analects. This book does not provide carefully organized or argued philosophical discourses, and the sayings seem to have been haphazardly arranged. Yet this short text became a sacred book, memorized by beginning students and known to all educated people. As such it influenced the values and habits of thought of Chinese for centuries. Many of its passages became proverbial sayings, unknowingly cited by illiterate peasants. In the selection that follows, sayings have been reorganized and grouped under four of the topics he most frequently discussed.

The eventual success of Confucian ideas owes much to Confucius's followers in the two centuries following his death, the most important of whom were Mencius (ca. 370–ca. 300 B.C.) and Xunzi (ca. 310–ca. 215 B.C.). The Mencius, like the Analects, is a collection of the philosopher's conversations, presented in no particular order, but unlike the Analects, specific points are often analyzed at length, perhaps because Mencius himself had a hand in recording them. Mencius, like Confucius, traveled around offering advice to rulers of various states. Over and over he tried to convert them to the view that the ruler who wins over the people through benevolent government would be the one to unify the realm. He proposed concrete political and financial measures for easing tax burdens and otherwise improving the people's lot. With his disciples and fellow philosophers, he discussed other issues in moral philosophy, particularly ones related to the goodness of human nature.

17

BEST COPY AVAILABLE

444

Xunzi, a half century later, had much more actual political and administrative experience than either Confucius or Mencius and was less committed to the precedents set in the early Zhou. He wrote fully argued essays on many of the issues in social, political, and moral philosophy that engaged thinkers of his age. He carried further than either Confucius or Mencius the tendency in Confucianism toward a humanistic and rationalistic view of the cosmos. Divination was to him fine as a social ritual but did not reveal Heaven's desires or tell anything about the future. He directly attacked Mencius's argument that human nature is inherently good, claiming to the contrary that men's inborn tendencies are bad and therefore education is essential.

SELECTIONS FROM THE ANALECTS

The Gentleman

Confucius said, "The gentleman concerns himself with the Way; he does not worry about his salary. Hunger may be found in plowing; wealth may be found in studying. The gentleman worries about the Way, not about poverty."

Confucius said, "When he eats, the gentleman does not seek to stuff himself. In his home he does not seek luxury. He is diligent in his work and cautious in his speech. He associates with those who possess the Way, and thereby rectifies himself. He may be considered a lover of learning."

Zigong inquired about being a gentleman. Confucius said, "First he behaves properly and then he speaks, so that his words follow his actions."

Sima Niu asked about the nature of the gentleman. Confucius replied, "The gentleman does not worry and is not fearful." Si asked, "Then, can not fearing and not worrying be considered the essence of being a gentleman?" Confucius responded, "If you can look into yourself and find no cause for dissatisfaction, how can you worry and how can you fear?"

Confucius said, "The gentleman reveres three things. He reveres the mandate of Heaven; he reveres great people; and he reveres the words of the

sages. Petty people do not know the mandate of Heaven and so do not revere it. They are disrespectful to great people and they ridicule the words of the sages."

Confucius said, "The gentleman must exert caution in three areas. When he is a youth and his blood and spirit have not yet settled down, he must be on his guard lest he fall into lust. When he reaches the full vigor of his manhood in his thirties and his blood and spirit are strong, he must guard against getting into quarrels. When he reaches old age and his blood and spirit have begun to weaken, he must guard against envy."

Confucius said, "The gentleman understands integrity; the petty person knows about profit."

Confucius said, "For the gentleman integrity is the essence; the rules of decorum are the way he puts it into effect; humility is the way he brings it forth; sincerity is the way he develops it. Such indeed is what it means to be a gentleman."

Confucius said that Zichan possessed the way of the gentleman in four areas. In his personal conduct he was respectful; in serving his superiors he was reverent; in nourishing the people he was kind; in governing the people he was righteous.

Confucius said, "The gentleman has nine concerns. In seeing he is concerned with clarity. In hearing he is concerned with acuity. In his expression he wishes to be warm. In his bearing he wishes to be respectful. In his words he is concerned with sincerity. In his service he is con-

cerned with reverence. When he is in doubt, he wants to ask questions. When he is angry, he is wary of the pitfalls. When he sees the chance for profit, he keeps in mind the need for integrity."

Confucius said, "The gentleman is easy to serve but difficult to please. When you try to please him, if your manner of pleasing is not in accord with the Way, then he will not be pleased. On the other hand, he does not expect more from people than their capacities warrant. The petty individual is hard to serve and easy to please. When you try to please him, even if your method of pleasing him is not in accord with the Way, he will be pleased. But in employing people he expects them to be perfectly accomplished in everything."

Confucius said, "The gentleman is in harmony with those around him but not on their level. The small man is on the level of those around him but not in harmony with them."

Confucius said, "The gentleman aspires to things lofty; the petty person aspires to things base."

Confucius said, "The gentleman looks to himself; the petty person looks to other people."

Confucius said, "The gentleman feels bad when his capabilities fall short of some task. He does not feel bad if people fail to recognize him."

Confucius said, "The gentleman fears that after his death his name will not be honored."

Confucius said, "The gentleman does not promote people merely on the basis of their words, nor does he reject words merely because of the person who uttered them."

Confucius said, "The gentleman is exalted and yet not proud. The petty person is proud and yet not exalted."

Zixia said, "The gentleman has three transformations. Seen from afar he appears majestic. Upon approaching him you see he is amiable. Upon hearing his words you find they are serious."

Confucius said, "If the gentleman is not dignified, he will not command respect and his teachings will not be considered solid. He emphasizes sincerity and honesty. He has no friends who are not his equals. If he finds a fault in himself, he does not shirk from reforming himself."

Zigong said, "When the gentleman falls into error, it is like the eclipse of the sun and moon: everyone sees it. When he corrects it, everyone will look up to him again."

Zigong said, "Does not the gentleman also have his hatreds?" Confucius replied, "Yes, he has his hatreds. He hates those who harp on the weak points of others. He hates those who are base and yet slander those who are exalted. He hates those who are bold but do not observe the proprieties. He hates those who are brash and daring and yet have limited outlook." Confucius then asked, "You too have your hatreds, do you not?" Zigong replied, "I hate those who pry into things and consider it wisdom. I hate those who are imprudent and consider it courage. I hate those who leak out secrets and consider it honesty."

Zengzi said, "The gentleman knows enough not to exceed his position."

Confucius said, "The gentleman is not a tool."

Humanity

Zizhang asked Confucius about humanity. Confucius said, "If an individual can practice five things anywhere in the world, he is a man of humanity." "May I ask what these things are?" said Zizhang. Confucius replied, "Reverence, generosity, truthfulness, diligence, and kindness. If a person acts with reverence, he will not be insulted. If he is generous, he will win over the people. If he is truthful, he will be trusted by people. If he is diligent, he will have great achievements. If he is kind, he will be able to influence others."

Zhonggong asked about humanity. Confucius said, "When you go out, treat everyone as if you were welcoming a great guest. Employ people as if you were conducting a great sacrifice. Do not do unto others what you would not have them do unto you. Then neither in your country nor in your family will there be complaints against you." Zhonggong said, "Although I am not intelligent, please allow me to practice your teachings."

Sima Niu asked about humanity. Confucius said, "The man of humanity is cautious in his speech." Sima Niu replied, "If a man is cautious

in his speech, may it be said that he has achieved the virtue of humanity?" Confucius said, "When a man realizes that accomplishing things is difficult, can his use of words be anything but cautious?"

Confucius said, "A person with honeyed words and pious gestures is seldom a man of humanity."

Confucius said, "The individual who is forceful, resolute, simple, and cautious of speech is near to humanity."

Confucius said, "The man of wisdom takes pleasure in water; the man of humanity delights in the mountains. The man of wisdom desires action; the man of humanity wishes for quietude. The man of wisdom seeks happiness; the man of humanity looks for long life."

Confucius said, "If a man does not have humanity, how can he have propriety? If a man does not have humanity, how can he be in tune with the rites or music?"

Confucius said, "The humanity of a village makes it beautiful. If you choose a village where humanity does not dwell, how can you gain wisdom?"

Confucius said, "Humanity is more important for people than water or fire. I have seen people walk through water and fire and die. I have never seen someone tread the path of humanity and perish."

Confucius said, "Riches and honors are the things people desire; but if one obtains them by not following the Way, then one will not be able to hold them. Poverty and low position in society are the things that people hate; but if one can avoid them only by not following the Way, then one should not avoid them. If the gentleman abandons humanity, how can he live up to his name? The gentleman must not forget about humanity for even the space of time it takes him to finish a meal. When hurried, he must act according to it. Even when confronted with a crisis, he must follow its tenets."

Confucius said, "The strong-minded scholar and the man of humanity do not seek to live by violating the virtue of humanity. They will suffer death if necessary to achieve humanity."

Confucius said, "In practicing the virtue of humanity, one should not defer even to one's teacher."

Confucius said, "Is humanity far away? Whenever I want the virtue of humanity, it comes at once."

Zigong asked about the virtue of humanity. Confucius said, "The artisan who wants to do his work well must first of all sharpen his tools. When you reside in a given state, enter the service of the best of the officials and make friends with the most humane of the scholars."

Confucius said, "Only the man of humanity can rightly love some people and rightly despise some people."

Confucius said, "People can be classified according to their faults. By observing an individual's faults, you will know if he is a person of humanity."

Confucius said, "Those who possess virtue will be sure to speak out; but those who speak out do not necessarily have virtue. Those who possess the virtue of humanity certainly have strength; but those who are strong do not necessarily have the virtue of humanity."

Confucius said, "Although there have been gentlemen who did not possess the virtue of humanity, there have never been petty men who did possess it."

Filial Piety

Ziyou inquired about filial piety. Confucius said, "Nowadays, filial piety is considered to be the ability to nourish one's parents. But this obligation to nourish even extends down to the dogs and horses. Unless we have reverence for our parents, what makes us any different?"

Confucius said, "When your father is alive observe his intentions. When he is deceased, model yourself on the memory of his behavior. If in three years after his death you have not deviated from your father's ways, then you may be considered a filial child."

Zengzi said, "I have heard from Confucius that

the filial piety of Meng Zhuangzi is such that it could also be attained by others, but his not changing his father's ministers and his father's government is a virtue difficult indeed to match."

Meng Yizi inquired about filial piety. Confucius said, "Do not offend your parents." Fan Zhi was giving Confucius a ride in a wagon, and Confucius told him, "Meng Sun questioned me about filial piety and I told him, 'Do not offend your parents.'" Fan Zhi said, "What are you driving at?" Confucius replied, "When your parents are alive, serve them according to the rules of ritual and decorum. When they are deceased, give them a funeral and offer sacrifices to them according to the rules of ritual and decorum."

Confucius said, "When your father and mother are alive, do not go rambling around far away. If you must travel, make sure you have a set destination."

Confucius said, "It is unacceptable not to be aware of your parents' ages. Their advancing years are a cause for joy and at the same time a cause for sorrow."

Confucius said, "You can be of service to your father and mother by remonstrating with them tactfully. If you perceive that they do not wish to follow your advice, then continue to be reverent toward them without offending or disobeying them; work hard and do not murmur against them."

The Duke of She said to Confucius, "In my land there is an upright man. His father stole a sheep, and the man turned him in to the authorities." Confucius replied, "The upright men of my land are different. The father will shelter the son and the son will shelter the father. Righteousness lies precisely in this."

On Governing

The Master said, "Lead them by means of government policies and regulate them through punishments, and the people will be evasive and have no sense of shame. Lead them by means of virtue and regulate them through rituals and they will

have a sense of shame and moreover have standards."

Duke Ding asked about how rulers should direct their ministers and ministers serve their rulers. Confucius responded, "A ruler directs his ministers through established ritual protocols. A minister serves his ruler with loyalty."

Zigong inquired about governing. The Master said, "Make food supplies sufficient, provide an adequate army, and give the people reason to have faith." Zigong asked, "If one had no choice but to dispense with one of these three, which should it be?" "Eliminate the army," Zigong continued, "If one had no choice but to get rid of one of the two remaining, which should it be?" "Dispense with food," Confucius said. "Since ancient times, death has always occurred, but people without faith cannot stand."

Jikangzi asked Confucius about governing, posing the question, "What would you think of my killing those without principles to help those with principles?" Confucius responded, "You are the government. Why employ killing? If you want what is good, the people will be good. The virtue of a gentleman is like the wind, the virtue of a small person like the grass. When the wind blows over it, the grass must bend."

When Zhonggong was serving as chief minister to the Ji family, he asked for advice on governing. The Master said, "Put priority on your subordinate officials. Pardon their minor mistakes and promote those who are worthy and talented." "How can I recognize those who are talented and worthy to promote them?" Confucius replied, "Promote those you know. Will others neglect those you do not know?"

The Master said, "If one has corrected himself, what problem would he have in governing? But if he is unable to correct himself, how can he govern others?"

Duke Ding asked, "Is there a single saying that can bring about the success of a country?" Confucius responded, "One cannot expect so much from a saying, but the people do have this maxim: 'To be a ruler is difficult; to be a minister is not easy.' If you recognize the difficulty of being a

ruler, that may come close to furthering your state through a single maxim." The Duke asked again, "Can a single saying lead to the ruin of a state?" Confucius responded, "One cannot expect so much from a saying, but the people do have this maxim, 'I get no pleasure from being ruler other than that no one can contradict what I say.' If what he says is good and no one contradicts it, that is fine. But if what he says is not good and no one contradicts it, isn't that almost a case of one maxim bringing about the ruin of the state?"

The Master said, "When superiors love ritual the people are easy to direct."

The Master said, "Shun was the one who governed effectively without activism. What was there for him to do? He simply made himself respectful and took up his position facing south."

SELECTIONS FROM THE MENCIUS

On Government

Mencius had an audience with King Hui of Liang. The king said, "Sir, you did not consider a thousand *li* too far to come. You must have some ideas about how to benefit my state." Mencius replied, "Why must Your Majesty use the word 'benefit'? All I am concerned with are the benevolent and the right. If Your Majesty says, 'How can I benefit my state?' your officials will say, 'How can I benefit my family,' and officers and common people will say, 'How can I benefit myself.' Once superiors and inferiors are competing for benefit, the state will be in danger. When the head of a state of ten thousand chariots is murdered, the assassin is invariably a noble with a fief of a thousand chariots. When the head of a fief of a thousand chariots is murdered, the assassin is invariably head of a subfief of a hundred chariots. Those with a thousand out of ten thousand, or a hundred out of a thousand, had quite a bit. But when benefit is put before what is right, they are not satisfied without snatching it all. By contrast, there has never been a benevolent person who neglected his parents or

a righteous person who put his lord last. Your Majesty perhaps will now also say, 'All I am concerned with are the benevolent and the right. Why mention 'benefit?'"

After seeing King Xiang of Liang, Mencius said to someone, "When I saw him from a distance, he did not look like a ruler, and when I got closer, I saw nothing to command respect. But he asked, 'How can the realm be settled?' I answered, 'It can be settled through unity.' 'Who can unify it?' he asked. I answered, 'Someone not fond of killing people.' 'Who could give it to him?' I answered, 'Everyone in the world will give it to him. Your Majesty knows what rice plants are? If there is a drought in the seventh and eighth months, the plants wither, but if moisture collects in the sky and forms clouds and rain falls in torrents, the plants suddenly revive. This is the way it is; no one can stop the process. In the world today there are no rulers disinclined toward killing. If there were a ruler who did not like to kill people, everyone in the world would crane their necks to catch sight of him. This is really true. The people would flow toward him the way water flows down. No one would be able to repress them.'"

King Xuan of Qi asked, "Is it true that King Wen's park was seventy *li* square?" Mencius answered, "That is what the records say." The King said, "Isn't that large?" Mencius responded, "The people considered it small." "Why then do the people consider my park large when it is forty *li* square?" "In the forty square *li* of King Wen's park, people could collect firewood and catch birds and rabbits. Since he shared it with the people, isn't it fitting that they considered it small? When I arrived at the border, I asked about the main rules of the state before daring to enter. I learned that there was a forty-*li* park within the outskirts of the capital where killing a deer was punished like killing a person. Thus these forty *li* are a trap in the center of the state. Isn't it appropriate that the people consider it too large?"

After an incident between Zou and Lu, Duke Mu asked, "Thirty-three of my officials died but no common people died. I could punish them, but I could not punish them all. I could refrain from

punishing them, but they did angrily watch their superiors die without saving them. What would be the best course for me to follow?" Mencius answered, "When the harvest failed, even though your granaries were full, nearly a thousand of your subjects were lost—the old and weak among them dying in the gutters, the able-bodied scattering in all directions. Your officials never reported the situation, a case of superiors callously inflicting suffering on their subordinates. Zengzi said, 'Watch out, watch out! What you do will be done to you.' This was the first chance the people had to pay them back. You should not resent them. If Your Highness practices benevolent government, the common people will love their superiors and die for those in charge of them."

King Xuan of Qi asked, "Is it true that Tang banished Jie and King Wu took up arms against Zhou?" Mencius replied, "That is what the records say." "Then is it permissible for a subject to assassinate his lord?" Mencius said, "Someone who does violence to the good we call a villain; someone who does violence to the right we call a criminal. A person who is both a villain and a criminal we call a scoundrel. I have heard that the scoundrel Zhou was killed, but have not heard that a lord was killed."

King Xuan of Qi asked about ministers. Mencius said, "What sort of ministers does Your Majesty mean?" The king said, "Are there different kinds of ministers?" "There are. There are noble ministers related to the ruler and ministers of other surnames." The king said, "I'd like to hear about noble ministers." Mencius replied, "When the ruler makes a major error, they point it out. If he does not listen to their repeated remonstrations, then they put someone else on the throne." The king blanched. Mencius continued, "Your Majesty should not be surprised at this. Since you asked me, I had to tell you truthfully." After the king regained his composure, he asked about unrelated ministers. Mencius said, "When the king makes an error, they point it out. If he does not heed their repeated remonstrations, they quit their posts."

Bo Gui said, "I'd like a tax of one part in

twenty. What do you think?" Mencius said, "Your way is that of the northern tribes. Is one potter enough for a state with ten thousand households?" "No, there would not be enough wares." "The northern tribes do not grow all the five grains, only millet. They have no cities or houses, no ritual sacrifices. They do not provide gifts or banquets for feudal lords, and do not have a full array of officials. Therefore, for them, one part in twenty is enough. But we live in the central states. How could we abolish social roles and do without gentlemen? If a state cannot do without potters, how much less can it do without gentlemen. Those who want to make government lighter than it was under Yao and Shun are to some degree barbarians. Those who wish to make government heavier than it was under Yao and Shun are to some degree [tyrants like] Jie."

On Human Nature

Mencius said, "Everyone has a heart that is sensitive to the sufferings of others. The great kings of the past had this sort of sensitive heart and thus adopted compassionate policies. Bringing order to the realm is as easy as moving an object in your palm when you have a sensitive heart and put into practice compassionate policies. Let me give an example of what I mean when I say everyone has a heart that is sensitive to the sufferings of others. Anyone today who suddenly saw a baby about to fall into a well would feel alarmed and concerned. It would not be because he wanted to improve his relations with the child's parents, nor because he wanted a good reputation among his friends and neighbors, nor because he disliked hearing the child cry. From this it follows that anyone who lacks feelings of commiseration, shame, and courtesy or a sense of right and wrong is not a human being. From the feeling of commiseration benevolence grows; from the feeling of shame righteousness grows; from the feeling of courtesy ritual grows; from a sense of right and wrong wisdom grows. People have these four germs, just as they have four limbs. For someone with these four po-

tentials to claim incompetence is to cripple himself; to say his ruler is incapable of them is to cripple his ruler. Those who know how to develop the four potentials within themselves will take off like a fire or burst forth like a spring. Those who can fully develop them can protect the entire land, while those unable to develop them cannot even take care of their parents."

Gaozi said, "Human nature is like whirling water. When an outlet is opened to the east, it flows east; when an outlet is opened to the west, it flows west. Human nature is no more inclined to good or bad than water is inclined to east or west." Mencius responded, "Water, it is true, is not inclined to either east or west, but does it have no preference for high or low? Goodness is to human nature like flowing downward is to water. There are no people who are not good and no water that does not flow down. Still, water, if splashed, can go higher than your head; if forced, it can be brought up a hill. This isn't the nature of water; it is the specific circumstances. Although people can be made to be bad, their natures are not changed."

SELECTIONS FROM XUNZI

A Discussion of Heaven

Constant principles underlie Heaven's behavior. Heaven does not prevail because you are the sage Yao or disappear because you are the tyrant Jie. Blessings result when you respond to Heaven by creating order; misfortune results when you respond to it with disorder. When you concentrate on agriculture and industry and are frugal in expenditures, Heaven cannot impoverish your state. When you store provisions and act quickly in emergencies, Heaven cannot afflict illness on your people. When you are singleminded in your cultivation of the Way, Heaven cannot send disasters. Thus, even if they come, droughts and floods will not bring starvation, extremes of temperature will not bring illness, uncanny phenomena will not prove unlucky.

On the other hand, if you ignore agriculture and industry and spend extravagantly, then Heaven cannot make your country rich. If you are negligent concerning provisions and slow to respond to crises, Heaven cannot keep your country whole. If you renounce the Way and act recklessly, Heaven cannot make you lucky. In such a case, starvation will result even without flood or drought; illness will occur even without severe weather; misfortunes will occur without any uncanny phenomena. Even though the seasons are identical to those of an orderly age, the resulting fortune or misfortune is different. But you should not resent Heaven. It is your Way that is responsible. Thus those who can distinguish what is in the realm of Heaven and what is in the realm of man are men of the highest order. . . .

Are order and disorder the product of Heaven? I say, the sun and the moon, the stars and the constellations are the same as they were in the time of Yu and Jie. Yu brought order, Jie created disorder, so order and disorder do not come from Heaven. Are they a product of the seasons? I say, plants sprout and grow in spring and summer, and are harvested and stored in fall and winter, just the way they were during the reigns of Yu and Jie. Yet Yu brought order, Jie disorder, so order and disorder are not the product of seasons. Is it land then? I say, obtaining land leads to life, losing it leads to death, just as in the time of Yu and Jie. Yet Yu brought order, Jie disorder, so order and disorder are not a product of land. . . .

Why does it rain after a prayer for rain? I say, for no reason. It is the same as raining when you had not prayed. When there is an eclipse of the sun or moon, you "save" it; when there is a drought, you pray for rain; when an important decision is to be made, you divine. It is not that you can get anything by doing so. It is just decoration. Hence, the gentleman considers them ornament, but the common people think spirits are involved. To consider them ornament is auspicious; to consider them as spiritual acts is inauspicious.

A Discussion of Ritual

Where does ritual come from? I say, people have desires from the time they are born. When they want something they do not get, they inevitably try to get it. When there are no limits imposed on how they can try to get it, they inevitably struggle for it. Struggles lead to disorder, disorder to exhaustion. The ancient kings detested disorder and so instituted ritual and moral principles to set shares, thus satisfying people's desires and supplying their wants. They saw to it that desires and the supply of goods were kept in balance. This is how ritual began. . . .

Sacrifices are concerned with the feelings of devotion and longing. Feelings of depression and melancholy cannot be prevented from occasionally arising. Thus, even when enjoying himself in pleasant company, a loyal official or a filial son will occasionally be overcome by grief. If he is greatly moved by his feelings, but he restrains himself and does not express them, he will be incomplete in ritual. Therefore the ancient kings established ways to fulfill the principle of honoring those deserving honor and expressing closeness to relatives. Hence, sacrifices are concerned with the feelings of devotion and longing. They fulfill loyalty, faith, love, and respect. Ritual conduct is the perfection of decorum. Only sages can fully understand this. Sages comprehend it, gentlemen comfortably carry them out, officials preserve them, and the common people consider them the custom. Gentlemen consider them to be part of the way of man; common people think they have something to do with ghosts. . . .

Human Nature Is Bad

Human nature is bad. Good is a human product. Human nature is such that people are born with a love of profit. If they follow these inclinations, they will struggle and snatch from each other, and inclinations to defer or yield will die. They are born with fears and hatreds. If they follow them, they will become violent and tendencies toward

good faith will die. They are born with sensory desires for pleasing sounds and sights. If they indulge them, the disorder of sexual license will result and ritual and moral principles will be lost. In other words, if people accord with human nature and follow their desires, they inevitably end up struggling, snatching, violating norms, and acting with violent abandon. Consequently, only after men are transformed by teachers and by ritual and moral principles do they defer, conform to culture, and abide in good order. Viewed this way, it is obvious that human nature is bad and good is a human product.

A warped piece of wood must be steamed and forced before it is made straight; a metal blade must be put to the whetstone before it becomes sharp. Since the nature of people is bad, to become corrected they must be taught by teachers and to be orderly they must acquire ritual and moral principles. When people lack teachers, their tendencies are not corrected; when they do not have ritual and moral principles, then their lawlessness is not controlled. In antiquity the sage kings recognized that men's nature is bad and that their tendencies were not being corrected and their lawlessness controlled. Consequently, they created rituals and moral principles and instituted laws and limitations to give shape to people's feelings while correcting them, to transform people's emotional nature while guiding it. Thus all became orderly and conformed to the Way. Those people today who are transformed by teachers, accumulate learning, and follow ritual and moral principles are gentlemen. Those who indulge their instincts, act impulsively, and violate ritual and moral principles are inferior people. Seen from this perspective, it is obvious that human nature is bad, and good is a human product.

Mencius said that people's capacity to learn is evidence that their nature is good. I disagree. His statement shows he does not know what human nature is and has not pondered the distinction between what is human nature and what is created by man. Human nature is what Heaven supplies. It cannot be learned or worked at. Ritual and moral principles were produced by the sages; they

are things people can master by study and effort. Human nature refers to what is in people but which they cannot study or work at achieving. Human products refers to what people acquire through study and effort. . . .

Now, it is human nature to want to eat to one's fill when hungry, to want to warm up when cold, to want to rest when tired. These all are a part of people's emotional nature. When a man is hungry and yet on seeing an elder lets him eat first, it is because he knows he should yield. When he is tired but does not dare rest, it is because he knows it is his turn. When a son yields to his father, or a younger brother yields to his elder brother, or when a son takes on the work for his father or a younger brother for his elder brother, their actions go against their natures and run counter to their feelings. And yet these are the way of the filial son and the principles of ritual and morality. Thus, if people followed their feelings and nature, they would not defer or yield, for deferring and yielding run counter to their emotional nature. Viewed from this perspective, it is obvious that man's nature is bad and good is a human product. . . .

Fanruo and Jushu were great bows of ancient times, but they could not on their own have become accurate without being pressed and straightened. The great swords of ancient times—Duke Huan's Cong, King Wen's Lu, Lord Zhuang's Hu,

and King Helü's Ganjiang, Moyeh, Juque, and Bilü—would never have become sharp without being put to the grindstone. Nor could they have cut without men using their strength. The great horses of ancient times—Hualiu, Qiji, Xianli, and Luer—could never have run a thousand *li* in a day if they had not first been restrained by the bit and bridle, taught to respond to the whip, and driven by someone like Zaofu. Similarly, a man may have a fine temperament and a discriminating mind, but he must first seek a wise teacher to study under and good friends to associate with. If he studies with a wise teacher, what he hears will concern the way of Yao, Shun, Yü, and Tang. If he finds good friends to associate with, what he observes will be loyalty, good faith, respect, and deference. Each day he will come closer to humanity and morality without realizing it, all because of their influence. But if he lives with bad people, what he will hear will be deceit and lies, and what he will observe will be wild, undisciplined, greedy behavior. Without knowing it, he will end up a criminal, all because of their influence. It has been said, "If you do not know the man, observe his friends. If you do not know the lord, look at his attendants." Influence affects everyone.

Translated by Mark Coyle and Patricia Ebrey

15

THE CLASSIC OF FILIAL PIETY

The family has always been considered by the Chinese as the fundamental unit of their society. Filial piety had been praised by Confucius, and thinkers of all schools took for granted that a well-run family was one in which parents looked out for the interests of their children and children obeyed their parents and supported them in their old age. In the Han dynasty, the exaltation of filial piety was carried to new heights. Men could be made officials if they were recommended as paragons of filial piety. The brief Classic of Filial Piety was probably written in the early Han. Purporting to be the recorded conversations between Confucius and his disciple, Zeng Zi, it extolled the vast powers of wholehearted devotion to parents and superiors more generally. Filial piety was presented as a political virtue, tied to loyalty to political superiors up to the Son of Heaven (the emperor). The Classic of Filial Piety was widely used in the Han and later as a primer to teach children basic moral maxims while they were learning how to read.

OPENING THE DISCUSSION

Confucius was at home and Zengzi was attending him. The Master said, "The former kings had the highest virtue and the essential Way. By using them they kept the world ordered and the people in harmony, and neither superiors nor inferiors resented each other. Do you understand this?"

Zengzi rose from his seat and replied, "Since I am not clever, how can I understand this?"

The Master said, "Filial piety is the root of virtue and the source of civilization. Sit down again and I will explain it to you. Since we receive our body, hair, and skin from our parents, we do not dare let it be injured in any way. This is the be-

ginning of filial piety. We establish ourselves and practice the Way, thereby perpetuating our name for future generations and bringing glory to our parents. This is the fulfillment of filial piety. Thus filial piety begins with serving our parents, continues with serving the ruler, and is completed by establishing one's character."

THE SON OF HEAVEN

The Master said, "Those who love their parents do not dare to hate others. Those who respect their parents do not dare to show contempt towards others. The filial piety of the Son of Heaven consists in serving his parents with complete love

and respect so that his moral influence reaches the common people and he becomes a model for the distant regions in all directions."

THE FEUDAL LORDS

"Although in superior positions, they are not arrogant and thus can hold lofty positions without peril. By exercising restraint and caution they can have plenty without going overboard. Holding a lofty position without peril is the way to preserve high rank for a long time. Having plenty without going overboard is the way to preserve wealth for a long time. If they retain their wealth and rank they will later be able to protect their heritage and keep their people in peace. This is the filial piety of the feudal lords."

THE MINISTERS AND HIGH OFFICERS

"They do not dare wear garments not prescribed by the former kings; they do not dare use words not approved by the former kings; they do not dare to behave in any ways outside the virtuous ways of the former kings. Thus, they will not speak improper words and will not follow anything outside the Way. Their words are not arbitrary, nor their actions capricious. Their words reach all in the world, yet offend no one. Their words fill the world, yet give no one cause for complaint. When these three conditions are fulfilled, they are able to preserve their ancestral altars. This is the filial piety of the ministers and high officers."

SCHOLARS

"They serve their mothers as they serve their fathers; the love shown them is the same. They serve their rulers as they serve their fathers; the respect shown both is the same. Therefore mothers get love and rulers elicit respect, and fathers combine them both. To serve a ruler with filial

piety is to be loyal. To serve an elder with filial piety is to be obedient. Never failing in loyalty or obedience in their service to superiors, they are able to preserve their offices and salaries and maintain their family line. This is the filial piety of the scholars."

THE COMMON PEOPLE

"They follow the laws of nature to utilize the earth to the best advantage. They take care of themselves and are cautious in expenditures in order to support their parents. This is the filial piety of the common people. Thus from the Son of Heaven to the common people, unless filial piety is pursued from beginning to end, calamities will surely result."

THE THREE POWERS

Zengzi said, "How exceedingly great is filial piety!"

The Master responded, "Filial piety is the pattern of Heaven, the standard of the earth, the norm of conduct for the people. When people follow the pattern of Heaven and earth, they model themselves on the brilliance of Heaven and make use of the resources of the earth and through these means comply with all under Heaven. Thus, [a ruler's] instruction succeeds without being stringent, and his policies are effective without being severe. The former kings, realizing that their instruction could transform the people, showed them an example of universal love. As a consequence, men did not neglect their parents. These kings set an example of rectitude and virtue, and as a consequence the people enthusiastically copied them. The kings showed an example of respectful yielding, and the people did not contend with each other. They taught through ritual and music, and the people lived in concord. They made clear to them the difference between good and evil, and as a consequence the people knew restraint."

GOVERNMENT BY FILIAL PIETY

The Master said, "Formerly the illustrious kings brought order to the world through filial piety. They did not dare neglect the ministers of small states—not to mention their own dukes, marquises, earls, counts, and barons. Therefore they gained the hearts of all the states and were able to serve their former kings. The rulers did not dare insult the widows and widowers—not to mention the upper class or the common people. Therefore they gained the hearts of all the people and were able to serve their former rulers. The heads of families did not dare mistreat their servants and concubines—not to mention their wives and children. Therefore they gained their hearts and were able to serve their parents. Accordingly, while living, parents were well taken care of; after their death, their ghosts received sacrifices. In this way the world was kept in peace and harmony. Calamities did not occur nor was disorder created. Such was the way the former illustrious kings brought order to the world through filial piety."

THE RULE OF THE SAGES

Zengzi said, "May I ask if there isn't anything in the virtue of the sages that surpasses filial piety?"

The Master replied, "Of all the creatures in Heaven and earth, man is the most important. Of all man's acts, none is greater than filial piety. In the practice of filial piety, nothing is greater than respecting one's father. For respecting one's father, nothing is greater than placing him on the level with Heaven. The person who did all this was the Duke of Zhou. In former times the Duke of Zhou sacrificed to the Spirit of Agriculture, placing him on a level with Heaven. He sacrificed to his father King Wen, in the Bright Hall, placing him on a level with the Supreme Lord. Therefore, within the four seas all of the lords, according to their stations, came to sacrifice. Thus, how can there be anything in the virtue of the sages that surpasses filial piety? From infancy a child's desire to care for his parents daily grows more re-

spectful. The sages used this natural reverence for parents to teach respect and used this natural affection to teach love. Thus, the teachings of the sages were effective though not severe and their rule was orderly though not harsh. This was because they relied on what was basic to human nature.

"The proper relation between father and son is a part of nature and forms the principles which regulate the conduct of rulers and ministers. Parents give life—no tie is stronger than this. Rulers personally watch over the people—no care is greater than this. Therefore to love others without first loving one's parents is to reject virtue. To reverence other men without first reverencing one's parents is to reject the rules of ritual. If one copies such perversity, the people will have no model to follow. Although a person who does not do good but only evil may gain a high position, a man of honor will not esteem him. The practice of a man of honor is different: his speech is praiseworthy, his behavior is pleasing, his standards are respected, his management of affairs can be taken as a model, his department is pleasant to observe, his movements are deliberate. When a man of honor deals with his people they look on him with awe and affection; they imitate and seek to resemble him. Thus he can carry out his moral instruction and put into effect his political directives."

FILIAL CONDUCT

The Master said, "In serving his parents a filial son renders the utmost reverence to them while at home. In supporting them he maximizes their pleasure. When they are sick he takes every care. At their death he expresses all his grief. Then he sacrifices to them with full solemnity. If he has fulfilled these five requirements, then he is truly able to serve his parents. He who really loves his parents will not be proud in high position. He will not be insubordinate in an inferior position. And among equals he will not be quarrelsome. If he were proud in high station he might be ruined. If he were insubordinate in an inferior position he

BEST COPY AVAILABLE

might incur punishment. If he were quarrelsome among his equals, he might end up fighting. Thus, unless these three evils are eliminated, a son cannot be called filial—even if every day he supplies his parents the three choice meats.”

THE FIVE PUNISHMENTS

The Master said, “There are three thousand offenses subject to the five punishments, but of these none is greater than lack of filial piety. To use force against the ruler is to defy authority. To deny the sages is to be unprincipled. And to decry filial piety is to renounce kinship ties. These are the road to chaos.”

ELABORATING “THE ESSENTIAL WAY”

The Master said, “For teaching men to love one another there is nothing better than filial piety. For teaching men ceremonial behavior and obedience there is nothing better than fraternal love. For transforming their manners and habits there is nothing better than music. For giving security to the rulers and governing the people there is nothing better than ritual. Ritual is essentially reverence. The son is happy when his father is revered. The younger brother is happy when his elder brother is revered. The ministers are made happy when their ruler is revered. Everyone is happy when the One Man, the Son of Heaven, is revered. Only a few are revered but multitudes are made happy. This is said to be the essential Way.”

ELABORATING “THE HIGHEST VIRTUE”

The Master said, “A man of honor in teaching the duties of filial piety does not need to go daily to the people’s homes to observe them. He merely teaches the principles of filial piety and all the fathers in the world receive the filial respect due to them. He teaches the principles of fraternal love

and all the elder brothers receive the respect due to them. He teaches the duties of subjects and all the rulers of the world receive the reverence due to them. The Odes say: ‘The man of honor, affectionate, is the father and mother to the people.’ Unless he possessed the highest virtue, who could educate the people to such an extent?”

ELABORATING “PERPETUATING ONE’S NAME”

The Master said, “The man of honor’s service to his parents is filial; the fidelity involved in it can be transferred to his ruler. His service to his elder brothers is deferential; the obedience involved in it can be transferred to his superiors. Self-disciplined at home, he can transfer his good management to official life. Through these means when his conduct is perfect at home his name will be perpetuated to later generations.”

REMONSTRATING

Zengzi remarked, “As regards kind affection, loving respect, comforting one’s parents, and bringing glory to one’s name, all this I have understood. May I ask if a son can be called filial if he obeys all of his father’s commands?”

The Master replied, “What kind of talk is this? In ancient times if the Son of Heaven had seven ministers to remonstrate with him, he would not lose his empire, even if he were imperfect. If a feudal lord had five good ministers to advise him, he would not lose his state, even if he were imperfect. If a high officer had three officials to remonstrate with him, he would not lose his home, even if he were imperfect. If a gentleman had a friend to correct him, he would not lose his good name. And if a father had a son to advise him, he would not fall into doing wrong. Thus, when he might do something wrong, a son must not fail to warn his father against it, nor a minister fail to warn his ruler. In short, when it is a question of doing wrong, one must remonstrate. How can following a father’s orders be considered fulfilling filial piety?”

MUTUAL INTERACTION

The Master said, "In ancient times the illustrious kings, because they were filial to their fathers were able to serve Heaven intelligently. Because they were filial to their mothers they were able to serve earth with circumspection. Superiors could govern interiors because the young obeyed their elders. Thus, because Heaven and earth were served with intelligence and care the spirits manifested themselves brilliantly. Even the Son of Heaven had someone he paid reverence to, that is to say, his father. He had someone he deferred to, that is to say, his elder brothers. At the ancestral temple he was reverential, not forgetting his parents. He cultivated his character and acted prudently, for fear of disgracing his ancestors. When he paid reverence at the ancestral temple, the ghosts and spirits sent blessings. When his filial piety and fraternity were perfected, his influence reached the spirits. He illuminated the four seas; there was no place his virtue did not penetrate."

SERVING THE RULER

The Master said, "In serving his superior the man of honor makes every effort to be faithful when he is in office. In retirement he tries to make up for his shortcomings. He encourages his superior in his good inclinations and tries to keep him from doing wrong. In this way, the relations between superiors and inferiors can be cordial."

MOURNING FOR PARENTS

The Master said, "When mourning a parent a filial son cries without wailing loudly, he performs the rites without attention to his appearance, he speaks without attention to the beauty of his words, he feels uncomfortable in elegant clothes, he gets no joy from hearing music, he does not relish good food—all of this is the emotion of grief. After three days he eats again to show men that the dead should not hurt the living and that the suffering should not lead to the destruction of life. This was the regulation of the sages. The period of mourning is not allowed to exceed three years, thus showing the people that everything ends. [The filial son] prepares a double coffin and grave clothes. When he sets out the sacrificial vessels, he grieves. Beating the breast, jumping up and down, and crying, he bids a last sad farewell. He divines to choose the burial place where the body can be placed to rest. He prepares an ancestral altar, so that the ghost can receive sacrifices. Spring and autumn he offers sacrifices thus thinking of the dead once every season. When his parents were alive he served them with love and reverence; in death he grieves. With the man's fundamental duty fulfilled, relations between the living and the dead are complete, and the filial son's service to his parents is finished."

Translated by Patricia Ebrey

I6

WANG FU ON FRIENDSHIP AND GETTING AHEAD

Service as a government official conferred great prestige in the Han, and educated men competed eagerly for posts. To enter the civil service, a man generally had to be recommended by either the official in charge of his local commandery or a high central government official. The rationale for this selection system was that moral character was what mattered most and only those personally acquainted with a candidate could judge it. From the beginning, critics of this system pointed out that officials often recommended friends, relatives, and men of wealth and influence rather than the most worthy.

In the following essay, Wang Fu (ca. 100–150) decries the effect this system of recruitment had on friendships within the educated class. He placed high demands on true friendship and believed that all talented men should have opportunities to gain office. Wang Fu himself never gained an official post, undoubtedly accounting for some of the bitterness of his complaints.

It is said, "With people, the old friends are best; with things, the new ones are best." In other words, brothers may drift apart as time goes by, but it is normal for friends to become closer with the passage of time.

Nowadays this is not so. People often seem to miss those they hardly know but forget close friends; they turn away from old friends as they seek new ones. Sometimes after several years friendships become weaker and weaker, and friendships of long standing break down. People not only discard the ancient sages' instruction to treasure old friends but also break oaths of enduring fidelity.

What are the reasons for this change in attitude

toward friendship? Careful analysis makes them clear. There are common tendencies and normal ways of operating in the world. People compete to flatter and get close to those who are wealthy and prominent; this is a common tendency. People are also quick to snub those who are poor and humble; this is a normal way of operating. If a person makes friends with the rich and prominent, he will gain the benefits of influential recommendations for advancement in office and the advantages of generous presents and other emoluments. But if he makes friends with the poor and humble, he will lose money either from giving them handouts or from unrepaid loans.

A powerful official may be as evil as the tyrant

Jie and the bandit Dao Zhi, but if he rides in a magnificent carriage to summon scholars to him, they will take it as a great honor and flock to his service. How can a person avoid being drawn to those who can render him tangible benefits? A scholar may have the combined talents of Yan Hui and Bao Shangyan, yet if he wears poor clothing when he pays visits, others will feel insulted and will look with dread upon the prospect of further calls. How can a person not avoid those who will bring him disadvantage? Therefore, those who are rich and prosperous find it easy to get along in society, while those who are poor and humble find it difficult to secure a place in the world.

The poor, if they wear fine clothes, are regarded as extravagant and ostentatious, but if they wear coarse clothing, they are taken to be in dire straits and difficulties. If they walk slowly, people say they are weak from hunger, but if they walk fast, they are accused of trying to flee from debts. If the poor do not visit others, they are regarded as arrogant, but if they come around too often, they are suspected of trying to sponge free meals. If they come empty-handed, they are taken for insincere friends, but if they bring a gift, they are regarded as degenerate. If they are confident and self-assured, they are regarded as unvirtuous. All these are the woes of the unemployed scholar, poor and without rank.

The poor scholar, being in a humble position, has much to bear. At home he has to put up with his wife's complaints. Outside he must endure the cutting remarks of the scholar-officials. At banquets his gifts are small and considered inadequate. His own parties are simple and not up to others' standards. He is not rich enough to come to the aid of friends in need, and his power is too meager to save them. A friendship may have been long and cordial, but since the poor scholar is unable to save his friend in need, the relationship weakens. Once this occurs, the humble scholar becomes more and more aware of his own low status, while the other individual busies himself with cultivating relationships with more useful persons and forgets his old friend.

Since friendship is founded on mutual advan-

tage, when disadvantage arises the friendship breaks down. An oath of friendship is meaningless and eventually will be discarded. Those who communicate often become close friends because they see advantage to themselves in the relationship. A commoner will act as follows. If a person can be useful, he will draw near to him. Being close to him, he will gradually develop a feeling of love for him. Because he thinks the friend is right, he will regard him as capable, and so he will turn his heart toward him and praise him happily. A commoner will keep his distance from those whom he regards as unable to render him benefits. Because they are distant, after a time he begins to feel hatred for them. Because he hates them, he always considers them in the wrong, and so feels disgust for them. Once he feels disgust for them, his heart naturally turns away from them and he slanders them. Therefore, even if one's friendship with a wealthy and prominent man is a new one, it will become closer and closer every day; and although one's friendship with a poor and humble man is of long standing, it will tend to become weaker and more distant. These are the reasons why a poor scholar cannot compete with officials for friends.

Rulers do not understand what causes people to form friendships, and so they readily believe the words of their high officials. This is why honest scholars are always excluded from court while crafty persons always get their way. In the past when Wei Qi lost his power, his retainers abandoned him to serve in another place. When the general Wei Qing lost imperial favor and was no longer able to shower his subordinates with rewards from the court, they left him to serve the newly powerful general Huo Quping. The retainers of the Zhao general Lian Po and of the Han general Di Gong came and went, depending on whether their benefactors were in power or not. These four gentlemen were all capable and all had illustrious pasts, yet the loyalty of their subordinates wavered with the amount of power they had. How much more would this happen to those who became really poor and humble!

Only those who have the heroic virtue of the

ancients will not desert their superiors and friends in such a fashion. When these people make commitments to friends, they do not abandon them their whole life long. If they love someone, their concern for him can only become greater as his situation worsens. The *Book of Songs* says, "The virtuous man, the princely one, is uniformly correct in his deportment. His heart is as if it were tied to what is correct." Only during the cold of winter, when all other trees have lost their leaves, do people realize that the pine trees resist the cold and do not shed their needles. Likewise, it is only when difficulties are encountered that a person's virtue can be noticed. You Ying and Yu Rang gave their lives to retain their master's good grace. Zhuan Zhu and Jing Ke sacrificed their lives to render service to their masters. It is easy to die, but to die for one's master willingly when he has encountered hard times is difficult indeed. . . .

Most scholars are very shortsighted, concerned only about the present moment. If they think that a powerful man will be of use to them, they rush to his service; but if they think that someone will be of no use, they are quick to avoid him. Those who burn for rapid promotion and advancement compete with one another to get close to persons of prominence but can find no time to associate with the humble. They scrape and claw to make their way to the front but have little time to concern themselves with those who have been left behind. When the Minister Han Anguo lost his official post, he sent some five hundred golden artifacts to the newly powerful Grand Commandant Dian Fen to seek a position. Yet not once did he give any assistance to a poor but capable scholar. Likewise the Minister Di Fangjin was eager to recommend Shun Youchang, a relative of the empress, for promotion, but was unable to recommend even one humble scholar. Now, both Han Anguo and Di Fangjin were good and loyal officials of the Han dynasty, and yet they still acted in such a snobbish way. How can one ex-

pect virtue from officials who are inferior to them? This is the reason that crafty, calculating individuals can worm their way up the official ladder while ordinary scholars slip ever more into obscurity. Unless the realm has a brilliant ruler, there may be no one to discern this. . . .

In this world there are three things which are loathsome indeed. These may be summed up as follows: first, to express in words extremely warm affections toward others while one's heart holds nothing but cold feelings; second, to express in writing dear thoughts toward others while in fact one's thoughts are rarely with them; third, to make appointments with others while having already decided not to show up at all. If people are always suspicious of others' words, they may fear that they will dismiss the genuine sentiments of a true worthy. But if people are quick to believe what they are told, they will be often fooled. This is why those disingenuous, mediocre people are so disgusting. . . .

Alas! The gentlemen of today speak nobly but act basely. Their words are upright, but their hearts are false. Their actions do not reflect their words, and their words are out of harmony with their thoughts. In talking of antiquity they always praise the conduct of Bo Yi, Shu Qi, Qu Yuan, and Yan Hui; but when it comes to the present, their only concern is the scramble for official ranks and positions. In their lofty speeches they refer to virtuous and righteous persons as being worthy. But when they actually recommend people for office, they consider only such requirements as influence and prominence. If a man is just an obscure scholar, even if he possesses the virtue of Yan Hui and Min Ziqian, even if he is modest and diligent, even if he has the ability of Yi Yin and Lu Shang, even if he is filled with the most devoted compassion for the people, he is clearly not going to be employed in this world.

Translated by Lily Hwa

17

WOMEN'S VIRTUES AND VICES

Pre-Han philosophers directed little of their writing to women, even women of the nobility. In the Han, however, the eminent scholar and bibliographer Liu Xiang (79–8 B.C.) wrote the Biographies of Heroic Women, a collection of accounts of the gallant deeds and unselfish behavior of 125 women of antiquity. Many of these women epitomized a single virtue—for instance, loyalty to the ruler, self-sacrifice to help husband or father, or preservation of chastity under duress. As seen in the selection from this book given below, however, the mother of Mencius had several virtues. It is followed here by two of the seven sections of the Admonitions for Women, an equally famous Han text on women's virtues. It was written by Ban Zhao (ca. 45–116), sister of the famous historian Ban Gu (32–92), as a guide to the cultivation of virtues appropriate to women, such as humility, resignation, subservience, self-abasement, obedience, cleanliness, and industry. The selections from these two texts show what people admired in women, but not what women were like. To complement them, a description of a real but far-from-ideal woman is also included here. It is from a letter written by the woman's husband, Feng Yan, to her younger brother explaining his reasons for divorcing her.

THE MOTHER OF MENCIUS

The mother of Mencius lived in Zou in a house near a cemetery. When Mencius was a little boy he liked to play burial rituals in the cemetery, happily building tombs and grave mounds. His mother said to herself, "This is no place to bring up my son."

She moved near the marketplace in town. Mencius then played merchant games of buying and selling. His mother again said, "This is no place to bring up my son."

So once again she moved, this time next to a school house. Mencius then played games of ancestor sacrifices and practiced the common courtesies between students and teachers. His mother said, "At last, this is the right place for my son!" There they remained.

When Mencius grew up he studied the six arts of propriety, music, archery, charioteering, writing, and mathematics. Later he became a famous Confucian scholar. Superior men commented that Mencius's mother knew the right influences for her sons. The *Book of Songs* says:

"That admirable lady, what will she do for them!"

When Mencius was young, he came home from school one day and found his mother was weaving at the loom. She asked him, "Is school out already?"

He replied, "I left because I felt like it."

His mother took her knife and cut the finished cloth on her loom. Mencius was startled and asked why. She replied, "Your neglecting your studies is very much like my cutting the cloth. The superior person studies to establish a reputation and gain wide knowledge. He is calm and poised and tries to do no wrong. If you do not study now, you will surely end up as a menial servant and will never be free from troubles. It would be just like a woman who supports herself by weaving to give it up. How long could such a person depend on her husband and son to stave off hunger? If a woman neglects her work or a man gives up the cultivation of his character, they may end up as common thieves if not slaves!"

Shaken, from then on Mencius studied hard from morning to night. He studied the philosophy of the master and eventually became a famous Confucian scholar. Superior men observed that Mencius's mother understood the way of motherhood. The *Book of Songs* says, "That admirable lady, what will she tell them!"

After Mencius was married, one day as he was going into his private quarters, he encountered his wife not fully dressed. Displeased, Mencius stopped going into his wife's room. She then went to his mother, begged to be sent home, and said, "I have heard that the etiquette between a man and a woman does not apply in their private room. But lately I have been too casual, and when my husband saw me improperly dressed, he was displeased. He is treating me like a stranger. It is not right for a woman to live as a guest; therefore, please send me back to my parents."

Mencius's mother called him to her and said, "It is polite to inquire before you enter a room. You should make some loud noise to warn anyone inside, and as you enter, you should keep your eyes low so that you will not embarrass anyone.

Now, you have not behaved properly, yet you are quick to blame others for their impropriety. Isn't that going a little too far?"

Mencius apologized and took back his wife. Superior men said that his mother understood the way to be a mother-in-law.

When Mencius was living in Qi, he was feeling very depressed. His mother saw this and asked him, "Why are you looking so low?"

"It's nothing," he replied.

On another occasion when Mencius was not working, he leaned against the door and sighed. His mother saw him and said, "The other day I saw that you were troubled, but you answered that it was nothing. But why are you leaning against the door sighing?"

Mencius answered, "I have heard that the superior man judges his capabilities and then accepts a position. He neither seeks illicit gains nor covets glory or high salary. If the dukes and princes do not listen to his advice, then he does not talk to them. If they listen to him but do not use his ideas, then he no longer frequents their courts. Today my ideas are not being used in Qi, so I wish to go somewhere else. But I am worried because you are getting too old to travel about the country."

His mother answered, "A woman's duties are to cook the five grains, heat the wine, look after her parents-in-law, make clothes, and that is all! Therefore, she cultivates the skills required in the women's quarters and has no ambition to manage affairs outside of the house. The *Book of Changes* says, 'In her central place, she attends to the preparation of the food.' The *Book of Songs* says, 'It will be theirs neither to do wrong nor to do good, / Only about the spirits and the food will they have to think.' This means that a woman's duty is not to control or to take charge. Instead she must follow the 'three submissions.' When she is young, she must submit to her parents. After her marriage, she must submit to her husband. When she is widowed, she must submit to her son. These are the rules of propriety. Now you are an adult and I am old; therefore, whether you go depends on what you consider right, whether I follow depends on the rules of propriety."

Superior men observed that Mencius's mother knew the proper course for women. The *Book of Songs* says, "Serenely she looks and smiles, / Without any impatience she delivers her instructions."

Translated by Nancy Gibbs

LETTER FROM FENG YAN TO HIS BROTHER-IN-LAW

Man is a creature of emotion. Yet it is according to reason that husband and wife are joined together or put asunder. According to the rules of propriety which have been set down by the sage, a gentleman should have both a primary wife and concubines as well. Even men from poor and humble families long to possess concubines. I am old and approaching the end of my life, but I have never had a concubine. I will carry regret for this into my grave.

My wife is jealous and has destroyed the Way of a good family. Yet this mother of five children is still in my house. For the past five years her conduct has become worse and worse day after day. She sees white as black and wrong as right. I never err in the slightest, yet she lies about me and nags me without end. It is like falling among bandits on the road, for I constantly encounter unpredictable disasters through this woman. Those who slander us good officials seem to have no regard for the deleterious effects this has on the welfare of the country. Likewise, those who indulge their jealousy seem to have no concern for the unjust strain this puts on other people's lives.

Since antiquity it has always been considered a great disaster to have one's household be dominated by a woman. Now this disaster has befallen me. If I eat too much or too little or if I drink too much or too little, she jumps all over me like the tyrant Xia Jie. If I play some affectionate joke on her, she will gossip about it to everyone. She glowers with her eyes and clenches her fists tightly in anger over things which are purely the product of her imagination. I feel a severe pang in my heart, as though something is poisoning my five viscera. Anxiety cuts so deeply that I can hardly bear to go

on living. My rage is so great that I often forget the calamities I might cause.

When she is at home, she is always lounging in bed. After she gave birth to my principal heir, she refused to have any more children. We have no female servants at our home who can do the work of weaving clothes and rugs. Our family is of modest means and we cannot afford a man-servant, so I have to work myself like a humble commoner. My old friends see my situation and feel very sorry for me, but this woman has not the slightest twinge of sympathy or pity.

Wu Da, you have seen our one and only female servant. She has no hairpins or hair ornaments. She has no make-up for her face, looks haggard, and is in bad shape. My wife does not extend the slightest pity to her, nor does she try to understand her. The woman flies into a rage, jumps around, and yells at her. Her screaming is so shrill that even a sugar peddler's concubine would be ashamed to behave in such a manner.

I should have sent this woman back long ago, but I was concerned by the fact that the children were still young and that there was no one else to do the work in our house. I feared that my children, Jiang and Bao, would end up doing servants' work. Therefore I retained her. But worry and anxiety plunge like a dagger into my heart and cause me great pain. The woman is always screaming fiercely. One can hardly bear to listen to it.

Since the servant was so mistreated, within half a year her body was covered with scabs and scars. Ever since the servant became ill, my daughter Jiang has had to hull the grain and do the cooking, and my son Bao has had to do all sorts of dirty work. Watching my children struggle under such labor gives me distress.

Food and clothing are scattered all over the house. Winter clothes which have become frayed are not patched. Even though the rest of us are very careful to be neat, she turns the house into a mess. She does not have the manner of a good wife, nor does she possess the virtue of a good mother. I despise her overbearing aggressiveness, and I hate to see our home turned into a sty.

She relies on the power of Magistrate Zheng to get what she wants. She is always threatening people, and her barbs are numerous. It seems as if she carries a sword and lance to the door. Never will she make a concession, and it feels as if there were a hundred bows around our house. How can we ever return to a happy family life?

When the respectable members of our family try to reason with her, she flings insults at them and makes sharp retorts. She never regrets her scandalous behavior and never allows her heart to be moved. I realize that I have placed myself in a difficult position, and so I have started to plan ahead. I write you this letter lest I be remiss in keeping you informed of what is happening. I believe that I have just cause, and I am not afraid of criticism. Unless I send this wife back, my family will have no peace. Unless I send this wife back, my house will never be clean. Unless I send this wife back, good fortune will not come to my family. Unless I send this wife back, I will never again get anything accomplished. I hate myself for not having made this decision while I was still young. The decision is now made, but I am old, humiliated, and poor. I hate myself for having allowed this ulcer to grow and spread its poison. I brought a great deal of trouble on myself.

Having suffered total ruin as a result of this family catastrophe, I am abandoning the gentry life to live as a recluse. I will sever relationships with my friends and give up my career as an official. I will stay at home all the time and concentrate on working my land to supply myself with food and clothing. How can I think of success and fame?

Translated by Lily Hua

BAN ZHAO'S ADMONITIONS FOR WOMEN

Humility

In ancient times, on the third day after a girl was born, people placed her at the base of the bed,

gave her a pot shard to play with, and made a sacrifice to announce her birth. She was put below the bed to show that she was lowly and weak and should concentrate on humbling herself before others. Playing with a shard showed that she should get accustomed to hard work and concentrate on being diligent. Announcing her birth to the ancestors showed that she should focus on continuing the sacrifices. These three customs convey the unchanging path for women and the ritual traditions.

Humility means yielding and acting respectful, putting others first and oneself last, never mentioning one's own good deeds or denying one's own faults, enduring insults and bearing with mistreatment, all with due trepidation. Industriousness means going to bed late, getting up early, never shirking work morning or night, never refusing to take on domestic work, and completing everything that needs to be done neatly and carefully. Continuing the sacrifices means serving one's husband-master with appropriate demeanor, keeping oneself clean and pure, never joking or laughing, and preparing pure wine and food to offer to the ancestors.

There has never been a woman who had these three traits and yet ruined her reputation or fell into disgrace. If a woman loses these three traits, she will have no name to preserve and will not be able to avoid shame.

Devotion

According to the rites, a man is obligated to take a second wife but nothing is written about a woman marrying twice. Hence the saying, "A husband is one's Heaven: one cannot flee Heaven; one cannot leave a husband." Heaven punishes those whose actions offend the spirits; a husband looks down on a wife who violates the rites and proprieties. Thus the *Model for Women* says, "To please one man is her goal; to displease one man ends her goal." It follows from this that a woman must seek her husband's love—not through such means as flattery, flirting, or false intimacy, but rather through devotion.

Devotion and proper demeanor entail propriety and purity, hearing nothing licentious, seeing nothing depraved, doing nothing likely to draw notice when outside the home; never neglecting one's appearance when at home; never gathering in groups or watching at the doorway. By contrast, those incapable of devotion and proper de-

m demeanor are careless in their actions, look at and listen to whatever they like, let their hair get messy when at home, put on an act of delicacy when away, speak of things they should not mention, and watch what they should not see.

Translated by Patricia Ebrey

Lao Tzu, Tao Te Ching

I

- 1 The way that can be told
Is not the constant way;
The name that can be named
Is not the constant name.
- 2 The nameless was the beginning of heaven and
earth;
The named was the mother of the myriad creatures.
3 Hence always rid yourself of desires in order to
observe its* secrets;
But always allow yourself to have desires in order
to observe its manifestations.†
- 3a These two are the same
But diverge in name as they issue forth.
Being the same they are called mysteries,
Mystery upon mystery –
The gateway of the manifold secrets.

* In translating from the Chinese it is often impossible to avoid using the pronouns 'it' and 'they' and their derivatives without any clear reference, whether these are expressed in the Chinese or only implied. In the present work 'it' used in this way sometimes refers to 'the way' and 'they' to 'the myriad creatures'.

† Superior arabic figures refer to notes, mainly of a textual nature, placed at the end of the book.

467

57

TAO TE CHING

II

- 4 The whole world recognizes the beautiful as the beautiful, yet this is only the ugly; the whole world recognizes the good as the good, yet this is only the bad.
- 5 Thus Something and Nothing produce each other;
The difficult and the easy complement each other;
The long and the short off-set¹ each other;
The high and the low incline towards each other;
Note and sound* harmonize with each other;
Before and after follow each other.†
- 6 Therefore the sage keeps to the deed that consists in taking no action and practises the teaching that uses no words.
- 7 The myriad creatures rise from it yet it claims no authority;²
It gives them life yet claims no possession;
It benefits them yet exacts no gratitude;
It accomplishes its task yet lays claim to no merit.
7a It is because it lays claim to no merit
That its merit never deserts it.

* The Chinese terms used here are not precise and it is not clear what the intended contrast is. The translation is, therefore, tentative.

† It may seem strange to say that before and after follow each other, but this refers probably to a ring. Any point on a ring is both before and after any other point, depending on the arbitrary choice of the starting-point.

468

58

III

- 8 Not to honour men of worth will keep the people from contention; not to value goods which are hard to come by will keep them from theft; not to display what is desirable will keep them from being unsettled of mind.
- 9 Therefore in governing the people, the sage empties their minds but fills their bellies, weakens their wills but strengthens their bones. He always keeps them innocent of knowledge and free from desire, and ensures that the clever never dare to act.
- 10 Do that which consists in taking no action, and order will prevail.

IV

- 11 The way is empty, yet use will not drain it.
Deep, it is like the ancestor of the myriad creatures.
Blunt the sharpness;
Untangle the knots;
Soften the glare;
Let your wheels move only along old ruts.²
- 12 Darkly visible, it only seems as if it were there.
I know not whose son it is.
It images the forefather of God.

² The word in the text meaning 'full' has been emended to one meaning 'empty'. Cf. 'Yet use will never drain it' (17); 'Yet it cannot be exhausted by use' (78); 'Yet use will not drain it' (101).

V

- 14 Heaven and earth are ruthless, and treat the myriad creatures as straw dogs*; the sage is ruthless, and treats the people as straw dogs.
 15 Is not the space between heaven and earth like a bellows?
 It is empty without being exhausted:
 The more it works the more comes out.
 16 Much speech leads inevitably to silence.
 Better to hold fast to the void.¹

VI

- 17 The spirit of the valley never dies.
 This is called the mysterious female.
 The gateway of the mysterious female
 Is called the root of heaven and earth.
 Dimly visible, it seems as if it were there,
 Yet use will never drain it.

471

* In the *T'ien yin* chapter in the *Chuang tzu* it is said that straw dogs were treated with the greatest deference before they were used as an offering, only to be discarded and trampled upon as soon as they had served their purpose.

VII

18 Heaven and earth are enduring. The reason why
 heaven and earth can be enduring is that they do not
 give themselves life. Hence they are able to be long-
 lived.

19 Therefore the sage puts his person last and it comes
 first,
 Treats it as extraneous to himself and it is preserved.
 19a Is it not because he is without thought of self that he
 is able to accomplish his private ends?

63

VIII

20 Highest good is like water. Because water excels in
 benefiting the myriad creatures without contending
 with them and settles where none would like to be,
 it comes close to the way.

21 In a home it is the site that matters;¹
 In quality of mind it is depth that matters;
 In an ally it is benevolence that matters;
 In speech it is good faith that matters;
 In government it is order that matters;
 In affairs it is ability that matters;
 In action it is timeliness that matters.

22 It is because it does not contend that it is never at fault.*

* In sense and, possibly, in rhyme, this line is continuous with 20.

64

X

- 24 When carrying on your head¹ your perplexed bodily soul* can you embrace in your arms the One And not let go?
In concentrating your breath can you become as supple
As a babe?²
Can you polish your mysterious mirror†
And leave no blemish?
Can you love the people and govern the state
Without resorting to action?³
When the gates of heaven‡ open and shut
Are you capable of keeping to the role of the female?⁴
When your discernment penetrates the four quarters
Are you capable of not knowing anything?⁴
25 It gives them life and rears them.
26 It gives them life yet claims no possession;
It benefits them yet exacts no gratitude;
It is the steward yet exercises no authority.
Such is called the mysterious virtue.

* Man has two souls, the *p'o* which is the soul of the body and the *hun* which is the soul of the spirit. After death, the *p'o* descends into earth while the *hun* ascends into heaven. Cf. 'The myriad creatures carry on their backs the *yin* and embrace in their arms the *yang*' (94).

† i.e. the mind.

‡ The gates of heaven are, according to the *K'ing sang ch'u* chapter of the *Chuang tzu*, the invisible gateway through which the myriad creatures come into being and return to nothing.

IX

- 23 Rather than fill it to the brim by keeping it upright
Better to have stopped in time;¹
Hammer it to a point
And the sharpness cannot be preserved for ever;
There may be gold and jade to fill a hall
But there is none who can keep them.
To be overbearing when one has wealth and position
Is to bring calamity upon oneself.
To retire when the task is accomplished
Is the way of heaven.

* This refers to a vessel which is said to have been in the temple of *Chou* (or *Lou*). It stands in position when empty but overflows when full. The moral is that humility is a necessary virtue, especially for those in high position.

BOOK ONE

XII

- 28 The five colours make man's eyes blind;
The five notes make his ears deaf;
The five tastes injure his palate;
Riding and hunting
Make his mind go wild with excitement;
Goods hard to come by
Serve to hinder his progress.
- 29 Hence the sage is
For the belly
Not for the eye.
29a Therefore he discards the one and takes the other.

XI

- 27 Thirty spokes
Share one hub.
Adapt the nothing therein to the purpose in hand, and
you will have the use of the cart. Knead clay in order
to make a vessel. Adapt the nothing therein to the
purpose in hand, and you will have the use of the
vessel. Cut out doors and windows in order to make
a room. Adapt the nothing* therein to the purpose in
hand, and you will have the use of the room.
27a Thus what we gain is Something, yet it is by virtue of
Nothing that this can be put to use.

* In all three cases, by 'nothing' is meant the empty spaces.

XIII

- 30 Favour and disgrace are things that startle;
High rank* is, like one's body, a source of great trouble.
- 30a What is meant by saying that favour and disgrace are things that startle? Favour when it is bestowed on a subject serves to startle as much as when it is withdrawn. This is what is meant by saying that favour and disgrace are things that startle. What is meant by saying that high rank is, like one's body, a source of great trouble? The reason I have great trouble is that I have a body. When I no longer have a body, what trouble have I?
- 31 Hence he who values his body more than dominion over the empire can be entrusted with the empire. He who loves his body more than dominion over the empire can be given the custody of the empire.

* It is probable that the word *kwei* ('high rank') here has crept in by mistake, since, as it stands, this line has one word more than the first. If this is the case, then the line should be translated: 'Great trouble is like one's body.' This brings it into line with the explanation that follows where 'high rank' is not, in fact, mentioned.

XIV

- 32 What cannot be seen is called evanescent;
What cannot be heard is called rarefied;
What cannot be touched is called minute.
32a These three cannot be fathomed
And so they are confused and looked upon as one.
- 33 Its upper part is not dazzling;
Its lower part is not obscure.
Dimly visible, it cannot be named
And returns to that which is without substance.
This is called the shape that has no shape,
The image that is without substance.
This is called indistinct and shadowy.
Go up to it and you will not see its head;
Follow behind it and you will not see its rear.
- 34 Hold fast to the way of antiquity
In order to keep in control the realm of today.
The ability to know the beginning of antiquity
Is called the thread running through the way.

XV

- 35 Of old he who was well versed in the way,¹
 Was minutely subtle, mysteriously comprehending,
 And too profound to be known.
 It is because he could not be known
 That he can only be given a makeshift description:
 Tentative, as if fording a river in winter,
 Hesitant, as if in fear of his neighbours;
 Formal like a guest;²
 Falling apart like thawing ice;
 Thick like the uncarved block;
 Vacant like a valley;
 Murky like muddy water.
- 36 Who can be muddy and yet, settling, slowly become
 limpid?³
 Who can be at rest and yet, stirring, slowly come
 to life?
 He who holds fast to this way
 Desires not to be full.
 It is because he is not full
 That he can be worm⁴ and yet newly made.*

* The present text reads 'That he can be worm and not newly made'. The negative must have crept in by mistake. Cf. *Wan* then new (50).

XVI

- 37 I do my utmost to attain emptiness;
 I hold firmly to stillness.
 The myriad creatures all rise together
 And I watch their return.
 The teaming creatures
 All return to their separate roots.
 Returning to one's roots is known as stillness.
 This is what is meant by returning to one's destiny.
 Returning to one's destiny is known as the constant.
 Knowledge of the constant is known as discernment.
 Woe to him who willfully innovates
 While ignorant of the constant,
 But should one act from knowledge of the constant
 One's action will lead to impartiality,
 Impartiality to kingliness,
 Kingliness to heaven,
 Heaven to the way,
 The way to perpetuity,
 And to the end of one's days one will meet with no
 danger.
- 38

BOOK ONE

XVII

- 39 The best of all rulers is but a shadowy presence to his subjects.
Next comes the ruler they love and praise;
Next comes one they fear;
Next comes one with whom they take liberties.
- 40 When there is not enough faith, there is lack of good faith.
- 41 Hesitant, he does not utter words lightly.
When his task is accomplished and his work done
The people all say, 'It happened to us naturally.'

484

453

7

DAOIST TEACHINGS

Amid the intellectual ferment of the three centuries after Confucius, a bewildering array of new ideas were propounded. Two strands that proved particularly long-lasting are those generally labeled "Daoist" and "Legalist." The two key texts of Daoism are the Laozi, also called the Classic of the Way and Its Power, traditionally ascribed to Lao Dan (sixth century B.C.) but probably written in the third century, and the Zhuangzi, a good portion of which was probably written by the philosopher Zhuang Zhou (369–286 B.C.). These two works share disapproval of the unnatural and artificial. Whereas plants and animals act spontaneously in the ways appropriate to them, humans have separated themselves from the Way by plotting and planning, analyzing and organizing. Both texts reject social conventions for an ecstatic surrender to the spontaneity of cosmic processes. The two books, nevertheless, differ in many regards as well. The Laozi is a long philosophical poem, so elliptical that it can be read in many ways. The Zhuangzi is more like a collection of tall tales; it is full of flights of fancy, parables, and fictional encounters between historical figures. Whereas Laozi seems concerned with protecting each person's life, Zhuangzi searches for a view of man's place in the cosmos which will reconcile him to death.

These two works are of interest not only for what they reveal of the intellectual ferment of the late Zhou, but also because they were among the favorite books of Chinese readers throughout history, enriching the Chinese imagination and giving pleasure to people who accepted most social conventions. Both books were also granted canonical status in the literature of the Daoist religion which developed after the second century A.D.

PASSAGES FROM THE LAOZI

The Way that can be discussed
Is not the constant Way.
The name that can be named
Is not the invariant name.
The nameless is the source of Heaven and earth.

The named is the mother of all creatures.
Ever without desires, one can observe its secrets.
Ever possessed of desires, one can observe its manifestations.
These two truths are the same, but appear under different names.
Their identity can be called a mystery.

Mystery upon mystery—the gate of the many secrets.

When everyone in the world sees beauty in the beautiful,

Ugliness is already there.

When everyone sees good in the good,

Bad is already there.

Thus existence and nonexistence give birth to each other,

The hard and the easy complement each other,

The long and the short stand in comparison to each other,

The high and the low incline toward each other,

Sounds and notes harmonize with each other,

And before and after follow each other.

Thus the sage takes on the task of doing nothing

And teaches without speaking.

All things arise from him, and he does not reject them.

He produces them but does not own them.

He acts on their behalf but does not depend on them.

He succeeds but does not stay.

Because he does not stay,

Nothing leaves.

Do not honor the worthy,

And the people will not compete.

Do not value rare treasures,

And the people will not steal.

Do not display what others want,

And the people will not have their hearts confused.

A sage governs this way:

He empties people's minds and fills their bellies.

He weakens their wills and strengthens their bones.

Keep the people always without knowledge and without desires,

For then the clever will not dare act.

Engage in no action and order will prevail.

Heaven and earth are ruthless.

They treat all creatures like straw dogs [to be discarded after the sacrifice].

The sage is ruthless and treats the common people like straw dogs.

Isn't the realm of Heaven and earth like a bellows?

Empty, it does not collapse,

But the more it is moved, the more that comes out.

But too much talking leads to depletion.

It is better to preserve what is within.

The spirit of the valley never dies.

Call it the mysterious female.

The gateway to the mysterious female
Is called the root of Heaven and earth.

Hard to perceive.

It cannot be used up.

Heaven persists and earth endures.

The reason they can do this is that they do not generate themselves.

Therefore the sage puts his own person behind and yet is ahead.

He puts his own person outside and yet survives.

Isn't it because he is without selfishness that he is able to be successfully selfish?

The highest good is like water. Water benefits all creatures but does not compete. It occupies the places people disdain. Thus it comes near to the Way.

For dwelling, the earth is good,

For minds, depth is good,

In social relations, human-heartedness is good,

In speaking, trustworthiness is good,

In governing, order is good.

For tasks, ability is good,

For action, timeliness is good.

Simply by not contending,

Blame is avoided.

The Way is eternally nameless.

The uncarved block may be small,

But no one in the world can subordinate it.

If lords and kings could preserve it,

All creatures would pay homage of their own accord,

Heaven and earth would join to send down sweet dew,

And without any decrees being issued, the people would be equitable.

As soon as cuts are made names appear.

Once there are names, one should sense it is time to stop.

Knowing when to stop is the means of avoiding danger.

The Way functions in the world

Much like the rivers flow into the sea.

If you want to shrink something,

Be sure to stretch it.

If you want to weaken something,

Be sure to strengthen it.

If you want to discard something,

Be sure to promote it.

If you want to take from something,
Be sure to give to it.
This is called the brilliance of the minute.
The soft and weak overcomes the hard and strong.
Fish should not be taken from the water;
The tools of statecraft should not be shown to
people.

In ancient times, those who excelled in the Way
Did not use it to enlighten the people but to keep
them ignorant.
When people are hard to govern, it is because they
know too much.
Thus those who use knowledge to rule a state
Are a plague on the country.
Those who do not use knowledge to rule the state
Are the country's blessing.
Understand these two—they are the standard.
Constant recognition of the standard is called mys-
terious virtue.
Mysterious virtue is deep and far-reaching;
It returns with things all the way to the great con-
formity.

Make the state small and its people few.
Let the people give up use of their tools.
Let them take death seriously and desist from distant
campaigns.
Then even if they have boats and wagons, they will
not travel in them.
Even though they have weapons and armor, they
will not form ranks with them.
Let people revert to the practice of rope-tying [in-
stead of writing].
Then they will find their food sweet,
Their clothes beautiful,
Their houses comfortable,
Their customs enjoyable.
People from neighboring states so close that they
can see each other and hear the sounds of each
other's dogs and chickens will then grow old
without ever visiting each other.

SELECTIONS FROM THE ZHUANGZI

Hui Shi said to Zhuangzi, "I have a large tree, of
the sort people call a shu tree. Its trunk is too
gnarled for measuring lines to be applied to it, its
branches are too twisted for use with compasses
or T-squares. If you stood it on the road, no car-

penter would pay any attention to it. Now your
talk is similarly vast but useless; people are unan-
imous in rejecting it."

Zhuangzi replied, "Haven't you ever seen a
wildcat or a weasel? It crouches down to wait for
something to pass, ready to pounce east or west,
high or low, only to end by falling into a trap and
dying in a net. But then there is the yak. It is as big
as a cloud hanging in the sky. It has an ability to
be big, but hardly an ability to catch mice. Now
you have a large tree but fret over its uselessness.
Why not plant it in Nothing At All town or Vast
Nothing wilds? Then you could roam about do-
ing nothing by its side or sleep beneath it. Axes
will never shorten its life and nothing will ever
harm it. If you are of no use at all, who will make
trouble for you?"

How do I know that enjoying life is not a de-
lusion? How do I know that in hating death we
are not like people who got lost in early child-
hood and do not know the way home? Lady Li
was the child of a border guard in Ai. When first
captured by the state of Jin, she wept so much
her clothes were soaked. But after she entered
the palace, shared the king's bed, and dined on
the finest meats, she regretted her tears. How do
I know that the dead do not regret their previous
longing for life? One who dreams of drinking
wine may in the morning weep; one who dreams
of weeping may in the morning go out to hunt.
During our dreams we do not know we are
dreaming. We may even dream of interpreting a
dream. Only on waking do we know it was a
dream. Only after the great awakening will we
realize that this is the great dream. And yet fools
think they are awake, presuming to know that
they are rulers or herdsman. How dense! You
and Confucius are both dreaming, and I who say
you are a dream am also a dream. Such is my
tale. It will probably be called preposterous, but
after ten thousand generations there may be a
great sage who will be able to explain it, a trivial
interval equivalent to the passage from morning
to night.

* * *

Once Zhuang Zhou dreamed he was a butterfly, a fluttering butterfly. What fun he had, doing as he pleased! He did not know he was Zhou. Suddenly he woke up and found himself to be Zhou. He did not know whether Zhou had dreamed he was a butterfly, or a butterfly had dreamed he was Zhou. Between Zhou and the butterfly there must be some distinction. This is what is meant by the transformation of things.

* * *

Cook Ding was cutting up a cow for Duke Wenhui. With a touch of his hand, a lunge of his shoulder, a stamp of his foot, a bend of his knee, zip, his knife slithered, never missing a beat, in time to "the dance of the mulberry forest," or the "Jingshou suite." Lord Wenhui exclaimed, "How amazing that your skill has reached such heights!"

Cook Ding put down his knife and replied, "What I love is the Way, which goes beyond skill. When I first butchered cows, I saw nothing but cows. After three years, I never saw a cow as a whole. At present, I deal with it through my spirit rather than looking at it with my eyes. My perception stops and my spirit runs its course. I rely on the natural patterning, striking at the big openings, leading into the main cavities. By following what is inherently so I never cut a ligament or tendon, not to mention a bone. A good cook changes his knife once a year, because he cuts. An ordinary cook changes his knife every month, because he hacks. This knife of mine is nineteen years old. It has carved several thousand cows, yet its blade looks like it had just come from the grindstone. There are spaces in the joints, and the blade has no thickness. So when something with no thickness enters something with space, it has plenty of room to move about. This is why after nineteen years it seems fresh from the grindstone.

However, when I come to something complicated, I inspect it closely to prepare myself. I keep my eyes on what I am doing and proceed deliberately, moving my knife imperceptibly. Then with a stroke it all comes apart like a clod of earth

crumbling. I stand there, my knife in my hand, look all around, enjoying my success. Then I clean the knife and put it away."

Lord Wenhui said, "Excellent! By listening to Cook Ding I learned how to nurture life."

* * *

Consider Cripple Shu. His chin is down by his navel. His shoulders stick up above his head. The bones at the base of his neck point to the sky. The five pipes of his spine are on top; his two thighs form ribs. Yet by sewing and washing he is able to fill his mouth; by shaking the fortune-telling sticks he earns enough to feed ten. When the authorities draft soldiers, a cripple can walk among them confidently flapping his sleeves; when they are conscripting work gangs, cripples are excused because of their infirmity. When the authorities give relief grain to the ailing, a cripple gets three measures, along with ten bundles of firewood. Thus one whose form is crippled can nurture his body and live out the years Heaven grants him. Think what he could do if his virtue was crippled too!

* * *

Root of Heaven roamed on the south side of Mount Vast. When he came to the bank of Clear Stream, he met Nameless Man and asked him, "Please tell me how to manage the world."

"Go away, you dunce," Nameless Man said. "Such questions are no fun. I was just about to join the Creator of Things. If I get bored with that, I'll climb on the bird Merges with the Sky and soar beyond the six directions. I'll visit Nothing Whatever town and stay in Boundless country. Why do you bring up managing the world to disturb my thoughts?"

Still Root of Heaven repeated his question and Nameless Man responded, "Let your mind wander among the insipid, blend your energies with the featureless, spontaneously accord with things, and you will have no room for selfishness. Then the world will be in order."

* * *

Duke Huan was reading a book in the hall. Wheelwright Pian, who had been chiseling a wheel in the courtyard below, set down his tools and climbed the stairs to ask Duke Huan, "May I ask what words are in the book Your Grace is reading?"

"The words of the sages," the duke responded.

"Are these sages alive?"

"They are already dead."

"That means you are reading the dregs of long gone men, doesn't it?"

Duke Huan said, "How does a wheelwright get to have opinions on the books I read? If you can explain yourself, I'll let it pass; otherwise, it's death."

Wheelwright Pian said, "In my case, I see things in terms of my own work. When I chisel at a wheel, if I go slow, the chisel slides and does not stay put; if I hurry, it jams and doesn't move properly. When it is neither too slow nor too fast, I can feel it in my hand and respond to it from my heart. My mouth cannot describe it in words, but there is something there. I cannot teach it to my son, and my son cannot learn it from me. So I have gone on for seventy years, growing old chiseling wheels. The men of old died in possession of what they could not transmit. So it follows that what you are reading is their dregs."

* * *

When Zhuangzi's wife died and Hui Shi came to convey his condolences, he found Zhuangzi squatting with his knees out, drumming on a pan and singing. "You lived with her, she raised your children, and you grew old together," Hui Shi said. "Not weeping when she died would have

been bad enough. Aren't you going too far by drumming on a pan and singing?"

"No," Zhuangzi said, "when she first died, how could I have escaped feeling the loss? Then I looked back to the beginning before she had life. Not only before she had life, but before she had form. Not only before she had form, but before she had vital energy. In this confused amorphous realm, something changed and vital energy appeared; when the vital energy was changed, form appeared; with changes in form, life began. Now there is another change bringing death. This is like the progression of the four seasons of spring and fall, winter and summer. Here she was lying down to sleep in a huge room and I followed her, sobbing and wailing. When I realized my actions showed I hadn't understood destiny, I stopped."

* * *

When Zhuangzi was about to die, his disciples wanted to bury him in a well-appointed tomb. Zhuangzi said, "I have the sky and the earth for inner and outer coffins, the sun and the moon for jade disks, the stars for pearls, and the ten thousand things for farewell gifts. Isn't the paraphernalia for my burial adequate without adding anything?"

"We are afraid the crows and kites will eat you, master," a disciple said.

"Above ground, I will be eaten by crows and kites; below ground by ants. You are robbing from the one to give to the other. Why play favorites?"

Translated by Patricia Ebrey

8

LEGALIST TEACHINGS

By the third century B.C., as small states one after another were conquered by large ones and the number of surviving states dwindled, those rulers still in contention were receptive to political theorists who claimed to understand power and the techniques that would allow rulers to strengthen control over officials and subjects. These advisors argued that strong government depended not on the moral qualities of the ruler and his officials, as Confucians claimed, but on establishing effective institutional structures. Because of their emphasis on laws, these thinkers are usually labeled the Legalists.

Below are selections from the two fullest Legalist treatises. The first has traditionally been ascribed to Lord Shang (Gongsun Yang, died in 338 B.C.), long chief minister of the state of Qin, the state most fully to adopt legalist policies. The second is from the major synthesizer of Legalist thought, Han Feizi. Han Feizi once studied with Xunzi and eventually traveled to Qin, where he had access to high court politics. Slandered by his former fellow student Li Si, then in power, he was forced to commit suicide in 233 B.C.

SELECTIONS FROM THE BOOK OF LORD SHANG

Changing the Laws

Duke Xiao was discussing policies. Three great officers, Gongsun Yang, Gan Long, and Du Zhi, were assisting him. They considered changes in social practices, debated the basis for laws, and searched for ways to lead the people.

The ruler said, "The proper course for the ruler is to keep in mind the sacrifices to the soil and grain from the time he first succeeds to his posi-

tion. The job of the minister is to shape the laws and devote himself to the lord of the people. Now I wish to change the laws in order to govern better and reform the rituals in order to instruct the common people. I am afraid that everyone will criticize me."

Gongsun Yang said, "I have heard that those who hesitate to act accomplish nothing. Your Highness should quickly make up your mind about reforming the laws, ignoring everyone's criticisms. After all, those who excel in what they do or have independent thoughts are always condemned by their contemporaries. There is a say-

ing. 'The dull cannot even see what has already happened, but the intelligent can see what is yet to sprout.' The people should not be consulted in the beginning; but they should join in in enjoying the results. The laws of Guo Yan said, 'Those who discuss the highest virtues do not accord with common sentiments; those who attain the greatest feats do not ask ordinary people for advice.' Laws exist to love the people; rites exist to make affairs go smoothly. Therefore, the sage does not stick to ancient laws if he can strengthen his state by changing them and does not keep ancient rituals if he can benefit the people by altering them."

Duke Xiao said, "Good."

Gan Long objected, "I disagree. I have heard that a sage teaches the people without changing them and a wise man governs without altering the laws. One can attain success without much effort when one teaches on the basis of the people's ways. When one governs on the basis of the established laws, the officials will have experience and the common people will feel secure. If you now change the laws, abandoning the old practices of the state of Qin, and alter the rituals to instruct the people, I fear that everyone will criticize Your Highness. Please give the matter careful consideration."

Gongsun Yang responded, "You have expressed the conventional wisdom. Ordinary people feel secure with old habits and scholars are mired in what they have heard. Both may be all right for occupying offices and enforcing laws, but they cannot be brought into discussion of matters outside the law. The founders of the three dynasties became kings using different rituals; the five hegemony established their supremacy using different laws. Therefore the wise person creates laws while the ignorant are controlled by them; the worthy alter the rites while the unworthy are held fast by them. Those held fast by rituals or controlled by laws are not the people with whom to discuss policies. Your Highness, have no doubts."

Du Zhi countered, "I have heard that unless the advantage is a hundredfold, one does not change the laws, and unless the success will be up

tenfold, one does not alter the equipment. I have also heard that modeling on the past eliminates errors and preserving rituals eliminates deviance. Let Your Highness plan that way."

Gongsun Yang said, "Former ages did not all have the same teachings. Which past will you use as a model? The great kings did not repeat each other. Which rituals will you follow? Fu Xi and Shen Nong taught but did not punish; the Yellow Emperor, Yao, and Shun punished but not in anger. More recently, Kings Wen and Wu each created laws suited to their time and rituals suited to the circumstances. Rituals and laws should be established according to the times, rules and regulations according to what is right, and military equipment according to what is needed. Therefore I say, 'There is more than one way to bring peace to the world and no need to follow the past.' The kings Tang and Wu flourished without copying the past; the Shang and Xia dynasties fell despite preserving their rituals. Consequently opposing the past is not necessarily wrong; following conventions is not worth much praise. Your Highness, have no doubts."

Duke Xiao said, "Good. I have heard that poor villagers are easily alarmed and pedantic scholars love to argue. What amuses the ignorant grieves the wise; what gives joy to the foolish gives grief to the wise. I will not worry about what people say." Thereupon he issued the law on reclaiming wastelands.

SELECTIONS FROM HAN FEIZI

Precautions with Regard to the Inner Quarters

The ruler gets into difficulties through placing his trust in others. When he trusts someone, he falls under the person's control. Ministers are not attached to their ruler through kinship, but serve only because they suit his needs. Therefore ministers observe their ruler's moods constantly while the ruler gets to take his ease. This is the reason some rulers are deposed or assassinated.

When a ruler puts great confidence in his son, treacherous ministers will make use of the son to achieve their private ends. Li Dai, for instance, helped the King of Zhao starve his father. When a ruler places great trust in his wife, then treacherous ministers will make use of her to achieve their private ends. The actor Shi, for instance, helped Lady Li kill [the heir apparent] Shensheng and set up Xiqi in his stead. Since one cannot trust even someone as close as a wife or child, there is no one who should be trusted.

Among the wives, concubines, and sons of a ruler of a state, large or small, there will probably be someone who would like to see the ruler die early. How do I know this? A wife is not tied by flesh and blood. When the ruler loves her, they are close; when he does not love her, they are distant. It is like the saying, "The child whose mother is loved is cherished." The opposite also holds true: The child whose mother is hated is cast aside. A man of fifty has not lost his interest in women, but a woman begins to lose her looks before thirty. When a woman whose looks are deteriorating serves a man who still loves sex, she will be despised and her son is not likely to be made heir. This is the reason queens, consorts, and concubines plot the death of the ruler. When the mother of the ruler is the queen, all orders are carried out and all prohibitions are effective. She enjoys male-female relations as much as when the previous ruler lived and can control all the powers of a large state without raising suspicions. [To preserve this situation she may well] poison (her son) the ruler or hang him in secret. It is for these reasons that Tao Zuo, in the *Spring and Autumn Annals*, said, "Not even half of all rulers die of illness." When a ruler does not realize this, his troubles will worsen. Hence the saying, "When many people will profit from his death, a ruler is in danger."

Lords

Lords' lives are endangered and their states perish when the high ministers are too honored and the rulers' attendants are too influential. Those too

highly honored will act on their own authority, disregarding the law and manipulating the organs of the state for their selfish ends. Those too influential will take advantage of the situation and act arbitrarily. One must be on guard for both of these.

The strength of their muscles is what makes it possible for horses to carry heavy loads and pull carriages long distances. The power of position is what makes it possible for lords of large or small states to control the world and subjugate the feudal lords. The power of position is a ruler's muscular strength. Now for senior officials to get influence and attendants to get power reduces the ruler's strength. Not one ruler in a thousand can keep his state if he loses his power. Tigers and leopards can win over men and catch other animals because of their claws and fangs, without which they would be dominated by men. Now, superior power constitutes the lords's claws and fangs, loss of it is comparable to tigers and leopards losing their claws and fangs. The ruler of Song lost his claws and fangs to Zihan, and Duke Jian lost his to Tian Chang. Because they could not get them back quickly enough, they lost their lives and their states were destroyed. Today, even rulers with no knowledge of techniques of control understand Song Jian's error. Still, they do not see their own failings and how similar they are.

Men of law and techniques of control [i.e., Legalists] do not get along with these sorts of ministers. How can I show this? When the ruler has men who know techniques of control, then the high ministers are not able to act arbitrarily and the close attendants will not dare to sell favors. When the influence of the ministers and attendants ceases, the ruler's way will be bright. This is not the case today. These sorts of ministers have the power to protect their private interests and the attendants and intimates form factions and control access in order to keep out those more distant from the ruler. When, then, can men of law and techniques of control get the chance to be employed? When can the lord get to discuss strategy and make decisions? It is for these reasons that techniques of control are not always employed

and legalists cannot coexist with these ministers and attendants.

Six Examples of Having It Backwards

The sort of person who out of fear of death avoids trouble and surrenders or retreats is honored by the world as a man who values life. The sort of person who studies the Way and proposes plans but distances himself from the law is honored by the world as a man of learning. The sort of person who travels around letting others support him is honored by the world as a man of talent. The sort of person who twists words, pretends to have knowledge, and practices deception, the world honors as a skilled debater. The sort of person who wields a sword to kill or intimidate is honored by the world as a man of courage. The sort of person who deserves to die because he has harbored criminals is honored by the world as a man of chivalry. The world praises these six sorts of people.

By contrast, the sort of person who will risk his life for matters of principle, the world belittles as a person who cannot calculate the odds. The sort of person who knows little but obeys the law, the world belittles as a simple rustic. The sort of person who does productive work, feeding himself through his own efforts, the world belittles as a fellow of little ability. The sort of person who is generous, honest, and good, the world belittles as silly. The sort of person who obeys orders and respects authority, the world belittles as timid. The sort of person who resists criminals and informs the authorities about them, the world belittles as a slanderer. The world belittles these six sorts of people.

The six sorts who plot, deceive, and do nothing of value the world honors; the six sorts who farm, wage war, and prove of use the world disparages. These are the six examples of having it backwards. Ordinary people, out of partiality, praise someone; then the ruler, hearing of his undeserved reputation, treats him with courtesy. Those who are treated courteously always end up gaining

profit as well. Ordinary people, because of a private grudge, slander someone; then the ruler, following convention, despises him. Those who are despised always come to harm. Thus rewards go to selfish and evil people who ought to be punished and harm comes to public-minded men who ought to be rewarded. Consequently there is no hope of enriching and strengthening the state.

The ancients had a saying, "Governing is like washing hair. Even if some hairs fall out, it must be done." Anyone who begrudges the loss of some hair and forgets the advantage to the growing hair has no understanding of expediency. Lancing boils hurts, drinking medicine tastes bitter. But if on that account one does not lance them or drink them, one will not recover.

Now, the relationship between superior and subordinate is not based on affection like that between father and son. So if one wishes to curb subordinates by acting righteously, the relationship will be flawed. Think of parents' relations to their children. They congratulate each other when a son is born, but complain to each other when a daughter is born. Why do parents have these divergent responses when both are equally their offspring? It is because they calculate their long-term advantage. Since even parents deal with their children in this calculating way, what can one expect where there are no parent-child bonds? When present-day scholars counsel rulers, they all tell them to rid themselves of thoughts of profit and follow the path of mutual love. This is expecting rulers to go further than parents. These are immature ideas, false and deceptive. Therefore the intelligent ruler does not accept them.

The sage's method of governing is as follows. He scrutinizes the laws and prohibitions, and once they are made clear, his officials are orderly. He defines the rewards and punishments, and when they are fair, the people can be employed by the officials. When the officials are orderly and the people are employed, the state will get rich and from that the army will be strong. Then it is possible to succeed in establishing hegemony over other states. For rulers, becoming hegemon or king is the ultimate benefit. A ruler must keep this

ultimate benefit in mind in governing. Therefore he must employ officials according to their talents and give rewards and punishments impartially so that all can see. When men work hard and risk their lives, military campaigns can succeed and rewards of rank and salary are deserved. Thus one succeeds in gaining wealth and high rank. For subjects, wealth and high rank are the ultimate benefit. When subjects attend to their work with these goals in mind, they will face danger and risk their lives, putting out every last bit of effort. This is what is meant by the saying that unless the ruler is generous and the subjects loyal hegemony cannot be achieved.

Criminals are careful if they are likely to be discovered and stop if they are likely to be executed. But they are reckless if they will not be discovered and carry out their plans if they will not be punished. If goods of little value are left in a deserted place, even Zeng and Shi could be tempted. But if a hundred pieces of gold are hung up in the marketplace, even great robbers will not take them. When no one will know, even Zeng and Shi can be suspected. When sure to be discovered, then even great robbers do not take the gold hung in the marketplace. Therefore the enlightened ruler, in ruling his country, increases the guards and makes the penalties heavier; he depends on laws and prohibitions to control the people, not on their sense of decency. A mother loves her son twice as much as a father does, but a father's orders are ten times more effective than a mother's. The relationship between officials and the people is not based on love and their orders are ten thousand times more effective than parents'. Parents pile up love, but their orders fail; officials are strict and the people obey. Such is the basis for choosing between severity and love.

Furthermore, parents make every effort to keep their children safe and far from trouble, but a ruler's relation to his people is different. In times of difficulty he needs them to risk death and in times of peace he needs them to exhaust their strength for him. Parents, who lovingly consider their children's comfort and benefit, are not obeyed. Rulers, who with no concern for their

benefit demand that they risk their lives or work hard, have their orders followed. The intelligent ruler recognizes this and so does not cultivate feelings of empathy but builds up awe for his power. Indulgent mothers generally spoil their sons through their love. Harsh fathers generally rear good sons through their strictness.

Esteemed Scholars

When a sage rules a state he does not count on people doing good on their own but rather takes measures to keep them from doing wrong. If he depended on people who do good of themselves, he could hardly find a few dozen in the whole realm. But if he uses methods to keep them from doing wrong, then everyone in the state can be made to act the same. In governing it is better to disregard the small minority to make use of the bulk of the population. Thus the ruler should concentrate on laws rather than on moral influence. After all, if one had to depend on shafts that were naturally straight, a hundred generations would go by before one could make an arrow, and if one had to depend on wood that was naturally curved, a thousand generations would go by without a wheel. Naturally straight shafts and naturally curved wood appear not even once in a hundred generations yet people ride carriages and shoot birds in every generation. How do they accomplish this? They use the techniques for straightening and bending. A skilled craftsman places no particular value on shafts that are straight or boards that are round of themselves even before straightening or bending. Why? Because there isn't only one person who wants to ride or shoot. In the same way, a ruler does not value people who are good of themselves even without rewards and punishments. Why? Because the state's laws should not be ignored and it is not enough to govern just one man. Therefore a ruler who knows the techniques is not swayed by accidental goodness but carries out policies that will assure success. . . .

Those who do not understand how to govern

all say: "Obtain the hearts of the people." . . . The people are no more intelligent than an infant. If an infant's head is not shaved, his sores will not heal; if his boils are not lanced, his illness will worsen. Even when someone holds him and his loving mother does the shaving or lancing, he will howl without stop, for a baby cannot see that a small discomfort will result in a major improvement. Now the ruler wants to people to till land and maintain pastures to increase their production, but they think he is cruel. He imposes heavy penalties to prevent wickedness, but they think he is

harsh. He levies taxes in cash and grain to fill the storehouses and thus relieve them in time of famine and have funds for the army, but they consider him greedy. He imposes military training on everyone in the land and makes his forces fight hard in order to capture the enemy, but they consider him violent. In all four cases, he uses means that will lead to peace, but the people are not happy.

Translated by Patricia Ebrey

Chinese Calligraphy

Calligraphy Project

Calligraphy (cah-LIH-grah-fee) means "beautiful writing." A calligrapher is someone who has mastered the art of writing. Oriental calligraphers write with brush and ink, just as you will learn to do.

First, cover your work area with newspapers, then lay out your brush, ink block, and ink tray. You will also need some blank white paper to "write" on. Tablet paper works well because it absorbs ink. Avoid glossy, coated paper--the ink might smear.

As with any creative effort, preparation of the mind is very important. The oriental artist knows that if his thoughts are not clear and calm, his design will turn out badly. He collects his thoughts as he gathers his materials, and thinks about his design as he mixes his ink. He rubs the ink block on a special flat stone to grind off some powder, concentrating on the soothing effect of the motion. As he adds water, he thinks of the ink as a living force that will bring his ideas to life on paper.

The Chinese symbol
for good health.



How to Hold the Chinese Brush

The Chinese hold their brushes in a special way. Although it will feel strange at first, it is the best way to make the basic strokes in each character.

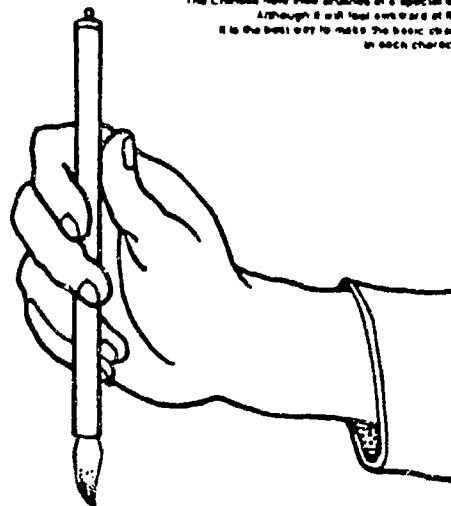

Hold your brush as shown on your World Explorer wall chart and make the strokes with your whole arm without moving your wrist or fingers. Be sure to sit up straight and raise your arm from the table to give sweep to your strokes. Follow the directions on the wall chart--and enjoy your new skill!

Sumi Painting

When you've gotten the knack of mixing the ink, holding the brush, and keeping your arm steady, you may want to try sumi painting (ink painting). As you prepare the ink, relax your body and think only of the picture you are about to make. Consider it in its simplest form without any details. Think about how you can suggest the idea of a tree or a bird with just a few strokes.

You can create many different effects with light and dark ink, thin lines, bold lines, slow strokes, and fast strokes. For light gray, add more water to the ink. If you want something to look soft and misty, blot your brush so that it is almost dry when you stroke. Try it with deep black ink, then with gray.

Now try "writing" a landscape. Put a bird in the sky. Can you make it with only one stroke? Add a cloud or two with wet gray strokes. How many strokes do you need for a rocky hill? Add a lake using dry strokes for the water. Now put a sailboat on the lake. Can you do it in three strokes?

Thesis Paper Project

The purpose of this assignment is to introduce you to the research, interpretive and writing skills used by historians when they study a civilization. The assignment due dates have been broken down into roughly one week periods: the intermediate steps will roughly equal the value of the final paper in number of points so that everyone can get a good grade if each student takes care to learn the steps in the research and writing process. The topic that you select to research is **your choice** as long as it relates to ancient Chinese civilization from the period of the earliest permanent settlements through the end of the Han dynasty in 220 BCE. Be sure to select a topic that you find interesting but make up your mind early so that you do not miss a deadline. Some topics to consider are:

a famous person	a military campaign
everyday life	religious beliefs
fashion and style	Confucianism
painting	monumental building (tombs, the Great Wall)
architecture	technological inventions
literature and poetry	social history of the family, roles, etc.
the writing system	women
math and science	agriculture
the calendar and time-keeping	laws
the government system	periods of dynastic change

Look through the entire China section of your textbook (pp. 34-55) for ideas; pay close attention to the illustrations and captions **for ideas** about a topic for your research. Remember what we learned in the first unit about the historical method--you will create your own hypothesis as a tentative answer to questions that you ask yourself about your topic and begin your research by searching for data that will answer your questions. You will formulate your hypothesis based on these original general readings and then move on to more specialized research to find specific evidence to support the assertion you make in your thesis statement. As you read, reflect on your thesis to see if it is supported by the information you are reading or if your thesis should be modified to fit the evidence. We will work on the actual writing in class.

Here are the deadlines for this assignment:

- 1) topic card: **due** _____ pts.
- 2) thesis statement: **due** _____ pts.

- 3) annotated bibliography cards: **due** _____ pts.
- 4) outline: **due** _____ pts.
- 5) rough draft: **due** _____ pts
- 6) final paper: **due** _____ pts.

Questions?

Comment?

World History
Ancient China Quiz

Open Notes: use the reading notes you have taken from pages 30-55 in the textbook to help you answer the following questions.

1. In what ways are the principles of Confucianism based on the concept of reciprocity? Reciprocity can be defined as the commitment to equality of exchange; to give and return mutually. State the "big idea" and give two specific examples that illustrate the concept.

2. Give a general statement describing the way in which Confucian philosophy affected the attitude of the Chinese people toward their government.

3. Make a statement describing one way in which Confucian thinking impacted the educational system in Han China.

4. Explain the importance of the family in Chinese society during the Han dynasty.

5. In what ways do the arts in China during the Han reflect the concept of the Tao?

6. Give one reason that you believe explains the stability of Chinese cultural values over time.