

DOCUMENT RESUME

ED 371 127

CE 066 474

AUTHOR Yee, Darlene; Melichar, Joseph F.  
 TITLE Accident Prevention through Driving Skills Assessment and Interventions for Older Drivers: A Programmatic Research Project.  
 INSTITUTION San Francisco State Univ., Calif.  
 SPONS AGENCY American Association of Retired Persons, Washington, DC. Andrus Foundation.  
 PUB DATE 30 Jun 92  
 NOTE 279p.  
 PUB TYPE Reports - Research/Technical (143)

EDRS PRICE MF01/PC12 Plus Postage.  
 DESCRIPTORS \*Accident Prevention; Adult Education; Computer Assisted Instruction; \*Driver Education; \*Instructional Development; \*Instructional Effectiveness; \*Older Adults; Pretests Posttests; Self Evaluation (Individuals); Simulation; Skill Development; \*Traffic Safety

ABSTRACT

A study examined the effectiveness of a new computer-based multiphasic approach to identifying "at-risk" older drivers and remediating deficits in their driving and traffic safety attitudes, knowledge, and skills. Data collected from 250 older drivers in 3 states were used to develop specifications for computer-based driver improvement modules. The effectiveness of the new program, which links the Older Driver Self-Assessment Inventory (ODSAI), Older Driver Improvement Program (ODIP) and Older Driver Simulation Program (ODSP), was assessed in a study involving control groups and pretests/posttests. The study established that, although exposure to the ODSAI resulted in improved attitudes regarding driving and traffic safety and exposure to the ODIP resulted in increased knowledge of driving and traffic safety, exposure to the ODSP alone resulted in little change in driving and traffic safety skills. The multiphasic approach incorporating all three components resulted in improvements in drivers' skills as well as in their attitudes and knowledge. (An 81-item bibliography and 27 figures/tables are included. Appendixes include copies of all assessment instruments used, the simulation protocol, abstracts/summaries of the study presented at four conferences, and a supporting statistical analysis.) (MN)

\*\*\*\*\*  
 \* Reproductions supplied by EDRS are the best that can be made \*  
 \* from the original document. \*  
 \*\*\*\*\*



San Francisco State University  
 1600 Holloway Avenue  
 San Francisco, California 94132

Department of Health Education  
 415/338-1413

ED 371 127

**Final Report:** "Accident Prevention Through Driving Skills Assessment And Interventions For Older Drivers: A Programmatic Research Project"

**Submitted To:** AARP Andrus Foundation  
 601 E Street, N.W.  
 Washington, D.C. 20049  
 Phone: (202) 434-6190

**Submitted By:** Principal Investigator  
 Darlene Yee, Ed.D., CHES  
 Associate Professor  
 Department of Health Education  
 San Francisco State University  
 1600 Holloway Avenue  
 San Francisco, CA 94132  
 Phone: (415) 338-7568

Co-Investigator  
 Joseph F. Melichar, Ph.D.  
 President and Senior Analyst  
 Adaptive Systems Corporation  
 P.O. Box 1148  
 San Mateo, CA 94403  
 Phone: (415) 573-6114

**Submitted On:** June 30, 1992

U.S. DEPARTMENT OF EDUCATION  
 Office of Educational Research and Improvement  
 EDUCATIONAL RESOURCES INFORMATION  
 CENTER (ERIC)

- This document has been reproduced as received from the person or organization originating it
- Minor changes have been made to improve reproduction quality

• Points of view or opinions stated in this document do not necessarily represent official OERI position or policy

"PERMISSION TO REPRODUCE THIS MATERIAL HAS BEEN GRANTED BY

TO THE EDUCATIONAL RESOURCES INFORMATION CENTER (ERIC)."

JE 066474

## ABSTRACT

**"ACCIDENT PREVENTION THROUGH DRIVING SKILLS ASSESSMENT AND INTERVENTIONS FOR OLDER DRIVERS: A PROGRAMMATIC RESEARCH PROJECT" by Darlene Yee, Ed.D., CHES, San Francisco State University, and Joseph F. Melichar, Ph.D., Adaptive Systems Corporation.**

The increase in the aging of the overall population has entailed a simultaneous increase in the number of older drivers. Drivers age 55 and over constitute 28% of all drivers today-- 39% by the year 2000. While many older drivers have commendable driving records, as a group, when exposure is considered, they are disproportionately involved in traffic accidents and fatalities. As individuals age, their functional capabilities and skills may change and require adjustments in their driving activities. For older adults to maintain their mobility and safety in an automobile-oriented society, they must sustain essential driving attitudes, knowledge and skills throughout these age-related changes.

The purpose of this research project was to develop and evaluate integrated assessment and intervention strategies to locate the "at-risk" older driver and remediate any deficits in knowledge or skills about driving and traffic safety. The impact of any assessment and/or intervention is accomplished when it is done cost-effectively, over a wide population, and with small numbers of false positives and negatives. To this end, the identification of the "at-risk" older driver should suggest appropriate intervention points and procedures. The outcomes should be increased older driver mobility, increased older driver safety, and increased traffic safety (i.e. reduced traffic accident and fatality rates) for all drivers and pedestrians.

The effectiveness of a multi-phasic, programmatic approach to accident prevention and injury control for older drivers was evaluated using a pretest-posttest control group design. This approach, consisting of three levels of interventions (assessment, education, and training) within a filter model, was evaluated to determine effectiveness in relation to cost. Level 1 used a proven screening instrument to assess the older driver's increased risk of accident followed by a simple intervention that provided information on those areas identified as problematic. Older drivers screened "at-risk" in Level 1 continued in a classroom education program (Level 2) developed specifically for older adults. Each level included internal assessments to determine how well the older driver performed. An assessment within Level 2 evaluated if the older adult's skills and understanding of driving and traffic safety have improved. If not, a third training method, driving simulation (Level 3), was used to remediate deficits.

Data was collected from a sample of 254 older drivers in three states (California, Maryland, and Texas) using the Melichar-Yee Comprehensive Older Driver Assessment (MY-CODA) Program (to obtain

background information), Attitudes Assessment Test (AAT, pre and post-tests), Knowledge Assessment Test (KAT, pre and post-tests), and Melichar-Yee Driver Assessment Profile (MY-DAP) Form (to obtain skills information). To reduce the costs of service delivery, the information generated was used to develop specifications for new computer-based training (CBT) modules for dissemination and utilization in driver improvement programs.

Results of this research project indicate that:

- 1) older drivers demonstrated improved attitudes on driving and traffic safety after exposure to the Older Driver Self-Assessment Inventory (ODSAI) (Level 1);
- 2) older drivers demonstrated increased knowledge on driving and traffic safety after exposure to the Older Driver Improvement Program (ODIP) (Level 2);
- 3) older drivers demonstrated little change in skills on driving and traffic safety after exposure to the Older Driver Simulation Program (ODSP) (Level 3);
- 4) older drivers demonstrated improved attitudes, increased knowledge and skills on driving and traffic safety after exposure to the multi-phasic, programmatic approach linking the ODSAI, ODIP and ODSP (Levels 1, 2 and 3);
- 5) the multi-phasic, programmatic approach showed increased cost-effectiveness over any single approach; and
- 6) the computer-based version of this approach showed decreased cost of delivery without loss of information delivery.

It can be concluded that older adults need and want comprehensive information concerning their driver performance. This information should suggest what older drivers can do for themselves as well as what other people can do for them through innovations in accident prevention and injury control programs. Specifically, the multi-phasic, programmatic approach of assessment and intervention enables differentially matching the level of intervention to the specific needs of the older driver. Primary prevention, secondary screening, and tertiary treatment correspond to older driver self-assessment (Level 1), older driver improvement program (Level 2), and older driver simulation program (Level 3). By linking these levels of interventions, this unique approach has the potential to promote and reinforce mobility and safety for older drivers.

**NOTE:** We would like to gratefully acknowledge the support that we received from: AARP Andrus Foundation; AAA Foundation for Traffic Safety; AARP's 55 ALIVE/MATURE DRIVING Program; DORON Precision Systems; San Francisco State University, Maryland Focus Group, and Texas Department of Health.

## ACKNOWLEDGEMENTS

The research project was sponsored by the AARP Andrus Foundation. We wish to express our appreciation to the Foundation for its support and to Dr. Albert J. Hollenbeck, Jr. who served as the project officer.

We would like to thank the many participants who volunteered their time. It is only through their willingness to participate that we can address the issues of older driver mobility and safety.

Professor Skip Kifer, Ph.D. of the University of Kentucky served as the statistical consultant for the analyses. His aid and support was crucial to the development of the results. We would like to express our appreciation for his flexibility in adjusting to in-process changes and his technical expertise.

Ms. Carla Baker of the Texas Department of Health provided invaluable support in the collection of the data on the Texas Control Group.

We would like to thank the AARP clubs of Houston, TX and San Francisco, CA for their provision of the 55 Alive/Mature Driver programs.

Ms. Janie B. Scott, OTR of Baltimore, MD was helpful in the review of the San Francisco State University Simulation Protocol, helped develop the Maryland based MY-DAP group assessment, and was responsible for its operation. Ms. Scott also ran the participant refusal/non-refusal survey.

We also would like to thank Mr. Frank P. Broz, Mr. George Thompson, and Mrs. Marilyn Jaedes of Sun City, AZ for their support in the participant refusal/non-refusal survey administration in Arizona, and to members of the San Francisco State University's 60 Plus Club.

We also would like to express our appreciation to Mr. Sam Yaksich, Jr, Executive Director of the AAA Foundation For Traffic Safety and Professor James L. Malfetti, Ed.D. of Teacher's College, Columbia University for their input on and review of the ODSAI software, and to the AAA Foundation for Traffic Safety for making it available.

We also would like to thank DORON Precision Systems for the 10 day loan of their LR-35 simulator for use at San Francisco State University, and the University for providing the lab space.

The project was administered through the San Francisco State University, and was housed in the Department of Health Education.

Darlene Yee, Ed.D., CHES  
Associate Professor  
San Francisco State University  
Principal Investigator

Joseph F. Melichar, Ph.D.  
Adaptive Systems Corporation  
San Mateo, California  
Co-Investigator

**TABLE OF CONTENTS**

ABSTRACT . . . . .	ii
ACKNOWLEDGEMENTS . . . . .	iv
TABLE OF CONTENTS . . . . .	v
LIST OF FIGURES . . . . .	vii
LIST OF TABLES . . . . .	vii
<b>1. INTRODUCTION . . . . .</b>	<b>1</b>
Overview Of Older Drivers . . . . .	1
General Purposes Of The Study . . . . .	3
Specific Purposes Of The Study . . . . .	4
Goals and Hypotheses . . . . .	5
Presentation Of The Findings . . . . .	6
Organization Of The Report . . . . .	6
<b>2. SURVEY METHODOLOGY . . . . .</b>	<b>7</b>
Rationale . . . . .	7
Data Collection And Management . . . . .	9
Filter Design . . . . .	10
Intervention Design . . . . .	11
Multivariate Design . . . . .	12
Instrumentation Overview . . . . .	12
AARP 55 Alive/Mature Driving Program . . . . .	13
MY-CODA . . . . .	13
Pre-Post Test . . . . .	14
ODSAI . . . . .	14
MY-DAP . . . . .	15
Simulation . . . . .	17
State-Trait Anxiety Scale . . . . .	18
Sample Description and Grouping Design . . . . .	18
Self Selection Assessment . . . . .	20
<b>3. MY-CODA . . . . .</b>	<b>22</b>
Summary Of Demographic Variables . . . . .	22
Summary Of Driving History . . . . .	22
Summary Of Driving Pattern . . . . .	22
Summary Of Driving Performance . . . . .	23
Summary Of Environmental Variables . . . . .	23
Summary Of Mobility Variables . . . . .	24
Summary Of Social Support Variables . . . . .	24
Summary Of Activity Variables . . . . .	24
Summaries Of Health and Well-Being Variables . . . . .	25
Discussion . . . . .	25
<b>4. MODULAR APPROACH AND FILTER MODEL . . . . .</b>	<b>26</b>
Modular Model . . . . .	26
Filter Model . . . . .	26
Cost-Effectiveness . . . . .	26
<b>5. PRE-POST TEST . . . . .</b>	<b>28</b>
Summary of Attitude Questions . . . . .	28
Summary of Knowledge Questions . . . . .	31
Change Pre To Post . . . . .	33
Discussion . . . . .	35
<b>6. OLDER DRIVER SELF-ASSESSMENT INVENTORY . . . . .</b>	<b>36</b>
Sample Description . . . . .	36
<b>D.Yee, Assessment and Interventions for Older Drivers</b>	<b>-v</b>

Variables Used . . . . .	37
Analysis Of ODSAI Items and Score . . . . .	41
ODSAI Scoring Prediction From MY-CODA . . . . .	47
Discussion of ODSAI Results . . . . .	54
<b>7. SIMULATOR . . . . .</b>	<b>55</b>
Texas Groups . . . . .	55
San Francisco State University Simulation . . . . .	55
Results Summary . . . . .	56
Discussion . . . . .	57
<b>8. MY-DAP . . . . .</b>	<b>58</b>
Model . . . . .	58
SFSU Implementation . . . . .	58
Maryland Implementation . . . . .	59
Relationship To Self-Report . . . . .	60
Discussion . . . . .	60
<b>9. COMPUTER PROGRAMS . . . . .</b>	<b>61</b>
Conceptual Approach . . . . .	62
ODSAI and Assessment . . . . .	63
AARP Course and Education . . . . .	64
MY-CODA and Background Variables . . . . .	64
Simulation . . . . .	64
Technical Issues . . . . .	65
Discussion . . . . .	66
<b>10. Self-Selection Survey . . . . .</b>	<b>68</b>
Sample Process and Description . . . . .	68
Activity Level . . . . .	70
Questionnaire Participation . . . . .	71
Intervention Participation . . . . .	72
Technology Interventions . . . . .	73
Other Influencing Factors . . . . .	74
Discussion . . . . .	75
<b>11. DISCUSSION . . . . .</b>	<b>76</b>
Modular Approach . . . . .	76
Assessment . . . . .	76
Education . . . . .	77
Training . . . . .	77
Simulation . . . . .	77
Technology . . . . .	77
Aging and Driving Issues . . . . .	78
Discussion . . . . .	78
<b>12. REFERENCES . . . . .</b>	<b>79</b>
<b>APPENDICES . . . . .</b>	<b>84</b>
A. MY-CODA and Pre-Post Test . . . . .	84
B. MY-DAP Assessment Profile . . . . .	84
C. SIMULATION PROTOCOL, San Francisco State University . . . . .	84
D. MY-DAP Trial - Simulation Protocol Without Simulator . . . . .	84
E. Participation Survey . . . . .	84
F. ODSAI Computer Program Users Manual . . . . .	84
G. Outline of Papers for Publication . . . . .	84
H. Presentation Abstracts and Summaries . . . . .	84
Gerontological Society of America . . . . .	84
American Society on Aging . . . . .	84
National Council On Aging . . . . .	84
Traffic Safety Summit - 1992 . . . . .	84
I. Statistical Analysis Supporting Documentation . . . . .	84

## LIST OF FIGURES

Figure 1.1	General Model of The Driving Situation.....	3
Figure 2.1	Three Level Multi-Phasic Integrated Model of Interventions for Older Drivers.....	8
Figure 2.2	The Filter Model of The Multi-Phasic Approach.....	10
Figure 2.3	Experimental Design.....	12
Figure 6.1	Histogram of Total Score.....	42
Figure 9.1	Purpose-Use Matrix.....	61
Figure 10.1	Age-Sex Profile of the Self-Selection Sample.....	68
Figure 10.2	Educational Level Profile.....	69
Figure 10.3	Summary Activity Scores.....	71
Figure I.1.	Probabilty Levels for Regression Coefficient.....	I.1
Figure I.2.	Distribution of Pre-test Knowledge Scores.....	I.1
Figure I.3.	Distribution of Post-test Knowledge Scores.....	I.1
Figure I.4.	Distribution of Difference Pre-Post Test Knowledge Scores....	I.2

## LIST OF TABLES

Table 2.1	Study Groups.....	19
Table 5.1	Summary of Knowledge Answers.....	32
Table 5.2	General Statistics Pre & Post Tests.....	33
Table 5.3	Total Score Pre-Test Statistics by Group.....	33
Table 5.4	Total Score Post-Test Statistics by Group.....	33
Table 6.1	Group Means for ODSAI Subsample.....	36
Table 6.2	ODSAI Demographic Variables Distributions.....	36
Table 6.3	ODSAI Response and Scores By Item.....	43
Table 6.4	Recode Variations for Item 1 (Seat Belts).....	53
Table 10.1	Summary of Demographic Variables.....	69
Table 10.2	Marital Status-Sex Profile of Sample.....	69
Table 10.3	Factors Influencing Likelihood of Participation.....	72
Table 10.4	Pattern of Technology Acceptance Questions.....	74
Table 10.5	Restricting Factor Patterns.....	75



## 1. INTRODUCTION

Mobility is a dimension of life which enhances the "quality of life" (1). Any reduction in mobility limits the capacity for self-maintenance, restricts participation in constructive activities and interactions with other people, and in turn may contribute to reduced involvement and alienation from society. This problem is accentuated by aging which reduces the skills which comprise mobility.

The growing number of older adults comprise a heterogeneous population with a range from some persons remaining mobile, while others do not. In addition, the literature suggests that an inverse relationship exists between aging and mobility (52) in the general population. The decreased ability of older adults to move around is caused by various physical and psychological limitations (36, 38, 47-51). These limitations also account for the high accident toll of older drivers and pedestrians (1, 2, 4, 16). Ironically, those older adults who attempt to remain mobile may experience more accidents, injuries, and disabilities caused by age-related physical and psychological changes.

The study reported herein addressed these problems faced by older drivers by looking at their characteristics and the methods for assessing and providing educational and training interventions related to driving by older adults. The effects of a multi-phasic intervention on 254 older drivers were studied. The study also includes: the development of several new assessment instruments and first generation computer based (CBT) assessment and education materials, an outline for CBTs for training using simulation, and a cost-effectiveness model applied to the specific issues addressed. The specific activities were:

1. develop a method for collecting background information on older drivers using a self report-format (about a half-hour survey form),
2. define a multi-level approach to assessment, education, and training of older drivers (differing levels depending on the person's needs) where assessment means to learn about the older driver, education seeks to provide information on knowledge or attitudes about driving, and training provides skills used in driving.
3. define a methodology and strategy for developing multi-level interventions that are individualized to the individual older driver; for example, have a range of interventions to assure that the problems are addressed, but that the person does not have to spend a lot of extra time in the process of being assessed or gaining information or skill,
4. provide more options on how the older person can gain access to information about their driving and how it might be made safer and easier,
5. learn where technologies such as computers or simulators can aid in reaching the above purposes, and
6. generally learn more about older drivers and their characteristics so the above activities can be done better.

### Overview Of Older Drivers

The increase in the age of the overall population translates to a simultaneous increase in the number of older drivers (17). Demographic trends show that the proportion of older drivers will continue to increase (54). Approximately 33 million drivers age 55 and over constituted 22 percent of all drivers in 1987 (2). Today older drivers represent 28 percent of the driving population and will grow to 39 percent by the year 2000 (16).

"Being able to get where they want to go" is an important factor in the physical and mental well-being of older adults. Surveys (17-18) reveal that driving is how they prefer to maintain mobility. There is consensus among traffic safety authorities that older drivers should be kept on the roadways as long as they can drive safely. No one seriously concerned with traffic safety

wants to use chronological age as the sole indicator of driving ability (19, 34, 39).

While many drivers over age 55 have commendable driving records, taking exposure into account, as a group they are disproportionately involved in traffic accidents and fatalities (6, 7, 34, 35). On the basis of miles driven, older drivers are involved in fatal crashes more frequently than any other age group except teenaged drivers (53). In addition, older drivers are more likely to be hospitalized as a result of their injuries sustained in traffic accidents than their younger counterparts (3); those who survive tend to recover very slowly (4).

Moreover, there are conditions and situations involving the traffic mix-- drivers, automobiles, highways-- that should be dealt with in order for older drivers to function safely, and thus maintain the mobility and independence so important for their physical and mental well-being. According to Wiener (7), "losing one's driving privilege, voluntarily or otherwise, is probably second only to total confinement in its effect on lifestyle, access to benefits of society, and general well-being." This is particularly true for older drivers in our automobile-oriented society.

Social learning theory suggests that when people understand the reason some restrictive action must be taken against them, and are told the specific steps by which they might be able to overcome the restriction, they are more willing to accept it than if it is imposed by an external authority (8-9). The license of an older driver often is essential to his or her independence and well-being. Every opportunity should be taken to insure that the older driver is made aware of impairments and of what action can be taken to overcome them (29). When a person thinks he or she can do something about an impairment, that person is more likely to try to do something about it (10).

One of the main problems facing older drivers stems from the decline of some of the performance skills necessary for safe driving (27, 40): 1) sensing the situation, 2) deciding what to do, and 3) acting quickly (5). Various age-related visual, auditory, and psychomotor changes have an adverse effect on driving ability (6). These factors have been combined into the project team's model of the driving situation (21) as depicted in Figure 1.1.

Of all the sensory problems that afflict older drivers, visual impairment can be the most devastating to driving performance. Cataract, glaucoma, senile macular degeneration, and several qualities of visual perception such as visual acuity, field of vision, distance judgment, illumination, glare sensitivity, night vision, and color recognition change with age. Similar changes occur in hearing, proprioception, and kinesthetic sense. The sensing changes require the older person to adjust their driving or alter their process to make needed adjustments.

Age-related changes in decision-making include decline in speed, processing efficiency, and selective attention and vigilance (30, 50-51). Judgement and response time to action changes making it harder to react to the high number of decisions (20) required per mile. Similarly, increase in anxiety, decrease in short term memory (50), and some reduction in patience produce added demands on processing. Slower motor responses results in increased reaction time with age compounding slower processing and decrease sensing abilities (47).

BEST COPY AVAILABLE

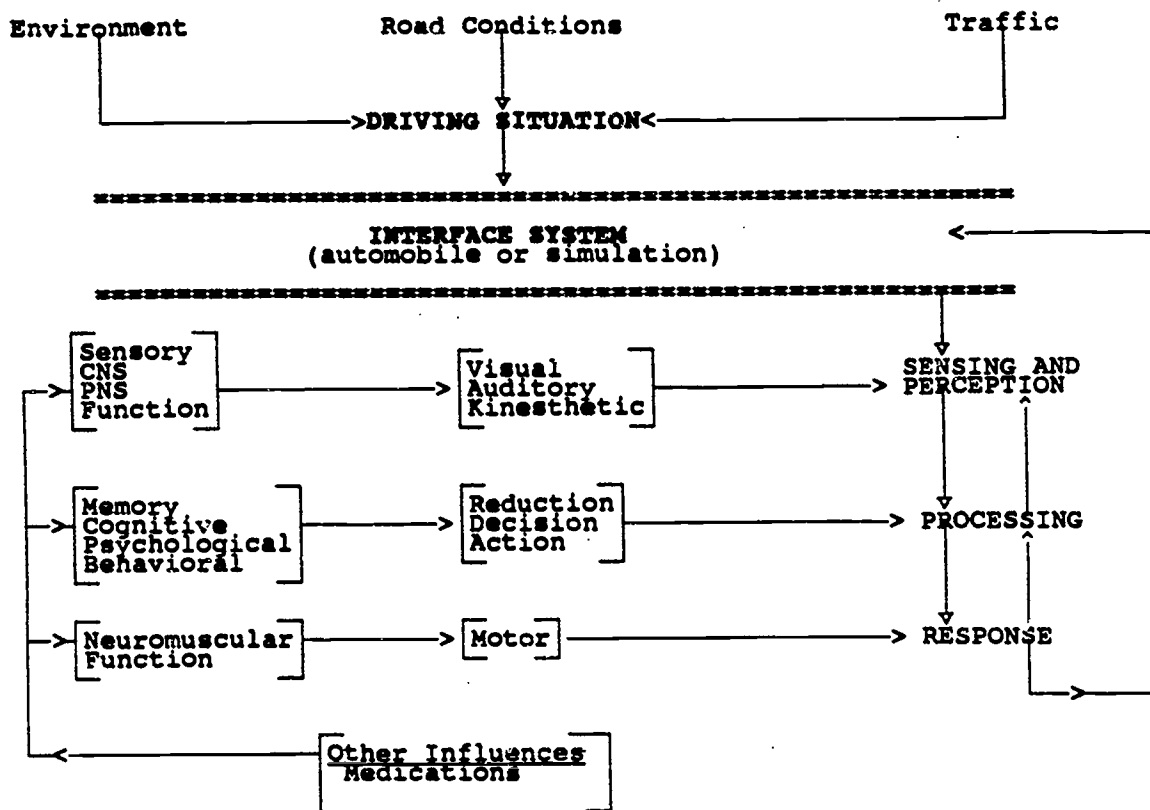

from ref. 21

Figure 1.1. General Model of The Driving Situation

### General Purposes Of The Study

The long-term goals of gerontologic health promotion and disease prevention programs are to increase the longevity and improve the "quality of life" of older persons through significant increases in health, mobility, and independence (13). One problem is a lack of appropriate transportation which reduces the "quality of life" of an older adult. This reduction results from limits to the capacity for self-maintenance, restrictions in participation in constructive activities and interactions with other people, and in turn may contribute to reduced involvement and subsequent alienation from society (14).

Transportation is a major facilitator between a person and his/her external environment and determines whether the community functions as an inhibiting environment or a favorable social support system. Like everyone in our society, the elderly depend upon the ability to travel in order to acquire the basic necessities of life (food, clothing, and health care) as well as participating in educational, employment, religious, cultural, recreational, and social activities. To the extent that the elderly are denied transportation services, they are also denied full participation in meaningful community life (11-12).

Provisions for adequate transportation services are beneficial not only to older adults whose activities otherwise would be limited, but also are of economic value to society in that they support the older individual's capacity for independent living within his or her community (15). Transportation thus serves to postpone or prevent costly short-term institutional care (e.g. acute

care hospital) and/or unnecessary long-term institutionalization (e.g. skilled nursing facility).

Mobility is then essential to the quality of life of older adults, and all trends indicate that the majority of the transportation needs of older adults into the next century will be met by the private automobile. The cost to society of providing alternative means of mobility would be enormous; hence, older drivers should be encouraged to drive as long as possible. This proposal addresses how the goal of maintaining the older person's driving capability for as long as possible may be accomplished while maintaining safety standards.

Older adults face a loss of functional capability which impacts upon their ability to drive. Elderly persons must adapt their driving habits to the changes in their skills, and also must be able to eliminate past bad habits for which previously used adjustments are limited by decreased abilities. Simultaneously they experience a reduced ability to use public transportation or walk long distances, but have the same mobility requirements to maintain themselves in the community.

The reduction in capability coupled with its requirement to adapt while the external demand on the person remains the same produces a risk situation. The risk situation reduces safety and increases the risk of accident and injury, and/or reduction in willingness to drive. The result is of immediate importance to the older driver who faces a loss of freedom of movement, to their family who must provide alternative support, and increasingly to society as the number of older drivers on the nation's roadways increases (4).

The general problem is to determine how best to address the assessment and subsequent remediation of the driving deficits of the older driver and still remain within safety standards. These deficits include knowledge and skills and in the processes to adapt to their changing functional capabilities. Responding effectively to the general problem requires identification of the at-risk driver and/or prevention or amelioration of the at-risk situation within the older driver population.

#### Specific Purposes of The Study

Without some form of intervention, the encouragement of automobile use by older adults to enhance their mobility would result in higher accident rates with the concomitant human, social, medical, and economic costs. There are inherent goal conflicts between the human and social costs and the medical and economic costs which the project outcomes would address by reducing accident rates. At the same time, the improvement in older driver knowledge and skills would maintain mobility and independence. The multi-phasic systematic program of assessment and intervention addresses these issues, but also enables differentially matching the level of intervention to the needs of the older driver.

The program has the potential to promote and reinforce mobility and safety for older drivers by linking three phases of health intervention. Primary prevention, secondary screening, and tertiary treatment correspond to the older driver self-assessment inventory (ODSAI), older driver improvement program (ODIP), and older driver simulator training (ODST). The three levels of health interventions exist, but typically have not been linked together in a coordinated and integrated program on accident prevention and injury control for promoting and reinforcing mobility and safety for older drivers.

The study would provide guidelines for either using the integrated multi-phasic approach or one or more component levels depending on the driver's need. The ability to use one or more levels of intervention increases individualization of assessment and intervention and thereby cost-effectiveness, and when projecting over regional or national service programs, lowered costs would allow reaching more older drivers. The integration of assessment and intervention by

level allows for reformulation of the strategies using computer based training to: further reduce cost of delivery, increase individualization, effectiveness, and breadth of assessment and training, and reach more older drivers.

The ability to address a large population is dependent on cost of the intervention or service delivery. The need must be met by a commensurate benefit. The desire is to keep older drivers on the road longer, and to increase their safety and safe driving practices. To reach these ends, it means intervening in some effective manner. Effective intervention is based on identifying a spectrum of needs for an individual or group of individuals and providing responsive and effective interactions to reduce or eliminate those needs.

Toward this end, the study include several purposes:

1. to increase understanding of alternative intervention strategies in terms of their relative differences,
2. to evaluate existing assessment and intervention methods as part of a cohesive strategy,
3. develop a comprehensive older driver descriptive format that includes information about driving, but also about factors in the older driver's life that impact on driving,
4. develop a method of profiling older driver characteristics to lead into further and more detailed assessments, and
5. evaluate how technological and specifically computer-based support systems can help to achieve the above purposes.

The intent also is to increase the understanding of the older driver while providing means to identify and address shortcomings identified. The study design is multi-faceted to enable approaching these multiple purposes.

#### Goals and Hypotheses

The primary goal of the proposed research is to determine the effectiveness of a three level multi-phasic program on driving knowledge and skills for older drivers, where each level addresses increased driver deficits and detailed intervention. A secondary goal is to evaluate each level and its components, and identify needs for their modification to enable widespread use. Tertiary goals are to develop and evaluate a computer-based method for Levels 1 and 2, evaluate the effectiveness of this type approach including possible applications to Level 3, evaluate the driver information and skill assessments, and develop specifications for further development of this type approach.

The primary objectives of the study are to develop and evaluate the effectiveness of a multi-phasic approach and its various levels. Given the approach of combining assessment with each intervention, it seeks to serve the driver at an appropriate level and at the lowest cost solution. This approach will enable the assessment of cost-effectiveness of the approach. The evaluation of effectiveness then will be applied to computer based versions of the multi-phasic approach which are expected to yield improved cost-effectiveness.

The following hypotheses were tested in the research using the multi-phasic approach:

- 1) older drivers will demonstrate increased knowledge on accident prevention and injury control after exposure to the Older Driver Self-Assessment Inventory (ODSAI) (Level 1),
- 2) older drivers will demonstrate increased knowledge on accident prevention and injury control after exposure to the Older Driver Improvement Program (ODIP) (Level 2),
- 3) older drivers will demonstrate increased skills on accident prevention and injury control after exposure to the older driver simulation program (ODSP)

- (Level 3),
- 4) older drivers will demonstrate increased (additive/ synergistic effect) knowledge and skills on accident prevention and injury control after exposure to the multi-phasic, systematic program linking the ODSAI, ODIP, and simulator experience,
  - 5) the multi-phasic approach will show increased cost-effectiveness over any single approach, and
  - 6) the computer-based version of the multi-phasic approach will show decreased cost of service delivery without loss of information delivery.

#### Presentation Of The Findings

The presentation of findings is done in multiple stages. This report first focuses on the process and methodology, and then on providing general findings with a heavy emphasis on descriptive analysis. The intent is to document process and general findings. Specific technical findings will be presented in technical papers to be published subsequently.

The analysis first will deal with specific instruments and their validity, reliability, distributions of results by items, and any groupings of items. The data will then be evaluated against demographic variables, groupings by intervention and the site of the interventions, and the pre-post measures. These analyses will raise specific questions which may be dealt with or passed to a second phase of multivariate issues and analyses to be addressed in the technical papers.

#### Organization Of The Report

The report is organized by sections and subsections as summarized in the Table of Contents. The general framework of the presentation is to provide an overview of the subject area (Introduction) and then to address the methodology and process of undertaking the study (Section 2) and includes the description of the sample. The MY-CODA instrument which captures the information about the subjects is then reviewed to provide an overall perspective of the study group.

The next section (4) discusses the use of the instruments in a design for the movement of the older driver through an increasingly complex set of interventions. The Pre-Post Test, ODSAI, Simulator, and MY-DAP are then discussed individually and relative to the design for movement through the different levels. These presentations highlight specific issues relative to the instrument and any striking relationships between instruments. The simulator section (7) also address the conceptualization of how simulators could be used and how they might be evaluated.

A separate section (9) is devoted to the use of technology and computer programs. The discussion includes descriptions of the computer programs developed under this grant, and those developed as tests and the findings from those trials. A general review of technological implications is included.

A discussion of a survey done on participation and conditions for participation in driving studies, interventions, education, and training is presented in Section 10. A general discussion of findings is presented in Section 11. An overall summary is presented of the findings.

The appendices include protocols, instruments developed, computer program documentation, presentations, and papers undertaken. Also in the appendices are supportive information for the analyses presented.

## 2. SURVEY METHODOLOGY

The survey design and method used in the experimental portion of the research is presented in this section. The purpose is to provide an overview of how the project's experimental activities were planned, designed, adjusted to changes encountered, and implemented. The instrumentation used to actualize the design is outlined and referenced to project goals, related to collecting information about older drivers, and to the project rationale.

### Rationale

The principal goal was to address multi-modality interventions with the older driver. The multi-modality approaches used three existing methods of treating the older driver: (1) the Drivers 55 Plus: Rating Form also called the Older Driver Self-Assessment Inventory which will be referred to as ODSAI in this report, (2) AARP's 55 Alive/Mature Driver Program, and (3) evaluation and training on a commonly used driving simulator. These three modalities approximately represent: assessment (followed by focused education), education, and training.

The terminology used has specific meaning as used in this report. "Assessment" refers to gaining information about the subject with the purpose of evaluating the individual and/or to help direct an intervention. "Education" is an intervention whose primary purpose is to provide knowledge and information about driving to the older adult. "Training" is an intervention that is designed to build driving skills. Historically these programs for older drivers have taken the following forms:

- o Self assessment with educational support as represented in the work by Malfetti and Winter (10) referred to herein as the *older driver self assessment inventory* (ODSAI). The older driver answers a 15 item inventory, scores it, is advised of meaning, and receives suggestions for improving driving habits. The older driver becomes more aware of shortcomings with motivation for self-regulation. Assessments by providers have tended to play less of a role unless part of a more complex intervention.
- o Educational interventions generally have focused on driver improvement and refresher courses such as the 55 Alive/Mature Driving Program offered by AARP, the Mature Operators Program offered by AAA, and similar courses by the National Safety Council. Driver improvement courses typically include a description of the relationship between age and driving skills, current rules of the road, and special safe driving techniques.
- o Training programs to directly address driving skills and attitudes are represented in on-road and simulation programs with simulation being the method of choice based on cost, safety, and flexibility. The older driver participates in real-life driving situations, analyzes its components, and practices related skills.

These three interventions are related and form the multi-phasic approach shown in Figure 2.1. The multi-phasic approach is based on the three level model of health education interventions. Level 1 is assessment based, with the purpose of a general evaluation of older driver knowledge and skills, accompanied by a limited educational intervention. The second level is a detailed educational program with an integrated assessment used to determine internal placement and guidance of the educational interventions. The third level is training of the older driver to improve knowledge and skills. Central to this model is movement of the older driver to interventions appropriate to their knowledge and skills based within and between levels.

Each of the three levels has associated component approaches which also reflect the additions from the present research as depicted in Figure 2. These approaches are matched to the older driver's specific deficits and/or needs on an individualized basis. The model is an integration of independent activities

currently in use to produce a coordinated effort to isolate and remediate deficits.

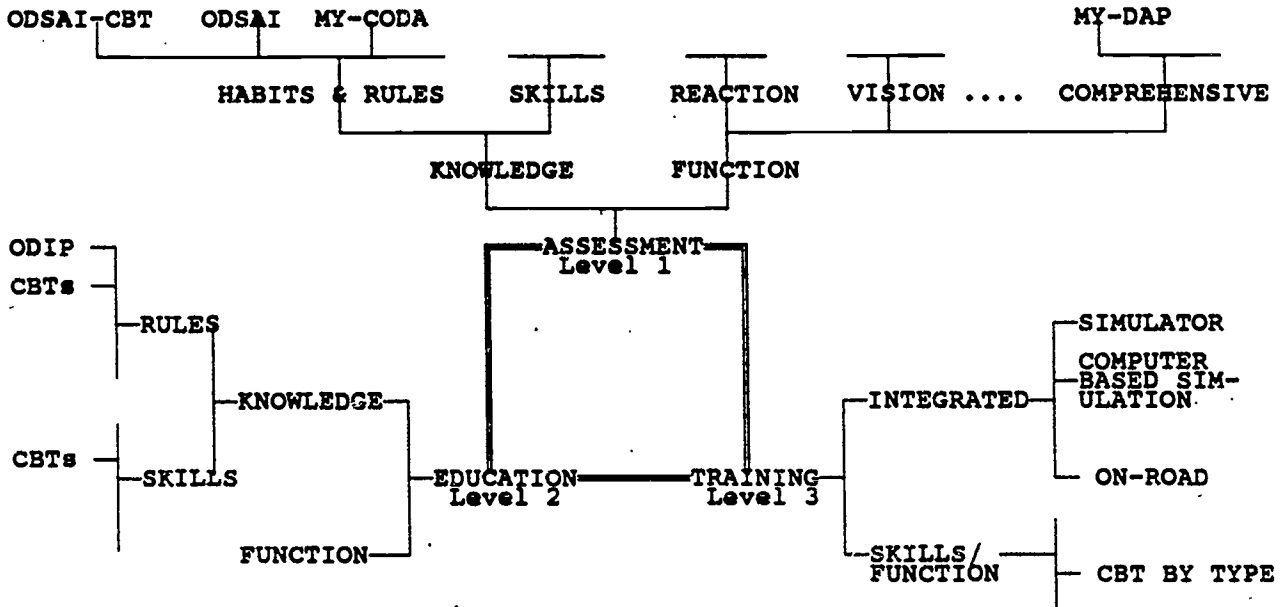

Figure 2.1 Three Level Multi-Phasic Integrated Model of Intervention for Older Drivers

The experimental design sought to isolate these activities to enable independently evaluating the three interventions more easily. The design also sought to look at the progression of interventions from the simplest level of assessment to the most complex and costly level - simulation. The goal was to understand the transitions between them, associated costs and benefits, and to help define a strategy for creating a cost-effective system of interventions using all three levels. The multi-level intervention process is similar to a filter, and is reviewed in more detail in the next subsection.

Treating each level as independent has some utility for analysis and developing understanding of the process. Realistically these separations do not always exist, nor are they necessarily desirable. An assessment without feedback to the older driver has limited utility, and general education requires covering topics that may not needed to be covered making the educational process more time consuming and costly. Secondly, if the overall process of addressing the older driver is considered (especially for all older drivers). then it is not one of these activities that is important, but rather all of them and their mix.

To enable addressing the multiple approaches and their mixtures, it was decided to include data collection that would allow looking at the intervention process more systematically. The intent was to learn more about how these three levels worked together, and how a system of intervention could be developed that was more individualized and responsive to individual needs and also be made more cost-effective to enable reaching larger numbers of older adults. The system would address both prevention and remediation and would form the basis for future work that could focus specifically on the systematic nature of the process and its use in a multiplicity of settings (clinical, educational, training, or public policy).



In looking at the systematic nature, it also was decided to not only link to existing interventions, but to also link to other survey instruments and attitude and knowledge questions (pre-post tests) to allow correlations between the present and past work. This provided field tested questions, allows for comparisons between studies, and at some future point a combination of the studies into one large data set.

In reviewing past and existing work with older drivers, it was felt that some of the information focused too heavily on driving, and not enough on aging and behavioral issues which could influence driving. This information is important because it underlies and influences the driving behavior, but also helps relate to the overall lives of the older person and keeps with the systematic theme identified above.

The design is a mixture of the traditional intervention effects approach used in educational research with the multivariate designs of aging research. The following subsections describe both approaches, and their integration into an experimental design and method.

#### Data Collection And Management

The data collection, entry, and management procedures was established early in the project which provided direction for collecting the data from the subjects, controlling the collection, and transferring it through data entry into the data management system. The core of the process was a coding document which described every item in every instrument and converted them to elements of a data set (variables in terms of the analysis). Each variable was described in terms of its source instrument, the specific question, its range of acceptable values, missing value codes, statistical program names and data sets, and input program names. The purpose was a thorough description of the data that was collected and would support both entry and analysis. A copy of the working draft of this document was submitted earlier with the progress report.

The data entry was done using microcomputers under computer program control with built in edits. The program was developed from the coding document. The program was written in MicroSoft Professional BASIC Version 7.1. The program was modular and table driven to allow for changes and the eventual conversion to a program which would allow older drivers to complete the questionnaire on computer if it was desired by the program staff. The program and its features and use in direct and indirect service is discussed in the Section 9 which discusses the computer based approaches investigated.

The participant survey did not use a computer program. Given it was a one time effort and the number of questions were small, a data entry procedure was set-up in QUATTRO PRO (version 4.0). The first pass at the data was done in this program, edits done as needed, and then the data was exported in a format that could be converted for use with the statistical programs.

The questionnaires were reviewed by the interviewer for completeness, and then by one of the project staff. A protocol guided dealing with missing or erroneous data, no formal encoding of the data was done. The program encoded the data during the entry process. The entry screen replicated the questions and answers on the questionnaires. The program allowed data to be reviewed on screen or printed to check for errors and enabled editing of data previously entered.

Data management was a two part process: (1) the process described above for controlling data from acquisition through entry into the data system, and (2) management of the data once it is in the data system. The management of the data would occur through a simple data base to control the data up to analysis. The data manager was built into the computer program developed and used a random

access flat file to control the data as it was entered. A check sheet was produced for each group and used to control the data flow.

The data file was designed to look like a standard card image file typically expected by a statistical package (fixed format without delimiters). The file was then imported by the statistical package that was to be used for a particular analysis. The control of the data during the analysis process was provided by the statistical package. Three packages were used: SAS on an IBM mainframe, MINITAB on both a microcomputer and mainframe, and DOS based SPSS. Each package used the same data file as the starting point.

### Filter Design

The project was based on the hypothesis that all persons did not need the same interventions. Some people were not at-risk and were knowledgeable, and therefore the interventions could be shortened for them. The multiphasic model is built around this concept of evaluation at different levels. Unsuccessful completion of a given level results in the subject being moved on to the next level, and successful completion of a level resulted in the intervention being ended.

The flow of the person through the multi-phasic intervention is similar to a filter. The filter sifts out persons who do not need further assistance, and passes on persons who do. The project assumed three levels using existing tools as the basis of its experimental approach, and if the concept was verified the filter model would then be expanded into a system model that was a network with many more options. The filter as used in the project is described in Figure 2.2.

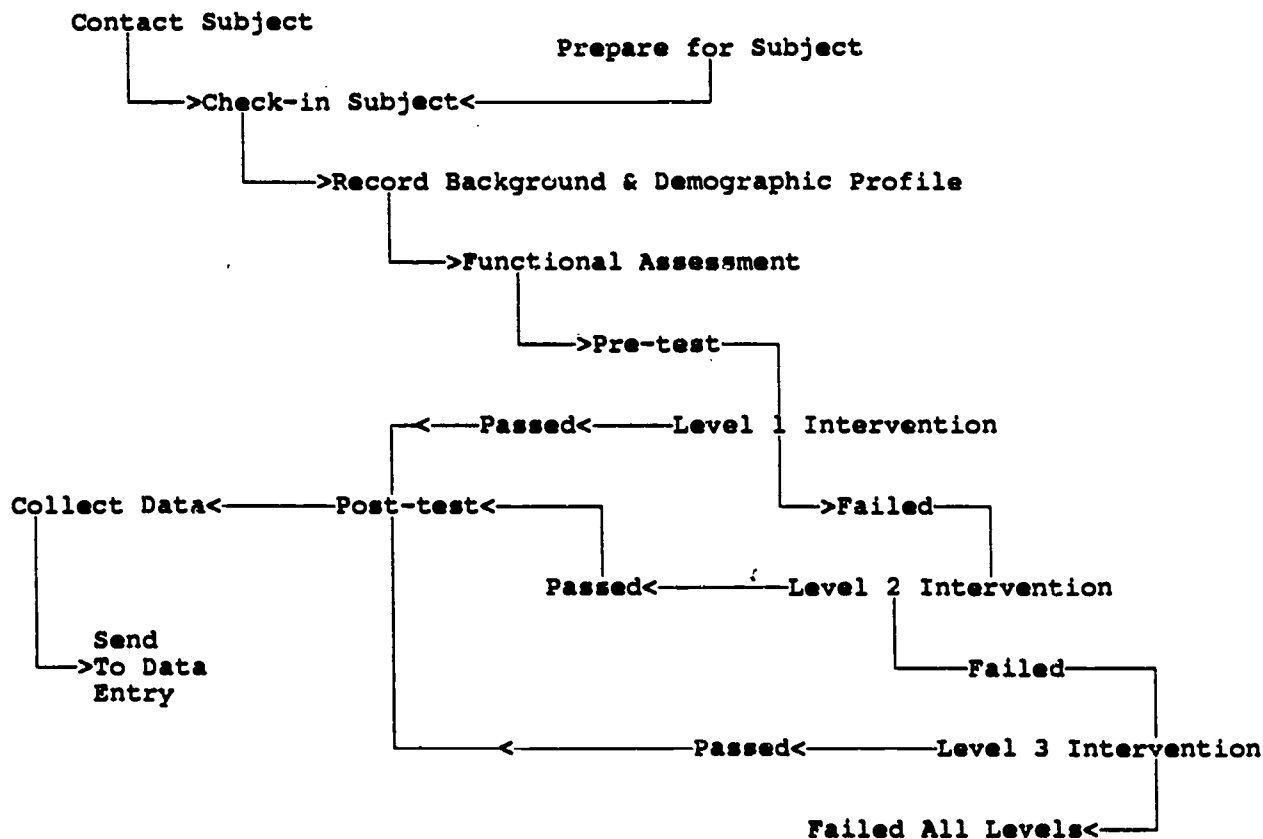

Figure 2.2. The Filter Model Of The Multi-Phasic Approach

The major events of the filter model and its operation are:

1. the subject is checked into the program,
2. demographic and background data are collected, the functional assessment is undertaken, and the pre driver skill and information measure is administered,
3. Level 1 Intervention is provided,
4. if the person is not at risk, they exit the program after a post measure is administered,
5. if the person is at risk, the Level 2 intervention is started,
6. if the person passes Level 2, the post measure is administered and they exit the program, and
7. if the person fails Level 2, they move on to Level 3 and upon completion are administered the post measure and leave the program.

The basis of this implementation was existing interventions which had three different focuses. The ODSAI was a simple assessment and educational intervention which is self administered. The AARP course is an educational activity that is complex in nature and takes a day to complete. The simulation activity especially when combined with both the preceding efforts is a combination assessment, educational, and training activity. The levels are clear and distinct and represent significantly different levels of intervention.

The filter model as presented fits existing programs fairly closely. A fourth level of on-road driving could be added. If the multi-phasic filter approach is proven valid, it is apparent from the model that enough intervention levels do not exist to provide a truly graded intervention system, and secondly, that the assessment components of the second and third levels are relatively weak for this systematic type format. One of the issues that grew in importance in the project, was the evaluation of the need for alternative interventions between the three levels and the types of assessments that would be required.

#### Intervention Design

The interventions in the filter model fall into a traditional intervention-effects design. The sample was divided into a control and experimental groups and pre and post instruments applied. The experimental groups received different treatments. The basic question was whether the groups differed as a result of the different interventions.

The analysis of the filter model used this classic pretest-posttest control group design. The experimental design applied to the filter model may be diagrammed in Figure 2.3. R indicates the random allocation of research participants (N = 254) who have been identified as older drivers; for the purposes of the proposed project, those drivers age 50 and over.

O1 and O2 indicate the pretest and posttest for treatment condition 1. X1 indicates treatment condition 1 (Older Driver Self-Assessment Inventory or ODSAI). O3 and O4 indicate the pretest and posttest for treatment condition 2. X2 indicates treatment condition 2 (Older Driver Improvement Program or ODIP). O5 and O6 indicate the pretest and posttest for treatment condition 3. X3 indicates treatment condition 3 (Older Driver Simulation Program or ODSP).

O7 and O8 indicate the pretest and posttest for treatment condition 4. X4 indicates treatment condition 4 (X1 + X2 + X3 or ODSAI + ODIP + ODSP linked together in a multi-phasic, systematic program). Finally, O9 and O10 indicate the pretest and posttest for the control group (no treatment condition).

Experimental Groups: (N = 200)	R	O1	X1	O2
	R	O3	X2	O4
	R	O5	X3	O6
	R	O7	X4	O8
Control Group: (N = 50)	R	O9		O10

Figure 2.3 Experimental Design

The implementation of the design varied slightly from that depicted. The groups were not equal in size and the control group was larger. The actual numbers of subjects in each group and the interventions and instruments they were administered is presented in Table 2.1.

#### Multivariate Design

In addition to the intervention-effects design, a multi-variate design was planned. This design was aimed at relating major issues about the older driver. Data was collected that exceeded that needed to complete the intervention-effects design. The data was focused at trying to understand more about older drivers and the relationships that exist between factors describing older drivers and their driving performance.

This analysis focused on defining associations versus identifying effects of interventions on groups. The analysis sought to learn about the older driver, aging factors, relationships between variables, the instrumentation itself, and the effects of factors that might influence the older driver and his/her performance.

The analysis used a variety of methods from simple descriptive statistics through the use of multi-variate techniques. The designs and approaches are detailed in the specific sections dealing with the instrumentation and results. This report includes mostly the descriptive statistics about the population and instruments used along with correlations, analysis of variance, and simple regressions to provide a first pass at the data collected and to frame the questions which can be addressed from the data. Subsequent analyses addressing these questions will use the appropriate and more powerful multivariate techniques.

#### Instrumentation Overview

The study design sought to capture information to meet the goals of all three experimental designs. The instrumentation selected and/or developed was administered to over 250 older drivers who received any of the following assessments and interventions:

1. Comprehensive Older Driver Assessment (MY-CODA),
2. Pre and post Knowledge Assessment Test (KAT),
3. Pre and post Attitudes Assessment Test (AAT).
4. Older Driver Self-Assessment Inventory (ODSAI),
5. Older Driver Assessment Profile (MY-DAP),
6. Driving simulator, and
7. AARP 55 Alive/Mature Driving Program, or the equivalent AAA Mature Operators Program.

The ODSAI, AARP 55 Alive/Mature Driving Program, and Driving Simulator, are interventions. The ODSAI has scores on 15 individual items and a summary

score with a pass/fail score, and the other two interventions have pass/fail marks. The ODSAI and MY-DAP are assessment instruments. MY-CODA combines background and demographic information about the older driver with self report information on driving history, habits, and performance. The pre-post knowledge and attitudes assessments are the change measures for the interventions.

The MY-CODA and MY-DAP were developed specifically for this project as was the simulator recording protocol. The pre-post tests were developed for the project using survey questions used in prior research. The other interventions already existed. All the instruments are discussed in the following subsections.

#### **AARP 55 Alive/Mature Driving Program**

Recognizing the need to help older drivers improve their skills and prevent traffic accidents, AARP offers 55 ALIVE/MATURE DRIVING to all motorists age 50 and older. The eight-hour classroom refresher is the first nationwide, comprehensive curriculum designed especially for the older motorist. Courses are conducted by volunteers aged 50 and older utilizing the peer concept. Each participant in 55 ALIVE/MATURE DRIVING is charged a minimal fee to help offset overall program costs.

The 55 ALIVE/MATURE DRIVING curriculum consists of six separate sessions (overview; physical changes; interacting with traffic; interacting with traffic continued, and safety belts; accident prevention measures, adverse driving conditions, other road users and recreation vehicles; and perception and course wrap-up). The course is given three sessions at a time over a two-day period. Each three session segment lasts four hours.

Currently several automobile insurance companies in selected states voluntarily provide premium reductions to graduates of 55 ALIVE/MATURE DRIVING. In addition legislation has been enacted in 25 states and the District of Columbia which require all automobile insurance companies conducting business in those states to provide a premium discount to graduates of state-approved driver improvement courses. AARP's 55 ALIVE/MATURE DRIVING is approved in every state. Many other states are currently considering this mandated legislation.

#### **MY-CODA**

The MY-CODA instrument was developed for this project from a number of instruments used previously by the project team in other studies of older drivers and general aging. A three part intent was established to: (1) provide basic demographic and control variables for the study, (2) collect information about older drivers, and (3) add more dimensions about the lives of older drivers. Part of the design was to provide some common links to existing studies to allow future cross-study (meta) analyses.

The overall structure of the instrument was linked to the model described earlier, and to related broader model of human function (73). Analysis of these models resulted in the production of the following categories:

1. A control category to enable identifying information about the subject and administration of the instrument,
2. Demographic information about the subject including some general information on travel and living arrangements,
3. A description of the driving history of the subject including information on traffic violations and accidents,
4. Information about the driving pattern of the subject including the mechanics of driving, when and where they drive, transportation habits, and alcohol usage relative to driving,
5. A description of the subject's driving performance and factors which influence performance (e.g., vision, physical performance, ..), medications,

- driving situations,
6. A brief overview of the subject's living environment which might influence decisions to drive or not drive,
  7. A profile of social supports in the form of a general count and contact summary,
  8. A profile of activities indicating their overall involvements and interests and some sense of the degree of activity,
  9. A description of well-being and life satisfaction, and
  10. A profile of health indicators including current health, outlook on health (past to future), health service use, general mental abilities, and a profile of health conditions and the degree they cause restrictions in the person's life.

Many of the questions pertaining to driving were drawn from a national survey done by the principal investigator (18), from related work by AARP and the AAA Foundation for Traffic Safety, and the work of Malfetti and others at Teachers College of Columbia University. The questions were selected to provide an overlap between studies as described above, and where feasible the wording was not changed. The remaining questions were drawn from work by the co-investigator in the areas of aging (74,78) and life transitions (75-77). The questions have a long history in aging and psycho-social research. The exception are the questions on mobility which were generated for the study of social supports in community dwelling well elderly (74) and an assessment of their environment (74). The environment questions were revisions of questions (74) which drew on the work of Golant (78).

The MY-CODA was intended to be item analyzed and shortened in the future. The purpose of this version was to provide the information needed for this study's pre-post test design and provide the option for the multivariate analyses. The instrument will be adapted for general clinical use after analysis.

#### Pre-Post Test

The strategy for designing the pre-post test was to draw questions from existing driving assessments instruments and courses (66-71). The rationale was that this approach was a less biased assessment, and also allowed for comparison to other assessments. Based on a review of the literature, it was decided to develop two components - attitudes towards driving and knowledge about driving and common traffic rules and regulations. Both parts were administered pre-intervention and post-intervention for all experimental and control groups. In the control group, there was no intervention, but simply a time lapse between administrations. The instrument is provided in Appendix A.

The Attitudes Assessment Test (AAT) was comprised of eighteen items drawn from a survey of the traffic safety needs and problems of drivers age 55 and over developed by Yee in 1985 (18). The attitudes assess outlook and therefore do not have a correct answer, although for some items there would be a preferred response. The items include questions on age and licensing, age and driving, and driver examinations.

The Knowledge Assessment Test (KAT) was comprised of thirty-one items drawn from a standardized knowledge test for older drivers developed by AARP's 55 ALIVE/MATURE DRIVING program (71) and related materials (e.g., ref 67). The items also parallel those found in materials from the AAA Foundation for Traffic Safety (68-70). These questions incorporate information on rules of the road, alcohol use, responses to driving conditions, aging and driving, and general driving procedures.

#### ODSAI

Malfetti and Winter (72) developed a self-rating form for drivers 55 years and older for the AAA Foundation for Traffic Safety in 1986. The self-rating

form is comprised of 15 questions which are self-scored and keyed to a series of related facts and suggestions. The older driver answers the questions, scores them, and then based on the scoring reviews appropriate facts and suggestions. The self-rating form, facts, and suggestions are included in a booklet. The booklet is a combination of assessment and provision of educational information about driving practices deemed critical to the older driver. Five main topics are addressed: physical conditions, emotions, health habits, driving records, and other indicators.

#### MY-DAP

The Driver Assessment Profile is a method for assessing the abilities and skills of older drivers using an integrated and systematic model of driving presented earlier. It is designed to provide a profile of the older driver that will:

- (1) help in studying abilities and skills of older drivers,
- (2) relate to performance and training parameters,
- (3) aid in assessment of age-related changes and function, and
- (4) relate to the integrated model of the driving experience.

The Driver Assessment Profile is a reflection of the driver response portion of this model. The outcome should be a description of the operational response of the driver based on the abilities and skills identified. The focus is on the overall integration of abilities and skills allowing for compensation of a deficit by a strength(s). The driver responds in an integrated manner, and it is this systematic response that will be measured.

The Driver Assessment Profile will isolate specific problem areas, but a profile of the abilities and skills is desired. One question being addressed in the present research is whether a specific profile reflects a systematic degradation of driving ability. A second question is whether there are any characteristics that are more predictive of loss of driving ability.

The Driver Assessment Profile (shown on the next page) asks for a rating of specific abilities and skills which are grouped in three categories: sensing or input type information, coordinating and integrative functions used to process the input information, and abilities needed to carry out the decisions to act. Additionally, two general questions relating to overall health and general attitude are included. The instruction manual is designed to be scored by a health professional working with the older driver and is presented in Appendix B.

This manual describes the use of the Driver Assessment Profile. The strategy is to assess the impairment of an ability and skill. If a person's ability is not impaired, then how much more capability exists is not assessed. The impairments are rated as: none, mild, moderate, or severe. The terms should be interpreted as:

- mild.....a noticeable change in abilities from a level expected a safe minimum for driving, but not sufficiently severe to cause a difficulty or lack of safety in driving ... a mild impairment normally would require some adjustments by the older driver
- moderate..the impairment in abilities would cause the older person difficulties in driving and especially in driving safely, adjustments required of the person are significant to achieve even the minimum level of functional performance
- severe...the impairment is significant enough to make it unlikely the person can make adjustments to allow safe driving performance.

**DRIVER ASSESSMENT PROFILE (MY-DAP)**

Agency #: \_\_\_\_\_ Site #: \_\_\_\_\_ Subject #: \_\_\_\_\_  
 Date: \_\_\_/\_\_\_/\_\_\_ Interviewer #: \_\_\_\_\_

DRIVER ABILITY OR SKILL	DEGREE OF IMPAIRMENT				CODER RATING (0-5)
	NONE	MILD	MODER-ATE	SEV-ERE	
<b>SENSING</b>					
Vision- Overall (1)....	[ ]	[ ]	[ ]	[ ]	[ ]
Acuity/Static.....	[ ]	[ ]	[ ]	[ ]	[ ]
Acuity/Dynamic.....	[ ]	[ ]	[ ]	[ ]	[ ]
Field of Vision.....	[ ]	[ ]	[ ]	[ ]	[ ]
Peripheral Vision....	[ ]	[ ]	[ ]	[ ]	[ ]
Depth Perception....	[ ]	[ ]	[ ]	[ ]	[ ]
Glare Refractory....	[ ]	[ ]	[ ]	[ ]	[ ]
Color Recognition....	[ ]	[ ]	[ ]	[ ]	[ ]
Known Pathologies....	[ ]	[ ]	[ ]	[ ]	[ ]
Hearing- Overall (2)..	[ ]	[ ]	[ ]	[ ]	[ ]
Left Ear.....	[ ]	[ ]	[ ]	[ ]	[ ]
Right Ear.....	[ ]	[ ]	[ ]	[ ]	[ ]
Kinesthesia.....	[ ]	[ ]	[ ]	[ ]	[ ]
Proprioception.....	[ ]	[ ]	[ ]	[ ]	[ ]
<b>PROCESSING</b>					
Short term memory.....	[ ]	[ ]	[ ]	[ ]	[ ]
Long term memory.....	[ ]	[ ]	[ ]	[ ]	[ ]
Cognitive skills.....	[ ]	[ ]	[ ]	[ ]	[ ]
Anger/aggression.....	[ ]	[ ]	[ ]	[ ]	[ ]
Anxiety.....	[ ]	[ ]	[ ]	[ ]	[ ]
Selective Attention....	[ ]	[ ]	[ ]	[ ]	[ ]
Stress Response.....	[ ]	[ ]	[ ]	[ ]	[ ]
Problem Solving.....	[ ]	[ ]	[ ]	[ ]	[ ]
Decision-Making.....	[ ]	[ ]	[ ]	[ ]	[ ]
Judgement.....	[ ]	[ ]	[ ]	[ ]	[ ]
Patience.....	[ ]	[ ]	[ ]	[ ]	[ ]
Insight into driving...	[ ]	[ ]	[ ]	[ ]	[ ]
<b>MOTOR</b>					
Strength upper limbs...	[ ]	[ ]	[ ]	[ ]	[ ]
Strength lower limbs...	[ ]	[ ]	[ ]	[ ]	[ ]
Strength hand.....	[ ]	[ ]	[ ]	[ ]	[ ]
Strength foot.....	[ ]	[ ]	[ ]	[ ]	[ ]
ROM upper limbs.....	[ ]	[ ]	[ ]	[ ]	[ ]
ROM lower limbs.....	[ ]	[ ]	[ ]	[ ]	[ ]
ROM neck.....	[ ]	[ ]	[ ]	[ ]	[ ]
ROM trunk.....	[ ]	[ ]	[ ]	[ ]	[ ]
RT simple.....	[ ]	[ ]	[ ]	[ ]	[ ]
RT eye-hand.....	[ ]	[ ]	[ ]	[ ]	[ ]
RT eye-foot.....	[ ]	[ ]	[ ]	[ ]	[ ]
Coordination.....	[ ]	[ ]	[ ]	[ ]	[ ]
Endurance.....	[ ]	[ ]	[ ]	[ ]	[ ]
General Attitude.....	[ ]	[ ]	[ ]	[ ]	[ ]
Overall Health.....	[ ]	[ ]	[ ]	[ ]	[ ]

(1) with glasses if worn (2) with hearing aide if worn

Coder Rating: 0=unable to rate      3=partial test data  
 1=subjective observation      4=past test data  
 2=limited test data      5=tested



The Driver Assessment Profile can be used to assess the abilities and skills using a number of means: "descriptive" which is based heavily on subjective observations, "measured" based on criterion reference measures, "assessed" based on formal assessment techniques, and "diagnostic" which would take the formal assessment and make the transition to formally creating suggested responses. The present form of the instrument supports the first three uses.

A rating system is provided to the rater to allow indicating the type of assessment for each item. If all the assessments of the abilities are of the same type, then the procedure is to indicate the time for the first characteristic and a downward arrow in the second. The types of assessment supported are:  
0...unable to rate this specific item,  
1...subjective observation,  
2...subjective observation combined with limited test data,  
3...rating is based on partial test data,  
4...rating is based on past test data available to the rater, and  
5...rating is based on testing.

The higher the number of the rating the greater the expected validity. The intent is to allow use of the profile over a greater range of situations than one which is strictly dependent on formal assessment techniques. The ratings provided enable use in a range of conditions, or when the conditions are not equal for all items. The result rating enables the interviewers to answer, and to assign a validity weight to the rating based on their assessment.

The scoring of the scale is not to be done by the interviewer at this time. The interviewer is to indicate the agency #, site #, subject #, and date. The agency # is a four character field. The site is a five character field.

#### Simulation

Simulation in the experimental portion of this study connotes a standard driving simulator. Specifically, a driving simulator from DORON Precision system was used with the film addressing driving risk was used. An older model was used at UTMB and the newer L35 was used at San Francisco State University, but for the purposes of this research both had the same functionality.

The DORON simulator is designed to evaluate a driver's readiness and capability to operate a vehicle safely. The simulator is comprised of: a Control Console contains the system computer with a video screen and printer for monitoring and recording driver responses, a computerized driver simulator station, 16mm projector and a series of assessment and training films, and a comprehensive Evaluator's Manual. Operational training that thoroughly familiarizes the operator with the system is provided by DORON.

DORON's Assessment Film Program and Driver Analyzer films have been specifically developed for assessment and rehabilitation purposes. These special purpose films were developed in cooperation with recognized experts in the assessment and rehabilitation fields and have been proven successful in numerous studies.

The process for using the simulator differed between the two sites, but the final recording at both was done on the MY-DAP form. The differences between the two are recorded on the form in the column indicating how the data were collected. The SFSU simulation used a formal protocol and incorporated the published format (Yee et al, 1990, ref. 79) of the UTMB group (a protocol or at least a description was requested, but not provided). The protocol for the SFSU simulation is Attached in Appendix C.

The testing for specific items on the scale was more detailed in the SFSU protocol. Every item on MY-DAP was at a minimum indirectly tested. The process for each subject was identical, as was the recording (verified by video taping two sessions and comparing them).

The simulator provided measures of reaction time, reaction to figure ground type stimuli, and reactions to hazardous driving situations. The simulator provided dynamic responses and insight into decision making under stress of the person being assessed. These results could be combined with the data on from

measures of sensory, information processing, and motor performance tested external to the simulation activity.

#### State-Trait Anxiety Scale

Spielberger's State-Trait Anxiety Test (65) was administered to a persons undertaking the simulator protocol at San Francisco State University and in the related MY-DAP evaluation in Maryland based on the same protocol. The State-Trait Anxiety Scale is a 60 item scale, half of which produces a score of a persons state anxiety and the second half the person's trait anxiety. The instrument is used widely and provides a score to compare with the MY-DAP assessments of anxiety.

The state-trait anxiety separation is designed to elicit the difference between a person's characteristic anxiety state versus a transient anxiety condition (Cattel ref. 66). The instrument is used widely and provides a score to compare with the MY-DAP assessments of anxiety and also links to other studies (e.g., on vision field loss, ref. 25). The addition of the instrument was made when the clinical work shifted to San Francisco State University (SFSU).

#### Sample Description and Grouping Design

The study was designed as a filter. The older driver was exposed to more interventions and assessments as he/she failed a given level. The first level was ODSAI, the second the AARP course, and the third the simulator. A group was added that took all the parts (through the simulator) without the filter. Two other groups were added: folks that took all the parts except the simulator without any consideration of filtering, people who went through all parts except the classroom course, a group of drivers who recently quit driving because of age related factors (all parts except the simulator without any filtering), a group who took all parts except the simulator and classroom course (aimed at MY-DAP), and an on road group.

The following are the groupings of subjects defined:

1. a control group that completed MY-CODA, KAT and AAT as pre tests, and after a delay took the KAT and AAT as post tests,
2. an assessment intervention group (N=50) that took the ODSAI, MY-CODA, and pre and post KAT and AAT,
3. an educational intervention group (N=50) that took the AARP 55 Alive/Mature Driver course and also completed the ODSAI, MY-CODA, and pre and post KAT and AAT,
4. a training group that was trained on a simulator, completed ODSAI, MY-CODA, AARP course, and pre and post KAT and AAT, and were scored on MY-DAP on the basis of the filter model (failed both ODSAI and 55 Alive/Mature Driver Program),
5. a group that took all three levels of intervention and completed ODSAI, MY-CODA, and pre and post KAT and AAT, and were scored on MY-DAP, but passed the ODSAI and 55 Alive program (no filtering),
6. a group that was tested/trained on the simulator without taking a classroom course and completed the pre and post KAT and AAT, MY-CODA, and ODSAI, and were scored on the MY-DAP, and
7. a group that took all first two levels of intervention, completed MY-CODA and the pre post KAT and AAT, and were scored on the MY-DAP (no filtering).

The groups originally were to be drawn from the Galveston and Houston areas of Texas by UTMB under contract to the study following the filter design. The plan was not followed and fewer subjects were drawn. The project as a result gathered information from additional groups in the San Francisco, California area. The groups, their location, and approximate size is presented in Table 2.1.

Groups 1a, 1b, and 1c are the control groups. Group 1a was done through a class at SFSU with different students administering the instruments. Group 1b was done by the Texas Department of Health in the Houston area. Group 1c was a group of Texas AARP instructors who did not do a post test.

Table 2.1. Study Groups

Group	Filter	Pre-post	MY-CODA	ODSAI	AARP	MY-DAP	Sim	#	SS	Site
Control...										
1a	No	X	X	-	-	-	-	18		SF
1b	No	X	X	-	-	-	-	53		TX/TDH
1c	No	X	X	-	-	-	-	6		TX/AARP
1d	No	X	X	-	-	-	-	1		TX/GCS
1e	No	X(no po)	X	-	-	-	-	2		TX/GSC
								80		
ODSAI....										
2a	Yes	X	X	X	-	-	-	17		TX/GSC
2b	Yes	X	X	X	-	-	-	20		SF
2c	Yes	X	X	X	-	-	-	1		SF/SIM
2d	Yes	X	X	X	-	-	-	7		TX/GSC
2e	Yes	X(no po)	X	X	-	-	-	1		TX/GSC
								46		
AARP.....										
3a	Yes	X	X	X	X	-	-	11		TX/GSC
3b	Yes	X	X	X	X	-	-	21		SF
3c	Yes	X(no po)	X	X	X	-	-	16		TX/GSC
								48		
TX Simulator (failed ODSAI)....										
4a	Yes	X	X	X	X	X	X	5		TX/GSC
								5		
TX Simulator (passed ODSAI)....										
5a	Yes	X(no po)	X	X	X	X	X	9		TX/GSC
								9		
SFSU Simulator....										
6a	No	X	X	X	-	X	X	20		SF/AAA
								20		
MY-DAP No Simulator or AARP....										
7a	No	X	X	-	-	-	X	1		TX/GSC
7b	No	X(no po)	X	X	-	-	X	3		TX/GSC
7c	No	X	X	-	-	-	X	2		TX/GSC
7d	No	X	X	X	-	-	X	40		MD/OTGRP
								46		

Total..254

Groups 2 and 3 followed the filter model. Group 2b was done using a senior center group in San Francisco, and 2a was part of the clinical group at UTMB that had been contracted to do the entire clinical intervention. The Group 2 people passed ODSAI and stopped the process.

Group 3 people failed the ODSAI and took a classroom course. Groups 3b (SFSU) and 3a (UTMB) were the continuation of groups 2b and 2a respectively. The course was the standard AARP course. Group 3c was part of group 3c which were not administered a post-test.

Groups 4, 5, and 6 were the groups who took the simulation. Group 4 is the continuation of the filter design. Group 4a has pre-post tests and group 5a has no post tests. The reason why UTMB caused this problem is not clear, but they were unwilling to clean up the problem or provide documentation on why it occurred. Group 5a are the UTMB subjects who went through the same sequence as the Group 4, but did not follow the filter model. They simply took the full sequence irrespective of passing or failing any level.

Group 6 were persons who were assessed using a DORON simulator at San Francisco State University in a two week period in February and March of 1992. This group did not take the classroom course, because the simulator was provided on short notice (less than two weeks). A group was located for the course, but AARP could not provide an instructor on this short a notice and the local AAA club scheduled classes twice and canceled them twice. The simulators used with Groups 4, 5, and 6 were both made by DORON, but the SFSU simulator is a later

model. The same procedures described by UTMB (79) were incorporated into a more broader formal protocol which added measures for the SFSU intervention.

Group 7 was a group of older persons assessed in May and June of 1992 with the clinical resources remaining from the non-performance of the UTMB contract. It was aimed at getting added information on the MY-DAP using another clinical setting. The classroom course and simulator training were not involved. The work was done by a group of five occupational therapists in Maryland and provided an evaluation of the MY-DAP using the same protocol as the SFSU simulator. The protocol was adjusted to the lack of a simulator and some replacement activities were added. A lead therapist was trained on the use of the protocol who recruited and trained the five OTs doing the work. The training included a video tape of two of the subjects evaluated under the protocol using the simulator at SFSU.

Groups 6 and 7 (MD portion) also received the State-Trait Anxiety Scale (65). The data has not been included in the data set for the analysis reported herein, but will be part of subsequent analyses. Additional data on simulator parameters (sequences and responses to them within the assessments) also was collected, but is not included in the main data set or analysis described herein.

#### Self Selection Assessment

During the project outlined in the preceding sections, it was noticed that certain types of persons did not seem to want to participate. The concern was that the people who decide to participate have certain characteristics. It was observed that in some cases poor drivers or drivers with problems seemed to avoid becoming involved. The persons most in need were the ones who may participate the least.

Obviously this observation had to be of concern. If the observation is true, it not only effects the current study, but likely most others. The results could indicate that the characteristics generally ascribed to older drivers may not accurately reflect them. More importantly, it might mean that many of the assessment, education, and training programs now in existence are not reaching those most in need. The implication of such a finding is that other ways of reaching the folks who chose not to participate may be needed.

To respond to this observation, a separate study using a survey methodology was designed to gain some insight about the conditions which influence an older driver's decision to participate in studies, interventions, and research. The survey was done during the last months of the project in Arizona, Maryland, Kentucky, and California with only the results of the Arizona portion of the survey being reported herein. The survey included 21 questions along with the demographics and activities sections from MY-CODA and is provided in Appendix E.

The survey form was designed to be confidential. The surveys were identified by an agency code (corresponding to the administering agency), a site code (referencing the location), and a subject number. These codes provide a means for identifying the survey and where it was done, but are non-personally identifiable. The cover sheets also included a place for interviewer (person who administers the form) and the date of administration. At the end of survey a form was provided for the person to sign-up for involvement in a subsequent study/driving program if it was to be offered in that area. These forms were to be separated from the main survey form to maintain confidentiality.

The cover sheet allowed the interviewer to check-off if the person refused totally to participate. The remainder of the first page provided a general overview of the problem of older drivers and was similar to the face sheet on MY-CODA. The following pages (#2 and #3) asked questions about the willingness to be involved in a study. The purpose of these questions was to determine both a yes-no response to a factor relating to participation, but also the conditions under which a yes becomes a no, or a no a yes. Room was provided at the end of this section of the survey for both the subject and interviewer to write comments.

The third and fourth pages asked a series of questions which identify general demographics. The questions were identical to the ones in the main

study survey and allow for comparison of the characteristics of the people in this study group versus those in the main study (254 subjects). The last page is a summary of the person's activities profile indicated how frequently they participate (or do not participate) in each of 17 general activities in check list format which also was drawn from the survey in the main study. The purpose of the activity check sheet was to enable distinguishing between the respondent who is active and who is not active. Logically, active persons would be expected to be more willing to be involved in programs.

All people contacted were recorded on a form using the check off for on the face sheet to record a total refusal. The interviewer then was to complete the demographics section of the report based on their knowledge of the subject. Although this procedure may include some inaccuracies, it is better than no information especially since it is known the interviewer completed the information versus the subject.

The process for gaining subjects in Arizona was to use neighbors, friends, and acquaintances of a few people as a starting point. In each interview, the person was asked if they could suggest some added persons. If they suggested a person, they made the first contact. The survey was then administered: in person, over the telephone, or if multiple persons were involved in group meetings. Which approach was used and any anecdotal notes about the administration were recorded on a control sheet. The process in Maryland added Senior Centers as added starting points, and California started the process using members of the San Francisco State 60 Plus club. The analysis and findings from the survey reported herein used only the Arizona data set (n=54) time constraints imposed by the end of the project. The full data set will be analyzed and reported in one or more technical papers.

### 3. MY-CODA

The proposed design included a limited collection of background and demographic variables. In the review and planning prior to implementing the study, it appeared that at about the same cost a more comprehensive collection of data would be feasible. This data would provide a background for the analysis of multiphasic outcomes, but also would allow a review of the characteristics of the older driver. The model developed to guide the review highlighted the deficiencies of simply monitoring a few parameters, because it would not allow the exploration of the relationships between parameters.

A comprehensive older driver assessment (CODA) was decided to be designed, piloted, and used. The design of the instrument was described in Section 2 and a copy of the instrument is provided in Appendix A. This section provides a summary of the variables in the major sections of the instrument. The summary is a simple overview of the key variables and includes outlines of methods for combining the variables. This approach is used to keep the section at a reasonable length.

#### Summary Of Demographic Variables

The age range was 43 to 89 with a mean of 64.3 and median of 64 years. The distribution of age was slightly skewed by a slightly larger number of subjects in their mid-fifties. There were 99 (46.7%) women and 115 (53.7%) men in the population. In terms of marital status, 56.5% were married, 22.4% were widowed, 9.8% were divorced, 7.0% were never married, 3.7% were separated, and the remainder indicated "other" as their status. The group was 79.4% white, 7.4% black, and the remainder almost equally divided between asian, hispanic, native american, and other.

There was almost an equal distribution of educational levels between high school, college, some college, college, and graduate school. The subjects lived in mixed settings: urban areas (42%), suburban (45%), and rural (13%). The majority lived with a spouse (55%), 27% live alone, and the remainder were equally divided between living with friends, family, and other relatives. The income levels were mixed: the highest percentage was over \$40,000 (42%) with about equal numbers (15%) reporting incomes in the 10-20, 20-30, and 30-40 thousand dollar ranges. Almost 9% reported incomes between 5 and 10 thousand dollars, and 3% below \$5,000. Only about 1% reported they could not pay their bills, 16% had some difficulty, 44% broke even, and 37% had excess cash at the end of the month.

Differences between the experimental groups existed for age ( $p=.000$ ). The main difference was a younger average age (56) in the SFSU simulation group. This group also was significantly ( $p=.000$ ) different in educational level and income. The differences between the other groups were minor.

Education and income were correlated ( $r=.789$   $p=.000$ ) and an SES variable was able to be created. The same group differences existed for the SES variable. For the following groupings of variables, age, sex, marital status, and income were included in all correlations.

#### Summary Of Driving History

In reviewing the characteristics of the driver and their driving, the subjects reported 67% did not take a driver education course, nearly 20 reported some degree of license renewal difficulty, and as a group they averaged just over 40 years of driving experience. Over 11% of the people reported moving violations, 2.3% reported DWIs, and 13% reported one or more accidents in the past two years. There few correlations between the items and the associations found were not of particular interest (e.g., income to number of automobiles owned).

#### Summary of Driving Pattern

The mean annual driving mileage reported was just under 10,000 miles with 75% reporting they drove every day. Most people drove outside of rush hour: the means were 24% during rush hour, 63% other than rush hour, and 11% at night. Rush hour driving was significantly correlated with being younger, and off-rush

hour driving with being older. The subject's reported they drove mainly at about the same speed as other cars on the road, did not pass more frequently, and used their mirrors to check before changing lanes and also turned and looked and signalled.

The subjects reported they wore their seat belts (85%). If a reason was given for not wearing seatbelts it was either lack of comfort or forgetfulness. Women appeared to be more likely to use seatbelts than men. Slightly less than half the subject used alcohol. Of the alcohol users nearly half said they drove after using alcohol. Over 80% of the subjects reported they did use or rarely used public transportation, and 92% said their preferred mode of transportation was driving themselves.

#### Summary of Driving Performance

The subject reported good to excellent eyesight (95%) although over 75% wore some form of eye glass or corrective lens. About 15% of the people reported visual problems: 7.6% reported cataracts, 5.2% reported night blindness, 1% reported glaucoma, and 0.5% reported tunnel vision. Only 20.7% of the persons reported frequent or a sometimes difficulty in reading traffic signs and with half the group ascribing it to size and the other half to clarity.

In terms of problems with driving situations, the major problems referenced were related to driving on city streets or freeways through cities (about 20% each). This relates to a finding discussed later in this report that the judgement and decision making changed with age and needed to be addressed in more specific terms in assessments and educational materials. Based on a subsequent question, the respondents did not see themselves as having problems in these areas. Another subsequent question on entering and exiting freeways had 2.4% of the respondents reporting serious problems and 21% reporting occasional problems.

Only about 10% of the subjects reported wearing hearing aides, and about the percentage reported having hearing problems. Of those persons taking medication nearly 30% said they did not check on the effects of the medication on driving. The subject's did report problems with impatience (17%), frustration (14%), and to a lesser degree anxiety (4%) and anger (2%); based on other data in this study these self-assessment seem low.

About 4% of the subjects reported problems with nodding off, and 2% with blacking out. Nearly 30% of the subjects reported some problems with joints, with the most frequent being hip, knee, and shoulder (each about 9%). Pain was experienced after long periods in the drivers seat by nearly 31% and about 8% experience pain most of the time. Over 30% of the subjects said they had difficulty adjusting entering or exiting an automobile, and 12% said they had difficulty looking back. These problems suggest that perhaps there are more problems with driving habits than reported on some of the safety questions earlier.

Compared to 5 years ago, the subjects did not see much change in their driving over a range of conditions. Similar results were found for their driving abilities in traffic.

#### Summary of Environmental Variables

The environmental variables describe the subject's home and neighborhood environments. Their inclusion was designed to provide a means for including the possibility that environment influenced the person's perception of a need to drive or their transportation alternatives. Feeling of a lack of safety also could influence a person's activity level which also was measured in the study.

One set of environmental variables identify a feeling of safety and security within the environment. The first set of questions #118 to #121 are questions about safety in and outside the home during the day and at night. A single variable was defined by summing the four items (SUMSAFE). The lower the score the safer the person considers their home.

A second set of questions (#s 122 to 129) addresses the issues of how the person rates their immediate environment (shopping, grocery stores, medical

facilities, visitor convenience, public transport, access to public transport, safety, and neighbors). An summary score (SUMENV) was developed by adding the eight items together. The lower the score the happier the subject is with their environment. Many of these items (e.g, public transport) will be used independently in other analyses.

The analyses reviewed the summed scores and the individual scores to assess their individual characteristics and their distribution. The relationship of the variables to the four key demographic variables (age, sex, SES, marital status, and adequacy of finances) was undertaken.

People general found their homes and environment to be safe and convenient. About 1 person in 3 had concerns about safety outside their home in the evening. The only real problems noted were the quality of and access to public transit where about 30% of the people rated the services as fair or poor.

#### Summary of Mobility Variables

The mobility variables (#s 130-135) were included to determine a sense of the persons mobility within their environment. The questions assess mobility without a car (#130), the frequency of leaving their home (#131) or their neighborhood (#132), whether they drive (#133), can public transportation be used (#134), and whether or not they need assistive supports to walk (#135). A total mobility score can be developed using the following algorithm:

SUMMOBIL= (if #130=no then add 4)+ add #131 -1 + add #132 -1 +  
add #133 -1 + (if #134 <>5 add 4 else add 0)

The respondents generally reported a high degree of mobility with few restrictions. Less than 10% reported they did not leave their homes or neighborhood. Most used cars for transport and could use public transportation. Less than 6% need assistive devices (canes, wheelchairs, or walkers) to move about.

#### Summary of Social Support Variables

The group of variables addressing the subject's social supports are found in questions # 136 through #151. These questions are designed to determine how connect the person is to a social support system. It provides an approximate measure of a potential sense of isolation. In terms of transportation, a lack of supports place more pressure on driving longer and more frequently. It also could be expected to influence attitudes toward driving.

These variables were reviewed and indicated good social supports, but an analysis strategy was still being developed relative to the issue of older drivers when this report was being written. There were some problem questions which probably would be removed from the analysis. The respondents had trouble with questions which asked for frequency of contact with options for defining the frequency rates. The remaining questions showed good consistency and appeared valid and will be used in subsequent analyses.

#### Summary of Activity Variables

The activities a person is likely to participate in is included in MY-CODA as a tabular check sheet. The 15 items provide a perspective of the main activities carried out by the person. Each activity was rated from 1 to 5 corresponding to their participation in the activity: (1) no participation, (2) 1-2 times a year, (3) 1 to 2 times a month, (4) 1 to 2 times a week, and (5) three or more times a week.

A total activity score was computed by using the following algorithm:

Total = #1\*0 + #2\*1 + #3\*20 + #4\*80 + #5\*200

where # is the response number and number of times it was reported. This score approximately reflects the number of times the person participated in the various events. Similar subscale scores were computed for Socially, Personally Active, and Physically Active. The components of these scales are:



**Socially Active**  
#152 Sr. Center  
#153 Church  
#154 Clubs  
#159 Cards  
#164 Baby Sit  
#168 Volunteer

**Personally Active**  
#154 Club  
#155 Movies  
#156 Sporting Events  
#162 Paint/Play Music  
#163 Restaurant  
#165 Visit Out of Town  
#166 Vacation Away  
#167 Out of Town Guests

**Physically Active**  
#157 General Sports  
#158 Aerobic Sports  
#160 Garden

The individual items also were evaluated for frequency and pattern including voting in the presidential election (#169). The items were then analyzed against the key demographic variables (age, sex, SES, and marital status). The total and group scores also were evaluated against the knowledge pre-test score and the ODSAI. The results for the whole group are similar to those discussed in the sections on the ODSAI and the participation survey and will not be repeated here.

#### Summaries of Health and Well-Being Variables

A well-being score was computed from questions 170 to 179 (a simple addition of the ratings with # 173 inverted). The higher the score the lower the sense of well-being or the greater the likelihood the person was depressed. The score was evaluated against the key demographic variables (age, sex, SES, marital status, and financial sufficiency).

The person's self-rating of overall satisfaction with life (#180) and their rating of whether their health interfered with activities (#181) were not combined with any other variables. Each question was rated against the five demographic variables, and against the activity total and grouped scores.

Questions 182 through 185 were the subjects indication of their health restriction in terms of confinement (home bound, bed bound, nursing home, or hospital). A restriction/confinement score was computed by using the algorithm:

Score = #182\*1 + #183\*2 + #184\*3 + #184\*4

The more the confinement the higher the weight assigned. The items also can be used individually. The number of doctor visits (#185) is left separate. The total score and the physician visits were evaluated against the 5 demographic variables and against the activity total and grouped scores.

The persons rating of their health was grouped (# 187-189) and their rating of their health relative to peers was left separate. The rating of their health was a comparison from now to 5 years ago. The summary grouping indicates a change with age. To get the sum, the score was produced by difference measures.

Questions 191 through 194 are looked at individually and as a summary score. The lower the score the less confused the person. The scores are evaluated against the five demographic variables and the total and grouped activity scores.

Questions 195 through 208 indicated health conditions and the degree of impairment they imposed. The conditions must be looked at separately, but it is possible to get a summary score of impairment across all conditions. The summary score is reviewed against the demographic and activity variables.

The well-being and health scores were used in analyses reported in other sections and will not be repeated here. The analysis of the health conditions was not undertaken prior to this report being submitted.

#### Discussion

The summary statistics of the variables indicate considerable information exists in the MY-CODA questions. The preliminary work suggests they are well behaved. Some respondent reporting problems were noted and are being further evaluated. The variables presented will be able to be used in working with the general model defined in Figure 1, and will lead to analysis both of the nodes of the model (major factors in older driver performance) as well as in defining the relationships between the factors.

#### 4. MODULAR APPROACH AND FILTER MODEL

A basic tenet of the research proposed was that it was important to create a modular approach and a multi-phasic process. A module was a stand-alone component that could be used based on the level of intervention need. It was argued that some older drivers needed less intervention and that from a cost-effectiveness viewpoint (theirs and social) the provision of unneeded intervention was counter productive. The modules selected to test this concept were existing interventions as discussed in Section 2.

The discussion in this section presents both the modular approach and a filter model. The filter model is the name given the flow between multi-phasic modes. Problems were encountered in this work, because the AARP courses did not provide a valid pass-fail criterion. Passing was associated with staying for the entire course, rather than a specific need for more intervention. The analyses accordingly are limited. Subsequently, the discussion will focus on methods and pending analyses.

##### Modular Model

The modular approach is based on creating distinct and separate modules. The method selected was to use existing interventions as the modules: ODSAI, the AARP course, and driving simulation. The cost of intervention between the three is drastically different. The ODSAI is the cost of the booklet and its distribution and less than fifteen minutes of the participant's time; the AARP course cost is a facility, an instructor, materials, and a day of the participant's time; and the simulator with the associated facility and clinician has a much higher per hour cost (perhaps \$200) in addition to an hour of the participant's time (these times exclude the travel time to and from the intervention).

The modules used are common interventions, but represent distinctly different levels of intervention. The design looked at differences in the pre-post tests in attitudes and knowledge for each level using questions that are standard in studies of older drivers. These distinct levels made for a very clean intervention type design, but do not have sufficient gradations to respond to a range of differing needs of older drivers.

##### Filter Model

The modular approach lends itself to the filter model discussed in Section 1. The modules can be thought of as screening activities. Each activity determines if the person needs further intervention. The ODSAI was the first level and passing it would result in the person not attending the AARP course. The result is a very simple, but powerful multi-phasic model. For the purpose of the research, the interventions were common and clearly distinct, but as discussed above had rather large steps in gradations of interventions.

About 50% of the subjects passed the ODSAI which means that 50% had to take the AARP course. If the sample were translated to the total population of elderly, then half of all the elderly would have to take the course. This expectation is unrealistic in terms of either having the resources to give the course or getting persons to take it. If observations made during the study that the study group was self-selecting, then the failure proportion is probably higher. Effectively, the filter model established a need existed for the process, but there needs to be other interventions between a 15 minute self-administered booklet and an all day course.

##### Cost-Effectiveness

The intent had been to do a cost-effectiveness analysis based on the data collected. The lack of valid pass-fails from the AARP course negates this analysis. The approach that had been selected from use was from classification analysis (81). Cost versus level is easy to ascribe. Effectiveness is related to reducing risk of accident and injury. The objective was to classify persons by risk levels and then relate those risk levels to intervention level costs.

The prediction of false positives and false negatives was to be addressed through the analysis of the results. These error rates would determine how much assessment is needed at each point of a filter model to assure a low false

positive rate and to try and establish the false negative cost. A simulation was planned without the experimental data, but it was decided to wait to see if the data analyses would provide added insights into estimations of risk levels. The simulation will be run at a future date using the final data including predictions of expected risk and cost levels.

The finding that there was a potential self-selection of low risk persons for the study was of particular concern to this analysis. The result would under estimate costs due to more persons passing assessments earlier in the filter sequence (given the lower risk persons are the ones most likely to participate).

The multi-phasic approach and filter model using modular components is a valid, useful, and probably the most cost-effective approach. The problems lie in creating the gradations to get a true screening (filter) effect, and then getting a true cross-section of the population. An alternative being considered is developing programs within the clinical community where persons thought to be at risk would be sent. This population would overstate the risk levels, but would provide a balance to the current self-selecting population.

## 5. PRE-POST TEST

The purpose of the pre-post test was to measure change in the interventions. The test measures attitude and knowledge toward driving. The test items were drawn from a series of existing survey instruments to insure there was an overlap with past work, and a way for relating the survey to prior results. The description of the process and sources for the questions was presented in Section 2. The following subsections provide: a summary of the findings on the attitude variables and then the knowledge variables, the pre-post test findings are then discussed, and a discussion of all the findings is presented at the end of the section.

The pre-post test correlation (reliability) was high ( $r=.847$   $p=.000$ ) which was true for both control and total population. The internal reliability also was high. The contribution of all items to the total scores as measured by correlations also was high (all items significant  $p<.01$ ). The pre-post test construction appeared consistent, reliable, and stable based on the analyses. These results were true for both the attitude and knowledge portions of the test.

### Summary of Attitude Questions

The attitude portion of the survey consists of 19 questions and 33 variables (several questions have multiple answers). The attitude questions are a mixture of types of questions which reflect different types of information about attitudes. The analysis process first identified the attitude items which would be used to measure change and those items which would be used to understand attitudes. The reason for the split was that it was determined that there were too many items for the survey size, and that many of the items could not be logically combined nor was it possible to create a total attitude score that had any meaning.

The process used created a number of combined variables which seemed logical. The list of combined and uncombined variables were then reviewed relative to the interventions and those most directly relating to the content covered were used for the pre-post change measure. The analyses looked at change across interventions for the total group and individual groups (interventions). An analysis also was made of the administration to control groups (no interventions).

Once these measures were selected, all the variables were evaluated. The evaluations reviewed the distribution of the items and also their change across interventions (groups) which are discussed in the pre-post subsection. The following is a description of the individual items in logical groupings (where Q# corresponds to the question number on the pre-post test, see Appendix A).

#### Attitude toward driving..

- Q1..Is a driver's license a right or privilege?.. 26.1% of the subject thought it was a right, 62.7% thought it was a privilege, and 5.2% did not care which it was.
- Q4..Cause of traffic accidents..60.1% felt they were in control, 7.6% thought chance was the cause, 30.3% felt accidents were due to circumstances beyond their control, 1.9% did not respond.

About 1 in 3 respondents thought driving was a right and accidents were out of their control. These responses suggest this proportion of the population appeared to exhibit some poor attitudes towards driving.

#### General driving issues..

- Q2..Evaluate national 55mph speed limit..66.8% felt 55mph was just right while 33.2% felt the limit should be increased.
- Q3..Safety of driving way below speed limit..93.4% thought it was unsafe and 6.6% though it was safe.

#### Driver reeducation..

- Q5..Willingness to take driver education, training, or retraining course.. 86.7% were will to take a course vs 13.3% who were not.

The strong positive willingness to take driver education, training, or retraining courses paralleled results compiled from ODSAI, MY-CODA, and the participation survey which are reported in other sections.

Understanding of age and driving..

- Q6..Judgmental abilities of drivers over 55 are poorer than for drivers below 40 ..10.9% strongly agreed, 27.0% slightly agreed, 19.4% had neutral opinions, 10.9% slightly disagreed, 31.3% strongly disagreed, and 0.5% did not answer the question.
- Q7..Reaction times of drivers over 55 relative to drivers under 40..25.1% strongly agreed, 41.7% slightly agreed, 8.1% were neutral, 12.3% slightly disagreed, 12.3% strongly disagree, and 0.5% did not answer the question.
- Q8..Difficult for drivers over 55 to learn or improve traffic safety..5.2% strongly agreed, 6.6% slightly agreed, 5.7% were neutral, 11.9% slightly disagreed, and 70.6% strongly disagreed.

In comparing attitudes on the three age effects, there were high awareness of change in reaction time and ability to learn and improve driving safety. There was a strongly lower proportion (1 in 3) who felt judgmental abilities decrease with age. The admission of problems in judgement, a core driving process, seemed not to be accepted.

Attitude toward own driving past to future..

- Q9..Driving compared to 5 years ago..14.2% said they were better, 79.2% indicated no change, and 6.6% said they were worse drivers.
- Q10..Driving relative to estimate of 5 years in future..3.8% felt they would be better drivers, 79.6% said they would not change, and 16.6% said they would become worse drivers in 5 years.

The respondents surveyed felt they were better drivers than five years ago, and over 80% said that they would be better or the same in five years. The suggestion is that the respondents either do not sense age-related changes or admit to them, or perhaps are adjusting which they feel makes them a better driver. Given the problems noted in judgmental changes with age, it would seem the former are the more likely reasons.

Self perception of driving age..

- Q11..Estimated age for not being able to drive..see below list
- Q12..Estimated age when will not want to drive..see below list

Age Range	Not Able(Q11)	Not Want(Q12)
60-64	1.4%	0.0%
65-69	4.7%	4.3%
70-74	6.2%	3.8%
75-79	19.0%	17.6%
80-84	23.2%	25.1%
85-89	19.0%	19.4%
90 and over	24.2%	27.5%
did answer	2.4%	2.4%

The interesting aspect of the above two variables is the close parallel in the percentages by age group between an estimate of not being able to drive and not wanting to drive. The suggestion is that the respondents project that when they are not able to drive, they will not want to drive. The issue is whether this perception holds up as the point of not being able to drive safely is reached, or whether the person pushes past this limit.

Decision to stop driving and reasons..

- Q13..Who should decide?..yes-no response to options were:
  - Driver...78.2%-21.8%
  - Doctor...56.9%-43.1%
  - Police..16.1%-83.9%
  - Family...46.9%-53.1%
  - DMV.....36.0%-64.0%
  - Other....3.3%-96.7%
- Q14..Age is the sole determinant..6.2% said yes and 93.8% said age should not be the sole determinant of determining when it is time to stop driving.
- Q15..Other than age what are determinants?..yes-no response to options were:
  - Health.....92.4%-7.6%
  - Need for Mobility..27.0%-73.0%
  - Accident record..76.8%-23.2%
  - Other transport....18.0%-82.0%
  - Other reasons.....6.6%-93.4%

The decision to stop driving generally was not viewed as age being the sole criteria. The respondents suggested that people feel they should make the decision, secondly the doctor and family, and finally the DMV or police department. The results suggested the respondents wanted a degree of control in the decision, and that as the decision moved farther away from them or persons with immediate involvement they saw it as less favorable. It also is interesting to note that a decision by police was by far the least favorable option.

Of the reasons to stop driving health and accidents were the most cited reasons. If these perceptions are maintained to the point at which the decision needs to be made, then logical reasons for stopping driving are favored. There is a concern that about one-quarter of the people included reasons of need for transportation and mobility as factors in determining the decision to stop driving. The proportion of these life style factors is large enough to consider how to address these perceptions in dealing with a person who needs to stop driving in the general population.

**Reexamination and licensure issues..**

**Q16..Age for requiring re-examination for licensure?**

Age Range	Choice
No age	36.5%
55-59	3.8%
60-64	4.3%
65-69	9.0%
70-74	14.2%
75-79	14.7%
80-84	9.0%
85-89	5.7%
90 and over	2.4%
did answer	.5%

**Q17..Type of periodic re-examination preferred?..yes-no response to options were:**

Eye test..65.4%-34.6%	Written test..27.5%-72.5%	All methods..25.1%-74.9%
Physical..15.2%-84.8%	Road test.....43.6%-56.4%	None.....5.7%-94.3%
		Comment.....7.1%-92.9%

**Q18..Would periodic exams cause threat or nervousness?..24.8% said they would be threatened or nervous and 75.2% said not.**

The age for requiring re-examination was normally distributed over the full range, after the respondents who indicated no specific age (just over a third of the respondents). In comparing the distribution of ages to the earlier discussion of when a person thought they would not be able to or not want to drive, those persons who indicated that age was a factor tended to indicate younger ages for re-examination than for when they would not want to or be able to drive.

The respondents were more willing to take an eye test (2/3rds) than any other method, and were rather negative toward a physical exam. Written tests were slightly preferred over the road test. One in four persons preferred all methods and about the same number said that they would be threatened or nervous.

In summary, about 1 in 3 respondents presented some suggestion of attitude problems relating to driving. Yet, most (86.7%) were willing to take a driver education or training course and indicated (70.6%) that there was a willingness and capacity to learn. The willingness to learn paralleled a sense of slowing of reactions with age (2 of 3 respondents), an understanding of the effects on judgement of age in relation to driving was not understood by 2 of 3 respondents. These findings must be of concern given similar findings from the ODSAI assessments were associated with a higher rate of traffic violations and accidents.

The respondent's projections on the age when they would not be able to drive or want to drive was similar. There was about a 20% decrease per five year period beginning at age 75, and about 1 in 4 placed that point at 90 or over. In light of other findings, there appears to be a proportion who underestimate (or deny) the effects of aging on their own driving.

The decision to stop driving was heavily focused on the driver themselves (4 of 5), and secondly the doctor and family (1 in 2). Police departments (1 in 6) and DMVs (1 in 3) were less favored. The results suggest people desire to maintain control of the decision process or have a high input or impact on the decision. The reasons for stopping driving were not age, but health and accident records being the most referenced (8-9 of 10 respondents cited). Of concern was the 1 in 4 respondents who included the need for mobility and transportation as factors in the decision.

Reexamination had 36.5% of the respondents stating age was not a factor in relicensure. About 10% of the group was added in 5 year increments from age 65 to 84 with 8.1% over age 85. The respondents indicated relicensure should be considered at earlier ages than when they thought they would want to drive or be able not to drive. Eye exams were the most cited preference for method of re-examination (65.4%) followed by road tests (43.6%). All the other methods were suggested by about 1 in 4 which is the same proportion that suggested all the methods be used which also is the same proportion of those who felt re-examination was threatening or would make them nervous. The data on the reexamination issue provides some interesting attitudes, but more analysis is needed to better understand the feelings reported.

### Summary of Knowledge Questions

A total score for the knowledge portion of the pre-post test was computed by summing the correct answers to the 31 knowledge questions. Only questions answered correctly were given a score, questions not answered were treated as if they were in error. The analysis for the knowledge portion of the pre-post test was the same as for the attitudes portion. As in the case of the attitude questions, the knowledge questions are separated into logical groupings. These groupings, the questions, and the responses are presented in Table 5.1.

The questions were correctly responded to in the pretest 56.3% of the time. As can be seen in Table 5.1, there was considerable item by item variation. The following discussion highlights the items whose differences are the greatest. The items used were from the pre-test since there were no significant post-test differences as discussed in the next subsection, the post-test scores will not be addressed in this subsection. The pre-test had the advantage of a larger N, 211 vs 176 for the post-test.

Only 1 in 3 respondents were correct about age-related issues which when related with the attitude issues that were noted as potential problems suggest at least 1 in 2 older drivers does not understand aging effects as much as would be desired. This problem is underscored when only 35.1% of the respondents were able to relate the increase use of mirrors with loss of hearing common to aging. These results when added to the problems on age related issues noted in the attitude items suggest more education is needed to help older people understand the changes they face.

The following distance measure for persons over 55 was only correctly answered by 34.6% of the people. The reason is that many of the respondents used the general rule of thumb for all ages cited in most driver's manuals. The AARP course recommends a slightly more conservative approach which when used as the correct answer caused most of the wrong answers. Accordingly, the result cannot be related to persons not knowing they need to adjust separation distance with speed.

Several other questions appeared to cause problems. The recognition of the passing zone control sign was correctly answered by only 1 in 3, as was the effect of large eye glass temples on side vision. Only 1 in 4 respondents knew how to react to a skid. It is likely sign shape and message are not associated, i.e., persons are textural versus iconic oriented. The lack of understanding of response to skids suggests a need for more education about the dynamics of driving (several other technical question also had relatively low correct responses).

Correlations of the items in the knowledge scale did not yield much added information. In general all items were correlated to total score ( $p < .01$ ) indicating a good test structure. The items with the lowest associations were the items with the lowest percentage correct.

Table 5.1 Summary of Knowledge Answers

Grouping/Question	% Correct
<b>Age related</b>	
Q23..Depth perception decreases with age.....	27.0
Q24..More accidents per mile over sixty.....	41.2
<b>Action in driving</b>	
Q20..Right of way situations.....	60.2
Q30..Entering a controlled access freeway.....	68.7
Q34..Passing in a two lane situation.....	70.1
Q38..Left turn from center of intersection - tire direction..	49.8
Q39..Exiting control access freeway.....	60.1
<b>Judgement in driving</b>	
Q26..Actions to be taken when driving in the rain.....	66.4
Q28..Actions in residential area, no sidewalks, and trees....	81.5
Q29..Action to take when freeway minimum speed is too fast...	66.7
Q31..Action when missing an exit on a freeway.....	92.9
<b>Driving mechanics knowledge</b>	
Q19..Reaction to skid.....	26.5
Q32..Vehicle action when making a left turn.....	55.5
Q37..Slow driving is dangerous after a crest of a hill.....	57.4
<b>Rules of road</b>	
Q21..Right-of-way when two vehicles approach an intersection	58.8
Q22..Yielding right-of-way at an uncontrolled intersection...	51.6
Q27..Recognizing sign for no passing zone.....	34.6
<b>Driving habits</b>	
Q35..Method for increasing visibility when backing-up.....	52.1
Q41..Following distance measure for drivers over 55.....	30.3
Q42..Checking blind spot procedure for changing lanes.....	63.5
<b>Alcohol use and abuse and driving</b>	
Q44..Temporary visual problems result from alcohol use.....	72.0
Q45..Amount of alcohol consumed in hour for .1% level.....	52.6
Q46..Alcohol factor in 50% of traffic deaths.....	56.9
Q47..As drink more alcohol driving ability steadily worsens..	77.3
Q48..Wait 1 before driving for each 1 oz of alcohol consumed	53.5
Q49..Time is the only method to sober up.....	68.6
<b>General knowledge about driving</b>	
Q25..Icy roads are most slippery at 32 deg F.....	54.0
Q33..Night time smoking may cause windshield reflection.....	41.7
Q36..Eyeglasses with heavy temples can restrict side vision..	31.5
Q40..Find out effects of medication on driving.....	79.2
Q43..Use of all mirrors more important with hearing loss.....	35.1

Pre-test scores were used for this table, N=211.



### Change Pre To Post

The pre-post change was reviewed by group, items within both the attitudes and knowledge sections, combinations of similar items within the groups, and combinations thereof. There were no significant differences found pre-post in any attitude measure or between the groups. The result is not particularly surprising as attitudes are difficult to change and the interventions used were one time events. This finding does not counteract specific findings about the attitudes discussed above. The remainder of this discussion of the pre-post test results will address the knowledge portion of the test.

The general statistics for the total pre and post test scores are presented in Table 5.2. The mean and medians are similar illustrating the approximately normal distributions for the scores. The plots for the variables showing the distributions are presented in Appendix I (Figures I.2 through I.4) which are approximately normal as is indicated by the closeness of the mean and median in the pre and post tests. A small tail was found on the pre-test between 3 and 6 correct.

Table 5.2. General Statistics Pre & Post Tests

Variable	N	Msg	MEAN	MEDIAN	STDEV	MIN	MAX
Total Pre Test	210	4	17.486	18.000	6.474	2	30
Total Post Test	176	38	19.892	20.000	5.242	4	30
Difference	175	39	1.354	0.000	3.202	-6	15

On average, the difference between the pre and post test scores was 1.35. The range was 2 to 30, with change scores ranging from -6 to 15 with most being within +/- 3 of the median. There were many more cases with positive gains from pre to post tests.

The total scores statistics for pre and post tests is presented in Tables 5.3 and 5.4. The mean for the pre-test for Group 3 was nearly 6 points lower than the other groups. The post-test score for this group rose to about the same as the other groups. Based on an analysis of variance there was no intergroup difference for the post-test, but a significant ( $p=.000$ ) intergroup difference on the pre-test. The difference noted on the pre-test was the lower score for Group 3 defined earlier.

Table 5.3. Total Score Pre-Test Statistics by Group

GROUP	N	Msg	MEAN	MEDIAN	STDEV	MIN	MAX
1	79	1	18.468	18.00	5.007	2	30
2	44	2	19.341	19.00	5.758	4	29
3	47	1	12.87	12.00	7.13	3	29
4	5	0	13.20	13.00	9.28	3	23
5	9	0	22.33	26.00	7.62	8	30
6	20	0	20.300	21.00	3.85	14	25
7	6	0	14.00	13.50	6.03	6	22

A pre-post change was found in only in Group 3 on the knowledge items, the folks who took both the ODSAI and AARP course. The folks who only took the ODSAI did not show any pre-post change (Group 2). The Texas groups (4 and 5) who took both the ODSAI and AARP and then were exposed to the simulator also did not show a significant change. The SFSU Simulator Group (6) did not show any change, but they were only exposed to the ODSAI and the simulator and also started with a higher score (an average of 11 incorrect).

Table 5.4. Total Score Post-Test Statistics by Group

GROUP	N	Msg	MEAN	MEDIAN	STDEV	MIN	MAX
1	66	14	19.621	19.000	4.353	9	29
2	43	3	19.674	19.000	5.22	6	29
3	31	17	19.55	21.00	6.07	6	29
4	5	0	16.00	21.00	8.19	4	23
5	9	0	23.78	27.00	7.56	11	30
6	20	0	20.800	22.000	4.21	13	28
7	2	4	22.00	22.00	4.24	19	25

The pre-post change on the knowledge items was found only in Group 3, the folks who took both the ODSAI and AARP course. The folks who only took the ODSAI did not show any pre-post change (Group 2). The Texas groups (4 and 5) who took both the ODSAI and AARP and then were exposed to the simulator also did not show a significant change. The SFSU Simulator Group (6) did not show any change, but they were only exposed to the ODSAI and the simulator.

The impact of the ODSAI on the pre-post test measure is not that surprising. Fifteen items are covered most of which deal with skills. The person is asked to read information for items to which they did not provide the correct response. Typically a person would have to review only 2 to 5 items. The pre-post knowledge test had 31 items so the effect of the intervention could not have been very great.

The simulator was expected to only have marginal impact on the knowledge items. There are no specific knowledge issues addressed, but rather some general information and an assessment of driving and driving-related skills. It had been hoped that more impact on attitudes would have been observed.

One of the problems is that the analysis of the attitude items is less clear cut than the knowledge items. The knowledge items have right and wrong answers, the attitudes simply express how a person feels. Combinations or like items were combined into groups and evaluated; age and driving (questions 6-8), attitude toward driving (questions 2-6), locus of control (questions 13-18). There were no pre-post or group differences found for the combinations. Further work is planned on the analyses to determine if the combinations are viable, what information they might yield, and how they relate to the other scales used.

Group 3 (ODSAI and AARP Course) which showed a difference on the knowledge pre-post test differed by approximately 4 correct answers from the other groups and was significant ( $p=.000$ ). This group was composed of two parts: a group in Texas and a group in San Francisco. The analyses showed the difference found was attributed to the San Francisco portion of the group which changed by a mean of 7 correct answers (mean difference for the Texas portion of the group was .4). This brings up the point that AARP courses may differ between locations and/or instructors.

Six AARP instructors in the Texas area who were going to be involved took the pre-test, MY-CODA, and ODSAI. A formal analysis of such a small number could not be undertaken, but the review and evaluation showed that the instructors did poorer on the knowledge test and ODSAI, exhibited poorer attitudes toward driving, and reported some unfavorable driving characteristics, habits, and performance on the MY-CODA. The poorer results noted in the Texas portion of Group 3 and the lack of difference in Groups 4 and 5 (although smaller) may be attributed to the quality of the course. Although this information is anecdotal, it suggests that there may be variability in courses provided and their value to participants.

## Discussion

Both tests appeared stable and reliable. The results of the pre post testing revealed few significant differences. It appeared only the AARP class at one site (San Francisco) was effective in changing the pre post test scores significantly. In all the groups in Texas, there was no significant pre-post change. This result suggested that there might be a large dependence on the instruction being given.

The main simulator group showed no pre-post change. The group started with one of higher mean scores and improved slightly, but not at a significant level. Only 10 questions on average were missed and some of which were missed by most persons (6 items were missed by approximately 1 in 3 persons) which makes it less likely that the group could have improved. Overall it had not been expected that the simulator would make much difference on attitudes or knowledge. It was used for assessment and some limited skill training, and did a priori address knowledge issues. The concern is more that the ODSAI intervention did not help with pre-post change, and will be reviewed in detail in the next subsection.

The mean total correct score was just over 50%. Given most of the items were multiple choice, this would suggest the scores were more than simple guessing. The higher scores were in the more educated groups which would support this conclusion. The impact on attitudes had hoped to be greater, but realistically it is hard to expect much change in attitudes as a result of a 45 minute assessment.

The individual items were more interesting. It appeared there was some need in improvement in attitudes toward driving in about 1/3rd of the group. There was an underestimation of effects of age on judgement although other dimensions of aging were better understood. Age was not seen as a reason for stopping driving, but health and increase in accidents were cited reasons. There were about 1 in 4 persons who felt that they should factor mobility and transportation needs into the decision when to stop driving. The respondents favored more control over the decision to stop driving either themselves (8 in 10) or family or doctor (1 in 2 cited), but were much less agreeable to police departments (1 in 6) or DMVs (1 in 3) making the decision.

When age was considered in a decision (for example, no longer wanting to or having to stop driving) the respondents tended to cite older ages with nearly half suggesting ages over 85. The re-examination age cited was lower with about 10% increases from age 65 to 85. There was some awareness of a need for re-examination, but it did not translate into the same age for making decisions about stopping driving. Age-related questions on the knowledge portion of the test were some of the most frequently missed with an average of only 1 in 3 respondents answering correctly. These results suggest there must be some concern that older drivers are not being effectively reached by present educational methods.

## 6. OLDER DRIVER SELF-ASSESSMENT INVENTORY

The background for the DRIVERS 55 PLUS instrument (referred to as the Older Driver Self-Assessment Inventory or ODSAI herein) (Malfetti & Winter 1986, ref. 72) was described in Section 2. It is a 15 item self-rated questionnaire that assesses older drivers risk level, self scores, and includes suggestions and comments for each item. The summary score is rated as pass (score 0-15), caution (score 16-34), and serious concerns (score 35 and above). The ODSAI was administered to 131 subjects as described in the design. The results of that administration are described in this section in the following format:

1. description of the sample,
2. presentation of the variables used,
3. analysis of the ODSAI item answers and total score,
4. relationship of ODSAI score to that predicted from MY-CODA, and
5. discussion of results.

### Sample Description

The 131 persons who took the ODSAI were a subsample of the study. The control groups (Group 1) took no interventions and thus were not administered the ODSAI. The 3 persons in Group 7 at the Texas site were not administered the ODSAI. The Maryland group (#7) were not included in the analysis in this report and accordingly the ODSAI scores are not included. The following paragraphs provide an overview of the sample who were administered the ODSAI. The significance of correlations for this sample size is described in Figure I.1 in Appendix I.

Of the groups included in the sample, there were differences noted by age, education, activity score, and well-being. The difference mainly was traced to the San Francisco State University Simulation Group (#6) which was more educated ( $r=.217$ ,  $p<.01$ ), was younger ( $r=-.192$ ,  $p<.05$ ), was slightly more active, and reported slightly less well-being ( $r=.133$ ). The difference in means by group for each variable is presented in Table 6.1.

Table 6.1. Group Means for ODSAI Subsample

Variable	Group 2	Group 3	Group 4	Group 5	Group 6	Group 7
N	46	48	5	9	20	3*
Age	63.5	64.0	68.6	65.8	56.5	66.7
Education	4.7	4.7	3.6	5.9	6.3	2.7
Activity Score	517	601	498	823	504	1089
Well-Being **	25.0	25.0	25.6	27.4	25.4	27.0

\* Without Maryland sample of 40, \*\* difference in means not significant.

The general demographics of the sample are summarized in Table 6.2. The mean age was 63.1 years with a range of 43 to 87 years and had an approximately normal distribution. There were 61 women and 70 men in the sample. The average educational level of the subjects was Junior College or Some College, but overall nearly half the group were college graduates of which over half had some graduate school training (7.1% did not finish high school, 28.4% completed high school, 17.6% had education beyond high school, 22.9% finished college, and 25.4% had graduate training).

Table 6.2. ODSAI Demographic Variables Distributions

Variable	Mean	Median	Min	Max	Std. Dev.
Age	63.1	63.0	43	87	0.709
Sex	1.53	2	1	2	0.044
Income	4.57	5	1	6	1.660
Education	4.94	5	1	7	1.779

The mean income reported was between \$30,000 and \$40,000. The subject's income was skewed to the upper income group; 7 (5.34%) <\$5,000, 14 (10.69%) >=\$5,000 and <\$10,000, 17 (12.98%) >=\$10,000 and <\$20,000, 15 (11.45%) >=\$20,000 and <\$30,000, 16 (12.21%) >=\$30,000 and <\$40,000, and 62 >=\$40,000. The skewing of the distribution in part was forced by categorizing everyone with a \$40,000 or greater income into one group.

#### Variables Used

Given the large number of variables in the various instruments, a review was held and a small number were selected for use. The selection process was based on the potential influence on the total score. The variables were selected from MY-CODA. The following is a listing of those variables and their coding including the MY-CODA question number (shown as Q#).

- o Age (Q1)..reported in years
- o Sex (Q2)..coded as 1= female and 2 = male
- o Education level (Q6)..coded as 1=elementary school, 2=junior high school, 3=high school, 4=technical/vocational school, 5= junior college or some college, 6= college, and 7=graduate school,
- o Income (Q14).. "What was your total annual income (all sources including social security) for you (and your spouse, if married) for the last year?" ..coded as 1=0-\$4,999, 2=\$5,000-\$9,999, 3=\$10,000-\$19,999, 4=\$20,000-\$29,999, 5=\$30,000-\$39,999, and 6=\$40,000 or more,
- o Years licensed to drive (Q19a).. "How many years have you been licensed to drive an automobile?" ..coded as 1=never, 2=not now licensed, 3=less than 1 year, and 4=more than one year,
- o Number of years licensed to drive (Q19b)..actual miles recorded in hundreds and less than 1 year coded as 1 and not licensed coded as 998 with missing coded as 999,
- o Miles driven in past year (Q34).. "How many miles have you driven in the past year?" ..recorded in hundreds of miles with 999 as missing,
- o Last read drivers manual (Q110).. "When did you last read the driver's manual for your state?" ..coded as 1=never, 2=in last 6 months, 3=in the last year, 4=in the last 2 years, 4=in the last 3 years, 5=4 or more years ago,
- o Informed on rules and regulations (Q111).. "How well informed are you about the current rules and regulations in your state?" ..code as 1=very well informed, 2=fairly well informed, 3=not very well informed, and 4=not at all informed,
- o Activity score (Q152-168),, There are 17 activity items on page 18 of MY-CODA whose frequency are selected and scored as 1=0 x per year, 2=1 to 2 x per year, 3=1 to 2 x per month, 4=1 to 2 x per week, and 5=3+ x per week..the responses were scored according to the following rules to produce a score base on a yearly count and then summed across the 17 items to produce a total activity count for the year..  
if response=1 multiply by 0,  
if response=2 multiply by 1,  
if response=3 multiply by 20,  
if response=4 multiply by 80, and  
if response=5 multiply by 200..  
the higher the score the more active the person,
- o Well-being (Q170-179)..These 10 questions ask about attitudes and feelings toward life and were score 1=yes, 2=sometimes, and 3=no..the scoring on item 173 was inverted (positive item vs other 9 being negative) and the responses summed..the lower the score the poorer the sense of well-being,
- o Overall outlook on life (Q181).. "Taking everything into consideration, how would you describe your satisfaction with your life at the present time?" ..code 1=excellent, 2=very good, 3=good, 4=fair, and 5=poor,
- o Health stand in way (Q181).. "Does your health stand in the way of things you want to do?" ..code 1=frequently, 2=sometimes, 3=seldom, and 4=never, and
- o Health now (Q187).. "Rate your health at the present time." ..coded..1=excellent 2=very good, 3=good, 4=fair, and 5=poor.

The question addressing whether a person would be willing to take a driver education or retraining course (Q5 on the pre-post test) was included in the selections, but was dropped. Most of the persons (119 of 131) responded yes to

the question. The coding of years driven also was dropped, because 127 of 131 subjects reported more than 1 year.

The general profile of the demographic variables (age, sex, education, and income) was described in the preceding subsection. The mean number of years driving was 39.5 (median 42.0) and was approximately normal except for a small tail in the range under 15 years. The overall range was 3 to 65 years. Overall the respondents were experienced drivers most of whom drove most of their adult lives (approximately 90%).

The subjects reported they drove from 100 to 50,000 miles per year. The mean was 9,530 miles and the median was 8,462 miles indicating a slightly skewed distribution. The skewing is due to the range from 100 to 9,530 being smaller than the range from 9,530 to 50,000 (the tail is on the end of more miles). If the seven highest mileages are removed, the distribution becomes approximately normal (StdDev=7.95 without removing the upper values). These responses indicate the subject were active drivers most likely within the confines of their communities with occasional longer trips.

The response to the question of when the subjects last read their state's driving manual produced a fairly even distribution of answers across all categories except "never" (only 4 persons). The categories and percent responding were: in the last - 6 months (16.0%), 1 year (22.9%), 2 years (19.1%), 3 years (14.5%), or 4 or more years ago (24.4%). The subjects felt they were either very well informed (33.9%) or fairly well informed (63.1%) versus only 3% feel they not very well or not informed. The people responding to ODSAI were positive about their understanding of driving rules and regulations.

The activity scores ranged from a minimum of 10 to a maximum of 2120 with a mean of 579 and a median of 513. The distribution was normal with a few outliers above a score of 1200. The score is the approximate number of days the person participated in the list of activities in one year. The group on average participated in nearly 2 activities per day which suggests a moderately active group of persons.

The well-being measure scores ranged from 11 to 29 (1 above and below the limits). The scores were skewed toward the upper end of the range (mean 25.2 and median 26). The higher scores indicated a better sense of well-being. The well-being scores approximated the distribution of the subject's reported general outlook on life (including distribution) where 73.1% reported excellent or very good satisfaction with life versus 18.5% good, and 8.5% fair or poor.

The subjects reported that health prevented them from doing activities almost equally between sometimes (37.7%), seldom (33.1%), and never (36.2%). Only 3.1% reported they were frequently stopped from their activities by their health. Health did have an influence, 73.8% report some prevention of activities by their health, yet the subjects saw their health as good to excellent. In their rating of their current health, 66.1% reported excellent or very good health, 35.3% reported good health, and only 8.4% reported fair or poor health.

Relationships between the variables provides a further overview of the respondents. Of the variables used only sex had no significant correlations. The following is a description of correlations by variable and some general comments about the subjects suggested by the correlations (significances are provide in Table I.1 of Appendix I) only those correlations at or above  $r=.100$  ( $p=.25$ ) are presented ( $p$  values are presented only to the .05 level).

#### Age..

Education.. $r=-.228$   $p<.01$ , older persons were less educated

Income.. $r=-.303$   $p=.00$ , older persons had less income

Years driven.. $r=.499$   $p=.00$ , expected - older persons have driven more years

Informed.. $r=-.285$   $p<.01$ , older persons felt less informed on highway rules and regulations

Well-being.. $r=.292$   $p=.00$ , older persons had higher sense of well-being.

The only surprise is the increase in sense of well-being with age. Although being older correlated significantly with feeling less informed on highway rules and regulations, there was no correlation to reading or not reading the state driver's manual.

#### Education..

Age..r=-.228 p<.01, more educated were younger  
Income..r=.624 p=.00, more educated had higher incomes  
Years driven..r=.180 p<.05, more educated drove more years  
Activity score..r=-.151..more educated were less active  
Well-being..r=.201 p<.05, more educated sensed higher well-being  
Health now..r=-.200 p<.05, more educated reported better current health.

#### Income..

Age..r=-.303 p=.00, higher income persons were younger  
Education...r=.624 p=.00, higher income persons were more educated  
Years driven..r=.328 p=.00, higher income persons drove more  
Miles/year..r=.227 p<.01, higher income more miles driven per year  
Activity score..r=-.143 p=.10, higher income lower activity score  
Well-being..r=.282 p<.01, higher income higher sense of well-being  
General outlook..r=-.191 p<.05, higher income better general outlook on life  
Health stops..r=.181 p<.05, higher income less health stops activities  
Health Now..r=-.342 p=.00, higher income better current health.

The education and income variables had many of the same correlations, which given their high correlation (r=.624) would be expected. Age also is highly correlated to both. The younger, more educated, and higher income the higher the sense of well-being, health now, and less likely to have activities stopped by health; and also the more miles driven. The one area that was inverted was the lower number of activities reported.

#### Years driven..

Income..r=.328 p=.00, more years driven a higher income  
Miles/year..r=.169 p=.051, more years driven more miles driven per year  
Last read drivers manual, r=.125, more years driven less recently read state driver's manual  
Informed..r=-.201 p<.05, more years driven more informed on highway rules and regulations  
Well-being..r=.411 p=.00, more years driven a greater sense of well-being  
General outlook..r=-.216 p<.01, more years driven the better the person's satisfaction with life  
Health stops..r=.103, more years driven the less health stops activities  
Health now..r=-.171 p=.05, more years driven better current health.

The longer the person drives the longer since they have read their state driver's manual and the more informed they felt about highway rules and regulations. These correlations suggest an investigation of age and education on driving - the longer they drive the less they keep current and yet feel more informed. The longer the person drove the better their sense of well-being, satisfaction with life, and current health which is consistent with earlier results, but is counter-intuitive to expectations for age.

#### Miles driven per year..

Income..r=.222 p<.01, more miles were driven by higher income subjects  
Years driven..r=.169 p=.051, more miles driven the more years of driving  
Last read drivers manual..r=.100, more miles driven longer since read the state driver's manual  
Informed..r=.110, more miles driven the lower the sense of being informed on highway rules and regulations  
Health stops..r=.183 p<.05, more miles driven the less health stops activities.

The indication that the more miles driven was related to less health stopping activities is probably caused by the association between miles driven per year and number of years driving (a carrier variable associated with age).

#### Last read driver's manual..

Years driven..r=.125, longer since read more years driven  
Informed..r=.243 p<.01, longer since read the less sense of being informed on highway rules and regulations  
Activity score..r=-.144, longer since read the lower the activity score  
General outlook..r=.167, longer since read the poorer the life satisfaction

The correlation of the time since the subject read the drivers manual and their sense of being informed about highway rules and regulations supports an argument for more older driver education. The activity score and general outlook are likely caused by the association with years driven (a carrier variable associated with age).

#### Informed..

Age..r=-.285 p<.01, more sense of being informed the younger the subject  
Income..r=.117, more sense of being informed the less income  
Years driven..r=-.201 p<.05, more sense of being informed more years driven  
Last read driver's manual..r=.243 p<.01, less sense of being informed longer since read the state driver's manual  
Activity score..r=-.290 p=.00, more sense of being informed more activities  
Well-being..r=-.292 p=.00, more sense of being informed greater sense of well-being  
General outlook..r=.319 p=.00, more sense of being informed better the persons life satisfaction  
Health now..r=.167 p=.054, more sense of being informed better the persons current health.

Similar profile for the "informed" as the "last driven" variable above.

#### Activity score..

Education..r=-.151, more activities less education  
Income..r=-.143, more activities less income  
Last read driver's manual..r=-.144, more activities more sense of being informed about highway rules and regulations  
Informed..r=-.290 p=.00, more activities higher sense of being informed  
Well-being..r=.116, more activities lower sense of well-being  
General outlook..r=-.190 p<.05, more activities better life satisfaction  
Health stops..r=.132, more activities less health stops activities  
Health now..r=-.219 p<.05, more activities the better current health.

The correlations except for "being informed" and wellness and health variables were not significant. More activities are related to better health and outlook, but not well-being which suggests it is measuring a different dimension of life. Interestingly, age is not related to activity score.

#### Well-being..

Age..r=.292 p=.00, a sense of well-being increases with age  
Education..r=.180 p<.05, a sense of well-being increased with education  
Income..r=.282 p=.00, a sense of well-being increased with income  
Years driven..r=.411 p=.00, a sense of well-being increased with the number of miles driven per year  
Informed..r=-.292 p=.00, a sense of well-being increased with a sense of being informed on highway rules and regulations  
Activity score..r=.116, a sense of well-being decreased with activity  
General outlook..r=-.554 p=.00, a sense of well-being increased with a satisfaction with life  
Health stops..r=.416 p=.00, a sense of well-being increased with more reports of health stopping activities  
Health now..r=-.394 p=.00, a sense of well-being increased with better current health.

The sense of well-being is highly correlated with a number of variables. Age, education, income, years driven, being informed on highway rules and regulations, and activity score were discussed above. The combination of age, income, and education appear to reflect one single dimension, and years driven is a carrier variable for age. The opposing directions of well-being and activity level is surprising, but the correlation is not significant and approaches p=.24 which makes it suspect. The more reports of health stopping activities increases with well-being perhaps reflecting an expectation. Life satisfaction and current health were strongly associated with a sense of well-being.

#### General outlook (life satisfaction)..

Age..r=-.167 p=.054, life satisfaction increases with age  
Income..r=-.191 p<.05, life satisfaction increases with income  
Years driven..r=-.216 p<.01, life satisfaction increases with years driven  
Last read driver's manual..r=.167 p=.054, life satisfaction was higher for



persons who more recently read their state driver's manual  
 Informed..r=.319 p=.00, life satisfaction was higher for persons whose sense  
 of being informed of highway rules and regulations was higher  
 Activity score..r=-.190 p<.05, life satisfaction increased with activity  
 Well-being..r=-.554 p=.00, life satisfaction increased with a sense of  
 well-being  
 Health stop..r=-.375 p=.00, life satisfaction increased with a decrease in  
 reports of health stopping activities  
 Health now..r=.554 p=.00, life satisfaction increased with current health.

The correlation of life satisfaction and last reading state driver's manual  
 and a sense of being informed on traffic rules and regulations is expected to be  
 a result of the correlation of age and income with life satisfaction. Activity  
 score was associated with life satisfaction, whereas, well-being and activity  
 score were not suggesting a measure of two different factors. Well-being and  
 current health were highly associated with life satisfaction.

#### Health stops activities..

Income..r=.183 p<.05, more stoppages with lower income  
 Years driven..r=.103, more stoppages with lower number of years driven  
 Miles/year..r=.183 p<.05, more stoppages with lower number of miles driven  
 Activity score..r=.132, more stoppages with higher activity score  
 Well-being..r=.416 p=.00, more stoppages with higher sense of well-being  
 General outlook..r=-.375 p=.00, more stoppages with less life satisfaction  
 Health now..r=.513 p=.00, more stoppages poorer current health

The associations suggested that health stopping activities was related to  
 higher activity scores and sense of well-being, but less life satisfaction and  
 a poorer current health. If you were more active, the subjects apparently were  
 more likely to sense health getting in the way of their activities and was  
 reflected in a higher sense of well-being (associated with activity). Yet if  
 there was increase in reports of health stopping activities, there was an  
 association with less life satisfaction and poorer current health.

#### Health now..

Education..r=-.200 p<.05, better current health the more education  
 Income..r=-.342 p=.00, better current health the more income  
 Years driven..r=-.171 p=.05, better current health the more years driven  
 Informed..r=.167 p=.054, better current health the more informed  
 Activity score..r=-.219 p<.05, better current health the more activities  
 Well-being..r=-.319 p=.00, better current health more sense of well-being  
 General outlook..r=.554 p=.00, better current health better life satisfaction  
 Health Stop..r=.513 p=.00, better current health less stoppages

The suggestions are that current health is strongly associated with activi-  
 ty, well-being, life satisfaction, and less health stoppages.

Overall the lack of influence of age on most factors other than demographic  
 suggests that age is not strongly associated with functioning and behavior  
 within this active age group. It appears that it is important to separate the  
 well elderly who live independent and drive from the less involved. It also is  
 possible that the self-selection of the sample discussed in a later section may  
 have increased the effect of this result. Also gender did not have much of an  
 impact. Both also were not associated with the ODSAI total score.

#### Analysis Of ODSAI Items and Score

The ODSAI was scored using the standard algorithm. The score was normally  
 distributed as is evident in the histogram in Figure 6.1. The distribution was  
 checked against computed normal scores first by using a normal probability plot  
 to determine if the normal and actual distributions formed a straight line.  
 They appeared straight (meaning a normal distribution), and a regression of the  
 actual versus computed scores indicated a normal distribution (R-sq=99% with  
 P=.00).

The mean score was 16.37, the mode 16, the standard deviation 0.788, the  
 minimum score was 0, and the maximum score was 45. Of the 131 subjects, 65  
 passed (49.6%), 63 scored a caution (48.1%), and 3 (2.3%) scored a serious  
 concern. Age and sex did not have a bearing on the pass-caution-serious rating

and income was only moderately inversely correlated ( $r=-.161$ ,  $P=.066$ ,  $R-sq=2.6\%$ ,  $b=.053$ ) as was number of years the person had driven ( $r=-.154$ ,  $P=.074$ ,  $R-sq=2.4\%$ ) and their activity level ( $r=-.124$ ,  $P=.158$ ,  $R-sq=1.5\%$ ). The suggestion is that the person who was more likely to pass had a higher income, drove for a longer period, and was more active.

Score	Count	Number of Cases
0-2	9	
3-7	7	
8-12	30	
10-17	25	
18-22	32	
23-27	14	
28-32	6	
33-37	7	
38-42	0	
43-47	1	

Total n=131

Figure 6.1 Histogram of Total Score

A summary of the item scores are provided in Table 6.3. The response columns indicate the person's responses to the questions indicated as 1, 2, or 3 as described above. The score columns provide the translations to scores. Both counts and percentages are provided for each item.

The items can be grouped by the amount of difference provided by the persons responding. For example, the first item (signalling and checking to the rear on lane changes) had 90.8% of the subjects responding in a positive manner which means that only 13 of 131 persons did not respond correctly. The result suggests few persons report having this bad driving habit, but also that the question does not forcefully separate persons with good and bad driving habits. The items were then separated into three groups based on the contribution to the score 85-100%, 65-84%, and 0-64%. The organization of the groups was:

85-100% Group..

- Item 10 (92.4%)..I get regular eye checks to keep my vision at its sharpest.
- Item 11 (91.6%)..I check with my doctor about effects of my medications.
- Item 1 (90.8%)..I signal and check to the rear when I change lanes.
- Item 12 (87.0%)..I try to stay abreast of information on health.

65-84% Group..

- Item 2 (83.2%)..I wear a seat belt.
- Item 3 (82.5%)..I try staying informed about driving and highway regulations.
- Item 15 (74.4%)..Number of traffic violations or "discussion" with officer.
- Item 8 (70.2%)..My thoughts wander when I am driving.
- Item 13 (68.7%)..My children and family are concerned about my driving.
- Item 14 (64.9%)..Number of traffic accidents in the last two years.

0-64% Group..

- Item 9 (61.1%)..Traffic situations make me angry.
- Item 5 (58.0%)..It is difficult to decide when to enter a busy highway.
- Item 4 (52.7%)..Intersections bother me - too much to watch for.
- Item 6 (52.7%)..I feel slower in reacting to dangerous driving situations.
- Item 7 (35.9%)..When I am upset I really show it in my driving.

These grouping indicate that 5-8 items contribute most to the scores. The first grouping (85-100% correctly responding) have little discrimination. The items have the most discrimination relate mainly to information processing functions and behavioral factors (0-64% group). These factors were felt to be the most important based on an analysis of the project's driving model (Figure 1 in Section 1) and are the least understood. The 65-84% grouping items relate mostly to driving characteristics and outcomes. The items in the 85-100%

correct range mainly are information and high visibility safety items (seat belts and looking to the rear and signalling on lane changes).

Table 6.3. ODSAI Response and Scores By Item

Item #	Response (#/pct)			Score (#/pct)			Response	
	1	2	3	0	3	5	Mean	Median
1	118 90.8	13 9.2	- 0.00	118 90.8	- -	13 9.2	1.09	1
2	109 83.2	18 13.7	4 3.1	109 83.2	- -	22 16.8	1.20	1
3	108 82.5	21 16.0	2 1.5	108 82.5	21 16.0	2 1.5	1.20	1
4	15 11.5	47 35.9	69 52.7	69 52.7	47 35.9	15 11.5	2.41	3
5	5 3.8	50 38.2	76 58.0	76 58.0	50 38.2	5 3.8	2.54	3
6	16 12.2	46 35.1	69 52.7	69 52.7	- -	62 47.3	2.40	3
7	7 5.3	40 30.5	84 64.1	47 35.9	- -	84 64.1	2.59	3
8	7 5.3	32 24.4	92 70.2	92 70.2	32 24.4	7 5.3	2.64	3
9	6 4.6	45 34.3	90 61.1	90 61.1	45 34.3	6 4.6	2.56	3
10	121 92.4	5 3.8	5 3.8	121 92.4	5 3.8	5 3.8	1.11	1
11	120 91.6	4 3.1	7 5.3	120 91.6	- -	11 8.4	0.92	1
12	114 87.0	11 8.4	6 4.6	114 87.0	11 8.4	6 4.6	1.18	1
13	28 21.7	13 9.9	90 68.7	90 68.7	13 9.9	28 21.7	2.47	3
14	85 64.9	21 16.0	25 19.1	85 64.9	21 16.0	25 19.1	1.54	1
15	104 74.4	12 9.2	15 11.4	104 74.4	- -	27 20.6	1.32	1

N=131. Item 11 was scored 0 for no medications; 0 and 1 counts were summed

Correlations were computed between items and generally supported the observations from the grouping reported above. The correlations between items that were significant are noted below and also values between  $r=.100$  or  $p<.25$  and significance at .05 level  $r=.171$ . The probabilities for correlations for an  $N=131$  are presented in Table I.1 of Appendix I. If the associations are inverted they also are noted, where one item adds to the score and the other does not. Each item will be followed by a brief discussion of the associations.

- Item 1..Signal and check to the rear,  
 Item 12 ( $r=-.120$ )..Information on health (inverse)  
 Item 13 ( $r=-.191$   $p<.05$ )..Family concerned.

Signalling and checking to the rear was not significantly associated with either total score or most items. Most persons (90.8%) said they always signaled and checked to the rear and no one said never. The item does not appear to add much discrimination. The only significant item correlation was to family being concerned about driving which may reflect an association between observation of this bad habit and a concern about their driving.

- Item 2..Wear seat belt,  
 Item 7 ( $r=-.338$   $p=.00$ )..Upset shows in driving  
 Item 8 ( $r=.229$   $p<.01$ )...Thoughts wander (inverse)  
 Item 9 ( $r=-.131$ )..Traffic situations anger  
 Item 10 ( $r=-.115$ )..Regular eye checks (inverse)  
 Item 12 ( $r=-.153$ )..Information on health (inverse)  
 Score ( $r=.134$ )

Wearing a seat belt was not significantly correlated with total score. The inverse relationship between thoughts wandering and not wearing a seat belt would not be expected and suggests an intervening variable other than memory. It is to note that the more upset and angry subjects tended to report they wore a seat belt.

- Item 3..Informed on regulations,  
 Item 4 ( $r=-.137$ )..Intersections are bothersome  
 Item 10 ( $r=.358$   $p=.00$ )...Regular eye checks  
 Item 13 ( $r=.241$   $p<.01$ )...Family concerned (inverse)  
 Item 15 ( $r=-.160$ )..Traffic accidents (inverse)  
 Score ( $r=.173$   $p<.05$ )

If the subject reported they were informed on regulations, they were more likely to have eye checks suggesting a person's sense of responsibility. The inverse relationship to family concern suggests that there is perhaps a compensation for reporting being informed if there is a sense of family concern.

- Item 4..Intersection are bothersome,  
 Item 3 ( $r=-.137$ )..Informed on regulations  
 Item 5 ( $r=.522$   $p=.00$ )...Interstate highway meld decision  
 Item 6 ( $r=.370$   $p=.00$ )...Slower reactions  
 Item 8 ( $r=.211$   $p=.01$ )...Thoughts wander  
 Item 9 ( $r=.124$ )...Traffic situations anger  
 Item 10 ( $r=.101$ )...Regular eye checks (inverse)  
 Item 11 ( $r=-.123$ )..Effects of medication  
 Item 12 ( $r=-.171$   $p=.05$ )..Information on health  
 Item 13 ( $r=.128$ )...Family concerned (inverse)  
 Item 14 ( $r=-.270$   $p<.01$ )..Traffic violations  
 Item 15 ( $r=-.155$ )..Traffic accidents  
 Score ( $r=-.585$   $p=.00$ ).

This item is one of the stronger and more interesting items and underscores the importance of decision making and information processing strategies particularly when the high correlations are noted to problems with interstate highway meld decisions and slower reactions. A moderately strong association existed between traffic accidents and violations and having difficulty with intersections.

- Item 5..Interstate highway meld decision,  
 Item 4 ( $r=.552$   $p=.00$ )..Intersections are bothersome  
 Item 9 ( $r=-.118$ )..Traffic situations anger  
 Item 11 ( $r=-.100$ )..Effects of medication  
 Item 13 ( $r=.202$   $p<.05$ )...Family concerned (inverse)  
 Item 14 ( $r=-.346$   $p=.00$ )..Traffic violations  
 Item 15 ( $r=-.176$   $p<.05$ )..Traffic accidents  
 Score ( $r=-.478$   $p=.00$ ).

This item parallels the findings for item 4. Decision making and information processing are difficult functions for the older driver. There was a high

correlation with total score. The association between the decision making to meld into interstate highways and traffic violations and accidents was strong suggesting the potential predictiveness of the information processing and decision making decrements on future safe driving behavior. The inverse relationship to family concerns again reappeared as it did in the preceding item addressing problems with intersections.

Item 6..Slower reactions,  
Item 4 ( $r=.370$   $p=.00$ )...Intersections are bothersome  
Item 8 ( $r=.220$   $p<.01$ )...Thoughts wander  
Item 13 ( $r=-.148$ )..Family concerned (inverse)  
Score ( $r=-.424$   $p=.00$ )

The item on slower reactions correlated with intersections being bothersome suggesting that slowness in reactions in part may contribute to problems in this area in addition to decision making and information processing. An association with thoughts wandering also occurred suggesting that a decrement in general function might relate to the negative driving behaviors noted in items 4 and 5.

Item 7..Upset shows in driving,  
Item 2 ( $r=-.338$   $p=.00$ )..Wear seat belt (inverse)  
Item 9 ( $r=.256$   $p<.01$ )...Traffic situations anger  
Item 10 ( $r=.128$ )...Regular eye checks  
Item 11 ( $r=-.125$ )..Effects of medications  
Item 12 ( $r=-.146$ )..Information on health  
Item 15 ( $r=-.103$ )..Traffic accidents (inverse)  
Score ( $r=-.314$   $p=.00$ )

The only interest and significant correlation was with item 9 (traffic situations anger). The correlation suggest that traffic situations cause anger and upset in some persons and some of those show it in their driving.

Item 8..Thoughts wander,  
Item 2 ( $r=.229$   $p<.01$ )...Wear seat belt (inverse)  
Item 4 ( $r=.211$   $p=.01$ )...Intersections are bothersome  
Item 6 ( $r=.220$   $p<.01$ )...Slower reactions  
Item 9 ( $r=.250$   $p<.01$ )...Traffic situations anger  
Item 11 ( $r=-.134$ )..Effects of medications  
Item 14 ( $r=.148$ )..Traffic violations (inverse)  
Score ( $r=-.303$   $p=.00$ ).

The item "wandering thoughts" was most notable in the associations with intersections are bothersome, slower reactions, and traffic situations anger. The preceding two item discussions suggest that the possibility of a underlying decrement in functional ability may be indicated would be supported by the associations noted.

Item 9..Traffic situations anger,  
Item 2 ( $r=-.131$ )..Wear seat belt  
Item 4 ( $r=.124$ )...Intersections are bothersome  
Item 5 ( $r=-.118$ )..Interstate highway meld decision (inverse)  
Item 7 ( $r=.256$   $p<.01$ )...Upset shows in driving  
Item 8 ( $r=.250$   $p<.01$ )...Slower reactions  
Item 13 ( $r=-.121$ )..Family concerned (inverse)  
Item 14 ( $r=.263$   $p<.01$ )...Traffic violations (inverse)  
Item 15 ( $r=.104$ )...Traffic accidents (inverse)  
Score ( $r=-.263$   $p<.01$ ).

As with the earlier item on upset shows in driving, the significant correlations were with decision making and information processing (items 4 and 5), showing upset, and slower reactions. There also was inverse association to traffic violations and traffic accidents (though the latter was not significant) suggesting that anger and upset are not a priori associated with negative driving outcomes and may result in more awareness.

Item 10..Regular eye checks,  
 Item 2 (r=-.115)..Wear seat belt (inverse)  
 Item 3 (r=.258 p<.05)...Informed on regulations  
 Item 4 (r=.101)..Intersections are bothersome  
 Item 7 (r=.128)...Upset shows in driving (inverse)  
 Item 12 (r=.125)...Information on health  
 Item 13 (r=.152)...Family concerned (inverse).

The only significant correlation was with keeping informed on regulations. The association may suggest a responsibility type characteristic underlies these two questions.

Item 11..Effects of medications,  
 Item 4 (r=-.123)..Intersections are bothersome  
 Item 5 (r=-.110)..Interstate highway meld decision  
 Item 7 (r=-.125)..Upset shows in driving  
 Item 8 (r=-.134)..Slower reactions  
 Item 12 (r=.114)...Information on health  
 Score (r=.304 p=.00)

There were no significant correlations. Perhaps this reflects an outcome of the continuing educational campaign on careful use of medications when driving and that this item is not a strong predictor of negative driving outcomes. Although as a preventative measure might be included in a broader battery of items.

Item 12..Information on health,  
 Item 1 (r=-.120)..Signal and check to the rear (inverse)  
 Item 2 (r=-.153)..Wear seat belt (inverse)  
 Item 4 (r=-.171 p=.05)..Intersections are bothersome  
 Item 7 (r=.146)..Upset shows in driving  
 Item 10 (r=-.125)..Regular eye checks  
 Item 11 (r=.114)...Effects of medications  
 Item 13 (r=-.265 p<.01)..Family concerned  
 Score (r=.233 p<.01)

Only two items were significant, and the non-significant items showed no pattern. The only item of interest is the relationship between the subject's reporting of keeping abreast of information on health and family concerns about driving. As stated earlier, this association may reflect a compensation by the older person to the families concerns.

Item 13..Family concerned,  
 Item 1 (r=-.191 p<.05)..Signal and check to the rear  
 Item 3 (r=.241 p<.01)...Informed on regulations  
 Item 4 (r=.128)...Intersections are bothersome (inverse)  
 Item 5 (r=.202 p<.05)..Highway meld decision (inverse)  
 Item 6 (r=-.148)..Slower reactions (inverse)  
 Item 9 (r=-.112)..Traffic situations anger (inverse)  
 Item 10 (r=.152)..Regular eye checks (inverse)  
 Item 12 (r=-.265 p<.01)..Information on health  
 Item 14 (r=-.311 p=.00)..Traffic violations  
 Item 15 (r=-.387 p=.00)..Traffic accidents  
 Score (r=-.339 p=.00)

The most significant associations for the family concerned item were between traffic violations and accidents (the more traffic violations and accidents the more concern). The inverse relationship on reporting of decision making and information processing items (#4 and 5) needs further analysis.

Item 14..Traffic violations,  
 Item 4 (r=-.270 p<.01)..Intersections are bothersome  
 Item 5 (r=-.346 p=.00)..Interstate highway meld decision  
 Item 8 (r=.148)..Slower reactions (inverse)  
 Item 9 (r=.263 p<.01)...Traffic situations anger (inverse)  
 Item 13 (r=-.311 p=.00)..Family concerned  
 Item 15 (r=.637 p=.00)...Traffic accidents  
 Score (r=.531 p=.00)

Item 15..Traffic accidents,

Item 3 (r=-.160)..Informed on regulations  
Item 4 (r=-.155)..Intersections are bothersome  
Item 5 (r=-.176 p<.05)..Interstate highway meld decision  
Item 7 (r=-.103)..Upset shows in driving  
Item 9 (r=-.104)..Traffic situations anger (inverse)  
Item 13 (r=-.387 p=.00)..Family concerned  
Item 14 (r=.637 p=.00)..Traffic violations  
Score (r=.425 p=.00)

Traffic violations and accidents were highly correlated to each other and to the total score. The relationship to the decision making and information processing were high. The significance of anger was significant for violations and not for accidents. Not addressed in the analysis or in the development of the ODSAI is the characteristic of an accident as a rare event, and that it is statistically more likely a Poisson distribution rather than a normal distribution. Added work needs to be done on how best to address this issue.

Score....Total item score,

Item 2 (r=.134)...Wear seat belt  
Item 3 (r=.173 p<.05)...Informed on regulations  
Item 4 (r=-.585 p=.00)..Intersections are bothersome  
Item 5 (r=-.478 p=.00)..Interstate highway meld decision  
Item 6 (r=-.424 p=.00)..Slower reactions  
Item 7 (r=-.314 p=.00)..Upset shows in driving  
Item 8 (r=-.303 p=.00)..Thoughts wander  
Item 9 (r=-.263 p<.01)..Traffic situations anger  
Item 11 (r=.304 p=.00)...Upset shows in driving  
Item 12 (r=.233 p<.01)...Information on health  
Item 13 (r=-.339 p=.00)..Family concerned  
Item 14 (r=.531 p=.00)..Traffic violations  
Item 15 (r=.425 p=.00)..Traffic accidents

The correlations between items and total score varies considerably. Items 1 and 2 are not significant and item 3 is only significant at the .05 level. These items may simply reflect the effects of strong educational efforts and a high awareness of what is socially expected by the subjects. If all the total score was regressed on all the items: all coefficients were significant at p=.000, the regression was significant at p=.000, and R-sq=92.3% of the variance.

The total score also was translated into the pass-caution-fail (PCF) outcomes defined by the ODSAI methods. Both the total score and the PCF outcomes were correlated with the variables identified earlier. The correlations were weaker for the PCF scores than the total scores, and overall both were weak. The significant and nearly significant correlations were:

Variable	Total Score	PCF Outcome
Income	r=-.157	r=-.161
Years Driven	r=-.159	r=-.154
Activity Score	r=-.185 p<.05	r=-.124
Well-being	r=-.132	r=.006
General outlook	r=.189 p<.05	r=.065
Health stops	r=-.212 p<.01	r=-.139
Health now	r=.266 p<.01	r=.183 p<.05

These results suggest very little association with the characteristics of the population with either score with the exception of current health.

The PCF outcome had nearly an even split between pass (49.6%) and caution (48.1%), and only 3 people (2.9%) failed. If pass is used as the discriminator, one-half of the persons needed educational intervention.

#### ODSAI Scoring Prediction From MY-CODA

MY-CODA approximated most of the ODSAI questions allowing a comparison between the two instruments. A matching was undertaken, and 11 of the 15 ODSAI questions were approximated clearly enough to make a comparison. In the case of the other 4 questions, the matching was too complex to be useful. The following is a listing of the ODSAI questions and scoring and the comparable MY-CODA and

its scoring and recoding to match the ODSAI scores. The valuation of the ODSAI response to produce the summary scores also is presented.

ODSAI #1..I signal and check to the rear when I change lanes...scored 1=always or almost always, 2=sometimes, and 3=never or almost never... for producing the summary score 1=0, 2=5, and 3=5.

MY-CODA #50a-50e..How do you usually check to the rear? a. use driver outside view mirror b. use driver outside view mirror c. turn and look back d. I rarely check to the rear e. other..coded 1=checked 2=not checked.. recoded..2 to 0 on a-e, 1 to 1 on a,d, and e, 1 to 2 on b, and 1 to 3 on c - then sum and code 1-2 to 3, 3-4 to 2, and 5-7 to 1.

ODSAI #2..I wear a seat belt...scored 1=always or almost always, 2=sometimes, and 3=never or almost never...for producing the summary score 1=0, 2=5, and 3=5.

MY-CODA #48..How often do you wear your seatbelt when you are the driver of an automobile?..code 1=always, 2=Most of time, 3=Sometimes, 4=Seldom, 5=Never..recoded..1-2 to 1, 3 to 2, and 4-5 to 3.

ODSAI #3..I try to stay informed of changes in driving and highway regulations ...scored 1=always or almost always, 2=sometimes, and 3=never or almost never...for producing the summary score 1=0, 2=3, and 3=5.

MY-CODA #111..How well informed are you about current rules and regulations in your state?..coded 1=very well informed, 2=fairly well informed, 3=not very well informed, and 4=not at all informed...recoded..1 to 1, 2-3 to 2, and 4 to 3.

ODSAI #4..Intersections bother me because there is so much to watch for from all directions...scored 1=always or almost always, 2=sometimes, and 3=never or almost never...for producing the summary score 1=5, 2=3, and 3=0.

MY-CODA #73a..On which roads do you have great difficulty with their: a. interstate highways (freeways)..coded 1=yes 2=no...recoded..1 to 1, and 2 to 3 - there is no comparable code for ODSAI response=2.

ODSAI #5..I find it difficult to decide when to join traffic on a busy interstate highway...scored 1=always or almost always, 2=sometimes, and 3=never or almost never...for producing the summary score 1=5, 2=3, and 3=0.

MY-CODA #82..Do you have difficulty entering or leaving high speed interstate highways (freeways)?..coded 1=always, 2=most of the time, 3=sometimes, 4=seldom, and 5=never...recoded..1-2 to 1, 3 to 2, and 4-5 to 3.

ODSAI #6..I think I am slower than I used to be in reacting to dangerous driving situations...scored 1=always or almost always, 2=sometimes, and 3=never or almost never...for producing the summary score 1=5, 2=5, and 3=0.

MY-CODA #115-117..In comparison to yourself two years ago, have you noticed that your judgement out on the road (when to pass or stay in lane) is? and In comparison to yourself two years ago, how is your ability to steer the automobile? and In comparison to yourself two years ago, how is your reaction time in breaking?..code 1=much better, 2=better, 3=about the same, 4=worse, and 5=much worse...recoded..summed scores for three questions and recoded sum; 1-5 to 3, 6-10 to 2, and 11-15 to 1.

ODSAI #7.. When I am upset I really show it in my driving...scored 1=always or almost always, 2=sometimes, and 3=never or almost never... for producing the summary score 1=5, 2=5, and 3=0.

MY-CODA #93a..Do you have difficulty controlling any of the following emotions while driving? a. anger..coded 1 for yes 2 for no...recoded.. 1 to 1, and 2 to 3 - there is no comparable code for ODSAI response=2.

ODSAI #9..Traffic situations make me angry...scored 1=always or almost always, 2=sometimes, and 3=never or almost never... for producing the summary score 1=5, 2=3, and 3=0.

MY-CODA #93a-d..Do you have difficulty controlling any of the following emotions while driving? a. anger, b. anxiety, c. frustration, or d=impatience..coded 1 for yes 2 for no...recoded..sum scores for the



four variables then recoded sum; 7-8 to 1, 4-6 to 2, and 1-3 to 1.

ODSAI #11..I check with my doctor about the effects of medications before driving...scored 0=do not take, 1=always or almost always, 2=sometimes, and 3=never or almost never...for producing the summary score 0 and 1=0, 2=5, and 3=5.

MY-CODA #80..Does your doctor or pharmacist tell you when prescribed drugs may affect your driving?..coded as 0=do not take, 1=yes, and 2=no...recoded..0 to 0, 1 to 1, and 2 to 3 - there is no comparable code for ODSAI response=2.

ODSAI #14..How many traffic tickets, warnings, or "discussions with officers have you had in the past two years...scored 1=none, 2=one or two, and 3=3 or more... for producing the summary score 1=0, 2=3, and 3=5.

MY-CODA #22..How many tickets have your received in the past two years for moving traffic violations..coded as 1=none, 2=1, 3=2, and 4=3 or more... recoded..1 to 1, 2-3 to 2, and 4 to 3.

ODSAI #15..How may accidents have you had during the past two years...scored 1=none, 2=one or two, and 3=3 or more...for producing the summary score 1=0, 2=5, and 3=5.

MY-CODA #25..How many accidents have you been involved in as the driver of an automobile in the past two years?..coded as 1=none, 2=1, 3=2, and 4= 3 or more...recoded..1 to 1, 2-3 to 2, and 4 to 3.

Total scores and PCF outcomes were computed for both the ODSAI and the MY-CODA items after they were rescored. The scores will be compared later after a review of the individual items. The correlation between items on the two scales is presented in the following paragraphs for significantly or nearly significantly correlated items only. The percent of the ratings (1=always or almost always, 2=sometimes, and 3=never or almost never) are indicated and also their contribution to the total score.

Items correlated	ODSAI	MY-CODA	Scored
1 to 2	r=.077	r=-.744	
1 to 4	r=.061	r=.177	
1 to 5	r=-.002	r=.147	
1 to 6	r=.137	r=-.188	
1 to 9	r=.117	r=.151	
Item 1 rated 1	90.8%	23.9%	0
rated 2	9.2%	74.6%	5
rated 3	0.0%	1.5%	5

For Item 1, ODSAI and MY-CODA have very poor internal correlation. Essentially there is no similarity. MY-CODA items 1 and 2 are very highly correlated. The scoring indicates differences between the two scales, although both agree on the score 3 (never or almost never). The contribution to the total score was almost identical in both scales, but within subject differences reduced the correlations.

Items correlated	ODSAI	MY-CODA	Scored
2 to 1	r=.077	r=-.744	
2 to 3	r=-.036	r=-.121	
2 to 4	r=-.107	r=-.242	
2 to 5	r=-.028	r=-.225	
2 to 7	r=.140	r=.002	
2 to 9	r=-.338	r=-.049	
2 to 15	r=-.081	r=.169	
Item 2 rated 1	83.2%	54.2%	0
rated 2	13.7%	32.1%	5
rated 3	3.1%	13.7%	5

The rating result in different contributions to the total score: ODSAI contributes 16.8% of the time and MY-CODA 45.8% of the time. The correlations between items is drastically different. The difference in part may be due to: the construction of the coding for MY-CODA, a difference in the types of questions asked where MY-CODA had more range, some minor content differences, and

ODSAI asked the more direct summary question and MY-CODA asked for a series of individual behaviors and did not ask about signalling.

The larger number of significant item associations suggest a single underlying factor may explain the driving habit and characteristic questions.

Items correlated	ODSAI	MY-CODA	Scored
3 to 2	r=-.036	r=-.121	
3 to 4	r=-.137	r=.100	
3 to 5	r=-.079	r=-.160	
3 to 15	r=-.160	r=-.002	
Item 3 rated 1	82.5%	33.8%	0
rated 2	16.0%	65.4%	3
rated 3	1.5%	0.8%	5

The correlations between item 3 and other items on the scale were insignificant. The contribution to the total score was very different in the subject's rating of sometimes (2) - 16.0% for the ODSAI vs 65.4% for MY-CODA. There is a slight difference in the questions: ODSAI relates to questions and MY-CODA to total knowledge about current driving rules and regulations. The difference may account for the shift in responses.

Items correlated	ODSAI	MY-CODA	Scored
4 to 1	r=.061	r=.177	
4 to 2	r=-.107	r=-.242	
4 to 3	r=-.137	r=.100	
4 to 5	r=.522	r=.365	
4 to 6	r=.370	r=.043	
4 to 7	r=-.089	r=.305	
4 to 9	r=.124	r=-.115	
4 to 11	r=-.123	r=-.108	
4 to 14	r=-.270	r=-.077	
4 to 15	r=-.155	r=-.149	
Item 4 rated 1	11.5%	7.6%	5
rated 2	35.9%	0.0%	3
rated 3	52.7%	92.4%	0

MY-CODA used a yes-no response versus ODSAI's three ratings which would not result in completely equally contributions to scores. The ODSAI question provided a situation and asked if it was a problem, and the MY-CODA asked if a situation was a problem (yes-no). The difference in coding and questions probably resulted in the differences noted.

The items on both scales showed more correlations than many of the other items (10 of the 11 possible). On significant or nearly significant associations the two scales had similar correlations, the weaker the correlations the less the agreement. The suggestion is that these items describing driving in intersections tapped a more common underlying factor which appears to be information processing and decision making.

Items correlated	ODSAI	MY-CODA	Scored
5 to 1	r=-.002	r=.147	
5 to 2	r=.140	r=-.225	
5 to 3	r=-.079	r=-.160	
5 to 4	r=.522	r=.365	
5 to 7	r=.051	r=.225	
5 to 9	r=-.118	r=.303	
5 to 14	r=-.346	r=-.099	
5 to 15	r=-.176	r=-.178	
Item 5 rated 1	3.8%	3.1%	5
rated 2	38.2%	20.0%	3
rated 3	58.0%	76.9%	0

The contribution to the total score on both scales was similar with ODSAI providing a slightly greater contribution for this item (melding with interstate traffic). The significant correlations were similar and in the same directions.

Again as for the preceding item, there is a suggestion of a common underlying factor which appears to be information processing and decision making.

Items correlated	ODSAI	MY-CODA	
6 to 1	r=.137	r=-.188	
6 to 4	r=.370	r=.043	
6 to 9	r=.190	r=.013	Scored
Item 6 rated 1	12.2%	1.5%	5
rated 2	35.1%	93.1%	5
rated 3	52.7%	5.4%	0

This item about slowed reactions was constructed from three question on MY-CODA versus a single question on ODSAI. The MY-CODA item contains some added influences and could be altered by the algorithm for combining the three items. As a result of these factors, MY-CODA made a greater contribution to the total score. The MY-CODA item indicated less correlation to other items and probably is more independent due to its probing three areas to produce one score.

Items correlated	ODSAI	MY-CODA	
7 to 2	r=-.338	r=-.013	
7 to 4	r=-.089	r=.148	
7 to 5	r=.051	r=.225	
7 to 9	r=.256	r=.573	
7 to 11	r=-.050	r=-.125	
7 to 15	r=.103	r=.056	Scored
Item 7 rated 1	5.3%	2.3%	5
rated 2	24.4%	0.0%	5
rated 3	64.1%	97.7%	0

The two questions are not exactly equivalent and the MY-CODA score resulted from a yes-no answer. The contribution to the total score of MY-CODA was less than that of ODSAI mainly due to the lack of an intermediate response (sometimes) on ODSAI. The correlations between items have some similarities in pattern, but the strength of the correlations vary between items.

Items correlated	ODSAI	MY-CODA	
9 to 1	r=.151	r=.117	
9 to 2	r=-.013	r=-.131	
9 to 4	r=.124	r=.305	
9 to 5	r=-.118	r=.303	
9 to 7	r=.256	r=.573	
9 to 14	r=.263	r=.027	
9 to 15	r=.104	r=.032	Scored
Item 9 rated 1	4.6%	0.8%	5
rated 2	34.3%	0.0%	3
rated 3	61.1%	99.2%	0

The MY-CODA item was a construction from 5 yes-no questions which adds both a difference in the content and the possibility of the combinatorial algorithm adding difference. There was almost no contribution to the total score from the MY-CODA item. The ODSAI item (traffic situations make me angry) contributed to the total score for 38.9% of the cases.

Both scales had many associations between items, although the magnitudes varied between the two scales. It appears that there were some differences in how the subjects responded, but that may have been due to content differences.

Items correlated	ODSAI	MY-CODA	
11 to 3	r=.081	r=-.152	
11 to 4	r=-.123	r=-.115	
11 to 5	r=-.100	r=.066	
11 to 6	r=-.007	r=-.123	
11 to 7	r=-.125	r=-.050	Scored
Item 11 rated 1	91.6%	83.7%	0
rated 2	3.1%	0.0%	5
rated 3	5.3%	16.3%	5

This item (11) addressed adjusting driving for medication and produced similar contributions to the total score between scales. The correlations between items were not significant and had no pattern.

Items correlated	ODSAI	MY-CODA	Scored
14 to 4	r=-.270	r=-.108	
14 to 5	r=-.346	r=-.045	
14 to 6	r=-.157	r=-.051	
14 to 9	r=.263	r=.027	
14 to 15	r=.637	r=.301	
Item 14 rated 1	64.9%	90.8%	0
rated 2	16.0%	9.6%	3
rated 3	19.1%	0.0%	5

Item 14 (traffic violations) differed between the two scales although the two had very similar questions. The correlations between items was very different. What caused this difference is not known at this time.

Items correlated	ODSAI	MY-CODA	Scored
15 to 3	r=-.160	r=-.002	
15 to 4	r=-.155	r=-.077	
15 to 5	r=-.176	r=-.099	
15 to 6	r=-.082	r=.039	
15 to 7	r=.103	r=.056	
15 to 9	r=.104	r=.032	
15 to 14	r=.637	r=.301	
Item 1 rated 1	74.4%	88.6%	0
rated 2	9.2%	11.4%	5
rated 3	11.4%	0.0%	5

Item 15 (traffic accidents produce similar contributions to total score, but ODSA I had more indications of 3 or more accidents in the past two years. The ODSA I number appears to be rather large and is suspect, but the reason for the response difference has not been established as of the writing of this report. The correlations generally are not significant except for the association to traffic violations (item 14).

One of the obvious activities would be to analyze each MY-CODA item that required an algorithm to evaluate its effectiveness. The concern was that the results would be biased by the process. Given Item 1 had a low contribution to the total ODSA I score, it was decided to experiment with it. Three different assignments of MY-CODA ratings to the ODSA I rating system were tested as depicted in Table 6.4.

The original coding of the MY-DAP variable produced a different distribution of ratings than ODSA I. The second recode adjusted the ratings profiles to being nearly identical, but lowered the correlation and variance explained. The third recode was somewhere in between.

In the regressions used to test the associations, several outliers were noted where a code was inverted from 3 to 1 or 1 to 3 between the two scales. The last columns in Table 6.4 illustrate the effects of removing these outliers. With 4 removed, the variance explained rose from 0.4% to 1.6%, and with 5 removed to 2.6% and approached significance.

The results illustrate the sensitivity of the translation algorithms, and the large influence of just a few subjects answering differently. These differences are exclusive of slight differences in the wording of the questions. It is expected that a combination of wording, a clear expectation of answers when undertaking ODSA I, and an occasionally careless respondent caused the variations. It is expected that this item was not the only one with such problems, and more investigation of the differences is needed to help determine how best to address gaining the information.

Table 6.4. Recode Variations for Item 1 (Seat Belts)

My-CODA Rating	N	ODSAI Rating	N	MY-CODA RECODES			LESS OUTLIERS	
				1st	2nd	3rd		
1	4	3	2	18	4	4	4	3
2	14				14	50	14	
3	36			42	110		77	106
4	6	2	18					
5	6			71				
6	23							
7	2	1	109					
Summary Statistics				r.....	.102	.059	.073	.110 .162
				p.....	.245	.501	.407	.153 .071
				R-sqd..	1.6%	0.4%	0.5%	1.6% 2.6%

There were differences in the total scores produced in both scales and also in their corresponding pass-caution-fail (PCF) outcomes. The association of ODSAI full score to the 11 item ODSAI scale was  $r=.875$  ( $p=.000$   $R\text{-sqd}=76.5\%$ ), but was reduced in relation to the MY-CODA scale  $r=.284$  ( $p=.001$   $R\text{-sqd}=8.1\%$ ). When the adjustment in item 1 was included the correlation increased  $r=.305$  ( $p=.000$   $R\text{-sqd}=9.3\%$ ). The means changed more: for the 11 item ODSAI scale 16.5, for MY-CODA scale the mean was 14.6, but for the adjusted score the mean was 20.2. These differences in means indicate the sensitivity of the score in this range to small changes and partly explains the low correlations. The range is around the pass-caution cutoff (score of 15) which would suggest the ODSAI items could not be replaced with MY-CODA items.

The associations are not as large as liked, but given the differences in the questions and the shown variation in the algorithms are within reasonable bounds. Further work is needed on the translations to try to establish a better baseline for correlation, but all the difference will not be removed due both to the differences in question wording between the two scales and that some MY-CODA items are based only on 2 ratings versus 3 for ODSAI.

The means for the PCF outcomes for the 11 item scales varied; ODSAI had a mean of 1.53, MY-CODA 1.53, and the adjusted MY-CODA 1.86. The PCF outcomes were:

	ODSAI	MY-CODA	
		Unadj.	Adj.
Pass	49.6%	51.2%	15.3%
Caution	48.1%	45.8%	84.0%
Fail	2.3%	3.1%	0.7%

The correlations between the ODSAI versus MY-CODA 11 item PCF outcome scales was  $r=.032$ . A regression of one scale on the other indicated only 0.1% of the variance was explained. This result suggests there was significant internal variation by case which was seen in the means. This finding suggests further analysis work is needed, and that the translation to PCF from the MY-CODA scale is not achievable.

Significant ( $p=.000$ ) intergroup variations were found. The main concern was a high mean score (21.9 in Group 3 (ODSAI and AARP interventions) versus a mean of 11 for Group 2 (ODSAI intervention only) and a mean of 13.8 for Group 6 (ODSAI and SFSU simulator interventions). The scores suggest differences do exist.

## Discussion of ODSAI Results

The ODSAI main scale and the variables used to analyze the results produced some interesting results. The ODSAI results by group were not equivalent. The group taking both the ODSAI and AARP interventions had significantly higher scores than the remainder of the population suggesting more room for improvement. The ODSAI only and SFSU simulator groups had lower scores and much less room for improvement. There would be expected influences on the pre-post knowledge test.

The variables used in the analysis of the ODSAI instrument had some interesting associations within the sample of 131 subjects. Age was associated with less education and income, feeling less informed about highway rules and regulations, and a higher sense of well-being. Gender seemed to have little or no effect. As education increased the subjects were less active, but had higher sense of well being and current health. Higher income was associated with being younger and more educated, more years driven, more miles per year driven, lower activity score, and higher sense of well-being and life satisfaction, less health stopped activities, and better current health.

In general, income and education were associated with better health and well-being but being less active. Being older was associated with a better sense of well-being. In general, the other associations were in expected directions.

Health and well-being variables were associated highly. The associations suggested some underlying common factors. There were a number of carrier variables suspected in several of the factors suggesting more analysis was needed to understand the associations. A surprise was a lack of impact of age on health and well-being factors which suggested that function was more important in the active community dwelling group of elders than age.

The ODSAI items contribution to the total score were able to be grouped. Several items produced little or no effect and mainly were items that are commonly addressed in health education and promotion and safe driving materials. The strongest contributions to total score dealt with items that dealt with emotional, information processing, and decision-making factors. This finding suggests more emphasis be placed on these items in further research.

The comparison of the ODSAI scores with the similar items in MY-CODA (11 items were matched) showed significant variations. The problems seemed to be a result of slightly different structure of the items in both scales, difficulties in making conversions on some items that had fewer or greater numbers of ratings per item, and variation on ratings both scales within cases. The variation in part may be explained by the differences in question content, but also in the answers. ODSAI had a consistent 3 item choice, in some of the MY-CODA items up to 5 choices were given and some people do not respond well to more options.

The results generally suggested the measures were similar, but there was some variability which remains unexplained. The results suggest more work is needed on the MY-CODA items and on how persons respond to the items and items in general.

## 7. SIMULATOR

The driving simulators used in the study were manufactured by DORON Precision Systems. The purpose of the simulation was to assess driving skills, and where possible to provide limited training. In addition to testing reaction time and motor skills, the simulator was used to measure persons risk avoidance skills using a 25 minute film. Additional tests of physical, sensory, and cognitive performance were added to the simulation experience.

The experimental design suffered problems as will be described in the following subsection. The use of the driving simulator was tied to a common recording format developed by the project, MY-DAP. As problems appeared with the UTMB contracted effort, an increased effort was placed on developing MY-DAP further and on creating replicable assessment protocols for the simulator. A secondary effort was placed on understanding the nature and state-of-the-art of simulation and how it might be added into the experimental design.

An opportunity to move the simulation experience a generation further appeared in the last quarter of the project. DORON loaned the project group at San Francisco State University (SFSU) a current model simulator for an 11 day period. The project was able to use the knowledge and experience gained and created a detailed assessment protocol. The protocol was used as described in the second subsection in this chapter. The protocol was then converted to a similar assessment without a simulator to evaluate differences and restrictions that not having a simulator would create. This converted protocol is described in the following section of this report describing the use of MY-DAP.

DORON now has made a permanent loan of a simulator beginning as the project ends, and it is planned to add more subjects to the study base using the same protocol to allow more detailed analysis. These plans and the impacts on analysis also will be presented in this section.

### Texas Groups

The simulator portion of the study will be discussed in terms of process, as will MY-DAP. The number of subjects restricts the analysis. The UTMB contractor provided only a small number of cases and no written material on the process. The only information available on the approach used was from observations done prior to grant submission, and summarized in a monograph chapter (79).

The 14 cases submitted were split in two groups, persons who failed ODSAI (Group 4, N=5) and those who passed ODSAI (Group 5, N=9). The persons all took the AARP course, but Group 5 were not administered the post-test. The analysis was designed when the group numbers were determined. Lumping the two groups together was one alternative, but it was decided to try to carry out the original design with the small numbers. In future analyses after using the SFSU simulator to increase the sample size, the two Texas groups will be lumped together for the purposes of analysis.

The lack of a process description and follow-up in the Texas site weakens the evaluation of the simulation experience. Pass-fail grades on the simulation exercise also were not provided. The use of MY-DAP to record results helps in providing a common analytic base, but problems of rating and administration are not known.

The Texas simulator was an older model, but used the same training film. The subject's experience should have been approximately the same. What is not known is how the staff problems in the administering agency influenced the participant's attitudes. It was decided not to analyze the data until the SFSU group size could be increased.

### San Francisco State University Simulation

As stated above, a DORON L-35 driving simulator was loaned to SFSU for 11 days 3 1/2 months prior to the end of the project on a two week notice. A lab was created at SFSU, a protocol written, and subjects recruited. The protocol is attached in Appendix C. The protocol was written around understanding factors in aging which influence driving performance, and then using the simula-

tor to help address more dynamic and interactive parameters with a particular emphasis on evaluating information processing and decision-making capabilities.

The protocol produced testing for every item on the MY-DAP. The protocol used a recording form as part of the administration. The results from the assessment events were recorded during the administration, and then transferred to MY-DAP after the subject departed. This procedure provided a common and replicable assessment and intervention across subjects. The activities undertaken in the simulation are presented in the attached protocol.

The protocol provides more data than is summarized within the MY-DAP. These data have been recorded and entered. Response times and pass-fail marks for each simulation event was recorded along with summaries of the performance factors noted on the last page of the recording sheet. There were two types of simulation events: (1) picking out a correct stimulus from a group of stimuli moving around the project screen (visual field of the subject), and (2) reactions to hazard situations. Each of the situations was broken down into visual zones, types of reactions required, alternative hazards, validity of the action, and the drivers judgement and decision making speed and quality.

Ranges for each of the items were developed, as were the frequency of failures to react properly. A preliminary analysis was done and indicated the following outcomes:

- o some of the response sets within the film were not properly reacted to by most if not all of the subjects and therefore had little discriminating value,
- o reaction time was associated with age, but equally with physical fitness based on observations of the subject and discussions about their physical activities (similar to findings by McPherson et. al. refs. 32-33),
- o field of vision was important in predicting the response failures where multiple clues were provided in the visual field and were separated outside the persons field of vision (also see ref. 27),
- o people had definite scan and viewing patterns depending on their visual fields,
- o the more dynamic and interactive the stimuli the easier it was to assess stress response, anxiety, judgement, and decision making,
- o the more stressed the person became the greater the likelihood of failing subsequent test events and the pattern did not seem to be recoverable, and
- o personality, emotional, and behavioral factors were important ingredients in the responses.

The analyses were limited by small numbers. It was decided not to report the data at this time. The simulator will be in place as of the end of the project on extended loan, and the number of subjects will be increased to between 40 and 50 by the end of autumn (or sooner). With the increased numbers it will be possible to statistically evaluate the simulation activity, as well as its conversion to MY-DAP scoring. Multiple assessors will be used in some cases to validate the scoring system.

#### Results Summary

No differences were found between pre and post tests for the simulator groups. The Texas groups (#s 4 and 5) took the AARP course, but there were no differences in Group 3 for the persons who took ODSAI and the AARP course (the difference in the group 3 was in the San Francisco site). There were no pass-fails assigned in the Texas Simulation. Based on a general guideline, there were no failures in the San Francisco Simulation group within the age range used in the sample. A failure was recorded on a younger person aged 31 not include in the project sample.

A discussion of the process results for the SFSU simulation are discussed in the ASA paper in Appendix F. The process information is perhaps more important for further development of the simulation activity than the quantitative data. As a result of the process information, a protocol for replicating the SFSU simulation activity in Maryland without a simulator was able to be developed.



## Discussion

Although the simulator results lent little to the results of the pre post test design of the intervention model, the work opened up a range of issues. As a direct result of the simulation activity at SFSU the following occurred:

- o a protocol for assessment was developed, used, and evaluated,
- o MY-DAP was related to recording in the simulation situation,
- o the simulator was integrated with other measures to produce an overall profile of the older driver,
- o there were increased information processing and decision measures added to the assessment of driver performance,
- o the protocol was able to be converted to one used without a simulator as is discussed in the next section,
- o the ODSAI software was used in a clinical situation to provide immediate and quick scoring and feedback to subjects,
- o observations on the acceptance/refusal pattern led to the development and implementation of the participation survey reported in Section 10, and
- o the basis for a longitudinal study was established.

The simulation activity focused on assessment without much in the way of training. This decision was made to keep the duration of the simulation activity within an hour. Feedback was provided to all subjects who requested it on specific aspects of functions related to driving. The feedback never discussed or evaluated overall driving of the subject. The simulation and its related activities produce a rather broad range of information and future work needs to develop improved feedback mechanisms. The subject should be able to take away materials to read and review based on the assessment undertaken.

The simulator used film technology that had minimal interaction with the subject and his/her responses. Using more current technology would allow for interactive assessment, such that as problem areas are noted subsequent situations could be altered to maximize the value of the time available in the assessment session. It also would be useful to alter the activities in the simulation to reduce the explanation time. Any simulation activity must run in a fixed time and is bounded by patient time and clinician cost; hence, optimization of output from the session would be desirable.

The simulation became real for most subjects within a few trials. Only one case of motion/simulator sickness occurred (the younger subject not included in the data set). Subjects were told to indicate when and if discomfort occurred to enable stopping the simulation before more than a passing queasy feeling occurred.

After further research, it is expected that the same information will be able to be gathered in 30 minutes or less. The main problem is that reduction of the non-simulation assessment will be hard to reduce and it takes nearly half the time. A replacement for the vision testing using a standardized measuring device which addresses multiple vision problems will help in the reduction of time, but the physical measures still remain. The optimization process that appears most fruitful is to set a time and then to select the highest yield activities to fit into that time frame. It is likely that multiple time frames might be used for different assessment situations.

### 8. MY-DAP

The MY-DAP instrument was developed within this project for the purpose of profiling older drivers' abilities and skills. The instrument was developed and first reviewed with the Texas contract site staff. Changes were made within the confines of the model (described in the next section) and a final protocol developed. The protocol was used with the Texas and SFSU simulations, and with the Maryland Focus Group of occupational therapists (OTs). This section will present the administration process and problems noted, the protocol was presented in Section 2.

The basis of the MY-DAP is a profiling of older drivers, and relating the profile to: (1) driver risk levels, (2) problems that need further analysis and related instruments, and (3) increasing the understanding of how problems on individual functions related to overall functioning. The number of MY-DAP instruments available for analysis at the end of the project would not support these analyses. Forty cases were being provided as the project ended (assessments were completed, but not received for data entry) and an added 20 to 30 simulations were planned for the SFSU simulation lab. The analysis of the data will be done as this data becomes available and sample size increases to a level that will support analysis.

#### Model and Concept

The basis of MY-DAP was the model described in Figure 1.1. The important aspect of the model is that it defines major components of the driving situation, but also attempts to define relationships between the components. The goal is to capture a picture of the driving experience either statically or dynamically. The components could be looked at independently, in relation to each other, as interactive and interdependent, or as a dynamic mix. From this picture, it was felt that the aging process could be studied more effectively.

The model is part of a class of functional models (73) which are based on a theory that human function can be represented hierarchically. Each node in the model can be described in more detailed in an ordered way in terms of sub-nodes, which in turn can be decomposed into sub-nodes (and the process repeated). The decompositions establish their own relationships which are consistent with the relationships of the parent node.

The model is a way of providing an ordered description of driving functions or components thereof. MY-DAP was a method for recording the order description at a summative level. It assumes that when added data is needed, additional assessments would be undertaken. The data set grows, but yet retains a relationship to the model framework.

MY-DAP would then collect information on nodes and to a lesser degree the relationships. The nature of the relationships have not as yet been fully defined. Even without a full definition, MY-DAP produces a profile of the older driver's functional characteristics. It was decided not to try to collect a normative rating (excellent to non-existing), but rather to rate functions as being adequate for driving or some degree of inadequacy.

It also was decided to include in the rating, the assessment basis from subjective to formally assessed. This information would allow a relative weighting of the items based on the confidence level in the data.

A scoring system is still under development. A total score is one possibility and is being investigated, but in general it is hard to place a meaning to the total score. A better method would use weights to relate relative risk of items, but the literature does not fully support the development of the weights. The continuing research will address this problem in detail.

#### SFSU Implementation

The SFSU implementation used one rater and therefore had a high consistency. Almost all items were tested for directly, and the remainder indirectly. The ratings of the scoring method varied greatly from the Texas ratings. The interpretation of the differences and their meaning is still being worked out.

Part of the difference was different assessment procedures, but some of the difference was perceptions of the rater.

The use of the protocol stabilized the recording. The subjectiveness was significantly reduced. The simulator activities were rated on an independent scale and then transferred to MY-DAP. Preliminary analyses showed a high consistency and reliability in the transfer, but the sample was too small for defining significance. This problem will disappear with the added assessments that have been planned.

A simple feedback could be provided from the profile, but it was not completed until after the subject left to avoid biasing the conclusions. This procedure needs to be altered to have MY-DAP be useful in providing feedback to the subject at the end of the session. It is likely that a computer scoring form would be useful.

The problems with the instrument and procedure were minimal in this implementation because the development staff were using the instrument and it was integrated into a protocol. The use became increasingly easy as more and more subjects were assessed. This situation was not replicated at the other sites.

### Maryland Implementation

The Maryland implementation was described in Section 2. The goal was to replicate the SFSU protocol without a simulator which tests the use of MY-DAP without a driving simulator. The same protocol was used, but was adapted for the lack of a simulator. The number of response scenarios was increased and were designed to use the subjects own car (but stationary in the driveway). The visual field discriminations and reactions of the DORON simulator were simulated by a computer program and transferred to video tape. The accident avoidance situations of the simulator were addressed by the scenarios, which were expected to provide less information. An easier scoring sheet for ODSAI also was created (see the end of the protocol in Appendix D).

The SFSU simulation was video taped and the Maryland occupational therapists viewed the tape as part of their training by a lead therapist. The protocols were reviewed with the therapists and questions answered and changes made where appropriate and integrated into the protocol. The subjects were recruited by each therapist. The completed forms were sent to the lead therapist who then forwarded them to the project. At the end of the session, the co-investigator met with the individual and lead therapist as a debriefing. Added to this debriefing are comments from the lead therapists. Both sets of comments are integrated into the following discussion.

One of the most interesting aspects of the review was the difference the various therapists assigned to their ratings of the coding using the same protocol. There was essentially total agreement between all the OTs that all motor items were specifically tested. One person felt almost all the non-motor ratings were subjective, and another rated all but three items on the entire scale specifically tested. The other raters varied, but there was more consistency in the sensory area. The ratings of the information processing segment were more variable suggesting less comfort with assessing the items which also was obvious in the debriefing. Sorting out the meaning of these variations will be the next task when the data is ready for analysis.

The OTs suggested the language grade level of MY-CODA needed to be reduced which was not mentioned in the other sites. The OTs felt the environment needed to be standardized, and that it was too difficult to use different settings. The use of a fixed setting also would reduce the time needed for administration.

The OTs reported that it was difficult to recruit some older persons because they felt negative results would jeopardize their ability to maintain or renew their driver's licenses. Many of these people could not be convinced that it could not. Overall it was felt that many of the elderly who participated did so based on some relationship to the therapist and were confident in their own driving abilities. The same sense was gained in the SFSU study and was the reason for the participant survey.

The group also suggested that more stringent guidelines for scoring scenarios was needed. This need was known, but the development process required some added field testing and research before this hardening of methods occurred. If the change is to be to a more standardized environment, then fixing methods would not gain much in the next iteration. The use of the person's car for doing evaluations also was found problematic, because it was hard to see the person's actions. Actually, the problem also exists in the simulator, but to a slightly lesser extent.

The group generally reported that the descriptions of the subjects hearing, visual acuity, or medication use was contradictory to the clinician's knowledge of the person. The analyses of the data provided suggestions of this observation, and it will be taken into account in further analyses. There were comments about duplicate questions in the various instruments which had been done on purpose to try to help evaluate this situation. At this time, the analysis is not completed, but is showing that the problem may be generalized.

The group also felt that shortening the time involved would increase willingness to participate. The time was under two hours for the combined completion of the written instruments and the clinical assessment. The participant survey suggested a maximum of an hour to an hour and a half. It was felt that by separating the two parts with each being in the range of 45 minutes that the time problem would not be an issue.

The Maryland group paid their participant's \$10. It did not seem to alter their perspective of the time and effort, or of the potential threat. The limited effect of paying subjects was consistent with the findings in the participant survey (Section 10). The presentation of the project, materials, and assessment was felt to be highly dependent on how the subject would respond. More thought needs to be given to how to address this population to reach the higher risk persons with the greatest needs.

#### Relationship To Self-Report

The relationship between MY-DAP and the self-report instruments (ODSAI, MY-CODA, and the pre-post test) were developed. The cross-reference still needs work on some of the coding to create similar responses (see the ODSA I review for a discussion of the problem). There were 47 cross-references established. Some of the cross-references required combining 7 individual items. With the added subjects from the Maryland group, the analyses will be completed.

#### Discussion

MY-DAP accomplished its goal of providing a common recording instrument. Exclusive of the problems noted, it was used across sites and clinicians and appeared to yield similar results. It allowed the development of assessment protocols which enabled replication. The work with the assessments produced some findings about older drivers willing to be involved which resulted in the participant survey. The observations from the assessments and the findings from the participant survey were similar.

## 9. COMPUTER PROGRAMS

The work in this project investigated the use of and approaches to computer based-training (CBT). The generic CBT heading includes: assessment, education, training, and combinations thereof. The purpose is to develop alternative approaches to working with the older driver, persons who work with older drivers, or research on older drivers and their problems. The intent is to provide support, develop alternatives, and add methods, but not to supplant effective existing techniques. The analysis of possible approaches suggested using three dimensions to evaluate possible approaches: content, purpose of the activity, and the use. The matrix in Figure 9.1 describes the possible combinations for two of the three dimensions - purpose and use.

PURPOSE	U S E			
	Direct Service	Indirect Service	Support to Service Staff	Research
Assessment				
Education				
Training				
Assessment & Education				
Assessment & Training				
Assessment, Education, & Training				

Figure 9.1 Purpose-Use Matrix

"Direct service" refers to direct involvement by the older driver with the CBT. The older driver uses the CBT to meet the purposes. "Indirect service" by contrast addresses the use the CBT in meeting one of the purposes, but not necessarily by the older driver themselves (e.g., a training video that is used in a group, or an assessment that is jointly done with a service provider). "Support" CBT units would be specifically designed to aid the service provider, or to train the service provider. Aid might include scoring of assessments, creation of handouts, maintaining data bases and clinical records, or design of service programs. Training of service providers would be CBTs that seek to develop service providers skills and knowledge, or to train new service providers. The "Research" purpose is a CBT that plays a direct role in trying to understand the process of aging, mobility, and the older-driver.

As will be discussed under conceptual approach (next subsection), assessment is included in all combinations of types, and where feasible, always will be integrated into the CBT. It is important to understand the older person, to establish a performance baseline, direct activities to problem areas, and to determine a final resolution of a topic being addressed (was it successful?). The purposes otherwise are fairly straight forward and correspond to the definitions presented in Sections 1 and 2.

The content can range over wide areas, but is focused around aging, older drivers, and mobility. The delimitation occurs in the definition of the specific CBT. For example, ODSAI has the purpose of assessment and education, is a direct intervention, and covers general topics relating to the older driver. By contrast, MY-DAP is an assessment tool used indirectly and assesses specific areas of age-related driving functions under three general headings (sensory input, information processing, and physical/motor performance).

## Conceptual Approach

The general idea for approaching the CBTs was to provide a continuum of materials from assessment through training. Each level would have feedback to the subject, and all levels would have some degree of assessment. The assessment would help focus the activity to the need area and the feedback would provide the subject with inputs on how to improve their driving. The feedback also might address general functions influenced by age; for example, a visual field defect might result in a suggestion for the older person to have their eyes checked.

The CBT also is desired to be more interactive and directed by the information provided by the subject. The CBT should be a reasonably intelligent process and be able to adapt to the information it is gathering. If an area of driving is found problematic, it should be probed versus continuing asking questions about non-applicable or non-problematic areas. In MY-CODA, the traditional method of skipping questions if a given response is received is an example of adapting to information on a simplistic level. MY-CODA in its paper form could not do the reverse and ask more detailed questions in a problem area that would be determined from prior questions.

The CBT approach is hierarchical. The first layer of questions should determine what questions are appropriate in a second layer. MY-DAP is based on this premise. The recording form is the first layer. It isolates problem areas to which other measures must be added in future versions. In the CBT, the computer can do ongoing analyses and branch into problem areas.

Educational activities would follow the same approach. Hierarchy is important if the duration of the intervention is important. There is a huge excess of information available, and if time is to be used wisely, only the information of maximum value to the user should be presented. The presentation of information also must weigh the use of iconic, textual, and auditory options .. which gets a particular idea across the fastest and most effectively. In later discussion of the OBSAI software, the difference is discussed in more detail.

Training activities also should follow the same general conceptual structure. The main difference is that knowledge is now not the sole issue, but also skills. The interactiveness is no longer peripheral, because a response cannot be addressed with a question. For example in a simulator, the response to an object crossing in front of a car is turning the wheel and/or hitting the brake versus a statement describing it. The event must be monitored in real time. The opportunity for focusing in on problem areas appears to increase.

Ultimately, the ideal would be a mixed mode of all three approaches. By designing the scenarios carefully it would be possible to assess, educate, and train. Based on the response, feedback would occur and the next sequence appropriate to the subject would be selected. In large part, the computer system would be used as an intelligent clinician, educator, and trainer and simulation becomes an inherent part of the process.

The term "simulation" is distinguished from driving simulator. A driving simulator is one type of simulation. A continuum of approaches again is needed ranging from the simple interactive display to a full scale simulator in which a real car is used. The simple simulations do not need to be complicated, but could be two or three dimensional static or animated situations (e.g., a car entering an intersection). The focus should be to match the simulation activity to the assessment, educational, or training need.

Cost-effectiveness is an inherent part of the conceptual approach. Use of any method will depend on its ability to be applied at a reasonable cost where cost includes the method, the time required, the staff time demanded, and the subjects time. If any cost becomes too high, the method will not be used. An example of the problem is the driving simulator in assessment, if the simulator costs \$50 an hour to use and the clinician \$100, the cost to the patient is \$150 a session exclusive of their time. This cost has to be reasonable to either the patient or some provider who will require it in order for the method to be used.

The above issue of cost is separate from the effectiveness and value of the intervention. Even if the cost is acceptable, it must yield some result that cannot be gained more efficiently by some other method. In designing any use of simulation, it is important to place both these factors into the design parameters to assure the resultant method will be utilized. In the research setting, these factors are less important, except that as the cost to the subject in time decreases and the value in terms of feedback increases the likelihood of having more subjects increases.

These general concepts were established for the work on the CBT approach. Three situations were addressed: (1) a working computer program of an assessment intervention approach using the ODSAI, (2) evaluation of the approach to education using the AARP course, and (3) analysis of simulation. The analysis of the simulation alternative was expanded to looking at and/or using several driving simulators.

#### ODSAI and Assessment

The ODSAI instrument was converted to a computer program (the user manual is attached in the Appendix F). The conversion provided three options: (1) direct administration of the fifteen questions and producing a score followed by a review of any items not passed, (2) being able to review the entire booklet on the computer screen, and (3) scoring support for an administrator without any feedback. The program was to be interactive, simple to use, and provide everything in the ODSAI booklet plus some added features (such as, quick scoring).

The ODSAI booklet was converted into a series of coded text files. A program was written to access the files. The user would simply answer questions and then have the test scored and the appropriate educational information retrieved. The program was written in MicroSoft Professional BASIC version 7.1 and the files were standard MicroSoft DOS operating system files. Access speed was improved by use of random access files. Pointers to specific sets of data within the files were kept separately (e.g., an educational suggestion to a specific question). The scoring program was developed separate from the administration program.

It was decided not to include a data management function (keeping track of who took the exam and the score) within the computer program. The purpose of the software was to be able to have persons use it on their own without any sense of threat. The data management system was available from other work, it simply was not included.

The pilot system was reviewed by Dr. James L. Malfetti, Professor Emeritus of Columbia University who developed the material, Mr. Sam Yaksich, Jr. Executive Director of AAA Foundation for Traffic Safety who sponsored the material, Dr. Darlene Yee who directed this project and also was involved in the piloting of the original material for Dr. Malfetti, and a number of older drivers. The results of the reviews were incorporated in revisions and a final copy was developed. The scoring system was evaluated by the co-investigator in doing the clinical work for the SFSU simulation activity. The resulting product is now available from the AAA Foundation for Traffic Safety.

The ODSAI CBT module follows the concepts outlined in the last section. It makes an assessment and provides immediate feedback on items which were not passed. An option to provide printed results was planned, but the reviewers suggested it not be added. The feedback on failed items can be expanded to more detailed information, or the entire booklet can be read. There is no hierarchy of assessment, because the source material did not have a hierarchy attached to it.

One of the problems that surfaced, is the amount of reading required. It is the same as in the booklet, which also had been held in question on this point. A second version of ODSAI based on graphical presentations was provided by AAA Foundation for Traffic Safety, but could not be implemented for reasons discussed in a subsequent section.

## AARP Course and Education

The AARP course was used as the test vehicle for educational activities. The course material was acquired from AARP and the text coded and transcribed to data files. The access program is similar to that designed for the ODSAI CBT, but there were many more graphics. The scope and size of the material and the graphics created a major problem in implementing the course in a reasonable amount of disk storage space. The problem and resolution are addressed in the section on technological issues.

An implementation was started and aborted. The methods were resulting in excess computer program coding, and were not truly reflecting current multimedia standards. The solution is discussed in the technology discussion.

## MY-CODA and Background Variables

Although not proposed as a CBT, the MY-CODA data entry process was developed as a potential assessment CBT. A program was written and used for all the data entry (Pre-Post Tests, MY-CODA, ODSAI, and MY-DAP). The design of the program used data files for both questions and answers and was interactive. The test situation was the data input which was done by three persons: a research assistant and both the principal investigator and co-investigator. The result was a rather full evaluation of the computer program.

The program was designed for data entry, but the files were designed to be used in a program that could be operated by any subject. A single control file needs to be added, the presentation format (user interface) altered slightly, and some help options added. The result would be a complete automation of the all the instruments except MY-DAP which is not completed by the subject. The MY-DAP data entry screen could be added as a separate program.

A feedback system for the results was not developed. To make it effective, it should have an analysis component added which evaluates the responses and then provides appropriate information after the assessment is completed. This feature would require developing the analysis and feedback systems which is under preliminary design at the current time. The feedback should be in printed form to avoid tying up the computer, and also allowing the subject to take the materials with them for review at a time that is convenient to them.

## Simulation

Simulation is seen as a continuum of procedures from the simple graphic to a physical simulator which encapsulates a vehicle. The focus of this work is up to the typical driving simulator such as that manufactured by DORON Precision Systems. The simulation should be adapted to the need. If the need requires less, then the simulation should be simpler.

The project started the process of differentiation of simulation by purpose and function. A profiling method similar to MY-DAP was developed. The final result of this work is being turned into a technical paper that will be submitted for publication within the year. The intent is to be able to rate the subject on MY-DAP and match the problem areas to appropriate simulations defined on the same scale.

The review of simulation suggested a lack of low and intermediate simulation solutions. There is a jump to the actual driving simulator without addressing simulations that would help in interventions. For example, a computer program to address reaction time or visual field (both written for the MY-DAP trials in Maryland). Programs reviewed generally were not simple and tended to be their own focus versus being developed to support assessment, education, or training.

Three driving simulators were reviewed and evaluated and two were used. The DORON system was used in this study and is described elsewhere. The ATARI simulator was tested at their site using a highway patrol pursuit exercise. Vibrasym made by Occusym of Denver, Colorado was reviewed with the developers, but not used (a test is planned for late July). The simulation devices had different characteristics and the ATARI had the disadvantage of not having materials available for use in assessing older drivers, yet technically was



perhaps the most sophisticated. The Vibrasym unit is presently designed for use in evaluating truck drivers and provides physical and motion feedback, but is being converted for use with the elderly.

It appeared there was no reason to develop another simulator, but rather to work with the three companies. The approaches are different. ATARI and Vibrasym use video monitors, while DORON uses a film projector. ATARI also provides side visual input, but it uses computer generated graphics. ATARI's use of sound was impressive, but in some assessment situations would be distracting. Both other companies use real videos recorded on the road, and in the case of Vibrasym they include the motions and forces of the road that are placed on the driver. The data for DORON is on 16mm film, whereas, Vibrasym uses a video disk. Of the three simulators, the ATARI was most focused on trying to reach "virtual reality" which is strongly imbedded in the companies history.

None of the units are truly set-up for work with the elderly, although all have been used for research with the elderly. None of the units addressed assessment specifically in any detail. A translation to assessment needs was made with the SFSU simulation protocol for the DORON unit. Further work will be done with the DORON unit aimed at improving its applicability to work with the elderly and also with Vibrasym starting as this project ends. The protocols will be extended, more assessment instruments will be added to meet the hierarchy criteria, and feedback provided to the subjects. With Vibrasym the potential for creating a continuum of simulation experience, more educational and training activities, and a greater range of situations in the interactive mode are being explored.

#### Technical Issues

The first CBT level which converted ODSAI into a computer program was fairly simple and straight-forward. One option offered by Mr. Sam Yaksich, Jr., Executive Director of AAA Foundation For Traffic Safety was to provide a third option under the software; an intervention which was more visual and less text oriented. Mr. Yaksich provided slides that were developed for this purpose. This simple addition illustrates the beginnings of problematic technical issues and their ultimate resolution.

The final product would require between 20 and 35 slides to be converted from film to a digitized format. Each slide would require approximately 75 to 200K of storage and a graphic adaptor on the host computer. The slides could be converted to digitized format for a few hundred dollars using a service bureau, and the computer code to implement the slides in a sequential presentation is fairly trivial. The problem was how to distribute 3 to 5 Mbytes in a cost-effective and simple way making it easy for the user to implement, and there is no easy solution to this dilemma. The transfer from floppies to a hard disk and then running the program is the simplest solution.

The simple ODSAI by generating this condition underscored a general problem of the mass storage required for graphics. It was simple to develop, but was based on writing computer programs. In looking at the AARP course, the problems increased dramatically due to the larger amount of material. The amount of code would increase, and if graphics and sound were desired to be added to textual presentations, a rather complex situation results.

One option to reduce the complexity and focus resources on material development versus computer program generation was to look at graphics and/or authoring packages. The first attempt was to use a simple animation language called GRASP (distributed by Paul Mace Software). A script is written to develop and move an object. The test condition was a car stopping at a stop sign and then making a left hand turn. The process became relatively complicated and a good example could not be developed.

The next step was to write the code to do the simulation using a procedural language (Microsoft Professional BASIC again was used). The computer program provided the movement and control, but it added considerable effort if a range of conditions were to be used. The effort required would be costly unless a generic program were written to cover all possible situations which reproduces a number of existing programs.

It was decided to evaluate authoring packages as an alternative. Authoring packages produce training materials with very little or no computer coding and either provide or link to animation packages. The packages also now link to specific computer multi-media environments to allow the use of sound and graphics (including film clips and sound bites). The packages run under the Apple McIntosh operating system and/or MicroSoft's Windows.

A copy of AuthorWare for the McIntosh was made available to the co-investigator at the University of Kentucky's Department of Special Education for review. Their staff also were available to discuss their use of it. The package was found to greatly simplify the production of a training package, but used a lot of disk space making it harder to distribute the resultant product. The list price for the package was \$8,000 and an educational discount for this project could not be secured.

IconAuthor from AimTech for Windows was tested. It was used less disk space, but still a considerable amount if a lot of graphics were used. It allowed using programs to generate the graphics (in some instances tested five to fifteen lines of code could generate a 200K graphic), and allowed using some of the better known graphic packages. Its list price was \$5,000 and an educational discount was secured and the package acquired by the co-investigator as the project ended. The data files for the AARP course were in the process of being translated to the format compatible for IconAuthor. IconAuthor also had the advantage of having more liberal and less costly licensing arrangements for distributions of completed products.

Lower end authoring packages also were reviewed. They did not meet the criteria for some of the more complex interactive applications of training materials defined and would take longer to develop. The critical element in the development cycle is time due to limited funding. The more complex and thorough systems such as IconAuthor would reduce development time significantly.

A third set of packages was explored. IconAuthor includes a two dimensional modeler and animator, but would not handle more complex situations or three dimensions. Arrangements were made to secure AutoDesk's 3D Studio and Animator Pro. These products can be integrated into the training packages much like video clips, but at a fraction of the storage requirement. The packages will allow the production of a full range of simulations as part of the training packages eliminating almost all need for writing specific computer programs. These two programs were pending delivery as the project ended.

The analysis of technical requirements also addressed the issue of output of the programs to tape, and the input of video clips. There are a range of interface boards available and several candidates have been selected. Two new boards are due out this summer, and a final selection will be made this summer. In the interim scanning services are planned to be used for 35mm slides in the presentations with the idea that animated sequences would be added.

The Maryland based study of MY-DAP's use (Group 7) without the simulator used videos of computer programs reflecting similar stimuli to those of the simulator. The video's were of low quality due to the frequency difference of the video camera and computer monitor scan rates. The result was still useable, but would have been improved by a video interface board.

#### Discussion

The CBT development produced one product for distribution (through AAA Foundation for Traffic Safety), ODSAI computer program and scoring system. The AARP course materials were translated to computer files with coding for graphics and text display. A number of alternative production mechanisms were tested before deciding on authoring systems and graphic production packages. These packages conform to the Windows and Multi-Media PC standards.

The solutions selected were in large part based on cost of development considerations. Excluding the fun of developing generalized systems, there is no utility in reproducing what already exists. The tools appear expensive until amortized against the number of potential copies of materials, and the significantly lowered productions costs.

The mass storage problem cannot be fully eliminated, its minimization has to be part of the design of individual modules. The tools to minimize the storage demands have been outlined, but they do not fully eliminate the problem. At some point it is expected that the material will have to be distributed on CD-ROMS. This option will become increasing cost-effective as the cost of their production decreases, and also the number of modules that become available increase.

The testing and evaluation done was time consuming, but the outline provided for solutions is viable and should be useful for a long period of time. It conforms to all known current and pending standards dealing with authoring of educational and training packages and also will support a continuum of simulation approaches.

## 10. Self-Selection Survey

A survey was undertaken to learn about the reasons why people participate in questionnaires, assessment, and interventions relating to older drivers and their safety. Questions also were included about attitudes towards the use of simulators and technology in assessment and interventions. The instrument, purposes, and method for the survey is described in Section 2. The following sections describe the results of that survey.

### Sample Process and Description

The survey method was simple. Three older drivers living in three different parts of Sun City, Arizona were provided the surveys. Each person contacted friends or neighbors and requested them to complete the survey. The people were given the option to take the survey or not, there were no refusals although 2 persons did not fully complete the survey. There were a total of 54 subjects.

Of the 54 subjects, 24 were male, 26 female, and 4 did not indicate their sex. The distribution of age by sex is presented in Figure 10.1. There was an unexpected correlation of age with sex ( $r=.29$ ) indicating the men were older.

Age Range	Count by Sex					Percent (based on N=49)			
	F	M	U	T		F	M	U	T
55-59	0	1	0	1	M	0.00	2.04	0.0	2.04
60-64	4	2	0	6	FFFFMM	8.16	4.08	0.0	12.24
65-69	5	4	0	9	FFFFFFMMMM	10.20	8.16	0.0	18.36
70-74	8	8	0	16	FFFFFFFFMMMMMMMM	16.34	16.33	0.0	32.67
75-79	2	8	2	12	FFMMMMMMMMUU	4.08	16.33	4.08	24.49
80-84	1	3	1	5	FMMMMMU	2.04	2	2.04	10.20
Missing	-	-	5	5		-	-	-	-
<b>Total</b>	<b>20</b>	<b>26</b>	<b>4</b>	<b>54</b>		<b>40.82</b>	<b>53.06</b>	<b>2</b>	<b>100.00</b>

-----  
 F=Female M=Male U=Unknown Sex T=Total  
 Age Range: Minimum=57 Maximum=82

Figure 10.1. Age-Sex Profile of The Self-Selection Sample

A summative profile of all the demographic variables is presented in Table 10.1. Each variable will be reviewed individually with references to the Table as needed. The ethnicity of the group was white (one Native American was the only exception); hence, the variable was not used in any further analysis. The marital status of the group is presented in Table 10.2. The subjects were predominately currently married (69%), of the 31% single the largest group were widowed (17%) the predominance of whom were female.

The educational level of the group was mixed as shown in Figure 10.2. The men tended to be more educated, there were more men in the graduate school grouping (7:2 with 1 of unknown sex) whereas there were more women in the high school group (10:2 with 2 of unknown sex).

The preponderance of the group lived with a spouse (35 of 52, 67.3%) and 14 lived alone (1 each lived with a children, friend, or other and 2 did not respond). Of the 14 who lived alone 10 were women, and of the 35 who were married 12 were women and 20 were men with 4 of unknown sex.

Table 10.1. Summary of Demographic Variables

VARIABLE	N	N*	MEAN	MEDIAN	STDEV	SEMEAN	MIN	MAX
Age	49	5	69.84	69	6.306	0.901	57	82
Sex	50	4	1.520	2	0.505	0.071	1	2
Marital Status	52	2	2.423	2	0.977	0.136	1	6
Ethnicity/Race	52	2	4.981	5	0.139	0.019	4	5
Education	51	3	4.922	5	1.468	0.205	3	7
Zipcode	54	0	-	-	-	-	-	-
Community Type	50	4	2.180	2	0.438	0.062	1	3
Live with	52	2	1.885	2	0.878	0.122	1	6
Employment	52	2	3.712	4	0.776	0.108	1	4
Occupation	51	3	2.471	1	1.793	0.251	1	6
Drive Mi/Yr (00s)	47	7	84.89	80	54.73	7.980	5	250
Travel: car	53	1	1.000	1	0.000	0.000	1	1
Travel: taxi	53	1	1.981	2	0.137	0.019	1	2
Travel: bus	53	1	1.925	2	0.267	0.037	1	2
Travel: train	53	1	1.981	2	0.137	0.019	1	2
Travel: cycle	53	1	1.868	2	0.342	0.047	1	2
Travel: walk	53	1	1.566	2	0.500	0.069	1	2
Travel: other	53	1	1.717	2	0.455	0.063	1	2
Income	44	10	4.977	5	1.089	0.164	3	6
Problem w/ bills	52	2	1.750	2	0.590	0.082	1	3

Table 10.2. Marital Status-Sex Profile of Sample

Marital Status	Count by Sex				Percent (based on N=52)			
	F	M	U	T	F	M	U	T
Never	1	1	0	2	1.92	1.92	0.0	3.84
Now	12	21	3	36	23.08	40.40	5.77	69.25
Widowed	7	2	0	9	13.47	3.84	0.0	17.31
Seperated	1	0	0	1	1.92	0.0	0.0	1.92
Divorce	1	2	0	3	1.92	3.84	0.0	5.76
Other	1	0	0	1	1.92	0.0	0.0	1.92
Missing	1	-	1	2	-	-	-	-
<b>Total</b>	<b>24</b>	<b>26</b>	<b>4</b>	<b>54</b>	<b>44.23</b>	<b>50.00</b>	<b>5.77</b>	<b>100.00</b>

-----  
 F=Female M=Male U=Unknown Sex T=Total  
 Age Range: Minimum=57 Maximum=82

Educational Level	Count	Pct.	Distribution
High School	14	27.45	*****
Technical/Vocational	4	7.84	****
Jr. College/Some College	15	29.41	*****
College	8	15.69	*****
Graduate School	10	19.61	*****
Missing	3	-	

Figure 10.2. Educational Level Profile

Of 52 responding subjects, 45 (86.5%) were retired or not working for pay. Only 2 subjects were working full-time (all females) and 4 part-time for pay (all males), and only 1 (a woman) was not working and looking for paid work. The distribution by age for this variable followed the profile of the overall sample. The large proportion of the persons were in one group thus this variable was not used in the analysis.

Of the 51 subjects responding to the question on occupation, 26 (50.9%) indicated they held a professional or managerial position. Only 3 subjects were manual or industrial workers, 9 were clerical or office workers, 3 were salespersons, 5 were skilled or technical workers, and 5 indicated an other occupation (mostly homemakers). The clerical/secretarial were predominately women, and the professional or managerial levels had a 2:1 ratio of men to women.

Of the 44 people reporting income (10 were missing), 18 (40.9%) reported incomes of over \$40,000. No one reported an income below \$10,000, with 7 (15.9%) reporting incomes between \$10,000 and \$19,999, 5 (11.4%) between \$20,000 and \$29,999, and 14 (31.8%) between \$30,000 and \$39,999. Only 4 people indicated they had difficulty paying their bills, 31 people indicated they had no problems while maintaining a balanced account, while 17 people indicated that they had excess savings (2 persons did not report). The likelihood of reporting a balanced account versus excess savings increased with income group ( $r = -.393$ ) suggesting lifestyle adjusted to income and expectations were greater. Income was correlated with sex ( $r = .368$ ), males reported higher incomes, with males reporting income over \$40,000 (14:4) with the other groups being approximately equal except for the \$20-29,999 range where 5 women reported their income versus no males.

All subjects drove, and the reported mileage driven ranged from 500 to 25,000 miles with a mean of 8,500 miles (47 or 54 subject responded). There was normal distribution of driving miles if the subjects reported less than 10,000 miles of driving. For the those persons reporting 10,000 miles or over: 10 reported 10,000 miles, 6 reported 12,000 miles, 2 who reported 15,000, 3 reported 20,000 miles, and 1 reported driving 25,000 miles. There were significant correlations for age and maleness with increased driving miles.

The distribution of subjects by geographic area approximated the region in which the person distributing the survey lived. There were some differences noted by age and sex by interviewer, but they appeared to reflect differences in the regions. Overall there were more males than expected which may simply reflect that two of the three persons distributing the survey were males. No formal refusals were received by any of the three people, although several forms which were to be mailed in were not received at the time this report was being prepared.

#### Activity Level

The activity profile from the main questionnaire (MY-CODA) was included. Only one missing activity profile was missing from the sample. Only one person did not vote in the last presidential election, so it was dropped from the analysis. An activity score was computed by recoding the response and summing the recodes across all 17 activities. A score of (1) indicated they did not do the activity and was recoded to 0, a score of (2) that the activity was done 1-2 times per year was left as a score of 2, a score of (3) indicating that the activity was done 1-2 times per month was recoded to 20, a score of (4) or 1-2 times per week was recoded to 70, and a score of (5) 3+ times per week was recoded to 200. The activity score is approximately the number of days per year that the person participated in the 17 activities listed. The distribution of the scores is presented in Figure 10.3.

The activity score correlated with age ( $r = .219$ ), the older persons were more active and women were more active than men ( $r = -.144$ ). Sex was not significant, and age was significant when adjusted for sex and income ( $P = .03$  with 5.7% of the variance explained). There were no relationships found between the activity score and income, age, miles driven per year, and the questions on participation (either for questionnaire or for intervention). Minimal effects were found in the intervention, technology, and other factors groupings as reported in the following sections.

Activity Score	N	Pct.	Cumm. Pct.	Distribution
0 - 99	2	3.77	3.77	
100 - 199	3	5.66	9.43	
200 - 299	4	7.55	16.98	
300 - 399	9	16.98	33.96	
400 - 499	14	26.42	60.38	
500 - 599	3	5.66	66.04	
600 - 699	4	7.55	73.59	
700 - 799	4	7.55	81.14	
800 - 899	5	9.43	90.57	
900 - 999	1	1.89	92.46	
1000 -1099	2	3.77	96.23	
1100 -1199	1	1.89	98.12	
Outlier 1586	1	1.88	100.00	
Missing=1				

Figure 10.3. Summary Activity Scores

In general, the activity score was a poor predictor of the other variables. The analysis was repeated removing the small and three largest scores. Removing the outlining scores reduced the significance of age to  $P=.130$  with 2.8% of the variance explained. The only improvement was a desire to participate in the longitudinal study where the significance increased from  $P=.142$  to  $P=.039$  and the variance explained increased from 2.3% to 6.8%.

#### Questionnaire Participation

The first six questions on the survey requested information about the person's willingness to complete a questionnaire. If the questionnaire took 30 to 60 minutes and could be done in the home, 37 of 54 respondents (68.5%) indicated they would complete it. If the time were increased to 1 1/2 to 2 hours, only 7 of 54 respondents (13.0%) were willing to complete the questionnaire. In looking at both questions, only 7 persons checked both, 30 checked only the 30 to 60 minute option, and 14 checked neither. The results suggest a change in willingness to participate in the range of one hour, and also indicated that they would rather do the questionnaire in their own home than in a group (45 out of 54 responses, 83.33%).

Information in the questionnaire about older drivers and how to adjust driving habits with age was favored by 39 of 54 respondents (72.2%). In response to the question of whether they would favor receiving information on how they answered questions compared to a large group of older drivers, 39 out of 54 respondents (72.2%) were in favor of receiving the information. There were 33 of the persons who wanted information about driving also wanted information about how they compared to other drivers (61.1% of all subjects); 11.1% (N=6 each) wanted one or the other set of information and 16.7% (N=9) wanted neither. There was an association ( $r=.446$ ) between those persons who wanted information about older drivers and feedback on their performance relative to other older drivers. In looking at both questions together (information and feedback), 33 of 54 (61.1%) answered both yes, 9 persons (16.67%) answered both no, and 6 each answered one of the two questions yes (11.11% each).

The results suggest that information about older drivers and comparisons to other older drivers was desired. Yet in response to the questions whether the likelihood of participation would be increased by providing information or feedback there was a decrease in affirmative responses; 29 vs 39 (information) and 32 vs 39 (feedback). Still, more than half the persons indicated that information and feedback would increase the likelihood of their participation. Another way to review the data is the combination of responses to the increased willingness to participate (information, feedback, and payment) which is summarized in Table 10.3. The combination also shows the respondents wanted the

information and feedback if they participated, but it was not as strong a factor in helping to increase the likelihood of participation.

Table 10.3. Factors Increasing The Likelihood of Participation

Number	Pct.	Information	Feedback	Payment
5	9.26	Yes	Yes	Yes
1	1.85	Yes	Yes	No
1	1.85	Yes	No	Yes
2	3.70	Yes	No	No
18	33.33	No	Yes	Yes
8	14.81	No	Yes	No
5	9.26	No	No	Yes
14	25.93	No	No	No

Persons who wanted information on adjustments for older drivers were likely to be associated with lower income ( $r=.267$ ), where as, those persons desiring feedback were likely to be correlated with higher income ( $r=-.129$ ), were older ( $r=-.129$ ), and would rather take the questionnaires by themselves. A like result (lower income) was found for increasing participation by providing information ( $r=.189$ ), but the people were more likely to want group participation ( $r=-.183$ ). Increasing participation by providing feedback was correlated to: lower income ( $r=-.108$ ), group participation ( $r=-.236$ ), desiring information on older driver adjustments ( $r=.243$ ), feedback on other older drivers ( $r=.411$ ), and also that information would increase the likelihood of participation ( $r=.440$ ).

Only 9 of 54 persons (16.7%) said being paid would increase the likelihood of their participation. Of the 9 persons, 2 did not indicate an amount, and of the others 1 indicated \$5, 4 indicated \$10, and 1 each indicated \$25 and \$50. Of the nine persons desiring payment, they were likely to be younger ( $r=.316$ ), female ( $r=.279$ ), drove less ( $r=.298$ ), and had lower incomes ( $r=.199$ ).

#### Intervention Participation

In response to questions about participation in an intervention based on the number of hours (53 responses with 1 missing), 26 persons (49.06%) said they would participate in a one hour session, whereas only 12 persons (22.64%) said they would be willing to participate in a two hour session, and 4 persons (7.54%) indicated that they would participate in an all day session. When asked what the maximum number of hours that they would participate, 30 persons (55.56%) indicated that they would not want to participate, 2 persons suggested a half an hour (3.70%), 12 persons (22.22%) indicated one hour, 8 persons (14.81%) responded with 2 hours, and 1 person each responded with 3, 4, and 8 hours (1.85% each). The combination of both questions (one hour and two hour sessions) had 12 of 53 persons (22.64%) responding yes to both, 14 (26.4%) to 1 hour and none to two hours, and 27 (50.94%) responding no to both.

The shorter the time of the intervention the more likely the person was to participate. There was a significant drop off between 1 and 2 hours, over 50% of those willing to participate. The all day option reduced that number by 300%. The obvious conclusion is that the participation is time sensitive. Given an option of defining the time they preferred, the persons were less likely to respond positively to involvement (24 vs 26 for the one hour option question) with a decrease in both the one, 2 and all day options. This result suggests that it might be best to simply offer activities in the 3/4 to 1 1/2 hour range and not offer choices when designing an intervention; the added decision making appears to result in fewer positive responses.

The "participate in one hour" question was correlated to age ( $r=.223$ ), income ( $r=.203$ ), to also responding on the "two hour" question ( $r=.262$ ), to desiring participation information ( $r=.170$ ) feedback ( $r=.168$ ) payment ( $r=.196$ ), and the more miles driven per year ( $r=-.306$ ) the more likely a positive response was received, and to completing the questionnaire by themselves (vs in a group) ( $r=-.446$ ). The "participate in two hours" question was correlated to



fewer items: being male ( $r=-.157$ ), higher income ( $r=-.193$ ), and more miles driven per year ( $r=-.161$ ). The correlations cited indicate direction, but are not statistically significant. Regression of age, sex, and educational level on the one hour intervention question did not yield any significant results.

When probed about the common inducers for involvement (insurance credit, erasure of moving violations, and payment), 36 persons (66.67%) responded to insurance credits, 8 persons (14.81%) responded to removal of moving violations, and 6 persons (11.11%) indicated that payment would be a factor. Of the 6 persons responding, only 2 indicated amounts (\$25 and \$100 respectively).

The more active persons were more likely to have responded they would be willing to participate in a 30 to 60 minute intervention ( $r=-.232$ ), and also in a 1 1/2 to 2 hour intervention ( $r=-.088$ ). In the cases where the subject selected the number of hours, the more active persons were more likely to have selected longer hours ( $r=.143$ ). Active persons also were more likely to indicate that they would participate in an intervention to remove a traffic violation ( $r=.155$ ). Again, these correlations suggest direction, but were not significant.

In responding to the question of how far they were willing to drive to a central location to participate in a training session, 52 of 54 subjects responded. Of the 52 persons responding, 18 (34.6%) said that they would not be willing to drive. Of the persons responding, the following is a synopsis of the responses in the format (miles, number, percent of responding): 1 mile,  $n=1$ , 1.92%; 5 miles,  $n=9$ , 17.31%; 6 miles,  $n=2$ , 3.85%; 10 miles,  $n=14$ , 26.92%; 13 miles,  $n=1$ , 1.92%; 15 miles,  $n=3$ , 5.77%; 20 miles,  $n=2$ , 3.85%; 25 miles,  $n=1$ , 1.92%; and 50 miles,  $n=1$ , 1.92%. The mean was 9 miles and the median 10 miles. The results suggest that people generally were not willing to drive any great distance to participate. There were no significant correlations to any demographic variables or to the number of miles driven by the subject.

#### Technology Interventions

Of 54 respondents, 39 indicated that they would be willing to use a driving simulator in a training session (intervention). In response to whether they would like to use driving simulator (vs being willing) 22 responded yes, 13 no, 18 did not care either way, and 1 subject did not respond. The use of simulators did not seem to cause any particular problems for the subjects. A regression of willingness to use a simulator on age, sex, and educational level did not yield significant results.

The willing to use simulators was favored more by men ( $r=-.116$ ), persons with a lower education ( $r=.168$ ), and a lower income ( $r=.139$ ). Those persons who would like to use a simulator were likely to be younger (correlated with age,  $r=.352$ ), weakly correlated with being female ( $r=-.091$ ), lower income ( $r=.139$ ), and to use of simulators ( $r=.152$ ).

Of 53 persons responding, 32 indicated that they would use video (i.e., 21 did not want to use videos for training. A few persons added anecdotal notes that they did not have VCRs, but a larger number of positive responses was expected. Persons wanting to use video as a training tool were; likely to be younger ( $r=.129$ ), male ( $r=-.343$ ), less educated ( $r=-.178$ ), and more likely to have viewed the simulator in the same light ( $r=.127$ ).

Of the persons who indicated that they would use video, the video tape lengths preferred were: 0.5 hours (9), 1 hour (17), 2 hours (5) and 5 hours (2). The video length durations that people preferred were again in the one hour range (the mean was 1.25 hours and the median was 1 hour). It might be interpreted that attention span or willingness to risk time on an educational activity is around an hour.

Of 53 of 54 persons responding, 28 (52.83%) indicated that they would be willing to use computer-based training systems (if they required no understanding of computers). The number does not differ greatly from use of VCRs (32) which indicates less resistance than expected. A regression of willingness to use computers on age, sex, and educational level was not significant.

Persons with high activity scores were less likely to like the idea of using a simulator ( $r=.133$ ), or to want to use a video for training ( $r=.143$ ). The time being willing to be spent watching a video (if a person selected that option) was associated with higher activity scores ( $r=.109$ ). These associations are not significant, and only suggest direction.

A more interesting pattern is suggested by looking at how the persons responded to the three technology use questions (simulator, video, and computer). The pattern is shown in Table 10.4 and suggests that if a person selected one it was likely that more than one was selected (61.54%), 36.5% ( $n=19$ ) selected all three, and only 13.46% did not select any. The technology aversion ascribed to the older person is not supported by the data.

Table 10.4. Pattern of Technology Acceptance Questions

Number	Pct.	Simulator	Video Tape	Computer
19	36.54	Yes	Yes	Yes
6	11.54	Yes	Yes	No
7	13.46	Yes	No	Yes
6	11.54	Yes	No	No
2	3.85	No	Yes	No
5	9.62	No	No	Yes
7	13.46	No	No	No

#### Other Influencing Factors

In response to the question of the person receiving additional training and education on general mobility in addition to driving, the subject's evenly split 26 of 52 (with 2 non-responses). Offering the additional training would be viewed positively by half the persons, thus an optional educational or training program added to the driving materials would be useful and could reach the older population without adding much additional cost.

With 51 of 54 persons responding, 24 indicated they would be more willing to participate if the education were provided by members of their community of the same age group (27 said it did not matter). For a portion of the population, there is a greater comfort zone with persons of their own age. Working through groups of older persons within the community (such as AARP clubs) should increase participation.

In response to the person's willingness to participate in a research project if educational and training programs were included as part of the project, of 53 responses 27 persons said it would be a positive factor and 26 said "no". Again as with the previous two factors, about half the population would be influenced by providing added benefits.

In responding to factors that would keep them from participating (53 of 54 subjects responded, with 18 citing interference with daily routine, 5 citing they did not like new things, 14 cited they did not have the time, and 4 cited other reasons of varying types). Regression of each of these factors on sex, age, and educational level were not significant. Persons with high activity scores were less likely to be associated with reporting trying new things ( $r=.112$ ) which is not statistically significant. Interestingly, not having enough time was not associated with activity level which suggests that it is a perception. The distribution of persons responding to daily routine, new things, and no time is presented in Table 10.5 which suggests a high degree of independence between the three factors.

Table 10.5. Restricting Factor Patterns

Number	Pct.	Routine	New Things	No Time
4	7.55	Yes	Yes	Yes
4	7.55	Yes	No	Yes
10	18.86	Yes	No	No
1	1.89	No	Yes	No
6	11.32	No	No	Yes
28	52.83	No	No	No

### Discussion

The survey suggested some factors to consider in terms of designing interventions. The results are summarized in the following list:

1. people are sensitive to the length of the intervention activity and prefer a time between 45 minutes and an hour and 15 minutes,
2. as intervention time exceeds the preferred range the willingness to participate decreases rapidly,
3. questionnaires were preferred to be done by the person in their own home rather than as a group activity,
4. people wanted information about older drivers and feedback on their abilities relative to the overall older driver population as part of the intervention,
5. providing information, feedback, and payment were likely to increase participation, but the responses were less positive than wanting information about driving and their results if they participated,
6. in general the interventions should be held within 1 to 10 miles of the person's home, there was a resistance to driving further,
7. technological approaches of simulation, video, and computer-based training were responded to favorably by over half the respondents and about 2 out of 3 people selected one or more of the approaches,
8. video tape lengths should be kept in the range of 1/2 to 1 and 1/4 hours,
9. routine and lack of time were major factors cited for not wanting to participate,
10. payment was not a good inducement to participate in questionnaires or interventions, the best inducement was insurance rate reductions, and
11. inclusion of educational and training programs and materials on general mobility and safety were requested by over half the respondents suggesting that they might be an inducement to participate, but more importantly that any activity or intervention does serve as an avenue to provide this information at the same time reducing the cost of delivery.

There were some surprises in the analyses. In general, the results did not seem to be influenced by age, sex, educational level, or income. Activity levels also did not seem to have a great influence on the results reported. By contrast, there was no surprise to finding routine and perceived lack of time as deterrents to participation.

The survey was added to the study when it was observed that the participants in the SFSU simulator group appeared to be self-selecting, i.e., some people who were contacted and did not participate seemed to fall into some general groupings. The survey supported some of these observations in the items listed above. The survey did not tap a person's fears of finding out or confirming fears of being poor drivers, and perhaps that it was time to stop driving or alter driving habits. In trying to keep the survey short and non-threatening, these issues were not addressed.

The survey sample had a higher proportion of males than the general population, but otherwise was generally representative of an older population. The sample came from a retirement community which is not truly representative of the overall population. The results were interesting enough to have additional data collected from other populations (Maryland and California samples are being gathered as this project ends) and will be used to test the generalizeability of the results reported herein. The combined samples will be analyzed and reported in the general literature.

## 11. DISCUSSION

The discussion provided in this section will provide general summative highlights of the work. The materials in the individual sections are too complex and diverse to provide detailed information, it is suggested that the summaries at the end of each chapter be reviewed. Secondly, the degree of analyses of the materials vary from first generation descriptive reviews to more complete analyses. In most cases, they were designed to present the basic process undertaken and the descriptive findings and setting up the next generation of analyses to be dealt with in technical papers.

Almost the entire project is built from two models. The first model suggests it is important to treat assessment and intervention in a modular and multi-phasic manner (a person progresses through increasingly more complicated assessments and interventions - if you fail you move on - if you pass you exit the process). The second model is of the driving situation and was used to guide the development of much of the instrumentation. A third consistent framework across the work was looking at the cost-effectiveness of a particular intervention or assessment from both the provider and subject perspectives.

### Modular Approach

The multi-phasic modular approach outlined appeared to work in process, but only produced differences in one experimental group. It appeared that the AARP course in one site did make a difference, but not in other sites. The problem in part was the lack of scoring of the AARP course as pass-fail (you pass if you stay through the course) and the simulator intervention being more focused on assessment than on knowledge or attitudes. Differences were not found for the ODSAI intervention on the pre-post tests.

The modular approach was supported in concept by the results of the participant survey. An all-day intervention was not a favored option by most of the older drivers polled. They favored interventions in the one-hour duration range. Modules addressing more specific issues would remain closer to this time frame.

In addressing cost, it also is important to consider the subject's time as a cost. The provider may evaluate cost in terms of their time and equipment costs, but the subject/patient views cost in terms of their time. There is potential for conflict in these two views. If the ability to assess and focus interventions on specific assessed problems existed, and if modules were available to fit these needs then a more responsive situation would exist and more persons could be served.

The modular or multi-phasic approach outlined still seems to provide the best options for reaching the most persons. One option would be to use technology to produce individualized training materials. The person is assessed using a standard instrument or even perhaps an assessment process such as the ones developed in this study. Based on the results, it should be possible to create individualized interventions using computer programs which could be output to video tape for home viewing. There would be some cases where needs and therefore tapes would be similar reducing the production requirement. The ability to undertake this approach is based on the hierarchical nature of the intervention system and the ability to relate assessed need to educational/training materials.

### Assessment

The ODSAI was failed by half the subjects, but the intervention phase of the system did not seem to effect the subject's attitudes or knowledge. The project added a general descriptive instrument (MY-CODA) and a profiling instrument for functions needed to drive effectively (MY-DAP). A pre post test also was developed.

The MY-DAP was a first generation tool. Conceptually, it is to be a profile of the older driver's limitations (if they exist) and would then lead to more detailed assessments in problem areas. The instrument was developed and used in a range of situations establishing its ease of use. Validity and reliability analyses are pending the addition of another 20 to 30 cases.

MY-CODA is a more general instrument with ties to many existing instruments in fields of aging and older driver safety. It is a self-report instrument. In the analyses done to date it appeared to have reasonable validity. Analyses of reliability are still being worked on.

The individual items on these tests yielded a lot of information on older drivers and their habits and characteristics. These results were reported in each section. Multivariate analysis both within and across scales are planned. The results relative to aging are reviewed below.

### Education

It appeared there was not a good link between assessment and education. There also are very few educational modules to provide based on assessment results. This problem seemed to be based on the lack of integrating procedures, and not using a multi-phasic approach to education. The gap between the ODSAI and the AARP course is rather large. There also needs to be a way to elicit more specific information about the participant and even to defining pass fail grades.

### Training

The training done on the simulator was limited. The problem lies in cost-effectiveness. Only a small portion of problematic drivers should reach this stage which is the most costly to provide. The methods to accomplish this goal do not seem to exist. The work undertaken showed that technological approaches could help in developing more alternatives.

### Simulation

Simulation was defined in this study as a continuum from a simple procedure such as a case study to a complex driving simulator. The focus principally was from the low-end through the typical driving simulator found in hospitals and clinics (e.g., DORON Systems simulators). A number of driving simulators were tested, case studies developed, and methods for producing interactive simulations between the two investigated.

The work on simulation focused mainly on creating replicable assessments. Protocols were developed for comprehensive assessments and procedures to complete MY-DAP from these assessments developed. An experimental situation for evaluating the protocol with and without a simulator was implemented.

The protocols lacked a good feedback system, as did the new assessment materials. This weakness needs to be cured. The protocols did validate the simulator as a good assessment tool, and was particularly useful in assessing information processing, judgement, and decision making.

### Technology

The approaches to CBTs addressed assessment, education, and training as well as including simulation. The ODSAI instrument was converted to a computer program including administration, feedback, and scoring and is being made available through AAA Foundation for Traffic Safety. Work was done on creating a computer version of the AARP course. The course was entered into data files and preliminary programming started.

Based on those tests it was decided to investigate more powerful tools for production of CBTs. The end result of this work was the selection of authoring and graphic and animation tools to do the production. The test of these tools was beginning as the project ended. The delay was in part due to the lengthy evaluation undertaken, but also to the finally emerging multi-media standard under MicroSoft's Windows allowing for a common working foundation.

Technological approaches seem a good way of approaching reaching a large number of older persons. They provide for interactive capabilities as well as use with different media (video tape or computer). The participant survey results suggested older persons were not adverse to using technology. It also indicated that many people will not spend much time in getting to or taking a

course, so the technological approaches provide a potential supplement to existing educational and training methods.

### Aging and Driving Issues

The research suggested some interesting characteristics of older drivers. One difference in the analysis was the low number of associations with gender and the range of characteristics investigated. About 1/3rd of the respondents showed some negative attitudes towards driving. There was a significant number of persons who did not fully understand the influences of age on driving suggesting the need for additional education.

The subjects wanted control over the decision to stop driving, and about half thought family or doctor were the next best alternative, and DMVs and police departments were the least favored choices. The reasons given that would be flags for persons to stop driving were poor health and accidents, but about 1 in 4 thought available transportation and need for mobility should be a factor in the decision. Age was not seen as a sole determining factor in stopping driving or in relicensure. There was a discrepancy of 10 to 15 in the ages when re-examination for relicensing should begin and when persons thought they might no longer want to drive. The pattern of responses to age questions suggested persons knew that problems might exist in their driving, but generally wanted the decision point put off into the late 80s and 90s.

The participant survey indicated that older people were not as adverse to technology as expected. The breaking of their routine was a factor cited by at least 1 in 3 respondents as a reason for not participating in studies or interventions as has been suggested in the literature on aging. There was considerable evidence that people at greatest risk did not want to participate in assessments for fear of learning (or confirming) their bad driving habit or that someone would learn how badly they were driving and would take away their licenses. The results when combined with the other data gathered suggested that the persons at greatest risk are the ones hardest and least likely to be reached.

There was significant evidence that information processing, judgement, and decision making were a major problem for older drivers. There also appeared to be a group of behavioral factors involved. Complex decisions which were centered about intersections and freeway merges were frequently cited as problems.

### Discussion

There were few group differences noted in the pre-post test. The only significant difference was in the group that received both the ODSAI interventions and the AARP course. A difference was found between two sites that administered the course; one site had no change and the other did. The suggestion is that there may be significant course variability between course sites and instructors. A pre-post change was not found for the group taking only the ODSAI intervention or for the simulation groups. Apparently, there was not enough general information to match the questions the on the pre-post test from the ODSAI, and the simulator activity was not aimed at the items on the pre-post test.

There was a clear indication that peoples participation was dependent on the time requirement (up to about an hour and a quarter was acceptable). Longer time periods reduced the willingness to participate and further reduced the pool of older drivers who might be reached. People also favored doing much of the interventions in the home, and not wanting to drive very far (5 to 10 miles maximum) for any activity.

The study produced some interesting results, though often not what was planned. The data set that resulted is rich and requires much more analyses and than done for this summary report. The computer-based training work started in one direction and changed as technology changed and matured from the time of the proposal to the completion of the project. The project's use of driving simulators changed and they became assessment tools more than training systems (partly influenced by the time people were willing to spend, and partly due to the research being undertaken). The study is being continued as part of a older driver and mobility lab at San Francisco State University.

## 12. REFERENCES

1. Wiener, E.L. "Elderly Pedestrians and Drivers: The Problem that Refuses to Go Away." In P. F. Waller (Ed.), 1972 North Carolina Symposium on Highway Safety, No. 7, Aging and Highway Safety: The Elderly in a Mobile Society, pp. 53-95. Chapel Hill: The University of North Carolina Highway Safety Research Center, 1973.
2. National Safety Council. Accident Facts. Chicago: National Safety Council, 1990.
3. Fife, D., Barancik, J.I. and Chatterjee, B.F. "Northeastern Ohio Trauma Study: II. Injury Rates by Age, Sex, and Cause." American Journal of Public Health, 1984, 74(5): 473-478.
4. Baker, S.P., O'Neill, B. and Karpf, R.S. The Injury Fact Book. Boston: D.C. Heath and Company, 1984.
5. Malfetti, J.L. and Winter, D.J. Development of a Traffic Safety and Alcohol Program for Senior Adults. New York: AAA Foundation for Traffic Safety, 1978.
6. Marsh, B.W. "Aging and Driving." Traffic Engineering, November 1960, 31: 3-21.
7. Evans, L. Traffic Safety and The Driver. NY, NY: Van Nostrand Reinhold, 1991
8. Shupe, D.R. "Perceived Control, Helplessness, and Choice." In J.E. Birren & J. Livingston (Eds.), Cognition, Stress, and Aging, pp. 174-192. Englewood Cliffs, New Jersey: Prentice-Hall Inc., 1985.
9. Wallston, B.S. & Wallston, K.A. "Social Psychological Models of Health Behavior: An Examination and Integration." In A. Baum, S. Taylor & J.E. Singer (Eds.), Handbook of Psychology and Health, Volume 4: Social Aspects of Health. Hillsdale, New Jersey: Erlbaum, 1984.
10. Malfetti, J.L. & Winter, D.J. Development of the Older Driver Self-Assessment Inventory. Falls Church, Virginia: AAA Foundation for Traffic Safety, 1986.
11. Koncelik, J.A. Aging and the Product Environment. Pennsylvania: Hutchinson Ross Publishing Company, 1982.
12. Schwartz, A.N. & Peterson, J.A. Introduction to Gerontology. New York, Holt, Rinehart and Winston, 1979.
13. Institute of Medicine. Healthy People: The Surgeon General's Report on Health Promotion and Disease Prevention. Washington, D.C.: U.S. Government Printing Office, 1979.
14. Lowy, L. Social Policies and Programs on Aging: What Is and What Should Be in the Later Years. Boston: D.C. Heath and Company, 1980.
15. Schultz, J.H. The Economics of Aging. Belmont, CA: Wadsworth Publishing Company, Inc., 1980.
16. United States Traffic Safety Administration. Highway Safety Facts, 1(2). Washington, D.C.: National Center for Statistics and Analysis, December 1979.
17. Harris, C.S. Fact Book on Aging: A Profile of America's Older Population. Washington, D.C.: National Council on Aging, Inc., 1978.
18. Yee, D. "A Survey of the Traffic Safety Needs and Problems of Drivers age 55 and Over." In Malfetti, J.L. (Ed.), Needs and Problems of Older Drivers: Survey Results and Recommendations. Proceedings of the Older Driver Colloquium, Orlando, Florida. Falls Church, Virginia: AAA Foundation for Traffic Safety, 1985.
19. Transportation Research Board. Transportation in an Aging Society: Improving Mobility and Safety for Older Persons (Volume 1). Washington, D.C.: National Research Council, 1988.

20. Planek, T.W. "The Aging Driver in Today's Traffic: A Critical Review." In P.F. Waller (Ed.), 1972 North Carolina Symposium on Highway Safety, No. 7, Aging and Highway Safety: The Elderly in a Mobile Society, pp. 1-38. Chapel Hill, The University of North Carolina Highway Safety Research Center, 1973.
21. Melichar, J.F. and Yee, D. "Driver Profiling Method", in preparation.
22. Melichar, J.F., "Hierarchical Categorization and Function", in preparation.
23. Melichar, J.F., ISAARE, An Introduction. AAESPH Review, 3(4), December 1978.
24. Yee, D. & Melichar, J.F. Final Report: Accident Prevention Through Driving Skills Assessment and Interventions For Older Drivers: A Programmatic Research Project. Washington, D.C.: AARP Andrus Foundation, May 1992.
25. Malfetti, J.L. and Winter, D.J. Safe and Unsafe Performance of Older Drivers: A Descriptive Study. Falls Church, VA: AAA Foundation for Traffic Safety, 1987.
26. Flannigan, J.C. Measures of Human Performance. Pittsburgh, PA: American Institutes for Research, 1962.
27. Szlyk, J.P., Severing, K., Fishman, G.A. Visual Field Loss and Driving Performance. Washington, D.C., AAA Foundation For Traffic Safety, 1991.
28. Laux, L.F. & Mayer, D. Locating Vehicle Controls and Displays: Effects of Expectancy and Age. Washington, D.C., AAA Foundation For Traffic Safety, 1991.
29. Malfetti, J.L. & Winter, D.J. Concerned About An Older Driver? A Guide for Families and Friends. Washington, D.C., AAA Foundation For Traffic Safety, 1991.
30. Kline, D. Aging and the Visibility of Highway Signs: A New Look Through Old Eyes. Washington, D.C., AAA Foundation For Traffic Safety, 1991.
31. Tiara, E.D. (Ed). Assessing the Driving Ability of the Elderly. NY, NY: Hayworth Press, 1989.
32. McPherson, K., Michael, J., Ostrow, A. & Saffron, P. Physical Fitness and the Aging Driver: Phase I. Washington, D.C., AAA Foundation For Traffic Safety, 1988.
33. McPherson, K., Michael, J., Ostrow, A. & Saffron, P. Physical Fitness and the Aging Driver: Phase II. Washington, D.C., AAA Foundation For Traffic Safety, 1989.
34. Rothe, J.P. The Safety of Elderly Drivers: Yesterday's Young in Today's Traffic. New Brunswick, NJ: Transaction Press, 1990.
35. Evans, L. Older Driver Involvement In Fatal and Severe Traffic Crashes. Jo. of Gerontology. 1988;43:S186-193.
36. Retchin, S.M., Cox, J., Fox, M., Irwin, L. Performance-based measurements among elderly drivers and nondrivers. Jo Amer Ger Soc. 1988;36:813-819.
37. McKnight, A.J. & Stewart, M.A. Development of a Competency Based Driver License Testing System. Landover, MD: National Public Services Institute, 1990.
38. Laux, L.F., & Brelsford, J., Jr. Age-related Changes in Sensory, Cognitive, Psychomotor, and Physical Functioning and Driving Performance in Drivers Aged 40 to 92. Washington, D.C., AAA Foundation For Traffic Safety, 1990.
39. Malfetti, J.L. & Winter, D.J. A Graded License for Special Older Drivers: Premise and Guidelines. Washington, D.C., AAA Foundation For Traffic Safety, 1989.
40. Owsley, C., Ball, K., Sloane, M.E., Roenker, D.L., Bruni, J.R. Visual/Cognitive Correlates of Vehicle Accidents In Older Drivers. Psychology and Aging. 1990.



41. National Highway Traffic Safety Administration. The National Highway Traffic Safety Administration's Traffic Safety Plan For Older Persons. (DOT Rpt# HS 807-316). Washington, D.C. Department of Transportation, 1988.
42. National Highway Traffic Safety Administration. Older Drivers: The Age Factor In Traffic Safety. (DOT Rpt# HS 807-402). Washington, D.C. Department of Transportation, 1989a.
43. National Highway Traffic Safety Administration. Conference on Research and Development Needed To Improve Safety and Mobility Of Older Drivers. (DOT Rpt# HS 807-554). Washington, D.C. Department of Transportation, 1989b.
44. Transportation Research Board. Transportation in an Aging Society: Volume 1. Washington, D.C.: National Research Council, 1988.
45. Bard, C., Fluery, M., & Hay, L. (Eds). Eye Hand Coordination Across The Life Span. Columbia, SC: U of South Carolina Press, 1990.
46. Wollacott, M.H, Shumway-Cook, A. (Eds). Posture and Gait Across The Life Span. Columbia, SC: U of South Carolina Press, 1989.
47. Birren, J.E., & Schaie, K.W. (Eds). Handbook of The Psychology of Aging. (3rd Edition). San Diego, CA: Academic Press, 1990.
48. Binstock, R.H. & George, L.K. (Eds). Handbook of Aging and The Social Sciences. (3rd Edition). San Diego, CA: Academic Press, 1990.
49. Schneider, E.L. & Rowe, J.W. (Eds). Handbook of the Biology of Aging. (3rd Edition). San Diego, CA: Academic Press, 1990.
50. Birren, J.E., & Schaie, K.W. (Eds). Handbook of The Psychology of Aging. (2nd Edition). NY, NY: Van Nostrand Reinhold, 1985.
51. Salthouse, T.A. Theoretical Perspectives on Cognitive Aging. Hillsdale, NJ: Lawrence Erlbaum, 1991.
52. Schaie, K.W., Blaxer, D, House, J.S. (Eds). Aging, Health Behaviors, and Health Outcomes. Hillsdale, NJ: Lawrence Erlbaum, 1992.
53. Romanowicz, R.A, Gervers, M.A. Teen and Senior Drivers. (CAL-DMV-RSS-90-126). Sacramento, CA: Department of Motor Vehicles, 1990.
54. Schaie, K.W, Schooler, C. (Eds). Social Structure and Aging: Psychological Processes. Hillsdale, NJ: Lawrence Erlbaum, 1989.
55. Fillenbaum, G.G. Multidimensional Functional Assessment of Older Adults: The Duke Older Americans Resources and Service Procedures. Hillsdale, NJ: Lawrence Erlbaum, 1982.
56. Lazarus, R.S. Emotion and Adaptation. NY, NY: Oxford U Press, 1991.
57. Rodin, J., Schooler, C., & Schaie, K.W. (Eds). Self-Directedness: Cause and Effects Throughout The Life Course. Hillsdale, NJ: Lawrence Erlbaum, 1990.
58. Schwebel, M, Maher, C.A., Fagley, N.S. (Eds). Promoting Cognitive Growth Over the Life Span. Hillsdale, NJ: Lawrence Erlbaum, 1990.
59. Gallo, J.J, Reichel, W., Andersen, L. Handbook of Geriatric Assessment. Rockville, MD: Aspen, 1988.
60. Strauss, A. Corbin, J. Basics of Qualitative Research: Grounded Theory Procedures and Techniques. Newbury Park, CA: Sage, 1990.
61. Morgan, D.L. Focus Groups As Qualitative Research. Newbury Park, CA: Sage, 1988.
62. Yin, R.K. Case Study Research: Design and Methods (Revised Edition). Newbury Park, CA: Sage, 1989.

63. Whyte, W.F. (Ed). Participatory Action Research. Newbury Park, CA: Sage, 1991.
64. Yee, D. & Melichar, J.F. Interim Report AARP Project. San Francisco State University, San Francisco, CA, 1991.
65. Spielberger, C.D. Manual for the State-Trait Anxiety Inventory. Palo Alto, CA: Consulting Psychologists Press, 1983.
66. Cattell, R.B. Patterns of Change: Measurement In Relation To State Dimension, and Trait Change, Liability and Process Concepts. Handbook of Multivariate Experimental Psychology. Chicago: Rand McNally & Co, 1966.
67. Mature Driving: A Unique Program for Older Drivers. Pamphlet, AARP 55 Alive/Mature Driving Program, AARP, Washington, D.C.
68. Safe Driving For Mature Operators. Pamphlet, AAA Driver Improvement Program, AAA Foundation For Traffic Safety. Falls Church, VA.
69. Safe Driving for Mature Operators: Course Manual. AAA Driver Improvement Program, AAA Foundation For Traffic Safety. Falls Church, VA, 1989.
70. Am I Too Old To Drive? Pamphlet, Traffic Safety Department, California State AAA, San Francisco, CA, 1986.
71. 55 Alive/Mature Driving: Course Manual. 3rd Edition, AARP 55 Alive/Mature Driving Program, AARP, Washington, D.C., 1988.
72. Malfetti, J.L. & Winter, D.J. Drivers 55 Plus: Test Your Own Performance. AAA Driver Improvement Program, AAA Foundation For Traffic Safety. Falls Church, VA, 1986.
73. Melichar, J.F. A System Model For Describing Human Function and Services. in final preparation, 1992.
74. Okun, M.A, Melichar, J.F., Hill, M.D. Negative Daily Events, Positive and Negative Social Ties, and Psychological Distress Among Older Adults. The Gerontologist. Vol 20, No 2, (193-199).
75. Melichar, J.F. Divorce As A Process. Doctoral Dissertation. University of California San Francisco. San Francisco, CA, 1982.
76. Melichar, J.F. & Chiriboga, D.A. Timetables in the Divorce Process. Jo. of Marriage and the Family. Aug 1985.
77. Melichar, J.F. & Chiriboga, D.A. The Importance of Time In The Adjustment to Divorce. Jo. of Orthopsychiatry. Vol 58, No 2, 1988.
78. Melichar, J.F. & Okun, M.A. The Effects of Negative Social Ties On Network Satisfaction Among Older Adults. presented 41st Annual Meeting, Gerontological Society of America, San Francisco, CA, 1988.

79. Yee, D., Melichar, J.F., Smith, D.L. Accident Prevention and Injury Control: Driver Safety and Health Promotion for Older Adults. Galveston, TX: Texas Consortium of Geriatric Education Centers, 1990.

80. Golan, S.M. A Place To Grow Old: The Meaning Of Environment in Old Age. New York: Columbia University Press, 1984.

81. Kulikowski, C.A. & Weiss, S.M. Computer Systems That Learn: Classification and Prediction Methods from Statistics, Neural Nets, Machine Learning, and Expert Systems. San Mateo, CA: Morgan Kaufman, 1991.

## APPENDICES

- A. MY-CODA and Pre-Post Test  
Melichar-Yee Comprehensive Older Driver Assessment (MY-CODA) Program  
Including Attitude Assessment Test (AAT) and Knowledge Assessment  
Test (KAT) (Pre and Post-Test)
- B. MY-DAP Assessment Profile  
Melichar-Yee Driver Assessment Profile (MY-DAP) Instruction  
Manual and Form
- C. SIMULATION PROTOCOL, San Francisco State University
- D. MY-DAP Trial - Simulation Protocol Without Simulator
- E. Participation Survey Protocol
- F. ODSAI Computer Program Users Manual
- G. Outline of Papers for Publication
- H. Presentation Abstracts and Summaries  
Gerontological Society of America  
American Society on Aging  
National Council On Aging  
Traffic Safety Summit - 1992
- I. Statistical Analysis Supporting Documentation

APPENDIX A:

MELICHAR-YEE COMPREHENSIVE OLDER  
DRIVER ASSESSMENT (MY-CODA)  
PROGRAM INCLUDING ATTITUDES  
ASSESSMENT TEST (AAT) AND  
KNOWLEDGE ASSESSMENT TEST (KAT)  
(PRE AND POST-TESTS)

# COMPREHENSIVE OLDER DRIVER ASSESSMENT (CODA) PROGRAM\*

---

## ADMINISTRATION INFORMATION

Agency #: \_\_\_\_\_ Site #: \_\_\_\_\_ Subject #: \_\_\_\_\_

Date: \_\_\_\_/\_\_\_\_/\_\_\_\_ Interviewer #: \_\_\_\_\_

---

## INTRODUCTION

The increase in the aging of the overall population has entailed a simultaneous increase in the number of older drivers. Drivers age 55 and over constitute 28% of all drivers today-- 39% by the year 2000. While many older drivers have excellent driving records, as a group, when exposure is considered, they are disproportionately involved in traffic accidents and fatalities.

Accident prevention and injury control emphasize the development of individual and community measures to protect against accidents and their harmful consequences. The purpose of this program is to identify the at-risk driver age 55 and over, and remediate any deficits in knowledge or skills about driving and traffic safety.

While your help in answering questions contained in this survey is completely voluntary, it is important that you try to answer all the questions. Please mark only one [X] to answer each question except where otherwise indicated. All of the information which you provide will be kept anonymous and confidential. No names are necessary.

When you have completed this survey, please return it to us as directed. Thank you for your help in the successful completion of this program.

\* This program is sponsored by a grant from the AARP Andrus Foundation.

--- ANONYMOUS AND CONFIDENTIAL ---

**DEMOGRAPHIC INFORMATION**

1. Your age? \_\_\_\_\_
2. Birth date? \_\_\_/\_\_\_/\_\_\_
3. Your sex?  Female  
 Male
4. Your current marital status?  
 Never Married  
 Now Married  
 Widowed  
 Separated  
 Divorced  
 Other: \_\_\_\_\_
5. Ethnicity/Race?  
 Asian  
 Black  
 Hispanic  
 Native American  
 White  
 Other \_\_\_\_\_
6. Your highest level of education?  
 Elementary School  
 Junior High School  
 High School  
 Technical or Vocational School  
 Junior College or Some College  
 College  
 Graduate School
7. What is the zip code where you live? \_\_\_\_\_
8. Community in which you live?  Rural  Suburban  Urban
9. With whom do you live?  
 No one  Spouse  Children  
 Other Relatives  Friend  Other: \_\_\_\_\_
10. What is your current employment status?  
 Working part-time for pay  
 Working full-time for pay  
 Not working, but looking for paid work  
 Retired and/or not working for pay
11. What is (or was) your principal occupation?  
 Professional/Managerial  Manual/Industrial Worker  
 Clerical/Office Worker  Salesperson  
 Skilled/Technical Worker  Other: \_\_\_\_\_
12. When you last worked (or if you still do), how many miles did (do) you travel round trip to your place of employment?  
 0-10  11-20  21-30  31-40  41 or more
13. By what means did (do) you travel to work? (Check all that apply)  
 Car or Car Pool  Taxi  Bus  
 Train or Subway  Bicycle  Walk  Other: \_\_\_\_\_
14. What was your total annual income (all sources including social security) for you (and your spouse, if married) for the last year?  
 \$ 0 - 4,999  \$20,000 - \$29,999  
 \$ 5,000 - 9,999  \$30,000 - \$39,999  
 \$10,000 - 19,999  \$40,000 or more

15. Which of these statements best describes your financial situation?
- My bills are no problem to me, I have excess savings
  - My bills are no problem to me, I have a balanced account
  - My expenses make it difficult to pay my bills
  - My expenses are so heavy that I cannot pay my bills

### DRIVER HISTORY

16. Did you complete a classroom driver education course or in-car driver training course before taking your driver's licensure examination?  No  Yes, classroom course only  
 Yes, in-car course only  
 Yes, classroom and in-car courses
17. How difficult was it for you to obtain or renew your driver's license?  Very  Somewhat  Not very  Not at all
18. Do you now have a valid driver's license?  Yes  No
19. How many years have you been licensed to drive an automobile?  
 Never licensed to drive  
 Not now licensed to drive  
 Less than 1 year  
 More than 1 year. Please specify the number of years: \_\_\_\_\_
20. How many automobiles do you and/or other members of your household own?  None  One  Two  Three or more
21. Do you have fender scrapes, door gouges or dents that are a result of your driving?  
 None  One  Two  Three or more
22. How many tickets have you received in the past two years for moving traffic violations?  
 None (SKIP to #24)  One  Two  Three or more
23. What were your violations for? (Check all that apply)  
 Failure to yield  Going too slowly  
 Not heeding traffic lights  Not heeding traffic signs  
 Improper passing  Improper turning  
 Reckless driving  Speeding  
 Tailgating  Other: \_\_\_\_\_
24. How many times have you been arrested for driving while intoxicated (DWI)?  
 None  One  Two  Three or more
25. How many accidents have you been involved in as the driver of an automobile within the past two years?  
 None (SKIP to #30)  One  Two  Three or more



26. What was the dollar amount of the damage that was done to your car in the most expensive of these accidents? \$ \_\_\_\_\_
27. How were you involved in this accident as the driver?  
 Was hit by a moving vehicle       Hit a pedestrian  
 Hit a moving vehicle               Hit a stationary object  
 Ran off the road                       Other: \_\_\_\_\_
28. Were you wearing your seatbelt in this accident?  Yes  No
29. As a result of this accident, did you or a passenger in your car receive medical treatment? (Check all that apply)  
 Yes, I received treatment  
 Yes, a passenger in my car received treatment  
 No one received treatment
30. How many automobile insurance claims have you made in the past two years?  None       One       Two       Three or more
31. How many automobile insurance claims have been made against you in the past two years?  
 None       One       Two       Three or more
32. Have you ever had your automobile insurance canceled or had to seek an alternate insurance carrier?  Yes       No
33. Whether or not you now own an automobile, do you have easy access to one?  Yes       No

#### DRIVING PATTERN

34. How many miles have you driven in the past year? \_\_\_\_\_ miles
35. How often do you drive an automobile?  
 Every day                               Every other day  
 Once or twice a week               Once or twice a month  
 Rarely                                       Not at all

What percent of your driving is done at the following times?

36. During rush hour: \_\_\_\_\_%
37. During the day other than rush hour: \_\_\_\_\_%
38. From dusk until mid-night \_\_\_\_\_%
39. From mid-night until dawn: \_\_\_\_\_%

40. How fast do you usually drive in comparison with the general flow of traffic?  
 Much faster                     Somewhat faster             About the same  
 Somewhat slower                 Much slower
41. When driving during the day, how often do you pass other cars?  
 Frequently             Sometimes             Seldom             Never
42. How often do you find yourself failing to see signs and other road markings?  
 Frequently             Sometimes             Seldom             Never
43. Whether you are a driver or a passenger, check the three main purposes for which you use an automobile:  
 Never use an automobile  
 Grocery and other shopping             Getting to and from work  
 Health care services                     Going to church  
 Getting to appointments                 Attending meetings  
 Visiting friends/relatives             Volunteer activity  
 Other: \_\_\_\_\_
44. When your car isn't used for long (more than one day) trips, why not?  
 Not applicable, car is used for long trips  
 Uncomfortable                             Too tiring  
 Too expensive                             Car may break down  
 Other: \_\_\_\_\_
45. How often do you use your inside rearview mirror?  
 Frequently             Sometimes             Seldom             Never
46. How often do you use your driver side view mirror?  
 Frequently             Sometimes             Seldom             Never
47. How often do you use your passenger side view mirror?  
 Do not have one  
 Frequently             Sometimes             Seldom             Never
48. How often do you wear your seatbelt when you are the driver of an automobile?  
 Always (SKIP to #50)  
 Most of the time             Sometimes             Seldom             Never
49. When you don't wear your seatbelt as the driver, why not?  
 (Check all that apply)  
 Passenger(s) doesn't                     I forget about it  
 Too hard to put on                         Inconvenient  
 Uncomfortable                               Don't have them  
 Don't need them                             Other: \_\_\_\_\_

50. How do you usually check to the rear? (Check all that apply)
- Use driver outside view mirror
  - Use driver inside view mirror
  - Turn and look back
  - I rarely check to the rear
  - Other: \_\_\_\_\_
51. How often do you wear your seatbelt when you are a passenger in an automobile?
- Always (SKIP to #53)
  - Most of the time     Sometimes     Seldom     Never
52. When you don't wear your seatbelt as a passenger, why not? (Check all that apply)
- Driver doesn't
  - Too hard to put on
  - Uncomfortable
  - Don't need one
  - I forget about it
  - Inconvenient
  - Don't have one
  - Other: \_\_\_\_\_
53. What alcoholic beverages do you usually drink? (Check all that apply)
- None (SKIP to #59)     Beer     Wine     Hard liquor
54. How often do you drink alcoholic beverages?
- More than once daily
  - Every day
  - Every other day
  - Once or twice a week
  - Once or twice a month
  - Rarely
55. When you drink, how many drinks do you usually have?
- One     Two     Three     Four or more
56. Do you drive soon after you have been drinking?
- Never (SKIP to #59)
  - Seldom     Sometimes     Frequently
57. How soon after drinking do you usually drive?
- Less than 1/2 hour
  - 2 to 4 hours
  - after 8 hours
  - 1/2 to 2 hours
  - 4 to 8 hours
58. In which way do you notice the most difference in the way you drive after drinking?
- No difference
  - I drive slower
  - I make more mistakes
  - I avoid driving at night
  - I do not pass other cars as often
  - Other: \_\_\_\_\_
59. How long were you or have you been the principal driver of the automobile in your family?
- Never
  - Less than 1 year
  - More than 1 year. Please specify the number of years: \_\_\_\_\_

60. Who usually rides with you when you drive? (Check all that apply)  
 No one                       Spouse             Children  
 Other relatives             Friend  
 Other: \_\_\_\_\_
61. How do you feel about having passengers when you drive?  
 Prefer             Don't mind             Dislike             Not applicable
62. Who usually drives for you if you do not drive yourself?  
 No one                       Spouse             Children  
 Other relatives             Friend  
 Other: \_\_\_\_\_
63. How often do you use public transportation?  
 Every day                       Every other day  
 Once or twice a week             Once or twice a month  
 Rarely                               Not at all
64. In which two ways do you prefer to get around?  
 Drive myself                       Have someone drive me  
 Use public transportation             Taxi  
 Senior services                       Bicycle  
 Walk                                       Other: \_\_\_\_\_
65. Five years from now, how often do you think you will have a need for an automobile as a driver or a passenger?  
 Every day                       Every other day  
 Once or twice a week             Once or twice a month  
 Rarely                               Not at all

#### DRIVER PERFORMANCE

66. How would you describe your eyesight (with glasses or contact lenses, if normally worn)?  
 Excellent             Good             Fair             Poor
67. Does your driver license require that you wear glasses or contact lenses?             Yes             No
68. Do you wear glasses or contact lenses for seeing in the distance?  
 Yes             No
69. Do you wear glasses or contact lenses for reading?  
 Yes             No
70. Do you have any of these visual problems? (Check all that apply)  
 Cataract                       Glaucoma                       Color blindness  
 Night blindness             Tunnel vision             None of the above  
 Other: \_\_\_\_\_

71. Do you have difficulty reading traffic signs or signals before you are too close for them to do any good?  
 Frequently     Sometimes     Seldom     Never
72. For traffic signs (highway or street), do you have difficulty with their: (Check all that apply)  
 Size     Shape     Colors  
 Clarity of lettering     Message     No difficulty
73. On which roads do you have great difficulty with traffic signs? (Check all that apply)  
 Interstate highways (freeways)     Freeways through cities  
 2-lane rural roads     City streets  
 None of the above
74. Can you see far enough ahead on 2-lane rural highways to take the curves and stay safely on the road?  
 Most of the time     Sometimes     Seldom     Never
75. On your last long trip (1,000 miles or more) along unfamiliar highways, how many times did you miss a sign (destination or route guidance) and take a wrong turn?  
 Never     1 - 2 times     3 - 4 times  
 5 - 6 times     7 times or more
76. Do you wear a hearing aid?     Yes     No
77. How would you describe your hearing (with hearing aid, if normally worn)?  
 Excellent     Good     Fair     Poor
78. How often do you "nod off" when you are driving an automobile?  
 Frequently     Sometimes     Seldom     Never
79. Have you ever blacked out from any of your medical problems while driving?  
 Frequently     Sometimes     Seldom     Never
80. Does your doctor or pharmacist tell you when prescribed drugs may affect your driving?  
 Yes     No  
 I do not take prescribed drugs (SKIP to #82)
81. Do any of your prescribed drugs make it more difficult for you to drive?  
 Frequently     Sometimes     Seldom     Never
82. Do you have difficulty entering or leaving high speed interstate highways (freeways)?  
 Always     Most of the time     Sometimes  
 Seldom     Never

83. Which if any of the following joints create difficulty when you drive: (Check all that apply)
- |  |                                |                                  |                                   |
|--|--------------------------------|----------------------------------|-----------------------------------|
| <input type="checkbox"/> Hip               | <input type="checkbox"/> Knee  | <input type="checkbox"/> Ankle   | <input type="checkbox"/> Shoulder |
| <input type="checkbox"/> Elbow             | <input type="checkbox"/> Wrist | <input type="checkbox"/> Fingers | <input type="checkbox"/> Toes     |
| <input type="checkbox"/> None of the above |                                |                                  |                                   |
84. How often does a painful or stiff joint interfere with your ability to drive?
- Frequently       Sometimes       Seldom       Never
85. Do you require that a car be equipped with an automatic transmission because of weak, painful or stiff lower extremity joints?
- Yes       No
86. Do you require that a car be equipped with power steering because of weak, painful or stiff upper extremity joints?
- Yes       No
87. How difficult is it for you to get into and out of your own car or cars of people you ride with?
- |   |   |
|---|---|
| <input type="checkbox"/> Very difficult     | <input type="checkbox"/> Somewhat difficult   |
| <input type="checkbox"/> Not very difficult | <input type="checkbox"/> Not at all difficult |
88. Do you experience any discomfort or pain when sitting in the driver's seat for a long period of time?
- Yes       No
89. How difficult is it for you to turn your head to look back over your shoulder when driving or backing up?
- |                               |                                   |                                   |                                     |
|-------------------------------|-----------------------------------|-----------------------------------|-------------------------------------|
| <input type="checkbox"/> Very | <input type="checkbox"/> Somewhat | <input type="checkbox"/> Not very | <input type="checkbox"/> Not at all |
|-------------------------------|-----------------------------------|-----------------------------------|-------------------------------------|
90. Do you have any trouble seeing or reading the gauges on your instrument panel?
- Yes       No
91. How valuable do you consider a clear center line road marking?
- |                               |                                   |                                   |                                     |
|-------------------------------|-----------------------------------|-----------------------------------|-------------------------------------|
| <input type="checkbox"/> Very | <input type="checkbox"/> Somewhat | <input type="checkbox"/> Not very | <input type="checkbox"/> Not at all |
|-------------------------------|-----------------------------------|-----------------------------------|-------------------------------------|
92. Do you have any trouble reaching, using or working any of these car parts? (Check all that apply)
- |  |   |
|--|---|
| <input type="checkbox"/> Seatbelt          | <input type="checkbox"/> Dashboard driving controls       |
| <input type="checkbox"/> Accelerator       | <input type="checkbox"/> Air conditioning/heater controls |
| <input type="checkbox"/> Brakes            | <input type="checkbox"/> Radio controls                   |
| <input type="checkbox"/> Horn              | <input type="checkbox"/> Gear shift - transmission        |
| <input type="checkbox"/> Turn signal lever | <input type="checkbox"/> Windshield washer/Wiper          |
| <input type="checkbox"/> 4-way flasher     | <input type="checkbox"/> Other: _____                     |
93. Do you have difficulty controlling any of the following emotions while driving? (Check all that apply)
- |                                     |                                      |  |
|-------------------------------------|--------------------------------------|--|
| <input type="checkbox"/> Anger      | <input type="checkbox"/> Anxiety     | <input type="checkbox"/> Frustration       |
| <input type="checkbox"/> Impatience | <input type="checkbox"/> Other _____ | <input type="checkbox"/> None of the above |

94. Do you have trouble with any of the following while driving?  
 (Check all that apply)
- |  |   |
|--|---|
| <input type="checkbox"/> Sensing information | <input type="checkbox"/> Processing information |
| <input type="checkbox"/> Solving problems    | <input type="checkbox"/> Deciding what to do    |
| <input type="checkbox"/> Executing decisions | <input type="checkbox"/> Physical endurance     |
| <input type="checkbox"/> Other: _____        | <input type="checkbox"/> None of the above      |

Please indicate whether your driving ability, for each condition below, is better, about the same, or worse than 5 years ago. Mark an [X] in the appropriate box:

	Doesn't Apply	Better	Same	Worse
95. Night driving				
96. Headlight glare				
97. Winter driving				
98. Rain and fog				
99. Snow, sleet or slush				
100. Interstate(freeway) driving				
101. City streets				
102. Rush hour driving				
103. When tired or upset				
104. After drinking				
105. After medication				
106. Holiday/vacation driving				
107. Going up/down steep hills				
108. Driving around curves				
109. Long-distance driving				

110. When did you last read the driver's manual for your state?
- |   |  |
|---|--|
| <input type="checkbox"/> Never have read it   | <input type="checkbox"/> In the last 2 years |
| <input type="checkbox"/> In the last 6 months | <input type="checkbox"/> In the last 3 years |
| <input type="checkbox"/> In the last year     | <input type="checkbox"/> 4 or more years ago |

111. How well informed are you about the current rules and regulations in your state?  
 Very well informed                     Not very well informed  
 Fairly well informed                     Not at all informed
112. When did you last attend a driver education, training or retraining course?  
 Never     1 - 2 years ago  
 Less than 6 months ago                     3 - 4 years ago  
 6 - 11 months ago                             5 years or more ago
113. In comparison to yourself two years ago, how is your ability to see when you are in traffic?  
 Much better                     Better                     About the same  
 Worse                                     Much worse
114. In comparison to yourself two years ago, how is your ability to hear when you are in traffic?  
 Much better                     Better                     About the same  
 Worse                                     Much worse
115. In comparison to yourself two years ago, have you noticed that your judgment out on the road(e.g. when to pass or stay in lane) is:  
 Much better                     Better                     About the same  
 Worse                                     Much worse
116. In comparison to yourself two years ago, how is your ability to steer the automobile?  
 Much better                     Better                     About the same  
 Worse                                     Much worse
117. In comparison to yourself two years ago, how is your reaction time in braking?  
 Much better                     Better                     About the same  
 Worse                                     Much worse

#### ENVIRONMENT

Do you feel safe...

118. in you own home during the day?.....  Yes                     No
119. in your own home at night?.....  Yes                     No
120. outside your home during the day?....  Yes                     No
121. outside your home at night?.....  Yes                     No



Please indicate how you rate the following characteristics of your environment. Mark an [X] in the appropriate box:

	Exce lent	Very Good	Good	Fair	Poor
122. Convenient for shopping					
123. Near grocery stores					
124. Convenient for visitors					
125. Near medical services					
126. Public transit					
127. Access to public transit					
128. Safety					
129. Neighbors					

#### MOBILITY

130. Could you live where you do without owning and driving an automobile, or having someone drive you?  Yes  No
131. Do you leave your home?  
 Regularly  Rarely  
 Occasionally  Only with assistance
132. Do you leave your neighborhood?  
 Regularly  Rarely  
 Occasionally  Only with assistance
133. Do you drive a car?  
 Frequently  Sometimes  Seldom  Never
134. Are you able to use public transportation?  Yes  No
135. Do you use any of the following as an aide for walking?  
 Cane  Walker  Wheelchair  
 Other \_\_\_\_\_  None of the above

## FAMILY AND FRIENDS

136. Do you have a close confidant?  Yes  No
137. How many times a week on average do you visit friends? \_\_\_\_\_
138. How many times a week do friends visit you? \_\_\_\_\_
139. How many hours during the week do you talk to friends on the telephone? \_\_\_\_\_
140. How many times a week do you go out with a friend? \_\_\_\_\_
141. How many close friends do you have? \_\_\_\_\_
142. How many living children do you have? \_\_\_\_\_
143. How many living siblings do you have? \_\_\_\_\_
144. How many other family members do you have? \_\_\_\_\_
145. How many close members of your family do you have? \_\_\_\_\_
146. For the close family members who do not live with you, how often do you talk with them on the telephone each week?  
\_\_\_\_\_ times for \_\_\_\_\_ hours \_\_\_\_\_ minutes per week
147. How often do you visit with your close family members?  
\_\_\_\_\_ times each  week  month  year for a total  
of \_\_\_\_\_ days \_\_\_\_\_ hours
148. What is the distance, in time, to the nearest close relative?  
\_\_\_\_\_ hours \_\_\_\_\_ minutes
149. If you were ill or incapacitated, how often could you expect help from your family or friends:  
 Always  Most of the time  Sometimes  
 Seldom  Never  Other \_\_\_\_\_
150. Is driving important to maintaining the contact and support of friends and family?  
 Always  Most of the time  Sometimes  
 Seldom  Never  Other \_\_\_\_\_
151. Do you depend upon hired help to assist you with the various activities of daily life?  
 Yes  No

## ACTIVITIES

Indicate how often you do the following activities...	0 x/yr	1-2 x/yr	1-2 x/mo	1-2 x/wk	3+ x/wk
152. go to a senior center?					
153. attend church?					
154. attend club meetings?					
155. go to the movies?					
156. attend sporting events?					
157. participate in general sports?					
158. participate in aerobic sports?					
159. play cards with others?					
160. garden?					
161. work on a hobby or hobbies?					
162. paint or play music?					
163. eat in restaurants?					
164. baby sit?					
165. visit away from your immediate neighborhood?					
166. take vacations away from home?					
167. entertain out-of-town guests or visitors?					
168. do volunteer work?					

169. Did you vote in the last presidential election?  
 Yes       No

## WELL-BEING AND OUTLOOK

Please answer the following questions...	YES	SOME-TIMES	NO
170. Is your daily life full of things that interest you?			
171. Have you at times very much wanted to leave your home?			
172. Does it seem that no one understands you?			
173. Are you happy most of the time?			
174. Do you feel weak all over much of the time?			
175. Is your sleep fitful and disturbed, or do you suffer from insomnia?			
176. Do feel nervous or tense?			
177. Do you have any major fears?			
178. Do you ever feel severely depressed?			
179. Do you ever have suicidal thoughts?			

180. Taking everything into consideration, how would you describe your satisfaction with your life at the present time?  
 Excellent     Very Good     Good     Fair     Poor

## HEALTH INDICATORS

181. Does your health stand in the way of things you want to do?  
 Frequently     Sometimes     Seldom     Never

During the last six months...

182. How many days were you unable to do your activities because of illness?	
183. How many days were you confined to your bed because of illness?	
184. How many days were you confined to nursing home or other non-hospital care facility?	
185. How many days were you confined to a hospital?	
186. How many visits did you make to a doctor?	

Rate your overall health now	Exce lent	Very Good	Good	Fair	Poor
187. At the present time					
188. Compared to 1 year ago					
189. Compared to 5 years ago					
190. Compared to peers now					

Do you ever	No	Rare- ly	Some- times	A Lot	Al- ways
191. Experience confused memory?					
192. Experience confusion with time?					
193. Experience confusion with where you are?					
194. Get confused while you are talking?					

Please indicate whether you have any of the following conditions then indicate whether your activities, for each of these conditions, is restricted a lot, somewhat restricted, or not restricted. Mark an [X] in the appropriate box:

Health condition/problem	Y e s	Restriction		
		None	Somewhat	A Lot
195. Arthritis/Rheumatism				
196. Bladder or Kidney				
197. Breathing or Lung				
198. Circulation				
199. Diabetes				
200. Glandular/Thyroid				
201. Heart Trouble				
202. Hypertension				
203. Low Blood Sugar				
204. Memory				
205. Osteoporosis				
206. Parkinson's				
207. Stroke				
208. Other _____				

---

**ADMINISTRATION INFORMATION**

Agency #: \_\_\_\_\_ Site #: \_\_\_\_\_ Subject #: \_\_\_\_\_  
Date: \_\_\_\_/\_\_\_\_/\_\_\_\_ Interviewer #: \_\_\_\_\_ [X] Pre [ ] Post

---

**ATTITUDES ASSESSMENT**

1. Do you think a driver's license is a privilege or a right granted to all qualified individuals?  
[ ] It is a right [ ] It is a privilege [ ] I don't care which
2. What do you think about the national maximum speed limit of 55 miles per hour?  
[ ] It is just right  
[ ] It should be increased  
[ ] It should be decreased
3. Do you think it is safe to drive way below the posted speed limit (e.g. 40 MPH in a 55 MPH zone)?  
[ ] Yes [ ] No
4. Do you believe traffic accidents are mainly:  
[ ] under your control  
[ ] due to chance or luck  
[ ] due to circumstances beyond your control
5. Would you be willing to take a driver education, training or retraining course?  
[ ] Yes [ ] No
6. The judgmental abilities of drivers aged at least 55 tend to be poorer than those of drivers below age 40.  
[ ] Strongly agree [ ] Slightly agree  
[ ] Neutral  
[ ] Slightly disagree [ ] Strongly disagree
7. The reaction time of most drivers aged at least 55 tends to be slower than the reaction time of drivers below age 40.  
[ ] Strongly agree [ ] Slightly agree  
[ ] Neutral  
[ ] Slightly disagree [ ] Strongly disagree
8. It is almost impossible for drivers aged 55 and over to learn and use anything new to improve traffic safety.  
[ ] Strongly agree [ ] Slightly agree  
[ ] Neutral  
[ ] Slightly disagree [ ] Strongly disagree

9. In comparison to yourself five years ago, are you a:  
 Better driver       About the same       Worse driver
10. Five years from now, do you believe you will be a:  
 Better driver       About the same       Worse driver
11. At about what age do you estimate you would no longer wish to drive an automobile?  
 55 - 59 years       60 - 64 years       65 - 69 years  
 70 - 74 years       75 - 79 years       80 - 84 years  
 85 - 89 years       90 years or more
12. At about what age do you estimate you would no longer be able to drive an automobile safely?  
 55 - 59 years       60 - 64 years       65 - 69 years  
 70 - 74 years       75 - 79 years       80 - 84 years  
 85 - 89 years       90 years or more
13. Who should make the decision about when it is time to give up driving? (Check all that apply)  
 Driver himself/herself       Family member(s)  
 Doctor(s)       Motor vehicle department  
 Police department       Other: \_\_\_\_\_
14. Is age alone a good basis for determining when it is time to give up driving?  
 Yes       No
15. If not, what other things should be considered? (Check all that apply)  
 Driver's health       Accident record  
 Need for mobility       Other available transportation  
 Other: \_\_\_\_\_
16. At what age do you think older drivers should be required to renew their licenses through reexamination?  
 No specific age requirement  
(same re-examination requirements as for younger drivers)  
 55 - 59 years       60 - 64 years       65 - 69 years  
 70 - 74 years       75 - 79 years       80 - 84 years  
 85 - 89 years       90 years or more
17. What kind of periodic driver re-examination would you favor for older drivers? (Check all that apply)  
 Eye test  
 Total physical examination  
 Written test  
 Driving (road) test  
 All of the above  
 None of the above  
 Comment: \_\_\_\_\_



18. Would periodic reexamination make you feel nervous or threatened?  
 Yes       No

### KNOWLEDGE ASSESSMENT

19. If your car goes into a skid, you should:  
 pump the brakes  
 apply the brakes firmly  
 avoid using the brakes  
 put your car into neutral
20. In which situation do you have the right-of-way?  
 when entering a controlled route  
 when already in a traffic circle  
 when approaching a merging traffic sign  
 when entering a street or highway from a driveway
21. If two vehicles arrive at an uncontrolled intersection at the same time from different directions, who should yield the right-of-way?  
 the vehicle on the left  
 the vehicle on the right  
 either vehicle  
 the slowest moving vehicle

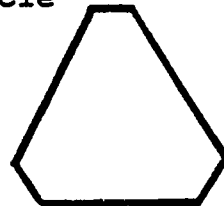

22. When you see a sign shaped like the one above, you will probably see it:  
 before entering a narrow bridge  
 on the left side of the road  
 on the back of a slow moving vehicle  
 just before a curve
23. Depth perception, which is important in knowing when to pass safely:  
 increases with age  
 remains the same with age  
 decreases with age  
 increases significantly with age
24. Drivers age 60 and over compared with drivers age 30-50 are involved in:  
 more than their share of accidents per mile  
 an equivalent share of accidents per mile  
 less than their share of accidents per mile  
 it varies each year

25. An icy road is most slippery at what temperature?  
 32     25     10     0    degrees Fahrenheit
26. What should you do when driving in the rain?  
 reduce speed and increase following distance  
 maintain speed with vehicle ahead  
 reduce speed and reduce following distance  
 vary speed to dry out brakes

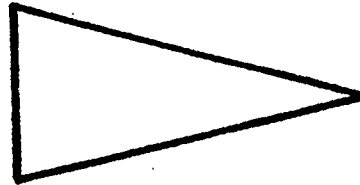

27. Where might you see a sign shaped like the one above?  
 on the right side of the road in a No Passing zone  
 on the left side of the road in a No Passing zone  
 before very sharp curves in the road  
 on roads where there is restricted travel
28. If you are driving through residential streets lined with tall shrubs and hidden driveways and no sidewalks, what should you do?  
 keep an eye on the rearview mirror for cars trying to pass you  
 slow down and beep your horn at pedestrians walking along the side of the road  
 drive down the center of the street to improve visibility  
 drive slowly and continually search the environment for potential hazards
29. What should a driver do if the minimum speed limit on a freeway or highway is too fast for him?  
 use the freeway only during non-rush hours and in daylight  
 stay to the right and drive very cautiously by keeping an eye on the rearview mirrors  
 keep off the freeway and select an alternate route  
 stay in the right lane and use the emergency flashers
30. When entering a controlled access highway (turnpike or freeway), what should you do?  
 accelerate to the traffic speed and enter highway by merging with traffic at the safest point  
 stop at the end of the entrance ramp and look for an opening in the traffic  
 proceed slowly and enter expressway when safe, trying not to stop  
 because you have the right-of-way, accelerate to the traffic speed and enter the highway quickly

31. If you miss your exit on an Interstate, you should do what?
- turn around at the first U-turn for emergency vehicles area
  - go on to the next exit
  - wait till the highway is clear and then back up
  - stop and back up on the shoulder with your flashers on
32. When rounding a left curve your vehicle tends to do what?
- move to the inside of the lane
  - stay in the center of the lane
  - move to the outside of the lane
  - speed up
33. Why should smoking be avoided when driving at night?
- the light from the cigarette can reflect in the windshield
  - it can impair night vision
  - you can start a fire in the car
  - smoking presents no hazard when driving

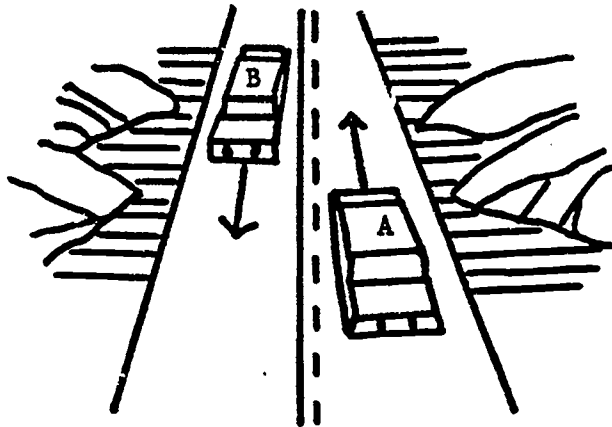

34. A road like the one pictured above means that:
- car A can pass whenever it is safe
  - car B can pass whenever it is safe
  - passing is prohibited in both directions
  - either car is permitted to pass
35. The best way to increase visibility when backing up is by:
- looking in the rearview mirror
  - looking in both the rearview and side mirrors
  - leaning your head out the window
  - turning around and looking out the rear window
36. How may eyeglasses adversely affect vision during driving?
- eyeglasses with heavy temples (side pieces) can restrict side vision
  - glare from oncoming headlights at night will reflect into the eyes
  - if the glasses slip, they can block the eyes
  - eyeglasses do not adversely affect driving

37. Very slow driving is especially dangerous in which of the following situations?
- when approaching the crest of a hill
  - just after passing the crest of a hill
  - when making a U-turn
  - when making a right turn
38. If you are planning to make a left turn across an intersection and you are waiting in the middle of the intersection for a break in oncoming traffic, which way should your front tires be turned?
- to the left
  - it depends upon the sharpness of the turn
  - straight ahead
  - to the right
39. What do you do when you are exiting a controlled access highway (turnpike or freeway)?
- slow down after you enter the deceleration lane
  - slow down before you enter the deceleration lane
  - start to brake as soon as you signal your intentions to exit
  - it is optional whether you signal your exit as long as you are in the lane closest to the exit
40. If you take medication before driving a long distance, what is the most important thing for you to do?
- have another person ride with you
  - be sure to eat a light meal
  - plan on making several rest stops along the way
  - find out the effects of the medication
41. What measure should the driver age 55 and over use in following the vehicle ahead?
- 1 car length for ten miles per hour you are traveling
  - 2 second following distance
  - 3 second following distance
  - 10 feet for every ten miles per hour you are traveling
42. You want to change lanes. You can see if a car is in your blind spot:
- only if you check your rearview mirror
  - only if you check your sideview mirror
  - only if you turn and glance over your shoulder
  - only if you check both mirrors
43. Making good use of all mirrors on a car is especially important for those drivers who:
- have peripheral vision
  - have hearing problems
  - drive a lot at night
  - are driving unfamiliar cars

44. What temporary visual condition can occur from drinking alcohol?  
 reduced side vision  
 blurring  
 seeing double  
 all of the above  
 none of the above
45. The blood alcohol level at which a driver is assumed to be "under the influence" is .10% in some states. For a 155 pound man to reach this level on an empty stomach, the amount of whiskey he would probably have to drink within one hour is:  
 3 ounces  
 6 ounces  
 9 ounces  
 12 ounces  
 15 ounces
46. Alcohol is a factor in approximately what percentage of traffic deaths?  
 10%     20%     30%     40%     50%
47. As you drink more alcohol, your ability to drive:  
 steadily improves  
 improves at first, but then gets worse  
 may get better or worse, depending on certain factors  
 worsens at first, but then gets better  
 steadily worsens
48. For each one ounce drink of whiskey, a person should wait before driving:  
 15 minutes     30 minutes     1 hour  
 2 hours     3 hours
49. Which will "sober you up" if you want to drive?  
 black coffee  
 a cold shower  
 time  
 vigorous exercise  
 all of the above

# COMPREHENSIVE OLDER DRIVER ASSESSMENT (CODA) PROGRAM

---

## ADMINISTRATION INFORMATION

Agency #: \_\_\_\_\_ Site #: \_\_\_\_\_ Subject #: \_\_\_\_\_  
Date: \_\_\_\_/\_\_\_\_/\_\_\_\_ Interviewer #: \_\_\_\_\_ [ ] Pre [X] Post

---

## ATTITUDES ASSESSMENT

1. Do you think a driver's license is a privilege or a right granted to all qualified individuals?  
[ ] It is a right [ ] It is a privilege [ ] I don't care which
2. What do you think about the national maximum speed limit of 55 miles per hour?  
[ ] It is just right  
[ ] It should be increased  
[ ] It should be decreased
3. Do you think it is safe to drive way below the posted speed limit (e.g. 40 MPH in a 55 MPH zone)?  
[ ] Yes [ ] No
4. Do you believe traffic accidents are mainly:  
[ ] under your control  
[ ] due to chance or luck  
[ ] due to circumstances beyond your control
5. Would you be willing to take a driver education, training or retraining course?  
[ ] Yes [ ] No
6. The judgmental abilities of drivers aged at least 55 tend to be poorer than those of drivers below age 40.  
[ ] Strongly agree [ ] Slightly agree  
[ ] Neutral  
[ ] Slightly disagree [ ] Strongly disagree
7. The reaction time of most drivers aged at least 55 tends to be slower than the reaction time of drivers below age 40.  
[ ] Strongly agree [ ] Slightly agree  
[ ] Neutral  
[ ] Slightly disagree [ ] Strongly disagree

8. It is almost impossible for drivers aged 55 and over to learn and use anything new to improve traffic safety.  
 Strongly agree                     Slightly agree  
 Neutral  
 Slightly disagree                     Strongly disagree
9. In comparison to yourself five years ago, are you a:  
 Better driver                     About the same                     Worse driver
10. Five years from now, do you believe you will be a:  
 Better driver                     About the same                     Worse driver
11. At about what age do you estimate you would no longer wish to drive an automobile?  
 55 - 59 years                     60 - 64 years  
 65 - 69 years                     70 - 74 years  
 75 - 79 years                     80 - 84 years  
 85 - 89 years                     90 years or more
12. At about what age do you estimate you would no longer be able to drive an automobile safely?  
 55 - 59 years                     60 - 64 years  
 65 - 69 years                     70 - 74 years  
 75 - 79 years                     80 - 84 years  
 85 - 89 years                     90 years or more
13. Who should make the decision about when it is time to give up driving? (Check all that apply)  
 Driver himself/herself                     Family member(s)  
 Doctor(s)                     Motor vehicle department  
 Police department                     Other: \_\_\_\_\_
14. Is age alone a good basis for determining when it is time to give up driving?  
 Yes                     No
15. If not, what other things should be considered? (Check all that apply)  
 Driver's health                     Accident record  
 Need for mobility                     Other available transportation  
 Other: \_\_\_\_\_
16. At what age do you think older drivers should be required to renew their licenses through reexamination?  
 No specific age requirement  
       (same re-examination requirements as for younger drivers)  
 55 - 59 years                     60 - 64 years  
 65 - 69 years                     70 - 74 years  
 75 - 79 years                     80 - 84 years  
 85 - 89 years                     90 years or more

17. What kind of periodic driver re-examination would you favor for older drivers? (Check all that apply)
- Eye test
  - Total physical examination
  - Written test
  - Driving (road) test
  - All of the above
  - None of the above
  - Comment: \_\_\_\_\_
18. Would periodic reexamination make you feel nervous or threatened?
- Yes
  - No

### KNOWLEDGE ASSESSMENT

19. If your car goes into a skid, you should:
- pump the brakes
  - apply the brakes firmly
  - avoid using the brakes
  - put your car into neutral
20. In which situation do you have the right-of-way?
- when entering a controlled route
  - when already in a traffic circle
  - when approaching a merging traffic sign
  - when entering a street or highway from a driveway
21. If two vehicles arrive at an uncontrolled intersection at the same time from different directions, who should yield the right-of-way?
- the vehicle on the left
  - the vehicle on the right
  - either vehicle
  - the slowest moving vehicle

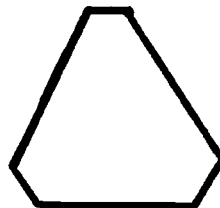

22. When you see a sign shaped like the one above, you will probably see it:
- before entering a narrow bridge
  - on the left side of the road
  - on the back of a slow moving vehicle
  - just before a curve



23. Depth perception, which is important in knowing when to pass safely:
- increases with age
  - remains the same with age
  - decreases with age
  - increases significantly with age
24. Drivers age 60 and over compared with drivers age 30-50 are involved in:
- more than their share of accidents per mile
  - an equivalent share of accidents per mile
  - less than their share of accidents per mile
  - it varies each year
25. An icy road is most slippery at what temperature?
- 32     25     10     0    degrees Fahrenheit
26. What should you do when driving in the rain?
- reduce speed and increase following distance
  - maintain speed with vehicle ahead
  - reduce speed and reduce following distance
  - vary speed to dry out brakes

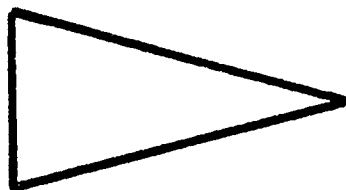

27. Where might you see a sign shaped like the one above?
- on the right side of the road in a No Passing zone
  - on the left side of the road in a No Passing zone
  - before very sharp curves in the road
  - on roads where there is restricted travel
28. If you are driving through residential streets lined with tall shrubs and hidden driveways and no sidewalks, what should you do?
- keep an eye on the rearview mirror for cars trying to pass you
  - slow down and beep your horn at pedestrians walking along the side of the road
  - drive down the center of the street to improve visibility
  - drive slowly and continually search the environment for potential hazards
29. What should a driver do if the minimum speed limit on a freeway or highway is too fast for him?
- use the freeway only during non-rush hours and in daylight
  - stay to the right and drive very cautiously by keeping an eye on the rearview mirrors
  - keep off the freeway and select an alternate route
  - stay in the right lane and use the emergency flashers

30. When entering a controlled access highway (turnpike or freeway), what should you do?
- accelerate to the traffic speed and enter highway by merging with traffic at the safest point
  - stop at the end of the entrance ramp and look for an opening in the traffic
  - proceed slowly and enter expressway when safe, trying not to stop
  - because you have the right-of-way, accelerate to the traffic speed and enter the highway quickly
31. If you miss your exit on an Interstate, you should do what?
- turn around at the first U-turn for emergency vehicles area
  - go on to the next exit
  - wait till the highway is clear and then back up
  - stop and back up on the shoulder with your flashers on
32. When rounding a left curve your vehicle tends to do what?
- move to the inside of the lane
  - stay in the center of the lane
  - move to the outside of the lane
  - speed up
33. Why should smoking be avoided when driving at night?
- the light from the cigarette can reflect in the windshield
  - it can impair night vision
  - you can start a fire in the car
  - smoking presents no hazard when driving

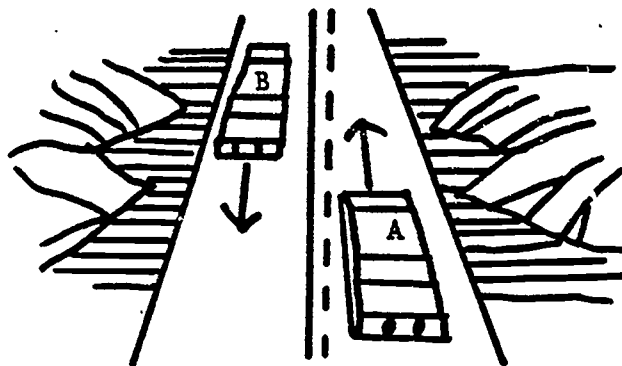

34. A road like the one pictured above means that:
- car A can pass whenever it is safe
  - car B can pass whenever it is safe
  - passing is prohibited in both directions
  - either car is permitted to pass
35. The best way to increase visibility when backing up is by:
- looking in the rearview mirror
  - looking in both the rearview and side mirrors
  - leaning your head out the window
  - turning around and looking out the rear window

36. How may eyeglasses adversely affect vision during driving?  
[ ] eyeglasses with heavy temples (side pieces) can restrict side vision  
[ ] glare from oncoming headlights at night will reflect into the eyes  
[ ] if the glasses slip, they can block the eyes  
[ ] eyeglasses do not adversely affect driving
37. Very slow driving is especially dangerous in which of the following situations?  
[ ] when approaching the crest of a hill  
[ ] just after passing the crest of a hill  
[ ] when making a U-turn  
[ ] when making a right turn
38. If you are planning to make a left turn across an intersection and you are waiting in the middle of the intersection for a break in oncoming traffic, which way should your front tires be turned?  
[ ] to the left  
[ ] it depends upon the sharpness of the turn  
[ ] straight ahead  
[ ] to the right
39. What do you do when you are exiting a controlled access highway (turnpike or freeway)?  
[ ] slow down after you enter the deceleration lane  
[ ] slow down before you enter the deceleration lane  
[ ] start to brake as soon as you signal your intentions to exit  
[ ] it is optional whether you signal your exit as long as you are in the lane closest to the exit
40. If you take medication before driving a long distance, what is the most important thing for you to do?  
[ ] have another person ride with you  
[ ] be sure to eat a light meal  
[ ] plan on making several rest stops along the way  
[ ] find out the effects of the medication
41. What measure should the driver age 55 and over use in following the vehicle ahead?  
[ ] 1 car length for ten miles per hour you are traveling  
[ ] 2 second following distance  
[ ] 3 second following distance  
[ ] 10 feet for every ten miles per hour you are traveling
42. You want to change lanes. You can see if a car is in your blind spot:  
[ ] only if you check your rearview mirror  
[ ] only if you check your sideview mirror  
[ ] only if you turn and glance over your shoulder  
[ ] only if you check both mirrors

43. Making good use of all mirrors on a car is especially important for those drivers who:  
 have peripheral vision  
 have hearing problems  
 drive a lot at night  
 are driving unfamiliar cars
44. What temporary visual condition can occur from drinking alcohol?  
 reduced side vision  
 blurring  
 seeing double  
 all of the above  
 none of the above
45. The blood alcohol level at which a driver is assumed to be "under the influence" is .10% in some states. For a 155 pound man to reach this level on an empty stomach, the amount of whiskey he would probably have to drink within one hour is:  
 3 ounces  
 6 ounces  
 9 ounces  
 12 ounces  
 15 ounces
46. Alcohol is a factor in approximately what percentage of traffic deaths?  
 10%     20%     30%     40%     50%
47. As you drink more alcohol, your ability to drive:  
 steadily improves  
 improves at first, but then gets worse  
 may get better or worse, depending on certain factors  
 worsens at first, but then gets better  
 steadily worsens
48. For each one ounce drink of whiskey, a person should wait before driving:  
 15 minutes     30 minutes     1 hour  
 2 hours     3 hours
49. Which will "sober you up" if you want to drive?  
 black coffee  
 a cold shower  
 time  
 vigorous exercise  
 all of the above

**APPENDIX B:**

**MELICHAR-YEE DRIVER ASSESSMENT  
PROFILE (MY-DAP) FORM INCLUDING  
INSTRUCTION MANUAL**

# DRIVER ASSESSMENT PROFILE (MY-DAP)

## INSTRUCTION MANUAL

Spring 1991  
Version 1.0

Developed by:

Darlene Yee, Ed.D., CHES  
Associate Professor  
Department of Health Education  
San Francisco State University  
1600 Hollaway Avenue  
San Francisco, CA 94132

(415) 338-1413

Joseph F. Melichar, Ph.D.  
Adaptive Systems Corporation  
P.O. Box 1148  
San Mateo, CA 94403

(415) 573-6114

Sponsored by a grant from the AARP Andrus Foundation.

The Driver Assessment Profile is a method for assessing the abilities and skills of older drivers using an integrated and systematic model of driving (Melichar and Yee, 1991a and 1991b). It is designed to provide a profile of the older driver that will:

- (1) help in studying abilities and skills of older drivers,
- (2) relate to performance and training parameters,
- (3) aid in assessment of age-related changes and function, and
- (4) relate to the integrated model of the driving experience.

The Driver Assessment Profile is a reflection of the driver response portion of this model. The outcome should be a description of the operational response of the driver based on the abilities and skills identified. The focus is on the overall integration of abilities and skills allowing for compensation of a deficit by a strength(s). The driver responds in an integrated manner, and it is this systematic response that will be measured.

The Driver Assessment Profile will isolate specific problem areas, but a profile of the abilities and skills is desired. One question being addressed in the present research is whether a specific profile reflects a systematic degradation of driving ability. A second question is whether there are any characteristics that are more predictive of loss of driving ability.

The Driver Assessment Profile (shown on the next page) asks for a rating of specific abilities and skills which are grouped in three categories: sensing or input type information, coordinative and integrative functions used to process the input information, and abilities needed to carry out the decisions to act. Additionally, two general questions relating to overall health and general attitude are included. The instruction manual is designed to be scored by a health professional working with the older driver.

This manual describes the use of the Driver Assessment Profile. The strategy is to assess the impairment of an ability and skill. If a person's ability is not impaired, then how much more capability exists is not assessed. The impairments are rated as: none, mild, moderate, or severe. The terms should be interpreted as:

mild.....a noticeable change in abilities from a level expected a safe minimum for driving, but not sufficiently severe to cause a difficulty or lack of safety in driving ... a mild impairment normally would require some adjustments by the older driver

moderate..the impairment in abilities would cause the older person difficulties in driving and especially in driving safely, adjustments required of the person are significant to achieve even the minimum level of functional performance

**DRIVER ASSESSMENT PROFILE (MY-DAP)**

Agency #: \_\_\_\_\_ Site #: \_\_\_\_\_ Subject #: \_\_\_\_\_  
 Date: \_\_\_\_/\_\_\_\_/\_\_\_\_ Interviewer #: \_\_\_\_\_

DRIVER ABILITY OR SKILL	DEGREE OF IMPAIRMENT				CODER RATING (0-5)
	NONE	MILD	MODER- ATE	SEV- ERE	
<b>SENSING</b>					
Vision- Overall (1)....	[ ]	[ ]	[ ]	[ ]	[ ]
Acuity/Static.....	[ ]	[ ]	[ ]	[ ]	[ ]
Acuity/Dynamic.....	[ ]	[ ]	[ ]	[ ]	[ ]
Field of Vision.....	[ ]	[ ]	[ ]	[ ]	[ ]
Peripheral Vision....	[ ]	[ ]	[ ]	[ ]	[ ]
Depth Perception....	[ ]	[ ]	[ ]	[ ]	[ ]
Glare Refractory....	[ ]	[ ]	[ ]	[ ]	[ ]
Color Recognition....	[ ]	[ ]	[ ]	[ ]	[ ]
Known Pathologies....	[ ]	[ ]	[ ]	[ ]	[ ]
Hearing- Overall (2)..	[ ]	[ ]	[ ]	[ ]	[ ]
Left Ear.....	[ ]	[ ]	[ ]	[ ]	[ ]
Right Ear.....	[ ]	[ ]	[ ]	[ ]	[ ]
Kinesthesia.....	[ ]	[ ]	[ ]	[ ]	[ ]
Proprioception.....	[ ]	[ ]	[ ]	[ ]	[ ]
<b>PROCESSING</b>					
Short term memory.....	[ ]	[ ]	[ ]	[ ]	[ ]
Long term memory.....	[ ]	[ ]	[ ]	[ ]	[ ]
Cognitive skills.....	[ ]	[ ]	[ ]	[ ]	[ ]
Anger/aggression.....	[ ]	[ ]	[ ]	[ ]	[ ]
Anxiety.....	[ ]	[ ]	[ ]	[ ]	[ ]
Selective Attention....	[ ]	[ ]	[ ]	[ ]	[ ]
Stress Response.....	[ ]	[ ]	[ ]	[ ]	[ ]
Problem Solving.....	[ ]	[ ]	[ ]	[ ]	[ ]
Decision-Making.....	[ ]	[ ]	[ ]	[ ]	[ ]
Judgement.....	[ ]	[ ]	[ ]	[ ]	[ ]
Patience.....	[ ]	[ ]	[ ]	[ ]	[ ]
Insight into driving...	[ ]	[ ]	[ ]	[ ]	[ ]
<b>MOTOR</b>					
Strength upper limbs...	[ ]	[ ]	[ ]	[ ]	[ ]
Strength lower limbs...	[ ]	[ ]	[ ]	[ ]	[ ]
Strength hand.....	[ ]	[ ]	[ ]	[ ]	[ ]
Strength foot.....	[ ]	[ ]	[ ]	[ ]	[ ]
ROM upper limbs.....	[ ]	[ ]	[ ]	[ ]	[ ]
ROM lower limbs.....	[ ]	[ ]	[ ]	[ ]	[ ]
ROM neck.....	[ ]	[ ]	[ ]	[ ]	[ ]
ROM trunk.....	[ ]	[ ]	[ ]	[ ]	[ ]
RT simple.....	[ ]	[ ]	[ ]	[ ]	[ ]
RT eye-hand.....	[ ]	[ ]	[ ]	[ ]	[ ]
RT eye-foot.....	[ ]	[ ]	[ ]	[ ]	[ ]
Coordination.....	[ ]	[ ]	[ ]	[ ]	[ ]
Endurance.....	[ ]	[ ]	[ ]	[ ]	[ ]
General Attitude.....	[ ]	[ ]	[ ]	[ ]	[ ]
Overall Health.....	[ ]	[ ]	[ ]	[ ]	[ ]

(1) with glasses if worn (2) with hearing aide if worn

Coder Rating: 0=unable to rate      3=partial test data  
 1=subjective observation      4=past test data  
 2=limited test data      5=tested



severe....the impairment is significant enough to make it unlikely the person can make adjustments to allow safe driving performance.

The Driver Assessment Profile can be used to assess the abilities and skills using a number of means: descriptive which is based heavily on subjective observations, measured based on criterion reference measures, assessed based on formal assessment techniques, and diagnostic which would take the formal assessment and make the transition to formally creating suggested responses. The present form of the instrument supports the first three uses.

A rating system is provided to the rater to allow indicating the type of assessment for each item. If all the assessments of the abilities are of the same type, then the procedure is to indicate the time for the first characteristic and a downward arrow in the second. The types of assesement supported are:

- 0...unable to rate this specific item,
- 1...subjective observation,
- 2...subjective observation combined with limited test data,
- 3...rating is based on partial test data,
- 4...rating is based on past test data available to the rater, and
- 5...rating is based on testing.

The higher the number of the rating the greater the expected validity. The intent is to allow use of the profile over a greater range of situations than one which is strictly dependent on formal assessment techniques. The ratings provided enable use in a range of conditions, or when the conditions are not equal for all items. The result rating enables the interviewers to answer, and to assign a validity weight to the rating based on their assessment.

The scoring of the scale is not to be done by the interviewer at this time. The interviewer is to indicate the agency #, site #, subject #, and date. The agency # is a four character field. The site is a five character field.

#### IDENTIFICATION VARIABLES..

The subject identifiers are assigned by the agencies and sites and are comprised of a three character field. It is requested that the subjects be numbered sequentially. The combination of the agency, site and subject numbers provide a unique identifier for the participant.

The interviewer # is assigned by the agency. The agency must keep the cross-reference list between site and site #, subject and subject #, and interviewer and interviewer #. A form to simplify this procedure is included in Attachment A.

The date is that of administration.

## DESCRIPTION OF ABILITIES OR SKILLS..

If an adaptive or assistive device or prosthesis is normally worn while driving, please conduct assessment with it on. For example, if the person wears glasses then assess the person's characteristics with the glasses on.

### SENSING ABILITIES AND SKILLS

**Vision...**the ability to sense, interpret and respond to visual information. Vision includes:

**Acuity/Static...**the ability to see a close or far object clearly, when there is no movement between the observer and the object.

**Acuity/Dynamic...**the ability to see a close or far object clearly, when there is relative movement between the observer and the object.

**Field of Vision...**the extent to which one can see to left and right while looking straight ahead.

**Lateral or Peripheral Vision...**the ability to detect motion, form, or color on either side of the head while looking straight ahead.

**Depth Perception or Distance Judgement...**the ability to judge distances, and changes in distances, between objects.

**Glare Refractory...**how sensitive is the person to glare including how well they recover from the glare (where glare is a bright concentrated light or brilliant reflection).

**Color Recognition or Sensitivity...**the ability to perceive and discriminate between different colors.

**Pathologies...**do any visual pathologies (i.e. cataract, glaucoma, senile macular degeneration) exist that produce an impairment to vision needed for driving?

**Hearing...**the ability to sense, interpret and respond to auditory information. Is there a hearing loss which impairs driving ability. The loss should be evaluated with a hearing aide if it is normally worn.

**Kinesthesia...**a position sense; an awareness of position and movements of body segments or the whole body as a

**Proprioception...**an integral component of balance and equilibrium for muscle sense in skilled movements requiring balancing competence.

## PROCESSING ABILITIES AND SKILLS

**Memory...**the ability to retain occurring events, store these new experiences, and recall that stored material.

**Cognitive skills...**the way an individual manipulates information through interpretation, storage and retrieval from memory, evaluation, and reasoning.

**Anger/aggression...**the person's ability to control anger and/or aggression caused by external events or persons.

**Anxiety...**an intense feeling of discomfort associated with fears and threats that have no basis in fact.

**Selective attention...**an individual's ability to concentrate for a certain length of time while a competing stimulus is present.

**Stress Response...**the person's ability to maintain their capability to react and produce directed activity without expending large amounts of personal resources and energy in coping and adapting to the stressor from the environment.

**Problem Solving...**the person's ability to take in information, organize and analyze it, and produce an effective response. Problems are encountered from many sources, and the rating is the degree to which the person is impaired in their problem solving capability.

**Decision-Making...**the person's ability to make a decision from information available to them. The ability to make a selection from alternatives is the outcome of the decision-making process. The rating is the degree of impairment to the decision process.

**Judgement...**the ability to understand a relationship and draw correct conclusions in order to make a reasonable decision and safe execution.

**Patience...**the ability to endure a period in which a desired outcome or a problem to be dealt with cannot be resolved. The inability to endure such a period is cause to rate the person's patience impaired. In driving such impairment might be seen as the inability to wait for a light, or perhaps an excessive use of the vehicle's horn.

**Insight...**the ability to understand the driving process, its implications, strategies, and tactics.

## MOTOR ABILITIES AND SKILLS

**Strength**..skill and performance in using muscular force within time periods necessary for purposeful task performance. The muscle strength of the following movements on both the right and left sides will be assessed: upper limbs, lower limbs, hand, and foot.

**Range of Motion (ROM)**..skill and performance in using maximum span of joint movement in activities with and without assistance to enhance performance. The active range of motion of the following movements on both the right and left sides will be assessed: upper limbs, lower limbs, neck, and trunk.

**Reaction Time (RT)**..amount of time an individual takes to respond and complete a movement after a stimulus has been presented. Simple reaction time, eye-hand reaction time, and eye-foot reaction time will be assessed.

**Coordination**...the person's general ability to order and bring together actions in a directed activity.

**Endurance**...the person's ability to continue a physical activity; such as, sitting, standing, or keeping arms up.

## GENERAL CONDITIONS

**General Attitude**...a rating of the person's general attitude toward life and its activities relative to active peers.

**Overall health**...an estimate if the person's general health is impaired and would influence a person's capability to drive, the rating is of the degree of impairment the person's health causes relative to the driving capability.

APPENDIX C:

MY-DAP USING SIMULATOR PROTOCOL  
SAN FRANCISCO STATE UNIVERSITY

# **DRIVER ASSESSMENT PROFILE (MY-DAP)**

## **INSTRUCTION MANUAL**

### **PROTOCOL DRIVER SIMULATION FEB-MAR 1992**

*Spring 1992  
Version 1.0*

*Developed by:*

*Darlene Yee, Ed.D., CHES  
Associate Professor  
Department of Health Education  
San Francisco State University  
1600 Hollaway Avenue  
San Francisco, CA 94132*

*(415) 338-1413*

*Joseph F. Melichar, Ph.D.  
Adaptive Systems Corporation  
P.O. Box 1148  
San Mateo, CA 94403*

*(415) 573-6114*

*Sponsored by a grant from the AARP Andrus Foundation.*

The Driver Assessment Profile is a method for assessing the abilities and skills of older drivers using an integrated and systematic model of driving (Melichar and Yee, 1991a and 1991b). It is designed to provide a profile of the older driver that will:

- (1) help in studying abilities and skills of older drivers,
- (2) relate to performance and training parameters,
- (3) aid in assessment of age-related changes and function, and
- (4) relate to the integrated model of the driving experience.

The Driver Assessment Profile is a reflection of the driver response portion of this model. The outcome should be a description of the operational response of the driver based on the abilities and skills identified. The focus is on the overall integration of abilities and skills allowing for compensation of a deficit by a strength(s). The driver responds in an integrated manner, and it is this systematic response that will be measured.

The Driver Assessment Profile will isolate specific problem areas, but a profile of the abilities and skills is desired. One question being addressed in the present research is whether a specific profile reflects a systematic degradation of driving ability. A second question is whether there are any characteristics that are more predictive of loss of driving ability.

The Driver Assessment Profile (shown on the next page) asks for a rating of specific abilities and skills which are grouped in three categories: sensing or input type information, coordinative and integrative functions used to process the input information, and abilities needed to carry out the decisions to act. Additionally, two general questions relating to overall health and general attitude are included. The instruction manual is designed to be scored by a health professional working with the older driver.

This manual describes the use of the Driver Assessment Profile. The strategy is to assess the impairment of an ability and skill. If a person's ability is not impaired, then how much more capability exists is not assessed. The impairments are rated as: none, mild, moderate, or severe. The terms should be interpreted as:

mild.....a noticeable change in abilities from a level expected a safe minimum for driving, but not sufficiently severe to cause a difficulty or lack of safety in driving ... a mild impairment normally would require some adjustments by the older driver

moderate..the impairment in abilities would cause the older person difficulties in driving and especially in driving safely, adjustments required of the person are significant to achieve even the minimum level of functional performance

**DRIVER ASSESSMENT PROFILE (MY-DAP)**

Agency #: \_\_\_\_\_ Site #: \_\_\_\_\_ Subject #: \_\_\_\_\_

Date: \_\_\_\_/\_\_\_\_/\_\_\_\_ Interviewer #: \_\_\_\_\_

DRIVER ABILITY OR SKILL	DEGREE OF IMPAIRMENT				CODER RATING (0-5)
	NONE	MILD	MODER-ATE	SEV-ERE	
<b>SENSING</b>					
Vision- Overall (1)....	[ ]	[ ]	[ ]	[ ]	[ ]
Acuity/Static.....	[ ]	[ ]	[ ]	[ ]	[ ]
Acuity/Dynamic.....	[ ]	[ ]	[ ]	[ ]	[ ]
Field of Vision.....	[ ]	[ ]	[ ]	[ ]	[ ]
Peripheral Vision....	[ ]	[ ]	[ ]	[ ]	[ ]
Depth Perception....	[ ]	[ ]	[ ]	[ ]	[ ]
Glare Refractory....	[ ]	[ ]	[ ]	[ ]	[ ]
Color Recognition....	[ ]	[ ]	[ ]	[ ]	[ ]
Known Pathologies....	[ ]	[ ]	[ ]	[ ]	[ ]
Hearing- Overall (2)..	[ ]	[ ]	[ ]	[ ]	[ ]
Left Ear.....	[ ]	[ ]	[ ]	[ ]	[ ]
Right Ear.....	[ ]	[ ]	[ ]	[ ]	[ ]
Kinesthesia.....	[ ]	[ ]	[ ]	[ ]	[ ]
Proprioception.....	[ ]	[ ]	[ ]	[ ]	[ ]
<b>PROCESSING</b>					
Short term memory.....	[ ]	[ ]	[ ]	[ ]	[ ]
Long term memory.....	[ ]	[ ]	[ ]	[ ]	[ ]
Cognitive skills.....	[ ]	[ ]	[ ]	[ ]	[ ]
Anger/aggression.....	[ ]	[ ]	[ ]	[ ]	[ ]
Anxiety.....	[ ]	[ ]	[ ]	[ ]	[ ]
Selective Attention....	[ ]	[ ]	[ ]	[ ]	[ ]
Stress Response.....	[ ]	[ ]	[ ]	[ ]	[ ]
Problem Solving.....	[ ]	[ ]	[ ]	[ ]	[ ]
Decision-Making.....	[ ]	[ ]	[ ]	[ ]	[ ]
Judgement.....	[ ]	[ ]	[ ]	[ ]	[ ]
Patience.....	[ ]	[ ]	[ ]	[ ]	[ ]
Insight into driving...	[ ]	[ ]	[ ]	[ ]	[ ]
<b>MOTOR</b>					
Strength upper limbs...	[ ]	[ ]	[ ]	[ ]	[ ]
Strength lower limbs...	[ ]	[ ]	[ ]	[ ]	[ ]
Strength hand.....	[ ]	[ ]	[ ]	[ ]	[ ]
Strength foot.....	[ ]	[ ]	[ ]	[ ]	[ ]
ROM upper limbs.....	[ ]	[ ]	[ ]	[ ]	[ ]
ROM lower limbs.....	[ ]	[ ]	[ ]	[ ]	[ ]
ROM neck.....	[ ]	[ ]	[ ]	[ ]	[ ]
ROM trunk.....	[ ]	[ ]	[ ]	[ ]	[ ]
RT simple.....	[ ]	[ ]	[ ]	[ ]	[ ]
RT eye-hand.....	[ ]	[ ]	[ ]	[ ]	[ ]
RT eye-foot.....	[ ]	[ ]	[ ]	[ ]	[ ]
Coordination.....	[ ]	[ ]	[ ]	[ ]	[ ]
Endurance.....	[ ]	[ ]	[ ]	[ ]	[ ]
General Attitude.....	[ ]	[ ]	[ ]	[ ]	[ ]
Overall Health.....	[ ]	[ ]	[ ]	[ ]	[ ]

(1) with glasses if worn (2) with hearing aids if worn

Coder Rating: 0=unable to rate      3=partial test data  
 1=subjective observation      4=past test data  
 2=limited test data      5=tested





severe....the impairment is significant enough to make it unlikely the person can make adjustments to allow safe driving performance.

The Driver Assessment Profile can be used to assess the abilities and skills using a number of means: descriptive which is based heavily on subjective observations, measured based on criterion reference measures, assessed based on formal assessment techniques, and diagnostic which would take the formal assessment and make the transition to formally creating suggested responses. The present form of the instrument supports the first three uses.

A rating system is provided to the rater to allow indicating the type of assessment for each item. If all the assessments of the abilities are of the same type, then the procedure is to indicate the time for the first characteristic and a downward arrow in the second. The types of assessement supported are:

- 0...unable to rate this specific item,
- 1...subjective observation,
- 2...subjective observation combined with limited test data,
- 3...rating is based on partial test data,
- 4...rating is based on past test data available to the rater, and
- 5...rating is based on testing.

The higher the number of the rating the greater the expected validity. The intent is to allow use of the profile over a greater range of situations than one which is strictly dependent on formal assessment techniques. The ratings provided enable use in a range of conditions, or when the conditions are not equal for all items. The result rating enables the interviewers to answer, and to assign a validity weight to the rating based on their assessment.

The scoring of the scale is not to be done by the interviewer at this time. The interviewer is to indicate the agency #, site #, subject #, and date. The agency # is a four character field. The site is a five character field.

#### IDENTIFICATION VARIABLES..

The subject identifiers are assigned by the agencies and sites and are comprised of a three character field. It is requested that the subjects be numbered sequentially. The combination of the agency, site and subject numbers provide a unique identifier for the participant.

The interviewer # is assigned by the agency. The agency must keep the cross-reference list between site and site #, subject and subject #, and interviewer and interviewer #. A form to simplify this procedure is included in Attachment A.

The date is that of administration.

## DESCRIPTION OF ABILITIES OR SKILLS..

If an adaptive or assistive device or prosthesis is normally worn while driving, please conduct assessment with it on. For example, if the person wears glasses then assess the person's characteristics with the glasses on.

### SENSING ABILITIES AND SKILLS

**Vision...**the ability to sense, interpret and respond to visual information. Vision includes:

**Acuity/Static...**the ability to see a close or far object clearly, when there is no movement between the observer and the object.

**Acuity/Dynamic...**the ability to see a close or far object clearly, when there is relative movement between the observer and the object.

**Field of Vision...**the extent to which one can see to left and right while looking straight ahead.

**Lateral or Peripheral Vision...**the ability to detect motion, form, or color on either side of the head while looking straight ahead.

**Depth Perception or Distance Judgement...**the ability to judge distances, and changes in distances, between objects.

**Glare Refractory...**how sensitive is the person to glare including how well they recover from the glare (where glare is a bright concentrated light or brilliant reflection).

**Color Recognition or Sensitivity...**the ability to perceive and discriminate between different colors.

**Pathologies...**do any visual pathologies (i.e. cataract, glaucoma, senile macular degeneration) exist that produce an impairment to vision needed for driving?

**Hearing...**the ability to sense, interpret and respond to auditory information. Is there a hearing loss which impairs driving ability. The loss should be evaluated with a hearing aide if it is normally worn.

**Kinesthesia...**a position sense; an awareness of position and movements of body segments or the whole body as a

**Proprioception...**an integral component of balance and equilibrium for muscle sense in skilled movements requiring balancing competence.

## PROCESSING ABILITIES AND SKILLS

Memory...the ability to retain occurring events, store these new experiences, and recall that stored material.

Cognitive skills...the way an individual manipulates information through interpretation, storage and retrieval from memory, evaluation, and reasoning.

Anger/aggression...the person's ability to control anger and/or aggression caused by external events or persons.

Anxiety...an intense feeling of discomfort associated with fears and threats that have no basis in fact.

Selective attention...an individual's ability to concentrate for a certain length of time while a competing stimulus is present.

Stress Response...the person's ability to maintain their capability to react and produce directed activity without expending large amounts of personal resources and energy in coping and adapting to the stressor from the environment.

Problem Solving...the person's ability to take in information, organize and analyze it, and produce an effective response. Problems are encountered from many sources, and the rating is the degree to which the person is impaired in their problem solving capability.

Decision-Making...the person's ability to make a decision from information available to them. The ability to make a selection from alternatives is the outcome of the decision-making process. The rating is the degree of impairment to the decision process.

Judgement...the ability to understand a relationship and draw correct conclusions in order to make a reasonable decision and safe execution.

Patience...the ability to endure a period in which a desired outcome or a problem to be dealt with cannot be resolved. The inability to endure such a period is cause to rate the person's patience impaired. In driving such impairment might be seen as the inability to wait for a light, or perhaps an excessive use of the vehicle's horn.

Insight...the ability to understand the driving process, its implications, strategies, and tactics.

## MOTOR ABILITIES AND SKILLS

**Strength.**..skill and performance in using muscular force within time periods necessary for purposeful task performance. The muscle strength of the following movements on both the right and left sides will be assessed: upper limbs, lower limbs, hand, and foot.

**Range of Motion (ROM)**..skill and performance in using maximum span of joint movement in activities with and without assistance to enhance performance. The active range of motion of the following movements on both the right and left sides will be assessed: upper limbs, lower limbs, neck, and trunk.

**Reaction Time (RT)**..amount of time an individual takes to respond and complete a movement after a stimulus has been presented. Simple reaction time, eye-hand reaction time, and eye-foot reaction time will be assessed.

**Coordination**...the person's general ability to order and bring together actions in a directed activity.

**Endurance**...the person's ability to continue a physical activity; such as, sitting, standing, or keeping arms up.

## GENERAL CONDITIONS

**General Attitude**...a rating of the person's general attitude toward life and its activities relative to active peers.

**Overall health**...an estimate if the person's general health is impaired and would influence a person's capability to drive, the rating is of the degree of impairment the person's health causes relative to the driving capability.

## MEASUREMENT PROCESSES

The measurement process will be a combination of specific tests, general scenarios, and work on the simulator. The overall schedule for the mixture of events is presented in Appendix A. An overview of the procedures that correspond to the activities on the schedule are presented in the following discussion. The recording of the events will be on the form shown in Appendix B. The material from the recording form will be used to produce the ratings on MY-DAP.

## SENSING ABILITIES AND SKILLS

### Visual Measures.

The following discussion presents the measurement of the person's vision with a focus on how it pertains to driving. Vision is defined in the following way:

**Vision...**the ability to sense, interpret and respond to visual information.

Vision has an overall effectiveness as well as component dimensions which are both evaluated. The components are those which most influence driving performance, and overall vision is defined as"

**Overall Vision...**the summarization of all the dimensions of vision into a single measure.

There is no single measure of overall vision. One's vision is a composite of a range of dimensions (acuity, depth of field, color recognition, ... ) and also is tied into the overall ability to use the sensory information. We define a measure of overall vision to be a subjective judgement based on a series of observations and measures of component activities. The goal is to produce a measure of vision which will define how the visual sense influences the person's driving performance. To accomplish this rating we set the following guidelines:

1. the measure is accomplished with any corrective eye wear in place,
2. the measurement is to determine the degree of impairment relative to the driving experience (for example, a reading problem does not a priori translate into a problem for driving),
3. the rating is a summation of effects and defines if the visual sense impairs driving performance and safety,
4. if the impairment occurs for a specific activity (such as night driving) it is considered an overall impairment,

Acuity/Static...the ability to see a close or far object clearly, when there is no movement between the observer and the object.

The simplest measure of static acuity is the Snelling chart. The individual will be asked to read the Snelling chart with corrective eye wear in place using both eyes and the result recorded. The interpretation of the value is:

Acuity/Dynamic...the ability to see a close or far object clearly, when there is relative movement between the observer and the object.

The subject is asked to read several signs on the walls while moving through the room. The measure is:

The evaluation of road signs and distances in the film. The measure is:

Field of Vision...the extent to which one can see to left and right while looking straight ahead.

While sitting in the drivers seat the person is asked to look straight ahead and read a series of numbers placed on the side walls from the front to the rear of the room.

The measure is the number which is correlated to a distance from the viewer. The interpretation is:

*Yee/Melichar Driver Assessment Profile Protocol V1.0 26Feb92 -9*

The person is asked to take the field of vision test using the field of vision tester. The angle is provided by the device both left and right. The test is done from back to front. Readings are taken on both eyes.

Lateral or Peripheral Vision...the ability to detect motion, form, or color on either side of the head while looking straight ahead.

The person is asked to take two objects and hold them in their hands. They raise their arms to vertical and as far back as they can. They are then asked to move their arms slowly forward until they can see the object.

The measure is the angle from 180 deg when they report they can see the object moving. The second measure is the ability to move the shoulder and upper arm in terms of range of motion. Also there is a provision of a weak measure of strength (grip on the object), fatigue, and the wrist.

Ask the patient to flex at the elbows and the wrist upon completing the peripheral vision task.

Depth Perception or Distance Judgement...the ability to judge distances, and changes in distances, between objects.

Move receptacles into size order small to large front to back on a desktop. Place objects into the receptacles first front, then rear, and finally center.

Measure is:

Glare Refractory...how sensitive is the person to glare including how well they recover from the glare (where glare is a bright concentrated light or brilliant reflection).

Look at light next to Snelling Chart. Count to 3 and then reread Snelling chart. Record value. Have subject look away, and reread Snelling chart at 30-45 seconds.

Measure two Snelling chart readings. Interpretation is:

Color Recognition or Sensitivity...the ability to perceive and discriminate between different colors.

Colored cards are placed in the front of the subject on the desk. The person is asked to name the colors in sequence. Correct answers are recorded. The cards include shades of the same color to indicate a degree of color discrimination sensitivity.

Successful: Yes \_\_\_\_\_ No \_\_\_\_\_

Pathologies...do any visual pathologies (i.e. cataract, glaucoma, senile macular degeneration) exist that produce an impairment to vision needed for driving?

Pathologies are determined by asking the person if they have any of the following conditions. The conditions are assessed by asking the person.

VISUAL CONDITION	EXISTS Y/N/P	----RESTRICTION-----			Comments
		None	Somewhat	A lot	
Cataract					
Glaucoma					
Color blindness					
Night blindness					
Tunnel Vision					
Macular degeneration					



## **HEARING.**

Hearing...the ability to sense, interpret and respond to auditory information. Is there a hearing loss which impairs driving ability. The loss should be evaluated with a hearing aide if it is normally worn.

When the person is sitting at the desk and again in the simulator, give instructions at varying voice volumes beginning in a whisper. Indicated the approximate level from whisper to a normal speaking voice can be heard.

**Kinesthesia...**a position sense; an awareness of position and movements of body segments or the whole body as a

Have the person standing close their eyes and touch their nose. Ask them to turn around (360 deg) and redo the process.

**Proprioception...**an integral component of balance and equilibrium for muscle sense in skilled movements requiring balancing competence.

Get information from putting the objects in the containers, key in the ignition, movement in the driving seat, getting in and out of the seat, adjusting the seat, and turning the wheel. Balancing on one foot and then the other.

## **PROCESSING ABILITIES AND SKILLS**

**Memory...**the ability to retain occurring events, store these new experiences, and recall that stored material.

Name the presidents since Eisenhower in order (Kennedy, Johnson, Nixon, Ford, Carter, Regan, and Bush). The sequence is a general measure of long term memory.

Please do the following sequence when I say ready:

1. Turn right
2. Turn left
3. Brake

Please do the following sequence when I say ready:

1. Turn right
2. Count to 5
3. Straighten the wheel
4. Count to 3
5. Brake
6. Count to 3
7. Turn right
8. Count to 5
9. Straighten the wheel

Make estimate of stress and anxiety.

Measure of long term memory: record sequence

Record instructions that were done correctly for both

Anxiety	None	Mild	Moderate	Severe
Stress	None	Mild	Moderate	Severe

Cognitive skills...the way an individual manipulates information through interpretation, storage and retrieval from memory, evaluation, and reasoning.

Observation based on tests plus simulator

Cognition    Normal    Mild    Moderate    Severe

Anger/aggression...the person's ability to control anger and/or aggression caused by external events or persons.

Two sets of measures: self report and observation in driving simulation and discussion of simulation. There are reports in MY-CODA and ODSAI, but gather information separately

Anxiety...an intense feeling of discomfort associated with fears and threats that have no basis in fact.

Observation from tests and simulation, and a self-report.

Selective attention...an individual's ability to concentrate for a certain length of time while a competing stimulus is present.

Data is to be gathered from observation of the simulator.

Stress Response...the person's ability to maintain their capability to react and produce directed activity without expending large amounts of personal resources and energy in coping and adapting to the stressor from the environment.

The driving simulator produces a stressed environment. There will be an evaluation of the stress observed in response to these conditions.

Problem Solving...the person's ability to take in information, organize and analyze it, and produce an effective response. Problems are encountered from many sources, and the rating is the degree to which the person is impaired in their problem solving capability.

Problem situations are provided in the simulation trial, and in the other tests. The evaluation will be based on these observations.

*Yee/Melichar Driver Assessment Profile Protocol V1.0 26Feb92 -14*

Decision-Making...the person's ability to make a decision from information available to them. The ability to make a selection from alternatives is the outcome of the decision-making process. The rating is the degree of impairment to the decision process.

Decision-making situations are provided in the simulation trial, and in other tests. The evaluation will be based on these observations.

Judgement...the ability to understand a relationship and draw correct conclusions in order to make a reasonable decision and safe execution.

Judgement situations are provided in the simulation trial, and in other tests. The evaluation will be based on these observations.

Patience...the ability to endure a period in which a desired outcome or a problem to be dealt with cannot be resolved. The inability to endure such a period is cause to rate the person's patience impaired. In driving such impairment might be seen as the inability to wait for a light, or perhaps an excessive use of the vehicle's horn.

Patience situations are provided in the simulation trial, and in other tests. The evaluation will be based on these observations.

The person also will be asked about what they do in the following situations:

1. a slow car is in the middle lane of freeway..how do you respond?
2. a slow car is in the fast lane of the freeway..how do you respond?
3. a car is standing in the middle of a local street..how do you respond?

4. a car is trying to standing at a stop sign, traffic is moving slowly past the intersection, after waiting for a minute how do you respond?

Insight...the ability to understand the driving process, its implications, strategies, and tactics.

A compendium of activities undertaken in the simulation.

### MOTOR ABILITIES AND SKILLS

**Strength**..skill and performance in using muscular force within time periods necessary for purposeful task performance. The muscle strength of the following movements on both the right and left sides will be assessed: upper limbs, lower limbs, hand, and foot.

#### Upper limbs

Taken from peripheral vision test and the accompanying requests. Added information from pulling driving seat forward. Request person to reach for shoulder strap left and right.

#### Lower limbs

Watch breaking, sitting, pulling seat, and getting up. When asking to break note difficulty.

#### Hand

Use of key, directional signals, grasping objects

#### Foot

Check ability to depress brake pedal. Rise up on toes. Also use of accelerator.

**Range of Motion (ROM)**..skill and performance in using maximum span of joint movement in activities with and without assistance to enhance performance. The active range of motion of the following movements on both the right and left sides will be assessed: upper limbs, lower limbs, neck, and trunk.

Upper limbs

Same as strength.

Lower Limbs

Same as strength

Neck

Look at right rearview mirror  
Look at left rearview mirror

Trunk

Position seat, adjustment of seat, and putting objects in receptacles at desk.

**Reaction Time (RT)**..amount of time an individual takes to respond and complete a movement after a stimulus has been presented. Simple reaction time, eye-hand reaction time, and eye-foot reaction time will be assessed.

Simple

From simulator

Eye-hand

From simulator

Eye-foot

From simulator

**Coordination**...the person's general ability to order and bring together actions in a directed activity.

From simulator

Endurance...the person's ability to continue a physical activity; such as, sitting, standing, or keeping arms up.

Observe fatigue rate in the simulator

#### GENERAL CONDITIONS

General Attitude...a rating of the person's general attitude toward life and its activities relative to active peers.

Discuss outlook on life. Avoid direct questions asked in MY-CODA. Add an observer assessment.

Patient observation

Observer

Overall health...an estimate if the person's general health is impaired and would influence a person's capability to drive, the rating is of the degree of impairment the person's health causes relative to the driving capability.

Discuss health relative to driving. Avoid direct questions in MY-CODA. Add an observer assessment.

Patient

Observer

## Schedule of Events in The Interview

### 1. Opening and introduction...

- 1.1. Welcome the person - ask if they have any questions  
There is coffee and some snacks on the desk. The rest room is in the next trailer.
- 1.2. Collect MY-CODA, State-Trait Anxiety, pre-test and study continuation sign-up.
- 1.3 Present overall sequence of events...
  - . assessment starts with some specific tests to measure baseline function on skills basic to driving
  - . next we will undertake some general activities which provide a series of measurement situations about physical and sensory functioning
  - . a number of self-report questions will be asked
  - . there will be a period of acclimation to the simulator
  - . the simulation experience will occur
  - . there will be a closing discussion, and you will then be asked to take the post test
- 1.4 If at any time you feel uncomfortable or need a break please request a pause
- 1.5 Did you drive to the site?
- 1.6 Are you taking any medications that might influence your involvement in the activities described?
- 1.7 Do you have any health conditions which might influence your involvement or safety?
- 1.8 Are there any questions .. if not here we go.

### 2. Vision and Physical Test Situations

- 2.1 Do you have any eye problems, diseases, pathologies,...?  
For example, glaucoma, macular degeneration, color blindness, glare sensitivity, tunnel vision; ...
- 2.2 Do you wear glasses or contacts?
- 2.3. Please step over to the eye chart reading area ... please read the chart to the best of your ability.
- 2.4. Please turn around ... turn on light next to the chart..  
Please turn around and look at the light, count to 3, and then read the chart again. What was the effect of looking at the light?



2.5 Please close your eyes and touch your nose with the index finger of your right hand. Now touch your nose with the index finger of your left hand.

2.6 Please balance on your left foot. Now balance on your right foot.

2.6. Please raise up on you toes.

2.7 Please walk the line on the floor.

### 3. Desk Activities

3.1. Please go to the desk and sit down.

3.2. There is a stack of colored papers on the desk. Please name the colors, place different colors into different stacks, but put shades of the same color on the same stack.

3.3. Remove the papers from the desk.

3.4 There are three vessels on the table. Please arrange them from the front of the desk to the rear with the smallest nearest to your. Have a distance of 6 to 12 inches between them. Now place the three objects into the containers starting with the rear vessel, then the front vessel, and finally the middle vessel.

3.5 Please swivel around in the chair. We are going to test your field of vision with a stand measuring device. Please look straight ahead. Please indicate when you can read the card on your right and tell me the letters. Please indicate when you can read the card on your left and tell me when you can read the letters. Still looking straight ahead, can you see both cards?

### 4. Field of Vision

4.1 Please stand up and move next to the driver's seat.

4.2 Looking straight ahead please read the numbers and letters on the left side of the room.

4.3. Looking straight ahead please read the numbers and letters on the right side of the room.

4.4 Can you see both of the last letters/numbers your read at the same time? If not, what are the last two that you can read?

## **5. Getting Into the Simulator And Adjusting To It**

- 5.1 Please sit in the simulator?
- 5.2 Please adjust the seat so it is comfortable for you.
- 5.3 Please put on the seat belt.
- 5.4 Please put both hands on the steering wheel. Turn it to the right and then to the left.
- 5.5 Put your foot on the accelerator. Please depress it fully and hold it in a depressed position for ten seconds. Was it fully depressed? Was it comfortable to do so?
- 5.7. Now step on the brake. Depress it fully. Release the brake.
- 5.8. Put your foot on the accelerator, hold it for 5 seconds, now quickly apply the brake. Remove your foot from the brake.
- 5.9 Reach around the steering wheel and place the key in the ignition and turn it. Put both hands on the steering wheel. Turn off the ignition.
- 5.10 Please put on the lights.
- 5.11 Please signal for a left turn. Turn the wheel to the left, and then return to center. Please signal for a right turn. Turn the wheel to the right and then return to center.
- 5.12 Please release the hand brake. Please apply the hand brake. Please release it again. Please apply it again. Please indicate any problems.
- 5.13 Please turn and look in the mirror over your right shoulder.
- 5.14 Please turn and look in the mirror over your left shoulder.
- 5.14 Please reach for a hypothetical shoulder belt near the mirror on your left side.
- 5.15 Please reach for a hypothetical shoulder belt near the mirror on your right side.

## **6. Memory and Sequencing**

- 6.1 Please name the presidents since Eisenhower..
- 6.2 Describe the cars on either side of your parked car.
- 6.3 What did the sign on the door say?

6.4 We are going to undertake two groups of sequenced driving activities in your new car seat. I will tell you the sequence and then ask you to preform it.

6.5 Here is the first sequence. Please wait until I say go. 1. turn right 2. count to 2 3. turn left 4. brake

6.6 Good. Now lets try a longer sequence. Please wait until I say go. The sequence is:

1. turn right
2. count to 5
3. straighten the wheel
4. count to 3
5. brake
6. count to 3
7. turn right
8. count to 5
9. straighten the wheel
10. brake

6.7 Thanks for working with the sequence.

6.8 I will now give you a series of instructions. Please do them as I give them to you. They will be vary in speed - some will be very quick others will be spaced apart. Do not run me over.

1. turn right +1
2. turn left +2
3. turn right 0
4. turn left 0
5. brake 0
6. turn right +3
7. signal for a left turn +2
8. turn left 0
9. brake 0
10. signal for a right turn +2
11. turn right 0
12. brake

6.9 Thank you take a breather

6.10 How did you feel about the different sequences? Did you sense any pressure? If so how and when?

## 7. Patience Questions

7.1 I would like to ask you four questions about driving situations. Please let me know how you would respond in each of the situations.

7.2 You are driving down the freeway at your normal speed in the center of three lanes. You come upon a car going slowly in that lane, there is a car slightly a head of it in the slow lane moving faster. A car is coming up behind your in the fast lane, but is 10 car lengths behind. What is your response?

7.3 You are driving in the fast lane of a freeway. There is a slow car in the lane blocking you. There is some, but not a lot of room in the adajent lane. How do your respond?

7.4 You are driving down a local street in a residential area on a Saturday afternoon. No other cars are about. How do you respond?

7.5 You come to a stop sign from a side street going into a busy thoroughfare. Traffic on the busy street is moving at a moderate pace. You have stopped with one car in frcnt of you. The car is signalling for a turn, but after a minute still has not moved? How do you respond?

7.6 What feelings do you generally have in this situation?

7.7 How do you respond after the car in front of you has made its turn?

## 8. Simulator

8.1 We are now going to start the simulator exercise. Are your ready? There are three exercises. The first will be simple reaction time test, the second the ability to recognize signs and react, and third driving situations. In all cases you must have the accelerator depressed and the wheel centered to start the test. The spedometer will read 55mph when the accelerator is depressed. If there are two yellow lights on the counsole the wheel is not centered and the test will not work. At the end each test sequence the distance it took you to react will appear on the counsole. In sequencing ... the lights flash across the console .. when there are two red lights please hit the brake.

We will start with the reaction tests. Note the lights moving across the console. When you see two red ones, please brake. We will do a trial case, and then do 5 repeats of the test. The distance you see is the distance in feet on braking if you were traveling at 55 on a dry road. The left number is your response, and the number on the right is the average distance (60ft) for most drivers.

In the sequence activities, its either right or left turn or brake. You must wait for the cue to change. The film will explain what to do and will prepare you for the testing. You must keep the wheel centered and the accelerator depressed. If the wheel is not

centered, two yellow lights will appear on the console. Center the wheel and they go off.

In the driving situation you must determine the correct reaction and sequence, brake and turn or turn and brake based on the situation you observe. In the driving sequences you are scenes which you would see through your windshield as you are driving. Again you must keep the accelerator depressed and the wheel centered to start each sequence.

Remember each sequence requires you to be aware of your surroundings to produce the correct sequence.

## **9. Closure and Post Test**

9.1 How do you generally feel about your health.

9.2 How would you describe your driving.

9.3 Please do the post test

9.4 Do you want feed back from the information collected and the simulation. If so please leave a name an telephone number and a good time to call. It may take a few weeks to get you the information, but we will follow up if you request it.

9.5 We also have provided you an evaluation sheet. We are trying to develop the methods and procedures for general use. Any comments or help you can provide would be of great interest.

9.6 We thank you for your help and cooperation.

**SIMULATOR RECORDING FORM**

Group: 06            Agency: 00            Site:04            ID: \_ \_ \_

Date: Feb Mar \_\_\_\_\_, 1992            Interviewer: 01

1.6 Did person drive to the site? Yes\_\_\_ No\_\_\_

1.7 Influencing medications? No \_\_\_ Yes no influ \_\_\_ Yes\_\_\_

1.8 Health Conditions? No \_\_\_ Yes no influence \_\_\_ Yes\_\_\_

2.1 Eye Pathologies

VISUAL CONDITION	EXISTS Y/N/P	-----RESTRICTION-----			Comments
		None	Somewhat	A lot	

Cataract					
Glaucoma					
Color blindness					
Night blindness					
Tunnel Vision					
Macular degeneration					

2.2 Do you wear glasses or contacts? Yes \_\_\_ No\_\_\_

2.3 Snelling chart read...line #                    \_\_\_ / \_\_\_

2 4 Snelling chart read-GLARE... line #            \_\_\_ / \_\_\_

Effect of light on readng comment: \_\_\_\_\_

2.5 Able to touch nose with right finger? Yes \_\_\_ No \_\_\_  
 Able to touch nose with left finger? Yes \_\_\_ No \_\_\_

Activity	Excellant	Good	Okay	Poor	No
2.6 Balance left foot Right foot					
Walk the line					
2.7 Raise up using feet					
Sitting down: 3.1 Balance					
Hip flexion					
Upper arm use					

3.4 Color recognition Yes\_\_\_ Paritial \_\_\_ No \_\_\_  
 Color sensitivity Yes\_\_\_ Paritial \_\_\_ No \_\_\_

Activity	Excellant	Good	Okay	Poor	No
3.4 Forward reach					
Trunk movement					
Grasp					
Arrangment					
Placement					
Depth Perception					
Fine motor					
Upper arm rom					
Leg mvmnt swivel					
Problem Solving					
Memory					

3.5 Field of vision angle right glasses glasses off  
left \_\_\_\_\_  
both \_\_\_\_\_

4.1 Movment to drivers seat

4.2 Read numbers/letters right \_\_\_\_\_

4.3 left \_\_\_\_\_

4.4 both \_\_\_\_\_

Drivers Seat Actvt's Mvmnt, Sit, Cntrls Problem Level  
None Minor Some Alot Failure

Sitting Leg movement Knee flexion strength rom Hip flexion strength rom			
Seat adjustment Leg movement Knee flexion strength rom Hip flexion strength rom Upper arm strength rom			
Instrument Panel Hand movement strngth rom Grasp Trunk strengt rom			
Hand Brake Hand Movement strngth rom Grasp			



Drivers Seat Activity  
Belts & Mirrors

Problem Level  
None Minor Some Alot Failure

	None	Minor	Some	Alot	Failure
Turn to mirror right Trunk strength rom					
Turn to mirror left Trunk strength rom					
Reach for belt right Arm strength rom Trunk strength rom					
Reach for belt left Arm strength rom Trunk strength rom					

6.1 Presidents since Eisenhower \_\_\_ Kennedy \_\_\_ Johnson \_\_\_ Nixon  
\_\_\_ Ford \_\_\_ Carter \_\_\_ Regan \_\_\_ Bush

6.2 Described cars on either side Yes \_\_\_ Partial \_\_\_ No \_\_\_

6.3 Awareness of sign on door Yes \_\_\_ Partial \_\_\_ No \_\_\_

6.4 Four step sequence Yes \_\_\_ Partial \_\_\_ # \_\_\_ No \_\_\_

1. turn right 2. count to 2 3. turn left 4. brake

6.5 Ten step sequence until I say go.

1. turn right
2. count to 5
3. straighten the wheel
4. count to 3
5. brake
6. count to 3
7. turn right
8. count to 5
9. straighten the wheel
10. brake

Did the person exhibit confusion? Yes \_\_\_ No \_\_\_

Yee/Melichar Driver Assessment Profile Protocol V1.0 26Feb92 -4

Did the person exhibit stress? None\_ Minor\_ Some\_ A lot\_ Extreme\_

6.8 Stressor sequence...

Did they complete the sequence? Yes\_\_\_ No\_\_\_

Did the person exhibit stress? None\_ Minor\_ Some\_ A lot\_ Extreme\_

6.10 Comments

Patience

Very Pretty Average Lacking None

	Very	Pretty	Average	Lacking	None
7.2 Scenario 1					
7.3 Scenario 2					
7.4 Scenario 3					
7.5 Scenario 4					

7.6 Feelings identified for scenario 4

7.7 Response identified for scenario 4

9.1 Health general feelings Excellant Good Average Poor Bad

9.2 Driving general approach Excellant Good Average Poor Bad

General Comments....

Simulator  
 Breaking reaction times \_\_\_\_\_

very good    good    okay    poor    serious

1. Sequencing

1	reaction.....	...	...	...	...	..
2	separation.....	...	...	...	...	..
3	decision making.....	...	...	...	...	..
4	scanning.....	...	...	...	...	..
5	figure ground.....	...	...	...	...	..
6	anxiety.....	...	...	...	...	..
7	stress.....	...	...	...	...	..
8	overall.....	...	...	...	...	..
9						
10						

very good    good    okay    poor    serious

2. Driving Situation

1	reaction.....	...	...	...	...	..
2	judgement.....	...	...	...	...	..
3	decision making.....	...	...	...	...	..
4	anxiety.....	...	...	...	...	..
5	stress.....	...	...	...	...	..
6	problem solving.....	...	...	...	...	..
7	anger.....	...	...	...	...	..
8	patience.....	...	...	...	...	..
9	overall.....	...	...	...	...	..
10						

APPENDIX D:  
MY-DAP USING SIMULATION PROTOCOL  
MARYLAND FOCUS GROUP

# **DRIVER ASSESSMENT PROFILE (MY-DAP)**

## **INSTRUCTION MANUAL**

### **PROTOCOL DRIVER NON-SIMULATION MAY-JUNE 1992**

*Spring 1992  
Version 1.0*

*Developed by:*

*Darlene Yee, Ed.D., CHES  
Associate Professor  
Department of Health Education  
San Francisco State University  
1600 Holloway Avenue  
San Francisco, CA 94132*

*(415) 338-7568*

*Joseph F. Melichar, Ph.D.  
Adaptive Systems Corporation  
P.O. Box 1148  
San Mateo, CA 94403*

*(415) 573-6114*

*Sponsored by a grant from the AARP Andrus Foundation.*

The Driver Assessment Profile is a method for assessing the abilities and skills of older drivers using an integrated and systematic model of driving (Melichar and Yee, 1991a and 1991b). It is designed to provide a profile of the older driver that will:

- (1) help in studying abilities and skills of older drivers,
- (2) relate to performance and training parameters,
- (3) aid in assessment of age-related changes and function, and
- (4) relate to the integrated model of the driving experience.

The Driver Assessment Profile is a reflection of the driver response portion of this model. The outcome should be a description of the operational response of the driver based on the abilities and skills identified. The focus is on the overall integration of abilities and skills allowing for compensation of a deficit by a strength(s). The driver responds in an integrated manner, and it is this systematic response that will be measured.

The Driver Assessment Profile will isolate specific problem areas, but a profile of the abilities and skills is desired. One question being addressed in the present research is whether a specific profile reflects a systematic degradation of driving ability. A second question is whether there are any characteristics that are more predictive of loss of driving ability.

The Driver Assessment Profile (shown on the next page) asks for a rating of specific abilities and skills which are grouped in three categories: sensing or input type information, coordinative and integrative functions used to process the input information, and abilities needed to carry out the decisions to act. Additionally, two general questions relating to overall health and general attitude are included. The instruction manual is designed to be scored by a health professional working with the older driver.

This manual describes the use of the Driver Assessment Profile. The strategy is to assess the impairment of an ability and skill. If a person's ability is not impaired, then how much more capability exists is not assessed. The impairments are rated as: none, mild, moderate, or severe. The terms should be interpreted as:

mild.....a noticeable change in abilities from a level expected a safe minimum for driving, but not sufficiently severe to cause a difficulty or lack of safety in driving ... a mild impairment normally would require some adjustments by the older driver

moderate..the impairment in abilities would cause the older person difficulties in driving and especially in driving safely, adjustments required of the person are significant to achieve even the minimum level of functional performance

**DRIVER ASSESSMENT PROFILE (MY-DAP)**

Agency #: \_\_\_\_\_ Site #: \_\_\_\_\_ Subject #: \_\_\_\_\_

Date: \_\_\_\_/\_\_\_\_/\_\_\_\_ Interviewer #: \_\_\_\_\_

DRIVER ABILITY OR SKILL	DEGREE OF IMPAIRMENT				CODER RATING (0-5)
	NONE	MILD	MODER-ATE	SEV-ERE	
<b>SENSING</b>					
Vision- Overall (1)....	[ ]	[ ]	[ ]	[ ]	[ ]
Acuity/Static.....	[ ]	[ ]	[ ]	[ ]	[ ]
Acuity/Dynamic.....	[ ]	[ ]	[ ]	[ ]	[ ]
Field of Vision.....	[ ]	[ ]	[ ]	[ ]	[ ]
Peripheral Vision....	[ ]	[ ]	[ ]	[ ]	[ ]
Depth Perception....	[ ]	[ ]	[ ]	[ ]	[ ]
Glare Refractory....	[ ]	[ ]	[ ]	[ ]	[ ]
Color Recognition....	[ ]	[ ]	[ ]	[ ]	[ ]
Known Pathologies....	[ ]	[ ]	[ ]	[ ]	[ ]
Hearing- Overall (2)..	[ ]	[ ]	[ ]	[ ]	[ ]
Left Ear.....	[ ]	[ ]	[ ]	[ ]	[ ]
Right Ear.....	[ ]	[ ]	[ ]	[ ]	[ ]
Kinesthesia.....	[ ]	[ ]	[ ]	[ ]	[ ]
Proprioception.....	[ ]	[ ]	[ ]	[ ]	[ ]
<b>PROCESSING</b>					
Short term memory.....	[ ]	[ ]	[ ]	[ ]	[ ]
Long term memory.....	[ ]	[ ]	[ ]	[ ]	[ ]
Cognitive skills.....	[ ]	[ ]	[ ]	[ ]	[ ]
Anger/aggression.....	[ ]	[ ]	[ ]	[ ]	[ ]
Anxiety.....	[ ]	[ ]	[ ]	[ ]	[ ]
Selective Attention....	[ ]	[ ]	[ ]	[ ]	[ ]
Stress Response.....	[ ]	[ ]	[ ]	[ ]	[ ]
Problem Solving.....	[ ]	[ ]	[ ]	[ ]	[ ]
Decision-Making.....	[ ]	[ ]	[ ]	[ ]	[ ]
Judgement.....	[ ]	[ ]	[ ]	[ ]	[ ]
Patience.....	[ ]	[ ]	[ ]	[ ]	[ ]
Insight into driving...	[ ]	[ ]	[ ]	[ ]	[ ]
<b>MOTOR</b>					
Strength upper limbs...	[ ]	[ ]	[ ]	[ ]	[ ]
Strength lower limbs...	[ ]	[ ]	[ ]	[ ]	[ ]
Strength hand.....	[ ]	[ ]	[ ]	[ ]	[ ]
Strength foot.....	[ ]	[ ]	[ ]	[ ]	[ ]
ROM upper limbs.....	[ ]	[ ]	[ ]	[ ]	[ ]
ROM lower limbs.....	[ ]	[ ]	[ ]	[ ]	[ ]
ROM neck.....	[ ]	[ ]	[ ]	[ ]	[ ]
ROM trunk.....	[ ]	[ ]	[ ]	[ ]	[ ]
RT simple.....	[ ]	[ ]	[ ]	[ ]	[ ]
RT eye-hand.....	[ ]	[ ]	[ ]	[ ]	[ ]
RT eye-foot.....	[ ]	[ ]	[ ]	[ ]	[ ]
Coordination.....	[ ]	[ ]	[ ]	[ ]	[ ]
Endurance.....	[ ]	[ ]	[ ]	[ ]	[ ]
General Attitude.....	[ ]	[ ]	[ ]	[ ]	[ ]
Overall Health.....	[ ]	[ ]	[ ]	[ ]	[ ]

(1) with glasses if worn (2) with hearing aide if worn

Coder Rating: 0=unable to rate      3=partial test data  
 1=subjective observation      4=past test data  
 2=limited test data      5=tested

severe....the impairment is significant enough to make it unlikely the person can make adjustments to allow safe driving performance.

The Driver Assessment Profile can be used to assess the abilities and skills using a number of means: descriptive which is based heavily on subjective observations, measured based on criterion reference measures, assessed based on formal assessment techniques, and diagnostic which would take the formal assessment and make the transition to formally creating suggested responses. The present form of the instrument supports the first three uses.

A rating system is provided to the rater to allow indicating the type of assessment for each item. If all the assessments of the abilities are of the same type, then the procedure is to indicate the time for the first characteristic and a downward arrow in the second. The types of assesement supported are:

- 0...unable to rate this specific item,
- 1...subjective observation,
- 2...subjective observation combined with limited test data,
- 3...rating is based on partial test data,
- 4...rating is based on past test data available to the rater, and
- 5...rating is based on testing.

The higher the number of the rating the greater the expected validity. The intent is to allow use of the profile over a greater range of situations than one which is strictly dependent on formal assessment techniques. The ratings provided enable use in a range of conditions, or when the conditions are not equal for all items. The result rating enables the interviewers to answer, and to assign a validity weight to the rating based on their assessment.

The scoring of the scale is not to be done by the interviewer at this time. The interviewer is to indicate the agency #, site #, subject #, and date. The agency # is a four character field. The site is a five character field.

#### IDENTIFICATION VARIABLES..

The subject identifiers are assigned by the agencies and sites and are comprised of a three character field. It is requested that the subjects be numbered sequentially. The combination of the agency, site and subject numbers provide a unique identifier for the participant.

The interviewer # is assigned by the agency. The agency must keep the cross-reference list between site and site #, subject and subject #, and interviewer and interviewer #. A form to simplify this procedure is included in Attachment A.

The date is that of administration.



## DESCRIPTION OF ABILITIES OR SKILLS..

If an adaptive or assistive device or prosthesis is normally worn while driving, please conduct assessment with it on. For example, if the person wears glasses then assess the person's characteristics with the glasses on.

### SENSING ABILITIES AND SKILLS

**Vision...**the ability to sense, interpret and respond to visual information. Vision includes:

**Acuity/Static...**the ability to see a close or far object clearly, when there is no movement between the observer and the object.

**Acuity/Dynamic...**the ability to see a close or far object clearly, when there is relative movement between the observer and the object.

**Field of Vision...**the extent to which one can see to left and right while looking straight ahead.

**Lateral or Peripheral Vision...**the ability to detect motion, form, or color on either side of the head while looking straight ahead.

**Depth Perception or Distance Judgement...**the ability to judge distances, and changes in distances, between objects.

**Glare Refractory...**how sensitive is the person to glare including how well they recover from the glare (where glare is a bright concentrated light or brilliant reflection).

**Color Recognition or Sensitivity...**the ability to perceive and discriminate between different colors.

**Pathologies...**do any visual pathologies (i.e. cataract, glaucoma, senile macular degeneration) exist that produce an impairment to vision needed for driving?

**Hearing...**the ability to sense, interpret and respond to auditory information. Is there a hearing loss which impairs driving ability. The loss should be evaluated with a hearing aide if it is normally worn.

**Kinesthesia...**a position sense; an awareness of position and movements of body segments or the whole body as a

**Proprioception...**an integral component of balance and equilibrium for muscle sense in skilled movements requiring balancing competence.

## PROCESSING ABILITIES AND SKILLS

**Memory...**the ability to retain occurring events, store these new experiences, and recall that stored material.

**Cognitive skills...**the way an individual manipulates information through interpretation, storage and retrieval from memory, evaluation, and reasoning.

**Anger/aggression...**the person's ability to control anger and/or aggression caused by external events or persons.

**Anxiety...**an intense feeling of discomfort associated with fears and threats that have no basis in fact.

**Selective attention...**an individual's ability to concentrate for a certain length of time while a competing stimulus is present.

**Stress Response...**the person's ability to maintain their capability to react and produce directed activity without expending large amounts of personal resources and energy in coping and adapting to the stressor from the environment.

**Problem Solving...**the person's ability to take in information, organize and analyze it, and produce an effective response. Problems are encountered from many sources, and the rating is the degree to which the person is impaired in their problem solving capability.

**Decision-Making...**the person's ability to make a decision from information available to them. The ability to make a selection from alternatives is the outcome of the decision-making process. The rating is the degree of impairment to the decision process.

**Judgement...**the ability to understand a relationship and draw correct conclusions in order to make a reasonable decision and safe execution.

**Patience...**the ability to endure a period in which a desired outcome or a problem to be dealt with cannot be resolved. The inability to endure such a period is cause to rate the person's patience impaired. In driving such impairment might be seen as the inability to wait for a light, or perhaps an excessive use of the vehicle's horn.

**Insight...**the ability to understand the driving process, its implications, strategies, and tactics.

## MOTOR ABILITIES AND SKILLS

**Strength**..skill and performance in using muscular force within time periods necessary for purposeful task performance. The muscle strength of the following movements on both the right and left sides will be assessed: upper limbs, lower limbs, hand, and foot.

**Range of Motion (ROM)**..skill and performance in using maximum span of joint movement in activities with and without assistance to enhance performance. The active range of motion of the following movements on both the right and left sides will be assessed: upper limbs, lower limbs, neck, and trunk.

**Reaction Time (RT)**..amount of time an individual takes to respond and complete a movement after a stimulus has been presented. Simple reaction time, eye-hand reaction time, and eye-foot reaction time will be assessed.

**Coordination**...the person's general ability to order and bring together actions in a directed activity.

**Endurance**...the person's ability to continue a physical activity; such as, sitting, standing, or keeping arms up.

## GENERAL CONDITIONS

**General Attitude**...a rating of the person's general attitude toward life and its activities relative to active peers.

**Overall health**...an estimate if the person's general health is impaired and would influence a person's capability to drive, the rating is of the degree of impairment the person's health causes relative to the driving capability.

## MEASUREMENT PROCESSES

The measurement process will be a combination of specific tests, general scenarios, and work on the simulator. The overall schedule for the mixture of events is presented in Appendix A. An overview of the procedures that correspond to the activities on the schedule are presented in the following discussion. The recording of the events will be on the form shown in Appendix B. The material from the recording form will be used to produce the ratings on MY-DAP.

## SENSING ABILITIES AND SKILLS

### Visual Measures.

The following discussion presents the measurement of the person's vision with a focus on how it pertains to driving. Vision is defined in the following way:

**Vision...**the ability to sense, interpret and respond to visual information.

Vision has an overall effectiveness as well as component dimensions which are both evaluated. The components are those which most influence driving performance, and overall vision is defined as"

**Overall Vision...**the summarization of all the dimensions of vision into a single measure.

There is no single measure of overall vision. One's vision is a composite of a range of dimensions (acuity, depth of field, color recognition, ... ) and also is tied into the overall ability to use the sensory information. We define a measure of overall vision to be a subjective judgement based on a series of observations and measures of component activities. The goal is to produce a measure of vision which will define how the visual sense influences the person's driving performance. To accomplish this rating we set the following guidelines:

1. the measure is accomplished with any corrective eye wear in place,
2. the measurement is to determine the degree of impairment relative to the driving experience (for example, a reading problem does not a priori translate into a problem for driving),
3. the rating is a summation of effects and defines if the visual sense impairs driving performance and safety,
4. if the impairment occurs for a specific activity (such as night driving) it is considered an overall impairment,

Acuity/Static...the ability to see a close or far object clearly, when there is no movement between the observer and the object.

The simplest measure of static acuity is the Snelling chart. The individual will be asked to read the Snelling chart with corrective eye wear in place using both eyes and the result recorded. The interpretation of the value is:

Acuity/Dynamic...the ability to see a close or far object clearly, when there is relative movement between the observer and the object.

The subject is asked to read several signs on the walls while moving through a room. The alternative is the tape with the moving objects. The measure is:

Field of Vision...the extent to which one can see to left and right while looking straight ahead.

The person is asked to take the field of vision test using the field of vision tester. The angle is provided by the device both left and right. The test is done from back to front. Readings are taken on both eyes.

The alternative is to create a field of vision test situation. For example in the drivers simulation example (see tape), while

*Yee/Melichar Driver Assessment Profile Protocol V1.0 26Feb92 -9*

sitting in the drivers seat the person is asked to look straight ahead and read a series of numbers placed on the side walls from the front to the rear of the room. The measure is the number which is correlated to a distance from the viewer from which the angle can be calculated. The interpretation is:

**Lateral or Peripheral Vision...**the ability to detect motion, form, or color on either side of the head while looking straight ahead.

Use the field of vision tester as described above.

An alternative is to do the following. The person is asked to take two objects and hold them in their hands. They raise their arms to vertical and as far back as they can. They are then asked to move their arms slowly forward until they can see the object.

The measure is the angle from 180 deg when they report they can see the object moving. The second measure is the ability to move the shoulder and upper arm in terms of range of motion. Also there is a provision of a weak measure of strength (grip on the object), fatigue, and the wrist.

Ask the patient to flex at the elbows and the wrist upon completing the peripheral vision task.

**Depth Perception or Distance Judgement...**the ability to judge distances, and changes in distances, between objects.

Move recepticles into size order small to large front to back on a desktop. Place objects into the recepticles first front, then rear, and finally center.

Also stood at distance of about 10 feet away and asked person to tell which of two pieces of paper (one in each hand) was farthest forward. Started even or at a 1/16th to 1/8th inch difference. If starting even, then went to the first separation. If the separation was not discerned increased it.

Meausre is:

Glare Refractory...how sensitive is the person to glare including how well they recover from the glare (where glare is a bright concentrated light or brilliant reflection).

Look at light next to Snelling Chart. Count to 3 and then reread Snelling chart. Record value. Have subject tell you when their original reading on Snelling Chart returned. Record time difference. Ask the subject how long it took to recover and what they saw originally and during the change. Have subject look away, and reread Snelling chart at 30-45 seconds.

Measure two Snelling chart readings. Interpretation is:

Color Recognition or Sensitivity...the ability to perceive and discriminate between different colors.

Colored cards are placed in the front of the subject on the desk. The person is asked to name the colors in sequence. Correct answers are recorded. The cards include shades of the same color to indicate a degree of color discrimination sensitivity.

Successful: Yes  No

Pathologies...do any visual pathologies (i.e. cataract, glaucoma, senile macular degeneration) exist that produce an impairment to vision needed for driving?

Pathologies are determined by asking the person if they have any of the following conditions. The conditions are assessed by asking the person.

VISUAL CONDITION	EXISTS Y/N/P	----RESTRICTION----- None Somewhat A lot	Comments
Cataract			
Glaucoma			
Color blindness			
Night blindness			
Tunnel Vision			
Macular degeneration			

## HEARING.

Hearing...the ability to sense, interpret and respond to auditory information. Is there a hearing loss which impairs driving ability. The loss should be evaluated with a hearing aide if it is normally worn.

When the person is sitting at the desk and again in the simulator, give instructions at varying voice volumes beginning in a whisper. Indicated the approximate level from whisper to a normal speaking voice can be heard. It is easy to get right and left discrimination, and also general level. With the simulator, also added background noise from the projector. The objective is a general measure of hearing ... is it a problem and how bad versus an actual measure of hearing loss.

Kinesthesia...a position sense; an awareness of position and movements of body segments or the whole body

Have the person standing close their eyes and touch their nose. Ask them to turn around (360 deg) and redo the process. Have them do a heel toe walk on a line on the floor.

Proprioception...an integral component of balance and equilibrium for muscle sense in skilled movements requiring balancing competence.

Get information from putting the objects in the containers, key in the ignition, movement in the driving seat, getting in and out of the seat, adjusting the seat, and turning the wheel. Balancing on one foot and then the other.

Other: Have the person balance on one foot and then the other. Also have them raise up on their toes. Watch walking and sitting as secondary sources of information. Integrate the information into the two above categories and include it in the physical skills section.



## PROCESSING ABILITIES AND SKILLS

Memory...the ability to retain occurring events, store these new experiences, and recall that stored material.

Name the presidents since Eisenhower in order (Kennedy, Johnson, Nixon, Ford, Carter, Regan, and Bush). The sequence is a general measure of long term memory.

Please do the following sequence when I say ready:

1. Turn right
2. Turn left
3. Brake

Please do the following sequence when I say ready:

1. Turn right
2. Count to 5
3. Straighten the wheel
4. Count to 3
5. Brake
6. Count to 3
7. Turn right
8. Count to 5
9. Straighten the wheel

Make estimate of stress and anxiety.

Measure of long term memory: record sequence

Record instructions that were done correctly for both

Anxiety	None	Mild	Moderate	Severe
Stress	None	Mild	Moderate	Severe

Cognitive skills...the way an individual manipulates information through interpretation, storage and retrieval from memory, evaluation, and reasoning.

Observation based on tests plus simulator

Cognition	Normal	Mild	Moderate	Severe
-----------	--------	------	----------	--------

Anger/aggression...the person's ability to control anger and/or aggression caused by external events or persons.

Two sets of measures: self report and observation in driving simulation and disucssion of simulation. There are reports in MY-CODA and ODSAI, but gather information seperately. There is no good objective test for these variables. Do not want to get the person angry. The best procedure is to talk about their driving and general attitude as you go through the interview. The scenarios for patience also are designed to get you some clues.

Anxiety...an intense feeling of discomfort associated with fears and threats that have no basis in fact.

Observation from tests and simulation, and a self-report. You will get a definite feeling in the instruction sequences for memory and response.

Selective attention...an individual's ability to concentrate for a certain length of time while a competing stimulus is present.

Data is to be gathered from observation of the simulator. Some information comes from interactions with the subject when giving them instructions. The tape being developed will try to give your added input on this characteristic.

Stress Response...the person's ability to maintain their capability to react and produce directed activity without expending large amounts of personal resources and energy in coping and adapting to the stressor from the environment.

The driving simulator produces a stressed environment. There will be an evaluation of the stress observed in response to these conditions. The response scenarios will give you a good indication. The more stressed the more rapid and exaggerated the movements. After the tests are over, ask the person about their feelings of being stressed or pressured and about their sense of anxiety.

**Problem Solving...**the person's ability to take in information, organize and analyze it, and produce an effective response. Problems are encountered from many sources, and the rating is the degree to which the person is impaired in their problem solving capability.

Problem situations are provided in the simulation trial, and in the other tests. The evaluation will be based on these observations.

Without the simulation, you have to make an estimate based on the patience scenarios and the "put the object in the jug" routine. The added scenarios at the end of the testing also will provide information.

**Decision-Making...**the person's ability to make a decision from information available to them. The ability to make a selection from alternatives is the outcome of the decision-making process. The rating is the degree of impairment to the decision process.

Decision-making situations are provided in the simulation trial, and in other tests. The evaluation will be based on these observations. Use the scenarios and the reaction sequences.

**Judgement...**the ability to understand a relationship and draw correct conclusions in order to make a reasonable decision and safe execution.

Judgement situations are provided in the simulation trial, and in other tests. The evaluation will be based on these observations. Use the two sets of scenarios as a basis.

**Patience...**the ability to endure a period in which a desired outcome or a problem to be dealt with cannot be resolved. The inability to endure such a period is cause to rate the person's patience impaired. In driving such impairment might be seen as the inability to wait for a light, or perhaps an excessive use of the vehicle's horn.

Patience situations are provided in the simulation trial, and in other tests. The evaluation will be based on these observations. Use the patience scenarios.

The person also will be asked about what they do in the following situations:

1. a slow car is in the middle lane of freeway..how do you respond?
2. a slow car is in the fast lane of the freeway..how do you respond?
3. a car is standing in the middle of a local street..how do you respond?
4. a car is trying to standing at a stop sign, traffic is moving slowly past the intersection, after waiting for a minute how do you respond?

Insight...the ability to understand the driving process, its implications, strategies, and tactics.

A compendium of activities undertaken in the simulation and testing and discussion with the subject.

### MOTOR ABILITIES AND SKILLS

**Strength**..skill and performance in using muscular force within time periods necessary for purposeful task performance. The muscle strength of the following movements on both the right and left sides will be assessed: upper limbs, lower limbs, hand, and foot.

#### Upper limbs

Taken from peripheral vision test and the accompanying requests. Added information from pulling driving seat forward. Request person to reach for shoulder strap left and right. Also from raising and lowering their arms.

#### Lower limbs

Watch breaking, sitting, pulling seat, and getting up. When asking to break note difficulty.

#### Hand

Use of key, directional signals, grasping objects

#### Foot

Check ability to depress brake pedal. Rise up on toes. Also use of accelerator.

**Range of Motion (ROM)**..skill and performance in using maximum span of joint movement in activities with and without assistance to enhance performance. The active range of motion of the fol-

lowing movements on both the right and left sides will be assessed: upper limbs, lower limbs, neck, and trunk.

#### Upper limbs

Same as strength.

#### Lower Limbs

Same as strength

#### Neck

Look at right rearview mirror  
Look at left rearview mirror

#### Trunk

Position seat, adjustment of seat, and putting objects in receptacles at desk. Looking to the rear over both shoulders. Putting on seat belt.

**Reaction Time (RT)**..amount of time an individual takes to respond and complete a movement after a stimulus has been presented. Simple reaction time, eye-hand reaction time, and eye-foot reaction time will be assessed.

#### Simple

From simulator ... use tape or create a reaction situation. With the tape do eye and hand movement from a green paper to a red paper. Move hand and foot. Get both, and then do separately.

#### Eye-hand

see simple

#### Eye-foot

see simple

**Coordination**...the person's general ability to order and bring together actions in a directed activity.

*Yee/Melichar Driver Assessment Profile Protocol V1.0 26Feb92 -17*

Get it from walking and sitting, the exercises in the car seat, and the strength and ROM exercises.

Endurance...the person's ability to continue a physical activity; such as, sitting, standing, or keeping arms up.

Observe fatigue rate in the simulator, exercises, and across the session.

#### GENERAL CONDITIONS

General Attitude...a rating of the person's general attitude toward life and its activities relative to active peers.

Discuss outlook on life. Avoid direct questions asked in MY-CODA. Add an observer assessment.

Patient observation

Observer

Overall health...an estimate if the person's general health is impaired and would influence a person's capability to drive, the rating is of the degree of impairment the person's health causes relative to the driving capability.

Discuss health relative to driving. Avoid direct questions in MY-CODA. Add an observer assessment.

Patient

Observer

## Schedule of Events in The Interview

### 1. Opening and introduction...

- 1.1. Welcome the person - ask if they have any questions  
There is coffee and some snacks on the desk. The rest room is in the next trailer.
- 1.2. Collect MY-CODA, State-Trait Anxiety, pre-test and study continuation sign-up.
- 1.3 Present overall sequence of events...
  - . assessment starts with some specific tests to measure baseline function on skills basic to driving
  - . next we will undertake some general activities which provide a series of measurement situations about physical and sensory functioning
  - . a number of self-report questions will be asked
  - . there will be a period of acclimation to the simulator
  - . the simulation experience will occur
  - . there will be a closing discussion, and you will then be asked to take the post test
- 1.4 If at any time you feel uncomfortable or need a break please request a pause
- 1.5 Did you drive to the site?
- 1.6 Are you taking any medications that might influence your involvement in the activities described?
- 1.7 Do you have any health conditions which might influence your involvement or safety?
- 1.8 Are there any questions .. if not here we go.

### 2. Vision and Physical Test Situations

- 2.1 Do you have any eye problems, diseases, pathologies,...?  
For example, glaucoma, macular degeneration, color blindness, glare sensitivity, tunnel vision, ...
- 2.2 Do you wear glasses or contacts?
- 2.3. Please step over to the eye chart reading area ... please read the chart to the best of your ability.
- 2.4. Please turn around ... turn on light next to the chart..  
Please turn around and look at the light, count to 3, and then read the chart again. What was the effect of looking at the light?

2.5 Please close your eyes and touch your nose with the index finger of your right hand. Now touch your nose with the index finger of your left hand.

2.6 Please balance on your left foot. Now balance on your right foot.

2.6. Please raise up on you toes.

2.7 Please walk the line on the floor.

### 3. Desk Activities

3.1. Please go to the desk and sit down.

3.2. There is a stack of colored papers on the desk. Please name the colors, place different colors into different stacks, but put shades of the same color on the same stack.

3.3. Remove the papers from the desk.

3.4 There are three vessels on the table. Please arrange them from the front of the desk to the rear with the smallest nearest to your. Have a distance of 6 to 12 inches between them. Now place the three objects into the containers starting with the rear vessel, then the front vessel, and finally the middle vessel.

3.5 Please swivel around in the chair. We are going to test your field of vision with a stand measuring device. Please look straight ahead. Please indicate when you can read the card on your right and tell me the letters. Please indicate when you can read the card on your left and tell me when you can read the letters. Still looking straight ahead, can you see both cards?

### 4. Field of Vision (optional .. should have data from #3)

4.1 Please stand up and move next to the driver's seat.

4.2 Looking straight ahead please read the numbers and letters on the left side of the room.

4.3. Looking straight ahead please read the numbers and letters on the right side of the room.

4.4 Can you see both of the last letters/numbers you read at the same time? If not, what are the last two that you can read?

### 4. Tape

*Yee/Melichar Driver Assessment Profile Protocol V1.0 26Feb92 -20*



## **5. Getting Into the Simulator And Adjusting To It**

5.1 Please sit in the simulator?

5.2 Please adjust the seat so it is comfortable for you.

5.3 Please put on the seat belt.

5.4 Please put both hands on the steering wheel. Turn it to the right and then to the left.

5.5 Put your foot on the accelerator. Please depress it fully and hold it in a depressed position for ten seconds. Was it fully depressed? Was it comfortable to do so?

5.7. Now step on the brake. Depress it fully. Release the brake.

5.8. Put your foot on the accelerator, hold it for 5 seconds, now quickly apply the brake. Remove your foot from the brake.

5.9 Reach around the steering wheel and place the key in the ignition and turn it. Put both hands on the steering wheel. Turn off the ignition.

5.10 Please put on the lights.

5.11 Please signal for a left turn. Turn the wheel to the left, and then return to center. Please signal for a right turn. Turn the wheel to the right and then return to center.

5.12 Please release the hand brake. Please apply the hand brake. Please release it again. Please apply it again. Please indicate any problems. (if in the subjects car ... be careful about the releasing the hand brake .. make sure they have foot on brake and that the car is in a level area).

5.13 Please turn and look in the mirror over your right shoulder.

5.14 Please turn and look in the mirror over your left shoulder.

5.14 Please reach for a hypothetical shoulder belt near the mirror on your left side (can use the head rest).

5.15 Please reach for a hypothetical shoulder belt near the mirror on your right side (can use the head rest).

## **6. Memory and Sequencing**

6.1 Please name the presidents since Eisenhower..

6.2 Describe the cars on either side of your parked car.

6.3 What did the sign on the door say?

6.4 We are going to undertake two groups of sequenced driving activities in your new car seat. I will tell you the sequence and then ask you to preform it.

6.5 Here is the first sequence. Please wait until I say go. 1. turn right 2. count to 2 3. turn left 4. brake

6.6 Good. Now lets try a longer sequence. Please wait until I say go. The sequence is:

1. turn right
2. count to 5
3. straighten the wheel
4. count to 3
5. brake
6. count to 3
7. turn right
8. count to 5
9. straighten the wheel
10. brake

6.7 Thanks for working with the sequence.

6.8 I will now give you a series of instructions. Please do them as I give them to you. They will be vary in speed - some will be very quick others will be spaced apart. Do not run me over.

1. turn right +1
2. turn left +2
3. turn right 0
4. turn left 0
5. brake 0
6. turn right +3
7. signal for a left turn +2
8. turn left 0
9. brake 0
10. signal for a right turn +2
11. turn right 0
12. brake

Now lets try a second sequence:

1. signal left +1
2. turn right
3. center wheel +1
4. brake +2
5. brake off
6. turn left +1
7. brake +2
8. brake off
9. center wheel +3
10. signal left +1
11. turn left

12. center wheel +2
13. look in rear view mirror +1
14. brake +2
15. brake off
16. turn left
17. turn right
18. center wheel
19. brake
20. turn right

6.9 Thank you take a breather

6.10 How did you feel about the different sequences? Did you sense any pressure? If so how and when?

## 7. Patience Questions

7.1 I would like to ask you to discuss four driving situations. Please let me know how you would respond in each of the situations.

7.2 You are driving down the freeway at your normal speed in the center of three lanes. You come upon a car going slowly in that lane, there is a car slightly ahead of it in the slow lane moving faster. A car is coming up behind you in the fast lane, but is 10 car lengths behind. What is your response?

7.3 You are driving in the fast lane of a freeway. There is a slow car in the lane blocking you. There is some, but not a lot of room in the adjacent lane. There is a car on your left coming up behind you which is now about 10 car lengths back. How do you respond?

7.4 You are driving down a local street in a residential area on a Saturday afternoon. No other cars are about. A car is sitting stopped without any occupants in your lane. How do you respond?

7.5 You come to a stop sign from a side street going into a busy thoroughfare. Traffic on the busy street is moving at a moderate pace. You have stopped with one car in front of you. The car is signalling for a turn, but after a minute still has not moved? How do you respond?

7.6 What feelings do you generally have in this situation?

7.7 How do you respond after the car in front of you has made its turn?

7.8 You are driving in a downtown area of Baltimore. You need to get home quickly for a family function. Traffic is heavy and some streets seem overly congested. How do you respond?

7.9 Do you get frustrated? Do you get angry? Do you get impatient? Do these types of situations make you tense and stressed?

7.10 You are on an interstate in an urban area. The traffic stops and stands for a few minutes. How do you usually respond? What are your reactions to this situation?

7.11 It is foggy and raining. You are driving on a suburban street with two lanes in each direction. The posted speed limit is 35mph. Traffic is moderate. How do you react to this situation?

7.12 You are driving through a residential area at 1 in the afternoon on a Monday in early May. There appears to be no one around. The speed limit is 20 mph. Do you drive the speed limit? What kinds of problems do you anticipate?

7.13 It is now 3:30pm in the same situation. Do you do anything different. If so, what are the changes?

7.14 It is now 6:00pm in the same situation. Do you do anything different. If so, what are the changes that you make?

## **8. Taped Situations**

to be added

## **9. Closure and Post Test**

9.1 How do you generally feel about your health.

9.2 How would you describe your driving.

9.3 Please do the post test

9.4 Do you want feed back from the information collected and the simulation. If so please leave a name an telephone number and a good time to call. It may take a few weeks to get you the information, but we will follow up if you request it.

9.5 We also have provided you an evaluation sheet. We are trying to develop the methods and procedures for general use. Any comments or help you can provide would be of great interest.

9.6 We thank you for your help and cooperation.

**SIMULATOR RECORDING FORM**

Group: 07            Agency: 03            Site:01            ID: \_ \_ \_

Date: Feb Mar \_\_\_\_\_, 1992    Interviewer: \_\_\_\_\_

1.6 Did person drive to the site? Yes \_\_\_ No \_\_\_

1.7 Influencing medications? No \_\_\_ Yes no influ \_\_\_ Yes \_\_\_

1.8 Health Conditions? No \_\_\_ Yes no influence \_\_\_ Yes \_\_\_

**2.1 Eye Pathologies**

VISUAL CONDITION	EXISTS Y/N/P	----RESTRICTION-----			Comments
		None	Somewhat	A lot	

Cataract					
Glaucoma					
Color blindness					
Night blindness					
Tunnel Vision					
Macular degeneration					

2.2 Do you wear glasses or contacts? Yes \_\_\_ No \_\_\_

2.3 Snelling chart read...line #                    \_\_\_ / \_\_\_

2.4 Snelling chart read-GLARE... line #            \_\_\_ / \_\_\_

Effect of light on readng comment: \_\_\_\_\_

2.5 Able to touch nose with right finger? Yes \_\_\_ No \_\_\_  
 Able to touch nose with left finger? Yes \_\_\_ No \_\_\_

Activity	Excellant	Good	Okay	Poor	No
2.6 Balance left foot Right foot					
Walk the line					
2.7 Raise up using feet					
Sitting down: 3.1 Balance					
Hip flexion					
Upper arm use					

3.4 Color recognition Yes\_\_\_ Paritial \_\_\_ No \_\_\_  
 Color sensitivity Yes\_\_\_ Paritial \_\_\_ No \_\_\_

Activity	Excellant	Good	Okay	Poor	No
3.4 Forward reach					
Trunk movement					
Grasp					
Arrangment					
Placement					
Depth Perception					
Fine motor					
Upper arm rom					
Leg mvmnt swivel					
Problem Solving					
Memory					

3.5 Field of vision angle right glasses \_\_\_\_\_ glasses off \_\_\_\_\_  
 left \_\_\_\_\_  
 both \_\_\_\_\_

4.1 Movement to drivers seat

4.2 Read numbers/letters right \_\_\_\_\_  
 4.3 left \_\_\_\_\_  
 4.4 both \_\_\_\_\_

Drivers Seat Actvt's Mvmnt, Sit, Cntrls	Problem Level				
	None	Minor	Some	Alot	Failure
Sitting					
Leg movement					
Knee flexion strength					
rom					
Hip flexion strength					
rom					
Seat adjustment					
Leg movement					
Knee flexion strength					
rom					
Hip flexion strength					
rom					
Upper arm strength					
rom					
Instrument Panel					
Hand movement strngth					
rom					
Grasp					
Trunk strength					
rom					
Hand Brake					
Hand Movement strngth					
rom					
Grasp					



**Drivers Seat Activity  
Belts & Mirrors**

**Problem Level**  
None    Minor    Some    Alot    Failure

	None	Minor	Some	Alot	Failure
Turn to mirror right Trunk strength rom					
Turn to mirror left Trunk strength rom					
Reach for belt right Arm strength rom Trunk strength rom					
Reach for belt left Arm strength rom Trunk strength rom					

6.1 Presidents since Eisenhower \_\_\_ Kennedy \_\_\_ Johnson \_\_\_ Nixon  
\_\_\_ Ford \_\_\_ Carter \_\_\_ Regan \_\_\_ Bush

6.2 Described cars on either side Yes \_\_\_ Partial \_\_\_ No \_\_\_

6.3 Awareness of sign on door Yes \_\_\_ Partial \_\_\_ No \_\_\_

6.4 Four step sequence Yes \_\_\_ Partial \_\_\_ # \_\_\_ No \_\_\_

1. turn right 2. count to 2 3. turn left 4. brake

6.5 Ten step sequence until I say go.

1. turn right
2. count to 5
3. straighten the wheel
4. count to 3
5. brake
6. count to 3
7. turn right
8. count to 5
9. straighten the wheel
10. brake



Now lets try a second sequence:

1. signal left +1
2. turn right
3. center wheel +1
4. brake +2
5. brake off
6. turn left +1
7. brake +2
8. brake off
9. center wheel +3
10. signal left +1
11. turn left
  
12. center wheel +2
13. look in rear view mirror +1
14. brake +2
15. brake off
16. turn left
17. turn right
18. center wheel
19. brake
20. turn right

Did the person exhibit confusion? Yes \_\_\_ No \_\_\_

Did the person exhibit stress? None\_ Minor\_ Some\_ A lot\_ Exteme\_

6.8 Stressor sequence...  
Did they complete the sequence? Yes \_\_\_ One \_\_\_ Neither \_\_\_

Did the person exhibit stress? None\_ Minor\_ Some\_ A lot\_ Exteme\_

6.10 Comments

Patience, Decision Making, Judgement (put P,D,J in appropriate box)  
Very Pretty Average Lacking None

7.2 Scenario 1					
7.3 Scenario 2					
7.4 Scenario 3					
7.5 Scenario 4					

7.6 Feelings identified for scenario 4

7.7 Response identified for scenario 4

Patience, Decision Making, Judgement, Anger, Frustration  
(put P,D,J,A,F in appropriate box)

	Very	Pretty	Average	Lacking	None
7.8 Scenario 5					
7.10 Scenario 6					
7.11 Scenario 7					
7.12 Scenario 9					

7.8 Feelings identified for scenario 5

7.8 Response identified for scenario 5

7.10 Feelings identified for scenario 6

7.10 Response identified for scenario 6

7.11 Feelings identified for scenario 7

7.11 Response identified for scenario 7

7.12 Feelings identified for scenario 8

7.12 Response identified for scenario 8

**8. Taped situations**

reaction time combined

reaction time eye-hand

reaction time eye-foot

selective attention/figure ground

dynammic acuity

color sensitivity

comments

9.1 Health geneal feelings      Excellant    Good    Average    Poor    Bad

9.2 Driving general approach    Excellant    Good    Average    Poor    Bad

General Comments.....

# DRIVERS 55 PLUS (ODSAI)

AGENCY..03 SITE...01 ID... \_ \_ \_

INTERVIEWER... \_ \_ DATE 92 0 \_ \_ \_

QUESTIONS	ALWAYS	SOME TIMES	NEVER
1. I SIGNAL AND CHECK TO THE REAR WHEN I CHANGE LANES .....	0	5	5
2. I WEAR A SET BELT .....	0	5	5
3. I TRY TO STAY INFORMED ON CHANGES IN DRIVING AND HIGHWAY REGULATIONS.....	0	3	5
4. INTERSECTIONS BOTHER ME BECAUSE THERE IS SO MUCH TO WATCH FOR FROM ALL DIRECTIONS	5	3	0
5. I FIND IT DIFFICULT TO DECIDE WHEN TO TRAFFIC ON A BUSY INTERSTATE HIGHWAY....	5	3	0
6. I THINK I AM SLOWER THAN I USED TO BE IN REACTING TO DANGEROUS DRIVING SITUATIONS	5	5	0
7. WHEN I AM REALLY UPSET I SHOW IT IN MY DRIVING.....	5	5	0
8. MY THOUGHTS WANDER WHEN I AM DRIVING....	5	3	0
9. TRAFFIC SITUATIONS MAKE ME ANGRY.....	5	3	0
10. I GET REGULAR EYE CHECKS TO KEEP MY AT ITS SHARPEST.....	0	5	5
11. I DO NOT TAKE MEDICATION (IF CHECKED)	0		
11. I CHECK WITH MY DOCOTO. ABOUT THE EFFECTS OF MY MEDICATIONS ON DRIVING...	0	3	5
12. I TRY TO STAY ABREAST OF CURRENT INFORMATION ON HEALTH PRACTICES AND HABITS..	0	3	5
13. MY CHILDREN OTHER FAMILY MEMBERS OR FRIENDS ARE CONCERNED ABOUT MY DRIVING.	5	3	0
14. HOW MANY TRAFFIC TICKETS, WARNINGS, OR "DISCUSSIONS" WITH OFFICERS HAVE YOU HAD IN THE PAST TWO YEARS.....	NONE	1-2	3-3+
15. HOW MANY ACCIDENTS HAVE YOU HAD IN THE PAST TWO YEARS.....	0	3	5
TOTAL OF COLUMNS.....			

ALTERNATE SCORING METHOD: #3= \_\_\_ x 3= \_\_\_ #5s= \_\_\_ x 5= \_\_\_

TOTAL SCORE = \_\_\_\_\_

**APPENDIX E:  
PARTICIPATION SURVEY**

---

**STUDY PARTICIPANT SURVEY  
PROTOCOL  
AND  
INSTRUCTION MANUAL**

---

*Spring 1992  
Version 1.0*

*Developed by:*

*Joseph F. Melichar, Ph.D.  
Adaptive Systems Corporation  
P.O. Box 1148  
San Mateo, CA 94403*

*(415) 573-6114*

*Sponsored by a grant from the AARP Andrus Foundation.*

The intent of this protocol is to provide the persons administering the survey: an understanding of its purpose, a general approach to its administration, and actual administration guidelines. The hope is that by providing this information and the guidelines there will be a common procedure across all regions and persons administering the survey. If at any time you have any questions you can call Joe Melichar (415) 593-8136 collect or leave a message and the call will be returned.

#### **SURVEY PURPOSE**

A study of older driver characteristics and methods for assessing and providing educational and training interventions is being supported by AARP Andrus Foundation. The study is housed at the Department of Health Education of the San Francisco State University with Professor Darlene Yee Ed.D serving as the principal investigator, and Joe Melichar Ph.D, as the co-investigator. The study is now in its 14th month and will end 30 June. A summary of the overall project is attached, but briefly the study seeks to:

1. determine how best build backgrounds on older drivers using a self report format (about a half-hour survey form),
2. define a multi-level approach to assessment, education, and training of older drivers (differing levels depending on the person) where assessment means to learn about the older driver, education seeks to provide information on knowledge or attitudes about driving, and training provides skills used in driving.
3. define a methodology and strategy for developing multi-level interventions that are individualized to the individual older driver; for example, have a range of interventions to assure that the problems are addressed, but that the person does not have to spend a lot of extra time in the process of being assessed or gaining information or skill,
4. provide more options on how the older person can gain access to information about their driving and how it might be made safer and easier,
5. learn where technologies such as computers can aid in reaching the above purposes, and
6. generally learn more about older drivers and their characteristics so the above activities can be done better.

In doing the study, we noticed that certain types of persons did not seem to want to participate. The study includes over 200 older drivers from California and Texas. The concern is that the people who decide to participate have certain characteristics. We think we have observed that in some cases poor drivers or drivers with problems seem to avoid becoming involved. The persons most in need are the ones who may participate the least.

Obviously this observation concerns us. If the observation is true, it not only effects our study, but likely most others. The results could indicate that the characteristics generally ascribed to older drivers may not accurately reflect them. More important-

ly, it might mean that many of the assessment, education, and training programs now in existence are not reaching those most in need. The implication is that we somehow need to develop other ways of reaching the folks who chose not to participate.

In this survey, we are trying to gain some insight about under what conditions people decide to participate or refuse to participate. The following sections describe the survey form and its administration. At the present time, we expect to have results from three to five states.

## **SURVEY OVERVIEW**

The survey form is designed to be confidential. The surveys are identified by an agency code (corresponding to your area), a site code (referencing this activity), and a subject number. These codes provide us a means for identifying the survey and where it was done. The cover sheets also has a place for interviewer (person who administers the form) and date. You can assign the numbers to the interviewers. The numbers simply allow us to see if there is a pattern between the persons administering the survey. We do not need to know the identity of the person.

In this approach, we will not be able to personally identify the person administering or taking the survey. The only person we can identify is the lead person at each agency (local area) who we contact to start the process. This person may chose to keep a cross-reference between interviewers and numbers and between subjects and their code numbers.

We provide the option at the end of survey form for the person to sign-up for involvement in a subsequent study/driving program if it decided to be offered in your area. These forms should be separated from the main survey form. We would prefer to have the local lead person retain the information which provides another level of confidentiality. We have the data, and the lead person has the personal identifying information, but not data.

The cover sheet allow you to fill in if the person refused totally (the participate Yes-No question). The remainder of the first page provides some general overview of the problem being addressed by the overall study. The procedures for administration of the survey are covered in the next section.

The following pages (#2 and #3) ask questions about the willingness to be involved in a study. The purpose is to determine both a yes-no response, but also the conditions under which a yes becomes a no, or a no a yes. There is room at the end for both the person to write comments, and for your to add comments.

The third and fourth pages ask a series of questions which identify general demographics. The questions are identical to the



ones in the main study survey and will allow us to compare the characteristics of the people in this study group versus those in the main study (over 200 subjects).

The last sheet is a summary of activities. It also is drawn from the survey in the main study. It simply provides a check list of activities undertaken by the person. The purpose is simple, we want to be able to distinguish between the respondent who is active and who is not active. Logically, you would expect active persons to be more willing to be involved in programs.

The person simply indicates by a check mark how frequently they participate in an activity, or do not participate in the activity.

It is very important to record all people you contact on a form. The form sheet provides you a way to record a total refusal. We then request that based on your knowledge of the person you complete the demographics section of the report. We realize that there may be some inaccuracies, but it is better than no information and secondly we will know when you completed the information versus the subject.

#### PROCESS FOR GETTING SUBJECTS

We would like you to use neighbors, friends, and acquaintances as a starting point. In each interview, ask if the person could suggest some added persons. If they suggest a person have them make the first contact. You can either then administer the form over the telephone or meet with them. You also can use any group meetings, but we would like to know if you used this approach and how. Anecdotal notes about the administration will do fine, but a control sheet is provided for your convenience to which you could add anecdotal comments.

If a telephone interview is used, you need to assure confidentiality. There is a need to be really sensitive about the two financial questions (#13 and #14) in the demographic section of the report. To date we have no refusals, but have had people do the questionnaire on their own which is less threatening.

Make sure that your subject is currently driving. If they say they indicate they recently have stopped, do not include them. It would be appreciated if you would ask then if they have stopped in the last two years, if they would participate in larger study of recently stopped older drivers.

The results will be analyzed with support from statisticians at the University of Kentucky. The results will be reported to AARP, and if warranted published for others to use.

## **Future Participation**

A form is include at the end of the survey for the person to indicate if they would like to participate if a study is begun in your area. The studies we plan deal with overall mobility, safety both with-in the home and in the community, public transport, and being a pedestrian. As in the present study, we would include information and feedback on results where appropriate, educational materials, and in some cases training.

There should be no pressure on the person to indicate future participation. It must be their choice totally. The future participation form should be separated from the survey form to maintain confidentiality. By placing the persons identifying number on the form, it will allow us to relate persons who sign-up and who do not sign-up to the response they made on the survey.

## **Comments**

It is not important to us who completes the form and how, or if they want to participate in the future. All the questions just need to be answered as the person feels. If all the questions are not answered, it requires that we get more surveys done to adjust for the missing information.

Thanks for your help and please thank the folks that filled out the survey for us.

# OLDER DRIVER PARTICIPATION SURVEY

## ADMINISTRATION INFORMATION

Agency #: \_\_\_\_\_ Site #: \_\_\_\_\_ Subject #: \_\_\_\_\_  
Date: \_\_\_\_/\_\_\_\_/\_\_\_\_ Interviewer #: \_\_\_\_\_ Participate: Yes \_\_\_  
No \_\_\_\_\_

---

## INTRODUCTION

The increase in the aging of the overall population has entailed a simultaneous increase in the number of older drivers. Drivers age 55 and over constitute 28% of all drivers today-- 39% by the year 2000. While many older drivers have excellent driving records, as a group, when exposure is considered, they are disproportionately involved in traffic accidents and fatalities.

Accident prevention and injury control emphasize the development of individual and community measures to protect against accidents and their harmful consequences. The purpose of this program is to identify the at-risk driver age 55 and over, and remediate any deficits in knowledge or skills about driving and traffic safety.

While your help in answering questions contained in this survey is completely voluntary, it is important that you try to answer all the questions. Please read each question carefully and mark an [X] in only one box for each question except where otherwise indicated. Please ask for help if you do not understand the instructions or any question.

All of the information which you provide will be kept anonymous and confidential. No names are necessary. When you have completed this survey, please return it to us as directed. Thank you for your help and time in the successful completion of this program.

This research is sponsored by a grant from the AARP Andrus Foundation.

---- ANONYMOUS AND CONFIDENTIAL ----

If a study of older drivers were to be available to you would you participate in the following?

1. A study in which you filled out a questionnaire that took 30 to 60 minutes in your home? Yes \_\_\_ No \_\_\_

2. If the questionnaire took 1 1/2 to 2 hours to complete would you still participate? Yes \_\_\_ No \_\_\_

3. Would you prefer to complete the questionnaire with a group of people rather than in your own home by yourself? Yes \_\_\_ No \_\_\_

4. Would information with the questionnaire about older drivers and how to adjust your driving habits with age be of interest to you? Yes \_\_\_ No \_\_\_

5. Would you want feedback about the information collected such as how you responded relative to a large group of older drivers? Yes \_\_\_ No \_\_\_

6. Would any of the following increase your willingness to participate?

information about older drivers \_\_\_  
feedback on your responses \_\_\_  
payment for doing the survey \_\_\_ If so, how much payment? \$ \_\_\_

7. After taking the questionnaire, would you be willing to participate in one hour evaluation and training session at some central location? Yes \_\_\_ No \_\_\_

8. If the evaluation and training session were two hours long would you participate? Yes \_\_\_ No \_\_\_

9. What is the maximum length of an evaluation and training session in hours that you would be willing to participate? \_\_\_ hours  
or check here \_\_\_ if you would not want to participate at all.

10. If a training session were run for an entire day, would you participate? Yes \_\_\_ No \_\_\_

11. Would any of the following factors influence your willingness to participate in an all-day training session?

insurance credit \_\_\_  
removal of a moving driving violation \_\_\_  
payment for attending \_\_\_ if so how much payment? \$ \_\_\_  
other \_\_\_\_\_

12. How many miles would you be willing to drive to a central location to participate in a training session? \_\_\_\_\_ miles

13. Would you be willing to use a driving simulator in the training session? Yes \_\_\_ No \_\_\_

14. Would you like a driving simulator to be used in the training sessions? Yes \_\_\_ No \_\_\_ Do care either way \_\_\_

15. Would you use a video tape educational program in your own home to help improve your driving? Yes \_\_\_ No \_\_\_

16. What video tape length would be optimum for your use?  
\_\_\_ hours

17. If computer-based training system that required no understanding of computers to use it were available, and if that system were able to respond to your own individual needs, would you use it if it were conveniently located? Yes \_\_\_ No \_\_\_

18. Would you be more interested if the study, educational materials, and training activity addressed general mobility (walking, being a pedestrian, ...) and in-home safety as well as driving?  
Yes \_\_\_ No \_\_\_

19. Would surveys, educational programs, and training be more attractive to you if they were provided by members of your community who were of a similar age? Yes \_\_\_ No \_\_\_

20. Would your willingness to participate in a research project increase if educational and training programs were included as part of the project? Yes \_\_\_ No \_\_\_

21. Would you not participate because of any of the following factors?

It would interfere with my daily routine. Yes \_\_\_ No \_\_\_

I do not like to do new things. Yes \_\_\_ No \_\_\_

I do not have the time. Yes \_\_\_ No \_\_\_

Other \_\_\_\_\_

---

Please add any comments you would like to make:

DEMOGRAPHIC INFORMATION

1. Your age? \_\_\_\_\_
2. Birth date? \_\_\_/\_\_\_/\_\_\_
3. Your sex?  Female  
 Male
4. Your current marital status?  
 Never Married  
 Now Married  
 Widowed  
 Separated  
 Divorced  
 Other: \_\_\_\_\_
5. Ethnicity/Race?  
 Asian  
 Black  
 Hispanic  
 Native American  
 White  
 Other \_\_\_\_\_
6. Your highest level of education?  
 Elementary School  
 Junior High School  
 High School  
 Technical or Vocational School  
 Junior College or Some College  
 College  
 Graduate School
7. What is the zip code where you live? \_\_\_\_\_
8. Community in which you live?  Rural  Suburban  Urban
9. With whom do you live?  
 No one  Spouse  Children  
 Other Relatives  Friend  Other: \_\_\_\_\_
10. What is your current employment status?  
 Working part-time for pay  
 Working full-time for pay  
 Not working, but looking for paid work  
 Retired and/or not working for pay
11. What is (or was) your principal occupation?  
 Professional/Managerial  Manual/Industrial Worker  
 Clerical/Office Worker  Salesperson  
 Skilled/Technical Worker  Other: \_\_\_\_\_
12. How many miles do you drive in a year? \_\_\_\_\_

13. By what means do you travel? (Check all that apply)
- Car or Car Pool     Taxi     Bus  
 Train or Subway     Bicycle     Walk     Other: \_\_\_\_\_
14. What was your total annual income (all sources including social security) for you (and your spouse, if married) for the last year?
- \$ 0 - 4,999     \$20,000 - \$29,999  
 \$ 5,000 - 9,999     \$30,000 - \$39,999  
 \$10,000 - 19,999     \$40,000 or more
15. Which of these statements best describes your financial situation?
- My bills are no problem to me, I have excess savings  
 My bills are no problem to me, I have a balanced account  
 My expenses make it difficult to pay my bills  
 My expenses are so heavy that I cannot pay my bills

## ACTIVITIES

Indicate how often you do the following activities...	0 x/yr	1-2 x/yr	1-2 x/mo	1-2 x/wk	3+ x/wk
152. go to a senior center?					
153. attend church?					
154. attend club meetings?					
155. go to the movies?					
156. attend sporting events?					
157. participate in general sports?					
158. participate in aerobic sports?					
159. play cards with others?					
160. garden?					
161. work on a hobby or hobbies?					
162. paint or play music?					
163. eat in restaurants?					
164. baby sit?					
165. visit away from your immediate neighborhood?					
166. take vacations away from home?					
167. entertain out-of-town guests or visitors?					
168. do volunteer work?					

169. Did you vote in the last presidential election?  
 Yes       No



We would like you to consider the following request.

We are undertaking studies in several parts of the country which will continue over a long period of time. The intent is to study change in driving and mobility over time. We are considering other locations to include with our present groups. In the present survey which you have just completed, we have not requested any identifying information. In order to start a project in your area, we need to be able to contact you in the future. To accomplish this contact, we need you to provide us your name, address, and telephone number.

The contact information will be kept separate from the data collected in the study, and is solely for contacting you about future participation. The information provided only will be seen by Dr. Melichar, and will not be released to anyone.

If you would like to participate, please fill out the following information. You may add comments on the back of the page. Your study ID# is on the face sheet of your form it consists of agency #, site#, and id#.

If you do not want to participate, do not fill out the information below and throw away the form.

Your study ID#: \_\_\_\_\_ Date of Birth: \_\_\_\_\_

Name: \_\_\_\_\_

Address: \_\_\_\_\_  
\_\_\_\_\_

City: \_\_\_\_\_ State: \_\_\_\_\_

Zip Code: \_\_\_\_\_ - \_\_\_\_\_

Daytime Telephone: (        ) \_\_\_\_\_ - \_\_\_\_\_

Home Telephone: (        ) \_\_\_\_\_ - \_\_\_\_\_

Signed: \_\_\_\_\_ Date: \_\_\_\_\_

You also can mail in this form to: Dr. Joseph F. Melichar  
Adaptive Systems Corporation  
P.O. Box 1148  
San Mateo, CA 94403-0748

Participant Survey Control Sheet

Agency 00    Site 05    Interviewer 02

Subject Number	Self Admin	Phone Admin	Group Admin	Date	Comments
001					
002					
003					
004					
005					
006					
007					
008					
009					
010					
011					
012					
013					
014					
015					
016					
017					
018					
019					
020					
021					
022					
023					
024					
025					

APPENDIX F:

OLDER DRIVER SELF-ASSESSMENT  
INVENTORY (ODSAI) COMPUTER  
PROGRAM - USER'S MANUAL

# DRIVERS 55 PLUS: TEST YOUR OWN PERFORMANCE

A SELF-RATING FORM OF  
QUESTIONS, FACTS AND SUGGESTIONS  
FOR SAFE DRIVING

COMPUTER VERSION USER'S MANUAL

Version 0.2  
15 March 1992

Form and Booklet Developed by:

James L. Melfatti, Ed.D.  
Darlene J. Winter, Ph.D.  
Safety Research and Education Project  
Teachers College, Columbia University

Sponsored by:  
AAA Foundation for Traffic Safety

Computer Version Developed by:

Joseph F. Melicher, Ph.D.  
Adaptive Systems Corporation  
P.O. Box 1148  
San Mateo, CA 94403-0748

Sponsored by:  
AARP Andrus Foundation

*AAA Foundation For Traffic Safety  
1730 M Street N.W., Suite 401  
Washington, D.C. 20036*

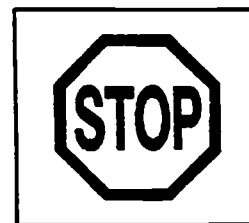
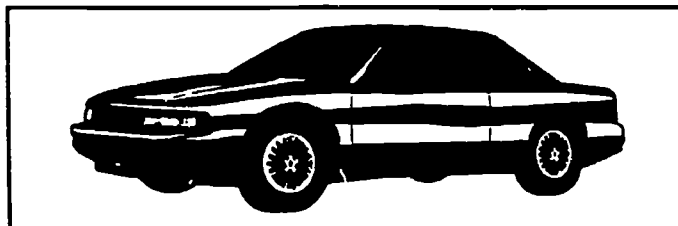

## FORWARD

The computer version of the "DRIVERS 55 PLUS: TEST YOUR OWN PERFORMANCE" self-report form and educational materials was developed under a grant from the AARP Andrus Foundation. The grant was administered by San Francisco State University. The principal investigator was Darlene Yee, Ed.D., Associate Professor, of the Department of Health Education. The computer version was done under contract to San Francisco State University.

Mr. Sam Yaksich, Jr., Executive Director of the AAA Foundation for Traffic Safety and Dr. James L. Malfetti Professor Emeritus of Teachers College of Columbia University reviewed the first version of the software. Their comments were incorporated into the final version.

The author would like to thank Mr. Yaksich, Dr. Malfetti, and Dr. Yee for their input and help. And also to the persons who used the software in pilot situations in Sun City, Arizona and at the San Francisco State University.

The original research under which the source materials were developed was sponsored by the AAA Foundation for Traffic Safety. These materials are described in the Introduction. The remainder of this manual describes the computer programs and their use.

Joseph F. Melichar, Ph.D.  
Adaptive Systems Corporation  
San Mateo, California  
15 March 1992

*COPYRIGHTED BY AAA FOUNDATION FOR TRAFFIC SAFETY ...1992*

## INTRODUCTION

Malfetti and Winters developed a self-rating form for drivers 55 years and older for the AAA Foundation for Traffic Safety in 1986. The self-rating form is comprised of 15 questions. The self-rating form questions are self-scored and are keyed to a series of related facts and suggestions. The older driver answers the questions, scores them, and then based on the scoring reviews appropriate facts and suggestions.

The self-rating form, facts, and suggestions are included in a booklet. The booklet is published by:

AAA Foundation for Traffic Safety  
1730 M Street N.W., Suite 401  
Washington, D.C. 20036

(202) 775-1456

The booklet is a combination of assessment and provision of educational information about driving practices deemed critical to the older driver. Five main topics are addressed: physical conditions, emotions, health habits, driving records, and other indicators.

As part of an AARP Andrus Foundation grant supported research effort it was decided to determine how combined computer based assessment and educational intervention might be transferred to a computer. Secondly, a computer-based scoring system was desired by some users. The result is the software described in this manual.

## MATERIALS INCLUDED

The materials included in the computer version of the DRIVERS 55 PLUS system are: this user's manual, and one computer disk. The disk contains three files: DRVRS55.EXE, SCORE55.EXE, and DRVRS55.TXT. The original DRIVERS 55 PLUS manual and the report describing it can be acquired from AAA Foundation for Traffic Safety as described above.

## HARDWARE REQUIREMENTS

The software will run on most MS-DOS or PC-DOS machines. The software requires an EGA or VGA graphics card. The software can be run from any type floppy disk or from a hard disk. The software has been tested on AT class and newer machines using DOS version 3.3 or later.

## INSTALLATION

It is recommended that you make a copy of the distribution disk using standard DOS commands. For example, on a two floppy drive computer system use the following process:

- (1) Place the distribution diskette in Drive A: ,
- (2) Place a formatted floppy into Drive B: ,
- (3) At the DOS prompt (>) issue the following command,

```
>COPY A:*. * B:
```

followed by pressing the ENTER key,

- (4) To make sure you have copied the files correctly use the following commands:

```
>CLS
```

```
>DIR A:
```

```
>DIR B:
```

- (5) three files of the same description should exist on both diskettes, and
- (6) if they are not the same repeat the procedure.

Store the distribution copy separate from the working floppy disk.

To use the software on the working floppy disk, there is no further installation required.

If you want to use the software on a hard disk, the following is an example set of instructions to install the software in directory DRVRS55 under the root directory on drive C.

```
>C:
```

```
>MKDIR DRVRS55
```

```
>CD DRVRS55
```

```
>COPY A:*. * C:
```

The installation is complete. You will be in the DRVRS55 directory on the C: drive. The following instructions tell you how to run the software.

## OPERATION

There are two programs that can be run: the main program DRVRS55 and a scoring program SCORE55. The DRVRS55 program: administers the self-rating scale, scores the result, identifies the questions which were answered problematically, provides suggestions for improvement on the questions identified as problem-

atic, and then allows you to review the entire booklet. The questions and written material are the same as those in the written booklet available from AAA Foundation For Traffic Safety.

### Using the DRVRS55 Program

To start the program, type DRVRS55 at the DOS prompt followed by ENTER.

The first screen is a title, authorship, and copyright screen. To move on, simply press any key on the keyboard. The next screen provides an overview of the software and allows you to proceed with the assessment (press any key) or terminate the software (press an X to exit). As a convenience for the administrator, a blind option is provided ... if you press D, the booklet will be reviewed without going through the assessment.

This option was not made visible to avoid the person's taking the self-assessment having the opportunity to read the answers prior to the self-assessment.

Once the user starts the program, the questions appear on the screen one at a time. The possible answers are indicated on the screen. The person will respond with the number (1,2, or 3) for the answer they desire. After question # 10, the person is asked if they use any medication in the form of a yes or no response which requires an entry of Y or N. The remaining questions revert to the earlier format.

At the end of the questions, the person has the option of reviewing their responses (by pressing R), scoring their responses (by pressing S), or exiting (by pressing X). The review will allow the person to continue one question after another (by pressing ENTER) or stop the review (by pressing S).

If the person decides to exit, their responses are not scored and control is passed to the start-up screen.

Upon requesting scoring, the responses are scored and the total score is then indicated as being within an acceptable range, a range suggesting more caution in their driving, or a range that is considered to be comprised of many unsafe driving practices. The person is then provided suggestions for any item that does not meet the acceptable criteria (answers reflecting both caution and potential hazardous driving are included in the review). The question is displayed along with the degree of severity of the response and suggestions for improvement.

At the end of the review sequence, the user has the option of reviewing the entire booklet (by pressing D) or exiting to the



start-up screen (by pressing X). During the review of the entire booklet, the user can exit at any time.

At the start-up screen, the system is ready for the next user. No information on the user's responses are stored.

To exit, simply press [X] from the start-up screen.

#### Using The SCORE55 Program

The second program SCORE55 allows you to score the form without doing any reviews of suggestions. It is designed to simplify scoring of hand administered tests. To start the program, at the DOS prompt type SCORE55 followed by ENTER.

The first two screens and the administration of the questions is similar to the process described above for the DRVRS55 program. However, in the scoring version of the software the responses are automatically scored. You have the option of changing any of the item displayed (by entering E and then the question number followed by an ENTER). Reenter the response, and you will return to the scoring screen with the change made and the score altered. You may continue this process until you are satisfied. To terminate the scoring and go back to the start-up screen press X.

You also may review all the questions and also rescore them while in the scoring screen just as in the DRVRS55 program (by pressing R).

You also can use the DRVRS55 program for scoring, but it lacks the rapid edit feature and also displays the suggestions on the screen. *The SCORE55 program should not be used to administer the self-rating form.*

# DRIVERS 55 PLUS:

**INSTRUCTIONS:** For each of the following 15 questions, check the circle  of the one answer that most applies to you.

Always or Almost Always      Sometimes      Never or Almost Never

- |   |                       |                       |                       |
|---|-----------------------|-----------------------|-----------------------|
| 1. I signal and check to the rear when I change lanes.....  | <input type="radio"/> | <input type="radio"/> | <input type="radio"/> |
| 2. I wear a seat belt.....  | <input type="radio"/> | <input type="radio"/> | <input type="radio"/> |
| 3. I try to stay informed on changes in driving and highway regulations....   | <input type="radio"/> | <input type="radio"/> | <input type="radio"/> |
| 4. Intersections bother me because there is so much to watch for from all directions .....  | <input type="radio"/> | <input type="radio"/> | <input type="radio"/> |
| 5. I find it difficult to decide when to join traffic on a busy interstate highway.   | <input type="radio"/> | <input type="radio"/> | <input type="radio"/> |
| 6. I think I am slower than I used to be in reacting to dangerous driving situations.....   | <input type="radio"/> | <input type="radio"/> | <input type="radio"/> |
| 7. When I am really upset I show it in my driving.....  | <input type="radio"/> | <input type="radio"/> | <input type="radio"/> |
| 8. My thoughts wander when I am driving .....   | <input type="radio"/> | <input type="radio"/> | <input type="radio"/> |
| 9. Traffic situations make me angry.....  | <input type="radio"/> | <input type="radio"/> | <input type="radio"/> |
| 10. I get regular eye checks to keep my vision at its sharpest.....   | <input type="radio"/> | <input type="radio"/> | <input type="radio"/> |
| 11. I check with my doctor about the effects of my medications on driving ability (If you do not take any medication, check this box <input type="checkbox"/> and skip this question.)... | <input type="radio"/> | <input type="radio"/> | <input type="radio"/> |
| 12. I try to stay abreast of current information on health practices and habits.  | <input type="radio"/> | <input type="radio"/> | <input type="radio"/> |
| 13. My children, other family members or friends are concerned about my driving ability.....  | <input type="radio"/> | <input type="radio"/> | <input type="radio"/> |

Note new headings → None      One or Two      Three or More

- |  |                       |                       |                       |
|--|-----------------------|-----------------------|-----------------------|
| 14. How many traffic tickets, warnings or "discussions" with officers have you had in the past two years?..... | <input type="radio"/> | <input type="radio"/> | <input type="radio"/> |
| 15. How many accidents have you had during the past two years? .....   | <input type="radio"/> | <input type="radio"/> | <input type="radio"/> |

**SELF SCORING:** Count the number of check marks in the red circles and record the total in the red box below. Follow the same procedure for the green and yellow circles.

--	--	--

← These are your Check Mark Totals. For score and interpretation, see next page. →



# SELF-RATING FORM

**SCORING:** There are 4 steps.

Step 1: Write your red and yellow Check Mark Totals from the previous page in the same color boxes to the right.

	X 5 = _____
--	-------------

Step 2: Multiply the number in the red box by 5.

	X 3 = _____
--	-------------

Step 3: Multiply the number in the yellow box by 3.

Step 4: Add the results of Steps 2 and 3.

**YOUR SCORE IS** \_\_\_\_\_

Interpretation of Score: The higher the score, the more the danger to yourself and others.

## SCORE

## MEANING

35 and over



**STOP!** You are engaging in too many unsafe driving practices, and are a potential or actual hazard to yourself and others. Examine the questions you checked red or yellow. Ask yourself how or if these conditions can be corrected, and what action you will take.

16 to 34



**CAUTION!** You are engaging in some practices which need improvement to ensure safety. See the red and/or yellow circles you checked for areas requiring change.

15 and below



**GO!** You are aware of what is important to safe driving, and are practicing what you know. Nevertheless see what red or yellow circles you checked. They are areas in which even you might improve your driving practices.

These scores are based on what you and other drivers 55 and over have told us about driving practices and habits as well as on research studies of older driver problems and needs. Your score is based on your answers to a necessarily limited group of important questions. For a complete evaluation of your driving ability, many more questions would be required, along with medical, physical and licensing examinations. Nevertheless your answers and score give some indication of how well you are doing, and of what should be done to improve things.

In general, a checked red circle for an item reflects an unsafe practice or situation that should be changed immediately. A checked yellow circle means a practice or situation that is unsafe, or on its way to becoming so, if nothing is done to improve it. Green is a sign that you are doing what you should be doing to be (and remain) a safe driver.

Most of the red and yellow answers represent practices or situations that can be improved by most drivers. The following pages discuss the various questions on the self-rating form you have completed. After a general introduction, the discussion is divided into five areas which traffic safety authorities have judged critical to safe performance—*driving habits, physical condition, emotions, health habits, driving records and other indicators*. As the discussion moves through these categories, you may wish to focus on what applies to the red and yellow circles you checked.

The discussion is organized around why an item is important (**FACTS**), and what, if anything, can be done to overcome shortcomings (**SUGGESTIONS**), so that you can maintain safe driving performance, or improve it.

APPENDIX G:  
PAPERS FOR PUBLICATION

APPENDIX G  
Papers Outlined For Publication

A paper has been accepted for presentation at the American Public Health Association meeting in November, and one is in review for the Gerontological Society Of America's November meeting. Both abstracts are attached.

The following is brief outline of papers planned for submission based all or in part on this research project.

- o A discussion of the underlying modeling structure used to define the driving model used in this research (Figure 1.1 of Section 1) and its relationship to a class of functional models.
- o A review of the characteristics of the older driver.
- o An analysis of simulation methods including a classification system for their use with older drivers.
- o A presentation of the MY-DAP instrument, its use, and applications with a discussion of hierarchical assessment. A second paper will review added experimental finding using the instrument.
- o A discussion of re-examination issues based on the data collected.
- o An analysis of information processing and decision making based on the data gathered.
- o A review of the ODSAI instrument and the findings from its application.
- o A discussion of the filter model relative to the results gathered, and the implications for altering assessment and intervention designs for older drivers.
- o A review of the technical approaches to education and training of the older driver based on the research done in this project and its immediate follow-ons.
- o A discussion of the results of the participation survey.
- o A summarization of finding relating to the older driver and the aging process.

Papers may be added to this list. No submission dates have been scheduled at this time.



# UNIVERSITY OF SOUTHERN MAINE

Edmund S. Muskie Institute of Public Affairs

96 Falmouth Street • Portland, Maine 04103 • Tel. 207-780-4430 • Fax 207-780-4417

May 8, 1992

Darleney Yee, Ed.D.  
Associate Professor  
Department of Health Education  
San Francisco State University  
1600 Holloway Avenue  
San Francisco, CA 94132

Dear Dr. Yee:

Congratulations! Your abstract, "Accident Prevention Through Driving Skills Assessment and Interventions for Older Drivers: Results and Recommendations", has been accepted as a poster presentation by the Gerontological Health Section at the 1992 APHA Annual Meeting in Washington, D.C. Over 120 abstracts were submitted for this year's Gerontological Health Section Program. The Abstracts were given a blind review and yours ranked very high.

You will be informed in the late summer by APHA of the exact time, date and location of your presentation.

You will be expected to follow the guidance of the presider assigned to chair your session. This may include sending in an outline or summary of your paper in advance of the meeting. Special instructions will be given to those assigned to poster sessions.

The program for this year's conference looks very good. Thank you for your strong contribution to our Section. I look forward to seeing you in Washington, D.C., in November.

Finally, if you have co-authors, please inform them of this news.

Sincerely,

Richard Fortinsky, Ph.D.  
1992 Program Chairperson  
Gerontological Health Section

RH/mc

(Author making presentation)

Name and title Dr. Darlene Yee, Associate Professor  
 Address Department Of Health Education  
San Francisco State University  
 City San Francisco State CA Zip 94132  
 Telephone (415) 338-7568

Call for Abstract  
 APHA 120th Annual Meeting  
 Washington, D.C.—November 8-12, 1992

Persons wishing to contribute presentations or papers to be considered for the APHA Annual Meeting must submit an abstract of the work on the form provided below. The abstract form must be accompanied by an Author/Co-Author ID Form. The 2 forms should be mailed to the designated Section, SPIG, or Caucus Representative and RECEIVED no later than March 9, 1992. Do not submit the same abstract to more than one Section or APHA component.

**TYPE ABSTRACT TITLE IN UPPER CASE LETTERS.**

Type author(s) and co-author(s) name(s) using upper and lower case letters and underline, with presenter's name listed first as the only one to receive the detailed program participant mailing. Four abstracts without the authors' names should also be sent for blind review. Type abstract text, flush left, single-spaced, within parameters of box, using carbon ribbon standard size type. Abstract should be of camera-ready quality, suitable for 50% reduction. A completed author/co-author ID Form must accompany each abstract. If the total number of authors and/or co-author exceeds three, please xerox and complete the appropriate number of ID Forms. Send original abstract and 4 copies of the abstract to the appropriate chairperson, accompanied by a self-addressed stamped envelope for notification of acceptance or rejection. Enclose a stamped, self-addressed postcard if you want notification of receipt of abstract. FAX copies of the abstracts will NOT be accepted. Deadline for receipt of abstracts is March 9, 1992. Notification will be mailed in June. Consult the January issue of the *The Nation's Health* or the February issue of the *American Journal of Public Health* for the specific topics and requirements for Sections, SPIGs, and Caucuses. If requirements and instructions are not followed, your abstract will not be considered for review. **NOTE TO NON-MEMBERS:** Contributed papers may only be read by APHA members. Non-members may submit a contributed paper but it may ONLY be read by an APHA member.

**TO BE COMPLETED BY  
PROGRAM CHAIRPERSON**

SESSION:

Day \_\_\_\_\_

Date \_\_\_\_\_

Time: From \_\_\_\_\_ To \_\_\_\_\_

Primary Sponsor \_\_\_\_\_

ABSTRACT:  Contributed  
 Solicited

Section, SPIG, Caucus, or APHA Group Abstract submitted to: \_\_\_\_\_  
 If your abstract is selected for presentation, you prefer to present it:

Gerontological Health

As a poster      \_\_\_\_\_ As a verbal presentation  
 \_\_\_\_\_ At a roundtable      \_\_\_\_\_ Any of these  
 \_\_\_\_\_ Slide projector or \_\_\_\_\_ Overhead projector  
 Yes      \_\_\_\_\_ No  
 Yes      \_\_\_\_\_ No  
 Yes      \_\_\_\_\_ No

AV equipment needed (subject to approval by Section Program Planner):

Is self-addressed stamped envelope enclosed?

Is self-addressed stamped postcard enclosed?

Are original abstract (and 4 blind review copies) and all author ID forms enclosed?

**ACCIDENT PREVENTION THROUGH DRIVING SKILLS ASSESSMENT AND INTERVENTIONS FOR OLDER DRIVERS: RESULTS AND RECOMMENDATIONS**  
Darlene Yee, Ed.D., CHES, San Francisco State University (SFSU); and  
Joseph F. Melichar, Ph.D., Adaptive Systems Corporation (ASC).

The increase in the aging of the overall population has entailed a simultaneous increase in the number of older drivers. Drivers 55+ constitute 28% of all drivers today-- 39% by the year 2000. While many older drivers have excellent driving records, as a group, when exposure is considered, they are disproportionately involved in traffic accidents and fatalities. Accident prevention and injury control emphasize the development of individual and community measures to protect against accidents and their harmful consequences. The purpose of this session is to report integrated assessment and intervention strategies to identify the at-risk driver 55+ and remediate any deficits in knowledge or skills about driving and traffic safety. At the end of the session, participants will be able to specify what older drivers can do for themselves and what other people can do for them through a programmatic approach to accident prevention and injury control consisting of primary prevention (Older Driver Self-Assessment Inventory), secondary screening (Older Driver Improvement Program), and tertiary treatment (Older Driver Simulation). Sponsored by the AARP Andrus Foundation.

# PLEASE FILL OUT THIS PAGE COMPLETELY

This form must be filled out COMPLETELY. The Society must be provided with seven copies of page 8 and seven copies of page 9. DO NOT SEPARATE page 8 from page 9 on the original.

## MEMBERSHIP STATUS

Status of first author or organizer. Check one.

- Member (1)     Student Member (2)     Nonmember (3)     Student Nonmember (4)

If you are not a member of the Society, then this submission must be sponsored by a member. (see page 2.)

Sponsor \_\_\_\_\_

Sponsor's Signature \_\_\_\_\_

Address: \_\_\_\_\_

## ADDRESS INFORMATION

The address listed below should be that of the first author (of papers or posters) or primary organizer (of symposia, media, and discussion sessions). Notifications will be mailed to the person listed here as well.

Y e e \_\_\_\_\_  
Last Name

D a r l e n e \_\_\_\_\_  
First Name, Middle Initial

A s s o c i a t e P r o f e s s o r \_\_\_\_\_  
Title

E d . D . , C H E S \_\_\_\_\_  
Degree(s)

S a n F r a n c i s c o S t a t e U n i v e r s i t y \_\_\_\_\_  
Organization

1 6 0 0 H o l l o w a y A v e n u e \_\_\_\_\_  
Address

\_\_\_\_\_  
Address

S a n F r a n c i s c o \_\_\_\_\_  
City

C A \_\_\_\_\_  
State/  
Province

9 4 1 3 2 \_\_\_\_\_  
Zip Code

U S A \_\_\_\_\_  
Country

4 1 5 3 3 8 7 5 6 8 \_\_\_\_\_  
Telephone

### PRESENTATION PREFERENCE

Preferred Choice. Check only one.

- Symposium (1)                       Poster (4)  
 Paper (2)                               Media (6)  
 Discussion (BSS Section only) (3)

If your choice of presentation type is unavailable, will you accept an alternative?

- YES                       NO

### APPLICATION FOR SECTION SPONSORSHIP/ SPECIAL PROGRAMS

Symposia may be sponsored by more than one section; for papers, posters, and media, CHECK ONLY ONE BOX. Discussions may be sponsored by BSS ONLY.

- Biological Sciences (1)     Social Research, Planning & Practice (4)  
 Clinical Medicine (2)                       Media (5)  
 Behavioral & Social Sciences (3)

### SUBJECT OR FIELD OF INTEREST CODES

Enter in the space below the appropriate code number(s) of the subject area or field of interest which you feel most accurately describes your abstract. (See page 11). List up three and include the number codes as well as alphabetical designation if applicable. Rank your choices in order of preference.

### ADDITIONAL INFORMATION/GENERAL

- Check if your name appears on more than one submission. (1)  
 Check if submission pertains to the humanities and arts. (2)  
 Check if submission relates to the theme. (3)

### AMERICAN GERIATRICS SOCIETY MEETING

Are you planning to submit this abstract to the 1992 Annual Meeting of the American Geriatrics Society?

- YES (4)                       NO (5)

If your abstract is accepted by both the GSA and AGS, at which meeting would you prefer to present it?

- GSA (6)                       AGS (7)

### STUDENT AWARDS

Check appropriate box if you would like to be considered for a student award (you must be a GSA member to be considered).

- Biological Sciences Student Award (8)  
 Clinical Medicine Section Person-in-Training Award (9)  
 Clinical Medicine Section Research Award (10)  
 Behavioral & Social Sciences Award-Dissertation (11)  
 Behavioral & Social Sciences Award-Pre-Dissertation (12)  
 Social Research, Planning & Practice Student Award (13)

### HANDLING FEE

- The handling fee of \$10 in check or money order has been included. (14)  
 First author/organizer is a student and is exempt from



# ABSTRACT FORMS: *Must be Postmarked by April 20, 1992*

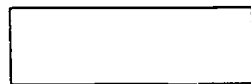

EACH SUBMISSION MUST BE ACCOMPANIED BY A \$10 HANDLING FEE.  
(Students are exempt from payment. See p. 2 for details.)

PLEASE READ AND FOLLOW INSTRUCTIONS CAREFULLY

(NOTE: Any abstract unsuitable for direct reproduction must be retyped—the charge to the author is \$15)

**INTEGRATED ASSESSMENT AND INTERVENTION STRATEGIES FOR OLDER DRIVERS-- RESULTS AND RECOMMENDATIONS.** D.Yee, Ed.D., CHES, San Francisco State Univ., 1600 Holloway Avenue, San Francisco, CA 94132; and J.F. Melichar, Ph.D., Adaptive Systems Corporation, P.O. Box 1148, San Mateo, CA 94403.

The goal of health promotion and disease prevention for older adults in our country is to achieve further increases in longevity and to improve quality of life through significant increases in health, mobility, and safety. The lack of mobility reduces the quality of life of an older adult, limits his or her capacity for self-maintenance, restricts participation in constructive activities and interactions with other people, and may contribute to disengagement and alienation from society. In this project, the driving and traffic safety problems and needs of 200+ older adults aged 50+ were examined through a programmatic approach using an integrated sequence of assessment, education and training. The purpose of this paper is to discuss how the MY-CODA (Melichar-Yee Comprehensive Older Driver Assessment) Program, MY-DAP (Melichar-Yee Driver Assessment Profile), ODSAI (Malfetti-Winter Older Driver Self Assessment Inventory), ODIP (AARP's Older Driver Improvement Program) and ODS (DORON's Older Driver Simulation) were used to identify at-risk drivers age 50+ as well as to report preliminary results and recommendations which will help to remediate deficits in knowledge or skills about driving and traffic safety.

Sponsored by the AARP Andrus Foundation.

## SECTION SPECIFIC CODES

The following codes will be used by the Clinical Medicine/Social Research, Planning & Practice Sections for the purpose of peer review and session organization of abstracts.

### Clinical Medicine

Select the *one* category below in which you prefer to have your abstract included:

- Clinical Physiology (including exercise, nutrition, metabolism) (1)
- Clinical Pharmacology & Therapeutics (2)
- Oral Health (3)
- Nursing Science (4)
- Organ Specific Disorders e.g., cardiac, renal, hepatic) (5)
- Systemic Disorders (e.g., arthritis, osteoporosis, diabetes) (6)
- Cognitive Disorders (7)
- Other Neuropsychiatric Disorders (8)
- Incontinence (9)
- Falls and Immobility (10)
- Other Geriatric Syndromes (e.g., malnutrition, frailty, sensory disorders) (11)
- Health Care Delivery (including rehabilitation, assessment, ethics) (12)
- Health Services Research (including epidemiology, health policy, health promotion) (13)
- Education (14)
- Other (15)

### Social Research, Planning & Practice

Select the *one* category below in which you prefer to have your abstract included:

- Successful Aging (1)
- Sensory Changes and Safety (2)
- Education—older adults (3)
- Education—professionals (4)
- Health Promotion/Acute Care (5)
- Health Care (6)
- Long-Term Care—facilities/institutions (7)
- Long-Term Care—community services (8)
- Long-Term Care—financing (9)
- Long-Term Care—personnel (10)
- Caregiving & Intergenerational Relations (11)
- Care Management (12)
- Special/Diverse Populations—cultural (13)
- Special/Diverse Populations—gender (14)
- Special/Diverse Populations—ethnicity (15)
- Special/Diverse Populations—rural/urban (16)
- Special/Diverse Populations—sexual preference (17)
- Ethics (18)
- Humanities and Arts (19)
- Employment/Retirement/Leisure (20)
- Economics of Aging (21)
- Housing & Environment (22)
- Mental Health/Cognition (23)
- Government Programs & Policies (24)
- Measurement & Assessment (25)
- Other (26)

Use full space for summaries of Symposia and Discussion Presentations and Individual Symposia Presentations  
Use space above dotted line for Papers, Posters, Media, and Individual Symposia Presentations

**APPENDIX H:**

**PRESENTATION OF PAPERS**

Gerontological Society of America, November 1991,  
San Francisco, CA

American Society on Aging, March 1992, San Diego, CA

National Council On the Aging, May 1992, Washington, DC

Traffic Safety Summit'92, May 1992, Anaheim, CA

---

# ACCIDENT PREVENTION THROUGH DRIVING SKILLS ASSESSMENT AND INTERVENTIONS FOR OLDER DRIVERS

---

*Sponsored by:*

***AARP-Andrus Foundation***

---

Presented at:

**Gerontological Society of America Annual Meeting**

November 1991  
San Francisco, CA

**Principal Investigator:**

**Darlene Yee, Ed.D., CHES**  
Associate Professor  
Department of Health Education  
San Francisco State University  
1600 Holloway Avenue  
San Francisco, CA 94132

**(415) 338-7568**

**Co-Investigator:**

**Joseph F. Melichar, Ph.D.**  
Adaptive Systems Corporation  
P.O.Box 1148  
San Mateo, CA 94403-0748

**(415) 573-6114**

## **PROJECT BACKGROUND**

**Goal:** to match the assessment and intervention strategies and services to the level of need for the specific person.

**Objective:** to reduce unnecessary assessments and interventions and to insure that needed and appropriate assessments and interventions are undertaken.

**Purpose:** to assure safe and long driving lives for the older adult.

**Process issues:** provision of appropriate services, increased cost effectiveness to assure services can be provided to the maximum number of persons, increasing public safety, factors in determining when restriction on driving and/or termination of a person's driving life are appropriate, and assessment, education, and training strategies and methods.

**Related issues:** aging processes, mobility, well-being, independent living, traffic safety, driving methods, and public policy.

**Population:** community dwelling independent drivers over age 50.

# PROJECT ACTIVITIES

1. Develop assessment methods and tools for describing older older drivers performance, capabilities, and problems.
2. Develop a multi-modality assessment and intervention strategy and determine how to match appropriate assessment and intervention strategies to individual drivers.
3. Test strategy and instrumentation on a sample of older drivers including use its use with existing interventions:
  1. Older Driver Self-Assessment Inventory,
  2. AARP 55 Alive/Mature Driver Program, and
  3. a simulator based assessment and training program.
4. Producing clear distinctions between assessment and intervention, and within intervention between education and training.
5. Using the clear distinctions to determine where intervention and assessment overlap and/or can be done concurrently.
6. Establishing cost-effectiveness models for the different strategies that could be develop from the mix of assessment/interventions.
7. Develop and evaluate computer based methods for assessment, education, and training with the goal of reaching more persons at a lower cost with more individualized materials.

# **THIS PRESENTATION'S FOCUS**

- 1. Differentiation between tools for describing older driver characteristics, history, and performance and assessment.**
- 2. Describe assessment strategy for profiling older driver characteristics.**
- 3. Relate the profiling method to a means for leading to more detailed assessments - a directed strategy from general to more specific assessments.**
- 4. Discuss the importance of valuing assessment information.**
- 5. Review the concept of a profile versus score as applied to assessment.**
- 6. Relate concepts to MY-DAP instrument and its use.**

## **DIFFERENTIATION BETWEEN DESCRIPTION AND ASSESSMENT**

Description...description is used to denote a reporting about the driver. Typically it is a self report, and usually does not have a score associated with it. The description provides a view of the older driver's background, surroundings, and driving capabilities. In this study, MY-CODA is a self-report generated by a questionnaire the older driver completes. The report describes the older persons's background, driving history, driving pattern, social supports, activities, and health and well-being.

Assessment..a criterion based formal measure of a dimension about the older person and/or their driving. For example, MY-DAP provides a profile, and ODSAI provides a score.

# **OLDER DRIVER ASSESSMENT AND PROFILING**

The Driver Assessment Profile is a method for assessing the abilities and skills of older drivers using an integrated and systematic model of driving (Melichar and Yee, 1991a and 1991b). It is designed to provide a profile of the older driver that will:

- (1) help in studying abilities and skills of older drivers,
- (2) relate to performance and training parameters,
- (3) aid in assessment of age-related changes and function, and
- (4) relate to the integrated model of the driving experience.

The Driver Assessment Profile is a reflection of the driver response portion of this model. The outcome should be a description of the operational response of the driver based on the abilities and skills identified. The focus is on the overall integration of abilities and skills allowing for compensation of a deficit by a strength(s). The driver responds in an integrated manner, and it is this systematic response that will be measured.

The Driver Assessment Profile will isolate specific problem areas, but a profile of the abilities and skills is desired. One question being addressed in the present research is whether a specific profile reflects a systematic degradation of driving ability. A second question is whether there are any characteristics that are more predictive of loss of driving ability.

The Driver Assessment Profile (shown on the next page) asks for a rating of specific abilities and skills which are grouped in three categories: sensing or input type information, coordinative and integrative functions used to process the input information, and abilities needed to carry out the decisions to act. Additionally, two general questions relating to overall health and general attitude are included. MY-DAP is designed to be scored by a health professional working with the older driver.



# **OLDER DRIVER ASSESSMENT AND PROFILING**

This following describes the use of the Driver Assessment Profile. The strategy is to assess the impairment of an ability and skill. If a person's ability is not impaired, then how much more capability exists is not assessed. The impairments are rated as: none, mild, moderate, or severe. The terms should be interpreted as:

mild.....a noticeable change in abilities from a level expected a safe minimum for driving, but not sufficiently severe to cause a difficulty or lack of safety in driving ... a mild impairment normally would require some adjustments by the older driver

moderate..the impairment in abilities would cause the older person difficulties in driving and especially in driving safely, adjustments required of the person are significant to achieve even the minimum level of functional performance

severe....the impairment is significant enough to make it unlikely the person can make adjustments to allow safe driving performance.

The Driver Assessment Profile can be used to assess the abilities and skills using a number of means: descriptive which is based heavily on subjective observations, measured based on criterion reference measures, assessed based on formal assessment techniques, and diagnostic which would take the formal assessment and make the transition to formally creating suggested responses. The present form of the instrument supports the first three uses.

**DRIVER ASSESSMENT PROFILE (MY-DAP)**

Agency #: \_\_\_\_\_ Site #: \_\_\_\_\_ Subject #: \_\_\_\_\_

Date: \_\_\_/\_\_\_/\_\_\_ Interviewer #: \_\_\_\_\_

DRIVER ABILITY OR SKILL	DEGREE OF IMPAIRMENT				CODER RATING (0-5)
	NONE	MILD	MODER-ATE	SEV-ERE	
<b>SENSING</b>					
Vision- Overall (1)....	[ ]	[ ]	[ ]	[ ]	[ ]
Acuity/Static.....	[ ]	[ ]	[ ]	[ ]	[ ]
Acuity/Dynamic.....	[ ]	[ ]	[ ]	[ ]	[ ]
Field of Vision.....	[ ]	[ ]	[ ]	[ ]	[ ]
Peripheral Vision....	[ ]	[ ]	[ ]	[ ]	[ ]
Depth Perception....	[ ]	[ ]	[ ]	[ ]	[ ]
Glare Refractory....	[ ]	[ ]	[ ]	[ ]	[ ]
Color Recognition....	[ ]	[ ]	[ ]	[ ]	[ ]
Known Pathologies....	[ ]	[ ]	[ ]	[ ]	[ ]
Hearing- Overall (2)..	[ ]	[ ]	[ ]	[ ]	[ ]
Left Ear.....	[ ]	[ ]	[ ]	[ ]	[ ]
Right Ear.....	[ ]	[ ]	[ ]	[ ]	[ ]
Kinesthesia.....	[ ]	[ ]	[ ]	[ ]	[ ]
Proprioception.....	[ ]	[ ]	[ ]	[ ]	[ ]
<b>PROCESSING</b>					
Short term memory.....	[ ]	[ ]	[ ]	[ ]	[ ]
Long term memory.....	[ ]	[ ]	[ ]	[ ]	[ ]
Cognitive skills.....	[ ]	[ ]	[ ]	[ ]	[ ]
Anger/aggression.....	[ ]	[ ]	[ ]	[ ]	[ ]
Anxiety.....	[ ]	[ ]	[ ]	[ ]	[ ]
Selective Attention....	[ ]	[ ]	[ ]	[ ]	[ ]
Stress Response.....	[ ]	[ ]	[ ]	[ ]	[ ]
Problem Solving.....	[ ]	[ ]	[ ]	[ ]	[ ]
Decision-Making.....	[ ]	[ ]	[ ]	[ ]	[ ]
Judgement.....	[ ]	[ ]	[ ]	[ ]	[ ]
Patience.....	[ ]	[ ]	[ ]	[ ]	[ ]
Insight into driving...	[ ]	[ ]	[ ]	[ ]	[ ]
<b>MOTOR</b>					
Strength upper limbs...	[ ]	[ ]	[ ]	[ ]	[ ]
Strength lower limbs...	[ ]	[ ]	[ ]	[ ]	[ ]
Strength hand.....	[ ]	[ ]	[ ]	[ ]	[ ]
Strength foot.....	[ ]	[ ]	[ ]	[ ]	[ ]
ROM upper limbs.....	[ ]	[ ]	[ ]	[ ]	[ ]
ROM lower limbs.....	[ ]	[ ]	[ ]	[ ]	[ ]
ROM neck.....	[ ]	[ ]	[ ]	[ ]	[ ]
ROM trunk.....	[ ]	[ ]	[ ]	[ ]	[ ]
RT simple.....	[ ]	[ ]	[ ]	[ ]	[ ]
RT eye-hand.....	[ ]	[ ]	[ ]	[ ]	[ ]
RT eye-foot.....	[ ]	[ ]	[ ]	[ ]	[ ]
Coordination.....	[ ]	[ ]	[ ]	[ ]	[ ]
Endurance.....	[ ]	[ ]	[ ]	[ ]	[ ]
General Attitude.....	[ ]	[ ]	[ ]	[ ]	[ ]
Overall Health.....	[ ]	[ ]	[ ]	[ ]	[ ]

(1) with glasses if worn      (2) with hearing aide if worn

Coder Rating: 0=unable to rate      3=partial test data  
                   1=subjective observation    4=past test data  
                   2=limited test data            5=tested

# VALUATION OF ASSESSMENT INFORMATION

A rating system is provided to the rater to allow indicating the type of assessment for each item. If all the assessments of the abilities are of the same type, then the procedure is to indicate the time for the first characteristic and a downward arrow in the second. The types of assessment supported are:

- 0...unable to rate this specific item,
- 1...subjective observation,
- 2...subjective observation combined with limited test data,
- 3...rating is based on partial test data,
- 4...rating is based on past test data available to the rater, and
- 5...rating is based on testing.

The higher the number of the rating the greater the expected validity. The intent is to allow use of the profile over a greater range of situations than one which is strictly dependent on formal assessment techniques. The ratings provided enable use in a range of conditions, or when the conditions are not equal for all items. The result rating enables the interviewers to answer, and to assign a validity weight to the rating based on their assessment.

The valuation provides a method of weighing the information presented. The source of the knowledge is indicated and can be used to determine then weight that is to be placed on the information.

# PROFILE VERSUS TOTAL SCORES

Total scores provide a summative valuation. The relationship between components of the scale are eliminated, and with them information. A profile provides the combination of measures and allows looking at the relative strengths and weaknesses. An example of profile is presented on the next page.

**DRIVER ASSESSMENT PROFILE (MY-DAP) - Sample Case**

Agency #: \_\_\_\_\_ Site #: \_\_\_\_\_ Subject #: \_\_\_\_\_  
 Date: \_\_\_/\_\_\_/\_\_\_ Interviewer #: \_\_\_\_\_

DRIVER ABILITY OR SKILL	DEGREE OF IMPAIRMENT				CODER RATING (0-5)
	NONE	MILD	MODER-ATE	SEV-ERE	
<b>SENSING</b>					
Vision- Overall (1)....	[x]	[ ]	[ ]	[ ]	[4]
Acuity/Static.....	[x]	[ ]	[ ]	[ ]	[5]
Acuity/Dynamic.....	[ ]	[x]	[ ]	[ ]	[5]
Field of Vision.....	[ ]	[x]	[ ]	[ ]	[4]
Peripheral Vision....	[x]	[ ]	[ ]	[ ]	[4]
Depth Perception.....	[ ]	[x]	[ ]	[ ]	[4]
Glare Refractory.....	[ ]	[x]	[ ]	[ ]	[4]
Color Recognition....	[x]	[ ]	[ ]	[ ]	[3]
Known Pathologies....	[x]	[ ]	[ ]	[ ]	[4]
Hearing- Overall (2)..	[x]	[ ]	[ ]	[ ]	[2]
Left Ear.....	[x]	[ ]	[ ]	[ ]	[2]
Right Ear.....	[x]	[ ]	[ ]	[ ]	[2]
Kinesthesia.....	[ ]	[x]	[ ]	[ ]	[3]
Proprioception.....	[ ]	[ ]	[x]	[ ]	[3]
<b>PROCESSING</b>					
Short term memory.....	[ ]	[x]	[ ]	[ ]	[3]
Long term memory.....	[x]	[ ]	[ ]	[ ]	[2]
Cognitive skills.....	[x]	[ ]	[ ]	[ ]	[2]
Anger/aggression.....	[ ]	[x]	[ ]	[ ]	[3]
Anxiety.....	[ ]	[ ]	[x]	[ ]	[3]
Selective Attention....	[ ]	[x]	[ ]	[ ]	[2]
Stress Response.....	[ ]	[x]	[ ]	[ ]	[3]
Problem Solving.....	[ ]	[ ]	[x]	[ ]	[2]
Decision-Making.....	[ ]	[ ]	[x]	[ ]	[2]
Judgement.....	[ ]	[ ]	[x]	[ ]	[2]
Patience.....	[ ]	[ ]	[x]	[ ]	[2]
Insight into driving...	[ ]	[x]	[ ]	[ ]	[2]
<b>MOTOR</b>					
Strength upper limbs...	[ ]	[x]	[ ]	[ ]	[4]
Strength lower limbs...	[ ]	[ ]	[x]	[ ]	[5]
Strength hand.....	[ ]	[ ]	[ ]	[x]	[5]
Strength foot.....	[ ]	[ ]	[x]	[ ]	[5]
ROM upper limbs.....	[ ]	[ ]	[x]	[ ]	[5]
ROM lower limbs.....	[ ]	[x]	[ ]	[ ]	[5]
ROM neck.....	[x]	[ ]	[ ]	[ ]	[5]
ROM trunk.....	[x]	[ ]	[ ]	[ ]	[5]
RT simple.....	[x]	[ ]	[ ]	[ ]	[5]
RT eye-hand.....	[ ]	[x]	[ ]	[ ]	[5]
RT eye-foot.....	[ ]	[x]	[ ]	[ ]	[5]
Coordination.....	[ ]	[ ]	[x]	[ ]	[5]
Endurance.....	[ ]	[x]	[ ]	[ ]	[3]
General Attitude.....	[ ]	[x]	[ ]	[ ]	[3]
Overall Health.....	[ ]	[x]	[ ]	[ ]	[3]

(1) with glasses if worn      (2) with hearing aide if worn

Coder Rating: 0=unable to rate      3=partial test data  
 1=subjective observation      4=past test data  
 2=limited test data      5=tested

# ASSESSMENT HIERARCHIES FROM PROFILING

For a given profile problem areas can be identified.

The quality of the information can be evaluated.

An identified problem area can be have additional tests administered.

Poor quality (more observational) assessments can be replaced by formal methods.

MY-DAP can be considered to be the first level of a hierarchy with increased specificity at each succeeding level.

For example, a potential problem with cognition can be evaluated by adding a general test of intelligence.

# MY-DAP AND ITS APPLICATION

The following page shows a hypothetical profile for an 80 year old woman driver with arthritis in her hands. The woman is alert, but has memory lapses and is anxious about driving. Her vision is normal for her age.

**DRIVER ASSESSMENT PROFILE (NY-DAP) - Sample Case**

Agency #: \_\_\_\_\_ Site #: \_\_\_\_\_ Subject #: \_\_\_\_\_

Date: \_\_\_/\_\_\_/\_\_\_ Interviewer #: \_\_\_\_\_

DRIVER ABILITY OR SKILL	DEGREE OF IMPAIRMENT				CODER RATING (0-5)
	NONE	MILD	MODER-ATE	SEV-ERE	
<b>SENSING</b>					
Vision- Overall (1)....	[ ]	[x]	[ ]	[ ]	[3]
Acuity/Static.....	[ ]	[x]	[ ]	[ ]	[1]
Acuity/Dynamic.....	[ ]	[ ]	[x]	[ ]	[1]
Field of Vision.....	[ ]	[x]	[ ]	[ ]	[4]
Peripheral Vision....	[ ]	[x]	[ ]	[ ]	[4]
Depth Perception....	[ ]	[x]	[ ]	[ ]	[4]
Glare Refractory....	[ ]	[ ]	[x]	[ ]	[2]
Color Recognition....	[x]	[ ]	[ ]	[ ]	[5]
Known Pathologies....	[x]	[ ]	[ ]	[ ]	[2]
Hearing- Overall (2)..	[x]	[ ]	[ ]	[ ]	[1]
Left Ear.....	[x]	[ ]	[ ]	[ ]	[1]
Right Ear.....	[x]	[ ]	[ ]	[ ]	[1]
Kinesthesia.....	[ ]	[x]	[ ]	[ ]	[2]
Proprioception.....	[ ]	[x]	[ ]	[ ]	[3]
<b>PROCESSING</b>					
Short term memory.....	[ ]	[ ]	[x]	[ ]	[1]
Long term memory.....	[ ]	[x]	[ ]	[ ]	[1]
Cognitive skills.....	[ ]	[x]	[ ]	[ ]	[1]
Anger/aggression.....	[ ]	[x]	[ ]	[ ]	[1]
Anxiety.....	[ ]	[ ]	[x]	[ ]	[1]
Selective Attention....	[ ]	[ ]	[x]	[ ]	[1]
Stress Response.....	[ ]	[ ]	[ ]	[x]	[1]
Problem Solving.....	[ ]	[ ]	[x]	[ ]	[1]
Decision-Making.....	[ ]	[ ]	[x]	[ ]	[1]
Judgement.....	[ ]	[ ]	[x]	[ ]	[1]
Patience.....	[ ]	[ ]	[x]	[ ]	[1]
Insight into driving...	[x]	[ ]	[ ]	[ ]	[1]
<b>MOTOR</b>					
Strength upper limbs...	[ ]	[x]	[ ]	[ ]	[3]
Strength lower limbs...	[ ]	[x]	[ ]	[ ]	[3]
Strength hand.....	[ ]	[ ]	[x]	[ ]	[3]
Strength foot.....	[ ]	[x]	[ ]	[ ]	[3]
ROM upper limbs.....	[ ]	[x]	[ ]	[ ]	[4]
ROM lower limbs.....	[ ]	[x]	[ ]	[ ]	[4]
ROM neck.....	[ ]	[x]	[ ]	[ ]	[4]
ROM trunk.....	[ ]	[x]	[ ]	[ ]	[4]
RT simple.....	[ ]	[ ]	[x]	[ ]	[5]
RT eye-hand.....	[ ]	[ ]	[x]	[ ]	[5]
RT eye-foot.....	[ ]	[ ]	[x]	[ ]	[5]
Coordination.....	[ ]	[x]	[ ]	[ ]	[3]
Endurance.....	[ ]	[x]	[ ]	[ ]	[1]
General Attitude.....	[x]	[ ]	[ ]	[ ]	[1]
Overall Health.....	[ ]	[x]	[ ]	[ ]	[1]

(1) with glasses if worn      (2) with hearing aide if worn

Coder Rating: 0=unable to rate      3=partial test data  
 1=subjective observation      4=past test data  
 2=limited test data      5=tested



## COMMENTS ON PROFILE

All the responses on the profile are not the result of equivalent assessments (the range is from observation through formal evaluations).

Several areas would suggest added assessment, particularly, in the information processing area. In this area, the reports are based on observation and indicate some problems exist. The procedure suggested would be to make added assessments to bolster the observations.

Instruments to address the problems areas need to be identified.

Once identified, the added information can be collected and the profile adjusted as needed.

The profile shown for the 80 year old woman suggests a significant problem in processing, a poor capacity to handle stress, a predisposition to anxiety, and some restrictions to movement. The profile would suggest an increased risk of accidents for this person.

# ACCIDENT PREVENTION THROUGH DRIVING SKILLS ASSESSMENT AND INTERVENTIONS FOR OLDER DRIVERS: A PROGRAMATIC APPROACH

*Darlene Yee, Ed.D., CHES*  
*Associate Professor*  
*Department of Health Education*  
*San Francisco State University*  
*San Francisco, California*

*Joseph F. Melichar, Ph.D.*  
*Senior Analyst*  
*Adaptive Systems Corporation*  
*San Mateo, California*

presented at  
38th Annual Meeting of the  
American Society On Aging  
San Diego, California  
14 March 1992

Research presented was sponsored by the AARP ANDRUS FOUNDATION

The needs of the older driver were addressed through an integrated sequence of assessment, education, and training within the framework of a programatic system of interventions. These interventions were arranged in a modular format from the simplest to the most complex. For the purposes of the study, three modules were created using existing interventions. The objective was to learn whether the modules using simpler interventions were effective at determining drivers at risk and how assessment, education (knowledge and attitude), and training (skills) strategies could be developed to better serve the older driver.

The first level module was comprised of the simple 15 item older driver self-assessment inventory developed by Malfetti and Winter (1986) hereafter referenced as ODSAI which includes an informational intervention. The second level module included the ODSAI and the eight-hour 55 Alive/Mature Driver program developed by AARP. The third level module included two variations: (1) the ODSAI and a simulator based assessment program, and (2) the AARP course with the ODSAI and the simulator program. All participants across all three levels were administered a survey and a pre-post test.

The survey (Comprehensive Older Driver Assessment form or MY-CODA; Melichar and Yee, 1992) provided information on the older driver's: background and demographics, driving history, driving performance, activities and social supports, outlook on life, well-being, and general health. The pre-post (Yee and Melichar, 1992) test secured information about their attitudes and general knowledge. Additionally, the simulation subjects were rated on a 41 item scale (MY-DAP; Melichar and Yee, 1992) which profiled the drivers sensory, process, and physical capabilities.

This summary paper discusses these approaches and their intents and makes some suggestions about intervention strategies based on the process of administering the multi-level intervention program to over 200 older drivers. The focus herein is the qualitative perspective derived from the process, the analysis of the data collected will be reported elsewhere. The intent is to

discuss concepts and approaches which might be useful to persons working with or considering developing intervention programs with older drivers within the limitations imposed by this short presentation.

The earlier discussion identified three different intervention focuses: assessment (learning about the older driver), education (changing attitudes and knowledge about driving), and training (driving skill development). In the programmatic model used, the interventions are integrated as much as possible. The assessment is the basis for developing focused education and training. The rationale was that it is more cost-effective for both the trainer and trainee to place more focus on driving problems specific to the individual, than to only address general driving issues. This focusing (or individualizations) occurs in the ODSAI, but not the AARP training course which is aimed at groups of 15 to 50 individuals. The simulations followed a standardized protocol which provided highly individualized screening and intervention information at the end of the process.

One issue which emerged was the difference between directed intervention versus interventions using group approaches. The ability to integrate the group courses into a true programmatic approach appears problematic. The participants problems are not identified and specifically addressed, but rather are responded to by presenting a wide range of information that is applicable to all older drivers. We found older drivers to be a rather diverse group with knowledge and skill that appeared to relate more to their previous driving patterns and skills than to their ages. Approaches that would adapt to this diversity would be more responsive to individual older driver needs.

The ODSAI provided a combined assessment and educational intervention. The limitation is it addresses only 15 items found to be most important to the older driver. The above issue of "an old driver" not responding to an age was observed. Many of the subjects objected to the language and presentation as not being appropriate to them. One of the strengths of the approach is that it provides both self-assessment and educational intervention.

There were no intervention levels between the ODSAI and the all-day classroom course. In recruiting subjects, we found that persons were less likely to want to spend all-day or two days in a course. The inducements of reduced insurance rates and erasure of three moving violation points from their record did not reach a broad range of active older drivers. The ability to provide shorter interventions mixed with some self-paced instruction would enable reaching even more people. By including assessments as part of the intervention, it would allow focusing parts of the materials to the individuals needs as well as providing general information.

The simulator was provided by DORON Precision Systems. The simulation activity combined a threat recognition film that included measures of reaction time, sign and symbol recognition, and driving threat recognition with measures of the person's sensory, processing, and physical performance levels combined under one protocol. The assessment and simulation activity took 45 to 50 minutes, and allowed for a ten minute review of problems observed and responses to the subjects questions. The subject also was required to complete the pre-test, ODSAI questions, and MY-CODA prior to the intervention (which included a review of the ODSAI problem areas). The pre-intervention activity took between 25 and 45 minutes.

The simulator level illustrated that it was possible to combine all assessment, education, and training into one intervention module. It also illustrated that the activity could provide general information while addressing different needs of each individual older driver. Based on the work undertaken, it would be beneficial to add one or more programmatic type modules between the brief ODSAI format and the one-day course. The format should provide more options for providing different types and degrees of training and

allow for individualization. The result should increase the cost-effectiveness of providing interventions for providers, recipients, and society, and make it more attractive to more to participate.

We would like to thank the AARP Andrus Foundation for support of this study. We also would like to thank the many persons who volunteered their time as subjects, and to DORON Precision Systems for the loan of the simulator.

#### REFERENCES

Malfetti, J. and Winter, D. Drivers 55 Plus: Test Your Own Performance. AAA Forundation For Traffic Safety, Washington, D.C., 1986

Melichar, J.F. and Yee, D. A Method For Profiling Older Driver Characteristics, in preparation, 1992

Yee, D. and Melichar, J.F. Older Driver Multi-Module Assessment and Intervention System, in preparation 1992

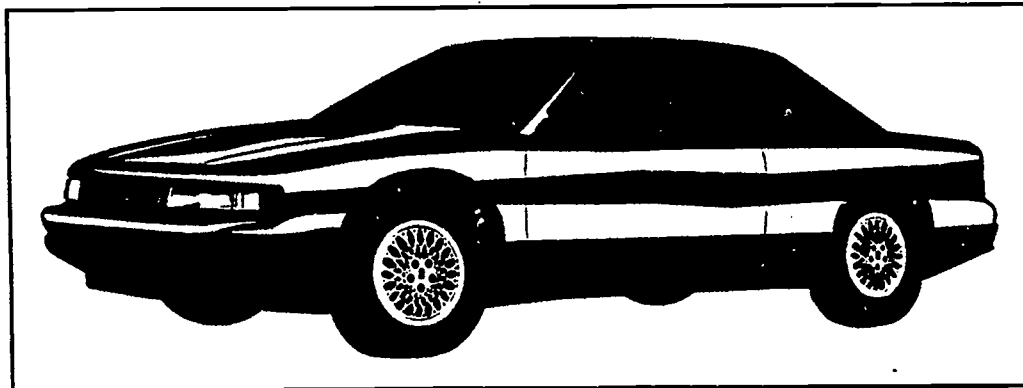

---

# DRIVING SKILLS ASSESSMENT AND INTERVENTIONS FOR OLDER DRIVERS

---

*Sponsored by:*

*AARP Andrus Foundation*

---

Presented at:

**The National Council on The Aging Annual Meeting**

May 1992  
Washington, D.C.

**Principal Investigator:**

**Darlene Yee, Ed.D., CHES**  
Associate Professor  
Department of Health Education  
San Francisco State University  
1600 Holloway Avenue  
San Francisco, CA 94132

**(415) 338-7568**

**Co-Investigator:**

**Joseph F. Melichar, Ph.D.**  
Adaptive Systems Corporation  
P.O.Box 1148  
San Mateo, CA 94403-0748

**(415) 573-6114**

# PROJECT BACKGROUND

**Goal:** to match the assessment and intervention strategies and services to the level of need for the specific person.

**Objective:** to reduce unnecessary assessments and interventions and to insure that needed and appropriate assessments and interventions are undertaken.

**Purpose:** to assure safe and long driving lives for the older adult.

**Process issues:** provision of appropriate services, increase cost-effectiveness to assure services can be provided to the maximum number of persons, increasing public safety, factors in determining when restriction on driving and/or termination of a person's driving life are appropriate, and assessment, education, and training strategies and methods.

**Related issues:** aging processes, mobility, well-being, independent living, traffic safety, driving methods, and public policy.

**Population:** community dwelling independent drivers over age 50.

# PROJECT ACTIVITIES

1. Develop assessment methods and tools for describing older drivers' performance, capabilities, and problems.
2. Develop a multi-modality assessment and intervention strategy, and determine how to match appropriate assessment and intervention strategies to individual drivers.
3. Test strategy and instrumentation on a sample of older drivers including its use with existing interventions:
  1. Older Driver Self-Assessment Inventory,
  2. AARP 55 Alive/Mature Driving Program, and
  3. a simulator-based assessment and training program.
4. Producing clear distinctions between assessment and intervention, and within intervention between education and training.
5. Using the clear distinctions to determine where intervention and assessment overlap and/or can be done concurrently.
6. Establishing cost-effectiveness models for the different strategies that could be develop from the mix of assessment/interventions.
7. Develop and evaluate computer based methods for assessment, education, and training with the goal of reaching more persons at a lower cost with more individualized materials.

# **THIS PRESENTATION'S FOCUS**

- 1. ASSESSMENT AS A MULTI-LEVEL PROCEDURE**
- 2. INTEGRATION OF ASSESSMENT WITH INTERVENTION**
- 3. SEPARATION OF INTERVENTION INTO EDUCATION AND TRAINING**
- 4. MULT-LEVEL INTERVENTIONS**
- 5. SIMULATION WITHIN THE MULTI-LEVEL SYSTEM OF ASSESSMENT AND INTERVENTION**
- 6. LEVELS OF SIMULATION**
- 7. PROTOCOL USE IN SIMULATIONS**
- 8. SIMULATION PROTOCOL REPLICATION WITHOUT USE OF A SIMULATOR**



# MULTI-LEVEL ASSESSMENT

- 1. Assessment is viewed as multi-level and multi-dimensional to enable individualization to the person's specific sets of needs.**
- 2. Assessment is a systematic hierarchy starting from an overview to increasingly specific focuses.**
- 3. There are multiple dimensions of assessment to correspond to the multiple dimensions of human performance and driving experience.**
- 4. Each dimension provides a specific in-sight into the person's functioning, but none alone defines the person's capability as a driver.**
- 5. Examples of major functions are: Sensing, Processing, and Motor Performance.**
- 6. Sensing can be broken down into subcategories of: vision, hearing, kinesthesia, and proprioception - as an example of the hierarchical definition.**
- 7. Each subcategory then can be broken down into yet more specific subcategories, which can be assessed.**
- 8. After the individual assessments a method must be employed to combine the information and evaluate it relative to the driving activity.**

# **INTERVENTION TERMINOLOGY**

- 1. Intervention is defined as a combination of educational and training activities.**
- 2. Educational interventions provide knowledge .. there is a transfer of information .. the person learns about driving, the driving situation, rules, regulations, ... .**
- 3. Training is an activity which focuses on the production of skills .. the skills used in or needed in driving.**
- 4. Both education and training are needed to improve driving performance and safety.**
- 5. Identification which is needed and in what areas can be determined through assessment.**
- 6. The more directed the intervention plan, the more cost-effective and the higher the likelihood that the person's specific needs will be met.**

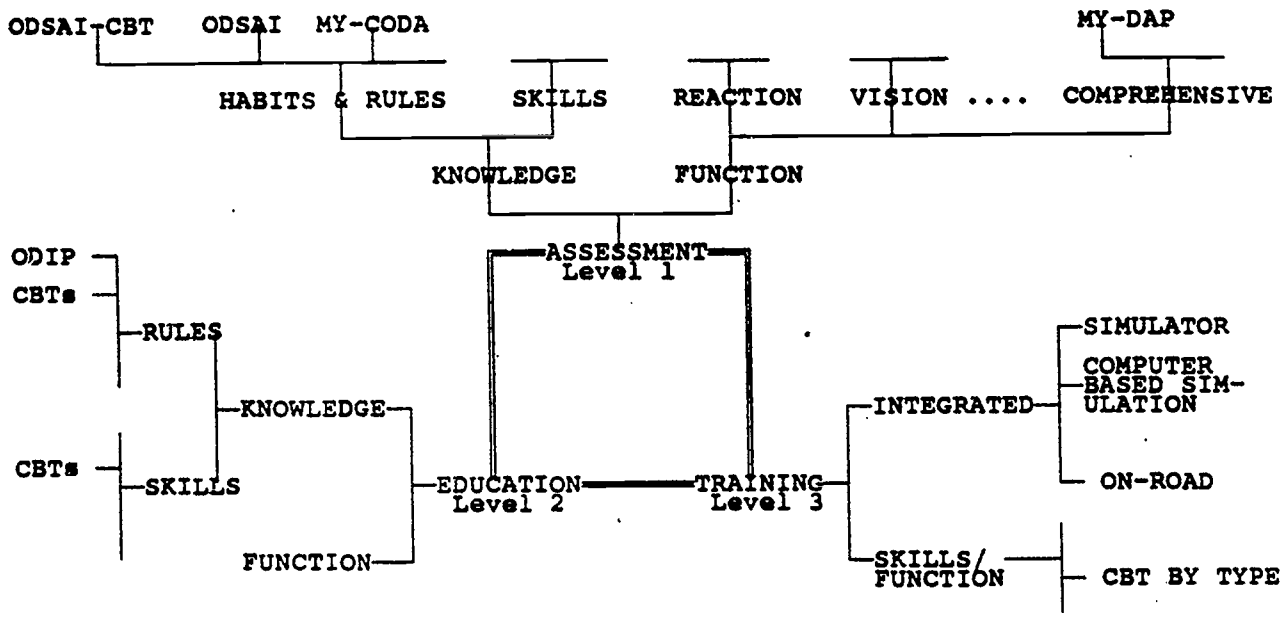

**Three Level Multi-Phasic Integrated Model of Intervention for Older Drivers**

# **SIMULATION FACTORS**

- 1. Simulation is a range of activities from simple scenarios that can be acted out to complex and highly technological equipment.**
- 2. Simulation has the goal of exposing the older driver to a series of situations which can result in assessing performance or developing their skills (or both).**
- 3. The simplest level is the use of a scenario to which the person responds. Perhaps this level can be defined as "quasi-simulation", but it brings the persons into a situation into which they must identify responses.**
- 4. We can then blend the scenario with actions required using a simulated auto, or perhaps a standing auto (e.g., a series of instructions to which the driver must respond).**
- 5. The next level requires the individual to react in a real fashion .. for example a reaction test.**
- 6. A more complex simulation would then require driving responses to visual cues.**
- 7. A more realistic level would then be to react to driving situations that are visually and auditorialy realistic.**
- 8. Subsequent levels would then introduce interactive driving situations and ultimately a virtual reality.**

# **SIMULATION PROTOCOLS**

- 1. To make each simulation a repeatable event, a simulation protocol is used for both assessment and intervention.**
- 2. The protocols make each simulation event as similar as possible. The recording forms for observations of the subject match the protocol and provide the source information for the final evaluation or scoring.**
- 3. The protocols can be used with a multi-level simulations combined with other assessments .. e.g., we used a protocol to do a series of sensory, physical, and processing activities without a simulator and then with a simulator.**
- 4. Once the protocol is established it can be replicated without a simulator ... the non-simulator activities are the same, and activities which mimic the simulator are used to gain that portion of the assessment (e.g., we used scenarios which required driver response or discussion, video taped situations, and physical tests to replace the simulator in a currently ongoing trial).**
- 5. The intent is to learn what levels of simulation provide the most return on investment, respond the best to the driver's needs, and best fit different community programs.**

# **SUPPORTING CONCEPTS AND PROCEDURES**

- 1. Differentiation between tools for describing older driver characteristics, history, and performance and assessment.**
- 2. Describe assessment strategy for profiling older driver characteristics.**
- 3. Relate the profiling method to a means for leading to more detailed assessments - a directed strategy from general to more specific assessments.**
- 4. Discuss the importance of valuing assessment information.**
- 5. Review the concept of a profile versus score as applied to assessment.**
- 6. Relate concepts to MY-DAP instrument and its use.**

## **DIFFERENTIATION BETWEEN DESCRIPTION AND ASSESSMENT**

Description...description is used to denote a reporting about the driver. Typically it is a self report, and usually does not have a score associated with it. The description provides a view of the older driver's background, surroundings, and driving capabilities. In this study, MY-CODA is a self-report generated by a questionnaire the older driver completes. The report describes the older persons's background, driving history, driving pattern, social supports, activities, and health and well-being.

Assessment..a criterion based formal measure of a dimension about the older person and/or their driving. For example, MY-DAP provides a profile, and ODSAI provides a score.

# OLDER DRIVER ASSESSMENT AND PROFILING

The Driver Assessment Profile is a method for assessing the abilities and skills of older drivers using an integrated and systematic model of driving (Melichar and Yee, 1991a and 1991b). It is designed to provide a profile of the older driver that will:

- (1) help in studying abilities and skills of older drivers,
- (2) relate to performance and training parameters,
- (3) aid in assessment of age-related changes and function, and
- (4) relate to the integrated model of the driving experience.

The Driver Assessment Profile is a reflection of the driver response portion of this model. The outcome should be a description of the operational response of the driver based on the abilities and skills identified. The focus is on the overall integration of abilities and skills allowing for compensation of a deficit by a strength(s). The driver responds in an integrated manner, and it is this systematic response that will be measured.

The Driver Assessment Profile will isolate specific problem areas, but a profile of the abilities and skills is desired. One question being addressed in the present research is whether a specific profile reflects a systematic degradation of driving ability. A second question is whether there are any characteristics that are more predictive of loss of driving ability.

The Driver Assessment Profile (shown on the next page) asks for a rating of specific abilities and skills which are grouped in three categories: sensing or input type information, coordinative and integrative functions used to process the input information, and abilities needed to carry out the decisions to act. Additionally, two general questions relating to overall health and general attitude are included. MY-DAP is designed to be scored by a health professional working with the older driver.



# OLDER DRIVER ASSESSMENT AND PROFILING

This following describes the use of the Driver Assessment Profile. The strategy is to assess the impairment of an ability and skill. If a person's ability is not impaired, then how much more capability exists is not assessed. The impairments are rated as: none, mild, moderate, or severe. The terms should be interpreted as:

mild.....a noticeable change in abilities from a level expected a safe minimum for driving, but not sufficiently severe to cause a difficulty or lack of safety in driving ... a mild impairment normally would require some adjustments by the older driver

moderate..the impairment in abilities would cause the older person difficulties in driving and especially in driving safely, adjustments required of the person are significant to achieve even the minimum level of functional performance

severe....the impairment is significant enough to make it unlikely the person can make adjustments to allow safe driving performance.

The Driver Assessment Profile can be used to assess the abilities and skills using a number of means: descriptive which is based heavily on subjective observations, measured based on criterion reference measures, assessed based on formal assessment techniques, and diagnostic which would take the formal assessment and make the transition to formally creating suggested responses. The present form of the instrument supports the first three uses.

**DRIVER ASSESSMENT PROFILE (MY-DAP)**

Agency #: \_\_\_\_\_ Site #: \_\_\_\_\_ Subject #: \_\_\_\_\_  
 Date: \_\_\_/\_\_\_/\_\_\_ Interviewer #: \_\_\_\_\_

DRIVER ABILITY OR SKILL	DEGREE OF IMPAIRMENT				CODER RATING (0-5)
	NONE	MILD	MODER- ATE	SEV- ERE	
<b>SENSING</b>					
Vision- Overall (1)....	[ ]	[ ]	[ ]	[ ]	[ ]
Acuity/Static.....	[ ]	[ ]	[ ]	[ ]	[ ]
Acuity/Dynamic.....	[ ]	[ ]	[ ]	[ ]	[ ]
Field of Vision.....	[ ]	[ ]	[ ]	[ ]	[ ]
Peripheral Vision....	[ ]	[ ]	[ ]	[ ]	[ ]
Depth Perception....	[ ]	[ ]	[ ]	[ ]	[ ]
Glare Refractory....	[ ]	[ ]	[ ]	[ ]	[ ]
Color Recognition....	[ ]	[ ]	[ ]	[ ]	[ ]
Known Pathologies....	[ ]	[ ]	[ ]	[ ]	[ ]
Hearing- Overall (2)..	[ ]	[ ]	[ ]	[ ]	[ ]
Left Ear.....	[ ]	[ ]	[ ]	[ ]	[ ]
Right Ear.....	[ ]	[ ]	[ ]	[ ]	[ ]
Kinesthesia.....	[ ]	[ ]	[ ]	[ ]	[ ]
Proprioception.....	[ ]	[ ]	[ ]	[ ]	[ ]
<b>PROCESSING</b>					
Short term memory.....	[ ]	[ ]	[ ]	[ ]	[ ]
Long term memory.....	[ ]	[ ]	[ ]	[ ]	[ ]
Cognitive skills.....	[ ]	[ ]	[ ]	[ ]	[ ]
Anger/aggression.....	[ ]	[ ]	[ ]	[ ]	[ ]
Anxiety.....	[ ]	[ ]	[ ]	[ ]	[ ]
Selective Attention....	[ ]	[ ]	[ ]	[ ]	[ ]
Stress Response.....	[ ]	[ ]	[ ]	[ ]	[ ]
Problem Solving.....	[ ]	[ ]	[ ]	[ ]	[ ]
Decision-Making.....	[ ]	[ ]	[ ]	[ ]	[ ]
Judgement.....	[ ]	[ ]	[ ]	[ ]	[ ]
Patience.....	[ ]	[ ]	[ ]	[ ]	[ ]
Insight into driving...	[ ]	[ ]	[ ]	[ ]	[ ]
<b>MOTOR</b>					
Strength upper limbs...	[ ]	[ ]	[ ]	[ ]	[ ]
Strength lower limbs...	[ ]	[ ]	[ ]	[ ]	[ ]
Strength hand.....	[ ]	[ ]	[ ]	[ ]	[ ]
Strength foot.....	[ ]	[ ]	[ ]	[ ]	[ ]
ROM upper limbs.....	[ ]	[ ]	[ ]	[ ]	[ ]
ROM lower limbs.....	[ ]	[ ]	[ ]	[ ]	[ ]
ROM neck.....	[ ]	[ ]	[ ]	[ ]	[ ]
ROM trunk.....	[ ]	[ ]	[ ]	[ ]	[ ]
RT simple.....	[ ]	[ ]	[ ]	[ ]	[ ]
RT eye-hand.....	[ ]	[ ]	[ ]	[ ]	[ ]
RT eye-foot.....	[ ]	[ ]	[ ]	[ ]	[ ]
Coordination.....	[ ]	[ ]	[ ]	[ ]	[ ]
Endurance.....	[ ]	[ ]	[ ]	[ ]	[ ]
General Attitude.....	[ ]	[ ]	[ ]	[ ]	[ ]
Overall Health.....	[ ]	[ ]	[ ]	[ ]	[ ]

(1) with glasses if worn      (2) with hearing aide if worn

Coder Rating: 0=unable to rate      3=partial test data  
 1=subjective observation      4=past test data  
 2=limited test data      5=tested

# VALUATION OF ASSESSMENT INFORMATION

A rating system is provided to the rater to allow indicating the type of assessment for each item. If all the assessments of the abilities are of the same type, then the procedure is to indicate the time for the first characteristic and a downward arrow in the second. The types of assessment supported are:

- 0...unable to rate this specific item,
- 1...subjective observation,
- 2...subjective observation combined with limited test data,
- 3...rating is based on partial test data,
- 4...rating is based on past test data available to the rater, and
- 5...rating is based on testing.

The higher the number of the rating the greater the expected validity. The intent is to allow use of the profile over a greater range of situations than one which is strictly dependent on formal assessment techniques. The ratings provided enable use in a range of conditions, or when the conditions are not equal for all items. The result rating enables the interviewers to answer, and to assign a validity weight to the rating based on their assessment.

The valuation provides a method of weighing the information presented. The source of the knowledge is indicated and can be used to determine then weight that is to be placed on the information.

# PROFILE VERSUS TOTAL SCORES

Total scores provide a summative valuation. The relationship between components of the scale are eliminated, and with them information. A profile provides the combination of measures and allows looking at the relative strengths and weaknesses. An example of profile is presented on the next page.

**DRIVER ASSESSMENT PROFILE (MY-DAP) - Sample Case**

Agency #: \_\_\_\_\_ Site #: \_\_\_\_\_ Subject #: \_\_\_\_\_

Date: \_\_\_/\_\_\_/\_\_\_ Interviewer #: \_\_\_\_\_

DRIVER ABILITY OR SKILL	DEGREE OF IMPAIRMENT				CODER RATING (0-5)
	NONE	MILD	MODER- ATE	SEV- ERE	
<b>SENSING</b>					
Vision- Overall (1)....	[x]	[ ]	[ ]	[ ]	[4]
Acuity/Static.....	[x]	[ ]	[ ]	[ ]	[5]
Acuity/Dynamic.....	[ ]	[x]	[ ]	[ ]	[5]
Field of Vision.....	[ ]	[x]	[ ]	[ ]	[4]
Peripheral Vision....	[x]	[ ]	[ ]	[ ]	[4]
Depth Perception....	[ ]	[x]	[ ]	[ ]	[4]
Glare Refractory....	[ ]	[x]	[ ]	[ ]	[4]
Color Recognition....	[x]	[ ]	[ ]	[ ]	[3]
Known Pathologies....	[x]	[ ]	[ ]	[ ]	[4]
Hearing- Overall (2)..	[x]	[ ]	[ ]	[ ]	[2]
Left Ear.....	[x]	[ ]	[ ]	[ ]	[2]
Right Ear.....	[x]	[ ]	[ ]	[ ]	[2]
Kinesthesia.....	[ ]	[x]	[ ]	[ ]	[3]
Proprioception.....	[ ]	[ ]	[x]	[ ]	[3]
<b>PROCESSING</b>					
Short term memory.....	[ ]	[x]	[ ]	[ ]	[3]
Long term memory.....	[x]	[ ]	[ ]	[ ]	[2]
Cognitive skills.....	[x]	[ ]	[ ]	[ ]	[2]
Anger/aggression.....	[ ]	[x]	[ ]	[ ]	[3]
Anxiety.....	[ ]	[ ]	[x]	[ ]	[3]
Selective Attention....	[ ]	[x]	[ ]	[ ]	[2]
Stress Response.....	[ ]	[x]	[ ]	[ ]	[3]
Problem Solving.....	[ ]	[ ]	[x]	[ ]	[2]
Decision-Making.....	[ ]	[ ]	[x]	[ ]	[2]
Judgement.....	[ ]	[ ]	[x]	[ ]	[2]
Patience.....	[ ]	[ ]	[x]	[ ]	[2]
Insight into driving...	[ ]	[x]	[ ]	[ ]	[2]
<b>MOTOR</b>					
Strength upper limbs...	[ ]	[x]	[ ]	[ ]	[4]
Strength lower limbs...	[ ]	[ ]	[x]	[ ]	[5]
Strength hand.....	[ ]	[ ]	[ ]	[x]	[5]
Strength foot.....	[ ]	[ ]	[x]	[ ]	[5]
ROM upper limbs.....	[ ]	[ ]	[x]	[ ]	[5]
ROM lower limbs.....	[ ]	[x]	[ ]	[ ]	[5]
ROM neck.....	[x]	[ ]	[ ]	[ ]	[5]
ROM trunk.....	[x]	[ ]	[ ]	[ ]	[5]
RT simple.....	[x]	[ ]	[ ]	[ ]	[5]
RT eye-hand.....	[ ]	[x]	[ ]	[ ]	[5]
RT eye-foot.....	[ ]	[x]	[ ]	[ ]	[5]
Coordination.....	[ ]	[ ]	[x]	[ ]	[5]
Endurance.....	[ ]	[x]	[ ]	[ ]	[3]
General Attitude.....	[ ]	[x]	[ ]	[ ]	[3]
Overall Health.....	[ ]	[x]	[ ]	[ ]	[3]

(1) with glasses if worn (2) with hearing aide if worn

Coder Rating: 0=unable to rate 3=partial test data  
 1=subjective observation 4=past test data  
 2=limited test data 5=tested

# ASSESSMENT HIERARCHIES FROM PROFILING

For a given profile problem areas can be identified.

The quality of the information can be evaluated.

An identified problem area can be have additional tests administered.

Poor quality (more observational) assessments can be replaced by formal methods.

MY-DAP can be considered to be the first level of a hierarchy with increased specificity at each succeeding level.

For example, a potential problem with cognition can be evaluated by adding a general test of intelligence.

# MY-DAP AND ITS APPLICATION

The following page shows a hypothetical profile for an 80 year old woman driver with arthritis in her hands. The woman is alert, but has memory lapses and is anxious about driving. Her vision is normal for her age.

**DRIVER ASSESSMENT PROFILE (MY-DAP) - Sample Case**

Agency #: \_\_\_\_\_ Site #: \_\_\_\_\_ Subject #: \_\_\_\_\_

Date: \_\_\_/\_\_\_/\_\_\_ Interviewer #: \_\_\_\_\_

DRIVER ABILITY OR SKILL	DEGREE OF IMPAIRMENT				CODER RATING (0-5)
	NONE	MILD	MODER- ATE	SEV- ERE	
<b>SENSING</b>					
Vision- Overall (1)....	[ ]	[x]	[ ]	[ ]	[3]
Acuity/Static.....	[ ]	[x]	[ ]	[ ]	[1]
Acuity/Dynamic.....	[ ]	[ ]	[x]	[ ]	[1]
Field of Vision.....	[ ]	[x]	[ ]	[ ]	[4]
Peripheral Vision....	[ ]	[x]	[ ]	[ ]	[4]
Depth Perception....	[ ]	[x]	[ ]	[ ]	[4]
Glare Refractory....	[ ]	[ ]	[x]	[ ]	[2]
Color Recognition....	[x]	[ ]	[ ]	[ ]	[5]
Known Pathologies....	[x]	[ ]	[ ]	[ ]	[2]
Hearing- Overall (2)..	[x]	[ ]	[ ]	[ ]	[1]
Left Ear.....	[x]	[ ]	[ ]	[ ]	[1]
Right Ear.....	[x]	[ ]	[ ]	[ ]	[1]
Kinesthesia.....	[ ]	[x]	[ ]	[ ]	[2]
Proprioception.....	[ ]	[x]	[ ]	[ ]	[3]
<b>PROCESSING</b>					
Short term memory.....	[ ]	[ ]	[x]	[ ]	[1]
Long term memory.....	[ ]	[x]	[ ]	[ ]	[1]
Cognitive skills.....	[ ]	[x]	[ ]	[ ]	[1]
Anger/aggression.....	[ ]	[x]	[ ]	[ ]	[1]
Anxiety.....	[ ]	[ ]	[x]	[ ]	[1]
Selective Attention....	[ ]	[ ]	[x]	[ ]	[1]
Stress Response.....	[ ]	[ ]	[ ]	[x]	[1]
Problem Solving.....	[ ]	[ ]	[x]	[ ]	[1]
Decision-Making.....	[ ]	[ ]	[x]	[ ]	[1]
Judgement.....	[ ]	[ ]	[x]	[ ]	[1]
Patience.....	[ ]	[ ]	[x]	[ ]	[1]
Insight into driving...	[x]	[ ]	[ ]	[ ]	[1]
<b>MOTOR</b>					
Strength upper limbs...	[ ]	[x]	[ ]	[ ]	[3]
Strength lower limbs...	[ ]	[x]	[ ]	[ ]	[3]
Strength hand.....	[ ]	[ ]	[x]	[ ]	[3]
Strength foot.....	[ ]	[x]	[ ]	[ ]	[3]
ROM upper limbs.....	[ ]	[x]	[ ]	[ ]	[4]
ROM lower limbs.....	[ ]	[x]	[ ]	[ ]	[4]
ROM neck.....	[ ]	[x]	[ ]	[ ]	[4]
ROM trunk.....	[ ]	[x]	[ ]	[ ]	[4]
RT simple.....	[ ]	[ ]	[x]	[ ]	[5]
RT eye-hand.....	[ ]	[ ]	[x]	[ ]	[5]
RT eye-foot.....	[ ]	[ ]	[x]	[ ]	[5]
Coordination.....	[ ]	[x]	[ ]	[ ]	[3]
Endurance.....	[ ]	[x]	[ ]	[ ]	[1]
General Attitude.....	[x]	[ ]	[ ]	[ ]	[1]
Overall Health.....	[ ]	[x]	[ ]	[ ]	[1]

(1) with glasses if worn      (2) with hearing aide if worn

Coder Rating: 0=unable to rate      3=partial test data  
 1=subjective observation      4=past test data  
 2=limited test data      5=tested



## COMMENTS ON PROFILE

All the responses on the profile are not the result of equivalent assessments (the range is from observation through formal evaluations).

Several areas would suggest added assessment, particularly, in the information processing area. In this area, the reports are based on observation and indicate some problems exist. The procedure suggested would be to make added assessments to bolster the observations.

Instruments to address the problems areas need to be identified.

Once identified, the added information can be collected and the profile adjusted as needed.

The profile shown for the 80 year old woman suggests a significant problem in processing, a poor capacity to handle stress, a predisposition to anxiety, and some restrictions to movement. The profile would suggest an increased risk of accidents for this person.

---

# **COMMENTS ON OLDER DRIVERS AS AN UNDERSERVED POPULATION**

---

*Sponsored by:*

***AARP Andrus Foundation***

---

Presented at:

**TRAFFIC SAFETY SUMMIT '92  
California Office of Traffic Safety**

**May 1992  
Anaheim, California**

**Darlene Yee, Ed.D., CHES  
Associate Professor  
Department of Health Education  
San Francisco State University  
1600 Holloway Avenue  
San Francisco, CA 94132**

**(415) 338-7568**

**Joseph F. Melichar, Ph.D.  
Adaptive Systems Corporation  
P.O.Box 1148  
San Mateo, CA 94403-0748**

**(415) 573-6114**

## INTRODUCTION

This handout is a brief summary of information about older drivers. The materials are a supplement to a overview description of older drivers as an under-served population at a panel at the California Department of Safety's **TRAFFIC SUMMIT 92** meeting in Anaheim: The handout is composed of five parts and an addendum:

1. a summary of the comments presented,
2. a brief review by the authors about driving and the older person,
3. a short list of references,
4. a summary of tables and figures describing the population, and
5. a short list of resource agencies addressing this population.

The addendum is a brochure for a locator system for assistive technologies that includes driving aides for both the elderly and the handicapped (who also being addressed in this session), and an brochure on attitude assessment of younger persons toward driving for use in schools.

The summary comments to be presented are a combination of discussions about the older driver, some misconceptions, and a few findings from our ongoing research. These comments are highlights designed to fit within the fifteen minute presentation format of the panel. Further information can be gained from the readings in the reference list.

More detailed information on programs and information in this area can be gotten from Professor Yee at San Francisco State University (address and telephone number are on the cover sheet).

## **SUMMARY OF COMMENTS**

### **General Problems**

- 1. Older drivers vision is poorer and grows poorer with age with the changes beginning in the late 40's and 50s .. of greatest importance to driving are decreases in static and dynamic acuity, glare sensitivity and recovery, and a narrowing of the field of vision.**
- 2. It is more difficult to distinguish meaningful cues from the environment, sort-out its meaning, and use the information.**
- 3. As the person grows through their seventies it becomes harder to organize information, make decisions, deal with complex situations, and depend on short-term memory.**
- 4. Physical responses and reactions decrease.**
- 5. Older drivers reduce their driving, but mileage adjusted data indicate that the older driver has higher accident rates.**
- 6. Fatalities per accident for older drivers are higher.**
- 7. The percentage of older drivers is increasing and will continue to increase and the proportion of the very old driver within the over 65 group is and will continue to increase well into the next century.**

### **Alternative Issues to be Considered**

- 1. Chronological age is a poor marker of age related changes and is not a good basis for determine when a person should stop driving.**
- 2. Performance and function are the best measures of older driver capability just as with younger drivers.**

- 3. Health, emotional state, physical condition, and well-being are strong influences on performance.**
- 4. Stereotypical perspectives of age do not provide us much guidance in addressing the problems of the older driver.**
- 5. Older drivers can adjust driving patterns to prolong their driving lives (e.g., avoid rush hours or night driving) and typically do.**
- 6. Methods for discriminating when it is appropriate to have a person stop driving because of functional deficits are still not well defined (either because of age or health).**
- 7. Educational programs such as the courses provided by the AARP and AAA provide effective interventions to make older drivers aware of potential problems they are facing and possible solutions.**
- 8. Our research suggests a systematic mixture of assessment, education (or knowledge about driving), and training (skills used in driving) appear to provide the best approach to identifying and remediating problems. The systemization must allow adjusting to individual differences by having multiple paths through the system, multiple interventions, and need responsive intervention strategies (i.e., find and address the person's specific problems versus a completely general process). We need to be cost conscious to enable reaching a large portion of the problem on a continuing basis, and with differing messages adjusting to age changes.**
- 9. To understand the problems, it is often useful to try to differentiate between a poor driver who has become older, and an older driver whose performance has deteriorated.**

## STATEMENT OF THE PROBLEM

The long-term goals of gerontologic health promotion and disease prevention programs are to increase the longevity and improve the "quality of life" of older persons through significant increases in health, mobility, and independence (13). One problem is a lack of appropriate transportation which reduces the "quality of life" of an older adult. This reduction results from limits to the capacity for self-maintenance, restrictions in participation in constructive activities and interactions with other people, and in turn may contribute to reduced involvement and subsequent alienation from society (14).

Transportation is a major facilitator between a person and his/her external environment and determines whether the community functions as an inhibiting environment or a favorable social support system. Like everyone in our society, the elderly depend upon the ability to travel in order to acquire the basic necessities of life (food, clothing, and health care) as well as participating in educational, employment, religious, cultural, recreational, and social activities. To the extent that the elderly are denied transportation services, they are also denied full participation in meaningful community life (11-12).

Provisions for adequate transportation services are beneficial not only to older adults whose activities otherwise would be limited, but also are of economic value to society in that they support the older individual's capacity for independent living within his or her community (15). Transportation thus serves to postpone or prevent costly short-term institutional care (e.g. acute care hospital) and/or unnecessary long-term institutionalization (e.g. skilled nursing facility).

Mobility is then essential to the quality of life of older adults, and all trends indicate that the majority of the transportation needs of older adults into the next century will be met by the private automobile. The cost to society of providing alternative means of mobility would be enormous; hence, older drivers should be encouraged to drive as long as possible. This proposal addresses how the goal of maintaining the elderly person's driving capability for as long as possible may be accomplished while maintaining safety standards.

### THE GENERAL PROBLEM

Older adults face a loss of functional capability which impacts upon their ability to drive. Elderly persons must adapt their driving habits to the changes in their skills, and also must be able to eliminate past bad habits which can no longer be adjusted for due to their decreased abilities. Simultaneously they experience a reduced ability to use public transportation or walk long distances, but have the same requirements to maintain themselves in the community.

The reduction in capability coupled with its requirement to adapt while the external demand on the person remains the same produces a risk situation. The risk situation reduces safety and increases the risk of accident and injury, and/or reduction in willingness to drive. The result is of immediate importance to the older driver who faces a loss of freedom of movement, to their family who must provide alternative support, and increasingly to society as the number of older drivers on the nation's roadways increases.

The general problem is to determine how best to address the assessment and subsequent remediation of the driving deficits of the older driver and still remain within safety standards. These deficits include knowledge and skills and in the processes to adapt to their changing functional capabilities. Responding effectively to the general problem requires identification of the at-risk driver and/or prevention or amelioration of the at-risk situation within the older driver population.

#### LITERATURE REVIEW

Mobility is one of the activities of daily living which enhances the "quality of life" (1). The growing number of older adults comprises a heterogeneous population: some remain mobile, others do not. In addition, the literature suggests that an inverse relationship exists between aging and mobility.

The decreased ability of older adults to move around is caused by various physical and psychological limitations. These limitations also account for the high accident toll of older drivers and pedestrians. Ironically, those older adults who attempt to remain mobile may experience more accidents, injuries, and disabilities caused by age-related physical and psychological changes.

#### DEMOGRAPHY OF OLDER DRIVERS

The increase in the age of the overall population translates to a simultaneous increase in the number of older drivers. Demographic trends show that the proportion of older drivers will continue to increase. Approximately 33 million drivers age 55 and over constitute 22 percent of all drivers today (2). In the year 1990 they will represent 28 percent of the driving population-- 39 percent by the year 2000 (16).

"Being able to get where they want to go" is an important factor in the physical and mental well-being of older adults. Surveys (17-18) reveal that driving is how they prefer to maintain mobility. There is consensus among traffic safety authorities that older drivers should be kept on the roadways as long as they can drive safely. No one seriously concerned with traffic safety wants to use chronological age as the sole indicator of driving ability (19).

#### OLDER DRIVER SAFETY PROFILE

While many drivers age 55 and over have commendable driving records, as a group, they are disproportionately involved in traffic accidents and fatalities when exposure is taken into account. On the basis of miles driven, older drivers are involved in fatal crashes more frequently than any other age group except teenaged drivers. In addition, older drivers are more likely to be hospitalized as a result of their injuries sustained in traffic accidents than their younger counterparts (3); those who survive tend to recover very slowly (4).

Moreover, there are conditions and situations involving the traffic mix-- drivers, automobiles, highways-- that should be dealt with in order for older drivers to function safely, and thus maintain the mobility and independence so important for their physical and mental well-being. According to Wiener (7), "losing one's driving privilege, voluntarily or otherwise, is probably second only to total confinement in its effect on lifestyle, access to benefits of society, and general well-being." This is particularly true for older drivers in our automobile-oriented society.

Social learning theory suggests that when people understand the reason some restrictive action must be taken against them, and are told the specific steps by which they might be able to overcome the restriction, they are more willing to accept it than if it is imposed by an external authority (8-9).

The license of an older driver might be essential to his or her independence and well-being. Every opportunity should be taken to insure that the older driver is made aware of impairments and of what action can be taken to overcome them. When a person thinks he or she can do something about an impairment, that person is more likely to try to do something about it (10).

#### **DRIVING PERFORMANCE FACTORS**

One of the main problems facing older drivers stems from the decline of some of the performance skills necessary for safe driving: 1) sensing the situation, 2) deciding what to do, and 3) acting quickly (5). Various age-related visual, auditory, and psychomotor changes have an adverse effect on driving ability (6).

Of all the sensory problems that afflict older drivers, visual impairment can be the most devastating. Cataract, glaucoma, senile macular degeneration, and several qualities of visual perception such as visual acuity, field of vision, distance judgment, illumination, glare sensitivity, night vision, and color recognition change with age.

Presbycusis, progressive bilaterally symmetrical hearing loss occurring with age, results from conductive, sensori-neural, central or mixed hearing loss. Age-related changes in decision-making include decline in speed, decline in efficiency and decline



in selective attention and vigilance. Slower motor responses results in increased reaction time with age.

Toward this end, it is evident that older adults need comprehensive information concerning their driver performance. This information should suggest what older drivers can do for themselves as well as what other people can do for them through innovations in accident prevention and injury control.

#### REFERENCES

1. Wiener, E.L. "Elderly Pedestrians and Drivers: The Problem that Refuses to Go Away." In P. F. Waller (Ed.), 1972 North Carolina Symposium on Highway Safety, No. 7, Aging and Highway Safety: The Elderly in a Mobile Society, pp. 53-95. Chapel Hill: The University of North Carolina Highway Safety Research Center, 1973.
2. National Safety Council. Accident Facts. Chicago: National Safety Council, 1987.
3. Fife, D., Barancik, J.I. and Chatterjee, B.F. "Northeastern Ohio Trauma Study: II. Injury Rates by Age, Sex, and Cause." American Journal of Public Health, 1984, 74(5): 473-478.
4. Baker, S.P., O'Neill, B. and Karpf, R.S. The Injury Fact Book. Boston: D.C. Heath and Company, 1984.
5. Malfetti, J.L. and Winter, D.J. Development of a Traffic Safety and Alcohol Program for Senior Adults. New York: AAA Foundation for Traffic Safety, 1978.
6. Marsh, B.W. "Aging and Driving." Traffic Engineering, November 1960, 31: 3-21.
7. Same as reference #1.
8. Shupe, D.R. "Perceived Control, Helplessness, and Choice." In J.E. Birren & J. Livingston (Eds.), Cognition, Stress, and Aging, pp. 174-192. Englewood Cliffs, New Jersey: Prentice-Hall Inc., 1985.
9. Wallston, B.S. & Wallston, K.A. "Social Psychological Models of Health Behavior: An Examination and Integration." In A. Baum, S. Taylor & J.E. Singer (Eds.), Handbook of Psychology and Health, Volume 4: Social Aspects of Health. Hillsdale, New Jersey: Erlbaum, 1984.
10. Malfetti, J.L. & Winter, D.J. Development of the Older Driver Self-Assessment Inventory. Falls Church, Virginia: AAA Foundation for Traffic Safety, 1986.
11. Koncelik, J.A. Aging and the Product Environment. Pennsylvania: Hutchinson Ross Publishing Company, 1982.
12. Schwartz, A.N. & Peterson, J.A. Introduction to Gerontology. New York, Holt, Rinehart and Winston, 1979.
13. Institute of Medicine. Healthy People: The Surgeon General's Report on Health Promotion and Disease Prevention. Washington, D.C.: U.S. Government Printing Office, 1979.
14. Lowy, L. Social Policies and Programs on Aging: What Is and What Should Be in the Later Years. Boston: D.C. Heath and Company, 1980.

15. Schultz, J.H. The Economics of Aging. Belmont, CA: Wadsworth Publishing Company, Inc., 1980.
16. United States Traffic Safety Administration. Highway Safety Facts, 1(2). Washington, D.C.: National Center for Statistics and Analysis, December 1979.
17. Harris, C.S. Fact Book on Aging: A Profile of America's Older Population. Washington, D.C.: National Council on Aging, Inc., 1978.
18. Yee, D. "A Survey of the Traffic Safety Needs and Problems of Drivers age 55 and Over." In Malfetti, J.L. (Ed.), Needs and Problems of Older Drivers: Survey Results and Recommendations. Proceedings of the Older Driver Colloquium, Orlando, Florida. Falls Church, Virginia: AAA Foundation for Traffic Safety, 1985.
19. Transportation Research Board. Transportation in an Aging Society: Improving Mobility and Safety for Older Persons (Volume 1). Washington, D.C.: National Research Council, 1988.
20. Planek, T.W. "The Aging Driver in Today's Traffic: A Critical Review." In P.F. Waller (Ed.), 1972 North Carolina Symposium on Highway Safety, No. 7, Aging and Highway Safety: The Elderly in a Mobile Society, pp. 1-38. Chapel Hill, The University of North Carolina Highway Safety Research Center, 1973.
21. Melichar, J.F. and Yee, D. "Driver Profiling Method", in preparation.
22. Melichar, J.F., "Hierarchical Categorization and Function", in preparation.
23. Melichar, J.F., ISAARE, An Introduction. AAESPH Review, 3(4), December 1978.
24. Flannigan, J.C. Measures of Human Performance. Pittsburgh, PA: American Institutes for Research, 1962.
25. Malfetti, J.L. and Winter, D.J. Safe and Unsafe Performance of Older Drivers: A Descriptive Study. Falls Church, VA: AAA Foundation for Traffic Safety, 1987
26. Evans, L. Traffic Safety and The Driver. NY, NY: Van Nostrand Reinhold, 1991
27. Szlyk, J.P., Severing, K., Fishman, G.A. Visual Field Loss and Driving Performance. Washington, D.C., AAA Foundation For Traffic Safety, 1991
28. Laux, L.F. & Mayer, D. Locating Vehicle Controls and Displays: Effects of Expectancy and Age. Washington, D.C., AAA Foundation For Traffic Safety, 1991
29. Malfetti, J.L. & Winter, D.J. Concerned About An Older Driver? A Guide for Families and Friends. Washington, D.C., AAA Foundation For Traffic Safety, 1991
30. Kline, D. Aging and the Visibility of Highway Signs: A New Look Through Old Eyes. Washington, D.C., AAA Foundation For Traffic Safety, 1991
31. Tiara, E.D. (Ed). Assessing the Driving Ability of the Elderly. NY, NY: Hayworth Press, 1989
32. McPherson, K., Michael, J., Ostrow, A. & Saffron, P. Physical Fitness and the Aging Driver: Phase I. Washington, D.C., AAA Foundation For Traffic Safety, 1988
33. McPherson, K., Michael, J., Ostrow, A. & Saffron, P. Physical Fitness and the Aging Driver: Phase II. Washington, D.C., AAA Foundation For Traffic Safety, 1989

34. Rothe, J.P. The Safety of Elderly Drivers: Yesterday's Young in Today's Traffic. New Brunswick, NJ: Transaction Press, 1990
35. Evans, L. Older Driver Involvement In Fatal and Severe Traffic Crashes. Jo. of Gerontology. 1988;43:S186-193
36. Retchin, S.M., Cox, J., Fox, M., Irwin, L. Performance-based measurements among elderly drivers and nondrivers. Jo Amer Ger Soc. 1988;36;813-819
37. McKnight, A.J. & Stewart, M.A. Development of a Competency Based Driver License Testing System. Landover, MD: National Public Services Institute, 1990
38. Laux, L.F., & Brelsford, J., Jr. Age-related Changes in Sensory, Cognitive, Psychomotor, and Physical Functioning and Driving Performance in Drivers Aged 40 to 92. Washington, D.C., AAA Foundation For Traffic Safety, 1990
39. Malfetti, J.L. & Winter, D.J. A Graded License for Special Older Drivers: Premise and Guidelines. Washington, D.C., AAA Foundation For Traffic Safety, 1989
40. Owsley, C., Ball, K., Sloane, M.E., Roenker, D.L., Bruni, J.R. Visual/Cognitive Correlates of Vehicle Accidents In Older Drivers. Psychology and Aging. 1990
41. National Highway Traffic Safety Administration. The National Highway Traffic Safety Administration's Traffic Safety Plan For Older Persons. (DOT Rpt# HS 807-316). Washington, D.C. Department of Transportation, 1988
42. National Highway Traffic Safety Administration. Older Drivers: The Age Factor In Traffic Safety. (DOT Rpt# HS 807-402). Washington, D.C. Department of Transportation, 1989a
43. National Highway Traffic Safety Administration. Conference on Research and Development Needed To Improve Safety and Mobility Of Older Drivers. (DOT Rpt# HS 807-554). Washington, D.C. Department of Transportation, 1989b
44. Transportation Research Board. Transportation in an Aging Society: Volume 1. Washington, D.C.: National Research Council, 1988
45. Bard, C., Fluery, M., & Hay, L. (Eds). Eye Hand Coordination Across The Life Span. Columbia, SC: U of South Carolina Press, 1990
46. Woollacott, M.H, Shumway-Cook, A. (Eds). Posture and Gait Across The Life Span. Columbia, SC: U of South Carolina Press, 1989
47. Birren, J.E., & Schaie, K.W. (Eds). Handbook of The Psychology of Aging. (3rd Edition). San Diego, CA: Academic Press, 1990
48. Binstock, R.H. & George, L.K. (Eds). Handbook of Aging and The Social Sciences. (3rd Edition). San Diego, CA: Academic Press, 1990
49. Schneider, E.L. & Rowe, J.W. (Eds). Handbook of the Biology of Aging. (3rd Edition). San Diego, CA: Academic Press, 1990
50. Birren, J.E., & Schaie, K.W. (Eds). Handbook of The Psychology of Aging. (2nd Edition). NY, NY: Van Nostrand Reinhold, 1985
51. Salthouse, T.A. Theoretical Perspectives on Cognitive Aging. Hillsdale, NJ: Lawrence Erlbaum, 1991
52. Schaie, K.W., Blaxer, D, House, J.S. (Eds). Aging, Health Behaviors, and Health Outcomes. Hillsdale, NJ: Lawrence Erlbaum, 1992

53. Romanowicz, R.A, Gervers, M.A. Teen and Senior Drivers. (CAL-DMV-RSS-90-126).  
Sacramento, CA: Department of Motor Vehicles, 1990

#### RESOURCE AGENCIES

AAA Foundation For Traffic Safety  
Mr. Sam Yaksich, Jr., Executive Director  
1730 M Street, NW, Suite 401  
Washington, D.C. 20036

(202) 775-1456

(also local AAA clubs)

AARP Andrus Foundation  
or  
AARP 55 Alive Mature Driving Program  
601 E Street, NW  
Washington, DC 20049

(also local AARP clubs)

APPENDIX I:  
STATISTICAL ANALYSIS AS  
SUPPORTING DOCUMENTATION

**APPENDIX I**  
**Statistical Analysis Supporting Documentation**

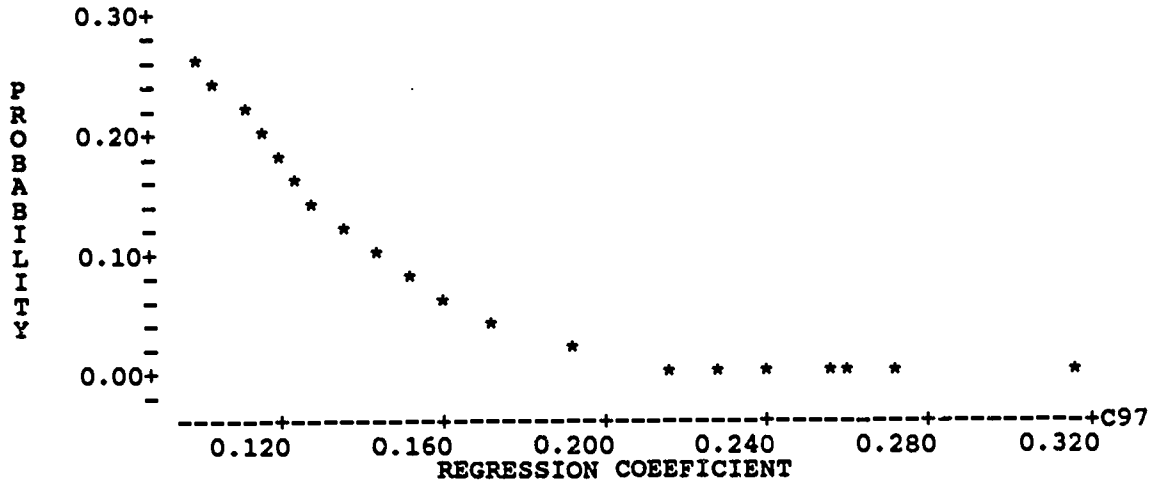

N=131  
P=.00 r=.292; P=.01 r=.211; P=.05 r=.171; P=.10 r=.144; P=.25 r=.101

Figure I.1. Probability Levels for Regression Coefficient

Each dot represents 5 cases.

N=211  
Missing=4

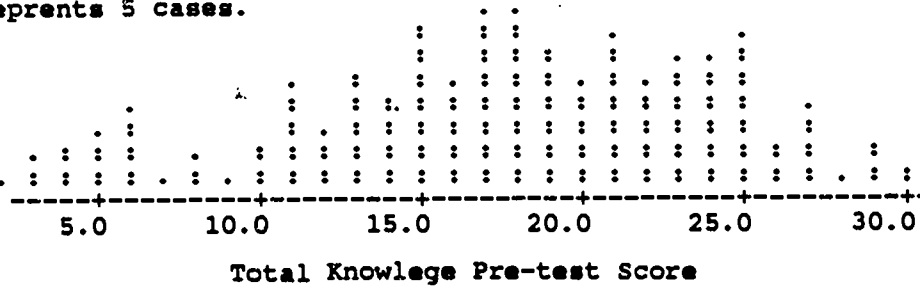

Figure I.2. Distribution of Pre-test Knowledge Scores

Each dot represents 5 cases.

N=176  
Missing=38

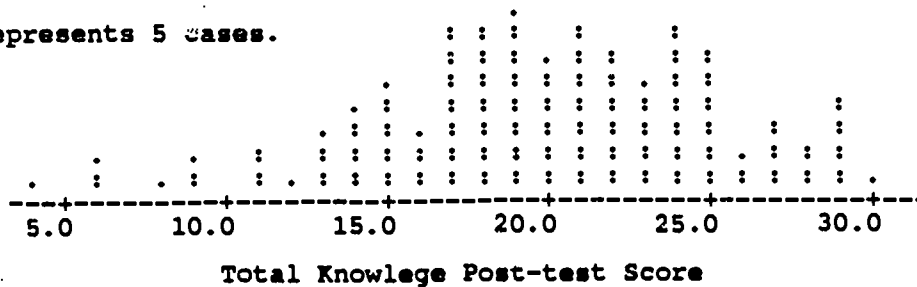

Figure I.3. Distribution of Post-test Knowledge Scores

Each dot represents 5 cases.

N=175  
Missing=39

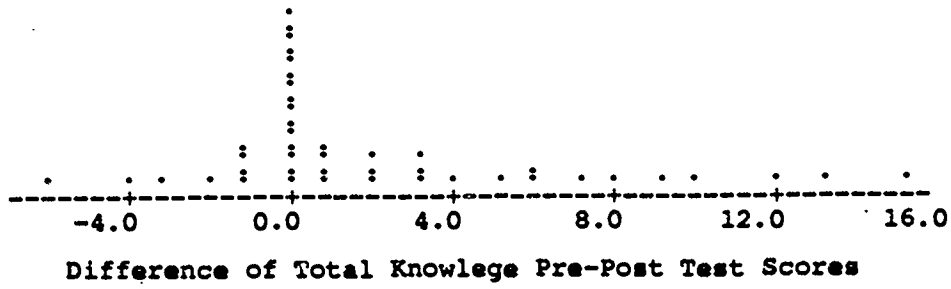

Figure I.4. Distribution of Difference Pre-Post Test Knowledge Scores