

## DOCUMENT RESUME

ED 369 974

CE 066 451

TITLE Wisconsin Workplace Partnership Training Program (National Workplace Literacy Program). June 1, 1992-December 31, 1993. Final Report.

INSTITUTION Wisconsin State Board of Vocational, Technical and Adult Education, Madison. Wisconsin Technical Coll. System.; Wisconsin Univ., Madison. Center on Education and Work.

SPONS AGENCY Office of Vocational and Adult Education (ED), Washington, DC. National Workplace Literacy Program.

PUB DATE 31 Dec 93

CONTRACT V198A20242

NOTE 517p.; For related documents, see ED 334 442-443, ED 361 535, ED 367 899-900, and CE 066 452-454.

PUB TYPE Guides - Non-Classroom Use (055) -- Reports - Evaluative/Feasibility (142) -- Tests/Evaluation Instruments (160)

EDFS PRICE MF02/PC21 Plus Postage.

DESCRIPTORS Adult Basic Education; Basic Skills; Behavioral Objectives; \*Content Area Reading; Learning Activities; \*Literacy Education; Metric System; Numeracy; \*Partnerships in Education; \*Peer Teaching; Program Effectiveness; School Business Relationship; Skill Development; Speed Reading; \*Statewide Planning; Technical Institutes; Technical Writing; Two Year Colleges; Unions; Vocabulary Development; Workshops

IDENTIFIERS \*Wisconsin; \*Workplace Literacy

## ABSTRACT

The Wisconsin Workplace Partnership Training Program involved the state's technical college system board, state chapter of the AFL-CIO, Wisconsin Manufacturers and Commerce, and Madison Center on Education and Work. The state-level education-labor-management partnership was mirrored at the local level in 28 worksite education centers. Instruction was offered in large (over 2,000 employees) and small (fewer than 100 employees) companies in the manufacturing, health care, service, and publishing industries. The partnership model on which the project was based featured open-entry/open-exit worksite educational programs, trained peer advisors to orient and encourage employees, and qualified instructional staff committed to teaching job-specific workplace basic skills curricula. In 1992-93, nearly 19,000 teaching hours of basic skills instruction was provided to 2,801 workers with a mean age of 37.5 years. Among the participants, 871 demonstrated improved test scores in basic skill areas and 496 showed improved communications skills. (Included in this package are the following: final project report; outside evaluation report; peer advisor handbook; peer advisor training activities; instructional materials for use in workshops on the metric system, battery construction, technical writing, math skills for auto repairers, speedreading, and workplace vocabulary; and 11 practice tests for city employment entrance examinations.) (MN)

ED 369 974

**WISCONSIN BOARD OF VOCATIONAL,  
TECHNICAL AND ADULT EDUCATION**  
310 Price Place, P. O. Box 7874  
Madison, Wisconsin 53707

WISCONSIN WORKPLACE PARTNERSHIP  
TRAINING PROGRAM  
V198A20242

June 1, 1992 - December 31, 1993

FINAL REPORT  
Narrative & Statistical

U.S. DEPARTMENT OF EDUCATION  
Office of Educational Research and Improvement  
EDUCATIONAL RESOURCES INFORMATION  
CENTER (ERIC)

- This document has been reproduced as received from the person or organization originating it.
- Minor changes have been made to improve reproduction quality.
- Points of view or opinions stated in this document do not necessarily represent official OERI position or policy.

BEST COPY AVAILABLE

**WISCONSIN WORKPLACE PARTNERSHIP TRAINING PROGRAM**  
**(National Workplace Literacy Program)**  
**June 1, 1992 - December 31, 1993**  
**V198A20242**

## **FINAL NARRATIVE REPORT**

### **Introduction**

This report covers the fourth consecutive discretionary grant from the United States Department of Education to the Wisconsin Technical College System Board as grant manager for the Wisconsin Workplace Partnership Training Program (WWPTP). The state-level partners were:

- Wisconsin Technical College System Board
- Wisconsin State AFL-CIO
- Wisconsin Manufacturers and Commerce
- University of Wisconsin-Madison Center on Education and Work (CEW)

This education/labor/management partnership was mirrored at the local level in the 28 worksite education centers. Ten of the 28 sites were non-union, and participating companies varied in size from under 100 to over 2,000 employees. Instruction was offered at manufacturing, health care, service and publishing industries. Local partners and locations included:

**Banta Company (Menasha)** Graphic Communications International Union  
Locals 77P & 531, Banta Maintenance Department Employees Union, Fox  
Valley Technical College

**City of Madison (Madison-2 Sites)** AFSCME Local 60, LIUNA Local 236,  
Madison Area Technical College

**Cray Research, Inc. (Chippewa Falls-2 Sites)** Chippewa Valley Technical  
College

**Curtitton, Inc./Royal Basket Trucks, Inc. (Darien)** Gateway Technical College

**Delco Electronics (Oak Creek)** United Auto Workers Local 438, Milwaukee  
Area Technical College

Goodyear Tire & Rubber Company (**Sun Prairie**) United Rubber Workers  
Local 904, Madison Area Technical College

Johnson Controls, Inc. (**Milwaukee-2 Sites**) Allied Industrial Workers Local  
322, International Association of Machinists & Aerospace Workers District 10,  
Milwaukee Area Technical College

Land O Lakes (**Spencer**) Teamsters Local 662, Northcentral Technical College

Lear Seating Corp. (**Janesville**) United Auto Workers Local 95, Blackhawk  
Technical College

Milwaukee County (**Milwaukee-2 Sites**) AFSCME District Council 48,  
Milwaukee Area Technical College

Monterey Mills (**Janesville**) Amalgamated Clothing and Textile Workers Local  
777, Blackhawk Technical College

Norlen, Inc. (**Schofield**) Northcentral Technical College

Northside Milwaukee Small Businesses Associated with the Milwaukee  
Enterprise Center (**Milwaukee**) HIRE Center, Milwaukee Area Technical  
College

Ore-Ida Foods, Inc. (**Plover**) Mid-State Technical College

Phillips Plastics Corp. (**Medford**) Northcentral Technical College

Schreiber Foods, Inc. (**Green Bay**) Drivers, Warehouse & Dairy Employees  
Local 75, Northeast Wisconsin Technical College

Serigraph, Inc. (**West Bend**) Moraine Park Technical College

Snap-On Tools Corp. (**Kenosha**) International Association of Machinists &  
Aerospace Workers Local 34; Metal Polishers, Buffers, Platers and Allied  
Workers International Local 45; Boilermakers, Iron Ship Builders, Blacksmiths,  
Forgers and Helpers Local 1652; Gateway Technical College



Southside Milwaukee Small Businesses (Milwaukee) HIRE Center, Milwaukee Area Technical College

Tecumseh Products (New Holstein) International Association of Machinists & Aerospace Workers Lodge 1259, Moraine Park Technical College

Valley Cast, Inc. (Appleton) United Paperworkers Local 995, Fox Valley Technical College

Waukesha Engine Division (Waukesha) International Association of Machinists & Aerospace Workers Local 1377, Waukesha County Technical College

Waukesha Memorial Hospital, Inc. (Waukesha) Waukesha County Technical College

Waukesha Hotels (Waukesha-3 Hotels) Waukesha County Technical College

In an effort to support *America 2000: The President's Educational Strategy*, the project emphasized:

1. The development and delivery of workplace-specific instruction
2. The development of workplace assessment and evaluation processes and strategies
3. The planning and delivery of staff development activities
4. The dissemination of strategies, data and products developed

As in the three prior grants, the project was based on a partnership model and included the following components, which experience has shown must be present in an effective workplace education program:

1. A strong commitment to the educational learning center by all partners, which will foster a noncompetitive, nonthreatening, supportive atmosphere conducive to lifelong learning.
2. The availability of an open-entry/open exit educational program at the worksite featuring hours of instruction convenient to all shifts.

3. Trained peer advisors to orient employees to the program, encourage program participation, assist in eliminating any barriers to participation and serve as program advocates and reliable sources of information.
4. Qualified instructional staff committed to teaching job-specific workplace basic skills curricula and the maintenance of confidential participant assessment, enrollment and progress records.

This model was customized as necessary to most effectively serve each worksite.

### Outcomes

The project proposed to provide workplace-specific basic skills instruction to 2,801 workers. This goal was exceeded by 13 per cent, with 3,170 employees receiving instructional services. Almost 19,000 teaching hours were provided at the sites, with an average of 16.5 hours of instruction available per week at each center. Instruction available per week varied from less than 10 hours at some of the smaller businesses to over 30 at the larger companies. The mean age of participants was 37.5 years, and each participant spent an average of 2.7 hours per week in a learning center. Personal goals identified at entry were achieved by 2,236 employees.

The number of persons testing higher in one or more of the basic skill areas was 871, with 496 showing improvement in communication skills. These figures are more significant by virtue of the fact that workplace education centers are not intended to provide general reading and/or math skill improvement measurable by standardized achievement tests. Workers generally sought help in areas such as math for blueprint reading, math for statistical process control or in the reading of certain job-specific technical manuals. Educational progress was unique to the student and the site. Measures of progress have not thus far been standardized for the worksite.

Other specific outcomes of the project were:

- 3,660 employees were assessed for basic skills levels
- 1,253 were referred to further educational opportunities
- 493 peer advisors were trained
- 76 job classifications were analyzed for necessary basic skills levels

- 224 received English as a Second Language instruction
- 14 completed a high school completion program
- 54 completed one or more parts of the HSED/GED examination
- 109 enrolled in further educational programs

Demographic data showed:

<u>Age</u>	<u>Race</u>	<u>Sex</u>
7% 16-24	70% White	41% Male
52% 25-44	13% Black	59% Female
28% 45-59	6% Hispanic	
2% Over 60	1% Asian/Pacific Islander	
11% Unknown	1% Am. Indian/Alaskan	
	9% Other/Unknown	

Promotional efforts conducted at the individual worksite education centers included open houses, raffles, posters, handouts, flyers, name the learning center/logo design contests, company/learning center newsletters and local newspaper articles. Among the more noteworthy names created for the local learning centers were Personal Achievement Center, Banta Employee Skills and Training (BEST) Center and Learning Is For Everyone (LIFE) Center. The Goodyear Tire and Rubber Company instructor instituted a travelling learning center, in the form of a cart loaded with learning and promotional materials, which visited employee break areas and proved to be highly effective in recruiting new participants to the program. Students at that site informed the instructor that self-esteem, feelings of accomplishment and the ability to train more easily were prime examples of success which were not measurable by any assessment method.

Perhaps the most meaningful project outcome occurred at the Phillips Plastics Corporation's facility in Medford, Wisconsin. Phillips piloted its first workplace education center at the Medford plant due to its low profitability and production rates. After 18 months of learning center operation, the Medford facility became the most productive and profitable plant among the 11 Phillips Plastics operations around the state. This dramatic turnaround has led Phillips to request learning centers at four additional plants.

Following is a list of the original program objectives with the resulting outcomes. For further discussion of the objectives and outcomes, please refer to the outside evaluation of the project.

1. To provide on-site basic skills instruction at 18 continuation sites and 10 replication sites to meet the base-line competencies needed to retrain 2,801 employees for specific job classifications.

Open-entry/exit individualized and group instruction directly related to the workplace were provided at 28 sites in the areas of reading, writing, computation, communication, problem solving, study skills and other basic skills areas. Individualized education plans were developed for each student, and 3,170 participants received instruction.

2. To provide Vocational English-as-a-Second Language (VESL) instruction at 10 continuation and seven replication sites to assist 180 employees to maintain and/or upgrade employment.

VESL instruction was provided to 224 participants at nine sites. Both individualized and group instruction were offered in the areas of reading, writing, listening, speaking and other basic skills areas.

3. To afford an opportunity for 25 workers to receive a GED or participate in other educational activities which will lead to an adult secondary education diploma or assist the employees in entering occupational training programs.

Fourteen participants completed a high school completion program, and 54 passed one or more parts of the HSED/GED exam. One hundred and nine participants enrolled in other educational programs.

4. To enhance the services provided by the WWPTP through the continued cooperation and active commitment of the local technical colleges, employers and the unions or employee representatives (where the workforce is not unionized).

The partnership concept was effective in the state partners group (labor, management, and education) and in local site steering committees comprised of workers, management and educators. These groups had direct input into the operation of the learning centers and helped to guide

curriculum development, job analyses and other program improvement processes.

5. To provide initial and developmental peer advisor training to 536 union, employee and management representatives.

Four hundred and ninety three employees were trained as peer advisors to orient employees to the program, encourage program participation and serve as program advocates and reliable sources of project information. Initial peer advisor training was accomplished during 2-3 hour workshops, with follow-up training as necessary. Peer advisors then served on learning center steering committees, provided program recruitment and promotion, and helped fellow employees with any questions regarding the program. A typical peer advisor training agenda included the following:

- I. Welcome to Training
  - A. Introductions of Presenters
  - B. Purpose of Training
- II. Workplace Partnership Training Programs: An Overview
- III. Program Structure
  - A. Elements of a Workplace Partnership Training Program
  - B. A Peer Advisor is ---
  - C. A Peer Advisor does ---
- IV. New Student Sign-up/Assessment
  - Registration Form
  - Goal Sheet
  - Time Card
  - WRAT Assessment
  - Carver Reading Progress Scale
- V. Program Services Overview
  - A. Instruction
  - B. Educational Offerings
  - C. Location, Times, Equipment, Materials
  - D. The Top Ten (Most Asked Questions)
  - E. Questions/Concerns

6. To analyze the basic skills competencies required for effective employee performance in 235 targeted job classifications.

Seventy-six job classifications were analyzed for required basic skills competencies using the Workplace Educational Skills Analysis (WESA) process developed under a prior grant. Some companies were not interested or objected to the amount of employee time required to complete the process, many instructors did not have enough time to do the analyses, and overtime work schedules, lay-offs and just-in-time production schedules at several companies simply would not accommodate the procedure. Job classifications analyzed included:

Accounting Manager	Accounts Payable
Assembler	Carding Set-Up/Operator
Coating Operator	Cooker
Delkor Operator	Driver - Shipping
Electrician III	Engineering Technician II - Design
Final Hose Preparation	Finisher Operator
Inspector	Line Operator
Machine Operator	Maintenance Supervisor
Maintenance Worker	Oiler - Maintenance
Personnel Assistant	Picking Operator
Pollution Control Technician	Preshear Operator
Production Lead Worker	Production Worker
Productions	Public Works Lead Worker - Parks
Quality Control Technician	Set-Up
Spiral Line Technician	Street Machine Operator 2 & 3
Traffic Manager - Shipping	

Completed WESAs are on file at the State Literacy Resource Network and available for guidance or actual use at other workplace education sites.

7. To conduct initial assessments of the basic skill competencies of 3,693 workers and to conduct follow-up assessments as needed.

Both standardized and site specific instruments were used to assess the basic skills competencies of 3,660 employees. These instruments and others were compiled into the publication *Alternative Assessment*

*Methodologies for Workplace Education Programs* by the University of Wisconsin-Madison Center on Education and Work.

- 8,9. Orientation and career advising services goals were deleted as they were broad based promotional activities.
10. To provide comprehensive management and evaluation which ensures that program objectives are being met in an effective and timely manner.

Site visits as well as monthly and semi-annual reports were employed to monitor program progress and effectiveness. Detailed program results are shown in the statistical report.

11. To provide more efficient literacy services to small businesses by creating partnership models which include the Chamber of Commerce offices along with education and labor representatives.

Small businesses served under this grant included small business incubators in north and south Milwaukee. Each housed a learning center which served a large number of very small businesses. The Royal Basket/Curtition site hosted employees from two neighboring businesses at one location. The primary hindrances to education centers at small businesses appear to be limited space, limited matching funds, and work schedules which will not allow instruction during work hours. Offering instruction at a central location to groups of small businesses has been effective and will be explored further in future projects.

12. To develop coordination methodologies which link program activities and the JTPA and JOBS clients who have been recently placed in jobs and who need continuing services for job retention.

This objective was intended to be accomplished at a site proposed by the Wausau Chamber of Commerce. During the period between the grant application and actual start-up, the Chamber lost its client base and the learning center was not initiated.



13. To plan and deliver a series of professional development and networking activities with and for workplace education personnel.

Personnel from all aspects of the project were in-serviced on a regular basis. Local technical college districts held in-services for their local partners, and two statewide meetings of state and local partners provided networking and professional development opportunities. The statewide meetings allowed the local partners to offer direct input and recommendations to their state counterparts. Representatives of all three partner groups (labor, education and management) were able to meet in homogeneous and heterogeneous groups to discuss and compare education center procedures. One statewide Workplace Educational Skills Analysis (WESA) training workshop was conducted for all available local partners. (See appendix for agendas and proceedings.)

14. To determine the effectiveness and efficiency of the WESA methodology developed and implemented under previous National Workplace Literacy programs.

The CEW gathered input from WESA users and from a panel of experts on the WESA Guide. Using teleconferences, a local partner survey and meetings of the WESA development committee, the CEW analyzed the effectiveness and efficiency of the existing methodology and produced a draft WESA Training Guide Supplement, with the final version to follow after formatting changes. The statewide WESA training workshop afforded another opportunity to assess existing WESA methodology.

15. To review and evaluate alternative methods of student assessment and develop a guide to developing competency-based participant assessment systems.

The CEW reviewed and evaluated assessment methods and produced a five-part evaluation tools document, *Alternative Assessment Methodologies for Workplace Education Programs*, compiled of assessment instruments from participants statewide and elsewhere.



16. To develop and test site-specific strategies to efficiently and effectively replicate workplace education centers at multiple sites within a corporation.

This goal was deleted during the negotiation process. However, multiple learning centers were operated and proved highly effective at Johnson Controls, Cray Research, Inc., Milwaukee County and the City of Madison.

17. To develop a process which more effectively evaluates program effectiveness.

The CEW produced two checklists for program evaluation and design:

- *Workplace Education Design Checklist: A Tool for Program Planning*
- *Workplace Education Evaluation Checklist: A Tool for Assessing and Improving Performance*

## Products

The following products were developed during this grant:

- *Workplace Education Evaluation Checklist: A Tool for Assessing and Improving Performance*
- *Workplace Education Design Checklist: A Tool for Program Planning*
- *Alternative Assessment Methodologies for Workplace Education Programs*
- *Workplace Educational Skills Analysis (WESA) Training Guide Supplement*
- *Workplace-specific curricula in Metric System, Battery Construction, Battery Assembly Process, Math Refresher, Writing Workshop and the Adult Learner, Speedreading, Vocabulary for the Workplace, Technical Writing Workshop Outline, Short Assessments (Spelling, Fractions, Percents, Decimals, Metrics) and Practice Tests for City Government Employment Entrance Exams. A Peer Advisor Training Activities Outline and a Peer Advisor Handbook were also produced.*

Local programs have been provided with copies of these products, and all are on file at the Wisconsin Literacy Resource Network.

# APPENDIX

**WISCONSIN WORKPLACE PARTNERSHIP TRAINING PROGRAM**  
**Statewide Partners Meeting**

The Concourse Hotel  
Madison  
December 8, 1992

**AGENDA**

**DIPLOMAT ROOMS (Blair, Fairchild, Gorham)**

9:15 AM Registration, Coffee & Rolls

9:45 Welcome & Overview  
Tom Grinde, WBVTAE  
Geoff Upperton, Wisconsin AFL-CIO

**Presentation by Ken Mericle, Director, UW-Madison School for Workers**

10:00 What is a Labor Agreement?

Typical content, provisions relating to education and training (job descriptions, pay levels, posting/bidding, selection, transfers, lay-offs, etc.), grievance procedures

11:00 What is Job Control Unionism?

Taylorism, unionism and the old theory of manufacturing

NOON Lunch in State Room

1:15 PM The New Manufacturing Environment

- Changing concepts of productivity, quality, technology and employee involvement
- New jobs and new skills

2:45 Break

3:00 New Manufacturing Theory: The Challenge to Labor Agreements  
and Trade Unions

Workplace training, new work organization,  
seniority, new pay systems

4:30 Adjourn

**WISCONSIN WORKPLACE PARTNERSHIP TRAINING PROGRAM**  
**Statewide Partners Meeting**

The Concourse Hotel  
Madison  
December 9, 1992

**AGENDA**

**DIPLOMAT ROOMS (Blair, Fairchild, Gorham)**

- 8:00 AM Registration, Coffee & Rolls
- 8:30 Some Legal Considerations in Workplace Education (See Separate Agenda)  
Robert Gregg, Attorney at Law

Mr. Gregg, of the Madison firm Tomlinson, Gillman & Ridders, has been professionally engaged in personnel and Equal Rights work for 20 years. He has conducted over 1,000 seminars for a variety of organizations in Wisconsin, and the majority of his work involves consulting to develop internal programs and resolve employment problems before they generate legal action. Prior to entering private practice, Mr. Gregg drafted a number of state laws affecting employment and the legal rights of employees.

- 10:00 Break
- 10:15 Legal Considerations (Continued)
- NOON Lunch in State Room
- 1:15 PM UW-Madison Center on Education and Work Update  
WESA, Local Evaluation/Assessment  
L. Allen Phelps, Director  
Donna Manly
- 2:15 Outside Evaluation Update  
Howard Lee, UW-Stout
- 2:45 Break
- 3:00 State AFL-CIO Update  
Geoff Upperton  
Phil Neuenfeldt, AFL-CIO Labor Liaisons
- 3:45 State Board of VTAE Update  
Tom Grinde
- 4:00 Questions/Adjourn

## LEGAL CONSIDERATIONS IN WORKPLACE EDUCATION

### AGENDA

- I. INTRODUCTION - Overview of Topics
  1. Confidentiality of Tests and Records
  2. Employment Tests
  3. Personality Tests
  4. Americans With Disabilities Act
  5. Use of Training Records for Other Purposes
  
- II. LEGAL OVERVIEW
  1. Family Education and Privacy Rights Act
  2. Fair Employment Acts
  3. Americans With Disabilities Act
  4. 42 U.S. Code §§1981 and 1983
  5. Civil Suits
  
- III. CONFIDENTIALITY

Rules on Disclosure
  
- IV. EMPLOYMENT TESTS
  1. What is a "Test"?
  2. Validity
  3. Personality Tests
  
- V. AMERICANS WITH DISABILITIES ACT
  1. Reasonable Accommodation
  2. Accessibility in Workforce Education
  
- VI. TRAINING RECORDS
  1. Authorized Release and Use
  2. Documentary Defamation

**WESA TRAINING**  
**April 6-7, 1993**  
**Concourse Hotel, Madison**

**DAY ONE:**      Workplace Educational Skills Analysis

- 9:00 - 9:15 AM    Introduction & Overview
- 9:15 - 9:30        Why WESA?
- 9:30 - 9:40        The Six Stage Process of WESA
- 9:40 - 10:00      The Design Meeting (Stage 1)  
                          Reason, Rationale and Recommendations
- 10:00 - 10:30     Establishing the Design Meeting with Labor, Management and  
                          Education (Groups A, B and C)
- 10:30 - 10:45     Design Meeting Report Out (Five Minutes Each Group)
- 10:45 - 11:00     Interview Preparation/Material Review (Stage 2)
- 11:00 - 11:45     Material Review (Group A/Job 1, Group B/Job 2, Group C/Job 3)
- 11:45 - NOON      Report Out (Groups A, B and C)
- NOON - 1:00 PM   LUNCH
- 1:00 - 1:15        Interviews and Observations (Stage 3)

		JOB 1	JOB 2	JOB 3
1:15 - 1:35	Interview (Live)	A1	B1	C1
1:15 - 1:35	Observation (Video/Live)	A2	B2	C2
1:35 - 1:55	Interview (Live)	A2	B2	C2
1:35 - 1:55	Observation (Video/Live)	A1	B1	C1

- 1:55 - 2:15 Discussion and Recommendations on Process
- 2:15 - 2:30 Data Analysis (Stage 4)  
Part One: Preparing for the Detailed WESA Report
- Two Part Statements
  - Frequency and Criticality
  - Readability
  - Bloom's Taxonomy
  - Vocabulary/Dictionary
- 2:30 - 2:45 BREAK
- 2:45 - 3:05 Detailed Data Analysis: Reading, Writing, Speaking, Listening, Teamwork, Mathematics and Problem Solving, Vocabulary/Dictionary and Frequency and Criticality (Subgroups A1, A2, B1, B2, C1, C2)
- 3:05 - 3:15 Data Analysis  
Part Two: Preparing for the Summary WESA Report
- Job Title or Goal
  - Summary of Job-Related Basic Skills
  - Tools, Equipment, Machinery and Work Aids
  - Career Ladder Information
  - Job Duties Summary
- 3:15 - 3:45 Summary WESA Report: Job Title/Goal; Job Duties Summary; Summary of Job-Related Basic Skills; Readability; Tools, Equipment, Machinery and Work Aids; Career Ladder Information (Subgroups A1, A2, B1, B2, C1, C2)
- 3:45 - 4:15 *DRAFT* Summary WESA Report and *DRAFT* Detailed WESA Report to Large Group (Material Ready for Duplication)
- 4:15 - 4:30 Day One Evaluation

**DAY TWO: Completing the WESA and Applying WESA to Curriculum Development and Assessment**

- 8:00 - 8:15 AM Response to Day One Concerns
- 8:15 - 8:30 Clarification Team Meeting (Stage 5)
- 8:30 - 9:00 Clarification Teams Using Day One WESA Material (Subgroups A1, A2, B1, B2, C1, C2)
- 9:00 - 9:15 Report Out on Clarification Team Meetings
- 9:15 - 9:30 Final Report (Stage 6)
- 9:30 - 9:45 BREAK
- 9:45 - 10:15 Framework for Curriculum Development
- 10:15 - 11:00 Developing a WESA Curriculum

	Job 1/A1	Job 1/A2	Job 2/B1	Job 2/B2	Job 3/C1	Job 3/C2
	Occupational	Basic Skill	Occupational	Basic Skill	Occupational	Basic Skill
3 Goals						
1 Cognitive 1 Psycho-motor						

- 11:00 - NOON WESA Curriculum Report Out
  - Occupational Goals Across Jobs 1, 2 and 3
  - Cognitive/Psychomotor Objectives Across Jobs
  - Job-Related Basic Skill Goals Across Jobs 1, 2 and 3
  - Cognitive/Psychomotor Objectives Across Jobs

**NOON - 1:00 PM LUNCH**

- 1:00 - 1:30 Overview of Assessment Methods: Standardized and Criterion-Referenced
- 1:30 - 1:45 Standardized Test Identification and Verification for WESA and/or WESA Curriculum Objectives
- 1:45 - 2:00 Report Out on Assessment Selection
- 2:00 - 2:15 Criterion-Referenced Test Item Development -- A Method
- 2:15 - 2:45 Report Out by Subgroup
- 2:45 - 3:00 Wrap-up and Evaluation



**WISCONSIN WORKPLACE PARTNERSHIP TRAINING PROGRAM**  
**Statewide Partners Meeting**

The Holiday Inn  
Wisconsin Dells  
December 8, 1993

**AGENDA**

- 8:30 AM Registration, Coffee & Rolls
- 9:00 Welcome & Overview (Holidome)
- Representatives from WBVTAE, Wisconsin AFL-CIO, Wisconsin Manufacturers & Commerce and UW-Madison, Center on Education & Work
- 9:15 Focus Groups
- Groups discuss successful aspects of Workplace Education Centers and areas of program that could have been improved
- 10:15 Focus Groups Report
- 10:45 Break
- 11:00 Labor/Education/Management Focus Groups Discuss Two Issues  
(Labor-Crandall Room, Management-Bennett Room, Education-Holidome)
1. What goals should the Workplace Education Program try to achieve in the future?
  2. What resources are needed to achieve these goals?
- NOON Lunch (Holidome)
- 1:00 PM Focus Groups Continue in Crandall, Bennett and Holidome  
(Prioritize Findings/Recommendations)
- 2:00 Break (Holidome)
- 2:15 Focus Groups Report
- 3:15 Wrap Up & Adjourn

# WISCONSIN WORKPLACE PARTNERSHIP TRAINING PROGRAM

## Proceedings Of The Statewide Partners Meeting

The Holiday Inn  
Wisconsin Dells  
December 8, 1993

### Focus Groups on Workplace Education Center Experiences

#### SUCSESSES

Strong partnerships are essential to any success. Weak partnerships will kill a learning center at any site.

Phillips Plastics has had excellent attendance. Computer-assisted instruction tracks student progress and uses actual job materials geared to the worksite. Phillips offers some paid time, open houses and rewards for recruiting and hours of attendance.

Successful sites have priorities and timetables set by a steering committee composed of all local partner groups. Education should be a prime component of the company's mission statement (Phillips Plastics). Strong company management support in word and action are critical to success. Develop a mission statement for each learning center to provide a clear vision of purpose and future.

All partners must be involved in clearly defined long range planning.

Sites with 24 hours/day learning center accessibility are appreciated by workforce. Any increased flexibility in center hours or service is helpful. Laptop computers and modems for at-home work would be nice.

Employees/peer advisors used as instructors in certain areas have proved effective.

Post names of peer advisors on bulletin board or in some other prominent place so that people will know who to approach for help.

Instructors need to get out on the work floor. It will make them more effective and even aid in curriculum development. Be visible--meet employees on the floor and hand out learning center information during shift changes. Do this periodically.

Instructors should be creative and non-traditional. Use outside resources for mini-courses on retirement planning, stress management, money management, etc. Put

some essentials from the learning center on a cart, take it to a central site (lunch or break room, etc.) and have peer advisors staff it, helping employees during breaks.

Company newsletters can be an effective method of learning center support.

Incorporate personalized training with job-specific training. Example: General Motors curriculum includes SPC along with training to do well on apprentice test. Some companies task individual departments to learn specific subjects in the learning center.

One solution to "voluntary" vs "on-the-clock" company-required participation has been to require educational participation and write it into job descriptions (e.g., two hours per week of paid time in the education center). Seniority may no longer determine success, as promotions are based on test results.

One-on-one basic skills instruction is preferable to workers attending a "basic class" where they are visible to all and, in their view, admitting to a deficiency.

One instructor has developed a customized assessment from company materials (employee handbook, union contract, safety manual) and on WESAs. It measures "perceived importance" of job skills from the employee and supervisor points of view. The two responses are then compared.

## CONCERNS

How can people be encouraged to attend regularly? How do we recruit the people who have most need of the education center? How do we increase participation at a company with multiple sites served by one learning center? Generally, allowing workers to attend on paid time results in greater use of the center, but it was noted that students working for the GED were not motivated by pay. Paid time seems to legitimize the program in the eye of the employee. Overtime schedules will always cause a participation problem. Local partners should attempt to work around the problem, or at least warn the education center of heavy workload periods.

There has always been worker concern about how testing is used. Confidentiality will remain a primary concern. Trust must be established, and testing should not begin too soon. All local partners must be actively involved in curriculum development and in allaying fear of testing.

Breakdown of the education process occurs at supervisor level, even with management support. Without the active and enthusiastic support of management, the program will probably fail.

More training for peer advisors is needed. Peer advisors are the key to recruiting and identifying workers' needs. What is the best way to recruit and retain peer advisors? They have been and are the most important advocates of any workplace education program. Sites operating without peer advisors are less successful. The role of peer advisors (and instructors) needs to be clearly defined. Once identified, peer advisors need to be kept involved and busy. Should companies pay peer advisors for time spent in meetings?

The most successful sites are those with full-time staff. Sites offering 10 or less hours of instruction per week are not always effective. How can we serve small businesses who cannot use or afford a full-time center? Consider mobile units for small businesses.

We need a realistic definition of basic skills, and it should include use of the computer. Almost all participants request computer training, and many need it for their jobs. Other suggestions for basic skills definition: how to learn, self-directed learning, critical thinking, research and accessing information, team work, diversity and handling change. Look toward mid-level skill training (beyond basic skills). Define "training" versus "education".

Instructor training is needed in: learning disabilities, industrial terms, computers, adult learning styles and labor relations.

More WESAs need to be done. WESAs should be more timely and accurate and followed by *immediate* training. Much is lost with a lag between WESA and subsequent curriculum development and training. Train instructors to do WESAs.

Companies should have a training coordinator, preferably a neutral third party to determine needs of both company and employees. Develop a clearly defined relationship between instructor, peer advisors and training department to coordinate educational efforts. Employee and management needs and goals should be addressed up front.

Centers should offer some type of motivational training and/or seminars to improve employee perception of education and how it pertains to the job. Promote the importance of life long learning.

Always look forward and have a plan for the future. Develop an up-front plan for continuing the center after federal/state funding ends.

Develop a network for instructors to get resources and teaching materials. Use state resource center for staff development, sharing curricula and resources. Is statewide teacher training (orientation/training program and mentor system) a possibility? More statewide communication between instructors would be helpful.

Develop a "Return on Investment" checklist or evaluation to demonstrate the effectiveness of the center to the company.

Instruction needs to be tied closely to job skills. There is frequently a conflict between grant-stipulated subjects and company-perceived goals.

\*\*\*\*\*

### Focus Groups on Future Directions

#### LABOR

The overall goal is greater employee participation for a more educated workforce. A greater commitment from top management and union officers is necessary and would be shown by allowing supervisors and other lower to middle management to be involved with the education center. This would send a message to supervisors that the centers are important. Maintain strong, active partnerships.

Fund centers at adequate levels, especially when seeking the initial commitment. (*If you think education is expensive, try illiteracy.*)

Pay for participation, and possibly adopt a Pay for Knowledge program.

Allow spouses/other family members to use centers.

Use full-time instructors. Companies will buy into this idea by using the full-time instructor as a "Training Coordinator." The instructor/coordinator would work closely with the peer advisor group, steering committee and human resources coordinator to facilitate basic skills and work specific training.

Have instructor/coordinator utilize Instructional TV, especially for more technical training. Training overall needs to be more job specific, and a much broader definition of basic skills is necessary.

Redefine education. Emphasize life long learning as opposed to getting a degree. Consider a short, required class/seminar for all employees to instill a motivation for education.

Instructors should assist in promotion and curriculum development. Time should be built in for this purpose, especially prior to the start of instruction.

Smaller companies should be encouraged to participate in joint education efforts.

Resource needs: More funding, full-time instructors/coordinators, more computers and software (e.g., robotics, CNC, blueprint), more reference material, greater access for all (especially at companies with multiple locations) and increased on-going peer advisor training. Develop a peer advisor handbook.

Advertise the product (education). Create in people a sense of need or importance for using the product. Possible areas to highlight: Pay for Knowledge, chance for promotion, make your job easier, etc.

## MANAGEMENT

Incorporate the value of workplace training into the company mission, vision or goals. Inform/educate top management of the social and economic value of workplace education. Return-on-investment studies would help.

Personalize basic skills training to companies and make it more applicable to participants. Provide a forum for labor/management/education cooperation.

Educate the federal government on what is *really* needed in workplace education (such as computer training).

Conduct further studies on who continues after three years, who doesn't, and why. When companies continue after funding ends, the contract price of instructors is often prohibitive. Can technical colleges negotiate a lower rate?

## EDUCATION

Develop an evaluation which includes management, education and labor definitions of success.

Company should designate resources to reward life-long learning.

State resource center should be a source of curricula. Can learning centers ever be electronically connected to the state resource center?

What should be the direction for the learning center after basic skills are addressed? Define up-front what happens after the grant is over.

Curriculum should be written immediately after WESAs are conducted. Company should indicate what learning needs exist.

Strong partnership is mandatory. The relationship with the company training department must be clearly defined. Develop return-on-investment studies, better reporting of gains and improved "useful" data collection. Find ways to show management that the program is working.

A system of orientation for new instructors is needed, as well as initial and continuing training for all teachers. More diversity is needed in teacher hiring.

Redefine basic skills to include: computer skills, self-directed learning, critical thinking, diversity training.

Seek funding for modems/laptop computers for student home learning.

Develop mobile education center as a shared facility for small companies.

Learning centers need more computers and need to use the same software as the company uses.

A steering committee and strong peer advisors are essential. The steering committee should have control over its own budget for the learning center.

The mission/vision of the education center should be decided at the beginning. Decide if the goals are technical or basic skills training. Give the instructor time for marketing and meeting with workers on the floor.

Use the "Train the Trainer" concept. Use employees, peer advisors and retirees as instructors.

**WISCONSIN WORKPLACE PARTNERSHIP TRAINING PROGRAM**  
**(National Workplace Literacy Program)**  
**June 1, 1992 - December 31, 1993**  
**V198A20242**

**FINAL STATISTICAL REPORT**

This report reflects activities conducted during the entire grant period, including no-cost extension, from June 1, 1992, through December 31, 1993. A participant is defined as an individual receiving instruction through the program during the grant period.

**I. Grant Objectives Data**

Job Classifications Analyzed . . . . .	76
Peer Advisors Trained . . . . .	493
Participants Assessed . . . . .	3,660
Participants Receiving Instruction . . . . .	3,170
Participants Receiving ESL Instruction . . . . .	224
Participants <u>Referred</u> To A:	
VTAE High School Completion Program . . . . .	88
VTAE Occupational Training Program . . . . .	252
Employer Training Program . . . . .	500
College . . . . .	109
Other . . . . .	304
<b>Total . . . . .</b>	<b>1,253</b>

Participants Enrolled in Other Educational Programs: 109



## II. Participant Background Data

### Participant Race/Ethnicity:

American Indian/Alaskan Native . . . . .	32
Asian/Pacific Islander . . . . .	21
Black . . . . .	414
Hispanic . . . . .	201
White . . . . .	2,226
Unknown . . . . .	276
Total . . . . .	3,170

### Participant Sex:

Male . . . . .	1,226
Female . . . . .	1,797
Unknown . . . . .	147
Total . . . . .	3,170

### Participant Age:

Unknown . . . . .	346
16-24 . . . . .	219
25-44 . . . . .	1,658
45-59 . . . . .	881
60 And Older . . . . .	66
Total . . . . .	3,170
Mean Age Of Those Reported . . . . .	37.5

### Participant Employment At The Worksite:

Unknown . . . . .	899
0-5 Years . . . . .	669
6-10 Years . . . . .	642
11-15 Years . . . . .	500
16 Years And Over . . . . .	460
Total . . . . .	3,170

Participant Program Goals At Entry:

Improve Math Skills . . . . .	1,000
Transfer To A Different Job . . . . .	247
Improve Writing Skills . . . . .	758
Pass A Labor Grade Test . . . . .	89
Improve Reading Skills . . . . .	673
Do Current Job Better . . . . .	692
Improve Communication Skills . . . . .	825
Improve Self-Image . . . . .	697
Receive A Promotion . . . . .	432
Improve ESL . . . . .	174
Retain A Job . . . . .	293
GED . . . . .	229
CDL . . . . .	31
Computer Literacy* . . . . .	1,433
Other . . . . .	619

\*The term "Computer Literacy" is used in the sense of keyboard familiarization and general information at sites converting to computerized production methods.

Participant Referral Source:

Unknown . . . . .	251
Family Member . . . . .	64
Peer Advisor . . . . .	327
Publication . . . . .	607
Employer Referral . . . . .	896
Other Training Program . . . . .	78
Open House . . . . .	532
Other Participant . . . . .	379
Other . . . . .	384

Years of School Completed By Participants  
 Prior to Enrolling in Workplace Center:

Unknown . . . . .	649
0-8 . . . . .	83
9-12 . . . . .	1,386
Over 12 . . . . .	1,052
 Total . . . . .	 3,170

**III. Instructional Information**

Number of Weeks Training Provided: 5,467

Contact Hours Provided

(Number Of Teaching Hours Workers Receive): 18,825

Average Hours Of Instruction Available Per Week Per Center: 16.5

Average Time Each Participant Spends In Center Per Week: 2.7 Hours

**IV. Program Evaluation Information**

Participants Testing Higher on Basic Skills:

Math . . . . .	271
Reading . . . . .	141
Writing . . . . .	90
Verbal Communication . . . . .	47
ESL (Reading, Writing and Verbal Communication) . . . . .	109
Problem Solving . . . . .	213

Total Number Of Participants Testing Higher On Basic Skills: 871

Participants Showing Improvement In Communication Skills: 496

Participants Completing a High School Completion Program: 14

Participants Passing One Or More Parts (But Not All) Of The GED: 54

Total Number Of Employees Achieving  
One Or More Goals Identified At Entry: 2,236

**V. General Information**

Number of Employees Requesting:

Child Care: 36    Transportation: 15    Counseling: 121

# WISCONSIN WORKPLACE PARTNERSHIP TRAINING PROGRAM

June 1, 1992 - December 31, 1993

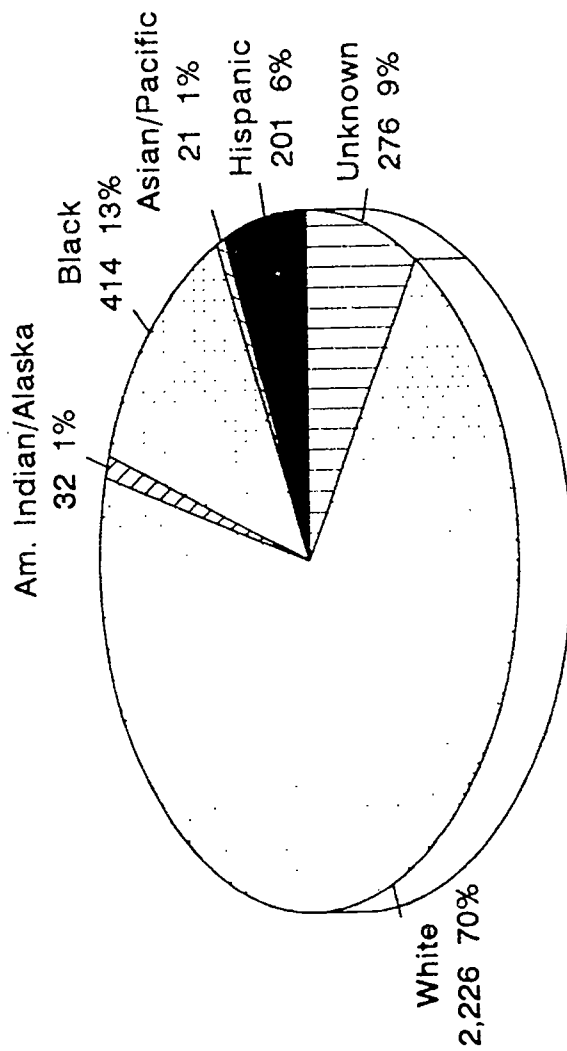

Race

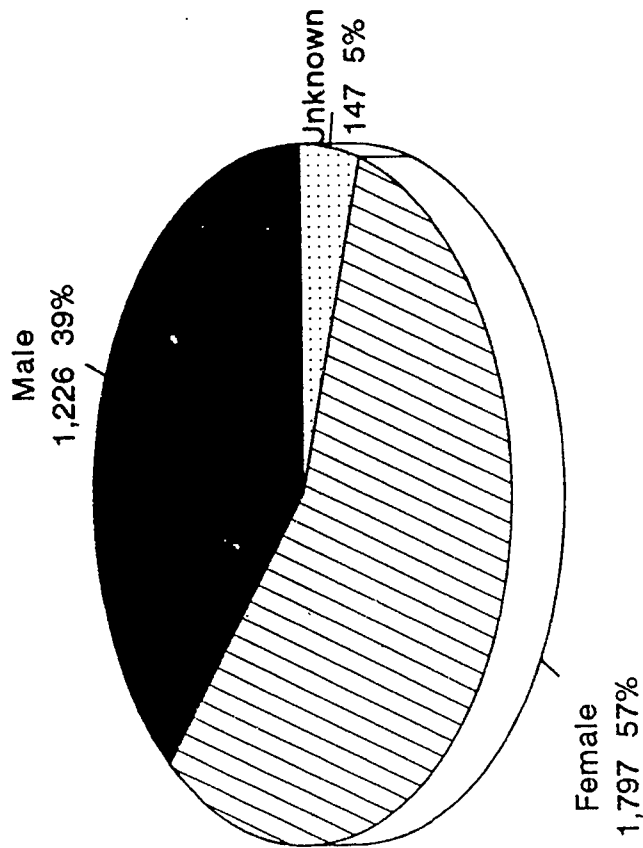

Sex

# WISCONSIN WORKPLACE PARTNERSHIP TRAINING PROGRAM

June 1, 1992 - December 31, 1993

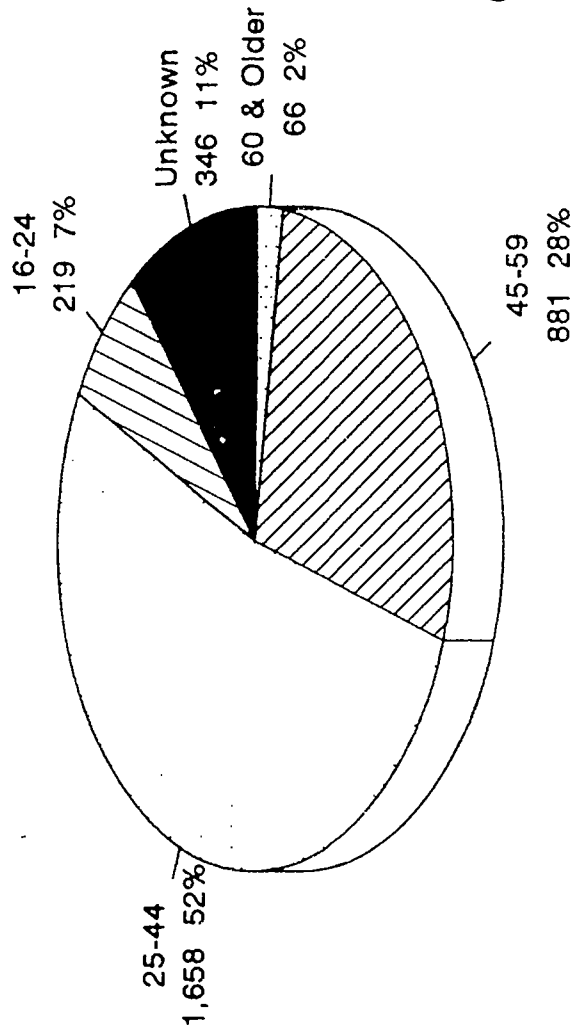

Age

34

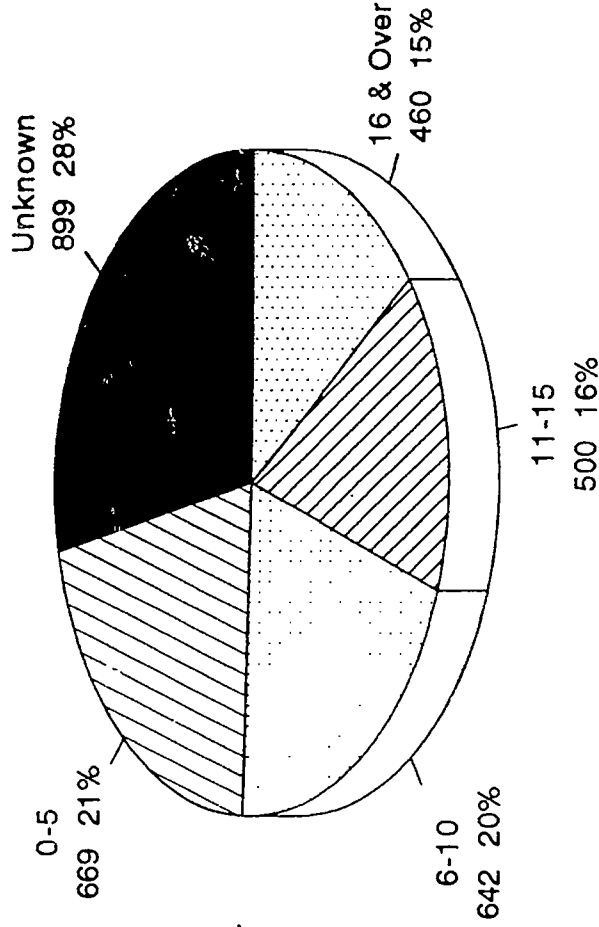

Years of Employment

35

# WISCONSIN WORKPLACE PARTNERSHIP TRAINING PROGRAM

June 1, 1992 - December 31, 1993

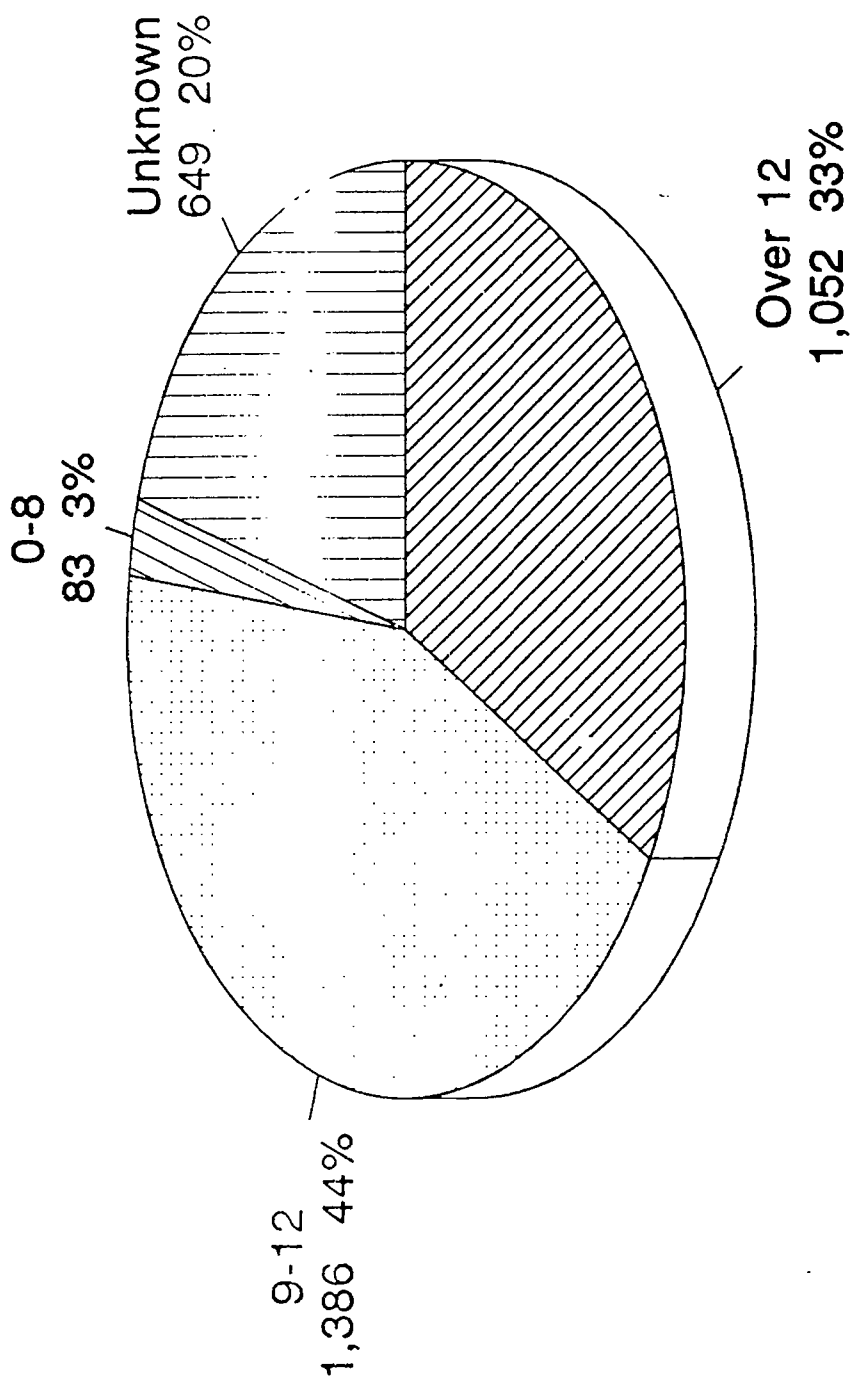

36

Years of School Completed

37

# Wisconsin Workplace Partnership Training Program

1992 - 1993

Participant Referrals

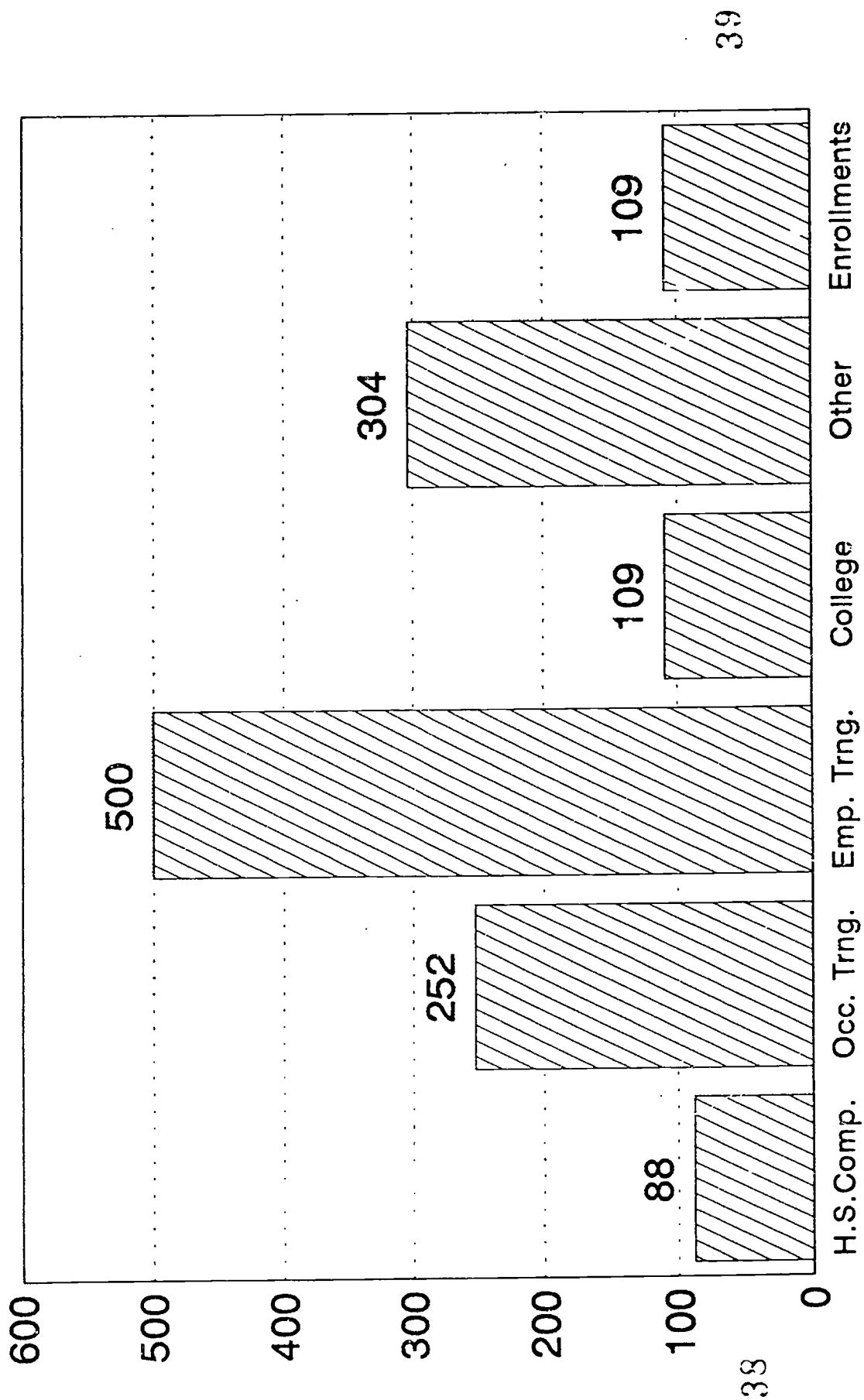

## **Third Party Evaluation**

for

### **Wisconsin Workplace Partnership Training Program**

Grant Number 4

6/1/92-12/31/93

#### **Third Party Evaluation Team**

**Howard Lee, Director**

Associate Dean, School of Industry and Technology

**Kathy Hirsch**

Research Associate

Center for Vocational, Technical and Adult Education

**Orville Nelson**

Evaluator

Director

Center for Vocational, Technical and Adult Education

UW-Stout

Menomonie, WI 54751

March 31, 1994



Project # 30-101-153-123

The materials herein were developed pursuant to Grant Number 30-101-153-123 with the Wisconsin Technical College System, partially reimbursed from allocation of federal funds from the Department of Education. Contractors undertaking such projects under government sponsorship are encouraged to express freely their professional judgment in the conduct of the project. Points of view or opinions stated do not, therefore, represent official Department of Education position or policy. The University of Wisconsin-Stout does not discriminate on the basis of race, sex, age, religion, handicap or national origin.

## Table of Contents

	Page
Acknowledgments.....	i
Table of Contents.....	ii
List of Tables.....	iii
Abstract.....	iv
Third Party Evaluation Report.....	1
Introduction.....	1
Purpose.....	1
Objectives.....	1
Limitations.....	2
Approach and Design.....	2
Results.....	8
Objective 1.....	9
Objective 2.....	15
Objective 3.....	18
Objective 4.....	20
Objective 5.....	21
Objective 6.....	24
Objective 7.....	25
Objective 8.....	25
Objective 9.....	27
Objective 10.....	29
Objective 11.....	30
Objective 12.....	30
Objective 13.....	31
Objective 14.....	31
Objective 15.....	33
Objective 16.....	34
Objective 17.....	35
Recommendations.....	36
Appendix A.....	37
Evaluation Surveys	
Cover Letters	

## List of Tables

	Page
Table 1: Survey Response Rates.....	9
Table 2: Age of Participants.....	10
Table 3: Seniority of Participants.....	10
Table 4: Highest Grade Completed in School by Participants.....	11
Table 5: Workplace Education Center Usage.....	11
Table 6: Area in Which Participants Studied.....	12
Table 7: Teachers' Perceptions of Areas in Which Gain.....	13
Table 8: Participants' Perceptions of the Impacts of Workplace Literacy Program.....	14
Table 9: Overall Rating of Workplace Education Center.....	14
Table 10: Survey Response Rates.....	16
Table 11: VESL Students' Reasons for Using the Workplace Education Center.....	17
Table 12: Impacts of Using a Workplace Literacy Center as Reported by VESL Students.....	18
Table 13: VESL Students' Willingness to Recommend Their Workplace Education Center to Other Students.....	18
Table 14: Additional Educational Impacts and Experiences Reported by Workplace Education Students.....	19
Table 15: Status of Local Steering/Advisory Committees.....	21
Table 16: Peer Advisors' Ratings of Their Experiences in the Workplace Literacy Program.....	23
Table 17: Types of Training Reported by Peer Advisors.....	23
Table 18: Peer Advisors Activities Reported by Teachers.....	24
Table 19: Sources of Information on the Local Workplace Literacy Programs as Reported by Local Partners.....	27
Table 20: Roles Reported by Workplace Literacy Teachers.....	28
Table 21: WESA Workshop Evaluation.....	32

## Abstract

The goal of the third party evaluation was to provide an independent assessment of the extent to which the 1992-93 Wisconsin Workplace Partnership Training Program accomplished its objectives. The goals of the evaluation were to determine the degree to which project objectives were attained and to assess the effectiveness of critical processes used by project staff to obtain program objectives.

Stakeholders, individuals and organizations involved in the literacy project, provided the data. The stakeholders included workplace education instructors, participants/students, peer advisors, steering committee members and local partners. Data was collected from stakeholders at each of the workplace literacy sites. Site visits were conducted at nine of the workplace education program sites. Sites continuing with the program from the previous year and new sites were selected for the visits. In addition to the site visits, survey instruments were developed for each of the stakeholder groups. Workplace education instructors distributed the surveys designed for the stakeholders at the plant sites.

The evaluation findings reveal that the workplace education program was effective. Students at the sites reported that they were very satisfied with their experiences and the progress they had made. Students reported major impacts in the areas of math, ability to ask questions, problem solving, reading and writing. In addition, they indicated that their self-esteem had grown and they became more confident students. Workplace education students also reported that their experiences prepared them to enter GED, technical college, and company training programs.

Vocational English as a Second Language was effectively provided to more than 200 participants in the workplace education centers. All of the VESL students were very satisfied with their experiences and progress.

Local steering committee and peer advisors received very favorable ratings. These ratings were given by the advisory committee members, peer advisors and workplace education teachers. Steering committee members helped the instructors start and direct their programs. Peer advisors provided assistance with the daily operation of the centers. They encouraged employees to participate in the workplace education centers, suggested instructional materials, and helped the instructors interpret the educational needs of the job site.

Although there were some areas for improvement in the program, the overall impact was very positive. In addition, all of the participants in the evaluation indicated that the workplace education program was a critical need in their companies and should be continued.

# Third Party Evaluation Report

## Introduction

This report presents the results of the evaluation surveys, interviews, and project document reviews completed by the third party evaluators. The results section presents the analyses of the data and the third party evaluators' judgments concerning attainment of each objective. The third party evaluators' decisions reflect their judgments based on the information and evidence available to them.

The first portion of this report describes the purpose, objectives, and approach/design. The second segment of the report presents the evaluation data and evaluators' decisions. The surveys used to collect the data and other pertinent documents are contained in the appendices.

## Purpose

The purpose of this evaluation project was to provide an independent assessment of the extent to which the 1993 Wisconsin Workplace Partnership Training Program (WWPTP) accomplished its objectives.

## Objectives

The following objectives were attained by this evaluation project.

1. Determined the degree to which project objectives, as listed on pages 20-24 in the project proposal, were attained.
2. Assessed the effectiveness of major processes used to attain project objectives.
  - Program Steering Committees.
  - Program Advisor Training.
  - Workplace Educational Skills Analysis (WESA) Process.
  - Professional Development Activities for Workplace Education Personnel.
  - Competency-Based Participant Assessment.
  - Enhanced Program Evaluation Process.

- Team Approach.
- Instructional Delivery Processes and Resources.
- Supportive Services.

3. Identified factors that facilitated and inhibited attaining project objectives.

### Limitations

The third party evaluators reviewed activities, outcomes and products that relate to the project's program objectives and outcomes. It did not review project expenditures and utilization of funds. In addition, the third party evaluation did not collect data on the number of students by classification at each site. The Wisconsin Technical College System (WTCS) staff collected this information and the evaluators did not want to duplicate this effort and create more work for the worksite staff. The evaluators did review records and observe students at a sample of sites. They found no data or evidence that would challenge the accuracy of the information supplied to WTCS by the worksites.

### Approach and Design

The third party evaluation was designed to collect the data needed to achieve the objectives listed for the evaluation project. Stakeholders, individuals and organizations involved in the literacy project provided the data. Data on the major processes and outcomes encompassed in the literacy project were collected.

The third party evaluators met with project staff at WTCS to review the information being collected at the state level, identify their data needs, and mesh data collection processes. The workplace literacy project staff placed the third party evaluators on their mailing list for all interim reports, correspondence, and other communiqués coming from the project. More details on the third party evaluators' activities are provided in the section on the evaluation activities.

There was substantial evidence to indicate that the workplace literacy program was needed; therefore, the third party evaluators accepted this as an assumption and did not collect data to determine the extent or validity of this need. It should be noted; however, that the enthusiastic comments found in the responses to the surveys and interviews reflects the importance of this program.

The third party evaluators focused on the stakeholders involved with the workplace education program. These stakeholders included the participants who were students, peer advisors, supervisors, labor representatives, instructors and technical college personnel.

### Population and Samples

All of the workplace literacy sites participated in the evaluation. The coordinators in each of the technical college districts and all of the instructors received surveys to complete. Additional information on the surveys and the stakeholders involved is given in the section on instrumentation.

A sample of eleven sites was selected for site visits. The objectives for the visits were to evaluate sites that were continuing with a workplace education program and sites that were in their initial year. The following continuation sites were visited. The Technical College involved is noted in parentheses

- Cray Research (CVTC)
- Goodyear Tire and Rubber (MATC-Madison)
- Royal Basket Trucks/Curtitions (GTC)
- Milwaukee Enterprise Center South (MATC-Milwaukee)
- Serigraph (MPTC)
- Waukesha Engine (WCTC)

The replication or new sites selected for on-site visits were:

- Phillips Plastics (NTC)
- Waukesha Hospital (WCTC)
- Johnson Controls (MATC-Milwaukee)
- Ore Ida (MSTC)
- Country Inn Motel (WCTC)

As noted above, these sites were selected to provide access to continuing sites and new sites. In addition, the third party evaluators selected them to obtain a geographic distribution, varied levels of technology used by the companies, and different types of products and services. After visiting the sites, the third party evaluators concluded that the sample provided the variation desired.



## **Instrumentation**

The main purpose of the initial visit to the sites in the sample was to learn more about the workplace education program, its participants and staff. A set of general questions was developed for use in the site visits. The primary focus of the visit was to gather information to determine the effectiveness and offerings of the program. To gather information the technical college coordinators, instructors, company supervisors and peer advisors were interviewed to obtain information on the program. Questions were asked to determine how the program was established, how participants (students) were identified, the types of assessments used, and the instructional activities employed. A list of the questions is included in the appendix.

After the site visits were completed in January and February, 1993, the third party evaluators developed a draft set of survey instruments for the stakeholders involved in the project. These instruments were reviewed with the Program Evaluation Committee of the Wisconsin Workplace Partnership Training Project on March 18. Based on the comments and feedback from the participants in this meeting, revisions were made. These revisions were discussed with the State Partners on March 31. Revisions were again made and forwarded to the members of the State Partners for final review. A few minor changes were made after this review and the instruments were put in final form during the third week of April.

The instruments were designed to collect information related to the objectives of the third party evaluation and the overall workplace education training program. The items in the instrument were cross-referenced with these objectives to assure content validity. The reviews by the two committees assured that the terminology used in the items was appropriate and that the roles of the various stakeholders were appropriately defined.

Although several modifications were made to the surveys based on inputs by the two committees, the third party evaluators did not feel that the independence of their evaluation was compromised. The input helped to clarify the items, use the appropriate terminology, and maintain a focus on the purpose of the WWPTP.

## Evaluation Design and Activities

The evaluation was designed to provide information on the major processes used in the Workplace Education Project and to determine the degree to which the project objectives were obtained. As noted above, the third party evaluators focused on obtaining information from the stakeholders involved. The questions asked of the stakeholders were directly related to the project objectives. However, the stakeholders also had opportunities to provide other information and make suggestions. These opportunities were provided to obtain a better understanding of how the program operated and to acquire information on actions that could be taken to improve the Workplace Education Program.

The list of activities and purposes given below further explains and describes the evaluation design and activities.

<u>Evaluation Activity</u>	<u>Purposes</u>
I. Participated in Workplace Education Project Conference Calls (throughout the year).	1. Monitored the progress of the participating instructors and obtained insights on their needs through the questions asked in the conference calls. In addition, the conference calls included some staff development activities and feedback on other types of assistance needed.
II. Met with Tom Grinde from the WTCS staff (October, 1992).	2. Discussed the revisions made in the project through the federal approval process. Discussed the third party evaluation and sites to visit during the project year. Communication procedures were also discussed.

- III. Presented at the Statewide Conference (November, 1992).
- IV. Conducted site visits at a sample of Workplace Education Programs (January, 1993).
- V. Developed draft survey instruments for the third party evaluation (February, 1993).
- VI. Met with project committees to review evaluation instruments (March 18 and 31, 1993).
- VII. Evaluated the WESA Workshop (April 6-7, 1993).
- VIII. Developed the final draft copy of the survey instruments (April 21-23, 1993).
3. Presented the third party evaluation design to participants in the Workplace Education Program Conference.
4. Learned more about the processes and procedures used at individual worksites. Became familiar with the facilities and resources available to teachers and participants. Reviewed the types of activities used to publicize the program.
5. Developed survey instruments for all of the stakeholders involved in the project. The purpose of the instruments was to collect data related to attainment of each of the project objectives.
6. Obtained input on the validity and clarity of the survey instruments.
7. Determined the effectiveness of the WESA Workshop and the relevancy of the competencies to the participants' activities in the Workplace Education Program.
8. Prepared the surveys for mailing.

- XI. Mailed surveys to technical college coordinators involved in the program; instructors, participants, peer advisors, and other local participants in the program.
- X. Visited spring sites to sample Workplace Education Programs. (May, 1993).
- XI. Analyzed Evaluation Data and wrote final report.
- 9. Obtained feedback from the stakeholders on the impacts and effectiveness on the Workplace Education Program. Acquired feedback from a broad cross-section of the stakeholders involved.
- 10. Cross validated the data collected from the mail surveys completed by participants during latter part of April and early part of May. In addition, this was an opportunity to observe any changes made in the facilities, resources, and programs at the eleven sites visited.
- 11. Presented the third party evaluators' judgments related to the project outcomes.

In order to assure that surveys were distributed to appropriate people and facilitate a high response rate, the surveys were mailed to two sets of stakeholders. One set of surveys was sent to the technical college coordinator directly involved with the Workplace Education Program in her/his district. The second set of surveys was sent to the Workplace Education Program instructors. Each instructor received a survey instrument to complete and, in addition, received the instruments for a sample of program participants, peer advisors and local partners. The local partners included peer advisors, managers, labor representatives, and employee representatives. A sample packet of surveys and cover letters is included in the appendix. As will be noted in the results section, this process did achieve a high response rate.

## Results

The results and conclusions stated in this section are based on the information received from participants, peer advisors, instructors, technical college coordinators, Workplace Education Partners and staff members at the Wisconsin Technical College System. The third party evaluators visited eleven sites during January, 1993. Post-site visits were done during the last part of April and the first part of May, 1993. Six sites were visited on both the January and spring visits.

Survey data comes from a set of evaluation surveys that was distributed during the third week of April, 1993. Workplace education teachers each received a survey to complete and three survey forms to distribute. Teachers received eight survey forms to distribute to their participants or students. Four were to be distributed to participants who started the program during the current year. The other four were to be distributed to participants who had been involved with the workplace education program over a longer period of time. Four peer advisory surveys were sent to the teachers and they were asked to distribute these to representative members of their peer advisory group. Four forms were also enclosed to be distributed to local partners. Survey forms were mailed directly to the technical college coordinators.

Only the number of teachers and technical college coordinators receiving forms is known for sure. The numbers in Table 1 reflect the maximum number of surveys that could have been distributed. Response rates from the instructors and technical college coordinators were excellent. After the data had been processed, an additional instructor survey was received. Also, after the data were processed, four additional student surveys were received, two additional peer advisor surveys, and five additional partner surveys. A review of the response patterns on these surveys did not reveal any unique patterns, therefore, the data analyses were not rerun.

The ages, gender and seniority of the participants indicated that the sample had a range similar to that of the population. There were slightly more males in the sample than in the population. However, an analysis of participant responses by gender did not reveal significant differences.

**TABLE 1**  
**Survey Response Rates**

Groups Surveyed	Surveys Sent	Surveys Received	Rate of Return
Student Participant	216	86	40%
Peer Advisors	108	50	46%
Instructor	27	25	93%
Technical College Coord.	12	9	75%
Workplace Partners	108	37	34%
<b>TOTALS</b>	<b>487</b>	<b>207</b>	<b>43%</b>

Project objectives were developed for this grant period. Each will be stated followed by presentation of evaluation data and the evaluator's conclusions.

**Objective 1:** To provide on-site basic skills instruction at 18 continuation sites and 10 replication sites to meet the base-line competencies needed to retrain 2,801 employees for specific job classifications.

Participant demographics were analyzed to determine if the sample was representative of the population.

Age: Over half (54%) of the surveyed participants in the evaluation were between ages 25-44. Over one-third (34%) of the participants were between ages 45-59. This indicates that the program serves a substantial portion of what might be called "older workers." (The federal definition, for purposes of defining older workers as a protected class, is age 40 and older.) Less than ten percent (9%) were under twenty-four and less than five percent (4%) were over sixty. Table 2 summarizes age data of the sample and presents the distribution of participant ages reported by the WTCS. The sample and population are similar.

**TABLE 2**  
**Age of Participants**

Years of Age	Sample		Participants %
	N	%	
16-24 Years	7	9	6.2%
25-44 Years	44	54	60.3%
45-59 Years	28	34	30.5%
60 and Older	3	4	3.0%
<b>TOTALS</b>	<b>82</b>	<b>100</b>	<b>100.0%</b>
N=82			

Gender: In this study, 82 participants from 28 Workplace Education Programs were surveyed. Half of the participants were male and half were female. Information on the total group of participants indicated that approximately 62 percent were female.

Seniority: The participants that had the "most" and the "least" amount of seniority with the company made up almost three fourths of the surveyed participants. Seventeen percent had worked 6-10 years. Nine percent had worked 11-15 years. Table 3 summarizes the longevity of the participants.

**TABLE 3**  
**Seniority of Participants**

Years Worked in Company	N	%
0-5 Years	26	32
6-10 Years	14	17
11-15 Years	7	9
16 Years and Over	34	41
Omits	1	1
<b>TOTALS</b>	<b>82</b>	<b>100</b>
N=82		

Educational Attainment: Almost half of the participants who completed the survey had a high school diploma, equivalency or GED. Sixteen percent had not graduated from high

school. In contrast, thirteen percent reported that they had a college degree. The sample had a wide range of educational attainment. This was also evident during the site visits. Table 4 summarizes the highest grade in school completed by participants.

**TABLE 4**  
**Highest Grade Completed in School by Participants**

Highest Grade	N	%
11th Grade or Less	13	16
High School Diploma/Equivalency/GED	40	49
Some College	16	20
Technical College Degree or Diploma	5	6
College Degree-Four Year	11	13
<b>TOTALS</b>	<b>85</b>	<b>100</b>
N=82		

Using the Workplace Education Center: One-third of the participants started using the services of the workplace education center this year (1993). Over one-fourth (27%) had been using the workplace education center since last fall, starting between September and December of 1992. Twenty-one percent started during the first half of 1992. Only six percent started during 1990 or earlier. Table 5 depicts the various beginning dates for using the workplace education center by the sampled respondents.

**TABLE 5**  
**Workplace Education Center Usage**

Began Using the Center in	N	%
This Year (1993)	27	33
Last Fall (Sept.-Dec., 1992)	22	27
January-June, 1992	17	21
During 1991	11	13
During 1990 or Earlier	5	6
<b>TOTALS</b>	<b>82</b>	<b>100</b>
N=82		



The demographic data indicated that the sample of participants represented the range of ages, seniority, and education found in the population.

Areas of Improvement: Participants were asked if they improved in fifteen competency areas since participating in the workplace education center. The median response ranged from 3.7 to 4.4 as shown in Table 6. The highest ratings in the impact column were given to self-esteem, assertiveness, computation, problem-solving and asking questions. It was the third party evaluators' perceptions that the increase in self-esteem was the result of a positive learning environment and students experiencing success in their learning activities. The impacts reported by the most students were problem solving (70%), self-esteem (71%), and assertiveness (63%). Also, these topics cut across some of the other topics. For example, problem solving can be taught in math. Self-esteem can be improved through success in any of the areas. Overall, the medians are in the "Some" to "A Lot" of impact range. Reading, writing and measurement received median ratings from 4 to 4.2.

**TABLE 6**  
**Area in Which Participants Studied**

Area	Participants Rating the Area		Impact Rating
	N	%	
Reading	41	50	4.0 <sup>#</sup>
Writing	41	50	4.0
Speaking	35	43	3.7
Listening	40	49	3.9
Computation	47	57	4.2
Measurement	37	45	4.0
Asking Questions	34	59	4.2
Time Management	39	48	3.9
Problem Solving	57	70	4.2
Self-Esteem	58	71	4.4
Assertiveness	52	63	4.3
Getting Along with Others	48	59	3.9
Teamwork	47	57	3.8
English as Second Language	13	16	4.0
Job Performance	51	62	3.9
Other	14	17	3.8

<sup>#</sup>Based on the Following Response Scale:

1=NA	
2=None	4=Some
3=A Little	5=A Lot

**Benefits:** Nine out of ten surveyed were satisfied with the progress they had made since attending the workplace education center (Table 8). Twenty-six percent have enjoyed their job more and almost one-fourth (24%) said they contributed more to the "team." Open-ended responses on other impacts included "GED," "math workshop," "fun," "not company sponsored," "related to job," "need to spend more time in this self-study program," "have worked toward the future," and "do my job more efficiently." Teachers' perceptions of the impacts of students workplace education activities are given in Table 7. Self-esteem, reading and computation were identified as the major impact areas. These have a high correspondence with the students' ratings.

Table 9 shows participants' evaluations of their experiences. Almost one-half (46%) rated their overall experiences with the workplace education center as excellent. Another 40% gave it a rating of very good. Table 10 displays the data.

**TABLE 7**  
**Teachers' Perceptions of Areas in Which Students Gain**

Competency Areas	Median	Results
		% Some + A Lot
Reading	4.0 <sup>#</sup>	75
Writing	3.8	67
Speaking	2.5	25
Listening	2.9	25
Computation	4.6	83
Measurement	3.1	34
Asking Questions	2.9	33
Time Management	1.9	13
Problem Solving	3.3	38
Self-Esteem	4.2	67
Assertiveness	3.3	37
Getting Along with Others	3.0	33
Teamwork	2.8	34
ESL	1.5	21
Job Performance	3.3	46
Other: Thinking Skills, Algebra Geometry, Etc.		29

#Medians are based on the following response scale:

1=N/A	4=Some
2=None	5=A Lot
3=A Little	

**TABLE 8**  
**Participants' Perceptions of the Impacts of Their**  
**Workplace Education Program**

Impacts	Total		Results		Male	
	N	%	N	%	N	%
Am satisfied with the progress I have made	75	91	39	95	36	88
Became eligible for a promotion	2	2	0	0	2	5
Have received a promotion	3	4	0	0	3	7
Enjoy my job more	21	26	10	24	11	27
Have transferred to a different job	5	6	2	5	3	7
Contribute more to the team	20	24	11	27	9	22
Have entered a technical college program	5	6	2	5	3	7
Other: Started GED, Do my job more efficiently, Learned new skills, Worked toward future.						
NUMBER		82		67		73

NOTE: Participants could select more than one response. Thus, the percentages total more than 100%.

**TABLE 9**  
**Overall Rating of Workplace Education Center**

Rating	N	%
Excellent	38	46
Very Good	33	40
Good	10	12
Fair	1	1
Poor	0	0
TOTALS	82	100
N=82		

The last set of enrollment data received from the Wisconsin Technical College System Board for the 1992-93 project year, indicated that 3,170 students had participated in the workplace education sites. This number is more than the target of 2,801.

Three separate criteria were evaluated for the objective - number served, job relatedness of the instruction, and quality of instruction. Teachers reported the numbers served and the project staff at the WTCS compiled the numbers. Our site visits revealed that the teachers made a concerted effort to keep accurate records on participants.

Teachers used the WESA job review process, plant tours, job shadowing and interviews to identify the content for the participants' IEPs and learning activities. The third party evaluators concluded that the teachers did an effective job in making their teaching relevant to the needs of the participants.

The data collected indicated that the teachers did a high quality job developing and carrying out their instructional activities. Based on interviews, data collected and analysis, objective one was attained by the project.

**Objective 2:** Provide Vocational English as a Second Language (VESL) Instruction at ten continuation and seven replication sites to assist 180 employees to maintain and/or upgrade employment.

The December Report from the Wisconsin Technical College System indicated that 224 people had participated in VESL at eight different workplace education sites. The third party evaluators visited four of the sites that offered VESL. In addition, the surveys completed by workplace education students and teachers included items on VESL.

The following tables are based on an analysis of the responses made by participants who indicated that they received VESL instruction. From the sample of 82 participants who completed the survey forms, 14.6 percent or 12 participants indicated that they had received VESL instruction. This percentage is slightly higher than the percentage of VESL students within the total population of participants served.

The sub-sample of VESL students includes six males and six females (Table 10). These students indicated that the most important reasons for participating in the workplace education program were to improve their communication skills and to meet personal goals. More than one-half of

the members of the sub-sample also indicated that qualifying for future job opportunities, improving math skills, and furthering their education were reasons for participating. A summary of these responses can be found in Table 11.

The people who were studying VESL in the workplace education centers appeared to be very satisfied with their experiences. More than 90 percent indicated that they were satisfied with the progress they had made (Table 12). In addition, all 12 said that they would recommend their workplace education centers to others (Table 13). One-half of the team members reported that they contributed more to the team as a result of their participation in the workplace education center. In addition, one-third of the VESL participants indicated that they enjoyed their job more (Table 12).

During site visits, the third party evaluators were able to observe some VESL classroom activities and instructional materials. It was apparent from the classroom sessions that the VESL students were interested in their learning activities and motivated to improve their English language skills. The third party evaluators also had an opportunity to interview an employer at one of the sites. He indicated that students in the VESL instructional program were communicating more effectively in English and, as a result, the production processes at the plant flowed more smoothly.

**TABLE 10**  
**Gender of VESL Students**

GENDER	N	%
Female	6	50%
Male	6	50%
TOTAL	12	100%

**TABLE 11****VESL Students' Reasons for Using the  
Workplace Education Center**

REASONS	Results	
	N	%
1. To improve my job performance	6	50
2. To qualify for future job opportunities	8	67
3. To improve my math skills	8	67
4. To further my education	8	67
5. To meet my personal goals	11	92
6. To improve my communication skills (reading, writing, listening, etc.)	10	83
7. To prepare for a company training program	4	33
8. Other	2	17

Based on the information provided by the Wisconsin Technical College System and the information collected by the third party evaluators, it was concluded that this objective had been met.

**TABLE 12****Impacts of Using a Workplace Education Center  
as Reported by VESL Students**

IMPACTS	Results	
	N	%
1. Am satisfied with the progress I have made	11	92
2. Became eligible for a promotion	0	0
3. Have received a promotion	0	0
4. Enjoy my job more	4	33
5. Have transferred to a different job	0	0
6. Contribute more to the team	6	50
7. Have entered a technical college program	1	8
8. Other	2	17

**TABLE 13****VESL Students' Willingness to Recommend  
Their Workplace Education Center  
to Other Students**

RECOMMEND TO OTHERS	Results	
	N	%
Yes	12	100
No	0	0
TOTAL	12	100

**Objective 3:** To afford an opportunity for 25 workers to receive a GED or participate in other educational activities which will lead to an adult secondary education diploma or assist employees in entering occupational training programs.

The survey of participants indicated that approximately four percent of the students in the sample were working on or acquired a GED since entering the workplace education program and another six percent had entered a technical college program (Table 14). These findings are consistent with the information reported by the teachers during the site visits.

A larger group of students (20%) reported that their experiences in the workplace education program were done in preparation for entering a company training program. In some companies participation in the workplace education center was a prerequisite for entering a company training program. In addition, 62 percent of the sample reported that they had expanded their education.

Information collected during the site visits agreed with the information presented above. The workplace education programs had an important, although small, impact on helping participants enter a GED or technical college program. A larger proportion of students/participants was helped to prepare for a company training program.

Approximately 16 percent of the participants in the sample reported that they did not have a high school diploma. An additional 49 percent reported that they had not gone on to a technical college or four year college. Therefore, there appeared to be an opportunity to encourage students to enroll in educational programs to advance their educational status. However, the teachers and many of the participants reported that it was difficult to find time for these activities. Several of the companies were working overtime and many of the participants had family obligations.

It is the third party evaluators' conclusion that the project had attained this goal.

**TABLE 14**

**Additional Educational Impacts and Experiences Reported by Workplace Education Students**

ADDITIONAL EDUCATIONAL IMPACTS	Results	
	N	%
Entered a technical college program	5	6
Working on/acquired a GED	3	4
Prepare for a Company Training Program	16	20
Expanded my education	51	62



**Objective 4:** Enhance the services provided by the workplace partnership training program through the continued cooperation and active commitment of local technical colleges, employers and union/employee representatives.

The third party evaluators met with the state level partnership/steering committee on several occasions. The local steering committees were discussed during the on-site visits. In addition, teachers were asked to indicate the status of their steering committees as a part of the survey they completed.

It was apparent from the questions asked and the level of interaction between the state level steering committee members that they were very interested in the project and actively working to help it meet its objectives. The state level steering committee members also participated in two statewide meetings designed for teachers and technical college coordinators.

The role and impact of local steering committees were discussed during the on-site visits. Teachers with active steering committees indicated that they were very helpful. Steering committee members informed them of company policies related to the workplace education center, helped them identify resources, provided suggestions for recruiting participants, and in some instances reviewed instructional materials for the teachers. Steering committee members also assisted with targeting jobs, gathering work related materials, conducting the job analyses, interviews and observations. Several teachers mentioned that one of the first activities that should be completed when starting a workplace education center is to identify a local steering committee.

Input from the teachers survey related to local steering advisory committees is summarized in Table 15. Of the 27 teachers surveyed, 24 returned their forms. Local steering committees were being used by 18 (75%) of those who returned their surveys. The most typical meeting pattern for the steering committees was once per month. One-half of the teachers reported that their committees met once per month.

It is the conclusion of the third party evaluators that the project met this objective. However, the on-site visits and the surveys indicated that there were opportunities to improve the functioning of the steering committees. Several sites did not have active steering committees and could have benefited from one. No particular reason was noted why these sites had not formed a steering committee, or why it was not active.

**TABLE 15**

**Status of Local Steering/Advisory Committees**

STATUS	Results	
	N	%
• Is local steering committee active?		
Yes	18	75
No	16	25
TOTAL	24	100
• If it is active, how frequently does it meet?		
Weekly	2	8
Monthly	12	50
Twice a Year	0	0
Annually	0	0
Other	4	17
-Every 2 months		
-As needed		
-Have not attended		
-Never (1)		

**Objective 5:** Provide initial and developmental peer advisor training to 536 union, employee and management representatives.

The last quarterly report indicated that 493 peer advisors had been trained. During the project, the third party evaluators reviewed peer advisor handbooks developed by technical colleges and local workplace education sites, interviewed peer advisors during site visits, and discussed the peer advisors role with the workplace education teachers. In addition, a survey form was developed specifically for peer advisors and several of the questions in the teacher's survey were concerned with the role of peer advisors.

The types of training reported by the peer advisors is summarized in Table 17. This summary is based on the written comments of peer advisors. The most common training reported was formal training sessions. These varied in length from two to six hours. Monthly meetings of peer

advisors and meetings with teachers were the next most common form of training. No specific training or "none" was reported by 24 percent of the sample of peer advisors. A review of the responses these people, those who reported no training, made on the rest of their survey forms indicated that at least two-thirds of them were actively involved in the peer advising process and had a positive perception of the program.

Peer advisors overall rating of their experiences in the workplace education program are summarized in Table 16. Eighty-six percent of those responding rated the program as "very good," or "excellent." None of the peer advisors indicated that the program was poor.

The types of activities peer advisors carried out as reported by teachers are summarized in Table 18. A majority of the teachers responded that their peer advisors provided public relations for the program (75%) and encouraged fellow employees to participate (83%). More than one-half (54%) of the teachers also reported that the peer advisor suggested teaching activities and topics. Peer advisors also helped to review teaching materials, identify company policies, and some mentored employees.

The third party evaluators' on-site visits provided an opportunity to interview a sample of peer advisors and to discuss the peer advisor roles with teachers. Both peer advisors and teachers thought that the peer advisors played an important role in the workplace education program. A large majority of the peer advisors indicated that they received adequate information on their roles and tasks. Several suggested that they would like to have more in-service training in the areas related to the instruction that was going on in their workplace education center and on coaching techniques. They also mentioned that they would like to get together with peer advisors from other sites to discuss strategies and techniques for peer advising. Teachers indicated that they would like to have more meetings with peer advisors; however, their busy schedule in the workplace learning center made it difficult to schedule more meetings.

It is the judgment of the third party evaluators that the project met the intent of this objective. As noted in the discussion above, there are opportunities to provide additional peer advisor training. In addition, there is an apparent need to conduct an ongoing training program for the peer advisors.

**TABLE 16****Peer Advisors' Ratings of Their Experiences  
in the Workplace Education Program**

OVERALL RATING	Results	
	N	%
Excellent	22	45
Very Good	21	43
Good	5	10
Fair	1	2
Poor	0	0
TOTAL	49	100

**TABLE 17****Types of Training Reported by Peer Advisors**

TYPES OF TRAINING	Results	
	N	%
Meetings with teachers	7	14
Formal Training Sessions	16	33
Monthly Meetings of Peer Advisors	9	18
On-the-job	2	4
None	12	25
Other	3	6
TOTAL	49	100

**TABLE 18**

**Peer Advisor Activities Reported by Teachers**

ACTIVITIES	Results	
	N	%
Provide public relations for the workplace education activities and services	18	75
Encourage fellow employees to participate	20	83
Assist employees identify career plans/goals	1	4
Assist employees identify the types of skills and competencies they need to develop	1	4
Assist as a mentor/tutor to employees	2	8
Identify company policies and procedures	7	29
Review teaching materials for you	5	21
Suggest teaching activities and topics to you	13	54

**Objective 6:** Analyze the basic skills competencies required for effective employee performance in 235 targeted job classifications.

This objective required that the Workplace Education Skills Analysis (WESA) be conducted on 235 job classifications. The last report provided by the Wisconsin Technical College System reported that 76 job classifications had been analyzed.

The data collected during the on-site visits and the survey of workplace education teachers agrees with the information provided in the WTCS report. Teachers reported during the on-site visits that they were having problems finding enough time to complete a WESA at their site. In at least one instance, the company refused to have the WESA done because they felt it took so much employee time.

In the teacher survey, 54 percent of those responding indicated that they had not used WESA reports (See Appendix A). However, information from the on-site visits indicated that the teachers were tailoring instruction to the workplace. They used plant tours, input from peer advisors and feedback from their students to design their instruction.

It is the conclusion of the third party evaluators that this objective was not attained. Some WESAs were done and proved to be useful in tailoring instruction to the needs of the job site. However, the target of 235 job classifications was not attained.

**Objective 7:** Conduct initial assessments of the basic skill competencies of 3,693 workers and to conduct follow-up assessments as needed.

The last report indicated that 3,660 people had been assessed during the project. The third party evaluators' on-site visits provided an opportunity to determine what types of pre-assessments were being done and how they were used. The evaluators found that the technical colleges were providing staff members to do assessments for the workplace education sites. In addition, the teachers were doing a variety of assessments. The teacher assessments were more site related and were often integrated with the initial instructional activities to reduce test anxiety.

In the teacher survey, 87 percent of the teachers reported that they were using formal pre-tests and 92 percent reported they were using informal pre-test techniques. Some instructors were also using specialized services available through local university campuses. For example, at one site an instructor and a graduate student from a communications disorders program at the local university assessed a student who was having unique learning problems. This information was used to design an IEP for the student. It was the evaluators' observation during on-site visits that teachers were making effective use of pre-assessment data to develop individualized educational plans for the students at their sites. Teachers' responses on the survey indicated that only eight percent were not developing individualized educational plans for their students. The remaining 92 percent were developing IEPs.

It is the judgment of the third party evaluators that the intent of this objective was met. A variety of pre-assessments were being done by technical college staff and by the workplace education teachers. In addition, teachers were using pre-assessment data to develop individualized educational programs.

**Objective 8:** Orient 14,912 employees to workplace partnership training program services.

This objective was removed as an official objective during the negotiation process. However, this was still an important operational activity related to objective one. Therefore, the evaluators monitored the area. The on-site visits by the third party evaluators provided an opportunity to review various materials and processes used to orient employees to workplace education

programs available in their plants. Almost all of the sites visited had posters and flyers that identified the services of the center. Some sites had special buttons, pencils and other items that promoted their centers. Several teachers noted that they had, or were planning on conducting an open house in their centers. The teachers at one site set up a display in the lunch room to attract the interest of workers. At some of the sites information on the workplace education program was included in the orientation package for new employees.

Peer advisors also reported that they actively promoted the workplace education program at their plants. In the sample of peer advisors surveyed, 75 percent indicated that they provided public relations (Table 18).

Managers, supervisors, and union leaders of local plants were asked to complete a survey on the workplace education program at their site. As a part of the survey they were asked to identify ways that they received information on their workplace education center. A summary of the responses to this item is presented in Table 19. The source of information most frequently mentioned was posters (55%). Slightly less than half of the respondents (45%) indicated that they heard about the center from employees who used the center. A center newsletter, open house and company newsletters were other common sources of information. Respondents were asked to check all the sources of information through which they received information on their local workplace education center. Each local partner completing the survey made an average of two and one-half responses on this item. In other words, there was strong evidence that the centers were using multiple ways to disseminate information on their program and services. This finding also agrees with the observations made during the site visits. A majority of the peer advisors reported that they receive monthly information on the workplace education program at their site.

**TABLE 19**

**Sources of Information on the Local Workplace Education Programs as Reported by Local Partners**

SOURCES OF INFORMATION	Results	
	N	%
Posters	18	55
Orientation sessions	2	6
Open house in the center	11	33
Newsletter from the center	13	39
Company newsletter	11	33
From employees who are using the center	15	45
Presentations by the instructors in the center	9	27
Other	9	27
-Meetings with instructor (3)		
-Training department supervisor		
-Monthly reports (2)		
-Ticker tape		
-Committee meetings (2)		

It is the conclusion of the third party evaluators that the workplace education centers were informing employees of their services. A variety of techniques were used to inform employees about the workplace education center. Attempts were made to reach as many of the employees as possible within each plant.

**Objective 9:** Provide peer advising services to 9,005 workers throughout the project period.

This objective was removed during the negotiation process. However, advising was an important activity related to objectives 1, 2 and 3. Thus, the third party evaluators reviewed the activities in this area. Teachers and peer advisors were actively involved with providing advising services to the workers in their plants. More than 80 percent of the peer advisors indicated that they encouraged fellow employees to participate in the program (Table 18). Four percent of the peer advisors indicated that they assisted employees in identifying career plans and goals and also helped them identify the types of skills they needed to develop.



Only 42 percent of the workplace education teachers reported that they performed in a counselor role (Table 20). However, the third party evaluation on-site visits indicated that all of the teachers interviewed were performing advising and counseling activities. It may be that they perceive this question as related to activities more traditionally performed by counselors. Of those who did indicate that they spent time in counseling, the median percentage of their time in this role was five percent.

More than nine out of ten teachers reported that they developed individualized education plans for their students. This involved reviewing the students' experiences, capabilities, interests and job assignments to develop a personalized educational plan.

Three-fourths of the participants surveyed reported that they had received assistance from peer advisors. All of those who had received information and assistance from a peer advisor rated it as being helpful or very helpful.

It is the conclusion of the third party evaluators that teachers and peer advisors were effectively providing this service. Teachers and peer advisors were actively providing program advising services. In addition, the technical colleges were providing specialized advisement services.

**TABLE 20**  
**Roles Reported by Workplace Education Teachers**

TEACHER ROLES	Results	
	N	%
Instructor	22	92
Counselor	10	42
Curriculum Development	16	67
Record Keeper	19	79
Learning Center Manager	13	54
Other	4	17
-Public Relations		
-Promoter		
-Advisory Board Member		
-Marketing		

**Objective 10:** Provide comprehensive management and evaluation which assures that program objectives are met in an effective and timely manner.

Data collected based on interviews with local partners, technical college coordinators and instructors and project participants clearly indicate that the objectives established at the beginning of the year were accomplished. At the beginning of the project year the objectives were shared with all participants schools and sites. Each had an opportunity to review the objectives and provide feedback.

Evaluation of the objectives was ongoing throughout the project year. Newsletters, meetings, conferences, workshops, on-site visits, correspondences, conferences calls, publications, and frequent communications with site and schools strongly demonstrate on going evaluation. Third party evaluators collected the following data:

Participants (students) perceptions of:

- Competencies acquired.
- Relevancy of competencies.
- Impacts on job performance.
- Other impacts from their involvement.
- Support services needed and how the training could be improved.

Instructors

- Data on competencies gained by participants.
- Applications of WESA.
- Suggestions on how the system could be improved.

Supervisors of Participants:

- Relevancy of competencies learned.
- Other impacts.
- Suggestions for improvement.

Employers:

- Relevancy of competencies learned.
- Other impacts.
- Suggestions for improvement.

#### Peer Advisors

- Assistance provided by project staff.
- Impacts on peer advisors.
- Support services needed.
- Suggestions for improvement.

#### Other Team Members:

- Quality of the team process.
- Perceptions of project impacts.
- Suggestions for improvements.

The details of the data collected are shown in the front of this report and clearly shows the objectives and evaluation activities were accomplished.

**Objective 11:** Provide more efficient literacy services to small businesses by creating partnership models which include the Chamber of Commerce offices along with education and labor representatives.

Several different sites dealing with small businesses were developed. The small business incubators in North and South Milwaukee developed a learning center which supported several small businesses in the incubator. A Curtition site was developed to host employees from two neighboring business. Based on these site developments, this objective was accomplished.

**Objective 12:** Develop coordination methodologies which link program activities and the JTPA and JOBS clients who have been recently placed in jobs and who need continuing services for job retention.

Based on interviews and data collected, this objective was not accomplished. The purpose of this objective was to develop a county-wide effort to link JOBS/JTPA placed workers into workplace literacy centers as soon as possible to ensure that ongoing support is available to them. In addition, this was an attempt to reduce the number of persons who repeatedly cycle back through federal programs because support services were unavailable after they became employed. Two things hindered the accomplishment of this objective. The first was that at the Wausau site which was selected to try this idea, no JTPA/JOBS clients applied or were hired at the sites. After six months, the in plant instructional load was so heavy that the objective was set aside.

**Objective 13:** Plan and deliver a series of professional development and networking activities with and for workplace education.

This objective was accomplished. Two statewide workshops were conducted, a WESA workshop conducted and numerous conference calls involving coordinators and teachers held. Data collected from participants in these workshops and conference calls attest to their value. Proceedings and minutes were also published and shared.

**Objective 14:** Determine the effectiveness and efficiency of the Workplace Education Skills Analysis methodology

The purpose of this objective was to determine the effectiveness and efficiency of the Workplace Education Skills Analysis (WESA) methodology developed and implemented under previous National Workplace Literacy Programs. This objective was met. This objective was based on the past experience with WESA methodology developed and used during the last two project cycles. Center for Education and Work Staff gathered input from users and from a panel of experts on the WESA Guide. User and expert input came from teleconference, Local Partner Survey, and the WESA Development Committee. Based on this input, CEW developed a three-pronged approach:

1. WESA Training Guide Supplement--with the inclusion of an educational skills checklist, tips fro WESA analysts, a modified interview process, and sample WESA reports, the overall WESA process should be more efficient (during this grant).
2. Make the supplement available on WordPerfect disks so the analyst will need to do minimal formatting and word processing (following the grant, if interim funding can be obtained.)
3. Develop WESA software to allow multiple reports to be generated, access to a database, linkages with curriculum and assessment design packages, etc., (grant application pending).

Also, the WESA Committee believes significantly more training is needed on the WESA process and that appropriate resources should be allocated to their conduct.

The original WESA training guide was developed in February 1991 and consists of a 6 stage process. This original guide was used during this recent grant and found to be useful.

Instructors were asked a series of questions concerning the WESA Workshop and its related activities. The data is presented in Table 21. Most of the participants gave the workshop positive ratings.

**TABLE 21**  
**WESA Workshop Evaluation**

STATEMENTS	Results MEDN	N=26 IOR
1. The WESA process is relevant to my work	4.1 <sup>#</sup>	1.4 <sup>#</sup>
2. The WESA Training Manual was helpful	4.1	.9
3. Interview and observation sessions were useful	4.3	1.0
4. The data analysis activities were worthwhile	4.0	.9
5. Preparing the WESA report was a valuable activity	4.0	.9
6. The discussion of the use of WESA information and reports in curriculum development was helpful	4.0	1.1
7. I plan on using the WESA process in my work	3.8	1.8
8. I learned techniques that will make my work more effective	4.1	1.3
9. The information and procedures given were presented in a practical form	4.2	1.0
10. I enjoyed the WESA training session	4.3	1.0

<sup>#</sup>Medians and Interquartile ranges are based on the following response scale:

1=SD=Strongly Disagree  
2= D=Disagree  
3= U=Undecided

4= A=Agree  
5=SA=Strongly Agree

Other feedback from instructors indicated that 76 WESA reports were done. In interviews with the instructional staff, those that used the process found it to be useful with several

expressing concern that the process was too detailed for use in their setting. Quicker, more accessible assessment processes were desired.

During this grant period, it was projected that 235 WESAs were to be completed. Data from the Project Director indicates that less than half were done.

CEW produced a WESA Training Guide Supplement draft with a final version to follow pending format changes. The draft is divided into four sections and covers suggested employee interview questions, detailed WESA report forms, WESA analyst tips and sample WESA reports completed for a maintenance mechanic. This additional guide should facilitate the WESA process.

**Objective 15:** To review and evaluate alternative methods of student assessment and develop a Guide to developing competency-based participant assessment systems.

The purpose of this objective was to study the best alternative assessment methodologies and develop and implement a process guide to assist local staff in developing appropriate assessment instruments.

An Alternative Assessment Methodologies For Workplace Education Programs booklet was developed by CEW staff. The booklet review questions to be asked when selecting assessment instruments and procedures, review of standardized tests, and a bibliography of competency-based/criterion-referenced assessment, participatory assessment and portfolio assessment, adult education and self-assessment instruments.

CEW also conducted a WisLine Teleconference for Instructors on January 21, 1993 which reviewed participant assessment practices used in the El Paso Community College National Workplace Literacy Grant, local partner survey, participant portfolio assessment and assessment requirement.

Based on a review of the document and activity of the WisLine, this objective was accomplished.

Based on a review of these documents, the objective is accomplished. However, it should be noted that none of the documents deal with developing competency-based assessment systems.

**Objective 16:** To develop and test site-specific strategies to efficiently and effectively replicate workplace education centers at multiple sites within a corporation.

Three draft documents were reviewed. *Workplace Education Design Checklist: A Tool for Program Planning*, *Workplace Education Evaluation Checklist : A Tool for Assessing and Improving Performance*, and *Evaluation Tools*. The Workplace Education Evaluation Design checklist is designed as a workplace education program planning aid for developing new workplace education programs and may also be used to enhance existing programs. Four sections; ie: Program design and administration indicators, Participant achievement indicators, Program outcome indicators and Evaluation tools sections make up the guide. A program evaluation committee with extensive dialog with Wisconsin Workplace Partnership Training Program participants reviewed the document.

*The Workplace Education Checklist: A Tool for Assessing and Improving Performance* was designed to evaluate and improve the performance of existing programs. The sections and items are the same as the Design checklist but incorporate a rating scale for each item along with space for participants to complete "Future Action." The guide is nicely laid out and easy to follow.

The evaluation tools document consists of five sections; Stakeholders Anecdotal Information, Participant Achievement Data, Cost-Effectiveness Data, Data Collection Reports and Workplace Education Program Data. This is a compilation of survey instruments from various participants across Wisconsin as well as other National Workplace Education Program funded projects.

All three documents should be of value to Workplace Education partners as they grapple with evaluation issues at their own sites. The value of these projects also extends to future site development.

It was reported by the project director that this objective was canceled at the time of project acceptance. Nevertheless, significant progress was made and this objective was accomplished.

It should be noted that The Workplace Education Design Checklist first section deals with Program Design and Administration Indicators and clearly has content geared to replication. All aspects of site development including education center development and maintenance, skills analysis, curriculum development, program support services, recruitment and program promotion, peer advising, instruction participant assessment, professional development and program evaluation are addressed. This document will serve as an excellent guide as business and industry, new to workplace education centers come to grips with this issue.

**Objective 17:** To develop a process which more effectively evaluates program effectiveness.

The purpose of this objective was to explore and expand evaluation strategies used in workplace education programs. Based on review of materials presented and interviews with project staff this objective was accomplished. An evaluation tools manual was assembled which included quantitative and qualitative methodologies, cost-benefit analysis and other strategies. A team of labor, management and educational representatives helped identify a series of measures for program effectiveness that are outlined in *The Workplace Education Checklist: A Tool for Assessing and Improving Performance*

*The Evaluation Tools Manual* presents evaluation instruments in the five areas of Stakeholders Anecdotal Information, Participant Achievement Data, Cost-Effectiveness Data, Data Collection Reports and Workplace Education Program Data. Each evaluation instrument presented has been developed and used by participants of the Wisconsin Workplace Education Project. With slight adaptation, each instrument can easily be used at any future site.

In addition, the Center on Education and Work conducted numerous meetings and teleconferences with WWPTP and the Program Evaluation Committee. Networking, discussions with speakers, sharing successful evaluation strategies, reviewing evaluation materials and developing appropriate activities to help evaluate programs more effectively were accomplished. These many activities were summarized in Quarterly Reports submitted to the project director from the Center on Education and Work.



Also contributing to this objective are the Proceedings of the Statewide Partners Meeting. Based on the issues identified, strategies and information were solicited from the partners on these problems. Several of the issues pertained to program evaluation.

### Recommendations

1. **The Wisconsin Workplace Partnership Training Program should continue.**

All data from interviews, surveys, and documents indicate that this program has been successful and has been making significant contributions to Wisconsin's workforce. It makes sense that if our workforce becomes more literate, that they will perform at a higher level. With new technology being introduced at all levels, higher levels of literacy are needed. This project meets that need and thus should continue.

2. **Identification of best practices should be documented and disseminated.**

As new sites are developed, participants need to be exposed to best practices. This will facilitate the planning, implementation, and evaluation of new programs and contribute significantly to success.

3. **Research alternate assessment strategies.**

Data collected indicates that the WESA works well, but in several cases takes too much time to implement. Too much detail is provided which may not be useful. Often times only a portion of a job needs to be analyzed. Alternative assessment strategies need to be proposed, tried and documented.

4. **Assess the needs of workplace education teachers.**

Many of the teachers indicated a desire to receive assistance with various aspects of their jobs. All of the teachers interviewed mentioned the value of the statewide meetings and the opportunity to share ideas.

APPENDIX A  
Evaluation Surveys  
Cover Letters

## January Site Visit Questions

Questions asked during the first site visits in January and February, 1993

### A. VTAE Coordinators

1. What workplace education sites are active in your district?
2. What public relations is done for workplace education?
3. What inservice and support activities do you provide for your workplace education instructors?
4. What roles do your local partners have?

### B. Workplace Education Instructors

1. What types of resources do you have in your center?
2. How do you work with the typical student?
3. How do you use the WESA reports?
4. What roles do the peer advisors have?
5. What staff development needs do you have?

C. Student Participants - These were interviewed only if they were in the center and the interviews could be done without interfering with their learning activities?

1. What are you studying?
2. How did you find out about the services of the center?

## Spring Site Visit Questions

Questions to be asked during the site visits conducted in April and May, 1997

### A. Workplace Education Instructors

1. What skills and competencies have you been teaching the past three months?
2. What public relations and orientation activities have you completed?
3. How have you been working with your peer advisors?
4. How have you been working with your local partners?
5. Are some of your students working on a GED or preparing to enroll at your technical college?

### B. Participants (Four to six participants will be interviewed at each site.)

1. What was your purpose for coming to the workplace education center?
2. How have you benefited from your studying in the center?
3. Do you plan on continuing to use the center?

### C. Peer Advisors (Interview 3 peer advisors)

1. What are your main activities as a peer advisor?
2. What are the most important contributions of the peer advisor to workplace education goals?
3. What type of assistance do you, as a peer advisor, need?

D. Local Partners (Steering/advisory committee members, union and employee representatives, management, etc.)

1. In what types of workplace education activities are you involved?

2. How is information on the program disseminated?

3. How could the program be improved?





# University of Wisconsin-Stout

Menomonie, Wisconsin 54751-0790  
A COORDINATOR LIST

Center for Vocational, Technical and Adult Education  
School of Industry and Technology  
Phone 715,232-1382

April 22, 1993

«Line 1»  
«Line 2»  
«Line 3»  
«Line 4»  
«Line 5»

Dear «Salutation»

Your assistance and participation in the third party evaluation are very important. The information you provide on the enclosed survey will help to determine the accomplishments of the workplace education project and generate ideas for improving the program.

We are serving as the third party evaluators this year. It is our responsibility to provide an independent evaluation of the projects' accomplishments. In the process of doing this, we also want to collect ideas for improving the workplace education program.

In addition to this survey, we are sending surveys to your instructors at the workplace education sites. Each instructor will receive a survey to complete. In addition, we are asking your instructors to distribute surveys to participants (students), peer advisors, and local partners. Each survey has a business reply envelope so the respondents can return their own surveys. A sample set of surveys is enclosed.

Your assistance with these surveys is sincerely appreciated.

Sincerely yours,

Kathleen Hirsch  
External Evaluator  
Workplace Literacy Project  
CVTAE/UW-Stout  
218 Applied Arts Bldg.  
Menomonie, WI 54751  
(715) 232-1382

Orville Nelson  
External Evaluator  
Workplace Literacy Project  
CVTAE/UW-Stout  
218 Applied Arts Bldg.  
Menomonie, WI 54751  
(715) 232-1382

Howard Lee  
External Evaluator  
Workplace Literacy Project  
CVTAE/UW-Stout  
218 Applied Arts Bldg.  
Menomonie, WI 54751  
(715) 232-1251

Enclosures Coordinator Survey  
Instructor Survey and Cover Letter  
Peer Advisor Survey and Cover Letter  
Participant Survey and Cover Letter  
Local Partner Survey and Cover Letter

Jack O'Connell  
Coordinator  
Chippewa Valley Technical College  
620 West Clairemont Avenue  
Eau Claire, WI 54701

Cynthia Bagley  
Coordinator  
Blackhawk Technical College  
6004 Prairie Road/Box 5009  
Janesville, WI 53547-5009

Eduardo Arangua  
Coordinator  
Madison Area Technical College  
211 North Carroll  
Madison, WI 53703

Sharon Fallon  
Coordinator  
Madison Area Technical College  
211 North Carroll  
Madison, WI 53703

Bernard O'Connell  
Coordinator  
Gateway Technical College  
3520-30th Avenue/Box 14856  
Kenosha, WI 53144

Ed Knudson, Coordinator  
Gateway Technical College  
Elkhorn Campus  
400 South Highway H  
Elkhorn, WI 53121

Jim Mullarkey  
Coordinator  
Waukesha County Technical College  
800 Main Street  
Pewaukee, WI 53072

Duane Schultz  
Coordinator  
Milwaukee Area Technical College  
700 West State Street  
Milwaukee, WI 53233

John Huminski  
Coordinator  
Moraine Park Technical College  
235 North National Avenue  
Fond du Lac, WI 54935-2897

Kay Chitwood  
Coordinator  
Fox Valley Technical College  
1825 North Bluemound/Box 2277  
Appleton, WI 54913-2277

Patricia Wouters  
Coordinator  
Northeast WI Technical College  
2740 West Mason Street/Box 19042  
Green Bay, WI 54307-9042

Bill Linstroth  
Coordinator  
Mid-State Technical College  
500 32nd Street North  
Wisconsin Rapids, WI 54494

Carolyn Michalski  
Coordinator  
Northcentral Technical College  
1000 West Campus Drive  
Wausau, WI 54401-1899

# Technical College Coordinator Survey

Directions: Please answer each question. This information will be used to improve the Workplace Education Program.

1. What would be your overall rating of your experiences with the workplace education program?  
(1) \_\_\_ Excellent  
(2) \_\_\_ Very good  
(3) \_\_\_ Good  
(4) \_\_\_ Fair  
(5) \_\_\_ Poor
2. What types of support services/in-services does your district provide for the instructors?  
\_\_\_\_\_  
\_\_\_\_\_  
\_\_\_\_\_
3. How often do you visit the workplace education sites?  
(1) \_\_\_ Weekly  
(2) \_\_\_ Monthly  
(3) \_\_\_ Once every 2-3 months  
(4) \_\_\_ Less frequently
4. How often do you meet with the instructors as a total group?  
(1) \_\_\_ Weekly  
(2) \_\_\_ Monthly  
(3) \_\_\_ Once every 2-3 months  
(4) \_\_\_ Less frequently
5. Please identify the number of workplace education sites, by source of funding, that your district is operating.  
(1) \_\_\_ Number of sites primarily supported by federal funds  
(2) \_\_\_ Number of sites primarily supported by state funds  
(3) \_\_\_ Number of sites primarily supported by district funds  
(4) \_\_\_ Number of sites paid for by the host company  
(5) \_\_\_ Other \_\_\_\_\_
6. What type of feedback have you received on the workplace education site(s) in your district?  
(1) \_\_\_ Very positive  
(2) \_\_\_ Positive  
(3) \_\_\_ Negative  
(4) \_\_\_ Very negative  
(5) \_\_\_ None received
7. Have you provided inservice for peer advisors?  
(1) \_\_\_ Yes  
(2) \_\_\_ No
8. Who provides the workplace education center equipment (computer, overhead, VCR, etc.)?  
(1) \_\_\_ Company  
(2) \_\_\_ Technical College  
(3) \_\_\_ Other \_\_\_\_\_
9. Are there requests to open additional workplace education sites?  
(1) \_\_\_ Yes  
(2) \_\_\_ No
10. Are there plans to open additional workplace education sites?  
(1) \_\_\_ Yes  
(2) \_\_\_ No
11. What impacts have you observed from the workplace education program? Students have....(Check all that apply)  
(1) \_\_\_ enrolled in a GED program  
(2) \_\_\_ entered a Technical College program  
(3) \_\_\_ became eligible for a promotion  
(4) \_\_\_ received a promotion  
(5) \_\_\_ other \_\_\_\_\_
12. Is additional inservice/staff development needed for your workplace education instructors?  
(1) \_\_\_ Yes, GO TO ITEM 13  
(2) \_\_\_ No, GO TO ITEM 14
13. Types of additional inservice/staff development needed:  
\_\_\_\_\_  
\_\_\_\_\_
14. Does your workplace education program serve any JTPA and/or JOBS clients who have been employed by the companies that host your workplace education programs? (We would like your comments on any special activities initiated for these employees.)  
\_\_\_\_\_  
\_\_\_\_\_
15. If you could change anything, or add to the program, what would it be?  
\_\_\_\_\_  
\_\_\_\_\_
16. Please list ways this program could be improved:  
\_\_\_\_\_  
\_\_\_\_\_
17. Additional Comments:  
\_\_\_\_\_  
\_\_\_\_\_

**THANK YOU FOR COMPLETING THIS SURVEY!!  
PLEASE MAIL IN PREPAID ENVELOPE TO:**

**Kathy Hirsch, UW-Stout  
218 Applied Arts Building  
Menomonie, WI 54751  
FAX 715-232-1985**

4/20/93





# University of Wisconsin-Stout

Menomonie, Wisconsin 54751-0790

Center for Vocational, Technical and Adult Education  
School of Industry and Technology  
Phone: 715 232-1352

April 22, 1993

«Line 1»  
«Line 2»  
«Line 3»  
«Line 4»  
«Line 5»

Dear «Salutation»

Your assistance and participation in the third party evaluation are very important. The information you provide on the enclosed survey will help to determine the accomplishments of the workplace education project and generate ideas for improving the program. In addition, we need your help in distributing surveys to your participants (students), peer advisors, and local partners.

We are serving as the third party evaluators this year. It is our responsibility to provide an independent evaluation of the projects' accomplishments. In the process of doing this, we also want to collect ideas for improving the workplace education program.

## Your Survey

A survey for you to complete is enclosed. You do not need to put your name on it. Your responses will be summarized with those from the other teachers. There is no way we can identify you or your site as we analyze and report the data. Return your survey in the business reply envelope provided.

## Other Surveys

Surveys for the following groups are enclosed:

- Participants (Students)
- Peer Advisors
- Local Partners

April 22, 1993  
Page 2

Each survey has a brief coverletter that explains the survey attached. Also, a business reply envelope is attached. Could you check to see if these can be dropped in the outgoing mail at your site? If they cannot, instruct the people who receive the surveys to use a mail box outside of the company/site.

A separate page of instructions for distributing these surveys is enclosed. If you have any questions, please call us at (715) 232-1382. If we are not in, leave your name, phone number and question with Mary Weber. Also, tell her when it would be most appropriate to return your call.

Your assistance with these surveys is sincerely appreciated.

Sincerely yours,



Kathleen Hirsch  
External Evaluator  
Workplace Literacy Project  
CVTAE/UW-Stout  
218 Applied Arts Bldg.  
Menomonie, WI 54751  
(715) 232-1382

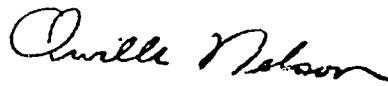

Orville Nelson  
External Evaluator  
Workplace Literacy Project  
CVTAE/UW-Stout  
218 Applied Arts Bldg.  
Menomonie, WI 54751  
(715) 232-1382



Howard Lee  
External Evaluator  
Workplace Literacy Project  
CVTAE/UW-Stout  
218 Applied Arts Bldg.  
Menomonie, WI 54751  
(715) 232-1251

jb

Enclosures Teacher Survey  
Peer Advisor Survey  
Participant Survey  
Local Partner Survey

P.S. Please encourage everyone to respond. We need a good response rate.

Conn Huffaker  
Instructor  
Waukesha County Technical College  
327 East Broadway  
Waukesha, WI 53186

Betty Antoniewski  
Instructor  
Waukesha County Technical College  
327 East Broadway  
Waukesha, WI 53186

Carolyn Evenson  
Instructor  
Waukesha County Technical College  
327 East Broadway  
Waukesha, WI 53186

Mernathan Sykes  
Instructor  
5706 North 27th Street  
Milwaukee, WI 53209

Abraham Bowie  
Instructor  
MATC  
700 W. State Street  
Milwaukee, WI 53233

Jane Rasmussen  
Instructor  
5036 North 56th Street  
Milwaukee, WI 53218

Deanna Durham  
Instructor  
W270 N152 Arrowhead Trail  
Waukesha, WI 53188

Roy Rodriguez  
Instructor  
MATC  
700 W. State Street  
Milwaukee, WI 53233

Terri Stevens  
Instructor  
MATC  
700 W. State Street  
Milwaukee, WI 53233

Genell Gialdini  
Instructor  
MATC  
700 W. State Street  
Milwaukee, WI 53233

Bruce Bell  
Instructor  
MSTC-Stevens Points  
933 Michigan Avenue  
Stevens Point, WI 54481

Diana Werner  
Instructor  
505 South Park  
Medford, WI 54451

Hal Ehrenreich  
Instructor  
Northcentral Technical College  
1000 W. Campus Drive  
Wausau, WI 54401

Sharon Nemirow  
Instructor  
Northcentral Technical College  
1000 W. Campus Drive  
Wausau, WI 54401

Virdean Meyer  
Instructor  
1521 South Locust #2  
Marshfield, WI 54449

June Vogel  
Instructor  
Northeast Wisconsin Technical College  
2740 West Mason Street/Box 19042  
Green Bay, WI 54307-9042

David Schmidtke  
Instructor  
2819 South River Road  
Janesville, WI 53543

Kay Carl  
Instructor  
1991 Bootmaker Drive  
Beloit, WI 53511

Sandy Noble  
Instructor  
38 South Street/Apt. A  
Plymouth, WI 53073

Bridget Schlaefter  
Instructor  
P.O. Box 321  
Campbellsport, WI 53010

Kathy Krueger  
Instructor  
Fox Valley Technical College  
150 North Campbell Road  
Oshkosh, WI 54901

Barb Hummel  
Instructor  
Fox Valley Technical College  
1825 North Bluemound Drive/Box 2277  
Appleton, WI 54913-2277

Dorothy Sorlie  
Instructor  
PC Facility-Cray Research Inc.  
234 Cashman Drive  
Chippewa Falls, WI 54729

Eleanor Antonacci  
Instructor  
2801 80th Street  
Kenosha, WI 53141

Jaci Renaud  
Instructor  
3022 W. Main  
East Troy, WI 53120

Doreen Peterson  
Instructor  
5709 Pheasant Hill Road  
Monona, WI 53716

Susan Goetz  
Instructor  
906 South Brooks #4  
Madison, WI 53715

Lisa Miller  
Instructor  
5602 Guilford #3  
Madison, WI 53716

Mary Cain  
Instructor  
6320 Devonshire Lane  
Sun Prairie, WI 53590

## Instructions for Distributing Surveys

### Participant (Student) Survey (yellow)

- Eight participant surveys are enclosed
- Distribute these surveys as described below:
  1. Have four of your participants who started the program this year complete a survey. Select these people to give a representative cross-section of participants. If you serve people from more than one shift, have some from each shift respond.
  2. The following people may or may not be currently active in your program. These people do not have to be active in your program at the present time.
    - a. Have two people who started the program in 1991-92, complete the survey.
    - b. Have two people who started the program in 1990-91, complete the survey.

NOTE: If your program is new this year, or you do not have access to 1990-91 and/or 1991-92, participants, you may have these surveys completed by this year's participants.

- If a participant or participants will have problems reading the survey, you may read it to them. If needed, you may have someone read the questions in the participants' native language. We do not want the participants' English skills to exclude them from completing the survey.

### Peer Advisors Survey (orchid)

- Four peer advisor surveys are enclosed.
- Distribute these to representative members of your peer advisor group.

### Local Partner Survey (green)

- The Workplace Education Partner Survey is designed for the local partners in your program. They may be steering committee members and/or representatives from labor and management. We want to have some supervisors, managers, and labor/employee representatives complete this form.
- Four workplace education partner surveys are enclosed. Distribute these to a representative cross-section of your local partners.

jb



# University of Wisconsin-Stout

Menomonie, Wisconsin 54751-0790

Center for Vocational, Technical and Adult Education  
School of Industry and Technology  
Phone 715-232-1382

April 22, 1993

Dear Participant:

Your responses to the questions on the attached survey are very important. The information you give will be used to determine what the Workplace Education Program has accomplished this year. Your responses will also help to improve the program.

Do not put your name on the survey. Your answers will be summarized with those of a large number of other participants. There is no way your responses and comments can be identified with you.

Please return your completed survey in the business reply envelope. Return it as soon as possible. The envelope may be placed with the outgoing mail or dropped in any U.S. Mail box.

Your responses and ideas are appreciated.

Sincerely yours,

Kathleen Hirsch  
External Evaluator  
Workplace Literacy Project  
CVTAE/UW-Stout  
218 Applied Arts Bldg.  
Menomonie, WI 54751  
(715) 232-1382

Orville Nelson  
External Evaluator  
Workplace Literacy Project  
CVTAE/UW-Stout  
218 Applied Arts Bldg.  
Menomonie, WI 54751  
(715) 232-1382

Howard Lee  
External Evaluator  
Workplace Literacy Project  
CVTAE/UW-Stout  
218 Applied Arts Bldg.  
Menomonie, WI 54751  
(715) 232-1251

jb

Enclosures

## Participant Survey

Directions: Please answer each question. This information will be used to improve and assess the Workplace Education Program.

- |  |   |      |          |      |          |      |       |                               |   |   |   |   |   |              |   |   |   |   |   |         |   |   |   |   |   |                     |   |   |   |   |   |                 |   |   |   |   |   |
|--|---|------|----------|------|----------|------|-------|-------------------------------|---|---|---|---|---|--------------|---|---|---|---|---|---------|---|---|---|---|---|---------------------|---|---|---|---|---|-----------------|---|---|---|---|---|
| <p>1. What is your age group?<br/>                 (1) ___ 16-24 yrs.<br/>                 (2) ___ 25-44 yrs.<br/>                 (3) ___ 45-59 yrs.<br/>                 (4) ___ 60 and older</p> <p>2. What is your sex?<br/>                 (1) ___ Male<br/>                 (2) ___ Female</p> <p>3. How long have you worked for this company?<br/>                 (1) ___ 0-5 years<br/>                 (2) ___ 6-10 years<br/>                 (3) ___ 11-15 years<br/>                 (4) ___ 16 years and over</p> <p>4. What is the last grade you completed in school?<br/>                 (1) ___ 11th grade or less<br/>                 (2) ___ High School Diploma, Equivalency, or GED<br/>                 (3) ___ Some College<br/>                 (4) ___ Technical College Degree or Diploma<br/>                 (5) ___ College Degree-Four Year</p> <p>5. Why do you use the workplace education center?<br/> <i>(check all that apply)</i><br/>                 (1) ___ To improve my job performance<br/>                 (2) ___ To qualify for future job opportunities<br/>                 (3) ___ To improve my math skills<br/>                 (4) ___ To further my education<br/>                 (5) ___ To meet my personal goals<br/>                 (6) ___ To improve my communication skills<br/>                     (reading, writing, listening, etc.)<br/>                 (7) ___ To prepare for a company training program<br/>                 (8) ___ Other _____</p> | <table border="0" style="width: 100%; border-collapse: collapse;"> <tr> <td style="width: 10%;"></td> <td style="width: 10%; text-align: center;">N/A</td> <td style="width: 10%; text-align: center;">None</td> <td style="width: 10%; text-align: center;">A little</td> <td style="width: 10%; text-align: center;">Some</td> <td style="width: 10%; text-align: center;">A lot</td> </tr> <tr> <td>17. Getting along with others</td> <td style="text-align: center;">1</td> <td style="text-align: center;">2</td> <td style="text-align: center;">3</td> <td style="text-align: center;">4</td> <td style="text-align: center;">5</td> </tr> <tr> <td>18. Teamwork</td> <td style="text-align: center;">1</td> <td style="text-align: center;">2</td> <td style="text-align: center;">3</td> <td style="text-align: center;">4</td> <td style="text-align: center;">5</td> </tr> <tr> <td>19. ESL</td> <td style="text-align: center;">1</td> <td style="text-align: center;">2</td> <td style="text-align: center;">3</td> <td style="text-align: center;">4</td> <td style="text-align: center;">5</td> </tr> <tr> <td>20. Job Performance</td> <td style="text-align: center;">1</td> <td style="text-align: center;">2</td> <td style="text-align: center;">3</td> <td style="text-align: center;">4</td> <td style="text-align: center;">5</td> </tr> <tr> <td>21. Other _____</td> <td style="text-align: center;">1</td> <td style="text-align: center;">2</td> <td style="text-align: center;">3</td> <td style="text-align: center;">4</td> <td style="text-align: center;">5</td> </tr> </table> <p>22. Since attending the education center, I: <i>(check all that apply)</i><br/>                 (1) ___ Am satisfied with the progress I have made<br/>                 (2) ___ Became eligible for a promotion<br/>                 (3) ___ Have received a promotion<br/>                 (4) ___ Enjoy my job more<br/>                 (5) ___ Have transferred to a different job<br/>                 (6) ___ Contribute more to the team<br/>                 (7) ___ Have entered a Technical College program<br/>                 (8) ___ Other _____</p> <p>23. How has your company helped you to participate in the workplace education program?<br/> <i>(check all that apply)</i><br/>                 (1) ___ Provides access during my breaks<br/>                 (2) ___ Center is open during my free time<br/>                 (3) ___ Allows me to use the center during work time<br/>                 (4) ___ Other _____</p> <p>24. Would you still attend if you had to go to another site?<br/>                 (1) ___ Yes<br/>                 (2) ___ No</p> |      | N/A      | None | A little | Some | A lot | 17. Getting along with others | 1 | 2 | 3 | 4 | 5 | 18. Teamwork | 1 | 2 | 3 | 4 | 5 | 19. ESL | 1 | 2 | 3 | 4 | 5 | 20. Job Performance | 1 | 2 | 3 | 4 | 5 | 21. Other _____ | 1 | 2 | 3 | 4 | 5 |
|  | N/A   | None | A little | Some | A lot    |      |       |                               |   |   |   |   |   |              |   |   |   |   |   |         |   |   |   |   |   |                     |   |   |   |   |   |                 |   |   |   |   |   |
| 17. Getting along with others  | 1   | 2    | 3        | 4    | 5        |      |       |                               |   |   |   |   |   |              |   |   |   |   |   |         |   |   |   |   |   |                     |   |   |   |   |   |                 |   |   |   |   |   |
| 18. Teamwork   | 1   | 2    | 3        | 4    | 5        |      |       |                               |   |   |   |   |   |              |   |   |   |   |   |         |   |   |   |   |   |                     |   |   |   |   |   |                 |   |   |   |   |   |
| 19. ESL  | 1   | 2    | 3        | 4    | 5        |      |       |                               |   |   |   |   |   |              |   |   |   |   |   |         |   |   |   |   |   |                     |   |   |   |   |   |                 |   |   |   |   |   |
| 20. Job Performance  | 1   | 2    | 3        | 4    | 5        |      |       |                               |   |   |   |   |   |              |   |   |   |   |   |         |   |   |   |   |   |                     |   |   |   |   |   |                 |   |   |   |   |   |
| 21. Other _____  | 1   | 2    | 3        | 4    | 5        |      |       |                               |   |   |   |   |   |              |   |   |   |   |   |         |   |   |   |   |   |                     |   |   |   |   |   |                 |   |   |   |   |   |
- Since you came to the workplace education center, how much have you improved in these areas. If you did not cover an area, circle N/A for Not Applicable. *(Circle one number for each)*
- |                      |     |      |          |      |       |
|----------------------|-----|------|----------|------|-------|
|                      | N/A | None | A little | Some | A lot |
| 6. Reading           | 1   | 2    | 3        | 4    | 5     |
| 7. Writing           | 1   | 2    | 3        | 4    | 5     |
| 8. Speaking          | 1   | 2    | 3        | 4    | 5     |
| 9. Listening         | 1   | 2    | 3        | 4    | 5     |
| 10. Computation      | 1   | 2    | 3        | 4    | 5     |
| 11. Measurement      | 1   | 2    | 3        | 4    | 5     |
| 12. Asking questions | 1   | 2    | 3        | 4    | 5     |
| 13. Time management  | 1   | 2    | 3        | 4    | 5     |
| 14. Problem solving  | 1   | 2    | 3        | 4    | 5     |
| 15. Self-esteem      | 1   | 2    | 3        | 4    | 5     |
| 16. Assertiveness    | 1   | 2    | 3        | 4    | 5     |
- |  |   |
|--|---|
|  |   |
|  | 25. How helpful were the peer advisors?<br>(1) ___ Very helpful<br>(2) ___ Helpful<br>(3) ___ Not Helpful<br>(4) ___ Have not contacted one   |
|  | 26. What would be your overall rating of your experiences with the workplace education center?<br>(1) ___ Excellent<br>(2) ___ Very good<br>(3) ___ Good<br>(4) ___ Fair<br>(5) ___ Poor  |
|  | 27. When did you start using the services of the workplace education center?<br>(1) ___ This year (1993)<br>(2) ___ Last fall (Sept. - Dec., 1992)<br>(3) ___ January - June, 1992<br>(4) ___ During 1991<br>(5) ___ During 1990 or earlier |



# University of Wisconsin-Stout

Menomonie, Wisconsin 54751-0790

Center for Vocational, Technical and Adult Education  
School of Industry and Technology  
Phone 715 232-1382

April 22, 1993

Dear Peer Advisor:

Your responses to the questions on the attached survey are very important. We need input based on your experiences with the Workplace Education Program at your location. The information you give will be used to determine what the workplace education project has accomplished this year. Your responses will also be used to identify ways to improve the program.

We are serving as external auditors or evaluators of the statewide workplace education program. Your responses will be combined with those of the peer advisors at other sites. Neither sites nor individuals will be identified with responses in our analyses or reports. You do not have to place your name on the survey.

Please return your completed surveys in the business reply envelope provided. Return it as soon as possible. The envelope may be placed with the outgoing mail or dropped in any U.S. Mail box.

Your responses, suggestions, and ideas are appreciated.

Sincerely yours,

*Kathleen Hirsch*  
Kathleen Hirsch  
External Evaluator  
Workplace Literacy Project  
CVTAE/UW-Stout  
218 Applied Arts Bldg.  
Menomonie, WI 54751  
(715) 232-1382

*Orville Nelson*  
Orville Nelson  
External Evaluator  
Workplace Literacy Project  
CVTAE/UW-Stout  
218 Applied Arts Bldg.  
Menomonie, WI 54751  
(715) 232-1382

*Howard Lee*  
Howard Lee  
External Evaluator  
Workplace Literacy Project  
CVTAE/UW-Stout  
218 Applied Arts Bldg.  
Menomonie, WI 54751  
(715) 232-1251

jb

Enclosures



# Peer Advisor Survey

Directions: Please answer each question. This information will be used to assess the progress of the Workplace Education Program and improve it.

1. What are your activities and roles as a peer advisor?  
(check all that apply)  
(1)\_\_\_ Provide public relations for the workplace education activities and services  
(2)\_\_\_ Encourage fellow employees to participate  
(3)\_\_\_ Assist employees identify career plans/goals  
(4)\_\_\_ Assist employees identify the types of skills and competencies they need to develop  
(5)\_\_\_ Assist as a mentor/tutor to employees  
(6)\_\_\_ Assist the workplace education instructor identify company policies and procedures  
(7)\_\_\_ Review teaching materials  
(8)\_\_\_ Suggest teaching activities and topics to the instructor  
(9)\_\_\_ Other \_\_\_\_\_
2. Do you tell employees about the workplace education program?  
(1)\_\_\_ Yes, what \_\_\_\_\_  
(2)\_\_\_ No
3. Do you encourage participation in the workplace education program?  
(1)\_\_\_ Yes  
(2)\_\_\_ No
4. Do you assist in eliminating barriers to participation in the workplace education program?  
(1)\_\_\_ Yes  
(2)\_\_\_ No
5. What types of training have you received to become a peer advisor?  
\_\_\_\_\_  
\_\_\_\_\_  
\_\_\_\_\_
6. What type of training or activities would you like to receive?  
\_\_\_\_\_  
\_\_\_\_\_  
\_\_\_\_\_
7. Would you be interested in information and ideas from other peer advisors?  
(1)\_\_\_ Yes  
(2)\_\_\_ No
8. How frequently do you get information on the workplace education program?  
(1)\_\_\_ Weekly  
(2)\_\_\_ Monthly  
(3)\_\_\_ Twice a year  
(4)\_\_\_ Once a year  
(5)\_\_\_ Never  
(6)\_\_\_ Other \_\_\_\_\_
9. From whom: \_\_\_\_\_
10. How long have you been a peer advisor?  
(1)\_\_\_ Started this year  
(2)\_\_\_ Started last year  
(3)\_\_\_ Started two years ago or more
11. What encourages people to participate in the workplace education center?  
\_\_\_\_\_  
\_\_\_\_\_  
\_\_\_\_\_
12. What discourages people from participating in the workplace education center?  
\_\_\_\_\_  
\_\_\_\_\_  
\_\_\_\_\_
13. Why do people who might benefit from the workplace education center not participate in the program?  
\_\_\_\_\_  
\_\_\_\_\_  
\_\_\_\_\_
14. What would be your overall rating of your experiences with the workplace education center?  
(1)\_\_\_ Excellent  
(2)\_\_\_ Very good  
(3)\_\_\_ Good  
(4)\_\_\_ Fair  
(5)\_\_\_ Poor
15. If you could change anything, or add to the program, what would it be?  
\_\_\_\_\_  
\_\_\_\_\_  
\_\_\_\_\_
16. Additional Comments:

**THANK YOU FOR COMPLETING THIS SURVEY!!  
PLEASE MAIL IN PREPAID ENVELOPE TO:**

Kathy Hirsch, UW-Stout  
218 Applied Arts Building  
Menomonie, WI 54751  
FAX 715-232-1985

4/20/93



# University of Wisconsin-Stout

Menomonie, Wisconsin 54751-0790

Center for Vocational, Technical and Adult Education  
School of Industry and Technology  
Phone: 715-232-1382

April 22, 1993

Dear Workplace Education Partner:

Your responses to the questions on the attached survey are very important. We need input based on your experiences with the Workplace Education Program at your location. The information you give will be used to determine what the workplace education project has accomplished this year. Your responses will also be used to identify ways to improve the program.

We are serving as external auditors or evaluators of the statewide workplace education program. Your responses will be combined with those of the peer advisors at other sites. Neither sites nor individuals will be identified with responses in our analyses or reports. You do not have to place your name on the survey.

Please return your completed survey in the business reply envelope provided. Return it as soon as possible. The envelope may be placed with the outgoing mail or dropped in any U.S. Mail box.

Your responses, suggestions, and ideas are appreciated.

Sincerely yours,

*Kathleen Hirsch*

Kathleen Hirsch  
External Evaluator  
Workplace Literacy Project  
CVTAE/UW-Stout  
218 Applied Arts Bldg.  
Menomonie, WI 54751  
(715) 232-1382

*Orville Nelson*

Orville Nelson  
External Evaluator  
Workplace Literacy Project  
CVTAE/UW-Stout  
218 Applied Arts Bldg.  
Menomonie, WI 54751  
(715) 232-1382

*Howard Lee*

Howard Lee  
External Evaluator  
Workplace Literacy Project  
CVTAE/UW-Stout  
218 Applied Arts Bldg.  
Menomonie, WI 54751  
(715) 232-1251

jb

Enclosures

## Workplace Education Partner Survey

Directions: Please answer each question. This information will be used to assess the progress of the Workplace Education Program and improve it.

1. How often do you get information on the workplace education center and its services?  
(1)  Weekly  
(2)  Monthly  
(3)  Twice a year  
(4)  Once a year  
(5)  Never  
(6)  Other \_\_\_\_\_
2. How do you receive information on the workplace education center?  
(Check all that apply)  
(1)  Posters  
(2)  Orientation sessions  
(3)  Open house in the Center  
(4)  Newsletter from the Center  
(5)  Company newsletter  
(6)  From employees who are using the center  
(7)  Presentations by the instructors in the center  
(8)  Other \_\_\_\_\_
3. Do you encourage participation in the workplace education program?  
(1)  Yes  
(2)  No
4. Do you assist in eliminating barriers to participation in the workplace education program?  
(1)  Yes, how \_\_\_\_\_  
(2)  No
5. Do you have opportunities to provide suggestions for the workplace education program?  
(1)  Yes  
(2)  No
6. What would be your overall rating of the workplace education center?  
(1)  Excellent  
(2)  Very good  
(3)  Good  
(4)  Fair  
(5)  Poor
7. Would you recommend this workplace education program to others?  
(1)  Yes  
(2)  No
8. Why do people who might benefit from the workplace education center not participate in the program?  
\_\_\_\_\_  
\_\_\_\_\_
9. What encourages people to participate in the workplace education center?  
\_\_\_\_\_  
\_\_\_\_\_  
\_\_\_\_\_
10. What discourages people from participating in the workplace education center?  
\_\_\_\_\_  
\_\_\_\_\_  
\_\_\_\_\_
11. What are positive outcomes of the program?  
\_\_\_\_\_  
\_\_\_\_\_  
\_\_\_\_\_
12. If you could change anything, or add to the program, what would it be?  
\_\_\_\_\_  
\_\_\_\_\_  
\_\_\_\_\_
13. Additional Comments:  
\_\_\_\_\_  
\_\_\_\_\_  
\_\_\_\_\_

THANK YOU FOR COMPLETING THIS SURVEY!!  
PLEASE MAIL IN THE PREPAID ENVELOPE TO:

Kathy Hirsch, UW-Stout  
218 Applied Arts Building  
Menomonie, WI 54751  
FAX 715 232-1985

4/20/93

# **WORKPLACE PARTNERSHIP TRAINING PROGRAM**



**PEER ADVISOR HANDBOOK**

## Developed By:

Tom Becker, AFL-CIO/BTC Workplace Education Coordinator

Kay Carl, Lead Instructor WPTP

David Schmidtke, Lead Instructor WPTP



# BLACKHAWK TECHNICAL COLLEGE

Federal Projects are funded by the U.S. Department of Education.

State Projects are funded with state administered funds.

Supplemental funding is provided by the local partners.

# PEER ADVISOR TRAINING AGENDA

## I. Welcome to training

- A. Introductions of presenters
- B. Purpose of training

## II. Workplace Partnership Training Programs, an overview

- A. Need for and history of the programs
- B. Videotape
- C. Partner endorsements

## III. Program Structure

- A. Elements of a Workplace Partnership Training Program
- B. A Peer Advisor is • • •
- C. A Peer Advisor Does • • •

## IV. Program Services overview

- A. Instruction
- B. Educational Offerings
- C. Location, Times, Equipment, Materials
- D. The Top Ten (most asked questions)
- E. Questions / Concerns



0/22/98

## **THE NEED**

The only way companies can consistently improve the quality of goods and services they provide and satisfy their customers' needs is to create high performance workplaces. Yet, today, American companies do much less training than some of our international competitors; in fact, fewer than 10% of front-line American workers now receive training of any kind.

\$200 billion or more annually is the estimated loss to American society as a result of having scores of millions of Americans who lack basic literacy skills (Congressional Research Service, 1990; Winkler, 1990; Kozol, 1985)

\$20 billion or more annually is the estimated cost to business and industry in lost profits and productivity (Winkler, 1990)

Several billion dollars annually is paid by business and industry for workers' compensation, industrial insurance, damage to equipment, et al. as a direct result of workers' inability to read and understand manuals, safety and warning signs, et al.  
(Kozol, 1985)

\$6 billion annually go to welfare and unemployment costs as a direct result of the number of illiterate adults who are unable to perform at standards necessary for available employment. (Kozol, 1985)

75% of the workforce of the year 2000 are currently employed, and 20-30 million have serious problems with basic skills. (Chisman, 1989)

The majority of new jobs will require some post-secondary education. (U.S. Depts of Education and Labor, 1988)

In the year 2000, only 27% of all new jobs will fall into low skill categories compared to 40% of jobs today. (U.S. Depts. of Education and Labor, 1988)

Annually, almost 2.4 million people try to enter the workforce with limited basic skills:

- 700,000 who drop out of high school each year
- 700,000 who graduate each year but still lack basic skills
- 1,000,000 new working age immigrants each year

1 out of 8 employees function at a 4th grade reading level

1 out of 5 employees function at a 5th grade reading level

70% of workplace reading material is between 9th and 12th grade level

15% of workplace reading material is higher than 12th grade level  
(The Business Council for Effective Literacy, 1988)

In Wisconsin:

- Estimated 50,260 totally illiterate
- Estimated 442,460 functionally illiterate
- 412,720 "at risk" due to increased demand for higher level basic skills
- Over 1,000,000 adults have not completed high school (Wisconsin Board of Vocational, Technical, and Adult Education, 1988)

## **THE WISCONSIN PROGRAM MODEL**

Began in August, 1988 at Navistar International Transportation, Inc.

Originally developed through a partnership with Navistar management, United Steelworkers of America Local 3740, and Waukesha County Technical College

One of the 11 initial partnerships that received federal funding through the Wisconsin Workplace Training Program administered by the Wisconsin Board of Vocational, Technical and Adult Education, the Wisconsin State AFL-CIO and the Wisconsin Manufacturers and Commerce.

In January 1991, there were more than 60 workplace education programs partially funded through grants from the U.S. Department of Education or the Wisconsin Board of Vocational, Technical and Adult Education.

The programs provide workplace-specific, job-specific and general basic skills instruction. They are designed to enable employees to realize both short and long term personal goals.

Employers benefit from a workforce with higher skill levels and an improved competitive position.

**Wisconsin's Workplace Partnership Program has been nationally recognized and commended. It is used as a model for other states.**



# PEER TRAINING OUTLINES

Space is provided on each sheet for additional notes if desired.

921/92



# WHY?

(Interesting Statistics)  
(Not Boring, but Alarming)



## NATIONAL PERSPECTIVE



## STATE PERSPECTIVE



## LOCAL PERSPECTIVE



## DISLOCATED WORKERS PERSPECTIVE



# HISTORY

## **Wisconsin Workplace Partnership Model** (Nationally Recognized)

### **Local Partnerships**

### **\$ Program Guidelines / Funding**



# ELEMENTS OF A WORKPLACE PARTNERSHIP TRAINING PROGRAM



## **PARTNERSHIP**

(Decision-making is a participatory process)



## **ON SITE / INNOVATIVE**

(new, non-traditional opportunities)



## **CONFIDENTIAL**

(records kept private by instructors)



## **JOB RELATED / JOB ANALYSIS**

(job materials used in instruction)



## **NEED BASED / PERSONALIZED**

(program to assist the persons total needs and schedule)

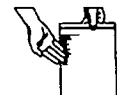

## **ASSESSMENTS**

(used to identify strengths, develop goals, and provide positive feedback)



## **FUTURE ORIENTED**

(preparation for change)



# A PEER ADVISOR IS • • •

**P PATIENT**

**E EDUCATIONALLY ORIENTED**

**E EASY TO TALK TO**

**R RESPECTFUL OF OTHERS DIGNITY**

**A AN ADVOCATE**

**D DETERMINED**

**V VERSATILE**

**I INTERESTED IN OTHERS**

**S SENSITIVE TO PEOPLES NEEDS**

**O ORGANIZED**

**R REALLY, REALLY GOOD AT LISTENING**

# A PEER ADVISOR DOES • • •

**R** RECEIVES TRAINING

**O** OBSERVES NEEDS

**L** LISTENS (LIAISON)

**E** ESTABLISHES TRUST

**M** MOTIVATES PARTICIPATION

**O** ORIGINATES PROGRAM DIRECTION

**D** DISTRIBUTES INFORMATION

**E** ELIMINATES FEAR

**L** LAUDS LIFELONG LEARNING



# INSTRUCTION

\* **INDIVIDUALIZED**

\* **SMALL GROUP**

## EDUCATIONAL OFFERINGS

(Specifics to be determined at each site)

\* **MATH**

\* **READING & WRITING**

\* **COMPUTER SKILLS**

\* **GED PREPARATION**

\* **MISC.**



## THE TOP TEN

(Most asked questions)

1. What do you mean by Confidential?
2. Do I have to take a test?
3. What do you mean I can come & go whenever I want?
4. How do I approach someone whom I suspect cannot read or write?
5. How do I motivate older employees, especially if they're close to retirement?
6. How often should I approach my co-workers?
7. If I'm asked a question and I don't know the answer, what do I do?
8. Why should I do this? What's in it for me?
9. Do I get college credit? How will anyone know I've done anything?
10. How does this "individual" stuff work? Are there regular classes like I remember?



# CONFIDENTIAL FORMS

Used for recordkeeping and statistical reporting for accountability



# WORKPLACE PARTNERSHIP TRAINING PROGRAM

## INFORMATION

Welcome to the training program being sponsored as a partnership between your corporation, your union(s), and Blackhawk Technical College. The goals of this program are to help employees improve skills, gain more job satisfaction, advance careers, enrich personal lives, and become more productive employees.

This program is special in that most of your training will be on your own, at your own speed, following a program developed jointly between you and the program instructor. You can spend as much or as little time as you want. Optional formal classes will be offered which will meet for periods of up to 4 weeks.

Anything you do in this program will be kept in confidence with records being released only upon your request. Because some of the funding comes through state or federal projects, certain forms and records must be filled out and kept for reporting purposes. The information on these forms is for statistical purposes only.

The keys to individualized instruction are setting goals, and developing a plan to achieve those goals. Below is a form to help you develop your plan.

-----  
 Name \_\_\_\_\_ Date \_\_\_\_\_

Program Instructor \_\_\_\_\_ Site \_\_\_\_\_

Check your goals at this time:

- |   |   |
|---|---|
| <input type="checkbox"/> Improve Math Skills          | <input type="checkbox"/> Retain a Job                 |
| <input type="checkbox"/> Improve Writing Skills       | <input type="checkbox"/> Receive a Promotion          |
| <input type="checkbox"/> Improve Reading Skills       | <input type="checkbox"/> Do Better at a Current Job   |
| <input type="checkbox"/> Improve Communication Skills | <input type="checkbox"/> Improve Self-Image           |
| <input type="checkbox"/> Improve Office Skills        | <input type="checkbox"/> Other (Please Specify) _____ |
| <input type="checkbox"/> Improve Computer Skills      | _____   |
| <input type="checkbox"/> English as a Second Language | _____   |

Educational Plan:

Date to review goals and your educational plan:



STUDENT'S WEEKLY RECORD

Name \_\_\_\_\_ Program \_\_\_\_\_

For The Week Of \_\_\_\_\_

	<u>Work Accomplished</u>	<u>Materials Used</u>	<u>In</u>	<u>Out</u>	<u>Total</u>
Monday	_____ _____	_____ _____	_____ _____	_____ _____	_____ _____
Tuesday	_____ _____	_____ _____	_____ _____	_____ _____	_____ _____
Wednesday	_____ _____	_____ _____	_____ _____	_____ _____	_____ _____
Thursday	_____ _____	_____ _____	_____ _____	_____ _____	_____ _____
Friday	_____ _____	_____ _____	_____ _____	_____ _____	_____ _____
<b>Total Weekly Hours</b>		_____	_____	_____	_____

Site \_\_\_\_\_ Project Number \_\_\_\_\_

Participant Enrollment Record

1. Date of Enrollment: \_\_\_\_/\_\_\_\_/\_\_\_\_ 1A. Social Security # \_\_\_\_-\_\_\_\_-\_\_\_\_  
MM DD YY
2. Participant's Name: \_\_\_\_\_  
First Last
3. Home Address: \_\_\_\_\_  
Street City ZIP
4. Home Phone: (\_\_\_\_) \_\_\_\_\_ 4A. Work Phone (\_\_\_\_) \_\_\_\_\_
5. Marital Status: [ ] single [ ] married [ ] separated  
[ ] divorced [ ] widowed
6. Site (employer): \_\_\_\_\_
7. Date of Birth: \_\_\_\_/\_\_\_\_/\_\_\_\_ 8. Sex: [ ] Male [ ] Female  
MM DD YY
9. Single, Head of Household: [ ] yes [ ] no
10. Ethnic Background:  
American Indian/Alaskan Native [ ] Hispanic [ ]  
Asian/Pacific Islander [ ] White/Non Hispanic Origin [ ]  
Black/Non Hispanic Origin [ ]
11. Job Classification (Title): \_\_\_\_\_ 11A. Shift \_\_\_\_\_
12. Job Duties: \_\_\_\_\_
13. Employed: [ ] Full Time [ ] Part Time [ ] Laid Off [ ] Financial Assistance  
Type \_\_\_\_\_
14. Years at Worksite: \_\_\_\_\_
15. Last Year of School completed: \_\_\_\_\_ 15A. High School Graduate [ ] yes [ ] no  
GED/HSED Graduate [ ] yes [ ] no  
Vocational Degree [ ] yes [ ] no  
Some Post-Secondary [ ] yes [ ] no
16. Is English your Primary Language? [ ] yes [ ] no  
Is English your Secondary Language? [ ] yes [ ] no  
Do you have limited English Proficiency? [ ] yes [ ] no
17. What were the Major causes for Enrollment in the Program?  
(Check all that apply)
- Peer Advisor [ ] Publication [ ]  
Employer Referral [ ] Family Member [ ]  
Open House [ ] Other [ ] (Please Specify) \_\_\_\_\_



**WORKPLACE PARTNERSHIP TRAINING PROGRAMS**

**TEACHING**

**FOR**

**A**

**REASON**



**WORKPLACE  
PARTNERSHIP  
TRAINING  
PROGRAM**



**PEER ADVISOR**

**TRAINING ACTIVITIES**



**PREPARED BY:**



**KAY CARL, Lead Instructor - Workplace Education  
BLACKHAWK TECHNICAL COLLEGE**

This booklet is intended to be a **SAMPLER** of activities that can be used for ongoing peer advisor training needs. The instruction that accompanies the activities is either not complete or not included.

For further information contact:

**KAY CARL**

**BLACKHAWK TECHNICAL COLLEGE  
6004 PRAIRIE ROAD  
BOX 5009  
JANESVILLE, WI 53547**

**PHONE: 608-757-7637  
FAX: 608-757-740**

# CONNECTING THROUGH COMMUNICATING

A drop of water striking a pool causes a ripple that moves outward in ever-widening circles, touching all of the surrounding water. Likewise, communication at its best has tremendous power to touch people - to inform, enlighten, influence, entertain, relieve, console. Like a water droplet hitting a pool, communicating is a repeatable event. Each instance is unique and has unique effects.

# AWARENESS

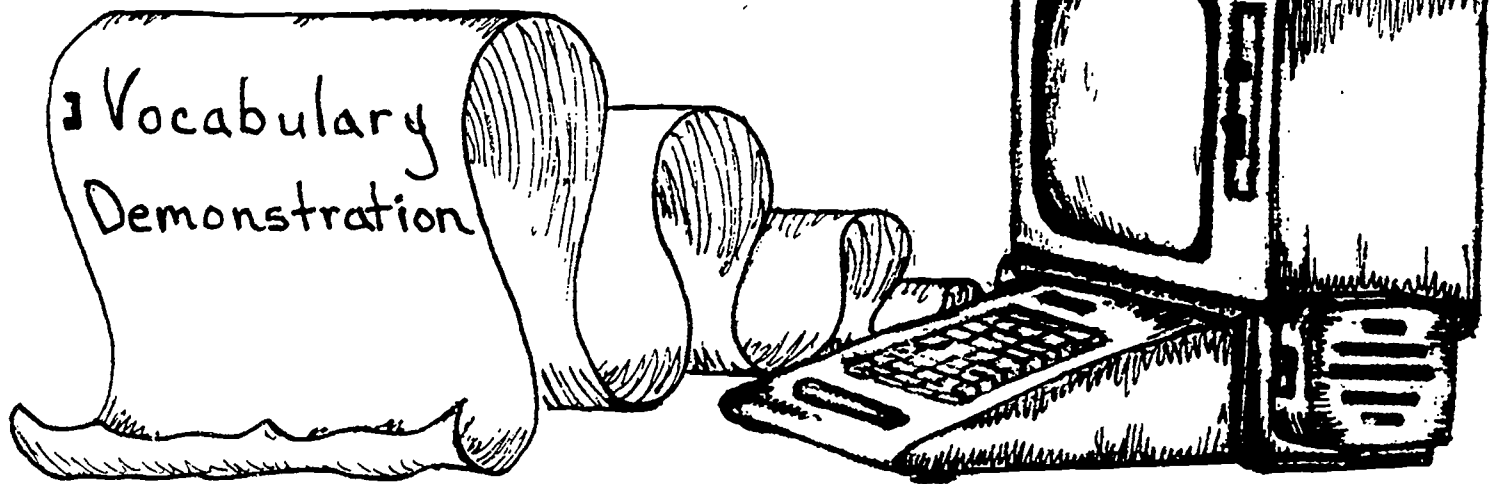

*Chris Freeman*

**DIRECTIONS:** In each of the nine blanks below, identify the job area (or department) that includes all the terms listed.

1. \_\_\_\_\_ 2. \_\_\_\_\_ 3. \_\_\_\_\_

nanosecond  
operand  
byte  
scrolling  
actuator  
GIGO  
digitizer  
plotter

doffer  
malimo  
lickerin  
slub  
roving  
osnaburg  
sinker  
cyclone

broach  
orthographic  
knurl  
bushing  
kerf  
anneal  
chamfer  
parabola

4. \_\_\_\_\_ 5. \_\_\_\_\_ 6. \_\_\_\_\_

crazing  
decalcomania  
atomization  
coalescence  
mottling  
retarder  
ductility  
per-chloroethylene

graffes  
folutes  
lesnics  
raptiforms  
hygrolated  
loors  
chamlets  
cresnites

cyanosis  
auscultation  
diaphoresis  
empyema  
fremitus  
turgor  
pyrexia  
homeostasis

7. \_\_\_\_\_ 8. \_\_\_\_\_ 9. \_\_\_\_\_

noncoplanar  
frisket  
truncate  
ellipse  
diazo  
crosshatching  
tensile

getter  
decoupling  
ferrite  
diode  
farad  
folded dipole  
rectification

molybdenum  
peening  
oxyacetylene  
ripple  
trammel  
porosity  
monolithic

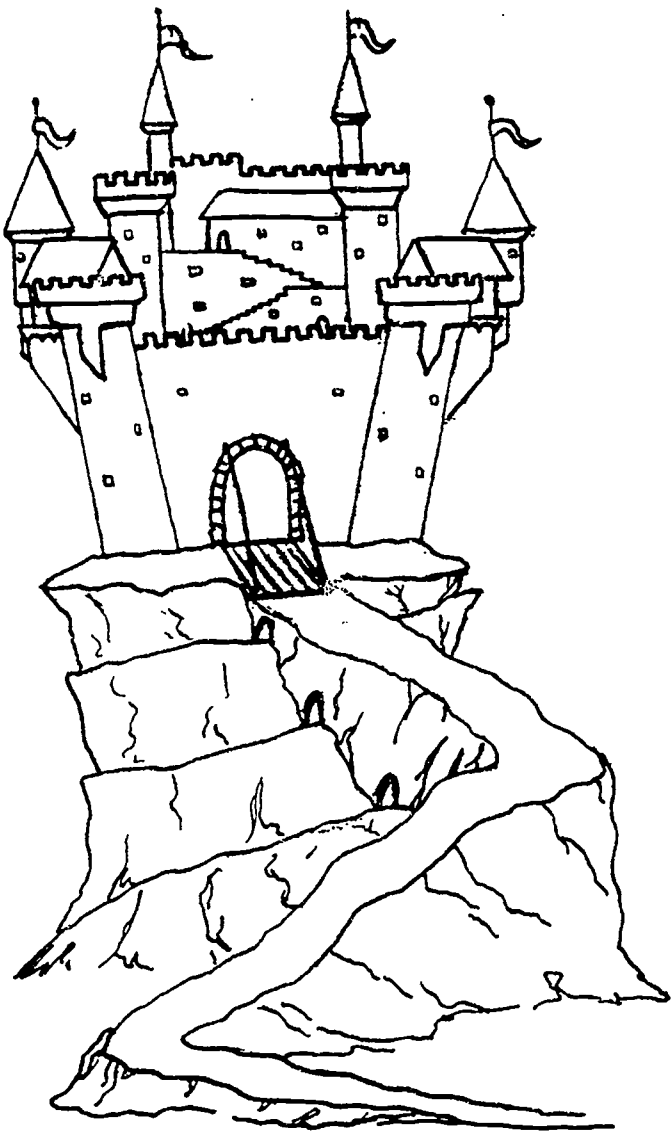

# KING Technology

Once in the Land of Employment there ruled a king called Technology. Retraining would be needed for the workers to be prosperous in the land.

So onx day thx bnxvolxnt king dxcidxd to sxnd zll his workxrs tq schqql. Zll qf thx wqrkxrs rxjqvxd "Blxss Txchnqlqy" thxy xxclzimxd.

Nqw, thx txzchxrs wxrx vxxy wvx. But zs wvx zs thxy wxrx, thxy qvxrlqqkxd thx nxxe fqr bzsve skvlls. Thxy dxcvdx thzt thx bxst fqrn qf unstrhctvqn wzs cqntxnt fqr zll.

Zs tvmx wxnt qn, thx kungdqm qf txchnqlqy bxgn tq splvt zt thx sxzms znd vt lqkxd lvks thus: Bex dqvfggj klzm nqxp qqt rqt vxwxxz bqxc dqf ghzj kqlxmxp.

Chris Freeman

# "Ordeal by Cheque"

DIRECTIONS: Analyze these bits of information and the relationship established among the events depicted by the checks. Reconstruct the story created by this series of checks.

PAID TO	ENTRY DATE	AMOUNT	SIGNED BY
U. of W. Bookstore	1/21/67	\$ 83.58	Megan Ayer
Badger Rental	6/7/67	\$ 12.41	Megan Ayer
Lundstrom Travel	7/15/67	\$ 1,300.00	Megan Ayer
Sentinel Realty	8/30/67	\$ 300.00	Megan Ayer
Hordy's Bakery	7/23/68	\$ 65.93	Megan Ayer
Sullaby Lane	8/23/69	\$ 156.00	Megan A. Ford
Wisconsin Memorial Hospital	9/28/69	\$ 129.68	Megan A. Ford
Likwich's Pharmacy	1/24/70	\$ 2.62	Megan A. Ford
Brad's Datours	8/6/70	\$ 2300.03	Megan A. Ford
Teacher's Credit Union	10/1/70	\$ 103.99	Megan A. Ford
U. of W. Milwaukee	10/1/70	\$ 244.00	Megan A. Ford
Mayflower Moving	1/23/71	\$ 257.77	Megan A. Ford
Community Day Care	6/15/72	\$ 35.00	Megan A. Ford
Kendall Karts	9/6/72	\$ 500.00	Megan Ayer Ford
atly:	4/30/73		

Chris Freeman

Adapted from the short story "Ordeal By Cheque" by Wuther Grue

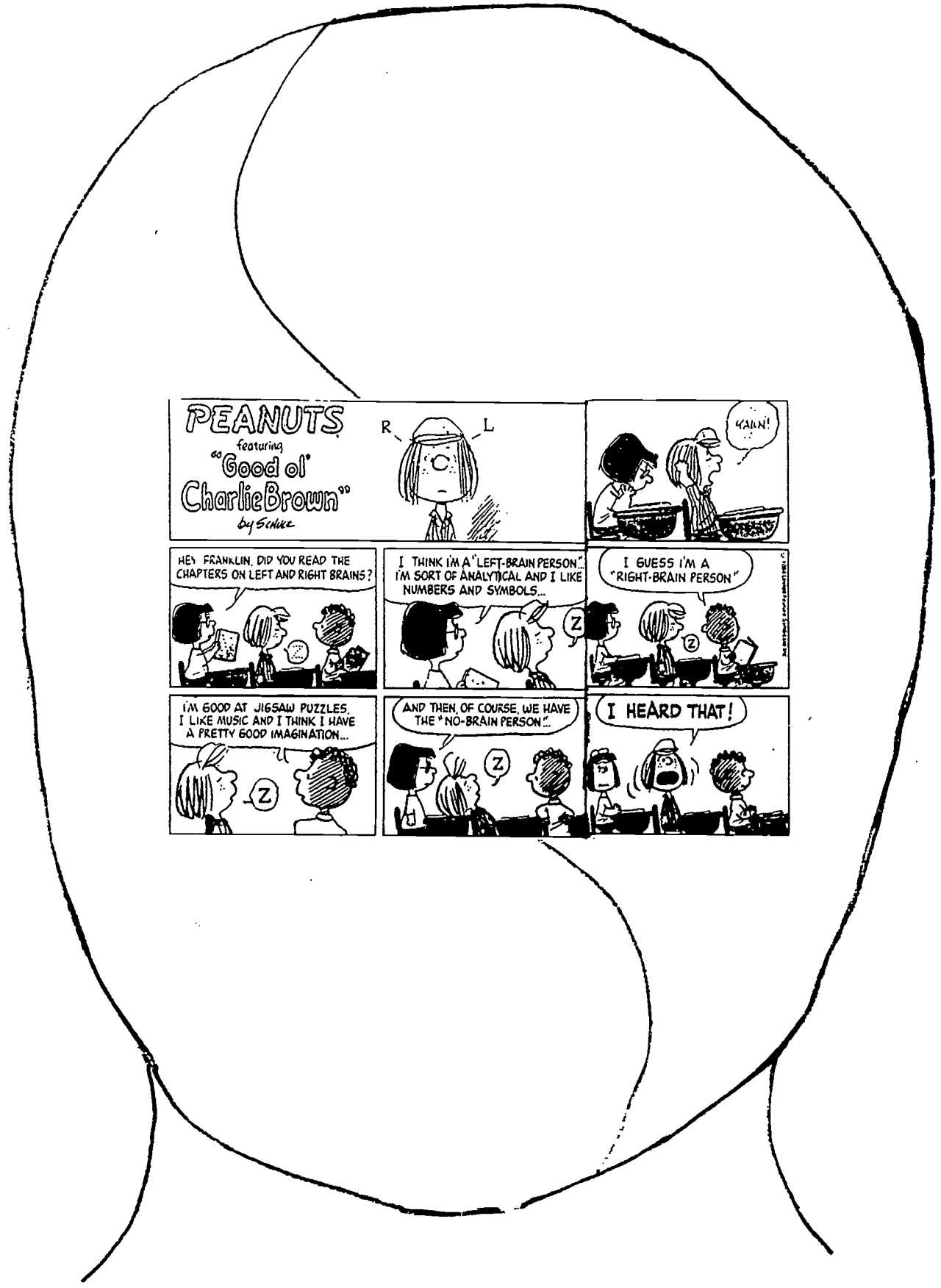

**PEANUTS**  
featuring  
**"Good ol' Charlie Brown"**  
by Schulz

R L

YARN!

HEY FRANKLIN, DID YOU READ THE CHAPTERS ON LEFT AND RIGHT BRAINS?

I THINK I'M A "LEFT-BRAIN PERSON" I'M SORT OF ANALYTICAL AND I LIKE NUMBERS AND SYMBOLS...

I GUESS I'M A "RIGHT-BRAIN PERSON"

I'M GOOD AT JIGSAW PUZZLES, I LIKE MUSIC AND I THINK I HAVE A PRETTY GOOD IMAGINATION...

AND THEN, OF COURSE, WE HAVE THE "NO-BRAIN PERSON"...

I HEARD THAT!

RIGHT BRAIN

LEFT BRAIN

Imagine that you are getting ready to put on your shoes and socks. Which sock would you put on first?

- A. Right
- B. Left

You are having a problem with a situation at work. Would you be more likely to:

- A. Think about, and maybe write down, all the ways you can think of to solve it, then choose one.
- B. Wait to see if the problem will go away.

When asked by a friend to tell what you did on vacation, do you:

- A. Easily talk about many things that happened.
- B. Say, "Oh nothing much".



- (a) not good at remembering faces.
- (b) not good at remembering names.
- (c) equally good at remembering names and faces.

- (a) easily lost even in familiar surroundings.
- (b) easily find directions even in strange surroundings.
- (c) moderately skilled in finding directions.

A LEFT-BRAINED WORLD?  
WHICH SIDE DO YOU PREFER?

In each item, two or three different styles of learning or thinking are described. Choose the one that describes most accurately your strength or preference.

After you've answered the questions, use the key to determine what the answers indicate.

1. (a) Not good at remembering faces.  
(b) Not good at remembering names.  
(c) Equally good at remembering names and faces.
2. (a) Respond best to verbal instructions.  
(b) Respond best to instruction by example.  
(c) Equally responsive to verbal instruction and instruction by example.
3. (a) Able to express feelings and emotions freely.  
(b) Not easily able to express feelings and emotions.
4. (a) Prefer classes where I have one assignment at a time.  
(b) Prefer classes where I am studying or working on many things at once.  
(c) I have equal preference for the above type classes.
5. (a) Preference for multiple-choice, essay tests.  
(b) Preference for essay tests.  
(c) Equal preference for multiple-choice, essay tests.
6. (a) Good at thinking up funny things to say and-or do.  
(b) Poor at thinking up funny things to say and-or do.  
(c) Moderately good at thinking up funny things to say or do.
7. (a) Prefer classes in which I am moving and doing things.  
(b) Prefer classes in which I listen to others.  
(c) Equal preference for above type classes.
8. (a) Use factual, objective information in making judgments.  
(b) Use personal experiences and feelings in making judgements.  
(c) Make equal use of factual information and personal experiences.
9. (a) Almost always can use whatever tools are available to get work done.  
(b) At times am able to use whatever is available to get work done.  
(c) Prefer working with proper materials for use they are intended for.

10. (a) Like classes or work to be planned and know exactly what I am to do.  
(b) Like my classes or work to be open, flexible.  
(c) Equal preference for structured work and activities open to change.
11. (a) Very inventive.  
(b) Occasionally inventive.  
(c) Never inventive.
12. (a) Think best while lying flat on back.  
(b) Think best while sitting upright.
13. (a) Like classes where the work has clear and immediate applications (such as mechanical drawing, shop, home economics).  
(b) Like classes where the work does not have a clearly practical application (such as literature, algebra, history).  
(c) Equal preference for both types of classes.
14. (a) Preference for intuitive approach in solving problems.  
(b) Preference for logical approach in solving problems.  
(c) Equal preference for intuitive, logical approaches.
15. (a) Preference for solving problems logically.  
(b) Preference for solving problems through experience.  
(c) Equal preference for using logic, experience in problem solving.
16. (a) Skilled in giving verbal explanations.  
(b) Skilled in showing by movement and action.  
(c) Equally able to explain verbally and through actions.
17. (a) Learn best from teaching that uses verbal explanation.  
(b) Learn best from teaching that uses visual presentation.  
(c) Equal preference for verbal explanation, visual presentation.
18. (a) Easily lost even in familiar surroundings.  
(b) Easily find directions even in strange surroundings.  
(c) Moderately skilled in finding directions.
19. (a) Like to be in noisy, crowded place where lots of things are happening.  
(b) Like to be where I can concentrate on one activity to my best ability.  
(c) Sometimes like both of the above, have no preference.
20. (a) Prefer to learn details and specific facts.  
(b) Prefer a general overview of a subject, looking at the whole picture.  
(c) Prefer overview intermixed with specific facts and details.

In the key to the test, R means right-brain, L means left-brain and I means both sides of brain are interactive.

1. a-L, b-R, c-I
2. a-L, b-R, c-I
3. a-R, b-L
4. a-L, b-R, c-I
5. a-R, b-L, c-I
6. a-R, b-L, c-I
7. a-R, b-L, c-I
8. a-L, b-R, c-I
9. a-R, b-I, c-L
10. a-L, b-R, c-I
11. a-R, b-I, c-L
12. a-R, b-L
13. a-R, b-L, c-I
14. a-R, b-L, c-I
15. a-L, b-R, c-I
16. a-L, b-R, c-I
17. a-L, b-R, c-I
18. a-L, b-R, c-I
19. a-R, b-L, c-I
20. a-L, b-R, c-I

Add up the number of R's, L's, and I's to determine if one side of your brain or the other dominates.

### *Test Directions, Part 2:*

Now look at Part 2 of the test. You will see a list of things with letters next to them from *a* through *t*. On the right side of your paper make a column of *only* the letters that are next to something you enjoy.

### *Test, Part 2:*

- |                      |                             |
|----------------------|-----------------------------|
| a. Drawing           | k. Soccer                   |
| b. Dancing           | l. Discussing               |
| c. Collecting things | m. Baseball                 |
| d. Swimming          | n. Hiking                   |
| e. Fishing           | o. Sewing                   |
| f. Playing cards     | p. Reading                  |
| g. Bicycling         | q. Jigsaw puzzles           |
| h. Scrabble          | r. Oral reports             |
| i. Video Games       | s. Making party decorations |
| j. Chess or checkers | t. Word find puzzles        |

### *Scoring:*

Now score your test. Match the answers on your paper with the SCORING KEY. Mark an R or L next to each one of the answers on your sheet. Next count the number of R's you have and the number of L's. Now what does it all mean? If you have the same number of each, your brain is probably rather evenly balanced. The further apart your two total numbers are, the more "brain preference" you have for one side or the other. For instance, if you have nine Rights and ten Lefts, you do not have a very strong preference. However, if you have fourteen Lefts and only five Rights, you can see what side of your brain is the strongest and which you prefer to use most. Having a "brain preference" to the right or to the left does not make you any better or worse than someone else. It is how we use our brains that count.

### *Scoring Key:*

#### PART 2:

- |          |          |
|----------|----------|
| a. Right | k. Right |
| b. Right | l. Left  |
| c. Left  | m. Right |
| d. Right | n. Right |
| e. Left  | o. Left  |
| f. Left  | p. Left  |
| g. Right | q. Right |
| h. Left  | r. Left  |
| i. Right | s. Right |
| j. Left  | t. Left  |

**LISTENING  
AND  
RESPONDING**

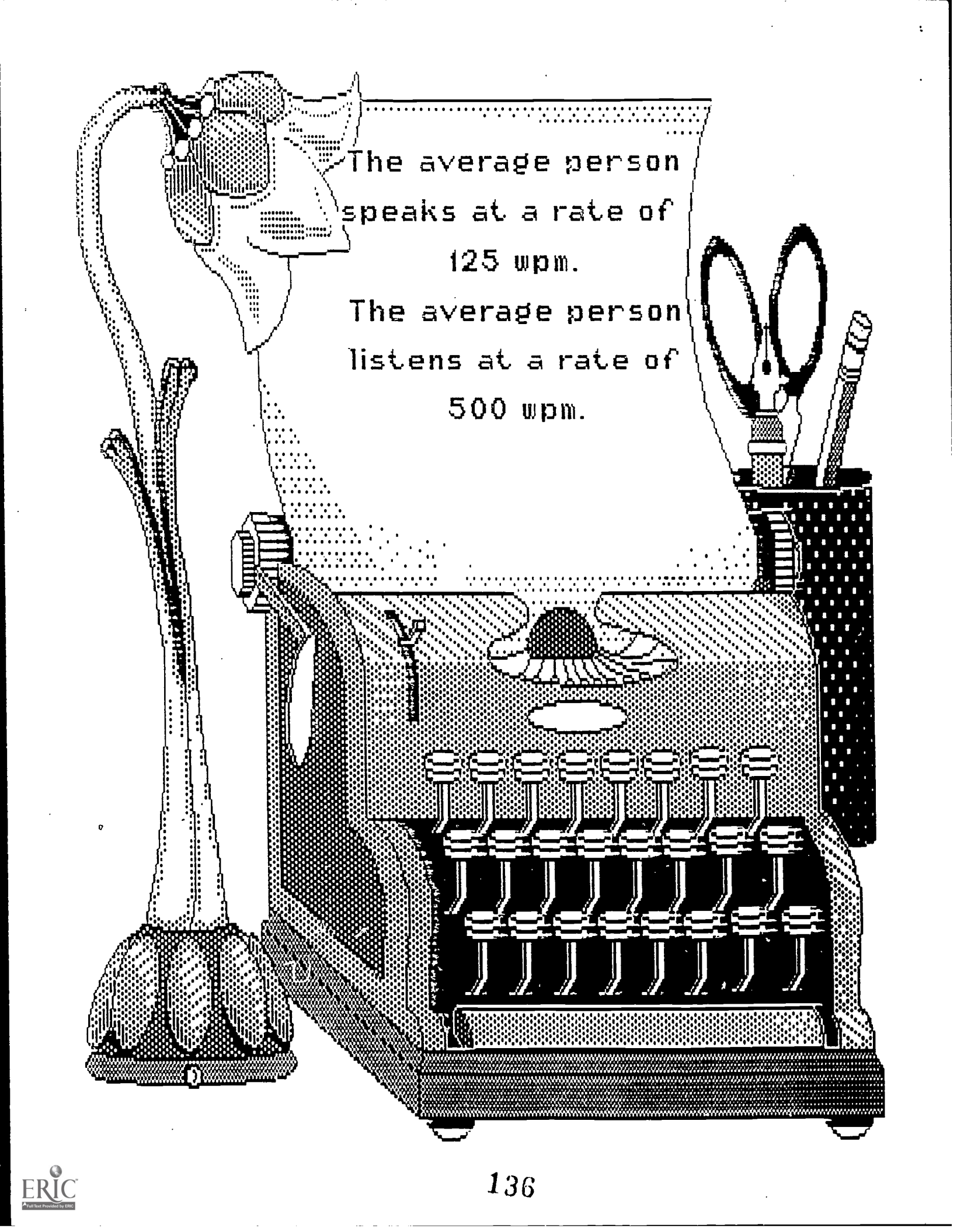

The average person  
speaks at a rate of  
125 wpm.

The average person  
listens at a rate of  
500 wpm.

Listening - Active Process which makes sense out of what you hear.

- validates Sounds
- organizing, interpreting,
- responding

All senses are interlocked and play a role in communication.

Training directors of Fortune 500 companies

cite poor listening as principle factor in

ineffective performance and low productivity.



Listen thru our "eyes"

Phenomenal capacity to make 5 million

discriminations per second

93% of total meaning emerges from visual cue

Ability of listener to focus is very limited

20 seconds on

1 stimulus (attention span)

# Hearing - Physical Process of Receiving Sound

Capacity to distinguish 340,000  
different tones

Range of 20 to 10,000 cycles per  
second

Nobody ever listened himself out  
of a job.

Calvin Coolidge

Listening for Information

**Purpose:** To listen for specific information. To evaluate listening and recall skills.

Listening Exercise #1: "Businessperson's Calendar." *Listen and follow directions.*

---

- 1. \_\_\_\_\_
- 2. \_\_\_\_\_
- 3. \_\_\_\_\_
- 4. \_\_\_\_\_
- 5. \_\_\_\_\_

- 6. \_\_\_\_\_
- 7. \_\_\_\_\_
- 8. \_\_\_\_\_
- 9. \_\_\_\_\_
- 10. \_\_\_\_\_

Score \_\_\_\_\_

**BUSINESSPERSON'S CALENDAR FOR (name of next month)**

GENERAL	FRIDAY	FRIDAY	THURSDAY	WEDNESDAY	TUESDAY	MONDAY
8	7	6	5	4	3	2
16	15	14	13	12	11	9
23	22	21	20	19	18	17
31	30	29	28	27	26	24
38	37	36	35	34	33	32

*Directions for filling out the calendar:*

1. Label the calendar on the line above the rectangle: "Businessperson's Calendar for (name of the next month)."
2. Label the calendar with the days of the week in the spaces above the double line in the rectangle. Write them in this order from left to right: General, Friday, Friday, Thursday, Wednesday, Tuesday, Monday.
3. This is the explanation for the days of the week:
  - a. Nobody likes Monday, so we put it at the end of the week. It won't be such a hard chore to get started on Monday if you have all week to get ready for it.
  - b. Please note, your boss will be glad there are no unproductive Saturdays and Sundays in this calendar.
  - c. Since all customers want their jobs completed by Friday, let's have two Fridays in each week.
  - d. There is a new day each week called General Day. This is an extra day each week on which orders may be cancelled, copy changes made, and everyone can catch up with business.
4. Now let's put in the days of the week as follows:
  - a. On the first week, number the days from left to right in this order: 8, 7, 6, 5, 4, 3, 2.
  - b. Now number the days of the second week from left to right in this order: 16, 15, 14, 13, 12, 11, 9.
  - c. Number the days of the third week from left to right in this order: 23, 22, 21, 20, 19, 18, 17.
  - d. Number the days of the fourth week from left to right in the following order: 31, 30, 29, 28, 27, 26, 24.
  - e. Number the days of the last week from left to right in this order: 38, 37, 36, 35, 34, 33, 32.

5. Here is an explanation for the new numbering system:
  - a. Please note, there are no firsts of the month, no tenths, and no twenty-fifths. This eliminates the need to pay bills.
  - b. Since every job is a rush job and all the customers want their orders delivered yesterday, the new numbers solve this problem. With this calendar, customers can order on the seventh and have delivery on the third.
  - c. If an advertising copy change is made on the eighth and reaches you on the fifth, you can still make corrections even if the goods were shipped on the sixth.
  - d. There are seven extra workdays at the end of the month to relieve those end-of-the-month pressures.
6. This calendar will guarantee that everybody will be happy. We can look forward to an exciting, ulcer-free business world.

*After each statement is read, write "true" or "false" in the appropriate space*

1. The first, tenth, and twenty-fifth have been eliminated, so bills will not have to be paid.
2. With this calendar it is possible to place an order on the twenty-second and have it delivered on the nineteenth.
3. This calendar provides for a seven-day workweek.
4. The reason there are two Fridays is that all the customers want their jobs completed by this day of the week.
5. General Day is an extra day each week to catch up on business.
6. Week Three has days numbered 31, 30, 29, 28, 27, 26, and 24.
7. There are seven extra days at the end of the month so everyone can claim a week of vacation.
8. Blue Monday has been eliminated from the calendar.
9. The twenty-fifth has been omitted from this calendar because it is a number no one likes.
10. The days listed for Thursday are 5, 13, 21, 29, and 35.

*Answers:* 1. True    2. True    3. True    4. True    5. True  
 6. False    7. False    8. False    9. False    10. False

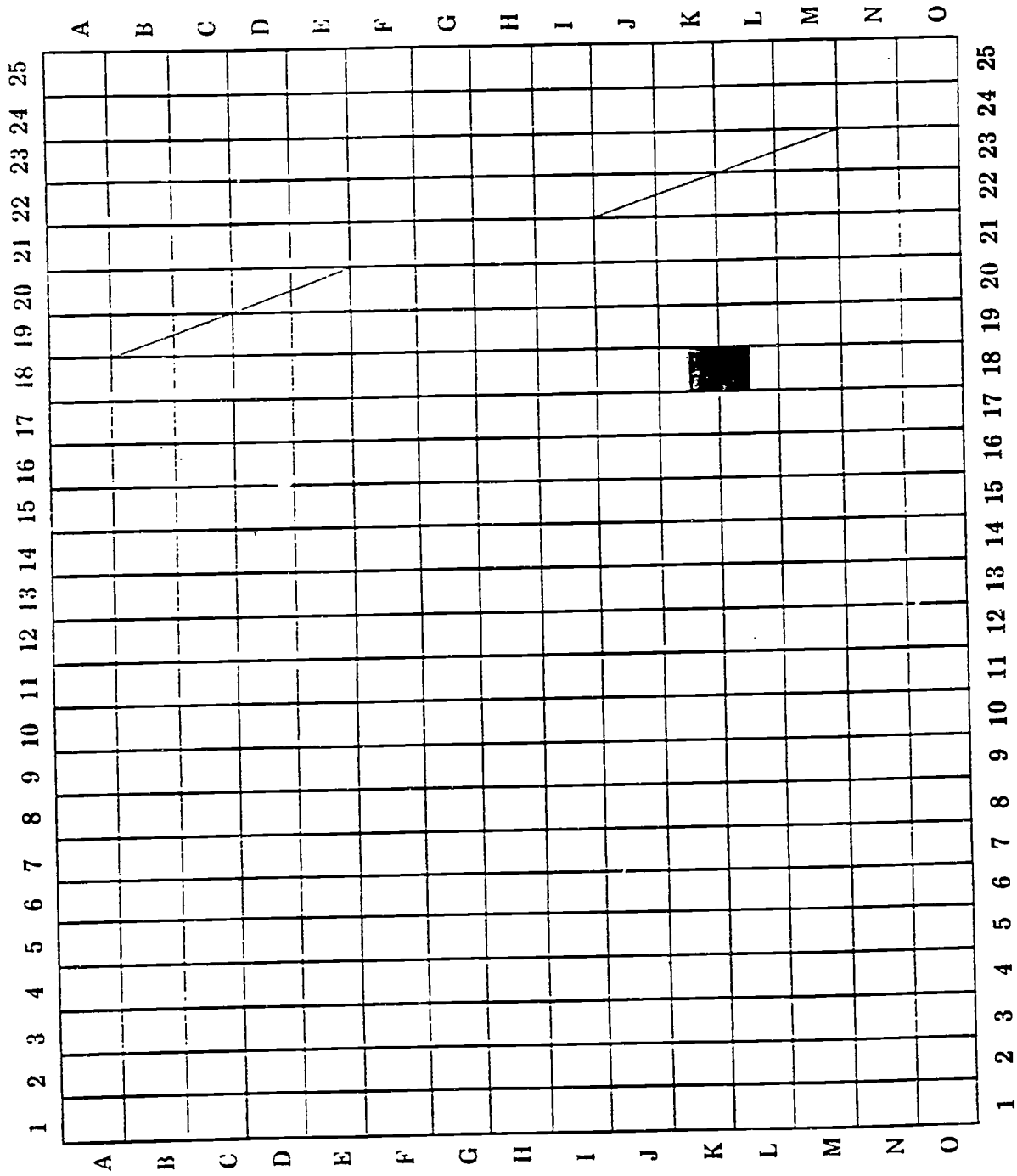

1. On your work sheet find the box on the grid where row B and column 4 intersect. Blacken that box with your pencil.
2. Blacken box C-4. \*
3. Blacken box M-11.
4. Blacken boxes J-2 and J-6.
5. Blacken boxes J-17 and L-2.
6. \*\* Blacken boxes D-4 and K-17.
7. Blacken boxes J-18 and L-6.
8. Blacken boxes C-9 and M-2.
9. Blacken boxes J-19 and E-18.
10. Blacken boxes E-21 and J-21.
11. From this point on, only the intersection of the row letter and column number will be given to you. Blacken the box of each intersection given.
12. B-11, E-4, K-2
13. D-14, L-24, M-3
14. B-21, K-6, M-10
15. B-9, B-13, B-14, B-16
16. D-15, D-16, D-18, D-21
17. M-4, M-6, M-19, M-24
18. B-10, B-15, B-18, C-13
19. C-16, C-18, C-21, D-9
20. D-13, J-10, J-13, J-14
21. \*\* From this point on, a row letter will be given, followed by a group of column numbers. Blacken the boxes where the column numbers intersect the given row.
22. E-9, 10, 11, 13, 16
23. J-8, 9, 11, 15, 24
24. K-8, 9, 14, 21, 24
25. L-10, 11, 14, 17, 21
26. M-8, 9, 14, 17, 18, 21

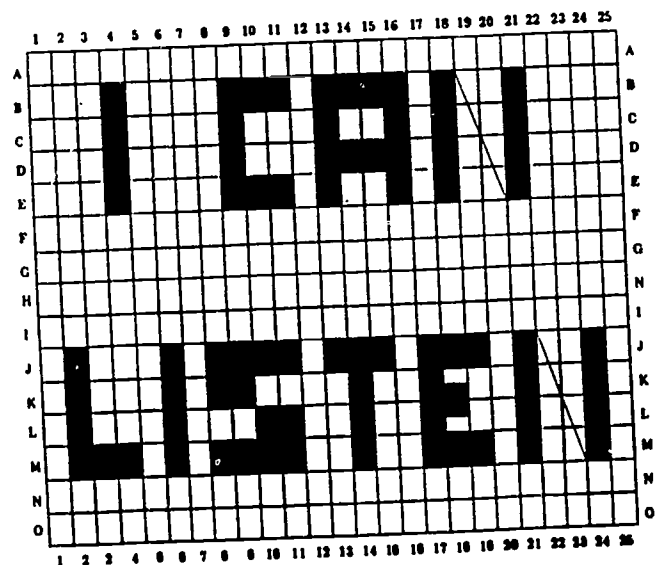

**LOGIC  
AND  
PROBLEM SOLVING**



## A RESCUE PROBLEM

**DIRECTIONS:** Due to hostile relations between Country A and Country B, five citizens of Country A have been seized as hostages by Country B and are being held in a tiny seaport. Given the data below, it is your task to map out a plan for the safe return of the hostages to Country A.

The Situation:

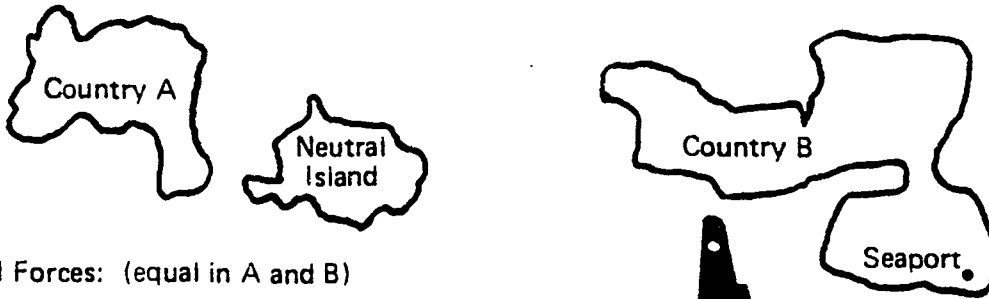

Armed Forces: (equal in A and B)

- 150 trained soldiers
- 3 planes, each capable of holding 50 men
- 6 helicopters with pilots
- 1 aircraft carrier
- sufficient supplies at all times

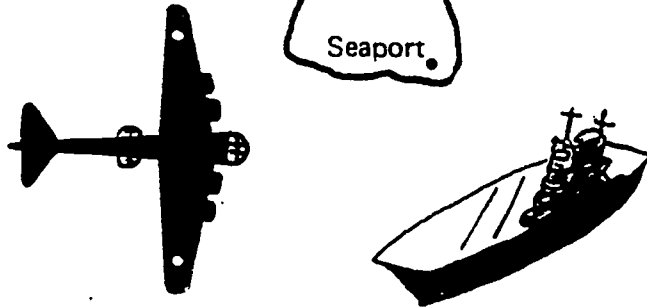

### YOUR RESCUE PLAN

Step 1		Alternative	
		a.	
		b.	
Step 2		Alternative	
		a.	
		b.	
Step 3		Alternative	
		a.	
		b.	
Step 4		Alternative	
		a.	
		b.	

Have you considered the countermoves of Country B? Mechanical defects in aircraft? Possible loss of men and material? Security? Workable alternatives?



FIND THE MURDERER AND THE VICTIM

Fred and Karen, soon after being married, invited Pete and Rose over to play cards with them. As a result of a quarrel, one of these people grabbed a knife and killed one of the others. From the following facts, determine the murderer and the victim:

1. Karen has played tennis regularly with one of the others.
2. Rose had been released from a hospital on the day of the murder, after having been confined there for two days.
3. Pete, who has had his broken leg in a cast for over a year, was driven to the apartment by Fred.
4. Pete had met Fred's mother only once.
5. Fred will not expose his sibling's guilt.
6. The victim had dined in a restaurant the previous evening with one of the people who has regularly played tennis with Karen.
7. Rose had met Karen only six days before the murder.
8. The hostess has been asked to give information about the murderer.



### A MATTER OF LIFE OR DEATH

An unscrupulous old sultan, wishing to be rid of one of his advisers, put two pieces of paper in a hat. He told a magistrate present that if the adviser drew out the piece of paper marked LIFE, he would be set free, but if he drew out the piece of paper marked DEATH, he must die. The sultan then wrote DEATH on both pieces of paper. However, when the adviser, who had been living by his wits for many years, showed the magistrate one piece of paper, the magistrate decided in his favor.

How did the adviser outwit the old sultan?

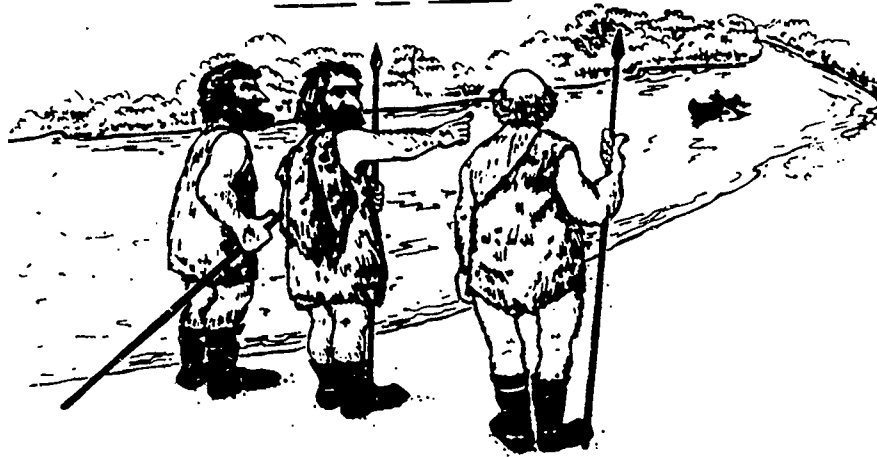

### TO WHICH TRIBE DOES EACH MAN BELONG?

An anthropologist was rowing up a stream in the wilds of a remote land where he knew the Waho and Tabo tribes lived. He knew the Waho always tell the truth, but that the Tabo always lie. As he rounded a bend in the river, he saw three men on the nearby river bank. He directed a question to the first of the three men, "Are you a Waho or a Tabo?"

The man answered, but the anthropologist could not understand what he had said. In the meantime, the second of the three men added, "He said that he is a Waho and he tells the truth."

The third man then said, "The second man who spoke is a Tabo!"

The anthropologist was able to tell the tribe to which each man belonged. Can you identify the three men and their tribes?

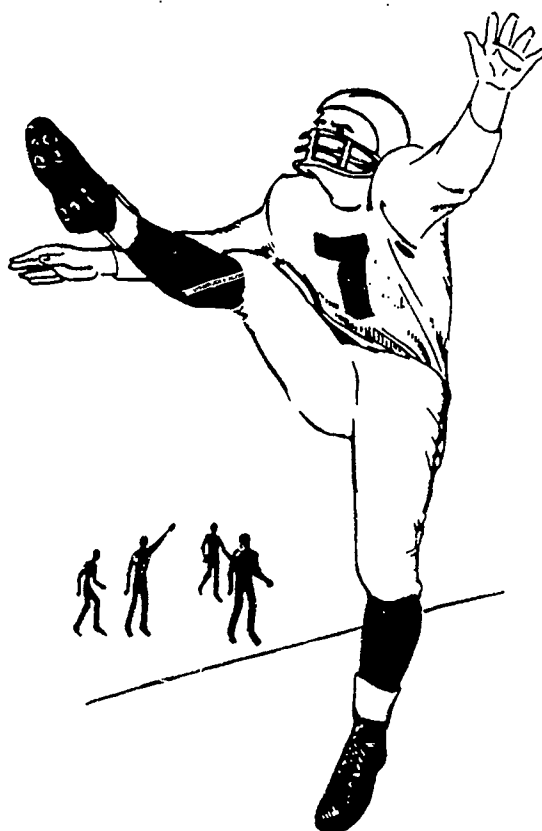

### NAMING THE FOOTBALL OFFICIALS

The team of officials assigned to cover an opening football game are Art, Claude, Jack, and Roy. They will serve in the capacity of referee, umpire, head linesman, and field judge, but not necessarily respectively. Match the names of the men and their assignments on the basis of the following information:

1. Only Art and Roy are married.
2. The field judge's wife is in the stands watching the game.
3. The referee does not wear glasses.
4. The head linesman wears glasses.
5. Claude and Art do not wear glasses.
6. The head linesman is engaged to be married.
7. Roy rode to the game with his neighbor, who is the umpire.
8. Jack or Roy may or may not wear glasses.
9. The referee and the umpire live in the same city; the others do not.



WHAT KIND OF A PERSON WOULD OWN A SNAKE?

There are five houses in a row, each a different color and each inhabited by a person of a different nationality. Each person has a different pet, each has a different profession, and each likes to play a different game. Additional information concerning these people is as follows:

1. The tan house is immediately to the left of the orange house.
2. The florist lives in the middle house.
3. The Egyptian owns a cat.
4. Chess is played in the house next to the house where the goldfish is kept.
5. The Brazilian plays Monopoly.
6. The Australian lives in the green house.
7. The domino player is the magician.
8. The botanist lives in the orange house.
9. The Greek is a physician.
10. The solitaire player has a pet rabbit.
11. The Canadian lives next to the brown house.
12. Chess is played in the white house.
13. The snake is not the zoologist's pet.
14. The person who plays backgammon lives in the house next to the person with a ferret.
15. The Canadian lives in the house furthest from the right.

Match the order number of house (starting from left to right), color of house, profession, game played, and pet with each person's nationality.

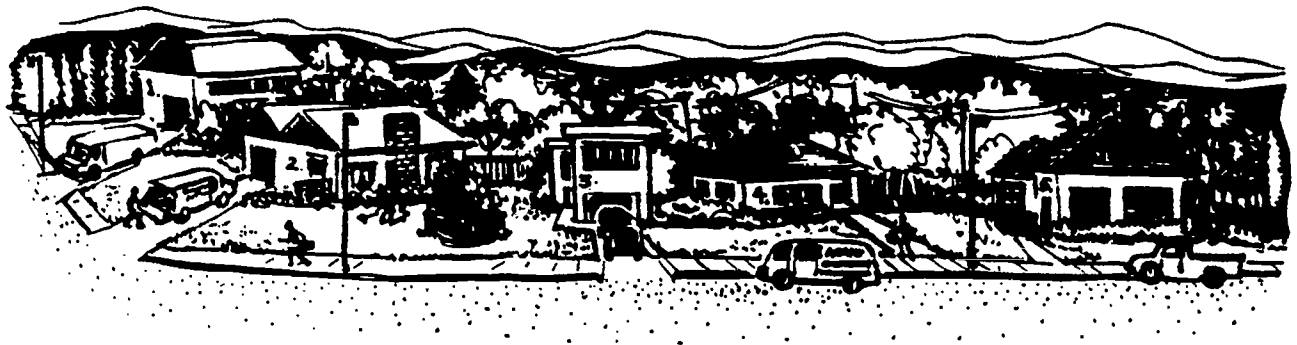

### THE WORKING PEOPLE AND THEIR NAMESAKES

There are five different houses on a city block numbered one through five, occupied by five different couples. The couples are Mr. and Mrs. Betts, Mr. and Mrs. Evans, Mr. and Mrs. Hollis, Mr. and Mrs. Peters, and Mr. and Mrs. Stanley, but not necessarily respectively. There are five workers, none of whom are married, who have done work at the five houses. They have the same surnames as the couples living in the five houses. The workers consist of a carpenter, an electrician, a glazier, a plumber, and a roofer. The following additional facts are known:

1. Mr. Stanley lives next door to the plumber's namesakes.
2. The electrician's namesakes live in house No. 2.
3. Mr. Peters goes to work with the electrician's brother-in-law.
4. The electrician's married sister lives in house No. 1.
5. Mrs. Hollis and Mrs. Peters are the only sisters.
6. Mr. Evans lives next door to the roofer's namesakes.
7. The carpenter's namesake has only one brother-in-law, who lives in house No. 4.
8. The plumber's namesakes have no relatives.

What is the name and trade of each of the working people and in what number house do each of the couples with the corresponding surname live?

# PROMOTIONAL ACTIVITIES

SHOP MATH  
1:45-2:45 p.m.

TUESDAYS

MAY 4  
11  
18

(EXT. 266)

EDUCATION CENTER

May 10,11,12 3:15-4:30 p.m.

Monday, Tuesday, Wednesday

All you ever wanted to know about blueprint  
reading..... well, at least the basics....  
In three easy lessons.....

EDUCATION CENTER



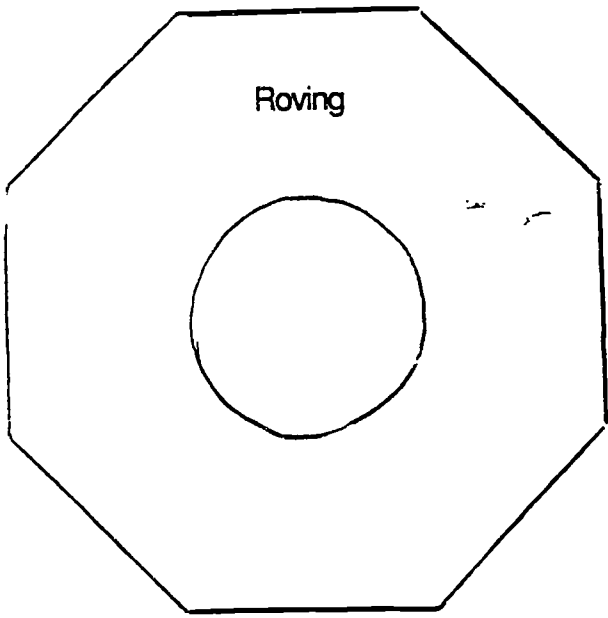

Roving

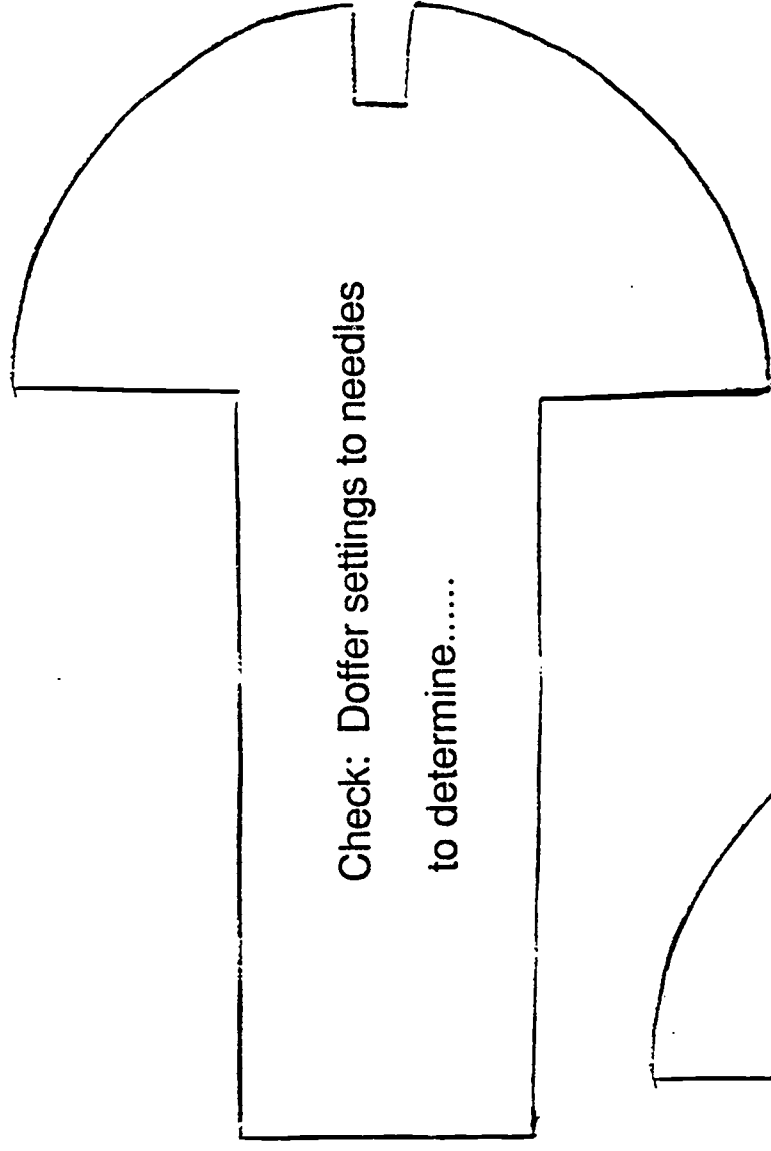

Check: Doffer settings to needles  
to determine.....

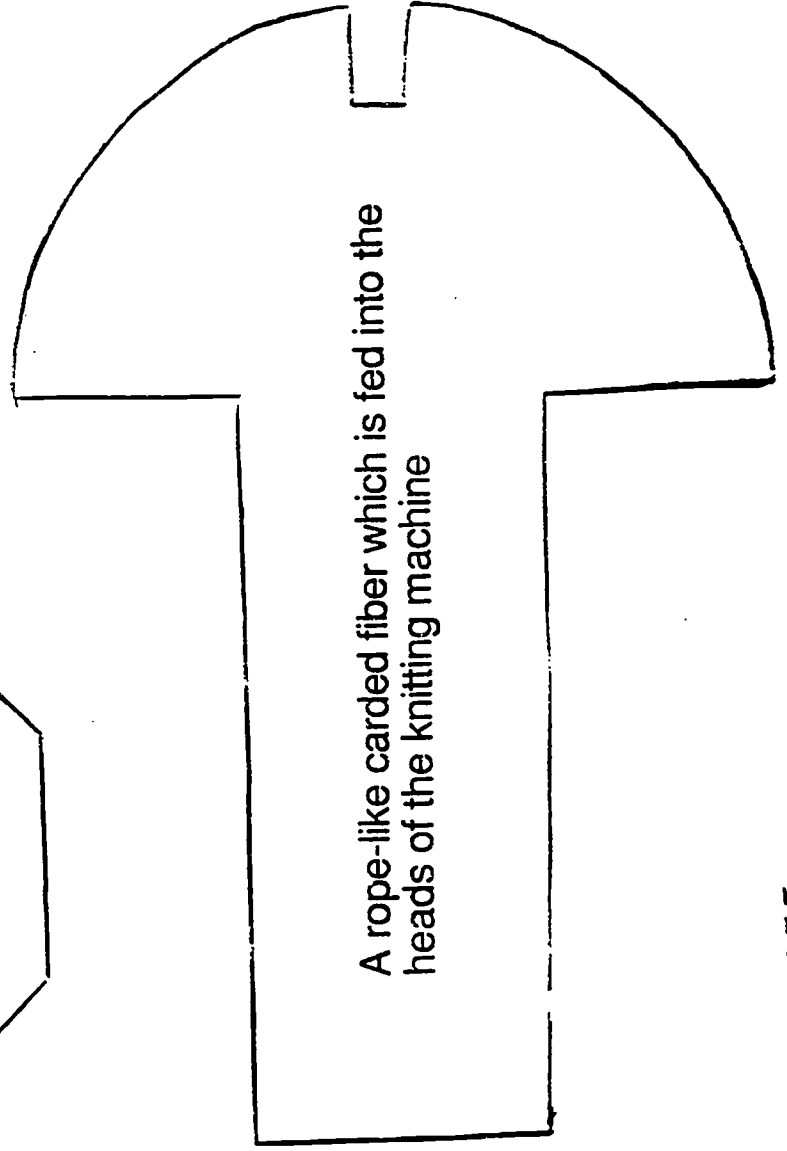

A rope-like carded fiber which is fed into the  
heads of the knitting machine

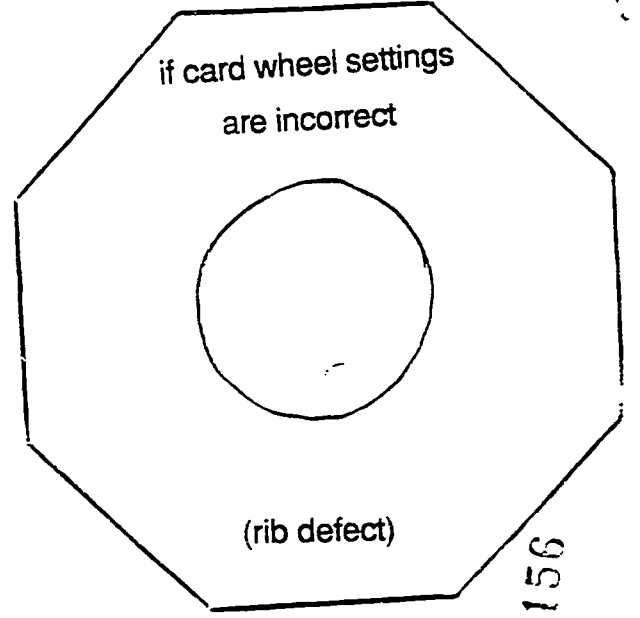

if card wheel settings  
are incorrect

(rib defect)

156

155

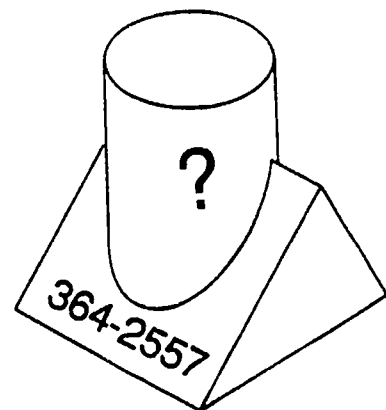
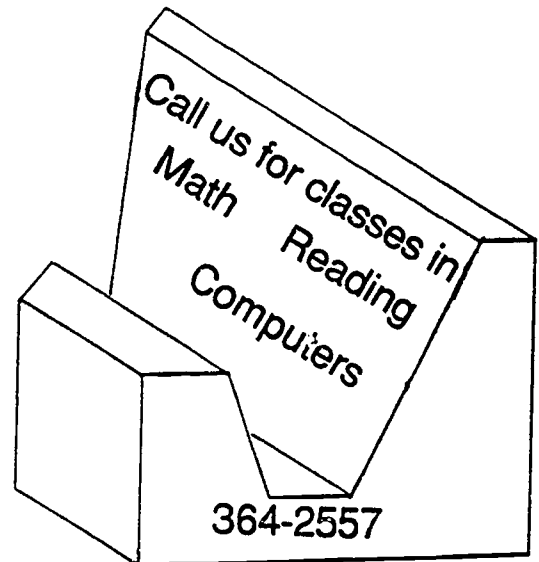
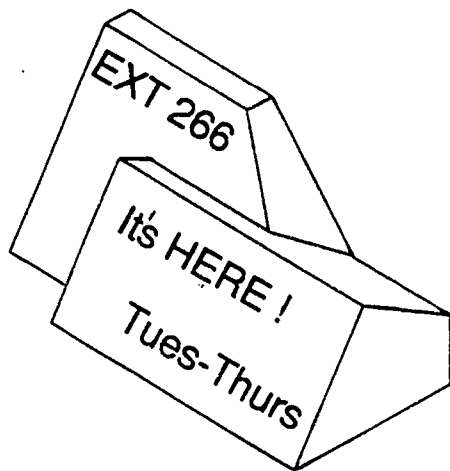
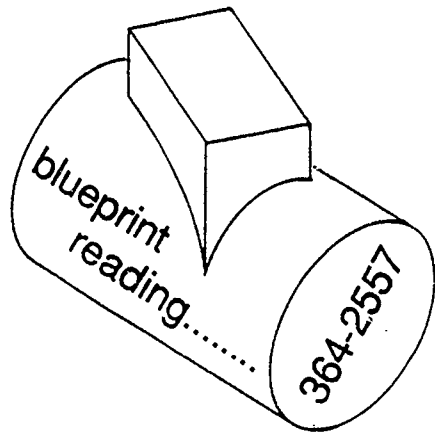

B	I	N	G	O
9 Needle lines	2 Endout	10 Cut-off	8 Stop lines	6 Gimme
4 Slugging	15 Gimme	7 Needle runs	1 Downpile	4 Needle breakage
2 Roving Ribs	6 Pulled yarn	12 Pills	14 Gimme	2 Off Shade
5 Gimme	9 Under Finished	3 Rib	27 Polisher Streaks	1 Holes

## CAUSES

1. Incorrect card wheel settings  
(Rib)
2. Poorly spliced roving  
(Slugging)
3. Insufficient air pressure  
(Downpile)
4. Incorrect sinker  
(Holes)
5. Yarn stop motions  
(Cut-off)
6. Hook breakage  
(Needle breakage)
7. Still or stuck latches  
(Needle runs)
8. Oil lines  
(Needle lines)
9. Roving  
(Endout)
10. Take-up roller  
(Pulled yarn)
11. Sparseness of roving  
(Stop lines)
12. One or more incorrect components in the blend  
(Off shade)
13. Unevenly carded knitting roving  
(Roving ribs)
14. Not enough tension between the feed and take-off rollers during polishing  
(Polisher Streaks)
15. Not enough crimp has been taken out of the pile fibre  
(Under finished)
16. Bad setting of the card for a particular fibre or blend  
(Pills)

B	I	N	G	O
How do I submit an article for the Newsletter?	<i>Gimme</i>	What new class will be held on Tuesday, May 5?	How does the Book Exchange work?	Date for the next Shop Math class
A new recruitment idea	No. of participants using the Center this past month	<i>Gimme</i>	What will be included in the "Forms Writing" class?	A new recruitment idea
What is meant by a "job analysis"?	What Blueprint materials are available in the Center.	Name 3 ways I can study Algebra.	<i>Gimme</i>	Center days and hours of operation
How can I become a "Friend of the Education Center"?	One way to increase reading speed	<i>Gimme</i>	Biggest challenge for the Center	Name of a video program available in the Center

# **WORKPLACE PARTNERSHIP TRAINING PROGRAMS**

**TEACHING**

**FOR**

**A**

**REASON**



**BLACKHAWK TECHNICAL COLLEGE**

**Federal Projects are funded by the U.S. Department of Education.**

**State Projects are funded with state administered funds.**

**Supplemental funding is provided by the local partners.**

# **Metric System**

# LEARNING THE SKILLS

## INTRODUCTION

In almost every job, workers need answers to questions such as these:

*How long or how far is it?* How long is the board? How wide is the paper? How far is it to the next town?

*How much is there?* How much weight? How much liquid? How much pressure? How much voltage? How much temperature?

To find answers to these questions, you *measure*—length, distance, weight, area, volume, pressure, voltage, temperature, and so on. You can use a variety of *instruments* to measure different quantities. Look at Figure 3-1 and see how many measuring instruments you recognize. Can you tell what quantity each one measures?

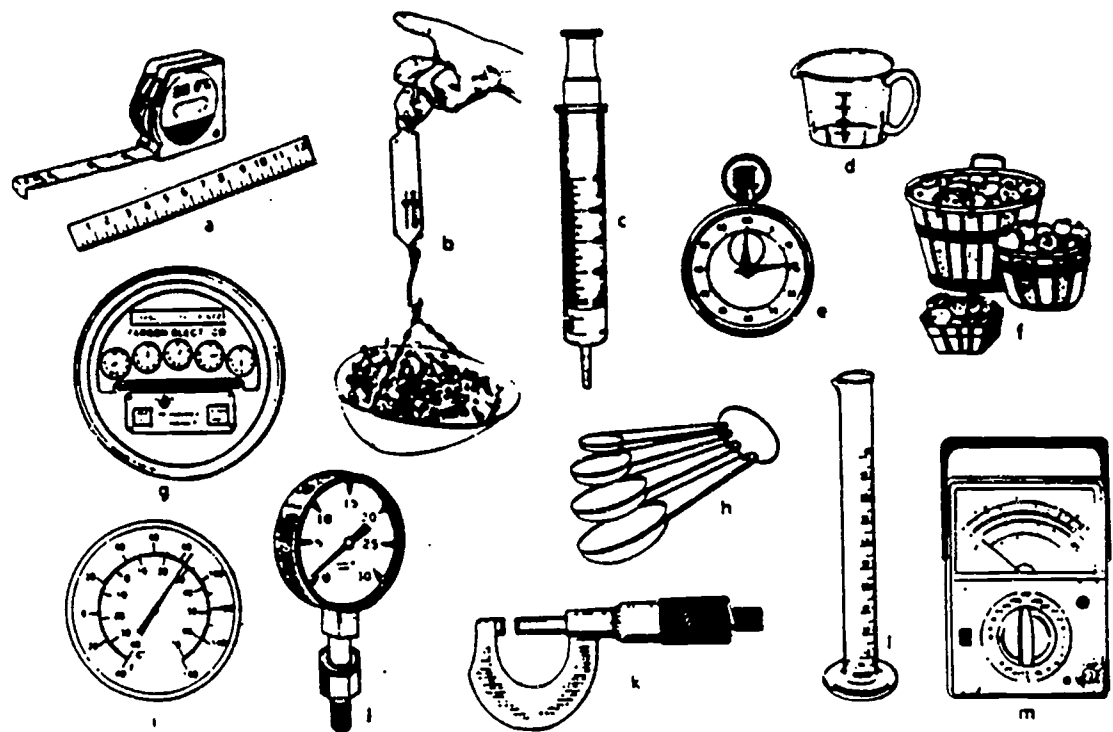

Figure 3-1  
Instruments that measure





Measure the length of your pencil with a ruler and write down how long it is. The ruler, in this case, is the instrument you choose to measure the length. Did you measure in *inches* or *centimeters*? These two units represent different ways to express a measure of length.

There are two widespread systems of measurement for common quantities such as length, weight, and capacity. You are probably most familiar with the *English system* of measurement. It's the most common system used in the United States. In it, *length* is measured in inches, feet, yards, or miles. *Weight* is measured in ounces or pounds, and *capacity* is measured in cups, quarts, or gallons. In most other countries in the world, people measure with the *metric system*. In it, *length* is measured in meters, *weight* is measured in grams, and *capacity* is measured in liters. Figure 3-2 shows some of the more common units used in each system.

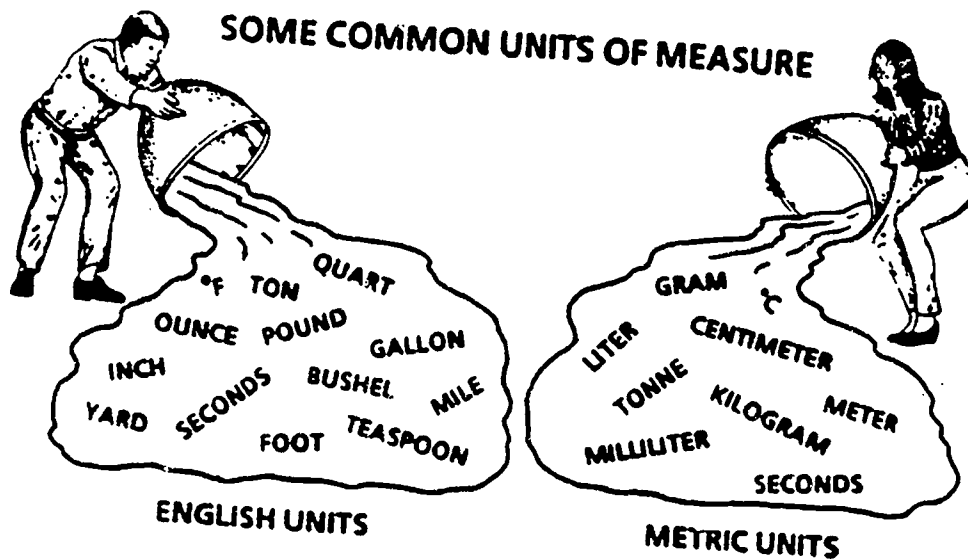

Figure 3-2  
Common units in English and metric systems

Because the United States does more and more business with other countries, the metric system is increasingly important to us. For example, an automobile mechanic now keeps two sets of tools—one for foreign-made cars and new American cars, and one for older American cars that were made with English measurements.

Sports events, such as track and field, swimming, and diving now often use metric lengths instead of feet, yards, and miles.

Watch the video to see examples of people using measurements in their daily work.

## ENGLISH SYSTEM OF MEASURE

How tall are you? How much do you weigh? How much milk did you pour on your breakfast cereal this morning?

You probably give your height in *feet* and *inches*, your weight in *pounds*, and the amount of milk you poured in *cups* (or parts of a cup). These measurements—feet, inches, pounds, and cups—are part of the English system of measurement.

The English system of measurement grew out of the way people measured for themselves. People measured shorter distances on the ground with their feet. They measured building supplies with their forearms, palms, and fingers. They measured longer distances by their paces (a "mile" was a thousand paces). They measured capacities with common household items such as cups, pails, and baskets. Our word *gallon* comes from an old name for pail. A *bushel* was a way to measure grain—and still is!

Because people, cups, pails, and baskets were likely to be of different sizes, the amount that each would measure was different. But craftsmen and merchants needed *standard* measures that were the same for everybody. In time, each common measure came to have one certain length, weight, or capacity that was accepted by everyone. Figure 3-3 shows how some of our common measures of length developed.

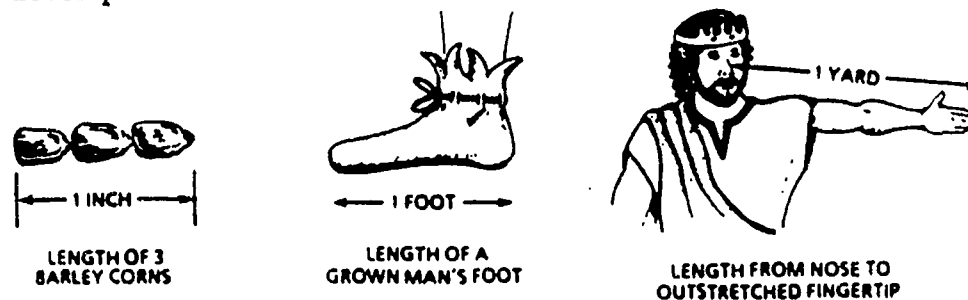

Figure 3-3

Where common measures of length came from

4. Convert 5 feet  $3\frac{7}{8}$  inches to feet (expressed in decimal form).
5. Convert 3.81 feet to a number in feet and inches—such as 2 feet  $5\frac{1}{2}$  inches.

## METRIC SYSTEM OF MEASURE

Do you ever buy 3-liter bottles of soft drink? Have you noticed that the speedometers on automobiles have numbers for miles per hour *and* kilometers per hour? Have you noticed that packaged food items are labeled with the weight in ounces *and* grams? These measures—liters, kilometers, and grams—are part of the metric system of measure.

The metric system was created about two hundred years ago by a group of French scientists to simplify measurement. In the metric system, each of the common kinds of measure—length, weight, and capacity—has *one* basic unit of measure. Length (or distance) is measured with *meters*, weight and mass is measured with *grams*, and capacity is measured with *liters*. To measure smaller amounts, you divide the basic unit into parts of ten, a hundred, or a thousand, and so on. To measure larger amounts, you multiply the basic unit by ten, a hundred, or a thousand, and so on. To convert, then, you either multiply or divide by 10, 100, 1000, and so on. Such calculations are easy to carry out.

Today, almost every country in the world uses the metric system as its standard of measure. The United States is the only major country in the world that still uses the traditional English system of measure. Even England has changed to the metric system, which is why the *English system* of measure is now often called the *U.S. system* of measure.

Nevertheless, within the United States, scientific work and much manufacturing is done with metric measurements. You can expect to encounter both English *and* metric measurements in your work.

### *Metric units of measure*

*Length*, in the metric system, is measured in *meters*. A meter is just a little longer than a yard. A football field is about 90 meters long.



 **Weight** is measured in *grams*. An ordinary metal paper clip weighs about one gram. A nickel, or 5-cent coin, weighs about 5 grams. Most packaged foods in the United States are now labeled with both pounds and grams. A one-pound box of powdered sugar, for example, weighs about 454 grams.

 **Capacity**—how much a container can hold—is measured in *liters*. A liter is just a little more than a quart. You can buy two-liter and three-liter bottles of soft drinks at the grocery store.

Just as the English system divides feet into smaller units called inches and multiplies feet into larger units such as yards and miles, the metric system divides and multiplies its basic units. However, in the metric system, the units are divided and multiplied by ten, hundred, thousand, and so on.

You can tell how a measure compares to a meter, gram, or liter by the prefix used with it—such as kilogram:

- Kilo- means thousand (1000)
- Hecto- means hundred (100)
- Deca- means ten (10)

The prefixes kilo-, hecto-, and deca- make the basic unit *larger*. A kilometer is a thousand meters. A hectogram is a hundred grams. A decaliter is ten liters.

- Deci- means one-tenth ( $1/10$ )
- Centi- means one-hundredth ( $1/100$ )
- Milli- means one-thousandth ( $1/1000$ )

The prefixes deci-, centi-, and milli- make the basic unit *smaller*. (To help you remember which prefixes make the unit smaller, notice that all these prefixes end in the letter *i*.) A decigram is one-tenth of a gram. A centimeter is one-hundredth of a meter. A milliliter is one-thousandth of a liter.

People measure with some metric units more than others. You most often see the basic units coupled with the prefixes *kilo-* and *milli-*.

Figure 3-6 lists the common metric units for measuring length, weight, and capacity and tells how similar metric measures compare. It also gives you a general comparison between metric units and English units. For example, one inch and one centimeter are different in length (if you have a ruler with both scales, you can see that a centimeter is shorter than an inch). However, both are used to



*Weight* is measured in *grams*. An ordinary metal paper clip weighs about one gram. A nickel, or 5-cent coin, weighs about 5 grams. Most packaged foods in the United States are now labeled with both pounds and grams. A one-pound box of powdered sugar, for example, weighs about 454 grams.



*Capacity*—how much a container can hold—is measured in *liters*. A liter is just a little more than a quart. You can buy two-liter and three-liter bottles of soft drinks at the grocery store.

Just as the English system divides feet into smaller units called inches and multiplies feet into larger units such as yards and miles, the metric system divides and multiplies *its* basic units. However, in the metric system, the units are divided and multiplied by ten, hundred, thousand, and so on.

You can tell how a measure compares to a meter, gram, or liter by the prefix used with it—such as kilogram:

Kilo- means thousand (1000)

Hecto- means hundred (100)

Deca- means ten (10)

The prefixes kilo-, hecto-, and deca- make the basic unit *larger*. A kilometer is a thousand meters. A hectogram is a hundred grams. A decaliter is ten liters.

Deci- means one-tenth ( $1/10$ )

Centi- means one-hundredth ( $1/100$ )

Milli- means one-thousandth ( $1/1000$ )

The prefixes deci-, centi-, and milli- make the basic unit *smaller*. (To help you remember which prefixes make the unit smaller, notice that all these prefixes end in the letter *i*.) A decigram is one-tenth of a gram. A centimeter is one-hundredth of a meter. A milliliter is one-thousandth of a liter.

People measure with some metric units more than others. You most often see the basic units coupled with the prefixes *kilo-* and *milli-*.

Figure 3-6 lists the common metric units for measuring length, weight, and capacity and tells how similar metric measures compare. It also gives you a general comparison between metric units and English units. For example, one inch and one centimeter are different in length (if you have a ruler with both scales, you can see that a centimeter is shorter than an inch). However, both are used to

measure short lengths. Likewise, miles and kilometers are used to measure long distances.

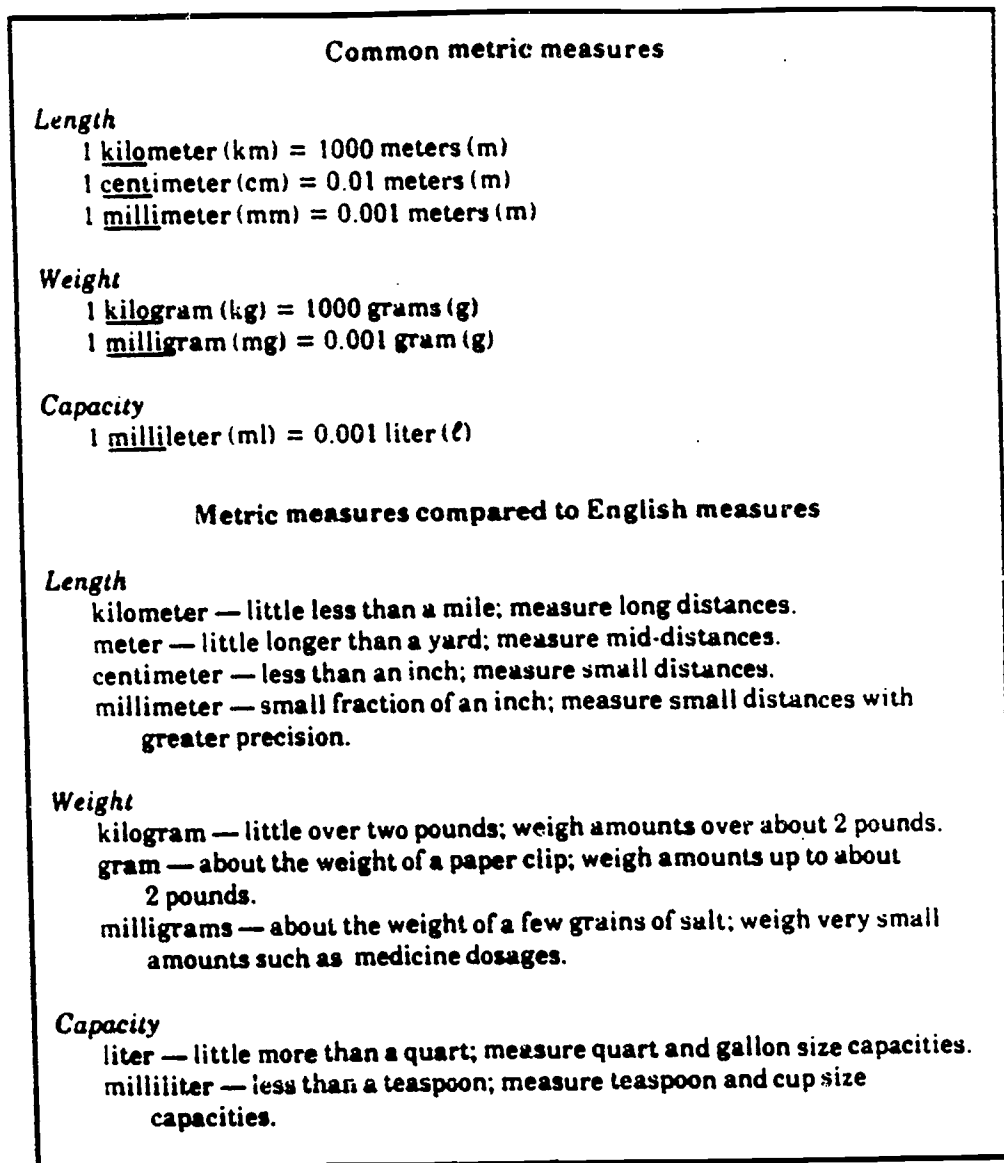

Figure 3-6

Metric measures

**Study Activity:** Practice measuring with metric units by carrying out the following measurements.

*Measuring with centimeters:*

Measure the length of your index finger with the centimeter scale on your ruler.

# GLOSSARY

**Caliper** A tool used for precision-length measurements. It has a fixed jaw, a sliding jaw, and a calibrated scale.

**Celsius** The scale of temperature measurement used in the metric system. On a Celsius scale—formerly known as the Centigrade scale—water freezes at 0° and boils at 100°. The Celsius scale is related to the Fahrenheit scale of temperature measurement by the formula

$$^{\circ}\text{C} = \frac{5}{9} (^{\circ}\text{F} - 32)$$

**Centi-** A prefix indicating "a hundredth part." For example, a centimeter is one hundredth of a meter (0.01 m).

**Fahrenheit** The scale of temperature measurement used in the English system. On a Fahrenheit scale, water freezes at 32° and boils at 212°. The Fahrenheit scale is related to the Celsius scale of temperature measurement by the formula

$$^{\circ}\text{F} = \frac{9}{5} ^{\circ}\text{C} + 32^{\circ}$$

**Gram** The basic unit of mass ("weight") in the metric system of measurement, equal to about  $\frac{1}{28}$  of an ounce. (It is the mass of one milliliter of distilled water at 4°C.)

**Kilo-** A prefix indicating "a thousand." For example, a kilogram is 1000 grams, or a kilowatt is 1000 watts.

**Liter** The basic unit of volume in the metric system of measurement, equal to 1.0567 liquid quarts. (It is officially defined as the volume of 1 kilogram of distilled water at 4°C.)

**Meter** The basic unit of length in the metric system of measurement, equal to 39.37 inches. (It is officially defined on the basis of the wavelength of Krypton light.)

**Milli-** A prefix indicating "a thousandth part." For example, a millimeter is one thousandth of a meter (0.001 m), or a milliliter is one thousandth of a liter (0.001 ℓ).

only need to know *which direction* (right or left) and *how far* to move it.

You can make a chart that helps you figure out how to move the decimal point when you convert from one metric unit to another.

To make your own chart, list the prefixes, *in order from left to right* and *without skipping any prefix*, from largest to smallest. Your chart should look like this:

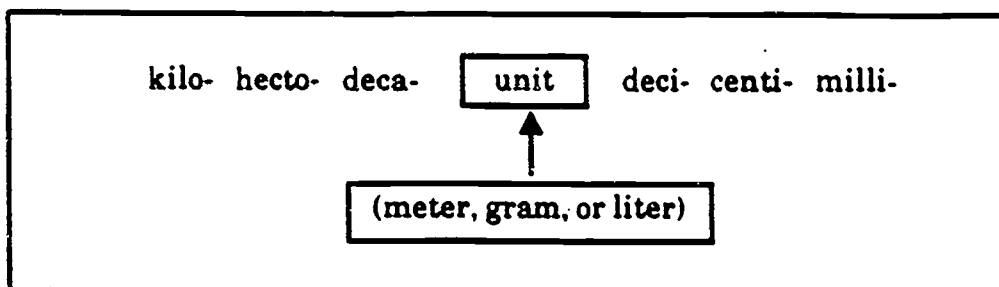

Follow the next examples to see how to use the chart.

**Example 5:**  
**Converting**  
**kilometers**  
**to meters**

*Convert 1.254 km to meters.*

If you convert from kilometers to meters with a unit conversion ratio, this is what you would do:

$$\frac{1.254 \text{ km}}{1} \times \frac{1000 \text{ m}}{1 \text{ km}} = 1254.0 \text{ m}$$

The number of kilometers (1.254) and the number of meters (1254) differ only in the position of the decimal point. The decimal point in the number 1254.0 is *three places to the right* of the decimal point in the number 1.254.

Look at the names in the chart you made:



The name *meter* is *three places to the right* of the name *kilo*.



Thus in converting from kilometers to meters, all you have to do is move the decimal point in the number for kilometers three places to the right.

**Example 6:  
Converting  
milligrams  
to kilograms**

Convert 50,281 milligrams to kilograms.  
To convert with unit conversion ratios, you have

$$50,281 \text{ mg} = \frac{50,281 \text{ mg}}{1} \times \frac{1 \text{ g}}{1000 \text{ mg}} \times \frac{1 \text{ kg}}{1000 \text{ g}} = \frac{50,281 \text{ kg}}{1,000,000} = 0.050281 \text{ kg}$$

The number of milligrams (50,281) and the number of kilograms (0.050281) differ only in the position of the decimal point. The decimal point in the number 0.050281 is *six places to the left* of the decimal point in the number 50,281 (remember, if the decimal point is not shown, it is to the *right* of the digits). On the chart, kilo- is six places to the left of milli-:

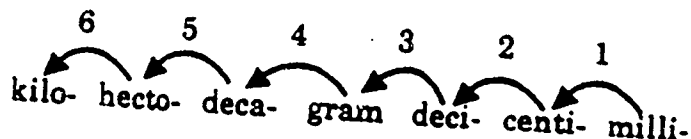

To use the chart to convert from one metric unit to another, count the number of places *from* the old unit *to* the new unit. Move the decimal point of the number you want to convert the *same number of places* in the *same direction* (right or left). The new number is in the new unit.



**Example 7:  
Using the  
conversion  
chart**

Use the chart to convert 358 millimeters to centimeters.  
First, find milli- and centi- on the chart:



Count the number of places *from* milli- *to* centi- and notice if it is to the right or left. In this case, centi- is *one place to the left* of milli-.

Move the decimal point in 358 *one place to the left*. The new number is in the new unit:

$$358 \text{ mm} = 35.8 \text{ cm}$$

**Study Activity:** Use the chart—or unit conversion ratios—to make the following conversions:

1. Convert 17.35 kilometers to meters.
2. How many grams are there in 34.83 kilograms?
3. Convert 0.075 hectoliters to liters.
4. How many milliliters are there in 15 liters?
5. Convert 156 centimeters to meters.

### Converting between English and metric measures

Usually you will do a job in either English units or metric units, but not both. Sometimes, however, you need to convert units not only within one system, but from one system to the other. The chart in Figure 3-7 tells how measures compare between the two systems.

<u>Metric to English</u>	<u>English to Metric</u>	
<b>Length</b>	<b>Length</b>	
1 mm = 0.04 in.	1 in. = 2.54 cm	
1 cm = 0.39 in.	1 ft = 30.48 cm = 0.305 m	
1 m = 39.37 in. = 3.28 ft	1 yd = 0.914 m	
1 m = 1.09 yd	1 mi = 1.609 km	
1 km = 0.62 mi		
<b>Weight</b>	<b>Weight</b>	
1 g = 0.035 oz	1 oz = 31.103 g	
1 kg = 2.2 lb	1 lb = 0.453 kg	
<b>Capacity</b>	<b>Capacity</b>	
1 ml = 0.2 tsp	1 tsp = 5 ml	
1 ℓ = 1.057 qt	1 c = 284 ml	
	1 qt = 0.946 ℓ	
	1 gal = 3.785 ℓ	
<b>Common abbreviations used above:</b>		
in. = inch	m = meter	c = cup
ft = foot	km = kilometer	qt = quart
yd = yard	oz = ounce	gal = gallon
mi = mile	lb = pound	tsp = teaspoon
mm = millimeter	g = gram	ℓ = liter
cm = centimeter	kg = kilogram	ml = milliliter

Figure 3-7

Comparison between English and metric measures



# Units of Weight

$$73 \text{ kg} = \underline{\quad? \quad} \text{ g}$$

$$1 \text{ kg} = 1000 \text{ g}$$

$$(73 \times 1) \text{ kg} = (73 \times 1000) \text{ g}$$

$$73 \text{ kg} = \underline{73.000} \text{ g}$$

$$54 \text{ mg} = \underline{\quad? \quad} \text{ g}$$

$$1 \text{ mg} = .001 \text{ g}$$

$$(54 \times 1) \text{ mg} = (54 \times .001) \text{ g}$$

$$54 \text{ mg} = \underline{.054} \text{ g}$$

Complete the following.

*a*

1.  $8 \text{ kg} = \underline{\hspace{2cm}} \text{ g}$

2.  $4500 \text{ mg} = \underline{\hspace{2cm}} \text{ g}$

3.  $6 \text{ g} = \underline{\hspace{2cm}} \text{ mg}$

4.  $.35 \text{ kg} = \underline{\hspace{2cm}} \text{ g}$

5.  $.007 \text{ kg} = \underline{\hspace{2cm}} \text{ g}$

6.  $5.5 \text{ g} = \underline{\hspace{2cm}} \text{ mg}$

7.  $.4 \text{ kg} = \underline{\hspace{2cm}} \text{ g}$

8.  $607 \text{ mg} = \underline{\hspace{2cm}} \text{ g}$

9.  $52 \text{ g} = \underline{\hspace{2cm}} \text{ mg}$

*b*

1.  $7.5 \text{ kg} = \underline{\hspace{2cm}} \text{ g}$

2.  $38 \text{ g} = \underline{\hspace{2cm}} \text{ kg}$

3.  $640 \text{ mg} = \underline{\hspace{2cm}} \text{ g}$

4.  $4.5 \text{ kg} = \underline{\hspace{2cm}} \text{ g}$

5.  $7000 \text{ g} = \underline{\hspace{2cm}} \text{ kg}$

6.  $.21 \text{ g} = \underline{\hspace{2cm}} \text{ mg}$

7.  $345 \text{ g} = \underline{\hspace{2cm}} \text{ kg}$

8.  $8.9 \text{ g} = \underline{\hspace{2cm}} \text{ mg}$

9.  $975 \text{ g} = \underline{\hspace{2cm}} \text{ kg}$

Solve.

10. Consider this tank filled with water. Assume that 1 liter of water weighs 1 kilogram. How many kilograms would the water in the tank weigh?



The water would weigh                      kilograms.

### Study Activity:

Use the information in Figure 3-7\* to create the unit conversion ratios you need to make the desired conversions:

1. Find how many gallons are in a 3-liter bottle of cola.
2. You are competing in the 100-meter run. How many yards will you run?
3. A French recipe calls for half a kilogram of butter. How many pounds of butter should you buy?
4. Two towns are 35 miles apart. How many kilometers separate them?
5. A piece of paper is 0.1 mm thick. How many inches thick would a stack of 100 sheets be?

## MEASURING WITH INSTRUMENTS

When you need to know the measure of a quantity—such as how long is the board, how wide is the paper, how high is the temperature, or what's the air pressure—you measure. Most often, you measure with an instrument designed for the task. When you use a measuring instrument, you need to know these things:

- What the instrument measures
- Units in which the instrument measures
- How to use the instrument
- How to read the measurement from the instrument

As you work through the remainder of this unit, make sure you know how to work with any instrument you need.

### Measuring length

### Study Activity:



If you needed to measure the length of a sheet of paper, you would probably reach for a ruler and measure the length without giving it much thought. However, if you were explaining how to measure with a ruler to someone who had never used a ruler before, what would you

\* A more complete table of information for creating unit conversion ratios can be found in the Reference Materials at the end of this text.

# BATTERY CONSTRUCTION

## SPECIAL VOCABULARY

<b>Positive:</b>	charged with positive electricity.
<b>Negative:</b>	charged with negative electricity.
<b>Dilute sulfuric acid:</b>	a chemical which allows electrons to travel from one plate to another.
<b>Chemical reaction:</b>	a change which takes place when two chemicals come in contact with each other for example, when oxygen comes in contact with iron, rust is produced.

This chapter will help the reader to understand

- the chemistry of electricity
- the parts of the battery
- how the parts of the battery are assembled

## LEARNING ACTIVITY

Study this diagram. There are ten important parts shown. Locate these parts on the model battery that comes with this learning guide. Put the correct label on each part of the battery.

BEST COPY AVAILABLE

- |                   |                   |
|-------------------|-------------------|
| 1. POSITIVE PLATE | 6. VENT PLUGS     |
| 2. NEGATIVE PLATE | 7. TERMINAL POSTS |
| 3. SEPARATORS     | 8. POST STRAP     |
| 4. ELEMENT RESTS  | 9. COVER          |
| 5. SEDIMENT SPACE | 10. PLATE LUGS    |

Each battery cell has both positive (+) and negative (-) plates which have a separator between them. The separator prevents a chemical reaction between the positive and negative plates. These plates are placed in a liquid called *dilute sulphuric acid*. This liquid allows electrons to pass between the positive and negative plates to create an electrical current AT THE PROPER TIME.

The lugs of positive plates and the lugs of negative plates are welded together and attached to a post strap. The set of positive and negative plates that are put together in one unit make up a battery cell. Each cell produces a little over 2 volts of electrical power.

Batteries are made of several cells that are connected to each other. When three battery cells are connected, they make a 6-volt battery. When six battery cells are connected, they make a 12-volt battery. Both 6-volt and 12-volt batteries contain the parts shown on the diagram found on page 2 (Fig.1).

**Note:** If you want to know more about positive and negative charges, consult the text Electricity and Electronics Fundamentals by Frank D. Petruzella, p. 19-25 which can be found in the Workplace Education Center. It shows how electrons work to produce an electrical charge.



# BATTERY CONSTRUCTION

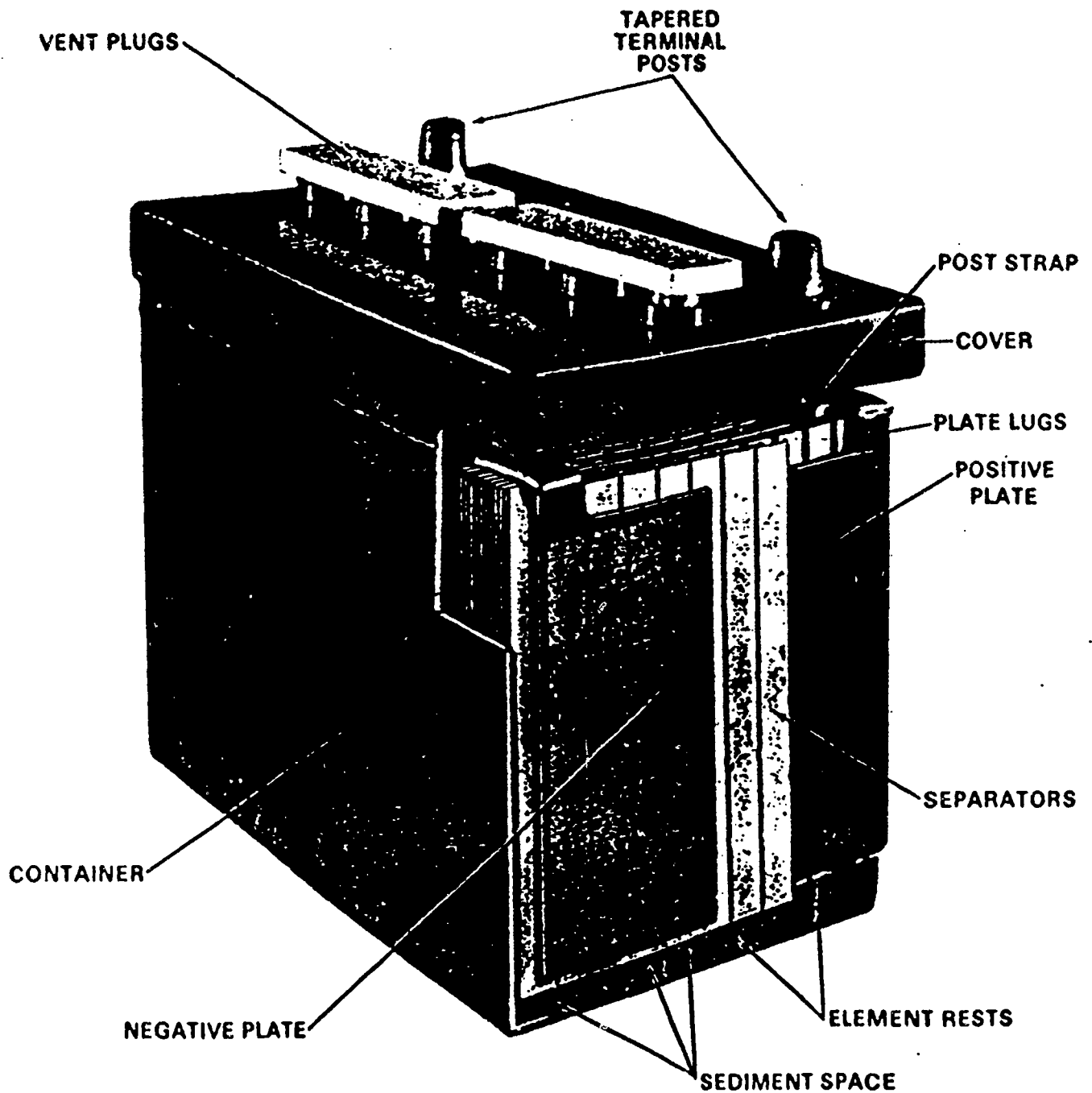

BEST COPY AVAILABLE





## Quick Check

Fill in the blanks with the correct information. Use the following list of words.

positive  
plates  
oxygen

dilute sulfuric acid  
12-volt battery  
6-volt battery

cell  
chemical reaction  
shock

1. Each battery cell has both a \_\_\_\_\_ and a negative plate.
2. Plates are covered with a liquid chemical called \_\_\_\_\_
3. Each battery \_\_\_\_\_ produces 2 volts of electrical power.
4. It takes six battery cells to produce a \_\_\_\_\_
5. Because batteries contain chemicals, a \_\_\_\_\_ can take place when the two chemicals come in contact.
6. To prevent the wrong kind of chemical reaction, the positive and negative \_\_\_\_\_ have a separator between them.

### CHALLENGE QUESTION:

***What dangers do you anticipate in working with a battery?***

---

---

---



TEST COPY AVAILABLE

# THE CHEMISTRY OF ELECTRICITY

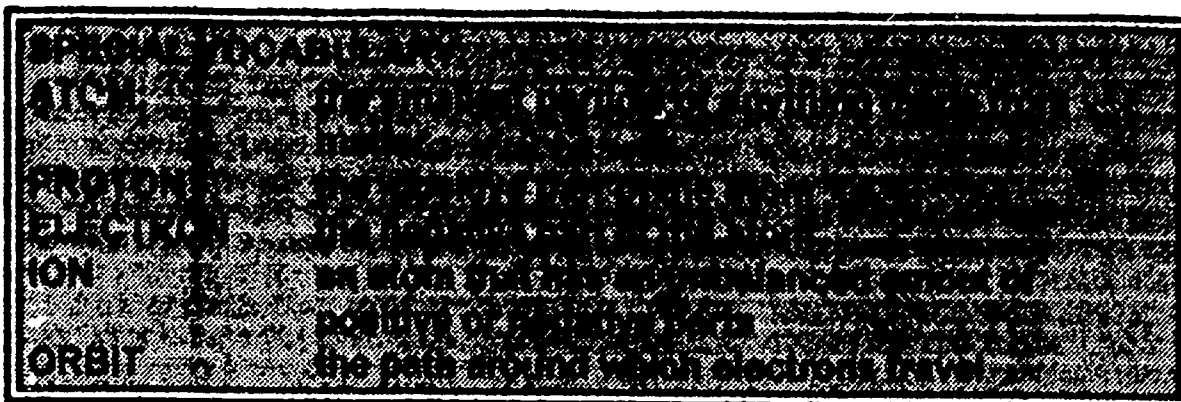

## The Atom

Long, long ago a Greek philosopher named Democritus decided that everything in the world is really made of tiny atoms. These atoms are much too small to see. In fact, atoms are so small that they are hardly even visible using the very powerful microscopes invented in this century.

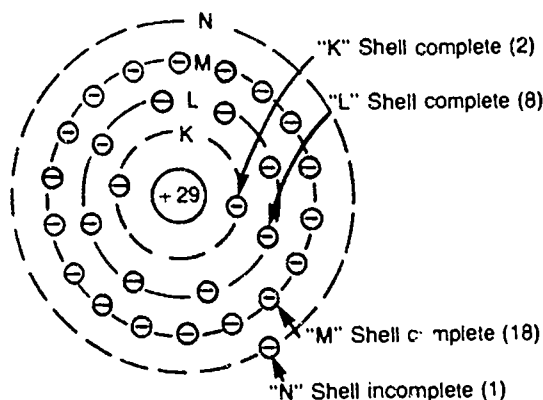
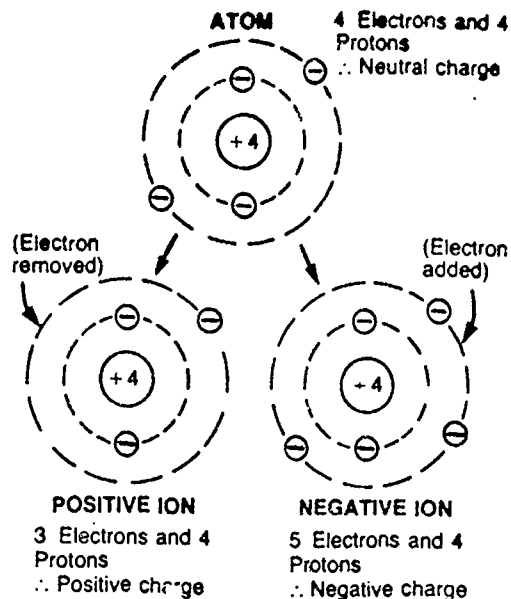

**FIG.1 THE COPPER ATOM**

(from *Electricity and Electronics Fundamentals*, p.22)

An atom, scientists tell us, has two important parts. It has a center or nucleus..with positive parts called protons. It also has electrons which travel in a circle around the nucleus much like the planets travel around the sun.

BEST COPY AVAILABLE



**FIG.2 HOW ATOMS FORM IONS**  
(*ibid*, p.22)

When atoms have an equal amount of positive and negative parts, the atoms are said to be neutral. Sometimes an atom has an unequal amount of electrons and protons. If there are more electrons than neutrons, the atom is unbalanced and it is said to be a *negative ion* with a negative (-) charge. If there are more neutrons than electrons, the atom is still unbalanced, but it is said to be a *positive ion* with a positive (-) charge.

**MATCH THE TERMS IN THE LEFT COLUMN WITH THE DEFINITIONS IN THE RIGHT BY DRAWING A CONNECTING LINE.**

- |             |   |
|-------------|---|
| 1. atom     | The path taken by electrons as they circle around the nucleus |
| 2. proton   | An unbalanced atom  |
| 3. electron | The smallest part of any material thing                       |
| 4. ion      | The negative part of the atom                                 |
| 5. orbit    | The positive part of the atom                                 |



**When atoms bond in new ways, chemical changes take place. By controlling the way atoms bond, scientists can make the atom, and the parts of the atom, work in the best interest of people.**

**By understanding the structure of atoms, scientists can predict how materials will act under certain conditions. Scientists can also move the electrons in atoms to produce electricity.**

**A battery is an example of a product that depends on the control of several chemical changes. When the proper changes take place, chemically produced electricity is made available to do important tasks such as:**

- running cars**
- providing power for boats**
- keeping medical equipment operating**
- supporting the work of computers**
- backing-up lights in emergency situations**
- maintaining emergency phone communication**

**The stored chemical electricity found in a battery is very useful to man. It can even save lives. The rest of this book will explain how you make batteries and use them.**

## PART ONE: THE PLATE GRID

### SPECIAL VOCABULARY

<b>Alloy:</b>	a mixture of two or more metals
<b>Antimony:</b>	a chemical element used in other elements to improve their resistance to chemical action
<b>Tin:</b>	a metal used to make the casting of grids easier
<b>Grid:</b>	the criss-cross framework that holds the active material of the battery plates

The grid provides the framework for the positive and negative plates. It also carries the current to and from the active materials of the positive and negative plates.

The grids are usually made of an alloy of lead. Lead is a difficult metal to work with because it is so soft. Other chemicals are added to the lead to improve it. Antimony may be added to add strength and stiffness to the lead. Calcium or strontium may be added to reduce the amount of gas that the battery produces. Calcium or strontium may also limit the amount of water the battery uses up. Tin may be added to make the casting of the grids easier.

Figure 3 shows one kind of grid design. The grid mesh is different for different kinds of batteries. The grid metal is usually thicker where there is more current and not as thick where there is less current.

Name some of the metals used in making grids.

1. \_\_\_\_\_ 2. \_\_\_\_\_ 3. \_\_\_\_\_ 4. \_\_\_\_\_

What two things do grids do?

1. \_\_\_\_\_ 2. \_\_\_\_\_



## PART TWO: THE POSITIVE AND NEGATIVE PLATES

<b>SPECIAL VOCABULARY:</b>	
<b>EXPANDERS:</b>	chemicals added to the paste which prevent an undesirable chemical action from taking place.
<b>ELECTROCHEMICALLY CHARGED:</b>	chemicals are added to the plate which make it either a positive or negative plate.
<b>POLARITY:</b>	the negative or positive magnetic charge of the plate.

Both positive and negative plates go through three steps in the manufacturing process. First, they are coated with a paste. Then they are dried. Finally, they are given an electrochemical charge.

The paste used on both kinds of plates are not quite the same. Both plates are covered with a paste which is a mixture of lead oxide, sulfuric acid and water. But, the paste used in the coating of negative plates has "expanders" added to it. The expanders prevent an undesirable chemical action from taking place. This could reduce the battery's performance - especially its cold cranking ability.

When the plates have been pasted and dried, there is a difference in their appearance. The positive plate has a light brown color. The negative plate has a slightly grey color because of the expanders that were added to the paste.

BEST COPY AVAILABLE

Now the plates are given an electrochemical charge. In the positive plate the charge converts the lead oxide to lead dioxide. The lead dioxide will let the electrolyte pass through the plate easier. Once it has been charged, the positive plate becomes a dark, chocolate brown color.

In the negative plate the charge converts the lead oxide to a grey, sponge lead. This lead will allow the electrolyte to mix with the material beneath the plate surface. Once it has been charged, the negative plate becomes a grey color.

If the plates are not charged properly, the polarity of the plates would be reversed. The plates that are supposed to be negative, will be positively charged and the plates that are supposed to be positive will be negatively charged. Furthermore, negative plates which are supposed to have an expander, in them would not have the expander. The performance of the battery -- especially in cold cranking -- would be ruined.





**List the three steps involved in the manufacturing of positive and negative plates. Be sure they are in the correct order.**

1. \_\_\_\_\_

2. \_\_\_\_\_

3. \_\_\_\_\_

**Can a person tell a plate's polarity just by looking at it? (Please explain your answer.)**

**Use the word "electrolyte" in a sentence that shows you understand its meaning.**

**Does it make any difference if someone accidentally gives a plate the wrong electrochemical charge? (Please explain.)**

## PART THREE: THE SEPARATORS

SPECIAL VOCABULARY	
<b>OXIDATION:</b>	to combine with oxygen or oxygen gas
<b>OXIDATION RESISTANCE:</b>	the ability to limit the chemical change which occurs when oxygen combines with something
<b>ELECTRICAL RESISTANCE:</b>	the ability to limit the amount of electric current which will flow through something
<b>ACID CIRCULATION:</b>	the movement of acids and gasses produced by gasses

Positive and negative plates must be kept apart. If they touch one another, electrons will travel between the plates and the plates will lose their stored energy. To prevent this kind of short circuit, plates are kept apart by SEPARATORS.

The separators are made of materials which

1. have oxidation resistance ( won't change when they come in contact with oxygen)
2. have low electrical resistance ( will allow free electrons pass through easily)
3. have pores which allow the electrolyte to pass between the plates
4. absorb the right amount of moisture
5. allow the circulation of acid and gasses which are formed when the battery is in use

**Rubber, glass fibre and some types of plastics make the best separators. They act as insulators to resist the flow of electrons between the plates.**

#### **FIG. 1 PLATES AND SEPARATORS - CONVENTIONAL BATTERY**

**Separators have ribs on the side facing the positive plates. The rib puts more acid next to the positive plate (because the acid fills in between the ribs). The ribs also reduce the amount of contact between the separator and the positive plate. This is important because the positive plate has materials which may react with separator materials and produce an unwanted chemical change. The ribs also provide more space for the acid and gasses to circulate.**

#### **FIG. 2 THE ENVELOPE SEPARATOR**

**Some batteries have a special kind of ENVELOPE SEPARATOR. It is sealed on three sides just like an envelope is sealed. The plates are slipped inside of the "envelope." The top remains open to allow gasses to escape to the top of the cell during use. These envelope separators are usually made of a flexible plastic. When envelope separators are used, sediment space in the battery is no longer necessary.**



## PART FOUR: ELEMENT AND CELL ASSEMBLY

### SPECIAL VOCABULARY

- ELEMENT:** a stack of alternating positive and negative plates with separators between the positive and negative plates.
- LUG:** the extending tab found at the top and bottom of each plate.
- POST STRAP:** a piece of metal which is welded to the lugs to attach a stack of positive plates or a stack of negative plates together.

There are two different ways that the elements that make up a cell can be assembled. In the first method, positive and negative plates are stacked with a separator between each plate. Then lugs of the positive plates are welded together with the post strap. The lugs of the negative plates are also welded together with a different post strap.

In the second method, the positive plates are welded together with the post strap. The negative plates are welded together with a post strap. Then the separators are inserted between the plates with the ribs of the separators next to the positive plates.

Placing one positive plate group and one negative plate group together results in the creation of an element. There is one element per cell. The amount of plates in each element can change, but no matter how many plates there are in each element, or how large the plates are, the cell still only produces approximately 2 volts of electricity.

BEST COPY AVAILABLE



The elements are placed in the cells of the container. Then the post straps of one cell are welded to the post straps of the cell next to it. This connects the cells in series with the positive group of one element welded to the negative group of the next cell.

The battery is not active until the electrolyte is added. The electrolyte is a mixture of sulfuric acid and water. It is added to carry the electric current between the positive and negative plates, through the separators.

### Exploring the Element

1. What is an element in a battery?
2. How are the plates held together?
3. When does the battery become active?
4. Do all cells have the same amount of elements?
5. Do all cells have the same amount of plates?

## The Container, Cover, and Vent Plugs

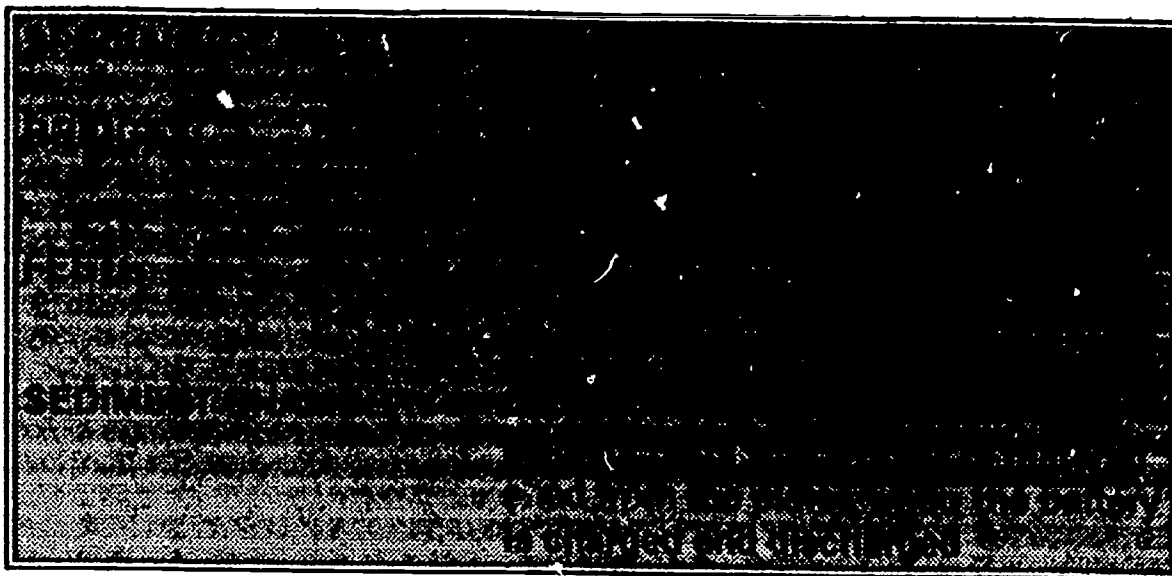

**Fig.1 A typical container and cover**

**The container or shell of the battery is a one-piece molded rectangular shaped container. It can be made of rubber or a plastic like material. This material must be able to withstand temperature extremes of hot and cold. It must be able to resist rough roads and rough handling. It must be able to resist acids that are found in the battery. Hard rubber and plastics can do all of these things.**

**Notice how the inner bottom portion of the container has element rests or "bridges" running the full length of the case. The "feet" of the plates rest on these bridges. The separators, however, extend below the bottom of the plates, resting on the floor of the container. The space between the top of the bridges and the**

**BEST COPY AVAILABLE**

**floor of the container acts as a sediment chamber. This collects material shed from the plates when the battery is charged and discharged.**

**Eventually the sediment chamber can get filled with the shedded material. If this happens, a short circuit can be created which causes the battery to fail. Usually the battery fails for other reasons long before this happens.**

### **CELL COVERS**

**Cell covers have several distinct features. Lead bushings are molded in the cover to fit over the two battery terminal posts. Vent wells are found in the cover. These wells allow gasses to escape from the battery without forcing the electrolyte to leave as well.**

**Often there is a ring or some other mark in the vent well which indicates the level to which the battery should be filled with water or the electrolyte. The electrolyte should only be filled to the bottom of the well. If the cover has no well, it should be 1/2" above the top of the plates.**

### **VENT PLUGS**

**There are various kinds of vent plugs used in the battery industry. Some have threads which screw into the vent well. Others are pushed into the vent well. Some are placed in individually; others are mounted in groups of three in a flexible plastic strip. Aircraft, marine and special vehicle batteries may have a lead valve system which prevents the acid from draining when the battery is turned upside down. All of these are designed so that gas can escape from the cell but the electrolyte does not.**

**"Flame arrester" vent plugs are used in the automotive type battery. These arresters allow gasses to escape but do not allow sparks or flames to accidentally enter the battery. This reduces the number of battery explosions.**



**Some maintenance-free batteries do not use vent plugs at all. Instead the gas is vented through passageways in the covers. Flame arresters are put in these passageways.**

**Why are the containers made of hard rubber or plastic?**

---

---

---

---

**Why does a battery have a sediment chamber at the bottom?**

---

**Vent wells are used for two purposes. What are they?**

1. \_\_\_\_\_

2. \_\_\_\_\_

**What do "flame arresters" do?**

---

---

**Label the parts of the battery container shown below.**

**a. vent plugs**

**b. vent wells**

**c. element rests**

**d. sediment chambers**

## HOW CELLS ARE CONNECTED

The cells of a battery are always connected in series. This means that a positive terminal of one cell is placed next to the negative cell of another terminal. These terminals are then connected to each other.

The terminals can be connected through the cell partitions or over the top of the partitions. If either of these two methods are used, the terminals are connected before the cover is added.

Terminals can also be connected with external cell connectors. When this method is used, the terminals are connected after the cover has been added to the battery. External cell connectors are welded over the terminal posts that are sticking out of the cover.

Terminal connectors must always be made of materials which are large enough and strong enough to carry high currents without melting or allowing for too much voltage to escape.

## TERMINAL DESIGNS

Four different terminal designs are found in the battery industry.

1. **Tapered Top Terminals:** These are built to standards that allow all cable clamps to fit the battery posts. The positive terminal is slightly larger than the negative terminal so that a person will not accidentally connect the wrong cable to the post.
2. **Side Terminals:** These terminals are molded into the side wall of the container. The battery cable is attached by a bolt which threads into the terminal.
3. **"L"-Terminals:** This is used on many European car batteries and on batteries for special applications. The battery cable is attached in the the terminal by a bolt and a wing nut.
4. **Stud Terminals:** This is a top terminal which is threaded.

## COVER TO CONTAINER SEAL

It is extremely important that the acid inside of the battery does not leak to the outside surface of the battery. It is also important that acid does not leak between the cover and partitions.

Therefore covers and containers must be bonded together with the proper seal.

Plastic one-piece covers and plastic containers can be bonded together by a high temperature and pressure process. Or epoxy resin can be used to bond the covers to the containers. Both of these methods provide a seal that cannot be broken by heat.

In batteries which have individual cell covers, asphalt sealing compound is used. The compound resists extremes of hot and cold.

Describe three ways in which terminals can be connected.

1. \_\_\_\_\_
2. \_\_\_\_\_
3. \_\_\_\_\_

Where are terminal posts found on the battery?

---

---

Why is it important to seal the cover to the container properly?

---

---

## PART II BATTERY CONSTRUCTION

The individual parts of a battery will be discussed to provide fundamental information concerning its construction and the chemical reactions taking place inside it. Each part will be discussed separately, beginning with the basic plate grids and progressing to the complete battery assembly.

Batteries are made with alternating positive and negative plates held apart by separators. Each battery cell contains a group of these positive and negative plates (an element) immersed in electrolyte (dilute sulfuric acid). Each cell supplies slightly more than two volts. Three of these cells connected in series give us a 6-volt battery; six cells in series give us a 12-volt battery. The parts of a 6-cell, 12-volt battery are identified in Figure 2.

### PLATE GRID

The grids are the supporting framework for the active material of the plates. They also conduct the current to and from the active materials of the positive and negative plates. They are made of an alloy of lead. Most batteries use a small amount of antimony in the grids to strengthen and stiffen the soft lead. This is necessary so the grids can be handled during the battery manufacturing process without bending or crumpling. Maintenance-free batteries may use grids containing other metals such as calcium or strontium for this purpose. These metals also reduce the gassing, water usage and self-discharge rates of batteries, compared to those using antimony. Small amounts of tin are used to facilitate casting the grid. Small amounts of other metals can be used in the alloy to obtain various desirable effects.

Figure 3 shows a typical grid design. Various grid mesh designs are used. The object of these designs is to use the grid metal more efficiently. They try to place more metal where the current density is greater and less metal where there is less current.

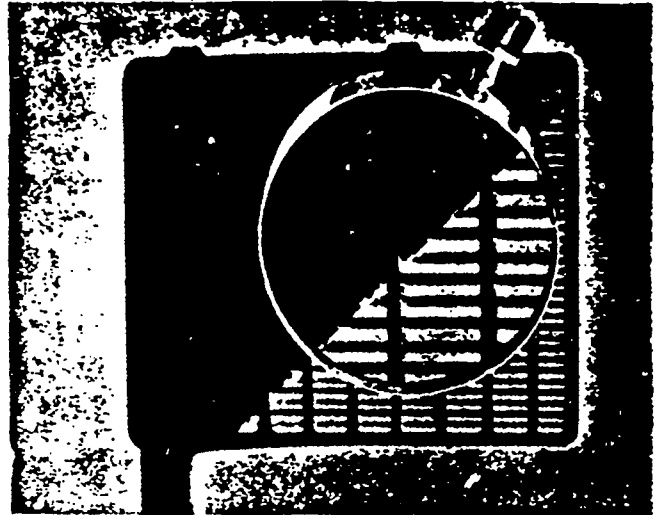

Fig. 3 Positive Plate With Part of Active Material Removed to Show Grid Structure.

### POSITIVE AND NEGATIVE PLATES

The first step in making a positive or negative plate is to paste a material (which has a consistency of firm mud) onto a grid. This paste is a mixture of lead oxide, sulfuric acid and water. The main difference between the paste used for the positive and negative plates is that "expanders" are added to the negative paste. These "expanders" are required to prevent the negative material from contracting in service and reverting to a dense, inactive state. This would greatly reduce the performance of the battery, especially its cold cranking ability. After the plates have been pasted and dried (hydroset), the positive plate has a light brown color. The negative plates have a slightly grey color due to the expander material in them.

The next step in manufacturing the plates is to give them a "forming" charge. This charge electrochemically converts the lead oxide of the positive plate to lead dioxide. This is a highly porous material which allows the electrolyte to freely penetrate the plate. The positive plate is now a dark, chocolate brown color.

The same "forming" charge converts the lead oxide of the negative plate to a grey, sponge lead. The "spongy"

lead allows the electrolyte to penetrate freely thus allowing the material beneath the plate surface to take part in the chemical reactions. The negative plates are now a grey color. Whether a plate becomes a positive or negative plate depends on the direction of the "forming" charge. If it is made in the reverse direction by accident, the polarity of the formed plates would be reversed. The plates with expanders would be formed into lead dioxide positive plates. The sponge lead negative plates would not contain expander material. The performance of the battery would be greatly impaired.

## SEPARATORS

If a positive plate touches a negative plate, a short circuit exists and all the plates in the cell lose their stored energy. Therefore, the plates are kept apart by separators. A separator is a thin sheet of electronically insulating, finely porous material which permits the passage of charged ions of the electrolyte between the positive and negative plates.

The most widely used separators at this time are made with resin impregnated cellulose fibers. Separators made with various plastic materials give excellent performance. Rubber or some type of plastic separator is often used in batteries where service conditions require a premium separator. In some instances, such as deep cycling and/or high vibration applications, separators are used in combination with glass fiber mats to retard the loss of active material from the positive plate. Important characteristics of a separator are its oxidation resistance, low electrical resistance, porosity, pore size and distribution, wettability and good acid diffusion.

Separators have ribs on the side facing the positive plates. This provides greater acid volume next to the positives and minimizes the area of contact. The positive plate has a highly oxidizing effect which may attack some separator materials. The ribs also provide space to facilitate acid circulation and permit gas to rise to the top of the cell as it is formed.

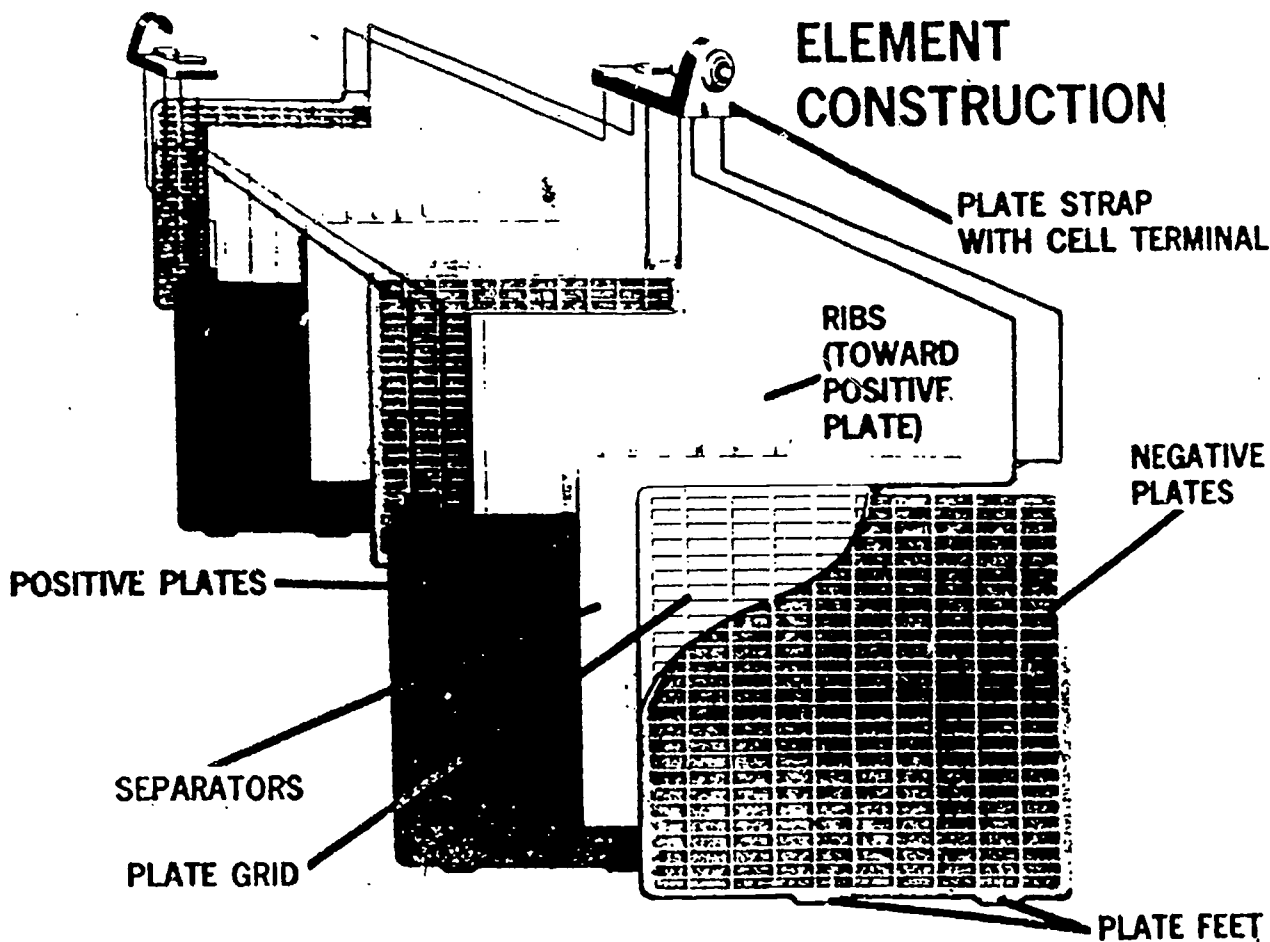

Fig. 4 Element Construction-Conventional Battery

Some batteries use envelope separators around the positive or negative plates. These separators are sealed on three sides. They are open at the top to allow the gases generated on the plates to escape to the top of the cell. The sediment space in a battery can be eliminated, if these separators are used. They also eliminate shorts due to misalignment of the plates and separators. Usually, separators used for enveloping are flexible and plastic to facilitate the encapsulation.

## ELEMENTS

In the most common method of construction, a stack of alternate positive and negative plates, with a separator between each positive and negative plate, is assembled. The ribs of the separator are in contact with the positive plates. The lugs of the negative plates and a post strap are welded together and the lugs of the positive plates and a post strap are welded together (see Figure 5). The post strap of each group of plates is used to connect them in series with the plate groups of adjacent cells.

In a second method of construction, the lugs of the desired number of negative plates and a post strap are welded together and the desired number of positive

plates and a post strap are welded together. Separators are then inserted between the plates with the ribs of the separators next to the positive plates.

The assembly resulting from placing one positive plate group and one negative plate group together, with separators, is known as an element. There is one element per cell. Any number or size of plates can be used in the assembly, depending on the desired performance. For example, more plates or larger plates will increase the total plate surface area per element. This will increase the voltage during discharge at high rates such as cranking an engine at low temperatures. The higher the voltage, the faster the starter will crank the engine. However, the open circuit voltage (battery not connected to a charge or discharge) of a single cell will be approximately 2.1 volts regardless of the size or number of plates. Therefore, a 12-volt battery has six cells and a 6-volt battery has three cells. The elements are placed in the cells of the container and the post straps of one cell are welded to the post straps of the adjacent cells. This connects the cells in series (positive group to the negative group of the next cell) so the voltage of the battery equals the sum of the voltages of the individual cells.

## PLATE GROUPS

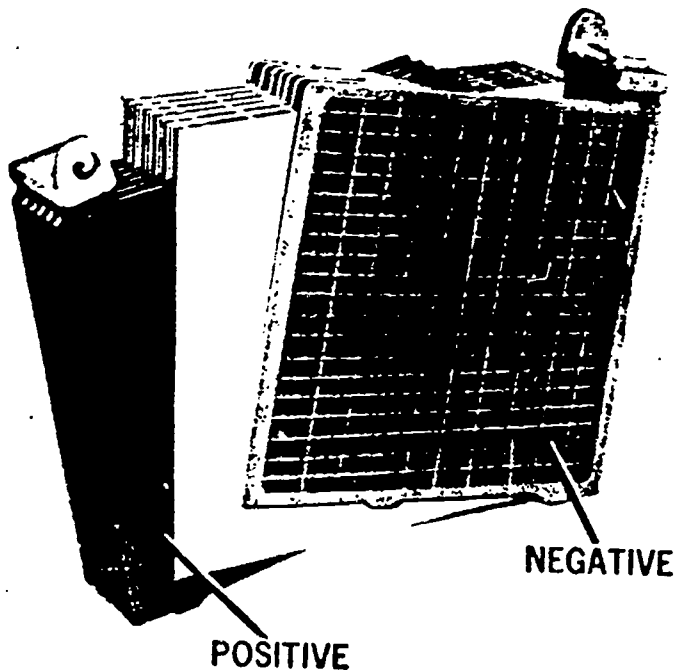

## ASSEMBLED ELEMENT

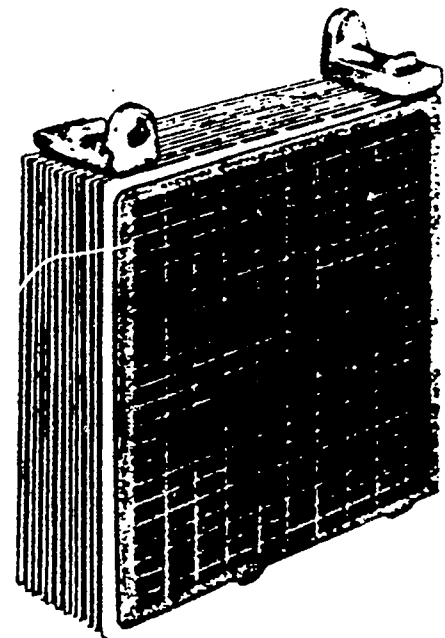

Fig. 5 Battery Element



The battery is not active until the electrolyte a mixture of sulfuric acid and water (see "Electrolyte And Specific Gravity" page 11) is added This is the last ingredient required for the chemical actions which take place in the battery The other ingredients are the sponge lead of the negative plate and the lead dioxide of the positive plate The electrolyte is also the carrier for the electric current to move between the positive and negative plates through the separators

## CONTAINER

The outside case or shell of the battery is a one-piece molded rectangular shaped container made of polypropylene, hard rubber or other plastic like materials It is designed to

- 1 Withstand the temperature extremes of cold and heat
- 2 Resist damage caused by mechanical shock in rough road service They can be damaged by rough handling
- 3 Resist acid absorption

The inner bottom portion of the container has element rests or "bridges" running the full length of the case (see Figure 6) These rests vary in height but are generally near one-half inch (1.27 cm) As mentioned earlier, the plates have "feet" which sit on the rests The plates are at right angles to the element rests. The feet permit the separators to extend below the bottom of the plates, thus reducing treeing shorts between positive and negative plates The space below the tops of the rests acts as a sediment chamber for collecting active material shed from the plates This loss of plate material is a part of the wear process caused by repeated discharging and charging of the battery If the battery stays in service long enough for the sediment space to fill to the bottom of the element, the shedded material will gradually form an electrical path or short circuit between the bottoms of the positive and negative plates. This will interfere with the charging of the battery and its ability to retain a charge When the short circuits become severe enough, the battery fails. Normally the battery fails for other reasons before this condition occurs.

## CELL COVERS

The cell covers are usually made of a plastic material although some are made of hard rubber. Most current designs are one-piece cover construction Lead bushings are molded in the cover for the two battery terminal posts (not on side terminal design). Some covers are grooved to fit over intercell connectors which go over the top of the partitions. However the intercell connection is made through the partition in most batteries. The

covers do not contact the intercell connection in these batteries

The vent wells of the cover are designed to provide the proper air space above the electrolyte to permit gas to vent from the cell without forcing electrolyte from the battery There is generally a ring or some other mark near the bottom of the vent well to indicate the proper height to fill the cell when adding water or activating the battery If there is no level indicator, fill the cell until the electrolyte touches the bottom of the vent well If the cover does not have vent wells the electrolyte level should be 1/2" (1.27 cm) above the tops of the plates

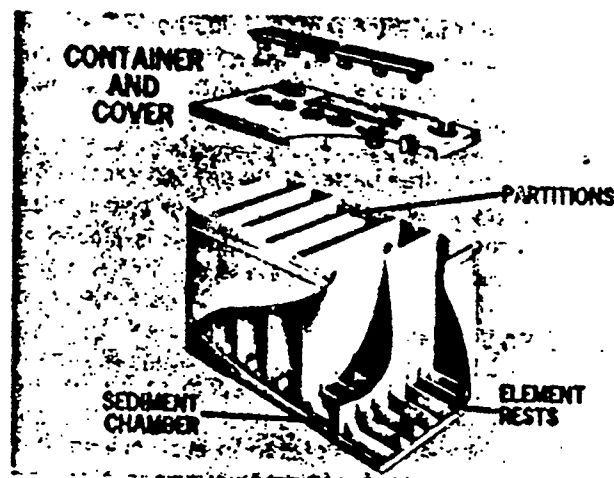

Fig. 6 Container And Cover-Typical

## VENT PLUGS

Vent plugs of various designs are used in the industry They are baffled so gas can escape from the cell, but electrolyte splashed into the vent will drain into the cell and not be "pumped" from the battery by the escaping gas

If an individual vent plug is used for each cell, it may have threads and screw into the vent well Others do not have threads, but are pushed into the vent well and are held in place by an interference fit.

The "push-in" type of vent plug may be a single plug, three plugs mounted in a manifold (gang vent plug), six plugs mounted in a manifold or in a flexible plastic strip These designs were developed to reduce the time required to remove and replace the vent plugs when adding water to the battery.

There are vent plugs with lead valve systems which prevent acid draining from the battery when it is turned upside down. These vent plugs are used in aircraft and marine service and batteries for special vehicles.

An important development in the design of vent plugs for the automotive type battery is the introduction of the "flame arrester" vent plug. If a hydrogen and oxygen gas

mixture outside the battery is accidentally ignited by a spark or flame the arrester prevents the resulting flame front from entering the battery through the vent opening and exploding the gas inside the cell. This will reduce the frequency of battery explosions

Flame arresters can be made of several materials including sintered plastics and ceramics. They must be sufficiently porous to pass large quantities of gases with a low back pressure but not so porous as to allow the flame front to pass through them.

Another type of flame arrester has several tiny vent holes in the gang vent. The holes are so small and the vent so designed that the flame is snuffed out. The heat of the flame front could melt the plastic around the opening and seal the hole, but several other openings would still be available to vent the battery cells.

Some maintenance-free batteries do not use vent plugs. Instead, the gas is vented through one or two baffled labyrinths in the cover. The flame arrester is placed at the exits of these intricate passage-ways.

## CELL CONNECTORS

The cells of a battery are connected in series so the battery voltage will equal the sum of the cell voltages. Therefore, the elements are placed in each cell so that the negative terminal of one cell is adjacent to the positive terminal of the next cell, and so on throughout the battery. Construction techniques commonly used today connect these element terminal posts in series, either through the cell partitions or over the top of the partitions, before the cover is placed on the battery. This type of construction gives a much shorter, lower resistance path through the battery and therefore, higher battery discharge voltage than the external connector construction. It also eliminates acid leaks around external element terminal posts and self-discharge paths between the external connectors.

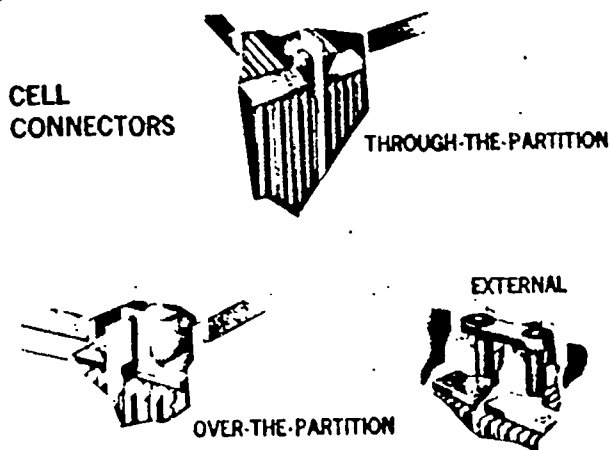

Fig. 7 Cell Connectors

Some batteries are still constructed with external cell connectors. In this type of construction, openings are provided in the cell cover for the element terminal posts. After the cover has been added to the battery, the cell connectors are placed over the protruding terminal posts, and are welded to them. Regardless of the type of construction used, the connectors must be large enough to carry high cranking currents without melting or having too large a voltage loss.

## TERMINAL DESIGNS (See Figure 8)

### Tapered Top Terminal —

This design uses tapered terminal posts built to industry standards so that all cable clamps will fit any battery with these posts (one size for the positive posts and one size for the negative posts). The positive terminal is slightly larger than the negative to minimize the danger of installing a battery in reverse. The positive terminal is 11/16" (17.5 mm) in diameter at the top. The negative terminal is 5/8" (15.88 mm) at the top. The minimum length of the taper is 5/8" (15.88 mm).

### Side Terminal —

These terminals are molded into the side wall of the container near the top edge (see Figure 8). The battery cable is attached to the terminal by a bolt which threads into the terminal. If the bolt is missing, install a new cable which is furnished with the proper bolt. When tightening the bolt, use the manufacturer's recommended torque values to prevent terminal damage.

### The "L" Terminal —

The "L" terminal is used on many European car batteries and batteries for special applications, such as marine and light duty vehicles. The battery cable is attached to the terminal by a bolt and a wing nut.

### Stud Terminal —

Another type of "top" terminal is a threaded or "stud" terminal. Detailed dimensions of this terminal are given in SAE Specification J-537.

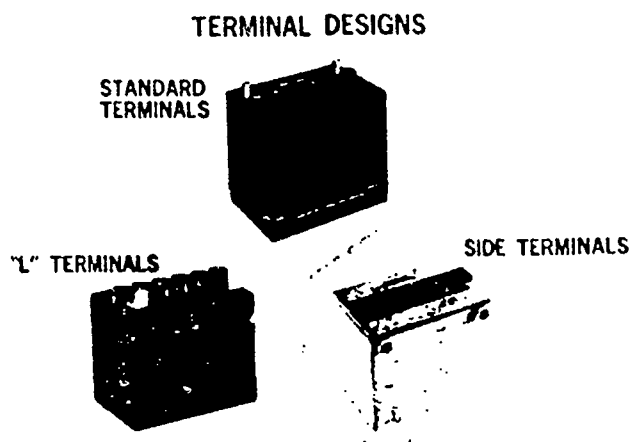

Fig. 8 Terminal Designs



## COVER TO CONTAINER SEAL

Acid cannot be permitted to leak between the cover and the container to the outside surface of the battery. Neither can it leak between the cover and partitions or shorts between cells will increase the self-discharge rate of the battery.

Plastic one-piece covers and plastic containers can be bonded together by a high temperature and pressure

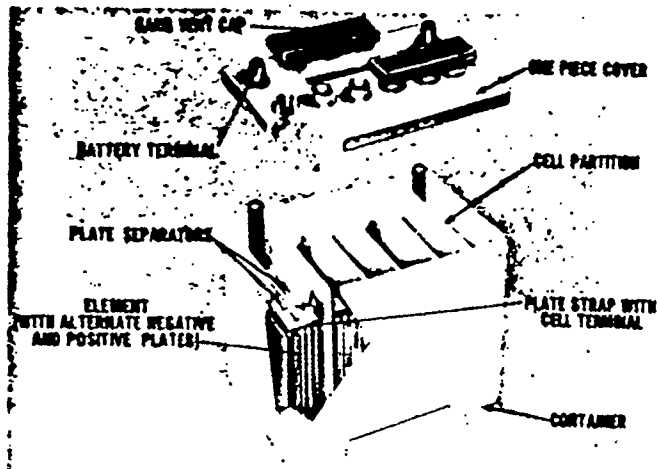

Fig. 9 The Complete Assembly-Conventional

process. Epoxy resin can be used to bond one-piece covers to containers whether one or both of the two components are plastic or hard rubber. Both of these processes form a permanent seal that cannot be broken by heat.

In the batteries still using individual cell covers "asphalt" sealing compound is often used. This seal is a blend of specially processed bituminous compositions that have resistance to flow at warm temperatures and resistance to cracking at cold temperatures.

## THE COMPLETE ASSEMBLY

Figure 9 shows the internal battery components as they are assembled into their relative positions. The one-piece cover and gang vents are shown. A typical through-the-partition type of cell connector is shown. The positive and negative plates are easily distinguished by their color. The positive plate is a dark brown color and the sponge lead negative plate is grey.

Each cell of the battery has an open circuit voltage of approximately 2.1 volts. Therefore, three cells connected in series make a 6-volt battery and six cells connected in series are required to make a 12-volt battery.

## PART III HOW THE BATTERY WORKS

A storage battery is an electro-chemical device. It stores chemical energy which can be released as electrical energy. When the battery is connected to an external load such as a starter, the chemical energy is converted into electrical energy and current flows through the circuit.

### PURPOSE OF THE BATTERY

The three main functions of the automotive battery are to:

- 1 Supply power to the starter and ignition system so the engine can be cranked and started.
- 2 Supply the extra power required when the vehicle's electrical load requirements exceed the supply from the charging system.
- 3 Act as a voltage stabilizer in the electrical system. The battery smooths out or reduces temporarily high voltages (transient voltages) which occur in the vehicle electrical system. These excessively high voltages would damage other components in the electrical system if it were not for the

protection provided by the battery.

Storage batteries are used in other fields for a variety of tasks such as providing power for lighting units and propelling special vehicles.

### HOW IT OPERATES

The action of the lead-acid storage battery is determined by the chemicals in it. These chemicals are:

- 1 Lead dioxide ( $PbO_2$ ) - the material on the positive plate.
- 2 Sponge lead ( $Pb$ ) - the material on the negative plate.
- 3 Sulfuric acid ( $H_2SO_4$ ) - the electrolyte.

When two unlike metals such as the positive and the negative plates are immersed in sulfuric acid (the electrolyte), the battery is activated and a voltage is developed. The voltage developed depends on the types of metals and the electrolyte used. It is approximately 2.1 volts per cell in a typical lead-acid battery. Electrical energy is produced by the chemical action between the

## Statement of Purpose:

**Johnson Controls Specialty Battery Division 's Steering Committee identified several training goals which this work hopes to address:**

**Goal One:** Employees will understand the entire assembly process, not just their own part, in producing a battery.

**Goal Two:** Employees will read, comprehend and use written instructions for performing their job.

=====

**Worksite profile:** Employees have been with the company for a long time. Many have over twenty years of experience in battery production. (Plant once owned by Globe Union.) Most training was given orally. Employees report that little **written** information has been made available about their jobs until very recently when the company began preparation for ISO90001 Certification

**Presenting problem:** The engineer-trainer who instructs employees in the use of machines in the factory approached me with several problems he had observed in teaching old and new employees.

Trainees failed to ask questions although later it was evident that they lacked the confidence and skill to use the information provided in training sessions.

Since there was a company policy to make all employees -- not just lead people -- responsible for setting up and maintaining equipment, it was important that all employees troubleshoot, without relying on only one or two people.

There was no "down time" to allow trainees the opportunity to practice on real machinery in a non threatening environment in order to gain understanding and confidence.

Tests were open-ended essay questions which were difficult for employees to answer since many lack the communication skills needed to respond to such a test.

Directions which came from the corporate headquarters were difficult to follow because terms were not used consistently; terms were often not defined; criteria for determining proper settings or alignment were vague or open to more than one interpretation.

**Process:** We began by using me as a "guinea pig" in a training session on the weld head assembly. I provided feedback on areas which were unclear or misleading. I suggested alternate "testing methods" and agreed to work on a sample lesson just for this portion of the training.

These documents are intended to serve as reading texts to enhance training provided by company engineers. They are to be used in conjunction with videos, diagrams and photos prepared by company trainers. The written text and tests are to be used for teaching reading skills as well as for increasing an understanding of the assembly process. The engineer's instructions would remain by the machines in the plant, but people who wanted to do so, could use the reading text, videos and diagrams to study their job in the WEC at a slower pace, in a non threatening environment.

The documents are **in process**. I would like to integrate math and writing skills into the text. The company has suggested using the materials with new employees to acquaint them with their jobs with and self-study in the Workplace Education Center. The materials are not complete, and have not been integrated into the new employee orientation process to date. A rush in job orders following ISO9001 certification has delayed the completion of the text. Pictures have been taken by the engineer. They will be scanned into the computer text. The videos are not taken yet.

Still needed:

- Figures 1 - 6      Photos
- \*1    Parts of a battery
  - \*2    Tools used in assembly
  - \*3    First check station
  - \*4    Control panel
  - \*5    Second machine
  - \*6    Third machine
- \*      Weld head

Diagrams or drawings

- \*      clamp plate
- \*      cable
- \*      jaw fixture
- \*      test probes
- \*      Jaw fixture's tombstone
- \*      clamp stop

## FIRST CHECK STATION MACHINE ASSEMBLY CONVEYOR SYSTEM

At the first check station, a machine checks the batteries coming from the COS (Cast On Straps) Department for shorts. The machine must be adjusted to fit different size batteries.

In order to understand these directions, you will need to know

THE PARTS OF THE BATTERY (Fig.1)

DIFFERENT KINDS OF TOOLS USED TO MAKE  
ADJUSTMENTS (Fig.2)

THE PARTS OF THE FIRST CHECK STATION MACHINE  
(Fig.3)

THE CONTROL PANEL FOR ALL THREE MACHINES (Fig.4)

Each of the **dark words** in the directions below is pictured on one of the drawings which go with these directions. If you do not know what the word means, please look at these drawings.

### REMOVING THE CIRCUIT BOARD

- ❑ 1. Go to the first check station on the right. Open the plastic door.
- ❑ 2. Locate the  **cable** . Unscrew the  **cable**  by hand.
- ❑ 3. Find the  **column mounted bracket** . It is attached with four screws. Use the  **allen wrench**  to remove these screws.
- ❑ 4. Locate the  **clamp plate**  on the first check station. Use an  **open end wrench**  to remove the  **clamp plate** .
- ❑ 5. Locate the  **clamp stop**  on the first check station. Use an  **open end wrench**  to remove the  **clamp stop** .

## INSTALLING THE CIRCUIT BOARD

- ❑ 1. Put the **circuit board** in place. Use the **allen wrench** to screw the bracket to the column.
- ❑ 2. Connect the **cable** by hand.
- ❑ 3. Put the **clamp plate** in position. Use the **open end wrench** to tighten the two nuts that hold the **clamp plate** in place.
- ❑ 4. Put the **clamp stop** in place. Use the **open end wrench** to tighten the two nuts that hold the **clamp stop** in position.

## USING THE JAW SET-UP FIXTURE

- ❑ 1. Put the jaw fixture between the **entry conveyorguide rails** lengthwise.
- ❑ 2. Adjust the **entry conveyor guide rail** to hold the **jaw fixture** firmly.
- ❑ 3. Use the **hand wheel** to put the **jaw fixture** under the **test probes** or **pogos**.
- ❑ 4. Line up the **test probes** on the **jaw fixture pedestals**.
- ❑ 5. The **points** on the **test probes** must make contact with the **jaw fixture's tombstone**. You may have to adjust the **circuit board 1/8 to 1/4 "** to make the proper contact. If the **circuit board** must be moved, go to the back of the machine. Use the **large crescent wrench** that hangs behind the machine to loosen the nut which holds the **circuit board** in place.

There are three kinds of wrenches used to adjust the first check station machine.

**O = Open end wrench**

**A = Allen wrench**

**C = Crescent wrench**

Which wrench would you use to do the following tasks? Put O, A, or C on the line before the task.

- \_\_\_\_\_ 1. Remove the column mounted bracket which holds the circuit board in place.
- \_\_\_\_\_ 2. Adjust the position of the circuit board so that the probes make proper contact.
- \_\_\_\_\_ 3. Remove the clamp stop.
- \_\_\_\_\_ 4. Remove the clamp plate.
- \_\_\_\_\_ 5. Screw the bracket on to hold the circuit board in place.

Draw a line from the name of the item in the first column to the correct picture of the item in the second column.

Clamp plate

Cable

Jaw fixture

Test probes

Jaw fixture tombstone

Clamp stop

Select the word or words from the list below that complete the sentences correctly.

Test probes  
remove  
behind  
tombstone

Guide rails  
install  
by hand

jaw fixture  
adjust  
hand wheel

1. You connect and disconnect the cable when you \_\_\_\_\_ and \_\_\_\_\_ the circuit board.
2. You \_\_\_\_\_ the position of the circuit board from \_\_\_\_\_ the machine.
3. Use the \_\_\_\_\_ to help position the different size batteries.
4. The \_\_\_\_\_ must make contact with the \_\_\_\_\_ of the \_\_\_\_\_.
5. Use the \_\_\_\_\_ to put the jaw fixture under the test probes.
6. You unscrew the cable \_\_\_\_\_.

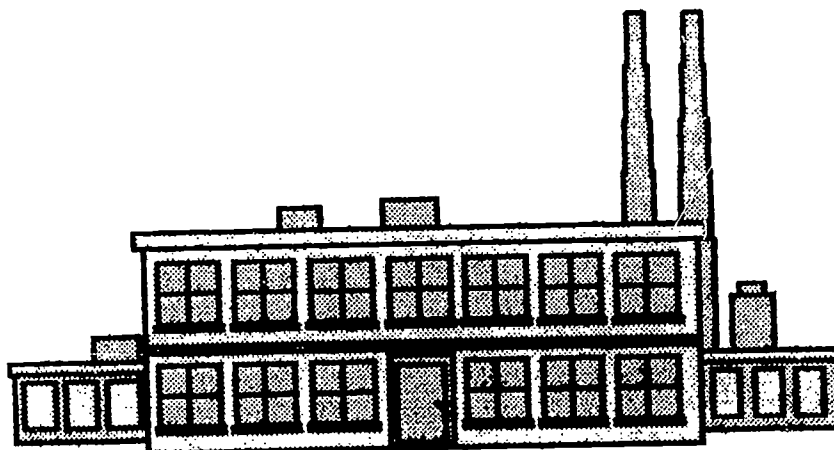



## WELD HEAD ASSEMBLY CONVEYOR SYSTEM

At this machine, the lugs are welded in place on the battery. After the welding has been done, the worker checks the lugs on every hundredth battery to make sure that the welds were done correctly because poor welds can decrease the life of a battery.

In order to understand these directions, you will need to know

THE PARTS OF THE BATTERY (Fig. 1)

DIFFERENT KINDS OF TOOLS USED TO MAKE  
ADJUSTMENTS (Fig. 2)

THE PARTS OF THE SECOND MACHINE (Fig. 5)

THE CONTROL PANEL FOR ALL THREE MACHINES (Fig. 4)

Each of the **dark words** in the directions below is pictured on one of the drawings which go with these directions. If you do not know what the word means, please look at these drawings.

### INSTALLING THE WELDER CLAMP BAR

- 1. Use the **allen wrench** to remove the **welder clamp bar**.
- 2. Find the three **weld stops** on the left side of the machine.. Use the **open end wrench** to loosen the screws that secure the 3 **weld stops**.
- 3. Install the **welder clamp bar** or **pressure bar** in the **welder**. Use the **allen wrench** to tighten the two **allen screws** that hold it in place.

## ADJUSTING THE 3 WELDER BATTERY STOPS

- 1. Release the **lock nuts** or **hold downs** on the **welder clamp bar**.
- 2. Place the **jaw fixture** at the **first battery stop**. Move the **clamp bar** in by hand until there is a **1/16"** gap between the bar and the **jaw set-up fixture**. Clamp it in place by selecting "**battery clamp**" on the **control panel**.
- 3. Use the **control panel** to lower the **weld head** on to the **jaw fixture**.
- 4. The **jaws** must be centered over the **jaw fixture pedestal**. If the **jaws** must be moved left or right to center it, use the **allen wrench** to loosen the nuts that hold the **jaws** in place.

(I think you must also change something on the panel -- my notes are not clear. Is there a l/r jaw adjust on the panel?)

- 5. Move the pedestal out of the way. Use the **allen wrench** to tighten the screws which will lock down the first stop.
- 6. Move the **panel selector** to #2. Move the **jaw fixture** to the **second battery stop**. See if the jaws are centered over the second set of **pedestals**. If they are not centered, adjust the stop by loosening the screws that hold the stop with an **allen wrench**, and moving the stop slightly.
- 7. Move the **panel selector** to #3. Move the **jaw fixture** to the **third battery stop**. See if the jaws are centered over the last **pedestal**. If they are not centered, adjust the stop by loosening the screws that hold the stop with an **allen wrench**, and moving the stop slightly.

## ADJUSTING THE WELD JAW HEAD HEIGHT

- 1. Go behind the machine. Find the **large crescent wrench** that is tied to the machine.
- 2. Screw the **large nut** up or down on the column to move the **weld head**. The tips of the **jaw** should be 1/16" from touching the **straps/gauge**.

## ADJUSTING THE JAW PRONGS LENGTH

- 1. Check to see if the individual **jaw prongs** are the same length. If the **jaw prongs** are not the same length, they will have to be adjusted.
- 2. Use the **allen wrench** to loosen the four **allen bolts** which hold the **jaw prongs** in place. Raise or lower the **jaw prong** as needed. Then tighten the **allen bolts** alternating front to rear.

## ADJUSTING THE JAW PRONGS ALIGNMENT

- 1. Check to see if the **jaw prongs** are **parallel** by inserting a **5/16 allen wrench** between the **jaws** and changing the panel control to "**no weld**." The wrench should hold firm.

(What do you do if the prongs are not parallel?)

- 2. The jaws must center on the **jaw set-up fixture tombstones**. If you need to adjust the front to back position of the **jaws** to center them, first loosen the bolts above the **jaws** with an **open end wrench**. Place the jaws in the correct position. Then tighten the bolts to lock them down. This can be done from the front of the machine.

**In each of the following cases, something is wrong with the weld head. Study the situation. Circle the correct action the operator should take to fix the machine.**

Dave is ready to weld 150 batteries. Just as he is about to begin, he notices that the weld clamp bar is at least 1" from the jaw set-up fixture.

- A. Dave begins welding because he is satisfied that the jaws are correctly centered over the jaw fixture pedestal.
- B. Dave calls a more experienced operator over to adjust the clamp bar.
- C. Dave moves the clamp bar in by hand until there is only a 1/16" gap between the bar and the jaw set-up fixture. Then he clamps the bar in place by selecting "battery clamp" on the control panel.

Jesse begins welding before he checks the alignment of the jaw prongs. Then he realizes that the prongs are pointed in toward each other.

- A.
- B.
- C.

James checks the first battery stop. Everything is properly set up. He begins welding.

- A. James should stop welding, and check the second and third battery stops. He should also adjust the jaw head height and the jaw prong position.
- B. James can assume the second and third battery stops are also set correctly. However he still needs to adjust the jaw head height.
- C. James can assume that if the first battery stop is correct, then the last worker to use the machine has checked out all the rest of the settings.

Label these parts on the control panel.

- A. I/r adjust
- B. no weld
- C. battery clamp
- D. (lower weld-head) -- I don't know how this is indicated on the panel.
- E. battery stops #1, #2, #3

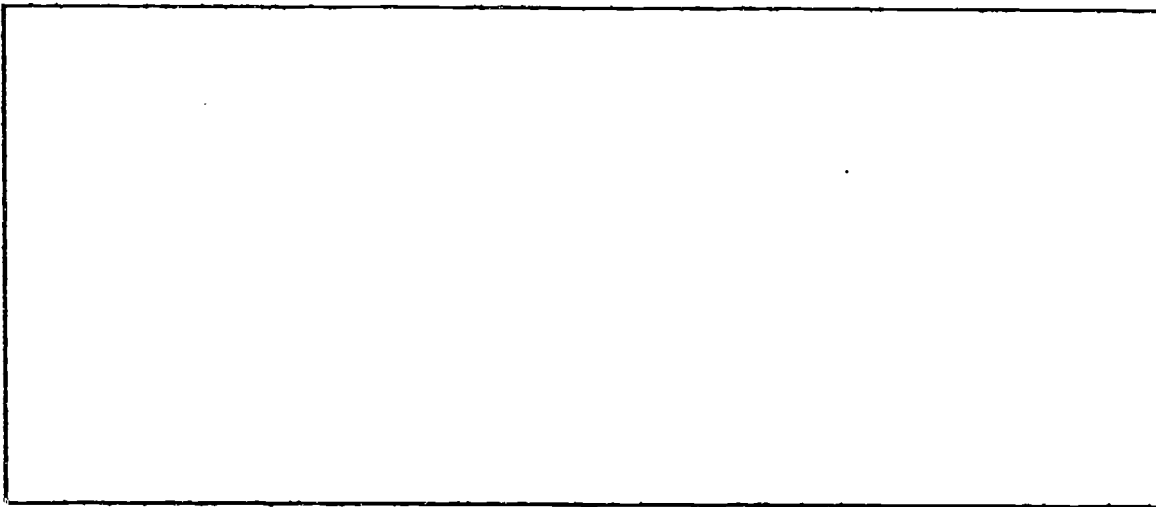

Label these parts of the weld head.

- A. Welder clamp bar
- B. Weld stop
- C. Jaw prongs
- D. Control panel

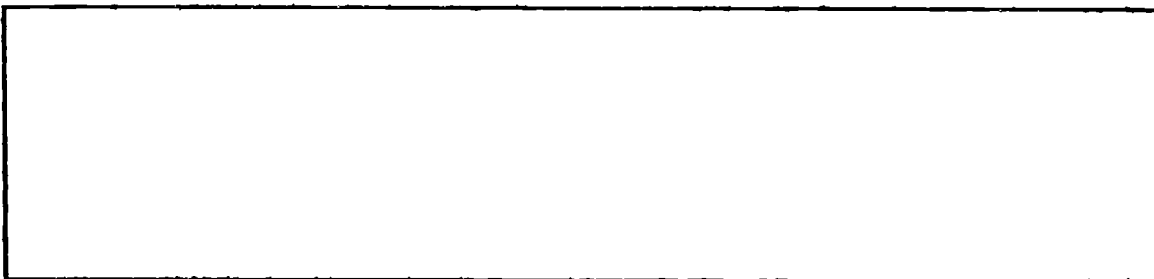

## SECOND TEST HEAD ASSEMBLY

After battery lugs are welded, the individual batteries are once more checked for shorts. Defective batteries are placed on a side table for further testing. Corrections must be made on the defective batteries before they can be forwarded to the next station.

These directions are to be used to set up the machine for the second testing.

In order to understand these directions, you will need to know

THE PARTS OF THE BATTERY (Fig. 1)

DIFFERENT KINDS OF TOOLS USED TO MAKE  
ADJUSTMENTS (Fig. 2)

THE PARTS OF THE THIRD MACHINE (Fig. 6)

THE CONTROL PANEL FOR ALL THREE MACHINES (Fig. 4)

Each of the **dark words** in the directions below is pictured on one of the drawings which go with these directions. If you do not know what the word means, please look at these drawings.

## REMOVING THE CIRCUIT BOARD

- ❑ 1. In order to remove the **circuit board** from the **second check station**, you must open the plastic door. Then you must unscrew the **cable** by hand.
- ❑ 2. Support the **circuit board** from underneath with an empty battery container. Remove the screws with an allen wrench.
- ❑ 3. Use the **open end wrench** to remove the **clamp plate**.
- ❑ 4. Use the **open end wrench** to remove the **clamp stop**.

## INSTALLING THE CIRCUIT BOARD

- 1. Use an empty battery case to support the **circuit board** in position.
- 2. Use the **allen wrench** to tighten the two **allen screws** in place.
- 3. Connect the **cable** by hand.
- 4. Put the **clamp plate** back in position. Use the **open end wrench** to tighten the two **nuts**.
- 5. Put the **clamp stop** back in place on the **second test station**. Use the **open end wrench** to tighten the two **nuts**.

## USING THE JAW SET-UP FIXTURE

- 1. Place the **jaw set-up fixture** on the assembly line **conveyor belt** at the **second test station**. Use the **open end wrench** to loosen the **nuts** on the **clamp stop**. Line up the **circuit board** using the **hand wheel**.

(I think there are some steps missing in here. How will I know when the jaw set-up fixture is lined up? 1/16" from the clamp stop?)

- 2. Use the **large crescent wrench** on the back of the **welder head** to loosen the **large board height adjustment nut**. Adjust the height so that the **pogos board** makes contact with the **straps**.
- 3. Remove the **jaw set-up fixture** from the assembly line **conveyor belt**, and keep it nearby for periodic checks.

**Circle the T if the statement is true. Circle the F if the statement is false.**

- T F 1. Batteries are tested once to determine if they have shorts.
- T F 2. Poor welds look bad but they don't really change a battery's performance.
- T F 3. All three welder battery stops must be adjusted before the welding can be done.
- T F 4. It does not matter if the jaw prongs are not exactly the same length as long as they are positioned correctly front to back.
- T F 5. The large open-end wrench is always tied to the back of the machine so that it can easily be used.
- T F 6. The battery lugs must be welded correctly in order to prevent short circuits.
- T F 7. Every operator who uses the machine should be able to adjust the equipment to fit different size batteries.
- T F 8. Batteries that are defective are thrown away.

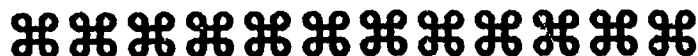



**Arrange these steps in proper order. Put a number 1 in front of the first thing an operator does in preparing the third station for testing. Put the number 2 in front of the next thing the operator does, and so on.**

- \_\_\_\_\_ Remove the jaw set-up fixture and set it aside to use for later checks.
- \_\_\_\_\_ Put the clamp late and clamp stop back in place.
- \_\_\_\_\_ Remove the circuit board, clamp plate and clamp stop.
- \_\_\_\_\_ Adjust the height of the welder head so that the test probes make contact with the straps.
- \_\_\_\_\_ Put the circuit board in place and tighten the screws that hold it secure.

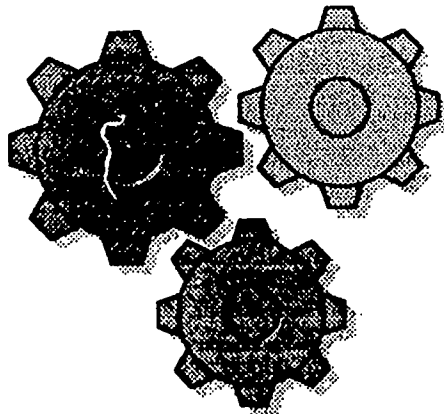

Date: July 7, 1993  
To: Art Brooks  
From: Jane C. Rasmussen  
Re: Training procedures

I thought it might be useful for me to summarize some of the comments I made regarding the training materials we discussed today. These are some of the recommendations I made.

- \* Use simulated activities which allow people to try out the procedures they are expected to follow without any serious consequence
- \* Allow employees to practice at their own pace with freedom to make mistakes and to learn from those mistakes. Feedback of some kind is important but it must be feedback that puts no blame on the learner. You want to build confidence, not emotional hangups that can interfere with learning.
- \* Repetition of ideas is important. Find different ways to say the same thing.
- \* All people do not learn in the same way. There are visual, aural, and tactile learners. Try to present in ways that appeal to different learning styles. Some learn through listening, some through reading or visual aids, some through doing. All people learn best when several senses are involved in the learning process. Some learn better alone, some in a group.
- \* Do not attempt to teach too many concepts at one time. Don't present more than five to seven ideas at one time.
- \* When testing, consider creative ways to determine mastery of information and skills. Demonstrations are useful. Written tests can use different formats. There are essay tests, fill in the blank tests, multiple choice tests, matching tests, graphic tests. There are oral tests as well.

Sample: In the Hv Welder Operator test, you ask "How do you know when the button is properly positioned for welding?" You could test the same knowledge by having a graphic which shows proper and improper alignment. Have the person select the graphic which shows the proper alignment.

- \* In preparing training materials, be sure that you consider factors which determine readability level -- vocabulary, size of print, writing style, length of sentences, organization of ideas, page layout. Include humor and interesting anecdotes if possible.

I look forward to working on a trial lesson once you have determined which part you want to emphasize and the content you want to cover.

**Samples of formats that can be used for training or testing**

**MULTIPLE CHOICE**

**Circle the correct answer.**

The best material to use as a nonconductor is

- A. wood
- B. copper
- C. lead
- D. water

**ANECDOTAL WITH MULTIPLE CHOICE**

**Circle the correct answer.**

Sam Jones was preparing a disk for storing the letters he was going to produce in WordPerfect 5.1. The computer refused to complete the formatting process, responding with the message "General failure reading drive a:" Circle the letter or letters which may explain why the computer was unable to format the disk.

- A. Sam was using a defective disk.
- B. Sam had typed in the wrong command.
- C. Sam was using the wrong kind of disk.
- D. There was something wrong with drive a.

**FILL IN THE BLANK**

**Select the word that correctly completes the sentences below.**

light  
gray

red  
green

green  
black

- 1. If the \_\_\_\_\_ light is on, you may enter the room.
- 2. If the \_\_\_\_\_ light is on, you must wait until the green light appears.
- 3. If you see no \_\_\_\_\_, the electricity is probably off.

## FILL IN THE CHART

The car won't start

The Gas company turned off the gas because the bills were not paid.

There is no gas in the tank

The monitor switch was not turned on.

The computer monitor is blank

There is no heat in the bedroom

Someone took the distributor cap.

The heat vent is closed.

The power switch is not flipped on.

The monitor is not connected to the computer.

This is the problem	This is probably what caused the problem

## MATCHING

Here are some problems that were observed in the house. Put the letter of the item in the second column which might have caused the problem observed in the first column.

- |       |    |   |    |                                       |
|-------|----|---|----|---------------------------------------|
| _____ | 1. | The cat appears to be sick.             | A. | The fireplace is going.               |
| _____ | 2. | The water is running in the toilet.     | B. | Someone left rat poison on the floor. |
| _____ | 3. | There is smoke pouring from the chimney | C. | The shut-off valve is defective.      |

## CODING TECHNIQUES

There are three possible reasons for problems that occur in the shop. People don't follow procedures. Equipment is faulty or needs adjustment. Materials may be defective or inadequate for the job.

Match the following problems with probable causes by placing the letter on the line before the problem.

Put **O** = Operator

**E** = Equipment

**M** = Materials

- |       |    |  |
|-------|----|--|
| _____ | 1. | The welds appear cold.   |
| _____ | 2. | Three hundred batteries are run incorrectly before anyone catches the mistake. |
| _____ | 3. | The battery is rejected at the first tester.                                   |

## CHECK LIST

There are certain items that must be checked before you take your car on a long trip. Check the Yes column for those items which must be checked, and the No column for those which do not have to be checked.

YES	No	Item
		Radiator Fluid
		Windshield-wiper Fluid
		Air Pressure in the Tires
		Change for the Tollway
		A Map of the city you are visiting
		Food Supply
		Rear Bumper

### COMPLETE A FLOW CHART

This flow chart shows the steps a person must follow to get their commercial driver's license (CDL.)

Fill in the missing steps in the flow chart below. Select from the list of words or phrases the follow.

- START
- PASS TEST
- STUDY FOR TEST
- GET CDL

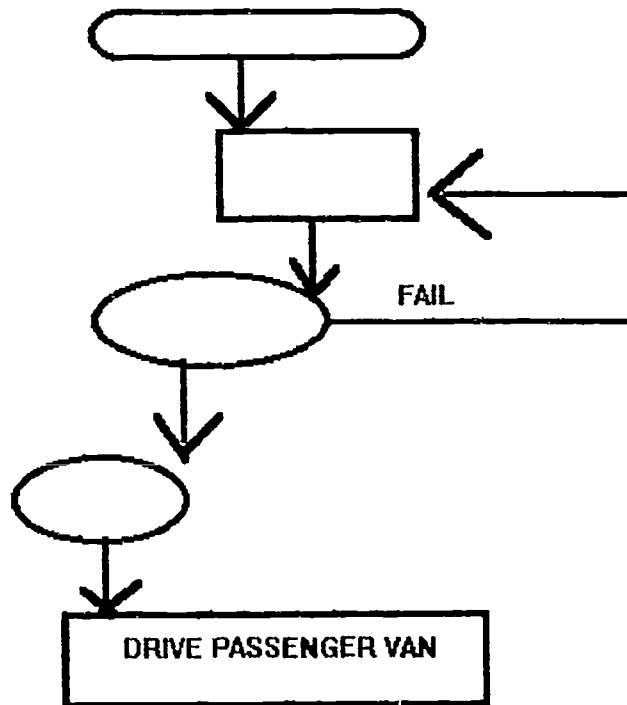

## VISUAL CHECK

A triangle is a figure with three angles and three sides.  
Circle the triangle

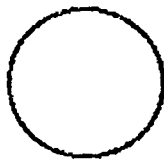



## Weld Head Assembly Training

Goal: Demonstrate confidence and speed

- \* in setting up machines for welding different size batteries
- \* in pre and post testing batteries for short circuits
- \* in identifying defective welds

Tasks:

1. Identify the parts of the machine.
2. Identify and use tools correctly.
3. Read and adjust gauges as needed.
4. Perform checks on machinery and product in proper sequence.
5. Use the technical manual to correct problems which may arise.
6. Properly position batteries for welding.
7. Test for short circuits before and after welding.
8. Test welds for strength and visual appearance
9. Set and monitor temperature and pressure for welds.

Art,

As I was trying to pull together what has already been done, I looked at your original directions and questions. It made me realize that there are tasks that are done at this machine which are not explained in any documents I have seen to date. I'd like some feedback on the tasks I have identified. Are they comprehensive, correct? Have they all been adequately addressed somewhere --- certainly not in the materials I worked on. Could you help me to complete at least this part? If you have other materials, could I see them?

*Jane*

8/93

Picture 1

First check station

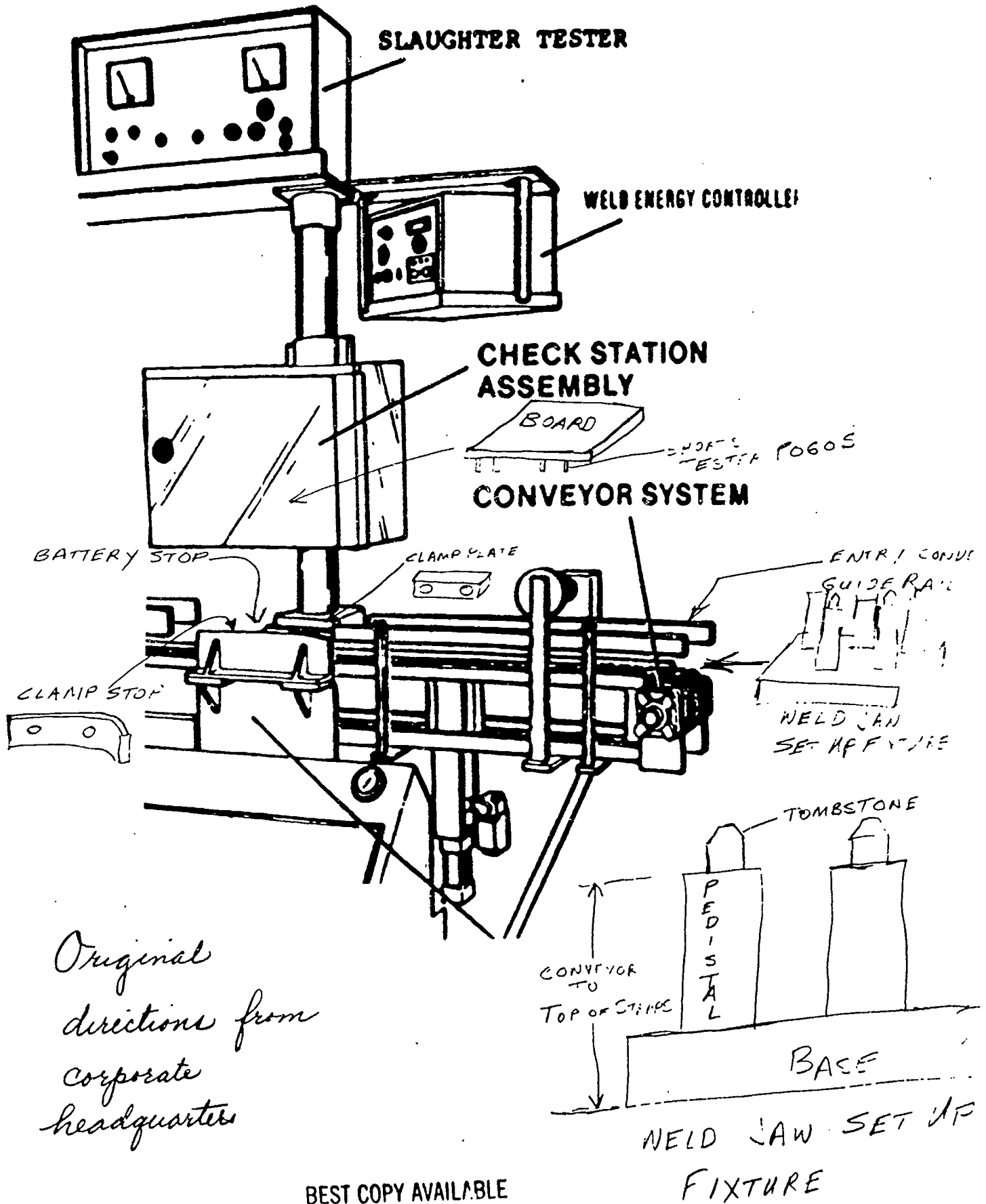

Original directions from corporate headquarters

BEST COPY AVAILABLE

The time direction - on how to repair the machine that tests in shorts - when it (brings) down?

# Title

- 2. Remove board (including the bracket) from first test station
  - A. Disconnect cable by hand. (Cable? Plug? Unplug?)
  - B. Remove four screws from column mounted bracket - use allen wrench. *I can see the column mounted bracket. Is it obvious to user?*
- 3. Remove clamp plate from first check station - open end wrench. *Use the*
- 4. Remove clamp stop from first check station - open end wrench. *Use the*
- 10. Install board in first test station.
  - A. Mount the bracket to the column - 4 screws - allen wrench.
  - B. Connect the cable - by hand.
- 11. Install clamp plate - first test station, 2 nuts - open end wrench. *Use the*
- 12. Install clamp stop - first test station, 2 nuts - open end wrench. *Use the*
- 17. Adjust entry conveyor guide rail spacing - use weld jaw set-up fixture.
- 18. Move first station battery stop to position set-up fixture under test probes - hand wheel.
- 19. Line up shorts tester by eye on weld jaw location fixture pedestals.
- 20. Adjust height of circuit board for point contacts from back welder - large crescent wrench. (Note: Move board down 1/8 to 1/4".) *the battery stop final position is set by trial and error.*

*From the...*

*I suggest a... draw...*

*I suggest a...*

*allen wrench  
open end wrench  
large...*

BEST COPY AVAILABLE



I got lost on these directions.  
I need to see the machine

### WELD HEAD ASSEMBLY

Picture 6

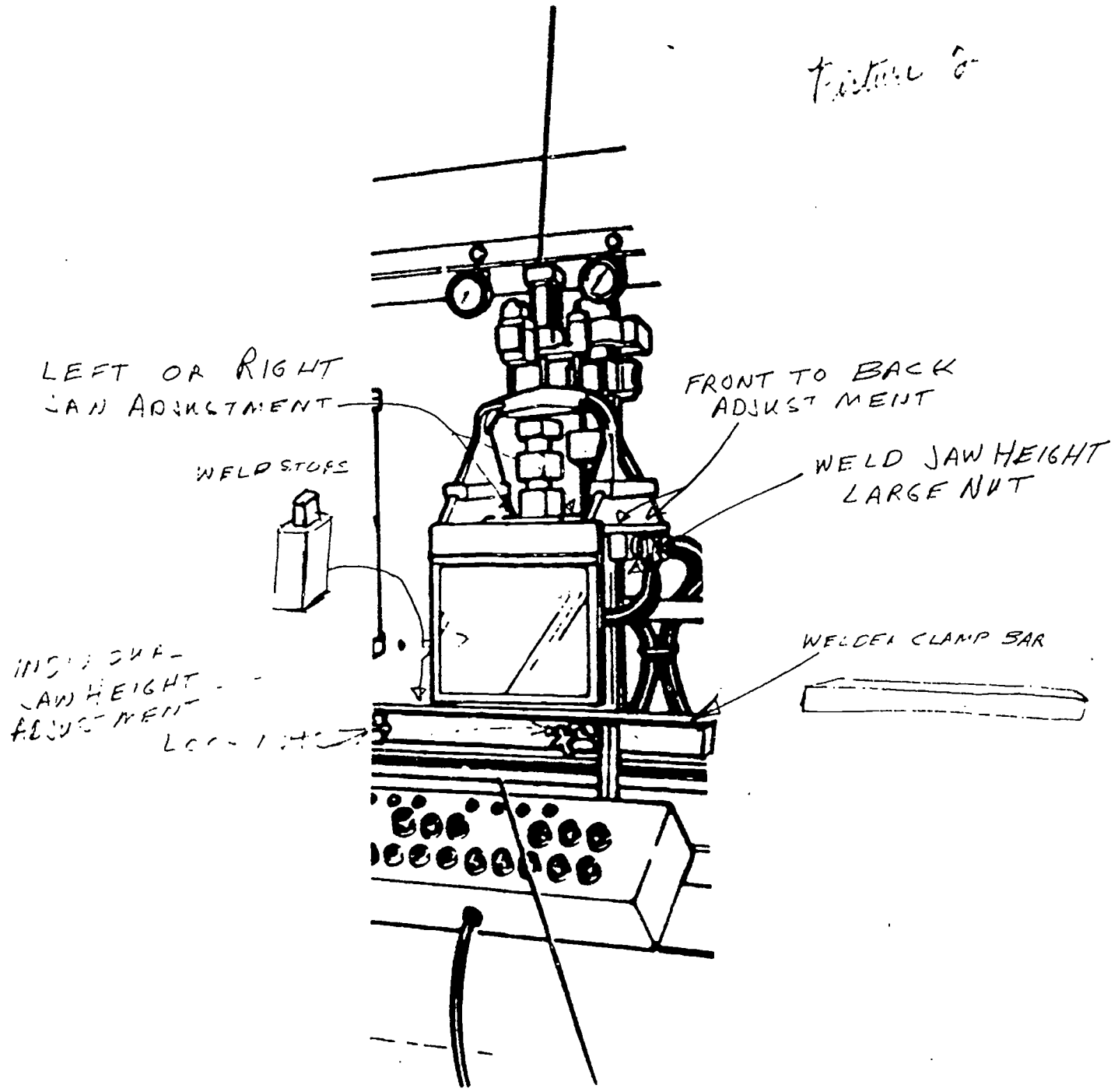

BEST COPY AVAILABLE

Find the welder clamp bar on the right side of the machine

Could use a grad system to locate carts if necessary.

Use square

- 2 5. Remove welder clamp bar - allen wrench. *Use an to*
- 2 9. Loosen screws behind welder that secure the (3) weld stops - open end wrench. *Is it screwed on? Lock for the 3*

- 2 13. Install pressure bar - welder - 2 allen screws - allen wrench. *Where is the pressure bar?*

- 2 21. Adjust the (3) welder battery stops.
  - A. Release the lock nuts on the pressure bar. *What is a lock nut (head) on side*
  - B. Move the bar in by hand until there is a 1/16" gap between the bar and the weld jaw set-up fixture. *Clamp 2" battery*
  - C. Use the stop location bars as gauge to position the three stops. *What are the stops?*
  - D. Move the jaw left or right to center over the pedestal - allen wrench. *Loosen nuts that hold it down - L/R Jaw*
  - E. Lock down the first stop. *Use the*

- 2 22. Advance the locator fixture to the second battery stop. *Move pedestal out of way. Tighten screws with*
  - A. If the jaws are not centered over the second set of pedestals, adjust the stop, slightly. *Move selector to #2 + move jaw fixture*

- 2 23. Advance the locator fixture to the third battery stop. *Move selector to #3*
  - A. If the jaws are not centered over the last pedestal, adjust the stop, slightly.
  - B. Lock down the stop. *Each has own screw*

- 2 24. Adjust the weld jaw head height.
  - A. Screw the large nut down or up on the column in the back of the welder - large crescent wrench. (The tips of the jaw should be 1/16" from touching straps/gauge.)
  - B. Individual Jaw Height Adjustment
    - 1. Loosen four (4) allen bolts holding jaw in place and raise/lower jaw as needed. Tighten bolts alternating front to rear. *Hang in between show*
  - C. Check jaws for parallelism by inserting 5/16" allen wrench between jaws and squeezing in "no weld". Wrench should hold firm. *Change jaws to parallel & adjust*

- 2 25. Adjust the front to back position of the jaws to center on the weld jaw set-up fixture tombstones.
  - A. Loosen bolts above jaws - open end wrench.
  - B. Check position of jaw by eye.
  - C. Lock down.

Use the left side of the jaw to the head of the stop. Use the stop to the side of the jaw.

Lower the jaw

Handwritten signature or initials



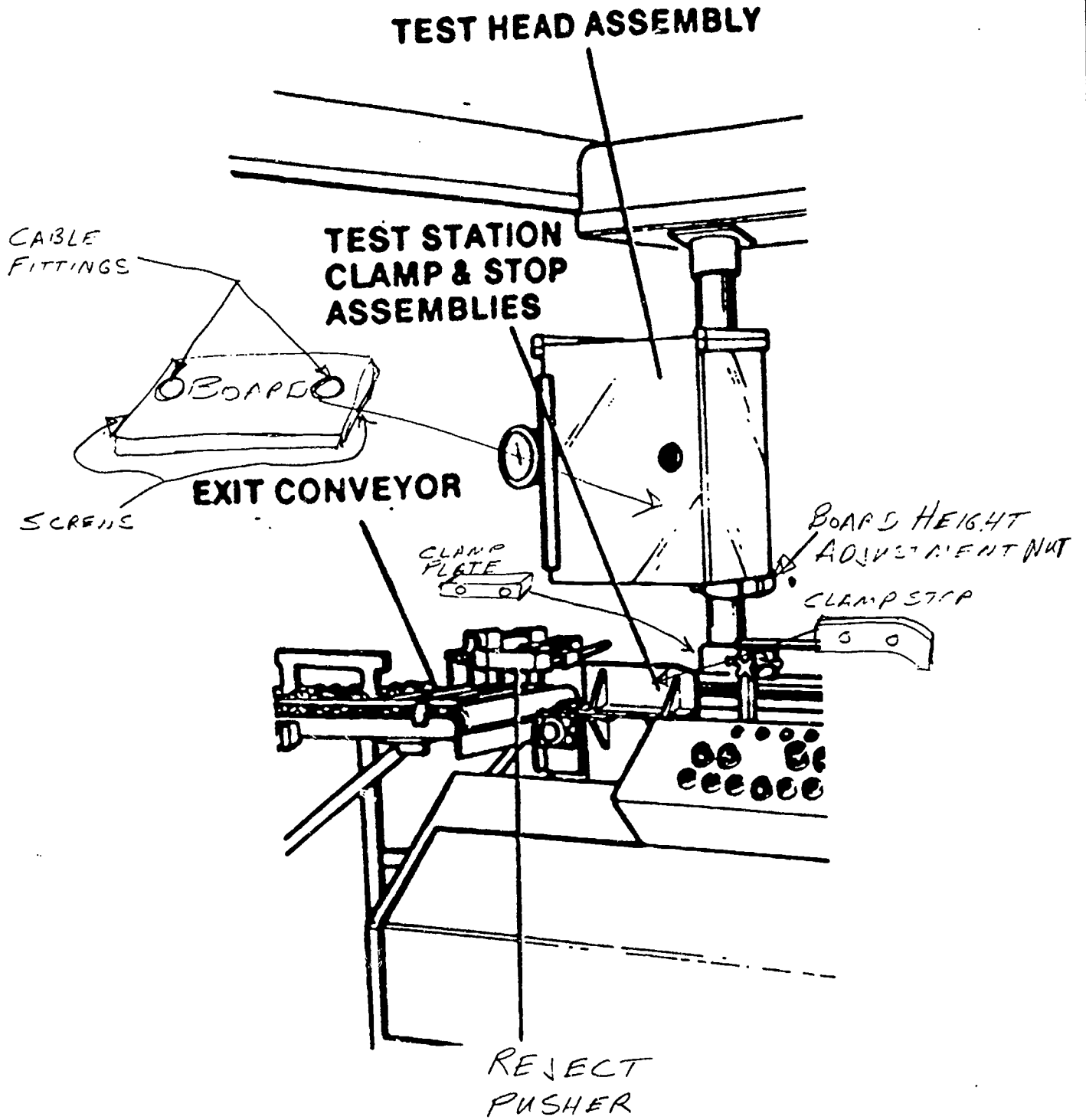

BEST COPY AVAILABLE

to the board inside  
in the test stand

Picture 3

cross 7 10 15 20  
10 15 20 25 30

- 3 6. Remove board from second check station.
  - A. Disconnect (2) cables - By hand.
  - B. Support board from underneath with empty container and remove screws - allen wrench.

*Don't have time to do that part*

- 3 7. Remove clamp plate - open end wrench.

- 3 8. Remove clamp stop - open end wrench.

- 3 14. Install board in second test station.

- A. Use empty case to hold the board in position.
- B. Install two (2) allen screws - allen wrench.
- C. Connect the ~~two (2)~~ cables - by hand.
- D. Same as C above

- 3 15. Install clamp plate - second test station, 2 nuts - open end wrench.

- 3 16. Install clamp stop - second test station, 2 nuts - open end wrench.

- 3 26. Advance the set-up fixture to the second test station.

- A. Position the stop to line up fixture with board by eye - hand wheel. (Use open end wrench - where is it?)
- B. Adjust height for contact with straps - back of welder, large nut - large crescent wrench. (Pogós retract by 1/2")

- 3 27. Remove fixture from line and keep nearby for periodic checks.

*Need  
to be  
checked*

BEST COPY AVAILABLE

**Technical Writing Workshop**  
**developed for PPG Industries**

by

**Barbara E. Seeger**  
**1993**

- RATIONALE:** The Workplace Education Partnership grant states that associates at PPG Industries felt that there is a need to improve technical writing skills. As a result of responses to a suggestion/interest survey in February, 1993, 15 percent of associates indicated an interest in participating in a technical writing course.
- PURPOSES:** To understand the tasks that technical writing encompasses.  
To enhance technical writing skills and effectiveness.  
To have participants practice these basic considerations of technical writing; defining an audience, using the mapping strategy to organize and clearly state information and learning to choose an organizational format for technical reports.
- SUGGESTED SESSIONS:** 10 one hour sessions or 5 two hour sessions
- SOURCES OF INFORMATION:** PPG Industries Process Information Reports prepared by Bill Michaels  
Technical Writing in the Corporate World  
Technically Write  
Write for Life curriculum guide
- PREPARING TO WRITE:** Discussion of the writing tasks related to associates' jobs.  
What is the writing process?  
Do the handout "Surveying Your Attitudes Towards Writing."  
What do you define as technical writing?  
Discuss the importance of the audience, clarity and organization of associates' technical writing.



**ACTIVITIES:**

**These activities are developmental. They begin with familiar topics and proceed to unfamiliar topics.**

Write a detailed set of directions for a daily activity that you can perform without thought. Exchange your writing with another associate and have him/her follow the directions. What changes should you make? How does it feel to follow directions written by someone else?

Describe a piece of equipment in your department to someone who is unfamiliar with it. Next describe it to someone who is familiar with the equipment.

Write a letter of complaint to a company from the customer's point of view. Exchange it at with a partner write a response.

Through examples, these six techniques for success will be discussed:

1. define terminology
2. use short, well written sentences
3. use brief paragraphs
4. strive for coherence
5. interpret all data
6. employ frequent closure

Find an example of ineffective technical writing, revise it to make the message more clear. What did the author do to detract from the message? What did you change? What are the most common errors discovered by the class?

Discussion of the pitfalls of technical writing.

1. agreement of pronoun reference
2. subject-verb agreement
3. vague pronoun reference
4. dangling modifiers
5. overuse of the passive voice
6. inappropriate comma use
7. inappropriate semicolon use

Examples of each will be presented and corrected.

**WORK RELATED  
TECHNICAL  
WRITING  
TASKS:**

After viewing the formats of these types of technical reports, associates will gather information and write the type of report that is related to their job; short informal, trip, inspection, memorandum, or formal report.

Examples of each kind of report will be discussed.

A plan will be developed for the specific type of report. This plan will be developed into a flow chart.

The group will evaluate each report in terms of audience, clarity and organization. Does this report have the regularly used terms? Are there transitional words? Has fonts, italics, bold type and graphs been effectively incorporated into the report's readability?

**EDITING  
TECHNICAL  
REPORTS:**

Now that reports are written, editing will be explained in terms of the reports' organization, style and correctness. These elements are defined in Technical Writing in the Corporate World.

The Learning Center has the Rightwriter computer software which interfaces with word processing programs to evaluate writing in terms of readability level, grammar, and organization.

**CLASS  
EVALUATION:**

Associates will review the original survey and note if their views have changed.

The Learning Center class evaluation will be used.

## SPELLING CHECKLIST

Circle the word which is spelled correctly:

average	avrage	avarege
comittee	committee	commitee
computer	<b>computer</b>	
ingeneer	<b>engineer</b>	engineer
difference	diffrence	diffirence
pin and dye	<b>pin and die</b>	pin and die
hygene	hygiene	hyqeine
flammible	<b>flamable</b>	flammable
eccentric	<b>eccentric</b>	eccentrick
kanban card	<b>combon card</b>	conbon card
lenght	length	
weight	wieght	weight
oparater	operater	operator
monarail	monorial	monorail
preperation	preparation	
quantity	quanity	
recommmend	recomend	recommend
rotary knife	rotary knife	rotary knife
maintinence	asintainance	maintenance

BEST COPY AVAILABLE

Spelling Assessment (continued)

Directions: correct the misspelled words (note: some are  
correct as written)

sincerly \_\_\_\_\_

Thusrday \_\_\_\_\_

Thurdsay \_\_\_\_\_

Febuary \_\_\_\_\_

fourty \_\_\_\_\_

fiftieth \_\_\_\_\_

ninty \_\_\_\_\_

hundreth \_\_\_\_\_

vegetables \_\_\_\_\_

warrantee \_\_\_\_\_

APPLYING YOUR SKILLS:

PER CENTS

1. The cost of materials for a \$728.00 bill was \$145.60. What percent of the total cost is the material cost?
  
2. A manufacturing plant uses 168 tons of rubber per week to make freon hose. This is 25% of the total rubber bought each week for manufacturing. How much rubber is bought each week?
  
3. During a period of 30 working days, Linda was late 80% of the time. How many days was she late?
  
4. 540 workers belong to the local of the United Rubber Workers union. If 65% of them went to the last meeting, how many members went to the meeting?
  
5. Paul makes a gross salary of \$600 each week. If 24% of his salary is withheld for taxes and social security, how much is withheld from his weekly check?
  
6. Sharon makes \$560 a week. If she gets a 4% raise, how much will her weekly salary be?
  
7. John, who made \$30,800 a year, got a 3.5% raise. How much more will he make in a year?

8. Joe was supposed to work 250 days last year. He was absent 4% of the time because he was sick. How many days did he work?
  
9. Paul makes \$720 a week. If he gets a raise of \$21.60 each week, what percent of his original salary was his raise?
  
10. Anna's weekly take-home pay is \$534, which is 76% of her gross pay ((before deductions). What is Anna's weekly gross pay?

## DECIMALS

### Reading and writing decimals

- Read 3.6 as "three point six" or "three and six-tenths"
- Write .97 as "ninety-seven hundredths"
- Read .032 as "point zero three two" or "thirty-two thousandths"

1. Write the following readings in words:  
pin .742 \_\_\_\_\_  
die .780 \_\_\_\_\_
2. Write the laser readings as decimals:  
thirty-three thousandths \_\_\_\_\_  
three hundredths \_\_\_\_\_
3. Brian took an OD reading on 534-725-013 hose. He used the vernier tape. The reading was 7 tenths, 4 hundredths and 6 thousandths. Write this in decimal form. \_\_\_\_\_

### Adding and subtracting decimals

1. A sample of 5/8" mandrel gave O.D. readings of .791, .787, .778, .781. A reading within tolerance would be .785 +/- .005. Which readings were out of spec.?
2. The following braid O.D. readings were taken on brake hose: .344, .351, .357, .341, .356; what was the average reading? (Note: average equals the sum divided by the number of readings.)

### Multiplying and dividing decimals

A customer ordered a variety of lengths of freon hose including 250 lengths of 13.31, 300 lengths of 21.95, and 400 lengths of 14.688. All of this was packed in one case. What was the total length of each size hose ordered? What was the total length of hose ordered? (Extra credit:!) What was the average length of hose ordered?

COMPUTER BASICS

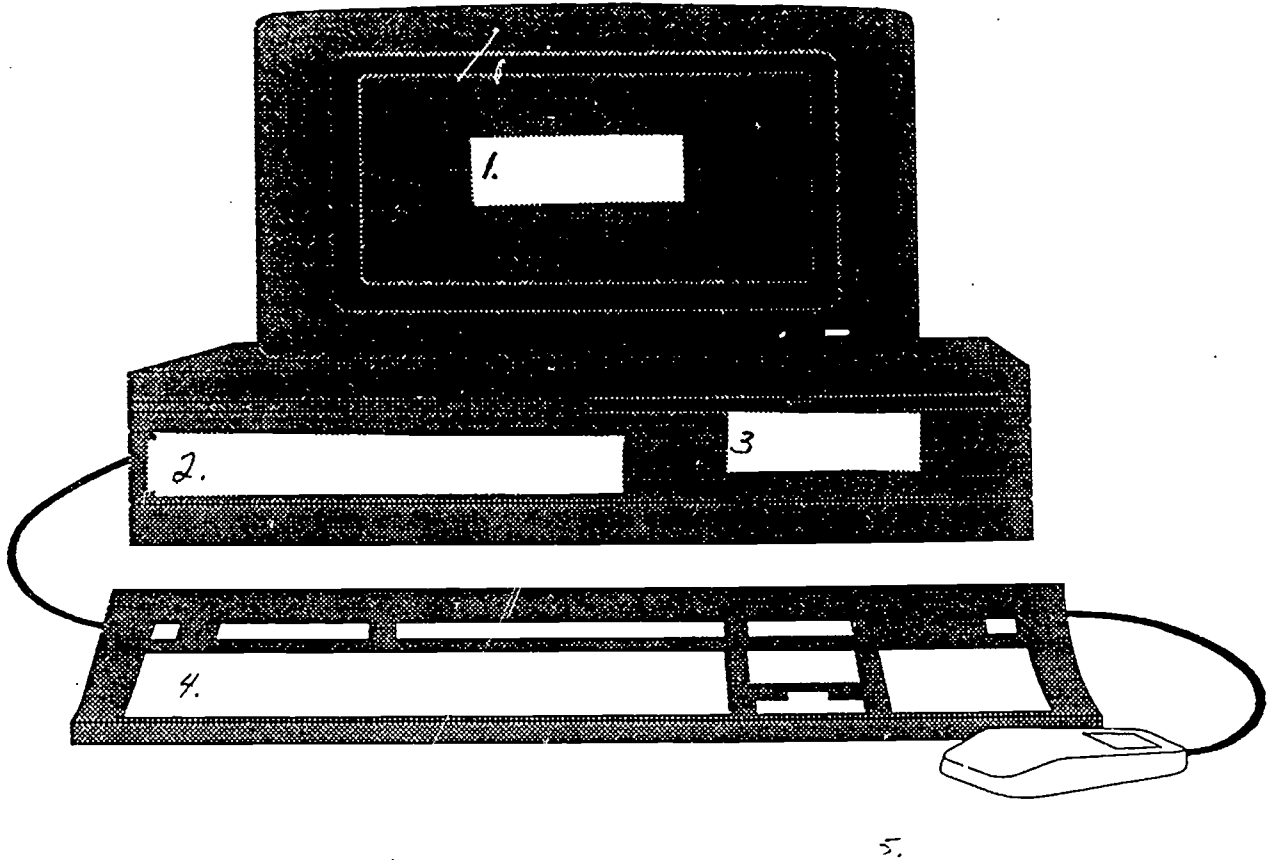

LABEL THE PARTS OF THE COMPUTER ABOVE USING THE FOLLOWING TERMS:

mouse      monitor      disk drive      keyboard      CPU

MATCH THE FOLLOWING TERMS AND DEFINITIONS:

- |  |                    |
|--|--------------------|
| 1. _____ information entered into a computer                         | a. program         |
| 2. _____ used for creating and editing letters, memos, reports, etc. | b. spreadsheet     |
| 3. _____ system of instructions for computer functions               | c. word processing |
| 4. _____ the computer, printer, monitor, modems are called this      | d. hardware        |
| 5. _____ program used for accounting                                 | e. data            |



**KEYBOARD**  
*ASSESSMENT*

Name \_\_\_\_\_ Date \_\_\_\_\_

Match the following:

- |           |                     |  |
|-----------|---------------------|--|
| 1. _____  | Function keys       | a. determines direction and location of cursor.  |
| 2. _____  | Numeric keypad      | b. causes what is currently on the screen to be printed.                                   |
| 3. _____  | Enhanced keyboard   | c. has function keys at the left.  |
| 4. _____  | NUM LOCK            | d. are used alone or with special keys.  |
| 5. _____  | ESC                 | e. allows for rapid entry of numbers.  |
| 6. _____  | CTRL, ALT and Shift | f. cancels certain operations.   |
| 7. _____  | BREAK KEY           | g. cancels certain operations.   |
| 8. _____  | Cursor pad          | h. has function keys in a row at the top.  |
| 9. _____  | PRTSCR              | i. are used with other keys to expand the function of the keyboard.                        |
| 10. _____ | Standard keyboard   | j. determines whether the arrow keys or the digit keys on the numeric keyboard are active. |

True or False (Circle correct answer):

1. T F Function keys are always used in conjunction with another key.
2. T F The CAPS LOCK key capitalizes all letters.
3. T F The NUM LOCK key controls the movement of the cursor on the screen.
4. T F Keys should be struck firmly.
5. T F The letter "l" and the number "1" cannot be used interchangeably.
6. T F The CTRL key is always used in conjunction with another key.
7. T F The numeric keypad controls the movement of the cursor on the screen if NUM LOCK is off.
8. T F The enhanced keyboard does not include the SCROLL LOCK-BREAK key.
9. T F Function keys can move the cursor in any direction.
10. T F The typing area on the keyboard duplicates the keyboard of a typewriter.

NAME \_\_\_\_\_

M E T R I C S   Q U I Z

List the basic metric units for each of the following:

1. Length \_\_\_\_\_
2. Mass or weight \_\_\_\_\_
3. Amount of a liquid \_\_\_\_\_

Abbreviate the following:

4. centimeter \_\_\_\_\_
5. milliliter \_\_\_\_\_
6. T or F    The meter is longer than a yard.
7. T or F    The liter is larger than a gallon.
8.  $200 \text{ m} =$  \_\_\_\_\_  $\text{km}$
9. Fill in the blanks:  
One cubic decimeter = \_\_\_\_\_ liter of water = \_\_\_\_\_  
kilogram.
10. Change  $10^{\circ}\text{C}$  to  $^{\circ}\text{F}$ .

BEST COPY AVAILABLE

## Math Refresher for the Auto Lab

The following resources will be used as necessary to refresh the specific math skills. Since associates learn in different ways, more than one resource may be used to reinforce a specific skill.

The process will be presented, practiced and the skill will be applied in a work related simulation.

### Videos

" Applied Mathematics" is a video presentation focusing on a hands on approach.

### Computer

The CD-ROM is an interactive video and computer approach. The pertinent units are numbers 14 - 24, 27 and 28. The associate interacts after a concept is explained. A test is included.

Math Blaster presents explanations followed by practice and immediate feedback.

Skills Bank is a program in which the associate interacts with the lesson presentations, takes quizzes and tests. Each associate has a data disk. He can review the problems that he missed.

**Books** Some of these are programmed in that after an associate works a problem, he is able to check his answer immediately and make corrections.

Basic Skills with Decimals

Introductory Math for Industry, Science and Technology

Number Power Book e3

Spectrum Math - green

Technical Math Is

# ***Fractions***

247

This is a refresher of your basic math skills as they relate to the concepts of fractions, decimals and metric conversions on your job. Calculators may be used on all problems **except** on those with an \* preceding the problem.

### Fractions

Circle the smallest fraction of each group.

1.  $\frac{1}{3}$        $\frac{1}{2}$        $\frac{1}{4}$
2.  $\frac{3}{7}$        $\frac{2}{7}$        $\frac{3}{4}$
3.  $\frac{1}{2}$        $\frac{1}{6}$        $\frac{1}{3}$
4.  $\frac{2}{3}$        $\frac{1}{2}$        $\frac{3}{4}$
5.  $\frac{2}{7}$        $\frac{5}{8}$        $\frac{1}{2}$
6.  $\frac{4}{15}$        $\frac{1}{3}$        $\frac{9}{10}$

Circle the largest fraction of each group.

1.  $\frac{1}{2}$        $\frac{1}{3}$        $\frac{1}{4}$
2.  $\frac{3}{4}$        $\frac{3}{8}$        $\frac{1}{6}$
3.  $\frac{1}{3}$        $\frac{2}{7}$        $\frac{1}{6}$
4.  $\frac{1}{2}$        $\frac{5}{6}$        $\frac{3}{4}$
5.  $\frac{7}{10}$        $\frac{2}{5}$        $\frac{2}{11}$
6.  $\frac{5}{12}$        $\frac{1}{6}$        $\frac{1}{3}$

Arrange these fractions from smallest to largest.

1.  $\frac{7}{12}$   $\frac{1}{3}$   $\frac{7}{8}$   $\frac{3}{4}$   $\frac{2}{3}$

\_\_\_\_\_

2.  $\frac{4}{5}$   $\frac{5}{6}$   $\frac{7}{8}$   $\frac{3}{7}$   $\frac{4}{9}$

\_\_\_\_\_

Arrange these fractions from largest to smallest.

1.  $\frac{5}{12}$   $\frac{2}{11}$   $\frac{7}{10}$   $\frac{8}{9}$   $\frac{3}{11}$

\_\_\_\_\_

2.  $\frac{5}{14}$   $\frac{7}{9}$   $\frac{5}{12}$   $\frac{9}{16}$   $\frac{8}{15}$

Circle the fractions that are already reduced to lowest terms.

$\frac{1}{2}$   $\frac{2}{4}$   $\frac{2}{3}$   $\frac{4}{6}$   $\frac{2}{9}$   $\frac{6}{9}$   $\frac{11}{12}$   $\frac{9}{12}$   $\frac{3}{7}$   $\frac{2}{16}$

# ***Decimals & Percents***

259

# LEARNING THE SKILLS

## INTRODUCTION

If you looked at a newspaper or magazine, listened to the radio, or watched TV today, you almost certainly came across the word "percent" or the symbol %.

Every time you buy a hamburger or gasoline, you work with decimal numbers.

When you share a pizza, or split the cost of a tape with your sister or brother, you work with fractions.

Fractions, decimals, and percents are different ways to *name* numbers.

These numbers *look* quite different. Do they have different *values*?

$\frac{1}{2}$  50% 0.5 one-half

This unit helps you understand different ways to name a number. It also shows you how to change from one kind of number to another when you need to.

You'll learn how to change from a percent (such as 75%) to a decimal (0.75) or to a fraction ( $\frac{75}{100}$  or  $\frac{3}{4}$ ). Or going the other way, you'll learn how to change from a fraction (say  $\frac{4}{10}$ ) to the decimal form (0.40) or to a percent (40%). In most cases, you'll be able to use your calculator to work with these numbers.

You may prefer to work with decimal numbers on your calculator. Some people are more comfortable with fractions and prefer to use that kind of number form. Certain problems use the % (or percent) form of a number.

In the video for this unit you see people using numbers in different forms to solve various kinds of problems.



## WORKING WITH PERCENT

You have probably read signs that said "50% Off." Or you've heard an ad on TV that claimed "93% prefer our product." Have you ever thought about what the word "percent" (or the symbol %) means?

To understand the word "percent," let's break it apart and think about what the separate words "per" and "cent" mean.

### What does "cent" mean?

You know that a *bicycle* has two wheels and a *tricycle* has three wheels. You probably also know that a *triangle* has three sides and you may know that *bifocal* lenses help people see at two different distances. Do you see a pattern here?



How many wheels would a "centcycle" have? How many sides would a "centangle" have? How many legs do you think a centipede should have? Look at Figure B-1 for some help with these questions.

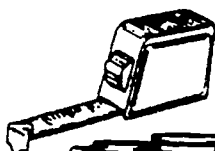

A centimeter is equal to  $\frac{1}{100}$  of a meter.



A cent (one penny) is equal to  $\frac{1}{100}$  of a dollar.

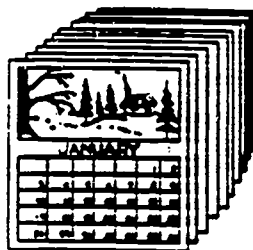

100 years make a century.

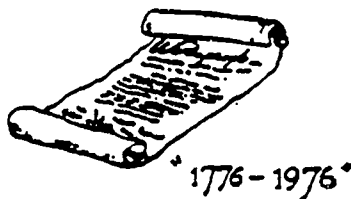

When the United States was 200 years old, the country celebrated its bicentennial.

Figure B-1  
Words with "cent"

The word "cent" comes from the Latin name for the phrase "one hundred." The word "cent" is related to the number 100. Depending

on how it's used, it can mean either 100 or  $\frac{1}{100}$ . In the word percent, "cent" means 100.

### What does "per" mean?

If "cent" (in percent) means one hundred, what does "per" mean?

What does it mean to say that a car is going "30 miles per hour?"

What does it mean to say that a savings account pays 5% (five percent) interest?

- Thirty miles per hour means that the car travels 30 miles in each hour.
- Five percent interest means that 5 dollars is earned for each 100 dollars in the account.



The word "per" stands for several simple words such as in each, for each, out of each, and so on.

A savings account that pays 5 percent interest will pay you \$5 for each \$100 you have in your account. What does it mean if a store advertises "30 percent off" all items in the store? It means that you can save \$30 out of each \$100 you spend or 30 cents out of each dollar you spend.



If a plant food mixture is 75 percent water, how many pints out of each 100 pints of mixture are water? How many pints will be pure plant food? Use Figure B-2 to help you figure out the answer.

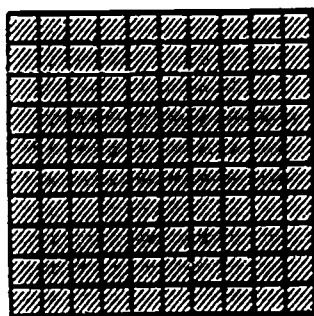

THE WHOLE  
(100 PARTS OUT OF 100 PARTS)

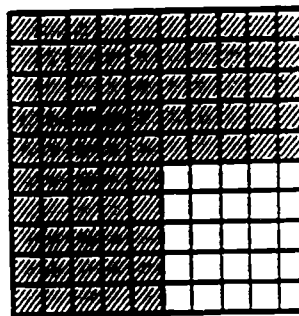

75% OF THE WHOLE  
(75 PARTS OUT OF 100 PARTS)

Figure B-2  
Representing seventy-five percent

BEST COPY AVAILABLE

Now that you know what the two words that make up "per cent" mean, let's put them back together. We usually write "percent" (or %) when we talk about how many parts for each hundred parts.



Percent means how many parts out of each hundred parts.

### *What kind of number is percent?*

Look at this list. Each item names something.

- 50 cents
- 7 pounds of apples
- 5 aspirins
- 20 sacks of feed
- 9 roofing nails
- 15 percent

If someone sent you on a scavenger hunt to find everything on the list, could you find each item and bring it back? Why not? Clearly, the last item—a percent—is not a thing. We have to know "15 percent of what?" before "15 percent" makes sense. You can draw 15 squares, or 15 circles, or 15 lines, but you can't draw "15 percent."



Where would you see the word *percent* when you read a newspaper or walk by some stores? When do you use the word percent? Write a list of the ways that you see or use the word percent.

### *Ways to use percent*

Do you leave a tip when you eat in a restaurant? If so, how much? Also, do you pay sales tax? How much? Figure B-3 shows a guest check that lists both the tip and the sales tax. (Would you rather pay the tip before or after the tax is figured?)

Both tips and sales tax are expressed as a percent of the total bill or the total amount of money spent.

Percents can be expressed easily as decimals because they are based on 100. Your calculator is helpful because it uses decimals.

Modern times RESTAURANT		
NO. 12345		
2 Filet	14.	25
1 T-bone	7.	95
1 chick fried	4.	95
1 New York Strip	7.	95
2 Tea	1.	25
2 soda	1.	25
1 milk		25
		38.15
	Tax	2.75
	15% Gratuity	5.84
		47.59

\*A gratuity of 15% will be added for parties of 3 or more.

Figure B-3  
Tip and sales tax on a meal

## CHANGING PERCENTS TO DECIMALS



Think about the tip you pay for a meal as an example. In many places, 15% (fifteen percent) is a usual amount to tip. The word "per" is a clue just like the slash (/) mark in a fraction. *Per* means  $\div$  or "divided by," so *percent* means "divided by 100."

Fifteen percent (15%) means  $\frac{15}{100}$  or  $15 \div 100$ . Enter this fraction into your calculator to see 15% written as a decimal number.

When you divide 15 by 100, your calculator displays 0.15. (Your calculator may not show the 0 before the decimal point, but we put it in so you will see the decimal point more clearly.) Your calculator tells you that 15% is the same as fifteen-hundredths.



To change a percent to a decimal number, write (or think of) the percent as a fraction (a number divided by 100) and then enter the fraction into your calculator.

**Study Activity:** Use your calculator to change these percents to decimal numbers.



- 10%
- 25%
- 85%
- 99%
- 125%



What happened with that last percent? How was your answer to 125% different from the others? Can you think why?

**Percents more than 100%**

One hundred twenty-five percent (125%) is  $\frac{125}{100}$  or one hundred twenty-five hundredths.

You know that  $\frac{100}{100}$  is another name for the number one (1). Because  $\frac{125}{100}$  is more than  $\frac{100}{100}$ , you can see that  $\frac{125}{100}$  has to be more than 1. Figure B-4 shows this.

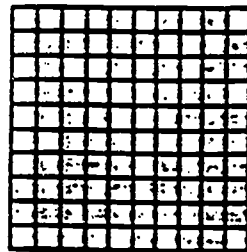

**THE WHOLE**  
(100 PARTS OUT OF 100 PARTS)

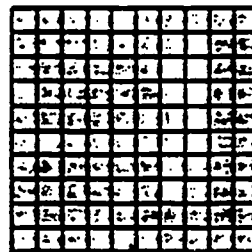

**100 PARTS + 25 PARTS**  
(125% OF THE WHOLE, OR 125 PARTS  
COMPARED TO 100 PARTS)

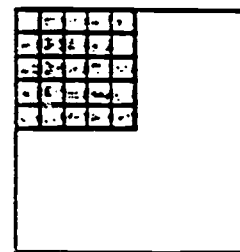

**Figure B-4**  
**Percents more than 100%**

**Study Activity:** Use your calculator to change these percents to decimal numbers.



- 150%
- 45%
- 100%
- 15%
- 275%
- 3%



Now look at your results and answer these questions.

1. If a percent is *less* than 100%, what will it look like as a decimal number? Where will the decimal point be?
2. If a percent is *more* than 100%, what will it look like as a decimal number? Where will the decimal point be?

What pattern did you notice? Choose some percent numbers yourself and change them to decimal numbers to double check your answers to the two questions.

### *Percents to decimals (shortcut)*

You now have practiced changing percents to decimal numbers by first writing the percent in its fraction form and then dividing the numerator by the denominator (which is always 100). Have you noticed a pattern that helps you quickly change a percent to a decimal number, even without a calculator? Write this sentence on your paper and fill in the blanks.



To change a percent to a decimal number, remove the \_\_\_\_\_ and move the decimal point \_\_\_\_\_ places to the \_\_\_\_\_.

If you remember that 1.0 (or  $\frac{100}{100}$ ) is 100% and 0.50 (or  $\frac{50}{100}$ ) is 50%, then you can use these two examples to check which way to move the decimal point. Remember that for a whole number like 10, 1 or 45, the decimal point is just to the right of the last digit even if it is not shown. Thus, for a number like 45%, you know that the decimal point is just after the 5, even though "45" is written without it.

### **Study Activity:**



Change these percents to decimal numbers using the shortcut method.

- 10%
- 1%
- 100%
- 0.1%
- 45%
- 125%
- 63.3%
- 5%

## CHANGING DECIMALS TO PERCENTS

How do you change a decimal number to a percent?

Think about the number 0.15. What is its name as a percent? That is,  $0.15 = \text{what } \%$ .

The decimal number 0.15 has two places to the right of the decimal point. Figure B-5 shows the name of each decimal place.

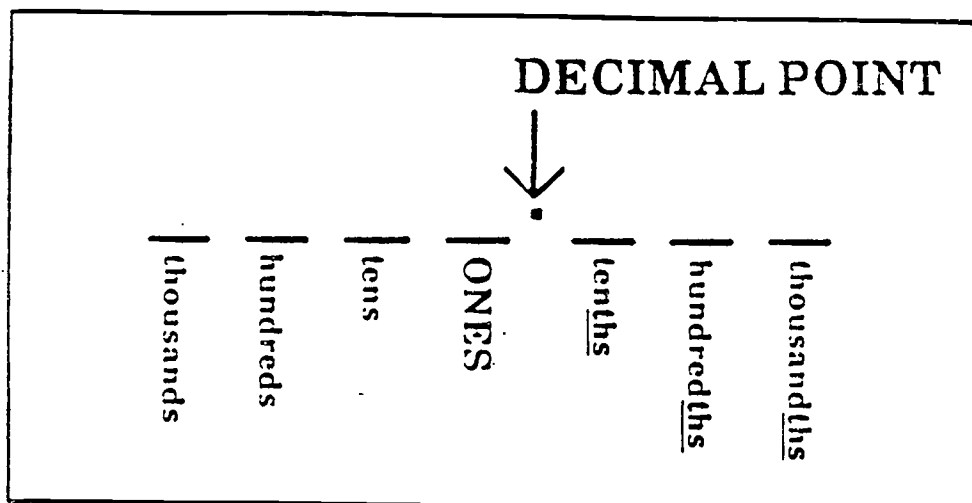

Figure B-5  
Decimal place names

Numbers that end in the second place to the right of the decimal point name the decimal place to hundredths.

$$0.15 = \frac{15}{100}$$

But  $\frac{15}{100}$  is 15 divided by 100, which can be written as 15%.

So now we have

$$0.15 = \frac{15}{100} = 15\%$$

### Study Activity:



Change these decimal numbers to a fraction and then change the fraction to a percent.

0.25

0.75

0.40

0.62

Here is another way to think about changing a decimal number to a percent.

Think about the decimal number 0.15 again. We want to rename it as a percent. Two facts help you make this change easily: One, we can multiply any number by the number one (1) without changing its value. Two, 100% is another name for 1.

To change 0.15 to a percent, multiply it by 100%. This does not change its value because 100% is another name for 1.

$$0.15 = 0.15 \times 100\% = (0.15 \times 100)\% = 15\%$$

### Study Activity:



Change each of these decimal numbers to a percent by multiplying by 100%.

0.12

0.45

1.35

1.00

6.00

0.125

0.01

0.5

Look at your answers. Can you see a pattern that helps you quickly multiply by 100, even without a calculator? Does the pattern hold true for the numbers given below?



Decimal		Percent
0.50	is	50%
0.5	is	50%
1.5	is	150%
0.15	is	15%
0.005	is	0.5%
3 (or 3.00)	is	300%
0.3	is	30%
0.03	is	3%
0.003	is	0.3%
0.0003	is	0.03%

### *Steps for changing decimals to percents*



On your paper, write the following four steps for changing any decimal number to a percent. Fill in the blanks as you write.



To change any decimal number to a percent:

1. If the decimal number does not have a decimal point, write one at the end (to the right of the last number).
2. Add zeros at the end (to the right) until the number has at least \_\_\_\_\_ decimal places.
3. Rewrite the number by moving the decimal point \_\_\_\_\_ places to the \_\_\_\_\_ and adding a percent sign.
4. If there is no digit in front of the decimal point, put a 0 there so the decimal point won't get lost.

If you understand how to work with zeros and decimal points, these four steps reduce to just one step:



To change a decimal number to a percent, move the decimal point two places to the right and add the % sign.



Notice that this is just the opposite of the shortcut that changes a percent to a decimal number.

### ***Comparing decimals, fractions, and percents***

Money is a common item that makes it possible for us to compare decimal names, fraction names, and percent names.

Our dollar is divided into 100 pennies. One penny (\$0.01 or 1 cent) is  $\frac{1}{100}$  of a dollar or 1% of a dollar.

If you think about 0.75 as seventy-five cents (\$0.75), you can see that it is the same as  $\frac{75}{100}$  (of a dollar) or 75% (of one dollar).

Figure B-6 lists different names for 0.75 and illustrates its value with pennies.

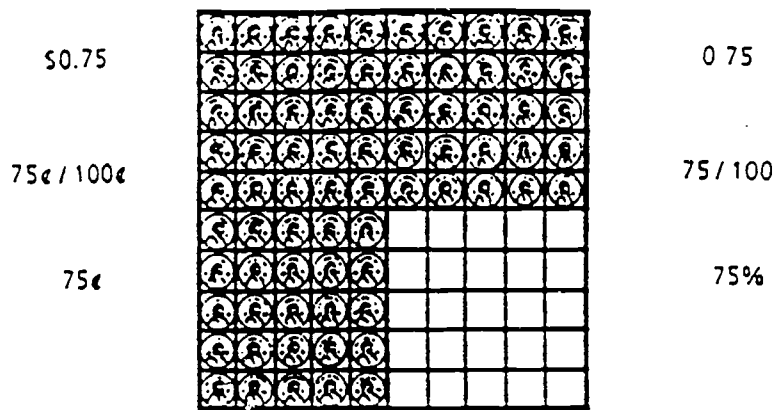

75% OF A DOLLAR  
75¢ OUT OF 100¢

Figure B-6  
Different names for the decimal number 0.75

## CHANGING DECIMALS TO FRACTIONS

Sometimes the decimal answer you get with your calculator is not in the form you want. You may want to change the decimal answer to a simple fraction—or to a mixed number. How do you change a decimal to a fraction?

### *Changing decimals to simple fractions*

Here's an example of changing a decimal number obtained with a calculator to a mixed number. The example also shows how to change the fraction part of the mixed number to a simpler fraction.

#### Example 1: Calculating molding needs

Marie has torn up the carpet in a room and measured how much molding she needs to put down over the gap where the floor meets the wall. She needs pieces that are these lengths:  $8\frac{3}{4}$  ft,  $6\frac{1}{2}$  ft,  $2\frac{1}{3}$  ft,  $2\frac{5}{8}$  ft,  $1\frac{2}{3}$  ft and  $5\frac{3}{8}$  ft. She uses her calculator to add these and her calculator tells her that she needs 27.25 feet of molding.

She knows, however, that the molding is usually bought in feet and fractions of a foot. How can she change 27.25 feet into a mixed number (made up of a whole number and a fraction)? She knows she wants 27 feet plus some fraction of a foot. What fraction is 0.25 equal to?

Marie remembers that 0.25 is  $\frac{25}{100}$ . Therefore, she could write the mixed number as  $27 \frac{25}{100}$ . But she thinks she can write  $\frac{25}{100}$  in a simpler form. So she "reduces" the fraction  $\frac{25}{100}$  by dividing both the numerator (top number) and the denominator (bottom number) of the fraction by 25, as follows:

$$\frac{25}{100} = \frac{25 \div 25}{100 \div 25} = \frac{1}{4}$$

This gives her  $\frac{1}{4}$ . Now she can write the mixed number as  $27 \frac{1}{4}$ . She can then go to the lumber store and buy 27 and  $\frac{1}{4}$  feet of molding. (She may have to buy 28 feet if the molding is sold only by the foot.)

If Marie had recognized right away that 0.25 is the same as  $\frac{1}{4}$  she would have been able to change from a decimal to a mixed number immediately. See Figure B-7.

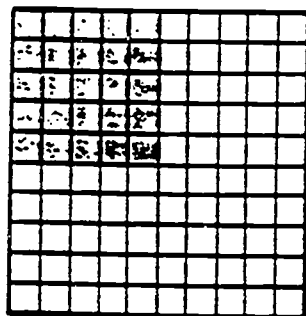

25% OF THE WHOLE  
( $\frac{25}{100}$  OR 25 PARTS OUT OF 100)

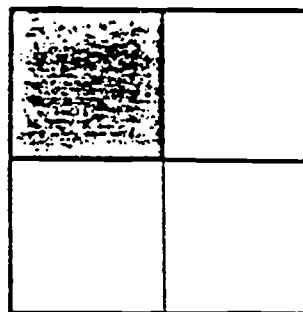

ONE-FOURTH OF THE WHOLE  
( $\frac{1}{4}$  OR ONE PART OUT OF FOUR PARTS)

**Figure B-7**  
Changing a decimal to a fraction

In the next section you'll make a chart that helps you change a decimal to a fraction.

## Eleven common fractions

In most practical situations, there are only a few fractions that we use as we measure most things. Let's make a chart so that we can easily change decimal answers from the calculator into these common fractions. This will also make it easy to change common fractions to decimals or percents.

### Study Activity:



Copy this list of proper fractions with denominators from two to ten onto your own paper. (Recall that a proper fraction always has a number in the numerator that is less than the number in the denominator, such as the fraction  $\frac{2}{3}$ .)

$\frac{1}{2}$   
 $\frac{1}{3}$     $\frac{2}{3}$   
 $\frac{1}{4}$     $\frac{2}{4}$     $\frac{3}{4}$   
 $\frac{1}{5}$     $\frac{2}{5}$     $\frac{3}{5}$     $\frac{4}{5}$   
 $\frac{1}{6}$     $\frac{2}{6}$     $\frac{3}{6}$     $\frac{4}{6}$     $\frac{5}{6}$

skip the sevenths—nobody measures in sevenths!

$\frac{1}{8}$     $\frac{2}{8}$     $\frac{3}{8}$     $\frac{4}{8}$     $\frac{5}{8}$     $\frac{6}{8}$     $\frac{7}{8}$

skip the ninths too!

$\frac{1}{10}$     $\frac{2}{10}$     $\frac{3}{10}$  and so on.

We skipped sevenths and ninths because they don't occur very often as we work real-world problems.



How can we convert tenths into decimals or percents? Take  $\frac{7}{10}$  as an example. This is 0.7 (or 0.70) as a decimal and 70% as a percent. Tenths are so easy to convert that we can leave them out of our chart.

What about fifths? What fraction does  $\frac{2}{10}$  reduce to? Did you get  $\frac{1}{5}$ ? Can you show how  $\frac{2}{10}$  reduces to  $\frac{1}{5}$ ?



The fraction  $\frac{2}{5}$  can be changed to tenths by multiplying both the numerator and denominator of the fraction by 2 (the opposite of reducing the fraction).

$$\frac{2}{5} = \frac{2 \times 2}{5 \times 2} = \frac{4}{10}$$

This changes  $\frac{2}{5}$  to  $\frac{4}{10}$  which is 0.4 or 40% (40 percent). By changing fractions in fifths to fractions in tenths or hundredths, they become easier to change to decimals. Figure B-8 shows graphically that  $\frac{2}{10} = \frac{1}{5}$ ,  $\frac{4}{10} = \frac{2}{5}$ ,  $\frac{6}{10} = \frac{3}{5}$  and  $\frac{8}{10} = \frac{4}{5}$ .

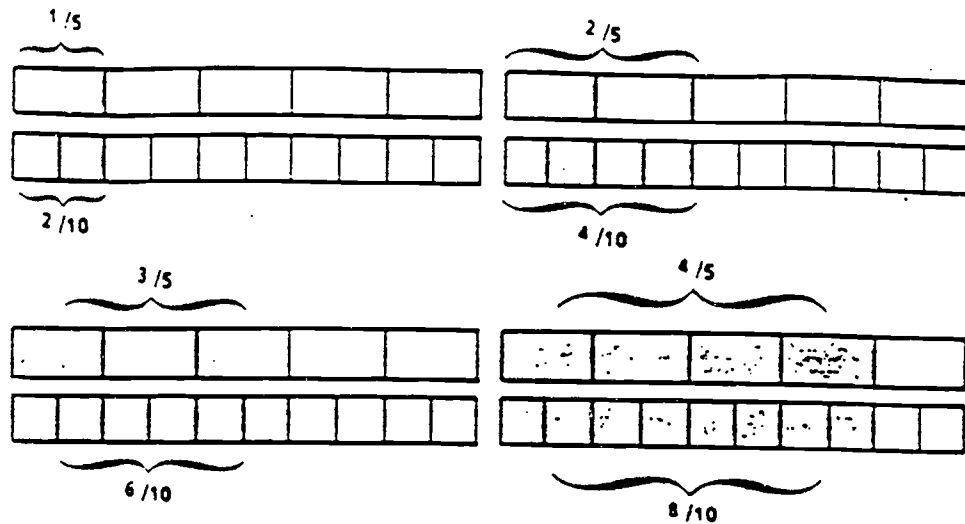

EXAMPLE:  $\frac{2}{5} = \frac{2 \times 2}{5 \times 2} = \frac{4}{10} = 0.4 = 40\%$

Figure B-8  
Changing fifths to tenths

Look at the chart that you just made. Circle all the fractions that have 5 as a denominator, and circle those that have 10 as a denominator. You know an easy way to convert those. Now look at the chart again.

How about  $\frac{2}{4}$ ? Can you reduce that fraction so that it equals another one in the chart? Circle  $\frac{2}{4}$  because it is the same as  $\frac{1}{2}$ .

$$\frac{2}{4} = \frac{2 \div 2}{4 \div 2} = \frac{1}{2}$$

Circle any of the sixths and eighths that you can reduce.

How many UNcircled fractions do you have left on your chart? If you have more than eleven, look again to see if you can reduce any of them.

The eleven fractions that are left *uncircled* are the ones that will be part of the chart. You should have:  $\frac{1}{2}, \frac{1}{3}, \frac{2}{3}, \frac{1}{4}, \frac{3}{4}, \frac{1}{6}, \frac{5}{6}, \frac{1}{8}, \frac{3}{8}, \frac{5}{8}, \frac{7}{8}$ . The circled fractions do not need to be in the chart; some of them are easy to convert to decimals. Other fractions (such as the ninths) are not common enough to worry about. The uncircled ones are the common fractions that you will often need to change into decimals, or to change from decimals back into fractions. Now you are ready to complete the chart for eleven common fractions.

Fraction	Decimal	Percent
$1/2$		
$1/3$		
$2/3$		
$1/4$		
$3/4$		
$1/6$		
$5/6$		
$1/8$		
$3/8$		
$5/8$		
$7/8$		

NAME \_\_\_\_\_

DECIMAL NUMBERS  
EVALUATION TEST 2  
PART 3-PART 5

Solve the problems below.

1.  $0.306 + 0.253 =$

1. \_\_\_\_\_

2.  $2.2 + 31.0006 + 14.026 =$

2. \_\_\_\_\_

3.  $2.3 + 3.0012 =$

3. \_\_\_\_\_

4.  $12.88 - 6.42 =$

4. \_\_\_\_\_

5.  $8.003 - 4.09 =$

5. \_\_\_\_\_

$$5\frac{1}{2} \quad 1.004 + 1.04 + 1.4 + .0014$$

6. \_\_\_\_\_

6. 
$$\begin{array}{r} 2.7 \\ \times 0.03 \\ \hline \end{array}$$

7. \_\_\_\_\_

7. 
$$\begin{array}{r} 8.2 \\ \times 0.004 \\ \hline \end{array}$$

8. \_\_\_\_\_

8. 
$$\begin{array}{r} 0.876 \\ \times 2.01 \\ \hline \end{array}$$

9. \_\_\_\_\_

9.  $0.8 \overline{)0.64}$

10. \_\_\_\_\_

10.  $2.2 \overline{)4.4}$

11. \_\_\_\_\_

11.  $0.09 \overline{)0.081}$

12. \_\_\_\_\_

12.  $27.2 \overline{)11.152}$

NAME \_\_\_\_\_

DECIMAL NUMBERS  
EVALUATION TEST 3  
PART 6

Use a calculator to solve these problems.

- |  |           |
|--|-----------|
| 1. $18.91 + 32.15 =$                                       | 1. _____  |
| 2. $21.87 + 0.95 + 11.27 =$                                | 2. _____  |
| 3. $98.27 - 62.97 =$                                       | 3. _____  |
| 4. $0.895 - 0.428 =$                                       | 4. _____  |
| 5. $7.55 \times 10.98 =$                                   | 5. _____  |
| 6. $0.87 \times 1.18 =$                                    | 6. _____  |
| 7. $35.75 \div 14.3 =$                                     | 7. _____  |
| 8. $0.9495 \div 0.211 =$                                   | 8. _____  |
| 9. $28.6 - 14.2 + 18.7 =$                                  | 9. _____  |
| 10. $0.987 + 1.154 - 0.243 =$                              | 10. _____ |
| 11. $\frac{44.44 \times 2.4}{9.6} =$                       | 11. _____ |
| 12. $\frac{0.139 \times 0.633}{0.211} =$                   | 12. _____ |
| 13. $\frac{48.4}{12.1 \times 1.25} =$                      | 13. _____ |
| 14. $\frac{0.99}{0.3 \times 1.1} =$                        | 14. _____ |
| 15. $\frac{1.8 \times 6.8}{0.9 \times 2} =$                | 15. _____ |
| 16. $\frac{28.8 \times 4.8}{14.4 \times 3.2} =$            | 16. _____ |
| 17. $9.7 \times \frac{1000}{100} =$                        | 17. _____ |
| 18. $400 \times \frac{300}{600} =$                         | 18. _____ |
| 19. $0.87 \times \frac{600}{300} \times \frac{546}{273} =$ | 19. _____ |
| 20. $520 \times \frac{100}{1000} \times \frac{50}{500} =$  | 20. _____ |



Convert these fractions to decimals.

$1/3$  \_\_\_\_\_       $3/8$  \_\_\_\_\_       $11/16$  \_\_\_\_\_  
 $3/32$  \_\_\_\_\_       $1/8$  \_\_\_\_\_       $3/4$  \_\_\_\_\_

Convert these decimals to fractions.

$0.0625$  \_\_\_\_\_       $0.4962$  \_\_\_\_\_       $0.7188$  \_\_\_\_\_  
 $*0.500$  \_\_\_\_\_       $*0.750$  \_\_\_\_\_       $0.0938$  \_\_\_\_\_  
 $*0.250$  \_\_\_\_\_       $0.5312$  \_\_\_\_\_       $0.9688$  \_\_\_\_\_

Complete this table.

Common percents	Equivalent fraction	Equivalent decimal
12 1/2%	_____	0.125
25%	_____	_____
33 1/3%	1/3	_____
_____	1/2	_____
_____	_____	0.625
66 2/3%	_____	_____
87 1/2%	_____	_____
_____	3/4	_____
_____	_____	0.1875
_____	_____	0.4375
34.38%	_____	_____

### Word Problems

Show your work.

A chemical technician adds  $3/4$  of an ounce of solution A to  $1/3$  of an ounce of solution B. What is the total volume of the solution. Give your answer in decimal format.

A lab technician was able to analyze 21 of 28 samples. What percent of the samples did he analyze.

Hit slip calls for 400 lbs. of 3090-L811. The drum on the tint rack contains 215 lbs. How many more pounds of 3090-l811 is required?

A hit slip calls for 1410 lbs. of 48A75-1180. Each drum of 48A75-1180 weighs 470 lbs. How many drums do you need to order from preassembly?

A hit slip calls for 38 lbs. of SRC-75. The weight per gallon of SRC-75 is 7.22 lbs./gal. Will the SRC-75 fit in one 5 gallon pail?

You can only fill 5 gallon pails with 4 gallon or 40 lbs. of material. A hit slip calls for 75 lbs. of SKF-74. The weight per gallon of SKF is 6.71 lbs./gallon.

a. What is the most number of lbs. of SKF-74 that you can fill in a pail? (remember, you can only fill the pail to 4 gallons)

b. How many pails will be required for this 75 lb. hit?

# *S-P-E-E-D-R-E-A-D-I-N-G*

a strategy for efficient comprehension

A six to eight session workshop  
developed by  
Barbara E. Seeger

# S-P-E-E-D-R-E-A-D-I-N-G

a strategy for efficient comprehension

A six to eight session workshop  
developed by  
Barbara E. Seeger

The purpose of this class is to have students understand the role of the eye movements in reading. It is my goal that students will understand that effective eye movements during reading can lead to efficient comprehension of reading materials.

There are two very encouraging things about working to increase reading speed; 1. it is the easiest reading skill to improve and 2 no matter how fast people read, they can learn to read still faster. People who want to increase their reading speed should be given careful instruction and guidance in the principles of speedreading and be willing to practice.

Use of the computer program can eliminate such interruptions as page turning and eye fixations and regressions. The Davidson program also provides the opportunity for presentation of material about the role of the eye in the reading process.

Comprehension strategies such as skimming, focusing, previewing and mapping can become more efficient when a student understands the role of eye movements in the reading process.

The truly efficient speedreader is able to adjust his rate of reading speed as it relates to his purpose such as skimming, focusing upon the main idea or reading for specific details

If you have any questions about the material presented in this curriculum call me at PPG Industries 764-6000 extension 270 or at home 786-4632.

## S-P-E-E-D-R-E-A-D-I-N-G

### **PURPOSE:**

To understand the process of improving reading speed.

To understand the role of the eye movements in reading.

To improve reading speed using text presented on the Davidson computer software program and in printed text.

To learn and practice comprehension strategies and integrate these strategies into the process of speedreading.

### **BACKGROUND**

**INFORMATION:** What do you think of when the concept of speedreading is discussed?

Some advertisements may claim that a person can read 30,000 words per minute.

President John F. Kennedy advocated speedreading for his staff.

Evelyn Wood developed the course Reading Dynamics at Columbia University in the early 60's; this became known as speedreading.

Most people can double or triple their beginning rate during the workshop. Some examples are:

89 to 400 words per minute

650 to 1500 words per minute

225 to 850 words per minute

200 to 650 words per minute

with 85 percent or better comprehension.

Reading is the process of constructing meaning through interaction between the reader, the text and context of the reading situation. (This definition was presented by Dr. Joanne Caldwell of Cardinal Stritch College.

## **DEFINITIONS:**

Fixations are when the eyes stop at a word or group of words.

Regressions are when the eye looks back at previously read text.

Return sweep is when the eyes move from the end of one line to the beginning of the next.

Span of recognition is when the eyes move ahead of the point of comprehension.

Subvocalization occurs when the reader is hearing the words in his head as he reads.

Vocalization is when a reader moves his lips as he reads.

## **INSTRUCTION SUGGESTIONS:**

Most of the roadblocks to increasing reading speed can be controlled or eliminated. These include correcting vision with glasses and vitamins can control vitamin deficiency,

Warm-up exercises are important either using an eyespan card or computer program.

Encourage students to "push" their eyes,

During reading done during the workshop have students graph their progress for both reading selections from the computer program and printed text.

Encourage students to practice. Have them observe how their eye muscles feel. Have practice at a speed that is double that of their beginning rate,

This is a suggested format for six sessions. The instructor is the decision maker as to the content of the sessions as it relates to the students' needs.

### Session 1

**Materials: Handouts Does Efficient Reading Really Pay Dividends, Why Should You Improve Your Reading Skills?, Twenty Reasons to Become a More Effective Reader, and How Fast Do You Really Read?**

**Eyespan cards for each students along with practice exercises. Speedreader II computer program by Davidson.**

Discuss the background and students' concept of speedreading

Define the terms and give examples of how students have improved their rate.

Discuss handouts.

Do How Fast Do You Really Read? Discuss results and goals.

Model the eyespan card. Most students can readily view four digits; some develop skill in viewing 12 to 20 digits. Practice moving the eyespan card down the columns at an even pace.

Introduce the computer program, Begin with the numbers and proceed to the phrases

### Session 2

**Materials: Eyespan cards. Cosby video on Rate. Davidson Computer program Handouts How Fast Do You Read, Reading Rate Formula, Phrases and charts for recording your rates.**

Show the Cosby video on rate. 30 minutes

Introduce the eye movement and column reading lessons from the computer program. Allow for practice time.

## TWENTY REASONS TO BECOME A MORE EFFECTIVE READER

1. To learn something.
2. To be entertained.
3. To understand a situation.
4. To obtain information.
5. To be more responsible.
6. To prevent accidents.
7. To be a team player.
8. To ask intelligent questions.
9. To improve confidence.
10. To protect freedom.
11. To find out the needs of others.
12. To make accurate evaluations.
13. To aid the enjoyment of travel to new places.
14. To help educate others.
15. To become a better conversationalist.
16. To prevent loneliness.
17. To understand opposing views or philosophies.
18. To learn the history or background of a topic or event.
19. To compare ideas.
20. To improve writing skills and/or vocabulary.

ADD YOUR OWN:

21. \_\_\_\_\_
22. \_\_\_\_\_
23. \_\_\_\_\_



# DOES EFFICIENT READING REALLY PAY DIVIDENDS?

By reading this book, it is evident that you already know the basics of reading. Is it really worth while then to improve your skills? The answer is a resounding YES!

Business people read on average four hours or more each day. Companies pay for millions of reading hours. Yet the average reading rate of 250 words per minute simply is not fast enough to provide people with the information they need to stay current. The fate of a company can depend on how well its employees read.

Reading more effectively benefits not only your organization, but also your career. There is a definite correlation between reading skills and career success.

*If you read at an average rate, you may be penalizing  
not only your organization—but also yourself.*

Check those items with which you agree:

Reading more effectively can—

- Increase my income.
- Improve my company's profits.
- Make me more promotable.
- Increase my job satisfaction.
- Improve my ability to solve problems.
- Keep me aware of what is going on in my organization.



## WHY SHOULD YOU IMPROVE YOUR READING SKILLS?

Why improve your reading skills? What are the advantages of overcoming poor reading habits? List as many reasons as you can think of in the space below. Place a check next to those that are most important to you. Then turn the page and read "Twenty Reasons to Become a More Effective Reader."

REASONS FOR ME TO BECOME A MORE EFFECTIVE READER

# HOW FAST DO YOU READ? TEST YOURSELF

Before you learn the new reading skills in this book, it is important to find out how well you already read. Take the following self-assessment quiz. Then when you take other reading tests in this book later, you'll be able to compare your progress with your beginning score.

It is not possible to read all kinds of written material with the same ease. The material presented in this first self-assessment is of average difficulty.

To determine your present reading rate, start reading and time yourself for 1 minute. Circle the number to the right where you have stopped. This is how many words you read per minute.

## Test #1

### SELF-ASSESSMENT

What is preventing us from reading as fast as we can?	11
There are three main reading faults we need to correct.	21
The first is regressing or going back. Do you ever	31
read along and say, "What was that and return to the	42
previous line? We spend as much as one-third of our	53
time going back. The second fault is vocalizing or	62
saying the words. Even if you are not saying each word	73
out loud, you are thinking about it or feeling it in	84
your throat. Try chewing gum or suck on candy or	95
bite a pencil. Don't let your tongue touch the pencil.	105
Music is good for concentration. Use earphones, turn	113
up the volume a few decibels higher than is comfortable	123
and listen to non-vocal music. It seems that the	133
privacy of the music entering the auditory system helps	142
concentration and helps to eliminate the vocalizing.	149
The third fault is fixations. If one were to fixate on	160
every word, you would have over 300 fixations per page.	170
Reading dimensionally, you'd be reading down the page	178
using the hand as a pacer and you'd have fewer and	189
fewer eye fixations.	192

## HOW FAST DO YOU READ? (Continued)

You will work on a reading index. Compare it to someone riding a bike. When you first learn, you must go fast to keep your balance, but when you become more proficient you can slow down and look at the scenery or speed up and get the thrill because you have control.	202 212 223 234 244
You can make this same comparison with a reader. The untrained reader will plod along at the same rate in every type of material, but the trained reader can turn it up or down. He or she will read 1500 words per minute in the daily paper, 1000 words per minute in the financial paper, 800 words per minute in a novel, 400 words per minute in technical materials or perhaps out loud in <i>The Prophet</i> or in a love poem. Speed-reading will help you when you go into that company meeting because you can review quickly and enter the meeting being more secure and knowledgeable. You will have control and a tool to turn your reading rate up or down. Listen to the newscaster at 140 words per minute if you are tired and want to relax. However, if you want to get the news quickly turn it on at 1,500 words per minute in the newspaper. You have the choice as a speed reader.	254 264 274 286 297 307 316 327 337 346 354 365 375 386 398 409 411
What about comprehension? If we get up to 1,000 words per minute with low comprehension it won't be very beneficial. Comprehension is better at 1,000 words per minute than it was at 100 wpm because not so many thoughts can enter your mind. You will get the feeling of looking at a movie.	421 430 438 449 459 464

When you look at a picture on the wall, you don't say,	476
"Sky—grass—girl—there are 5,380 artist's brush	484
strokes." You simply see the picture and get the	493
message. Pictures go to the brain—not words. The	502
faster we read, the clearer the picture becomes but	511
this will take some application in order to convince	520
yourself.	521

Comprehension is so strongly based on what one brings	530
to the material. <i>Alice in Wonderland</i> is now a	539
philosophy book. At age 12 it was a fairytale.	548
Speed-reading is a tool. You can use it to suit your	560
needs.	561

Record your beginning rate on your score sheet on page 71, under A.  
Beginning Rates.

# HOW FAST DO YOU READ?

**Test #2**

Test yourself by reading from a novel. (See page 17 to calculate your rate). Read for one minute, then mark where you stopped. Record your rate on the score sheet on page 71 under Beginning Rates.

**Optional:**

Calculate your reading rate using a non-fiction book. Record your rate on the score sheet.

**WORDS, WORDS, WORDS...HOW FAST DO YOU READ?**

250 to 300 words per minute .....	Average reader
160 words per minute .....	Average speaker
140 words per minute .....	Professional story teller
33,000 words .....	An average individual speaks in a day

**TRUST ME. IT'LL BE GREAT! TERRIFIC! YOU'LL SEE... IT'LL WORK!**

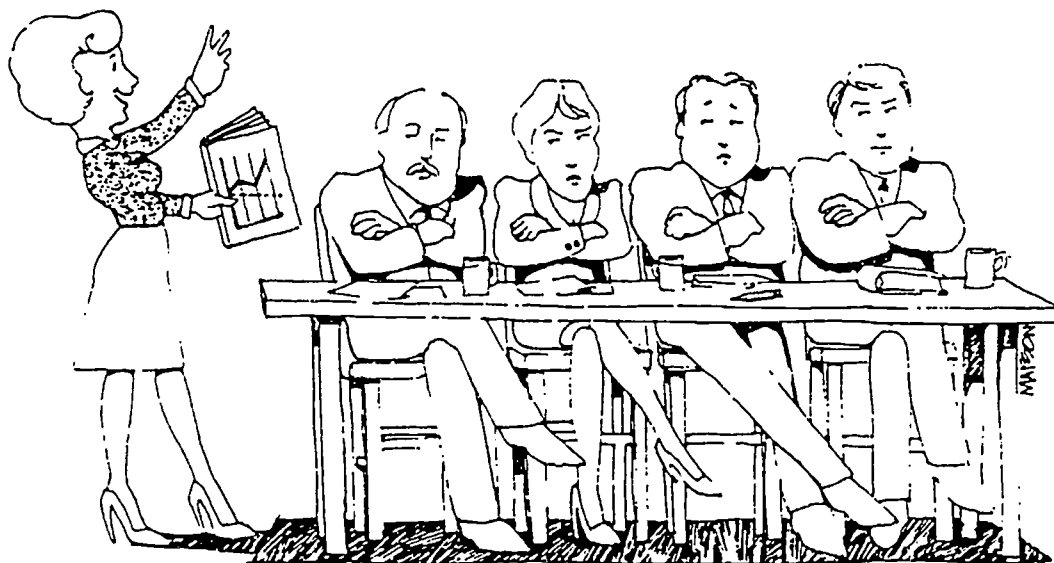

# READING RATE FORMULA

To check your reading rate with material outside this book, select a novel or non-fiction book and turn to a page with at least six full lines.

Count each word, whether it's *at* or *supercalifragilistic*. The word length will average itself out. Count the words and divide by six. This gives you the average number of words per line (WPL). Multiply the WPL by the number of lines per page, and you will know the words per page (WRP). (If you have only a few words on a line, combine them with another short line to count as one full line.) In pencil, write this formula in the front of your book and refer to it later to see how you've improved. There isn't a typical formula or number of words per page. It varies greatly from book to book.

## THE READING RATE FORMULA

1. Count the number of words in the first full six lines.  
(Example: 60 words)
2. Divide this number by six to determine the average number of words per line (60 words  $\div$  6 lines = 10 words per line)
3. Multiply this number by the number of lines on the page.  
(10 words per line  $\times$  30 lines = 300 words)
4. Multiply this number by the number of pages read.  
(300 words  $\times$  10 pages = 3,000 words)
5. Divide this number by the reading time.  
(3,000 words  $\div$  3 minutes = 1,000 words per minute)

Using this formula, time yourself for one minute. After the minute is over, use the above formula to determine the number of words you read per minute. For a longer check, you might time yourself using a digital clock. Begin at 10:01, for example, and read until 10:16. Then add the pages you've read, including extra lines, and divide by 15 minutes. A pocket calculator will make your task easier.

Because these are figures, graphs, and charts, it's sometimes difficult to determine your reading rates with technical material. For easy practice, try "The Reader's Digest," which has 6 words per line, 246 words per column.

# SCORE SHEET

Name \_\_\_\_\_ Phone \_\_\_\_\_

Address \_\_\_\_\_ Date \_\_\_\_\_

City & Zip \_\_\_\_\_ Company \_\_\_\_\_

## PRACTICE RATES

	TITLE	RATE	COMP.
1			
2			
3			
4			
5			
6			
7			
8			
9			
10			
11			
12			
13			
14			
15			
Average Rate			



Words per Chap- Minuter:	1	2	4	4	4	5	6	7	8	9	11	12	12	13	14	15	16
1200																	
1175																	
1150																	
1125																	
1100																	
1075																	
1050																	
1025																	
1000																	
975																	
950																	
925																	
900																	
875																	
850																	
825																	
800																	
775																	
750																	
725																	
700																	
675																	
650																	
625																	
600																	
575																	
550																	
525																	
500																	
475																	
450																	
425																	
400																	
375																	
350																	
325																	
300																	
275																	
250																	
225																	
200																	
175																	
150																	
125																	
100																	
75																	
50																	
25																	
0																	

### Session 3

**Materials: Davidson computer program. Handouts  
Secure Hand Movement and Smooth Hand Movement.  
Eyespan cards with practice exercises.**

Allow warmup practice on the computer.

When practicing with the eyespan cards begin with numbers and proceed to words and phrases.

Using printed text, instructor will model the hand movements. Use the same text when modeling each movement.

Students will practice. suggested practice materials might be the article on the Wright Brothers or "How Fast Do You Read".

The eyespan card is used to allow students to practice increasing their the number of numbers or letters that they can see and comprehend. Through the movement of the card by the students, the span of numbers, letters and/or words increases. The attached exercises may be used.

A sample of a card is below. Use a 3 x 5 index card. Cut a window 3 inches by  $\frac{3}{8}$  inch, 1 and  $\frac{1}{4}$  inches from the top..

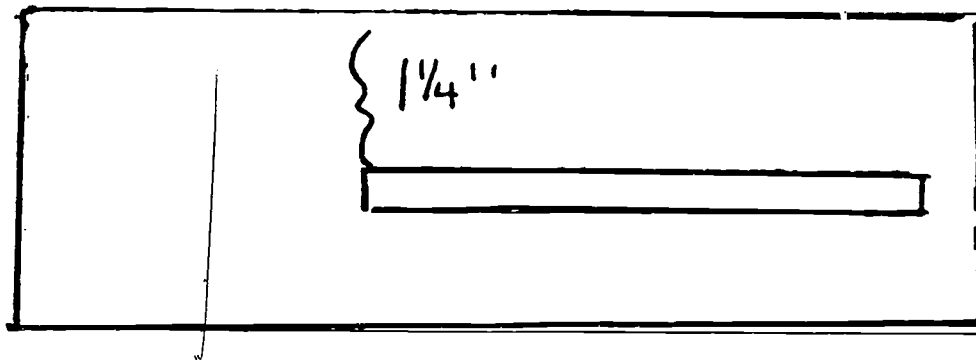

To use the eyespan card, place it at the top of the column and move the card down a column of numbers or words at a steady pace.

Begin

•  
7  
•  
1  
•  
•  
3  
•  
8  
•  
5  
•  
9  
•

43328  
•  
24316  
•  
17571  
•  
59141  
•  
72357  
•  
34186  
•  
29162  
•  
42487  
•  
79894  
•  
48123  
•  
37272

Begin

Begin

•  
2  
•  
72  
•  
147  
•  
6339  
•  
54327  
•  
384028  
•  
9793364  
•

•  
4  
•  
41  
•  
272  
•  
3663  
•  
98366  
•  
191924  
•  
5566312  
•  
69271334  
•  
241167989  
•  
5657154356  
•

•  
27  
•  
17  
•  
83  
•  
79  
•  
42  
•  
69  
•  
71  
•  
339  
•  
373  
•  
738  
•  
717  
•  
883  
•  
962  
•  
534  
•  
9336  
•  
4217  
•  
1743  
•  
5283  
•  
6152  
•  
8235  
•  
6381  
•

•  
27  
•  
17  
•  
83  
•  
79  
•  
42  
•  
69  
•  
71  
•  
339  
•  
373  
•  
738  
•  
717  
•  
883  
•  
962  
•  
534  
•  
9336  
•  
4217  
•  
1743  
•  
52  
•  
6152  
•  
8235  
•  
6381  
•

•  
595717

•  
343143

•  
452145

•  
257696

•  
127212

•  
536154

•  
926692

•  
384571

•  
252585

•  
492578

•  
296521

•  
796173

•  
413181

•  
531239

•  
692768

•  
796951

•  
383127

•  
423491

•  
392639

87625731

•  
54372983

•  
94652748

•  
25692748

•  
17923816

•  
94763128

•  
74318548

•  
38458137

•  
73452962

•  
59484236

•  
78693512

•  
62931283

•  
52419728

•  
14768936

•  
58379412

•

amuse  
•

ripen  
•

stomp  
•

navel  
•

twist  
•

molar  
•

waist  
•

plump  
•

eager  
•

mouse  
•

cross  
•

venal  
•

spore  
•

wrist  
•

dress  
•

plumb  
•

quirt  
•

agony  
•

high solo  
•

other thing  
•

moral sign  
•

sits light  
•

never even  
•

candy cart  
•

teeth item  
•

slow burn  
•

loud tale  
•

wily catch  
•

take up the slack

one at a time

say what you mean

forty cars can run

easy for the young

see our nice vase

halt with the crowd

dry on a rack

look back to December

caught on a look

bound to each other

grasped at one trial

deeper for the fish

tenth in the line

cowed by a bat

call when store closed

gun had no sight

on a sad day

kick the new ball

worn by the town

down on the mall

eel had no fight

has to say where

island in the sea

worry has no place

fortune of the times

certain to be done

watch my dog

match any dot

try this tie

pitch the hay

nail the board

come down last

find the boy

read the line

ride one time

beat on tin

all are heard

dry your eyes

eat some meat

grow more wheat

hide in there

it comes last

fort can hold

calm on lake

state the taste

mark in time

buy that bag

cost is set

set a pin

wait for walk

this fine alley

corn is easy

last in salt

bran to barn

why that dray

for my roof

The purpose of this drill is to discipline the little muscles that move the eyes from left to right. Incorrect habits of reading have frequently caused these muscles to behave in an undisciplined and inefficient manner. Try to make your eyes march in three rhythmic leaps across the line. Try to feel the tiny tug on these six little muscles that move each eye. You will note that some phrases are short others are longer. This is done intentionally. The amount of line width that various people can see, differs with the individual. In these exercises try to group. At times you will feel as though the field of your vision is being stretched. So much the better. At other times the phrase will be too short. We shall strive for wider and wider units as we proceed. In that way your eyes will grasp more and more at a glance. Read this exercise two or three times every day. for a few days. Try always to cut down on the time that it took you to read it each preceding time. You will soon get the knack of it. Do not Let your eyes "skid"



or "slide" when you look at a phrase.

Look at it "amidships". Give it a strong

fleeting glance. See it all in one look;

then be off to see the next and the next,

and so on to the very end of the exercise.

And now, how long did it take you

to read this? Put your time one the back

each day, to accustom the eyes to see

natural groupings of words and to force them

to accept phrase after phrase, line after line

down the page without faltering, or hesitating

or turning back, but to march dauntlessly forward

across each successive line of type.

Some fixation troubles may have mental rather than

physical causes. The trouble is not with the muscles

of the eye. It is rather with the inability

of the mind to grasp quickly and unerringly

the successive bits of information fed into it

at each fixation of the eyes. True, this information

does come piecemeal, and perhaps because of this

phrase by phrase injection of ideas we are likely

not to catch the full meaning of each one  
as it arrives. One or two get by in a momentary lapse  
of attention. The meaning is lost, and we regress  
go back to find the missing link of thought.

Move your eyes, therefore, down the lines  
as quickly as possible, but always be sure to get  
the thought at each fixation along the line.

These exercises will help you to do this consciously.

In normal reading you will do it involuntarily.

Drive yourself ever more quickly down the lines.

But not too fast to sacrifice meaning for speed.

# THE SECURE HAND MOVEMENT

The secure hand movement is the most basic technique you can use to increase your reading rate. It is the most "secure" because it allows you to follow with your finger on every line. Even after you've mastered more advanced movements, you may still prefer to use this method for difficult material.

Here's how the secure hand movement works:

Using your finger as a guide, follow each line of a page from far left to far right. At the end of each line, swing your finger up slightly to the right. In this way you will avoid sudden "fixations," or stops.

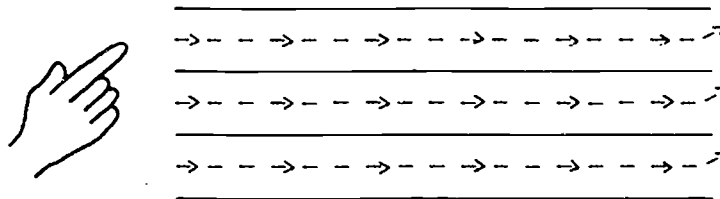

Maintaining a good rhythm is essential. If you come to a partial line, continue to move your finger to the right margin anyway, then proceed as usual to the next line.

**NOTE:** Comfort is important. If you become fatigued during any of the hand movement techniques, you won't be able to read at your maximum rate. To avoid fatigue:

Place your reading material on a table or desk in a position that is comfortable for you.

Keep your elbow close to your body so your arm doesn't become tired.

Don't move your head from side to side.

# THE SMOOTH HAND MOVEMENT

For material that's easy to read, try the smooth hand movement.

## PRACTICING THE SMOOTH HAND MOVEMENT

Place your pacer under one line. Begin at the far left and move to the far right. Keeping your pacer on the page, come back under a line or two as you follow it back to the left. Repeat.

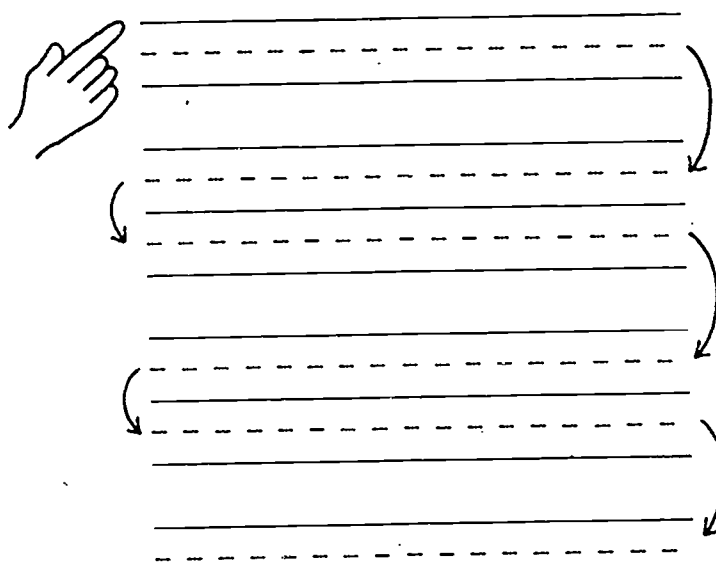

You are observing the entire area rather than thinking word, phrase, sentence, paragraph. It takes a bit of application in order to start thinking pictures.

At first you may not like this movement. But once you develop it, it will feel as natural as a tennis or golf swing. In sports, you know when your swing is correct by the way it feels; it's a kinesthetic experience. Similarly, the smooth hand movement will eventually become automatic and should significantly improve your rate of reading.

## MORE SMOOTH HAND MOVEMENT PRACTICE (Continued)

In your own book, using the smooth hand movement, try the following exercises:

### Exercise A

Read for 1 minute and mark where you stop with a paper clip.

Re-read the same passage in 50 seconds.

Re-read the same passage in 40 seconds.

### Exercise B

What is your rate? \_\_\_\_\_

In new, unread material time yourself as you read for 1 minute.

Record your reading rate on #3 of your score sheet, (page 71).

### Exercise C

Read for 3 minutes and mark where you stop with a paper clip.

Re-read the same passage in 2 minutes.

Re-read the same passage in 1 minute.

### Exercise D

What is your rate? \_\_\_\_\_

In new unread material, read for 1 minute.

Record your reading rate on #4 of your score sheet, (page 71).

Comprehension is the purpose for reading. Comprehension is the interaction of the reader's background knowledge, understanding of the printed text, and the integration of the information into his knowledge and experiences. The strategies presented in sessions 4, 5, and 6 will enable students to read efficiently and comprehend the text.

In my experiences, training, and research several percentages of acceptable comprehension have been presented. These ranges are from 50 to 90 percent. This relates to one's purpose of reading the chosen text. If a reader is reading a selection for the first time, to obtain the general idea of the content, he may only comprehend 50 percent of the material because he is only skimming. On the other hand, if his purpose is to comprehend the main idea and supporting details, a comprehension of 85 to 90 percent is appropriate.

## DEFINITION OF

### STRATEGIES:

**Focus** is reading the first several paragraphs completely, only the first sentence of the other paragraphs and the last several paragraphs completely. This enables the student to get the main idea and details.

**Mapping** is writing the main idea and important details. This enables students to recall and/or organize information for writing,

**SQ3R** is to survey the text, develop questions and read, reflect and reread.

**Scanning** is used to locate a specific piece of information.

**Skimming** is reading at the fastest possible speed.

#### Session 4

**Materials: Handouts "Skimming" and "How to Skim", Davidson SpeedreaderII program, articles about The Enquirer and Shark Tagging and others chosen by the instructor,**

Discuss what comprehension means to students.

Have textbooks or company literature available.  
Explain the handouts "Skimming".and "How to Skim"  
Practice with available materials.

Skimming can keep you informed, enables you to read supplementary materials more efficiently and helps the reader determine which parts of the material is important to his purpose for reading.

Allow time for practice with the computer program.

Have students record their reading rate either from the computer program or text reading.

#### Session 5

**Materials: Articles on The Enquirer and Shark Tagging, Davidson Speedreader II program.**

Using the article about The Enquirer model the focus strategy.

Do the focus strategy with two or three other articles  
Answer the comprehension question to demonstrate that the strategy works.

Introduce the scanning strategy. Scanning enables readers to locate specofoc material quickly

Practice this strategy with the "Systematic Previewing" handout.

# SKIMMING

The following diagram illustrates the "z" motion. The lines show the places to read while the broken lines show the places to scan.

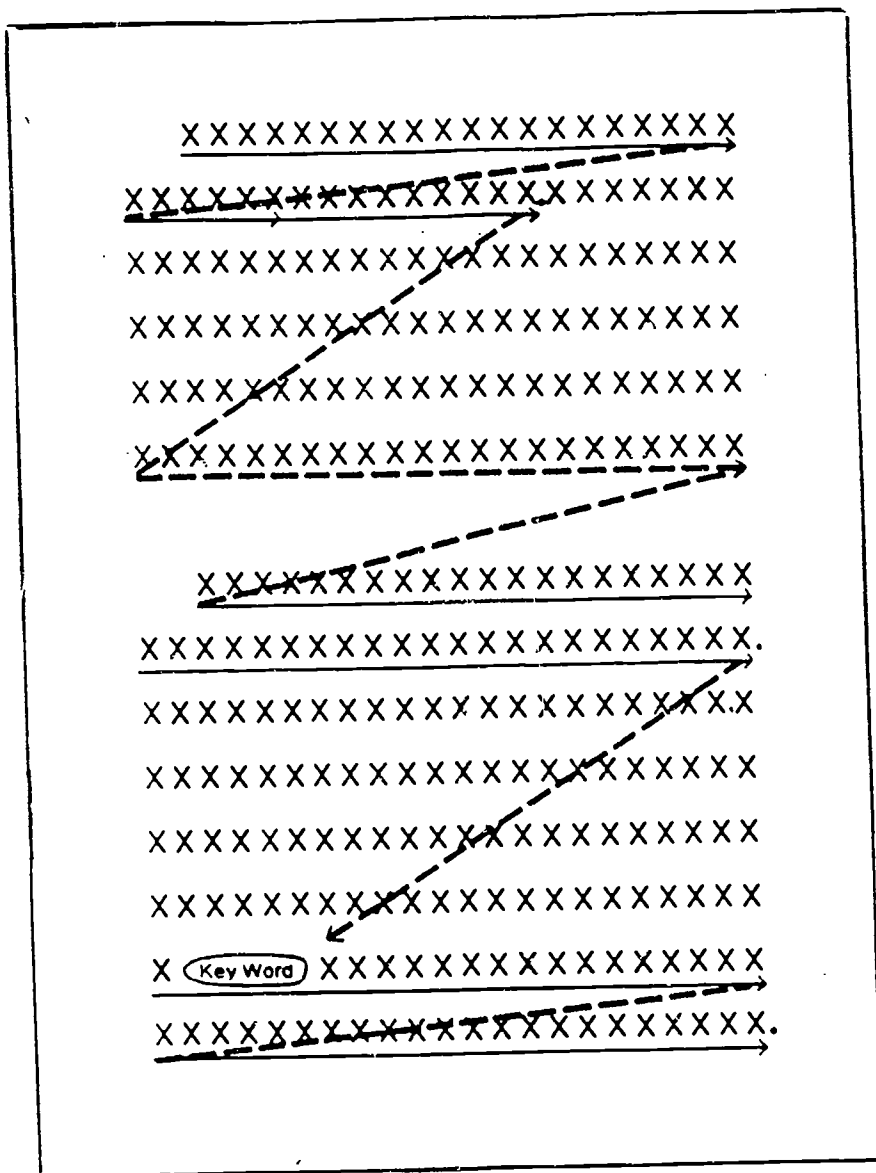



HOW TO SKIM

Usually the first paragraph will be read at average speed all the way through. It often contains an introduction or overview of what will be talked about.

Sometimes, however, the second paragraph contains the introduction or overview. In the first paragraph the author might just be "warming up" or saying something clever to attract attention.

Reading a third paragraph completely might be unnecessary but

the main idea is usually contained in the opening sentence

topic sentence

Besides the first sentence the reader should get some but not all the detail from the rest of the paragraph

names

dates

This tells you nothing

hence sometimes the main idea is in the middle or at the end of the paragraph.

Some paragraphs merely repeat ideas

Occasionally the main idea can't be found in the opening sentence. The whole paragraph must then be read.

Then leave out a lot of the next paragraph

to make up time

Remember to keep up a very fast rate

800 wpm

Don't be afraid to leave out half or more of each paragraph

Don't get interested and start to read everything

skimming is work

Lowered comprehension is expected

50%

not too low

Skimming practice makes it easier

gain confidence

Perhaps you won't get anything at all from a few paragraphs

don't worry

Skimming has many uses

reports

newspapers

supplementary

text

The ending paragraphs might be read more fully as often they contain a summary.

Remember that the importance of skimming is to get only the author's main ideas at a very fast speed.

## THE ENQUIRER: SENSATIONALISM PERSONIFIED

Read { For some reason, people love to read gossip and sensationalism. One of the best examples of the public's taste in such reading is reflected by the success of *The Enquirer*, a weekly tabloid recently forced by the court to pay a huge sum of money in damages to Carol Burnett for slander and insinuations about her character. *The Enquirer*, seemingly untroubled by the huge financial loss in court, nor by the many others waiting in line to sue them, continues to find readers who want to read distorted and misleading information. Its sales are as good as ever despite the attention that has been called to its poor writing and poor factual support for its many articles.

Read { One can't help but wonder what type of people read *The Enquirer*. They must be poor readers with very low vocabulary levels because nothing is ever written above the eighth-grade level. And certainly no one who reads with any intelligent comprehension could stand to spend much time on the tabloid. For example, a recent article was headlined, "College Students Flunk 8th Grade Exam Prepared in 1906." Now the headline itself is no worse than many respectable newspaper headlines. But a close look at the article makes one wonder what all the furor is about.

Read { The opening statement of the article reads, "College students of today are so poorly educated that they flunked an 8th grade exam prepared 70 years ago!" It goes on to quote a Dr. John Cundy, schools superintendent in Lincoln, Kansas, who doubts, he says, if any of today's high school graduates could pass the 1906 Oregon state exam without prior coaching.

Read { We are told that "overall, the students did very poorly." None correctly answered the two math questions on the test. "Passing scores were achieved by only one student in physiology, one in spelling, two in geography and two in American history. Just one student did well in grammar." Certainly this is shocking news.

Read { But the shock that students did so poorly soon dissolves when we learn that this great concern is based on—now get this—the test results of *five* students. That's right, the entire article and its suggestion that college students are not as educated as students graduating from the eighth grade in 1906 is based on the sum total of only five junior college students who took the 70-year-old exam.

Read { Another misleading point in the article is that it boldly states, "Top educators said the results of *The Enquirer* experiment illustrates the worsening academic crisis in U.S. schools," but who exactly are these "top educators"? The article does quote Dr. Cundy, already mentioned,

Skip	<p>and a Dr. Verne A. Duncan, superintendent of public schools in Oregon somewhere. These are hardly names brought to mind when the phrase "Top educators" is mentioned. This is not to disparage the two educators cited in the article, but merely to point out that they are not "Names in the News." Perhaps <i>The Enquirer</i> felt they could be called "top" people because as superintendents of schools they are at the top of the educational ladders in their communities.</p>
Read	<p>In addition to misleading the reader, the article also uses the old clichés that always sound ominous but never say anything concrete. Here are some quotes. Look for <i>facts</i> in them: "Kids were taught better and were smarter back in the old days than they are now, and our standardized tests show it." (How can you prove they were "taught better"? Smarter "back in the old days"? Standardized tests in 1906?) Another quote: "You could be assured around the turn of the century that when a person graduated from the 8th grade, he or she was at least as smart as most of the 12th graders are today, if not smarter." (Assured? How? And what is meant by "smart"?) Are there facts presented to bear all this out? No, only insinuations and opinions based on a 1906 exam given to five college students and the opinions of two educators unknown beyond their communities.</p>
Skip	<p>It's easy to blame the fault of sensationalism and slanted reporting on <i>The Enquirer</i>. But shouldn't the real blame be placed on all the millions of readers who buy such tabloids and magazines, read them as "fact" and then pass along the misleading, unfounded information to family and friends? But perhaps <i>The Enquirer</i> article is right, and students today aren't as "smart" as they were in 1906. After all, millions of people are apparently not smart enough to see <i>The Enquirer</i> for what it is.</p>
Read	<p>It's easy to blame the fault of sensationalism and slanted reporting on <i>The Enquirer</i>. But shouldn't the real blame be placed on all the millions of readers who buy such tabloids and magazines, read them as "fact" and then pass along the misleading, unfounded information to family and friends? But perhaps <i>The Enquirer</i> article is right, and students today aren't as "smart" as they were in 1906. After all, millions of people are apparently not smart enough to see <i>The Enquirer</i> for what it is.</p>

### Focusing Check

Even though you haven't *read* the article in the true sense of the word, you should be able to answer the following questions. Don't look back.

1. What is the reading selection about? (Don't just answer "*The Enquirer*.")

---



---

2. Why does the author feel that the information about testing in *The Enquirer* article is misleading?

---

---

3. What does the author think of *The Enquirer's* writing style and standards?

---

---

4. Who does the author blame for the existence and success of such publications as *The Enquirer*?

---

---

You may feel that being able to answer all four of those questions is impossible after only 40 or 50 seconds of focusing. However, if you had difficulty with them, it simply indicates that you need more practice in focusing. Let's look at the questions more closely and see why you should have been able to answer them.

1. The answer to the first question is that *The Enquirer* is an example of reporting sensationalism. The title, the first and the last paragraphs—all places you were told to focus on—give you the answer.
2. It's misleading because of the informational source—only five students were tested and yet it was made to sound like a national scandal in education (first sentence in paragraph 5)—and because of those points mentioned in the first sentence of paragraphs 6 and 7, both places you were told to focus on.
3. Both the first and second paragraphs answer this: the writing is poor, the vocabulary level low, and it's gossipy in nature.
4. The people who buy it and continue to support it. See both the opening and closing paragraphs.

After doing this exercise, you can probably see that focusing on what you are going to read requires concentration. These four steps are not meant to replace close, thorough reading, but rather they are meant to help you read better and faster when you need to read closely. Focusing literally pushes from your mind whatever else you may be thinking about and prepares you for faster reading. Try this focusing technique on all your future reading. At first it may seem awkward and more time consuming than time saving. Like any new skill you learn, the awk-

# SYSTEMATIC PREVIEWING

Previewing is a short, yet important process. Used with technical and informative materials, it is the best way to analyze a source to see how it will fit your needs, and to quickly access information. It helps in planning your reading to get the most from the time you have available.

## Four Phases Of Previewing:

### 1) Check for ease and credibility

#### Ease:

- format of material (how it's laid out)
- print size and column width
- chapter lengths
- visual organizers
- detail in the table of contents
- a possible index at the back
- references, bibliography, charts

#### Credibility:

- information on the author
- copyright date

### 2) Identify key information

- major issues or topics
- major points
- the perspective (point of view)
- key concept words
- summary information (brief reviews)

#### Places To Find Key Information:

- table of contents
- index
- preface or introduction
- the first and last parts of the first and last chapters (concept words, objectives, major points, and the perspective may all be present here)

### 3) Get a workable mental outline

- condense the top areas (or chapter) to a half a dozen or fewer parts. This will let you see which areas you may want to read together.

### 4) Decide how to proceed

- a high interest area
- an area containing the materials main contribution to the topic
- summary areas
- the beginning
- choose three top priority sections

**Purpose of Previewing:** It breaks front to back reading (passive) and makes you, the reader, more active.

## Questions For Previewing

1. What page is information on the incentive plan located?

Where did you find this information? Table of Contents? Index?

Was it provided in more than one area?

2. If you leave work for the death of a relative and you want to find out if you will still get paid, under what possible headings would you look for this information?

Were you able to locate this information in both the table of contents and the index?  
Which was more helpful?

3. As a potential new father, under what heading would you find out about your rights to a leave?

Is this information located in more than one place? If so, where?

4. If you are taking a course at the local college and it is providing information which will enhance your job performance, under what heading do you find out about receiving reimbursement for the course fee?

Is this information located in more than one place? If so, where?

Directions: Using the Table of Contents and Index on the following pages, answer the questions listed at the end of the index.

TABLE OF CONTENTS

	Page Number		
<b>CENTRAL AGREEMENT</b>		Section 5 Layoffs	17
<b>ARTICLE I - Recognition</b>	1	Section 6 Recalls	17
<b>ARTICLE II - No Discrimination</b>	1	Section 7 Ability to Perform the Work	17
<b>ARTICLE III - Union Security</b>	2	Section 8 Permanent Transfers	18
Section 1 Union Shop	2	Section 9 Promotions	19
Section 2 Payroll Deduction of Union Dues	3	Section 10 Preferential Assignments to Light Work	19
Section 3 Introduction of New Employees	4	Section 11 Shift Preference	19
<b>ARTICLE IV - Functions of Management</b>	4	Section 12 Notice of Layoff	20
<b>ARTICLE V - No Strikes or Lockouts</b>	5	Section 13 Seniority List	20
Section 1 No Strikes	5	Section 14 Seniority Preference	20
Section 2 Special Exception to No-Strike Clause	5	Section 15 Corporate-wide Seniority	21
<b>ARTICLE VI - Union Representation</b>	6	Section 16 Transfer of Seniority	21
Section 1 Bargaining Committee	6	Section 17 Skilled Trades	21
Section 2 Meetings with Bargaining Committee	6	<b>ARTICLE X - Leave of Absence</b>	24
Section 3 Stewards	7	Section 1 General	24
Section 4 Union Business During Working Hours	7	Section 2 Union Activities	24
Section 5 List of Union and Company Representatives	7	Section 3 Government Offices	25
<b>ARTICLE VII - Grievance Procedure</b>	8	Section 4 Armed Forces; Peace Corps	25
Section 1 Definition	8	Section 5 Maternity Leave	26
Section 2 Grievance Steps	8	Section 6 Educational Leave	27
Section 3 Arbitration	9	<b>ARTICLE XI - Hours of Work and Overtime</b>	28
Section 4 Time Limits and Employee Attendance	11	Section 1 The Workweek	28
Section 5 Company pay for Union Time	11	Section 2 The Workday	28
Section 6 Plant Visitation	13	Section 3 Shift Schedules	28
Section 7 Expedited Arbitration Procedure	13	Section 4 Time and One-Half Payments	29
Section 8 Special Discharge Arbitration	13	Section 5 Double Time and Time and One-Quarter	30
<b>ARTICLE VIII - Discipline and Discharge</b>	14	Section 6 Shift Changes	30
<b>ARTICLE IX - Seniority</b>	15	Section 7 No Pyramiding	30
Section 1 Definition	15	Section 8 Overtime Distribution	30
Section 2 Probationary Employees	15	Section 9 Report-in and Call-back	31
Section 3 Transfers out of Bargaining Unit	15	Section 10 Holiday Pay	31
Section 4 Termination of Seniority	16	Section 11 Attendance Bonus Day	35
		<b>ARTICLE XII - Vacations</b>	38
		Section 1 Vacation Time Off and Pay	38
		Section 2 Vacation Assignments	40
		Section 3 Terminated and Deceased Employees	40
		Section 4 Employees Transferred into the Bargaining Unit	41

BEST COPY AVAILABLE

Section 5 Scheduled Plant Shutdown for Vacations	41
Section 6 Paid Absence Allowance	42
Section 7 Vacation Bonus	43
<b>ARTICLE XIII - Wages</b>	<b>43</b>
Section 1 General Principles	43
Section 2 Schedule of Rates	44
Section 3 Application of Schedule	44
Section 4 New or Changed Classifications	45
Section 5 Standard Hour Incentive Plan	45
Section 6 Payment System	49
Section 7 Union Work Standards Representatives	54
Section 8 Incentive Standards Complaint and Grievance Procedure	56
Section 9 Cost-of-Living	59
Section 10 Shift Premiums	63
Section 11 Pay Day	63
<b>ARTICLE XIV - General Provisions</b>	<b>64</b>
Section 1 Non-Unit Employees	64
Section 2 Bulletin Boards	64
Section 3 Safety and Health	64
Section 4 Group Insurance	67
Section 5 Supplemental Unemployment Benefit Plan	68
Section 6 Designated Break Period	68
Section 7 Jury Service Pay	68
Section 8 Bereavement Pay	69
Section 9 Unenforceable Provisions	70
Section 10 Scope of Agreement	70
Section 11 Mutual Interest	70
<b>ARTICLE XV - Termination</b>	<b>71</b>
<b>CENTRAL LETTERS AND EXHIBITS</b>	<b>73</b>



## INDEX

		Page
<b>A</b>		
Ability to Perform Work	Article IX Section 7	17
Absence, Leaves of	Article X	24
Absenteeism, Alcoholism and Drug Addiction Committee	Letter of Understanding	184
Absenteeism - Overtime	Letter of Understanding	192
Agreement, Duration of	Article XV (Central)	71
	Local Supplement	175
Alcoholism	Letter of Understanding	184
Apprentice Rate	Letter of Understanding	88
Apprenticeship Affirmative Action	Letter of Understanding	89
Arbitration	Article VII Section 3	9
Arbitration, Discharge	Article VII Section 8	13
Arbitration, Expedited	Article VII Section 7	13
	Letter of Understanding	85
Armed Forces (Leaves of Absence)	Article X Section 4	25
Attendance Bonus Days	Article XI Section 11	35
<b>B</b>		
Bargaining Committee	Article VI Section 1 (Central)	6
	Article VI Section 1 (Local)	154
Bargaining Committee, Meetings with	Article VI Section 2	6
Bereavement Pay	Article XIV Section 8	69
Break Period	Article XIV Section 8	68
Break-in Period	Article IX Section 7 (Central)	17
	Article IX Section 8 (Local)	155
Bulletin Boards	Article XIV Section 2	64
<b>C</b>		
Call-Back	Article XI Section 9	31
C.A.S.E. Program	Appendix	129
C.A.S.E. Program Interpretations		151
C.A.S.E. Overtime Penalty		152
Check-Off of Union Dues	Letter of Understanding	75
Classification - New or Changed	Article XIII Section 4	45
Company Pay for Grievance Time	Article VII Section 5	11
Complaints on Incentive Standards	Article XIII Section 8	56
Corporate-Wide Seniority	Article IX Section 15	21
Cost-of-Living	Article XIII Section 9	59
Coveralls	Letter of Understanding	179
Cutter and Tool Grinding Training Program	Letter of Understanding	181

BEST COPY AVAILABLE

<b>D</b>		
Day - definition of	Article XI Section 2	28
Departments	Exhibit #3	205
Designated Break-Period	Article XIV Section 6	68
Discharge Arbitration	Article VII Section 8	13
Discipline - Absenteeism	Daily - Letter of Understanding (Local)	184
	Saturday - Letter of Understanding (Local)	192
Discipline and Discharge	Article VIII (Central)	14
Discrimination	Article II	1
Dismissal for Cause	Article VIII	14
Distribution of Stewards	Article VI Section 3	154
Double-Time	Article XI Section 5	30
Downtime - Definition	Article XIII Section 6 Para 1	53
Drill Grinding	Letter of Understanding (Local)	183
	Letter of Understanding	184
Drug Addiction	Article III Section 2	
Dues Deduction	Local Letter	193

<b>E</b>		
Educational Leave	Article X Section 6	27
Emergency Meeting	Article VIII	14
Employee Record Updates	Article IX Section 7 (Local)	159
Equal Employment Opportunity	Letter of Understanding	82
Exception to No-Strike Clause	Article V Section 2	5
Exhibit No. 1 (Central) Authorization for Check-off of Dues	Letter of Understanding	78
Exhibits (Local)		
#1 Select Classifications		201
#2 Non-Select Classifications		204
#3 Departments		205
#4 Overtime Districts		208
Expedited Arbitration	Letter of Understanding	84
	Article VII Section 7	13
Expenses - Arbitration	Article VII Section 3	9

<b>F</b>		
Flood Duty	Letter of Understanding	105
Foundry Preventive Maintenance Force	Letter of Understanding (Local)	198
Function of Management	Article IV	4
Funeral Leave	Article XIV Section 8	69

<b>G</b>		
G E L. Program	Appendix	129
General Provisions	Article XIV (Central)	64
	Article XIV (Local)	174
Government Controls, Future	Letter of Understanding	81
Grievance, Definition of	Article VII Section 1	8
Grievance Meetings	Article VI Section 2	6
Grievance Procedure Time Limits	Article VII Section 4	11
	Article VII Section 2	8
Grievance Procedure, Employee Attendance	Article VII Section 4	11
Grievances, Reinstatement	Letter of Understanding (Central)	102
	Article VII Section 2	8
Grievance Steps		
Grind, Cutter & Tool Training Program	Letter of Understanding	181
Group Insurance	Article XIV Section 4	67
Guaranteed Rate	Article XIII Section 6 Para D	49

<b>H</b>		
Health, Safety and	Article XIV Section 3 Central	64
	Article XIV Section 3 Local	174
Holiday Pay	Article XI Section 10	31
Holidays	Article XI Section 10	31
Holidays Pay Eligibility	Article XI Section 10 Para B	33
Holidays Procedure for Hours Worked on a Paid Holiday Date	Letter of Understanding	177
Holidays Work On	Article XI Section 10 Para G	34
Hourly Rate for Incentive Employees	Article XIII Section 6 Para E	50
Hours of Work and Overtime	Article XI	28

<b>I</b>		
Incentive Employees, Hourly Rate for	Article XIII Section 6	50
Incentive Plan SHP	Article XIII Section 5	45
Incentive Procedures	Article XIII Section 6	49
Incentive Standards, Complaints on	Article XIII Section 8	56
Insurance Claim Administration	Letter of Understanding	106
Insurance, Group	Article XIV Section 4	67
Introduction of New Employees	Article III Section 3	4
Inventory Procedure	Letter of Understanding	190
Inventory Rate	Letter of Understanding	190
Inventory Work Seniority Preference	Letter of Understanding	190
In Plant Election Space	Article VI Section 1	154

<b>J</b>					
Job Posting (Promotions)	Article IX Section 10	159	Plant Closings - Notification		109
Joint Safety Committee	Letter of Understanding	78	Plant Preferential Seniority Placement List		111
Journeyman Status	Letter of Understanding (Central)	90	Posting practices/Temporary Assignments/GEL		122
Jury Service Pay	Article XIV Section 7	68	Prearbitration Agenda		117
			Prearbitration Schedules		117
<b>L</b>			Retraining and Placement - Joint Committee		110
Layoff Notice of	Article IX Section 12	20	Seniority Preference - Executive Board		107
Layoffs (Procedural)	Article IX Section 5	155	Seniority Preference - U.W.S.R.		107
Leaves of Absence	Article X	24	Set-Up Standards - Steward Notification		120
Armed Forces	Article X Section 4	25	SHP Incentive System		119
Educational	Article X Section 6	27	Special Conditions Reinstete Grievances		102
Government Offices	Article X Section 3	25	Special Flood Duty		105
Maternity	Article X Section 5	26	Subcontracting - Skilled Trades - Notification		31
Peace Corps	Article X Section 4	25	Subcontracting - Committee - Skilled Trades		92
Union Activities	Article X Section 2	24	Tool Replacement		90
			Tool Security		90
			Training on New Machine Tools During Installation		83
			Tuition Refund		84
			Union Security		75
			Video Tapes, Use of		97
			Voluntary Political Contributions		115
<b>LETTERS OF UNDERSTANDING (CENTRAL)</b>			<b>LETTERS OF UNDERSTANDING (LOCAL)</b>		
Apprenticeship Affirmative Action		89	Absenteeism - Overtime		192
Apprentice Rate		88	Absenteeism, Alcoholism and Drug Addiction Committee		184
Attendance Bonus - Suspension of Time Off		127	Coveralls		179
Commitment, Letter of		94	Drill Grinding		183
Cutter and Tool Grinding Training Program		105	Foundry Prevention Maintenance Force		198
Earnings Protection Agreement		119	Grind, Cutter and Tool Training Program		181
Employee Development and Training Program		101	Inventory Procedure		190
Employee Involvement Process		99	Medical Examinations for Foundry Employees		180
Equal Employment Opportunity		82	Oilier Duties		189
Equality of Sacrifice		108	One Foreman Concept		176
Exhibit No. 1 - Authorization for Check Off of Dues		76	Procedure for Hours Worked on a Paid Holiday Date		177
Expedited Arbitration		84	Promotion Plans		194
Future Government Controls		81	Foundry Pattern Vault		188
Health and Safety		78	Repair Tractors		187
Incentive Data - Access		118	Psychologist		191
Incentive Group Change - Steward Notification		120	Rates, Fleet Truck		196
Insurance Claim Administration		106	SPS Standby - 7 Program		193
Journeyman Status (Central)		90	Union Dues Deduction		178
List of Employees and Pensioners		77	Vacation Assignments SPS, Skilled Trades and Department 245		178
Master Recall List/C.A.S.E. Program		121	Vacation Policy		
Metric Tools		88	Light Work, Preferential		19
Mutual Interests		103	Assignments to	Article IX Section 10 (Central)	
Negotiations Meetings		85	List of Company and Union		7
Negotiations Meetings		108	Representatives	Article VI Section 5	
New Technology		77	Loss (Termination) of Seniority	Article IX Section 4	16
Orientation Program		113			
Outsourcing					

Management, Function of	Article IV	4	Hourly Rate for	Article XIII Section 7	50
Maternity Leave	Article X Section 5	26	Incentive Employees	Article XIV Section 7	68
Medical Examinations for			Jury Service		
Foundry Employees	Letter of Understanding (Local)	180	Multiple Job or		
Metric Tools	Letter of Understanding	88	Machine Operations	Article XIII Section 6 Para A	11
Military Service			Paid Absence Allowance	Article XII Section 6	42
Eligibility for Vacation	Article XII Section 1 Para F	40	Probationary Employees	Article XIII Section 3 Para A	44
Emergency Duty	Article X Section 4 Para D	25	Schedules of Rates	Exhibit	216
Leave of Absence	Article X Section 1	24	Set up Rate	Article XIII Section 6	51
Training Leaves	Article X Section 4 Para C	25	Shift Premiums	Article XIII Section 10	63
Mutual Interests	Article XIV Section 11	70	Temporary Assignments	Article XIII Section 3	44
			Time and One-Half Payments	Article XI Section 4	29
			Time and One-Quarter Payments	Article XI Section 5	30
			Vacations	Article XII	38
			Vacation Bonus	Article XII Section 7	43
New Hire Rate		217	Payday	Article XIII Section 11	63
New or Changed Classifications	Article XIII Section 4	45	Pay for Grievance Time	Article VII Section 5	11
Non-Discrimination	Article II	1	Payroll Deduction of Union Dues	Article III Section 2	3
Non-Unit Employees	Article XIV Section 1	64	Peace Corps (Leaves of Absence)	Letter of Understanding (Local)	193
Notice of Layoff	Article IX Section 12	20	Permanent Transfers	Article X Section 4	25
Notification Union Business	Article VI Section 4	7	Personnel Record - Update	Article IX Section 8	18
				Article IX Section 7	17
				(Local)	159
			Physical Examination for Specific		
Other Duties	Letter of Understanding	189	Foundry Employees	Letter of Understanding	180
One Foreman Concept	Letter of Understanding	176	Plant Ventilation (Grievances)	Article VII Section 6	13
Orientation Program	Letter of Understanding	77	Policy Grievance	Article VII Section 1	8
Overtime - Cancellation	Article XI Section 8 Para 1		Preferential Assignments to	Article IX Section 10 (Central)	19
(Local)		169	Light Work	Article IX Section 10 (Local)	163
Overtime			Probationary Employees	Article IX Section 2	15
Double Time	Article XI Section 5	30	Procedures for Hours Worked		
Time and One-Half Payments	Article XI Section 4	29	On a Paid Holiday Rate	Letter of Understanding	177
Time and One-Quarter	Article XI Section 5	30	Promotion Plans		
Overtime Distribution	Article XI Section 8	167	Foundry Pattern Vault	Letter of Understanding	194
Overtime Districts	Exhibit #4	208	Repair Tractors	Letter of Understanding	188
			Promotions	Article IX Section 9	159
			Psychologist	Letter of Understanding	187
			Pyramiding	Article XI Section 7	30
Paid Absence Allowance	Article XII Section 6	42	R		
Paid Lunch	Article XI Section 3 Para C	29	Reassignment, Temporary	Article XIII Section 3	44
Pay			Recalls	Article IX Section 6	158
Attendance Bonus Days		35	Recognition	Article I (Central)	1
Bereavement	Article XIV Section 8	69		Article I (Local)	153
Cost of Living	Article XIII Section 9	59	Reinstatement of Veterans	Article X Section 4	25
Double Time	Article XI Section 5	30	Report-in and Call Back	Article XI Section 9	31
Grievance Time	Article VII Section 5	11	Representation, Union	Article VI (Central)	6
Guaranteed Rate	Article XIII Section 6	49		Article VI (Local)	154
Holiday	Article XI Section 10	31			

BEST COPY AVAILABLE

Employees Transferred into the Bargaining Unit	Article XII Section 4	41
Paid Absence Allowance	Article XII Section 6	42
Scheduled Plant Shutdown	Article XII Section 5	41
Terminated and Deceased Employees	Article XII Section 3	40
Time Off and Pay	Article XII Section 1	38
<b>W</b>		
Wages	Article XIII	43
Application of Schedule	Article XIII Section 3	44
Changing Incentives	Article XIII Section 5	48
Complaints on Incentive Standards	Article XIII Section 8	56
Cost-Of-Living	Article XIII Section 9	59
Group Incentive Guarantee	Article XIII Section 6	54
Guaranteed Rate	Article XIII Section 6	49
Hourly Rate for Incentive Employees	Article XIII Section 6	50
Incentive Standards	Article XIII Section 5	45
Multiple Job or Machine Operations	Article XIII Section 6	52
New or Changed Classifications	Article XIII Section 4	45
Probationary Employees	Article XIII Section 3 Para A	44
Schedules of Rates	Article XIII Section 2 (Central)	44
	Article XIII Section 2 (Local)	216
Set-Up Rate	Article XIII Section 6	51
Shift Premiums	Article XIII Section 10	63
Temporary Assignments	Article XIII Section 3	44
Workday	Article XI Section 2	28
Workweek	Article XI Section 1	28

*The table of contents and index were taken from the Central Agreement between J.I. Case Company, International Union United Automobile Aerospace, and Agricultural Implement Workers of America and Local Union No. 180 Racine, Wisconsin.*

## Session 6

**Materials: Handouts on SQ3R and mapping.  
Reading Magazines and Newspapers  
Davidson Speedreader II program.**

Warm up using the eyespan exercises. The reason is that now we are focusing upon comprehension and students do not normally read with a computer.

Bring in newspapers to model how to skimming, scanning and students' increased eye span is used in a daily situation.

Discuss the SQ3R handout.

Choose a newspaper article to practice the SQ3R strategy.

## Session 7

**Materials: Handouts on instant replay and mapping, Davidson Speedreader II program.**

Warm up using the computer program.

Explain that the purpose of mapping is to organize and comprehend the information that is read.. This is done **as we read**. Thus we are able to recall the information later.

Use the instant replay sentences to model and practice mapping. After mapping sentences, have students paraphrase in their own words.

Next practice using materials from the company or those from the attached list.

BEST COPY AVAILABLE

## READING FASTER AND SMARTER WITH SQ3R

Using the SQ3R approach is comparable to doing a puzzle. A person doesn't just "do" a puzzle. He or she follows steps.

1. **SURVEY.** Look for clues to the organization of the information. Detailed information can be remembered only if it is learned in relationship to more important ideas.

**Surveying is like looking at a picture of the completed puzzle to see how the end product will appear.**

- Think about the title. What do you already know about this subject? What do you anticipate learning from material with this title?
- Read the first paragraph. Here you may find the author's plan of organization. The introduction may state the topics included as well as the author's purpose for writing the material.
- Hit the headings in the material. These are the main topics or concepts that have been developed by the author.
- Check the illustrations. What ideas are presented or clarified by charts, graphs, maps, or tables?
- Read the last paragraph or the summary. A review of main ideas and conclusions may be found.

2. **QUESTION.** Questions aid in understanding by creating curiosity, giving purpose to your search, and making significant ideas more visible.

**Questioning is like constructing the frame for the puzzle and determining which and how pieces will fit together. When putting the puzzle together, you need to decide how you'll begin.**

- Turn main headings and subheadings into questions.
- Write down questions that occur to you while you're surveying the material.

3. **READ.** Now read the first section only (the material under the first heading) to actively search for the answer to your questions.

**Reading is like putting together the puzzle in sections so you begin to see how it will look as a completed task.**

4. **RECITE.** At the end of each section, look away from the material for a few seconds, recite, and think about what you've just learned. This makes a deeper imprint on your brain.

Reciting is like periodically referring back to the picture of the completed puzzle and then comparing it to what you've pieced together at those points.

5. **REVIEW.** After you've read the material section by section, you're ready to look at the total selection in order to see all the parts in relationship to the whole. This total review is the final step for organizing the information to understand and remember it.

Reviewing is like sitting back and surveying the finished picture of your puzzle while noting how each section fits together to create the whole.



# READING NEWSPAPERS AND MAGAZINES

## THE COMMUTER'S NEWSPAPER FOLD

In planes, buses, and other crowded places the commuter's fold is a great space-saver and will add to your reading efficiently because it forces you to focus on one column at a time.

1. Most metropolitan pages are six columns wide. Fold the paper or tabloid as demonstrated in the illustration below:

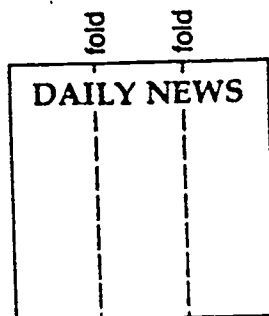

2. Read the three columns on the left side of the front page, then the three columns on the right front page.
3. After reading the front page, peel the right side of page 1 back and read three columns on the left side of page 2.
4. Unfold page 2 (six columns are now in front of you) and read the right side of page 2 and the left side of page 3.
5. Fold the paper together again and read the right side of page 3. Turn page 3 back and read the left side of page 4. Repeat throughout the rest of the paper.

Read 3 left columns, unfold to 6 columns, fold back to read 3 right columns, and so forth.

## INSTANT REPLAY PRACTICE: SHORT PARAGRAPHS (Continued)

<p>4. Making a sale can be compared to hitting a baseball. Making the sale is like getting a homerun. You go to bat and take your swings. Sometimes you hit the ball and sometimes you don't.</p>	
<p>5. Functional illiteracy hurts business. Millions of people can't read or write well enough to fill out a job application, understand the label on a medicine bottle, or exercise the responsibilities of citizenship.</p>	
<p>6. Millions of functionally illiterate employees are costing their companies the expenses associated with low productivity, workplace accidents, absenteeism, poor product quality, and lost management and supervisory time.</p>	

A good method of strengthening your comprehension skills is to read an article in the newspaper in the morning and jot an instant replay of it on a pad of paper. In the evening tell it to someone using your instant replay as a guide. This process will become more comfortable with practice.

# STEPS FOR MAPPING IDEAS

After applying the strategies of previewing and then skimming or reading the material, you'll want to develop a method of recording key information to aid in remembering it. There are several terms used for such a technique. Some examples are schematic mapping, fishboning, flow charts, and idea mapping. Think of documenting ideas as a blueprint of the material. Steps to follow in mapping are:

- 1) Identify the *central idea/overall point* of the material. Center that on the page, in a circle.
- 2) Identify *sub-topics*. Put them in circles surrounding the center one.
- 3) Identify points important to you or the writer.
- 4) Diagram relationships of points and topics.

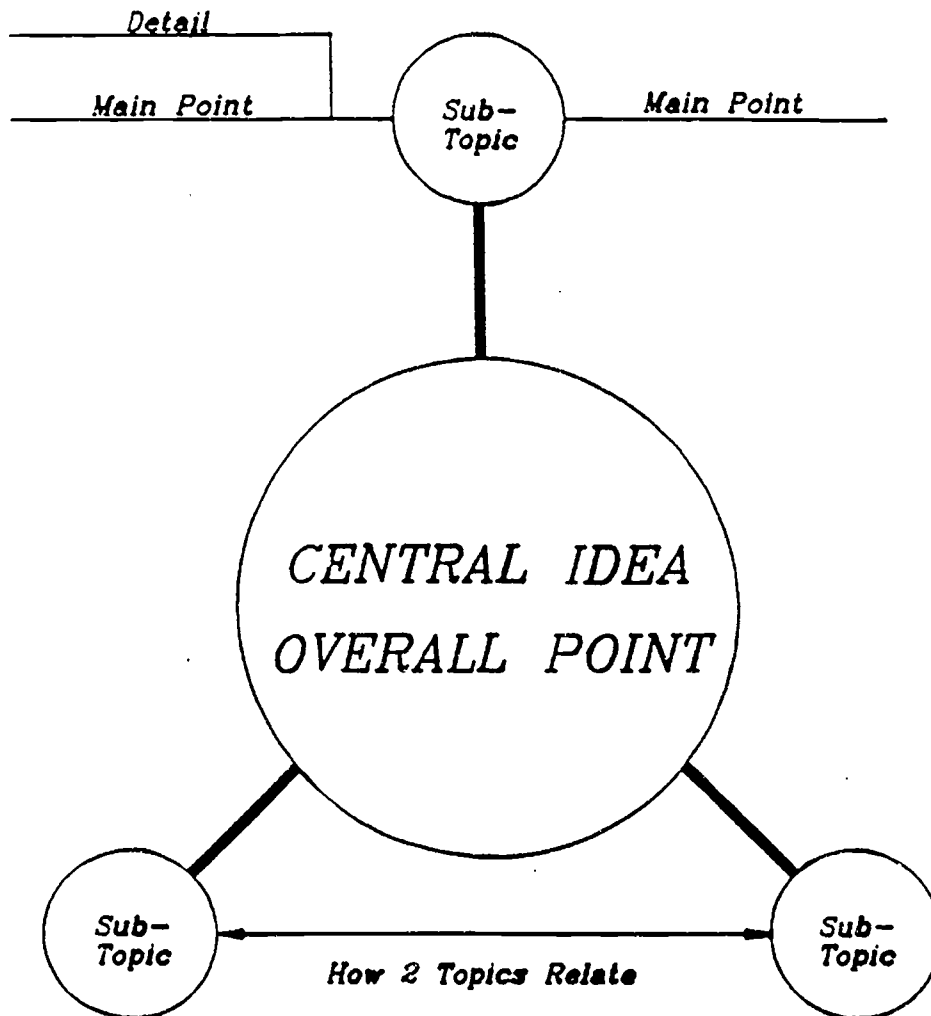

BEST COPY AVAILABLE

**Directions:** This chart will help you to limit a topic. Begin by writing your topic in the box at the top of the chart (left side of page). Then think of two limited topics related to it. Write these in the two boxes at the next level. Think of two limited topics that are related to each of the two topics you just listed. Write these in the four boxes at the next level. Think of two limited topics that are related to each of the four topics you just listed. Write these in the eight boxes at the next level. Write your final topic in the space provided.

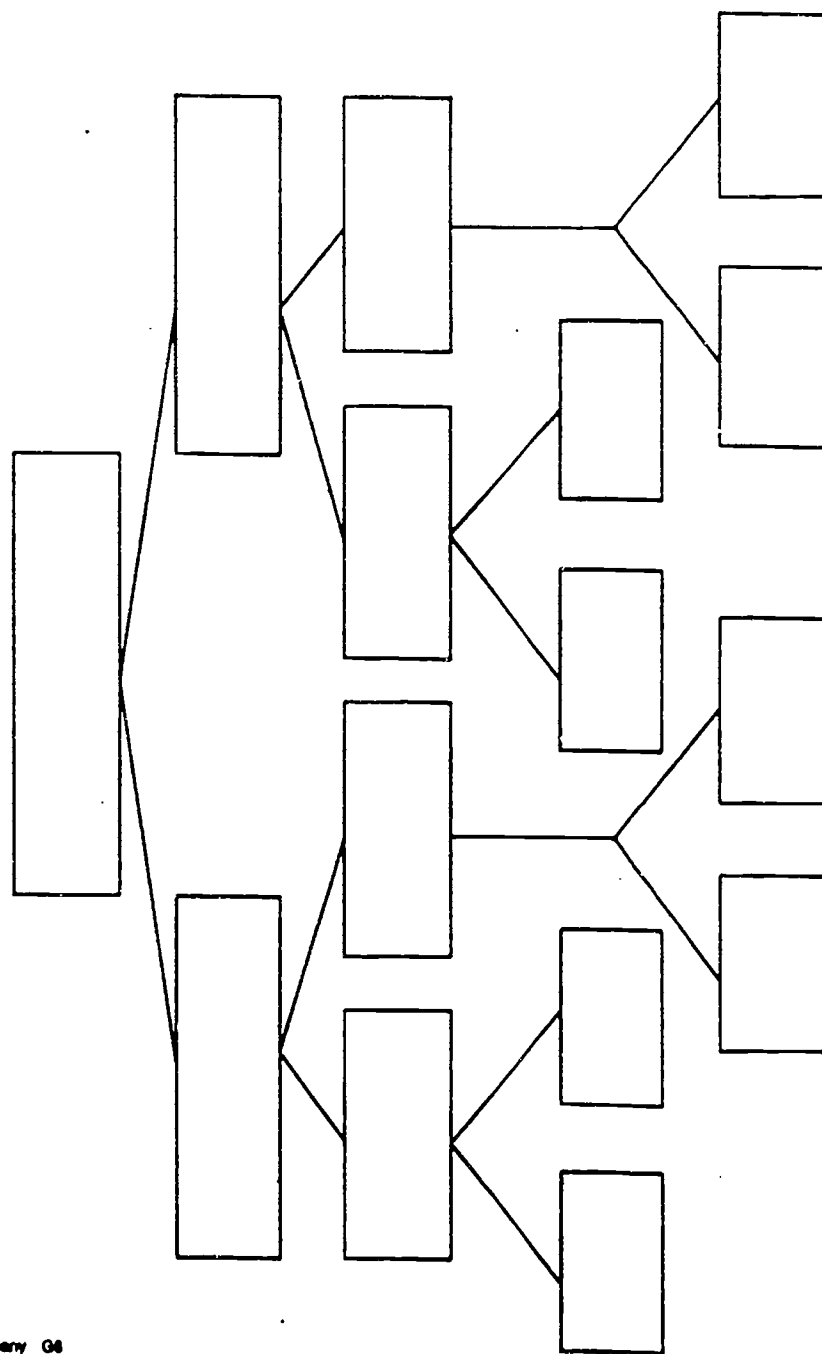

Topic: \_\_\_\_\_

**Directions:** Clustering will help you organize details for your composition. Begin by writing your topic in the circle. Then think of four ideas about your topic that you want to write about. Write these in the first space at the end of each of the four lines. (If you have more than four ideas, you can add lines.) Then think of two details that relate to each of the four ideas. Write these at the end of the two branches at the end of each line. (If you have more than two details, you can add lines.) Each cluster of ideas can be used in a separate paragraph.

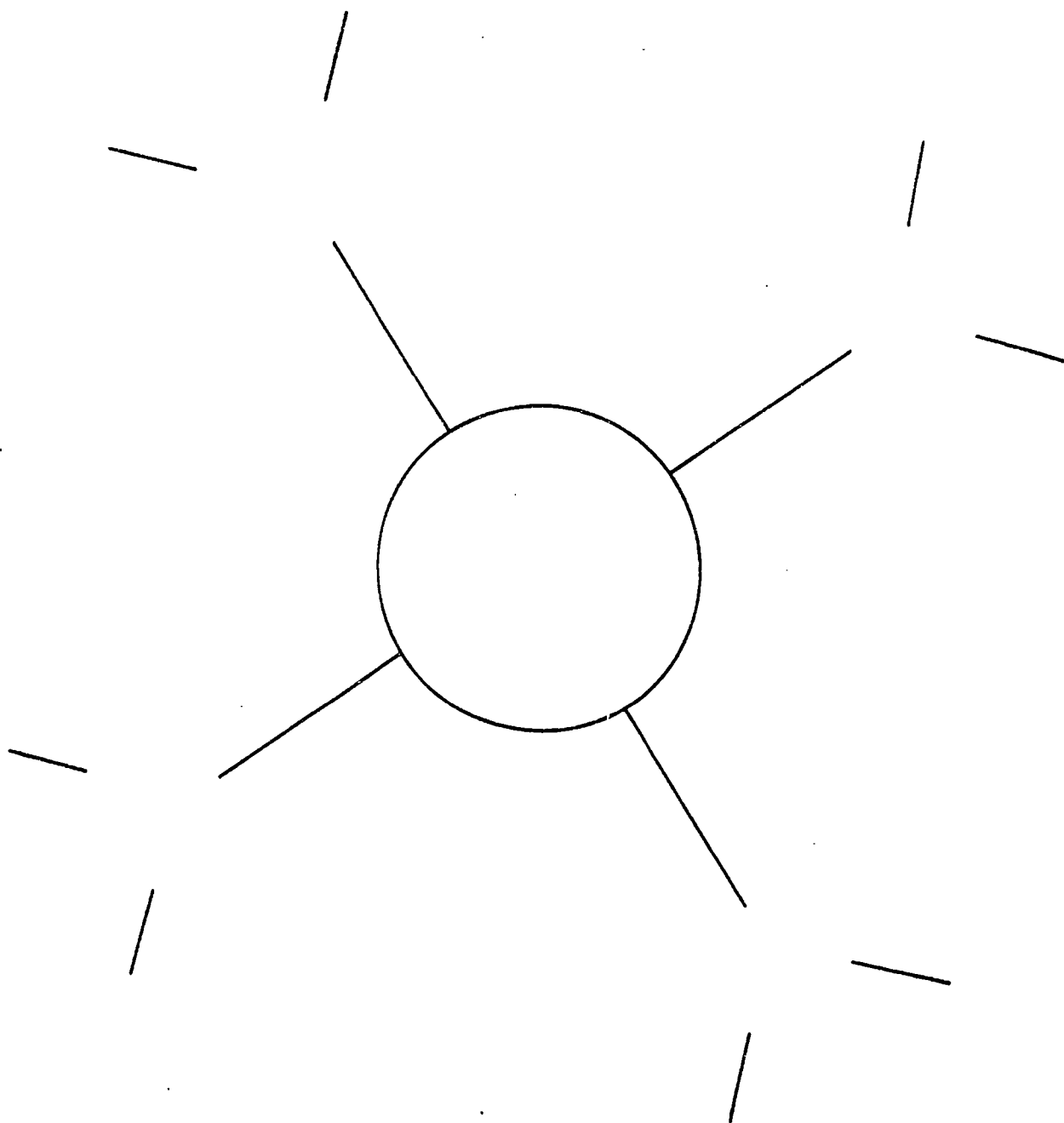

The two attached course summaries may be used for mapping practice. The map format should be decided **with the students**. The skills review is self explanatory. The second example can be used to organize information. Listed below is information from the course and can be organized into a map format.

fixations	regressions
skim	glance through a selection for headings
know the vocabulary	
is there an introduction	
periphial vision	
scanniing	
SQ3R	purpose
divide into sections	
adjust your speed	practice regulary
who, what, when. where	
reflect upon what you've read at the end of a section	
what do character's conversations reveal?	
introduction	summary

# SPEED-READING SKILLS REVIEW

Try to reflect on materials you read and organize. Ask yourself, "What are the main points of speed-reading? There are four aspects to be remembered." Elaborate and use the patterns for a guide when you're teaching a friend.

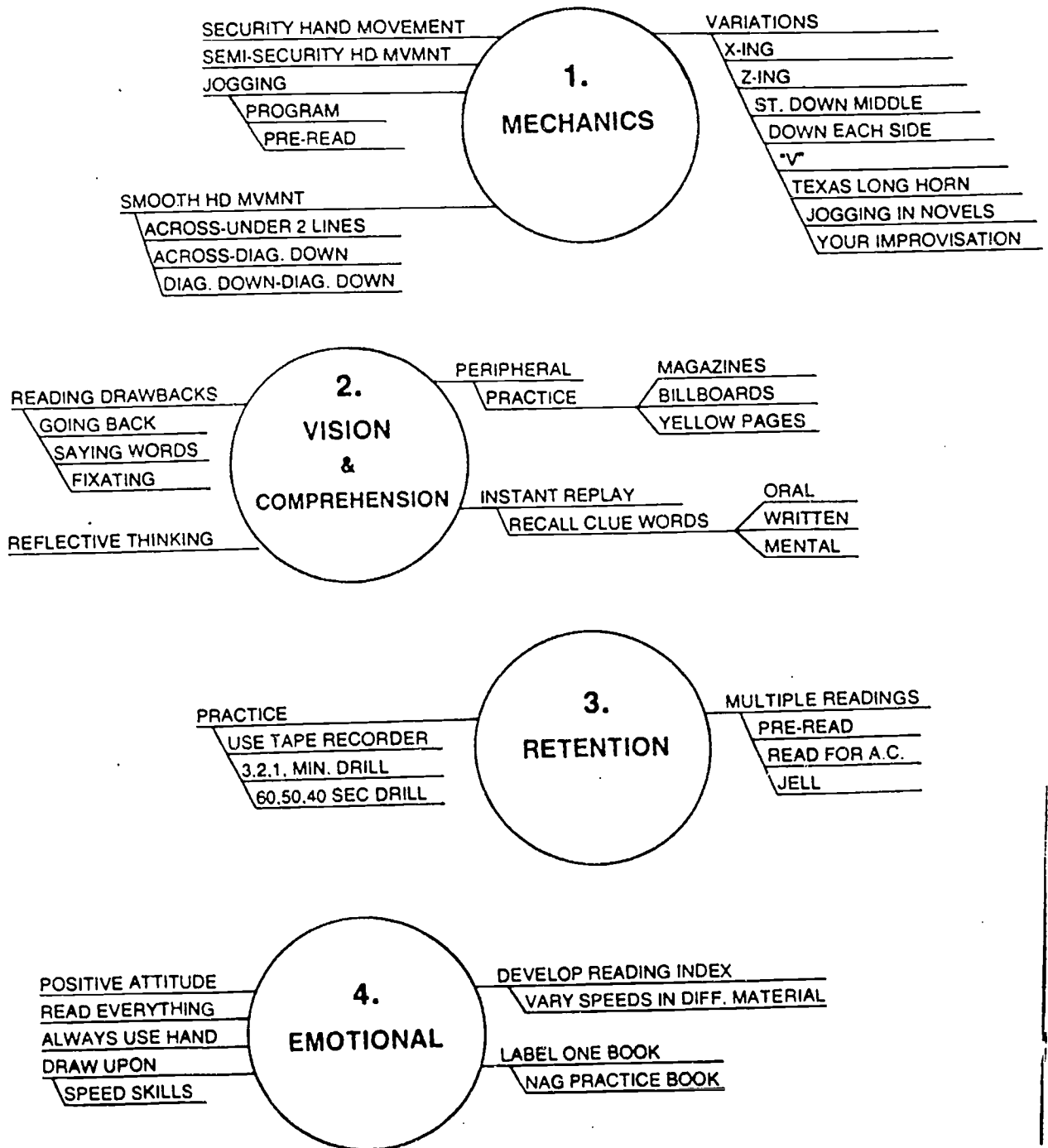

# SPEED-READING SKILLS REVIEW

Try to reflect on materials you read and organize. Ask yourself, "What are the main points of speed-reading? There are four aspects to be remembered." Elaborate and use the patterns for a guide when you're teaching a friend.

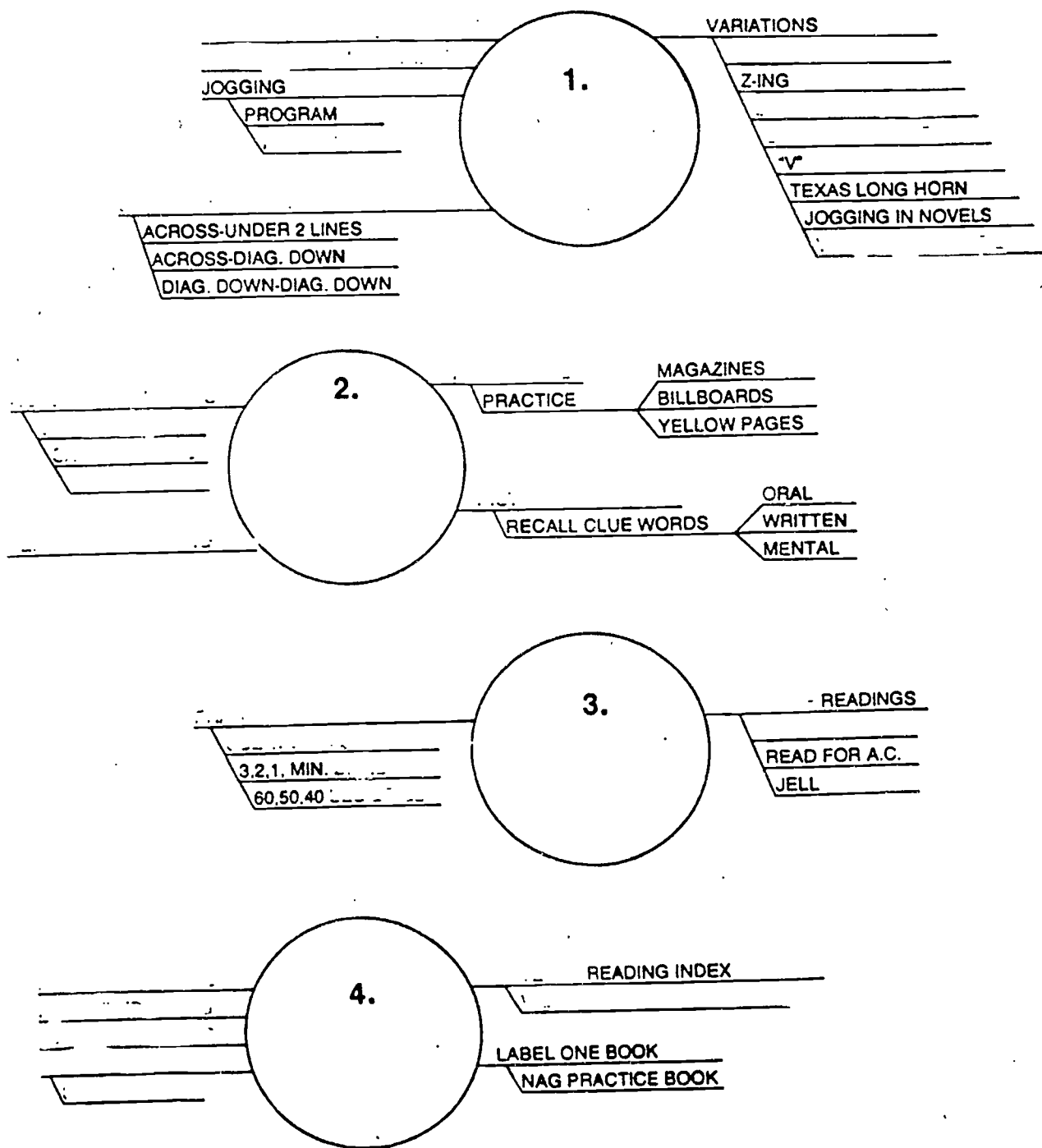



Listed below is instructional information for the attached articles.

The selections chosen are topics of interest to most students and the information presented is not familiar. Comprehension questions are included. These present a challenge to students to apply their speedreading skills and practice comprehension strategies.

"Action! The Stuntman's Call to Duty" use to practice rate and the focus strategy and skimming and scanning

"Custer Died for Your Sins" use to practice the focus strategy

"How do You Master the In Basket?" use for reading rate 848 words in the selection

"Shark Tagging Spectacular" practice the focus strategy,skimming and scanning

"The Enquirer: Sensationalism Personified" model the focus strategy.

"What is an Eyeful" practice reading rate 754 words

"Why Procrastinate?" reading rate 754 words

Wright Brothers reading rate 454 words.

ACTION! THE STUNT MAN'S CALL TO DUTY / Michael Tennesen

( 1 ) It's still dark as the stunt man passes through the studio gates, arriving on the set in the early morning hours.

( 2 ) While his make-up is being applied, he reads the script. Looks like a normal day ahead. At about 10 a.m. he's due to be beaten by three heavies and then tossed through a plate glass window. At about mid-day, he'll take a dive off a five-story building. And later, by evening light, he and his clothing will be set on fire.

( 3 ) Already this week he has been hit over the head with a bottle, struck by a moving car, punished with a bull whip and shot numerous times. He took a bad spill off a motorcycle last Friday, roiled his car on Monday and fell from a 50-foot bridge on Tuesday. But with all these

From *Rainbow Magazine*. Reprinted by permission.

*Five Ways to Develop Vocabulary*

calamities, he still maintains his spirit, singing "There's No Business Like Show Business," all the way to the bank—and for good reason.

( 4) Stunt men get \$225 a day just for showing up. Then they're paid extra for each stunt performed. For the fall, our stunt man will make about \$10 a foot or \$500 for a 50-foot dive. To be transformed into a human torch, he'll make in the neighborhood of \$1,800. At those rates, he can take home as much as \$4,000 for a single day's work.

( 5) In Hollywood, whenever the action gets rough, the stunt man is called to duty. Forget all those stories you've heard about Burt Reynolds, Paul Newman and Steve McQueen doing their own stunts. Most Hollywood productions cost in the neighborhood of \$40,000 a day. Claims stunt man Ron Kelly: "If a production gets held up because the star got hurt doing his own stunt, then the insurance company has to pay that money. Believe me, they don't allow the stars to do anything dangerous."

( 6) So it's the stunt man who takes the risks, though few of them like to think of themselves as risk-takers. Most try to engineer the risk *out* of the stunt. Claims Rick Baker, an active Hollywood stunt man: "There's a lot of homework involved in film stunts. We look at each stunt analytically. Some of them even get run through a computer."

( 7) It wasn't always that way, though. Back in the silent film days it was not unusual for a cameraman and a stunt man to drive the streets looking for burning buildings from which to fall. Stunt men would tumble from cars in Hollywood traffic and dodge through—sometimes even under—screaming sedans to get the real-life drama.

( 8) But then a few of the more prominent stunt men began to insist on some safety and common sense. One of these stunting pioneers was Yakima Canutt, a former world champion rodeo cowboy, who used to double for John Wayne. Canutt came to Hollywood when stunt men were paid \$2 a day and \$2 a fall. It was through the efforts of Canutt and other dedicated stunt men that the pay got better and the conditions safer. In 1966, Canutt was awarded an honorary Oscar, the only one ever given a stunt man, for his efforts to instill safety in the business.

( 9) In his later years, Canutt worked as a stunt coordinator, setting up difficult stunts and hiring persons to do the work. Canutt coordinated the big chariot race in "Ben Hur," still considered one of Hollywood's grandest stunt performances. In that scene, Canutt's son, Joe, doubling for Charlton Heston, rode the chariot as it was catapulted over two other furious racers.

(10) For Joe, getting into the inner circle of the Hollywood stunt world was easy. After all, he was Yakima Canutt's son. For others, that introduction has come a lot harder.

BEST COPY AVAILABLE

(11) Greg Anderson, an active stunt man, left his home in Wisconsin and came out to Hollywood some 13 years ago. He spent time doing industrial safety films but had a rough time getting stunt work. Says Greg: "There are a few stunt men organizations in town, but they're pretty tight groups. If you're not a cousin or relative of one of the members, they won't let you in the door." Greg finally turned the lock by financing a documentary about stunt men in which he starred. "Most of my work was instigated by that film," Greg claims.

(12) Stunt work requires both agility and versatility. "As a stunt man, you have to know how to do most anything that has to do with action," claims Greg. "You must know how to drive cars and motorcycles, take high falls, ride horses, climb mountains, dive under water, work with swords and bull whips and make a fight look realistic."

(13) Setting up a fight scene is one of the basic elements of the stunt business. In reality, stunt men don't make contact with each other during a fight. The punch usually misses by as much as a foot. Only the camera angle and the reaction of the stunt man receiving the punch make it look real.

(14) Still it's not always peaches and cream. When we ran into Greg recently, he was sporting a black eye he'd received in a stunt fight. Says Greg: "The other guy didn't have enough experience. He didn't know what he was doing."

(15) We asked Greg and several other stunt men what were the easiest stunts. Their replies were unanimous: "There are no easy stunts." Still, several of them had ideas about the more difficult stunts, one of which was the fire stunt. Rick Baker worked on the set of "The Towering Inferno" and was set on fire several times.

(16) For that stunt, he had to wear a special asbestos suit fitted with oxygen bottles. His face was covered with two masks, and over all this was applied a burn gel. Though this outfit can stop the flames from burning the skin, it does not stop the heat generated by the flames, and a stunt man can only withstand about 40 to 60 seconds of heat that intense. "After that, your sweat starts to turn to steam," says Rick, "and that will burn you faster than the fire."

(17) Another of the more dangerous stunts is the high fall, and Rick admits to a fear of heights when he first began stunt work. "I'd stand up on the edge of the building and say to myself, 'OK, let's go. You've got to do this...right now.' If that didn't work, I'd start thinking about the money: 'Well, what are we going to make off this, \$400?' That usually did the trick."

(18) Rick has worked in a variety of films, but perhaps one of his most unusual assignments was as a stunt man on the set of Irwin Allen's "The Swarm," a story about an invasion of killer bees. Twenty people

*Five Ways to Develop Vocabulary*

worked round the clock during the production to individually clip the stingers off over a million bees used for that film.

(19) "Still, the stunt men kept getting bit," claims Rick. "It seems about one percent of the bees were getting past the clippers. With a million bees, that meant a thousand of them were flying around with their stingers still intact."

(20) To dodge stinging bees and to execute the falls and fights expected of him, a stunt man must be in excellent physical condition. Ron Kelly presently works in the Stunt Man Show at Universal Studio Tours in Los Angeles, where he gets whipped, beaten and shot off a building at least five times a day. According to Ron: "You have to stay in shape to do this kind of stuff. In stunt work, your hands, arms and body are the tools of your trade, and like a carpenter or a mechanic, you have to keep those tools in good condition."

(21) According to Ron: "Hollywood has no schools to teach stunt work." Ron learned his skills from stunt man Bill Williams. Williams was killed in 1964 on the set of "Hallelujah Trail," when he was crushed under a wagon, and that experience made Ron a lot more cautious. "It made me aware of my own mortality," he says.

(22) Fears of mortality have long kept the stunt world a society "for men only." It used to be that when the show required a double for an actress, the stunt was performed by a man dressed up in women's clothing. But these days women have become active in the trade. One stunt woman who has become famous is Kitty O'Neil.

(23) Kitty has been deaf since infancy, but her disability hasn't hurt her work. "Being deaf helps a lot," she claims. "I can concentrate better and focus on the physical movements. I can feel the vibes before I do a stunt and know if it's not right."

(24) Kitty's life was the subject of a film starring Stockard Channing, called "Silent Danger." Kitty's not the only stunt person to see her name in lights. Burt Reynolds and Michael Landon both started out as stunt men. Hal Needham, who was Burt Reynolds' double for years, began as a stunt man and now directs films. He shot "Smokey and the Bandit" and is now working on a sequel to that picture. Between directing and stunting, Hal claims: "I make more money than I ever knew they printed."

(25) More than just money is in the future of stunt work. "As technological developments grow and computers get larger, the stunts are going to get grander," claims stunt man Rick Baker. "The heights will get higher, the car crashes more spectacular and the bridge jumps wider."

(26) Rich feels the main concern, however, will always be safety. Rick still carries around an X-ray of his most serious injury, a broken

BEST COPY AVAILABLE

## INCREASING READING SPEED

shoulder. "Was it from one of your high falls?" he was asked. "No," he answered, smiling. "I broke it in a neighbor's living room trying to show some kids how to take a fall."

Record your finishing time: \_\_\_\_\_ mins. \_\_\_\_\_ secs.

Subtract your starting time: \_\_\_\_\_ mins. \_\_\_\_\_ secs.

Total reading time: \_\_\_\_\_ mins. \_\_\_\_\_ secs.

Turn to the Reading Rate Conversion Chart on page 334 for your rate: \_\_\_\_\_ WPM.  
Record your rate on the Student Record Chart on page 340.

### *Part 3: Increasing Comprehension and Vocabulary*

*Directions:* Answer the following questions without looking back at the article.

## COMPREHENSION

- The article is about
  - the changes in film stunt safety
  - the danger of being a stunt man
  - the life of film stunt men
  - Yakima Canutt and Kitty O'Neil
- The main idea of the article is that
  - stunt men get paid well
  - there are men and women stunt performers
  - stunt men get hurt frequently
  - stunt performers live a life of dangerous action
- Doing stunts in Hollywood today is not as safe as it was back in the silent film days because people expect bigger, more spectacular stunts.
  - True
  - False because \_\_\_\_\_
- It is difficult today to get into the stunt trade.
  - True
  - False because \_\_\_\_\_
- A stunt man can take home as much as \_\_\_\_\_ a day.
  - \$225
  - \$500

BEST COPY AVAILABLE

- c. \$1800
- d. \$4000
- 6. Circle all the items below a stunt man must know how to do
  - a. drive cars and motorcycles
  - b. climb high mountains and take high falls
  - c. dive under water
  - d. make sword and fist fights look real
- 7. What was dangerous about doing stunts for the movie *The Swarm*?

---

---

---

- 8. We can infer from the article that most stunt men are probably in the trade for the money.
  - a. True
  - b. False because \_\_\_\_\_
- 9. We can infer that the author probably has respect for the stunt man.
  - a. True
  - b. False because \_\_\_\_\_
- 10. It can be concluded that as technology grows and computers get larger, the stunts are going to get more spectacular.
  - a. True
  - b. False because \_\_\_\_\_

*SELECTION—"Action: The Stunt Man's. . . ."*

*Comprehension*

(1) c (2) d (3) b; because there were no safety standards; see paragraphs 7 and 8 (4) a; see paragraph 11 (5) d; see paragraph 4 (6) all; see paragraph 12 (7) even though the bees' stingers were clipped, over 1,000 escaped with stingers; see paragraph 19 (8) a; see paragraphs 4, 17, and 24 (9) a; the article says nothing negative about stunt men or what they do (10) a; see paragraph 25.

*Part 2: Increasing Reading Speed*

*Directions.* Use the following reading \_\_\_\_\_ as a means to check your present reading rate. Time yourself or have someone time you. Always keep track of the minutes and seconds it takes you to read all the selections in this book.

\_\_\_\_\_

Begin timing. Starting time: \_\_\_\_\_ mins. \_\_\_\_\_ secs.

CUSTER DIED FOR YOUR SINS / Vine Deloria, Jr.

( 1 ) The most popular and enduring subject of Indian humor is, of course, General Custer. There are probably more jokes about Custer and the Indians than there were participants in the battle. All tribes, even those thousands of miles from Montana, feel a sense of accomplishment when thinking of Custer. Custer binds together implacable foes because he represented the Ugly American of the last century and he got what was coming to him.

( 2 ) Some years ago we put out a bumper sticker which read "Custer Died for Your Sins." It was originally meant as a dig at the National Council of Churches. But as it spread around the nation it took on additional meaning until everyone claimed to understand it and each interpretation was different.

Reprinted with permission of Macmillan Publishing Co., Inc., from *Custer Died for Your Sins*, by Vine Deloria, Jr. Copyright © 1969 by Vine Deloria, Jr.



( 3) Originally, the Custer bumper sticker referred to the Sioux Treaty of 1868 signed at Fort Laramie in which the United States pledged to give free and undisturbed use of the lands claimed by Red Cloud in return for peace. Under the covenants of the Old Testament, breaking a covenant called for a blood sacrifice for atonement. Custer was the blood sacrifice for the United States breaking the Sioux treaty. That, at least originally, was the meaning of the slogan.

( 4) Custer jokes, however, can barely be categorized, let alone sloganized. Indians say that Custer was well-dressed for the occasion. When the Sioux found his body after the battle, he had on an Arrow shirt.

( 5) Many stories are derived from the details of the battle itself. Custer is said to have boasted that he could ride through the entire Sioux nation with his Seventh Cavalry and he was half right. He got half-way through.

( 6) One story concerns the period immediately after Custer's contingent had been wiped out and the Sioux and Cheyennes were zeroing in on Major Reno and his troops several miles to the south of the Custer battlefield.

( 7) The Indians had Reno's troopers surrounded on a bluff. Water was scarce, ammunition was nearly exhausted, and it looked like the next attack would mean certain extinction.

( 8) One of the white soldiers quickly analyzed the situation and shed his clothes. He covered himself with mud, painted his face like an Indian, and began to creep toward the Indian lines.

( 9) A Cheyenne heard some rustling in the grass and was just about to shoot.

(10) "Hey, chief," the soldier whispered, "don't shoot, I'm coming over to join you. I'm going to be on your side."

(11) The warrior looked puzzled and asked the soldier why he wanted to change sides.

(12) "Well," he replied, "better red than dead."

(13) Custer's Last Words occupy a revered place in Indian humor. One source states that as he was falling mortally wounded he cried, "Take no prisoners!" Other versions, most of them off color, concentrate on where those \*\*\*\* Indians are coming from. My favorite last saying pictures Custer on top of the hill looking at a multitude of warriors charging up the slope at him. He turns resignedly to his aide and says, "Well, it's better than going back to North Dakota."

(14) Since the battle it has been a favorite technique to boost the numbers on the Indian side and reduce the numbers on the white side so that Custer stands out as a man fighting against insurmountable odds. One question no pseudohistorian has attempted to answer, when changing the odds to make the little boy in blue more heroic, is how

what they say were twenty thousand Indians could be fed when gathered into one camp. What a tremendous pony herd must have been gathered there, what a fantastic herd of buffalo must have been nearby to feed that amount of Indians, what an incredible source of drinking water must have been available for fifty thousand animals and some twenty thousand Indians!

(15) Just figuring water-needs to keep that many people and animals alive for a number of days must have been incredible. If you have estimated correctly, you will see that the Little Big Horn was the last great *naval* engagement of the Indian wars.

(16) The Sioux tease other tribes a great deal for not having been at the Little Big Horn. The Crows, traditional enemies of the Sioux, explain their role as Custer's scouts as one of bringing Custer where the Sioux could get at him! Arapahos and Cheyennes, allies of the Sioux in that battle, refer to the time they "bailed the Sioux out" when they got in trouble with the cavalry.

(17) Even today variations of the Custer legend are bywords in Indian country. When an Indian gets too old and becomes inactive, people say he is "too old to muss the Custer anymore."

---

Record your finishing time: \_\_\_\_\_ mins. \_\_\_\_\_ secs.

Subtract your starting time: \_\_\_\_\_ mins. \_\_\_\_\_ secs.

Total reading time: \_\_\_\_\_ mins. \_\_\_\_\_ secs.

Turn to the Reading Rate Conversion Chart on page 334 for your rate: \_\_\_\_\_ WPM.  
Record your rate on the Student Record Chart on page 340.

### *Part 3: Increasing Comprehension and Vocabulary*

*Directions:* Answer the following questions without looking back at the article. Circle the best answer.

#### COMPREHENSION

1. The subject of the reading selection is
  - a. Indian battles
  - b. Custer and the Little Big Horn battle
  - c. incorrect Indian history
  - d. Indian humor regarding Custer

2. The main idea of the reading selection is that
  - a. the most popular subject of Indian humor is Custer
  - b. there is historical disagreement regarding Custer
  - c. Custer was incompetent and highly overrated
  - d. Indians have been misrepresented
3. To the Indians, Custer represents the Ugly American of the last century.
  - a. True
  - b. False because \_\_\_\_\_
4. According to the author, the original meaning behind the bumper sticker "Custer Died for Your Sins" got lost as it gained more popularity.
  - a. True
  - b. False because \_\_\_\_\_
5. The original meaning behind the phrase "Custer Died for Your Sins" was a dig at the Indians put out by the National Council of Churches.
  - a. True
  - b. False because \_\_\_\_\_
6. Custer's death at the Little Big Horn battle is regarded by some Indians as the blood sacrifice needed for the U.S. government's atonement, since it broke the peace treaty.
  - a. True
  - b. False because \_\_\_\_\_
7. Explain this statement from the reading selection: "When the Sioux found Custer's body after the battle, he had on an Arrow shirt."
 

\_\_\_\_\_

\_\_\_\_\_

\_\_\_\_\_

8. We can infer from the selection that the author feels historians have given an accurate account of the number of Indian warriors at the battle of the Little Big Horn.
  - a. True
  - b. False because \_\_\_\_\_
9. Why does the author call a battle that took place on the Plains "the last great *naval* engagement of the Indian wars"?
  - a. Because the battle took place in and around a river.
  - b. Because he feels the number of Indians historians claim were in the battle is grossly overestimated.
  - c. Because the Plains was "a sea" of Indian warriors.
  - d. He doesn't say that.

10. We can conclude from the way the author writes that he sympathizes with the Indians.
- True
  - False because \_\_\_\_\_

—“Custer. . . .”

*Comprehension*

(1) d (2) a; see paragraph 1 (3) a; see paragraph 1 (4) a; see paragraphs 2 and 3 (5) b, because the Indians were spoofing the National Council of Churches; see paragraph 2 (6) a; see paragraph 3 (7) Arrow is a brand name for a shirt company; a double meaning is used since Indians probably filled Custer's shirt with real arrows. (8) b, see paragraphs 14 and 15 (9) b; see paragraph 15 (10) a; he is an Indian.

The cartoonist who portrayed an American businessman "clearing his desk" at four p.m. by sweeping off everything into the wastepaper basket was simply stating in a humorous way what is often not especially funny. A pertinent question: *Is there any solution to this increasingly vexatious problem of the daily mail?*

An obvious and sensible line of action is often overlooked. The way to master an in-basket is not through plodding persistence. Instead, it is through increased skill—specifically, increased reading skill.

Correspondence, memorandums, reports, newspapers, trade and professional publications, not to mention direct mail advertising material, all can be dealt with much more efficiently each day if you acquire this skill.

You may go about it in two ways: one, by increasing reading speed; two, by increasing reading flexibility.

Before considering the steps which will lead toward fast and flexible reading one point might be stressed.

*Useless printed and written material not only clutters up desks but also clutters up minds.*

Some of the material entering an in-basket therefore needs to be rejected completely. This process permits no time for dawdling. Useless stuff should be dealt with promptly and without a second thought.

Rejection may not necessarily mean the wastepaper basket. Perhaps somebody else will be interested in seeing the latest statistics on imported cowbells from Ruritania. If so, then that information should by all means be routed on to the person who will appreciate it.

Other material may gain a tentative consideration but be put aside for later perusal. This is a fine idea if used in moderation. Experience shows, however, that if you let deferred material pile up too high, nothing will ever be done about it.

Still other material needs to be read at once,

#### HOW TO MASTER AN IN-BASKET

The distinguished British official finally retired "full of honors and of years," according to a recent newspaper account. His former associates were in for a shock, however. A routine house-cleaning turned up a batch of important papers stuffed under the office rug!

Perhaps this official shouldn't be judged too harshly. Every executive has undoubtedly been tempted upon occasion to get rid of some of his own business correspondence in just such a fashion.

When an in-basket begins to threaten you, any number of desperate measures may be taken.

rapidly and with understanding so that intelligent action may be taken. This is the material which demands skill in reading, and skill comes only with practice.

Practice, in this case, means reading a wide selection of printed material systematically, at varying levels of difficulty, accurately timed and with careful checks on comprehension.

Some businessmen have decided to go back to school to find the quick-reading way of battling a basket. Speed reading courses for adults have thus been flourishing on college campuses, in the so-called commercial reading laboratories, and in company in-service training programs.

Happily, these courses for the most part produce fruitful results.

Group work has certain advantages. Individuals are stimulated to compete with others, in spite of the fact that they are competing against their own scores and not with the scores of anybody else.

A disadvantage of the formal classroom is that the businessman as student often expects too much. He may literally lean back in his chair facing the instructor with a belligerent attitude of: "All right, now teach me!"

The despair of reading specialists is the businessman-student who practically demands to be taught to read at up to 10,000 words a minute. And with perfect comprehension to boot. He may have a friend named Jones who can actually read this fast (or claims as much) and if Jones can do it, so can he.

Publicity about reading courses often encourages dreams of supersonic speeds. Median scores are rarely reported in newspapers, radio and television, but instead the sky-high scores of the whiz in the class who can analyze an entire book before anybody else can take the stiffness out of the binding.

Moreover, such reports are likely to be accurate. Some people *can* read certain material at 10,000 words a minute—and double that, upon

occasion—with comprehension adequate for the particular task.

But these sensational results are obtained by exceptional individuals, who have the knack and skill of moving down a page of print like a brilliant broken-field runner on a football field.

Although most businessmen exposed to reading training, either on their own or in the classroom, respond well they ordinarily do not reach in ten easy lessons a cherished 10,000 w.p.m., if they ever reach it at all.

Individual reading rates will, however, often double and sometimes triple and quadruple.

For example, executive personnel at the Humble Oil and Refining Company, in Houston, Texas, entered a training program with a median score of 280 words per minute, and 77.3 per cent comprehension.

At the end of a few weeks, they were reading at a median of 554 w.p.m. Comprehension rose to 87.5 per cent.

A beginning class of adults at the Pace College Reading Laboratory tested initially at a median of 260 w.p.m., with 70 per cent comprehension. After a few weeks, they were reading at 460 w.p.m., with a comprehension level of 85 per cent.

Available data show that about fifty per cent of the gains made in these classes were still held a year after training ended.

These figures are fairly representative. Other groups in classrooms across the nation could match and some could even better these scores.

Individuals working conscientiously on their own in reading can also compare their scores favorably with the classroom groups.

Some executives begin their reading speed-up campaign by having their secretaries screen out useless material. The secretaries also highlight important ideas in required reading matter by using a red pencil to underline main points and principal passages.

An efficient reader, however, can do both

these tasks for himself, employing both his eyes and his brain.

Now for a rapid run-down on the steps to follow for better and faster handling of printed, typed, or handwritten material.

1. **Discriminate.** Select the material which requires attention, and reject firmly the useless. Route information to others if it is appropriate to do so.

2. **Practice.** Learn to speed up in reading by timing your performance and keeping a record.

3. **Adjust.** Be flexible in your approach to various kinds of reading material found in your in-basket as well as to various levels of difficulty.

A conscious application of these three plans for action will soon demonstrate who is the master in your office, the in-basket—or you.

848 words      Time in seconds \_\_\_\_\_

Directions: Select the best answer and place the appropriate letter in the parentheses.

1. A sensible solution for the incoming mail problem in a business office is to (a) stuff important papers under the rug; (b) sweep off everything into the wastepaper basket at 4 P.M.; (c) speed up your reading; (d) all of these. ( )

2. Another possibility for efficient handling of daily mail is to (a) let printed material pile up for later perusal; (b) route certain material on to people who will appreciate it; (c) take time to mull over the correct action; (d) use a sharp letter opener. ( )

3. The mythical country of Ruritania, mentioned by the writer, supposedly exports (a) wood-blocks; (b) triangles; (c) cymbals; (d) cowbells. ( )

4. Improving reading skill through classroom work has the advantage, according to the writer, of (a) stimulating progress through apparent competition with the group; (b) direct competition with the reading speed of others in the group; (c) shifting the burden of learning to an instructor; (d) shifting the burden of learning to a machine. ( )

5. You might infer from reading this article that a reading speed of up to ten thousand words per

minute is (a) easy; (b) not possible; (c) possible, but not probable; (d) harmful to the eyes. ( )

6. The name of the oil company mentioned as having a reading program for executives is (a) Humble; (b) Texas; (c) Shell; (d) Standard. ( )

7. According to the article, after a period of training individual reading rates will often (a) double; (b) triple; (c) quadruple; (d) any one of these. ( )

8. Secretaries are likely to be helpful to the executive in his reading speed-up campaign by (a) throwing away all mail; (b) reading all mail; (c) underlining important passages; (d) taking a course in speed reading. ( )

9. One plan of action for battling an in-basket not mentioned in this article is to (a) discriminate; (b) practice; (c) resign; (d) adjust. ( )

10. The distinguished official described in the opening of this article was (a) American; (b) British; (c) French; (d) Ruritanian. ( )

1. C  
2. b  
3. d  
4. a  
5. C  
6. a  
7. d  
8. C  
9. C  
10. b

## SHARK TAGGING SPECTACULAR / Geri Murphy

( 1 ) Shark tagging has got to be the most controversial contest ever devised in the history of scuba diving. Most divers view it with either disdain or envy. Opinions of this unique tournament vary widely.

( 2 ) To many divers, shark tagging is lunacy on the high seas. They view it as a stupid stunt which could be as dangerous as playing baseball with a hand grenade. To them, there is no reason on earth for a group of adults to attempt to play underwater tag with unpredictable beasts that could snap off a hand or a foot in a split second. Yet, on the other side of the fence, there are many divers who find the shark tagging contest an imaginative event which calls for daring, skill and an extremely cool performance under stressful conditions. These divers regard the movements and behavior of sharks with utter fascination, convinced that man may be standing at the threshold of understanding an animal that has survived more than 300 years of evolution. And, of course, non-diving spectators find this event absolutely incredible. The thought of people deliberately swimming with a dozen hungry sharks is both horrifying and enthralling.

( 3 ) Whatever your viewpoint on this topic, one must admit that the contest is gaining credibility because of the divers involved. This event has attracted competitors from three different continents and now involves almost half of the world's top shark divers.

( 4 ) The site chosen for this year's shark tagging event was a point 50 miles northwest of San Diego, in the deep channel which runs between San Clemente Island and the Southern California mainland.

*From Skin Diver, October 1980. Reprinted by permission of Skin Diver and Geri Murphy.*



Averaging 2000 feet in depth, this channel is reputed to be full of sharks in the summer months. The species of shark most frequently seen in this area is the blue shark, which ranges in length from four to eight feet. The blue shark is a long and slender creature, normally slow swimming and curious, but nonetheless considered dangerous. The blue shark has been known to bite divers on occasion, particularly when there is live bait in the water.

( 5) A crew of 35 technicians and divers converged on San Diego to prepare for the event. The competition was televised by CBS Sports for a weekend Sports Spectacular show. Field producer and director was Stuart Goodman, the original creator and developer of this unusual contest. Dive Coordinator for the 1980 competition was Howard Hall, a well-known underwater photographer and author of many SKIN DIVER Magazine articles. Howard was one of the competitors representing the U.S. in the previous shark tagging competition, staged two years earlier in the U.S. Virgin Islands. Assisting Howard with the underwater camera work was Gordy Waterman, Howard's teammate in the earlier competition. Other safety divers and underwater technicians involved in the event included: Larry Cochran, Marty Snyderman and Steve Earley; all veteran blue shark divers familiar with the area and the animals involved.

( 6) The shark tagging event took place aboard the *Sand Dollar* and the *Bottom Scratcher*, San Diego's two best known dive charter boats. Close to one-half million dollars in television monitors and video tape equipment was set up in the galley of the *Sand Dollar*. The *Bottom Scratcher* carried the competitors and the judge for the contest. Special equipment included a large shark cage, two underwater color television cameras, topside video cameras, special television recording equipment, TV monitors, and electronic cables.

( 7) The shark tagging competition rules devised for the event are perhaps the most bizarre in the annals of sport diving. One might describe this event as an undersea variation of Pin the Tail on the Donkey, except this donkey bites!

( 8) The shark tagging contest was an invitational event, restricted to professional divers with extensive experience in the handling of sharks at close range. Three competing teams consisting of two divers each were invited to represent the countries of Australia, West Germany and the U.S.

( 9) A shark cage was lowered into the water to a depth of 15 feet and suspended from floating and tethered buoys. The cage became the central point of the event. The competitors could stray no further than 25 feet from the cage, and no deeper than 15 feet below the floor of the cage. The reason for this restriction was simple—the cameramen

## INCREASING READING SPEED

were to film the contest from the same vantage point as the judge who was inside the cage. If the competitors tagged sharks that were beyond the visibility of the cameras or judge, the points were not counted. Since the purpose of the event was entertainment, all action had to occur close to the camera. The competition director and official judge, Paul Tzimoulis, was stationed inside the cage to observe each tagging and score the contestants.

(10) Official Marine Fisheries tags, supplied by the Scripps Institute of Oceanography, La Jolla, California were used.

(11) If a tagged shark is caught at a later date, the tag is supposed to be sent to Scripps along with vital data on where and when it was caught. Data gathered from previous tagging efforts indicates that blue sharks have an amazing range. A shark originally tagged off Point Loma, San Diego was eventually captured in the Galapagos Islands, a distance of over 1100 miles.

(12) Each team was given ten minutes to tag as many sharks as possible. The team was armed with a 24 inch long pole spear equipped with a quick release head, and a bandolier holding 33 stainless steel Marine Fisheries tags. Each team was made up of two divers; one designated as the tagger and the other as support diver. Each team was permitted to carry fish food for attracting the sharks to the competition area. Scoring for the competition consisted of three points for a dorsal fin tag, or one point for a body tag. Each team would be permitted to tag a specific shark only once, but each team could tag a shark which had been previously tagged by another team. The shark tags were clearly identified by colored plastic streamers which identified the origin of the tag. The Australians were equipped with orange tags, the Germans with yellow, and the Americans with blue.

(13) Australia was represented by Ron and Valerie Taylor, the defending champions of the first shark tagging competition. The Taylors are world renowned for their underwater films of sharks and have an impressive list of screen credits including: *Blue Water, White Death; Jaws; Jaws II; Orca;* and the *Blue Lagoon*. Ron and Val have a great deal of experience tagging sharks for scientific studies conducted in Australia. They have even tagged three great whites, the tag of one of which was returned.

(14) West Germany was represented by Herwarth Voigtmann and Helmut Debelius. Herwarth is a veteran shark handler who has been diving with sharks for the past 20 years. He was recently seen on the television special, *Mysteries Of The Sea*, hand-feeding reef sharks in the Indian Ocean. Helmut is an underwater photographer and writer who formed his own photo agency in Germany. He supplies many magazines with photos and articles. Neither Herwarth nor Helmut had ever used

a pole spear because spearfishing is prohibited in Germany. Neither diver had worked with blue sharks either, but each felt confident that the blues would be easy to handle.

(15) The U.S. team was Chuck Nicklin and Jack McKenney. Chuck is the founder and owner of the Diving Locker in San Diego, and is a 30 year veteran spearfishing champion. Chuck has worked with blues off California since 1965 and has made underwater films for the past 25 years. He has been involved with such projects as: *Gentle Giants Of The Pacific*, *Shark's Treasure*, and *The Deep*. Jack McKenney is a film producer, writer and photographer, published in many books and magazines around the world. Jack was formerly editor of SKIN DIVER, and now produces underwater films with his own company. Some of his films include: *Things That Go Bump In The Night*, *Fish Antics*, *U/W World of California*, and *Ten Fathoms Deep*.

(16) On Tuesday, June 4, the teams were given a practice day to warm-up for the main event. The deck crew and dive technicians carefully lowered the shark cage in the water and positioned it under the buoys. Meanwhile, the CBS television crew warmed-up their equipment for an open water test. A large steel chum container was lowered into the water to create a slick.

(17) It was not long before the first blues started to appear, and soon there were 12 to 15 sharks circling the boat and cage. The pace quickened as the competitors began suiting up for their long anticipated encounter with the sharks. For some, it would be the first close-up view of the blue shark. Unlike other shark species, the blue moves with an almost casual nonchalance, acting indifferent to the bait or divers at hand. It was almost disquieting to watch their long, streamlined bodies move gracefully past you, carefully eye-balling each diver. Each team spent 20 to 30 minutes diving with the sharks and testing their tagging devices. The shark tagging pole spears had been greatly modified since the previous contest and were therefore completely new to all of the participants. This competition would be as fair and as evenly matched as possible.

(18) The practice day turned out to be even more exciting than anyone had anticipated. The U.S. team found themselves confronted by a nasty mako shark with intentions other than those held by the contestants. Unlike the docile blue shark, the mako is considered to be very dangerous, and is often extremely aggressive in the open sea. The mako made several deliberate passes on Chuck Nicklin before being discouraged by Jack McKenney's powerhead.

(19) A still more exciting incident took place while the Australian team was attempting to chum in a few friendly blues. While Valerie Taylor was intent on coaxing in a shark with an offering of mackerel,

## INCREASING READING SPEED

another blue sneaked up from behind and gently plucked a few mackerel off the fish stringer around her waist.

(20) By the end of the day, all three teams were exhilarated at having confronted the blues and tested their equipment successfully. Anticipation for the coming day ran very high.

(21) The main event began on Wednesday, June 5 at approximately 12:45 in the afternoon. It was a bright, sunny day with a gentle chop. Visibility was about 40 feet and there were at least one dozen sharks circling the cage. Conditions were perfect.

(22) The three teams had drawn lots for position and the Australians had won. Displaying the cool concentration of the professionals they are, Ron and Valerie Taylor quickly slipped into the water and moved directly toward the shark cage, Valerie chummed the water with mackerel while Ron loaded his tagging device and stretched the pole spear rubber to the limit. Judge Paul Tzimoulis was positioned in the shark cage and the two cameramen kept their backs against the cage bars for protection. In addition, each cameraman had a safety diver beside him at all times watching for unexpected visitors. The contest began.

(23) Ron immediately made several good tags, including two body tags and two dorsal tags. Intermixed were a number of misses, as the blues became more elusive. Their flexible bodies would bend and twist at a thousand angles, making it difficult to connect with a solid hit. For every tag that stayed in the shark, there were at least three or more misses. By the end of the first half of his ten minute time, Ron had made approximately six tags. It seemed to be getting harder and harder to approach the sharks or to find specimens which were still untagged. There were less hits now and many more misses. Some of the attempted tags were out of range of the judge's vision and the TV cameras. The pressure was almost unbearable, and one could see that Ron was frantically trying to make solid contact with a shark in the few remaining minutes of the contest. Then, it was over. The judge's flag announced the close of the ten minute time limit. The Australian team logged four dorsal tags and two body hits, for a total score of 14 points. The Australians had set the pace for what was to become a lively competition.

(24) The second team into the water was the West Germans. Herwarth Voigtmann would tag, while Helmut Debelius chummed. Herwarth's first tagging attempt almost ended in disaster, as the shark tagging device unexpectedly flew forward and completely out of his hands. Herwarth's reflexes are quick and he managed to spring forward and grab the pole spear before it sank into the 2000 foot depths. It soon became apparent that the Germans were having a great deal of difficulty operating the tagging device. The tags were not piercing the sharks' skin, but instead bouncing off because of the sideward angle of contact. Her-

warth managed to make two dorsal tags but had a frustrating dozen or so misses. You could see the tension building each time he missed, thus causing even greater difficulty on the next attempt. Frequently Herwarth ripped away the stainless steel tag from the tip of his pole spear and replaced it with a new one—hoping it would be sharper than the last. Perhaps the greatest difficulty was the blue shark's dorsal fin; it was so flexible that it actually bent completely over when struck by the shark tagging device, resulting in a miss. It was like trying to spear a wet noodle with a cardboard fork. At the end of the competition the West Germans were terribly disappointed.

(25) The last team into the water was Jack McKenney and Chuck Nicklin, representing the U.S. Chuck acted as support diver and chief chummer, while Jack operated the tagging device. From the very beginning it was apparent that the American team meant business. McKenney was incredibly aggressive, pressing forward for every shark tagging opportunity. Within minutes he made four dorsal tags—each with uncanny accuracy. Every tag was placed squarely in the center of the shark's dorsal with the grace and ease of an expert swordsman. Meanwhile Chuck Nicklin lashed a large bag of chum to the very front of the shark cage and shook it vigorously in the hope of attracting more targets. The American team's strategy was indeed unique. They attracted the sharks directly to the front of the cage and to the TV cameras, thus assuring a full documentation for maximum scoring. McKenney never slowed his pace but instead kept pressing his advantage with dorsal tag after dorsal tag.

(26) At one point the competition endured an unexpected turn of events. An enterprising blue shark decided to grab the chum bag and attempted to make a run for it. Instead, the shark's teeth became entangled in the mesh of the chum bag and it then proceeded to thrash violently against the front of the shark cage, almost working its way inside the cage and alongside Paul Tzimoulis. Fortunately, he was able to slam the door on this uninvited guest, while Nicklin became engaged in a tug of war over possession of the chum bag. The shark finally broke free but was unable to make its escape before McKenney neatly placed a tag in its dorsal fin. By the end of the ten minute tagging session, the American team was credited with 12 solid dorsal tags for an incredible score of 36 points. The U.S. team walked away with this year's contest—and the \$2000 first prize.

(27) Postscript—If you are still skeptical about the sanity of divers who play games with wild sharks, you have every right to be. Barely two weeks after the conclusion of this year's incredible shark tagging contest, Valerie Taylor was bitten on the leg by a four to five foot shark while diving in the very same location. She and her husband Ron

## INCREASING READING SPEED

had returned to the channel in the hopes of shooting underwater movie footage of Valerie hand-feeding blue sharks. Never let it be said that a shark will not hesitate to bite the hand that feeds it!

Record your finishing time: \_\_\_\_\_ mins. \_\_\_\_\_ secs.

Subtract your starting time: \_\_\_\_\_ mins. \_\_\_\_\_ secs.

Total reading time: \_\_\_\_\_ mins. \_\_\_\_\_ secs.

### *Part 3: Increasing Comprehension and Vocabulary*

*Directions:* Answer the following questions without looking back at the article.

## COMPREHENSION

1. The article is about
  - a. sport diving for sharks
  - b. tagging sharks for sport
  - c. a shark tagging competition
  - d. the dangers of shark tagging
2. The main idea of the article is
  - a. to show the stupidity of shark tagging
  - b. to report the shark tagging competition
  - c. to convince readers to try shark tagging
  - d. to show how the shark tagging contests are gaining credibility
3. The shark tagging contest took place in the waters off the coast of
  - a. Australia
  - b. West Germany
  - c. San Diego
  - d. La Jolla
4. The shark tagging contest was an open invitation to all divers who wanted to join the competition.
  - a. True
  - b. False because \_\_\_\_\_

5. Other than competitive entertainment, the point of tagging is to provide scientific information about sharks.
  - a. True
  - b. False because \_\_\_\_\_
6. The first shark tagging competition was won by an Australian team, Ron and Valerie Taylor.
  - a. True
  - b. False because \_\_\_\_\_
7. How many countries were represented in the contest?  
\_\_\_\_\_
8. What type sharks were tagged in the contest?  
\_\_\_\_\_
9. We can infer from the way the article is written that the author thought the contest was horrifying and dangerous.
  - a. True
  - b. False because \_\_\_\_\_
10. It can be concluded that even the experts can't be too cautious when diving with sharks.
  - a. True because \_\_\_\_\_
  - b. False because \_\_\_\_\_



## Test I

## WHAT IS AN EYEFUL?

Time: \_\_\_\_\_ minutes \_\_\_\_\_ seconds

One is often advised to go to this or that scenic spot where, if he wishes, he may "get an eyeful." But how much is an eyeful? This is a question which we may ask facetiously, or which we may consider seriously, depending on what we mean and in what context. Let's consider it seriously for a few moments.

For you as a reader how much really is an eyeful? To answer this question adequately we should consider the whole matter of eye movements in reading. Perhaps most inexpert readers exaggerate the importance of eye movements out of all proportion to their actual significance. Only because you should know at least something about the way your eyes behave while reading is this subject mentioned here at all.

One general rule should be clearly emphasized at the very outset of this discussion: Never concentrate on the movement of your eyes; never think about what they are doing. Concentrate rather on the thought of the sentences you are reading, and your eyes will usually perform as they should. Poor eye movements are not causes of poor reading; they are rather symptoms of more basic reading trouble such as the failure to think of the words beneath one's gaze in terms of logical phrases and significant thought patterns.

Different readers take in varying amounts of print at a glance. Some grasp only one word at a time; their eyes feed the mind information in tidbits. Each word is a separate mental and physical effort, and cumulatively, the result of such activity is fatigue and loss of interest. The physical effort is simply too great to be justified by the result.

The rapid reader, on the other hand, scoops up *groups* of words at a single glance. His eyes travel across a line of print in three or four jerks and then return along the white alley between the rows of printed characters to the beginning of the next line. To each three or four stops (*fixations*) per line for the rapid reader, the less efficient reader makes eight, ten, or twelve separate pauses. Perhaps the difference between the word-by-word reader and the phrase-by-phrase reader might be illustrated by the following groupings of words, showing how each would look at a line of print:

The word- by- word reader reads like this.

But the phrase reader would read the line like this.



Sometimes the eyes make little backward jumps to reread or to confirm what they have already read. These backward movements are called *regressions*. They usually occur when you have not been giving the text your full attention. One of the worst deterrents to the improvement of comprehension is the habit of letting your mind wander while you are reading. Compel yourself to concentrate on the thought behind the words that your eyes are seeing.

When you find your eyes passing over the words while your mind wanders from their meaning, make yourself get down to business. Comprehension and concentration are practically identical, and they are both attitudes that can be learned. Stop pampering yourself by thinking that it's difficult for you to concentrate on what you're reading or that you're not interested in the particular subject matter to which you must give your attention. These are merely excuses. You conjure them up because you do not want to keep your mind on the book. At one time or another even the best readers find it hard to concentrate; but you must focus your attention if you are to improve your reading skill.

To return to the matter of eye movements, read each line of print with as few fixations as possible and without allowing regressions to impede your pace. Discipline yourself to read unswervingly ahead. Even if you feel for the moment, at least, that you have lost the continuity of the thought, compel yourself to read on. Do not regress. Soon you will break the habit entirely. Here are a few lines that may help you to determine for yourself exactly what an eye-ful is. Try in reading them to develop a reading stride.

Read this for the purpose of seeing how much easier it is to grasp meaningful phrases rather than disconnected words. Of course, a page of print will not have wide separations between the groups of words like this. Let's reduce these spaces so that they will become smaller and smaller until at last the words will group themselves in a regular line of print, and only your eyes will make the divisions between them. Your mind then will be grasping groups of words and combining them into meaningful units, as you are probably doing now, and before you realize what is happening you will actually be reading phrases with your eyes while your mind will be assimilating the meaning of groups of words as units of thought. This is the way to speed your reading, to improve your comprehension.

Finishing time: \_\_\_\_\_ minutes \_\_\_\_\_ seconds

Total reading time: \_\_\_\_\_ minutes \_\_\_\_\_ seconds

KEY LETTERS: hr

**WHAT IS AN EYEFUL?**

Select (encircle) the best answer from the choices given. Do *not* refer to the text.

1. In this article the author considers the question. "What is an eyeful?" (a) facetiously; (b) popularly; (c) seriously; (d) educationally.

2. The answer to the question. "What is an eyeful?" depends upon (a) how much one reads; (b) how much one sees at a single glance; (c) the difficulty of the material; (d) the visual acuity of the reader.

3. A good rule to follow is: (a) concentrate on eye movements; (b) forget about eye movements; (c) march your eyes across the page unswervingly from left to right; (d) have someone else check your eye movements.

4. Regressions are (a) lapses of memory; (b) reading word-by-word fashion; (c) backward glances; (d) reading backward.

5. The student who has learned to comprehend well has also learned to (a) read well; (b) develop rapid fixation patterns; (c) think; (d) concentrate.

6. If you lose the thought momentarily, the author suggests that you (a) read on; (b) go back to find it; (c) slow down your reading; (d) do none of the things mentioned.

7. The author suggests that reading is basically (a) muscular; (b) visual; (c) mental; (d) emotional.

8. The white "alleys" between the lines of type are (a) to make the page more attractive; (b) to help the reader comprehend better; (c) to facilitate the return sweep to the beginning of the next line; (d) to aid eye movements.

9. The general rule for reading is: (a) bound across the line in three to four fixations; (b) get an eyeful; (c) stride along the line with as few fixations as possible; (d) concentrate on the thought.

10. Regressions are usually symptomatic of (a) poor eye movements; (b) inattention; (c) lack of muscular coordination; (d) word-by-word reading.

Check the correctness of your answers with those in the Answer Key, pages 380-381.

Number correct \_\_\_\_\_ x 10 = \_\_\_\_\_ % correct

Enter your rate of reading on the Profile under I, A (page 15; enter your comprehension under II, A.

- |      |       |
|------|-------|
| 1. c | 6. a  |
| 2. b | 7. c  |
| 3. b | 8. c  |
| 4. c | 9. c  |
| 5. d | 10. b |

## THE ENQUIRER: SENSATIONALISM PERSONIFIED

- Read { For some reason, people love to read gossip and sensationalism. One of the best examples of the public's taste in such reading is reflected by the success of *The Enquirer*, a weekly tabloid recently forced by the court to pay a huge sum of money in damages to Carol Burnett for slander and insinuations about her character. *The Enquirer*, seemingly untroubled by the huge financial loss in court, nor by the many others waiting in line to sue them, continues to find readers who want to read distorted and misleading information. Its sales are as good as ever despite the attention that has been called to its poor writing and poor factual support for its many articles.
- Read { One can't help but wonder what type of people read *The Enquirer*. They must be poor readers with very low vocabulary levels because nothing is ever written above the eighth-grade level. And certainly no one who reads with any intelligent comprehension could stand to spend much time on the tabloid. For example, a recent article was headlined, "College Students Flunk 8th Grade Exam Prepared in 1906." Now the headline itself is no worse than many respectable newspaper headlines. But a close look at the article makes one wonder what all the furor is about.
- Read { The opening statement of the article reads, "College students of today are so poorly educated that they flunked an 8th grade exam prepared 70 years ago!" It goes on to quote a Dr. John Cundy, schools superintendent in Lincoln, Kansas, who doubts, he says, if any of today's high school graduates could pass the 1906 Oregon state exam without prior coaching.
- Skip {
- Read { We are told that "overall, the students did very poorly." None correctly answered the two math questions on the test. "Passing scores were achieved by only one student in physiology, one in spelling, two in geography and two in American history. Just one student did well in grammar." Certainly this is shocking news.
- Skip {
- Read { But the shock that students did so poorly soon dissolves when we learn that this great concern is based on—now get this—the test results of *five* students. That's right, the entire article and its suggestion that college students are not as educated as students graduating from the eighth grade in 1906 is based on the sum total of only five junior college students who took the 70-year-old exam.
- Skip {
- Read { Another misleading point in the article is that it boldly states, "Top educators said the results of *The Enquirer* experiment illustrates the worsening academic crisis in U.S. schools," but who exactly are these "top educators"? The article does quote Dr. Cundy, already mentioned.

- Skip { and a Dr. Verne A. Duncan, superintendent of public schools in Oregon somewhere. These are hardly names brought to mind when the phrase "Top educators" is mentioned. This is not to disparage the two educators cited in the article, but merely to point out that they are not "Names in the News." Perhaps *The Enquirer* felt they could be called "top" people because as superintendents of schools they are at the top of the educational ladders in their communities.
- Read { In addition to misleading the reader, the article also uses the old clichés that always sound ominous but never say anything concrete. Here are some quotes. Look for *facts* in them: "Kids were taught better and were smarter back in the old days than they are now, and our standardized tests show it." (How can you prove they were "taught better"? Smarter "back in the old days"? Standardized tests in 1906?) Another quote: "You could be assured around the turn of the century that when a person graduated from the 8th grade, he or she was at least as smart as most of the 12th graders are today, if not smarter." (Assured? How? And what is meant by "smart"?) Are there facts presented to bear all this out? No, only insinuations and opinions based on a 1906 exam given to five college students and the opinions of two educators unknown beyond their communities.
- Skip {
- Read { It's easy to blame the fault of sensationalism and slanted reporting on *The Enquirer*. But shouldn't the real blame be placed on all the millions of readers who buy such tabloids and magazines, read them as "fact" and then pass along the misleading, unfounded information to family and friends? But perhaps *The Enquirer* article is right, and students today aren't as "smart" as they were in 1906. After all, millions of people are apparently not smart enough to see *The Enquirer* for what it is.

### Focusing Check

Even though you haven't *read* the article in the true sense of the word, you should be able to answer the following questions. Don't look back.

1. What is the reading selection about? (Don't just answer "*The Enquirer*.")

---



---

2. Why does the author feel that the information about testing in *The Enquirer* article is misleading?

---

---

3. What does the author think of *The Enquirer's* writing style and standards?

---

---

4. Who does the author blame for the existence and success of such publications as *The Enquirer*?

---

---

You may feel that being able to answer all four of those questions is impossible after only 40 or 50 seconds of focusing. However, if you had difficulty with them, it simply indicates that you need more practice in focusing. Let's look at the questions more closely and see why you should have been able to answer them.

1. The answer to the first question is that *The Enquirer* is an example of reporting sensationalism. The title, the first and the last paragraphs—all places you were told to focus on—give you the answer.
2. It's misleading because of the informational source—only five students were tested and yet it was made to sound like a national scandal in education (first sentence in paragraph 5)—and because of those points mentioned in the first sentence of paragraphs 6 and 7, both places you were told to focus on.
3. Both the first and second paragraphs answer this: the writing is poor, the vocabulary level low, and it's gossipy in nature.
4. The people who buy it and continue to support it. See both the opening and closing paragraphs.

After doing this exercise, you can probably see that focusing on what you are going to read requires concentration. These four steps are not meant to replace close, thorough reading, but rather they are meant to help you read better and faster when you need to read closely. Focusing literally pushes from your mind whatever else you may be thinking about and prepares you for faster reading. Try this focusing technique on all your future reading. At first it may seem awkward and more time consuming than time saving. Like any new skill you learn, the awk

**WHY PROCRASTINATE?**

This essay deals with a common human failing. For students especially it contains some excellent advice. The thought is straight to the point. Read the essay to appreciate what the author is saying and to see the excellent organization of the thought.

Time: \_\_\_\_\_ minutes \_\_\_\_\_ seconds

More than two centuries ago Edward Young, disappointed in law, politics and in his thirty-five-year rectorship of a small church, wrote the often-quoted line "Procrastination is the thief of time." In fact, procrastination is much more.

It is the thief of our self-respect. It nags at us and spoils our fun. It deprives us of the fullest realization of our ambitions and hopes.

In business, a man who hesitates is lost. In our other life, the cultural part, procrastination is equally damaging. There is usually no want of desire on the part of most persons to arrive at the results of self-culture, but there is great temptation not to pay the necessary cost of it in time and work.

Even our leisure is eaten into by procrastination. So many people complain that they have no time for leisure. They are constantly driven. Life for them is a steady grind or a mad dream. These are people who do not organize their time and energy. They are of the sort that find themselves nervously unfit to deal with immediate things, to stand the pressure of an urgent job.

Young people particularly need to beware of putting off. Dante described the vice in this way: "Hesitating I remain at war 'twixt will and will not in my thoughts." Eventually, perhaps sooner than we think, it is too late. When things are deferred till the last minute, and nothing prepared beforehand, every step finds an impediment. It becomes harder to do things. We are pushed into blundering through hasty judgments.

Herein is a paradox. By trying to take things easy we do not make things easy. It is possible to spend more energy in figuring out ways to escape a task than is necessary to accomplish it. Our available energy is lowered by inward conflict between "do it now" and "put it off." We lose our poise, because we are always catching up, always in a hurry to do today what we should have done yesterday, always off balance.

Not only is procrastination a deadly blight on a man's life, but it is a nuisance to all his companions. Everybody with whom the procrastinator has to do in family, factory or office is thrown from time to time into a state of fever. Everyone else has to work harder to take up the slack he leaves.

**HABIT COMES SLYLY.**

The habit of putting off has a way of creeping up on us insidiously. What does it matter, we think, if we don't write that letter today or telephone that prospect for business, or make that dental appointment? Tomorrow is always another day, we say blithely but childishly.

It is a salutary exercise to consider the successes we almost enjoyed but which escaped us because we put off decision or action. By doing things as they come along we entertain our great opportunities. But if we say to opportunity: "I am young; there is plenty of time," then opportunity passes us by and we find that, as Francis Bacon remarked in one of his essays, "opportunity has a bald noodle behind; there is nothing to grasp."

11

It is all very well to admit that procrastination is a bad thing, but if we are to do anything effective toward its cure we must know something of what causes it.

It may be the product of indolence, a vice which rewards everyone scurvily. Indolence may be the weak link in the chain of a business man's character. It may show itself in the dawdling of the workman, in the listlessness of the housewife, in the sloth of the panhandler. All these people are putting off something. They are reluctant to tackle a job, or are baffled by small difficulties, or are engrossed in spinning out some activity unnecessarily.

Procrastination may, in some instances, be attributed to ill health. Energy to tackle jobs and get them out of the way is the product of physical health and a purpose.

A child who cannot find his clothes in the morning may be unknowingly rebelling against school and postponing his having to go there. A man who explodes in the midst of a business conference may be motivated by an inward irritation that follows a sense of putting off something that should have been given immediate attention.

If you are a chronic procrastinator it may be that your parents did more for you than they should have done. Perhaps they "picked up" after you, and did the things you left undone. You learned that by putting off duties nothing serious happened: someone else did the work.

But today you find that your habit leads to unending ills. You are actually putting off living to some fictional future date. You are making yourself unhappy because in deferring life to the future you are missing the present and its golden opportunities for rich living. You are putting off until tomorrow not only duties and jobs but happiness and achievement.

Samuel Johnson called tomorrow "that fatal mistress of the young, the lazy, the coward and the fool."

#### UNPLEASANT THINGS

The truth is that we are most inclined to postpone doing things that seem at the time to be unpleasant, distasteful or difficult. When we have something like that to do, we putter around with little things, trying to keep busy so that we have an excuse that will ease our consciences. Dreading and postponing a task may be more tiring than doing it, and apprehension over delayed unpleasantnesses may so preoccupy us that other things cannot be done effectively.

None of us escapes his quota of difficult or disagreeable tasks, and it would be well to learn from the experience of others rather than from our own that

BEST COPY AVAILABLE



they do not fade away by being ignored. Eventually, we have to roll up our sleeves and wade into them. In the meantime, we suffer.

#### WAITING FOR INSPIRATION

An excuse sometimes made by writers, composers, business executives and other people engaged in creative work is that they are waiting for inspiration. But inspiration is a guest who does not visit the lazy or the procrastinator as often as he does the busy and diligent. Most writers find that the best way to win inspiration is to insert a blank sheet of paper in their typewriters.

Sir Arthur Sullivan, composer of the Gilbert and Sullivan operas, oratorios and a score of other sorts of music said this: "One day work is hard and another day it is easy, but if I had waited for inspiration I should have done nothing."

Many offices have people in them who sharpen pencils instead of getting down to solving the puzzles in a job. Other people shroud their actions in a maze of red tape, giving as the excuse for delay that they must consider the problem carefully from every angle and think of all the possibilities.

By debating every problem, awaiting the divine spark that will shine upon the right decision, we show ourselves to be timid and distrustful of our own judgments. The Hamlets among us must learn that it is better to make a wrong decision than none at all. At least an error teaches a lesson that need never be repeated. To stand indecisively midway between our duty and our task is calamitous.

Duty is not merely to do the thing we ought to do, but to do it when we should, whether we feel like it or not. When we make ourselves responsible for doing a job, making a plan, or directing others, we are duty and honour bound to do it at the time promised or expected.

This brings up the matter of punctuality. Immature people excuse themselves for lateness by saying that they have no sense of time, without stopping to think that if this were so they would be ahead of time as often as they are behind time.

A word should be said to the person who is the victim of another's procrastination. Dr. Helen Brandon, a psychological counsellor, made constructive use of her time. In one year, she says, she spent some 120 hours a month waiting for something or somebody. "During this time I thought of 1,000 article-ideas, worked on the case histories of more than 100 people, and spent at least one-third of the time relaxing in one way or another."

#### III

Time enters into efficiency in every activity. The essence of efficiency is economy of energy, space and time. The well-organized life leaves time for everything,



## WHY PROCRASTINATE?

## Part I

Select the best answer for each question.

1. You might assume from the author's remarks about Edward Young that Young was (a) an eighteenth-century English author; (b) past middle age and somewhat disillusioned; (c) a young lawyer and politician; (d) a retired English curate recalling the days of his youth.

2. With regard to the saying, "Procrastination is the thief of time," the author (a) disagrees with Young; (b) was himself a procrastinator; (c) knew Young; (d) considers that Young has stated the case only partially.

3. The procrastinator is considered (a) a social nuisance; (b) a social hazard; (c) a social adjunct; (d) a social misfit.

4. The author feels that the advice offered in this essay is especially needed by (a) factory and office workers; (b) writers and composers who lack inspiration; (c) young people everywhere; (d) business men and young executives.

5. The author considers it a salutary exercise (a) to compare our own achievements with those of our associates; (b) to review our failures caused by procrastination; (c) to make dental appointments periodically; (d) to analyze the process of procrastination.

6. To get inspiration the author suggests (a) the elimination of red tape; (b) thoughtful preparation; (c) diligence and application; (d) consideration of the problem from every angle.

7. The essence of efficiency is (a) economy of energy, space, and time; (b) avoidance of procrastination; (c) knowing when and when not to procrastinate; (d) the avoidance of hasty judgments and deferred action.

8. The most valuable result of education is (a) developing the discipline of prompt and responsible action; (b) distinguishing between better and worse ways of doing things; (c) recognizing the enemies of prompt action; (d) getting new information in order to make one's task easier.

9. As an antidote to procrastination the author suggests (a) making a general time budget; (b) accounting for wasted time; (c) looking before and after and pining for what is not; (d) making a purposeful and specific time budget.

10. The author suggests that the one most important factor in conquering procrastination is (a) thought; (b) planning; (c) action; (d) analysis.

Number correct \_\_\_\_\_ x 10 = \_\_\_\_\_ % correct

1. b	6. c
2. d	7. a
3. a	8. a
4. c	9. d
5. b	10. c

Wilbur and Orville Wright knew that they had made a great discovery, but their belief was not supported by the general public. Not only were there no receptions, brass bands, or parades in their honor, but people paid no more attention to the history-making feat than they would have paid to a report that the brothers had been on vacation and caught a big fish or shot a bear.

One reason almost no one was willing to believe the reports about flying with a machine heavier than air was that important scientists had already explained why it was impossible. At the very time that the Wrights were assembling their power machine at Kitty Hawk, a famous scientist of the day, Professor Newcomb, published an article "proving" that trying to fly was nonsense. His calculations showed that even if a man did fly, he would not dare to stop. "Once he slackens his speed, down he begins to fall. . . . How shall he reach the ground without destroying his delicate machinery?"

The professor's arguments were given added weight by the fact that just a few days previously another famous scientist, Professor Langley of the Smithsonian Institution, had crashed on his latest attempts at flight.

Although Newcomb's statements were probably read by only a few people, they were seen by newspaper editors. And

an editor who "knew" a thing could not be done would hardly feel justified in permitting his paper to record the fact that it *had* been done.

Oddly enough, one of the first public announcements of the Kitty Hawk flight was made in an Ohio Sunday school. One morning a teacher, A. I. Root, observed that the boys in his class were becoming restless. Hoping to catch their interest, he said, "Do you know that two young Ohio men have outstripped the world in demonstrating that a flying machine can be constructed without the aid of a balloon?"

Immediately the class became attentive and began firing questions at the teacher. Root described the Kitty Hawk flights and added, "When the Wright boys make their next trial, I am going to try to be on hand to witness it." Mr. Root did witness some of the later experiments.

Mr. Root told of this Sunday school incident in a magazine that he published for beekeepers. By printing that story, he became one of the first editors to report in a scientific journal that man was now capable of flight.

The Wrights were more amused than disturbed by the lack of general recognition that flight was now possible. They chuckled inwardly whenever they heard people use the old expression, "Why, a person could no more do *that* than fly!"

BEST COPY AVAILABLE

## Bibliography

This listing includes sources of materials for instructional use as well as research articles for you to read.

Adams, W. Boyce, *Increasing Reading Speed*, Macmillan Publishing Co., 1982

Banton-Smith, *Be a Better Reader*

Brandt, James David "Internal Versus External Locus of Control and Performance in Controlled and Motivated Reading Rate Improvement Instruction", *Journal of Counseling Psychology*, 22: Sept.,1975, pages 377-382.

Brozo, William G., "A Content and Critical Analysis of 40 Speedreading Books", *Journal of Reading*; vol.30, December, 1986, pages 242-247.

Carver, Ronald P. "Reading Theory Predictions of Amount Comprehended Under Different Purposes and Speedreading Conditions, *Reading Research Quarterly*, vol.19, Winter, 1984, pages 205-218.

Carver, Ronald P., "How Good Are Some of the World's Best Readers?", *Reading Research Quarterly*, vol. 20, summer 1985, pages 389-419.

Cranney, A. Garr and others, "Rate and Reading Dynamics Reconsidered", *Journal of Reading*, vol. 25, Mar. 1982, pages 525-533.

Crisp Publications, *Speedreading in Business: An Action Plan for Success*.

Fry, Edward B., *Skimming and Scanning*

*Flexible Reading*, from Morraine Park Technical College

Masson,, Michael E.J., "Cognition Processes in Skimming Stories", *Journal of Experimental Psychology: Learning, Memory and Cognition*; vol. 8, September, 1982, pages 400-417.

*Be a Better Reader* Fifth ed. 6  
by Nilda Cantor Smith President Hall 1984

SESSIO

No doubt one of your most important reading goals is to learn how to read faster than you now read. Rapid reading enables you to cover your textbooks and reference reading in a shorter time; it enables you to get more out of your reading, for the rapid reader usually comprehends better; and it helps you to enjoy your reading and studying so that you don't consider these activities as laborious tasks.

There are two very encouraging things about increasing speed in reading: (1) it is one of the easiest reading skills to improve, and (2) no matter how fast people read, they can learn to read still faster. Even an excellent reader can achieve higher goals in speed. People who wish to increase their speed can do so if they understand the principles of speed reading, are given careful guidance in applying these principles, and are willing to practice.

When you try to read fast, it is important also that you know how to pronounce any words that are unfamiliar to you. In this book word helps are provided for you at the bottoms of pages. Be sure to study them before beginning to read each selection that contains them.

The principles of rapid reading will be explained to you in this chapter. You will be given guidance in applying these principles, and plenty of material will be provided for you to practice upon in this chapter and others that follow. The amount of your gain in speed is up to you.

## *Building the Foundations For Speed*

---

Experiments have shown that the best readers glance rapidly at fairly large, meaningful groups of words as their eyes move over the lines of print. Poor readers usually glance at small, meaningless units of a few letters or words. Because of this information, it was thought that people would become more rapid readers if they could learn to grasp large, meaningful units of thought at each eye pause. It was also thought that comprehension might im-

prove if a reader learned to read in thought units rather than in separate words or in other small units that do not have much meaning in themselves. So the first step toward increasing your present speed is to learn to grasp longer units of thought.

Something else that you need to do is to quicken your pace. Just as you walk faster when you want to, you can also read faster when you want to. Just consciously push yourself to higher speeds.

## Breaking Yourself of Undesirable Habits

Perhaps you have some habits that will stand in the way of your progress in learning to read faster. Some people develop such habits in the early grades, and these habits stay with them all through life. These bad habits are pointing to words, reading with the lips, vocalizing in your throat, and moving your head from left to right as you read across the page and back again. It would be advisable to check yourself to find out if you have any of these habits.

Read the paragraph below just as you would read normally. Notice as you read if your finger automatically "flies" to the lines and moves across them, pointing to each word.

Sunni Ali Ber was a great ruler in West African Songhay. This was a large kingdom on the flat plains of the Niger River. Sunni Ali was ambitious and cruel in battle, but he is recognized as a ruler of great importance in the past history of Africa. He built dikes and canals along the Niger River and used the river as a highway for transportation and trade. He divided his kingdom into provinces and placed each under an officer. His soldiers and many of his people called him "Most High," which meant that he was like a god.

Did you actually point with your finger as you read? Or did you want to point?

If you have the habit of pointing because it seems to make your reading easier, you must take note of it and stop yourself every time you do it. Your mind can leap across the lines of print much faster than

vocalizing (vó'kj 1z'in), speaking; uttering.

Sunni Ali Ber (sōō'nē a'le bër), former ruler of West African Songhay.

Songhay (son gá'), a West African country.

Niger River (ní'jër riv'ër), the river flowing from West Africa into the South Atlantic.

your finger can move. Don't let your finger hold down your speed!

One way to break yourself of this habit is to hold the book or magazine you are reading with both hands, the left hand holding the left side of the book and the right hand grasping the right side. Then your fingers won't be free to point.

Now check yourself on lip movements. Place your finger lightly over your lips while you read the next paragraph. Note whether or not you feel your lips moving against your finger.

Return to earth from a space journey poses vast problems to the engineer and dangers for the pilot. A spaceship plunging into the atmosphere directly at earth would be destroyed in four seconds by air turbulence, which would shatter the ship, and by air-friction heat, which is able to vaporize any known material.<sup>1</sup>

To avoid these dangers, a landing spaceship spirals around the earth in a gradual, slowing descent. A blunt, ceramic-faced heat shield intercepts most of the heat before it can reach the capsule. Retrorockets and finally parachutes slow the ship still more. When the spaceship strikes the sea at splashdown, it is moving only at a few miles per hour.

Did your lips move? If so, place your fingers lightly over them when you are reading. When you feel your lips moving, hold them still. Holding a pencil tightly between your teeth is helpful also in breaking this habit. Perhaps you can think of some other way to keep your lips from moving.

turbulence (tër'bya lens), a disorder; tumult; commotion.

retrorocket (ret'rō rok'it), a rocket on an airplane or spaceship that produces thrust in a direction opposite to the direction of the spaceship, for purposes of slowing down.



But whatever you do, stop them! You can read much faster than your lips can form the words.

Now check to see if by any chance you move your head while reading. Hold your hand firmly under your chin. Notice if your head moves, taking your hand along with it, as you read these paragraphs:

When I looked at Mars through the 100-inch (2.5-meter) telescope in the early evening, the polar cap presented its usual smooth, unbroken appearance. But when I next looked at Mars directly, about midnight, to my astonishment there was a great gash in the polar cap.

Although this rift in the polar cap was new to me, a little investigation in the library revealed that it has been known for at least a century. It appears regularly in the south Martian spring about a month before the beginning of summer.

As the snow melts, the rift lengthens until a portion of the cap is completely detached from the main snow field. This de-

rift (rift), split; break; crack.

tached part breaks up into several white spots, presumably as a result of snow lingering on elevated ground. These white spots are the famous Mountains of Mitchel, the only markings on Mars that rate the name of mountains.<sup>2</sup>

If you found that you moved your head as you read, then continue to rest your chin in your hand whenever you read, and hold your head still every time it starts to move. Head movement, like all other physical movements that accompany reading, holds you down to a much slower rate than your mind is capable of.

Check yourself next on the possibility of vocalizing words in your throat. Place your open hand tightly over your throat. Read the following paragraphs. Note whether or not you can feel a slight movement against your hand.

Ages ago when civilization was emerging into the early light of history, young people made the discovery that there was rare fun attached to a game played on the ground with small hard earthen pellets. Juvenile cave dwellers invented the game of marbles. Among neolithic remains, scientists have discovered small spheres which they have declared too small for projectiles and have concluded were for sport. In addition the British Museum contains marbles from more modern times that were used by Egyptian and Roman children.<sup>3</sup>

Did you feel slight movements in your throat? If you have this habit, hold your hand over your throat when you read and control the movements whenever you feel them.

neolithic (nē ə lith'ik), referring to the later Stone Age, when polished stone weapons and tools were made and used.  
projectile (prə jek'tl), an object that can be thrown, hurled, or shot, such as a stone or bullet.



## Looking for Meaningful Thought Groups

The next paragraph is divided into meaningful thought groups. See if you can read it, taking in an entire group of words at each quick glance.

In June of 1849 / a slow-moving, / bearded man  
of about thirty-five / strolled up the long street /  
which formed / the little hamlet of Barbizon, /  
near Fontainebleau. / At the top of the village /  
he finally stopped / at a three-room cottage. /  
The gossips watched him, / for this man had  
come from Paris, / where there was fighting. /  
Within a day or two / this very same man appeared  
again / but this time as tenant / of the cottage, /  
and the good folk / of Barbizon were able /  
to accept him / as one of themselves, / because now /  
he wore a blouse / and wore the wooden  
sabots / of the peasant. / He was a painter, it was  
said, / but he wore the clothes / of a peasant  
as if / he had never known others, / and his talk  
showed these good people / he knew the ways  
of peasants / from experience.<sup>4</sup>



On your own paper, mark the rest of the selection into thought groups. Divide it into meaningful phrases in about the same way as the preceding paragraph was divided.

In that little house, which was enlarged bit by bit as his family grew, Jean François Millet lived like the real peasant he was, until his death came twenty-six years later. There, ten years after he had settled in Barbizon, he painted *The Angelus*, which was scorned at first, but became the most popular picture of the nineteenth century.

Millet's little cottage, after having been turned to ordinary uses for years, became a memorial to him. Through the devotion of a follower of the artist, his home was purchased as a museum and restored to the condition in which it was when Millet died. Thousands of visitors came to see it. Millions of people have seen paintings by Millet in museums, including the most famous museums of Europe and America.

When he died, the cottage was filled with his work, including many partly finished canvases. He was a slow worker: he created pictures with the patience of a peasant tilling the soil. He would make sketch after sketch and would return again to his subject till he was satisfied. In thirty-one years, he produced eighty pictures. Many were incomplete, but unfinished designs from his studio were sold after his death for 321,034 francs, then nearly \$65,000.<sup>4</sup>

VOCABULARY  
FOR  
THE  
WORKPLACE



**DEVELOPED BY: JODY WINCHESTER**



**BLACKHAWK TECHNICAL COLLEGE**

**Federal Projects are funded by the U.S. Department of Education.**

**State Projects are funded with state administered funds.**

**Supplemental funding is provided by the local partners.**

**THIS REPRESENTS WORK  
IN PROGRESS**

**IT IS NOT COMPLETE**

9-11-93

BEST COPY AVAILABLE

# TABLE OF CONTENTS

I. Dictionary Use

II. Using Manuals

III. Glossary: Paper Terminology

IV. Using Contracts

V. Computer Terminology

VI. Greek and Latin Etymology

DICTIONARY

USE

**Directions:** Complete the following exercise by matching the words provided to the correct definition.

- |                         |   |
|-------------------------|---|
| 1. _____ dimension      | A. The act of changing into another form, substance, state of product; transform.   |
| 2. _____ bearings       | B. The act of manufacturing.  |
| 3. _____ output         | C. Any of various devices that regulate the flow of gases, liquids, or loose materials through structures, such as piping, or through apertures by opening, closing, or obstructing ports or passageways. |
| 4. _____ gear           | D. Any of a wide variety of seals or packings used between matched machine parts or around pipe joints to prevent the escape of a gas or fluid.   |
| 5. _____ productivity   | E. To adjust (parts of a mechanism, for example) to produce a proper relationship or condition.   |
| 6. _____ gasket         | F. To fit or join together the parts of.  |
| 7. _____ cam            | G. An eccentric or multiply curved wheel mounted on a rotating shaft and used to produce variable or reciprocating motion in another engaged or contacted part.   |
| 8. _____ valve          | H. The act or process of pressing or squeezing together.  |
| 9. _____ insulator      | I. Of involving, moved, or operated by a fluid, esp. water, under pressure.   |
| 10. _____ assemble      | J. A measure of spacial extent esp. width, height, or length.   |
| 11. _____ conversion    | K. Parts that support another machine part.   |
| 12. _____ circumference | L. A material that prevents the passage of heat or electricity or sound into or out of.   |
| 13. _____ compression   | M. A toothed wheel, cylinder, or other machine element that meshes with another toothed element to transmit motion or to change speed or direction.   |
| 14. _____ hydraulic     | N. The boundary line of a circle.   |
| 15. _____ align         | O. To solder (two pieces of metal) together using a hard solder with a high melting point.  |
| 16. _____ brazing       | P. The amount of something produced or manufactured, esp. during a given time.  |

Directions: Write a definition for each word in the following list.

1. abbreviation \_\_\_\_\_

2. amplifier \_\_\_\_\_

3. binary \_\_\_\_\_

4. casein \_\_\_\_\_

5. compensation \_\_\_\_\_

6. decigram \_\_\_\_\_

7. diesel \_\_\_\_\_

8. gasket \_\_\_\_\_

9. hydraulic \_\_\_\_\_

10. juxtaposition \_\_\_\_\_

11. media \_\_\_\_\_

12. ratio \_\_\_\_\_

13. semi-conductor \_\_\_\_\_

14. torque \_\_\_\_\_

15. vernier \_\_\_\_\_

☛ Directions: Write a definition for each word in the following list.

1. acronym \_\_\_\_\_

2. analog \_\_\_\_\_

3. caliper \_\_\_\_\_

4. classification \_\_\_\_\_

5. cumulative \_\_\_\_\_

6. document \_\_\_\_\_

7. flatpack \_\_\_\_\_

8. hardware \_\_\_\_\_

9. input \_\_\_\_\_

10. magnetic disk \_\_\_\_\_

11. ohmmeter \_\_\_\_\_

12. precision \_\_\_\_\_

13. reamer \_\_\_\_\_

14. software \_\_\_\_\_

15. vertical \_\_\_\_\_

Directions: Write a definition for each word in the following list.

1. align \_\_\_\_\_

2. brazing \_\_\_\_\_

3. cathode ray tube \_\_\_\_\_

4. compression \_\_\_\_\_

5. conversion \_\_\_\_\_

6. decode \_\_\_\_\_

7. dimension \_\_\_\_\_

8. etymology \_\_\_\_\_

9. gear \_\_\_\_\_

10. linear \_\_\_\_\_

11. microprocessor \_\_\_\_\_

12. polymer \_\_\_\_\_

13. solder \_\_\_\_\_

14. turnaround time \_\_\_\_\_

15. viscosity \_\_\_\_\_



Directions: Write a definition for each word in the following list.

1. alloy \_\_\_\_\_

2. application \_\_\_\_\_

3. bread boarding \_\_\_\_\_

4. central processing unit \_\_\_\_\_

5. convert \_\_\_\_\_

6. delete \_\_\_\_\_

7. diode \_\_\_\_\_

8. filament \_\_\_\_\_

9. guarantee \_\_\_\_\_

10. imprint \_\_\_\_\_

11. lubricant \_\_\_\_\_

12. ratchet \_\_\_\_\_

13. scriber \_\_\_\_\_

14. text editor \_\_\_\_\_

15. velocimeter \_\_\_\_\_

✎ Directions: Write a definition for each word in the following list.

1. alternative \_\_\_\_\_

2. blueprint \_\_\_\_\_

3. cathode \_\_\_\_\_

4. compile \_\_\_\_\_

5. decimal \_\_\_\_\_

6. differential \_\_\_\_\_

7. electrode \_\_\_\_\_

8. gauge \_\_\_\_\_

9. ignite \_\_\_\_\_

10. kilowatt \_\_\_\_\_

11. metric \_\_\_\_\_

12. polarity \_\_\_\_\_

13. quality \_\_\_\_\_

14. rough draft \_\_\_\_\_

15. technician \_\_\_\_\_

☛ Directions: Write a definition for each word in the following list.

1. ammeter \_\_\_\_\_

2. bearings \_\_\_\_\_

3. cam \_\_\_\_\_

4. clutch \_\_\_\_\_

5. conductivity \_\_\_\_\_

6. cursor \_\_\_\_\_

7. depreciation \_\_\_\_\_

8. draft \_\_\_\_\_

9. floppy disk \_\_\_\_\_

10. hazard \_\_\_\_\_

11. insulator \_\_\_\_\_

12. macro \_\_\_\_\_

13. output \_\_\_\_\_

14. scanning \_\_\_\_\_

15. technology \_\_\_\_\_

Directions: Write a definition for each word in the following list.

1. alphanumeric \_\_\_\_\_

2. brochure \_\_\_\_\_

3. circumference \_\_\_\_\_

4. competent \_\_\_\_\_

5. crosscut saw \_\_\_\_\_

6. demonstration \_\_\_\_\_

7. fetch \_\_\_\_\_

8. hard copy \_\_\_\_\_

9. indication \_\_\_\_\_

10. machinist \_\_\_\_\_

11. obsolete \_\_\_\_\_

12. productivity \_\_\_\_\_

13. resin \_\_\_\_\_

14. tachometer \_\_\_\_\_

15. valve \_\_\_\_\_

**Directions:** Write a definition for each word in the following list.

1. ampere \_\_\_\_\_

2. bevel \_\_\_\_\_

3. capital \_\_\_\_\_

4. combustion \_\_\_\_\_

5. conductor \_\_\_\_\_

6. debit \_\_\_\_\_

7. diagnostic \_\_\_\_\_

8. ferrous \_\_\_\_\_

9. internal \_\_\_\_\_

10. maintenance \_\_\_\_\_

11. overhaul \_\_\_\_\_

12. porous \_\_\_\_\_

13. requisition \_\_\_\_\_

14. specification \_\_\_\_\_

15. uniformly \_\_\_\_\_

**Directions:** Create a list of five key terms used in your professional area. Imagine you are training a new employee with little background in the paper machine industry. Define the word and explain how the word originated and is pronounced.

1.

2.

3.

4.

5.

# USING MANUALS

## 4 FOURDRINIER PAPERMAKING

Evolved over hundreds of years, papermaking encompasses the art of fiber preparation, dispersion and formation. The following is intended as a general guide to this phase, with the presumption that the principles of headbox operation are understood.

As the basis of formation, three forming forces (*Figure 4-1*) are available as the building blocks of table production: drainage, oriented shear and turbulence. Drainage is generated by gravity and the pressure differential of vacuum. Oriented shear is an orderly aligned fluid flow generated by headbox rush/drag. Lastly, turbulence is a random, foil induced activity.

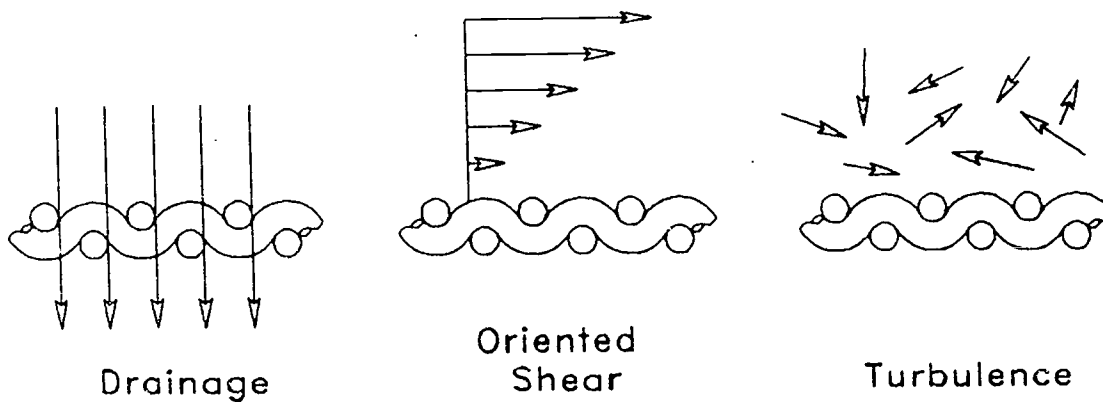

Figure 4-1. Forming Forces

Knowledge of these forces along with a study of their applications to the Fourdrinier table, indicate the optimum arrangement of table equipment. Any table can be divided into four consolidation zones based on function. These are blending, formation, transition and consolidation zones (*Figure 4-2*). Each zone's function can be reviewed from two key papermaking aspects, drainage and activity.

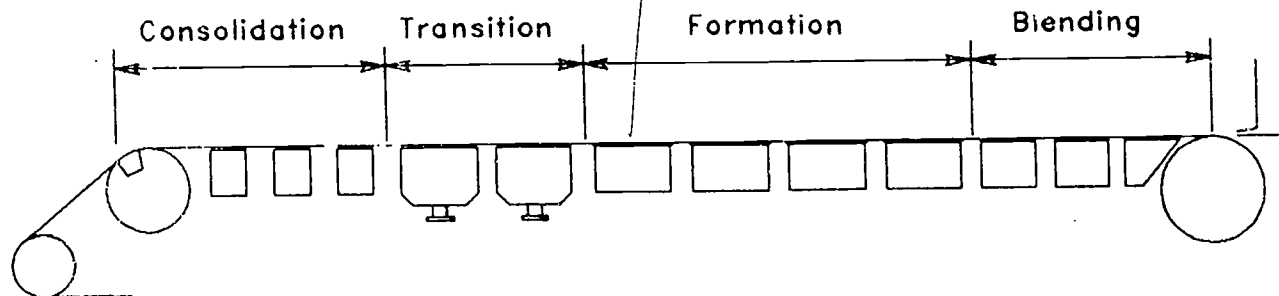

Figure 4-2. Example of Fourdrinier Drainage Zones

The first key element, drainage is essentially a function of the stock and the rate at which it gives up water. As an example, the following illustration shows the four zones of a typical forming table, and the dividing lines of table gallonage and consistency (*Figure 4-3*).



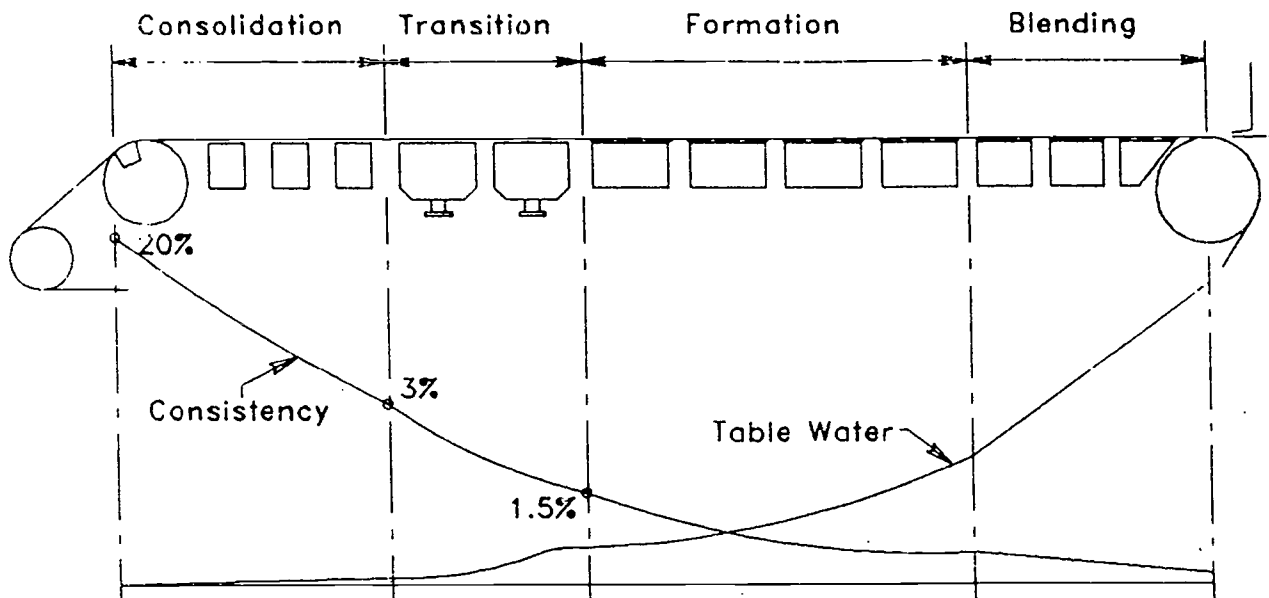

Figure 4-3. Fourdrinier Drainage Model

We know that as the consistency of the stock increases, water removal becomes more difficult and gradually increasing forces are required. Secondly, an increasing mat thickness improves retention under a given drainage force.

Our experience indicates that an optimum drainage rate is established when the jet is gently impinged on the wire and a short period of time is available to blend the headbox discharge and allow gravity to form a fiber mat on the wire (fabric). This presents a uniform stock mat to the formation zone, maximizing retention and minimizing two-sidedness.

For these reasons, the blending zone contains closely spaced, low angle foils serving simply to support the wire. The length of the zone increases with the machine speed, but shortens with improved quality discharges, which are possible with headboxes like the Converflo Headbox.

Approximately 20-30% of the headbox flow is drained in the blending zone, with the forming board providing the wire support for the jet as it is discharged onto the table. The point of discharge relative to the forming board can be controlled by either headbox jet trajectory or physical relocation of the forming board relative to the apron lip.

Normally, the best operation occurs when the jet lands on the fabric and penetrates it about one inch ahead of the lead strip of the forming board. This "strike through" causes the air in the fabric to be forced out ahead of the strip and form a seal, preventing sheet formation disruptions.

The formation zone drains the majority of the sheet's water. It uses increased blade spacing and higher angles to dewater the sheet as quickly as possible without disrupting the formed mat. Very important is the knowledge that blade spacing and machine speed affect the maximum blade angles usable on a given table.

At a sheet consistency of 1.5%, foil dewatering alone becomes inefficient and low vacuum augmented boxes (VAFB) are employed to speed water removal.

At 3% consistency, higher vacuums are required to further dewater and harden the sheet prior to transfer to the press. As these higher vacuums require more wire support, the consolidation zone is composed of typical suction boxes. Generally, once you apply vacuum, it is best to maintain its use down the table and gradually increase its level.

The second key element is activity which has its major influence on the formation of the product. Activity is required to prevent fiber flocculation and to maximize fiber distribution. Realizing that Fourdrinier drainage is relatively slow, one directional and that the sheet is layered, sufficient activity must be maintained until all fibers have been placed on the drainage mat. Only fibers adjacent to this mat (about to be formed) are affected by activity at any given time. Any interruption of activity thus affects the fiber layer being formed by that portion of the table.

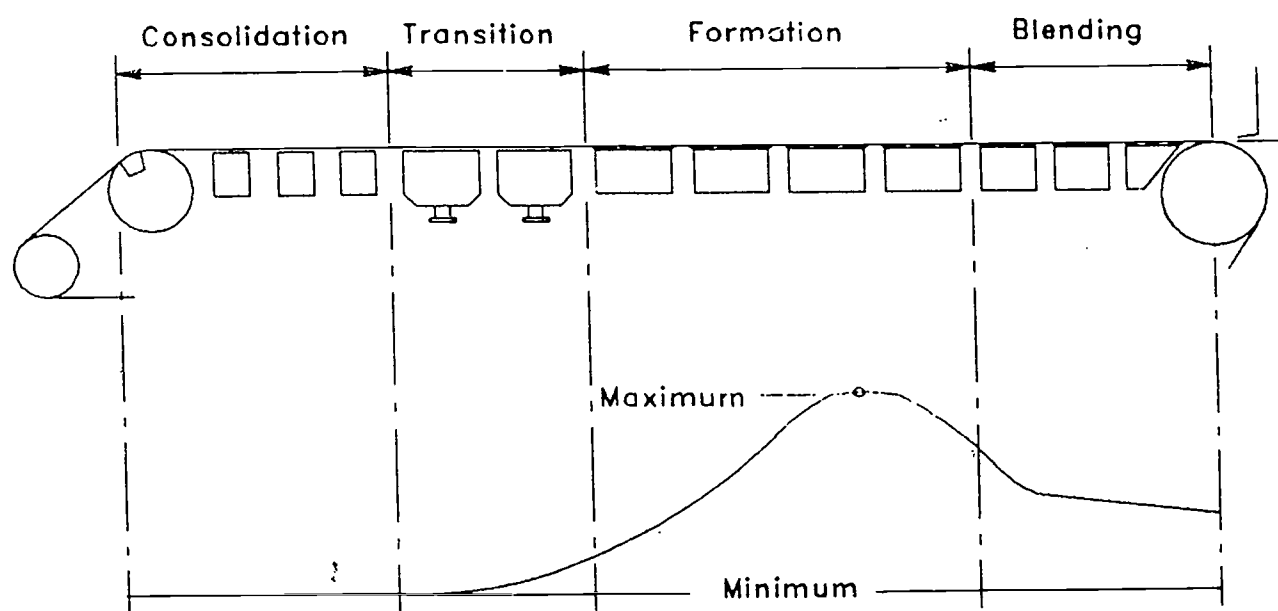

Figure 4-4. Fourdrinier Activity Model

Shown here (*Figure 4-4*) are four zones of the table and a line of relative activity. Initially, headbox turbulence and rush/drag shear supply the activity needed by the sheet forming on the fabric. The finer the scale of turbulence from the headbox, the better the initial mat formation becomes.

Upon entrance to the formation zone, the stock conditions on the wire are such that the activity level required must be increased. Supplemented with foil induced turbulence, the formation zone builds the central sheet and produces the best formation when foil activity is built up quickly and slowly reduced as sheet consistency is increased.

The latter portion of the formation zone and the transition zone then work on the top most layer of the sheet. A major relocation of fibers at this high consistency will produce a flocculated look to the sheet due to insufficient fiber mobility. Desired is a very fine scale activity to slightly shift fibers for optimum formation.

## ACTIVITY 8

**Directions:** Using the selected pages from the Fourdrinier's Manual and a dictionary, write a definition for each word in the following list. (Use context to determine the best one.) Create a sentence using each term as defined.

1. adjacent: \_\_\_\_\_  
sentence: \_\_\_\_\_
2. blending: \_\_\_\_\_  
sentence: \_\_\_\_\_
3. consolidation: \_\_\_\_\_  
sentence: \_\_\_\_\_
4. differential: \_\_\_\_\_  
sentence: \_\_\_\_\_
5. dispersion: \_\_\_\_\_  
sentence: \_\_\_\_\_
6. drainage: \_\_\_\_\_  
sentence: \_\_\_\_\_
7. flocculation: \_\_\_\_\_  
sentence: \_\_\_\_\_
8. headbox: \_\_\_\_\_  
sentence: \_\_\_\_\_
9. mat thickness: \_\_\_\_\_  
sentence: \_\_\_\_\_
10. optimum: \_\_\_\_\_  
sentence: \_\_\_\_\_
11. oriented shear: \_\_\_\_\_  
sentence: \_\_\_\_\_
12. retention: \_\_\_\_\_  
sentence: \_\_\_\_\_
13. stock: \_\_\_\_\_  
sentence: \_\_\_\_\_
14. turbulence: \_\_\_\_\_  
sentence: \_\_\_\_\_
15. uniform: \_\_\_\_\_  
sentence: \_\_\_\_\_

Dictionary Used: \_\_\_\_\_

**Directions:** Using the section provided on the Fourdriner Machine, write a definition for each term as if you were explaining it to a new employee. Create a sentence using the word as defined.

1. foreign: \_\_\_\_\_  
sentence: \_\_\_\_\_  
\_\_\_\_\_

2. corrosion: \_\_\_\_\_  
sentence: \_\_\_\_\_  
\_\_\_\_\_

3. breakage: \_\_\_\_\_  
sentence: \_\_\_\_\_  
\_\_\_\_\_

4. disassembly: \_\_\_\_\_  
sentence: \_\_\_\_\_  
\_\_\_\_\_

5. hydraulic: \_\_\_\_\_  
sentence: \_\_\_\_\_  
\_\_\_\_\_

6. torque: \_\_\_\_\_  
sentence: \_\_\_\_\_  
\_\_\_\_\_

7. pneumatic: \_\_\_\_\_  
sentence: \_\_\_\_\_  
\_\_\_\_\_

8. lanyard: \_\_\_\_\_  
sentence: \_\_\_\_\_  
\_\_\_\_\_

9. precautionary: \_\_\_\_\_  
sentence: \_\_\_\_\_  
\_\_\_\_\_

10. provision: \_\_\_\_\_  
sentence: \_\_\_\_\_  
\_\_\_\_\_

Directions: There are many words found in workplace manuals. Find the words listed below within the word find, and circle them.

L R O Y W P Z Q Y M T E N D W D O E P P F N  
 R X Z T W T X E A R R J V Z M Y Y R L S V P  
 J Q Z S W E K V K S P G D I L J Z D T I N H  
 B O B S O L E T E X R D Q F A G J M X N M Z  
 T R Z R F D S W Q L C G L S J I A J W Z L Z  
 M L A U Z I C O M P R E S S I O N S H N J M  
 F A C Z D M H T W S G N I R A E B X K M U V  
 P B D T I E K O Y C Q J S L I W C N C E B O  
 A S Z V T N P B U Z T X W J R R R I E L T L  
 D G K R G S G H J T J I U D O F R C R G T B  
 M U I Q F I A O K O P N B T J M N C O C T W  
 U G J H R O H V P Z Z U A M P E O O U Y U D  
 U S B N J N Y V L U Q L T O R N P N J H Q M  
 B S V E S E D B V H U H Q E T V H V J U F F  
 I V A L V E R H H S G I F Y U C O E L T L X  
 H G F J R H A P N N T M D Q F D N R F L Z Y  
 X P P L F O U I N T U S A C N G H S V E I B  
 I F K V O Y L W B C S O M N I X F I X I Y Y  
 X K I C O E I Y R V V F C L K R Z O N Y K W  
 F Z F B O J C I I C J N A G W D A N Y E T P  
 M H V H H P C V U R Z E A D B L I E A V F K  
 B Y O A R S Y T I V I T C U D O R P G I X D

ALIGN  
 COMPRESSION  
 GEAR  
 OUTPUT

BEARINGS  
 CONVERSION  
 HYDRAULIC  
 PRODUCTIVITY

BRAZING  
 DIMENSION  
 INSULATOR  
 VALVE

CIRCUM-  
 FERENCE  
 GASKET  
 OBSOLETE

FOURDRINIER

Directions: Using the word list below, locate the terms in the word find and circle them.

K Z G B U A M K R V C I O Z U S P J Q S Y O  
 C W W E P S X C Y P N D A Y C X F V I B C B  
 W Q F K Q T B Q B I B E Z Q I L T M I J M Q  
 Y R S O I I K R P X D C Z X N D B F Y F N P  
 U E K S K T Y N E S L K G L L G Q N U O E Z  
 O W S A W W Q Z P A Q L D U L O A D O L R M  
 G R Z W P G L K L I S E O H Y U D Q M A X X  
 D U F H C E N V W P Y T R R C U S J I L M M  
 I R V D Q R B X F A A Q R I H O A E B R K S  
 H L A A U Y D H N H A K I O N C L Z A H D D  
 G Z U I P N D I H H G R B Y L L T E E U M T  
 Z C K M N O S A V E A L L M O L H E U K B T  
 V X Z T P A O K E V C K L R T S S T R L C K  
 P J H X X B G L A I E K Y O D M E J M T Y K  
 Y X A F K U R E C L M D N E W F P V F N S Z  
 A Z F I Q B C E J I N L T V S C A T I Q H Q  
 Q A I X Q R U M A A R N A B E K R F W N B L  
 Y A Q Z V J H S D K E B H P P G A J T Q Z L  
 U X A O R N M W F I E U A S A J T H K Y Z I  
 R E G U L A T O R O M R G F M A O K W L Z C  
 D M I B Z O I O L O C K I N G B R A K E Y Y  
 E B L L I M I T S W I T C H K Z K S Z G D G

BREAST ROLL  
 FABRIC LOOP  
 LUMP-  
 BREAKER  
 SAVEALL

DANDY ROLL  
 LIMIT SWITCH  
 ORIENTED-  
 SHEAR  
 SEPARATOR

DECKLE  
 LOAD  
 PALM  
 STRETCH ROLL

DRAINAGE  
 LOCKING-  
 BRAKE  
 REGULATOR

HEADBOX

Directions: Using the word list below, locate the terms in the word find and circle them.

T E C K B R A H L Y K L E V M L B J G Q K O  
M S L U S W E F V E L V U L U D D P L Y U T  
K Q H R A B E C L A S C W O C S D L I C A N  
C P Z B Q W F K U F U O Q W B M G W N L J Z  
A K C S D G C V W D I K R S E E M O I N W S  
E H E O Q U Z U S Z S K N A B E B U T L Q L  
F A C W N F D F A E I N S T C L T A R Q F U  
E A C K G O T F U V D O A U P N M E I O L R  
K B C F P Y X H J L M I T R O C C M R L C R  
L L O R E V I R D A D P S R T U E M T T C Y  
X I A G O X C W V V D G D D D T I J U T A Q  
J N V Q G F S E H G P B B E N N E N R O V J  
Z M A I M F C M G N M B R S G O X J B R J M  
C C O F B M H P M I C B M R Z N P J U H Y P  
K V P M C N T E G L W P O Y Q P O B L T P X  
K Z A Q E K Z N F T Y L A P R O N C E Z A R  
P S S C S D B C I T L W Y P B R Q F N X R H  
W K I O A J Q Y Y O Q V D E L N B P C O T E  
W L F B R E K A E R B M U U C A V M E F Z S  
S Z Y C O Y Q I R H D F W L D O W H G W Y P  
I C L X E O J V O T E V G B U Y U L C C R B  
P N T B J T B A Q I S H V G I D L V F L C C

APRON  
 KNUCKLE  
 SLURRY  
 TURBULENCE

DRIVE ROLL  
 PONDSIDES  
 THROTTLING-  
 VALVE  
 VACUUM-  
 BREAKER

FORMING ROLL  
 REDUCER  
 TRANSDUCER

JET  
 SLICE  
 TUBE BANK

THE YANKEE PRESS SECTION

Directions: Using the word list below, locate the terms in the word find and circle them.

Q F T Z M F R W U B D R Y E R Z W M A L Y X  
 C X O T T X U D D A M E M M T C L M O F F G  
 I J O H P Q N C A J W Q U U E D M C M K D A  
 S C F G L C N N J N Y J C B R O K E K T F P  
 P Z G V H B A U Z I D P C Z I C T E K R Q D  
 N V E K E X B M Y V C Y J U A T G J Z A F D  
 K O R L K Y I P V P T L R B I O A S N K U T  
 W Q I U N E L U T J N N R O G R U O S H D J  
 Z O Y T Y X I J S L G Z J E L I F P O I F M  
 R F I V C I T V F Y S A N E W L Q N B K Y P  
 O E T Y G E Y Y V E Y L U Z K O P D L K B M  
 V S H M M J S T N W U S X Z H G H C N E H X  
 V Q U C B W R S U G J F I I K N D S C S B N  
 O W T C T Y O B S Z G G T E O R P I C W P Q  
 L Z K T T E T H B E N A J F Q B E P F I K M  
 H B L A C I R W V R R G F R R D T W E N R N  
 O E A U P W O T A R E P A C K I N G L G N X  
 F F D C D D Z N S C O N C H R O L L T O T W  
 W V M X I X N S I T V X U Q N Q D X R F B Z  
 B H O M Q G P A S I L X L I D P T G O U E V  
 T R T J M X T M M Q U E A E G K S Q L C D Q  
 L D C M A Y E K R Y Y W F O H W Z E L X Y A

BROKE  
 DRYER  
 PACKING  
 SUCTION

CONCH ROLL  
 FELT  
 PRESS-  
 SECTION  
 SWING

DANDY ROLL  
 FELT ROLL  
 RUNNABILITY

DOCTOR  
 FELT-  
 STRETCHER  
 SHOWER



USING  
GLOSSARIES  
IN  
THE  
PAPER  
INDUSTRY

**AGAINST THE GRAIN:** Applied to paper folding when fold is made at right angles to the grain of the paper.

**AIR DRIED:** The artificial drying of paper by contact with air over skeleton dryers after the paper has been surface sized.

**AIR KNIFE COATING:** The so-called air knife acts on the principle of a doctor blade and uses a thin, flat jet of air for removing the excess coating and smooths the surface.

**ANTIQUÉ FINISH:** A term describing the surface usually on book and cover papers that has a natural rough surface.

**ASH:** The mineral residue after burning a sample of paper to determine the percentage of filler it contains.

**BASIS WEIGHT:** The weight in pounds of a ream (500 sheets) of paper cut to a given standard size for that grade: 25 x 38 for book papers, 20 x 26 for cover papers, 22-1/2 x 28-1/2 or 22-1/2 x 35 for bristols, 25-1/2 x 30-1/2 for index. e.g., 500 sheets 25 x 38 of 80 lb. coated will weight eighty pounds.

**BLEACH:** A chemical used to whiten paper pulp; a solution of chlorine or similar chemicals.

**BOND PAPER:** The name "bond" was originally given to a paper which was used for printing bonds and stock certificates. It is now used in referring to paper used for letterheads and many printing purposes. Important characteristics are finish, strength, freedom from fuzz, and rigidity.

**BONDING STRENGTH:** The resistance of a coated or uncoated paper to picking or lifting of its surface fibers, or splitting of the paper while being printed.

**BOOK PAPERS:** A class of paper used for books, catalogs, periodicals, booklets and general advertising literature.

**BRIGHTNESS:** Judgment of the amount of light reflecting to the eye from the surface of paper, irrespective of hue or saturation of the color.

**BROKE:** Paper trimmings or damaged paper from the Machine or Finishing Rooms. Usually returned to beaters for re-processing into saleable paper.

**BULK:** The degree of thickness of paper.

**BURSTING STRENGTH:** Resistance of paper to rupture under pressure, as indicated in pounds per square inch on a mullen or "pop" tester.

**CALENDER BLACKENING:** A term descriptive of darkening of the intended shade of paper by excessive calendering or by calendering wet paper.

**CALENDER CUTS:** Defects caused by creasing or cutting of the web of paper during calendering due to wrinkles in the web.

**CALENDER STREAKS:** Dark lines in paper, parallel with the grain. Caused by uneven pressing and drying before calendering.

**CALENDERED:** A term descriptive of a high surfaced paper procured by passing a paper between calender rolls.

**CALIPER:** The thickness of a single sheet expressed in thousandths of an inch.

**CAST COATING:** A term applied to the process in which the coated paper is pressed against a solid surface while the coating is in a highly plastic condition. For most coatings a steam-heated drum is used. When dried, the finish is similar to the contacted surface.

**CHEMICAL PULP:** Pulp obtained by cooking wood with solutions of various chemicals. The principal chemical processes are the sulfite, sulfate, (kraft) and soda processes.

**CHIPBOARD:** A paperboard used for many purposes where strength and quality are not needed. The board is of relatively low density and is made from waste papers usually mixed papers.

**CLAMP MARKS:** Marks in paper produced by the clamps which hold it in position for guillotine trimming.

**CLOUDY:** A term indicating unevenness or irregular formation in look-through of paper.

**COATED ART PAPER:** A paper used for high-grade printing work, especially in halftone printing, where detail and definite handling of shading and highlights are important. It is usually a high-grade coated paper having a high brightness and a glossy, highly uniform printing surface.

**COATED PAPERS:** Any paper to which has been applied a surface coating.

**COCKLING:** A rippling effect given to the surface of a sheet of paper which has not been properly dried. Moisture pick-up of the sheet can also cause the cockling or wavy edges.

**CONVERTING PAPER:** Any paper which may be converted by a separate operation to produce a paper of different characteristics or to produce a product quite distinct from the original paper. Thus, kraft paper is made and sold to be converted into asphalt paper, waxed paper, gummed tape, or paper bags; writing paper is converted into envelopes, etc.

**CORRUGATED BOARD:** Usually a nine-point board after it has passed through a corrugating machine. When this corrugated board is pasted to another flat sheet of board, it becomes a single-faced corrugated board; if pasted on both sides, it becomes a double-faced corrugated board or corrugated (shipping) container board. The flat sheets are designated the container liner or, if it has to meet a specified test, test container (test liner). See Corrugating material, Double-faced corrugated board, Double-wall corrugated board, Liners, Single-faced corrugated board.

**CROSS DIRECTION:** The dimension in a piece of paper at right angles to the direction of the grain.

**CURL:** Tendency of a sheet of paper to coil or roll up at the edges. Usually caused by changes in weather or faulty drying on the paper machine.

**DANDY "PICK":** A defect in paper caused by the dandy roll picking up fibers from the sheet or otherwise disturbing the sheet formation to leave thin spots or other imperfections.

**DANDY ROLL:** A skeleton cylinder covered with a woven wire cloth, or with an arrangement of fine longitudinal wires, crossed at close intervals by heavier circumferential wires. The former structure produces wove and the latter, laid paper. The dandy roll is one method of applying watermarks to paper while wet. It is positioned on the top of the wire in front of the couch roll.

**DECKLE-EDGE:** The rough feather edges on untrimmed paper.

**DIMENSIONAL STABILITY:** That property of a sheet of paper which relates to the constancy of the dimensions in the machine and cross-machine directions under conditions of different relative humidity.

**DOCTOR:** A device for keeping the surface of a roll clean by a scraping action. Doctors may be fairly rigid boards of plastic extending across the face of a roll or they may be very thin sheets of metal with a sharpened edge.

**DRAW:** (1) In trimming paper, the displacement of the cut sheet by the thickness of the knife; this is a common cause of inaccurately cut paper. (2) The tension applied to the paper between sections of a paper machine, such as the press section or dryer section.

**DULL FINISH:** Any finish lacking in luster but which is somewhat smooth. Example--English finish book paper.

**DUPLEX PAPER:** Paper having different colors or finishes on opposite sides.

**DUPLICATING PAPER:** Generally speaking, any paper that is designed for the reproduction of multiple copies by processes such as mimeograph, spirit duplicating, diazo, etc.

**EGGSHELL:** A paper having a surface similar to that of an eggshell.

**ENAMEL:** Coated paper with a highly polished surface.

**ENGLISH FINISH:** A finish, applied to book papers, which is higher than machine finish and lower than supercalendered.

**ENVELOPE PAPER:** A term used to describe certain grades of paper commonly used for the manufacture of envelopes.

**FELT:** A woven cloth used to carry the web of paper between press and dryer rolls on the paper machine. Woolen felts are used for the wet web in the press section. Dryer felts of cotton or synthetic materials carry the paper web through the dryer section of the machine.

**FELT MARK:** An imperfection in paper caused by some coarse or grainy character of the felt after it has become worn, or filled with extracted material disrupting its porosity, so as to disturb the uniform expulsion of water from the web of paper.

**FELT SIDE:** The correct side of the paper for printing. The top side of the sheet when manufacturing.

**FINE PAPERS:** Writing papers which usually have good pen and ink writing characteristics, such as bond, mimeo, ledger, duplicator and manifold papers.

**FOLDING ENDURANCE:** A test made on paper either by means of M.I.T. or the Schopper Folding Endurance tester. This test measures the number of double folds that can be given to a strip of paper clamped between two jaws before it will break.

**FOLIO:** Trade term for size of 17 x 22 inches.

**FOURDRINIER:** The name given to the wet end of the type of paper machine invented by Louis Robert, financed by Messrs. Henry and Sealy Fourdrinier. It is usually applied to an entire modern paper machine, including the dry end, which, however, was not a part of the first paper machines.

**FUZZ:** Fibrous projections on the surface of a sheet of paper, caused by excessive suction, insufficient heating or lack of surface sizing. Lint appears in much the same manner but is not attached to the surface.

**GENERAL PURPOSE BOND:** A bond paper that is visually opaque but is translucent to ultra violet rays. This permits easy reading and reproduction by means of the diazo type process.

**GLASSINE:** A lightweight, very dense, usually translucent (unless colored) paper used for packaging and wrapping. Most common use is candy bar wrapper and the cups in boxed candy. Sometimes embossed for decorative fly-sheets.

**GRAIN:** In any sheet of paper fibers lie chiefly one way; in other words, grain direction. Paper can be specified grain long or short when ordering, and it is very important that grain direction be given.

**GROUNDWOOD:** A mechanically prepared coarse wood pulp used chiefly in the manufacture of newsprint and lowest priced grades of book paper.

**GUILLOTINE:** An instrument for trimming paper with a downward cutting action similar in operation to the guillotine used in France.

**GUMMED PAPER:** A general name for any paper coated on one side with an adhesive gum, the adhesive being a dextrin, a fish, or an animal glue, or a blend of two or three of these.

**HUMIDITY:** The moisture condition of the air. Actual humidity is the number of grains of moisture in the air at any given time. Relative humidity is the percent of moisture relative to the maximum which air at any given temperature can retain without precipitation.

**INDEX BRISTOLS:** Bristols used principally for index records, business and commercial cards. They are a group of cardboards made on the fourdrinier or cylinder machine of homogeneous stock.

**INDIA PAPER (Oxford India or Bible Paper):** A paper used in dictionaries, Bibles, and reference books, where a very lightweight, strong, opaque paper is required. It is made from strong rag pulp and loaded with barium sulphate.

**INTERNAL BOND STRENGTH:** Is the measure of the strength of the bond between body stock and coating as measured by Dennison's Graded Waxes. Low internal bond strength could lead to "picking" the clay from the paper when tacky inks are used.

**JOB LOT:** (1) Paper produced in excess of an order or small lots of discontinued lines. (2) Paper rejected because of defects or failure to conform to specifications, or paper which, although of standard quality at the time of manufacture, has become non-standard because of a change in standards subsequent to manufacture.

**Kraft Paper:** A tough wrapping paper made from sulphate pulp.

**LABEL PAPER:** Especially sized for label printing; can be machine finished, supercalendered or coated one side (CIS).

**LAIID:** A watermark made by means of dandy roll with close parallel lines running at right angles to chain marks.

**LEDGER PAPER:** A strong smooth writing paper used for records and ledgers.

**LINEN FINISH:** A paper finished with a surface similar to linen.

**MACHINE DIRECTION:** The direction of paper parallel to its forward movement on the paper machine. The direction at right angles to this is called the cross direction.

**MACHINE FINISH:** It is a finish between eggshell and English finish in smoothness.

**MANIFOLD PAPER:** Paper used for additional carbon copies. It is manufactured in substance weight of 7 to 9 lbs. with an unglazed or machine glazed finish. Important properties are finish and porosity.

**MECHANICAL PULP:** Carefully cleaned and de-barked logs are pressed against the face of a rapidly revolving grindstone, the abrasive action of which tears the fibers from their setting in the wood. Fiber strength can be varied by using stone of different surfaces. Usually called "Groundwood" Pulp.

**MIMEO-BOND:** Writing paper used for making copies on the mimeograph machine. Bleached chemical wood pulps and mixtures of fibers are used. Opacity, finish, absorbency, lack of fuzz, scuff resistance and mimeographing qualities are significant properties. In addition to good mimeographing qualities, it must have good writing and printing qualities.

**MOISTURE CONTENT:** The percent of moisture found in finished paper. The amount varies according to atmospheric conditions because paper may either absorb or emit moisture.

**MULLEN TESTER:** Equipment which tests bursting strength.

**NATURAL:** A paper color, such as cream, white or ivory.

**OFFSET PAPER:** A paper designed for use on offset presses with general characteristics to resist distortion from stretching or shrinking, good pick strength, freedom from fuzz, and a smooth surface which will take ink evenly without "set-off". May also be used on lithographing presses and for letterpress printing.

**ONIONSKIN:** A very thin paper made either from wood or rag pulps, or a combination of both. Used for carbon copies, air mail and stuffers.

**OPACITY:** When printed literature is heavily illustrated, opacity of the paper is essential to eliminate "show through". For heavy printing, paper of high opacity should be used.

**OVER-RUN:** A quantity of paper made in excess of the amount ordered. Trade practices permit a certain tolerance for over-runs and under-runs.



PAPER: A homogeneous formation of primarily cellulose fibers which are formed in water suspension on the machine wire and bound together by weaving of the fibers and by bonding agents. Originated as a medium of fluid writing.

PEBBLING: A process of embossing paper after printing to give a uniform ripple effect.

PICKING: The lifting of any portion of a paper surface during the printing impression, due sometimes to inadequate surface sizing and sometimes to ink being excessively tacky.

PLATE FINISH: A fine, smooth, hard finish.

PLATE-FINISHED PAPER: Any paper finished on a sheet plater. The finish may be a smooth or a fancy finish such as linen, ripple or coarse finish.

POROSITY: A test which measures the time required for a given amount of air to flow through a sheet of paper. This test is a measure of how closely the fibers are compacted and bonded together. A paper of high porosity is one that is quite dense and relatively non-porous. This test is made with a "Densometer".

PULP: A mixture, as of wood fibers--or rags, reduced to a pulpous condition and forming the basis from which paper is made.

QUARTO: A result of folding or cutting a sheet in four.

QUIRE: One-twentieth of a ream. In coarse papers (wrapping, tissues, etc.) 24 sheets, and in fine papers (books, writing, etc.) 25 sheets, are considered a quire.

RAG CONTENT: A term which indicates that a paper contains a percentage of rag pulp. The rag content normally used may vary from 25 to 100 percent.

REAM: A quantity of paper - 500 sheets for most papers; some tissues 480 sheets.

REGISTER PAPER: A type of bond paper for multiple form use.

RIPPLE FINISH: A dimpled or rippling effect given to the surface of paper by means of an embossing roll.

**SAFETY PAPER:** Specially made protective paper for bank checks, negotiable certificates, etc., with an overall design to disclose any erasures.

**SHOW-THROUGH:** The condition where printing on one side of paper can be seen from the other side when the latter is viewed by reflected light.

**SIZING:** The treating of paper to control the absorption of ink.

**SKID:** A platform, usually wooden, on which a sheet paper is packed for shipment.

**SLACK-SIZED:** Paper which has not been sized.

**STRETCH:** The elongation of a strip of paper when subjected to a tensile pull. The term colloquially but incorrectly used to indicate expansion caused by moisture absorption of a sheet of paper.

**STRIKE-THROUGH:** The penetration of ink through paper.

**SUCTION BOX:** A device at the wet end of the machine which removes water from the paper web. It is located under the wire and removes water by means of a vacuum pump.

**SULFATE:** Alkaline process of cooking pulp. More often referred to as kraft process.

**SULFITE:** Acid process of cooking pulp. Also the pulp cooked by this process.

**SUPERCALENDERED PAPER:** A paper highly finished by running it through a calender stack which is usually made up of a number of chilled iron and hard paper rolls.

**TEXT PAPER (See Book Papers):** A high grade of antique, eggshell, laid or wove book paper, frequently watermarked and deckle-edged and used for deluxe books, booklets, brochures, announcements and advertising literature.

**TWO SIDED:** A variation in the two sides of a sheet. The wire or under side of a sheet is more compact than the felt side or upper part of the sheet.

**VELLUM FINISH:** A smooth finish on paper imitating the surface of real vellum.

**WATERMARK:** A mark, name or design made into the sheet of paper by the dandy roll during the process of manufacture.

**WAVINESS:** A wrapping effect occurring along the edges of paper, particularly across the grain of paper exposed to an excess of atmospheric moisture.

**WEB:** The continuous sheet of paper forming or having been formed and finished on a paper machine. In the finished state a web is not necessarily the full, trimmed width of paper made, but may be any portion of the original web wound into a roll for coating, embossing or printing.

**WET STRENGTH:** The tensile strength of paper if it is wetted after manufacture. Wet strength is increased by adding certain synthetic resins to the furnish.

**WIRE:** The moving "screen" at the wet end of a paper machine where the sheet is formed.

**WIRE SIDE:** The under side of a sheet of paper as it comes off papermaking machine.

**WITH THE GRAIN:** A term applied to folding paper parallel to the grain of the paper.

**YANKEE MACHINE:** A type of Fourdrinier paper machine employing a single dryer of large circumference with highly polished surface. The side of the paper coming in contact with this surface takes a glazed finish.

## ACTIVITY 12

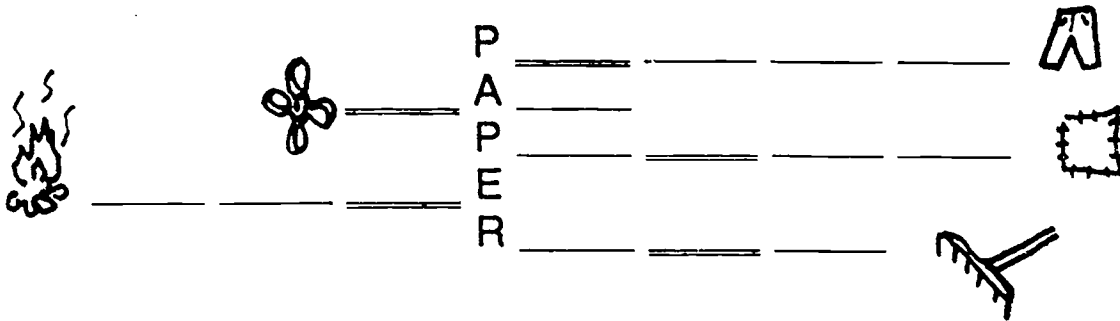

India paper is a lightweight strong and fairly opaque paper used in Bibles, dictionaries and reference books. It is loaded with barium sulphate and it consists of rag pulp. Another type of paper is made from sulphate. It is used very differently than India paper. Find out the name of this PAPER by filling in the blanks next to each picture. When all words are completed, rearrange the letters with the double underline to discover the answer.

In your own words, define the paper you discovered above and describe its uses.

**Directions:** Correctly match the letter of the terms provided to the following definitions. Locate the terms using the glossary of paper terminology.

- \_\_\_\_\_ 1. A very thin paper made either from wood or rag pulps, or a combination of both. Used for carbon copies, air mail and stuffers.
- \_\_\_\_\_ 2. A lightweight, very dense, usually translucent (unless colored) paper used for packaging and wrapping. Most common use in candy bar wrapper and the cups in boxed candy. Sometimes embossed for decorative fly-sheets.
- \_\_\_\_\_ 3. The moisture condition of the air. Actual humidity is the number of grains of moisture in the air at any given time. Relative humidity is the percent of moisture relative to the maximum which air at any given temperature can retain without precipitation.
- \_\_\_\_\_ 4. A strong smooth writing paper used for records and ledgers.
- \_\_\_\_\_ 5. A type of bond paper for multiple form use.
- \_\_\_\_\_ 6. The penetration of ink through paper.
- \_\_\_\_\_ 7. Specially made protective paper for bank checks, negotiable certificates, etc., with an overall design to disclose any erasures.
- \_\_\_\_\_ 8. A finish, applied to book papers, which is higher than machine finish and lower than supercalendered.
- \_\_\_\_\_ 9. One-twentieth of a ream.
- \_\_\_\_\_ 10. The tensile strength of paper if it is wetted after manufacture.

a. english finish  
 b. ledger paper  
 c. wet strength  
 d. register paper  
 e. humidity

f. quire  
 g. onionskin  
 h. safety paper  
 i. glassine  
 j. strike-through

## ACTIVITY 10 - PART A

---

**Directions:** In each sentence below, a term related to paper production is hidden. Underline the words as you find them.

1. Because we live in the United States, we are American.
2. The ashtrays need emptying.
3. "Mary said if you cook an egg, she'll eat it."
4. We believe that all men are created equal.
5. Trees littered the ground; wood fell everywhere.
6. The frames need glass in each eye hole.
7. The flowered ledge ran the length of the window.
8. The deep water marked the start of the river.
9. The face of the young mother looked tired and drawn.
10. To prepare for a winter that is raw, stock up the pantry.

## ACTIVITY 10 - PART B

**Directions:** Taking each word underlined in the preceding exercise (Activity 10 - Part A), write a definition as it relates to the paper industry. Write as if you are describing it to someone with no knowledge of your profession.

1. \_\_\_\_\_  
\_\_\_\_\_  
\_\_\_\_\_
2. \_\_\_\_\_  
\_\_\_\_\_  
\_\_\_\_\_
3. \_\_\_\_\_  
\_\_\_\_\_  
\_\_\_\_\_
4. \_\_\_\_\_  
\_\_\_\_\_  
\_\_\_\_\_
5. \_\_\_\_\_  
\_\_\_\_\_  
\_\_\_\_\_
6. \_\_\_\_\_  
\_\_\_\_\_  
\_\_\_\_\_
7. \_\_\_\_\_  
\_\_\_\_\_  
\_\_\_\_\_
8. \_\_\_\_\_  
\_\_\_\_\_  
\_\_\_\_\_
9. \_\_\_\_\_  
\_\_\_\_\_  
\_\_\_\_\_
10. \_\_\_\_\_  
\_\_\_\_\_  
\_\_\_\_\_

# CONTRACTS



Directions: There are many words found in contracts. Find the words listed below in the word find, and circle them.

M X C G F D N F M M K Q L V N K C J G M T O  
 X D C X F U E L H Z K N E F E V O U H U N N  
 X C R G D E R E W O P M E G N U L Q F V Y O  
 P S C Z A O B M N U Z W K O P K S T Y F X N  
 Y U O B T T Q R K Q U I I W D P M J R T F T  
 R J N N B O T B Y W I T L N X R T D Z O U R  
 A S T F G A R R P H A W O G T O R Q H Y R A  
 M C I H E U M V I T L I X Q Y B L I E U P D  
 I P N T F K R T N T T C H A Z A R D O U S I  
 I T G U F X I E S A I Z L G J T J J R H R T  
 I D E R T J M R C X V O I A J I F S E H Y I  
 N Y N Q K E F I T Y C S N A F O P T I F E O  
 G U C P L K F W I S U U J I N N W E M L I N  
 X O Y P B I N C E N T I V E B A Q W B S F A  
 E D M Z S U B S E C T U C N G R W A U O W L  
 N I G S Y I K Z E H O G J E U Y L R R W Z F  
 W L A P R E F E R E N T I A L L G D S T N N  
 O L Z R K L W Q J T L U E B A L E N E R A S  
 C S E X W H J Y Y P G W V C D O Q W M U Q O  
 K F O C R L V H A O Y V E P S R B M E J L H  
 Q U G I E K B W Q S H R G S F P P M N R S J  
 A T T R G F F A R B I T R A T I O N T V R X

ARBITRATION  
 EMPOWERED  
 LIEU  
 PYRAMIDING  
 STRIKE  
 ATTRITION  
 HAZARDOUS  
 NONTRADITIONAL  
 RECALLABLE

SUBSECTION  
 CLASSIFICATION  
 IMPLEMENTATION  
 PREFERENTIAL  
 REIMBURSEMENT  
 CONTINGENCY  
 INCENTIVE  
 PROBATIONARY  
 STEWARD



## MAGIC SQUARE

**Directions:** Select the best match for each lettered word from the numbered definitions. Place the number in the proper space in the Magic Square Box. If done correctly, the total of the numbers will be the same across each row and down each column.

**WORDS:**

- A. reimbursement
- B. subsection
- C. contingency
- D. pyramiding
- E. arbitration
- F. attrition
- G. empowered
- H. classification

- I. recallable
- J. preferential
- K. lieu
- L. probationary
- M. strike
- N. implementation
- O. incentive
- P. hazardous

1. A refusal by employees to continue working in an attempt to force an employer to grant certain demands such as higher wages or better working conditions
2. The settlement of a dispute by a person or persons chosen to hear both sides and come to a decision
3. Involving the period of testing or trial
4. To speculate in (stock) by making a series of buying and selling transactions in which paper profits are used as margin for buying more stock. American Heritage
5. A subdivision of any of the sections into which the contract is divided
6. In place of, instead of
7. Given power or authority
8. Put into effect
9. A share or quota, as of troops, laborers, delegates, etc.
10. Designating a union shop which gives preference, as by contract, to union members in hiring, layoffs, etc.
11. The loss in the personnel of an organization in the normal course of events as because of death, retirement, etc.
12. Something that stimulates on to take action, work harder-stimulus, encouragement
13. dangerous, perilous
14. Arrangement according to some systematic division into classes or groups
15. Able to call back
16. To repay or compensate for expenses, damages, or losses

A	B	C	D
E	F	G	H
I	J	K	L
M	N	O	P

Definitions were obtained from Webster's New World Dictionary - The New Color Edition

# COMPUTER TERMINOLOGY

# COMPUTER VOCABULARY

**Backup** - Pertaining to procedures or equipment that are available for use in the event of failure or overloading of the normally used equipment or procedures.

**Boot** - Copy the operating system into RAM.

**Data** - The raw material of information.

**Document** - A record that has permanence and that can be read by a person or machine.

**Downtime** - The length of time a computer system is inoperative due to a malfunction.

**Edit** - To check the correctness of data.

**Execute** - To run a program on the computer or to carry out an instruction.

**Fax** - Abbreviation for a term meaning an exact copy.

**Feed** - The mechanical process whereby lengthy materials are moved along the required operating position.

**Glitch** - A popular term for an electrical hardware or software problem.

**Index** - A table of references held in storage.

**Key** - The field or fields that identify a record.

**Layout** - The overall design or plan.

**Load** - To read information into the storage of a computer.

**Log** - A record of the operations of data processing equipment, listing each job or run, the time it required, and other pertinent data.

**Memory** - The storage facilities of the computer, capable of storing vast amounts of data.

**Menu** - A list of options within a program that allows the user to choose which part to interact with.

**Modem** - An acronym for a device that provides the appropriate interface between a communications link and a data processing machine.

**Mouse** - Pointing device to move cursor around screen or to choose menu items.

**Output** - Data transferred from a computers internal storage unit to some storage or output device.

**Paddle** - A type of input device. It has a stick that is manipulated by the user to produce different inputs.

**Readout** - The manner in which a computer presents the processed information.

**Software** - The name given to the programs that cause a computer to carry out particular operations.

**Terminal** - An input/output peripheral device that is on-line to the computer, but is in a remote location: another room, another city, or another country.

**Transistor** - A semiconductor device for controlling the flow of current between two terminals.

**Source for Definitions:** The Illustrated Computer Dictionary Revised Edition by Donald D. Spencer

COMPUTER LANGUAGE

Directions: With the increase in computer-generated work, you come in contact with the jargon or terms connected with computers more often. Find the terms listed below in the word find, and circle them.

A K L Z U N L T Y X R G H X T M Y R B O B V  
 H Z B Z N Y U D U U N A H Z L E F K H K F S  
 N C J L W Z W X Y A F C E N K J R K W O N S  
 A Q S K N X C I G L Q T J D F O S M R Q X G  
 D A F L M Y P B A E B K L N N B I C I X X S  
 H X T O N R B N Q K G W S B V I E D N N J U  
 L W U B W O G J M N W Y H Y Q X F L R Q A R  
 M S P L N U C O I M O T H E R E O A R D P L  
 E I J O A N R S X S C I H P A R G A P P L I  
 G E C G D Y B A C K U P T W K E T A L L O C  
 Q M E R J L F T Q F B A R A Z W B R B O K A  
 Q I S I O B N S F E M S E Y C V G O Y L H D  
 L T T Z M P J O Y S T I C K N I H P T R S A  
 V S S G Y Z R V U G M N R T J W L N E X B A  
 I S Q C L P P O I Y B D Y S S F T P S K O M  
 R E D W A E O A C G L L M E Q U C X P D X P  
 U C J P L N J C R E E E T R D A T A B A S E  
 S C X I R N N X D A S K G I W R S F F I M Y  
 N A F P P A E E F R L S H A T U P Q O U K W  
 Y K R F B G H G R Q A L O L B L U D V D T K  
 N B A C X R F R W F S H E R U X M O B C I H  
 D Z L X V N S Z S J I C R L Q T K L S T Z K

ACCESS TIME  
 COLLATE  
 HARDCOPY  
 MOTHERBOARD  
 SCANNER  
 APPLICATION

DATE BASE  
 JOYSTICK  
 MOUSE  
 SERIAL  
 BACKUP

FILE  
 LANGUAGE  
 PARALLEL  
 TERMINAL  
 BYTES

GRAPHICS  
 MICRO-  
 PROCESSOR  
 ROM  
 VIRUS

## COMPUTERS

asoft \_\_\_\_\_ arecua  
print \_\_\_\_\_ utahnv  
ebina \_\_\_\_\_ yghkun  
sucvl \_\_\_\_\_ atajel  
ekout \_\_\_\_\_ utrgux  
psent \_\_\_\_\_ rminal  
thlup \_\_\_\_\_ ogramd  
sioqs \_\_\_\_\_ ilerst  
fnuvk \_\_\_\_\_ yboard  
repza \_\_\_\_\_ cesste  
punby \_\_\_\_\_ esrlmb

Each row of letters includes a computer term, but one letter is missing. All the letters in each line will not be needed to spell the term. Circle each term after filling in the missing letter. If done correctly, the missing letters (reading down) will reveal the name of a computer "package".

Directions: Using the glossary, provided find the words defined by the following descriptions. Place the words in the correct boxes.

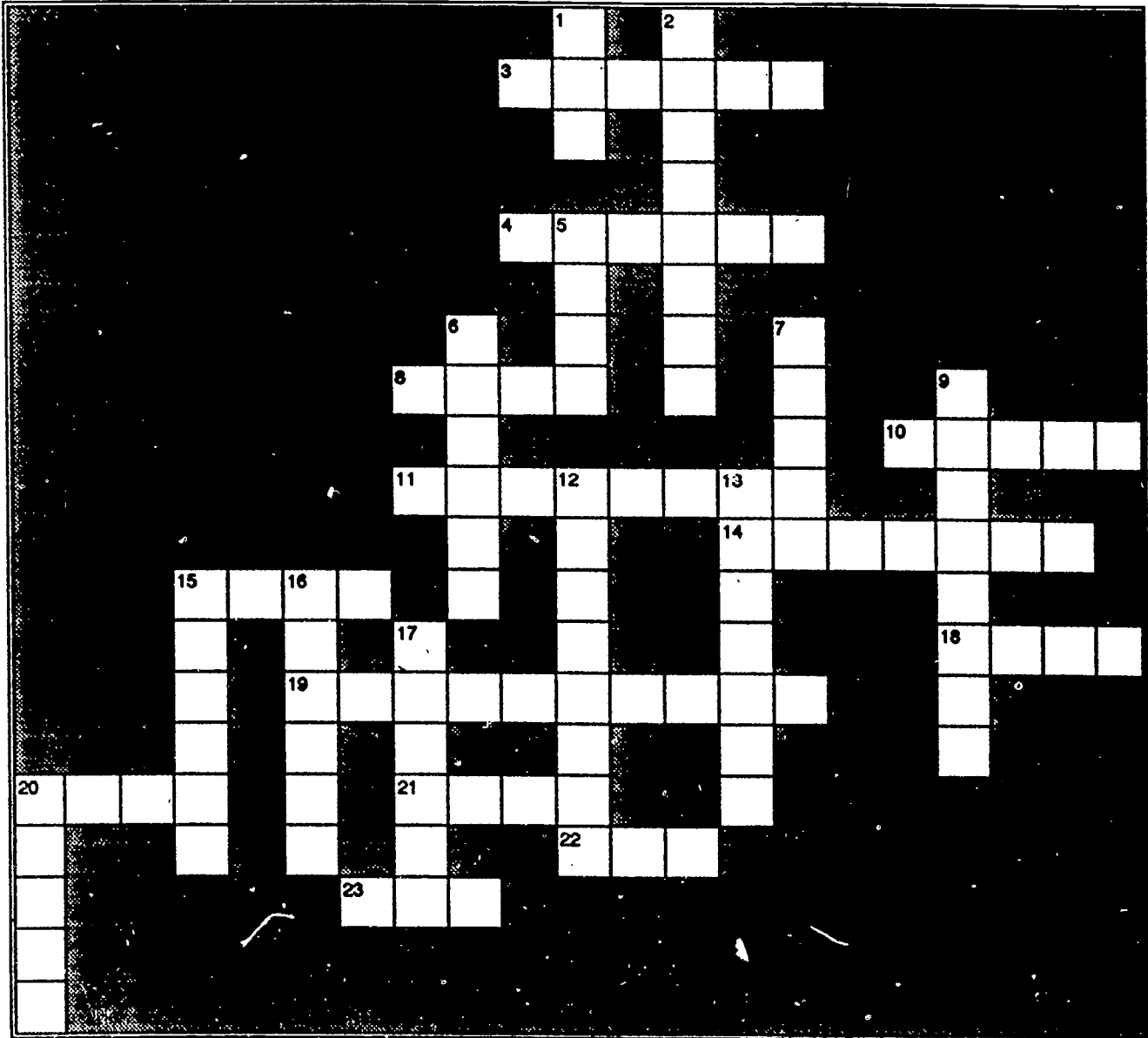



## ACROSS

3. The overall design or plan.
4. A popular term for an electrical hardware or software problem.
8. The mechanical process whereby lengthy materials are moved along the required operating position.
10. Pointing device to move cursor around screen or to choose menu items.
11. The name given to the programs that cause a computer to carry out particular operations.
14. To run a program on the computer or to carry out an instruction.
15. Copy the operating system into RAM.
18. To check the correctness of data.
19. A semiconductor device for controlling the flow of current between two terminals.
20. A list of options within a program that allows the user to choose which part to interact with.
21. The raw material of information.
22. A record of the operations of data processing equipment, listing each job or run, the time it required, and other pertinent data.
23. The field or fields that identify a record.

## DOWN

1. Abbreviation for a term meaning an exact copy.
2. The length of time a computer system is inoperative due to a malfunction.
5. To read information into the storage of a computer.
6. The storage facilities of the computer, capable of storing vast amounts of data.
7. A table of references held in storage.
9. A record that has permanence and that can be read by a person or machine.
12. An input/output peripheral device that is on-line to the computer, but is in a remote location: another room, another city, or another country.
13. The manner in which a computer presents the processed information.
15. Pertaining to procedures or equipment that are available for use in the event of failure or overloading of the normally used equipment or procedures.
16. Data transferred from a computer's internal storage unit to some storage or output device.
17. A type of input device. It has a stick that is manipulated by the user to produce different inputs.
20. An acronym for a device that provides the appropriate interface between a communications link and a data processing machine.

WORKPLACE COMPARISONS

**Directions:** Find a word in the word box that is related to the underlined word. Place the word in the corresponding blank.

log	collate	layout	graphics	gulp
package	WordPerfect	screen	justify	syntax
semiconductor	memory	glitch	bug	menu
hacker	batch	trunk	wafer	backup
nybble	noise	ARTSPEAK	prototype	Apple

1. software: \_\_\_\_\_
2. system: \_\_\_\_\_
3. malfunction: \_\_\_\_\_
4. design: \_\_\_\_\_
5. enthusiast: \_\_\_\_\_
6. bytes: \_\_\_\_\_
7. disturbance: \_\_\_\_\_
8. problem: \_\_\_\_\_
9. visual: \_\_\_\_\_

10. record: \_\_\_\_\_
11. list: \_\_\_\_\_
12. storage: \_\_\_\_\_
13. copy: \_\_\_\_\_
14. collection: \_\_\_\_\_
15. align: \_\_\_\_\_

GREEK

AND

LATIN

# GREEK PREFIXES

## Prefix

a  
an  
anti  
auto  
cosm  
di  
dia  
dys  
ec  
em  
en  
epi  
eu  
hemi  
homo  
hyper  
hypo  
kilo  
meta  
mono  
neo  
para  
penta  
peri  
poly  
pro  
sym  
syn  
tele

## Meaning

not  
not  
against  
self  
order, world  
two  
through, apart  
ill, bad  
out of  
in, on  
in, on  
on, upon  
good, well  
half  
same  
over  
under  
thousand  
change, beyond  
one, same  
new  
beside  
five  
around  
many  
before  
with, together  
with, together  
far

## Example

amoral, apathetic  
anarchy  
antifreeze  
autograph, automatic  
cosmic  
diabolical  
diagonal  
dysentery  
ecstasy  
empathy  
engrave  
epicenter  
eulogy  
hemisphere  
homonym  
hyperactive  
hypothermic  
kilometer  
metamorphosis  
monotone  
neo-Nazi  
parallel  
pentameter  
perimeter  
polygraph  
propose, program  
sympathy  
synonym  
telegraph

# LATIN PREFIXES

<u>Prefix</u>	<u>Meaning</u>	<u>Example</u>
a	from, away	avert
ab	from, away	abnormal, absent
ad	to, toward	advance
ambi	both	ambidextrous
ante	before	anteroom
bene	good, well	benefit
bi	two	biannual, bicycle
cent	hundred	century
circum	around	circumstance
co	with, together	cooperate
com	with, together	committee
con	with, together	conduct
counter	against	counterattack
contra	against	contradict
cor	with, together	correlate
de	down, away	deport
dec	ten	decimal
dis	apart, away, not	dislike, dishonor
ex	out of, formerly	exit
extra	beyond, outside	extraordinary
in	in, into, on	include
in	not	inactive, inconvenient
inter	between, among	interaction, independent
intra	within, into	intramural, intrapersonal
intro	within, into	introduce
mal	bad	malfunction
micro	small	microscope
mille	thousand	millimeter
multi	many, much, multiple	multiply
non	not	nonprofit, nontoxic
ob	against, upon	object
oct	eight	octagon
of	against, upon	offense
op	against, upon	oppose
per	through	pervade
post	after	postpone
pre	before	precede, prejudice
pro	forward, in favor of	produce
quadr	four	quadrant
re	back, again	repay
retro	backward	retroactive
se	apart, away from	segregation
semi	half	semicircle
sub	under	substandard
super	over, more than, extra	superior
trans	across, over, beyond, through	transport
tri	three	tricycle
ultra	beyond, extremely	ultra-conservative
uni	one	unify uniform

# GREEK ROOTS

<u>Root</u>	<u>Meaning</u>	<u>Example</u>
acro	height, point	acrobat
andro	male	androgeny
anthropo	mankind	anthropology
arch	chief	monarch
aster	star	asterisk
astro	star	astrology
athl	contest, prize	decathlon
bibl	book	Bible, bibliography
bio	life	biography
chrom	color	monochromatic
chron	time	chronicle
cracy	power, rule	theocracy
crat	power, rule	bureaucrat, autocrat
crypt	hidden, secret	cryptic
cycl	circle, wheel	motorcycle
dem	people	democracy
derm	skin	dermatitis, epiderm
dyna	power	dynamite, dynamic
gam	marry, marriage	bigamy
geo	earth	geography
gnos	know, knowledge	diagnosis
gram	write, written	telegram
graph	write, written	autograph
gyn	female	gynecology
hetero	different	heterogeneous
homo	same, one	homonym
hydr	water	hydrant
log	speech, speak	prologue
mark	sign, boundary	landmark
mega	large, great	megaphone

<u>Root</u>	<u>Meaning</u>	<u>Example</u>
meter	measure	barometer
metr	measure	optometry
mis	hate, hatred	misogynist
morph	form, shape	metamorphosis
neur	nerve	neurology
nym	name	antonym
ology	study of	psychology
op	sight, eye	optical
ortho	straight, corrective	orthodontist
pan	all	panchromatic
path	feeling, suffering, disease	pathological
phil	love, lover, have an affinity for	anglophile
phobe	fear	claustrophobia
phon	sound, voice	phonograph
photo	light	photography, photon
pod	foot, feet	tripod
polis	city, citizen	metropolis
polit	city, citizen	politician
pseudo	false	pseudonym
psych	mind, brain, spirit	psychiatrist, psychic
pyr	fire, heat	pyrogenic
scop	see	telescope
soph	wise	sophisticated
tax	arrangement	taxonomy
techn	art, skill	technical
tele	far, distant	television
the	god	theology
therm	heat, warm	thermometer
tom	cut	appendectomy
zoo	animal	zoology

# LATIN ROOTS

<u>Root</u>	<u>Meaning</u>	<u>Example</u>
act	do	active
alter	other	alternative
altus, alte	high	altitude
amor	love	amorous
anno	year	anniversary
aqua	water	aquatic
audio	hear, sound	audio
ban	proclaim, banish	banner
barr	to obstruct	barricade
bat	to strike	combat
brev	short	abbreviate
cand	white, bright, shining	candle
capt	take, hold	capture
caput	head	capital
carn	flesh	carnage, carnal
ced	yield, move, go	concede
cess	yield, move, go	procession
cide	cut, kill	homicide
cit	speak, say, tell	incite
cite	call to action	civilian
civis	citizen	clarity
clar	clear	incline
clin	lean	cogitate
cogito	turn over in one's mind, ponder	recognize
cognitio	know	corpse
corp	body	incredible
cred	believe	current
cur	run	dictate
dens, dent	tooth	dentist
dict	say	predict
doc, doct	instruct, teach	doctrine
duc	lead	reduce
dur	hard, lasting	durable
fac	make, do	factory
fec	make, do	effect
fic	make, do	efficient
fer	carry, bear	transfer
fin	limit	final
fort	strong	fortress
frag, fract	to break	fragment, fracture
frat	brother	fraternity
fund, found	to base, establish	fundamental, foundation
gen	race, birth, kind	genesis, genetic
grad	walk, step, go	gradual
grat	thankful, free	grateful, gratitude
gress	walk, step, go	progress
it	to go	transit
ject	throw	project
junct	join	junction
juris	right, justice, law	jury
jus	right, justice, law	justice
loc	place	location, local
locu	speak	elocute
loqu	speak	ventriloquist
luc	light	lucite



<u>Root</u>	<u>Meaning</u>	<u>Example</u>
magn	great	magnificent
mal	bad	malfunction
man	hand	manual, manuscript
mania	madness	maniac
mare	the sea	marine
mater	mother	maternal
medi	middle	median, mediate
ment	mind	mental
miss	send	missile, mission
mit	send	submit
moni	to advise	monitor
mort	death, die	mortal
mov, mot, mob	to move	motion, mobile
nat	birth, born	nation, native
nom	name	nominate
nov	new	novice
ocul	eye	binoculars
oper	work	operate
orb	circle	orbit
orn	to decorate	ornate
osteo	bone	osteopathy
pac	peace	pacify
pact	to agree, fasten	pact
par	equal	compare
pater	father	paternal
ped	foot, child	pediatrician, pedicure
pel	drive	repel
pend	way, hang	pendant
plac	to please	placate
plen	full	plenty
plet	fill	complete
pon	place, put	opponent
popul	people	population
port	carry, to bring	porter, transport
pos	place, put	position
prim, prin	first	primary, principle
quest, quir, quis	to ask, seek	question, inquire
rat	reckon, reason	rationalize
rect, reg	to rule right	rectify, regent
rupt	to break	rupture, bankrupt
san	healthy	sanity, sanitary
sat	enough	saturate
scend, scent	to climb	transcend
sci	know	science
scrib	write	prescribe
script	write	transcript
sect	cut	dissect, section
secut	follow	consecutive
sen	old	senior
sens	feel	sensitive
sent	feel	sentiment
sequ	follow	sequence
sign	mark, sign	resign
soci	companion	associate
sol	alone	solitude

Latin Roots Cont.

<u>Root</u>	<u>Meaning</u>	<u>Example</u>
somnus	sleep, slumber	insomniac
son	sound	sonic
soror	sister	sorority
spect	look, watch	spectator
spir	breath	respiration
stat	stand	constant
strict	tighten	constrict
structum	to build, to put together or in order	construct
tact	touch	contact
tend	stretch, hold	contend
tens	stretch, hold	tension
tent	stretch, hold	intert
terra	earth, land	terrace
termin	end, limit	terminate, terminal
test	witness	testify
tol	to raise, support	extol
tort	twist	contort, torture
tract	draw, pull	tractor
ven	come	convent
vers	turn, change	versatile
vert	turn, change	convertible
vis	see	vision
vita	life, live	vital
viv	life, live	vivacious
voc	call, voice	vocal, vocation
vol	wish	volunteer

## SUFFIXES

<u>Suffix</u>	<u>Meaning</u>	<u>Example</u>
able	capable of	movable
ac	like, related to	cardiac
acious	having the quality	vivacious
acy	quality or state of	privacy
age	state of, act of	marriage
al	relating to	annual
an	belonging to	suburban
ance	state of, act of	persistence
ancy	state of, act of	malignancy
ant	a person who	merchant
ar	relating to	similar, polar
arium	place for	aquarium
ary	relating to	aviary
ate	a person who	delegate
ate	to perform	nominate
ation	action	creation
ee	a person who	employee
eer	a person who	racketeer
en	to make, become	lengthen
ence	state of, act of	independence
ency	state of, act of	dependency
ent	a person who	resident
er	a person who	employer
ern	relating to	southern
ery	a place for	grocery
esque	in the style of	picturesque
ful	full of	thankful
fy	to make	fortify
hood	state of	fatherhood
ian	belonging to	civilian
ible	capable of, able to	edible
ic	like	historic

<u>Suffix</u>	<u>Meaning</u>	<u>Example</u>
ical	like	chronological
ice	state of	justice
ier	a person who	carrier
ify	to make	clarify
ile	like	juvenile
ine	like	canine
ion	state of, act of	religion
ise	to make	compromise
ism	practice of	communism
ist	a person who	artist
ity	state of, condition	morality
itis	inflammation	bursitis
ive	quality of	creative
ize	to make	legalize
lent	full of	indolent
less	without	careless
ly	like	princely
ly	in the manner of	nicely
ment	state of, act of	improvement
mony	condition, state of	matrimony
ness	state of	loneliness
or	a person who	tailor
ory	relating to	circulatory, oratory
osis	condition, state of	diagnosis
ous	full of	dangerous
ship	state of	friendship
sis	process of, state of	metamorphosis
some	like	quarrelsome
tion	act of, process of	transportation
tude	state of, quality of	solitude
try	profession, art of	dentistry
ure	act of	departure

## ACTIVITY 33

---

**Directions:** Using the Greek prefixes listed below, provide a word. It can be work-related. Use each word in a sentence.

1. dia-

Sentence: \_\_\_\_\_

2. mono-

Sentence: \_\_\_\_\_

3. tele-

Sentence: \_\_\_\_\_

4. pro-

Sentence: \_\_\_\_\_

5. en-

Sentence: \_\_\_\_\_

## ACTIVITY 32

**Directions:** Using the Latin prefixes listed below, provide a word. It can be work-related. Use each word in a sentence.

1. dis-

Sentence: \_\_\_\_\_

2. non-

Sentence: \_\_\_\_\_

3. con-

Sentence: \_\_\_\_\_

4. sub-

Sentence: \_\_\_\_\_

5. uni-

Sentence: \_\_\_\_\_

## ACTIVITY 16

**Directions:** Complete the following exercise by matching the Greek root to the English definition.

- |                  |                                      |
|------------------|--------------------------------------|
| 1. _____ pyr     | A. female, woman                     |
| 2. _____ phil    | B. false                             |
| 3. _____ soph    | C. form, shape                       |
| 4. _____ acro    | D. study of                          |
| 5. _____ homo    | E. wise                              |
| 6. _____ dem     | F. name                              |
| 7. _____ dyna    | G. great, large                      |
| 8. _____ morph   | H. animal                            |
| 9. _____ gyn     | I. fire, heat                        |
| 10. _____ nym    | J. time                              |
| 11. _____ ology  | K. height, point                     |
| 12. _____ derm   | L. love, lover, have an affinity for |
| 13. _____ chron  | M. power                             |
| 14. _____ mega   | N. same                              |
| 15. _____ zo     | O. skin                              |
| 16. _____ pseudo | P. people                            |

## ACTIVITY 17

Directions: Using the Greek roots given, complete the crossword puzzle by providing the English counterpart.

### ACROSS

1. soph
4. dem
6. chron
7. pseudo
9. sym

### DOWN

2. olgy
3. homo
4. dyna
5. zo
8. derm

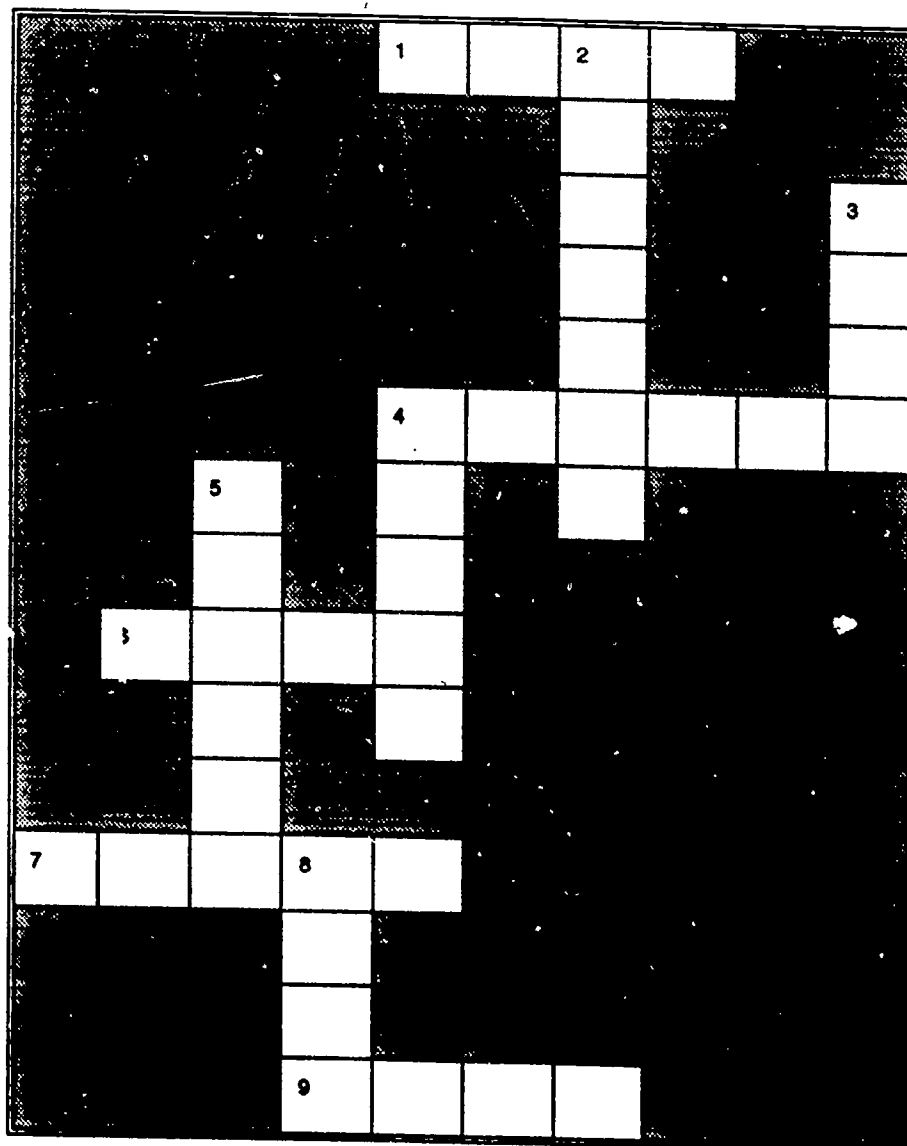



**Directions:** Complete the following exercise by matching the Latin roots to the corresponding English definitions.

- |                 |                    |
|-----------------|--------------------|
| 1. _____ vert   | A. death, die      |
| 2. _____ cite   | B. child, foot     |
| 3. _____ termin | C. flesh           |
| 4. _____ frat   | D. other           |
| 5. _____ ped    | E. call to action  |
| 6. _____ acul   | F. move            |
| 7. _____ alter  | G. to bring, carry |
| 8. _____ man    | H. limit           |
| 9. _____ fin    | I. brother         |
| 10. _____ cide  | J. eye             |
| 11. _____ mort  | K. join            |
| 12. _____ cur   | L. run             |
| 13. _____ fort  | M. cut, kill       |
| 14. _____ junct | N. touch           |
| 15. _____ tact  | O. strong          |
| 16. _____ port  | P. turn, change    |
| 17. _____ carn  | Q. end, limit      |
| 18. _____ fec   | R. make, do        |
| 19. _____ mot   | S. voice, call     |
| 20. _____ voc   | T. hand            |

Directions: Locate and circle the Latin roots listed below in the word find, and circle them.

V Y R E V A L F O D Y N M Y S X T X E I H D A Y  
 E X A Z D M A N S U R U E B T G M W D H E F O B  
 S W I L R I I G V X N X V F Y H F F R R U I L Q  
 B V Y C L D C T D Q V U N P L N R A S R D E D W  
 K Q O T E W Q N S U B G T A H X R C Q J H V K B  
 Z V A M Y B D I F P M O Q C P U Z C M P D G F S  
 A C D O R J H V I R H M B F A C R U V U N U U E  
 I F O R T L W W Q C A R N A L T E R Z J V R Z L  
 O N S J O U O K M F F R L J I Y E P Y U F G S Q  
 M S W V T J U W T R E V U C P Z G B X N G I A S  
 O L Z O J J B I R O Q Z C B R A B Z H H W A P M  
 F I N B H N B L L M K R A C U H T F L O M P K H  
 T C S F Y K T D Y Y E W I V J X K E K N S O G M  
 E K O S R Z E W Q T K T W I C Y A C R H W R T G  
 R J B K L A U M A D E Y M V L I E U O W A T Q V  
 M S E T V E T M X H H E Y K D L F B P M B M T N  
 I A Z B N I T U Y M C U K S A E T H G U Y W K V  
 N K P Y U P X R B T J U Q K U L B R B J O W N Y  
 S M W A L Q P D R Z S L J B O R W K S G A U N D  
 S Y I N T G Q O R D D P W W O T D G U T W P C X  
 T K M U W Z M Y F U N V W E C C R Q C P T F M I  
 X D E P J C I Y P C X W P N M R T K Z I A K Y Q  
 L P E R B D N C H X S R U L K F Z M O T Z V O E  
 L Z C H A Y A G Q S W J Q L Q L Z F N Y X L E N

ACUL  
 CITE  
 FORT  
 MATER  
 PATER  
 TERMIN  
 VOL

ALTER  
 CUR  
 FRAT  
 MEDI  
 PED  
 VERT

CARN  
 FEC  
 JUNCT  
 MORT  
 PORT  
 VIV

CIDE  
 FIN  
 MAN  
 MOT  
 TACT  
 VOC

## ACTIVITY 22

**Directions:** Using the Latin roots given, complete the crossword puzzle by providing the English counterpart.

### ACROSS

- 2. mot
- 4. alter
- 7. cur
- 9. carn
- 11. fin
- 12. man

### DOWN

- 1. frat
- 3. acul
- 5. tact
- 6. cite
- 8. junct
- 10. fort

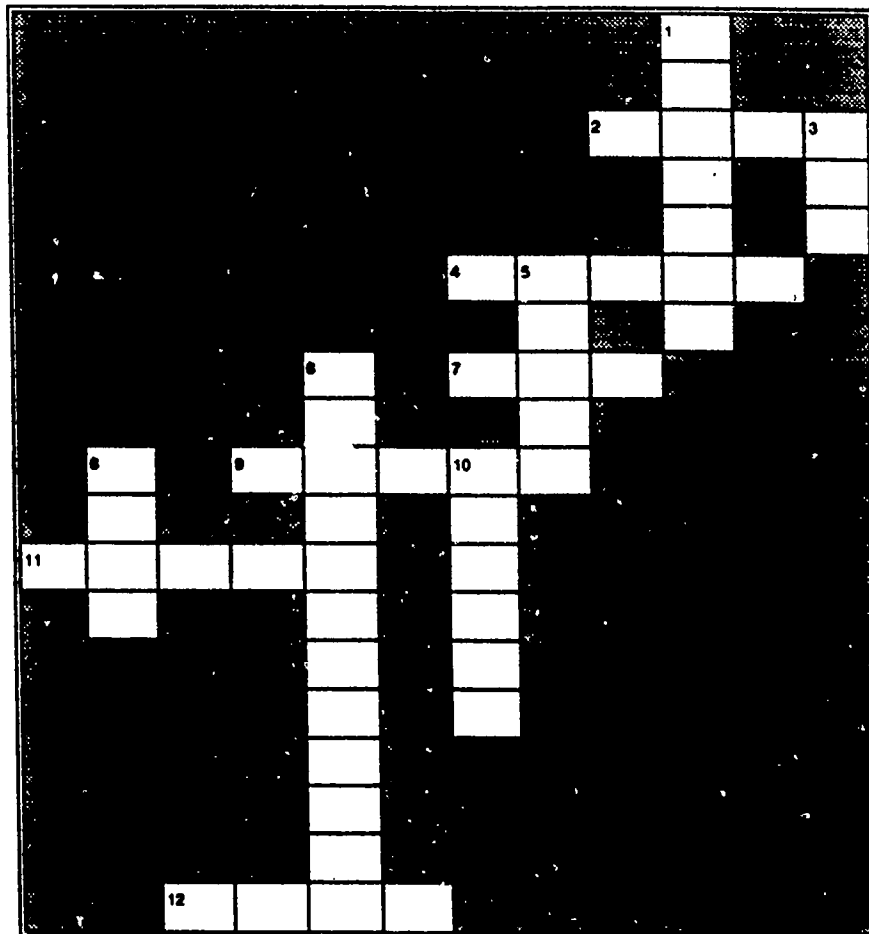

## ACTIVITY 34

---

**Directions:** Using the suffixes listed below, provide a word. It can be work-related. Use each word in a sentence.

1. -ity

Sentence: \_\_\_\_\_

2. -ate

Sentence: \_\_\_\_\_

3. -ify

Sentence: \_\_\_\_\_

4. -er

Sentence: \_\_\_\_\_

5. -ive

Sentence: \_\_\_\_\_

KEY  
TO  
VOCABULARY  
FOR  
THE  
WORKPLACE

☛ **Directions:** Write a definition for each word in the following list.

1. **abbreviation:** A shortened form of a word or phrase used chiefly in writing to represent the complete form.
2. **amplifier:** A device used to produce amplification, esp. one using transistors or electron tubes of an electrical signal.
3. **binary:** Characterized by or composed of two different parts or components; two-fold.
4. **casein:** A white tasteless, odorless milk and cheese protein, used to make plastics, adhesives and foods.
5. **compensation:** The act of counterbalancing.
6. **decigram:** One tenth ( $10^{-1}$ ) of a liter
7. **diesel:** A vehicle powered by a diesel engine
8. **gasket:** Any of a wide variety of seals or packings used between matched machine parts or around pipe joints to prevent the escape of a gas or fluid.
9. **hydraulic:** Of involving, moved, or separated by a fluid, esp. water, under pressure.
10. **juxtaposition:** The act of placing side by side, esp. for comparison or contrast, or the state of being so.
11. **media:** Several means of mass communication, as newspapers, magazines, or television
12. **ratio:** Relation in degree or number between two similar things
13. **semi-conductor:** Any of various solid crystalline substances, such as geranium or silicon, having electrical conductivity greater than insulators but less than good conductors.
14. **torque:** The moment of a force, a measure of its tendency to produce torsion and rotation about an axis, equal to the vector product of the radius vector from the axis of rotation to the point of application of the force by the force applied.
15. **vernier:** A small, movable auxiliary graduated scale attached parallel to a main graduated scale, calibrated to indicate fractional parts of the subdivisions of the larger scale, and used on certain precision instruments to increase accuracy in measurement.

**Directions:** Write a definition for each word in the following list.

1. acronym: A word formed from the initial letters of a name or by combining initial letters or parts of a series of words.
2. analog: An organ or structure that is similar in function to one in another kind of organisms, but is of dissimilar evolutionary origin.
3. caliper: An instrument consisting essentially of two curved hinged legs and used to measure internal and external dimensions.
4. classification: The act or result of arranging or organizing according to class or category.
5. cumulative: Increasing or enlarging by successive addition.
6. document: To support (an assertion or claim, for example) with evidence or decisive information.
7. flatpack: A small, low-profile (flat), integrated circuit package that can be spot-welded or soldered to a terminal or a printed circuit board. The pins extend outward, rather than pointing down as on a DIP.
8. hardware: A computer and the associated physical equipment directly involved in the performance of communications or data processing function.
9. input: Something put into a system or expended in its operation to achieve a result or output.
10. magnetic disk: A disc made of rigid material (hard disk) or heavy mylar (floppy disk). The disk surface is used to hold magnetized information.
11. ohmmeter: An instrument for direct measurement of a conductor in ohms.
12. precision: The state or quality of being clearly expressed or delineated; definite.
13. reamer: Any of various tools used to shape or enlarge holes.
14. software: Written or printed data, such as programs, routines, and symbolic language, essential to the operation of computers.
15. vertical: Pertaining to, composed of, or controlling all the grades or levels in the manufacture and sale of a product.

**Directions:** Write a definition for each word in the following list.

1. align: To adjust (parts of a mechanism, for example) to produce a proper relationship or condition.

2. brazing: To solder (two pieces of metal) together using a hard solder with a high melting point.

3. cathode ray tube: A vacuum tube in which a hot cathode emits electrons that are accelerated as a beam through a relatively high voltage anode, further focused or deflected electrostatically or electromagnetically, and allowed to fall on a fluorescent screen.

4. compression: The act or process of pressing or squeezing together.

5. conversion: The act of changing into another form, substance, state of product; transform.

6. decode: To convert from code into plain text.

7. dimension: A measure of spacial extent esp. width, height, or length.

8. etymology: The origin and historical development of a linguistic form as shown by determining its basic elements, earliest known use, and changes in form and meaning, tracing its transmission from one language to another and identifying its cognates in other languages.

9. gear: A toothed wheel, cylinder, or other machine element that meshes with another toothed element to transmit motion or to change speed or direction.

10. linear: Of, relating to, or resembling a line; straight.

11. microprocessor: A semiconductor central processing unit usually contained on a single integrated circuit chip.

12. polymer: Any of numerous natural and synthetic compounds of usually high molecular weight consisting of up to millions of repeated linked units, each a relatively light and simple molecule.

13. solder: Any of various fusible alloys, usually tin and lead, used to join metallic parts when applied in the melted state to the solid state.

14. turnaround time: The time needed to load, unload, and service a vehicle, as a ship or airplane.

15. viscosity: The condition or property of being relatively resistant to flow.



**Directions:** Write a definition for each word in the following list.

1. alloy: A homogenous mixture of solid solution, usually of two or more metals, the atoms of one replacing or occupying interstitial positions between.
2. application: The act of putting something to a special use or purpose.
3. bread boarding: To construct an experimental model.
4. central processing unit: The part of a computer that interprets and executes instructions.
5. convert: To change into another form, substance, state or product; transform.
6. delete: To strike out or cancel; omit.
7. diode: An electronic device that restricts current flow chiefly to one direction.
8. filament: A fine or thinly spun thread, fiber, or will.
9. guarantee: A promise or assurance, esp. as to the quality or durability of a product or service.
10. imprint: To produce or impress (a mark or pattern) on a surface.
11. lubricant: A usually oily substance, such as grease that reduces friction, heat and wear when applied as a surface coating to moving parts.
12. ratchet: A mechanism consisting of a pawl, or hinged catch, that engages the sloping teeth of a wheel or bar, permitting motion in one direction only.
13. scribe: A sharply pointed tool used for marking lines, as on wood, metal or ceramic.
14. text editor: Editor of a book or manual, esp. for use in schools or the workplace.
15. velocimeter: A device for measuring the speed of sound in water.

**Directions:** Correctly match the letter of the terms provided to the following definitions. Locate the terms using the glossary of paper terminology.

- g 1. A very thin paper made either from wood or rag pulps, or a combination of both. Used for carbon copies, air mail and stuffers.
- i 2. A lightweight, very dense, usually translucent (unless colored) paper used for packaging and wrapping. Most common use in candy bar wrapper and the cups in boxed candy. Sometimes embossed for decorative fly-sheets.
- e 3. The moisture condition of the air. Actual humidity is the number of grains of moisture in the air at any given time. Relative humidity is the percent of moisture relative to the maximum which air at any given temperature can retain without precipitation.
- b 4. A strong smooth writing paper used for records and ledgers.
- d 5. A type of bond paper for multiple form use.
- j 6. The penetration of ink through paper.
- h 7. Specially made protective paper for bank checks, negotiable certificates, etc., with an overall design to disclose any erasures.
- a 8. A finish, applied to book papers, which is higher than machine finish and lower than supercalendered.
- f 9. One-twentieth of a ream.
- c 10. The tensile strength of paper if it is wetted after manufacture.

a. english finish  
b. ledger paper  
c. wet strength  
d. register paper  
e. humidity

f. quire  
g. onionskin  
h. safety paper  
i. glassine  
j. strike-through

Directions: In each square, you'll see two letters. Cross out a letter in each square so your leftover letters spell words found in contracts.

The crossword puzzle grid consists of the following words formed by crossing out one letter in each square:

- CONTRACT** (Horizontal, top row)
- LIABILITY** (Vertical, second column)
- BREACH** (Vertical, third column)
- DAMAGES** (Vertical, fourth column)
- DEFENSE** (Vertical, fifth column)
- PERFORMANCE** (Horizontal, sixth row)
- OBLIGATION** (Horizontal, seventh row)
- REMEDY** (Vertical, eighth column)

**Directions:** Using the selected pages from the Fourdrinier's Manual and a dictionary, write a definition for each word in the following list. (Use context to determine the best one.) Create a sentence using each term as defined.

1. adjacent: adjoining; touching at some point
2. blending: to mix or fuse thoroughly
3. consolidation: to make or become solid or compact
4. differential: constituting or making a specific difference
5. dispersion: to break up and scatter in all directions; spread widely
6. drainage: The process of drawing off water or other liquids so material will dry
7. flocculation: the process of organizing into small, wooly masses
8. headbox: The paper machine component that regulates and delivers uniform paper stock flow to the forming section
9. mat thickness: self-explanatory; thickness of the mat
10. optimum: the most favorable amount, condition, degree, etc.
11. oriented shear: An orderly aligning fluid flow, generated by headbox rush/drag or by a fourdrinier shake.
12. retention: the power or capacity for staying the same.
13. stock: Mixture of pulp fiber, water and additives from which the water is drained to form paper.
14. turbulence: The erratic movement of stock within its flow which is vital to and causes uniform fiber dispersion.
15. uniform: Being or looking the same in all parts; undiversified

1. **not natural to the person or thing specified; not belonging; not characteristic**  
The inclusion of a foreign substance in the pulp can change the consistency of the paper.
2. **a substance, such as rust, formed by gradual eating into and deterioration**  
Corrosion of machinery parts can affect the machine's performance and safety in operation.
3. **an act or instance of breaking**  
Breakage of parts is a distinct possibility with too much stress.
4. **something taken apart**  
Disassembly is required when moving a large piece of equipment.
5. **operated by the movement and force of liquid**  
The machine operates by hydraulics.
6. **force that acts to produce rotation**  
The machine required a high level of torque to function.
7. **of or containing wind, air, or gases**  
Pneumatic devices aid in conserving manpower by using natural elements to help complete manually demanding jobs.
8. **a short rope or cord with an attached hook used for holding or fastening something**  
At each machine site a lanyard is available to provide assistance and help to prevent back injury.
9. **of, having the nature of, or expressing care or caution used in advance to avert possible danger, failure, etc.**  
Before operating the machine, there are certain precautionary steps one must complete.
10. **a providing, preparing, or supplying of something**  
Rules of operation are a necessary provision for running the machine.

Definitions selected from Webster's New World Dictionary: Deluxe Color Edition

**Directions:** In each sentence below, a term related to paper production is hidden. Underline the words as you find them.

1. Because we live in the United States, we are American.
2. The ashtrays need emptying.
3. "Mary said if you cook an egg, she'll eat it."
4. We believe that all men are created equal.
5. Trees littered the ground; wood fell everywhere.
6. The frames need glass in each eye hole.
7. The flowered ledge ran the length of the window.
8. The deep water marked the start of the river.
9. The face of the young mother looked tired and drawn.
10. To prepare for a winter that is raw, stock up the pantry.

**Directions:** Taking each word underlined in the preceding exercise (Activity 10 - Part A), write a definition as it relates to the paper industry. Write as if you are describing it to someone with no knowledge of your profession.

1. A ream is 500 sheets of paper.
2. Ash is what's left of a paper sample (mineral residue) after it's been burned to determine the amount of filler contained.
3. Paper which has the consistency of an eggshell is termed eggshell.
4. A web is a continuous sheet of paper being formed or already formed by a paper machine.
5. Used in newsprint and low grade book paper, groundwood is mechanically prepared coarse wood pulp.
6. Used for candy bar wrappers and cups in boxed candy, glassine is a very dense, lightweight paper which is usually translucent.
7. A strong, smooth writing paper used for ledgers and records is called ledger paper.
8. Mark made into the sheet of paper by a dandy roll during the making of the paper. With the Corp, many times it is a name.
9. When paper is trimmed, the displacement of the cut sheet by the thickness of the knife. If not considered, the draw can cause paper size to be inaccurate.
10. Rawstock is the pure paper mix that comes out of the headbox. The mix consists mostly of water and wood stock. It contains very few additives.

A 16	B 5	C 9	D 4
E 2	F 11	G 7	H 14
I 15	J 10	K 6	L 3
M 1	N 8	O 12	P 13

BEST COPY AVAILABLE



P A N T S  
                  F A N  
                  P A T C H  
F I R E  
                  R A K E

K R A F T

## COMPUTERS

asoft W arecua  
 print O utahnv  
 ebina r yghkun  
 sucvl d atajel  
 ekout p utrgux  
 psent e rminal  
 thlup r ogramd  
 sioqs f ilerst  
 fnuvk e yboard  
 repza C cesste  
 punby f eslmb

Each row of letters includes a computer term, but one letter is missing. All the letters in each line will not be needed to spell the term. Circle each term after filling in the missing letter. If done correctly, the missing letters (reading down) will reveal the name of a computer "package".

Directions: Find a word in the word box that is related to the underlined word. Place the word in the corresponding blank.

log	collate	layout	graphics	gulp
package	WordPerfect	screen	justify	syntax
semiconductor	memory	glitch	bug	menu
hacker	batch	trunk	wafer	backup
nybble	noise	ARTSPEAK	prototype	Apple

1. software: Wordperfect
2. system: Apple
3. malfunction: bug
4. design: layout
5. enthusiast: hacker
6. bytes: gulp
7. disturbance: noise
8. problem: glitch
9. visual: graphics

10. record: log
11. list: menu
12. storage: memory
13. copy: backup
14. collection: package
15. align: justify

Directions: There are many words found in contracts. Find the words listed below in the word find, and circle them.

M X C G F D N F M M K Q L V N K C J G M T Q  
 X D C X F U E L H Z K N E F E V O U H U N N  
 X C R G D E R E W O P M E G N U L Q F V Y O  
 P S C Z A O B M N U Z W K O P K S T Y F X N  
 Y U O B T T Q R K Q U I I W D P M J R T F T  
 R J N N B O T B Y W I T L N X R T D Z O U R  
 A S T F G A R R P H A W O G T O R O H Y R A  
 M C I H E U M V I T L I X Q Y B L I E U P D  
 I P N T F K R T N T T C H A Z A R D O U S I  
 D T G U F X I E S A I Z L G J T J J R H R T  
 I D E R T J M R C X V O I A J I F S E H Y I  
 N Y N Q K E F I T Y C S N A F O P T I F E O  
 G U C P L K F W I S U U J I N N W E M L I N  
 X O Y P B I N C E N T I V E B A Q W B S F A  
 E D M Z S U B S E C T I O N G R W A U O W L  
 N T G S Y I K Z E H O G J E U Y L R R W Z F  
 W L A P R E F E R E N T I A L L G D S T N N  
 O L Z R K L W Q J T L U E B A L E N E R A S  
 C S E X W H J Y Y P G W V C D O Q W M U Q O  
 K F O C R L V H A O Y V E P S R B M E J L H  
 Q U G I E K B W Q S H R G S F P P M N R S J  
 A T T R G F F A R B I T R A T I O N T V R X

ARBITRATION  
 EMPOWERED  
 LIEU  
 PYRAMIDING  
 STRIKE  
 ATTRITION  
 HAZARDOUS  
 NONTRADITIONAL  
 RECALLABLE

SUBSECTION  
 CLASSIFICATION  
 IMPLEMENTATION  
 PREFERENTIAL  
 REIMBURSEMENT  
 CONTINGENCY  
 INCENTIVE  
 PROBATIONARY  
 STEWARD

Directions: Complete the following exercise by matching the Greek root to the English definition.

- |                     |                                      |
|---------------------|--------------------------------------|
| 1. <u>I</u> pyr     | A. female, woman                     |
| 2. <u>L</u> phil    | B. false                             |
| 3. <u>E</u> soph    | C. form, shape                       |
| 4. <u>K</u> acro    | D. study of                          |
| 5. <u>N</u> homo    | E. wise                              |
| 6. <u>P</u> dem     | F. name                              |
| 7. <u>M</u> dyna    | G. great, large                      |
| 8. <u>C</u> morph   | H. animal                            |
| 9. <u>A</u> gyn     | I. fire, heat                        |
| 10. <u>F</u> nym    | J. time                              |
| 11. <u>D</u> ology  | K. height, point                     |
| 12. <u>O</u> derm   | L. love, lover, have an affinity for |
| 13. <u>J</u> chron  | M. power                             |
| 14. <u>G</u> mega   | N. same                              |
| 15. <u>H</u> zo     | O. skin                              |
| 16. <u>B</u> pseudo | P. people                            |



Directions: Locate the Latin roots listed below in the word find and circle them.

V Y R E V A L F O D Y N M Y S X T X E I H D A Y  
 E X A Z D M A N S U R U E B T G M W D H E F O B  
 S W I L R I G V X N X V F Y H F F R R U I L Q  
 B V Y C L D C T D Q V U N P L N R A S R R D E D W  
 K Q O T E W Q N S U B G T A H X R C Q J H V K B  
 Z V A M Y B D I F P M O Q C P U Z C M P D G F S  
 A C D O R J H V I R H M B F A C R U V U N U U E  
 I F O R T L W W Q C A R N A L T E R Z J V R Z L  
 O N S J O U O H M F F E R L J I Y E P Y U F G S Q  
 M S W V T J U W T R E V U C P Z G B X N G I A S  
 Q L Z O J J B I R O Q Z C B R A B Z H H W A P M  
 F I N B H N B L L M K R A C U H T F L O M P K H  
 T C S F Y K T D Y Y E W I V J X K E K N S O G M  
 E K O S R Z E W Q T K T W I C Y A C R H W R T G  
 R J B K L A U M A D E Y M V L I E U O W A T Q V  
 M S E T V E T M X H H E Y K D L F B P M B M T N  
 I A Z B N I T U Y M C U K S A E T H G U Y W K V  
 N K P Y U P X R B T J U Q K U L B R B J O W N Y  
 S M W A L Q P D R Z S L J B O R W K S G A U N D  
 S Y I N T G Q O R D D P W W O T D G U T W P C X  
 T K M U W Z M Y H U N V W E C C R Q C P T F M I  
 X D E P J C I Y P C X W P N M R T K Z I A K Y Q  
 L P E R B D N C H X S R U L K F Z M O T Z V O E  
 L Z C H A Y A G Q S W J Q L Q L Z F N Y X L E N

ACUL  
 CITE  
 FORT  
 MATER  
 PATER  
 TERMIN  
 VOL

ALTER  
 CUR  
 FRAT  
 MEDI  
 PED  
 VERT

CARN  
 FEC  
 JUNCT  
 MORT  
 PORT  
 VIV

CIDE  
 FIN  
 MAN  
 MOT  
 TACT  
 VOC

### COMPUTER LANGUAGE

Directions: With the increase in computer-generated work, you come in contact with the jargon or terms connected with computers more often. Find the terms listed below in the word find, and circle them.

A K L Z U N L T Y X R G H X T M Y R B O B V  
 H Z B Z N Y U D U U N A H Z L E F K H K F S  
 N C J L W Z W X Y A F C E N K J R K W O N S  
 A Q S K N X C I G L Q T J D F O S M R Q X G  
 D A F L M Y P B A E B K L N N B I C I X X S  
 H X T O N R B N Q K G W S B V I E D N N J U  
 L W U B W C G J M N W Y H Y Q X F L R Q A R  
 M S P L N U C O I M O T H E R B O A R D P L  
 B I J O A N R S X S C I H P A R G A P P L I  
 G E C G D Y B A C K U P T W K E T A L L O C  
 Q M E R J L F T Q F B A R A Z W B R B O K A  
 Q I S I O R N S F E M S E Y C V G O Y L H D  
 L T T Z M P J O Y S T I C K N I H P T R S A  
 V S S G Y Z R V U G M N R T J W L N E X B A  
 I S O C L P P O I Y B D Y S S F T F S K O M  
 R E D W A E O A C G L L M E Q U C X F D X P  
 U C J B L N J C R E E T R D A T A B A S E  
 S C X I R N N X D A S K G I W R S F F I M Y  
 N A E P P A E E F R L S H A T U P Q O U K W  
 Y K R F B G H G R Q A L O L B L U D V D T K  
 N B A C X R F R W F S H E R U X M O B C I H  
 D Z L X V N S Z S J I C R L Q T K L S T Z K

ACCESS TIME  
 COLLATE  
 HARDCOPY  
 MOTHERBOARD  
 SCANNER  
 APPLICATION

DATE BASE  
 JOYSTICK  
 MOUSE  
 SERIAL  
 BACKUP

FILE  
 LANGUAGE  
 PARALLEL  
 TERMINAL  
 BYTES

GRAPHICS  
 MICRO-  
 PROCESSOR  
 ROM  
 VIRUS

BEST COPY AVAILABLE



Directions: Using the glossary, provided find the words defined by the following descriptions. Place the words in the correct boxes.

The crossword puzzle grid contains the following words:

- 1. FILE
- 2. DISPLAY
- 3. LAYOUT
- 4. GLITCH
- 5. WINDOW
- 6. FEEDBACK
- 7. MENU
- 8. MOUSE
- 9. SOFTWARE
- 10. EXECUTE
- 11. BOOT
- 12. RAM
- 13. EDIT
- 14. TRANSISTOR
- 15. MENU
- 16. DATA
- 17. LOG
- 18. KEY
- 19. MENU
- 20. MENU
- 21. MENU
- 22. MENU
- 23. MENU

Directions: Complete the following exercise by matching the Latin roots to the corresponding English definitions.

1. P

2. E

3. Q

4. I

5. B

6. J

7. D

8. T

9. H

10. M

11. A

12. L

13. O

14. K

15. N

16. G

17. C

18. R

19. F

20. S

Directions: Using the Latin roots given, complete the crossword puzzle by providing the English counterpart.

ACROSS

- 2. mot
- 4. alter
- 7. cur
- 9. carn
- 11. fin
- 12. man

DOWN

- 1. frat
- 3. acul
- 5. tact
- 6. cite
- 8. junct
- 10. fort

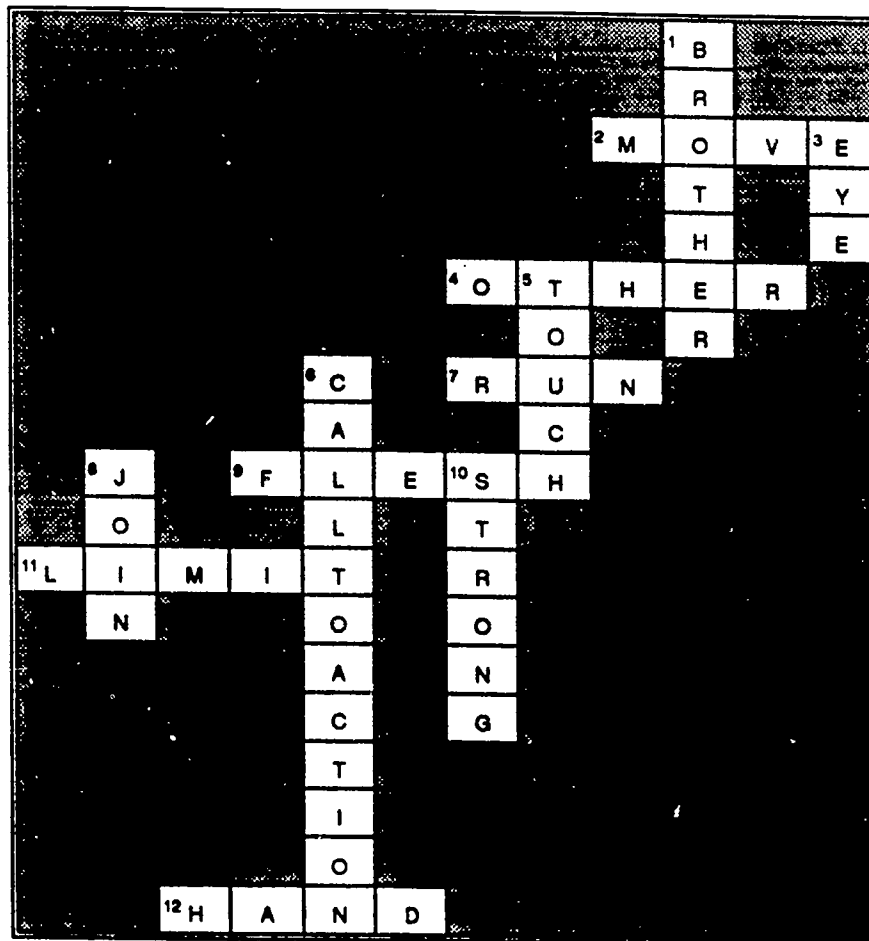

**Directions:** Complete the following exercise by matching the words provided to the correct definition.

1. J
2. K
3. P
4. M
5. B
6. D
7. G
8. C
9. L
10. F
11. A
12. N
13. H
14. I
15. E
16. O

☛ Directions: Write a definition for each word in the following list.

1. alternative: The choice between two mutually exclusive possibilities.
2. blueprint: A photographic reproduction, as of architectural plans or technical drawings, rendered as white lines on a blue background.
3. cathode: A negatively charged electrode, as of an electrolytic cell, storage battery, or electron tube.
4. compile: To put together or compose from materials gathered from several sources.
5. decimal: A linear array of integers that represents a fraction, every decimal place indicating a multiple of a positive or negative power of 10.
6. differential: An infinitesimal increment in a variable.
7. electrode: A collector or emitter of electric charge or electric-charge carriers as in a semiconducting device.
8. gauge: Thickness or diameter, as of sheet metal or wire
9. ignite: To cause to burn.
10. kilowatt: One thousand watts.
11. metric: Designating, pertaining to, or using the metric system.
12. polarity: Intrinsic polar separation, alignment, or orientation, esp. of a physical property.
13. quality: Degree or grade of excellence.
14. rough draft: Something written in non-perfected manner.
15. technician: A person whose occupation requires training in a specific technical process.

Directions: Write a definition for each word in the following list.

1. ammeter: An instrument that measures electric current.
2. bearings: Part that support another machine part.
3. cam: An eccentric or multiply curved wheel mounted on a rotating shaft and used to produce variable or reciprocating motion in another engaged or contacted part.
4. clutch: A device for gripping and holding.
5. conductivity: The ability or power to conduct or transmit.
6. cursor: A visual indicator on a video terminal showing the position of next entry.
7. depreciation: A decrease or loss in value because of wear, age, or other cause.
8. draft: A pull or traction of a load.
9. floppy disk: A flexible plastic disk coated with magnetic material used to store computer data.
10. hazard: A possible source of danger.
11. insulator: A material that prevents the passage of heat or electricity or sound into or out of.
12. macro: A single, symbolic programming language statement that when translated results in a series of machine language statements.
13. output: The amount of something produced or manufactured, esp. during a given time.
14. scanning: Any of various electronic or optical techniques by which images or recorded information are sensed for subsequent modification, integration, or transmission.
15. technology: The application of science, esp. to industrial or commercial objectives.

Directions: Write a definition for each word in the following list.

1. alphanumeric: Consisting of alphabetic and numerical symbols
2. brochure: A small pamphlet or booklet
3. circumference: The boundary line of a circle
4. competent: Properly or well qualified; capable
5. crosscut saw: A saw used or constructed for cutting crosswise.
6. demonstration: An illustration or explanation as of a theory or product, by exemplification or practical application.
7. fetch: To locate and load a quantity of data from storage.
8. hard copy: Readable printed copy of the output of a machine, as a computer.
9. indication: Something which suggests or demonstrates the necessity, expedience, or advisability of.
10. machinist: One skilled in operating machine tools.
11. obsolete: Outmoded in design, style, or construction
12. productivity: The act of manufacturing
13. resin: Any of numerous clear to translucent yellow or brown solid or semi-solid viscous substances of plant origin, such as copal, rosin and amber, used principally in lacquers, varnishes, inks, adhesives, synthetic plastics, and pharmaceuticals.
14. tachometer: An instrument used to determine speed, esp. the rotational speed of a shaft.
15. valve: Any of various devices that regulate the flow of gases, liquids, or loose materials through structures, such as piping, or through apertures by opening, closing, or obstructing ports or passage-ways.

Directions: Write a definition for each word in the following list.

1. ampere: A unit of electric current in the meter-kilogram-second system. It is the steady current that when flowing in straight parallel wires of infinite length and negligible cross section, separated by a distance of one meter in free space, produces a force between the wires of  $2 \times 10^{-7}$  newtons per meter of length.

2. bevel: The angle or inclination of a line or surface that meets another at any angle but 90 degrees.

3. capital: Wealth in the form of money or property owned, used or accumulated in business by an individual, partnership, or corporation.

4. combustion: The process of burning.

5. conductor: A substance or medium that conducts heat, light, sound, or esp. an electric charge.

6. debit: Any item of debt as recorded in an account.

7. diagnostic: Of, pertaining to, or used in a diagnosis.

8. ferrous: Of pertaining to, or containing iron, esp. with valence 2.

9. internal: Of, relating to, or located within the limits or surface of something; inner.

10. maintenance: The work of keeping something in proper condition.

11. overhaul: To examine or go over carefully for needed repairs.

12. porous: Having or full of pores.

13. requisition: A formal written request for something that is needed.

14. specification: A detailed and exact statement of particulars, esp. a statement prescribing materials, dimensions, and workmanship for something to be built, installed, or manufactured.

15. uniformly: Having the quality of consistency in appearance; having an unvaried texture, color, or design.



Directions: There are many words found in workplace manuals. Find the words listed below within the word find, and circle them.

L R O Y W P Z Q Y M T E N D W D O E P P F N  
R X Z T W T X E A R R J V Z M Y Y R L S V P  
J Q Z S W E K V K S P G D I L J Z D T I N H  
B O B S O L E T E X R D Q F A G J M X N M Z  
T R Z R F D S W Q L C G L S J I A J W Z L Z  
M L A U Z I C O M P R E S S I O N S H N J M  
F A C Z D M H T W S G N I R A E B X K M U V  
P B D T I E K O Y C Q J S L I W C N C E B O  
A S Z V T N P B U Z T X W J R R R I E L T L  
D G K R G S G H J T J I U D O F R C R G T B  
M U I Q F I A O K O P N B T J M N C O C T W  
U G J H R O H V P Z Z U A M P E O O U Y U D  
U S B N J N Y V L U Q L T O R N P N J H Q M  
B S V E S E D B V H U H Q E T V H V J U F F  
I V A L V E R H H S G I F Y U C O E L T L X  
H G F J R H A P N N T M D Q F D N R F L Z Y  
X P P L F O U I N T U S A C N G H S V E I B  
I F K V O Y L W B C S O M N I X F I X I Y Y  
X K I C O E I Y R V V F C L K R Z O N Y K W  
F Z F B O J C I I C J N A G W D A N Y E T P  
M H V H H P C V U R Z E A D B L I E A V F K  
B Y O A R S Y T I V I T C U D O R P G I X D

ALIGN  
 COMPRESSION  
 GEAR  
 OUTPUT

BEARINGS  
 CONVERSION  
 HYDRAULIC  
 PRODUCTIVITY

BRAZING  
 DIMENSION  
 INSULATOR  
 VALVE

CIRCUM-  
 FERENCE  
 GASKET  
 OBSOLETE

# HEADBOX

Directions: Using the word list below, locate the terms in the word find and circle them.

T E C K B R A H L Y K L E V M L B J G Q K O  
 M S L U S W E F V E L V U L U D D P L Y U T  
 K Q H R A B E C L A S C W O C S D L I C A N  
 C P Z B Q W F K U F U O Q W B M G W N L J Z  
 A K C S D G C V W D I K R S E E M O I N W S  
 E H E O Q U Z U S Z S K N A B E B U T L Q L  
 F A C W N F D F A E I N S T C L T A R Q F U  
 E A C K G O T F U V D O A U P N M E I O L R  
 K B C F P Y X H J L M I T R O C C M R L C R  
 L L O R E V I R D A D P S R T H E M T T C Y  
 X I A G O X C W V V D G D D D T I J U T A Q  
 J N V Q G F S E H G P B B E N N E N R O V J  
 Z M A I M F C M G N M B R S G O X J E R J M  
 C C O F B M H P M I C B M R Z N P J U H Y P  
 K V P M C N T E G L W P O Y O P O B L T P X  
 K Z A Q E K Z N F T Y L A P R O N C E Z A R  
 P S S C S D B C I T L W Y P B R Q F N X R H  
 W K I O A J O Y Y O O V D E L N B P C O T E  
 W L F B R E K A E R B M U U C A V M E F Z S  
 S Z Y C O Y Q I R H D F W L D O W H G W Y P  
 I C L X E O J V O T E V G B U Y U L C C R B  
 P N T B J T B A Q I S H V G I D L V F L C C

APRON  
 KNUCKLE  
 SLURRY  
 TURBULENCE

DRIVE ROLL  
 PONDSIDES  
 THROTTLING-  
 VALVE  
 VACUUM-  
 BREAKER

FORMING ROLL  
 REDUCER  
 TRANSDUCER

JET  
 SLICE  
 TUBE BANK

THE YANKEE PRESS SECTION

Directions: Using the word list below, locate the terms in the word find and circle them.

Q F T Z M F R W U B D R Y E R Z W M A L Y X  
 C X O T T X U D D A M E M M T C L M O F F G  
 I J O H P Q N C A J W Q U U E D M C M K D A  
 S C F G L C N N J N Y J C B R O K E K T F P  
 P Z G V H B A U Z I D P C Z I C T E K R Q D  
 N V E K E X B M Y V C Y J U A T G J Z A F D  
 K O R L K Y I P V P T L R B I O A S N K U T  
 W Q I U N E L U T J N N R O G R U O S H D J  
 Z O Y T Y X I J S L G Z J E L I F P O I F M  
 R F I V C I T V F Y S A N E W L Q N B K Y P  
 O E T Y G E Y Y V E Y L U Z K O P D L K B M  
 V S H M M J S T N W U S X Z H G H C N E H X  
 V Q U C B W R S U G J F I I K N D S C S B N  
 O W T C T Y O B S Z G G T E O R P I C W P Q  
 L Z K T T E T H B E N A J F Q B E P F I K M  
 H B L A C I R W V R R G F R R D T W E N R N  
 O E A U P W O T A R E P A C K I N G L G N X  
 F F D C D D Z N S C O N C H R O L L T O T W  
 W V M X I X N S I T V X U Q N Q D X R F B Z  
 B H O M Q G P A S I L X L I D P T G O U E V  
 T R T J M X T M M Q U E A E G K S Q L C D Q  
 L D C M A Y E K R Y Y W F O H W Z E L X Y A

BROKE  
 DRYER  
 PACKING  
 SUCTION

CONCH ROLL  
 FELT  
 PRESS-  
 SECTION  
 SWING

DANDY ROLL  
 FELT ROLL  
 RUNNABILITY

DOCTOR  
 FELT-  
 STRETCHER  
 SHOWER

## FOURDRINIER

Directions: Using the word list below, locate the terms in the word find and circle them.

K Z G B U A M K R V C I O Z U S P J Q S Y O  
 C W W E P S X C Y P N D A Y C X F V I B C B  
 W Q F K Q T B Q B I B E Z Q I L T M I J M Q  
 Y R S O I I K R P X D C Z X N D B F Y F N P  
 U E K S K I T Y N E S L K G L L G Q N U O E Z  
 O W S A W W Q Z P A Q L D U L O A D O L R M  
 G R Z W P G L K L I S E O H Y U D Q M A X X  
 D U F H C E N V W P Y T R R C U S J I L M M  
 I R V D Q R B X F A A Q R I H O A E B R K S  
 H L A A U Y D H N H A K I O N C L Z A H D D  
 G Z U I P N D I H H G R B Y L L T E E U M T  
 Z C K M N O S A V E A L L M O L H E U K B T  
 V X Z T P A O K E V C K L R T S S T R L C K  
 P J H X X B G L A I E K Y O D M E J M T Y K  
 Y X A F K U R E C L M D N E W F P V F N S Z  
 A Z F I Q B C E J I N L T V S G A T I Q H Q  
 Q A I X Q R U M A A R N A B E K R F W N B L  
 Y A Q Z V J H S D K E B H P P G A J T Q Z L  
 U X A O R N M W F I E U A S A J T H K Y Z I  
 R E G U L A T O R O M R G F M A O K W L Z C  
 D M I B Z O I O L O C K I N G B R A K E Y Y  
 E B L L I M I T S W I T C H K Z K S Z G D G

BREAST ROLL  
 FABRIC LOOP  
 LUMP-  
 BREAKER  
 SAVEALL

DANDY ROLL  
 LIMIT SWITCH  
 ORIENTED-  
 SHEAR  
 SEPARATOR

DECKLE  
 LOAD  
 PALM  
 STRETCH ROLL

DRAINAGE  
 LOCKING-  
 BRAKE  
 REGULATOR

OFFICE MEMO AD-2

To	Date	Time
From	<input type="checkbox"/> Please Call <input type="checkbox"/> Returning Call <input type="checkbox"/> Will Call	
Phone	Taken By	
<input type="checkbox"/> Comment <input type="checkbox"/> Route	<input type="checkbox"/> For Your Inf. <input type="checkbox"/> Approve/Sign	<input type="checkbox"/> Prepare Reply <input type="checkbox"/> Take Action
		<input type="checkbox"/> Return <input type="checkbox"/> File

*From City of Madison  
 11 practice tests for City  
 entrance exams to be  
 used to increase minority  
 participation in city employment.*

No. of Copies:	<input type="checkbox"/> Typing	<input type="checkbox"/> Photocopy	<input type="checkbox"/> Copy Center	<input type="checkbox"/> Copy from Microfilm
Date Need	Time Need	<input type="checkbox"/> Rough <input type="checkbox"/> Final	<input type="checkbox"/> Double <input type="checkbox"/> Single	<input type="checkbox"/> Original Document <input type="checkbox"/> Revised Document

### Custodial Worker Questions

Sweep cloths are often chemically treated with

- A. water
- B. scouring powder
- C. corn starch
- x D. mineral oil

The best cleaning tool to use to dust the tops of radiator covers is a

- A. wet sponge
- B. bowl brush
- x C. counter brush
- D. corn broom

A comparison of wet mopping by hand with scrubbing by hand indicates that mopping

- A. needs more cleaning solution
- B. is more time consuming
- C. requires twice as much water
- x D. is less effective on hardened soil

A detergent manufacturer recommends mixing 8 ounces of detergent in one gallon of water to prepare a cleaning solution. The amount of the same detergent which should be mixed with thirty gallons of water to obtain the same strength cleaning solution is

- A. 24 ounces
- B. 30 ounces
- x C. 240 ounces
- D. 380 ounces

The floor area of a corridor 8 feet wide and 72 feet long is most nearly

- A. 80 square feet
- B. 420 square feet
- x C. 580 square feet
- D. 870 square feet

Of the following types of flooring, the one which does not require waxing to preserve its finish is

- A. rubber tile
- B. cork tile
- C. linoleum
- x D. terrazzo

Of the following terms, the one which best describes the size of a floor-scrubber brush is

- A. 10 quarts
- B. 32 ounce
- x C. 24 inch O.D.
- D. 10 square foot

Of the following types of pipe, the one which is most brittle is

- A. brass
- B. copper
- x C. cast iron
- D. wrought iron

If a plumbing fixture is allowed to stand unused for a long time, its trap is apt to lose its seal by

- x A. evaporation
- B. capillary action
- C. siphonage
- D. condensation

Of the following statements concerning lubricating oil, the correct one is

- A. SAE 10 is heavier and more viscous than SAE 30
- B. diluting lubricating oil with gasoline increases its viscosity
- x C. oil reduces friction between moving parts
- D. in hot weather, thin oil is preferable to heavy oil

The main purpose of periodic inspections and tests made on mechanical equipment is to

- A. make the operating workers familiar with the equipment
- B. keep the maintenance mechanics busy during otherwise slack periods
- x C. discover minor faults before they develop into serious breakdowns
- D. encourage the workers to take better care of the equipment

An air compressor which is driven by an electric motor is usually started and stopped automatically by a (an)

- A. unloader
- B. pressure regulator valve
- C. float switch
- x D. pressure switch

Of the following, the first thing to check if the power lawn mower failed to start is the

- A. lubrication
- B. magneto
- C. sparkplug
- x D. loose ignition wires

Generally, it is better to seed a lawn in the fall than in the spring. Of the following, the best reason for this gardening rule is

- A. the ground is drier in the spring than in the fall
- B. tree shading is at a minimum in the fall
- C. pedestrian traffic over a lawn is at a minimum in the fall
- x D. weed growth is less in the fall than in the spring

An ordinary wall switch which is called a "silent switch" contains a liquid called

- A. water
- x B. mercury
- C. oil
- D. naphtha

The best way to stop a faucet drip is to

- x A. replace the washer
- B. tighten the faucet handle with a wrench
- C. replace the faucet
- D. clean the trap

Of the following, the most important step to be taken before starting to operate a steam boiler is to see that the

- x A. water is at the proper level
- B. fuel is heated
- C. steam pressure is above 2 psi
- D. vacuum pump is off

Of the following materials, the one most effective in dusting office furniture is a

- A. silk cloth
- B. chamois
- x C. soft cotton cloth
- D. counter brush

High sheen and good wearing qualities can be obtained when polishing a waxed floor by using an electric scrubbing machine equipped with

- A. nylon disks
- x B. soft brushes
- C. steel wool pads
- D. pumice wheels

When not in use, a broom should be stored

- A. resting on the floor with the handle end down
- B. resting on the floor with the bristle end down
- x C. hanging by the handle from a hook
- D. lying flat on the floor

The device which shuts off the oil burner when the water level in the boiler is too low is the

- A. feedwater regulator
- x B. low water cutoff
- C. high water alarm
- D. programmer

The most effective method for cleaning badly soiled carpeting is

- x A. wet shampooing
- B. vacuum cleaning
- C. dry shampooing
- D. wire brushing



- The first step in routine cleaning of offices at night should be
- A. sweeping floors
  - x B. emptying ash trays
  - C. dusting furniture
  - D. damp mopping the floors

- In order to improve its appearance, extend its life, and reduce the labor involved in dusting, wood furniture should be polished with a (an)
- A. oil polish
  - B. water emulsion wax
  - x C. silicone and spirit chemical spray
  - D. clear water

- In an air conditioned office, most people would feel comfortable when the room temperature and humidity are maintained respectively at
- x A. 75 F and 50%
  - B. 70 F and 30%
  - C. 75 F and 20%
  - D. 65 F and 75%

- When a public building is equipped for security purposes with exterior lights on or around the building, the lights should be kept lit
- A. all night except for Saturdays, Sundays, and holidays
  - B. twenty-four hours a day on weekends
  - x C. throughout the night, every night of the week
  - D. until midnight, every night of the week

- The American flag should be
- A. raised slowly and lowered briskly
  - x B. raised briskly and lowered slowly
  - C. raised briskly and lowered briskly
  - D. raised slowly and lowered slowly

- Rubbish, sticks, and papers on the lawn in front of a building should be collected by using a
- x A. rake
  - B. broom
  - C. paper sticker
  - D. hoe

- Mortar stains on brick work can be scrubbed off by using a solution of
- A. benzine
  - B. trisodium phosphate
  - x C. muriatic acid
  - D. acetic acid

The best chemical for melting ice on sidewalks is

- A. sodium chloride
- B. calcium carbonate
- C. hydrogen sulphide
- x D. calcium chloride

When washing the outside of a window with a narrow inside sill, a window cleaner should place his water pail on

- A. the outside window sill
- B. the nearest desk or chair
- C. a radiator at the center of the window
- x D. the floor at a convenient point toward one side of the window

Under normal conditions, during the growing season lawns should receive a good saturation of water with a spray

- A. once a day
- x B. once a week
- C. once a month
- D. twice a month

With the same outdoor winter temperature (24 F), the load on a heating boiler starting up is greater than the normal morning load mainly because of

- A. loss of heat escaping through the stack
- x B. steam required to heat boiler water and piping to radiators
- C. viscosity of the fuel oil
- D. low outdoor temperatures

One of the important benefits to floors that wax does not provide is

- A. easier soil removal
- B. improved stain resistance
- C. reduction in wear
- x D. resistance to fire

In accordance with the uniform method of identifying piping in public buildings, pipes carrying materials classified as being dangerous are colored

- A. blue
- B. red
- x C. orange and yellow
- D. green and white

When vacuum cleaning rugs, the suction tool should be pushed

- A. diagonally across the lay of the nap
- x B. with the lay of the nap
- C. across the lay of the nap
- D. against the lay of the nap

Chloride of lime should be used for the removal of

- A. alkali stains on wood
- B. grass stains on wood or marble
- x C. indelible pencil and marking ink stains on concrete or terrazzo
- D. ink stains on wood

The main reason for applying floor finish to a floor surface is to

- A. protect against germs
- x B. protect the floor surface
- C. increase traction
- D. waterproof the floor

To help plants survive the shock of transplanting, in most cases it is best to

- A. spray them with insecticide every day for a week
- B. cover the foliage with burlap for a day or two
- x C. shade them from the sun for a week or two
- D. prune them every day for a week or two

Of the following, the first action to take in the event a low pressure steam boiler gauge glass breaks is to

- A. bank the fires
- x B. close the water gauge glass cocks
- C. open the safety valve
- D. blow down the boiler

Spontaneous ignition is most likely to occur in a

- x A. pile of oily rags
- B. vented fuel oil tank
- C. metal file cabinet filled with papers in file folders
- D. covered metal container containing clean rags

A vacuum pump is used in a (an)

- x A. steam heating system
- B. hot air heating system
- C. hot water heating system
- D. electric heating system

The domestic hot water in a large public building is circulated by

- A. gravity flow
- B. a pump which runs continuously
- C. a pump which is controlled by water pressure
- x D. a pump which is controlled by water temperature

The try cocks on a steam boiler are used to

- A. drain the boiler
- B. check the operation of the safety valves
- x C. check the water level in the boiler
- D. drain the pressure gauge

The stack temperature in a low pressure oil-fired steam boiler installation should be about

- A. 212 F
- B. 275 F
- x C. 350 F
- D. 875 F

The one thing a junior building custodian should not do after his/her building has been broken into is to

- A. notify the police
- B. report the incident to his supervisor
- x C. leave the damage to doors or windows unrepaired until his supervisor can inspect them on his regularly scheduled visit
- D. make the point of entry more secure than it was before the break-in

The insulation covering on steam lines

- A. increases the flow of steam
- x B. reduces the loss of heat
- C. increases the loss of heat
- D. prevents leaks

A cleaning solution of one cup of soap chips dissolved in a pail of warm water can be used to wash

- x A. painted walls
- B. rubber tile
- C. marble walls
- D. terrazzo floors

Sodium fluoride is a

- x A. pesticide
- B. disinfectant
- C. detergent
- D. paint thinner

Scratches or burns in linoleum, rubber tile, or cork floors should be removed by rubbing with

- A. crocus cloth
- x B. fine steel wool
- C. sandpaper
- D. emery cloth

A cleaning solution should be applied to a painted wall using a

- A. wool rag
- B. brush
- x C. sponge
- D. squeegee

When scrubbing a wooden floor it is advisable

- A. flood the surface with the cleaning solution in order to float the dirt out of all cracks and crevices
- B. hose off the loosened dirt before starting the scrubbing operation
- x C. pick up the cleaning solution as soon as possible
- D. mix a mild acid with the cleaning solution in order to clean the surface quickly

One gallon of water contains

- A. 2 quarts
- x B. 4 quarts
- C. 2 pints
- D. 4 pints

The best agent to use to remove chewing gum from fabric is

- A. ammonia
- B. chlorine bleach
- x C. a degreaser
- D. water

Water emulsion wax should not be used on

- A. linoleum
- B. cork tile flooring
- x C. wood furniture
- D. rubber tile flooring

Tops of desks, file cabinets, and book cases are best dusted with a

- A. damp cloth
- x B. treated cotton cloth
- C. damp sponge
- D. feather duster

A chamois is properly used to

- A. wash enamel surfaces
- B. wash window glass
- C. dry enamel surfaces
- x D. dry window glass

A twenty-four foot long extension ladder is placed with its top resting against a vertical wall. The safest procedure would be to place the base of the ladder a distance from the wall of

- A. 3 feet
- x B. 6 feet
- C. 9 feet
- D. 12 feet

A flushometer would be connected to a

- A. water meter
- x B. toilet bowl
- C. garden hose
- D. fire hose

The type of lock which can be opened only from the lock side of a door is the

- A. cylinder lock
- B. spring latch
- x C. padlock
- D. mortise lock

A key which will open many locks of the same type is usually called a

- A. tumbler key
- x B. master key
- C. magnetic key
- D. cotter key

Of the following, the best lubricant to use on locks is

- A. grease
- x B. graphite
- C. mineral oil
- D. talc

A junior building custodian should tour his assigned building a short time after the public closing time mainly to see that

- A. any office workers who are on overtime are really working
- x B. no unauthorized persons are in the building
- C. all the hall lights are turned off
- D. all the typewriters have dust covers on

A device which allows an exit door to be opened from the inside by pressing on a horizontal bar is known as a

- A. door pull
- B. double bolt bar lock
- C. cross bolt dead lock
- x D. panic bolt

The primary responsibility of a building custodian is to

- A. make friends of all subordinates
- B. search for new methods of doing the work
- C. win the respect of her superior
- x D. get the work done properly within a reasonable time

The first objective of all fire prevention is

- A. confining fire to a limited area
- x B. safeguarding life against fire
- C. reducing insurance rates
- D. preventing property damage

An office worker frequently complains to the building custodian that her office is poorly illuminated. The best action for the building custodian to follow is to

- A. ignore the complaints as those of an habitual crank
- B. inform the worker that illumination is a fixed item built into the building originally and evidently is the result of faulty planning by the architect
- C. request a licensed electrician to install additional ceiling lights
- x D. investigate for faulty illumination features in the room, such as dirty lamp globes and incorrect lamp wattages

In the satisfactory handling of a complaint which is fancied rather than real, the complaint should be considered

- x A. as important as a real grievance
- B. unimportant since it has no basis in fact
- C. an attempt by the complainant to stir up trouble
- D. indicative of overpaternalism

The chief purpose for changing the handle of a floor brush from one side of the brush block to the other side is to

- A. allow the janitor to change hands
- B. make both sides of the brush equally dirty
- x C. give both sides of the brush equal wear
- D. change the angle of sweeping

Nylon treated scrubbing discs

- A. require more water than scrubbing brushes
- B. require more detergent solution than scrubbing brushes
- C. must be used with cold water only
- x D. are generally more effective than steel wool pads

When washing painted wall areas by hand, a person should be expected to wash each hour an area in square feet equal to

- A. 75-125
- x B. 150-300
- C. 400-600
- D. 750-1000

Of the following, the one that is most desirable to use in dusting furniture is

- A. a feather duster
- B. a paper towel
- C. a counter brush
- x D. a soft cotton cloth

A wood framed picture is to be attached to a plaster and hollow tile wall. Of the following, the proper installation would include the use of

- A. wire cut nails
- B. miracle glue
- x C. expansion shields and screws
- D. self-tapping screws

It is advisable to remove broken bulbs from light sockets with

- x A. a wooden or hard rubber wedge
- B. pliers
- C. a hammer and chisel
- D. a fuse puller

The third prong on the plug of portable electric power tools of recent manufacture is for

- A. using the tool on a 3-phase power outlet
- B. eliminating interference in radio or television sets
- x C. grounding the tool as a safety precaution
- D. using the tool on direct current circuits

When changing brushes on a scrubbing machine, of the following, the first step to take is to

- A. lock the switch in the off position
- x B. be sure the power cable electric plug supplying the machine is disconnected from the wall outlet
- C. place the machine on top of the positioned brushes
- D. dip the brushes in water

Window cleaners should carefully examine their safety belts

- A. once a week
- x B. before they put them on each time
- C. once a month
- D. once before they enter a building

Chewing gum should be removed from rubber, asphalt, or linoleum flooring with

- x A. a putty knife
- B. steel wool
- C. gritty compounds
- D. a solvent

Of the following, the best procedure to follow when the linoleum floor of a meeting room containing movable furniture is to be mopped is to

- A. move the furniture by sliding it along the floor to prevent injury to the cleaners
- B. not move the furniture
- x C. move the furniture by lifting it and carrying it to a clear spot to prevent damage to the linoleum
- D. use very little water in order to prevent the legs of the furniture from getting wet

The use of alcohol in water for washing windows is not recommended because it

- A. is a hazard to cleaners in that they may be affected by the fumes
- x B. will damage the paint around the edges of the glass
- C. pits the surface of the glass
- D. destroys the bristles of the brush applying the solution to the pane



Of the following, the best material to use for removing grass stains on marble or wood is

- A. oxalic acid
- B. chloride of lime
- C. sodium silicate
- x D. sodium hypochlorite

Shades or Venetian blinds are preferably cleaned with a

- A. feather duster
- B. counter brush
- C. damp sponge
- x D. vacuum cleaner

Washing soda is used to

- A. eliminate the need for rinse mopping or wiping
- B. make the cleaning compound abrasive
- C. decrease the wetting power of water
- x D. increase the wetting power of water

Varnish or lacquer may be used as a sealer on floors finished with

- A. asphalt tiles
- B. linoleum
- C. rubber tiles
- x D. cork tiles

Usually, when a large room is gradually filled with people the room

- A. temperature and humidity both decrease
- B. temperature increases and the humidity decreases
- x C. temperature and humidity increase
- D. temperature decreases and humidity increases

In warm air heating and in ventilating systems, laboratories and kitchens should not be equipped with return ducts in order to

- A. keep air velocities in other returns as high as possible
- B. reduce fire hazards
- x C. reduce the possibility of circulating odors through the system
- D. keep the temperature high in these rooms

The temperature at which air is just saturated with the moisture present in it is called its

- A. relative humidity
- B. absolute humidity
- C. humid temperature
- x D. dew point

All portable fire extinguishers shall be inspected

- A. once a year
- x B. once a month
- C. once a week
- D. once every 3 months

The floor that should not be machine scrubbed is the floor of a (an)

- A. lobby
- B. lunchroom
- x C. gymnasium
- D. auditorium aisle

Pick-up sweeping in a school building is the occasional removal of the more conspicuous loose dirt from corridors and lobbies. This type of sweeping should be done

- A. after scrubbing or waxing of floors
- B. with the aid of a sweeping compound
- C. at night after school hours
- x D. during regular school hours

If it is not possible to plant new shrubs immediately upon delivery in the spring, they should be stored in a (an)

- x A. sheltered outdoor area
- B. unsheltered outdoor area
- C. boiler room
- D. warm place indoors

Oil-soaked waste and rags should be

- x A. deposited in a self-closing metal can
- B. piled in the open
- C. stored in the supply closet
- D. rolled up and be available for the next job

If the directions given by your superior are not clear, the best thing for you to do is to

- x A. ask to have the directions repeated and clarified
- B. proceed to do the work taking a chance on doing the right thing
- C. do nothing until some later time when you can find out exactly what is wanted
- D. ask one of the other workers in your crew what to do under the circumstances

If, as a custodian engineer, you discover an error in your report submitted to the main office, you should

- A. do nothing, since it is possible that one error will have little effect on the total report
- B. wait until the error is discovered in the main office and then offer to work overtime to correct it
- C. go directly to the supervisor in the main office after working hours and ask him unofficially to correct the error
- x D. notify the main office immediately so that the error can be corrected, if necessary

Prior to reseeding a patch of burned out grass, the ground is turned over down to subsoil preferably with a

- A. spade
- x B. fork
- C. hoe
- D. cultivator

Considerable debris has accumulated along the bottom of a chain link fence. To properly dispose of this debris

- A. burn it with gasoline
- x B. rake it away from the fence and put it out with the garbage
- C. pick it up by hand and put it out with the garbage
- D. dig it under with a round point shovel

After a chamois skin has been used to dry windows or other glass surfaces, it should be washed in

- A. hot water containing a small amount of soap
- x B. warm water alone
- C. a weak solution of trisodium phosphate
- D. a weak warm solution of ammonia in water

Paste wax is desirable for waxing all of the following surfaces except

- A. wood furniture
- B. hardwood trim
- C. metal lockers
- x D. asphalt tile

Chrome plated hardware should be cleaned periodically to remove dirt with

- A. a mild scouring powder
- B. fine steel wool
- x C. mild soap solution
- D. an abrasive metal polish

Corn brooms should be wet with warm water once or twice a week in order to

- x A. keep the fibers flexible
- B. deep the fibers clean
- C. prevent the fibers from rotting
- D. maintain the stiffness of the fibers

Painted cement floors should not be mopped with a strong trisodium phosphate solution because it

- A. will tend to decompose the cement surface
- x B. may dissolve the paint surface
- C. will not remove stains and dirt from this type of floor surface
- D. tends to rot the fibers of mop

The cleaning tool which is used for sweeping window sills and under radiators is a

- A. hopper brush
- B. 10 inch floor brush
- C. deck brush
- x D. counter brush

The accepted procedure in wall washing is to start at the bottom of the wall and work toward the top. The reason for this procedure is

- x A. the wall is less likely to show streaks after the job has been completed
- B. there is less effort required when the process is started at the bottom
- C. rinsing of the wall after use of cleaning solution is reduced to a minimum
- D. the amount of time the wall remains wet is reduced by this method

A practice which should not be followed in the cleaning of hall windows is

- A. use of warm water containing a very small amount of trisodium phosphate
- x B. use of a mild soap solution as the cleaning agent
- C. use of a sponge to apply water to the glass surface
- D. use of a chamois skin to wipe the glass dry

Tarnishing of chromium plated valves, faucets, hinges, and door knobs of toilet rooms can be prevented by

- A. monthly wax polishings
- B. semi-annual cleaning with abrasive and solvent
- C. daily wiping with cloth dampened with cold water
- x D. daily wiping with cloth dampened with kerosene

In the daily cleaning of an office, the first thing the cleaner usually does is to

- A. sweep the floors
- B. open the windows
- C. dust the furniture
- x D. empty waste paper baskets

Cleaning agents containing oil or kerosene should not be used in mopping mastic tile floors mainly because

- A. they tend to give a shine to the surface
- B. the tile surface will become slippery
- x C. use of such cleaners will tend to dissolve the tile
- D. dust will collect more rapidly on a surface cleaned with an agent containing oil or kerosene

Of the following, the one which can be used both as a disinfectant and as a bleach is

- x A. chlorine solution
- B. powdered whiting
- C. pine oil
- D. boric acid

The word abrasive means most nearly the same as

- A. smooth
- B. powdered
- x C. scratchy
- D. sticky

Of the following, the one which is not considered to be a hard floor is

- A. concrete
- B. marble
- C. terrazzo
- x D. asphalt tile

The type of fire extinguisher which should not be used on an oil fire is the

- x A. soda-acid type
- B. carbon-dioxide type
- C. foam type
- D. dry-chemical

An extension ladder has been placed with its top resting against a wall and its base resting on a concrete floor. The horizontal distance from the wall to the base of the ladder should be

- A. one-tenth of the length of the ladder
- x B. one-quarter of the length of the ladder
- C. one-half of the length of the ladder
- D. three-quarters of the length of the ladder

The two types of fire extinguishers which should be placed in a boiler room which has automatically controlled rotary cup oil burners are

- A. foam and soda acid
- B. carbon dioxide and loaded stream
- x C. carbon dioxide and foam
- D. foam and loaded stream

A ballast is a part of

- x A. a fluorescent light fixture
- B. an electric motor
- C. a door bell circuit
- D. an incandescent light fixture

## Street and Sewer Maintenance Questions

Of the following statements relating to new bell and spigot pipe being laid in a trench, the one that is CORRECT is that

- A. the enlarged end of the pipe faces downstream.
- B. bell and spigot pipe is usually elliptical in shape
- x C. when building a new line using bell and spigot pipe, you start from the downstream end
- D. vitrified pipe is usually thicker than concrete pipe of same diameter

The invert of a sewer pipe is its

- A. outer top
- x B. inner bottom
- C. inner top
- D. outer bottom

Of the following, the BEST reason for placing manholes on sewers is to

- x A. provide access for inspection and maintenance
- B. allow for overflow during a heavy storm
- C. pinpoint the location of the sewer
- D. give access to the sewer for the purpose of snow removal

A specification for a new sewer requires that the pavement not be restored for a period of at least six months after the backfill is in place. The BEST reason for this requirement is to

- A. be sure that the sewer will work before restoring the pavement
- x B. minimize the settlement of the pavement
- C. defer final payment to the contractor
- D. allow the use of a lighter pavement

A storm sewer GENERALLY differs from a sanitary sewer in that a storm sewer

- x A. is generally larger in size than a sanitary sewer and carries little dry-weather flow
- B. is generally made of concrete whereas a sanitary sewer is generally made of cast iron
- C. generally requires fewer manholes than a sanitary sewer
- D. generally has a large slope whereas a sanitary sewer generally has a small slope

The spacing of rungs used for steps in a manhole is, MOST NEARLY

- A. 4 inches
- x B. 12 inches
- C. 20 inches
- D. 26 inches

The water-cement ratio of a concrete mix is USUALLY expressed in terms of

- A. barrels of cement per gallon of water
- B. bags of cement per gallon of water
- x C. gallons of water per bags of cement
- D. gallons of water per barrel of cement

The PRIMARY purpose of curing freshly poured concrete is to

- A. keep the surface smooth
- B. prevent honeycombing of the surface
- C. improve the appearance of the surface
- x D. prevent evaporation of water from the surface

A bag of cement weighs MOST NEARLY

- x A. 94 pounds
- B. 104 pounds
- C. 114 pounds
- D. 124 pounds

In a 1:2:4 concrete mix, the 2 stands for the quantity of

- A. water
- x B. fine aggregate
- C. coarse aggregate
- D. cement

As commonly used, 3000-pound concrete refers to

- A. 3000 pounds per inch
- x B. 3000 pounds per square inch
- C. 3000 pounds per cubic inch
- D. 3000 pounds per foot

The factor that has the GREATEST EFFECT on the strength of concrete is the

- A. size of coarse aggregate
- B. uniformity of the aggregate
- x C. water-cement ratio
- D. quality of the fine aggregate

The MAIN purpose of adding an air entraining agent to a concrete mix used for sidewalks is to

- x A. improve the resistance of the concrete to freezing and thawing conditions
- B. decrease the weight of the concrete to lighten the dead load of the concrete
- C. increase the compressive strength of the concrete
- D. decrease the resistance of the concrete to bleeding

Of the following operations on a fresh concrete surface, the one that should be performed first is

- x A. screeding
- B. floating
- C. trowelling
- D. brooming

A pneumatic jack hammer is powered by

- x A. compressed air
- B. electricity
- C. steam
- D. water pressure

Concrete that has become partly set in the mixer should be

- A. covered with water for about 24 hours to soften it before using
- x B. discarded and not used at all
- C. mixed in with another regular batch of concrete before using
- D. re-tempered by adding more cement and mixed again before using

The type of cement used in MOST concrete work is called

- A. asbestos
- B. natural
- x C. Portland
- D. rock

Cement brought on the job in bags should be

- A. piled in criss-cross stacks on the ground near the work
- B. piled in stacks 10 bags high in a convenient place on the ground
- x C. put on a platform and covered with water-proof covering
- D. put under a tree or awning where the sun's rays can't reach it

In the concrete trade, sand is called

- A. binder
- B. coarse aggregate
- C. filler
- x D. fine aggregate

A 1:2:4 concrete mix means

- A. one part cement, two parts gravel, four parts sand
- x B. one part cement, two parts sand, four parts gravel
- C. one part gravel, two parts sand, four parts cement
- D. one part sand, two parts gravel, four parts cement

After mixing, the initial set of concrete will take place in about

- x A. 3/4 of an hour
- B. 2 1/4 hours
- C. 4 3/4 hours
- D. 8 hours

In hot weather, newly-placed concrete will set better when it is

- x A. covered with wet burlap
- B. dried by exposure to the sun
- C. mixed with grout
- D. shaded from the sun's rays



When concrete is referred to as "3000-pound concrete," the 3000 refers to its strength at the end of

- A. 7 days
- B. 14 days
- C. 21 days
- x D. 28 days

An advantage of using sand instead of salt on concrete roadway surfaces when snow and ice settle on them is that

- A. sand is easier to remove than salt when the snow disappears
- B. sand will harm catch basins less than salt when the materials are washed into the catch basins
- x C. sand will not harm the concrete surface whereas salt is harmful to the surface
- D. sand will help melt the surface ice whereas salt will have no effect on the ice on the surface

In building a new street, sidewalk and curb in a previously unpaved area, the order of construction PRACTICALLY ALWAYS followed is that the

- A. sidewalk precedes the road pavement
- B. sidewalk follows the road pavement
- x C. curb precedes the road pavement
- D. road pavement precedes the curb

The BASE course of a sheet asphalt pavement is usually made of

- A. sheet asphalt
- x B. concrete
- C. tar
- D. bituminous binder

The specification for a pavement states that the penetration of asphalt is measured in units of mn. This stands for

- A. micrometer
- B. macrometer
- C. manometer
- x D. millimeter

In an asphalt pavement, the LIQUID part of the asphalt mix is

- x A. bitumen
- B. water
- C. gasoline
- D. benzene

In placing temporary asphaltic pavement upon completion of the backfill in a street opening, a 3 inch thick pavement should be laid one inch above the adjoining asphalt permanent pavement. The MAIN reason for making the temporary pavement one inch above the finished pavement is to

- A. provide adequate drainage
- x B. allow for settlement
- C. identify the temporarily paved area
- D. save excavation when the permanent pavement is placed

The usual method of repairing cracks in concrete roadways is to fill with

- A. limestone
- B. mineral filler
- C. sand
- x D. tar

The top course of an asphalt pavement is known as the

- A. aggregate course
- B. binder course
- C. limestone course
- x D. wearing course

The foundations for an asphalt surface should be

- A. clean and damp
- x B. clean and dry
- C. damp and sprinkled with sand
- D. dry and sprinkled with sand

A catch basin is used to

- x A. detain floating rubbish which might clog a sewer
- B. hold water used in flushing sewers
- C. record and measure the depth of flow of sewage
- D. regulate the flow of sewage to a treatment plant

The PRINCIPAL effort in maintaining sewers is to keep them

- x A. clean and unobstructed
- B. free from poisonous gases
- C. free of illegal connections
- D. properly backfilled

Catch basins in unpaved streets should be cleaned

- A. daily in winter, weekly in summer
- B. once a year
- C. every six months
- x D. after every large storm

In using a flexible sewer rod to clean a sewer, the work is usually begun at the

- A. chimney between manholes
- B. nearest catch basin
- x C. top of the flooded manhole
- D. nearest house connection

In flushing sewers, the MOST important of the following qualities of the water used is its

- A. cleanliness
- B. quantity
- C. temperature
- x D. velocity

BEST COPY AVAILABLE

Manholes are used CHIEFLY as a(n)

- x A. access for cleaning sewers
- B. outlet for sewer gas
- C. run-off for storm water
- D. support for sewer pipes

If the sewage at a manhole is backed up, it indicates most probably, that, with respect to this manhole, there is an obstruction in the

- A. nearest catch basin
- B. nearest house connection
- C. upstream sewer
- x D. downstream sewer

The one of the following that is the LEAST important health precaution for a sewer worker to take is

- A. frequent washing
- x B. shading his eyes from reflected light
- C. using an antiseptic in cuts
- D. wearing rubber gloves

If the mechanic to whom you are assigned gives you a job to be done in a certain way and, after starting the job, you think of another method which you are convinced is better, you should

- A. follow the procedure given by the mechanic since this procedure will most likely be done anyway
- B. try your own method since the mechanic probably will not know the difference
- C. tell the supervisor about your method the next time he or she appears at your job
- x D. request the mechanic's opinion of your method before proceeding further

If it is necessary for you to make some adjustment with your hands under a piece of heavy equipment, while a fellow worker lifts up and holds one end of it by means of a pinch bar, one important precaution you should take is to

- x A. insert a temporary block to support the piece
- B. watch the bar to be ready if it slips
- C. wear gloves
- D. work as fast as possible

Sewer gas is prevented from backing up through a fixture by a

- x A. water tap
- B. vent pipe
- C. check valve
- D. float valve

A tool intended for cutting a hole in concrete is a

- x A. star drill
- B. center punch
- C. countersink
- D. cold chisel

BEST COPY AVAILABLE

A stone frequently used to sharpen tools is

- A. marble
- B. soap stone
- C. sand stone
- x D. carborundum

A fellow employee working in a confined space is seen to stagger and fall unconscious apparently due to sewer gas poisoning. Your first action should be to

- A. start artificial resuscitation
- B. call for an ambulance
- x C. move the victim into good air
- D. give the victim a stimulant

When new concrete work is to be joined to existing concrete, it is important to

- A. oil the existing concrete
- B. always use a special keyed joint
- C. level the new concrete 1/2 inch below the existing concrete
- x D. thoroughly soak the existing concrete with water

When threading the end of a piece of pipe it is not good practice to

- x A. start with a right-hand die and finish the threads with a left-hand die
- B. ream the pipe after making the threads
- C. smooth the end of the pipe before threading
- D. use oil for lubrication while threading the pipe

Diagonal pliers are properly used to

- A. cut pipe
- B. flatten steel tubing
- C. turn hexagonal nuts
- x D. cut wire

The type of screwdriver which will develop the greatest turning force is a

- x A. screwdriver-bit and brace
- B. spiral push-type
- C. standard straight handle
- D. straight handle with ratchet

The tool shown at the right is used to

- A. set nails
- B. set lead anchors
- x C. drill holes in concrete
- D. centerpunch for holes

The tool shown at right is a

- A. punch
- B. Philips-type screwdriver
- C. drill holder
- x D. socket wrench

The tool shown at the right is

- A. an Allen-head wrench
- x B. an offset screwdriver
- C. a double scraper
- D. a nail puller

The tool shown at the right is

- A. an offset wrench
- B. a spanner wrench
- C. a box wrench
- x D. an open end wrench

A tool that can be used properly to cut on both forward and reverse strokes is a

- A. hacksaw
- B. rip saw
- C. file
- x D. 3-wheel pipe cutter

A double-thread is

- A. always defective
- B. a combination of left-hand and right-hand threads
- C. a tapered thread
- x D. two parallel threads in the same direction

Socket wrenches are especially useful

- x A. for turning nuts in close quarters
- B. on pipe
- C. for removing studs
- D. for threading rods

A tool which should never be turned counterclockwise is a

- A. tap
- B. die
- x C. reamer
- D. screw extractor

The practice of placing extra weight on the rear of a fork-lift truck which is carrying an overload is

- A. undesirable, because the operator has too much balancing to do
- x B. undesirable, because it puts a strain on the motor, tires, and axle of the truck
- C. desirable, because this prevents the truck from turning over
- D. desirable, because more material can be transported at a time

When removing a shrink-fitted collar from a shaft, it would be easiest to drive out the shaft after

- x A. heating only the collar
- B. heating only the shaft
- C. chilling only the collar
- D. chilling the collar and heating

BEST COPY AVAILABLE

A clutch is a device that is used

- A. to hold a work piece in a fixture
- B. for retrieving small parts from hard to reach areas
- x C. to disengage one rotating shaft from another
- D. to level machinery on a floor

Of the following, the most important advantage of a ratchet wrench over an open-end wrench is that the ratchet wrench

- x A. can be used in a more limited space
- B. measures the torque applied
- C. will not strip the threads of a bolt
- D. is available for all sizes of hex bolts

The purpose of a water trap in a plumbing drainage system is to

- A. prevent the leakage of water
- B. prevent freezing of the pipes
- x C. block off sewer gases
- D. reduce the water pressure in the system

The tool that holds the die when threading pipe is generally called a

- A. vise
- x B. stock
- C. yoke
- D. coupling

A fitting used to join a small pipe at right angles to the middle of a large pipe is called a

- A. union
- B. coupling
- C. cap
- x D. reducing tee

Gaskets are commonly used between the flanges of large pipe joints to

- x A. make a leakproof connection
- B. provide for expansion
- C. provide space for assembly
- D. adjust for poor alignment

The pipe fitting that should be used to connect a 1" pipe to a 1-1/2" valve is called a

- A. reducing coupling
- B. nipple
- x C. bushing
- D. union

Small leaks in a compressed air pipe line leading from a shop compressor are most easily located by

- A. creating a vacuum in the air line
- B. allowing the compressor to pump water through the lines
- C. monitoring air gauges throughout the piping system
- x D. applying soapy water to the pipeline

The basic purpose of an idler gear in a gear train is to

- A. change gear speed
- B. increase gear torque
- C. reduce friction in the gear train
- x D. change the direction of rotation of a shaft

Cleaning sewer lines is USUALLY done by the use of a

- A. catch basin
- B. flushometer
- x C. sewer rod
- D. center line

One of the ways locating a leak in a water line is by using a

- A. manometer
- x B. sounding rod
- C. poling board
- D. diffuser

MOST sewer pipes are made of

- x A. cast iron
- B. agricultural tile
- C. brass
- D. copper

The FIRST precaution a worker should take before entering a sewer manhole is to

- A. put on hard toed shoes
- B. put on safety goggles
- C. check that the next manhole upstream is not obstructed
- x D. test the air in the manhole

Of the following material, the one that is BEST for fill as a subgrade for a road is

- A. sand
- B. silt
- C. clay
- x D. a mixture of sand, silt and clay

Water hammer in a pipe line is BEST reduced by installing

- A. a pressure regulator
- x B. an air chamber
- C. smaller pipes and valves
- D. larger pipes and valves

Frequent stalling of a truck engine is MOST probably due to a

- A. weak battery
- B. low battery water level
- C. leaking oil filter
- x D. dirty carburetor

A tractor is to be stored for two months. In order to keep it in BEST condition it should be

- A. drained of all fuel and oil
- B. lubricated every week
- x C. started up periodically and run until warm
- D. steam cleaned and all water drained from the radiator

The blades of a lawn mower should be set so that the blades

- A. firmly touch the bed knife
- x B. barely touch the bed knife
- C. clear the bed knife by 1/16 inch
- D. clear the bed knife by 1/8 inch

The MAIN reason for making a crown in a road pavement is to

- A. reduce the amount of paving material necessary
- B. make it easier for cars to go around a curve
- x C. drain surface water
- D. increase the strength of the pavement where it is most needed

To loosen compacted rocky earth road surfaces, the BEST piece of equipment to use is a

- A. disc harrow
- B. drag line
- C. bulldozer
- x D. scarifier

Cracks in concrete roads are BEST repaired by filling them with

- x A. tar
- B. grout
- C. mineral filler
- D. sand

When repairing patches in old asphalt pavements, the edges of the patch should FIRST be painted with

- A. the same material used for the patch
- B. kerosene
- x C. asphalt cement
- D. asphalt binder

A plumbing device that prevents the passage of bad odors and gases from the sewer system to a building is a

- A. corporation stop
- B. union
- C. curb box
- x D. trap

A device used in a combined sewer to bypass excess stormflow is a(n)

- A. soffit
- x B. side-flow weir
- C. aquafer
- D. cellular cofferdam



A device installed at the discharge end of a sewer outfall which operates to permit gravity flow at low stages in the receiving waters, but closes to prevent backflow when the elevation of the receiving waters is high, is a

- A. flume
- B. buttress
- x C. tide gate
- D. flucculator

A pipe used to carry streamflow under a highway embankment is a

- x A. culvert
- B. lock
- C. standpipe
- D. pitot

A model 6520 Sewer Cleaner is rated at 60 GPM at 1000 psi. As used here, PSI is an abbreviation for

- A. positive surging inflow
- B. per sewer invert
- x C. pounds per square inch
- D. pounds per sewer inlet

Lateral sanitary sewers should PREFERABLY intersect at a

- A. catch basin
- B. weir
- x C. manhole
- D. tide gate

The flow of ground water into sanitary sewers through defective joints is called

- A. back siphonage
- x B. infiltration
- C. overflow
- D. exfiltration

In a combined sewer system, the amount of sewage flowing to the treatment plant is USUALLY controlled by a

- x A. regulator
- B. bar screen
- C. siphon
- D. mud valve

Of the following, the one which is NOT a sewer cleaning tool is the

- A. gouge
- B. wire brush
- x C. pilaster
- D. claw

BEST COPY AVAILABLE

A sewer which carries only sewage from the plumbing fixtures in a house is a

- A. storm sewer
- B. combined sewer
- x C. sanitary sewer
- D. subsurface drain

The frequency of oiling and greasing of bearings and other moving parts of machinery depends mainly on the

- A. size of the parts requiring lubrication
- B. speed at which the parts move
- C. ability of the operator
- x D. amount of use of the equipment

Painted cement floors should not be mopped with a strong trisodium phosphate solution because it

- A. will tend to decompose the cement surface
- x B. may dissolve the paint surface
- C. will not remove stains and dirt from this type floor surface
- D. tends to rot the fibers of the mop

The cleaning tool which is used for sweeping window sills and under radiators is a

- A. hopper brush
- B. 10 inch floor brush
- C. deck brush
- x D. counter brush

A practice which should not be followed in the cleaning of hall windows is

- A. use of warm water containing a very small amount of trisodium phosphate
- x B. use of a mild soap solution as the cleaning agent
- C. use of a sponge to apply water to the glass surface
- D. use of a chamois skin to wipe the glass dry

A 5 foot x 5 foot slab of concrete sidewalk in front of the building is broken and creating a hazard to the public. The proper mix of materials and water to replace this slab is

- A. 1 part cement, 2 parts sand
- B. 1 part cement, 4 parts sand
- C. 1 part cement, 1 part sand, 1 part gravel
- x D. 1 part cement, 3 parts sand, 4 parts gravel

Although rock salt is commonly used on sidewalks when they are iced or heavily packed with snow, the chief disadvantage of its use is that it

- A. creates a very slushy condition
- B. generally causes deterioration of concrete walks
- C. increases cleaning costs if used intensively
- x D. is harmful to adjacent trees and shrubs

If a map must be filed at a scale of 1" = 40', six inches on the map represents

- A. 600 ft. on the ground
- x B. 240 ft. on the ground
- C. 120 ft. on the ground
- D. 60 ft. on the ground

In making a field report, it is poor practice to erase information on the report in order to make a change because

- x A. there is a question of what was changed and why it was changed
- B. you are liable to erase through the paper and tear the report
- C. the duplicate copies will be smudged
- D. the duplicate copies will show different information

It is PREFERABLE to print information on a field report rather than write it out longhand mainly because

- A. printing takes less time to write than writing longhand
- x B. printing is usually easier to read than longhand
- C. longhand writing on field reports is not acceptable in court cases
- D. printing occupies less space on a report than longhand writing

Where the length of roadway pavement is less than 100 lineal feet, the requirement of cores may be waived.

The term waived in the above statement means, MOST NEARLY

- x A. eliminated
- B. enforced
- C. considered
- D. postponed

Where only part of the sidewalk is to be relaid, the concrete shall match the predominant color of the existing sidewalk.

The word predominant in the sentence above means, MOST NEARLY

- A. lightest
- B. darkest
- x C. main
- D. contrasting

Where a street opening is made by a licensed plumber, a plumber's bond may be filed in lieu of a street obstruction bond.

The words in lieu of mean, MOST NEARLY

- A. in addition to
- x B. instead of
- C. immediately as
- D. appurtenant to

The MOST important feature of a written report is

- A. length
- x B. accuracy
- C. organization
- D. grammar

Written reports to your superior should have the same general arrangement and layout. The BEST reason for this requirement is that the

- A. report will be more accurate
- B. report will be more complete
- C. person who reads the report will know what the subject of the report is
- x D. person who reads the report will know where to look for information in the report

Where feasible, concrete sidewalk panels should be made in squares of

- A. 3 ft. by 3 ft.
- x B. 5 ft. by 5 ft.
- C. 6 ft. by 6 ft.
- D. 7 ft. by 7 ft.

A liquid asphalt is designated "RC70". The letters RC stand for

- A. Rough Course
- B. Rubber Cement
- x C. Rapid Curing
- D. Reinforced Concrete

The difference between sheet asphalt and asphaltic concrete is that sheet asphalt

- A. contains no sand while asphaltic concrete contains sand
- x B. contains no coarse aggregate while asphaltic concrete contains coarse aggregate
- C. contains no mineral filler while asphaltic concrete contains mineral filler
- D. has no flux while asphaltic concrete has flux

When tops of manholes must be raised because of repaving, the MOST practical of the following methods to use is to

- A. break out the manhole frame and replace it with a deeper frame
- B. remove the manhole frame, build up the top of the manhole with bricks and reset the frame
- C. use a thicker manhole cover
- x D. place a metal collar on top of the existing frame

An asphalt macadam pavement consists of a base course and a wearing course. The PURPOSE of the base course is to

- A. provide drainage
- B. provide a level surface for the wearing course
- x C. spread the load from the surface when it reaches the soil
- D. replace defective soil

BEST COPY AVAILABLE

A wooden horse, used to warn traffic away, should be placed in front of which of the following defects in the street?

- A. broken curb
- B. piece of roadway pavement that is very thin and the pavement base is starting to show through
- x C. very badly broken manhole cover in the center of the street
- D. catch basin filled to the surface with debris

Of the following the BEST way to insure long trouble free operation of mechanical equipment is by periodic inspection and

- A. use
- x B. servicing
- C. painting
- D. rotation of operators

Of the following, the BEST reason why deep potholes should be repaired immediately is that

- A. they look bad
- x B. they are a safety hazard
- C. they present a drainage problem
- D. people complaining about unfilled potholes cause unfavorable publicity

Of the following, the MOST serious safety hazard on highway and street maintenance work is

- A. injury from flying debris during pavement breaking
- x B. motor traffic
- C. working close to trucks, bulldozers, and rollers
- D. cave-ins

One of the laborers on the job feels unusually tired, has a headache and nausea, is perspiring heavily, and the skin is pale and clammy. He/She is, probably, suffering from

- A. epilepsy
- B. food poisoning
- x C. heat exhaustion
- D. sunstroke

Of the following types of fire extinguishers, the one to use on an electrical fire is

- A. soda acid
- x B. carbon dioxide
- C. water pump tank
- D. pyrene

The GREATEST number of injuries from equipment used in construction work result from

- x A. carelessness of the operator
- B. poor maintenance of the equipment
- C. overloading of the equipment
- D. poor inspection of the equipment

## Public Works Maintenance Questions

Of the following statements relating to new bell and spigot pipe being laid in a trench, the one that is CORRECT is that

- A. the enlarged end of the pipe faces downstream
- B. bell and spigot pipe is usually elliptical in shape
- C. when building a new line using bell and spigot pipe, you start from the downstream end
- D. vitrified pipe is usually thicker than concrete pipe of same diameter

The invert of a sewer pipe is its

- A. outer top
- B. inner bottom
- C. inner top
- D. outer bottom

A cradle is usually placed under a sewer pipe when the

- A. trench is narrow
- B. trench is wide
- C. soil is poor
- D. pipe is near the surface

Of the following, the BEST reason for placing manholes on sewers is to

- A. provide access for inspection and maintenance
- B. allow for overflow during a heavy storm
- C. pinpoint the location of the sewer
- D. give access to the sewer for the purpose of snow removal

The sheeting of a trench for a sheeted sewer is ordered left in place after the sewer has been built and backfilled. The BEST reason for ordering the sheeting left in place is that

- A. the sheeting is too expensive to remove
- B. the removal of the sheeting would disturb the sewer
- C. this minimizes the settlement outside the sheeted area
- D. the sheeting is too difficult to remove

The two MOST frequently used types of sheeting for normal soil conditions and average depths are

- A. soldier beams with horizontal sheeting and vertical wood sheeting with bracing
- B. steel sheet piling and vertical wood sheeting
- C. precast concrete planks with soldier beams and steel sheet piling
- D. slurry walls and vertical wood sheeting

A specification for a new sewer requires that the pavement not be restored for a period of at least six months after the backfill is in place. The BEST reason for this requirement is to

- A. be sure that the sewer will work before restoring the pavement
- x B. minimize the settlement of the pavement
- C. defer final payment to the contractor
- D. allow the use of a lighter pavement

As used in relation to sewers, infiltration refers to the

- A. leakage of sewage from the sewer to the surrounding soil
- B. connection of sanitary sewer lines into storm water sewers
- x C. inflow of ground water into the sewer
- D. loss of mortar at the joints of prefabricated sewers

A BAD effect of infiltration in a sanitary sewer is that it

- x A. tends to overload the sewage treatment plant
- B. corrodes the sewer
- C. causes cavitation in the sewer
- D. increases the carrying capacity of the sewer

The spacing of rungs used for steps in a manhole is, MOST NEARLY

- A. 4 inches
- x B. 12 inches
- C. 20 inches
- D. 26 inches

Well points would MOST likely be used in the construction of a sewer when the

- A. sewer is very deep
- B. sewer is in rock
- C. soil is clayey
- x D. water table is above the sewer

The purpose of jetting the well points in sewer construction is to

- A. clean out the screen
- x B. set the well point in place
- C. clean out the area outside the screen
- D. remove water from the surrounding area

The water-cement ratio of a concrete mix is USUALLY expressed in terms of

- A. barrels of cement per gallon of water
- B. bags of cement per gallon of water
- x C. gallons of water per bags of cement
- D. gallons of water per barrel of cement

The PRIMARY purpose of curing freshly poured concrete is to

- A. keep the surface smooth
- B. prevent honeycombing of the surface
- C. improve the appearance of the surface
- x D. prevent evaporation of water from the surface

A bag of cement weighs MOST NEARLY

- x A. 94 pounds
- B. 104 pounds
- C. 114 pounds
- D. 124 pounds

In a 1:2:4 concrete mix, the 2 stands for the quantity of

- A. water
- x B. fine aggregate
- C. coarse aggregate
- D. cement

As commonly used, 3000-pound concrete refers to

- A. 3000 pounds per inch
- x B. 3000 pounds per square inch
- C. 3000 pounds per cubic inch
- D. 3000 pounds per foot

The factor that has the GREATEST EFFECT on the strength of concrete is the

- A. size of coarse aggregate
- B. uniformity of the aggregate
- x C. water-cement ratio
- D. quality of the fine aggregate

The MAIN purpose of adding an air entraining agent to a concrete mix used for sidewalks is to

- x A. improve the resistance of the concrete to freezing and thawing conditions
- B. decrease the weight of the concrete to lighten the dead load of the concrete
- C. increase the compressive strength of the concrete
- D. decrease the resistance of the concrete to bleeding

Of the following operations on a fresh concrete surface, the one that should be performed first is

- x A. screeding
- B. floating
- C. trowelling
- D. brooming

When concrete is referred to as "3000-pound concrete," the 3000 refers to its strength at the end of

- A. 7 days
- B. 14 days
- C. 21 days
- x D. 28 days



The MAIN difference between reinforced concrete and plain concrete is that plain concrete uses

- x A. larger aggregate for reinforcing
- B. high early strength cement for reinforcing
- C. steel for reinforcing
- D. a low water-cement ratio for reinforcing

In building a new street, sidewalk and curb in a previously unpaved area, the order of construction PRACTICALLY ALWAYS followed is that the

- A. sidewalk precedes the road pavement
- B. sidewalk follows the road pavement
- x C. curb precedes the road pavement
- D. road pavement precedes the curb

The USUAL range of depth of a curb from top surface of road at curb to top of curb is

- x A. 4 inches to 8 inches
- B. 8 inches to 12 inches
- C. 12 inches to 16 inches
- D. 16 inches to 20 inches

When steel curb angles are used for the curbs, anchors are attached to the curb angles. The MAIN purpose of the anchors is to

- A. hold the curb in place when the curb is being poured
- x B. bond the curb angle into the concrete curb
- C. anchor the curb angle into the soil
- D. anchor the curb angle into the sidewalk

If a map must be filed at a scale of 1" = 40', six inches on the map represents

- A. 600 ft. on the ground
- x B. 240 ft. on the ground
- C. 120 ft. on the ground
- D. 60 ft. on the ground

The MOST important feature of a written report is

- A. length
- x B. accuracy
- C. organization
- D. grammar

A written report to your superior contains many spelling errors. Of the following statements relating to spelling errors, the one that is MOST NEARLY correct is that

- A. this is unimportant as long as the meaning of the report is clear
- B. readers of the report will ignore the many spelling words
- x C. readers of the report will get a poor opinion of the writer of the report
- D. spelling errors are unimportant as long as the grammar is correct

Of the following, the one that is INCORRECT curb construction is a curb made

- A. with a height of 5 inches
- B. with a steel angle for the face
- C. without a steel face
- x D. monolithically with the sidewalk

Expansion joints in steel curb facing shall be 1/4 inch wide and shall be filled with

- A. sand
- x B. premolded filler
- C. poured asphalt
- D. dry pack

A 15-foot-wide sidewalk has a pitch of 1/4 inch per foot. The difference in elevation from the curb to 15 feet from the curb in the direction of the pitch is

- A. 3 inches
- x B. 3 3/4 inches
- C. 4 inches
- D. 4 1/2 inches

When tops of manholes must be raised because of repaving, the MOST practical of the following methods to use is to

- A. break out the manhole frame and replace it with a deeper frame
- B. remove the manhole frame, build up the top of the manhole with bricks and reset the frame
- C. use a thicker manhole cover
- x D. place a metal collar on top of the existing frame.

A tree pit shall be located in the area immediately in back of the curb. The MAXIMUM size of the tree pit shall be

- A. 3' x 3'
- B. 4' x 4'
- x C. 5' x 5'
- D. 6' x 6'

A wooden horse, used to warn traffic away, should be placed in front of which of the following defects in the street?

- A. broken curb
- B. piece of roadway pavement that is very thin and the pavement base is starting to show through
- x C. very badly broken manhole cover in the center of the street
- D. catch basin filled to the surface with debris

Of the following the BEST way to insure long trouble free operation of mechanical equipment is by periodic inspection and

- A. use
- x B. servicing
- C. painting
- D. rotation of operators

Of the following, the MOST serious safety hazard on highway and street maintenance work is

- A. injury from flying debris during pavement breaking
- x B. motor traffic
- C. working close to trucks, bulldozers, and rollers
- D. cave-ins

One of the laborers on the job feels unusually tired, has a headache and nausea, is perspiring heavily, and the skin is pale and clammy. He/She is, probably, suffering from

- A. epilepsy
- B. food poisoning
- x C. heat exhaustion
- D. sunstroke

Of the following types of fire extinguishers, the one to use on an electrical fire is

- A. soda acid
- x B. carbon dioxide
- C. water pump tank
- D. pyrene

The GREATEST number of injuries from equipment used in construction work result from

- x A. carelessness of the operator
- B. poor maintenance of the equipment
- C. overloading of the equipment
- D. poor inspection of the equipment

A mattock could be BEST used in place of a

- A. hammer
- x B. pick-axe
- C. rake
- D. shovel

The type of cement used in MOST concrete work is called

- A. asbestos
- B. natural
- x C. Portland
- D. rock

Cement brought on the job in bags should be

- A. piled in criss-cross stacks on the ground near the work
- B. piled in stacks 10 bags high in a convenient place on the ground
- x C. put on a platform and covered with water-proof covering
- D. put under a tree or awning where the sun's rays can't reach it

In the concrete trade, sand is called

- A. binder
- B. coarse aggregate
- C. filler
- x D. fine aggregate

A 1:2:4 concrete mix means

- A. one part cement, two parts gravel, four parts sand
- x B. one part cement, two parts sand, four parts gravel
- C. one part gravel, two parts sand, four parts cement
- D. one part sand, two parts gravel, four parts cement

A slump test is used in concrete to determine

- x A. consistency
- B. construction
- C. expansion
- D. slope

After mixing, the initial set of concrete will take place in about

- x A. 3/4 of an hour
- B. 2 1/4 hours
- C. 4 3/4 hours
- D. 8 hours

In hot weather, newly-placed concrete will set better when it is

- x A. covered with wet burlap
- B. dried by exposure to the sun
- C. mixed with grout
- D. shaded from the sun's rays

Grout is used MAINLY to

- x A. fill surface impressions and imperfections
- B. lower the freezing point of the concrete mix
- C. make the base harden faster
- D. provide a wearing surface layer

Joints are placed in concrete sidewalks to take care of

- A. bumps
- B. cracks
- C. drainage
- x D. expansion and contraction

To take care of surface drainage, concrete sidewalks usually have slopes of

- x A. 1/4 inch to the foot
- B. 1 inch to the foot
- C. 2 inches to the foot
- D. 3 inches to the foot

In paving terms, a two-course concrete sidewalk is one which is

- A. composed of concrete both hand and machine mixed
- x B. composed of two layers, a base and a wearing surface
- C. wide enough for traffic going in opposite directions
- D. wide enough for two pedestrians to walk side by side.

A catch basin is used to

- x A. detain floating rubbish which might clog a sewer
- B. hold water used in flushing sewers
- C. record and measure the depth of flow of sewage
- D. regulate the flow of sewage to a treatment plant

A sewer built to carry the flows in excess of the capacity of an existing sewer is called a

- A. lateral sewer
- B. main sewer
- x C. relief sewer
- D. trunk sewer

A pipe conveying sewage from a single building to a common sewer is called a

- A. catch basin
- B. grease trap
- x C. house connection
- D. relief sewer

Manholes are used CHIEFLY as a(n)

- x A. access for cleaning sewers
- B. outlet for sewer gas
- C. run-off for storm water
- D. support for sewer pipes

The one of the following at which a manhole in a sewer line is NOT necessary is wherever there is a

- A. change in direction
- B. change in pipe size
- C. considerable change in grade
- x D. house connection

Manholes are usually placed at intervals of

- x A. 50 to 75 ft.
- B. 100 to 200 ft.
- C. 700 to 900 ft.
- D. 1200 to 1400 ft.

Of the following, the STRONGEST method for sheeting a trench is

- A. box sheeting
- B. poling boards
- C. stay bracing
- x D. vertical sheeting

The one of the following that would be MOST commonly used to join a house sewer to a common sewer is a(n)

- A. increaser
- B. reducer
- C. running trap
- x D. Y branch

After making joints in sewer pipe, the minimum safe length of time to allow before they should be exposed to running water is

- A. 1 hour
- B. 8 hours
- x C. 24 hours
- D. 48 hours

The one of the following that is the LEAST important health precaution for a sewer worker to take is

- A. frequent washing
- x B. shading his eyes from reflected light
- C. using an antiseptic in cuts
- D. wearing rubber gloves

The pipe that is most likely to break if it is dropped is one made from

- A. soft steel
- B. wrought iron
- C. aluminum
- x D. cast iron

If the mechanic to whom you are assigned gives you a job to be done in a certain way and, after starting the job, you think of another method which you are convinced is better, you should

- A. follow the procedure given by the mechanic since this procedure will most likely be done anyway
- B. try your own method since the mechanic probably will not know the difference
- C. tell the supervisor about your method the next time he or she appears at your job
- x D. request the mechanic's opinion of your method before proceeding further

Compound used on threaded pipe joints should be applied on

- x A. the piece that is threaded on the outside
- B. the joint edge after tightening
- C. both threaded pieces
- D. the piece that is threaded on the inside

If it is necessary for you to make some adjustment with your hands under a piece of heavy equipment, while a fellow worker lifts up and holds one end of it by means of a pinch bar, one important precaution you should take is to

- x A. insert a temporary block to support the piece
- B. watch the bar to be ready if it slips
- C. wear gloves
- D. work as fast as possible

When used in reference to pipe the abbreviations I.D. and O.D. refer to the pipe

- A. density
- x B. diameters
- C. length
- D. weight

Because of its weather-resistant properties a varnish commonly used on exterior wood surfaces is

- x A. spar varnish
- B. flat varnish
- C. rubbing varnish
- D. hard oil varnish

Sewer gas is prevented from backing up through a fixture by a

- x A. water tap
- B. vent pipe
- C. check valve
- D. float valve

A tool intended for cutting a hole in concrete is a

- x A. star drill
- B. center punch
- C. countersink
- D. cold chisel

A stone frequently used to sharpen tools is

- A. marble
- B. soap stone
- C. sand stone
- x D. carborundum

Packing is used in an adjustable water valve mainly to

- A. make it air-tight
- B. prevent mechanical wear
- C. regulate the water pressure
- x D. make it water-tight

When threading the end of a piece of pipe it is not good practice to

- x A. start with a right-hand die and finish the threads with a left-hand die
- B. ream the pipe after making the threads
- C. smooth the end of the pipe before threading
- D. use oil for lubrication while threading the pipe

Diagonal pliers are properly used to

- A. cut pipe
- B. flatten steel tubing
- C. turn hexagonal nuts
- x D. cut wire

BEST COPY AVAILABLE

The least likely cause for a leaky threaded pipe joint would be

- x A. use of too much white lead on the threads
- B. insufficient length of threads
- C. rough pipe threads
- D. lack of white lead on the threads

The type of screwdriver which will develop the greatest turning force is a

- x A. screwdriver-bit and brace
- B. spiral push-type
- C. standard straight handle
- D. straight handle with ratchet

The tool shown at the right is used to

- A. set nails
- B. set lead anchors
- x C. drill holes in concrete
- D. centerpunch for holes

The tool shown at right is a

- A. punch
- B. Philips-type screwdriver
- C. drill holder
- x D. socket wrench

The tool shown at the right is

- A. an Allen-head wrench
- x B. an offset screwdriver
- C. a double scraper
- D. a nail puller

The tool shown at the right is

- A. an offset wrench
- B. a spanner wrench
- C. a box wrench
- x D. an open end wrench

When making a piping or conduit installation, small steel pipe is best turned by using a

- A. monkey wrench
- x B. stillson wrench
- C. spanner wrench
- D. chain wrench

A tool that can be used properly to cut on both forward and reverse strokes is a

- A. hacksaw
- B. rip saw
- C. file
- x D. 3-wheel pipe cutter



A double-thread is

- A. always defective
- B. a combination of left-hand and right-hand threads
- C. a tapered thread
- x D. two parallel threads in the same direction

Socket wrenches are especially useful

- x A. for turning nuts in close quarters
- B. on pipe
- C. for removing studs
- D. for threading rods

A tool which should never be turned counterclockwise is a

- A. tap
- B. die
- x C. reamer
- D. screw extractor

A torsion might be found in the

- A. transmission
- B. distributor
- C. speedometer
- x D. suspension

What source of trouble can be tested by removing a spark plug and holding a thumb over the spark plug hole while the engine is being cranked?

- A. Poor ignition
- x B. Low compression
- C. High oil consumption
- D. High fuel consumption

Which of the following instruments can be used to adjust the air fuel ratio, valve timing and check for leaky head gaskets?

- A. Compression tester
- x B. Vacuum gauge
- C. Timing light
- D. Dwell meter

When removing a shrink-fitted collar from a shaft, it would be easiest to drive out the shaft after

- x A. heating only the collar
- B. heating only the shaft
- C. chilling only the collar
- D. chilling the collar and heating

Caulking a joint means

- x A. applying sealing material to the joint
- B. tightening the joint with wrenches
- C. opening it with wrenches
- D. testing the joint for leaks

A clutch is a device that is used

- A. to hold a work piece in a fixture
- B. for retrieving small parts from hard to reach areas
- x C. to disengage one rotating shaft from another
- D. to level machinery on a floor

Of the following, the most important advantage of a ratchet wrench over an open-end wrench is that the ratchet wrench

- x A. can be used in a more limited space
- B. measures the torque applied
- C. will not strip the threads of a bolt
- D. is available for all sizes of hex bolts

The purpose of a water trap in a plumbing drainage system is to

- A. prevent the leakage of water
- B. prevent freezing of the pipes
- x C. block off sewer gases
- D. reduce the water pressure in the system

The tool that holds the die when threading pipe is generally called a

- A. vise
- x B. stock
- C. yoke
- D. coupling

A fitting used to join a small pipe at right angles to the middle of a large pipe is called a

- A. union
- B. coupling
- C. cap
- x D. reducing tee

Gaskets are commonly used between the flanges of large pipe joints to

- x A. make a leakproof connection
- B. provide for expansion
- C. provide space for assembly
- D. adjust for poor alignment

The pipe fitting that should be used to connect a 1" pipe to a 1-1/2" valve is called a

- A. reducing coupling
- B. nipple
- x C. bushing
- D. union

Small leaks in a compressed air pipe line leading from a shop compressor are most easily located by

- A. creating a vacuum in the air line
- B. allowing the compressor to pump water through the lines
- C. monitoring air gauges throughout the piping system
- x D. applying soapy water to the pipeline

The basic purpose of an idler gear in a gear train is to

- A. change gear speed
- B. increase gear torque
- C. reduce friction in the gear train
- x D. change the direction of rotation of a shaft

The instrument that is commonly used to check the armature of small d.c. motors for shorts, grounds or an open circuit is

- A. an ammeter
- B. a dynamometer
- x C. a growler
- D. a voltmeter

The purpose of the packing which is generally found in the stuffing box of a centrifugal pump is to

- A. prevent the impeller from chattering
- x B. prevent the leakage of fluid
- C. reduce bearing wear
- D. reduce the discharge pressure

A certain type of paint is capable of covering about 400 square feet of wall surface per gallon. How many gallons of this type of paint will be required to cover a wall that measures 73 feet by 15 feet?

- A. 1 1/2 gallons
- x B. 2 3/4 gallons
- C. 5 gallons
- D. 6 1/2 gallons

Algae in reservoirs may be killed by using

- A. zeolite
- x B. copper sulphate
- C. sodium chloride
- D. calcium chloride

One of the ways of locating a leak in a water line is by using a

- A. manometer
- x B. sounding rod
- C. poling board
- D. diffusor

MOST sewer pipes are made of

- x A. cast iron
- B. agricultural tile
- C. brass
- D. copper

Water pipe must be laid at least two feet below the ground surface MAINLY to

- x A. prevent freezing
- B. discourage malicious tampering
- C. reduce the pressure required to make the water flow
- D. eliminate possibility of damage to roads in case of water main break

When digging a deep trench, the sides are USUALLY prevented from caving in by using

- A. shoulders
- B. blocking
- C. pins
- x D. sheathing

The FIRST precaution a worker should take before entering a sewer manhole is to

- A. put on hard toed shoes
- B. put on safety goggles
- C. check that the next manhole upstream is not obstructed
- x D. test the air in the manhole

When dealing with leaking chlorine, it is IMPORTANT to remember that chlorine is

- A. highly flammable
- B. made safe by spraying water on it
- C. not corrosive
- x D. heavier than air

Cast iron pipe is MOST frequently cut with a(n)

- A. hack saw
- x B. diamond point chisel
- C. burning torch
- D. abrasive wheel

If the reading of the oil pressure gauge on a gasoline motor should suddenly drop to zero, the FIRST thing the operator should do is to

- A. check the filter
- B. inspect the oil lines
- C. tighten the oil pan bolts
- x D. stop the motor

A tractor is to be stored for two months. In order to keep it in BEST condition it should be

- A. drained of all fuel and oil
- B. lubricated every week
- x C. started up periodically and run until warm
- D. steam cleaned and all water drained from the radiator

The blades of a lawn mower should be set so that the blades

- A. firmly touch the bed knife
- x B. barely touch the bed knife
- C. clear the bed knife by 1/16 inch
- D. clear the bed knife by 1/8 inch

The MAIN reason for mulching is to

- A. fertilize the soil
- B. prevent erosion
- x C. protect plants from the cold
- D. kill insects

Of the following statements with regard to "seeding", the one that is CORRECT is:

- A. Seeds should be sown on a windy day
- x B. The ground should be watered heavily after seeding
- C. Seeding should be done primarily on a bright and sunny day
- D. It is not necessary to carefully apportion the amount of seeds sown

Organic matter is often added to soil to better condition it for growing plants. Of the following, the item that is NOT organic matter is

- x A. lime
- B. peat
- C. manure
- D. leaf mold

A plumbing device that prevents the passage of bad odors and gases from the sewer system to a building is a

- A. corporation stop
- B. union
- C. curb box
- x D. trap

A device used in a combined sewer to bypass excess stormflow is a(n)

- A. soffit
- x B. side-flow weir
- C. aquafer
- D. cellular cofferdam

A device installed at the discharge end of a sewer outfall which operates to permit gravity flow at low stages in the receiving waters, but closes to prevent backflow when the elevation of the receiving waters is high, is a

- A. flume
- B. buttress
- x C. tide gate
- D. flucculator

A pipe used to carry streamflow under a highway embankment is a

- x A. culvert
- B. lock
- C. standpipe
- D. pitot

Lateral sanitary sewers should PREFERABLY intersect at a

- A. catch basin
- B. weir
- x C. manhole
- D. tide gate

BEST COPY AVAILABLE

A device SUITABLE for pumping sewage from deep basements into city sewers is a

- A. pressure relief valve
- B. vacuum breaker
- x C. pneumatic ejector
- D. comminutor

In a combined sewer system, the amount of sewage flowing to the treatment plant is USUALLY controlled by a

- x A. regulator
- B. bar screen
- C. siphon
- D. mud valve

The LOWEST portion of the inside of a sewer pipe is the

- A. crown
- B. haunch
- x C. invert
- D. spring line

Wellpoints are used in sewer construction PRIMARILY to

- A. remove gases
- x B. dewater trenches
- C. locate wells
- D. replace hydrants

Longitudinal timbers used to support the vertical sheeting in a sewer trench excavation are called

- x A. wales
- B. cross braces
- C. piles
- D. cradles

The most accurate of the following statements concerning the venting of soil and waste systems is that

- A. vent lines must not enter a soil line above the first floor
- x B. vent lines equalize the pressure on both sides of the water seal of a trap
- C. venting is not required when fresh air inlets are provided
- D. venting prevents the development of unsanitary and harmful conditions by introducing fresh air

A complaint is received that water is continually leaking from the low-down tank into the bowl of a water closet. An inspection reveals that the ball cock and float are operating properly. Of the following, the most probable cause of leakage is

- A. the overflow tube has become clogged
- B. the supply valve does not close when the tank is full
- x C. the rubber ball flush valve is defective
- D. there is siphonic action between the tank and the closet bowl

A tenant complains that sewer odors are present in her kitchen, and appear to come from the sink drain. Of the following, the first item to check is

- A. water pressure in the water supply lines in the kitchen
- B. the vent pipe of the sink trap
- x C. water seal in the trap
- D. pitch of the waste line

To permit the fullest discharge from a blowdown valve and prevent the building up of sediment or sludge, the type of valve that should be used is a

- A. check valve
- x B. gate valve
- C. globe valve
- D. butterfly valve

A tenant complains that the water from the cold water tap has a milky appearance which clears up shortly after standing. The action that should be taken is

- A. advise the tenant to attach a filter to the tap
- x B. advise the tenant that there is nothing wrong with the water
- C. inspect the water supply line for defects and corrosion
- D. recommend cleaning the water service line

To help prevent leaks at the joints of water lines, the threads are frequently covered with

- A. tar
- B. cup grease
- C. oakum
- x D. white lead

The name of a fitting commonly used to make a turn in the direction of a pipe line is

- A. union
- B. bushing
- x C. elbow
- D. coupling

To determine whether stock is square the tool to be used on smaller places is a

- A. carpenter
- B. framing square
- x C. try square
- D. marking gauge

To determine width and thickness, the tool to be used is a

- A. micrometer
- x B. marking gauge
- C. ruler
- D. tape measure

To turn a nut, it is not correct to use a

- A. monkey wrench
- B. open end wrench
- C. box wrench
- x D. stillson wrench

The tool that would be used to cut out a circular disc is a

- A. circular saw
- B. shaper
- C. planer
- x D. band saw

Splitting of wood can be reduced by using nails with points that are

- A. long and sharp
- x B. blunt
- C. spirally grooved
- D. common

Wood screws properly used as compared to nails properly used

- A. are easier to install
- x B. hold better generally
- C. are easier to drive flush with surface
- D. are more likely to split the wood

A pipe column filled with concrete is called a

- A. pintle
- B. buttress
- C. pilaster
- x D. lally

The set in the teeth of a hand saw primarily

- x A. prevent the saw from binding
- B. make the saw cut true
- C. give the saw a sharper edge
- D. remove the sawdust

An expansion bolt is used to

- A. enlarge a hole
- B. fasten into hollow tile
- x C. fasten into solid masonry
- D. allow for expansion and contraction

The frequency of oiling and greasing of bearings and other moving parts of machinery depends mainly on the

- A. size of the parts requiring lubrication
- B. speed at which the parts move
- C. ability of the operator
- x D. amount of use of the equipment



Of the following procedures, the one that is most likely to be a hazardous or unsafe practice is

- A. pulling on a wrench to loosen a tight nut
- x B. using a cold chisel whose head is mushroomed
- C. leaning one's weight toward the ladder while using it
- D. carrying a scraper in one's pocket with the blade down

Red lead is used in painting mainly to

- x A. prevent rusting of metal surfaces
- B. prevent pinholes and air bubbles in the finish coat
- C. waterproof metal surfaces
- D. prevent checking of finish coat

The most desirable preservative to apply to several new wood exterior benches several days in advance of painting is

- A. creosote oil
- x B. raw linseed oil
- C. kerosene oil
- D. Japan dryer

Of the following, the first thing to check if the power lawn mower failed to start is the

- A. lubrication
- B. magneto
- C. sparkplug
- x D. loose ignition wires

The most desirable of the following practices with respect to the watering of established lawns in the summertime is

- x A. lawn areas should be watered heavily once or twice a week
- B. daily shallow watering is preferred for established lawns
- C. watering of lawns is best done in the late morning or noon to prevent excessive evaporation
- D. watering should be done only when the soil appears excessively dry and powdery

Prior to reseeding a patch of burned out grass, the ground is turned over down to subsoil preferably with a

- A. spade
- x B. fork
- C. hoe
- D. cultivator

A supervisory practice which is most likely to lead to confusion and inefficiency is for the supervisor to

- A. issue orders only in writing
- x B. relay orders to the workers through co-workers
- C. follow up orders after issuing them
- D. give orders verbally directly to the worker assigned to the job

- In order to avoid injuries it is proper to lift heavy objects
- x A. with the knees bent and the back held stiff
  - B. with both the knees and the back held stiff
  - C. using the arms only
  - D. in the manner best suited to the individual doing the lifting

A worker notices a piece of equipment which he believes can aid him in performing his work. The equipment is somewhat complicated, and he has never received any instruction as to its operation, although other employees have. He should

- A. use the equipment because he will be able to do his work faster
- B. put off doing his work until he has received adequate instruction in the use of the equipment
- C. ask another worker to teach him to use the equipment
- x D. not use the equipment until he has received adequate instruction in its operation

When a building superintendent reports corroded flashings resulting in leakage, the part of the building he is referring to is the

- A. basement piping
- B. boiler room
- C. pavement adjoining building.
- x D. roof

Although rock salt is commonly used on walks when they are iced or heavily packed with snow, the chief disadvantage of its use is that it

- A. creates a very slushy condition
- B. generally causes deterioration of concrete walks
- C. increases cleaning costs if used intensively
- x D. is harmful to adjacent trees and shrubs