

DOCUMENT RESUME

ED 366 347

IR 054 828

AUTHOR White, Dorothy J., Ed.  
 TITLE All Aboard for Summer Fun! Departing 1993: Louisiana Summer Reading Program 1993 Manual.  
 INSTITUTION Louisiana State Library, Baton Rouge.  
 PUB DATE 93  
 NOTE 398p.  
 PUB TYPE Guides - Non-Classroom Use (055) -- Reports - Descriptive (141) -- Tests/Evaluation Instruments (160)

EDRS PRICE MF01/PC16 Plus Postage.  
 DESCRIPTORS \*Childrens Libraries; Elementary Education; Library Associations; Library Role; \*Library Services; Publicity; \*Public Libraries; Puppetry; Rail Transportation; \*Reading Programs; State Libraries; Story Reading; Story Telling; \*Summer Programs; Vacation Programs  
 IDENTIFIERS Louisiana; Story Boards

ABSTRACT

This manual for the 1993 Louisiana Summer Reading Program has ideas for libraries to get the summer program started. The theme is trains, and all of the ideas have something to do with this theme. The following topics are covered: (1) evaluation; (2) promotion, publicity, and programs; (3) calendar; (4) decorating the library; (5) storytime planners; (6) action stories; (7) coloring pages and handouts; (8) costumes; (9) crafts; (10) fingerplays; (11) flannelboards; (12) games, riddles, and puzzles; (13) poems; (14) puppets and puppet plays; (15) songs; (16) audiovisual materials; and (17) a resource list. (Contains 129 references.) (JLB)

\*\*\*\*\*  
 \* Reproductions supplied by EDRS are the best that can be made \*  
 \* from the original document. \*  
 \*\*\*\*\*



- This document has been reproduced as received from the person or organization originating it.
- Minor changes have been made to improve reproduction quality.
- Points of view or opinions stated in this document do not necessarily represent official OERI position or policy.

## LOUISIANA SUMMER READING PROGRAM 1993 MANUAL

ED 366 347

### ALL ABOARD FOR SUMMER FUN! DEPARTING 1993

Dorothy J. White, Editor



Library Development Division  
State Library of Louisiana  
P.O. Box 131  
Baton Rouge, LA 70821-0131  
(504) 342-4931

1993 MANUAL  
LOUISIANA SUMMER READING PROGRAM

"PERMISSION TO REPRODUCE THIS  
MATERIAL HAS BEEN GRANTED BY

Dorothy White

054828

# ALL ABOARD

FOR  
SUMMER FUN!  
DEPARTING 1998

## TABLE OF CONTENTS

### Acknowledgments

### Evaluation

### Promotion, Publicity, and Programs

- Getting the Information Out
- Opening and Closing Ceremonies
- Programs, Demonstrations and Exhibits
- Programs to Include the Special Child

### Calendar

### Decorating the Library

- Decorating Ideas
- Name Tag Designs
- Bulletin Board Suggestions

### Storytime Planners

- Toddlers
- Preschool - Kindergarten
- First - Third Grades
- Fourth - Fifth Grades
- Sixth Grade

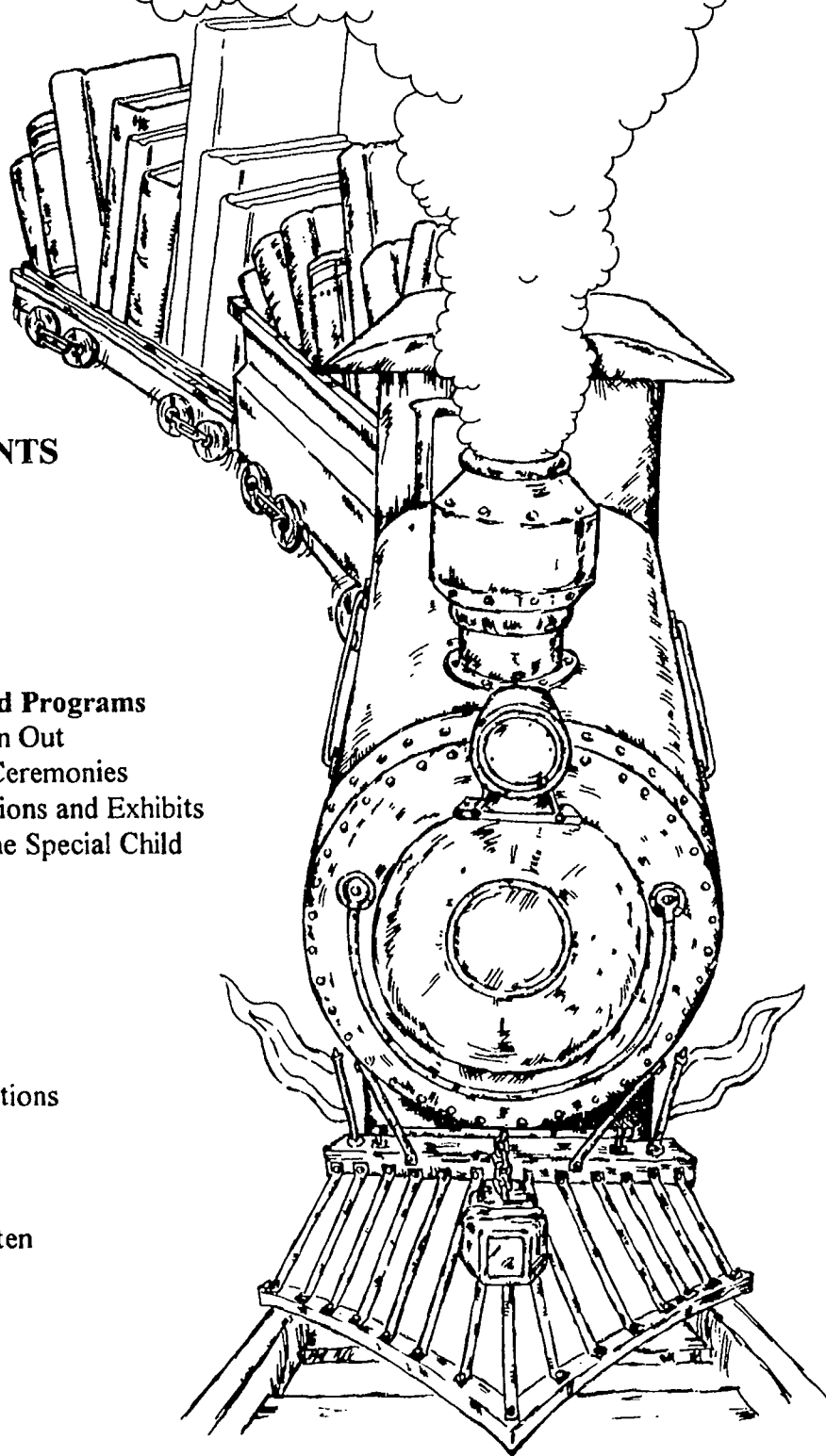

**Action Stories**

**Coloring Pages and Handouts**

**Costumes**

**Crafts**

**Fingerplays**

**Flannelboards**

**Games, Riddles and Puzzles**

**Poems**

**Puppets and Puppet Plays**

**Songs**

**Audiovisual Materials**

**Resource List**

**Bibliography**



## ACKNOWLEDGMENT

*All Aboard for Summer Fun! Departing 1993* is Louisiana's current Summer Reading Program theme. Summer Reading Program projects are designed to provide a focus for the summer months to connect kids and books. Louisiana's Summer Reading Program has been a success in each of the years since its inception in 1984.

This year's Summer Reading Program is sure to be one of the most exciting ever. Trains are loved by boys, girls, and adults. The mystery, excitement and romance will surely excite the imagination of everyone. This manual has hundreds of ideas to help you get started on the Summer Reading Program, but each of you will also want to develop your own ideas.

A special thanks to the Committee for their many hours of hard work. They have been dedicated and have shown imagination in their efforts.

I know this summer's program will be a big success.

Howard Coy, Chair  
1993 Summer Reading Program Committee

### 1993 Summer Reading Program Committee

Howard Coy, Chair  
Vernon Parish Library

Martha Jordan  
Ouachita Parish Library

Yolanda Blanchard  
Calcasieu Parish Library

Donna Ledet  
Avoyelles Parish Library

Ann Davis  
St. Bernard Parish Library

Francis MacFarlane  
Washington Parish Library

Lucille DeFatta  
Bossier Parish Library

Karen Plauche  
Tangipahoa Parish Library

Lois Grant  
Rapides Parish Library

Frances Ropollo  
St. Charles Parish Library

## **About the Artist**

Kate Ferry is no stranger to the Louisiana Summer Reading Program, having designed the artwork for the 1989 theme, *The Circus Comes to Town*. Kate, a native of New Iberia, is presently employed as a designer in an advertising agency in Lafayette. She is a graduate of The Art Institute of Houston, and has won numerous awards for illustration and design. In addition to her work as a commercial artist, she is also a watercolor painter.

## **Bulletin Board Designs and Decorating Ideas**

The Summer Reading Program Committee once again wishes to thank Chris Menard, Lafayette Public Library, for contributions to this year's manual. Her artistic talents are greatly appreciated.

## **Copyright**

The "All Aboard for Summer Fun! Departing 1993" materials, as well as Ms. Menard's designs, are copyrighted and cannot be used for commercial purposes.

## **Louisiana Summer Reading Program Themes**

1984*	Reading and All That Jazz
1985	Find Your Own Adventure--Read!
1986	Reading Is Magic
1987	Castle Quest
1988*	Summer Safari
1989	The Circus Comes to Town
1990	Louisiana Libraries: Festivals of Reading
1991	Summer Treasure: Find It At Your Library
1992	Grins and Giggles at the Library

\* John Cotton Dana Public Relations Award

**EVALUATION**  
**1993 LOUISIANA SUMMER READING PROGRAM**

Please complete by system, not by individual branches.

Name of Library: \_\_\_\_\_

Name and title of person coordinating program systemwide: \_\_\_\_\_

**I. GENERAL**

Number of weeks program lasted: \_\_\_\_\_

Inclusive dates of program: \_\_\_\_\_

Budget for program: \_\_\_\_\_

**II. STATISTICS**

Number of children registered: \_\_\_\_\_

Number of children earning a certificate: \_\_\_\_\_

Number of children's books circulated during summer reading program: \_\_\_\_\_

Number of special programming events: \_\_\_\_\_

Number of children attending these events: \_\_\_\_\_

**III. PUBLICITY**

A. Check each of the following ideas used:

_____ School visits	_____ Bookmarks
_____ Television	_____ Posters & flyers
_____ Radio	_____ Displays & exhibits
_____ News releases	_____ Club/civic visits
_____ Church bulletins	_____ Other (please specify)

B. How do you rate your publicity?

\_\_\_\_\_ Very successful  
\_\_\_\_\_ Successful  
\_\_\_\_\_ Need help

**IV. PROGRAM**

A. How do you rate this year's summer reading program?

- \_\_\_\_\_ Very successful
- \_\_\_\_\_ Successful
- \_\_\_\_\_ Less than successful

B. Describe your kickoff program:

C. Please list special programming events and the performing artists, workshop presenters, or other presenters scheduled during the summer.

D. Briefly describe your most successful event.

E. Describe your closing program

F. If your Summer Reading Program was less than successful, briefly explain.

**IV. PRE-READERS**

Did you have special programming targeting pre-readers? If so, briefly describe.

**V. YOUNG ADULTS**

Did you have special programming targeting young adults? If so, briefly describe.



**VI. INCENTIVES**

Briefly describe your use of incentives (What? When?)

**VII. MANUAL**

A. Which sections of the manual were most useful?

B. What additions/improvements/deletions would you like to see in future manuals?

C. Please suggest themes for future years. Include ideas for storytime planners and activities.

**VIII. ADDITIONAL COMMENTS**

Thank you for completing this form. Please return no later than **September 1, 1993** to:

Dorothy White  
Library Development Division  
State Library of Louisiana  
P.O. Box 131  
Baton Rouge, LA 70821-0131

## PROMOTION, PUBLICITY, AND PROGRAMS

Timely, well planned publicity is a primary factor in the success of your summer reading program. Like any other enterprise, libraries must advertise and market their programs, services, and collections to generate community interest, participation, and support.

### GETTING THE INFORMATION OUT

#### Formats and Media

A variety of formats and media can be used to promote your program. These include posters, flyers, and bookmarks; library staff presentations to schools and community agencies and organizations; newspaper articles; and radio and television announcements.

#### Word of Mouth

Never underestimate the value of word of mouth promotion. Person to person communication is the most effective form of communication. Use it. Make sure all your staff, your board, and your Friends know all about the summer reading program including registration dates, opening and closing ceremonies, and a schedule of special events. Have staff tell patrons about the program as a matter of routine. Be sure to talk it up yourself at every opportunity.

#### Community Groups and Agencies

Distribute posters, flyers, and bookmarks to churches, schools, toy and hobby shops, children's clothing stores, banks, variety stores, bicycle shops, YMCAs, service organizations, scout headquarters, swimming pools, supermarkets, Laundromats, medical offices, dentist offices, day care centers, and any other place where children and parents congregate.

Ask businesses that contribute to your summer reading program to include information about the program in their advertising. Ask them to include the theme, schedule, registration information, and the library's phone number.

#### Schools

School visits offer the best opportunity of attracting children to the summer reading program. School visits can be done by library staff, Friends of the Library, or library volunteers. Do not hesitate to ask locally well known individuals to participate in school visits to help you promote the program. Try businessmen and politicians. You have a good product to sell and they will be happy to be associated with it. Plan to visit public, private, and parochial schools.

Once you have scheduled your summer program and have promotional materials in hand, contact school principals and librarians, preferably the latter. Make appointments to visit.

## **2 • PROMOTION, PUBLICITY, AND PROGRAMS**

Schedule presentations in individual classrooms or grade level assemblies rather than a general school assembly. Presentations to smaller groups are more effective than those to general school assemblies or announcements made over school public address systems. As with good storytime programs, school visits should be carefully planned, appropriately designed for the varying age groups, rehearsed, and evaluated.

During school visits make a visual impact by delivering your presentation dressed in context with the theme. Use props. Stage a skit. Let the "ham" in you emerge. Bring flyers and posters for display in classrooms and in other key areas of the school, and hand out bookmarks to the students. Make sure that all publicity materials include the dates, times, and locations of summer reading program activities and registration information.

Initiate participation in the program by asking the students to draw funny pictures, write short essays, or design bookmarks illustrating the theme. Let students know that you will exhibit these items in the library. If you think that too many items will be received, organize a contest and display the winning entries.

Speak to as many school organizational meetings as possible: school board meetings, school librarians' meetings, principals' meetings, PTA meetings, and library clubs.

Make a video promoting your program and duplicate it as many times as you can afford. A video tape can be sent to schools that you may not have time to visit personally. Some public schools have video equipment and might consider filming and duplicating your promotion as a class project. Or you might consider getting a grant to pay for the tapes and the cost of duplicating. Reclaim the tapes to use again next year.

Note which schools your summer reading program participants attend. In the fall send the registration information by school to the parish school superintendent, the school board, school principals, and librarians. This will be good public relations for your program. In addition, you might build some competitiveness between schools and thus increase program participation.

### **Day Care Centers**

Make special visits to day care centers to interest them in your program and to let them know of the scheduling arrangements you require for participation.

**Sample Letter**

(Principal/Librarian)

Dear Principal/Librarian,

Summer vacation is rapidly approaching and we know that students are looking forward to it. Vacation is great, but it does often mean that children are not encouraged to read until school resumes.

The \_\_\_\_\_ Public Library, through its Summer Reading Program, encourages reading during the summer months to reinforce skills learned during the school year. The program offers children the opportunity to practice reading and to become familiar with public library services. The theme for this summer's program is *All Aboard for Summer Fun! Departing 1993*. We extend an invitation to your students to join us for this exciting and fun filled project.

If you would like, library representatives will be happy to visit your school and talk to you, the teachers, and the students about the program. I will be in touch with you in the next two weeks about scheduling these visits and to discuss any ideas you may have for other public library/school cooperative programs for children. Teachers are again this year encouraged to send us copies of their summer reading lists so that we can make these books readily available for the children.

Thank you for your support.

Sincerely,

(Name), (Title)

#### 4 • PROMOTION, PUBLICITY, AND PROGRAMS

##### Sample Letter

(Day Care Administrator, Summer Day Camp)

Dear Administrator,

Summer will soon be here. You may be searching for free community activities which will offer your children good entertainment and educational opportunities. We can help. The \_\_\_\_\_ Library is offering a series of preschool and grade school storytimes in conjunction with the Louisiana Summer Reading Program. The theme for this year's program is "All Aboard for Summer Fun! Departing 1993." During the weekly storytimes, the children will listen to stories and poetry, learn finger plays, see puppet shows and films, sing songs, play games, and make arts and crafts that complement the Summer Reading Program theme. Children who register for the program will be invited to participate in the library's end-of-the-program party on \_\_\_\_\_.

Attending storytime stimulates the child's development of good language and listening skills so important to later school success and encourages positive group interaction and sharing.

The storytime program is available at the following locations and times:

(List locations and times)

On behalf of the library staff, I would like to invite your children to participate in our Summer Reading Program. Please do call to make arrangements for your group visits. This will help us to better plan for serving your children as well as to assure that we will be able to accommodate you. For further information or to arrange visits, please call us at \_\_\_\_\_.

Thank you for your interest and support of the library and its activities.

Sincerely,

(Name), (Title)

### Press Releases

Find out from the appropriate newspapers, as well as radio and television stations, to whom to direct these. Adapt the samples to fit the preferred format of the newspaper or station. Encourage live coverage of opening, closing, and special events. Here are a few other pointers:

- Send announcements approximately two weeks in advance of the event.
- Type on white paper, using only one side of the paper. Double space and leave wide margins in the article. Triple space between paragraphs. Begin typing about one-third of the way down the page – the editor may use the white space for notes or title.
- Use a press release for the following reasons: to announce a program or meeting, before it takes place, or to report on a program that has actually taken place. Do not report an event before it takes place – this can cause serious problems if there are last minute changes.
- Ask yourself "What do I want this to accomplish?" Answer the questions: Who? What? Where? When? Why? How? Be concise, and don't use flowery language.
- Write the article for someone who has never heard of the library. In other words, don't assume your reader knows your library, even though you have repeated the information in numerous articles.
- Identify people by their full names and titles. Be accurate. Check dates. Spell out abbreviations the first time they appear.
- Write END or type a row of asterisks at the end of the release.
- Make a copy of the article for your files.

## 6 • PROMOTION, PUBLICITY, AND PROGRAMS

### Sample News Release

#### NEWS RELEASE

**DATE:**

**SUBJECT: 1993 LOUISIANA SUMMER READING CLUB THEME**

**RELEASE DATE:**

**FOR FURTHER INFORMATION, CONTACT:**      Name of Librarian  
Library  
Address  
Telephone Number

In all corners of the state, in cities large and small, Louisiana's children will soon be invited to travel full steam ahead to their local public library and learn all about all types of trains. "All Aboard for Summer Fun! Departing 1993" is this year's theme for the Louisiana Summer Reading Program, which is sponsored by the State Library of Louisiana and your public library. The Summer Reading Program is designed to foster a child's enjoyment of books, reading, and library use through child oriented library programs and activities. Participation also assists development of the preschool child's listening skills and helps the school aged child maintain reading skills. Reading certificates are awarded to school children who read a minimum number of books.

Registration will begin \_\_\_\_\_ . For further information, call  
\_\_\_\_\_ .

END

**Sample Public Service Announcements**

**PSA #1**

*All Aboard!* Chug along to the Library Station at the \_\_\_\_\_  
Public Library during its exciting Summer Reading Program, "All Aboard for Summer Fun!  
Departing 1993." Read a certain number of books this summer and receive a certificate and  
other awards. Programs and activities will be going on all summer long. For further  
information contact the \_\_\_\_\_ Public Library at \_\_\_\_\_.

**PSA #2**

Pick up a ticket for a summer of fun and adventure when you visit the  
\_\_\_\_\_ Public Library and sign up for the Summer Reading Program, "All  
Aboard for Summer Fun! Departing 1993." You'll learn about all types of trains, help build a  
model railroad, and you can even *be* a train! Throughout the summer, children may earn  
incentives and receive a certificate by reading a certain number of books. The Library is also  
offering storytimes, activities, contests, crafts, and movies. Don't miss out on the fun! Call the  
\_\_\_\_\_ Public Library at \_\_\_\_\_ for further information.



## **8 • PROMOTION, PUBLICITY, AND PROGRAMS**

### **OPENING AND CLOSING CEREMONIES**

#### **Guidelines for Opening and Closing Ceremonies**

- Coordinate games and activities to theme.
- Plan to use volunteers (Friends group, Scouts, etc.)
- For refreshments, serve juice and cookies. Ask TCBY Yogurt or another yogurt or ice cream company to give free samples. Ask McDonald's to donate orange drinks or beverage distributors for free drinks. Ask a local theater to donate popcorn and grocery stores with bakeries to donate cookies. If you cannot get donations, ask your local Friends to have a booth selling food, drinks and t-shirts as their fund raiser.
- For the opening, give each child who registers 12 tickets to use at game or refreshment booths. For the closing, children earn tickets by reading a certain number of books per ticket.
- Order prizes from novelty catalogs listed in resource section of manual.

#### **Ideas for Opening and Closing Ceremonies**

- Have a "railway station" booth where children pick up their tickets.
- Have performers telling stories, leading songs, making balloon figures, or doing cartooning. Or invite mimes, jugglers, clowns, magicians, and face painters.
- Ask a local drama group (possibly a high school drama club) to perform Shel Silverstein's poetry. Be sure and approach the group in the spring to give them time to prepare.
- Let the children cut out paper train engineer hats to wear.
- Set up an area of the library to look like a train station with a cardboard train (either a cardboard cut-out or large decorated boxes). Take pictures of children with a Polaroid camera. This could be a money making project for your Friends.
- Ask a local radio station to do a remote broadcast from your festival. This is a large colorful event that newspapers love to cover also.
- Organize games listed in games section of manual.

## PROGRAMS, DEMONSTRATIONS AND EXHIBITS

Here are several ideas that incorporate the transportation theme and safety with high interest programs. Safety tips from these experts would count more than any amount of warnings by parents and teachers. Be sure to review the presenter's demonstration beforehand.

- Model Railroad: Invite a hobbyist to display and talk about model railroads. Display hobby magazines.
- Unicycle Demonstration: Ask unicyclist to speak about bike safety.
- Toy Train Exhibit: Invite a railroad engineer to discuss railroad crossing safety.
- Skateboard Demonstration: Demonstrators can stress use of helmet and protective pads.
- Stock Car/Race Car Exhibit: Speaker can discuss street crossing safety.
- Posterboard Skateboards: Children trace and cut skateboard shapes out of poster. Then shapes can be decorated as desired. Next tissue paper rolls are cut in half and glued to bottom of board for wheels. Let dry and display!
- Fancy Balloons: Recommended for children who will not put things in their mouth. Balloons should be blown up to about six inches. Then balloons can be decorated with colorful pieces of floral ribbon, "silk" flowers, and other inexpensive items using white glue. (Idea by Andrea Menard, 8 years old.)
- Display a model train set. Let children make houses, trees, and other items for the town in the display.

## 10 • PROMOTION, PUBLICITY, AND PROGRAMS

### PROGRAMS TO INCLUDE THE SPECIAL CHILD

#### State Library Programs for the Visually Impaired

The State Library of Louisiana, through its Section for the Blind and Physically Handicapped, sponsors a summer reading program for visually impaired children, ages 5-14 years, who are registered with the National Library Service for the Blind and Physically Handicapped of the Library of Congress. The goal of the program is to encourage visually impaired children to read for pleasure during their summer vacation from school. The Section for the Blind's collection includes children's books in Braille and on audio cassette tape. Children certified as visually impaired may make an application to the State Library's Section for the Blind and Physically Handicapped to participate in the program. The applications may be prepared by a teacher, professional librarian, or other competent authority.

The Section for the Blind's summer reading program is conducted as follows:

1. Section representatives contact teachers conducting special education programs for the visually impaired to remind them to encourage the children to participate in the summer reading program.
2. They visit the Louisiana School for the Visually Impaired in the spring to host a party to register students for the summer reading program.
3. Promotional materials are developed by the Section to inform parents of visually impaired students, their teachers, and the public about the summer reading program and State Library services.
4. Summer reading program promotional materials are mailed to the Light House for the Blind in New Orleans, the Louisiana Center for the Blind in Ruston, and the Louisiana School for the Visually Impaired in Baton Rouge.
5. Reading program packets are mailed to children registered with the National Library Service. The packet contains a summer reading program registration form, a summer reading program log, a book order form, and a bibliography of recorded cassettes, discs, and Braille books available for loan from the State Library.
6. The Section encourages program participation with reading incentives, prizes, and certificates.

For more information about the summer reading program for the visually impaired, the public may call the Section's toll-free number, 1-800-543-4802, or the Baton Rouge number, 504-342-4944.

### **Public Library Programs for the Visually Impaired Child**

Public libraries can include the visually impaired child in the summer reading program by using twin vision books (stories accompanied with Braille text), in addition to discs, audio cassettes, and Braille materials. The Little Golden Books, produced by the Western Publishing Company, are available in the twin vision format. The visually impaired child should be encouraged to attend storytimes and puppet programs with sighted children.

### **Public Library Programs for the Physically Impaired Child**

The physically impaired child can participate in the summer reading program in several ways. Books and other reading materials can be adapted with mechanical page turners to permit the physically impaired child's participation. The impaired reader might also be paired with a helper who can turn pages.

To assist children physically unable to browse book shelves, materials can be pulled and displayed where access is convenient. Encourage parents to bring their impaired children to those library programs in which they can participate. If the child cannot come to the library, send the summer reading program materials to his home. All children love mail and the impaired are no exception.

Because there is such a variety in the type and degree of disability in physically impaired conditions, there is no easy solution or simple suggestion as to how children with these conditions may be encouraged and assisted in participating in the program. Children with temporary conditions, like broken arms or legs, seem to join right in, whereas children with more serious handicaps are seldom seen. Make an effort to find those children and help them succeed in summer reading.

### **Hearing Impaired**

Deaf children should be included and urged to participate in the summer reading program. Reading can be very difficult for a deaf person because written language is so different from sign language.

Highly visual materials need to be used in any program in which deaf children might be present. Deaf children tend to choose non-fiction books which have captions and pictures instead of fiction books of mostly text. Displays of non-fiction books, along with high/low materials, would appeal to the deaf child.

Deaf children should be invited to library storytime programs. Arrange to have one of their parents or a volunteer translate the stories or activities in sign language.

The Louisiana School for the Deaf has captioned educational and theatrical films and videos which may be borrowed for programs serving deaf children. The School is under contract with the U.S. Department of Education, Office of Special Education Programs, and Modern

## 12 • PROMOTION, PUBLICITY, AND PROGRAMS

Talking Picture Service, Inc. to distribute films or videos to the deaf or hearing impaired in Louisiana. The Captioned Films/Videos for the Deaf Program provides films and videos in an open-captioned format, in which subtitles appear on each film and video, making it possible for the deaf or hearing impaired viewer to understand the same information a hearing person would receive from the sound track without the need for a decoder. The Educational Captioned Films/Videos Program includes titles in clearly defined school subject areas and student interest levels from pre-school through post-secondary. Titles within the Theatrical Captioned Films/Videos Program are available for various purposes. Classic features, the latest Hollywood releases, short subjects, continuing educational titles and after-school specials touch an entire spectrum of entertaining subjects and are all open-captioned. This is a free-loan service funded by the U.S. Department of Education. Users of either educational or theatrical titles are required to pay only the return postage for the 16mm films. Video-cassettes have prepaid return postage labels included and are absolutely free to use. Catalogs of the captioned films and videos for the deaf as well as applications to participate in the programs are available through the School for the Deaf or from the Modern Talking Picture Service.

The educational captioned films and videos may be used by teachers and others who work with one or more deaf or hearing impaired students in residential, day programs, or mainstreamed programs. The theatrical captioned films and videos are available to deaf or hearing impaired audiences of three or more.

For more information, contact:

Modern Talking Picture Service  
5000 Park Street North  
St. Petersburg, FL 33709  
(813) 541-7571      Voice/TTY  
(813) 237-6213      Voice/TTY

Louisiana School for the Deaf  
Public Relations Department  
P.O. Box 3074  
Baton Rouge, LA 70821  
(504) 769-8160  
Contact: Scott Mentor

MONTH: FEBRUARY

Sunday	Monday	Tuesday	Wednesday	Thursday	Friday	Saturday
	1	2	3	4	5	6
7	8	9	10	11	12	13
14	15	16	17	18	19	20
21	22	23	24	25	26	27
28						

NOTE: Order films - have alternates in mind. Plan type of programs.  
 Select dates and check on other community activities for conflict.  
 Order materials from state or other sources.

MONTH: MARCH

Sunday	Monday	Tuesday	Wednesday	Thursday	Friday	Saturday
	1	2	3	4	5	6
7	8	9	10	11	12	13
14	15	16	17	18	19	20
21	22	23	24	25	26	27
28	29	30	31			

NOTE: Contact sources of programs. Check for film confirmation.  
 Plan decorations for library. Do quick inventory of popular titles and order more if necessary.

MONTH: SPRIL

Sunday	Monday	Tuesday	Wednesday	Thursday	Friday	Saturday
				1	2	3
4	5	6	7	8	9	10
11	12	13	14	15	16	17
18	19	20	21	22	23	24
25	26	27	28	29	30	

NOTE: Plan PR campaigns. Contact schools and school librarians. Show release of general theme and notice of programs with pre-registration dates (if any).



MONTH: MAY

Sunday	Monday	Tuesday	Wednesday	Thursday	Friday	Saturday
						1
2	3	4	5	6	7	8
9	10	11	12	13	14	15
16	17	18	19	20	21	22
23	24	25	26	27	28	29
30	31					

NOTE: Plan school field trips with samples and bookmarks.  
Distribute flyers and posters around town and in library.  
Decorate library. Radio release and TV appearances.  
Follow-up check on programs.

MONTH: JUNE

Sunday	Monday	Tuesday	Wednesday	Thursday	Friday	Saturday
		1	2	3	4	5
6	7	8	9	10	11	12
13	14	15	16	17	18	19
20	21	22	23	24	25	26
27	28	29	30			

MONTH: JULY

Sunday	Monday	Tuesday	Wednesday	Thursday	Friday	Saturday
				1	2	3
4	5	6	7	8	9	10
11	12	13	14	15	16	17
18	19	20	21	22	23	24
25	26	27	28	29	30	31

MONTH: AUGUST

Sunday	Monday	Tuesday	Wednesday	Thursday	Friday	Saturday
1	2	3	4	5	6	7
8	9	10	11	12	13	14
15	16	17	18	19	20	21
22	23	24	25	26	27	28
29	30	31				

NOTE: Send SRP Evaluation to State Library at end of month.

## DECORATING THE LIBRARY

### DECORATING IDEAS

Draw and cut out a locomotive, and place on a bulletin board. Have each child draw and cut out a train car. Add their name on the car, or glue a headshot of the child onto the train to show them looking out of the train window. Add the train cars end to end to the locomotive throughout the summer.

Draw a railroad track around the library walls with stations at each end. For every book read by a child, advance their train marker along the track. Readers win a prize if their train reaches the station by the closing ceremony.

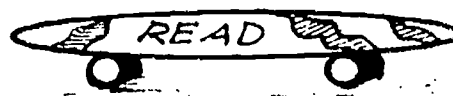

### Skateboard

Cut skateboard shape out of cardboard.  
Cut two tissue paper rolls in half. Use white glue to attach rolls (wheels) to bottom of shape. Paint in wild colors.

### Hot Air Balloon

Blow up a large balloon and cover it with vaseline. Tear up strips of newspaper. Mix flour with water. Apply strips dipped in mixture to balloon. Let dry after each layer. Paint in bright primary colors. Attach a small basket ( like a plastic strawberry basket ) with yarn to balloon. Fill basket with miniature books and stuffed toys. Hang to display. (This project was constructed several years ago. Please refer to a book on pinatas or papier mache for exact directions.)

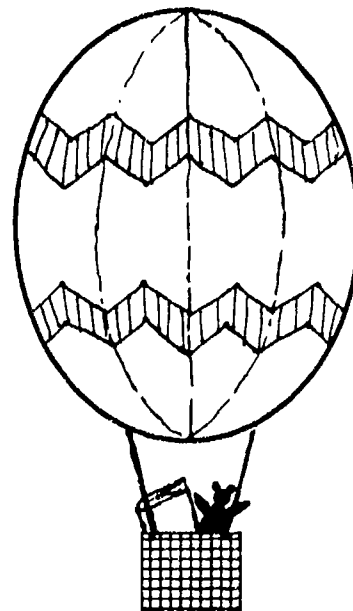

© 1992 Christine Menard Lafayette Public Library

# Room Decorations

## Stuffed Shapes

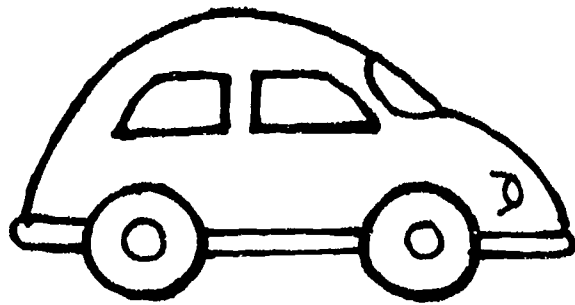
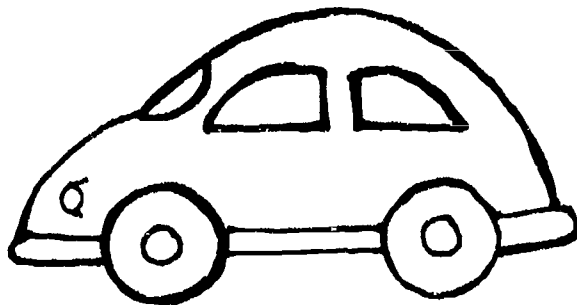
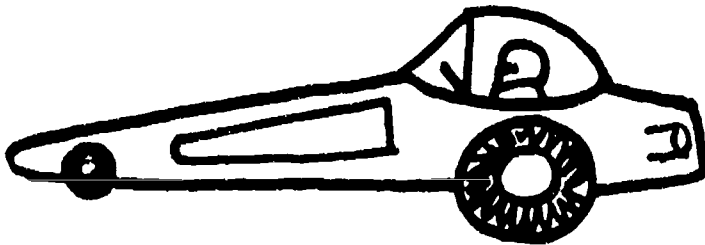
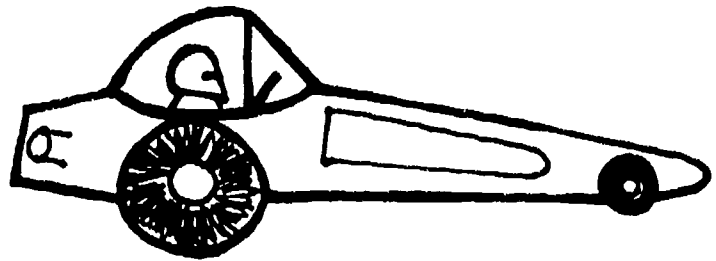
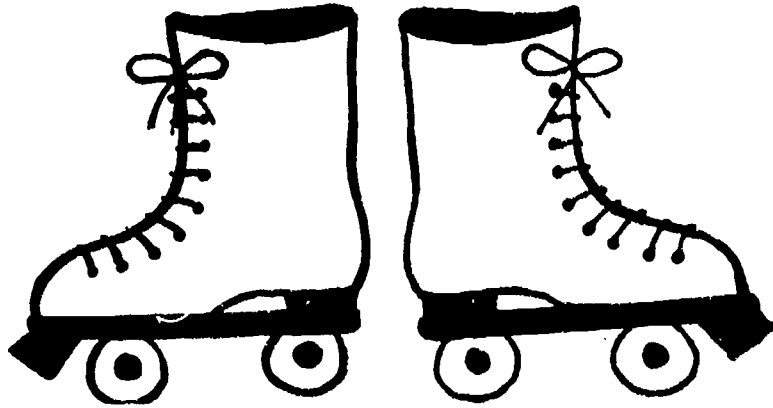

Enlarge both sides of shape on white art paper. Paint with poster paint as desired. Place right sides out and staple around most of edge. Stuff with shredded newspaper. Staple the rest. Hang from ceiling or place on bookshelves.

© 1992 Christine Menard Lafayette Public Library

## Room Decorations Stuffed Shapes

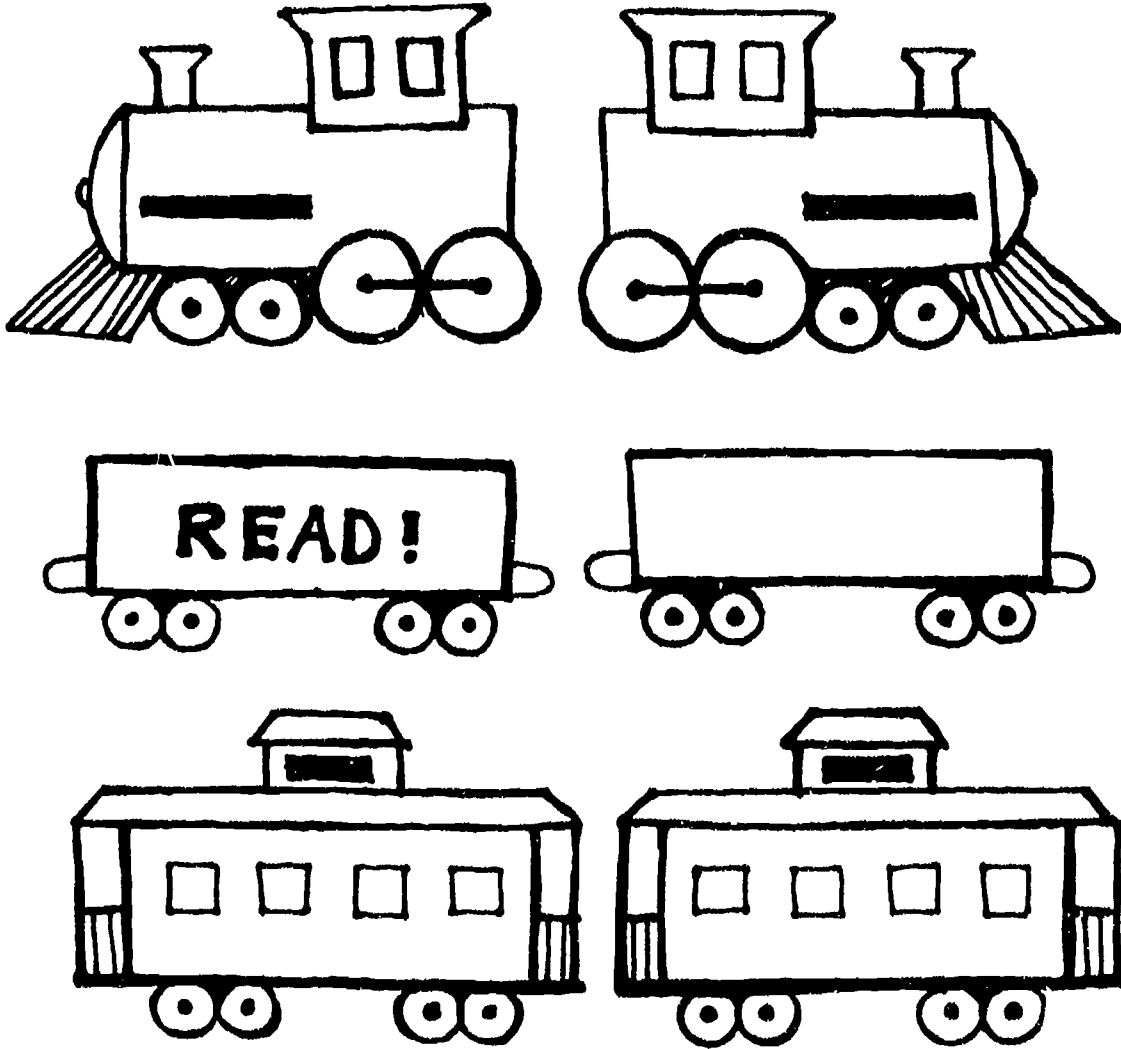

Enlarge both sides of shape on white art paper. Paint with poster paint as desired. Place right sides out and staple around most of edge. Stuff with shredded newspaper. Staple the rest. Hang from ceiling or place on bookshelves.

© 1992 Christino Menard Lafayette Public Library

NAME TAG DESIGNS

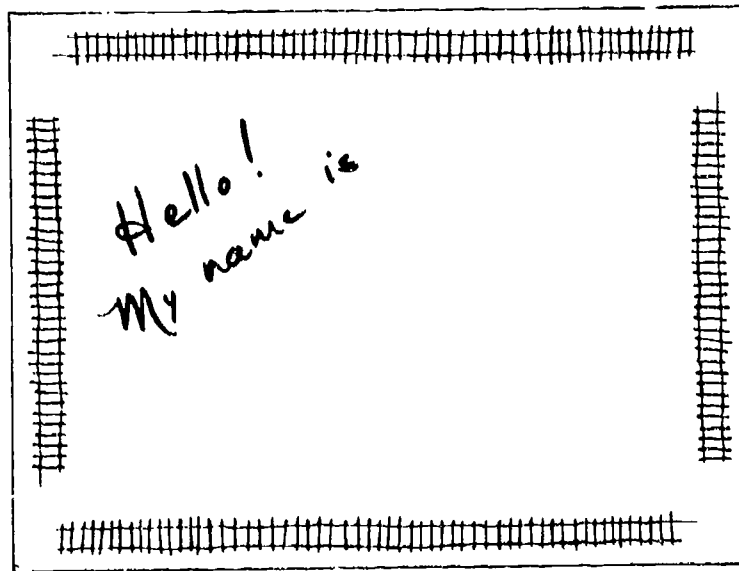
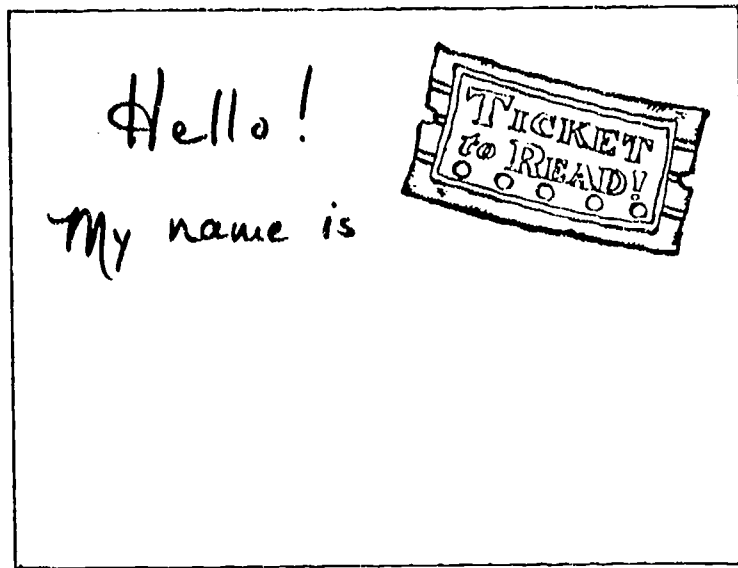



BULLETIN BOARD SUGGESTIONS

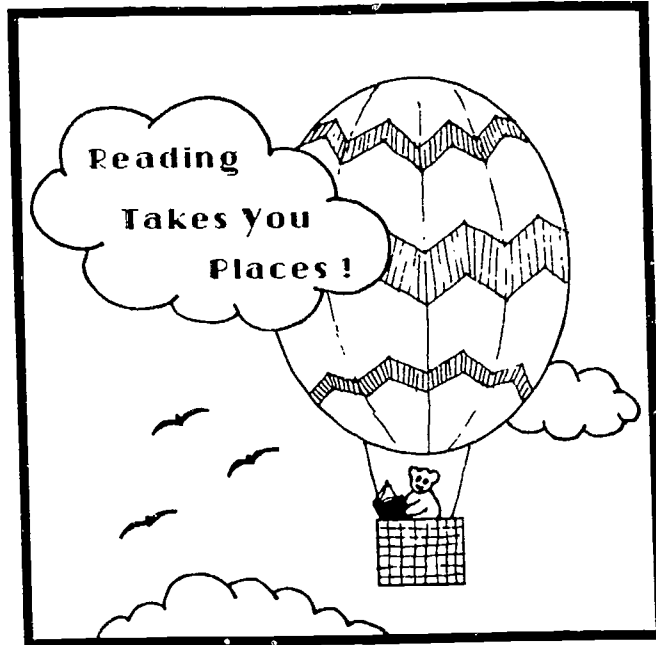

# TRAIN CAR POCKETS

## Materials:

Butcher paper to cover the bulletin board  
 Tagboard  
 All colors of tempera paint  
 Construction paper

**Activity:** Cover the bulletin board with the butcher paper. Cut out one engine, you paint it and tack it to the bulletin board. Cut out a large train car shape from tagboard for each child. Let him pick the car he would like and then paint it at the easel. Let it dry and then write his name on it.

After all of the train cars have dried have the children help you connect them into a train. Staple each car securely to the board on three sides, leaving the top side open. (These train cars may run off the board onto your walls.) As you're putting the cars up talk with the children about how each one was painted. When all of the cars are up, the children might want to make short paper chains and link the cars together. They might also want to cut tracks.

Each child can decide if he wants to display his work on the outside of his car, let the work peek over the top, or hide it inside especially if it has been made for someone.

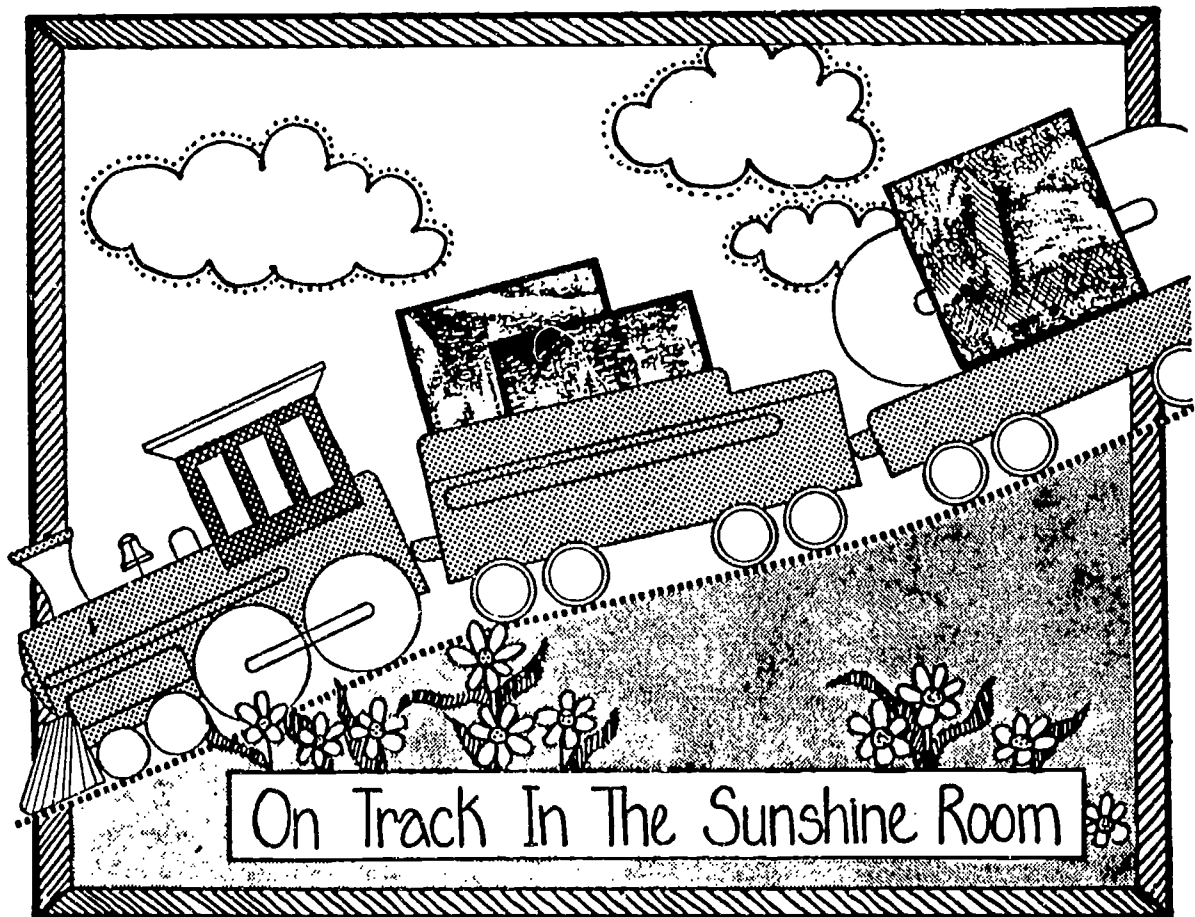

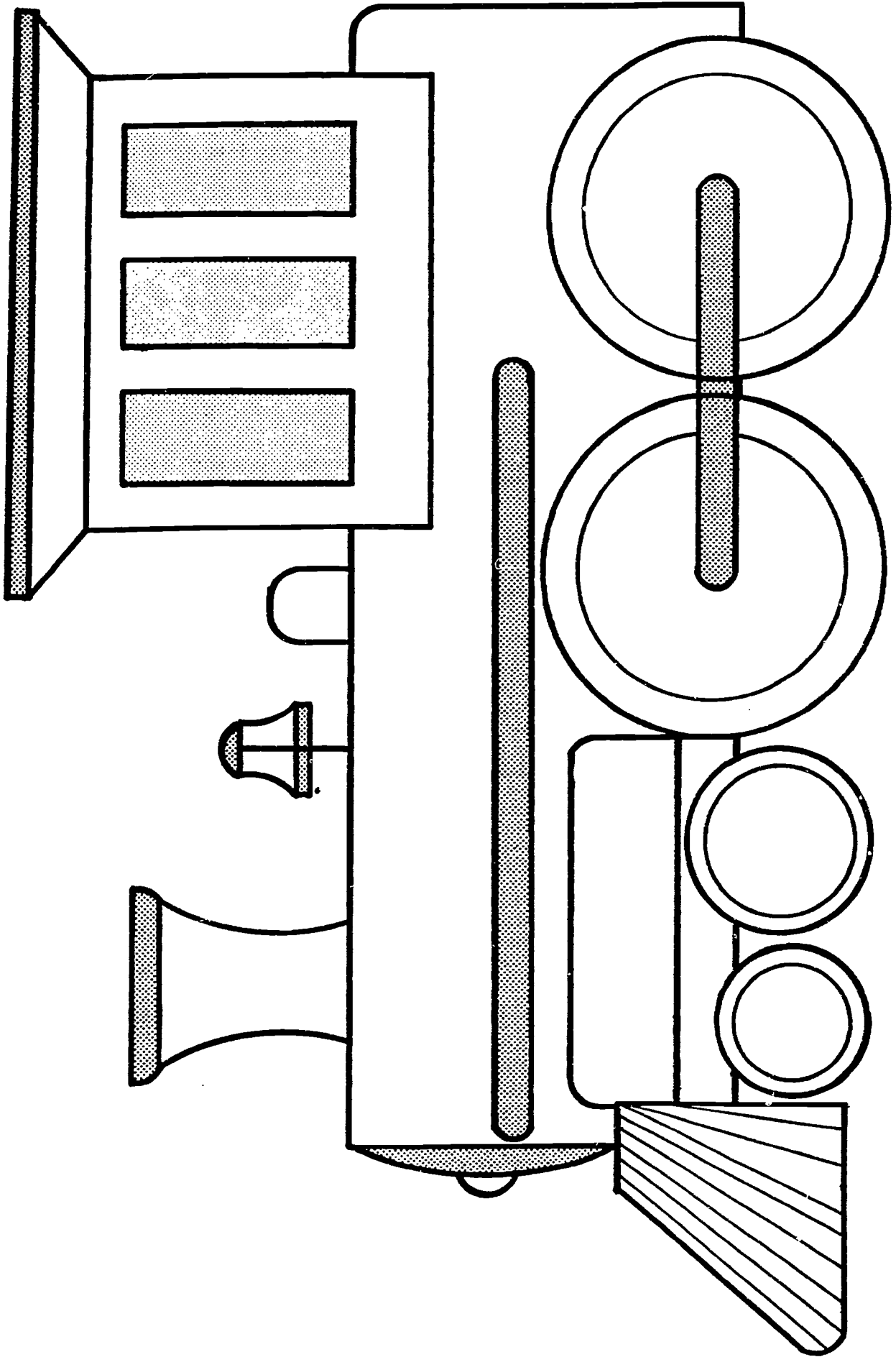

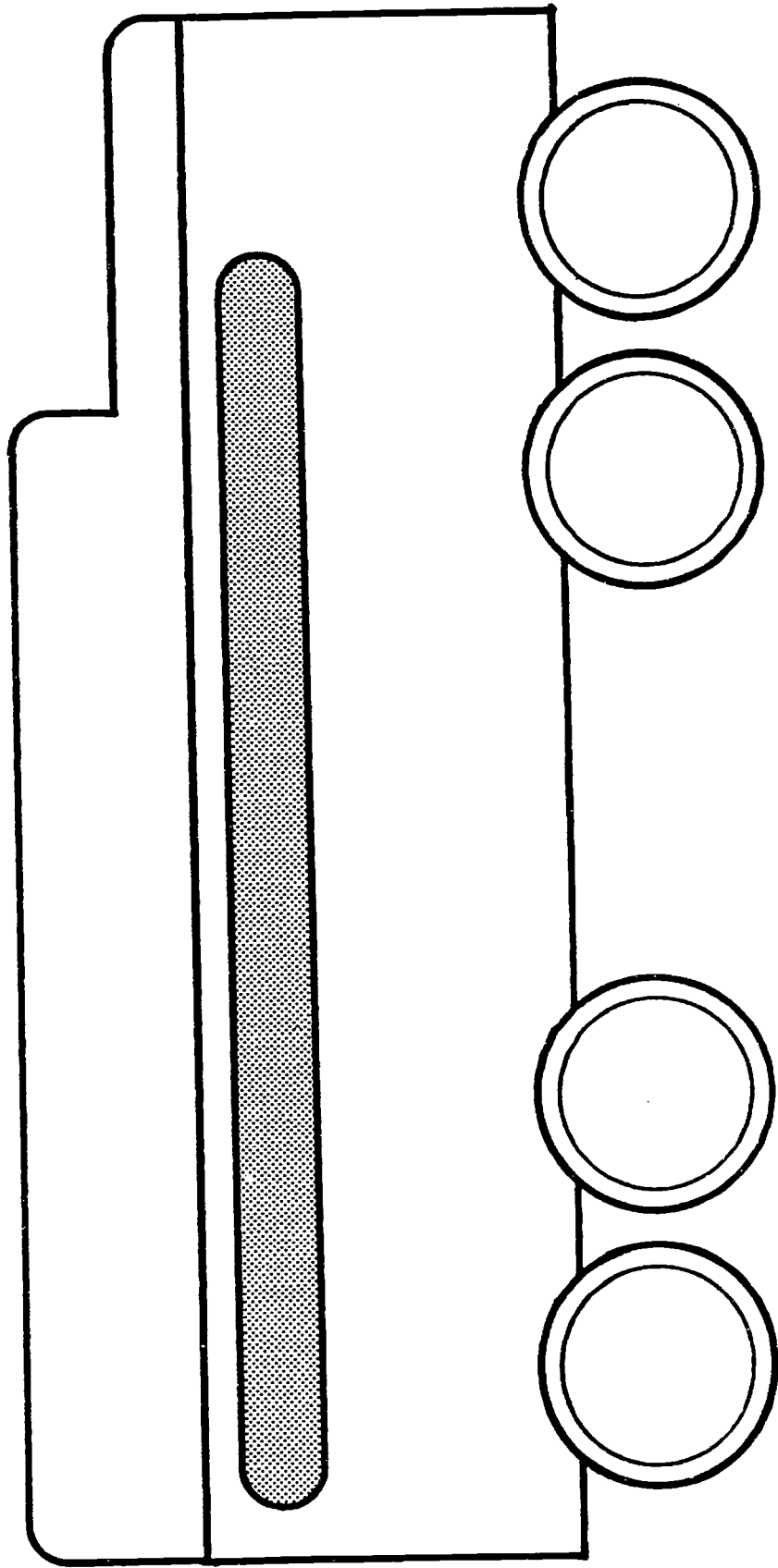

45

44

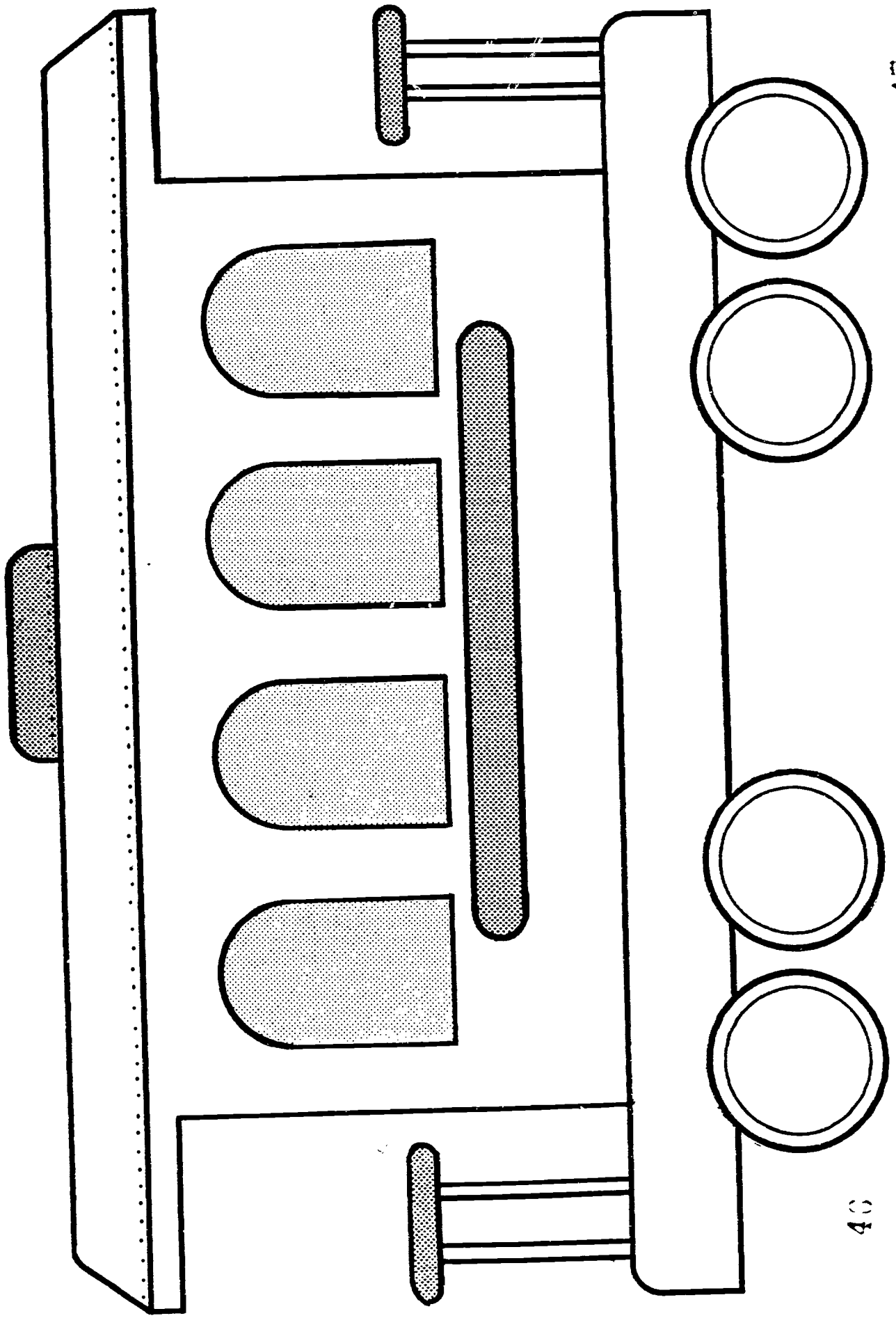

47

46

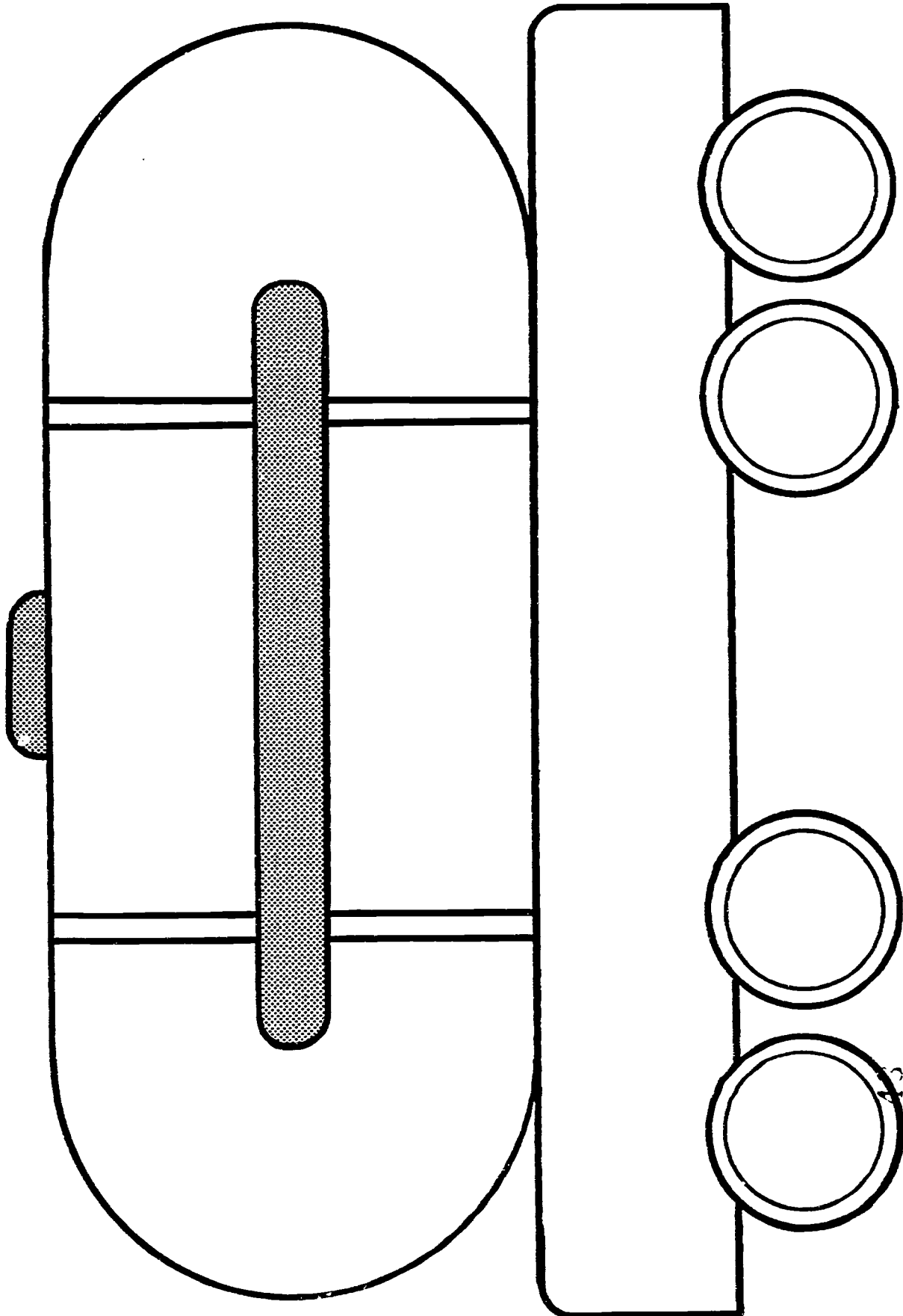

40

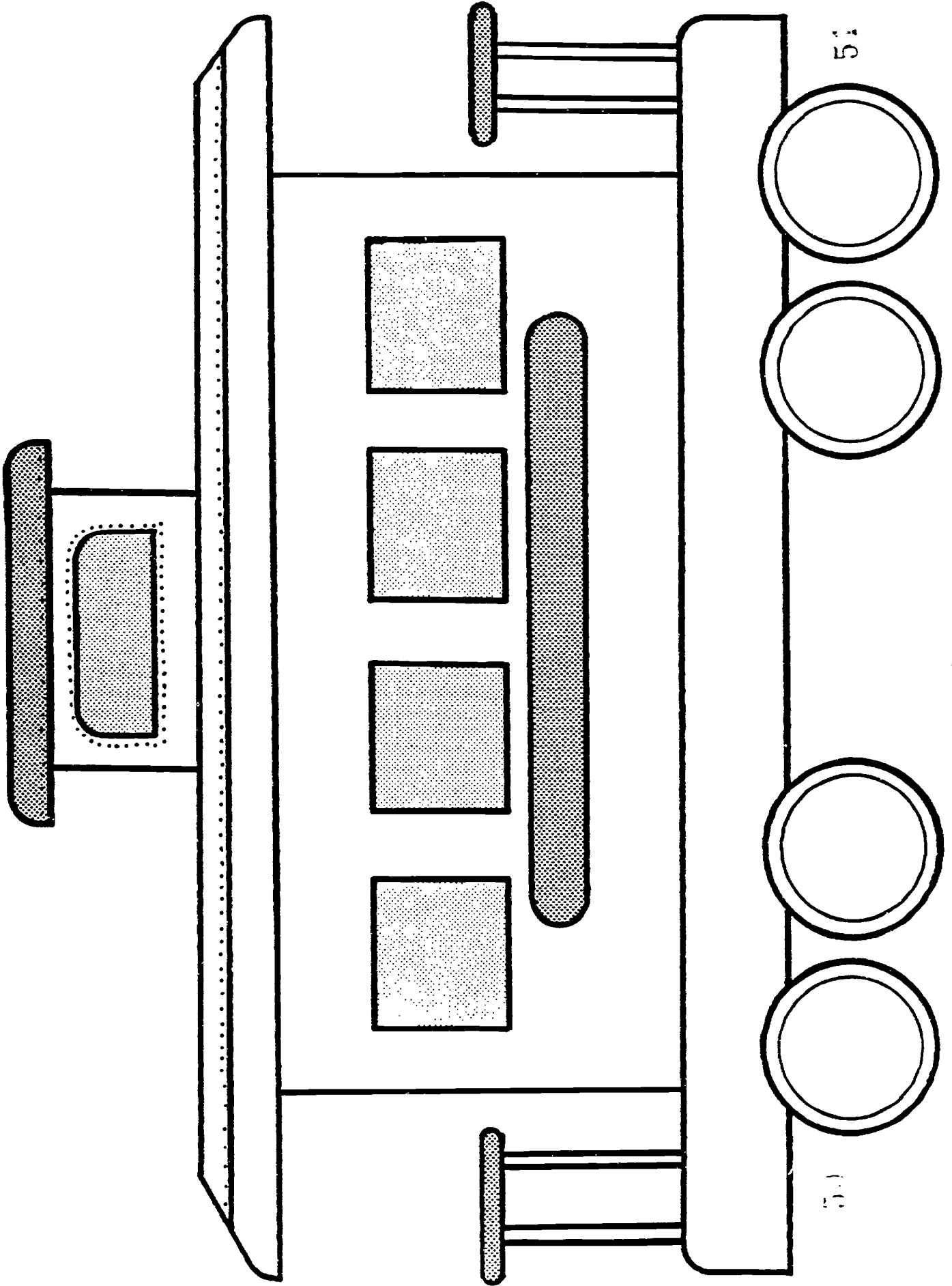

<b>THEME:</b>	All Aboard!
<b>AGE RANGE:</b>	Toddler
<b>BOOKS:</b>	Johnson, John E. <i>Here Comes the Train!</i> Awdry, W. <i>Choo-Choo, Peek-a-Boo</i>
<b>SONGS:</b>	Down by the Station The Wheels on the Train
<b>POEM:</b>	Song of the Train Herbert the Hobo
<b>FINGERPLAY:</b>	Clickety-Clack The Train
<b>VIDEO SONG:</b>	Daylight Train (In: <i>Kidsongs: Cars, Boats, Trains &amp; Planes</i> )
<b>FLANNEL BOARD STORY:</b>	Little Train's Busy Day
<b>HANDOUTS:</b>	Train to color



## 2 • STORYTIME PLANNERS

- THEME:** Animal Trains
- AGE:** Toddler
- BOOKS:** Carle, Eric. *One Two Three to the Zoo*  
Gretz, Susanna. *Teddy Bears Take the Train*  
Barkan, Joanne. *Whiskerville Train Station*  
Awdry, W. *Thomas and the Hide-and-Seek Animals*
- VIDEO SONG:** The Circus Is Coming to Town (In: Kidsongs: A Day at the Circus)
- FINGERPLAY:** The Big Train  
Train
- SONG:** Chugging Trains
- AUDIOCASSETTE:** Little Red Caboose (In: Wee Sing Fun 'n' Folk)
- HANDOUT:** Craft suggestion for extension of storytime at home: Shoe boxes can be fastened together end to end with a string 2-3 feet long tied to the first box. Child can place small stuffed animals in boxes and take them for a train ride.

<b>THEME:</b>	I Love Trains
<b>AGE:</b>	Toddler
<b>BOOKS:</b>	Awdry, W. <i>James the Red Engine</i> Crews, Donald. <i>Freight Train</i>
<b>FINGERPLAY:</b>	Choo Choo Train Here is the Engine
<b>SONG:</b>	I'm a Little Red Train
<b>FLANNEL BOARD POEM:</b>	The Train
<b>POEM:</b>	Eight Big Black Bears
<b>FILM:</b>	The Little Engine That Could
<b>HANDOUTS:</b>	Duplicate shapes of various types of train cars on colored card stock. Make a set for each child and provide popsicle sticks to glue on to make stick puppets.

#### 4 • STORYTIME PLANNERS

<b>THEME:</b>	The Elephant Express
<b>AGE:</b>	Preschool
<b>BOOKS:</b>	Murphy, Jill. <i>All In One Piece</i> Mayer, Mercer. <i>Ah-Choo</i> Punnett, Dick. <i>Help Jumbo Escape</i> Riddell, Chris. <i>Trouble With Elephants</i> Kasza, Keiko. <i>When The Elephants Walk</i>
<b>FINGERPLAYS:</b>	The Elephant's Trunk The Elephant
<b>FLANNEL BOARD STORY:</b>	Ellie the Elephant Saves the Day!
<b>SONG:</b>	The Elephants Go Marching (Sung to: When Johnny Comes Marching Home)
<b>POEM:</b>	Elephant on a Lion Hunt
<b>16MM FILMS:</b>	Cecily The Elephant Who Couldn't Forget
<b>CRAFT:</b>	Ernie Elephant
<b>HANDOUT:</b>	Circus Elephant
<b>SNACK:</b>	Elephant Smacks (Peanut butter cookies)

<b>THEME:</b>	I Know I Can – I Know I Can
<b>AGE RANGE:</b>	Preschool
<b>BOOKS:</b>	Piper, Watty. <i>The Little Engine That Could</i> Chlad, Dorothy. <i>Stop Look &amp; Listen for Trains</i> Knoll, Steven. <i>Toot! Toot!</i> McPhail, David. <i>The Train</i>
<b>POEM:</b>	Toot! Toot!
<b>FINGERPLAY:</b>	Choo-Choo Train
<b>SONG:</b>	The Wheels on the Train
<b>FLANNEL BOARD STORY:</b>	Animal Train
<b>ACTION STORY:</b>	The Birthday Surprise
<b>HANDOUTS:</b>	Train and Engineer Right – Wrong
<b>CRAFT:</b>	Train Construction
<b>FILM:</b>	The Little Engine That Could

## 6 • STORYTIME PLANNERS

<b>THEME:</b>	Let's Make Tracks
<b>AGE RANGE:</b>	Preschool
<b>BOOKS:</b>	Crews, Donald. <i>Freight Train</i> Greene, Graham. <i>The Little Train</i> Hurd, Edith. <i>Engine. Engine Number 9</i> Weelen, Guy. <i>The Little Red Train</i>
<b>FINGERPLAY:</b>	Little Red Train
<b>FLANNEL BOARD STORIES:</b>	Little Train's Busy Day The Train
<b>SONG:</b>	Chugging Trains
<b>HANDOUT:</b>	Wheels
<b>CRAFTS:</b>	Number Trains Nonsense Shapes
<b>FILMS:</b>	Red Ball Express Morris Goes to School

<b>THEME:</b>	The Zoo Express
<b>AGE:</b>	Preschool - Kindergarten
<b>BOOKS:</b>	Burningham, John. <i>John Patrick Norman McHennessy - The Boy Who Was Always Late</i> Gammell, Stephen. <i>Once Upon Old MacDonald's Farm</i> Lopshire, Robert. <i>Put Me In The Zoo</i> Lillegard, Dee. <i>Sitting In My Box</i> Coats, Laura Jane. <i>Ten Little Animals</i>
<b>FINGERPLAYS:</b>	Counting At The Zoo This Little Tiger
<b>FLANNEL BOARD STORY:</b>	The Zoo Express
<b>SONG:</b>	A Trip To The Zoo (Sung to: Mulberry Bush)
<b>POEM:</b>	The Zoo
<b>ACTION STORY:</b>	The Watersville Zoo
<b>16MM FILMS:</b>	Lambert the Sheepish Lion The Tawny Scrawny Lion Little Tiger A Zoo's Eye View: Dawn to Dark.
<b>COLORING SHEET:</b>	Lion in cage
<b>CRAFT:</b>	Larry Lion
<b>SNACK:</b>	Animal Crackers

## 8 • STORYTIME PLANNERS

- THEME:** All Aboard, Take a Trip
- AGE RANGE:** 1st - 3rd grade
- BOOKS:** Bauer, Caroline. *My Mom Travels a Lot*  
Harwood, Pearl. *Mrs. Moon's Harbor Trip*  
Ross, Pat. *Your First Airplane Trip*  
Kramor, Florence. *Eugene Packs a Grip*  
Keats, Ezra. *The Trip*
- POEMS:** Flight Plan  
To an Aviator  
Travel
- FINGERPLAYS:** I Think I'll Go To Tim-buc-tu  
My Airplane Ride  
Here is a Car  
The Car Ride  
If I Were an Airplane  
My Bicycle  
How Do I Get From Here to There
- SONGS:** Old McDonald's Truck  
Off We Go  
The Wheels on the Bus  
My Favorite Machine  
Let's Go Driving
- FILMS:** Ride  
Country Coyote Goes Hollywood  
Truck Song



<b>THEME:</b>	All Aboard the Caboose
<b>AGE RANGE:</b>	1st - 3rd grade
<b>BOOKS:</b>	Peet, Bill. <i>The Caboose Who Got Loose</i> Gramatdy, Hardie. <i>Homer and the Circus Train</i> Curren, Polly. <i>The Little Red Caboose That Ran Away</i>
<b>FINGER PLAYS:</b>	Train If I were a Train Clickety Clack
<b>POEMS:</b>	Herbert the Hobo The Land of Potpourri Train Song Travel
<b>SONGS:</b>	The Train I'm a Little Red Train Down By the Station
<b>FILMS:</b>	Thomas the Tank Engine and Friends (video)
<b>FINGERPLAYS:</b>	Zoo Train Little Red Train Birthday Train
<b>HANDOUTS:</b>	Train color sheets
<b>FLANNELBOARD POEM:</b>	The Train
<b>CRAFT:</b>	Using train patterns, have each child color one, then attach each to a super long mural.



## 10 • STORYTIME PLANNERS

- THEME:** Going to Grandma's
- AGE RANGE:** 1st - 3rd grade
- BOOKS:** Gantschev, Ivan. *The Train to Grandma's*  
Siebert, Diane. *Train Song*  
Howard, Elizabeth Fitzgerald. *The Train to Lulu's*
- POEMS:** Train Windows  
Halfway Where I'm Going  
The Train  
The Train Melody
- ACTION STORY:** The Birthday Surprise  
The Animal Train
- FLANNEL BOARD STORY:** Little Train's Busy Day
- CRAFT:** Paper plate puppets from "The Animal Train" (In Action Story section)

- THEME:** Magical Mystery Tour
- AGE RANGE:** 1st - 3rd grade
- BOOKS:** Fleischman, Paul. *Time Train*  
Macaulay, Davis. *Why the Chicken Crossed the Road*  
Rodgers, Frank. *Who's Afraid of the Ghost Train?*  
Van Allsburg, Chris. *The Polar Express*  
Vernon, Tannis. *Adriana & the Magic Clockwork Train*
- PUPPET PLAY:** The Golden Spike
- CRAFTS:** Papier-Mache Dragon  
Marbled Accordion Book  
Mexican Flowers  
Choo-Choo Costume  
Whirly Twirly
- FILMS:** Toccato for Toy Trains

## 12 • STORYTIME PLANNERS

<b>THEME:</b>	The Language of the Train
<b>AGE RANGE:</b>	4th - 6th grade
<b>BOOKS:</b>	<i>Creative Activities: Communicating, Vol 7</i> Yepsen, Roger. <i>Train Talk</i>
<b>GAME:</b>	The Railroad Slang Match Game The Mystery of the Runaway Train
<b>SNACK:</b>	Peanuts
<b>CRAFT:</b>	My Train Trip to the Library

- THEME:** Train Fun
- AGE RANGE:** 4th - 6th grade
- BOOKS:** Schultz, Charles. *Charlie Brown's Super Book of Questions and Answers*
- GAMES:** Train Riddles  
Train Scramble
- ACTION STORY:** All Aboard the Railroad Train
- CRAFT:** Funny Pictures
- SNACK:** Train cookies (using miniature Oreo cookies and fig newtons, arrange the cookies on napkins so that they appear as little train boxcars. Any round, square or rectangular shaped cookies may be used.)

## 14 • STORYTIME PLANNERS

- THEME:** Train Heroes
- AGE RANGE:** 4th - 6th grade
- BOOKS:** DeLceuw, Adele. *Casey Jones Drives and Icecream Train*  
Keats, Ezra Jack. *John Henry: An American Legend*  
Miller, Olive Beaupre. *My Book House: "Casey Jones" (p. 64) and "John Henry" (p. 135)*  
Piper, Watty. *The Little Engine That Could*
- GAMES:** The Big Train Mystery Treasure  
Train Potpourri
- CRAFT:** Train from *Seasonal Arts and Crafts Activities for Early Childhood*. (Place your favorite hero in the train.)
- SNACK:** Hero Sandwich (Use three slices of bread. Spread the first layer with peanut butter. Spread the second layer with jelly. Add bananas, apples, or raisens to the layers. Cut sandwich in fourths.)

**THEME:** The Train Story

**AGE RANGE:** 4th - 6th grade

**BOOKS:** Cullum, Carolyn N.. *The Storytime Sourcebook*

**GAMES:** The Train Story Game

**CRAFT:** Box trains

**SNACK:** Popcorn

## 16 • STORYTIME PLANNERS

<b>THEME:</b>	Trains
<b>AGE RANGE:</b>	4th - 6th grade
<b>FILMSTRIPS:</b>	The Brave Engineer Freight Train There's a Train Going By My Window
<b>BOOK:</b>	<i>Lots To Do In Little Golden Book Land</i>
<b>GAME:</b>	Train Bingo
<b>SNACK:</b>	Sandwiches cut in fourths
<b>CRAFT:</b>	Tootle the Train Chain

**ALL ABOARD THE RAILROAD TRAIN***by Yolanda Blanchard, Calcasieu Parish Library*

*All Aboard the Railroad Train* is a choral reading. Give each child a copy. Divide the children into two groups. They can make up fun gestures as they read along.

All	All aboard, all aboard
All	All aboard the library train
Group 1	Come one, come all
Group 1	Hear the sound of the whistle call
Group 2	Hear the sound of the whistle call
Group 1	Clickety, clickety
Group 2	Clackety, clackety, clackety, clackety clack
All	Racing down the railroad track
All with hand claps	1, 2, 3, 4, 5! 6, 7, 8, 9, 10
All	Let's start over again.
Group 1	The people come from near and far
Group 2	To ride on each and every car
Group 1	Little girls and boys, moms and dads too
Group 2	Climb aboard the Library Choo-choo!
All	Bumbling, rumbling down the track
All	The train roars smoke from its stack.
Group 1	Through the tunnels and around the bend,
Group 2	We hear the whistle as it calls again.
All	All aboard, all aboard
All	All aboard the library train
Group 1	Come one, come all
Group 1	Hear the sound of the whistle call
Group 2	Hear the sound of the whistle call
Group 1	Clickety, clickety
Group 2	Clackety, clackety, clackety, clackety clack
All	Racing down the railroad track
All with hand claps	1, 2, 3, 4, 5! 6, 7, 8, 9, 10
All	Let's start over again.



Group 1	The trees, the sky, and sun wave at us as we pass
Group 2	Moving right alongside the fields of clover and grass.
Group 1	Without even a tiny bit of hesitation
Group 2	We unboard and reach our destination
All	As we open the library doors to find
Group 1	Great books, stories, and fun of all kind
Group 2	Welcoming us to worlds and places old and new
Group 1	Telling us tales of people and the things they do
Group 2	Filling us with laughter, jokes and songs too.
All	Everyday the library train brings us here, brings us back
All	Keeping us reading great books to stay on track
Group 1	With the sound of clickety, clickety
Group 2	Clackety, clackety, clackety clack
All	All aboard, all aboard
All	All aboard the library train
Group 1	Come one, come all
Group 2	Hear the sound of the whistle call
Group 1	Clickety, clickety
Group 2	Clackety, clackety, clackety, clackety clack
All	Racing down the railroad track
All with hand claps	1, 2, 3, 4, 5! 6, 7, 8, 9, 10
All	Let's start over again.

**THE ANIMAL TRAIN***by Yvonne Winer*

There is nothing quite as thrilling to children as taking a trip somewhere by train, boat, car, or even possibly a spaceship! The destination hardly matters because the real fun seems to be the anticipation of "getting there" and the ride itself. This story blends a lively combination of action, sound effects, and characters around the theme of a train ride and picking up animal passengers. Suggestions are included for converting the central theme into other types of locomotion.

**Characters**

Train	Children with
Sheep	Stick Puppets
Cow	(patterns or child-make)
Hen	
Duck	
Pig	

**Props**

Bridge	Small rug
Mountain	Low stool or platform
Tunnel	Two or more children with upraised connected arms

**Introducing the Story**

Ask the children if they have ever ridden on a train before. Where did they go? What did they like best about the ride? Discuss with them the many things a train can transport, such as animals, lumber, cars, and coal.

Invite the children for a train ride, and assign one child to play the Train with the Stick Puppet. Place the Train at one end of the playing space. (This could be the train station.)

Assign other children to play the animal roles with puppets. If you wish to include the entire class, consider adding other farm animals to the cast. Place the animals in their proper position in order of their appearance. Have each child provide a sound for the animal.

Assign several children to be the tunnel. Arrange the bridge, mountain, and tunnel around the playing space, in order of appearance.

Cue the children on the story's actions, and begin the story.

From *Pocketful of Puppets*, by Yvonne Winer, ©1983. Reprinted with permission of Nancy Renfro Studios, Inc., P.O. Box 164226, Austin, TX 78716 (512) 327-9588. Write for a free catalog.

## THE ANIMAL TRAIN

### The Story

This is a story about a wonderful animal Train that travelled through valleys, over bridges, over mountains and through tunnels. It was a steam Train that huffed and puffed and blew out billows of grey smoke and hisses of steam, "phsssh, phsssh!" Its busy little wheels went rushing along the track, "clicketty-clack, clicketty-clack!" It was a noisy, bustling, busy little Train. "Toot-toot-too-toot!"

As it travelled through the valley with a "CHOO-CHOO, CHUFF-CHURR-CHUFF," a little Sheep along the way called out. "Baa, Baa, STOP, STOP TRAIN! I want to come for a ride!" So the Train stopped, "Pshhhht, pshhhht . . . sssshhhhh!" And the one little Sheep hopped on.

"Baa, Baa," said the Sheep; and

"Toot, Toot," said the little Train as it started off.

"Clicketty-clack, Clicketty-clack," said its busy wheels as it rushed through the valley.

Then the Train came to a bridge, "CHOO-CHOO, CHUFF-CHURR-CHUFF!" A Cow along the way called out, "Moo, Moo, STOP! STOP TRAIN! I want to come too!" So the Train stopped, "Pshhhht, pshhhht . . . sssshhhhh!"

"Baa, Baa," said the Sheep;

"Moo, Moo," said the Cow; and

"Toot, Toot," said the little Train as it started off.

"Clicketty-clack, Clicketty-clack," said the busy wheels as they raced across the Bridge.

The Train slowed down a bit as it climbed the mountain. "CHOO-CHOO, CHUFF-CHUFF! There stood a Hen. "Cluck, Cluck, Cluck! STOP, TRAIN, STOP! I want to come too!" So the Train stopped, "Pshhhht, pshhhht . . . sssshhhhh!" and the little Hen hopped on.

"Baa, Baa," said the Sheep;

"Moo, Moo," said the Cow;

### The Actions

*The Train should move around the perimeter of the playing space. The child playing the Train can mimic its actions such as blowing out puffs of smoke, making busy little movements with the feet for the wheels, and calling out the Train's "toot-toot" sounds.*

*The Train travels through the valley and stops. The Sheep makes "Baa, Baa" sounds as it steps behind the Train to board it.*

*The Sheep and the Train make additional sounds as the Train starts off.*

*The Train comes to a bridge and stops. The Cow makes "Moo, Moo" sounds as it steps behind the Sheep to board the Train.*

*All the animals and the Train make additional sounds as the Train starts off.*

*The Train climbs up a mountain and stops. The Hen makes "Cluck, Cluck" sounds as it steps behind the Cow to board the Train.*

*All the animals and the Train make additional sounds as the*

“Cluck, Cluck,” said the Hen; and  
 “Toot, Toot,” said the little Train as it started off.

“Clicketty-clack, Clicketty-clack,” said the busy wheels  
 as they raced down the mountain-side.

The Train raced even faster still. “CHOO-CHOO . . .  
 CHUFF-CHUFF, CHOO-CHOO . . . CHUFF-CHUFF!”  
 A Duck was half-way down the mountain-side. “Quack,  
 Quack, STOP TRAIN! I want to come for a ride, too.” So  
 the Train stopped. “Pshhhht, pshhhht . . . sssshhhhh,”  
 and the Duck hopped on.

“Baa, Baa,” said the Sheep;  
 “Moo, Moo,” said the Cow;  
 “Cluck, Cluck,” said the Hen;  
 “Quack, Quack,” said the Duck; and  
 “Toot, Toot,” said the Train as it started off.  
 “Clicketty-clack, Clicketty-clack,” said the busy little  
 wheels.

At last the Train came to a tunnel. “CHOO-CHOO,  
 CHUFF-CHUFF, CHOO-CHOO - - - CHUFF-CHUFF!”  
 There stood a Pig. “Oink, Oink, STOP! STOP TRAIN! I  
 want to come, too.” So the Train stopped. “Pshhhht,  
 pshhhht . . . sssshhhhh,” and the little Pig got on.

“Baa, Baa,” said the Sheep;  
 “Moo, Moo,” said the Cow;  
 “Cluck, Cluck,” said the Hen;  
 “Quack, Quack,” said the Duck;  
 “Oink, Oink,” said the Pig; and  
 “Toot, Toot,” said the Train as it went into the tunnel.  
 “Clicketty-clack, Clicketty-clack,” said the busy little  
 wheels.

First the Train went into the tunnel—then the Sheep,  
 then the carriage with the Cow, then the carriage with the  
 Hen, then the carriage with the Duck, then the carriage with  
 the Pig.

For a long time, no one could see any of the animals.  
 But, if you listened very carefully, you could hear the  
 wheels of the Train racing along inside the tunnel.  
 “Clicketty-clack, clicketty-clack, clicketty-clack,” louder  
 and louder, “Clicketty-clack, clicketty-clack, clicketty-  
 clack.”

*Train starts off.*

*The Train climbs down the moun-  
 tain and stops. The Duck makes  
 “Quack, Quack” sounds as it  
 steps behind the Hen to board  
 the Train.*

*All the animals and the Train  
 make additional sounds as the  
 Train starts off.*

*The Train comes to the tunnel  
 and stops. The Pig makes “Oink,  
 Oink” sounds as it steps behind  
 the Duck to board the Train.*

*All the animals and the Train  
 make additional sounds as the  
 Train starts off.*

*The Train goes through the tun-  
 nel, followed by the entire cast of  
 animals, one by one.*

*The entire Train goes to the fur-  
 thest point in the room or down a  
 hallway, then turns around and  
 comes back again through the  
 tunnel for one last noisy call of the  
 sounds.*

And out came the little Train. "TOOT, TOOT!"  
Next came the Sheep, "BAA, BAA";  
Then came the Cow, "MOO, MOO";  
Then came the Hen, "CLUCK, CLUCK";  
Then came the Duck, "QUACK, QUACK";  
And last of all the Pig, "OINK, OINK."  
What a wonderful, noisy train ride!

THE END



The Chugging Animal Train  
(bodi-bag puppets)

## Puppetmaking

### Storyteller's Puppets

*To Make Train and Animal Stick Puppets* — Cut out and color a photocopy of the Train and each of the animal characters. Glue each character onto the end of a cardboard towel tube, blunt skewer, stick, or other rod control.

### Children's Puppets

*To Make Animal Bodi-Puppets*— Children will enjoy interpreting this story while wearing Bodi-Bag Puppets. Follow the instructions found under the story *Park Tree, Park People* for constructing the basic puppet. For the various animals, glue on cotton for the Sheep, make a pink snout for the Pig, horns for the Cow, add fabric wings, instead of arms, for the Hen and Duck.

### Follow-up Activities

*All Aboard!* — Have the children make Stick Puppets of other characters of their choosing that might enjoy going for a train ride, such as a monster, dog, king, or alligator. Ask them to think of some appropriate sounds that the characters could make. For example, a monster could make terrible growling sounds, or a king could say, "My Kingdom! My Kingdom!"

Retell the story with the new cast.

*A Fantastic Trip* — This would be an excellent story to adapt to another type of trip such as an outer space journey, ocean voyage, or city bus ride. Simply exchange the Train for a cutout image of a spaceship, boat, bus, or other vehicle. The characters and text could also be changed to fit the new theme such as outer space creatures, interesting sea life, or community workers, such as police officer, doctor, mail deliverer, etc.

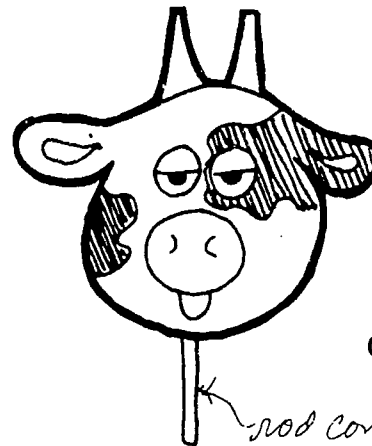

Cow Stick Puppet

rod control



A Sheep puppet  
(bodi-bag puppet)

**Train**

*Stick Puppet*

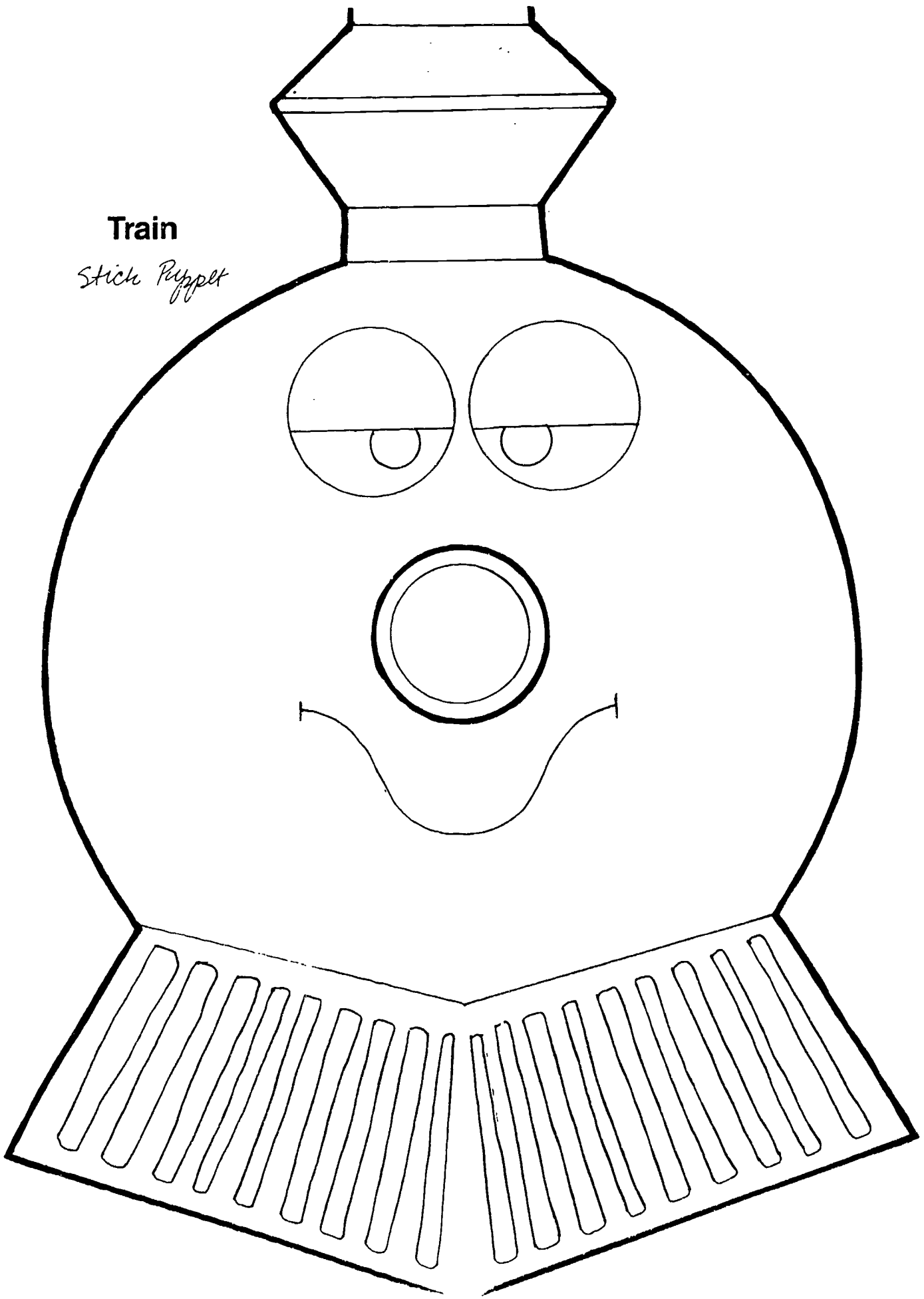

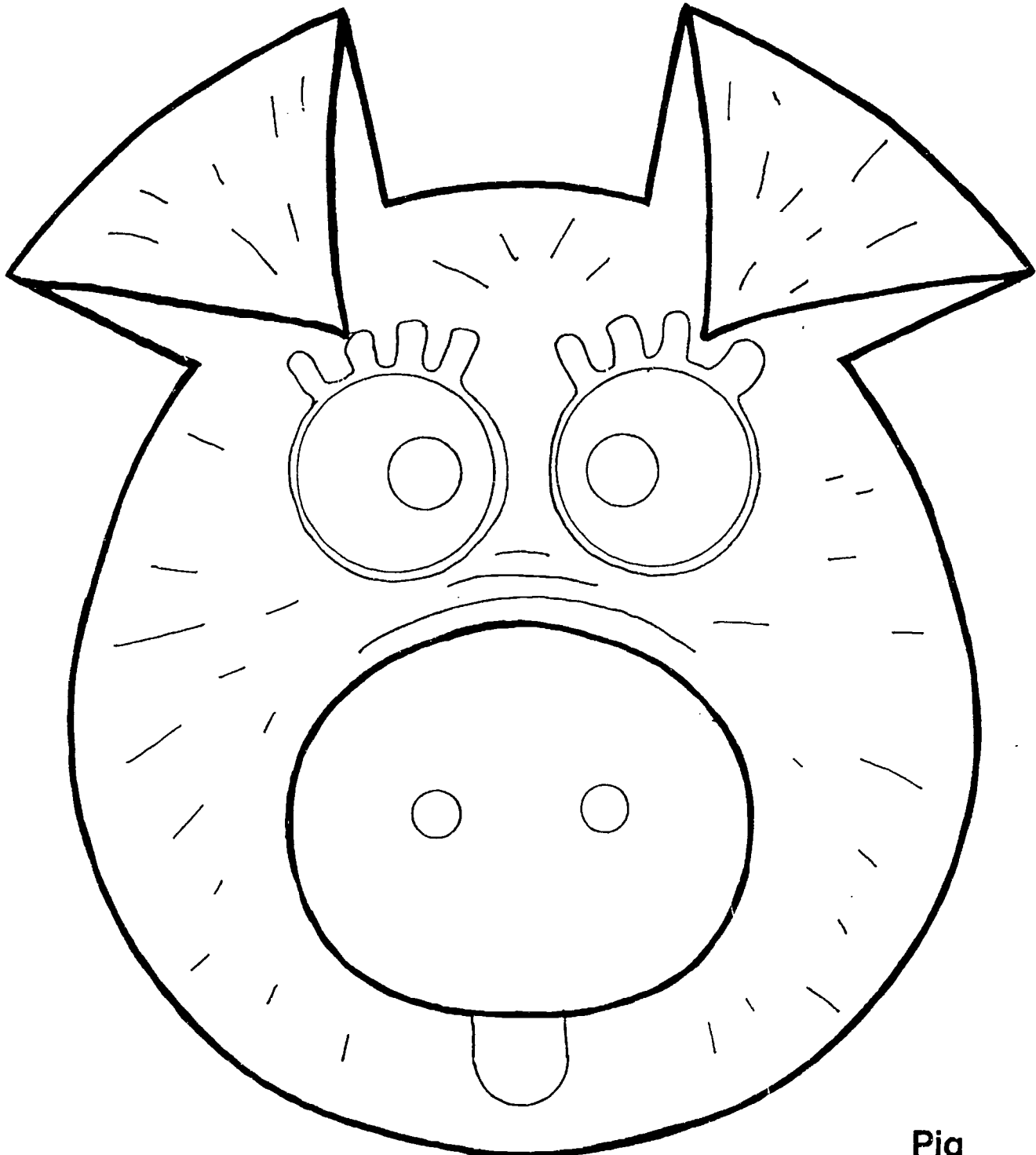

Pig



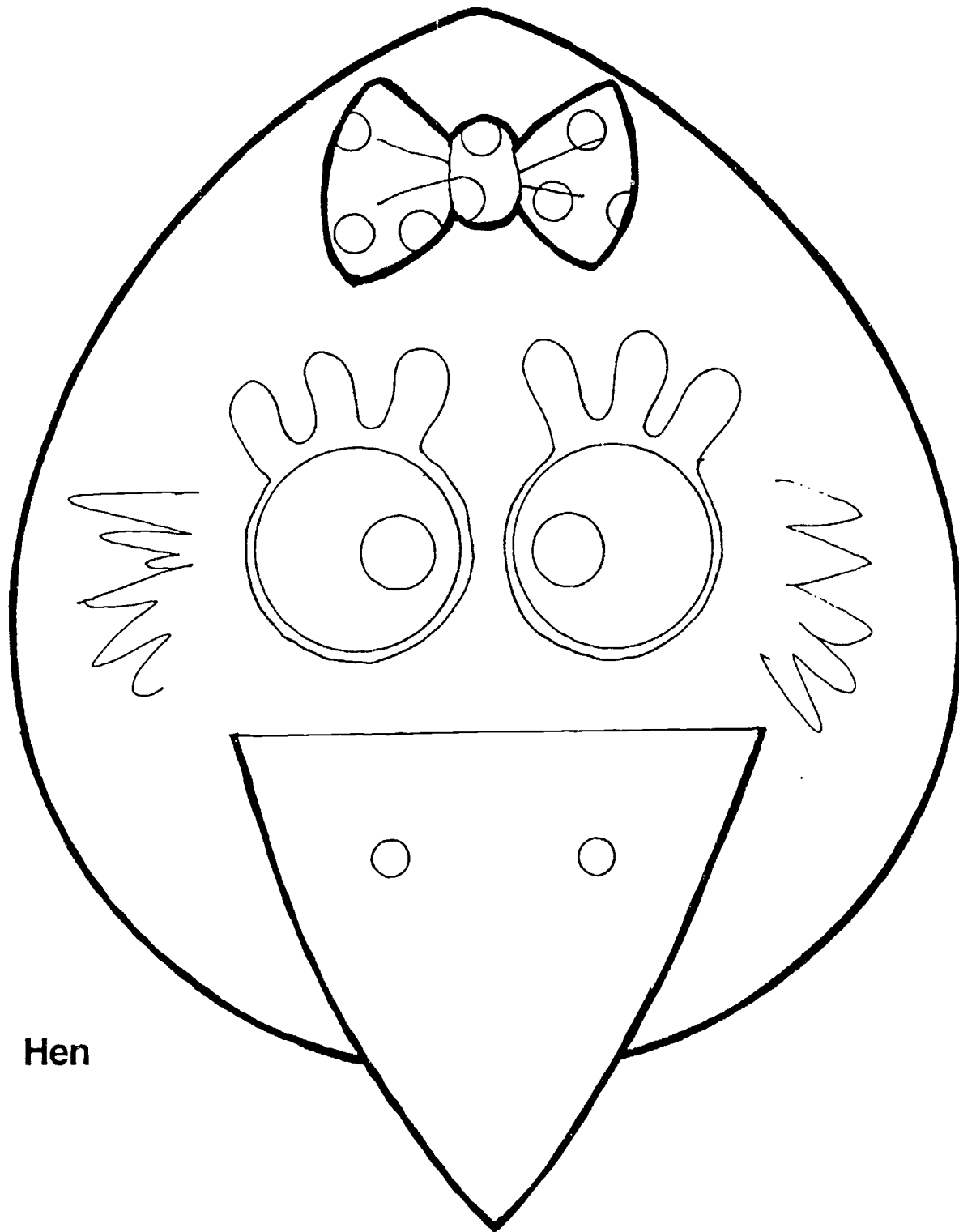

Hen

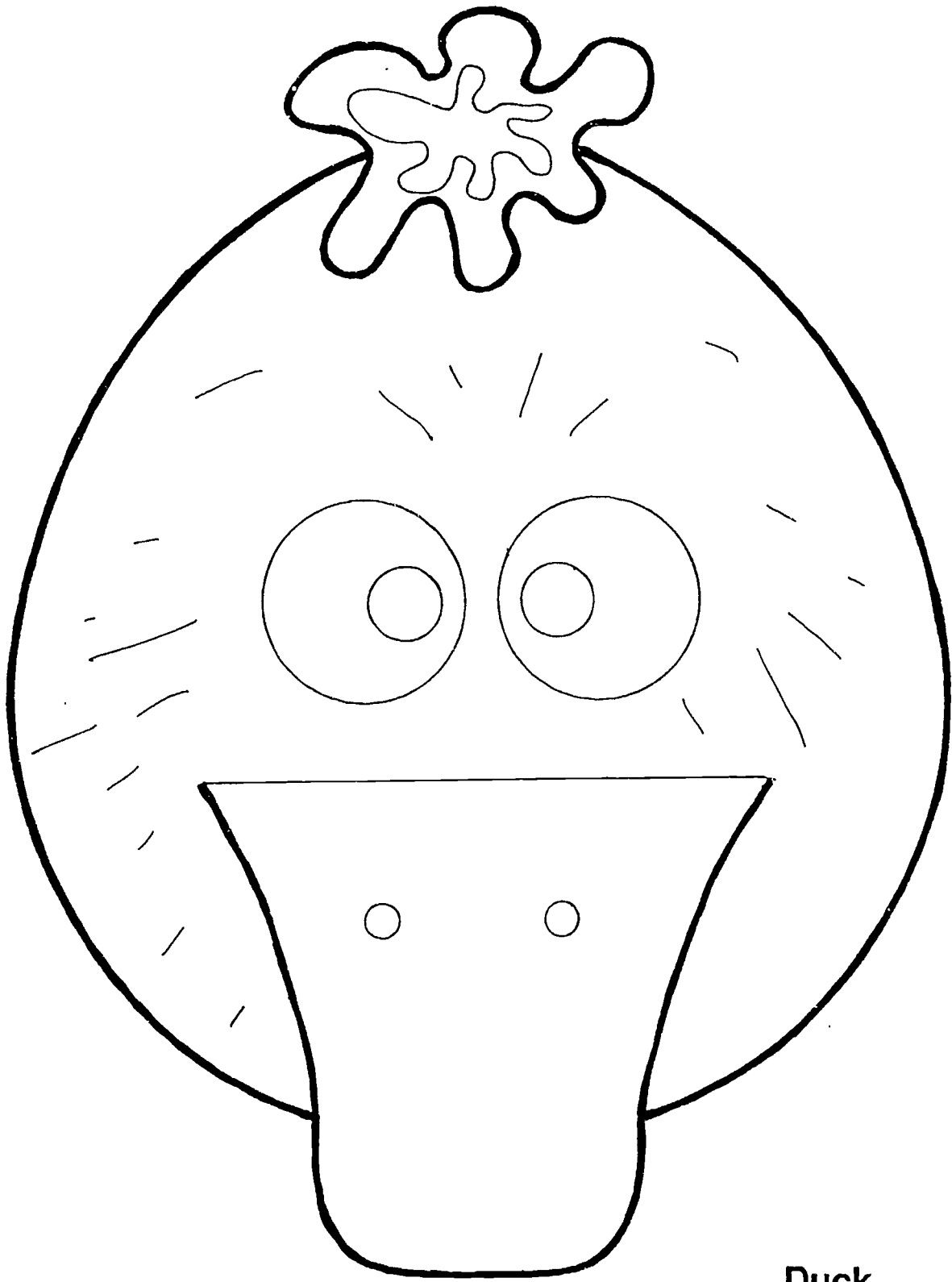

Duck

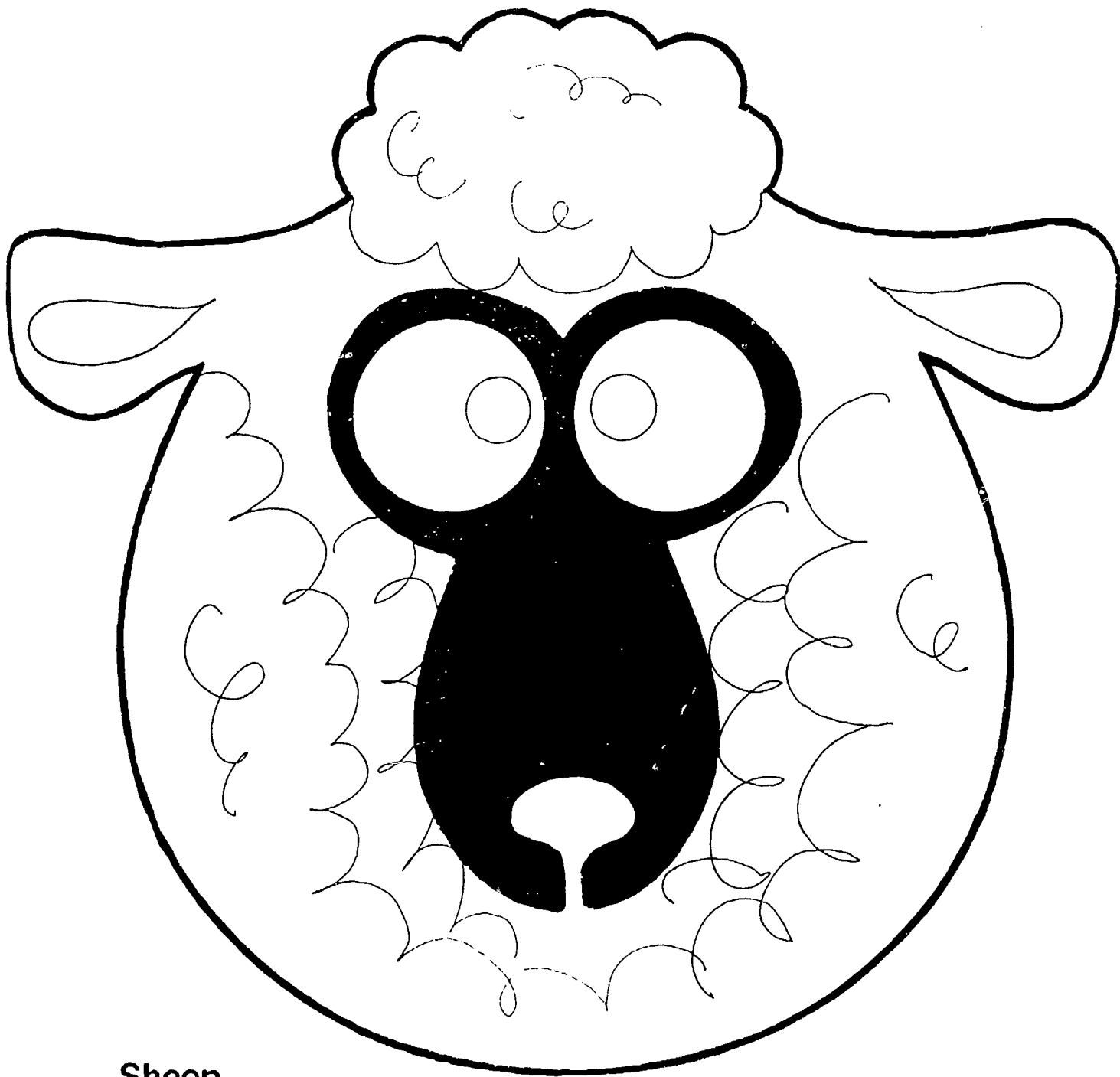

Sheep

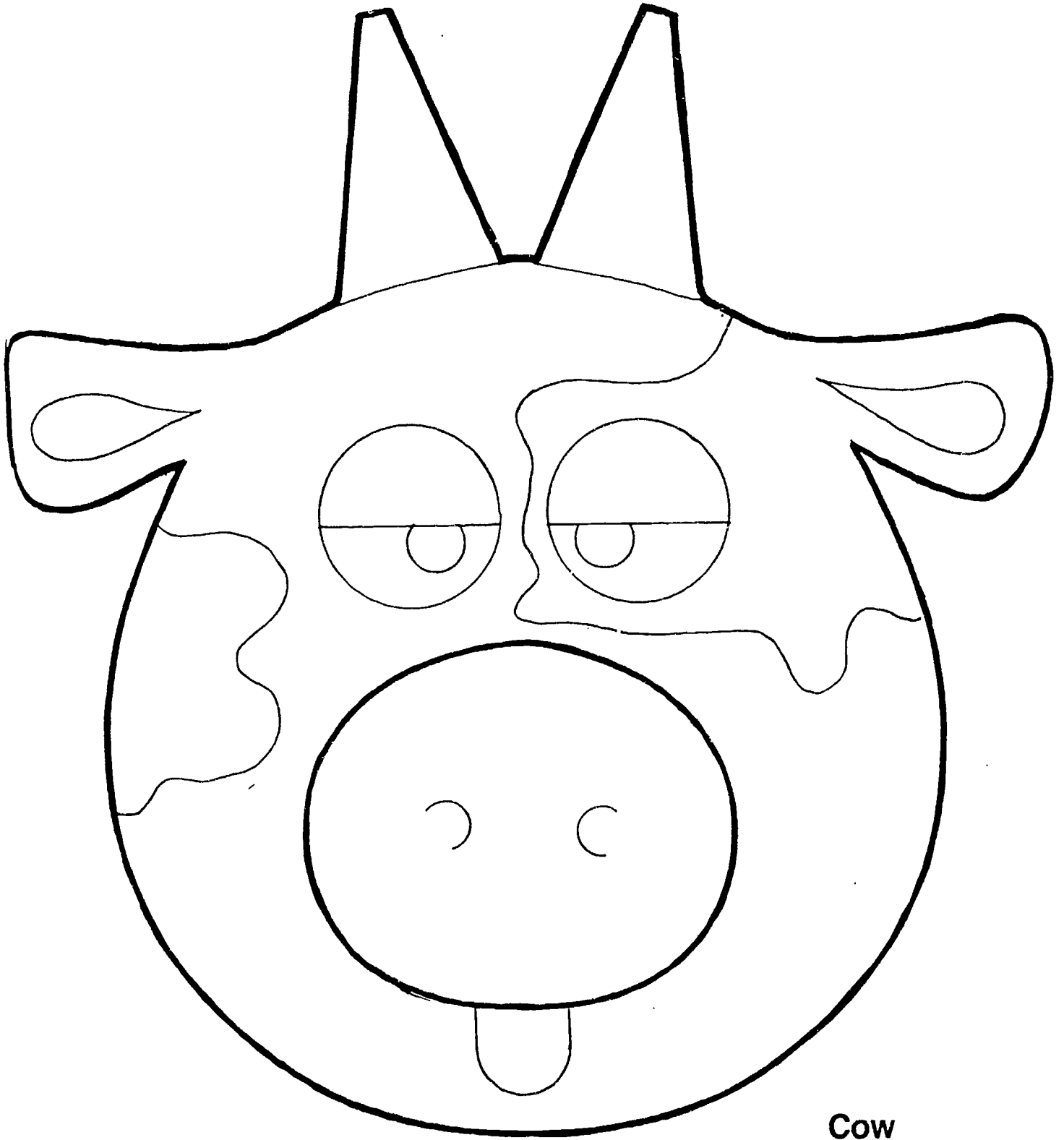

Cow

# THE BIRTHDAY SURPRISE

"Happy birthday, sleepy head!" said Steve's mother as he came into the kitchen. "I thought you were going to sleep right through your birthday!"

"Oh, Mom," laughed Steve. "What time are the kids coming over for the party?"

"The invitations said two o'clock. Have you been in the living room yet?"

"No, why?"

"Well . . . there's something you might find interesting in there," said his mother with a twinkle in her eye.

Steve headed for the living room. "Terrific!" he shouted.

In the center of the living room sat a large wrapped PACKAGE.

"Can I open it?"

"Not until your party, young man," chuckled his dad as he looked up from his newspaper.

"Oh, please!" moaned Steve. "How can I ever wait?"

"Why don't you go outside and find something to do?" suggested his dad.

"All right," said Steve. He was really too excited to do anything else anyway, so he took a walk around the fence in their BACKYARD.

"Maybe there's something good on TV," he thought to himself. He went back inside and turned on the TELEVISION.

As he was watching a cartoon show, his parents came in carrying another package.

"Here, Steve," said his mother. "Before your friends arrive, we thought you might want to open this present your grandparents sent."

"Great!" shouted Steve. He flipped off the TV and began opening the present. "Oh boy . . . look at this," he said holding up a new BASKETBALL in one hand . . .

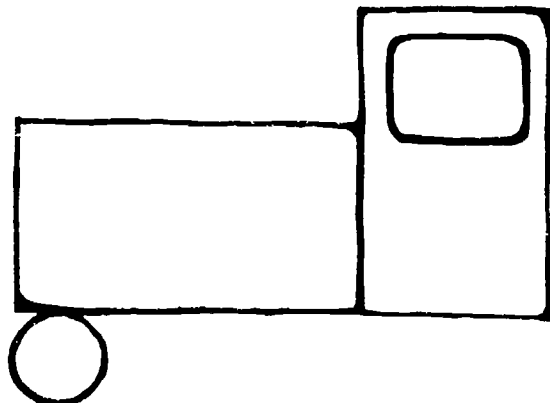
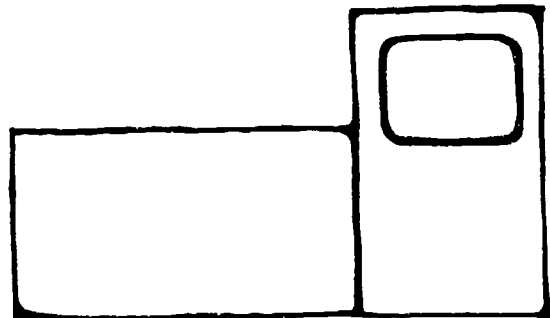
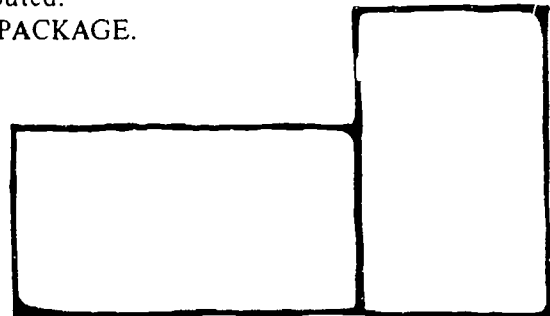

From *Stories to Draw*, by Jerry J. Mallett and Marian R. Barch. © 1982. Available from Freline, Inc., Box 889, Hagerstown, Maryland 21741 (800) 448-4887.

... and a basketball HOOP in the other.

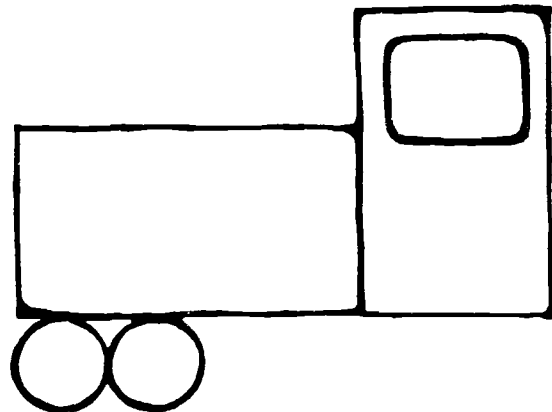

"I wonder how Grandma and Grandpa knew what I wanted."

"Oh, somebody must have told them," said his mother as she gave his father a wink.

"And now I get to open the big package ... right?" said Steve.

"Oh no you don't!" laughed his father. "You'll have to wait for that one!"

Fortunately, Steve didn't have long to wait, because at that moment his friends began arriving for his party.

"Here," said Steve's father handing out a PARTY HAT to each of Steve's friends. "Put one of these on and look at yourself in the mirror!"

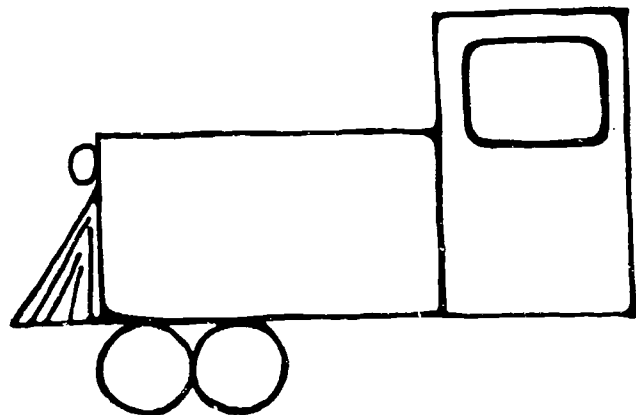

They all put on their hats and laughed at how funny they looked. "And everyone gets a PARTY POPPER," added his father as he passed them out.

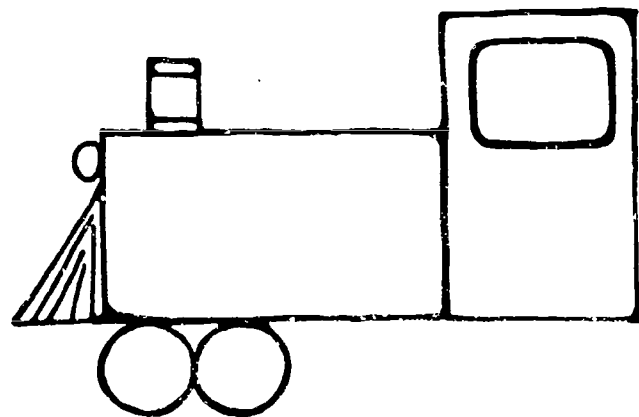

"What's a party-popper?" asked Steve's friend, Bill.

"Here, let me show you." Steve's father took one and gave its string a yank.

"Bang! !!" went the popper, and different colored STREAMERS shot out the end.

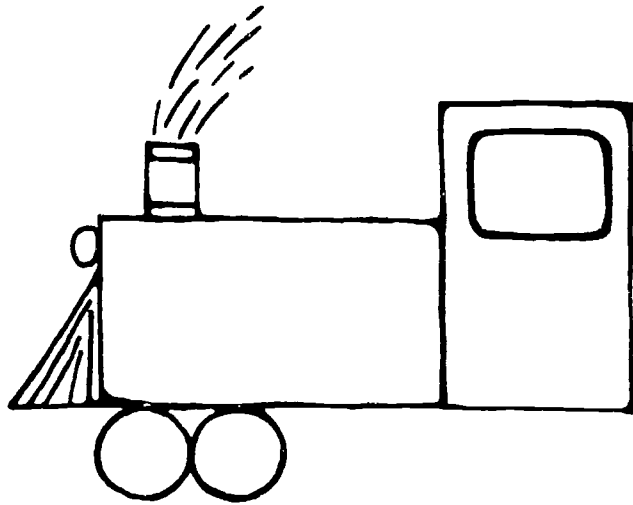

"Wow!" exclaimed everyone as they began shooting off their poppers. For the next few seconds all anyone could hear was laughing and the "Bang! Bang! Bang!" of party-poppers shooting into the air.

Then it was time for refreshments. Steve's mother opened the kitchen door and came in with a large round BIRTHDAY CAKE. She put it on the table, and everyone joined in singing "Happy Birthday."

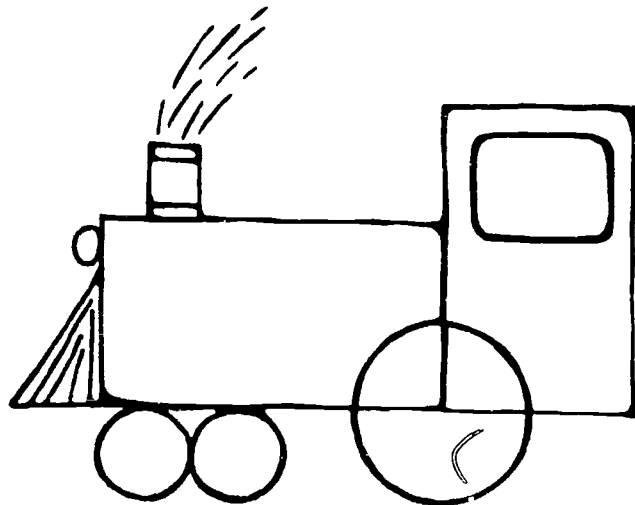

When they had finished singing, Steve's mother cut the cake into EIGHT SLICES and served everyone a piece.

After they had all finished eating their cake, Steve looked at his parents with that certain special look.

"Okay," laughed his mom and dad. "Go ahead and open your present."

Steve could hardly wait. He ran to his present and ripped off the paper as fast as he could. Off came the box lid.

"Wow! Just what I wanted!" he exclaimed.

Can you guess what his present was?

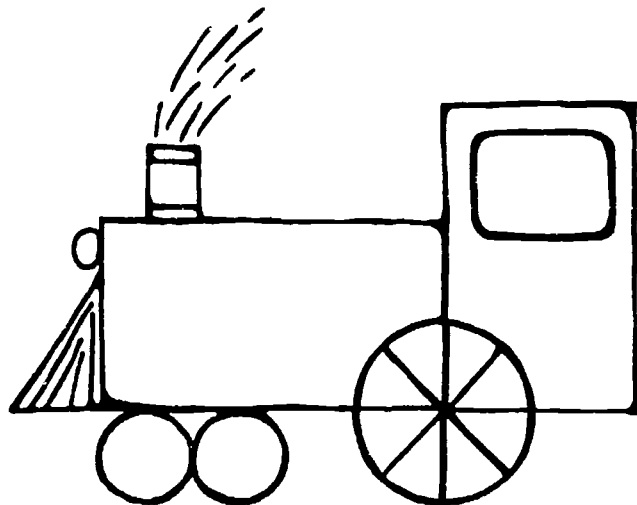

JASON'S HOUSE

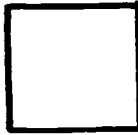

One day Jason found a box that was big enough to sit in. Here it is.

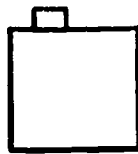

So he climbed inside. All you can see is the top of his hat right here.

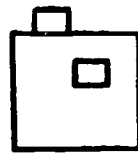

"This box will be my very own house," said Jason. But a house needs a window, so he put a window on this side.

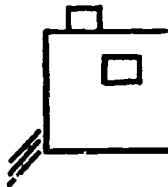

A house should have some front steps too, so he piled some of his old picture books here for steps,

From *Chalk In Hand - The Draw And Tell Book*, by Phyllis Pflomm, © 1986, Scarecrow Press. Used by permission.



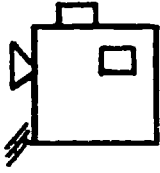

and he glued a paper cup right here for a porch light.

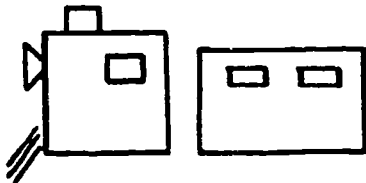

Jason really liked his house, but he was lonely and thought it would be nice to have some neighbors. So he asked his friend Kelly to bring a box, and she put hers right here. It was longer than Jason's, so she put two windows in her house.

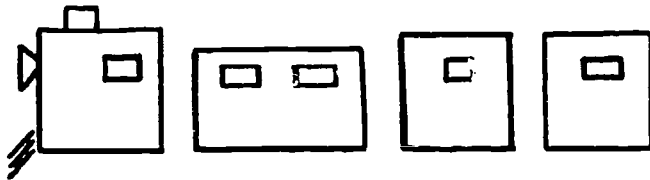

Then along came Stacy and Sean bringing their boxes, which they put here and here, and they put some windows in their houses too.

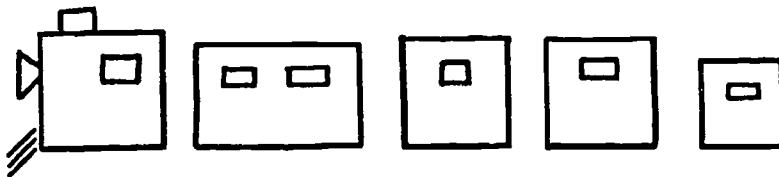

About that time Jason's little brother Dougie woke up from his nap, and he wanted to play too. His mother found him a box which was smaller than the others, but it was big enough for him to sit in, so he put it down here.

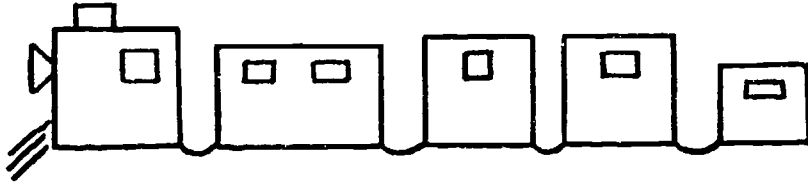

All that afternoon Jason and his friends had a great time playing in their houses. No one was fussing or fighting, and Jason's mother was really happy that they were acting like good neighbors. She even had time to bake cookies. When they were done, she took them out of the oven and went from house to house like this,

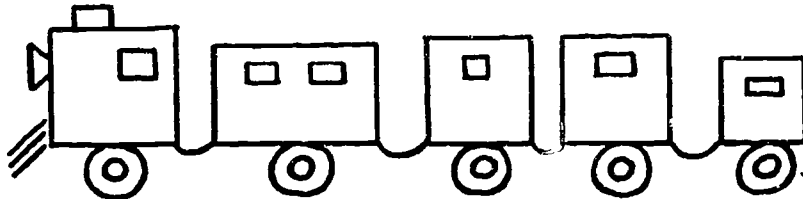

and in front of each one she left a paper plate with a big cookie on it.

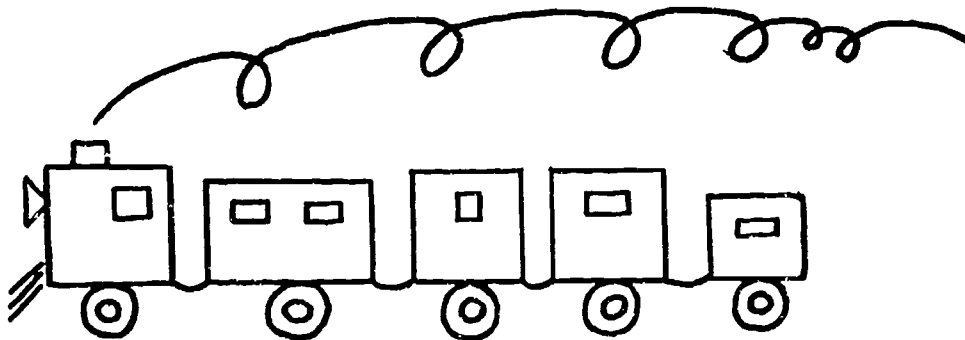

Those cookies smelled so good that they all tumbled out of their houses (like this) to eat them. Jason turned around and said, "Look, everyone. Our houses have turned into a train!" And sure enough he was right. Also, of course, the cookies were delicious.

---

# THE WATERSVILLE ZOO

---

"Can we, can we?" pleaded Nancy. "Please, can we go to the zoo?"

"You may if it's okay with Mrs. Delight," said her mother.

"Oh, I just know Mom won't care," said Carol.

"You'd better call and ask her though," advised Nancy's mother.

"All right," said Carol. A quick call and everything was arranged.

Before long the TWO GIRLS were standing in front of the main gate to the Watersville Zoo.

• •

"I'll pick you up here at three o'clock," called Nancy's mother.

"We'll be right here at the gate," Nancy called back.

"This is really going to be fun!" exclaimed Carol.

"Sure is," said Nancy as they WALKED INTO THE ZOO.



As they walked through the gate, Carol motioned excitedly.

"Look, look over there," she said, pointing to a huge brown camel.

"Isn't he big!" said Nancy.

"And look at the TWO LARGE HUMPS on his back," said Carol.



"Is it true camels store water in their humps?" asked Nancy.

"That's what I read in a book," said Carol.

Next, the girls WALKED . . .



. . . over to the SEAL POOL.

• •

"Look at them swim and dive," said Nancy.

"I sure wish I could swim that fast," said Carol.

"Now let's go over to see the polar bears next," said Nancy.

"They're always fun to watch, too."

"Okay," agreed Carol. "Remember last summer when one of the mother bears had twin cubs?"

"Oh, yes! I wonder how big they've grown," said Nancy.

"Let's have a look," said Carol as they walked along the long CURVING PATH to the polar bear area.



From *Stories to Draw*, by Jerry J. Mallett and Marian R. Barch.  
 © 1982. Available from Freline, Inc., Box 889, Hagerstown,  
 Maryland 21741 (800) 448-4887.

When they arrived at the polar bear POOL, they saw that all the bears were fast asleep in the sun.

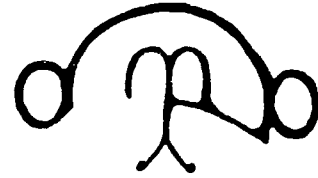

"Too bad they're all snoozing," said Nancy.  
"Well," suggested Carol, "let's go on to the new Animal Mountain. We can come back when the bears are awake."

So they WALKED DOWN THE PATH leading to the new Animal Mountain.

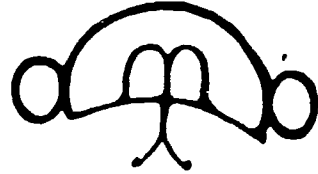

On their way they passed a LARGE GOLDFISH POND.  
"What beautiful fish," said Nancy.  
"Yes, I've never seen goldfish so large," added Carol.

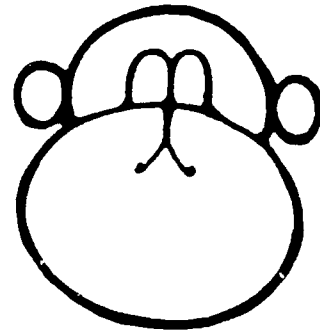

As they turned away from the goldfish pond, they caught their first glimpse of the new Animal Mountain. It was huge and had many animals on it. "Mountain goats!" exclaimed Carol. "I don't know how they ever manage to balance on those high rocks. Look at those TWO."

"It makes me scared just watching them," said Nancy.

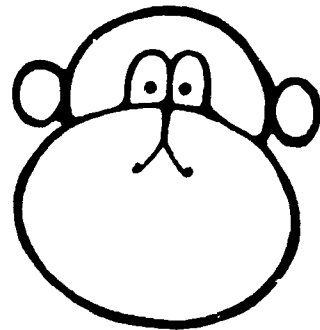

Then both girls started laughing, because right in front of them one of the animals had poked its head up and was staring right at them. While it watched them it ate a BANANA.

"Wouldn't you just love to take him home with us?" asked Carol. What kind of animal was it?

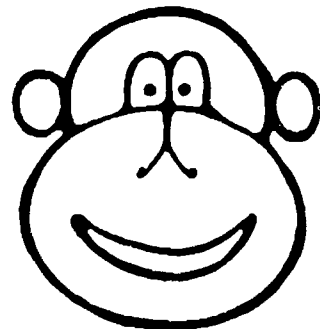

From *Stories to Draw*, by Jerry J. Mallett and Marian R. Barch. © 1982. Available from Freline, Inc., Box 889, Hagerstown, Maryland 21741 (800) 448-4887.

**CIRCUS ELEPHANT**

*by Lois Grant, Rapides Parish Library*

**HERE COMES THE TRAIN!**

From *Let's Take A Ride*, by William Hooks, Barbara Bienner, Joanne Oppenheim, Seymour Keit, Joan Auclair. Text copyright © by Bank Street College of Education. Illustrations copyright © 1986 by Barron's Educational Series, Inc. Reprinted by arrangement with Barron's Educational Series, Inc., Hauppauge, New York.

**HIDDEN PICTURES**

Reprinted from *Hidden Pictures Coloring Book - Cars, Trucks, Trains, and Planes*, © 1989 with permission from Price Stern Sloan Inc., Los Angeles.

**IF I RODE A TRAIN**

From *Story Sparklers (Starters and Extenders for 66 Noted Children's Picture Books)*, by Jean Stangl, 1991. Reprinted with the permission of T.S. Denison Co. MPLS MN.

**LION IN CAGE**

*by Lois Grant, Rapides Parish Library*

**RIGHT - WRONG**

From *Resources for Every Day in Every Way*, by Cynthia Holley and Faraday Burditt, © 1989, Simon & Schuster. Reprinted by permission of the publisher.

**THINGS THAT GO**

From *Let's Take A Ride*, by William Hooks, Barbara Bienner, Joanne Oppenheim, Seymour Reit, Joan Auclair. Text copyright © by Bank Street College of Education. Illustrations copyright © 1986 by Barron's Educational Series, Inc. Reprinted by arrangement with Barron's Educational Series, Inc., Hauppauge, New York.

**TRAIN**

Used with permission of Frank Schaffer Publications, Inc. Taken from the publication *Preschool Activities* FS-3901

**TRAIN AND ENGINEER**

From *Resources for Every Day in Every Way*, by Cynthia Holley and Faraday Burditt, © 1989, Simon & Schuster. Reprinted by permission of the publisher.

**TRAIN PUZZLE**

by Lucille DeFatta, Bossier Parish Library

Copy train pattern, cut out, then cut on dotted lines.

**TRAINS**

Reprinted with the permission of Greenberg Publishing Company, Sykesville, MD 21784

**WHEELS**

From *Resources for Every Day in Every Way*, by Cynthia Holley and Faraday Burditt, © 1989, Simon & Schuster. Reprinted by permission of the publisher.

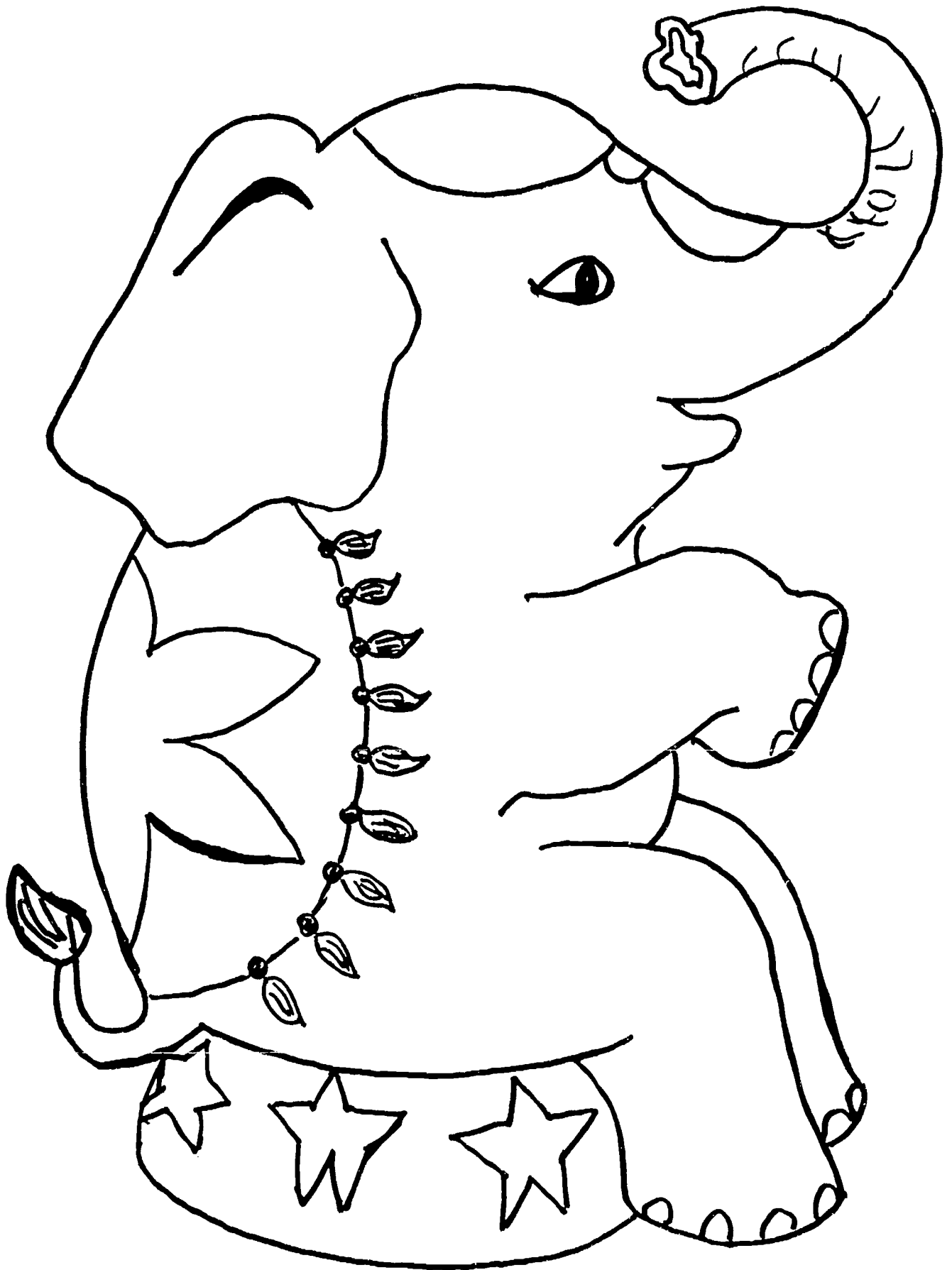

**ASSORTED COLORING PAGES**

by Chris Spitale, Tangipahoa Parish Library

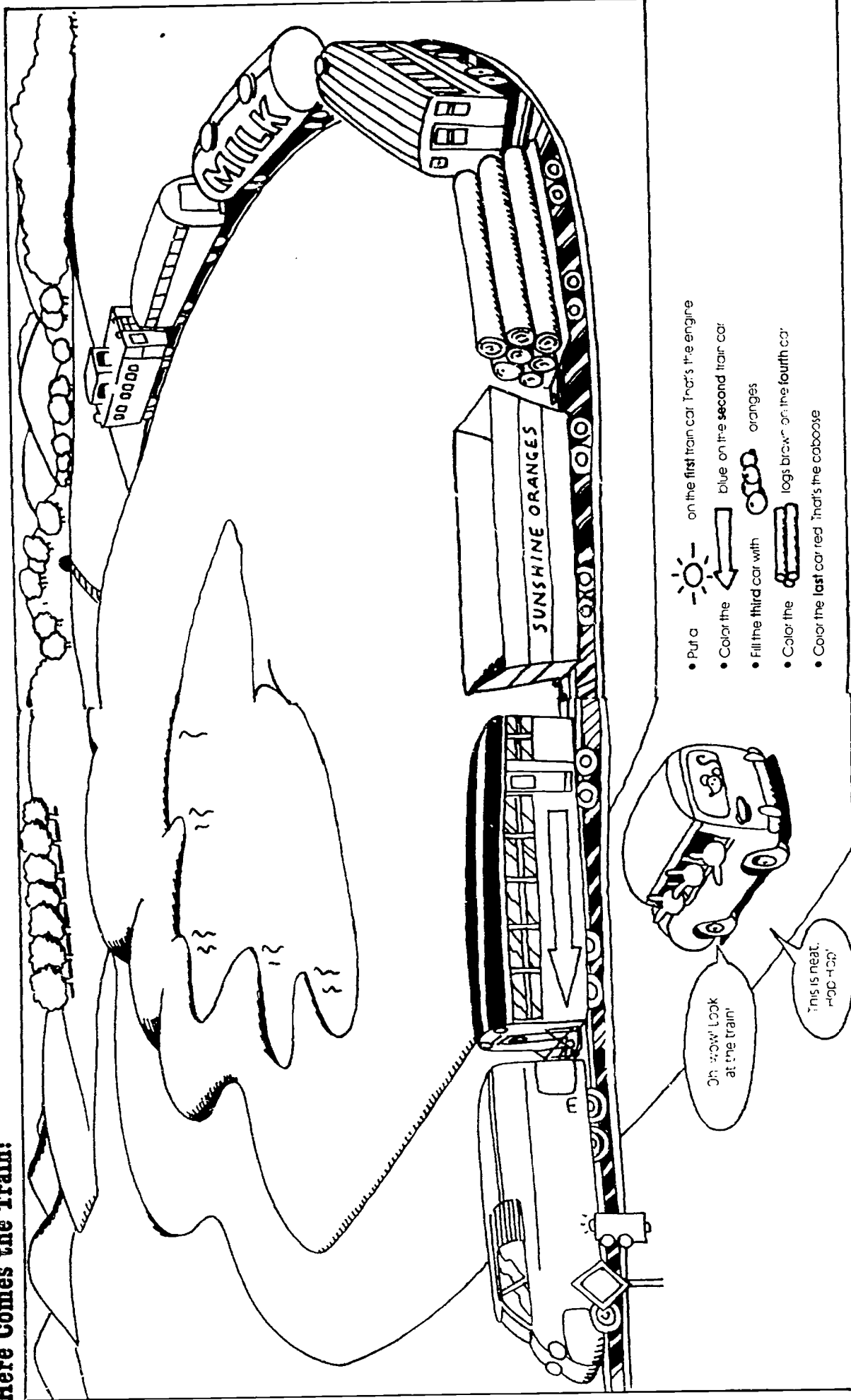

# Here Comes the Train!

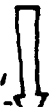

- Put a  on the first train car. That's the engine.
- Color the  blue on the second train car.
- Fill the third car with  oranges.
- Color the  logs brown on the fourth car.
- Color the last car red. That's the caboose.

Oh wow! Look at the train!

This is neat. Hop-hop!



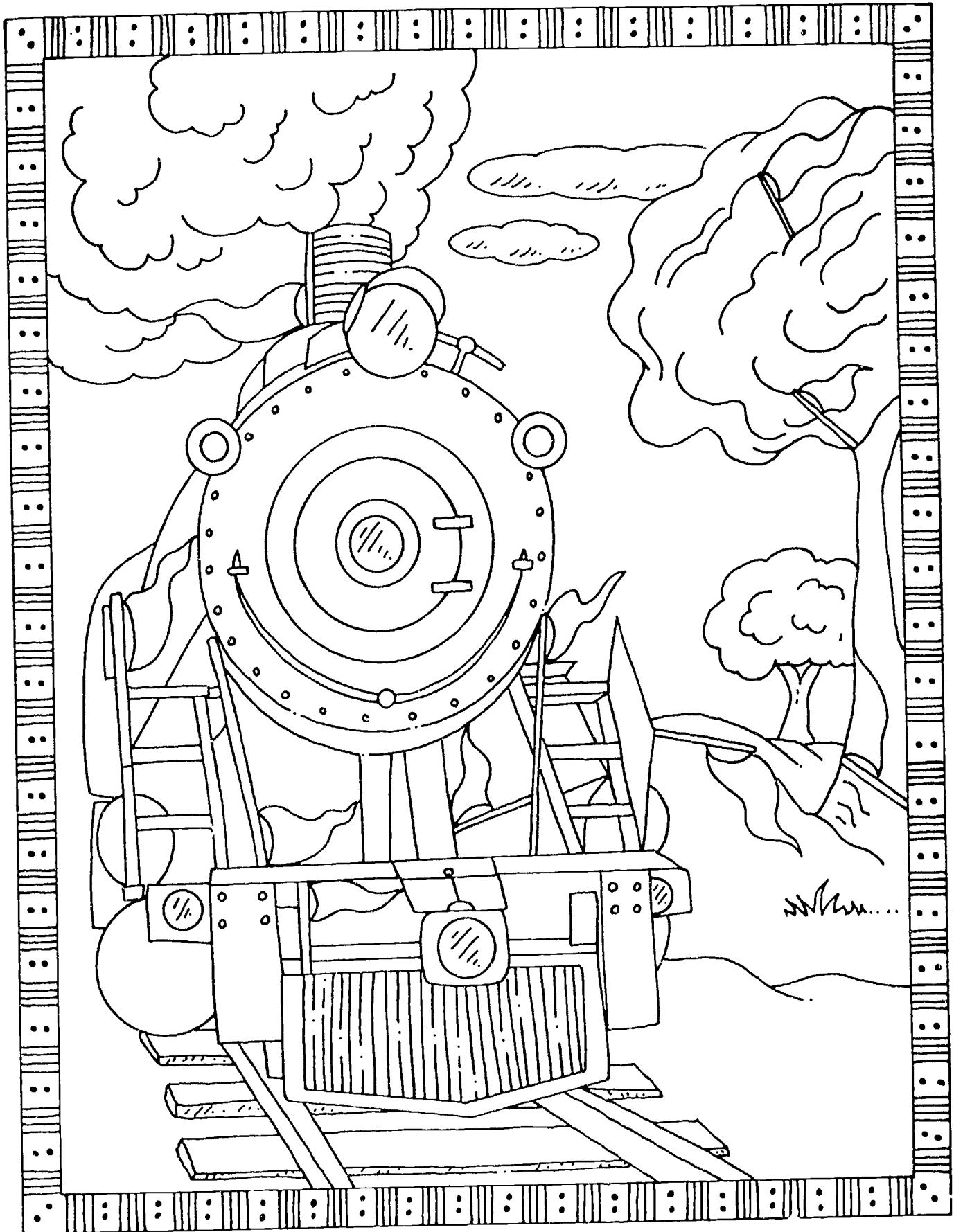

Find ten flags.

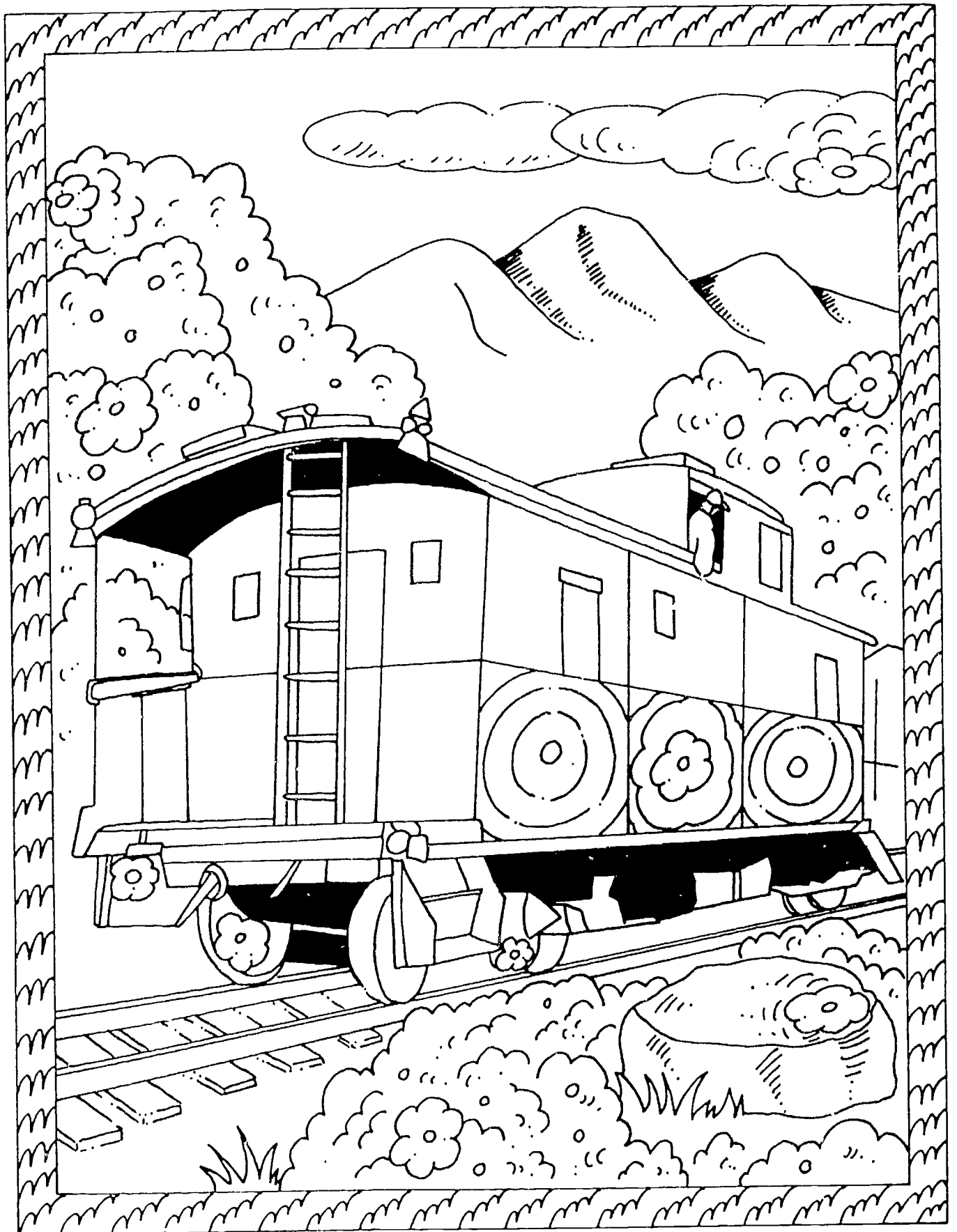

Find ten flowers.

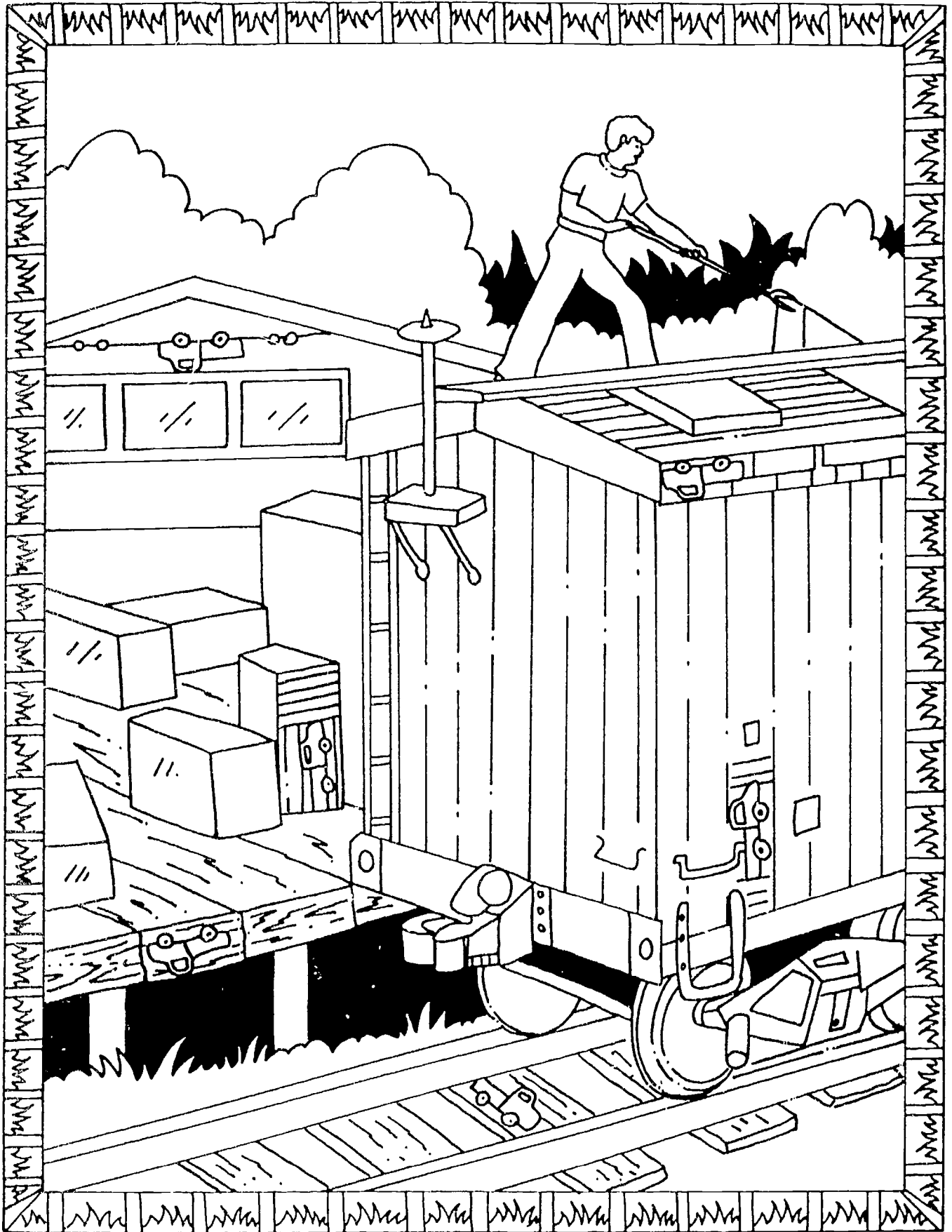

Find six pickup trucks.

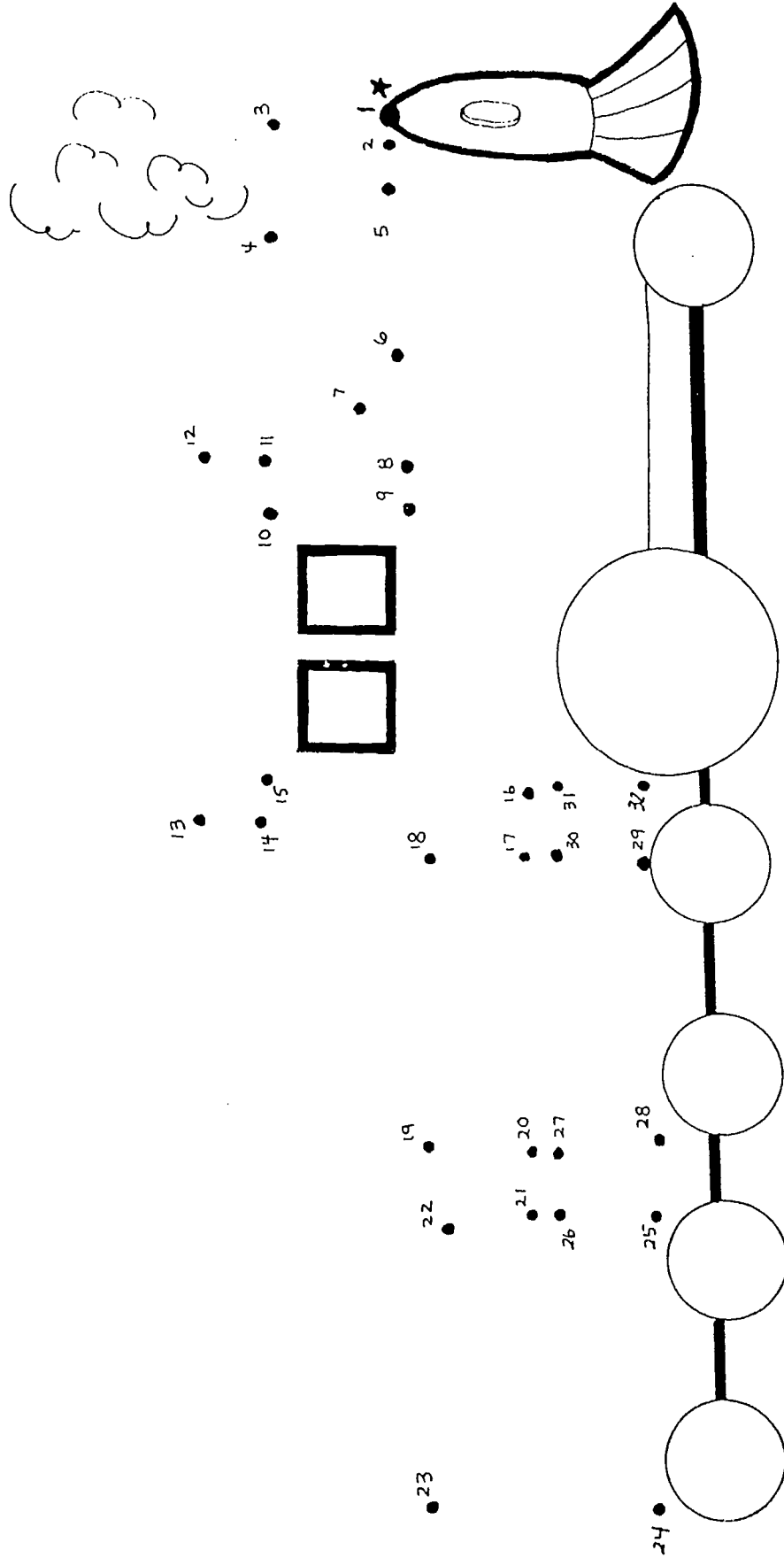

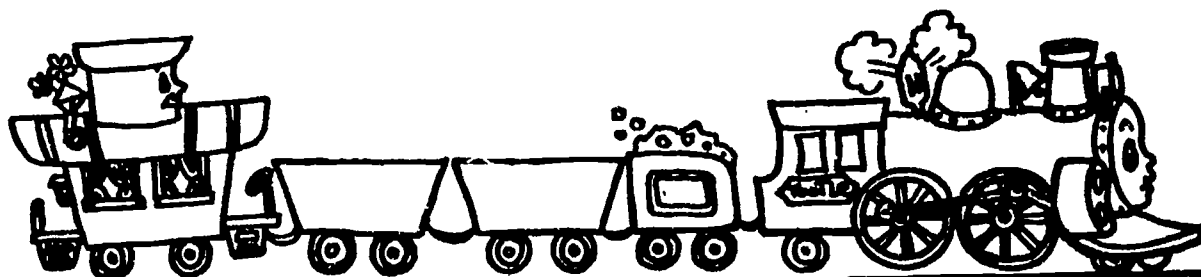

### Last Laugh

Katy Caboose is always last, but that doesn't bother her much. Think of the times you have been last. Maybe you were the last one to get a slice of pizza, but maybe it was the biggest piece and it had the most toppings. Draw a picture of a time when it was good to be last.

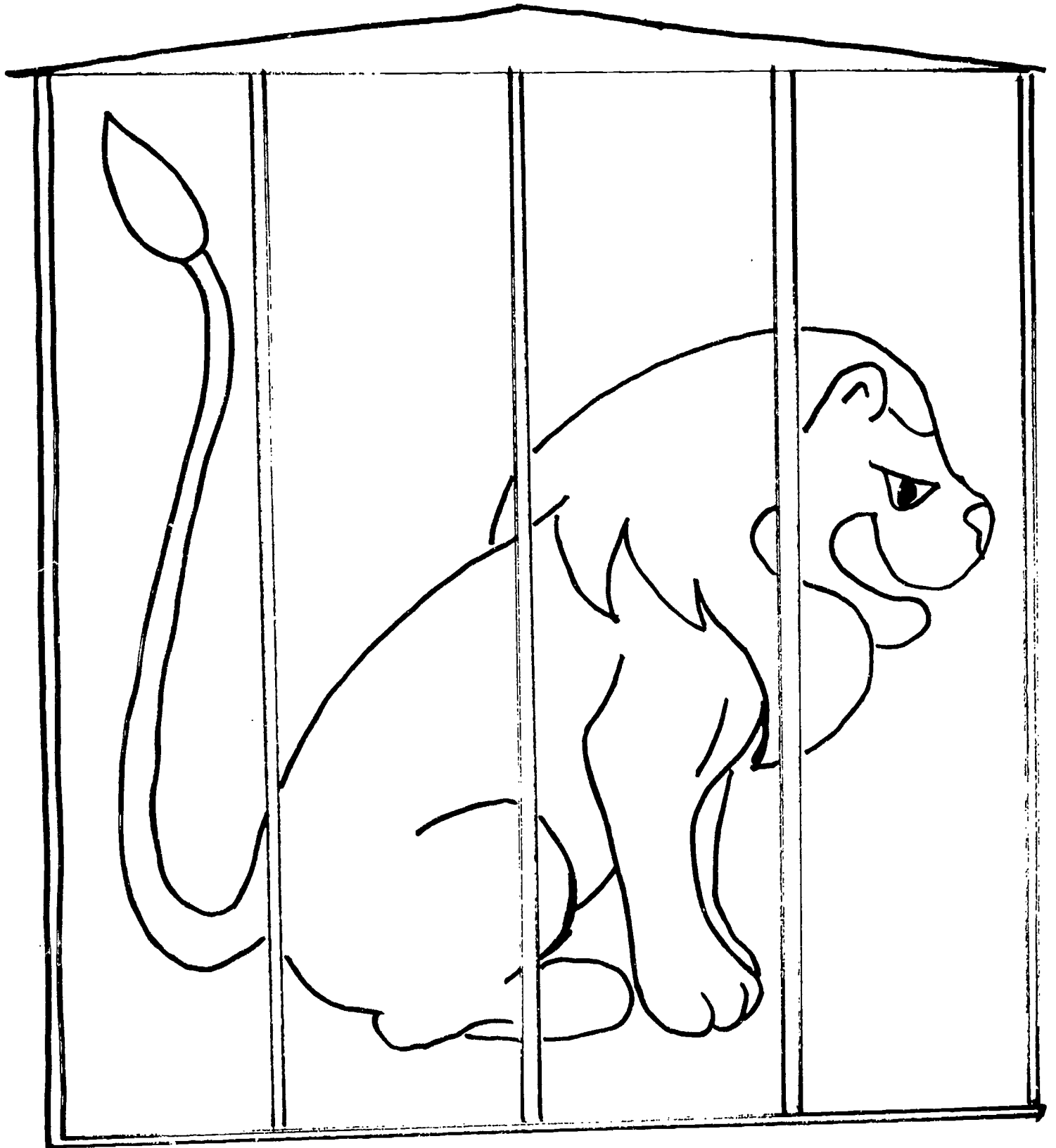

# Right • Wrong

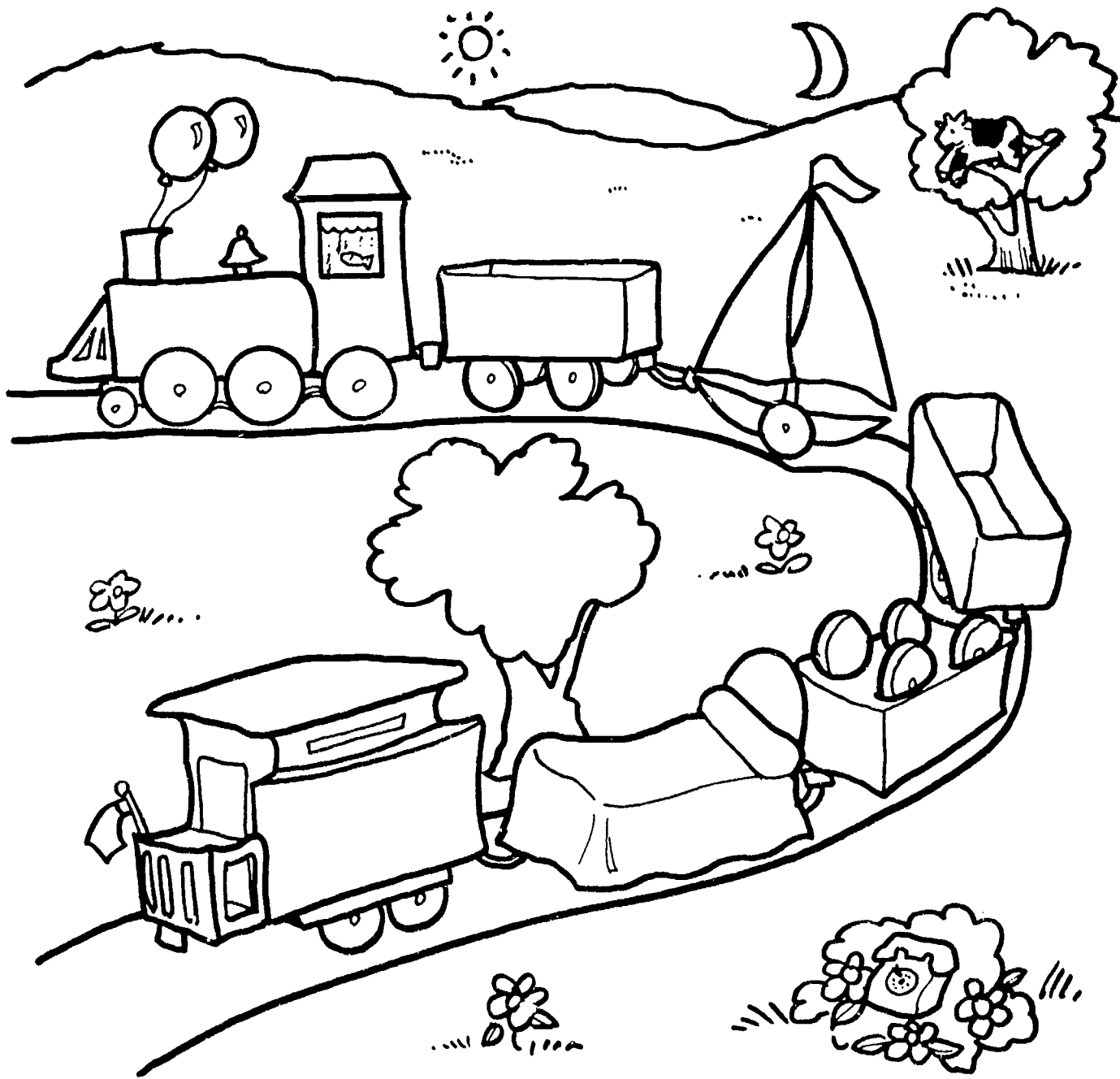

Directions: What's wrong with this picture? What's **right** with this picture? Have the children color the things that are **right** and circle the things that are **wrong**.

# Things that go!

Here are some things we've seen in these pages. Their names are all hidden in the puzzle. Circle the word that goes with each picture. One has been done for you!

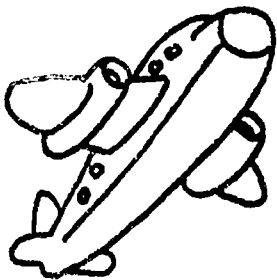
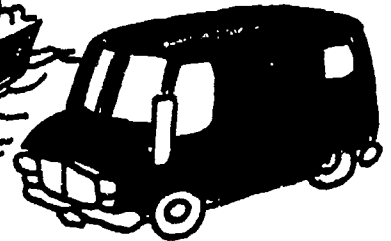
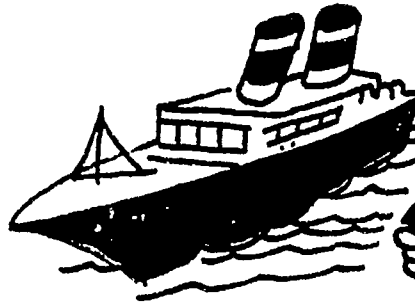
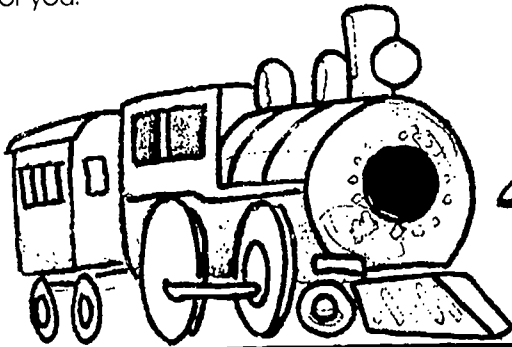

T	B	O	A	T	T	B
R	<b>T</b>	A	X	I	R	I
A	B	C	A	R	U	K
I	U	J	E	T	C	E
N	S	V	A	N	K	G
R	O	C	K	E	T	E

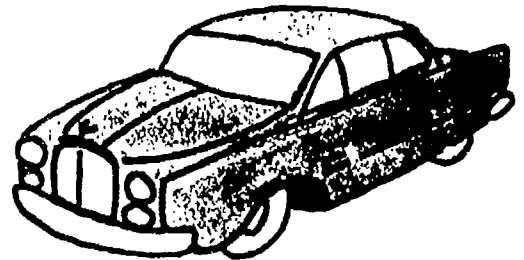
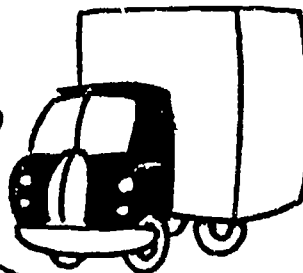
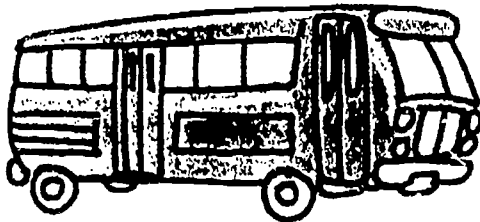
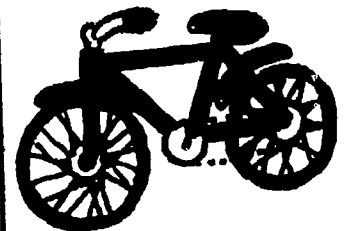
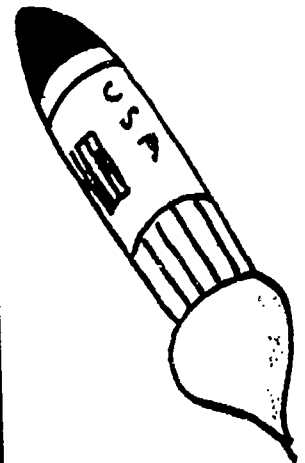

Hop Hop found 10 names, all together. How many can you find?





Name \_\_\_\_\_

### Color

○ red

□ blue

△ yellow

□ green

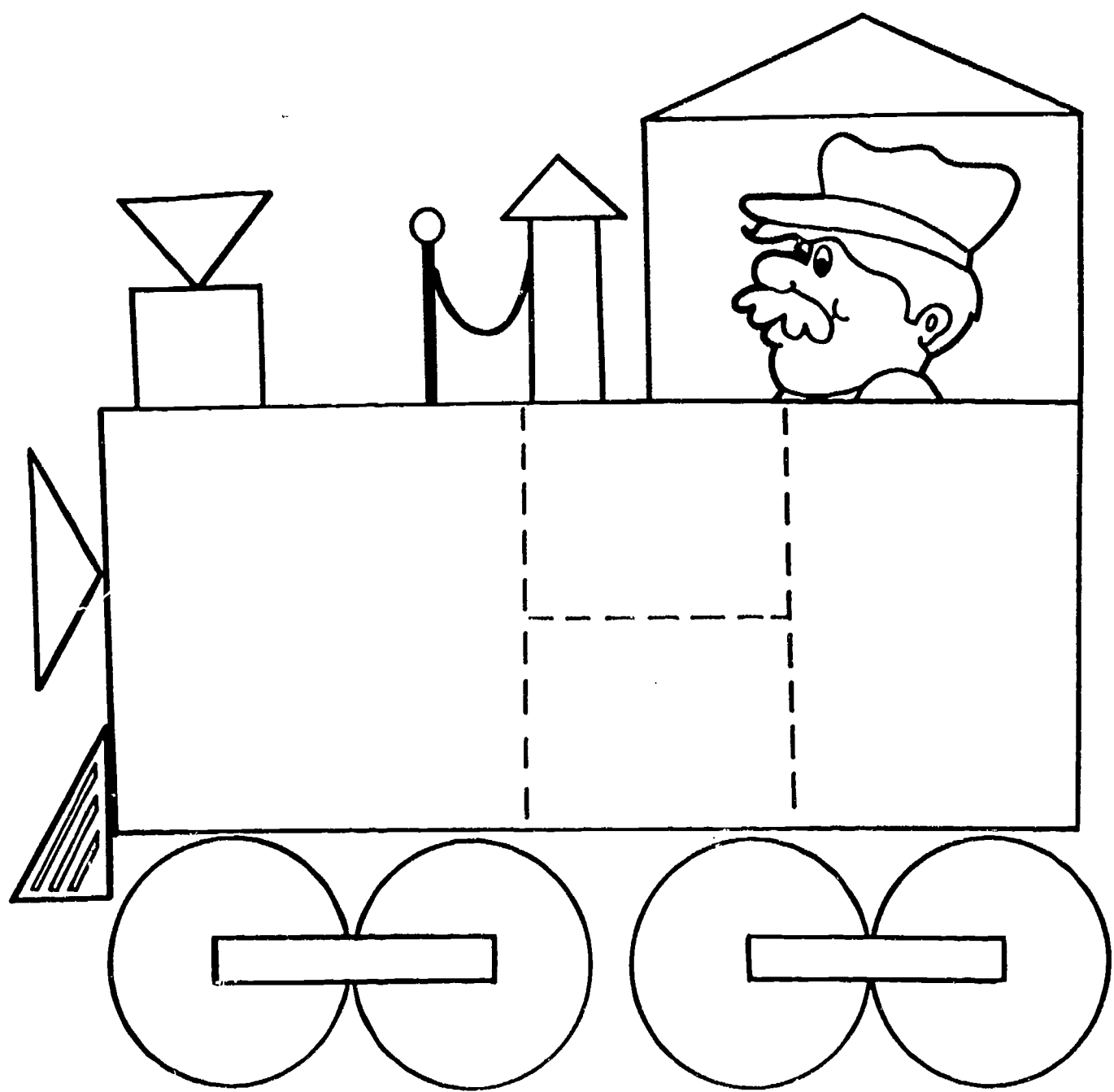

Name \_\_\_\_\_

# **Train and Engineer**

Color the train.

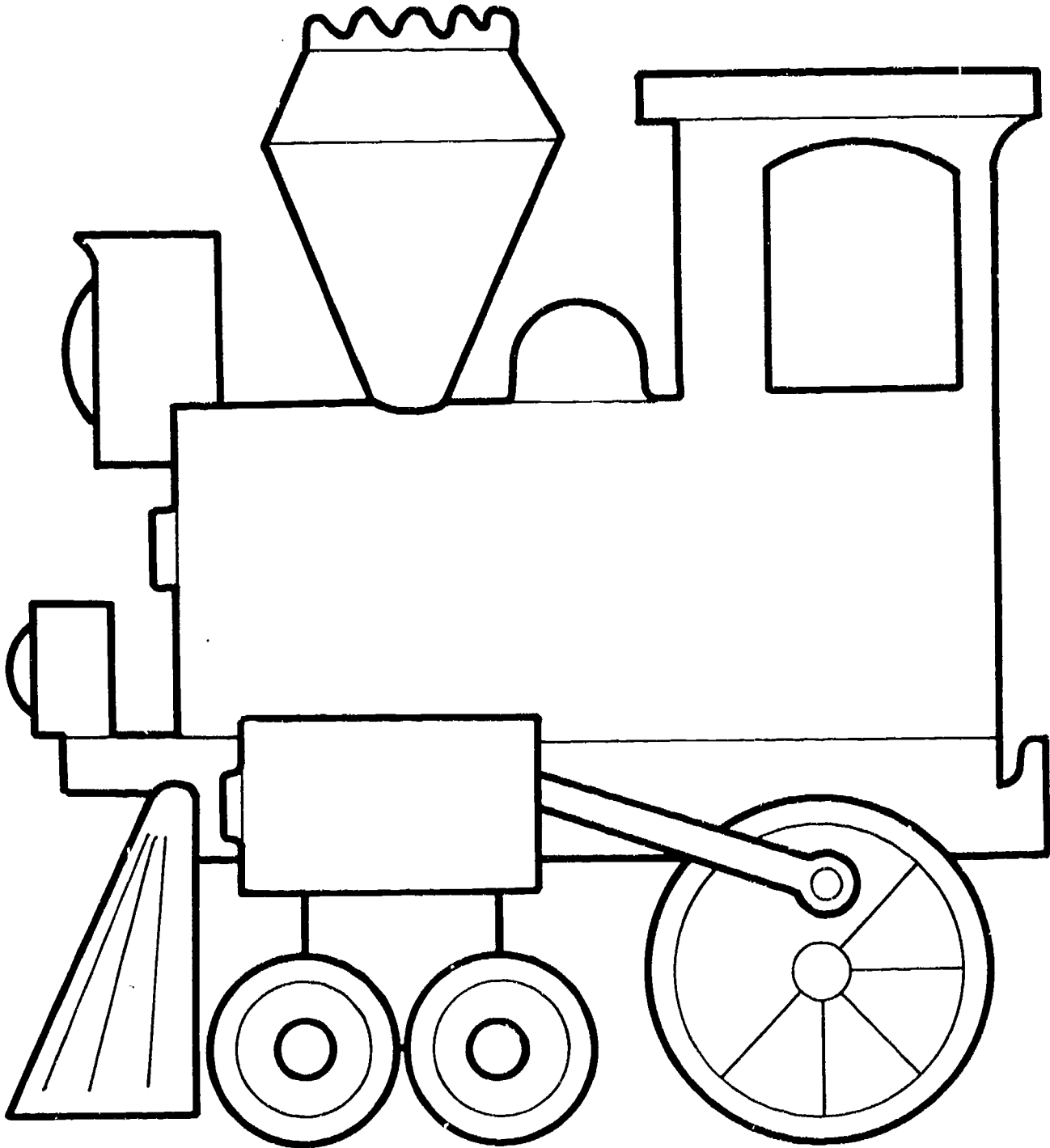

TRAIN PUZZLE

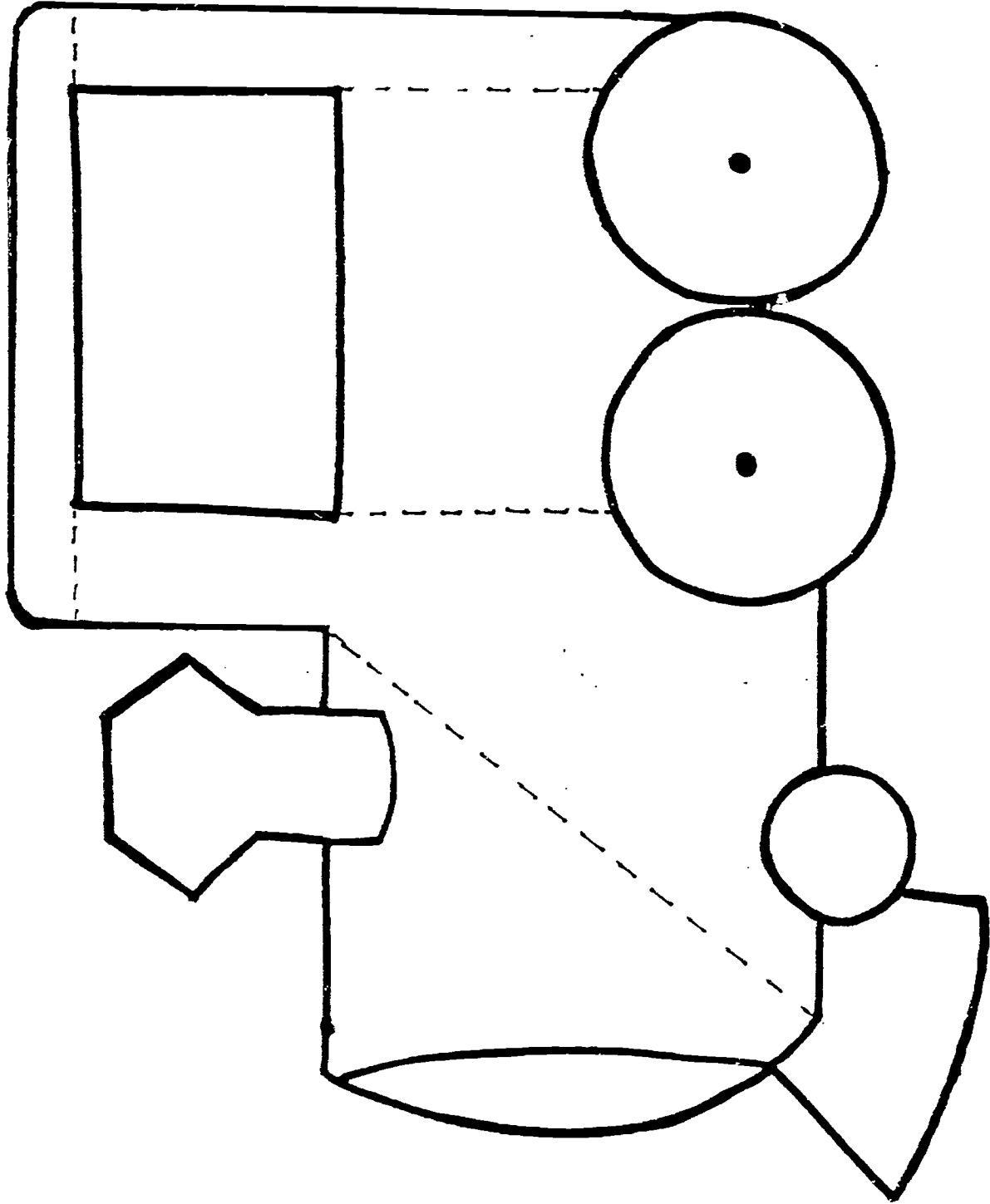

Copy train pattern onto index paper. Cut on dotted lines.

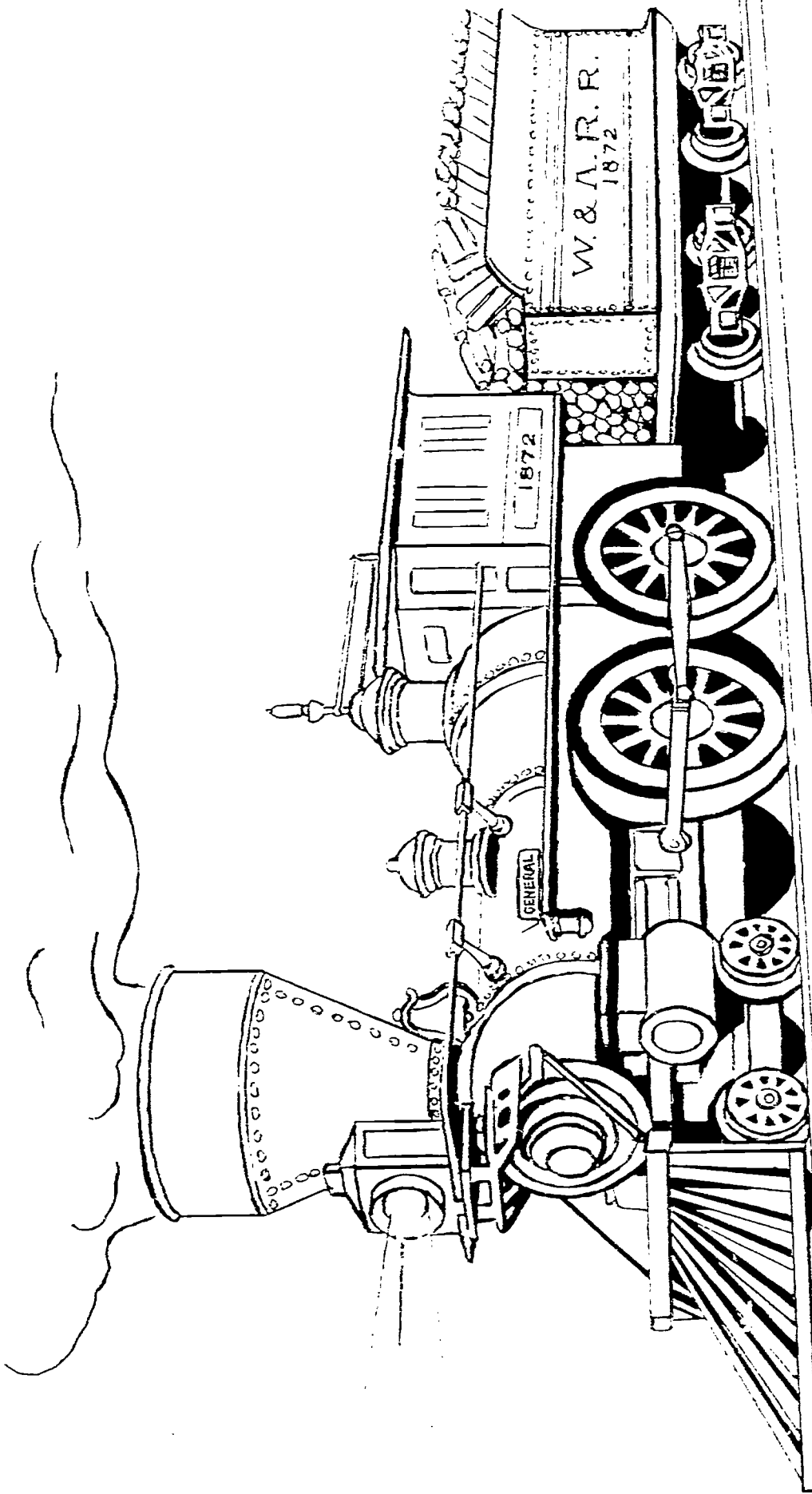

103 Here comes the 1872 "General" steam locomotive!

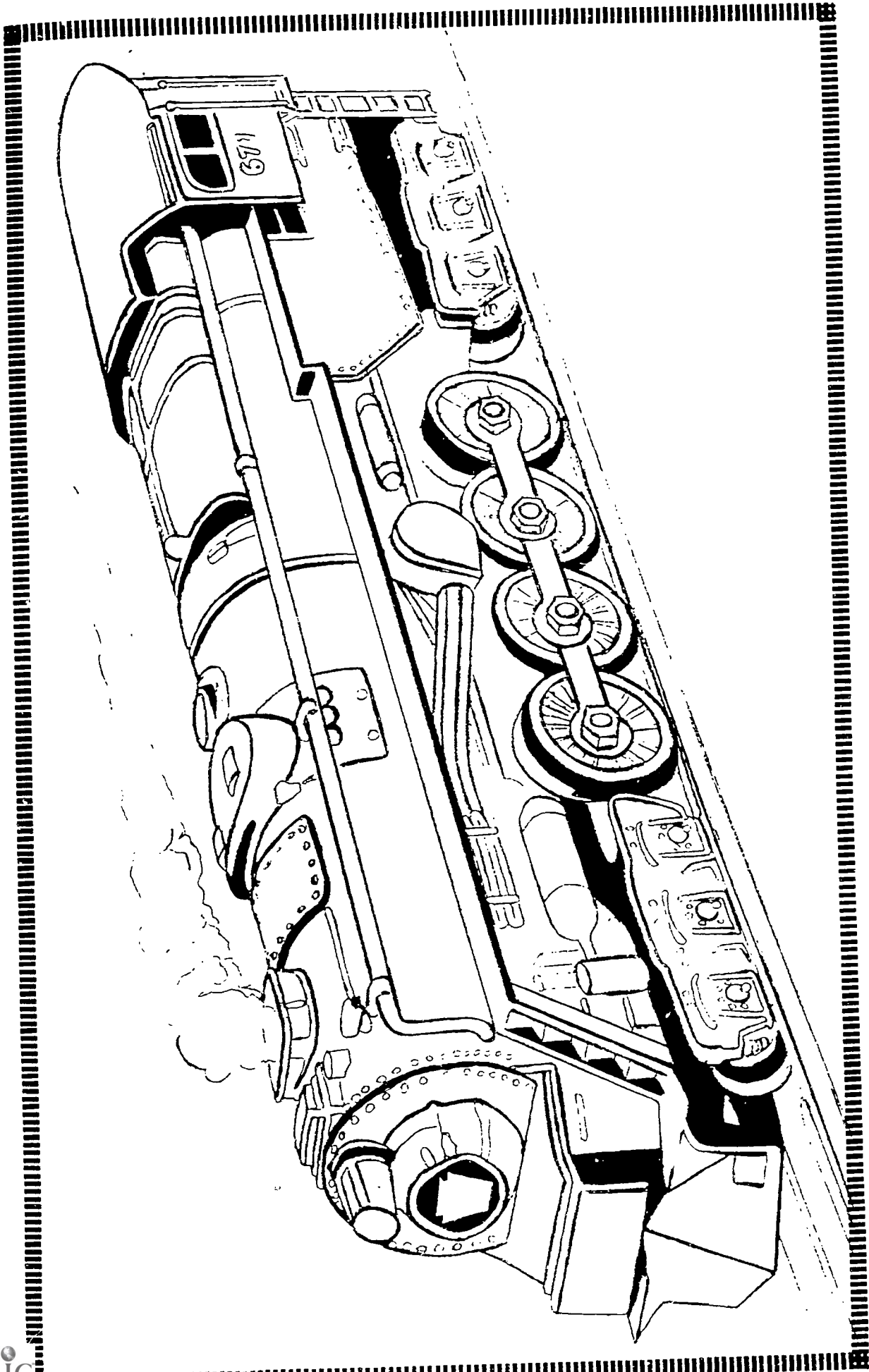

110 The 671 steam locomotive was designed originally for 110 long-distance high-speed passenger and freight service.

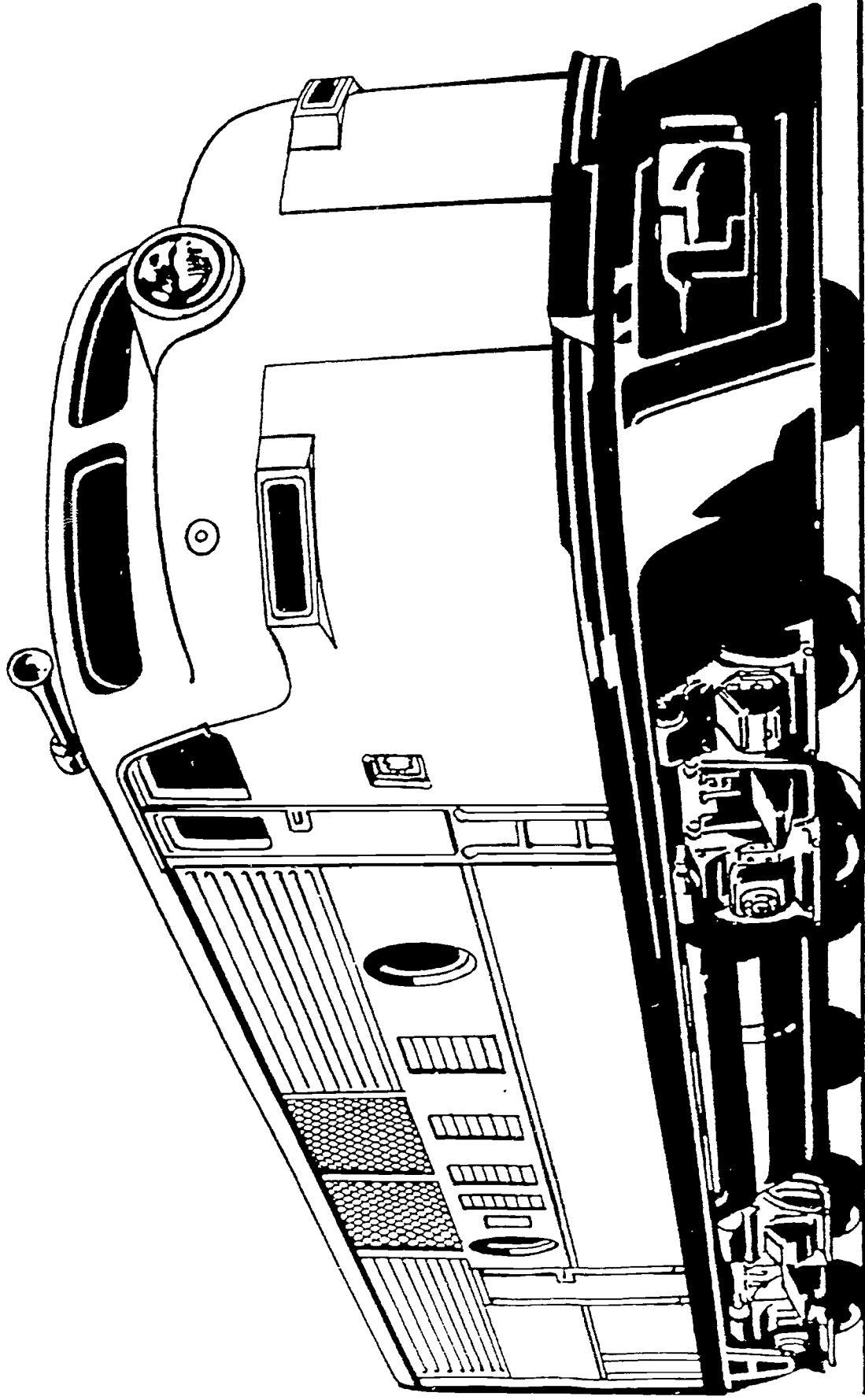

130

111

**2378 Milwaukee Road comes with a powered unit,  
shown here, and a dummy or unpowered unit.**

A tender tank is being filled with water from the 138 Water Tower.

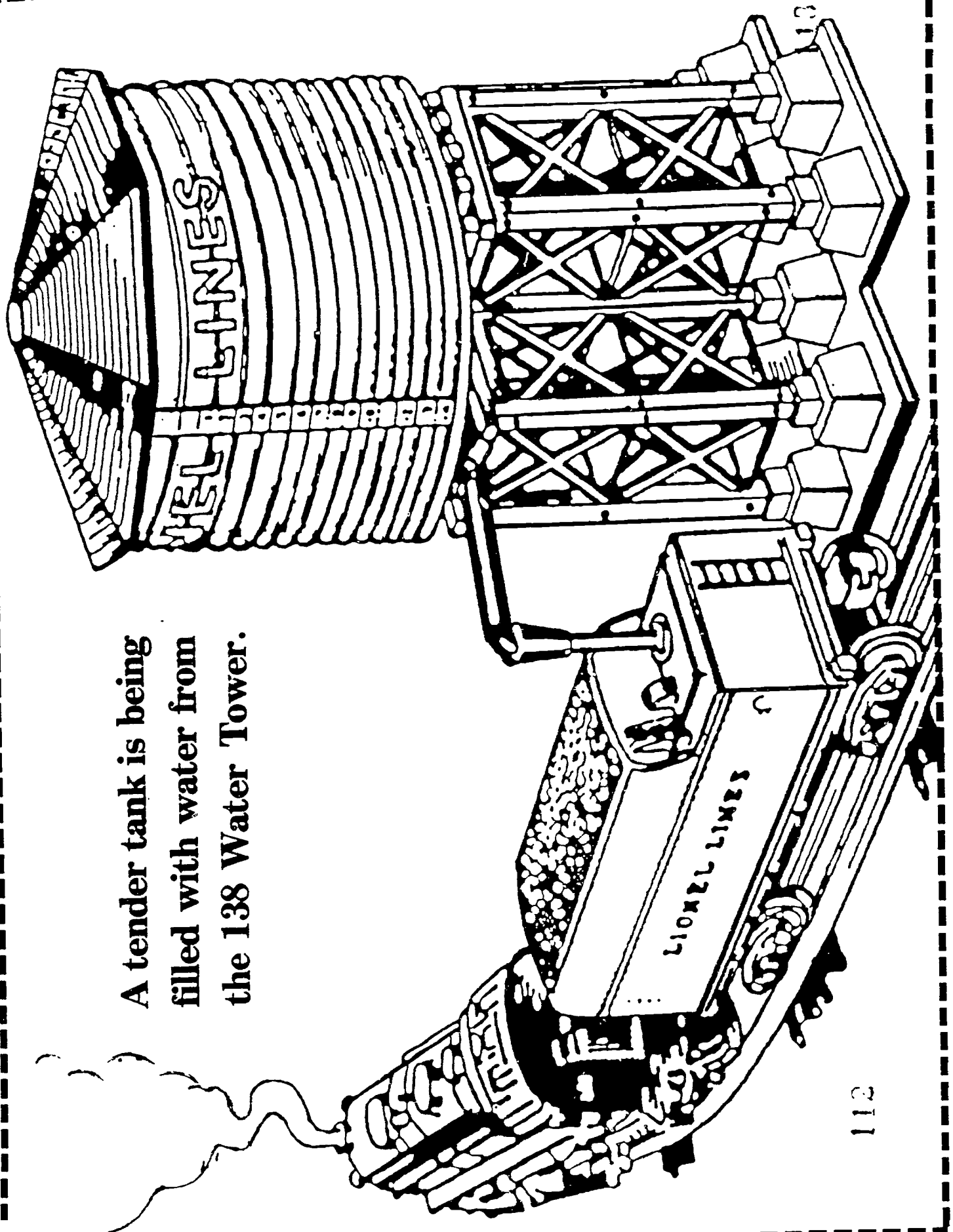

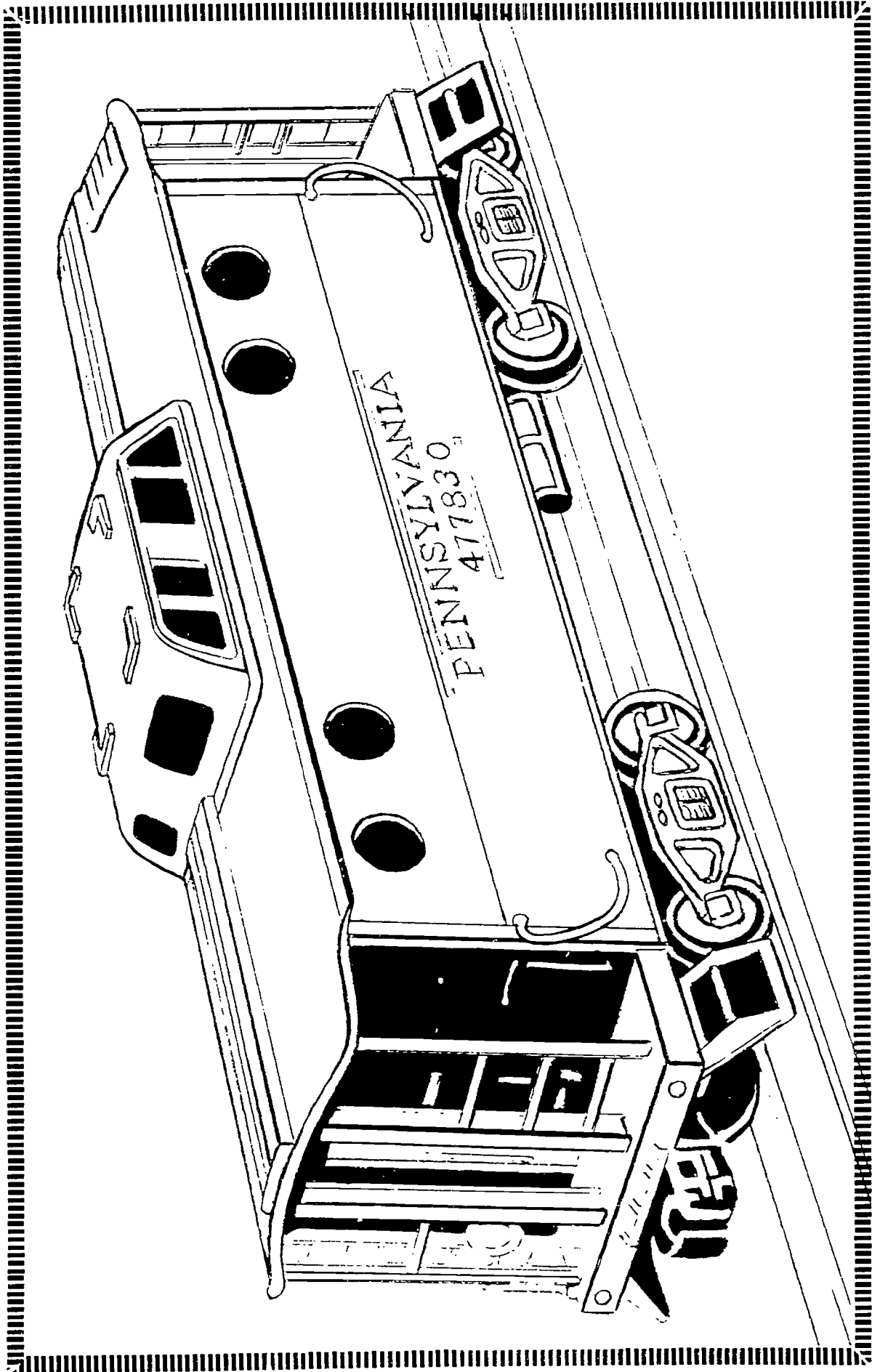

114

115

**The 6417 streamlined caboose carries the crew of the  
Pennsylvania Railroad.**



Name \_\_\_\_\_

# **Wheels**

Trace the dotted line to complete each item. Color the pictures.

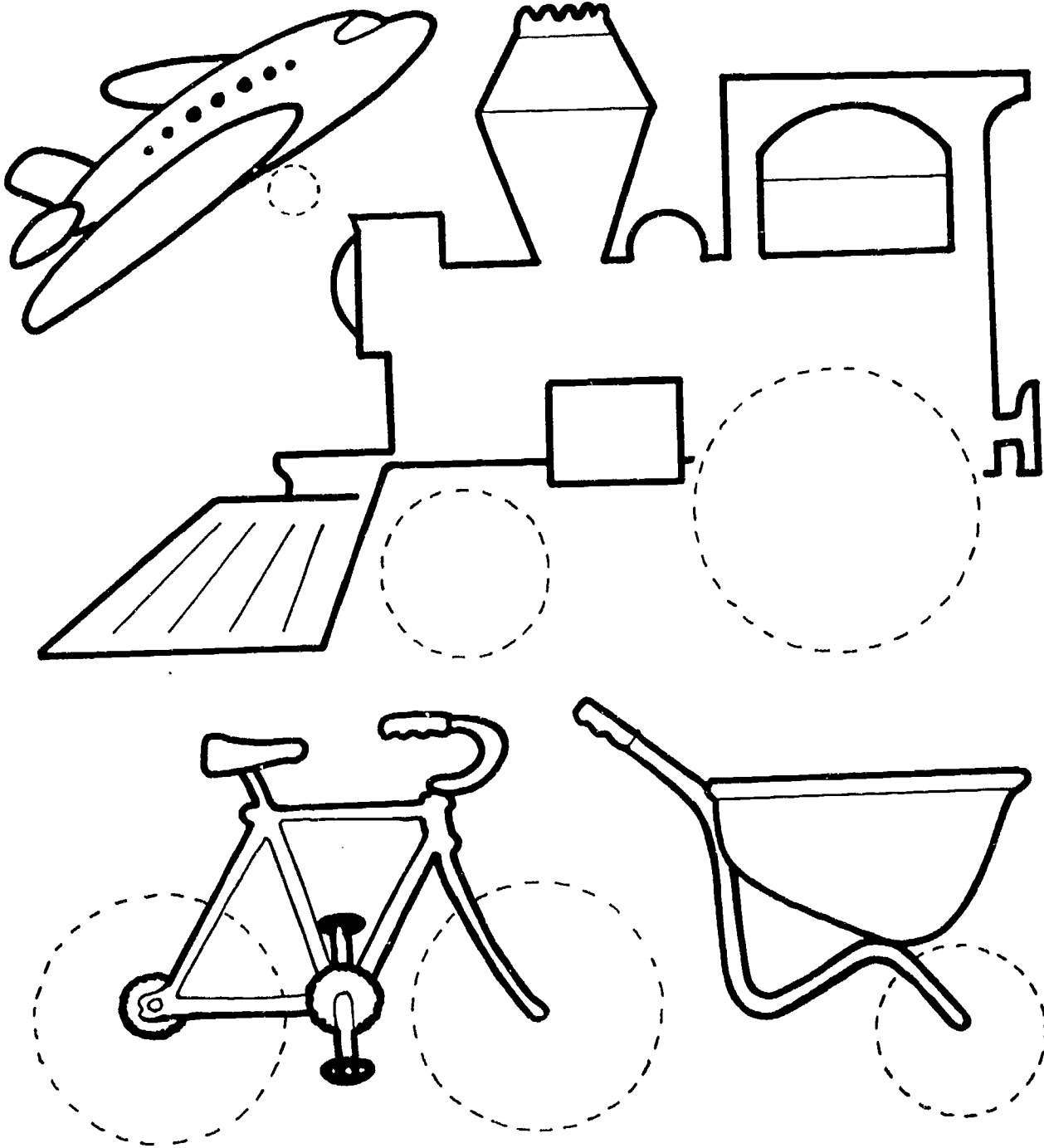

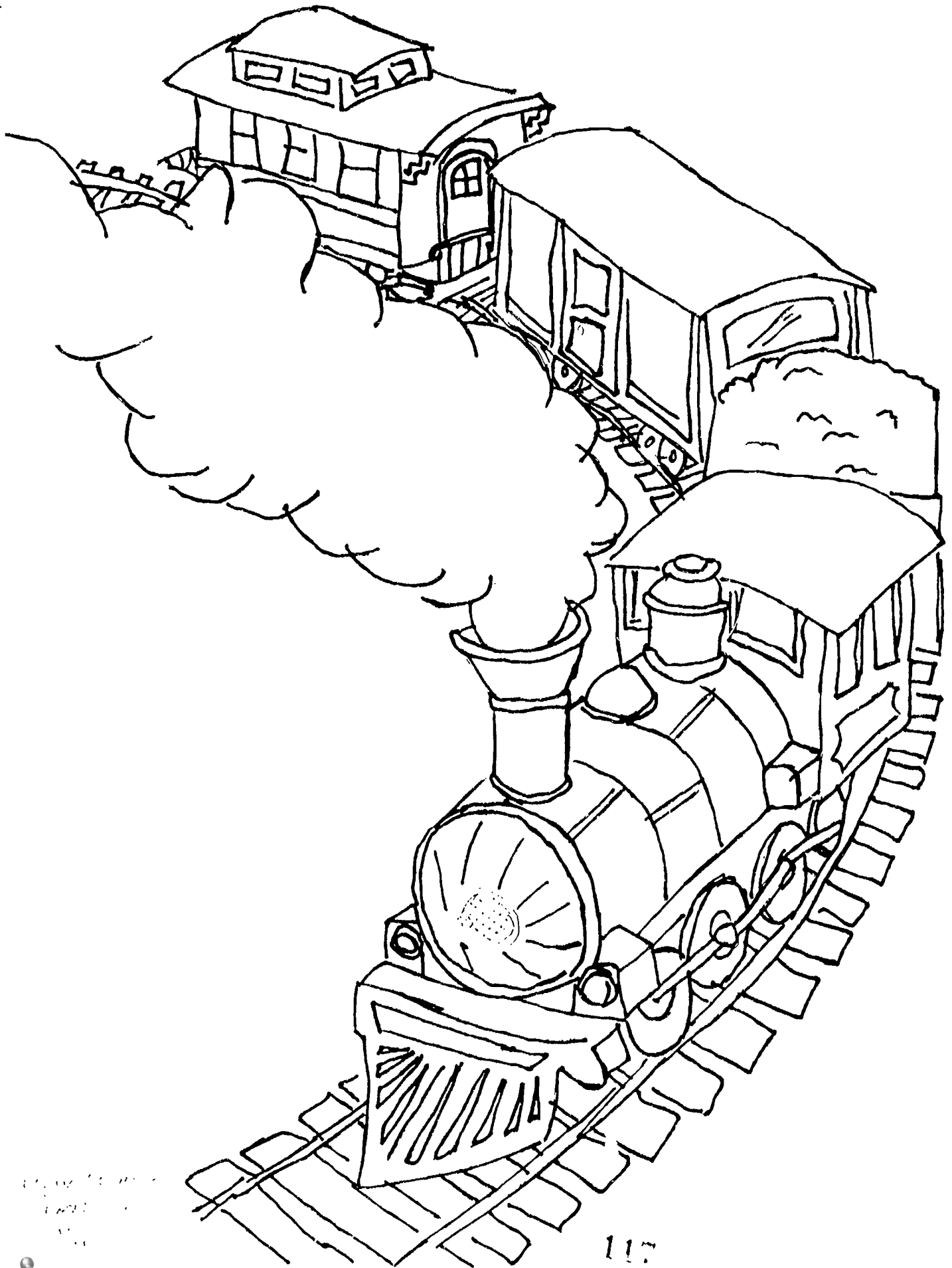

Handwritten notes in the top right corner, possibly describing the scene or the drawing process.

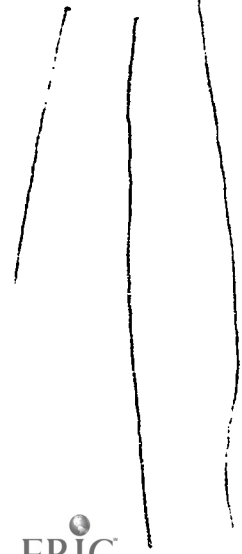
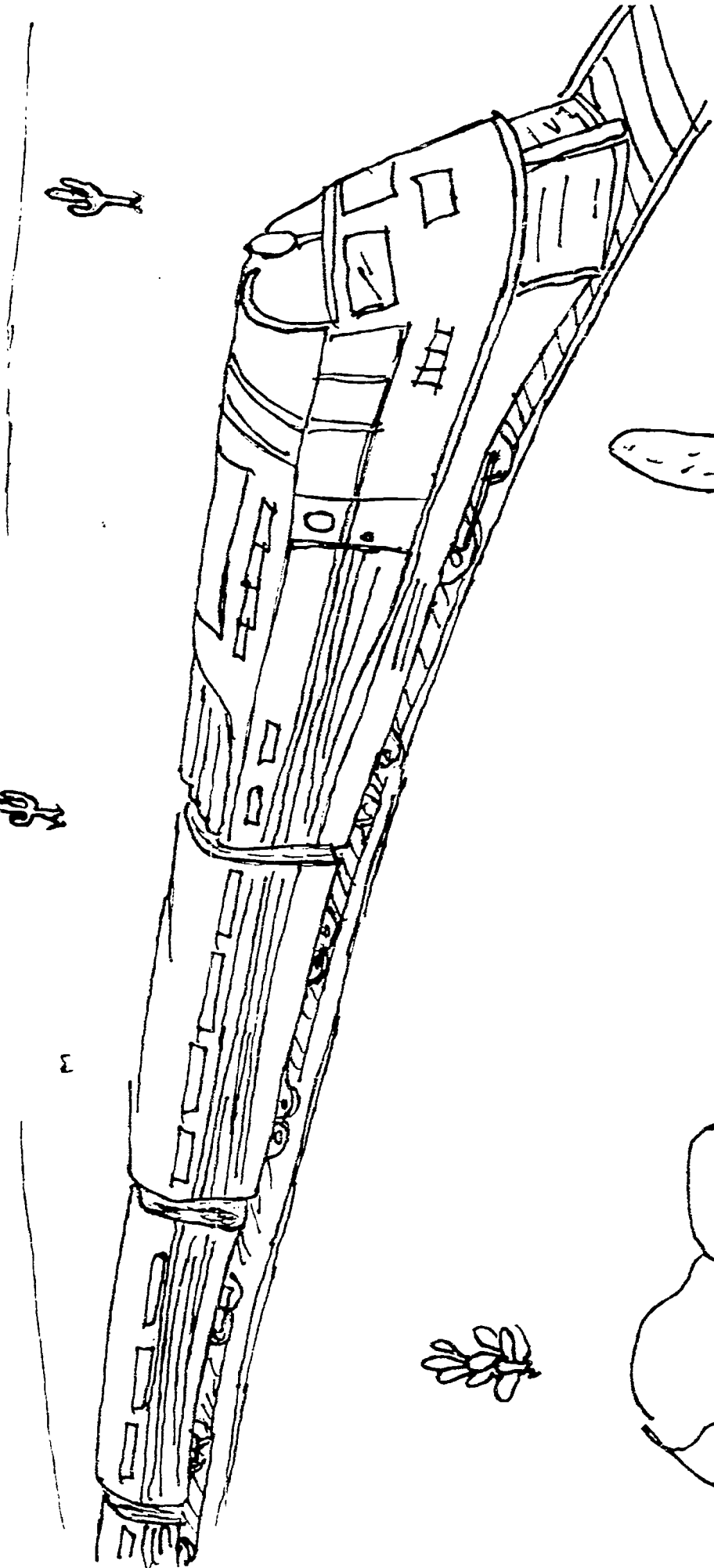
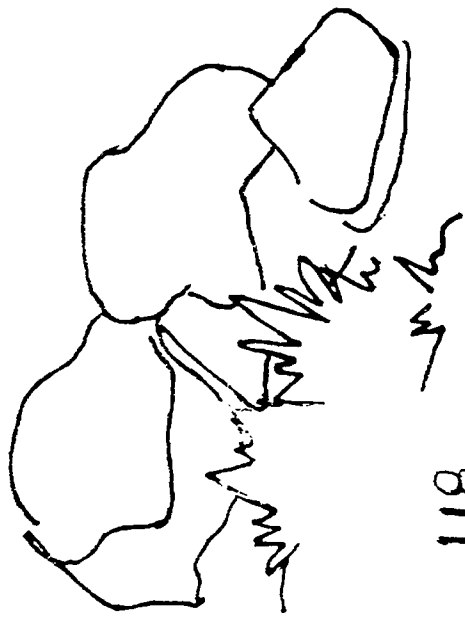
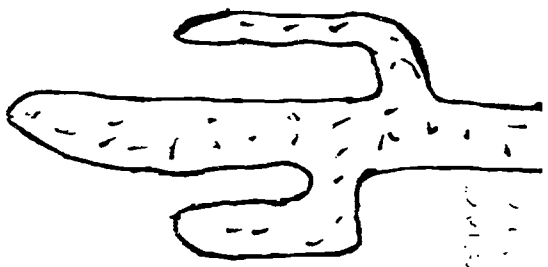

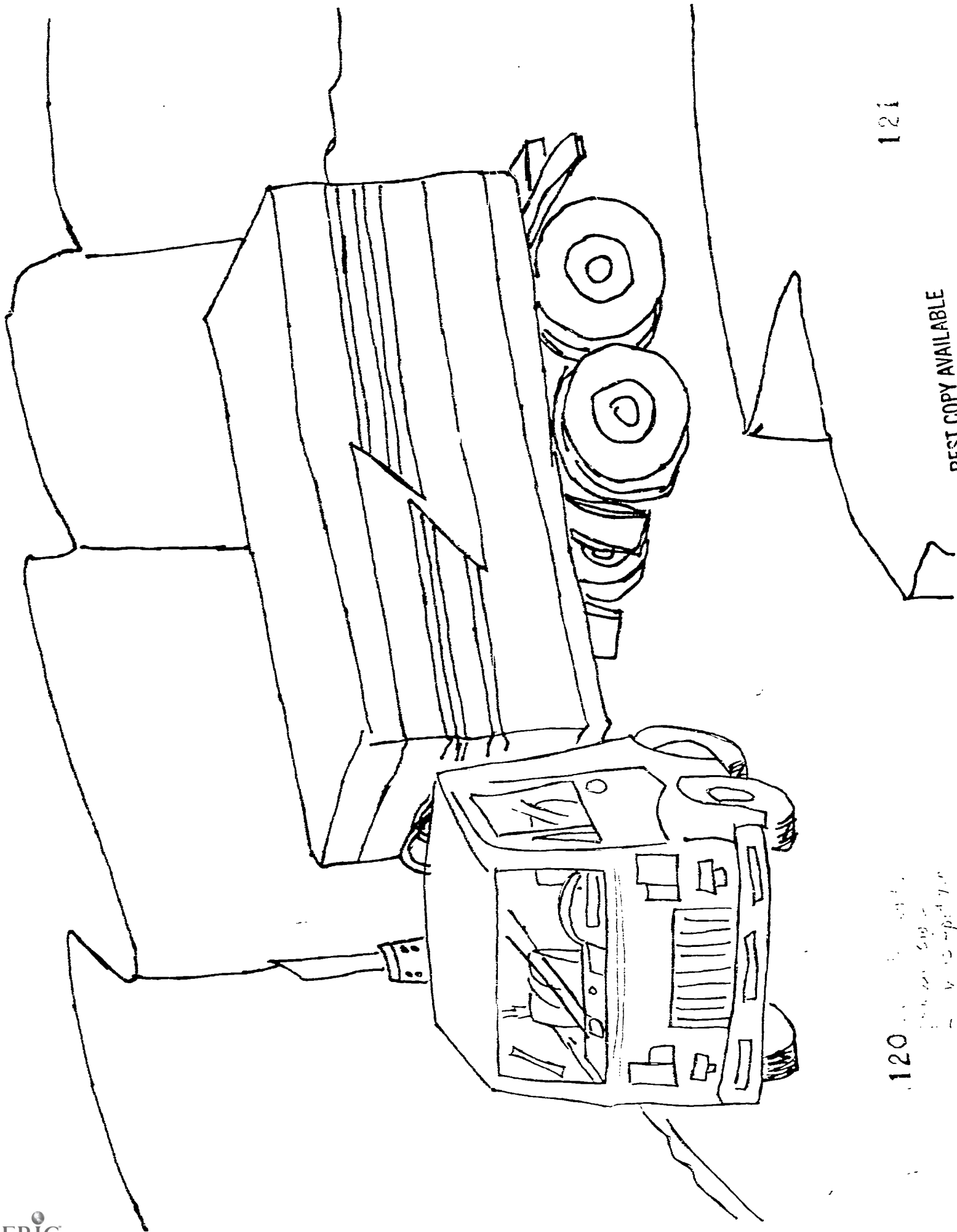

BEST COPY AVAILABLE

120  
...  
...  
...  
...

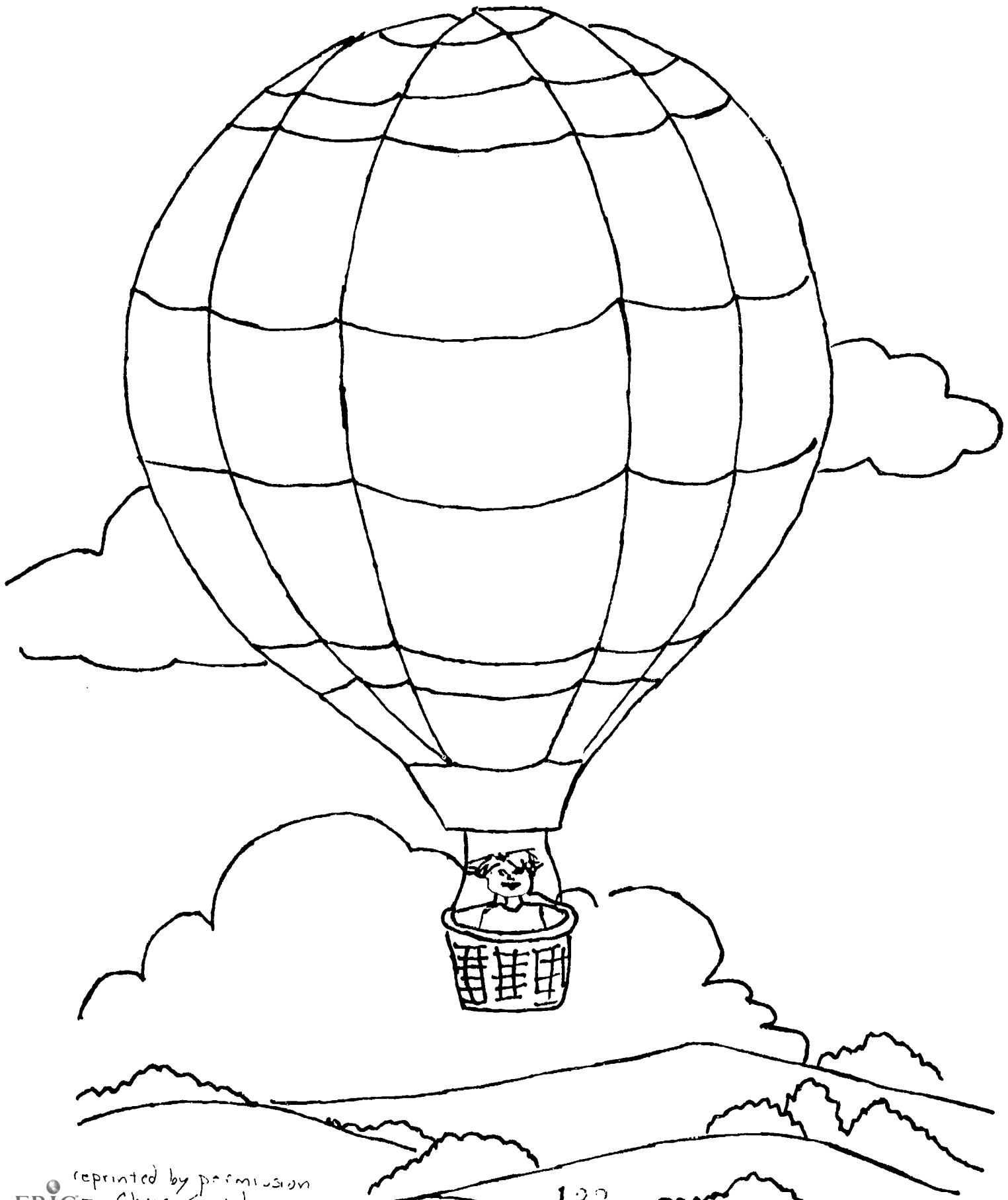

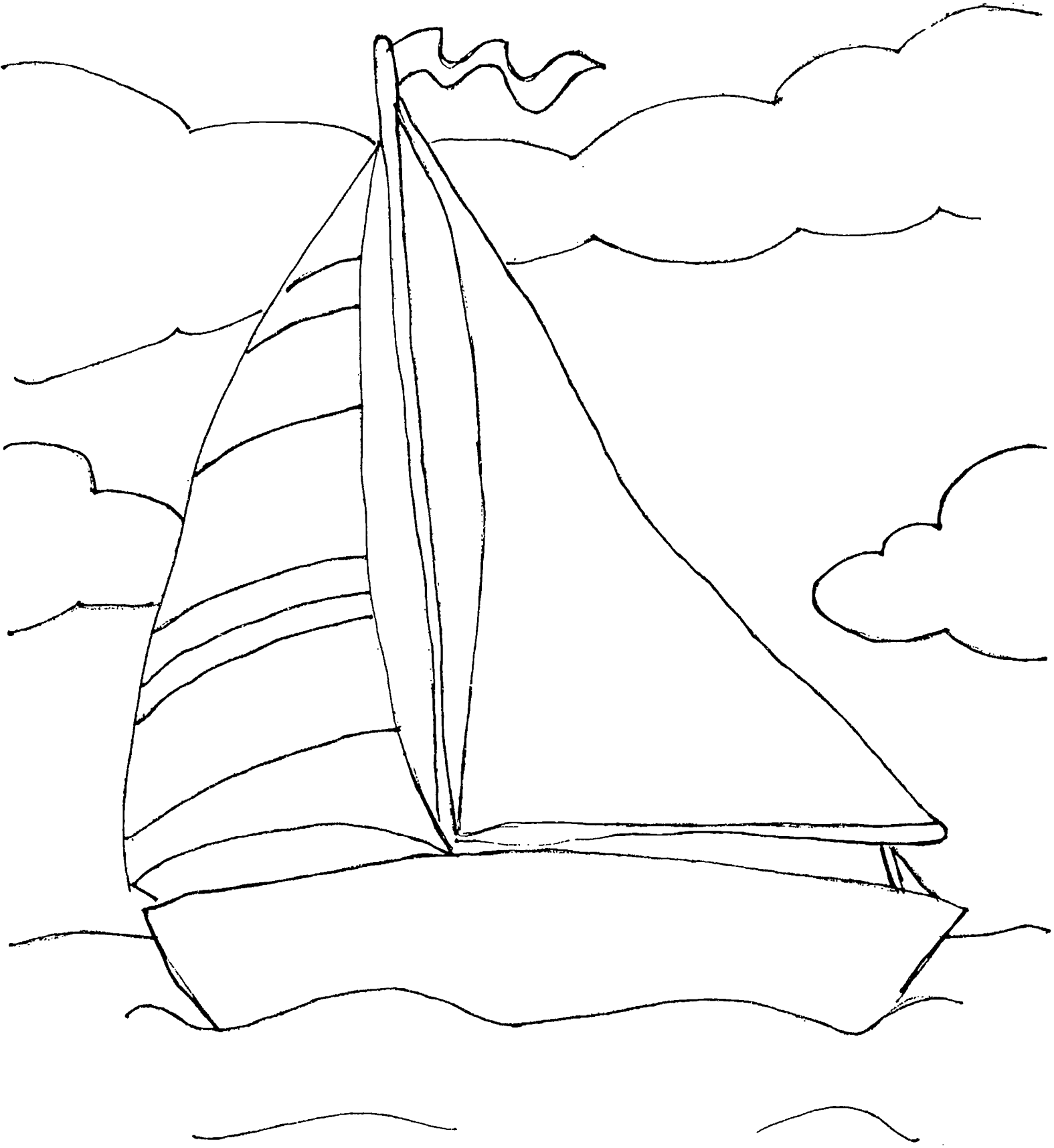

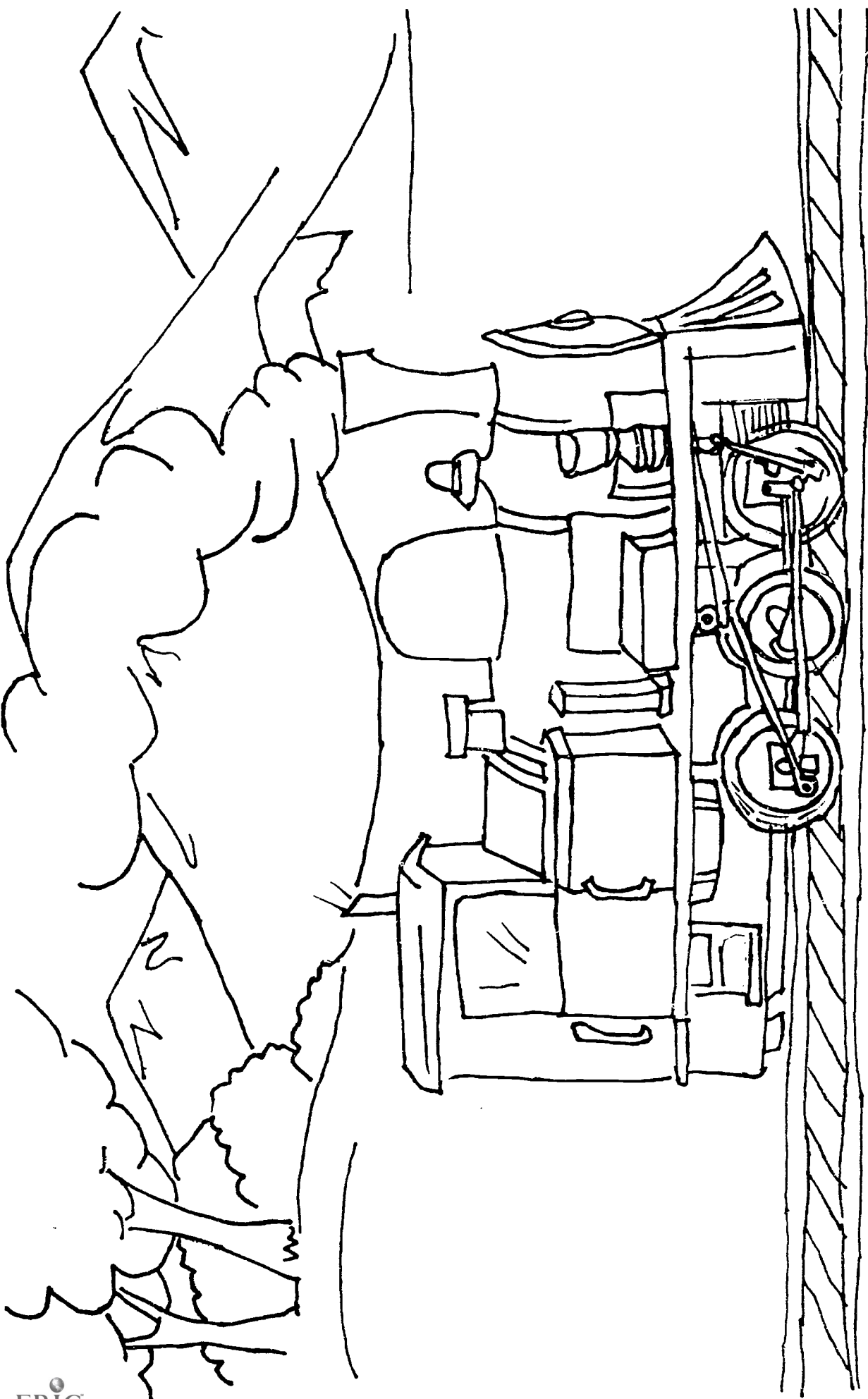

BEST COPY AVAILABLE

125

reproduced by permission  
of the copyright owner

124

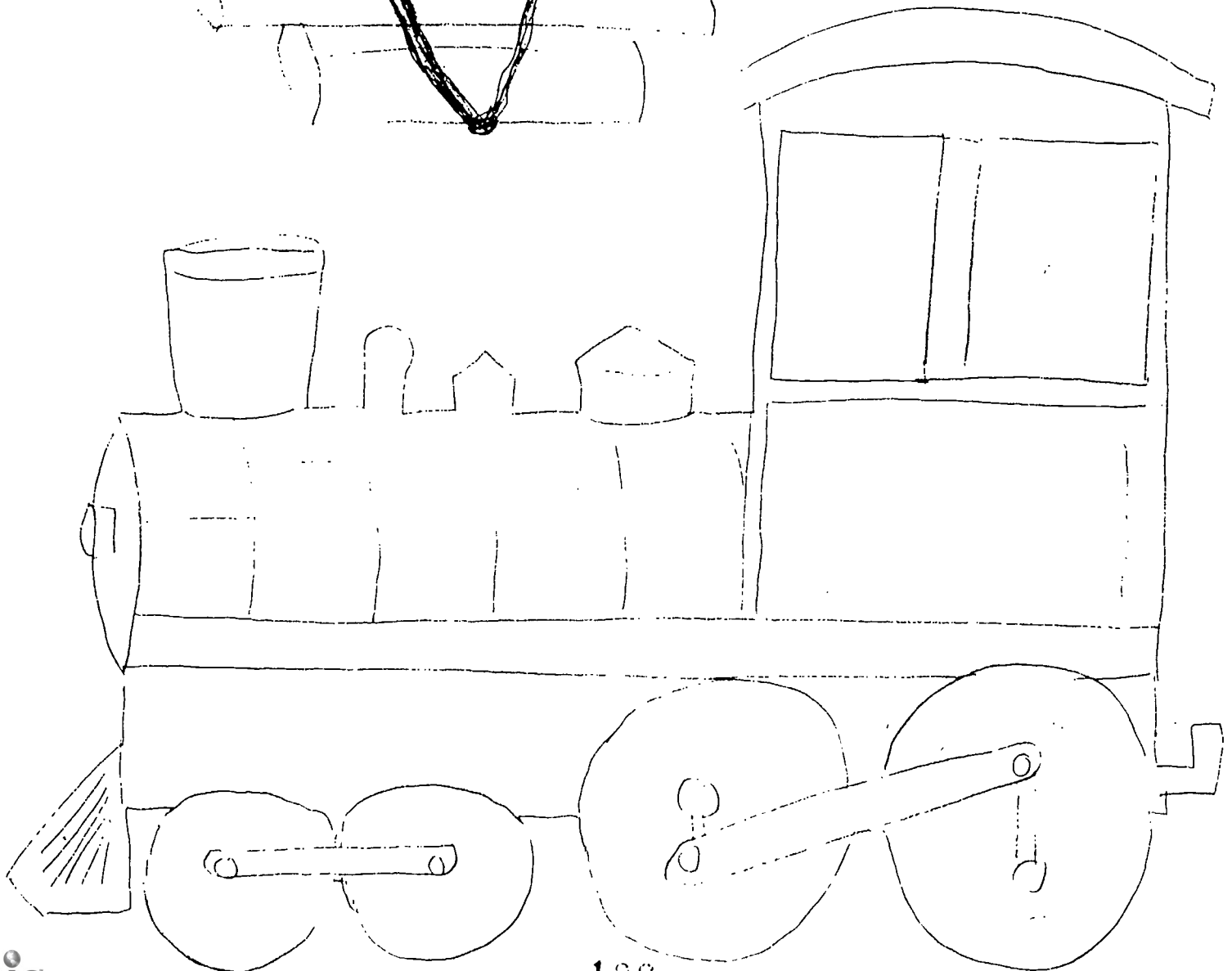
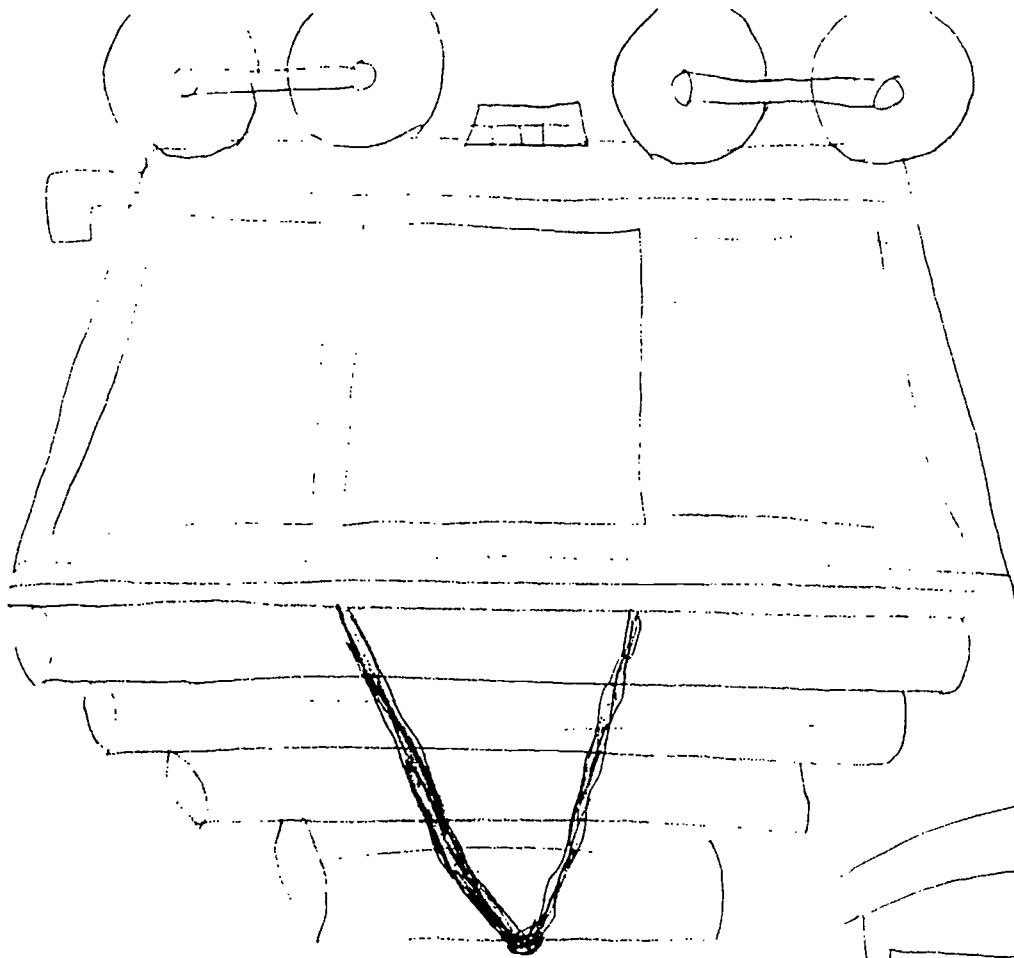



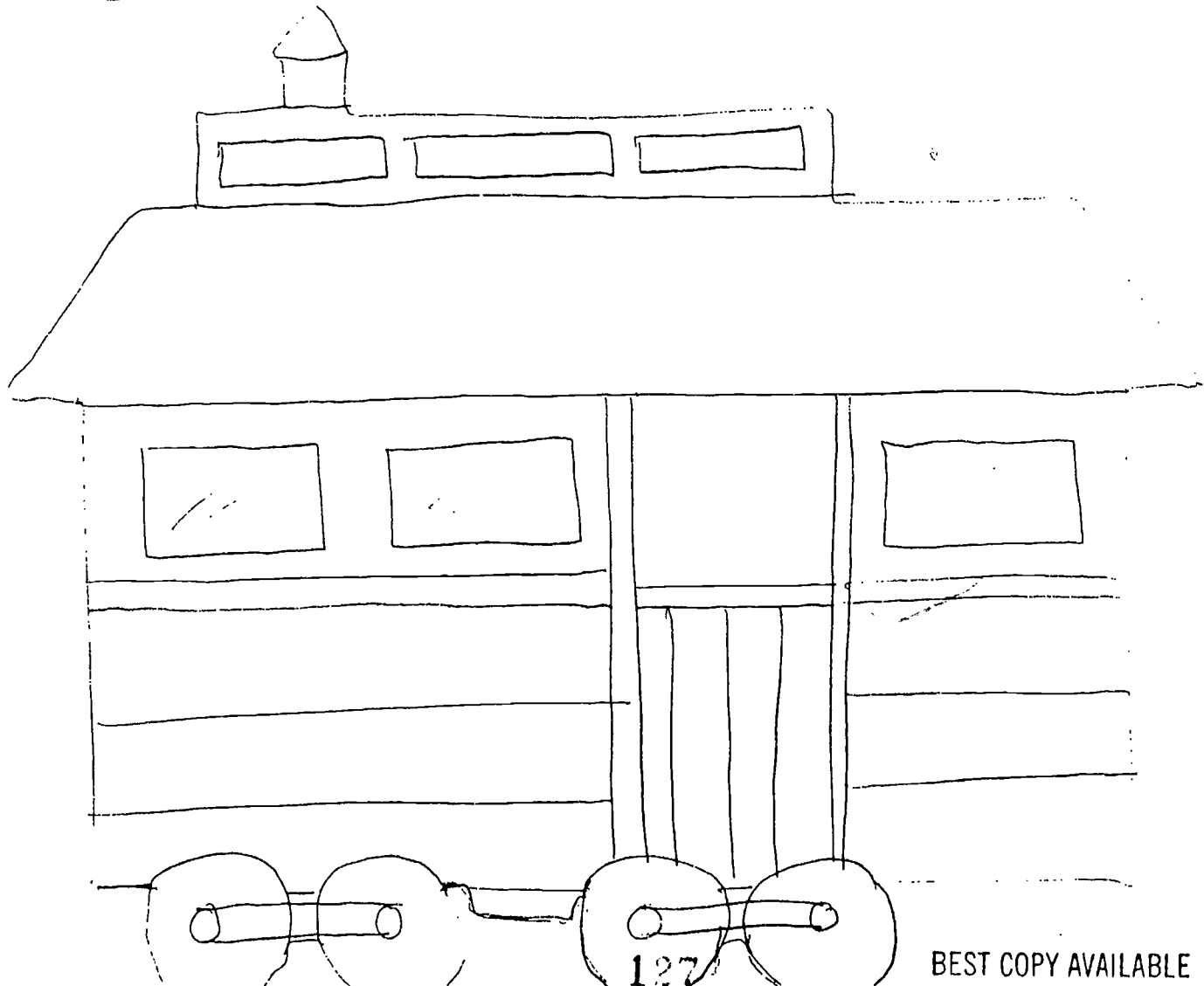
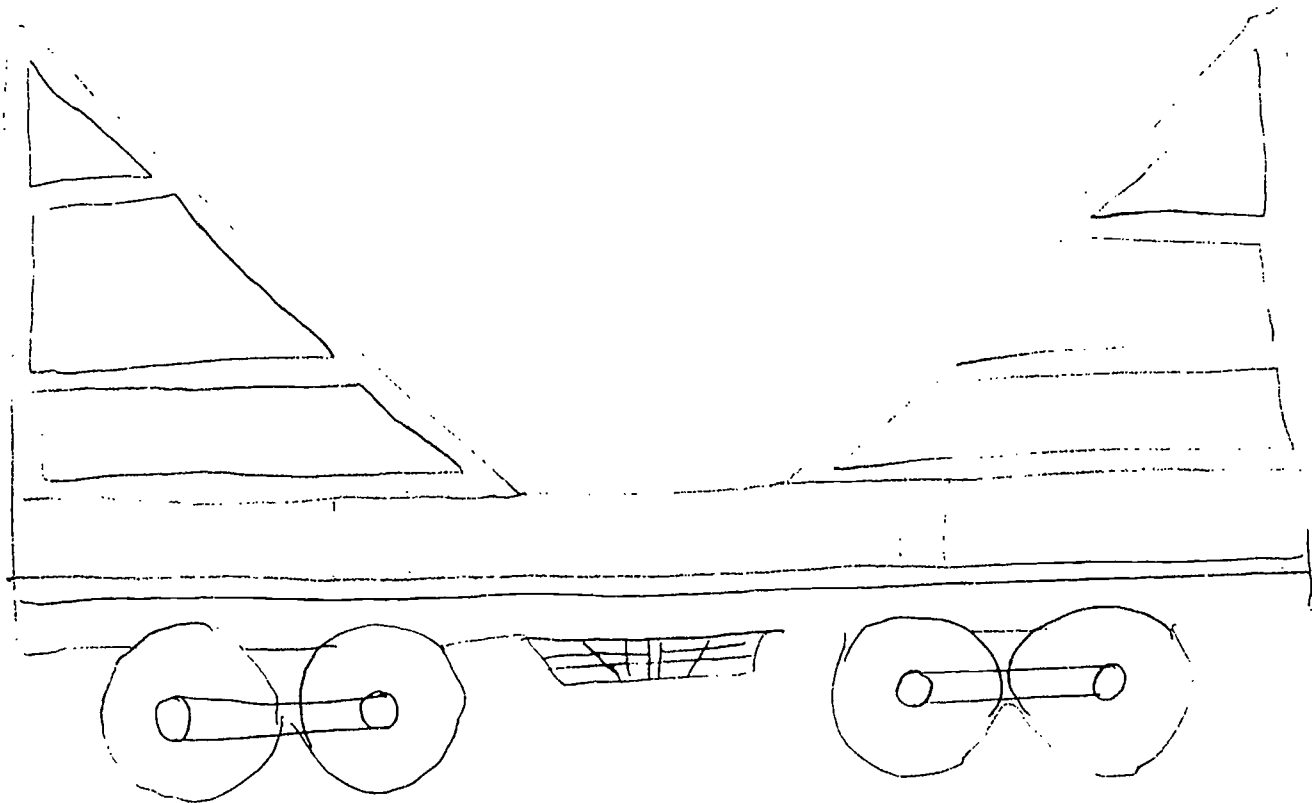

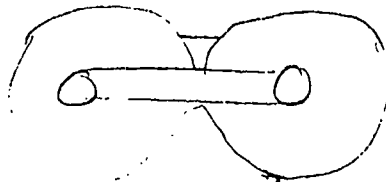
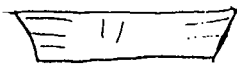
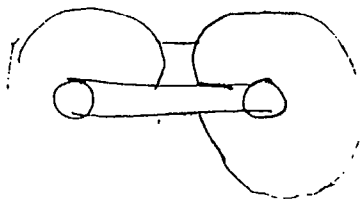
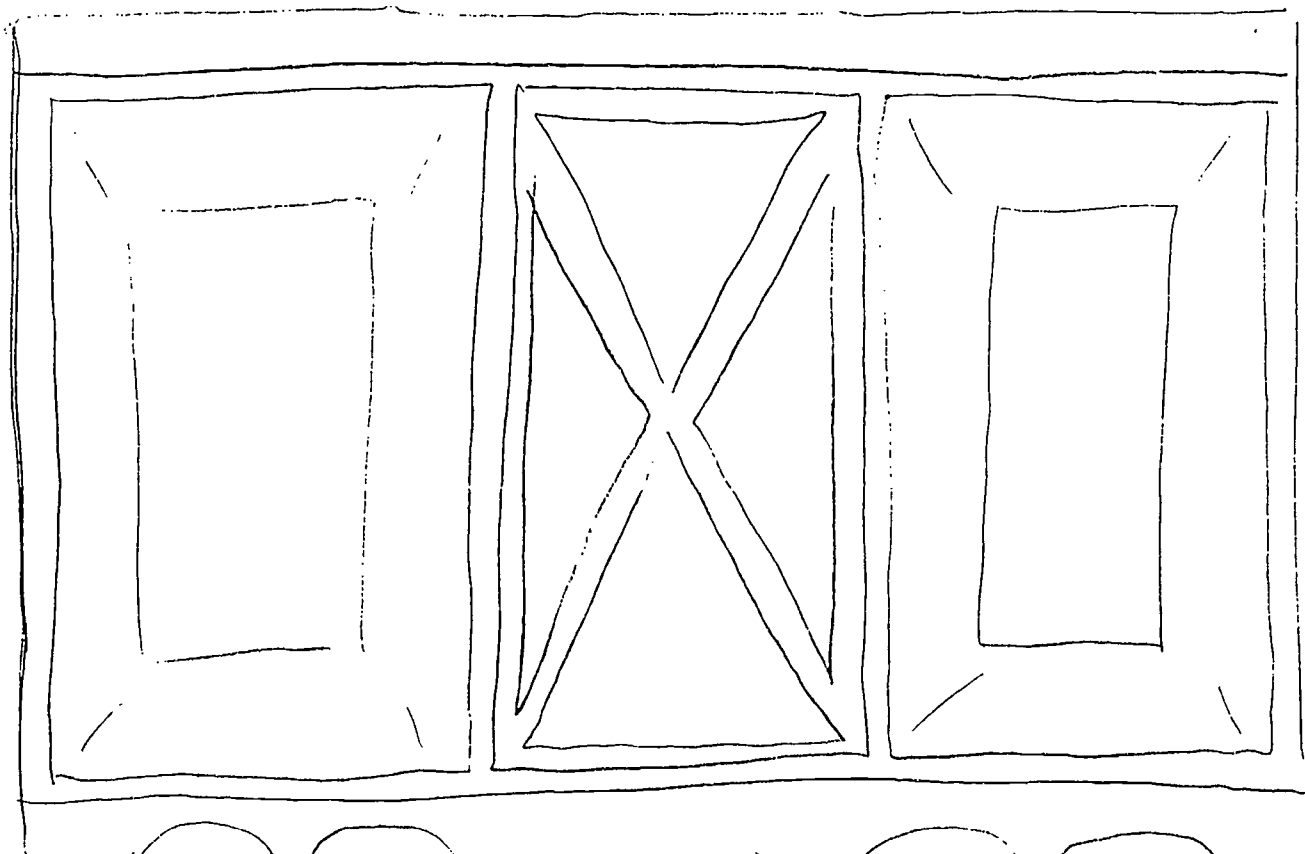
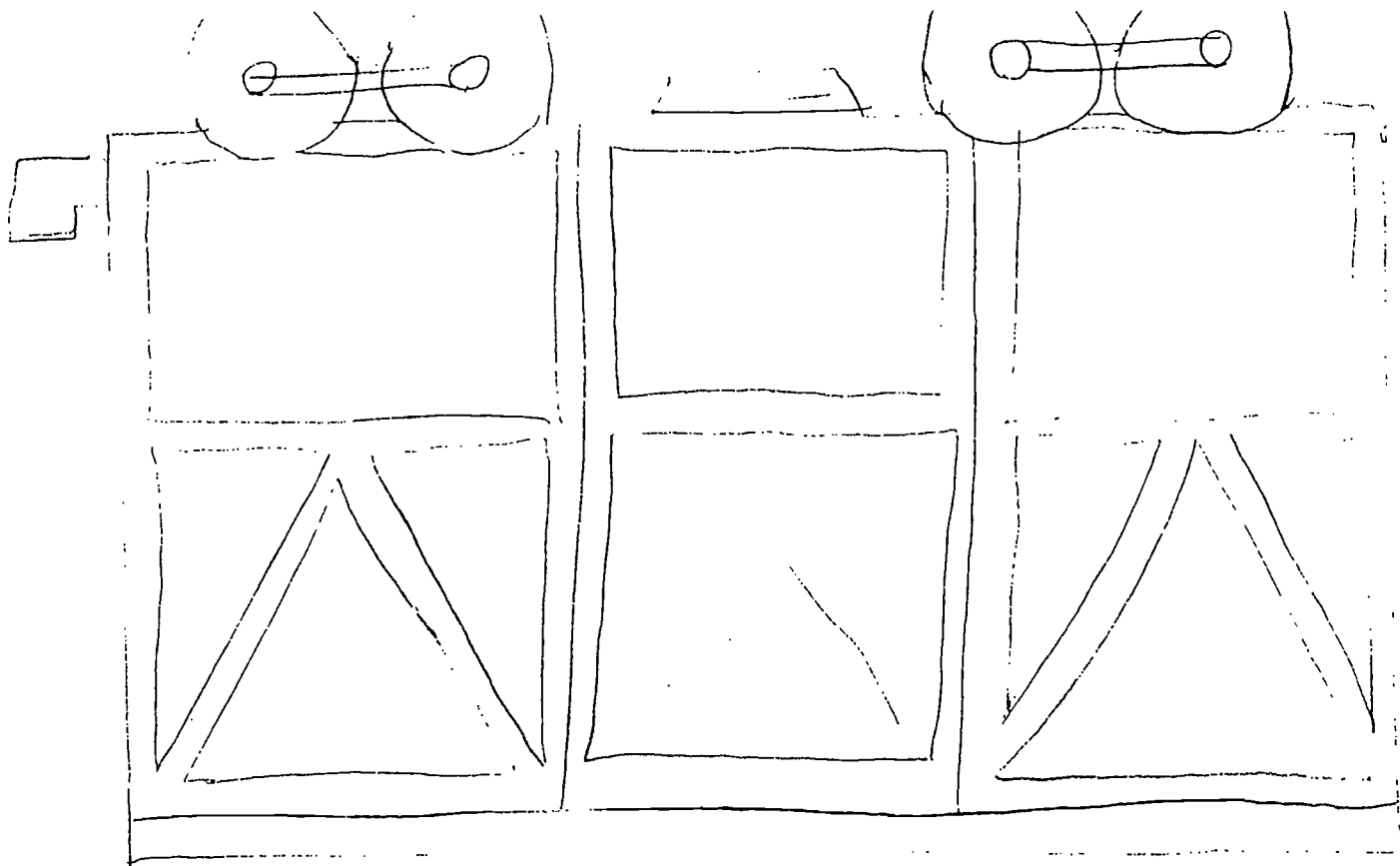

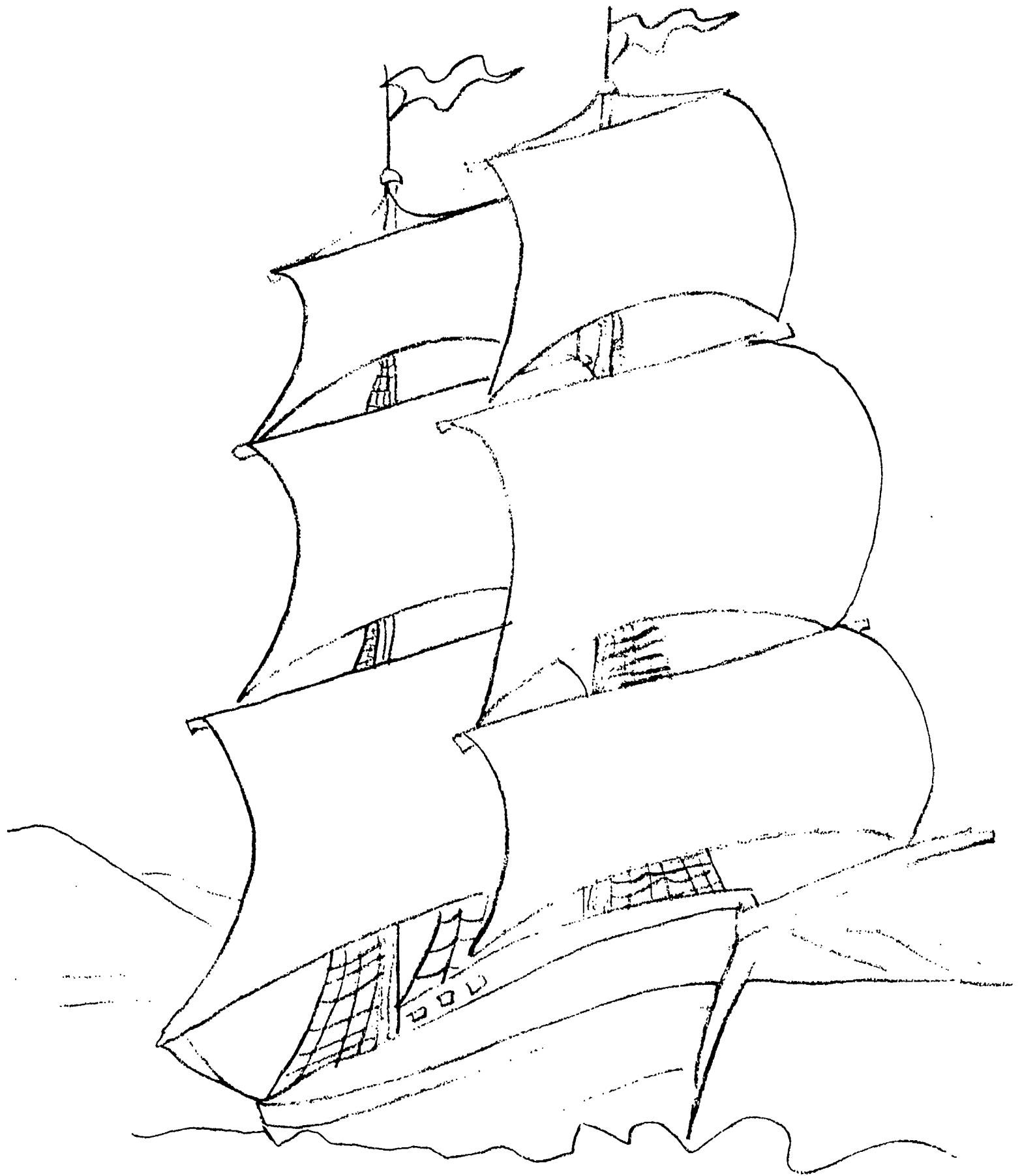

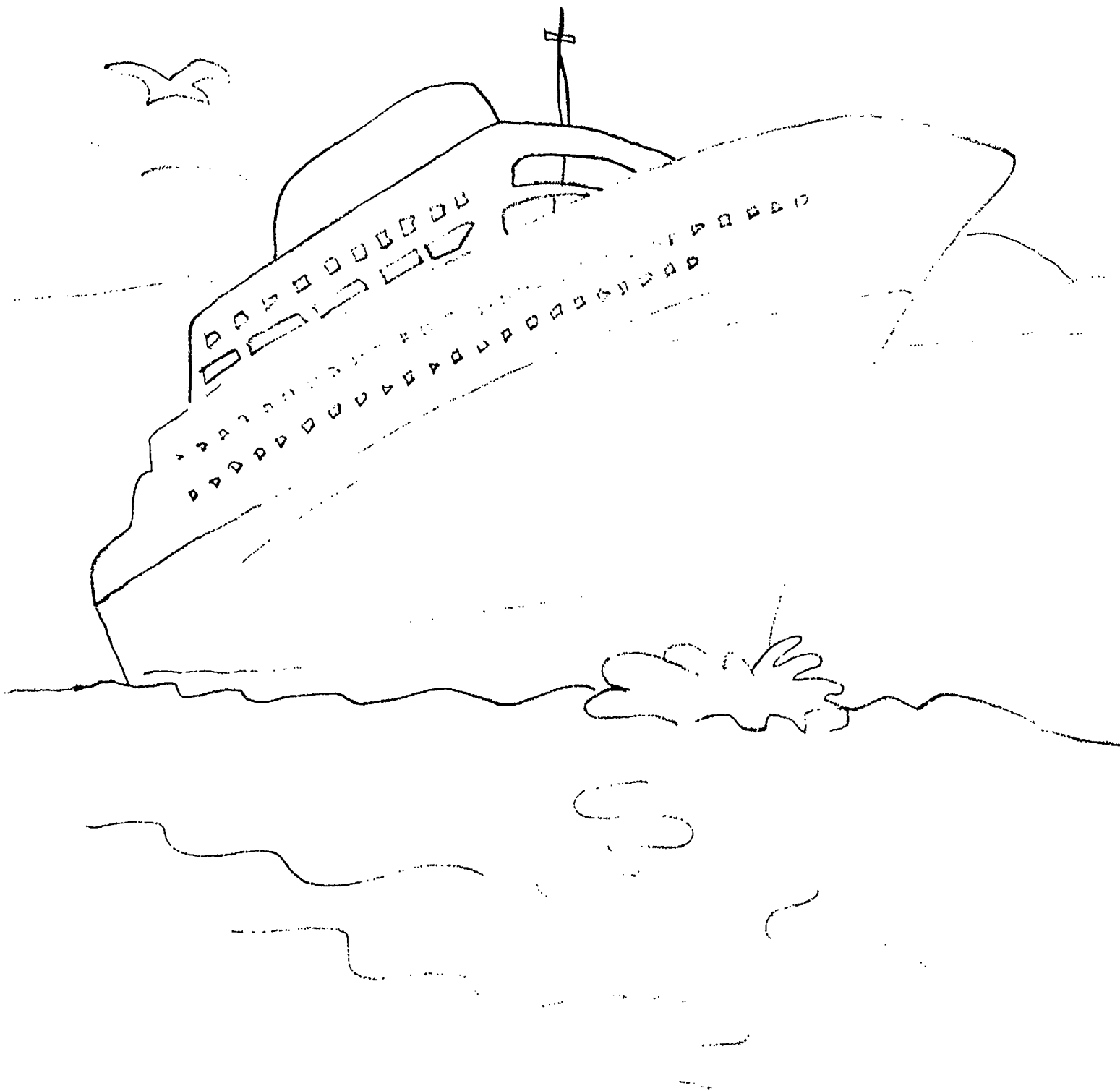

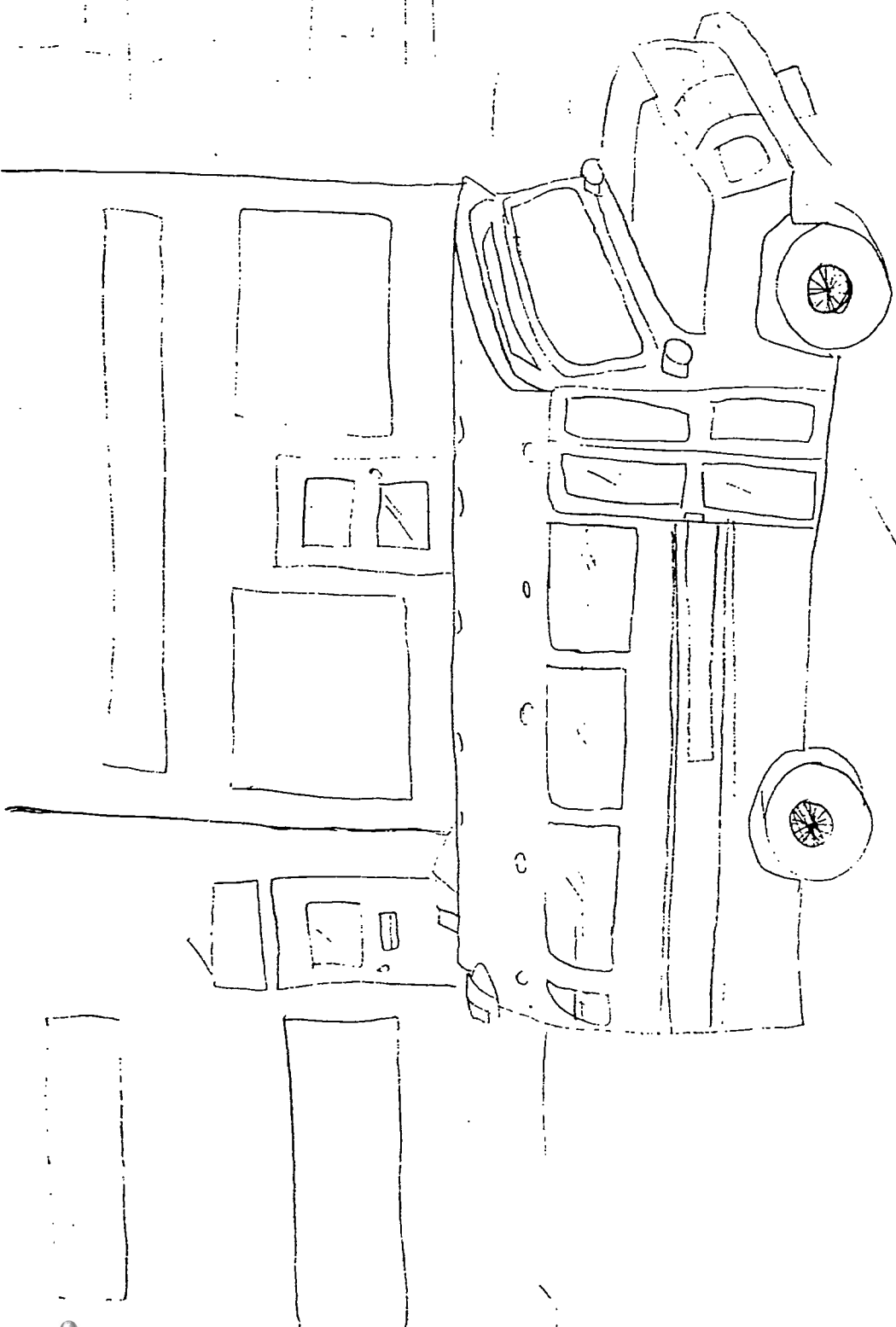

1- provided with  
 information  
 - other ipHole

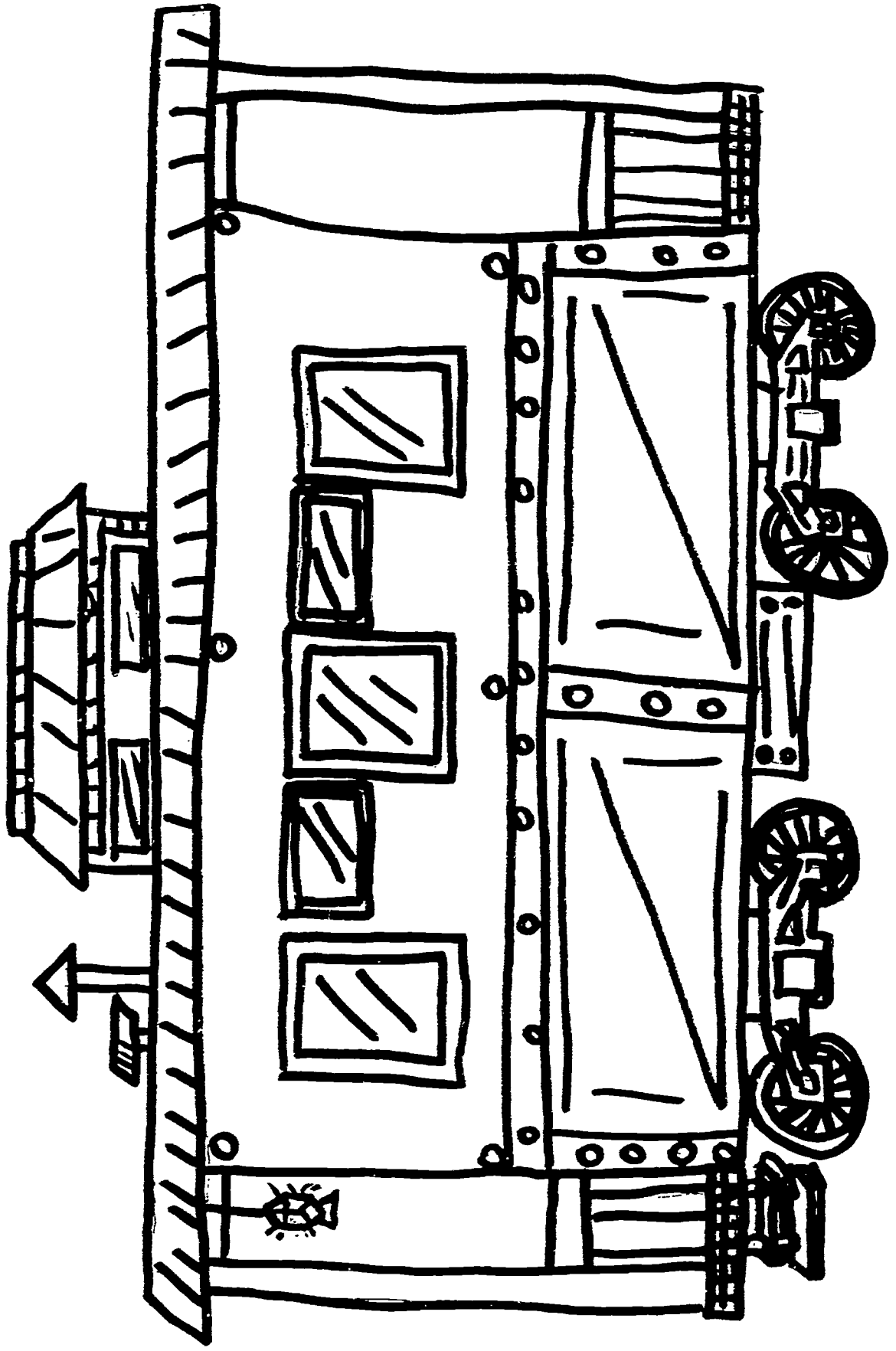

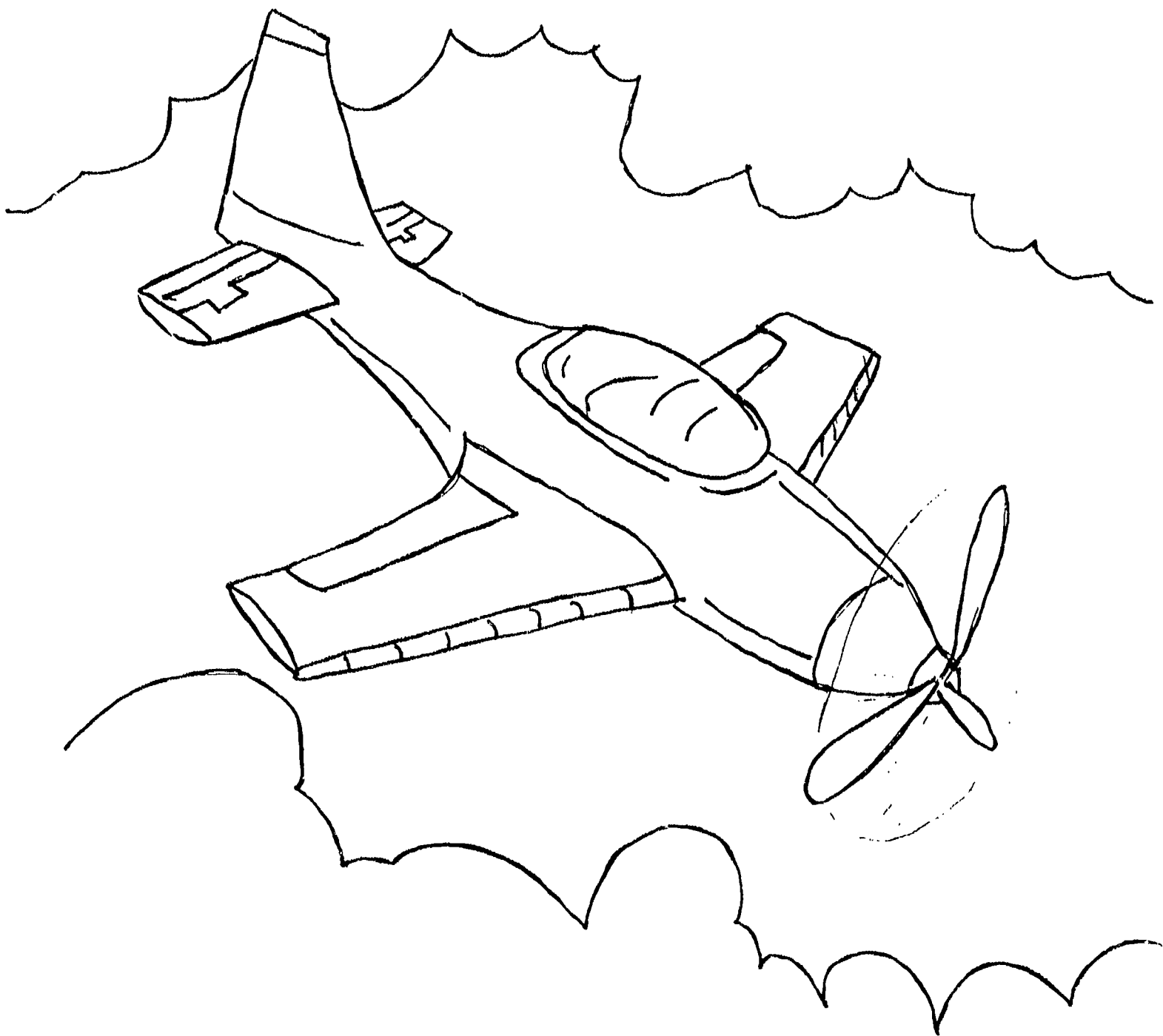

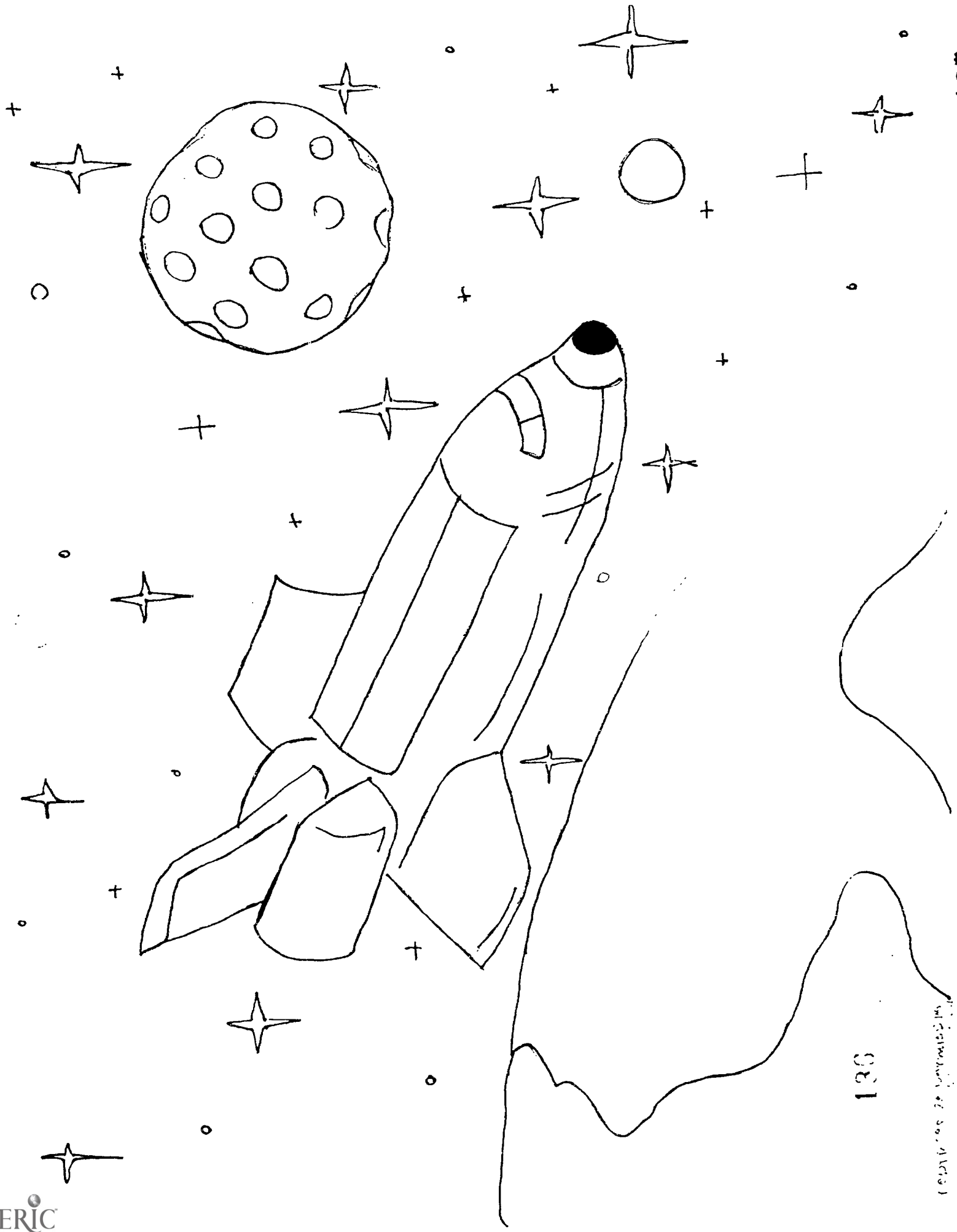



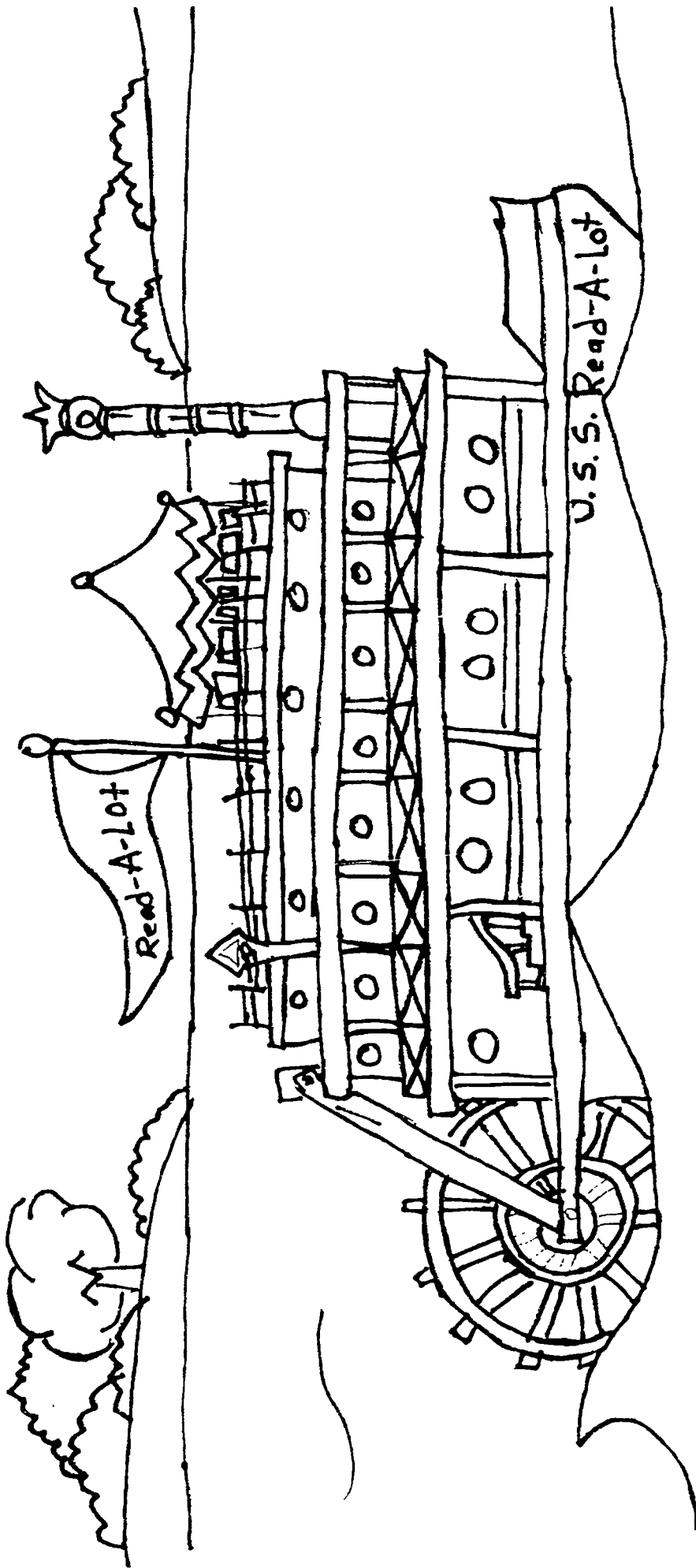

130

131

explore by the way of the ship

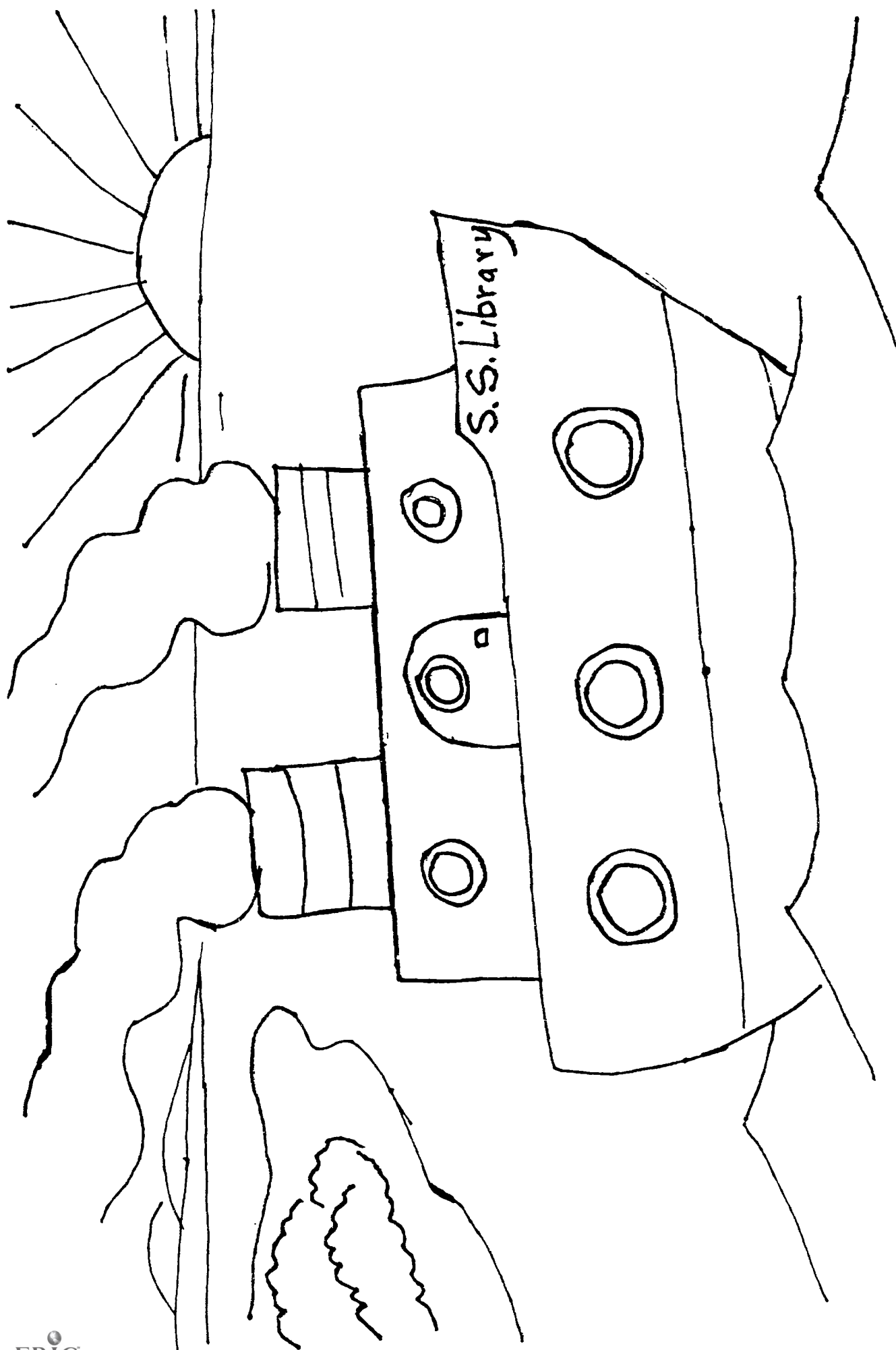

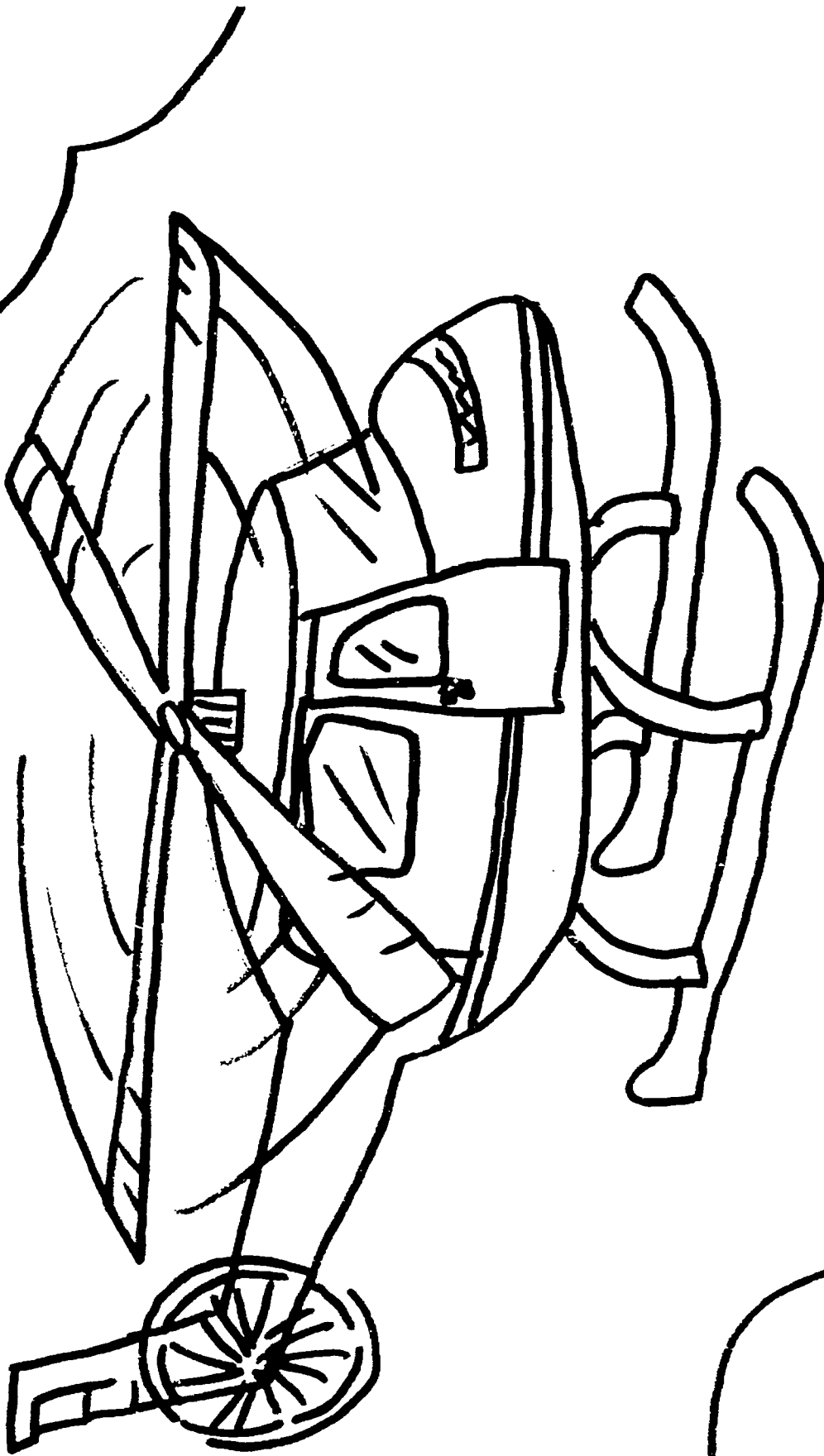

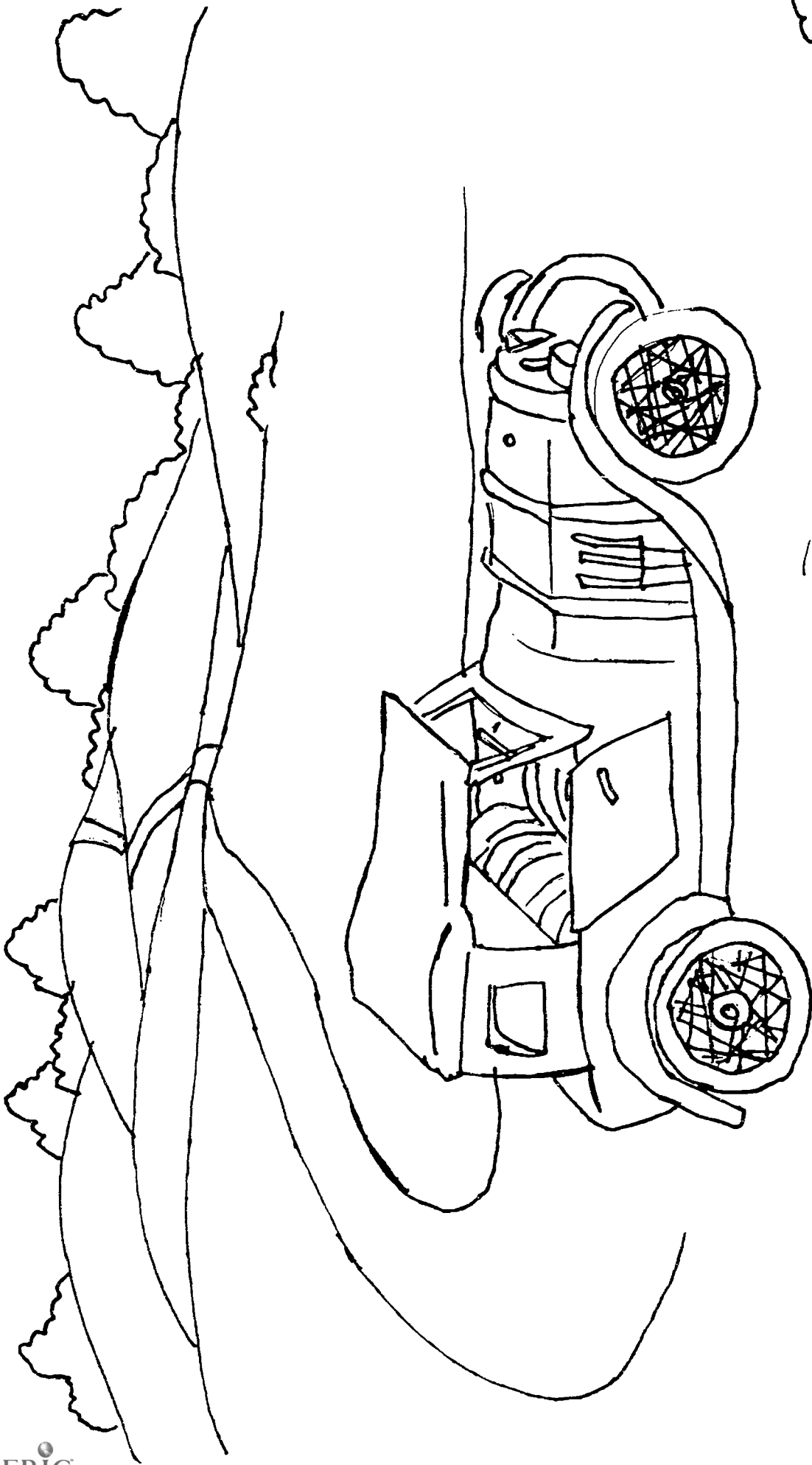

145  
145  
145

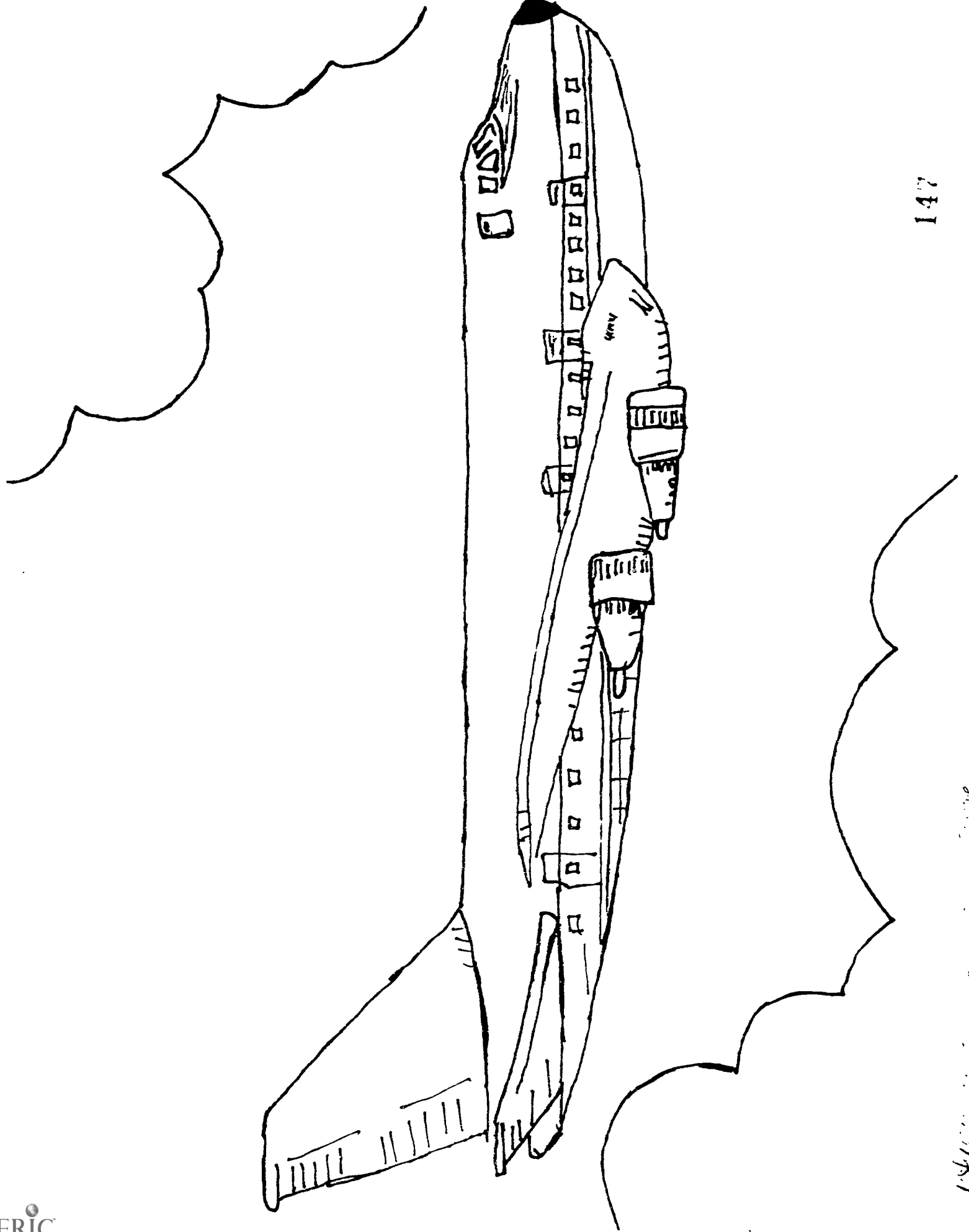

146... ..

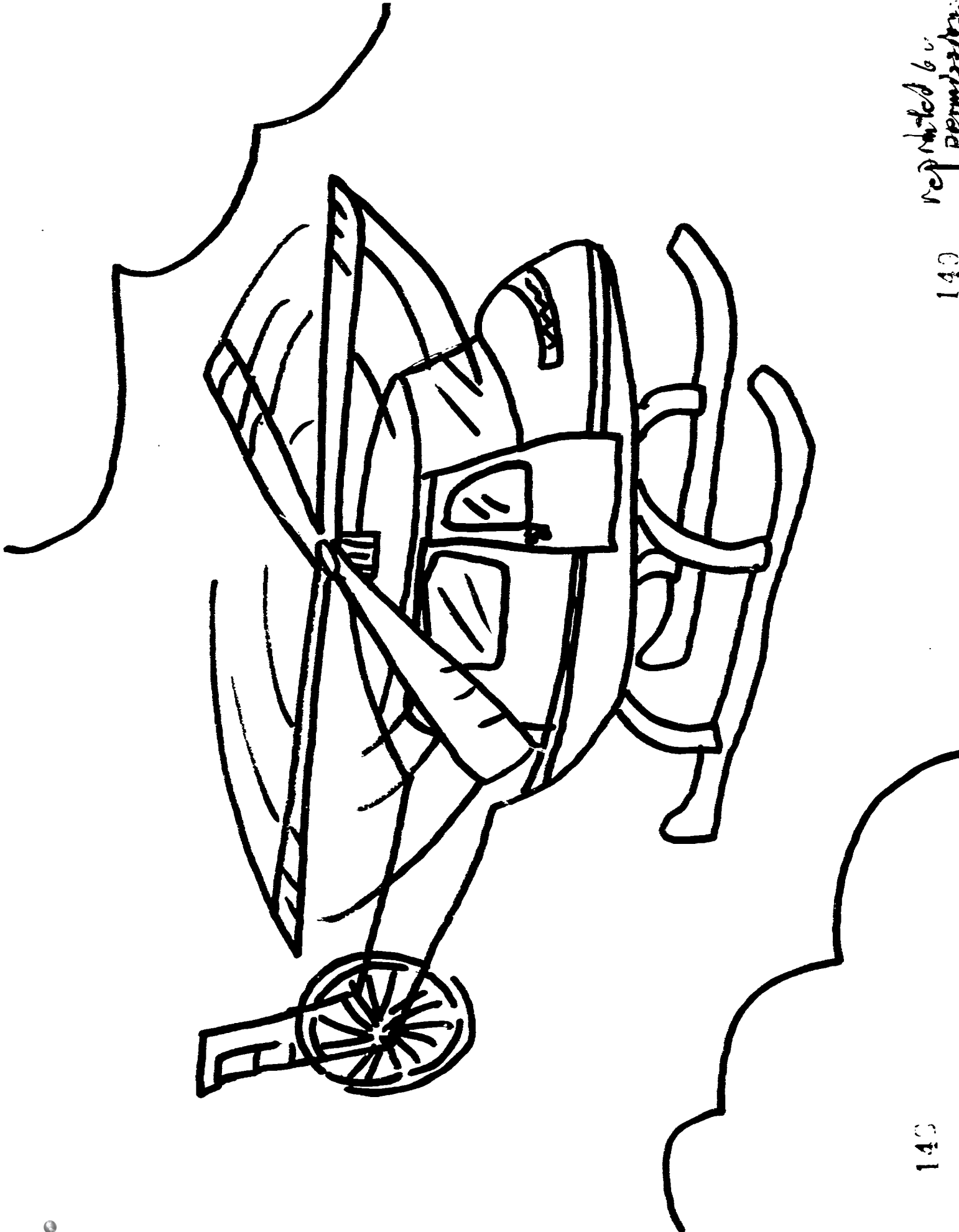

reprinted by permission

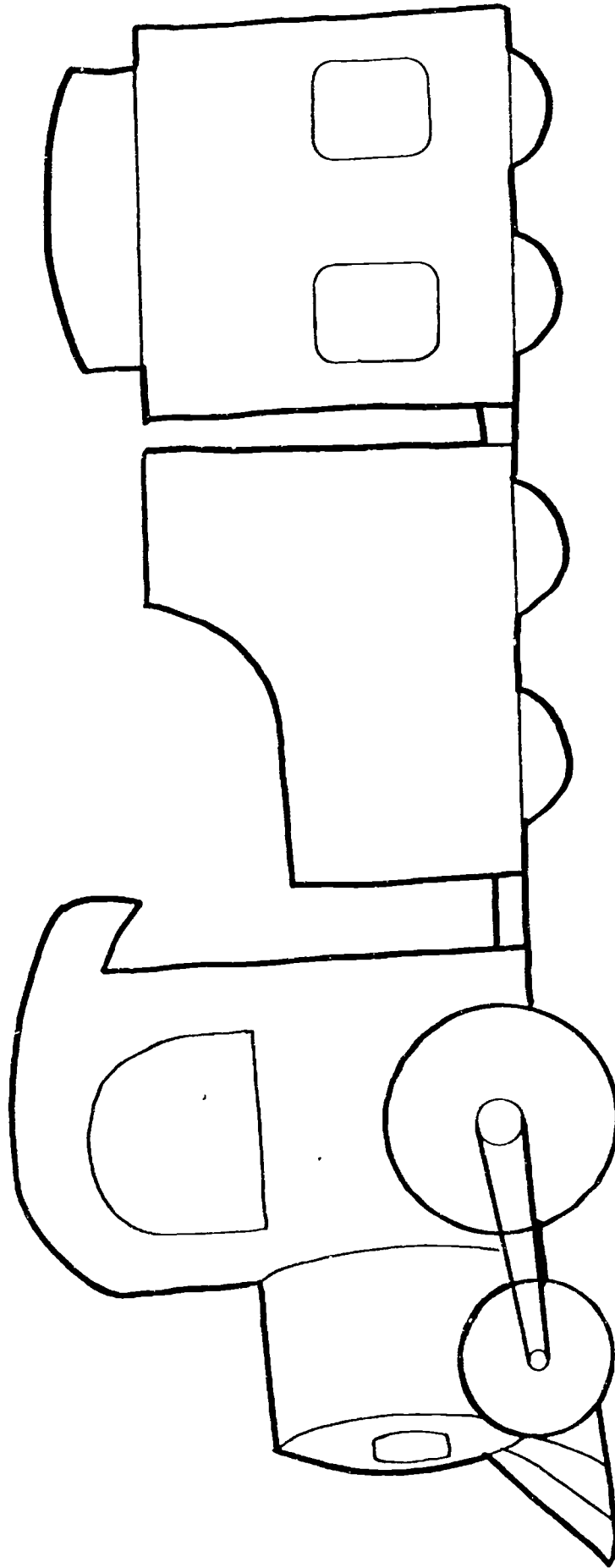

## COSTUME SUPPLIERS

Train accessories and costumes are available from the following companies:

Paper engineer caps:

Boswell Enterprises  
129 Alcosta Blvd.  
San Ramon, CA 94583  
(415) 866-1644

Engineer's cap:

O'Byrne Costumes  
80015-A Castor Ave.  
Philadelphia, PA 19152  
(215) 342-2808

Engineer's cap:

Cook's Collectors Corner  
4402 Youree Dr.  
Shreveport, LA 71105  
(318) 865-7632

General purpose hickory strip denim overalls are available from Sears, Roebuck and Co. for \$25.00 (waist sizes 28-56, inseam sizes 28-38; also infant and toddler sizes).

Big Mac basic overalls are available from J.C. Penney and Co. for \$27.00 (waist sizes 30-56, inseam sizes 30-36).



# ENGINEER BOX CAP

## Materials

cardboard box that fits your head closely

tape

scissors

spray paint

## Procedure

1. Cut the box down from the open end so that it is 4" high on three sides and 8" high on one side (Fig. A).
2. Spray paint the box and allow it to dry.
3. Fold the 8" side up to form a visor and reinforce the crease with tape (Fig. B).
4. Round the corners of the visor (Fig. C).
5. Decorate as desired.

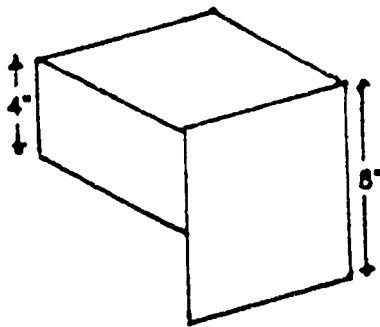

Figure A

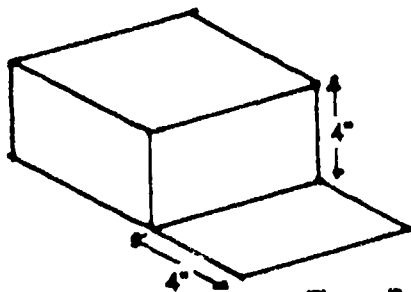

Figure B

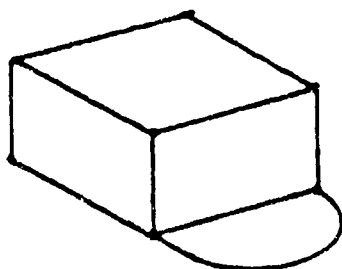

Figure C



From *Hats, Hats, and More Hats!* by Jean Stangl, © 1989, Fearon Teacher Aids. Used by permission.

**HOBO COSTUME**

See "Hobo Hobnob" party in GAMES section, this manual.

**LITTLE TRAIN COSTUME**

From *More Great Pretenders*, by Joy Wilt and Kathy Berry, © 1977, Creative Resources.  
Used by permission.

**You will need:**

<i>1 red posterboard</i>	<i>Paintbrush</i>
<i>(40" × 30")</i>	<i>Paper punch</i>
<i>Scissors</i>	<i>Sharp pencil or ice pick</i>
<i>Large black felt marker</i>	<i>Large paper brads</i>
<i>Poster paint</i>	

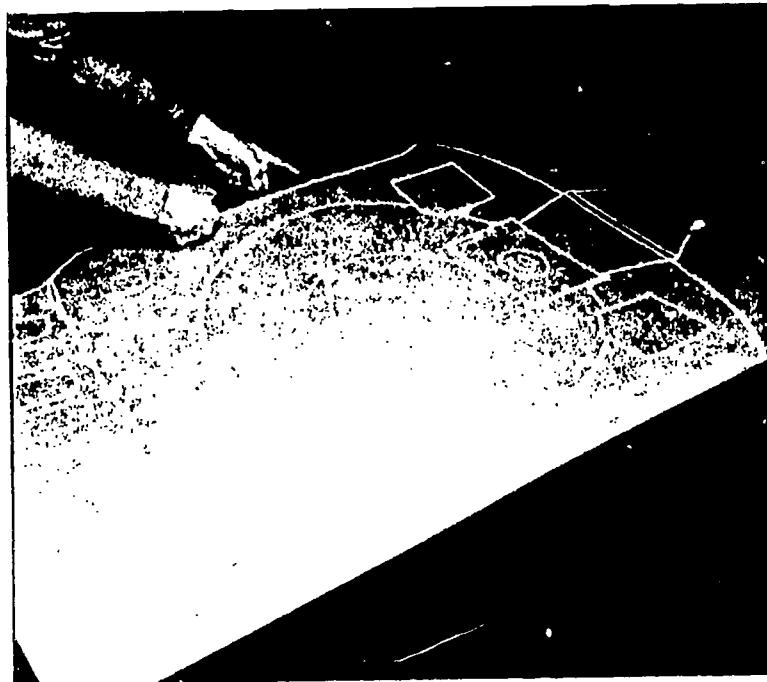

1. Make train pattern (pattern 6, p. 15a) and trace it onto posterboard. Cut out.

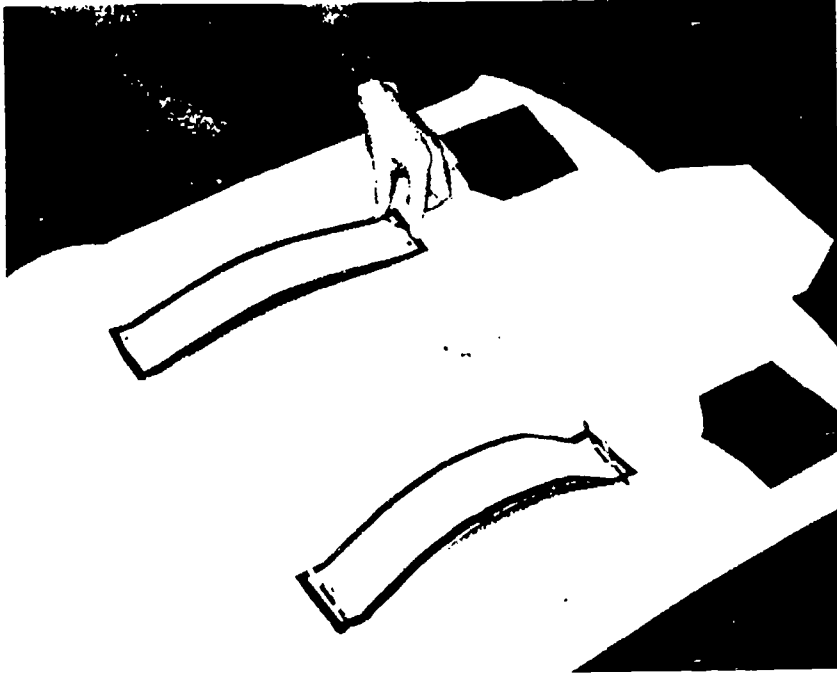

3. Trace two handles (pattern 5, p. 152) and cut out of posterboard. Cut holes in handles with paper punch; punch holes in body of train with sharp pencil or ice pick. Attach handles to back of train with paper brads as shown.

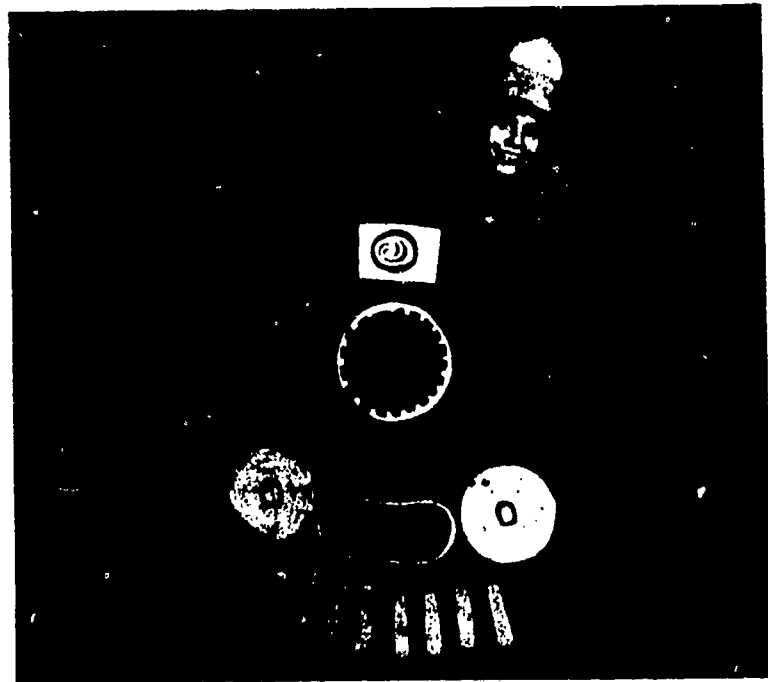

4. "Start your engine with a huff and a puff!  
In your little red train you're really hot stuff!"

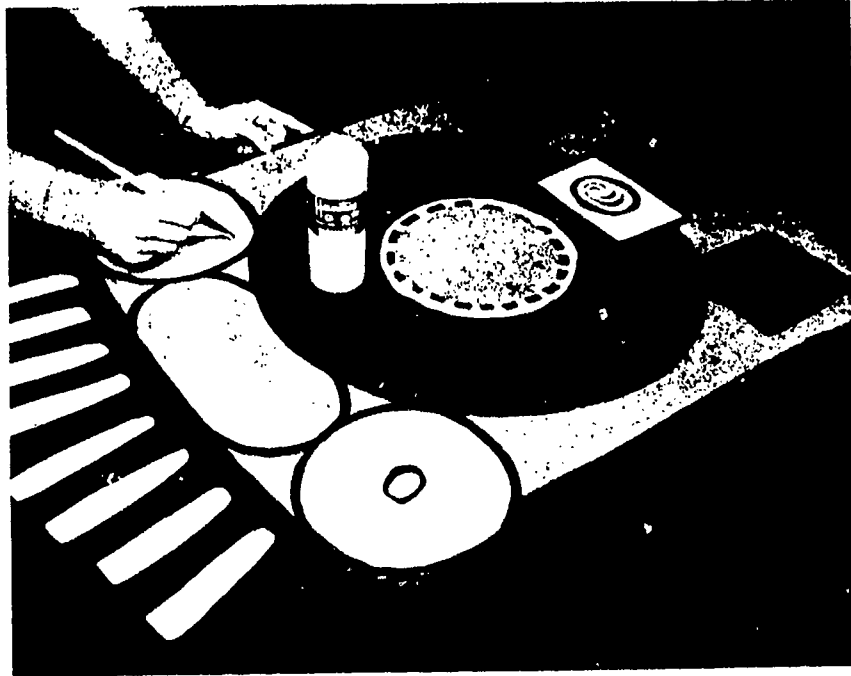

2. With black felt marker or black poster paint, color in the smoke stack, the grill at the bottom, and the big circle on the front. With yellow poster paint, color the two big lights at the bottom and the small light on the top (you may want to use your own colors and decorate train differently).

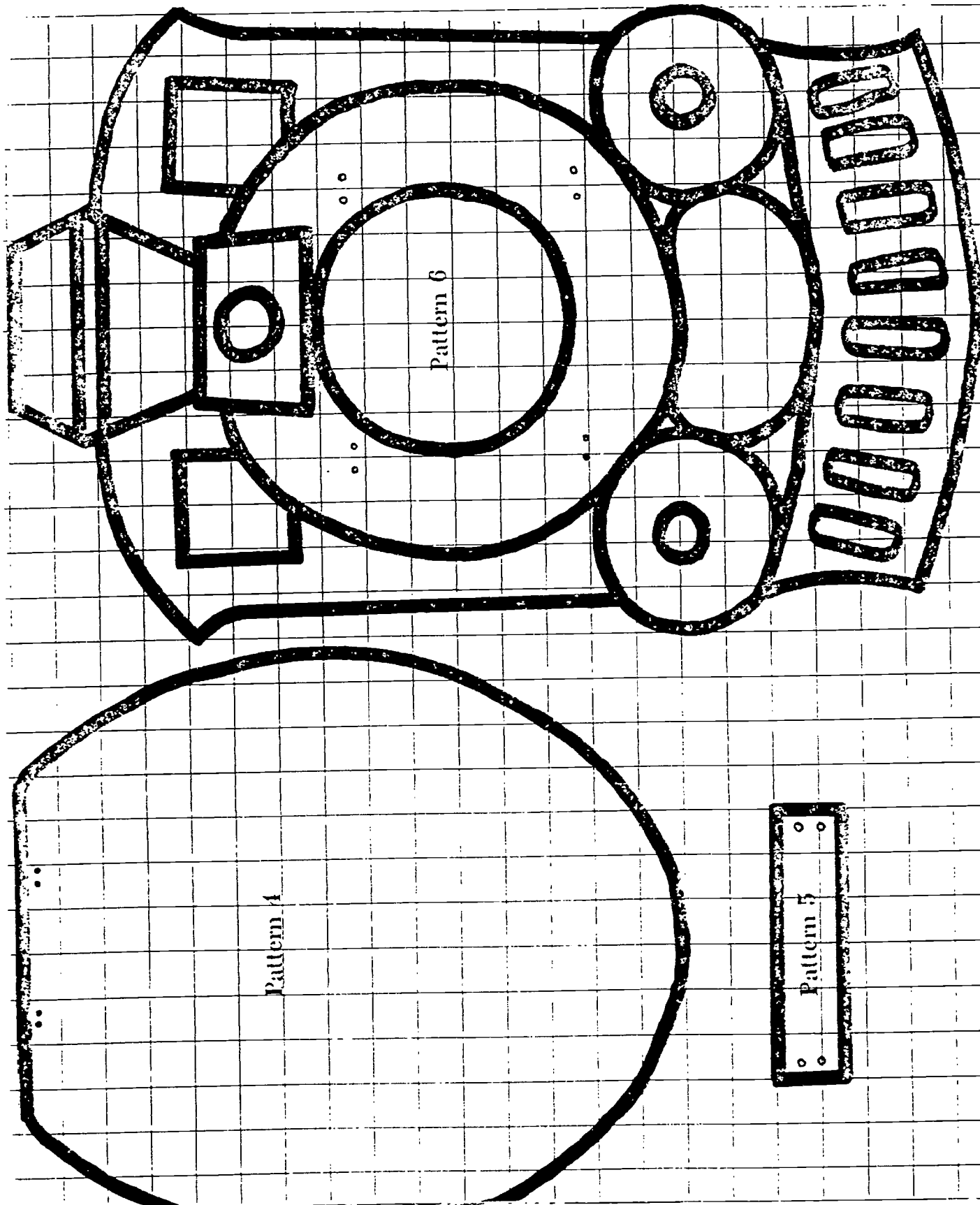

Pattern 4

Pattern 6

Pattern 5

## Choo-Choo Costume

Ages 4 to 6

Must be made by an adult

### Materials

cardboard box (about 12 x 14 x 24 inches)  
utility knife  
heavy-duty scissors  
cardboard piece (about 14 inches square)  
1½-inch-wide fabric ribbon (2 yards)  
glue  
interior latex enamel paint  
liquid tempera paint  
brushes

1

Outline and cut out an oval hole big enough for your child to step into in a sealed box's top (below), leaving about 1½ inches of cardboard on each long side. Do not remove the box's bottom flaps.

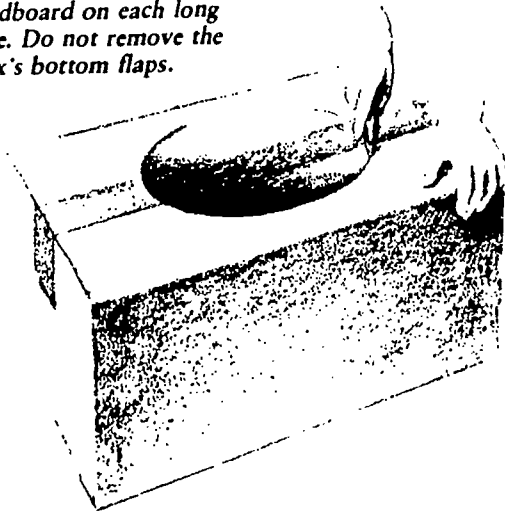

3

For handholds, cut 4-inch-wide slits in the long sides of the box, about 6 inches down from the top and 7 inches from the front edge. At each slit, cut ½ inch toward the body hole and fold the flaps in to cushion fingers (right).

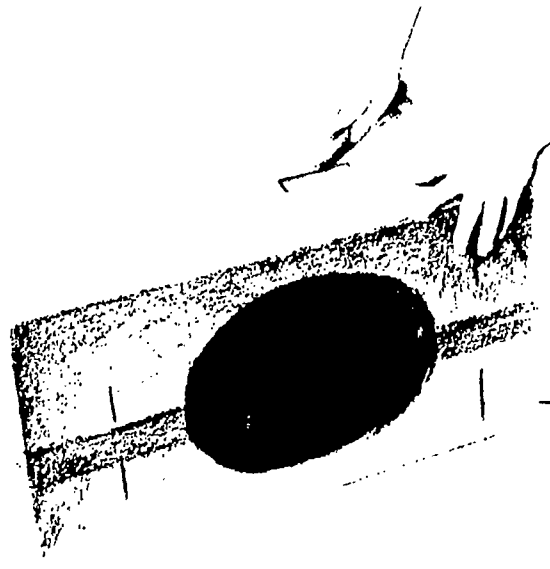

2

Starting at a narrow end of the box top, cut two slits 8 inches apart, 3 inches from what will become the costume's front edge. Cut two others about 3 inches forward from the opposite edge, 2 inches apart. The slits will be used for ribbon suspenders.



From *Successful Parenting: Creative Projects Big and Small.*

By the Editors of Time-Life Books  
© 1988 Time Life Books Inc.

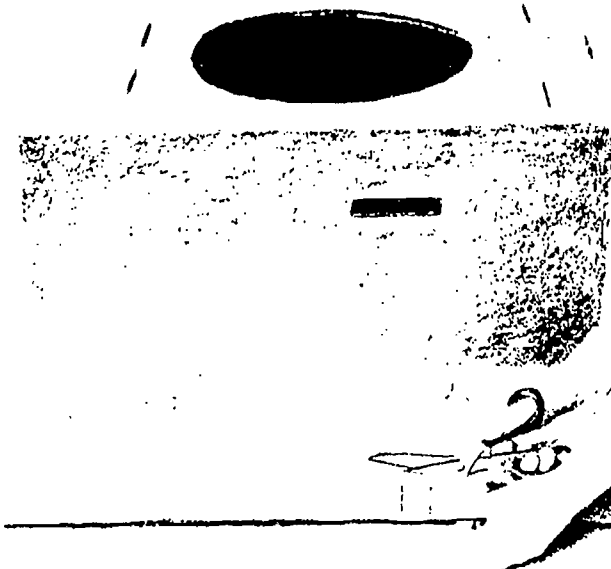

4

To make the lower portions of the large wheels and a connecting rod, draw semicircles that almost fill each side bottom flap. Cut away the extra cardboard (left).

5

On the front bottom flap, outline and cut out the cow catcher and grillwork (right). Remove the corresponding back flap. Paint the locomotive with the enamel, then apply details with the tempera.

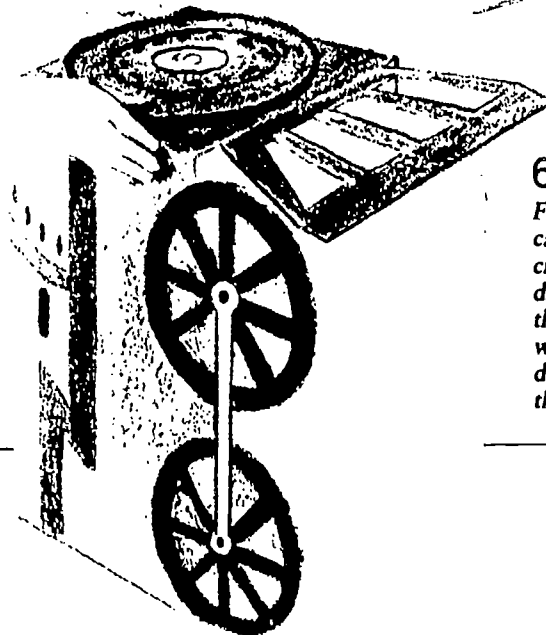
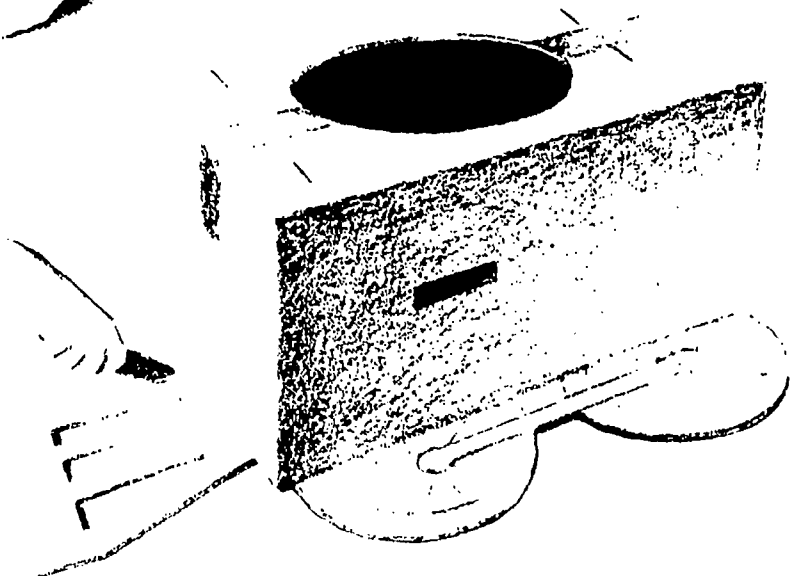

6

From the square of cardboard, fashion the circular front, making its diameter the width of the box. Paint the circle with the enamel and add details in tempera. Glue the disk to the front (left).

BEST COPY AVAILABLE

7

*Have your child step into the box and support it at a comfortable height (right) as you insert the suspenders (below). Or you may thread them beforehand and adjust them.*

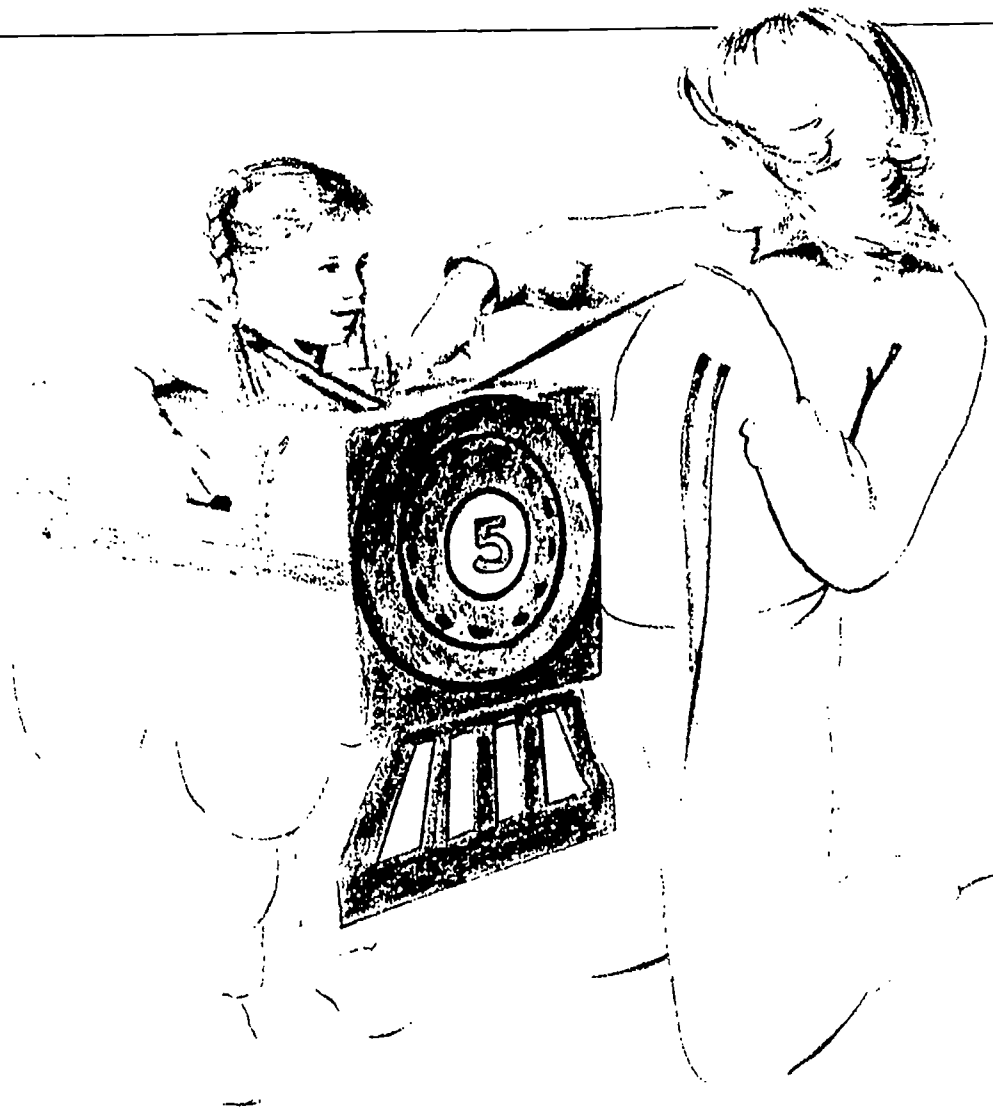

**Threading suspenders.**  
*The knotted ribbon is threaded from inside the box out through the left rear slit, in through the right front, and out through the left front. Then the ribbon is inserted into the right rear slit and tied to its other end.*

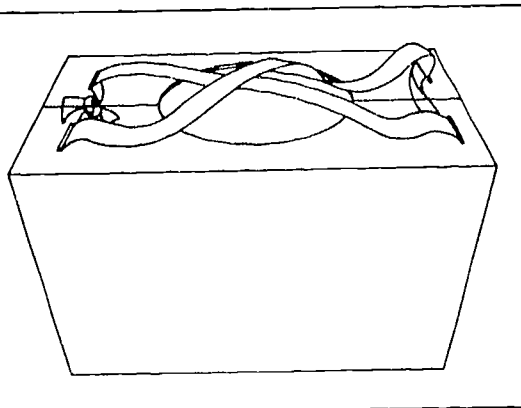

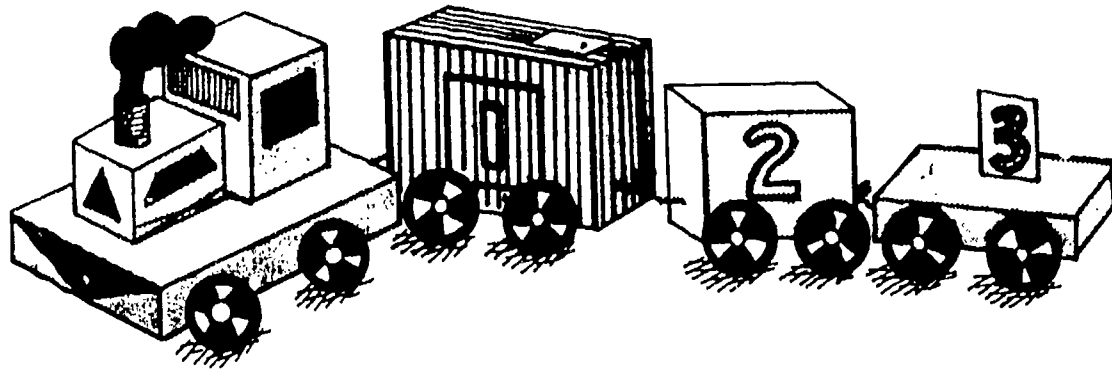

## BIRTHDAY TRAIN

**You Will Need:**

assorted small boxes  
 black plastic thread spools or  
 35 mm film container lids (See Note.)  
 paper fasteners  
 construction paper  
 pipe cleaners (4 inches long)  
 35 mm plastic film container (lid not needed)  
 pencil

scissors  
 ruler  
 glue  
 crayons or felt makers  
 transparent tape  
 ice pick or sharp-pointed scissors\*\*  
 poster board (optional)

**Note:** To make wheels, cut ends from spools with a heated sharp knife.\*\* After peeling off paper label, remove glue residue with cloth dipped in acetone or rubber cement thinner. If film container lids are used, punch hole in center of each with heated ice pick.\*\*

**What to Do:**

To make engine, cover base box with construction paper, leaving one end open. Punch holes for wheels as illustrated.\*\* Insert paper fastener through center of spool "wheel."  
 Attach to engine base.  
 Tape or glue end of box shut.  
 Cover end with construction paper.  
 Punch hole in center of one end of base.\*\*  
 Twist ends of pipe cleaner together about 1 inch, leaving a loop at top.  
 Place glue on twisted end.  
 Insert into hole.

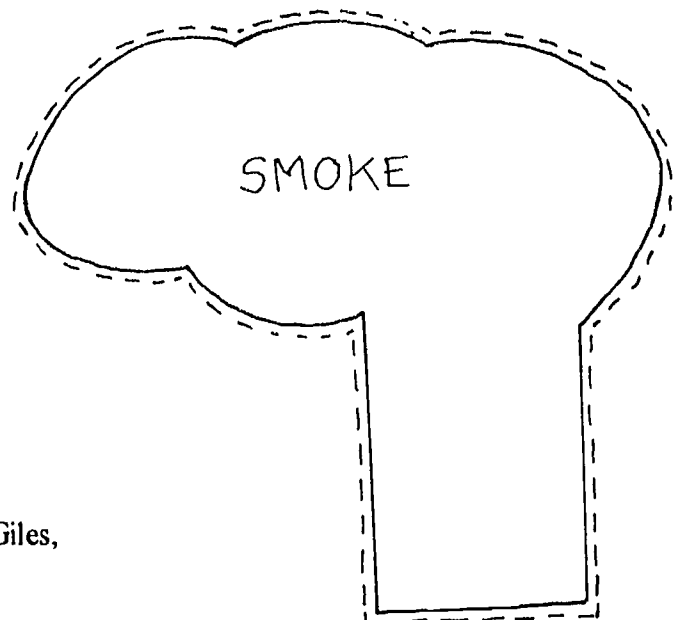

From *Creative Food Box Crafts*, by Nancy H. Giles,  
 © 1989, Good Apple, Inc. Used by permission.

Cover cab box and fuel box with construction paper.  
 Glue into place on base box.  
 Glue film container "smokestack" to fuel box. (Elmer's Glue-All or Contact cement recommended.)  
 Decorate engine as desired.  
 Draw smoke pattern on construction paper or poster board.  
 Cut out.  
 Place in smokestack.

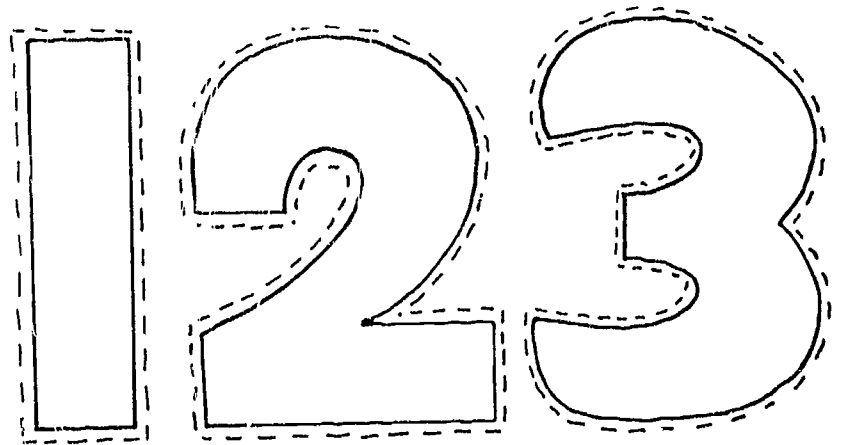

To make train cars, cover boxes with construction paper, leaving one end open.  
 Punch holes for wheels.\*\*  
 Attach wheels with paper fasteners.  
 Tape or glue end shut.  
 Cover end with construction paper.  
 Punch hole in center of both ends of each box.\*\*  
 Twist ends of pipe cleaner together about 1 inch, leaving a loop at top.  
 Make two.  
 Place glue on twisted end of each.  
 Insert one into hole made on each end of box.  
 Decorate train cars as desired.  
 Draw desired number patterns on construction paper.  
 Make two of each.  
 Cut out.  
 Glue one into place on each side of car.  
 (If numbers are to stand, as illustrated on the "flat car," cut a 2-inch wide by 3-inch long piece of poster board. Draw number near top of both sides. Cut slit in center top of car and insert poster board.)

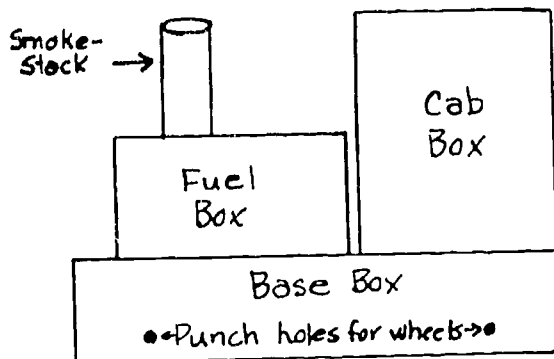
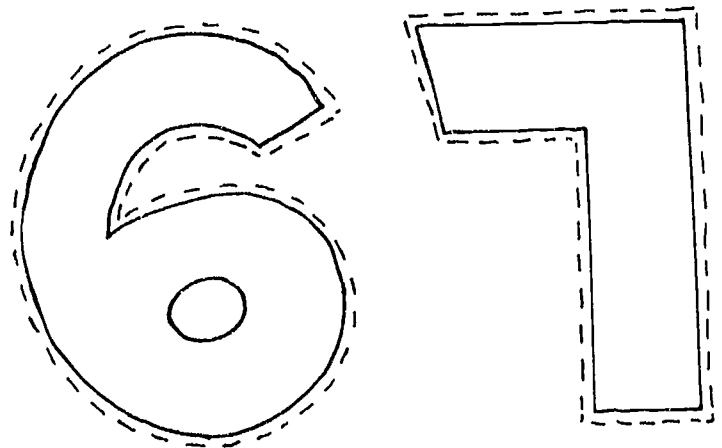
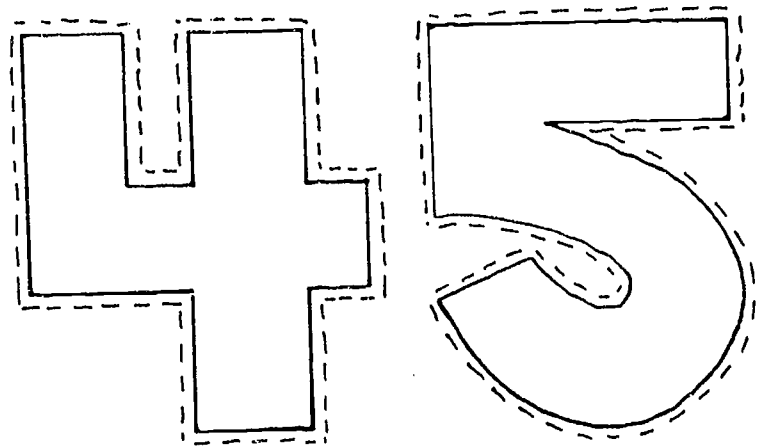
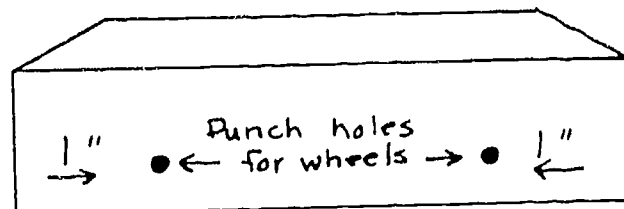

Illustration guide for engine parts



To connect cars, on front of each car, press pipe cleaner sections together. Bend end up to make hook. Leave pipe cleaner in loop shape on back of each car and on engine. Place hooks in loops.

\*\*Adult help needed

**BOX TRAINS**

by Yolanda Blanchard, Calcasieu Parish Library

To make a train: string together boxes (for example, cereal boxes, clean milk cartons, cookie boxes) that have been colored or covered with construction paper. As a variation, use cartons that are large enough to hold a child.

**CIRCUS TRAIN**

Let the children work together to make a circus train. Have them decorate cardboard boxes with paints, crepe paper streamers and colorful paper scraps. Hook the boxes together with heavy yarn and add a yarn handle. Have the children place stuffed animals in the decorated boxes. Then play circus music and let them take turns pulling their circus train around the room.

From *Totline*, July/August 1990. Reprinted by permission.

**CLICKETY-CLACK CIRCUS TRAIN**

Tiny little sandpaper tooter is a real wall charmer! (See Figure 4-7A.)

**Materials:**

- assorted colors of crayons
- a sheet of sandpaper (approximately 8" × 6")
- a pencil
- electric iron (optional)
- coloring books (they provide an abundance of pictures to trace or copy)
- tracing paper (optional)
- old newspapers
- a sheet of light colored art paper (or unlined white paper)
- an ironing board (or, a hard, flat surface such as a table top or floor)

From *A Carnival of Classroom Arts and Crafts Projects*, by Peggy Palmer, © 1980. Reprinted by permission of the publisher, Parker Publishing, A division of Simon and Schuster, West Nyack, NY.

Enlarge the train pattern provided (or select any design of your choice from a coloring book) and draw it with a pencil onto the sandpaper. (See Figure 4-7B.) You may transfer a design onto sandpaper with carbon paper or draw it free hand. (Older students may prefer to create their own pencil sketched designs.)

Now, color the picture with crayons. Color hard leaving a thick application of wax on the sandpaper. Then, set up an ironing board (or a similar object) and cover it with old newspapers. Turn the setting on the iron to warm or permanent press. Lay a sheet of lightly colored art paper on the newspaper and lay the sandpaper colored picture—upside down—on top of it. The crayon colored side **MUST** face down.

Slowly, glide the warm iron over the back (wrong side) of the sandpaper. Then, set the iron aside and immediately lift the sandpaper off the art paper. Now, let both picture cool, then mount one or both of them on a larger sheet of art paper. (See Figure 4-7C.)

You can make an attractive wall plaque by cutting a piece of light-weight cardboard slightly larger than the finished pictures. Then, cover the cardboard with fabric or felt glued in place and glue the sandpaper picture (or copy) in the center.

### Teaching Tips

Students of all ages will enjoy this challenging visually textured art activity. Display these colorful, touchable pictures at an art carnival or family night festivities.

Exercise extreme caution while the iron is on and in use. With close supervision older students can iron their own art.

Pupils can also color their designs as directed and not iron them! Leaving them as is is the safest, and therefore recommended, technique for young children.

Various grades of sandpaper produce differing designs. Experiment with a variety of types so students can see and feel the differences.

### Lesson Value

This activity artfully exposes students to the word *texture*. Use it to define the surface appearance of sandpaper in comparison to other types of paper.

In addition, students can study the composition, purpose and construction of sandpaper.



Figure 4-7A

*Crayon colored sandpaper and heat produce this mosaic-like design.*

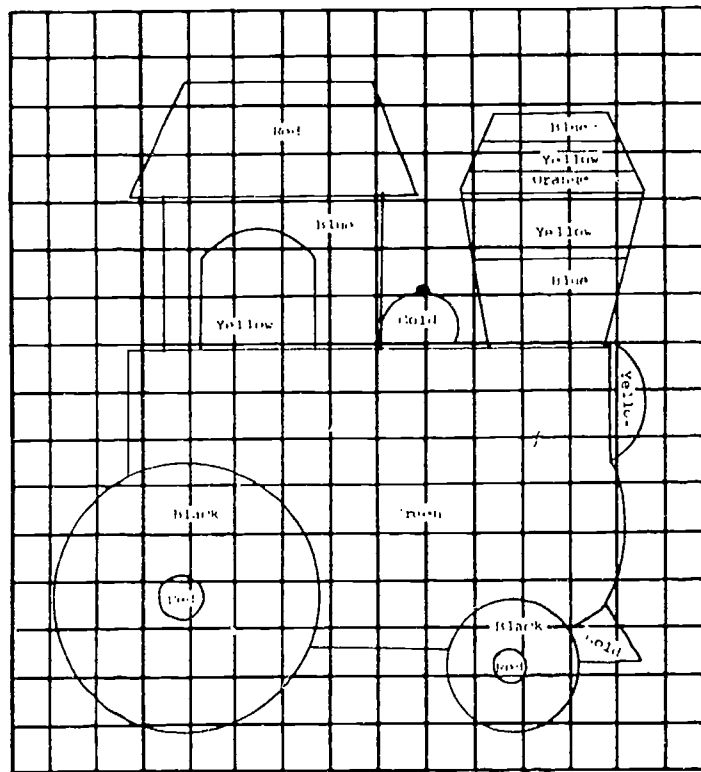

Figure 4-7B

*Clickety-Clack Circus Train pattern.*

**CORK TRAIN**

# Train

**MATERIALS**

- 3 large, round corks
- 4 small corks and half of a very small cork
- a piece of cork tile  $\frac{1}{8}$  inch (3 mm.) thick
- thumbtacks in different colors
- embroidery thread
- a large needle
- a knife
- some paraffin or a piece of candle wax
- sandpaper

**CONSTRUCTION**

- Cut the 4 bases for the cars from the cork tile (see drawing 1 for the size). Use a ruler to do this. The cork cuts easily if you pass the knife through the paraffin once. Sand the cut part.

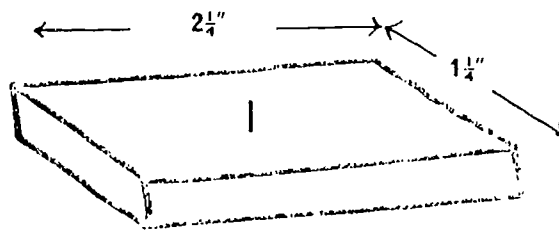

base for the cars and locomotive

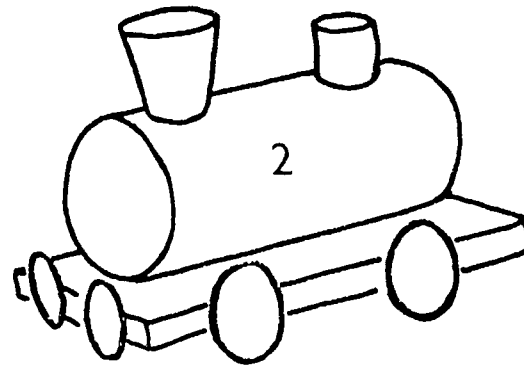

locomotive

**The Locomotive**

- Glue the large cork to a base.
- Glue the smokestack on the large cork. Make it from a little cork and half of a very small cork.
- Put 2 red thumbtacks on the front of the base. Stick in 4 colored thumbtacks to make wheels (see drawing 2).

**First Car**

- Cut a large cork in half. Sand the cut ends. Glue the two halves onto the base (see drawing 3).
- Stick in 4 thumbtacks for wheels.

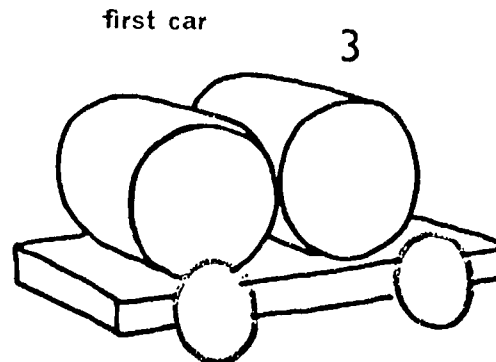

From *Cork Toys You Can Make* - Geneviève Ploquin - © Fleurus 1976 / © Search Press 1976.

**Second Car**

- Cut a large cork as shown in drawing 4. Glue it on a base.
- Add the 4 thumbtack wheels.

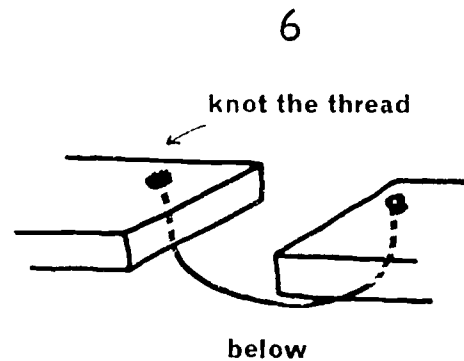
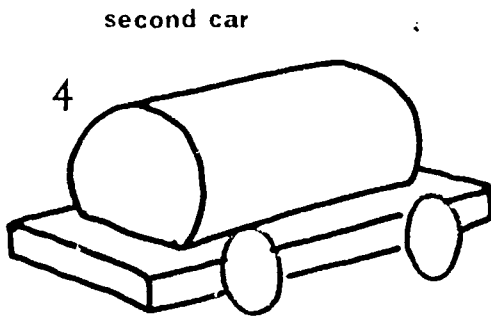

**Third Car**

- Glue 3 small corks on the base (see drawing 5).
- Stick in the 4 thumbtack wheels.

Of course, you can make many other cars, all different.

- Hook the cars and the locomotive together by sticking a large needle, threaded with embroidery thread, into the back of the base of a car. Then stick it into the front of the next car, leaving  $\frac{1}{4}$  inch (1 cm.) of thread between them. Make a large knot (see drawings 6 and 7).

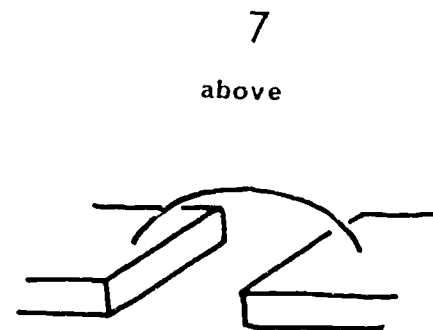
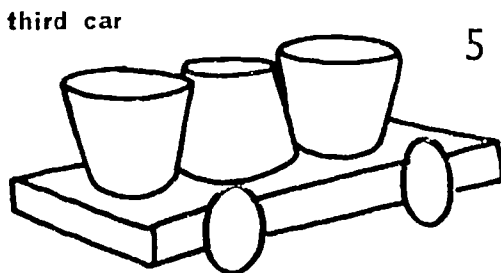





## EGG CARTON TRAINS

For each child you will need a row of six egg cups cut from a cardboard egg carton and half of a cardboard toilet tissue tube. Have the children turn their egg cup rows upside down and paint them as desired. Then let them paint their toilet tissue tubes black. Allow the paint to dry. Have the children glue their toilet tissue tubes to the tops of the first cups on their egg carton "trains" to complete.

From *Theme-A-Saurus II*, by Jean Warren, © 1990. Reprinted by permission of Warren Publishing House, Inc., P.O. Box 2250, Everett, WA 98203.

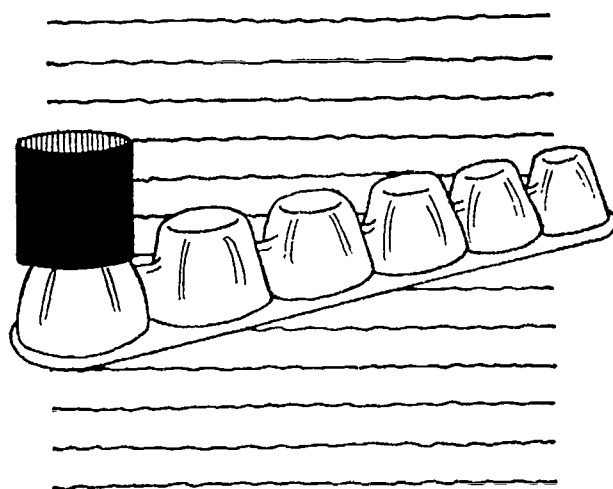

## ERNIE ELEPHANT

Another circle body, four more rectangle legs, and a trunk that reaches and moves make Ernie a popular elephant.

### Materials List

For each child you will need:

- a pencil
- scissors
- glue
- gray and white construction paper
- a hole punch
- yarn, cut into a 4" piece
- black and red markers

You will also need a razor blade

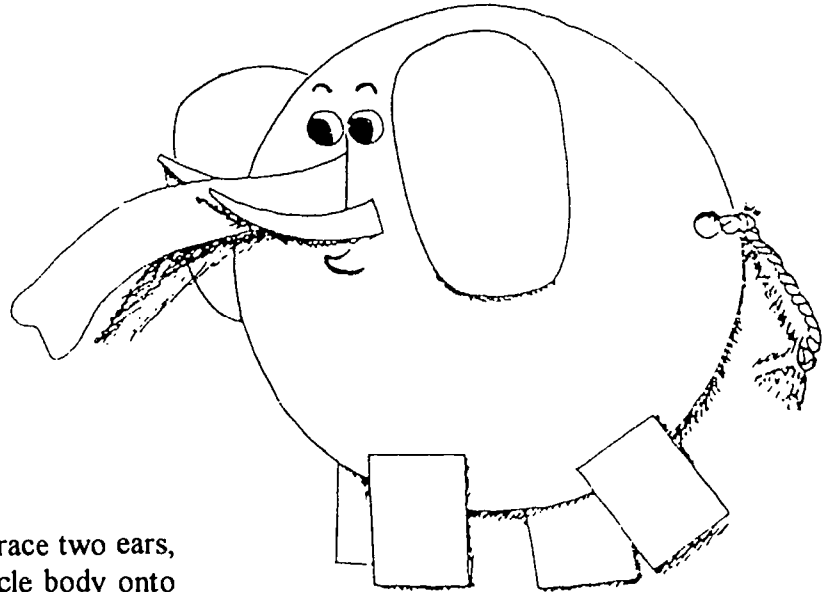

**CHILDREN:** Instruct the children to trace two ears, four rectangle legs, a trunk, and a circle body onto gray construction paper. Trace two tusks and two eyes onto white construction paper. Cut them out.

To assemble Ernie Elephant, glue two legs at the bottom of the body so they hang over the edge of the circle. Glue the other two legs under the body and a little ahead of the first legs so you can see them.

Glue two circle eyes on the upper left of the body. Put them close together. Glue one ear to the right of the eyes. Glue the other ear to the left of the eyes and under the body, partly sticking out.

**ADULTS:** Use the razor blade to make a  $\frac{3}{4}$ -inch slit in the body, as shown on the pattern.

**CHILDREN:** glue one tusk on the left side of the slit. Glue the other tusk beneath the slit. Fold the fat end of the trunk (as shown on the pattern) and insert it in the slit. Unfold it. The fat end would be hidden behind the elephant's body.

Make a hole in the body (as shown on the pattern) with a hole punch. Tie on the yarn for a tail. Tie a knot 1-inch from the end of the tail. Separate the individual strands of yarn at the end to make a tassel.

Use the black marker to draw eyeballs, eyebrows, and feet. Use the red marker to draw a mouth beneath the tusks.

From *Year-Round Crafts for Kids*, by Barbara L. Dondiego, © 1988, TAB Books, Inc. Reprinted by permission.

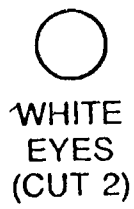
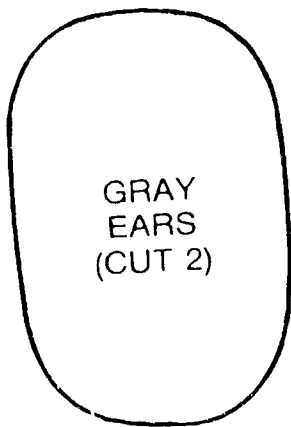
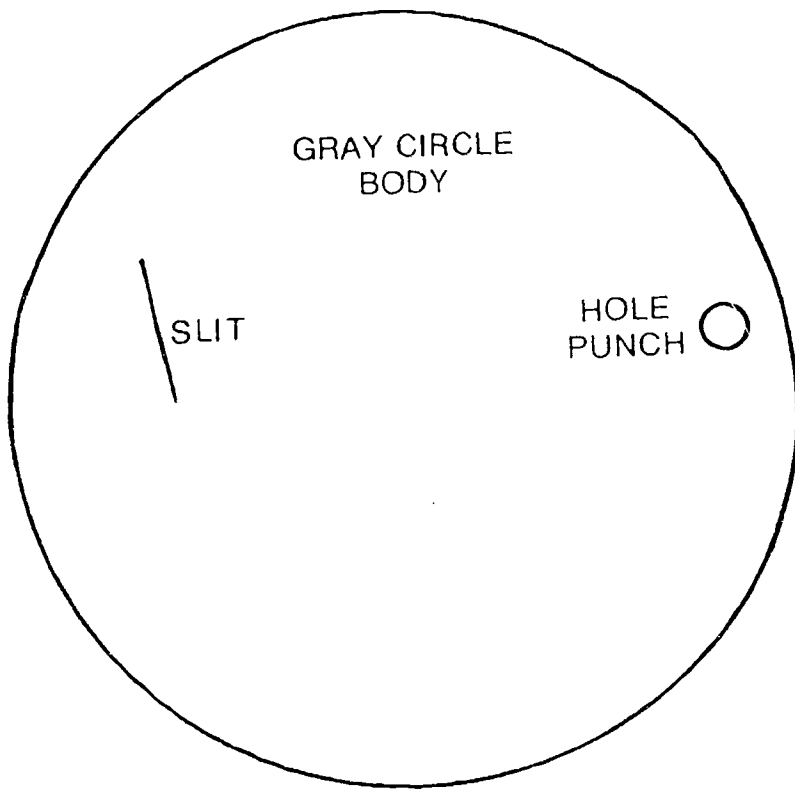

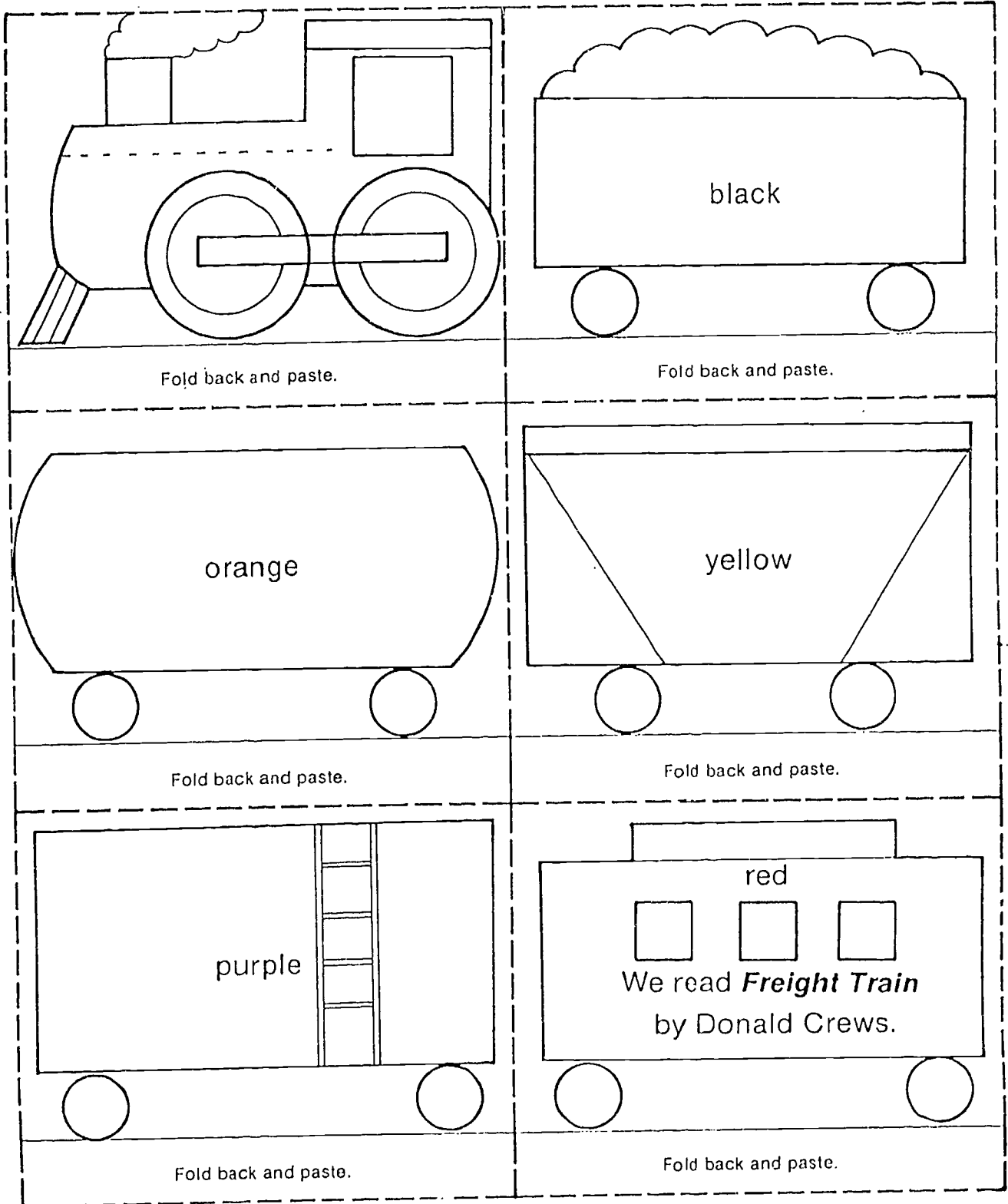

From *Fun With Books*, by Joy Evans and Jo Ellen Moore. © 1987 by Evan-Moor Corp. Used with permission.

**FUNNY PICTURES**

by Yolanda Blanchard, Calcasieu Parish Library

Use pictures and advertisements from old newspapers and magazines to make trains, people who ride trains, etc.

**HOBO KAZOO**

by Lucille DeFatta, Bossier Parish Library

Color or cover a cardboard tube. Cover one end of the tube with waxed paper and secure with a rubber band. Now blow and hum through the open end of the tube.

**LANTERN**

1. Fold a piece of construction paper in half, lengthwise.
2. Starting at the folded edge, make cuts about an inch apart to within one inch of edge of paper.
3. Unfold and staple edges of paper together, top to bottom.
4. Punch holes at either side of top of lantern and thread yarn through for handle.

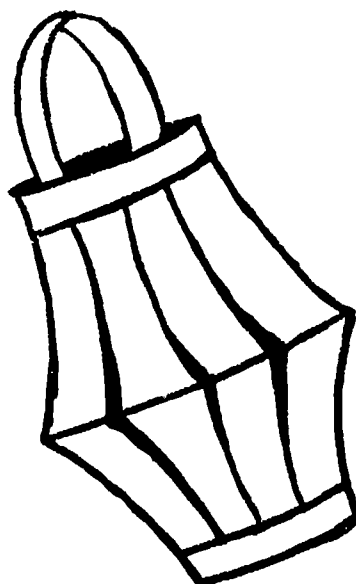

Adapted from *Fun Projects for Kids*, by Judith F. Neal, Childrens Press. Used by permission.

**LARRY LION**

His mouth opens so he can eat; his tail is braided nice and neat.

**Materials List**

For each child you will need:

- a pencil
- scissors
- glue
- a paper punch
- a black marker
- yellow, brown, black, and white construction paper
- 3 pieces of yarn, 6" each

You will also need a razor blade

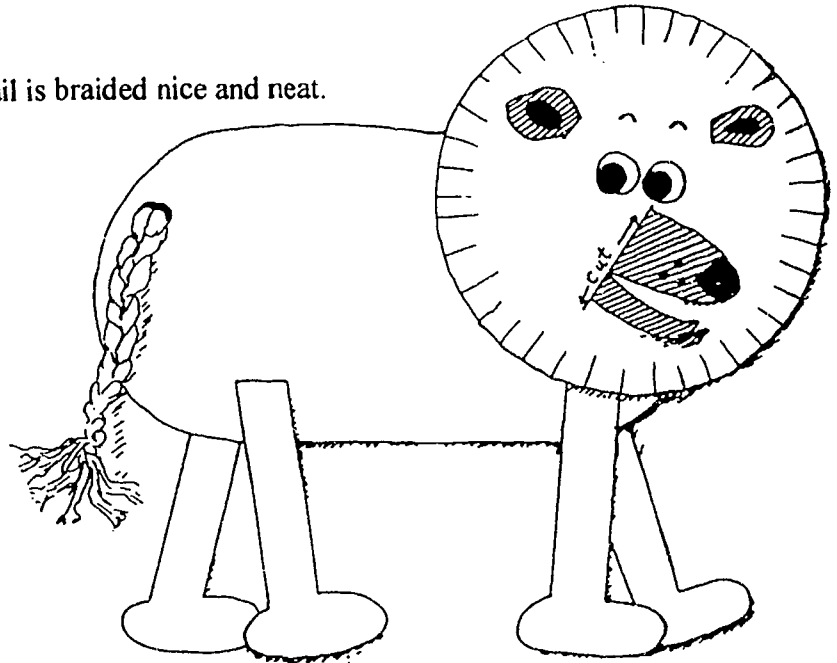
**Directions**

**CHILDREN:** Instruct the children to trace a head, body, and four legs onto yellow construction paper. Trace two ears, a snout, and a mouth onto brown construction paper. Trace two white eyes and a black nose. Cut out everything.

Fringe the head by making shallow cuts all around it with scissors. This is the mane. Bend the fringes with your fingers so the mane curls a little. Glue the head on one end of the body.

**ADULTS:** Use the razor blade to make a ½-inch slit in the head, as shown on the pattern. Since the head is glued to the body, make the slit go through the body also.

**CHILDREN:** Then tell the children to glue two feet on the body so they stick downward. Glue the other two feet under the body and a little behind or in front of the first feet so you can see them.

Glue the brown snout above the slit and to the right of it. Glue two white circle eyes close together and above the snout. Add two black eyeballs made with the paper punch. Glue the black nose to the snout. Glue on two brown ears. With a black marker, draw three dots on the snout, eyebrows, and a center on each ear.

Use the paper punch to make a hole for the lion's tail. Tie three pieces of yarn together at one end. Braid them and tie the braid at the end with an extra piece of yarn. Separate the individual threads of yarn to make a fluffy tassel on the end. Insert the tail through the hole in the body so that the tassel hangs down and the knot is hidden behind the body.

Insert the lion's mouth through the slit. Hide the rounded end behind his body. Make his mouth open and shut by moving the hidden end up and down.

From *Year-Round Crafts for Kids*, by Barbara L. Dondiego, © 1988, TAB Books, Inc. Reprinted by permission.

WHITE EYES (CUT 2)



BLACK NOSE



BROWN EARS (CUT 2)



BROWN  
SNOUT



BROWN MOUTH

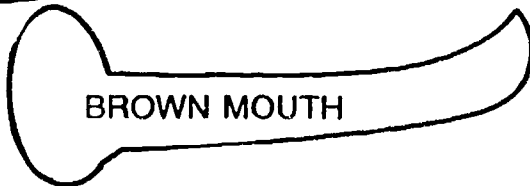

YELLOW LEGS  
(CUT 4)

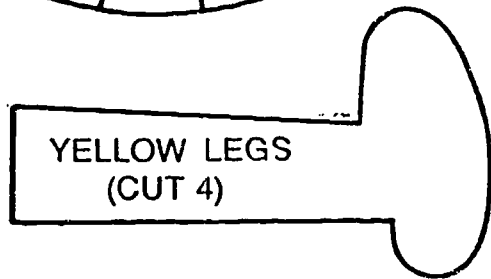

YELLOW HEAD

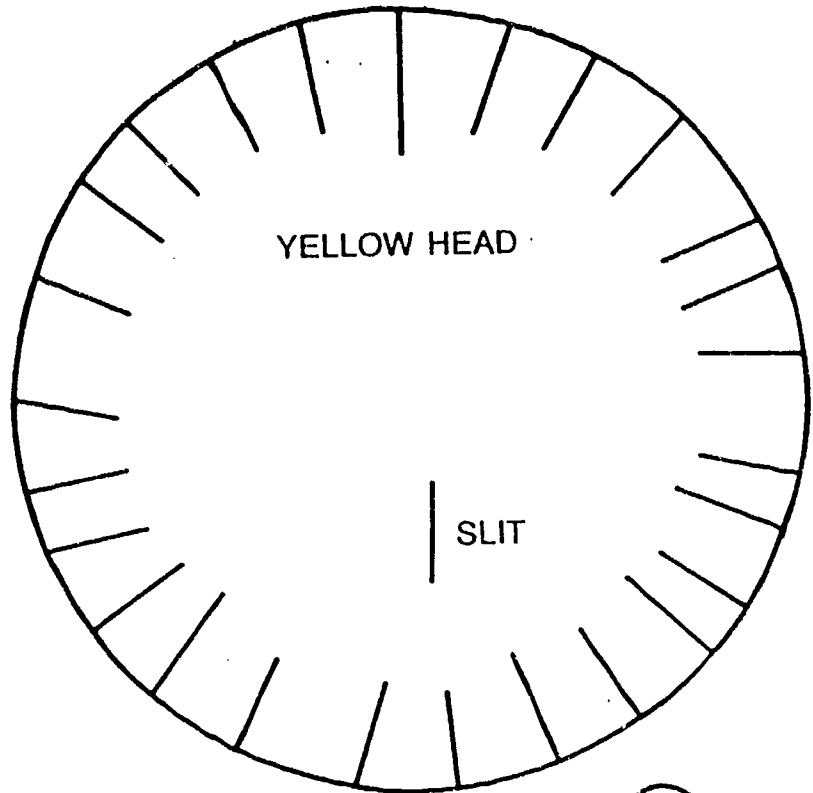

YELLOW BODY

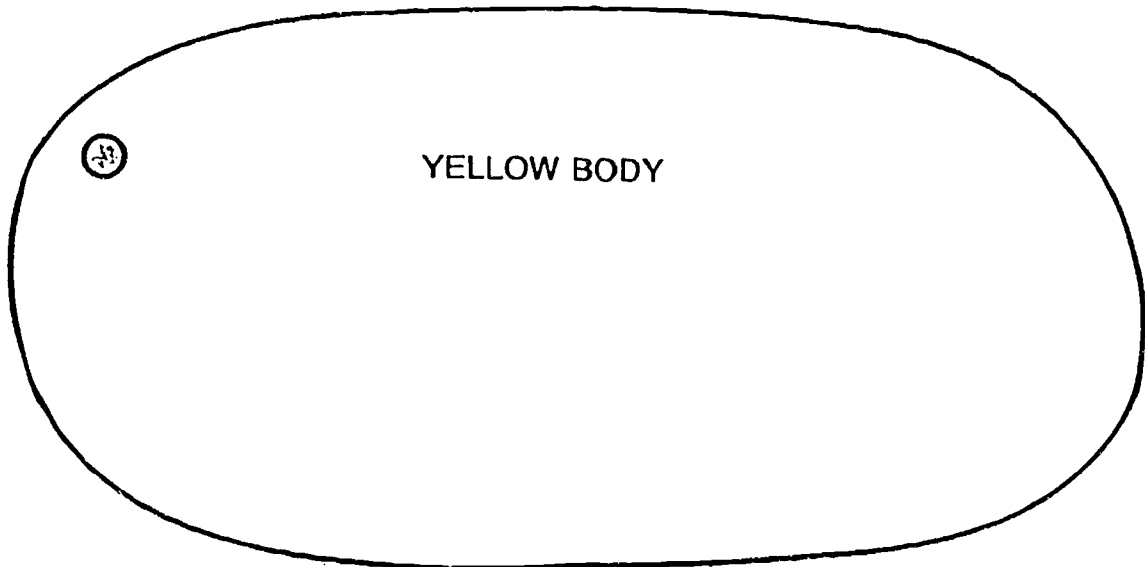

## LAUNDRY BASKET TRAIN

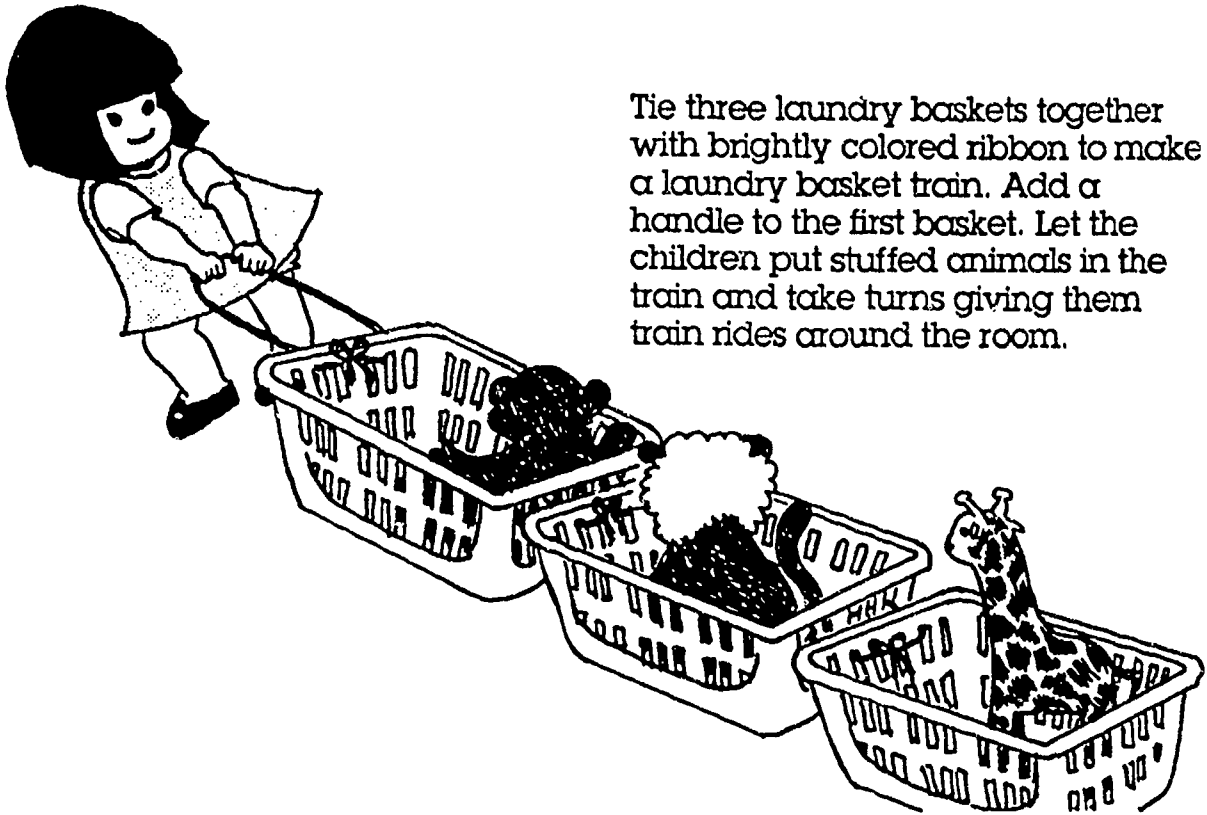

Tie three laundry baskets together with brightly colored ribbon to make a laundry basket train. Add a handle to the first basket. Let the children put stuffed animals in the train and take turns giving them train rides around the room.

From *Toddler Theme-A-Saurus*, by Jean Warren, © 1991. Reprinted by permission of Warren Publishing House, Inc., P.O. Box 2250, Everett, WA 98203.

## THE LITTLE ENGINE THAT COULD

by Lucille DeFatta, Bossier Parish Library

Let the children color the train (pattern is on following page) and glue smoke (three cotton balls) coming out of the smoke stack. The cotton balls may be dusted with black powdered tempera for a smoky effect. This can be used as an activity when you read *The Little Engine That Could* by Watty Piper.



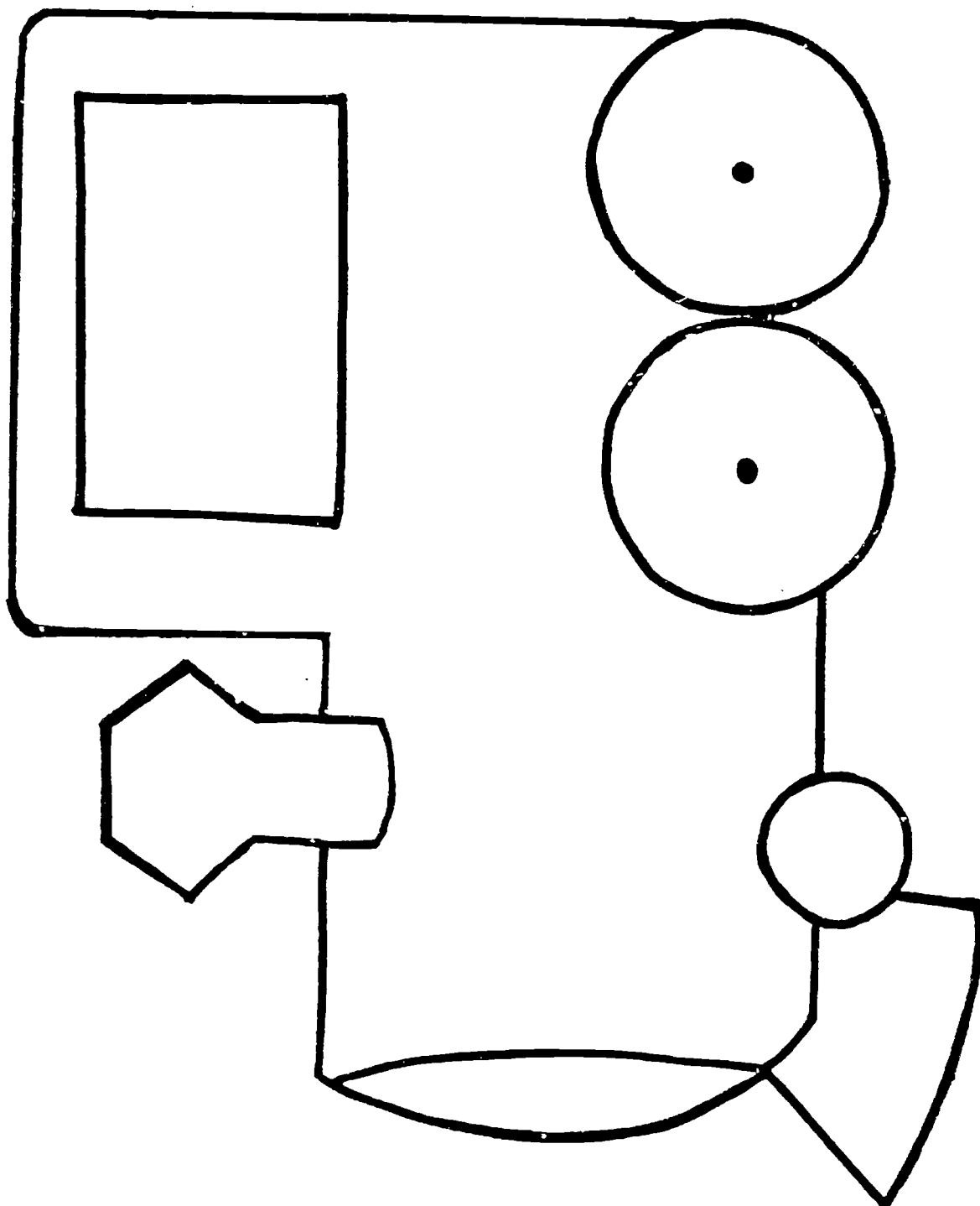

**THE LITTLE RED CABOOSE**

by Lucille DeFatta, Bossier Parish Library

Use the following pattern as a craft activity when you read *The Little Red Caboose* by Marian Potter.

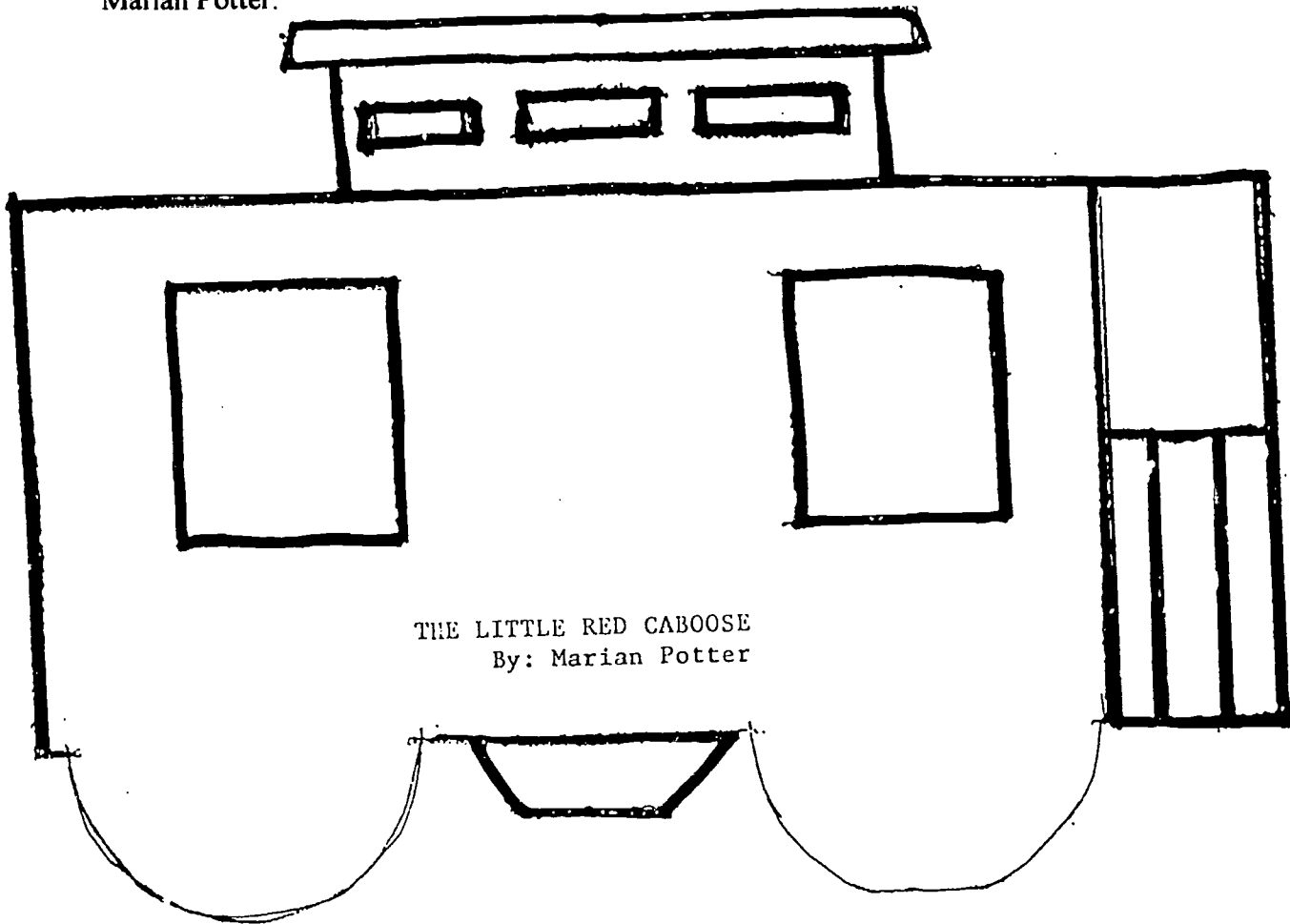

Caboose drawn onto red tag board and outlined with a black sharpie pen

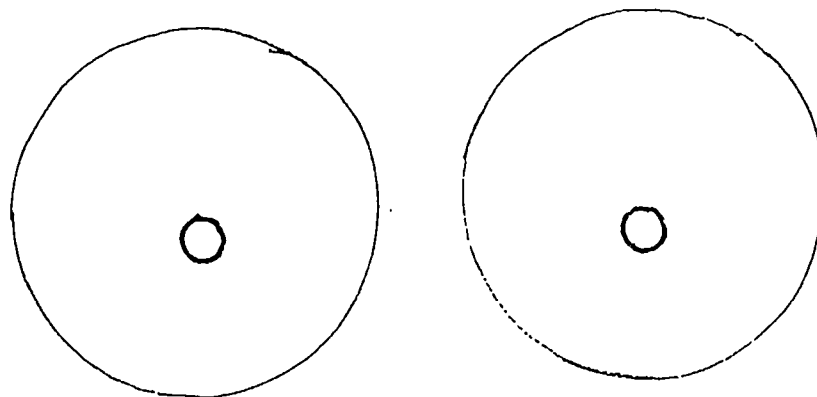

Caboose wheels cut from black tag board and attached to caboose using paper fasteners

MAGIC LADDER

# Magic ladder

*You will need*

*2 sheets of newspaper*

*Sticky tape*

*Scissors*

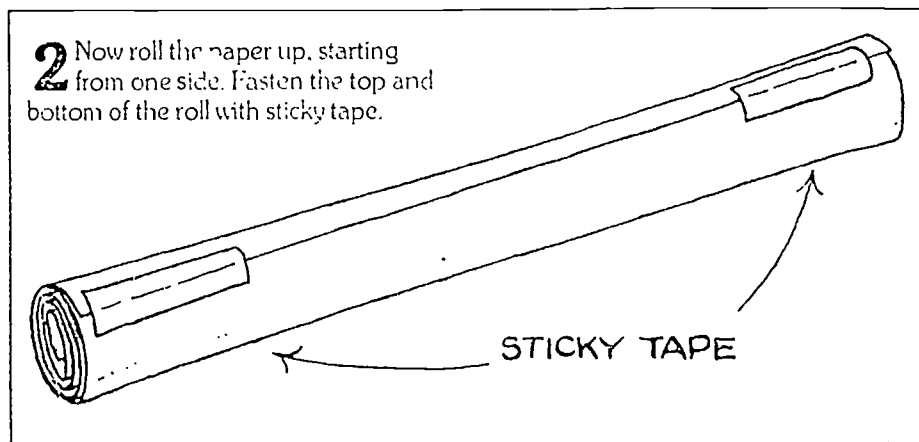
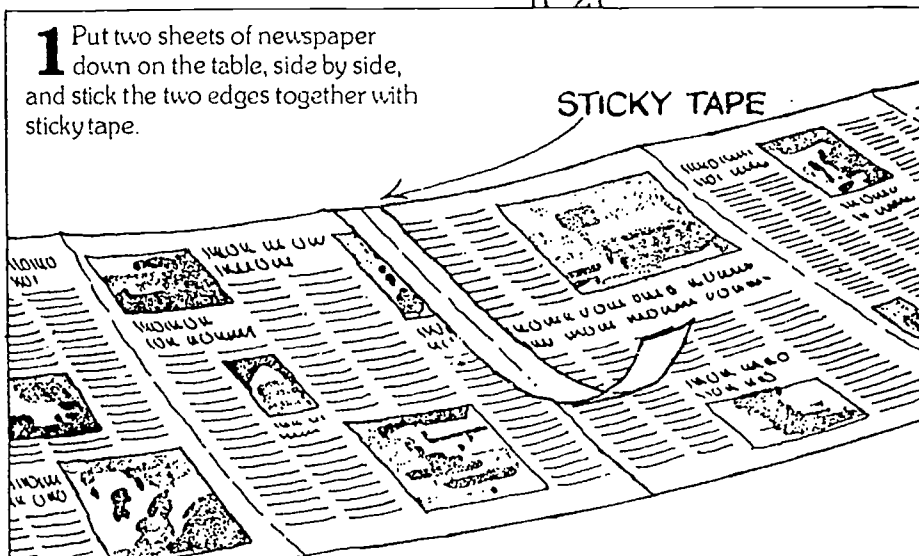

From *My Biggest Playtime Book Ever*, © 1986. Reprinted by permission of the publisher, Simon & Schuster Inc.

**3** Cut a piece out of the side of the roll.

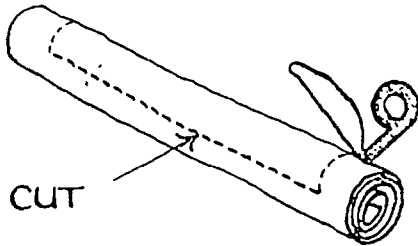

**4** Now bend the roll back so that the two ends are flat upon the table.

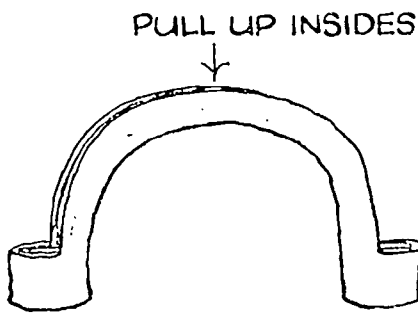

**5** Pull the insides out carefully and your magic ladder will appear!

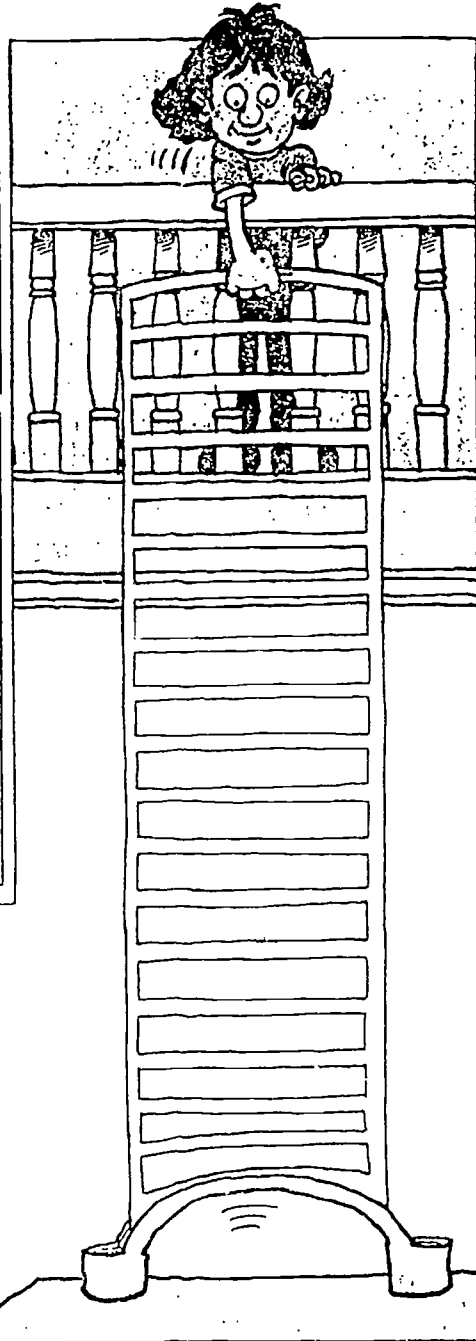

## MAKE YOUR OWN BOOK

### Did you know?

Theodor (Dr. Seuss) Giesel worked as a cartoonist and Hollywood animator before he began to write children's books.

Maurice Sendak was a sickly boy, who loved stories like *Pinocchio* and *The Phantom of the Opera*, but hated school.

Madeleine L'Engle has written stories ever since she was old enough to hold a pencil. If she has something to say that is too difficult for adults to swallow, then she puts it in a book for kids.

Can you write each author's name after the books she or he wrote?

*Meet the Austins* \_\_\_\_\_

*Green Eggs and Ham* \_\_\_\_\_

*Chicken Soup with Rice* \_\_\_\_\_

*Where the Wild Things Are* \_\_\_\_\_

*A Wrinkle in Time* \_\_\_\_\_

*The Sneeches* \_\_\_\_\_

## Make your Own Book!



1. Cut along the dotted lines.



2. Fold at the first fold line.

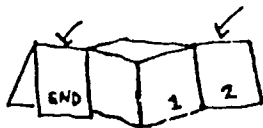

3. Open. Fold at the second fold line.

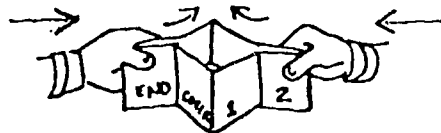

4. Holding each end, push inward.



5. Pinch the pages together, so front and back covers enclose them.

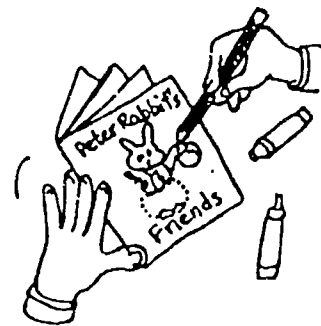

6. Crease the edge where the pages come together (people call this the spine of a book). Fill in the blanks on each page with "your story" and color "your illustrations." Have fun!

From *The Kids Holiday Book: Activities Through the Seasons*, © 1990, Glove Compartment Books. Used by permission.

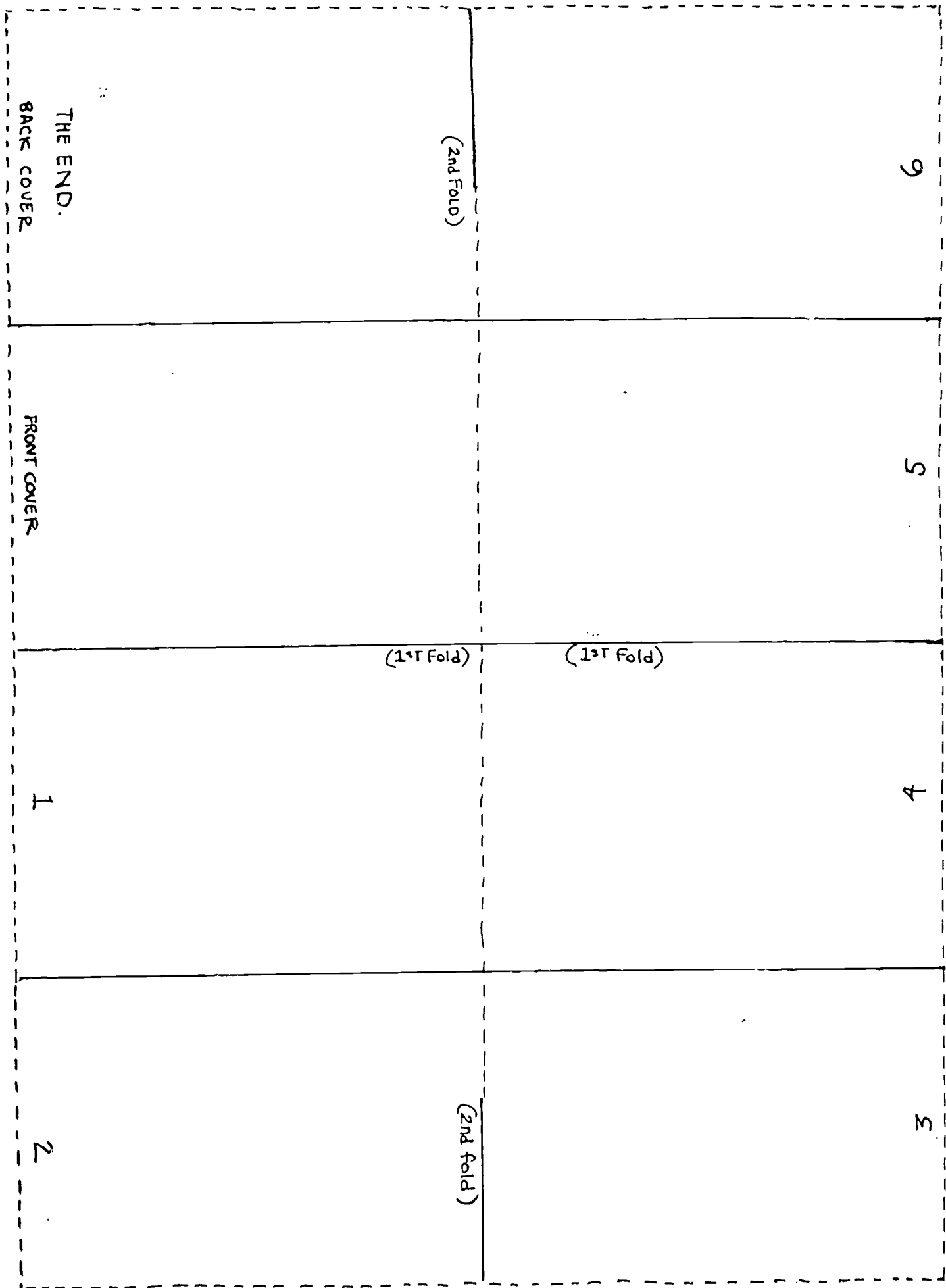

## Marbled Accordion Book

Ages 4 to 6

Adult participation required

With adult assistance, a preschooler can make marbled covers for a book of his own.

### Materials

#### For the marbled paper

water  
cornstarch  
liquid dish detergent  
liquid tempera paint  
1-inch-wide paintbrush  
toothbrush  
drawing paper, 4¼ by 9 inches  
newspaper

#### For the book

two pieces of posterboard, 3⅞ inches square  
drawing paper, 3 by 18 inches  
two pieces of marbled paper (*instructions below*)  
narrow fabric ribbon, 24 inches long  
safety scissors  
glue  
½-inch-wide paintbrush  
wax paper



1  
Combine 1 tablespoon of cold water with 1 tablespoon of cornstarch and add the mixture to 9 tablespoons water boiling in a saucepan. Stir it until the mixture turns translucent (a minute or two) and remove from the heat. Add ¼ teaspoon of liquid dish detergent and let the mixture cool. Stir in 2 tablespoons of tempera.

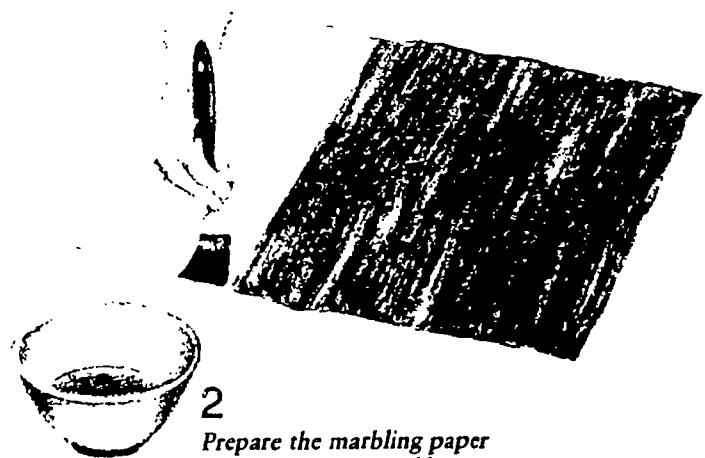

2  
Prepare the marbling paper by moistening one side with a damp sponge. Place it damp side down on a pad of newspapers, then smooth it flat. Use the paintbrush to coat the paper with the colored paste (above).

From *Successful Parenting: Creative Projects Big and Small*.

By the Editors of Time-Life Books

© 1988 Time Life Books Inc.

3

Using the toothbrush, swirl patterns in the paste; you might make regular scallops (right) or a more free-form design. Let the paper dry overnight; then cut out two squares, each 4½ inches on a side.

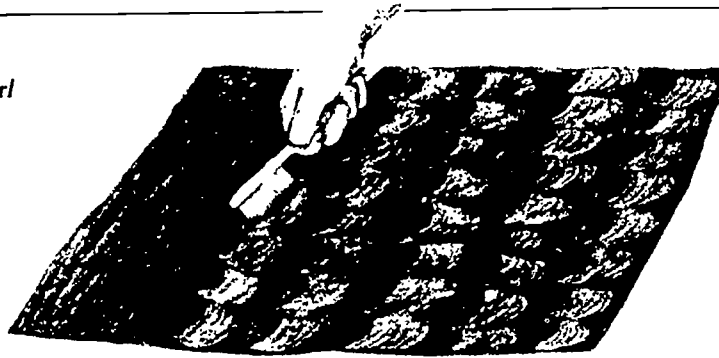

4

To begin assembling a cover, lay the decorated side of one square down on a work surface. Now brush glue on one side of a posterboard square and center it, glue side down, on the back of the marbled paper (right), pressing to make it stick.

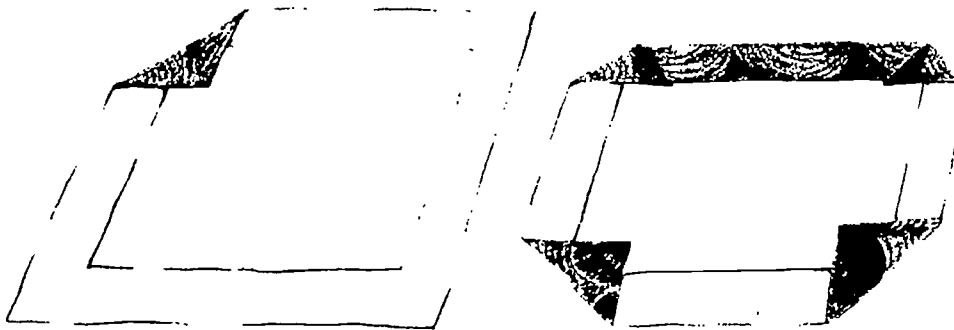
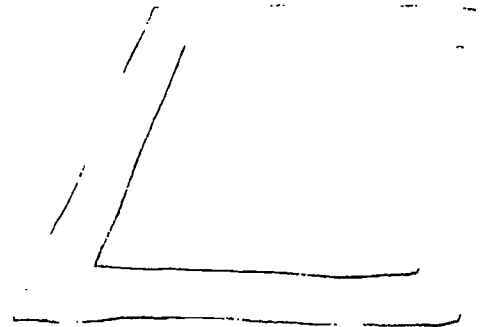

5

Put glue on each corner of the paper and fold it over the posterboard, forming triangles (above). Then glue and fold each remaining edge over the posterboard (above, right). Repeat Steps 4 and 5 with the other posterboard and marbled paper.

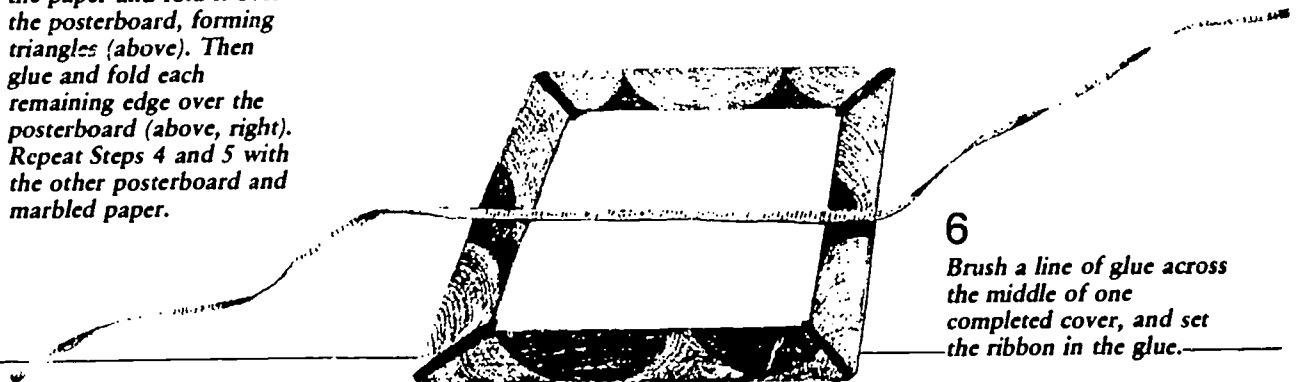

6

Brush a line of glue across the middle of one completed cover, and set the ribbon in the glue.



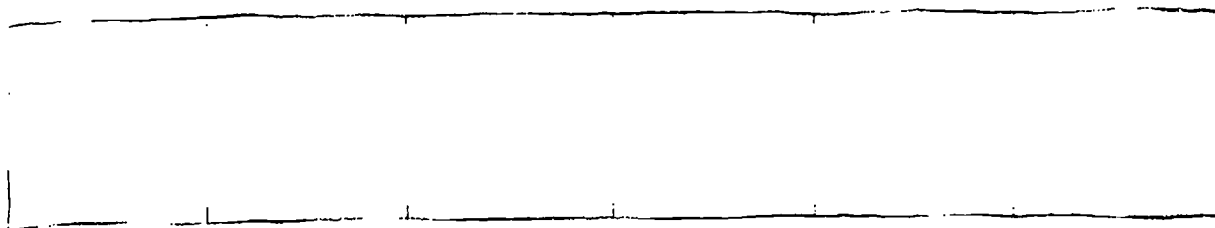

7

To shape the book's pages, mark light pencil ticks at 3-inch intervals along the 18-inch strip of paper. Accordion-fold the strip at the marks (right), forming six panels. Erase the ticks.

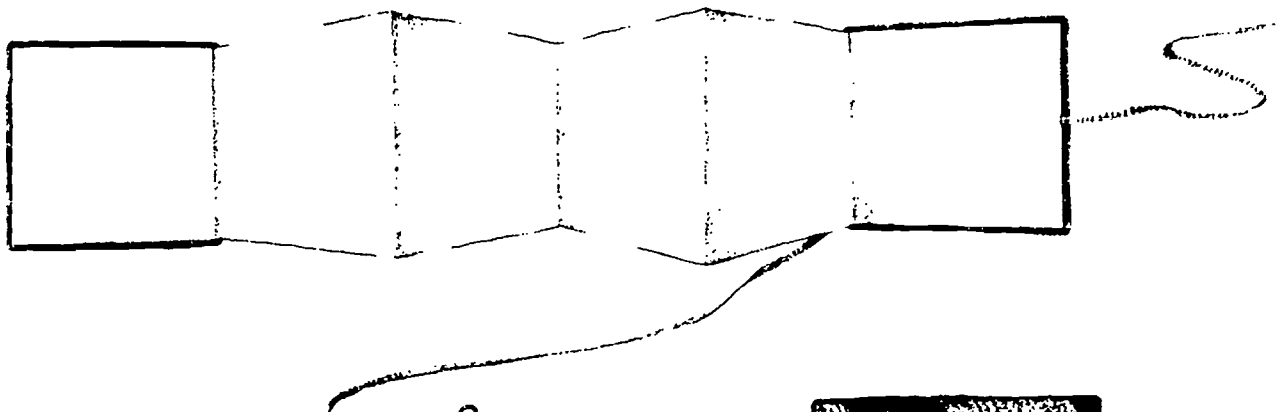
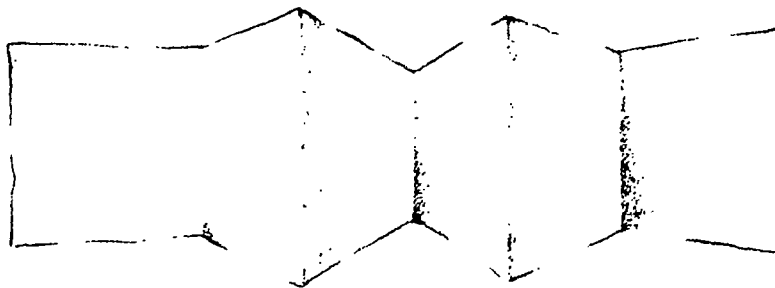

8

Brush the end pages with glue. Press a cover to each end page (above). Insert wax paper between each cover and facing page, and close the book. Sandwich it in wax paper, and let it dry under a weight overnight. Tie it shut with the ribbon (right).

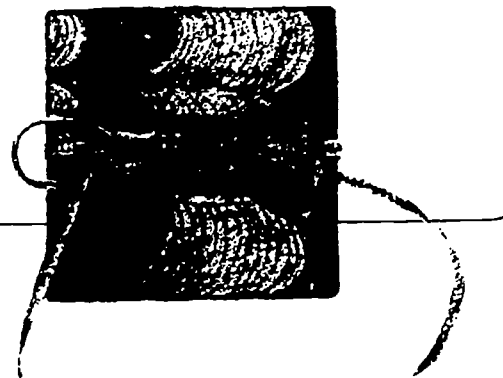

# Mexican Flowers

**Ages 4 to 6**

Adult participation required

**Materials**

- tissue paper in five colors
- paper clip
- plate 4 to 6 inches in diameter
- pencil
- safety scissors
- pipe cleaners



1

Clip together a stack of five sheets of tissue paper, each a different color. Lay the plate face down on the paper and trace its outline; following this outline, cut a circle out, through all five layers (above).

2

With a pencil point, poke two holes to either side of the circle's center, making sure to pierce all five layers. Bend a pipe cleaner in half, push one end through each hole, and twist the ends together (below) into a stem.

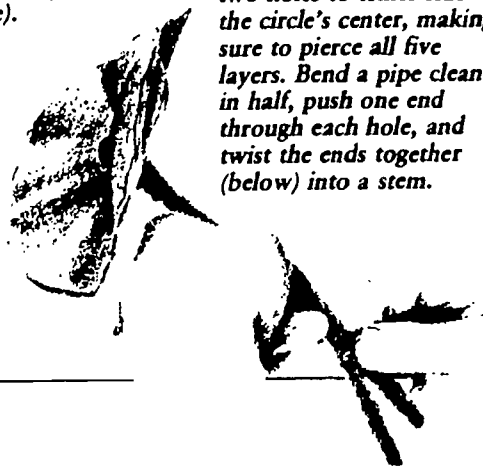

3

Create the flower by separating the layers and fluffing them individually. Begin by forming the innermost petals, and work outward (above).

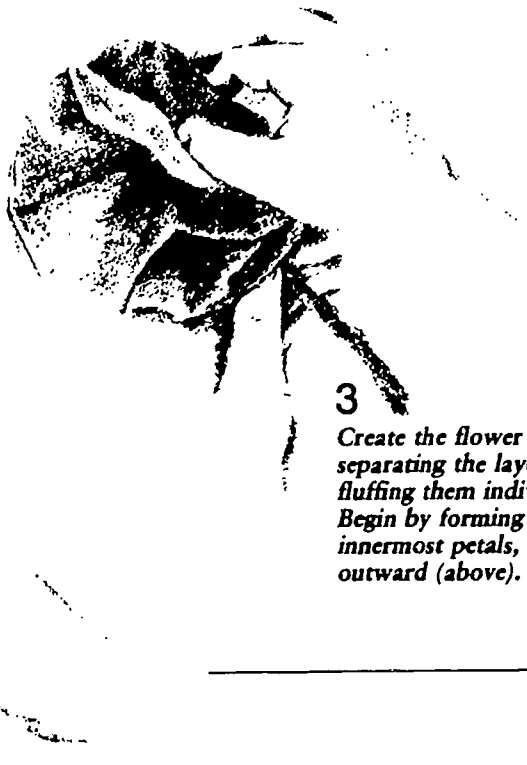

From *Successful Parenting: Creative Projects Big and Small*.

By the Editors of Time-Life Books

© 1988 Time Life Books Inc.

**MY TRAIN TRIP TO THE LIBRARY**

by Yolanda Blanchard, Calcasieu Parish Library

Have a large piece of paper taped to the wall for a mural and crayons, pencils, or other drawing equipment available. Ask the children to close their eyes and imagine "My Train Trip to the Library." Then ask them to draw pictures on the paper which describe what they imagined.

**NONSENSE SHAPES**

Directions: Duplicate as many shapes as needed to make a car or cars.

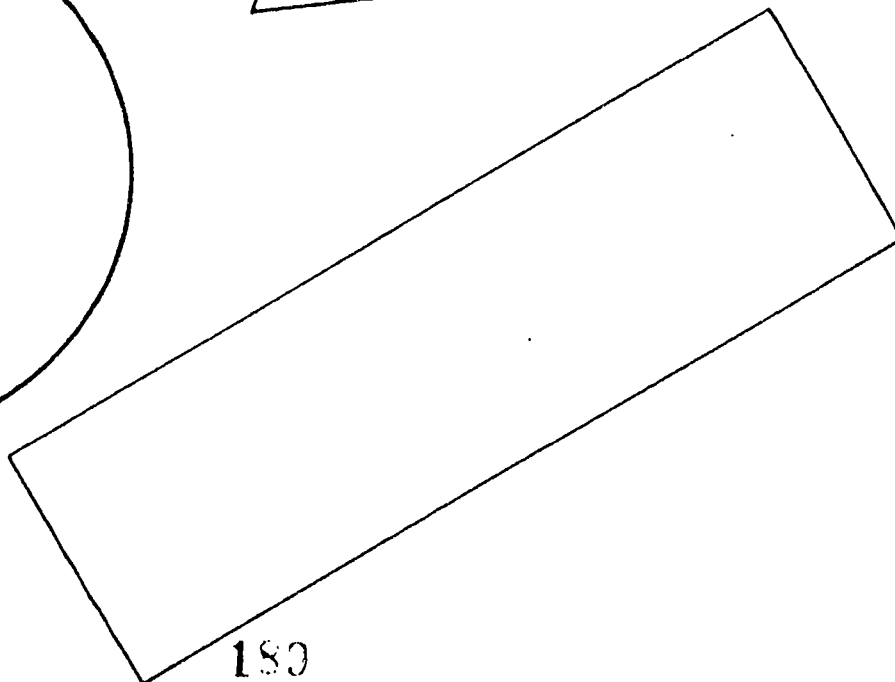
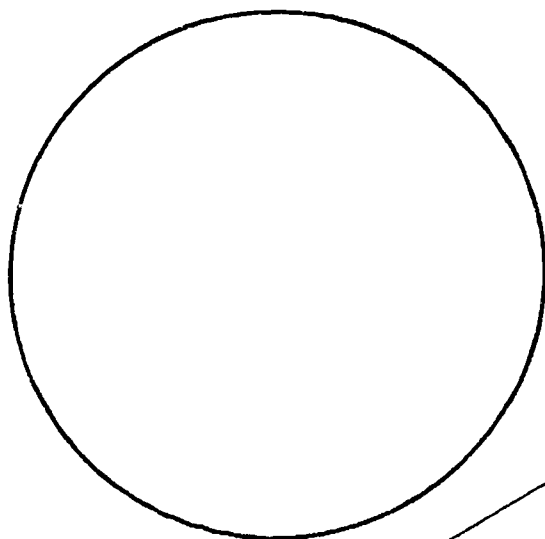
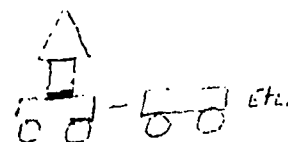
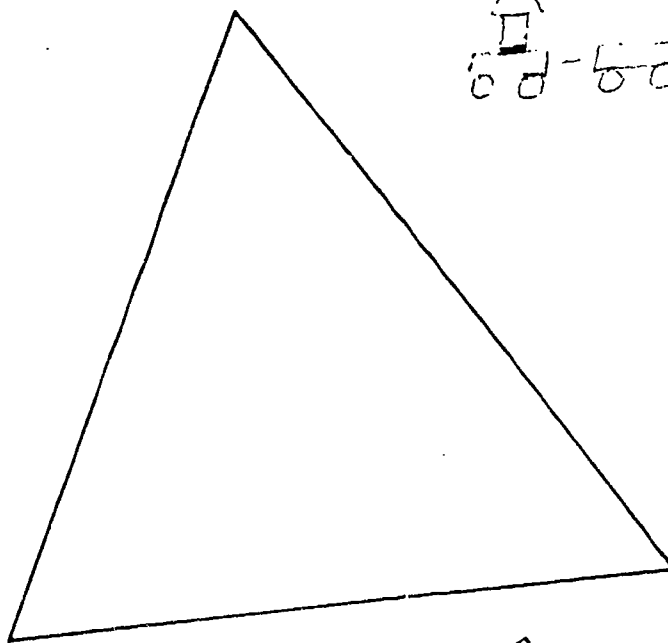
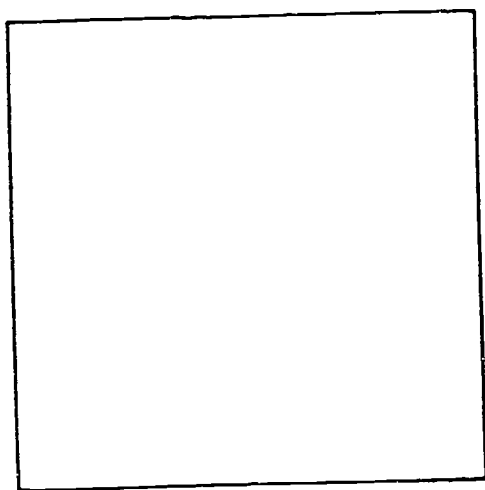

**NUMBER TRAINS**

Enlarge patterns and cut out of construction paper: one engine shape, five boxcar shapes, and one caboose shape. Number the boxcars from 1 to 5. Give each child a set of the train shapes and fifteen stickers. Have the children identify the numbers on their boxcar shapes and attach the corresponding numbers of stickers to them. Ask them to line up their train shapes on a table with their engines first, their boxcars next (in order) and their cabooses last. Tape the shapes together along their sides. Then hang up the number trains or fold them into books.

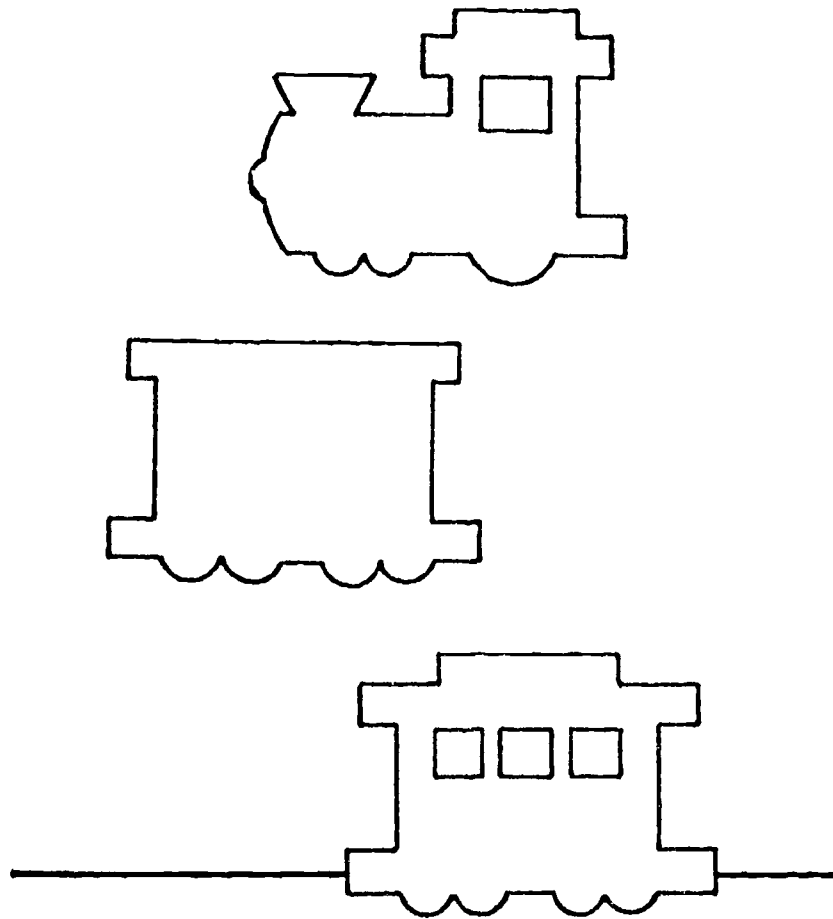

From *Theme-A-Saurus II*, by Jean Warren, © 1990. Reprinted by permission of Warren Publishing House, Inc., P.O. Box 2250, Everett, WA 98203.

PAPER PLATE PUPPET

YOU WILL NEED

- 2 paper plates
- Stapler or sticky tape
- Scraps of wool, card etc.
- Non-toxic glue
- Your paint box, felt pens or crayons

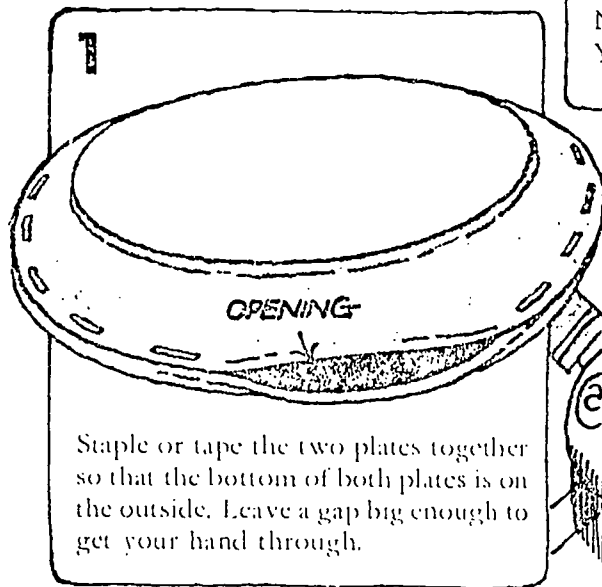

Staple or tape the two plates together so that the bottom of both plates is on the outside. Leave a gap big enough to get your hand through.

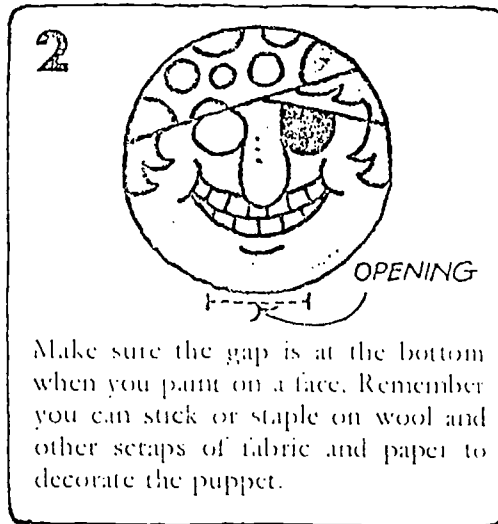

Make sure the gap is at the bottom when you paint on a face. Remember you can stick or staple on wool and other scraps of fabric and paper to decorate the puppet.



From *My Biggest Playtime Book Ever*, © 1986. Reprinted by permission of the publisher, Simon & Schuster Inc.

## Papier-Mâché Dragon

**Ages 4 to 6**

Adult participation required

With your assistance, your child can create a menagerie of creatures.

### Materials

newspapers, including color comics  
masking or packing tape  
premixed wallpaper paste  
shallow bowl  
scissors  
liquid tempera paint  
paintbrushes

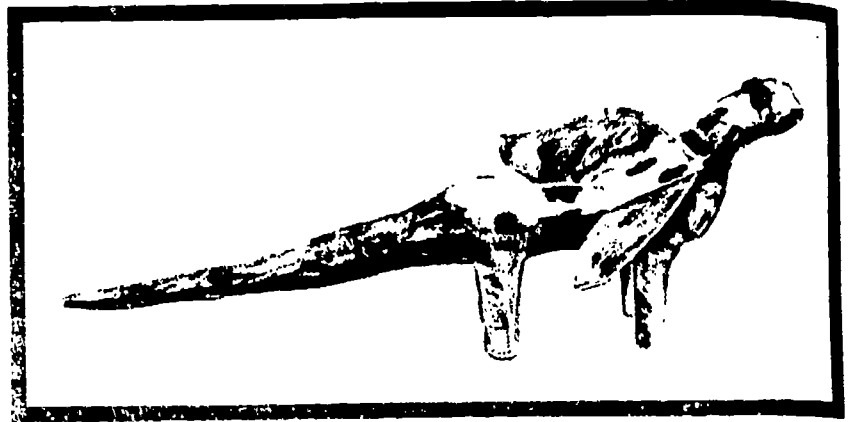

1

Spread out four to six full sheets of newspaper on a flat work surface. Roll the sheets into a thick tube, and secure it with tape to prevent it from opening (above). Make two thinner tubes in the same way, using two whole sheets for each tube. The thick tube will form the creature's body and head; the thin tubes become its legs.

2

Bend the thick body tube in half to make a neck section and a body section. Bend one of the thin tubes over the body tube at the fold, and tape (below) to the body for front legs. Fold the other tube in half, and tape it to the end of the body for rear legs.

From *Successful Parenting: Creative Projects Big and Small*.

By the Editors of Time-Life Books

© 1988 Time Life Books Inc.

3

*Holding the body at the shoulders, shape the head and neck by bending the front portion of the body tube in half (right). Wind tape around the fold to brace the head.*

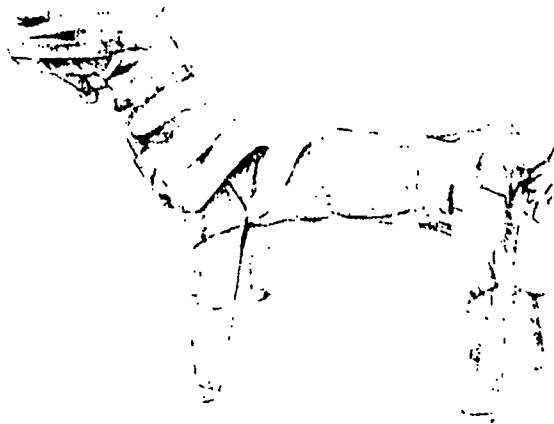

4

*For a tail, roll two sheets into a tube, and tape to the hips. Cut wings from several sheets, and tape them to the shoulders. To round out the chest, crumple a sheet and tape it to the body. To make the eyes, tape on balled-up bits of paper. Reinforce with tape where needed.*



5

*Tear comics into strips 3 to 6 inches long and 3/4 inch wide (right). Using colored paper will help you keep track later of the sections of the animal you have already covered.*

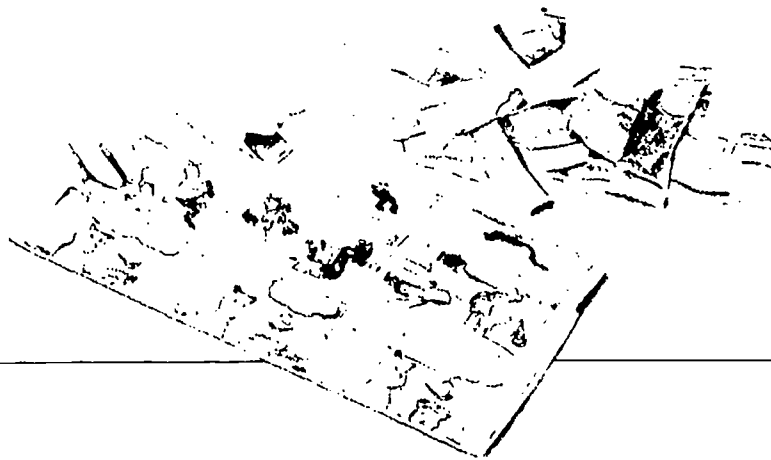



6

*Pour a little wallpaper paste into a bowl. Dip a strip of the comics into the paste to coat the paper thoroughly. Let excess glue drip back into the bowl (left) before pasting the strip on the figure.*

7  
*Beginning wherever you like, drape the strips over the figure, but be sure that they partially overlap. Smooth the excess glue over the surface as you work. Apply an extra layer or two, or as many as needed for reinforcement.*



8

*With cardboard supports under the wings, set the dragon in a warm, dry location to harden. After 24 hours, test for dryness. If the surface feels cool, the inside is still damp and needs more time to dry.*

9  
*When the dragon is completely dry, apply several coats of tempera paint. Yarn hair and various decorations can be pasted on once the paint itself dries.*

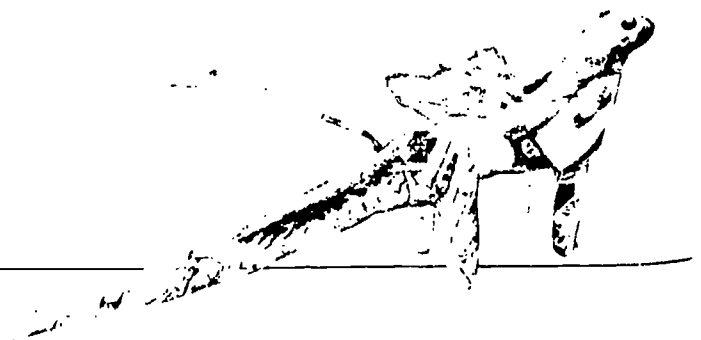



## POP-UP HOBO

Draw a hobo onto a piece of construction paper and cut out. Glue a Popsicle stick to the back of the hobo. Punch a hole in the bottom of a paper or styrofoam cup. Insert the hobo into the cup, stick first, and make the hobo pop out of the cup by pushing up the stick.

Adapted from *Fun Projects for Kids*, by Judith F. Neal, Childrens Press. Used by permission.

## A RAILWAY ENGINE

Materials: plastic bottles, washing-powder boxes, stiff cardboard, dowel, upholsterers' pins.

The funnel is cut from the top of a plastic bottle. Another bottle with the screw top removed forms the body of the engine.

A washing-powder box has part of its length cut away to make a narrow box, and the body of the engine is glued on this.

The cabin is made from another similar box cut to the right size. Windows and doors are cut out.

A hole is cut from the body piece and the funnel fitted into this. Part of an egg box is trimmed down and also glued to the body.

Make the wheels by cutting six rims from a plastic bottle. Fill these rims with circles of stiff card. Mark the centre of each wheel. Pierce a hole through the centre of each wheel.

Cut three lengths of dowel to go through the box beneath the engine body. Leave just enough dowel protruding for the wheels to be pinned on.

Upholsterers' pins will be found useful for pinning the wheels in place. These can be bought in most hardware stores. The holes in the wheels should be just large enough to allow the wheels to turn freely.

Tenders and carriages can be made in a similar manner from cardboard boxes: petrol and oil containers can be made from plastic bottles or boxes.

### Painting Plastic

After cutting the bottle to the required shape, give it a coat of flat white paint, such as Dulux white undercoat, and let this dry hard. A pattern or design can then be drawn on this with a felt or fibre pen.

Several different colours can be made with the aid of the white undercoat. Purchase some tubes of Students' Oil Colours: red, blue and yellow, and black. These and mixtures of these mixed with the white paint will provide suitable colours for all your models.

An egg box with six containers makes a useful palette for mixing colours and can be thrown away when finished with.

Reprinted by permission of S.G. Phillips, Inc. from *Carton Craft* by Richard Slade © 1972 by Richard Slade.

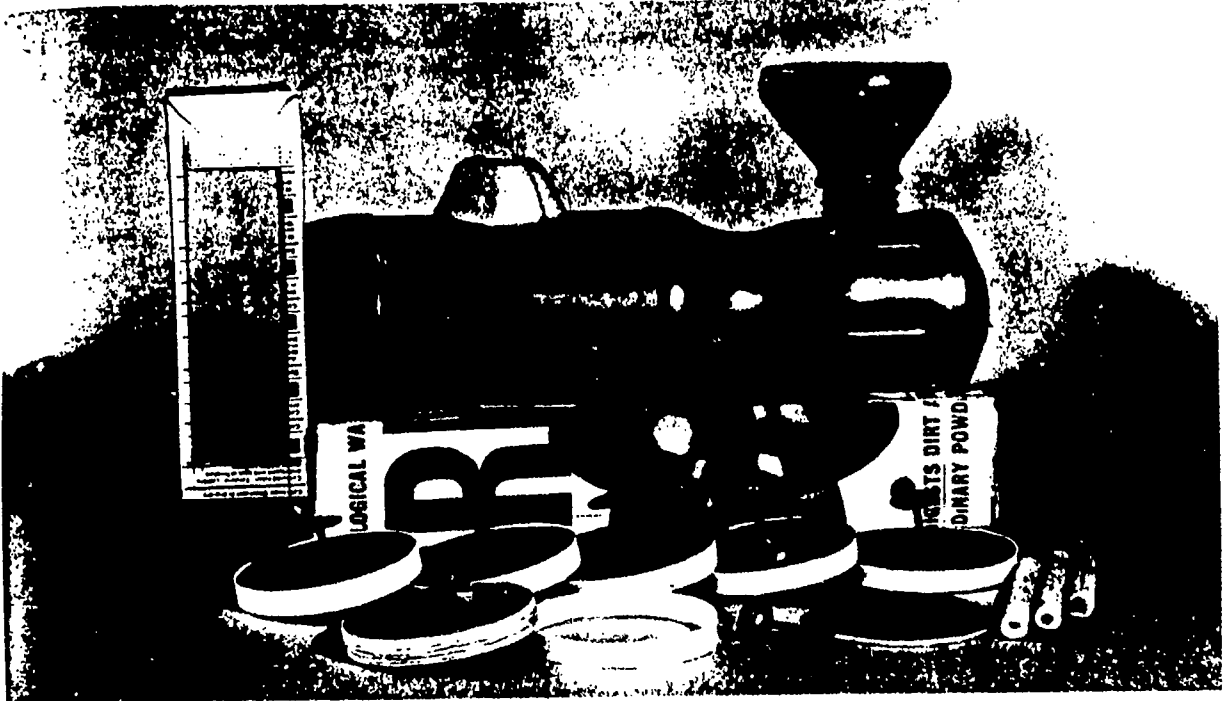

8. Making a Railway Engine

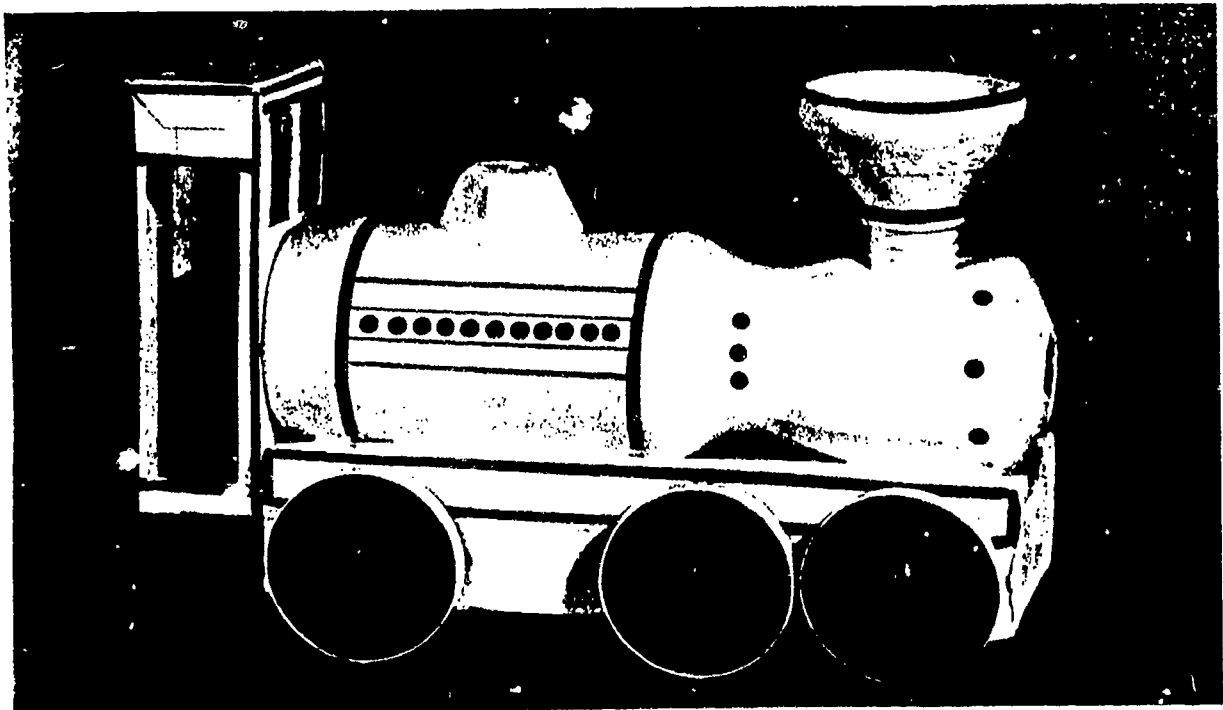

9. A Railway Engine

**RIGATONI AND CEREAL CHOO-CHOO****Materials**

1 sheet any color construction paper  
 ¼ sheet black construction paper  
 small handful of cheerios and rigatoni  
 watercolors and container of water for paints  
 scissors  
 glue  
 paintbrush

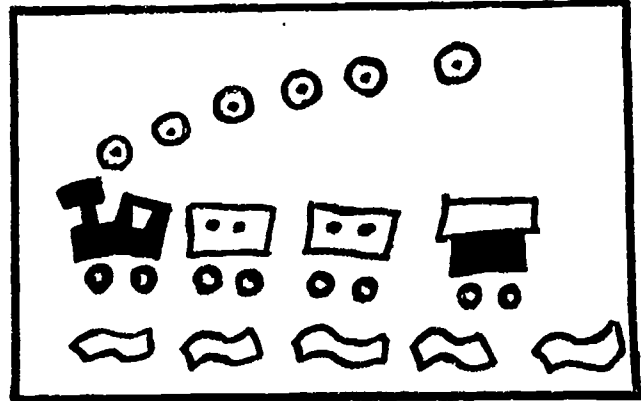

1. Using scissors, cut a rectangle shape for the locomotive.
2. Cut a small rectangle and cut off the corners on one end to make a wedge-shaped smokestack.
3. Glue the locomotive with smokestack over one end at the bottom of the construction paper.
4. To make the cars behind the engine, glue pieces of rigatoni along the bottom of the paper.
5. Glue cheerios underneath the pasta cars for wheels.
6. Glue cheerios coming out of the smokestack and drifting across the construction paper at the top in a wavy line to resemble smoke.
7. Using watercolors, paint the rigatoni train cars bright colors.
8. Paint the cheerios wheels black.
9. Crush a few pieces of rigatoni and glue to black paper locomotive for windows.
10. Paint these pieces yellow.

Adapted from *Fun Projects for Kids*, by Judith F. Neal, Childrens Press. Used by permission.

**SCISSORS AND SHAPES**

by Lucille DeFatta, Bossier Parish Library

Let the children cut different shapes out of paper, and then glue these shapes onto construction paper in the form of train cars.

SHOE STOMPERS

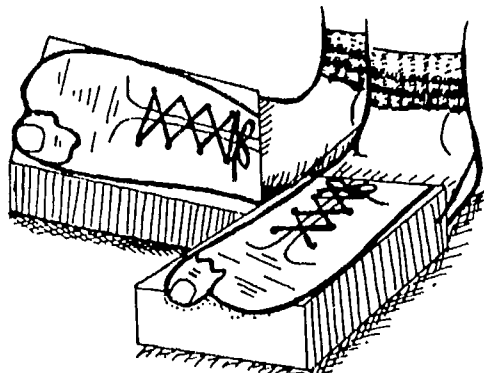
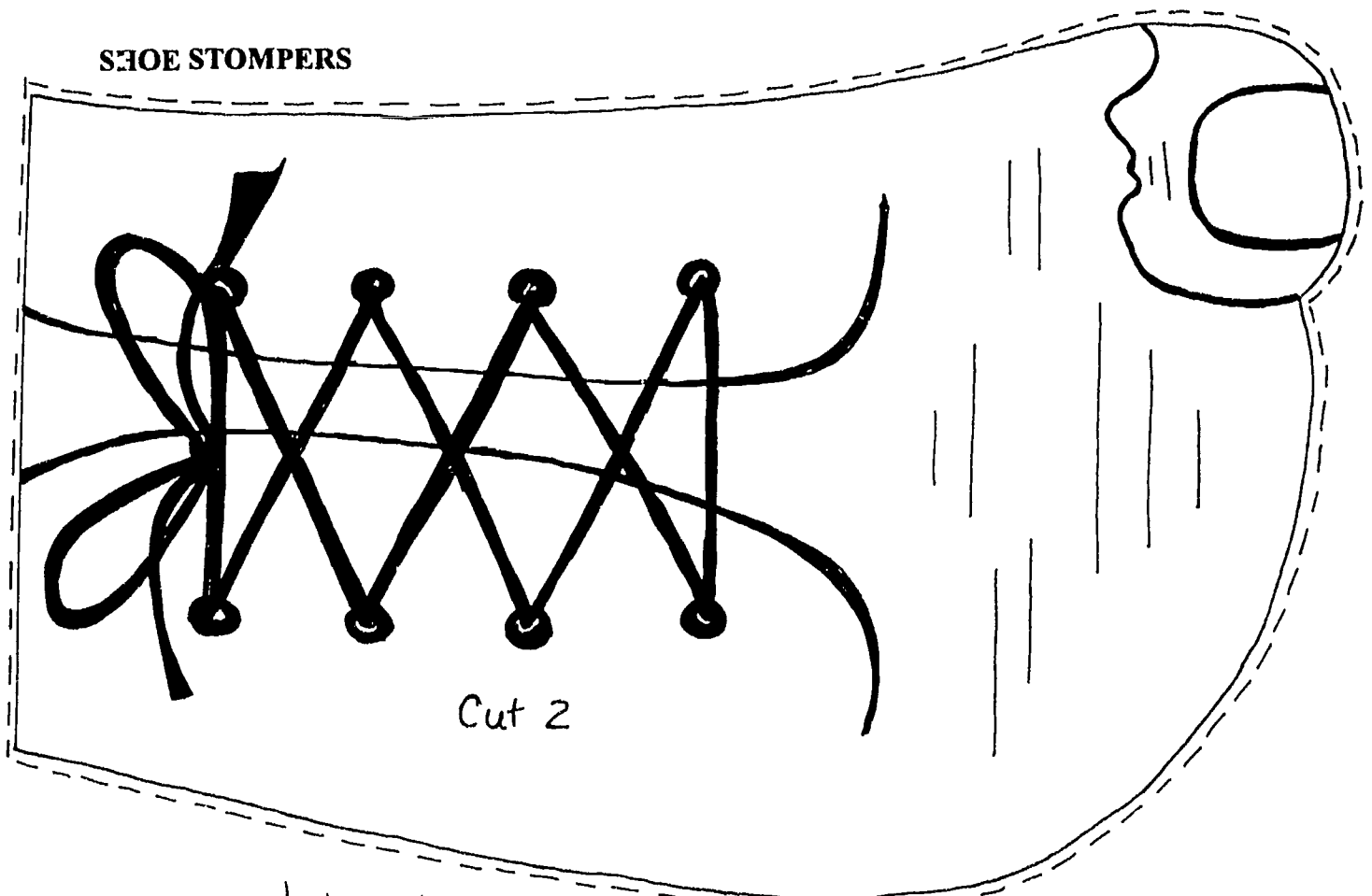

**You Will Need:**

- 2 boxes, approximately 5 x 7 inches (cake mix, cookies, rice, hot cocoa mix)
- 2 pieces elastic cord or narrow elastic (10 inches long)
- construction paper
- pencil
- scissors
- glue
- transparent tape (optional)
- crayons or felt markers
- ice pick or sharp-pointed scissors\*\*

**What to Do:**

- Cut one short end off each box.
- Tape sides, if necessary.
- Cover boxes with construction paper.
- Trace two shoe patterns on construction paper. (Remember to turn pattern over to make second shoe.)
- Color and decorate as desired.
- Cut out.
- Match straight edge of shoe pattern to opened end of box.
- Glue into place.
- Punch a hole in center of each narrow side of box, near the opened end.\*\*
- Tightly tie each end of elastic piece through a hole.
- Repeat for other box.
- Slide your feet (with or without shoes on) into boxes.
- Place elastic around heel.
- "Stomp" with high marching steps.

\*\*Adult help needed

From *Creative Food Box Crafts*, by Nancy H. Giles, © 1989, Good Apple, Inc. Used by permission.

## A STEAM LOCOMOTIVE

This old fashioned locomotive is made up almost entirely of round shapes. The wheels, boiler, smokestack and many of the other parts are circular. The boiler is made from a cardboard tube from inside a roll of toilet paper. The smokestack and cylinders are made from tightly rolled up strips of cardboard.

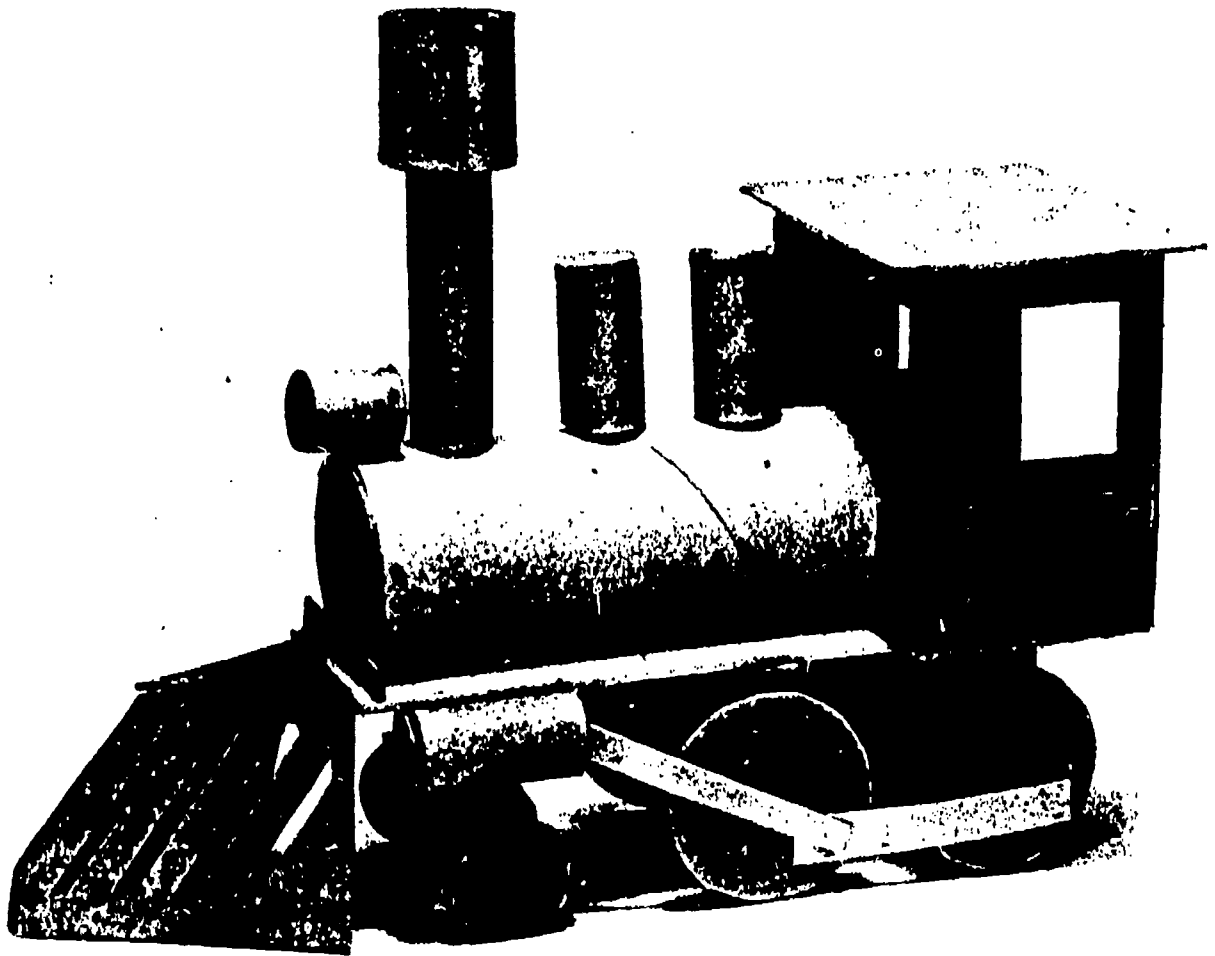

From *Working With Cardboard and Paper*, by Harvey Weiss, © 1978, Addison-Wesley Pub Co. Used by permission.

You might want to try a smokestack of your own design.

steam dome

sand dome

Use a heavy piece of cardboard or glue two pieces together to make this chassis fairly strong.

cow-catcher

Little rectangular cardboard boxes serve as supports for the wheels. (They won't turn.) Or if you prefer, use small strips of wood if you can find a suitable size.

Thin columns for the smokestack, cylinder, headlight and the steam dome can be made by rolling a strip of cardboard around a pencil. Apply glue as you come to the end of the roll; then hold it with a rubber band or your fingers till it sets. When dry, you can cut or sandpaper down any rough edges.

You won't get a neat roll unless the grain of the cardboard is going like this. (It helps if you dampen the cardboard before starting to roll it up.)

Thin strips of cardboard or wood can be used for the rods that connect the cylinders to the wheels.

A wire handrail will look nice.

The windows in the cab could be made fairly elaborate.

Your finished, painted model can be best displayed on tracks set on cross-ties and mounted on a wood plank.

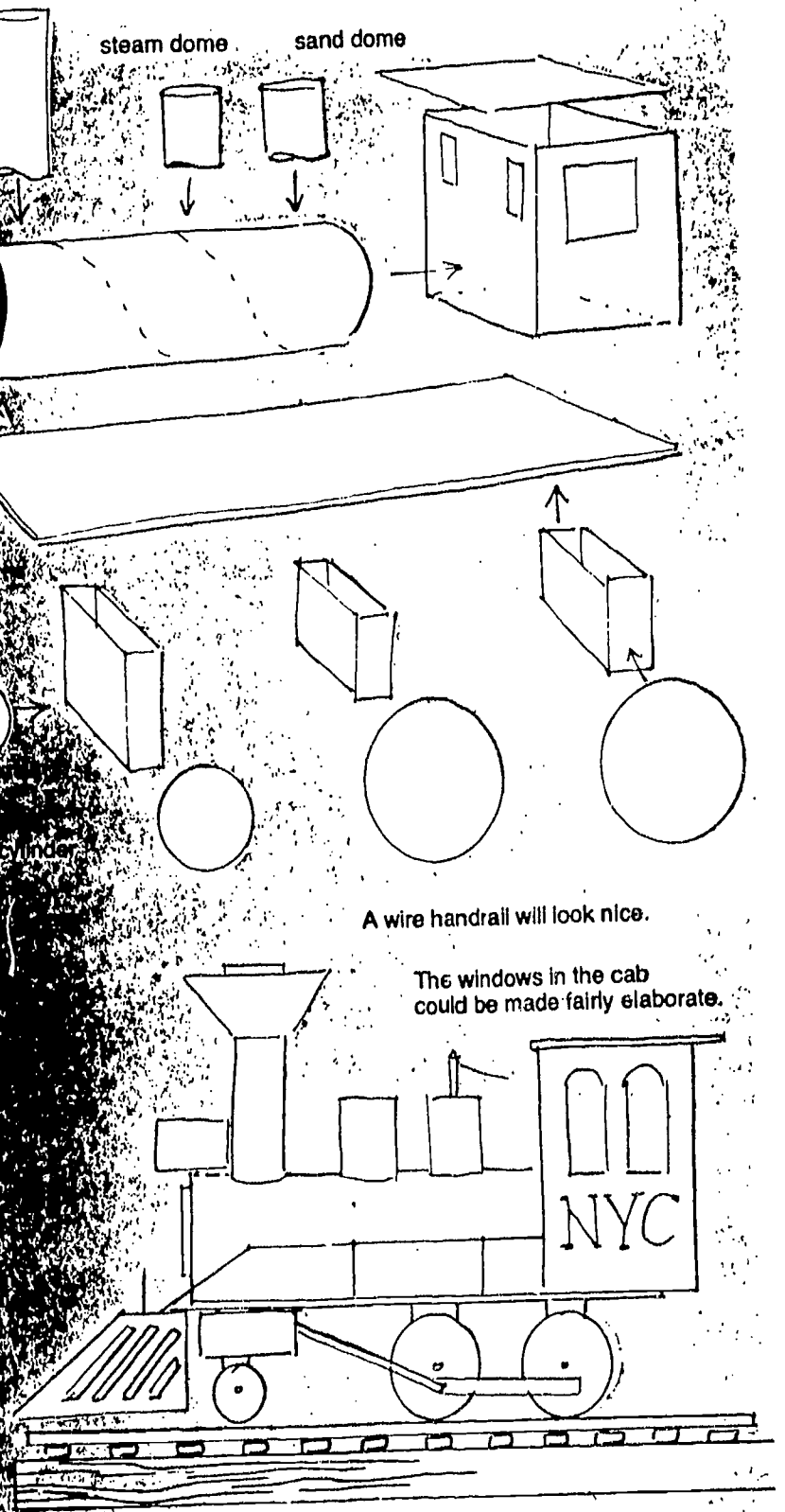

## TEDDY BEAR TRAIN

Hook five or six small cardboard boxes together with yarn. Let the children decorate the boxes with tempera paints or felt-tip markers. Attach a posterboard smokestack shape and a yarn handle to the first box. Have the children put teddy bears or other stuffed animals in the boxes. Let them take turns pulling the boxes by the yarn handle and chugging around the room.

From *Theme-A-Saurus II*, by Jean Warren, © 1990. Reprinted by permission of Warren Publishing House, Inc., P.O. Box 2250, Everett, WA 98203.

## TIN PUNCHING

by Lucille DeFatta, Bossier Parish Library

Draw a design on a piece of paper. Tape the paper to an aluminum pie tin. Punch the design onto the pie tin through the paper using a hammer and a large, flat-head nail.

## TOOTLE THE TRAIN CHAIN

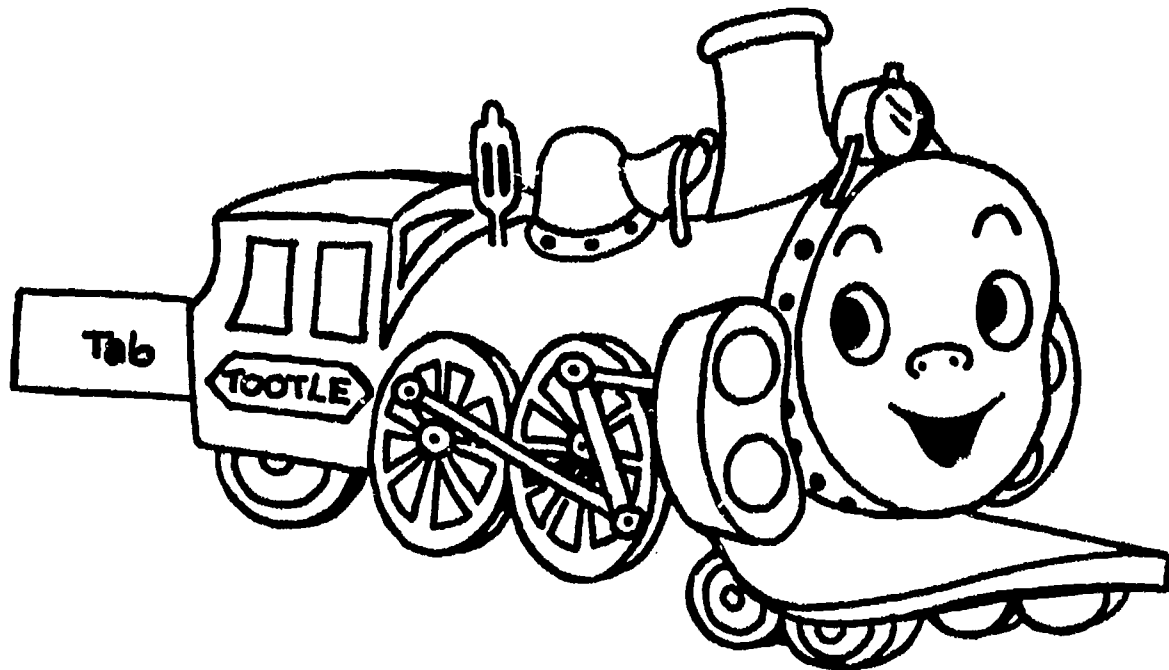

From *Lots To Do In Little Golden Book Land*  
 © 1989 Western Publishing Company, Inc.  
 Used by Permission

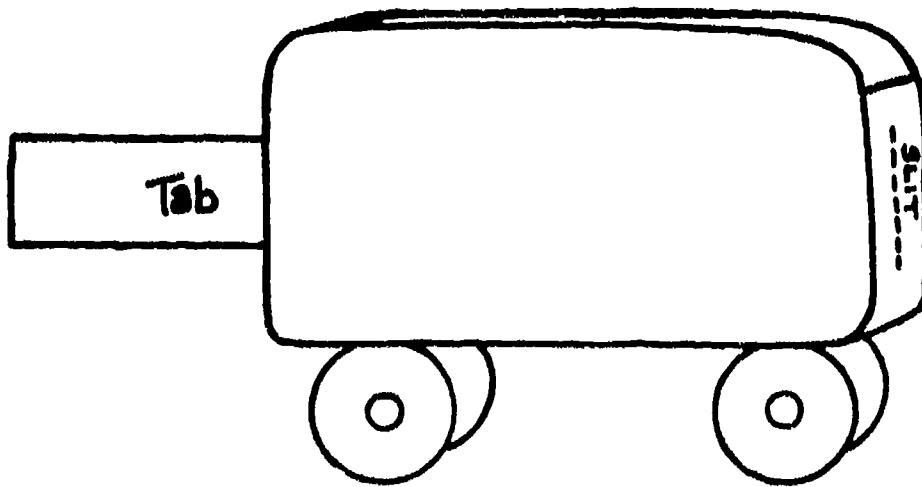
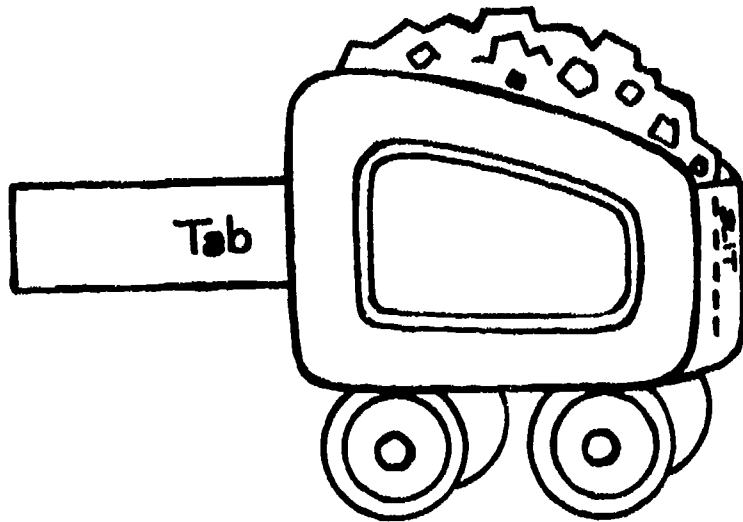



## TOY TRAIN

### MATERIALS

1. box from a roll of waxed paper or aluminum foil
2. sheet of shirt cardboard
3. tempera paint, diluted with liquid detergent soap
4. pencil
5. aluminum foil (optional)
6. stapler
7. scissors

### BEFORE YOU BEGIN

Ask the children to do some research about trains before you begin this activity. Your school library should have many books on the subject. Youngsters will enjoy sharing their reading about the many types of trains which carry people and freight to places far and near. Display these books around the room, permitting the children to look through them in their spare time. Some might be willing to bring in a few of their electric trains for group discussion.

On the board, list the types of trains about which your class has learned. You may choose this to be a group activity; with some making passenger cars, and others working on a variety of freight trains. If so, let the groups meet once for a planning session. Have each child decide the type of car he will construct. Before you begin, choose helpers to distribute paint, paste, and other necessary materials.

### PROCEDURE (Illustration 1-3)

1. Tear the serrated edge off the box and discard it. Caution the children to handle the metal strip by its end. (steps a & b)
2. Section off the box in pencil, to produce the effect of several cars. (steps c & d)
3. Cut a "pie wedge" from cardboard. Staple it to the box to make the front end of a locomotive. (steps e and f)
4. Paint the box, using the penciled lines as a guide in making multicolored box cars. (step d)
5. Cut wheels out of cardboard. These may be painted or covered with aluminum foil. Staple them in place. (steps g & h)
6. If desired, use aluminum foil, instead of paint, to make windows and doors.

From *Arts and Crafts Activities Desk Book*, by Joyce Novis Laskin, © 1971, Parker Pub. Co.  
Used by permission.

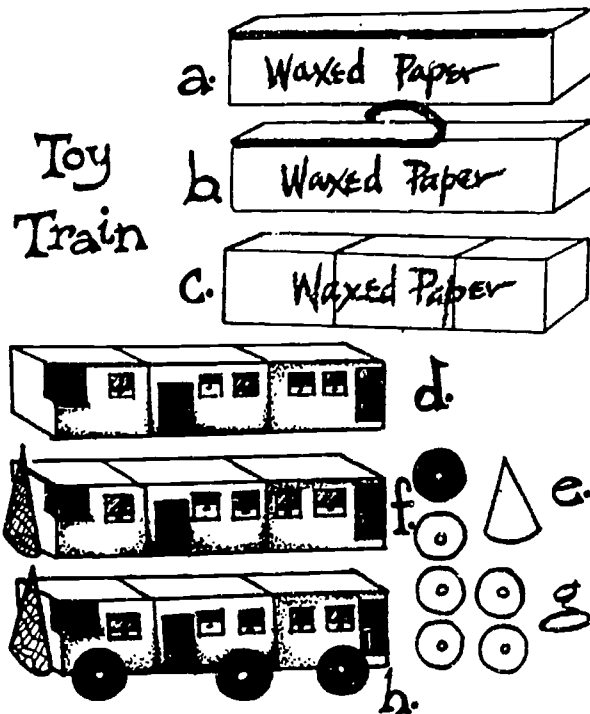

ILLUSTRATION 1-3

*WHAT THE CHILDREN CAN DO AFTERWARD*

1. Set up a railyard on a large table. Let each group explain the type of train it has contributed.
2. Use some of the trains in a model of the community to represent the local station.
3. Ask that each child write a short explanation about his creation on a 3" x 5" card. Display the trains and cards on a table, or along a window sill.

*RELAX WITH TIME SAVERS*

1. Group the children so that there are no more than four or five to a table. This will facilitate class management, whether the activity is to be an individual or group experience.
2. Place all materials needed in the center of each table. A stapler and a plastic ice-cube tray of assorted paint colors can easily be shared by each group.
3. Spread newspapers on the tables before starting to paint.

## TRAIN

### YOU WILL NEED:

- At least four large cardboard boxes
- String
- Small pieces of thin card
- Non-toxic glue or sticky tape
- Green emulsion paint and large brush
- Your paint box, felt pens or crayons
- Scissors

Glue or tape two boxes together to make the engine. Paint them all over with green emulsion paint. Make wheels and a window from scraps of thin card, paint them in bright colors using your own paints, felt pens or crayons and stick them to the engine.

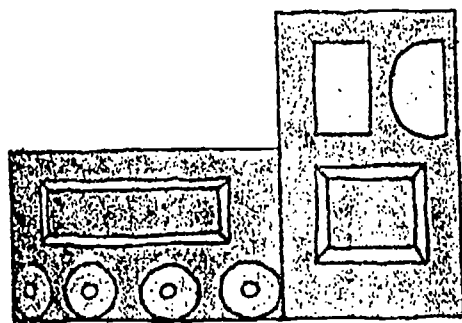

Now the other boxes can be carriages – one for each of your friends. And everyone can decorate his or her own carriage. Make a small hole in the ends of each carriage. Thread string through a hole in two boxes and tie knots on the insides. Join all your carriages together.

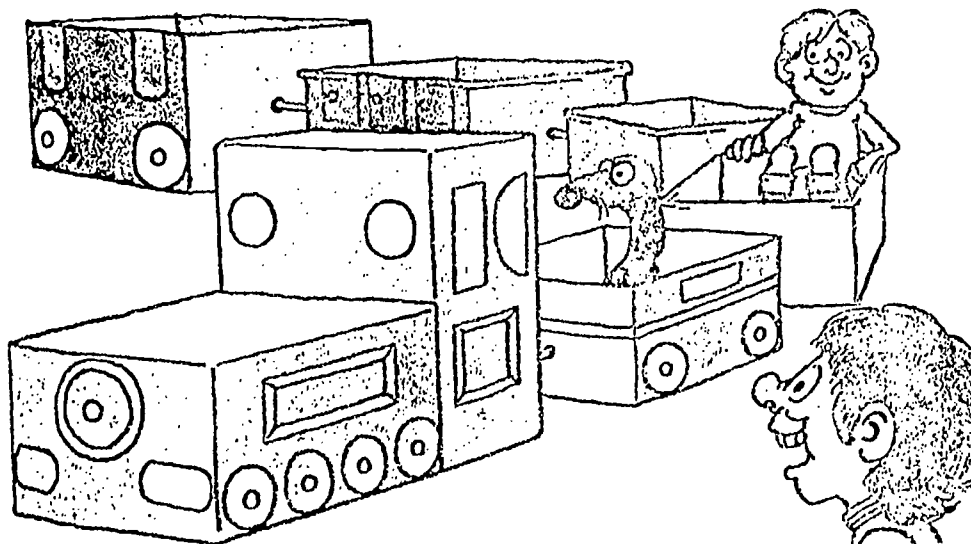

From *My Biggest Playtime Book Ever*, © 1986. Reprinted by permission of the publisher, Simon & Schuster Inc.

## TRAIN

1. Trace the train, wheels, and Santa patterns on your paper.
2. With your crayons or felt-tipped markers color the train—use bright, Christmas colors. Give Santa a red suit and hat. Black boots, belt, and buttons would be nice.
3. Cut everything out.
4. Attach the wheels with the paper fasteners, from front to back.

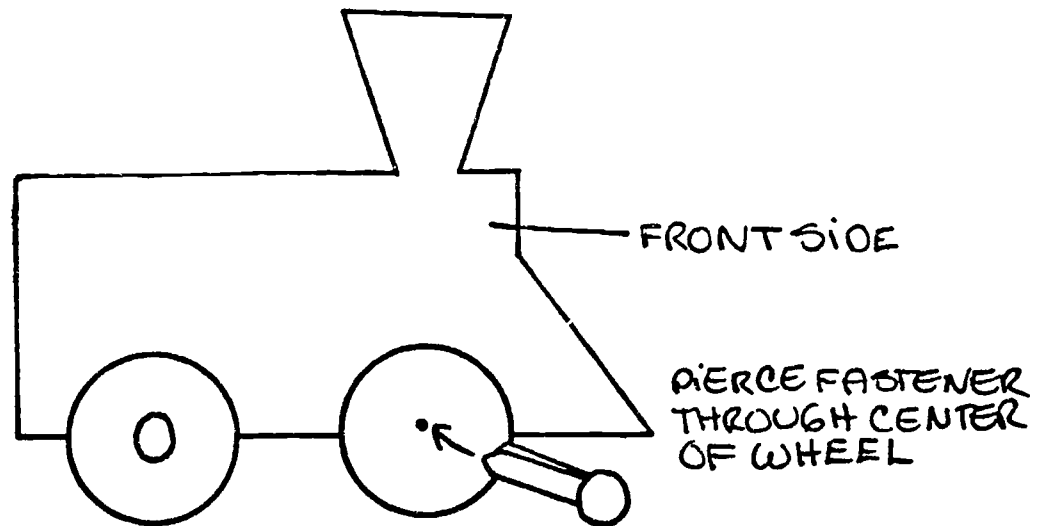

5. Make a little pocket for Santa to stand in by taping the square piece of paper to the back of the train:

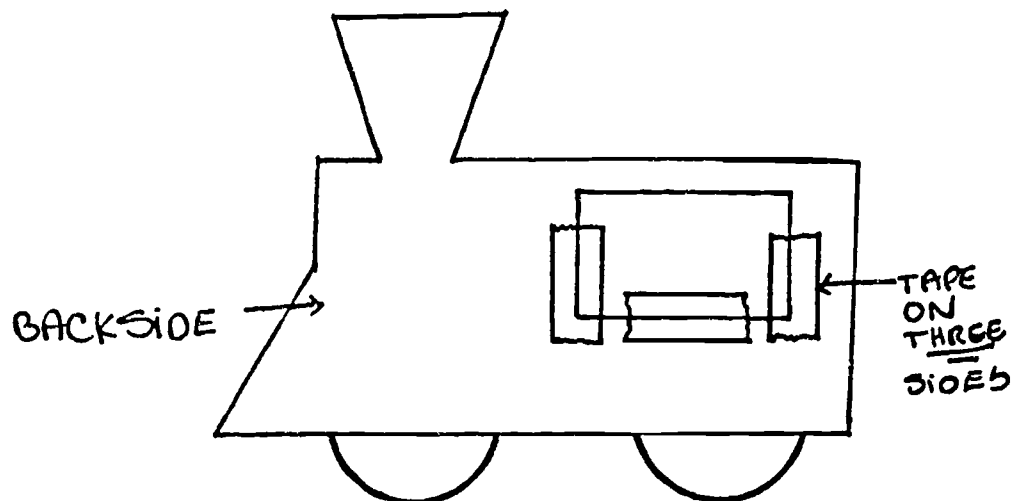

6. Put Santa in his train and roll along the carpet or up your arm. Use your Santa to talk to your friends about what they want for Christmas.

From *Seasonal Arts and Crafts Activities for Early Childhood*, by Lorraine Clancy, © 1988, Parker Pub. Co. Used by permission.

### Follow-ups

1. Now draw (or paint) a Santa and his train of your own.
2. You can add cars to Santa's train to hold his toys. Use 3" x 6" construction paper for the cars. Decorate the cars and add wheels and a pocket on the back of the car. Make some simple toy shapes and insert in pocket.

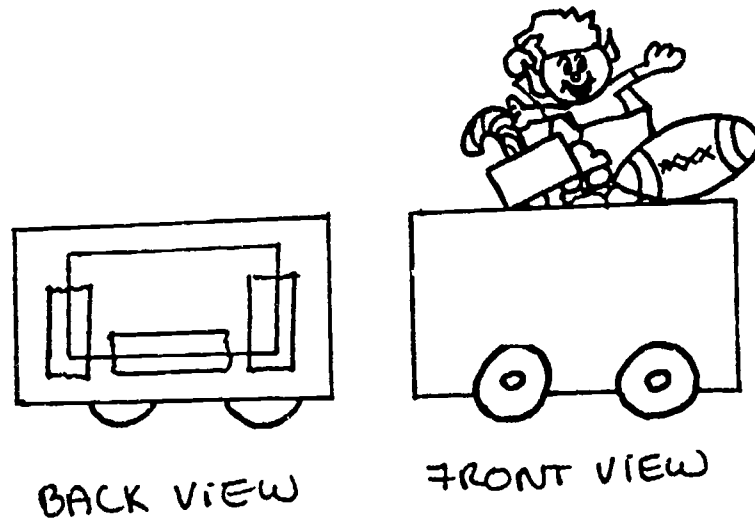

Attach to the engine with a peel-and-stick label or glue on a strip of construction paper.

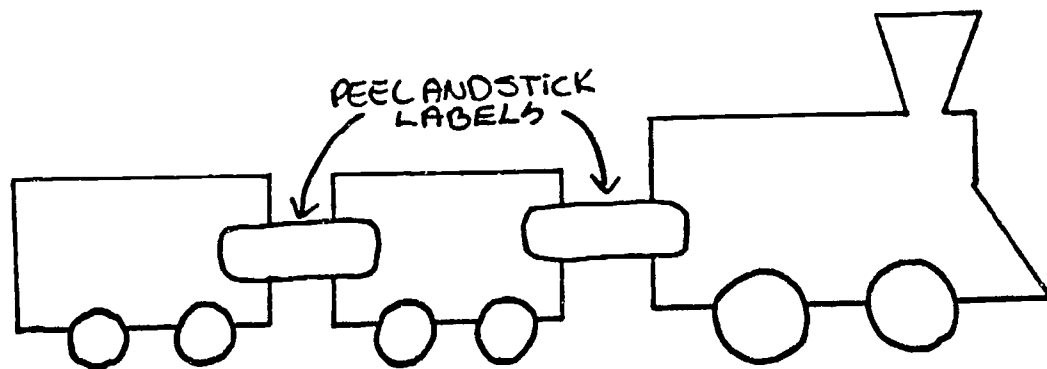

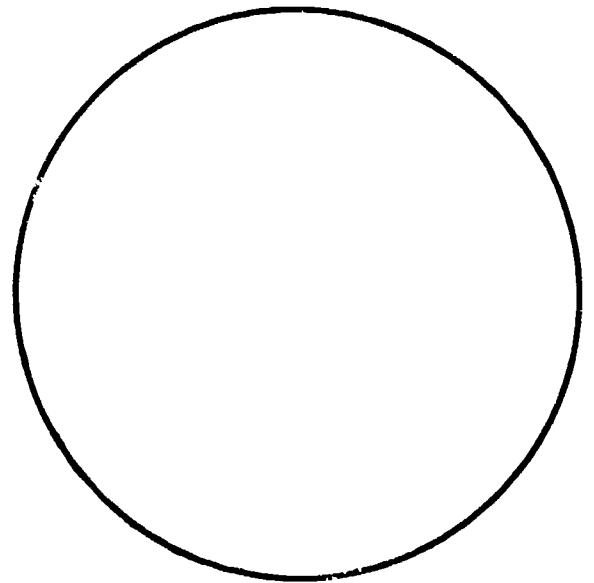
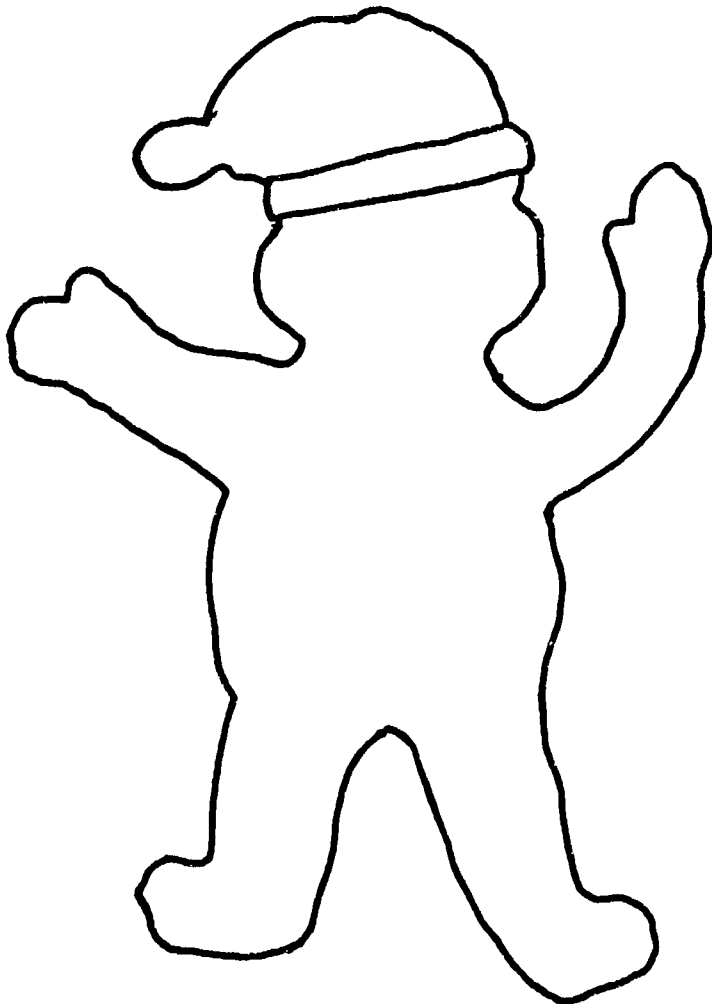
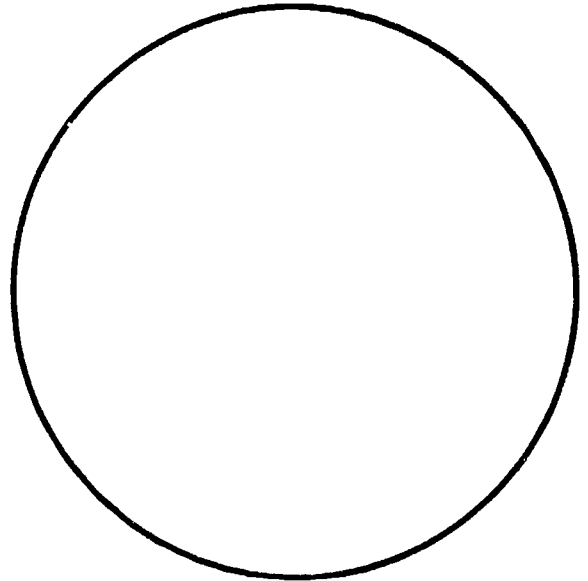
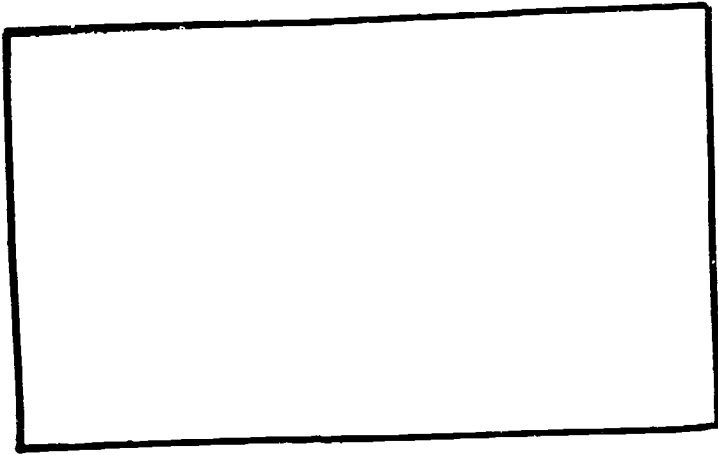

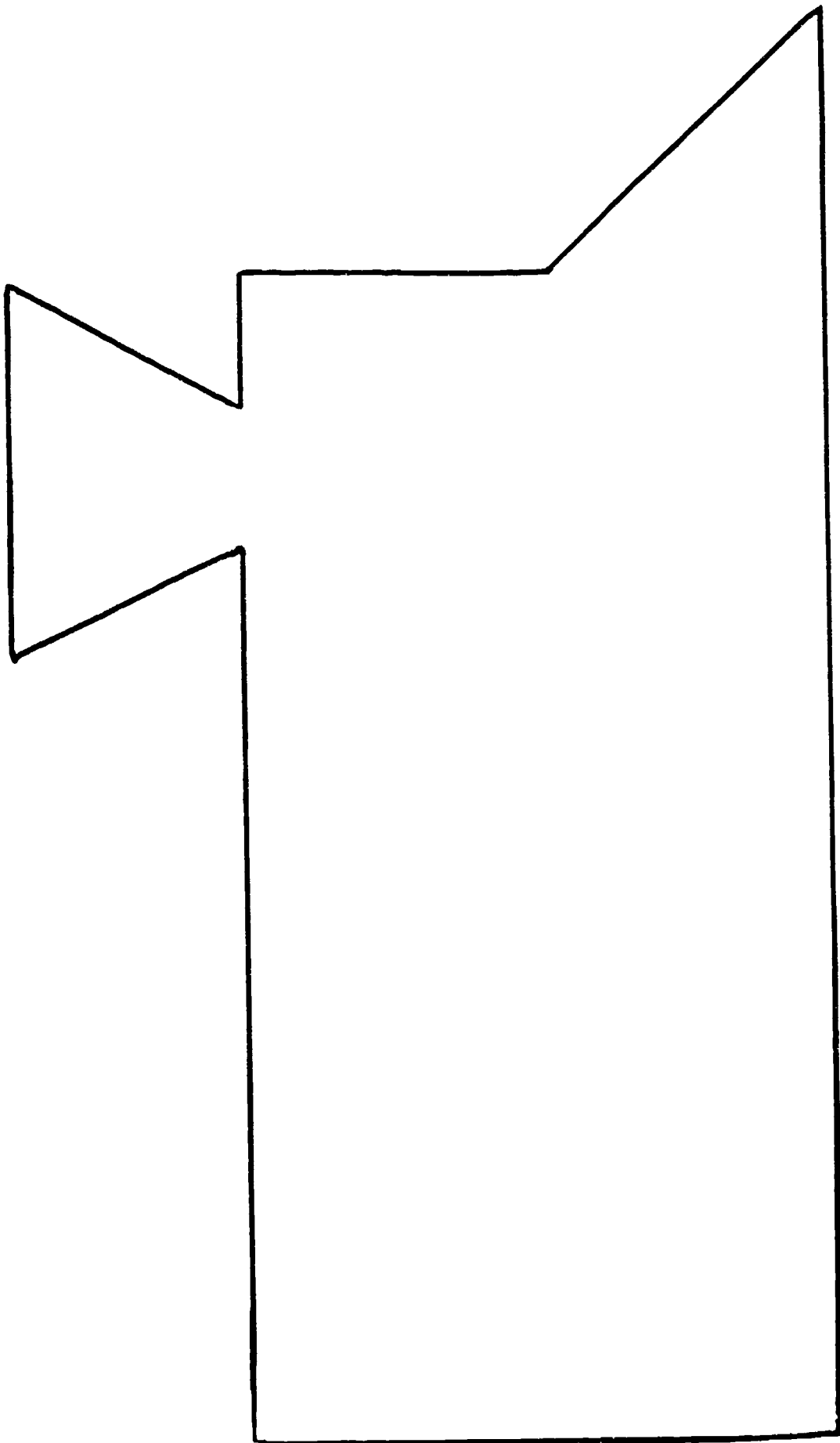

**1. Cut out all pieces.**

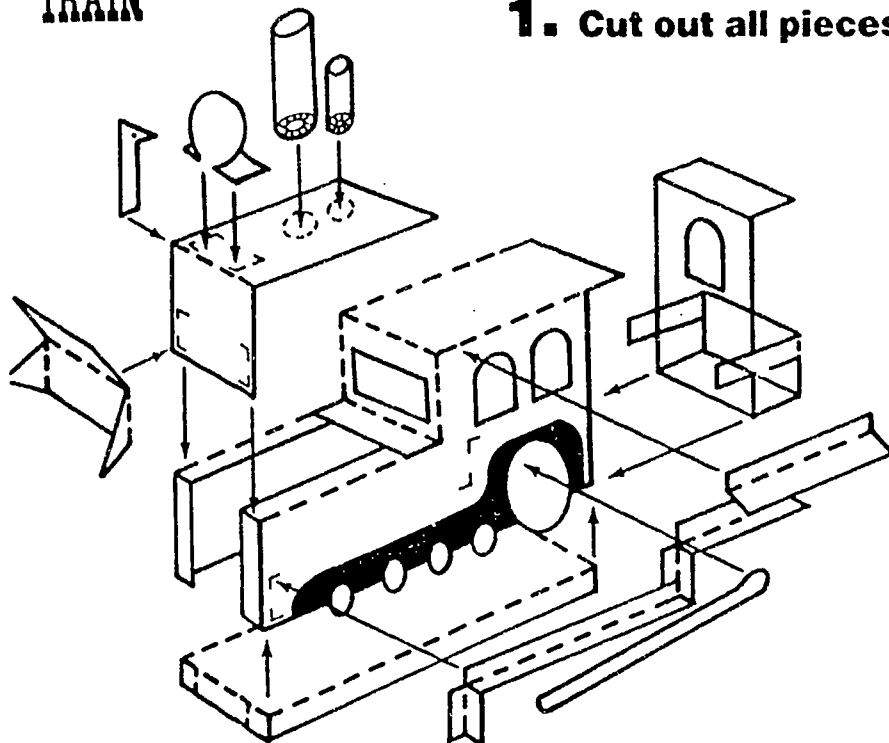

**2. Fold and assemble complete engine. Put a small hole in whistle for string.**

**3. Fold coalcar pieces and assemble.**

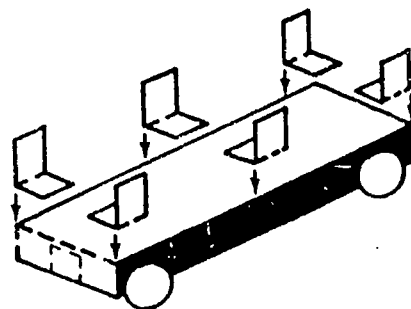

**4. Fold and assemble flatcar and attach flatcar stakes.**

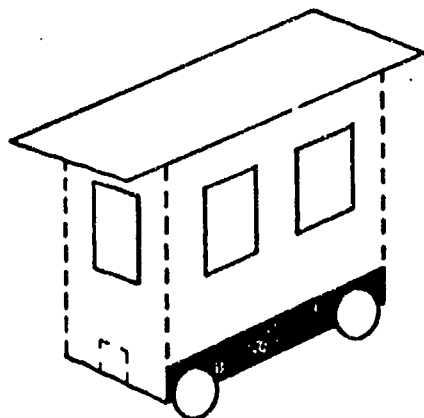

**5. Cut away caboose back as indicated on pattern. Fold and assemble passenger car.**

**6. Fold and assemble caboose and attach chimney.**

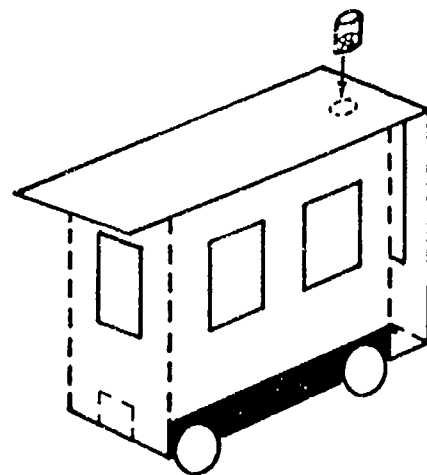

From *Three Dimensional Paper Art Projects*, by Ronald J. Morris. Judy/Instructo. Used by permission.



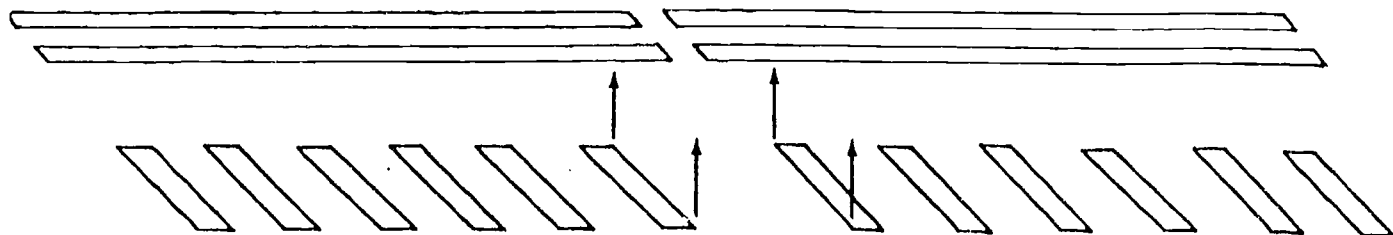

**7. Glue down railroad tracks.**

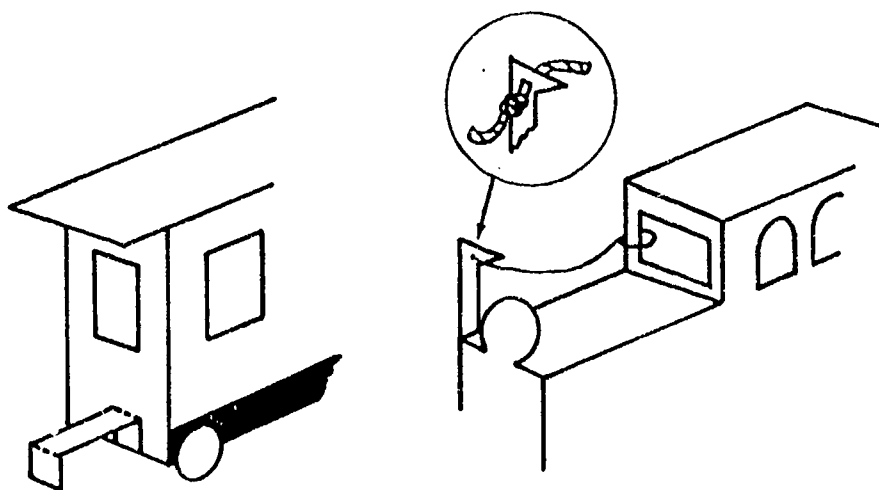

**8. Attach couplers to cars and add string to engine.**

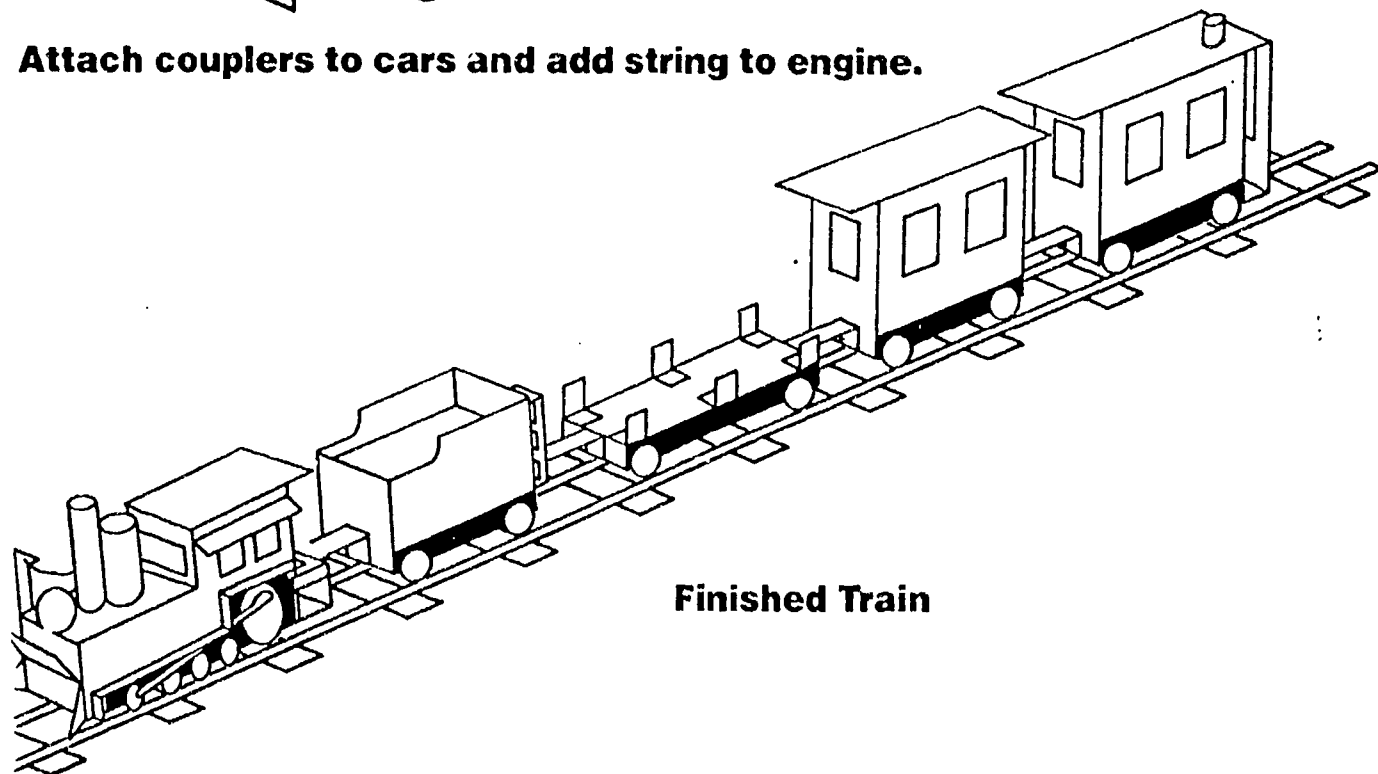

**Finished Train**

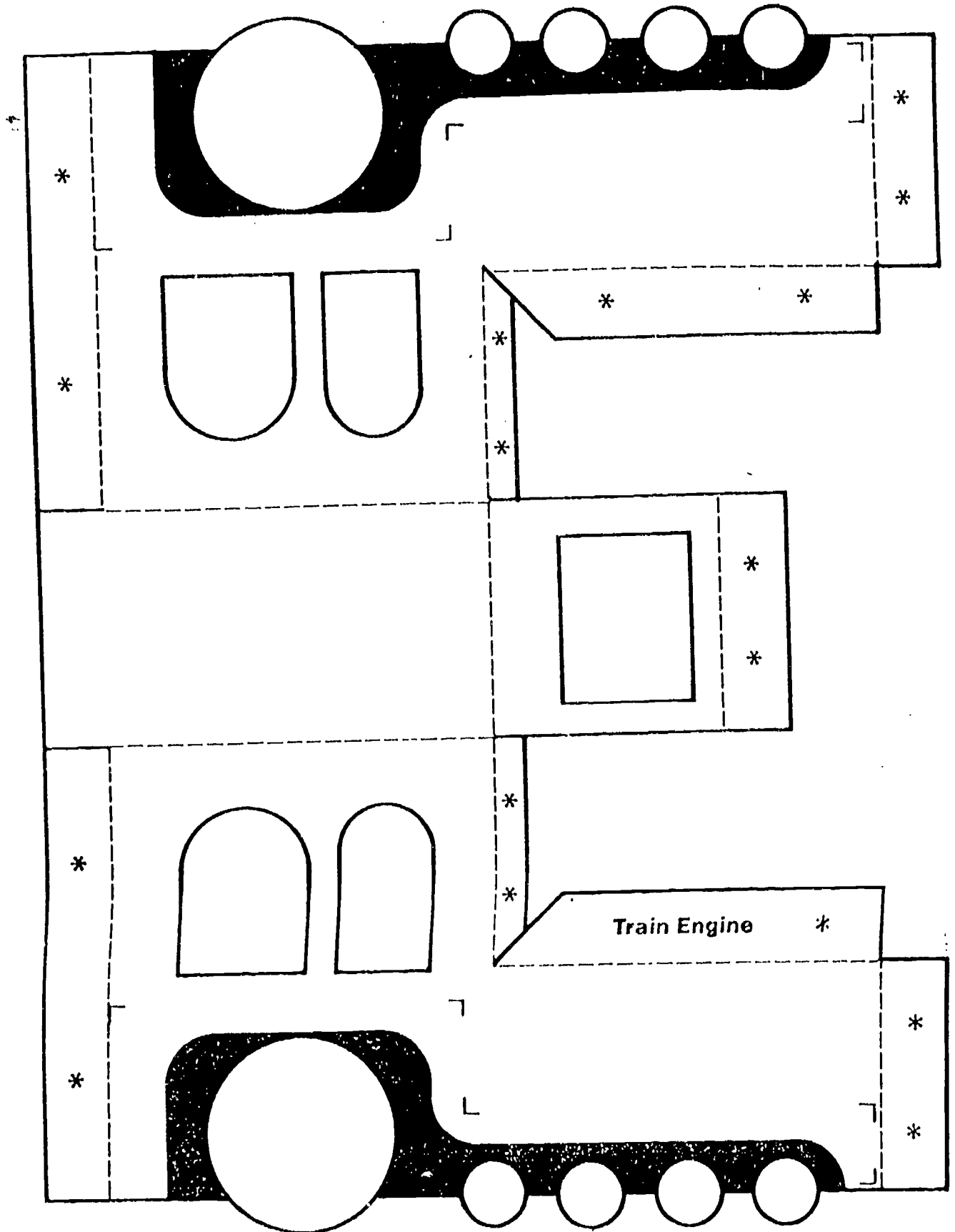

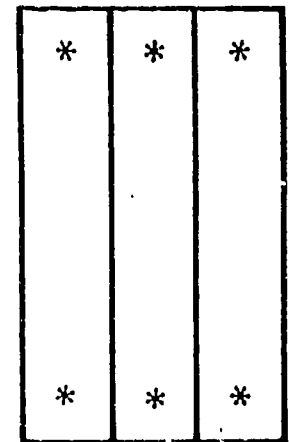
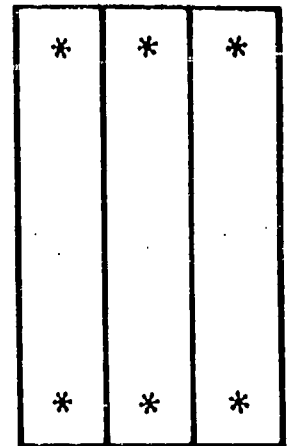
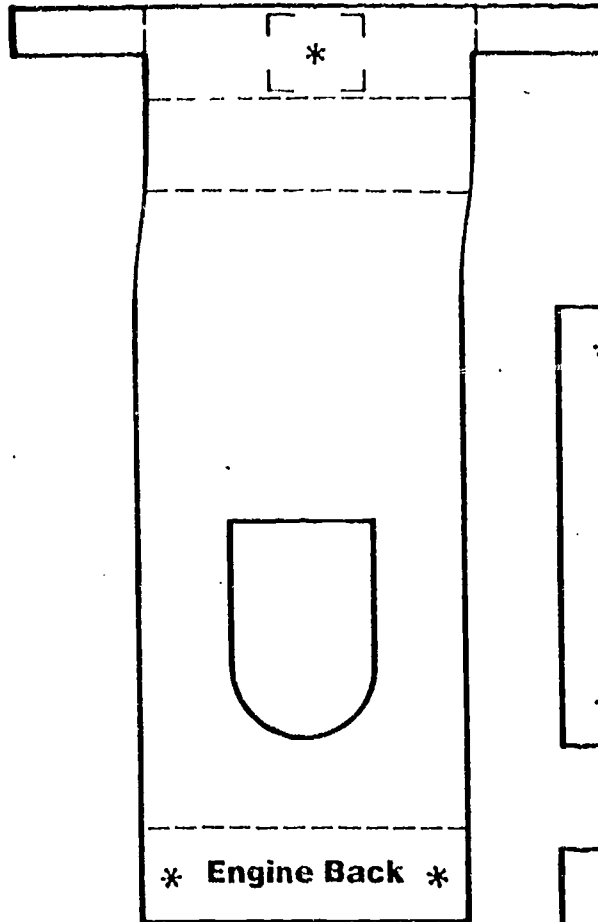
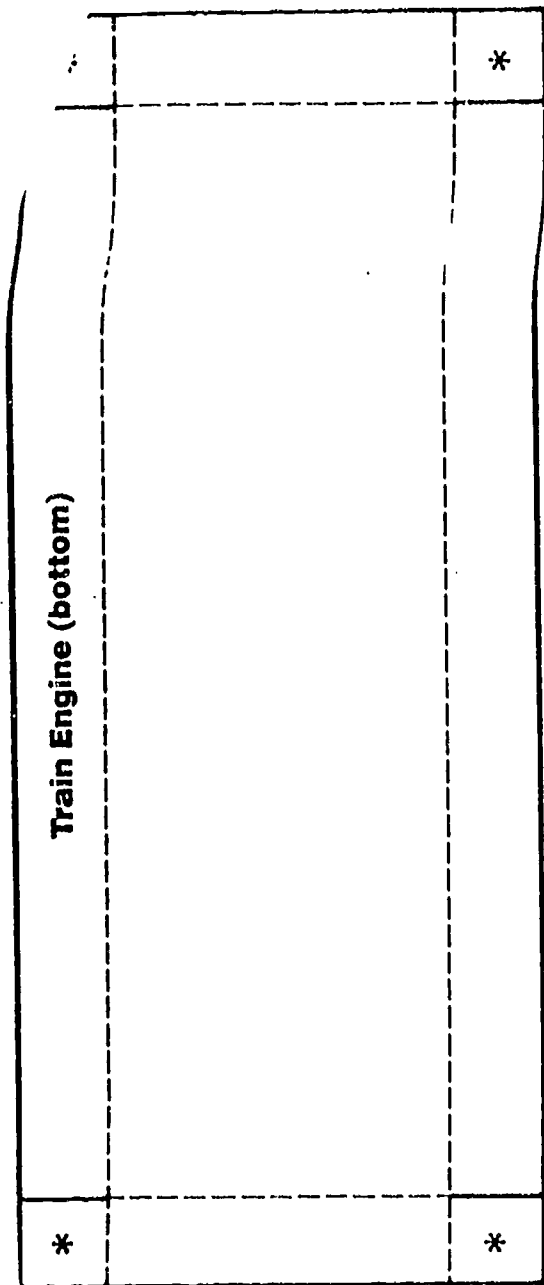

**Caboose  
Smokestack**

**Ties**

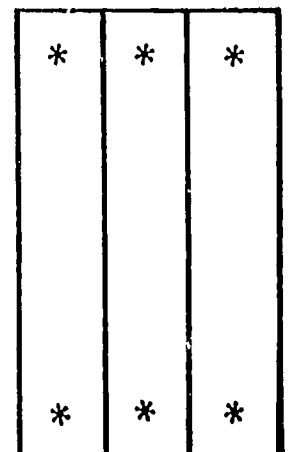
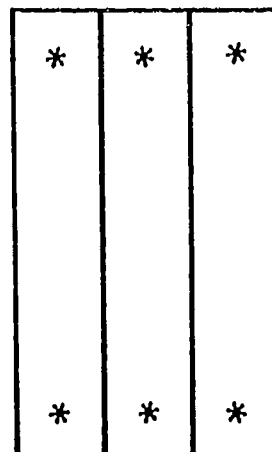
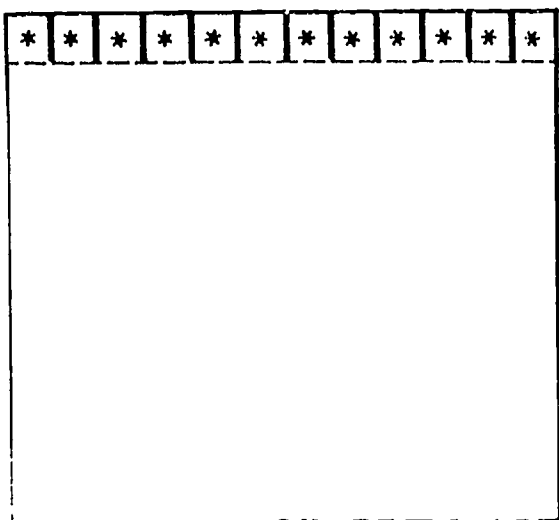

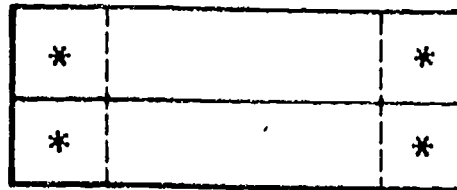

**Couplers**

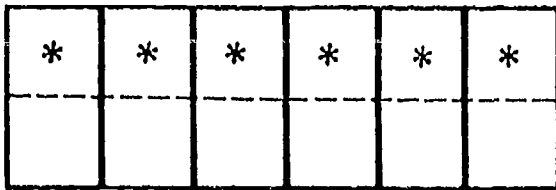

**Flatcar Stakes**

**Smokestacks**

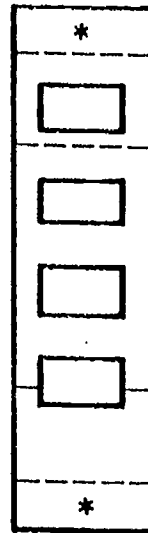
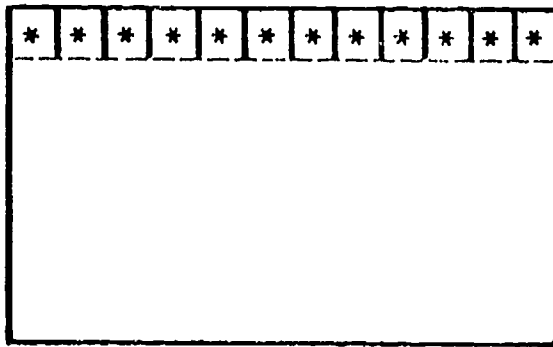

**Ladder**



**Rails**

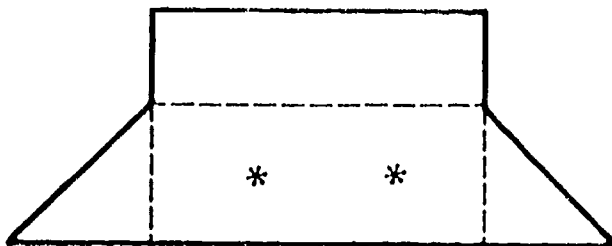

**Pilot**

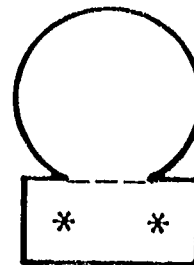

**Headlight**

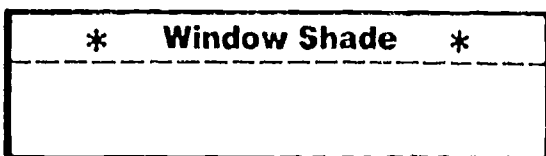
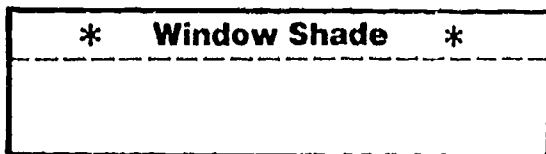

**Whistle**

**Running Board**

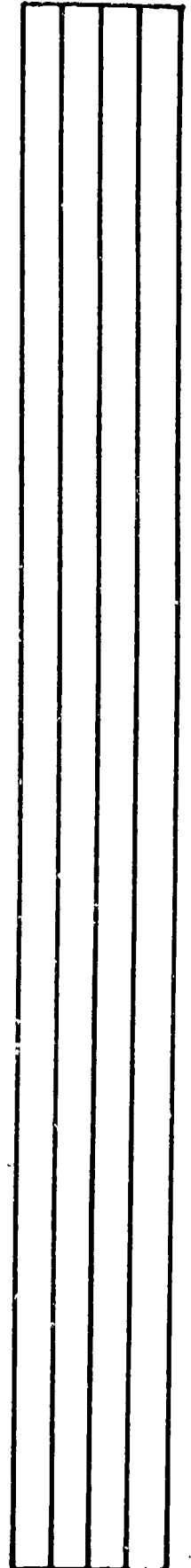

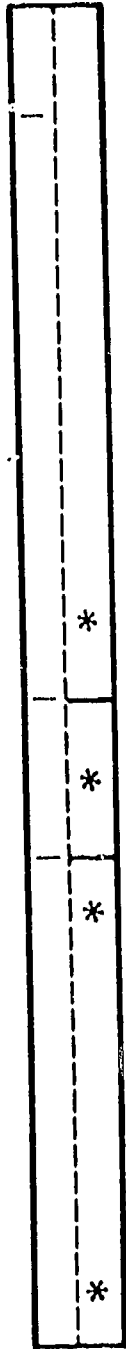
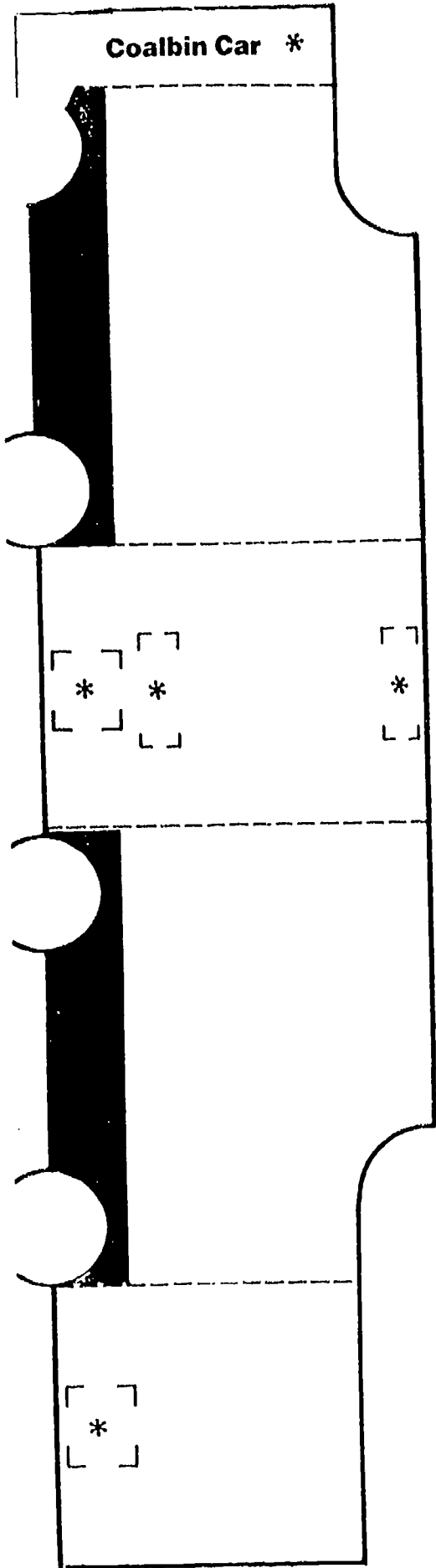

Running Board

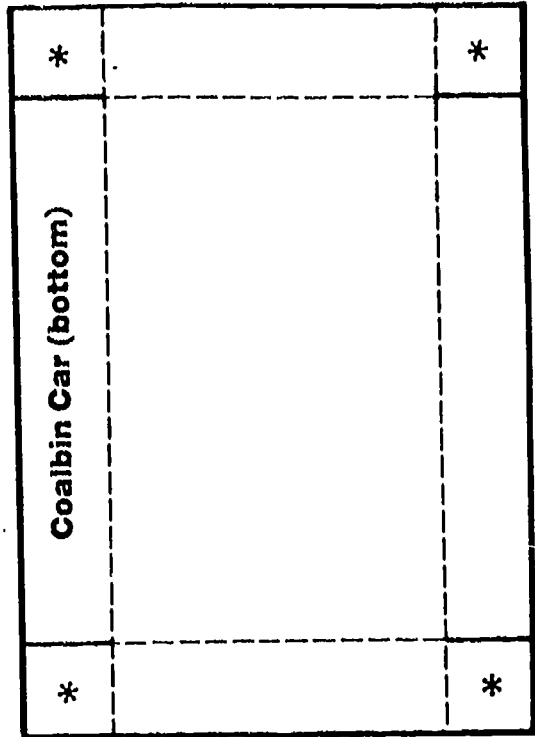

Coalbin Car (bottom)

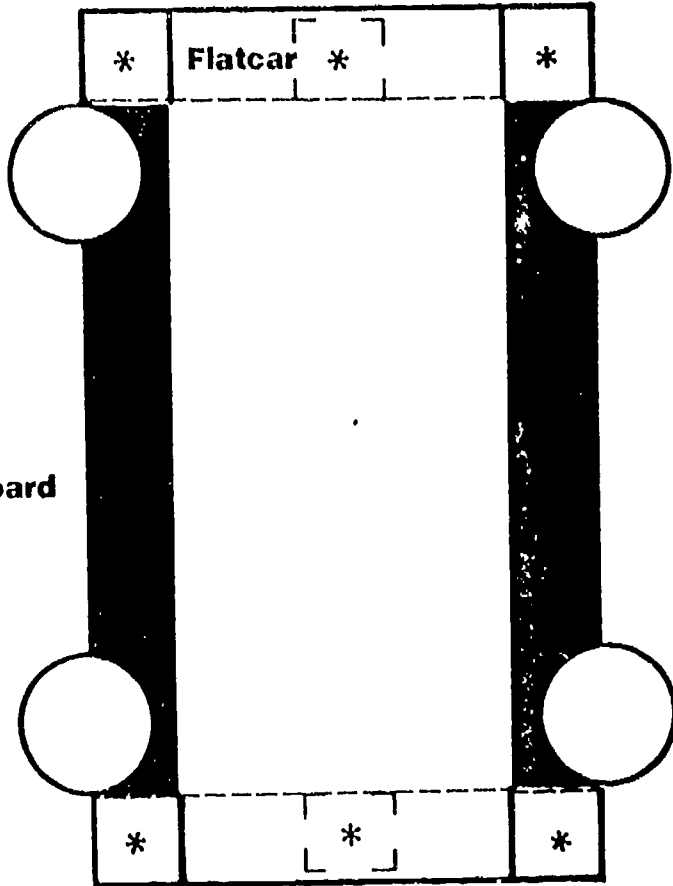

Flatcar

Cut off here to make passenger car. Leave on when making caboose.

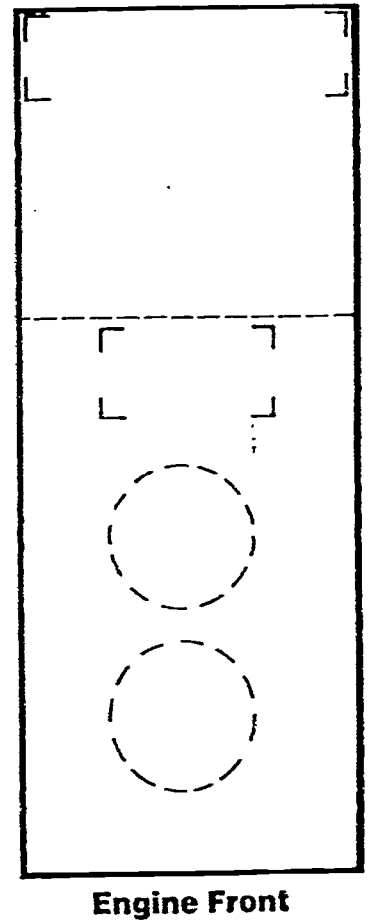
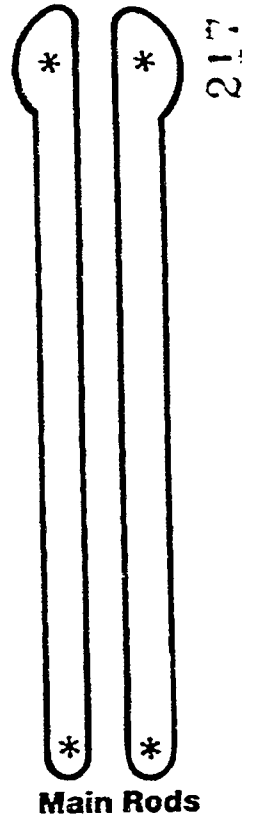
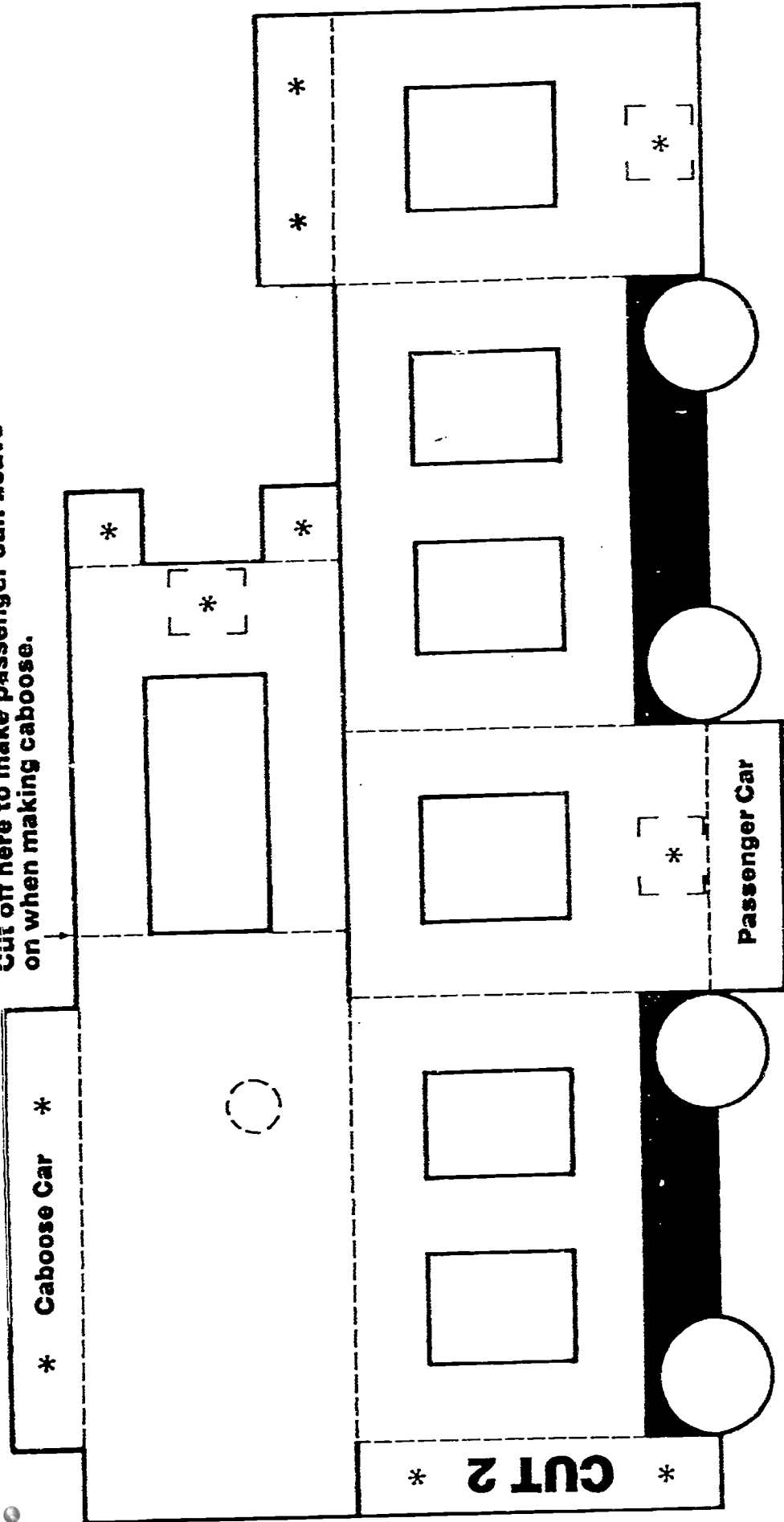

## Train Construction

After the children make a train, they can take turns being the conductor and blowing the whistle or "choo-chooing" around the room.

### You Will Need:

assorted small boxes (approximately 4"x2"x2")  
 large thread spools (2 per train car)  
 unsharpened pencils  
 paper punch  
 crayons or non-toxic felt-tip markers  
 paper clips (optional)

### Here's What To Do:

1. Give each child two pencils, two spools, and one box.
2. Help the children punch four holes in each box as shown.
3. Show the kids how to insert a pencil through the hole on one side of the box, through the spool, and out the hole on the other side of the box. Have them repeat the process for the second set of holes.
4. Let the children decorate their boxes with crayons or markers.
5. Train cars can be connected by punching holes in the front and back of each car and clipping them together as shown.

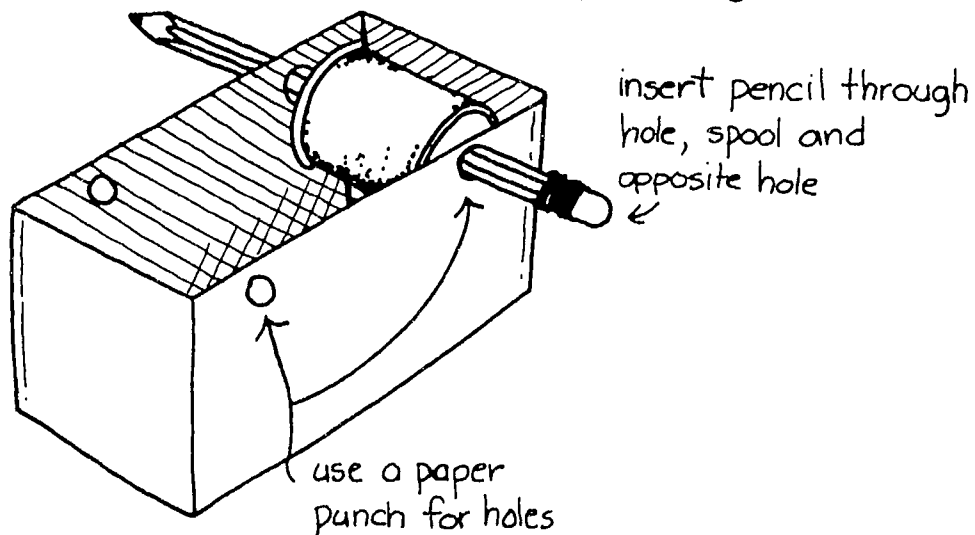

From *Nursery Rhyme Crafts*, by Susan True, © 1985, by Monday Morning Books, Inc. Used by permission.

**TRAIN MOBILE**

*by Lucille DeFatta, Bossier Parish Library*

Copy the train cars, cut out, and draw the lines indicated on the pattern. Crisscross two straws at the centers and cross tie them together firmly with thread. Do not crush straws. Cut four pieces of thread 20" long and attach one to each car with tape, then tie the loose ends of the thread to the straws. To hang the mobile, tie a piece of thread to the center of the straws.

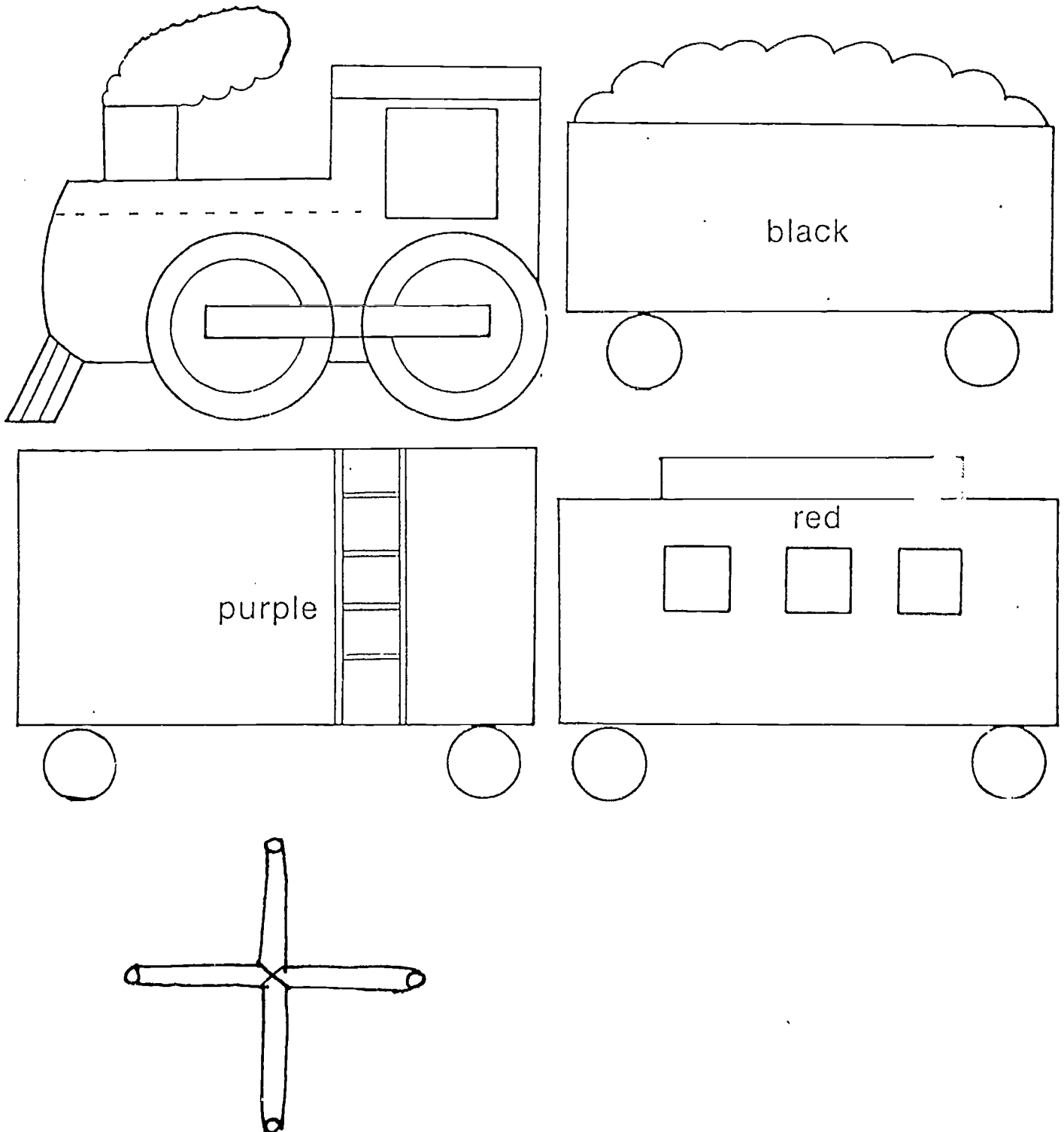



## TRAIN STICK PUPPETS

You will need: construction paper, cut in 3"×5" rectangles  
 black construction paper (for engine and wheels)  
 scissors  
 crayons or markers  
 glue and tape  
 popsicle sticks

Make various train cars in the follow manner:

Engine: 3"×5" black construction paper  
 1" square black paper (smoke stack)  
 2" square black paper, with window (cab)  
 triangle of black paper (scoop)  
 2 wheels  
 1 popsicle stick

Train cars: 3"×5" construction paper (various colors for each car)  
 2 wheels for each car  
 1 popsicle stick  
 (Decorate the train cars with doors, slats, and windows.)

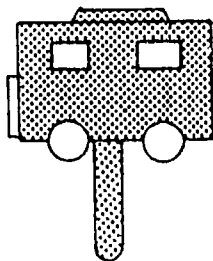
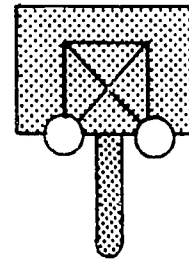
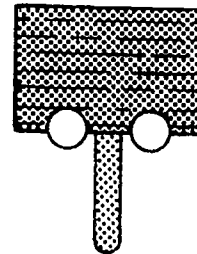
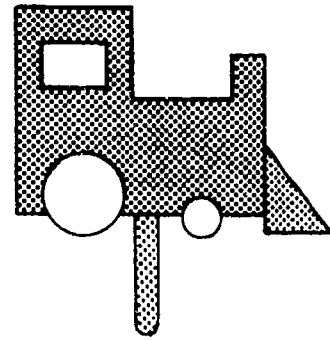

Caboose: 3"×5" red construction paper  
 2 wheels  
 1" square cut in half (observation deck and back railing)  
 1 popsicle stick

Attach pieces of each train car with glue, and tape the car to a popsicle stick. Stand the train up along the back of a sofa with the sticks between the cushions or have a train parade when friends visit. This is also a good opportunity to talk about colors, shapes, first-middle-last, and other kinds of vehicles with your child.

Reproduced with permission of the American Library Association from *Storytimes for Two-Year-Olds* by Judy Nichols, © 1987.

# Train Time

Position and paste  
the largest rectangle first.

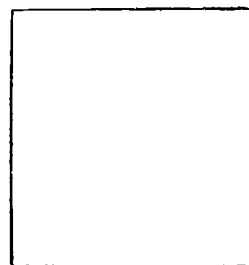
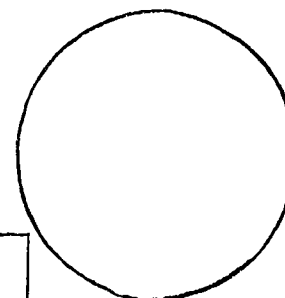
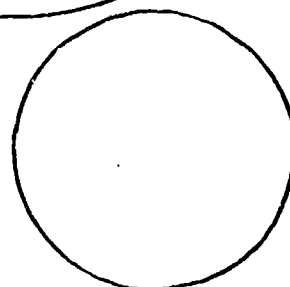
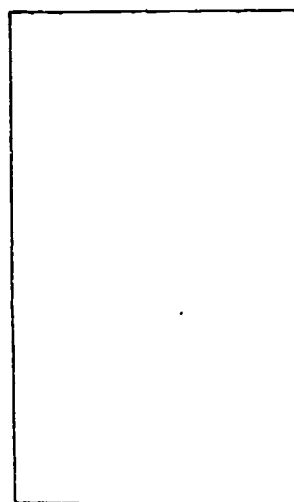
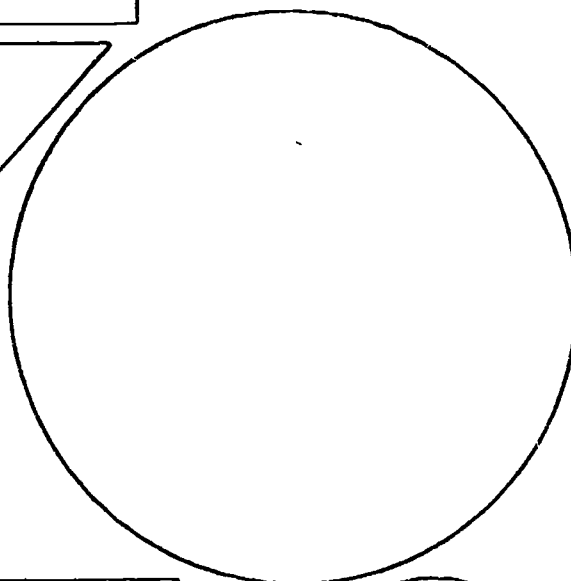
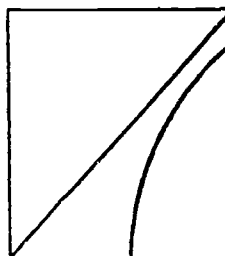
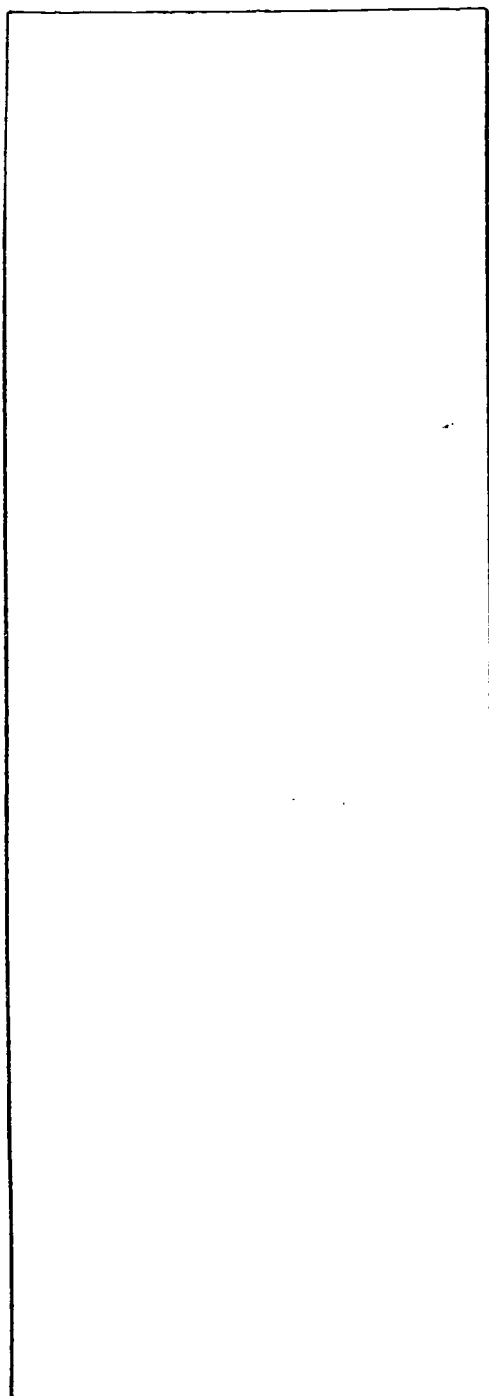
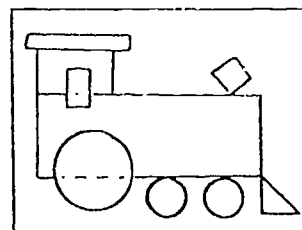

From *Paper Shapes Projects*, by Bee Gee Hazell, © 1985, Judy/Instructo. Used by permission.

## WALK-IN CITY

### MATERIALS

1. large appliance cartons, or paper product packaging cartons
2. pencils
3. scissors or mat knife
4. paint and brushes
5. masking tape

### BEFORE YOU BEGIN

What child wouldn't like to have his own skyscraper to play in? A visit to your local appliance store or supermarket should provide enough necessary boxes for your class to build one or more play buildings. Quite easily, children can construct an apartment house, supermarket, skyscraper, or any of a dozen city structures. The basic materials are large cartons and imagination.

Help youngsters decide what building or buildings they would enjoy making. You might want to draw some pictures first. Then, the entire group can decide which details to include in the model. List the steps to be followed on the board, and divide your class into groups. Each one will be responsible for a particular step.

### PROCEDURE (Illustration 1-11)

1. Cut away flaps from one end of the carton. This end will be the building base.
2. Draw a door with pencil, making certain it is both tall and wide enough for a child to walk through. Draw in windows. (steps a and b)
3. Using a mat knife or scissors, cut out the door on two sides, and fold it back on the third. If desired, cut openings for windows (this is advisable if children are to play inside). (step b)
4. To make a skyscraper, stack smaller boxes on top of a larger box. Use masking tape to hold these boxes in place. (step a)

From *Arts and Crafts Activities Desk Book*, by Joyce Novis Laskin, © 1971, Parker Pub. Co. Used by permission.

5. To make a house; separate two adjacent sides from an extra carton and tape this entire section, in triangular form, to a larger, bottom carton. (steps c & d)
6. Have one of the appointed groups paint the building a background color. When it has dried, another group can add details.

*WHAT THE CHILDREN CAN DO AFTERWARD*

1. Write a poem on large chart paper about the building and display it next to the structure.
2. Invite other classes for guided tours through the "city."
3. Build a model of the school for display in the lobby.

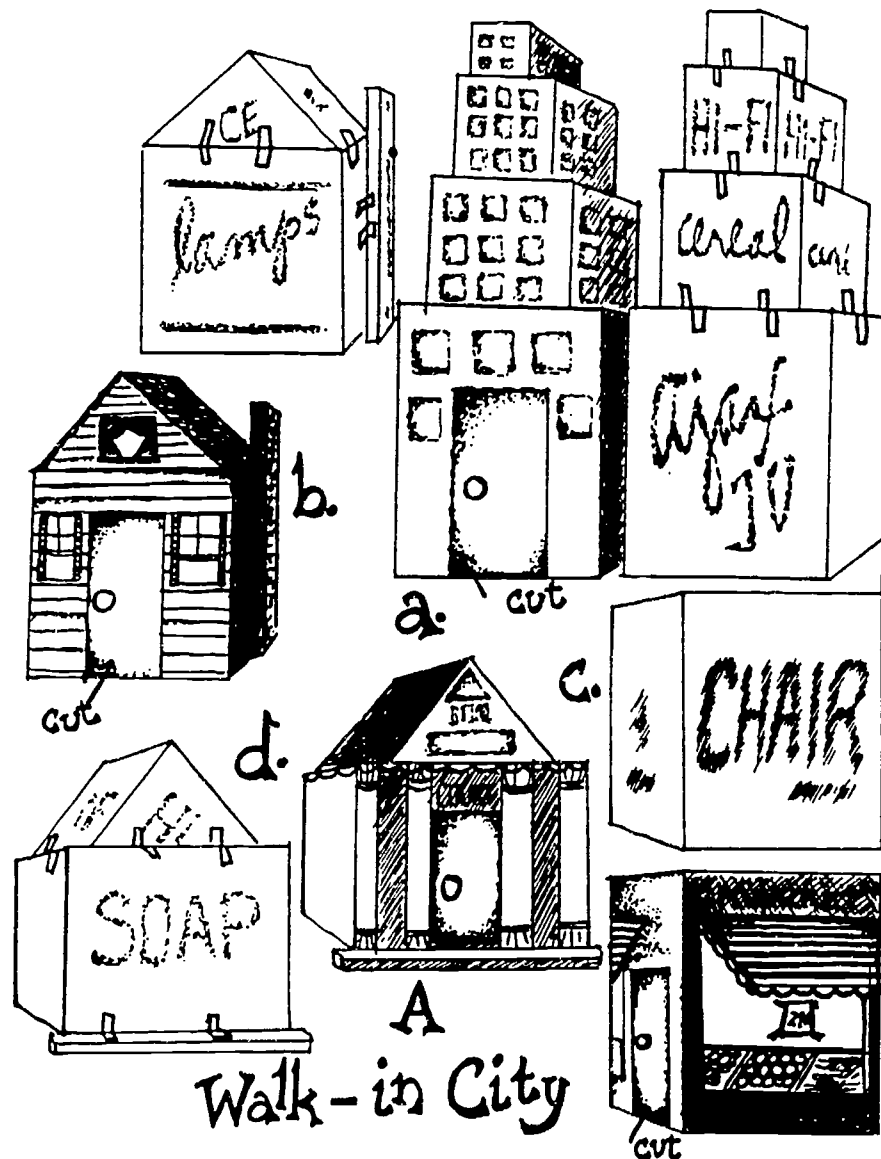

ILLUSTRATION 1-11

4. Use the model as a permanent play-house.
5. Find out about the people who work in the created buildings. Let children play-act the roles of these individuals.

#### RELAX WITH TIME SAVERS

1. Eliminate conflict by assigning each child in a given group a particular job. A child in group one might hold the boxes steady, while another tears masking tape for a third to use in securing the boxes for the skyscraper.
2. Spread newspaper beneath the carton before beginning to paint.
3. Permit the background paint to dry thoroughly before applying details.

## Whirly Twirly

Ages 4 to 6

The streamers are designed to flap behind your child as he runs.

*Cut a disk from a piece of light cardboard. Poke two holes  $\frac{1}{2}$  inch apart through the center. Insert the end of a rubber band through each of the holes so that two loops protrude on the opposite side. Pull one loop through the other to make a single loop and tie one end of a piece of string to it. Loop and knot the other end for a handle. Glue crepe-paper streamers to the back of the disk and paint a face on the front.*



From *Successful Parenting: Creative Projects Big and Small*.

By the Editors of Time-Life Books

© 1988 Time Life Books Inc.

**THE BIG TRAIN**

The great big train goes up the track  
 (hold index and third finger together and move up other arm)  
 And says "Whoo-oo" and then goes back.  
 (stop at shoulder, blow whistle and then go back down arm)

**BIRTHDAY TRAIN**

**Ages:** 2 - 5

**Number of Players:** 3 - 10

**Materials:** An index card for each child, yarn, scissors, stapler or hole punch, felt-tip marker.

**Preparation:** Write the age of each child on a separate index card. Make the cards into necklaces by stapling on loops of yarn or by punching holes in the cards and stringing the yarn through the holds.

**Game:** Have the children sit in a semicircle at an imaginary train station. Pass out "tickets" (age card necklaces) and let the children put them on. Call out a number and have the children who are that age get on the Birthday Train. For example, you might say "Everyone who is two climb aboard the Birthday Train!" Then have all the two-year-olds hook on behind you. Lead them around the room as everyone sings:

Sung to: The Mulberry Bush

Hop aboard the Birthday Train,  
 Birthday Train, Birthday Train.  
 Hop aboard the Birthday Train  
 If you are (two) years old.

Riding on the Birthday Train,  
 Birthday Train, Birthday Train.  
 Riding on the Birthday Train,  
 Chugging just for you.

Lead the children back to the station and call out a different age. Have those children climb aboard and repeat the process. Keep playing until everyone has had a ride on the Birthday Train.

**Hint:** Try letting the older children take turns being the Engineer.

From *1-2-3 Games*, by Jean Warren, © 1986. Reprinted by permission of Warren Publishing House, Inc., P.O. Box 2250, Everett, WA 98203.

## 2 • FINGERPLAYS

### THE CAR RIDE

(Left arm, held out bent, is "road"; right fist is "car")  
"Vroom!" says the engine (Place "car" on left shoulder)  
As the driver starts the car. (Shake "car")  
"Mmm," say the windows  
As the driver takes it far. (Travel over upper arm)  
"Errrr," says the tires  
As it rounds the final bend, (Turn at elbow; proceed over forearm)  
"Ahh," says the driver  
As his trip comes to an end. (Stop car on left flattened palm)

From *Finger Frolics Revised*. Compiled by Liz Cromwell, Dixie Hibner, and John R. Fritel. © 1976, Partner Press. Reprinted by permission.

### CHOO, CHOO, CHOO

Choo, choo, choo,	Slide hands together
The train runs down the track	Run fingers down arm
Choo, choo, choo	Slide hands together
And then it runs right back	Run fingers up arm

From *Story Programs: A Source Book of Materials*, by Carolyn Sue Peterson and Brenny Hall, © 1980 The Scarecrow Press, Inc. Reprinted by permission.

### CHOO CHOO TRAIN

Choo-choo-choo-choo,  
The train puffs down the track. (Bend arms at elbows and imitate chugging)  
Now it's going forward (Chug leaning forward)  
Now it's chugging back. (Chug arms back to sitting position)  
Now the bell is ringing. (Imitate ringing clapper of bell)  
Now the whistle blows. (Imitate pulling chain of train whistle up and down)  
Chugging, chugging, chugging, chugging, (move bent arms back and forth)  
Down the track it goes!

From *Resources for Every Day in Every Way*, by Cynthia Holley and Faraday Burditt, © 1989, Simon & Schuster. Reprinted by permission of the publisher.

**CHOO CHOO TRAIN**

This is a choo choo train  
 (bend arms at elbows)  
 Puffing down the track  
 (rotate forearms in rhythm)  
 Now its going forward,  
 (continue rotating motion)  
 Now its going back.  
 (reverse rotating motion)  
 Here the bell a-ringing,  
 (reach above head and pull cord)  
 Ding . . . ding . . . ding . . . ding.  
 Hear the whistle blow,  
 (cup hands around mouth)  
 Whooooooooo, Whooooooooo!  
 What a lot of noise it makes  
 (cover ears with hands)  
 Everywhere it goes.

Reproduced with permission of the American Library Association from *Storytimes for Two-Year-Olds* by Judy Nichols, © 1987.

**CLICK-CLACK**

Click-Clack, Click-Clack (Place elbow on desk and swing arm)  
 Back and forth, forth and back  
 Wiper works with might and main  
 To keep the windshield free from rain.

From *Finger Frolics Revised*. Compiled by Liz Cromwell, Dixie Hibner, and John R. Faitel. © 1976, Partner Press. Reprinted by permission.

**CLICKETY-CLACK**

Clickety-clack, clickety-clack (bend arms and pump like pistons)  
 Back and forth, forth and back (shuffle feet forward, then backward)  
 The wheels are singing on the railroad track (continue pumping)  
 Clickety, clickety, clickety-clack.



## 4 • FINGERPLAYS

### COUNTING AT THE ZOO

One, one; the zoo is lots of fun!

(Hold up hands with fingers extended; bend down one finger.)

Two, two; see a kangaroo!

(Bend down one finger)

Three, three; see a chimpanzee!

(bend down one finger)

Four, four; hear the lions roar!

(bend down one finger)

Five, five; watch the seals dive!

(bend down one finger)

Six, six; there's a monkey doing tricks!

(bend down one finger)

Seven, seven; elephants eleven!

(bend down one finger)

Eight, eight; a tiger and his mate!

(bend down one finger)

Nine, nine; penguins in a line!

(bend down one finger)

Ten, ten; I want to come again!

(bend down last finger; then clap hands)

From *Rhymes For Fingers and Flannel Boards*, by Louise Binder Scott and J.J. Thompson.  
© 1984. Reprinted with the permission of T.S. Denison and Co., Minneapolis, Minnesota.

### THE ELEPHANT

The elephant has a trunk for a nose,

And up and down is the way it goes;

(Clasp hands together, extend arms, and raise and lower them.)

He wears such a saggy, baggy hide!

(Relax body)

Do you think two elephant would fit inside?

(Hold up two fingers.)

From *Rhymes For Fingers and Flannel Boards*, by Louise Binder Scott and J.J. Thompson.  
© 1984. Reprinted with the permission of T.S. Denison and Co., Minneapolis, Minnesota.

### THE ELEPHANT'S TRUNK

The elephant has a great big trunk  
(Pretend an arm is the trunk)  
That goes swinging, swinging so.  
(Swing trunk)  
He has tiny, tiny eyes that show him where to go.  
(Point to eyes)  
His huge long ears go flapping, flapping up and down,  
(Pretend hands are ears)  
His great feet go stomping, stomping on the ground.  
(Stomp with feet)

From *Finger Frolics Revised*. Compiled by Liz Cromwell, Dixie Hibner, and John R. Faitel. © 1976, Partner Press. Reprinted by permission.

### ENGINE ON THE TRACK

Here is the engine on the track. (*Hold up thumb*)  
Here is the coal car, just in back. (*Pointer*)  
Here is the box car to carry freight. (*Middle*)  
Here is the mail car. Don't be late. (*Ring*)  
Way back here at the end of the train (*Little*)  
Rides the caboose through the sun and rain.

From *Mitt Magic: Fingerplays for Finger Puppets*, by Lynda Roberts, © 1985, Gryphon House, Inc. Used by permission.

### HERE IS A CAR

Here is a car, shiny and bright. (Cup one hand and place on other palm)  
This is the windshield that lets in the light. (Hands open, fingertips touching)  
Here are wheels that go round and round (Two fists)  
I sit in the back seat and make not a sound. (Sit quietly)

From *Finger Frolics Revised*. Compiled by Liz Cromwell, Dixie Hibner, and John R. Faitel. © 1976, Partner Press. Reprinted by permission.

## 6 • FINGERPLAYS

### HERE COMES THE CHOO-CHOO TRAIN

Here comes the choo-choo train  
(elbows against sides, arms make forward circles)  
Puffing down the track,  
Now it's going forward . . .  
Now it's going back.  
(reverse circles)  
Hear the bell a-ringing.  
(one hand above head, make bell-ringing motion)  
Ding . . . Ding . . . Ding . . . Ding  
Hear the whistle blow.  
(cup hands around mouth)  
Whooooo-Whooooo!  
Chug, chug, chug, chug  
(make side circles slowly, then pick up speed)  
ch . . . ch . . . ch . . . ch . . . ch . . . ch . . . ch  
Shhhhhh . . .  
(fold hands in lap)  
Everywhere it goes.

Reproduced with permission of the American Library Association from *Storytimes for Two-Year-Olds* by Judy Nichols, © 1987.

### HERE IS THE ENGINE

(point to each finger as rhyme is spoken)  
Here is the engine on the track. (thumb)  
Here is the coal car just in back. (pointer)  
Here is the boxcar to carry the freight. (middle finger)  
Here is the mail car. Don't be late! (ring finger)  
Way back here at the end of the train  
Rides the caboose through sun and rain. (wiggle pinky)

Reproduced with permission of the American Library Association from *Storytimes for Two-Year-Olds* by Judy Nichols, © 1987.

**HOW DO I GET FROM HERE TO THERE?**

How do I get from here to there? (Scratch head in puzzlement)  
 If I were a bird, I'd fly through the air. (Flap arms)  
 How do I get to a mountain peak? (Scratch head in puzzlement)  
 If I were a snake, I'd slither and sneak. (Move shoulders and body in slithering motion)  
 How do I get to the merry-go-round? (Scratch head in puzzlement)  
 If I were a horse, I'd run on the ground. (Stoop, "run" with arms and legs)  
 How do I get to the candy shop? (Scratch head in puzzlement)  
 If I were a frog, I'd hop, hop, hop. (Do so, on each "hop")  
 How do I get to Snickersnee? (Scratch head in puzzlement)  
 If I were a fish, I'd swim through the sea. (Make swimming motions with arms)

From *Finger Frolics Revised*. Compiled by Liz Cromwell, Dixie Hibner, and John R. Faitel. © 1976, Partner Press. Reprinted by permission.

**I THINK I'LL GO TO TIM-BUC-TU**

*Children are standing*

<i>Walk, walk, walk in place</i>	I think I'll go to Tim-buc-tu, If there is such a place;
<i>"Comb hair"</i>	But, first, I'd better comb my hair,
<i>Rub face</i>	And, maybe, wash my face.
<i>Take a step to the right</i>	I wonder: should I take a bus
<i>Take a step to the left</i>	Or get aboard a train?
<i>Take a step forward</i>	But, if it's very far away, I'd better take a plane!
<i>Put finger on chin, wondering</i>	I need to pack a suitcase.
<i>Shiver</i>	Is the weather cold or hot??
<i>Fan self</i>	And will I need long underwear, Or summer clothes, or what?!
<i>Scratch head, confused</i>	There's such a lot to think about— So many things to do . . .
<i>Shake head "no"</i>	I may decide, instead, that I Won't go to Tim-buc-tu!

From *Move Over, Mother Goose!* by Ruth I Dowell, © 1987, Gryphon House, Inc. Reprinted by permission of the publisher.

## 8 • FINGERPLAYS

### IF I WERE A TRAIN

If I were a choo-choo train.  
I'd run along a track.  
I'd blow my whistle. (Hand closed like pulling whistle) Toot! Toot!  
And let out steam. (Make sound with mouth) Sh . . . Sh . . .  
As I go clickety-clack, clickety-clack, clickety-clack.

From *Finger Frolics Revised*. Compiled by Liz Cromwell, Dixie Hibner, and John R. Fritel. © 1976, Partner Press. Reprinted by permission.

### IF I WERE AN AIRPLANE

If I were an airplane, (Extend arms from shoulder, hold up)  
Flying way up high.  
I'd tip my wings, (Bend body, one arm up, the other down)  
To make a turn.  
As I go zooming by. (Make zooming sound)

From *Finger Frolics Revised*. Compiled by Liz Cromwell, Dixie Hibner, and John R. Fritel. © 1976, Partner Press. Reprinted by permission.

### LITTLE RED TRAIN

by Jean Warren

Little Red Train  
Chugging down the track,  
First it goes down,  
Then it comes back.  
Hooking on cars as it goes,  
Little Red Train just  
Grows and grows.

**Action:** Have the children sit down and wait in line at an imaginary train station. Chug around the room as everyone recites the poem below. Each time you stop at the station, have the child at the head of the line hook onto the back of your train. Continue until everyone is hooked on and has had a chance to chug around the room.

**Variation:** Let each child choose to be a specific type of car such as a boxcar or a circus car. Change the third line of the poem to match the type of car chosen. For example, if a child chooses to be a tank car, change the line to read, "Hooking on a tank car as it goes." Let the last child in line be the caboose.

From *Theme-A-Saurus II*, by Jean Warren, © 1990. Reprinted by permission of Warren Publishing House, Inc., P.O. Box 2250, Everett, WA 98203.

**MY AIRPLANE RIDE**

We went to the airport to board our plane. (Hand makes swooping motion)  
 To go away and come back again.  
 The car was parked and we took the little bus. (Body makes bouncing motions)  
 We were early so we didn't rush.

As we walked along the airport hall.  
 We saw the airplanes through big windows in the wall. (Pointer fingers form square)  
 Big planes, small planes, all in a row. (Hands spread apart horizontally)  
 The pilots were waiting for their turn to go. (Hands move a pretend wheel)

Many, many people I could see.  
 Tall ones, short ones, some the same as me. (Right hand up, left hand down, right pointer  
 points to self)  
 Our plane was now ready for the flight.  
 I thought it was the biggest one in sight.

It was time for the passengers to board. (Point to watch or clock)  
 And it wasn't long before we soared. (Right hand upward sweep)  
 I was sitting in an airplane seat.  
 For a little person it was really neat.

I wanted to sit so straight and tall.  
 So people wouldn't know I was small. (Sit up straight with shoulders back)  
 I'm sure people knew it was a big person's seat.  
 Because they could see by my dangling feet. (Move feet back and forth)

So up in the airplane, oh so high.  
 Flew our airplane into the sky. (Hands up high)  
 Through the wind and with the sun.  
 Faster than a horse can run. (Hands hit knees)

Sitting in our seats so still.  
 Flying over the tallest hill. (Hands up touching)  
 To a city so far away we could fly in less than a day.  
 Oh, it's fun to fly! (Arms outstretched)

From *Finger Frolics Revised*. Compiled by Liz Cromwell, Dixie Hibner, and John R. Faitel. ©  
 1976, Partner Press. Reprinted by permission.

## 10 • FINGERPLAYS

### MY BICYCLE

My bicycle is shiny and new

(Move hands in a circular motion at sides, as if pedaling a bicycle)

I like to ride with my friends, do you?

Sometimes we ride fast

Sometimes we ride slow

But we are always careful, you know?

From *Finger Frolics Revised*. Compiled by Liz Cromwell, Dixie Hibner, and John R. Faitel. © 1976, Partner Press. Reprinted by permission.

### THIS LITTLE TIGER

This little tiger is very wild, (Thumb)

This little tiger is a loving child, (pointer finger)

This little tiger has some big black spots, (middle finger)

This little tiger has small black dots; (ring finger)

This little tiger likes to prowl and smell, (little finger)

But his teeth are too small to bite very well.

From *Finger Frolics Revised*. Compiled by Liz Cromwell, Dixie Hibner, and John R. Faitel. © 1976, Partner Press. Reprinted by permission.

### THE TRAIN

*Traditional*

Choo, choo, choo,

(slide hands together)

The train runs down the track.

(run fingers down arm)

Choo, choo, choo,

(slide hands together)

And then it runs right back.

(run fingers up arm)

**TRAIN**

The train's big wheels go clickety-clack  
 (make circular motions)  
 As they choo-choo over the railroad track.  
 (make circular motions over opposite outstretched arm)  
 It'll never get lost through thick and thin,  
 For a train only goes where it's already been.

From *Finger Frolics Revised*. Compiled by Liz Cromwell, Dixie Hibner, and John R. Faitel. © 1976, Partner Press. Reprinted by permission.

**ZOO TRAIN**

**Ages:** 2½ - 5

**Number of Players:** 3 - 10

**Materials:** None

**Preparation:** None

**Game:** Have the children line up in a row to make a "zoo train." Designate one area in the room to be the train station. Let the first child in line be the Engineer. Have the children sing the first verse of this song with you:

Sung to: Down by the Station

Down by the station,  
 Next to the zoo,  
 On came an animal.  
 Do you know who?

Let the Engineer tell what animal came aboard the train and what action that animal is performing. For example, he or she might say "A kangaroo came aboard and it is hopping." Then let the children sing the rest of the song with you as the train "hops" around the room:

We picked up a (kangaroo),	(Hopping, hopping) watch us go,
And what do you know.	(Hopping) fast, then (hopping) slow.
This is the way	(Hopping) down, then (hopping) back.
The train started to go.	Watch us (hop) around the track.



## 12 • FINGERPLAYS

When the train returns to the station, have the Engineer go to the back of the line. Then let the child at the front of the line become the new Engineer and choose the next animal. Continue playing until everyone has had a turn being the Engineer.

Before playing the game, review various zoo animals and how they move.

From *1-2-3 Games*, by Jean Warren, © 1986. Reprinted by permission of Warren Publishing House, Inc., P.O. Box 2250, Everett, WA 98203.

**ELLIE THE ELEPHANT SAVES THE DAY!**

*Original story by Lois Grant, original art work by Jan Jeffus*

The Barney Bailey Circus was supposed to leave town that morning to go to Hooterville for the next show. The big tents had been taken down, all of the trucks were loaded and the animals packed up except for Ellie the Elephant. She always liked to go sightseeing in each town, but she had a terrible memory and forget what time it was. Everyone in the circus looked all over, but could not find her. Mr. Bailey finally told everyone to quit looking. If they were to start the next show on time, they would have to go on to Hooterville. He said they would have to come back for her, but that she would miss her next performance. This was really too bad as Ellie was one of the stars of the show. She would not be there for the big circus parade. The show packed up and left.

Five minutes after they left, Ellie showed up. "Oh no!" She said. "They left me behind. I was too late. How am I going to make it to Hooterville?"

About that time, Ellie heard a train whistle. "I know! I will take the train. Hooterville is only four towns away and the train goes right through town. That way, I will be in time for the show and Mr. Bailey will not be mad at me."

Ellie rushed down to the train station. Mr. MacGregor, the engineer was ready to start his engine and leave the station. "Oh please, Mr. Engineer! Please let me ride on your train to Hooterville. I was left behind by the Barney Bailey Circus and I must be there to lead the circus parade."

"You might be too heavy for my train," said Mr. MacGregor, "I was slowed down enough by a storm last night and I do not want to be slowed down any more."

"Oh, I won't slow you down," said Ellie, "And as I am nice and strong, I might be of help to you."

Mr. MacGregor finally agreed to take her to Hooterville and told her to ride in one of his empty railroad cars. The train chugged-chugged out of the station and they were on their way.

They had only traveled a few miles when Mr. MacGregor realized that he had forgotten his hook with which he used to grab the mail bags. The train did not always stop at every station, and when it didn't stop, he would grab the mail bags with the hook as the train passed the station.

"Now I will have to stop and that will slow me down even more," complained Mr. MacGregor.

"That's okay," said Ellie. "I will use my trunk and grab the mail bags for you as we pass by the station. That way you will not have to stop and we will not lose time."

"That is a very good idea," said Mr. MacGregor. "You are a very handy elephant." As they passed through the station, Ellie grabbed the mail bags with her trunk and they were on their way.

A little further down the track, the train came to an abrupt stop. "What is wrong," cried Ellie. "I thought that we were in a big hurry."

"The storm blew a tree down on the tracks," said Mr. MacGregor. "Now I will have to wait for the repair crew."

"There is no need for that," said Ellie. "I will move the tree myself. Remember elephants are very strong and very smart." Ellie used her trunk and her great strength to pull the tree off the tracks. In no time at all they were on their way again.

Around the next bend, Mr. MacGregor stopped at the water tank to fill his steam engine with water, but there was another problem. The wind from the storm had knocked the pipe off the water tank and he could not put water in his engine. "Drat! I really will have to wait for the repair crew now!" said Mr. MacGregor.

"Never mind the repair crew," said Ellie. "Remember how useful an elephant's trunk is!" Then she used her trunk to draw up some water and put it in the steam engine. In no time at all they were on their way again.

They were almost to Hooterville, when they had to stop again. An automobile had broke down on the railroad crossing and could not move. Mr. MacGregor asked Ellie if she could help move the car. He remembered how useful and how strong she was.

"I will be glad to help," said Ellie. She climbed down from the railroad car and used her big head and her great strength to push the automobile off the tracks. The owner of the automobile and Mr. MacGregor were very grateful to her. The train started up again and in no time at all, pulled into the station at Hooterville.

The Barney Bailey Circus had just arrived in town so everything worked out fine. Everyone was very happy that Ellie would get to lead the parade. Ellie promised that from now on she would be more careful of the time. Mr. MacGregor told her that if she ever got left behind again, she could ride his train.

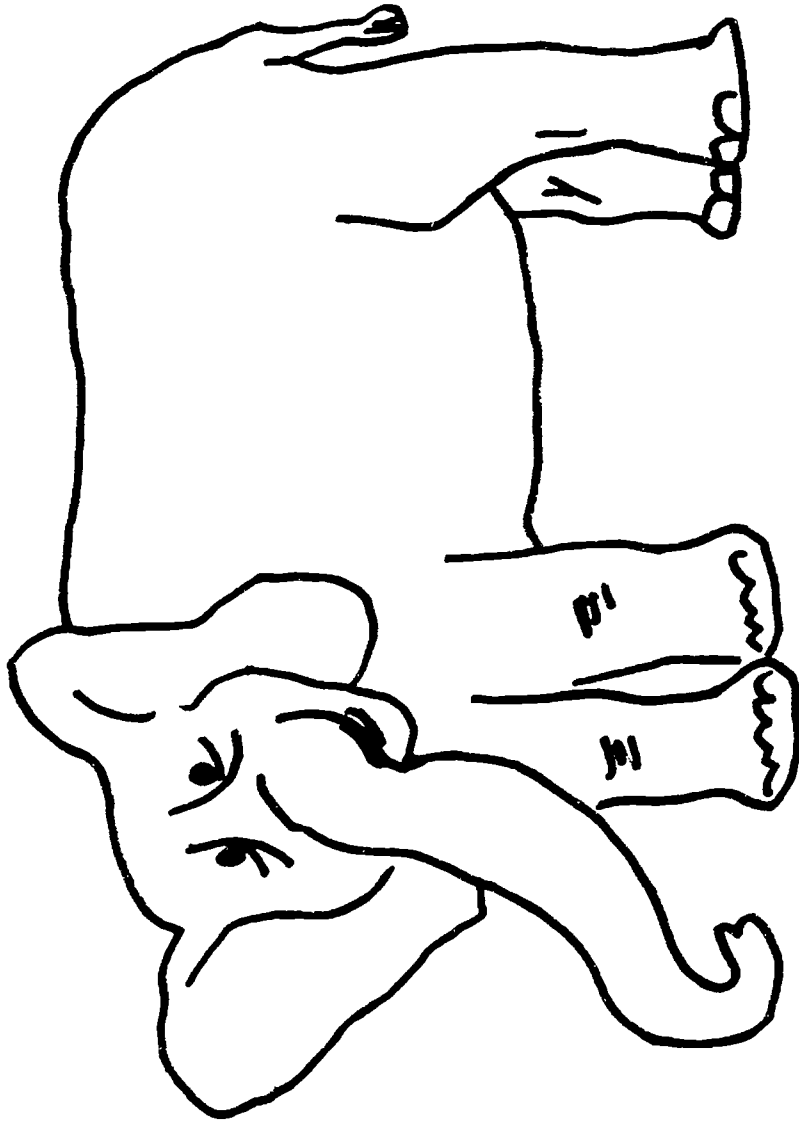

Artwork by Jan Jeffus

240  
1992

230

Ellie the Elephant Saves the Day!

242

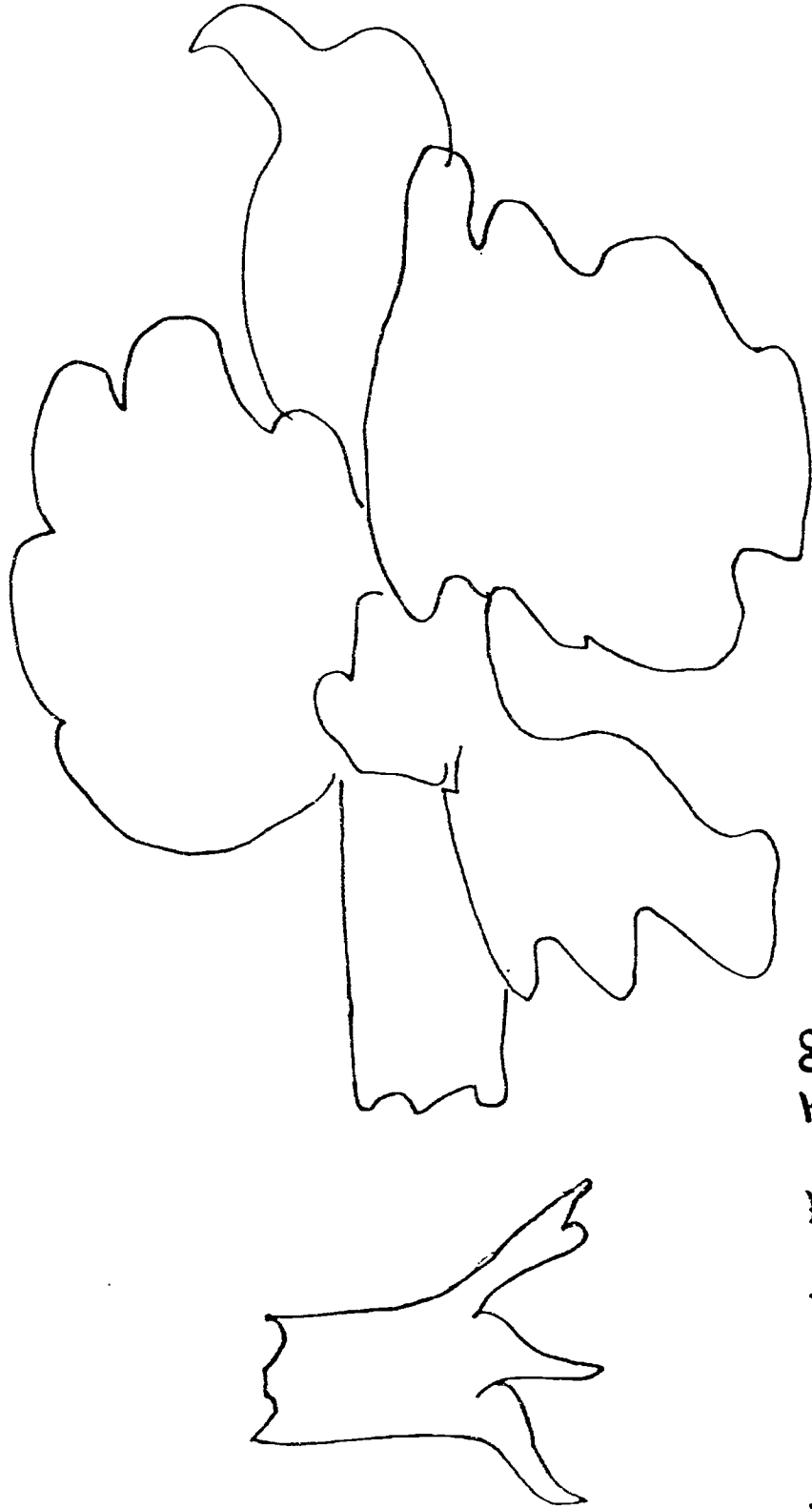

Artwork by Jan Jeffus

241

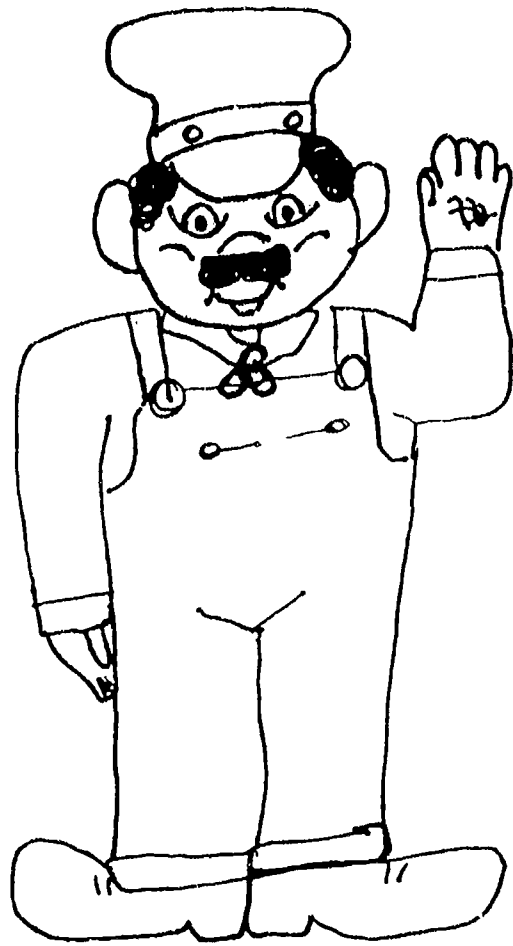

Artwork by Jan Jeffus

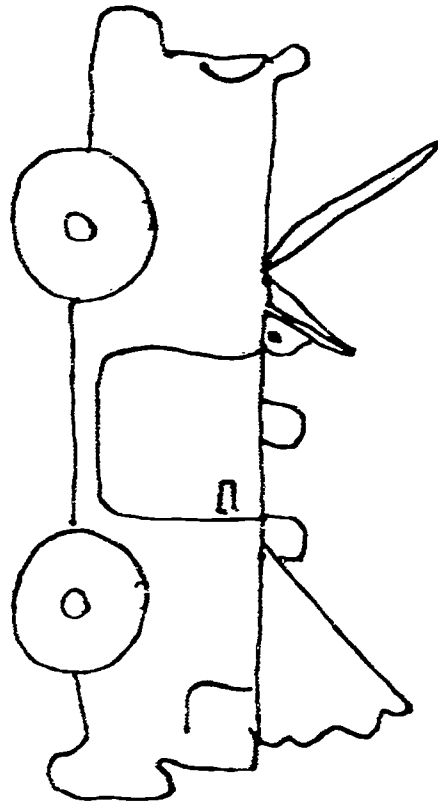

Artwork by Jan Jeffrus

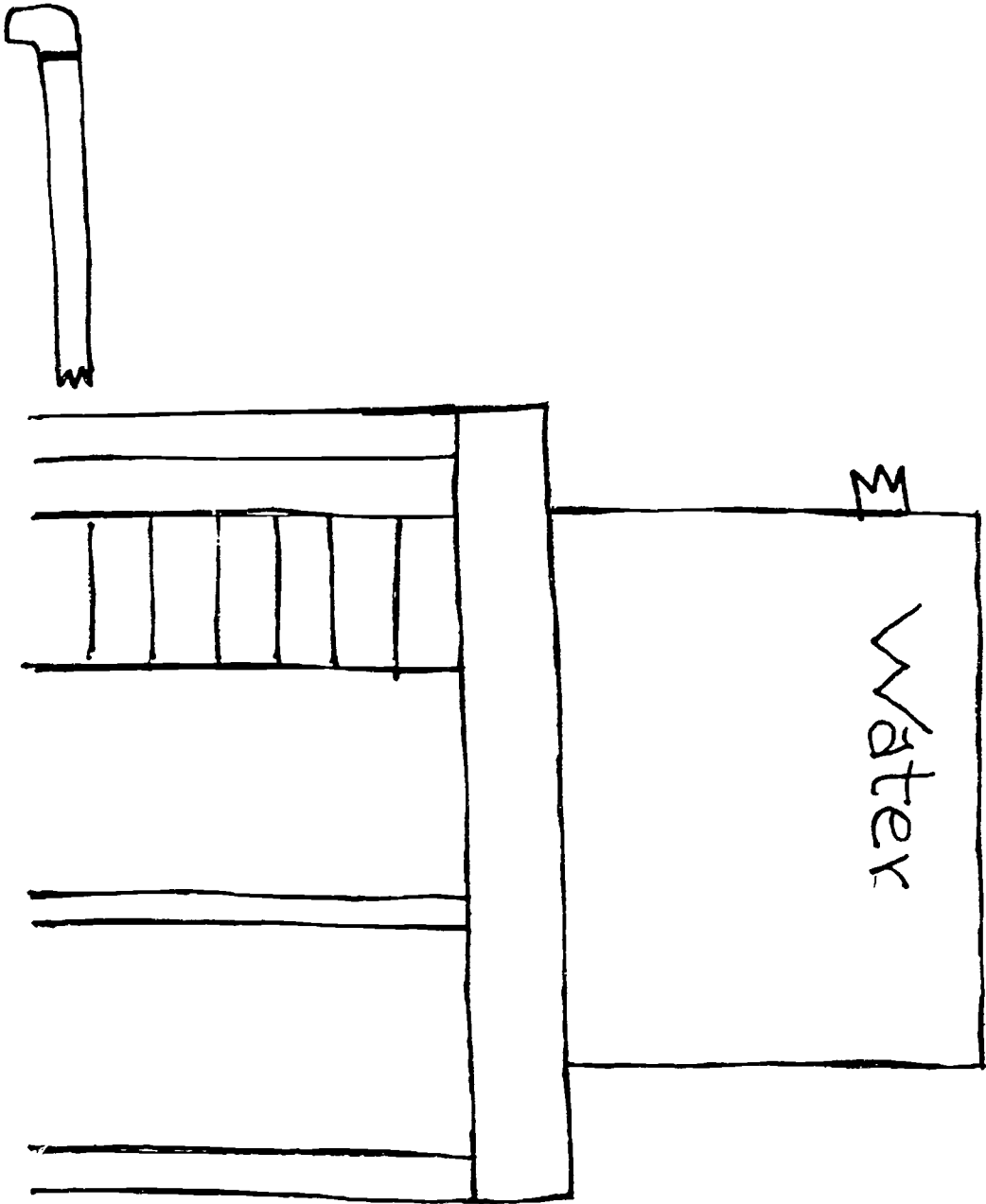

Artwork by Jan Jeffus



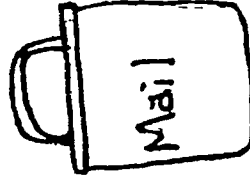
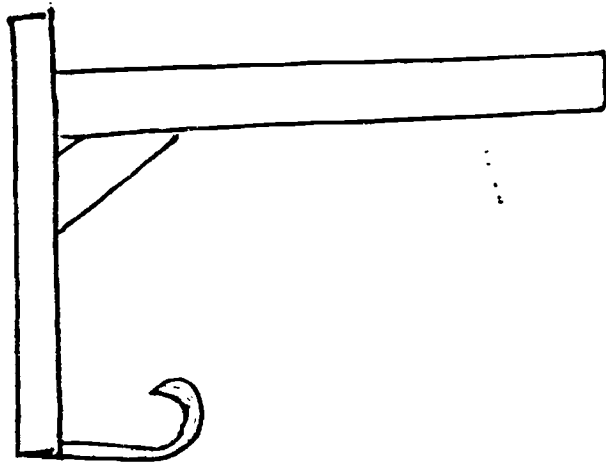

Artwork by Jan Jeffus

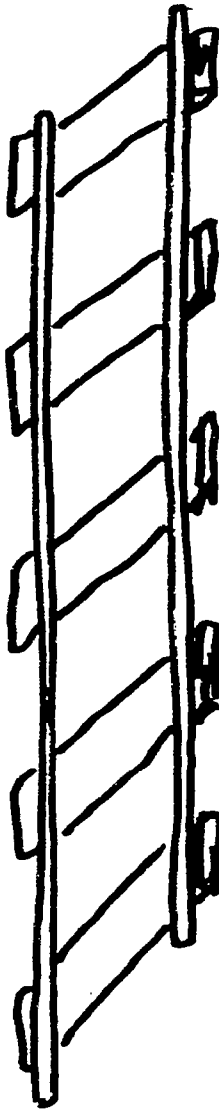

Track

**LITTLE TRAIN'S BUSY DAY***by Mabel Watts*

It was a lovely day. Little Train felt gay as a lark. He stood in the station and watched the people get on his coaches. He watched the mail sacks and the milk cans being lifted into his baggage cars.

"All aboard," shouted the conductor. And Little Train was off.

Puff, puff, puff,

Choo, choo, choo,

Toot, Toot!

Little Train was happy. He was having fun. Uphill and downhill he went. Swish across the bridges. Swoosh around the curves.

Suddenly Little Train saw a lot of bunnies running along beside his tracks.

There were bunnies running to the carrot patch.

There were bunnies running to school.

And there were bunnies just running.

Little Train picked out the fastest bunny. He was a white bunny with a fluffy tail.

"Whoo, whoo,

I can beat you," sang Little Train. He went faster and faster.

But . . . Just then Little Train came to a station.

"Shucks,

Shucks,

Shucks,

he said, slowing down. "Now I can never beat that bunny."

And Little Train stopped right smack in front of the platform.

A little girl got off the train and ran to meet her grandmother.

"Oh, well," said Little Train. "Maybe I didn't beat that bunny, but I did bring a little girl to her grandmother. and that makes me feel very happy.

"All aboard," shouted the conductor and Little Train was off again.

Puff, puff, puff,

Choo, choo, choo,

Toot, Toot!

Little Train sailed along his shiny tracks. He looked beside him. There along the road came a stream of cars.

Cars that were on their way to the seashore.

Cars that were on their way to the city.

Cars that were just on their way.

Little train picked out the fastest car. It was a long, low blue one.

"Whoo, whoo,

I can beat you," sang Little train and he went faster and faster.

But . . . Little Train came to another station.

"What a nuisance,

What a nuisance,

What a nuisance,"

he hissed as he slowed down. "Now I can never beat that car "

And Little Train stopped right smack in front of the platform.  
 A man took milk cans from the baggage car.  
 Little Train chuckled to himself. "I know I didn't beat that car," he said, "but I've brought milk to the children. That makes me happy."

"All aboard," shouted the conductor. Little Train was off again.

Puff, puff, puff,

Choo, choo, choo,

Toot, Toot!

Suddenly Little Train looked above him. There were airplanes in the sky.

Airplanes going a long way.

Airplanes going a short way.

Airplanes just going.

Little Train picked out a small shiny one that glinted in the sun.

"Whoo, whoo,

I can beat you," sang Little Train.

But . . . then Little Train came to another station.

"Too bad,

Too bad,

Too bad,"

said Little Train, slowing down, "Now I can never beat that airplane."

And he stopped right smack in front of the platform.

A man took mail sacks from the baggage car.

Little Train smiled. "I know I didn't beat that airplane," he said. "But I've brought letters to children. That makes me happy."

"All aboard," shouted the conductor. And Little Train was off again.

But this time Little Train was on his way back to the roundhouse. His work was over.

Swish he went across the field.

Swoosh he went around curves.

Zoom he went past houses.

Little Train arrived at his roundhouse.

"Ho hum," yawned Middle-sized Train steaming to the left of him.

"Time to sleep," yawned Big Train creaking to the right of him.

"Choo, choo,

I can beat you," said Little Train.

And what-do-you-know???

He did!!!

Middle-sized Train was still steaming.

Big Train was still creaking.

But Little Train was fast asleep!

From *Storytelling With the Flannel Board*, by Dr. Paul S. Anderson, ©1970 T. S. Denison & Co., Inc. Reprinted by permission.

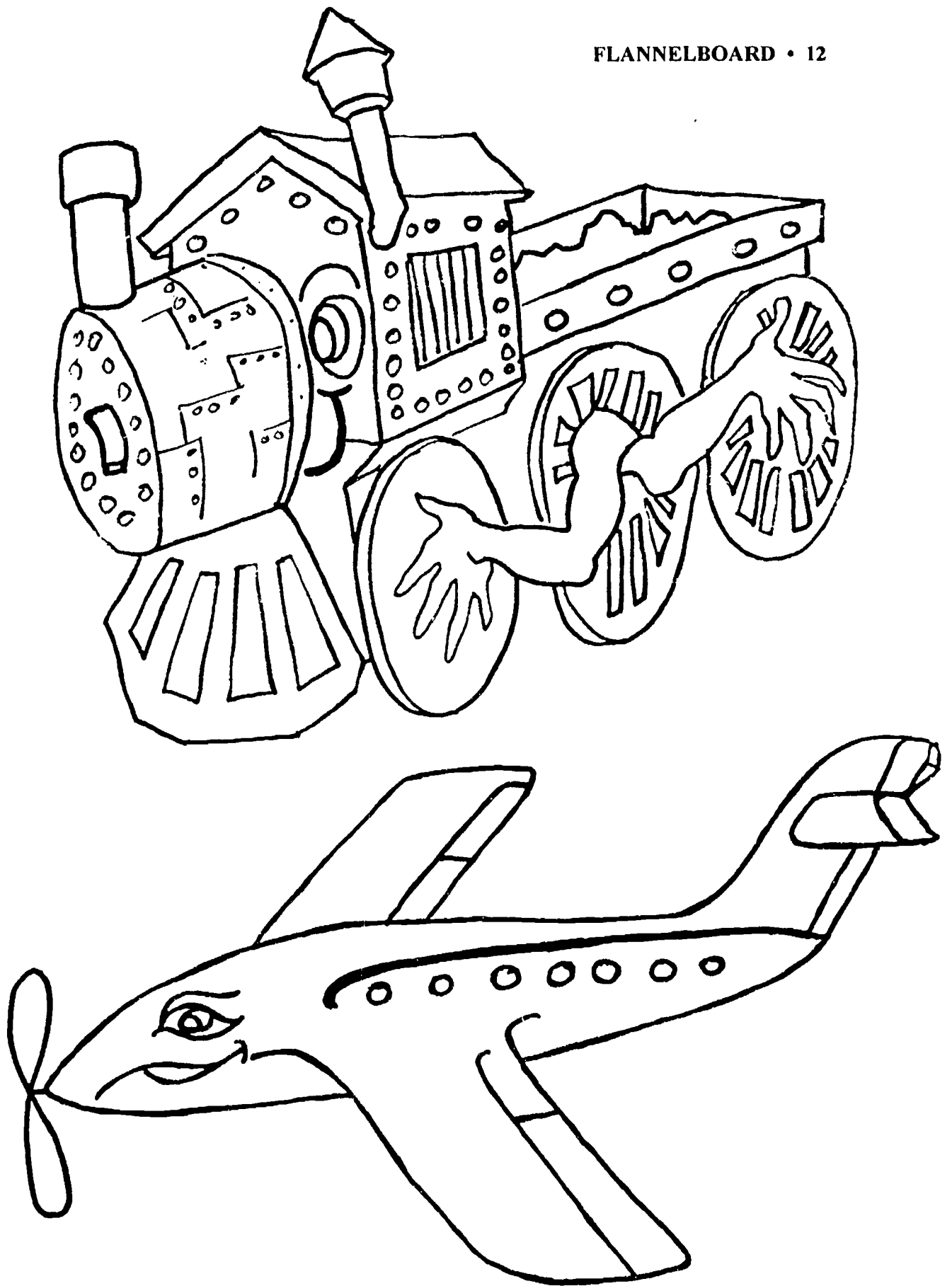







SEE OTHER  
STORIES FOR  
TRAINS

253

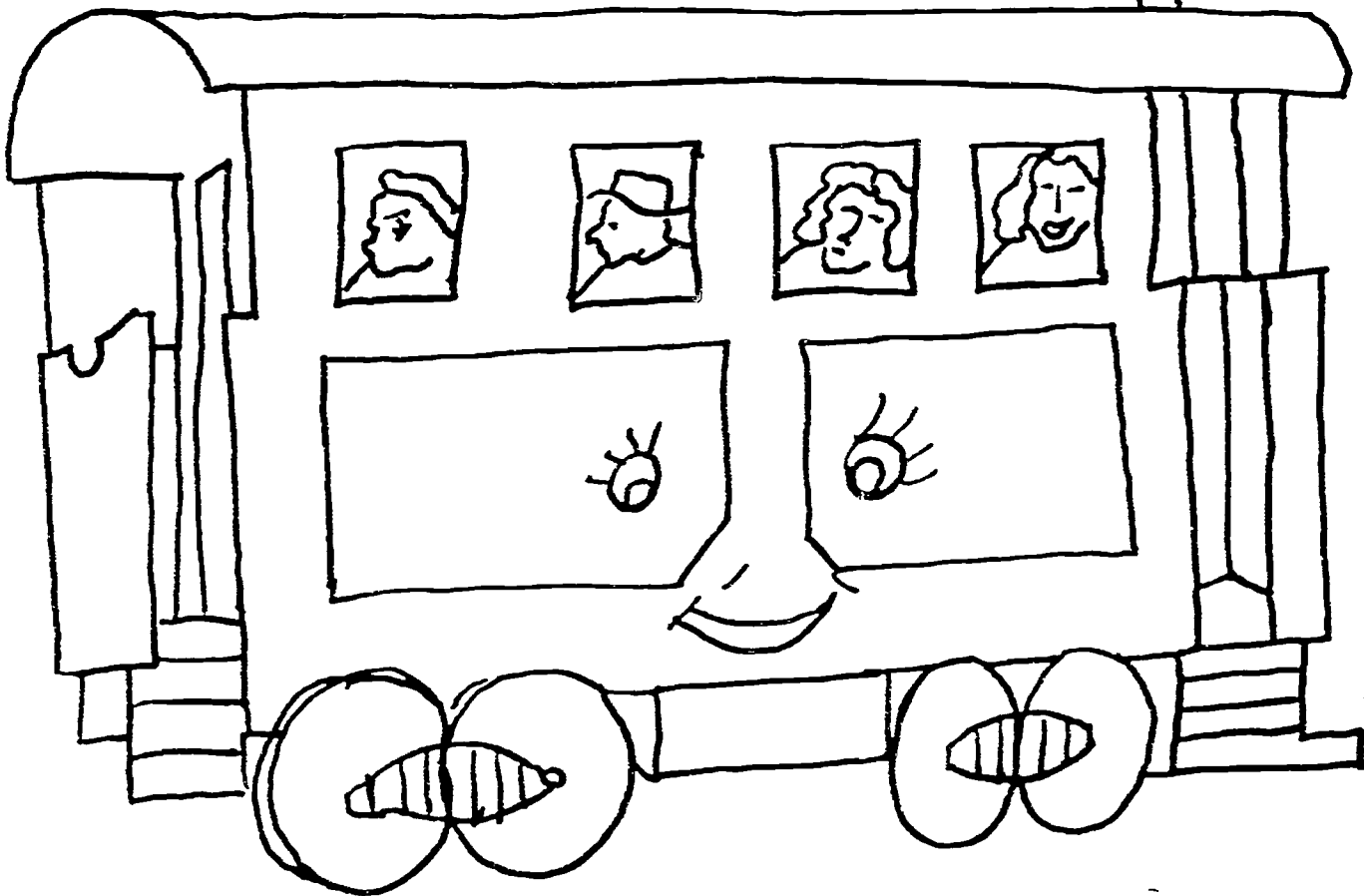

257



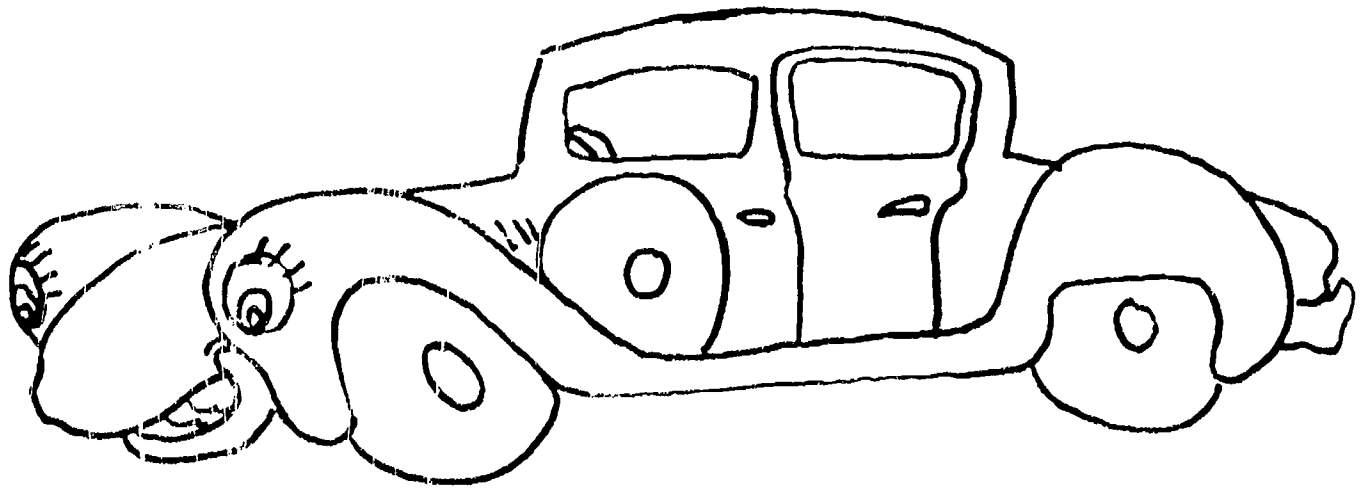

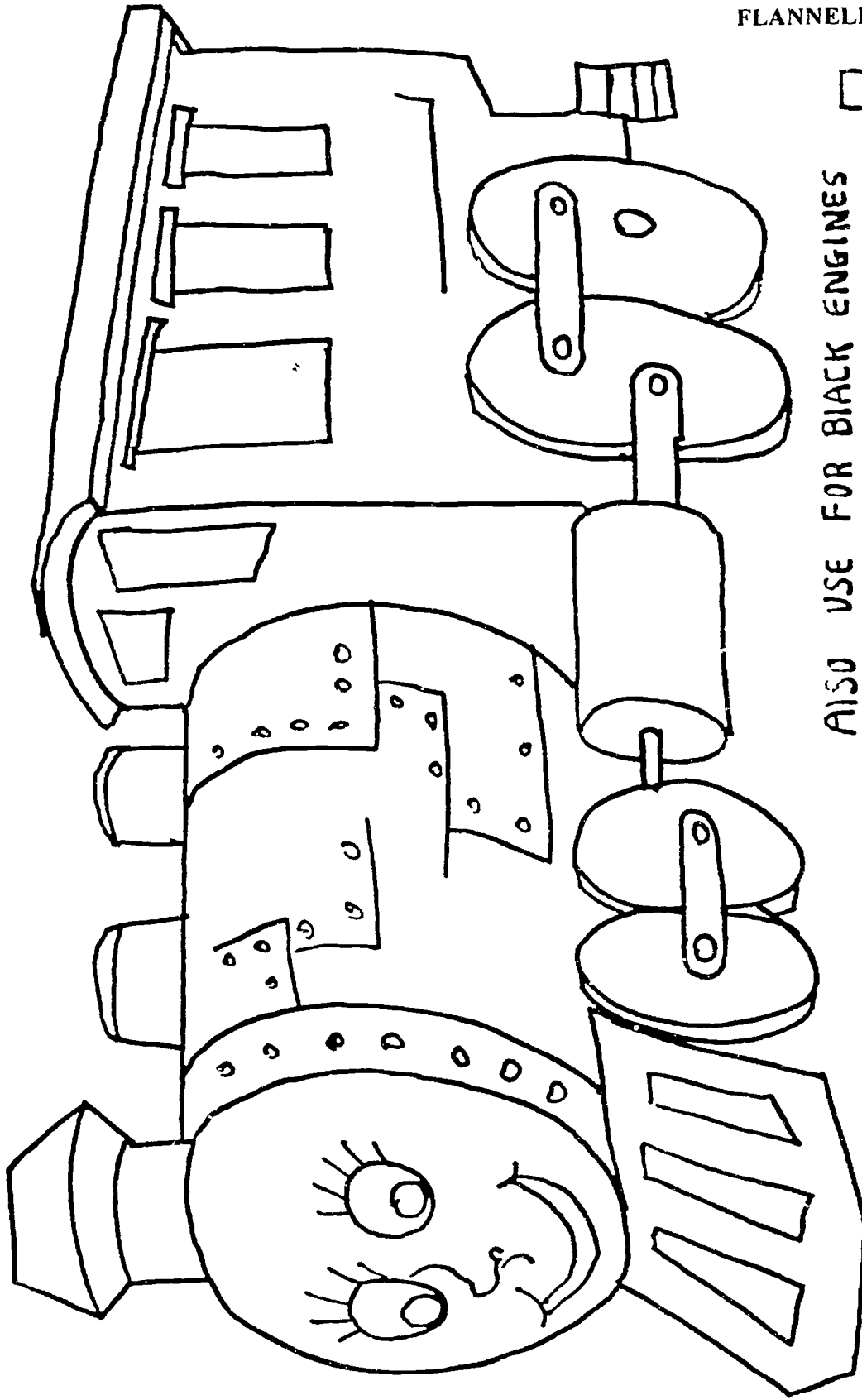

ALSO USE FOR BLACK ENGINES

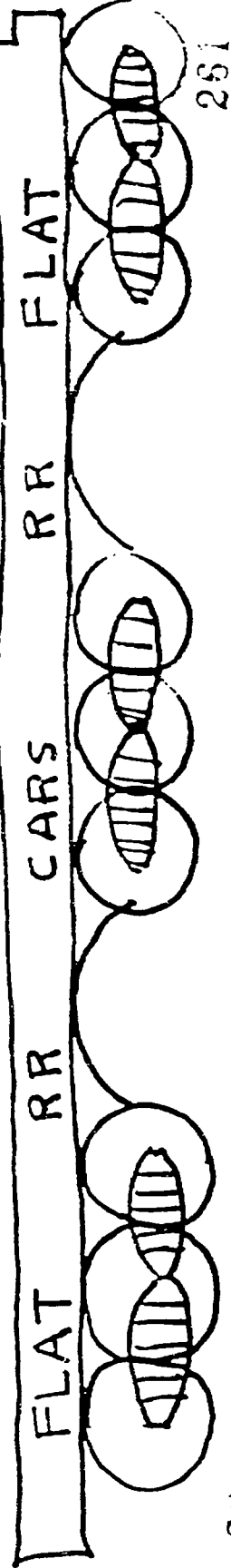

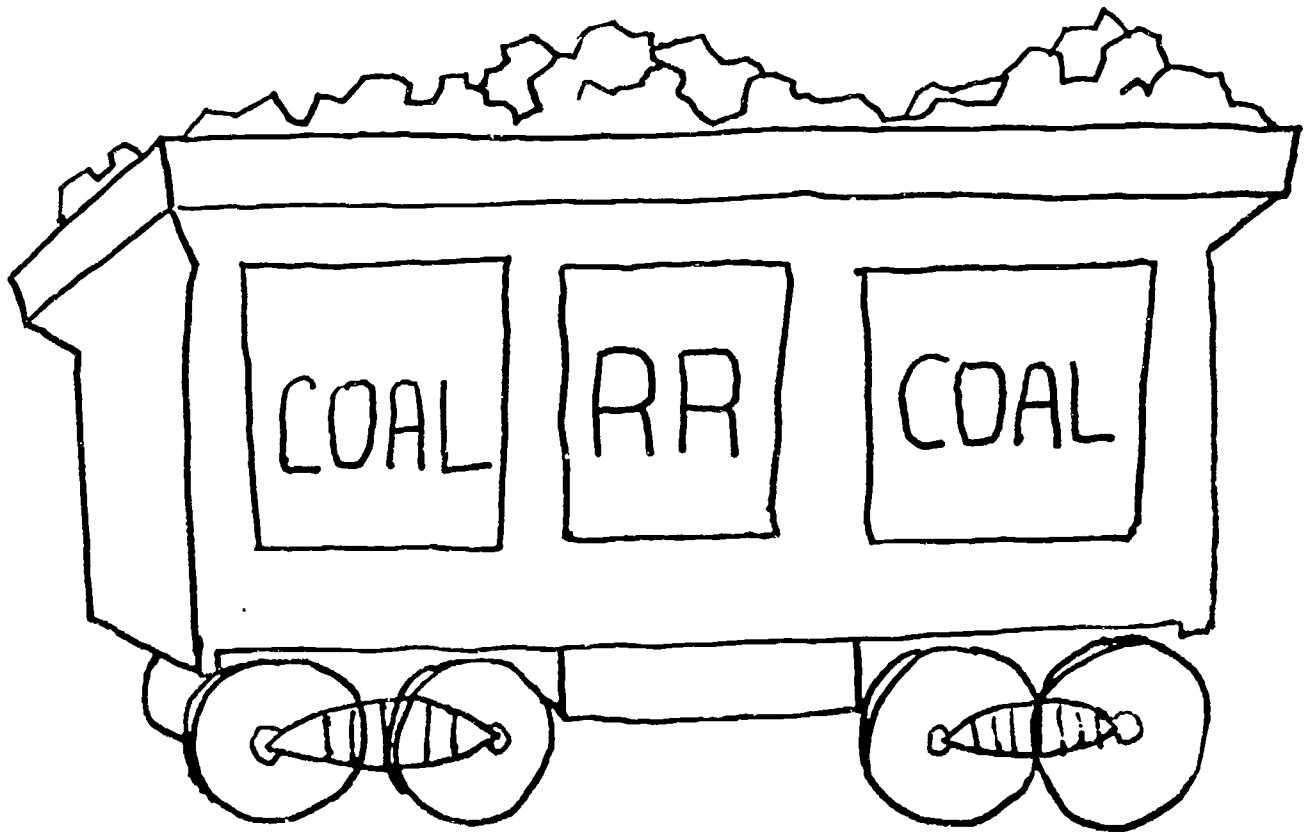
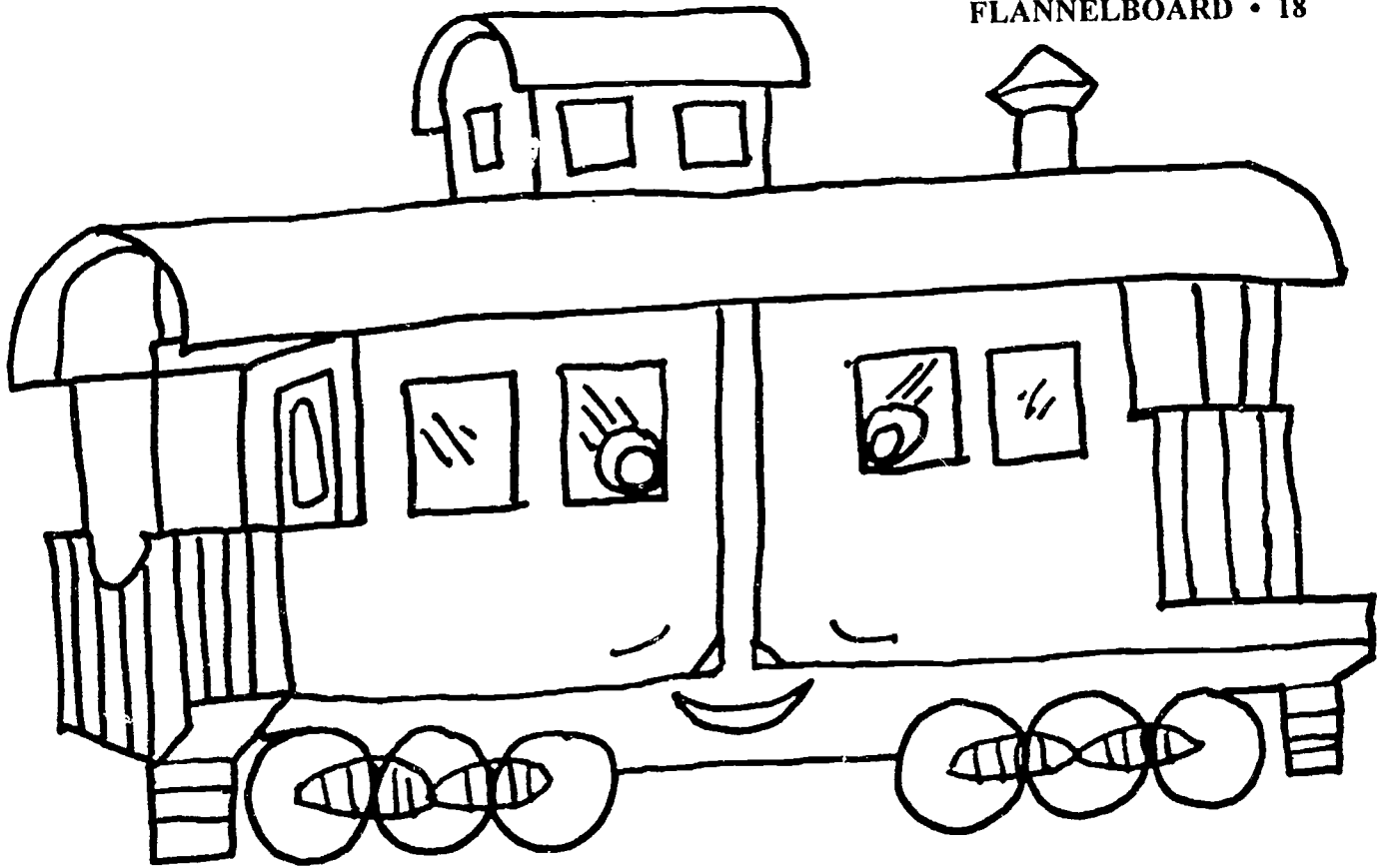

MINIATURE IDEA FOR  
MOUNTAIN PATTERN

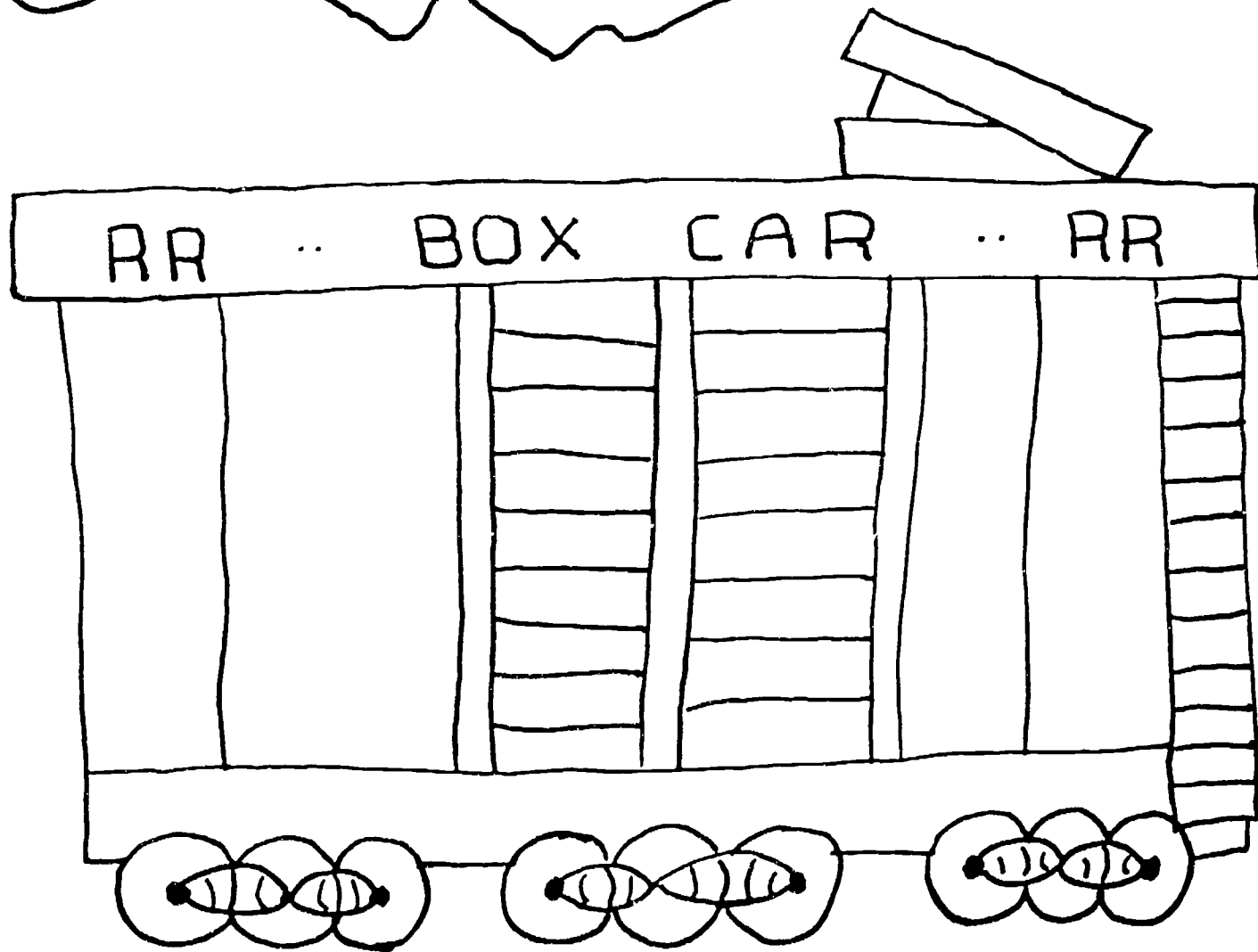
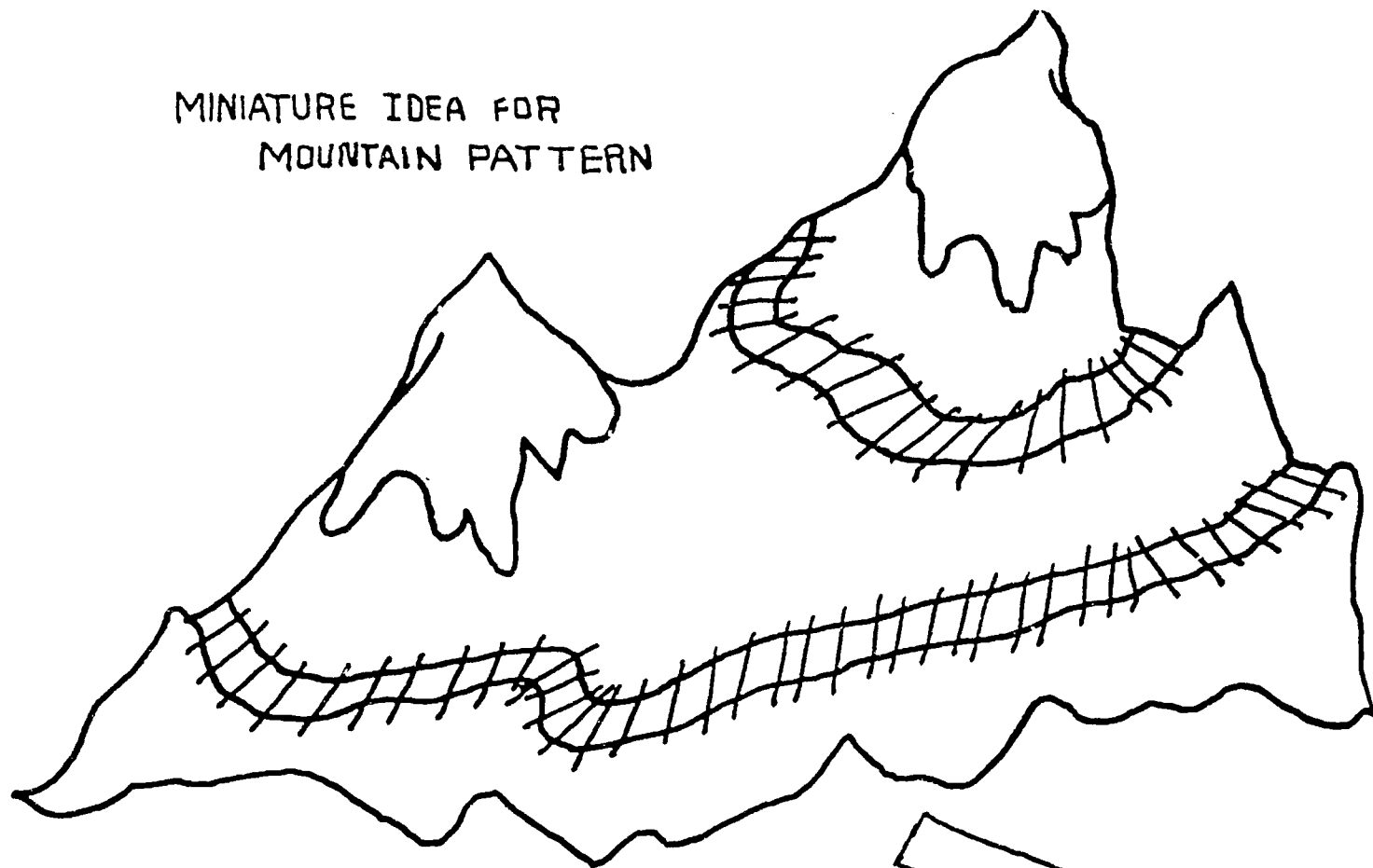

**THE TRAIN***by C. S. Peterson*

Chug, chug, choo, choo, choo down the track.  
 First comes the engine with the coal car in back;  
 Boxcar, flat car, boxcar again;  
 Last the caboose at the end of the train.

Make two boxcars. Color as desired and outline in black. Place the engine on the board, and follow with the other cars as the poem dictates. You may want to repeat the poem, increasing speed and creating the rhythm of a moving train.

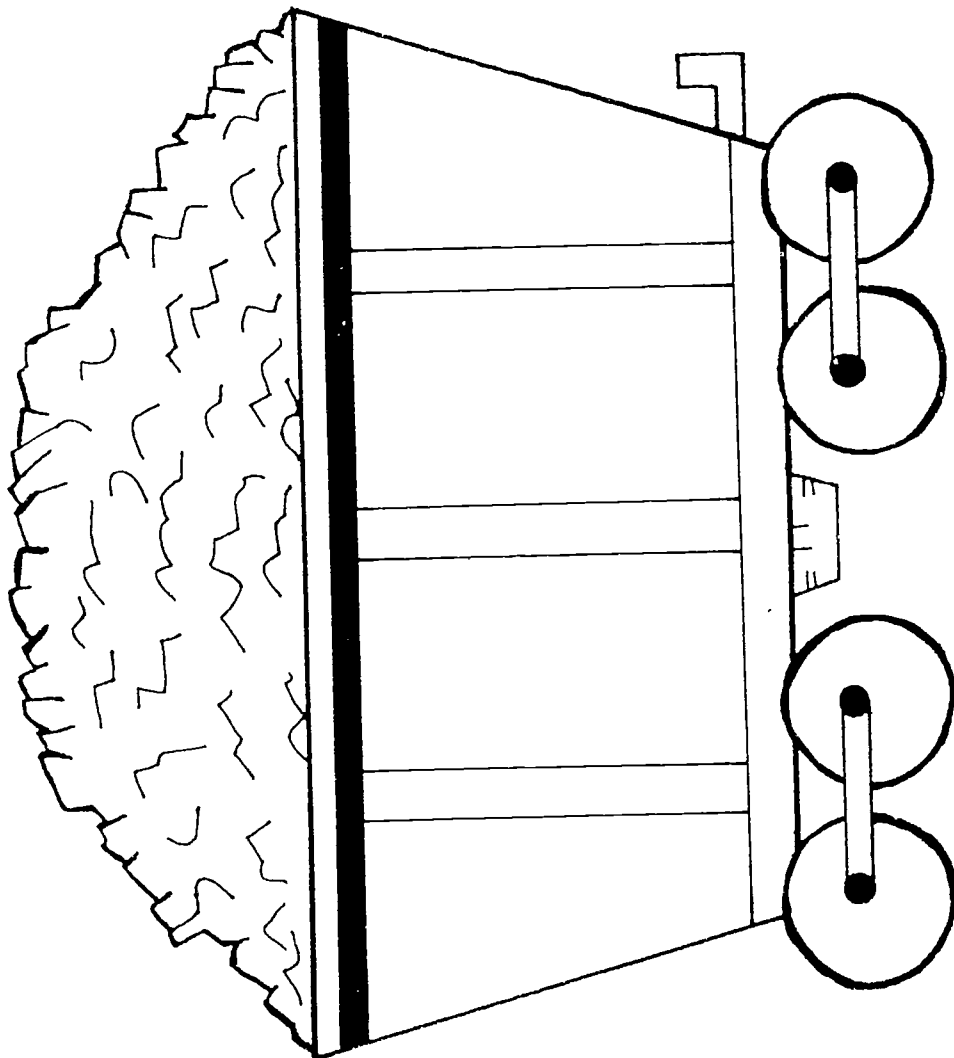

From *Story Programs: A Source Book of Materials*, by Carolyn Sue Peterson and Brenny Hall, © 1980 The Scarecrow Press, Inc. Reprinted by permission.

233

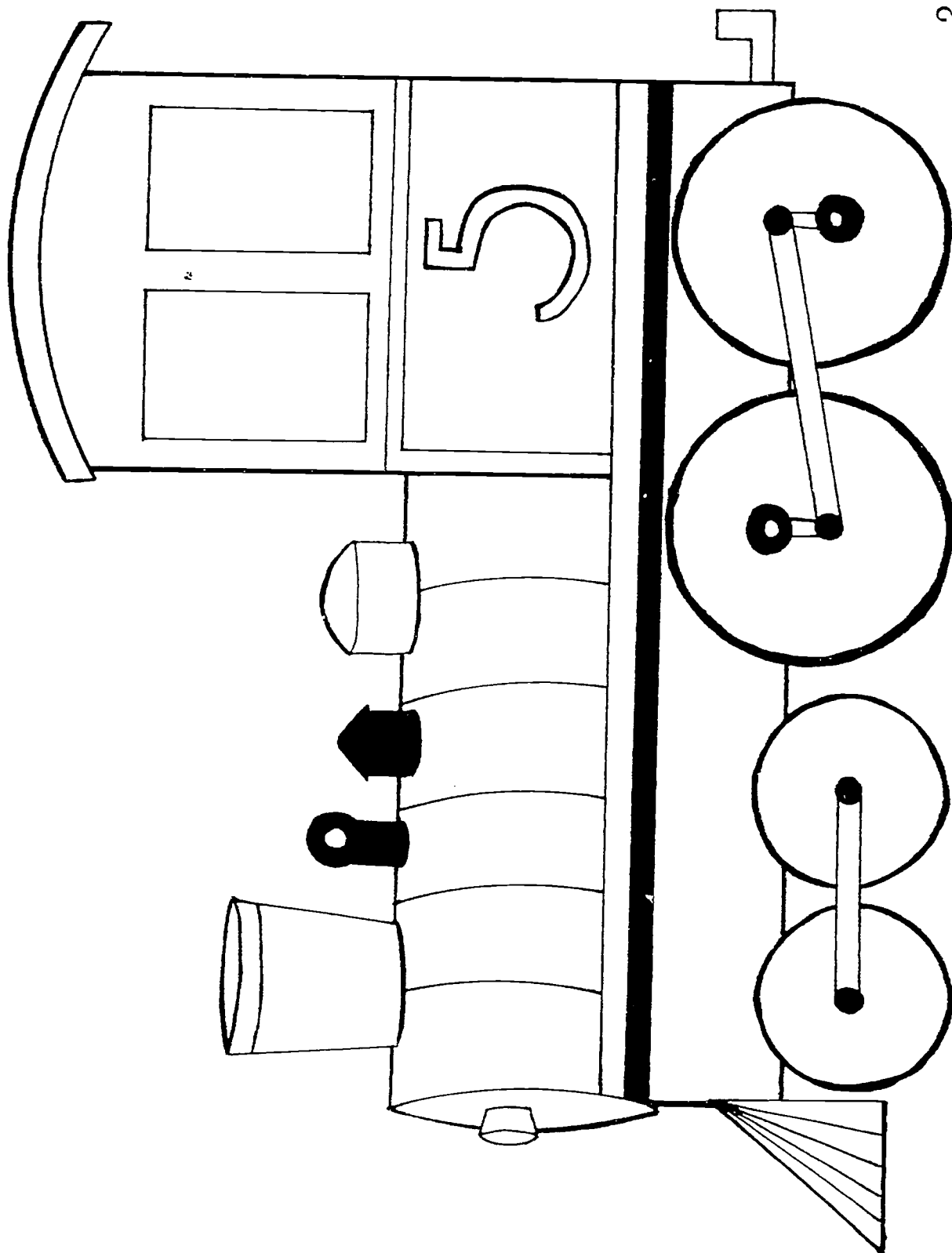

235

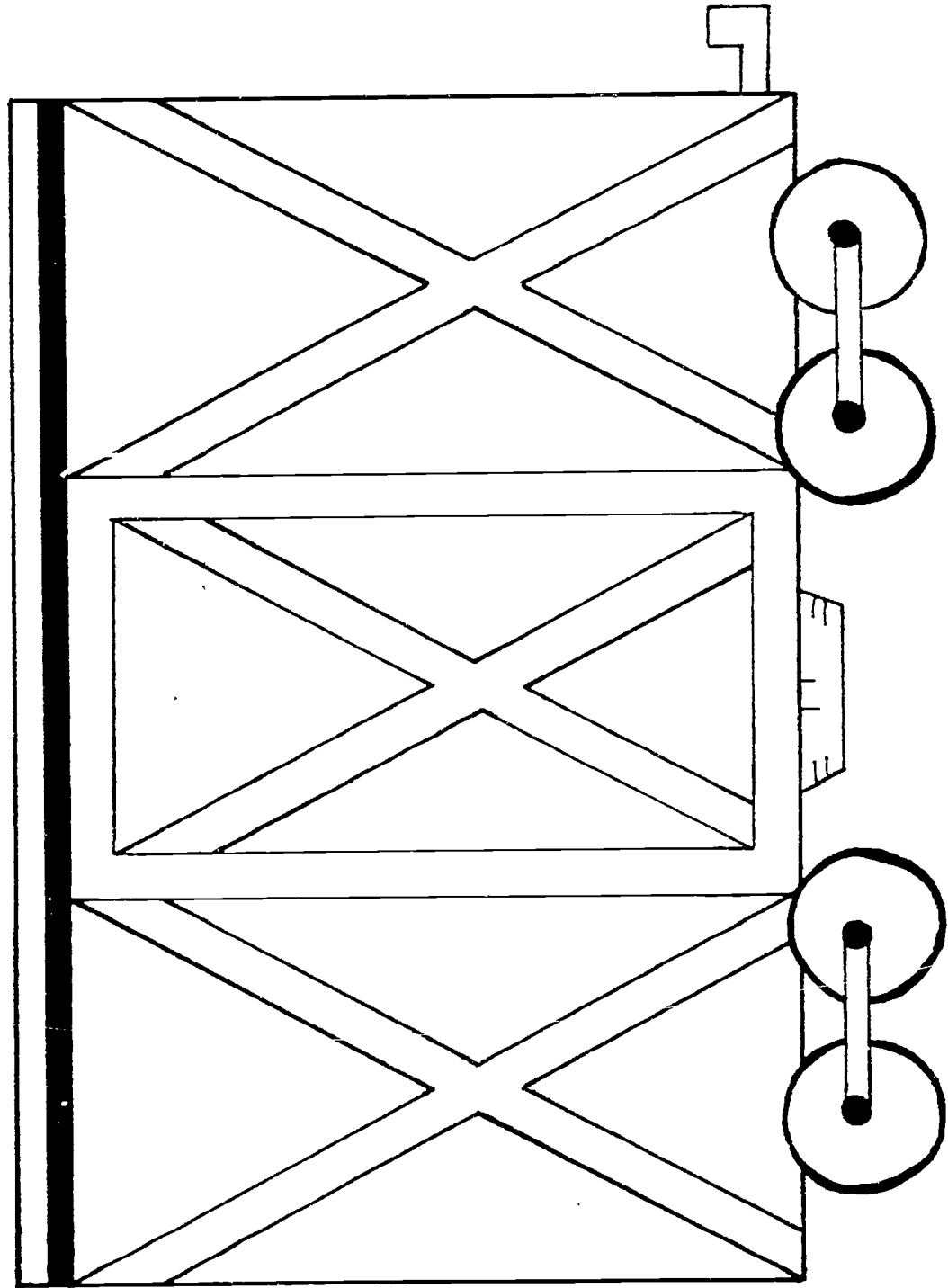

270

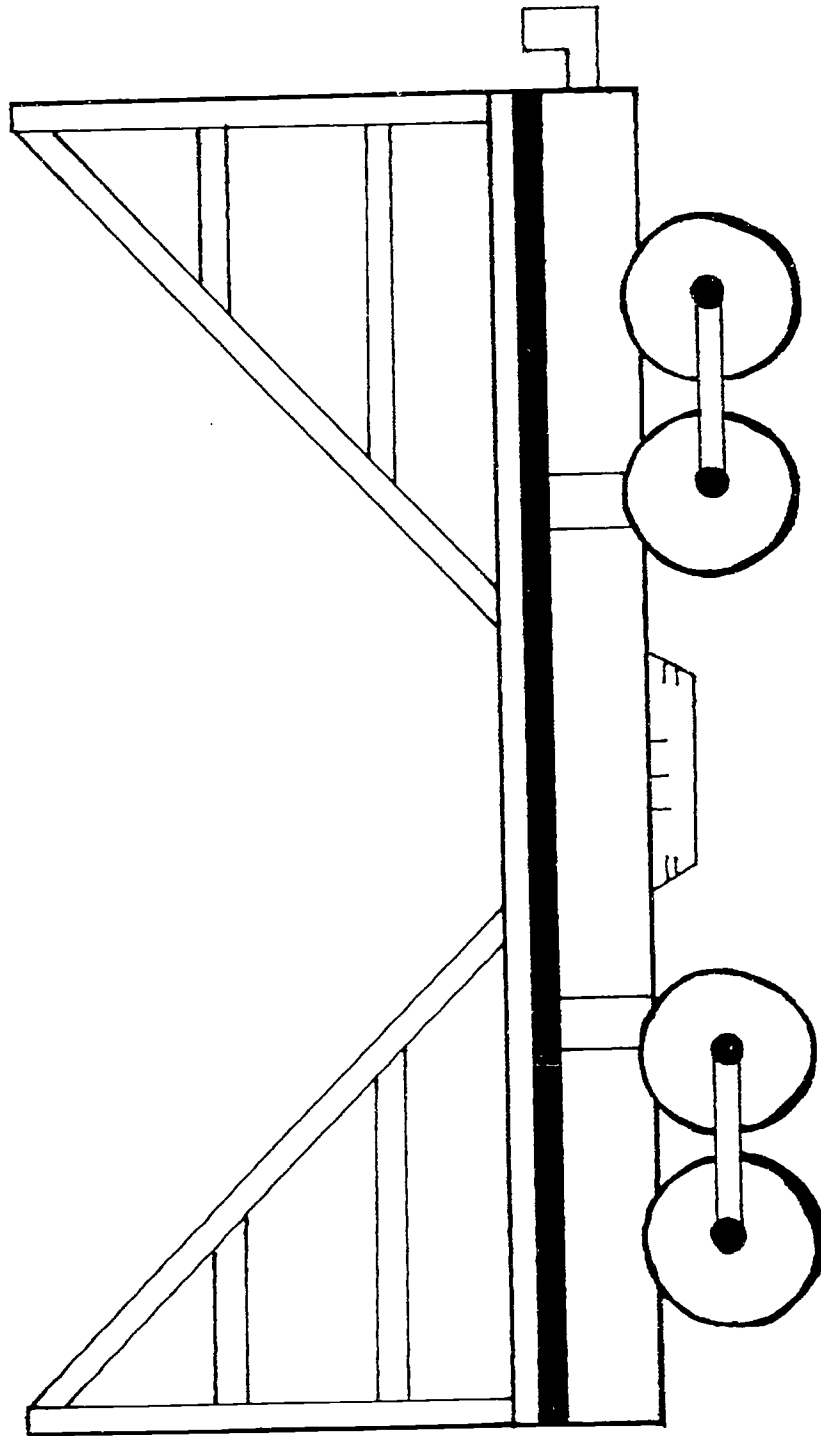

263



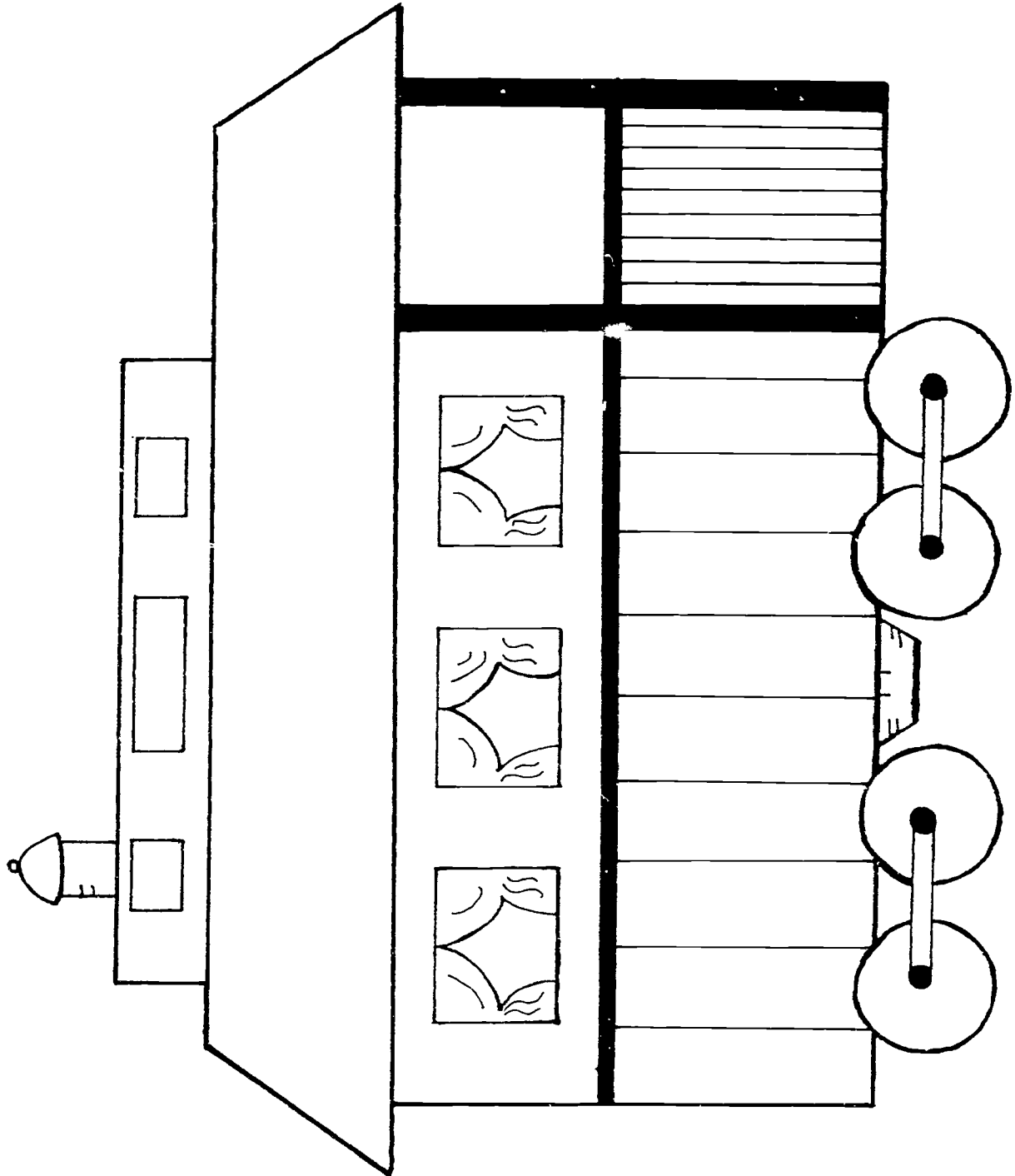

# Train Car Patterns

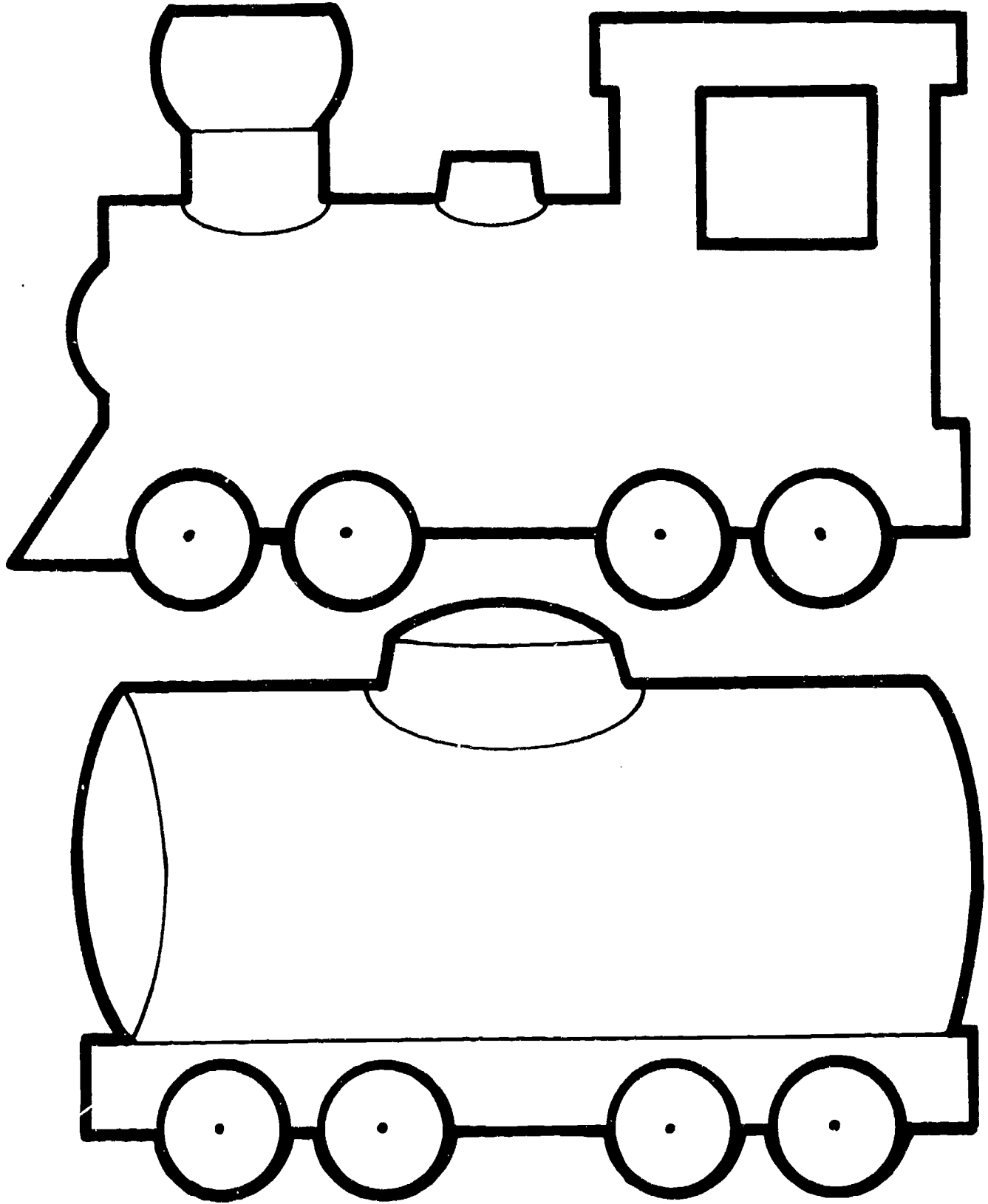

From *Transportation*, by Rozanne Williams, © 1990, Creative Teaching Press, Inc. Used by permission.

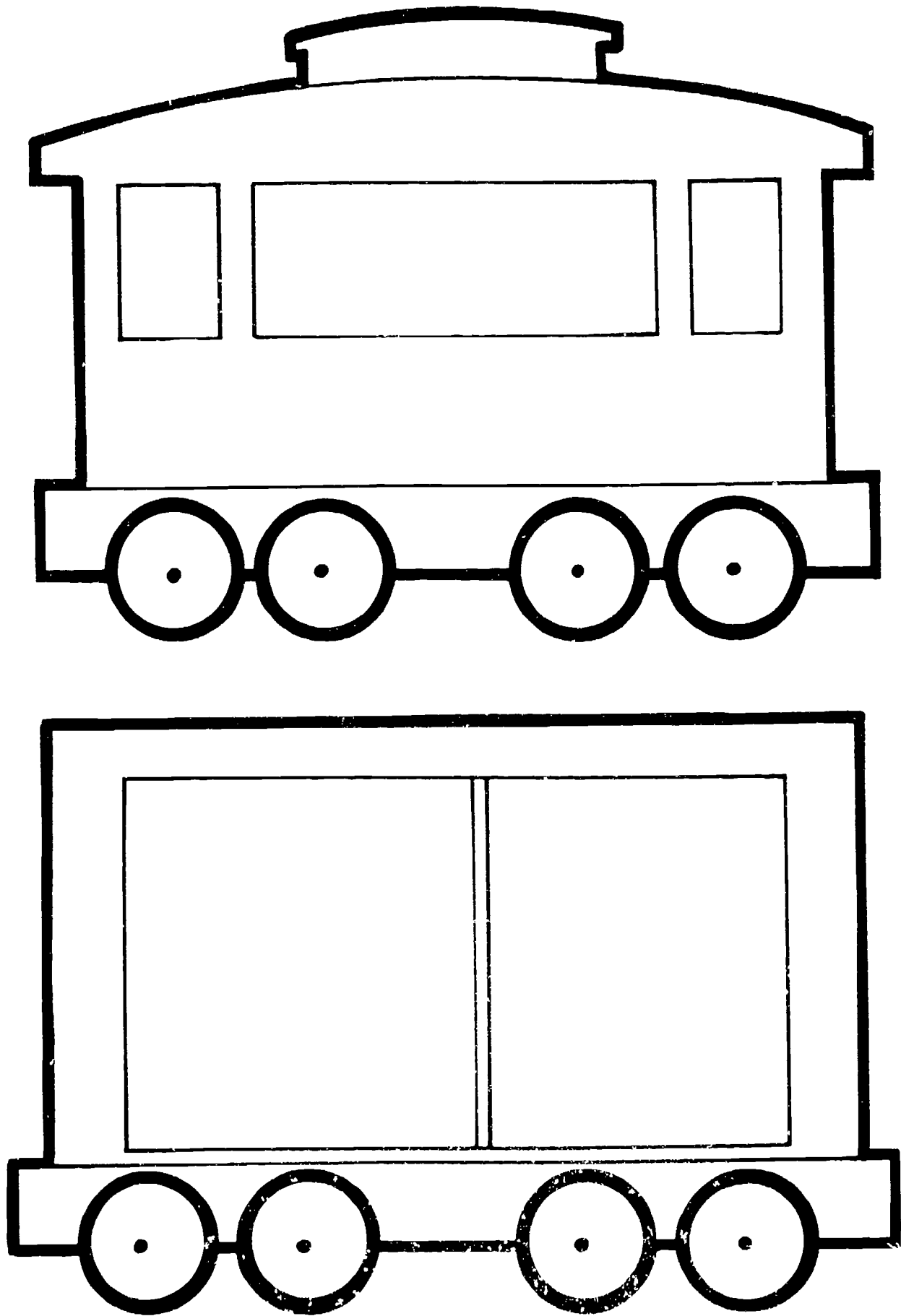

**THE ZOO EXPRESS**

*Original story and art by Lois Grant, Rapides Parish Library*

Sam and Mary skipped along beside their parents. They were both so excited. This was the day they had waited for all week. Mom and Dad were taking them to the zoo today.

"Mother, will we see the monkeys?" asked Mary.

"Yes, Mary, we will see the monkeys," replied Mother.

"Dad, will we see the lions?" asked Sam.

"Yes, Sam, we will see the lions. We will see all the animals." said Dad. "And we will see them in a special way as we will be riding a miniature train through the zoo."

"Oh! A train ride," said both of the children. "We have never had a train ride before."

"Can I drive the train?" asked Sam.

"I'm sorry, Sam," replied Mother. "But you have to be an adult to drive the train."

In a few minutes, they entered the gates of the zoo and walked to the miniature train station. It looked just like a real train station, just smaller.

"I want to sit behind the engineer so that I can blow the train whistle," demanded Sam.

"I want to sit in the last car so that I can be the caboose," said Mary.

"All right!" said Mother. "I will sit with Mary at the back of the train and Father can sit with Sam behind the engine." Other people were also waiting for the next train ride.

Sam was the first to hear the train whistle, whoo-who-ooo-oo. "The train is coming. The train is coming," he exclaimed. "I hear the whistle. Doesn't it sound neat. I hope that he lets me blow the whistle."

"Well, Sam. I hope so too."

"Oh, Mother! Look how beautiful the train is. The engine is so shiny and black. Look at that bell, all silver and gold. Oh, I hope that I can ring it. Look, Dad. Every car is a different color." It was truly a beautiful train. It pulled to a stop in front of Sam and his father. They were able to sit in the car behind the train engine. The engineer was wearing overalls and a engineer's hat just like real train engineers wear. Mary and her mother hurried to get into the last car.

The engineer told Mary that she could be the conductor since she was riding in the last car. Mary was so excited. While the people were climbing into their seats, Mary kept shouting, "All aboard! A-l-l-l-l-l A-Boa-oa-oa-rd! Finally the train's engine began, "Choo, choo, choo, choo, choo. Choo, choo, choo, choo, choo. Choo, choo, choo, choo, choo." Slow at first, but getting faster and faster. "Choo, choo, choo, choo, choo. Choo, choo, choo, choo, choo. Choo, choo, choo, choo, choo." The wheels went clickty, clack; clickty clack; clickty clack on the tracks. The engineer blew the whistle, "Whoo-whoo-ooo-oo. Whoo-whoo-ooo-oo. Whoo-whoo-ooo-oo."

The train rounded a bend and Sam and Mary could see a small pond. In the middle of the pond was an island. On the island was a family of monkeys swinging from vines. Everyone on the train shouted, "Look at the monkeys! Aren't they cute! Look at the baby monkeys!"

The train whistle went whoo-whoo-ooo-oo. Chug, chug, chug went the engine. Clickty-clack, clickty-clack went the wheels.

The train traveled a little further down the track and the next exhibit they saw was the Elephant Pit. "Mother, look how big they are." exclaimed Mary. "Is that a mother elephant and a baby elephant?"

"Yes, I believe they are," replied Mother.

The train whistle went whoo- whoo-ooo-oo. Chug, chug, chug went the engine. Clickty-clack, clickty-clack went the wheels.

The train rounded a curve and the next animals they saw were the lions. Ro-ar-r-r-r-r-r went the lions. "See how ferocious they look," said Father.

"Yes!" said Sam. "I am glad that I'm in the train and they are on that side of the fence."

The train whistle went whoo-whoo-oooo-oo. Chug, chug, chug went the engine. Clickty-clack, clickty-clack went the wheels.

The train went over a bridge. Sam and his father could see that the little train station was the next stop. The train ride was coming to an end. The train engineer asked Sam if he would like to blow the whistle to signal that they were coming into the station. "Oh, yes!" exclaimed Sam. "Could I please blow the whistle?"

The engineer showed him how to pull the rope to blow the whistle. Whoo-whoo-ooo-oo. Whoo-whoo-ooo-oo. Whoo-whoo-ooo-oo. At last the train trip came to an end.

"Could we please come again?" "Could we ride the train when we come?" asked Sam and Mary. "Yes," said their parents and they all left the zoo happy.



Artwork by Lois Grant

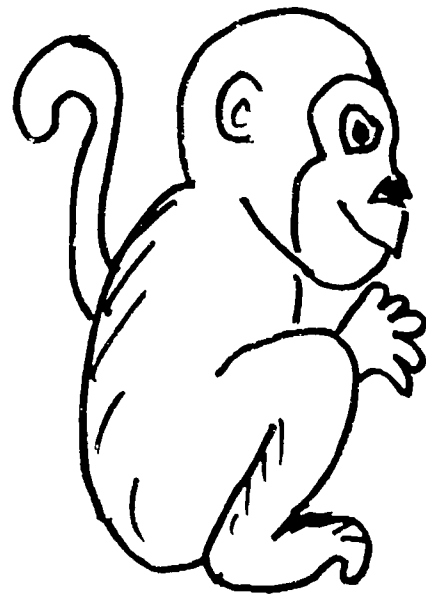
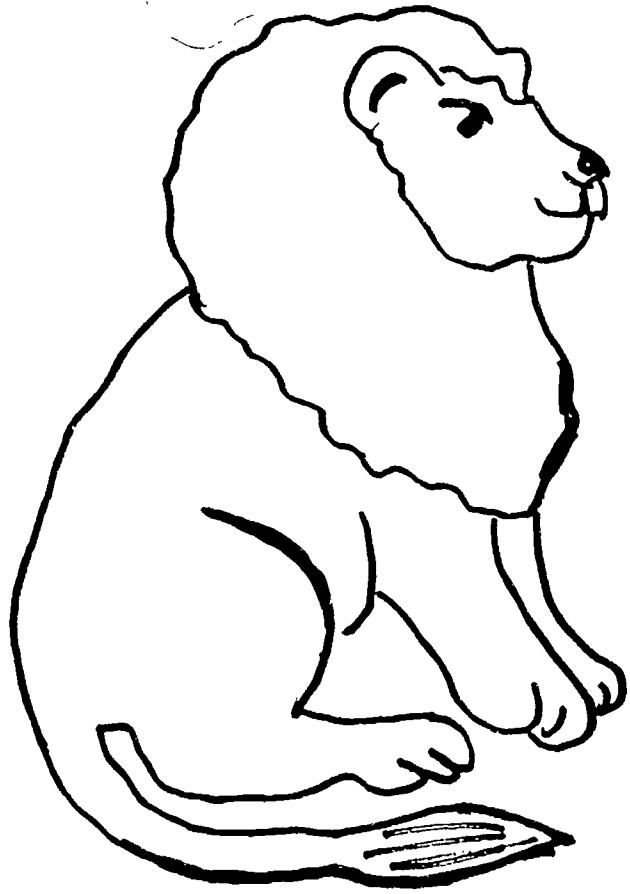

277

The Zoo Express

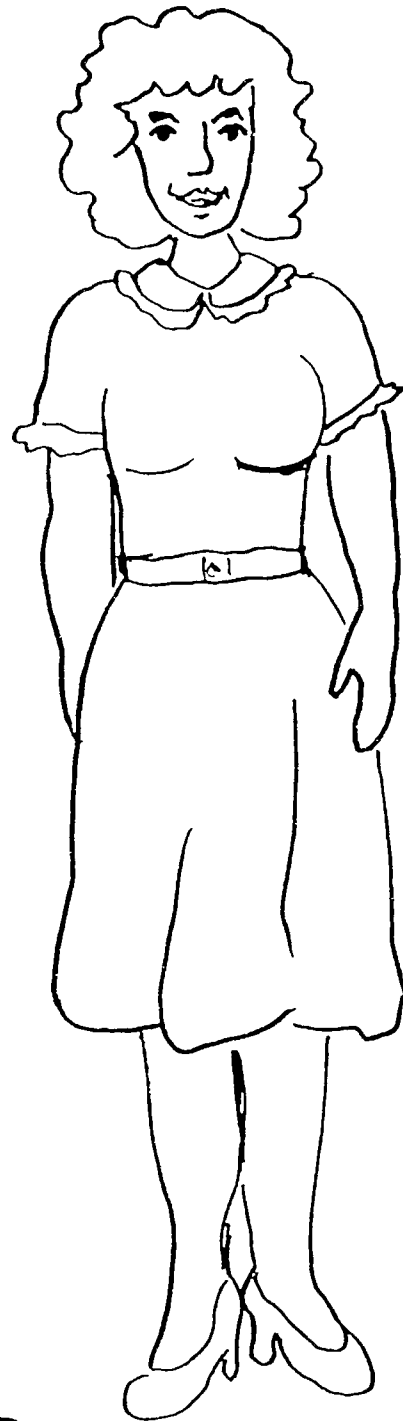

The Zoo Express

Artwork by Lois Grant

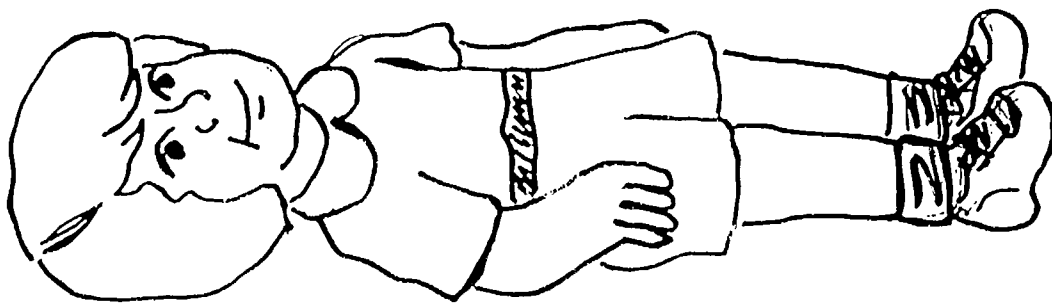

Artwork by Lois Graut

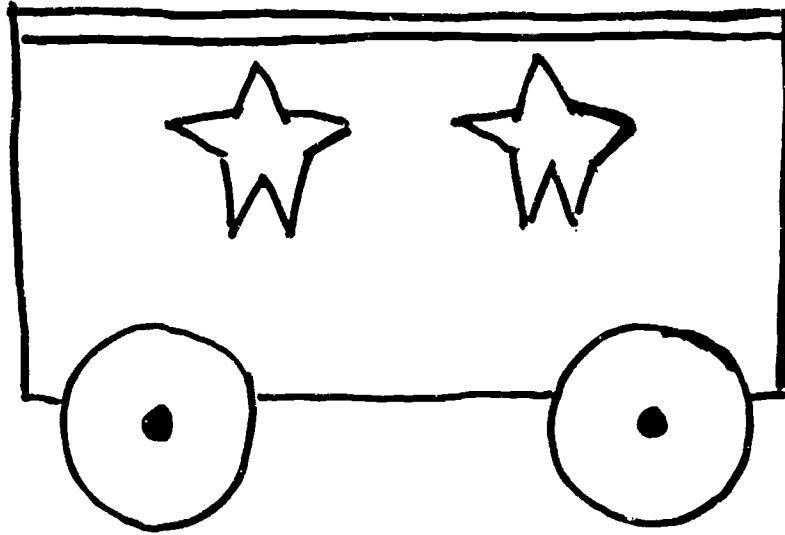

Make several train cars in different colors.

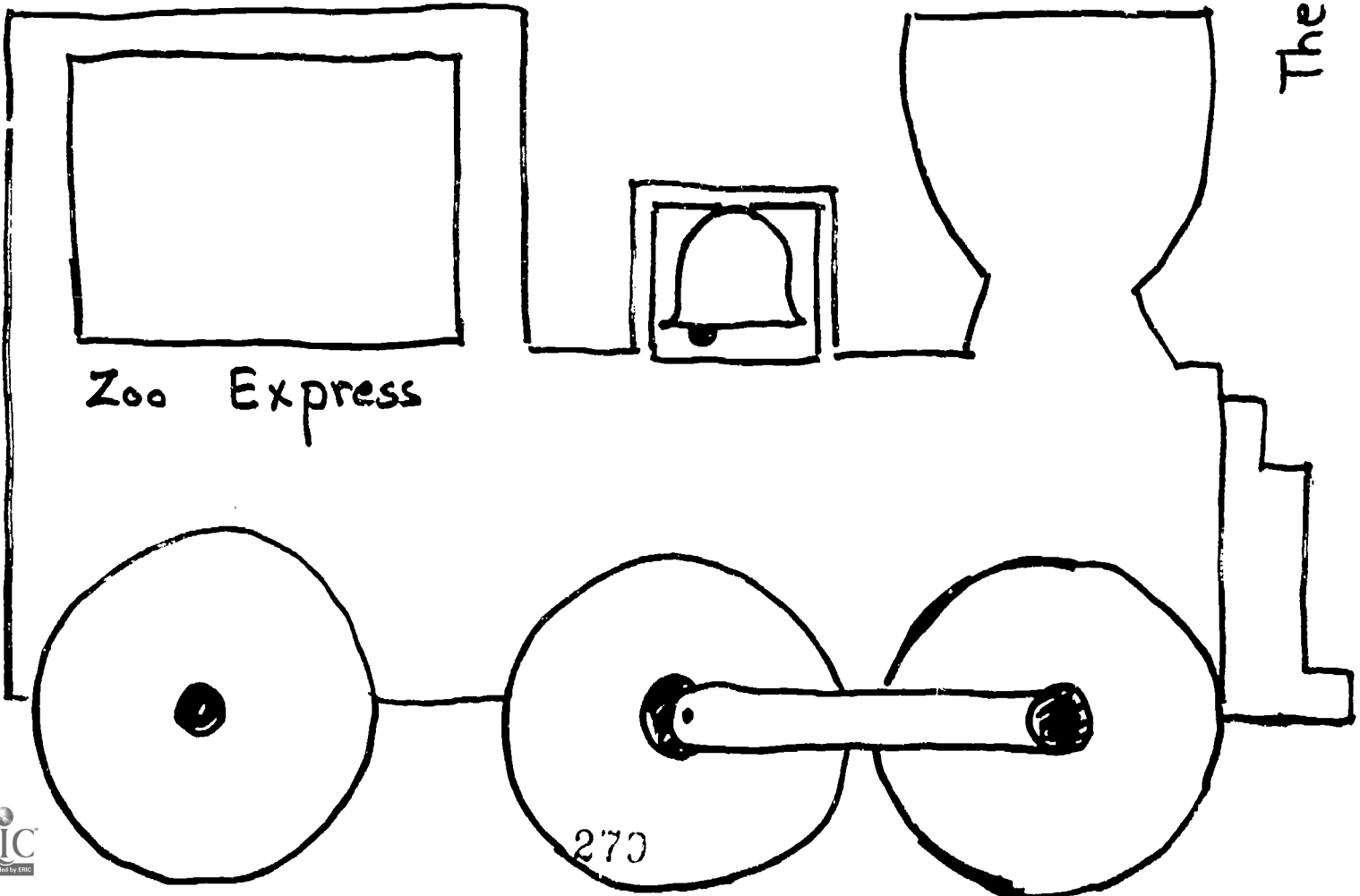

The Zoo Express



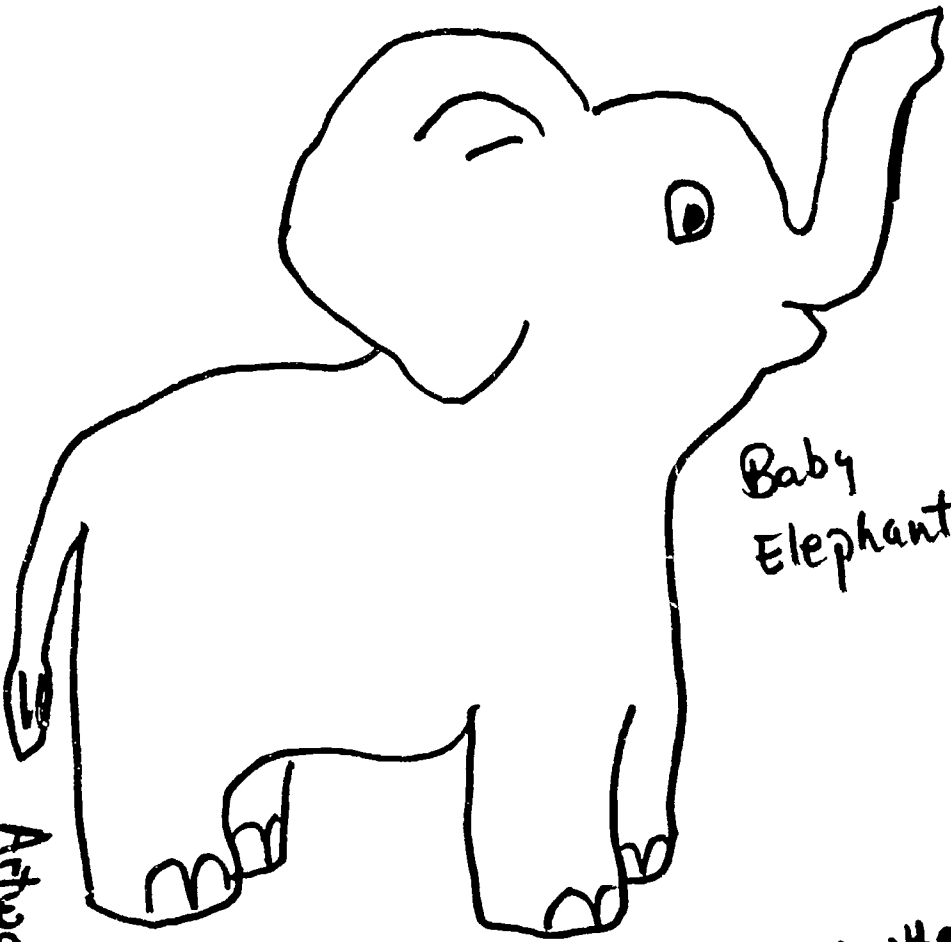

Baby  
Elephant

Artwork by Lois Grant

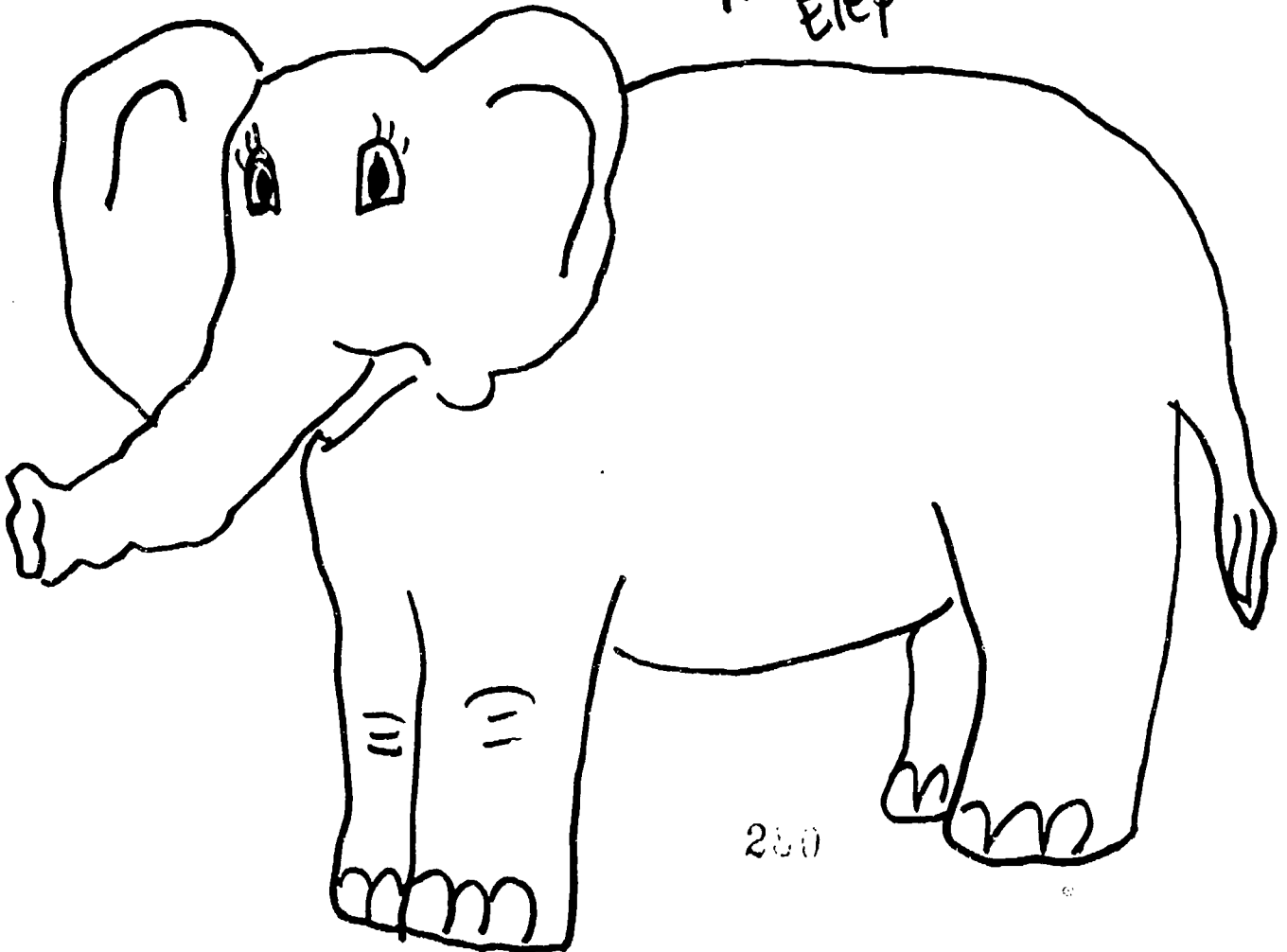

Mother  
Elephant

The Zoo Express

280

**THE BIG TRAIN MYSTERY TREASURE**

*by Yolanda Blanchard, Calcasieu Parish Library*

As you are riding on the train, you may discover wonderful treasures as you look out the window, and even perhaps right there on the train. Close your eyes and listen to find the treasures. Allow the children to listen as you give them clues to the various treasures.

- Treasure Number One      Close your eyes to see the treasure.  
This treasure has arms, legs, eyes, ears  
When this treasure is sad, it cries tears  
It is very beautiful, beautiful as can be  
When you look in the mirror the treasure  
You can see  
It is true. The treasure is YOU.
- Treasure Number Two      Close your eyes to see the treasure.  
It may tell a tale of something true  
Its colors can be white, yellow or blue  
Or all the colors of the rainbow too  
Many pages are found inside oh yes!  
We read one today. Can you guess?
- Treasure Number Three      Close your eyes to see the treasure.  
It can be found up high  
Yes, way up in the sky  
It does not shine at night  
But in the day, gives light  
Five, four, three, two, one  
Why it is indeed the sun
- Treasure Number Four      Close your eyes to see the treasure.  
When it is oh so hot in the summertime  
Up in its arms we can climb  
It makes us cool and gives us shade  
All of its branches are very well-made  
When I see it, I am happy as I can be  
This treasure is a tree.
- Treasure Number Five      Close your eyes to see the treasure.  
It smiles at us each and every night.  
It twinkles, twinkles with delight.  
On it I can make a wish that might come true,  
For my brother, sister, for me and you  
You don't have to look too far  
The treasure is a star.

- Treasure Number Six      Close your eyes to see the treasure.  
 These people will love you  
 No matter what you do  
 They bring you to school and play  
 And show they car in every way  
 Who are these treasures we know so well?  
 They are Momma and Daddy, and they are oh so swell
- Treasure Number Seven      Close your eyes to see the treasure.  
 Wings and feathers are the clothes they wear.  
 Many of them go soaring in the air  
 Duck, goose, eagle, pelican, are some of their names  
 They are especially known for their singing games.  
 They fly in flocks, not herds  
 These treasures are our wonderful birds.
- Treasure Number Eight      Close your eyes to see the treasure.  
 Sometimes it sprinkles, sometimes it pours.  
 Sometimes it thunders and sometimes it roars.  
 It leaves you very wet, not dry  
 As it comes tumbling down from the sky  
 What is it that goes "plop, plop, plop"?  
 It is the great and wonderful raindrop!
- Treasure Number Nine      Close your eyes to see the treasure  
 Wearing coats as soft as silk  
 They give us lots of delicious mild  
 Four-legged creatures, lovers of grass  
 In the fields, we watch them as we pass  
 It is quite evident that by now  
 We know these treasures have the name Cow.
- Treasure Number Ten      Close your eyes to see the treasure.  
 Throughout this place, the people move here and there.  
 In cars, buses, and other vehicles we  
 See them travel everywhere.  
 What is this huge place we discover as we look out?  
 The place where there is so much activity  
 and movement running about.  
 Why what in the world could it be?  
 It is the big city you see.

# BIRTHDAY TRAIN

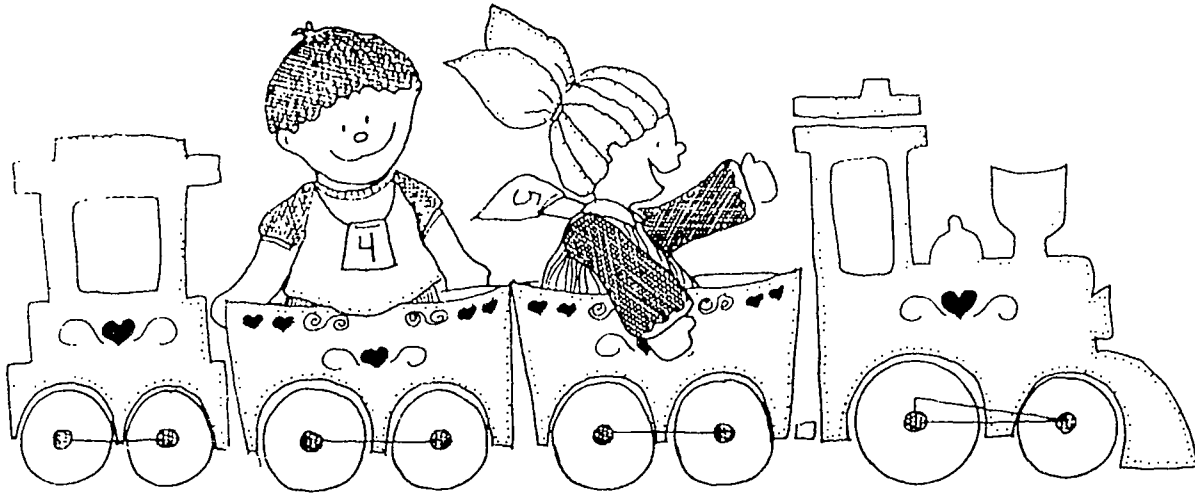

AGES: 2-5.

NUMBER OF PLAYERS: 3-10.

**MATERIALS:** An index card for each child, yarn, scissors, stapler or hole punch, felt-tip marker

**PREPARATION:** Write the age of each child on a separate index card. Make the cards into necklaces by stapling on loops of yarn or by punching holes in the cards and stringing the yarn through the holes.

## GAME:

Have the children sit in a semicircle at an imaginary train station. Pass out "tickets" (age card necklaces) and let the children put them on. Call out a number and have the children who are that age get on the Birthday Train. For example, you might say "Everyone who is two climb aboard the Birthday Train!" Then have all the two-year-olds hook on behind you. Lead them around the room as everyone sings:

Sung to: "The Mulberry Bush"

Hop aboard the Birthday Train,  
 Birthday Train, Birthday Train  
 Hop aboard the Birthday Train  
 If you are (two) years old.

Riding on the Birthday Train,  
 Birthday Train, Birthday Train  
 Riding on the Birthday Train,  
 Chugging just for you

Lead the children back to the station and call out a different age. Have those children climb aboard and repeat the process. Keep playing until everyone has had a ride on the Birthday Train.

## HINT:

Try letting the older children take turns being the Engineer

From *1-2-3 Games*, by Jean Warren, © 1986. Reprinted by permission of Warren Publishing House, Inc., P.O. Box 2250, Everett, WA 98203.



# GERTRUDE CHANDLER WARNER



## “The Boxcar Children”

Read “The Boxcar Children.” Find the words from the Word Bank in the word search puzzle below.

The Alden family children love to solve mysteries. If you like this book, you’ll be happy to know there are more.

Q U R Y V E K O V Z E M U O C Q D D H H  
 Z O P P I L L O W S Z H T J E C N M U T  
 W I O S O B A K E R Y A T F H D T Z V O  
 E M S S L F W U U Y R O D H H M M C I V  
 V E J Q E Y A K N J B J H W K W O J F R  
 J A K F T O K N K D O E U F W H E N R Y  
 D N I K X K E A A G R A N D F A T H E R  
 P N Y Y K B D E A A X Y G C L X R I H Y  
 K M J D K X R B P C A R R Y H P D X V D  
 O A M P B B O N B X J M Y R X E T C Q Y  
 T S O C A I V V O F G Y K S R V S J G D  
 Q R S V X X L Y G X P L W I R P B O I T  
 V T K V U X A H V J O B T S B Y V G I E

### Word Bank

GRANDFATHER	LAUNDRY	PILLOWS
BENCHES	HUNGRY	BAKERY
VIOLET	JESSIE	BREAD
AWAKE	CARRY	MONEY
KNIFE	TIRED	HENRY
BENNY	MEAN	BAG

From *Authors and Illustrators Through the Year*, by David J. Fiday, ©1989. Reprinted by permission of the publisher, The Center for Applied Research in Education, A division of Simon & Schuster, West Nyack, NY.

CANDY LAND JUNCTION

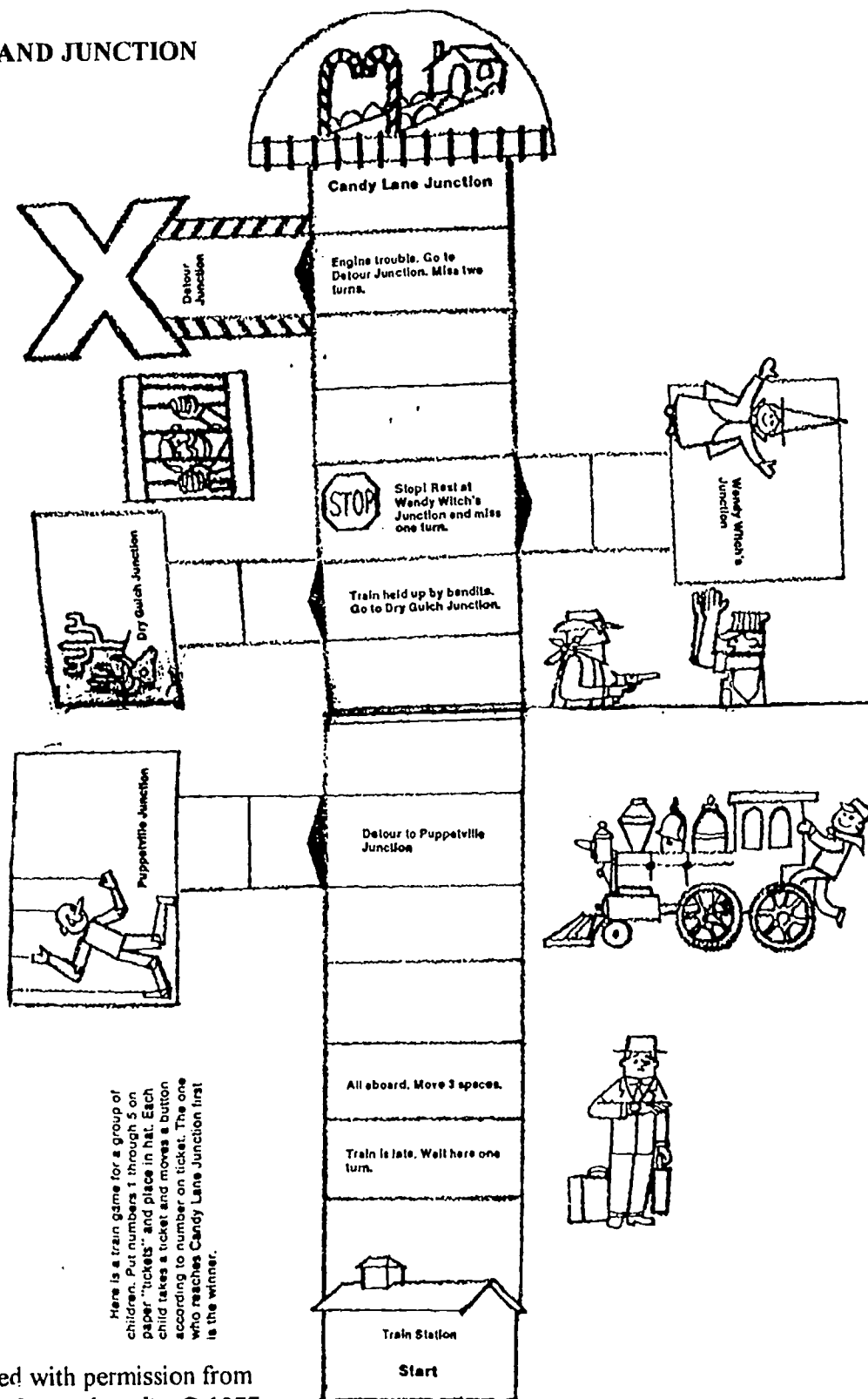

Here is a train game for a group of children. Put numbers 1 through 5 on paper "tickets" and place in hat. Each child takes a ticket and moves a button according to number on ticket. The one who reaches Candy Lane Junction first is the winner.

Reproduced with permission from *Compton's Precyclopedia*, © 1977 by Encyclopedia Britannica, Inc.

BEST COPY AVAILABLE

CHARLIE BROWN CARTOONS



John Massis moved two cars of a train  
by pulling them with his teeth.  
The cars weighed 80 tons  
(72 metric tons)!

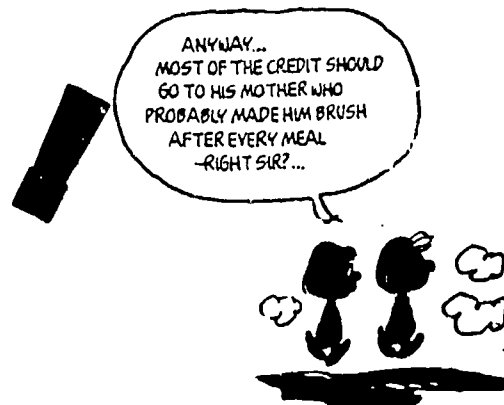

From CHARLIE BROWN'S SUPER BOOK OF QUESTIONS AND ANSWERS by Charles M. Schulz. Copyright © 1976 by United Feature Syndicate. Reprinted by permission of Random House, Inc.

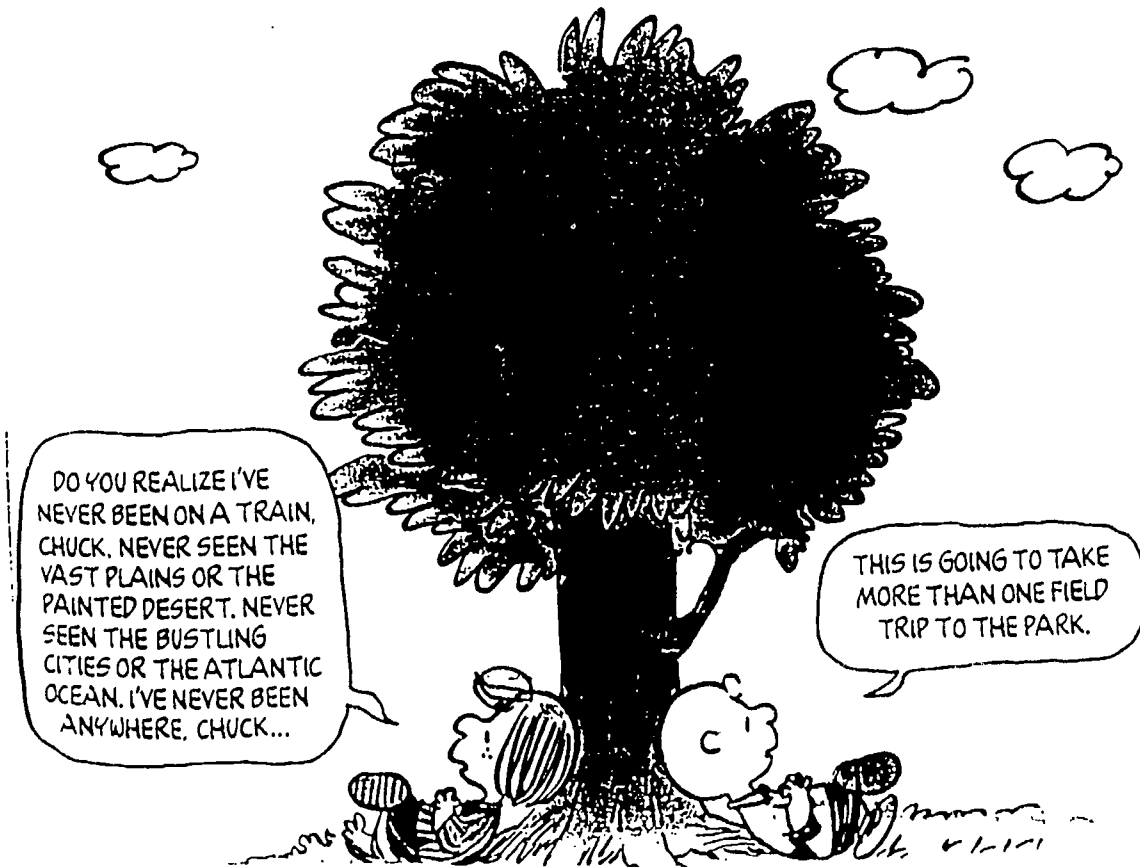
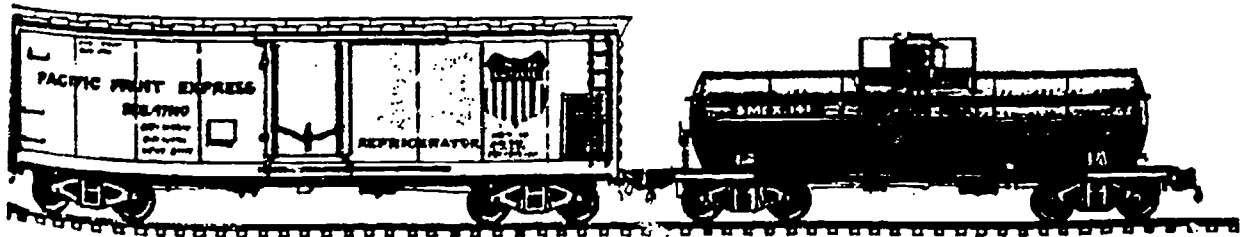



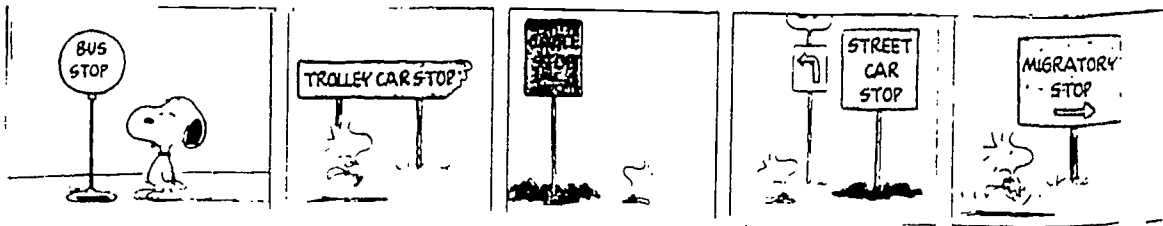

# Fast Tracks

Funny cars, dragsters, stock cars are fast cars. Drivers of these cars need to be brave, smart and have great reflexes. Janet Guthrie, A.J. Foyt, Danny Sullivan and Shirley Muldowney are just a few of the great drivers. To read more about fast cars and their drivers, ask for books at your local library.

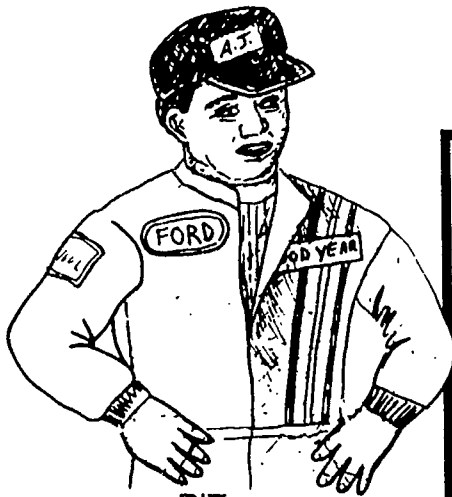

Ready! Set! Go!  
Find the words listed below.

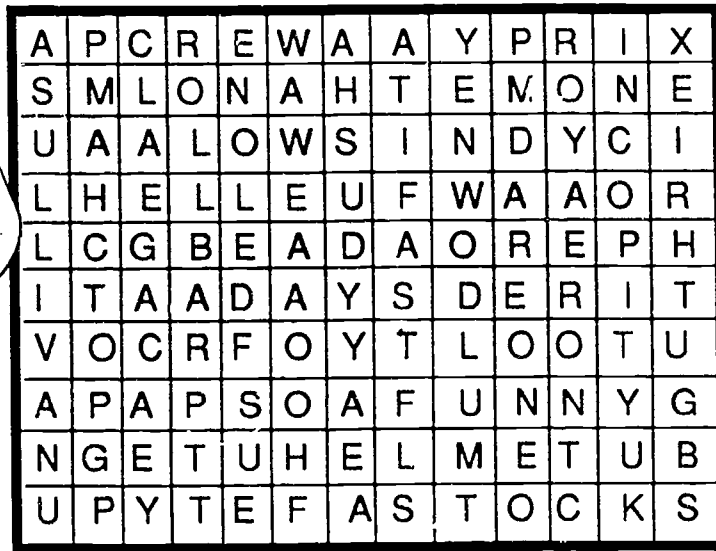

PIT  
TUB  
TIRE  
PRIX  
FAST  
FUEL  
INDY  
RACE  
CARS  
ROAD  
FOYT  
DRAG  
CAGE  
CREW

STOCK  
CHAMP  
FUNNY  
HELMET  
SAFETY  
GUTHRIE  
ROLL BAR  
SULLIVAN  
METHANOL  
MULDOWNEY

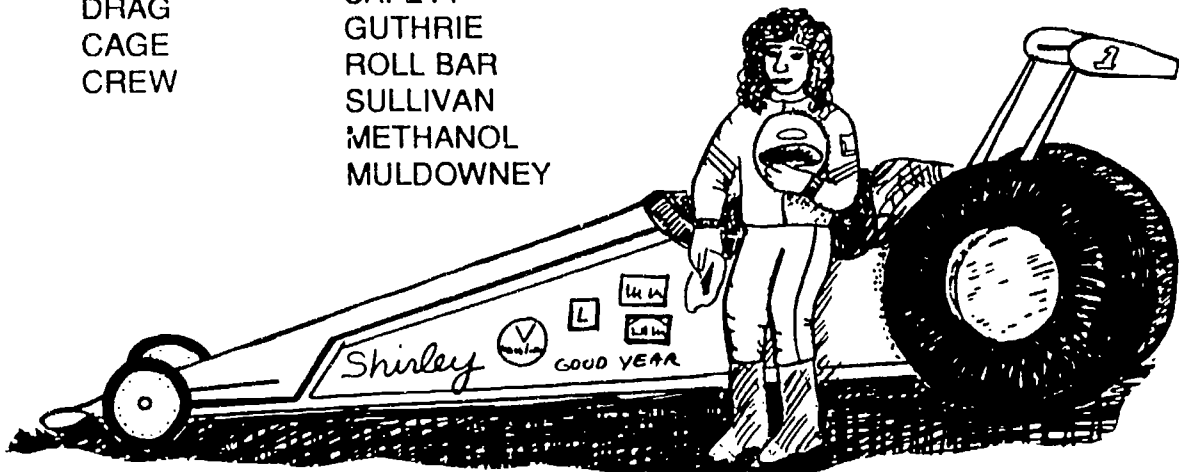

© 1992 Christine Menard Lafayette Public Library

**HOBO HOBNOB PARTY****Invitations**

Using a standard-size post card from the post office, glue patchwork wrapping paper to the information side of the card. Write out the party information with a bold black felt-tip pen. Address and mail.

**Decorations**

Have a sign hanging over or on the front door that reads: "Welcome to Chris's Hobo Hobnob." If you really want to create an effect, nail a 1" x 4" board at an angle across your front door. The children will get a kick out of crawling through a "condemned building." If you really don't want extra nail holes in your house, use brown mailing paper to simulate boards and tape up.

Interior decorations can be trains, patches, old tin cans and cleaned and decorated garbage cans.

**Centerpiece**

Invert an old hat and place a block of Styrofoam inside. Arrange mini knapsacks filled with goodies on skewers in Styrofoam.

**Knapsack**

Cut a round (circle) of fabric 10" in diameter. Using a hole puncher, punch holes 1" in from the edges and about 1" apart. (Yes, a hole puncher works on fabric) Lace a 12" shoestring through the holes and draw together

**Placecard/Place Mat**

Cut a brown paper grocery bag into 11" x 17" place mat size. Write each guest's name boldly on the place mats. Place a cloth bandanna on the side or tuck into a glass. The bandanna will then double as a napkin and a knapsack.

**Menu**

Goldfish crackers

Boston Baked Beans Candy in tins

Mudmilk (chocolate milk)

Boxcar cake (Frost a 9" x 13" rectangular cake with dark chocolate frosting. Add the boxcar effect with white frosting. Use commercial chocolate cupcakes for the wheels.)

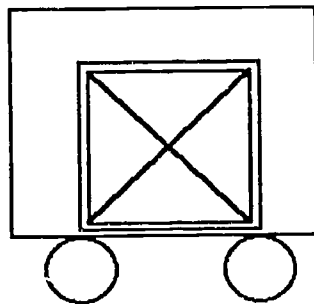

**Costumes**

On the invitation, ask each child to come to the party dressed as a hobo. When a child arrives, smear some cocoa on his face for the "hobo-look."

**Activities**

Upon arrival, have each child take a plain white 11" x 17" paper place mat, and glue patches to it. The patches can be made from scraps of wrapping paper or fabric. Have the children rip rather than cut the patches.

**Games**

Gone Fishin' (Go Fish)

Penny Pitch

Scavenger Hunt

**Favors**

Bubble gum cigars

Marbles

Knapsacks

Bubble Pipe

**Take Home**

Before the children leave, have them place their favors and prizes in the center of their bandanna. Tie the opposite corners together in a knot, then tie them again around a pole. Bring the two remaining ends together and tie twice around the pole. For the pole, buy 1/4" doweling at a lumberyard and cut it into desired lengths (approximately 24" each).

Adapted from *Great Parties for Young Children*, copyright © 1981 by Cheryl Carter Barron and Cathy Carmichael Scherzer.

Reprinted with permission of Walker and Company

## IF I DROVE A TRAIN

The following program uses the book *If I Drove a Train* by Miriam Young (Lothrop, 1972).

Discover about trains as a boy shows why he wants to drive a train when he grows up. Pictures show different kinds of trains and tunnels, subways and bridges as the trains travel along their routes.

### STARTERS

#### Materials Needed:

1. None.
2. Invite a train buff to visit and bring his train and uniform or invite a friend who has a train set.

A cut-out paper train engine, crayons.

#### Procedure:

1. What would you like to be when you grow up?

What would you do if your job was to drive a train?

2. Have all the children write their names on the train engine picture.

Welcome your guest speaker.

Present the thank-you train engine picture to your guest and sing "A big thank-you to you. . ." to the tune of Happy Birthday.

From *Story Sparklers (Starters and Extenders for 66 Noted Children's Picture Books)*, by Jean Stangl, 1991. Reprinted with the permission of T.S. Denison Co. MPLS MN.

## EXTENDERS

### Materials Needed:

1. Check with the local Amtrack station or a travel agent for pictures of trains, large sheet of butcher paper, paint and brushes.
2. Collect small boxes, paint and brushes, safe object for punching holes, yarn (optional: cardboard circles for wheels and paper brads).
3. Classroom chairs, tag board, stapler, paper, hole punch, visor hat pattern from page 121.
4. Fun Sheet from page 122, pencils or crayons.

### Procedure:

1. Paint a large train track the length of the paper. Add a bridge, trestle and tunnel. Cut out the trains and glue them along the track. Identify the cars.
2. Paint the boxes. For a train, punch holes in both ends of the boxes. Place the boxes end to end and string them on the yarn. Knot both ends. (Optional: attach 4 wheels to each box with paper brads).
3. Set up the chairs to form the passenger car. Take turns as the conductor and engineer.

Overlap the ends of the headband to fit your head and staple together. Bend the cap bill on the dotted line and staple the straight end to the center of the headband.

Make paper tickets to pass out and punch as passengers board the train.

4. Dot-to-dot Fun Sheet for each child to complete.

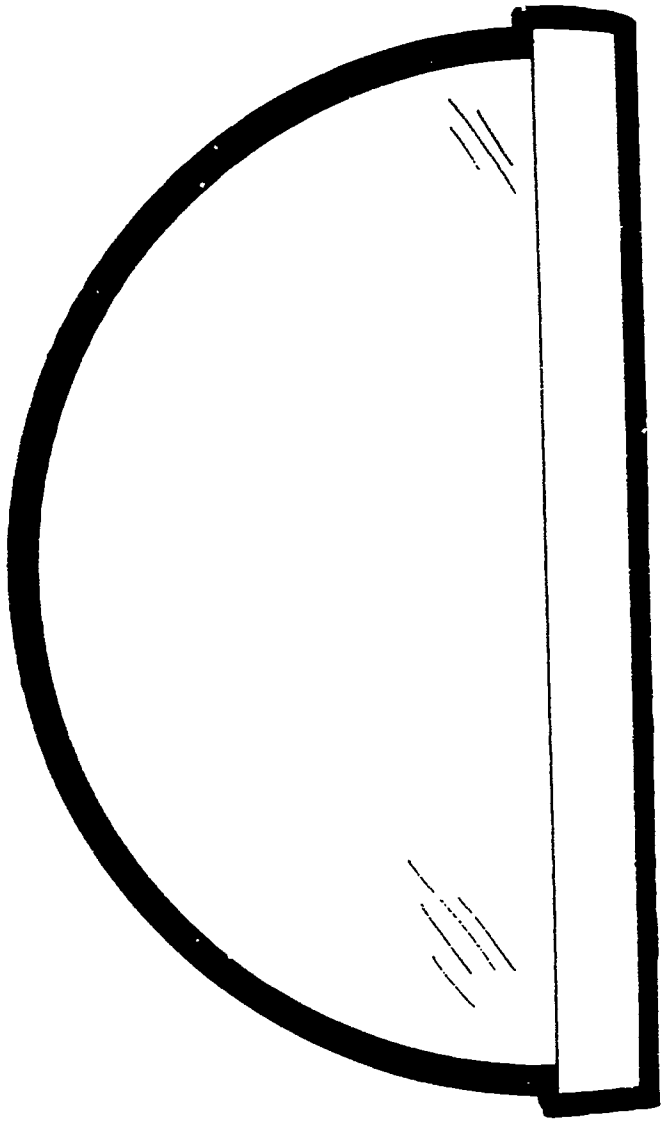

292

295

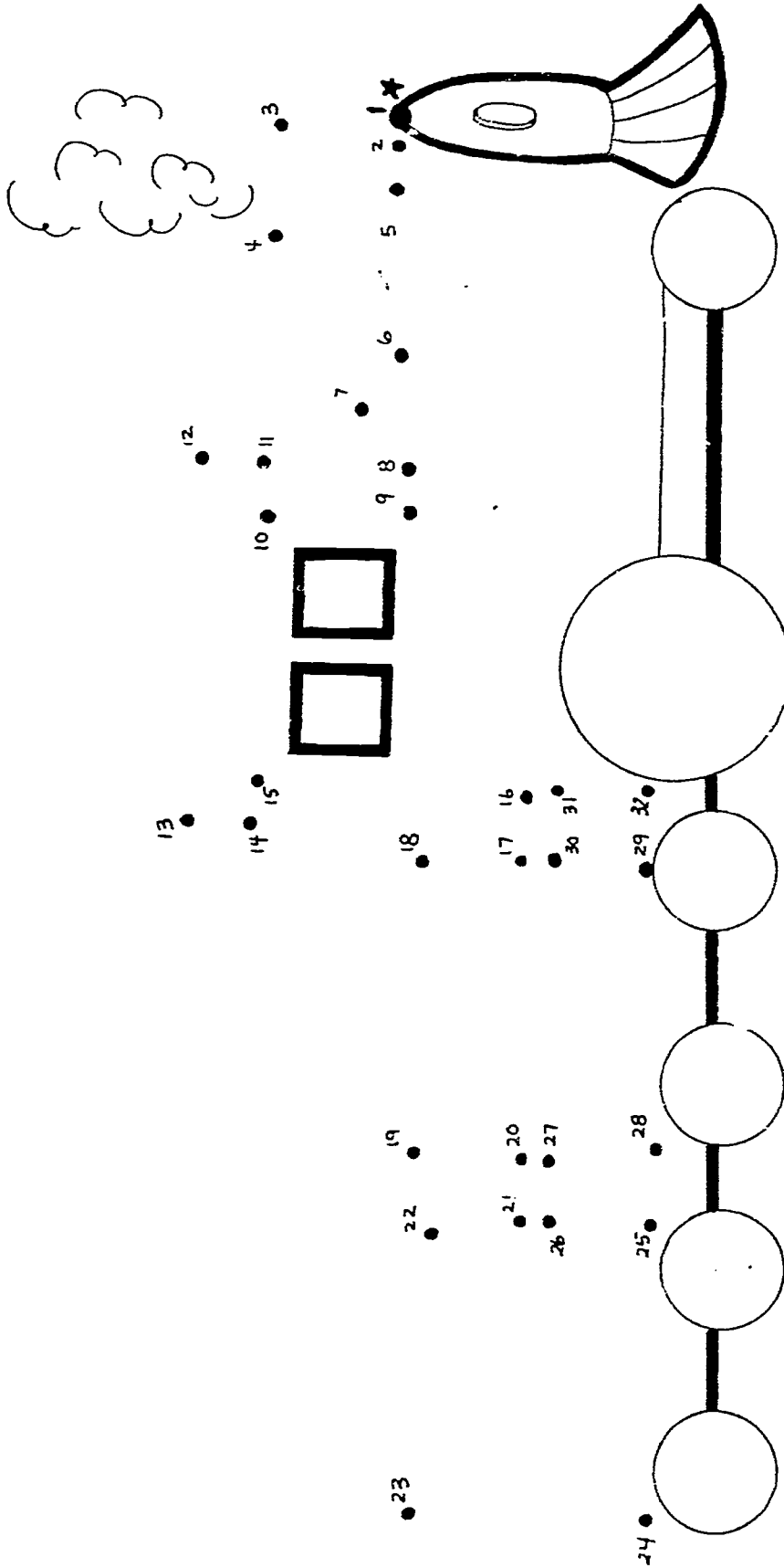

297

296



I'VE-BEEN-WORKIN'-ON-THE--

# RAILROAD

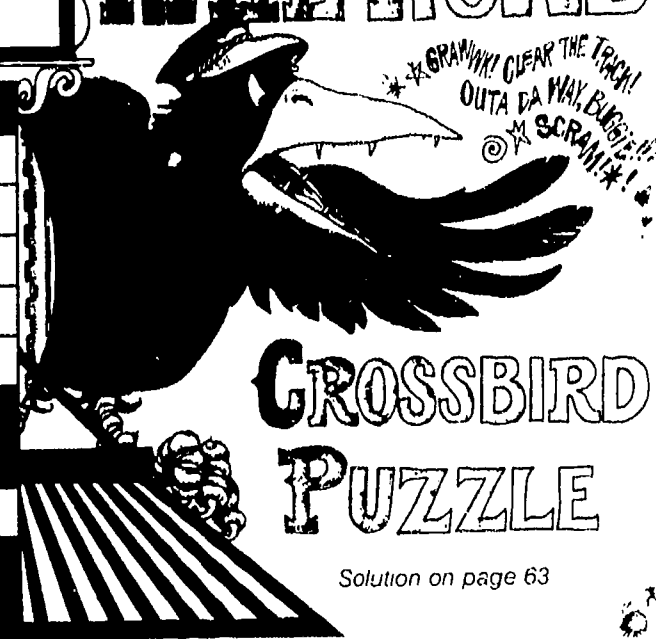
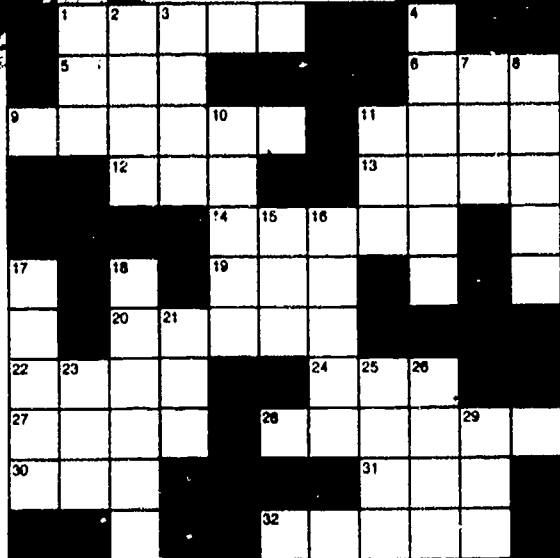

## CROSSBIRD PUZZLE

Solution on page 63

**Across**

1. A travel \_\_\_\_\_ can help you plan your trip
5. State's chief officer (abbreviation)
6. Early locomotives \_\_\_\_\_ on steam
9. Someone in the twelfth grade
11. Payment for a train ride
12. Shade tree
13. Someone who "puts on \_\_\_\_\_" is stuck-up
14. Nut from an oak tree
19. The first trains \_\_\_\_\_ no sleeping cars
20. Get on a train
22. Somebody who is admired very much
24. Railroading increased in the gold rush \_\_\_\_\_ (time period)
27. A depot is a rail \_\_\_\_\_ station
28. What trains run on
30. The first train ran four miles \_\_\_\_\_ hour
31. Wooden crosspiece of a railroad track
32. Having many seeds

**Down**

1. We are living in the Space \_\_\_\_\_
2. "Bobby Shaftoe's \_\_\_\_\_ to Sea" is a Mother Goose rhyme
3. Wicked
4. \_\_\_\_\_ are pulled by locomotives
7. Abbreviation for *arrival* on a railroad's timetable
8. Birds lay their eggs in \_\_\_\_\_
10. \_\_\_\_\_, Nebraska (headquarters of the Union Pacific Railroad)
11. The cost of a train ticket depends on how \_\_\_\_\_ you are going
15. On a train, you eat in a dining \_\_\_\_\_
16. More peculiar; stranger
17. Sound made by a cricket
18. "All \_\_\_\_\_!" (conductor's call)
21. Railroading is about 150 years \_\_\_\_\_
23. A female deer
25. The highest \_\_\_\_\_ of speed set by a steam locomotive was 126 miles per hour
26. A sharp, bitter chemical substance
28. Lock opener

**Solution to Crossbird Puzzle**

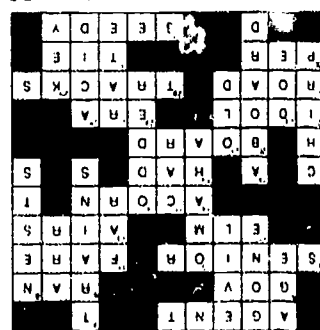

UGLY BIRD IS VERY BEHIND SCHEDULE!  
WHAT DO YOU EXPECT OF A TRAIN CALLED THE "WORMSIE EXPRESS"!

BY DENNIS HARRIS AND THINK-I-CAN GRALLEY

Reprinted by permission of CRICKET Magazine, Vol. 16, No. 8, April 1989, © 1989 by Carus Corporation.

# LITTLE RED TRAIN

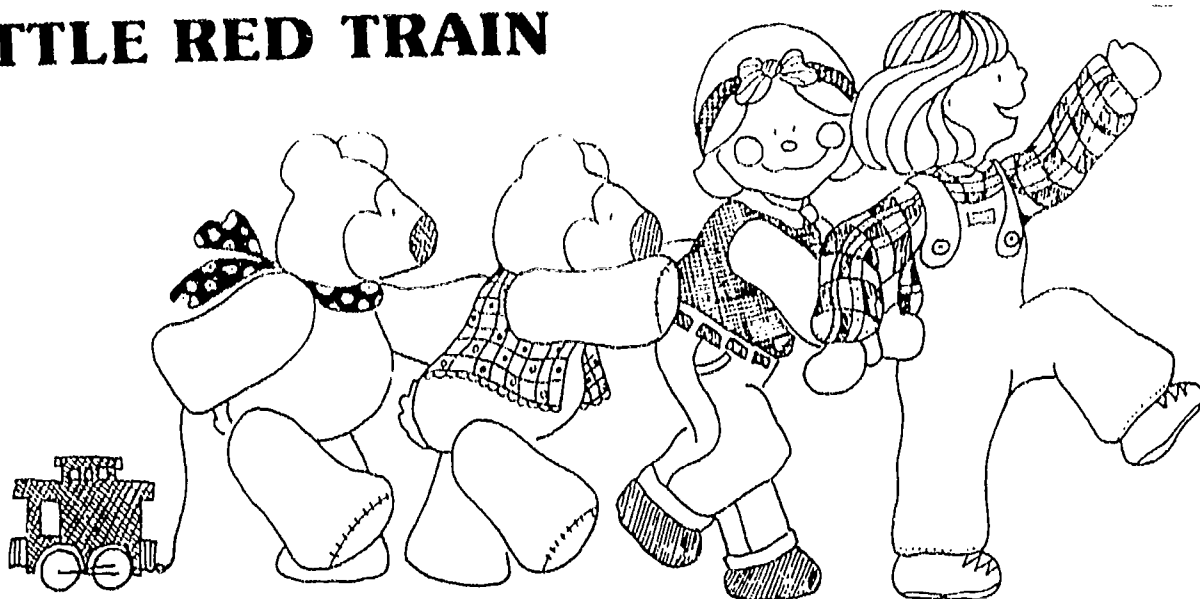

AGES: 2-6.

NUMBER OF PLAYERS: 2-10.

MATERIALS: None.

PREPARATION: None.

## GAME:

Have the children sit down and wait in line at an imaginary train station. Chug around the room as everyone recites the poem below. Each time you stop at the station, have the child at the head of the line hook onto the back of your train. Continue until everyone is hooked on and has had a turn chugging around the room.

Little Red Train chugging down the track,  
 First it goes down, then it comes back.  
 Hooking on cars as it goes,  
 Little Red Train just grows and grows.

## VARIATION:

Let each child choose to be a specific type of car, such as a boxcar or a circus car. Change the third line of the poem to match the type of car chosen. For example, if a child chooses to be a tank car, change the line to read: "Hooking on a tank car as it goes." Let the last child in line be the caboose.

From *1-2-3 Games*, by Jean Warren, © 1986. Reprinted by permission of Warren Publishing House, Inc., P.O. Box 2250, Everett, WA 98203.

**THE MYSTERY OF THE RUNAWAY TRAIN**

by Yolanda Blanchard, Calcasieu Parish Library

The following is a Train Mystery Story. The story remains a mystery because no one has unlocked the secret code. Using the key, solve the train mystery.

One day while resting in the train station, before boarding the train, the *Brains*, the *Boomer* and the *Big Hook* crew heard a dreadful screaming noise! Frantically running outside, they beheld the strangest sight! The *Cleopatra*, the *Varnish*, the *Crummy* and all of the train cars had vanished! Oddly enough, there was one small book that lay on the railroad track. The *Brains*, *Boomer* and *Big Hook* crew stood frozen in awe when out of nowhere, they heard a voice. The voice, which seemed to come from the tiny book, said, "Open me up and turn my pages to find your missing train. Open me up and turn my pages over and over again." The *Brains* went over to the tiny book, and opened it as the book suggested. What did his eyes behold on the very first page but the *Cleopatra*, the *Crummy* and all of the *Varnish* full of children. They were assisting some little children whose bus had broken down. The children needed a ride to the library because they wanted to participate in the Summer Reading Program. First the *Cleopatra Bent the Iron* and the *Crummy* and all of the *Varnish* followed her as the children boarded the train and the train raced to get to the library on time. The children enjoyed their delightful train ride and watched the *Window Music* as they ate their *Nosebags*. Just as the *Brains* closed the book, he heard shouts of laughter and excitement; it was the train filled with happy children returning from the library. When the *Brains* boarded the train, he found that the children could not stop talking about all the fun they had as they listened to stories, played games, made crafts and sang songs at the library. The *Brains* was so impressed with all the great activities that the library provided for the children that he decided that every week throughout the summer, the train would make a weekly run to take the children to the library for the Summer Reading Program.

**Key**

Bend the iron	Throw a switch
Big Hook	Wrecking crane
Boomer	Railroader changing jobs
Brains	Conductor
Clear board	Green or clear signal
Cleopatra	Railroad business car
Crummy	Caboose
Deadhead	Railroader riding free
Joining the birds	Leaping from a train
Monkey	Derail mechanism
Nosebag	Lunch brought from home
Varnish	Passenger cars or train
Window Music	Passing scenery

RAIL CARS AND ENGINES

N A M L L U P M C A T T L E  
 U O R E E F E R A C T A L F  
 U D I X K W Z A B M A R F V  
 E V I T O M O C O L R G B D  
 R E K N A T F G O N D O L A  
 R E L J Q V D R S A X E R A  
 E P Q M Y I R U E W C E E K  
 P A S S E N G E R I H H D U  
 P M W S W N N E S C G K N I  
 O K E G I G G P T B J H E D  
 H L G N I G H I D L O H T R  
 Q O I N O K W Z U Y R Z U P  
 W D E L M S R T Z W N L T C

WORD LIST: RAIL CARS AND ENGINES

BOX  
 CABOOSE  
 CAR  
 CATTLE  
 COACH

DIESEL  
 DINING  
 ENGINE  
 FLATCAR  
 FREIGHT

GONDOLA  
 HOPPER  
 LOCOMOTIVE  
 LOGGER  
 OBSERVATION

PASSENGER  
 PULLMAN  
 REEFER  
 SWITCHER  
 TANKER

TENDER

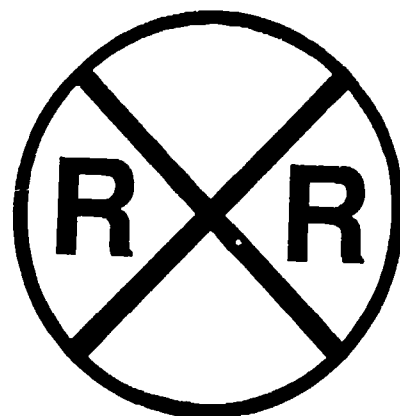

SOLUTION: RAIL CARS AND ENGINES

```

/\
[N\ A M L L U F] + [C\ A T T L E]
+ \O\ [R E E F E [R] A C T A L F]
+ + \I\ + + + + A B + + + +
+ + + + + + + + + + + +
[E V I \T\ O M O \C\ O\ L] + + /B/ +
+ + + + + + + + + + + +
[R E K N \A\ T] \F\ [G \O\ N D /O/ L A]
+ + + + \V\ D\ R\ S\ A\ X\ + /R/ +
+ + + + X X \ \ \ \ X / \ \
+ + + + /I\ R\ + \E\ + \C\ E\ E\ +
+ + + + / \ \ X\ X\ X\ \ \ X X
[P A S S /E/ N /G\ X\ E\ X\ R\ I\ H\ H\ D\ +
+ + / / / / X X X X \ \
+ + /S/ + /N//N//E/\S\ C\ G\ + N\ +
+ + / / / / / X X \ \ \
+ + /E/ + /I//G//G/ + /T\ B\ + H\ E\ +
+ + / / / / / / / \ \ \ \ \
+ + /N//I//G/ + /I/ + + \O\ + \T\ +
+ + / / / / / / / \ \ \ \ \
+ + /I//N//O/ + /W/ + + + + + + +
+ + / / / / / / / \ \ \ \ \
+ /D//E//L/ + /S/ + + + + + + +
\ \ \ \ \ \ \ \ \ \ \ \

```



**THE RAILROAD SLANG MATCH GAME**  
*by Yolanda Blanchard, Calcasieu Parish Library*

Let's see how great you are at "railroad slang!" Match the "railroad slang expressions" with the correct meanings.

Cleopatra	Railroader riding free
Crummy	Railroad business car
Deadhead	Caboose
Joining the birds	Leaping from a train
Monkey	Throw a switch
Nosebag	Railroader changing jobs
Bend the iron	Lunch brought from home
Boomer	Derail mechanism
Varnish	Green or clear signal
Window music	Passenger cars or train
Brains	Conductor
Clear board	Passing scenery

**Answers:**

Cleopatra	Railroader riding free
Crummy	Railroad business car
Deadhead	Caboose
Joining the birds	Leaping from a train
Monkey	Throw a switch
Nosebag	Railroader changing jobs
Bend the iron	Lunch brought from home
Boomer	Derail mechanism
Varnish	Green or clear signal
Window music	Passenger cars or train
Brains	Conductor
Clear board	Passing scenery

Name \_\_\_\_\_

## Railroad Switching Station

Cut out the circles below. Put them on the gameboard as shown. Switch the engines and the cabooses by moving them one square at a time. A caboose may jump over an engine but not another caboose. An engine may jump over a caboose but not another engine. Keep track of how many moves it takes to make the switch.

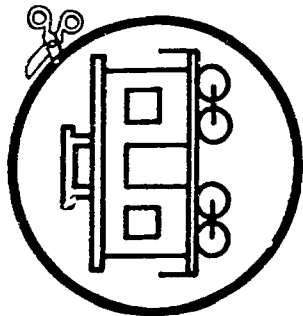
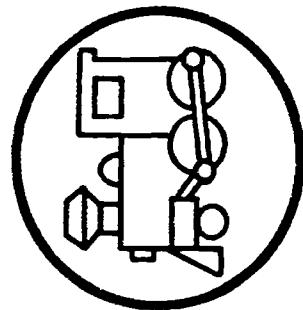
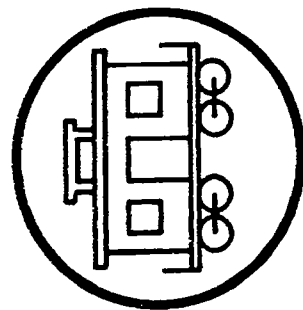
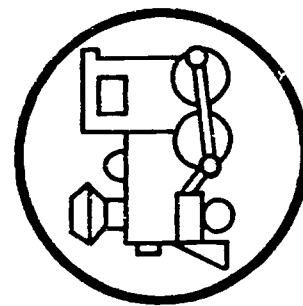
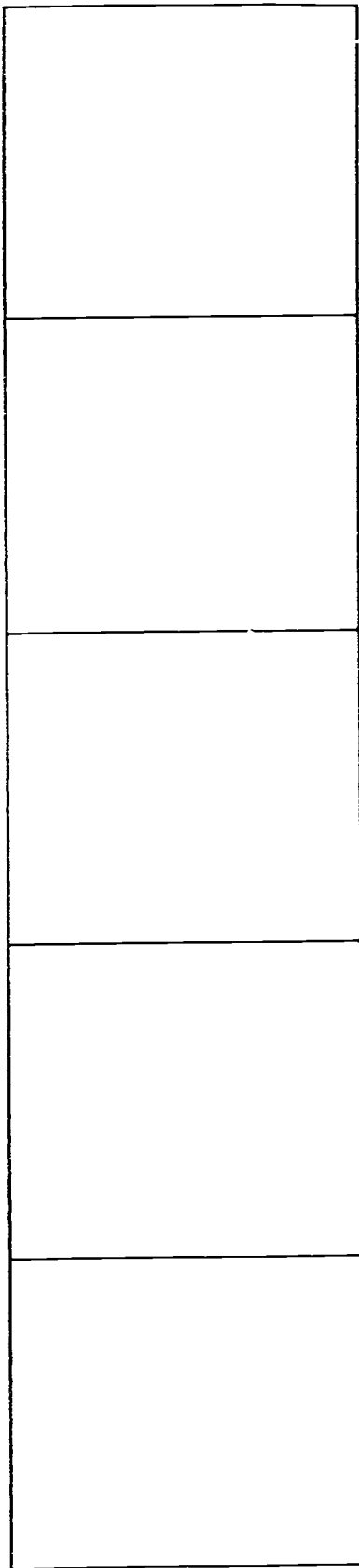
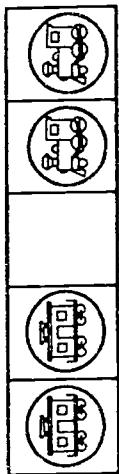

**RAILROAD WORKERS**

*by Ann Davis, St. Bernard Parish Library*

F M E F S T P Q P H H Q D Z W  
 P G A A W G R E O H H E W W W  
 J Y N K I W N A G I T P Z K L  
 B J H F T E G A C Y L B C M R  
 Z Y F K C Y Q N M K C E E N B  
 X U J X H L F O A R M C R R W  
 V H T V M L F B M M E E O I A  
 D I S P A T C H E R E T N I D  
 Y S I G N A L M A N C K A H P  
 E X M A S T W K I U Y M A W O  
 F A U N G G D G D T V G D R S  
 N U O G Y H N N R O Q F D B B  
 D Z O Y E E O I S A S I T V W  
 N F W A T C H M A N B G W H M

WORD LIST: RAILROAD WORKERS

BRAKEMAN  
 CONDUCTOR  
 DISPATCHER

ENGINEER  
 FLAGMAN  
 GANG

OILER  
 SIGNALMAN  
 SWITCHMAN

TRACKMEN  
 WATCHMAN  
 WATERMAN





SOLUTION: RAILROAD WORKERS

```

+ + + + |S|T| + + + + + + + +
+ + + + |W| + |R| + |O| + + + + +
+ + + + |I| + |N| |A| + |I| + + + +
+ + + + |T| + + |A| |C| + |L| + + + +
+ + + + |C| + + |N| |M| |K| + |E| + + +
+ + + + |H| + |F| + |A| |R| |M| + |X| |X| |X|
+ + + + |M| |L| + + + |M| |E| |X| |E| |O| + +
+ + + + |D| |I| |S| |P| |A| |T| |C| |H| |E| |R| |X| |E| |X| |T| |X| |N| + +
+ + + + |S| |I| |G| |N| |A| |L| |M| |A| |N| |C| |K| |A| + +
+ + |M| |A| + + + + |I| |U| + + |A| |W| +
+ |A| + |N| + + + |G| |D| + + + + |R| +
|N| + + |G| + + |N| |N| + + + + + + |B|
+ + + + + |E| |O| + + + + + + + +
+ + [W A T |C| H M A N] + + + + +

```

**TRAIN BINGO**

*by Yolanda Blanchard, Calcasieu Parish Library*

Train Bingo is played much like the regular Bingo Game except you call the "train" words out instead of letters and numbers. You will find twenty-five "Train Bingo Cards" following this page to hand out to the children. The children can use buttons to place on the "train words" that are called. The first person who "train bingos" horizontally, vertically, or diagonally wins a prize. The words to call for "Train Bingo" are below.

Caboose	Box Car	Passenger
Trestle	Track	John Henry
Red Eye	Flat Car	Signal
Engineer	Switch	Railroad
Coach	Lantern	Cab
Trolley	Diesel	Casey Jones
Locomotive	Steam	Bell
Street Car	Lights	Whistle Cargo
Electricity	Coal	Cross Tie
Derailment	Bridge	Tank Car
Crossing	Semaphore	Hopper Car
Gondola	Piggy Back	Railroad Days Festival
Amtrak	Freight	Spike
Depot	Station	Ticket
Time Table	Departure	Trip
First Class	Sleeper	Inspection
Baggage Mail	Siding	Ticket Agent
Yard	Brakes	Air Hoses
Intersection	Conductor	Travel
Seats	Packages	Platform
Caution	Terminal	All Aboard!
Transportation		

T	R	A	I	N
B	I	N	G	O
STEAM	LANTERN	TRACK	CAUTION	FREIGHT
COACH	TANK CAR	TRESTLE	ELEC- TRICITY	TRANS- PORTATION
CROSSING	PASSENGER	FREE	STREET CAR	CABOOSE
CONDUCTOR	SIDING	BRAKES	TROLLEY	CROSS TIE
TRIP	HOPPER CAR	BRIDGE	ENGINEER	INTER- SECTION

T	R	A	I	N
B	I	N	G	O
STEAM	LANTERN	TRACK	CAUTION	FREIGHT
COACH	TANK CAR	TRESTLE	ELEC- TRICITY	TRANS- PORTATION
CROSSING	PASSENGER	FREE	STREET CAR	CABOOSE
CONDUCTOR	SIDING	BRAKES	TROLLEY	CROSS TIE
TRIP	HOPPER CAR	BRIDGE	ENGINEER	INTER- SECTION

T	R	A	I	N
B	I	N	G	O
CASEY JONES	COAL	CABOOSE	PACKAGES	SWITCH
TRANS- PORTATION	DEPARTURE	FLAT CAR	STATION	STREET CAR
DEPOT	FIRST CLASS	FREE	YARD	PLATFORM
TERMINAL	TRAVEL	DERAILMENT	TIME TABLE	AIR HOSES
RED EYE	TICKET	JOHN HENRY	LIGHTS	CROSS TIE

T	R	A	I	N
B	I	N	G	O
LOCOMOTIVE	RAILROAD	TICKET AGENT	TROLLEY	MAIL
ALL ABOARD	ELEC- TRICITY	BELL	PIGGY BACK	FREIGHT
CAB	RAILROAD DAYS FESTIVAL	FREE	SEATS	SLEEPER
SEMAPHORE	INSPECTION	INTER- SECTION	AMTRAK	GONDOLA
ORIENT EXPRESS	ENGINEER	CARGO	BAGGAGE	WHISTLE

T	R	A	I	N
B	I	N	G	O
SIDING	HOPPER CAR	MAIL	SWITCH	BOX CAR
ENGINEER	WHISTLE	TRIP	SEATS	BELL
TICKET AGENT	AMTRAK	FREE	CONDUCTOR	PIGGY BACK
TANK CAR	STREET CAR	COACH	CROSS TIE	ELEC-TRICITY
ORIENT EXPRESS	BAGGAGE	LANTERN	SLEEPER	INTER-SECTION

T	R	A	I	N
B	I	N	G	O
PASSENGER	TROLLEY	RAIL ROAD DAYS FESTIVAL	CARGO	RAILROAD
CROSSING	AIR HOSES	BRIDGE	TIME TABLE	INSPECTION
TRESTLE	LIGHTS	FREE	ALL ABOARD	TRACK
CAUTION	BRAKES	FREIGHT	SEMAPHORE	SPIKE
CAB	PLATFORM	STEAM	GONDOLA	LOCOMOTIVE

T	R	A	I	N
B	I	N	G	O
STREET CAR	CARGO	TRACK	LIGHTS	SEMAPHORE
ORIENT EXPRESS	TRAVEL	CROSS TIE	CROSSING	TANK CAR
SWITCH	AMTRAK	FREE	ENGINEER	PLATFORM
MAIL	SLEEPER	STEAM	BELL	BRAKES
BAGGAGE	TICKET AGENT	PACKAGES	CABOOSE	RED EYE

T	R	A	I	N
B	I	N	G	O
AIR HOSES	PLATFORM	ALL ABOARD	CONDUCTOR	RED EYE
RAILROAD DAYS FESTIVAL	BRAKES	CROSS TIE	TRACK	BELL
LIGHTS	YARD	FREE	FLAT CAR	CROSSING
DERAILMENT	CABOOSE	PIGGY BACK	PACKAGES	CARGO
TRAVEL	TIME TABLE	LOCOMOTIVE	FREIGHT	TRANSPORTATION

T	R	A	I	N
B	I	N	G	O
COACH	LOCOMOTIVE	JOHN HENRY	SEATS	RAILROAD DAYS FESTIVAL
ALL ABOARD	LANTERN	SPIKE	YARD	BRIDGE
RAILROAD	AIR HOSES	FREE	TRANS- PORTATION	SIDING
TRIP	FREIGHT	WHISTLE	HOPPER CAR	DERAILMENT
FLAT CAR	DEPARTURE	CONDUCTOR	TIME TABLE	PIGGY BACK

T	R	A	I	N
B	I	N	G	O
CAUTION	TERMINAL	ELEC- TRICITY	FIRST CLASS	BRIDGE
GONDOLA	CASEY JONES	CAB	TROLLEY	JOHN HENRY
COAL	INSPECTION	FREE	DEPARTURE	SLEEPER
TICKET	DEPOT	STATION	SEMAPHORE	STEAM
BOX CAR	PASSENGER	INTER- SECTION	RAILROAD	SPIKE

T	R	A	I	N
B	I	N	G	O
YARD	GONDOLA	TICKET	PIGGY BACK	FIRST CLASS
ENGINEER	CARGO	INSPECTION	BRIDGE	TRANSPORTATION
CROSS TIE	TERMINAL	FREE	TRAVEL	STEAM
BRAKES	PACKAGES	STATION	RAILROAD DAYS FESTIVAL	CABOOSE
TICKET AGENT	CROSSING	CAUTION	CAB	STREETCAR

T	R	A	I	N
B	I	N	G	O
TRACK	BELL	SLEEPER	ELECTRICITY	BAGGAGE
SEMAPHORE	COAL	BOX CAR	AMTRAK	MAIL
ORIENT EXPRESS	CASEY JONES	FREE	DERAILMENT	DEPOT
RED EYE	INTERSECTION	TRESTLE	TANK CAR	HOPPER CAR
PLATFORM	TIME TABLE	SIDING	LIGHTS	TROLLEY



T	R	A	I	N
B	I	N	G	O
TICKET AGENT	ELECT- RICITY	TICKET	INSPECTION	SIDING
SPIKE	CONDUCTOR	TRACK	CABOOSE	RED EYE
RAILROAD	PLATFORM	FREE	HOPPER CAR	PASSENGER
AIR HOSES	INTER- SECTION	ALL ABOARD	DEPARTURE	DERAILMENT
FREIGHT	BRAKES	COAL	CAB	SLEEPER

T	R	A	I	N
B	I	N	G	O
COACH	SWITCH	STATION	TROLLEY	ORIENT EXPRESS
TERMINAL	LANTERN	SIGNAL	CARGO	RAILROAD DAYS FESTIVAL
TRAVEL	LOCOMOTIVE	FREE	BOX CAR	TANK CAR
SEATS	TRIP	JOHN HENRY	GONDOLA	PACKAGES
CROSS TIE	PIGGY BACK	FIRST CLASS	CAUTION	MAIL

T	R	A	I	N
B	I	N	G	O
INSPECTION	DERAILMENT	CAUTION	TROLLEY	TRAVEL
COACH	CASEY JONES	BOXCAR	AMTRAK	CARGO
STREETCAR	TANK CAR	FREE	FREIGHT	TRANS-PORTATION
COAL	TICKET AGENT	INTER-SECTION	LOCOMOTIVE	DIESEL
BRIDGE	DEPOT	TIME TABLE	LIGHTS	TICKET

T	R	A	I	N
B	I	N	G	O
DEPOT	BELL	STREET CAR	TRANS-PORTATION	TIME TABLE
CASEY JONES	ORIENT EXPRESS	AMTRAK	BRIDGE	PACKAGES
FLAT CAR	CROSSING	FREE	STEAM	LIGHTS
BAGGAGE	YARD	TANK CAR	RAILROAD DAYS FESTIVAL	ENGINEER
MAIL	TROLLEY	CARGO	TRESTLE	SEMAPHORE

T	R	A	I	N
B	I	N	G	O
COAL	BAGGAGE	BELL	SEATS	TICKET
SIDING	MAIL	GONDOLA	TIME TABLE	JOHN HENRY
TICKET AGENT	CAB	FREE	DIESEL	COACH
SPIKE	TRIP	RAILROAD DAYS FESTIVAL	TERMINAL	TANK CAR
TERMINAL	PACKAGES	CARGO	RED EYE	BRAKES

T	R	A	I	N
B	I	N	G	O
TRESTLE	PACKAGES	ALL ABOARD	DERAILMENT	TICKET AGENT
SLEEPER	CROSSING	TIME TABLE	PASSENGER	TERMINAL
LIGHTS	TROLLEY	FREE	BRIDGE	COAL
CABOOSE	TICKET	ENGINEER	SEMAPHORE	DIESEL
SIDING	BRAKES	TANK CAR	JOHN HENRY	SPIKE

T	R	A	I	N
B	I	N	G	O
INSPECTION	CROSSING	CASEY JONES	ORIENT EXPRESS	LANTERN
TRACK	BRIDGE	TERMINAL	PASSENGER	SLEEPER
TRANS-PORTATION	FIRST CLASS	FREE	SEATS	AIR HOSES
ALL ABOARD	COAL	TICKET AGENT	PACKAGES	LIGHTS
STEAM	PLATFORM	SPIKE	CROSS TIE	RAILROAD DAYS FESTIVAL

T	R	A	I	N
B	I	N	G	O
AMTRAK	ELEC-TRICITY	PASSENGER	SPIKE	CABOOSE
FLAT CAR	LOCOMOTIVE	ALL ABOARD	CAUTION	CROSS TIE
TIME TABLE	TROLLEY	FREE	BRIDGE	COACH
LIGHTS	TICKET	TERMINAL	PIGGY BACK	BRAKES
PACKAGES	LANTERN	ORIENT EXPRESS	ENGINEER	TRANS-PORTATION

T	R	A	I	N
B	I	N	G	O
TRESTLE	ALL ABOARD	COAL	STEAM	PASSENGER
SWITCH	LIGHTS	YARD	INSPECTION	PIGGY BACK
ORIENT EXPRESS	AIR HOSES	FREE	BRIDGE	PLATFORM
CABOOSE	DIESEL	DEPOT	TRANS-PORTATION	SPIKE
AMTRAK	TRACK	RAILROAD	PACKAGES	RAILROAD DAYS FESTIVAL

T	R	A	I	N
B	I	N	G	O
CAUTION	LIGHTS	JOHN HENRY	FREIGHT	TRANS-PORTATION
CARGO	INTER-SECTION	LANTERN	TRAVEL	PIGGY BACK
TRESTLE	LOCOMOTIVE	FREE	CASEY JONES	AMTRAK
SEMAPHORE	GONDOLA	ALL ABOARD	CONDUCTOR	ORIENT EXPRESS
YARD	FLAT CAR	FIRST CLASS	TROLLEY	CROSSING

T	R	A	I	N
B	I	N	G	O
INSPECTION	LIGHTS	BELL	CAB	SLEEPER
RED EYE	CROSS TIE	SIDING	ORIENT EXPRESS	CABOOSE
ALL ABOARD	HOPPER CAR	FREE	RAILROAD	LOCOMOTIVE
DEPOT	STATION	SWITCH	DEPARTURE	SEMAPHORE
DIESEL	SEATS	TIME TABLE	JOHN HENRY	TROLLEY

T	R	A	I	N
B	I	N	G	O
DEPOT	TICKET AGENT	BELL	FIRST CLASS	RED EYE
CASEY JONES	CROSS TIE	SEMAPHORE	COACH	TERMINAL
HOPPER CAR	SEATS	FREE	ORIENT EXPRESS	TRAVEL
TANK CAR	INSPECTION	SIGNAL	RAILROAD DAYS FESTIVAL	PACKAGES
TIME TABLE	STREETCAR	LOCOMOTIVE	LIGHTS	BOXCAR

T	R	A	I	N
B	I	N	G	O
CABOOSE	BOXCAR	PASSENGER	TRESTLE	TRACK
JOHN HENRY	RED EYE	FLAT CAR	SIGNAL	ENGINEER
SWITCH	RAILROAD	FREE	COACH	LANTERN
CAB	TROLLEY	DIESEL	CASEY JONES	LOCOMOTIVE
STEAM	BELL	STREETCAR	LIGHTS	WHISTLE

T	R	A	I	N
B	I	N	G	O
INSPECTION	LIGHTS	BELL	CAB	SLEEPER
RED EYE	CROSS TIE	SIDING	ORIENT EXPRESS	CABOOSE
ALL ABOARD	HOPPER CAR	FREE	RAILROAD	LOCOMOTIVE
DEPOT	STATION	SWITCH	DEPARTURE	SEMAPHORE
DIESEL	SEATS	TIME TABLE	JOHN HENRY	TROLLEY

T	R	A	I	N
B	I	N	G	O
SEMAPHORE	GONDOLA	ALL ABOARD	ENGINEER	FLAT CAR
JOHN HENRY	STATION	DERAILMENT	SIDING	SLEEPER
PACKAGES	TRANS- PORTATION	FREE	TERMINAL	SPIKE
PIGGY BACK	PASSENGER	BRIDGE	BELL	CASEY JONES
CAUTION	YARD	DEPOT	CARGO	CONDUCTOR



### **TRAIN CAR BUILDING CONTEST**

*by Frances Roppolo, St. Charles Parish Library*

This contest can fit any library's needs or space requirements. The rules listed are for example only.

1. The train car must be original and constructed entirely by the child. There are four age categories: 4-5 years, 6-8 years, 9-11 years, and 12 and up. A child's age is determined by how old he/she is by June 1.
2. Construction materials may not include purchased toys (such as Legos, tinker toys) or fruits and vegetables. Suggested materials are construction paper, cardboard, balsa wood, toothpicks, clay, straws, etc.
3. The size of the train car should be no larger than 2 feet high on a base no larger than 2 feet square. The child's entry blank should be attached to the underside of the base.

The judges may be people from the community such as an art teacher, an architect, or a train engineer. Because the entrant's name is underneath the base of the car, the judging will be impartial.

This contest also has the added benefit of providing creative and colorful train decorations for the library.

### **TRAIN PARTY (FOR BOYS)**

*by Bernice Hogan*

This is a party especially designed for small boys, but don't be misled into thinking that little girls are not equally fascinated by "choo-choos."

The Game section of this party has been planned in a somewhat different manner, but recently my four-year-old daughter Carol called to her two-year-old brother and said, "Come on, Bobby. Let's play 'choo-choo train!'" And she stood behind him, grabbed him about the waist, and off they galloped, "horse and buggy" fashion, around the dining-room table. So the directions for the train game have a note of definite pre-school authenticity!

**Invitations:** Make a train of various colors of construction paper and "couple" the cars together with bits of thread or string. Why not have a black engine, a yellow freight car, a blue coach, and finally, of course, a red caboose?

On the black engine print: "Come to a train party!" Let the yellow freight car say: "Scheduled for Saturday, October 10." And the blue coach will bear the timetable: "Time of Arrival - 2:30 p.m.; Time of Departure - 3:30 p.m. Central Standard Time." The little red caboose will bear the name of the "Conductor" for the day.

**Decorations:** Be it spring or fall, summer or winter, get out all the mobile trains and pieces of trains available. Use them for the central attraction of the party. With bridges and tunnels of cardboard, and Mother blowing a shrill engine whistle, as well as engines and cabooses and dining cars of all sizes and colors in different corners of the room, no other decorations are necessary. Don't use the electric trains for these pre-school children. They will enjoy much more the kind that stand pulling, tugging, and investigation.

Make engineer caps for your guests to don upon arrival. Take a medium-size brown paper bag (the kind that opens flat at the bottom), and using the bottom as the top of the cap, cut off the bag so that it is only three inches deep. From the remainder of the paper sack make a small visor and paste it on the front of the hat.

If white bags of this type are available, crayon blue-gray stripes on them before cutting. Thus you will have a cap with real authenticity.

**Game Time:** Allow a period of "free time" at the beginning of the party for investigating the marvels of being an engineer. But before the children tire of undirected activity, gather them in one spot for a romping game of "Choo-Choo," or more aptly termed by adults, "Dodge the Furniture."

Explain that everyone is about to take a trip across the country on a sleek and modern train pulled by a new and shining locomotive. Have the children then line up, one behind the other, each holding his hand on the waist of the youngster in front of him.

The one at the head of the line will be the locomotive and have the privilege of sounding the whistle (you can provide one for blowing or merely let the child himself make the engine whistle sound). Each time the train stops at a station, however, the engines are changed and the head child goes to the end of the line. A new engine replaces him, blowing the whistle energetically.

You may want to be the locomotive at first, to lead the way around the living-room sofa or the dining-room table. Show the children a map of the United States first, and mark the route in bright red crayon with large circles around the stations where this miraculous train will stop. Perhaps you will have a route like this:

San Francisco, California  
 Denver, Colorado  
 Kansas City, Kansas  
 St. Louis, Missouri  
 Indianapolis, Indiana  
 Pittsburgh, Pennsylvania  
 New York, New York

Be sure to have as many cities and stations as you have guests, so that each child will have at least one chance to be the "locomotive," and blow the whistle as the living-room mountains and the kitchen plains whiz by.

Probable no one ever went on a train trip without going over a bridge, and it would certainly be a disaster if the bridge were to really fall down, but fortunately this is only the game of "London Bridge Is Falling Down."

Two children are chosen to be the bridge, perhaps because one has red polka dots on her dress and the other child has a red bow tie on for the party. With the "bridge children" arching their arms the others pass underneath singing:

London bridge is falling down,  
Falling down, falling down,  
London bridge is falling down,  
My fair lady!

Build it up with iron bars,  
Iron bars, iron bars,  
Build it up with iron bars,  
My fair lady.

Iron bars will bend and break . . .

Build it up with gold and silver . . .

Gold and silver I've not got . . .

Off to prison you must go . . .

At the end of each stanza, on the word "lady," the children drop their hands and capture one boy or girl, who then replaces one of the youngsters at the bridge. At the second capture the other boy or girl originally at the bridge is replaced.

This simplified version of this familiar party game will often be more successful with a small group of pre-school children than the commonly used, longer version, which ends in a tug-of-war.

Just before refreshment time give each child a ticket which must be punched before he can receive his cake and ice cream.

**Story Time:** *The Little Engine That Could* by Watty Piper will fit nicely in a train party.

**Favors:** If your guest list is not too large, an inexpensive book of train pictures, or a story about trains, would make an excellent party favor for each child. The 25-cent books with large

print, bright pictures, and cardboard covers are a fine choice and available in grocery, drug, dime, or stationery stores.

If you plan the party well ahead of time, the store owner may be able to order the specific books for you that you feel will best suit the occasion.

**Food:** Little boys and chocolate ice cream go very well together. Make this ice cream extra-special by adding a dab of marshmallow topping for added goodness and "gooiness."

Use a packaged mix for an easy white cake with cocoa frosting. Use a large oblong pan instead of two layer tins, as there is enough "sweet stuff" on the ice cream without an extra portion of frosting between the layers. And the oblong cake is easier for baking too. Frost it in the pan and you'll save dish washing as well.

From *Pre-School Party Parade*, Bernice Hogan, Pages 87-91 "Train Party (For Boys)" copyright © 1958 Abingdon Press. Reprinted by permission.

### **TRAIN POTPOURRI**

*by Yolanda Blanchard, Calcasieu Parish Library*

#### **Your Ticket, Please**

Each week the children are given "tickets" to get aboard the storyhour train. The ticket is a "train" word. The children are asked for the "ticket" when they come to storyhour. Some suggested words are: train, caboose, track, conductor, railroad, engine, passenger, freight, locomotive, boxcar, signal, brake.

#### **Train Seat**

Sitting in rows as one would sit on a train, the children sit in twos. Each child says his or her name as the "conductor" passes by. The next time, the "conductor" passes by, the children name their favorite colors. The third time, they name their favorite fruit. They can share the places they wish to travel, their favorite characters, their dreams, etc.

#### **Stay Tuned Next Week for the Conclusion of the Train Mystery**

Read short excerpts from "train mysteries." Stop reading at very exciting points of the stories. Tell the children when they return next week, they will hear the conclusion of the "train cliffhangers." Use some of the "Train Hero Stories." The children may want to guess some of the conclusions.

#### **"My Train Trip to the Library" Essay Contest**

Encourage the children to write essays describing their journeys to the library and the wonderful things they discover upon their arrival at the library.

**Train Cargo**

Different groups of children pretend to be trains and give clues of various animals, stories, people, foods, dogs, desserts, etc. that they are carrying. The other children must figure out what kind of cargo is being carried on the train.

**Follow the Train Signals**

Tell the children to imitate the "train" signals that you demonstrate for them; these signals may be body language signals that they use in everyday life. The conductor and other workers on the train must be able to read these signals to help keep their passengers happy. The signals are stop, go, come, okay, hello, good-bye, all aboard, read, hungry, listen, no, yes, up, down, around, one, two, happy, sad, sleepy, angry, I don't know, etc. The children may wish to show these "signals" as you call the words out.

**TRAIN RIDDLES**

*by Yolanda Blanchard, Calcasieu Parish Library*

1. What kind of mint do they serve on trains? A Derail (Mint) (derailment)
2. What do you tell a car that is sitting on the train track? Car, go! (cargo)
3. What do you use to cook with while you are waiting for the train to come? De-pot (depot)
4. What kind of train carries pigs? Hamtrak (Amtrak)
5. What do you call a railroad car with a square on top of it? A boxcar
6. Why did the train stop at the mortuary? To kill a little time.
7. What kind of dessert is served on the train that stops on the North Pole? Ice-steam
8. What number does a train carry? Fr-(eight)
9. What kind of train do you catch when you have not slept all night? The red eye
10. What place does a train pass through that weighs two thousand pounds? A (ton)-nel
11. What did the conductor tell the children who were visiting the library? "Stop, Look and Read!"
12. What kind of tie does a railroad wear? A Crosstie
13. What kind of sport do trains accelerate in? Racing Tracks
14. What kind of train car do frogs and kangaroos ride in? A hopper car
15. Where do the kindergarten children want to sit on the train? In first class
16. What street does the train live on? On Railroad Avenue
17. What did the mosquito make the train do? Sw-(itch)
18. What do you call a chair that is leaving a train? A depart-(chair) (departure)
19. What does a train do for intermission? It takes a brake.

20. What train car gets the most rest? The sleeper
21. What do you need to be able to hear directions on a train? An engine ear (engineer)
22. What train has very little sense? A (loco)-motive
23. What are trains in Alaska filled with? Coal
24. Where do ghosts hide on the train? In the Ca-(boo)se
25. What does a train do when it gets angry? It lets off steam.

### TRAIN SCRAMBLE

*by Yolanda Blanchard, Calcasieu Parish Library*

For this game, write the scrambled words in large letters on poster boards in front of the room. Divide the children into two teams. Each team is given ten minutes to unscramble the words that are related to trains. The team that unscrambles the train words first is the winner. One child will be selected by each group to be the conductor; this child will write the answers on the poster board. Remind the children that each team must unscramble the train words as quietly as possible so that the other team will not hear the answers.

- |              |           |
|--------------|-----------|
| 1. ratin     | train     |
| 2. arbek     | brake     |
| 3. ctakr     | track     |
| 4. lidarroa  | railroad  |
| 5. sepsanrge | passenger |
| 6. xarbco    | boxcar    |
| 7. gislan    | signal    |
| 8. eobcsao   | caboose   |
| 9. gienrnee  | engineer  |
| 10. ftegirh  | freight   |
| 11. sprexex  | express   |
| 12. graco    | cargo     |
| 13. nunlet   | tunnel    |
| 14. lira     | rail      |
| 15. meats    | steam     |
| 16. bac      | cab       |
| 17. loca     | coal      |
| 18. leolrty  | trolley   |
| 19. kesip    | spike     |
| 20. gosrisch | crossing  |

## THE TRAIN STORY GAME

Tell the children that they are going to ride on a special story train. Give them clues for the names of favorite stories, authors, or items in a story as they ride on the story train. Ask them to bring a suitcase, book bag, or knapsack to storyhour next week. In this suitcase, ask them to put one of their favorite books or stories.

At the next storyhour, have them sit in a circle and tell why their story is their favorite story. Have them make pennants of each other's stories out of construction paper or felt, which they can then tape onto their suitcase.

### Clues: Name That Character

Say the phrase and ask the children to name the character who said it.

"I'll huff and I'll puff and I'll blow your house down!"  
The Big Bad Wolf

"Grandmother, what big eyes you have!"  
Little Red Riding Hood

"This porridge is just right."  
Goldilocks

"Rapunzel, let down your hair."  
The Prince

"Mirror, Mirror on the wall, who's the fairest of them all?"  
The Queen

"I think I can. I think I can."  
The Little Engine

"Everything I touch turns to gold."  
King Midas

"Run, Run as fast as you can. You can't catch me."  
The Gingerbread Man

"They call me Snow White."  
Snow White

"I can rope a dozen cows with one lasso."  
Pecos Bill

"You cannot go to the ball."  
The Stepmother

"Not by the hair of my chinny chin chin."  
The Three Little Pigs

"Where is Toto? Where is my dog?"  
Dorothy

"The sun'll come out tomorrow."  
Annie

"Click your heels three times if you believe."  
The Good Witch

**Clues: Name That Author**

Give the name of the author and ask the children to name the book.

Amelia Bedelia

Peggy Parish

The Giving Tree

Shel Silverstein

Clovis Crawfish

Mary Alice Fontenot

Where the Wild Things Are

Maurice Sendak

The Cat in the Hat

Dr. Seuss

Curious George

Hans Augusto Rey

The Berenstain Bears

Stan Berenstain

Superfudge

Judy Blume

The Babysitters Club

Ann Martin

Detective Mole

Robert Quakenbush

Anno's Alphabet

Mitsumasa Anno

The Fables of Aesop

Aesop

The Gift of the Magi

O. Henry



Romeo and Juliet	William Shakespeare
Where the Sidewalk Ends	Shel Silverstein
Ramona the Pest	Beverly Cleary
Brer Rabbit	Joel Chandler Harris
Encyclopedia Brown Sets the Pace	Donald J. Sobol
How To Eat Fried Worms	Thomas Rockwell
Mirandy and Brother Wind	Patricia McKissack
How the Grinch Stole Christmas	Dr. Seuss
Alexander and the Terrible, . . .	Judith Viorst
The Raven	Edgar Allan Poe

**Clues: Do You Remember?**

Say the word or show a picture of the following items for the children to recall the story.

A Candle	Jack Be Nimble
A Mirror	Snow White and the Seven Dwarfs
A Slipper	Cinderella
A Red Coat	Little Red Riding Hood
An Egg	Humpty Dumpty
A Pail of Water	Jack and Jill
A Bone	Old Mother Hubbard
Some Gingersnaps	The Gingerbread Man
A Nose	Pinocchio
Some Straw	Rumpelstiltskin
A Spider	Little Miss Muffet

A Star

Twinkle Twinkle Little Star

A Dollar

A Diller, A Dollar

A Cake

Pat-A-Cake

**Book Title:**

**What I liked about the story:**

**Book Title:**

**What I liked about the story:**

**Book Title:**

**What I liked about the story:**

**TRAIN TRIP**

by Frances Roppolo, St. Charles Parish Library

If your parish has more than one library branch (or if you have public spirited merchants), children can go on a "train trip." Print tickets (such as the sample below) with rules. At each "depot" the child will have ticket punched or stamped, and initialed by library staff. When the child has finished his trip around the parish, he can bring it back to his home library branch to be included in a prize drawing. Suggested prizes are bandannas, train books, engineer caps.

# GATOR EXPRESS

<b>West</b>	This ticket is issued to: _____ Telephone: _____ Good for travel between _____ and _____	<b>East</b>
<b>Hahnville</b>	Have ticket stamped at each depot. Station master must initial ticket.	<b>Norco</b>

**Departs Summer 1993.**

# GATOR EXPRESS

<b>West</b>	This ticket is issued to: _____ Telephone: _____ Good for travel between _____ and _____	<b>East</b>
<b>Hahnville</b>	Have ticket stamped at each depot. Station master must initial ticket.	<b>Norco</b>

**Departs Summer 1993.**

# ZOO TRAIN

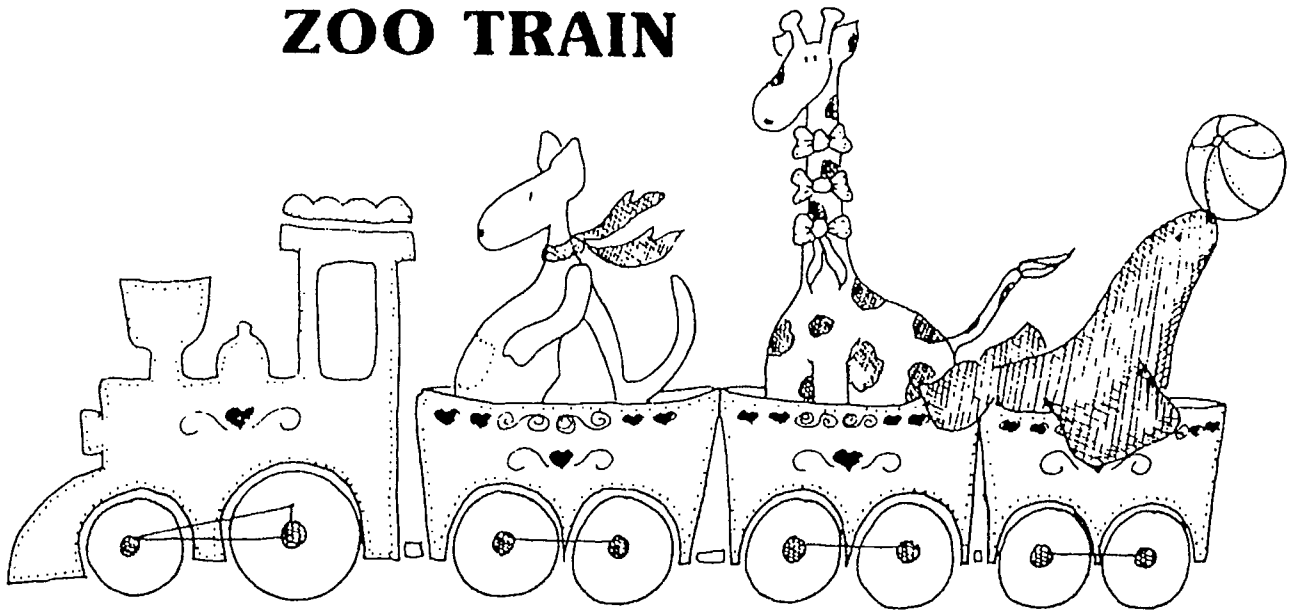

AGES: 2½-5.

NUMBER OF PLAYERS: 3-10.

MATERIALS: None.

PREPARATION: None.

## GAME:

Have the children line up in a row to make a "zoo train." Designate one area in the room to be the train station. Let the first child in line be the Engineer. Have the children sing the first verse of this song with you:

Sung to: "Down by the Station"

Down by the station,  
Next to the zoo,  
On came an animal.  
Do you know who?

Let the Engineer tell what animal came aboard the train and what action that animal is performing. For example, he or she might say "A kangaroo came aboard and it is hopping." Then let the children sing the rest of the song with you as the train "hops" around the room:

We picked up a <u>(kangaroo)</u> ,	<u>(Hopping)</u> , <u>(hopping)</u> , watch us go,
And what do you know.	<u>(Hopping)</u> fast, then <u>(hopping)</u> slow.
This is the way	<u>(Hopping)</u> down, then <u>(hopping)</u> back.
The train started to go.	Watch us <u>(hop)</u> around the track.

When the train returns to the station, have the Engineer go to the back of the line. Then let the child at the front of the line become the new Engineer and choose the next animal. Continue playing until everyone has had a turn being the Engineer.

## HINT:

Before playing the game, review various zoo animals and how they move.

**THE EARLY MORNING TRAIN**

Early in the morning, let's go to the country  
 See the little puff-puffs, all in a row.  
 Man in the engine pulls a little lever;  
 Choo-choo, whoo-who, off we go!

From *Nursery Rhyme Crafts*, by Susan True, © 1985, by Monday Morning Books, Inc. Used by permission.

**THE ELEPHANT ON A LION HUNT**

by *Lois Grant, Rapides Parish Library*

There once was an elephant  
 Who went on a lion hunt.  
 When he heard the lion roar,  
 He said, "I forgot to go to  
 the store.  
 And he hasn't been on a lion  
 hunt anymore!

**FLIGHT PLAN**

by *Jane Merchant*

Of all the ways of traveling in earth and air and sea  
 It's the lively helicopter that has captivated me.  
 It hovers anywhere in air just like a hummingbird.  
 Flies backward; forward, up or down, whichever is preferred.  
 It doesn't pierce the stratosphere as zipping rockets do  
 Nor pop sound barriers and puff fat jet streams through the blue.  
 It isn't first in speed or weight or anything but fun  
 And deftly doing dangerous jobs that often must be done.  
 When anyone is lost in storm or flooded river's span  
 And other planes can't help at all, a helicopter can.  
 It lights on snow or mountaintop—wherever it is needed.  
 The plane that's like a hummingbird will not be superseded  
 By satellite or Stratojet. No supershuttle has topped her.  
 And just as soon as ever I can I'll fly a helicopter!

From *The Random House Book of Poetry for Children*, © 1983. Reprinted by permission of Random House, Inc.

## 2 • POEMS

### GET A TICKET

Get a ticket, ticket, ticket for the train.  
Get a ticket, ticket, ticket for the train  
Don't stand out in the wind and rain.  
Get a ticket, ticket, ticket for the train.

Verse 2. *Bus*: Climb aboard, you can ride with us  
Verse 3. *Plane*: Don't stand out in the wind and rain.  
Verse 4. *Boat*: The water's too cold to swim or float.  
Verse 5. *Bike*: It's way too far to walk or hike.

From *Mitt Magic: Fingerplays for Finger Puppets*, by Lynda Roberts, © 1985, Gryphon House, Inc. Used by permission.

### HALFWAY WHERE I'M GOING

Trains and boats and cars and wagons  
are a way to go,  
bikes and carriages and sleds  
cutting through the snow.

Chairs and beds and sofas  
are a way to stay,  
swings and steps to sit on  
for an ordinary day.

Sometimes I want to go away  
to roam and roam and roam,  
but halfway where I'm going  
I always long for home.

From *Everything Glistens and Everything Sings*, by Charlotte Zolotow, © 1987, Harcourt Brace Jovanovich, Publishers. Reprinted by permission.

**HERBERT THE HOBO**

Herbert the Hobo, he hopped on a train  
 And he lived in a boxcar from Georgia  
     to Maine!  
 They didn't collect and he didn't pay rent.  
 He followed the engine wherever it went!

Action: There are two circles. The outer one is the train. The inside smaller one is hobos. The train circle holds onto each other's shoulders and shuffles feet. Each time "hopped" is said, one hobo moves onto the train circle. Repeat until all hobos are on the train.

From *Move Over, Mother Goose!* by Ruth I Dowell, © 1987, Gryphon House, Inc. Reprinted by permission of the publisher.

**THE LAND OF POTPOURRI**

Oh, take my hand and stroll with me  
 into the Land of Potpourri,  
 a land to think, a land to dream,  
 a land of peaches topped with cream,  
 of orange crayons, yellow pears,  
 a wind-up frog upon the stairs,  
 a windy beach, a flying bed,  
 a helicopter overhead.

In Potpourri you're sure to spy  
 a locomotive clacking by,  
 a toaster pop, a rocket roar,  
 a shovel like a dinosaur,  
 a puzzled mouse in outer space,  
 a breathless theft of second base;  
 so take my hand and stroll with me  
 into the Land of Potpourri.

From *The Random House Book of Poetry for Children*, © 1983. Reprinted by permission of Random House, Inc.

## 4 • POEMS

### TO AN AVIATOR

by *Daniel Whitehead Hicky*

You who have grown so intimate with stars  
And know their silver dripping from your wings,  
Swept with the breaking day across the sky,  
Known kinship with each meteor that swings—

You who have touched the rainbow's fragile gold,  
Carved lyric ways through dawn and dusk and rain  
And soared to heights our hearts have only dreamed—  
How can you walk earth's common ways again?

From *The Random House Book of Poetry for Children*, © 1983. Reprinted by permission of Random House, Inc.

### TOOT! TOOT!

A peanut sat on a railroad track;  
His heart was all flutter.  
The five-fifteen came rushing by —  
Toot! Toot! peanut butter!

From *Resources for Every Day in Every Way*, by Cynthia Holley and Faraday Burditt, © 1989, Simon & Schuster. Reprinted by permission of the publisher.

### THE TRAIN

I hear it  
home in my bed--  
somewhere out in the night  
the cry of a train  
flying through  
the darkness.  
    To where?  
    To whom?

From *Everything Glistens and Everything Sings*, by Charlotte Zolotow, © 1987, Harcourt Brace Jovanovich, Publishers. Reprinted by permission.



**THE TRAIN MELODY**

The train keeps on  
with its chug chug song,  
and on it is me  
with my own melody:

river	house	tree		
flower		fence		fisherman
river	house	tree		

All these are in my train melody.

Someone waves  
and I wave back,  
and the train chugs on  
down the track,  
chug chug chug  
and on it is me  
with my own melody:

flower		fence		fisherman
river	house	tree . . .		

From *Everything Glistens and Everything Sings*, by Charlotte Zolotow, © 1987, Harcourt Brace Jovanovich, Publishers. Reprinted by permission.

**TRAIN SONG**  
*by Diane Siebert*

Out in back  
railroad track  
clickety-clack  
clickety-clack  
great trains  
freight trains  
talk about your late trains  
the 509  
right on time  
straight through to L.A.  
whistle blows  
there she goes  
slicing through the day.  
Trains with faces in a row  
going places: Buffalo  
New York City, Boxtton, Mass.  
Slowing 'neath the underpass

## 6 • POEMS

engineers with striped hats  
head-of-the-line aristocrats  
up in front, sitting high,  
wave at me as they go by  
    Southern Route  
    Sante Fe  
    Cotton Belt  
    on their way  
    boxcars  
    flatcars  
goint-to-North Platte cars  
    grain trains  
    Maine trains  
going-through-the-rain trains  
    long trains  
    strong trains  
singing-clickety-song trains  
    cars with lumber  
    cars wit' cattle  
    clickety-clacking  
    to Seattle.  
    Detroit to Chicago  
    departing at five  
    whenever we get there  
    is when we arrive.  
    Midnight special  
    to Cheyene  
    get a sleeper  
    if you can  
ALL ABOARD! say good-bye  
hear the railroad lullaby.

From *The Random House Book of Poetry for Children*, © 1983. Reprinted by permission of Random House, Inc.

**TRAIN WINDOWS***by Myra Cohn Livingston*

Train windows always seem to be  
 Like picture frames for all I see--  
     a painted sky,  
     a running stream,  
     or just a waving tree.  
 But when the train moves on so fast  
 My window pictures never last.

From *Whispers and Other Poems*, by Myra Cohn Livingston, © 1958, Harcourt, Brace and company. Reprinted by permission.

**TRAVEL***by Edna St. Vincent Millay*

The railroad track is miles away,  
 And the day is loud with voices speaking,  
 Yet there isn't a train goes by all day  
 But I hear its whistles shrieking.

All night there isn't a train goes by,  
 Though the night is still for sleep and dreaming  
 But I see its cinders red on the sky  
 And hear its engine steaming.

My heart is warm with the friends I make,  
 And better friends I'll not be knowing,  
 Yet there isn't a train I wouldn't take,  
 No matter where it's going.

From *The Random House Book of Poetry for Children*, © 1983. Reprinted by permission of Random House, Inc.

**THE ZOO***by Lois Grant*

We love to visit the zoo,  
 There is so much to see and do.  
 The elephants are so big.  
 The monkeys jump and dance a jig;  
 And once I even saw a gnu.

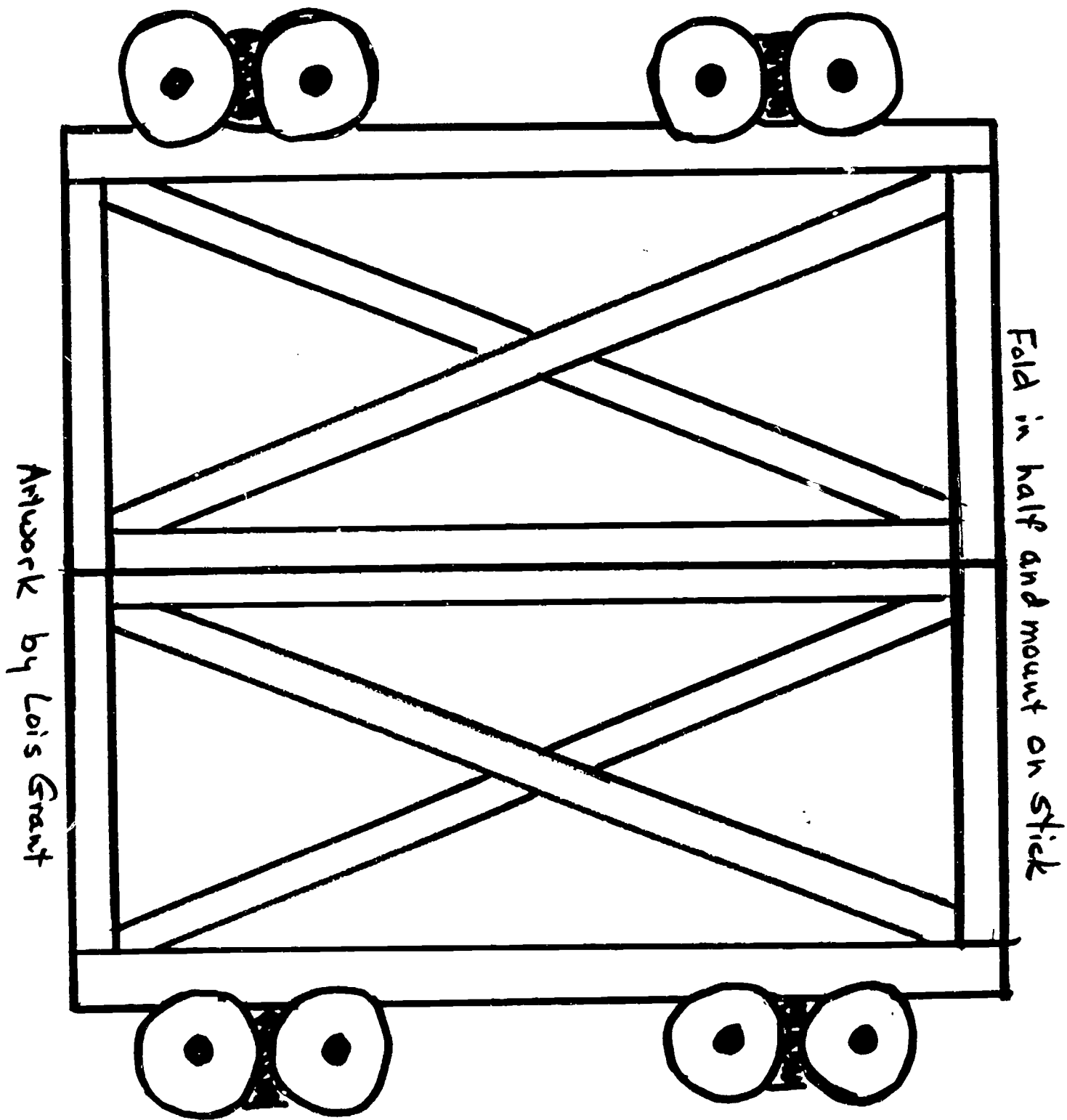

Stick puppet patterns for the book Freight Train by Donald Crews.

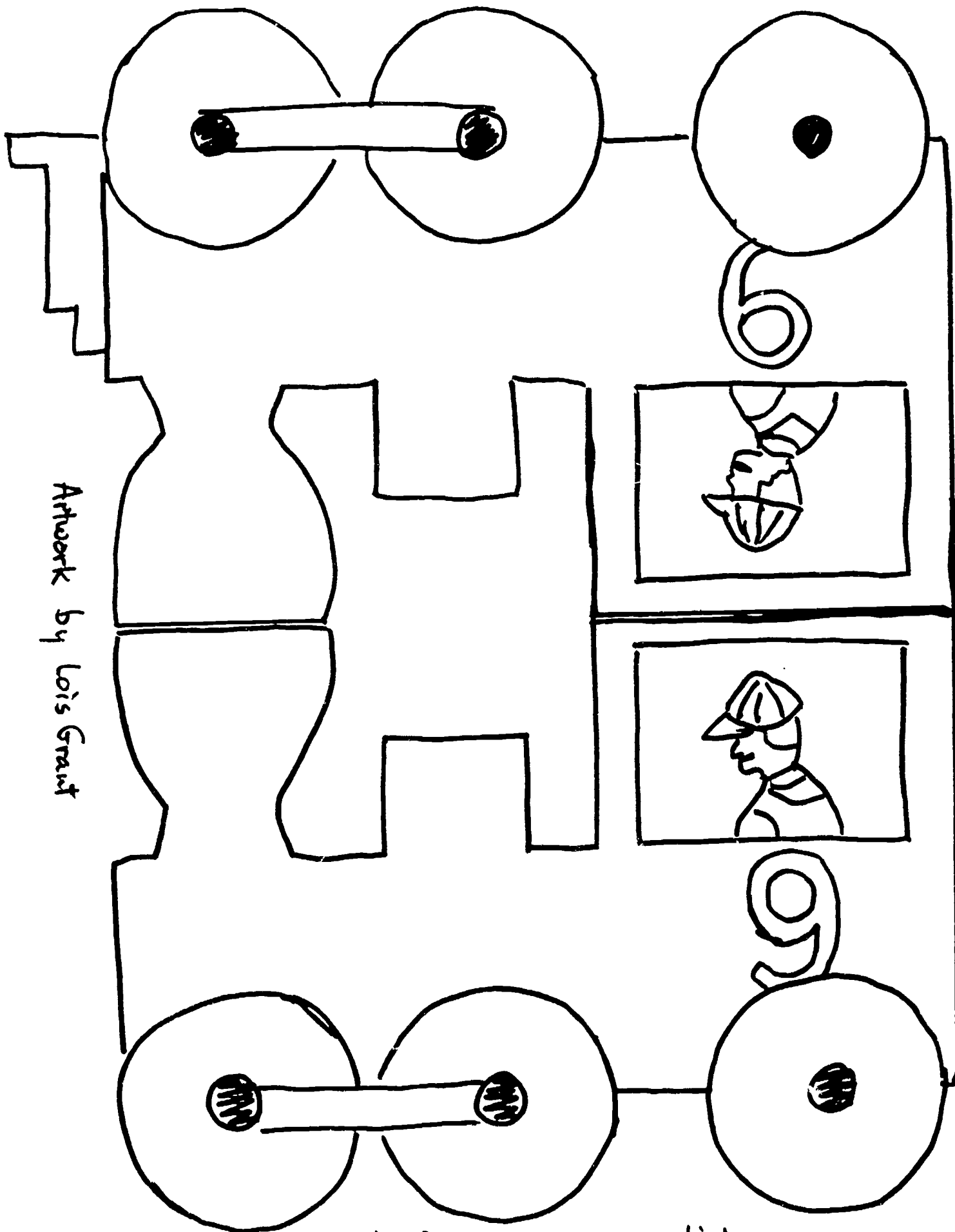

Artwork by Lois Graaf

Fold in half and mount on stick.

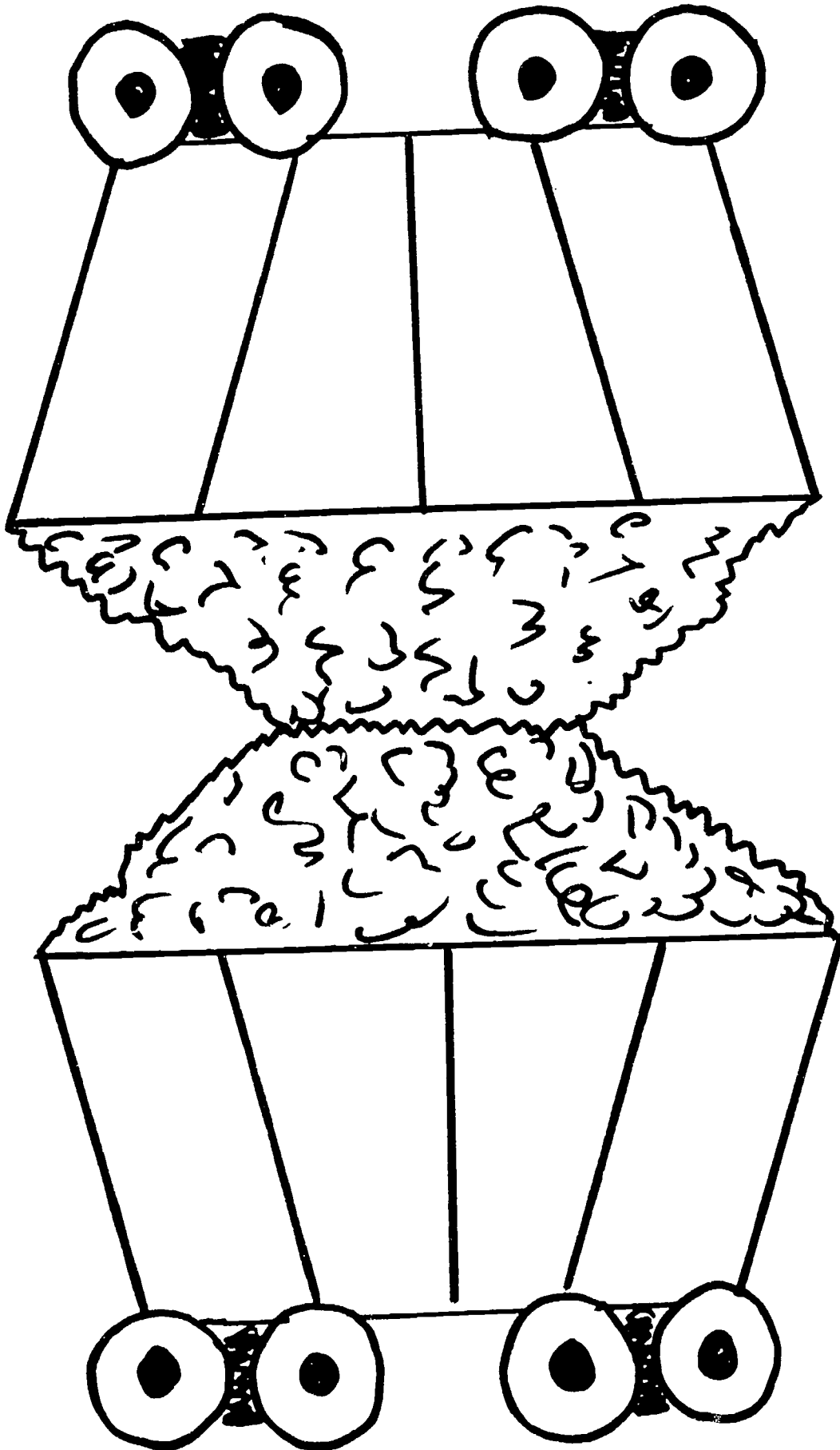

Artwork by Lois Grant

Fold in half and mount on stick

Fold in half and mount on stick.

Artwork by Lois Grant

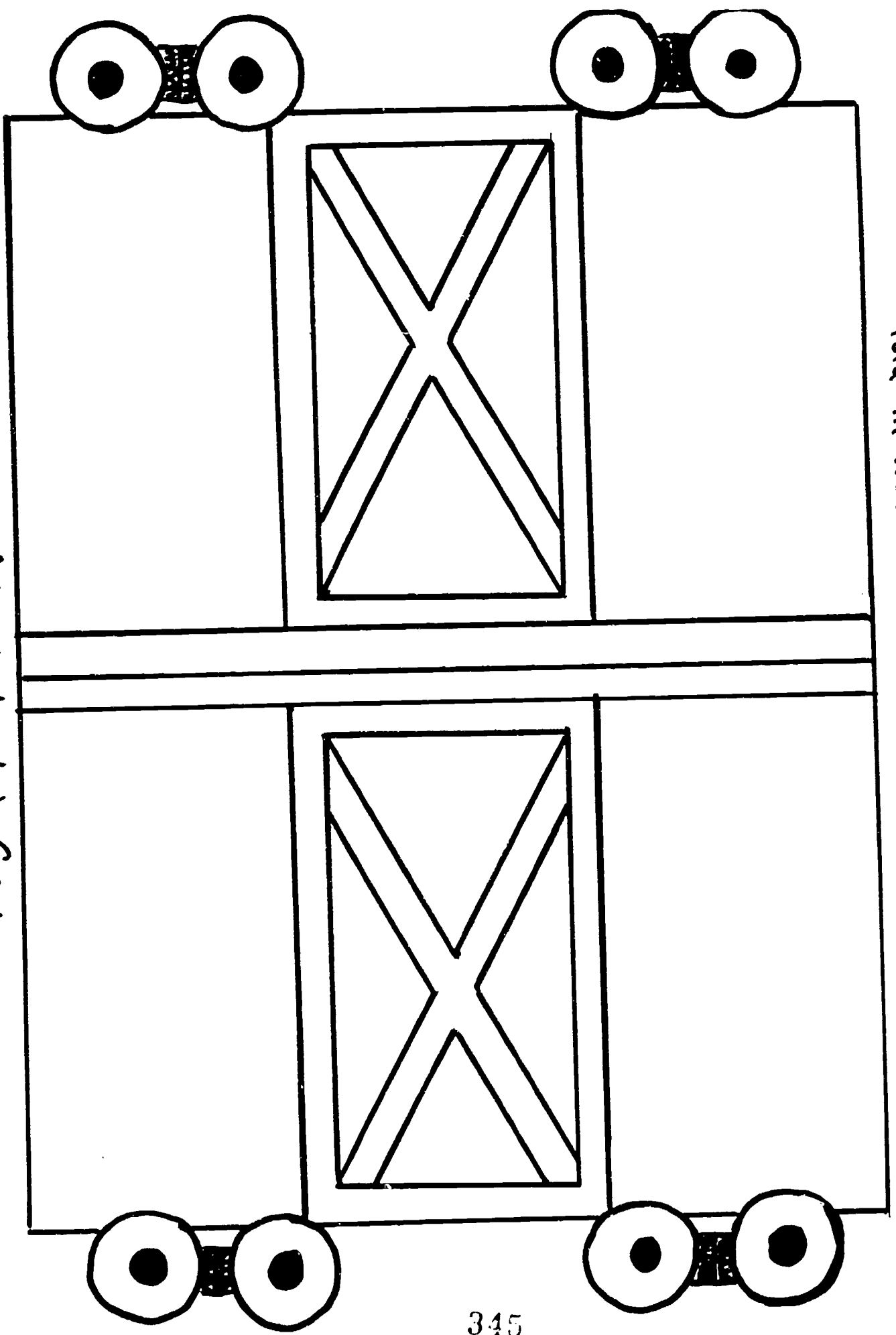

Artwork by Lois Gray

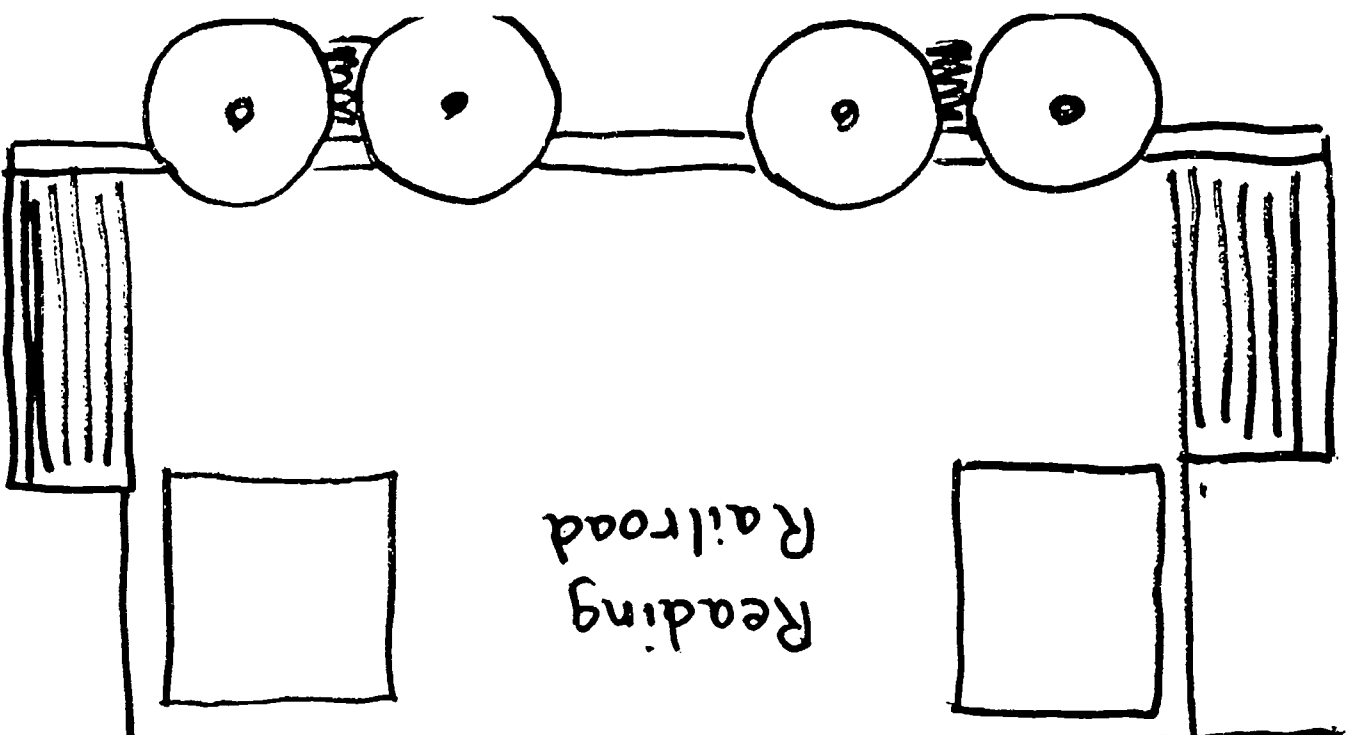

Fold in half  
and  
mount on  
stick.

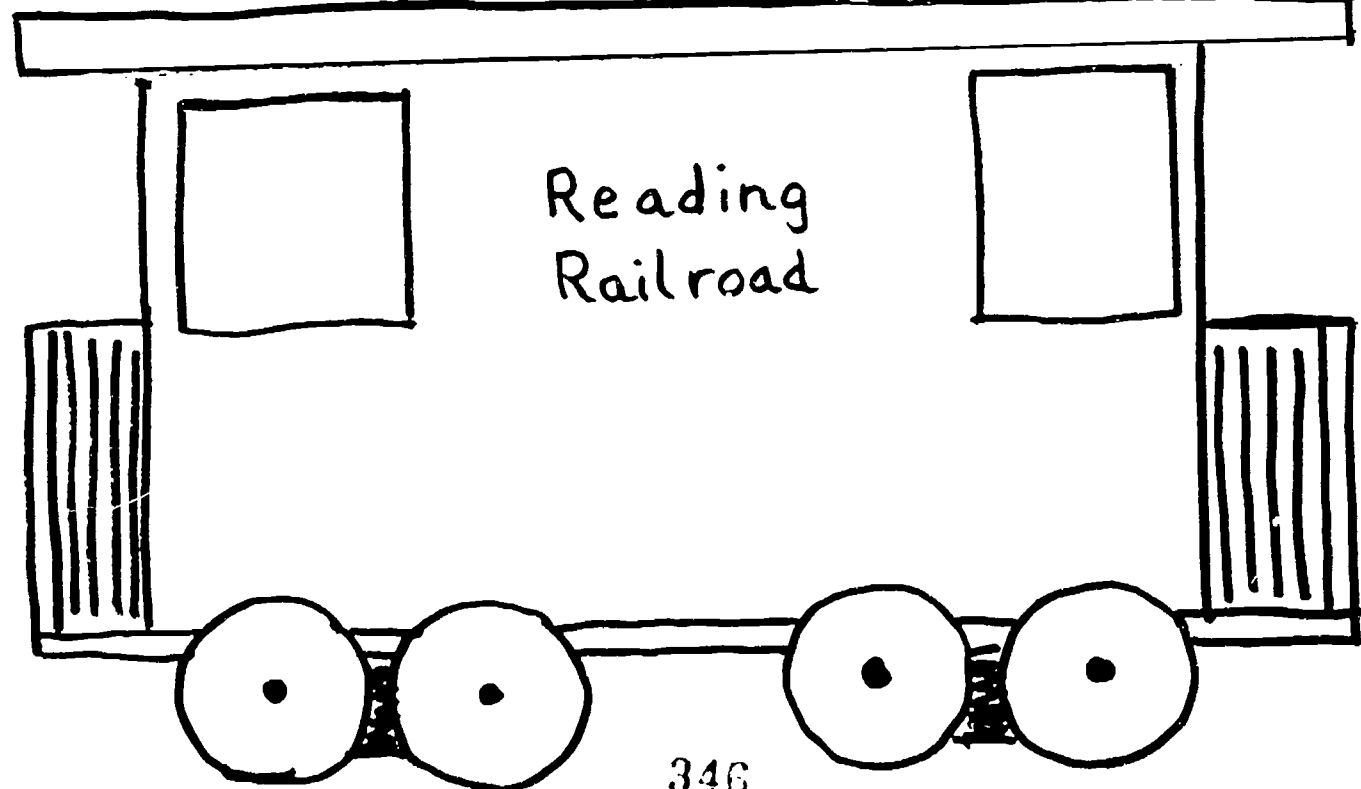
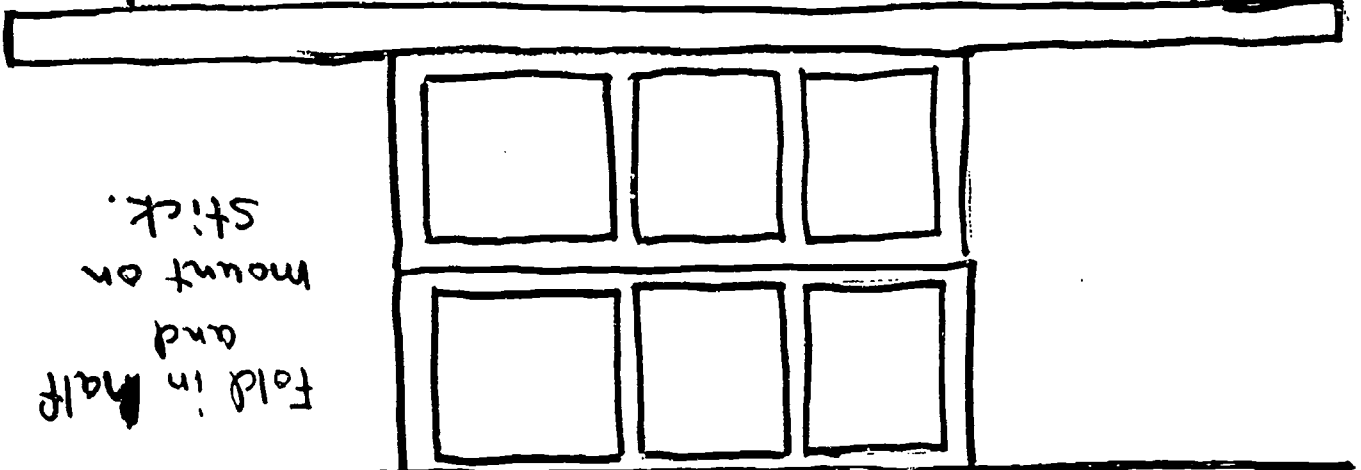



## THE GOLDEN SPIKE

### Introduction

In this play, the actors or puppeteers who act and speak for the puppets must pretend they are earthworms living in a tunnel underneath Promontory Point, Utah, on that day in 1869 when the first continental railroad was dedicated. If you had never seen a train, how would you feel about having one run overhead? Puzzled? Disgusted? Excited? Happy? Earthworms in this puppet skit have all of these reactions. Puppeteers must express them with their voices.

The lines about the railroads must be spoken slowly and clearly. Lem and Zeke are trying to explain the new situation to old Granny, so that she can understand why the event is important. If the characters can make Granny understand, then the audience also will understand. Offstage noises must be timed perfectly.

The skit may be put on with only the main characters, or there may be as many earthworms as can be used on the stage. The extra earthworms must react to speeches by nodding or shaking their heads or making exclamations that will not slow up the skit.

If you have a good idea about how to construct earthworm puppets, create your own; or make a puppet like the one described at the end of this play.

If this skit is being presented before a small audience, such as your class, group of playground friends, Brownie troop, Cub pack, or family, just pretend there is a golden spike in the ceiling of the tunnel. However, if you wish, you can make a simple stage that represents a tunnel. Suspend two curtains or barriers across your stage (see page 31). The top of one curtain, the front one, should be slightly lower, perhaps twelve inches lower, than the curtain in back of it. There should be ample room between the two curtains to permit the puppeteers to move freely. At the proper time the golden spike may be suspended from, or fastened over, the wire that holds the back curtain.

### Puppet Plays

If you have a large cardboard puppet stage and want to use it limit the number of players to three earthworms. Combine the lines of Lem and Zeke so they are said by one player. Suspend the spike from the top of the cardboard stage so that it can be lowered at the correct time.

### Characters

Lem Earthworm  
Zeke Earthworm  
Granny Earthworms

Young 'Un Earthworm  
Other Earthworms  
Narrator

**Scene.** *(To be described for the audience by the Narrator.)* The tunnel of a group of earthworms beneath Promontory Point, Utah, May 19, 1869. As the scene opens, all of the earthworms are singing and dancing.

**Earthworms.** *(Dancing and singing to the tune of "Turkey in the Straw.")*

Do you think that an earthworm  
can dance beneath the ground?  
Bow to his partner,  
and turn himself around;  
Bow to the left and bow to the right,  
Then jig up and down  
with all his might?  
Oh-oh, yes, I know an earthworm  
can dance beneath the ground.  
Bow to his partner  
and turn himself around.  
Bow to his left  
and bow to his right,  
then jig up and down  
with all his might.  
Yeah! *(Noise of hammers is heard offstage.)*

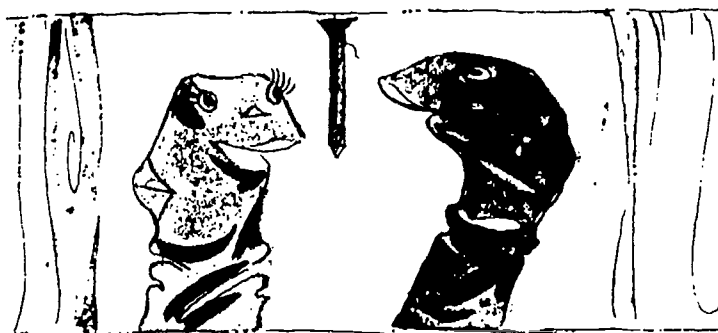

**Granny.** Land o' Goshen! There goes that noise again. What can it be?

**Lem.** I told you, Granny. Twenty thousand men are laying eight miles of track a day.

**Granny.** Track? What's that?

**Lem.** For a train, they say.

**Granny.** Train? What's that?

**Lem.** I don't know. Never saw one.

**Granny.** Zeke, do you know what a train is? *(All earthworms shake their heads.)*

**Zeke.** No, Granny, but one is coming from the East.

**Lem.** And one is coming from the west.

**Young 'Un.** What'll happen when they meet?

**Lem.** They are going to stop. And someone is going to drive a golden spike into the ground right here at Promontory point. That golden spike will join the two railroads.

**Granny.** Railroads. I thought you said train. *(Speaks seriously.)* Lem, I think you better go up on top of the earth. Go to the West, and do be careful! Find out what a train is like.

**Lem.** Yes, Granny. *(Exits.)*

**Granny.** And Zeke, I want you to go to the top of the earth, too. Go to the East. And do be careful! Find out what a train is like.

**Zeke.** Yes, Granny. *(Exits.)*

*(Loud train whistles are heard offstage.)*

**Young 'Un** *(jumping up and down).* I bet it's a train! A train! A Train! *(Yells are heard offstage.)* What's that?

**Granny.** People. Lots of people. *(Pounding is heard offstage.)*

**Young 'Un.** Granny, look up there. *(A spike appears in the ceiling.)*

**Granny.** Now, what's that?

**Young 'Un.** Don't know. But it's pretty.

**Granny.** Go see what it is. Might be good to eat.

**Young 'Un.** *(stretching up to touch the spike)* Owwww. My jaw! *(Drops to stage level.)*  
That's not good to eat.

**Granny.** What's it good for?

**Young 'Un.** I don't know. But it surely is pretty, up there on our ceiling.

**Lem.** *(entering and speaking excitedly)* Granny! Granny! The train's a fire wagon! It runs on tracks. It came from the West. They call it Central Pacific.

**Granny.** So what?

**Lem.** It's full of people and cargo!

**Zeke** *(entering and speaking excitedly)* Granny! Granny! The train's a fire wagon. It came from the East.

**Granny.** So what?

**Zeke.** Its full of people.

**Granny.** I just can't understand what all the fuss is about.

**Lem.** Don't you see? It's important!

**Granny.** Why?

**Lem.** Because now folks can ship goods from the West Coast to the East Coast. The Central Pacific brought Japanese tea right here. Tomorrow the Union Pacific will carry that tea east all across the EN-TIRE United States.

**Granny.** Who wants tea?

**Zeke.** And, Granny, the Union Pacific carried passengers. Those passengers are going to get on the Central Pacific. Now, people can travel by train across the en-tire United States.

**Granny.** Who wants to travel by train?

**Young 'Un.** And, Granny, they drove a golden spike into the ground to join the two railroads.

**Granny.** What's important about that?

**Young 'Un.** Don't you know, Granny?

**Granny.** No.

**Young 'Un.** We are the earthworms in the whole wide world who have a golden spike in the ceiling of their tunnel.

**Granny.** Now I understand. That's something to celebrate!

*(Earthworms sing the dance to tune of "Turkey in the Straw.")*

**First group of earthworms.**

Oh, the Central Pacific  
was best in the west.

**Second group of earthworms.**

Folks in the East  
thought the Union was best.

**All earthworms.**

So they all got together  
and joined the two.  
Now folks can cross the country  
And say "How'd you do?"  
Boom de-de-ada.  
Boom! Boom!

**Granny** (loudly). Ladies and gentlemen, let me remind you. The important point is: we the earthworms of Promontory Point, Utah, are the only earthworms in the whole wide world who have a golden spike in the ceiling of their tunnel. Thank you!

**Others.** Yeah! Yeah! (*The puppets disappear singing, "Da, da, da" to the tune of "Turkey in the Straw." Song fades out after a few measures.*)

**How to Make an Earthworm Puppet**

**Materials:** old stocking or long sock, poster paint or marking pencils, and construction paper or aluminum foil.

Put one hand and arm into an old stocking or long sock with your fingers in the toe. Close your fist. Open it slightly. As you look at your sock-covered palm, can you imagine how an earthworm would look if he were talking?

Take poster paint or marking pencils (or any colored paint that will stick to the stocking or sock you have chosen) and at the tip end of the sock, where it covers your fingernails, paint the earthworm's big upper lip. Paint his big lower lip near the base of the palm of your hand. Paint big eyes on the stocking covering your hand's middle knuckles.

When you open your fist slightly and close it again, the puppet's mouth will appear to change position as you talk for him. If you do not want to paint features on the stocking, cut eyes and mouth from construction paper or aluminum foil and fasten them in place.

From *Play A Part*, Bernice Wells Carlson, Pages 54-59, "The Golden Spike" copyright © 1970 Abingdon Press. Reprinted by permission.



## THE LITTLE ENGINE THAT COULD

A little engine scales the mountain by sheer willpower and positive thinking in this familiar story by Watty Piper.

### APPROACH

Leader narrates story and uses the Little Blue Engine puppet; children supply dialogue and/or manipulate a puppet.

### PUPPETS/PROPS

#### Characters/Props

Happy Little Train (Red)  
Shiny New Engine  
Big Black Engine  
Rusty Old Engine  
Little Blue Engine  
Toys and gifts

#### Types/Materials

Picture pin-on puppets  
  
  
  
Large paper puppet  
Children

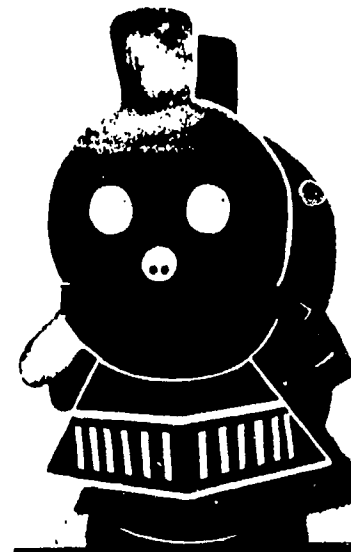

Cardboard puppet for *The Little Engine That Could*

### PRESENTATION

#### General procedures

Have the children sit on the floor near the back of the storytelling area with a large open space in front of them. Be sure to have the Little Blue Engine puppet hidden behind your chair. After the children have been assigned their parts, they will move around the story area acting the parts of different toys, gifts, and trains as the story is told.

#### Introduction

Warm-up activities based on the characters and theme of the story will prepare children for sound and action participation.

Ask the children to find their own space in the storytelling area. Then say, "Close your eyes and picture all the special food and presents you'd like to have on your birthday. Open your eyes. What are some of the things you imagined?" Give children an opportunity to share their ideas.

Continue, "When I clap my hands, move as if you were the thing I name. When I say 'Freeze,' stand as still as a statue until I clap my hands again." Use the following toys, as well as toys mentioned by the children, as examples: clown, teddy bear, spinning top, basketball, elephant, sailboat.

Reproduced with permission of the American Library Association from *Storytelling With Puppets*, by Connie Champlin and Nancy Renfro, © 1985.

"This time when I clap my hands, imagine that you are eating whatever I name. You might want to add sound effects as you eat each item." Examples include: ice cream cone, candy bar, pretzel, glass of milk, birthday cake with lots of frosting.

"Now, imagine that you are a freight train with a long line of boxcars moving along the railroad track. When I clap my hands begin to move around the room as if you were that long freight train. Don't forget to make the sound effects for your train."

"Now the train is very small. It has only an engine and a caboose. How does that train move and sound as it travels along the track?"

When children are seated, introduce the story.

*The Little Engine That Could* is about a Happy Little Train with a cargo of toys and food who is having trouble getting over the mountain. Luckily, a Little Blue Engine passes by who is willing to try to pull the Happy Little Train over the mountain.

Bring out the pin-on pictures of the trains in the story and select children to be each one: the Happy Little Train, the Shiny New Engine, the Big Black Engine, and the Rusty Old Engine. Pin the picture of the appropriate train directly onto the children's clothing. The Happy Little Train is at the front of the storytelling area, while the other trains sit at the back. Ask the remaining children to be the toys and other good things being carried by the Happy Little Train. Children will move and talk as that toy or present during the storytelling.

### **Story actions**

Happy Little Train makes chugging sounds as the first part of the story is told.

Happy Little Train comes to a halt. Chugging sounds stop.

Shiny New Engine moves to front. Children (as toys) ask Shiny New Engine to help them get over the mountain.

Shiny New Engine refuses and steams off to the back of the playing area.

Repeat action and dialogue for Big Black Engine and Rusty Old Engine.

Little Blue Engine appears. Toys ask for help getting over the mountain.

Little Blue Engine moves in front of Happy Little Train.

With Little Blue Engine the storyteller leads the Happy Little Train and all its toys and presents around the room in a continuous line while saying, "I think I can, I think I can, I think I can!" Toys join in repeating the refrain.

Little Blue Engine circles the room once and then returns to original position saying, "I thought I could. I thought I could. I thought I could."

#### **FOLLOW-UP ACTIVITIES**

Make up a refrain for each of the other engines to say as it moves around the room.

#### **Construction of Little Engine Cardboard Puppet**

##### **MATERIALS**

Poster board sheet                      Paint  
Paper cup

##### **PROCEDURES**

Cut outline for top section and bottom section of train from poster board as shown on page 180. Paint these two sections blue.

Cut two strips 2½" wide from red poster board for the mouth. Paint these two pieces red.

Tape mouth pieces together; then tape to engine top and bottom sections. Fold mouth as shown.

Cut two finger holes, two inches apart, in center of top train section to hold puppet.

Tape a cup, open end down, over the holes. The cup serves as a nose and covers the holes.

Paint on features.

##### **OPERATION**

Slip pointer and index fingers through nose holes. Place thumb under bottom folded mouth section. Move fingers and thumb together and apart to open and close mouth.

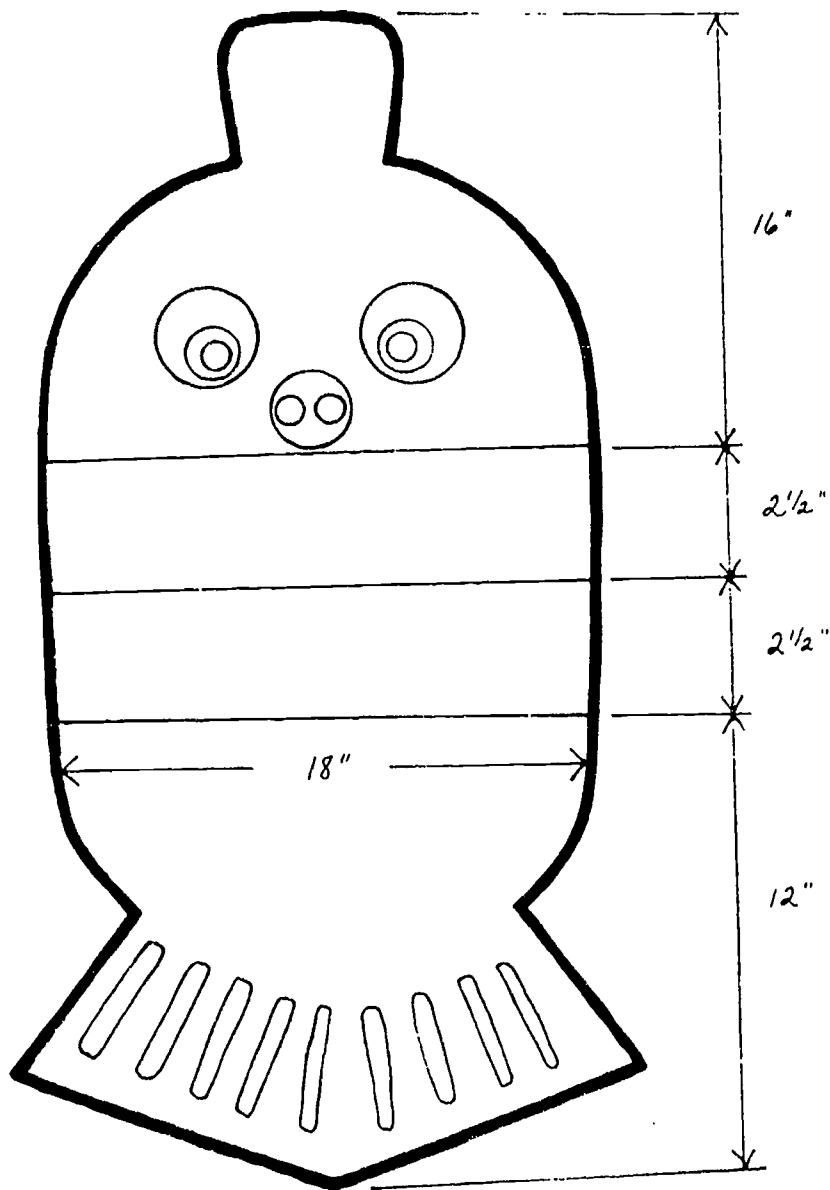

*32" long x 18" wide*

Pattern for making the Little Engine cardboard puppet



**TRAIN ENGINEER PUPPET**

*by Lois Grant, Rapides Parish Library*

Supplies:

- (1) 12" x 18" red construction paper
  - (1) 12" x 18" gray or blue construction paper
  - (1) 9" x 12" gray or blue construction paper
  - (1) 9" x 12" pink, brown or yellow construction paper  
(for face and hands)
  - (1) 9" x 12" black or brown construction paper
  - (1) 4" x 4" white construction paper
- assortment of markers



Make train engineer's basic body out of red construction paper, 12" x 18". Fold 12" x 18" paper in half (12" x 9")

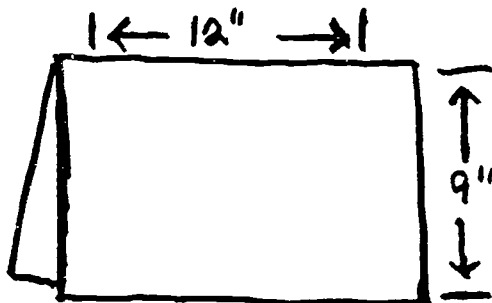

Cut in 2" on each side, fold flaps inside. Cut rounded neck hole.

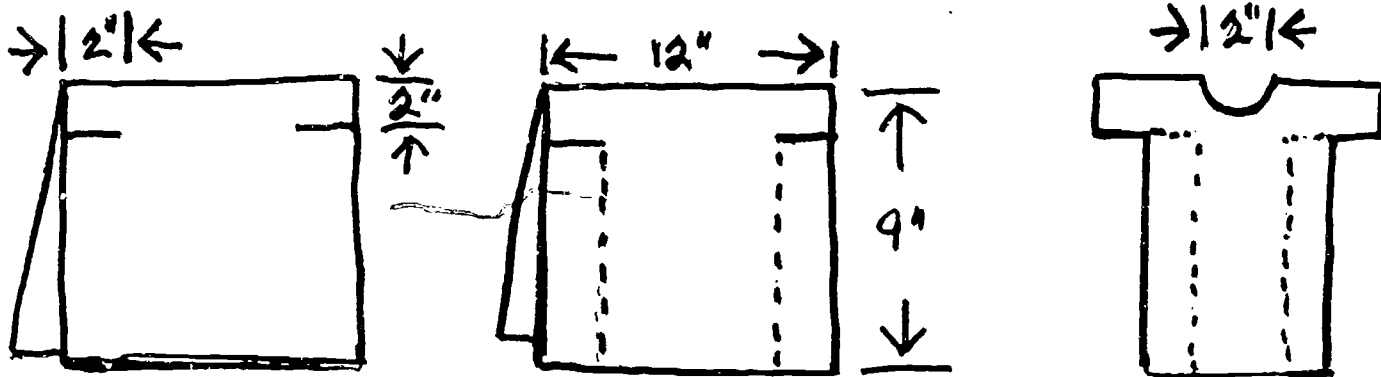

Head and hands are made of the same color. Cut two neck strips 1 1/4" x 10" (same color as head and hands). Cover a 1" x 10" cardboard strip with the two neck strips. Glue the neck between the two heads allowing 6" to extend. Insert neck into neck opening in puppet body.

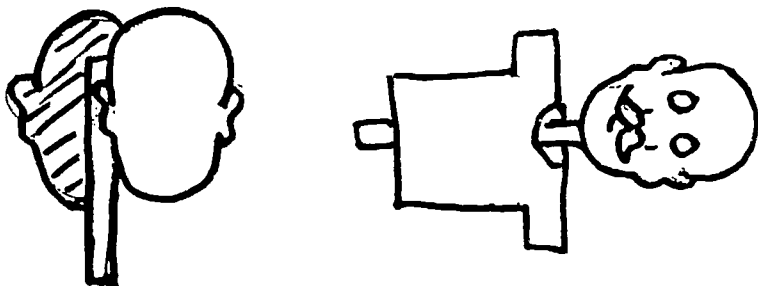

Make his overalls out of gray or blue construction paper. Give overalls a pinstriped look by drawing in lines with pencil or marker. Slip overalls over puppet body and glue in place. Train engineer has red longhandles under overalls (formed with red puppet body). Draw buttons at neck of longhandles. Her kerchief is out of white construction paper, colored red red with white & black accents. (Make it look like a bandana.) Slit the side pocket open and slip part of bandana through opening. Glue in place. Glue side of puppet body together. Hat is out of same color construction paper as overalls. Hair and mustache are black or brown. Shoes are black. If you like, you can further embellish by having Bull Durham tag hanging out of top overall pocket or by adding pocket watch chain.

Place on fold.

### Train Engineer's Overalls

Place on fold.

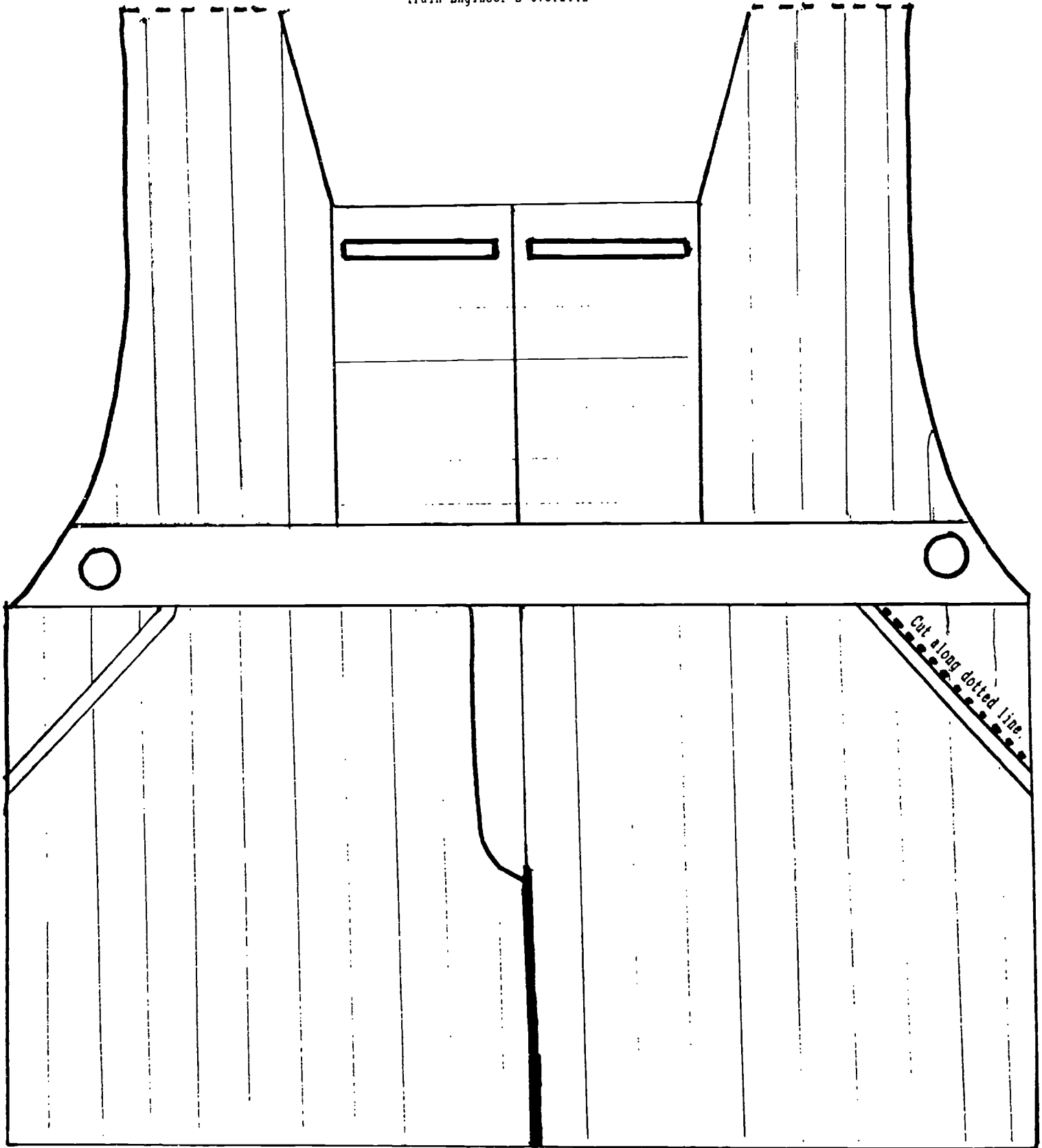

Use 12" X 18" gray or blue construction paper. Fold in half, place pattern with shoulders on fold.  
Cut out. Make light pin stripes with pencil or markers.

Train Engineer's Hat (back view)

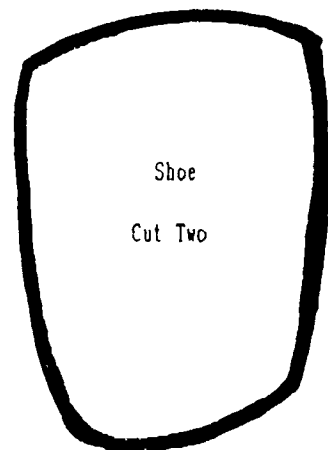
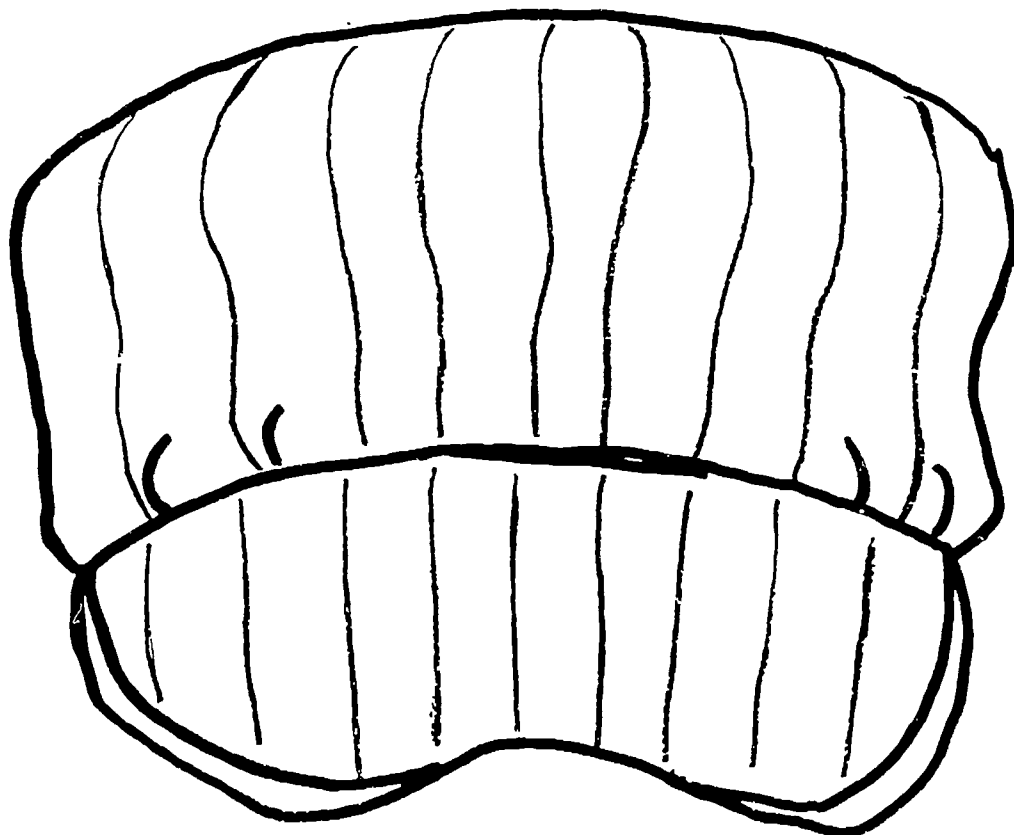
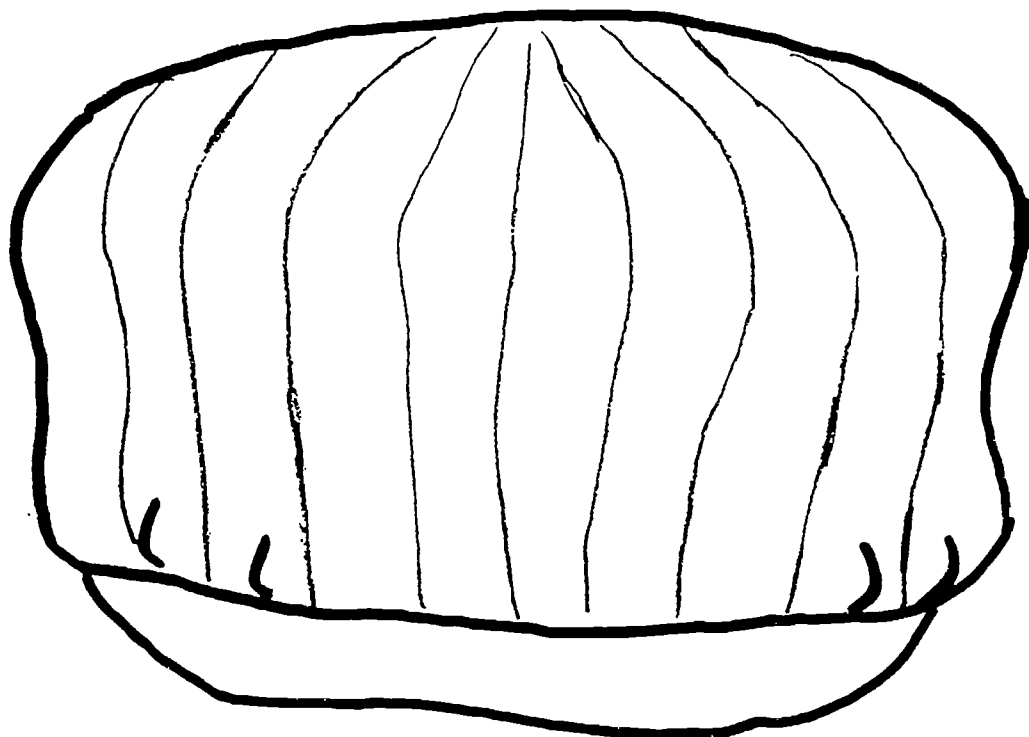

Train Engineer's Hat (front view)

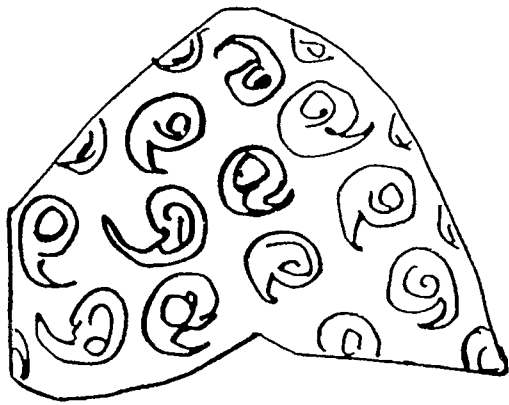

Train Engineer's Kerchief

Mustache

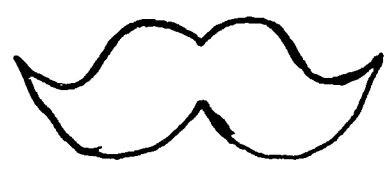

Hands  
Cut two

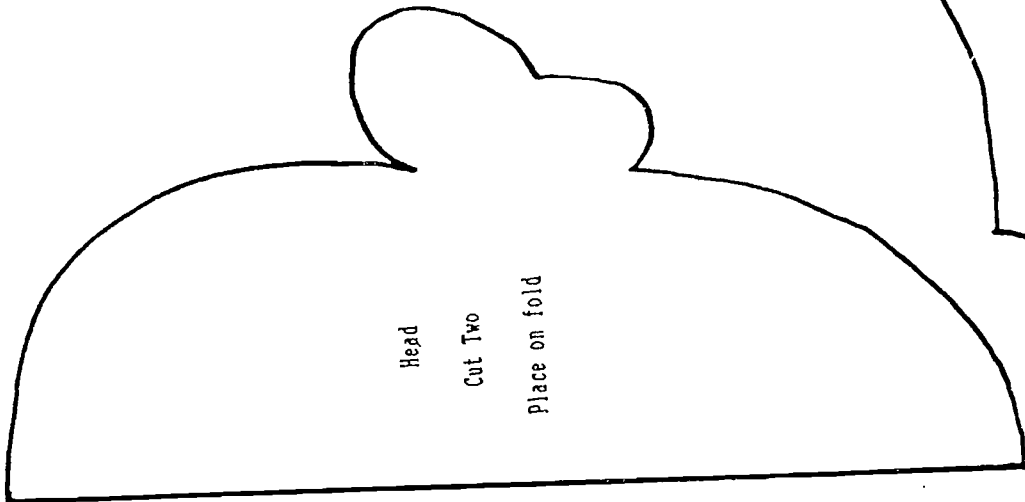

Head  
Cut Two  
Place on fold

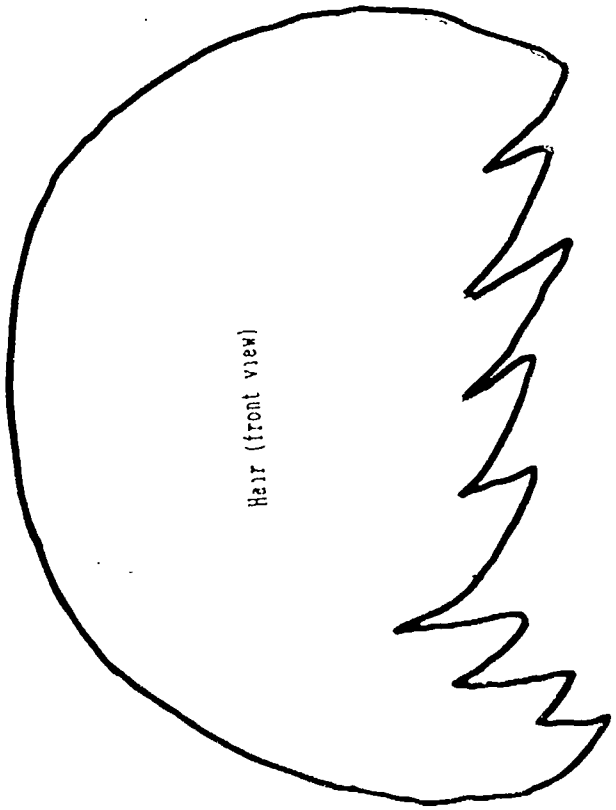

Hair (front view)

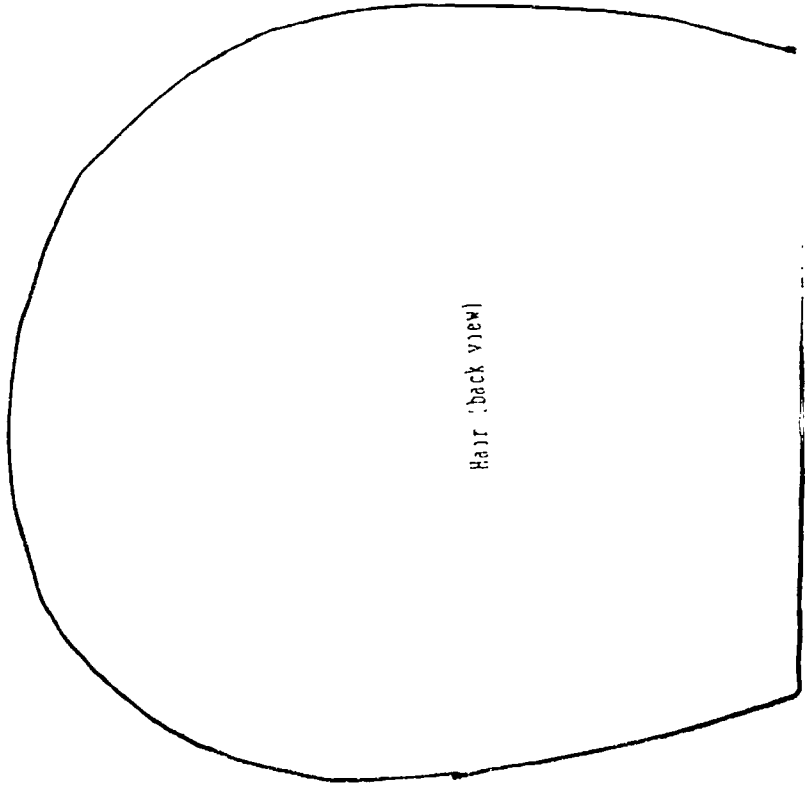

Hair (back view)

**CHUGGING TRAINS**

(Tune: Frere Jacques)

I am chugging, I am chugging,  
Round and round, round and round.  
First I chug one way,  
Then I chug the other way.  
Round and round, round and round.

I am chugging, I am chugging,  
Round and round, round and round.  
First I chug one way,  
Then I chug the other way.  
Now sit down, now sit down.

From *Totline: Preschool Patterns Activity Booklet*, by Jean Warren, © 1987. Reprinted by permission of Warren Publishing House, Inc., P.O. Box 2250, Everett, WA 98203.

**DOWN BY THE STATION**

*Traditional*

Down by the station, early in the morning,  
See the little puffer bellies all in a row.  
See the engine driver pull the little throttle,,  
Puff, puff! Toot, toot! Off we go!

From *Transportation*, by Rozanne Williams, © 1990, Creative Teaching Press, Inc. Used by permission.

# RAILROAD TALK

*Dummy* is the nickname for a small, slow train. These dummies used to stop at every cow barn to pick up milk for the city markets.

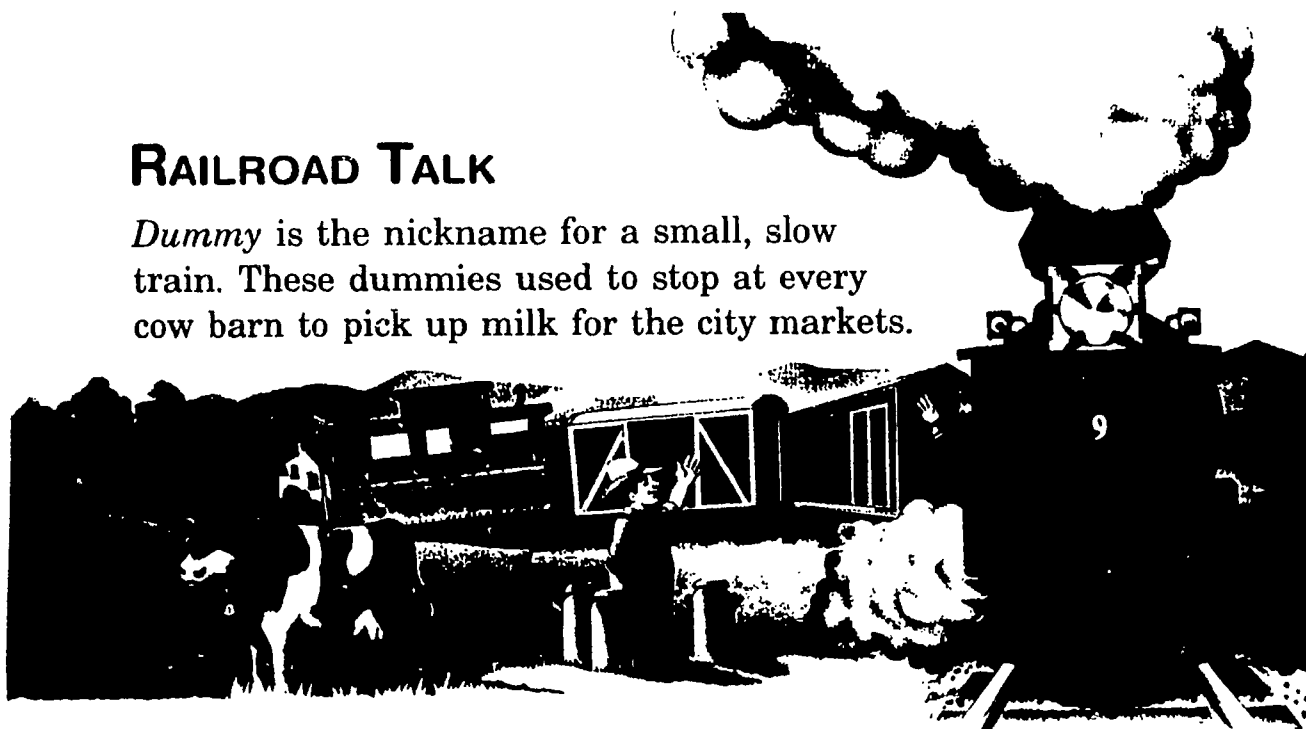

## The Dummy Line

Folk Song from Southern United States



(A) G C G C

1. Some folks say that the Dum - my don't run.  
 2. I got on the Dummy, did - n't have \_\_\_ my fare,

G D7

Come and let me tell you what the Dum - my's \_\_\_ done;  
 7 Con - duc - tor hol - lered, "What you do - ing \_\_\_ there?"

G C D7

She left St. Louis at half past one. And she  
 7 I jumped up and made for the door, And he

G D7 G

rolled in - to Mem - phis at the set - ting of the sun.  
 cracked me on the head \_\_\_ with a two \_\_\_ by \_\_\_ four.

**B** REFRAIN

On the Dum - my, ——— on the Dum - my line,  
 Rise and shine. Rise and shine and pay your fine,  
 When you're rid - ing on the Dum - my,  
 on the Dum - my, Dum - my line.

3. I hopped off the Dummy and I lit on the track,  
 Dragged my feet and scraped my back.  
 I came to life and slung my dogs,  
 Looked for sure like I'm on the hog. *Refrain*
4. Some folks say that the Dummy don't run;  
 Come and let me tell you what the Dummy's done.  
 She left St. Louis at half-past two,  
 But I walked to Memphis 'fore the Dummy came through. *Refrain*

Can you find this melody pattern in the song?  
 Can you sing it? Can you play it on the bells?

B

© 1991 Silver Burdett & Ginn from WORLD OF MUSIC. All rights reserved. Used with permission.



## 4 • SONGS

### THE ELEPHANTS GO MARCHING

(Tune: When Johnny Goes Marching Home)

The elephants go marching ten by ten,  
Hurrah, hurrah.

The elephants go marching ten by ten,  
Hurrah, hurrah.

The elephants go marching ten by ten,  
The tenth one stops to scratch his chin,  
As they all go marching down,  
To the town,  
To visit the zoo.

The elephants go marching nine by nine,  
Hurrah, hurrah.

The elephants go marching nine by nine,  
Hurrah, hurrah.

The elephants go marching nine by nine,  
The ninth one stops to look for twine,  
As they all go marching down,  
To the town,  
To visit the zoo.

(3rd verse)

The elephants go marching eight by eight . . .  
The eighth one stops to shut the gate, . . .

(4th verse)

The elephants go marching seven by seven . . .  
The seventh one stops to pray to heaven, . . .

(5th verse)

The elephants go marching six by six . . .  
The sixth one stops to pick up sticks, . . .

(6th verse)

The elephants go marching five by five . . .  
The fifth one stops to see the bee hive . . .

(7th verse)

The elephants go marching four by four . . .  
The fourth one stops to open the door, . . .

(8th verse)

The elephants go marching three by three . . .  
The third one stops to rests his knees, . . .

(9th verse)

The elephants go marching two by two . . .  
The second one stops to admire the view, . . .

(10th verse)

The elephants go marching one by one . . .  
The first one stops have some fun,  
So no one made it down,  
To the town, to visit the zoo.

### **I'M A LITTLE RED TRAIN**

(Tune: I'm a Little White Duck)

I'm a little red train,  
Chugging down the track,  
A little red train  
going up and back.  
I travel all day  
Going round and round,  
Taking goods from town to town.      •  
I'm a little red train  
Going down the track,  
Chug-chug-chug.

From *Totline*, July/August 1987, words by Jean Warren. Reprinted by permission.

### **LET'S GO DRIVING**

(Sung to: Frere Jacques)

Let's go driving, let's go driving,  
Around the block, around the block.  
We will keep on driving, we will keep on driving,  
Then we'll stop, then we'll stop.

From *Piggyback Songs for Infants and Toddlers*, © 1985. Reprinted by permission of Warren Publishing House, Inc., P.O. Box 2250, Everett, WA 98203.

## 6 • SONGS

### MY FAVORITE MACHINE

(Sung to: My Bonnie Lies Over the Ocean. Substitute various machines and their functions where indicated by parenthesis.)

My favorite machine's a (steam shovel)  
I sure like the way that it works.  
My favorite machine's a (steam shovel)  
Oh come watch my (steam shovel) work!  
(Scoop dirt, scoop dirt) I sure like the way that it works.  
(Scoop dirt, scoop dirt) O come watch my (steam shovel) work.

From *Piggyback Songs: Compiled from Songs Contributed to the Totline Newsletter*, © 1983.  
Reprinted by permission of Warren Publishing House, Inc., P.O. Box 2250, Everett, WA 98203.

### OFF WE GO - A TRAVELING SONG

(Sung to: Frere Jacques)

Here's the train  
Here's the train  
All aboard  
All aboard  
Chug-a-chug a-choo-choo  
Chug-a-chug a-choo-choo  
Off we go  
Off we go

From *Piggyback Songs: Compiled from Songs Contributed to the Totline Newsletter*, © 1983.  
Reprinted by permission of Warren Publishing House, Inc., P.O. Box 2250, Everett, WA 98203.

### OLD MACDONALD'S TRUCK

(Sung to: Old MacDonald Had a Farm)

Old MacDonald had a truck, E-I-E-I-O.  
And into town he drove his truck, E-I-E-I-O.  
With a bump, bump here,  
And a bump, bump there,  
Here a bump, there a bump,  
Everywhere a bump, bump.  
Old MacDonald had a truck, E-I-E-I-O.

Old MacDonald had a truck, E-I-E-I-O.  
 And on his truck he had a horn, E-I-E-I-O.  
 With a beep, beep here,  
 And a beep, beep there,  
 Here a beep, there a beep,  
 Everywhere a 'beep, beep.  
 Old MacDonald had a truck, E-I-E-I-O.

From *Piggyback Songs for Infants and Toddlers*, © 1985. Reprinted by permission of Warren Publishing House, Inc., P.O. Box 2250, Everett, WA 98203.

### THE TRAIN

by *Judith Taylor*

(Sung to: The Farmer in the Dell)

The train is on the track,  
 the train is on the track.  
 Clickity-clack, oh, clickity-clack,  
 The train is on the track.

The engineer drives the train,  
 The engineer drives the train.  
 In the snow and in the rain,  
 The engineer drives the train.

The caboose is at the back,  
 The caboose is at the back.  
 Clickity-clack, oh, clickity-clack,  
 The caboose is at the back.

From *Theme-A-Saurus II*, by Jean Warren, © 1990. Reprinted by permission of Warren Publishing House, Inc., P.O. Box 2250, Everett, WA 98203.

### TRAIN SONG

(Sung to: Wheels on the Bus)

The conductor on the train yells, "All aboard."  
 All aboard, all aboard.  
 The conductor on the train yells, "All aboard."  
 Early in the morning.

## 8 • SONGS

The engine on the train goes chug, chug, chug.  
Chug, chug, chug,  
Chug, chug, chug.  
The engine on the train goes chug, chug, chug.  
As it leaves the station.

The wheels on the train go clickty clack,  
Clickty clack,  
clickty clack.  
The wheels on the train go clickty clack,  
As it rides down the railroad track.

The passengers on the train say, "Ooh and aah,"  
Ooh and aah,  
ooh and ahh.  
The passengers on the train say, "Ooh and aah."  
As they ride down the railroad track.

The brakes on the train go sshh, sshh, sshh;  
Sshh, sshh, sshh;  
sshh, sshh, sshh.  
The brakes on the train go sshh, sshh, sshh.  
As it comes into the station.

The conductor on the train says, "Everybody off."  
Everybody off, everybody off.  
The conductor on the train says, "Everybody off."  
As it comes into the station.

### A TRIP TO THE ZOO (sung to: Mulberry Bush)

We get in line to march to the zoo,  
March to the zoo, march to the zoo.  
We get in line to march to the zoo.  
So early one fine morning.

We tiptoe by the lion cage,  
Lion cage, lion cage.  
We tiptoe by the lion cage.  
So early one fine morning.

We peer into the elephant pit,  
 Elephant pit, elephant pit.  
 We peer into the elephant pit.  
 So early one fine morning.

We laugh so hard at the monkeys there,  
 The monkeys there, the monkeys there.  
 We laugh so hard at the monkeys there,  
 So early one fine morning.

We take a ride on the choo choo train,  
 The choo train, the choo train.  
 We take a ride on the choo choo train,  
 So early one fine morning.

### THE WHEELS ON THE BUS

Oh, the wheels on the bus go round and round,  
 Round and round, round and round.  
 Oh, the wheels on the bus go round and round,  
 All through the town.  
 (make circling motions with hands.)

Oh, the wipers on the bus go swish, swish, swish,  
 Swish, swish, swish, swish, swish, swish.  
 Oh, the wipers on the bus go swish, swish, swish,  
 All through the town.  
 (Move hands back and forth like windshield wipers.)

Oh, the people on the bus go up and down,  
 Up and down, up and down.  
 Oh, the people on the bus go up and down,  
 All through the town.  
 (Move body up and down.)

(Additional verses: The horn on the bus goes toot, toot, toot; The baby on the bus goes waa, waa, waa; the mother on the bus goes shh, shh, shh; etc.)

From *Piggyback Songs for Infants and Toddlers*, © 1985. Reprinted by permission of Warren Publishing House, Inc., P.O. Box 2250, Everett, WA 98203.

## 10 • SONGS

### THE WHEELS ON THE TRAIN

*adapted by Martha Jordan, Ouachita Parish Library*

The wheels on the train go clickety-clack,  
Clickety-clack, clickety-clack.  
The wheels on the train go clickety-clack,  
All along the tracks.

The brakes on the train go hiss, hiss, hiss . . .

The conductor on the train goes "All aboard!" . . .

The engine on the train goes choo, choo, choo . . .

The whistle on the train goes toot, toot, toot . . .

The people on the train go wave, wave, wave . . .

## AUDIOVISUAL MATERIALS

## AUDIOCASSETTES

*The Boxcar Children Mystery Series* by Gertrude Chandler Warner, performed by Phyllis Newman. Each unabridged 2-cassette title is \$15.95. Available from: Listening Library, Inc., One Park Avenue, Old Greenwich, CT, 06870-1727, (800) 243-4504. Titles include:

<i>The Boxcar Children</i>	C YA 830 CX
<i>Surprise Island</i>	C YA 831 CX
<i>Yellow House Mystery</i>	C YA 832 CX

*Railway Children* by E. Nesbit, read by Dinah Sheridan. 2 cassettes, 1 book, 2½ hours, 1981. Available from: Listen for Pleasure, One Colomba Dr., Niagara Falls, NY 14305, (800) 962-5200 or (716) 298-5150.

*Trouble for Thomas and Other Stories* by Rev. W. Awdry. 21:26 min., 1991. Available from: Random House AudioBooks, 201 E. 50 St., New York, NY 10022, (212) 751-2600.

*Wee Sing Fun 'n' Folk*, by Pamela Conn Beall, 1989: ISBN cassette: 0843127597. ISBN book: 0843127600. Available from Price/Stern/Sloan, 11150 Olympic Blvd., 6th Floor, Los Angeles, CA 90064-1823, (800) 421-0892, (213) 657-6100 Also available from Walden Books.

## FILMS, VIDEOS, AND FILMSTRIPS

The following films, videos, and filmstrips may be borrowed from the State Library (LSL), Jefferson Parish Library, (JPL), and Vernon Parish Library (VPL).

**AMERICA'S RAILROADS: HOW THE IRON HORSE SHAPED OUR NATION** (LSL) 16mm, 22 min, 1985, gen

Presents an overview of events which led to the growth of the railroad system in the United States. Also shows how railroads molded the pattern of immigrant communities in America.

**ANGUS LOST** (LSL) 16mm, 11 min, 1982, p-el

Angus is a very curious, very clever Scottish terrier whose curiosity gets him into a number of close scrapes. A live action non-verbal adaptation of Marjorie Flack's classic book.

**BASICS OF MODEL RAILROADING** (VPL) VHS

**BIG HENRY AND THE POLKA DOT KID** (LSL) 16mm, 32 min, 1976, el-jh

A young boy's efforts to save an old dog teach his uncle that "being practical" is not the only thing in life. Morley Callaghan's story is filled with humor and suspense.



## 2 • AUDIOVISUAL MATERIALS

**BLACKBERRY SUBWAY JAM (JPL)** 16mm, 8 min, 1938, p-j

**CAJUN COUSINS (LSL)** 16mm, 24 min, 1976, jh-sh

Lisa lives in Sunset, in the bayou country of Louisiana, and Randy lives in Acadian Nova Scotia - 3,000 miles apart, yet they share a common heritage. Many scenes are familiar to rural Louisiana: crawfish harvesting, hunting, the small rural school house where the students are bilingual.

**CAPTAIN SILAS (JPL)** 16mm/VHS, 14 min, 1977, p

**CATERPILLAR (LSL)** 16mm, 16 min, 1971, p-el

A caterpillar dancing to a lively tune played on a harmonica by a young boy is "discovered" by a promoter and made a world star. The caterpillar disappears but when spring comes a butterfly appears and dances the familiar jig. No narration or dialogue.

**CECILY (LSL)** 16mm, 7 min, 1974, p-el

An animated story about a little girl who, discovering she can fly by flapping her ears, takes off for Africa. She makes friends with the elephants, whose ears are as big as hers, and becomes famous as the leader of the Pachyderm Chorus.

**CICERO: THE QUEEN'S DRUM HORSE (LSL)** 16mm, 31 min, 1978, el-a

A heartwarming true-life story of an Irish farm horse which today prances in the forefront of Britain's royal parades bearing the Queen's silver drums. Includes lovely scenes of Ireland as well as the trooping of the colors parade in London.

**COAL, SMOKE & STEAM (VPL)**

**COUNTRY COYOTE GOES HOLLYWOOD (LSL)** 16mm, 37 min, 1967, gen

Chico, a desert coyote, accidentally hitches a ride to Hollywood. Viewers will delight in watching this remarkable creature adapt to his new environment.

**ELEPHANT WHO COULDN'T FORGET (LSL)** 16mm, 10 min, 1981, p-el

A funny and tender animated story about a young elephant, Congo, who has a super memory. It takes a long talk with his grandmother to convince him that sometimes you have to forget something that isn't important in order to remember something that is. Based on the book by Faith McNulty.

**FIRE CHIEF DONALD (LSL)** 16mm, 8 min, 1940, p-el

Here's everyone's favorite duck - enraged, exasperated, and always ready to try again. Only Fire Chief Donald could set fire to his own fire station and then douse the fire with gasoline instead of water. With personality fully developed, Donald is at his irascible best in this cartoon.

**FREIGHT TRAINS TODAY (JPL)** 16mm, 11 min, 1968, p

**THE GENERAL** (LSL) 16mm, 27 min, b&w, 1964, gen

Made in 1927, directed by a starring Buster Keaton, this is a spoof on Civil War espionage, combining some spectacular war action with Keaton's dry wit. This edited version has narration which points out the film's significance in motion picture history and provides interesting commentary on the craftsmen who made this type of film.

**GNOMES** (LSL) 16mm, 48 min, 1980, gen

Tells of the wedding day in a family of woodland gnomes. Seeing a glorious opportunity to wipe out a whole group of gnomes, the wicked trolls kidnap the bride and groom. All the gnomes, including the happy pair who escape, join the friendly forest creatures in an all-out war against the trolls. A fascinating adaptation of Wil Huygen and Rien Poortvliet's popular book.

**HOOBER-BLOOB HIGHWAY** (LSL) 16mm, 24 min, 1975, p-el

Mr. Hooper-Bloob, a dispatcher from outer space, sends one of his characters down to earth via his Hooper-Bloob Highway to see what it would be like to be a human.

**IRON HORSE, GOLDEN SPIKE** (VPL) filmstrip FSC-754, 17 min, 1975

**JOHNNY CASH: RIDIN' THE RAILS** (LSL-16mm & VPL-vhs) 16mm/VHS, 50 min, 1983, gen

An exciting, colorful history of America's railroads from 1830 to the present, with Johnny Cash narrating and singing 18 railroad folk songs. Filmed entirely on location at historic sites, railroad yards, and museums.

**KANSAS CITY SOUTHERN LINERS** (VPL) VHS, 80 min

**LAMBERT THE SHEEPISH LION** (LSL) 16mm, 8 min, 1951, p-el

The stork delivers Lambert, by mistake, to a flock of sheep. They poke fun at him because he is different but he earns their respect when he saves the flock from a hungry wolf.

**LITTLE ENGINE THAT COULD** (LSL & JPL) 16mm, 10 min, 1963, p-el

Based on the children's classic which tells of the Little Engine that pulled a trainload of toys over the mountain because she thought she could. Based on the book by Watty Piper.

**LITTLE TOOT** (LSL & JPL) 16mm, 9 min, 1948, p-el

This little tugboat wants to be as successful as his dad, but he keeps getting into trouble and disgracing his poor father. As punishment, he is banished beyond the 12-mile limit. One night, a ship becomes lost in a storm, and Little Toot brings it in to the harbor, against all odds, and redeems himself. From the book by Hardie Gramatky.

**LOVE THOSE TRAINS** (VPL) VHS, 60 min, 1984

#### 4 • AUDIOVISUAL MATERIALS

**MADLINE'S RESCUE (LSL)** 16mm, 7 min, 1968, p-el

The full text of the story by Ludwig Bemelmans. Tells the story about a dog who saves Madeline from the waters of the Seine River and becomes a companion to Madeline and her little friends.

**MAGOO'S PUDDLE JUMPER (JPL)** 16mm, 7 min, 1956, i-j

**MICKEY'S TRAILER (LSL & JPL)** 16mm, 8 min, 1938, p-el

Mickey, Donald and Goofy go for a holiday in Mickey's trailer with Goofy driving. But when Mickey announces breakfast is ready, Goofy leaves the car driverless and the trailer comes unhooked!

**MODEL RAILROADING UNLIMITED, TITLE B (edited version) (JPL)** VHS, 19 min, 1978, i-sh

**MORRIS GOES TO SCHOOL (LSL)** 16mm, 14 min, 1990, p-el

Morris the Moose finds life confusing and a bit overwhelming --until he goes to school. There he learns to read, write, spell, and count! Three-dimensional puppet animations. Includes two songs.

**MOUSE AND THE MOTORCYCLE (LSL)** 16mm, 41 min, 1987, p-el

Uses the live-action and dimensional animation to present the story of a young boy who is saved from a boring weekend in a run-down hotel by a motorcycle-loving mouse who leads him on a series of exciting adventures. Based on the book by Beverly Cleary.

... **A NICE FLYING MACHINE (JPL)** VHS, 9 min, 1985, i-sh

**RAILROAD (VPL)** VHS, 45 min

**RAILWAY OF DEATH: BURMA (VPL)** VHS, 45 min, 1988

**RALPH S. MOUSE (LSL)** 16mm, 40 min, 1990, p-el

Ralph accompanies his friend Ryan to school, where he "shares" the students' lunches, has run-ins with the janitor, and helps with a maze experiment.

**RED BALL EXPRESS (LSL)** 16mm, 4 min, 1975, gen

Uses animation techniques in order to create various shapes and colors representing a train. Background music is "Orange Blossom Special."

**REMARKABLE RUNAWAY RIDERLESS TRICYCLE** (LSL) 16mm, 11 min, 1982, p-el

A live-action, non-verbal story of a young boy who leaves his tricycle to play with a kite retrieved from a trash can. The tricycle is mistakenly picked up on trash day and taken to the junk yard. Just as it is about to be crushed for scrap metal, the tricycle magically takes off. The tricycle has an amazing adventure through town, finally pedaling its way back to the little boy.

**THE RIDE** (LSL) 16mm, 8 min, 1968, gen

A chauffeur and his business tycoon employer take a ride in the beautiful Laurentian country. Slapstick comedy, good for old and young alike. No narration.

**RUNAWAY RALPH** (LSL) 16mm, 40 min, 1988, p-el

In this sequel to *The Mouse And The Motorcycle*, Ralph the mouse runs away from home on his motorcycle and continues his adventurous life. Based on the book by Beverly Cleary.

**SONGS OF THE RAILROAD** (VPL) filmstrip FSC-742, 1974.

**STEAMBOAT** (LSL) 16mm, 11 min, 1976, p-el

A non-verbal exploration of the Delta Queen steamboat, the oldest overnight paddle-wheeler on the Mississippi River. Presented from a child's viewpoint. Records the actual sound of the boat's operations, combined with steam piano and river songs.

**STEAMBOAT-A-COMIN'** (LSL) 16mm, 22 min, 1981, jh-a

Traces the development and impact of steamboats on the Mississippi River and shows different boats which are still seen on the river. Uses archival photographs and current footage.

**STEAMBOAT WILLIE** (LSL & JPL) 16mm, 8 min, b/w, 1928, p-el

On November 18, 1928, the world's first synchronized sound cartoon opened at the Colony Theater in New York - and a new film star was born. The cartoon was "Steamboat Willie;" the new star was Mickey Mouse. Here's Mickey just as he was then, in a performance that made film history.

**TAWNY SCRAWNY LION** (LSL) 16mm, 7 min, 1974, p

A lion who is always hungry and always trying to catch other animals for his next meal is outwitted by a fat little rabbit who finds a way to satisfy the lion's appetite and save all the other animals. Based on the book by Kathryn Jackson.

**THUNDER ON THE RAILS** (VPL) VHS, 30 min, 1990

**TOCCATA FOR TOY TRAINS** (JPL) 16mm, 14 min, 1957, p

**TRAINS, A FIRST FILM** (JPL) 16mm, 11 min, 1969, p-i

## 6 • AUDIOVISUAL MATERIALS

**TROLLS AND THE CHRISTMAS EXPRESS (JPL)** 16mm, 25 min, 1981, p-a

**TRUCK SONG (LSL)** 16mm, 13 min, 1988, p-jh

In a child's eye, trucks (and truck drivers) are special. A lively country/western tune is the background for Diane Siebert's narrative poem. From the loading of a large gray-white-chrome beauty to its unloading across the country, Truck Song shows trucks of every imaginable kind, size and color.

**20,000 LEAGUES UNDER THE SEA (JPL)** 16mm, 27 min, 1978, j-sh

**TUGBOAT MICKEY (LSL)** 16mm, 8 min, 1937, p-el

Tugboat Captain Mickey hears on the radio what he thinks is a distress signal from a sinking ship and orders his two-man crew to the rescue. Their energetic ineptitude leads from one hilarious mishap to another.

**UNION PACIFIC 8444 (VPL)** VHS, 60 min, 1987

**WHERE THE WILD THINGS ARE (LSL)** 16mm, 8 min, 1975, p-el

Maurice Sendak's story of the wild things who roar their terrible roars and gnash their terrible teeth and roll their terrible eyes and show their terrible claws.

## RESOURCE LIST

### ASSOCIATIONS

#### **Association of American Railroads**

American Railroad Building  
50 East, N.W.  
Washington, D.C. 20001  
Office of Information and Education - Public Relations  
(202) 639-2550

#### **National Railway Historical Society**

P.O. Box 58153  
Philadelphia, PA 19102  
(215) 557-6606

#### *Louisiana Chapters:*

New Orleans Chapter  
P.O. Box 4355  
New Orleans, LA  
(504) 835-6021  
Contact: Maunsel White

Ponchartrain Chapter  
(New Orleans, Kenner & Metairie)  
(504) 288-6489

Southeast Louisiana Chapter  
P.O. Box 3042  
Baton Rouge, LA 70821  
(504) 753-5286  
Contact: David Brighters, Pres.

Pearl River Valley Chapter  
(Bogalusa Area)  
(504) 735-6335  
Contact: L. Everett Watson

**Crescent City Model Railroad Club**

601 North Lester  
Metairie, LA 70003  
(504) 737-3723 (message machine)  
Contact: Mike Poche  
(504) 834-2691

Membership is willing to provide speakers to local libraries. Some members may be able to provide displays for libraries. The club has a large model railroad layout in Metairie. Members have pictures, slides and videos.

**CATALOGS**

**Accent Annex**

1120 S. Jeff Davis Pkwy.  
New Orleans, LA 70125-9901

Engineer Cap, \$4.25 ea., 1 dozen or more, \$4.00 ea.

**Avon Products, Inc.**

9 West 57th St.  
New York, NY 10019

Christmas catalog included a "Jolly Express Gingerbread Cookie Kit" with ingredients and instructions for making a gingerbread, three dimensional train. Contact an Avon representative to purchase.

**Demco**

Box 7488  
Madison, WI 53707  
(800) 356-1200

First train set.

**Dover Pictorial Archive Catalog**

Dover Publications  
31 East 2nd Street  
Mineola, NY 11501

Several Dover publications include modern and historical trains.

**Early Learning Materials**

ABC School Supply, Inc.  
3312 N. Berkeley Lake Rd.  
P.O. Box 100019  
Duluth, GA 30136

Toy trains, train whistle, puzzles, building set.

**Harriet Carter**

Dept. 32  
North Wales, PA 19455

Train clocks, cap desk pen set, stapler, tape dispenser, and other items.

**Highsmith Co.**

W5527 Highsmith 106  
P.O. Box 800  
Fort Atkinson, WI 53538-0800

Corrubaord Train Display; *The Polar Express* book, audiocassette, sleigh bell, and poster; Bi-Fokal kit, "Remembering Train Rides".

**Listening Library, Inc.**

One Park Avenue  
Old Greenwich, CT 06870-1727

*The Little Engine That Could* book, cassette, and 9" high doll.

**Music for Little People**

P.O. Box 1460  
Ridway, CA 95560

Thomas the Tank Engine books, videos, toys.

**Play Fair Toys**

P.O. Box 18210  
Boulder, CO 80308

Train set, train music box.



**Rivershore Reading Store**

2005 32nd Street  
Rock Island, IL 61201  
(309) 788-7717

Locomotive paper punch, assorted engine erasers, wheel rubber stamp, wood train whistle, "READ" wooden train (engine, caboose, and four letters, 3" tall).

**Shapes, Etc.**

8840 Route 36  
P.O. Box 400  
Dansville, NY 14437  
(800) 888-6580

Stencils/template set which includes six different train cars, the conductor, and a railroad crossing sign.

**SmileMakers**

P.O. Box 2543  
Spartanburg, SC 29304

Stickers.

**Taylor Gifts**

335 East conestoga Road  
P.O. Box 206  
Wayne, PA 19087-0206

Train watch, ornaments, lamp, clocks, doormat, desk pen set, tape dispenser, stapler, and other items.

**Tipp Novelty Company**

222 N. Sixth St.  
Tipp City, OH 45371-0186  
(800) 669-2445  
FAX (513) 667-1989

**U.S. Toy Company**

1227 E. 119th Street  
Grandview, MO 64030

Engineer hat in children's and adult's sizes.

**COMPUTER DISK**

Computer Disk 223 – PC-Railroad  
**Software Labs**  
 Los Angeles, CA

**MUSEUMS**

**Illinois Railway Museum**  
 Olson Road  
 Union, IL

The museum bookshop is located in an 1851 train depot and sells everything having to do with trains, including records with famous train whistles and chugs, train schedules from across the country, destination flags, and hundreds of other varieties of railroading.

**Louisiana Toy Train Museum**  
 519 Williams Blvd.  
 Kenner, LA 70062  
 Owner: Dom C. Schwab

Model railroad museum and shop in Kenner. The collection is only a portion of Mr. Schwab's collection. He will make a proclamation for the 1993 Summer Reading Program. He is also available (locally) as a guest speaker and feels extremely comfortable with children. May be able to hook up librarians with local speakers on model railroads in areas outside of New Orleans.

**STORES**

**Big Wheel Novelties, Inc.**  
 2440 Veterans Boulevard  
 Kenner, LA 70062  
 (504) 464-1682  
 (800) 375-6853  
 FAX (504) 466-5434

**Cook's Collectors Corner, Inc.**  
 4402 Youree Dr.  
 Shreveport, LA  
 (318) 865-7632

**The Great Train Store**  
114 Riverwalk Marketplace  
New Orleans, LA 70130  
(504) 581-3531  
Manager: Shane Cron

Store in Riverwalk Marketplace. Books, whistles, toys, model trains, conductor hats. Will take telephone orders and ship.

**Kenner Train Shop**  
2000 20th St.  
Kenner, LA  
(504) 466-5876

**Louisiana Central Hobbies**  
10246 Florida Blvd.  
Baton Rouge, LA 70816  
(504) 273-0095

**Mike's Train Shop**  
1916 Williams Blvd.  
Kenner, LA  
(504) 466-8531

**Ron's Model Railroad Shop**  
1416 S. College Road  
Lafayette, LA  
(318) 232-5536

# The Trumpet Club Presents...

## All-New...On-Location...Live-Action

# TRUMPET VIDEO VISITS!



"Everything in these books is realistic. All the things that happen in both *Hatchet* and *The River* have happened to me."

Trumpet Video Visits: Gary Paulsen  
Item # 39 \$14.95 *Introductory price*  
Running time: 24 minutes VHS



"I've drawn it and re-drawn it. You have to find a way to make the illustrations work."

Trumpet Video Visits: Donald Crews  
Item # 40 \$14.95 *Introductory price*  
Running time: 19 minutes VHS



"People say *Koala Lou* must be about you and your daughter... but it's actually about my mother and me."

Trumpet Video Visits: Mem Fox  
Item # 41 \$14.95 *Introductory price*  
Running time: 18 minutes VHS

Trumpet's new live-action videos take you into the homes, studios, and memories of such celebrated classroom favorites as Donald Crews, Mem Fox, and Gary Paulsen. Witness spectacular views of the Manhattan skyline, Australian coast, and New Mexican desert and canyons...create a drawing in a real artist's studio, frolic with koalas and kangaroos, ride horseback up trails and mountains...share intimate details of the writers' lives and craft. It's all here! And each Trumpet Video Visit includes a teaching guide featuring ideas for integrating the video with author and genre studies.

"After I saw the Donald Crews and Mem Fox videos, I couldn't imagine doing author studies without them."

Cheryl Stroud, Co-Director, Teachers College Writing Project, Columbia University

## TRUMPET VIDEO VISITS...*You've never seen anything like them!*

### ORDER FORM

**Yes!**

I want to experience Trumpet Video Visits with my class and earn valuable Trumpet Club bonus points

My Trumpet Teacher Account No. is \_\_\_\_\_

Name \_\_\_\_\_

School \_\_\_\_\_

Address \_\_\_\_\_

City, State \_\_\_\_\_

Zip \_\_\_\_\_

Please send this coupon with your payment (check, payable to "The Trumpet Club") to The Trumpet Club • P.O. Box 604 • Holmes, PA 19043

Title	Item No.	Quantity	Unit Price
Trumpet Video Visits: Gary Paulsen	39		\$14.95*
Trumpet Video Visits: Donald Crews	40		\$14.95*
Trumpet Video Visits: Mem Fox	41		\$14.95*
<b>Total</b>			

\* Trumpet Video Visits are regularly priced at \$24.95. For a limited time, The Trumpet Club is offering these wonderful videos at the remarkable price of \$14.95, and we'll pay the shipping and handling costs.

Trumpet Video Visits: Donald Crews and Mem Fox will be shipped upon receipt of order. Trumpet Video Visits: Gary Paulsen will begin shipping December 1, 1992.

CR

# On the Rails

by Mary Lou Burket

**M**atthew loves trains. He plays with trains all evening, only to reach for a book about trains when it is time to go to bed. So it's no surprise to discover that Matthew dreams about trains when he goes to sleep. Toys, books, and dreams merge sublimely in *The Train* by David McPhail. They also merge in life for real children.

From a child's point of view, trains belong in an exalted class with dinosaurs. Like dinosaurs, trains are vaguely old, very big, and somehow alive. (Fleischman and Ewart combine these themes in *Time Train*.) Yet while children tend to lose interest in dinosaurs after a certain age, trains become, if anything, more interesting as children grow older: 8-year-olds play with model trains; 10-year-olds master the intricacies of how trains work; 12-year-olds discover the importance of trains in shaping American life. The subject expands to meet the needs of children at different stages of development.

Fortunately, many adults retain this sense of wonder about trains, which makes the subject an ideal one to share with younger fans. From reading about trains to remembering trains "when I was young" is a short step. Children should be encouraged to observe trains, to visit train museums, to ride trains, and to glory in books about these somewhat magical inventions.

## Picture Books

**Aylesworth, Jim.** *Country Crossing*. Illus. by **Ted Rand**. 1991. 32p. Atheneum, \$13.95 (0-689-31580-5).

**Barton, Byron.** *Trains*. 1986. 32p. HarperCollins, \$11.89 (0-690-04534-4); paper, \$4.95 (0-694-00061-2).

**Carrick, Carol.** *Left Behind*. Illus. by **Don Carrick**. 1988. 32p. Clarion, \$13.95 (0-89919-535-0); paper, \$4.95 (0-395-54380-0).

**Crews, Donald.** *Freight Train*. 1978. 32p. Greenwillow, \$12.95 (0-688-80165-X); paper, \$3.95 (0-14-050480-X).

Preschool-Gr. 2. As a man and boy in an old car approach a country crossing late at night, the peaceful scene is disrupted by the noisy approach, climactic passing, and fading sight of a train. Together Aylesworth and Rand re-create the sights and sounds of a simple but exciting event.

Preschool-Gr. 1. Bright, compact pictures of some easily observed characteristics of modern trains are supplemented by the clear text, narrated in the manner of an attentive adult.

Gr. 1-3. In a story that has a happy ending but nevertheless shows the downside of train traveling, Christopher panics when he gets separated from his class enroute to the aquarium via the subway.

Preschool-Gr. 2. The first half of this Caldecott Honor Book presents the types of cars in a freight train, each car a different color. The second half

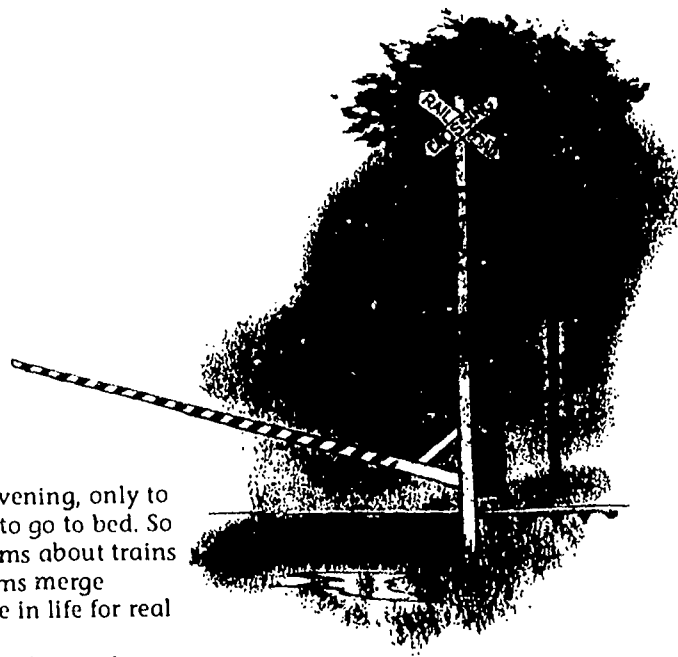

Art above from Jim Aylesworth *Country Crossing* illustrated by Ted Rand

depicts the train in motion, with colors streaming, as the train passes through darkness into light. Also note Crews' book *Shortcut* (Greenwillow).

**Fleischman, Paul.** *Time Train.* Illus. by **Claire Ewart.** 1991. 32p. HarperCollins, \$14.95 (0-06-021709-X).

Gr. 1-3. A class boards the *Rocky Mountain Unlimited* for a marvelous journey through time and meets dinosaurs up close.

**Gantschev, Ivan.** *The Christmas Train.* 1984. 32p. Little, Brown, \$12.95 (0-316-30346-1).

K-Gr. 2. On Christmas Eve, a girl warns an oncoming train of fallen rock and prevents disaster.

**Gantschev, Ivan.** *The Train to Grandma's.* 1987. 32p. Picture Book Studio, \$16.95 (0-88708-053-7).

Preschool-Gr. 1. A long train journey over mountains and rivers and through tunnels is depicted by means of foldout and cutaway pages and die-cut holes.

**Gibbons, Gail.** *Trains.* 1987. 32p. Holiday, \$13.95 (0-8234-0640-7); paper, \$5.95 (0-8234-0699-7).

K-Gr. 2. Through precise text and pictures, Gibbons presents fascinating facts about trains, including a few specific terms such as *tie* and *berth*.

**Goble, Paul.** *Death of the Iron Horse.* 1987. 32p. Bradbury, \$12.95 (0-02-737830-6).

K-Gr. 3. This narrative account of the derailment of a Union Pacific freight train by Cheyenne braves in 1867 is brought to life through Goble's bright, stylized artwork.

**Goode, Diane.** *Where's Our Mama?* 1991. 32p. Dutton, \$13.95 (0-525-44770-9).

Preschool-Gr. 1. At the train station two children become separated from their mother, but finally a helpful gendarme comes to their rescue. Goode's illustrations evocatively capture the details of Paris.

**Hines, Gary.** *A Ride in the Crummy.* Illus. by **Anna Grossnickle Hines.** 1991. 24p. Greenwillow, \$13.95 (0-688-09691-3).

Preschool-Gr. 2. While traveling with his grandson, a man recounts the special trip he made as a boy with his brother, riding the high seats of the crummy, or caboosie.

**Keats, Ezra Jack.** *John Henry: An American Legend.* 1987. 32p. Knopf, \$11.99 (0-394-99052-8); paper, \$3.95 (0-394-89052-3).

K-Gr. 3. Dramatic episodes depict the life of that mighty steel-driving black man John Henry, who was "born with a hammer in his hand" and helped to lay tracks across the West.

Art here and opposite from Gary Hines. *A Ride in the Crummy* illustrated by Anna Grossnickle Hines



**Lyon, George Ella.** A Regular Rolling Noah. Illus. by **Stephen Gammell.** 1986. 32p. Bradbury, \$13.95 (0-02-761330-5); Aladdin, paper, \$4.95 (0-689-71449-1).

**Maestro, Betsy and Giulio.** All Aboard Overnight: A Book of Compound Words. 1992. 32p. Clarion, \$14.95 (0-395-51120-8).

**Magee, Doug and Robert Newman.** All Aboard ABC. 1990. 48p. Cobblehill, \$13.95 (0-525-65036-9).

**McAllister, Angela.** Jessie's Journey. Illus. by **Anne Magill.** 1992. 32p. Macmillan, \$13.95 (0-02-765366-8).

**McPhail, David.** The Train. 1977. 32p. Little, Brown/Joy Street, \$13.95 (0-316-56316-1); paper, \$4.95 (0-316-56331-5).

**Mott, Evelyn Clarke.** Steam Train Ride. 1991. 32p. Walker, \$13.95 (0-8027-6995-0).

**Peet, Bill.** The Caboose Who Got Loose. 1971. 48p. Houghton, \$13.95 (0-395-14805-7); paper, \$4.95 (0-395-28715-4); paper with audiocassette, \$7.95 (0-395-45740-8).

**Rockwell, Anne.** Trains. 1988. 32p. Dutton, \$10.95 (0-525-44377-0); paper, \$3.99 (0-525-44888-8).

**Rosenberg, Liz.** Adelaide and the Night Train. Illus. by **Lisa Desimini.** 1989. 32p. HarperCollins, \$13.95 (0-06-025102-6).

K-Gr. 2. A young Kentuckian is hired by a farmer to accompany a boxcar of livestock bound for Canada.

Gr. 1-4. The Maestros detail an overnight train ride to illustrate the concept of compound words.

Preschool-Gr. 1. Full-color photographs of today's trains introduce the alphabet through such railroad terms as *junction* and *roadbed*.

Preschool-Gr. 2. Jessie muses about her upcoming train trip, and when it actually happens she finds it more wonderful than she ever imagined.

Preschool-Gr. 2. A young boy, distressed when his baby brother breaks his train, fixes it in his dreams and has a grand time assisting the make-believe conductor, fireman, stationmaster, and engineer.

Preschool-K. Mott photographs young Christopher as he learns about and rides the steam train, and meets the people who work there: Red, the engineer; Mel, the fireman; and Bill, the conductor.

Gr. 2-4. Katy Caboose, tired of being last, takes advantage of a freak accident to find the peace and solitude she craves. Another classic is Watty Piper's *The Little Engine That Could* (Platt & Munk).

Preschool-Gr. 1. Foxes dressed as people operate several kinds of trains, including toy trains, while illustrating concepts such as "above" and "below."

K-Gr. 2. Lying awake at night, a girl listens to the whistle of a train; in her dreams she boards it, and witnesses seemingly real sights along its route.

#### Close Up:

Using Sattler's  
*Train Whistles*

Suggest that children prepare a choral reading, with individual children taking the part of the bell, whistle, air brakes, wheels, and cars bumping together. Once they have these noises down pat, they might also want to do a reading of Aylesworth's *Country Crossing*.

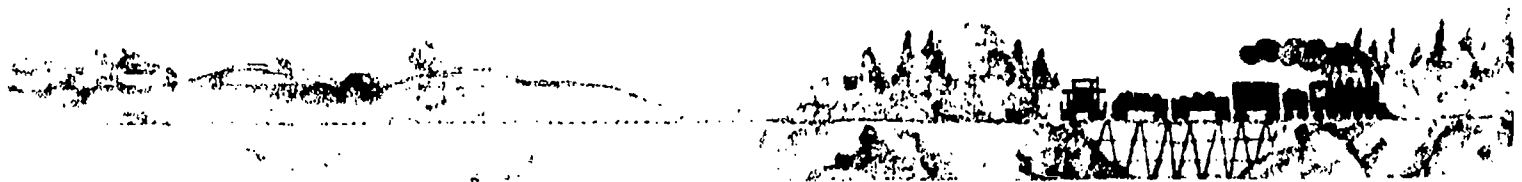

### All Aboard

Working in pairs or small groups, children might plan a train trip that takes them cross-country and back home without going through the same city twice. After they write letters requesting train schedules from Amtrak (1-800-872-7245), bring math into the study by having them learn to read a timetable. Then they could plan a day-by-day itinerary; decide on sight-seeing stops; figure the cost of tickets (private compartment, first-class, or coach), food, and incidentals, and determine what to pack in their bags. As an alternative, they could plan a trip for a grandparent or elderly friend, using senior citizen discounts to figure the cost of their trip.

**Sattler, Helen Roney.** *Train Whistles.* Illus. by **Giulio Maestro.** Revised edition. 1985. 32p. Lothrop, \$12 (0-688-03978-2).

**Siebert, Diane.** *Train Song.* Illus. by **Mike Wimmer.** 1990. 32p. HarperCollins, \$14.95 (0-690-04726-6).

**Smith, E. Boyd.** *The Railroad Book.* 1983. 56p. Houghton, \$12.95 (0-395-34832-3).

**Van Allsburg, Chris.** *The Polar Express.* 1985. 32p. Houghton, \$16.95 (0-395-38949-6).

### Fiction

**Aaron, Chester.** *Lackawanna.* 1986. HarperCollins, o.p.

**Ardizzone, Edward.** *Nicholas and the Fast-Moving Diesel.* 1959. Walck, o.p.

**Fleischman, Sid.** *Me and the Man on the Moon-eyed Horse.* Illus. by **Eric Von Schmidt.** 1977. 58p. Little, Brown/Joy Street, \$14.95 (0-316-28571-4).

**Holland, Isabelle.** *The Journey Home.* 1990. 192p. Scholastic, \$13.95 (0-590-43110-2).

**Hyde, Dayton.** *Thunder down the Track.* 1986. 171p. Atheneum, o.p.

**Nesbitt, Edith.** *The Railway Children.* 1991. 224p. Oxford, paper, \$3.95 (0-19-282659-X).

K-Gr. 3. Large, scenic watercolors illustrate the route of a train as the text explains the need for a system of whistles to convey various messages. Also note Roger Yepson's *Train Talk: An Illustrated Guide to Lights, Hand Signals, Whistles, and Other Languages of Railroad* (Knopf).

Preschool-Gr. 2. Rhyming text mimics the sound of "steel wheels rolling on steel rails," while paintings depict the sights both inside the train and along the tracks.

Gr. 2-5. Reprint of a 1913 title, this introduces the world of trains through the eyes of an eager brother and sister who are taking a cross-country trip. Adults should be prepared to discuss the book's depiction of minorities.

K-Gr. 3. A boy is delivered to the North Pole on Christmas Eve by a magical train that arrives at his house.

Gr. 6-9. Riding the rails during the Depression is at the center of this book and Clayton Bess' *Tracks* (Houghton, o.p.).

Gr. 1-3. In this easy-to-read story, two boys, desperate for money, and a dog embark on a series of funny adventures on a train.

Gr. 3-5. In this quick-paced escapade, young Clint saves the circus train from being derailed by a notorious robber. Another Old West story is Alan Coren's *Railroad Arthur* (Little, Brown, o.p.).

Gr. 4-7. Two orphans in the late 1880s leave New York City to find homes in the West. Also note Joan Lowry Nixon's *A Family Apart* (Delacorte), the first title in the Orphan Train Quartet.

Gr. 5-7. Two parallel plots make up this action-filled story: establishing a short line railroad and protecting Michigan's Upper Peninsula wilderness from being turned into a toxic waste dump.

Gr. 5-7. In this classic story originally published in 1906 and also made into a film, a mother and her three children move to a simple house near



## On Writing *The Train to Lulu's* by Elizabeth Fitzgerald Howard

*Trains are links between today and yesterday, between what is and what might be. For me, writing *The Train to Lulu's* was a journey to a new persona, from a full-time professor to a sometime author. I'm still on that train.*



Elizabeth Howard (right), seen here with her sister. Is a professor at the University of West Virginia. She has written such memorable books as *Chita's Christmas Tree* (Bradbury) and *Aunt Flossie's Hats* (Clarion)

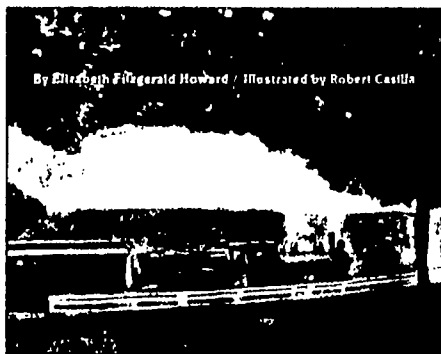

Howard, Elizabeth Fitzgerald. *The Train to Lulu's* illus by Robert Castilla. 1988 32p Bradbury, \$13.95 (0-02-744620-4)

The scene: South Station, Boston. The time: June morning, 1930-something.

"Remember now, girls. Wait until the conductor calls 'New Haven!' Then you may open your lunch boxes."

"We'll remember, Mommy. And when he calls 'Philadelphia' we can eat our supper sandwiches!"

And so my sister Barbara and I internalized our parents' whole catalog of how-to-be-good-girls-on-a-long-train-ride instructions.

"All aboard!"

Last kisses, last hugs. Two brave little girls waved to two very, very brave, teary-eyed parents. The big adventure began. We were on the train to Lulu's!

The year I was seven and my sister was four, we were sent by ourselves to spend the summer vacation with Great-Aunt Lulu in Patapsco, Maryland, outside of Baltimore. There must have been some reflection and no doubt some hesitation on our parents' part about our traveling alone, but they no doubt felt it was a special opportunity for the relatives as well as a happy solution to what to do with us for three months while they both worked.

So, the plans began. Clothes were washed, ironed, mended, and packed. Arrangements were made with Travelers' Aid for the conductors to watch out for us, and to ensure that only Lulu would take us away from the station in Baltimore. Instructions were repeated and repeated. Finally, the day of departure! Lunch and supper packed. Books, paper dolls, crayons, paper, pencils, Babs' teddy bear, and even tissue paper toilet seat covers hand fashioned by Mother. Nothing had been forgotten. A long, long day. But there was plen-

ty to look at and since this was pre-TV times we weren't easily bored. And we were, truly, well-behaved little girls. In New Haven we ate our lunch—but my sister didn't want all of her chicken sandwich. I didn't know what to do with the leftover bits and crusts, so I carefully stuffed everything down in between the train seat and the wall of the coach. In Philadelphia, we ate our molasses sandwiches. Finally we heard "Baltimore! Baltimore!" and the conductor helped us off.

As Uncle Brad told us later, the porters queried "Who's coming in on this train?" expecting personages of grand importance as there were so many people waiting. All the relatives—Aunt Flossie, Chita, assorted uncles, aunts, cousins—along with the Travelers' Aid representative, and, then, at last, Lulu, with her white, white hair!

That was only the first summer. We took that same train every June for five years. For five glorious rich and full summers we stayed with Lulu and all those aunts and uncles and cousins, memorable summers full of stories I want to write someday. The train was a connection between the future my parents hoped for and the past that would always be part of them. The train linked my sister and me to the extended family whom we otherwise would have known only casually. It was a thread between the North with its veneer of racial acceptance and the South of traditional segregated living. It was a bridge between winter and summer. And oh yes, between childhood and growing up. The last summer that we took the train to Lulu's I was 11. Then Lulu retired, sold her house in Patapsco, and moved to Boston. A few years later we did take the train back to Baltimore again, and many times after that, but everything was different then.

#### Activities

- Keep a glossary of train terminology, using books listed here. Older children may illustrate these glossaries in their notebooks, while younger ones may work together to label the parts of a train on a mural or poster.
- Play recordings of "I've Been Working on the Railroad," "Chatanooga Choo Choo," "Casey Jones," and other train songs; suggest that some students look up the history of the words in books such as Kathleen Krull's *Gonna Sing My Head Off* (Knopf), which includes numerous train songs.
- Provide children with large sheets of paper and ask them to copy or draw train cars and cut them out. (Crews' *Freight Train*, Gibbons' *Trains*, and Magee and Newman's *All Aboard ABC* contain examples.) Make a train by trailing these cars across a bulletin board or wall.
- Invite a railroad official in to speak about what products a freight train carries. Children might map where these items originate, where they are going, and the length of time it takes them to get from one place to another.

**Wetterer, Margaret.** Kate Shelley and the Midnight Express. Illus. by **Karen Ritz.** 1990. 48p. Carolrhoda, \$9.95 (0-87614-425-3).

### Information and Pop-up Books

**Brown, Dee.** Lonesome Whistle: The Story of the First Transcontinental Railroad. 1980. 144p. Holt, o.p.

**Coiley, John.** Train. 1992. 64p. Knopf, \$15 (0-679-81684-4).

**Fisher, Leonard Everett.** Tracks across America: The Story of the American Railroad, 1825-1900. 1992. 192p. Holiday, \$17.95 (0-8234-0945-7).

**Hovey, Tamara.** Paris Underground. 1991. 96p. Orchard, \$14.95 (0-531-05931-6).

**Jefferis, David.** Trains: The History of Railroads. 1991. 32p. Watts, \$11.90 (0-531-14192-6).

**Marshall, Ray and John Bradley.** The Train: Watch It Work! 1986. Viking, \$13.95 (0-670-81134-3).

**McKissack, Patricia and Fredrick McKissack.** A Long Hard Journey. 1990. 144p. Walker, \$18.95 (0-8027-6885-7).

**Moseley, Keith.** Steam Locomotives. 1989. 14p. Orchard, \$17.95 (0-531-05844-1).

the railroad when their father is taken into custody; the children's experiences and their efforts to clear their father's name make up the plot.

Gr. 2-5. Wetterer retells, in easy-to-read format, the true story of how an Iowan girl crawled across a bridge to save two drowning men and stop a speeding train from plunging into Honey Creek on a stormy night in 1869.

Gr. 5-8. While describing the construction of the first tracks, Brown relates the growth of railroads to immigrants' lives, to Irish and Chinese railroad laborers, and to robbers and outlaws who plagued the early train trips.

Gr. 2-8. One in the Eyewitness series, this book showcases trains from early Babylonian roadways to this year's European supertrain. Crisp close-up photographs show the vehicles from various and interesting angles.

Gr. 5-9. Primary source material, including quotes from passengers and workers, period photographs, and maps give authenticity and vitality to this perceptive account.

Gr. 5-8. This photo-essay examines the construction of the Paris subway during the late 1890s and relates some of the Metro's subsequent history.

Gr. 3-6. Jefferis investigates trains from various parts of the world and various times in history through photos, diagrams, and straightforward text.

Gr. 5-8. Five pop-up spreads reveal the moving parts of a steam, a diesel, and an electric train. Included is an easy-to-assemble model of the French TGV, the world's fastest train.

Gr. 5-8. Accompanied by black-and-white period photographs, this well-researched text describes how black Pullman porters organized to end harsh working conditions on our nation's trains.

Gr. 4-8. Pop-ups and drawings present the history of steam engines from the early nineteenth through the mid-

**Scarry, Huck.** Aboard a Steam Locomotive. 1987. 64p. Prentice-Hall, \$12.95 (0-13-000373-5).

**Spangenburg, Ray and Diane K. Moser.** The Story of America's Railroads. 1991. 90p. Facts On File, \$18.95 (0-8160-2257-7).

**Weiss, Harvey.** How to Run a Railroad: Everything You Need to Know about Model Trains. 1983. 96p. HarperCollins, paper, \$4.95 (0-690-04329-5).

**Yancey, Diane.** Desperadoes and Dynamite: Train Robbery in the United States. 1991. 64p. Watts, \$11.90 (0-531-20038-8).

twentieth century. A sumptuous display item that will intrigue students at the beginning of a railroads unit.

Gr. 4-8. Scarry's personal guide to the workings of steam engines employs detailed pencil drawings.

Gr. 5-9. The authors provide a chronological history of railroads in America, including the technology and the people involved.

Gr. 4-7. Diagrams and photographs extend Weiss' step-by-step instructions on how to purchase or build the components as well as assemble and operate the system.

Gr. 3-6. Short chapters trace the history of train robberies in the U.S. and give an overview of the careers of several notorious train robbers and of the authorities' attempts to apprehend these outlaws. ■

*Mary Lou Burket, a Minneapolis freelancer, writes about and reviews children's books.*

**If you wanted to find a dinosaur,  
where would you look?  
How about in Connecticut?  
Or Canada? Or Scotland?**

In this engaging dinosaur-geography book, beloved children's author and illustrator Bernard Most discovers dinosaurs on every continent. Filled with fun dinosaur facts and a list of museums around the world that house dinosaur fossils, this book is a treasure for teachers and librarians!

**Where to Look for a Dinosaur**  
by Bernard Most

0-15-295616-6 March 1993 \$12.95 Ages 4-8

**HBJ**

HARCOURT BRACE JOVANOVIICH, PUBLISHERS  
Children's Books Division  
1250 Sixth Avenue, San Diego, CA 92101  
1-800-543-1918



## BOOKS FOR YOUNG READERS

as discussed by Karen Breen at the  
1993 Summer Reading Program Workshop

Adler, David A. *Cam Jansen and the Mystery of the Stolen Diamonds*. New York: Puffin Books, 1980. \$3.99. ISBN 0-14-034670-8.

Adler, David A. *The Fourth Floor Twins and the Fish Snitch Mystery*. New York: Puffin Books, 1986. \$3.99. ISBN 0-14-032082-2.

Conford, Ellen. *A Case for Jenny Archer*. New York: Springboard Books, 1988. \$2.95. ISBN 0-316-15352-4.

Delton, Judy. *Camp Ghost-Away* (Pee Wee Scouts Series). New York: Dell Publishing, 1988. \$2.95. ISBN 0-440-40062-7.

Giff, Patricia Reilly. *Fancy Feet* (New Kids at the Polk Street School Series). New York: Dell Publishing, 1988. \$2.95. ISBN 0-440-40086-4.

Giff, Patricia Reilly. *Riddle of the Red Purse* (The Polka Dot Private Eye Series). New York: Dell Publishing, 1987. \$2.99. ISBN 0-440-47534-1.

Giff, Patricia Reilly. *Sunny-Side Up* (The Kids at the Polk Street School Series). New York: Dell Publishing, 1986. \$2.99. ISBN 0-440-48406-5.

Levy, Elizabeth. *Something Queer at the Library* (a mystery). New York: Dell Publishing, 1977. \$2.99. ISBN 0-440-48120-1.

Levy, Elizabeth. *Something Queer in Rock 'n' Roll*. New York: Dell Publishing, 1989. \$2.95. ISBN 0-440-40159-3.

Ross, Pat. *M & M and The Super Child Afternoon*. New York: Puffin Books, 1987. \$3.95. ISBN 0-14-032145-4.

Ziefert, Harriet and Jon. *The Small Potatoes Club*. New York: Dell Publishing, 1984. \$2.99. ISBN 0-440-48034-5.

Ziefert, Harriet and Jon. *The Small Potatoes and the Birthday Party*. New York: Dell Publishing, 1985. \$2.75. ISBN 0-440-48035-3.

## TRAIN BIBLIOGRAPHY

books displayed by Karen Breen at the  
1993 Summer Reading Program Workshop

Aylesworth, Jim. *Country Crossing*. New York: Atheneum, 1991. \$13.95.  
ISBN 0-689-31580-5.

Late at night, way out in the country, an old car approaches a railroad crossing. Suddenly the peacefulness of the country evening explodes with all the sights and sounds of a tremendous freight train that barrels past the crossing and off into the night, leaving the countryside as peaceful as before.

Barkan, Joanne. *Come Aboard Books*. New York: Macmillan Pub. Co., 1992.  
\$3.50 each. *Locomotive* ISBN 0-689-71576-5. *Boxcar* ISBN 0-689-71573-0.  
*Passenger Car* ISBN 0-689-71575-7. *Caboose* ISBN 0-689-71574-9.

Each book is shaped like the train car.

Barton, Byron. *Trains*. New York: Harper Collins, Publishers, 1986. \$4.95.  
ISBN 0-690-04534-4.

Brief text and illustrations present a variety of trains and what they do.

Coiley, John. *Train*. New York: Alfred A. Knopf, 1992. \$15.00. ISBN 0-679-91684-9 (lib. bdg.)

Traces the development of railways from the first Babylonian rutways to the electromagnetic, driverless trains of today and describes how trains are built and operated. Illustrated with numerous photographs and drawings.

Crews, Donald. *Bigmama's*. New York: Greenwillow Books, 1991. \$13.95.  
ISBN 0-688-09951-3 (lib.)

Visiting Bigmama's house in the country, young Donald Crews finds his relatives full of news and the old place and its surroundings just the same as the year before.

Crews, Donald. *Freight Train*. New York, Greenwillow Books, 1978. \$3.95.  
ISBN 0-688-11701-5.

Brief text and illustrations trace the journey of a colorful train as it goes through tunnels, by cities, and over trestles.

**Crews, Donald.** *Shortcut.* New York: Greenwillow Books, 1992. \$14.00. ISBN 0-688-06437-X (lib.)

Children taking a shortcut by walking along a railroad track find excitement and danger when a train approaches.

**Fisher, Leonard Everett.** *Tracks Across America: The Story of the American Railroad 1825-1900.* New York: Holiday House, 1992. ISBN 0-8234-0945-7.

Using primary source material, period photographs, and quotes from workers, passengers, owners, and politicians, Mr. Fisher paints a vivid picture of the nineteenth-century American railroad.

**Gantschev, Ivan.** *The Train to Grandma's.* Saxonville, MA: Picture Book Studio Ltd., 1987. ISBN 0-88708-053-7.

Two children make a journey by train to visit their grandparents in a book with fold-out pages, die-cut to show the train racing across the countryside, into tunnels, over bridges, and across mountains.

**Gibbons, Gail.** *Trains.* New York: Holiday House, 1987. \$5.95. ISBN 0-8234-0699-7 (pbk.)

A picture book that examines different kinds of trains, past and present, describing their features and functions.

**Graham, Ian.** *Cars, Bikes, Trains and Other Land Machines.* New York: Kingfisher Books, 1993. \$5.95. ISBN 1-85697-871-0.

Text, illustrations, and diagrams introduce the parts, operation, and uses of cars, trains, motorcycles, trucks, and other land vehicles.

**Howard, Elizabeth Fitzgerald.** *The Train to Lulu's.* New York: Bradbury Press, 1988. \$14.95. ISBN 0-02-744620-4.

The immediacy of Elizabeth Fitzgerald Howard's first-person narrative and the changing moods reflected in Robert Casill's watercolor paintings let readers travel along with Beppy and Babs, sharing the girls' excitement and camaraderie throughout this memorable journey.



**McKissack, Patricia and Fredrick.** *A Long Hard Journey: The Story of the Pullman Porter.* New York: Walker Publishing Co., 1989. \$17.95. ISBN 0-8027-6884-9.

A chronicle of the first black-controlled union, made up of Pullman porters, who after years of unfair labor practices staged a battle against a corporate giant resulting in a "David and Goliath" ending.

**McPhail, David.** *The Train.* Boston: Little, Brown and Co., 1977. \$5.95. ISBN 0-316-56316-1 (HC).

During the night while everyone is asleep, a young boy takes a ride on his toy train.

**Merriam, Eve.** *Train Leaves the Station.* New York: Henry Holt and Co., Inc., 1992.

A toy train and its occupants make a journey that introduces the numbers one to ten.

**Peet, Bill.** *The Caboose Who Got Loose.* Boston: Houghton Mifflin Co., 1971. \$4.95. ISBN 0-395-28715-4 (pbk.)

Katy, "a caboose who disliked being last," finds happiness when an accident releases her from the other cars on the train and perches her high between two evergreen trees.

**Ringold, Faith.** *Aunt Harriet's Underground Railroad in the Sky.* New York: Crown Publishers, 1992. \$15.00. ISBN 0-517-58768-8.

With Harriet Tubman as her guide, Cassie retraces the steps escaping slaves took on the Underground Railroad in order to reunite with her younger brother.

**Royston, Angela.** *Trains.* New York: Macmillan Pub. Co., 1992. \$7.95. ISBN 0-689-71647-8.

A simple introduction to different types of freight and commuter trains.

**Siebert, Diane.** *Train Song.* New York: Harper Collins Publishers, 1990. ISBN 0-690-04726-6.

Diane Siebert's rhyming text captures the very essence of the sound and feel of these mighty machines as they crisscross the land.

## BIBLIOGRAPHY

- Ainsworth, Ruth. *Roly, the Railroad Mouse*. New York: Franklin Watts, Inc., 1967.
- American Heritage Editors. *Railroads in the Days of Steam*. New York: American Heritage Publishing Co., Inc., 1960.
- Ault, Phillip H. *"All Aboard!" The Story of Passenger Trains in America*. New York: Dodd, Mead & Company, 1976.
- Awdry, W. *Choo-Choo, Peek-a-Boo*. New York: Random House Books for Young Readers, 1992. \$3.99.
- Awdry, W. *Thomas and the Hide-and-Seek Animals*. New York: Random House Books for Young Readers, 1991. \$7.95.
- Awdry, W. *James the Red Engine*. New York: Random House Books for Young Readers, 1991.
- Awdry, W. *Meet Thomas the Tank Engine and His Friends*. New York: Random House Books for Young Readers, 1989. \$6.95.
- Aylesworth, Jim. *Country Crossing*. New York: Atheneum, 1991. \$13.95
- Barkan, Joanne. *Whiskerville Train Station*. New York: Putnam Pub. Group, 1991. \$3.95.
- Bauer, Caroline. *My Mom Travels a Lot*. Puffin Books, 1985. \$3.95.
- Big Book of Train Stories*. New York: Grosset & Dunlap, 1955.
- Blassingame, Wyatt. *Great Trains of the World*. New York: Random House, 1953.
- Boehm, Peggy Strauss. *The Story of Stations*. New York: Sterling Publishing Co., 1959.
- Brandt, Betty. *Special Delivery*. Minneapolis: Carolrhoda Books, 1988.
- Broekel, Ray. *Trains*. Chicago: Children's Press, 1981. \$4.95
- Brown, Margaret Wise. *Two Little Trains*. New York: Harper Collins, 1986.
- Brown, Dee. *Lonesome Whistle: The Story of the First Trans-Continental Railroad*. New York: Holt, Rinehart and Winston, 1980.
- Burleigh, David Robert. *Let's Ride In The Caboose*. Chicago: Follett, 1969.
- Burningham, John. *John Patrick Norman McHennessy - The Boy Who Was Always Late*. New York: Crown Books for Young Readers, 1987. \$14.95.
- Burton, W. E. *Down Among The Sugar Cane*. Moran, 1930.
- Burton, Virginia Lee. *Choo Choo: The Story of a Little Engine Who Ran Away*. Boston: Houghton Mifflin Co., 1988.
- Burton, Virginia Lee. *Maybelle, the Cable Car*. Boston: Houghton Mifflin Co., 1952.
- Carle, Eric. *One Two Three To The Zoo*. New York: Putnam Pub. Group, 1989. \$14.95.
- Carter, Ernest Frank. *Let's Look at Trains*. Chicago: Albert Whitman and Company, 1964.



- Chandler, Edna Walker. *Circus Train*. Westchester, Ill.: Benefic Press, 1971.
- Chandler, Edna Walker. *Gold Train*. Westchester, Ill.: Benefic Press, 1969.
- Chlad, Dorothy. *Stop, Look & Listen for Trains*. Chicago: Children's Press, 1983. \$15.00.
- Coats, Laura Jane. *Ten Little Animals*. New York: Macmillan Children's Group, 1990. \$12.95.
- Cohen, Daniel. *Railway Ghosts And Highway Horrors*. New York: Cobblehill Books, 1991. \$13.95.
- Crampton, Gertrude. *Tootle*. New York: A Golden Book, 1945.
- Creative Activities. *Communicating*. Vol 7
- Crews, Donald. *Freight Train*. New York: Greenwillow Books, 1978. \$3.95.
- Cross, Gilbert. *Terror Train*. New York: Macmillan, 1987.
- Cullum, Carolyn N. *The Storytime Sourcebook*. New York: Neal-Schuman, 1990. \$24.95.
- DeLeeuw, Adele. *Casey Jones Drives an Ice Cream Train*. Champaign, Ill: Garrard Pub. Co., 1971.
- Dixon, Malcolm. *On the Railway*. New York: Bookwright Press, 1984.
- Dupasquier, Phillip. *Train Station*. New York: Putnam, 1984. \$3.95
- Ehrlich, Amy. *The Everyday Train*. New York: Dial Press, 1977.
- Elting, Mary. *All Aboard! The Railroad Trains Built America*. New York: Four Winds Press, 1970.
- Elting, Mary. *Trains at Work*. Irvington-on-Hudson, NY: Harvey House, Inc., 1962.
- Epstein, Samuel and Beryl Epstein. *The Andrews Raid, or the Great Locomotive Chase, April 12, 1862*. New York: Coward-McCann, Inc., 1956.
- Fisher, Leonard Everett. *The Railroads* (Nineteenth Century America series). New York: Holiday House, 1979.
- Fleischman, Paul. *Time Train*. New York: Harper, 1991. \$14.95
- Fleischman, Albert Sidney. *Me and the Man on the Moon-eyed Horse*. New York: Little Brown, 1977. \$14.95
- Gammell, Stephen. *Once Upon Old MacDonald's Farm*. New York: Macmillan Childrens Group, 1984. \$13.95.
- Gantschev, Ivan. *The Christmas Train*. New York: Little, 1984. \$13.95.
- Gantschev, Ivan. *The Train to Grandma's*. Saxonville, MA: Picture Book Studio Ltd., 1991. \$16.95.
- Gauch, Patricia Lee. *Christina Katerina and the Great Bear Train*. New York: Putnam, 1990.
- Gibbons, Gail. *Trains*. New York: Holiday House, 1987.
- Goble, Paul. *Death of the Iron Horse*. New York: Macmillan, 1988. \$13.95
- Gramatky, Hardie. *Homer and the Circus Train*. New York: Putnam, 1957.

- Greene, Graham. *The Little Train*. Garden City, N.Y.: Doubleday, 1973.
- Gretz, Susanna. *Teddy Bears Take the Train*. New York: Macmillan Children's Group, 1988. \$13.95.
- Harding, Mary. *All Aboard Trains*. New York: Putnam Pub. Group, 1989. pap. \$1.95.
- Harwood, Pearl. *Mrs. Moon's Harbor Trip*. Lerner Publications, 1967. \$5.95 PLB.
- Hawkinson, Lucy Ozone. *That New River Train*. Chicago: A. Whitman, 1970.
- Hindley, Judy. *The Little Train*. New York: Orchard Books, 1989.
- Hoff, Syd. *Barney's Horse*. New York: Harper, 1987. \$10.95
- Howard, Elizabeth Fitzgerald. *The Train to Lulu's*. New York: Bradbury Press, 1988. \$14.95.
- Hubbard, Freeman H. *The Train That Never Came Back, and Other Railroad Stories*. New York: Whittlesey House, 1952.
- Hurd, Edith. *Engine, Engine Number 9*. New York: Lothrop, 1940.
- Hurd, Edith Thacher. *Caboose*. Eau Claire, WI: E.M. Hale and Company, 1950.
- Hutchins, Pat. *The Best Train Set Ever*. New York: Greenwillow Books, 1978.
- Johnson, John E. *Here Comes the Train!* New York: Random House Books for Young Readers, 1985. \$3.99.
- Kasza, Keiko. *When the Elephants Walk*. New York: Putnam Pub. Group, 1990. \$13.95.
- Keats, Ezra Jack. *The Trip*. New York: Morrow, 1987. \$4.95.
- Keats, Ezra Jack. *John Henry: An American Legend*. New York: Knopf Books for Young Readers, 1987. \$12.99.
- Kesselman, Wendy Ann. *There's a Train Going By My Window*. Garden City, N.Y.: Doubleday, 1981.
- Kroll, Steven. *Toot! Toot!* New York: Holiday, 1983.
- Lenski, Lois. *The Little Train*. New York: Oxford, 1940.
- Lillegard, Dee. *Sitting In My Box*. New York: Dutton Children's Books, 1989. \$12.95
- Lopshire, Robert. *Put Me In The Zoo*. Beginner Books, 1960. \$7.99 Lib. bdg.
- Macaulay, Davis. *Why the Chicken Crossed the Road*. Boston: Houghton Mifflin Co., 1987. \$13.45.
- Marshall, Ray and John Bradley. *The Train: Watch It Work*. New York: Viking, 1986. \$13.95
- Mayer, Mercer. *Ah-Choo*. Dial Books for Young Readers, 1977. \$4.58.
- McCall, Edith S. *Buttermilk Bili and the Train*. Westchester, Ill.: Benefic Press, 1969.
- McCall, Edith S. *Men On Iron Horses* (Frontiers of America). Chicago: Childrens Press, 1960.
- McPhail, David. *The Train*. Boston: New York: Little, Brown and Co., 1977. \$5.95.
- Miller, Olive Beaupre. *My Book House* ("Casey Jones" p. 64 and "John Henry" p. 135). Lake Bluff, Ill.: Book House for Children, 1971.

- Mott, Evelyn Clarke. *Steam Train Ride*. New York: Walker, 1991.
- Murphy, Jill. *All In One Piece*. New York: Putnam, 1987. \$10.95.
- Nixon, Joan Lowery. *The Orphan Train Quartet: Caught in the Act*. New York: Bantam Books, 1988.
- Olds, Elizabeth. *Riding the Rails*. Eau Claire, WI: E.M. Hale and Company, 1964. (First Cadmus edition).
- Olsen, Ib Spang. *Little Locomotive*. New York: Coward, McCann & Geoghegan, Inc. 1976.
- Peet, Bill. *The Caboose Who Got Loose*. Boston: Houghton Mifflin Co., 1971. \$4.95.
- Peet, Bill. *Smoky*. Boston: Houghton Mifflin Co., 1962
- Pierce, Jack. *The Freight Train Book*. Minneapolis: Carolrhoda Books, Inc., 1980.
- Piper, Watty. *The Little Engine That Could*. 60th anniversary ed. New York: Putnam Pub. Group, 1990. \$12.95
- Punnett, Richard. *Help Jumbo Escape*. Child's World, Inc., 1982. \$19.95.
- Railroading*. New Brunswick: Boy Scouts of America, 1954.
- Reck, Alma Kehoe and Helen Hall Fichter. *At the Railroad Station*. Los Angeles: Melmont Publishers, Inc., 1958.
- Reit, Seymour. *Trains*. Western, 1990.
- Reit, Seymour. *All Kinds Of Trains*. Golden, 1978.
- Retan, Walter. *Big Book Of Real Trains*. New York: Grosset & Dunlap, 1987. \$7.95.
- Riddell, Chris. *Trouble With Elephants*. New York: Harper Collins, 1988. \$12.95.
- Rockwell, Anne F. *Trains*. New York: Dutton, 1988. \$12.95.
- Rodgers, Frank. *Who's Afraid of the Ghost Train?* New York: Harcourt Brace Jovanivich, 1989. \$12.95.
- Rose, Deborah Lee. *Meredith's Mother Takes the Train*. Niles, Ill.: A. Whitman, 1991.
- Rosenberg, Liz. *Adelaide and the Night Train*. New York: Harper and Row, 1989.
- Rosenfield, Bernard. *Let's Go to a Freight Yard*. New York: Holiday House, 1981.
- Rounds, Glen. *Mr. Yowder and the Train Robbers*. New York: G.P. Putnam's sons, 1958.
- Sandin, Joan. *The Long Way Westward* ( An I Can Read Book). New York: Harper & Row, 1989.
- Sattler, Helen Roney. *Train Whistles: A Language in Code*. New York: Lothrop, Lee & Shepard, 1985. \$13.00
- Scarry, Huck. *Aboard a Steam Locomotive*. New York: Prentice-Hall, 1987. \$12.95.
- Seymour, Dorothy Z. *The Crate train*. New York: Wonder Books, 1966.
- Schultz, Charles. *Charlie Brown's Super Book of Questions and Answers*. New York: Random House, Inc., 1976.
- Sheffer, H.R. *Trains*. Mankato, MN: Crestwood House, 1982.

- Siebert, Diane. *Train Song*. New York: New York: Harper Collins Publishers, 1990. \$14.89.
- Slobodkin, Louis. *Clear the Track for Michael's Magic Train*. New York: Macmillan Company, 1945.
- Snow, Paul. *Iron Horse To Diesel*. Racine, WI: Whitman Publishing Company, 1961.
- Steele, Phillip. *Trains*. Macmillan Children's Group. \$9.95
- Steele, Philip. *Land Transport Around the World* (International Picture Library). Minneapolis: Dillon Press, Inc., 1986.
- Stein, R. Conrad. *Story of the Golden Spike*. Chicago: Children's Press, 1978. \$13.27.
- Stephenson, Brian. *Steam Locomotives*. New York: Silver Burdett, 1980.
- Step toe, John. *Train Ride*. New York: Harper, 1971.
- Stuart, Jesse. *A Ride with Huey the Engineer*. New York: McGraw-Hill Book Company, 1966
- Townsley, John. *Getting Started With Model Trains*. New York: Sterling Publishing Co., Inc., 1991.
- Van Allsburg, Chris. *The Polar Express*. Boston: Houghton Mifflin, 1985. \$17.45.
- Vernon, Tannis. *Adriana & the Magic Clockwork Train*. New York: Crown Books for Young Readers, 1990. \$13.99.
- Warner, Gertrude. *Mystery of the Mixed-up Zoo*. Whitman, 1992. \$10.95 PLB.
- Webb, Robert N. *Illustrated True Book of American Railroads*. New York: Grossett & Dunlap, 1957.
- Weelen, Guy. *The Little Red Train*. New York: Lothrop, Lee & Shepard Co., Inc., 1966.
- Welber, Robert. *The Train*. Toronto: Pantheon Books, 1972.
- Wellman, Paul Iselin. *Race to the Golden Spike*. Boston: Houghton Mifflin, 1961.
- Wetterer, Margaret K. *Kate Shelley and the Midnight Express*. Minneapolis, MN: Carolrhoda Books, 1990.
- Wood, Sydney. *Trains and Railways*. (See & Explore Library). London: Dorling Kindersley, 1992. \$12.99 PLB.
- Yates, Raymond Francis. *Boys' Book of Model Railroading*. New York: Harper, 1951.
- Yepsen, Roger. *Train Talk. An illustrated guide to lights, hand signal, whistles, and other languages of railroading*. Toronto: Pantheon Books, 1983.
- Zarchy, Harry. *Model railroading*. New York: Alfred A. Knopf, 1955.