

DOCUMENT RESUME

ED 364 420

SE 053 917

TITLE Space Station Freedom. An Activity Book for Elementary School Students.

INSTITUTION National Aeronautics and Space Administration, Washington, D.C.

REPORT NO NASA-PED-128

PUB DATE Feb 93

NOTE 26p.

PUB TYPE Guides - Classroom Use - Teaching Guides (For Teacher) (052)

EDRS PRICE MF01/PC02 Plus Postage.

DESCRIPTORS Aerospace Education; \*Aerospace Technology; Elementary Education; Elementary School Science; Elementary School Students; Parent Materials; \*Science Activities; Science Education; Science Teachers; Scientific Concepts; \*Space Exploration; Space Sciences

IDENTIFIERS \*Space Colonization; Space Shuttle

ABSTRACT

This booklet was prepared by the National Aeronautics and Space Administration (NASA) for use by teachers in the classroom or by parents at home. The descriptions, classroom activities and illustrations are designed for elementary-level school children. On each right-hand page is a simple line drawing that illustrates the narrative and the activities described on the left-hand page. The drawings can be reproduced and colored by the students. The activities' subject matter include: the space shuttle, communications, weightlessness, solar energy, hatches and airlocks, and living and working in outer space. (PR)

\*\*\*\*\*  
 \* Reproductions supplied by EDRS are the best that can be made \*  
 \* from the original document. \*  
 \*\*\*\*\*

SE



ED 364 420

# Space Station Freedom

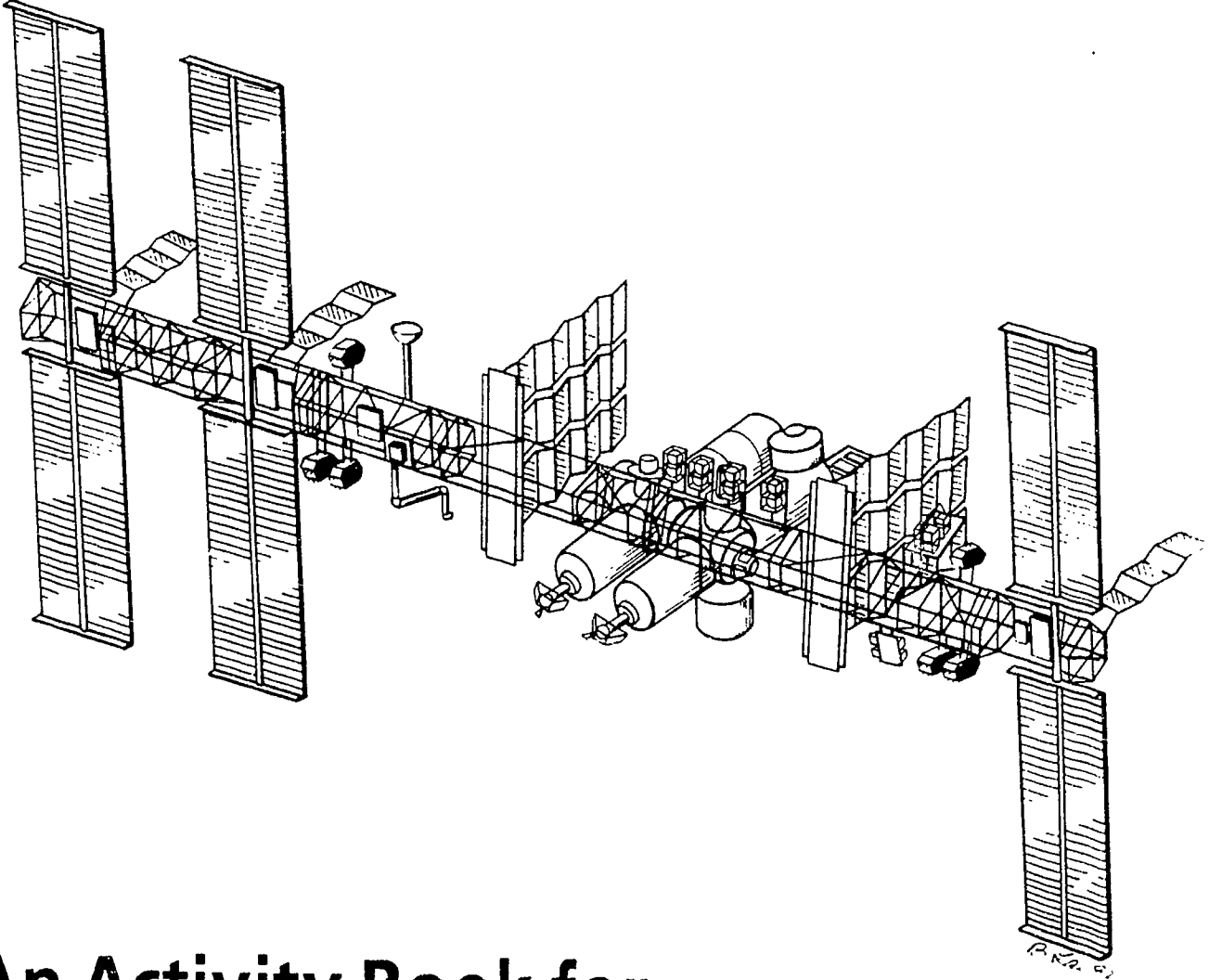

## An Activity Book for Elementary School Students



U.S. DEPARTMENT OF EDUCATION  
Office of Educational Research and Improvement  
EDUCATIONAL RESOURCES INFORMATION  
CENTER (ERIC)

This document has been reproduced as received from the person or organization originating it.  
 Minor changes have been made to improve reproduction quality.

• Points of view or opinions stated in this document do not necessarily represent official OERI position or policy.

SE 063917

## Welcome to Space Station *Freedom*

This booklet was prepared by the National Aeronautics and Space Administration (NASA) for use by teachers in the classroom or by parents at home.

The descriptions, classroom activities and illustrations are meant to be presented to elementary-level school children by a teacher or a parent. On each right-hand page is a simple line drawing that illustrates the narrative and the activities described on the left-hand page. The drawings can be reproduced and colored by the students. The activities are presented in the following format:

**Classroom Activity: Subject Matter**

Briefly describes the classroom activity.

**Materials and Tools:** Lists items needed to conduct the classroom activity.

**Procedures:** Describes how to conduct the classroom activity step-by-step.

**Additional Activity:** Gives ideas of additional activities that can be conducted or explains how to use the illustrations for an educational activity.

This booklet may be reproduced in whole or in part without permission or restrictions.

Illustrations on facing pages 

## Space Shuttle Lift-off!

The National Aeronautics and Space Administration (NASA) will launch Space Station *Freedom* part by part in the large cargo bay of the Space Shuttle. It will take about 19 Shuttle flights over a period of four years to build *Freedom* in orbit around Earth.

In 1996, the Shuttle will carry four important parts of *Freedom* into orbit. Just as toy building blocks need bottom blocks to hold them together, the first four parts will provide the foundation on which the rest of *Freedom* will be built. Additional parts will be taken up throughout 1996.

In 1997, *Freedom* will be ready for people to come aboard for short periods of time. The first astronauts will visit for at least 13 days at a time.

In 2000, the building process will be complete. Four or five times a year after that, the Shuttle will return to *Freedom* to bring up crew replacements, new experiments, new supplies and spare parts, and will return people, equipment, and finished products to Earth.

How old will you be in 2000, when *Freedom* is completed?

---

### Classroom Activity: Space Shuttle Model Construction

This activity allows an entire class or group to participate in building a Space Shuttle (orbiter) model.

#### Materials and Tools:

- 2-liter plastic soda pop bottle
- 2 egg cartons
- 177 ml paper cup
- Masking tape
- Newspaper
- Glue for papier-mâché
- White glue
- Scissors

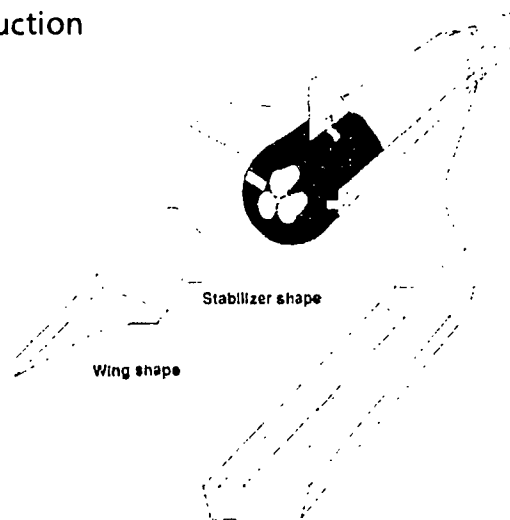

#### Procedures:

1. Cut two wings from the top of an egg carton as shown in the diagrams. Have the students tape the wings, as shown, to the bottle.
2. Cut out an "egg well" from the carton. Have the students tape this to the bottom of the cup to round off the flat surface. Ask them to tape the cup over the neck of the bottle. If the neck is too long to permit a good fit, trim it off a bit with a sharp knife.
3. Cut out a vertical tail for the model from the egg carton. Instruct the students to tape it onto the bottle.
4. Show the students how to cover the model with papier-mâché using narrow strips of newspaper. Let the papier-mâché dry and add additional layers for strength.
5. Cut three egg wells to make engines for the orbiter. Have the students cover each well with papier-mâché. Let it dry.
6. When the body of the orbiter and the engines are dry, show the students how to glue the engines to the tail end of the model.
7. Have the students paint the model and add decals, stars, and other decorations.

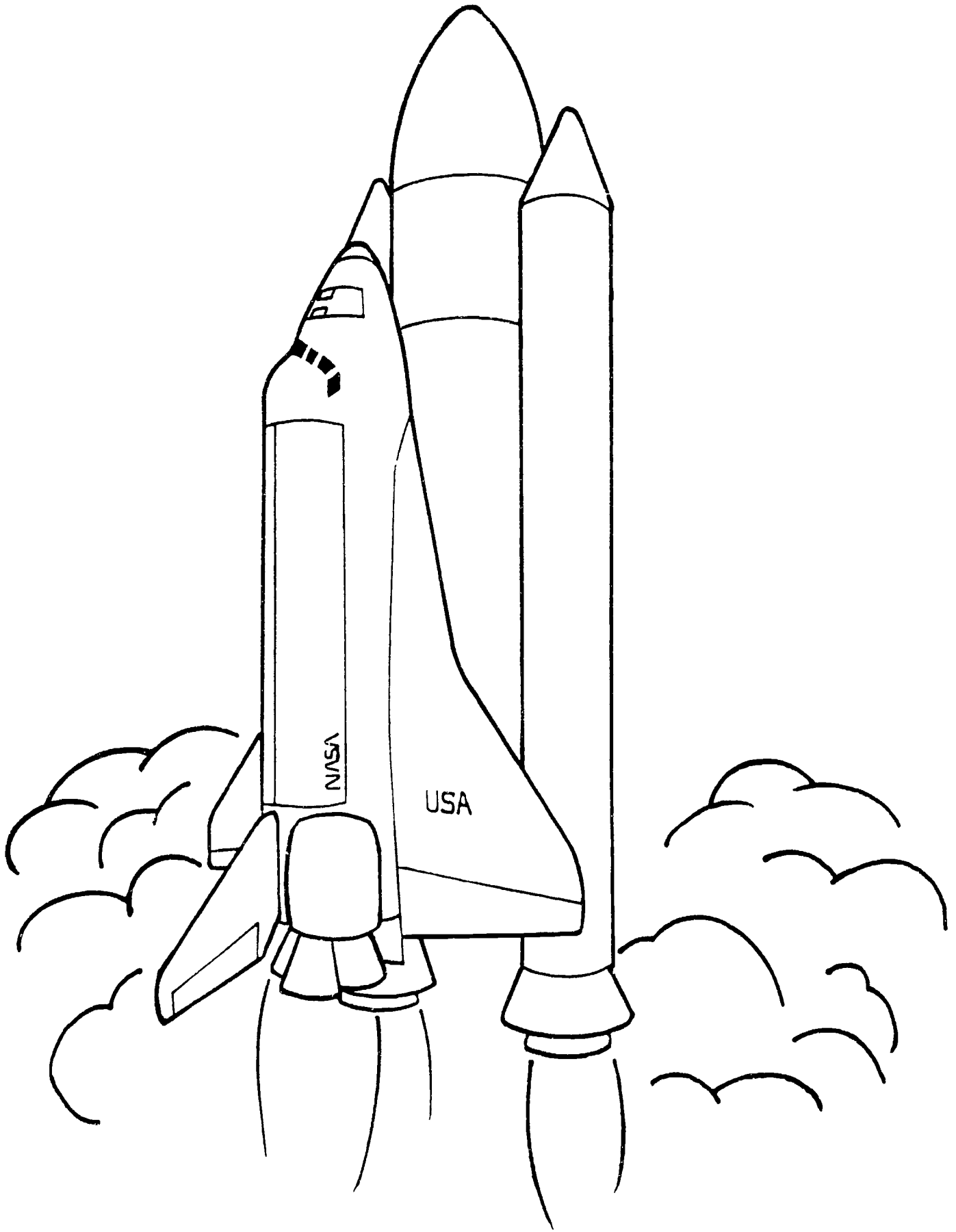

## Space Station Control Center

NASA will need many people on Earth to monitor the systems and the crew on Space Station *Freedom*. Most of this will be done using satellite communications from the Space Station Control Center at the Johnson Space Center in Texas. Scientists and engineers at different locations around the world also will be able to receive and send messages to and from *Freedom*.

The Control Center will have many computers operated by flight controllers who will be in continual contact, day and night, with the astronauts. The flight controllers and astronauts also will use earphones and microphones to communicate with each other. They will be able to help the astronauts solve any problems, answer their questions, or assist them with experiments.

The Control Center will have large screens that will show the location of *Freedom* in relation to Earth at all times.

---

### Classroom Activity: Communications

This activity demonstrates how people who cannot see each other must communicate in order to get a job done.

#### Materials and Tools:

Partition or wall that separates two people but still allows them to hear each other  
Tinker Toys

#### Procedures:

1. Ask for two volunteers. Ask one student to sit behind a partition while the second student constructs a simple structure of any design using Tinker Toys. The first student must not be able to see the model being built.
2. After the model is completed, give the first student the correct number and type of Tinker Toys needed to build another model.
3. Ask the second student to tell the first student how to build the model again, step by step, without describing what the finished model looks like.
4. After the second model is completed, have the two students compare their models.

How is this exercise like communicating with astronauts in space?

Do the two models resemble each other?

Do you think it is important for the astronauts to practice their tasks on Earth before performing them in space? Why?

**Additional Activity:** Identify the continents and oceans on the Control Center screen in the illustration. Use a globe to show the path of Space Station *Freedom* over the continents.

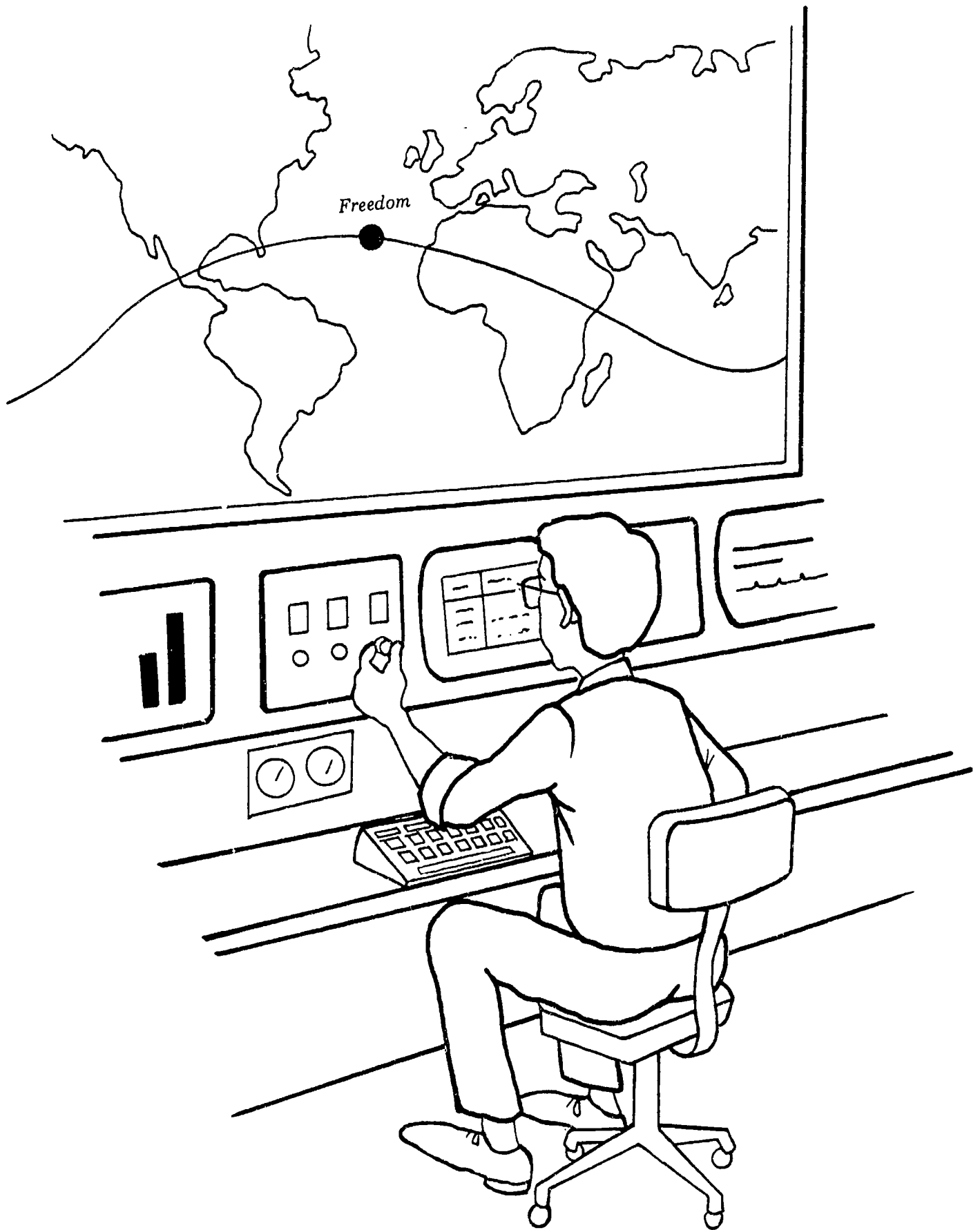

## Rendezvous

Here comes the Space Shuttle on a resupply mission to Space Station *Freedom*. Every 90 days the Space Shuttle will transport a new crew, supplies, and new experiments to *Freedom*. It will return to Earth with the previous crew members, wastes, experiment results, and new products made in space.

Most of the crew will return to Earth every three months. Some will stay on *Freedom* for six months and some may stay longer, maybe as long as one full year. Long stays will allow us to study the effects of low gravity or "weightlessness" on people.

Right now, we do not know enough about staying in space for a long time. Astronauts can get sick and weak from being weightless. We need to find a way to keep them healthy and fit before we can send a crew to Mars. It may take two years to get to Mars and two years to get back. We also want to build an outpost and factories on the Moon. Before we do those things, we have a lot to learn about living and working on Space Station *Freedom*.

---

### Classroom Activity: Weightlessness

This activity demonstrates that free-fall eliminates the local effects of gravity. If your school has videotape equipment, you may wish to tape the activity and replay the action using slow motion or pause controls.

#### Materials and Tools:

Plastic drinking cup  
Cookie sheet (with at least one edge without a rim)  
Catch basin (large pail or wastebasket)  
Water  
Chair or stepladder (optional)  
Towels

#### Procedures:

1. Place the catch basin in the center of an open area in the classroom. Fill the cup with water.
2. Place the cookie sheet over the opening of the cup. Hold the cup tight to the cookie sheet while inverting the cookie sheet and the cup.
3. Hold the cookie sheet and cup high above the catch basin. You may stand on a sturdy table or climb on a stepladder to raise the cup higher. While holding the cookie sheet level, slowly slide the cup to the edge of the cookie sheet. Observe what happens.
4. Refill the cup with water and invert it on the cookie sheet again. Quickly pull the cookie sheet straight out from under the cup. Observe the fall of the cup and the water.

What happens to the water when the cup is inverted on the cookie sheet?  
What happens to the water when the cup falls?



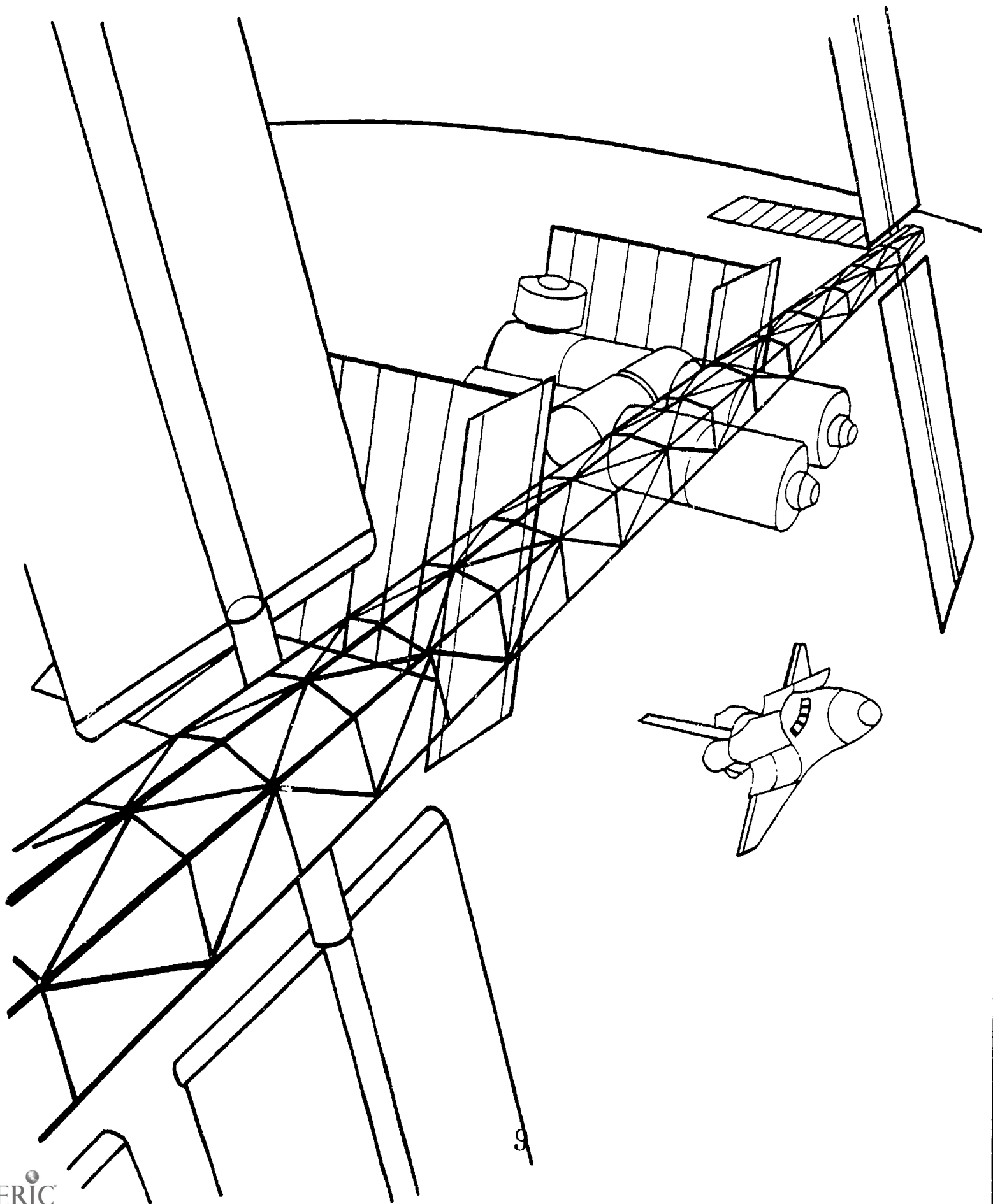

9

## A Description of Space Station *Freedom*

Space Station *Freedom* will be about as long as a football field, including the end zones, and will weigh about as much as a jumbo 747 airplane. It will be about as tall as a 24-story building.

At the middle of *Freedom* will be four modules that will be pressurized to Earth's atmosphere. Two of the modules are being built in the United States: The U.S. Laboratory (Lab) Module, where the crew will work and perform experiments; and the Habitation (Hab) Module, or living module, where the crew will eat, sleep, exercise, or relax after work. The two other laboratories will be built by Japan and Europe.

Located on either side of the modules will be radiators to get rid of extra heat generated by equipment and experiments inside *Freedom*. The radiators will also get rid of extra heat generated by the intense heat of the Sun.

The truss, which looks like a large building crane, will be the backbone of *Freedom*. The solar arrays will be at each end of the truss. They will rotate to catch the Sun's rays as *Freedom* circles Earth. *Freedom's* power system will turn sunlight into electricity, like a solar-powered calculator works on Earth.

---

### Classroom Activity: Using Solar Energy to Capture Heat

This activity shows how sunlight can be captured to heat water. Dark materials absorb the Sun's energy and transfer it to the water more readily than light materials.

#### Materials and Tools:

Clear glass casserole dish with clear glass lid  
A piece of dark-colored material, like a black garbage bag or black construction paper  
Thermometer

#### Procedures:

1. Fill the glass casserole dish with 5 centimeters of water. Place a thermometer in the bottom of the dish. Ask a student to record the water temperature, leaving the thermometer in place. Cover the dish with the lid.
2. Have another student place a piece of dark-colored material on a sunny windowsill and place the covered casserole dish on top of the dark material.
3. Wait for one hour and remove the thermometer. Ask a student to record the temperature.

What is the difference in temperature? Why is there a difference?

**Additional Activity:** Conduct the same experiment using a piece of light-colored material under the casserole dish. Explain that the water will not heat as quickly because light-colored materials reflect the Sun's energy.

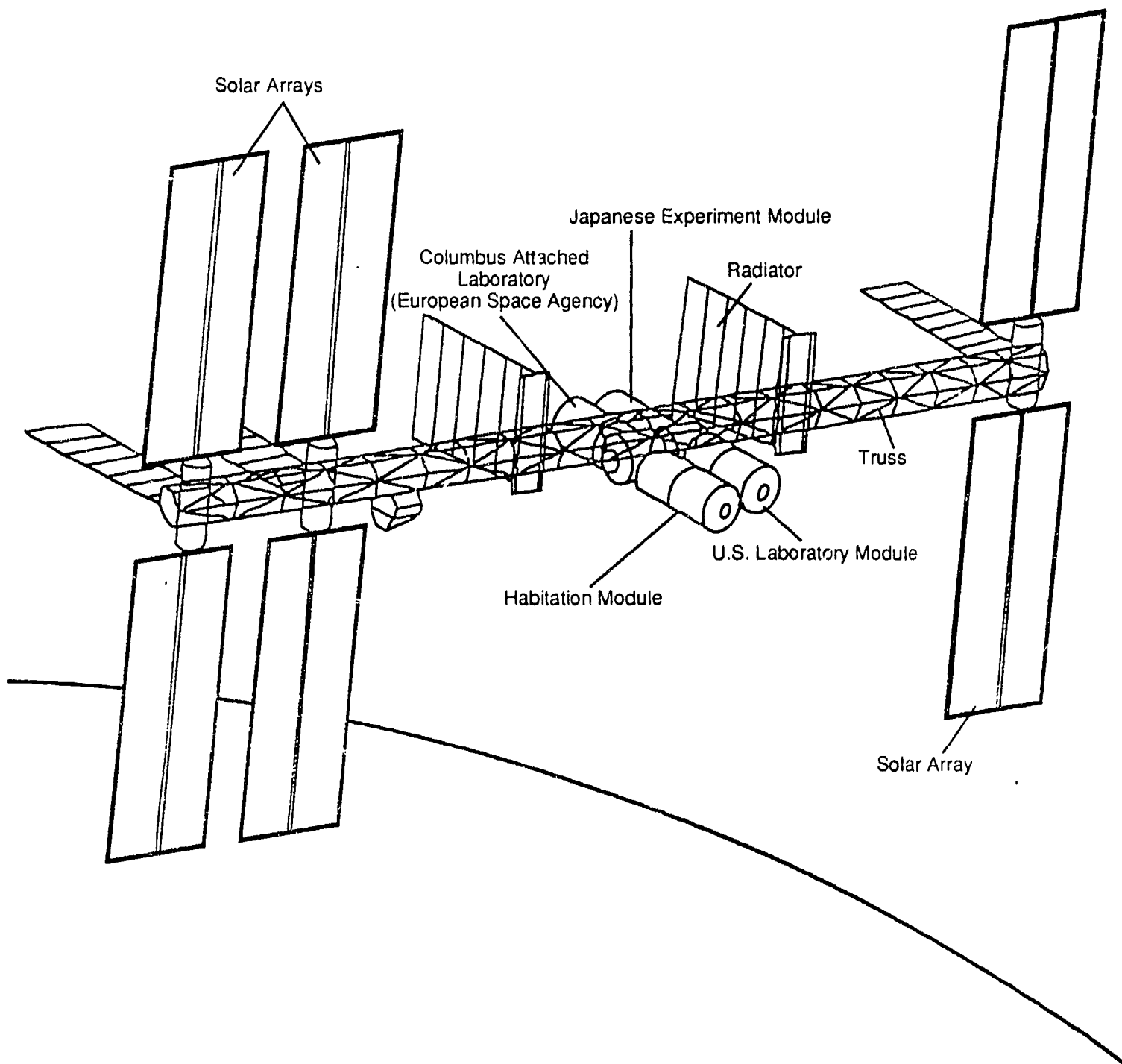

## Inside Space Station *Freedom*

In the Hab Module, or living module, the crew will eat, sleep, exercise, and relax. The health center will be located here along with the sleeping quarters, a toilet, and a shower.

In the Lab Modules, the crew will perform experiments and do research.

On Earth we cannot work, play, or move around on ceilings or walls because gravity holds us down. Inside Space Station *Freedom*, there will be no feeling of "up" or "down" because there is very little gravity in space to pull us down. The astronauts will float inside the Space Station.

The living module and the laboratories will be connected to smaller modules, called resource nodes, that are passageways to other parts of *Freedom*. Equipment needed to operate *Freedom* will be stored in the resource nodes. Other modules, called logistics carriers, will hold supplies.

An airlock will be connected to a resource node. In the airlock, the astronauts will put on space suits and prepare to go outside *Freedom* through an opening called a hatch.

---

### Classroom Activity: Hatches and Airlocks

This activity simulates movement through hatches and airlocks aboard Space Station *Freedom*.

#### Materials and Tools:

- One large cardboard box (from a new refrigerator or dishwasher)
- Exacto knife
- Teacher's board compass (or a string and pencil)

#### Procedures:

1. Using a board compass (or a string and pencil), draw large circles on opposite sides of the cardboard box.
2. Cut open the circles, leaving one side of each circle attached to the box.
3. Ask the students to open one hatch (circle) and crawl inside. Then ask them to close the hatch and move to the other side of the box. Have them open the other hatch (circle) and crawl out, then close the hatch.

How is the cardboard box like an airlock?

Why does an astronaut use an airlock, rather than a door, like we do on Earth?

**Additional Activity:** Using the attached illustration and large marker pens, draw paths through Space Station *Freedom*. Describe what astronauts do in each area.

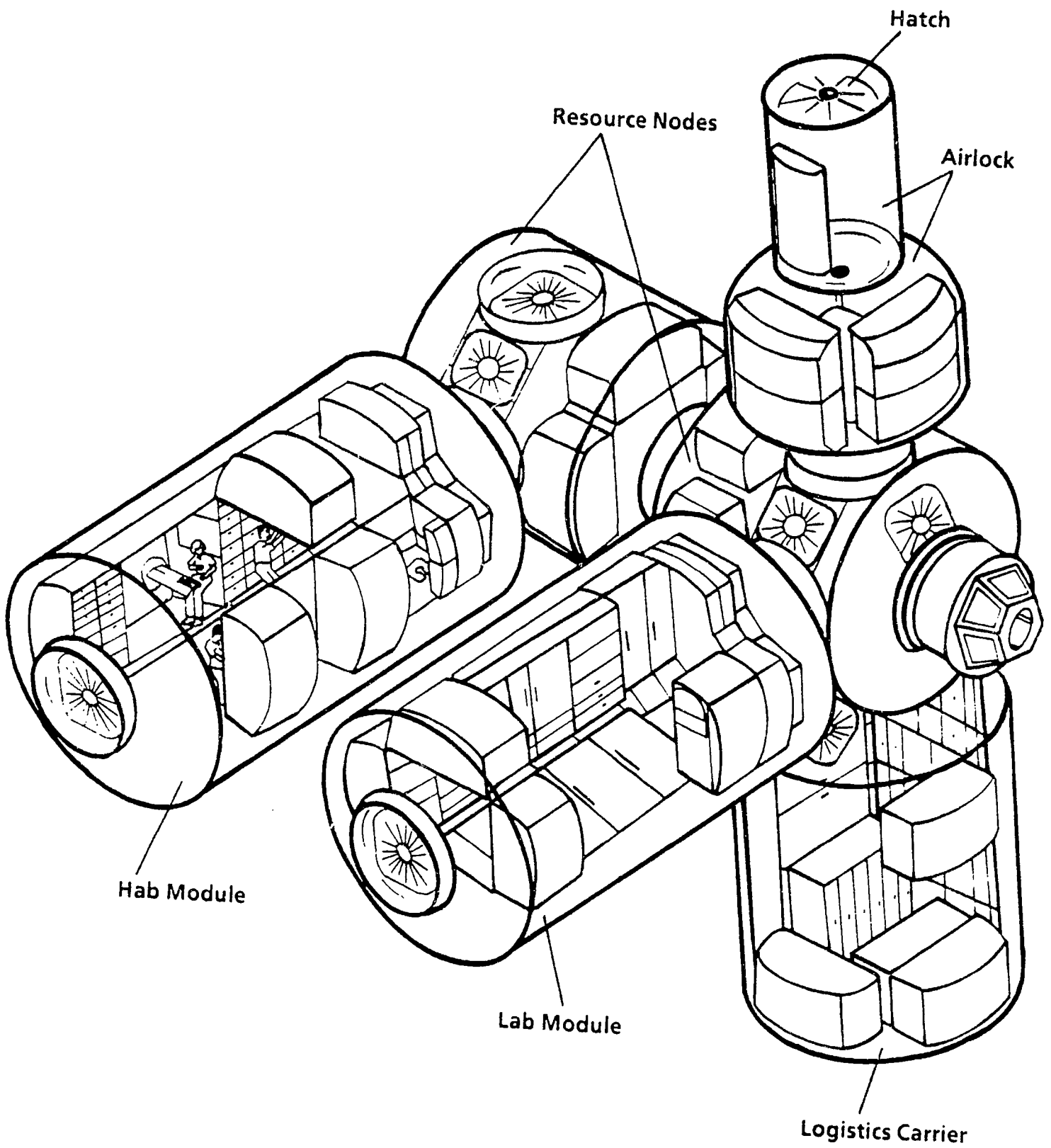

## Cupola

NASA engineers have designed a window for Space Station *Freedom* called a cupola. This "window on the world" will give a great view of Earth and equipment outside *Freedom*.

Inside the safety and comfort of the cupola, two of *Freedom's* crew members will observe Earth below or the universe above. They will also watch the Space Shuttle approach *Freedom*.

When astronauts are outside on a space walk, which NASA calls extravehicular activity, the crew member inside the cupola will watch out for them, turn on lights and cameras, and provide assistance. The astronauts may be outside to repair parts of *Freedom* using special tools designed for their bulky space suit gloves.

Special manipulators (like robots) outside *Freedom* will be controlled by crew members inside the cupola. The manipulators are part of the Mobile Servicing System, built by Canada, which will move along the truss like a train on a track. The crew members in the cupola can look out and control the robots outside the *Freedom* using a process called telerobotics.

---

### Classroom Activity: Space Gloves and Tools

This activity simulates the problem astronauts have manipulating objects while wearing bulky gloves during a space walk.

#### Materials and Tools:

- Several sets of thick insulated ski gloves or heavy rubber work gloves
- Needle-nose pliers
- Screwdriver
- Socket wrenches
- Small machine screws and nuts
- Board with nails and screws partially inserted

#### Procedures:

1. Ask the students to pick a tool and use it with their bare hands, being careful not to damage their surroundings or each other.
2. Ask the students to put on the gloves and then use the tool to perform the same task again.

Are the tools easier or harder to use with the gloves on?  
Why do the astronauts have to wear bulky gloves during space walks?

**Additional Activity:** Assemble a large model of Space Station *Freedom* using a set of Tinker Toys™ or Legos™. Remove parts of the structure and have the students reassemble the parts while wearing the bulky gloves. Explain that the Space Station will be built in space in much the same way, by astronauts using their gloved hands and special tools to attach the Space Station's parts to each other.



## Sitting Down to Dinner

When it is time to eat, the astronauts will meet in the dining area of the living module. They will strap themselves to fixed benches in order to stay seated at the table.

Little vacuum holes in the table will keep their plates and cups from sliding or floating away. Their plates and glasses also will be covered. Otherwise, food would scatter and drinks would float in large globs all over the place.

Fresh food will be delivered to Freedom's astronauts by the Space Shuttle every 90 days. Because fresh food only lasts a short time, meals will consist mostly of rehydrated and vacuum-packed foods. The kitchen on *Freedom* will be equipped with microwave and convection ovens.

---

### Classroom Activity: Food Rehydration

This activity allows hands-on experience with rehydrating a familiar food.

#### Materials and Tools:

Dehydrated soup  
Cup or mug  
Hot water

#### Procedures:

1. Ask the students to weigh an unopened package of dehydrated soup mix, then open the package and taste the contents.
2. Pour the soup mix into a cup or mug. Add hot water. Weigh the cup. Ask one student to taste the soup.

Which takes up less room, the soup mix or the soup? Which weighs less?  
Why is this important to astronauts? Which tastes better?

**Additional Activities:** Sort food coupons from the newspaper according to the different food groups. Identify any that are vacuum-packed or dehydrated. Discuss why foods are dehydrated or vacuum-packed. Make a list of food items using the coupons. How much money would be saved if these coupons were used to purchase the items on the list?



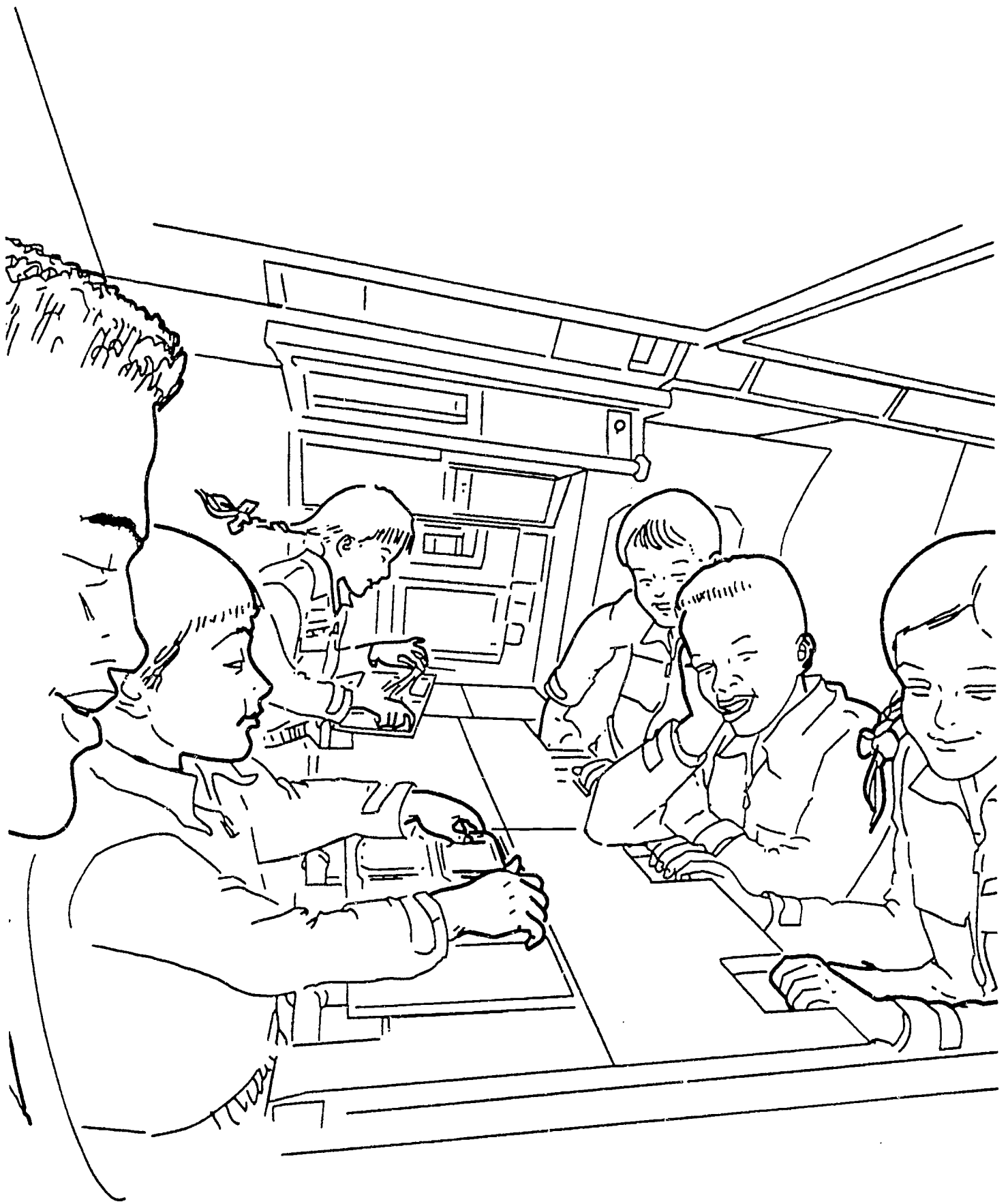

## Personal Care

Just like you, the astronauts aboard Space Station *Freedom* will have to brush their teeth, take showers, and go to the bathroom.

A typical crew member will use about 23 liters of water each day for drinking, dishwashing, laundry, and personal care. That's more than 2,760 liters a month for a crew of four, about 33,580 liters a year, or 31 metric tons of water. Water will be recycled and used again and again. Even waste water will be recycled and purified for drinking. The oxygen from air will be recycled, too.

Brushing teeth will be easy. Taking a shower or using the bathroom will be a bit more difficult in space. Suction equipment and air flows will remove water and waste from the astronauts' hair and bodies. The crew will have to take brief showers to conserve water.

### Classroom Activity: Water Usage and Conservation

This activity shows an approximate comparison of water used by astronauts on Space Station *Freedom* to that used in typical households on Earth.

#### Materials and Tools:

Paper and pencils

#### Procedures:

1. Create a large chart that looks like this:

	<u>Mon</u>	<u>Tue</u>	<u>Wed</u>	<u>Thu</u>	<u>Fri</u>	<u>Sat</u>	<u>Sun</u>	<u>Totals</u>
Drink of Water	—	—	—	—	—	—	—	—
Dishwashing	—	—	—	—	—	—	—	—
Laundry	—	—	—	—	—	—	—	—
Personal Care								
Brushing Teeth	—	—	—	—	—	—	—	—
Showering	—	—	—	—	—	—	—	—
Flushing Toilet	—	—	—	—	—	—	—	—

2. Mark the number of times each day that water is used in the categories above. At the end of the week, add up the rows and write in the totals.
3. Multiply the totals in each category by the amounts listed below to determine how much water each student used in each category for the week. Now add all the totals for the class in each category. Then figure out the total water usage for the week.

Drink of Water	.5 liters	Brushing Teeth	6 liters
Dishwashing	53 liters	Showering	258 liters
Laundry	190 liters	Flushing Toilet	15 liters

**Additional Activity:** Discuss ways that students can conserve water at home or at school. Implement the conservation ideas for one week. Using a 2-liter bottle and a bucket or large container, measure the amount of water used by the entire class for drinking water in one day. Weigh it. Discuss why carrying large amounts of water into space is a problem.

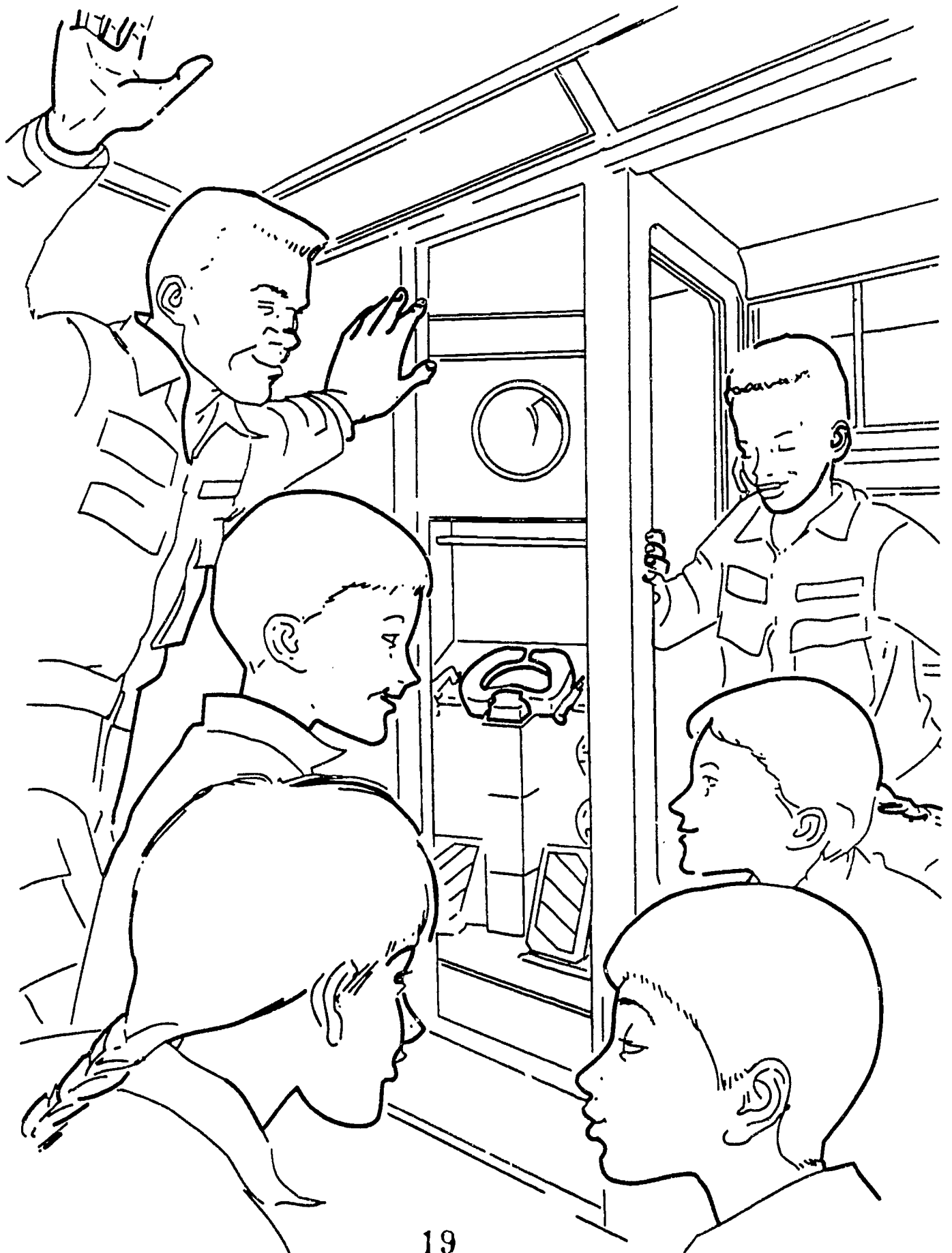

## Health Care

The Crew Health Care Facility is a small area in the living module where the crew will go for treatment if they become sick or are injured.

The Health Care Facility will have the medicines, equipment and supplies needed to treat the astronauts and monitor their health.

The facility also has exercise equipment for the crew to use to keep healthy and fit. Exercise is especially important in a weightless environment.

---

### Classroom Activity: Exercise

This hands-on activity uses isometric exercises that strengthen muscles through the use of immovable resistance. This activity also shows how exercise changes pulse rates.

#### Materials and Tools:

Clock with a second hand

#### Procedures:

1. Ask the students to grasp their right hands with their left hands, palms facing, and then pull in opposite directions for five seconds. Release. Repeat for ten seconds. What muscles are strengthened by this exercise?
2. Have the students do the exercise again, this time pushing their hands together, palms facing. Release. Repeat for ten seconds. What muscles are strengthened by this exercise?
3. Show the students how to take their pulses at rest. They should run in place for two minutes and then take their pulses again. Use the chart below to show how pulse changes.

Pulse at Rest \_\_\_\_\_ Pulse After Running \_\_\_\_\_

4. Think of other examples of isometric exercises and try them. Ask your gym teacher to help.

**Additional Activity:** Compare your pulse rates with those of your classmates. What explains the differences? Why does your pulse increase with exercise?

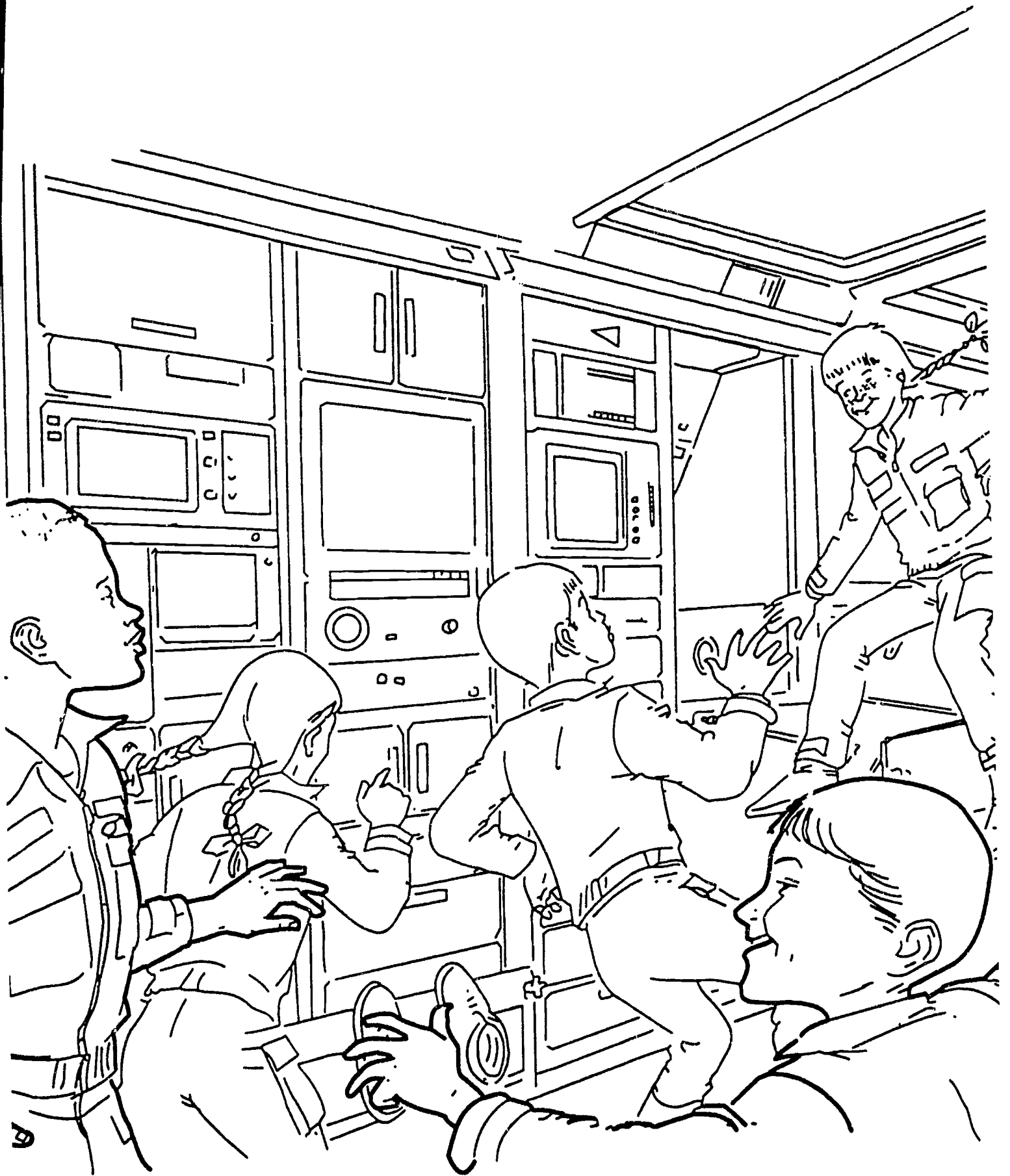

## Bedtime Aboard Space Station *Freedom*

There are no real beds on Space Station *Freedom*. The astronauts will sleep in sacks, like sleeping bags. Each sleep sack is attached to the interior of the living module to prevent the sleeping astronauts from drifting around the module.

Astronauts on *Freedom* will work 10 hours a day, 6 days a week. When they are not working, the astronauts are free to sleep or relax in the living module.

---

### Classroom Activity: Simulating Sleeping in Space

This hands-on activity simulates what it is like to sleep in space.

#### Materials and Tools:

Sleeping bag  
Belt

#### Procedures:

1. Take off your shoes. Zip yourself inside the sleeping bag. Raise your arms outside the sleeping bag. How do you feel?
2. Have a friend strap the belt around the sleeping bag so that your arms are held down. Wait two minutes. How do you feel now? Could you sleep like this?

Why do you think astronauts must be strapped down while they are sleeping?

**Additional Activity:** Write a story about any unusual places you have slept – cots, couches, chairs, hammocks, car seats. Describe how it would be different to sleep the same way in space. Illustrate your story, showing the difference between sleeping on Earth and sleeping in space. Ask the students to make a list of things they do to relax and ask these questions:

Do your classmates enjoy the same things?

What do your parents do to relax? Your teacher?

If you were in space, could you relax in the same way? Why or why not?



**Notes**

---

---

---

---

---

---

---

---

---

---

---

---

---

---

---

---

---

---

---

---

---

---

---

---

---

---

---



## NASA Teacher Resource Centers

Teachers should contact the appropriate field center below for additional information about NASA educational programs and resources.

Alaska Arizona California Hawaii Idaho Montana Nevada Oregon Utah Washington Wyoming	NASA Teacher Resource Center Mail Stop TO-25 <b>NASA Ames Research Center</b> Moffett Field, CA 94035 PHONE: (415) 604-3574	Connecticut Delaware District of Col. Maine Maryland Massachusetts New Hampshire New Jersey New York Pennsylvania Rhode Island Vermont	NASA Teacher Resource Laboratory Mail Code 130.3 <b>NASA Goddard Space Flight Center</b> Greenbelt, MD 20771 PHONE: (301) 286-8570
California (Mainly cities near Dryden Flight Research Facility)	NASA Teacher Resource Center Public Affairs Office (Trl. 42) <b>NASA Dryden Flight Research Facility</b> Edwards AFB, CA 93523 PHONE: (805) 258-3546	Illinois Indiana Michigan Minnesota Ohio Wisconsin	NASA Teacher Resource Center Mail Stop 8-1 <b>NASA Lewis Research Center</b> 2100 Brookpark Road Cleveland, OH 44135 PHONE: (216) 433-2016 or 2017
Kentucky North Carolina South Carolina Virginia West Virginia	NASA Teacher Resource Center Mail Stop 146 <b>NASA Langley Research Center</b> Hampton, VA 23665-5225 PHONE: (804) 864-3293	Florida Georgia Puerto Rico U.S. Virgin Islands	NASA Educators Resource Lab Mail Code ERL <b>NASA Kennedy Space Center</b> Kennedy Space Center, FL 32899 PHONE: (407) 876-4090
Alabama Arkansas Iowa Louisiana Missouri Tennessee	NASA Teacher Resource Center <b>U.S. Space and Rocket Center</b> Huntsville, AL 35807 PHONE: (205) 544-5812	Mississippi	NASA Teacher Resource Center Building 1200 <b>NASA John C. Stennis Space Center</b> Stennis Space Center, MS 39529 PHONE: (601) 688-3338
Colorado Kansas Nebraska New Mexico North Dakota Oklahoma South Dakota Texas	NASA Teacher Resource Room Mail Code AP-4 <b>NASA Johnson Space Center</b> Houston, TX 77058 PHONE: (713) 483-8696	Virginia's and Maryland's Eastern Shores	NASA Teacher Resource Center Education Complex - Visitors Center, Bldg. J-17 <b>Wallops Flight Facility</b> Wallops Island, VA 23337 PHONE: (804) 824-1176

The Jet Propulsion Laboratory (JPL) serves inquiries related to space and planetary exploration and other JPL activities.

**NASA Teacher Resource Center**  
JPL Educational Outreach  
**Jet Propulsion Laboratory**  
4800 Oak Grove Drive, Mail Code CS-530  
Pasadena, CA 91109  
PHONE: (818) 354-6916

Central Operation of Resources for Educators (CORE) provides educators with another source for NASA educational audiovisual materials. CORE will process teacher requests by mail for a nominal fee. Educators can request a catalog and order form on school letterhead.

**NASA CORE**  
Lorain County Joint Vocational School  
15181 Route 58 South  
Oberlin, Ohio 44074  
PHONE: (216) 774-1051 Ext. 293/294

PED-128  
February 1993