

DOCUMENT RESUME

ED 363 506

SE 053 786

TITLE Aviation & Space Curriculum Guide K-3. Revised.
 INSTITUTION Alabama State Dept. of Aeronautics, Montgomery;
 Alabama State Dept. of Education, Montgomery.
 SPONS AGENCY Federal Aviation Administration (DOT), Washington,
 DC. Office of Public Affairs.
 PUB DATE 92
 NOTE 319p.
 PUB TYPE Guides - Classroom Use - Teaching Guides (For
 Teacher) (052)

EDRS PRICE MF01/PC13 Plus Postage.
 DESCRIPTORS *Air Transportation; *Aviation Education; Earth
 Science; Elementary School Science; Elementary School
 Teachers; Primary Education; Science Activities;
 Science History; Science Instruction

ABSTRACT

This guide is designed for teachers of grades K-3 who have little or no experience in the area of aviation or space. The purpose of this guide is to provide an array of aviation and space activities which may be used by teachers to enrich locally-designed programs. Units in this book include: (1) History of Aerospace; (2) Kinds and Uses of Aircraft; (3) Parts of an Airplane; (4) Why Aircrafts Fly; (5) Weather; (6) Instruments and Navigation; and (7) Airports. Each unit begins with valuable teacher information concerning purpose, major messages, background information, and vocabulary words. Activities in each unit are organized by topic. A summary at the beginning of each topic lists materials needed, grade levels, and subject areas for each activity. Teacher resource sheets and student handout sheets are located at the end of each unit. A teacher resource section is provided. This section includes the glossary, the Fantastic Flight Dictionary, a resource speakers' guide, a list of aviation and space books, and sources for free or inexpensive teaching aids. (PR)

 * Reproductions supplied by EDRS are the best that can be made *
 * from the original document. *

AVIATION & SPACE CURRICULUM GUIDE K-3



U.S. DEPARTMENT OF EDUCATION
Office of Educational Research and Improvement
EDUCATIONAL RESOURCES INFORMATION
CENTER (ERIC)

- This document has been reproduced as received from the person or organization originating it.
- Minor changes have been made to improve reproduction quality.
- Points of view or opinions stated in this document do not necessarily represent official OERI position or policy.

"PERMISSION TO REPRODUCE THIS MATERIAL HAS BEEN GRANTED BY

Hank Verbais

TO THE EDUCATIONAL RESOURCES INFORMATION CENTER (ERIC)."

Department of Transportation:
Federal Aviation Administration

Office of Public Affairs
Aviation Education Program APA-100-92
Revision 1992

Developed by the
Alabama State Department of Education
Montgomery, Alabama

SE 053 786

FAA AVIATION EDUCATION PROGRAM

The Federal Aviation Administration (FAA) has a rich history of dedication and commitment to aviation education. The Congress has recognized this historic leadership role by requiring a civil aviation information distribution program within each FAA region to support the agency's aviation education program.

Aviation education is an integral element of the agency's mission and is essential to carrying out its responsibilities of promoting aviation and flight safety.

The agency is dedicated to the development and implementation of aviation education programs which provide general education for all citizens and information on aviation careers for America's young people.

FEDERAL AVIATION ADMINISTRATION



FOREWARD

The United States, world leader in air and space (aerospace) activities, is being challenged from many directions. To meet these increasingly competitive international challenges, we need a well-educated work force and a citizenry that understands the importance of aerospace activity to our society and its economy.

Students today live in an aerospace environment. If our youth are to understand that environment and develop the technology associated with it, they will need more education and training than did previous generations. As educators, we cannot begin too early to promote students' growth in basic knowledge, skills, and attitudes about aerospace that will be vital to living and functioning in tomorrow's society.

The Alabama Department of Education, in cooperation with the Alabama Department of Aeronautics, is proud to take a significant step in this direction. The Alabama Aerospace Curriculum Guide was written by a former Alabama classroom teacher who had a desire to share her aerospace education successes with other early childhood teachers. Iris Harris, 1987 Christa McAuliffe Fellowship recipient, spent a year in our department in order to make this guide possible. We believe that the education of our students will be greatly enriched because of the activities contained herein.

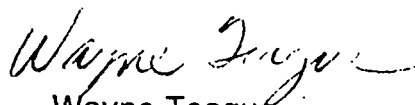
Wayne Teague

State Superintendent of Education

INTRODUCTION

The Alabama Aerospace Curriculum Guide is designed for teachers of grades K-3 who have little or no experience in the area of aviation or space. The purpose of this guide is to provide an array of aviation and space activities which may be used by teachers to enrich locally-designed programs.

The Alabama Aerospace Curriculum Guide is supplemental in nature. Teachers can infuse the exciting and highly motivating aviation and space activities into the core-curriculum: language arts, science, math, social studies and art. The practical application of these modern-day situations will give purpose to basic subject matter and make learning more meaningful.

The Alabama Aerospace Curriculum Guide has three distinct sections. The guide begins with a TABLE OF CONTENTS that lists the units and topics to be taught and specifies a page number(s) on which the units and topics may be found.

The second and largest section of this guide consists of seven units of classroom ACTIVITIES. Each unit begins with valuable teacher information concerning Purpose, Major Messages, Background Information, and

Vocabulary Words. The vocabulary word list is used in conjunction with the Fantastic Flight Dictionary (Teacher Resource Section) throughout all seven units.

Activities in each unit are organized by topic. A summary at the beginning of each topic lists materials needed, grade levels, and subject areas for each activity. Teacher Resource Sheets and Student Handout Sheets, which are referenced in the activities, are located at the end of each unit. These materials will need to be made into transparencies or duplicated for students.

The third section is referred to as the TEACHER RESOURCE SECTION. This section contains valuable materials that are referenced in the activities. Included in the section are the Glossary, Fantastic Flight Dictionary, Resource Speakers' Guide, List of Aviation and Space Books, and sources for Free or Inexpensive Teaching Aids.

ACKNOWLEDGEMENTS

From the beginning, the development of this document has been viewed as a cooperative effort between the Alabama Department of Aeronautics and the Alabama Department of Education. The Curriculum Development Section, under the leadership of Katherine Mitchell, had the responsibility for coordinating this project. Iris Harris, Aerospace Education Specialist, served as principle author and project director. Writing of activities, preparation of graphics, editing of drafts, typing of numerous revisions, and reading for technical accuracy and clarity took place over a period of ten months. The contributions of the agencies or people listed below are greatly appreciated.

Reviewers

Jacqueline Autrey
Early Childhood Specialist
Alabama Department of Education

Rosemary Mobley
Early Childhood Specialist
Alabama Department of Education

Bob Lock
Senior Engineer
Boeing Airplane Company

Editor

Nell Kilpatrick
Language Arts Specialist
Alabama Department of Education

Illustrations/Graphics

Lisa Smith
Curriculum Development Section
Alabama Department of Education

Jimmy Harris
Student
University of Alabama

Agency Contributions

Jack K. Barker
Federal Aviation Administration
Southern Region
Atlanta, Georgia

Mike Schrier
Civil Air Patrol
Aerospace Education Headquarters
Maxwell AFB, Alabama

Typists

Shirley Dorman
Leigh Ann Kyser
Lisa Smith
Curriculum Development Section
Alabama Department of Education

**AEROSPACE EDUCATION
GRADES K-3
Table of Contents**

	<u>Page</u>
UNIT 1: HISTORY OF AEROSPACE -----	3
Topic 1: Introduction to Flight-----	6
Topic 2: Milestones Prior to 1903-----	11
Topic 3: Heroes and Heroines 1903 to Present-----	16
Student Handouts-----	25
UNIT 2: KINDS AND USES OF AIRCRAFT -----	42
Topic 1: Four Groups of Aircraft-----	45
Topic 2: Three Users of Aircraft-----	64
Student Handouts-----	72
UNIT 3: PARTS OF AN AIRPLANE-----	91
Topic 1: Airplane Parts-----	93
Student Handouts-----	101
UNIT 4: WHY AIRCRAFT FLY -----	107
Topic 1: Four Forces of Flight-----	110
Topic 2: Jet Propulsion-----	118
Topic 3: Three Basic Aircraft Movements-----	121
Student Handouts-----	128
UNIT 5: WEATHER-----	134
Topic 1: Weather Changes Daily-----	137
Topic 2: Clouds-----	141
Topic 3: Wind-----	147
Topic 4: Air-----	156
Topic 5: Fronts-----	163
Teacher Resource Sheets-----	168
Student Handouts-----	170

Table of Contents (Continued)

	<u>Page</u>
UNIT 6: INSTRUMENTS AND NAVIGATION -----	187
Topic 1: Basic Flight Instruments -----	190
Topic 2: Navigation -----	195
Teacher Resource Sheets -----	202
Student Handouts -----	206
 UNIT 7: AIRPORTS -----	 215
Topic 1: Kinds of Airports -----	217
Topic 2: Planning an Airport -----	224
Student Handouts -----	228
 TEACHER RESOURCE SECTION	
Glossary -----	231
Fantastic Flight Dictionary -----	239
Resource Speakers' Guide -----	247
List of Aviation and Space Books -----	248
Free or Inexpensive Teaching Aids -----	254

UNIT 1: HISTORY OF AEROSPACE

PURPOSE OF UNIT 1

The purpose of Unit 1 is to introduce students to the development of flight. Specifically, students should:

1. sense that mankind has been fascinated with flight throughout history;
2. experience first hand the sensation of flight through kite-making and related activities;
3. recognize the names of persons who have made major contributions to the evolution of flight; and
4. be able to give examples of how air travel developed gradually over time.

MAJOR MESSAGES IN UNIT 1

- Progress or improvement often involves numerous trials and errors.
- Success often requires that we try and try and try again.

BACKGROUND INFORMATION FOR UNIT 1

Unit 1 consists of 3 topics:

TOPIC 1: INTRODUCTION TO FLIGHT

TOPIC 2: MILESTONES PRIOR TO 1903

TOPIC 3: HEROES AND HEROINES: 1903 to Present

Topic 1 conveys that throughout history mankind has been fascinated with flight. At first, the ability to fly was considered a supernatural event. Folklore, legends, and art depict man's longing to soar to the heavens. Man has, in his imagination, traveled through air and space for as long as he has been on earth. Topic 1 emphasizes that in early history, people flew kites and were fascinated by the thought of flying like the birds.

In Topic 2, pictures of Leonardo da Vinci (1500), the hot air balloon of Montgolfier (1783), and the Zeppelin airship (1900) are presented as early milestones in the history of flight.

The first successful powered flight by the Wright Brothers in 1903 introduces Topic 3. Other heroes and heroines mentioned are:

Amelia Earhart
Charles Lindbergh
Robert Goddard
Neil Armstrong
Sally Ride
Christa McAuliffe

VOCABULARY WORDS FOR UNIT 1

Topic 1

kite
Chinese

Topic 2

balloon
dirigible
Leonardo da Vinci
airship
parachute
helicopter

Topic 3

airplane
rocket
glider
apollo II
space shuttle

TOPIC 1: INTRODUCTION TO FLIGHT

The activities, suggested materials, grade level, and related subject areas for each activity are summarized below.

<u>ACTIVITY</u>	<u>MATERIALS NEEDED</u>	<u>GRADE LEVEL</u> <u>SUBJECT</u>
1. The Birds Started It	THE BIRDS STARTED IT, Student Handouts 1, 2, 3, and 4	Grades K-1 language arts
2. Making a Pre-kite	paper lunch bags tissue paper strips string hole punch	Grades K-1 art science
3. Making a Kite	plastic trash bags or tissue paper 3/8" X 3/16" X 36" spruce wood sticks (keel) 3/8" X 3/16" X 30" spruce wood sticks (spar) 1" X 6' cloth strip (tail) string tape Fantastic Flight Dictionary	Grades 2-3 art science

ACTIVITY 1: THE BIRDS STARTED IT

Begin by asking students questions that direct their attention to flying. Questions that can arouse interest are ones such as the following:

1. Have you ever wished that you could fly?
2. Why would you want to fly?
3. Where do you think airplanes came from?
4. How do you think people learned how to build airplanes?

Distribute THE BIRDS STARTED IT (Student Handouts 1, 2, 3, and 4).

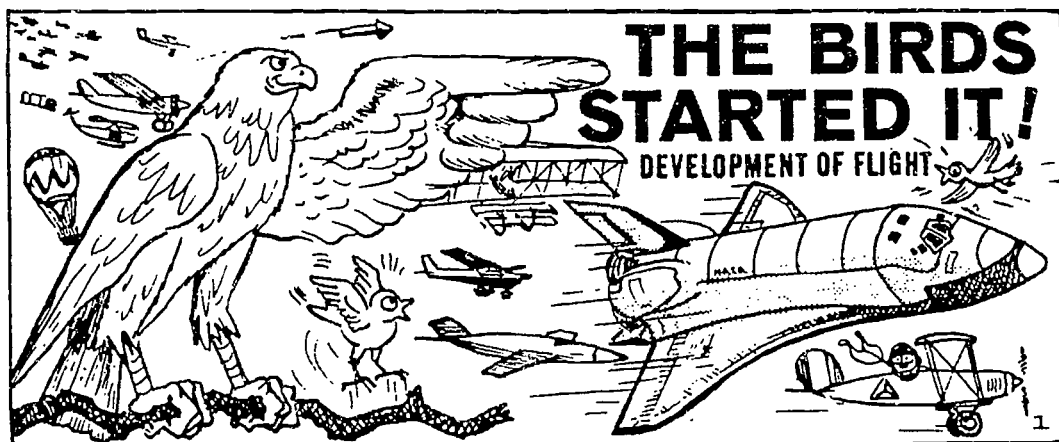

Cut sheets apart, stack, and staple to form a book. Read the story or have students read it. Discuss questions similar to the following:

1. What is meant by the title, "The Birds Started It"?
2. What were the first things that people tried to make fly?
3. Describe some of the different aircraft that people flew.
4. What is a space shuttle?

ACTIVITY 2: MAKING A PRE-KITE

Tell students that the Chinese invented the first kite about 2000 years ago. Ask students a question similar to the one that follows and wait for several student responses.

Question: Why do you think that people have been interested in flying kites for at least 2000 years?

Possible Answers: People wish they could fly kites. People were interested in how things fly. Flying kites is fun. Kites teach you how things fly.

Explain to students that some people think that the first kites were huge, man-carrying kites that lifted people high enough to see what their enemies were doing.

Construct a pre-kite. Decorate a paper bag. Add tissue paper streamers. Punch holes in both sides near the open end of the bag. Attach string to form a loop.

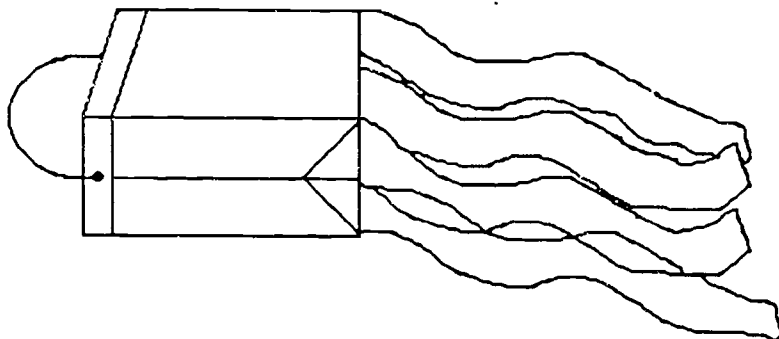

Take students to an outdoor play area. Let students observe the pre-kite fill with air and float as they hold the string and run. Allow ample time for students to experiment.

Return to the classroom and ask students to discuss questions such as the following:

1. Why do you think some kites fly better than others?
Answer: Some kites are lighter and balanced better.
2. Why do you think kites fly better on some days than on other days?
Answer: Wind conditions are more favorable.

ACTIVITY 3: MAKE A KITE

Make a drawing similar to the one that follows and introduce the vocabulary associated with kite construction.

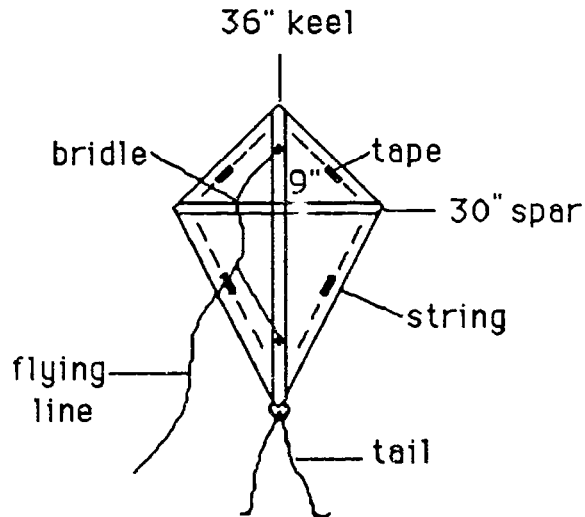

Be sure that the drawing is displayed where students can see it.

Tell students that there are six steps in making a kite. Write these steps where students can see them. (Wording can be adjusted for younger students.)

1. Glue 30" spar about 9" from top of 36" keel.
2. Cut notches in each end of the spar and keel.
3. Run string through notches in spar and keel. Tie string ends.
4. Lay frame on lightweight plastic or tissue paper. Fold plastic or tissue paper over string and tape or glue.
5. Cut bridle 54" long. Attach bridle as shown in the drawing.
6. Tie flying line to bridle as shown in the drawing.
7. Tie the tail to the bottom of the keel.

Show how a kite is made by reading each step and demonstrating how that action is carried out.

Leave the drawing and the six steps in full view of students and distribute kite-making supplies. Explain the importance of following directions one step at a time.

ACTIVITY 3 (Continued)

When kites are completed, take students to a large outdoor area and conduct a kite-flying contest. Give prizes for the highest, fastest, and/or most durable kite.

NOTE: The kite must be lightweight or it will not fly. This is true of all things that fly.

Extended Activities

- Have students write a poem or short story about how it feels when flying a kite.
- Have students pretend that they are kite makers. Have them design, draw, and name several different types of kites.
- Have a group or groups of students use library resources to research the invention, development, and/or uses of kites. Have students report their findings to the class.
- Write Topic 1 vocabulary words in the Fantastic Flight Dictionary.

TOPIC 2: MILESTONES PRIOR TO 1903

The activities, suggested materials, grade level, and related subject areas for each activity are summarized below.

<u>ACTIVITY</u>	<u>MATERIALS NEEDED</u>	<u>GRADE LEVELS</u> <u>SUBJECT</u>
4. First People and First Aircraft	Student Handouts 5, 6, and 7 Fantastic Flight Dictionary	Grades K-3 social studies science
5. Match People and Accomplishments	Student Handouts 8, 9, and 10	Grades 2-3 language arts social studies science

ACTIVITY 4: FIRST PEOPLE AND FIRST AIRCRAFT

Direct students' attention to early flight. Stir their interest by asking questions such as the following:

1. When did man first become interested in flight? How do we know?
2. What aircraft did man fly first?
3. How do you think the first man to fly felt?

Explain to the students that over 470 years ago an Italian artist, architect, and scientist named Leonardo da Vinci made the world's first known drawings of the parachute and the helicopter. None of the flying machines he drew were ever built.

Distribute Student Handout 5. Complete per directions.

Further explain that 200 years ago Joseph Montgolfier came up with the idea for the balloon as he watched smoke and sparks rise from his fireplace. The birth of the balloon and lighter-than-air flight came as a result of Montgolfier experimenting with a paper bag held over a lighted fire. The bag filled with warm air causing it to rise into the air. Soon Montgolfier attached a basket under his balloon. First he flew animals in the basket, and finally came the 25-minute historic flight of two men. This historic flight is recorded as "man's first flight."

Distribute Student Handout 6. Complete per directions.

Impress students with the fact that man continued his efforts, despite many failures, to become airborne. Count Ferdinand Von Zeppelin built the world's first successful dirigible 88 years ago. The dirigible was a floating aircraft with an attached motor that made it steerable. The Zeppelin was the first aircraft to be used for public transportation. It made the first successful flight across the Atlantic Ocean.

ACTIVITY 4 (Continued)

Distribute Student Handout 7. Complete per directions.

Determine major advantages of the Zeppelin dirigible over the Montgolfier balloon. (1. The Zeppelin could transport more passengers than the balloon. 2. An attached motor made it steerable.)

Extended Activities

- Have students pretend they are Leonardo da Vinci. Have them develop a drawing of their own design for the first mass transport spacecraft.
- Have students pretend they were passengers in Montgolfier's balloon. Ask them to write stories about the first balloon flight and describe what they saw while aloft. Ask them to describe their feelings about being one of the first people to fly. Have them illustrate their stories.

An alternative for K-1 would be to write a class experience chart or class story.

- Seek out and report on other things Leonardo da Vinci is famous for.
- Divide the class into three groups. Ask each group to select one of the following topics. Tell students to use library resources to further research the topic and write a short report. Ask each group to select a group reporter to report findings to the entire class.

Leonardo da Vinci
Montgolfier/Balloons
Zeppelin/Dirigibles

An alternative for K-1 would be to select additional books and stories to read to the students.

ACTIVITY 4 (Continued)

- Write Topic 2 vocabulary words in Fantastic Flight Dictionary.
- Write stories using Topic 1 and Topic 2 vocabulary words.

ACTIVITY 5: MATCH PEOPLE AND ACCOMPLISHMENTS

Distribute Student Handout 8. Locate names of people and aircraft important in the history of aerospace.

Distribute Student Handout 9. Match aerospace hero to the accomplishment.

Answers: 1. d 2. c
 3. a 4. e

Distribute Student Handout 10. Match the famous aircraft to the inventor.

Answers: 1. Chinese/kite
 2. da Vinci/winged drawing
 3. Zeppelin/dirigible
 4. Montgolfier/balloon

TOPIC 3: HEROES AND HEROINES: 1903 TO PRESENT

The activities, suggested materials, grade level, and related subject areas for each activity are summarized below.

<u>ACTIVITY</u>	<u>MATERIALS NEEDED</u>	<u>GRADE LEVELS</u> <u>SUBJECT</u>
6. First Real Flight	Student Handout 11 drawing paper map of the United States	Grades K-3 language arts social studies
7. Planned Writing Outline and Biography of Heroes/Heroines	Single-Concept Learning Packets: "Amelia Earhart," "Wright Brothers," Charles Lindbergh," and "Robert Goddard" (These are free from Civil Air Patrol. See Teacher Resource Section for address.) Student Handouts 12 and 13	Grades 2-3 language arts social studies
8. Time Line	Student Handout 14 Single-Concept Poster Packet: "Chronology of Aerospace Events" (These are free from Civil Air Patrol. See Teacher Resource Section for address.) Fantastic Flight Dictionary Student Handouts 5, 6, 7, 11, 15, 16, and 17	Grades 1-3 mathematics social studies

ACTIVITY 6: FIRST REAL FLIGHT

Direct students' thinking to the first real flight by asking questions such as the following:

1. What do you think the first airplane to fly looked like?
Answer: large, awkward, and unstreamlined
2. What kind of materials do you think was used to build the plane?
Answer: lightweight wood and fabric
3. How many people were able to fly in it?
Answer: one
4. How long do you think it stayed in the air?
Answer: less than a minute
5. Do you think the builders had problems or failures before they finished building the plane? Why?
Answer: Builders had problems because they were developing the first aircraft.

Distribute Student Handout 11. Complete per directions.

Explain to the students that Orville and Wilbur Wright built the first heavier-than-air aircraft. It had an engine and could be controlled. They named their small, flimsy, wood and cloth airplane The Flyer. They flew The Flyer at Kitty Hawk, North Carolina, in 1903. The flight was less than one minute.

Extended Activities

- Read or tell students about the life and accomplishments of Orville and Wilbur Wright.
- Display a map of the United States. Help students locate their hometown and Kitty Hawk, N. C. Discuss the location of Kitty Hawk in relation to the students' hometown.
- Distribute drawing paper. Ask students to draw a picture of the Wright Brothers at Kitty Hawk with The Flyer.

ACTIVITY 6 (Continued)

- Discuss the failures and successes of Orville and Wilbur Wright. Ask students to brainstorm ways they can learn from their failures while at play (bike riding) or in the classroom (learning math facts).

ACTIVITY 7: PLANNED WRITING OUTLINE BIOGRAPHY OF HEROES/HEROINES

Direct the students' thoughts to facts about themselves by asking questions such as the following:

1. What is your name and age?
2. When and where were you born?
3. What are the names of your family members?
4. What thing do you like to do most?

Introduce a planned writing outline. Write an outline on the board such as the following:

- I. Important Facts About Yourself
 - A. Your name
 - B. Your age
 - C. One thing you like to do
- II. Your Own History
 - A. Where you were born
 - B. Date of your birth
 - C. Other places you have lived
- III. Introduce Your Family
 - A. Give parents' names
 - B. Tell names of brothers and sisters
 - C. Mention other relatives or pets

ACTIVITY 7 (Continued)

Inform students that the outline will be used to write a story about themselves. After studying the planned outline, ask students to copy the outline from the board. Have students write simple sentences for each of the outline items. Have students read their personal stories to the class.

Explain to the students that stories about a person's life are called biographies. Tell the students that they are going to develop a planned outline for writing biographies of famous aviation and space personalities. Ask that they use at least three major headings with at least two subheadings under each. Ask students to consider the following questions as they develop the outline:

1. When and where was the personality born?
2. How old would this person be today?
3. What did this person's parents do?
4. Did this person's parents have an effect on his/her life?
5. How and where did this person learn to fly?
6. What great contributions did this person make to aviation or space?
7. What kind of failures did this person experience?

Ask students to use their planned outline to write a biography about their favorite aviation or space hero or heroine. Suggest a list of aviation and space heroes and heroines such as the following:

Orville and Wilbur Wright
Amelia Earhart
Charles Lindbergh
Robert Goddard
Neil Armstrong
Sally Ride
Christa McAuliffe

ACTIVITY 7 (Continued)

Extended Activities

- Develop an aviation and space hero/heroine bulletin board. Display students' biographies of famous aviation and space heroes/heroines. Ask students to develop drawings that depict accomplishments that made each hero/heroine famous.
- Divide the class into six groups. Ask each group to select a famous aviation or space hero/heroine. Tell them to brainstorm and develop a creative presentation (show and tell, picture presentation, or play) as a way to inform the class about their selected personality.
- Distribute Student Handout 12. Complete per directions.

Answers:	<u>Down</u>	<u>Across</u>
	1. Yeager	1. Wright
	2. Lindbergh	2. Goddard
	3. Ride	3. Earhart

- Ask students to create an acrostic, a poem in which the first letter of each line forms a name or message, using one of the following words:

Wright	glider	rocket
kite	Amelia	Yeager

Example:

B	Buoyant bag
A	Ascending upward
L	Light, wind
L	Lift, liberate
O	Onward, observation
O	Oblate shape
N	Natural

- Distribute Student Handout 13. Complete per directions.
Answer: Goddard was the Father of Rocketry.

ACTIVITY 8: TIME LINE

Direct the students' attention to where they fit in aviation and space history. Ask thought-provoking questions such as the following:

1. What major aviation and space events have taken place since you were born?
2. Name some of the major aviation and space events that your parents may have seen.
3. Did the Wright brothers fly before your parents were born, your grandparents, or great-grandparents?
4. During what time period did the greatest number of aviation and space achievements take place?
5. How long has it been since the Wright brothers' first powered, sustained and controlled flight?

Ask students to brainstorm and compile a list of the aviation/space events they think were major milestones to the developments we have today. Write the list on the board. Ask that they develop reasons for their selections. Limit the list to ten events. Using the list and Student Handout 14, ask students to develop a time line of major aviation and space achievements. Complete Student Handout 14 per directions.

Extended Activities

- Develop a "Major Events in the History of Flight" bulletin board. Divide the class into seven groups. Assign each group a major event. Give each group a copy of one of the major events as listed:
 - Student Handout 5: Leonardo da Vinci
 - Student Handout 6: Montgolfier Balloon
 - Student Handout 7: Zeppelin Airship
 - Student Handout 11: Wright Brothers
 - Student Handout 15: Jet Service
 - Student Handout 16: Apollo II
 - Student Handout 17: Space Shuttle

ACTIVITY 8 (Continued)

Grades 2-3

Ask each group to use library resources to research information and write a one-page report on their assigned major event. Ask each group to select a reporter to report findings to the class. Display the completed handout and the one-page report on the bulletin board.

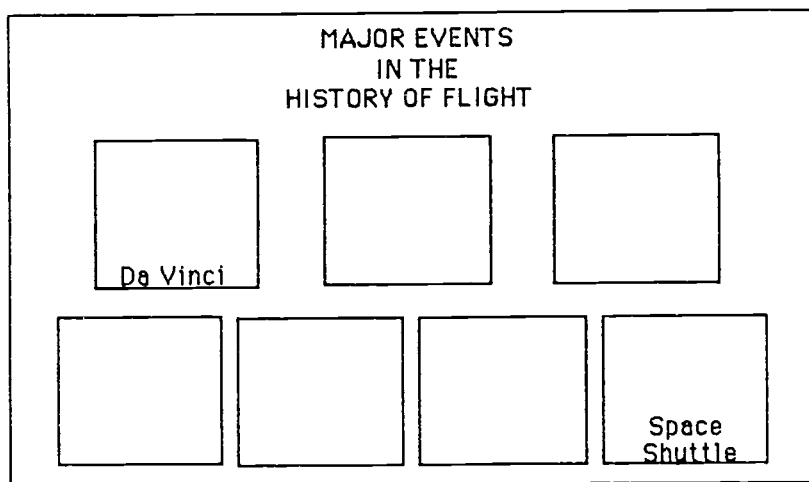

Kindergarten-Grade 1

Use the same bulletin board as grades 2-3. Distribute Student Handouts 5, 6, 7, 11, 15, 16, and 17 one at a time. Discuss each major event in the history of flight. Color each handout and display on the bulletin board.

- Develop an aviation and space current events bulletin board. Have students design, color, and cut out aircraft and rockets to border the bulletin board. Ask students to collect news articles about aviation and space events. Have students report their news. Display the articles on the board.



ACTIVITY 8 (Continued)

- Write Topic 3 vocabulary words in the Fantastic Flight Dictionary.

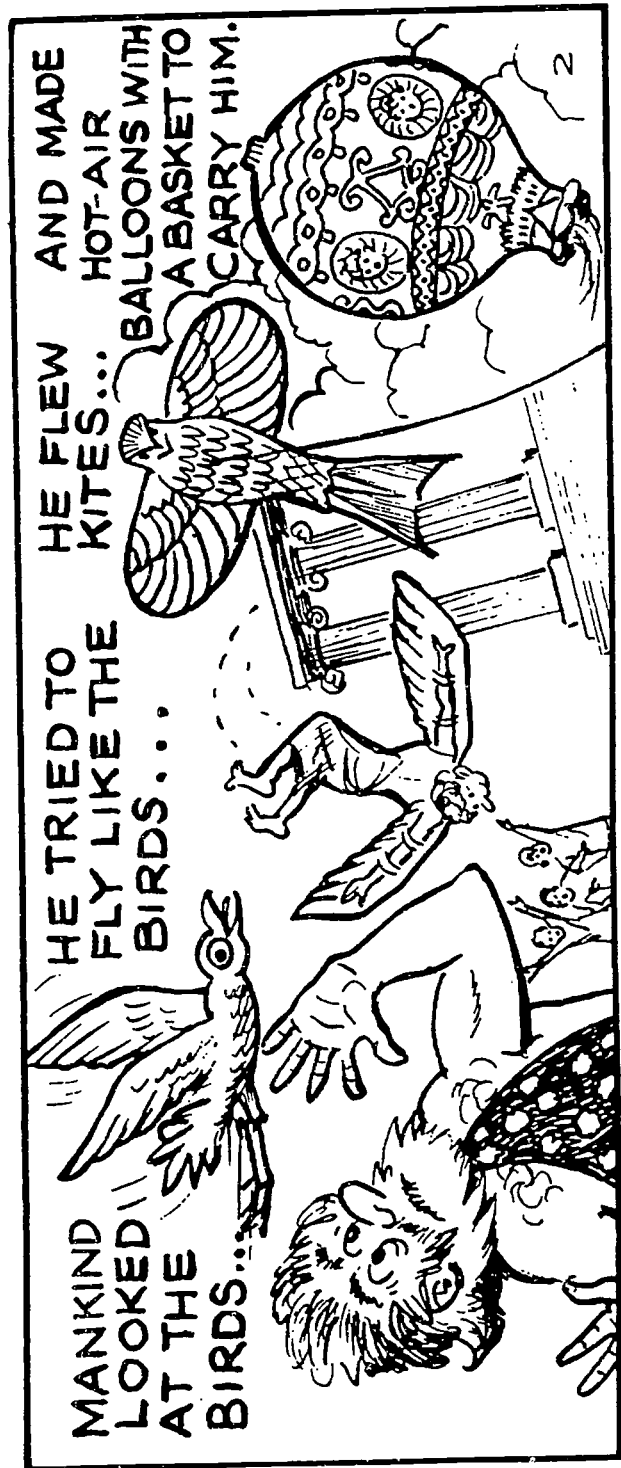
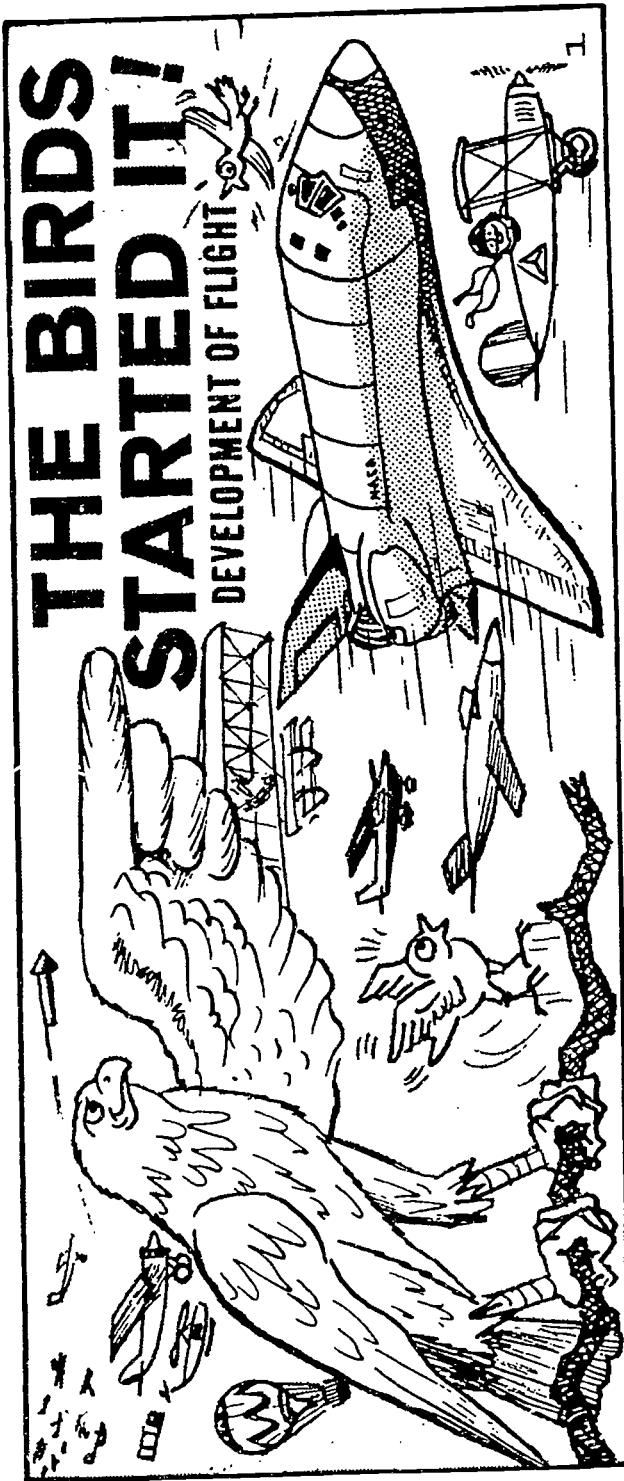

UNIT 1 ACTIVITY 1

STUDENT HANDOUT 2

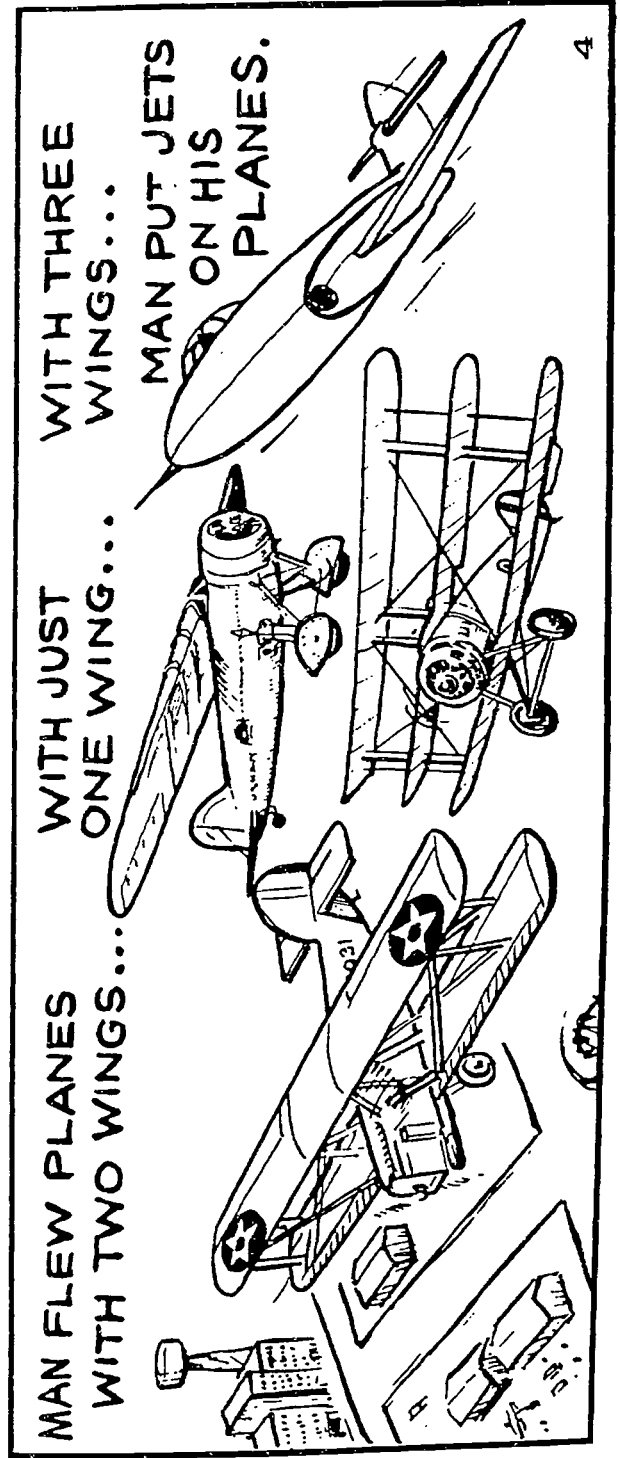
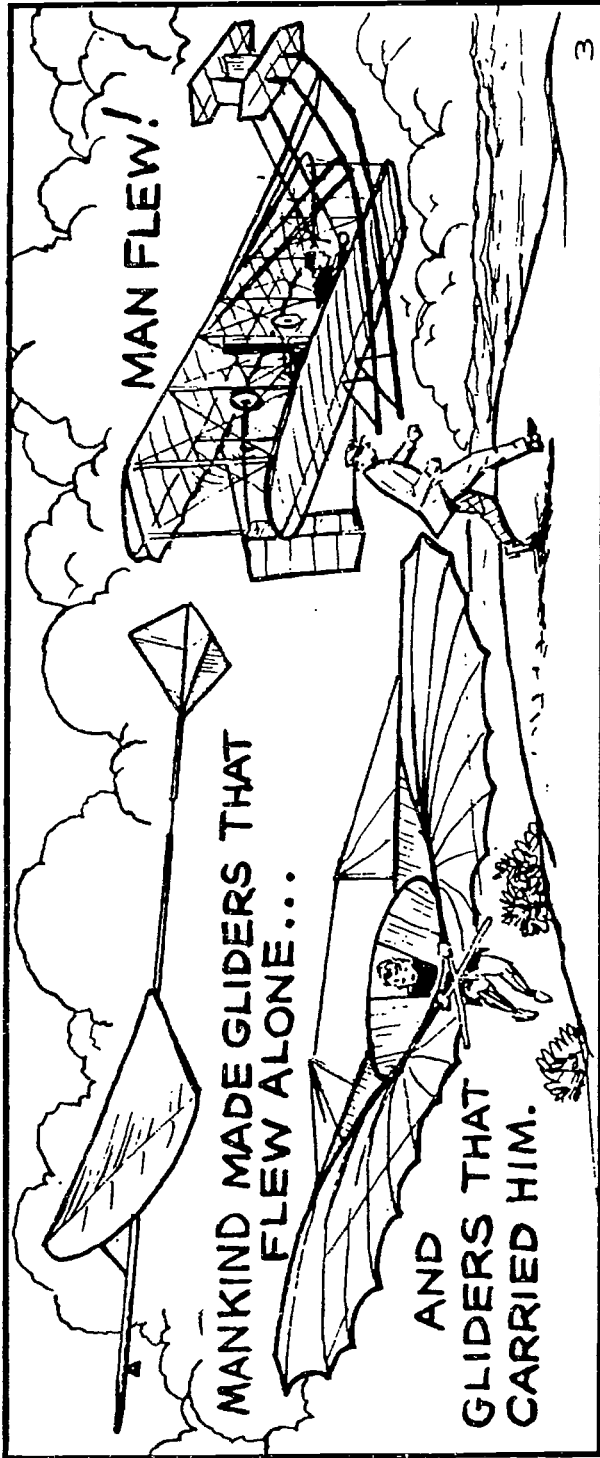

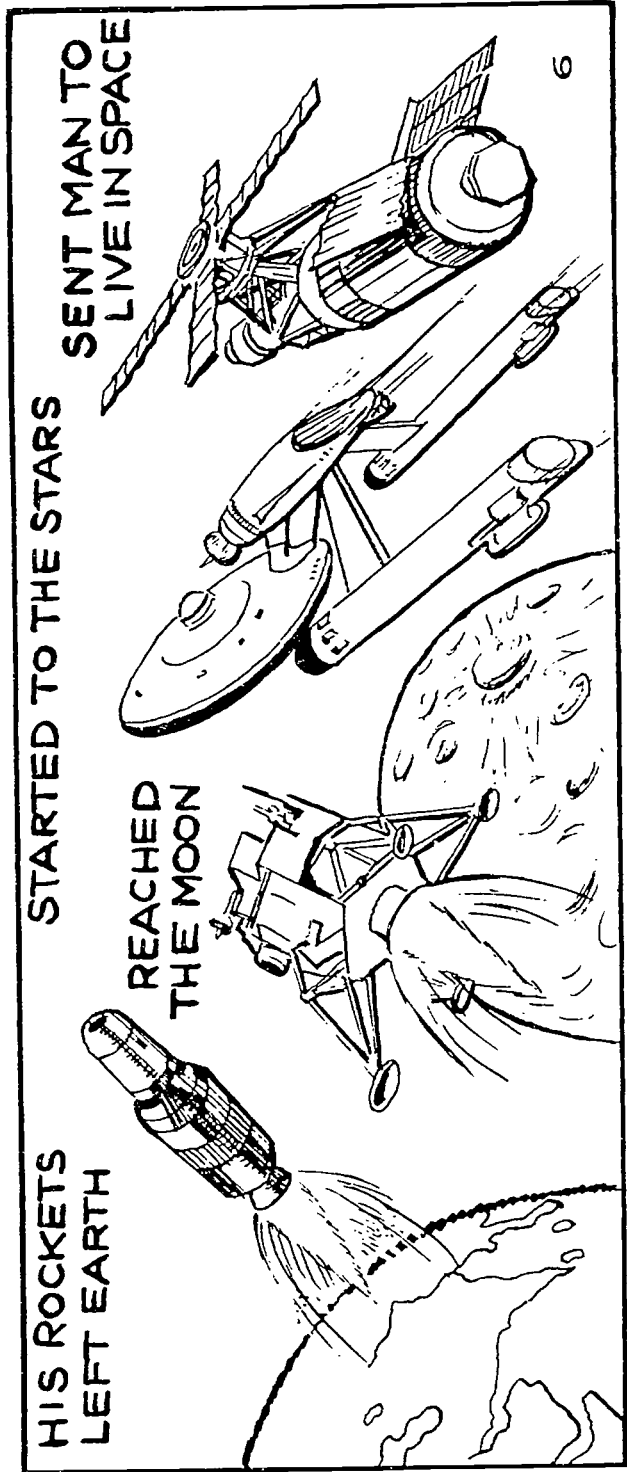
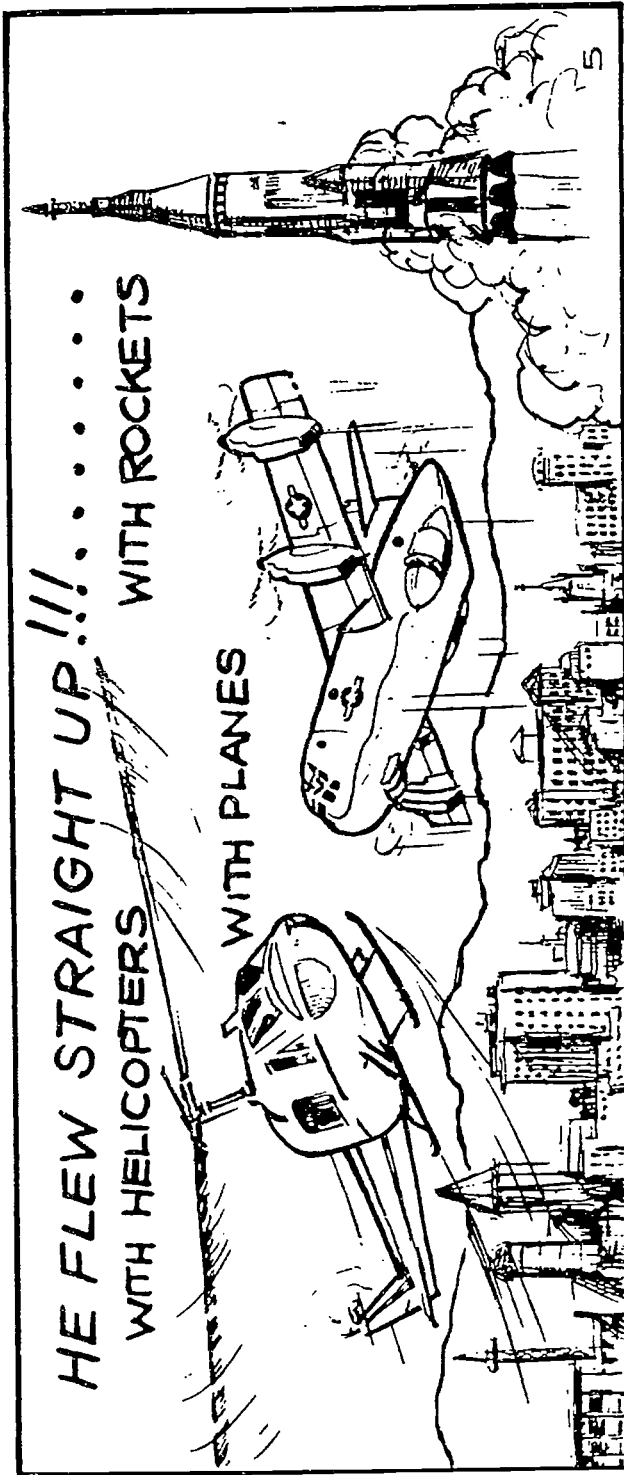

UNIT 1 ACTIVITY 1

STUDENT HANDOUT 4

34

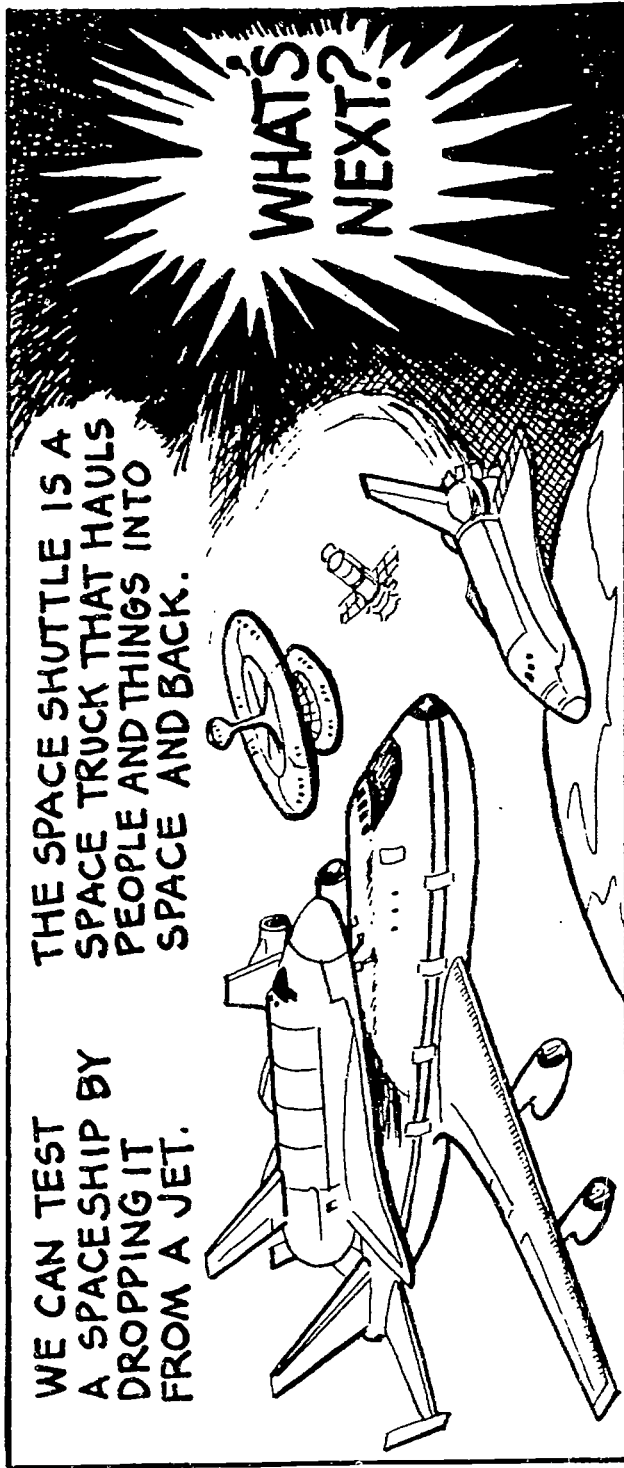

UNIT 1 ACTIVITY 4

STUDENT HANDOUT 5

Directions: Read and color.



LEONARDO DA VINCI

Leonardo da Vinci was an artist. He drew the world's first known designs of the parachute and the helicopter.

UNIT 1 ACTIVITY 4

STUDENT HANDOUT 6

Directions: Read and color.



MONTGOLFIER BALLOON
1783

Man's "first flight" was made in a Montgolfier balloon. The flight lasted 25 minutes.

UNIT 1 ACTIVITY 4

STUDENT HANDOUT 7

Directions: Read and draw a countryside scene for the Zeppelin.

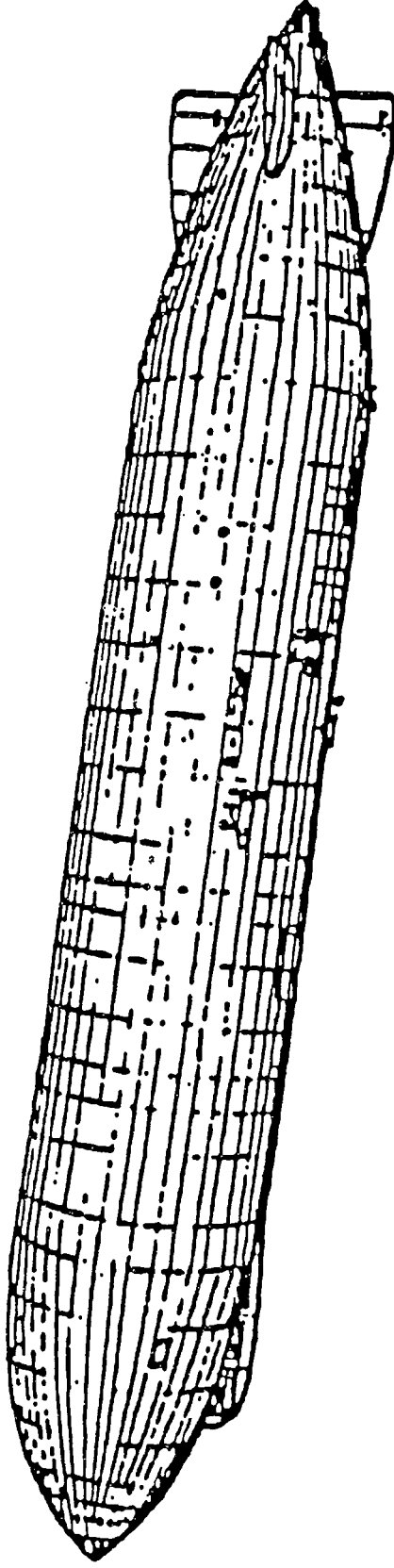

**ZEPPELIN AIRSHIP
1900**

Count Ferdinand Von Zeppelin built the first aircraft for public use. It made the first successful flight across the Atlantic Ocean.

UNIT 1 ACTIVITY 5

STUDENT HANDOUT 8

FAMOUS PEOPLE AND AIRCRAFT

FIND: Balloon

Da Vinci

Kite

Chinese

Zepplin

Parachute

Dirigible

Montgolfier

B	A	L	L	O	O	N	A	G	J	Z	T
Y	M	O	N	T	G	O	L	F	I	E	R
O	E	W	U	W	E	N	G	R	K	P	T
A	N	R	R	E	L	G	I	E	T	P	Y
C	H	I	N	E	S	E	Y	R	L	E	W
A	O	G	R	R	D	E	I	L	C	L	Y
E	S	H	Y	B	A	L	L	O	O	I	B
B	O	T	K	M	V	Y	I	C	K	N	O
A	J	I	I	A	I	W	T	K	S	T	B
O	M	S	N	L	N	L	O	I	A	N	Y
E	P	A	R	A	C	H	U	T	E	I	O
D	I	R	I	G	I	B	L	E	L	W	W

UNIT 1 ACTIVITY 5

STUDENT HANDOUT 9

Directions: Match accomplishments to name of aerospace hero.

1. _____ Chinese

2. _____ Leonardo da Vinci

3. _____ Montgolfier

4. _____ Zeppelin

a. Man's first flight

b. Made first powered, controlled, and sustained flight

c. World's first designer of the helicopter and the parachute

d. Invented the kite

e. Perfected the dirigible for public use

UNIT 1 ACTIVITY 5

STUDENT HANDOUT 10

Directions: Color, cut, and paste the picture of the famous aircraft above the name of the inventor.

34

1. Chinese

2. Leonardo da Vinci

3. Zeppelin

4. Montgolfier

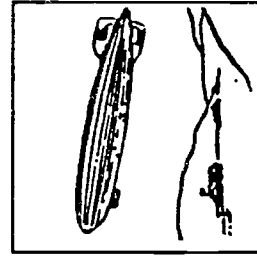
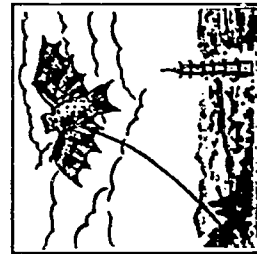
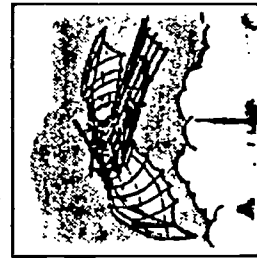
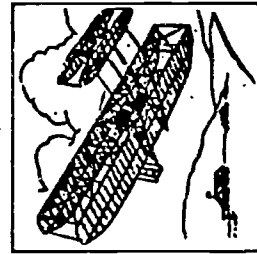
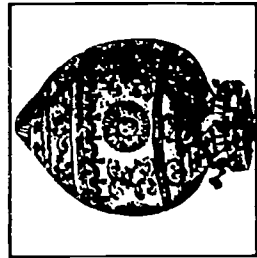

CUT

UNIT 1 ACTIVITY 6

STUDENT HANDOUT 11

Directions: Read the story. Color The Flyer.

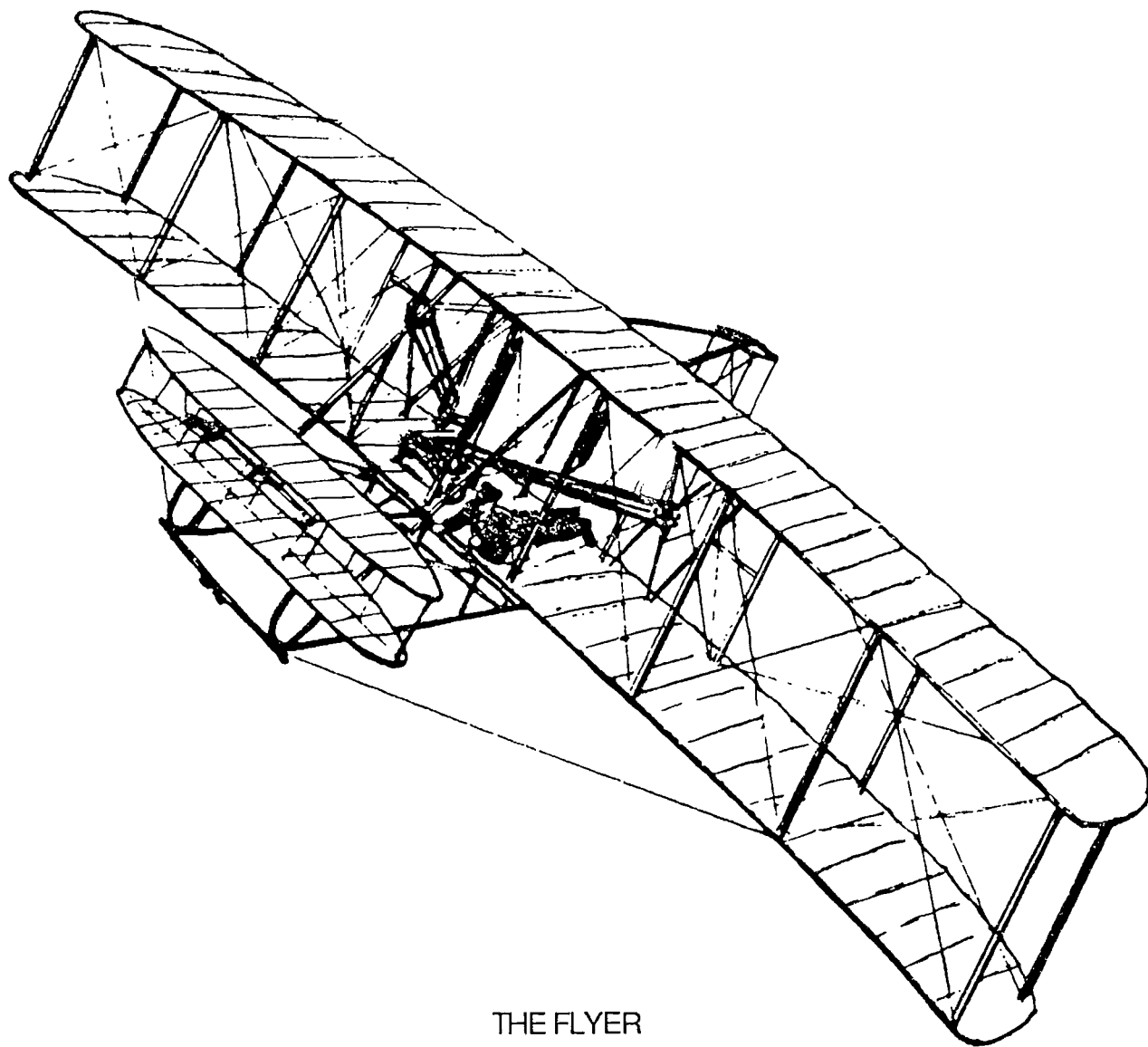

THE FLYER
1903

Orville and Wilbur Wright flew the first powered and controlled flight in Flyer I. Real flight was born.

UNIT 1 ACTIVITY 7

STUDENT HANDOUT 12

FAMOUS AVIATION AND SPACE PERSONALITIES

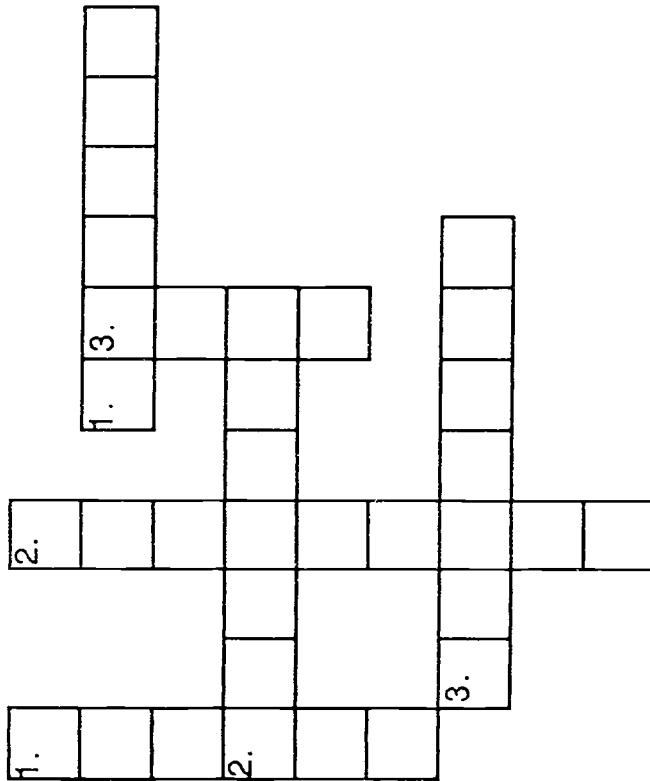

WORD BANK

Goddard	Earhart
Yeager	Lindbergh
Wright	Ride

Down

1. First to fly faster than the speed of sound.
2. First man to fly solo across the Atlantic.
3. First United States woman in space.

Across

1. Flew the first powered, controlled, and sustained heavier-than-air aircraft.
2. Father of rocketry.
3. First aviatrix to fly solo across the Atlantic.

UNIT 1 ACTIVITY 7

STUDENT HANDOUT 13

Directions: Add or subtract. Use secret code to find secret message.

Secret Code:

$\frac{5}{a}$	$\frac{6}{c}$	$\frac{7}{d}$	$\frac{8}{e}$	$\frac{9}{f}$	$\frac{10}{g}$	$\frac{11}{h}$	$\frac{12}{k}$	$\frac{13}{o}$
$\frac{14}{r}$	$\frac{15}{s}$	$\frac{16}{t}$	$\frac{17}{w}$	$\frac{18}{y}$				

SECRET MESSAGE

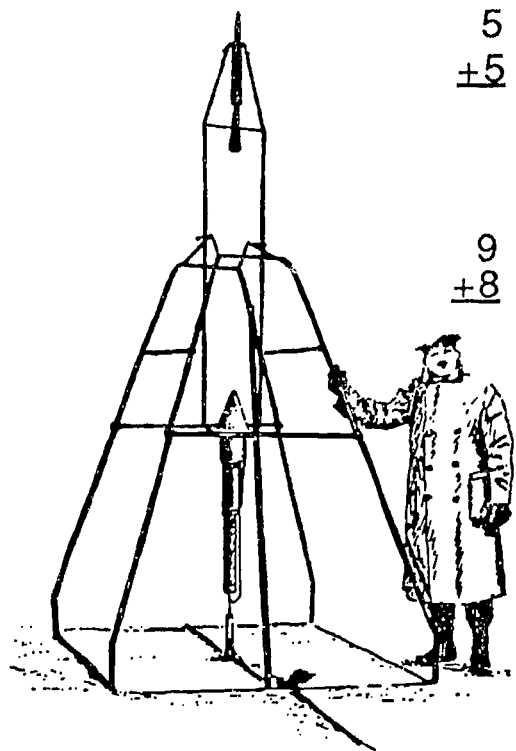

5	6	3	10	9	7	13
<u>+5</u>	<u>+7</u>	<u>+4</u>	<u>-3</u>	<u>-4</u>	<u>+7</u>	<u>-6</u>

9	10	8	8	6	16
<u>+8</u>	<u>-5</u>	<u>+7</u>	<u>+8</u>	<u>+5</u>	<u>-8</u>

17	11	9	8	11	9
<u>-8</u>	<u>-6</u>	<u>+7</u>	<u>+3</u>	<u>-3</u>	<u>+5</u>

6	17
<u>+7</u>	<u>-8</u>

8	4	13	12	15	7	6	9
<u>+6</u>	<u>+9</u>	<u>-7</u>	<u>-0</u>	<u>-7</u>	<u>+9</u>	<u>+8</u>	<u>+9</u>

UNIT 1 ACTIVITY 8

STUDENT HANDOUT 14

Directions: Cut out pictures. Glue the pictures in chronological order on a piece of plain paper.
Write the age of grandmother, dad, and yourself.

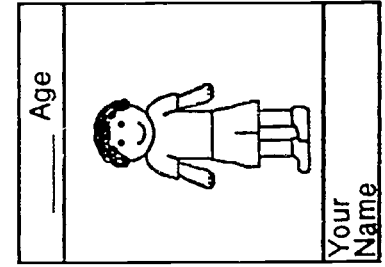
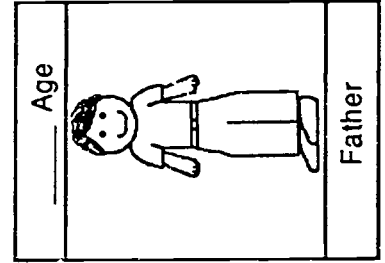
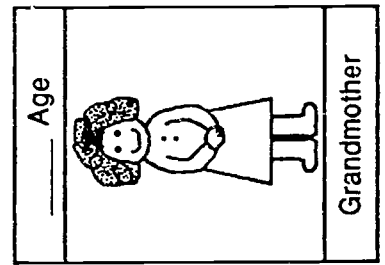
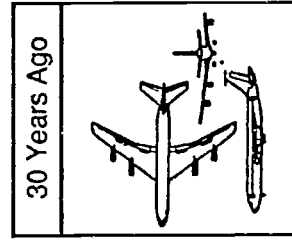
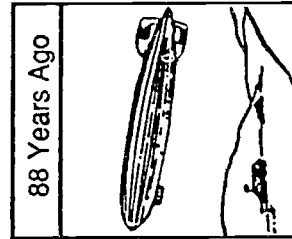
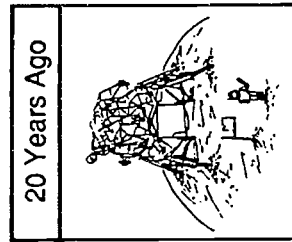
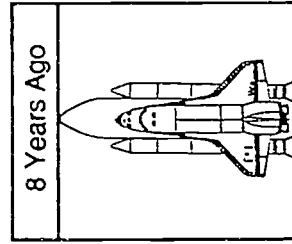
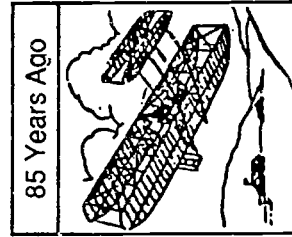
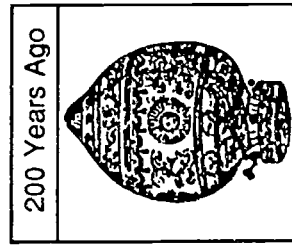
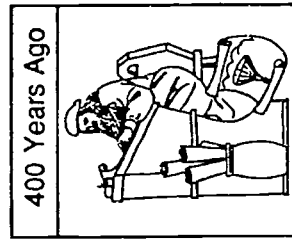

UNIT 1 ACTIVITY 8

STUDENT HANDOUT 15

Directions: Read the story. Color the picture.

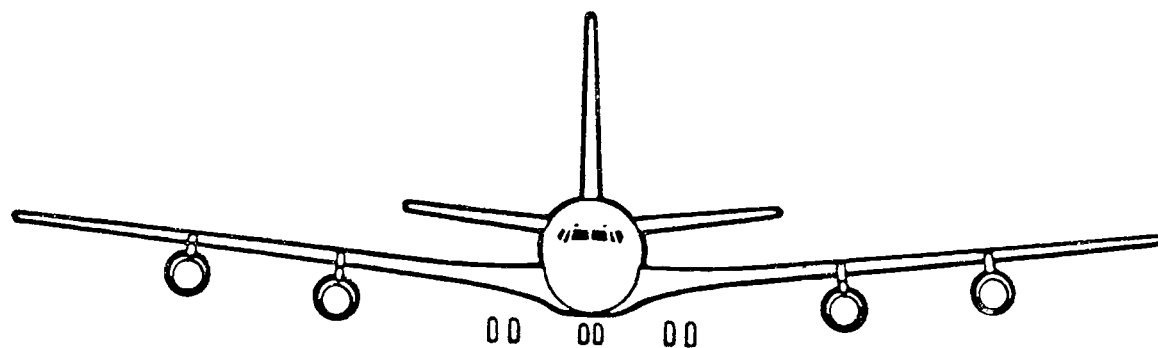

Front View

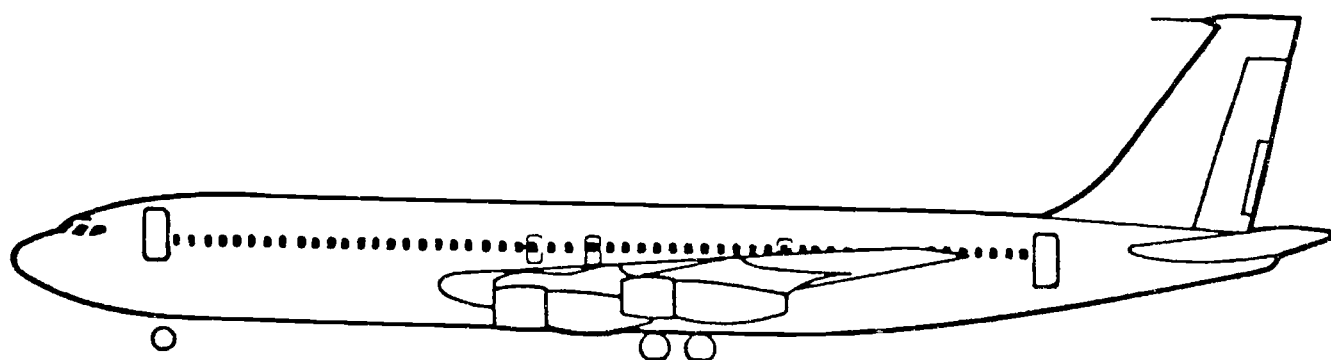

Side View

1958 JET SERVICE

Airlines flew the first passenger jet in 1958. For the first time, man could travel 600 miles per hour.

UNIT 1 ACTIVITY 8

STUDENT HANDOUT 16

Directions: Read the story. Color the picture.

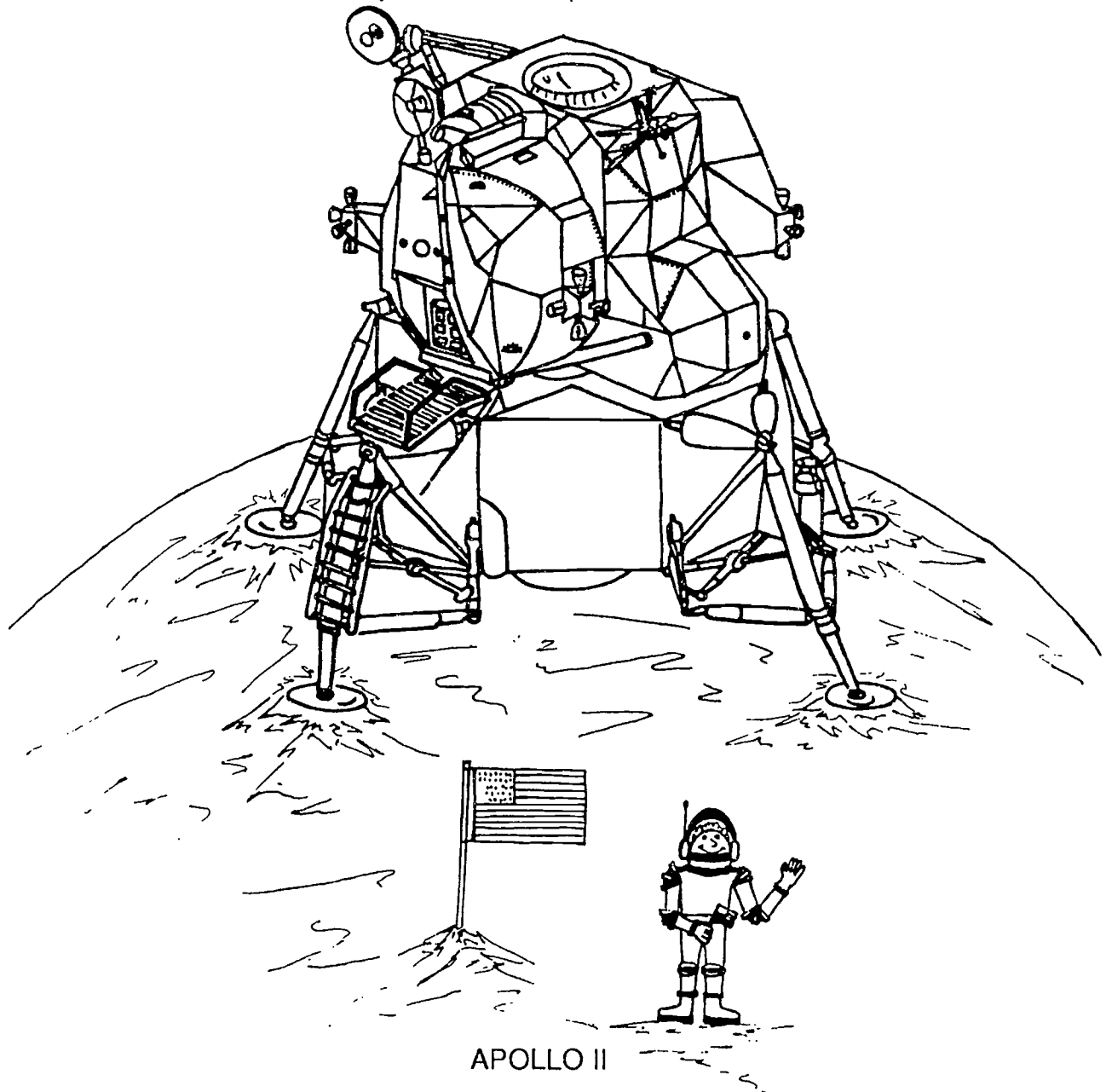

APOLLO II

Apollo II landed on the moon on July 20, 1969. Neil Armstrong was the first man to walk on the moon.

UNIT 1 ACTIVITY 8

STUDENT HANDOUT 17

Directions: Read the story.
Color the picture.

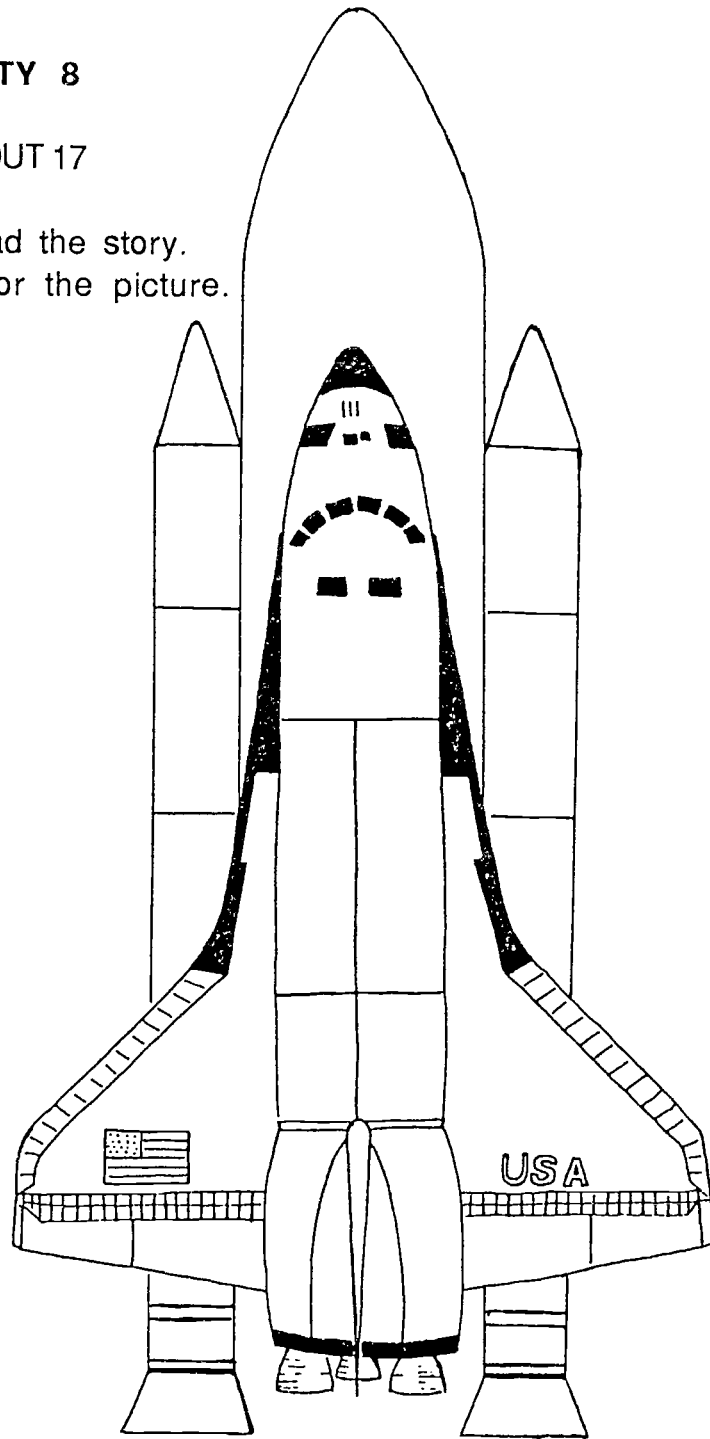

SPACE SHUTTLE

The first space shuttle was launched in 1981. A space shuttle has three main parts: the orbiter, the solid rocket boosters, and the external fuel tank.

UNIT 2: KINDS AND USES OF AIRCRAFT

PURPOSE OF UNIT 2

The purpose of Unit 2 is to introduce students to the kinds and uses of aircraft. Specifically, students should:

1. identify different kinds of transportation for use on land, air, and water;
2. define the term "aircraft";
3. recognize the four different groups of aircraft;
4. demonstrate that air has weight;
5. demonstrate that cool air is heavier than warm air;
6. recognize the three users of aircraft: military, airlines, and general; and
7. explore the many uses of aircraft.

MAJOR MESSAGES IN UNIT 2

- Most aircraft are useful, but some are for sport or fun.
- Aircraft both directly and indirectly help each of us daily in some way.

BACKGROUND INFORMATION FOR UNIT 2

Unit 2 consists of 2 topics:

TOPIC 1: FOUR GROUPS OF AIRCRAFT

TOPIC 2: THREE USERS OF AIRCRAFT

Topic 1 divides the many kinds of aircraft into four groups. Emphasis is placed on the differences of each group.

Topic 2 takes a look at the different users of aircraft: military, airlines, and general. The many ways in which the users use aircraft are further explored in Topic 2.

VOCABULARY WORDS FOR UNIT 2

Topic 1

aircraft
rotocraft
lighter than air
glider
airplane
balloon
blimp
dirigible
helicopter
sailplane
hang glider
gyrocopter

Topic 2

military
airline
general
crop duster

TOPIC 1: FOUR GROUPS OF AIRCRAFT

The activities, suggested materials, grade level, and related subject areas for each activity are summarized below.

<u>ACTIVITY</u>	<u>MATERIALS NEEDED</u>	<u>GRADE LEVEL</u> <u>SUBJECT</u>
1. Ways to Travel	magazines bulletin board	Grades K-1 social studies mathematics
2. What Is an Aircraft	aviation magazines Student Handouts 1 and 2	Grades K-1 social studies mathematics
3. Lighter than Air	BALLOONS AND BLIMPS, Student Handouts 3, 4, and 5 string, dowel, 2 balloons Little Thinker cassette tape: Ways to Travel: A Balloon Trip (See Teacher Resource Section [Jerome Enterprises, Inc.] for address.) drawing paper, crayons tissue paper, gluestick or rubber cement, coffee can (ends removed), single burner camp stove, string, masking tape round balloons, newspaper, glue, water, string, fruit baskets (boxes), paint	Grades K-3 science language arts

TOPIC 1 (Continued)

<u>ACTIVITY</u>	<u>MATERIALS NEEDED</u>	<u>GRADE LEVEL</u> <u>SUBJECT</u>
4. Rotocraft	Student Handout 6 white drawing paper	Grades K-3 language arts art
	Student Handout 7	
5. Glider	8 1/2" X 11" white paper wood glider kits (See Teacher Resource Section for free or inexpensive glider kits.)	Grades K-3 science language arts art
6. Airplanes	Student Handouts 8, 9, 10, 11, and 12 Fantastic Flight Dictionary	Grades K-3 language arts mathematics

ACTIVITY 1: WAYS TO TRAVEL

Begin by directing students' attention to different kinds of transportation. Create an interest by asking questions such as the following:

1. Before the car was invented, what were some ways man traveled from one place to another?
2. What are some ways we travel today?
3. What is the fastest way to travel today? What is the slowest?

Explain that we can travel on land, on air, and on water. Point out that there are many kinds of land vehicles, water vehicles, and air vehicles. Ask students to collect pictures of ways to travel from magazines, books, and newspapers. Use pictures to develop a bulletin board. Make title and caption cards per diagram.

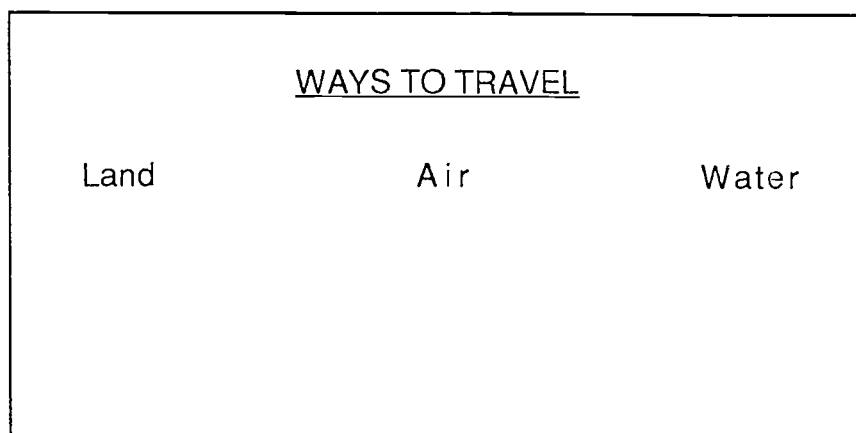

Discuss pictures of different vehicles that the students have collected. Ask students to sort the pictures into three groups: land vehicles, air vehicles, and water vehicles. Display the students' pictures under the appropriate bulletin board caption.

ACTIVITY 2: WHAT IS AN AIRCRAFT

Direct the students' attention to the word "aircraft." Arouse student interest by asking the following questions:

Questions: What is air?
What is a craft?
What is an aircraft?

Answers: air: the earth's immediate atmosphere (air)
craft: boat, ship; a vehicle
aircraft: a vehicle that travels in the air

Wait for a variety of responses. After the discussion, help students formulate a definition for the word "aircraft."

Definition: An aircraft is any machine or device capable of moving through the air. An aircraft can be non-motorized or motorized.

Distribute aviation magazines. Ask students to cut out pictures of different aircraft (airplanes, balloons, helicopters, and gliders). Have students share their pictures with the group. Develop an awareness of aircraft differences by asking questions such as the following:

1. Does this aircraft have wings?
2. Does this aircraft have an engine?
3. How does this aircraft become airborne?
4. What moves this aircraft through the air?
5. Does this aircraft help move people or things from place to place?
6. Is this aircraft useful or is it for fun?

ACTIVITY 2 (Continued)

Tell students that there are many kinds of aircraft. Explain that the different kinds of aircraft are grouped according to the way they sustain themselves (stay in the air) during flight. Distribute Student Handouts 1 and 2. Explain to the students that there are four groups of aircraft:

1. lighter than air
2. rotocraft
3. gliders
4. airplanes

Ask students to examine Student Handouts 1 and 2. Instruct students to determine the way in which each aircraft group sustains itself (stays in the air) during flight. Emphasize the four groups of aircraft by drawing the following diagram on the board.

AIRCRAFT
A Device that Flies

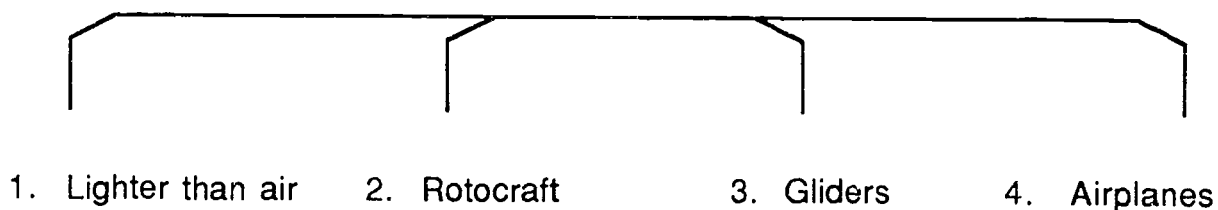

ACTIVITY 3: LIGHTER THAN AIR

Direct students' attention to LIGHTER-THAN-AIR aircraft. Develop an interest by asking questions such as the following:

1. What does lighter than air mean?
2. What kind of aircraft are lighter than air?

Explain to the students that balloons, blimps, and dirigibles are in the lighter-than-air aircraft group because they are lifted into the air by a gas that weighs less than air.

Distribute BALLOONS AND BLIMPS (Student Handouts 3, 4, and 5).

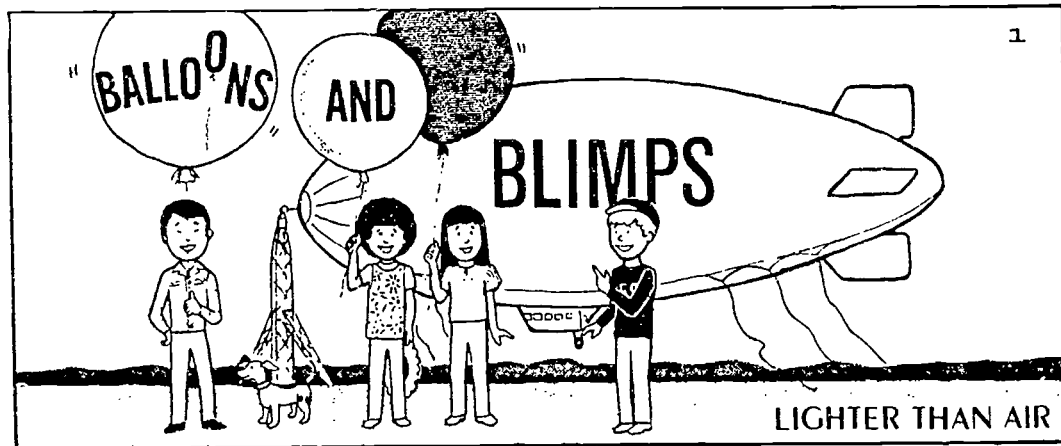

Cut sheets apart, stack, and staple to form a book. Read and discuss. Ask questions similar to the following:

1. What makes a balloon rise?
2. What is a blimp?
3. Compare a balloon to a blimp.
4. What are balloons and blimps used for?

Explain that BALLOONS were the first aircraft that enabled man to break the bond that held him to earth. Today, the balloon is used primarily for sport. A hot-air balloon is made of a large, air-tight cloth or plastic bag filled with heated air. Hot air is lighter than cool air. The balloon rises because the heated air inside is lighter than the cool air outside. When the heated air cools, the balloon will stop rising and come down.

ACTIVITY 3 (Continued)

BLIMPS AND DIRIGIBLES are wingless, have an engine or engines, and can be steered with a rudder. Dirigibles do not exist today, and only a few blimps exist. Large corporations, such as the Goodyear Rubber Company, own and maintain blimps for advertising purposes. A blimp is really a small dirigible. A rigid piece of metal or wood runs along the bottom of the helium-filled envelope, to which a control car or cabin is attached.

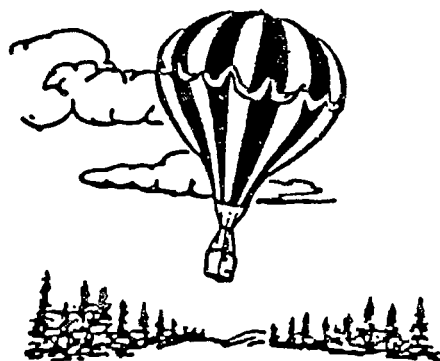

Balloon

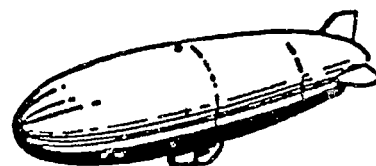

Blimp



Dirigible

ACTIVITY 3 (Continued)

Extended Activities

- Explain to students that air has weight. Inflate two balloons to the same size. Tie ends with string. Attach a balloon to each end of a dowel. Tie a string to the middle of the dowel. Balance the dowel. Ask students to predict what will happen when one balloon is pricked with a pin. Explain why.

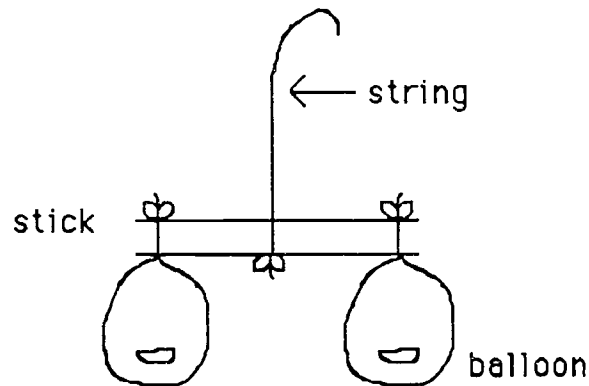

- Tell students that they are going to take an imaginary trip in a hot-air balloon. Play the Little Thinker cassette tape: "Ways To Travel: A Balloon Trip." (Check Teacher Resource Section for purchase information.) Give students white drawing paper and crayons. Ask students to draw the things seen on the trip.

ACTIVITY 3 (Continued)

- HOT-AIR BALLOON CONSTRUCTION

Grades K-2
(Demonstrated
by the teacher)

Grade 3
(Made by students in
groups of four or six
under adult
supervision.)

- Carefully glue three sheets of 20" X 28" tissue paper together lengthwise. Overlap each sheet 1/2". Use glue stick or rubber cement.

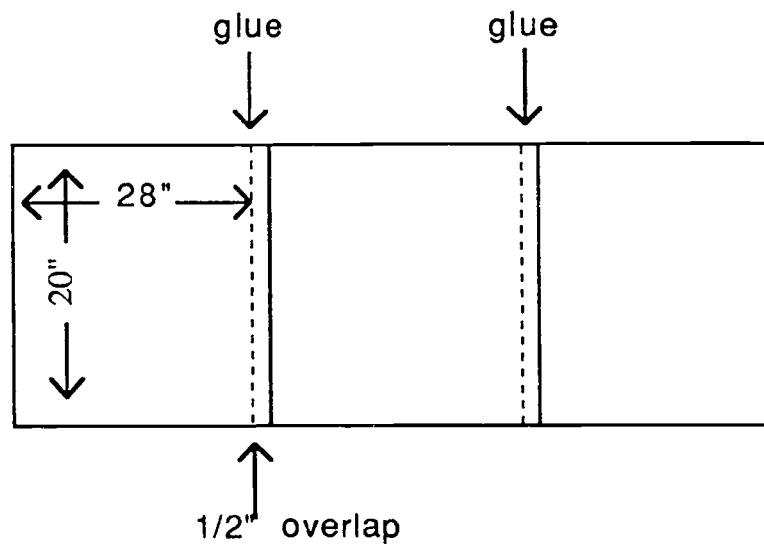

ACTIVITY 3 (Continued)

- Repeat step one seven times. Stack the seven 84" long sheets of tissue. Draw the shape of a gore on the top sheet using the diagram below.

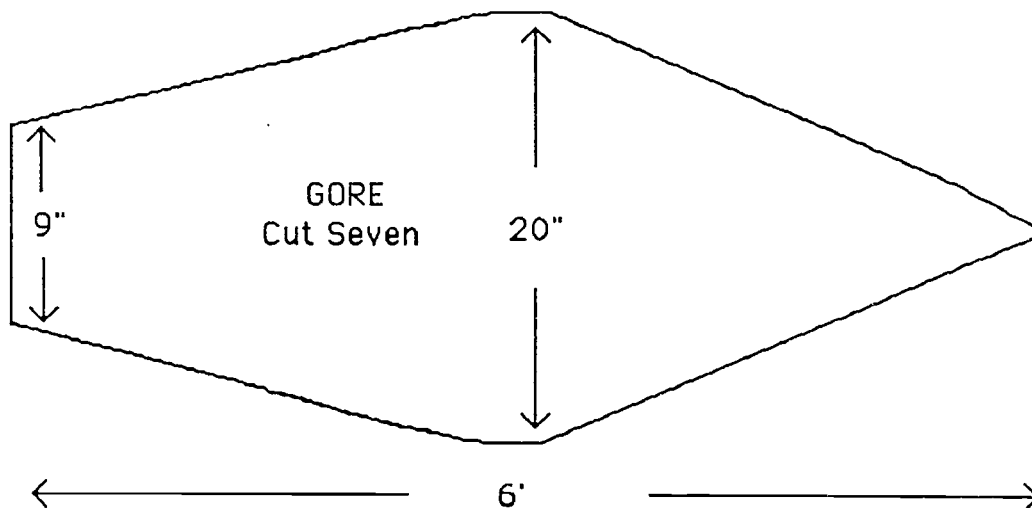

- Cut out all seven gores at once using the top sheet as a guide.
- Decorate the gores with felt tip pens.
- Stack gores. Slide top gore #1 about one-half inch to the side of gore #2. Fold the one-half inch margin of gore #2 over gore #1. Glue the margin of gore #2 to gore #1.

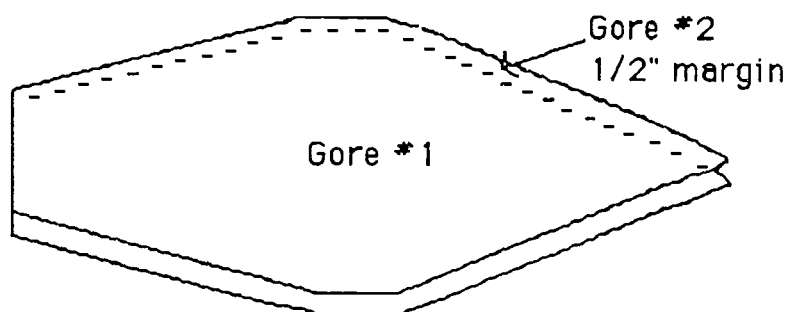

ACTIVITY 3 (Continued)

- Slide gore #1 and #2 to the side of gore #3. Leave a one-half inch margin. Fold the one-half inch margin of gore #3 over gore #2. Glue. Repeat this procedure with gore #4, #5, #6 and #7. Finally, glue gore #7 to the free edge of #1.
- Gather the top of all seven gores (small opening) and tie with string. Make a loop in the string.
- Bind the tissue paper at the bottom (large opening) of the balloon with masking tape. The masking tape reinforces the bottom edge of the balloon.
- Use a single burner camp stove and a coffee can to direct the heat into the bag. Carefully ignite the stove. Place the coffee can on the grill of the stove. Use a pole with an attached hook in the end to lift the balloon (by the string loop) over the coffee can. Hold the masking tape reinforced opening by hand. Guide the opening over the heat source. When the balloon is inflated and becomes buoyant, let go. This operation takes 2-3 people.

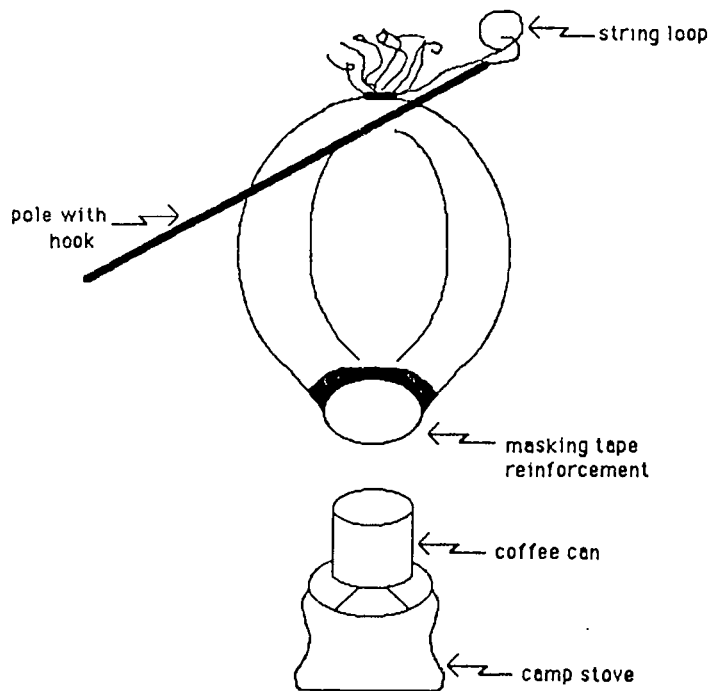

ACTIVITY 3 (Continued)

Once the experiment is finished, evaluate the outcome with students. To clarify the term lighter than air, ask questions such as the following:

1. What made the balloon rise into the air?
 2. What made the balloon return to the ground?
 3. Predict how the balloon would perform on (1) a very cold day and (2) a very hot day.
- Have students write an adventure story about an imaginary trip in a hot-air balloon. Ask students to illustrate their stories.
 - Organize a debate about the following:
 - hot-air balloons vs. blimps
 - hot-air balloons vs. airplanes
 - Have students research the hot-air balloon:
 1. Discover the name of the inventor.
 2. Draw a diagram showing the parts of the balloon.
 3. Explain the function of each part.
 - Make PAPIER-MACHE BALLOONS: Give each student a round balloon, glue, water, and newspaper.
 1. Inflate the balloon.
 2. Mix equal parts of glue and water.
 3. Tear the newspaper into strips, dip in the glue mixture, and cover the inflated balloon.

When balloons are completely dry, prick with a pin. Paint the balloons. Attach strings around the balloon and secure a small basket to simulate a gondola. Hang balloons from ceiling using transparent nylon string.

- Use elongated balloons to create dirigibles or blimps.

ACTIVITY 4: ROTOCRAFT

Explain to the students that the ROTOCRAFT is another group of aircraft. Tell the students that there are two kinds of rotocraft: the helicopter and the gyroplane. Rotocraft aircraft are different in that they become airborne by way of a rotating wing.

The HELICOPTER is wingless. It has a rotating wing called a "rotor." Air passing over the whirling rotor blades lifts the helicopter upward like the wing lifts the airplane. The helicopter is more versatile than any other aircraft. When taking off or landing, it can fly straight up or straight down. This allows it to go places other aircraft cannot. Helicopters require very little take off or landing space and can hover (stay in one place) while in the air. They can fly much closer to the ground than airplanes. The versatility of helicopters make them a valuable work horse. Accident victims can be picked up at the accident site and flown quickly to the hospital. News reporters use helicopters to check and report traffic conditions on busy city streets. Helicopters help farmers plant seeds, fertilize crops, and control insects. The helicopter can perform rescue missions in places that can not be reached by other forms of transportation.

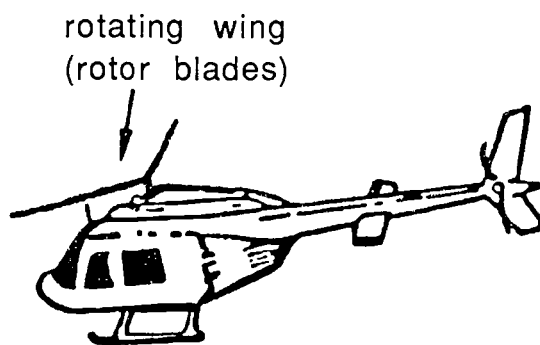

helicopter

ACTIVITY 4 (Continued)

The wingless GYROPLANE has a rotating wing to lift it and a pusher-type propeller in the rear to push it through the air. Few gyroplanes exist. They are used mostly for sport.

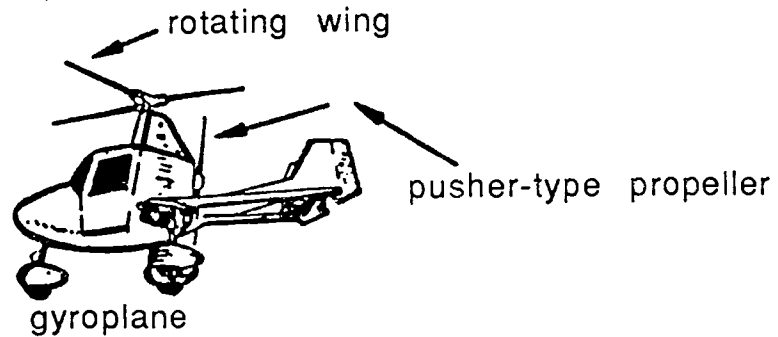

Distribute Student Handout 6. Read the story and discuss. Ask questions such as the following:

1. What lifts a helicopter into the air?
2. Compare a helicopter to an airplane.
3. Why are helicopters more versatile than airplanes?
4. Name jobs that need the use of a helicopter.

Distribute white drawing paper. Ask students to create a drawing of a helicopter using the five steps. Complete the picture showing the helicopter doing one of the jobs in the story. Ask students to share their pictures with the class.

Extended Activity

- Distribute Student Handout 7. Complete per directions.

ACTIVITY 5: GLIDER

Stimulate the students' imagination by directing their attention to a group of aircraft without engines. Develop an interest by asking questions such as the following:

1. Do all aircraft have engines?
2. What do we call an aircraft without an engine?
3. What keeps it in the air?
4. What do you think it looks like?
5. Do you think this aircraft is useful?

After students have had an opportunity to brainstorm ideas, explain that the group of aircraft without engines is called GLIDER. There are two kinds of aircraft in the glider group: (1) sailplanes and (2) hang gliders.

The sailplane is the most popular glider today. It is usually towed or pulled up into the air by an engine-powered airplane. A tow rope connects the sailplane to the airplane. The sailplane flies currents of rising air after the tow rope is released. Air currents called "up drafts" keep the motorless sailplane aloft. Warm air rising from hot, flat areas of the earth and wind currents that have been turned upward after hitting a hillside are necessary for a sailplane pilot to enjoy his sport.

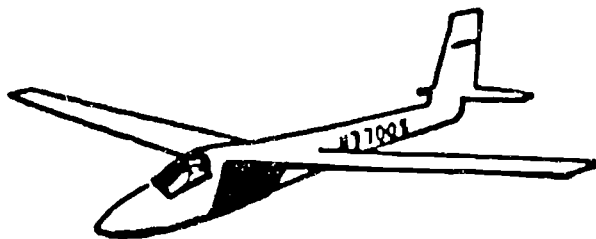

sailplane

ACTIVITY 5 (Continued)

The hang glider looks something like a triangle-shaped kite. A harness is attached to the underside to hold the pilot. The pilot, wearing the harness, holds the glider and runs down a hill or jumps off a cliff to become airborne. The wind lifts the glider into the air. The hang glider usually travels as fast as a car on a busy street. Hang gliders usually fly about as high as a one-story building. Experienced pilots may go higher but never as high as an airplane.

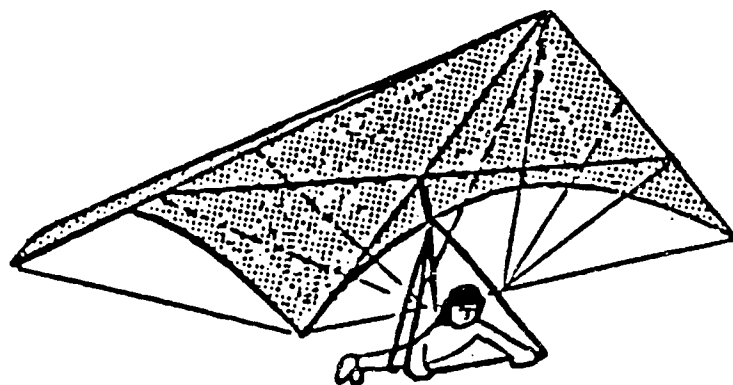

hang glider

Demonstrate the folding of paper to make a glider (paper airplane). Distribute white 8 1/2" X 11" paper. Ask students to design a paper glider of their choice. Decorate glider with crayons or felt tip pens. Take paper gliders to outside play area for test flight. Allow students to practice flying their gliders. After practice, have students line up and fly their paper gliders to determine the one that can fly the greatest distance. Formulate reasons why the glider that flew the greatest distance won.

Extended Activity

- Distribute wood glider kits. Remind students that directions are essential. Explain that directions must be followed step-by-step if construction is to be successful. Take completed glider to outside play area for test flight. Ask students to compare the flight of the wood glider with the flight of the paper glider.

ACTIVITY 6: AIRPLANE

Tell students that the most important group of aircraft is the AIRPLANE group. Arouse students' interest by asking questions such as the following:

1. Which group of aircraft do we see the most of: lighter than air, rotocraft, gliders, or airplanes?
2. Which group of aircraft transports the most people or cargo?
3. What group of aircraft is most useful to man? Why?

Explain to students that airplanes are heavier than birds, yet they can rise into the air and fly like birds. Further explain that airplanes have wings to lift them into the air and an engine or engines to pull them through the air. Small airplanes carry one or two people while larger ones carry 350 or more passengers. Some airplanes travel as slow as the family car. Others, like the Concorde-SST, travel as fast as 1,350 miles per hour. There are many different kinds of airplanes. Some airplanes have one engine, and some have two or more engines. Some airplanes land on land and others on water. The wings on some planes are attached near the top of the fuselage, and others have wings attached near the bottom (belly) of the fuselage.

ACTIVITY 6 (Continued)

Distribute Student Handout 8. Complete per directions.

Extended Activities

- Distribute Student Handout 9. Remind students that some airplanes land on land and some on water.

Student Handout 9 Answers: 1. d 3. c
 2. a 4. b

- Distribute Student Handout 10. Make Aircraft Match Game per directions. Divide class into groups of three. Spread completed cards, face down, on a table. The first player selects two cards. If the cards match, he gets to keep them. The student continues to take another turn until the two selected cards do not match. When the cards do not match, they should be placed face down on the table. The next player selects two cards and repeats the process. Playing is continued until all pairs are matched.
- Draw the following graph on the board. Show students how to graph the characteristics of a boat and a car.

VEHICLE CHARACTERISTICS

	Boat	Car
Wheels		X
Engine	X	X
Moves People	X	X
Needs Roads		X
Needs Water	X	

ACTIVITY 6 (Continued)

Discuss and compare the different characteristics of the boat and the car. Distribute Student Handout 11. Have students color a box on the graph for each characteristic of the balloon, blimp, glider, helicopter, and airplane. Discuss and compare aircraft on the completed graph. Ask students to evaluate the graph and select the most useful kind of aircraft.

- Distribute Student Handout 12. Complete per directions. Compare the different kinds of aircraft.

Student Handout 12 Answers:

1. helicopter	4. rocket
2. airplane	5. blimp
3. balloon	6. glider

- Develop an "AIRCRAFT GROUPS" bulletin board. Use pictures that students cut from magazines. Ask students to identify each aircraft. Place the aircraft picture under the correct group: lighter than air, gliders, rotocraft, or airplanes.

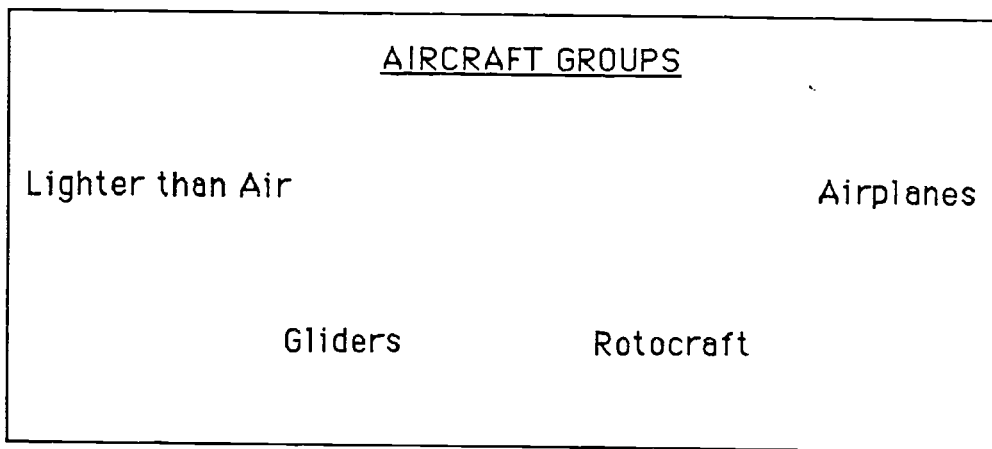

- Have students select an aircraft group and research the library for information. Have them write a story about the group and illustrate the story. Display stories on the Aircraft Groups bulletin board.
- Write Topic 1 words in Fantastic Flight Dictionary.

TOPIC 2: THREE USERS OF AIRCRAFT

The activities, suggested materials, grade level, and related subject areas for each activity are summarized below.

<u>ACTIVITY</u>	<u>MATERIALS NEEDED</u>	<u>GRADE LEVEL</u> <u>SUBJECT</u>
7. Aircraft Users	Student Handout 13 aviation magazines	Grades K-3 social studies language arts
8. Military	white drawing paper Student Handouts 14 and 15	Grades 1-3 art social studies mathematics
9. Airlines	Student Handout 16	Grades 1-3 language arts mathematics
10. General	Student Handout 17 aviation magazines, coat hanger, index cards, glue, string Fantastic Flight Dictionary Student Handout 18 Student Handout 19 Books: <u>Farmer John</u> and <u>Ag Aviation and Friends</u> (See Teacher Resource Section [Women of National Agricultural Aviation Association] for address.)	Grades 1-3 social studies language arts

ACTIVITY 7: AIRCRAFT USERS

Explain to the students that there are three users of aircraft. Explain that each user uses aircraft to do many different jobs.

1. MILITARY USE refers to the Army, Navy, and Air Force aircraft that stand prepared to defend our nation.
2. AIRLINE USE refers to aircraft that move passengers and cargo for pay.
3. GENERAL USE refers to all flying that is not airline or military.

Distribute Student Handout 13. Ask students to examine the three different users of aircraft as pictured on the handout. Point out that all aircraft have a special purpose or use by asking questions about the handout such as:

1. Who owns and operates this aircraft?
2. What does this aircraft do?
3. How does this aircraft help us?
4. Does this aircraft help many people or only a few?

Cover a bulletin board. Make title cards per diagram.



Distribute aviation magazines. These may be obtained from the local airport or pilots. Have students cut out pictures of different kinds of aircraft. Discuss the uses of each. Attach pictures under the correct user.

ACTIVITY 8: MILITARY

Direct students' attention to military aircraft. Arouse an interest in different kinds of military aircraft by asking questions such as:

1. Who is the military?
2. What do you think the military uses aircraft for?
3. What does the military do with the following kinds of aircraft?
bombers reconnaissance
attack aircraft observation aircraft
fighters transports
tankers trainers
4. Do you think military aircraft are expensive (1) to purchase, (2) to maintain, and (3) to fuel?
5. Who pays for military aircraft?
6. Why does the military own these aircraft instead of you, your father, or a friend?

Explain that bombers and attack aircraft destroy things on the ground; fighters destroy other aircraft; reconnaissance and observation aircraft watch what the enemy is doing; transports airlift men and materials; tankers are gas trucks in the sky; and trainers are used to teach men to fly.

ACTIVITY 8 (Continued)

Explain that it is very expensive to operate all these planes. Our tax dollars keep them flying. Military aircraft keep our country safe.

Distribute white drawing paper. Tell students to pretend they have been asked by the military to design a new military aircraft. Ask students to draw their idea and be prepared to tell the class about their aircraft design and what it will do.

Extended Activities

- Invite a speaker from a branch of the military (Air Force, Navy Army, or Coast Guard) to explain the importance of aviation to our national security. Have the speaker further expand by discussing the expense incurred in designing, purchasing, and maintaining military aircraft.
- Distribute Student Handouts 14 and 15. Read the story on Student Handout 14. Work the mathematics problems on Student Handout 15.

Student Handout 15 Answers:

- | | |
|-------|-------|
| 1. 22 | 3. 10 |
| 2. 4 | 4. 21 |

- Tell students to pretend they have been asked by the military to design a new military aircraft. Ask students to build their design from junk (milk cartons, tissue tubes, or wood scraps) found at home. Ask students to write or be prepared to tell the class about their aircraft design and what it will do.

ACTIVITY 9: AIRLINES

Explain to the students that airline aircraft users are paid to move people and cargo. Help students develop an understanding of the differences between airline and military aircraft by asking questions such as:

1. Who owns military aircraft?
2. Who owns airline aircraft?
3. Who flies military aircraft?
4. Who flies airline aircraft?
5. What do military aircraft do?
6. What do airline aircraft do?
7. Can we fly on military aircraft?
8. Can military men/women fly on airline aircraft?

Invite a guest speaker from an airline (airline pilot, stewardess, air-cargo agent, or ticket agent) to speak about topics such as:

1. the different services, other than passenger service, offered by the airlines
2. airline careers
3. the importance of the airlines
4. the effect the airlines have on the economy

Extended Activity

- Distribute Student Handout 16. Complete per directions.

ACTIVITY 10: GENERAL

Direct students' attention to the general user of aircraft. Stimulate an interest by asking questions such as:

1. What are some other uses of aircraft that are not military or airline?
2. Have you ever flown in an aircraft that was not military or airline?
3. How does the use of an aircraft help the injured and sick?
4. What is meant by "farming from the sky"?
5. How does the forest ranger use aircraft?
6. Do you think people fly just for the fun of it?

After students have had ample time to discuss the questions above, explain that GENERAL users of aircraft touch peoples lives in many different ways. General users of aircraft include all flying that is not military or airline. To the businessman, it means an efficient, productive means of transportation. Farmers plant large fields quickly by farming from the air with aircraft. The forest ranger looks for sick trees, fires, and fights fires using aircraft. Aircraft can also perform aerial mapping, carry patients, watch herds of cattle, conduct search and rescue, and check power lines and pipelines.

Distribute Student Handout 17.

Student Handout 17 Answers:

- | | |
|----------------|-----------------|
| 1. hospital | 4. sport pilot |
| 2. farmer | 5. sport pilot |
| 3. sport pilot | 6. business men |

ACTIVITY 10 (Continued)

Extended Activities

- Review the three users of aircraft. Divide class into three groups. Assign each group an aircraft user (military, airline, or general). Give each group a coat hanger, aviation magazines, index cards, glue and string. Tell each group to make an aircraft user mobile.

1. Label two (2) index cards with aircraft user name.



2. Glue the cards back to back, to the neck of the hanger.
3. Cut out pictures that depict the aircraft user. Glue the pictures to index cards.
4. Attach the index cards to the hanger with string.

Suspend students' work from ceiling with string.

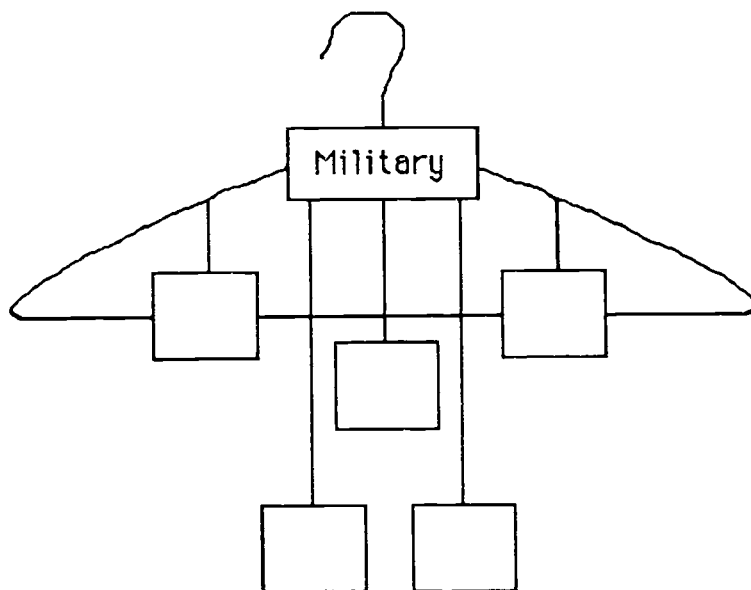

ACTIVITY 10 (Continued)

- Write Topic 2 vocabulary words in the Fantastic Flight Dictionary.
- Write a sentence with each vocabulary word.
- Write a story using the vocabulary words. Display stories on Aircraft Users bulletin board.
- Ask a pilot or forest ranger from the Alabama Forestry Commission to speak. (Check with your local airport for contacts.) Ask speaker to discuss the use of aircraft for fire control, forest inventories, and disease control. Suggest that the speaker use a slide or film presentation to enrich the program.
- Distribute Student Handout 18. Discuss reasons why aircraft are more useful to the forest ranger than the forest tower. Color the picture.
- Ask a crop duster to come speak. (Contact a local airport for crop dusters in your area.) Distribute Student Handout 19. Read the story. Draw a crop duster planting seeds.
- Show the film "Farming from the Sky." This film is free, on loan, from the Federal Aviation Administration. (Check Teacher Resource page for address.)
- Distribute one of the following coloring books: Farmer John's or Ag Aviation and Friends. Read the story of how aircraft helps put food on our table. Color pictures. (Check Teacher Resource page for ordering information.)
- Invite guest speakers to expand students' knowledge of general use of aircraft such as:
 - Alabama State Police - Aircraft for traffic control
 - Air Ambulance Service - Aircraft for medical services
 - Local business aircraft owners - (Check your local airport operator for contacts.)

UNIT 2 ACTIVITY 2

STUDENT HANDOUT 1

KINDS OF AIRCRAFT

1. Lighter-Than-Air

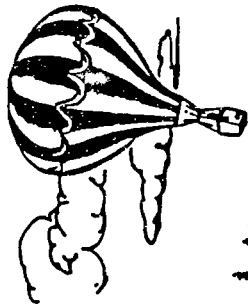

Hot-Air Balloon

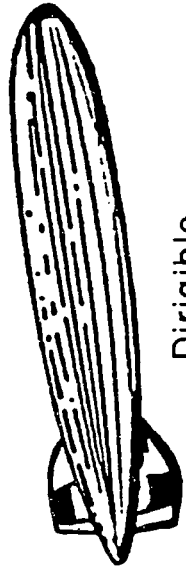

Dirigible



Blimp

2. Rotocraft

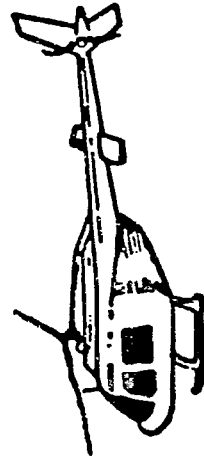

Helicopter

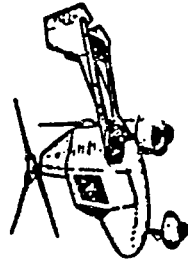

Gyroplane

UNIT 2 ACTIVITY 2

STUDENT HANDOUT 2

KINDS OF AIRCRAFT

3. Glider

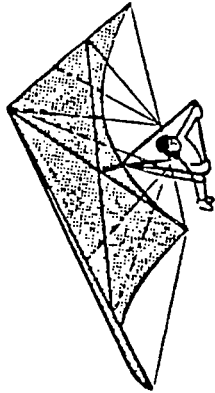

Hang Glider



Sailplane

4. Airplane

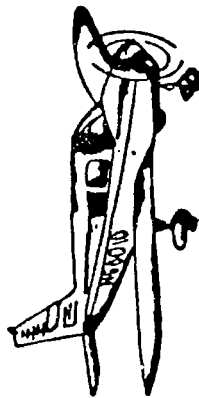

Single-engine land

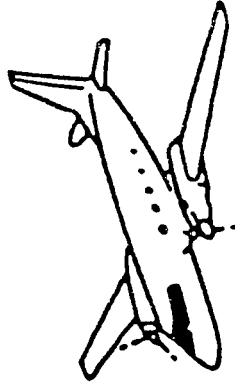

Multi-engine land



Single-engine sea

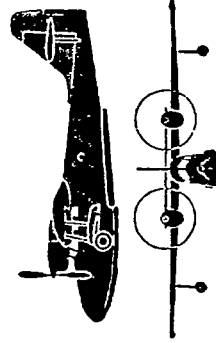

Multi-engine sea

UNIT 2 ACTIVITY 3

STUDENT HANDOUT 3

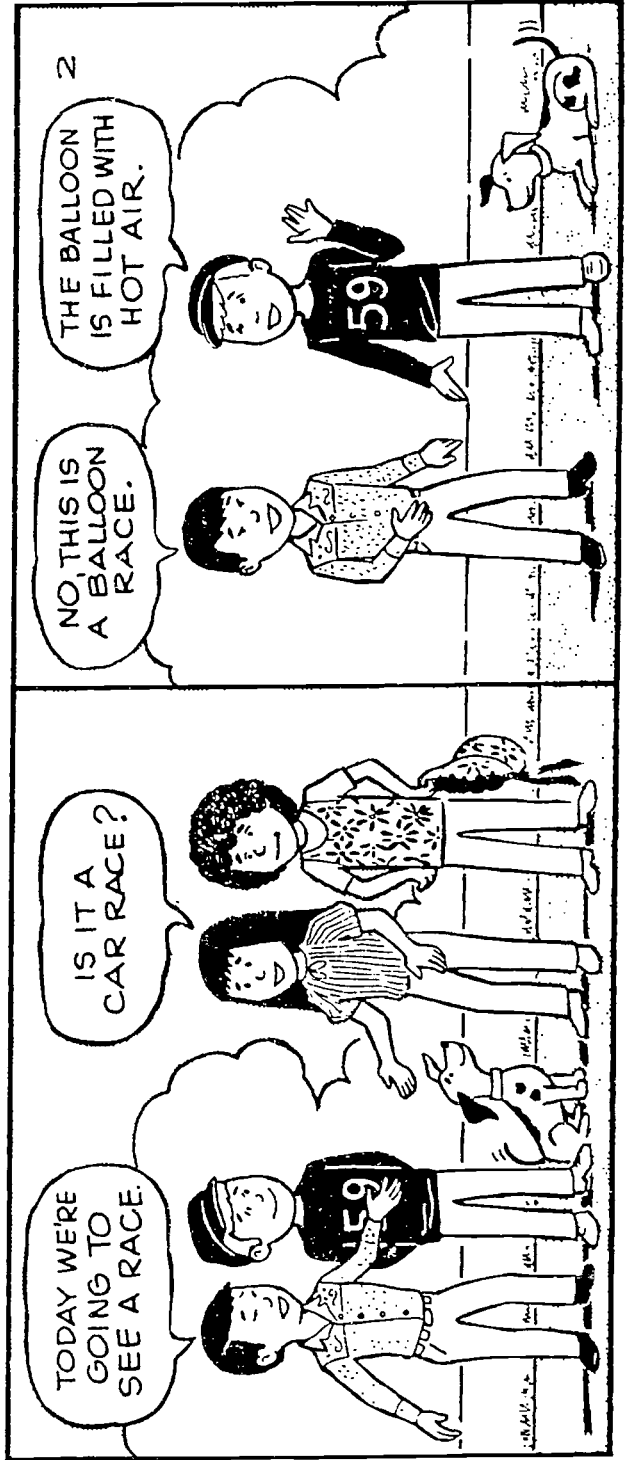
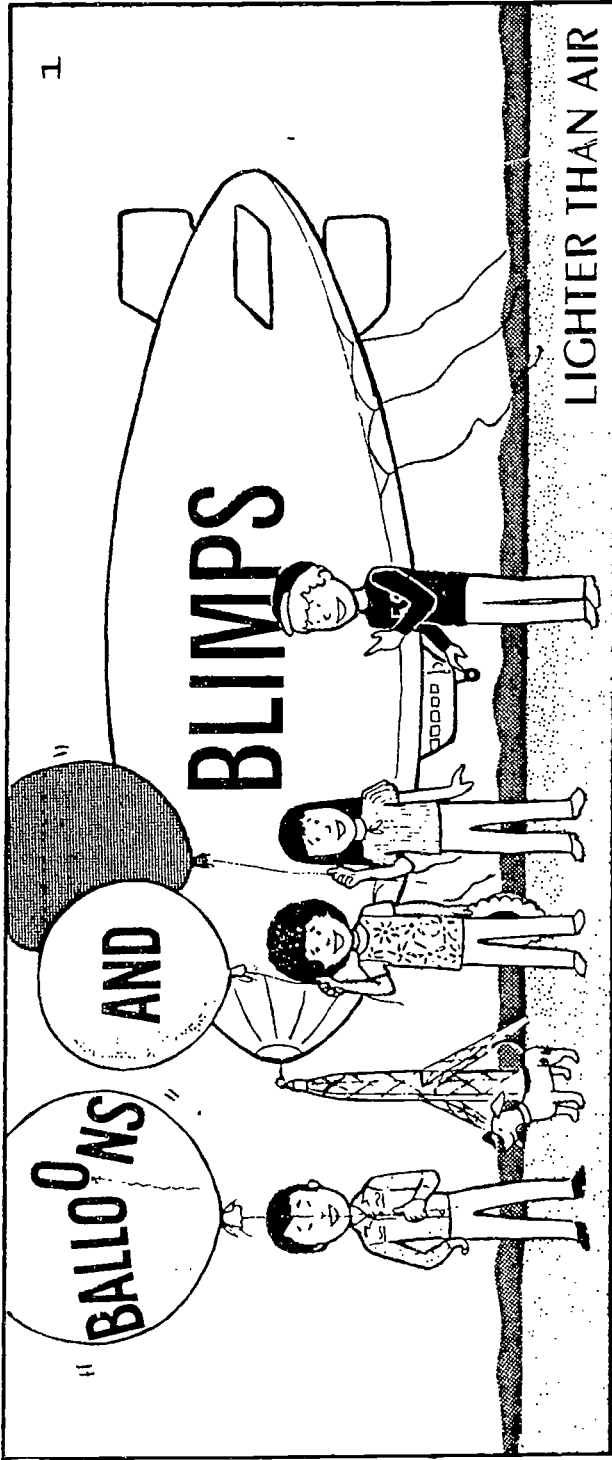

UNIT 2 ACTIVITY 3

STUDENT HANDOUT 4

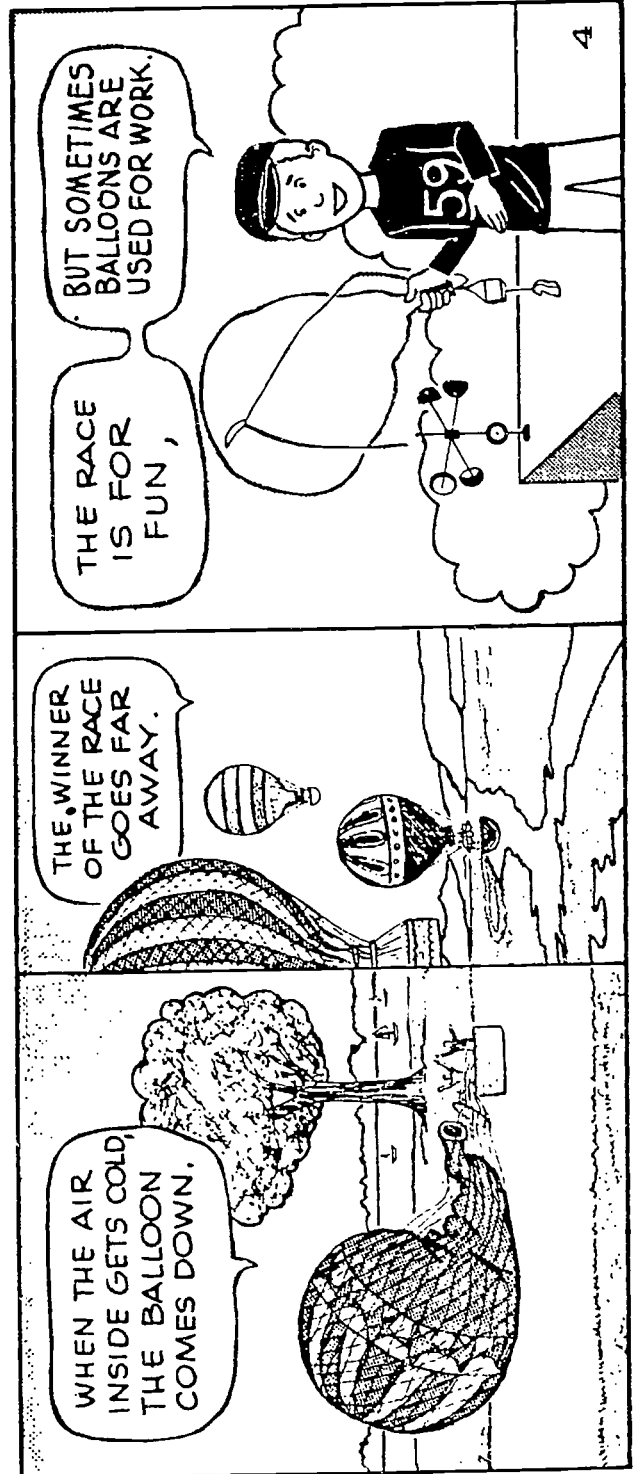
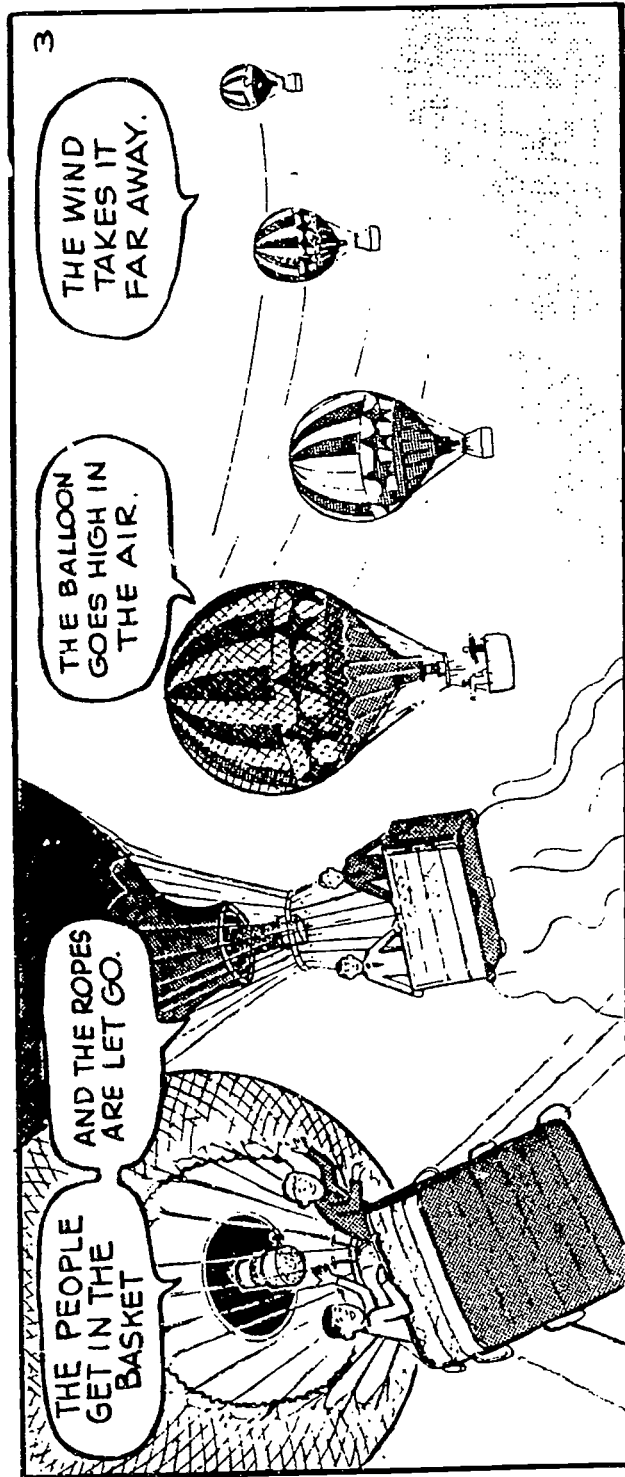

UNIT 2 ACTIVITY 3

STUDENT HANDOUT 5

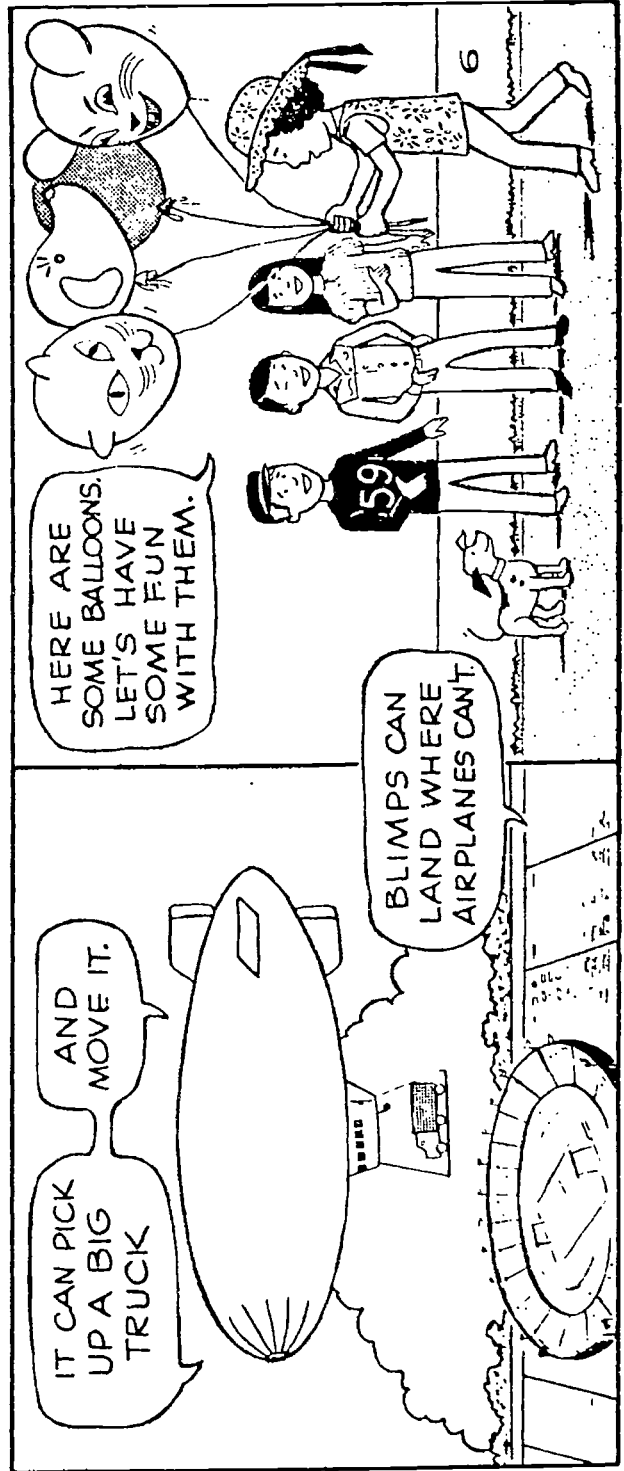
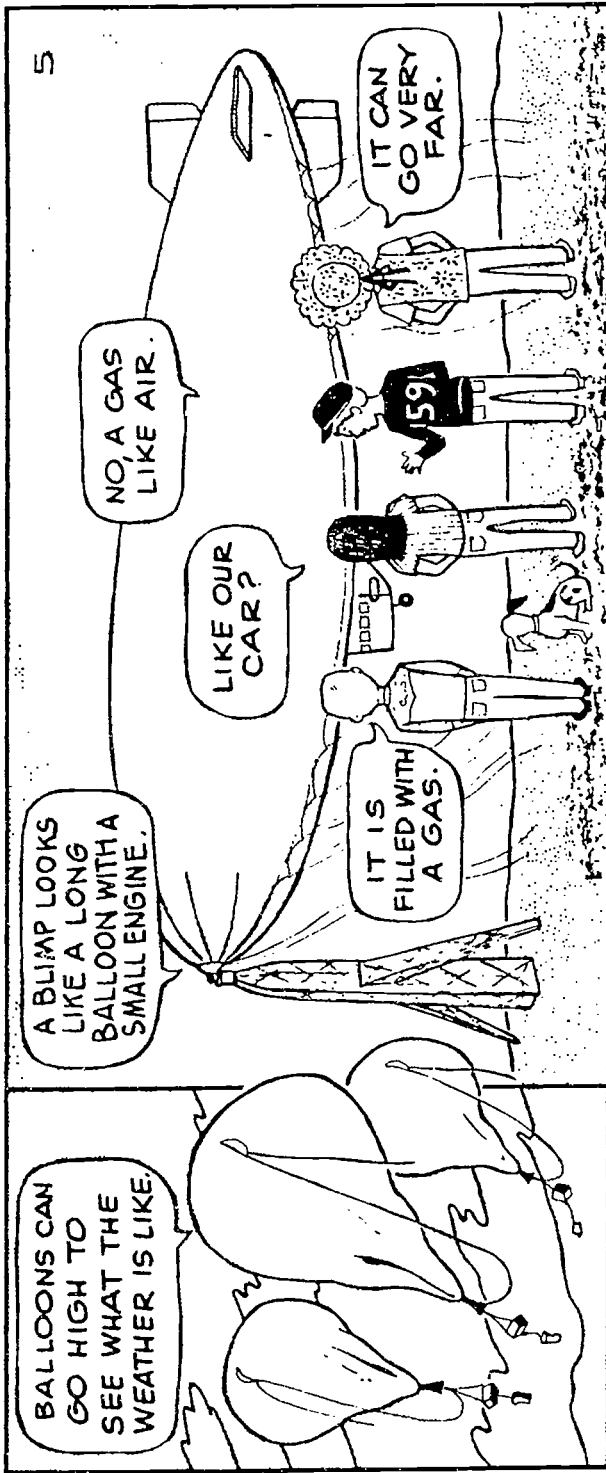

UNIT 2 ACTIVITY 4

STUDENT HANDOUT 6

HELICOPTERS

Helicopters are different from airplanes. Helicopters do not have wings. They have blades called rotor blades. These blades are on top of the helicopter. The helicopter's engine turns the blades round and round in a circle. The turning blades lift the helicopter into the air. When taking off or landing, helicopters can fly straight up and straight down. While in the air, they can hover, or stay in one place. Helicopters can fly much closer to the ground than airplanes.

People use helicopters to do many jobs. News reporters in helicopters check traffic on busy highways. Paramedics rescue accident victims in helicopters and fly sick and hurt people to hospitals. The coast guard looks for boats lost at sea. Busy women and men travel by helicopters across big cities to avoid traffic tie-ups.

HELICOPTER ART

Use the five easy steps to draw a helicopter. Complete the picture by showing the helicopter doing one of the jobs in the story.

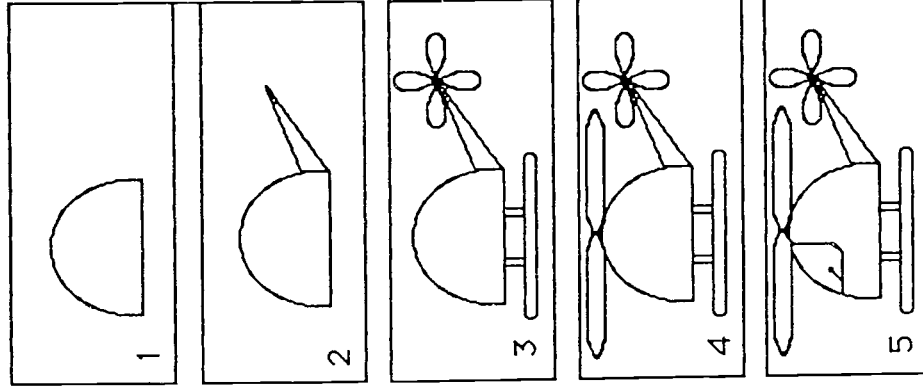

UNIT 2 ACTIVITY 4

PICTURE PUZZLE

STUDENT HANDOUT 7

This picture puzzles Art! Help him by cutting out the pieces and putting them back together. Glue the completed puzzle on a piece of cardboard. Color the picture.

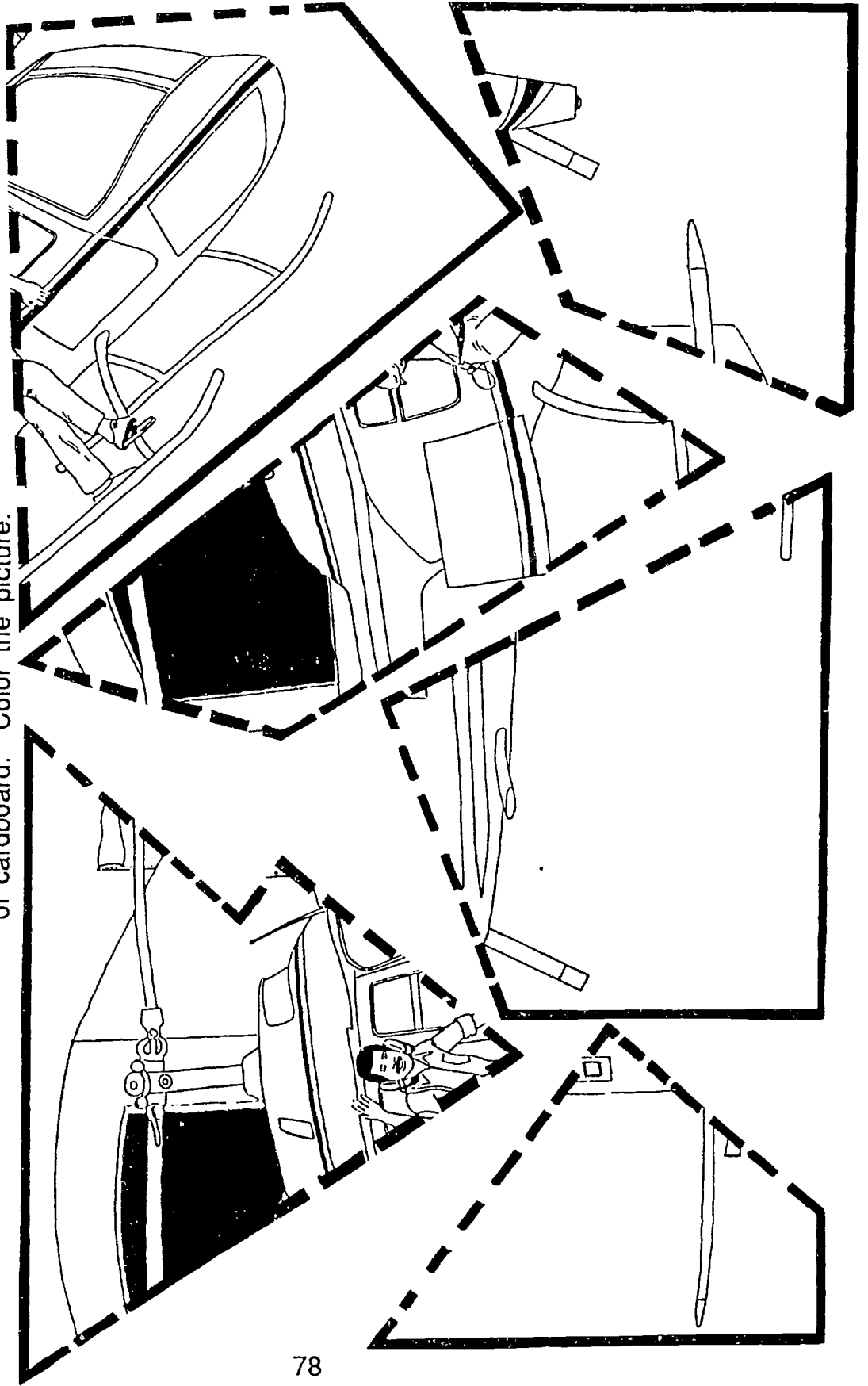

UNIT 2 ACTIVITY 6

STUDENT HANDOUT 8

Directions: Color the airplanes with one engine red. Color the airplanes with two engines blue.

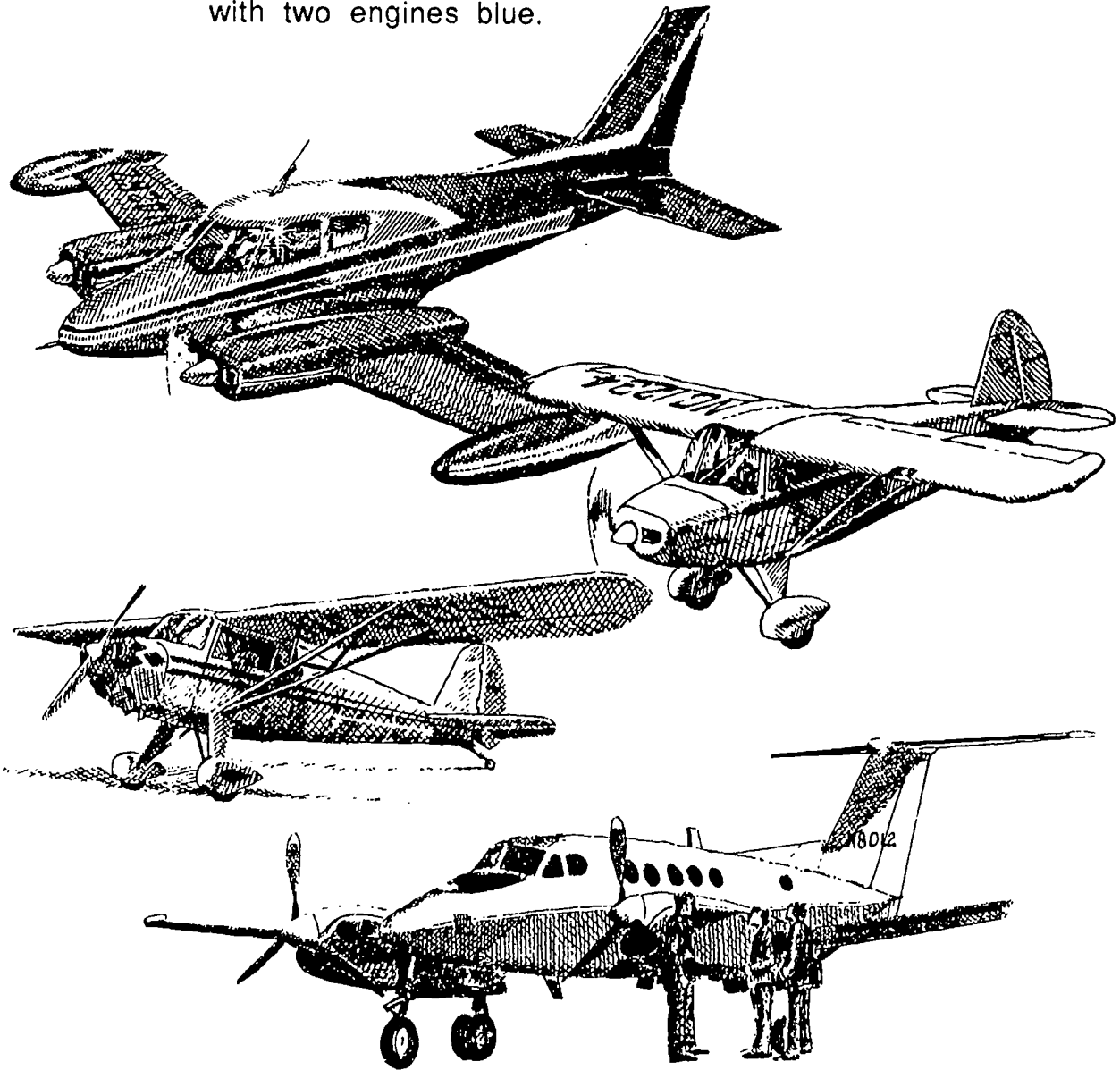

_____ airplanes have one engine.

_____ airplanes have two engines.

UNIT 2 ACTIVITY 6

STUDENT HANDOUT 9

Directions: Read each airplane description.
Cut and paste next to the correct
airplane.



1.

80



2.



3.



4.

104

I have one engine. I can
land on a grass strip.

a

I like big airports. I carry many
passengers. I have two strong
engines.

b

I have one engine. I can take my
owner to his home on the lake.

c

My passengers like to fish. My
big engines help me move many
passengers and heavy cargo. I
will land near the fish.

d

1 5

UNIT 2 ACTIVITY 2

STUDENT HANDOUT 10

AIRCRAFT MATCH GAME

Directions: Color aircraft. Cut apart and glue to cards. Place cards face down on table. Draw two cards. If they match, keep them and take another turn. If they do not match, return face down to the table. Move to next player. Play in groups of three.

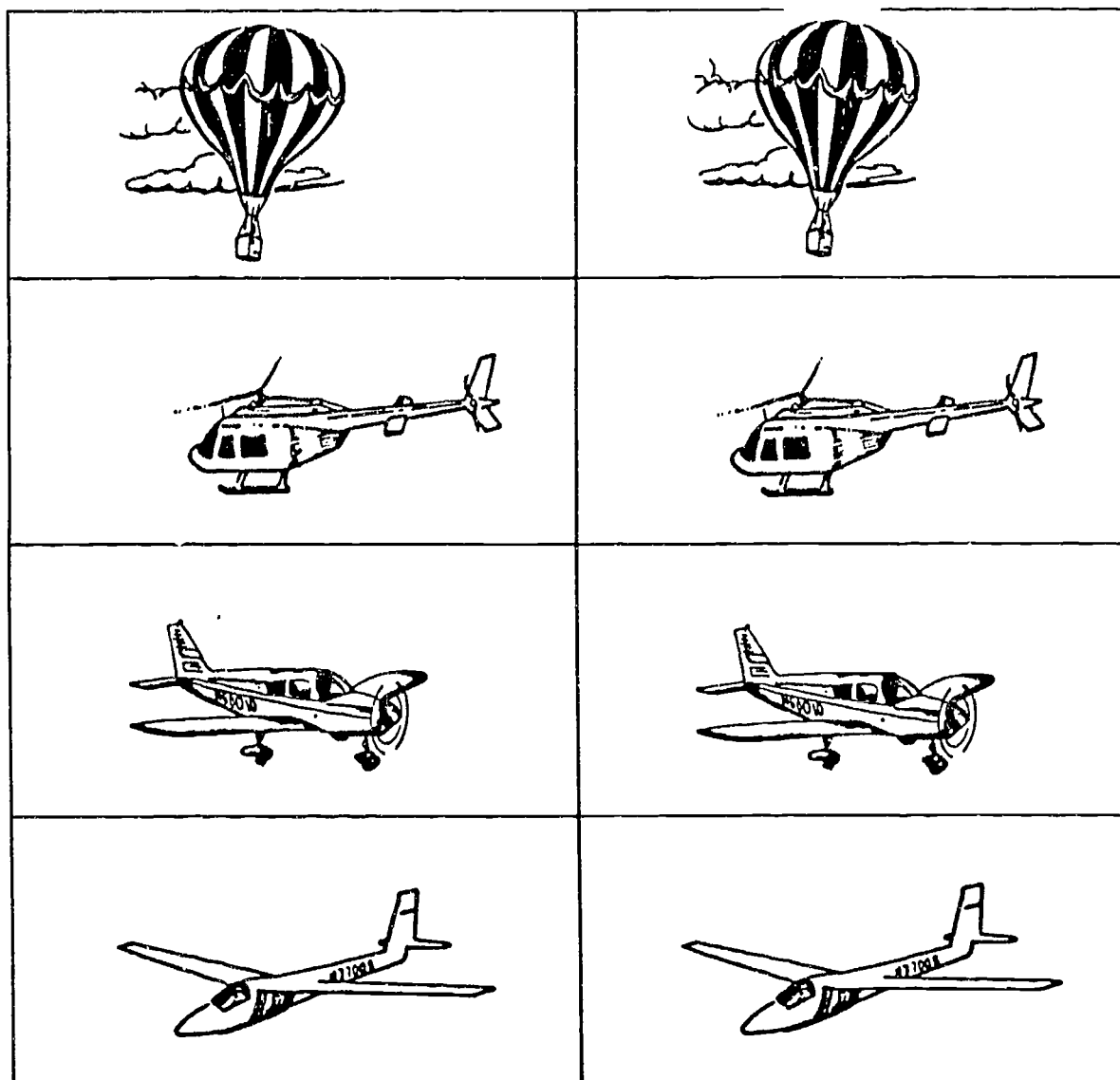

UNIT 2 ACTIVITY 6

STUDENT HANDOUT 11

Directions: Color a box for each aircraft characteristic.

AIRCRAFT CHARACTERISTICS

	Balloon	Blimp	Glider	Helicopter	Airplane
Wings					
Engine					
Rotor blades					
Wheels					
Needs a runway for landing					
Can move many passengers plus cargo					
Used mostly for fun					

UNIT 2 ACTIVITY 6

STUDENT HANDOUT 12

KINDS OF AIRCRAFT

_____ helicopter, rocket, balloon, glider, blimp, airplane

Directions: Use the words above to complete the sentences below.



1. The _____ has no wings. It does not need a long runway for take-off or landing.

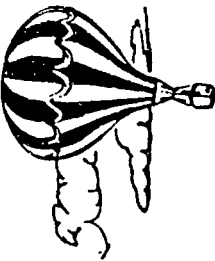

3. The _____ has no wings or motor. It is a fun aircraft.



5. The _____ has a motor and no wings. Only a few of these aircraft exist.

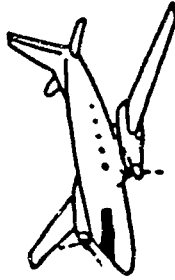

2. The _____ has a motor and wings. It can move people and cargo quickly over great distances.

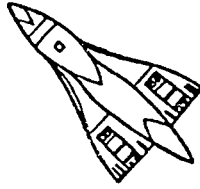

4. The _____ takes off from a launch pad. It has taken man into space.



6. The _____ has wings and no motor. A towplane helps it become airborne.

UNIT 2 ACTIVITY 7

STUDENT HANDOUT 13

AIRCRAFT USERS

AIRLINE

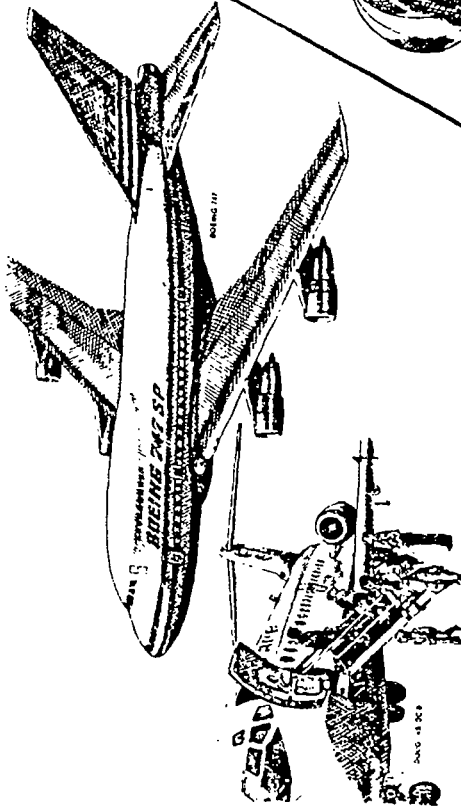

GENERAL

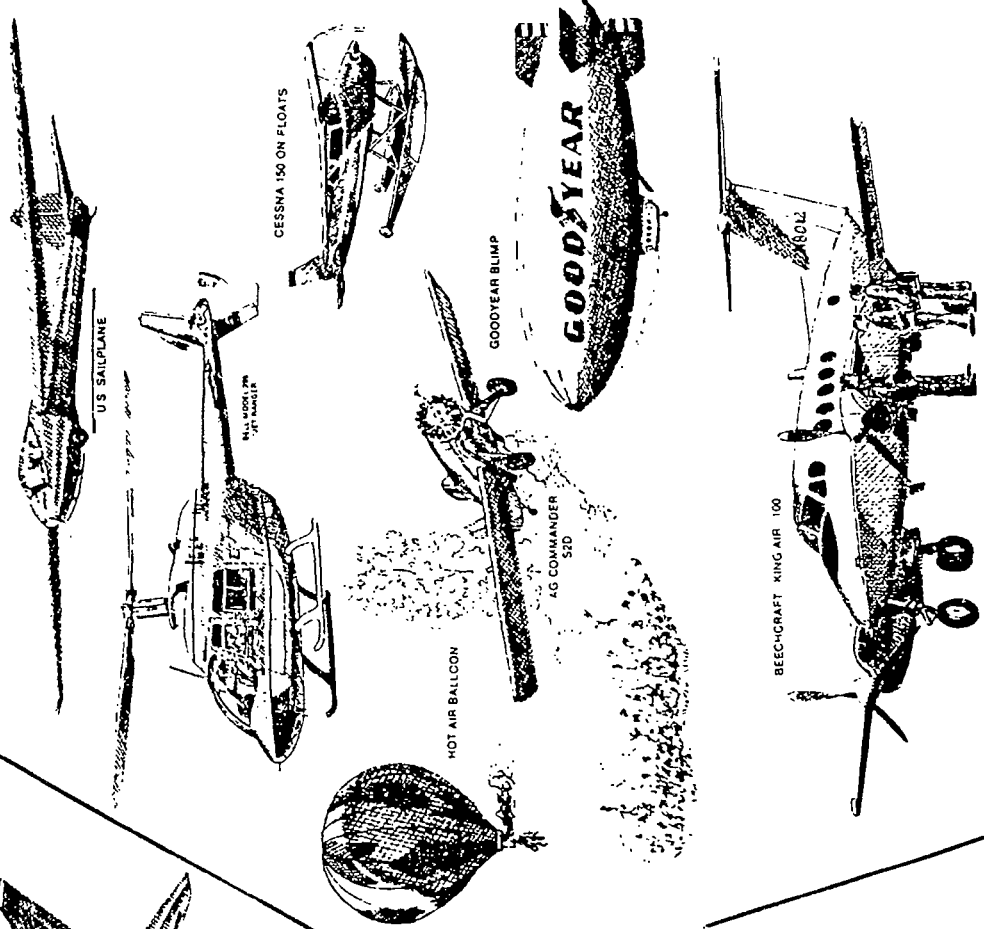

MILITARY

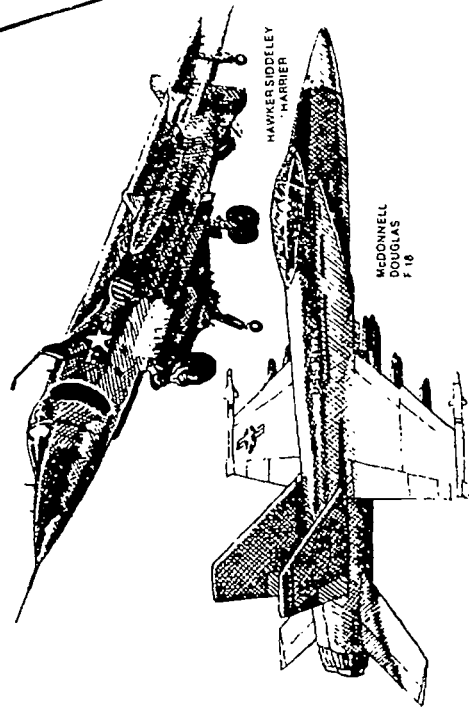

UNIT 2 ACTIVITY 8

STUDENT HANDOUT 14

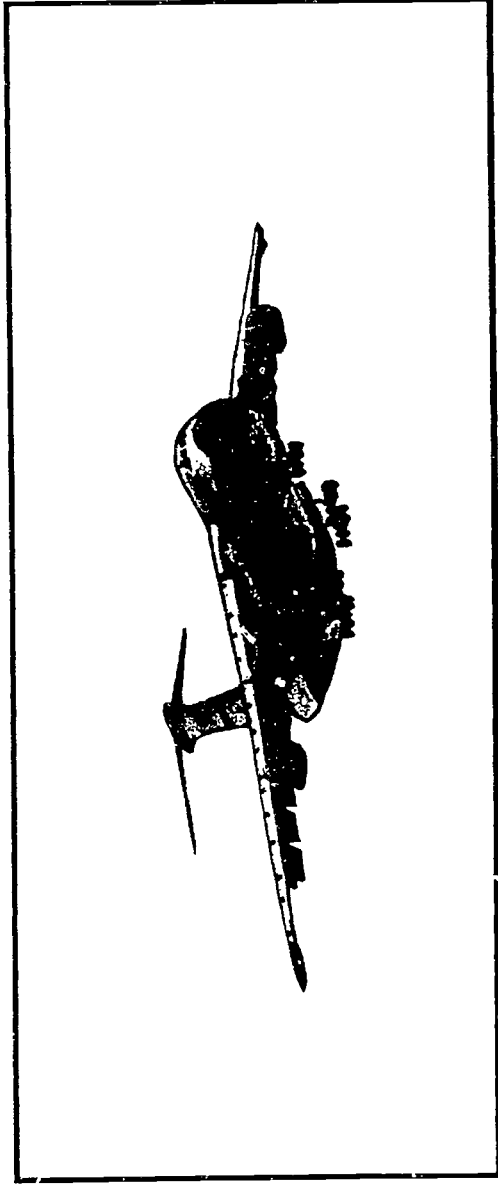

85

C-5 GALAXY

The C-5 is the world's largest transport aircraft. It is almost as long as a football field and as high as a six-story building. The nose and rear doors open at the same time. Cargo moves out the rear door as cargo is loaded through the nose opening.

The C-5 has 28 wheels, four engines under the wings, and six fuel tanks in each wing.

It takes a crew of six to fly it. A relief crew of seven and eight also help.

115

114

UNIT 2 ACTIVITY 8

STUDENT HANDOUT 15

C-5 GALAXY

Directions: Read each problem. Add or subtract.

1. The C-5 has 28 wheels. The mechanic replaces 6 tires. How many tires are in good condition?
2. The C-5 has a wing on each side of the fuselage. Two engines are attached under each wing. How many engines does the C-5 have?
3. The C-5 has 12 fuel tanks. Two tanks are empty. How many tanks are full?
4. The C-5 has a crew of 6, a relief crew of 7 and 8. How many men help fly the plane?
5. Draw a picture of the C-5 loading and unloading cargo.

UNIT 2 ACTIVITY 9

STUDENT HANDOUT 16

Directions: Color the military aircraft blue.
Color the airline aircraft red.
Count the aircraft.

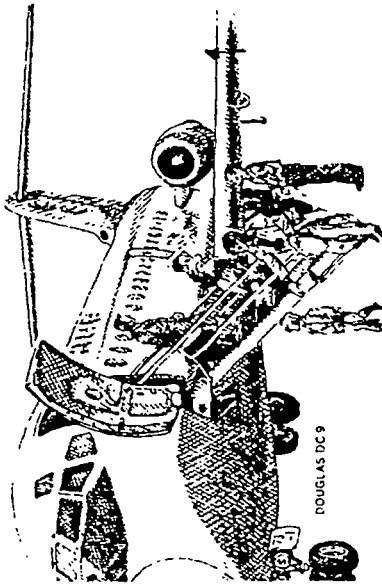

87

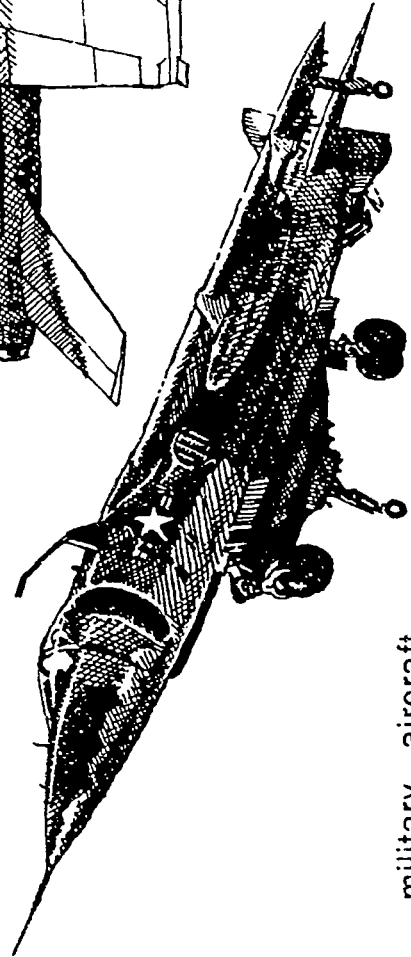
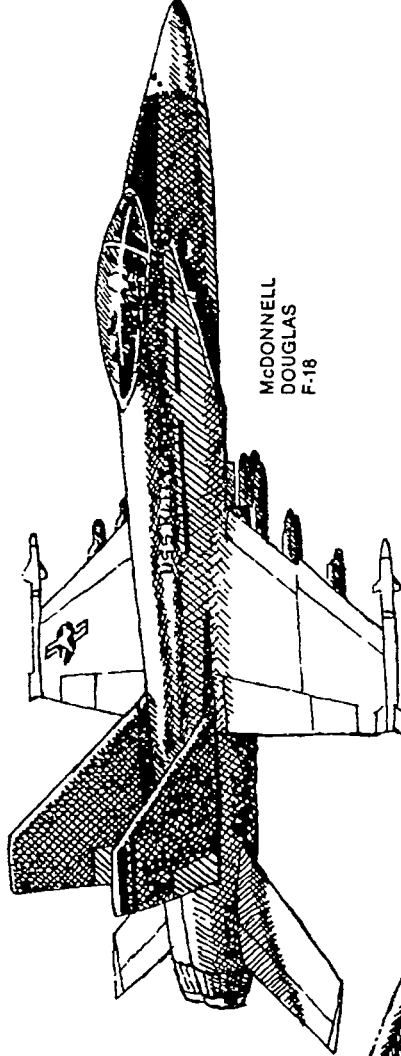
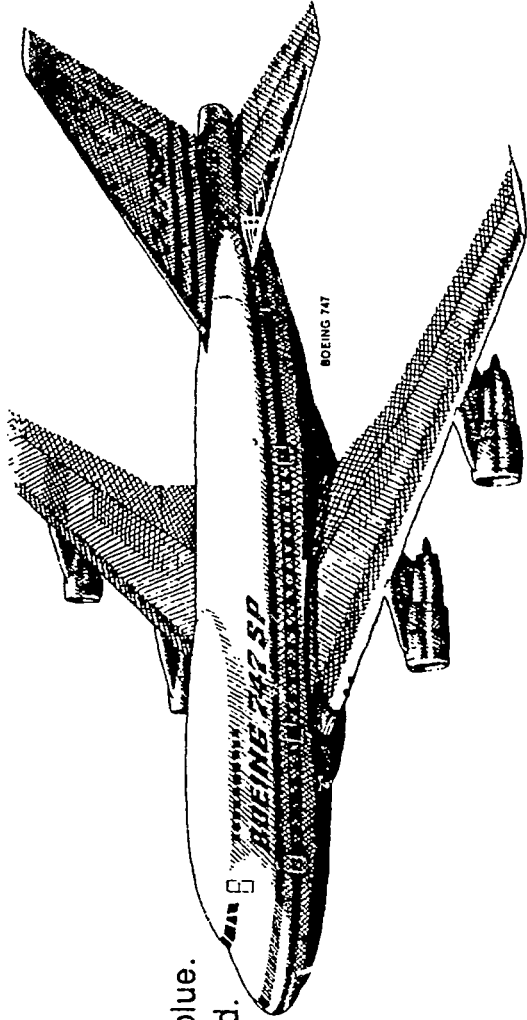

_____military aircraft

_____airline aircraft

UNIT 2 ACTIVITY 10

STUDENT HANDOUT 17

Directions: Use the word bank. Name the user of each aircraft.

WORD BANK

business men farmer
hospital sport pilot

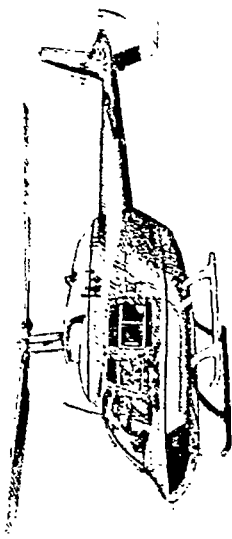

1. _____

88



2. _____



3. _____



4. _____

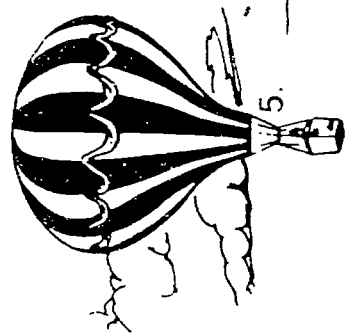

5. _____

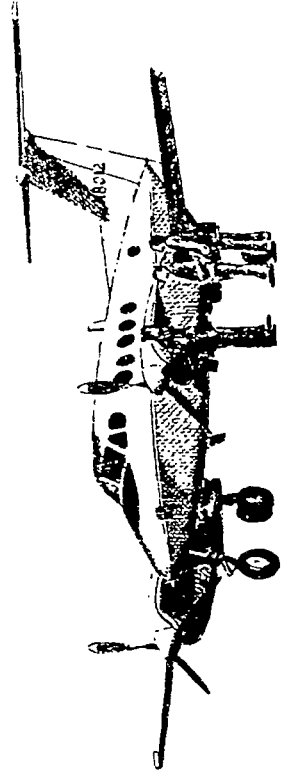

6. _____

118

UNIT 2 ACTIVITY 10

STUDENT HANDOUT 18

Directions: Color the picture.

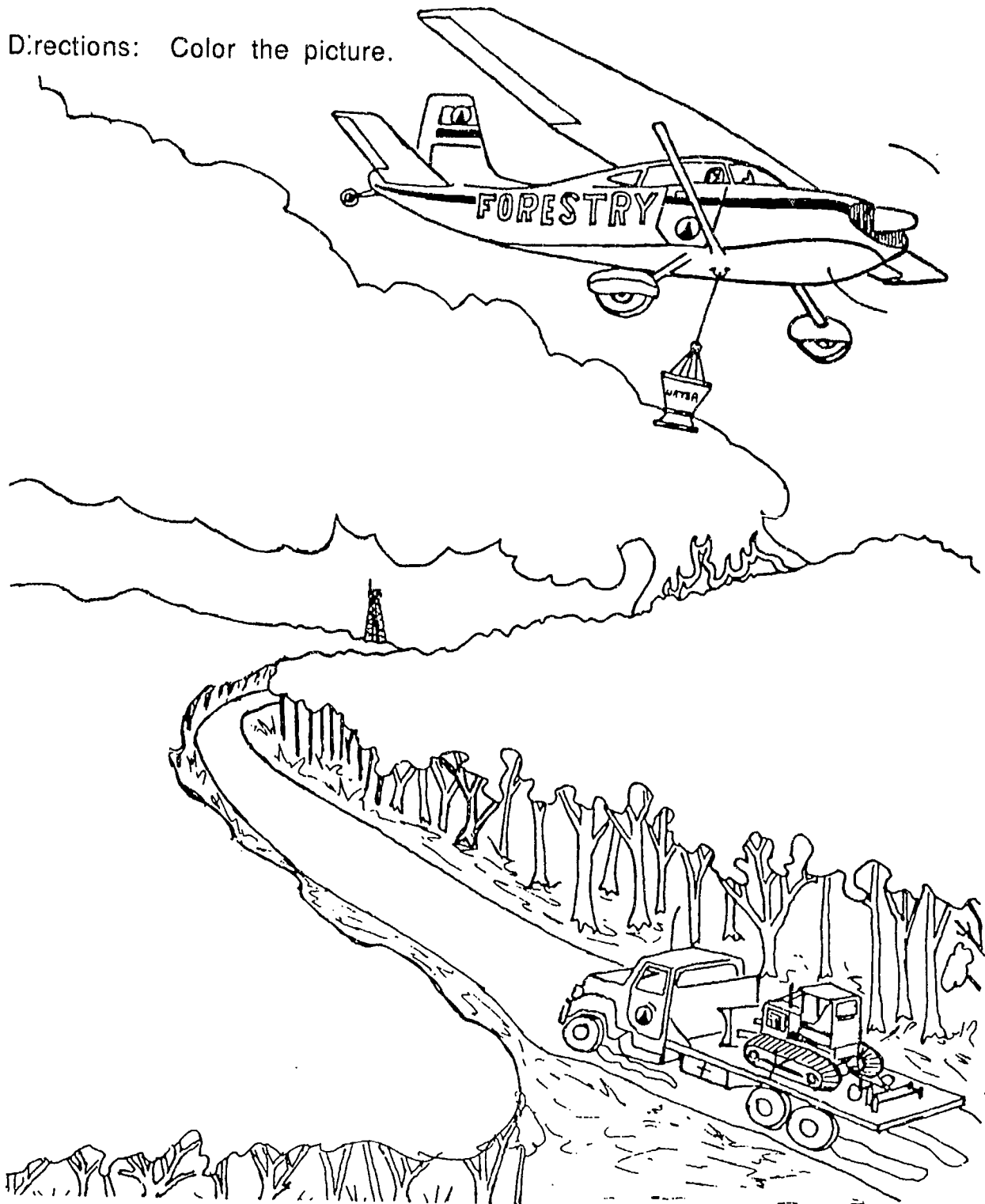

UNIT 2 ACTIVITY 10

STUDENT HANDOUT 19

Directions: Read the story.

Draw a picture of a crop duster planting wheat.

THE CROP DUSTER

90

The fields are wet. It is planting time. The farmer needs help. A crop duster can quickly fertilize and plant seeds with an airplane. The crop duster has a special plane. It can carry heavy loads of chemicals, seeds, and fertilizer.

121

122

UNIT 3: PARTS OF AN AIRPLANE

PURPOSE OF UNIT 3

The purpose of Unit 3 is to introduce students to the parts of an airplane. Specifically, students should:

1. identify the parts of a bird and a fish and relate them to similar parts on an airplane;
2. recognize the seven main parts of an airplane; and
3. develop an understanding of how the main airplane parts function.

MAJOR MESSAGES IN UNIT 3

- Machines are made of many parts.
- All parts must work together for a machine to function properly.

BACKGROUND INFORMATION FOR UNIT 3

Unit 3 consists of 1 topic:

TOPIC 1: AIRPLANE PARTS

Topic 1 examines the seven main airplane parts. Parts of the airplane are compared with the parts of the bird and the fish.

VOCABULARY WORDS FOR UNIT 3

Topic 1

wing
fuselage
landing gear
cockpit
propeller
ailerons
elevator
rudder
flaps
engine

TOPIC 1: AIRPLANE PARTS

The activities, suggested materials, grade level, and related subject areas for each activity are summarized below.

<u>ACTIVITY</u>	<u>MATERIALS NEEDED</u>	<u>GRADE LEVELS</u> <u>SUBJECT</u>
1. Birds, Fish, and Airplanes	Student Handouts 1 and 2	Grades K-3 science art
2. Airplane Parts	Student Handout 3 Cessna airplane model (See Teacher Resource section for source.) Student Handouts 4, 5, and 6 Fantastic Flight Dictionary	Grades K-3 science language arts

ACTIVITY 1: BIRDS, FISH AND AIRPLANES

Direct the students' attention to birds and fish. Arouse an interest in the similarity of birds and fish as they compare to airplanes. This may be accomplished by using Student Handouts 1 and 2 and by asking questions such as the following:

STUDENT HANDOUT 1

1. How is a bird like an airplane?
2. What parts of the bird are like airplane parts?
3. What parts of the bird gave man ideas for building airplanes?

STUDENT HANDOUT 2

1. How is a fish like an airplane?
2. What parts of the fish are like airplane parts?
3. What part of the fish gave man ideas for building airplanes?

Emphasize the fact that birds and fish have many parts. Each part does something special. Explain that it takes all parts working together to make the bird fly or the fish swim. To clarify this point ask questions such as the following:

1. What happens if a bird loses the feathers on one wing?
2. What happens if a bird breaks a leg?
3. What happens if a fish loses part of his tail?

Explain that the bird has a tail, feet, body, and wings just like an airplane. Further explain that a fish has a body and a tail like an airplane. If we put the fish and bird parts together, we have parts equivalent to an airplane. To make the airplane fly, we add an engine to make it go and a pilot to steer it. Complete Student Handout 2 per directions at the bottom of the page.

ACTIVITY 2: AIRPLANE PARTS

Begin by transferring the students' knowledge of fish and bird parts to airplane parts. Distribute Student Handout 3. Generate an interest in the different airplane parts by asking questions such as the following:

1. What parts on the airplane are like parts of a fish or a bird?
2. Do you think airplane parts work the same as those of a fish or a bird?
3. Do you see some parts that are different?
4. What makes these parts different?

Using Student Handout 3, the Cessna model airplane, and the information and diagrams that follow, explain each special airplane part as listed below.

KINDERGARTEN - GRADE 1

fuselage
wings
tail
wheels (landing gear)
propeller
engine

GRADES 1-3

fuselage
wings
landing gear
propeller
engine
cockpit
ailerons
elevator
rudder
flaps

Fuselage

The fuselage is the central (middle) part of the airplane. Pilots, passengers, and cargo are carried inside the fuselage. The wings, engine, tail, and landing gear are attached to the fuselage. Old airplanes had an outside covering of fabric. Today, very light metal covers the fuselage.

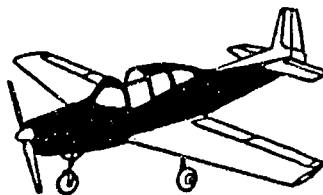

ACTIVITY 2 (Continued)

Wings

Air flowing over the wings helps lift the airplane into the air. Most airplanes today have a wing attached to each side of the fuselage. These planes are called "monoplanes" because they have one set of wings. Some old airplanes, sport (fun) airplanes, and agricultural airplanes have two wings attached to each side of the fuselage. These planes are called "biplanes" because they have two sets of wings.

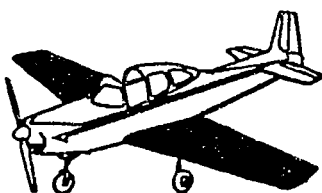

Landing Gear

The wheels and the parts that attach the wheels to the fuselage make up the landing gear. The landing gear supports the airplane while on the ground. The landing gear is also used to taxi, takeoff, and land. The landing gear isn't needed in the air for flying. Therefore, during flight, large airplanes fold (retract) the landing gear into the fuselage or wing. This makes the airplane aerodynamic (sleek in shape). Small airplanes do not have landing gear that folds up.

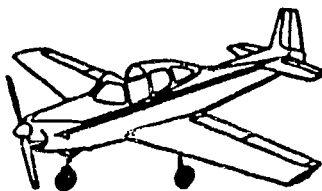

ACTIVITY 2 (Continued)

Propeller

The propeller is a rotating blade attached to the engine in front of the airplane. The engine turns the propeller which pulls the airplane through the air. If an airplane has two engines, a propeller is attached to each engine.

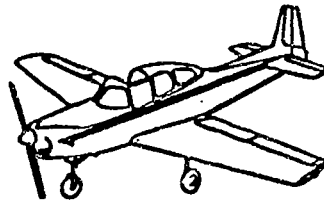

Engine

The engine is the part that provides the power that moves the airplane through the air.

Cockpit

The cockpit contains all the instruments that keep the pilot informed about how the various systems are working and whether he is on course.

In smaller planes the cockpit is usually the space in the fuselage for the pilot and passengers. In large airplanes, the cockpit is the space for pilot and flight crew only.

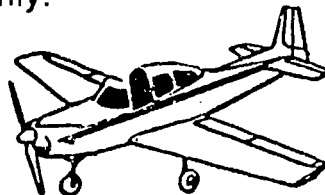

ACTIVITY 2 (Continued)

Ailerons

The ailerons are moving parts attached to the outside rear edge of each wing. This part, when moved, makes the airplane tilt and roll to the left or right.

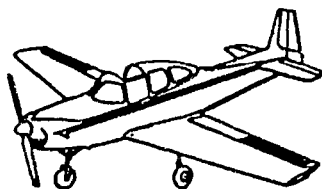

Elevators

The elevators are moving parts attached to the horizontal section on each side of the tail. The elevators, when moved, make the airplane climb or descend.

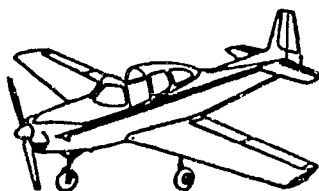

ACTIVITY 2 (Continued)

Rudder

The rudder is a moving part attached to the vertical section of the tail. This part, when moved, makes the airplane turn to the left or to the right.

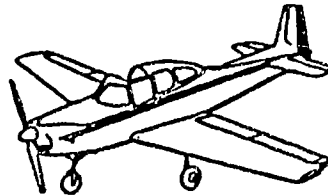

Flaps

Flaps are moving parts attached to the inside rear edge of each wing. They help slow the airplane down for takeoff and landing.

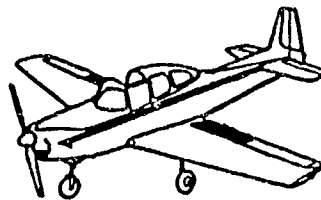

ACTIVITY 2 (Continued)

Distribute Student Handout 4 to kindergarten or first grade students. Complete per directions.

Distribute Student Handout 5 to students in grades 1-3. Complete per directions.

Distribute Student Handout 6 to students in grades 2-3. Complete per directions.

Student Handout 6 answers:

- | | |
|--------------|-----------------|
| 1. cockpit | 5. flaps |
| 2. rudder | 6. aileron |
| 3. elevator | 7. landing gear |
| 4. fuselage | 8. wings |
| 9. propeller | |

Extended Activities

- Draw a large airplane on poster board. Label each part. Cut out each labeled part. Ask students to assemble the puzzle.
- Make a name card for each airplane part. Place cards in a box. Have students draw a card from the box. Ask students to identify the word, locate the part on the Cessna model or similar model, and demonstrate its function.
- Write Topic 1 vocabulary words on the board. Ask the students to do exercises such as the following:
 1. Write the words in alphabetical order.
 2. Write the words in the Fantastic Flight Dictionary.
 3. Write a sentence with each word.

UNIT 3 ACTIVITY 1

STUDENT HANDOUT 1

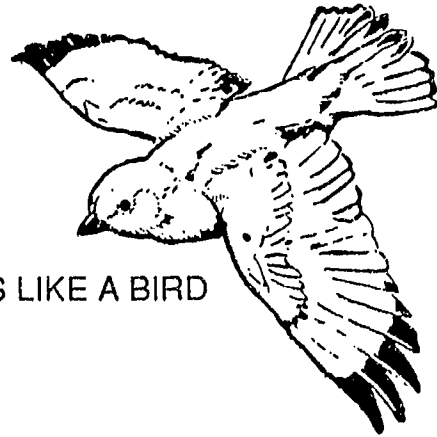

AN AIRPLANE IS LIKE A BIRD

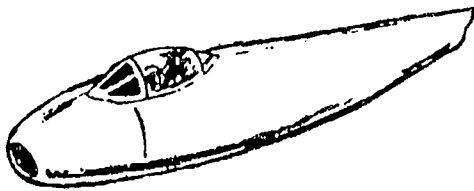

It has a body.

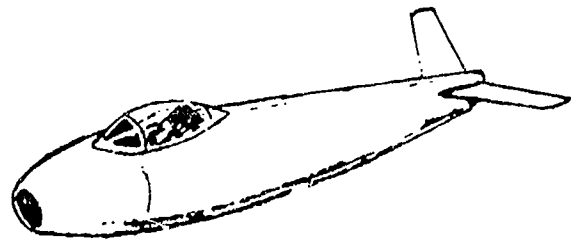

It has a flat tail.

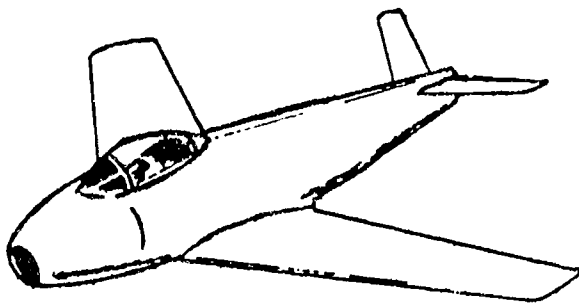

It has wings.

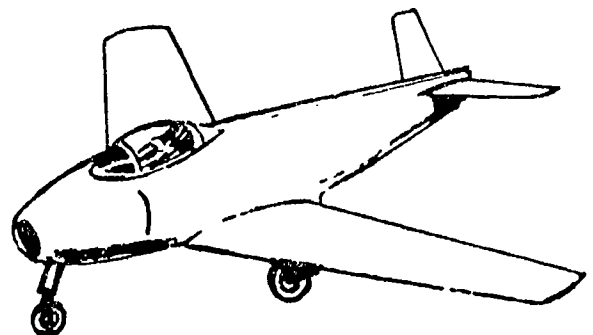

Its wheels are like feet.

UNIT 3 ACTIVITY 1

STUDENT HANDOUT 2

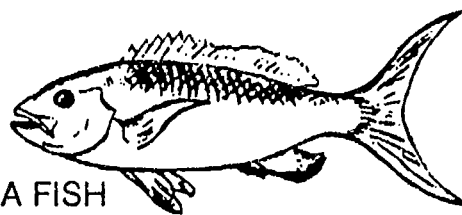

AN AIRPLANE IS LIKE A FISH

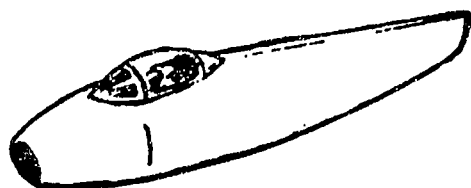

It has a body.

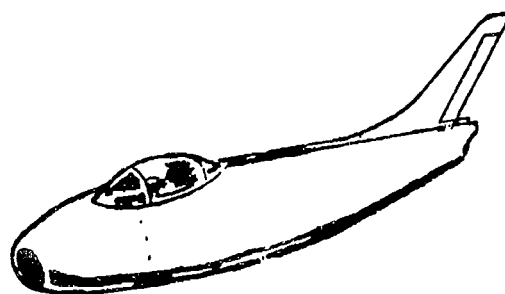

It has a tail
called a
rudder.

Directions: Draw an airplane by putting the bird and fish parts together.

UNIT 3 ACTIVITY 2

STUDENT HANDOUT 3

AIRPLANE PARTS

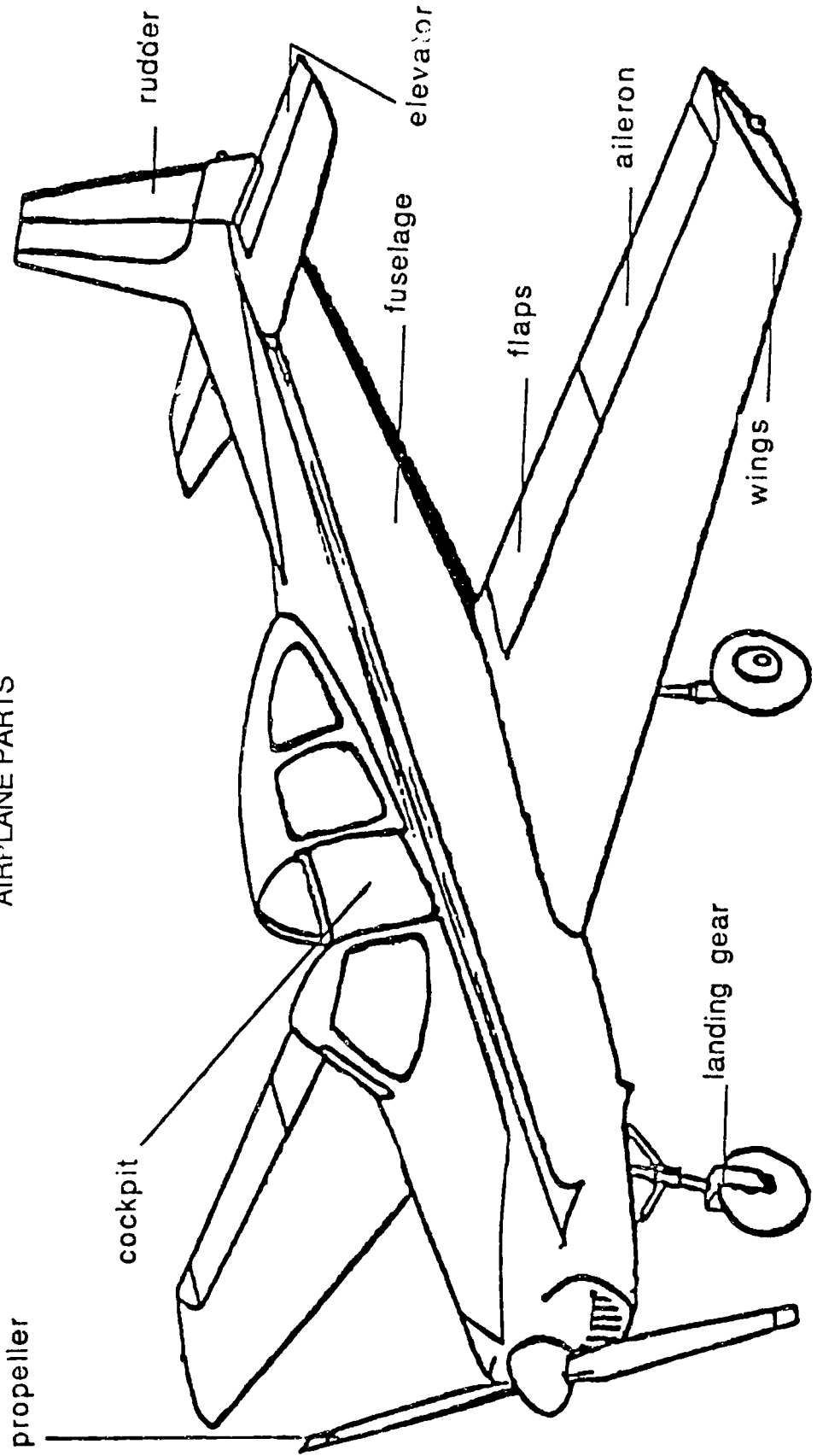

UNIT 3 ACTIVITY 2

STUDENT HANDOUT 4

- Directions:
- Color the wings red.
 - Color the fuselage green.
 - Color the tail blue.
 - Color the wheels black.

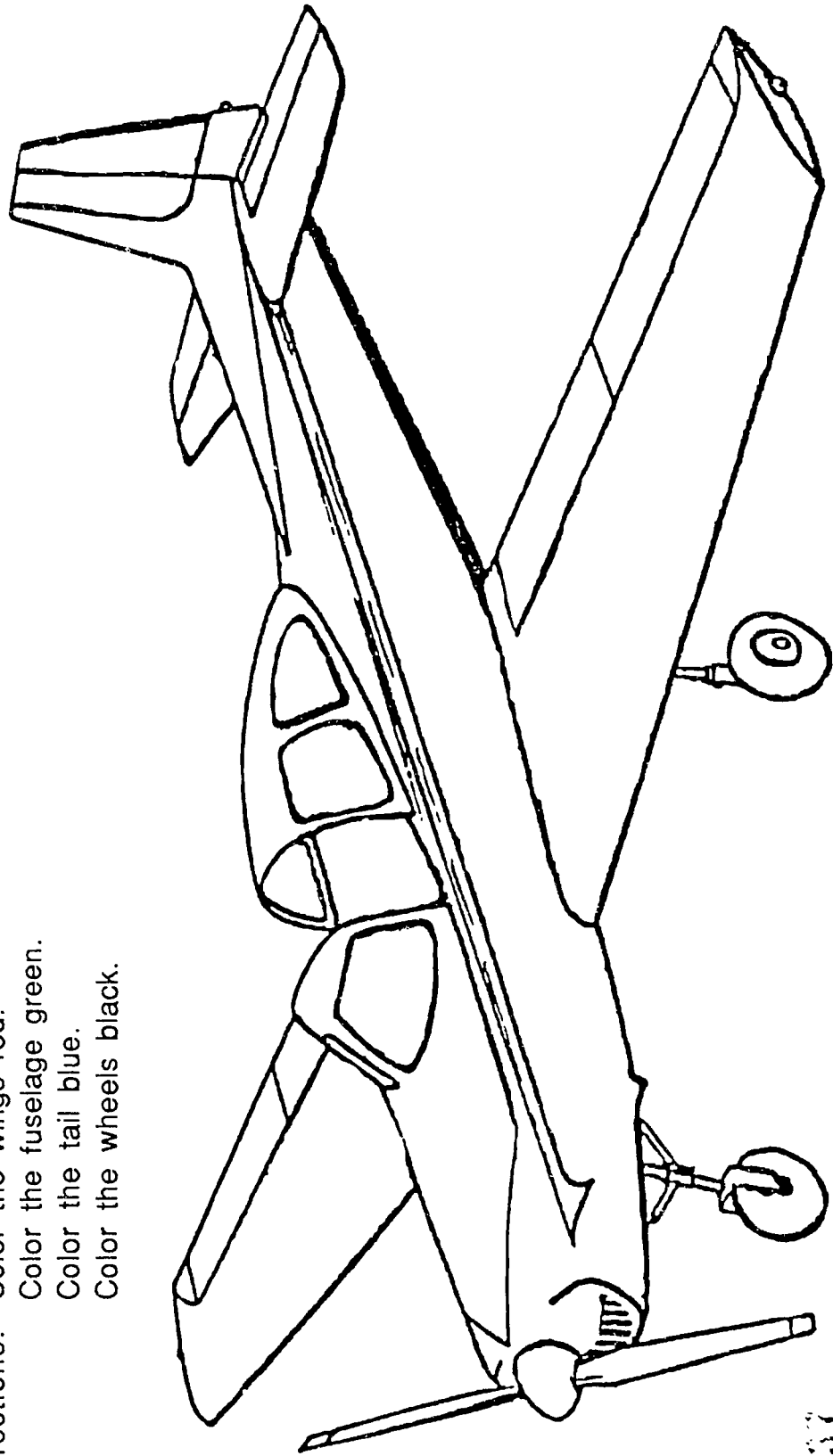

UNIT 3 ACTIVITY 2

STUDENT HANDOUT 5

- Directions:
- Color the flaps brown.
 - Color the fuselage blue.
 - Color the landing gear green.
 - Color the propeller black.
 - Color the ailerons orange.
 - Color the elevators purple.
 - Color the rudder red.
 - Color the wings yellow.

105

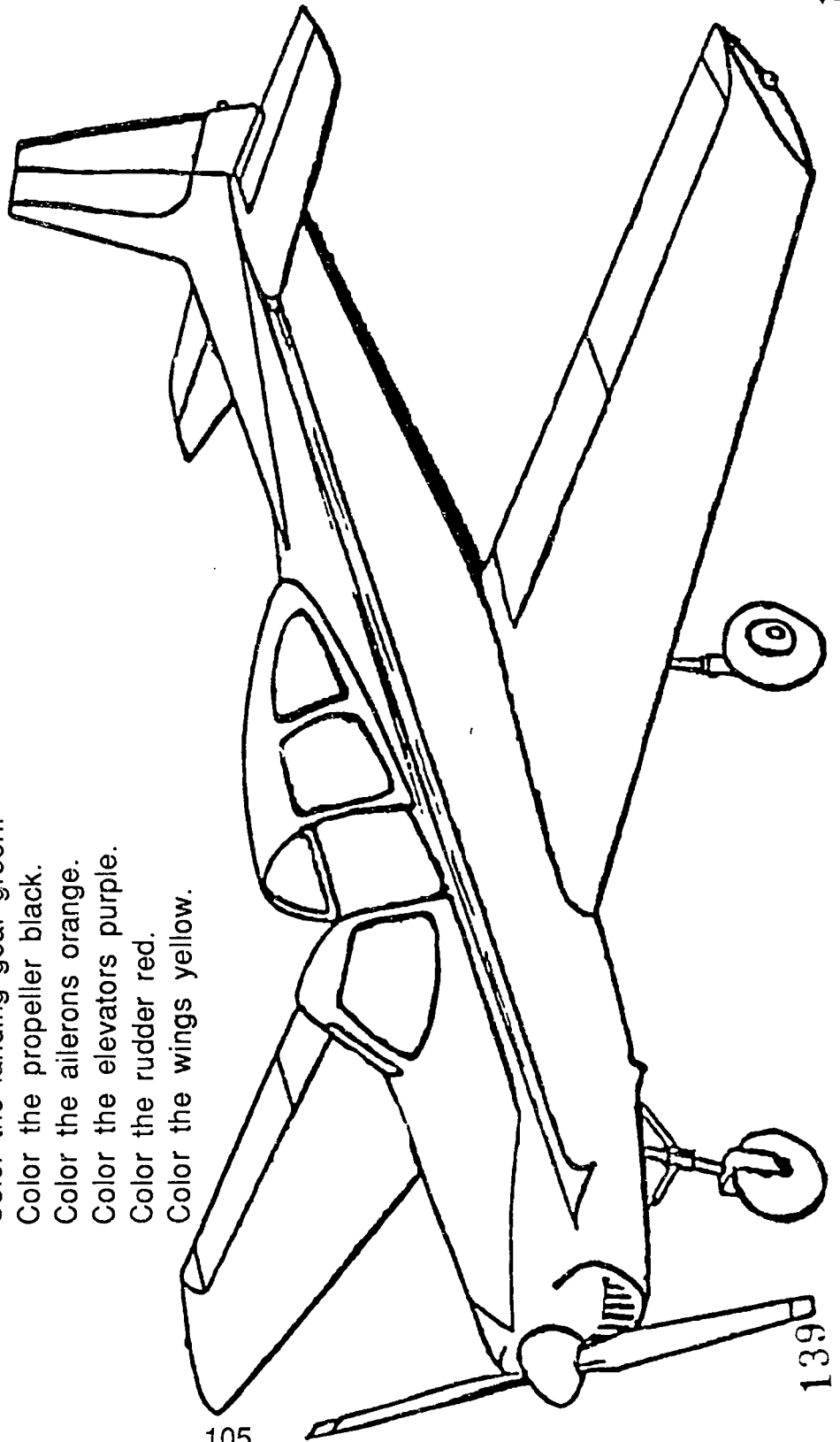

139

140

UNIT 3 ACTIVITY 2

STUDENT HANDOUT 6

Directions: Discuss words in the word box. Label each part.

WORDBOX

fuselage	propeller
cockpit	aileron
landing gear	elevator
wings	rudder
	flaps

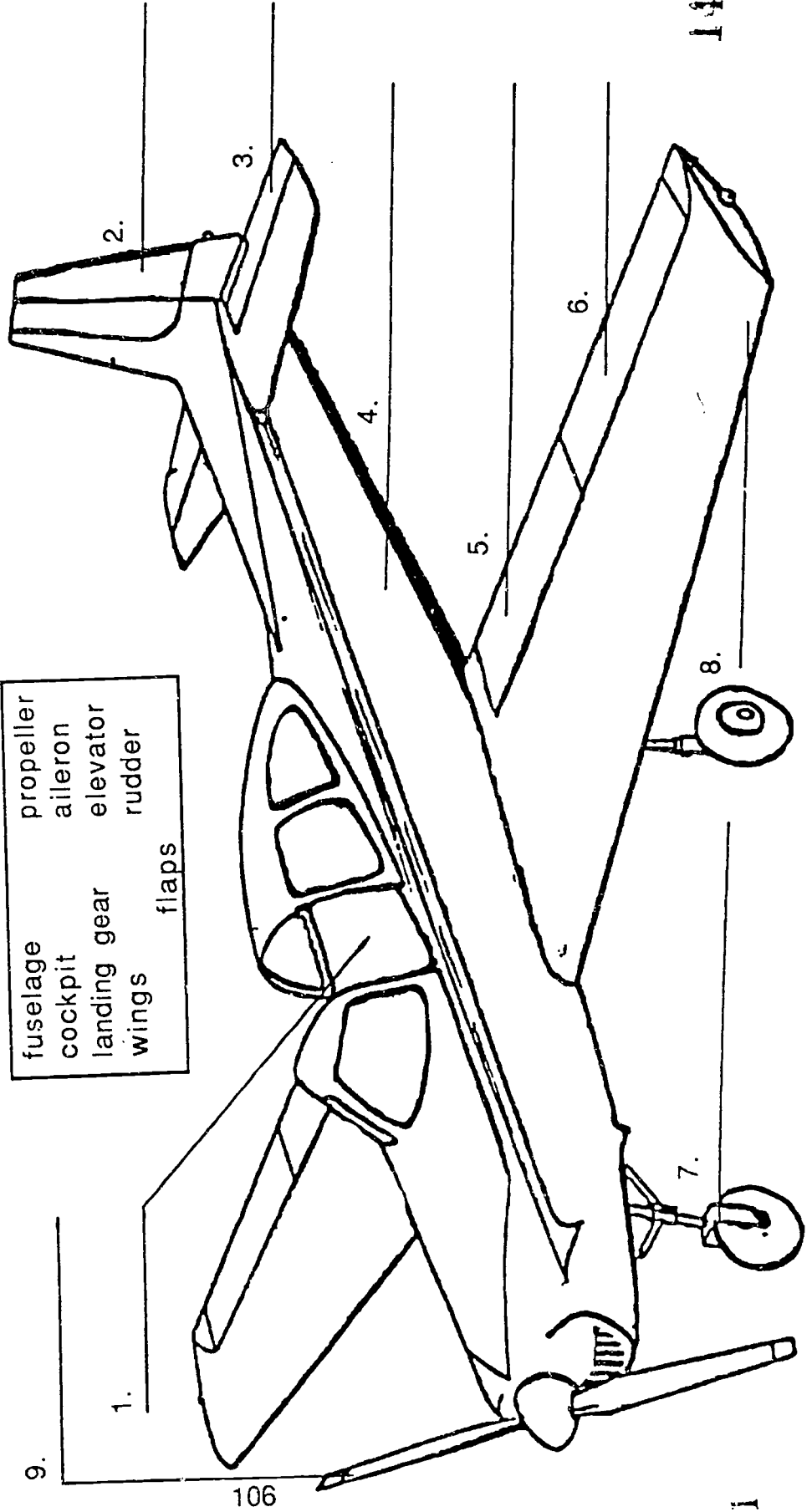

UNIT 4: WHY AIRCRAFT FLY

PURPOSE OF UNIT 4

The purpose of Unit 4 is to introduce the theory of flight. Specifically, students should:

1. demonstrate how lift can overcome weight (gravity);
2. demonstrate how thrust (power) can overcome drag (air resistance);
3. recognize the importance of aerodynamics in daily activities;
4. experience firsthand that for every action there is an equal and opposite reaction; and
5. develop an understanding of how the pilot controls an aircraft.

MAJOR MESSAGES IN UNIT 4

- There are four forces that affect flight: lift, gravity, thrust, and drag.
- There are three basic aircraft movements: turn (yaw), climb and descend (pitch), and lean to the left or right (roll).

BACKGROUND INFORMATION FOR UNIT 4

Unit 4 consists of 3 topics:

TOPIC 1: FOUR FORCES OF FLIGHT

TOPIC 2: JET PROPULSION

TOPIC 3: THREE BASIC AIRCRAFT MOVEMENTS

Topic 1 introduces the four forces of flight as lift, gravity, thrust, and drag. Topic 1 emphasizes that gravity (weight) and drag (bulky shape) must be overcome by lift and thrust in order for an aircraft to become airborne.

Topic 2 introduces Newton's Third Law of Physics: for every action there is an equal and opposite reaction.

The three basic aircraft movements, roll, pitch, and yaw, are examined in Topic 3.

VOCABULARY WORDS FOR UNIT 4

Topic 1

lift
thrust
weight
gravity
drag
propel
aerodynamic

Topic 2

jet
propulsion

Topic 3

roll
pitch
yaw

TOPIC 1: FOUR FORCES OF FLIGHT

The activities, suggested materials, grade level, and related subject areas for each activity are summarized below.

	<u>ACTIVITY</u>	<u>MATERIALS NEEDED</u>	<u>GRADE LEVELS</u> <u>SUBJECT</u>
1.	Lift Versus Weight	2" x 10" paper strips hard back book	Grades 1-3 science
2.	Thrust		Grades 1-3 science
3.	Drag	2 sheets of typing paper	Grades 1-3 science
4.	Culmination	Student Handout 1 Student Handout 2 Fantastic Flight Dictionary	Grades 2-3 science

ACTIVITY 1: LIFT VERSUS WEIGHT

Probe students' imagination by asking questions such as the following:

1. Will an airplane float like a balloon? Why?

Answer: No, it is too heavy.

2. What holds an airplane on the ground?

Answer: Weight (gravity) holds an airplane on the ground.

3. If an airplane will not float, then what lifts it into the air?

Answer: Air moving over the wings creates lift greater than the weight of the airplane.

Explain to the students that weight or gravity holds an airplane on the ground. Therefore, a force greater than the weight of the plane must be used to lift it. Tell the students that the force that lifts an aircraft and keeps it airborne is created by the air flowing over the wings and the angle of the wings into the wind. Most aircraft wings are flat on the bottom and curved on the top.

ACTIVITY 1 (Continued)

Draw the following diagram on the board to show and explain the cross section of a wing:



Explain that air traveling over the wing must reach point B (see diagram below) at the same time as the air traveling under the wing. This means the air traveling over the wing must go faster. This creates a lower air pressure. Lower air pressure creates a suction which causes the wing to lift upward. Draw the following diagram on the board to illustrate lift.

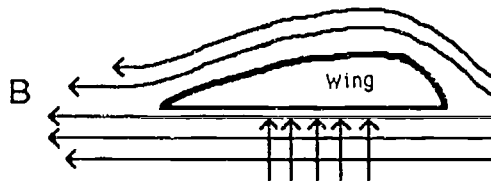

Distribute 2" x 10" paper strips. Ask students to make a wing by placing one end of the paper strip between the pages of a book so that the other end hangs over the top of the book.

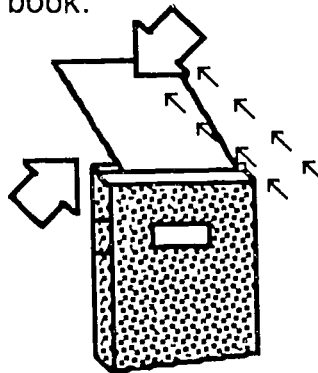

Encourage students to analyze what will happen when air passes over the strip of paper by asking questions similar to the following:

1. What will the paper do with no air passing over it?
2. Will the paper move up or down with air passing over it?

Tell students to blow across the top of the paper strip. Ask students to explain what happened.

ACTIVITY 1 (Continued)

Extended Activities

- Explain to the students that air flowing over the wing is not the only thing needed to lift the aircraft, but also the wing must hit the air at the correct angle. Use the following diagram on the board for explanation.

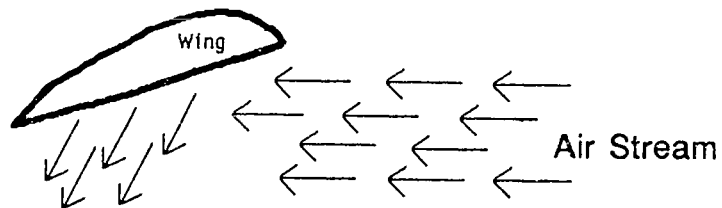

Further explain that the aircraft will climb or lift higher according to the angle of the wing.

- Hold two sheets of notebook paper about four inches apart. Blow between them.

Question: What happens? Why?

Answer: The paper comes together. The rapid movement of air between the two pieces of paper creates less pressure than the air pressing on the outer sides of the paper.

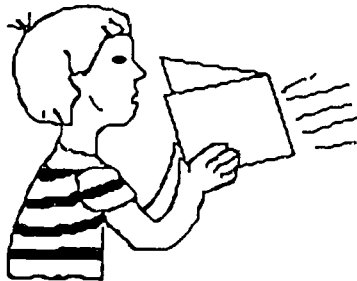

ACTIVITY 2: THRUST

Explain to the students that thrust is the force needed to propel an aircraft through the air. Pose questions, for student thought, such as the following:

1. What is used to thrust (propel) an aircraft through the air?

Answer: Add an engine to thrust an aircraft through air.

2. What can be done to thrust an aircraft through the air faster?

Answer: To thrust an aircraft through the air faster, reduce drag or increase power.

Allow time for discussion. After considering a variety of ideas, tell students that an airplane propeller, turned by the engine, pulls the airplane through the air as it blows air over the wings and fuselage. Illustrate how the propeller pulls an airplane through the air by drawing the following sketch on the board. Pretend the fan is the propeller.

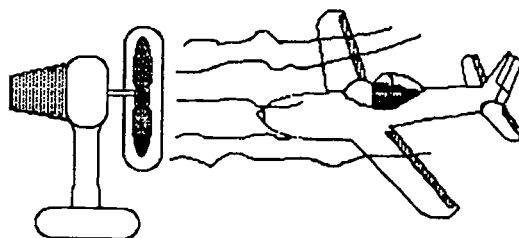

After discussing the sketch, ask students to consider the following question:

Where would you stand so you could feel the wind of the propeller---in front of the plane or behind it?

ACTIVITY 3: DRAG

Explain to the students that, while the propeller pulls the airplane forward, another force called drag holds the airplane back. Air can not flow quickly around large-bulky objects. In order for objects to travel quickly through the air, they must be streamlined (aerodynamic). Show students a crumpled piece of paper and a piece left as is. Ask questions such as the following:

1. If dropped, which piece will hit the floor first?
2. If thrown, which piece will go the farthest?

Give each student two sheets of paper. Ask them to crumple one and leave the other as is.

1. Drop each piece from a predetermined height.
2. Throw each piece.

After the experiment, pose the following question to the students:

Question: Why did the crumpled piece travel the fastest in both cases?

Answer: The crumpled piece had less drag (resistance to the air) because it was more streamlined or compact. Therefore, it traveled through the air faster with less drag.

Extended Activities

- Ask students to think of other ways aerodynamics (streamlining) is used. Ask students to give reasons for using aerodynamics (speed and fuel efficiency).

Examples: cars

trucks---sleek cab designs with air spoilers between the truck and the trailer

clothing---tights used by speed skaters and bicyclist motorcycles

speed boats

ACTIVITY 3 (Continued)

- Experiment with paper airplanes. Have students discover how sleek designs travel through the air faster than bulkier designs.
- Brainstorm ways in which drag can be reduced on an airplane.

Examples: Put a hood (cowling) over the engine.
Make the fuselage design sleek and streamlined.
Put a cover over the open cockpit.
Pull wheels up inside the fuselage or wing.

ACTIVITY 4: CULMINATION

Distribute Student Handout 1. Review the four forces of flight.

- Major review points:
1. Two forces keep an airplane from flying: weight (gravity) and drag (bulky shape).
 2. Lift and thrust must overcome weight and drag before an airplane will fly.

Distribute Student Handout 2. Complete per directions.

- Answers:
- | | |
|------------|------------|
| 1. Lift | A. Lift |
| 2. Thrust | B. Drag |
| 3. Gravity | C. Thrust |
| 4. Drag | D. Gravity |

Extended Activities

- Discuss problems such as the following:
 1. How can the lift on an aircraft be increased?
Answer: Increase the speed of the air passing over the wing. Increase the angle of the wing into the wind.
 2. What parts of an aircraft cause drag?
Answer: landing gear (wheels)
open cockpit
wing supports
exposed engine
bulky fuselage shape
 3. How can drag be reduced on a car?
 4. How can drag be reduced on a truck and trailer?
 5. How can a bicyclist reduce drag to gain speed?
- Write Topic 1 vocabulary words in Fantastic Flight Dictionary.

TOPIC 2: JET PROPULSION

The activities, suggested materials, grade level, and related subject areas for each activity are summarized below.

<u>ACTIVITY</u>	<u>MATERIALS NEEDED</u>	<u>GRADE LEVELS</u> <u>SUBJECT</u>
5. Balloon Jet	string tape straw balloon	Grades 1-3 science
6. Newton's Third Law of Physics	glass bottle cork vinegar water baking soda pencils vaseline	Grades 2-3 science

ACTIVITY 5: BALLOON JET

Begin by directing students' attention to jets. Ask questions that arouse curiosity such as the following:

1. Do all airplane engines have a propeller?
2. What kind of airplane engine has no propeller?
3. How do jet engines provide thrust?
4. Do you think jets are like rockets?

Explain to students that the fuel burned in a jet engine gives off hot gases. The gases shoot out the back of the engine in a stream called a jet. As the gas shoots out the back of the engine, the jet airplane is pushed forward. This forward movement is called thrust or jet propulsion.

Conduct the following experiment to illustrate. Tape a string to the ceiling or tall bookcases. Thread the loose end through a straw and tape it to the floor at a 45° angle. Inflate a balloon and tape it to the straw. Let students take turns inflating a balloon and releasing the neck. Ask students questions such as the following:

1. What did the balloon do?
2. What caused the balloon to travel to the ceiling?
3. How does the balloon compare to a jet engine?

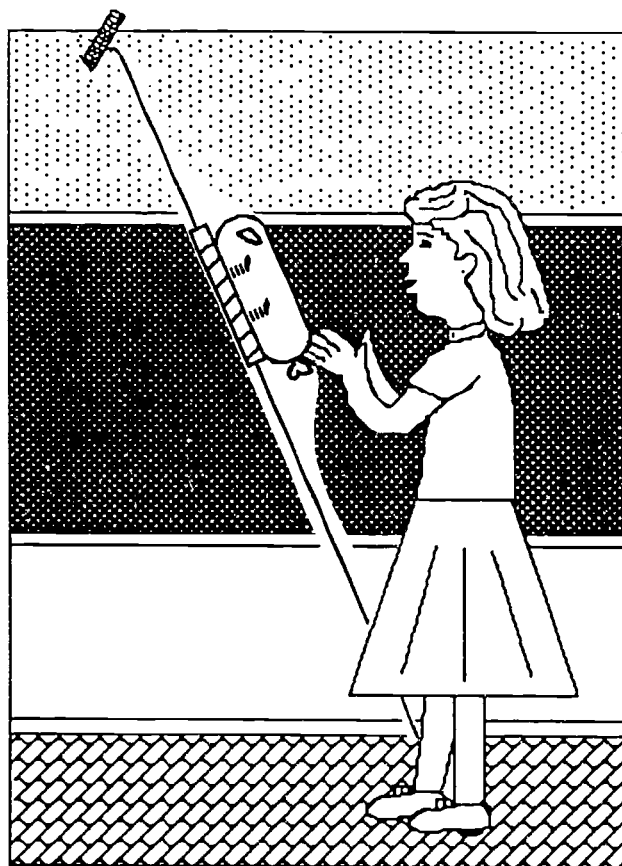

ACTIVITY 6: NEWTON'S THIRD LAW OF PHYSICS

Tell the students that for every action there is an equal and opposite reaction just like every problem has a cause. Ask students to examine the following actions and determine the reaction.

1. Tossed ball
2. Air escaping from a balloon

Illustrate by conducting the following experiment. Fill a glass bottle, half full, with a mixture of 50% water and 50% vinegar. Pour two teaspoons of baking soda into the bottle. Lubricate a cork with vaseline and insert in the bottle top. Place the bottle on its side on a row of round pencils.

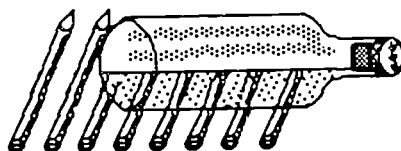

After completing the experiment, help the students assess the outcome by asking questions such as the following:

1. What was the action?
2. Describe the reaction?
3. Explain what caused the reaction.
4. Relate the reaction to a jet engine.

Note: The pressure build-up inside the bottle, caused by the vinegar, water, and baking soda mixture, will pop the cork. The force exerted to pop the cork will thrust (push) the bottle in the opposite direction across the pencils.

Caution: Clear the work area to accommodate possible spillage of the vinegar, water, and baking soda mixture.

TOPIC 3: THREE BASIC AIRCRAFT MOVEMENTS

The activities, suggested materials, grade level, and related subject areas for each activity are summarized below.

<u>ACTIVITY</u>	<u>MATERIALS NEEDED</u>	<u>GRADE LEVELS</u> <u>SUBJECT</u>
7. Control Parts	Student Handout 3 Cessna airplane model (See Teacher Resource Section for address.) Student Handout 4	Grades K-3 mathematics science
8. Turns	Cessna airplane model 2 1/2" x 8" paper strips	Grades 1-3 mathematics science
9. Climb and Descend	Student Handout 5	Grades 1-3 science
10. Roll	Student Handout 5	Grades 1-3 science
11. Culmination	Student Handout 6 Fantastic Flight Dictionary	Grades 1-2 science

ACTIVITY 7: CONTROL PARTS

Begin by directing the students' attention to how a driver controls a car. Arouse interest by asking questions such as the following:

1. How does a driver make the car turn left or right?
2. What part of the car does the steering wheel control?
3. Does the steering wheel control any other part of the car?
4. What control, inside the car, causes the car to stop and go?
5. What control, inside the car, causes the car to go forward or reverse?

Explain to students that a pilot controls his airplane, from the cockpit, just like a driver controls a car. Stimulate the students' curiosity by asking questions such as the following:

1. What kind of movements can an airplane make?
2. What movements can an airplane make that are impossible for a car to make?
3. What movement can a car make that is impossible for an airplane to make?

- Answers:
1. Turns, rolls, climbs, descents, and straight/level
 2. Rolls, climbs, and descents
 3. Reverse

Distribute Student Handout 3 and the Cessna airplane model. Direct the students' attention to the parts of the airplane that control the way it moves.

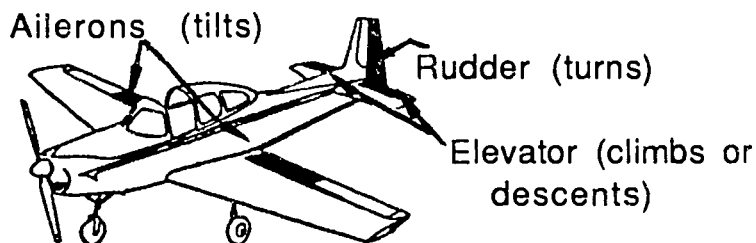

Distribute Student Handout 4. Complete per directions.

- Answers: 1. elevator 2. rudder 3. aileron

ACTIVITY 8: TURNS

Explain to the students that the airplane has two rudder pedals in the floor of the cockpit that attach to the rudder with cables. (Check rudder location on the Cessna model.) When the pilot wants to go left, he pushes the left rudder pedal with his foot. The cable pulls the rudder, on the tail, to the left so the wind hits it and pushes the plane to the left.

Give each student a paper clip and a 2 1/2" x 8" strip of paper. Have students pretend the flat paper strip is an airplane. Fold the paper 2" from one end to form a rudder. Push a clip through the paper 2 1/2" from the fold. Hold the clip so that the folded end (rudder) of the paper is opposite your mouth. Blow gently.

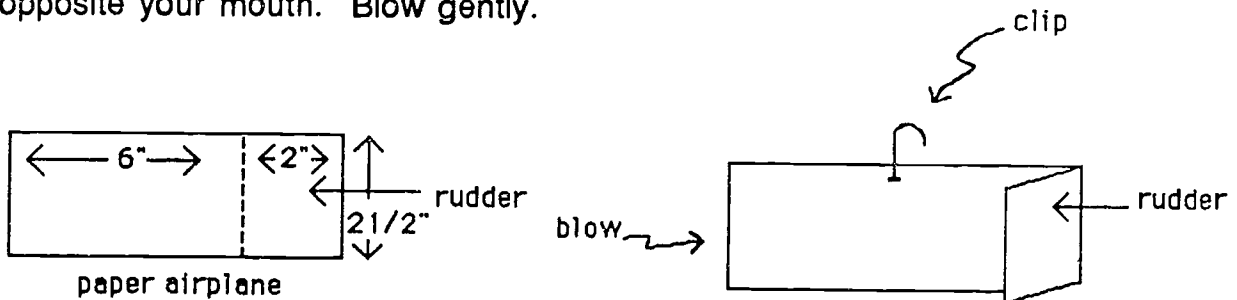

Ask students to perform experiments such as the following:

1. Determine what direction the plane turns when the rudder is folded to the left.

Outcome: Air hitting the rudder, that is folded to the left, pushes the tail of the airplane to the right which points the nose of the airplane to the left. The plane is now making a left turn.

2. Determine what direction the plane turns when the rudder is folded to the right.

Outcome: Air hitting the rudder, that is folded to the right, pushes the tail of the airplane to the left which points the nose of the airplane to the right. The plane is now making a right turn.

ACTIVITY 9: CLIMB AND DESCEND

Tell the students that the pilot also uses a long joy stick or yoke, like a car steering wheel, to control an airplane from the cockpit. The joy stick or yoke attaches to the elevators with cables. When a pilot wants to make his airplane climb higher, he pulls the joy stick or yoke back. The elevators turn up so the wind hits them. The wind pushes the tail of the airplane down, causing the nose to point upward.

Distribute Student Handout 5. Cut and fold paper airplane per directions. Tell students to conduct the following experiments to clarify the effect of the wind on the elevator control surfaces:

Experiment: 1

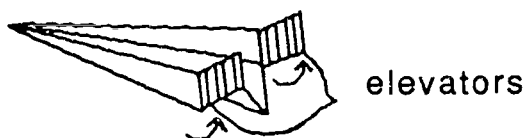

fig. 1

To make the airplane climb, fold both elevators up (fig. 1). Air hitting the elevators pushes the airplane tail down, causing the nose to point upward.

Experiment: 2

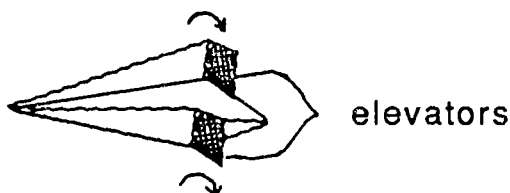

fig. 2

To make the airplane descend, fold both elevators down (fig. 2). Air hitting the elevators pushes the airplane tail up, causing the nose to point down.

Take students to an outside play area. Allow ample time for experimentation with elevators folded up and elevators folded down. Ask students to consider what would happen if the elevators were in a neutral (flat) position.

ACTIVITY 10: ROLL

Direct students' attention to what made an airplane climb, descend, and turn. Review the control surfaces that make these movements take place. Now ask a question such as the following:

What can be done with the controls to make the airplane roll or tilt to the right or left?

After the students have attempted various answers, tell them that the ailerons make the airplane roll or tilt. The ailerons are located on the outer section of the rear edge of the wing. A cable connects the ailerons to the joy stick or control wheel (yoke).

To make a plane roll to the right, the control wheel or joy stick must be turned to the right. The left aileron moves down so the wind pushes the wing up. The right aileron moves up so the wind pushes the wing down.

Tell the students the opposite must be done to make the plane roll to the left: left aileron must be up and the right aileron must be down.

Distribute Student Handout 5. Cut and fold the paper airplane per directions. Pretend the folded parts are the ailerons located on the airplane wing. Take the students outdoors to conduct the following experiment:

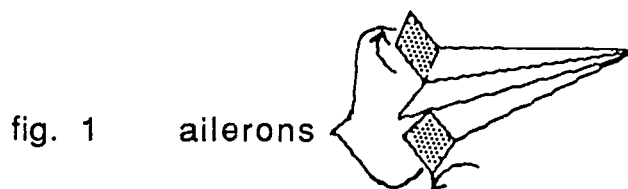

To make the airplane roll to the left, fold left aileron up and the right aileron down (fig.1).

Outcome: The paper airplane will roll or tilt to the left during flight.

ACTIVITY 10 (Continued)

To make the airplane roll to the right, fold the left aileron down and the right aileron up. This is the reverse of fig. 1.

Outcome: The paper airplane will roll or tilt to the right during flight.

ACTIVITY 11: CULMINATION

Explain that the controls of an airplane must all work together. The pilot can make the airplane climb, turn, and roll all at the same time.

Conduct a brainstorming session to help students visualize the simultaneous operation of the controls to produce specific airplane movements. Ask questions such as the following:

- Questions:
1. What makes an aircraft fly straight and level?
 2. What would you do to make the aircraft climb and turn right at the same time?
 3. What would you do to make the aircraft descend and turn left at the same time?

- Answers:
1. Put all controls in neutral--do not push, pull, or turn.
 2. Pull the control wheel back, turn the wheel to the right, and push right rudder.
 3. Push the control wheel in, turn the wheel left, and push left rudder.

Extended Activities

- Distribute Student Handout 6. Complete per directions.

Answers: 1. elevator 2. rudder 3. aileron
4. climb 5. descend 6. left turn
7. tilt right

- Ask students to alphabetize Topic 1, 2, and 3 vocabulary words.
- Tell students to write Topic 2 and 3 vocabulary words in the Fantastic Flight Dictionary.

UNIT 4 ACTIVITY 4

STUDENT HANDOUT 1

WHY AIRCRAFT FLY

LIFT

Air flowing over the wings and the angle of the wing into the wind moves the aircraft upward.

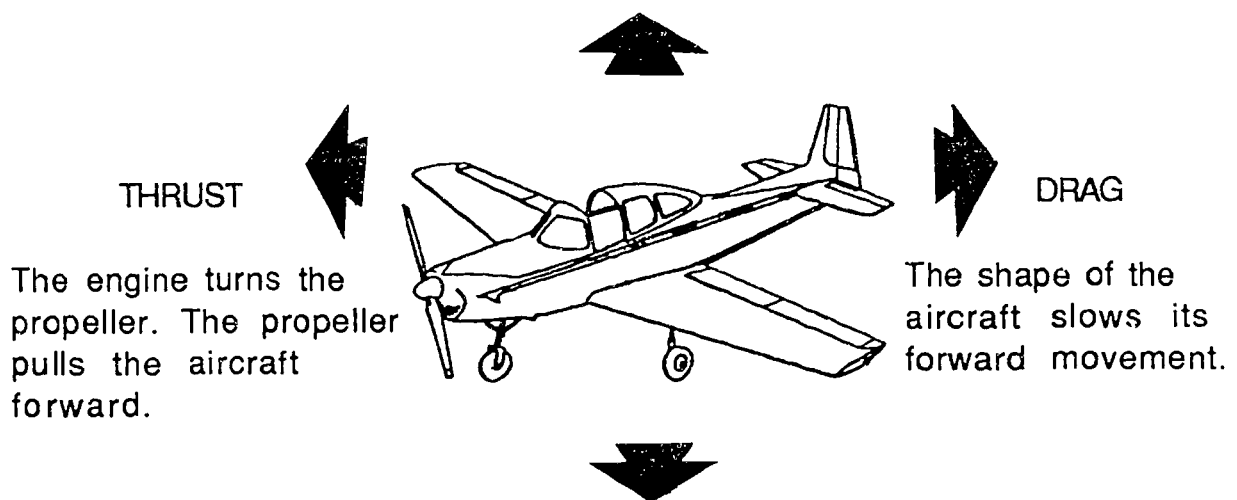

THRUST

The engine turns the propeller. The propeller pulls the aircraft forward.

DRAG

The shape of the aircraft slows its forward movement.

GRAVITY

Weight holds the aircraft down.

To make an aircraft fly:

1. Lift must be greater than gravity (weight).
2. Thrust (power) must be greater than drag.

UNIT 4 ACTIVITY 4

STUDENT HANDOUT 2

Directions: Fill in the blank with the appropriate term. Label the airplane.

FOUR FORCES OF FLIGHT

Word Bank

Drag
Lift

Thrust
Gravity

1. _____ is produced by air flowing over the wings and the angle of the wing into the wind.
2. _____ is the forward movement produced by an engine-driven propeller, jet, or rocket engine.
3. _____ is the force that pulls an aircraft down.
4. _____ slows the forward movement of an aircraft.

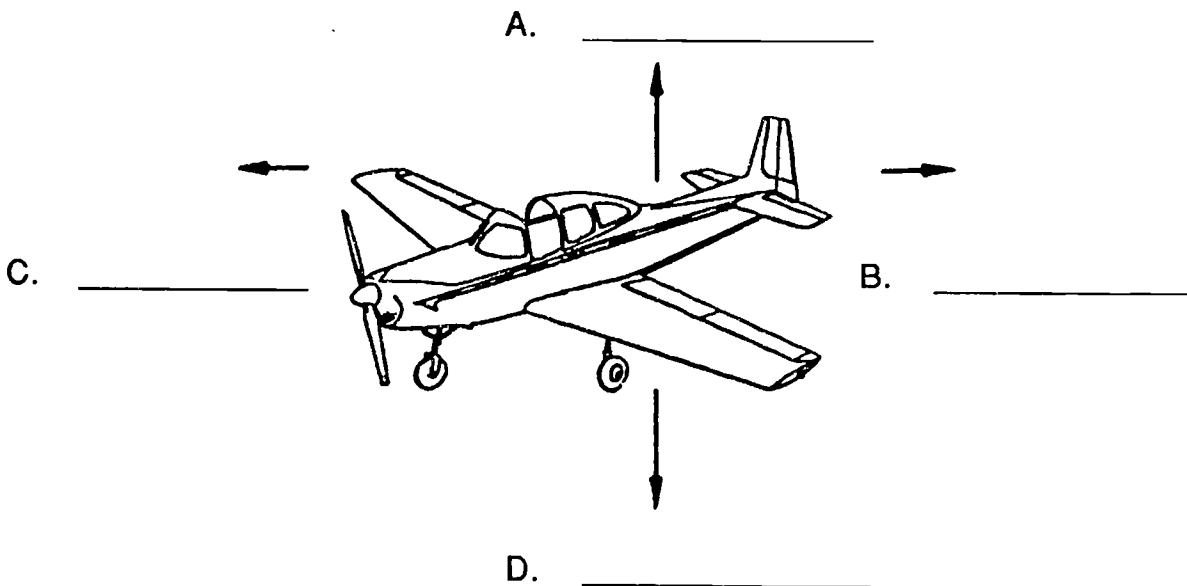

UNIT 4 ACTIVITY 7

STUDENT HANDOUT 3

PARTS THAT CONTROL AIRPLANE MOVEMENT

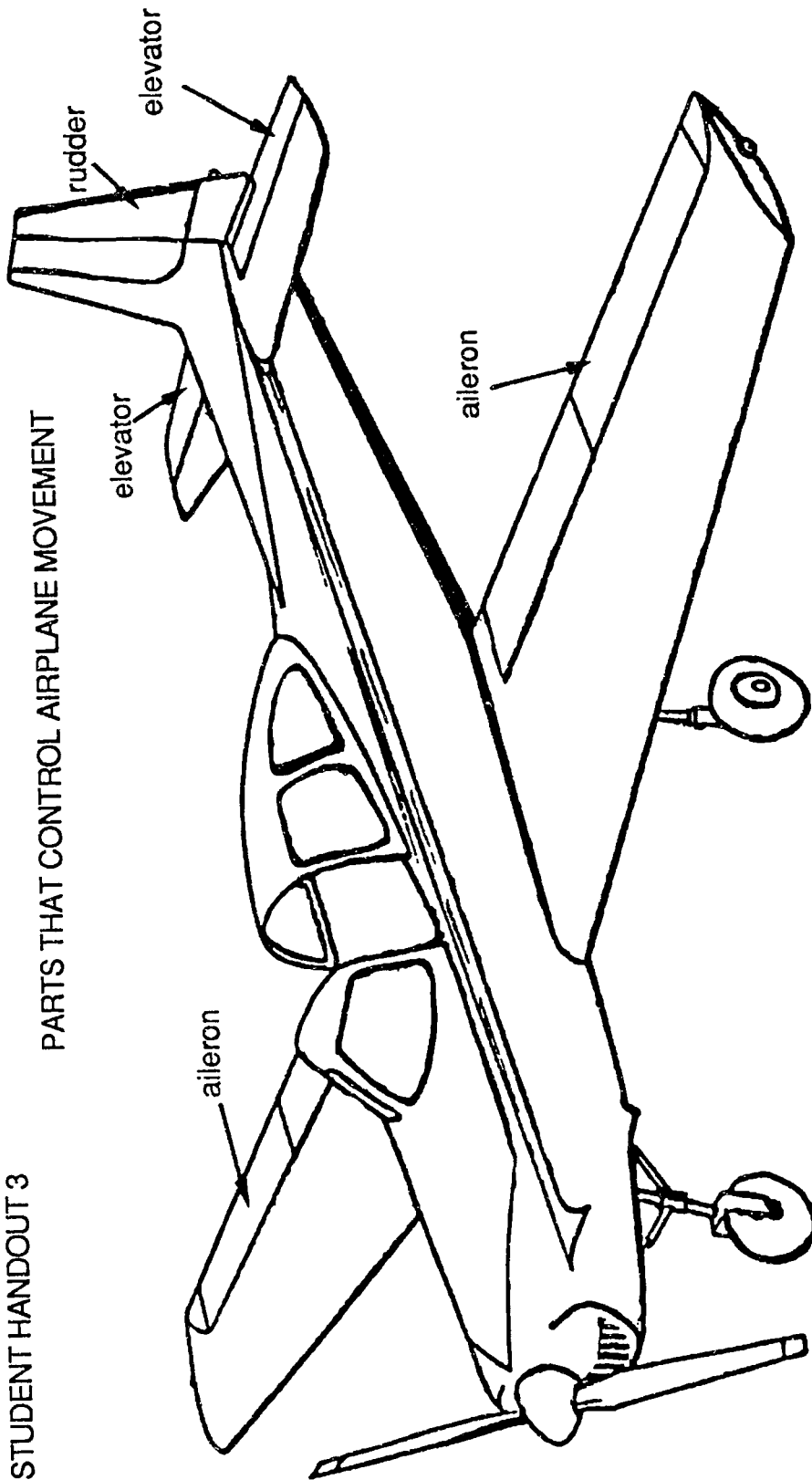

- The ELEVATOR makes the plane climb or descend.
- The RUDDER turns the plane left or right
- The AILERON makes the plane tilt left or right.

UNIT 4 ACTIVITY 7

STUDENT HANDOUT 4

PARTS THAT CONTROL AIRPLANE MOVEMENT

- Directions:
1. Color the rudder red.
 2. Color the ailerons green.
 3. Color the elevators blue.

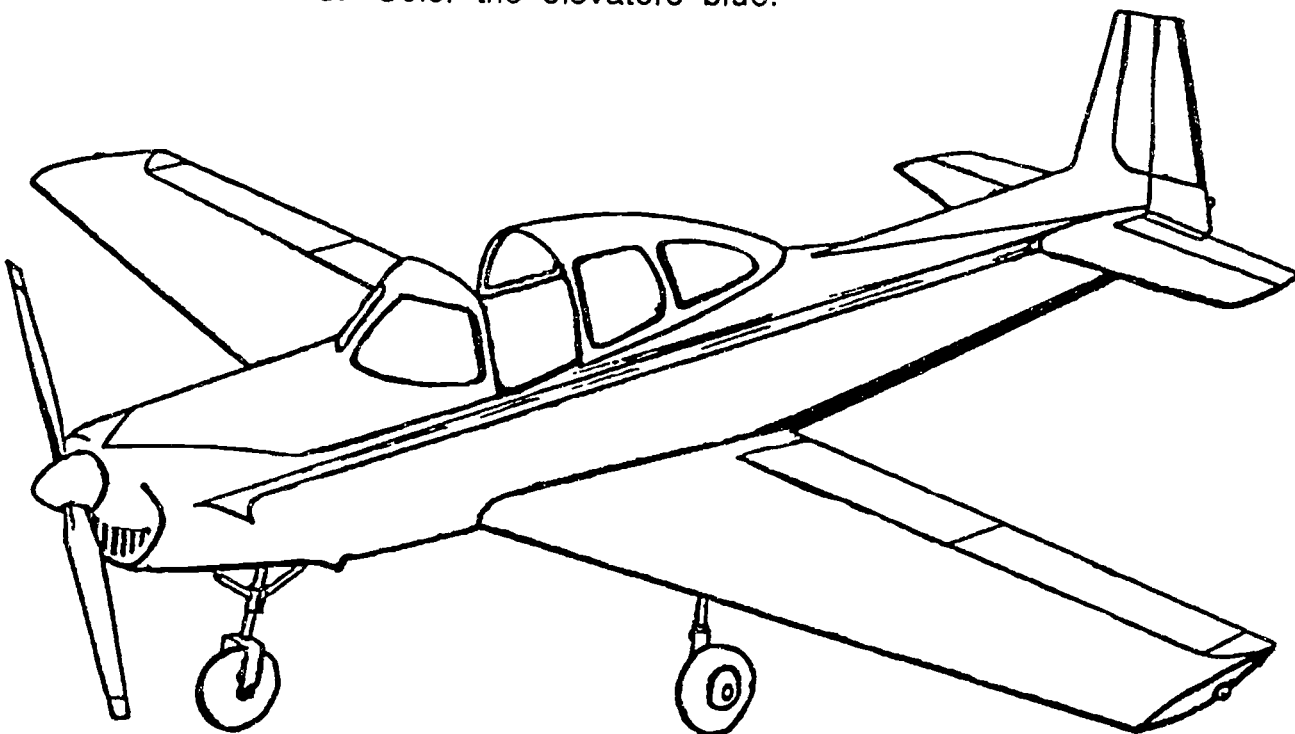

Fill in the blanks. Use the words rudder, aileron and elevator.

1. The _____ makes the plane climb and descend.
2. The _____ makes the plane turn left or right.
3. The _____ makes the plane tilt left or right.

UNIT 4 ACTIVITY 9 AND 10

STUDENT HANDOUT 5

Directions: Cut out along solid line. Fold using five folding steps.

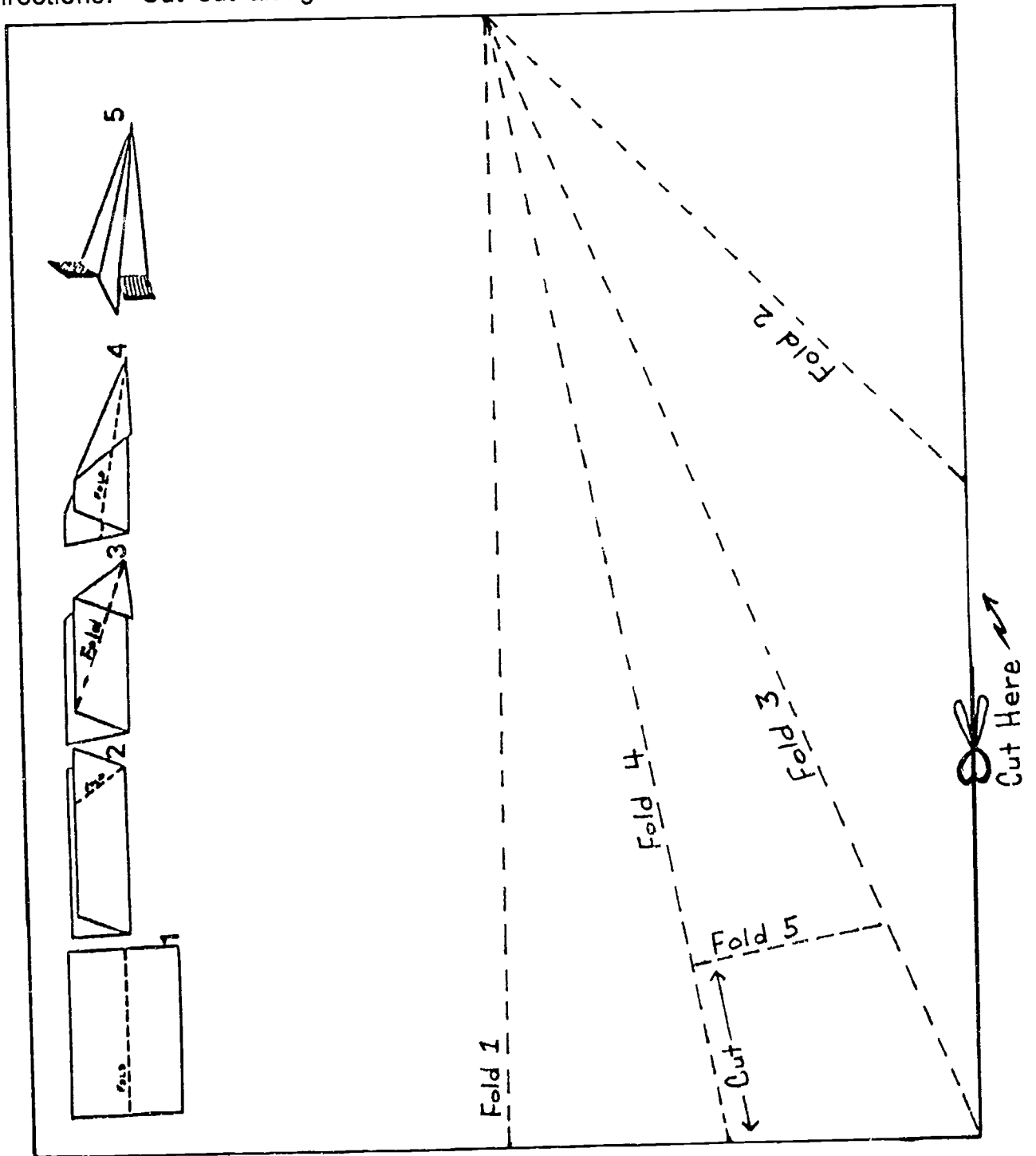

UNIT 4 ACTIVITY 11

STUDENT HANDOUT 6

Directions: Select a word from the word bank for each description below.

Word Bank

rudder climb elevator
descend left turn turn tilt right

1. _____ aircraft part that makes the aircraft move up (climb) or down (descend).
2. _____ aircraft part that turns the aircraft left or right.
3. _____ aircraft part that makes the aircraft tilt left or right.
4. _____ pull control wheel out.
5. _____ push control wheel in.
6. _____ push left rudder.
7. _____ turn control wheel to the right.

UNIT 5: WEATHER

PURPOSE OF UNIT 5

The purpose of Unit 5 is to develop the students' understanding of weather. Specifically, students should:

1. sense that weather changes daily;
2. experience weather reporting first hand through visual observations;
3. construct and demonstrate simple instruments to determine wind direction and speed, temperature and air pressure; and
4. demonstrate the ability to interpret radio, newspaper, and TV weather forecasts.

MAJOR MESSAGES IN UNIT 5

- Weather changes daily.
- Weather affects our daily lives.
- Weather plays a major role in aviation and space activities.

BACKGROUND INFORMATION FOR UNIT 5

Unit 5 consists of 5 topics:

TOPIC 1: WEATHER CHANGES DAILY

TOPIC 2: CLOUDS

TOPIC 3: WIND

TOPIC 4: AIR

TOPIC 5: FRONTS

Topic 1 presents weather as changing daily. The changes affect our daily lives.

Topic 2 introduces types of clouds and how they affect weather.

Topic 3 demonstrates ways to measure wind speed and direction.

Topic 4 demonstrates that air has weight and takes up space and presents ways to measure air temperature and pressure.

Topic 5 introduces air masses and weather fronts and emphasizes interpretation of weather reports.

VOCABULARY WORDS FOR UNIT 5

Topic 1	weather calendar sun
Topic 2	clouds stratus clouds cumulus clouds fog
Topic 3	wind air windsock
Topic 4	atmosphere weight pressure meteorologist barometer temperature thermometer
Topic 5	air mass cold front warm front stationary front occluded front

TOPIC 1: WEATHER CHANGES DAILY

The activities, suggested materials, grade level, and related subject areas for each activity are summarized below.

<u>ACTIVITY</u>	<u>MATERIALS NEEDED</u>	<u>GRADE LEVEL</u> <u>SUBJECT</u>
1. What's It Doing Today?	WHAT'S IT DOING TODAY? Student Handouts 1, 2, 3, and 4 large wall calendar Teacher Resource Sheet 1 Student Handouts 5 and 6 Fantastic Flight Dictionary	Grades K-3 language arts mathematics science

ACTIVITY 1: WHAT'S IT DOING TODAY?

Direct the students' attention to weather. Develop a sense of changing weather by displaying pictures of a sunny day, a cloudy day, a rainy day, a snowy day, and a windy day. Ask questions about each picture, such as:

1. Name things in each picture that help tell what the weather is like.
2. What in each picture tells us there is air in motion (wind)?
3. What in each picture tells us there is moisture (rain or snow) in the air?
4. What in each picture tells the temperature (hot or cold)?

Explain to the students that weather is the condition of the air (wind, temperature, and air pressure) surrounding the earth. Weather changes daily.

Distribute WHAT'S IT DOING TODAY? (Student Handouts 1, 2, 3, and 4).



Cut sheets apart, stack and staple to form a book. Read the story, or have the students read it. Discuss questions similar to the following:

1. What makes weather?
2. Why are days warmer than nights?
3. How can clouds make the day cooler?
4. What is inside some clouds?
5. How can the wind make the day warmer or cooler?

ACTIVITY 1 (Continued)

Explain to students that weather affects everything we do. Stimulate students' thoughts about how weather affects our lives by asking questions such as the following:

1. How does knowing about the weather help us dress for school?
2. Why does the farmer watch the weather before he plants his crops?
3. Why do pilots watch the weather?

Display a large calendar on a classroom wall. Discuss the term "symbol." Introduce the weather symbols from Teacher Resource Sheet 1.

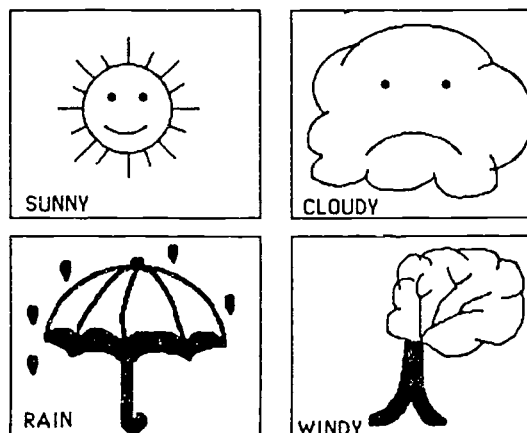

Each morning have students determine the weather for the day. Let students take turns pasting weather symbols to the calendar. At the end of the week, review the weather. Summarize the month-long weather watch by telling students that weather changes daily. We can't change what the weather does. We can observe the weather and make changes in our daily plans for our comfort and safety.

Emphasize that weather gives us hints about what will happen. We can look at the hints (clouds, wind, air pressure, air masses, and fronts) to find what will happen next.

ACTIVITY 1 (Continued)

Extended Activities

- Distribute Student Handouts 5 and 6. Tell students they will become daily weather reporters. Ask students to color and cut out the correct weather symbol for the day and paste it in the correct date box. Write the number of the day in the box. Review the overall weather picture at the end of each week or month.
- Write Topic 1 vocabulary words in the Fantastic Flight Dictionary.

TOPIC 2: CLOUDS

The activities, suggested materials, grade level, and related subject areas for each activity are summarized below.

<u>ACTIVITY</u>	<u>MATERIALS NEEDED</u>	<u>GRADE LEVEL</u> <u>SUBJECT</u>
2. Look Up in the Sky	LOOK UP IN THE SKY, Student Handouts 7, 8, and 9	Grades K-3 language arts mathematics science
3. Cloud Making	Teacher Resource Sheet 2 kettle, water, strainer, ice	Grades 1-3 science
4. Stratus and Cumulus Clouds	Student Handouts 5 and 10 blue construction paper, cotton balls, glue, crayons Fantastic Flight Dictionary	Grades 1-3 science mathematics art

ACTIVITY 2: LOOK UP IN THE SKY

Excite students by telling them clouds give us messages about the weather. Clouds let us see what is happening in the air.

Distribute LOOK UP IN THE SKY (Student Handouts 7, 8, and 9).

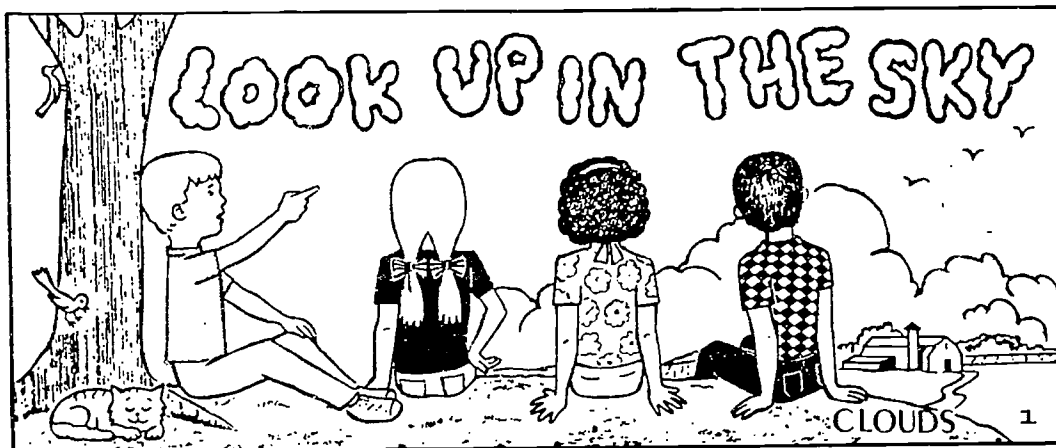

Cut sheets apart, stack and staple to form a book. Read the story, or have students read it. Discuss questions similar to the following:

1. What messages do clouds give us about the weather?
2. Describe the look of stratus clouds.
3. Describe the look of cumulus clouds.
4. What do we find inside clouds?
5. What is fog?
6. How do clouds affect the weather?

ACTIVITY 2 (Continued)

Extended Activities

- Tell students to write a story using the following idea:

"If I could move a cloud, I could help mankind by"

Ask students to illustrate their work. Have students share their stories with the class.

For K-1 students, have the class dictate an experience chart about clouds.

- On a cold day, instruct students to blow their breath into the air. Ask students to explain what happened.

ACTIVITY 3: CLOUD MAKING

Explain to students that clouds are visible bodies of very fine droplets of water (or ice) dispersed in the air. Clouds filled with water grow large and can reach a height of several miles. When full, the water falls as rain or snow. Display Teacher Resource Sheet 2. Explain the cloud cycle and how temperature affects falling moisture.

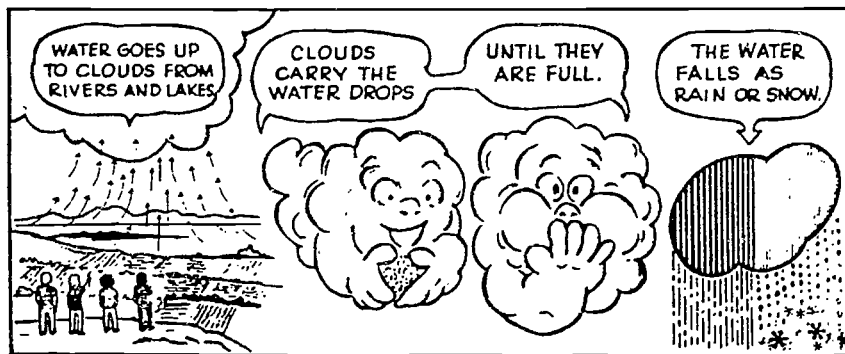

Further explain the formation of a cloud by conducting the following experiment:

Boil water in a kettle until steam comes from the spout. Point out to the students that the steam disappears into the air almost immediately. Fill a strainer with ice and hold it near the spout of the kettle so the steam will go through it. Point out the formation of a cloud. Ask the students to retell in their own words what happened.

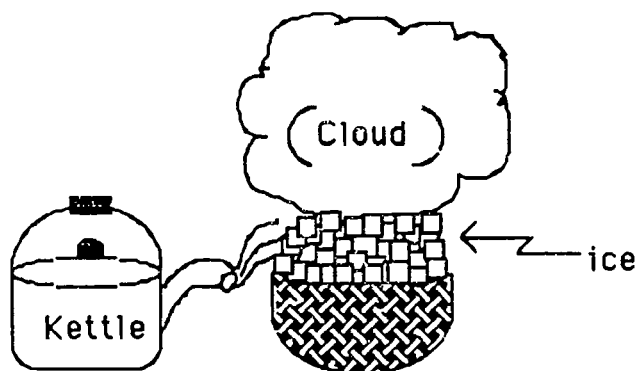

ACTIVITY 4: STRATUS AND CUMULUS CLOUDS

Explain to the students that the two basic types of clouds are cumulus and stratus.

CUMULUS clouds are fluffy, dome-shaped masses that may produce heavy rainstorms and strong winds, forecasting colder weather.

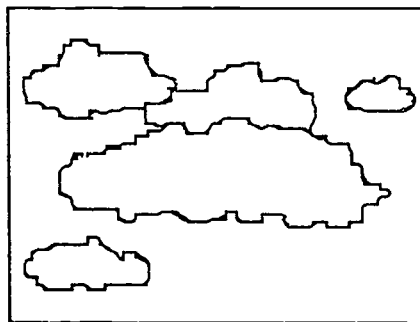

Cumulus Clouds
White, Puffy, Full

STRATUS clouds are low horizontal layers that create poor visibility in the form of haze, fog, drizzle, or rain, forecasting warmer weather.

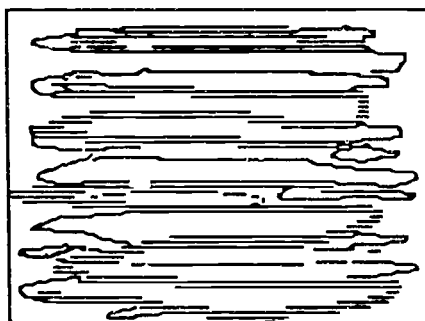

Stratus Clouds
Gray, Glooms

ACTIVITY 4: (Continued)

Using the above information, help students formulate some conclusions on how clouds affect air transportation by asking questions such as:

1. How will low stratus clouds or fog affect a pilot's take-off or landing?
2. What message would a cumulus cloud give us?
3. What type clouds would concern a pilot most?

Explain that air transportation depends on accurate weather reports to make flying safe and comfortable. Bad weather still causes delayed flights and accidents. Pilots must be able to see to take-off or land. Aircraft have not been built that will fly through thunderstorms or very high winds.

Distribute Student Handouts 5 and 10. Discuss cloud symbols. Have students observe sky conditions for a month and record their findings on Student Handout 5. Leave the date box empty if it is a clear or sunny day. At the end of the month, ask students to examine the weather calendar to determine the number of clear days, days with cumulus clouds, and days with stratus clouds.

Extended Activities

- Distribute blue construction paper and two cotton balls. Ask students to draw a simple picture of an outdoor scene with crayons. Glue puffy cotton balls in the sky to represent cumulus clouds or stretched cotton balls in the sky for stratus clouds. Have each student tell the class about the weather conditions portrayed in their picture.
- Write Topic 2 vocabulary words in the Fantastic Flight Dictionary.

TOPIC 3: WIND

The activities, suggested materials, grade level, and related subject areas for each activity are summarized below.

<u>ACTIVITY</u>	<u>MATERIALS NEEDED</u>	<u>GRADE LEVEL</u> <u>SUBJECT</u>
5. Air In Motion	string, small dish strong perfume, cotton balls electric fan, strips of paper	Grades K-3 science
6. Windsock Making	<u>Grades K-1</u> 2" X 18" construction paper strips, 1 1/2" X 20" tissue paper strips, glue, string, paper punch <u>Grades 2-3</u> 36" X 24" nylon cloth, four 10-inch lengths of heavy wire, wire coat hanger, 36" X 1" wooden dowel, large nail, wooden spool, two paint stir sticks helium-filled balloons, string, tags, United States map posterboard, magazines, glue	Grades K-3 science art

TOPIC 3: WIND (Continued)

<u>ACTIVITY</u>	<u>MATERIALS NEEDED</u>	<u>GRADE LEVEL</u> <u>SUBJECT</u>
	Student Handout 11	
7. Airplanes In The Wind	string, wooden glider, small fan	Grade 3 science
	Student Handout 12 Fantastic Flight Dictionary	

ACTIVITY 5: AIR IN MOTION

Direct students' attention to the wind. Stimulate students' thoughts about the wind by asking question such as:

1. What is wind?
2. How do we know air is moving?
3. Does air always move at the same speed?
4. Does air always move in the same direction?

Demonstrate air in motion by conducting the following experiments:

1. Ask students to blow into the palms of their hands. Ask them how they know air is moving.
2. Burn a string or some incense in a dish. Ask students to observe the direction the smoke travels. Ask them why the smoke is moving.
3. Take students on a hike around the school grounds. Ask them to observe the leaves on the trees. Are the leaves moving? Are the trees bending? Why?
4. Put strong perfume on a cotton ball. Ask students to raise their hands as soon as they smell it. Ask them why they are able to smell the perfume across the room.
5. Tell students to fan themselves with a piece of paper, move their arms rapidly back and forth, or turn around rapidly. Ask students to describe what they felt.
6. Fasten some strips of paper to an electric fan. Ask students to explain what happens with the fan on and what happens with the fan off. What did the fan do to the air?

ACTIVITY 6: WINDSOCK MAKING

Explain to the students that wind can change direction and speed. A windsock can tell us the direction in which the wind is blowing and how hard (fast) it is blowing.

Grade K-1 Windsock

1. Glue two construction paper strips together to form a loop.
2. Glue tissue paper strips to the inside of the loop.
3. Punch a hole on each side of the loop and attach a string.
4. Take finished windsocks to outside play area. Have students determine the wind direction.

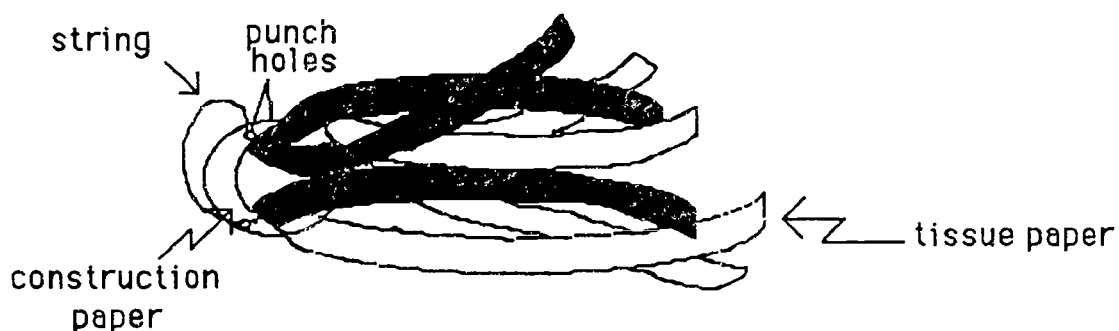

Grade 2-3 Windsock

1. Shape a hanger into a 9" diameter loop.
2. Attach four wires to this circular loop at four equidistant points.
3. Cut cloth (see diagram) and glue sides together to form a cone.
4. Glue large end of cone to wire loop.
5. Gather the four lengths of wire and bind the exposed ends to the spool with wire.
6. Place a nail through the spool so that the spool pivots freely. Hammer nail into the end of the long dowel.
7. Nail paint stir sticks to long dowel about twelve inches below the windsock.
8. Mark the ends of each paint stir stick with N, S, E, and W.

ACTIVITY 6 (Continued)

Grade 2-3 Windsock (Continued)

9. Place the windsock outdoors on a tall post. Make sure the paint stir stick marked N is pointing North.
10. Have students observe newly constructed windsocks daily for wind direction and speed.

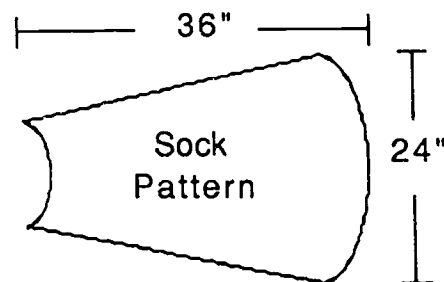
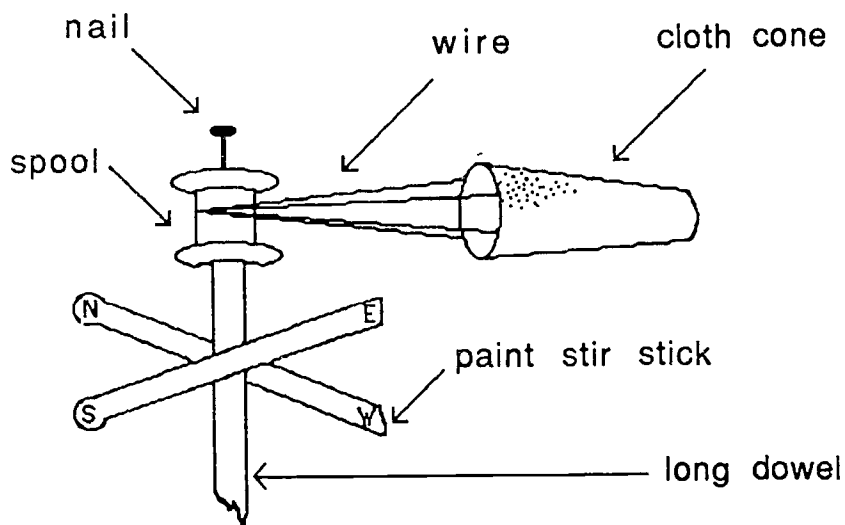

Explain that the wind blows into the big end of the windsock and out the little end. Tell the students that the direction and speed of the wind is very important to the pilot. Point out that the little end of the windsock

ACTIVITY 6 (Continued)

points in the direction the pilot must land or take off. Emphasize that airplanes must take off and land as directly into the wind as possible. Explain that the more the sock is extended, the greater the speed of the wind.

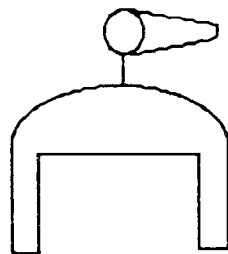

strong wind

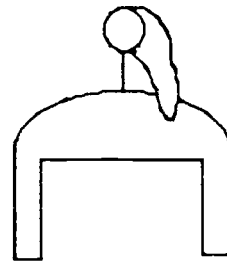

no wind

Extended Activities

- Give each student a helium-filled balloon. Attach a card to the balloon asking the finder to return the card and give the location where it was found and the date when it was found. Release the balloons as a group. Display a large map of the United States on the classroom wall. Clearly mark north, south, east, and west. Mark your school/city location with a red star. Attach the returned cards to the map at the location where they were found.

After a month, ask students to look at the map and make observations such as the following:

1. Was the wind blowing in the same direction for all the balloons? How do you know?
2. In what direction was the wind blowing?
3. What was the distance traveled by the balloon that went the farthest?

ACTIVITY 6 (Continued)

- Divide the class into four groups. Explain to students that many devices depend on the force of wind for successful operation such as pinwheels, sailboats, kites, gliders, balloons, and windmills. Give each group a sheet of poster board. Ask students to collect and cut out pictures of devices that depend upon wind for operation. Have them glue the pictures to poster board and decide on a name for the poster. Ask each group to tell the class about its poster.
- Distribute Student Handout 11. Instruct students to observe and record the wind direction and wind speed each day. At the end of the recording period, ask students to examine the chart for wind direction and wind speed patterns during the observation period. Help students interpret the chart by asking questions similar to the following:
 1. In what time period was the wind speed the greatest?
 2. Did the wind change direction during the day?

ACTIVITY 7: AIRPLANES IN THE WIND

Direct the students' attention to the wind and the effect it has on flying. Ask students questions similar to the following and allow time for several responses.

1. What happens if an airplane flies into the wind?
2. What happens if the wind blows against the rear of the airplane?
3. What will an airplane do if the wind blows against its side?

Using a small fan and a wooden glider, demonstrate what wind does to an airplane.

1. Attach a string to the glider.
2. Hold the glider several feet away from the front of the fan (point nose toward the fan, then the tail and finally the sides.)

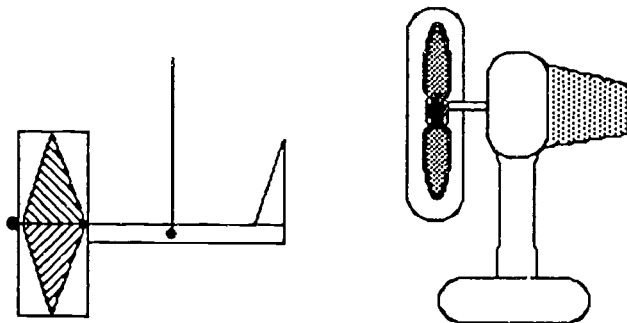

ACTIVITY 7 (Continued)

After the experiment, discuss the outcome with the students. The outcome should be similar to the following:

1. If the pilot flies into the wind, the wind will hold back (retard) the airplane's forward movement. The airplane will move forward but not as fast.
2. If the wind is on the tail of the airplane, the wind will help push the airplane to its destination faster.
3. If the wind direction is from the side of the airplane, the wind will push the airplane away from the desired course (route) of flight.

Extended Activities

- Instruct students to complete Student Handout 12.
Answers: 1. North
2. East
3. West
- Write Topic 3 vocabulary words in Fantastic Flight Dictionary.

TOPIC 4: AIR

The activities, suggested materials, grade level, and related subject areas for each activity are summarized below.

<u>ACTIVITY</u>	<u>MATERIALS NEEDED</u>	<u>GRADE LEVEL</u> <u>SUBJECT</u>
8. Air Takes Up Space	paper cups, soil, rocks, water balloon, basketball, swim float, plastic bag dish pan, water, bottle	Grades K-3 science
9. Air Has Weight	two balloons, string, balance scale 5" X 5" cloth squares, string, toy Student Handout 13	Grades 1-3 science
10. Barometer	glass barometer tube (36" long and closed on one end), small peanut butter jar, mercury, ring stand with clamp, 2" X 3" card strip, yardstick, masking tape	Grade 3 science
11. Thermometer	two thermometers, Student Handout 14 Fantastic Flight Dictionary	Grades 1-3 science mathematics

ACTIVITY 8: AIR TAKES UP SPACE

Develop the students' inquiring minds by directing attention to air. Stimulate the students' thoughts by asking questions such as the following:

1. Can we see air?
2. Where do we find air?
3. Can we feel air?
4. Why do we need air?

Explain to students that we live, play, and work in an ocean of air. The ocean of air called ATMOSPHERE surrounds the earth. The atmosphere extends some 500 miles upward from the earth's surface. Draw the following diagram on the board to illustrate:

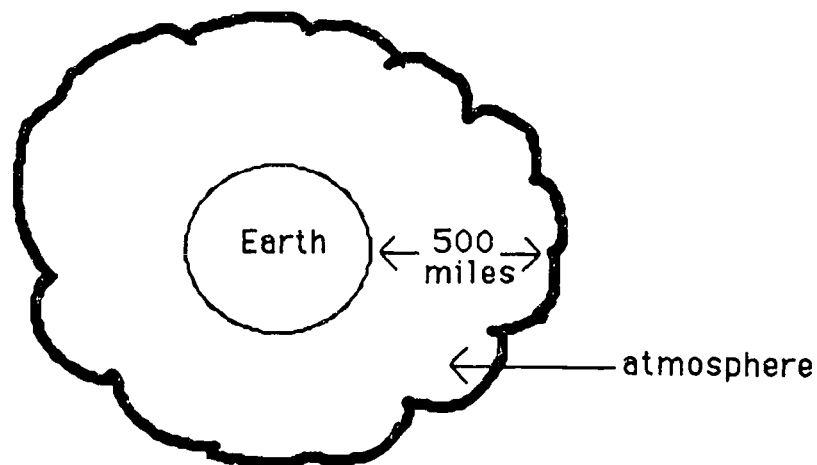

Distribute two paper cups per student. Ask students to fill one cup loosely with soil and the other with rocks. Fill each cup with water. Tell students to observe and explain their observations.

Explanation: Air (bubbles) that is trapped in the soil or rocks is pushed out by the water.

Emphasize that the atmosphere is all around us, including the inside of every building, car, crack, or hole.

ACTIVITY 8 (Continued)

Extended Activities

- Blow air into deflated objects such as the following:

1. a balloon
2. a basketball
3. a swim float
4. a plastic bag

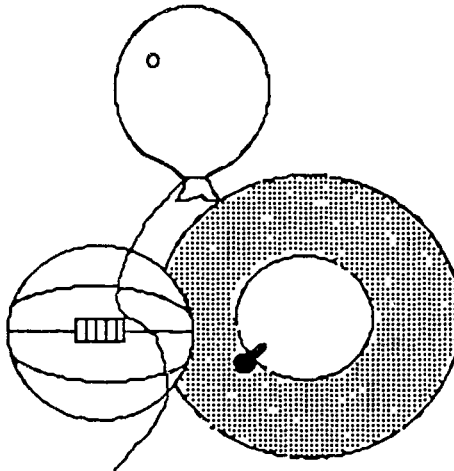

- Blow soap bubbles.
- Make a list of things that depend upon air as a filling. Example: automobile tires and basketballs.
- Fill a pan with water. Put a bottle into the pan. Observe the bottle fill with water. Ask students to explain what happens.

Explanation: The bottle is full of air. Air must escape from the bottle before filling with water.

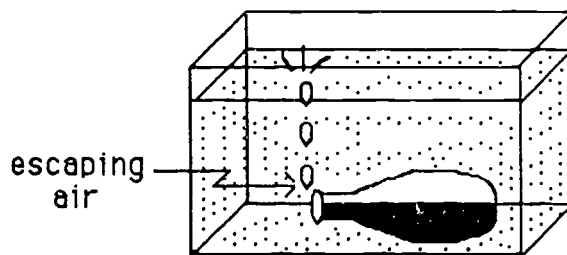

ACTIVITY 9: AIR HAS WEIGHT

Explain to students that the atmosphere (air) pushes down on the surface of the earth. The weight of the atmosphere pushing down on the earth is called **ATMOSPHERIC PRESSURE** or air pressure. The weight pushes down on water, land, people, houses, and even our desk. At the same time some air pushes upward (from beneath objects), and some pushes from the sides.

Distribute two identical balloons to each student. Ask students to blow up and tie a knot in the end of one balloon. Place the full balloon on one end of a balance scale and the empty one on the other end. Ask students questions such as the following:

1. Which balloon is heavier?
2. Why is it heavier?

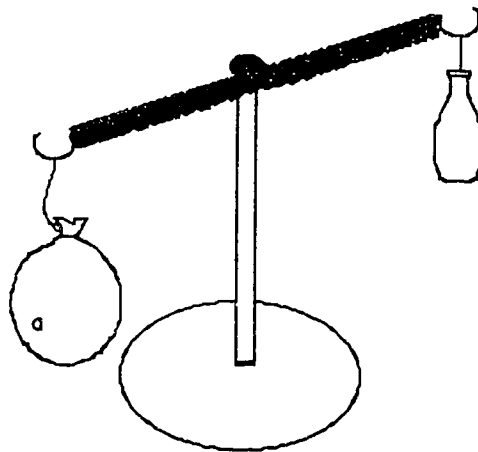

Extended Activity

- Distribute squares of cloth, string, and a small toy. Punch a hole in each corner of the fabric square. Tie a string to each corner. Attach all four strings to a toy. Throw into the air and observe the descent. Ask students to evaluate the value of the parachute and to explain what slowed the fall of the parachute.

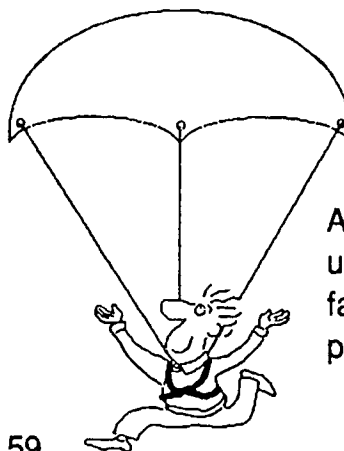

Air pushing upward slows the fall of the parachute.

ACTIVITY 10: BAROMETER

Point out to students that the pressure of the air pushing down on the surface of the earth changes daily and sometimes during the day. Air pressure can be measured with a BAROMETER which means weight meter.

Divide class into groups of five or six. Distribute materials. Demonstrate how to construct a barometer, using the following steps:

1. Fill barometer tube completely with mercury.
2. Fill small jar half full of mercury.
3. Place a finger over the open end of the tube and lower open end into jar of mercury. Remove finger from end of tube.
4. Clamp the tube to a ring stand with a clamp.
5. Make a scale in one half inch increments on cardboard. Label the scale from 24 to 26 inches. Measure the height of the mercury in the tube. Tape the cardboard to the barometer tube at the exact 24" to 26" point.
6. Record the daily barometer reading on Student Handout 13.

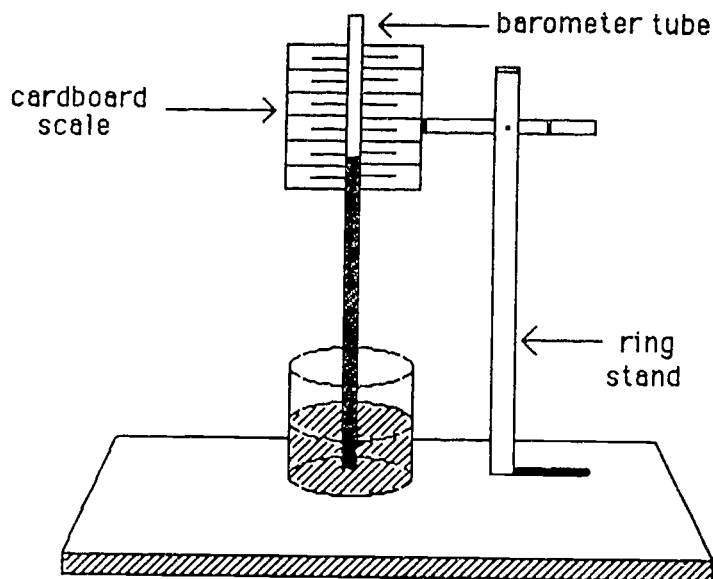

Caution: This demonstration should be conducted by the teacher. Do not allow mercury to come in contact with jewelry.

ACTIVITY 10 (Continued)

Ask students to examine their barometer readings each week for a month. Lead students to make conclusions about weather conditions related to low pressure days and high pressure days.

Low pressure: low clouds, poor visibility, rain, snow, fog, gusty winds, and turbulence

High pressure: few clouds, good visibility, light winds, and less severe turbulence

Lead students to predict the type of air pressure system that would provide more favorable flying conditions. Discuss reasons to support their prediction.

Extended Activity

- Compare daily classroom air pressure reports with reports from the radio, TV, and newspaper.

ACTIVITY 11: THERMOMETER

Guide students' thoughts to the air around us. Stimulate an interest in the temperature of the air by asking questions such as:

1. What is temperature?
2. What part does the sun play in heating the air around us?
3. What part does the earth play in heating the air around us?
4. What are some ways we can detect or measure the temperature of the air?

Point out that the sun warms the surface of the earth. The surface of the earth radiates heat to warm 85% of the air around us. The degree of hotness or coldness of the air is called TEMPERATURE.

Place a thermometer in the shade and one in the full sun. Ask students to make daily recordings for each thermometer on Student Handout 14. Ask students to justify reasons why the temperature reading was always lower in the shade.

Extended Activities

- Compare daily classroom temperature recordings with those from radio, TV, or newspaper.
- Record Topic 4 vocabulary words in the Fantastic Flight Dictionary.

TOPIC 5: WEATHER FRONTS

The activities, suggested materials, grade level, and related subject areas for each activity are summarized below.

<u>ACTIVITY</u>	<u>MATERIALS NEEDED</u>	<u>GRADE LEVEL</u> <u>SUBJECT</u>
12. Air Masses and Fronts	Student Handout 15 Student Handout 16 newspaper, weather maps and reports video of TV weather report weather instruments (thermometer, windsock, and barometer) Student Handout 17 Fantastic Flight Dictionary	Grades 2-3 science

ACTIVITY 12: AIR MASSES AND FRONTS

Tell students that an air mass is a large body of air that has approximately the same temperature and moisture content. Explain that each air mass has a different temperature and moisture content. When two different air masses meet, they do not mix easily. When two air masses collide, they form a **front**. Point out that fronts are of great importance to pilots because they present dangerous weather hazards to aviation activities.

Distribute Student Handout 15. Discuss the cold front, warm front, and occluded front as pictured on the handout.

A **COLD FRONT** is a cold air mass advancing toward a warm air mass. The cold air attempts to push under and lift the warm air.

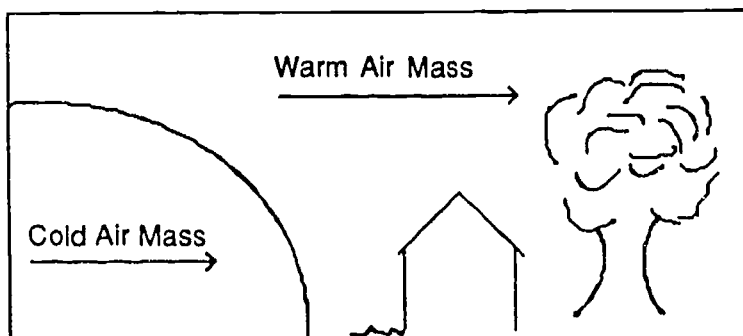

COLD FRONT

A **WARM FRONT** is a warm air mass advancing toward a cold air mass. The warm air pushes up over the cold air.

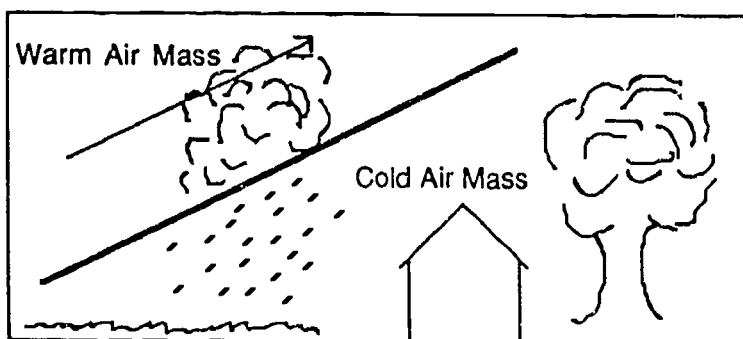

WARM FRONT

ACTIVITY 12 (Continued)

An OCCLUDED FRONT occurs when a complex storm system consists briefly of a warm front followed by a cold front.

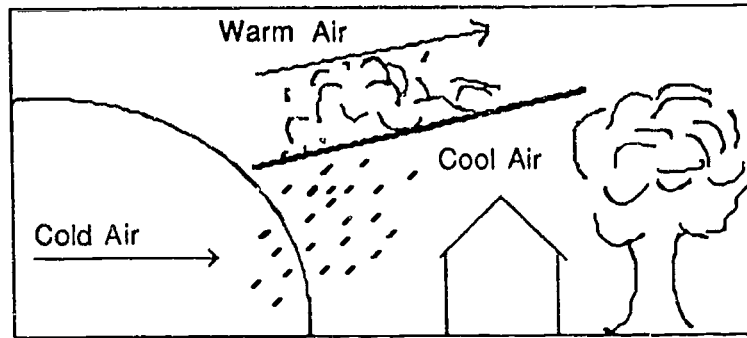

OCCLUDED FRONT

A STATIONARY FRONT occurs when the boundary between two air masses does not move.

Point out that weather fronts are shown on weather maps with symbols. Distribute Student Handout 16. Analyze and discuss the symbols in box A that represent each of the four weather fronts. Identify the air masses in box B, C and D. Name each front.

Student Handout 16 Answer key

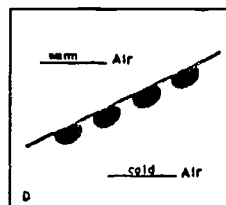
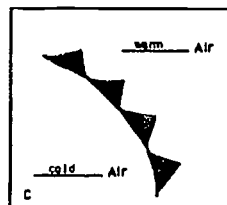
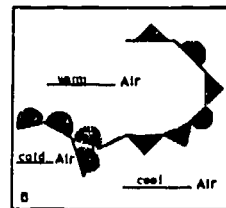
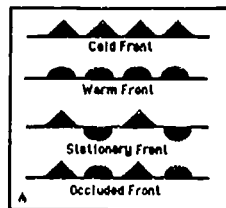

ACTIVITY 12 (Continued)

Extended Activities

- Compile a list of places where weather information can be found.
- Invite a meteorologist from the local television station or nearest Flight Service Station to speak to the class. Ask students to prepare a list of questions they want answered concerning weather. In addition, ask students to seek information about jobs related to weather, requirements of those jobs, and the different people who depend on weather information.
- Take students on a field trip to the nearest television station's weather department or Flight (weather) Service Station. Have students make a list of questions to be answered during the trip. After the trip, discuss the highlights of the trip. Have students discuss answers to the list of questions. Make a class experience chart, or write a story for a class bulletin board.
- Explain that it takes many people to make a weather report happen on television. Have students name different workers they saw during the trip. List jobs on the board. List educational requirements for each job.
- Ask students to clip weather maps and reports from daily newspapers. Post clippings on a daily weather report bulletin board. Discuss and compare the different reports for kinds of information contained and consistency of information.
- Show students a video copy of a television weather report. Analyze each element of the report (fronts, cloud cover, temperature, and symbols used). Compile a list of the information found in the report. Compare the information found in this report with the information found in newspaper reports. Ask students to select the more thorough report and provide reasons to support the selection.

ACTIVITY 12 (Continued)

- Help students set up a simple school weather reporting station. Use student-made instruments (thermometer, windsock, and barometer) made in Unit 5 or instruments that are purchased to collect weather data. Ask students to record daily data on Student Handout 17. Select a student meteorologist for the week to report the daily weather to the entire school.
- Write Topic 5 vocabulary words in the Fantastic Flight Dictionary.
- Give each student two words from the list below. Ask students to find the meaning of each word; write a sentence with each word; and give a report to the class about each word.

WORD LIST

anemometer	atmosphere	barometer
ceiling	cirrus	cumulus
crosswind	front	hail
high pressure area	humidity	low pressure area
meteorology	moisture	precipitation
stratus	turbulence	velocity
visibility	weather	winusock
hygrometer	thermometer	

UNIT 5 ACTIVITY 1

TEACHER RESOURCE SHEET 1

20

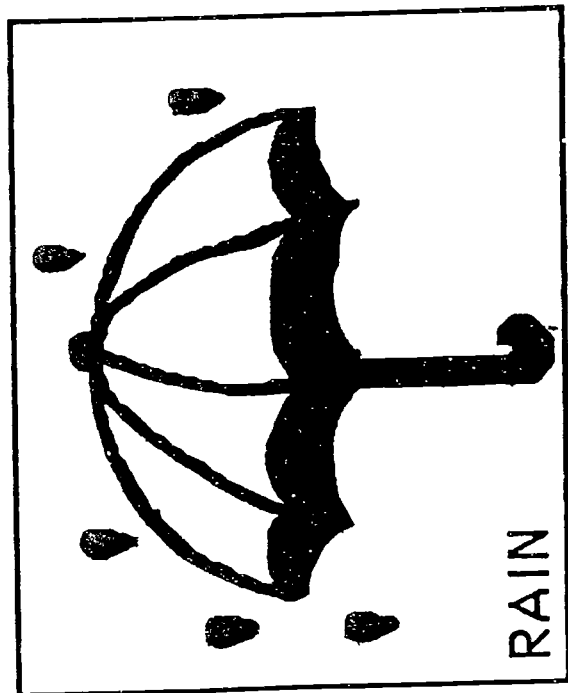
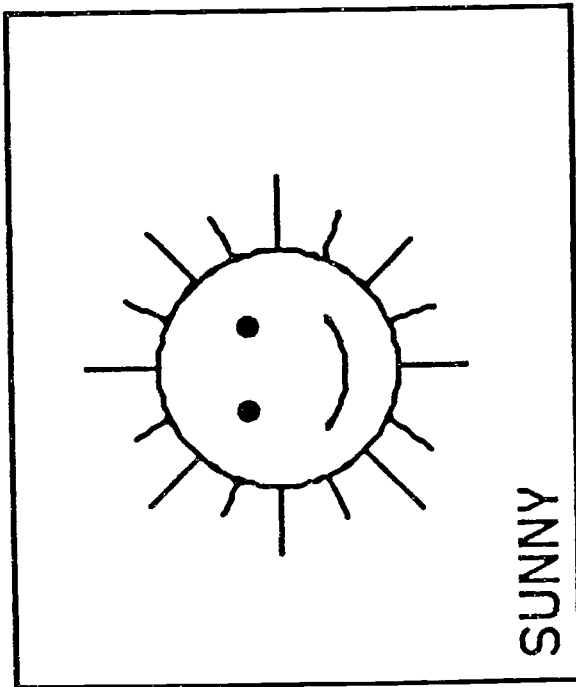
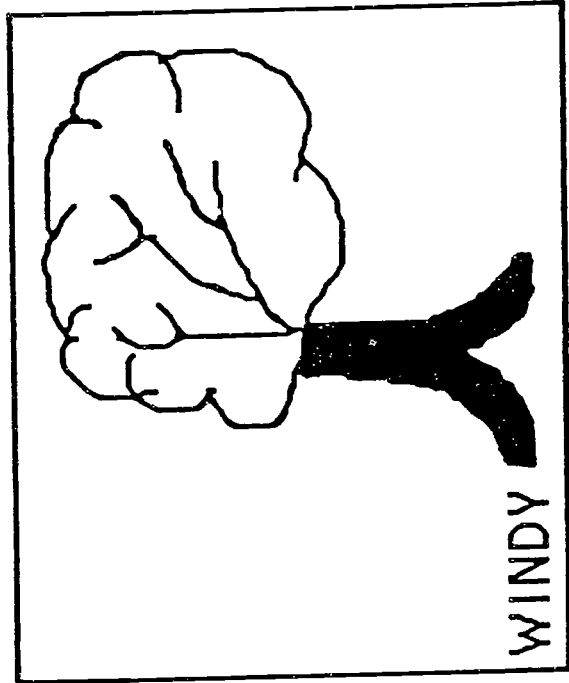
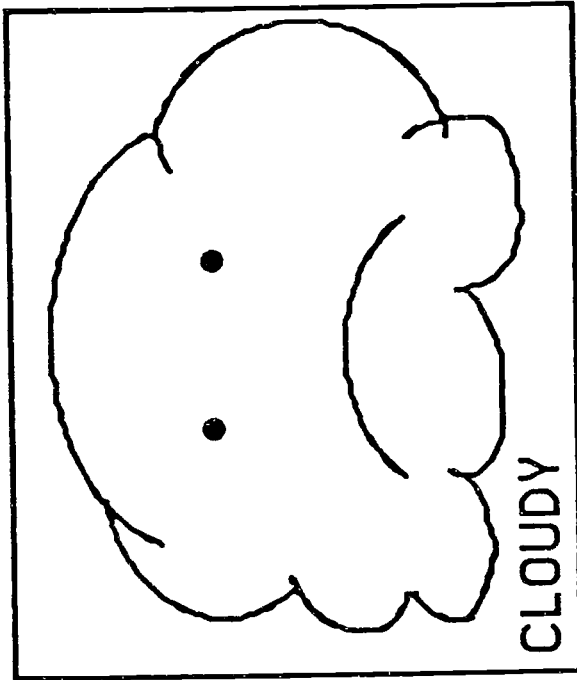

UNIT 5 ACTIVITY 3

CLOUD CYCLE

TEACHER RESOURCE SHEET 2

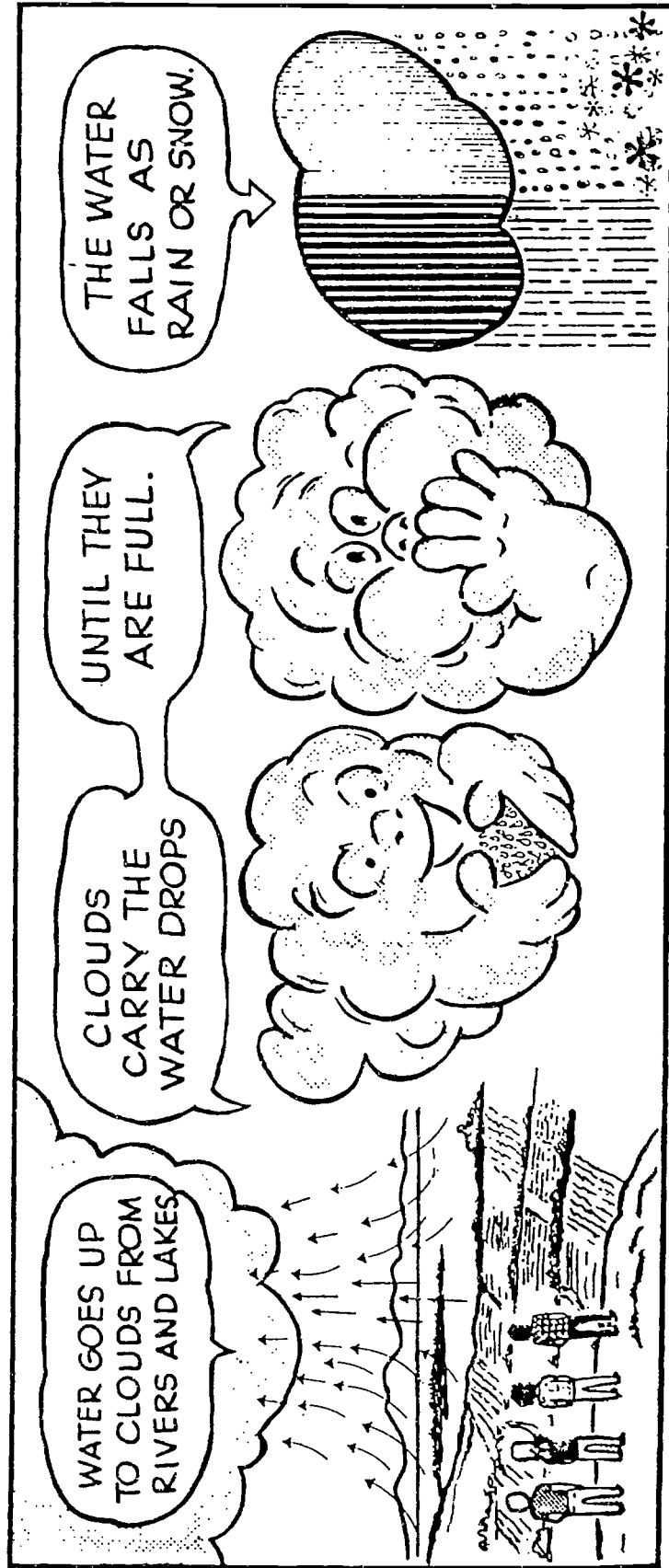

UNIT 5 ACTIVITY 1

STUDENT HANDOUT 1

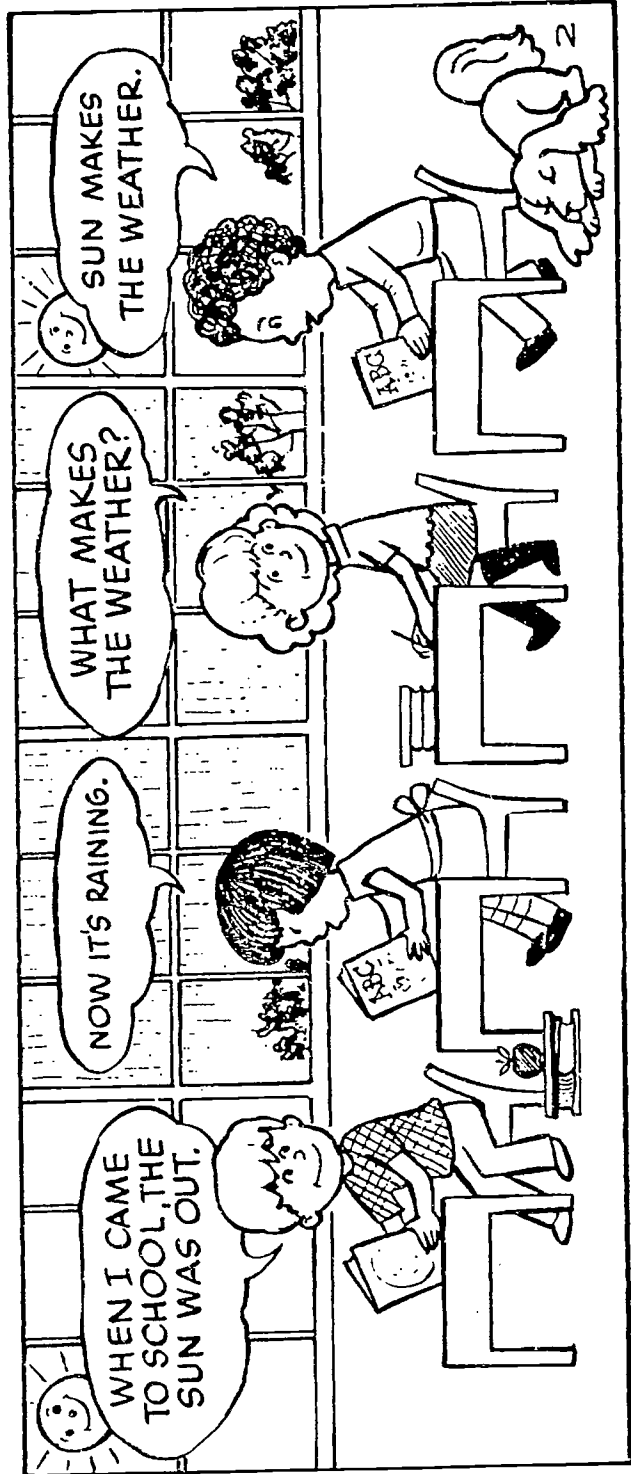
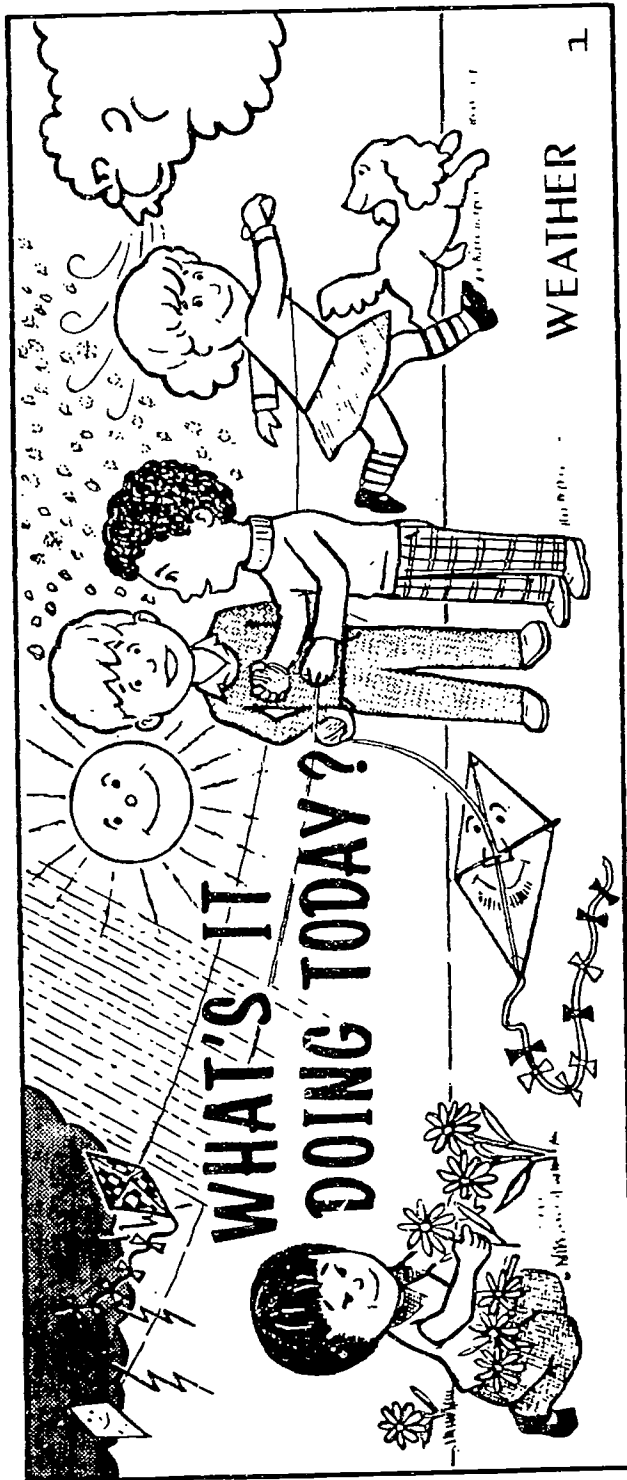

UNIT 5 ACTIVITY 1

STUDENT HANDOUT 2

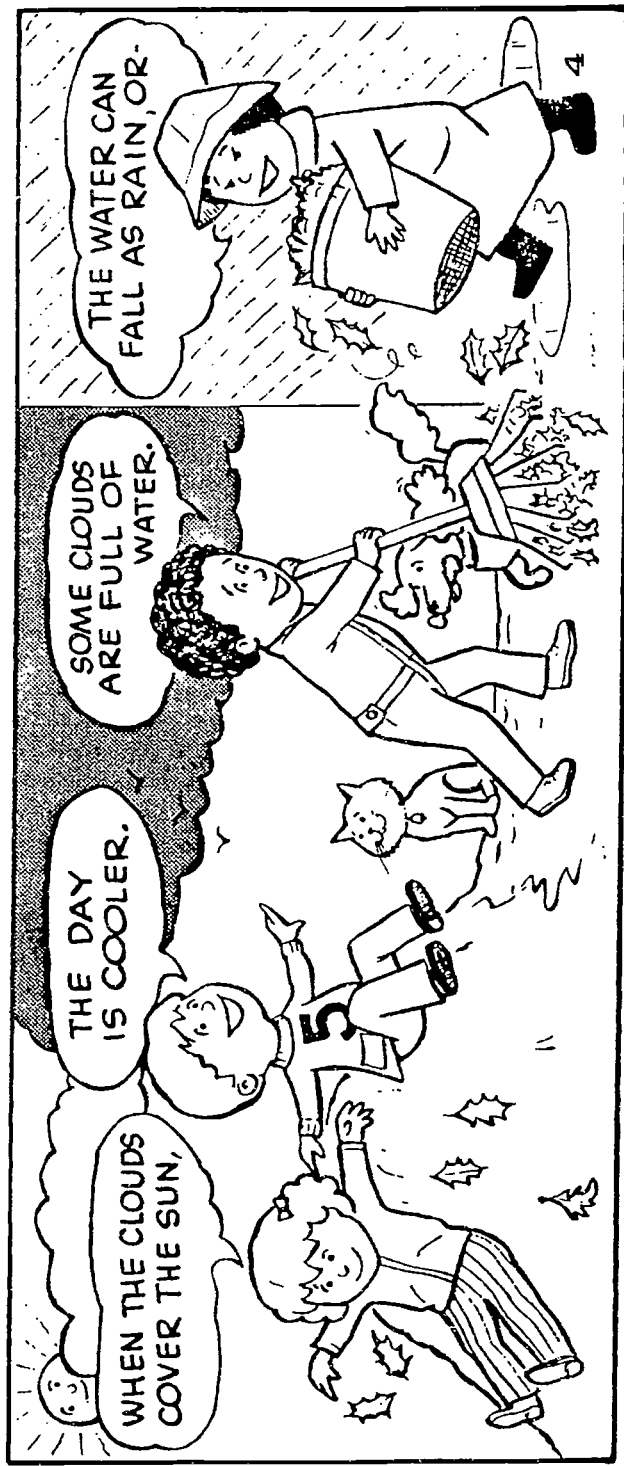
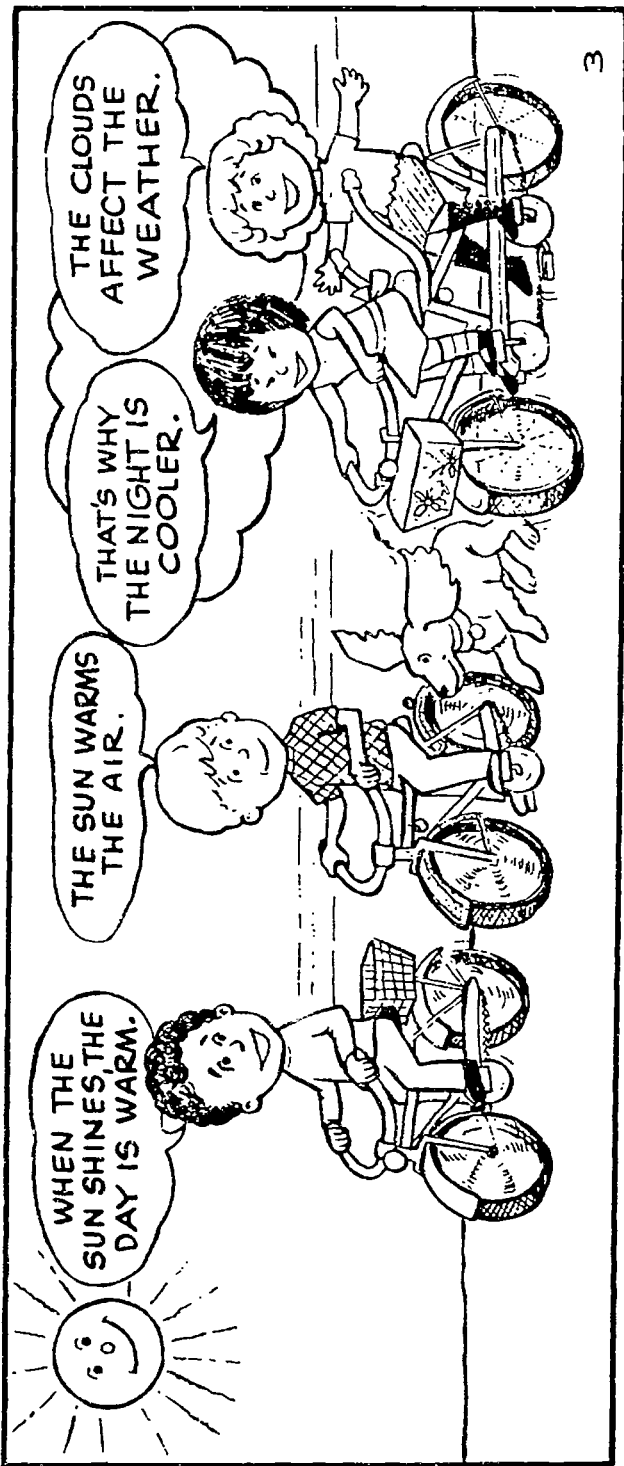

UNIT 5 ACTIVITY 1

STUDENT HANDOUT 3



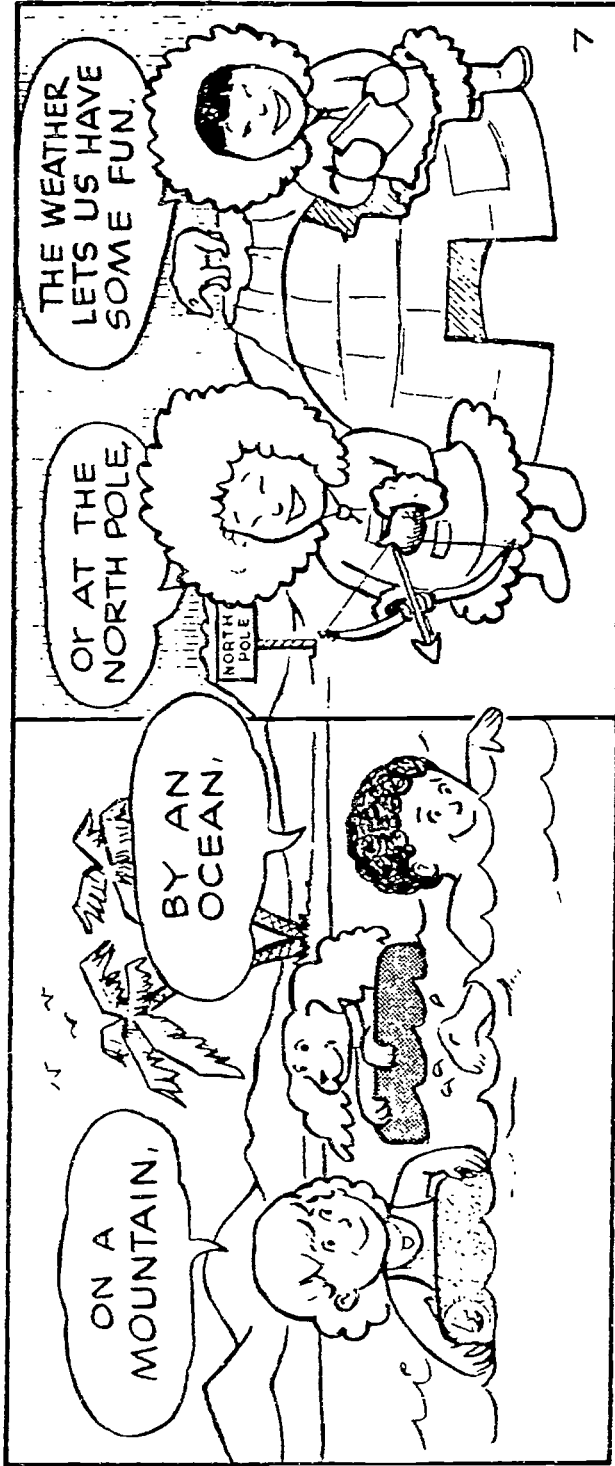

EXPERIMENT

How much did it rain?

1. Get a jar or a glass.
2. Put a tape on its side.
3. Mark every $\frac{1}{2}$ inch and 1 inch.
4. Put outside away from trees.
5. After the rain is over, look to see how many inches it rained.

8

COME ON LET'S SAIL A BOAT IN THIS PUDDLE.

215

UNIT 5 ACTIVITY 2**CALENDAR****STUDENT HANDOUT 5**

NAME _____ MONTH _____

SUNDAY	MONDAY	TUESDAY	WEDNESDAY	THURSDAY	FRIDAY	SATURDAY

UNIT 5 ACTIVITY 2

STUDENT HANDOUT 6

WEATHER SYMBOLS

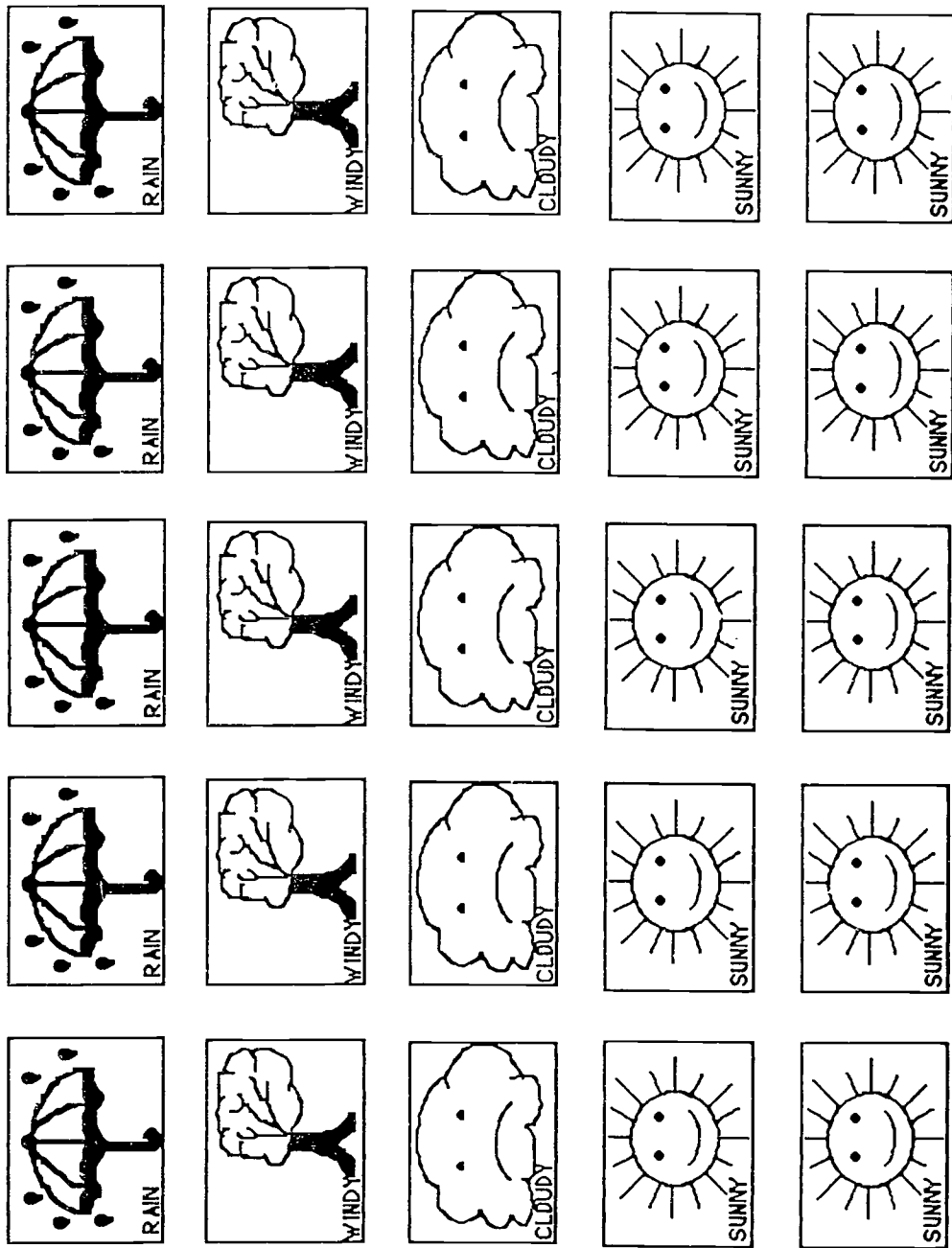

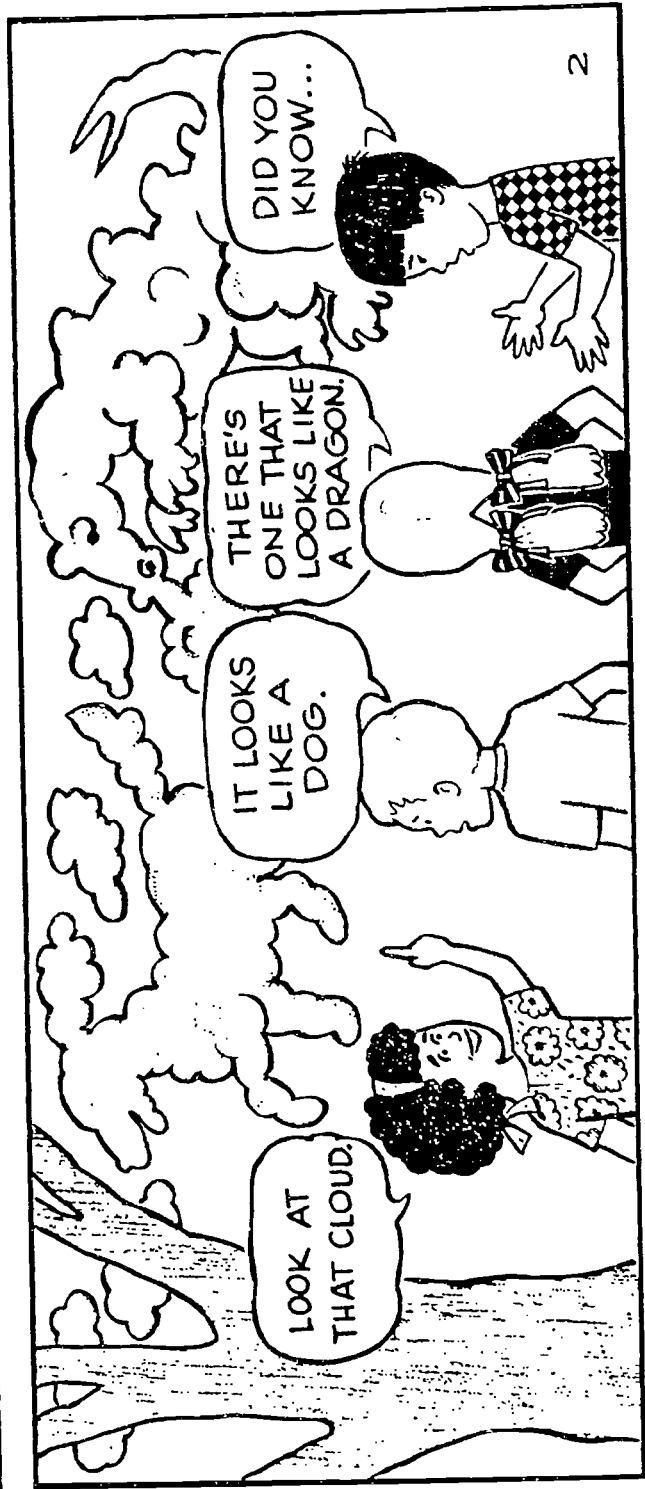
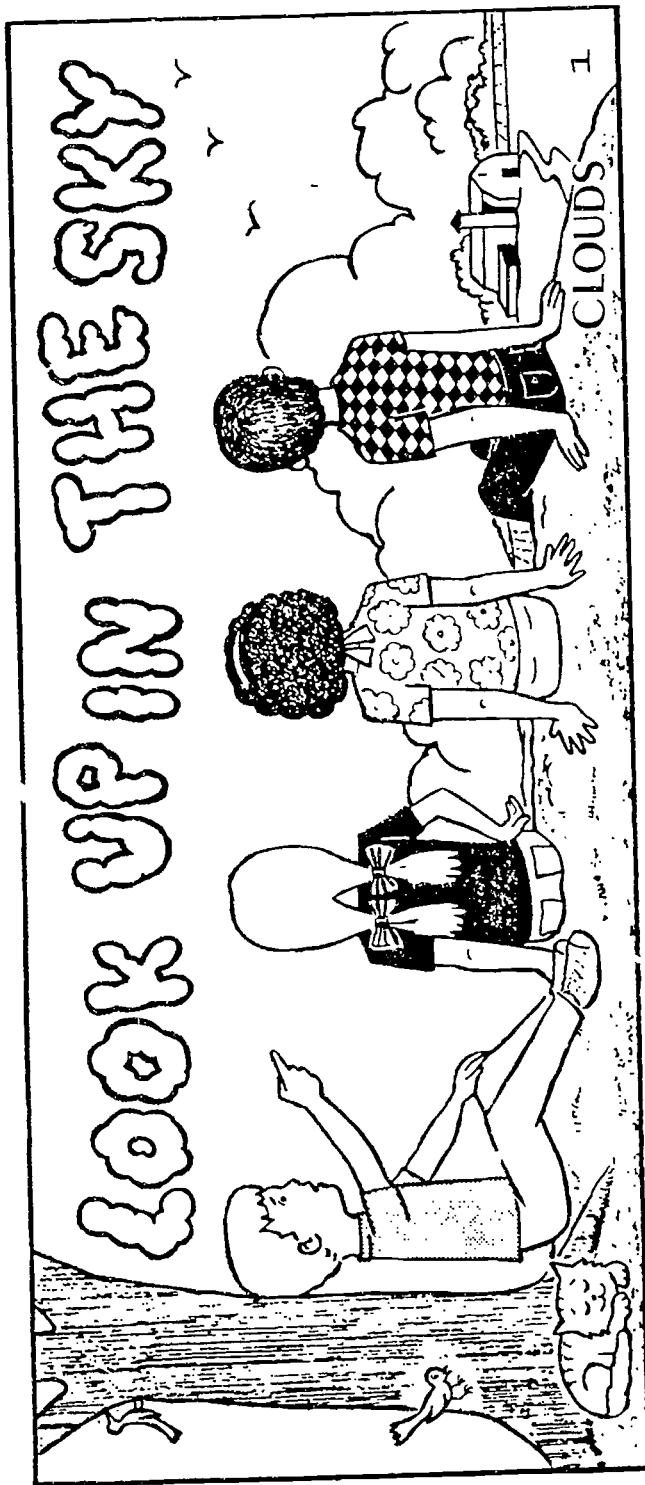

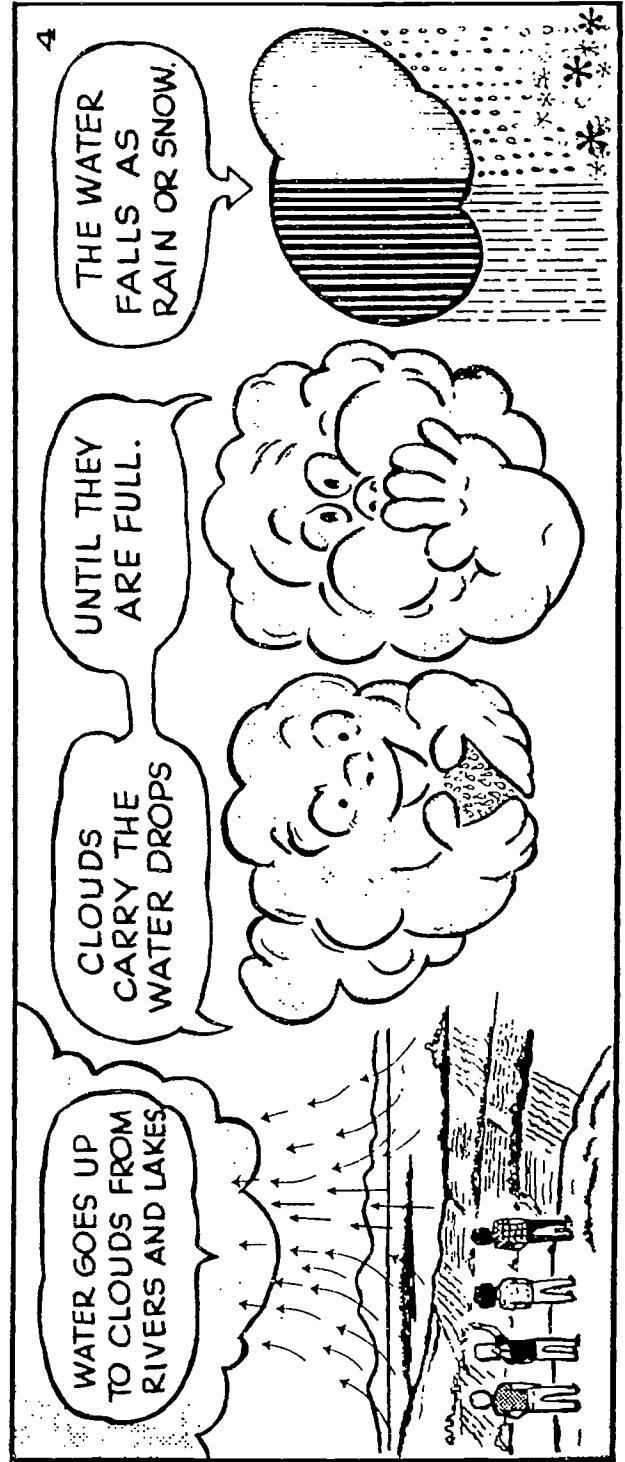
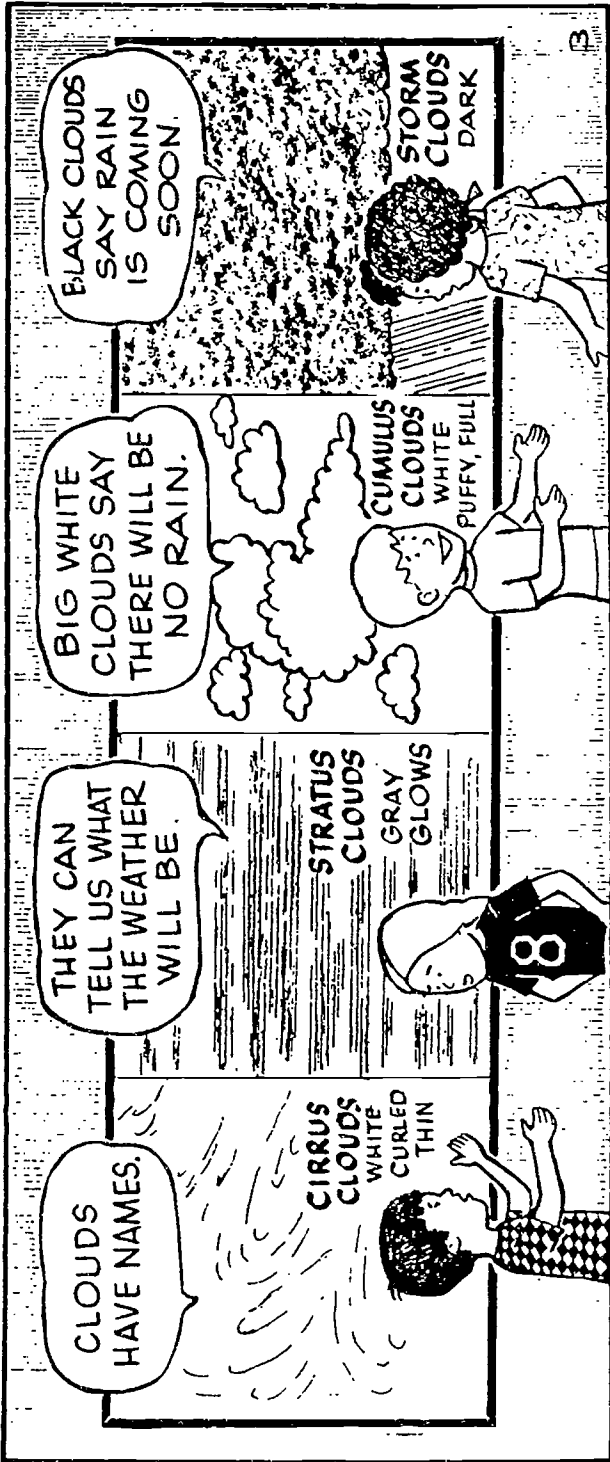

UNIT 5 ACTIVITY 2

STUDENT HANDOUT 9

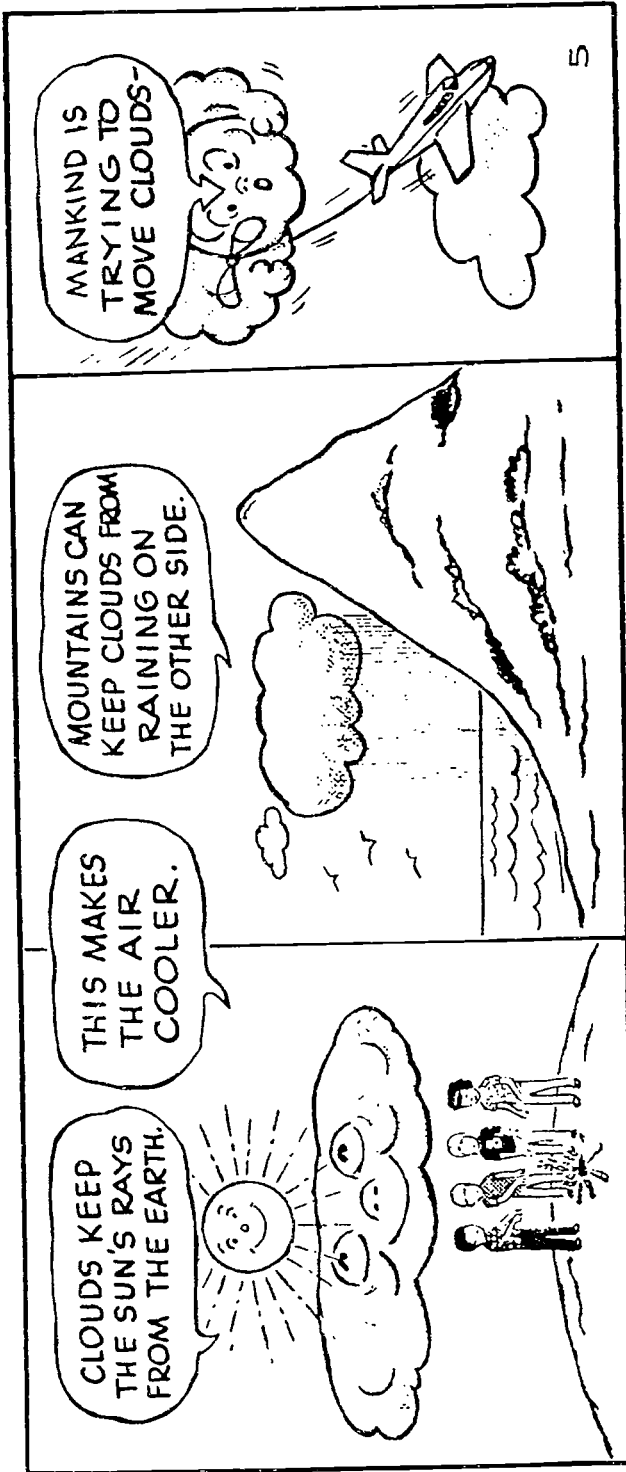

UNIT 5 ACTIVITY 4

STUDENT HANDOUT 10

Directions: Select the correct cloud for the day. Cut and paste on the correct date. Leave box empty if the day is clear or sunny.

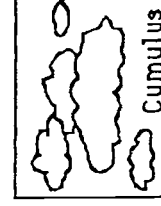
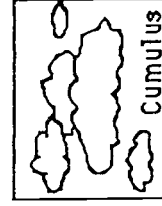
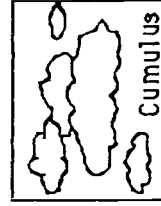
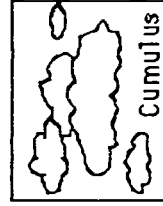
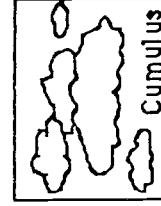
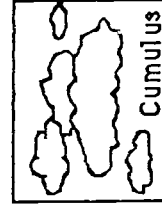
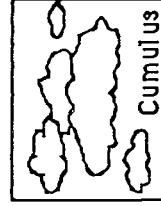
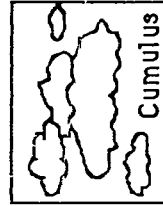
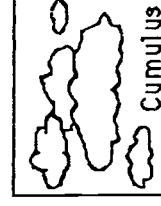
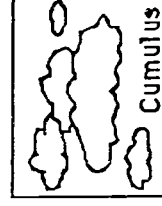
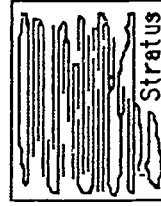
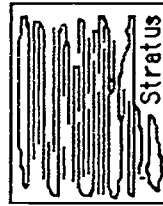
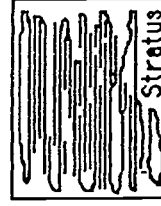
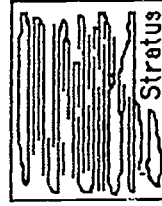
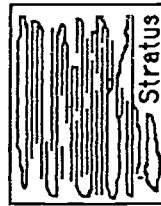
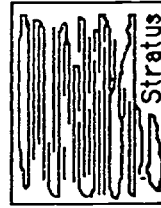

UNIT 5 ACTIVITY 6

STUDENT HANDOUT 11

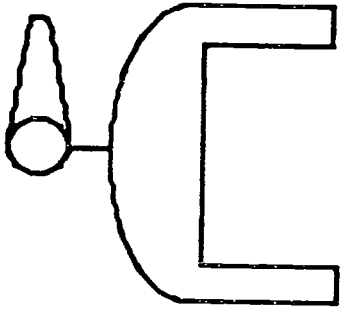

Directions: Record daily wind direction: N, S, E, W, NE, SE, NW, and SW.
 Record daily wind speed: no wind, mild wind, or strong wind.

WIND DIRECTION AND SPEED

DATE								
Wind Direction	8 A. M.							
	12 P. M.							
	3 P. M.							
Wind Speed	8 A. M.							
	12 P. M.							
	3 P. M.							

UNIT 5 ACTIVITY 7

STUDENT HANDOUT 12

Directions: Answer the questions.

Airplanes, like the balloon, are affected by wind direction. Ships at sea are affected by wind in the same way.

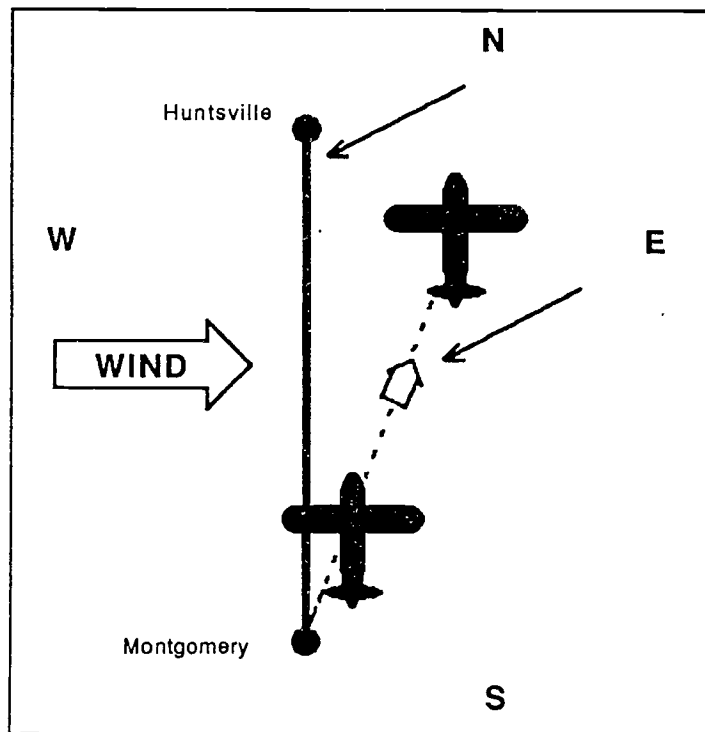

Use this diagram to answer questions.

1. In what direction is the airplane headed? _____
2. Will the wind push the airplane to the east or west of Huntsville? _____
3. To get to Huntsville, should the pilot correct for the wind by turning the airplane a little to the east or west?

UNIT 5 ACTIVITY 10

STUDENT HANDOUT 13

Directions: Record daily barometer reading.
Circle daily prediction and actual weather.

DAY	AIR PRESSURE READING	PREDICTION	ACTUAL WEATHER
MONDAY		Low Pressure (Stormy Weather)	Poor Visibility Gusty Winds
		High Pressure (Fair Weather)	Good Visibility Light Winds
TUESDAY		Low Pressure (Stormy Weather)	Poor Visibility Gusty Winds
		High Pressure (Fair Weather)	Good Visibility Light Winds
WEDNESDAY		Low Pressure (Stormy Weather)	Poor Visibility Gusty Winds
		High Pressure (Fair Weather)	Good Visibility Light Winds
THURSDAY		Low Pressure (Stormy Weather)	Poor Visibility Gusty Winds
		High Pressure (Fair Weather)	Good Visibility Light Winds
FRIDAY		Low Pressure (Stormy Weather)	Poor Visibility Gusty Winds
		High Pressure (Fair Weather)	Good Visibility Light Winds

UNIT 5 ACTIVITY 11

STUDENT HANDOUT 14

Directions: Record the daily temperature in the shade and in the full sun.

TEMPERATURE CALENDAR

NAME _____ MONTH _____

	MONDAY	TUESDAY	WEDNESDAY	THURSDAY	FRIDAY
TIME					
DATE					
SHADE					
FULL SUN					

UNIT 5 ACTIVITY 12

STUDENT HANDOUT 15

When air masses collide, they form a front.

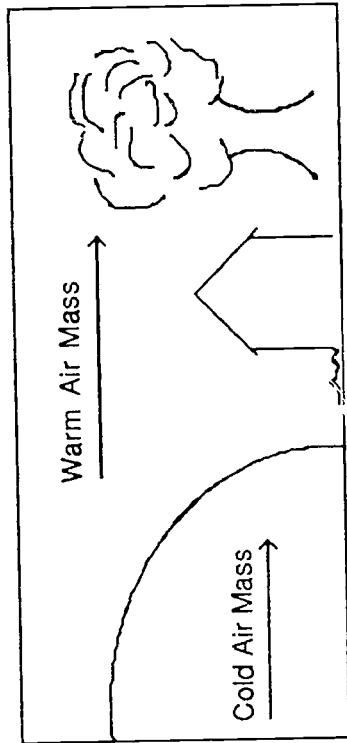

COLD FRONT

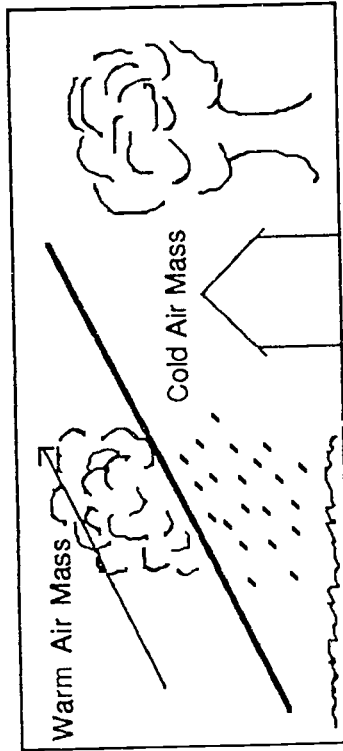

WARM FRONT

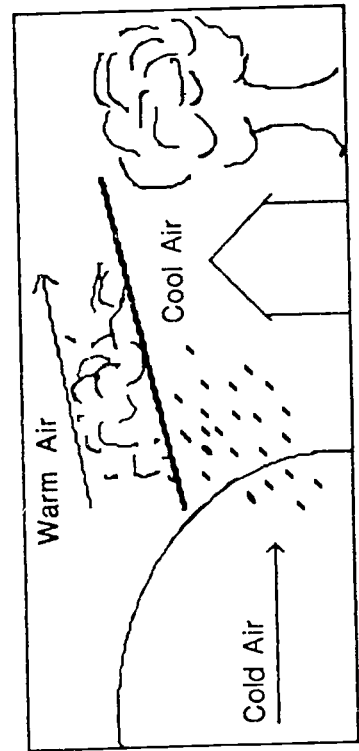

OCCCLUDED FRONT

UNIT 5 ACTIVITY

STUDENT HANDOUT 16

Directions: Study box A. Identify the air masses in box B, C, and D. Name the front.

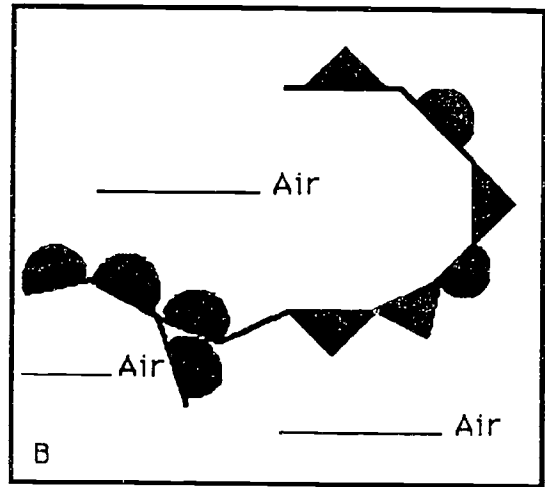
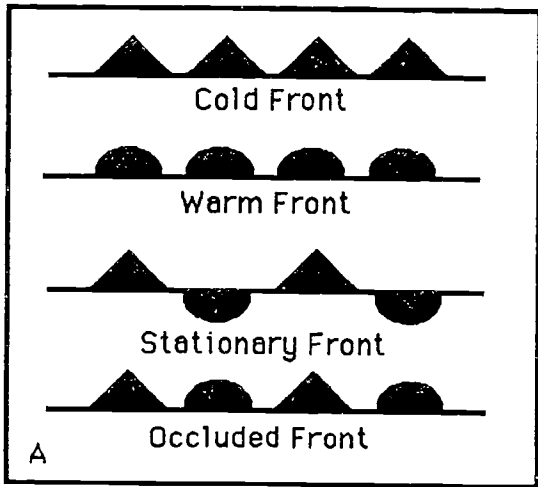

_____ Front

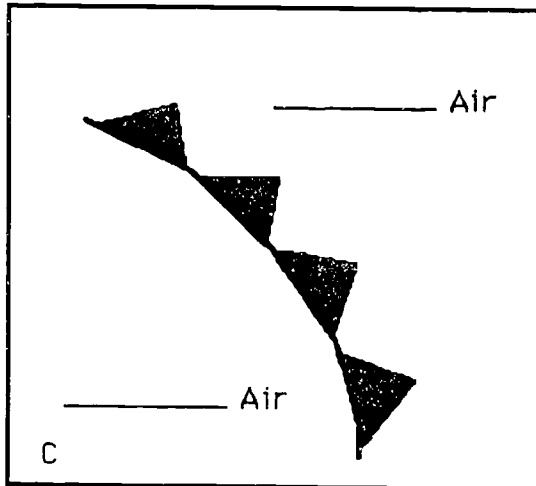

_____ Front

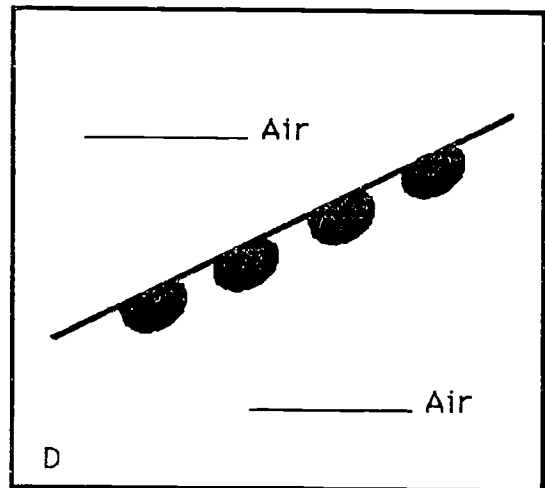

_____ Front

UNIT 5 ACTIVITY 13

STUDENT HANDOUT 17



WEEKLY WEATHER REPORT

DAY	MONDAY	TUESDAY	WEDNESDAY	THURSDAY	FRIDAY
TEMPERATURE					
WIND SPEED					
WIND DIRECTION					
AIR PRESSURE					
SKY CONDITION 1. clear 2. cloudy 3. foggy					

UNIT 6: INSTRUMENTS AND NAVIGATION

PURPOSE OF UNIT 6

The purpose of Unit 6 is to introduce students to the basic instruments and maps used by pilots for navigation. Specifically, students should:

1. recognize the importance of the basic flight instruments (airspeed indicator, altimeter, compass, and tachometer) to the pilot;
2. experience first hand the importance of the map and compass to navigation; and
3. develop an awareness of the importance of radio communications to the pilot.

MAJOR MESSAGES IN UNIT 6

- Instruments and maps are essential to navigation on land, at sea, and in the air.
- Accurate and prompt monitoring of instruments and maps is necessary for safe flight.

BACKGROUND INFORMATION FOR UNIT 6

Unit 6 consists of 2 topics:

TOPIC 1: BASIC FLIGHT INSTRUMENTS

TOPIC 2: NAVIGATION

Topic 1 emphasizes and explains the basic instruments necessary for safe flight.

Topic 2 stresses the importance of maps as an aid to navigation. Topic 2 also explores the use of radio equipment as an aid to navigation and safety in the sky.

VOCABULARY WORDS FOR UNIT 6

Topic 1

altimeter
airspeed indicator
tachometer
instrument
navigation
compass
cardinal points
degree

Topic 2

map
sectional chart
legend
air traffic controller
radio

TOPIC 1: BASIC FLIGHT INSTRUMENTS

The activities, suggested materials, grade level, and related subject areas for each activity are summarized below.

<u>ACTIVITY</u>	<u>MATERIALS NEEDED</u>	<u>GRADE LEVEL</u> <u>SUBJECT</u>
1. Basic Flight Instruments	Teacher Resource Sheets 1, 2, 3, and 4 Student Handout 1 white drawing paper Cessna Air Age education materials (See Teacher Resource Section for address.)	Grades 1-3 mathematics art
2. The Compass	Student Handouts 2, 3, and 4 airplane compass scout compass	Grades 2-3 mathematics social studies

ACTIVITY 1: BASIC FLIGHT INSTRUMENTS

Begin by directing the students' attention to the family car. Kindle an interest in the instruments on the dash by asking questions such as:

1. Why do you think instruments were put in a car?
2. Do you think cars today have more instruments than cars of long ago? Why?
3. What are some of the instruments in the family car?
4. What do these instruments do?

Point out that airplanes also have instruments. Stimulate an interest in aircraft instruments by asking question such as:

1. Do you think car instruments and airplane instruments are the same? Why?
2. What kind of instruments do you think would be found in an airplane?
3. How do you think these instruments would help the pilot?

Tell students that early airplanes had only a few simple instruments to help the pilot navigate (find his way) such as the following:

ALTIMETER---tells how high the airplane is above
the ground (Teacher Resource Sheet 1)

AIRSPEED INDICATOR---tells how fast the airplane
is traveling through the air
(Teacher Resource Sheet 2)

TACHOMETER---tells how fast the engine is turning
or running (Teacher Resource Sheet 3)

COMPASS---tells the direction the airplane is
traveling (Teacher Resource Sheet 4)

Today, airplanes are larger, faster, and more complicated. Many instruments are needed to make them operate.

ACTIVITY 1 (Continued)

Distribute Student Handout 1. Review and complete per directions.

Extended Activities

- Give each student a sheet of white drawing paper. Instruct them to draw an instrument panel of an airplane (like the dash of a car). Ask them to select and arrange on the panel flight instruments that are essential to air navigation. When complete, have students tell the class about their drawings, giving reasons for the instruments used.
- Divide the class into groups. Allow students to use library resources and Cessna Air Age educational materials to research other types of flight instruments used in aircraft today. Have each group select a reporter to report the group's finding to the class. Encourage creative presentations through the use of drawings or simulated instrument panel displays.

ACTIVITY 2: THE COMPASS

Explain to students that the compass is an instrument of navigation on the ground, at sea, and in the air. Pilots use the compass to find their direction as they fly the imaginary highways in the sky.

Explain that a compass has the shape of a circle. Distribute Student Handout 2. Direct the students' attention to the **CARDINAL POINTS**---N for North, S for South, E for East, and W for West. Show students the lines between the cardinal points. Explain that the distance between the lines is called a **DEGREE**. Tell students there are 360 degrees on a compass. To summarize, distribute Student Handout 3. Ask students to complete the activity using knowledge gained from class discussion and Student Handout 2.

Extended Activities

- Distribute Student Handout 4. Have students pretend they live in Birmingham. Explain the map of Alabama as pictured on the front of the compass. Ask students to visualize trips as described under the compass. Tell students to name each city and give the direction that must be flown to reach the city from Birmingham.
- Borrow a used aircraft compass from the nearest local airport. Secure a compass used for land navigation from a local scout. Examine and compare the two. If possible, ask an aircraft mechanic to talk to the class about the compass. Ask him to take the compass apart to illustrate its function.
- Give the students a scout compass. Instruct them to locate and walk in a specific direction.
- Allow students to use library resources to research information on the history of the compass.

ACTIVITY 2 (Continued)

- Write Unit 1 vocabulary words on the board. Ask students to do exercises such as the following:
 1. Write the words in alphabetical order.
 2. Write the words in the Fantastic Flight Dictionary.
 3. Write a sentence with each word.

TOPIC 2: NAVIGATION

The activities, suggested materials, grade level, and related subject areas for each activity are summarized below.

<u>ACTIVITY</u>	<u>MATERIALS NEEDED</u>	<u>GRADE LEVEL</u> <u>SUBJECT</u>
3. Kind of Maps	floor plan of house city and state map United States map world map globe relief map white drawing paper	Grades K-3 social studies
4. Aerial Maps	pilot's sectional charts Student Handouts 5 and 6 pilot's sectional chart Alabama road map	Grades 1-3 social studies
5. Radio Navigation and Communication	Student Handouts 7, 8, and 9	Grades K-3 language arts social studies

ACTIVITY 3: KINDS OF MAPS

Direct students' attention to travel. Stimulate an interest in how one navigates from one place to another by asking questions such as:

1. Have you ever gone on a long trip?
2. How did you find the way?
3. Did you ever get lost?
4. Why did you get lost?

Allow students ample time to share travel experiences with the class. Lead them to the discovery of maps as an aid to navigation.

Explain that maps can be drawn for buildings, parts of a city, an entire city, a state, a country, or the world. Display and discuss a variety of maps such as:

1. floor plan of a house
2. city map
3. state map
4. United States map
5. world map
6. relief map
7. globe

Guide students' discussion by asking questions about each map such as the following:

1. What does this map tell us?
2. Who may want to use this map?

Demonstrate how to make a classroom map by drawing a map of the classroom on the board. Once walls are drawn, allow students to take turns drawing furniture, windows, and doors.

ACTIVITY 3 (Continued)

Make a bedroom map bulletin board. Make a title card as shown below.

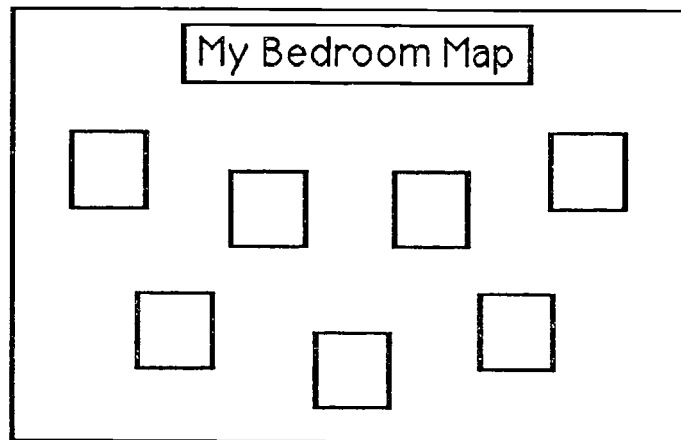

Distribute white drawing paper. Ask students to draw maps of their bedrooms. Have students share their maps with the class, then display them on the bulletin board.

Extended Activities

- Ask students to draw maps of their school or home.
- Make a "Kinds of Maps" bulletin board. Instruct students to collect different kinds of maps, including those found in newspapers and magazines. Ask students to share their findings with the class, then display them on the bulletin board.
- Ask students to draw maps showing the school and their homes. Ask each student to give directions on how to locate his/her home.

ACTIVITY 4: AERIAL MAPS

Tell students that the pilot of an aircraft uses maps to help him find his way just as a motorist uses road maps. Pilots that fly slow and medium speed aircraft use maps called SECTIONAL CHARTS. Sectional charts show things on the ground that can be seen visually from the air, such as cities, roads, tall towers, and airports.

Secure two new or used sectional charts from a local pilot or airport. Display one chart on a classroom wall. Point out that blue designates water. Point out the meaning of the different colorations that designate land. Cut the other chart into pieces along the fold lines. This makes 22 pieces. Give each student a piece of the sectional chart.

Distribute Student Handout 5. Discuss the symbols that represent items found on a sectional chart. Using Student Handout 5 as a guide, help students locate symbols on their piece of the sectional chart such as the following:

- airports
- towers
- roads
- water
- rivers
- airport runways
- large and small cities (yellow)
- power lines
- railroad tracks
- mountains (dark green to orange)

Once students have had ample time to study their pieces of the sectional chart, ask them to formulate answers to the following:

1. In your opinion, why would a pilot need to know where towers and mountains are located?
2. Point out reasons why pilots need airports to be shown in the map.
3. Suggest ways lakes, rivers, roads, power lines, and railroads could help the pilot navigate.

ACTIVITY 4 (Continued)

Distribute Student Handout 6. Instruct students to examine the sectional chart to determine answers for questions to the left of the chart.

Extended Activities

- Divide the class into small groups. Give each group an Alabama road map and a pilot's sectional chart. Ask the students to list and compare information found on the maps.
- Divide the class into small groups. Give each group a pilot's sectional chart. Explain that the term "legend" is the explanatory caption accompanying a map. Ask students to locate the legend and make a list of items found on the legend. When finished, allow each group to select a reporter to report to the class. Write the list on the board as each group reports.

ACTIVITY 5: RADIO NAVIGATION AND COMMUNICATION

Arouse an interest in traffic control by asking questions such as:

1. Where do we find policemen directing traffic?
2. How does the policeman communicate with the driver in each vehicle?
3. Does the driver of each vehicle communicate with the policeman?
4. Why do we need policemen to direct traffic?

Point out that the air around airports is full of airplanes. The air traffic controller is like a policeman. He directs air traffic from a control tower located on the airport. Emphasize that the radio is essential to the safety of the pilot, his passengers, and other aircraft in the nearby vicinity. The air traffic controller talks to each pilot by radio, giving him information such as:

1. how high to fly;
2. what direction to fly;
3. other aircraft in the nearby vicinity;
4. what speed to fly;
5. when to take off or land;
6. which runway to use for take off or landing; and
7. weather information

Stimulate an interest in air traffic control by asking questions such as:

1. What is an air traffic controller?
2. Where do we find air traffic controllers?
3. How does the air traffic controller communicate with the pilot?
4. What kinds of information does the air traffic controller give the pilot?
5. Why is the air traffic controller important to the pilot?

Allow students time to develop answers to the questions through discussion.

ACTIVITY 5 (Continued)

Distribute THE WAY TO GO (Student Handouts 7, 8, and 9).

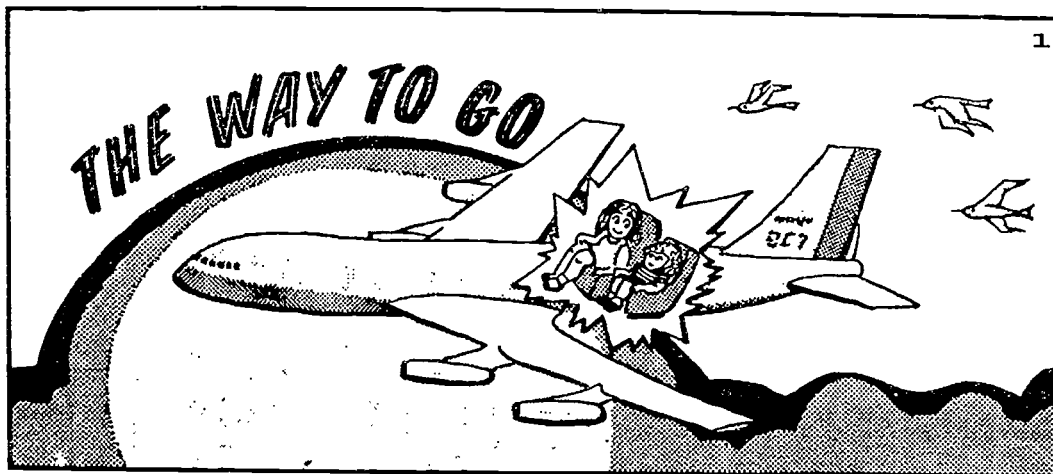

Cut sheets apart, stack, and staple to form a book. Divide students into groups. Read the story or have students read it. Ask each group to dramatize or retell the story in their own words.

Extended Activities

- Contact the nearest large airport that has a control tower. Ask an air traffic controller to come speak to the class about his job and the use of radios in navigation. Prepare each guest with a Resource Speakers' Guide (located in the Teacher Resource Guide).
- Invite an airline pilot, a stewardess, and an air traffic controller to come to the class to do a simulated flight. Ask the pilot and controller to simulate their job in preparing for take-off. Have the stewardess do her pre-flight briefing to the passengers (students). Continue in this manner until touch down. Prepare each guest with a Resource Speakers' Guide (located in the Teacher Resource Guide).
- Invite a pilot from a local airport to instruct students in the way he uses radios to navigate and communicate. Prepare each guest with a Resource Speakers' Guide (located in the Teacher Resource Guide).

UNIT 6 ACTIVITY 1

TEACHER RESOURCE SHEET 1



ALTIMETER

202

UNIT 6 ACTIVITY 1

TEACHER RESOURCE SHEET 2

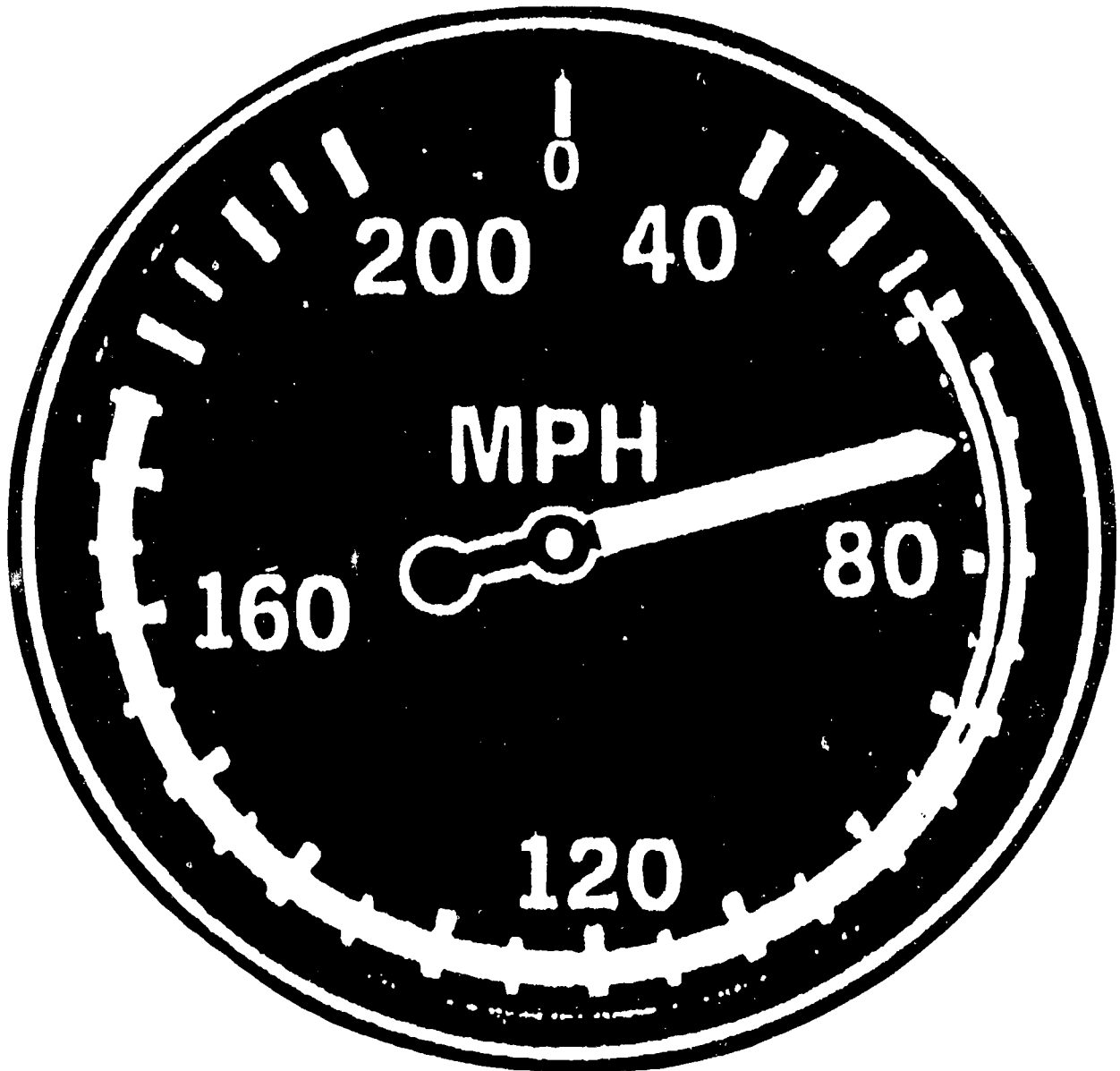

AIRSPEED INDICATOR

203

255

UNIT 6 ACTIVITY 1

TEACHER RESOURCE SHEET 3

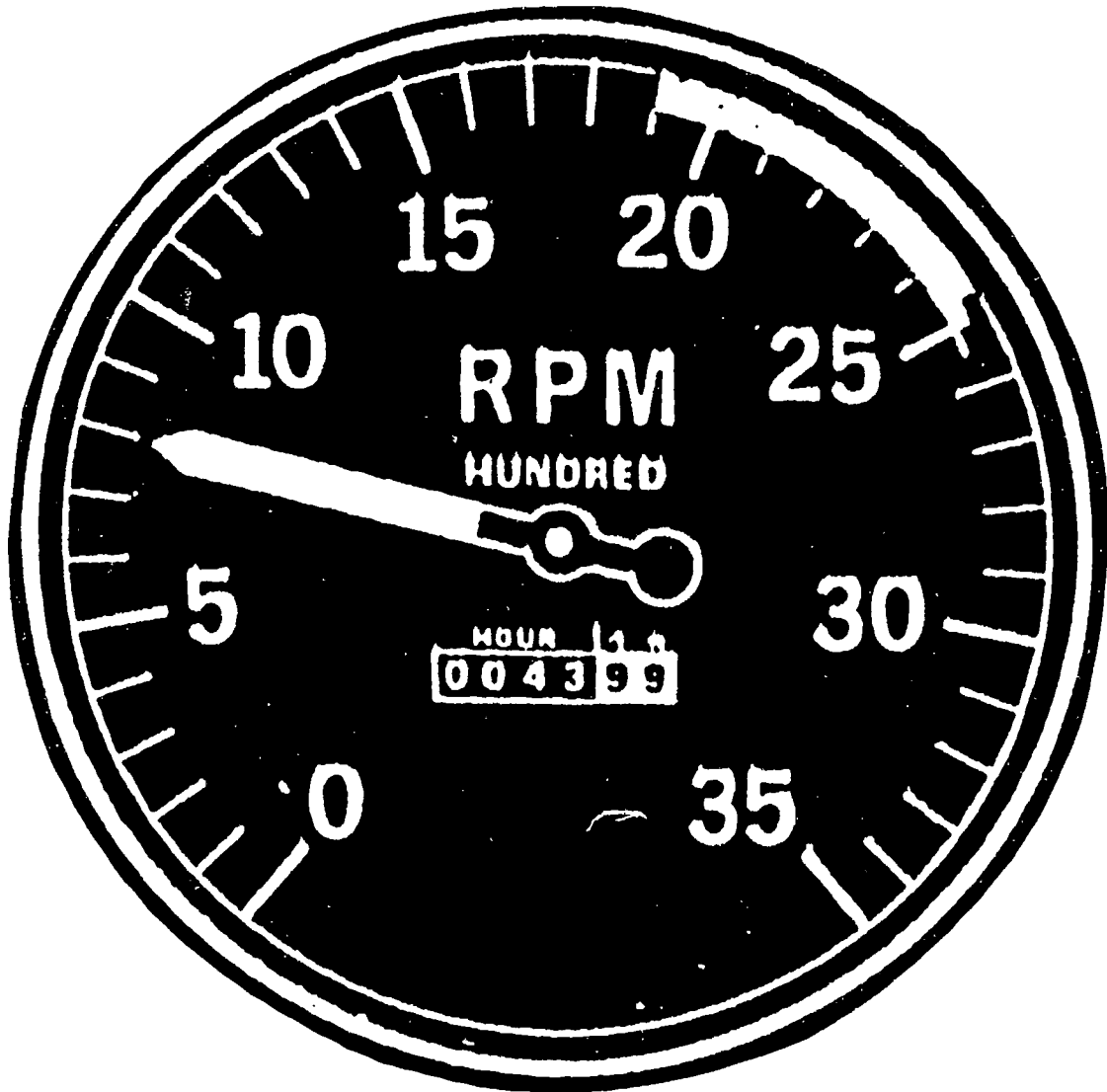

TACHOMETER

UNIT 6 ACTIVITY 1

TEACHER RESOURCE SHEET 4

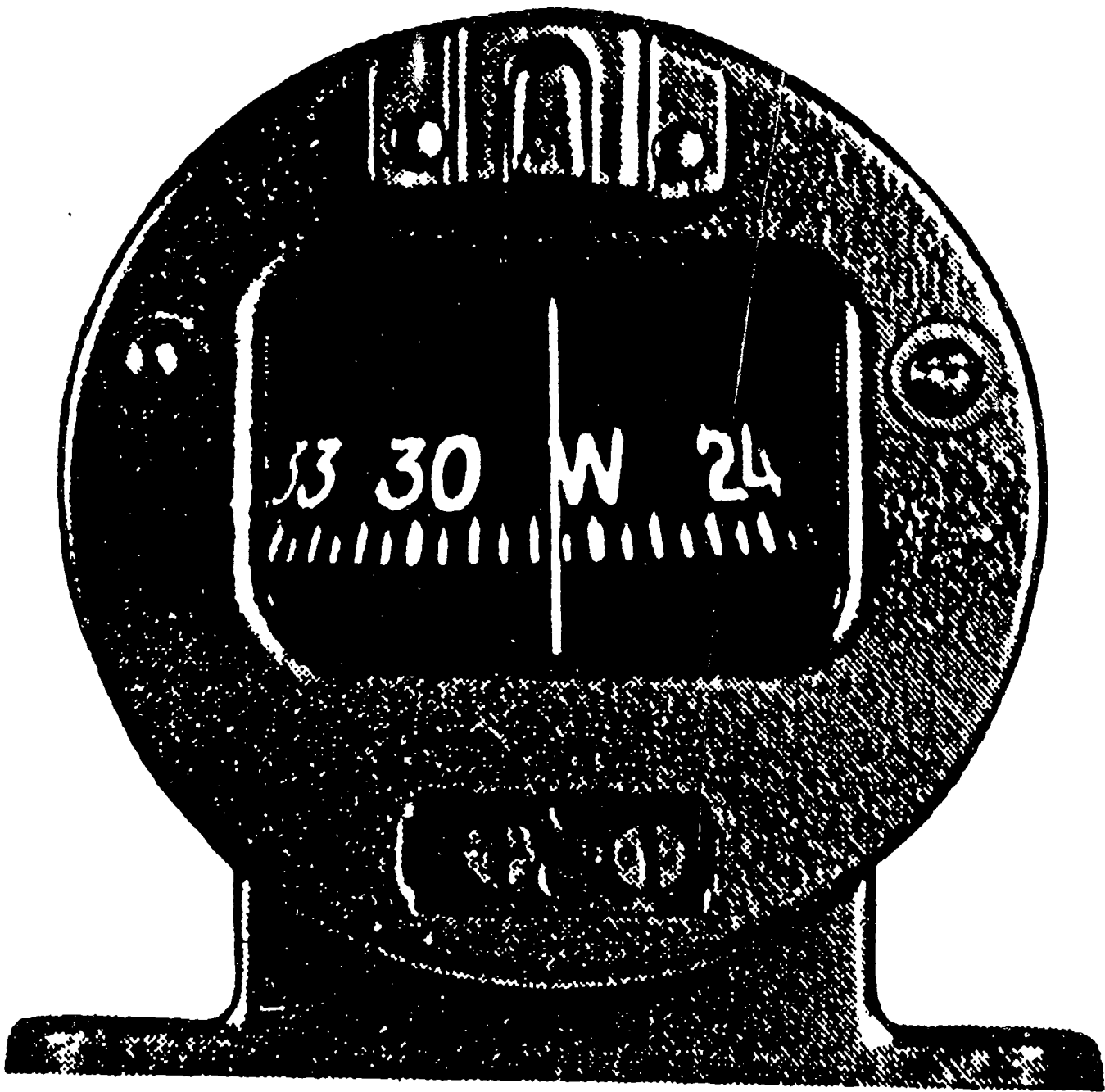

COMPASS

205

257

BEST COPY AVAILABLE

UNIT 6 ACTIVITY 1

STUDENT HANDOUT 1

Directions: Read the descriptions.
Number each instrument.

1. The altimeter tells the pilot how high he is above the ground.
2. The tachometer tells the pilot how fast the engine is running.
3. The airspeed indicator tells the pilot how fast the airplane is moving through the air.
4. The compass tells the pilot the direction he is flying.

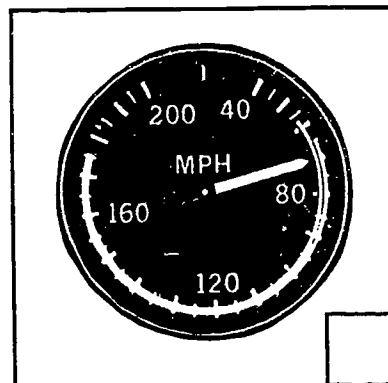
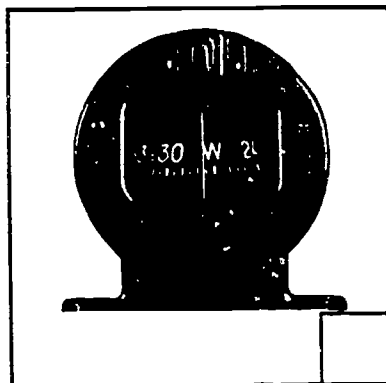
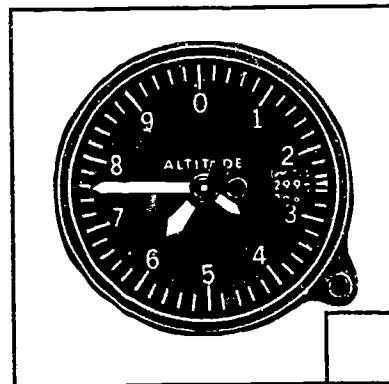
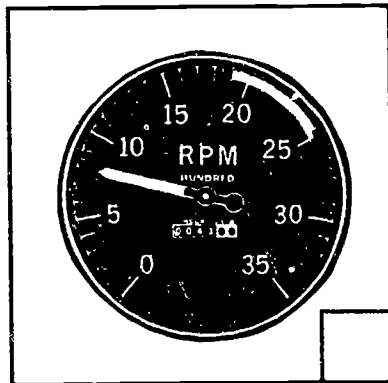

UNIT 6 ACTIVITY 2

STUDENT HANDOUT 2

THE COMPASS

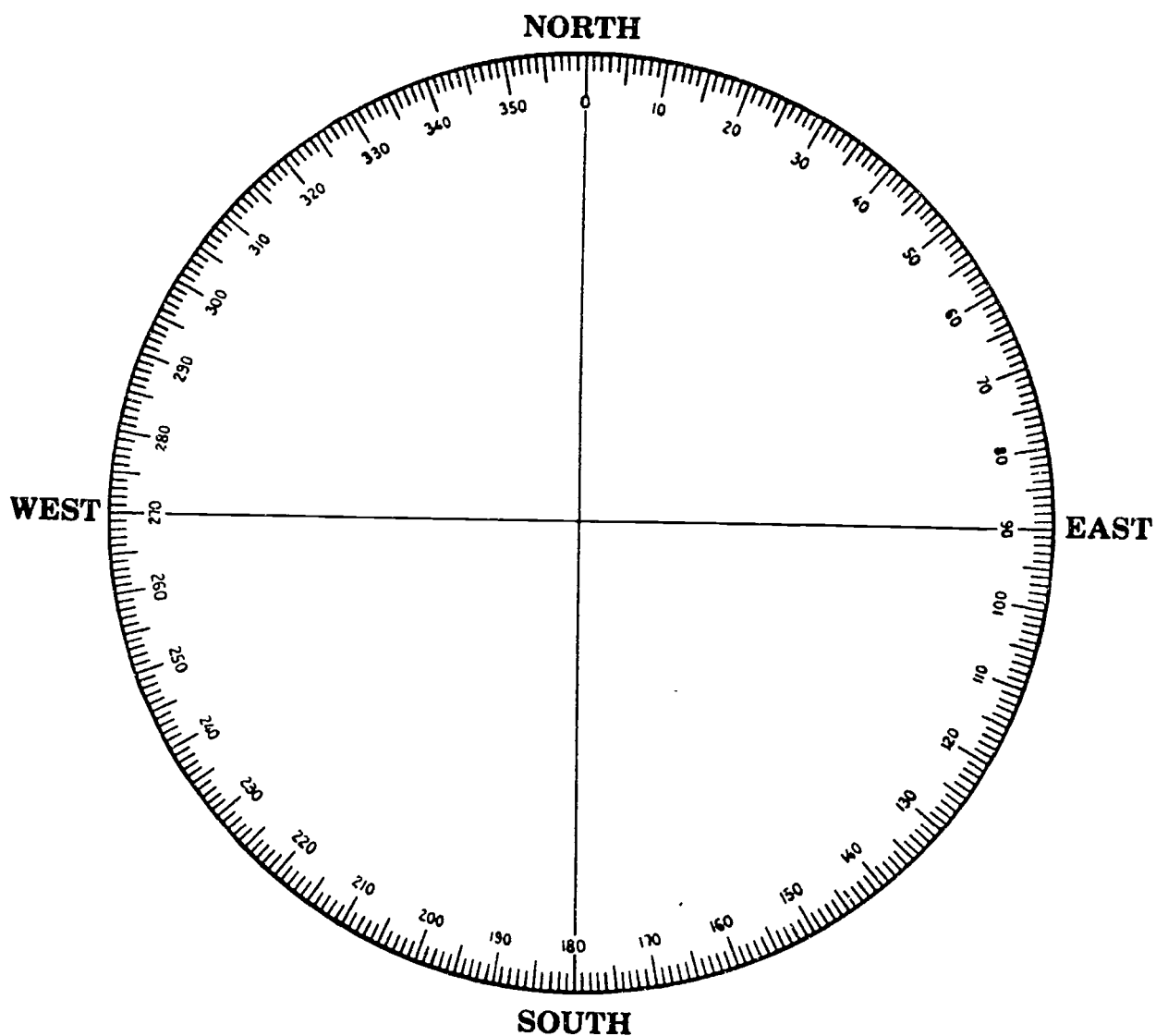

The **CARDINAL POINTS** on the compass are North, South, East, and West.

The distance between the lines on the compass is called a **DEGREE**.

There are 360 degrees on the compass.

UNIT 6 ACTIVITY 2

STUDENT HANDOUT 3

Directions: Fill in the blanks.

THE COMPASS

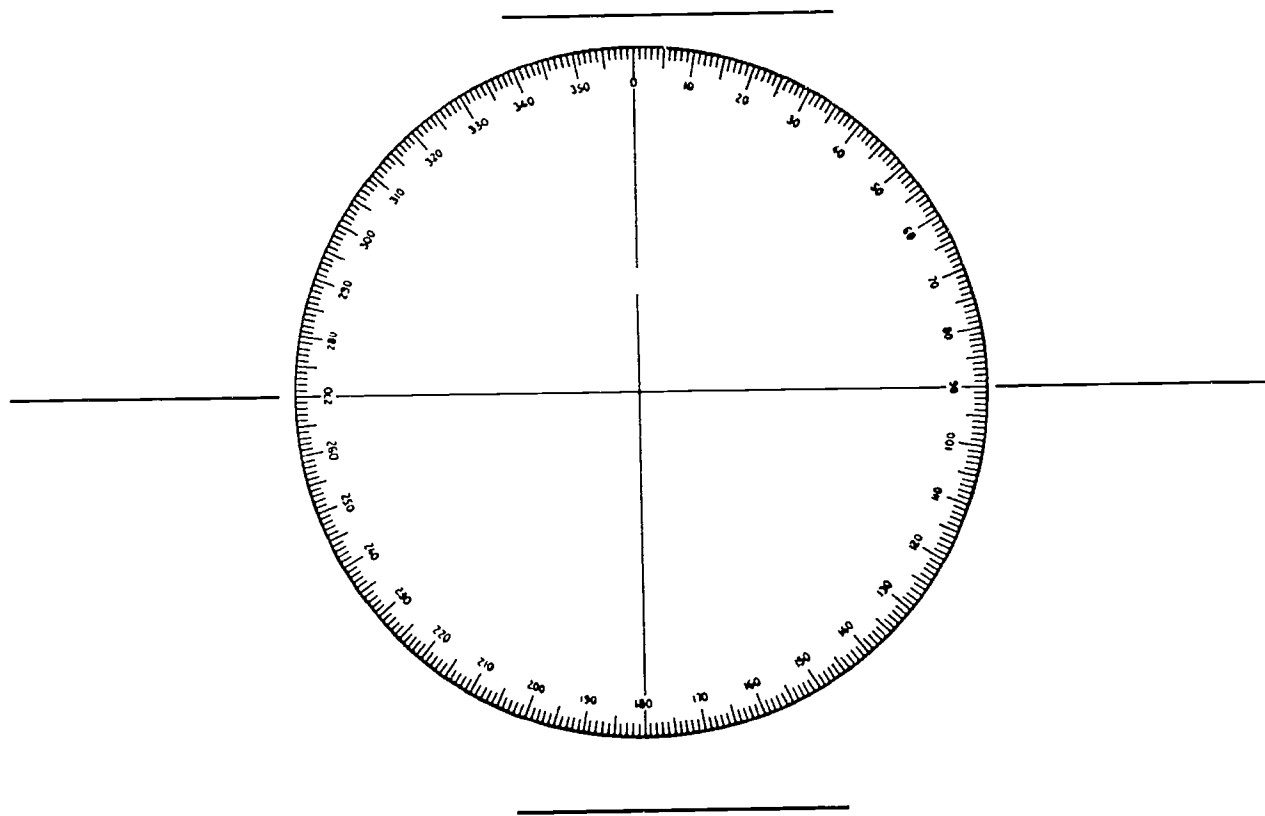

1. The cardinal points on the compass are _____, _____, _____, and _____.
2. The distance between the lines on a compass is called a _____.
3. There are _____ degrees on the compass.
4. Label the cardinal points on the compass pictured above.

UNIT 6 ACTIVITY 2

STUDENT HANDOUT 4

Directions: You live in Birmingham. Name the city you will travel to. Give the direction you must fly to reach the city.

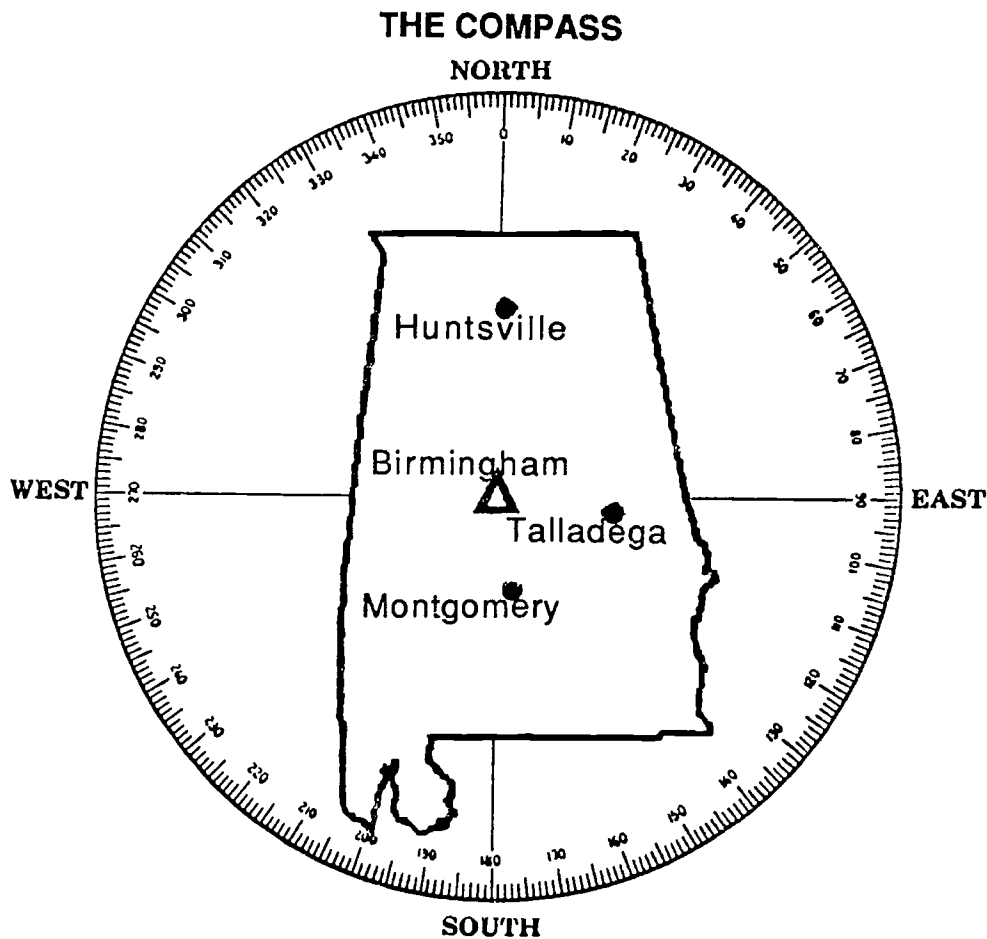

1. If you want to see rockets you would fly to _____. What direction will you fly? _____
2. A trip to _____ would take you to the Capitol of Alabama. What direction will you fly? _____
3. Car racing at the Alabama International Motor Speedway would take you to the city of _____. What direction will you fly? _____

UNIT 6 ACTIVITY 4

STUDENT HANDOUT 5

SECTIONAL CHART

SYMBOLS HELPFUL TO THE PILOT



airport with paved runways---one white dash for each runway



private airport--not for public use



tall tower



short tower



power lines

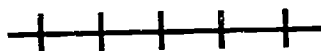

railroads



open pit mine

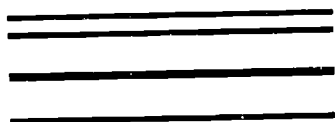

roads

UNIT 6 ACTIVITY 4

STUDENT HANDOUT 6

Directions: Use the map to locate the answers.

1. There are _____ public airports.
2. There are _____ short towers.
3. There are _____ tall towers.
4. Put a blue X on the four-lane highway.
5. Circle the airport with three runways red.
6. There are _____ private airports.
7. Put a red X on a railroad.
8. Circle the open-pit mine with blue.

SECTIONAL CHART

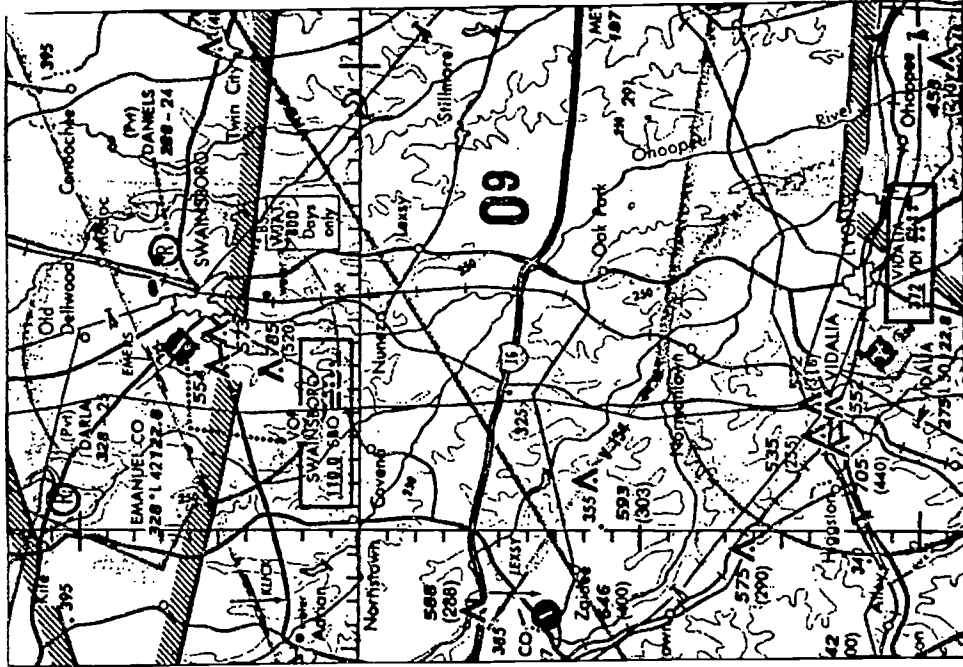

UNIT 6 ACTIVITY 5

STUDENT HANDOUT 7

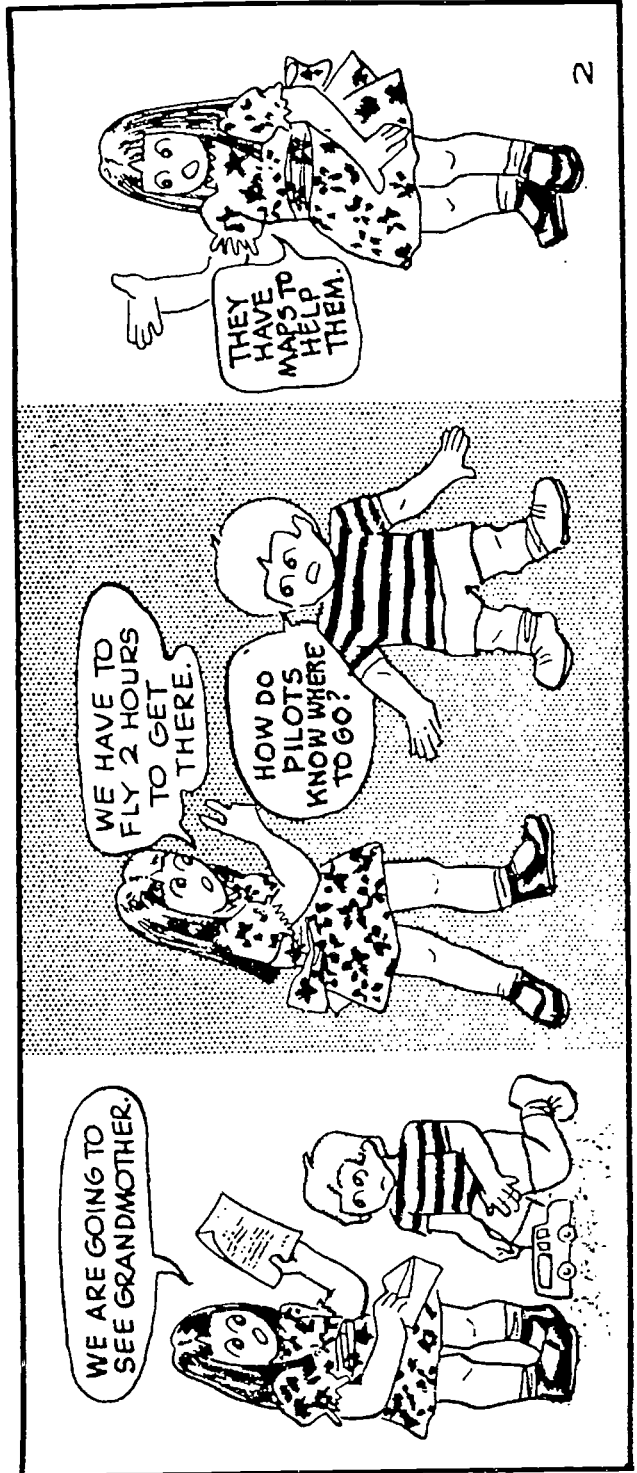
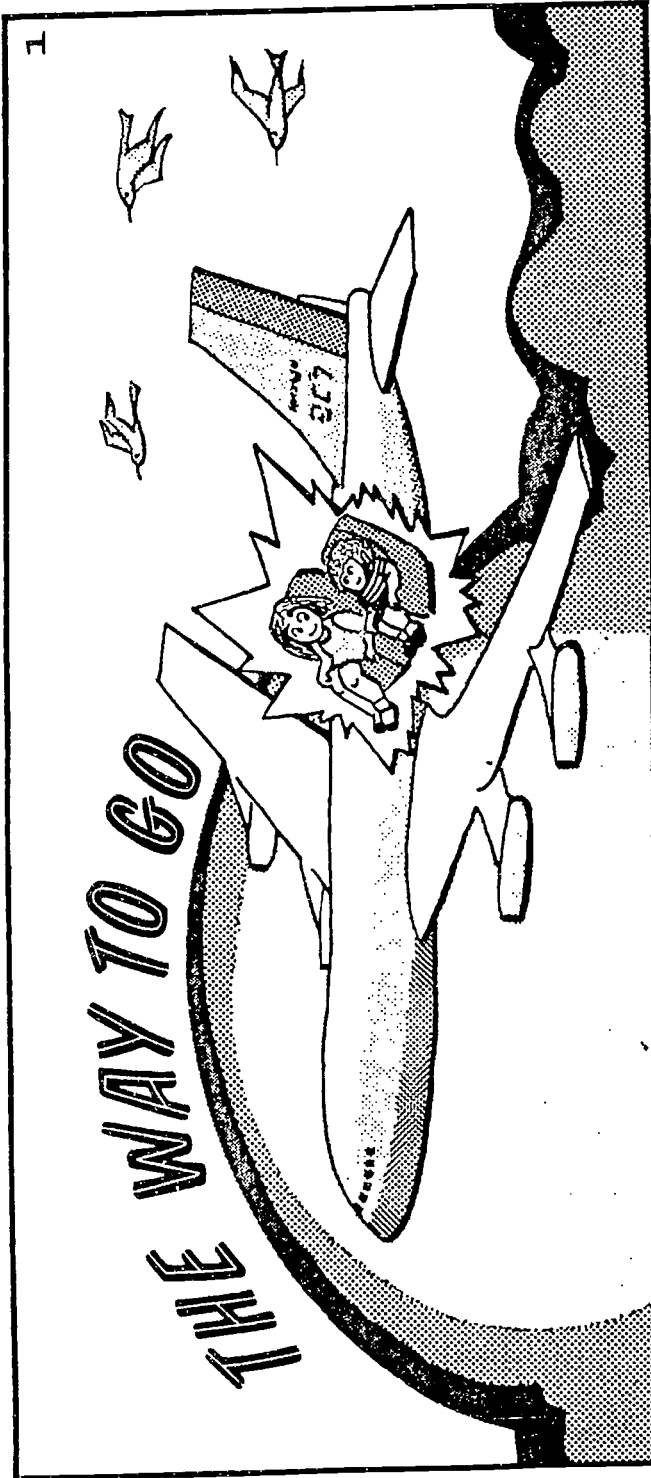

UNIT 6 ACTIVITY 5

STUDENT HANDOUT 8

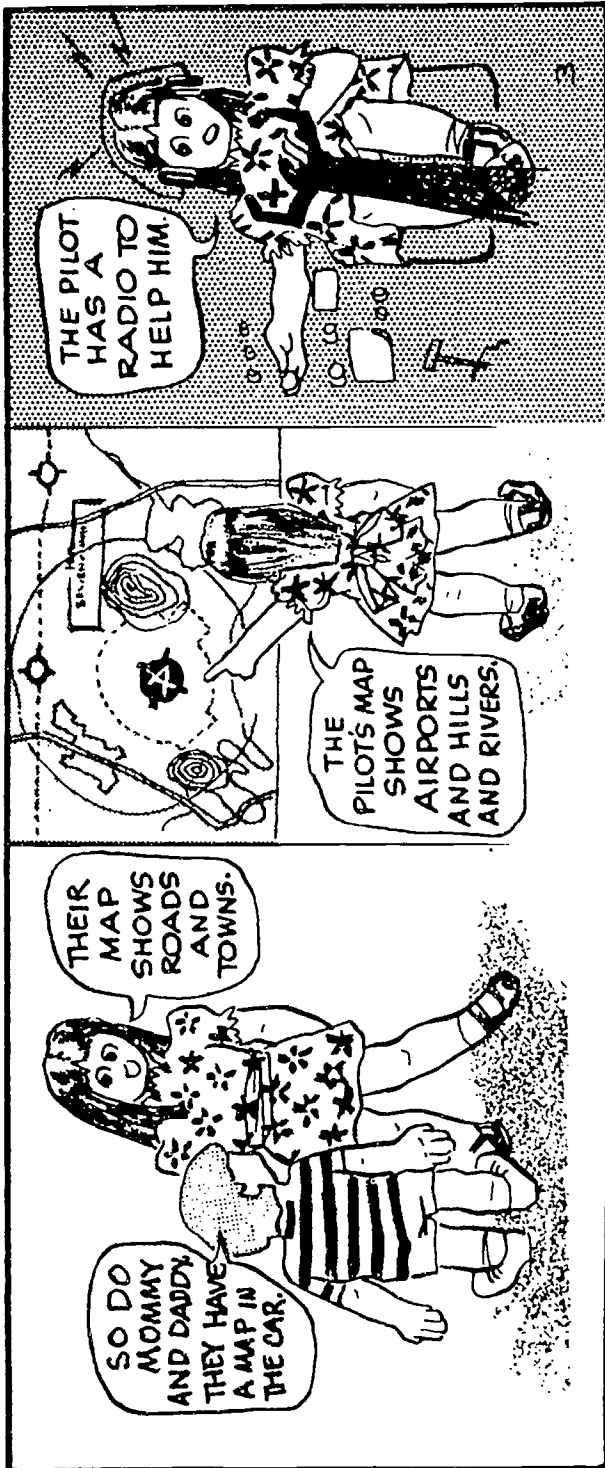

213

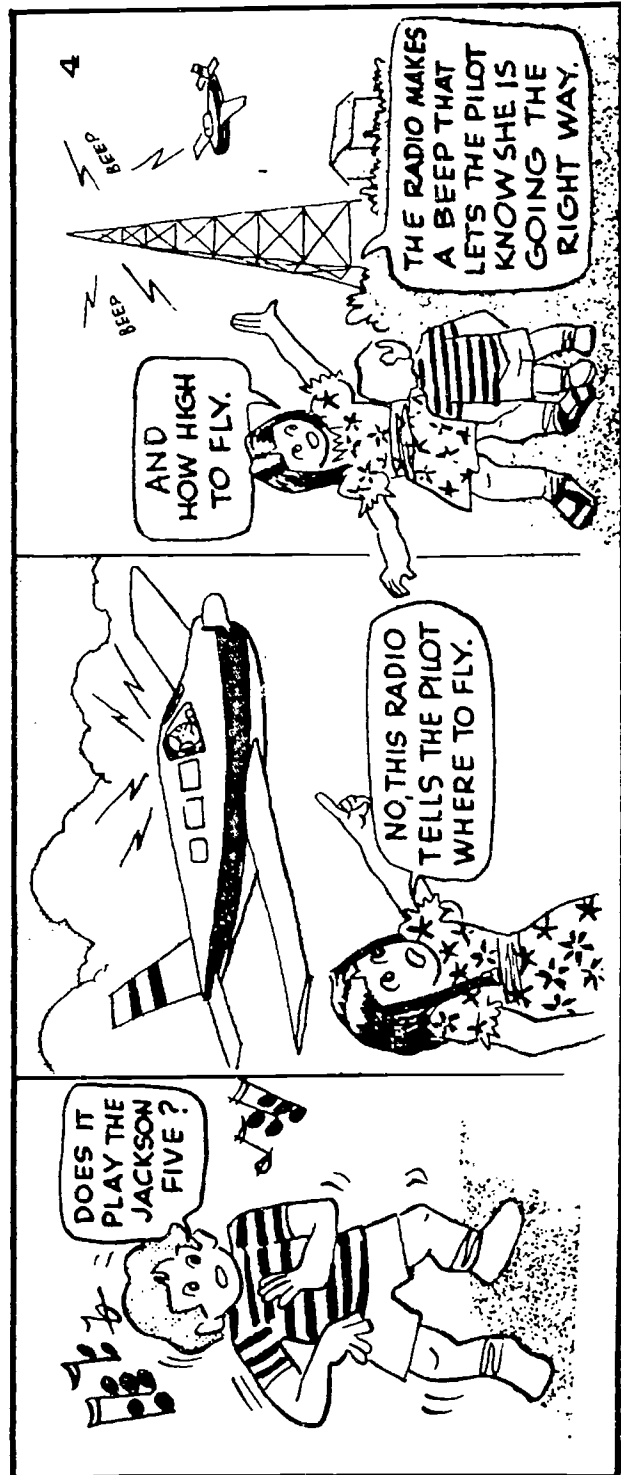

267

BEST COPY AVAILABLE

268

UNIT 6 ACTIVITY 5

STUDENT HANDOUT 9

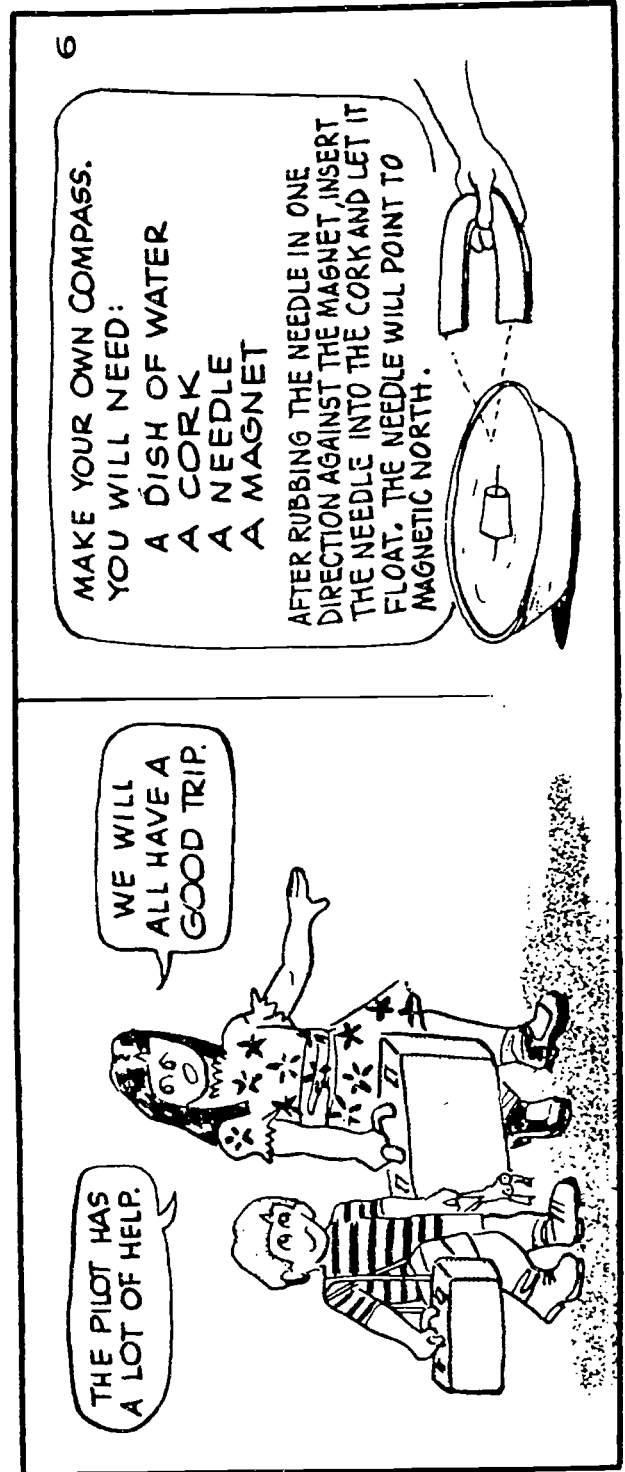
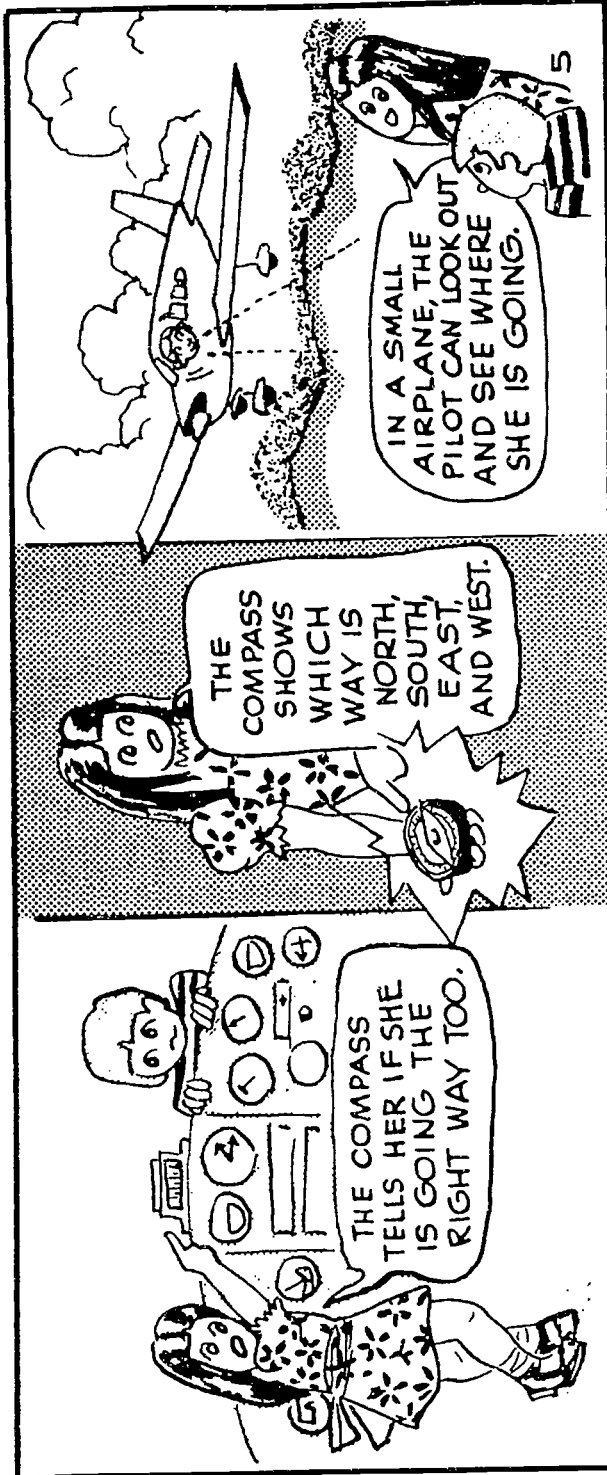

UNIT 7: AIRPORTS

PURPOSE OF UNIT 7

The purpose of Unit 7 is to introduce the importance of airports. Specifically, students should:

1. sense the importance of airports to all mankind;
2. recognize different kinds of airports;
3. experience first hand the planning of an airport;
4. discover the many careers needed to make an airport; and
5. be able to give examples of how airports boost economic growth.

MAJOR MESSAGES IN UNIT 7

- The airport is a necessary component of our national transportation system.
- Airports are essential to the economic growth of communities.
- Airports are a community's link with the rest of the world.

BACKGROUND INFORMATION FOR UNIT 7

Unit 7 consists of 2 topics:

- TOPIC 1: KINDS OF AIRPORTS
- TOPIC 2: PLANNING AN AIRPORT

Topic 1 defines the term "airport" and identifies the different kinds of airports.

Topic 2 introduces the airport as the community's link with the rest of the world. Planning is emphasized as an essential part of present and future airport development.

VOCABULARY WORDS FOR UNIT 7

Topic 1-2	airport
	hangar
	windsock
	ramp
	tower
	runway
	taxiway
	terminal
	controller

TOPIC 1: KINDS OF AIRPORTS

The activities, suggested materials, grade level, and related subject areas for each activity are summarized below.

<u>ACTIVITY</u>	<u>MATERIALS NEEDED</u>	<u>GRADE LEVELS</u> <u>SUBJECT</u>
1. A Trip to the Airport	A TRIP TO THE AIRPORT (This Federal Aviation Administration booklet is free. See Teacher Resource Section for address.)	Grades K-3 language arts social studies
2. Small Community Airport	Student Handout 1	Grades 1-3 language arts social studies
3. Major City Airports	Student Handout 2	Grades 1-3 language arts social studies
4. Airport Field Trip	chart paper Fantastic Flight Dictionary	Grades 1-3 language arts social studies

ACTIVITY 1: A TRIP TO THE AIRPORT

Direct the students' attention to airports. Arouse an interest by asking questions such as:

1. Have you ever wanted to visit an airport?
2. What do you think you would see at an airport?
3. Why do you think we need airports?
4. Do you think all airports are alike?

Read A TRIP TO THE AIRPORT to the students. Discuss questions similar to the following:

1. What is an airport?
2. In what ways did the airport help the people?
3. Describe some of the jobs being done by airport workers.
4. Do you think this was a large or small airport? Why?
5. In what size community would you find this airport? Why?

Extended Activities

- Have students tell about trips they have made by air.
- Divide the class into groups. Assign or let each group select a number of jobs as found in A TRIP TO THE AIRPORT. Ask students to research information about each job (for example: pay scale, duties, and educational requirements). Ask students to report their findings to the class. Students may use library sources or free Federal Aviation Administration publications such as:

GA-300-122 Career Pilots and Flight Engineers
GA-300-124 Aviation Maintenance
GA-300-124 Airport Careers
GA-300-126 Airline Careers
GA-300-127 Flight Attendants
GA-300-128 Government Careers

ACTIVITY 1 (Continued)

- Ask resource people such as a pilot, an air traffic controller, an aircraft mechanic, a stewardess, a ticket agent, or an airport manager to speak to the class. Prepare each speaker with a Resource Speakers' Guide (located in the Teacher Resource Section).

ACTIVITY 2: SMALL COMMUNITY AIRPORTS

Begin by telling students that small community airports are for non-airline aircraft (small planes that carry non-paying passengers) to land or take off. The runway may be a grass strip or paved. Distribute Student Handout 1. Ask students to identify and discuss major features such as:

1. Runway---a special place for planes to take off and land
2. Windsock---wind direction indicator
3. Ramp---a special parking area for aircraft
4. Auto Parking Area
5. Office/Lounge Area
6. Aircraft Fuel Pumps
7. Hangar---a place to store aircraft

Ask students to pretend that they are pilots about to land. Instruct them to analyze the handout and determine features they will utilize while at the airport (ramp, windsock, fuel, runway, lounge, auto parking and hangar) and give reasons why these features are a necessity.

Extended Activities

- Mark off a runway and ramp area on the classroom floor with masking tape. Provide boxes and other materials for students to make a windsock, fuel pumps, lounge area and a hangar. Let students experience airport operations as they take turns role playing planes landing or taking off, an aircraft mechanic, fuel pump operator, injured person waiting for an air ambulance, or student pilot.
- Tell students to pretend that they are pilots. Ask students to write a story about their stop at a small community airport including features and services they will use. Have them illustrate their story.

Ask younger students to draw a picture about their stop at a small community airport. Allow each student ample time to share his or her drawing with the class.

ACTIVITY 3: MAJOR CITY AIRPORT

Tell students that major city airports are much larger than small city airports. Passengers come to major city airports by car or by small aircraft from small community airports. Commercial airlines (large jets) take these passengers to places all over the United States and to countries across the ocean. Major city airports are located away from the center of the city for safety and noise reasons. Because of their size, many kinds of services must be provided for the many passengers that are landing or taking off. Phones, restrooms, restaurants, a post office, magazine stands, and seating areas are among a few of the services found at larger airports. Some very large city airports employ as many as 50,000 workers.

Distribute Student Handout 2. Ask students to identify and discuss features not found at a small community airport.

1. Taxiway---a paved area used by planes coming to and from the runway.
2. Control tower---a tall building with a glassed-in room at the top. Controllers prevent accidents by watching traffic in the air and on the ground.
3. Terminal---a building where passengers buy tickets, pick-up or check baggage, wait for planes to arrive or depart, find food and restrooms.
4. Fuel truck---a truck used to fuel aircraft at their parking spots.

Conduct a brainstorming session. Ask students to think of reasons why major city airports have special features such as:

1. control towers,
2. taxiways,
3. scheduled airlines,
4. mobile fuel trucks,
5. very large work forces, and
6. locations outside the city.

ACTIVITY 3 (Continued)

Extended Activity

- Ask students to search for information concerning the following:
 1. the world's busiest airport,
 2. the number of take offs and landings possible at the world's busiest airport per hour or per day,
 3. the world's largest airport,
 4. the number of passengers using the world's largest airport per year and per day, and
 5. the number of runways, terminals, and gates at the world's largest airport.

ANSWERS:

1. Chicago International Airport at O'Hare Field
 2. Approximately 800,000 takeoffs and landings per year or more than one every minute day and night.
 3. Dallas/Fort Worth Airport in Texas
 4. Sixty million per year
 5. 9 runways, 13 terminals and 260 gates
- Develop a MAJOR AIRPORTS IN ALABAMA bulletin board. Display a large map of Alabama. Ask students to search for information about each of the four largest airports in Alabama, such as:
 1. location
 2. number of employees
 3. number of take off and landings each year
 4. number of passengers served each year.

Display this information on the map of Alabama near each major airport.

ACTIVITY 4: AIRPORT FIELD TRIP

Plan a trip to the nearest small airport or, if possible, to one of Alabama's larger airports (Huntsville, Birmingham, Montgomery, or Mobile). Before the trip, plan with the airport manager in advance. Secure safety rules and prepare the students to follow them. Ask students to make a list of questions they would like answered while on the trip. Write the list on chart paper.

After the trip, conduct follow-up activities such as the following:

1. Answer questions listed on chart paper;
2. Compare the visited airport with a small community airport;
3. Compare the visited airport with a major city airport;
4. Discuss vocabulary words for Unit 7. Write the vocabulary words in the Fantastic Flight Dictionary; and
5. Write thank you letters to the airport manager.

TOPIC 2: PLANNING AN AIRPORT

The activities, suggested materials, grade level, and related subject areas for each activity are summarized below.

<u>ACTIVITY</u>	<u>MATERIALS NEEDED</u>	<u>GRADE LEVELS</u> <u>SUBJECT</u>
5. Airport Diorama	Student Handouts 1, 2, and 3 shoe box glue cotton balls crayons scissors	Grades K-1 art language arts
6. Our Airport	guest speakers: airport manager Mayor Airport Board Commissioner member	Grades 2-3 social studies language arts
7. Table Top Diorama	card table milk cartons/boxes tempra paint construction paper tape scissors glue toy cars and planes tree twigs	Grades 2-3 art social studies language arts

ACTIVITY 5: AIRPORT DIORAMA

Begin with interest-building questions such as:

1. What are some of the most important features of an airport?
2. Why are these features so important to the pilot and his passengers?
3. Why do you think a city would do a lot of planning before building an airport?

Distribute Student Handouts 1 and 2. Review the features of both handouts and compare. Distribute Student Handout 3. Tell students they will build an airport diorama using a shoe box and Student Handout 3. Before construction starts, help students by planning what is to be done inside the shoe box (color grass and sky; glue runway, tower, terminal, fuel truck, and jet in correct place; and complete scene with a cloud in the sky).

ACTIVITY 6: OUR AIRPORT

Direct students' attention to planning for a new airport or for expansion of an existing airport. Tell students a guest speaker will be coming to discuss planning for their local airport. Ask students to brainstorm a list of questions for the speaker such as the following:

1. How many years of planning does it take before building or expanding an airport?
2. How is a location for the airport decided?
3. How is the size of the airport decided?
4. Who does the planning?
5. Who pays for the land and building of the airport?
6. What part do local businesses or citizens play in airport planning?
7. What kind of planning is done for the future?

ACTIVITY 7: TABLE TOP DIORAMA

Divide the class into five groups. Tell the students they are to plan a new airport for their community. Discuss questions similar to the following:

1. Where will the airport be located? Why?
2. What size will it be? Why?
3. What facilities (taxiway, auto parking, tower, terminal, ramp, and hangars) will it have? Why?

Tell students that large cities have many aircraft landing and taking off each day. Therefore, they need a large airport with many facilities and services. Explain that small communities have fewer people needing the use of an airport and therefore, this type airport needs fewer facilities and services. Tell students to consider their community when constructing their table top diorama. Suggest that they cut grass, soil and runways out of construction paper. Tape to a card table top. Paint milk cartons and boxes to simulate buildings. Use tree twigs to simulate trees. Complete display with toy cars, truck and planes. Encourage creative use of other materials.

Ask each group to select a speaker to tell the class about their new community airport and the reasons for the airport location, size, and design.

Extended Activities

- Tell students to write a story using the following idea:

"The airport is a window to our community."

Ask students to illustrate their work. Have students share their stories with the class.

- Ask students to make a list of things a visitor may see through the community window. Ask them to consider changes to the list that would make the image of their community more inviting to a visitor.

UNIT 7 ACTIVITY 2

STUDENT HANDOUT 1

SMALL COMMUNITY AIRPORT

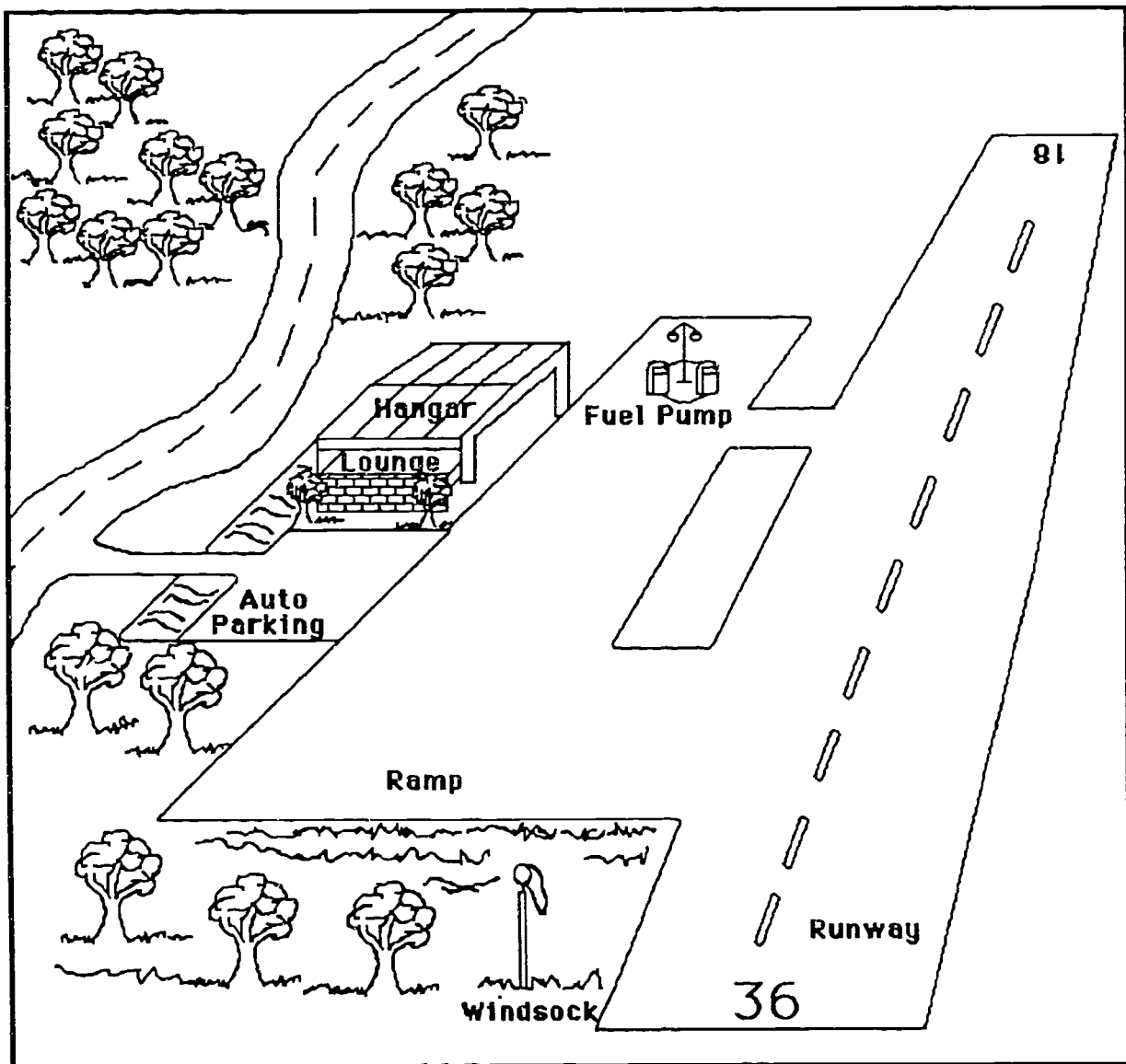

UNIT 7 ACTIVITY 3

STUDENT HANDOUT 2

MAJOR CITY AIRPORT

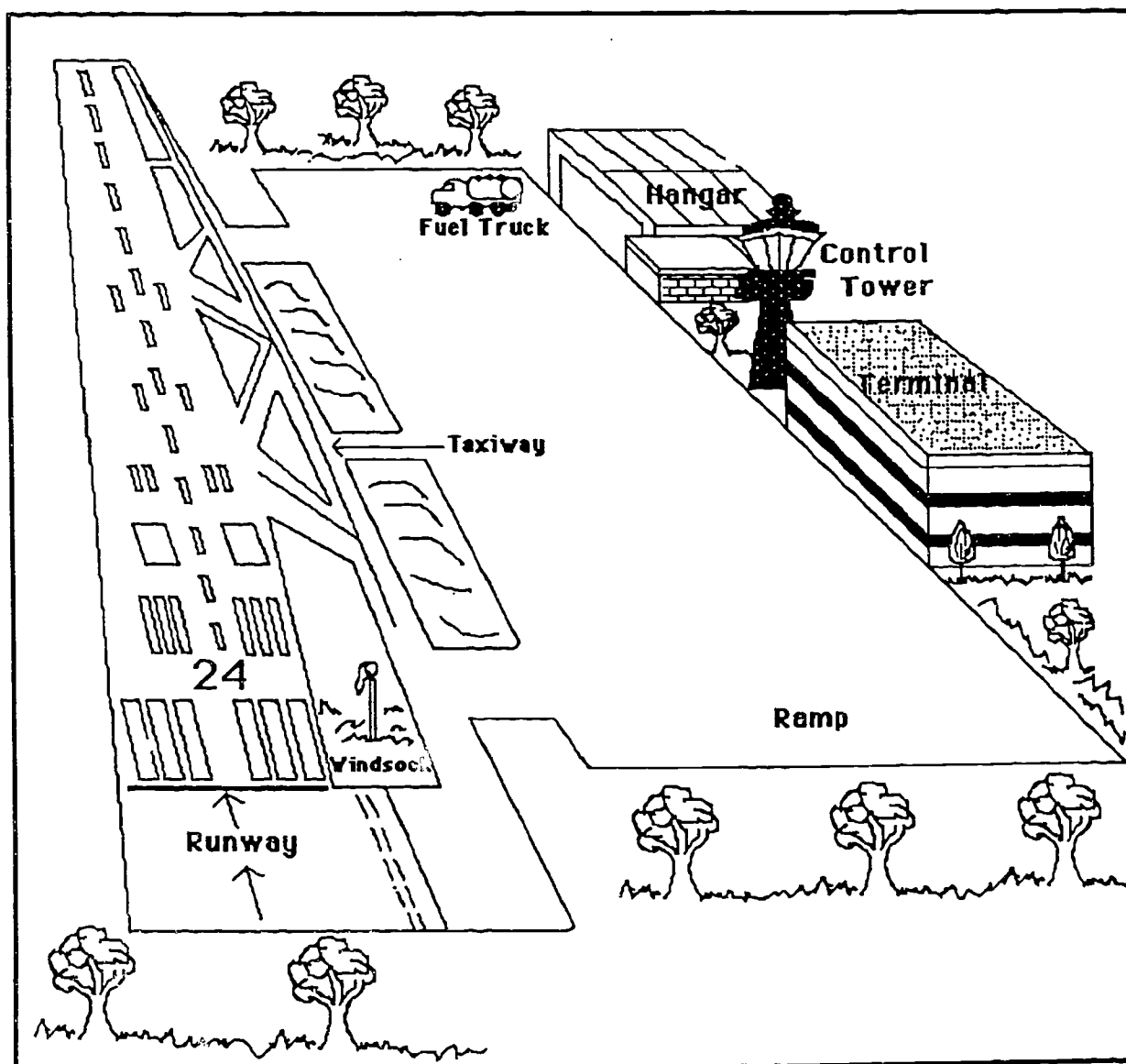

UNIT 7 ACTIVITY 5

STUDENT HANDOUT 3

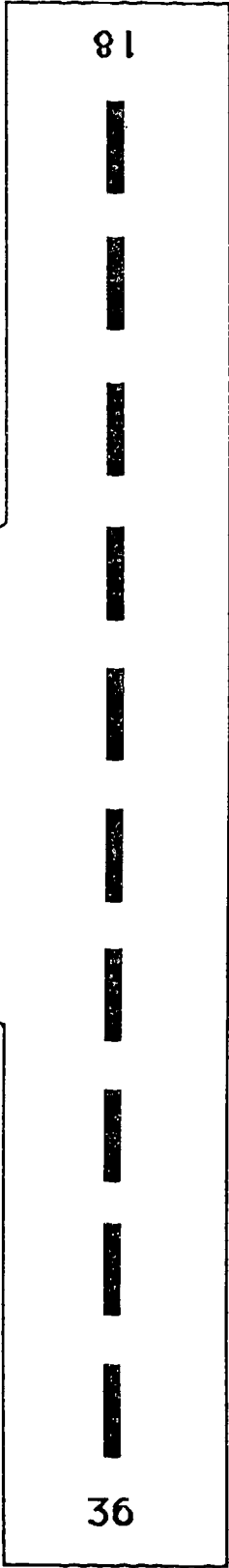
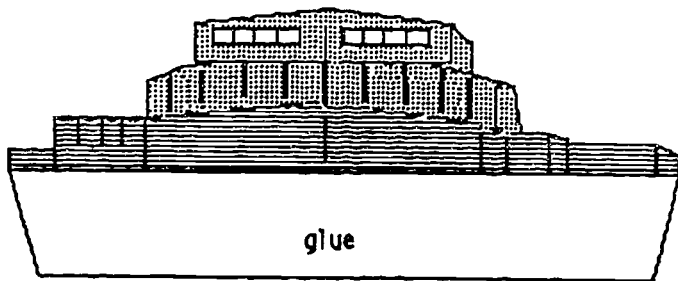
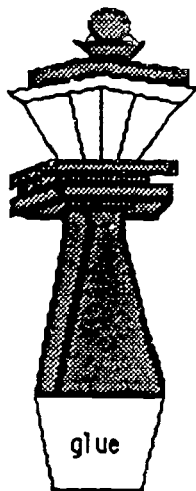
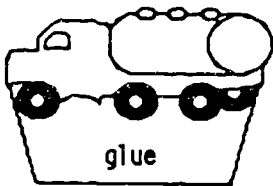
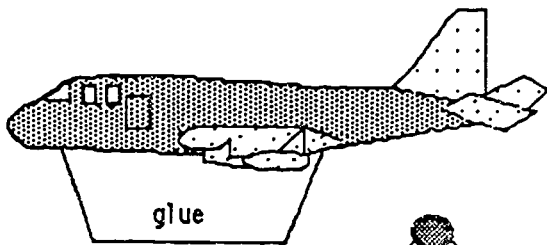

GLOSSARY

aerodynamics (aer-o-dy-nam'ics): the study of the forces of air acting on objects in motion relative to air.

aileron (a'le-ron): the moving parts, attached to the rear edge of plane wings, that help the plane tilt or roll.

air: a mixture of gases making up the atmosphere which surrounds the earth.

air cargo: the goods carried on an airplane.

airplane: an engine-driven, fixed-wing, heavier-than-air aircraft.

airline: a business that provides scheduled flights to carry passengers or cargo from place to place.

airport: a tract of level land where aircraft can take off and land; usually equipped with a control tower, hangars, and accommodations for passengers and cargo.

air traffic controller: a person who controls the movement of aircraft in the air and on the ground.

airspeed: the speed of the aircraft relative to the air through which it is moving.

airway: a designated air route for aircraft passage from airport to airport. Aids to air navigation such as beacons, radio ranges, and direction-finding equipment help pilots find their way.

altimeter (al-tim'e-ter): an instrument for measuring in feet the height of the airplane above sea level.

altitude: the vertical distance from a given level (sea level) to an aircraft in flight.

GLOSSARY (Continued)

- amphibian plane:** an airplane that can land on both land and water.
- anemometer (an-e-mom'e-ter):** an instrument to measure speed of wind.
- ascend:** to climb.
- atmosphere:** the blanket of air surrounding the earth.
- aviation:** a term applied to all phases of the manufacture and operation of aircraft.
- balloon:** a bag filled with a gas that is lighter than air, propelled by the wind, and non-steerable.
- bank:** to tilt one wing toward the ground and the other toward the sky.
- barometer:** an instrument to measure pressure of the atmosphere.
- beacon:** a light or other signal indicating direction.
- biplane:** a plane with two sets of wings, one wing above the other.
- blimp:** a small dirigible that is lighter than air, propelled by an engine, and steerable.
- bomber:** a plane specially made to carry bombs.
- check in:** to report to the check-in desk at an airport with ticket and baggage before a flight.
- cockpit:** the place where a pilot sits to fly a plane. It contains the instruments and controls.
- cold front:** a mass of cold air overtaking a mass of warm air.
- compass:** an instrument used by pilots to determine direction.

GLOSSARY (Continued)

control tower: a glassed-in observation tower at large airports from which air traffic controllers observe and direct airport air and ground traffic.

course: the direction over the earth's surface that an airplane is intended to travel.

cowling: the metal covering for the engine that is similar to the hood of a car.

cumulus: a type of cloud formed in puffs or shaped like a dome.

degree: $1/360$ of a circle, or $1/90$ of a right angle.

descend: to go down.

dirigible (dir'i-gi-ble): a long cigar-shaped bag filled with a gas that is lighter than air, propelled by an engine, and steerable.

drag: the force that slows down a plane as it flies through the air.

elevators: the moving parts on the tail of a plane that move up or down to make the plane climb or descend.

engine: the part of the airplane which provides power, or propulsion, to pull the airplane through the air.

engineer: a member of the flight crew or ground crew who takes care of the engine and other moving parts.

flaps: the moving parts attached to the rear edge of plane wings which help to slow a plane down for landing.

GLOSSARY (Continued)

flight plan: the details written by the pilot which show where a plane is going, how long the flight will take, and other important facts.

forecast: a statement about what is expected to happen in the future.

force: a push or pull exerted on an object.

freight: cargo.

front (weather): boundary of two overlapping air masses. Cold air advancing on warm air is said to be a cold front; warm air advancing on cooler air is a warm front.

fuel: the gasoline or kerosene used to run engines.

fuselage (fu'se-lage): the streamlined body of an airplane to which are fastened the wings and tail.

gear: the understructure (wheels, skis, or pontoons) of an airplane which supports the airplane on land or water. Retractable gear folds up into the airplane in flight. Fixed gear does not retract or fold up.

glider: a plane without an engine.

gravity: the force which pulls toward the center of the earth.

hangar: a large building at the airport where planes are stored or repaired.

hang glider: a glider where the pilot hangs underneath the wing.

headset: headphones which fit over the pilot's ears to help him hear better.

GLOSSARY (Continued)

helicopter: an aircraft that becomes airborne by way of a rotating wing.

humidity: the amount of invisible moisture in a given mass of air.

instrument: a dial like a clock face which gives the pilot information about fuel, speed, direction, or altitude.

inventor: a person who makes or introduces a new thing or way of doing something.

jet aircraft: an aircraft that travels very fast and is propelled by a jet engine.

jet engine: an engine which turns air and fuel into a hot gas that shoots out the back of the engine and pushes the plane through the air.

knot: a measure of speed (one knot being one nautical mile per hour).

land: the act of making the airplane descend, lose flying speed, and make contact with the ground or water, thus ending the flight.

lift: the force needed to get a plane into the air.

lighter-than-air: aircraft that is lifted into the air by a gas that weighs less than air.

meteorology: the scientific study of the weather.

moisture: water in some form in the atmosphere.

monoplane: an airplane having one set of wings.

multi-engine: having more than one engine.

GLOSSARY (Continued)

navigate: to plan and follow a specified route from one airport to another airport.

nose wheel: the wheel at the front of a plane.

occluded front: warm air mass "sandwiched" between two cold air masses.

parachute: a fabric device attached to objects or persons to reduce the speed of descent.

pedals: the foot controls in the cockpit by which the pilot controls the action of the rudder.

pilot: the person who controls the airplane.

precipitation: any falling visible moisture: rain, snow, sleet, hail.

pressure: the continuous application of force.

propeller: two or more twisted blades which pull a plane forward as they turn.

radar: a way of finding out where an object is. Radio waves are sent out. When they meet an object, they bounce back to the radar set.

ramp: an area where airplanes are parked to be serviced or to pick up and discharge passengers and cargo.

rudder: the moving part on the tail that steers or turns the plane to the left or right.

runway: a long, straight road for planes to take off and land on.

seaplane: an airplane that takes off or lands on water.

GLOSSARY (Continued)

- seat belt:** the belt attached to the seat which fasten around the pilot and passengers to hold them firmly in their seats in bouncy air and during take-offs and landings.
- sectional chart:** a special map used by pilots to navigate from place to place.
- simulator:** a training machine on the ground which imitates flight in the air.
- stationary front:** a front along which one air mass does not replace another.
- stratus:** a layered cloud.
- streamline:** the shape of an object which causes air to flow smoothly around it.
- supersonic:** faster than the speed of sound.
- symbol:** a printed sign that represents a word.
- tachometer (ta-kom'-e-ter):** an instrument which measures the speed at which the engine crankshaft is turning, hence the propeller speed in r.p.m.'s (rounds per minute).
- tail:** the part of the airplane to which the rudder and elevators are attached.
- takeoff:** the part of the flight during which the airplane gains flying speed and becomes airborne.
- taxi:** to move a plane along the ground.
- taxiway:** the roads used by planes when they move on the ground.

GLOSSARY (Continued)

temperature: the degree of hot and cold.

terminal: a building on the airport where planes arrive or depart, people board planes, buy tickets, and have their luggage handled.

throttle: the lever which regulates the speed of an engine.

thrust: the force of the engines which drives a plane forward.

transmitter: the microphone or part of the radio that sends the message.

tricycle landing gear: the airplane's landing wheels--two main wheels and a steerable nose wheel.

turn: the maneuver which the airplane makes in changing its direction of flight.

warm front: a mass of warm air overtaking a mass of cold air.

weather: the condition of the atmosphere at a given time with respect to air motion, moisture, temperature, and air pressure.

weight: how heavy something is.

wind: air in motion.

windsock: a cone-shaped, open-ended cylinder of cloth which catches the wind and shows its direction.

wing: the part of the airplane shaped like an airfoil and designed in such a way as to provide lift when air flows over it.

FANTASTIC FLIGHT DICTIONARY



239

295

Aa

airplane



Bb

blimp



Cc

cloud



Dd

dirigible



Ee

elevator

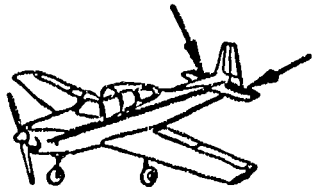

Ff

fuselage

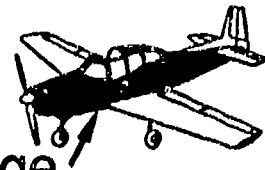

Gg

glider



Hh

helicopter

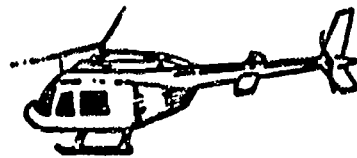

Ii

instruments

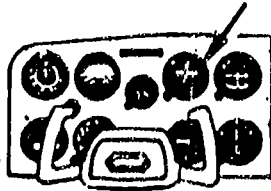

Handwriting practice lines for the word 'instruments'.

Jj

jet



Handwriting practice lines for the word 'jet'.

Kk

kite



Handwriting practice lines for the word 'kite'.

Ll

landing gear

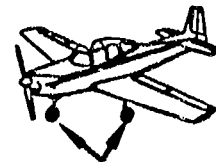

Handwriting practice lines for the word 'landing gear'.

Mm
maps

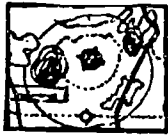

Nn

Oo

Pp
parachute



Qq

Rr

rocket

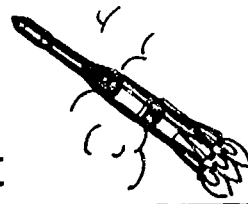

Ss

seat belt



Tt

terminal



Uu

Vv

Ww

windsock

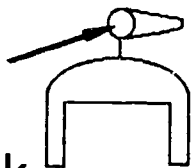

Xx

Yy
yoke

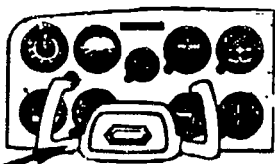

Zz

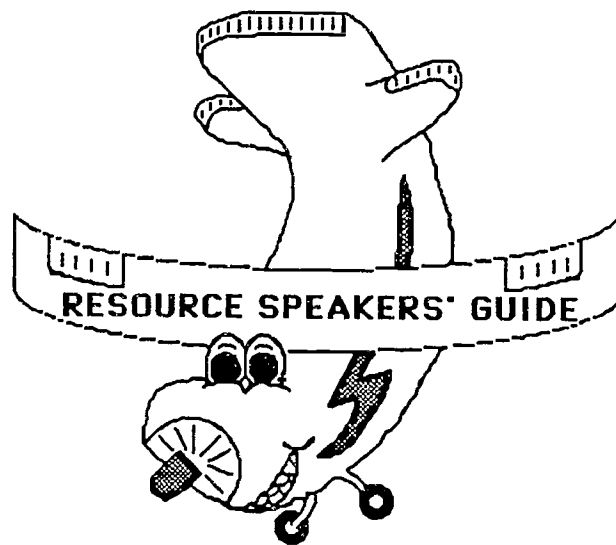

Thank you for taking time from your busy schedule to share your career experiences with our students. Students who live in a world of aviation and space need role models to look up to for guidance and help in planning for the future. We ask that you leave a vital message: "EDUCATION IS THE KEY TO YOUR FUTURE," as you encourage students by discussing topics such as the following:

1. a description of what you do,
2. the educational requirements for what you do,
3. certain job-related responsibilities that you have found to be important (such as arriving to work on time, being dependable, and having necessary work materials on hand),
4. ways in which reading, writing, mathematics, and science are used in your job,
5. the importance of staying in school,
6. the importance of academic excellence or doing your best, and
7. the importance of saying NO to drugs.

CHILDREN'S BOOKS

FLIGHT - NONFICTION GRADE KINDERGARTEN - TWO

- Baker, Donna. I Want to be a Pilot. Chicago: Childrens Press, Inc., 1978.
- Barton, Byron. Airplanes. New York: Harper and Row Publishers, 1986.
- Greene, Carla. I Want to be an Airline Hostess. Chicago: Childrens Press, Inc., 1960.
- _____. Airplane Pilots; What Do They Do? New York: Harper and Row Publishers, 1964.
- Ingoglia, Gina. The Big Book of Real Airplanes. New York: Grossett and Dunlap, Inc., 1987.
- Johnson, Spencer. The Value of Patience; The Story of the Wright Brothers. La Jolla, CA: Value Communications, 1976.
- Kanetzke, Howard. Read About Airplanes and Balloons. Raintree, 1978.
- Peterson, David. Airplanes. Chicago: Childrens Press, Inc., 1981.
- _____. Helicopters. Chicago: Childrens Press, Inc., 1983.
- Petty, Kate. On a Plane. New York: Franklin Watts, Inc., 1984.
- Provinsen, Alice. The Glorious Flight. New York: Viking Press, Inc., 1983.
- Radlauer, Ed. Flying Mania. Chicago: Childrens Press, Inc., 1974.
- Wilkinson, Jean. Come to Work with Us in an Airport. Sextant, 1970.

CHILDREN'S BOOKS

FLIGHT - NONFICTION GRADE THREE AND UP

Bagwell, Richard. This Is an Airport. Chicago: Follett Publishing Company, 1967.

Baker, David. Military Aircraft Library. Rourke, 1987.

Set of six books

Bombers

Helicopters

Land Fighters

Navy Fighters

Research Planes

Spy Planes

Barrett, N.S. Airliners. New York: Franklin Watts, Inc., 1984.

_____. Helicopters. New York: Franklin Watts, Inc., 1985.

Gennett, Ann. Aviation. Dillion Press, 1986.

Halacy, Dan. Soaring. Philadelphia: J.B. Lippincott Company, 1977.

Heatley, C.J. The Cutting Edge: Naval Aviators. Thomasson-Grant, 1987.

Heatley, Michael. Jet Aircraft, 1984.

Knight, Clayton. Big Book of Real Helicopters. New York: Grossett and Dunlap, Inc.

Makanna, Philip. Ghosts: Vintage Aircraft of World War II. Thomasson-Grant, 1987.

Meyer, Mark. Wings. Thomasson-Grant, 1986.

GRADE THREE AND UP

NONFICTION (Continued)

- Munson, Kenneth. Book of Warplanes. Crescent, 1985.
- Nicklaus, Carol. Flying, Gliding and Whirling. Making Things That Fly. New York: Franklin Watts, Inc., 1981.
- Pitcher, Caroline. Build Your Own Airport. New York: Franklin Watts, Inc., 1985.
- Settle, Mary. Story of Flight. New York: Random House, Inc., 1967.
- Simon, Seymour. Paper Airplane Book. New York: Viking Press, Inc., 1971.
- Thompson, Brenda. Famous Planes. Minneapolis: Lerner Publishing Company, 1977.
- Yenne, Bill. Great Book of Warplanes of the 1980's. Gallery, 1986.
- _____. U.S. Airforce Today. Gallery, 1986.

CHILDREN'S BOOKS

FLIGHT - FICTION GRADE KINDERGARTEN - THREE

- Calhoun, Mary. Hot Air Henry. Morrow, 1981.
- Coerr, Eleanor. The Big Balloon Race. New York: Harper and Row Publishers, 1981.
- Delage, Ida. Old Witch Gets a Surprise. Scarsdale, N.Y.: Garrard Publishing Company, 1981.
- Lenski, Lois. Little Airplane. New York: Oxford University Press, 1983.
- Scarry, Richard. Richard Scarry's Great Big Air Book. New York: Random House, Inc., 1971.
- Wasserman, Jack. Chopper Malone Series (Helicopter Adventures). West Chester, IL.: Benefic Press, 1976.
- Wildsmith, Brian. Bear's Adventure. New York: Pantheon Books, 1981.

CHILDREN'S BOOKS

SPACE FLIGHT GRADE KINDERGARTEN - TWO

- Attmore, Stephen. Now You Can Read About Space Travel. Brimax, 1985.
- _____. Spacecraft. Brimax, 1985.
- Blacknall, Carolyn. Sally Ride: American's First Woman in Space. Dillion Press, 1986.
- Friskey, Margaret. Space Shuttles. Chicago: Childrens Press, Inc., 1982.
- Gaffney, Timothy. Kennedy Space Center. Chicago: Childrens Press, Inc., 1985.
- Petty, Kate. Satellites. New York: Franklin Watts, Inc., 1984.
- _____. Space Shuttle. New York: Franklin Watts, Inc., 1984.
- Wheat, Janis. Let's Go to the Moon. Washington: National Geographic, 1977.

CHILDREN'S BOOKS

SPACE FLIGHT GRADE THREE AND UP

Appel, Fred. The Moon and Beyond. Aldus, 1971.

Baker, David. Today's World in Space. Vero Beach: Rourke, 1987.

Set of six books

Believe It or Not Space Facts

Exploring Mars

Factories in Space

I Want to Fly the Shuttle

Journey to the Outer Planets

Peace in Space

Branley. A Book of Moon Rockets for You. New York: Crowell Collier and Macmillan, Inc., 1970.

Fradin, Dennis. Moon Flights. Chicago: Childrens Press, Inc., 1985.

_____. Skylab. Chicago: Childrens Press, Inc., 1984.

Hendrickson, Walter. Apollo II to the Moon. Irvington-on-Hudson, N. Y.: Harvey House, Inc., 1970.

Martin, Patricia. Christa McAuliffe: Reach for the Stars. Vero Beach: Rourke, 1987.

Maurer, Richard. Nova Space Explorers Guide. New York: Crown Publishers, Inc., 1986.

McPhee, Raymond. Your Future in Space. New York: Crown Publishers, Inc., 1987.

FREE OR INEXPENSIVE TEACHING AIDS

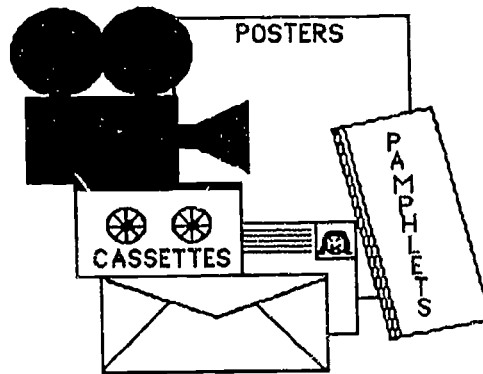

ALABAMA DEPARTMENT OF AERONAUTICS

Arthur G. Jones, Director
555 South Perry Street, Suite 308
Montgomery, Alabama 36130
(205) 261-4480

Information pertaining to aviation/space education, Alabama aerospace activities, and Alabama airports is available upon request.

ALABAMA SPACE AND ROCKET CENTER

Attn: NASA Teacher Resource Center
Huntsville, Alabama 35807

A variety of videotapes, slides, audiotapes, publications, lesson plans, and activities are available for educators to copy at the center. Further information may be requested.

BOEING COMMERCIAL AIRPLANE COMPANY

MS 65-47
P. O. Box 3707
Seattle, Washington 98124

A free information packet about the Boeing Company may be requested. Included in the packet are color posters of fifteen different airplanes manufactured by Boeing.

CESSNA AIRCRAFT COMPANY

Russ Watson
Air Age Education Department
P. O. Box 1521
Wichita, Kansas 67201

Valuable demonstration aids, posters, and booklets are available for the educator. These include:

- An airport packet with airport diagram poster and discussion guide,
- A plastic model airplane with movable control surfaces,
- An International Air Age Education Packet which includes six posters and a teacher's guide, and
- A cloud chart, 20" X 25", which describes weather.

An order form for complete listing of educational materials may be requested.

CIVIL AIR PATROL

Aerospace Education
HQ CAP/EDF
Maxwell AFB, Alabama 36112-5572
(205) 293-5371

Free materials, such as activity booklets, coloring books, posters, single-concept learning packets, teacher reference books and more, are available for the educator. An order form may be requested on school letterhead stationery.

FEDERAL AVIATION ADMINISTRATION

Jack K. Barker
Southern Region, Public Affairs
P. O. Box 20636
Atlanta, Georgia 30320
(404) 763-7201

Materials free to educators include activities for students and informative teaching aids, such as:

- Aviation Science Activities for Elementary Grades
- A Trip to the Airport
- Teacher's Guide for Aviation Education
- Demonstration Aids for Aviation Education
- FAA Film Catalog

A complete list of available materials may be requested.

FEDERAL EXPRESS CORPORATION

Box 727
Memphis, TN 38194
1-800-238-5355

Free styrofoam jets are available for students to assemble. Item code DC-10 should be used when requesting the jets.

GENERAL AVIATION MANUFACTURERS ASSOCIATION

Suite 801
1400 K Street, N. W.
Washington, D.C. 20005

Material such as Activities and Resources to Use in General Aviation Teaching Units are free upon request. A complete Aviation Education Publication list may be requested.

JEROME ENTERPRISES, INC.

6500 North West 15th Avenue
Fort Lauderdale, Florida 33309

Cassette tapes that stimulate the students' imagination are available. A complete list of Little Thinker tapes, such as "Ways to Travel: Balloon Trip," may be requested.

MARTIN MARIETTA

Michoud Aerospace
Public Relations Department
P.O. Box 29304
New Orleans, Louisiana 70189

Materials such as A Teacher's Companion To The Space Station contain activities geared to the elementary student. A complete list of available education materials may be requested.

FEDERAL EXPRESS CORPORATION

Box 727
Memphis, TN 38194
1-800-238-5355

Free styrofoam jets are available for students to assemble. Item code DC-10 should be used when requesting the jets.

MCDONNELL DOUGLAS

P. O. Box 516
Saint Louis, MO 63166-0516

Materials such as What We Do and colorful airplane posters are free upon request.

MIDWEST PRODUCTS COMPANY, INC.

P. O. Box 564
Hobart, Indiana 46342

Models such as the Star Glider are available for building by students in grades one and up. An order form for the Star Glider and more may be requested.

NATIONAL AERONAUTICS AND SPACE ADMINISTRATION

Educational Publications Services, LEP
Washington, D. C. 20546

Elementary classroom activities, charts, posters and more are available. Placement on the NASA educator mailing list may be requested.

NATIONAL AIR AND SPACE MUSEUM

Smithsonian Institution
Washington, D. C. 20560

The educational materials list for grades kindergarten-three may be requested.

NINETY - NINES

P. O. 59965
Oklahoma City, Oklahoma 73519

A list of educational materials for elementary students may be requested.

SIKORSKY AIRCRAFT

Public Relations
North Main Street
Stratford, Connecticut 06601

Free materials available include a biography of Igor Sikorsky, a "What Makes a Helicopter Fly" pamphlet, and colorful helicopter posters.

WOMEN OF NATIONAL AGRICULTURAL AVIATION ASSOCIATION

Ester Pickle
P.O. Box 461
Cimarron, Kansas 67835

Coloring books, such as "Ag Aviation" and "Farmer John", are excellent for teaching kindergarten and first grade students the importance of aviation to our food supply. Order form may be requested.

Aviation Education Representatives

FAA Headquarters

Phillip S. Woodruff, APA-100
Director of Aviation Education
Headquarters Aviation
Education Staff
Mary Jo Byberg
Josie M. Clark
Latisha Ferguson
Carolyn Clark
800 Independence Avenue, SW
Office of Public Affairs
Aviation Education Program
Washington, DC 20591
(202) 267-3471

Aeronautical Center

Robert Hoppers, AAC-5
Room 356, Headquarters Bldg.
PO Box 25082
Oklahoma City, OK 73125
(405) 680-7500

Technical Center

Michele Pareene, ACM-100
Atlantic City International Airport
Human Resource
Management Division
Atlantic City, NJ 08405
(609) 484-6032

Alaskan Region

Mary Lou Wojtalik, AAL-5B
222 West 7th Avenue, Box 14
Anchorage, AK 99513-7587
(907) 271-5293
STATE: Alaska

Central Region

Patrice Shalda, ACE-5
601 East 12th Street
Federal Building, Room 1501
Kansas City, MO 64106
(816) 426-5449
STATES: Iowa, Kansas, Missouri,
and Nebraska

Eastern Region

Charles Pagnini, AEA-15C
JFK International Airport
Federal Building
Jamaica, NY 11430
(718)553-1056
STATES: Delaware,
District of Columbia, Maryland,
New Jersey, New York,
Pennsylvania, Virginia, and
West Virginia

Great Lakes Region

Lee Carlson, AGL-5A
O'Hare Lake Office Center
2300 East Devon Avenue
Des Plaines, IL 60018
(312) 694-7042
STATES: Illinois, Indiana,
Michigan, Minnesota,
North Dakota, Ohio, South Dakota,
and Wisconsin

New England

Shelia Bauer, ANE-8
12 New England Executive Park
Burlington, MA 01803
(617) 273-7064
STATES: Connecticut, Maine,
New Hampshire, Rhode Island,
Vermont, and Massachusetts

Northwest Mountain Region

Shelly McGillivray, ANM-5E
1601 Lind Avenue, SW
Renton, WA 98055
(206) 227-2804
STATES: Colorado, Idaho,
Montana, Oregon, Utah,
Washington, and Wyoming

Southern Region

Mary Ann Cassano, ASO-5
PO Box 20636
Atlanta, GA 30320
(404) 763-7201
STATES: Alabama, Florida,
Georgia, Kentucky, Mississippi,
North Carolina, South Carolina,
Tennessee, Puerto Rico, and
the Virgin Islands

Southwest Region

Debra Myers, ASW-5
4400 Blue Mound Road
Ft. Worth, TX 76193-0005
(817) 624-5804
STATES: Arkansas, Louisiana,
New Mexico, Oklahoma, and Texas

Western-Pacific Region

Hank Verbais, AWP-5
PO Box 92007
Worldway Postal Center
Los Angeles, CA 90009
(310) 297-1431
STATES: Arizona, California,
Nevada, and Hawaii

Aviation Education Resource Centers

Alabama

Alabama Aviation
Technical College
Ms. Megan Johnson, Director
Learning Resource Center
PO Box 1209
Ozark, AL 36361
(205) 774-5113

University of North Alabama
Ms. Michele R. Walker
Programming Coordinator
UNA Box 5145
Florence, AL 35632-0001
(205) 760-4623

University Aviation Association
Mr. Gary W. Kiteley
Executive Director
3410 Skyway Drive
Opelika, AL 36801
(205) 844-2434

Alaska

University of Alaska Fairbanks
Mr. Dennis Stephens
Collection Development Officer
Elmer E. Rasmuson Library
Fairbanks, AK 99775-1006
(907) 474-6695

Alaska Pacific University
Dr. Rusty Myers, Project Director
4101 University
Anchorage, AK 99508
(907) 564-8207

University of Alaska Anchorage
Ms. Barbara Sokolov
Library Director
3211 Providence Drive
Anchorage, AK 99508
(907) 786-1825

Arizona

Embry-Riddle Aeronautical
University
Ms. Karen Hudson
Educational Programs Coordinator
3200 N. Willow Creek Road
Prescott, AZ 86301
(602) 771-6673

South Mountain High School
Mr. Lew Davis, Prgm. Manager
Center for Aerospace Education
5401 S. 7th Street
Phoenix, AZ 85040
(602) 271-3439

California

National University
Mr. Ernest Wendt, Chairman
Department of Applied Sciences
4141 Camino Del Rio South
San Diego, CA 92108
(619) 563-7122

San Jose State University
Dr. H. Gene Little, Chairman
Department of Aviation
1 Washington Square
San Jose, CA 95192-0081
(408) 924-6580

Museum of Flying
Mr. Harvey Ferer
2772 Donald Douglas Loop N.
Santa Monica, CA 90405
(310) 392-8822

San Bernardino County
Superintendent of Schools
Ms. Nancy Harlan, Coordinator
Instructional Services Division
601 North E. Street
San Bernardino, CA 92410-3093
(714) 387-3152

Colorado

U.S. Space Foundation
Dr. Jerry Brown, Ed. Director
1525 Vapor Trail
Colorado Springs, CO 80916
(719) 550-1000

Metropolitan State
College of Denver
Mr. Jonathan R. Burke
Assistant Professor
Aerospace Science Department
Campus Box 30, P.O. Box 173362
Denver, CO 80217-3362
(303) 556-2923

Connecticut

Connecticut DOT
Bureau of Aviation and Ports
Ms. Andre J. Libert
Director of Marketing for Aviation
24 Wolcott Hill Road
PO Drawer A
Wethersfield, CT 06129
(203) 566-4417

Delaware

Delaware Teachers Center
Ms. Stephanie Wright
Claymont Education Campus
3401 Green Street
Claymont, DE 19703
(302) 798-3806

Florida

Embry-Riddle Aeronautical
University
Ms. Patricia Fleener-Ryan
AvEd Teacher
Resource Center
Daytona Beach, FL 32114
(904) 226-6499

Florida Institute of Technology
Dr. Ballard M. Barker, Head
Department of Aviation Studies
The School of Aeronautics
150 West University Boulevard
Melbourne, FL 32901-6988
(407) 768-8000 ext. 8120

Florida Memorial College
Mr. Anthony J. Sharp, Director
Division of Airway Science
15800 Northwest 42 Avenue
Miami, FL 33054
(305) 623-1440

Georgia

Conyers Middle School
Ms. Viki Dennard, Asst. Principal
335 Sigman Road
Conyers, GA 30207-3699
(404) 483-3371

Hawaii

Mid-Pacific Institute
Dr. Phillip R. Brieske
Aviation/Space Science
2445 Kaala Street
Honolulu, HI 96822
(808) 973-5000

Idaho

Idaho State Bureau of Aeronautics
Mr. John Maakestad
Safety/Information Officer
Chief Pilot
3483 Rickenbacker Street
Boise, Idaho 83705-5018
(208) 334-8775

Illinois

Parks College of
St. Louis University
Dr. Peggy Baty
Associate Vice Pres. and Dean
500 Falling Springs Road
Cahokia, IL 62206
(618) 337-7500

Southern Illinois University
Dr. Elaine Vitello
College of Technical Careers
Room 222
Carbondale, IL 62901
(618) 453-8821

State of Illinois
Division of Aeronautics
Mr. Richard M. Ware
One Langhorne Bond Drive
Capital Airport
Springfield, IL 62707-8415
(217) 785-8516

Kansas

Kansas State University-Salina
Ms. Karlene Propst
Tullis Library
2408 Scanlan Avenue
Salina, KS 67401
(913) 825-0275

Louisiana

Louisiana State University
Dr. Marlon Abbas, Director
Transportation Systems Group
Louisiana Trans. Resource Cntr.
4101 Gourrier Avenue
Baton Rouge, LA 70808
(504)767-9127

Northeast Louisiana University
Mr. William T. Hemphill, Head
Department of Aviation
700 University Ave.
Monroe, LA 71209-0590
(318) 342-1780

Maine

Kennebec Valley Technical
College
Ms. Sue Doner
92 Western Avenue
Fairfield, ME 04937-0020
(207) 453-9762

Biddeford School Department
Ms. Sara Jane Poli
Maplewood Avenue
Biddeford, ME 04005
(207) 282-8280

Penobscot Nation Tribal Admin.
Mr. Mark Sanborn, Asst. Director
Vocational Training and Ed.
6 River Road, Community Bldg.
Indian Island, ME 04468
(207) 827-7776

Northern Maine Technical Center
Mr. Timothy D. Crowley
Dean of Students
33 Edgemont Drive
Presque Isle, ME 04769
(207) 769-2461

Massachusetts

Bridgewater State College
Mr. Bill Annesley
Management Science & Aviation
Science Department
Bridgewater, MA 02325
(508) 697-1395

North Shore Community College
Dr. Robert Finklestein
One Ferncroft Road
Danvers, MA 01923
(508) 762-4000 ext. 6296

Museum of Science
Ms. Carolyn Kirdahy
Lyman Library
Science Park
Boston, MA 02114-1099
(617) 589-0266

Westfield State College
Ms. Maureen McCartney
Director of Career Services
Ely Campus Center
Western Avenue
Westfield, MA 01086
(413) 568-3311 ext. 206

Massachusetts Aeronautics
Commission
Dr. Toby Penstlen
Transportation Library
10 Park Plaza
Boston, MA 02116-3966
(617) 973-8000

Michigan

Oakland University
Ms. Karen Conrad, Interim Dir.
Aviation & Space Center
216 O'Dowd Hall
Room 216
Rochester, MI 48309-4401
(313) 370-2485

Project STARS
Ms. Barbara Koscak
Box 450082, Building 814
Selfridge ANG Base, MI 48045
(313) 466-4884

Minnesota

Minnesota DOT
Office of Aeronautics
Mr. Gordon Hoff, Director
Aviation Education Relations
644 Bayfield Street
St. Paul, MN 55107-1008
(612) 297-7652

Vermilion Community College
Mr. Julius Salinas, Aviation Dir.
1900 E. Camp Street
Ely, MN 55731
(218) 365-7200

Mississippi

Jackson State University
Dr. Harry A. Cooley, Director
Airway Science Program
1400 Lynch Street
Jackson, MS 39217
(601) 968-2471

Montana

Montana DOT Aeronautics Div.
Mr. Michael D. Ferguson
P.O. Box 5178
Helena, MT 59601
(406) 444-2506

Nebraska

University of Nebraska
Mr. William S. Shea, Director
Aviation Institute
60th and Dodge
Omaha, NE 68182-0508
(402) 554-3424

Nebraska Dept. of Aeronautics
Mr. Val J. Hruska, Aviat. Specialist
P. O. Box 82088
Lincoln, NE 68501-2088
(402) 471-2371

New Hampshire

New Hampshire DOT
Division of Aeronautics
Mr. Ronald Wanner
65 Airport Road
Concord Municipal Airport
Concord, NH 03301-5298
(603) 271-2551

Daniel Webster College
Ms. Hanna McCarthy, President
20 University Drive
Nashua, NH 03063-1699
(603) 883-3556

New Mexico

University of New Mexico
Mr. Richard S. Sanchez
Director of NAA/FAA Teacher
Resource Center
Division of Continued Education
Albuquerque, NM 87131-4006
(505) 277-3861

New Mexico State University
Ms. Judy McShannon
Education Administrator
P.O. Box 30001, Dept. SG
Las Cruces, NM 88003-0001
(505) 646-6414

New Jersey

Northeast Curriculum
Coordination Center
Dr. Martha Pocs
Division of Vocational Education
Crest Way
Aberdeen, NJ 07747
(908) 290-1900

New York

Dowling College
Dr. Albert E. Donor
Provost, Executive Vice President
Oakdale Long Island, NY 11769
(516) 244-3200

North Dakota

University of North Dakota
Mr. Charles L. Robertson
Assistant Professor
Department of Aviation
Box 8216, University Station
Grand Forks, ND 58202-8216
(701) 777-2791

Ohio

Bowling Green State University
Mr. Stephen M. Quilty, A.A.E.
Assistant Professor
Aerotechnology Program,
Technology Annex
Bowling Green, OH 43403-0307
(419) 372-8926

Oklahoma

University of Oklahoma
Dr. Lee Morris, Director
Education & Aviation/Aerospace
1700 Asp Avenue
Norman, OK 73037-0001
(405) 325-1964

Rhode Island

Warwick Public Schools
Mr. Anthony Gagliardi
Warwick Career & Tech School
575 Centerville Road
Warwick, RI 02886
(401) 737-3300

Tennessee

Middle Tennessee State Univ.
Dr. Wallace R. Maples, Chairman
Aerospace Department
East Main Street
P.O. Box 67 MTSU
Murfreesboro, TN 37132
(615) 898-2788

Texas

Texas Southern University
Dr. I. Richmond Nettey, Director
Airway Science Prgm.
3100 Cleburn Avenue
Houston, TX 77004
(713) 639-1847

University of Texas at El Paso
Dr. James Milson, Chairman
College of Education
El Paso, TX 79968-0574
(915) 747-5426

Texas State Technical College
Mr. Ray Sancton
Campus Library
Aerospace Technologies
3801 Campus Drive
Waco, TX 76705
(817) 867-4838

Palo Alto College
Mr. Bruce Hoover
Aviation Department
1400 West Villaret
San Antonio, TX 78224
(512) 921-5000

Vermont

St. Johnsbury Academy
Mr. John Barney, Vocational Dir.
St. Johnsbury, VT 05816
(802) 748-8171

Virginia

Virginia Aviation Museum
Ms. Betty P. Wilson
5701 Huntsman Road
Sandston, VA 23150-1946
(804) 786-1364

Washington

Museum of Flight
Mr. Gregory Moyce
Education Program Manager
9404 East Marginal Way South
Seattle, WA 98108
(206) 764-5700

West Virginia

Salem-Teikyo University
Dr. Ronald Ohl, President
223 West Main Street
Salem, WV 26426
(304) 782-5234

Wisconsin

Experimental Aircraft Association
Mr. Chuck Larsen
EAA Aviation Center
3000 Poberezny Road
Oshkosh, WI 54903-3065
(414) 426-4800

Department of Transportation
Bureau of Aeronautics
Mr. Duane Esse
4802 Sheboygan Avenue
P.O. Box 7914
Madison, WI 53707-7914
(608) 266-3351

University of Wisconsin-Superior
Mr. Michael J. Wallschlaeger
Chairman
Division of Education
1800 Grand Avenue
Superior, WI 54880-2898
(715) 394-8309