

DOCUMENT RESUME

ED 362 419

SE 053 929

TITLE Investigating Your Environment--Intermountain Region.

INSTITUTION Forest Service (DOA), Washington, D.C.

PUB DATE [93]

NOTE 627p.

AVAILABLE FROM Forest Service, Intermountain Region, 324 25th Street, Ogden, UT 84401-2310.

PUB TYPE Guides - Classroom Use - Teaching Guides (For Teacher) (052)

EDRS PRICE MF03/PC26 Plus Postage.

DESCRIPTORS Class Activities; *Discovery Learning; *Environmental Education; Forestry; Geology; *Integrated Activities; *Investigations; *Learning Activities; Measurement; Natural Resources; Plants (Botany); Secondary Education; Simulation; Soil Conservation; Urban Areas; Water Quality: Water Resources; Wildlife

IDENTIFIERS Deserts; *Environmental Issues; Ponds; Wilderness

ABSTRACT

This resource notebook contains over 100 activities in which students investigate different aspects of the environment. The activities are presented in 21 sections covering the following environmental topics and issues: (1) soil; (2) water; (3) forests; (4) plant relationships; (5) wildlife; (6) measurement; (7) urban communities; (8) deserts; (9) dunes; (10) ponds; (11) rangelands; (12) riparian zones; (13) wilderness areas; (14) planning an environmental study area; (15) investigating an environmental issue; (16) land use simulations; (17) school yard activities; (18) natural resources in an urban environment; (19) developing environmental investigations; (20) interpreting your environment; and (21) geological history. Each section contains an introduction to the topic, a list of the activities, approximate time required for each activity, suggestions on how to coordinate the activities, suggestions for relating the activities to different curriculum areas, and procedures for doing the activity. Reproducible worksheets accompany many of the activities. (MDH)

 * Reproductions supplied by EDRS are the best that can be made *
 * from the original document. *

ED 362 419

Soil

JE 053929



U.S. DEPARTMENT OF EDUCATION
Office of Educational Research and Improvement
EDUCATIONAL RESOURCES INFORMATION
CENTER (ERIC)

- This document has been reproduced as received from the person or organization originating it.
- Minor changes have been made to improve reproduction quality.

• Points of view or opinions stated in this document do not necessarily represent official OERI position or policy.

BEST COPY AVAILABLE



INTRODUCTION

Soil is the skin of planet Earth -- its natural covering formed by the forces of nature acting upon native rocks and vegetation throughout the ages. All life is dependent upon the productivity of soil either directly or indirectly. Therefore, it is important we understand the capabilities and limitations of this resource -- soil.

THE ACTIVITIES

TIME REQUIRED

What Do You Already Know About Soil?	30 to 45 minutes
What's This "Duff" on the Forest Floor?	20 to 30 minutes
"Dirt" Data	45 minutes
Analyze the Duff Data	30 to 45 minutes
Slope -- it's the Aspect	20 minutes
Soil Savvy	45 minutes



COMBINING THE ACTIVITIES

The activities in this unit are displayed singly. Depending upon the time available and the skill of the participants, you may choose to do only one activity or the entire series. For maximum learning, the activities should be experienced in the order listed in the unit, however, other suggestions are:

Suggestion 1:

Title: Soil, A Basic Part of Our Environment/What's This Duff?/Dirt Data/ Slope

Introduction: Soil is a part of our natural environment that includes rocks, plants, water, wildlife and other natural resources. Their effect is shown by the number and kinds of horizons (layers) that develop in soils. Each horizon has its own characteristics which determine a soil's suitability for a use and thus, its related management problems.

Activity: What's This Duff...?

Transition Statement: We've looked at the surface to discover what makes up soil. Now, let's look deeper.

Activity: Dirt Data

Transition Statement: Another important factor when looking at soil is the slope of the land. In the next few minutes we are going to examine slope and experiment with an easy method of determining slope.

Activity: Slope

Transition Statement: We've collected and analyzed a number of data about soil and slope. Now, let's apply this information by determining possible land uses for an area.

Suggestion 2:

Title: What Do You Already Know About Soil/with any other activity

Introduction: People already "know" quite a lot about soil. This activity helps them search memories and recall experiences that lead to learning even more.

Activity: What Do You Already Know

Transition: Now that you have been thinking about soil, let's examine a concept in depth.

CURRICULUM RELATIONSHIPS

Social Studies

1. Read about early farmers or settlers who homesteaded your state. What resources brought them? Where were the first fruit orchards planted? When?
2. How are soils influenced by the environment in your area? How do mountain ranges affect soil formation in valleys? How are climate, forests and weather affected by mountain ranges in your state?



3. Use a map to locate agricultural areas in your state. Discuss questions such as: do crops have different soil requirements, how did soils form in different geographic regions, how are local economics tied to soil types?
4. Find out if soils played an important part in politics. Did homestead acts, railroad, wagon road and school land grants help develop our nation? How?
5. Look at soil, climate and agricultural maps of the world. Draw comparisons.
6. Research soil topics such as development of the soil survey system, how pH tests and minerals tests were developed. Share your findings in a form appropriate to class activities.
7. Research and share knowledge about land management and conservation practices people use to increase productivity of land and/or wisely use soil resources.
8. What is happening to world soil resources? How are they being used or abused? What is being done to improve soil? Where are these projects taking place? Share your research appropriately.
9. Find out about the geology of your area. What forces shaped the land? What geologic forces are still at work? What forces may work in the future?
10. Construct a geologic landform map of your state and label the major areas by the processes which formed them.
11. Discuss how the landscape in which people settled and built affected their social lives and mobility.
12. How is land classified? What percentage of your state's agricultural income comes from each classification? What classification produces the highest percentage, the lowest? Summarize and graph your findings.

Science

1. Study the processes that produce soil.
2. Play the "Web of Life" game including soil as a component. This game begins with a ball of yarn. It is held by the "sun" who names an organism it affects and throws it to that organism. That organism names another upon which it depends or affects and throws the yarn ball to it. Each organism hold on to the string, so that after 10 to 20 relationships, the "web" is apparent to all.
3. Study the relationship of soil and water including such components as pH and suspension.
4. Observe and record plant growth in different environments, i.e. sun, shade, slope, elevation.
5. Measure the pH reaction in soils around your school, home and community. Chart your observations and infer why the reaction is what it is.
6. Experiment with water and soil to measure which has the greater force.
7. Different rock types weather at different rates, thereby forming hills, valleys and other interesting formations. Design an experiment(s) to show these processes.



Mathematics

1. Use a balance scale to weigh samples of different soil types.
2. Determine the ratio of topsoil thickness to the subsoil and parent material thickness in several soils. Graph your findings. Extend knowledge to relationship of soil depths to plant life growing in the different soils.
3. Measure and calculate the amount of soil erosion in a given area.
4. Determine the amount of water in a given amount of soil. Fill a coffee can with soil and weigh. (Know the Weight of the can first). Dry the soil in an oven. Weigh the soil after drying. What percentage of the first weight was water? What is the use of water in the soil?

Language Arts

1. Research and write about different aspects of soil formation.
2. Write a creative essay about how a rock becomes a grain of sand, or —choose your own topic after soil study.
3. Using any poetry form, students write poetry about any soil subject.
4. Write and illustrate a story about the formation of soil or any other soil subject for a primary classroom. Use the whole-language approach.
5. Write explicit directions for someone else on how to ascertain pH of a soil sample, or conduct any other kind of soil test.

Creative Arts

1. Sketch and label the soil profile of a road cut.
2. Using any materials, create a mosaic of a soil profile.
3. Construct models of a particular landscape.
4. Sketch landscape scenes showing improper use and/or management of land. Then, sketch the same scenes showing proper use and management.
5. Complete a "blind contour drawing" of a rocky landscape. Consult the art teacher if you do not know what a blind contour drawing is.
6. Construct a mobile or time line of the geologic history of your area.



WHAT DO YOU ALREADY KNOW ABOUT SOIL?

CONCEPT	Interaction, System, Theory, Organism
PRINCIPLE	Soil is basic to the environment and human life upon the earth. It is, however, often taken for granted and mis-used. People think of soil as "dirt" and do not recognize that many of their needs rely on soil.
OBJECTIVE	<ul style="list-style-type: none">• The student will be able to recall and share in groups previous experiences, values and knowledge about soil and its parts.• The student will cooperatively work in small groups to answer questions based upon previous knowledge and group values and to discover what they know or need to learn more about.
PREPARATION	The teacher may want to assign one or two of these activity parts as an actual lesson. The resource person may want to ask the teacher to assign all or part of this as home work prior to his/her classroom presentation. S/he should complete the discussion with the students to ascertain what the class knows.
MATERIALS NEEDED	<ul style="list-style-type: none">• Markers• Butcher paper or easel pads
PROCESSES USED	<ul style="list-style-type: none">• Observe• Infer• Hypothesize• Communicate
TIME	30 to 45 minutes



DOING THE ACTIVITY — (indoors or outdoors)

There are five options to meeting the stated objectives. The teacher and/or facilitator should choose the option most relevant to the group. Or, you may want to approach the lesson from more than one viewpoint, so you could use more than one approach. Use cooperative learning as any teaching strategy normally employed in your classroom.

Option 1: A. Set stage:

“Soil, upon which human life depends, is basic to the environment. Most of us have had some experience with soil and probably know more than we think we know.”

B. Procedure:

- (1) “Let’s find out what we already know.” Close your eyes and think or image: What’s our favorite use of soil?”, “if you could lie on your favorite beach, what would that beach look like?” What does soil look like, feel like or smell like?” If you needed to buy a truckload of soil, what would you use it for?”
- (2) Students then write their thoughts and rememberings down on paper. Students may share with another if you want them to.

C. Retrieve Data:

Ask students to share their ideas. Record answers, accept all answers, no order necessary. Total time - about 20 minutes.

Option 2: A. Set Stage:

Soil is being formed continuously. How much do we already know about how soil is formed?”

B. Procedure:

In small groups, brainstorm about “how soil is formed, and about the processes involved in soil formation.” This should be about 10 minutes.

C. Retrieve Data:

Groups share charts while facilitator makes a master chart for the entire class. Discussion will probably center around clarification of answers.



Option 3: A. Set Stage:

“What is soil anyway? Let’s see if we can develop a definition.

B. Procedure:

- (1) In small groups, come to as complete a definition of soil as possible. Write the definition large enough to be seen by the rest of the class. About 15 minutes.

NOTE TO TEACHERS: Textbook definitions:

Soil: weathered rock or parent material usually mixed with organic material and contains water, air and living organisms.

Organism: a name for a living thing. Plant or animal.

Organic Material: matter which has been related to life as life processes and is subject to decay by bacteria.

C. Retrieve Data:

- (1) Display all definitions for class to see.
- (2) Come up with one class definition. If you can’t, you may be able to do so after this unit.

Option 4: A. Set Stage:

“Soil has many uses. What uses can you think of?”

B. Procedure:

1. Individuals have two minutes to write down all the uses they can think of for soil and/or land.
2. They then have two minutes to check with a partner and add newly thought of uses.
3. Two students volunteer to act as recorders.

C. Retrieve Data:

1. Students alternately record comments working on separate easels as chalkboards. Then discuss.



Option 5 (Use this option if you want to transition to land use or land issue studies.)

A. Set Stage:

“Soil is not all the same. It has different characteristics. Let’s explore some of the ways soils may be different from each other.”

B. Procedure:

1. List at least three soil characteristics that effect how land can be used and the expand upon how each characteristic can affect land use.
2. Do this with a partner in about 10 minutes.

C. Retrieve Data:

1. Record answers on a flipchart or chalkboard.
2. Combine like answers and group.
3. Make a master chart of class responses.

CLOSURE

Use your favorite closure activity combined with the transition you want. This depends upon the option you selected.



WHAT'S THIS "DUFF ON THE FOREST FLOOR?"

- CONCEPT** System, Fundamental Entities
- PRINCIPLE** Learners involved in this activity will examine part of a forest floor and through guided discovery, come to an understanding of what materials make up a forest floor.
- OBJECTIVE**
- The student will be able to identify some of the materials on the forest floor which compose soil.
- PREPARATION** Locate an area of forest floor big enough for your class. Try the activity to make sure you can find all the components you'll be investigating.
- MATERIALS NEEDED**
- Activity Sheet A: Look at the Forest
 - Pencils
 - Clip board/student group
- PROCESSES USED**
- Observe
 - Infer
 - Question
 - Define
 - Operationally classify
- TIME** 20 to 30 minutes



DOING THE ACTIVITY (Outdoors or indoors)

A. Set Stage:

"To help us learn more about how soil is formed, we will take a closer look at what materials are becoming soil by examining the forest floor.

B. Procedure:

1. Think back to the last time you walked through a forest. Write down some of the things you saw on the forest floor. What did you expect to see? Record on Activity Sheet A, #1.

ACTIVITY A: Look at the Forest!

20 min.
grades

1. Predict what you will find in the top few inches of the area to be studied. List your predictions:

2. Select an area about 2 or 3 feet square on the ground and sift through the top 3 inches, recording the evidence of plants and animals you observe. Replace the ground in as near original condition as possible.

Name or Description of Item in the Soil	Quantity	Possible Effect on Soil

3. The terms: litter, duff, humus, are used to describe organic matter at the top of the soil. From your study above, complete the following chart:

Term and definition	Describe the characteristics, e.g., feel, smell, color	List the identifiable parts of plants and animals you found
Litter (identifiable dead things on surface)		
Duff (partially decomposed organic matter--compacted)		
Humus (almost completely decomposed non-identifiable organic matter)		

Investigating Your Environment
Soil 



Investigating Your Environment
Soil

2. Discuss answers to questions in #1.
3. Facilitator records answers for all to see.
4. Now, take class to the site for this activity.
5. Ask student pairs to find a site about two feet square to investigate.
6. Students have 15 minutes to complete Activity Sheet A, #2 and #3.

C. Retrieve Data:

Conduct a group discussion asking such questions as:

1. What did you find?
2. In which materials did you find the most animals or evidence? The Least? What about plants? What might account for the difference?
3. Under what conditions would you expect to find a different numbers or kinds of animal or plant?
4. What are some ways in which these components affect the soil?
5. What senses did you use to examine your area? What did you notice?

CLOSURE

Based upon your observations take 5 minutes to describe soil and identify ways it can be formed.

TRANSITION

Many times we use terms but can't visualize what they are. Now, when someone talks about humus, you should be able to remember not only what it is but how it feels, smells and looks. Let's use the knowledge gained from through our observations as we learn more about soil.



COLLECT SOIL DATA

CONCEPT

Order, Fundamental Entities, Interaction

PRINCIPLE

Learners have examined the top horizon of soil and discovered that it is made up of different things. In this activity, they have the opportunity to examine a soil profile and explore the composition of deeper soil layers and how they are relate to each other.

OBJECTIVE

- The student will be able to determine how many horizons make up a specific soil profile.
- The student will be able to discuss soil characteristics of the different horizons and apply that knowledge to specific examples.

PREPARATION

The leader will need to locate and clean off a soil pit, cut bank or exposed stream bank with at least three major horizons. Print the soil micromonolith on card stock.

MATERIALS NEEDED

- Jelly cups and lids
- Can of water
- Stapler and staples
- Two cans of spray
- Activity Sheet B: Analyzing Soil Horizons (print on heavy card stock and Activity B: Soil Horizons Data
- Spray bottles
- Cans of loam and clay
- Measuring device
- Thermometer
- Pencils
- pH kits
- Hand lenses
- Coffee grounds
- Rotten log pieces

PROCESSES USED

- Classify
- Measure
- Use numbers
- Observe
- Communicate
- Interpret data

TIME

45 minutes



DOING THE ACTIVITY — (outdoors)

A. Set Stage

"The properties or characteristics of a soil layer (also known as horizons) will tell what uses can be made of the land. In the previous activity we examined the top of the soil; in this activity we will examine a cross-section or profile of soil layers."

B. Procedure

1. Begin with a discussion: "What things do you notice as you look at this soil profile?", "what are some things it might be important to know about soil in order to determine its use?"
2. Extend the questioning to bring forth as much data as possible.
3. End the discussion by saying, "Because various soil characteristics such as color, texture, structure, temperature and pH affect the ways land can be used, knowing these conditions is essential to land use planning.

We are going to collect, record and analyze some information about these soil characteristics.

4. Hand each student Activity Sheet B. Tell the class that they will complete the activity by collecting the information needed. Show equipment to use as needed.

ACTIVITY B: Soil Horizons Data 85 min. continued

ACTIVITY B: Analyzing Soil Horizons Individuals

Use the "Soil Horizons Data Sheet" and the available equipment to record your observations below. Make a micrograph using the materials provided.

Sketch your soil profile, label the layers or horizons, and record the data.

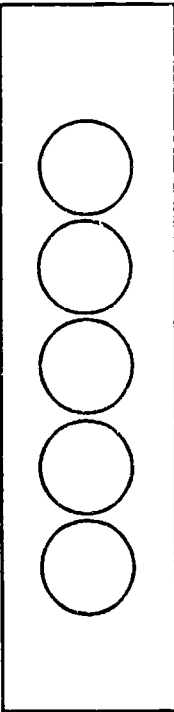
PROFILE SKETCH	DATA	OBSERVATIONS
	<p>Air temperature _____ 3' above surface _____ just above surface _____</p> <p>Contents of layers above top soil (if existing):</p> <p>Litter _____</p> <p>Duff _____</p> <p>Humus _____</p> <p>Total depth of layer above top soil _____</p> <p>Horizon _____</p> <p>Depth _____ Color _____</p> <p>Texture _____ Structure _____</p> <p>Temperature _____ pH _____</p> <p>Plant roots visible _____</p> <p>Horizon _____</p> <p>Depth _____ Color _____</p> <p>Texture _____ Structure _____</p> <p>Temperature _____ pH _____</p> <p>Plant roots visible _____</p> <p>Horizon _____</p> <p>Depth _____ Color _____</p> <p>Texture _____ Structure _____</p> <p>Temperature _____ pH _____</p> <p>Plant roots visible _____</p> <p>Horizon _____</p> <p>Depth _____ Color _____</p> <p>Texture _____ Structure _____</p> <p>Temperature _____ pH _____</p> <p>Plant roots visible _____</p> <p>Horizon _____</p> <p>Depth _____ Color _____</p> <p>Texture _____ Structure _____</p> <p>Temperature _____ pH _____</p> <p>Plant roots visible _____</p> <p>Parent Material (C Horizon)</p> <p>Describe type of rock in the bedrock (if present)</p>	<p>parts or horizons; you may find more</p> <p>I got a mass</p> <p>light. Soil on</p> <p>--- sandy</p> <p>--- heavy</p> <p>--- sticky</p> <p>1 cm of these</p> <p>in the soil.</p> <p>Just fast enough pH soil sample with pH</p> <p>small amount of a</p> <p>ty of the soil.</p> <p>is for plants.</p> <p>lar. High levels of water.</p> <p>no organic</p> <p>colored—more</p> <p>more than</p> <p>only mass from a few roots.</p>



Investigating Your Environment
Soil

5. Go over the information on the Soil Horizons Data Sheet. Model how to collect soil data characteristics, but let participants do most of the observations.
6. Use cans of loam, sand and clay to demonstrate texture. Then participants have a comparison for textures. Soil must be moistened to get true colors and texture, so spray often with a water bottle.
7. Demonstrate how to use the pH kits on coffee grounds or parts of a rotten log.
8. If the group is constructing a micromonolith, show them a model. Alternative instructions are part of this lesson.
9. Give the students 30 minutes to gather the data and construct the micromonolith. They should complete an individual activity sheet but they should work in groups of 4 in a pit and help each other.
10. Make sure each group determines the number of horizons in their pit or on their cut bank.

C. Retrieve Data

1. Discuss briefly the data recorded on the activity sheet, Possible discussion questions are:
 - (a) What did you find?
 - (b) How did you describe The A horizon? B Horizon?
 - (c) What evidence did you find that the parent material was becoming part of the soil? What evidence did you find about the material on the forest floor becoming soil?
 - (d) How might we define soil now that we have added some information?

CLOSURE

Look at your data or micromonolith card and share what you have learned so far about soil.

TRANSITION

In the next activity, we will use the information gathered in this activity to complete an analysis of your findings.



ANALYZE SOIL

CONCEPT Cause and Effect, Change, Order

PRINCIPLE This activity is a discussion and group analysis of the soil data collected in the previous activity.

OBJECTIVES

- The student will be able to determine possible land uses by analyzing soil characteristics.
- The student will be able to use data collected, and combined with observations and prior knowledge, make basic assumptions about potential land use.
- The student will be able to define soil in their own words.

PREPARATION Information gathered in "Soil Data"

**MATERIALS
NEEDED**

- Activity Sheet C: Analyzing Soil Data
- Information gathered in Activity C: Analyzing Soil Data and Soil Data Tables
- Pencils
- Local plant identification books

**PROCESSES
USED**

- Communicate
- Use numbers
- Infer
- Classify
- Observe
- Interpret data

TIME 30 to 45 minutes

DOING THE ACTIVITY (indoors, outdoors)

A. Set Stage:

"Soil properties have a lot to do with the land's potential to be safely used for different purposes. We will use the data you gathered in the soil pit to further our understanding of soil."

B. Procedure:

1. Hand out Activity Sheet C and accompanying Soil Data Table needed to complete the assignment.

ACTIVITY C: Soil Data Tables

1. RELATIONSHIPS OF SOIL DEPTH TO PLANT GROWTH AND WATER STORAGE

Soil Depth*	Water Storage
Deep Soil (near 40")	Excellent water storage and plant growth
Med. Deep Soil (20" - 40")	Good water storage and plant growth
Shallow Soil (0" - 20")	Poor water storage and plant growth

* Total depth in feet

203 9001
groups

ACTIVITY C: Analyze Soil Data

Work in small groups.

Using the soil data you collected and the information provided in the soil data tables included in this Activity, complete the following:

1. Based on soil depth, complete the following (Refer to Table 1):
The potential of my soil for water storage is _____
Why? _____
2. Based on color, complete the following (Refer to Table 2):
 - a. The top soil, or A horizon:
amount of organic material _____
erosion factor _____
fertility _____
 - b. The drainage in the subsurface soil or B horizon is: _____
3. Based on the texture complete the following (Refer to Table 3):

Layer or horizon	Water holding capacity	Looseness of soil
Top soil A		
Subsoil B		

4. Based on the structure complete the following (Refer to Table 4):

Layer or horizon	Penetration of Water	Drainage	Aeration
Top soil A			
Subsoil B			

5. Based on the pH ranges complete the following (Refer to Table 5):

Some plants could grow here based on the soil pH plant chart	Some plants actually observed growing here

6. Based on the soil temperatures complete the statement below (Refer to Table 6): The plants on my soil have _____ growth taking place now. In 3 months I predict that the growth conditions of the soil based on soil temperature will be _____. The growing season (best two days) in this area is about _____ days.



2. Activity C is based upon data collected in Activity B.
3. As groups or pairs work, the facilitator circulates among the groups, keeping them engaged and monitors progress. This activity should take between 20 to 30 minutes.

C. Retrieve Data:

1. After all groups have finished ask: "Using the observed color of the top layer and Tables 2A and 2B of the Soil Data Sheet, what did you say about the erosion factor of your soil?"
2. Using the structure of your soil and Table 4, what did you say about the drainage of water?
3. How well did the plants in the study area conform to the soil pH plant chart?
4. Have groups read how they would set up their own soil pH plant chart. Point out that soil scientists determine soil pH and record the plants growing in the area to construct a table or chart for use in interpreting soil pH-plant relationships elsewhere.

CLOSURE

Ask how their soil description (from Activity A) now that they know more about soil, compares to what they now know.

TRANSITION

Slope is an aspect of land used to determine land use. This next activity explores slope.



SLOPE—IT'S THE ASPECT

CONCEPT	Quantification, Force
PRINCIPLE	Knowing the slope of the land is needed in order to adequately discuss land use possibilities. This activity provides "hands-on" experience in determining the slope of a given site.
OBJECTIVES	<ul style="list-style-type: none">• The student will be able to measure the slope of a given site following directions and then calculate the percent age of slope.
PREPARATION	Select an area near the soil pit for slope measurement. Use two areas of different slope to demonstrate how land use can vary according to slope. Practice before teaching if you are not familiar with the technique.
MATERIALS NEEDED	<ul style="list-style-type: none">• For each group: 50" or 100" stick• Tape measure• Water jars, half full of water• Activity Sheet D: Determine Slope of the Land
PROCESSES USED	<ul style="list-style-type: none">• Measure• Observe• Communicate• Use numbers
TIME	20 minutes



DOING THE ACTIVITY (outdoors)

A. Set Stage:

"The slope of the land is an important consideration when determining the potential use of the land.

B. Procedure:

1. Hand out the activity sheet D and equipment to complete the activity.

10 min.
group

ACTIVITY SHEET D: Determine The Slope Of The Land

1. Select a place that represents the average slope of the land being studied or take several measurements and average them.
2. Place one end of a 100" stick on the slope you want to measure. Hold stick so it is level.
3. Place a level or jar with same liquid in it on the outright stick. Raise or lower the stick until the water is level level.
4. Measure the number of inches the free end of the stick is off the ground.
5. The number of inches is the slope of the land in percent.
6. Repeat the above steps in several different areas to get an average slope of the land being investigated.

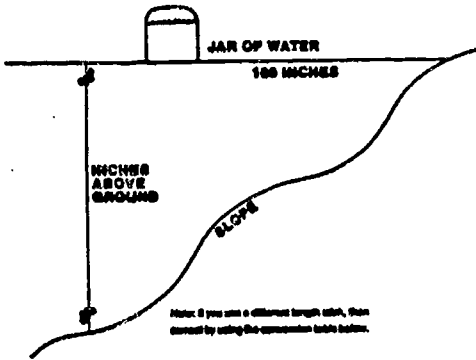

Note: If you use a different length stick, then convert by using the conversion table below.

Stick length (inches)	Distance the end of the stick is above the ground (inches)	Multiply by conversion factor	Slope (percent)
100"	_____ X	1	= %
50"	_____ X	2	= %
25"	_____ X	4	= %

Investigating Your Environment 



Investigating Your Environment
Soil

2. Demonstrate the techniques.
3. Give students 10 minutes to complete the activity.

C. Retrieve Data:

During the discussion, determine what was the average slope measurement and if participants have any questions about percent of the process.

CLOSURE

Let's review what we've accomplished. We've identified some parts of the forest floor, collected and analyzed some observable characteristics of soil layers and determined average slope of a site. Have participants supply this information in a way you are comfortable with.

TRANSITION

Now we are ready to determine some appropriate uses of this land.



SOIL SAVVY

CONCEPT

Cause & Effect, Interaction, System

PRINCIPLE

Land is evaluated by different criteria depending upon what it can be used for. Regardless of the use, criteria is based upon the characteristics of the soil resource.

OBJECTIVES

- The student will be able to use published criteria to evaluate a piece of land for two potential uses. The student will be able to make inferences about soil management.

PREPARATION

Completion of previous activities by the participants

MATERIALS NEEDED

- Data from previous investigations
- Activity Sheet E: Determine Possible Land Uses and Activity E: Land Use Data Tables
- Pencils

PROCESSES USED

- Interpret data
- Use numbers
- Communicate
- Observe
- Infer
- Classify
- Question
- Hypothesize
- Interpret data
- Use numbers

TIME

45 minutes



DOING THE ACTIVITY (indoors, outdoors)

A. Set Stage:

Different sets of criteria are used to evaluate land for different uses. In this investigation we will evaluate for two uses, agriculture and occupancy.

B. Procedure:

1. Distribute Activity E and Land Use Data Tables to all students.

ACTIVITY E: Determine Possible Land Uses 20 min.
groups

The great diversity of potential land uses requires different sets of criteria that analyze a variety of soil and land factors in different ways. These factors must be considered in determining the most appropriate land use for a given area. The most limiting soil factor will be the major influence in determining the best use of the land. See Land Use Data Table for definition of limiting soil factor.

Using the data from Activity D, E and the Land Use Data Table, answer the following questions.

According to the Land Use Data Tables, this land could be used for agriculture use (list and explain why)

Occupancy:

Land uses

Road and streets

Building sites

Septic tank filter fields

Picnic and camp areas

I feel the best uses of this land would be:

Investigating Your Environment 
Soil

2. Working in groups, use the information you have gathered and the agricultural use table to determine the best agricultural use. Follow the directions on the table.
3. When you finish agriculture, evaluate for the four occupancy uses.



ACTIVITY E: Land Use Data Tables

10 min group

AGRICULTURAL USES

Directions: Circle the item in each of the five columns below that best describes each of the five soil factors in the soil you studied. The most limiting soil factor will determine the best agricultural use of the land. A limiting soil factor can be defined as something that will restrict the use of land for desired activities. The most limiting factor determines the most appropriate agricultural use.

SOIL FACTORS					Agricultural Uses
Moisture (%)	Drainage Hazard	Soil Depth	Drainage	Texture	
0-4	None	Deep	Good	Loam or silty loam*	Fruit crops - sufficient good soil management practices
5-9	Slight to moderate	Med. deep	Some what poor	Sandy, loam or silty clay	Fruit crops - try to avoid special cultivation practices
10-19	Severe	Shallow	Poor	Sand or clay	Commercial cultivation, many special practices
20-29	None to slight	Deep	Good to poor	Silty	Pasture - commercial cultivation; no machinery can be used
30-39	Very severe	Deep to shallow	Good to poor	Sandy, loam, clayey or rocky	Pasture, timber growing, woodland, wildlife, no cultivation-machinery
40	None to moderate	Deep to shallow	Excellent to poor	Rocky, over much sand/dunes	Wildlife, recreation

*Loam is a combination of sand, silt, and clay particles.

Occupancy land uses

Select the most limiting factor for each land use and record the overall limitation (slight, moderate or severe) on Table F.

Land Uses and Factors Affecting That Use	Slight Limitation	Moderate Limitation	Severe Limitation
Roads and Streets			
Depth	0-10%	10-20%	Over 20%
Drain	Over 40 in.	20-40 in. (20.0-191.0 cm)	Less than 20 in.
Water Table	Over 20 in.	10-20 in. (25.4-50.8 cm)	Less than 10 in.
Building Sites			
Depth	0-10%	10-20%	Over 20%
Drain	Over 40 in.	20-40 in. (20.0-191.0 cm)	Less than 20 in.
Water Table	Over 20 in.	10-20 in. (25.4-50.8 cm)	Less than 10 in.
Buildings After Frost			
Depth	0-7%	7-15%	Over 15%
Drain	Over 6 ft.	4-6 ft. (1.21-1.83 m)	Less than 4 ft.
Water Table depth below surface	Over 4 ft.	2-4 ft. (0.61-1.22 m)	Less than 2 ft.
Plants and Camp Areas			
Depth	0-7%	7-15%	Over 15%
Drain	Over 20 in.	10-20 in. (25.4-50.8 cm)	Over 20 in.
Water Table during season of use	Over 20 in.	10-20 in. (25.4-50.8 cm)	Less than 10 in.

Investigating Your Environment 

C. Retrieve Data:

Conduct a discussion and find the answers to these questions:

1. Based on the tables, what do you feel is the most appropriate agricultural use? What was the most limiting factor for agricultural use?
2. What types of limitations does this soil impose on occupancy uses?
3. What were some of your thoughts after looking at occupancy use limitations? What might "slight, moderate,, severe" mean for building a road?
4. So far we've discussed only physical characteristics of land. What other factors would we need to consider in determining other uses for this land?
5. What examples can you recall where some of these factors have affected land use?

CLOSURE

Based on our investigations and discussions, what have we found out about soil? Record on chart as summary to the unit.



ACTIVITY A: Look at the Forest

20 min.
groups

1. Predict what you will find in the top few inches of the area to be studied. List your predictions:

2. Select an area about 2 or 3 feet square on the ground and sift through the top 3 inches, recording the evidence of plants and animals you observe. Replace the ground in as near original condition as possible.

Name or Description of Item in the Soil	Quantity	Possible Effect on Soil

3. The terms: litter, duff, humus, are used to describe organic matter at the top of the soil. From your study above, complete the following chart:

Term and definition	Describe the characteristics, e.g., feel, smell, color	List the identifiable parts of plants and animals you found
Litter (identifiable dead things on surface)		
Duff (partially decomposed organic matter—compacted)		
Humus (almost completely decomposed non-identifiable organic matter)		



ACTIVITY B: Analyzing Soil Horizons

35 min.
individuals

Use the "Soil Horizons Data Sheet" and the available equipment to record your observations below. Make a micromonolith using the materials provided.

Sketch your soil profile, label the layers or horizons, and record the data.

PROFILE SKETCH

DATA

Air temperatures
3' above surface _____ just above surface _____

Contents of layers above top soil (if existing):

Litter - _____

Duff- _____

Humus - _____

Total depth of layer above top soil _____

Horizon _____

Depth _____ Color _____

Texture _____ Structure _____

Temperature _____ pH _____

Plant roots visible _____

Horizon _____

Depth _____ Color _____

Texture _____ Structure _____

Temperature _____ pH _____

Plant roots visible _____

Horizon _____

Depth _____ Color _____

Texture _____ Structure _____

Temperature _____ pH _____

Plant roots visible _____

Horizon _____

Depth _____ Color _____

Texture _____ Structure _____

Temperature _____ pH _____

Plant roots visible _____

Horizon _____

Depth _____ Color _____

Texture _____ Structure _____

Temperature _____ pH _____

Plant roots visible _____

Parent Material (C Horizon)

Describe type of rock in the bedrock (if present)

ACTIVITY B: Soil Horizons Data

continued

Here are some ways to collect information about different soil characteristics.

1. soil layers (horizons)

Mark where the soil changes color and general appearance. Many soils have 3 major layers or horizons; i.e., top soil, subsoil, and parent material. Because soil information has many variables, you may find more or fewer layers.

2. color

Describe the color of each major layer, using your own descriptive terms. Moisten soil to get a more accurate color description.

3. texture (how the soil feels)



Determine the texture of each major layer.

Texture is determined by feel. Rub a moistened sample of soil between thumb and forefinger. Spit on sample to moisten, if water is not available.

- If it feels very gritty and not plastic _____ sandy
- If it feels smooth and slick or somewhat gritty and sticky _____ loamy*
- If it feels smooth, plastic, very sticky _____ clayey

4. structure (how the soil is put together in geometric shapes)

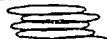
Determine the structure of each major layer.

Carefully break apart a shovelful of soil from each layer and match its characteristics with one of these structure words: blocky  platy  columnar  granular 

5. temperature

Determine the temperature of each layer. Use the soil thermometer.

6. pH (acidity or alkalinity)

Determine the pH of each major layer. Soil pH is an indication of how well certain plants can grow in the soil.

Put a small sample of the soil to be tested in a porcelain dish. Do not touch the sample. Use just enough pH reagent to saturate the soil sample. Match the color of the pH reagent at the edge of the soil sample with pH color chart.

Each person should construct a soil micromonolith. (Activity B) A micromonolith is a small model of a soil profile in which samples of each soil layer are attached to a card.

*Loamy is a combination of sand silt and clay particles.

Things to look for in soil:

- 1. Color —tells about organic matter, drainage, biotic activity, fertility.
- 2. Texture —the feel;—sandy, silt, clay—tells water holding capacity; looseness, workability of the soil.
- 3. Structure —the shape—blocky, platy, granular—tells of drainage, aeration, water intake.
- 4. Depth —the size of the storage bin—moisture; availability of minerals for plants.
- 5. Reaction —the suitability of plant growth, the amount of acid or alkalinity in the soil.

The general soil profile below is how you might find some of the different layers:

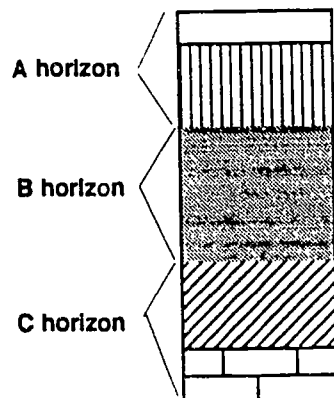

- Surface** - Dark gray colored—high organic matter, high biotic activity, abundant roots, commonly leached.
- Subsurface** - Moderately dark—many roots, moderate organic matter, commonly leached.
- Subsoil** - Below plow depth—brown or reddish colored—more clay than surface, fewer roots.
- Lower subsoil** - More yellowish and less clay—fewer roots than subsoil, less aeration than above.
- Parent material** - Unconsolidated—slightly weathered rocky mass from which soil develops. No biotic activity, few roots.
- Bedrock** - Consolidated rock



ACTIVITY C: Analyzing Soil Horizons (alternative)

ALTERNATIVE:

1. Staple as many jelly cup lids to the card as you have horizons.
2. Gather a sample from each level in the jelly cup.
3. Snap the cup to the lid.
4. Complete the written soil data.

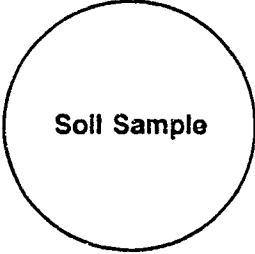
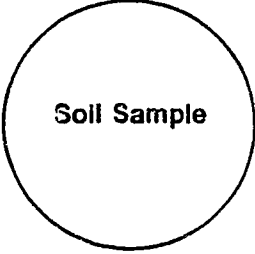
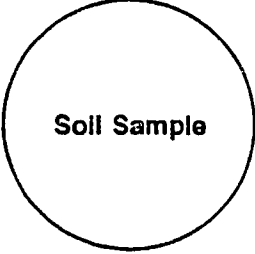
SOIL MICROMONOLITH CARD	
 Soil Sample	Horizon _____ Color _____ Texture _____ Structure _____ Depth _____ pH _____
 Soil Sample	Horizon _____ Color _____ Texture _____ Structure _____ Dep _____ pH _____
 Soil Sample	Horizon _____ Color _____ Texture _____ Structure _____ Depth _____ pH _____

ACTIVITY C: Soil Data Tables

1. RELATIONSHIPS OF SOIL DEPTH TO PLANT GROWTH AND WATER STORAGE

Soil Depth*	Water Storage
Deep Soil (over 42")	Excellent water storage and plant growth
Mod. Deep Soil (20" - 42")	Good water storage and plant growth
Shallow Soil (20" & under)	Poor water storage and plant growth

* Total depth to bedrock

Condition	Color		
	Dark (dark grey, brown to black)	Moderately dark (brown to yellow-brown)	Light (pale brown to yellow)
Amt. of organic material	High	Medium	Low
Erosion factor	Low	Medium	High
Aeration	High	Medium	Low
Available Nitrogen	High	Medium	Low
Fertility	High	Medium	Low



B. SUBSURFACE SOIL (B HORIZON)

Subsurface soil color	Condition
Dull Grey (if in low rainfall soils 0 - 20")	Water-logged soils, poor aeration
Yellow, red-brown, black (if in forest soils)	Well drained soils
Mottled grey (if in humid soils)	Somewhat poorly to poorly drained soils

3. SOME EFFECTS OF TEXTURE ON SOIL CONDITIONS

Texture	Water holding capacity	Looseness of soil
Sandy	Poor	Good
Loamy	Good to excellent	Good
Clayey	High (water held too tightly for plant use)	Poor

4. SOME EFFECTS OF STRUCTURE ON SOIL CONDITIONS

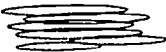
Type	Penetration of water	Drainage	Aeration
Columns 	Good	Good	Good
Blocky 	Good	Moderate	Moderate
Granular 	Good	Best	Best
Platey 	Moderate	Moderate	Moderate

5. RELATIONSHIP OF SOIL pH TO PLANT SPECIES

1	4.5	6.5 7.0	8.5	14
---	-----	---------	-----	----

(1 to 3.5 is too acid for most plants) (most plants do best here) (8.5 to 14 is too alkaline for most plants) Example of soil pH plant indicators:

- pH 4.0-5.0: rhododendrons, camellias, azaleas, blueberries, fern, spruce, pines, firs, red cedar
- pH 5.0-6.0: pines, firs, holly, daphne, spruce, oaks, birch, willow, rhododendron, alder, red cedar
- pH 6.0-7.0: maple, mountain ash, pansy, asters, peaches, carrots, lettuce, pines, firs, alder, red cedar
- pH 7.0-8.0: beech, mock orange, asparagus, sagebrush

Note: These relationships may vary in different environments.

6. SOME RELATIONSHIPS OF SOIL TEMPERATURE TO PLANT GROWTH

Soil temperature	Conditions during growing season
Less than 40°F	No growth, soil bacteria and fungi not very active
40°F to 65°F	Some growth
65°F to 70°F	Fastest growth
70°F to 85°F	Some growth
Above 85°F	No growth

ACTIVITY C: Analyze Soil Data

20 min.
groups

Work in small groups.

Using the soil data you collected and the information provided in the soil data tables included in this Activity, complete the following:

1. Based on soil depth, complete the following (Refer to Table 1):

The potential of my soil for water storage is _____

Why? _____

2. Based on color, complete the following (Refer to Table 2):

- a. The top soil, or A horizon:

amount of organic material _____

erosion factor _____

fertility _____

- b. The drainage in the subsurface soil or B horizon is: _____

3. Based on the texture complete the following (Refer to Table 3):

Lay or horizon	Water holding capacity	Looseness of soil
Top soil A		
Subsoil B		

4. Based on the structure complete the following (Refer to Table 4):

Layer or horizon	Penetration of Water	Drainage	Aeration
Top soil A			
Subsoil B			

5. Based on the pH ranges complete the following (Refer to Table 5):

Some plants could grow here based on the soil pH plant chart	Some plants actually observed growing here

6. Based on the soil temperatures complete the statement below (Refer to Table 6): The plants on my soil have _____ growth taking place now. In 3 months I predict that the growth conditions of the soil based on soil temperature will be _____.
- The growing season (frost free days) in this area is about _____ days.



ACTIVITY SHEET D: Determine The Slope Of The Land

10 min.
groups

1. Select a place that represents the average slope of the land being studied or take several measurements and average them.
2. Place one end of a 100" stick on the slope you want to measure. Hold stick so it is level.
3. Place a level or jar with some liquid in it on the outright stick. Raise or lower the stick until the water is level level.
4. Measure the number of inches the free end of the stick is off the ground.
5. The number of inches is the slope of the land in percent.
6. Repeat the above steps in several different areas to get an average slope of the land being investigated..

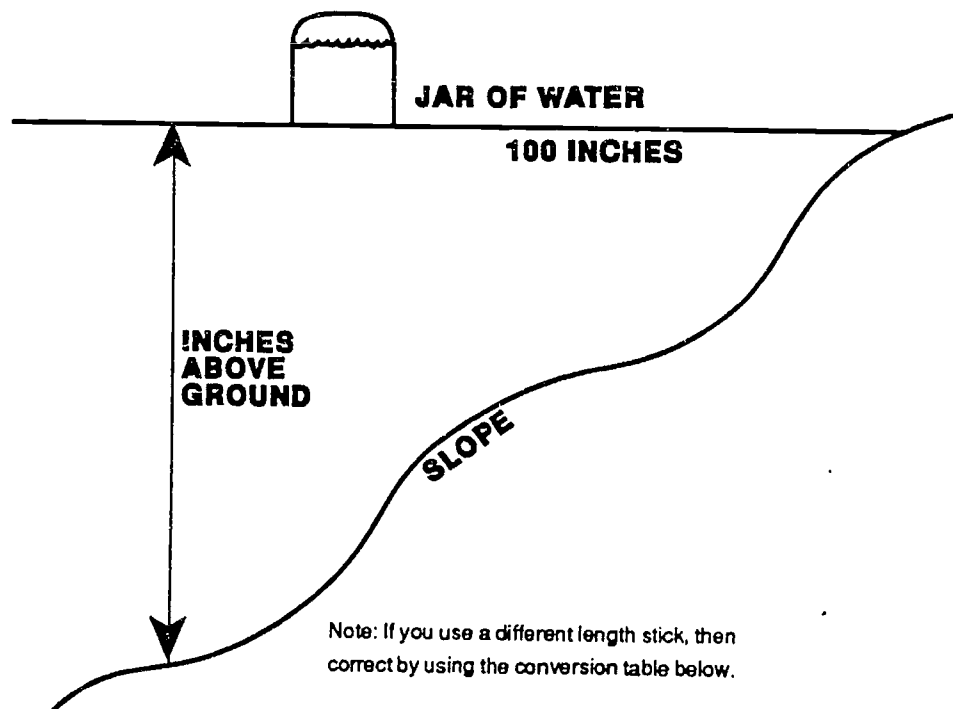

CONVERSION TABLE

Stick length (Inches)	Distance the end of the stick is above the ground (inches)	Multiply by conversion factor	Slope (percent)
100"	_____ X	1	= %
50"	_____ X	2	= %
24"	_____ X	4	= %



ACTIVITY E: Determine Possible Land Uses

20 min.
groups

The great diversity of potential land uses requires different sets of criteria that analyze a variety of soil and land factors in different ways. These factors must be considered in determining the most appropriate land use for a given area. The most limiting soil factor will be the major influence in determining the best use of the land. See Land Use Data Table for definition of limiting soil factor.

Using the data from Activity D, E and the Land Use Data Table, answer the following questions.

According to the Land Use Data Tables, this land could be used for agriculture use (list and explain why)

Occupancy:

Land uses

Road and streets

Building sites

Septic tank filter fields

Picnic and camp areas

I feel the best uses of this land would be:

because—



ACTIVITY E: Land Use Data Tables

10 min.
groups

AGRICULTURAL USES

Directions: Circle the item in each of the five columns below that best describes each of the five soil factors in the soil you studied. The most limiting soil factor will determine the best agricultural use of the land. A limiting soil factor can be defined as something that will restrict the use of land for desired activities. The most limiting factor indicates the most appropriate agricultural use.

SOIL FACTORS					Agricultural Uses
Slope (1%)	Erosion Hazard	Soil Depth	Drainage	Texture	
0-3	None	Deep	Good	Loam or silt loam*	Farm crops – cultivation good soil management practices
3-20	Slight to moderate	Mod. deep	Somewhat poor	Sandy, loam or silty clay	Farm crops—few to several special cultivation practices
20-30	Severe	Shallow	Poor	Sand or Clay	Occasional cultivation, many special practices
0-2	None to slight	Deep	Good to poor	Stony	Pasture-woodland cultivation; no machinery can be used
30-90	Very severe	Deep to shallow	Good to poor	Sandy, loam, clayey or rocky	Pasture, timber growing, woodland, wildlife, no cultivation machinery
all	None to extreme	Deep to shallow	Excessive to poor	Rockland, river wash, sand dunes	Wildlife, recreation

*Loam is a combination of sand, silt, and clay particles.

Occupancy land uses

Select the most limiting factor for each land use and record the overall limitation (slight, moderate or severe) on Task F.

Land Uses and Factors Affecting That Use	Slight Limitation	Moderate Limitation	Severe Limitation
Roads and Streets Slopes Depth Water Table	0-12% Over 40 in. Over 20 in.	12-30% 20-4 in. (50.8-101.6 cm) 10-20 in. (25.4-50.8cm)	Over 30% Less than 20 in. Less than 10 in.
Building Sites Slopes Depth Water Table	0-12% Over 40 in. Over 30 in.	12-20% 20-40 in. (50.8-101.6cm) 20-30 in. (50.8-76.2cm)	Over 20% Less than 20 in. Less than 20 in.
Septic Tank Filter Fields Slope Depth Water Table depth below trench	0-7% Over 6 ft. Over 4 ft.	7-12% 4-6 ft. (121.9-182.9cm) 2-4 ft. (61.0-121.9cm)	Over 12% Less than 4 in. Less than 2 ft.
Picnic and Camp Areas Slope Stones Water Table during season of use	0-7% 0-20% Over 30 in.	7-15% 20-50% 20-30 in. (50.8-76.2cm)	Over 15% Over 50% Less than 20 in.





Investigating Your Environment — Intermountain Region

BEST COPY AVAILABLE

INTRODUCTION

Water is in the news every day. The issue may be a drought, flood, or transporting or sale of water to another state. Water is our most important renewable resource. We can go for days without eating food, but we can survive only a short time without drinking water. No other animal or plant can survive without water either, and water is needed for industry, food production, comfort, and recreation. Therefore, we need to understand the characteristics of water to make wise decisions about its use.

THE ACTIVITIES

TIME REQUIRED

Determine Watershed Boundaries	15 to 20 minutes
Collect and Identifying Aquatic Life	30 to 45 minutes
Predict Water Characteristics from Aquatic Animals Found	20 minutes
Measure Water Characteristics to Test Predictions	30 to 45 minutes
Measure Water Volume of a Stream or Pond	45 minutes

COMBINING THE ACTIVITIES

The activities in this chapter are displayed singly. Depending upon your time and the skill of your audience, you may choose to do only one activity or the entire series. For maximum learning, the activities should be experienced in the order listed in the unit. Other suggestions are:

Title: Collect Aquatic Life/Identify Aquatic Life/Predict Water Characteristics from Aquatic Animals Found/Test Predictions

Introduction: We are going to collect and identify aquatic life in a specific water environment and then use the kinds of life found to make predictions about the physical characteristics of the water. We then will use some simple testing equipment to validate our predictions.

Activity: Collect Aquatic Life

Transition Statement: Use the Pond Life books and the drawings of aquatic life on the back of the activity sheet to identify as many of the aquatic animals collected as possible.

Activity: Identify Aquatic Life

Transition Statement: Based on the aquatic animals found and the tables on the back of the activity, predict the temperature, pH and dissolved oxygen content of the water.



Activity: Predict water characteristics from aquatic animals found

Transition Statement: Let's check out our predictions using some simple water test kits.

Activity: Measure Water Characteristics to Test Predictions

Transition Statement: What can we say about the characteristics that we did help you discover these ideas?

CURRICULUM RELATIONSHIPS

Social Studies

1. Read and discuss how the quality of rivers and streams in your community have changed since the area first was settled. Have they remained pure or become polluted? Are they free-flowing or impounded by dams and channelization?
2. Find out what the source is for water used in your town or city. Why was this source chosen? Did landforms influence the selection?
3. Find out how much it costs to have each gallon of water delivered to your home or school. How else is water used in your community? Does industry pay more or less for water than you?
4. Discuss the role that rivers and streams played in the location and settlement of your town or city.
5. Read and discuss how the political boundaries of states, counties and cities affect the management of rivers.
6. Explore a pond or lake that has died (filled up with organic and inorganic matter). Talk to long time residents about what they remember about the lake so you can trace its history.
7. Observe the topography and stream drainage patterns on a topographic map of your area. How has the geology of the area affected how the streams flow?
8. Take picnics with your family or class along a polluted, clean river, or stream. Which experience was more enjoyable? Why?
9. Find out what government agencies are concerned and involved in water quality management. Make a display about these agencies, their responsibilities and work.

Science

1. Study how the water in your town or city is purified before you use it. What happens to water after it is used in your community?
2. Explore how water is used for cleaning purposes.
3. Study and compare how aquatic life differs in a stream environment compared to a pond or lake environment.
4. Construct a chart showing some aquatic animals can stand various degrees of water pollution in relation to the degree of pollution.
5. Find out how rural dwellers get their water? How is it treated before and after it is used?



Mathematics

1. Calculate and compare the flow of water from different streams. Locate a stream that would just support your city?
2. Construct a graph to show the increase in water use in your city over the past 50 years.
3. Read about the various units of measurement in water work.
4. Develop a pH scale range correlated with some common liquid products such as orange juice, vinegar and bleach.

Language Arts

1. Describe the anatomy of a stream from source to mouth.
2. Write about the different ways oxygen gets into water.
3. Write about the differences between the biological, chemical and physical qualities of water.
4. Write a story about the birth or death of a pond.
5. "Aquatic Wild" has several good activities involving water and writing, including "Water Words."

Creative Arts

1. Construct an abstract sketch or painting of the water cycle.
2. Sketch a map of the route a stream near you takes to the ocean, naming the larger stream and watersheds it joins.
3. Sketch a spot along a stream at different times of the year.
4. Draw detailed sketches of different aquatic insects collected.



DETERMINE WATERSHED BOUNDARIES

CONCEPT	System, cause/effect, change
PRINCIPLE	Determining watershed boundaries on a map can enlarge one's understanding of watersheds, ecosystems and community. This activity takes a student from where they are standing to the concept of this particular stream and its watershed.
OBJECTIVE	<ul style="list-style-type: none">• The student will be able to identify and describe a watershed for a specific stream or river.• The student will be able to identify how certain land uses can affect the quality of water.
PREPARATION	Select a study area "Watershed": (1) a ridge of high land dividing two areas that are drained by different river systems (2) the region draining into a river, river system or a body of water.
MATERIALS NEEDED	One for every three to four people <ul style="list-style-type: none">• Topographic maps, aerial photographs or good planimetric maps of the watershed to be studied, one for every 3-4 people• pencils• Activity Sheet A: Describe a Watershed, B: What is a Watershed
PROCESSES USED	<ul style="list-style-type: none">• observe• communicate• infer• define Operationally• hypothesize
TIME	15 to 20 minutes



DOING THE ACTIVITY (indoors)

A. Set the Stage

In order to talk about the water in a river or stream, we also need to be able to talk about the land that affects or is affected by the water.

B. Procedure

1. Distribute the activity sheet and map.

DESCRIBE A WATERSHED Work in small groups 15 min.

Describe what you think is meant by a watershed:

Find your location on the creek (pond, lake) on a map of your area.

Where does the water come from? _____

Where does it go? _____

Draw lines around the boundaries of our watershed. We're in the _____ watershed.

Activity	Ways the activity might change the characteristics of the water

2. Tell them to work in small groups and tell them they have 15 minutes to fill out the sheet.



C. Retrieve Data

In a discussion, ask:

1. What is a watershed?
2. What are the boundaries of this watershed?
3. Where does the water come from? Where does the water go to?
4. What activities could change the characteristics of the water?
5. What would be some reasons for looking at watershed boundaries on a map?

CLOSURE

Distribute "What is a watershed" sheet and ask group to review.

**What is a
WATERSHED?**

"Watershed" is a new term to many people. The increasing use of soil and water conservation measures for watershed protection and flood prevention is bringing the term into more common use. Its definition is almost as simple as the well-known phrase "water runs downhill."

The drainboard that carries rain water into your kitchen sink can be compared to a watershed.

On the land, water that does not evaporate or soak into the soil usually drains into ditches, streams, marshes, or lakes. The land area from which the water drains to a given point is a watershed.

When you were a small child, you probably had a favorite mud puddle in which you liked to play. The part of the yard from which the water drained into the puddle was its watershed.

Possibly a small stream ran by your house. It may have been dry most of the year or it may have flowed continuously.

Water from a few acres drained into that little stream. These few acres were its watershed. This small stream and others like it ran into a larger one. The land areas drained by the small streams made up the watershed of the larger stream into which they flowed.

Small watersheds make up the larger ones. The Mississippi River, for example, drains a watershed of about 1,243,000 square miles.



Diagram of a watershed showing the drainage pattern.

Ask:

1. "How can we summarize the concept of watersheds?"
2. "Can a watershed be part of a larger watershed?" Explain.

TRANSITION

We have used maps to understand the concept of watershed. Now let's look at a particular stream in this watershed and see what animals consider this stream home.

COLLECT AND IDENTIFY AQUATIC LIFE

- CONCEPT** Aquatic animal life is not well known or studied at this age level. This activity gives participants the opportunity to look at water in any form as habitat and to identify animals found there.
- PRINCIPLE** Organism, population, interaction
- OBJECTIVE**
- The student will be able to collect aquatic life from a stream or pond.
 - The student will be able to identify some of the aquatic life they collected from the water.
- PREPARATION** Locate a stream and make sure it contains some aquatic life in it.
- MATERIALS NEEDED**
- One for every four people:
- white dishpans
 - jelly cups/baby food jars/clear pill bottles
 - screens
 - dip nets
 - "Pond Life" (Golden Nature Guide) books
 - Activity Sheet C: Observe & Collect Aquatic Life with Aquatic Insect sheet on back
- PROCESSES NEEDED**
- observe
 - predict
 - hypothesize
 - classify
- TIME** 30 to 45 minutes, depending upon how the search is going



DOING THE ACTIVITY (outdoors)

A. Set the Stage

"Life in a stream can tell us many things about the water it contains. In this activity, we will be finding out what lives here." Ask questions to get participants thinking. What kind of life would you expect to find in this water environment? Where would you expect to find them?

B. Procedure

1. Handout the activity sheet.

OBSERVE & COLLECT AQUATIC LIFE Work in small groups 30 min.

Using the "Golden Nature Guide Pond Life" books or similar field manuals or attached picture keys, carefully identify the specimens you found.

List or sketch the animals you found below. Return animals to water as soon as finished.

Type (name or sketch)	Description of where found	No.	Name



2. Make sure each group has a set of equipment.
3. Tell the students:
"Using this equipment, collect as many types of aquatic animals as possible. Put them in the white pans containing water for observation by the group. Identify as many of the aquatic animals as possible using the "Pond Life" books and the drawings on the back of the activity sheet. Return the animals to the water as soon as you are finished. Be careful not to unduly disturb the water environment."

C. Retrieve Data

In your discussion, ask questions such as: what animals did you find? Where did you find most of them? What other life would you expect to find in this stream? What might account for the differences in the numbers from place to place?

CLOSURE

You have collected and identified some aquatic insect life of this stream. What other life would you expect to find in this stream?

TRANSITION

Sometimes animals in their environment tell us how healthy or unhealthy an environment is, just by their presence. In the next activity, we'll look more deeply at water characteristics using the aquatic animals we found as indicators.



PREDICT WATER CHARACTERISTICS FROM AQUATIC ANIMALS FOUND

CONCEPT	Cause/effect, change, interaction
PRINCIPLE	A healthy environment can be indicated by what animals live there. Likewise, an unhealthy environment can be indicated by what does <u>not</u> live there. Specific animals are often used as indicators to determine the health of a particular environment is. In this activity, participants predict the health of their aquatic environment using animal indicators.
OBJECTIVE	<ul style="list-style-type: none">• The student will be able to analyze and predict water characteristics based on the life requirements of aquatic life collected from a stream or pond.
PREPARATION	Completion of previous activities by participants pH: the measure of the acidity or alkalinity of a solution (or soil). Numerically, pH equals 7 for a neutral solution; less than 7 for acid solutions and more than 7 for alkaline solutions. Dissolved oxygen: (DO) amount of usable oxygen dissolved in a stream, lake, ocean or other body of water. DO is written as parts per million (ppm) and is essential to fish and aquatic life. Must be 4 ppm for aquatic life to live.
MATERIALS USED	One for each group of three to four: <ul style="list-style-type: none">• selection of aquatic animals from previous activity if following activity• Activity Sheet D: Predict Water Characteristics
PROCESSES USED	<ul style="list-style-type: none">• classify• observe• infer• hypothesize• interpret data• predict
TIME	20 minutes



DOING THE ACTIVITY (outdoors, indoors)

A. Set the Stage

"Many aquatic organisms have rather specific needs to support their life functions. The presence or absence of various plants and animals can be used to make "educated guesses" about water characteristics of a stream. In this activity, we will see how well we can predict some water quality factors based on what lives there."

B. Procedure

1. Handout activity sheet

PREDICT WATER CHARACTERISTICS Work in small groups. 10 min.

Based on the aquatic animals you found, the tables below in the Aquatic Data section, and your observations, predict the following characteristics of this stream.

I predict: the water temperature will be _____ because _____
 the air temperature will be _____ because _____
 the pH will be _____ because _____
 the dissolved O₂ count will be _____ because _____
 I can see about _____ fly down into the water.
 The color of the water is _____

Keep these predictions for future use.

Table A: TEMPERATURE RANGES (APPROXIMATE) REQUIRED FOR CERTAIN ORGANISMS

Temperature (Fahrenheit)	Examples of life
Greater than 60° (warm water)	Most plant life, many fish diseases, Most bass, crapple, largemouth, carp, catfish, mudpuppy.
Middle range (55-60°)	Some plant life, some fish diseases, Salmon, trout, stone fly, mayfly, caddis fly, water bug.
Low range (cold-less than 50°)	Trout, caddis fly, stone fly, mayfly.

Table B: pH RANGES THAT SUPPORT AQUATIC LIFE

	MOST ACID	NEUTRAL	MOST ALKALINE
	1 2 3 4 5	6 7 8 9 10	11 12 13 14
Reptiles	1.0		13.0
Plants (algae, rooted, etc.)		6.5	12.0
Carp, catfish, caddis, some insects		6.0	9.0
Bass, crapple		6.5	8.5
Brook, stone, minnow		7.0	9.0
Largest variety of animals (trout, mayfly, stone fly, caddis fly)		6.5	7.5

Table C: DISSOLVED OXYGEN REQUIREMENTS FOR NATIVE FISH AND OTHER AQUATIC LIFE

Examples of Life	D.O. in parts per million or milligrams per liter
Cold-water organisms including salmon and trout (below 60° F.). Spawning, growth and well-being (caddis fly, stone fly, mayfly)	6 ppm and above
Warm-water organisms including game fish such as bass, crapple, catfish and carp (above 60° F.). Growth and well-being (some caddis fly)	5 ppm and above

Note: Pure, cold water can hold a maximum of 18 ppm under cold conditions



2. Instruct group to make predictions based on the kinds of aquatic life found.
Tell them they have 10 min.

C. Retrieve Data

What were your predictions? Why?

CLOSURE None

TRANSITION Your predictions are the base data from which you will continue with the next activity — testing what you have just hypothesized.

MEASURE WATER CHARACTERISTICS TO TEST PREDICTIONS

CONCEPTS	Cause/effect, Cycles, Change, Interaction
PRINCIPLE	Predictions are often scientifically-based hypotheses. Participants have the opportunity to use instruments that scientists use to evaluate a habitat. In this activity, participants will use these instruments to compare their predictions to actual measurements.
OBJECTIVE	<ul style="list-style-type: none">• The student will be able to measure the physical characteristics of water in a stream or pond using scientific instruments.• The student will be able to compare the results of scientific measuring to his/her predictions.
PREPARATION	Use predictions about the physical characteristics of a stream or pond from the previous activity.
MATERIALS NEEDED	One for every four people <ul style="list-style-type: none">• thermometer• Hach water test kit• Activity Sheet E: Check Out Your Inferences and Table A: Relationship of Water Color to Productivity• Secchi disk & rope
PROCESSES USED	<ul style="list-style-type: none">• measure• interpret data• use numbers• hypothesize• predict
TIME	30 to 45 minutes



DOING THE ACTIVITY (outdoors, aquatic environment)

A. Set the Stage

"One way to test a prediction about water characteristics is to use a water test kit to actually measure those characteristics. That is what you are going to do in the next 45 minutes."

B Procedure

1. Hand out activity sheet and Table A & B

Table A: Relationships of water color to productivity:

The quantity of life that may be present in a water body is called the "productivity." A water body of low productivity is a water supply or for humans to use or it may be highly desirable for a reservoir; however, bumper crop highly desirable.

Color of Water	
Clear	A
Greenish blue	
Yellow to yellow-brown	Dist
Red	
Dark Brown	
GEOLOGICAL FACTS	
In limestone geology Green	A
In volcanic geology Yellow-green, Red	J

Table B: Relationships of Water Clarity to Fish Food Production and W

Depth you can see into water (Secchi disk reading)	
	Fish Food Production (if reasons for degree are listed, list degree)
0' - 6"	Most productive water food Maximum oxygen photosynthesis (greatest diurnal % Maximum algae g)
30' +	Least productive for Minimum oxygen for synthesis (least if water is Minimal algae g)

CHECK OUT YOUR INFERENCES

Work in small groups. 30 min.

MAKE SURE EVERYONE IN YOUR GROUP GETS INVOLVED IN THE TESTING.

1. Using the water test kit, determine the water and air temperature, dissolved oxygen count, and pH of the stream or pond. Record predictions from activity.

Record the data below.

Name of stream, pond or lake: _____

Location of water sample (edge or middle of stream, bank of pond, etc.)	Time Taken	Temperature				pH		Dissolved Oxygen (ppm)	
		Water	Air	Water	Air	Actual	Actual		
		My Prediction	Actual Test	My Prediction	Actual Test	My Prediction	Actual Test	My Prediction	Actual Test

2. Water productivity and color.

Based on the color you recorded in activity and from Table A, what can you say about this water?

3. Light penetration (pond or lake).

My estimate of how far I could see into water from activity, is _____ ft. Transparency of lake and pond waters can be roughly determined by the use of a white and black plate (called a Secchi disk) which is lowered on a line until it can no longer be seen. It is approximately 8 inches in diameter, painted white and black in alternate quadrants. Vary this sunlight penetration below the point at which the disk disappears.

Lower the Secchi disk into the water until it can no longer be seen. Measure depth from surface of the water to the disk and record _____ ft. Based on the depth of the Secchi disk and Table B, what can you say about the water?

4. Temperature layering (pond or lake):

Based on the temperature you recorded for your pond, the season of year and the information in Table C, describe what you think is happening in the water now.



2. Make sure each group has one set of equipment.
3. Tell the group they have 30 minutes to do the testing.
4. Instructions are on the inside of the test kit lid. There are lots of jobs to be done — clipping, squirting, dipping, counting, reading. Every one should participate in the testing. Record the test measurements beside the predictions. Spread out along the edge of the water so that each group is testing from a different location.

C. Retrieve Data

Compare test data with predictions.

1. What did we find out?
2. How did the test results compare with the predictions?
3. Under what conditions might you expect to get different results than you did today?
4. What can you say about the water quality of this stream or pond based on your test results?

CLOSURE

1. "What have we found out about this stream so far?"
2. "What else would you need to know to decide whether or not to drink this water?"

TRANSITION

We have collected aquatic life, used them to predict the quality of water and tested the physical characteristics of this water. Have you ever stood on the edge of a river or stream and wondered how much water was there? Have you stood on a bridge, tossed in a stick and rushed to the other side to see your "boat" float on by? If you have, then you have wondered about the volume of that body of water. In the next activity, you will have the opportunity to measure water volume.

MEASURE WATER VOLUME OF A STREAM OR POND

CONCEPT	Quantification, Interaction
PRICIPLE	Using mathematical skills, participants measure the volume of their body of water and then calculate how many people could live off that water volume.
OBJECTIVE	<ul style="list-style-type: none">• The student will be able to measure and calculate water volume for a stream.• The student will be able to determine how many people could live off the water volume for one day.• The student will be able to identify the environmental effects of diverting the water for domestic use.
PREPARATION	Locate the study site. You may want more than one site.
MATERIALS NEEDED	One for each group of three to four: <ul style="list-style-type: none">• string and other materials for group to problem solve with• 50 foot or 100 foot measuring tape• watch with second hand• Activity Sheet F: Determine Streamflow, G: Determine Stream Volume• pencil• calculator (optional)
PROCESSES USED	<ul style="list-style-type: none">• measure• use numbers• communicate• design experiments• interpret data
TIME	45 minutes



DOING THE ACTIVITY (outdoors)

A. Set the Stage

"We have investigated some factors that relate to the quality of water of a stream. In this activity, we will be considering the quantity of water."

Ask:

How many people do you think could live off the water in this stream?

This prediction should be only domestic water use. What measurements do you need to know in order to determine the amount of water in this stream so you can validate your prediction? How can you make the measurements?

B. Procedure

Working in groups of three to four, follow the instructions on the activity sheet and calculate how many people could live off the water here.

10 min.
small groups

ACTIVITY F: Determine Streamflow

Instructions for collecting and recording streamflow measurements:

a. Measure and mark a 100 foot distance along a straight section of your stream. If you can't find a 100' section, use 25' or 50'. Throw a stick (S or G) number of seconds it takes to float down the distance by the total seconds it took the stick to cross the line.

First measurement 100 ft. + _____ (stick) (S or G)
to _____

Second measurement 100 ft. + _____
Third measurement 100 ft. + _____

Total _____ (S. per second)

b. Find the average width of your section of 100 foot area. Divide the total by 3 to get the

First measurement _____
Second measurement _____
Third measurement _____
Total _____

c. Find the average depth of your section of the stream in a straight line. Divide the total

First measurement _____
Second measurement _____
Third measurement _____
Total _____

10 min.
small groups

ACTIVITY G: Determine Stream Volume

d. Find the cubic feet of water per second. Multiply the average width, average depth, and the number of feet the stick floated each second.

_____ R. x _____ R. x _____ = _____
Average width Average depth Number of feet per second Cubic feet of water flowing per second

NOTE: A cubic foot of water is the water in a container 1 foot wide, 1 foot high and 1 foot long. It contains 7.48 gallons. In order to find out how many people could live from the water in this stream, complete the following calculations.

_____ x _____ 7.48 = _____
Stream flow in cu. ft. per sec. Gallons in 1 cu. ft. of water Gallons of water per second

_____ x _____ 60 = _____
Gallons of water per second Seconds in minute Gallons of water per minute

_____ x 1440 = _____ + *200 Gal. = _____
Gallons of water per minute No. minutes in a day Total gallons water per day Amount of water one person uses per day Total no. people who could live from water in this stream

*The average person uses about 200 gallons of water a day for home use. This does not reflect each person's share of water used for industrial, public buildings, and commercial. (U.S. Office of Education figures.)

NOTE: The reason you take 3 depth measurements of the stream. It can be explained by the following picture in A(B), B(10'), C(5'), total 20', find an average depth (D) which is 6'. Take total of day



C. Retrieve Data

Conduct a discussion. Discussion points to be made are:

1. How many people could live off this water for one day?
(Have groups compare their results).
2. How did your predictions compare with your calculations?
3. What would happen to this environment if we piped all the water at this point to a community?
4. If we decided to use some of this water to support a community, how would we determine the amount to be left to maintain the environment?
5. What might affect the amount of water?
6. What else would we need to do if we wanted a more accurate result to determine the adequacy of this water for a community supply?

CLOSURE

In this unit we have explored many different aspects of water. Share within your work group at least two new concepts or ideas you have learned. Look back at your original definition of watershed. Can you expand upon that definition now? How?



ACTIVITY A: Describe a Watershed

15 min.
small groups

Describe what you think is meant by a watershed : _____

Find your location on the creek (pond, lake) on a map of your area.

Where does the water come from? _____

Where does it go? _____

Draw lines around the boundaries of our watershed. We're in the _____ watershed.

What activities in this watershed might change the characteristics of this water?

Activity	Ways the activity might change the characteristics of the water

TABLE A: Relationships of water color to productivity

handout for Activity E

The quantity of life that may be present in any given body of water at any given time is often referred to as the "productivity." A water of low productivity is a poor water, biologically speaking, but is a clean water and desirable as a water supply or for recreational use. A productive water may be either a nuisance to man or it may be highly desirable. Foul odors and weed-choked waterways are usually branded a nuisance; however, bumper crops of bass, catfish or sunfish may be the result and are highly desirable.

Color of Water	Probable Cause	Fish Food Productivity
Clear	Absence of algae and micro-organisms	Low
Greenish hue	Blue-green algae	Moderate
Yellow to yellow-brown	Diatoms (microscopic, one-celled algae)	Moderately high
Red	Micro-crustaceans	High
Dark Brown	Peat, Humus	Low
GEOLOGICAL FACTORS HAVING BEARING ON COLOR		
In limestone geology Green	Abundant calcium	Moderate
In volcanic geology Yellow-green, Red	Abundant sulfur Abundant iron	Low Moderate

Table b: Relationships of Water Clarity to Fish Food Production and Watershed Condition

Depth you can see into water (Secchi disk reading)	Interpretations of Depth Readings		
	Fish Food Production (If reasons for degree of clarity are biological-algae, etc.)	Condition of Watershed above Water Readings (If reasons for degree of clarity are physical-soil situation, etc.)	Possibility of Dissolved Minerals
0" - 6" ↓ 24" +	<p>Most productive waters for fish food</p> <p>Maximum oxygen from photosynthesis (greatest diurnal variation)</p> <p>Maximum algae growth</p> <p>↓</p> <p>Least productive for fish food</p> <p>Minimum oxygen from photosynthesis (least diurnal variation)</p> <p>Minimal algae growth</p>	<p>Poor condition due to soil runoff, slides, etc.</p> <p>↓</p> <p>May indicate better condition because of vegetation cover, more stable soil, etc..</p>	<p>Most</p> <p>↓</p> <p>Least</p>



ACTIVITY B: What is a Watershed

5 min.
individual

What Is a WATERSHED?

"Watershed" is a new term to many people. The increasing use of soil and water conservation measures for watershed protection and flood prevention is bringing the term into more common use. Its definition is almost as simple as the well-known phrase "water runs downhill."

The drainboard that carries rinse water into your kitchen sink can be compared to a watershed.

On the land, water that does not evaporate or soak into the soil usually drains into ditches, streams, marshes, or lakes. The land area from which the water drains to a given point is a watershed.

When you were a small child, you probably had a favorite mud puddle in which you liked to play. The part of the yard from which the water drained into the puddle was its watershed.

Possibly a small stream ran by your house. It may have been dry most of the year or it may have flowed continuously.

Water from a few acres drained into that little stream. Those few acres were its watershed. This small stream and others like it ran into a larger one. The land areas drained by the small streams made up the watershed of the larger stream into which they flowed.

Small watersheds make up the larger ones. The Mississippi River, for example, drains a watershed of about 1,243,000 square miles.

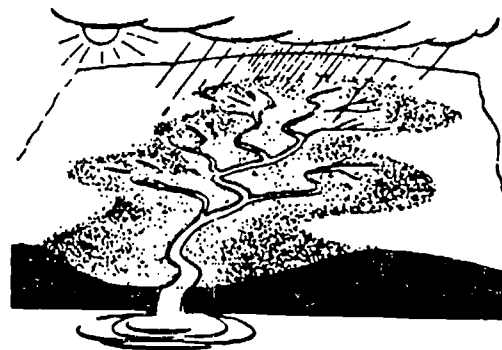

Diagram of a watershed showing the drainage pattern.

ACTIVITY C: Observe & Collect Aquatic Life

30 min.
small groups

Using the "Golden Nature Guide Pond Life" books or similar field manuals or attached picture keys, generally identify the specimens you found.

List or sketch the animals you found below. Return animals to water as soon as finished.

Type (name or sketch)	Description of where found	No.	Name



HANDOUT FOR ACTIVITY C: Aquatic Insects

SOME SUB-SURFACE FRESH WATER ORGANISMS

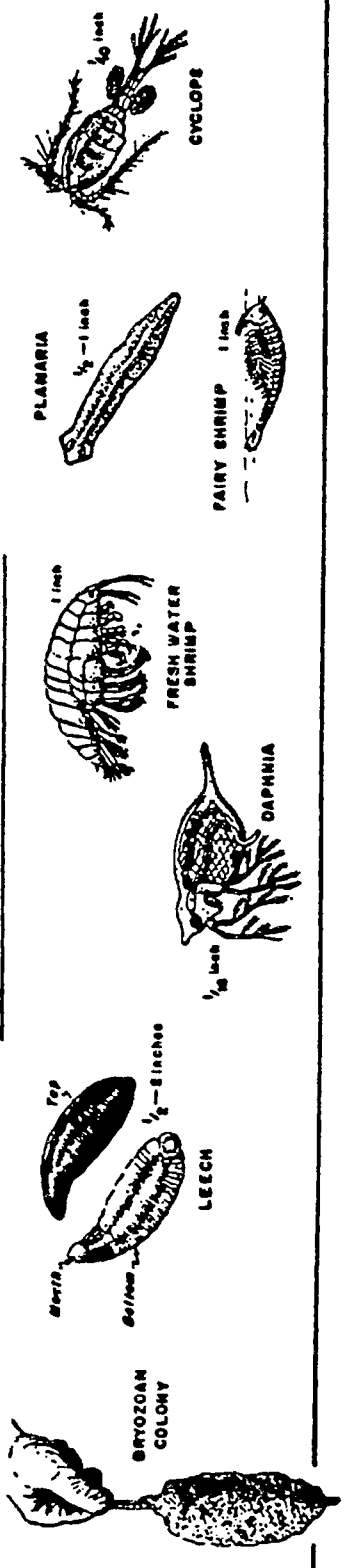

SOME AQUATIC INSECTS

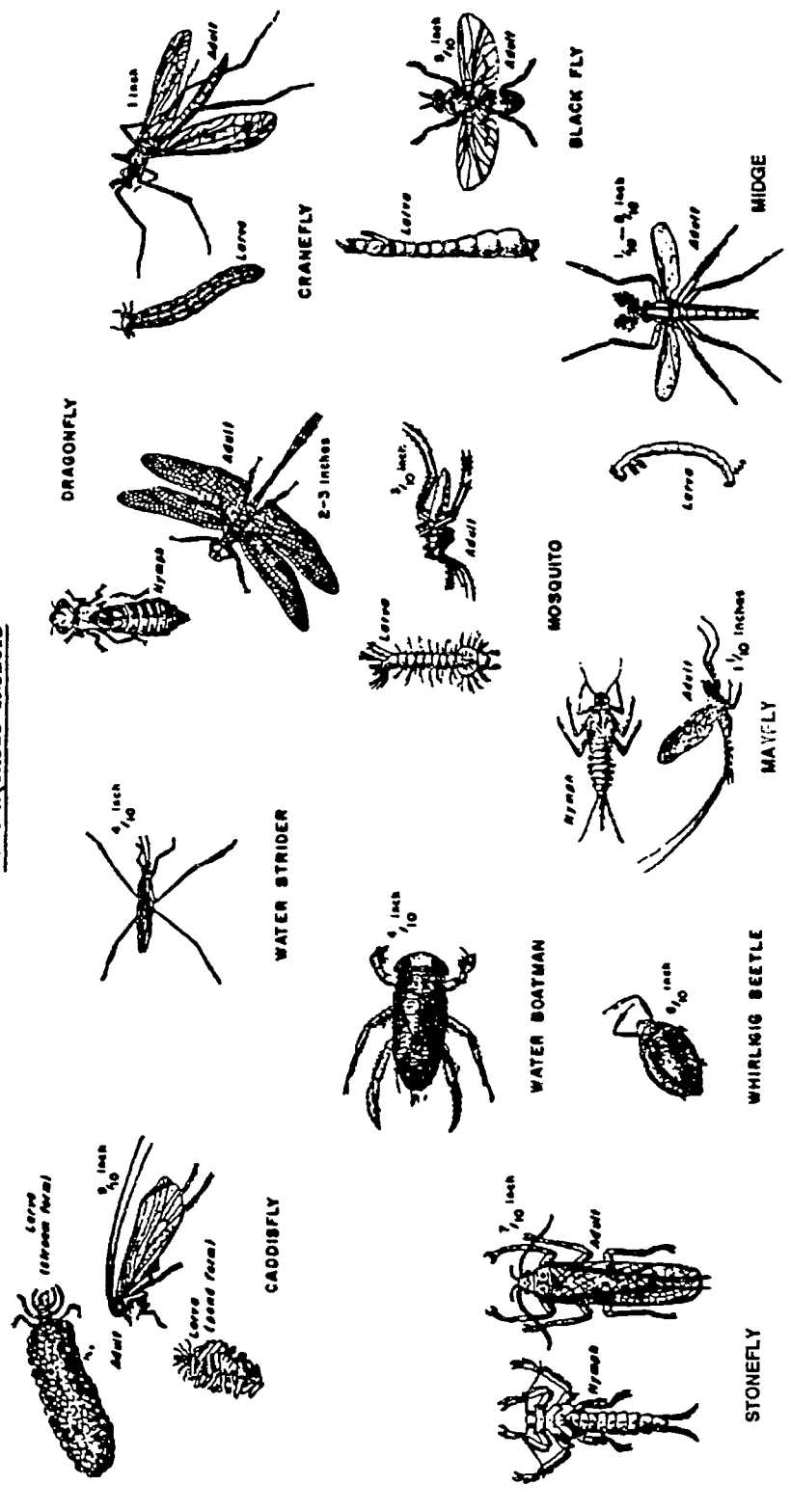

Oregon Department of Fish & Wildlife



ACTIVITY D: Predict Water Characteristics

10 min.
small groups

Based on the aquatic animals you found, the tables below in the Aquatic Data section, and your observations, predict the following characteristics of this stream.

I predict: the water temperature will be _____ because _____
 the air temperature will be _____ because _____
 the pH will be _____ because _____
 the dissolved O₂ count will be _____ because _____
 I can see about _____ ft. down into the water.
 The color of the water is _____

Keep these predictions for future use.

Table a: TEMPERATURE RANGES (APPROXIMATE) REQUIRED FOR CERTAIN ORGANISMS

Temperature (Fahrenheit)	Examples of life
Greater than 68° (warm water)	Much plant life, many fish diseases. Most bass, crappie, bluegill, carp, catfish, caddis fly.
Middle range (55-68°)	Some plant life, some fish diseases. Salmon, trout, stone fly, mayfly, caddis fly, water beetles.
Low range (cold-less than 55°)	Trout, caddis fly, stone fly, mayfly.

Table b: pH RANGES THAT SUPPORT AQUATIC LIFE

	MOST ACID			NEUTRAL						MOST ALKALINE				
	1	2	3	4	5	6	7	8	9	10	11	12	13	14
Bacteria	1.0									13.0				
Plants (algae, rooted, etc.)				6.5						12.0				
Carp, suckers, catfish, some insects				6.0						9.0				
Bass, crappie				6.5						8.5				
Snails, clams, mussels				7.0						9.0				
Largest variety of animals (trout, mayfly, stone fly, caddis fly)				6.5						7.5				

Table c: DISSOLVED OXYGEN REQUIREMENTS FOR NATIVE FISH AND OTHER AQUATIC LIFE

Examples of Life	D.O. in parts per million or/milligrams per liter
Cold-water organisms including salmon and trout (below 68° F.). Spawning, growth and well-being (caddis fly, stone fly, mayfly)	6 ppm and above
Warm-water organisms including game fish such as bass, crappie, catfish and carp (above 68° F.) Growth and well-being (some caddis fly)	5 ppm and above
Note: Pure, cold water can hold a maximum of 15 ppm under field conditions	

ACTIVITY E: Check Out Your Inferences

MAKE SURE EVERYONE IN YOUR GROUP GETS INVOLVED IN THE TESTING.

1. Using the water test kit, determine the water and air temperature, dissolved oxygen count, and pH of the stream or pond. Record predictions from activity.

Record the data below.

Name of stream, pond or lake: _____

Location of water sample (edge or middle of stream, bank of pond, etc.)	Time Taken	Temperature				pH		Usable Oxygen (ppm) (mg/liter)	
		Water		Air		My Pred.	Actual Test	My Pred.	Actual Test
		My Pred.	Actual Test	My Pred.	Actual Test				

2. Water productivity and color.

Based on the color you recorded in activity and from Table a, what can you say about this water?

3. Light penetration (pond or lake).

My estimate of how far I could see into water from activity, is _____ ft. Transparency of lake and pond waters can be roughly determined by the use of a white and black plate (called a Secchi disk) which is lowered on a line until it can no longer be seen. It is approximately 8 inches in diameter, painted white and black in alternate quadrants. Very little sunlight penetrates below the point at which the disk disappears.

Lower the Secchi disk into the water until it can no longer be seen. Measure depth from surface of the water to the disk and record _____ ft.

Based on the depth of the Secchi disk and Table b, which can you say about the water? _____

4. Temperature layering (pond or lake):

Based on the temperatures you recorded for your pond, the season of year and the information in Table C, describe what you think is happening in the water now.

ACTIVITY F: Determine Streamflow

10 min.
small groups

Instructions for collecting and recording streamflow measurements:

a. Measure and mark a 100 foot distance along a straight section of your stream. If you can't find a 100' section, use 25' or 50'. Throw a stick (5 or 6 inches long) in the water above the upstream marker. Record the number of seconds it takes to float downstream between the markers. Record below. Now divide the 100 foot distance by the total seconds it took the stick to float between the stakes. Do this three times and use the average time.

First measurement 100 ft. + _____ = _____ ft. per second
(distance) (total seconds (number of feet stick to float 100 ft.) floated each second)

Second measurement 100 ft. + _____ = _____ ft. per second

Third measurement 100 ft. + _____ = _____ ft. per second

Total _____ + 3 = _____
(ft. per second) (ft. per second average)

b. Find the average width of your section of the stream. Measure the width of the stream at 3 places within the 100 foot area. Divide the total by 3 to get the average width of the stream.

First measurement _____ feet.

Second measurement _____ feet.

Third measurement _____ feet.

Total _____ feet + 3 = _____ ft. (average width)

c. Find the average depth of your section of the stream. Measure the depth of the stream in 3 places across the stream in a straight line. Divide the total by 4 to get the average depth of the stream.

First measurement _____ feet.

Second measurement _____ feet.

Third measurement _____ feet.

Total _____ feet + 4 = _____ ft. (average depth).

NOTE: The reason you take 3 depth measurements then divide by 4 is to take into account the shallow areas of the stream. It can be explained by the following example of a drawing of a stream cross-section. If depth in 3 places is A(5'), B(10'), C(5'), (total 20'), find an average by dividing by 3 (20'÷3 = 6 2/3'). Now look at the mean or average depth (D) which is 5'. Take total of depths and divide by 4 (20'+4 = 5'), the correct average depth.

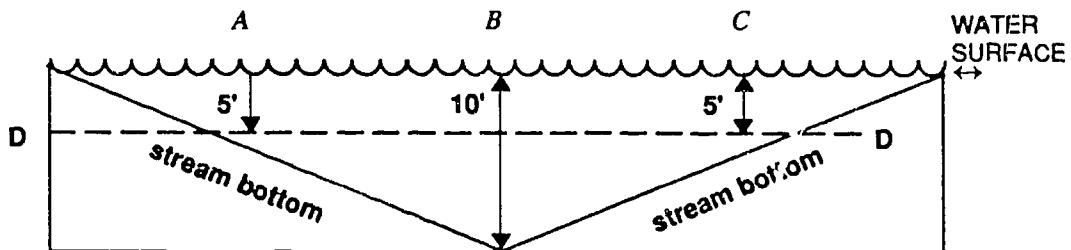

ACTIVITY G: Determine Stream Volume

10 min.
small groups

d. Find the cubic feet of water per second. Multiply the average width, average depth, and the number of feet the stick floated each second.

$$\underline{\hspace{2cm}} \text{ ft.} \times \underline{\hspace{2cm}} \text{ ft.} \times \underline{\hspace{2cm}} = \underline{\hspace{2cm}}$$

Average width Average depth Number of feet per second Cubic feet of water flowing per second

NOTE: A cubic foot of water is the water in a container 1 foot wide, 1 foot high and 1 foot long. It contains 7.48 gallons. In order to find out how many people could live from the water in this stream, complete the following calculations.

$$\underline{\hspace{2cm}} \times \underline{\hspace{2cm}} 7.48 = \underline{\hspace{2cm}}$$

Stream flow in cu. ft. per sec. Gallons in 1 cu. ft. of water Gallons of water per second

$$\underline{\hspace{2cm}} \times \underline{\hspace{2cm}} 60 = \underline{\hspace{2cm}}$$

Gallons of water per second Seconds in minute Gallons of water per minute

$$\underline{\hspace{2cm}} \times 1440 = \underline{\hspace{2cm}} + *200 \text{ Gal.} = \underline{\hspace{2cm}}$$

Gallons of water per minute No. minutes in a day Total gallons water per day Amount of water one person uses per day Total no. people who could live from water in this stream

*The average person uses about 200 gallons of water a day for home use. This does not reflect each person's share of water used for industrial, public services, and commercial. (U.S. Office of Education figures.)





BEST COPY AVAILABLE

Investigating Your Environment — Intermountain Region



INTRODUCTION

Forests are important for many reasons. They provide wood products important to our economy and our daily lives. They are valuable as recreation areas where we can enjoy their natural beauty and the wildlife that make their homes there. Forests provide oxygen for all animals, including humans, and help make and hold valuable topsoil in place.

We need to understand how forests work and what affects them so we can better understand what it takes to manage forest resources effectively.

THE ACTIVITIES

TIME REQUIRED

Cross Sections	20 minutes
Tree Growth	45 minutes
Tree Characteristics	30 to 45 minutes
Evidence of Change	30 minutes
Determine Site Index	30 minutes
Observe A Rotten log or Stump	20 minutes
Communicate Through Sketching and Writing	30 minutes
Transfer the Process to Other Environments	20 minutes



COMBINING THE ACTIVITIES

The activities in this unit are displayed singly. Depending upon the time available and the skill of the participants, you may choose to do only one activity or the entire series. For maximum learning, the activities should be experienced in the order listed in the unit, however, other suggestions are:

Suggestion 1

Title: Cross Sections/Tree Growth/Tree Characteristics Evidence of Change

Introduction: In these activities we will be looking at some things that affect how well trees grow in the forest. First we'll examine tree growth rings.

Activity: Cross Sections

Transition Statement: We've identified some of factors that affect tree growth in the forest. Now, let's look at a way to use that information.

Activity: Tree Characteristics

Transition Statement: What goes on in the environment has an effect on how trees grow. Next we will look for clues to events that have taken place in this environment.

Activity: Evidence of change

Summary: Now that we've seen some things that affect how trees grow, how could we use that information to grow healthier forests?

Suggestion 2

Title: Observe a Rotten Log or Stump/Communicate Through Sketching and Writing

Introduction: Data can be collected in many ways. It can be read, listened to, observed directly or determined by measurement. In this activity, we are going to gather data in yet a different way.

Activity: Observe a Rotten Log or Stump

Transition Statement: Just as there are many ways to gather information, there is also more than one way to record and interpret that data, as you will see when we begin the next activity.

Activity: Communicate Through Sketching and Writing

Summary: How could we use these sketches and writings? (By sharing the sketches and poems they could pass along their positive feelings about the forest environment to others.)

CURRICULUM RELATIONSHIPS

Social Studies

1. Read about past tools foresters used to measure trees and survey land. What tools and methods are used today? How have tools been adapted, if any?
2. Calculate the total number of board feet of lumber harvested yearly in your area. What is the importance of timber management in your community? How much money is the total board footage worth? Extend these calculations and figures to your county and then your state.
3. Draw or locate forested areas in your state. Locate the wood manufacturing mills in your county and draw arrows from the forest where the mills get their logs to the mills. Find out how many board feet of logs the mills use daily. If each log truck has about 6000 board feet on it, how many trucks of logs does it take daily to supply the mills with wood?



4. Read about forest seed orchards that produce seeds for reforesting harvested areas. How does forest genetics relate to human genetics?
5. Research early taxonomists like David Douglas. How did they contribute to the identification and classification of plants? Who developed the system of classification we use and has it changed? How?
6. Classify the economic importance of various tree species. How are population and industrial centers in the state affected by forest location? How important are forest resources to the state's economy? Which tree species are economically important?
7. Explore how trees are used in our environment. What kinds of trees are used in parks and along streets? What criteria are used for selection of trees in these areas, around water lines and underground utility lines?
8. Discuss how trees affect people's feelings about where they live or take vacations. What role do trees play in helping people relax or stay healthy? Do trees affect our mental and physical health? How?
9. Determine historical events of a tree cross-section based on ring count. Relate the size of the tree to important past events in state and/or local history.

Science

1. Grow tree seedlings following directions from the U.S. Forest Service, State Forester or Nursery. Keep good records and graph results. Grow beans at the same time and compare the growth rates.
2. Identify and classify different species of trees or associated stands of trees (forest types) the methods of silviculture used to manage timber stands.
3. Identify and classify the physical requirements of major forest types in your state. Consider factors like: general soil types, amount of light needed, climate, shade tolerance, even-aged stands, other trees found in the community.
4. Experiment with seeds such as radish to determine the optimum spacing for maximum growth. Manipulate factors such as selection and thinning.
5. Obtain samples of different species of wood. Experiment with strength and other physical properties. Determine its best use, then conduct research to verify or change your results.
6. Collect tree specimens and develop a classification key based on the major likenesses and differences of their leaf characteristics. Rework the key and provide an alternative way to classify the same leaves.
7. Make collections and classify them, devising a key. Keys can be made for rocks, soil, animal signs, skeletons, wood, bark, twigs; just about anything you classify.
8. Find a rotten log and explore it using ideas from "A Rotten Log" study.
9. Construct a model of a board foot.

Mathematics

1. Determine the height, diameter and board foot in a tree or telephone pole on your school yard. Determine the board feet in a standard cord of firewood.



2. Calculate the acres and percentages of state land in different forest types and make a bar graph to show the relationships, or use the computer to show the information many graph forms.
3. Graph local tree types to show growth rates and when they reach maturity.
4. Develop math vocabulary such as diameter, radius and circumference.

Language Arts

1. Write descriptive paragraphs about any of the activities in which you participated in this unit.
2. Write instructions for ways to germinate a Douglas-fir or other kinds of seeds using the "stratification" process.
3. Write and illustrate a book about the life of a tree for a primary classroom.
4. Pick a tree topic and write and illustrate an informative brochure for students your age. Place in the school's resource center.
5. Ask any forest management agency if they want some interpretive signs or brochures written. Work with agency personnel to develop the written material.
6. Write an article for the school newspaper about trees and their uses in your community.

Creative Arts

1. Use charcoal from a fire to sketch forest scenes. Spray with a fixative to save.
2. Make mosaics using materials found in the forest, i.e. bark, twigs, cones, needles, rocks, etc. Illustrate a concept or cycle learned in this unit, i.e. rotten log study.
3. Make rubbings of different tree barks, cross-sections, leaves and needles. Label and create an informative display for a school display case or create a book.
4. Construct models of forests in which you display different methods of forest management such as thinning, selective cutting, clearcutting, etc.
5. Create wreaths of forest materials such as cones, twigs, branches and grasses.
6. Explore music, poetry and song which has been written about trees. Create a dance or illustrate the writings.



CROSS SECTIONS

CONCEPT

Cause and Effect, Interaction, Gradient

PRINCIPLE

Reading tree rings can be as fascinating as reading books. A tree cross-section can help us understand more about the environment in which the tree grew thereby helping students understand more about the environment in which they grow. Accurate observations are the first step to interpreting the environment, and observations are key in this activity.

OBJECTIVE

- The student will be able to list at least four observations when reading a tree cross-section.
- The student will be able to define and distinguish between an inference and an observation.
- The student will be able to name at least three factors that can affect tree growth.

PREPARATION

Collect cross sections of trees 4" to 6" in diameter that show a variety of growth patterns and influences (wide and narrow annual ring spacing) such as fire, insects, diseases, damage from construction, or weather changes.

MATERIALS NEEDED

- cross sections of trees (one for every one to two people)
- easel paper or chalk board for recording responses
- Activity Sheet A: Looking at Cross-Sections (for each participant)

PROCESSES USED

- observe
- hypothesize
- infer
- communicate

TIME

20 minutes for the activity, discussion time as needed.



DOING THE ACTIVITY (indoors, outdoors)

A. Sci Stage

"Reading tree rings can be as fascinating as reading a book. A tree records in its growth rings information about the environment in which it grew and is now growing. In this activity we will be making observations using tree cross-sections to help us find out more about life and growth in a forest."

B. Procedure

1. Students will look at the tree cross-sections and discuss with other students some of their observations about their cross-section.
2. Distribute cross-sections, one to every one or two students.
3. After about five minutes, hand each student "Activity A" sheet, and ask them to use the top space on the sheet to record some of their observations about the cross-sections. They may work with another student after they've observed their cross-section. (5-10 minutes)

5-10 min.
Individual/group

ACTIVITY A: Looking at Cross Sections

Write down some things you notice about your cross section.

INFERRING TREE GROWTH RING PATTERNS

Work by yourself or with a partner

Select 3 observations about the cross sections from the group list. List possible reasons for these observations. List ways you could set up an investigation to find out more about your observations and inferences.

Observations (What you noticed)	Inferences (Possible reasons for this)	Investigations (How we could find out)
1.		
2.		
3.		

Tree Rings Information:

The current year's growth is the ring next to the cambium layer just inside the bark. The rapid spring growth is lighter colored than the growth made in the summer, so a light-and-dark colored ring makes one year's growth. It is easier to see and count the summer wood (dark rings) to determine the age of the tree when it was cut.

These rings are easily counted on the stumps of cut trees.



This tree was 42 year old when it was cut.
The dark rings are summer wood and the light rings are spring wood. One light and one dark ring makes one year's growth.

Investigating Your Environment
Forests 



Investigating Your Environment
Forests

4. Direct students to read the "Tree Rings Information" at the bottom of the sheet when they finish with the assignment. They may do this individually or with another student.
5. Mid-Activity Discussion: Begin by asking:
 - A. "What are some things you noticed about the cross-section?" List responses for participants to see. Make sure you point out that these are observations the participants are making. May need to define observation.
 - B. Point to two or three items from the list that deal with growth characteristics and rings, such as varying growth ring width, center not in the center, etc. What are some possible reasons for these growth patterns being present in the cross-sections? Point out that these reasons are inferences, that we infer from our observations what the reasons might be.
6. Ask students to extend their observations and inferences, then speculate about how they would find out whether their observations and inferences were true or not. To do this, complete the middle section of "Activity A".

C. Retrieve Data:

1. Insure that all students have read the last section of "Activity A".
2. Conduct a discussion. Make sure each student or student group reports on their observations.
3. Ask: "What observations did you select to think more about?" "Generally, what can growth rings tell us about a group of trees? (competition, climate, temperature)." "What do you notice about the ring pattern?"

CLOSURE

Students share with each other or group on the question "What have we found out about the conditions which affect tree growth?"

TRANSITION

We've identified some factors that affect tree growth in a forest. In the next activity (Tree Growth) we will explore ways to use that information.



TREE GROWTH

- CONCEPT** Cause - Effect, Interaction about some of the factors foresters use.
- PRINCIPLE** In this activity, participants learn a way to manage a forest stand for maximum growth potential. By studying core borings from living trees, they learn it is possible to study trees and improve growing conditions without destroying the living resources — trees.
- OBJECTIVE**
- The student will be able to identify and discuss factors that affect a pre-selected stand of trees.
 - The student will be able to design an investigation to find reasons for similarities and differences in tree growth patterns.
- PREPARATION**
- Select a timber stand for study. Tag four to five trees, number them and record the diameter of each tree. Select trees that show effects of environmental conditions — injury, over-crowding, lack of sunlight, etc. Bore each tree ahead of time. Number the cores to correspond with the tree numbers. Tape the tree cores to cardboard with transparent tape or place in plastic straws to keep the cores intact. If you plan to do this activity again, on this site, place the cores in liquid resin. They will keep indefinitely. In any event, keep the numbered cores and permanently mark the trees to eliminate the necessity of reborings.
- Prepare a large-sized matrix of the chart in step 2 of this activity. Cover the matrix with a sheet of plastic and record data with a grease pencil. This way, you can use the chart again.
- You can also do this activity using stumps that grew under a variety of competitive influences if you can find enough different examples in a relatively close relationship.
- MATERIALS NEEDED**
- increment borer
 - tags for trees
 - hand lenses
 - large chart of activity matrix
 - Activity Sheet B: Interpret Data About Tree Growth (for each participant)
- PROCESSES USED**
- observe
 - interpret data
 - hypothesize
 - communicate
 - infer
 - measure
 - use numbers
- TIME** 45 minutes



DOING THE ACTIVITY (indoors, then outdoors on site)

A. Set Stage

"In this activity, we will demonstrate a method for estimating how the environment influences tree growth".

B. Procedure

1. Show a sample of a tree core. Then use an increment borer to demonstrate how a core is taken. Answer any questions that arise.
2. Hand out core samples, hand lenses and Activity Sheet B. Use all the prepared cores so there will be good choices available when students get to #3 on the Activity Sheet.

15 min.
groups

ACTIVITY B: Interpret Data About Tree Growth

1. Observe the tree core your group has been given and record the following information:

Tree no.	Number of dark rings from center to bark (approx. age)	Remarks about the pattern of rings

2. When your group has the above information, one person from the group should read this information on the blackboard or easel board. Chart to be the ACTIVITY C, part 2.

DRAWING OF TREE CORE

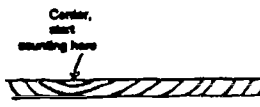

Record the following information about tree cores (the diameter information.)

Tree No.	Number of rings from center to bark (approx. age)	Diameter of tree trunk (Cir. * 3)	
1			
2			
3			
4			
5			
6			

ACTIVITY B: Interpret Data About Tree Growth (continued)

3. Set up an investigation to find out reasons for some of the differences in the data.
 - a. Select 2-3 trees from the list that show differences in growth rates.
 - b. Which trees did you select? (Indicate by number)
 - c. Why did you select these trees?
4. Go with your group to the site of the trees you selected for investigation and do (Part 4). Collect and Record Data. Record your observations:
 - a. Interpret Data. Record possible interpretations of the above data:
 - b. Summarize your investigation. Write your group's summary below. Include:
 - what you were trying to find out
 - what data you collected about it
 - what interpretations you made
 - what other data you would collect about your investigation

3. Review information about cores if you feel you need to, then instruct students to use next 5 minutes to complete #1 on the activity sheet. **TEACHER NOTE:** Monitor group work and adjust time to complete the activity - you can add 2 to 3 minutes if groups seem to need it.
4. Students record the information on their tree core in the chart in Point #2, columns 1 and 3. Facilitator asks, "what further information does this data provide?" and conducts a short (2-3 minute) discussion.
5. While the groups are working, teacher/facilitator records tree diameters on the large chart prepared ahead of time. Chart is the same one as found in Point #2 of the activity sheet, and asks students to record pertinent information on their activity sheet.
6. Transition: The cores you've been examining were removed from premarked trees on site. In a few minutes, we'll go find them and conduct further investigations.
7. Students should read part 3 on Activity B, gather all materials needed outside and follow the instructions. Teacher/facilitator: You may want to ask students which trees they choose and why.
8. Groups go outside to where trees are tagged and numbered and finish parts 3 and 4.

C. Retrieve Data

Each group provides a two to three minute summary of their findings. Ask questions that will help groups compare their information. Record or highlight information you think might help in the comparison.

CLOSURE

From our investigations, what are some factors that you think are affecting the growth of this forest?

TRANSITION

What goes on in the environment has an effect on how trees grow. In the next activity you will examine a forest environment looking specifically at how individual trees grow.



TREE CHARACTERISTICS

CONCEPT	Cause - effect, interaction, replication
PRINCIPLES	You've heard the old cliché, "can't see the forest for the trees." In this activity, participants will look at trees in a forested stand and examine specific characteristics, important if timber production is one of the objectives of the forest manager. Management for wildlife can also be an objective.
OBJECTIVE	<ul style="list-style-type: none">• The student will be able to analyze the growth characteristics of a group of young trees.• The student will be able to select trees with the desirable characteristics for timber production.• The student will be able to select trees with desirable characteristics for some kinds of wildlife.
PREPARATION	Select a young forest stand, 20 to 60 years old. Many times it can be the same stand used for collecting and interpreting data about tree growth.
MATERIALS NEEDED	<ul style="list-style-type: none">• selected tree stand• Activity Sheet C: Look at Tree Characteristics (for each participant)• tags to mark trees• plastic tagging of different colors
PROCESSES USED	<ul style="list-style-type: none">• observe• predict• hypothesize• infer• communicate
TIME	30 to 45 minutes



DOING THE ACTIVITY (outdoors)

A. Set Stage

1. "In the next 45 minutes, we will be investigating the factors affecting tree growth. There is a fixed amount of moisture and nutrients in the soil for plant use. Theoretically, all of this is used by plants for food manufacture and growth. For example, if there were 1,000 trees on one acre, they would use all the available moisture and nutrients and grow at a certain rate. If we evenly cut or thinned 900 trees out of the stand, the remaining 100 trees could have a potential of growing ten times faster than each of the original 1,000 trees. That might be important depending on the objectives for that group (or stand) of trees."
2. Not all trees in a forest are the same. The land manager, in selecting the trees in areas being managed, looks for certain characteristics in a tree to decide which trees have the best quality and the fastest growth.
3. "What are some of the characteristics that are important to look for in identifying which have the greatest economic potential?"

B. Procedure

1. Hand out the Activity sheet C.

NOTE :

Have students get in groups of 3 or 4. Provide each small group with different colored flagging.

2. "Working in your small groups spend 20 minutes doing the activity and filling out the activity sheet."

ACTIVITY C: Look at Tree Characteristics

20 min. groups

Using the characteristics below, look at the trees in a thick stand and mark at least five trees that you think are the best formed and fastest growing, and if at all should be left standing.

Some Characteristics to look for in Evaluating Trees in a Coniferous Forest:

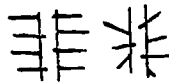

Tree Selection

The trees I selected to keep had the following characteristics:

The trees I selected to remove had the following characteristics:

Investigating Your Environment Forest 



Investigating Your Environment Forests

C. Retrieve Data

1. Have each group identify selected trees and give reasons.
2. Ask about other factors that could have bearing on selection of trees.
3. Ask what reasons were used the most for selecting trees, the least.
4. Ask how criteria and selection have been different if the trees were being managed for other objectives, such as wildlife or scenic quality.

CLOSURE

Discuss activity by asking:

1. "From our investigations, what have we found out about tree characteristics?"
2. "How do different management objectives affect which trees are left and which are taken?"
3. "What have we found out about managing tree stands?"

NOTE:

If you have students who are in an urban environment, you might ask:

- a. "How could you use this knowledge to develop a planting plan for your yard or school?"
- b. "What city environmental factors would you want to consider?"

TRANSITION

You have looked at individual tree cross sections, then at individual trees and how they grow, now you will look at a forested site to see if you can determine how this environment came to exist.



EVIDENCE OF CHANGE

CONCEPT	Cause and effect, change, system
PRINCIPLE	Using knowledge gained and observation powers, participants examine a site new to them to see if they can discern part of its history. The skills used and learned in this activity will transfer to the examination of any new site.
OBJECTIVE	<ul style="list-style-type: none">• The student will be able to identify at least three evidences of change in the environment.• The student will be able to describe the cause and effect relationships of the changes they identify.
PREPARATION	Locate a forest environment in which some evidence of changes can be observed. This could be the same site used for the "Tree Growth Rate" and "Tree Characteristics" activities. Prepare an easel paper chart of the activity "Recording Evidence of Change".
MATERIAL NEEDED	<ul style="list-style-type: none">• selected forest site• Activity Sheet D: Record Evidence of Change (for each participant)• flip chart sized activity sheet D
PROCESSES USED	<ul style="list-style-type: none">• observe• communicate• infer• hypothesize
TIME	30 minutes



DOING THE ACTIVITY (outdoors)

A. Set Stage

“Forests are continually in change, the results of natural and human causes. In this activity, we will be identifying evidence of change and determining the effects of those changes”.

1. What are some of the factors that could cause change in the forests?”
2. What are some indicators of change we might look for in the environment?”

B. Procedure

1. Hand out activity sheet D “Recording Evidence of Change”

ACTIVITY D: Record Evidence of Change 15 - 20 min.
small groups

Look for evidence of change (natural and human-caused) in the environment. Record and fill out other columns.

Evidence of changes in the environment	What might have caused them?	Effect on the environment

Investigating Your Environment
Forests 



2. "In small groups take 15 to 20 minutes looking for evidence of change. Record your findings on the activity sheet and transfer your results on the large chart."

C. Retrieve Data

1. Have groups share their results. Determine if any of the information enables the group to put the events into a time sequence. If it does, ask the students and record the information on another easel sheet.
2. Ask "What does this information tell us about the past history of this area?"
3. Ask "What natural influences have caused the most changes here?"
4. Ask "What human influences have caused the most change?"
5. Ask "What other information would be useful in creating the area's past?"

CLOSURE

Discuss activity by asking:

1. "What can we say about change in a forest?"
2. "In what other environments could we create past histories?"

TRANSITION

The preceding activities have helped demonstrate the complexity of a forest community. The next activity will help you look at a site and determine its potential for growing trees.



DETERMINE SITE INDEX

CONCEPT	Change, Evolution
PRINCIPLE	Site index is based on the relationships of the total height to the age of the dominant or tallest trees in the forest stand. The site is rated for growth of different tree species.
OBJECTIVE	<ul style="list-style-type: none">• The student will be able to conduct an investigation to determine growth rate differences in a given stand of trees.• The student will be able to determine the timber site index or growth potential of a piece of land.
PREPARATION	<p>Locate a dominant tree so that total height can easily be measured using the method on the activity sheet. It may be possible to use one of the dominant trees from "Tree Characteristics".</p> <p>Bore the tree. Tape the core to a card so the rings can be counted.</p> <p>Measure and mark a 100' or 200' distance so participants can determine their length of step.</p>
MATERIALS NEEDED	<ul style="list-style-type: none">• 100' tape• increment borer• tree identification key• local site index tables• Activity Sheet E: Determine Site Index (for each participant)• stakes, such as green garden stakes for measurement
PROCESSES USED	<ul style="list-style-type: none">• observe• measure• use numbers• interpret data
TIME	30 minutes

NOTE TO TEACHER: Although more sophisticated measuring techniques exist to measure the height of trees, this technique makes the mathematical principle visible and uses equipment that is readily available.



DOING THE ACTIVITY outdoors

A. Set the Stage

Now let's determine the potential of this site for tree growth. "Site index" is an important measurement in determining the productivity of a certain area or site for growing trees. Site index is based on the relationships of the total height to the age of the dominant or tallest trees in the forest stand. The site for growing trees is rated from excellent to poor and can be different for different tree species.

B. Procedure

1. Hand out the Activity sheet E.

20 min.
group

ACTIVITY E: Determine the Site Index of an Area

Work by yourself.

A. Determine the length of your step.
 Count the number of normal steps you walk in 200' and record below.
 No. of steps walked _____
 Length of step is _____ (Use chart to determine)

No. steps in 200'	Length of step
60-73	3'
74-87	2.5'
88-113	2'
114-149	1.5'

B. Determine the height of the tree.
 1. Hold your arm in front of you and parallel to the ground. Measure the distance from your hand to your eye. Cut a stick this length.
 2. Now hold the stick upright to form a right triangle with your eye.
 3. Facing the tree you wish to measure, walk backwards away from the tree on level ground, until the top of the tree can be sighted without the upper end of the stick. Place your hand in line with the letter at the tree.
 4. You are now the exact distance from the tree to the height of the tree. Count the number of steps it takes to return to the base of the tree.



C. Determine the age of the tree.
 Count the number of dark rings from the center of the tree core to the bark, and record in box at right.

Tree species and/or tree cut	Number of dark rings from center to bark (Approx. age)

D. Site Classification. Record the tree species, tree height, and age below. Using the following table, determine the site and classification.
 Tree Species: _____ H: _____ ft.: Age: _____ years:
 Site: _____

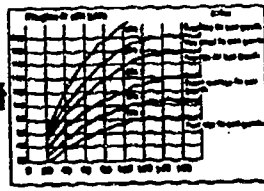

E. General Plant Index.
 Identification of ground plants can be used as a rule of thumb for determining site index. Using the chart below, compare the site index determined above.

Ground Plant	Site I, III, or IV (Poor to Fair)		Site II (Fair to Good)	
	Present	Absent	Present	Absent
Chickweed				
Sheep Sorrel				
Plantain				
White Clover				
Red Clover				
Trifolium				
Yarrow				

Site I
 Site II
 Site III
 Site IV

Investigating Your Environment



2. Site index is determined using these 3 pieces of information:
 - a. The length of your step which you can find out using the 200' course over there.
 - b. The tree height, using that tagged tree.
 - c. Tree age using this increment borer.

“By making these measurements and using the activity sheet, you can determine site index.”

“Another way to find site index is to inventory the ground cover. Ecologists have determined that there is a relationship.”

3. Take 20 minutes and work in small groups.

C. Retrieve Data

Discuss findings and compare results. Look at differences in results.

1. Ask “How did index derived from measurement compare to the index derived from ground cover?”
2. Ask “What are some ways that site index could be used?”
3. Ask “What other information would be important in determining future uses of this area?”

CLOSURE

“We have looked at the complexity of the forest ecosystems and the growth of trees. In the next activity we will complete our look at the life cycles of the tree and forest.”

TRANSITION

Now we will observe the impact and importance of the life-death cycle in a forested community.



OBSERVE A ROTTEN LOG OR STUMP

CONCEPT	Cycle, Organism
PRINCIPLE	A rotten log or stump is often called a "nurse" log because it acts as a nursery for young forest plants. Many concepts can be learned while studying the stump. In this activity, the concept of "cycle" is explored.
OBJECTIVE	<ul style="list-style-type: none">• The student will be able to observe the living and non-living things on the log and record their effects.• The student will be able to draw a simple cycle that is taking place on the log and explain what they have drawn.• The student will be able to demonstrate understanding of the importance of rotten logs by not tearing it apart as they explore it.
PREPARATION	Locate a rotting log or stump on which the effects of living and non-living things can be observed. If possible, locate more than one so that small groups can work on each log.
MATERIALS NEEDED	<ul style="list-style-type: none">• hand lenses, one for each participant• Activity Sheet F: Analyze a Rotten Stump (for each participant)
PROCESSES USED	<ul style="list-style-type: none">• observe• infer• communicate• interpret data
TIME	20 minutes



DOING THE ACTIVITY (outdoors)

A. Set the Stage

“Now let’s look at an ecosystem that is much smaller than others we may have investigated.”

B. Procedure

1. Hand out hand lenses and demonstrate how to use them. Many people have never used them before.
2. Hand out Activity sheet F. Point out that the sheet states “**DO NOT TEAR THE STUMP APART**”. Discuss why this warning is on the card. If working with students, insure that this is understood.

20 min.
individual

ACTIVITY F: Analyze a Rotten Stump

Work in groups or by yourself.

NOTE: DO NOT TEAR THE STUMP APART!

1. Record your observations and ideas below:

*LIVING THINGS	EFFECT ON STUMP

2. In the space below, construct a diagram of one of the cycles taking place in the rotten log or stump:

*You define the word cycle any way you want to.



BEST COPY AVAILABLE

3. Spend 20 minutes working by yourself.

NOTE TO TEACHER: You may have to help your group differentiate between "living", non-living", and "once living". Once living goes in "living", "non-living" are soil, rocks, air, water, sunlight.

C. Retrieve Data

1. Groups should share observations. Help them to compare and contrast their findings. Then ask for volunteers to share their diagrams or cycles. If appropriate, comment on how people defined and illustrated "cycle" differently.
2. Ask "What cycles did you identify?"
3. Ask "What roles do these cycles play in this environment?"
4. Ask "What caused the log or stump to die?"
5. Don't forget the possibility of social or economic cycles. Discuss the events that may have created the stump or log.

CLOSURE

Choose a closure idea you like or make up your own. If many cycles are similar, have those groups draw one cycle, combining the elements. Ask the group to illustrate the life cycle of the birth of a tree to death making sure to illustrate several of the forest influences they have studied. If cycles are different, ask the group to combine all the elements into one cycle.

TRANSITION

There are many ways to record data. The next activity emphasizes one more way to observe and record your observations.



COMMUNICATE THROUGH SKETCHING AND WRITING

CONCEPT Perception, change

PRINCIPLE People need to value all ways of observing. Some observe better with measure and instrument in hand. Others "feel" their environment and write music, poetry and create images to share. This activity is an opportunity to learn about a specific environment in another way.

OBJECTIVE

- The student will be able to explore and use colors from nature in a simple drawing of the site or elements of the site.
- The student will write about the forest's processes of change using a form of poetry.

PREPARATION Locate the log or stump to be used in this activity. More than one is helpful, so participants can spread out.

The subject of the sketch depends upon the environment. It can be anything that is significant about the area...rotten log, stump, or snag, an old homestead, fence, or barn, a city building, transmission tower or freeway.

MATERIALS NEEDED

- sketching paper, such as white or manilla construction paper
- pieces of charcoal from a fireplace or campfire, (not commercial)
- natural drawing materials such as rotten wood, leaves, flower
- petals, wet clay or soil

PROCESSES USED

- observe
- communicate

TIME 30 minutes

NOTE: See appendix for forms of poetry.



DOING THE ACTIVITY (outdoors)

A. Set the Stage

"We observe and make order of our environment in different ways. Some people are most comfortable when measuring and recording in scientific ways. Others feel their environment and are more comfortable expressing themselves through the arts. Today, we are going to record some impressions through the use of sketching and poetry."

B. Procedure

1. Hand out paper and charcoal (use charcoal from a fire, if possible).
2. Tell them they have 15 minutes to find a comfortable place where they can see a log or stump.

NOTE: You may want to provide the group with leaves, rotten wood, flowers, etc. which might provide color. Just be careful not to disrupt the site.

3. When most people have finished their sketch ask them, "Would you please take out a pencil or pen and find a place on your sketch (across the bottom, or down the side) to write some things as I give you the directions." Repeat the instructions each time.
 - a. Write down two descriptive words about the scene, log or stump - words that tell what it looks like.
 - b. Write three action words about the scene, log or stump - words that describe processes or changes taking place, or things happening to it.
 - c. Now write a short phrase (4-5 words) that tells how the scene, log or stump affects the rest of the environment - a phrase to describe its value or usefulness, or a phrase describing any thought you have about the stump.
 - d. Write one word that sums up everything - a word that suggests a comparison, an analogy, or synonym.
 - e. Optional: Now, if you wish, go back and give a title to what you have written.

C. Retrieve Data

Encourage people to read their writings if they wish, but keep it voluntary. They may also display their sketches if they want.

CLOSURE

Notice that sketching and writing are other ways to collect data and make interpretations of observations about some of the environment. You have just written a cinquain, a Japanese form of poetry, about the stump or whatever object you wrote about.

TRANSITION

You have learned the basics of a lot of skills which professional foresters use to manage forested lands. The thought processes that enabled you to learn the skills, are processes which are transferable to new and different environments. The following activity will give you some experience in the transfer process.

88



TRANSFER THE PROCESS TO OTHER ENVIRONMENTS

CONCEPT	Replication
PRINCIPLE	The goal of education is to provide learning experiences and then test to see if the student understands the concept or processes well enough to use the knowledge and skills to solve other, similar problems.
OBJECTIVE	<ul style="list-style-type: none">• The student will be able to identify other things that would be important to investigate and interpret in the forest.• The student will be able to identify how the same processes can be used elsewhere.• The student will be able to summarize, either verbally or in writing, their learning in this activity
PREPARATION	Complete all of the forest investigations you plan to use
MATERIALS NEEDED	<ul style="list-style-type: none">• Activity Sheet G: Transfer the Process (for each participant)
PROCESSES USED	<ul style="list-style-type: none">• observe• infer• hypothesize• predict• communicate
TIME	20 minutes



DOING THE ACTIVITY (indoors)

A. Set the Stage

We have identified a lot of information about the forest. This asks you to look for some additional things in the forest environment that might be important for you to know.

B. Procedure

Hand out the "Transferring the Process" Activity Sheet and say, "take a few minutes, and in groups of no more than four, fill out this sheet."

ACTIVITY G: Transfer the Process

10 min.
groups

List some other things in this environment that could help us further interpret the forest.

Things in the forest	What it can tell us about the forest?

Identify and list some of the methods and processes we used today in our investigation.

Describe how we could use those methods and processes in another environment to find out more about it (city, schoolyard, etc.).

Investigating Your Environment
Forests 

30



Investigating Your Environment
Forests

C. Retrieve Data

1. "What are some things you listed and what can they tell us about the forest?" "What were some of the methods and processes used in our investigation?" "What are some ways we could apply our experience today to other environments back home?"
2. "Working in groups, list some things you found out about the forest environment".
3. "In what ways do these things help us understand how forests are managed?"
4. "What are some of the economic considerations of forest management? Social? Political?"
5. "What other information do we need for a better understanding of the forest?"

CLOSURE

"If we had to put all of these things into one or two big ideas, what would we say?" List these on chart paper.
"How could we use these methods & processes in another environment to find out more about it (city, schoolyard and etc...)".



ACTIVITY A: Looking at Cross Sections

5-10 min.
individual/group

Write down some things you notice about your cross section.

INFERRING TREE GROWTH RING PATTERNS

Work by yourself or with a partner

Select 3 observations about the cross sections from the group list. List possible reasons for these observations. List ways you could set up an investigation to find out more about your observations and inferences.

Observations (What you noticed)	Inferences (Possible reasons for this)	Investigations (How we could find out)
1.		
2.		
3.		

Tree Rings Information:

The current year's growth is the ring next to the cambium layer just inside the bark. The rapid spring growth is lighter colored than the growth made in the summer, so a light-and-dark colored ring makes one year's growth. It is easier to see and count the summer wood (dark rings) to determine the age of the tree when it was cut.

These rings are easily counted on the stumps of cut trees.



This tree was 42 year old when it was cut. The dark rings are summer wood and the light rings are spring wood. One light and one dark ring makes one year's growth.



ACTIVITY B: Interpret Data About Tree Growth

15 min.
groups

1. Observe the tree core your group has been given and record the following information:

Tree no.	Number of dark rings form center to bark (approx. age)	Remarks about the pattern of rings

2. When your group has the above information, one person from the group should record this information on the blackboard or easel board. Chart to be like ACTIVITY C, part 2.

DRAWING OF TYPICAL TREE CORE

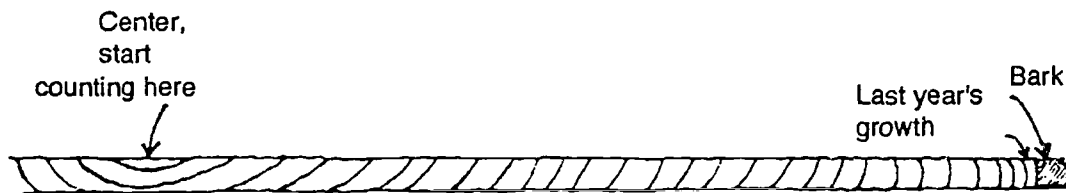

Record the following information about tree cores from the master chart. (Instructor will provide the diameter information.)

Tree No.	Number of rings from center to bark (approx. age)	Diameter of tree trunk (Cir. " 3)	Remarks about the ring pattern
1			
2			
3			
4			
5			
6			



ACTIVITY B: Interpret Data About Tree Growth

(continued)

3. Set up an investigation to find out reasons for some of the differences in the data.
 - a. Select 2-3 trees from the list that show differences in growth rates.
 - b. Which trees did you select? (Indicate by number)
 - c. Why did you select these trees?

4. Go with your group to the site of the trees you selected for investigation and do (Part 4).
Collect and Record Data. Record your observations:
 - a. Interpret Data. Record possible interpretations of the above data:

 - b. Summarize your Investigation. Write your group's summary below. Include:
what you were trying to find out

what data you collected about it

what interpretations you made

what other data you would collect about your investigation



ACTIVITY C: Look at Tree Characteristics

20 min.
groups

Using the characteristics below, look at the trees in a timber stand and mark at least five trees that you think are the best formed and fastest growing, and that should be left standing.

Some Characteristics to look for in Evaluating Trees in a Coniferous Forest:

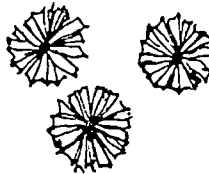
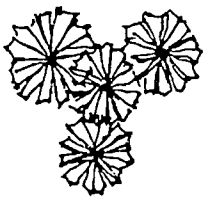
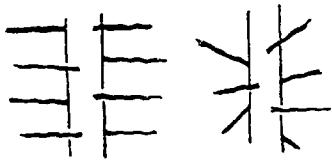

Tree Selection

The trees I selected to keep had the following characteristics:

The trees I selected to remove had the following characteristics:



ACTIVITY D: Record Evidence of Change

15 - 20 min.
small groups

Look for evidence of change (natural and human-caused) in the environment.
Record and fill out other columns.

Evidence of changes in the environment	What might have caused them?	Effect on the environment



ACTIVITY E: Determine the Site Index of an Area

20 min.
groups

Work by yourself.

A. Determine the length of your step.

Count the number of normal steps you walk in 200' and record below.

No. of steps walked

Length of step is

(use chart to determine)

no. steps in 200'	length of step
66-73	3'
74-87	2.5'
88-113	2'
114-over	1.5'

B. Determine the height of the tree.

1. Hold your arm in front of you and parallel to the ground. Measure the distance from your hand to your eye. Cut a stick this length.
2. Now hold the stick upright to form a right triangle with your arm.
3. Facing the tree you wish to measure, walk backwards away from the tree on level ground, until the top of the tree can be sighted across the upper end of the stick. Make sure your hand is in line with the base of the tree.
4. You are now the same distance from the tree as the height of the tree. Count the number of steps it takes to return to the base of the tree.

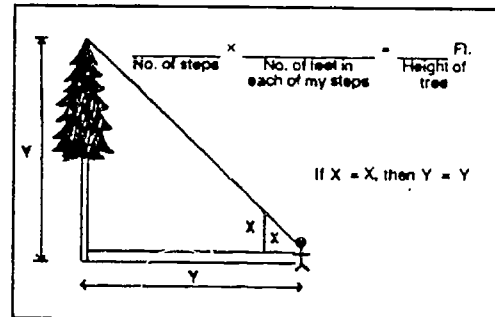

C. Determine the age of the tree.

Count the number of dark rings from the center of the tree core to the bark, and record in box at right.

Tree species and/or tree no.	Number of dark rings from center to bark (approx. age)

D. Site Classification. Record the tree species, tree height, and age below. Using the following table, determine the site and classification.

Tree Species ____; Ht. ____ ft.; Age ____ yrs.;
Site ____; Index ____.

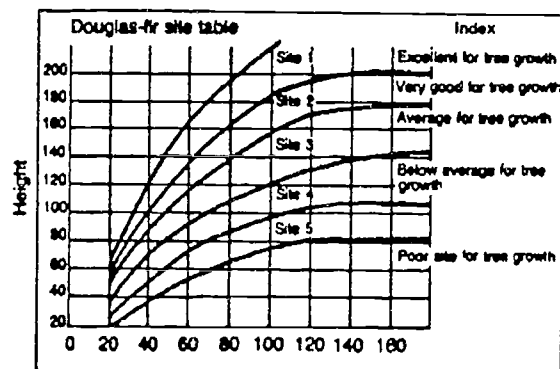

E. Ground Plant Index.

Identification of ground plants can be used as a rule of thumb for determining site index. Using the chart below, compare the site index determined above.

	Site II	Site III	Site IV	Site V
Sword fern	XXX*	X		
Oxalis	XXX	X		
Ducks-foot (inside-out flower)	XXX	X		
Trillium	XXX			
Salal	X	X	XXX	XXXX
Oregon grape	X	X	XXX	XXXX
Rose		X		X
Ocean spray		X		
Honeysuckle		X	X	
Snowberry		X	X	
Lupine			X	
Kinnikinnik			X	
* / bundance				

X Below 25%
 XX Between 25 & 50%
 XXX Between 50 & 75%
 XXXX Over 75%

of ground covered by one species



ACTIVITY F: Analyze a Rotten Stump

20 min.
individuals

Work in groups or by yourself.

NOTE: DO NOT TEAR THE STUMP APART!

1. Record your observations and ideas below:

*LIVING THINGS	EFFECT ON STUMP
*NON-LIVING THINGS	EFFECT ON STUMP

2. In the space below, construct a diagram of one of the *cycles taking place in the rotten log or stump:

*You define the word cycle any way you want to.



ACTIVITY G: Transfer the Process

10 min.
groups

List some other things in this environment that could help us further interpret the forest.

Things in the forest	What it can tell us about the forest?

Identify and list some of the methods and processes we used today in our investigation.

Describe how we could use those methods and processes in another environment to find out more about it (city, schoolyard, etc.).





BEST COPY AVAILABLE

Investigating Your Environment — Intermountain Region



INTRODUCTION

The idea that plants have particular places where they prefer to live, and even particular plants with which they live congenially in communities, may seem a paradox. No plant, after all, exercises a willful choice as to where its seeds fall and germinate. Wind-borne, bird-borne, carried in water or by mammals in their fur, seeds seemingly face a haphazard distribution. Yet there is no doubt that plants grow only in particular places, whether these be the rock to which some lichen clings, the treetop to which some climbing vine laboriously makes its way, or even, a host which provides a parasite with what is needed. Nor is there any doubt that plants live in specific communities with definite boundaries - we've all seen how abruptly a forest gives way to prairie or meadow.

Part of the reason for this apparent choosiness of plants lies in requirements of light, moisture, temperature and soil condition. If distribution depended only on these factors, many species would be far more widespread. As it is, we find that a forest undergrowth of pines is different from that of a hardwood forest. When we analyze these differences, patterns of definite plant communities emerge. The reasons why plants grow in communities are only partly known. One interesting aspect is that certain plants definitely inhibit others. In a plant-like way, they are antisocial. There are plants which help other plants to grow better. Clover, a well-known example, contains bacteria which cause the growth of its root nodules to fix nitrogen from the air, thus producing nitrate fertilizer, which benefits not only clover but any other plants as well.

We gain a better understanding of plants by observing their habitats and seeing how they fit into the world as a whole. The following activities offer a guideline for learning how to observe plants and for gaining a better understanding of plant needs, adaptations, communities and management.

THE ACTIVITIES

TIME REQUIRED

Define and Locate Plant Communities	30 minutes with discussion
Map Plant Communities and look at Plant Distribution	60 minutes
Study of a Single Plant	45 minutes
Plant Influences, Functions and Values	60 minutes
Dramatize Plant Roles	20 to 30 minutes

COMBINING THE ACTIVITIES

The activities in this unit are displayed singly. Depending upon the time available and the skill of the participants, you may choose to do only one activity or the entire series. For maximum learning, the activities should be experienced in the order listed in the unit, however, other suggestions are:

Suggestion 1

Title: Define and Locate Plant Communities/Map Plant Communities and Observe Plant Distribution/ Study of A Single Plant/ Plant Influences, Functions and Values/ Dramatize Plant Roles.

Introduction: We will examine plants, their relative locations and how the plants effect and are affected by various factors, including people, in their environments. We will then look at the roles, functions and values of the plant communities and develop some guidelines about the use and protection of plant communities within an ecosystem. We will conclude by looking at ways that plants may function or have roles similar to individuals in a human community.

Transition Statement: Now that we have used our sense of vision to identify some plant communities, let's develop some skills in mapping individual communities.

Activity: Map Plant Communities and Observe Plant Distribution.

Transition Statement: Plant communities are composed of individual plants. Let's look at characteristics of some of the dominant plants in our plant community.

Activity: Study Of A Single Plant

Transition Statement: We have now located several plant communities, looked at how individual plants are distributed and drawn composite maps of the communities. Now let's investigate the affects the study plants have on the rest of the plant community, and ways your plant community has been effected by people and other factors.

Activity: Plant Influences, Functions and Values

Transition Statement: Another way of communicating how plants relate to each other is by role playing.

Activity: Dramatize Plant Roles

Suggestion 2

Title: Study Of A Single Plant/ Map Plant Communities and Observe Plant Distribution/ Plant Influences, Functions and Values/ Define and Locate Plant Communities/Dramatize Plant Roles.

Introduction: The activities we will be involved in focus on plant adaptations and how these adaptations relate to the distribution of certain plants. We will examine the plants, their relative locations and how the plants effect and are affected by various factors in their particular environments. We will then look at the roles, functions, and values of the plant communities within an ecosystem.



Transition Statement: Now that we have examined the characteristics of individual plants, let's develop some skills in mapping the location of the plants in their natural habitats.

Activity: Map Plant Communities

Transition Statement: We have gathered information about some plant characteristics and the distribution of plants on our study plots. To help us identify some of the relationships that exist among our plant communities we will prepare visual displays of the study plots and look for similarities and differences.

Activity: Look At Plant Distribution

Transition Statement: We have now located several plant communities, looked at how individual plants are distributed and drawn composite maps of the communities. Now let's investigate the effects the study plants have on the rest of the plant community, and ways your plant community has been affected by people and other factors.

Activity: Plant Influences, Functions and Values

Transition Statement: Another way of communicating how plants relate to each other is by role playing.

Activity: Dramatize Plant Roles

CURRICULUM RELATIONSHIPS

Social Studies

1. Find out which plants have played an important role in the history of your area. What were they used for? What changes in human history did they cause, if any?
2. Investigate the importance of plants to the Native American populations in your area. What economic, social or religious value do plants have?
3. Investigate what plants are important to the economic stability of your state, if any. Has the economic value of these plants always been the same? Are changes in the future? How? Why?
4. Investigate if changing land uses have affected the plant communities in your area. How have the increase in the number of people affected plant communities?
5. Investigate the threatened or endangered species of plants in your state. How did they get listed? What is being done to insure that they will not become extinct?
6. Investigate your state flower and state tree. How and when were they nominated? Tell about them in an oral presentation of your choice.

Science

1. Set up transects to inventory plants near your schoolyard or outdoor site. How does the diversity of plants compare to the diversity in natural communities?
2. Compare aquatic plant communities to terrestrial plant communities in your area. What defines the boundaries between aquatic plant communities?



3. Help create an area for native plants near your school. How do these differ from those used to landscape peoples' houses in your area?
4. Investigate the life cycles of different types of plants.
5. Find out the effects of different concentrations of herbicides and fertilizers on plants. How does air or water pollution affect plants?

Mathematics

1. Inventory plants on a local golf course, the schoolyard lawn and a wild area. Plot this information on a graph to determine the influence of people on species diversity.
2. Measure the size of plants in your garden. Calculate the average size of a particular species of plant.
3. Estimate the number of seeds that will be produced by a common garden plant, such as a marigold. Scatter the seeds in a flower box and estimate how many will germinate. Compare your estimates with actual counts.
4. Grow some plants in your classroom. Graph the growth rate of the plants, the number of plants that germinate and the number that survive to maturity.

Language Arts

1. Write a poem or a song about your favorite plant.
2. Visit a botanical garden or local nursery and write a story that takes place in that area.
3. Learn new plant related vocabulary such as pistil, stamen, petal, pollen, fruit, community, association, etc. Use these words to write a story or a song. Include these words in a spelling or vocabulary list.
4. Read poems, stories or novels in which real or imaginary plants are important to the plot. e.g. Dr. Seuss' "The Lorax".

Creative Arts

1. Keep a sketchbook of plants you see in your neighborhood.
2. Create a poster of plants that are economically important in your state.
3. Draw a mural depicting the plants and flowers around your school. Use only natural materials.
4. Use different media to create postcards, bookmarks or note cards with plant themes.
5. Make leaf print T-shirts as gifts for family or friends.
6. Make a sculpture of some native species of plants.
7. View artwork and sculpture from different times and cultures that portray plants or natural environments containing plants. What can you tell about the artist's attitude toward plants or his/her understanding of ecosystem concepts by looking at the art? Do not forget to include cave art, Native American symbols and sand paintings, painting and sculpture by early American pioneers, Renaissance painting, and African, Oriental and East Indian art.



DEFINE AND LOCATE PLANT COMMUNITIES

CONCEPT	Organism, population, system, perception
PRINCIPLE	This activity gives participants the opportunity to discuss new terms related to the environment, visually select different plant communities and predict which communities will differ enough to be compared.
OBJECTIVE	<ul style="list-style-type: none">• The student will be able to define population, community, plant community, and ecosystem.• The student will be able to differentiate between different plant communities.• The student will be able to list the components of an ecosystem.
PREPARATION	Locate the group adjacent to the boundaries of three different plant communities such as a north and south slope and a riparian zone in between. Decide on some physical limits. The "base" location is an important consideration for participant comfort and satisfaction. Attempt to choose sites that do not require the participants to walk too far, or back and forth too often.
MATERIALS NEEDED	<ul style="list-style-type: none">• 2' x 3' cardboard with flip chart paper attached• definitions of population, community, plant community and ecosystem on flip chart paper
PROCESSES USED	<ul style="list-style-type: none">• observe• infer• define operationally
TIME	30 minutes with discussion



DOING THE ACTIVITY (outdoors)

A. Set Stage

"We will be discussing some terms that are important to our understanding of this environment. We will also be selecting plant communities that we may wish to investigate. Make sure you are sitting where you have a clear view of this environment."

B. Procedure

1. Pre-investigation Discussion (10 minutes)

"In order to make sure we all interpret the instructions for the following activities in a similar fashion, there are certain terms we should understand".

NOTE: record answers as they are given on the flip chart.

- a. "What are some things you think of when you hear the word population? community? plant community? ecosystem?" Give people time to think. Accept all reasonable answers. Below are definitions of each word.

1. **Population:** A group of a single kind of organism.
2. **Community:** A group of people with common characteristics living together within a larger society. [or populations of organisms interacting with each other].
3. **Plant Community:** An association of plants, each occupying a certain position, inhabiting a common environment and interacting with each other.
4. **Ecosystem:** Communities of organisms interacting with each other and the physical environment.

- b. Ask, "In addition to plants, what other things may be found in ecosystems?" Record responses.

Possible answer might be: Soil, water, air, decomposers, insects, animals, (birds, mammals, insects, people, etc), energy sources/ flow, rocks, etc.



2. Instructions: Begin activity (5 to 7 minutes)

“From where you are sitting, take 3 to 4 minutes to look around and identify nearby areas (within 200 feet) that appear to support different plant communities. Write your ideas down, then discuss your observations and ideas with other students.” You have about 5 minutes.

C. Retrieve Data

Discuss student observations.

1. What are some areas that appear to support different plant communities? Record whole groups observations as before.
2. Refer to the list just generated. Which of the sites appear to show the most significant differences? Why do you think so?
3. If the next activity is to be done, let the group decide which three sites they would like to investigate further.

CLOSURE

“Identifying different plant communities here, what can we say about plant distribution?”

TRANSITION

“In the next activity we will be mapping plant communities you just selected.”



MAP YOUR PLANT COMMUNITY AND LOOK AT PLANT DISTRIBUTION

- CONCEPT** Quantification, organism, population, perception, scale, system
- PRINCIPLE** This activity gives students the opportunity to estimate spatial relationships and map the distribution of selected plants in their environment.
- OBJECTIVE**
- The student will be able to identify, map and inventory a plant community.
- PREPARATION** Students should select three distinct plant communities for this study. Place a "transpiration bag" over a sample plant as a demonstration.
- MATERIALS**
- NEEDED**
- Activity Sheet A: Map Your Plant Community and B: Look at Plant Distribution
 - 3 rolls of flagging, each roll a different color
 - 24 clear plastic bags - various sizes (ziplock or regular with ties)
 - 12 marking pens in assorted colors
 - (3) 2' x 3' cardboard flip charts with paper [paper with squares works best]
- PROCESSES USED**
- hypothesize
 - observe
 - measure
 - use numbers
 - communicate
 - infer
 - classify
- TIME** 60 minutes



DOING THE ACTIVITY (outdoors)

A. Set Stage

"In this activity, we will start the process of determining how plants are distributed in plant communities. We will lay out plots and map the plants growing there."

B. Procedure

1. Divide students into three groups; one group per area to be studied. Ask groups to choose an area to study or assign an area.
2. Demonstrate the proper way to "bag" a plant to collect transpired water. (you have already bagged one plant in teacher preparation; this is a second plant on which you demonstrate the technique).
3. Distribute Activity Sheet A, flagging and plastic bags and ties.

ACTIVITY A: Map your plant community

30 min.
groups

1. Select a representative area, mark the boundaries (corners and mid-points) of your plot with flagging. The plot should be twelve steps square.
2. As a group, decide upon the most significant or most characteristic plants of your plot.
3. Each person should choose one of them as a primary study plant to map, describe, and mount, and a secondary study plant if so instructed by your teacher.
4. Place a plastic bag over your primary study plant. You will use these plants later.
5. Working individually, map the location of all occurrences of your study plant. Develop your own plant symbols.

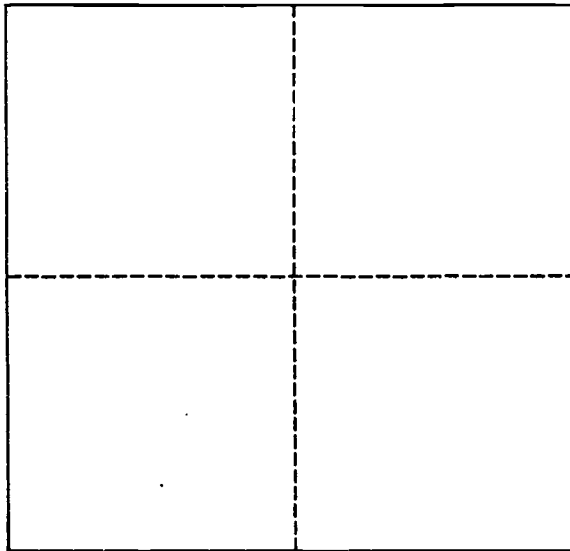

←----- 12 steps -----→

Primary Study Plant (Name) _____ (Symbol) _____
Primary Study Plant (Name) _____ (Symbol) _____

Investigating Your Environment
Plant Relationships 



4. Instructions: Go over instructions with groups before they go to their plot.
 - a. Select an area within your specific plant community which appears to be representative of your community.
 - b. Use colored flagging and lay out a plot that is 12 steps by 12 steps.

NOTE: If this group has laid out a plot in another investigation, they may use that method, or you may have them measure a plot of specific dimensions. Tell the students that the points to flag are listed on the activity sheet.

- c. Once plot is established and marked, as a group, determine the plants that seem to be most significant or characteristic of your site.
 - d. Each team member should select one of these plants as a primary study plant to map. A secondary study plant may be included if time allows. If possible, the plants chosen should not be the same as those chosen by another team member.
 - e. Place a plastic bag over your primary study plant. This was demonstrated for you earlier. Instructions also appear on Activity Sheet A.
 - f. Now work by yourself to map the location of all occurrences of your plant on your study plot. Use Activity Sheet A. Follow instructions on your activity sheet. Also map significant features such as rocks, fallen logs, fences or streams.
 - g. Finally, after individually mapping your study plants, work with the other team members to make a representative map of all of study plot plants on a large piece of flip chart paper provided. Your group will give a three to four minute presentation describing your map and the distribution of the study plants. Involve at least two team members in the presentation.
5. Give students at least 30 minutes to do the activity. Teacher/facilitator circulates, monitors and adjusts and checks for understanding.



ACTIVITY B: Look at Plant Distribution

Individual

As presentations are made, please characterize each plot by sketching general plant patterns that you see.

1st Plot



Thoughts : _____

2nd Plot



Thoughts : _____

3rd Plot

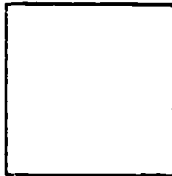

Thoughts : _____

Investigating Your Environment
Plant Relationships



C. Retrieve Data

1. Hand out Activity Sheet B while teams are laying their large-scale maps side by side.
2. Each team makes their 3 to 4 minute presentation. They should describe the plants they investigated. If another team studied the same plant, they should agree on a common symbol so composite maps in Activity B are comparable.

111



Investigating Your Environment
Plant Relationships

3. Continue until each team has reported. Have the students look for some patterns (similarities and differences) among the plots as the groups present findings. Tell students that they will be deducing reasons for the differences between the various study sites. To help accomplish this, have students record information from the presentations on Activity Sheet B.
4. Discussion during data retrieval should include the following thoughts: (Allow about 20 minutes)
 - a. What did you notice about the plots?
 - b. Which plots seemed to have the most plants? the most different plant species?
 - c. What factors could have led to the distribution of the plants on these plots?
 - d. What similarities and/or differences did you notice between plots?
 - e. Which plant communities were the most similar? Why?
 - f. What patterns seem evident after listening to the presentations and viewing the composite map?

CLOSURE

“From our investigation what factors have influenced the patterns of plant distribution we observed today?”

TRANSITION

“Now that we have looked at the distribution of plants on your study plot, let’s focus on the characteristics of an individual plant.”



STUDY OF A SINGLE PLANT

CONCEPT	Organism, evolution, interaction, population
PRINCIPLE	Characteristics of plants can be described without knowing the plant's name or having a vast knowledge of botany.
OBJECTIVE	<ul style="list-style-type: none">• The student will be able to describe and record the characteristics of a plant.• The student will be able to infer how plant characteristics make the plant more suited to specific environments.
PREPARATION	Find an area with an abundance of plants. The plants should be common enough so that removing a few specimens will not disrupt the environment.
MATERIALS NEEDED	Equipment per group: <ul style="list-style-type: none">• tape measure or ruler• two sheets of contact paper or one roll of clear packing tape (2-3" wide)• 2 pair of scissors• 6 pieces of absorbent mounting paper (inexpensive drawing paper)• Activity Sheet C: Study of a Single Plant• garden trowel• soil or air thermometer• 1 increment borer, if trees present (share among all three groups if needed)
PROCESSES USED	<ul style="list-style-type: none">• observe• measure• infer• predict• communicate• use numbers• classify• hypothesize
TIME	45 minutes



DOING THE ACTIVITY (outdoors)

A. Set Stage

"The structural characteristics of a plant often are closely related to the type of habitat in which it is found. In this activity you will be noting some general characteristics and the typical location of a plant."

B. Procedure

1. Distribute Activity Sheet C to students. Tell them to use the equipment provided to investigate further one plant from their study plot. They are to work individually to complete Activity Sheet C, and take about 30 minutes.

30 min.
individual

ACTIVITY C: Study of a Single Plant

1. Working individually, describe the following information about your primary and secondary study plants.

Describe the following:	Primary Plant	Secondary Plant
a. TYPICAL LOCATION (sun/shade)		
b. BRANCH PATTERN (describe or sketch)		
c. KIND OF LEAF (sketch)		
d. ROOT SYSTEM (sketch)		
e. REPRODUCTIVE BODIES (describe or sketch)		
f. APPROXIMATE AGE		
g. MAJOR FEATURES		
h. RELATIVE SIZE		
i. NAME: DESCRIBE MAJOR FEATURES		
j. COMMON AND SCIENTIFIC NAME (ask us later)		

2. Prepare a specimen of your primary study plant.

3. If time and materials are available, prepare a specimen of your secondary plant; record information for later use.

Investigating Your Environment
Plant Relationships 



Investigating Your Environment
Plant Relationships

2. **NOTE:** At this point, tell students if they are also further investigating a secondary plant.
3. Show students a prepared mounted plant sample. Remind them to disturb the environment as little as possible. Show them where and what mounting materials they can use. Instruct them to bring plant(s) back here to mount.
4. Instruct students to meet back at the central site by (time, within so many minutes, at sound of the whistle, etc.). Allow 30 minutes.

C. Retrieve Data

Conduct a discussion. Ask the following questions:

1. What did you find?
2. What were some typical locations in which you found your plants?
3. What kind of leaves (root systems, branch pattern, reproductive bodies) did you find on plants located in sunny areas? shady areas? wet areas? dry areas? etc.
4. How do the plant features relate to typical location? How might plant features change if over a long period of time the plant's environment changed? (This question may need specific information, e.g. if the environment became more arid, colder, wetter, etc.)

CLOSURE

"How can we summarize what we have learned about the adaptations plants make to their environment?"

TRANSITION

"Now that we have looked at the characteristics of individual plants, let's investigate how plants influence their environment."



PLANT INFLUENCES, FUNCTIONS AND VALUES

CONCEPT	Cause/effect, change, interaction, system, organism
PRINCIPLE	Organisms both effect and are affected by their environment.
OBJECTIVE	<ul style="list-style-type: none">• The student will be able to list three ways a plant community is influenced by other factors, natural and human-caused.• The student will be able to list three ways plants influence other things.
PREPARATION	An area with several distinct plant communities.
MATERIALS	<ul style="list-style-type: none">• Activity Sheet D: Influence of Plants, E: Influence on Plants, F: Plant Community Tour.
NEEDED	<ul style="list-style-type: none">• pens or pencils
PROCESSES USED	<ul style="list-style-type: none">• observe• infer• interpret data• communicate• question• hypothesize
TIME	60 minutes



DOING THE ACTIVITY (outdoors).

A. Set Stage

"We have now located several plant communities, looked at how individual plants are distributed and drawn composite maps of the communities. We will now investigate the effects the study plants have on the rest of the plant community, and look at ways your plant community has been affected by other factors."

B. Procedure

1. Students may work in the groups they were in for activities A and B, or choose new groups. Hand out Activity Sheets D, E, and F.
2. Give the following instructions, allowing for clarifying questions.
3. Using Activity Sheet D, return to your plot and determine the influence your plant(s) have had on other elements of the community. This should take about 15 minutes.

ACTIVITY D: Influence of Plants 15 min. groups			
Record the influence your plant(s) have in the following:			
ACTIVITY E: Influence on Plants 15 min. groups			
Describe the following: As a group, record evidence of things both natural and the result of people which have influenced your plant community.			
1. NEIGHBORING PL. (size, shape, number, variety) 2. LOCAL CLIMATE (estimate humidity, temperature, and wind) 3. SOIL 4. ANIMALS (wildlife or domestic) 5. WATER RELATIONSHIPS (estimate the lagged) to one amount of water that the plant has trans 6. OVERALL CONTRIBUTION (to environment) (to people)	Influence (list)		
	<table border="1"> <tr> <td style="text-align: center;">Natural</td> <td rowspan="2"> ACTIVITY F: Plant Community Tour 10 min. groups This is the first chance your group has to show your plot to the other teams. Present them a 5 minute tour which summarizes your findings. Use your Activity Sheets A, B, C, D & E to help you plan your tour. Your group should decide what you want to present on your tour and how you will present it. Consider these elements: 1. Major contributions of your plant community: 2. Major influences on your plant community: 3. Special or unique properties of your community: 4. If you owned this property, what management guidelines would you make about the use/protection of your plant community. Why? </td> </tr> <tr> <td style="text-align: center;">Human</td> </tr> </table>	Natural	ACTIVITY F: Plant Community Tour 10 min. groups This is the first chance your group has to show your plot to the other teams. Present them a 5 minute tour which summarizes your findings. Use your Activity Sheets A, B, C, D & E to help you plan your tour. Your group should decide what you want to present on your tour and how you will present it. Consider these elements: 1. Major contributions of your plant community: 2. Major influences on your plant community: 3. Special or unique properties of your community: 4. If you owned this property, what management guidelines would you make about the use/protection of your plant community. Why?
Natural	ACTIVITY F: Plant Community Tour 10 min. groups This is the first chance your group has to show your plot to the other teams. Present them a 5 minute tour which summarizes your findings. Use your Activity Sheets A, B, C, D & E to help you plan your tour. Your group should decide what you want to present on your tour and how you will present it. Consider these elements: 1. Major contributions of your plant community: 2. Major influences on your plant community: 3. Special or unique properties of your community: 4. If you owned this property, what management guidelines would you make about the use/protection of your plant community. Why?		
Human			



4. Then, go on to Activity Sheet E and record the human-caused and natural things that have modified or influenced your plant community. This should also take 15 minutes.
5. Then, as a team, use Activity Sheet F to plan a "tour" of your site, which you will present to the other teams. More than two people must be involved in the tour and you need to be ready by _____. Notice that the teams must speak to management guidelines and rules for use and protection.
6. Allow a total of 40 minutes for activities D, E and F. Give students times along the way, and encourage them to go right onto activities. Constantly monitor and adjust while they are working.

C. Retrieve Data

Spend 10 minutes at each plot, 5 minutes for the presentation and 5 minutes for questions. The team should use their notes to present their tour/findings. As you leave each plot, remind the group to remove and save all flagging.

Once each group has presented their tour/findings, conduct a discussion, asking:

- a. How do these influences affect or contribute to people and their needs?
- b. What general statement can we make as to the value of plants?
- c. Now that we have seen how plants affect their environment, including people, what evidence of human influence did you find on your study plot?
- d. What are some of the guidelines for the use and protection of plant communities that your group developed?
- e. What were some of the influences your plants had on their environment?
- f. How do these influences affect the survival of the plant community?

Concentrate on those questions not answered well or completely on plot tours.

CLOSURE

"From our investigation, what can we say about the relationships between plants and humans?"

TRANSITION

"Another method of communicating the functions of plants in a community or ecosystem is by role-playing."



DRAMATIZE PLANT ROLES

CONCEPT	System, perception, interaction
PRINCIPLE	Similarities can be drawn between plant and human communities.
OBJECTIVE	<ul style="list-style-type: none">• The student will be able to compare a plant community to a human community.
PREPARATION	A comfortable location for the presentations.
MATERIALS NEEDED	<ul style="list-style-type: none">• pens or pencils
PROCESSES USED	<ul style="list-style-type: none">• interpret data• communicate• observe
TIME	20 to 30 minutes



DOING THE ACTIVITY (outdoors)

A. Set Stage

“We have discussed some of the roles plants play in their community. One means of summarizing what we have learned about plant communities, for an individual who has not seen your study plot, is to develop analogies to human communities.”

B. Procedure

1. Give the instructions:

In your group develop a brief presentation (skit, drama, poem, pictures) which depicts how you (representing your primary study plant) relate to the others in your group.

- 2. Review the instructions for preparing their small group presentations.**
- 3. Give groups 15 minutes to prepare.**

C. Retrieve Data

- 1. Groups make their presentations.**
- 2. Conduct a discussion after all presentations of what happened. Questions to consider are:**
 - a. What are some things we found out about plant communities?**
 - b. What are some influences that plants have on the environment?**
 - c. How can we summarize the role of plants in this world?**

CLOSURE

What are some similarities between plant and human communities?



ACTIVITY A: Map your plant community

30 min.
groups

1. Select a representative area, mark the boundaries (corners and mid-points) of your plot with flagging. The plot should be twelve steps square.
2. As a group, decide upon the most significant or most characteristic plants of your plot.
3. Each person should choose one of these as a primary study plant to map, describe, and mount, and a secondary study plant if so instructed by your teacher.
4. Place a plastic bag over your primary study plant. You will use these plants later.
5. Working individually, map the location of all occurrences of your study plant. Develop your own plant symbols.

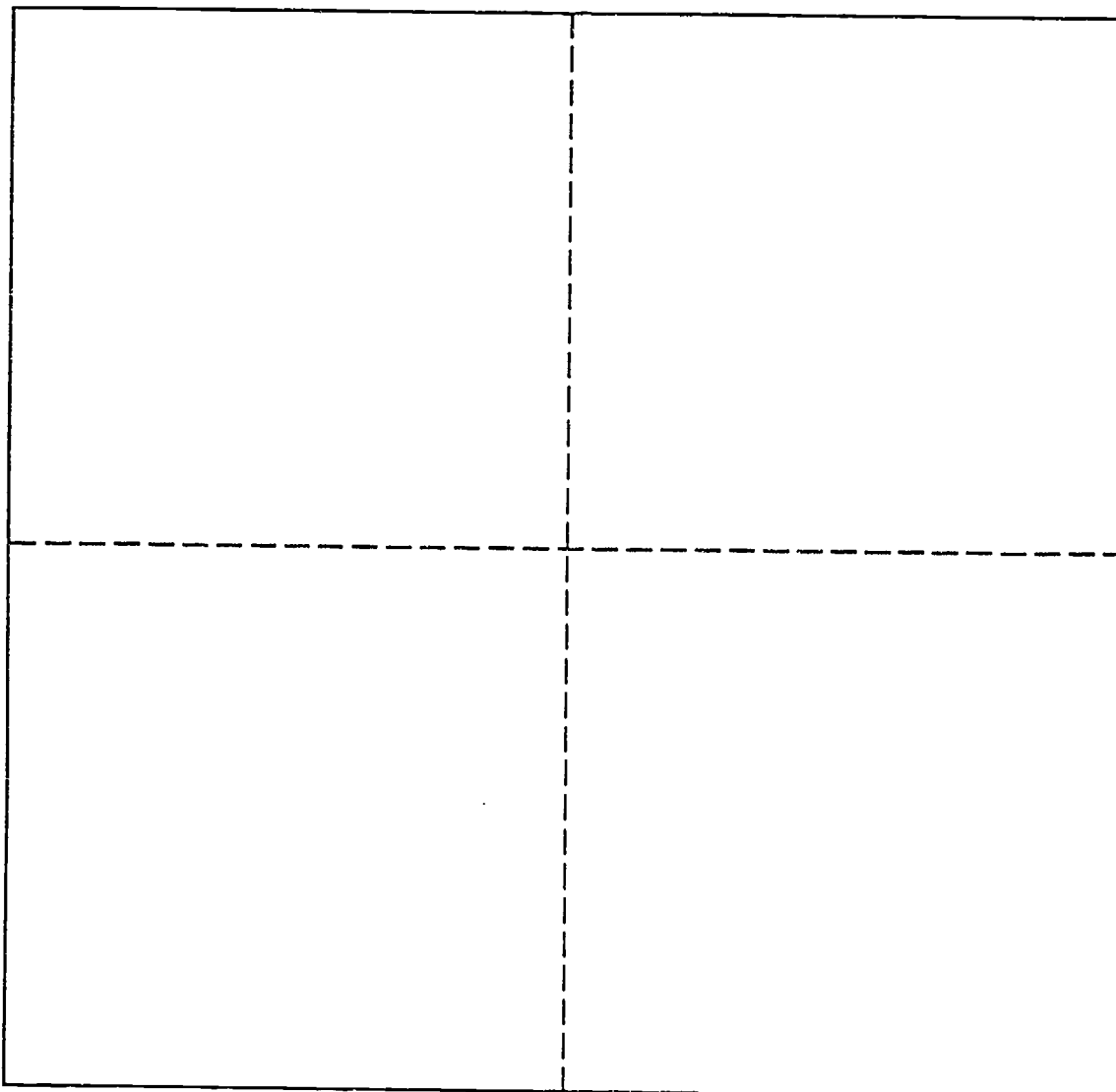

← - - - - 12 steps - - - - →

Primary Study Plant (Name) _____ (Symbol) _____
Primary Study Plant (Name) _____ (Symbol) _____



ACTIVITY B: Look at Plant Distribution

individual

As presentations are made, please characterize each plot by sketching general plant patterns that you see.

1st Plot

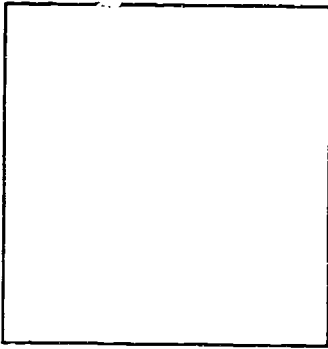

Thoughts : _____

2nd Plot

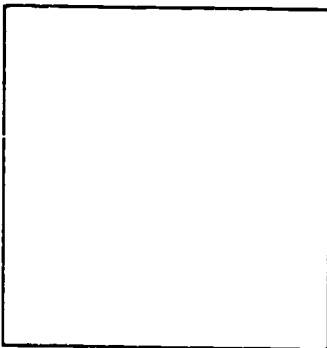

Thoughts : _____

3rd Plot

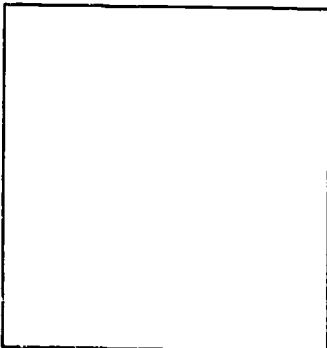

Thoughts : _____



ACTIVITY C: Study of a Single Plant

30 min.
individual

1. Working individually, describe the following information about your primary and secondary study plants.

Describe the following:	Primary Plant	Secondary Plant
a. TYPICAL LOCATION (sun/shade)		
b. BRANCH PATTERN (describe or sketch)		
c. KIND OF LEAF (sketch)		
d. ROOT SYSTEM (sketch)		
e. REPRODUCTIVE BODIES (describe or sketch)		
f. APPROXIMATE AGE		
g. MAJOR FEATURES		
h. RELATIVE SIZE		
i. NAME: DESCRIBING MAJOR FEATURES		
j. COMMON AND SCIENTIFIC NAME (look up later)		

2. Prepare a specimen of your primary study plant.
3. If time and materials are available, prepare a specimen of your secondary plant; record information for later use.



ACTIVITY D: Influence of Plants

15 min.
groups

Record the influence your plant(s) have in the following:		
Describe the following:	Primary Study Plant Name _____	Secondary Study Plant Name _____
1. NEIGHBORING PLANTS (size, shape, number, variety)		
2. LOCAL CLIMATE (estimate humidity, temperature, and wind)		
3. SOIL		
4. ANIMALS (wildlife or domestic)		
5. WATER RELATIONSHIPS (examine the bagged plant to see amount of water that the plant has transpired)		
6. OVERALL CONTRIBUTION (to environment)		
(to people)		



ACTIVITY E: Influence on Plants

15 min.
groups

As a group, record evidence of things both natural and the result of people which have influenced your plant community.

Influence (list)	Evidence	Result
Natural		
Human		



ACTIVITY F: Plant Community Tour

10 min.
groups

This is the first chance your group has to show your plot to the other teams. Present them a 5 minute tour which summarizes your findings. Use your Activity Sheets A, B, C, D & E to help you plan your tour. Your group should decide what you want to present on your tour and how you will present it. Consider these elements:

1. Major contributions of your plant community:

2. Major influences on your plant community:

3. Special or unique properties of your community:

4. If you owned this property, what management guidelines would you make about the use/ protection of your plant community.
Why?





BEST COPY AVAILABLE

Investigating Your Environment — Intermountain Region



INTRODUCTION

Wildlife — the word brings many images to mind — a herd of deer, squirrels scolding from a treetop, a pack of wolves, the silent flight of an owl. But the world of wildlife includes many not-so-glamorous creatures as well: spiders, ghost shrimp, segmented worms, bark beetles and protozoa. Each has basic needs for food, water, shelter and space that must be met. None live totally on their own. Each lives out its life in a kaleidoscope of relationships with other individuals and species, in different plant communities in various climatic conditions and in all the various elements that affect life on planet Earth.

Just as wildlife individuals and species are interconnected, people too, are part of the living community on Earth. With the same basic needs, we affect and are affected by life around us. As we understand wildlife better, we may also experience a greater understanding of our own place in the mosaic of life on earth. Much is known about some wildlife species while little is known about others. We gain a better understanding of wildlife by observing animals and their habitats and by looking at how they fit into the world as a whole.

The following activities offer a guideline for learning how to observe wildlife and for gaining a better understanding of wildlife needs, habitats, population dynamics, adaptations and management.

THE ACTIVITIES

TIME REQUIRED

Who Lives Here	60 minutes
Skins and Skulls	45 minutes
Toothpick Predator	20 minutes



Evaluate A Habitat	30 to 45 minutes
Design an Animal	30 to 45 minutes
Oh My Deer	60 minutes

COMBINING THE ACTIVITIES

The activities in this unit are displayed singly. Depending upon the time available and the skill of the participants, you may choose to do only one activity or the entire series. For maximum learning, the activities should be experienced in the order listed in the unit. However, other suggestions are:

Suggestion 1:

Title: Wildlife Observation/Who Lives Here/Skins and Skulls

Introduction: We will be involved in making observations about wildlife and drawing conclusions from our observations. We'll use observation skills to identify habitat characteristics and how the habitat is used by wildlife; identify similarities and differences between habitats, make inferences about how animals live by observing their body parts and draw some conclusions based on observations.

Transition: To learn about wildlife and how they live, let's begin by looking at a habitat-(river bottom, forest, etc) and recording our observations.

Activity: Who Lives Here?

Transition: We were able to draw many conclusions about these habitats and the wildlife by walking around and observing. We can also learn by observing the animals themselves, and making inferences about their behaviors and interactions.

Activity: Skins and Skulls



Suggestion 2:

Title: Animal Adaptations/Skins and Skulls/Toothpick Predators/Design an Animal

Introduction: Activities focus on animal adaptations. We'll identify habitat components animals need to live; look at animal parts and make inferences about where and how they live; identify ways animals are adapted to their environment and tell how adaptations help animals survive.

Transition: Before we get to adaptations, let's take a look at what different kinds of animals need to live or survive.

Activity: Skins and Skulls

Transition: Using what we've learned about adaptation, here are two more creatures that live in this area. How are the "toothpick" and the "toothpick predator" adapted to their environment?

Activity: Toothpick Predator

Transition: We are standing in the middle of a wonderful habitat for some kind of animal. Use your imagination and your knowledge of adaptation to invent an animal adapted to live in this habitat.

Activity: Invent An Animal (skip setting the stage in this activity, it's done by the combining of activities).

Suggestion 3:

Title: Wildlife, Habitats and Management/Who Lives Here/Evaluate a Habitat/Oh My Deer

Introduction: What things would a habitat need in order to be suitable for wildlife?

In addition to knowing the answer to that question, we will be able to describe similarities and differences between habitats, evaluate suitability among habitats and the suitability of a habitat for certain wildlife species, recognize that wildlife populations constantly fluctuate and make wildlife management decisions that affect the survival of a wildlife population.

Transition: We will begin by examining three different habitats and the wildlife that live in them.

Activity: Who Lives Here

Transition: We have examined and recorded data on three habitats. Let us now focus on one habitat and evaluate its suitability for wildlife.

Activity: Evaluate A Habitat

Transition: Recall the components of habitat learned for we will use them to take a closer look at these components in relationship to a making management decisions.

Activity: Oh My Deer

Transition: Wildlife biologists use observation, habitat analysis and population dynamics to make management decisions. Now it is your turn to manage a wildlife population.

Activity: Oh My Deer



CURRICULUM RELATIONSHIPS

Social Studies

1. Find out which wild animals have played an important part in the history of your area. What were they used for? What changes did they cause in human history?
2. Find out if changing land uses have affected the wildlife in your area. How has the increase in people affected wildlife?
3. Find out if there are any threatened or endangered species in your area. How did they become listed? What is being done about these animals?
4. Find out what laws have been created to protect wildlife. What is the process for creating a law in your state? How have laws affected wildlife? How have they affected people?
5. Write to wildlife agencies and organizations in your area to find out what they do, and for which kinds of wildlife they are responsible?
6. Map your neighborhood to locate which areas are for people and which are for wildlife. If areas overlay, what effect occur?
7. Talk with city or county planners to find out what is being done for wildlife habitat preservation in your area. How can citizens influence city and county planning?
8. Help create an area for wildlife around your own neighborhood or schoolyard. What things should you put in the area that wildlife need?

Science

1. Set up transects to inventory the wildlife in your schoolyard or outdoor site.
2. State a hypothesis about wildlife and then experiment to see if it is correct.
3. Look at micro-organisms under a microscope. Discuss their role(s) in the natural world?
4. Measure habitat characteristics to see how one habitat is different from another.
5. Investigate the life cycles of different kinds of animals.
6. Investigate how wildlife is affected by air and water pollution and by human uses of materials such as fertilizers, PCB's, lead shot, etc.

Mathematics

1. Inventory birds observed in your area by traveling a given route once a week, or develop another survey method. Plot this information on a graph to determine seasonal numbers and species of birds.
2. Find out the birth rates and life span of common animals in your area. Calculate and graph the size of a hypothetical population over a number of years. How could this population be affected by habitat changes? By predators?
3. Measure the size of individuals within a population of ants, grasshoppers, spiders or worms to determine species characteristics and variations. Visually chart data collected.



4. Measure and record changes as an animal or group of animals grows from birth to maturity (i.e. tadpoles, cocoons, eggs). What were the changes in body size and characteristics, weight and number of body parts? How fast did the changes take place? Graph and compare results.

Language Arts

1. Keep a field journal of wildlife observations you have made in your area. Illustrate the journal as appropriate.
2. Write a poem or song about your favorite wild animal.
3. Write a letter to an influential person or the newspaper expressing your opinion about a local, national or global wildlife issue.
4. Read poems, stories or novels that have been written about wildlife. Depending upon age of students, you may read these aloud or have students read them. Suggestions are Indian legends and books by Jack London, Walt Morey, Ernest Thomas Seaton, Farley Mowatt, or Byrd Baylor.
5. Visit an area such as a wildlife refuge, National Park or Forest or game preserve, then write a story that takes place in that area.
6. Listen to songs written about wildlife and the environment. Music by Pete Seeger, Paul Winter and John Denver are possibilities. Students may also find counterparts among current artists. Write a song that expresses your feelings about wildlife and the environment.
7. Learn new wildlife related vocabulary such as habitat, census, population, species, carrying capacity, predator. Use these words to produce a poem, story or letter to the editor. These may also become part of a vocabulary or spelling list.
8. Read newspaper and magazine articles for current events related to wildlife. Write news summaries for the rest of the class.
9. Picture books for non-readers and beginning readers are usually well-illustrated. Read and compare how animals are portrayed in these books. Pay special attention to the illustrations for they communicate the most to this age of reader. Take note of the Caldecott Award winners. Then write and illustrate a picture book for a primary classroom. This can be a group project.

Creative Arts

1. Make a mural or mosaic showing wildlife in a complete habitat, ecosystem or biome.
2. Keep a sketchbook of wildlife and habitat features you observe in your neighborhood and travels. This could be combined with a journal.
3. Create a poster or series of posters that express your feelings or opinions about wildlife, habitat or wildlife issues. You could also create pins or T-shirt designs.
4. Illustrate the evidence of wildlife you have found in your classroom, around the school and in your neighborhood.
5. Create a dance that portrays the life of a wild animal.
6. Create a game, any type, that involves some wildlife concept. Teach or play this game with classmates or teach it to a class of younger students.



7. View art work and sculpture from different times that portray wildlife. What can you tell about the artist's attitude toward wildlife by looking at his/her work? What did the artist want to communicate about the animal? Don't forget to include cave art, Indian symbols and sand paintings, early American painting and sculpture, Renaissance painting, African, Oriental and East Indian art.
8. Create postcards, bookmarks or notecards with wildlife themes, using different media.



WHO LIVES HERE?

CONCEPT

Population, System, Organism

PRINCIPLE

This activity gives participants opportunities to make observations about wildlife with whom they share the environment and to explore that shared habitat.

OBJECTIVE

- The student will be able to observe and record characteristics of habitats and evidence of wildlife.
- The student will be able to identify similarities and differences among different habitats.
- The student will be able to draw some conclusions about the ways animals use habitats.

PREPARATION

Locate at least three different habitat types. Habitats should be in close proximity so the entire group can spread out and walk through the first habitat, meet at a designated location on the far side and then split into two groups to investigate each of the other two habitats.

MATERIALS NEEDED

- Clipboard and writing instrument for each participant
- 6 to 8 markers of different colors
- Activity A: Habitat data sheets
- Hard surface for writing on large habitat data sheets
- 3 flip-chart sized habitat data sheets

PROCESSES USED

- Communicate
- Infer
- Interpret data
- Use numbers

TIME

60 minutes, field time 45 minutes. Setting the Stage and the summary discussion can take place on different days.



DOING THE ACTIVITY (outdoors)

A. Set stage:

1. Gather the group in the first habitat you want them to explore.
2. Explain the objectives.
3. Discuss with the group: What animals can we expect to find living in this area? What do those animals need to live? As we walk through this area, where would be good places to look for animals? If we don't see animals themselves, what evidence of animals might we see? Are there ways we can minimize our impact on the environment while doing this activity?

B. Procedure:

1. Instruct group to walk through the habitat they're in (physically define boundaries if need to) and complete the left hand column of the Activity Sheet A.

ACTIVITY A: Habitat Data Sheet

20/18 min
Individual/pairs

HABITAT #1	HABITAT # _____
1. Record the characteristics of this habitat.	1. Record the characteristics of this habitat.
2. Explore as many places as you can in this habitat. Record what animals you see and the numbers of each.	2. Explore as many places as you can in this habitat. Record what animals you see and the numbers of each.
3. Record any evidence of animals you see (tracks, nests, feathers, dropp, etc.)	3. Record any evidence of animals you see (tracks, nests, feathers, dropp, etc.)

Investigating Your Environment
Wildlife 

135



Investigating Your Environment
Wildlife

8

BEST COPY AVAILABLE

2. Give students 20 minutes to complete this, alone or in pairs - teachers choice.
3. Group meets back at designated spot, discussion follows with responses recorded on large sized flip chart for all to see. Contrast and compare, look at similarities and differences as appropriate.
4. Move to the next part of the activities which is an investigation of another habitat. Say to students, "Now that we've collected information about one habitat, I'm going to divide this group into two. I want this half to explore environment and this half to explore environment. You are to collect the same kinds of information we collected and recorded before but in your new habitat. Use the right hand column of your activity sheet this time. Be back here in 15 minutes.
5. NOTE: Select three different habitats in close proximity so you can monitor all students, and physically define the habitats to each group.
6. When groups get back, give them 5 to 10 minutes to put their "combined" data on a piece of flip chart sized paper for each habitat.

C. Retrieve Data:

1. Conduct a "compare and contrast" discussion of the three habitats investigated, with the charts displayed side-by-side.
2. Possible discussion questions are:
 - Are there any similarities among these three habitats?
 - What are the differences among these habitats?
 - What could account for the similarities and differences?

CLOSURE

After looking at this information and our discussions, are there any general statements we can make about these habitats and the animals that live in them? List statements as spoken.

TRANSITION

The transition depends upon the next activity you do. Look at "Combining the Activities" for a specific transition.



SKINS AND SKULLS

- CONCEPT** Systems, Organism, Fundamental Entities
- PRINCIPLE** Using different parts of animals, inferences about that animals habitat, food needs and place in the "web of life" can be made.
- OBJECTIVE**
- The student will be able to observe the different parts of animals and make inferences about where that animal lived and what it ate.
 - The student will be able to construct a food chain or web based on animal characteristics they have observed.
 - The student will be able to realize they don't need to know an animal's name to learn about that animal.
- PREPARATION** Place the animal parts in like piles, so there are four piles; one of skulls, one of pelts, etc. Have five to eight people at each pile.
- MATERIALS NEEDED**
- 5/6 skulls (carnivores, omnivores and herbivores)
 - 5/6 study specimens (i.e. weasel, skunk, mole, chipmunk)
 - 5/6 pelts (coyote, bobcat, fox, otter, raccoon)
 - 5/6 birds (woodpecker, grosbeak, flicker, bluejay, hummingbird)
 - This activity can be done with the actual animal parts or with pictures cut and copied from encyclopedias, field guides and wildlife magazines.
- PROCESSES USED**
- Observe
 - Classify
 - Infer
 - Hypothesize
 - Predict
 - Question
 - Interpret data
- TIME** 45 minutes or longer, depending upon interest



DOING THE ACTIVITY (indoors)

A. Set the Stage:

For the next 30 minutes, we will observe animal parts and use them as clues to tell us more about the animals.

B. Procedure:

1. Each group works with one type of animal part to observe and record adaptations.
2. The group should list the types of adaptations observed and infer the type(s) of habitats the animals lived in and the animals position in the food chain. Names are not important at this stage.
3. After 10 minutes, ask the groups to compile their data and prepare to share their findings with the whole group.
4. After the presentations, conduct a discussion to draw out more information.
Possible questions are:
 - a. What did you notice about the _____ (animal part)?
 - b. Which senses seem to be the most important to your animal? Least important?
 - c. What might be some things that account for these differences?
5. Tell the group, "We've made some inferences about the habits of animals based on some adaptations of their body part. Now we will add some parts and see what additional inferences can be made."
6. Place 3 to 4 skulls and matching pelts or study specimens in the center of each group.
7. Ask group to match the parts of each animal and be able to give their rationale for matching. NOTE: let the group solve the problem without Teacher/Facilitator help. (10 minutes)
8. Add to each group a third component of one of the animals. It should be different, e.g. - a cast of a track, a foot, the jaw bone, a component of the habitat. The idea is to give the group an additional piece of information upon which to refine their inference. Give them time to discuss.
9. Ask, "By adding the additional information, what, if any, changes did you make in your original decision?" "What more do we know about the animal?"
Continue the discussion until every group has had a change to share.
10. Say, "let's look at some relationships between different kinds of animals by making a food chain."
11. "Who can tell us what a food chain is?" Discuss until there is a working definition such as 'what animals eat and what they are eaten by.' Use a chart similar to the one on the next page.
12. Put a mole, squirrel, chipmunk, weasel, coyote skull and bobcat skin in a pile.
(Can use other parts or pictures)
13. Ask students to draw a food chain showing the relationship between the animals.
14. NOTE: you may want to add in abiotic components such as soil, rocks, N₂ cycle, etc.



List the animals you have seen or their evidences in the appropriate places in this diagram. Put in arrows. What other words and ways you can think of to illustrate a simmliar cycle?

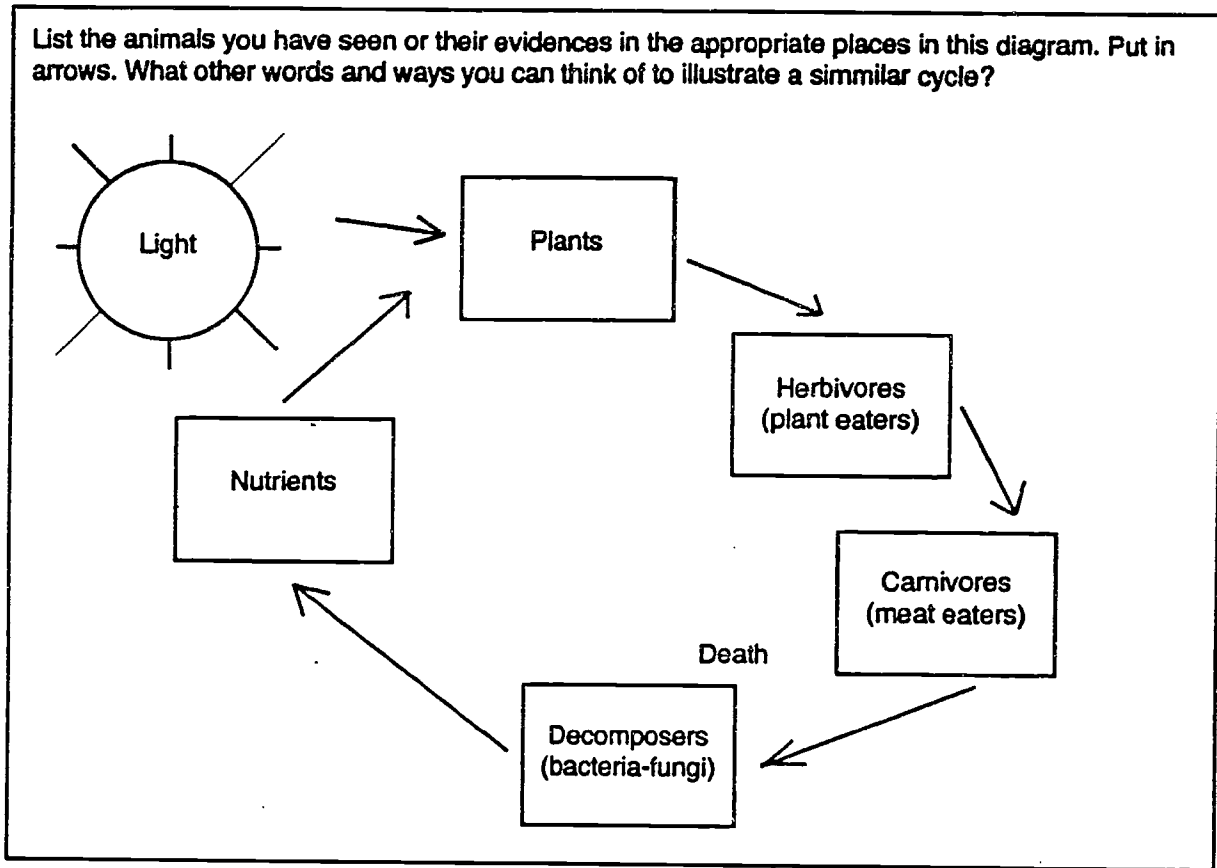

C. Retrieve Data:

1. Have groups or individuals show and discuss their drawings. Discuss the similarities and differences.
2. You may have them construct another chain using different animals, animal parts or including humans in the chain.

CLOSURE

We have learned many things about these animals by observing them and making inferences. We did not need to know the name of a single animal. What are some of the things we learned about animals from this activity? What are some other ways we can use this technique of observing and making inferences to learn about other things in the world around us?

TRANSITION

Use the appropriate transition for the next activity you choose.

TOOTHPICK PREDATOR

- CONCEPT** Interaction, Quantification
- PRINCIPLE** The predator-prey relationship is explored in an activity which simulates some of the conditions animals live with. The activity is extended to consider animal adaptations to a specific habitat.
- OBJECTIVE**
- The student will be able to identify ways that animals are adapted to their environment.
 - The student will experience how adaptations can affect competition for food.
 - The student will be able to determine how certain characteristics might affect the growth or survival of a population of animals.
- PREPARATION** Find an open area large enough for all participants to stand in a circle. If you are doing the activity more than once, you will need at least three different habitats so comparisons can be made. Habitats can be as small as landscape plantings if the group is small. Prepare the flip chart.
- MATERIALS NEEDED**
- Flip chart paper marker pens
 - 20 - 30 toothpicks of each color: red, green, blue, yellow, black and natural. Toothpicks can be dyed with food color.
 - Marker pens
 - Containers for toothpicks
- PROCESSES USED**
- Communicate
 - Observe
 - Formulate models
 - Hypothesize
 - Interpret data, predict
- TIME** 20 minutes first game & discussion; 5 minutes for each game thereafter



DOING THE ACTIVITY (outdoors)

A. Set Stage:

Take the class to the habitat they'll be working in. Tell them, "You are a toothpick predator and today you will have one minute, a day, in the life of the predator to find all the food you can."

B. Procedure:

1. Scatter the toothpicks prior to bringing the group to the site. If you can't, do this while they are listening to you set the stage. Scatter no less than 25, add more as participants increase. "Some toothpick caterpillars are better adapted to this environment than others."
2. Ask the students to predict which color of toothpick they will find the most of, the next, the least. Record their predictions on the chart by writing "1" next to the most and "4" next to the least. (see chart)

HABITAT 1		HABITAT 2		HABITAT 3	
Predict	Actual	Predict	Actual	Predict	Actual
red		red		red	
yellow		yellow		yellow	
green		green		green	
blue		blue		blue	
black		black		black	
natural		natural		natural	



3. Participants should be reminded they have one minute from when you say "Go." When you say "stop", they are to stop collecting, come back to the gathering site and start separating their toothpick prey by color.
4. Start the day. As participants search for food, it is helpful to provide a running commentary about the day, k.e. "the sun is coming up and the toothpick predators are hungry...the sun is getting higher in the sky...the sun begins to go down, the predators only have a few minutes left to feed." This is important for getting them into the activity.
5. Stop the predators, send them back to their homes (the circle) and have them count the number of toothpicks they caught.
6. Record the total number of toothpicks found by color. If it's a small group, have them call out the numbers, record and tally. If it's a large group, have smaller groups add numbers until there's a total.
7. Find out who found the most toothpicks by asking, "Did anyone find 20 toothpicks? 19?" Count down until someone responds. Ask, "How were you able to find so many?" As a group discuss characteristics that might help a toothpick predator find more food than others.
8. Who found the least amount of toothpicks? What happened? As a group discuss what hinders the search for food.
9. Compare the activity's results with the predictions. Were the numbers the same or different? Why? What role does ground cover play?
10. At this point, play the game again, only choose a different environment in which to scatter the toothpicks. Replace any toothpicks not found the first time so you have 20 to 30 of each color. Repeat the entire procedure, steps 2 through 9, except you do not have to do #4, pacing them through the one minute.
11. Do this again, in a third environment, if there's time.

C. Retrieve Data:

Group discussion questions that can be used are:

1. What characteristics or adaptations made the toothpicks easy to find?
2. Were there characteristics that made toothpicks hard to find?
3. Are there ways the toothpicks could be better adapted to escape the predators?

CLOSURE

Review the activity then extend the activity by asking, How does this activity relate to the ways animals live and find food? From our discussion, what conclusions can we make about animal adaptations?

TRANSITION

Use the transition statement appropriate to the activity you choose to do next.



EVALUATE A HABIT

CONCEPT

Interaction, Organism

PRINCIPLE

Using knowledge and experience gained from other unit lessons, participants will look at a specific area and make rudimentary decisions for wildlife.

OBJECTIVE

- The student will be able to analyze an area for its suitability as habitat for a particular animal.

PREPARATION

Locate an area suitable for evaluation. This may be an undeveloped area suitable for the type of animal listed on the back of the activity sheet or it may be an urban, schoolyard or indoor environment. Activity is suitable for any environment in "Who Lives Here."

MATERIALS NEEDED

- Pencil and clipboard for two to share
- Activity sheet B: Evaluate an Area for Animals
- Wildlife guides for local area or make animal data cards for 6-8 or more species common to your area.

PROCESSES USED

- Communicate
- Hypothesis
- Classify
- Observe
- Infer

TIME

30 to 45 minutes



DOING THE ACTIVITY (outdoors best, can do indoors)

A. Set Stage:

1. Begin by saying something like, "for the next half hour, we will be looking at this area and analyzing whether it is suitable habitat for various animals."

ACTIVITY B: Evaluate an Area for Animals

25 min.
pairs

Evaluate this area for one animal.

ANIMAL DATA

ANIMAL _____

Where it lives _____

Food needs _____

Predators _____

Other (adaptability to man, life span, reproduction rate, etc.)

1. How would you rate the area for the animal's following needs:
 - a. General habitat:
 - b. Winter and summer food supply:
 - c. Evidence of predators for your animal:
 - d. Other factors:
2. How many of your assigned animals or their evidence did you find in the area?
List some relationships that you think exist among members of the same species already living there?
How might the animals react to others of the same species moving in?
3. Which of the habitat types will these animals use?
Where will they probably locate home, nest, den or burrow? Why?
4. What are some ways that this species of animal affect this environment?
5. Summarize how your animal might react to living in this environment.

Investigating Your Environment
Wildlife 

144



Investigating Your Environment
Wildlife

B. Procedure:

1. Have participants pair up and hand out activity sheet on clipboard to each pair.
2. If you haven't done previous activities, discuss; "what are some things animals need to live?"
3. Instruct participants to select one animal of their choice from the list present define the site limits to be studied. To evaluate the site for their animal, answer the questions on the activity sheet. Ask them to take different animals so the area will be evaluated for a variety of animals. Tell them they have 25 minutes to finish and return to the gathering point.

C. Retrieve Data:

1. Participants report on the animal for which they evaluated the habitat.
2. Possible discussion questions:
 - a. In what ways did this habitat meet the needs of the animals for which it was suitable?
 - b. How did it fail to meet the needs of other animals?
 - c. How might the results change if we evaluated a different habitat?
 - d. How might the results change if we evaluate this habitat for different animals, such as a _____?

CLOSURE

In a closing discussion ask participants to generalize, "what can we say about the suitability of this particular habitat for the animals we selected."

TRANSITION

Choose the appropriate transition statement for the next activity.



DESIGN AN ANIMAL

CONCEPTS	Organism, Evolution
PRINCIPLE	This activity reinforces the concept of animal adaptation.
OBJECTIVES	<ul style="list-style-type: none">• The student will be able to create an imaginary animal that is adapted to a specific environment.• The student will be able to discern and explain the adaptations that allow their imaginary animal to successfully live in the environment.
PREPARATION	Participants need a basic understanding of adaptations. Locate a space for the activity; unusual environments such as parking lots and playgrounds are perfect. It is also an excellent indoor "rainy day" activity. Set up flip chart before activity begins.
MATERIALS NEEDED	<ul style="list-style-type: none">• Large-sized paper and pens for each small group• Instruction card for each group Flip chart easel, pad and pens or chalkboard and chalk
PROCESSES USED	<ul style="list-style-type: none">• Communicate• Observe• Classify• Interpret data• Infer
TIME	30 to 45 minutes



DOING THE ACTIVITY (indoors, outdoors)

A. Set stage:

1. "We have looked at some different environments and ways animals are adapted to those environments. Now let's put some adaptations together and invent a "model" animal to live in one of the habitats found here."

B. Procedure:

1. Group brainstorms a short list of different environments or habitats. Record ideas, using sample of chart below.
2. Have the group think of two or three animals that live in each of the environments. Record next to the environment(s).

Environment	Animal	Adaptation

3. Next, the group brainstorms examples of how those animals are adapted to their environments.
4. Note: Record these ideas on a flip chart for all to see.
5. Working in groups of three or four, give each group , flip chart paper and colored markers.

147



6. They have 20 minutes to design a "model" animal they feel would be best adapted to (habitat). You must consider the adaptations listed in the instructions.

Instructions • Design an Animal

Design a "model" animal that you feel would be the best adapted to the habitat you've chosen. When you have finished give your animal a name that seems to sum up its characteristics.

Consider the following needs in your sketch and identify the parts of the animal that you designed for the items listed below or any other items you consider.

- | | |
|---|--|
| 1. Adaptations for food gathering. | 4. Major food required (kind and amount) |
| 2. Adaptations for defense, protection. | 5. Amount of habitat required for needs. |
| 3. Adaptations for seasonal changes. | 6. Value of animal to environment. |

C. Retrieve data:

Groups share their sketches and describe the adaptations they have given their animal.

CLOSURE Small group sharing on the question, "Tell about one new or reinforced wildlife concept you learned from this activity."

TRANSITION Choose transition appropriate to your next activity.



OH MY DEER

CONCEPT Population, Cycles, Cause & Effect, Cycle, Organism Interaction, Order

PRINCIPLE Participants role play as wildlife managers in charge of the management of a deer herd. They make the decisions that affect the size of the population and fate of individuals in the herd.

- OBJECTIVES**
- The student will be able to recognize factors that affect the survival and size of a deer herd.
 - The student will be able to describe how hunting and the absence of hunting affect a deer herd.
 - The student will be able to gain skills in making cooperative management decisions.
 - The student will be able to appreciate the complexity of making wildlife management decisions.
 - The student will be able to understand wildlife management principles.
 - The student will be able to make biological and political decisions about managing wildlife resources.

PREPARATION Stack the "winter" cards in each game so all groups are playing with the same environmental conditions. Construct a flip chart that will hold all team's data (see example).

- MATERIALS NEEDED**
- Flip chart paper and colored marking pens
 - One "Oh My Deer" board game for each 4 to 6 participants (Available from Carolina Biological Supply Co. 2700 York Road, Burlington, NC 27215)

- PROCESSES USED**
- Control variables
 - Infer
 - Use numbers
 - Communicate
 - Formulate models
 - Hypothesize
 - Interpret data
 - Question

TIME 60 minutes



DOING THE ACTIVITY (indoors, outdoors for a change of pace)

A. Set Stage:

1. Open the activity by saying, "Wildlife observation, habitat analysis and population dynamics are all considered when management decisions are made by biologists in resource agencies." "What other factors are also a part of the decision-making process when managing wildlife?"
2. Tell participants, "In this simulation exercise you are in charge of managing a deer herd for six years. As a wildlife biologist team, you make all decisions that affect the size of the population and the fate of individuals in the herd."

B. Procedure:

1. Divide the participants into groups of four to six players and give each group a game. Assign a group member to read the instructions to the rest of the team. They may ask questions to clarify.
2. Make sure that the players realize that approximately 14 deer can survive an average winter.
3. Once instructions are understood, begin playing the game. Play six rounds.
4. As the game is played, the participants record the herd size at the end of each year and the final totals of bucks and does in the harvest and non-harvest boxes.

C. Retrieve Data:

1. A group member should record that group's data on a chart visible to the whole class. Each group records in a different color.
2. After data is recorded on the group chart, each group reports to the others on what their management strategies were and the results achieved.
3. The data displayed on the table are the focus of a discussion that brings out some fundamental ideas of wildlife management. When several groups play there is usually considerable variation in the data. One group may have been too liberal with their initial seasons and then fought to have their herd recover. Another may have been too conservative and been caught by a hard winter. A third may have been too conservative but lucky enough to miss hard winters. A fourth may have been committed to buck seasons only throughout the game. As each group describes what happened to their herd, the other groups gain experience equivalent to much more than the six years they played.



4. In the discussion that follows ask:
 - a. Which group was best able to manage their deer herd?
 - b. Was it the group with the largest number of deer?
 - c. The greatest number of "harvested" deer?
 - d. The herd closest to the carrying capacity? (no "right" answer).
Each group must explain the reasons for their answer.

5. In the course of discussion, the following important ideas of wildlife management should surface:
 - a. Populations can be managed; that is, people make decisions affecting the number of animals in a population and, within limits, the fate of those that die. (How do wildlife regulations affect wildlife?)
 - b. The size of a population is ultimately limited by the number that survive winter. This is called the "carrying capacity." Extra animals can survive in some years but, in the long run, the population is kept in check by the winter carrying capacity. (How does winter carrying capacity affect long run population numbers?)
 - c. That other (non-winter) causes of death can result in high losses if the herd is large and no losses if the herd is small. This is the principle of "density dependence" which is important in keeping the herd in balance with its habitat. (How do other non-winter factors influence herd size?)
 - d. Management of a herd requires information about its status. How could you select the proper seasons if you had no idea how large your herd was? (Why is it important to survey herd size and condition?)
 - e. Chance plays an important part in what happens to a herd. Road kills, dogs, weather in deer season, winter conditions, are all unpredictable, yet must be taken into account in managing a herd. (What place does chance play in herd management?)

CLOSURE

Have participants summarize in the group up what they have learned about wildlife management. They may also answer questions like what would happen if all deer management activities ceased? What do we have to do to ensure healthy deer herds in our state?

TRANSITION

Choose the appropriate transition to the next activity.



ACTIVITY A: Habitat Data Sheet

20/15 min
individual/pairs

HABITAT #1

HABITAT # _____

1. Record the characteristics of this habitat.

1. Record the characteristics of this habitat.

2. Explore as many places as you can in this habitat. Record what animals you see and the numbers of each.

2. Explore as many places as you can in this habitat. Record what animals you see and the numbers of each.

3. Record any evidence of animals you see (webs, nests, feathers, song, etc.)

3. Record any evidence of animals you see (webs, nests, feathers, song, etc.)



ACTIVITY B: Evaluate an Area for Animals

25 min.
pairs

Evaluate this area for one animal.

ANIMAL DATA

ANIMAL _____

Where it lives _____

Food needs _____

Predators _____

Other (adaptability to man, life span, reproduction rate, etc.)

1. How would you rate the area for the animal's following needs:

- a. General habitat:
- b. Winter and summer food supply:
- c. Evidence of predators for your animal:
- d. Other factors:

2. How many of your assigned animals or their evidence did you find in the area?

List some relationships that you think exist among members of the same species already living there?

How might the animals react to others of the same species moving in?

3. Which of the habitat types will these animals use?

Where will they probably locate home, nest, den or burrow? Why?

4. What are some ways that this species of animal affect this environment?

5. Summarize how your animal might react to living in this environment.



BEST COPY AVAILABLE

Investigating Your Environment — Intermountain Region



INTRODUCTION

Since competition for land uses are increasing rapidly, a better understanding of land utilization, spatial relationships, proper zoning, and land measurement are essential. The activities and tasks in this lesson plan provide some simple tools to involve students in land and space measurement. Although the instruments used are relatively primitive, the principles are the same as used in the most sophisticated surveys.

Participants receive immediate feedback and the satisfaction of seeing how the maps they have constructed reflect the area they have "surveyed." Compass bearings and distances become personalized.

THE ACTIVITIES

TIME REQUIRED

Measure the Length of your Step	20 minutes
Learn to Use the Silva Compass	20 to 30 minutes
Use the Compass and Pacing Skills	30 minutes
Construct and Use the Instant Mapper	60 minutes
Construct and Use a Cardboard Box Plane Table	60 minutes

COMBINING THE ACTIVITIES

The activities in this unit are displayed singly. Depending upon the time available and the skill of the participants, you may choose to do only one activity or the entire series. For maximum learning, the activities should be experienced in the order listed in the unit, however, other suggestions are:

Title: Measure the Length of your Step/Learning to Use the Silva Compass/Use the Compass and Pacing Skills

Introduction: A map is a representation of a portion of the face of the earth. The features displayed on a map bear the same relationship to each other in terms of direction and distance (although at a reduced scale) as the features on the face of the earth that they represent. In order to use or make a map it is necessary to have some means of determining distance and direction. In these activities, participants will learn to measure distance by "pacing" and use the compass to determine direction. This is followed by a practical exercise to reinforce the acquired skills.

Activity: Measuring the Length of your Step

Transition Statement: Now that you are able to measure the distance between points what else do we need to be able to do to determine the relationship of one point to another?

Activity: Learn to use the Silva Compass

Transition Statement: Now that we have the skills to determine both distance and direction let's combine the two.

Activity: Using the Compass and Pacing Skills

CURRICULUM RELATIONSHIPS

Social Studies

1. Research and report on the history of the compass. What does the term "mariner's compass" mean? How did the very first compass work? For what was it used? What effect did it have on exploration and discovery? What important historical events, explorations and discoveries have resulted because of the compass? Draw a time line and correlate it to improvements in different kinds of compasses.
2. Find where the magnetic north pole is located on a globe of the world. (75 N. latitude and 100 W. longitude; off SW corner of Bathhurt Island in the Parry Islands). Run a strip of adhesive tape from your city to the magnetic north pole. Now run a strip of adhesive tape from your city to geographic north pole. Measure the angle. Repeat the above activity for Cincinnati, Ohio, and New York City. What are the angles created from these cities? This is called the angle of declination.
3. Find out what occupations require a knowledge of the compass and navigation. What economic gains have been made because of the improvements in the compass? Will the compass someday be obsolete? What recreational interests require a knowledge of the compass?
4. Read about incidents of people getting lost and even dying in the woods because they did not know how to use a compass properly. Discuss how this could have been prevented.
5. Find out if the compass and magnetic needle could have had any effect on boundary disputes between nations.



Science

1. Make your own compass by magnetizing a needle and floating it in oil. Many elementary science books will give you detailed instructions on how to do this.
2. Find out how space travelers navigate. Create a display or report of your findings.

Mathematics

1. Read about the history of measurement.
2. Measure the distance from home to school by pacing. Measure the perimeter of the schoolyard using "chains" (66 feet of plastic clothesline will do). Measure other distances by pacing and chains.
3. Find out how many laps around the schoolyard equal a mile. Is the schoolyard more or less than an acre? What is the average length of blocks in your neighborhood? What are isotonic lines, bearings, azimuths, degrees?

Language Arts

1. Develop spelling and vocabulary words such as azimuth, bearing, degree, declination.
2. Write a paragraph defining and explaining the difference between magnetic north and true north.
3. Write a creative story using the following questions as starters: Do you think the compass will someday be obsolete? If so, what other methods of navigation do you think will take its place?
4. Write a specific set of directions for measuring activities such as learning your pace, using a compass for the first time or measuring the perimeter of the classroom!

Creative Arts

1. Sketch an early mariner's compass or other measurement instruments.
2. Draw true north and magnetic arrows on maps on classroom maps.
3. Using your skills, create a map of the classroom, the school or the schoolyard.
4. Invite a landscape architect into class to demonstrate how they create maps of the areas they landscape.



MEASURE THE LENGTH OF YOUR STEP

CONCEPT	Quantification, scale
PRINCIPLE	Relatively accurate measurements can be made without measuring tapes.
OBJECTIVE	<ul style="list-style-type: none">• The student will be able to determine the distance between two points by counting the number of steps taken between the two points.• The student will be able to walk a predetermined distance to locate a given point.• The student will be able to compute the length of his/her average step given a premeasured 100 foot distance.
PREPARATION	Place a stake in the ground or make a mark on the sidewalk with chalk. Using a long tape measure, make another stake or mark 100 feet from the first mark. Be sure to measure in a straight line. Make one course for each five people to reduce delays.
MATERIALS NEEDED	<ul style="list-style-type: none">• chalk or wooden stakes, two stakes per course• bright colored paper or ribbon so stakes can be seen• 100 foot tape measure• paper and pencil for calculations• copy of Activity Sheet A: Determine Length of Step, A-1: Determine the Number of Steps in Distances for each participant• step foot conversion chart for each participant
PROCESSES USED	<ul style="list-style-type: none">• measure• use numbers
TIME	20 minutes



DOING THE ACTIVITY (outdoors preferred, can be done in a gym or large hall)

A. Set Stage

“We haven’t always had tapes to measure distance. Earliest methods used the length of one’s own stride or pace as a unit of measure.”

B. Procedure

1. Distribute Activity A

10 min.
Individual

ACTIVITY A: Determine Length of Step

DETERMINE LENGTH OF STEP

Method 1

Walk 2 times (in a normal step) the distance marked off. Record number of steps you took each time.

Number of steps 1st time _____
 Number of steps 2nd time _____
 Total steps (A) _____

Total number of feet in distance walked (B) _____ 200'

(B) (A) (C)
 (total distance (total steps (number of feet
 walked) taken) in each step)

NOTE: Round the length of your step to the nearest half foot: 2', 2 1/2', 3', 3 1/2'

Method 2

# of steps in 200'	Length of step
88-75	2'
74-67	2.5'
68-113	3'
114-over	3.5'

Investigating Your Environment
Measuring

2. Refer to the stakes: “The distance from the first to the last stake is 100 feet”.
3. “Walk an even, normal step all the way down, then all the way back.”
4. “Count the total number of steps you take on the way down and on the way back.”
5. “Using Activity A, determine the length of your step. Take 10 minutes.”

C. Retrieve Data

In a discussion, ask:

1. What is your length of step?
2. How did you determine your length of step?
3. How many steps would you have to take to go 100 feet?
4. What might make it difficult to determine the number of steps between one point and another?

Hand out Activity A-1 (alternate method)

ACTIVITY A-1: Determine the Number of Steps in Distances handout

Find the column for the length of your step and determine the number of steps for the distance you want to walk in the distance column.

Distance column:	Length of step column:			
	1 1/2 feet	2 feet	2 1/2 feet	3 feet
1 foot	1/2 step	1/2 step	1/2 step	1/2 step
2 feet	1 step	1 step	1 step	1/2 step
3 feet	2 steps	1 1/2 steps	1 step	1 step
4 feet	2 1/2 steps	2 steps	1 1/2 steps	1 1/2 steps
5 feet	3 steps	2 1/2 steps	2 steps	1 1/2 steps
6 feet	4 steps	3 steps	2 1/2 steps	2 steps
7 feet	5 steps	3 1/2 steps	3 steps	2 1/2 steps
8 feet	6 1/2 steps	4 steps	3 steps	2 1/2 steps
9 feet	6 steps	4 1/2 steps	3 1/2 steps	3 steps
10 feet	6 1/2 steps	5 steps	4 steps	3 steps
15 feet	10 steps	7 1/2 steps	6 steps	5 steps
20 feet	13 1/2 steps	10 steps	8 steps	6 1/2 steps
30 feet	20 steps	15 steps	12 steps	10 steps
40 feet	26 1/2 steps	20 steps	16 steps	13 steps
50 feet	33 1/2 steps	25 steps	20 steps	17 steps
60 feet	40 steps	30 steps	24 steps	20 steps
70 feet	46 1/2 steps	35 steps	28 steps	23 steps
80 feet	53 1/2 steps	40 steps	32 steps	27 steps
90 feet	60 steps	45 steps	36 steps	30 steps
100 feet	66 1/2 steps	50 steps	40 steps	33 steps



“This is another aid to help you quickly convert distances into steps or vice-versa.”

CLOSURE

Ask:

1. What is the range of steps in this group?
2. What does it mean to have a step of 2 or 3 feet?
3. Who would you like to go hiking with and why?
4. Does everyone walk the same step all the time? Why or why not?

TRANSITION

Now that you are able to measure the distance between points, let's determine what else we need to be able to do to determine the relationship between one point to another?



LEARN HOW TO USE THE SILVA COMPASS

CONCEPT	Quantifications, order, field replication
PRINCIPLE	A compass may be used to find direction and your way around.
OBJECTIVE	<ul style="list-style-type: none">• The student will be able to determine the direction a given object is from a given point using a compass.• The student will be able to go from one point to another when given the compass bearing.
PREPARATION	Place a series of numbered stakes in a straight line at one end of an area. Easily identified landmarks such as trees, building corners, fireplugs, etc. should be visible from each stake. Using a compass, determine the direction of a number of landmarks from each of the stakes. Record this information. Be sure that each stake has a number or other means of identification (color, letter, shape). Apply scotch tape with declination marked on each compass.
MATERIALS USED	<ul style="list-style-type: none">• one silva compass for each student• scotch tape with declination marks on each compass• record of bearings from stakes or spots to each previously identified landmark• illustration of difference between true and magnetic north• identified stakes or spots on the ground
PROCESSES USED	<ul style="list-style-type: none">• observe• measure• use numbers• define operationally
TIME	20 to 30 minutes



DOING THE ACTIVITY (outdoors)

A. Set Stage

By the time you are finished with this activity, you will be able to use the compass to determine the direction to object or point from where you are and, given a compass bearing, determine what is located on that bearing. You will also be able to locate a point by given only the compass bearing.

B. Procedure 1: Parts of the Compass

1. Give everyone a Silva Compass and have them stand facing you. Make sure the compass has a piece of write-on scotch tape with a pencil mark on it opposite the declination for your area. Do not let the participants do this sitting down.
2. The Silva Compass is used. It is one of the least expensive, most dependable, and one of the easiest to use.
3. Ask, "What do you notice as you look at the compass?"

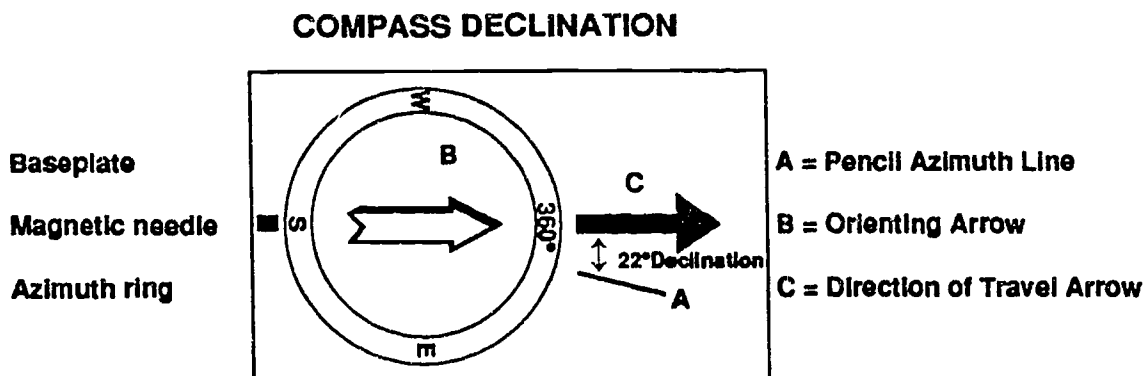

4. Discuss the major parts of the compass with the students. Make sure they are locating these parts throughout the discussion.
 - (a) **Base Plate** - What is on it? Direction of Travel Arrow—always pointed directly away from you. (Clear plastic, has direction of travel arrow and two different scales.)
 - (b) **Azimuth Ring** - a dial with degrees marked on it. Also called a compass housing, it has an orienting arrow inside the bottom of the housing. (The orienting arrow makes the Silva Compass different from other compasses and easy to use.)



- (c) Magnetic Needle - red and white needle. Where does it point? (magnetic north) What makes it point there? (earth's magnetic field) The magnetic needle pivots freely within the azimuth ring and the red end always points to magnetic north.

Transition "Now that you are familiar with the parts of the Silva compass, let's look at how you can use the compass."

C. Procedure 2: Holding the Compass

Describe these steps to the group by saying:

"Holding the compass correctly is necessary for an accurate reading."

1. Stand up: rest base plate on your index fingers; hold the edges with your thumbs. Keep your arms close to your sides for better stability and point the direction of travel arrow directly away from you.
2. Hold compass level. Tilt the compass up and down and from side to side to see what happens when it is not level.
3. You and the compass are a UNIT — TOGETHER. When you turn, the compass turns with the direction of travel arrow, always pointing away from you. Turn your whole body and compass, including feet, don't just twist around. Practice this as a group.

D. Procedure 3: Orienting to North

1. Turn dial and set 360° on Direction of Travel Arrow.
2. You and the compass turn as a unit until the red part of the magnetic needle and the pointing part of the orienting arrow go together.
3. Where does the magnetic needle point? (North—magnetic north)
4. Are you facing the same direction as the magnetic needle? (Yes, you should be, anyway.)
5. Which direction are you facing? Magnetic north, same as the magnetic needle.
6. Is magnetic north the same as the North Pole? (No—North Pole is called Geographic North or True North).
7. Refer to chart of North Pole and magnetic pole. (Magnetic north is located somewhere north of Hudson Bay, Canada in the Gulf of Boothia.)

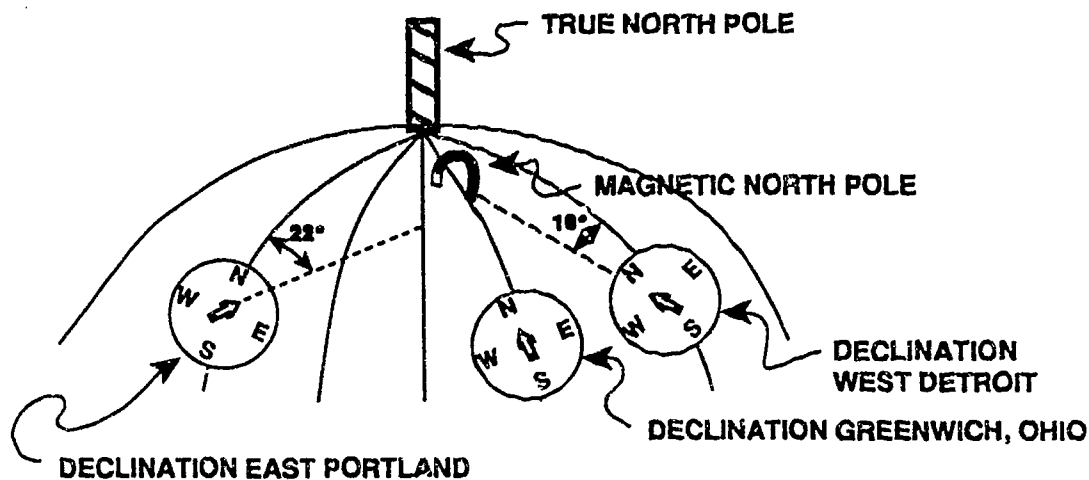

8. If you are here (point to your location), and facing the North Pole, then magnetic north is at a degree angle to the right of you, in parts of western Oregon and Washington. Find your declination. In Portland, Oregon, it's about 22°.
9. If you're in Greenwich, Ohio, and facing the North Pole, then magnetic north and the North Pole would be in the same line of sight.
10. Most of the maps we use are drawn according to the North Pole or true North.

E. Procedure 4 Correcting for the Declination which is the difference between true and magnetic north.

1. On your compass is a piece of tape with a pencil line on it at _____degrees. (22° in Portland, Oregon)
2. Turn dial and set 360° on the pencil line.
3. Now turn yourself and the compass until the magnetic needle and orienting arrow go together.
4. Which way does the magnetic needle point? (Magnetic north—it always points there)
5. Are you facing the same direction as the magnetic needle? (No—you shouldn't be, anyway)
6. Which direction are you facing? (True North)
7. You and the Direction of Travel Arrow should be facing true North. The magnetic needle should be pointing to magnetic north, at a 22 degree angle to your right, or left depending upon location in the U.S.
8. From now on we will SET and READ all degree readings at the pencil line.
9. Continue to hold the compass so the Direction of Travel Arrow is pointing directly away from you.



F. Procedure 5 Practice Orienting to the Four Cardinal Compass Points

1. $N=0^\circ$, $E=90^\circ$, $S=180^\circ$, $W=270^\circ$
2. Set 90° on the pencil line and orient yourself to it. This means you and the compass move as a unit until the red part of the magnetic needle and pointing part of orienting arrow are together.
3. Before proceeding, answer these questions:
 - (a) Which direction are you facing? (true east)
 - (b) Which direction is the magnetic needle pointing? (magnetic north)

NOTE: To explain the difference between magnetic and true North: Extend your arm in the direction of true north. With your arm, make a 90° swing to the right. That should be the direction you are facing. Extend your arm in the direction of magnetic north. Now make a 90° swing with your arm at the right. That should be magnetic east, which should be at a 22° angle to the right of where you are facing.

4. Now set 180° on the pencil line. Orient yourself to that degree reading. Extend your arm in the direction the magnetic needle is pointing — (magnetic north). Now extend your arm directly opposite which would be magnetic south. Which direction are you facing? (magnetic south) Which direction is the magnetic needle facing? Which direction does it always face?
5. Repeat for 270° and 360° .

G. Procedure 6 Following a Predetermined Azimuth Bearing

1. INSTRUCTOR: Before class, pick a point and sight on several objects (up to 10). Give the group bearings to set and then objects to sight on, until you feel they are confident using the compass.
2. Set _____ degrees on pencil line.
3. Orient to that degree reading. Remind them to hold compass correctly.
4. Select a landmark in the line of sight found by you and the Direction of Travel Arrow. To do this, look down at direction of travel arrow, then jerk your head up. Whatever you see on the horizon, in line of sight of the travel arrow, is your landmark.
5. Repeat this several times to make sure you are sighting on an object directly in line of sight of the direction of travel arrow.
6. Now that you have selected a landmark, you could put your compass away and walk toward that landmark, always keeping your eyes on that landmark and walking straight toward it.



7. Why wouldn't you keep looking at your compass as you walk along? (You could wander all over the place)
8. Orient yourself to _____ degree reading.
9. Select landmark. Repeat previous instructions on selecting landmark, if necessary.

CLOSURE

Practice using the compass to follow a bearing as the closure activity. The steps are:

1. Work with a partner. Give that partner a degree reading.
2. Check to make sure they oriented to that degree reading.
3. Check: did s/he set the degree reading on the pencil line? Did s/he hold the compass level? Is the direction of travel arrow pointing away from him/her?
4. Check to make sure that person can select a landmark.
5. Is the person looking directly in line with the direction of travel arrow? (Most people tend to look either to the right or left, so watch them select the landmark.)
6. Is the person holding his/her head straight and in line with rest of his/her body and the compass?
7. Repeat, having the other person check you this time.

TRANSITION

You have learned two skills, pacing and using a compass. Now you are ready to put them together and practice another skill.



USE THE COMPASS AND PACING SKILLS

- CONCEPT** Quantification, replication, perception, time/space
- PRINCIPLE** The skills of pacing and using a compass can be used to move within an area. These skills are helpful in making a map.
- OBJECTIVE**
- The student will be able to follow a prescribed course using the compass and pacing to go from point to point.
 - The student will be able to record the identifier for each point.
 - The student will be able to demonstrate proper use of the silva compass by sighting on an object and setting the correct bearing and following that bearing for a short distance.
- PREPARATION** Set a row of numbered or lettered stakes about four feet apart. From each stake run a course with measured distances and bearings that lead back to one of the other stakes in the row. Use at least three distances and bearings. Record the information and reproduce it for the students. Leave off the identification of the last stake on student copies. If you are uncomfortable laying out a course, use the Boy Scout Compass and Pacing game. An example of the game is included at the end of the lesson.
- MATERIALS NEEDED**
- one compass for each participant
 - 20 stakes
 - score card for compass course
 - pencils
 - Boy Scout compass and pacing game
- PROCESSES USED**
- measure
 - observe
 - use numbers
- TIME** 30 minutes



DOING THE ACTIVITY (outdoors)

A. Set Stage

"The skills of pacing and using a compass can be used to move from point to point and keep track of where you are. They are also useful in making a map."

B. Procedure

1. Distribute score cards for game from the Boy Scouts Compass and Pacing Game.

SCORE CARD
for
COMPASS COURSE

SAMPLE

NAME _____

Starting Point No. 2

1. Go 17 degrees for 164 feet _____
2. Then 150 degrees for 52 feet _____
3. Then 171 degrees for 55 feet _____

DESTINATION (Number of nearest marker reached) _____

CORRECT DESTINATION (Supplied by leader) _____

SCORE (Base for correct trial is 100. Deduct 5 points for each marker player missed correct destination.) _____

Starting Point No. 3

1. Go 36 degrees for 125 feet _____
2. Then 207 degrees for 60 feet _____
3. Then 167 degrees for 60 feet _____

DESTINATION (Number of nearest marker reached) _____

CORRECT DESTINATION (Supplied by leader) _____

SCORE (Base for correct trial is 100. Deduct 5 points for each marker player missed correct destination.) _____

TOTAL SCORE _____

Investigating Your Environment
Measuring 

2. Participants write down the number of steps they need to take for each distance given using the Step-Foot Conversion Chart from the "Measuring Your Length of Step" lesson.
3. When most people have finished, select a volunteer to demonstrate the game.
4. Take his/her scorecard and call instructions while the group watches. Try to get the group to tell him/her what to do.
5. Starting place _____



6. Degree reading_____
Set degree reading on pencil line.
Orient to that degree reading.
Select landmark.
Put compass away.
7. Distance to walk
Tell the group the distance, the length of volunteer's step, and have them figure out how many steps s/he needs to take.
8. Repeat for the second instruction.
9. Repeat for the third instruction.
10. Ask the volunteer to which stake the directions led. Where were they supposed to lead.
11. Explain how the scoring works.
12. Give volunteer his score.

NOTE: Anything above 70 is good!! If they get below 70, maybe should do over.

B. Procedure 2

1. Group follows their individual instructions. Let them know you have the answers.
2. Help individuals. If someone in group finishes first and did well, ask them to help others. Or give him/her the answer sheet, then you are free to help others.

C. Retrieve Data

1. Ask, "What things did you have trouble with in solving the problem?"
2. Point out that practice increases accuracy. If you lose your landmark when following an azimuth (line of sight), sight back toward your starting point, then check your compass to see if you are still on the line. This requires sighting a back azimuth which is in the opposite direction from the azimuth.

TRANSITION

Tell participants that they will use their compass skills to find a line of direction.



D. Procedure 3

Select an object everyone can see and face it. Ask:

1. "How do you we find the direction of that object?"
2. "What do you have to do now? You need to line up the magnetic needle and the orienting arrow lines. "How will you do that?" (turn the dial)."
3. "Now read the degree reading. Where will you read it from? (the pencil line, not the direction of travel arrow)."
4. "Why do people on one side of the group have different degree readings than people on the other side? (everyone is at a different angle)"
5. Practice taking bearings on other objects.

CLOSURE

Ask the group:

1. What have we found out about pacing today?
2. What have we learned about using the compass?

CLOSURE

If you have time, let them do this activity, which takes about 15 minutes.

(ALTERNATIVE ACTIVITY)

1. Start at a given point (A). Take a reading (azimuth) on an object. Proceed to that point (B). At Point B, set your compass so you can return to Point A. Then, do so.
2. Ask, "What sort of hypothesis would apply to the shooting of a back azimuth?"
3. Possible answer is that if the original bearing is less than 180° , add 180° . If it is more than 180° , subtract 180° . Reverse the red arrow so that the tail of the red arrow is superimposed over the head of the black arrow in the compass housing.

TRANSITION

Let's use the skills learned to make a map.



CONSTRUCT AND USE THE INSTANT MAPPER

CONCEPT	Quantification, scale, perception
PRINCIPLE	The instant mapper is a way to make a map.
OBJECTIVE	<ul style="list-style-type: none">• The student will be able to construct and use the instant mapper to make a map of a specific area.
PREPARATION	Assemble the materials listed below. Locate an area relatively free of obstructions with easily identifiable features (i.e. trees, buildings, flagpoles). School playgrounds or parks are good sites.
MATERIALS NEEDED	<p>For each person:</p> <ul style="list-style-type: none">• one piece smooth cardboard (both sides) 8 1/2 x 11 inches• one piece graph paper 8" x 10 1/2" with azimuth printed on it (attached)• piece clear "contact" paper (one side adhesive) 8 1/2"x 11"• 40" scotch or masking tape, 1" or 2" wide• 1 - 7/16 brass fastener• 1 - 7" acetate disc, frosted one side• scissors• compass• drawing• vis-a-vis or dry erase pens
PROCESSES USED	<ul style="list-style-type: none">• measure• observe• use numbers• interpret data
TIME	60 minutes



DOING THE ACTIVITY (construction indoors; using mapper outdoors)

A. Set the Stage

There are many ways to make maps. One of the easiest and most fun is to use the instant mapper. You can easily make and learn to use the instant mapper.

B. Procedure 1

1. Gather all the materials you will need to make the mapper.
2. To **construct the mapper**, position graph paper on cardboard, leave edge of cardboard exposed for contact paper to adhere to.
3. Peel back edge of paper covering the sticky part of contact paper and position the sticky part at the top of cardboard and graph paper. Now strip off rest of contact backing paper smoothing the clear part over the cardboard and graph paper.
4. Bind edges of instant mapper with masking or scotch tape.
5. Center the acetate disc over the circle on the graph paper with the rough side up.
6. Make a slit hole (with knife) through the cardboard and acetate at center of the circle.
7. Push a brass fastener down through the acetate disc and slit hole in the mapper. Bend back the fastener prongs.
8. Make one straight ink mark from any point on the edge of the acetate toward the brass fastener until it meets the circle on the graph paper. This is your map making orienting mark.
9. Attach a short piece of masking tape to the outside of the acetate disc to use as a handle.

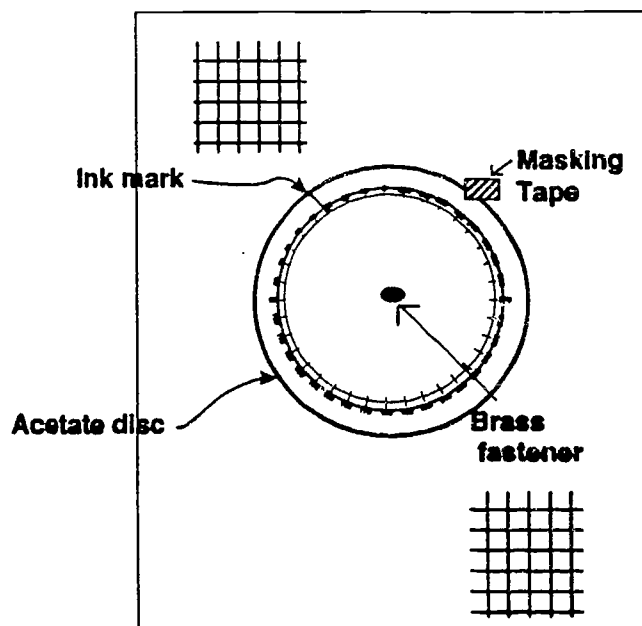
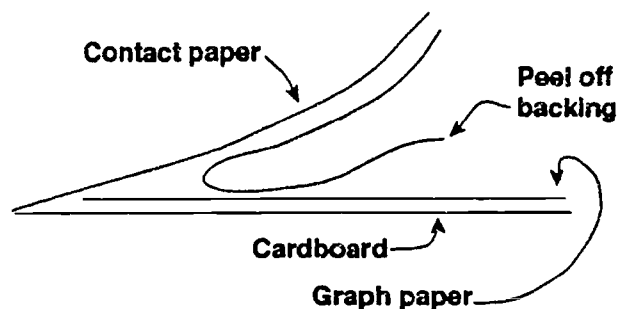

C. Procedure 2

The instant mapper is designed to draw a map of your area as you determine the compass bearings and distances. It will be easier to learn to use if you already have the bearings and distance recorded of the area you want to map. You can map one of the Compass and Pacing Problems. Here is how to map an area with the following field notes.

Degree Reading	Field Notes	Dist.
320°	• ← 20' ⇒ 	⇐ 5' ⇒ • 25'
225°	• ← 20' ⇒ 	⇐ 10' ⇒ • 30'
85°	• ← 10' ⇒ 	⇐ 25' ⇒ • 35'

1. To plot the first bearings and distance turn the acetate disc until the ink line is directly over the 320° mark on the DIAL.
 - (a) Pick any point where two graph paper lines cross. Put a dot on the acetate disc at this point. Label with a (1).
 - (b) Determine a scale for your map. Let's say that each square is 1'. (Select a scale that allows you to draw your whole map on the acetate disc.)
 - (c) Draw a line from point #1 toward the top of the instant mapper parallel with the lines on the graph paper (for 25 squares (25 feet). Put a (2) along side the point where the 25' distance ended.

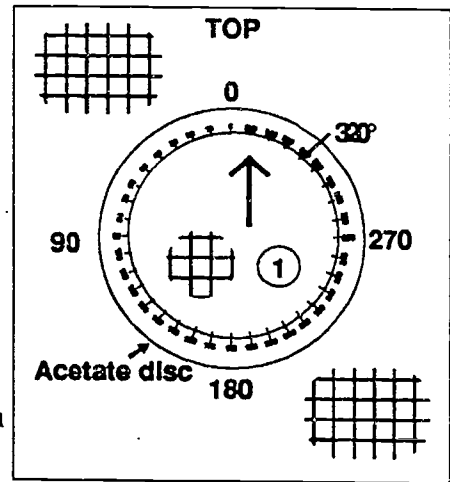

2. To obtain the second bearing and distance turn the acetate disc until the ink mark is directly over the 225° on the dial.
 - (a) Draw a line from point (2) toward the top of the instant mapper for 30 feet (30 squares) parallel to the lines on the graph paper. At the end of the line make a dot and label it (3)

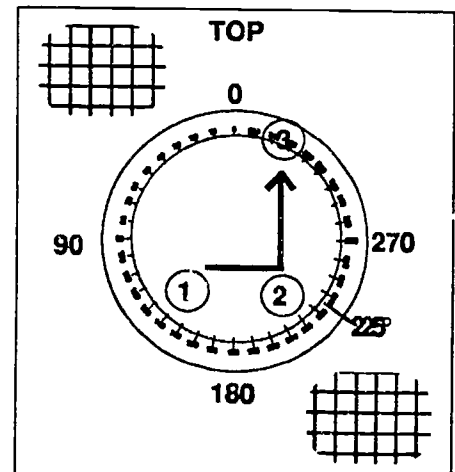

3. To obtain the third bearing and distance turn the acetate disc until the ink line is directly over 85° on the dial.
 - (a) Draw a line from point (3) toward the top of the instant mapper for 40 squares (40 ft.) parallel to the line on the graph paper. At the end of the line make a dot and a (4).
 - (b) Number (4) should coincide with the starting point (1).

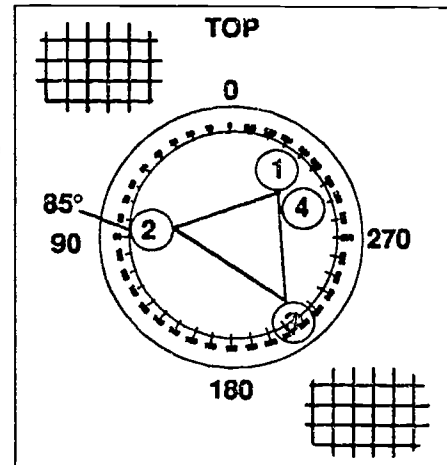

D. Procedure 3

To draw land features on the map stand at starting point #1 and face ground point, #2.

1. Hold mapper waist high and turn acetate disc until the ink mark is on 320° on the inside dial. You, the instant mapper and the line from #1 to #2 should all be facing point number #2 on the ground.
2. Now, measure distances along the line by pacing. Put in any land features such as trees, fences, roads or buildings that you want located on the map. Refer to hypothetical problem on page.
3. Repeat for other bearings and distance.

E. Retrieve Data

This step is accomplished throughout each activity since it is a skills activity and the participant can not proceed unless the previous skill is mastered.

CLOSURE

Share with the group your feelings about this activity and where you think these skills might be useful or who might use these skills in their careers.

TRANSITION

There is another way to learn to construct a map. It is called the "plane table."

174



CONSTRUCT AND USE A CARDBOARD BOX PLANE TABLE

CONCEPT	Quantification, model, scale, perception
PRINCIPLE	Many times it is not possible to learn to use a compass or an instant mapper. This cardboard box plane table provides a way to make a map without the use of the compass. The plane table is a device used for mapping that locates points by the intersection of two lines rather than by bearings and distances.
OBJECTIVE	<ul style="list-style-type: none">• The student will be able to learn to construct a plane table.• The student will be able to use the plane table to map a predetermined area and included at least three reference points.• The advanced student will be able to use a plane table to measure a non-paceable distance.
PREPARATION	Assemble materials needed. Locate an area to map. The area can be a school yard, park, or any relatively open area that contains some easily identifiable features, such as trees or flagpoles.
MATERIALS NEEDED	For each group of two to five (four preferable): <ul style="list-style-type: none">• cardboard cartons (3 per group), stout, like empty liquor boxes• pencil with eraser• plastic flagging - 2 colors• unlined paper 8 1/2" by 11"• heavy twine• wooden 12" ruler (one per table)• 2 stakes• map tacks (4 per group, small nails will do)• sacking needle• roll of duct tape
PROCESSES USED	<ul style="list-style-type: none">• measure• observe• define operationally• interpret data• formulate model
TIME	60 minutes



DOING THE ACTIVITY (construction indoors, use plane table -outdoors)

A. Set Stage

Many of our early maps, including some still in use, were made using plane tables. Surveyors would carry them to mountain tops and draw lines to other peaks and features. Then they would move to another mountain top, whose bearing and distance from the first was known, and draw lines to the same features. The location of the feature was at the point where the lines intersected.

B. Procedure 1 Construct a plane table

1. Place cardboard boxes one on top of the other. Thread boxes together with a sacking needle and stout cord. It may be easier to sew if boxes are on their sides. Duct tape may be used to fasten boxes together in lieu of "sewing".
2. Tape paper to the top of the box.
3. The 12" sight ruler will be used as a sighting guide. Drive map tacks into the ruler making sure tacks are equidistant from the edge of the ruler.

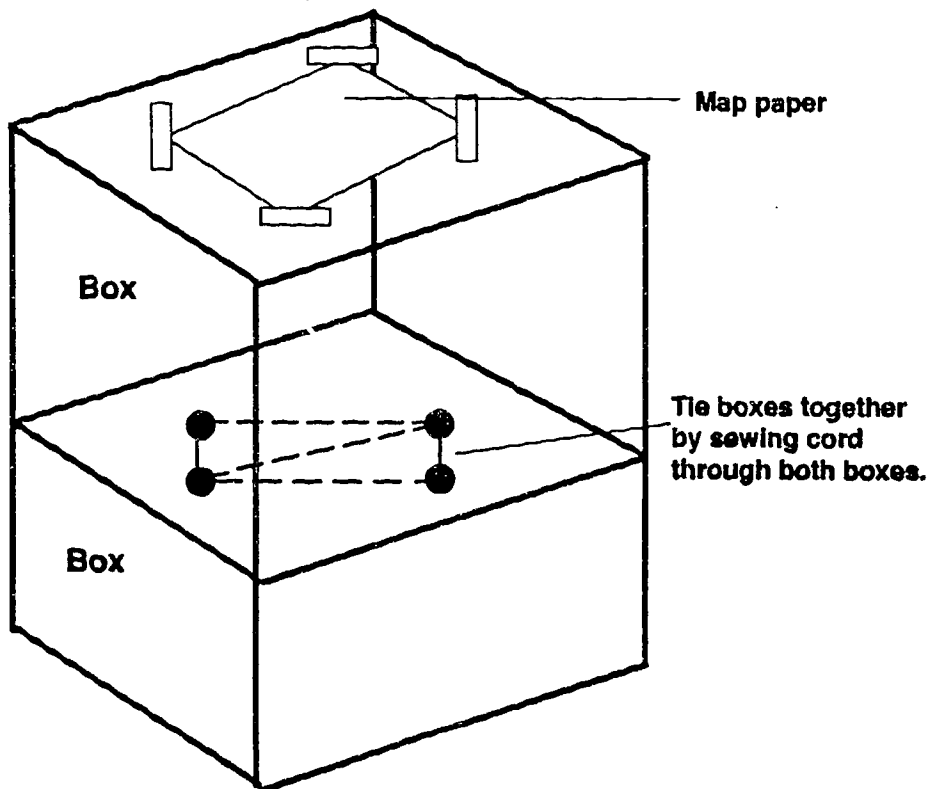

C. Procedure 2 Use the plane table to establish a base line:

1. After you determine the area to be mapped, pick two objects to be included in the map that are the farthest apart. Set up your plane table near one of these objects.
2. Drive a stake at the base of the plane table. Now pace the longest distance that must be mapped and drive in the other stake. On the way back to the plane table measure the distance. This is your base line and the only measurement needed.



3. Choose a place on the paper for a starting point.
4. Stick a pin in the paper at the starting point. Put the edge of the sight ruler against the pin.
5. Get your head down toward the plane table so you can sight over the pins of the sight ruler toward Station 2, the second point on your map.
6. Keep the edge of the sight ruler against the pin. Line up the tops of the two pins on the sight ruler so they are in a direct line with Station 2.
7. Draw the first line on the paper, from Station 1 toward Station 2. Don't shift the ruler while drawing this line.

D. Procedure 3

1. To locate map features, draw lines toward all the other features you want to include on your map. It is done the same way you drew the line toward Station 2. The theory behind the plane table is to locate points of intersecting lines.
2. Do not move the plane table. Keep the edge of the ruler against the pin. Line up the tops of the two pins on the sight ruler so they are in direct line with the object you wish to include on your map.
3. Keep the ruler still. Draw a line from the pin along the edge of the ruler to the end of the ruler.
4. Label each line with the name of the object.



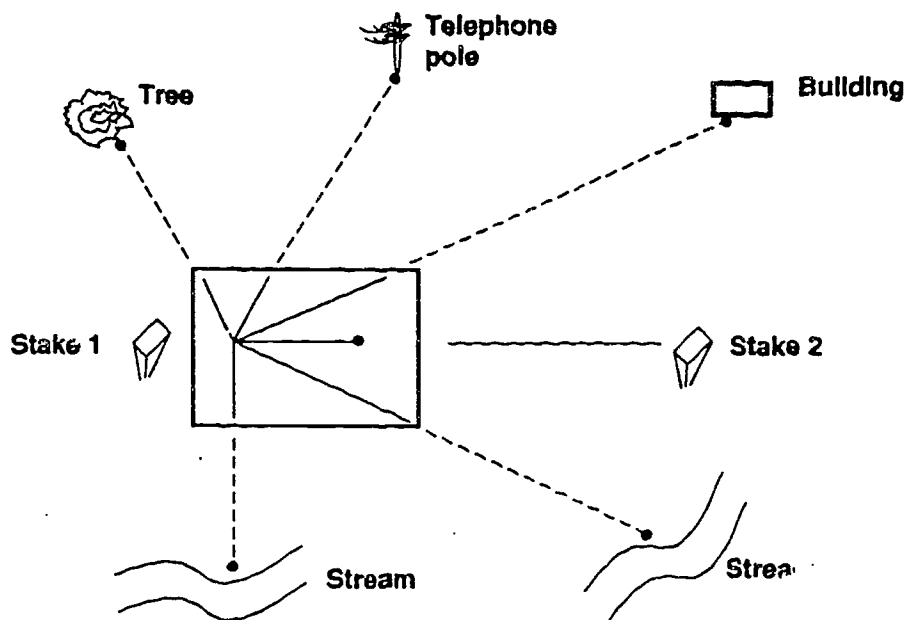

E. Procedure 4

To measure the base line and determine scale pick up the plane table and walk to Station 2. Count the number of steps between Station 1 and 2. This is your base line.

1. The size of the area to be mapped determines the map scale.
 Using 8" wide paper:
 - 1" = 100' will map a space 800'
 - 1" = 40' will map a space 320'
 - 1" = 20' will map a space 160'
2. Since we are using standard rulers with inches and quarter inches, the scale is best divisible by 4'. Thus if 1" = 40' then 1/4" = 10'. If 1" = 20' then 1/4" = 5'. If 1" = 80', then 1/4" = 20'.
3. This must be determined by observation and estimate, or by actually measuring the greatest distance between two objects to be included on the map.

F. Procedure 5

To orient the plane table between Station 2 and 1 measure and place a pin on your map at the point indicating Station 2. Position determined by scale.

1. Put the sight ruler up against this pin and sight backwards to Station 1, turning the plane table so that the edge of the ruler runs exactly along the line you just drew.
2. Your plane table is now oriented to Station 1. **DO NOT MOVE THE PLANE TABLE AGAIN.**

G. Procedure 6

To plot features on the map you are now ready to locate the positions of those objects on which you sighted in Step 1.

1. Let's say one of the features you wanted to include on the map was a lone apple tree. **WITHOUT MOVING THE PLANE TABLE FROM ITS ORIENTATION TO STATION 1**, put the edge of the sight ruler against the pin indicating Station 2, and line up the tops of the two pins on the sight ruler so they are in direct line with the apple tree.
2. Without moving the ruler, draw a line along the edge of the ruler toward the apple tree. The line you are drawing now should cross the line you drew in Step 1. Where the two lines cross is the location of the apple tree on the map.
3. Repeat this procedure for all the other features you want to include on the map, and for which you drew lines in Step 1.
4. This procedure may be carried on indefinitely. You can set up a Station 3 beyond Station 2. This could be a prolongation of the base line 1-2 or it may be in another direction.

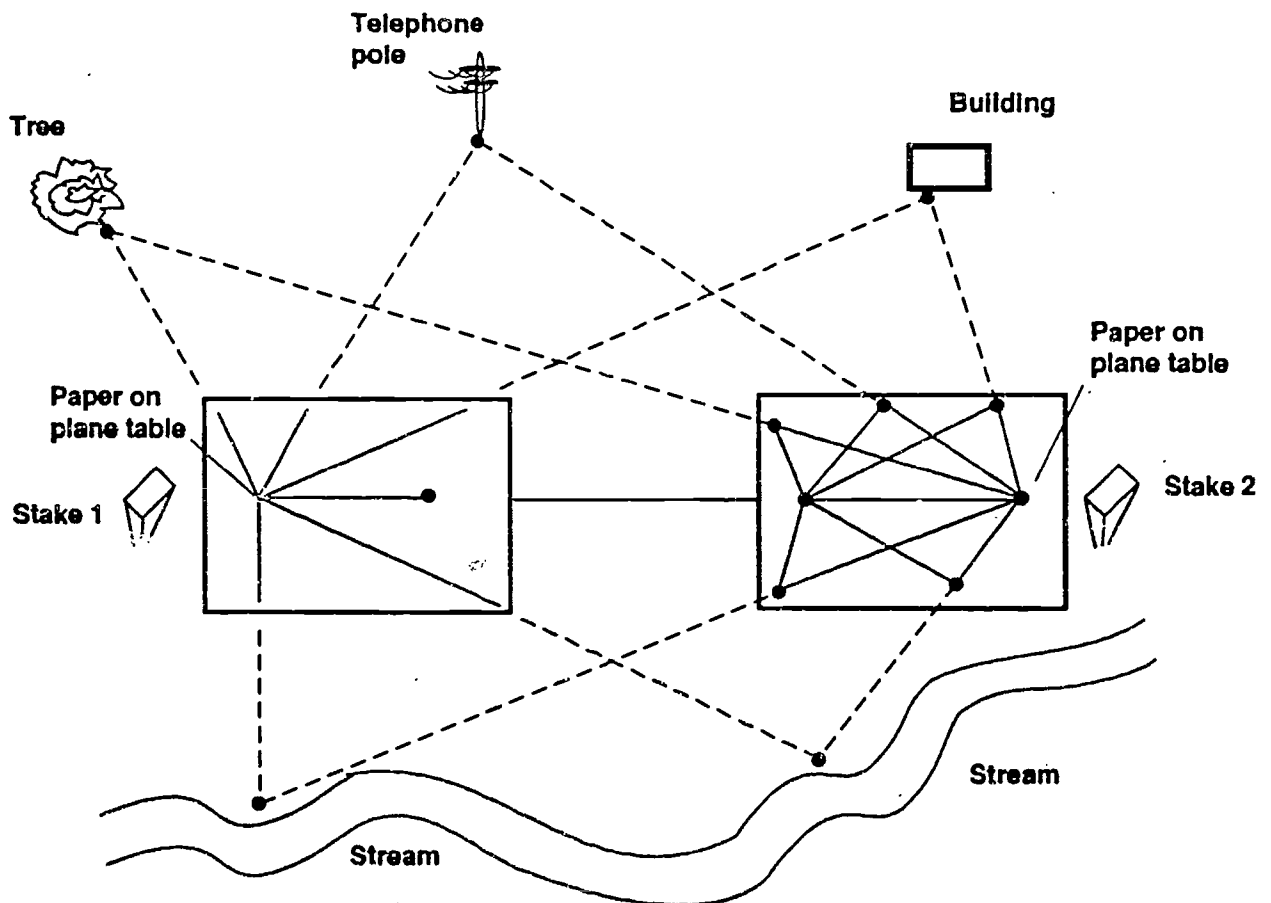

CLOSURE

Display maps and discuss the difficulties and procedures inherent in this process.

Ask:

1. "What have we found out about mapping from our activities and discussions?"
2. "How could you use these skills to help plan for the future of a piece of land?"
3. "What are your feelings about the activities we have done?"

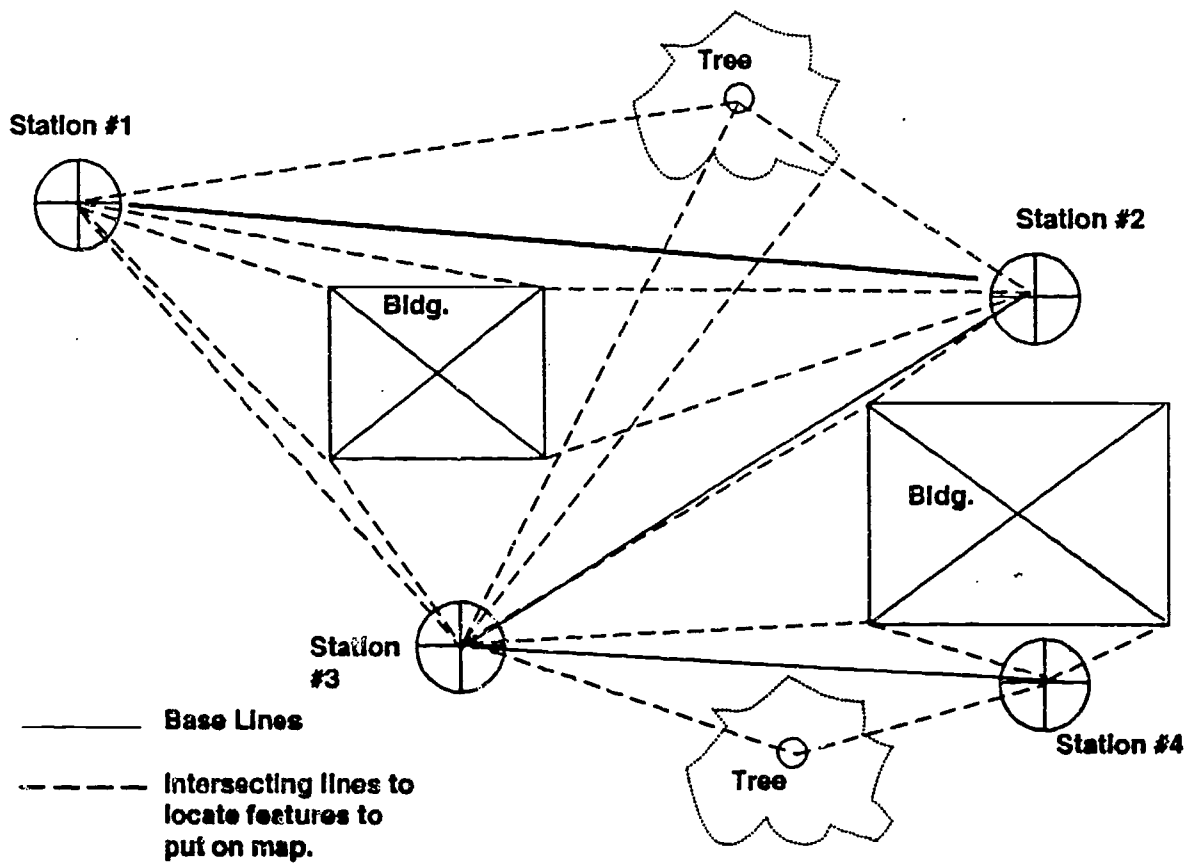

180



Investigating Your Environment
Measuring

ACTIVITY A: Determine Length of Step

10 min.
individual

DETERMINE LENGTH OF STEP

Method I

Walk 2 times (in a normal step) the distance marked off. Record number of steps you took each time.

Number of steps 1st time _____

Number of steps 2nd time _____

Total steps (A) _____

Total number of feet in distance walked (B) 200'

$$\begin{array}{ccccc} \underline{\hspace{2cm}} & + & \underline{\hspace{2cm}} & = & \underline{\hspace{2cm}} \\ \text{(B)} & & \text{(A)} & & \text{(C)} \\ \text{(total distance} & & \text{(total steps} & & \text{(number of feet} \\ \text{walked)} & & \text{taken)} & & \text{in each step)} \end{array}$$

NOTE: Round the length of your step to the nearest half foot: 2', 2 1/2', 3', 3 1/2'

Method II

# of steps in 200'	Length of step
66-73	3'
74-87	2.5'
88-113	2'
114-over	1.5'

ACTIVITY A-1: Determine the Number of Steps in Distances

handout

Find the column for the length of your step and determine the number of steps for the distance you want to walk in the distance column.

Distance column	Length of step columns			
	1 1/2 feet	2 feet	2 1/2 feet	3 feet
If you want to walk this distance:	Then take:			
1 foot	1/2 step	1/2 step	1/2 step	1/2 step
2 feet	1 step	1 step	1 step	1/2 step
3 feet	2 steps	1 1/2 step	1 step	1 step
4 feet	2 1/2 steps	2 steps	1 1/2 step	1 1/2 step
5 feet	3 steps	2 1/2 steps	2 steps	1 1/2 steps
6 feet	4 steps	3 steps	2 1/2 steps	2 steps
7 feet	5 steps	3 1/2 steps	3 steps	2 1/2 steps
8 feet	5 1/2 steps	4 steps	3 steps	2 1/2 steps
9 feet	6 steps	4 1/2 steps	3 1/2 steps	3 steps
10 feet	6 1/2 steps	5 steps	4 steps	3 steps
20 feet	13 1/2 steps	10 steps	8 steps	6 1/2 steps
30 feet	20 steps	15 steps	12 steps	10 steps
40 feet	26 1/2 steps	20 steps	16 steps	13 steps
50 feet	33 1/2 steps	25 steps	20 steps	17 steps
60 feet	40 steps	30 steps	24 steps	20 steps
70 feet	46 1/2 steps	35 steps	28 steps	25 steps
80 feet	53 1/2 steps	40 steps	32 steps	27 steps
90 feet	60 steps	45 steps	36 steps	30 steps
100 feet	66 steps	50 steps	40 steps	33 steps



SAMPLE

**SCORE CARD
for
COMPASS COURSE**

NAME _____

Starting Point No. 2

1. Go 17 degrees for 104 feet _____

2. Then 150 degrees for 52 feet _____

3. Then 171 degrees for 55 feet _____

DESTINATION (Number of nearest marker reached) _____

CORRECT DESTINATION (Supplied by leader) _____

SCORE (Score for correct finish is 100. Deduct 5 points for each marker player missed correct destination.) _____

Starting Point No. 3

1. Go 38 degrees for 125 feet _____

2. Then 237 degrees for 90 feet _____

3. Then 187 degrees for 50 feet _____

DESTINATION (Number of nearest marker reached) _____

CORRECT DESTINATION (Supplied by leader) _____

SCORE (Score for correct finish is 100. Deduct 5 points for each marker player missed correct destination.) _____

TOTAL SCORE _____

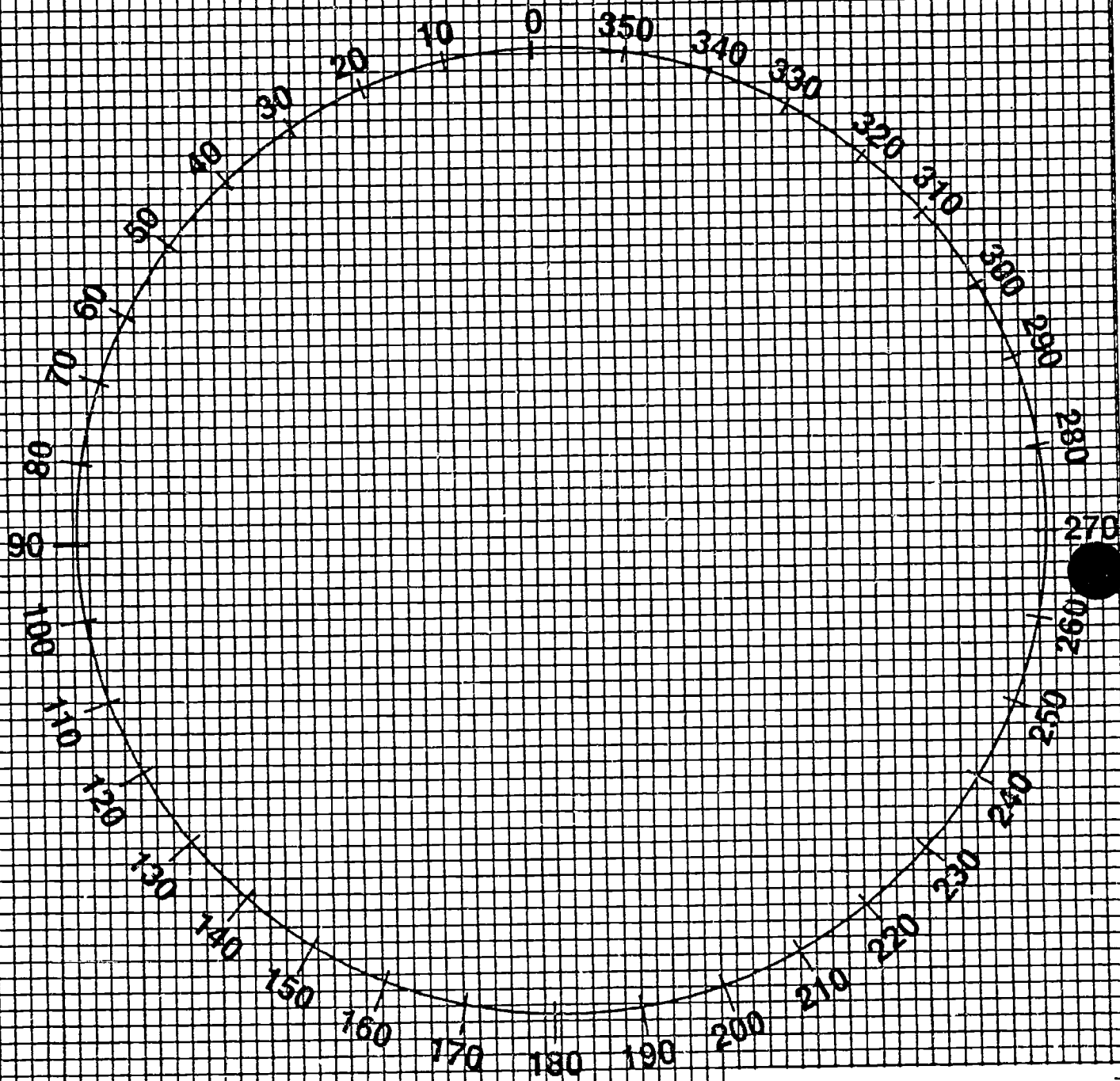

Always hold so that the North end is pointed away from you.

Draw directly away from you and parallel with the sides of the map (using the graph paper as a guide).



BEST COPY AVAILABLE

Investigating Your Environment — Intermountain Region





INTRODUCTION

"Investigating a Built Community" provides students with a clearly defined and easy-to-follow process to use when studying an urban or other human-built community. With rapid growth of urban and suburban areas, it is important for students look at patterns of land use and understand the critical importance of developing these lands wisely for future generations. In this session, students will identify parts of a human-built community, look at land use patterns and construct a process to investigate one part of the community. After data are collected and analyzed for different solutions, an action plan is developed to implement one of the recommendations. Throughout, the emphasis is placed on the processes of planning and carrying out the investigations.

This lesson plan, if done in its entirety, will involve 8-10 hours of time, including 2 field investigations: one 3 hours in length; one 1 hour in length. The field investigations in a built community can be:

- the community around a school
- a separate part of town
- a farm complex
- school building and immediate area around it



Because the field investigations require small groups to work independently, adequate advance planning for supervision is important. This investigation is ideal for structuring a cooperative learning format. If direct supervision is required by your school, aides, parents or other volunteers are possible sources of leadership.

THE ACTIVITIES

A complete correlation is impossible without first determining the issue and the direction of study. The depth of study and time spent on the investigations will also cause this correlation to vary. At a minimum level, and with almost any issue, the following goals and guidelines will most likely be involved:



Steps And Components

TIME REQUIRED

- | | |
|---|------------|
| I. Preparing for the Investigation | 2 Hours |
| A. Review on 8-step chart | |
| B. Identify land use areas and patterns. | |
| C. Develop overall view of the community. | |
| D. Introduction of a 3-stage data
collecting chart. | |
| E. Construct a 3-stage data collecting chart. | |
| F. Use the 3-stage data collecting chart to
analyze investigations. | |
| G. Construct a data collecting and
recording chart to use in the investigation. | |
| H. Develop a procedure to test out the
investigation process. | |
| II. Conduct the Investigation and Report on it. | 5 hours |
| A. Test out the investigation process. | |
| B. Make modifications in the procedure,
data collecting tools, etc. | |
| C. Describe the process, procedures and
modifications made in the investigation. | |
| III. Analyzing Alternatives | 45 minutes |
| A. List factors that contribute to
current conditions and problems. | |
| B. Brainstorm how changes would affect
the situation. | |
| IV. Develop an Action Plan. | 45 minutes |
| A. Determine if the solution is feasible. | |
| B. Develop a plan of action. | |
| V. Implement the Plan | 45 minutes |
| A. Analyze individual's role | |
| B. Summarize process. | |

187



Investigating Your Environment
Built Community

CURRICULUM RELATIONSHIPS

Generally speaking, any subject area can be brought into this study. However, social studies and science are most likely to be strong components in the investigation.

Math, language arts, and the creative arts can be worked in as the students report on what they found while working through the steps in the process. The fact that all curriculum areas come into use make these environmental investigations uniquely relevant and motivating. Students can clearly see the usefulness of the various subject matter.

Social Studies

1. Investigate the history of development of your community. What was it like before development? How have land uses changed over the years? What factors caused these changes? Interview old timers, collect old pictures, maps and other information.
2. How do social patterns affect land use?
3. How does technology affect land use?
4. What are the zoning and planning regulations? What are the processes for changes and appeals? How are decisions made?

Science

1. Investigate water supply and distribution systems and sewage and surface run-off systems.
2. Look for evidence of natural communities present before development.
3. Look for evidence of wildlife. Conduct back-lot and blacktop ecology studies.

Mathematics

1. Figure the cost of planting an arboretum and other landscaping to beautify the built community.
2. Calculate the cost of maintenance of the built community.
3. Investigate the water supply system and map it, relating pipe size, volume, pressure, etc.

Language Arts

1. Write a proposal for implementing a litter campaign in your area.
2. Write a narrative poem about how technology has changed our environment or an issue.
3. Write a story from a ground squirrel's point of view observing construction equipment invade its home territory to begin a construction project.
4. Write one or more scenarios for what the study area will be like in 5, 10, 50, and 100 years.

Create Arts

1. Beautify a part of your own community by planting flowers or shrubs.
2. Draw before-and-after pictures of a built community.



STEP I: PREPARE FOR THE INVESTIGATION

CONCEPT

Change, Interaction, Cause/Effect, System

PRINCIPLE

Built communities are where we spend most of our time. People should work with integrity and responsibility when developing environments for ourselves and future generations.

OBJECTIVES

As a result of completing the activities in this process, students will be able to:

- Identify at least five different land use categories in built environment.
- Name and describe three themes often found in communities.
- Construct a data collecting and recording tool for some part of an built environment for data that is observable, collectable, and recordable.
- Describe a procedure to use in initiating an urban environmental investigation.

MATERIALS NEEDED

- Maps of the urban area to be investigated (1 per small group)
- Marking pens - various colors
- Blackboard or easel board/pad
- Newsprint, butcher paper, or easel pad
- Paper, pencils
- Masking tape
- Activity sheets - A; 3-Stage Chart
- Wall chart - samples included in lesson plan

PROCESSES USED

- Question
- Hypothesize
- Use numbers
- Observe
- Predict
- Interpret data
- Classify
- Communicate
- Infer

TIME

2 Hours



DOING THE ACTIVITY - indoor, 2 hours

A. Set Stage:

"The urban or built environment is where most people spend most of their time. The way a built environment is planned and managed affects how easily, safely, and pleasantly we spend a great part of our lives. Winston Churchill said, "We shape our cities, after that they shape us." Today we are going to investigate the built environment in this immediate area. We will do this by following a process which will allow us to develop our own investigations to collect and interpret information and to make some suggestions for improving the area. We will spend some time here in the classroom first, then about three hours collecting information in the community and then time back in the classroom reporting on our findings. Most of the work will be done in small groups."

B. Procedure:

1. Put up wall chart.
2. Describe steps to students. Give them an opportunity to ask questions.
3. Ask the students: What are major land use categories found in most communities. (List examples on board)

8 Steps to Investigating a Built Community

1. Become familiar with community
2. Identify and focus on land use patterns and interrelationships.
3. Identify and analyze a specific topic.
4. Conduct the investigation.
5. Prepare and report on findings.
6. Analyze factors and alternatives to the present condition.
7. Develop an action plan.
8. Communicate feelings and values.

B. Procedure:

1. Hand out maps of community along with marking pens.
2. Have students locate on the map all the major land use categories they can think of and mark with their pens.

C. Retrieve Data:

1. Have students share information.
2. Ask them if they came up with any new categories as they studied their map.

CLOSURE Ask the students what conclusions they can draw about land uses in the community.

TRANSITION "There are many ways of looking at a community, from a simple, overall look like we just did to a more in-depth look."



A. Set Stage:

"We want to find out more about different land use categories in this area. One way to do this is with a 3-stage data collecting chart.

ACTIVITY A: 3-Stage Data Collecting and Analyzing Chart 45 min. small groups

B. Procedure:

1. Hand out Activity Sheet A.
2. "Before we start our chart, let's look at an example of one."
Note: Pick a subject other than a land use category listed on the board. Have a large wall chart made out ahead of time, with headings made.
3. Work through the 3-stage chart column by column.

Working in your group fill out the land use category and column 1 of the chart below.

Land Use Category _____

Column 1 What we want to find out about our land use category in the area.	Column 2 How to collect the information	Column 3 How to Record the information

C. Retrieve Data:

After filling out the chart as an example, ask:

1. "What might be the benefits of analyzing a land use in this way before going out to do an investigation about it?" (Easier to see all parts, community is broken into manageable parts, problems aren't as simple as they seem)

Investigating Your Environment Built Community

Column 1	Column 2	Column 3
<p>What We Want to Find Out Location of major arterials Kinds of transportation What is needed How much is available Accessibility of terminals Land topography Is it working What is being used now Growth pattern Traffic flow pattern Peak traffic needs Attitude of People</p>	<p>How to Collect Observation Interview people Existing studies Count # of cases at certain place Count types of vehicles</p>	<p>How to Record Graphs Statistics Pictures Film Tape recorders Questionnaire Map Tables</p>

TRANSITION "Now that we have looked at a simple recording device, let's apply that to our area."

A. Set Stage:

Describe the specific area the group is going to investigate and have them locate on the map.

Note: Some things to consider in identifying an area to investigate:

- within walking distance in the time allotted (3 hours of investigation)
- area should have a variety of land use categories
- should be interesting to study

B. Procedure:

1. Split class into appropriate number of study teams (4-5 to a team).
2. Have each study team pick a land use category.
3. Have study teams fill out column 1 in the 3-stage chart, giving them 10 minutes.
4. Have students identify one or two items from Column 1 of their charts that they want to find out more about from actual observations in the area to be investigated, and then construct a data-collecting and recording device to use in collecting and recording observations. The items must deal with data that is observable, collectable, and recordable in the area during the actual field investigation and within the time constraints. Having them fill out Columns 2 and 3 may help in their planning.

Note: Charts of samples of data-collecting and recording charts may be helpful.

<p>Use of Parks By Age Groups</p> <table border="1" style="width: 100%; border-collapse: collapse;"> <thead> <tr> <th style="width: 10%;">Age Gr.</th> <th style="width: 15%;">Swim</th> <th style="width: 15%;">Walk</th> <th style="width: 15%;">Bike</th> <th style="width: 15%;">Etc.</th> </tr> </thead> <tbody> <tr> <td>0-6</td> <td></td> <td></td> <td></td> <td></td> </tr> <tr> <td>7-12</td> <td></td> <td></td> <td></td> <td></td> </tr> <tr> <td>13-21</td> <td></td> <td></td> <td></td> <td></td> </tr> <tr> <td>21-30</td> <td></td> <td></td> <td></td> <td></td> </tr> <tr> <td>30-40</td> <td></td> <td></td> <td></td> <td></td> </tr> <tr> <td>40-40+</td> <td></td> <td></td> <td></td> <td></td> </tr> </tbody> </table>	Age Gr.	Swim	Walk	Bike	Etc.	0-6					7-12					13-21					21-30					30-40					40-40+					<p>No. People in cars at Intersection - 4:00-4:15 PM</p> <table border="1" style="width: 100%; border-collapse: collapse;"> <thead> <tr> <th style="width: 10%;">No Cars</th> <th style="width: 10%;">Occup.</th> </tr> </thead> <tbody> <tr> <td>50</td> <td></td> </tr> <tr> <td>40</td> <td></td> </tr> <tr> <td>30</td> <td></td> </tr> <tr> <td>20</td> <td></td> </tr> <tr> <td>10</td> <td></td> </tr> <tr> <td>0</td> <td></td> </tr> </tbody> </table>	No Cars	Occup.	50		40		30		20		10		0		<p>Location of Public Services</p>  <p>Legend X Fire Hy. + Telephone ~ Rest Rooms • Fire Station</p>
Age Gr.	Swim	Walk	Bike	Etc.																																															
0-6																																																			
7-12																																																			
13-21																																																			
21-30																																																			
30-40																																																			
40-40+																																																			
No Cars	Occup.																																																		
50																																																			
40																																																			
30																																																			
20																																																			
10																																																			
0																																																			

5. When the students are about through making their data-collecting chart, tell them to develop a plan of action to investigate their part of the environment using data-collecting and recording devices in the allotted field time. Consider dividing responsibilities for collecting and recording information: who goes where, other tools needed, etc.



6. After 10 minutes into the planning, pick up and read the following sign:

Planning for an Investigation

Usually, the problems that people have are:

1. Deciding what to do.
2. Narrowing down the scope of the topic to something specific enough to actually investigate.

HAS YOUR GROUP EXPERIENCED THIS?

C. Retrieve Data:

1. Before going out to do the investigation, have each group make a short presentation to describe the procedures and display the recording devices to be used in the investigation. If you have a large class, have groups pair up and critique each other's plans instead of each small group presenting to the total group.
2. Just before dismissing the groups to do the field investigation, put up the following chart:

This Session is all About Learning How to Prepare for an Investigation

Today the procedures are more important than the content. The idea is to try out your data-collecting and recording methods.

It may be necessary to modify your investigation procedures as you become involved in your task.

CLOSURE

Explain that today, learning how to plan and carry out an investigation which involves collecting and interpreting data is more important than the actual content of the investigation.



STEP II: CONDUCT THE INVESTIGATION

CONCEPT

Change, Interaction, Cause/Effect, System

PRINCIPLE

Built communities are where we spend most of our time. People should work with integrity and responsibility when developing environments for ourselves and future generations.

OBJECTIVE

The student will be able to:

- Test out the investigative process.
- Make modifications in the process.
- Adapt data collection tools to specific situations.
- Organize data into a report.
- Prepare or prevention using the highlights of the data collected.

MATERIALS NEEDED

- More copies of Activity A (optional).
- Wall chart -- sample included in lesson plan.
- Newsprint, butcher paper, or easel pad.
- Masking tape.
- Paper, pencils.
- Marking pens -- various colors.

PROCESSES USED

- Observe
- Predict
- Infer
- Communicate
- Interpret Data
- Use Numbers
- Design Experiments

TIME

5 hours



DOING THE ACTIVITY -outdoor, 3 hours; indoor, 2 hours

A. Set Stage:

1. Tell the group that they have 3 hours to do the field work.
2. When they return, they will have 1 hour to prepare a 5 minute report about the investigation. The instructions for the report will be posted when the groups return.
3. Remind them of safety requirements and whatever supervision the students may need to have for your situation.
4. Send students out to do investigation.

Note: While students are out doing their 3-hour investigation, make this into a chart.

Instructions for the Presentation

1. Describe your task.
2. Report on what you did, how you did it, and what it meant.
3. Describe how you modified your procedure, methods, recording devices, etc.
4. Use more than one person as spokesperson.
5. Use visual display(s).
6. Limit report to 5 minutes.
7. This is a report about the investigation process and not the content or solutions to problems unless it relates to the process.
8. Do not report on all the minute details.

5. When students return, review the chart with them.

B. Procedure:

Give group 1 hour to develop presentation.

C. Retrieve Data:

Have each group give their presentation. Make sure they stick to the time limits.

CLOSURE

Ask the Group:

1. What problems did you encounter in your investigation?
2. What were the things that made you modify your procedures, etc?
3. What are some things you'd consider if you did this step again?
4. How did you decide what to report on?
4. What is the next thing to do with all this information?

A. Set Stage:



STEP III: ANALYZE FACTORS AND ALTERNATIVES

CONCEPT	Change, Interaction, Cause/Effect, System
PRINCIPLE	Built communities are where we spend most of our time. People should work with integrity and responsibility when developing environments for ourselves and future generations.
OBJECTIVE	The student will be able to: <ul style="list-style-type: none">• Analyze factors that contribute to a problem in the built environment.• Identify change agents that can be used for the improved livability of the area.• Develop alternatives to the present situation that would reduce or eliminate the factor that causes the problem.
MATERIALS NEEDED	<ul style="list-style-type: none">• Activity B: Analyze Factors and Alternatives.• Activity B: Example.• Wall chart or overhead of Activity B.• Paper, pencils.
PROCESSES USED	<ul style="list-style-type: none">• Hypothesize• Formulate Models• Define Operationally• Question• Classify• Control Variables
TIME	45 minutes



DOING THE ACTIVITY (indoor, 45 minutes)

1. Remind group that the process is the important thing here and not the content.
2. Ask them any of the following questions that gets the group to look at their area as a whole.
 - a. What are some of the characteristics of the area you studied?
 - look like
 - land uses present
 - what do people do there
 - b. What are some needs of your area?
 - housing
 - transportation
 - services
 - c. What examples in your area that
 - illustrate the past?
 - typify the present?
 - indicate the future?
 - d. What are some interrelationships, based on your observations? (residential to business, business to transportation, etc.)
 - e. How do the interrelationships affect the community? (vacancies affect appearances, apartments affect community spirit, etc.)

B. Procedure:

1. Hand out Activity Sheet B: Analyze Factors
2. Put up chart on wall (or use overhead) and discuss with group.
3. Have individual teams select one issue, concern or problem and fill out the activity sheet. Give them 25 minutes.

C. Retrieve Data:

This is not necessary; move on to step IV.

CLOSURE

This is not necessary, move on to step IV.

TRANSITION

"Now that we've looked at some possible factors that affect your area and have brainstormed some alternative solutions, let's see if we can make one work."

ACTIVITY B: Analyze Factors and Alternatives to Present Condition (Example)

25 min. groups

ANALYZE FACTORS AND ALTERNATIVES TO PRESENT CONDITIONS (This activity is designed to brainstorm all possible alternatives.) List the factors contributing to the issue. Take each factor and ask, "How can we change this factor (eliminate, modify, substitute) to bring about a change in the issue?" Consider all alternatives, no matter how silly they may seem.			
Example: Traffic Management			
FACTOR	HOW IT CONTRIBUTES TO THE PROBLEM OR ISSUE	ALTERNATIVES TO ITS PRESENT CONDITION (Elimination, Modification, Substitution)	DESCRIBE HOW THE CHANGE WILL EFFECT THE PROBLEM OR ISSUE
Width of streets	Causes traffic jam	Put in walking or bicycle paths One-way streets	Eliminate car traffic, cause changes in working-visual patterns Less congestion because of one-way flow
Everyone start and quit work at same time	Causes traffic jam	Mass transit Adjust starting, ending, working hours	Reduce number of vehicles, no congestion, less air pollution, etc. Spread out traffic over a longer period of time
Describe the alternative or combination of alternatives that might bring about an improvement or solution to the problem of the environment investigated. Give reasons for your choices.			



STEP IV: DEVELOP AN ACTION PLAN

CONCEPT	Change, Interaction, Cause/Effect, System
PRINCIPLE	Built communities are where we spend most of our time. People should work with integrity and responsibility when developing environments for ourselves and future generations.
OBJECTIVE	The student will be able to: <ul style="list-style-type: none">• Develop an action plan to implement an alternative.• Analyze feasibility of alternative solutions.
MATERIALS NEEDED	<ul style="list-style-type: none">• Activity C: Develop an Action Plan.
PROCESSES USED	<ul style="list-style-type: none">• Interpret Data• Communicate• Formulate Models• Control Variables
TIME	45 minutes



DOING THE ACTIVITY (indoor, 45 minutes)

A. Set Stage:

Remind the group again that this is lesson the process.

B. Procedure:

1. Hand out Activity Sheet C: Develop an Action Plan.

30 min.
small group

ACTIVITY C: Develop an Action Plan

Select one of the solutions suggested by your group in ACTIVITY B. Write it below under "Suggested Solution". Complete the rest of the sheet.

ACTION PLANNING FOR PROBLEM SOLVING

SUGGESTED SOLUTION	TYPE OF ACTION NECESSARY TO IMPLEMENT THE SOLUTION	IDENTIFY CHANGE AGENTS WHO COULD HELP IMPLEMENT THE SOLUTION	IMPLEMENTATION STEPS TO PROBLEM SOLUTION	EVALUATION METHODS HOW WILL YOU FOLLOW UP AND EVALUATE THE EFFECTIVENESS OF YOUR ACTION?

Investigating Your Environment
Built Community

2. Have group select one alternative from the activity sheet and:
 - a. determine if it's feasible
 - b. develop an action plan
3. Tell group they have 30 minutes to develop their action plan and give a 3 minute report on: solutions and implementation steps only.

C. Retrieve Data:

1. Have each team give 3 minute report.

CLOSURE Ask group "if you were the planning commission, what guidelines would you develop for consideration of future developments in your area?"

TRANSITION "Now that we think we have a solution, let's look at what we can do to carry



STEP V: IMPLEMENT THE PLAN

CONCEPT	Change, Interaction, Cause/Effect, System
PRINCIPLE	Built communities are where we spend most of our time. People should work with integrity and responsibility when developing environments for ourselves and future generations.
OBJECTIVE	The student will be able to: <ul style="list-style-type: none">• Describe what they can do to become involved in community action.• Describe how you and the people of your community can become involved in affecting the local political decision-making process through investigations of a built environment.
MATERIALS NEEDED	<ul style="list-style-type: none">• Activity D: Implement the Plan.
PROCESSES USED	<ul style="list-style-type: none">• Communicate• Summarize
TIME	45 minutes



DOING THE ACTIVITY (indoor, 45 minutes)

A. Set Stage:

Say, "Now that we have looked very analytically at a built environment, let's switch gears a little and talk about how you feel about what you have just done."

B. Procedure:

1. Hand out Activity D.

ACTIVITY D: Implement the Plan

20 min.
Individual

Describe the part you could play in implementing your group's action plan.

a. As an individual:

b. As a member of a community action group:

c. As a part of the political decision-making process in your community.

2. Have students fill out the 3 parts. Give them 20 minutes.

Investigating Your Environment
Built Community 

C. Retrieve Data:

1. Ask for individuals to share their thoughts.
2. Ask, "What type of community action can be taken to motivate people to take informed action in situations such as we have been analyzing?"

CLOSURE Ask the following (for entire lesson):

1. "What procedure did we use about our investigations?"
2. "Can you think of other uses for this investigation process?"
3. "What did we find out about our environment in our study?"
4. "What are some things we learned as we went through this process?"



Investigating Your Environment
Built Community

ACTIVITY A: 3-Stage Data Collecting and Analyzing Chart

45 min.
small groups

Working in your group fill out the land use category and column 1 of the chart below.

Land Use Category _____

Column 1 What we want to find out about our land use category in the area.	Column 2 How to collect the Information	Column 3 How to Record the Information



ACTIVITY B: Analyze Factors and Alternatives to Present Condition (Example)

ANALYZING FACTORS AND ALTERNATIVES TO PRESENT CONDITIONS

(This Activity is designed to brainstorm all possible alternatives.) List the factors contributing to the issue. Take each factor and ask, "How can we change this factor (eliminate, modify, substitute) to bring about a change in the issue?" Consider all alternatives, no matter how silly they may seem.

Example: Traffic Management

FACTOR	HOW IT CONTRIBUTES TO THE PROBLEM OR ISSUE	ALTERNATIVES TO ITS PRESENT CONDITION (Elimination Modification Substitution)	DESCRIBE HOW THE CHANGE WILL EFFECT THE PROBLEM OR ISSUE
Width of streets	Cause traffic jam	Put in walking or bicycle paths One-way streets	Eliminate car traffic, cause changes in working-social patterns Ease congestion because of one-way flow
Everyone start and quit work at same time	Cause traffic jam	Mass transit Adjust starting, closing, working hours	Minimize number of vehicles, no congestion, less air pollution, etc. Spread out traffic over a longer period of time

Describe the alternatives or combination of alternatives that might bring about an improvement or solution to the problem of the environment investigated. Give reasons for your choices.



25 min.
groups

ACTIVITY B: Analyze Factors and Alternatives to Present Condition

ANALYZING FACTORS AND ALTERNATIVES TO PRESENT CONDITIONS

(This Activity is designed to brainstorm all possible alternatives.) List the factors contributing to the issue. Take each factor and ask, "How can we change this factor (eliminate, modify, substitute) to bring about a change in the issue?" Consider all alternatives, no matter how silly they may seem.

FACTOR	HOW IT CONTRIBUTES TO THE PROBLEM OR ISSUE	ALTERNATIVES TO ITS PRESENT CONDITION (Elimination Modification Substitution)	DESCRIBE HOW THE CHANGE WILL EFFECT THE PROBLEM OR ISSUE

Describe the alternatives or combination of alternatives that might bring about an improvement or solution to the problem of the environment investigated. Give reasons for your choices.



ACTIVITY C: Develop an Action Plan

Select one of the solutions suggested by your group in ACTIVITY B. Write it below under "Suggested Solution"
Complete the rest of the chart.

ACTION PLANNING FOR PROBLEM SOLVING

SUGGESTED SOLUTION	TYPE OF ACTION NECESSARY TO IMPLEMENT THE SOLUTION	IDENTIFY CHANGE AGENTS WHO COULD HELP IMPLEMENT THE SOLUTION	IMPLEMENTATION STEPS TO PROBLEM SOLUTION	EVALUATION METHODS HOW WILL YOU FOLLOW UP AND EVALUATE THE EFFECTIVENESS OF YOUR ACTIONS?

ACTIVITY D: Implement the Plan

20 min.
individual

Describe the part you could play in implementing your group's action plan.

a. As an individual;

b. As a member of a community action group;

c. As a part of the political decisionmaking process in your community.





BEST COPY AVAILABLE

Investigating Your Environment — Intermountain Region

230



INTRODUCTION

The desert is an integral part of our natural environments and our lives. Defined as a region rendered barren or partially barren by environmental extremes, especially low rainfall; it is important to understand the implications of managing the desert and its value to us. Since deserts are often taken for granted or misused, in this session, we will investigate a desert environment and collect information that will tell us about the plants, animals, soils, and climate conditions found on a desert. We'll also examine human impact on the desert and make inferences about the condition of the desert.

THE ACTIVITIES

TIME REQUIRED

Observe the Desert
Environment

25 minutes

Observe Weather
Factors

45 minutes

Observe Soil
Characteristics

25 minutes

Test Soil Character-
istics

45 minutes

Observe Animal Life

75 minutes

Observe Plant Life

45 to 90 minutes



Observe Human
Impact

30 minutes

Putting It All
Together

45 minutes

COMBINING THE ACTIVITIES

The activities in this unit are displayed singly. Depending upon the time available and the skill of the participants, you may choose to do only one activity or the entire series. For maximum learning, the activities should be experienced in the order listed in the unit, however, other suggestions are:

Suggestion 1:

Title: Observe the Desert Environment/Observe Soil Characteristics/Test Soil Characteristics

Introduction: The soil in the desert is quite different from soil in the forest, on farm lands or in your own backyard. Use these activities to note differences and to determine desert soil's unique characteristics.

Activity: Observe the desert environment.

Transition Statement: Let's take a close look at the soil in the desert and describe what we find at different levels.

Activity: Observe soil characteristics

Transition Statement: Now let's look closer at the soil and test it for such characteristics as temperature, texture, acidity, and moisture content.

Activity: Testing soil characteristics.

Transition Statement: By testing and analyzing the soil here, we can draw some conclusions about the implications for the plants and animals living on the desert.

Suggestion 2:

Title: Observe the Desert Environment/Observe Animal Life/Observe Plant Life.

Introduction: It's not easy for living things to survive in a desert environment. They must be able to adapt to a dry and arid land, yet the desert is home to many animals and much vegetation. These activities will help you determine what kinds of plants and animals have been able to adapt to this environment.

Activity: Observe the Desert Environment.

Transition Statement: By locating a number of animals in different locations, we will be able to determine what their needs are and how they interrelate.

Activity: Observe Animal life

Transition Statement: Just as the animals must adapt, so must the plants. Also, plants and animals may depend on each other in order to survive and thrive in the desert community.

Activity: Observe Plant life

Transition Statement: If you had to summarize our discussions and investigations into several generalizations or summary statements, what would you say? (Record answers on chart).



CURRICULUM RELATIONSHIPS

Social Studies

1. Read about land management practices that people use to increase the productivity of desert land.
2. Learn what your state is doing to increase desert land use.
3. Discover which desert animals contribute to the economy of your state.
4. Nomads are often associated with desert environments. Research and write a paper describing the interesting lifestyle of these people in the world's deserts.

Science

1. Determine how the fur, feathers, scales, or hair may help to insulate an animal. Discover other unique adaptations of desert animals.
2. Identify and classify the physical requirements of plants that enable them to survive on the desert, or "invent" a plant (with adaptations) that is suitable for the desert ecosystem.
3. Read about the effect of weather on the natural environment. For example, what weather elements favorably or adversely affect desert plants and animals.
4. Setup, research and collect plant examples from the desert. House in your science department.

Mathematics

1. Measure the weather using various tools, such as a barometer, anemometer, or psychrometer.
2. Calculate the acres and percentages of desert land in: your state; country; the world.
3. Measure and calculate the amount of soil erosion in a given area.

Language Arts

1. Use similes and metaphors in a descriptive paragraph about a desert animal.
2. Write an article for your school newspaper explaining what people can do to improve and use our desert land.
3. Write a poem about a dust (or lightning) storm on the desert.
4. Read Shabanu, Child of the Wind or any other book set in a desert. Prepare a report in any format emphasizing the importance of the desert to the main character's way of life.

Creative Arts

1. Draw pictures of desert vegetation.
2. Write a ballad about life on the desert.
3. Make a collage of all the plants and animals on the desert.
4. Study the art of desert cultures. What do you think are the environmental influences on the art. Are there similarities in different culture's art that can be explained by the similarities in environment?



OBSERVE THE DESERT ENVIRONMENT

CONCEPT: Organism, Order, System

PRINCIPLE: Many factors contribute to the desert environment—
animals, vegetables, minerals, climate, etc.

OBJECTIVE:

- Students will be able to observe and record their observations of a desert area.

PREPARATION: Conduct a discussion with students to find out what they already know. Teachers may also want to assign parts of the activities ahead of time as homework.

**MATERIALS
NEEDED**

- Activity Sheet A: Observe a Desert Environment
- pencils

**PROCESSES
USED**

- Observe
- Communicate
- Classify

TIME 25 minutes



DOING THE ACTIVITY (outdoors)

A. Set Stage:

Many living and non-living things influence and are part of the desert environment.
Let's see what we can find.

B. Procedure:

Distribute Activity A sheet and have students use this to record their observations. Encourage them to use the "other" category to record phrases, sensations, colors, etc., they don't want to lose. Tell them they have 15 minutes.

ACTIVITY A: Observe a Desert Environment

15 min.
Individual

Observe and record your observations about this desert area.

Plants _____

Soil _____

Terroir _____

People _____

Air _____

Animals _____

Weather _____

Other _____

Investigating Your Environment
Desert 

C. Retrieve data:

1. What did you notice about the desert?
2. What did you notice about plant life?
3. What did you notice about the soil?
4. What evidence of animal life did you find?
5. Turn to someone you did not work with and share one of your observations about the desert.
6. What do you observe as the biggest difference between this desert environment and other environments in which you have lived?

CLOSURE

From our investigation how could we define a "desert?"

TRANSITION

We have investigated a number of factors that contribute to the desert environment. Now let's focus on weather and how it affects the desert environment.



OBSERVE THE WEATHER FACTORS

CONCEPT Probability, Fundamental Entities, Interaction, Quantification, Replication

PRINCIPLE Various means can be used to observe and predict weather conditions. Once students have made their predictions based upon their best knowledge, instruments will be used to modify the prediction.

OBJECTIVE

- Students will be able to observe, record, and predict the weather conditions on the desert by using various instruments.
- Students will use appropriate instruments to verify their predictions.

PREPARATION Locate a suitable site for this lesson. Make an enlarged copy of Activity Sheet C. Familiarize yourself with how equipment works.

**MATERIALS
NEEDED**

- Activity Sheet B: Measuring Weather Factors
- Pencils
- Enlarged copy of Activity Sheet B
- For each group:
 - Thermometers
 - Wind speed indicators
 - Sling psychrometers
 - Pint size jars
 - Water

**PROCESSES
USED**

- Observe
- Measure
- Infer
- Communicate
- Use numbers
- Predict
- Interpret data
- Classify

TIME 45 minutes



DOING THE ACTIVITY (outdoors)

A. Set Stage:

“Weather factors and climate are important influences in the desert. In this activity we will predict some weather factors and take measurements to test our predictors.”
Brainstorm various weather conditions students have observed in their past experiences.

B. Procedure:

1. Distribute Activity Sheet B.
2. Have students work in groups of 3 or 4 to complete the predictions column on Activity Sheet B.
3. Have students report findings in 10 minutes.

ACTIVITY B: Measuring Desert Environmental Factors 30 min.
groups

Based on my observations of this site, I predict the following weather conditions:

The air temperature will be _____ because _____

The wind speed will be _____ because _____

The relative humidity will be _____ because _____

Make sure everyone is involved in this testing. Using the instruments, determine air temperature, wind speed, relative humidity.

Record the data below:

Location of Test (by plants, in open areas, etc.)	Time Taken	Temperature		Wind Speed		Relative Humidity	
		Pred.	Test	Pred.	Test	Pred.	Test

C. Retrieve Data:

1. Bring the groups back together. On an oversized example of Activity B, have each group record their data. Then facilitate a discussion using the following questions:
 - a. What do you notice about the results?
 - b. How did you make your predictions?
 - c. How do your results compare with your predictions?
 - d. Under what conditions might we get different test results?
 - e. How do weather conditions differ from other areas?
 - f. How do you account for those differences?(NOTE: Cover "rain shadow effect" if appropriate in your area)
2. We can test our predictions about weather conditions by using the thermometer, wind speed indicator and sling psychrometer. There are a number of jobs to do in making the tests, so make sure everyone has a activity to complete.
3. Demonstrate use of the instruments.
4. Allow students 15-20 minutes to complete activity and record data.

CLOSURE

What can we say about weather conditions in the desert? Write down 5 descriptive words about the desert.

TRANSITION

We have focused on weather conditions in the desert. Now let's focus on another environmental factor: soils.



OBSERVE SOIL CHARACTERISTICS

CONCEPT	System, Cause-Effect, Quantification, Invariance
PRINCIPLE	Desert soils are characteristically different from those with higher precipitation.
OBJECTIVE	<ul style="list-style-type: none">• Students will be able to investigate and report on desert soils.• Students will be able to compare re with other groups.• Students will be able to draw generalizations about desert soil.
PREPARATION	Identify suitable sit. Dig soil pit.
MATERIALS NEEDED	<ul style="list-style-type: none">• Activity Sheet C: Investigating Desert Soils• Pencils• Shovels and hand trowels• Rulers
PROCESSES USED	<ul style="list-style-type: none">• Observe• Infer• Communicate• Use numbers• Classify• Interpret data• Predict
TIME	25 minutes

219

DOING THE ACTIVITY (outdoors)

A. Set Stage:

Soils in desert areas are often quite different from those in areas with high rainfall. Let's take a look at the soil. What might you expect to find?

B. Procedure:

1. Distribute Activity C Sheets.
2. Arrange students in groups of 3 or 4.
3. Report findings in 15 minutes.

ACTIVITY C: Investigating Desert Soil

groups

1. Predict what you will find in the top 6 inches of the desert floor. List your predictions.

2. In a 2 or 3 ft square on the desert floor, sift through the top 6 inches of soil and record the items you find.

Description of Items in the Soil	Quantity	Depth Located from Surface	Possible Effect on Soil

Investigating Your Environment

Desert



Investigating Your Environment
Desert

230

12

BEST COPY AVAILABLE

C. Retrieve Data:

Students use completed Activity C cards as basis for discussion. Questions the facilitator can use are:

1. What did you find?
2. How do the items from the bottom part of your sample compare with the items found near the surface?
3. How did your findings compare with other groups?

CLOSURE

Share with your group one finding like another groups and one finding different than another group. Record your likenesses and differences on flip chart. (Facilitators, set up a simple chart for recording, e.g.)

LIKES	DIFFERENCES

TRANSITION

“Our next study builds upon this lesson. We have observed desert soil conditions, now lets test some soil/characteristics.” Note: If Activity D is to be done, facilitator may wish to dig soil pit (or “freshen” it up) while participants complete Activity Sheet C. (See “Preparation under Test Soil Characteristics Lesson Plan - next page)

TEST SOIL CHARACTERISTICS

CONCEPT	Cause-Effect, Interaction, Quantification, Gradient, Replication
PRINCIPLE	Soil characteristic such as texture, temperature, pH (acidity or alkalinity), and moisture content are indications of soil conditions that may affect the plant and animal life present.
OBJECTIVE	<ul style="list-style-type: none">• Students will be able to determine soil texture, temperature, pH, and moisture at three separate levels in the soil profile and then determine implications for plant and animal life in that area.
PREPARATION	Site and dig a soil pit. Cover until ready to use to prevent soil temperature and moisture changes that can affect result. Practice using the instruments so you can help students as needed.
MATERIALS NEEDED	<ul style="list-style-type: none">• Activity Sheet D: Testing Soil Characteristics• Pencils• Shovels and trowels• Rulers• Soil thermometers• Soil pH kits• Soil moisture indicators (available at nurseries)• Pint size jars• Canteens of water
PROCESSES USED	<ul style="list-style-type: none">• Observe• Measure• Infer• Use numbers• Communicate• Control variables• Interpret data
TIME	45 minutes



DOING THE ACTIVITY (outdoors)

A. Set Stage:

"The characteristics of soil directly affect the plant and animal life in that area. In this activity we will determine those characteristics." Each group should have Activity D from the previous lesson.

B. Procedure:

1. Distribute Activity D cards.
2. Review techniques for gathering soil data.
3. Students work in small groups to complete sheet D. Tell them they have 25 minutes.

C. Retrieve Data:

1. What were your test results?
2. How do you account for difference/similarities between group's data?
3. Why did we keep the soil pit covered until we were ready to use it?
4. Based on soil characteristics, what are the implications for plant and animal life there?

Note: The facilitator will want to show the data to the entire group in some fashion (See "closure" under last activity)

CLOSURE

Share with your work group, one new thing you learned and one thing you think was positive about working with this group. What conclusions can we draw about soil conditions in this area?

TRANSITION

"We have investigated two abiotic (nonliving) components of the desert environment, now let's investigate the first biotic component -- the animals of the desert."

ACTIVITY D: Testing Soil Characteristics

25 min.
groups

Determine soil texture, temperature, pH, and moisture presence at three separate levels in the soil profile. Record your data in the table below.

Layer	Texture	Temperature	pH	Moisture Presence
At Surface				
Depth of 1-2 feet				
Depth of 3 feet				

Texture: Determine texture by feel or by sediment layer.

Test: Push and rub moistened soil sample between thumb and forefinger. Split an sample to moisture.

Gritty feel sand
Smooth, slick, not sticky silt
Smooth, slick, sticky clay

Sediment layer: Place sample in jar of water, shake and allow soil to settle. Sand will settle first as it is the largest particle size. Silt will settle second. Clay, which is the smallest particle size, will settle last. Compare layers and determine percentage of sand, silt, and clay.

Temperature: Determine using soil thermometer. Be sure to insert probe full distance in soil. Leave it in the soil 3-5 minutes before taking reading.

pH: Determine using LaMotte test kits. Demonstrate the use of the kit. Mention not to compact soil sample in the porcelain dish, use just enough pH reagent to saturate the soil sample, match color at the edge of the soil sample and porcelain dish with pH color chart.

Moisture: Presence can be determined by placing soil sample in jelly cup and cover tightly. Leave in sun. Any moisture will condense on jar sides. This will only indicate presence of moisture -- not amount! You can also use a "Moisture Meter" available at your local nurseries.

Investigating Your Environment
Desert UAS



OBSERVE ANIMAL LIFE

CONCEPT	Organism, Interaction, Population, Equilibrium, Quantification Model
PRINCIPLE	Animals must adapt to their environment in order to survive.
OBJECTIVE	Students will be able to: <ul style="list-style-type: none">• Investigate and report their findings.• Compare results with other groups.• Draw generalizations about the needs of animals in adapting to a desert environment.
PREPARATION	Read activity.
MATERIALS NEEDED	<ul style="list-style-type: none">• Activity Sheet E: Observe Desert Animals and Activity Sheet F: Desert Animal Relationships• Paper for drawing or writing• Ball of string• 3 push pins per group plus extras
PROCESSES USED	<ul style="list-style-type: none">• Observe• Infer• Communicate• Use numbers• Classify• Formulate models
TIME	75 minutes - there are two lessons here-the first must be done outdoors (45 minutes); the second can be used as follow up in the classroom.



DOING THE ACTIVITY (outdoors/indoors)

A. Set Stage:

"Animals that live in the desert have special behaviors and adaptation in order to survive there. In this activity we will see what evidence of animals we can find!"

B. Procedure:

1. Ask students what kinds of animal life they might expect to find in a desert environment, what the needs of animals are, and where they would look for animals in the desert.
2. Distribute Activity Sheet E. They have 30 minutes to complete.

ACTIVITY E: Observing Desert Animals 30 min.
groups

Explore as many places as you can and record animals or evidence of animals, quantity noted, and location.

Animals/Evidence	Location	Quantity

Investigating Your Environment
Desert 

3. Arrange students in groups of 3-4.
4. Have students complete Activity Sheet E and be prepared to report findings.



C. Retrieve Data:

Students use completed Activity E cards to take part in a discussion. The following questions may be helpful to the discussion:

1. What animals did you find?
2. Where did you find them?
3. How do you account for differences in quantity?
4. What do you think is the function of these animals in the environment?
5. (Review) What are the basic needs of animals?
6. How have the animals you found adapted to the desert in order to meet their needs?

NOTE: You may need to visually show some of the information for your visual learners.

D. Procedure 2:

1. Distribute Activity F. Work in groups of 2. They have 15 minutes to complete. (Note: This is an optional activity you can do in the classroom after you have completed the field work.)

15 min.
groups

ACTIVITY F: Desert Animal Relationships

1. Select 2 or three animals from the list of animals found. In your small group make a drawing or name plate of your animals. Discuss how your animals are related to each other and the rest of the desert animals (and plants).

Animal 1 Name _____
Drawing: _____

How related to other animals/plants _____

Animal 2 Name _____
Drawing: _____

How related to other animals/plants _____

Animal 3 Name _____
Drawing: _____

How related to other animals/plants _____

Investigating Your Environment
Desert 

Investigating Your Environment
Desert 

BEST COPY AVAILABLE

2. Groups post animals on the chart provided by the facilitator. Place a push pin by each animal.

Note to Facilitator: You may wish to add soil and plant cards either before or as the discussion develops.

E. Retrieve Data:

As they discuss their pictures, they should share with the rest of the group the names of their animals and how they are interrelated, showing the relatedness by connecting the push pins by each animal with yarn or string.

CLOSURE

When all groups have shared, discuss your "model" of the desert animal interrelationships. Then pull one of the pens and discuss the tangled mess. (e.g. "What happens if we eliminate all the coyotes?") What have we found out about animal relationships?

TRANSITION

You often hear people talk about the "flora and fauna" of an area. We've just studied about the fauna of the desert. Animals (the "fauna") require plants (either directly or indirectly) to survive. Let's look at desert plants - the "flora" of the desert.

227



OBSERVE PLANT LIFE

CONCEPT Organism, Evolution, Population, Order, Quantification

PRINCIPLE Plants must respond to their environment in order to survive.

OBJECTIVE Students will be able to:

- Investigate desert plants and report their findings.
- Compare results with other groups.
- Draw generalizations about the needs of plants adapted to a desert environment.

PREPARATION Stake out a 100' square area and divide into four 50' square areas as illustrated. Mark each of the nine corners with a different color flag.

MATERIALS NEEDED

- Activity sheets and pencils
- Sketch paper and sketching materials
- 9 different color flags
- Circle labels (Office supply store)
- 100' measuring tapes on rope lengths
- 12 X 12" poster board - 1/group

PROCESSES USED

- Observe
- Infer
- Classify
- Communicate
- Use numbers

TIME 45 to 90 minutes (45 minutes for first activity. Second activity is optional - add a second 45 minutes if you choose to do this one)

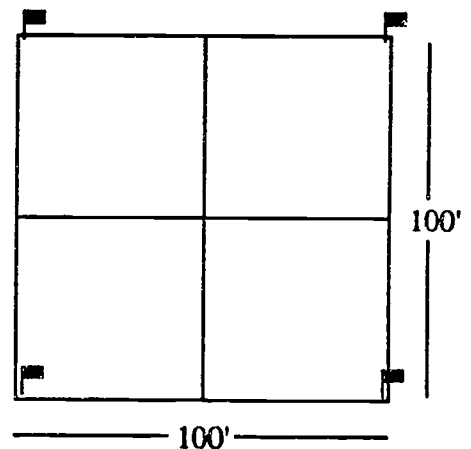

DOING THE ACTIVITY (outdoors)(45 minutes)

A. Set Stage:

"Plants that live in the desert respond to that environment in different ways in order to grow and reproduce. In this activity we will look at some of the plant adaptations in this area."

B. Procedure:

1. Arrange students into groups of 4 or 5.
2. Ask students what kinds of plant life they might expect to find in a desert environment, what the needs of plants are, and where they would look for plants in the desert.
3. Pass out Activity Sheet G and materials needed to prepare plant map. Obtain square 12" X 12" of poster board for map preparation. Suggest color circles with adhesive backing (get at office supply store) to use as symbols for plants. Using appropriate symbols, the students should plot the location of the plants within their area on the poster board squares. Give the group 20 minutes to complete.

ACTIVITY G: Plant Map 20 min.
groups

1. Individually collect a sample from 5 different plants. (At the end of this activity you may wish to tape or contact paper these samples to the back of this page.)
2. Show your plants with the other members of your group. After all samples have been discussed select 5 plant samples that are important to your group.
3. Compare your plants with those of other groups. Select 5 plants for the entire group. Develop a symbol for each plant.
4. Divide into 4 groups and obtain the necessary materials from the instructor to prepare a plant map of one 10' square.
5. Survey your group's 10' square for the 5 plants. Use appropriate symbol to mark the location of each plant on your map. Notice the four different color flags that delineate each square.
6. Upon completion of your map, meet with the entire group and prepare the overall map.

Put an "X" in the location of your square

Investigating Your Environment 



4. Review instructions on Activity Sheet G. Point out that each group's 50' square is delineated by four different color flags. Assign squares to each group.
5. Have groups complete Activity Sheet G and return in 30 minutes.
6. As an optional activity, complete Activity H working in small groups. The activity takes 20 minutes.

ACTIVITY H: Plant Adaptations

20 min.
groups

Complete the following chart for the plants that were important to your small group.

Plant Description	How It has Adapted	Data Used to Make Inferences

Investigating Your Environment
Desert 

230

C. Retrieve Data:

1. What did you find in your area?
2. How did your area compare with other areas?
3. How did you account for the differences or similarities?
4. Discuss adaptation--how things respond to their environment in order to survive.
5. How have your plants adapted to this environment?

SUMMARY: "What can we say about the plant community at this site?"

TRANSITION

Desert plants and animals must adapt to survive in their environment. Rather than adapt to the desert environment, as humans we often change the environment to suit our needs. We call this "Human Impact". Let's look at how this happens.

(NOTE: Depending upon how you are using these lessons and your site - there are two Project Wild activities you could use to extend knowledge of adaptation - "The Thicket Game" and "Adaptation Artistry." "Fashion & Fish" from Aquatic Wild might also be useful.)

231



OBSERVE HUMAN IMPACT

CONCEPT	Interaction, Cause-Effect, Change
PRINCIPLE	Humans use affects the desert environment both positively and negatively.
OBJECTIVE	Students will be able to: <ul style="list-style-type: none">• Investigate the impact of people on the desert.• Compare results with other groups.• Draw conclusions about how human use affect desert areas.
PREPARATION	Select a suitable site for this activity.
MATERIALS NEEDED	<ul style="list-style-type: none">• Activity I: Observe Human Impact
PROCESSES USED	<ul style="list-style-type: none">• Observe• Infer• Communicate• Interpret data
TIME	30 minutes



DOING THE ACTIVITY (outdoors)

A. Set Stage:

"People affect the desert environment in beneficial and harmful ways. In this investigation we will see what affect people have had on this area."

B. Procedure:

1. Distribute Activity Sheet I.
2. Have students work individually or in pairs to complete sheet I.
3. Be prepared to report findings in 15 minutes.

C. Retrieve Data:

Students use completed Activity I cards to discuss:

1. What evidence of people did you find?
2. How have they affected the area?
3. How do you feel about human impact here?
4. What could people do to improve the environment?

ACTIVITY I: Human Impact on the Desert

20 min.
group/individual

Explore the area and list evidence of people and how they have affected the area.

Evidence of People	What It Affects	How It Affects

Investigating Your Environment
Desert 

CLOSURE

Discuss in your group - "Is everything humans do to or in an environment beneficial?" List one example of a human action in the desert environment which has been beneficial. Harmful? What can we say about the effects of people on this environment?

TRANSITION

"We have been gathering information about various aspects of the desert environment. Now it is time to review the entire desert ecosystem."



PUTTING IT ALL TOGETHER

CONCEPT	Perception
PRINCIPLE	A desert environment is unique and can be clearly defined.
OBJECTIVE	<ul style="list-style-type: none">• Students will be able to write a description of a desert environment.
PREPARATION	Conduct a discussion encouraging students to think about all the ideas they learned in the previous lessons. Copy Activity J and K back-to-back, one for each student.
MATERIALS NEEDED	<ul style="list-style-type: none">• Activity Sheets J: Putting it all Together and K: Feelings• pens or pencils
PROCESSES USED	<ul style="list-style-type: none">• Define operationally<ul style="list-style-type: none">◦ Infer• Communicate• Interpret data
TIME	45 minutes



DOING THE ACTIVITY

A. Set Stage:

In the next 30 minutes, you will work by yourself to explore your understanding of this desert site. I will signal when it is time to begin working on the second activity. Follow the written instructions on the activity sheets. Remain silent after you are done.

B. Procedure:

Distribute Activity J and K sheets.

ACTIVITY J: Putting It All Together	20 min. Individual
Using knowledge gained in the session, write a description of the desert environment using at least 10 sentences. Try to include something that you learned from each of our desert lesson.	
ACTIVITY K: Feelings	10 min. Individual
Describe how you feel about the desert. Choose words, sketches, poems, prose or a combination to illustrate your feelings.	

C. Retrieve Data:

Students share their completed Activity K and L cards, using the following questions as discussion starters:

1. Have students share their description and feelings if they wish.
2. What did we discover about the desert environment today?

CLOSURE

In summary, how is a desert different from other areas? Quickly list the common factors of desert. How can we summarize our investigations and discussions? What are some of the things in the desert about which you would like to know more?

ACTIVITY A: Observe a Desert Environment

15 min.
individual

Observe and record your observations about this desert area.

Plants _____

Soil _____

Terrain _____

Rocks _____

Air _____

Animals _____

Weather _____

Other _____



ACTIVITY B: Measuring Desert Environmental Factors

30 min.
groups

Based on my observations of this site, I predict the following weather conditions:

The air temperature will be _____ because _____

The wind speed will be _____ because _____

The relative humidity will be _____ because _____

Make sure everyone is involved in this testing. Using the instruments, determine air temperature, wind speed, relative humidity:

Record the date below:

Location of Test (by plants, in open areas, etc.)	Time Taken	Temperature		Wind Speed		Relative Humidity	
		Pred.	Test	Pred.	Test	Pred.	Test



ACTIVITY C: Investigating Desert Soil

groups

1. Predict what you will find in the top 6 inches of the desert floor. List your predictions.

2. In a 2 or 3 ft square on the desert floor, sift through the top 6 inches of soil and record the items you find.

Description of Items in the Soil	Quantity	Depth Located from Surface	Possible Effect on Soil



ACTIVITY D: Testing Soil Characteristics

Determine soil texture, temperature, pH, and moisture presence at three separate levels in the soil profile. Record your data in the table below.

Layer	Texture	Temperature	pH	Moisture Presence
At Surface				
Depth of 1-2 feet				
Depth of 3 feet				

Texture: Determine texture by feel or by sediment layer.

feel: Push and rub moistened soil sample between thumb and forefinger. Spit on sample to moisten.

Gritty feel sand
 Smooth, slick, not sticky silt
 Smooth, slick, sticky clay

sediment layer: Place sample in jar of water, shake and allow soil to settle. Sand will settle first as it is the largest particle size. Silt will settle second. Clay, which is the smallest particle size, will settle last. Compare layers and determine percentage of sand, silt, and clay.

Temperature: Determine using soil thermometer. Be sure to insert probe full distance in soil. Leave it in the soil 3-5 minutes before taking reading.

pH: Determine using LaMotte test kits. Demonstrate the use of the kit. Mention not to compact soil sample in the porcelain dish, use just enough pH reagent to saturate the soil sample, match color at the edge of the soil sample and porcelain dish with pH color chart.

Moisture: Presence can be determined by placing soil sample in jelly cup and cover tightly. Leave in sun. Any moisture will condense on jar sides. This will only indicate presence of moisture -- not amount! You can also use a "Moisture Meter" available at your local nurseries.



ACTIVITY E: Observing Desert Animals

30 min.
groups

Explore as many places as you can and record animals or evidence of animals, quantity noted, and location.

Animals/Evidence	Location	Quantity



ACTIVITY F: Desert Animal Relationships

15 min.
groups

1. Select 2 or three animals from the list of animals found. In your small group make a drawing or name plate of your animals. Discuss how your animals are related to each other and the rest of the desert animals (and plants!).

Animal 1 Name _____

Drawing:

How related to other animal/plants _____

Animal 2 Name _____

Drawing:

How related to other animal/plants _____

Animal 3 Name _____

Drawing:

How related to other animal/plants _____



ACTIVITY G: Plant Map

1. Individually collect a sample from 5 different plants. (At the end of this activity you may wish to tape or contact paper these samples to the back of this page.)
2. Share your plants with the other members of your group. After all samples have been discussed select 5 plant samples that are important to your group.
3. Compare your plants with those of other groups. Select 5 plants for the entire group. Develop a symbol for each plant.
4. Divide into 4 groups and obtain the necessary materials from the instructor to prepare a plant map of one 50' square.
5. Survey your group's 50' square for the 5 plants. Use appropriate symbol to mark the location of each plant on your map. Notice the four different color flags that delineate each square.
6. Upon completion of your map, meet with the entire group and prepare the overall map.

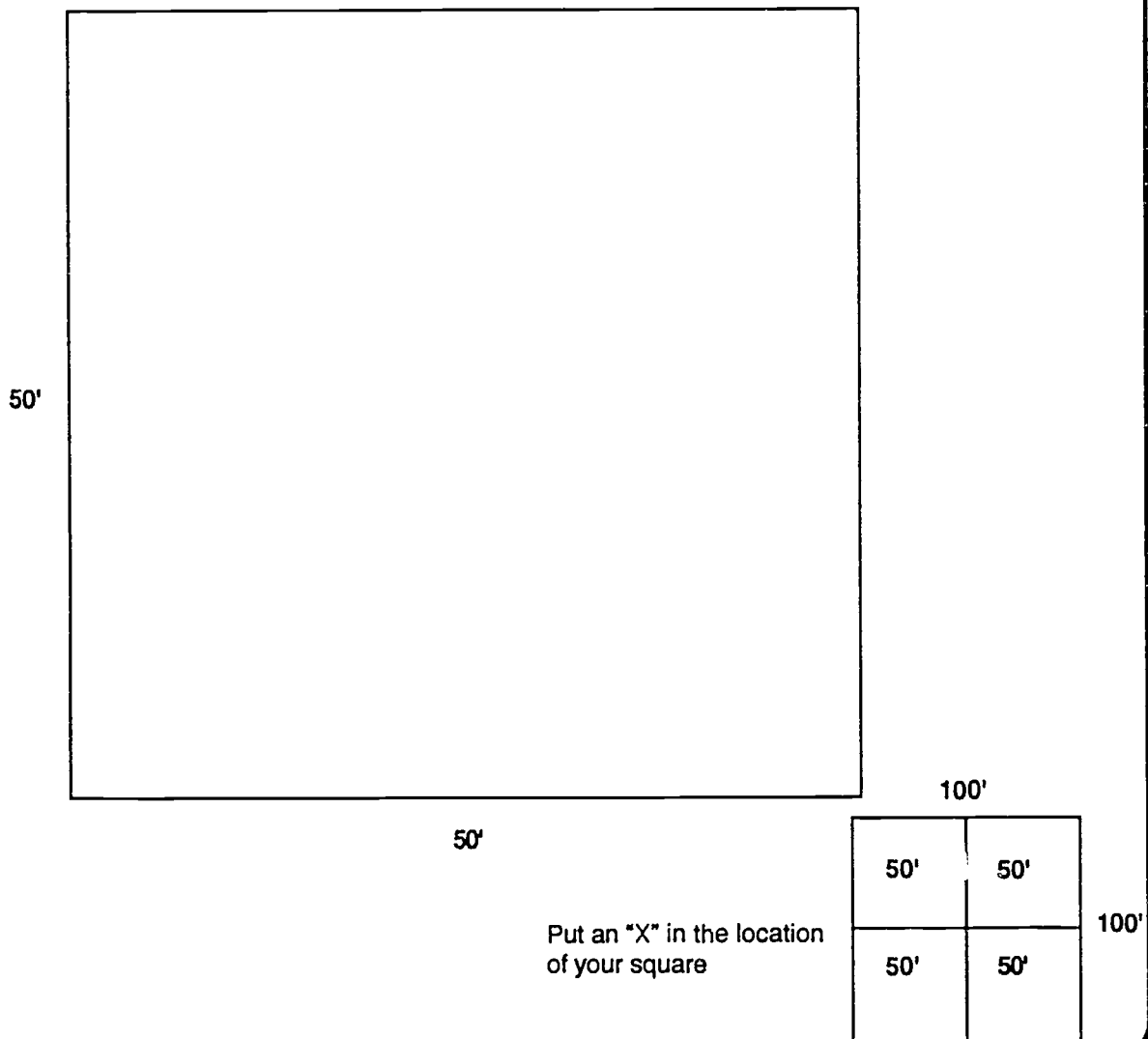

ACTIVITY H: Plant Adaptations

20 min.
groups

Complete the following chart for the plants that were important to your small group.

Plant Description	How it has Adapted	Data Used to Make Inferences



ACTIVITY I: Human Impact on the Desert

20 min.
groups/individual

Explore the area and list evidence of people and how they have affected the area.

Evidence of People	What it Affects	How it Affects



ACTIVITY J: Putting It All Together

20 min.
individual

Using knowledge gained in the session, write a description of the desert environment using at least 10 sentences. Try to include something that you learned from each of our desert lesson.





BEST COPY AVAILABLE

Investigating Your Environment — Intermountain Region



INTRODUCTION

Sand dunes are mounds of loose sand grains heaped up by the wind. Regarded by some as little more than expansive sand boxes for recreation and exploitation, dunes are complex and beautiful structures formed over many years. Yet while they are the product of many years, dunes are constantly changing as the blowing winds rearrange their basic structural unit — sand.

Dunes are most likely to develop where strong winds blow in the same direction. Generally they are associated with deserts or beaches. Extensive fields of dunes occur on some of the world's deserts such as the Sahara of Africa. Patches of dunes are found scattered throughout the deserts of the southwest United States. Dunes are also commonly found just landward of beaches, where sand is blown inland by sea or lake breezes.

In the next several hours you will explore not only the structure of sand dunes, but also the dynamic factors that make dunes and the dune ecosystem so varied and interesting. Hopefully when you have finished this unit, you will view the dune ecosystem as a place as beautiful as it is unique, and as fragile as it is complex.

THE ACTIVITIES

TIME REQUIRED

Sand Exploration	2 1/2 to 3 1/2 hours.
Dune Shapes	45 minutes
Dune Migration	20 minutes
Dune Habitat Transect	90-120 Minutes

COMBINING THE ACTIVITIES

The activities in this unit are displayed singly. Depending upon the time available and the skill of the participants, you may choose to do only one activity or the entire series. For maximum learning, the activities should be experienced in the order listed in the unit. However, other suggestions are:

Title: Sand Exploration/Dune Shape/Dune Habitat Transect

Introduction: Sand dunes are a laboratory for the scientist, an inspiration for the artist, and a recreational haven for many. Participants in this unit will investigate the complex relationships found in the dune ecosystem.



Activity: Sand Exploration

Introduction to the First Activity: Since sand is the basic structural unit of dunes, the first activity focuses on the composition of sand. Students identify a variety of common minerals that comprise sand, and estimate the percentages of each in a given sand sample.

Transition: Now that we have looked at the composition of sand, let's look at dunes in order to learn how to identify the common dune types.

Activity: Dune Shape

Transition: Now that we have looked at dune types, let's see how the wind works to rearrange sand to create the various dune types.

Activity: Dune Habitat Transect

Transition: How has this unit changed your thinking about dunes?

CURRICULUM RELATIONSHIPS

Social Studies

1. Prepare a map showing and/or write a short paper describing the dune areas of the world. Be sure to include the reason dunes are there.
2. Compile a list of the native people/cultures in the world who are associated with dune areas. Choose one. Research the culture. In what ways does the dune habitat with which they are associated influence their culture?

Science

1. "Invent" a plant (with adaptations) that is suitable for the dune ecosystem.
2. Using the kangaroo rat as an example, write a paper discussing the pressures placed on animals that live in arid climates, and what features they possess to enable them to survive in this harsh environment.
3. Report on the insect, bird or reptile/amphibian life if of a sand dune ecosystem.

Mathematics

1. Calculate the volume of a dune.
2. Estimate the amount of sand found on earth, assuming the average depth of sand where it is found is 1 m. (Do not include the sand found on ocean bottoms or under water)

Language Arts

1. Write a short story about a day in your life, assuming you are a young person your age who lives in the coastal dunes. (Past or present)
2. Write poems or essays about some aspect(s) of dunes.

Creative Arts

1. Using charcoal and white paper, sketch several dunes.
2. Using glue and sand, make dunes on construction paper. Additional material may also be applied, if desired. Or, construct models of the different dune types.



ACTIVITY I: SAND EXPLORATION

- CONCEPT** Quantification, Fundamental Entities, Invariance
- PRINCIPLE** Participants will classify sand particles based upon observable characteristics.
- OBJECTIVE**
- Using previously acquired knowledge the student will be able to identify as well as determine the relative percentage of the minerals that make up the particles of sand in a given sample.
- PREPARATION** The student should have knowledge about mineral identification to successfully perform this activity. A mineral identification book may be useful. The teacher will need to obtain 30-40 grams of coarse-grained sand for each group from the same source.
- MATERIALS USED**
- Activity Sheet A: Sand Exploration
 - Hand lens
 - Magnet
 - Tweezers, forceps, or toothpicks
 - Sand
 - 1 cm grid graph paper
 - Mineral Reference guide
 - Tubs/containers to put sand in
 - Dissecting microscope (optional)
 - Calculator
 - Samples of mineral types (optional)
 - Overhead, flipchart, chalkboard, or enlarged copy of Activity Sheet A
- PROCESSES USED**
- Classify
 - Predict
 - Interpret data
 - Observe
 - Measure
 - Communicate
 - Use numbers
- TIME** 2 1/2 to 3 1/2 hours.



DOING THE ACTIVITY (indoors)

A. Set Stage:

The mineral composition of the sand grains in sand dunes depends on both the character of the original sand source and the intensity of chemical weathering in the region. In this activity students will examine individual sand particles to identify their mineral make-up.

Before beginning the activity review the names and characteristics of the minerals you expect to find that make up the sand in your sample. Some common minerals seen will be:

quartz — colorless or light colored
 biotite mica — blackish, shiny, flat
 muscovite mica — white or clear, shiny and flat
 pyrite — light yellow and brassy
 feldspar — white, gray or red
 hornblende — dull green or black
 calcite — clear or nearly so; blockish

ACTIVITY A: Sand Exploration

45 min.
groups

1. Spread sand sample in a single layer onto graph paper so that it covers a single square (one square cm.).
2. Remove all the sand except the sand covering the square cm. to be used.
3. Using a hand lens or dissecting microscope, use a thin toothpick or tweezers to sort the sand in the remaining square cm. into piles based on the color and size.
4. Now that you have observed your sand sample, estimate the percentage of various minerals you expect to find in your sample. Record this estimate in column 1.
5. Identify each pile of minerals and count the number of grains of each. Record data in left side of column 2.
6. Next calculate the total number of sand grains, and the percentage of each mineral type in the total sample, using the formula below. Record calculations in left side of column 3.

Mineral Name	Estimated % of Grains	Actual # of Grains		Percentage of Total	
		Group Data	Class Data	Group Data	Class Data
Quartz: colorless or light colored					
Biotite: blackish, shiny, flat					
Muscovite: white or clear, shiny and flat					
Pyrite: light yellow and brassy					
Feldspar: white, gray or red					
Hornblende: dull green or black					
Calcite: clear or nearly so; blockish					
Other					

*To calculate the percentage of each mineral type in the whole sample, use the following formula:

$$\text{Number of Grains of Any Mineral Type} \div \text{Total Number of Grains Counted}$$

Investigating Your Environment
Dunes 



Investigating Your Environment
Dunes

B. Procedure:

1. Divide the class into groups and distribute materials.
2. Spread sand sample in a single layer onto graph paper so that it covers a single square (one square cm).
3. Remove all the sand **except** the sand covering the square cm to be used.
4. Using a hand lens or dissecting microscope, use a thin toothpick or tweezers to sort the sand in the remaining square cm into piles based on color.
5. Now that you have observed your sand sample, estimate the percentage of various minerals you expect to find in your sample. Record this estimate on Activity Sheet A.
6. Identify each pile of minerals and count the number of grains of each. Record data in Activity Sheet A.
7. Next calculate the total number of sand grains, and the percentage of each mineral type in the total sample, using the formulas on Activity Sheet A.

C. Retrieve Data:

Within their groups have students answer the following questions:

1. What does the mineral composition tell you about the sand's history?
2. If you were asked to estimate the amount of sand grains in a given dune, briefly describe how you would go about doing this.
3. Why is it important to know the composition of sand?
4. Where do you think the minerals that are found in sand come from?
5. What do we use sand for?
6. Have students prepare a bar graph or pie chart displaying their results, or use a computer program to display the data in different formats.

Now combine the data from all students. (Increase the size of the sample.) Add the data up for each mineral type and have students calculate the percentage of each mineral in the class data. Show this data on overhead, flip chart, chalkboard, or enlarged copy of Activity Sheet A. Have students add class data to appropriate columns on Activity Sheet A.

Now have students answer the following:

1. How did the data from the whole class compare to the data in your individual sample? What could account for the differences found?
2. Which data is probably more representative of the composition of the area where the sand was collected?
3. What does this tell you about the size or number of samples that should be obtained in scientific experiments?

CLOSURE

What did we find out about sand? What did we learn about the size of samples desired in an investigation?

TRANSITION

Now that you have taken a close look at the composition of sand, let's look at the arrangement of sand into dunes.



ACTIVITY II: DUNE SHAPES

CONCEPT	Change, Symmetry, Perception, Cause/Effect, Interaction, Order Invariance
PRINCIPLE	Sand dunes vary in shape and structure due to external environmental forces.
OBJECTIVE	<ul style="list-style-type: none">• The student will be able to demonstrate knowledge about dune shape by correctly identifying various dune structures.
PREPARATION	Select an appropriate site which has several different examples of dune shapes.
MATERIALS USED	<ul style="list-style-type: none">• Activity Sheet B: Dune Shapes• Pen/pencil
PROCESSES USED	<ul style="list-style-type: none">• Observe• Classify• Communicate• Infer• Hypothesize
TIME	45 minutes



DOING THE ACTIVITY (outdoors)

A. Set Stage:

Sand dunes tend to develop certain characteristic shapes, depending on wind velocity and direction, sand supply and how the vegetation cover, if any, is distributed.





Some dunes are very difficult to identify because they are quite irregular and have no recognizable shape, while others are very easy to identify and exhibit "typical" patterns. The side of a dune that faces into the wind is called the windward side. The side of the dune away from the wind is called the leeward side. Which side of the dune do you think is steeper and why?

B. Procedure:

1. Distribute Activity Sheet B

30 min.
Individually

ACTIVITY B: Dune Shapes

DUNE INFORMATION		
Shape	Name	Description
	Barrow	Forms where sand is limited and wind is strong and constant.
	Star	Forms where sand is plentiful and wind is strong and shifting.
	Linear	Forms primarily along seacoasts where the sea breeze and land breeze push the sand into long lines.
	Transverse	Forms where sand is plentiful and wind blows from one direction.
	Parabolic	Forms along seacoasts where vegetation holds the sand.

YOUR OBSERVATIONS

Sketch	Observation	Dune Type

Investigating Your Environment
Dunes 

253



Investigating Your Environment
Dunes

2. Work individually for 30 minutes to observe and sketch as many dune shapes as you can on the back or bottom of Activity Sheet B.
3. Using the information and data table at the top of Activity sheet B, identify as many of the dune shapes you have sketched as possible. (10 minutes) Note: Facilitator should let students know when to start and end step #3.

C. Retrieve Data:

Gather the group together and discuss the following questions:

1. What were some of the dune shapes that you found?
2. Which of these shapes were most common?
3. What made some easier to identify than others.
4. Chose one dune that you sketched and identified. Think about how this dune will change over time. How will it be different in one week? One month? One year?

CLOSURE

As you have just seen, sand dunes are dynamic structures that come in many shapes and sizes. Take a moment to think of ways that dunes may change over time:

1. What are some environmental factors that may cause these changes?
2. What have we found out about dunes so far?

TRANSITION

Change in sand dunes often occurs slowly and is difficult to observe. In the next activity you will speed up the dune formation process as you experiment with one environmental factor and see how this can drastically change the size and shape of a dune.



ACTIVITY III: DUNE MIGRATION

CONCEPT	Cause/Effect, Model, Change, Force, Interaction, Order, Replication
PRINCIPLE	Participants make a dune and analyze its movement.
OBJECTIVE	The student will demonstrate how the changes in wind direction affect the shape of sand dunes.
PREPARATION	The teacher needs to obtain several hair dryers with low-cool settings.
MATERIALS USED	<ul style="list-style-type: none">• Fine, dry sand• Hair dryer• Tray with low sides• Goggles
PROCESSES USED	<ul style="list-style-type: none">• Observe• Infer• Predict• Define operationally• Control variables• Communicate
TIME	20 minutes



DOING THE ACTIVITY (indoors)

A. Set Stage:

Sand dunes differ in shape according to environmental conditions. In this next activity you will be influencing dune shape by one environmental factor, wind. The side of the dune that faces the wind is called the windward side. The side of the dune away from the wind is called the leeward side. Before beginning this activity, discuss safety and hair dryers.

B. Procedure:

1. Divide the class into groups of three or four.
2. Groups pour sand into the tray and manually construct a barchan-shaped dune.
3. Put on goggles. Turn the dryer on a low, cool setting and direct the air at a low angle toward the dune. Experiment with the dryer to determine how close you should be to the dune to make sand grains roll up the side of the dune.
4. Hold the dryer in a fixed position and study the way in which the dune slowly travels or migrates across the tray.
5. Shift the dryer about 10 cm to one side of your original position to change the wind direction. Study the way in which this change in wind direction causes the dune to change shape.

C. Retrieve Data:

Discuss the following questions with the class:

1. Explain the differences in appearance between the two sides of a sand dune.
2. Why is the leeward side not absolutely vertical?
3. What happens to the dune when you shift the wind direction?
4. Describe the sequence of events that occurs as the dune migrates.
5. Under what conditions could we repeat this experiment and expect to get the same results? Where in nature do the conditions compare (basically) to our experimental conditions?
6. What other factors influence the formation of dunes in natural areas?

CLOSURE

Discuss with the class how dune formation using hair dryers compares to dune formation in the natural environment.

TRANSITION

In the next activity you will be gathering data about the entire dune area. Bear in mind that the dune ecosystem is fairly unique, and that they may contain a variety of rare, threatened or endangered organisms.



ACTIVITY IV: DUNE HABITAT TRANSECT

- CONCEPT** Population, System, Organism, Interaction, Order, Invariance
- PRINCIPLE** Participants will record landforms, dune types and plant communities encountered along a beach/dune transect.
- OBJECTIVE** Students will be able to:
- Identify and record major physical and biological changes along a transect.
 - Describe the effects of wind and water on dunes and plant communities.
- PREPARATION** Facilitator needs to select a suitable beach area for this activity; ideally students would encounter most of the landforms and plant communities that are on Activity Sheet C as they walk away from the ocean beach into the uplands.
- For this activity, it is acceptable to walk in a course that is generally perpendicular to the shore, rather than to follow a specific, linear transect line. The length of the "transect" will vary based on the site. (It needs to be long enough to encompass the desired landforms/dunes and vegetative features. Because of this, transect lines do not need to be established prior to the activity.
- Students should have a basic understanding of dune formation and vocabulary prior to the activity, as well as the basis of "transects."
- If it is desired that students identify species of plants, some advance training in this is required, and reference materials should be provided; two pages of plants commonly found in the Oregon Dunes are included in this activity. Otherwise, identifying general plant types (e.g., grasses, shrubs, pines) will probably yield satisfactory data.
- Note: Since European Beach Grass has been planted in many areas to stabilize dune slope, it is recommended that students learn this large grass species, since it allows the group to discuss the important subject of introduced species — and to learn about how plants help to prevent erosion.
- MATERIALS USED**
- Activity Sheet C: Beach Dune Transect and Teacher's Guide
 - Pens or pencils
 - Reference materials
 - Overhead projector or flip chart
- PROCESSES USED**
- Classify
 - Infer
 - Observe
 - Interpret Data
- TIME** 90-120 Minutes - (Note to instructor: you may break into 2 45-60 minute classes. Conduct this exploration and observation in one period, then finish up in the second period.)



DOING THE ACTIVITY

A. Set Stage:

As you walk away from the ocean shore into the uplands, you are likely to encounter a variety of landforms and plant communities — as well as evidence of animals that either visit or depend upon those habitats.

In this activity students will record their findings on Activity Sheet C as they work their way from the beach, into the dune areas, and finally arrive at the forested uplands.

B. Procedure:

1. Distribute Activity Sheet C and appropriate reference materials.
2. Working in small groups, take 45-60 minutes to hike from the beach to the dune areas, to the forested uplands. While on your hike, record your observations on Activity Sheet C.

ACTIVITY C: Beach/Dune Transect (1) 45-60 minutes
work in small groups

During your hike from beach to the uplands, record your observations on the sheet below.



	BEACH	FOREDUNE
LAND-FORMS		
VEGETATION		

ACTIVITY C: Beach/Dune Transect (2) 45-60 minutes
work in small groups

During your hike from beach to the uplands, record your observations on the sheet below.



	BEACH	FOREDUNE	MID-DUNE (SAND-DRY)	SPLASH PLAIN	OPEN SAND (Transition & Open Dunes)	TREE ISLAND	PARABOLA DUNES	FOREST
ANIMALS								
VISUAL UNUSUALNESS								

Investigating Your Environment



Investigating Your Environment



C. Retrieve Data:

Once students have completed the "transect" hike, group them together and, using an overhead projector or flip chart, complete Activity Sheet C using information provided by students.

(Note: A completed Activity Sheet C is included for use by the instructor.)

Discuss the following questions:

1. What were some of the things you found?
2. How closely did the field observations match the activity sheet?
Were extra habitats/landforms encountered, or were some missing?
3. Some species of wildlife are classified as rare or peripheral in certain areas. Did your group encounter any of these? If so, where? *Note to instructor: This information varies from region to region; the sheets and the information below are specific for the Washington and Oregon coastal dune areas. Use animal keys and contact your local wildlife (state or federal) office to get information on which species of birds, mammals, reptiles, insects, etc. are rare or peripheral, or common in your study area.

Brown Pelican (June - Oct.)
Common Egret (Aug - April)
Bald Eagle (all year)
Osprey (April - Oct.)
Peregrine Falcon (late summer - Feb.)
Snowy Plover (all year)
Caspian Tern (spring, fall)
Purple Martin (April - Sept.)
White-footed Vole (all year)
Elephant Seal (all year)

4. Many species of birds and mammals depend on snags for nesting or den sites. Did the group observe any snag use during the transect hike?
5. The foredune in many areas has been built up largely because of the introduction of the European Beach Grass. How has it helped to form the foredune? What problems can arise due to importing a new species to an area, if any?

CLOSURE

1. What is a dune? Discuss the factors responsible for forming and maintaining them, their composition, and their role in providing essential habitat for plants and animals.
2. From our investigations, what can we say are some values of dunes?
3. Some people feel that dunes are little more than the world's largest sandbox. After examining the nature of sand dunes how would you respond to these people?
4. Dunes are extremely fragile ecosystems. Which human activities are detrimental to dunes? What strategies can you recommend for protecting the dunes from these activities?
5. Has this unit changed your thinking in any way(s) about dunes? If so, how? If not, why not?



ACTIVITY A: Sand Exploration

45 min.
groups

1. Spread sand sample in a single layer onto graph paper so that it covers a single square (one square cm.).
2. Remove all the sand except the sand covering the square cm. to be used.
3. Using a hand lens or dissecting microscope, use a thin toothpick or tweezers to sort the sand in the remaining square cm. into piles based on the color and size.
4. Now that you have observed your sand sample, estimate the percentage of various minerals you expect to find in your sample. Record this estimate in column 1.
5. Identify each pile of minerals and count the number of grains of each. Record data in left side of column 2.
6. Next calculate the total number of sandgrains, and the percentage of each mineral type in the total sample, using the formula below. Record calculations in left side of column

Mineral Name	Estimated # of Grains	Actual # of Grains		Percentage of total*	
		group data	class data	group data	class data
Quartz: colorless or light colored					
Biotite: blackish, shiny, flat					
Muscovite: white or clear, shiny and flat					
Pyrite: light yellow and brassy					
Feldspar: white, gray or red					
Hornblende: dull green or black					
Calcite: clear or nearly so; blockish					
Other					

*To calculate the percentage of each mineral type in the whole sample, use the following formula:

$$\frac{\text{Number of Grains of Any Mineral Type}}{\text{Total Number of Grains Counted}} = \text{Percentage}$$







ACTIVITY B: Dune Shapes

30 min.
individually

DUNE INFORMATION

Types of Dune

Shape	Name	Description
	Barchan	Forms where sand is limited and wind is strong and constant.
	Star	Forms where sand is plentiful and wind is strong and shifting.
	Linear	Forms primarily along seacoasts where the sea breeze and land breeze push the sand into long lines.
	Transverse	Forms where sand is plentiful and wind blows from one direction.
	Parabolic	Forms along seacoasts where vegetation holds the sand.

YOUR OBSERVATIONS

Sketch	Observation	Dune Type



ACTIVITY C: TEACHER'S GUIDE Beach/Dune Transect (1)

During your hike from beach to the uplands, record your observations on the sheet below.

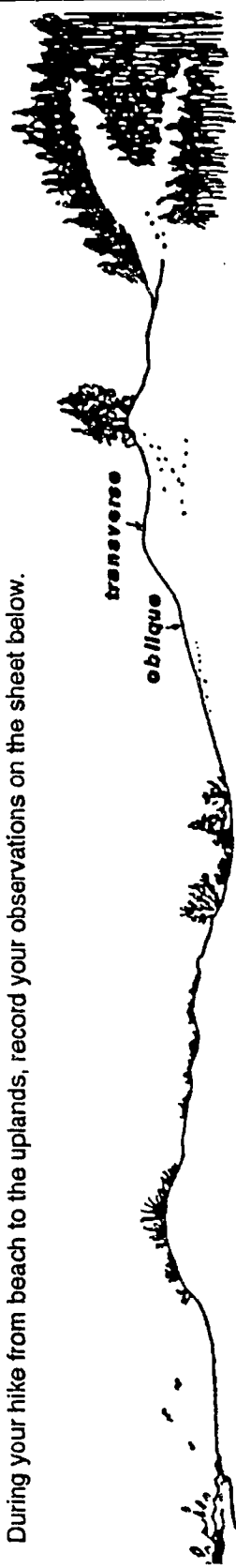

LAND-FORMS	BEACH	FOREDUNE	HUMMOCKS (wet-dry)	DEFLATION PLAN	OPEN SAND Transverse & Oblique Dunes	TREE ISLAND	PARABOLA DUNES	FORESTS
	Flat Ocean Tides Cover	First Hill From Beach	Occur Behind Foredune	Product of Wind Scouring Down to Water Table Culick Sand Where High Water Table	Transverse Broad Sloping Ridge & Slip Face Product of Summer Winds 5-20' high Oblique Broad Long Sloping Ridges with Slip Faces 180' high	Island of Mature Trees Surrounded by Sand. Caused by Opening in Forest	Open Sand with Veg. on 3 Sides 4th Side Joins Oblique Dune Caused By Opening Edge of Forest	
VEGETATION	None	Dense Stand of Beach Grass	50-75% Cover with Veg. Beach Grass Lupine Bluegrass Morning Glory Knotweed Pea Silvertop	40 Plant Species Fescue Dandelion Strawberry Rushes Buttercup Willow Wax Myrtle Shore Pine Sitka Spruce	No Plants	Shore Pine Hemlock Sitka Spruce Dense Understory Rhododendron Huckleberry Salal	No Plants	East Edge Of Dunes Shore Pine Sitka Spruce Hemlock Dense- Rhododendron Huckleberry, Salal

45-60 minutes
work in small groups

ACTIVITY C: TEACHER'S GUIDE Beach/Dune Transect (2)

During your hike from beach to the uplands, record your observations on the sheet below.

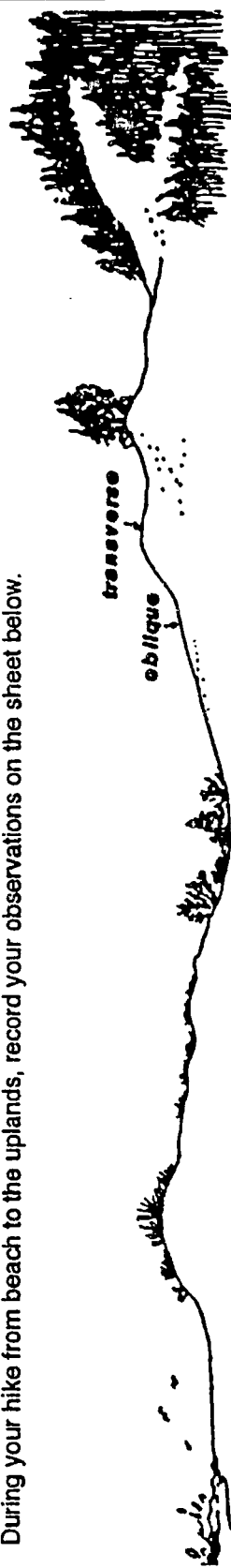

	BEACH	FOREDUNE	HUMMOCKS (wet-dry)	DEFLATION PLAN	OPEN SAND Transverse & Oblique Dunes	TREE ISLAND	PARABOLA DUNES	FORESTS
ANIMALS	Gulls Clams Sand Fleas Shells Nesting Site in Driftwood for Snowy Plover	21 Species Use But Not Depend On It	54 Species Wildlife 37 Birds Northern Alligator Lizard Skunk Sparrows Kestrel	92 species Whistling swan Meadowlark Marsh Hawk Vole Treefrog Deer Ducks Raccoon Squirrel Garter Snake	Only Use Is For Travel	Isolated Population of Small Mammals Deer, Mouse, etc. Used by Birds	Only Use Is For Travel	Greatest No. Species & Diversity Wildlife 145 Species Song Birds Cavity Nesting Birds & Hawks Use Snags Mammals Use Snags too. Raccoon, Bear, Deer, Skunk
VISUAL UNIQUE- NESS		Barrier to Ocean Waving Grass In Wind Covered With Driftwood	Curious formations Inviting to Explore Quicksand In Low Areas In Winter	Sheltered from wind Variety of plant life Diversity of Wildlife Habitat & Species Sporadic Use Short Stays Curiosity	Extremely Inviting To Pedestrians & Vehicles Spectacular Slip Faces Will Be Gone in 75 Yrs.	Like Island at Sea Inviting to Explore	Use As Travel Route	Contrast Between Dark Dense Forest & White Sand Protection For Animals

45-60 minutes
work in small groups

ACTIVITY C: Beach/Dune Transect (1)

During your hike from beach to the uplands, record your observations on the sheet below.

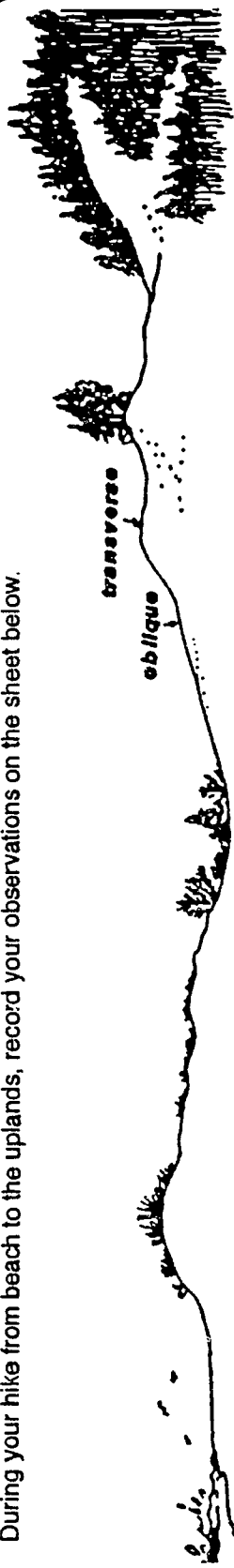

	BEACH	FOREDUNE	HUMMOCKS (wet-dry)	DEFLATION PLAN	OPEN SAND Transverse & Oblique Dunes	TREE ISLAND	PARABOLA DUNES	FORESTS
LAND-FORMS								
VEGETATION								

45-60 minutes
work in small groups

ACTIVITY C: Beach/Dune Transect (2)

During your hike from beach to the uplands, record your observations on the sheet below.

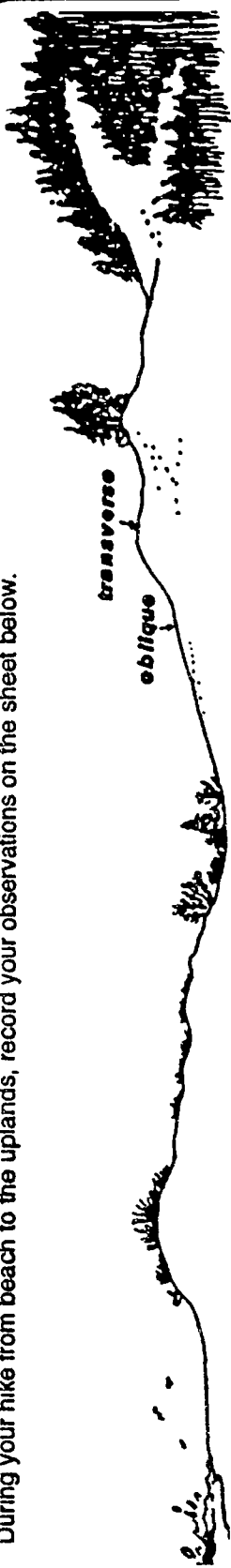

	BEACH	FOREDUNE	HUMMOCKS (wet-dry)	DEFLATION PLAN	OPEN SAND Transverse & Oblique Dunes	TREE ISLAND	PARABOLA DUNES	FORESTS
ANIMALS								
VISUAL UNIQUE- NESS								

ACTIVITY C: Plants of the Dune Community

(1)

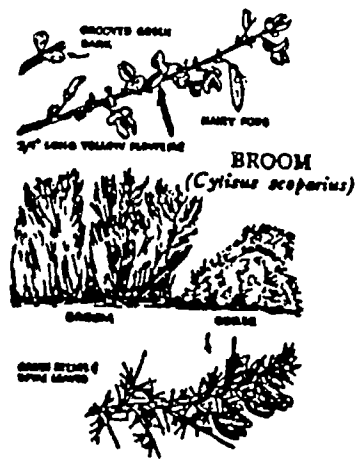
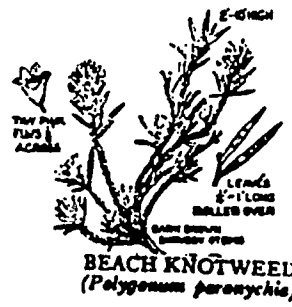
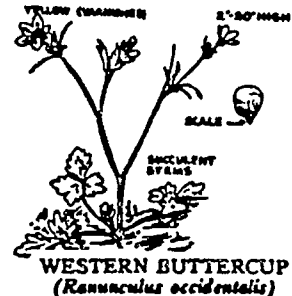
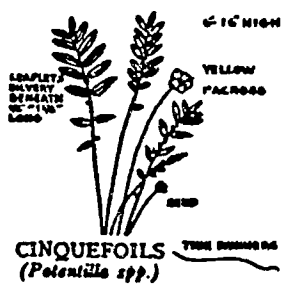
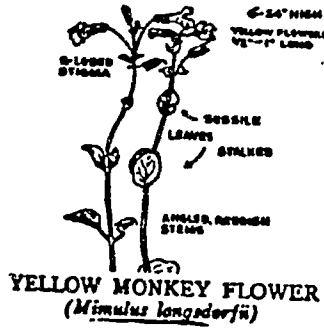
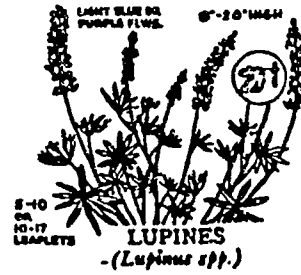
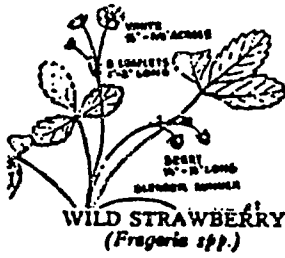

ACTIVITY C: Plants of the Dune Community

(2)

PACIFIC WILLOW
(*Salix lasioandra*)

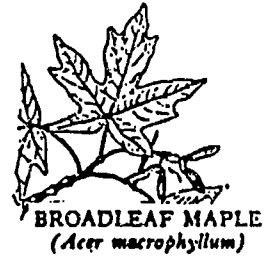
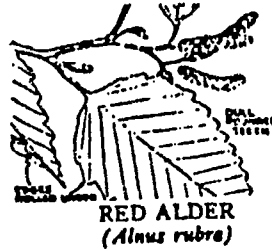

DOUGLAS FIR
(*Pseudotsuga menziesii*)

SITKA SPRUCE
(*Picea sitchensis*)



WESTERN RED CEDAR
(*Thuja plicata*)

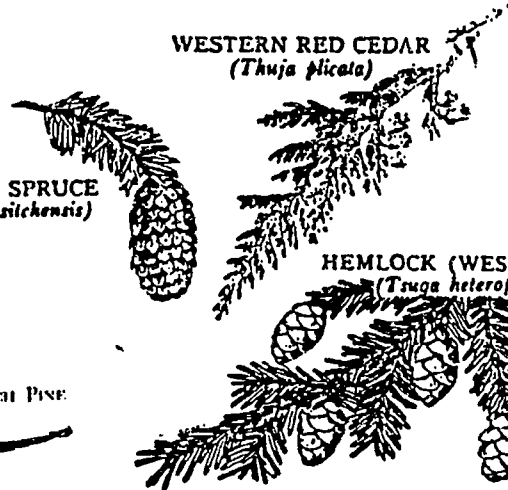

HEMLOCK (WESTERN)
(*Tsuga heterophylla*)

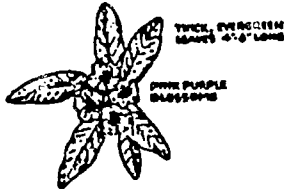

RED RHODODENDRON
(*Rhododendron macrophyllum*)



SALAL
(*Gaultheria shallon*)



PACIFIC DOGWOOD
(*Cornus nuttallii*)

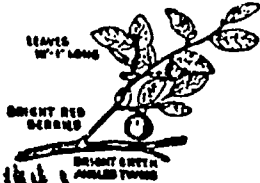

RED HUCKLEBERRY
(*Vaccinium parvifolium*)



EVERGREEN HUCKLEBERRY
(*Vaccinium ovalum*)



WESTERN WAX MYRTLE
(*Myrica californica*)





BEST COPY AVAILABLE



INTRODUCTION

A pond is a dynamic and ever-changing community of plants and animals. Ponds may be natural, year around or seasonal. They may be human-influenced in that ditches and dikes provide and hold water or bring water to an impoundment, which becomes more natural year after year. We will look at the kinds of birds and mammals that you would expect to see in and near a pond and at the two general classes of plants to be found in the pond itself: submergent and emergent.

THE ACTIVITIES

TIME REQUIRED

Describe a Pond	20 minutes.
Observe a Pond Environment	10 minutes.
Identify Pond Plants and Record Their Distribution	20 minutes.
Observe and Identify Pond Vertebrates	20 minutes.
Construct a Food Web	45 minutes.
Observe and Infer Daily and Seasonal Differences	20 minutes.
Measure Water Volume of a Pond	45 minutes.



COMBINING THE ACTIVITIES

The activities in this chapter are displayed singly. Depending upon your objective, time and level of knowledge of your audience, you may want to combine selected activities. Here are some suggestions.

Title: Demonstrate the cause and effect relationship between animals and their habitat in a stream.

Introduction: We are going to collect and identify aquatic life in a specific water environment and then use the kinds of life found to make predictions about the physical characteristics of the water. We then will use some simple testing equipment to validate our predictions.

Activity: Collecting Aquatic Life

Transition Statement: Use the Pond Life books and drawings of aquatic life on the back of the activity sheet to identify as many of the aquatic animals collected as possible.

Activity: Identifying Aquatic Life

Transition Statement: Based on the aquatic animals found and the tables on the back of the activity, predict the temperature, pH and dissolved oxygen content of the water.

Activity: Predicting Water Characteristics From Aquatic Animals Found

Transition Statement: Let's check out our predictions using some simple water test kits.

Activity: Measuring Water Characteristics to Test Predictions

Closure: What can we say about the characteristics of this stream? Which activities helped you discover these ideas?

Title: Demonstrate the interaction between plants and animals in a pond by constructing a food web.

Introduction: The plants and animals found in a pond are always interacting. We are going to investigate some of those interactions by collecting and identifying some of the plants and animals and constructing a food web.

Activity: Identify Pond Plants

Transition Statement: Animals are also important members of a pond community. Now we are going to collect and identify some of the invertebrates found here.

Activity: Collecting and Identifying Aquatic Life

Transition Statement: Vertebrates (animals with backbones) also live in and around ponds. Next we are going to look for these animals and evidence of their presence.

Activity: Pond Vertebrates

Transition Statement: The lives of all the different kinds of plants and animals we have found are interconnected. We can get some idea of their interactions by constructing a food web.

Activity: Construct a Food Web

Closure: What are some things we can say about organisms in this pond?



Title: Demonstrate the importance of water to people

Introduction: Water is essential for the lives of people and for society.

Not only is water important for drinking and bathing, but it is needed for industry, food preparation and recreation.

Activity: Determine Watershed Boundaries

Transition Statement: Now that we know something about the land that drains water into this part, we will determine how much water there is and how many people it will support.

Activity: Measure Water Volume of a Pond

Closure: We have learned how many people could be supported by the water in this pond. But water is valuable for other uses as well. What would happen if we were to take all the water from this stream for people? What other resources might be affected?

CURRICULUM RELATIONSHIPS

Social Studies

1. Explore a pond that has died (filled up with organic and inorganic matter). Talk to old-timers about what they remember about the pond so you can trace the history of its death.
2. Research what government agencies are concerned and involved in water quality management.
3. Research national and state wetland regulations.
4. Research wetland issues in your local community.

Science

1. Study about how aquatic life has adapted differently in a stream environment and a pond environment.
2. Construct a chart showing some aquatic animals that can stand various degrees of water pollution, as related to the degree of pollution.
3. Conduct some studies of temperature, pH, dissolved oxygen, plant and animal life through a 24-hour period or throughout the year.
4. Contact Saturday Academy or your State Environmental agencies to find out how the class can be involved in ongoing water quality monitoring.

Mathematics

1. Read about the various units of measurement in water work.
2. Develop a pH scale range correlated with some common water products such as orange juice, vinegar, bleach, etc.

Language Arts

1. Write a poem or story about the death of a pond.

Creative Arts

1. Sketch a section of a pond at different times of the year.
2. Draw detailed sketches of the different plant and/or animal life in or near a pond.



STEP 1: DESCRIBE A POND

CONCEPT	System
PRINCIPLE	People often have different ideas about what a pond is. This activity will help the students in the class reach a common definition which will serve as a base for their investigations.
OBJECTIVE	<ul style="list-style-type: none">• The student will be able to define the word pond and list some characteristics of a pond.
PREPARATION	Select a pond for study. Ecologists usually describe a pond as a quiet body of water which is shallow enough that plants often grow all the way across it. A lake is usually larger and deeper than a pond. The definition is not precise, and what some people call a pond, others may call a lake, a wetland or a marsh.
MATERIALS NEEDED	<ul style="list-style-type: none">• Activity Sheet A: Describe A Pond.• Blackboard or easel and chart paper.
PROCESSES USED	<ul style="list-style-type: none">• Define Operationally• Communicate
TIME	20 minutes.



DOING THE ACTIVITY (indoor)

A. Set Stage:

"Today we will be doing an investigation of a pond. To make sure we are all talking about the same thing, we will need to develop a common understanding of what a pond is."

B. Procedure:

1. "Take 10 minutes to write, in as much detail as possible, a description of a pond with which you are familiar." Hand out Activity Sheet A.
2. "Now, in groups of three, compare your descriptions and write a one sentence definition of a pond."

C. Retrieve Data:

Have the groups read their definitions. As they read them, list on the blackboard the kinds of things they use to describe a pond; e.g. depth, size, plants and animals. When all groups have shared their definitions ask: "What are some of the similarities and differences in your definitions?" "What are some of the things that seem to be common to all of your definitions?"

CLOSURE

Share the ecologists' definition of a pond. "Ecologists usually describe a pond as a quiet body of water shallow enough that plants often grow all the way across it. A lake is usually larger and deeper than a pond. The definition is not precise, and what some people call a pond, others may call a lake or a wetland or a marsh." Discuss the definition and develop a group consensus on a definition to be used for the day's investigations.

TRANSITION

"We now have a definition of a pond with which we can all agree. We also have listed a number of characteristics of ponds. Now let's look at a particular pond and see how all of the components of the pond fit together."

ACTIVITY A: Describe a Pond

10 min.
Individual

Think of a pond with which you are familiar. In as much detail as possible describe the pond.

In groups of three, compare your descriptions. What things are similar? What things are different?

Together, write a description of a pond with which you can all agree.

Investigating Your Environment
Ponds 



STEP II: OBSERVE THE POND ENVIRONMENT

CONCEPT	System
PRINCIPLE	This activity will help the students get an overview of the pond to be studied and to see how well the previously developed definition fits that particular pond.
OBJECTIVE	<ul style="list-style-type: none">• The student will be able to describe the pond and compare it to the previously developed definition.
PREPARATION	Make a reconnaissance trip to the pond to determine access, logistics, and safety considerations. Inform the students of proper clothing needed for the investigation.
MATERIALS NEEDED	<ul style="list-style-type: none">• Activity Sheet B: Observe The Pond Environment.
PROCESSES USED	<ul style="list-style-type: none">• Observe• Define Operationally• Communicate
TIME	10 minutes.



DOING THE ACTIVITY

A. Set Stage:

"We will be spending two to three hours at the pond. The first activity will give you an overview of this pond environment and provide an opportunity to see how well this pond fits the definition of a pond that you developed in the classroom."

"The pond environment is very fragile. What are some ways that we can avoid damaging the pond and its surroundings?"

B. Procedure:

1. Hand out Activity Sheet B.
"As you approach the pond, observe and record your observations on Activity Sheet B."

C. Retrieve Data:

1. "What are some of the things you listed?"

ACTIVITY B: Observe a Pond Environment

5 min.
Individual

Work by yourself.

As you approach the pond, observe and record your observations.

PLANTS _____

ANIMALS _____

AIR _____

SOIL AND ROCKS _____

WATER _____

OTHER _____

Investigating Your Environment
Ponds 

CLOSURE

Ask the class:

1. "How well does this pond fit the definition we developed in the classroom?"
2. "Do we need to change our definition?"

TRANSITION

"You have observed some of the particular components of the pond environment. Now we will do some activities which focus on these components and how they fit together."



Investigating Your Environment
Ponds

STEP III: IDENTIFY POND PLANTS AND RECORD THEIR DISTRIBUTION

- CONCEPT** Cause and Effect, Population, Order, System, Interaction
- PRINCIPLE** By collecting and recording data about plants and animals and their environment, relationships are often made obvious. This activity gives students the opportunity to explore the pond and begin to draw some conclusions about the way the environment affects the organisms living there.
- OBJECTIVE**
- The student will be able to identify the growth forms of pond plants and describe their habitats.
- PREPARATION** The distribution and abundance of plants and animals is determined in large measure by the availability of suitable habitat. The habitat for a particular species is characterized by the presence of physical, chemical and biological conditions such as temperature, moisture, soil nutrients, and, in the case of animals, food sources.
- Proper clothing and equipment are necessary for successfully completing this activity.
- MATERIALS NEEDED**
- Activity Sheet C: Pond Plants and Their Distribution
 - Plant illustrations and Pond Life books.
 - Hip waders.
 - Buckets for collecting plants.
 - Yard sticks (longer poles would be better).
 - Plant presses (optional).
 - (A small boat or inflatable raft would be a helpful tool in deeper ponds.)
- PROCESSES USED**
- Observe
 - Measure
 - Use Numbers
 - Infer
 - Classify
- TIME** 20 minutes.



DOING THE ACTIVITY

A. Set Stage:

1. Tell the students about habitats.
2. Pass out Activity Sheet C: Pond Plants and Their Distribution.
3. Review the various growth forms of aquatic plants: shoreline, emergent, floating leaf, submerged and algae.
4. "What are some of the guidelines we need to consider when collecting plants and animals to have the least impact on the environment?" "What are some guidelines we need to consider for this to be a safe activity?"

B. Procedure:

1. Review Activity Sheet C and discuss the procedures to be followed. Divide the class into groups of 4 to 6. Have the students collect the plants and complete the Activity Sheet.
2. Hand out Activity B: Pond Plant Identification Sheets (4).

ACTIVITY C: Pond Plants and their Distribution

20 min.
groups

SHORELINE PLANTS: Plants which usually grow around the edge of a pond and thrive in the moist soil there.

EMERGENT PLANTS: Plants which are rooted on the bottom and have stems and leaves above the surface of the water.

FLOATING LEAF PLANTS: Plants which are rooted on the bottom and have leaves floating on the surface.

SUBMERGED PLANTS: Plants which grow completely under the water. Only the flowers and seeds are above the water. They usually have long or leafy, very branched leaves.

ALGAE: Algae grow in a variety of forms and can be very diverse. If they grow floating in the water or on the surface, attached to the bottom or attached to other plants.

Work in small groups.

Collect plants from various parts of the pond and around the edges of the pond. Complete the information asked for in the chart below. Use the accompanying illustrations and the Plant Life books to help you identify the plants.

NAME (if known)	DESCRIPTION	GROWTH PATTERN (floating, emergent, leafy, submerged, algae)	DEPTH OF WATER	ABUNDANCE (abundant, common, uncommon)

Investigating Your Environment
Ponds 



Investigating Your Environment
Ponds

C. Retrieve Data:

1. "What kinds of plants did you find?" You may want to compile a master list on an easel chart.
2. Prepare a large outline map of the pond (or the portion of it which was studied) and have the students mark the distribution of the various kinds of plants.

CLOSURE Ask the class:

1. "Can you determine any relationships between growth patterns, depth of water and distance from shore?"
2. "We have learned some things about the distributions of various kinds of plants growing in and near the pond. What can we say in general about where plants live?"

TRANSITION "Animals are also found in habitats which provide for their needs. Next we are going to look at insects and other invertebrates found in the pond and try to determine some of their habitat requirements."



STEP IV: OBSERVE AND IDENTIFY POND VERTEBRATES

- CONCEPT** Organism, Interaction, System
- PRINCIPLE** Vertebrates are often the most important animals found in a pond, particularly for sportsmen. Their presence is often an indicator of the health of the pond. The evidence of an animal's presence is more easily found than the animal itself.
- OBJECTIVE**
- The student will be able to find and identify vertebrates and evidence of vertebrates in and around the pond.
- PREPARATION** None.
- MATERIALS NEEDED**
- Pond Life books.
 - Binoculars.
 - A seine or dip nets can be used to catch fish.
 - Activity Sheet D: Pond Vertebrates.
- PROCESSES USED**
- Observe
 - Infer
 - Classify
- TIME** 20 minutes.



DOING THE ACTIVITY

A. Set Stage:

"In addition to insects and other aquatic invertebrates, vertebrates (animals with back bones) also consider the pond to be home. Vertebrates include fish, amphibians, reptiles, birds and mammals. Often these animals are important to people, particularly to sportsmen. They are also important members of the pond community from an ecological standpoint as well."

B. Procedure:

1. "In your small groups spend 10 minutes looking for vertebrates and evidence of vertebrates. Use the Pond Life books to help you identify your discoveries."
2. Pass out Activity Sheet D and go over the instructions with the students.
3. Have the students do the investigation and record their observations.

ACTIVITY D: Pond Vertebrates

10 min.
groups

Name or Description	Evidence	Where Found	Abundance (abundant, common, uncommon)

C. Retrieve Data:

1. Discuss the discoveries with the students. "What kinds of animals did you find?" "Where did you find them?" "What evidence of other kinds of animals did you find?"

CLOSURE

"Based on what you know about the pond, how do you think these animals fit into the pond community?"

TRANSITION

"You have identified many plants and animals found in and around the pond. In the next activity, we will try to figure out some of the interactions between these organisms."

Investigating Your Environment
Ponds 



Investigating Your Environment
Ponds



STEP V: CONSTRUCT A FOOD WEB OF POND LIFE

CONCEPT

Organism, Interaction, Order, System

PRINCIPLE

One way to various kinds of plants and animals interact is as links in a food web. A food web shows the feeding relationships between the various plants and animals. Food webs in a pond can be very complex and to construct a complete web would be a difficult task. However, if the students have collected a fairly good sample of plants and animals, it should be possible to identify at least a few links in the web.

OBJECTIVE

- The student will be able to construct a food web of pond life.

PREPARATION

Complete Identification of Pond Plants, Collect and Identify Aquatic Life and Observe and Identify Aquatic Vertebrates. Write the names of all of the plants and animals identified on 5" x 7" cards. (If the student's discoveries are too few to do this activity successfully, you may wish to add some other organisms you know are likely to be present in and around the pond.)

MATERIALS NEEDED

- 5" x 7" Index cards.
- Pond Life books, identification sheets from Identify Pond Plants and Collect and Identify Aquatic Life lessons and other reference books.
- Blackboard.
- Tape.

PROCESSES USED

- Infer
- Question
- Interpret Data

TIME

45 minutes.



DOING THE ACTIVITY (indoor)

A. Set Stage:

"The plants and animals living in and around the pond interact within each other in a variety of ways. One of the most important interactions is as links in a food web. A food web shows which animals eat which other plants and animals. In this activity you will be able to construct a food web for the plants and animals you identified at the pond."

B. Procedure:

1. Pass out the cards with the names of the pond plants and animals on them.
2. Using the Pond Life books, the identification sheets from the lessons, and other reference books, try to find out what each animal eats and what eats each kind of plant and animal. Write what the animal eats below the animal's name on the card. Write what eats the animal or plant above its name on the card. Remember most animals eat more than one kind of food.

C. Retrieve Data:

1. Have the students tape the names of the plants across the bottom of the backboard.
2. Next have the students tape the names of animals that eat plants above the plants names and draw lines to the kinds of plants they eat.
3. Finally, have the students tape the animals that eat other animals above the other cards and draw lines to their food sources.

Note: Not all animals and plants may be connected to others. This may be because not all of the kinds of plants and animals present were collected and identified. Also, it may mean that the students were not able to locate the food sources for some of the animals.

CLOSURE

Ask the student:

1. "What can you say about the food web in the pond?"
2. "Why do you think some of the plants and animals don't connect to any others?"
3. "What would we need to do to complete the web?"
4. "Are there other kinds of interactions between the various plants and animals in the pond?"



STEP VI: OBSERVE AND INFER DAILY AND SEASONAL DIFFERENCES

CONCEPT	Cause and Effect, Change, Cycle, Population, System
PRINCIPLE	Unless the studies of a pond or stream extend over a period of several weeks or months, the observations and measurements the students make will be representative of one particular time. One characteristic of bodies of water, just as with the terrestrial environment is differences over the course of a day or through the seasons of the year. In this activity the students will use evidence they find around the pond and their past experiences to draw inferences about changes that may occur over time.
OBJECTIVE	<ul style="list-style-type: none">• Using observations and drawing on prior experiences and knowledge, the student will be able to draw inferences about conditions in a pond or stream at other times of day or seasons and the effects these conditions have on life in the body of water.
PREPARATION	None.
MATERIALS NEEDED	<ul style="list-style-type: none">• Activity Sheet E: Daily and Seasonal Differences.
PROCESSES USED	<ul style="list-style-type: none">• Observe• Infer• Hypothesize
TIME	20 minutes.



DOING THE ACTIVITY

A. Set Stage:

"You have done your investigation on just one day, and the observations and measurements you made were only for that one time. At different times of day and in different seasons you might find the conditions very different. Even the weather can have an effect on the aquatic environment. To help us get a more complete understanding of the pond or stream, it might help if we looked for evidence of differences and how they affect life here."

B. Procedure:

1. Hand out Activity Sheet E. "Spend about 10 minutes exploring the pond and its surroundings looking for evidence of differences at other times of the day or year. Record your observations on the top of the Activity Sheet."

C. Retrieve Data:

1. "What are some of the things you discovered that indicated conditions were not always the same at other times of the day or year?"
2. "What would be different about the pond or stream?"
3. "Using your past experiences and knowledge can you think of other things that might be different." Write these on the bottom part of the Activity Sheet.
4. Hand out Activity E: Temperature Layering and discuss with the group.

ACTIVITY E: Daily and Seasonal Differences in a Pond

10 min.
Individual

1. Walk around the pond and look for evidence of differences in this environment at other times. Record your observations below.

Evidence	How was the environment different?	How would the difference affect life in the pond?

2. Based upon your knowledge of the weather and other activities in this area what other differences would you expect to find at other times of the day or year? Record your ideas below.

How would the environment differ?	Cause of the difference?	How would this affect life in the pond?

Investigating Your Environment Ponds 

CLOSURE

Ask the class:

1. "What effect would these differences have on life in the pond?"
2. "What sorts of investigations could you set up to test your hypotheses? Prepare an investigation which states:
 - a. Your hypothesis,
 - b. The kind of information you would collect to test the hypothesis,
 - c. How you would collect the information, and
 - d. A form for recording the information."

TRANSITION

"We have not talked about how people use water. Everyone needs water to live. We will now try to figure out how many people could be supported by the water in this stream or pond."



STEP VIII: MEASURE WATER VOLUME OF A POND

CONCEPT	Quantification, Interaction
PRINCIPLE	Using mathematical skills, participants measure the volume of their body of water and calculate how many people could live off that water volume.
OBJECTIVE	<ul style="list-style-type: none">• The student will be able to measure and calculate water volume for a pond.• The student will be able to determine how many people could live off the water volume.
PREPARATION	Locate the study site.
MATERIALS NEEDED	<ul style="list-style-type: none">• Measuring tape.• Yard stick or other vertical measuring device, such as weighted rope.• Hip waders.• Activity Sheet F: Determine Water Volume of a Pond.• Small stakes.
PROCESSES USED	<ul style="list-style-type: none">• Measure• Use Numbers• Communicate• Design Experiments• Interpret Data
TIME	45 minutes.



DOING THE ACTIVITY (outdoors)

A. Set Stage:

"We've looked at the pond ecosystem and investigated its various parts. In this next activity, we will consider the volume of water in this pond. How many people could live off the water in this pond? What measurements do you need to know in order to determine the amount of water in this pond so you can validate your predictions?"

B. Procedure:

1. Hand out Activity F and tell them they will be working in small groups.

20 min.
small groups

ACTIVITY F: Determine Water Volume of a Pond

Work in groups.

Instructions for collecting and recording volumes of water in ponds or lakes.

a. Find the average diameter (diameter across) of the pond. Measure the length and width of the pond. You may have to take several length and width measurements and get the average of them.

Pond width _____ feet.
Pond length _____ feet.
Total _____ feet $\div 2 =$ _____ ft. (average diameter)
Average diameter _____ ft. $\times 3.14 (\pi) =$ _____ sq. ft. surface (area of pond)

b. Find the average depth of the pond or lake. Measure the depth in 3 places along a line (transversal) across the pond, as near the middle as possible. Add these depths and divide by 4 (see explanation below) to get the average depth. (If additional accuracy is desired, repeat this process along additional transversals and average the results.)

First measurement _____ feet.
Second measurement _____ feet.
Third measurement _____ feet.
Total _____ feet $\div 4 =$ _____ ft. (average depth).

NOTE: The reason you take 3 depth measurements then divide by 4 is to take into account the shallow areas of the pond. It can be explained by the following example of a drawing of a pond cross-section. If depth in 3 places is A(2'), B(10'), C(2'), find an average by dividing by 3 ($22' \div 3 = 7.33'$). Now look at the mean or average depth (D) which is 6'. Take total of depths and divide by 4 ($22' \div 4 = 5.5'$). The correct average depth.

a. Formula for computing number of gallons of water in pond.

1. _____ \times _____ = _____ cubic feet
area of pond average depth volume in cubic feet

2. _____ cu. ft. $\div 7.48 =$ _____ no. gals. water in pond
volume in cu. ft. no. gals. water in pond

NOTE: A cubic foot of water is the water in a container 1-foot wide, 1-foot high, and 1-foot long. It contains 7.48 gallons.

d. Formula for computing the volume using one-foot of water.

1. (surface) _____ \times _____ = _____ volume cu. ft.
area of pond in feet average depth in feet volume cu. ft.

2. _____ cu. ft. $\div 1.356 =$ _____ one-foot of water.
volume cu. ft. (sq. ft. in an acre) one-foot of water.

3. _____ \div _____ = _____ no. gallons in pond
one-foot gal./one-foot no. gallons in pond

e. In order to find out how many people could get their domestic needs for one day from the water in the pond, complete the following calculations.

_____ gallons of water in the pond \div _____ amount of water one person uses per day = _____ total no. people who could live one day from this water

*The average person uses about 200 gallons of water a day for home use. This does not reflect each person's share of water used for industrial, public services, and environmental. (U.S. Office of Education Series.)

Investigating Your Environment
Ponds

2. Describe a couple of ways that the diameter of the pond can be measured if you cannot get across the pond on the water.

230

- Offset measurements: Using small stakes, mark edges of pond on dry land next to pond.

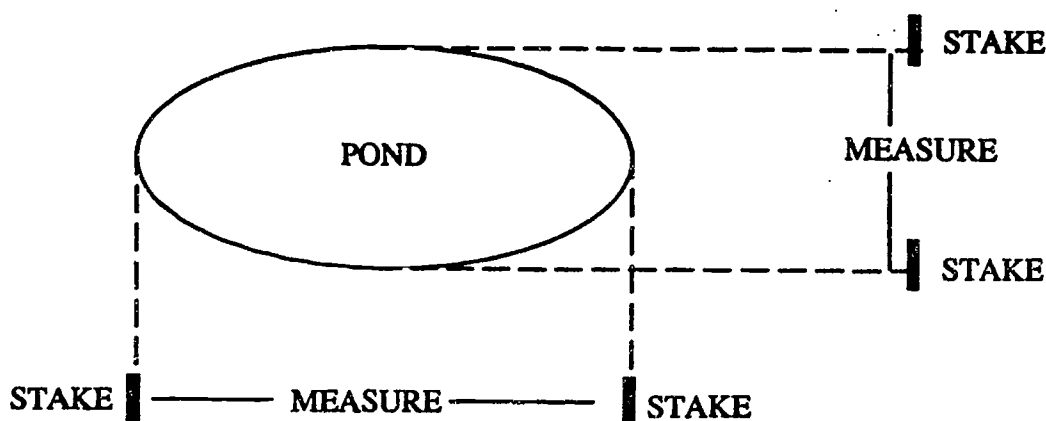

- Offset angle: This is also called the "Napoleon hat brim" method, if you cannot walk around the pond, but can get to 2 sides. Stand on one side and shade you eyes with your hand. Move your head until the far side of the pond is lined up with the edge of your hand. Holding your head rigid snap your head around until the bottom of your head lines up with the land. You now are as far from the pond as the pond is wide. Do this for both the width and length of the pond.
 - Rock on a rope! Throw the rock across the pond and mark where the near edge lines up with the rope. Measure the length of the rope.
3. Describe ways in which the depth of the pond can be measured.
 - Weighted rock.
 - Measuring stick.
 4. Ask the group if they have other ideas on how to measure the width and depth of your pond.
 5. Have the individual groups work on their activity sheet.

C. Retrieve Data:

Ask them some questions:

1. "What measurement techniques did you each use? How were the individual group's answers different?"
2. "How many people could live off the pond?"
3. "How did your predictions compare with your calculations?"
4. "How would we determine how much water should be left in the pond and how much should go to human use?"
5. "What other things would we want to know about the pond before we made any decisions?"

CLOSURE

Ask the class:

1. "A pond is a unique water environment - its plants, animals and characteristics. Look back at your original description of a pond. Can you expand on that now?"



ACTIVITY A: Describe a Pond

10 min.
individual

Think of a pond with which you are familiar. In as much detail as possible describe the pond.

In groups of three, compare your descriptions. What things are similar? What things are different?

Together, write a description of a pond with which you can all agree.



ACTIVITY A: Pond Plant Identification Sheet (1 of 4)

ARROWHEAD

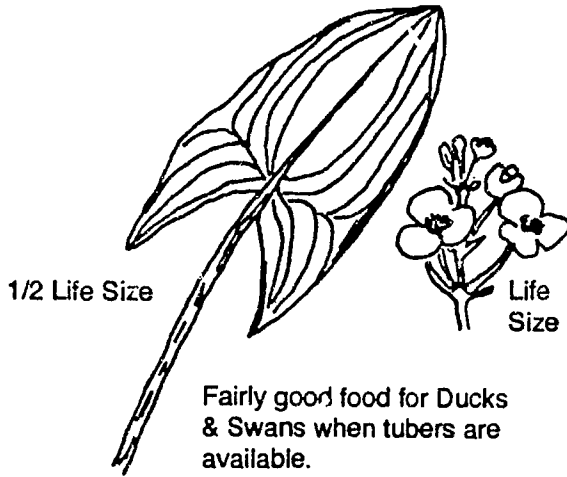

Fairly good food for Ducks & Swans when tubers are available.
Muskrats also feed on it.

Also called "Duck Potato" or "wapato," it was eaten by Indians and early settlers.

SMARTWEED

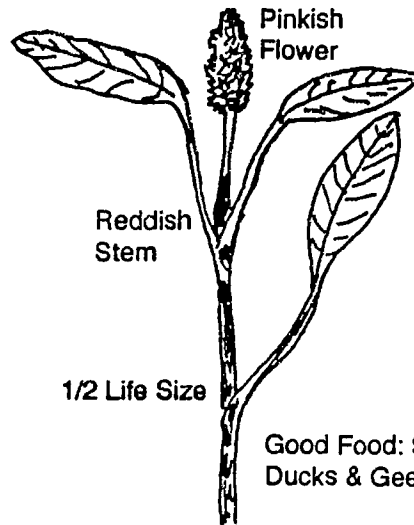

Good Food: Some Ducks & Geese

FLOATING - LEAF PONDWEED

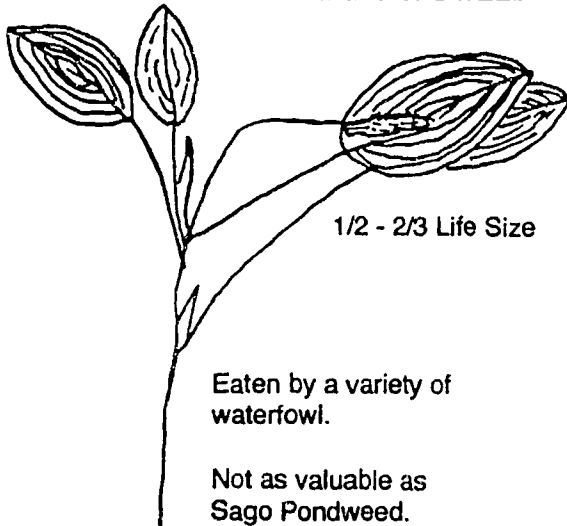

Eaten by a variety of waterfowl.

Not as valuable as Sago Pondweed.

SAGO PONDWEED

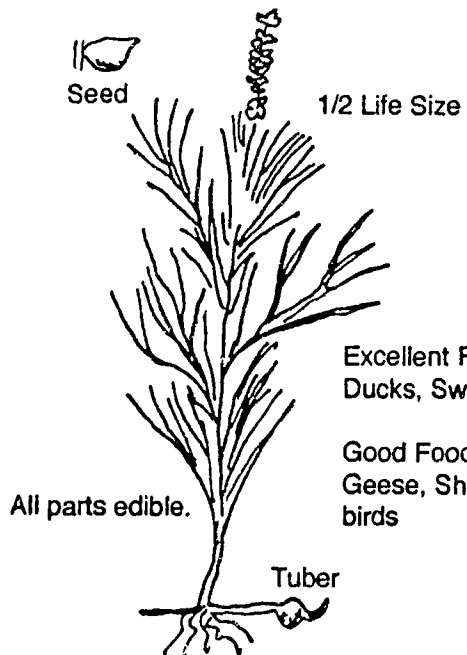

Excellent Food: Ducks, Swans

Good Food: Geese, Shore-birds

All parts edible.



ACTIVITY A: Pond Plant Identification Sheet (2 of 4)

HARDSTEM BULRISH

"Tule"

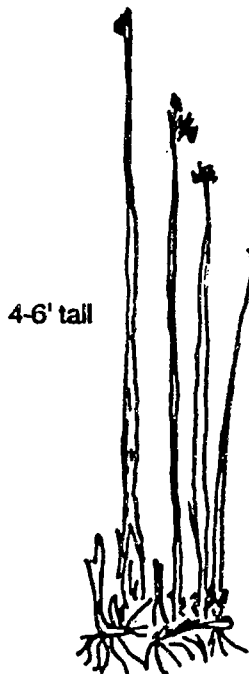

4-6' tall

One of the most conspicuous plants in the marsh.

Good food & cover for ducks, geese, & coots when in small clumps. Dense patches become almost useless because food isn't available to birds.

Good cover & food for muskrats.
Good cover for blackbirds & marsh wrens.

SPIKE RUSH

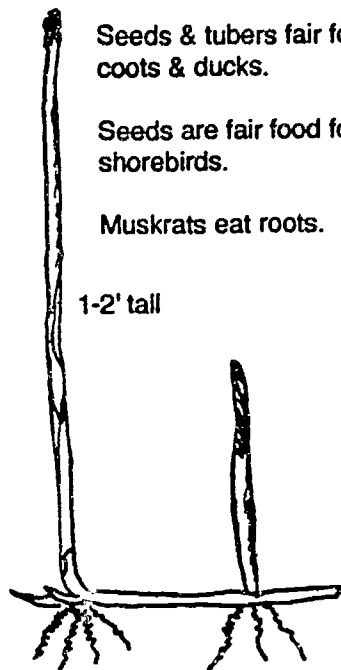

Seeds & tubers fair food for coots & ducks.

Seeds are fair food for shorebirds.

Muskrats eat roots.

1-2' tall

RUSH or JUNCUS

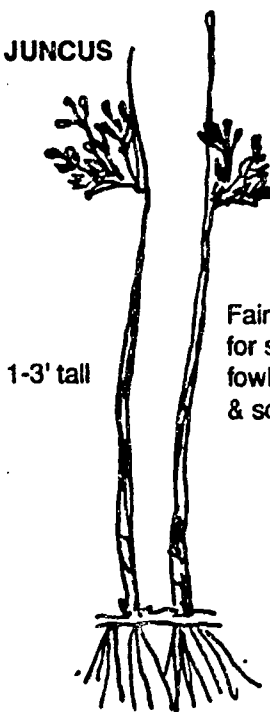

1-3' tall

Fair food & cover for some water-fowl, marsh birds & song birds.

SEDGE or CAREX

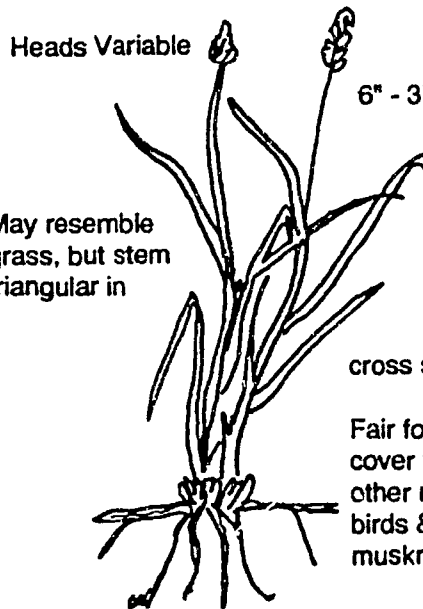

Heads Variable

6" - 3' tall

May resemble grass, but stem triangular in

cross section.

Fair food & cover for ducks, other marsh birds & muskrats.

ACTIVITY A: Pond Plant Identification Sheet (3 of 4)

WATER BUTTERCUP

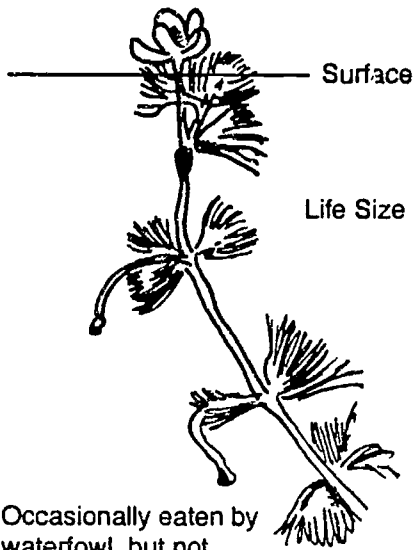

Occasionally eaten by waterfowl, but not important food item.

WATER PLANTAIN

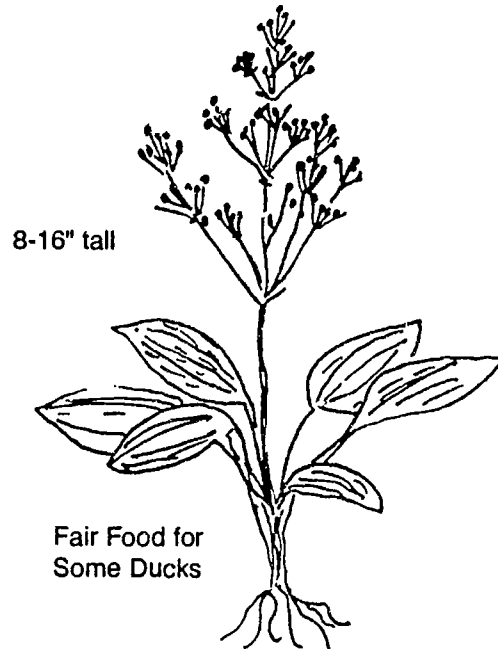

WATER MILFOIL

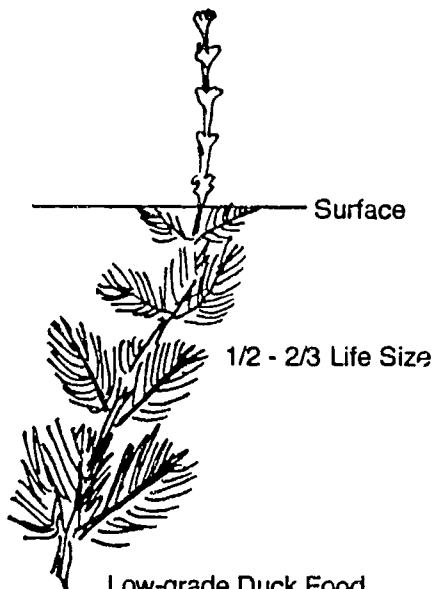

Low-grade Duck Food
Often considered a weed.

BLADDERWORT

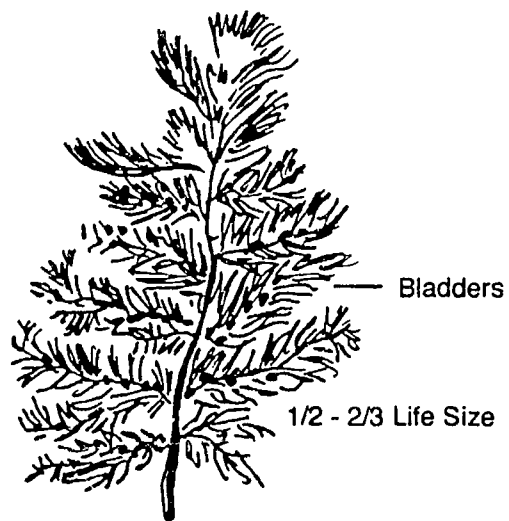

Little or no food value for waterfowl.
A carnivorous plant—bladders catch small invertebrates.

ACTIVITY A: Pond Plant Identification Sheet (4 of 4)

BURREED

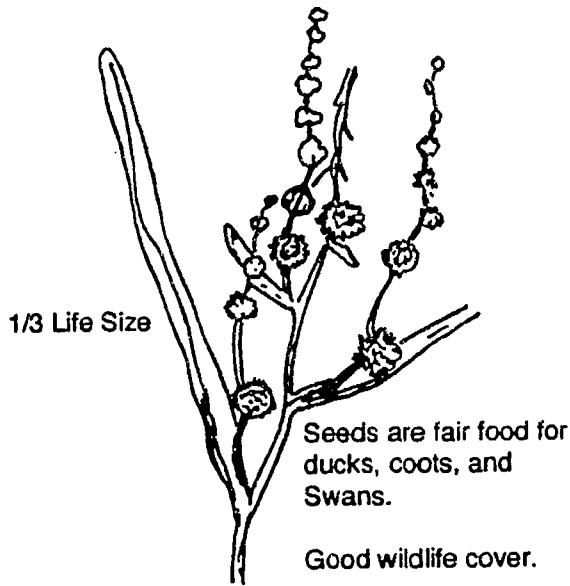

Musk rats use the entire plant.

CATTAIL

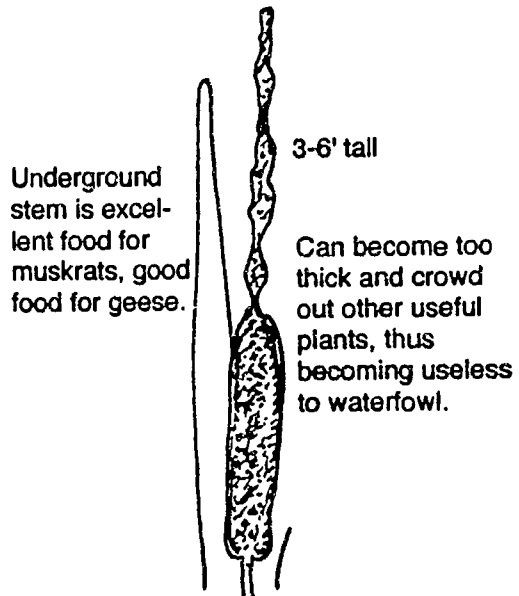

Nesting cover for marsh wrens and blackbird.

DUCKWEED

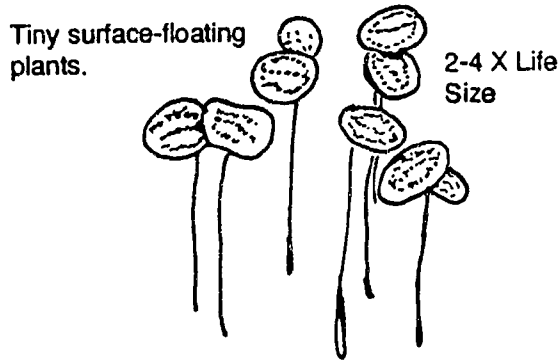

Fair food for some ducks & coots.

CHARA (MUSKGRASS)

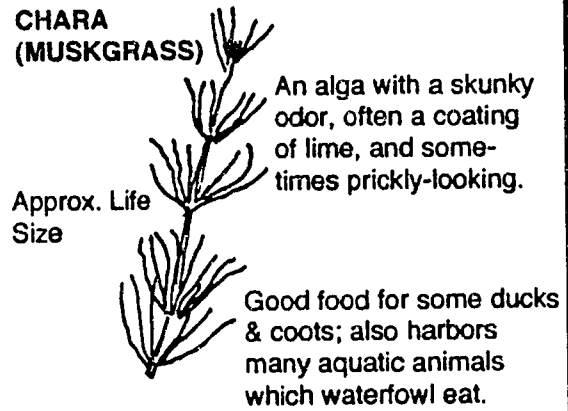

Other "scummy" algae may serve as fair food for ducks and coots. They can become too thick and thus smother more valuable plants.



ACTIVITY B: Observe a Pond Environment

5 min.
individual

Work by yourself.

As you approach the pond, observe and record your observations.

PLANTS _____

ANIMALS _____

AIR _____

SOIL AND ROCKS _____

WATER _____

OTHER _____



ACTIVITY C: Pond Plants and their Distribution

20 min.
groups

SHORELINE PLANTS: Plants which usually grow around the edge of a pond and thrive in the moist soil there.

EMERGENT PLANTS: Plants which are rooted on the bottom and have stems and leaves above the surface of the water.

FLOATING LEAF PLANTS: Plants which are rooted on the bottom and have leaves floating on the surface.

SUBMERGED PLANTS: Plants which grow completely under the water. Only the flowers and seeds are above the water. They usually have long or bushy, very branched leaves.

ALGAE: Algae grow in a variety of forms and can be very dense. It may grow floating in the water or on the surface, attached to the bottom or attached to other plants.

Work in small groups.

Collect plants from various parts of the pond and around the edges of the pond. Complete the information asked for in the chart below. Use the accompanying illustrations and the Pond Life books to help you identify the plants.

NAME (if known)	DESCRIPTION	GROWTH PATTERN (shoreline, emergent, floating, submerged, algae)	DEPTH OF WATER	ABUNDANCE (abundant, common, uncommon)



ACTIVITY D: Pond Vertebrates

10 min.
groups

Name or Description	Evidence	Where Found	Abundance (abundant, common, uncommon)



ACTIVITY E: Daily and Seasonal Differences in a Pond

10 min.
individual

1. Walk around the pond and look for evidence of differences in this environment at other times. Record your observations below.

Evidence	How was the environment different?	How would the difference affect life in the pond?

2. Based upon your knowledge of the weather and other conditions in this area what other differences would you expect to find at other times of the day or year? Record your ideas below.

How would the environment different?	Cause of the difference?	How would this affect life in the pond?



ACTIVITY E: Temperature Layering in Ponds - Lakes

In summer, the surface water absorbs the sun's heat and warms faster than the water below. The warmed water is lighter than the cold, so it floats on the cool layers. By midsummer there are three distinct layers.

During the summer, mixing or circulation is prevented by these stratified layers of water which act as a barrier.

The upper layer of water cools in autumn until it approaches the temperature of the water in the middle and lower layers. Aided by winds, the surface water sinks causing circulation from top to bottom.

In winter, the cold surface water continues to sink and the water becomes stagnated, photosynthesis slows, and oxygen levels drop.

In spring, aided by winds, another circulation and mixing occurs, called the "Spring Overturn."

1. Seasonal Change Diagram

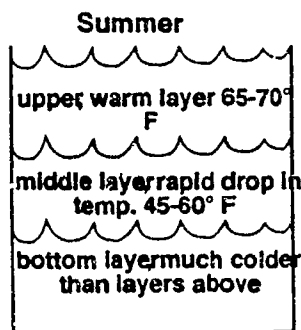

During the summer, fish and aquatic life are most active.

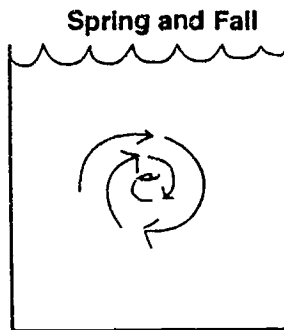

During the spring and fall overturns, the temperature of the water is equalized throughout the lake. Fish and other animals are more active than in winter, but less active than in summer.

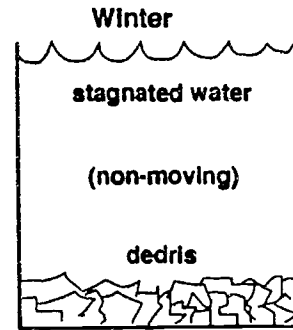

Activity is greatly reduced during the winter. Many animals hibernate in the mud or debris at the bottom.

2. Seasonal Change Chart

Maximum

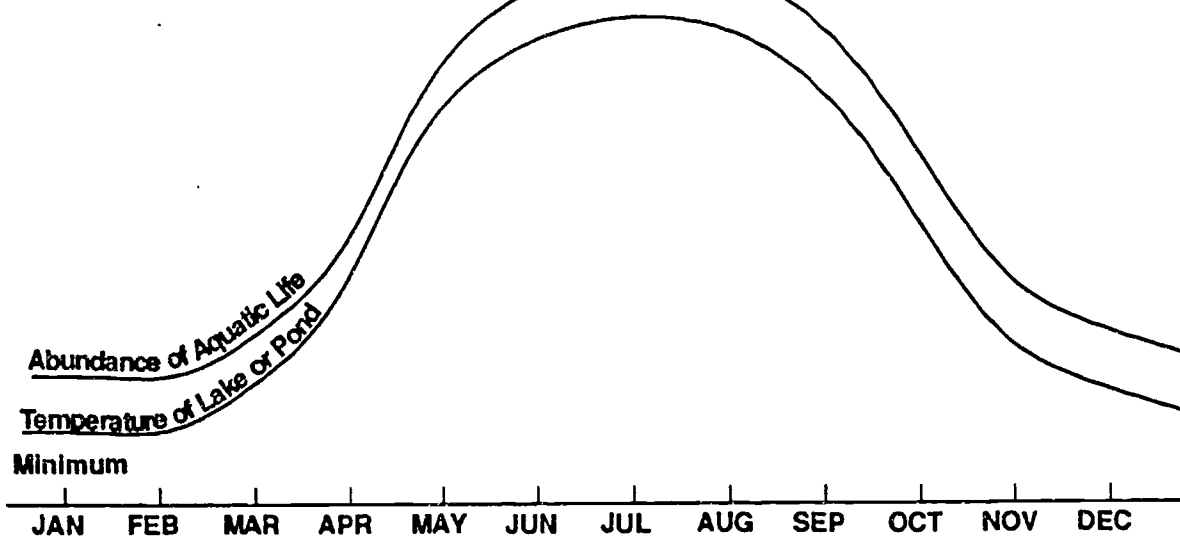

ACTIVITY F: Determine Water Volume of a Pond

20 min.
small groups

Work in groups.

Instructions for collecting and recording volumes of water in ponds or lakes.

- a. Find the average diameter (distance across) of the pond. Measure the length and width of the pond. You may have to take several length and width measurements and get the average of them.

Pond width _____ feet.
 Pond length _____ feet.
 Total _____ feet + 2 = _____ ft. (average diameter)
 Average diameter _____ ft. x 3.14 (_____) + 4 = _____ sq. ft. surface
 (area of pond)

- b. Find the average depth of the pond or lake. Measure the depth in 3 places along a line (transect) across the pond, as near the middle as possible. Add these depths and divide by 4 (see explanation below) to get the average depth. (If additional accuracy is desired, repeat this process along additional transects and average the results.)

First measurement _____ feet.
 Second measurement _____ feet.
 Third measurement _____ feet.
 Total _____ feet + 4 = _____ ft. (average depth).

NOTE: The reason you take 3 depth measurements then divide by 4 is to take into account the shallow areas of the pond. It can be explained by the following example of a drawing of a pond cross-section. If depth in 3 places is A(5'), B(10'), C(5'), (total 20'), find an average by dividing by 3 ($20' \div 3 = 6 \frac{2}{3}'$). Now look at the mean or average depth (D) which is 5'. Take total of depths and divide by 4 ($20' \div 4 = 5'$), the correct average depth.

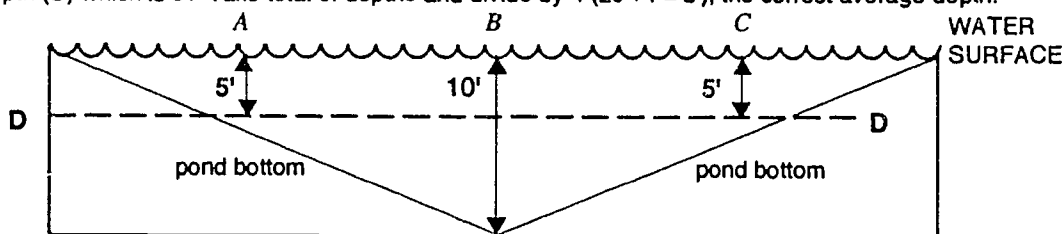

- c. Formula for computing number of gallons of water in pond.

1. _____ x _____ = _____ cubic feet
 area of pond average depth volume in cubic feet
 2. _____ cu. ft. x 7.48 = _____
 volume in cu. ft. no. gals water in pond

NOTE: A cubic foot of water is the water in a container 1-foot wide, 1-foot high, and 1-foot long. It contains 7.48 gallons.

- d. Formula for computing the volume using acre-feet of water.

1. (surface) _____ x _____ = _____
 area of pond in feet average depth in feet volume cu. ft.
 2. _____ + 43,560 = _____ acre-feet of water.
 volume cu. ft. (sq. ft. in an acre)
 3. _____ x _____ = _____
 acre-feet gal./acre-foot no. gallons in pond

- e. In order to find out how many people could get their domestic needs for one day from the water in the pond, complete the following calculations.

_____ + _____ = _____
 gallons of water amount of water one total no. people who could live one day
 in the pond person uses per day from this water

*The average person uses about 200 gallons of water a day for home use. This does not reflect each person's share of water used for industrial, public services, and commercial. (U.S. Office of Education figures.)

Investigating Your Environment
Ponds





BEST COPY AVAILABLE

Investigating Your Environment — Intermountain Region



503

INTRODUCTION

Range — what do you think of when you hear that word — range wars, land under starry skies above, cowboys living a hard, yet free life, buffalo, Plains Indians? Do you see cows or sheep grazing, moonlit coyotes howling from the hilltops? Do you smell the biting dryness or feel the green of spring? Do you hear the rattle of Basque sheepherder's wagons bouncing along or taste strong campfire coffee?

Rangelands are important for more than the feelings we have experienced either directly or vicariously. Rangelands make up more than 40% of the world's land use. It is, geographically, an extensive area of relatively level, rolling, broken or mountainous land, usually not adapted to cultivation. It is covered with native grasses and other forage plants; sometimes ranges are seeded to grow specific types of vegetation. Range may be privately or publicly owned and fenced or unfenced. It is an area of land having a distinctive combination of soil, topography, climate and vegetation.

THE ACTIVITIES

TIME REQUIRED

Observe the Range Environment	25 minutes
Range Plant Inventory	25 to 30 minutes
Life Along the Line (transect survey)	60 minutes
How Healthy is this Range?	20-25 minute
Better or Worse? What is the Prescription for Health?	30 minutes



Determine Range
Utilization

30 minutes to 60 minutes

Determine Food Value
of Plants for Animals

20 to 30 minutes

Whose Home is this
Range?

40 to 60 minutes

Map the Range
(Optional)

two to three 45 minute class periods (estimate)

COMBINING THE ACTIVITIES

The activities in this unit are displayed singly. Depending upon the time available and the skill of the participants, you may choose to do only one activity or the entire series. For maximum learning, the activities should be experienced in the order listed in the unit, however, other suggestions are:

Suggestion 1:

Title: Range Site Exploration

Introduction: Range is an uncommon environment for many people, but one which is readily available for study. Participants use their knowledge of their home environment to learn about range.

Activity: Observe the Range Environment

Transition Statement: Let's take one aspect of the range environment; plants, and explore it further.

Activity: Conduct a Range Plant Inventory

Transition Statement: The next activity looks closer ye at range plant life and introduces the principles of "transect line" and inventory.

Activity: Life Along the Line

Transition Statement: Range plants are classified into three groups which help determine the overall health of a range site.



Activity: How Healthy is this Range?

Transition Statement: The determination of a range's health can lead to wise land management.

Activity: Evaluate Range Utilization

Transition Statement: Do you think livestock are picky eaters? Well, in this next lesson, perhaps we can find out.

Activity: Determine Food Value of Plants and Animals

Transition Statement: Livestock aren't the only animals on the range. What about prairie dogs, jack rabbits and ...

Activity: Observe and Record Evidence of Animals

Transition Statement: We can summarize in discussions what's been learned about this site. Or, some may prefer to summarize through mapping.

Activity: Map the Range

Suggestion 2:

Title: Typical Range Plants

Introduction: People like to compare plants in a new area to plants where they live. These activities introduce some specific range plant types.

Activity: Observe the Range Environment

Transition Statement: Let's take one aspect of the range environment; plants and explore it further.

Activity: Conduct a Range Environment

Transition Statement: The next activity allows us to look even closer at range plant life.

Activity: How Healthy is this Range?

Transition Statement: This exploration is just a beginning of what we can learn about range plants.

Suggestion 3:

Title: Oh Give Me a Home, Where...

Introduction: Cows, sheep and buffalo are all range animal. So are spiders, ants, sage hens and jack rabbits. The activities dealing with animals are short and form a foundation for further investigation.

Activity: Observe the Range Environment

Transition Statement: Let's take one aspect of the range environment; animals and investigate it further.

Activity: Determine Food Value of Plants and Animals

Transition Statement: Here's another activity to expand your understanding of range animal life.

Activity: Observe and Record Evidence of Animals



CURRICULUM RELATIONSHIPS

Social Studies/Science

1. Read about and explore how rangelands in your state were settled. What made people settle there? When did they come? Why?
2. What Native American Indian groups lived there? Where? What Native American Indian groups live there now? Where? Compare their life and lifestyle today to 100 years ago, 150 years ago. Construct a display or write a report detailing your research.
3. How is the use of range land influenced by the environment? Consider all aspects.
4. Locate different agricultural crops or businesses on rangelands in your state. Can you determine why certain crops or livestock can be found in a specific area?
5. Map range lands in your state. Compare them to rangelands world-wide and draw comparisons.
6. Determine how land is classified in your state and then determine how much of your state's agricultural production comes from rangelands.
7. What other uses are there for rangeland besides agriculture?

Language Arts

1. Research literature for poetry, story and songs about rangeland, range animals or a way of life associated with range. Then present or perform part of what you find. Be sure to explore the rich legends, mythology and history of the Native American people.
2. Write your own poem, story or song about the range.
3. Pick an aspect of the range environment, research it and write a complete report.
4. Interview a person whose career involves some aspect of range. Tape the interview and then edit it, videotape it or present the interview in some form.
5. Learn and tell a Native American Indian legend, tall tale or folk tale about range associated things.
6. Read a novel — historical fiction, biography or autobiography about range or someone associated with range.

Creative Arts

1. American painters have produced many paintings about the American West. Select one, review his or her work and share your new knowledge with your classmates in a manner decided upon with your teacher.
2. Write and film a project on the American range. Subject and Script must be discussed with the teacher first.
3. Create a play or puppet show about range or an associated subject which you perform for a younger class.
4. Use your own favorite form of creative talent to depict an aspect of range you wish to share.

Math

1. Measure and mark off one acre.
2. Measure soil temperature and pH on different range sites. Graph and see if you can find a relationship.



OBSERVE THE RANGE ENVIRONMENT

- CONCEPT** Organism, interaction, system
- PRINCIPLE** Participants use their observation skills in a new environment to discover what they “know” about the site within a range environment.
- OBJECTIVE**
- The student will be able to observe and record his/her observations about the range environment.
- PREPARATION** Select a site where the group can spread out and work individually. Site should have a variety of plant types, animal evidence and possible differences in range conditions within a short distance. Facilitator should read the activities in this unit before selecting a site and even do Activities C and D in preparation for this lesson.
- MATERIALS USED**
- Copies of activity A: Observe the Range Environment
 - flip chart and markers
 - writing instruments
- PROCESSES USED**
- observe
 - communicate
 - infer
 - hypothesize
- TIME** 25 minutes with discussion



DOING THE ACTIVITY (outdoors)

A. Set the Stage

"Rangelands often have distinctive combinations of soil, vegetation, climate and land form. In this investigation, we will be finding out what is here."

B. Procedure

1. Distribute Activity A to each student.
2. "You have fifteen minutes to find out all you can about this site. Individually record observations on the sheet you just received. You may sit in one place or work through the area".

ACTIVITY A: Observe the Range Environment

15 m. k.
Individuals

As you investigate the study area, observe and record your observations.

Soil

Rocks

Air

Plants

Animals

Investigating Your Environment
Range 



Investigating Your Environment
Range

309

6

BEST COPY AVAILABLE

C. Retrieve Data

1. Gather the students for a discussion.
2. Record data on flip chart. You may want to pre-prepare a flip chart. An example of a flip chart page is shown.

Soil	Rocks
Air	Plants
Animals	Other

3. Ask "What did you notice about this area?"
4. Ask "What did you notice about plants in this area?"
5. Ask "What animals or animal evidence did you see?"
6. Ask "What did you find out about the non-living components of this environment?"
7. Ask "How are the living and non-living elements of the environment related?"

CLOSURE

Share your observations by stating the word or words which summarize your impression of the area.

TRANSITION

Choose a transition specific to your next activity.



PLANT RANGE INVENTORY

CONCEPT	Organism
PRINCIPLE	Range plants can be either annuals or perennials. Plants are often classified in categories such as grasses, shrubs, forbes (herbs) and grass-like plants.
OBJECTIVE	<ul style="list-style-type: none">• The student will be able to classify plants found on site into one of four range plant groupings.• The student will be able to classify plants found on the site as either annuals or perennials.
PREPARATION	Prepare a display board of range plants from the four broad plant groups and another board showing annuals and perennials. Make duplex copies of the plant identification sheet, laminate if possible, one per group. Copy activity sheets and organize supplies.
MATERIALS NEEDED	<ul style="list-style-type: none">• copies of Activity Sheet B: Range Plant Inventory and Activity B: Range Plant Inventory Identification Sheet (3)• pencils• pens• sack of loose plants• display board of plants• plant guides• range plant identifying sheet
PROCESSES USED	<ul style="list-style-type: none">• classify• infer• hypothesize• communicate• observe
TIME	25 to 30 minutes



DOING THE ACTIVITY (outdoors)

A. Set the Stage

"Range plants are divided into four broad groups. Today we will identify plants in these groups in order to complete a range analysis. We will also determine whether a plant is an annual or perennial. Knowledge of plant groups helps us understand what is happening on rangelands".

B. Procedure

1. Hand out Activity B: Range Plant Inventory sheets.
2. Work in pairs to study the two plants display and then classify the plants you are given.

ACTIVITY B: Range Plant Inventory pairs

Describe or name in the appropriate column below the plants found on your study area. Classify the annuals and perennials. Use the Range Plant Identification chart as necessary.

	Grasses	Grasslike	Forbs	Shrubs
perennial				
annual				

Investigating Your Environment Range 

312



Investigating Your Environment
Range

3. Distribute plants to groups as they study the displays.
4. About 10 minutes into the activity, ask, "What characteristic has helped you classify your plants thus far?" Partners should answer the question for themselves.
5. Hand out Activity Sheet B: Range Plant Inventory and explain, "We need to get an idea of the plant types in this area. Use the information you've just learned, describe or name the plants you've found here. Record your observations on Activity "B". Allow 10 minutes.

ACTIVITY B: Range Plant Inventory - Identification Sheet

DECREASERS



Bluebunch Wheat
(*Agropyron spic.*)

Idaho Fescue
(*Festuca idahoae*)

INCREASESERS

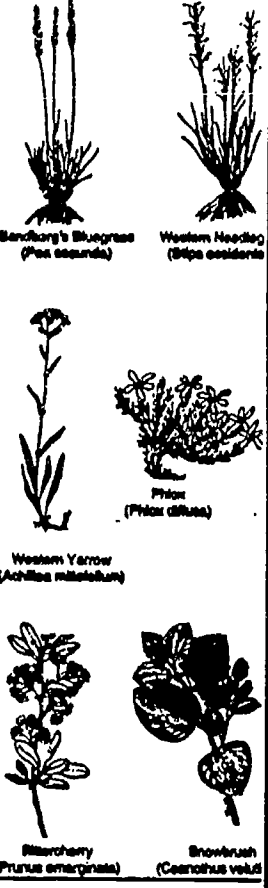

Sandberg's Bluegrass
(*Poa secunda*)

Western Needlegrass
(*Stipa occidentis*)

Western Yellow
(*Achillea millefolium*)

Snowbrush
(*Ceanothus velut*)

INVADERS

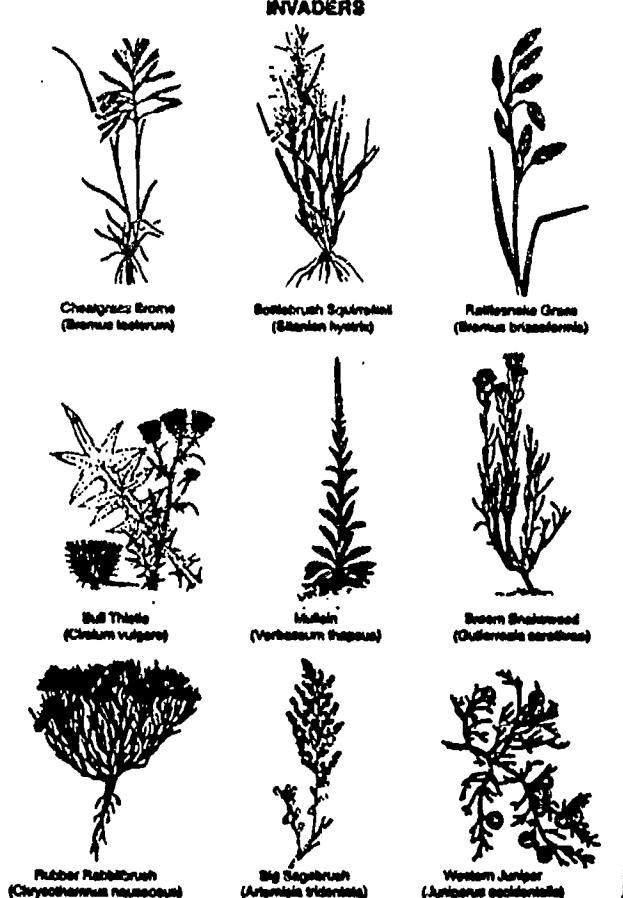

Cheatgrass Bromes
(*Bromus tectorum*)

Bottlebrush Squarroot
(*Gnaphalium hirsutum*)

Rottonek Grass
(*Barnesia brizarioides*)

Bull Thistle
(*Cirsium vulgare*)

Mullein
(*Verbascum thapsus*)

Green Shalwood
(*Dalea serotina*)

Rubber Rabbitbrush
(*Chrysothamnus nauseosus*)

Big Sagebrush
(*Artemisia tridentata*)

Western Juniper
(*Juniperus occidentalis*)

Investigating Your Environment 

C. Retrieve Data

Guide a group discussion with questions such as;

1. What did you find?
2. Which plant group had the most plants in it?
3. Where did you find the different plants growing? (separately, in clumps, mixed).
4. What other observations did you make about the plants growing on this site?

CLOSURE End the discussion by asking, "What can we say about plants that grow on the range?"

TRANSITION "In the next activity, we will investigate range plant life more extensively.

314



LIFE ALONG THE LINE (A TRANSECT SURVEY)

- CONCEPT** Change, evolution, interaction, organism, population, system
- PRINCIPLE** A transect line is a cross-section of an area previously unknown to the observer. Careful study of a transect renders a wealth of information upon which the scientist can act. Transects are used in many fields of science, not just range science.
- OBJECTIVES**
- The student will be able to count and record the number and types of plants growing on a portion of an area.
 - The student will be able to compute the percentage of vegetative cover along a given transect and hypothesize as to why the growth is as it is.
- PREPARATION** Survey the area carefully and predetermine several areas which would hold a 100' transect line. You may need to establish the lines yourself if working with younger students. Make sure the one foot intervals are marked. Make duplex copies of activity sheet C back to back.
- MATERIALS NEEDED**
- 100' tape or strings
 - stakes to tie down the transect lines
 - copies of Activity Sheet C: Transect Survey (2 pages)
- PROCESSES USED**
- classify
 - communicate
 - observe
 - measure
 - hypothesize
 - infer
 - use numbers
 - interpret data
- TIME** 60 minutes. Can break into shorter sessions by laying out the line one day and conducting the survey the second day



DOING THE ACTIVITY (outdoors)

A. Set the Stage

Transect studies are conducted in many scientific fields. Today, you'll have a chance to conduct a transect survey of the plant numbers and types growing here.

B. Procedure

1. Distribute Activity Sheet C.
2. Working in groups of four, stretch a 100' tape along the ground where you want to inventory plant types. Stake down the ends of the tape.
3. Walk the line and record information observed on Activity Sheet C. Check (✓) the appropriate column. Make sure you are recording at each foot.
4. Once the survey is recorded, complete the summary portion of the activity within your group. Allow 45 minutes for this activity.

C. Retrieve Data

Conduct a discussion asking questions like:

1. What did you find?
2. Which column had the greatest percentage of coverage?
3. The least percentage of coverage?
4. What could account for those coverages?
5. Which plants, if any, tend to be associated with certain areas, such as bare places, curbs, etc.?
6. What reason(s) might account for this?

CLOSURE

Ask the participants to summarize (1) What did you find out about transect today? and (2) What are your feelings about this activity? their feelings about this activity?

TRANSITION

Now that we have a good background in range plants, let's look at how plants are grouped. This helps determine range health.

45 min. groups

ACTIVITY C: Transect Survey

ACTIVITY C: Transect Survey (continued)

World types: a check

Group Survey Part 1

Transect Survey (Continued)

Summarize your data below:

Item	Record the total # of ✓s from chart for each item below.
Rock	
Bare soil	
Litter	
Annual grass	
Perennial grass	
Forb	
Shrub	
Tree	
Animal sign	
Totals	

(The # of ✓s for each item is equal to the percentage of the total for that item.)

Which column had the greatest percentage coverage _____ the least _____

Which plants if any tend to be associated with certain areas, such as bare places, rocks, protective shrubs, etc.?

What reasons might account for this?

Investigating Your Environment Range 



Investigating Your Environment
Range

HOW HEALTHY IS THIS RANGE?

- CONCEPT** Change, cycle, cause and effect, organism
- PRINCIPLE** All the data gathered thus far will help us determine the health of this range. By knowing the health of the area, range managers can better prescribe management practices.
- OBJECTIVE**
- The student will be able to use his/her knowledge gathered thus far to infer the healthiness of the range.
 - The student will be able to explain how plants can be indicators of healthy rangeland and predict how this knowledge might be of help in another field.
- PREPARATION** Print Activity Sheet D, back to back
- MATERIALS NEEDED**
- Completed copy of Activity Sheet C for each student
 - Copies of Activity Sheet D: Infer Range Health or Condition (2 pages)
- PROCESSES USED**
- observe
 - infer
 - classify
 - communicate
 - hypothesize
 - interpret data
- TIME** 20-25 minute



DOING THE ACTIVITY (indoors or outdoors)

A. Set Stage

The type, number and condition of certain plants serve as indicators of the health or condition of the range and, the ability of the range to produce food or forage. We'll use one approach to determine the health of our range. We call it the "traffic signal" method.

B. Procedure

1. Distribute Activity Sheet D to pairs. Allow 15 minutes.
2. Based on data gathered in the previous Activity C and using the information in Activity D, determine the range condition class for this range.
3. Apply the meaning of traffic signals to range plants to make this determination easier: (a) green group plants (b) yellow group plants (c) red group plants.

ACTIVITY D: Infer Range Health or Condition / Inferring Range Health Or Condition (Continued)

Use the data gathered in Activity C and the information below to class of this range.

TECHNICIAN'S GUIDE TO RANGE CONDI			
Green-Group Plants		Yellow-Group Plants	
DECREASERS: Plants that disappear when range is abused. Percentage figures indicate approximate amount found in climax for the site but count all found on site as climax.		INCREASERS: Plants that increase when range is abused. Percentage figures indicate approximate amount found in climax for the site, so count no more than amount shown toward climax.	
80% Bluebunch wheatgrass 5 Idaho fescue 1 Giant wild rye 9% Siltcrush		15% Sandberg bluegrass 5 Western needlegrass 2 Prairie junegrass 10% Misc. in aggregate 1 Squirrelroot 2 Yarrow 2 Yucca 1 Bluestem 1 Silver lupine 1 Servilletia 1 Arrowweed 1 Siltcrush 1 Snowbrush 1 Shrewy aster 1 Pearly everlasting	
Condition:	Excellent	Good-to-Fair	Poor
Our area is in the green, yellow, red group plant condition—(circle plants found there)			
This would mean that the condition of the range is excellent, go			

The Green Group—Plants in this group are the most desirable; the ones that livestock like best. When you see the green-group plants in abundance on the range, you know your grazing program is going well. The green-group plants consist of those which are plentiful, in excellent condition on native range, and are the first to decrease if range conditions are forced down to "good," "fair," and finally to "poor" range. Range in the poorest condition has very few green-group plants on it.

The Yellow Group—These are also native plants, but they are less attractive to livestock. They escape grazing because they are short or because they are less tasty to livestock. Yellow-group plants are the ones to watch with "caution." They replace the green-group plants which have become smaller and weaker.

The range manager uses caution when he sees the number of yellow-group plants increasing on his range. He is safe if they are being replaced by green-group plants. That means the range is improving.

If heavy grazing continues, the yellow-group plants begin to weaken and die out. Their place is taken by the red-group plants.

The Red Group—These plants really do not need any explanation. They simply mean "danger" to the range, so far as production is concerned. These plants are usually annuals or unpalatable species which have come in from other areas and occupy the range as invaders.

Red-group plants seldom, if ever, are as effective in controlling soil erosion and conserving water resources as the native plants which are more abundant when the range is in good or excellent condition. Soil and water losses cause nature's plant and soil development process to go in reverse. The range becomes less healthy and less productive.

Investigating Your Environment
Range 

C. Retrieve Data

In a discussion of the group findings, look for similarities and differences. If you are all in the same area, each group should come up with about the same classification. Ask questions such as:

1. What color group did you put your range in and why?
2. What condition does your site appear to be in?

CLOSURE Review findings with class and write a group statement about the range's health.

TRANSITION We have gathered information about the health of our range. In the next activity, we will predict future health trends.



BETTER OR WORSE? WHAT IS THE PRESCRIPTION FOR HEALTH?

CONCEPT	Change, cause/effect, organism, evolution
PRINCIPLE	Determining what is happening on a piece of land requires many steps. This activity lets you continue putting the pieces together to predict the direction of the health of the range.
OBJECTIVE	<ul style="list-style-type: none">• The student will be able to use information gathered to determine in which direction the health of the range is heading.
PREPARATION	Duplex copy Activity E back to back for each student.
MATERIALS NEEDED	<ul style="list-style-type: none">• previous data sheets C and D• Activity sheet E: Range Health and Condition• pencils
PROCESSES USED	<ul style="list-style-type: none">• observe• infer• predict• communicate• hypothesize• interpret data
TIME	30 minutes



DOING THE ACTIVITY (indoors or outdoors)

A. Set the stage

"In this activity, we will record and interpret data to predict the direction of the health of the range".

B. Procedure

1. Distribute Activity Sheet E, allowing about 15 minutes.
2. Work in groups and compile the information you have gathered. Use the Activity Sheet E to help you organize your information.

15 min.
GROUP

ACTIVITY E: Range Health and Condition Information

Observer _____ Date _____
 _____ Location _____

ACTIVITY E: Range Trend Indicators*

Plant	%
Bluestem wheatgrass	
Little bluestem	
Sandberg bluegrass	
Chickgrass	
Other	
Forbs	
Yellow	
White	
Black	
Carrot	
Other	
Shrubs and trees	
Total Usable Plants	

Condition Indicators (from Activity D)	Condition class based on vegetation
Excellent	_____
Good to Fair	_____
Poor	_____

Indicators of Upward Vegetation Trend

1. Desirable and intermediate forage plants becoming more abundant.
2. Desirable and intermediate forage plants invading bare ground or stands of undesirable plants. A variety of all age classes of better forage plants must be present.
3. Establishment of perennial plants on erosion pavement.
4. Several years of vigorous growth on browse.
5. Desirable plants increasing and vigorous. Grasses with long green leaves, and numerous healthy seed stalks.
6. A well dispersed accumulation of litter.

Indicators of Upward Soil Trend

1. Gullies approaching the angle of repose and healing.
2. Gullies stabilizing by the growth of perennial vegetation on both sides and bottom.
3. Soil remnants having sloping sides or sides covered with mosses, lichens, or higher plants.
4. Terraces characterized by sloping sides which are being covered with vegetation. Tops of terraces should be occupied by perennial plants.

Indicators of Downward Vegetation Trend

1. Desirable and intermediate species decreasing in vigor.
2. Lack of young plants from desirable and intermediate species.
3. Invasion by undesirable species.
4. Holed and high-tined shrubs. Dead branches generally indicating that shrubs are dying back.
5. Litter scarce and poorly dispersed.

Indicators of Downward Soil Trend

1. Fill mark, small active gullies that indicate shrubs are dying back.
2. Active gullies. Established gullies are rare and actively cutting. This type of gully may vary from a few inches to several feet in depth.
3. Alluvial deposits. Soil material transported and laid down by running water.
4. Soil remnants. Original topsoil held in place by vegetation or plant roots.
5. Active terraces. Terraces usually caused by hooves of animals. They are "steer step-like" in appearance on slopes.
6. Exposed plant crowns or roots (pedestalled plants).
7. Wind-eroded depressions between plants.
8. Wind deposits.

* Forest Service Range Environmental Analysis Handbook

Investigating Your Environment Range



Investigating Your Environment
Range

C. Retrieve Data

1. Discuss the results. You may want to graph the results and discuss the trend or direction in which this range is going.
2. Ask, "What did you find is the trend of this range?"
3. Ask, "What could account for your findings?"
4. Ask, "Which things are influencing the trend the most?"
5. Ask, "How might this area look in 10 years?"

CLOSURE

Participants share answers to the question, "What have we found out about changes on this range?"

TRANSITION

We have just finished determining the health of the range. Now, let's look at the degree to which it is being used by livestock.



DETERMINE RANGE UTILIZATION

- CONCEPT** Cause/effect, change, equilibrium, interaction, population.
- PRINCIPLE** Rangelands are used for livestock grazing. This activity shows a student how to look at one use of range, specifically livestock grazing.
- OBJECTIVE**
- The student will be able to determine how much use an area of range receives from livestock grazing.
- PREPARATION** Copy Activity Sheet F
- MATERIALS NEEDED**
- Activity sheet F: Evaluate Range Utilization
 - string
 - sharp knife
- PROCESSES USED**
- communicate
 - define operationally
 - infer
 - interpret data
 - measure
 - observe
 - classify
 - use numbers
- TIME** 30 minutes to 60 minutes depending upon number of plants measured



DOING THE ACTIVITY (outdoors)

A. Set the Stage

1. "Rangelands are often used for livestock grazing. In this activity, we will look at a method to measure how much grass can be used."
2. Utilization is the amount of the current year's plant growth that is removed by grazing livestock. Heavy utilization may occur on a range in excellent condition, or in poor condition. Heavy utilization over a period of years causes regression and lowers range condition.
3. Livestock do not use all species of range plants to the same degree. They eat more of the better-tasting plants. Each grass, forb and shrub can be grazed a certain amount without hurting its ability to grow year after year. We will consider three categories of range use.

B. Procedure

1. Arrange students into groups and distribute Activity Sheet F.
2. Go over the instructions and model the procedure.
3. Allow 30 to 45 minutes to complete the activity.

ACTIVITY F: Evaluate Range Utilization

30 min.
groups

For some grasses, the proper use is considered removal of about one-half of the growth made in the present year. While proper use must be considered in the light of the above-named factors, "taking half and leaving half" can sometimes be used as a "rule of thumb."

To determine the amount of stubble left when one-half the growth is removed, follow these steps:

1. Wrap an average-sized, mature, ungrazed plant with string to hold it together when cut.
2. Cut off plant at crown (ground level).
3. Adjust the wrapped plant across a knife blade to make it balance. Measure with ruler from bottom of plant to point of balance. This gives height, indicating 50 percent use for that particular species of grass. Desirable approximate stubble heights for some native grasses are:

Grass	Inches stubble left
Bluestem wheatgrass	4-6
Idaho fescue	2-4
Big bluestem	3-5
4. Repeat this for 10 average plants of a species to get an average.
5. Select 100 plants randomly, measure their heights (whether grazed or not), and average the measurements. If the average grazed height is more than the standard shown above, the range is not fully used. If it is less, the range is overused.

Grass	Inches stubble left	Utilization rate heavy-moderate-light

Definition of Utilization Rate

Light use: Only choice plants are grazed. Only a small amount of the less desirable forage plants are consumed, thereby wasting much valuable forage. Ungrazed plants and heavy litter build-up may result in serious fire hazard. Also, excessive amounts of ungrazed plant material may contribute to poor utilization of forage by the grazing livestock because usually they will eat out last year's old stems and leaves.

Moderate use: The most economically important forage plants have been fully grazed on the most popular parts of the management unit. Factors to be considered when determining proper use are: (1) species of grasses being grazed; (2) season of year the grass is grazed; (3) amount of growth made in the present year; and (4) amount of soil moisture this year.

Heavy use: The range has a "slippage" or matted appearance. Over half of the green and the yellow forage plants are grazed. This leads eventually to a decrease in forage production and range condition. Heavy use is directly harmful to plants and soil and indirectly to animals. Grasses are grazed short. As a result, the soil "food factories" are inefficient, roots are decreased in size and length, and plants die during the dry summer season or a severe drought. Heavy use results in unprofitable returns and reduces the value of the land for sale. The land may be ruined for many years by speed-wind water and wind erosion and by trampling. Grasses that are grazed short require three to five weeks of top growth before root growth begins.

Investigating Your Environment 
Range



Investigating Your Environment
Range

C. Retrieve Data

Conduct a discussion asking the following questions:

1. What utilization rate did you find?
2. What different rates did you find among the different grasses?
3. What could account for the different rates?
4. Of what value, if any, are the stubble and plant litter remains on a properly utilized range?

CLOSURE What have we found out about the use of plants (grasses) by livestock?

TRANSITION We have looked at how much use our range receives from livestock, now let's investigate the food value of range plants.



DETERMINE FOOD VALUE OF PLANTS FOR ANIMALS

CONCEPT	Cause/effect, change
PRINCIPLE	Plants are usually eaten by animals. In this activity, you'll explore the food value of different types of range plants.
OBJECTIVE	<ul style="list-style-type: none">• The student will be able to evaluate the value of certain food plants for their food value for grazing animals.
PREPARATION	Copy worksheets for each student
MATERIALS NEEDED	<ul style="list-style-type: none">• Activity sheet G: Food Plant Values for Animals
PROCESSES USED	<ul style="list-style-type: none">• communicate• infer• interpret data• observe
TIME	20 to 30 minutes



DOING THE ACTIVITY (indoors or outdoors)

A. Set Stage

"Plants have different food values for different animals".

B. Procedure

1. Hand out Activity Sheet G and have students get into pairs.
2. Students look at the plant value chart and the plants of the area, then complete the chart on the bottom of the activity sheet.
3. Allow 15 minutes.

ACTIVITY G: Food Plant Values for Animals

15 m in.
pairs

Use the range plant identification sheets and the chart below to complete the chart at the bottom of the page.

PLANT VALUE CHART

Value I - Poor II - Fair III - Good	Most plants on area	Small Mammals	Medium Mammals (Example Rabbit)	Hooved Browsers (Example Deer)	Birds (Example Sparrow)	Wild Game Birds (Example Quail)	Cattle	Wild Game Value

Based on the plants found in the area and the plant value chart above check the value of the plants for the animals listed.

Value of plants on area for food for animals

Animal	Value of plants on area for food for animals		
	poor	fair	good
Small mammals (Mouse)			
Medium mammals (Rabbit)			
Hooved browser (Deer)			
Birds (Sparrow)			
Game birds (Quail)			
Cattle			

Investigating Your Environment
Range 

C. Retrieve Data

Discuss findings:

1. What did you find?
2. Which animals would find the most food value here?
3. What might account for the different foods?

CLOSURE

What can we say about food values here?

TRANSITION

This activity is the beginning of a look at how different animals use and live in this area. Let's go to the next activity for a more in-depth look.



Investigating Your Environment
Range

WHOSE HOME IS THE RANGE?

- CONCEPT** Equilibrium, interaction, organism, population
- PRINCIPLE** Animals are often not seen. Instead, we catch hints of their existence — a tuft of fur on a branch, a footprint in wet sand, a smell or a sound. In this activity the student becomes a close observer of animals.
- OBJECTIVE** • The student will gather information about animals that live in the area and estimate the use the area receives.
- PREPARATION** Make wire hoops ahead of time. Copy Activity Sheet H and I. Make sure the site contains animal burrows.
- MATERIALS
NEEDED** • 5, 40" diameter wire hoops per group
• pencils
• screen box
• Activity Sheets H: Animal Evidence Survey and I: Investigate An Animal Burrow, for each student
• 12" rulers
• knife
- PROCESSES
USED** • classify
• communicate
• infer
• hypothesize
• question
• observe
• measure
• use numbers
- TIME** 40 to 60 minutes



DOING THE ACTIVITY (outdoors)

A. Set Stage

Animals are often not seen. Instead, we catch hints of their existence — a tuft of fur on a branch, a footprint in wet sand, a smell or a sound. In this activity the student becomes a close observer of animals.

“We’re sitting here now, but who or what was here at 5:00 AM and what will be here at tonight after we’re gone? If we look carefully, we may be able to find out.

B. Procedure

1. Distribute Activity Sheets H and I (should be copied back-to-back) to students while they group themselves.

15 in. pairs

ACTIVITY H: Animal Evidence Survey

Observe and record evidence of animals. Make a wire hoop 40" diameter. Five hoops equals about 1/1000 of an acre. Take 5 samples by throwing your hoop out in 5 different places. **ACTIVITY I: Investigate an Animal Burrow**

30 in. groups

Locate an abandoned animal burrow such as kangaroo, rat or mouse. Dig out the burrow, record information and sketch the burrow below.

Type of Sign	Animal that made it	Number of Signs
EXAMPLE: Web	Spider	2
EXAMPLE: Tracks	Horse	4

1. Draw a Profile Sketch

--	--	--	--	--	--	--	--	--	--

Soil Information— (Soil Activity C)

color _____

texture _____

structure _____

depth _____

temperature _____

pH _____

(repeat as necessary for different layers)

2. Animal Stored Foods and Remains of Caches

As you find evidence of stored foods or remains of caches, record:

Name of plant	Evidence found	Distance and direction to plant source

3. Other Animal Evidence

List and describe other evidences such as droppings, bones, hair, etc.

4. On the back side of this page, write a description of the burrow and what animals you think built and lived there. Consider types of construction, foods used, different parts of burrow used for different purposes, etc.

Investigating Your Environment Range UAS



2. Distribute wire hoops. Model and verbally explain the hoop tossing procedure as well as how to record data.
3. Allow about 20 minutes to complete the activity, including calculations.
4. Gather group back together, explain Activity I. Make sure they know the instructions are on the activity card.
5. Allow 20 or so minutes to finish "I".

C. Retrieve Data

1. Conduct a discussion, record data, if and where you think appropriate.
2. Question for Activity H, Animal Evidence Survey
 - a. What did you find?
 - b. What animals did you find the most evidence of? the least?
 - c. What might account for the differences you found?
 - d. How might the evidence be different if this were during an other time of the year?
3. Questions for Activity I, Burrow Investigation.
 - a. How would you describe your burrow?
 - b. What can you say about the habitats of the animals that lived there?
 - c. How does the animal and burrow affect the area?

CLOSURE

How can we summarize our discussions and investigations?
Go back over all that you did to form a conclusive picture.
How would you summarize the processes we used?



MAP THE RANGE (OPTIONAL)

- CONCEPT** System, change, interaction, population
- PRINCIPLE** Range sites are most easily recognizable on the basis of their vegetative and soil characteristics. On all but the most severely depleted ranges, sites are most easily recognized by similar plant communities which cover them. Each range site is thought of as a separate part of the range for management purposes. Since each range site grows different plant combinations, each site should be judged separately.
- OBJECTIVE** • The student will use skills learned in the "Measuring the Environment" lesson to construct a map of the area studied.
- PREPARATION** Gather materials used in measuring lesson plans so students know what's needed. Review skills used in measuring lesson so you can help students. Establish minimum criteria for a finished product.
- MATERIALS
NEEDED** • compass
 • instant mappers
 • cardboard box
 • plane tables
 • pencils
 • paper
 • tape measures
- PROCESSES
USED** • classify
 • communicate
 • formulate model
 • interpret data
 • measure
 • observe
 • use numbers
 • use time-space relationships
 • scale
- TIME** two to three 45 minute class periods (estimate)



DOING THE ACTIVITY (outdoors, on site)

A. Set Stage

Range sites are most easily recognizable on the basis of their vegetative and soil characteristics. On all but the most severely depleted ranges, sites are most easily recognized by similar plant communities which cover them. Each range site is thought of as a separate part of the range for management purposes. Since each range site grows different plant combinations, each site should be judged separately.

"We will map out range site using knowledge and skills learned in a previous investigation."

B. Procedure

Use the skills learned in the "Measuring the Environment" lesson plan, construct a map of your area such as the sample below. Work in groups of 4. Allow two to three 45 minute periods.

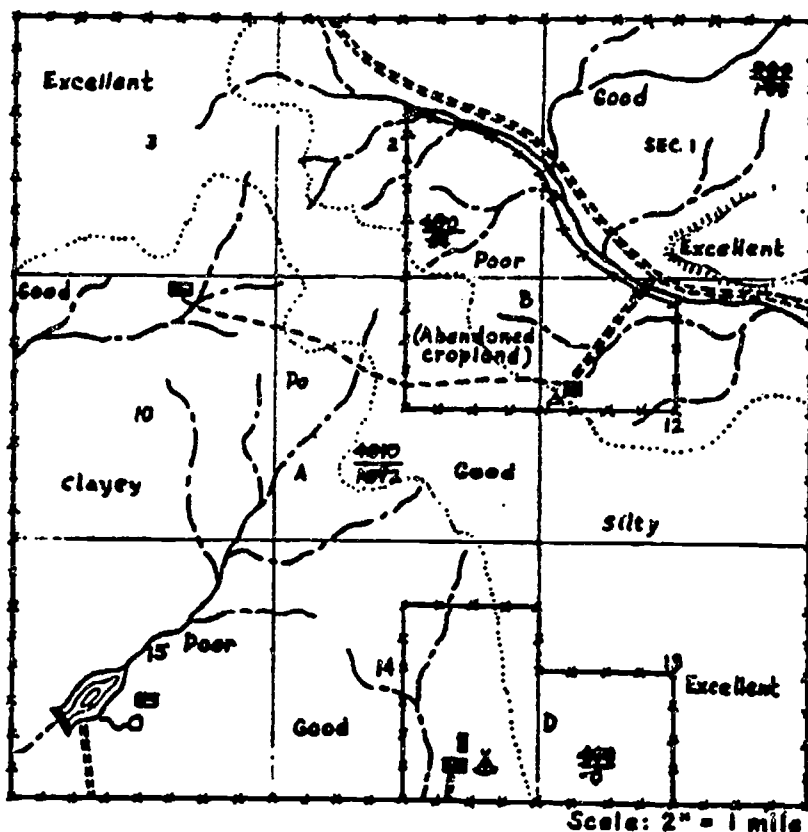

- | | |
|---------------------------|--|
| ■ Building | == Public road |
| ▣ Salt trough | --- Private road |
| ⊙ Windmill | - - - Trail |
| ○ Natural spring | — Permanent stream |
| ⊕ Spring developed | - - - Intermittent stream |
| — Fence | ⊘ Cliffs |
| D Pasture or field number | ⊕ Stock water or reservoir |
| Po Poisonous plants | Excellent, good, fair, or poor = Range condition |
| | ⋯ Site boundaries |



C. Retrieve Data

In the discussion of each map, find out:

1. How did you map your area?
2. How do the maps you made differ?
3. What could account for the differences?
4. How could your map be helpful in planning for the future of the area?

CLOSURE

What can we say about rangelands from our investigations?



ACTIVITY A: Observe the Range Environment

15 min.
individuals

As you investigate the study area, observe and record your observations.

Soil











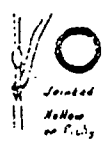
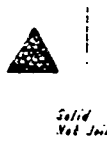
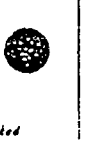
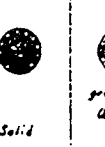

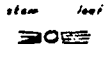
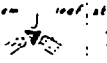
Rocks

Air

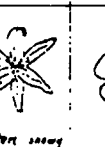
Plants

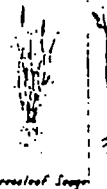
Animals

ACTIVITY B: Range Plant Inventory Identification Sheet

IMPORTANT RANGE PLANT GROUPS					
	GRASSES	GRASSLIKE		FORBS	SHRUBS (Browns)
		Sedges	Rushes		
SYSTEMS	 Jointed Hollow or Pithy	 Solid Not Jointed	 Solid	 growth rings Woody Solid	
LEAVES	 Parallel Veins			 Veins are family netlike	
	 stem leaf stem	 leaf stem	 leaf stem leaf		
	Leaves on 2 sides of stem	Leaves on 3 sides of stem	Leaves on 2 sides of stem, rounded		
FLOWERS	 (Floral)	 Stamen pistil male female (may be combined)			
			Often stony		
EXAMPLE	 Western Bluegrass	 Arrowleaf Sage	 Rice Rush	 Narrowleaf Yarrow	 Big Sagebrush

Definitions:
litter--plant debris on ground surface.
annual grass--lives for a single year and depends on seeds for reproduction.
perennial grass--lasts from year to year from the same root base.
forb--wildflowers and "weeds"
shrub--persistent woody plant smaller than a tree.

Examples of Green Group plants (decreasers)

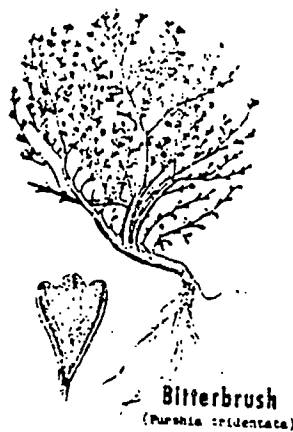
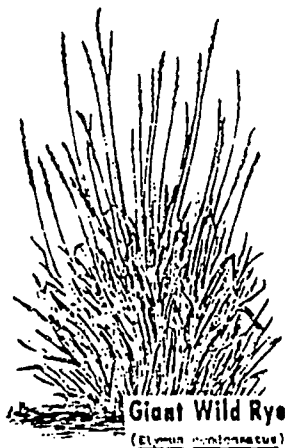

ACTIVITY B: Range Plant Inventory

pairs

Describe or name in the appropriate column below the plants found on your study area. Classify the annuals and perennials. Use the Range Plant Identification chart as necessary.

	Grasses	Grasslike	Forbs	Shrubs
perennial				
annual				



Range Plants

Samples of the Yellow Group Plants
(Increasers)

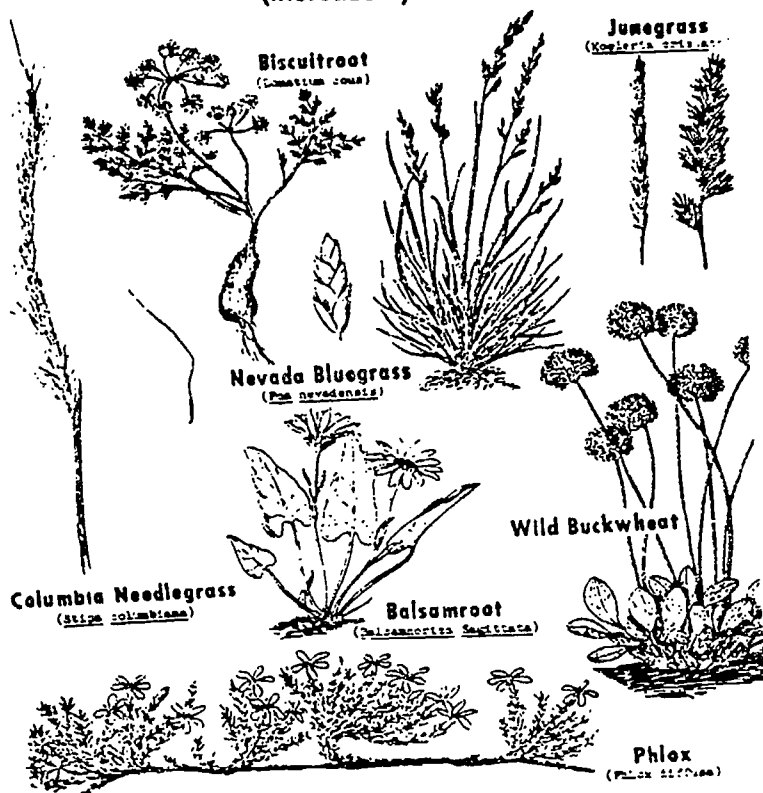

Samples of the Yellow Group Plants
(Invaders)

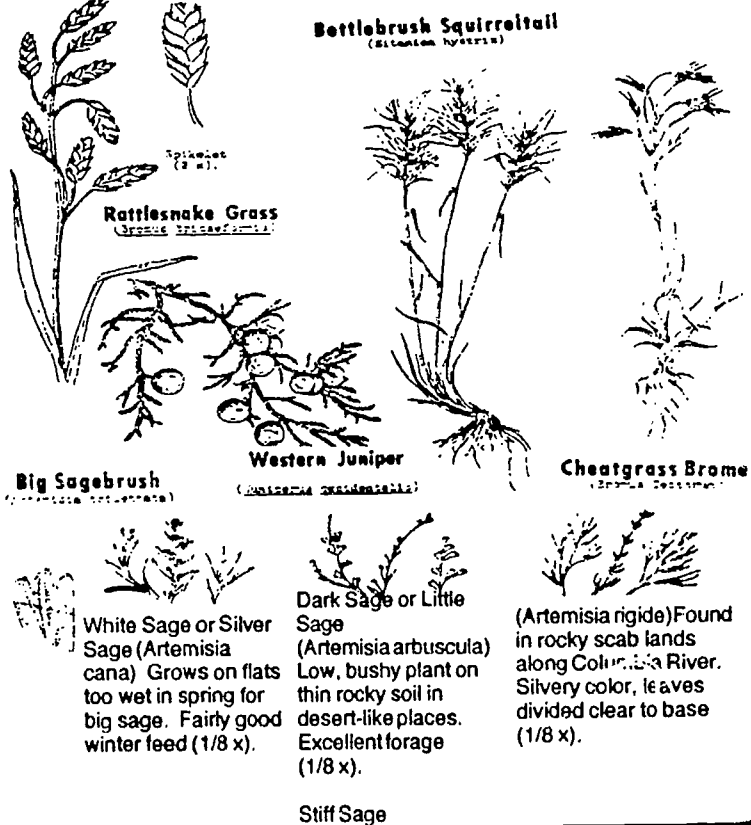

White Sage or Silver Sage (*Artemisia cana*) Grows on flats too wet in spring for big sage. Fairly good winter feed (1/8 x).

Dark Sage or Little Sage (*Artemisia arbuscula*) Low, bushy plant on thin rocky soil in desert-like places. Excellent forage (1/8 x).

(*Artemisia rigida*) Found in rocky scab lands along Columbia River. Silvery color, leaves divided clear to base (1/8 x).

Stiff Sage

ACTIVITY B: Range Plant Inventory - Identification Sheet

DECREASERS



Arrowleaf Balsamroot
(*Balsamorhiza sagittata*)

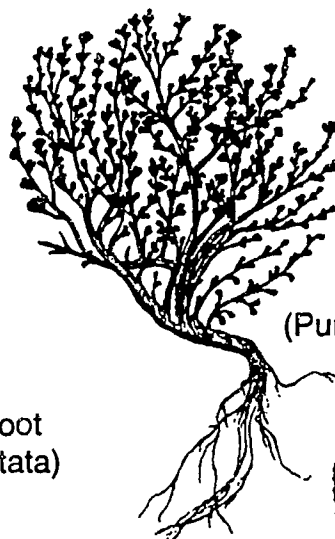

Bitterbrush
(*Purshia tridentata*)

Bluebunch Wheatgrass
(*Agropyron spicatum*)

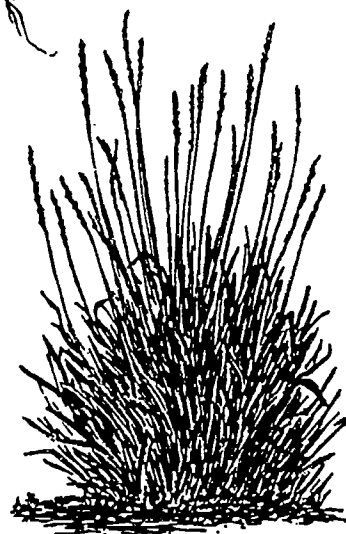

Giant Wild Rye
(*Elymus condensatus*)

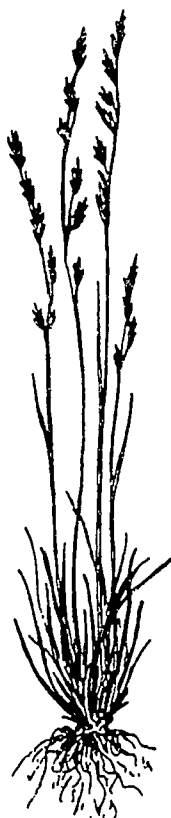

Idaho Fescue
(*Festuca idahoensis*)

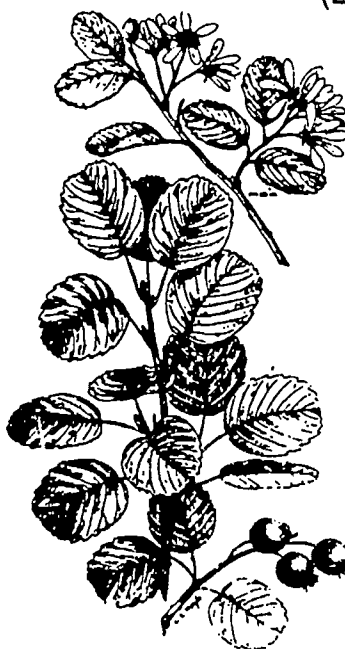

Saskatoon Serviceberry
(*Amelanchier alnifolia*)

ACTIVITY B: Range Plant Inventory - Identification Sheet

INCREASERS

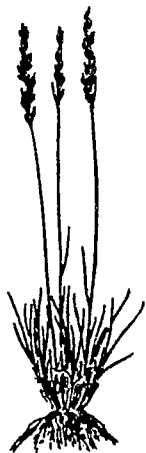

Sandberg's Bluegrass
(*Poa secunda*)



Western Needlegrass
(*Stipa occidentalis*)



Prairie Junegrass
(*Koeleria cristata*)



Biscuitroot
(*Lomatium cous*)



Western Yarrow
(*Achillea millefolium*)



Phlox
(*Phlox diffusa*)

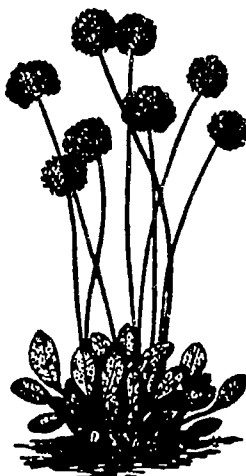

Wild Buckwheat
(*Eriogonum ovalifolium*)



Slivery Lupine
(*Lupinus argenteus*)



Bittercherry
(*Prunus emarginata*)



Snowbrush
(*Ceanothus velutinus*)



Showy Aster
(*Aster conspicuus*)



Pearly Everlasting
(*Anaphalis margaritacea*)

ACTIVITY B: Range Plant Inventory - Identification Sheet

INVADERS



Cheatgrass Brome
(*Bromus tectorum*)



Bottlebrush Squirreltail
(*Sitanion hystrix*)



Rattlesnake Grass
(*Bromus brizaeformis*)



Bull Thistle
(*Cirsium vulgare*)



Mullein
(*Verbascum thapsus*)



Broom Snakeweed
(*Gutierrezia sarothrae*)

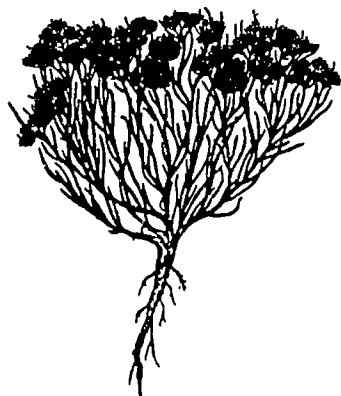

Rubber Rabbitbrush
(*Chrysothamnus nauseosus*)



Big Sagebrush
(*Artemisia tridentata*)



Western Juniper
(*Juniperus occidentalis*)

ACTIVITY C: Transect Survey

45 m in.
groups

Working in groups, stretch a 100 foot tape along the ground where you want to inventory the types of plants of your area. Record what you find at each foot along the transect by putting a check (✓) in the appropriate column.

Sample Every Foot										Sample Every Foot									
	Rock	Bare Soil	Litter	Annual Grass	Per. Grass	Forb	Shrub	Trees	Animal Signs		Rock	Bare Soil	Litter	Annual Grass	Per. Grass	Forb	Shrub	Trees	Animal Signs
1										51									
2										52									
3										53									
4										54									
5										55									
6										56									
7										57									
8										58									
9										59									
10										60									
11										61									
12										62									
13										63									
14										64									
15										65									
16										66									
17										67									
18										68									
19										69									
20										70									
21										71									
22										72									
23										73									
24										74									
25										75									
26										76									
27										77									
28										78									
29										79									
30										80									
31										81									
32										82									
33										83									
34										84									
35										85									
36										86									
37										87									
38										88									
39										89									
40										90									
41										91									
42										92									
43										93									
44										94									
45										95									
46										96									
47										97									
48										98									
49										99									
50										100									

ACTIVITY C: Transect Survey (continued)

Transect Survey (Continued)

Summarize your data below:

Item	Record the total # of ✓s from chart for each item below.
Rock	
Bare soil	
Litter	
Annual grass	
Perennial grass	
Forb	
Shrub	
Trees	
Animal sign	

Totals

(The # of ✓s for each item is equal to the percentage of the total for that item.)

Which column had the greatest percentage coverage _____, the least _____.

Which plants if any tend to be associated with certain areas, such as bare places, rocks, protective shrubs, etc.? _____

What reasons might account for this? _____



ACTIVITY D: Infer Range Health or Condition

15 min.
pairs

Use the data gathered in Activity C and the information below to determine the range condition class of this range.

TECHNICIANS' GUIDE TO RANGE CONDITION CLASSES

Green-Group Plants	Yellow-Group Plants	Red-Group Plants
<p>DECREASERS: Plants that disappear when range is abused. Percentage figures indicate approximate amount found in climax for the site but count all found on site as climax.</p> <p>60% Bluebunch wheatgrass 5 Idaho fescue T Giant wild rye 5% Bitterbush</p>	<p>INCREASERS: Plants that increase when range is abused. Percentage figures indicate approximate amount found in climax for the site, so count no more than amount shown toward climax.</p> <p>15% Sandberg bluegrass 5 Western needlegrass 2 Prairie junegrass</p> <p>10% Max. in aggregate 1 Biscuitroot 2 Yarrow 2 Phlox 1 Buckwheat 1 Silver lupine 1 Serviceberry 1 Arrowleaf balsamroot 1 Bitter cherry 1 Snowbrush 1 Showy aster 1 Pearly everlasting</p>	<p>INVADERS: Plants that invade when range is abused. These did not occur in climax, so none of these are counted toward climax.</p> <p>Cheatgrass Brome Squirreltail Rattlesnake grass</p> <p>Bull thistle Mullein Broom snakewood</p> <p>Rubber rabbitbrush Big sagebrush Western Juniper</p>

Condition: Excellent Good-to-Fair Poor

Our area is in the green, yellow, red group plant condition—(circle one) because of the following plants found there _____

This would mean that the condition of the range is excellent, good to fair, poor, because

Inverring Range Health Or Condition (Continued)

The Green Group—Plants in this group are the most desirable; the ones that live-stock like best. When you see the green-group plants in abundance on the range, you know your grazing program is going well. The green-group plants consist of those which are plentiful, in excellent condition on native range, and are the first to decrease if range conditions is forced down to "good," "fair," and finally to "poor" range. Range in the poorest condition has very few green-group plants on it.

The Yellow Group—These are also native plants, but they are less attractive to livestock. They escape grazing because they are short or because they are less tasty to livestock. Yellow-group plants are the ones to watch with "caution." They replace the green-group plants which have become smaller and weaker.

The range manager uses caution when he sees the number of yellow-group plants increasing on his range. He is safe if they are being replaced by green-group plants. That means the range is improving.

If heavy grazing continues, the yellow-group plants begin to weaken and die out. Their place is taken by the red-group plants.

The Red Group—These plants really do not need any explanation. They simply mean "danger" to the range, so far as production is concerned. These plants are usually annuals or unpalatable species which have come in from other areas and occupy the range as invaders.

Red-group plants seldom, if ever, are as effective in controlling soil erosion and conserving water resources as the native plants which are more abundant when the range is in good or excellent condition. Soil and water losses cause nature's plant and soil development process to go in reverse. The range becomes less healthy and less productive.

ACTIVITY E: Range Trend Indicators*

Indicators of Upward Vegetation Trend

1. Desirable and intermediate forage plants becoming more abundant.
2. Desirable and intermediate forage plants invading bare ground or stands of undesirable plants. A variety of all age classes of better forage plants must be present.
3. Establishment of perennial plants on erosion pavement.
4. Several years of vigorous growth on browse.
5. Decreaser plants increasing and vigorous. Grasses with long green leaves, and numerous healthy seed stalks.
6. A well dispersed accumulation of litter.

Indicators of Upward Soil Trend

1. Gullies approaching the angle of repose and healing.
2. Gullies stabilizing by the growth of perennial vegetation on both sides and bottom.
3. Soil remnants having sloping sides or sides covered with mosses, lichens, or higher plants.
4. Terraces characterized by sloping sides which are being covered with vegetation. Tops of terraces should be occupied by perennial plants.

Indicators of Downward Vegetation Trend

1. Desirable and intermediate species decreasing in vigor.
2. Lack of young plants from desirable and intermediate species.
3. Invasion by undesirable species.
4. Hedged and highlined shrubs. Dead branches generally indicating that shrubs are dying back.
5. Litter scarce and poorly dispersed.

Indicators of Downward Soil Trend

1. Rill mark, small active gullies that indicate shrubs are dying back.
2. Active gullies. Established gullies are raw and actively cutting. This type of gully may vary from a few inches to several feet in depth.
3. Alluvial deposits. Soil material transported and laid down by running water.
4. Soil remnants. Original topsoil held in place by vegetation or plant roots.
5. Active terraces. Terraces usually caused by hooves of animals. They are "stair step-like" in appearance on slopes.
6. Exposed plant crowns or roots (pedestalled plants).
7. Wind-scoured depressions between plants.
8. Wind deposits.

* Forest Service Range Environmental Analysis Handbook

ACTIVITY E: Range Health and Condition Information

Observers _____ Date _____

_____ Location _____

Plants	%
bluebunch wheatgrass	
Idaho fescue	
Sandberg bluegrass	
Cheatgrass	
Other	
Forbs	
Yarrow	
Phlox	
Balsam	
Carrot	
Other	
Shrubs and trees	
Total Usable Plants	

Condition Indicators (from Activity D)	
Condition class based on vegetation:	
Excellent	_____
Good to Fair	_____
Poor	_____

• Other

• Slope: steep **Exposure:** North
 gradual East
 flat West
 South

• Soil erosion: some
 none

• Litter: many
 some
 none

• Trend Indicators
Health or Vigor of green-group (based on your observation).

healthy ____ average ____ sick ____

Seedlings and young key (green group) forage plants.

abundant ____ some ____ none ____

Seedlings and young key increasers (yellow group) and invaders (red group).

abundant ____ some ____ none ____

• Final trend rating:

improving _____

stable _____

going down _____



ACTIVITY F: Evaluate Range Utilization

For some grasses, the proper use is considered removal of about one-half of the growth made in the present year. While proper use must be considered in the light of the above-named factors, "taking half and leaving half" can sometimes be used as a "rule of thumb."

To determine the amount of stubble left when one-half the growth is removed, follow these steps:

1. Wrap an average-sized, mature, ungrazed plant with string to hold it together when cut.
2. Cut off plant at crown (ground level).
3. Adjust the wrapped plant across a knife blade to make it balance. Measure with ruler from bottom of plant to point of balance. This gives height, indicating 50 percent use for that particular species of grass. Desirable approximate stubble heights for some native grasses are:

Grass	Inches stubble left
Bluebunch wheatgrass	4-8
Idaho fescue	2-4
Big bluegrass	3-5

4. Repeat this for 10 average plants of a species to get an average.
5. Select 100 plants randomly, measure their heights (whether grazed or not), and average the measurements. If the average grazed height is more than the standard shown above, the range is not fully used. If it is less, the range is overused.

Grass	Inches stubble left	Utilization rate heavy-moderate-light

Definition of Utilization Rate

Light use: Only choice plants are grazed. Only a small amount of the less desirable forage plants are consumed, thereby wasting much valuable forage. Ungrazed plants and heavy litter build-up may result in serious fire hazard. Also, excessive amounts of unused plant material may contribute to poor utilization of forage by the grazing livestock because usually they will not eat last year's old stems and leaves.

Moderate use: The most economically important forage plants have been fully grazed on the most popular parts of the management unit. Factors to be considered when determining proper use are: (1) species of grasses being grazed; (2) season of year the grass is grazed; (3) amount of growth made in the present year; and (4) amount of soil moisture this year.

Heavy use: The range has a "clipped" or mowed appearance. Over half of the green and the yellow forage plants are grazed. This leads eventually to a decrease in forage production and range condition. Heavy use is directly harmful to plants and soil and indirectly to animals. Grasses are grazed short. As a result, the leaf "food factories" are inefficient, roots are decreased in size and length, and plants die during the dry summer season or a severe drought. Heavy use results in unprofitable returns and reduces the value of the land for sale. The land may be ruined for many years by speeded-up water and wind erosion and by trampling. Grasses that are grazed short require three to five weeks of top growth before root growth begins.



ACTIVITY G: Food Plant Values for Animals

15 m in.
pairs

Use the range plant identification sheets and the chart below to complete the chart at the bottom of the page.

PLANT VALUE CHART

Value: X - Poor XX - Fair XXX - Good	Check plants on area	Small Mammals	Medium Mammals (example Rabbit)	Hoofed Browsers (Example Deer)	Songbird (Example Sparrow)	Upland Game birds (Example Quail)	Cattle	Watershed Value
Grasses:								
	cheatgrass crested	X	X	XX	X	XXX	XX	X
	wheatgrass	X	X	XX	X	X	XXX	XXX
	squirreltail	X		X	X	X	XXX	XXX
Forbs:								
	bull thistle	X	X		X	X	X	X
	lettuce		XX		X	XXX		X
	mustard				X	X		X
	pepper grass	X			X			X
	pigweed	X	X		X	X		X
	Russian thistle	X	X	X	X	X	X	X
Shrubs:								
	rabbit brush			X				XX
	sagebrush		X	XXX		XX		XX

Based on the plants found in the area and the plant value chart above check the values of the plants for the animals listed.

Value of plants on area for food for animals

Animal	poor	fair	good
Small mammals (Mice)			
Medium mammals (Rabbits)			
Hoofed browser (Deer)			
Song birds			
Game birds (Quail)			
Cattle			



ACTIVITY H: Animal Evidence Survey

15 m in.
pairs

Observe and record evidences of animals.

Make a wire hoop 40" diameter. Five hoops equals about 1/1000 of an acre. Take 5 samples by throwing your hoop out in 5 different places. Record the evidences of animals found within each hoop area below.

(Multiply total animal signs by 1,000 to get number per acre).

Numbers of individual signs (such as rabbit pellets) may be convenient to work with. For small social insects such as an ant, record number of anthills, active or inactive.

Type of Sign	Animal that made it	Number of signs/hoop					5-hoop total	Multiply by 1,000	Approx. #/acre
		1	2	3	4	5			
EXAMPLE: Web	Spider	2	0	4	3	0	9	1,000	9,000
EXAMPLE: Tracks	Horse	4	0	0	0	0	4	1,000	4,000

1. What other types of animal evidence do you observe in your plot?

2. What certain types of signs are most often associated with particular kinds of plants?

3. From the evidence found, are small (jackrabbit size or less) or large animals found in greater numbers of your area? Why?

ACTIVITY I: Investigate an Animal Burrow

Locate an **abandoned** animal burrow such as kangaroo, rat or mouse. Dig out the burrow, record information and sketch the burrow below.

1. Burrow Profile Sketch

Soil Information—
(Soil Activity D)

color _____
 texture _____
 structure _____
 depth _____
 temperature _____
 pH _____

(repeat as necessary
for different layers)

2. Animal Stored Foods and Remains of Caches

As you find evidences of stored foods or remains of caches, record:

Name of plant	Evidence found	Distance and direction to plant source

3. Other Animal Evidence

List and describe other evidences such as droppings, bones, hair, etc.

4. On the back side of this page, write a description of the burrow and what animals you think built and lived there. Consider types of construction, foods used, different parts of burrow used for different purposes, etc.



BEST COPY AVAILABLE

Investigating Your Environment — Intermountain Region



INTRODUCTION

Riparian zones or areas have been defined in various ways, but essentially they consist of fairly narrow strips of land that border creeks, rivers, lakes, or other bodies of water. Plant species, soil types, and topography are very distinctive when compared to the surrounding, drier upland area.

Although riparian areas generally occupy only a small percentage of the area of a watershed, they are extremely important components of the ecosystem. A healthy riparian area provides excellent habitat including forage for fish and wildlife, increases groundwater recharge, reduces flooding, and often increases the overall quality of the adjacent waterway.

The purpose of this unit is to identify the characteristics and benefits of productive riparian systems, to promote awareness of the importance of riparian areas, and to introduce students to the need for effective riparian management.

THE ACTIVITIES

TIME REQUIRED

Introduction to Riparian Areas	30 minutes
Riparian Areas and Watersheds	20-30 minutes
A Transect of Riparian Vegetation	90-120 Minutes
Wildlife Blind	45 - 60 Minutes (can be repeated)
Riparian Assessment	60 minutes

COMBINING THE ACTIVITIES

The activities can be combined in any manner depending on time available, knowledge and level of students. It is recommended that students complete the first activity if they are to participate in the "Riparian Evaluation."

The last three activities generally require access to a riparian area. If none is available near your school or meeting location, you may consider a field trip in order to allow students to do any of the last three activities listed above.



CURRICULUM RELATIONSHIPS

Social Studies

1. Find out what government agencies are involved with riparian area management. Write a paper describing how they identify and manage riparian habitats.
2. "Adopt" a disturbed riparian area (perhaps in conjunction with other school groups) with the help of a public agency.

Science

1. Conduct physical and/or biological tests of the water quality in the waterway surrounded by the riparian zone.
2. Establish a year-round, perennial study to determine whether the riparian area changes seasonally, and in what ways.

Mathematics

1. Using a map of your state, calculate the percent of land which is considered to be riparian.
2. Assuming the data you calculated in the transect study was accurate, calculate the relative percentage of plant types in the transect study area.

Language Arts

1. Write a persuasive paper to ranchers encouraging them to consider restricting their cattle from grazing in riparian areas.
2. Write and illustrate a short children's book which introduces the audience to the riparian area.

Creative Arts

1. Make a poster that shows the stages a riparian area goes through as it matures.
2. Make stationery illustrating various plants and/or animals found in the riparian area.
3. Work with other students to construct a mural or diorama that displays the features and benefits of the riparian system.



INTRODUCTION TO RIPARIAN AREAS

CONCEPT	Change, System, Interaction
PRINCIPLE	Participants use their observation skills to identify typical characteristics of undisturbed and disturbed riparian systems.
OBJECTIVE	<ul style="list-style-type: none">• The student will be able to identify, list and discuss qualities of a healthy riparian area.
PREPARATION	Facilitator should photocopy Activity Sheet A and be familiar with characteristics and function of riparian areas before the activity.
MATERIALS USED	<ul style="list-style-type: none">• Activity Sheet A: Introduction to Riparian Areas• pens or pencils
PROCESSES USED	<ul style="list-style-type: none">• Observe• Infer
TIME	30 minutes



DOING THE ACTIVITY (indoors)

A. Set the Stage

The features of a riparian area -- plants and animals present, stream flow, bank slope and stability, etc -- are the result of not only the physical conditions of the area, but of the presence or absence of disturbances, such as livestock grazing. Like most areas, riparian systems have been changed dramatically because of disturbances. The result is almost always a system that provides less environmental benefits.

The purpose of this activity is to introduce students to the various characteristics of riparian zones by contrasting typical qualities of simple (disturbed) areas with complex (healthy, undisturbed) riparian regions. Hand out Activity A: Introduction to Riparian Areas. Tell them they will do the activity by themselves and that they have 30 minutes to complete the activity. NOTE: The activity sheet is intentionally left vague as to which one is "disturbed" or "undisturbed." Lead a discussion on characteristics of "disturbed" and "undisturbed" areas.

30 min.
Individual

ACTIVITY SHEET A: Introduction to Riparian Areas

Introduction: Below are two illustrations, one of a riparian system disturbed by human or grazing activity, and a second illustration of an undisturbed riparian area.

Directions: Below the illustrations is a chart. Your task is to complete the chart based on your observations of the illustrations. When you have completed this, you will have identified the typical qualities that make a riparian system either healthy or degraded.

Characteristics	Disturbed System	Undisturbed System
Vegetation		
Stream Flow		
Water Temperature		
Habitat/Forage		
Wildlife Diversity		
Topography		
Other		

Investigating Your Environment
Riparian



Investigating Your Environment
Riparian

355
4

BEST COPY AVAILABLE

B. Retrieve Data

After students have completed Activity Sheet A, ask students the following:

1. What are the important features of riparian areas compared to other natural areas?
2. Ask students to compare the characteristics of undisturbed vs. disturbed riparian areas.
3. Would more streamside plants be important to fish and bank stability? Why?
4. What factors might be responsible for disturbing riparian areas?
5. Using the factors discussed in question number 4, have students brainstorm possible solutions.
6. Ask students to list as many riparian areas near their community as they can think of. How do these areas differ from one another? How are they similar?

CLOSURE Discuss why it is important to protect riparian areas.

TRANSITION Riparian areas are often a watershed and, by definition, part of a larger watershed. Now that we have seen some general characteristics of riparian areas, let's look at the key role of riparian systems in watersheds.



RIPARIAN AREAS AND WATERSHEDS

CONCEPT	Cause-Effect, Interaction, System
PRINCIPLE	Participants observe the importance of watershed protection.
OBJECTIVE	The student will construct a model watershed and analyze its ability to control erosion.
PREPARATION	Facilitator needs to select a site where watershed construction is possible. A sandy area is optimal. A knowledge of watersheds and the essential elements for healthy watersheds is important.
MATERIALS USED	<ul style="list-style-type: none">• Trowels or small shovels• Watering Can• Ground cover such as sticks, leaves and grass
PROCESSES USED	<ul style="list-style-type: none">• Observe• Define Operationally• Hypothesize• Control variables• Predict• Formulate models• Communicate
TIME	20-30 minutes



DOING THE ACTIVITY (outdoors)

A. Set the Stage

All of the land area that is drained into a body of water is a watershed. A watershed may be as small as a single field or as large as several states. The watershed of the Mississippi River, for example, includes almost half of the United States.

A watershed made up of land without plants will not soak up water. Since there are no plants to hold the soil together, soil is washed into the streams and reservoirs. Muddy water can run off rapidly and cause floods. A healthy watershed can prevent this by absorbing and storing this runoff.

The purpose of this next activity is to see how a healthy watershed can reduce erosion.

B. Procedure

1. Divide class into groups of four.
2. Hand out two shovels/trowels to each group.
3. Instruct the groups to discuss those qualities that make a watershed healthy.
4. After they have discussed this tell the groups that they will have 15 minutes to construct one healthy and one unhealthy watershed. The general watershed shape should be defined by several streams that drain into a common river. Watershed health will be tested by the teacher as she/he simulates a severe rain storm using a watering can.
5. Stress to students that materials for ground cover may be collected from the surrounding area but that they may not uproot growing plants.
6. When all groups have finished making their model watersheds, gather the class together. Visit each watershed site, where the teacher will "rain on" the watersheds one at a time, while students observe the result.

C. Retrieve Data

Discuss the following with the entire group:

1. Identify the watershed(s) that provided the best protection from erosion. What made these watersheds better than others?
2. How do watersheds affect the water quality of a water system?
3. What human activities damage the health of watersheds? Which ones help to maintain them in a healthy state?
4. How are cities affected by their watershed? What might happen if several of the small streams draining into an urban area's watershed were polluted from livestock or mining operations?
5. Generate a list of positive things that can be done to maintain and protect watersheds. Try to include items that could be done in the local area.

CLOSURE How do the narrow riparian strips along each stream contribute to the function and health of the watershed?

TRANSITION In the next activity, participants will conduct a transect study of a riparian area and then pool their data to show vegetative bands.



A TRANSECT OF RIPARIAN VEGETATION

CONCEPT	Organism, Population, System
PRINCIPLE	Participants will record plants located along a transect established perpendicular to a stream or shoreline on regular interval.
OBJECTIVE	<ul style="list-style-type: none">• Students should be able to identify and record vegetation types located along a transect.• Students should be able to describe the relationship between vegetation and the water system, and explain vegetation zones.
PREPARATION	<p>Facilitator needs to select a suitable riparian area for this activity. The ideal site would be a creek or stream with at least three distinct vegetation zones running generally parallel to it.</p> <p>The facilitator also needs to set up a number of transects equal to the number of small groups that will be gathering data. Transects should run perpendicular to the bank or shore and parallel to each other at 5 meter intervals. This distance is not critical. The length of the transect will vary based on the site. It needs to be long enough to encompass the desired vegetative bands; generally 10-25 meters on each side of the water should be sufficient. Data can be gathered only on one side, if desired. This is recommended for lakes or other large water bodies.</p> <p>If it is desired that students identify species of plants, some advance training is required, and reference materials i.e., identification guides, such as books, drawings, or collections, should be provided. Otherwise, identifying general plant types (sedges, shrubs, trees) will probably yield satisfactory data.</p>
MATERIALS USED	<ul style="list-style-type: none">• Stakes for transects (4-6 per transect)• Flagging (optional)• Plant identification references• Activity Sheet B: Transect of Riparian Vegetation• Metric tape• pens or pencils• 1m x 1m sampling square frame, hula hoops or string can be used
PROCESSES USED	<ul style="list-style-type: none">• Classify• Measure• Infer• Interpret Data
TIME	90-120 Minutes

DOING THE ACTIVITY

A. Set the Stage

As you walk away from a stream or lake, the plant community often changes quickly and dramatically. Along the bank you are likely to find plants that are able to survive frequent flooding. Next are plants that thrive in soggy soils, but may not be able to withstand flooding. Finally you will encounter plants that do not require much water at all. You may find four or five distinct "bands" of plants within this riparian transition area.

In this activity students will gather data along a plant transect that runs perpendicular to the bank or shore of a waterway. Several small groups will work along parallel transects, recording the most dominant plant found in a one square meter frame. Later, all data will be joined to construct a map of the plant "zones" that are present in the riparian system.

B. Procedure(Inside)

1. Divide class into the the same number of small groups as there are transects. Assign each group to one transect.

2. Distribute to each group: hand-sketched map of area; metric measuring tape, frames, pens or pencils, reference materials as required, Activity Sheet B.

3. Stress any necessary safety and environmental concerns.

(Outside)

4. Place the sampling square along the transect line at 1 meter intervals. Always place one side of the frame along the right side of the transect as you move away from the water.

ACTIVITY SHEET B: A Transect of Riparian Vegetation

90-120 min.
small groups

Use this sheet to record the dominant plant type found at each step. Record data from a transect of up to 25m in length on each side of the stream or waterway (total 50 meters). The 25 steps on the "+" (left) column should be on one side of the waterway, while the other 25 steps correspond to the other side. Step numbers correspond to meters from the water; therefore, the #1 (both + and -) samples are a single meter from the water, while the 25th step are 25 meters from the water.

Transect # _____

Group Members _____

Step #	Dominant Plant
+1	
+2	
+3	
+4	
+5	
+6	
+7	
+8	
+9	
+10	
+11	
+12	
+13	
+14	
+15	
+16	
+17	
+18	
+19	
+20	
+21	
+22	
+23	
+24	
+25	

Step #	Dominant Plant
-1	
-2	
-3	
-4	
-5	
-6	
-7	
-8	
-9	
-10	
-11	
-12	
-13	
-14	
-15	
-16	
-17	
-18	
-19	
-20	
-21	
-22	
-23	
-24	
-25	

Investigating Your Environment
Riparian



Investigating Your Environment
Riparian

360

5. Record the name or description of the single most dominant type of plant located within the frame. If plants appear to be co-dominant, name them both. If you can't get the frame around the plants, draw a one meter square line in the soil with a stick. Use the frame to measure the line.
6. Continue until the entire transect has been sampled at 1m intervals.

C. Retrieve Data

Gather the class together. (Indoors)

1. Next, have a large map (hand-sketched is fine) of the water and transect lines on display for all to see. The map should be on a grid with each line representing 1m.
2. Have a representative from each group place a dot along their transect line wherever the dominant plant type changed.
3. Once the dots are on the map, a single word that describes the plant type (e.g., "sedge") should be written between the dots.
4. Next, connect the dots vertically for similar plant types to illustrate the vegetative zones in the area. Only connect dots of plants that occur in at least three transects, and where connecting these will not bisect another zone.
5. Make up a legend for the map.

CLOSURE Ask the students;

1. What were the predominant vegetative zones in the riparian area?
2. What kinds of adaptations would you expect plants from different zones to possess?
3. What environmental factors account for these distinct bands of plants?

TRANSITION Now that we have looked at the plant communities present in the riparian area, we are going to use an observation blind to look for wildlife.



WILDLIFE BLIND

CONCEPT Organism, Population, Evolution

PRINCIPLE Participants will observe and record wildlife in the riparian zone and discuss factors important to wildlife that may be influenced by humans.

OBJECTIVE

- Students will demonstrate observation and data gathering skills by recording wildlife observed.
- Students will be able to describe the relationship between riparian zones and animal habitat.

PREPARATION The blind may be ready for student use, or students may be involved in its construction. Blinds may be temporary shelters made from readily assembled and dismantled materials (e.g., camouflage tarp tied down with strings and tent stakes), or they may be permanent (e.g., stone or wood) structures. Setting up the blind several days prior to observation, will give wildlife a chance to get used to it. Baiting and seeding the area one or two weeks prior to the study will also increase sightings.

If time allows, it is desirable to provide students with an introduction to observation and identification, as well as an overview of common animals (especially birds) of the area. Some kind of reference material for use in identification is essential -- either a field guide or a simple sheet with common animals of the area.

**MATERIALS
USED**

- Observation blind
- Binoculars
- Identification guide
- Dull colored clothing
- Activity Sheet C: Wildlife Blind
- pen or pencil

**PROCESSES
USED**

- Observe
- Classify

TIME 45 - 60 Minutes (can be repeated)



DOING THE ACTIVITY (outdoors)

A. Set the Stage

Riparian areas are among the most productive and diverse natural environments. Because of this, they are excellent areas for wildlife observation. It is not uncommon to find a variety of insects and birds, as well as amphibians, snakes, and occasional mammals in the riparian community. Being quiet is important to avoid scaring away wildlife.

B. Procedure

1. In this activity students will use an observation blind to observe but not be seen by animals using the area.
2. Sightings will be recorded using Activity Sheet C.

ACTIVITY SHEET C: Wildlife Blind 40-60 min.
Individual

For wildlife observation. Record your observations using this form.

Animal	Name	Behavior	Location	Number	Time

Investigating Your Environment
Riparian 

3. Work in small groups, each taking turns in the blind (or have several blinds set up).



C. Retrieve Data

After the observation period is concluded, gather students to discuss the following:

1. Which animals were most abundant?
2. Which group found the greatest diversity of different species?
3. Does your data support the idea that riparian areas provide important habitat for animals? Where else could you conduct an observation to support this hypothesis?
4. List the factors found in the riparian zone that are important to wildlife.
5. Has this area been impacted by human activity? If so, is there anything you or the group could do to minimize that impact in the future?

CLOSURE Summarize the importance of riparian areas to wildlife.

TRANSITION In the first activity you learned how some riparian areas are fairly undisturbed while others have been degraded. Next we will look at riparian systems in greater detail -- their function in erosion control and their importance to plants and animals. In the next activity you will apply your knowledge of these critical areas as you visit and analyze a riparian area for its usefulness as a productive ecological area.



RIPARIAN ASSESSMENT

CONCEPT	System, Change, Interaction, and Order
PRINCIPLE	Participants analyze the health of a riparian area and discuss management considerations.
OBJECTIVE	<ul style="list-style-type: none">• The student will observe and collect data on a riparian system.• Using the collected data the student will be able to describe the relationship between riparian zones and management considerations.
PREPARATION	The teacher may wish to select two or more riparian areas to visit if time permits. It is also recommended that the class review the information discussed during the "Introduction to Riparian Areas" lesson. Photocopy Activity Sheet D.
MATERIALS USED	<ul style="list-style-type: none">• Activity Sheet D: Riparian Evaluation• Pen or pencils
PROCESSES USED	<ul style="list-style-type: none">• Observe• Interpret Data• Communicate
TIME	60 minutes



DOING THE ACTIVITY (outdoors)

A. Set the Stage

As we have learned thus far, healthy riparian areas are dynamic and diverse ecosystems. In this activity you will visit one or more riparian areas to assess the relative health of the area(s).

In general, the following are characteristics found in mature, undisturbed (or recovered) riparian areas:

- well-established vegetation and root system; zones apparent
- steeper banks, stable slopes
- year around stream flow
- cooler water temperatures (shaded)
- higher water table/better storage
- diverse habitat/forage/wildlife
- stream bottom contains some gravel
- aquatic organisms diverse, require oxygen, include variety of fish

Poorly managed, disturbed riparian areas generally have the opposite features.

B. Procedure

1. Discuss with students those characteristics which are indicative of a mature, undisturbed riparian area and those of a poorly managed, disturbed system.
2. Divided class into pairs and hand out one Activity Sheet D to each group.
3. Instruct students that they have 30 minutes to work with their partner to complete the Activity Sheet. Careful observations are essential.

ACTIVITY SHEET D: Riparian Assessment

30 min.
group

Sketch of Area (aerial, bird-eye view)		Typical cross section		
<p>Riparian Assessment Ratings 1 disturbed, 2 only slightly disturbed, 3 undisturbed Determine the rating for each characteristic then write the rating number in the appropriate box.</p>				
Characteristics	Ratings			Recommendations
	area A	area B	area C	
PLANTS species diversity varied canopy emergent root system				
STREAMWATER QUALITY debris available substrate (bottom) clear, flowing perennial flow				
FISH & WILDLIFE aquatic invertebr's fish type/diversity wildlife forage variety of habitats				
OTHER FACTORS bank steepness bank stability bank disturbance				
TOTAL SCORE				
<p>SUMMARY COMMENTS:</p>				
<p>Key: Excellent = 30-42 Good = 20-28 Fair = 11-18 Poor = 1-10</p>				

366

Investigating Your Environment
 Riparian



Investigating Your Environment
 Riparian

C. Retrieve Data

When students have completed the sheet, discuss the following questions for each area evaluated:

1. Do you feel this area is undisturbed and productive, or has its ecological condition been reduced due to disturbance?
2. Are there certain species that seem to be present mainly in undisturbed (or disturbed) areas, but not in the other?
3. Do current management practices, if any, seem to be adequate for this area?
4. List any management recommendations you have for this area -- e.g., fences, trails, restricted access, etc.
5. Summarize the role you feel public agencies and private landowners should play, if any, in the management of riparian areas. What environmental as well as economic factors do you think should be considered in this decision-making process?

CLOSURE Summarize the unique role of riparian systems. Be sure to discuss the value of these in watersheds, controlling runoff and erosion, stabilizing stream banks, and as diverse habitat for plants and wildlife.



ACTIVITY SHEET A: Introduction to Riparian Areas

30 min.
individual

Introduction: Below are two illustrations, one of a riparian system disturbed by human or grazing activity, and a second illustration of an undisturbed riparian area.

Directions: Below the illustrations is a chart. Your task is to complete the chart based on your observations of the illustrations. When you have completed this, you will have identified the typical qualities that make a riparian system either healthy or degraded.

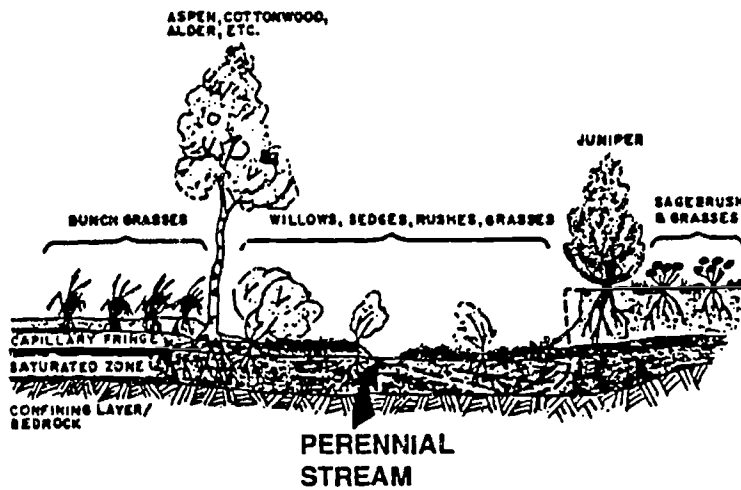
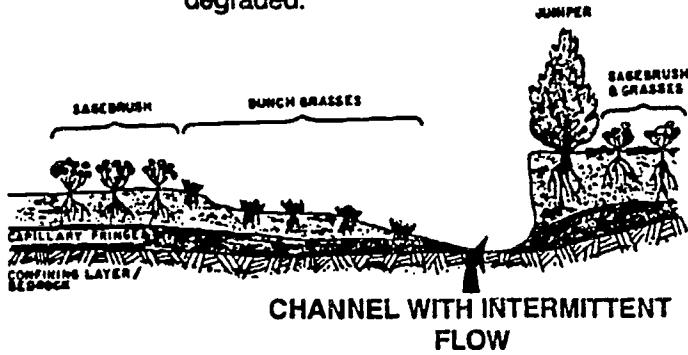

Characteristics	Disturbed System	Undisturbed System
Vegetation		
Stream Flow		
Water Temperature		
Habitat/Forage		
Wildlife Diversity		
Topography		
Other		

ACTIVITY SHEET B: A Transect of Riparian Vegetation

90-120 min.
small groups

Use this sheet to record the dominant plant type found at each stop. Record data from a transect of up to 25m in length on each side of the stream or waterway (total 50 meters). The 25 stops on the "+" (left) column should be on one side of the waterway, while the other 25 stops correspond to the other side. Stop numbers correspond to meters from the water; therefore, the #1 (both + and -) samples are a single meter from the water, while the 25th stop are 25 meters from the water.

Transect # _____

Group Members _____

Stop #	Dominant Plant
+1	
+2	
+3	
+4	
+5	
+6	
+7	
+8	
+9	
+10	
+11	
+12	
+13	
+14	
+15	
+16	
+17	
+18	
+19	
+20	
+21	
+22	
+23	
+24	
+25	

Stop #	Dominant Plant
-1	
-2	
-3	
-4	
-5	
-6	
-7	
-8	
-9	
-10	
-11	
-12	
-13	
-14	
-15	
-16	
-17	
-18	
-19	
-20	
-21	
-22	
-23	
-24	
-25	



ACTIVITY B: Reference

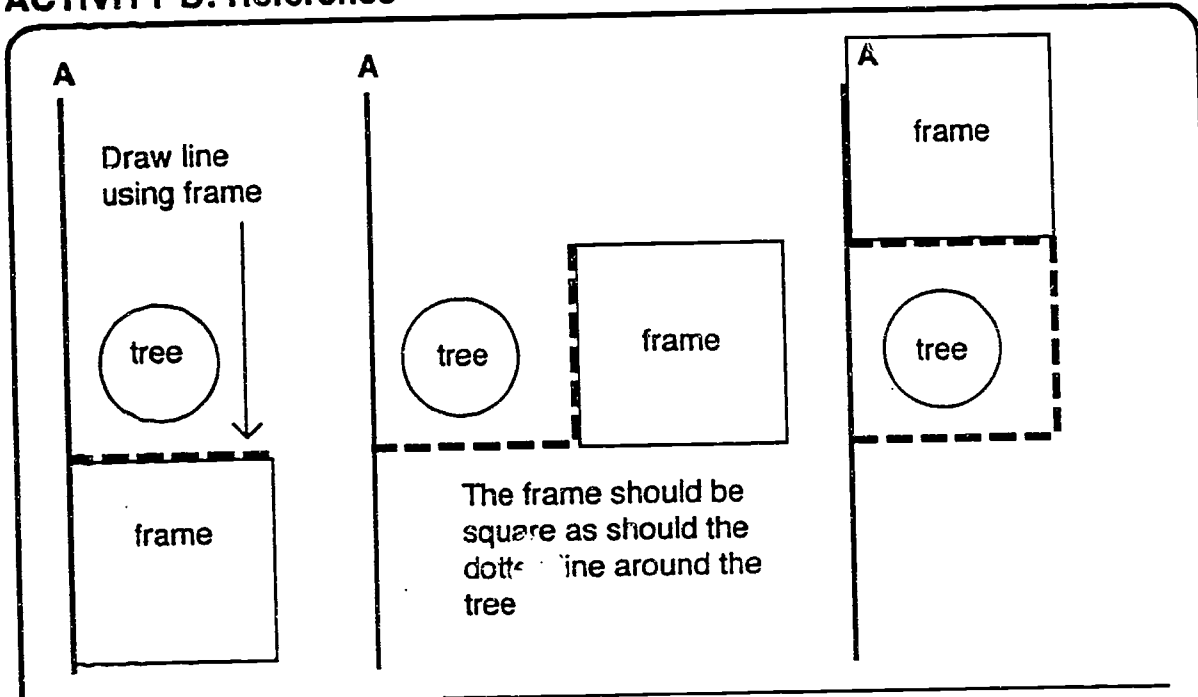

SAMPLE MAP

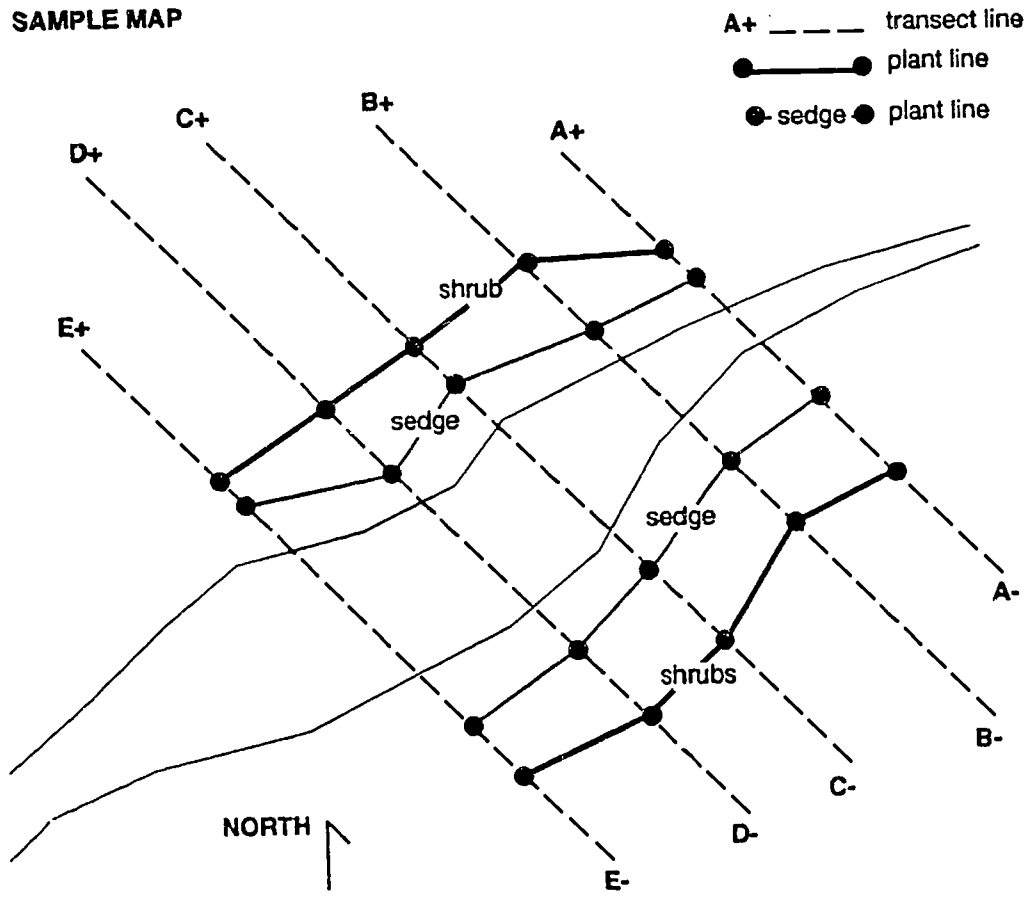

ACTIVITY SHEET C: Wildlife Blind

40-60 min.
individual

For wildlife observation. Record your observations using this form.

Animal	Name	Behavior	Location	Number	Time



ACTIVITY SHEET D: Riparian Assessment

60 min.
groups

Sketch of Area (quick, birds-eye view)

Typical cross section

Riparian Assessment Ratings 1 disturbed, 2 only slightly disturbed, 3 undisturbed
Determine the rating for each characteristic then write the rating number in the appropriate box.

Characteristics	Ratings			Recommendations
	area A	area B	area C	
PLANTS species diversity varied canopy complex root system				
STREAM/WATER QUALITY shade available substrate (bottom) clear, flowing perennial flow				
FISH & WILDLIFE aquatic inverteb's. fish type/difersity wildlife forage variety of habitats				
OTHER FACTORS bank steepness bank stability lack of disturbances				
TOTAL SCORE				

Key:
 Excellent = 36-42
 Good = 29-35
 Fair = 21-28
 Poor = 14-20

SUMMARY COMMENTS:



BEST COPY AVAILABLE

INTRODUCTION

What do you think of when someone says the word "wilderness?" Chances are, you think about a rugged, desolate, perhaps even scary place that does not offer you all of the "creature comforts" you're accustomed to. Or, maybe your mind conjures up visions of the old West with cowboys and Indians fighting over their piece of the "wilderness." Some of you may have focused on the word "wild" in the word wilderness and come up with a picture of an untamed, wild area. Perhaps wilderness seems like a place where you can feel alone with nature, away from the noise and busyness of cities and towns. It might be a deep forest, a deserted coastline, an open meadow, a rugged mountain top, or a vast desert.

Each of us may have our own individual and personal idea about the meaning of wilderness. At different times throughout history there have been various social perceptions of wilderness, too, depending on the religious and cultural values that existed at the time. To Native Americans, what we now call wilderness was not "wild" but, rather, their natural home which provided the physical and spiritual foundations of their lives and culture. Early Anglo-European explorers saw America as a vast and bountiful land, rich in many resources. More and more non-native settlers arrived with the belief that wilderness was a useless wasteland that needed to be conquered, tamed and civilized. To them, the wilderness was valuable only if the resources there could be used for human purposes. In the 19th century, some people began to see the beautiful ruggedness of untamed lands as something inspirational and valuable in its own right. As environmental awareness grew, more and more citizens recognized the need to conserve the natural resources and protect the landscapes that wilderness offered from development and exploitation. Finally in 1964, the Wilderness Act was passed by Congress which set up a system for preserving some public lands as official and legally protected Wilderness areas. These Wilderness areas are part of the National Wilderness Preservation System and are to be managed in ways that preserve their "unspoiled" and natural state to benefit all generations of Americans, present and future.

Our American Wilderness is an important asset. It is, in many instances, the only "unspoiled" nature left to us. It is a place for camping, hiking, canoeing, horseback riding, fishing, hunting, wildlife observation, plant study, geological exploration, mountain climbing, artistic expression, scientific investigation, spiritual renewal, personal challenge, and inspiration. It is a place where natural systems of life exist without significant human interference or control. Wilderness areas are protected for their many resources and benefits to humans and to preserve all aspects of nature -- animals, plants, earth, air, water -- and ongoing natural processes for their own sake.

The concept of wilderness can mean different things to different people. To some, the park at the edge of town or the woods behind one's house can seem like a wild and untamed place. To others, wilderness areas are remote and pristine landscapes far removed from civilization such as forests, mountains, beaches, deserts, swamps, or meadows which may all seem to elicit a sense of what might be called wilderness. These wild lands may or may not be an actual part of the legally designated National Wilderness Preservation System. Often you will find those public wild lands that are legally designated and protected as part of the National Wilderness Preservation System identified as "Wilderness" -- spelled with a capital "W." Those areas that are essentially wild and natural in character but are not part of the National Wilderness Preservation System are often referred to as "wilderness" -- spelled with a lower case "w." Which ever meaning of wilderness is being referred to, it is important to foster an attitude of respect and responsibility toward all wild and natural areas.



THE ACTIVITIES

The study units that explore the meaning of "wilderness" for individual people are "Personal Wilderness" and "Background, History, and Philosophy." The other units -- "Legislation and Management," "Natural Characteristics," and "Wilderness Skills" -- focus more on wilderness defined as those public lands legally designated to be part of the National Wilderness Preservation System or "Wilderness." Learning about wilderness and the need for its protection can help us learn about the value of the natural world in general and about our place in that world.

TIME REQUIRED

Personal Wilderness	30 minutes
Wilderness Investigation	
- Background, History and Philosophy	45 to 60 minutes
- Legislation and Management	45 to 60 minutes
- Natural Characteristics	90 minutes
- Wilderness Skills	70 minutes with closure

COMBINING THE ACTIVITIES

The activities in this unit are displayed singly. For maximum learning, the activities should be experienced in the order listed in the unit, however, another suggestions is: Begin with the first activity entitled, "Personal Wilderness." When you start the second activity, you will have the opportunity to decide which categories you want to focus on. The Wilderness Investigation Course is arranged in four general categories. Identify group needs and budget your time accordingly. This unit is recommended for 8th grade and up. The information and activities could also make several good sessions to uses with groups working on Backpacking or Camping Merit Badges or with "low impact, no trace" camping presentations.

CURRICULUM RELATIONSHIPS

These Curriculum Relationships show how learning about wilderness relates to subject areas and skills. They also provide other ideas for extending the study of wilderness beyond those suggested by this unit.

Social Studies

1. Find out what additional government agencies are concerned about and involved in designating Wilderness Areas and write a report on at least one.
2. Research what laws protect Wilderness Areas and their resources. Examine some political issues, such as that of the "Spotted Owl." Prepare a debate on all sides of the issues.
3. Study about how various federal agencies have divided up aspects of the Wilderness to manage and protect. Construct a chart to show your findings.
4. If you were a Ranger, what would be your top priorities regarding the land for which you are responsible?

Science

1. We hear a lot about "balance of nature." How does this principle work when we "balance" uses of a Wilderness Area, i.e. human use vs. Wilderness, backpacking vs. horseback use?
2. Can the Wilderness be managed for ecological succession as in climax stages or ecological succession and still be a wilderness?
3. What is the role of fire, and fire fighting in a Wilderness?

Mathematics

1. Study amount of human population a wilderness can support (campsites) before its resources are in danger of depletion. (Lessen biological and social impacts.)

Language Arts

1. Henry David Thoreau wrote, "In wildness is the preservation of the world." Write what you think he meant by this quote.
2. Interview a ranger. Tape the interview and then edit it; videotape it or present the interview in some form, such as role playing with a classmate.

Creative Arts

1. Draw the "perfect" wilderness scene you can imagine.
2. Create your own "waste buster" symbols that would caution people against indiscriminately disposing of their waste in wilderness sites.



WILDERNESS INVESTIGATION

CONCEPT	Change, perception
PRINCIPLE	Participants use what they already know about a wilderness area to increase their understanding of it .
OBJECTIVE	The student will develop an understanding of; <ul style="list-style-type: none">• what wilderness is• what values they can find in wilderness• we can use the resource without damaging it
PREPARATION	Tell students that this activity will take place largely in their imagination. They will draw on their previous experiences with wilderness sites.
MATERIALS NEEDED	<ul style="list-style-type: none">• Copies of Activity Sheet A: Personal wilderness and Activity B: Drawing your wilderness (copied back to back)• pens or pencils
PROCESSES USED	<ul style="list-style-type: none">• communicate• classify• observe• infer• hypothesize• define operationally• formulate models
TIME	5-10 minutes, each activity, 30 minutes total



DOING THE ACTIVITY (outdoors, indoors)

A. Set Stage

"During this session we will develop an understanding of what wilderness is and how we can use this resource without damaging it. There will also be opportunity for you to explore wilderness in relation to your own set of values."

B. Procedure:

1. Do a short visualization. Ask students to close their eyes and spend the next few moments in a real or imagined area of wilderness where they would feel comfortable. Give them time to think.
2. Hand out "Activity Sheet A." Work individually for about 7 minutes to complete your ideas.

ACTIVITY A: Personal Wilderness

7 min.
Individual

Spent a few moments and think of a real or imagined area of wilderness where you would feel comfortable.

1. Describe your area using words or phrases. What do you see, hear, smell, feel?

2. How would you use this wilderness, what could you do or experience there?

3. How could you make sure that your wilderness would be preserved for the kinds of things you want to do or see there?

Investigating Your Environment
Wilderness



Investigating Your Environment
Wilderness

378

6

BEST COPY AVAILABLE

ACTIVITY B: Drawing Your Wilderness

Draw a picture depicting the essence of your area. You will then explain your picture to the group, using the first person: "I am the _____ wilderness."

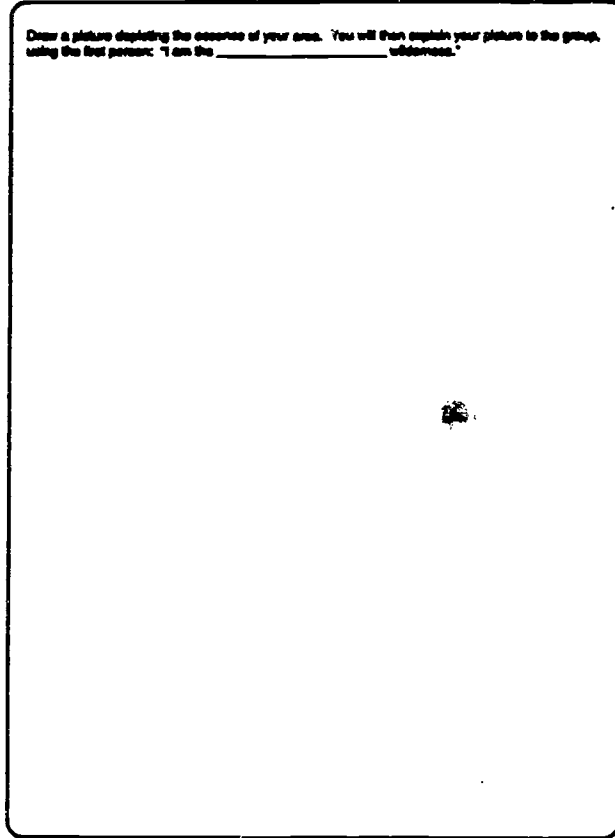

Investigating Your Environment
Wilderness 

3. After 7 to 10 minutes, have students do Activity B. These two worksheets should be copied back-to-back. (Draw a picture of your area). Students should work individually.

C. Retrieve Data:

Conduct a group discussion, asking the following questions along with others you can think of:

1. What kinds of uses, activities, or experiences can wilderness provide for people?
2. What does wilderness provide for nature?
3. How would you define wilderness?
4. Why might a "wild and natural" area have to be managed or controlled?
5. How would you control or manage wilderness to protect and preserve it for the kinds of uses and experiences that make it unique and valuable?

CLOSURE Summarize your ideas about the definitions of wilderness. Talk about why management of wilderness is necessary. Explain the importance of preserving and protecting wilderness through management ideas presented and discussed?

TRANSITION **Note to facilitator:** At this point, you can decide with the group which of the following categories to focus on. The Wilderness Course is arranged in four general categories. Identify group needs and budget your time accordingly.

The Four General Categories:

Background, History, and Philosophy

- c. Quotes From the Past
- d. Through The Eyes of a Pioneer
- e. Search for Solitude

Legislation and Management

- f. Wilderness and Special Areas
- g. Wilderness Myths
- h. You're the Ranger

Natural Characteristics

- i. The Lone Wolf
- j. Fire on the Mountain
- k. Change with Time

Wilderness Skills

- l. Impacts and Traces
- m. Recycling in Wilderness (Waste)
- n. On Nature's Terms
- o. Packing Light



WILDERNESS INVESTIGATION BACKGROUND, HISTORY AND PHILOSOPHY

CONCEPT	Change, evolution, perception
PRINCIPLE	Participants gain a better understanding of wilderness by first viewing it from an historic perspective.
OBJECTIVE	<ul style="list-style-type: none">• The student will develop an understanding of what wilderness is based on its background, history, and philosophy.
PREPARATION	Participants learn about the background, history and philosophy of wilderness through a variety of creative activities. You may elect to have your students do all or just a select few.
MATERIALS NEEDED	<ul style="list-style-type: none">• Copies of Activity Sheets C: Your Wilderness Quote, D: Pioneer Letter Home, E: Search for Solitude• pens or pencils
PROCESSES USED	<ul style="list-style-type: none">• communicate• question• classify• predict• observe• hypothesize• infer
TIME	45 to 60 minutes, based on discussion time



DOING THE ACTIVITY (indoors, outdoors)

A. Set Stage

During this session, we will develop an understanding of what wilderness is based on background information, perspectives about wilderness at different times of history, and the resulting wilderness philosophy.

B. Procedure

1. Begin by reading the following collection of quotes from the past. They coincide with the development of the wilderness concept in the United States.

It is important to discuss each quote. Talk about the meaning of each quote, the people who said it, and the peoples' lifestyles and cultural views. A library can provide biographical information for either the teacher/leader or students to look up.

NOTE: These quotes should be posted on the wall around the room for people to read on their own, and/or copy down.

"Is not the sky a father and the earth a mother, and are not all living things with feet or wings or roots their children?...Give me the strength to walk the soft earth, a relative to all that is!"
Black Elk

"In wildness is the preservation of the world."
Henry David Thoreau, 1851

"Climb the mountains and get their good tidings. Nature's peace will flow into you as the sunshine into the trees. The winds will blow their freshness into you, and the storms their energy, while cares drop off like autumn leaves."
John Muir, 1871

"If we are to have broad-thinking men and women of high mentality, of good physique, and with a true perspective on life we must allow our populace a communion with nature in areas of more or less wilderness condition."
Arthur Carhart, 1921

"There is just one hope of repulsing the tyrannical ambition of civilization to conquer every niche on the whole earth. That hope is the organization of spirited people who will fight for the freedom of the wilderness."
Robert Marshall, 1930

"Like winds and sunsets, wild things were taken for granted until progress began to do away with them. Now we face the question whether a still high 'standard of living' is worth its cost in things natural, wild, and free. For us the minority, the opportunity to see geese is more important than television, and the chance to find a pasque flower is a right as inalienable as free speech."
Aldo Leopold, 1948



"Out of the wilderness has come the substance of our culture, and with a living wilderness... we shall also a vibrant, vital culture, and enduring civilization of healthful, happy people who... perpetually renew themselves in contact with the earth. We are not fighting progress, we are making it."

Howard Zahniser, 1964

"This land is a place of all seasons, for even in winter there is the promise of spring, and in spring, the foretaste of summer. Here, part of every season is contained in every other. The tight-woven knowledge from all our yesterdays...is held in the stern simplicity of tree and sky and flower and rock, a certainty of tomorrow...there is always a sense of coming home, a feeling of belonging...this wild mountain land is home in a way that no city house can ever be."

Ann Zwinger, 1970

"In order to assure that an increasing population accompanied by expanding settlement and growing mechanization, does not occupy and modify all areas within the United States and its possessions, leaving no lands designated for preservation and protection in their natural condition, it is hereby declared to be the policy of the Congress to secure for the American people of present and future generations the benefits of an enduring resource of Wilderness."

*Wilderness Act, Public Law 88-577,
U.S. Congress, 1964*

2. Distribute Activity Sheet C; students come up with their own quote. Give students about 10 minutes to do this. Individual work.

ACTIVITY C: Your Wilderness Quote

10 min.
Individual

Many years from now people will read what you said and will think about what you believed in. Develop your own "quote from the past" that best describes your present thoughts on wilderness. Remember, this will be passed onto the next generation. You may also illustrate your quote. Use your best handwriting or calligraphy.

Investigating Your Environment
Wilderness 

383

11

Investigating Your Environment
Wilderness 

BEST COPY AVAILABLE

3. Mid Activity Discussion

Students share their quotes if they want to. Give them paper to add their quotes to the wall.

4. Introduce the next activity, Through The Eyes of a Pioneer, by saying, "The year is 1862. You and your family have moved from Baltimore, Maryland, and plan to homestead along the Missouri River. Write a short letter to friends back in Baltimore. Try to describe the pioneer's attitude toward wilderness and the settling of the frontier. Describe possible interactions with the environment. Tell about the journey westward." You could have a group of students brainstorm ideas and then assign members to write down the groups' idea. Draft the letter based on the recorder's notes, or edit and write the final draft. Or, you could have students work individually. Hand out Activity Sheet D. Allow 25 to 30 minutes for this activity. If you chose to work in groups, instruct one group member to send the letter to another group where the letter will be read aloud.
5. **TEACHER NOTE:** If students seem stymied about pioneer attitudes, send them to library to look up references - or remind them of literature like Sarah Plain and Tall, the Cabin Faced West, and Laura Wilder's books.

ACTIVITY D: Pioneer Letter Home

30 min.
Individually

Write a short letter to friends back in Baltimore. Try to describe the pioneer's attitude toward wilderness and the settling of the frontier. Describe possible interactions with the environment. Tell about the journey westward.

July 18, 1862

Dear

Investigating Your Environment
Wilderness



Investigating Your Environment
Wilderness

6. Mid Activity Discussion

Conduct a group discussion, asking the following questions about the letters your students wrote:

- a. What attitudes about wilderness are apparent in the letters?
 - b. What differences might have existed between the pioneers and the Native Americans about wilderness?
 - c. Have attitudes about wilderness changed from the pioneer days?
 - d. Could Americans today have an experience like the pioneers coming to settle in the West? Are there any unknown and unsettled "frontiers" for us?
 - e. What can we say about present day attitudes toward wilderness?
7. Distribute Activity Sheet E, Search for Solitude. Say, "Think about a special place or hideout where you used to go, now go, or would like to go to get away from the world...to think...to be alone...to experience solitude." Individuals have 5 to 10 minutes to complete this activity.

ACTIVITY E: Search for Solitude

10 min.
Individual

Describe this special place or hideout. You may also sketch or draw all or part of this place.

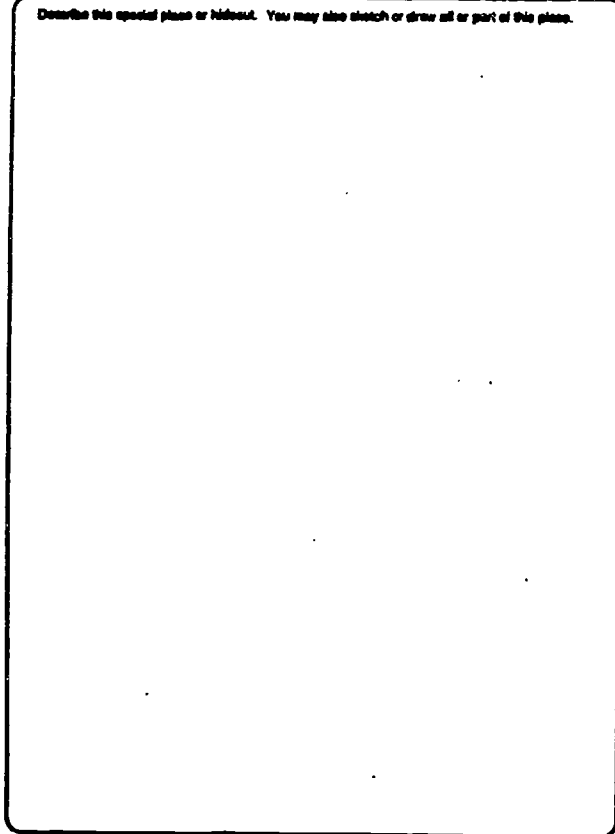

Investigating Your Environment
Wilderness



C. Retrieve Data

1. Have students share this place with the group after they are finished.
2. Ask the following questions about solitude to summarize this activity:
 - a. What is solitude? Why is it important? Do you have to be alone to experience it?
 - b. Where is your special place now? Has it changed? Will it always be there for you to enjoy?
 - c. How have your thoughts about solitude changed as you have gotten older?
3. Discuss the mention of "solitude" in the Wilderness Act. The Wilderness Act includes the provision of "outstanding opportunities for solitude" as one of the main characteristics necessary for an area to be designated as a wilderness area.
 - a. Why do you think "opportunities for solitude" were included in the Wilderness Act?
 - b. What kinds of things could threaten or take away opportunities for solitude in wilderness areas?
 - c. How can wilderness be managed so that opportunities for solitude can always remain?

CLOSURE

Summarize your definitions of Wilderness. Explain the significance of preserving it through careful management techniques we discussed.

TRANSITION

Note to facilitator: At this point, you can decide with the group which of the following categories to focus on. The Wilderness Investigation is arranged in four general categories. Identify group needs and budget your time accordingly. Decide upon the proper transition statement.

386



Investigating Your Environment
Wilderness

WILDERNESS INVESTIGATION - LEGISLATION AND MANAGEMENT

- CONCEPT** Change, perception
- PRINCIPLE** Participants gain a better understanding of Wilderness by looking at legislation that has been created to protect and manage it, and, at the agencies who apply the legislation.
- OBJECTIVE**
- The student will know what legally designated Wilderness is, what agencies protect and manage it, and the types of regulations with which Wilderness users must comply.
- PREPARATION** Through a variety of creative activities, participants learn that four federal agencies are responsible for management of our public, federally-owned lands and that in terms of human activity, legally designated Wilderness Areas have some restrictive land use regulations. You may elect to do all or just a portion of the activities. Obtain a land management map for your local area to help students understand the complexity of land management. These might be obtained from your county planning department or a local U.S. Forest Service, National Park, Fish and Wildlife Service, or Bureau of Land Management office.
- MATERIALS NEEDED**
- Copies of Activity Sheets F: Management Challenges (p. 1 & 2); G: Wilderness Myths and "Key"; H: You're the Ranger
 - pens or pencils
 - Wilderness Act Fact Sheet
- PROCESSES USED**
- communicate
 - question
 - classify
 - infer
 - predict
 - hypothesize
 - observe
 - interpret data
- TIME** 45 to 60 minutes, allowing for discussion



DOING THE ACTIVITY (indoors, outdoors)

A. Set Stage

During this session, we will learn that four federal agencies manage most of our public, federally-owned lands. We will learn that in order to protect them, legally designated Wilderness lands have regulations concerning what people can or can not do there. We will also learn about the many responsibilities a ranger has in managing these protected sites, and about the responsibilities that Wilderness visitors have in adhering to the established laws and regulations.

B. Procedure

1. Begin by saying, "Wilderness is just one of the many official land use designations that can be placed on our federally-owned lands. Currently, there are close to 91 million acres in the National Wilderness Preservation System. This equals 15 percent of the federal public lands and 4 percent of the total United States land base. Four federal agencies are responsible for the management of Wilderness Areas. These are the U.S. Forest Service, which is part of the United States Department of Agriculture and the National Park Service, the Bureau of Land Management, and the U.S. Fish and Wildlife Service which all are part of the United States Department of the Interior. It may seem strange to talk about "managing" something that is "wild" or "controlling" lands that are "natural." But management of Wilderness is important because there need to be ways of making sure that people who use Wilderness Areas and the lands around those areas do not do things to harm the natural characteristics of Wilderness. In Wilderness Areas, certain uses and human activities that are allowed on other public lands are more restricted. For instance, while you would be able to use a power boat or a ski mobile in a National Recreation Area, you would not be able to in a Wilderness Area because no motorized vehicles are allowed there. You can not log timber in a designated Wilderness. If you wanted to have a camp out with lots and lots of friends in a National Park, you might have to do it outside the Wilderness boundaries because there are often limits on the number of people that can travel or gather as a group in Wilderness Areas. These are some of the ways that Wilderness is "managed" to preserve and protect it.

You can think of Wilderness as being on the "pristine" or wild and natural end of a land use spectrum or continuum, with cities or towns at the other "paved" and civilized end. In the middle of the spectrum are rural or "pastoral" lands where there is more of a balanced use between people and nature. There are also federal land use designations such as Wild and Scenic Rivers, National Recreation Areas, National Parks, and Wildlife Refuges that seem to be somewhere between the rural and the wilderness designations on the land use spectrum. Of course, these separate land areas do not exist in a straight line, but overlap and compliment each other such as when a National Recreation Area exists inside a National Forest. Together, they form a mosaic or jigsaw puzzle picture of land designation and use. You can imagine that because each of these different areas have different uses, purposes and regulations, the management of them, especially those that are next to or within each other, is a complicated task for the federal agencies."



2. Distribute Activity Sheet F, Management Challenges for Federal Agencies. Assign pairs to each of the 4 scenarios. Students should work as partners. Allow 20 minutes.

20 min.
pairs

ACTIVITY F: Management Challenges for Federal Agencies (x 1)

1. Four agencies are responsible for managing federal lands. These are:

- U.S. Department of Agriculture manages National Forests, forest and grassland resources and recreation opportunities.
- U.S. Department of Interior national parks, monuments, areas, etc., for their natural resources.
- Bureau of Land Management manages lands under multiple-use permit, grazing, and research.
- Fish and Wildlife Service management of a system of wild and endangered species, and wildlife.

ACTIVITY F: Management Challenges for Federal Agencies (x 2)

Each of the four agencies develops its own plans and policies to help manage the lands for which it is responsible, including its Wilderness areas. Because each agency has several different purposes or uses for which their lands are managed, conflicts and challenges about how to best manage them in certain situations can occur.

Below are several hypothetical situations in which a management agency must make a complicated Wilderness management decision. Write down your ideas and thoughts about each situation and for what you would do.

1. To prevent the popular Sunset Wilderness Area from being "loved to death" by the approximately twenty thousand visitors who come there each year, the Bureau of Land Management must decide whether or not to institute a permit system that will limit the size of groups and numbers of visitors. Local rangers who have used the area for years are quite unhappy about the limitations and restrictions being put on their options for Wilderness experiences. A public meeting to discuss the permit system will soon be held.
2. Within the Falling Water National Park is a National Recreation Area where popular helicopter flights enable tourists to enjoy a breathtaking "bird's eye view" of a spectacular waterfall and gorge. The helicopters' flight plan from the heliport to the waterfall takes them along a Wilderness Area boundary. Backcountry visitors to the Wilderness Area complain that noise from the helicopters disturbs the quiet and feeling of solitude that they came to the Wilderness to find. Park Service managers face a dilemma about whether to make management decisions based on National Recreation Area or Wilderness Area priorities and regulations.
3. Scientists have been involved with a three year study of a rare and endangered plant that exists within the Green Mountains Wilderness Area of the Otter National Forest. A winter storm and flood event has wiped out the existing trail into the study area. Many large logs and other thick and tangled debris lay across the only pathway along the river to where the rare plant study is to continue. The study is at a crucial stage and the scientists must get in within a week or all their previous investigations will be wasted. They want the U.S. Forest Service to change its policy of not allowing mechanical chainsaws in this Wilderness Area so that the logs and debris can more quickly be removed.
4. At the Big Prairie Wilderness Wildlife Refuge, a serious infestation of mosquitoes known to be carrying a disease that could be deadly to the antelope herds is getting out of control. The only known way to deal effectively with the mosquitoes is to either use an airplane to spray a pesticide over the infested areas or to dig deep ditches and install culverts to drain away the water where the mosquitoes eggs are laid. Both these measures would contradict regulations of the Wilderness management plan that was adopted for the area.

Investigating Your Environment
Wilderness 

3. Mid Activity Discussion

Discuss the following questions with your group after completing Activity Sheet F.

- a. What are some problems that might arise when management agencies have situations in which Wilderness policies conflict with other management needs?
 - b. What are some ways of solving such dilemmas?
 - c. What are some advantages or disadvantages of having more than one federal agency manage Wilderness?
 - d. Would you rather be in charge of a National Park Service, U.S. Forest Service, Bureau of Land Management, or U.S. Fish and Wildlife Service Wilderness Area? Why?
4. Distribute Activity Sheet G, Wilderness Myths, and say, "While there are some restrictions in Wilderness Areas, there are many authorized uses. Look through the following list and mark the travel methods and activities you think are allowed inside Wilderness." Do this by yourself. You have 5 minutes. Then have them check their list against a partner's list. Changes can be made if they can explain their reasons.

ACTIVITY G: Wilderness Act Fact Sheet

A wilderness, in contrast with those areas where man and his own works dominate the landscape, is hereby recognized as an area where the earth and its community of life are untrammeled by man, where man himself is a visitor who does not remain. An area of untrammeled wilderness is further defined to mean in this Act an area of undeveloped Federal land retaining its primitive character and influence, without permanent improvements or human habitation, which is protected and managed as so to preserve its natural conditions and values:

1. generally appears to have been affected primarily by the forces of nature, with the impact of man's work substantially unnoticeable
2. has outstanding opportunities for solitude or a primitive and unconfined type of recreation
3. has at least five thousand acres of land or is of sufficient size as to make practicable its preservation and use in an unimpaired condition
4. may also contain ecological, geological, or other features of scientific, educational, scenic, or historical value

Investigating Your Environment
Wilderness 

5. Mid Activity Discussion

Discuss Activity G with the help of these questions and the Wilderness Act Fact Sheet

- a. Do any of the permitted uses seem to harm Wilderness?
- b. What might be some of the potential harm or benefits of the authorized uses?
- c. Are there any prohibited uses that you might allow, or permitted uses that you might prohibit? Why?

From the 1964 Wilderness Act:

"Except as otherwise provided in this Act, each agency administering any area designated as wilderness shall be responsible for preserving the wilderness character of the area and shall so administer such area for such other purposes for which it may have been established as also to preserve its wilderness character. Except as otherwise provided in this Act, wilderness areas shall be devoted to the public purposes of recreational, scenic, scientific, educational, conservation, and historic use."



Investigating Your Environment
Wilderness

Prohibition of Certain Uses - Section 4 (c):

"Except as specifically provided for in this Act, and subject to existing private rights, there shall be no commercial enterprise and no permanent road within any wilderness area designated by this Act and, except as necessary to meet minimum requirements for administration of the area for the purpose of the Act (including measures required in emergencies involving the health and safety of persons within the area), there shall be no temporary road, no use of motor vehicles, motorized equipment or motorboats, no landing of aircraft, no other form of mechanical transportation, and no structure or installation within any such area."

- a. How might various agencies manage their Wilderness differently?
 - b. What are some potential problems that might arise when an area has dual designations (i.e. Wilderness in a Wildlife Refuge)?
 - c. What are the advantages or disadvantages to having several agencies managing Wilderness?
4. Distribute Activity Sheet G, Wilderness Myths, and say, "There are many authorized uses in Wilderness. Look through the following list and mark the travel methods and activities you think are allowed inside Wilderness." Do this by yourself. You have 5 minutes. Then have them check their list against a partners list. Changes can be made if they can explain their reasons.

ACTIVITY G: Wilderness Myths

5 min.
Individual

Look through the following items and mark (X) the ones that are allowed inside Wilderness:

Travel Methods

- _____ Foot
- _____ Horseback
- _____ Bicycle
- _____ Aircraft
- _____ Motorcycle
- _____ Boat
- _____ Four wheel drive vehicle
- _____ Snowmobile
- _____ Wheelchair
- _____ Mountain bike
- _____ Parascals
- _____ Wagons

Activities

- _____ Hunting and Fishing
- _____ Energy Development Projects (Dams, Powerlines, Installments)
- _____ Mining
- _____ Outfitting and Guide Operations
- _____ Fire, Insect, and Disease Control
- _____ Livestock Grazing
- _____ Roadbuilding
- _____ Trail Construction
- _____ Cabins or Shelters
- _____ Restroom Facilities
- _____ Picnics

Investigating Your Environment
Wilderness



5. Mid Activity Discussion

Discuss Activity G with the help of these questions:

- Do any of the permitted uses seem to harm the Wilderness?
- What might be some potential harm or benefit?
- Are there any prohibited uses that you might allow?

6. Introduce Activity Sheet H, **You're the Ranger**, by saying, "You land a job as the Wilderness Ranger for the Pine Tree Wilderness. This 38,000 acre wilderness is 27 miles southeast of a city of 60,000 people. This is the most rugged of the local mountain areas with deep, narrow canyons and high, barren peaks. There are 36 lakes, providing for some excellent fishing. A major magazine does a feature story high-lighting the breathtaking beauty and excellent fishing in the Pine Tree Wilderness. Here come the crowds! Campsites spread in number and size. Native vegetation is being replaced by knapweed and bare soil. Water quality becomes questionable. Firewood supplies are depleted and campers have started chopping down live trees. Several fights have been reported between campers at crowded lake basin sites."

ACTIVITY H: You're the Ranger

25 min.
small groups

You're the ranger! List some possible management options. Think. Are you educating, regulating, or addressing users? Remember that Wilderness is to be managed so that the richness and impact of humans is "substantially unrecognizable" and offers opportunities for culture and primitive, unimpaired types of recreation. (see also Activity G: Wilderness Act Post Sheet)

Management Option

(example) Limit group size

Desired Result

Lessen biological and social impacts

Investigating Your Environment
Wilderness 



Investigating Your Environment
Wilderness

C. Retrieve Data

Discuss Activity H with your students. These questions might help in the discussion.

1. What problems might there be in managing an area so it looks untouched by humans?
2. How will you assess and monitor changes or impacts within Wilderness?
3. How will you decide what is acceptable and unacceptable change?
4. What will you do about this change?

CLOSURE

- List the agencies that manage wilderness.
- How would you summarize their role(s) in wilderness management?
- What, if any, differences do you see in the agencies' roles?
- What should be the overall purpose behind any Wilderness management?

TRANSITION Depends upon which activity you choose next.



WILDERNESS INVESTIGATION - NATURAL CHARACTERISTICS

CONCEPT	Change, perception, cycles
PRINCIPLE	Participants gain a better understanding of changes that occur in Wilderness by studying its natural characteristics.
OBJECTIVES	<ul style="list-style-type: none">• The student will be able to identify several natural characteristics of a Wilderness.
PREPARATION	Participants learn to respect Wilderness by understanding the important role they can play in helping to manage and preserve our natural environment. Use as many visuals of natural characteristics as you can find to enhance the activities. Example: rock outcropping, forest, lake, stream, deer or other wildlife, wildfire, lightning, night sky, etc.
MATERIALS NEEDED	<ul style="list-style-type: none">• Copies of Activity Sheets I: The Lone Wolf, J: Fire on the Mountain K: Change with Time• pens or pencils• visuals of natural characteristics
PROCESSES USED	<ul style="list-style-type: none">• communicate• classify• observe• space-time relation• questions• infer• predict• hypothesize• formulate models
TIME	90 minutes, depending upon discussion, break into 2 class periods



DOING THE ACTIVITY (indoors, outdoors)

A. Set Stage

Students explore natural characteristics in an imaginative, creative way. They begin their first activity by pretending to be one of the Wilderness' valuable creatures, the wolf.

B. Procedure

1. Begin by saying, "A Rocky Mountain wolf has been seen in a nearby Wilderness. People rarely visit this remote area. Let your imagination work. You are the wolf."
2. Distribute Activity Sheet I, The Lone Wolf. Give individual students about 10 minutes to work on this.

3. Mid Activity Discussion

Discuss the following questions with your group, this should take about 5 minutes.

- a. What would make life easy for you as a wolf?
 - b. What would make life more difficult?
 - c. If a conflict arose between man and wolf, whose rights should be protected?
 - d. What will happen to the lone wolf?
 - e. If you could be any other animal, plant, or part of the Wilderness such as a rock, mountain, or stream what would you be - why?
- Discuss in pairs or triads.

ACTIVITY I: The Lone Wolf

10 min.
Individual

List some natural characteristics about this area that would benefit you as a wolf. What do you need to survive and thrive?

Characteristics

Benefit

Investigating Your Environment
Wilderness



Investigating Your Environment
Wilderness

4. Distribute Activity Sheet J, Fire on the Mountain, and say, "A thunderstorm makes its way down the Bitterroot Mountain Range. Lightning strikes on Beaver Ridge. A fire starts just inside the Wilderness boundary. Remember that the fire was caused in the Wilderness by a natural event. And unless there are emergencies involving the health and safety of persons within the area, no motorized or mechanical vehicles are to be used within Wilderness Areas." Assign the following interest groups as participants.

_____ Adjacent landowner

_____ Wilderness ranger

_____ Local hunter

_____ Backpacker

_____ Naturalist

_____ Nearby city council member

_____ Outfitter and guide

You have 35 minutes to complete this activity. Teacher or students could prepare a map graphic to use in your oral presentation.

ACTIVITY J: Fire On The Mountain

35 min.
group

1. Meet with your interest group. Decide on how you want this fire managed. Write down what you want done and why.

2. Have a Town Meeting. Collectively decide on a management of this fire. Assume each interest's position. Evaluate all options.

Investigating Your Environment
Wilderness



Investigating Your Environment
Wilderness



5. Mid Activity Discussion

Have each group present their plan with their map and during the discussion, try to answer these questions.

- a. Under what conditions should the fire be allowed to burn?
- b. What are the benefits or costs to man or nature?
- c. Is there a possible compromise between interests?
- d. What should be done about other natural processes at work in Wilderness?

NOTE: The Resource Manager has responsibility to manage a wilderness and any fire activity to protect the resource and any property in the way of fire. Although these positions will be considered, the bottom line is that decisions are made to protect the resource value.

6. Introduce Activity Sheet K, Change with Time, by saying, "Close your eyes - revisit through visualization your favorite wilderness spot. Wilderness is dynamic. As we speak, changes are taking place. There is a continuous cycle of birth, death, and change. Describe this changing environment in terms of the following times." Take 10 minutes to complete Activity K by yourself.

ACTIVITY K: Change With Time

10 min.
Individual

Use all your creative energy and thought to share what it would be like in the Wilderness at the following times. You may draw, sketch, write poetry, etc. How would the Wilderness be the same or different at these different times?

at night?

In a lightning storm?

In the winter?

next spring?

In a fire?

In 25 years?

In 50 years?

In 100 years?

other:

Investigating Your Environment
Wilderness



Investigating Your Environment
Wilderness

C. Retrieve Data

In the next 5 to 7 minutes, discuss Activity K. Ask the following questions:

1. What personal feelings of fear, excitement, or contentment do you associated with any of these times?
2. How do you distinguish between natural and unnatural characteristics occurring there?
3. What is so important about having a place, like Wilderness, where nature can change, unaffected by human population?

CLOSURE

- List as many natural characteristics of wilderness as you can.
- Summarize the changes and the processes that take place in Wilderness unaided by humans?

TRANSITION

We've thought a lot about Wilderness - let's look at some of the skills we would need to enjoy wilderness - and use it well!



WILDERNESS INVESTIGATION - WILDERNESS SKILLS

CONCEPT	Cause/effect, equilibrium, interaction
PRINCIPLE	Participants gain a better understanding of the personal skills necessary to use Wilderness areas without destroying the balance of nature within a Wilderness.
OBJECTIVE	<ul style="list-style-type: none">• The student will be able to identify ways in which humans can reduce their impact on Wilderness areas.
PREPARATION	Gather visuals, audio-visual, etc. to support the activities.
MATERIALS NEEDED	<ul style="list-style-type: none">• Copies of Activity Sheets L: Impacts and Traces M: Cleaning Up the Wilderness and key N: On Nature's Terms, O: Packing Light• pens or pencils
PROCESSES USED	<ul style="list-style-type: none">• communicate• question• classify• observe• hypothesize• infer• predict
TIME	70 minutes with closure



DOING THE ACTIVITY (indoors, outdoors)

A. Set Stage

Students determine how they can limit their impact on Wilderness, thus allowing nature to function uninterrupted.

B. Procedure

1. Begin by saying, "Each Wilderness visitor has a personal responsibility to help manage and preserve our natural environment. This is especially important in Wilderness and other undeveloped areas. The challenge is to limit your impact and leave no trace."
2. Distribute Activity L, Impact and Traces. Ask students to work individually to complete the sheet. (10 minutes). They may want to work with a partner to finish or gain new ideas after they've worked alone.

10 min.
Individual

ACTIVITY L: Impact and Traces

How could your actions influence these different aspects of an undeveloped or wilderness area? List the possible impacts and preventive measures associated with human use of an undeveloped or wilderness area. There may be more than one impact or preventive measure.

Aspects	Impact	Preventive Measures
Wildlife		
Alpine Meadows		
Mountain Streams		
Lakehores		
Personal Galtate		
Excellent Fishing Waters		
Glaciers, Alpine Tundra, Mowbray Area		

Investigating Your Environment
Wilderness 

400

30

BEST COPY AVAILABLE



Investigating Your Environment
Wilderness

3. Making sure to take care of trash and waste items is one of the most effective ways humans can preserve the environment. Ask, "What do you do with trash in the Wilderness where there are no garbage cans or recycling bins?" Then, distribute Activity Sheet M and instruct your students to write down how they would dispose of the following items in a way that would least impact Wilderness. Work individually. (5 minutes).

ACTIVITY M: Recycling in the Wilderness Individual

Individuals

How would you dispose of the following waste items? Write the item letter in a picture corresponding with the proper disposal technique.

- a. aluminum foil
- b. cigarette filter
- c. paper box
- d. human waste
- e. full food waste package
- f. nylon shoe string
- g. paper towel wrapper
- h. plastic bag
- i. pull tab
- j. frozen food package
- k. tin can
- l. plastic spoon
- m. used disposable diaper
- n. orange peel
- o. aluminum container
- p. metal can



Bury It



Burn It

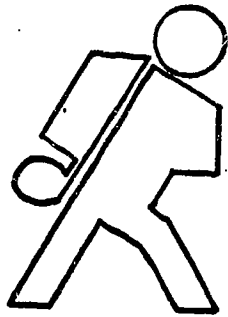

Pack It Out

Investigating Your Environment
Wilderness 

4. This activity will generate a lot of discussion. Start by asking what they would do with an item; such as a freeze-dried food package, for which there is more than one right answer. Discuss about 10 to 15 minutes or until it seems settle. You may want to obtain some brochures or booklets on "No Trace" camping techniques to provide more information.

5. Distribute Activity Sheet N, On Nature's Terms, and say, "Nature has a way of challenging visitors in the back country. While meeting the personal risks and challenges that Wilderness can offer is a reason why many people go there, remember that safety plays a big part in Wilderness survival. It is always a good idea to remember the following three things:

Go prepared!

Be observant!

Anticipate dangers!

NOTE: You may want these on a board or flip chart somewhere.

"Read through the following situations and see if you know how to deal with them."

Split into small groups and assign one situation to each small group and have them spend 10 minutes discussing what they would do. Ask for a 3 minute summary.

ACTIVITY N: On Nature's Terms

10 min.
small group

Would you know how to deal with these situations? Define potential problems and hazards. List some possible precautions you would take.

Situation #1.
You decide the lake you are looking for is over the last ridge. You head up the steep grassy slope and arrive at the top. The lake is in view now. But first you must get through the boulder field below. And the stream you must cross is still swollen from spring runoff. Darkness falls as you arrive at the lake.

Situation #2.
The thick undergrowth of cedar seems to be ten feet high in places. You cut your way through, not sure where you're going. A black bear cub pops up out of nowhere. You hurry to escape the brush and make it into the forest. You find yourself face to face with the black bear cub and she advances toward you. You run off through the woods.

Situation #3.
This early June hike takes you right into a snow field. The trail up over Friday Pass is all covered with snow. You stop for a break and study your map. Unfortunately you forget the compass and have difficulty orienting yourself. You feel a tickle on the back of your neck and discover an insect-bite. The sky turns dark and lightning begins to strike all around you. A steady rain begins to soak all your clothing.

Situation #4.
You've read in a newspaper article that the climb up Mt. Adams is "a stroll". You've been driving for hours and are in a hurry to start climbing so you don't stop at the ranger station to register. It's a warm sunny day, so you're wearing tennis shoes and shorts. You don't want to carry too much extra weight, so you leave your jacket and extra food in the car, taking along your camera and one water bottle. By 2:00 p.m. you're just getting to the snowfield, still several hours from the summit where threatening clouds have begun to gather. A cool wind has begun to blow and you're tired and hungry, but determined to make it to the top. You stop for a drink of water and realize that you only have 1/4 of a canteen left.

Situation #5.
You're hiking in a new area, but have borrowed a map from a friend and plan to take a good look at it when you take your first snack break. You come to a trail junction and take the unmarked fork. After climbing over several high areas the trail, forming a difficult creek, and wading through a marshy meadow, you've thoroughly appreciated with the poor condition of the trail and determined to express yourself to the next Wilderness Ranger that you see! When you finally stop to snack and study the map, you realize that a corner of it is missing (the dog?) -- especially the area that you're hiking. You also read that there are unmarked trails in the area that have been abandoned because they were impacting sensitive areas.

Investigating Your Environment
Wilderness



Investigating Your Environment
Wilderness

6. Mid Activity Discussion

Ask groups to report. Summarize Activity N with the help of these questions:

- a. How much risk should people take when using Wilderness?
- b. Are there some feelings of danger or challenge that are associated with a quality Wilderness experience?
- c. When users are in trouble, who should be responsible for search and rescues?
- d. What can we say about risk in Wilderness?

7. Introduce Activity Sheet O, Packing Light, by saying, "Packing light reduces impact on the land. This exercise will get you thinking about essential items and their weights." Distribute Activity Sheet O. This should take 10 to 15

ACTIVITY O: Packing Light

10 min.
Individual or small group

Look at the following list of items and their estimated weights. Circle which items are essential and re-estimated for a 3 day backpack trip. Then prioritize (1,2,3...) the items.

Item	Weight (pounds)	
Nylon tent	6	---
Canvas tent	35	---
Canvas tent	30	---
Protein dried food	7	---
Iron skillet and plates	7	---
Aluminum cooking set and plates	3	---
Eating utensils	1	---
Foam pad	2	---
Army cot	12	---
Polyester sleeping bag	4	---
Cotton sleeping bag	6	---
Metal bucket	3	---
Nylon bucket	1	---
Backpack with steel frame	10	---
Backpack with aluminum frame	4	---
Cothos	5	---
Raincoat	2	---
Backpack stove	2	---
Flashlight	1	---
Matches, first aid kit, knife	1	---
Map and compass	1	---
	YOUR TOTAL	---

Investigating Your Environment
Wilderness 



minutes depending on if you prioritize the list or not.

8. Mid Activity Discussion

Discuss the completed activity with your students by asking them the following questions:

- a. Which items help you limit your impact on Wilderness?
- b. Which items did you leave behind?
- c. What did you base your decisions on?
- d. Which items are truly essential for survival?

C. Retrieve Data

As a group, discuss the following questions:

1. How and where would you teach Wilderness skills?
2. What Wilderness skills do you think humans absolutely must possess in order to be wise users?
3. Think back to Activity L, which impacts could be lessened or eliminated with the use of good wilderness skills? Which can not?

CLOSURE "At the start of this investigation, you described to us your personal definitions of Wilderness. We then proceeded to take a closer look at the resource. Now apply your newly gained knowledge to that original Wilderness you described. What are some changes you would make? Could your Wilderness actually exist? What will our Wilderness areas be like 50 years from now?" Go back to your personal wilderness quotation - Is this still how you feel? Revise and re-illustrate if you've changed or grown in your philosophy.

Wilderness Areas are special places that are valuable for human uses and for the protection and preservation of nature itself. If you visit Wilderness Areas, acting wisely and responsibly will help ensure your safety and the health of the wilderness as well. Even if you never actually go the Wilderness, you can let people know that it is important to protect. And you can help take care of nature where you do find it...in parks, woods, at the beach or even in your own back yard.



ACTIVITY A: Personal Wilderness

7 min.
individual

Spend a few moments and think of a real or imagined area of wilderness where you would feel comfortable.

1. Describe your area using words or phrases. What do you see, hear, smell, feel?

2. How would you use this wilderness, what could you do or experience there?

3. How could you make sure that your wilderness would be preserved for the kinds of things you want to do or see there?

Investigating Your Environment
Wilderness



ACTIVITY B: Drawing Your Wilderness

Draw a picture depicting the essence of your area. You will then explain your picture to the group, using the first person: "I am the _____ wilderness."

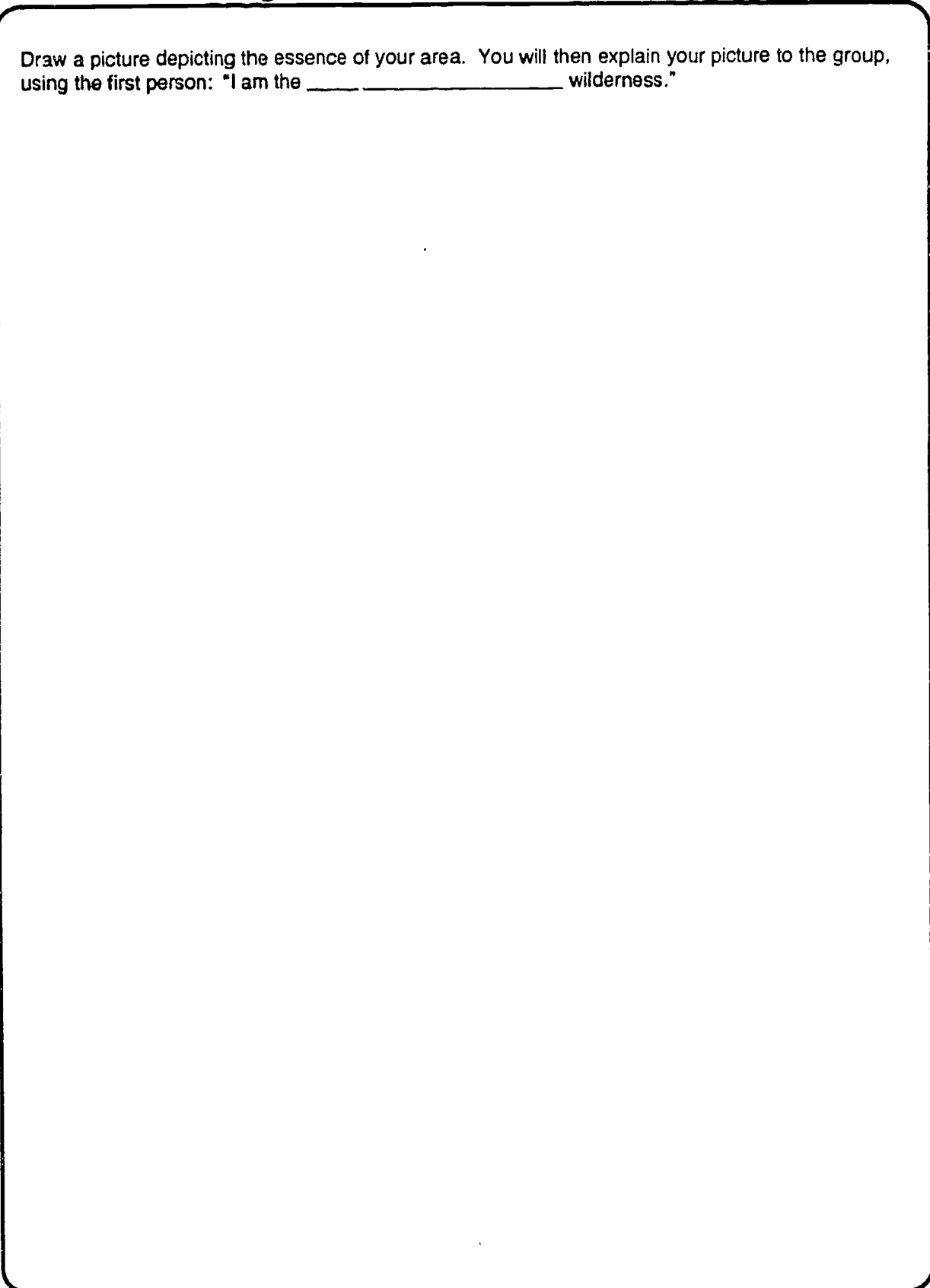

Investigating Your Environment
Wilderness



ACTIVITY C: Your Wilderness Quote

10 min.
individual

Many years from now people will read what you said and will think about what you believed in. Develop your own "quote from the past" that best describes your present thoughts on wilderness. Remember, this will be passed onto the next generation. You may also illustrate your quote. Use your best handwriting or calligraphy.

"

"

Investigating Your Environment
Wilderness



ACTIVITY D: Pioneer Letter Home

30 min.
individually

Write a short letter to friends back in Baltimore. Try to describe the pioneer's attitude toward wilderness and the settling of the frontier. Describe possible interactions with the environment. Tell about the journey westward.

July 15, 1862

Dear _____

Investigating Your Environment
Wilderness



ACTIVITY E: Search for Solitude

10 min.
individual

Describe this special place or hideout. You may also sketch or draw all or part of this place.

Investigating Your Environment
Wilderness



ACTIVITY F: Management Challenges for Federal Agencies (p. 1)

20 min.
pairs

1. Four agencies are responsible for the management of most of our public, federally-owned lands. These are:
 - U.S. Department of Agriculture, Forest Service (FS). An agency that administers and manages National Forests and Grasslands for the maintenance, production, and protection of forest and grassland resources, such as timber, wildlife and fish, water, grazing land, minerals and recreation opportunities.
 - U.S. Department of Interior, National Park Service (NPS). An agency that administers national parks, monuments, historical sites, scenic rivers, preserves, seashores, recreation areas, etc., for their natural, historical, and recreational value.
 - Bureau of Land Management (BLM). An agency that administers and manages public lands under multiple-use principles, including timber and mineral production, wildlife management, grazing, and recreation.
 - Fish and Wildlife Service (FWS). An agency that administers the development and management of a system of wildlife refuges and fish hatcheries for migratory birds, game fishes, and endangered species; also oversees research, development, and law enforcement related to wildlife.

Investigating Your Environment
Wilderness



ACTIVITY F: Management Challenges for Federal Agencies (p. 2)

Each of the four agencies develops its own plans and policies to help manage the lands for which it is responsible, including its Wilderness areas. Because each agency has several different purposes or uses for which their lands are managed, conflicts and challenges about how to best manage them in certain situations can occur.

Below are several hypothetical situations in which a management agency must make a complicated Wilderness management decision. Write down your ideas and thoughts about each situation and /or what you would do.

1. To prevent the popular Sunset Wilderness Area from being "loved to death" by the approximately twenty thousand visitors who come there each year, the Bureau of Land Management must decide whether or not to institute a permit system that will limit the size of groups and numbers of visitors. Local recreationists who have used the area for years are quite unhappy about the limitations and restrictions being put on their options for Wilderness experiences. A public meeting to discuss the permit system will soon be held.
2. Within the Falling Water National Park is a National Recreation Area where popular helicopter flights enable tourists to enjoy a breathtaking "bird's eye view" of a spectacular waterfall and gorge. The helicopters' flight plan from the heliport to the waterfall takes them along a Wilderness Area boundary. Backcountry visitors to the Wilderness Area complain that noise from the helicopters disturb the quiet and feeling of solitude that they came to the Wilderness to find. Park Service managers face a dilemma about whether to make management decisions based on National Recreation Area or Wilderness Area priorities and regulations.
3. Scientists have been involved with a three year study of a rare and endangered plant that exists within the Green Meadows Wilderness Area of the Orion National Forest. A winter storm and flood event has wiped out the existing trail into the study area. Many large logs and other thick and tangled debris lay across the only pathway along the river to where the rare plant study is to continue. The study is at a crucial stage and the scientists must get in within a week or all their previous investigations will be wasted. They want the U.S. Forest Service to change its policy of not allowing mechanical chainsaws in this Wilderness Area so that the logs and debris can more quickly be removed.
4. At the Big Prairie Wilderness Wildlife Refuge, a serious infestation of mosquitoes known to be carrying a disease that could be deadly to the antelope herds is getting out of control. The only known way to deal effectively with the mosquitoes is to either use an airplane to spray a pesticide over the infested areas or to dig deep ditches and install culverts to drain away the waters where the mosquitoes eggs are laid. Both these measures would contradict regulations of the Wilderness management plan that was adopted for the area.



ACTIVITY G: Wilderness Act Fact Sheet

A wilderness, in contrast with those areas where man and his own works dominate the landscape, is hereby recognized as an area where the earth and its community of life are untrammeled by man, where man himself is a visitor who does not remain. An area of untrammeled wilderness is further defined to mean in this Act an area of undeveloped Federal land retaining its primeval character and influence, without permanent improvements or human habitation, which is protected and managed so as to preserve its natural conditions and which;

1. generally appears to have been affected primarily by the forces of nature, with the imprint of man's work substantially unnoticeable
2. has outstanding opportunities for solitude or a primitive and unconfined type of recreation
3. has at least five thousand acres of land or is of sufficient size as to make practicable its preservation and use in an unimpaired condition
4. may also contain ecological, geological, or other features of scientific, educational, scenic, or historical value



ACTIVITY G: Wilderness Myths

5 min.
individual

Look through the following items and mark (X) the ones that are allowed inside Wilderness:

Travel Methods

- _____ Foot
- _____ Horseback
- _____ Bicycle
- _____ Aircraft
- _____ Motorcycle
- _____ Boat
- _____ Four wheel drive vehicle
- _____ Snowmobile
- _____ Wheelchair
- _____ Mountain bike
- _____ Parasails
- _____ Wagons

Activities

- _____ Hunting and Fishing
- _____ Energy Development Projects (Dams, Powerlines, Impoundments)
- _____ Mining
- _____ Outfitting and Guide Operations
- _____ Fire, Insect, and Disease Control
- _____ Livestock Grazing
- _____ Roadbuilding
- _____ Trail Construction
- _____ Cabins or Shelters
- _____ Restroom Facilities
- _____ Fences

Investigating Your Environment
Wilderness



ACTIVITY G: "Key"

Look through the following items and mark (X) the ones that are allowed inside Wilderness:

Travel Methods

- Foot
- Horseback
- Bicycle
- Aircraft
- Motorcycle
- Boat
- Four wheel drive vehicle
- Snowmobile * on a case-by-case basis, waivers can be obtained for disabled users
- Wheelchair
- Mountain bike
- Parasails
- Wagons

Activities

- Hunting and Fishing
- Energy Development Projects (Dams, Powerlines, Impoundments)
- Mining
- Outfitting and Guide Operations
- Fire, Insect, and Disease Control
- Livestock Grazing
- Roadbuilding
- Trail Construction
- Cabins or Shelters
- Restroom Facilities
- Fences

Investigating Your Environment
Wilderness



ACTIVITY H: You're the Ranger

25 min.
small groups

You're the ranger! List some possible management options. Think. Are you educating, regulating, or eliminating users? Remember that Wilderness is to be managed so that the influence and impact of human's is "substantially unnoticeable" and offers opportunities for solitude and primitive, unconfined types of recreation. (see also Activity G: Wilderness Act Fact Sheet)

Management Option

(example) Limit group size

Desired Result

Lessen biological and social impacts

Investigating Your Environment
Wilderness



ACTIVITY I: The Lone Wolf

10 min.
individual

List some natural characteristics about this area that would benefit you as a wolf. What do you need to survive and thrive?

Characteristic

Benefit

Investigating Your Environment
Wilderness



ACTIVITY J: Fire On The Mountain

35 min.
group

1. Meet with your interest group. Decide on how you want this fire managed. Write down what you want done and why.
2. Have a Town Meeting. Collectively decide on a management of this fire. Assume each interest's position. Evaluate all options.



ACTIVITY K: Change With Time

10 min.
individual

Use all your creative energy and thought to share what it would be like in the Wilderness at the following times. You may draw, sketch, write poetry, etc. How would the Wilderness be the same or different at these different times?

at night?

in a lightning storm?

in the winter?

next spring?

in a fire?

in 25 years?

in 50 years?

in 100 years?

other:

Investigating Your Environment
Wilderness



ACTIVITY L: Impacts and Traces

10 min.
individual

How could your actions influence these different aspects of an undeveloped or wilderness area? List the possible impacts and preventive measures associated with human use of an undeveloped or wilderness area. There may be more than one impact or preventive measure.

Aspects	Impact	Preventive Measure
Wildlife		
Alpine Meadows		
Mountain Streams		
Lakeshores		
Personal Solitude		
Excellent Fishing Waters		
Glaciers, Alpine Tundra, Moraine Areas		



ACTIVITY M: Recycling in the Wilderness

individual

Individuals

How would you dispose of the following waste items? Write the item letter in a picture corresponding with the proper disposal technique.

- a. aluminum foil
- b. cigarette filter
- c. paper box
- d. human waste
- e. foil lined cocoa package
- f. nylon shoe string
- g. paper candy wrapper
- h. plastic bag
- i. pull tab
- j. freeze dried food package
- k. tin can
- l. plastic spoon
- m. used disposable diapers
- n. orange peels
- o. styrofoam container
- p. nutshells

Burn It



Bury It

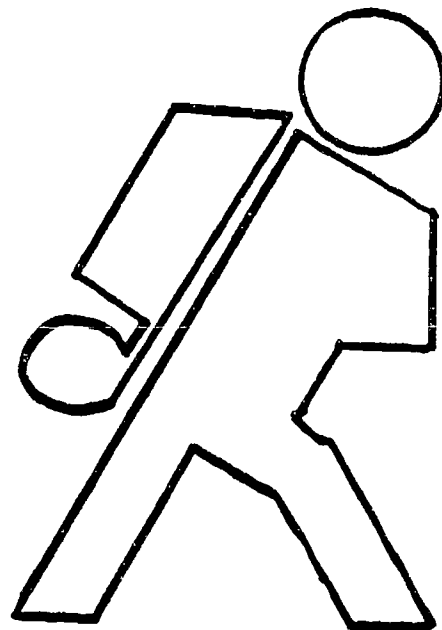

Pack It Out



ACTIVITY M: "Key"

Individuals

How would you dispose of the following waste items?
Write the item letter in a picture corresponding with the proper disposal technique.

- | | |
|-----------------------------|------------------------------|
| a. aluminum foil | i. pull tab |
| b. cigarette filter | j. freeze dried food package |
| c. paper box | k. tin can |
| d. human waste | l. plastic spoon |
| e. foil lined cocoa package | m. used disposable diapers |
| f. nylon shoe string | n. orange peels |
| g. paper candy wrapper | o. styrofoam container |
| h. plastic bag | p. nutshells |

Burn It a, b, c, e, f
g, j, k, m

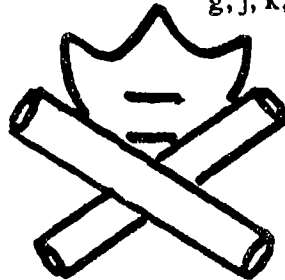

Bury It

d, m

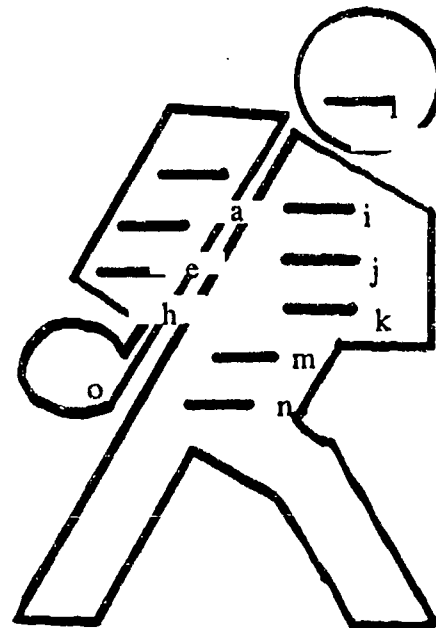

Pack It Out

p -- burn or back out, but don't drop on ground as they don't decompose swiftly

a, e, j, k, n -- all can be burned to lessen load and remove food smell, but remains must be cooled and packed out

d -- discuss proper manner for disposing of human waste

m -- if you are making a long trip, proper management of diapers is necessary. Strip of plastic, pack it out. Paper liner that is next to plastic can be burned; liner containing human waste urine only can be burned (not pleasant); fecal material carry out or bury in some sites as adult waste

Investigating Your Environment
Wilderness



ACTIVITY N: On Nature's Terms

10 min.
small group

Would you know how to deal with these situations? Define potential problems and hazards. List some possible precautions you would take.

Situation #1.

You decide the lake you are looking for is over this last ridge. You head up the steep grassy slope and arrive at the top. The lake is in view now. But first you must get through the boulder field below. And the stream you must cross is still swollen from spring runoff. Darkness falls as you arrive at the lake.

Situation #2.

The thick undergrowth of alder seems to be ten feet high in places. You swim your way through, not sure where you're going. A black bear cub pops up out of nowhere. You hurry to escape the brush and make it into the forest. You find yourself face to face with the black bear sow and she advances toward you. You run off through the woods.

Situation #3.

This early June hike takes you right into a snow field. The trail up over Friday Pass is all covered with snow. You stop for a break and study your map. Unfortunately you forgot the compass and have difficulty orienting yourself. You feel a tickle on the back of your neck and discover an imbedded tick. The sky turns dark and lightning begins to strike all around you. A steady rain begins to soak all your clothing.

Situation #4.

You've read in a newspaper article that the climb up Mt. Adams is "a stroll". You've been driving for hours and are in a hurry to start climbing so you don't stop at the ranger station to register. It's a warm sunny day, so you're wearing tennis shoes and shorts. You don't want to carry too much extra weight, so you leave your jacket and extra food in the car, taking along your camera and one water bottle. By 2:00 p.m. you're just getting to the snowfield, still several hours from the summit where threatening clouds have begun to gather. A cool wind has begun to blow and you're tired and hungry, but determined to make it to the top. You stop for a drink of water and realize that you only have 1/4 of a canteen left.

Situation #5.

You're hiking in a new area, but have borrowed a map from a friend and plan to take a good look at it when you take your first snack break. You come to a trail junction and take the unmarked fork. After climbing over several logs across the trail, fording a difficult creek, and wading through a marshy meadow, you're thoroughly aggravated with the poor condition of the trail and determined to express yourself to the next Wilderness Ranger that you see. When you finally stop to snack and study the map, you realize that a corner of it is missing (the dog?) — apparently the area that you're hiking. You also read that there are unmaintained trails in the area that have been abandoned because they were impacting sensitive areas.

Investigating Your Environment
Wilderness



ACTIVITY O: Packing Light

10 min.
individual or small group

Look at the following list of items and their associated weights. Decide which items are essential and nonessential for a 3 day backpack trip. Then prioritize (1,2,3,...) the items.

Item	Weight (pounds)	
Nylon tent	6	_____
Canvas tent	25	_____
Canned food	30	_____
Freeze dried food	7	_____
Iron skillet and plates	7	_____
Aluminum cooking set and plates	3	_____
Eating utensils	1	_____
Foam pad	2	_____
Army cot	12	_____
Polyester sleeping bag	4	_____
Cotton sleeping bag	6	_____
Metal bucket	3	_____
Nylon bucket	1	_____
Backpack with steel frame	10	_____
Backpack with aluminum frame	4	_____
Clothes	5	_____
Raincoat	2	_____
Backpack stove	2	_____
Flashlight	1	_____
Matches, first aid kit, knife	1	_____
Map and compass	1	_____
	YOUR TOTAL	_____





BEST COPY AVAILABLE

Investigating Your Environment — Intermountain Region

424

INTRODUCTION

The educational process must encompass a wide variety of learning environments to give students the experiences necessary to develop skills necessary for making intelligent and effective environmental decisions. Field trips to a variety of natural environments are desirable, but the availability of an accessible outdoor area on or near the school grounds greatly increases the frequency and ease with which such experiences can be incorporated into the instructional program.

The development of an Environmental Study Area (ESA) can be a major project involving an entire school and community over several years. It can also be much smaller in scale, simply one of identifying the instructional resources of a site and utilizing existing instructional materials. Outdoor activities can be done on a ball field, blacktop and along a fence line. Teachers are encouraged to use the outdoors for learning at every appropriate opportunity, just as they would use the library, a laboratory or a gymnasium.

This lesson is designed to allow students to plan an ESA. The primary goal is for students to develop an understanding that they are capable of having a positive impact on their environment and community. If done in its entirety, the activities will take place over a period of several weeks or months and incorporate a variety of activities from all disciplines.

After completing this lesson, the teacher can carry the project forward with the actual development and use of the ESA.

THE ACTIVITIES

TIME REQUIRED

I. Introduction to Environmental Study Areas

Introduction and Planning - 1 hour
Field Trip - at least 1/2 day
Wrap-up, Reporting - 2 hours

II. Inventory of the Potential ESA Site

Preparation - 1 hour
Investigation - at least 3 hours
Wrap-up, Reporting - at least 2 hours

III. Potential Uses and Users of the ESA

Introduction - 1 to several hours
Collecting the Data - 1 to several hours
Wrap-up, Reporting, Summarizing - at least 2 hours



COMBINING THE ACTIVITIES

Activities in this section are designed to be used as a unit. They are displayed singly for convenience and clarity. While it is possible to pick and choose between them, it is strongly recommended that the activities be used in the order given and in their entirety. However, the activities can be completed over several days or class periods, depending upon your schedule. However, activities can be modified or abbreviated and still maintain their effectiveness.

CURRICULUM RELATIONSHIPS

Social Studies

1. Investigate zoning regulations and the processes for obtaining government and school district approval for an ESA.
2. Invite a land use planner to speak to the class about how planners work to identify and manage natural areas.
3. Investigate the role of volunteers in meeting community needs.

Science

1. Do outdoor learning activities on the ESA site.
2. Prepare a science field trip for students in primary grades.
3. Use the science text to identify problems that could be investigated in the ESA.
4. Collect environmental information at the ESA for a government agency such as the Department of Fish and Wildlife, Forest Service, Bureau of Land Management.
5. Prepare a nature trail guide for the ESA.

Mathematics

1. Develop a "math path" with activities for all grade levels.

Language Arts

1. Make presentations to community organizations such as the Rotary Club or school board.
2. Write a proposal to the school district asking for funds to help build the ESA.

Creative Arts

1. Prepare a video tape presentation about the ESA.
2. Make signs for the ESA.
3. Design a "logo" which identifies the ESA.



INTRODUCTION TO ENVIRONMENTAL STUDY AREAS

- CONCEPT** System, Interaction
- PRINCIPLE** An Environmental Study Area (ESA) is a valuable instructional resource where students can learn through direct involvement. This activity prepares students to plan an ESA by exposing them to existing facilities in the community.
- OBJECTIVE**
- The student will be able to list things that can be learned at an ESA.
 - The student will be able to describe characteristics of an ESA that help learning to take place.
 - The student will be able to explain the importance of ESAs.
- PREPARATION** Visit a variety of ESAs and make arrangements for field trips to visit one or more of them. Students will be able to do this activity better if they have had several outdoor learning experiences beforehand. Students will also use activities from the Built Environment lesson plan.
- MATERIALS NEEDED**
- Blackboard or easel board/pad or butcher paper.
 - Marking pens -- various colors.
 - Masking tape.
- To conduct their investigations, students may wish to use such things as tape recorders, Polaroid cameras, video cameras, clip boards, sketching paper, etc.
- PROCESSES USED**
- Observe
 - Infer
 - Define Operationally
 - Interpret Data
 - Built Environment lesson plan
- TIME**
- Introduction and Planning - 1 hour
Field Trip - at least 1/2 day
Wrap-up, Reporting - 2 hours



DOING THE ACTIVITY (indoors, then outdoors)

A. Set Stage:

"Most of your studies are done in a classroom, but you also learn in the gymnasium, science laboratory and library. The out-of-doors can be a great place for learning too. We are going to plan for the development of an outdoor classroom called an Environmental Study Area or ESA. To get us started with our planning we are going to look at some nearby ESAs on a field trip.

"To make the most of our time, we will need to plan carefully beforehand. We want to collect information that will be useful to us later."

B. Procedure:

1. Introduction and Planning - Classroom Chart

Do Steps III and IV from "Investigating the Built Environment."

Step III: Identify and Focus on Land Use Patterns and Interrelationships

Step IV: Identify and Analyze the Topic for Your Investigation

NOTE: These activities will require minor modifications to meet the needs of this lesson.

NOTE: When planning their investigations, make sure the students include use and management aspects of the ESA: user groups, ownership, programs offered, etc., in addition to a physical inventory of the site and its development.

2. Conduct the investigation -- Field Trip.

Do Step V from "Investigating the Built Environment."

Step V: Conducting the Investigation.

At the conclusion of the investigation have the students generate a list of things that could be studied at the ESA they have visited.

C. Retrieve Data:

1. Prepare and report on the investigation - Classroom.
2. Do Step VI from "Investigating the Built Environment."
Step VI: Prepare and report on the investigation.

CLOSURE

Ask the class:

1. "What are some things you learned about ESAs?"
2. "How are the ESAs you looked at similar? How are they different?"
3. "What were things you liked and disliked about the ESAs you visited?"
4. "When we plan our ESA, what are some things you would like to include in the plan?"

TRANSITION

"Now that you have studied some ESAs, we can begin to plan one for our school."



INVENTORY OF THE POTENTIAL ESA SITE

- CONCEPT** Organism, System, Qualification, Model
- PRINCIPLE** To plan an ESA, it is necessary to have an understanding of what is currently on the site. In this activity, students will inventory and map the potential ESA site.
- OBJECTIVE**
- The student will be able to conduct an inventory of a natural area.
 - The student will be able to draw a map of a natural area.
 - The student will be able to report his findings to others.
- PREPARATION** Complete Step I: Introduction to ESAs. Identify a potential ESA site on the school grounds or in the community. Obtain approval and support from the administration to proceed with the project.
- It would be helpful if the students have completed other lessons in the Investigating Your Environment series, particularly the Measuring Your Environment lesson.
- MATERIALS NEEDED**
- Map of ESA.
 - Cardboard plane table or instant mapper from Measuring Your Environment lesson.
 - Marking pens - various colors.
- The students may wish to use such things as tape recorders, cameras, video cameras, clipboards, sketching paper, etc.
- PROCESSES USED**
- Observe
 - Measure
 - Use numbers
 - Infer
 - Classify
 - Question
 - Interpret Data
- TIME**
- Preparation - 1 hour
Investigation - at least 3 hours
Wrap-up, Reporting - at least 2 hours



DOING THE ACTIVITY

A. Set Stage:

"To plan for development and use of an ESA, we need to know about what is there now. We will do this by collecting lots of information and displaying it in a way that is understandable by others when we tell them about our ESA."

B. Procedure:

1. Introduction and Planning - Classroom.
Prepare a map of the site - Classroom, ESA.
Do Step ____ : "Construct and Use the Instant Mapper" or from the Measuring Your Environment: "Construct and Use a Cardboard Plane Table."
NOTE: It may be possible to obtain a map of the ESA site from your school district, city, county, Soil Conservation District or other agency.
2. Do Step IV from "Investigating the Built Environment."
Step IV: Identify and Analyze the Topic for Your Investigation.
Make sure the students include natural communities, topography and man-made features in addition to lists of trees and animals.
3. Conduct the Investigation - ESA.
Do Step V from "Investigating the Built Environment."
Step V: Conducting the Investigation.

C. Retrieve Data:

1. Prepare and report on the investigation - Classroom.
2. Do Step VI from "Investigating the Built Environment".
Step VI: Prepare and Report on the Investigation.

The class may wish to follow-up with its preparation of a large report, display, slides or a video tape which can be used for presentations to other individuals or groups.

CLOSURE

Ask the class:

1. "What are some things that are special or unique about this area?"
2. "Do you think this area would make a good ESA? Why?"
3. "What kinds of things could be studied here?"
4. "What kinds of improvements would you recommend for this area?"

TRANSITION

"There may be other people interested in our ESA. To have a really good ESA it must have a variety of resources that can be used by lots of different people."



POTENTIAL USES AND USERS OF THE ESA

CONCEPT	Interaction, System
PRINCIPLE	To develop a plan for an ESA, it is important to know who might use the facility and how they would use it. It is also important to begin to promote the ESA so others will help with its development.
OBJECTIVE	<ul style="list-style-type: none">• The student will be able to collect information through surveys and/or interviews.• The student will be able to interpret the data collected.• The student will be able to report the findings to others.
PREPARATION	Complete Steps I and II. Contact other teachers and members of the community to get their support for the ESA project.
MATERIALS NEEDED	<ul style="list-style-type: none">• Blackboard or easel board/pad.• Marking pens - various colors.
PROCESSES USED	<ul style="list-style-type: none">• Infer• Classify• Design Experiments• Interpret Data• Communicate
TIME	Introduction - 1 to several hours Collecting the Data - 1 to several hours Wrap-up, Reporting, Summarizing - at least 2 hours



DOING THE ACTIVITY

A. Set Stage:

"Now that we have a good description of our ESA we are ready to share our information with others and get their ideas and their support."

B. Procedure:

1. "Who else might be interested in the ESA? Why would they be interested?"
(List on blackboard).
2. "What are some things we would like to tell them about the ESA?"
(List on blackboard).
3. "What information would we like to collect from these people or groups?"
(List on blackboard). "How could we collect this information?"
4. "Working in small groups, select one individual or group you would like to collect information from. Prepare a short presentation about the ESA and develop a process for collecting and recording the information."
NOTE: The students may decide to use questionnaires, conduct interviews, publish a booklet or to use another process. If doing presentations or interviews, they may wish to practice with their own class before actually collecting the information.
5. Have the students collect the information.

C. Retrieve Data:

1. Have each group prepare a presentation about the information they collected. The presentation should include how they collected, recorded and interpreted the data as well as the information itself. The presentation should include a visual display of the information so that it will remain available for the students to use later.
2. Have the groups make their presentations to the class.

CLOSURE Discuss with the class and record on the blackboard or chart paper:

1. "Which individuals or groups seemed most enthusiastic about the ESA? What help could they give in planning and building the ESA?"
2. "What kinds of things would people like to do and study at the ESA?"
3. "Overall, who are the most important in using the ESA? What kinds of activities will be most important to them?"

TRANSITION "We now have all the information we need to make a plan for our ESA."



PLANNING THE ESA

CONCEPT

Interaction, System, Model

PRINCIPLE

In a successful ESA, the needs of users match the resources of the site. In this activity, the students use the information they have collected and develop a plan for the ESA.

OBJECTIVE

- The student will be able to use data to prepare alternative solutions to a problem.
- The student will be able to develop criteria for evaluating alternatives.
- The student will be able to select a solution.

PREPARATION

Complete Steps I, II and III.

MATERIALS NEEDED

- Easel board/paper or butcher paper.
- 11" x 17" Maps of the ESA site showing natural features.
- Yellow tracing paper.
- Marking pens - various colors.

PROCESSES USED

- Measure
- Use numbers
- Infer
- Classify
- Hypothesize
- Communicate

TIME

2 1/2 hours over several days



DOING THE ACTIVITY

A. Set Stage:

"The next and final part of our project is to use the information we have collected about the ESA site and potential users and to make a plan for constructing improvements to the site."

B. Procedure:

1. "First we have to decide what makes a good plan. What things do you think are important to have in a good plan?" (List on blackboard.)
2. Discuss the list. Some items may be grouped together. By consensus or some other method select a manageable list of criteria against which the plans can be evaluated.
3. "Your next task is to develop a plan for the ESA site to meet the needs of the user groups." Divide the class into groups of 4 or 5 and pass out maps of the site and tracing paper to each group. Assure them that more tracing paper is available. NOTE: If tracing paper is not available, multiple copies of the map could be used. "Place the tracing paper over the map and sketch out your ideas. It is important to make several plans with different solutions to the problem. You might consider these to be rough drafts, just like when you write a theme. When planners face a tough problem, they might try dozens of possible solutions before they are satisfied."
4. "When you have several rough plans drawn, discuss them with your group. Identify the good points and bad points of each plan and how well the plans meet the criteria developed earlier."
5. "Now you can make a final plan which incorporates all the best ideas you have developed."
6. "Make a large size map to share with the class and prepare a presentation explaining your plan."
7. Have each group make a presentation explaining their plan. Include an opportunity for questions and discussion.
8. Following the presentations, hang the plans on the bulletin board or wall. By each plan place a large sheet of paper divided in half. Label one half "good features", the other "not such good ideas and problems." Have the students review the plans and write down their comments. This could be done over several days.
9. Select representatives of each small group to be members of the final planning team. Have them use the group plans, student comments and the evaluation criteria to develop a final plan. When the plan is finished, there should be an opportunity for a critique by the class followed by revisions if necessary before the class gives its final approval.



CLOSURE

"This has been a complicated project. It has involved many activities over a long period of time." Review the steps with the students. Have the students reflect on their efforts.

1. "What did you like best about the project?"
2. "What went well? What could have gone better?"
3. "What skills did you develop and use?"
4. "What would you do differently next time?"

Inevitably, the students will want to know about the next phase -- Getting the ESA Built and Used. This is an opportunity to make a plan for this if one has not been developed previously. The plan could include:

- a. Phases of development, priorities and timelines.
- b. Resources from the community, both material and human.
- c. Work parties for students, parents and the community.
- d. Field trips for other grade levels.
- e. Development of guides and instructional materials.





BEST COPY AVAILABLE

Investigating Your Environment — Intermountain Region

436



INTRODUCTION

The processes and procedures included in Investigating An Environmental Issue were developed because of the need to involve people more meaningfully in the study of current problems and issues related to natural resource use and management. It is designed to be used by an individual or group interested in investigating an environmental issue. It is a logical process for educators and students to use in school classes.

Most environmental issues are extremely complex; there are many varied interest groups affected by any situation, and the factors affecting a situation are many. Common factors in a given environmental issue might include resource commodity, agency management policies, land use planning policy, land ownership, weather and climate, local economies, and recent national environmental policy.

The effect of an issue and any action about it can be local, state wide, national, international, or regional. An issue has both short-range and long-range effects and implications: economically, socially, politically and environmentally. Environmental issue like many other issues today have no "absolute rights or wrongs," no "cut and dried" answers, and are generally more than two sided! Any decision about an issue will be a selection of one of several possible alternatives. It may reflect trade-offs in values of the factors involved and the people and groups affected by the decision.

Completing some of the lesson plans in the "Investigating Your Environment" series such as the soil investigation, water investigation, or forest investigation may help in collecting and analyzing information about an issue.

THE ACTIVITIES

A complete correlation is impossible without first determining the issue and the direction of study. The depth of study and time spent on the investigations will also cause this correlation to vary. At a minimum level, and with almost any issue, the following goals and guidelines will most likely be involved:

TIME REQUIRED

Depends upon how in-depth you get, what means of information gathering you choose, i.e. interviewing people takes longer than looking up references and how complete of an issue analysis you want.



COMBINING THE ACTIVITIES

This series of involvement activities focuses on a current environmental issue or situation. The process is designed so all or selected phases depending upon the objectives of the study can be used. For example, Phase 1 is usable by itself as the basis for analyzing data for an issue and having a group discussion about it. If all phases are used, the elements of role playing with a simulated decision-making process or simulation model are involved.. Each phase identifies sound options to consider (from large group to small group interaction) in studying the issue.

The process and format used here can be easily modified or adapted to fit the study of any environmental issue or concern. The study can be brief or as long as motivation and interest of the audience hold out.

When planning to use this process, follow these steps:

1. analyze the needs of your students
2. analyze the time constraints in your teaching situation
3. analyze the role that this plays in your curriculum
4. decide what phases of the process you want to accomplish
5. decide what modifications will best meet the objectives you want to teach and the needs of the group being taught.

CURRICULUM RELATIONSHIPS

This process can be used to tie virtually any subject areas together into a neat and meaningful package. Curriculum areas would vary with the environmental issue chosen and the direction taken with the investigation; for example:

A class chooses to investigate the proposed damming of a local river for hydroelectric purposes. Curriculum relationships could include science in the preparation of scientific data, such as electrical generation and interruption of migrating fish; social studies/government in testimony at a public meeting involving the decisionmakers for the dam; mathematics/social studies/science (physical science) in preparing electricity needs for the area, calculating the amount of electricity generated and projected increases over the next ten to fifty years, revenues; language arts in preparing various reports (written or oral), and communication arts can be included by having the final report take an oral or visual format.

Following are two optional forms teachers may use to plan an investigation:



TEACHER PLANNING SHEET #2
For Optional Use by Teachers in Planning the Activity

You will notice that in each phase several procedural options are given. The teacher or facilitator should select or help the participants select the most appropriate option based on time constraints, needs and capabilities of the student and the objectives of the studying the issue. (See lesson plans for descriptions of options and activities)

PHASE I: A LOOK AT THE ISSUE (Activities A to D) Check Option

Options: Entire class	_____
Selected students	_____
Teacher	_____

PHASE II: IDENTIFY AND INVESTIGATE INTEREST GROUPS (Activities E to H)

1. Identify interest groups (Activity E & F)

Options: Entire class	_____
Teacher/Small groups	_____

2. Summarize interest groups points of view (Activity G)

Options: Entire class	_____
Small groups	_____

3. Divide into interest groups for role playing (Activity H)

Options: Entire class into interest groups	_____
Entire class into interest groups and Decisionmakers	_____
Selected students represent interest Groups, rest are decision makers	_____

4. Note: Phase IV, Decisionmaking, Preparation, Point #4. A decision needs to be made at this point. This group will need to work on this role while others do interest groups.



PHASE III: DEVELOP RECOMMENDATIONS TO PRESENT TO DECISION-MAKERS (Activities I to L)

- Options: Verbal presentation _____
Written statement _____
Combination of above _____
(Visual displays to accompany
verbal/written statement) _____

PHASE IV: DECISIONMAKING (Activity M)

- Options: Entire class discussion after presentations _____
Small groups make autonomous decision then
entire class discussion _____
Each interest group elects one person to form
decisionmaking body _____
Selected students are decisionmakers _____
Outside group is decisionmaker _____

PHASE V: EVALUATE THE PROCESS (Activity N)

- Options: Entire class _____
Small groups _____

PHASE VI: FOLLOW-UP WITH THE REAL ISSUE (Activity O & P)

- Options: Entire class _____
Small groups _____
Selected students _____



PHASE I: A LOOK AT THE ISSUE

CONCEPT

Concept depends upon the issue you select, the direction you take. Perception is a part of any issue you select. Cause and effect, change, interaction, system, model and scale will (most likely) also apply.

PRINCIPLE

In the next four activities, participants discover the basics of an issue by learning how to explore sources of information from which to begin an issue analysis.

OBJECTIVE

As a result of participation in this investigative process, the student will be able to:

- Identify, collect and analyze data and information about an issue.
- Summarize facts about that issue.

PREPARATION

Identify an environmental issue that you would like your class to investigate. Collection of data can be done by either the teacher or students, depending upon grade level and time available. Information sources include but are not limited to: newspaper reports, data from appropriate agencies, state and federal agency reports, magazine articles, interviews, maps, etc.

Select one of the following options to use with class in Phase I

- ___ a. Entire class researches problem using basic data provided in written material. Students complete activities A - D individually or in small groups. Class discussion about the problem.
- ___ b. Selected students introduce the problem in oral presentations. Students each present one part of the problem or make presentation "through the eyes of" one of the interest groups affected by the issue. Students complete activities A - D from the information given in the presentation(s) and written material provided.
- ___ c. Teacher introduces issue with an oral presentation about the problem. Students complete activities from information gathered from the presentation and written material.

MATERIALS NEEDED

- Copies of activities A, B, C (2 pages) and D for each student
- information sources for each activity, depending upon option selected in Phase I

PROCESSES

- All processes may apply depending on issue selected and the direction the class proceeds with it.

TIME

Depends upon how in-depth you get, what means of information gathering you choose, i.e. interviewing people takes longer than looking up references and how complete of an issue analysis you want.



DOING THE ACTIVITY -- indoors

Activity A - Describing the Issue

A. Set Stage:

Discuss with the class what they already know and how they feel about the issue.

B. Procedure:

Depending upon option selected, the class:

- (a) conducts own research
- (b) receives information from oral student presentations
- (c) receives information from teacher's oral presentation.

Then students complete activity sheet A. They have about 40 minutes.

40 min.
Individual/Group

ACTIVITY A: Describe The Issue

Title of Issue _____

Description of Issue:
What is happening?

Where is it happening? (Past history and events, etc.)

Who is affected?

How are they affected?

What are the impacts of the issue? (Economically, aesthetically, socially, politically, etc.)

What are the possible courses of action about the issue?

Is there an environmental impact statement required and available? Where?

Name, address and telephone number of agency/organization
with major responsibility for final decision and management:

C. Retrieve Data:

Investigating Your Environment
Investigating an Environmental Issue 

In a class discussion, class comes to an agreement on a statement of the issue.



Investigating Your Environment
Investigating an Environmental Issue

442

8

BEST COPY AVAILABLE

Activity B -- Choosing a Direction

A. Set Stage:

"We have stated a problem, now we need to agree on what direction we need to take to understand this problem."

B. Procedure:

Using data gathered in Phase 1, activity A students complete activity sheet B, taking about 45 minutes.

ACTIVITY B: Collect and Record Information 45 min.
Individual/Group

List some factors that might contribute to the issue.

Describe what you want to find out about this issue and/or its factors.

Describe the kind of data that needs to be collected.

Information sources about this resource or activity (people, places, reports, etc.).

- 1.
- 2.
- 3.

Based on the information we have read and the things we've discussed, our group would like to find out more about:

- 1.
- 2.
- 3.

Questions we will ask to find out these things are:

- 1.
- 2.
- 3.
- 4.

In order to find out more about these things, we will make specific observations about:

- 1.
- 2.
- 3.

We will use the following data recording procedures:

Investigating Your Environment
Investigating an Environmental Issue



C. Retrieve Data:

Discuss the activity. On the board or chart paper, summarize questions students generated to find out more about the issue.



Activity C -- Exploring Interrelationships and Identifying Conflict

A. Set Stage:

"Let's take a look at how the various players fit together in this issue." What are some interrelationships of this issue? What are some potential or existing conflicts inherent in this issue?

B. Procedure:

1. Refine data gathered in Phase 1, activity A & B if necessary. Students may want to dig deeper into some aspects of the issue.
2. Student complete activity C, taking about 45 minutes, for both pages.

45 min. Individual/Group

ACTIVITY C: Interpret The Information Collected

Describe what the collected data tells you about the issue.

Management Practices Used for this Resource or Activity	Why

List correlations, contrasts, or cause-and-effect relationships that can be inferred from the collected data.

What big ideas are suggested by the interpretation of this data?

What implications do these big ideas have to environmental management?

Extending the Investigation
List parts of the investigation that can be explored more fully by further data collection.

Describe data that still needs to be collected. (Where? How often? Time of year?)

Describe what might be significant about collecting the additional information.

Investigating Your Environment
Investigating an Environmental Issue

C. Retrieve Data:

Discussion and charts are needed for summation. Ask questions such as: "What significant information did you discover?" "What relationships do you think are critical to our investigation of this issue?" "Where do we go from here?"



Activity D -- Analyzing Impacts

A. Set Stage:

"You've defined the problem, figured out how to obtain more information and looked at the players involved. Now let's put this issue into perspective in its broadest context. Let's look at potential impacts this issue could have."

B. Procedure:

Data collected in the previous phases will be helpful. Students work in small groups to complete activity D. They have 45 minutes.

C. Retrieve Data:

Using Activities A through D, construct a brief statement which would summarize the general impact of this resource or activity.

ACTIVITY D: Analyze The Impact

25 min.
Individual/Groups

Based on the data you have collected so far, describe the general interest and impact, as you see it, that this issue can have in the following areas.

Area	Impact on Other Nearby Environments	Social Patterns	Economic	Political	Other
Locally (county, city)					
Interest					
Impact					
Regionally (State or states)					
Interest					
Impact					
Nationally					
Interest					
Impact					
Internationally					
Interest					
Impact					

From the chart above, your observations and the analyzing of information about the issue--construct a brief statement which would summarize the general impact of this resource or activity.

Investigating Your Environment
Investigating an Environmental Issue



CLOSURE

Not necessary if continuing this investigation. If ending here: have students share aloud facts or data they learned or something about the process or both - make a class list.

TRANSITION

Using the data you've collected, we are going to go further with this investigation. Let's take a look at the groups of people who are directly involved with this issue.

PHASE II: IDENTIFY AND INVESTIGATE INTEREST GROUPS

CONCEPT	Change, Population, Perception, Interaction System		
PRINCIPLE	These activities should lead to increased understanding of special interest groups and the beliefs and concerns which lead them to action.		
OBJECTIVE	<p>As a result of the participation in this investigative process, the student will be able to:</p> <ul style="list-style-type: none">• identify and list individual and/or groups who might be interested or affected by an issue, and;• identify and list questions and concerns they might have about an issue.• The student will be able to describe in writing a summary listing of interest groups and point of view of those interest groups.• The student will be able to describe in writing the history of an assigned interest group and role play that group's position in a simulation model about an issue.		
PREPARATION	<p>Complete Phase I of this process. Decide how you wish to run each of these activities by selecting one of the following options in Phase II. Each student fills out an entire lab sheet.</p> <p>___ a. Entire class does research for activities E and F:</p> <ol style="list-style-type: none">1. Individually2. Small Groups <p>___ b. Teacher provides list of interest groups for a "starter":</p> <ol style="list-style-type: none">1. Students fill out list of questions and concerns<ol style="list-style-type: none">a) Individuallyb) Small Groups2. Divide class into small groups. Each group lists five to six questions or concerns for <u>one</u> of the interest groups. Each group list is compiled into a "master" list.		
MATERIALS NEEDED	<ul style="list-style-type: none">• Copies of activities E, F, G* and H for each student (*Note: if option G is chosen each student will need one copy of sheet G for <u>each</u> interest group)• Reference materials on groups• Chart paper and markers		
PROCESSES USED	<table><tr><td><ul style="list-style-type: none">• Classify• Question• Interpret Data• Observe</td><td><ul style="list-style-type: none">• Infer• Define operationally• Predict• Communicate</td></tr></table>	<ul style="list-style-type: none">• Classify• Question• Interpret Data• Observe	<ul style="list-style-type: none">• Infer• Define operationally• Predict• Communicate
<ul style="list-style-type: none">• Classify• Question• Interpret Data• Observe	<ul style="list-style-type: none">• Infer• Define operationally• Predict• Communicate		
TIME	Depends upon how in-depth you get, what means of information gathering you choose, i.e. interviewing people takes longer than looking up references and how complete an understanding you want students to have of interest groups.		



DOING THE ACTIVITY -- indoors

Activity E -- Listing Possible Special Interest Groups (Skip this if option "B" selected - see "Preparation")

A. Set Stage:

"It is important to identify groups and individuals who have a right to be involved in investigating, reporting and solving an issue."

B. Procedure:

Students complete activity sheet E either individually or in small groups (see options in "Preparation"). Take 35 minutes.

ACTIVITY E: List The Possible Interest Groups 35 min.
Individual/Groups

It is important to identify the groups and individuals who have a right to be involved in investigating, reporting, and solving the issue. List key groups or individuals in the categories below.

Who These groups of individuals interested in the issue.	Why
Who These groups or individuals that should be interested in the issue.	Why
Who These groups or individuals affected by the issue. (May include some from above.)	Why

C. Retrieve Data:

Investigating Your Environment
Investigating an Environmental Issue 

"What are some of the groups/individuals that may be affected by this issue?" You may want to summarize group findings on the board or chart paper and add groups as the participants discover those who weren't considered.



Activity F -- Analyzing the Interest Groups

A. Set Stage:

"By taking a close look at what each interest group is concerned about, we can learn a lot about what role these groups might take concerning this issue."

B. Procedure:

Students conduct research as needed. This may involve interviewing group representatives or reading files. Then students complete activity sheet F.

30 min.
Individual/groups

ACTIVITY F: Analyze The Interest Groups

- List interest groups and individuals who might be interested in (or affected by) this issue.
- List questions or concerns each group might have.
- Check each interest group who would share question or concern. (From Dr. Mike Glumacette)

Interest groups and individuals (list vertically by name)					

Questions/Concerns (Place x in each column of group that shares this question or concern)					
1.					
2.					
3.					
4.					
5.					
6.					
7.					
8.					
9.					
10.					
11.					

Investigating Your Environment
Investigating an Environmental Issue 

C. Retrieve Data:

How many of the interest groups share concerns? What are the concerns they share? How many sides of this issue are there as far as the special interest groups are concerned? Were there any surprises for you in doing this activity? Were any of your beliefs about a specific interest group either confirmed or shaken. Record data for all to see.



Activity G -- Summarizing the Points of View of Interest Groups (May be done after Activity Sheet H)

A. Set Stage:

"Understanding the interest group's points of view and concerns will help us predict what roles they may play in confronting the issue."

B. Procedure:

1. Select one of the following options to use with the class.
 - ___ a. Individuals (If this option is chosen each student will need multiple copies of Activity Sheet G).
 - ___ b. Small groups can use activity sheet G or can wait and use after each interest group has developed their own "group's history" (Activity H)
2. Complete the research and discussion based on method chosen; activity sheet G.

25 min.
group

ACTIVITY G: Summarize The Points Of View Of Interest Groups

Analyzing the information in Activity H and other information you can gather about the interest groups, complete the following chart:

<u>Interest Group:</u> _____	<u>History of Interest—</u> Past, Present, Future
<u>Concerns they have about the issue</u>	
<u>How they are affected by the problem</u>	
<u>Alternatives they might choose and why</u>	

C. Retrieve Data:

Investigating Your Environment
Investigating an Environmental Issue

"How can we summarize each interest group's points of view?"



Activity H -- Developing the Interest Group History (may be done before Activity G) and Role Playing

A. Set Stage:

"We've had a chance to identify some of the special interest groups and analyze their relationship to this issue. Now let's take a look at how these groups behave."

B. Procedure:

1. Select an option on how to form groups:
 - a. Divide entire class into interest groups
 - b. Divide part of class into interest groups; rest of group are decisionmakers.
 - c. Selected students become individual representatives of interest groups; remainder of class are decisionmakers.
2. "We've had a chance to identify some of the special interest groups and analyze their relationship to this issue. Now we need to look at how these groups behave. To help do that, you need to do a capsule history for the group first."
3. Divide the class into groups. (May use previous groups)
4. Caution the groups to not become too involved in the "answers or solutions" to the problems, before analyzing who they are or represent, determine the philosophy of the group they represent and prepare a capsule "group history".
5. Students complete activity H, assess how they will behave and determine what they will say in the role-playing.

C. Retrieve Data:

Students role-play their assigned group in the context of a public hearing, a T.V. debate, a radio show, a panel discussion or any situation the class chooses.

CONCLUSION Summarize your experience with these activities.

TRANSITION Now that you're familiar with the points of view of the various special interest groups, it is probably clear that different groups would hope for a different final decision to be made about this issue. How can the different groups affect that decision making process? Let's see how.



PHASE III: DEVELOP RECOMMENDATIONS TO PRESENT TO THE DECISION MAKERS

- CONCEPT** Cause/Effect, Interaction, Model
- PRINCIPLE** A conclusion to researching an issue and understanding groups, is to make recommendations to the decisionmakers.
- OBJECTIVE** The student will be able to:
- identify factors contributing to an issue, identify possible alternatives to the present condition of an issue and analyze the alternatives.
 - generate possible courses of action to solve problems and analyze the advantages and disadvantages of these courses of action.
 - select a proposed solution, recommendation, or course of action; determine its feasibility and plan its implementation.
 - prepare an effective presentation to forward their group's plan.
 - construct a list of criteria to evaluate the presentations of the action plans.
- PREPARATION** The presentation of recommendations is made by each special interest group identified and analyzed in Phase Two. Each group should use a combination of verbal and written presentations and make visual displays.
- MATERIALS NEEDED**
- copies of activity sheets I, J, K, L and M for each participant
 - chart paper, colored pens and tape
 - materials from which to create visual displays: paper, markers, pens, chalk, camera, film, overhead transparencies, etc.
- PROCESSES USED**
- Classify
 - Communicate
 - Infer
 - Question
 - Hypthesize
 - Interpret data
 - Predict
 - Formulate models
 - Communicate
- TIME** Depends on how in-depth you get, what methods of information presenting you allow , i.e. film development takes longer and how complete the recommendations need to be.



DOING THE ACTIVITY -- indoors

Activity I -- Analyzing Factors and Alternatives to Present Conditions

A. Set Stage:

"Now that we have some knowledge about the issue and the interest groups, let's see if we can generate and analyze some alternatives to the present condition."

B. Procedure:

1. Brainstorm using Activity I for the format and record in group memory all the factors contributing to the issue.
NOTE: See example of Activity I.

ACTIVITY I: Analyze Factors And Alternatives To Present Conditions 45 min. group

Activity I is designed to generate a list of possible alternatives. List the factors contributing to the issue. Take each factor and ask: "How can we change this factor (eliminate, modify, substitute) to bring about a change in the issue?" Consider all alternatives, no matter how silly they may seem.

Factor	How it contributes to the problem or issue	Alternative to its present condition Select one to show alternative being and describe how the factor might be changed (Elimination, Modification, Substitution)	Describe how the change will affect the problem or issue.

2. Now analyze how each contributes to the problem.
3. After all factors have been analyzed, take each factor and ask: "How can we change (eliminate, modify, substitute) this factor to bring about change in the issue?" Consider all alternatives no matter how silly they seem.
4. Students complete Activity I including the last column and describe how the change will effect the problem or issue.

C. Retrieve Data:

Are you surprised that some of the alternatives that seemed silly at first seem plausible now?" "How will the interest groups view these alternatives?"



Activity J -- Analyzing Possible Courses of Action

A. Set Stage:

"We've come up with some alternatives to the present conditions which should suggest various courses of action. Let's see how many courses of action we can come up with and look at the advantages and disadvantages of each."

B. Procedure:

1. Divide students into small groups that include a representative of each special group from Phase II.
2. Groups discuss and develop a list of possible courses of action and the advantages and disadvantages of each. Since the groups contain members of all interest groups, opinions may differ about the advantages and disadvantage of the course of action. All Students need to write on their sheets as they'll need the data for the next activity.
3. Students complete activity sheet J.

30 min.
group

ACTIVITY J: Analyze Possible Courses Of Action

Develop a list of possible courses of action from Activity I and all the other information and data you have collected. List below, analyze advantages and disadvantages of each.

Possible Courses of Action	Advantages	Disadvantages

Based on the interests, needs, and history of your assigned group, select one or more courses of action that your interest group might support.

Before deciding on your final recommendations, your group should analyze these courses of action using the chart in Activity J.

C. Retrieve Data:

Based on the interests, needs and history of your assigned group, select one or more courses of action that your interest group might support.

Investigating Your Environment
Investigating an Environmental Issue 

BEST COPY AVAILABLE

21
453

Investigating Your Environment
Investigating an Environmental Issue



Activity K -- Developing an Action Plan

A. Set Stage:

"You've all seen that there are many possible courses of action at this point and that people disagree about which one(s) might be the best. Let's take this opportunity for the special interest groups to get together and each come up with what they feel is the best plan of action."

B. Procedure:

Special interest groups from Phase II get together and review data from activities I and J and then complete activity K. **NOTE:** See example for Activity K. More than one sheet may be needed per group.

ACTIVITY K: Develop An Action Plan To Implement Your Proposed Recommendations 75 min. group

Select one of the solutions, recommendations, or courses of action suggested by your group. Write it below under "Suggested Solution." Complete the rest of the chart. This Activity can help you determine if your solution is feasible or not, and what course of action you plan to take for its implementation.

Suggested solution (or recommendation or course of action)	Type action necessary to implement your idea	Identify change agents who could help implement your idea	Implementation steps		Evaluation methods How will you follow up and evaluate the effectiveness of your actions?
			Steps	Target Date	
	Technological	Individual	1.		
	Social	Groups	2.		
	Political	Agencies	3.		

Original published by the Environmental Action Foundation

C. Retrieve Data:

How is the action plan your group has selected consistent with your group's history and values?



Activity L -- Preparing to Present your Action Plan

A. Set Stage:

"Now that your groups have developed action plans it is important to consider how you will present these plans. Your presentations can make the difference between having your plan or someone else's plan selected. I will give you all an outline of the information that should be included in your presentation. It is up to your group to decide the best way to present your plan."

B. Procedure:

Small groups meet, review and complete activity sheet L.

ACTIVITY L: Make Recommendations By Interest Groups 40 min.
group

We recommend (We action about the issue) _____

because (of these facts) _____

(and these opinions from our group) _____

The following steps would be necessary to implement our recommendation _____

By _____
Interest Group



C. Retrieve Data:

Prepare presentations within guidelines set by instructor.

Activity M -- Establishing Criteria to Evaluate Recommendations

A. Set Stage:

"We will soon be involved in presenting our action plans to a decisionmaking body. Let's take a look at how those decisionmakers will evaluate our presentations."

B. Procedure:

1. Students brainstorm list of items needed to consider in evaluating presentations. The group needs to agree on which criteria will be used.
2. Students complete left column of activity sheet M.

25 min.
group

ACTIVITY M: Establish Criteria To Evaluate Recommendation

To be used by decision making body. After hearing the presentation, rate the recommendations on the sheet below.

Note: There are many ways to make a decision. Voting is only one of them.

Criteria (List items needed to consider in evaluating presentations)	Recommendations by Interest Group
	Name of Interest Group
	(Rate recommendations against criteria)

Summary of the Decision-makers evaluation and report:

C. Retrieve Data:

What were some of the criteria for evaluation you listed? Should some of these be weighted (considered more than others?)

Investigating Your Environment
Investigating an Environmental Issue

CLOSURE

Do you think your presentations will be evaluated fairly by the decisionmaker(s)? Why or why not?

TRANSITION

Eventually a decision must be made on the issue in question. How can the best decision possibly be made?



PHASE IV: DECISIONMAKING

CONCEPT	Interaction, Model
PRINCIPLE	This activity allows participants to become decisionmakers or to evaluate the decisionmaker's decisions against established criteria. It is an opportunity to "do a better job" than we perceive decisionmakers as doing.
OBJECTIVE	<ul style="list-style-type: none">• The student will be able to make the presentation prepared in Phase III and make a decision based on the evaluation criteria generated in Activity M.
PREPARATION	<p>Set up the room to accommodate the option selected. Options are:</p> <ol style="list-style-type: none">1. No decision-makers. After presentations, the entire class evaluates and discusses the proposals, analyzing the consequences of each of the alternatives.2. Entire class is divided into small groups. Each new group consists of one member from each interest group. The new groups each act as an autonomous decision-making body.3. Appoint, select, or elect one person from each interest group to be a decision-making body.4. Selected students (by chance or appointment) are designated as the decisionmaking body early in the game and do not become involved in an interest group.5. Outside groups come in, hear the presentations and become the decisionmaking body. Could be: 1) another class studying the problem (2) another class not studying the problem (3) group of students from different classes or (4) a group of local adult decisionmakers. <p>Decisionmaking body needs time to prepare the operating rules and the stage-setting details.</p>
MATERIALS NEEDED	Multiple copies of activity M with left column completed for each decision maker. Each decisionmaker will need one of these sheets for each presentation to be evaluated.
PROCESSES USED	Depends somewhat upon option selected above and in Phase Three Activities L presentation mode. At a minimum: <ul style="list-style-type: none">• Communicate• Interpret data
TIME	60 minutes, depending upon number of groups presenting and how you want to close this activity.



DOING THE ACTIVITY -- indoors

A. Set Stage:

*Present the decisionmakers; let them set the stage for the presentations.

B. Procedure:

1. Student groups make their presentations.
2. Decisionmakers listen, use Activity Sheet M and make a decision and present their decision to the group depending upon the option selected above.
3. There are many ways to make a decision, voting is only one of them. Decisionmakers need to know how they will decide prior to hearing the presentations.

C. Retrieve Data:

After group has analyzed factors affecting the problem, analyzed alternatives and made a decision on a possible course of action in activity M, it is important to actually write a letter with their recommendations for solving the issue, including justification and data, to the appropriate group responsible. (See activity A).

*Decisionmakers need 10-15 minutes to decide how they want presentations made. Than after they set the "ground rules", give groups 5-10 minutes to set up.

CLOSURE None - go to next activity.

TRANSITION An evaluation of what's been accomplished is always necessary, so that you know how to complete the process again and how to improve it.

ACTIVITY M: Establish Criteria To Evaluate Recommendation 25 min. group

To be used by decision making body. After hearing the presentation, rate the recommendations on the sheet below.

Note: There are many ways to make a decision. Voting is only one of them.

Criteria (List items needed to consider in evaluating presentations)	Recommendations by Interest Groups
	Name of Interest Group
	(Make recommendations against criteria)

Summary of the Decision-makers evaluation and report:

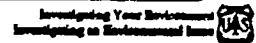

PHASE V: EVALUATE THE PROCESS

CONCEPT	Model, Change
PRINCIPLE	Students will have spent some time in this activity. This lesson offers the opportunity to evaluate what they have done and how it might have been done more effectively or efficiently. Evaluating the process will allow students to increase the effectiveness of their participation in subsequent processes similar to this one, and to actively design better processes for decisionmaking in all phases of their lives.
OBJECTIVE	<ul style="list-style-type: none">• The student will be able to describe in writing his/her ideas about the processes in which they have been involved.
PREPARATION	Select one of the following options for this phase: <ul style="list-style-type: none">a. Entire class discussionb. Small group discussionsc. A written evaluationd. Any combination of the above
MATERIALS NEEDED	<ul style="list-style-type: none">• Copy of activity sheet N for each participant
PROCESSES USED	<ul style="list-style-type: none">• Observe• Infer• Communicate• Interpret data• Question• Hypothesize
TIME	30 minutes



DOING THE ACTIVITY -- indoors

A. Set Stage:

"We've just spent a lot of time studying about environmental issues. The processes we used may have been different than those you are used to in school. Now you will have a chance to evaluate this process and, as you do, think also about what my reasons for involving you in this type of investigation may have been."

B. Procedure:

Using the option selected, students complete activity sheet N.

C. Retrieve Data:

Discuss what they think is the value of doing this activity. Do make the point of the "real life" transferral of the skills they have gained in participating in this activity. Don't let them see it just as information accumulation!

CLOSURE

Make sure students realize the process they went through is important in addition to the information they have gained on the issue.

List answers to the question: What things have you learned that you consider important?

TRANSITION

Not necessary if the issue used was not one currently being worked on. If issue is currently before the public, then lead into the next activity.

ACTIVITY N: Evaluate The Process

35 min.

Individual/Group

Respond to the following questions:

1. Group Interaction and Individual Participation

a) How did you feel about your participation as an individual? Is there anything you would change about the way you participated for another time?

b) What were some factors that helped people to work together in a group?

c) What things were done to encourage participation by everyone?

d) Did new leadership emerge during these activities? What factors enabled this to happen?

e) How did you feel playing a role with which you were only slightly familiar?

f) What things have you learned about yourself and/or groups that will help you participate better in your real life group decision-making processes?

2. Content and Procedures

a) In what ways was the decision-making process similar to real decision-making processes in your life? (In our school, in our community)

b) What techniques were used to convince, persuade, or sell an idea?

c) What additional information would you like to have had in order to prepare a better presentation or to gain more understanding about the issue?

Investigating Your Environment
Investigating an Environmental Issue



460



Investigating Your Environment
Investigating an Environmental Issue

**PHASE IV: FOLLOW UP WITH THE ISSUE AS IT
ACTUALLY HAPPENS (OR HAPPENED)**

CONCEPT Interaction, System

PRINCIPLE Students compare their environmental investigation and how it turned out to the actual issue or an issue in contention. Perhaps, their work and analysis is better than what is currently happening or they can see where their work is lacking.

OBJECTIVE The student will be able to:

- construct a matrix of at least six different information sources.
- make a comparison between the study and the real issue.
- compare their discussions and decisions with those of the people responsible for the management of the particular issue being studied.
- compare their data collection techniques and processes with those of people in the professions concerned with the issue.
- have the opportunity to write for additional information about the actual decision.

PREPARATION Complete phases I through V of this lesson plan

**MATERIALS
NEEDED**

- Copies of activities O and P (2 pages back to back) for each student
- Access to media or information on the actual issue

**PROCESSES
USED**

- Communicate
- Infer
- Question
- Interpret data

TIME 2 to 3 hours depending upon the depth of the research



DOING THE ACTIVITY -- indoors

Activity O -- Analyzing Information Sources

A. Set Stage:

"There may have been some differences between our study and the real issue. Let's see whether any differences exist."

B. Procedure:

Students research actual issue and gather sources of information, then complete activity sheet O.

45 min.
group

ACTIVITY O : Analyze information Sources

Examine sources of information about the real issue.

Media (Newspaper, TV, interview, report, etc.)	Source of Information (Who put it out) (Agency, indiv., Org.)	Title	Date	Purpose of Publication or other info.	Points of view Expressed

C. Retrieve Data

Investigating Your Environment
Investigating an Environmental Issue 

How different were the sources of information for our study and those of the real issue?
What difference(s) would this make to the final outcome of the real issue compared to that of our study?



Activity P -- Comparing Results

A. Set Stage:

"How well did we do? Let's take a look at the results of our study and those of the real issue. How well do you think they'll match?"

B. Procedure:

Discuss questions as a class or in small groups. An option is for students to complete activity sheet P first and use this as a basis for discussion and a final report.

ACTIVITY P: Compare Results (page 1)	ACTIVITY P: Compare Results (page 2)
<p>Compare your study of the issue with the actual issue or if identified or other if necessary</p> <p>Interest Groups Were the interest groups you identified in your study the same as those in the real issue?</p> <p>Which interest groups were most vocal in your study?</p> <p>Which questions on your list (Activity B) were asked in the real issue?</p> <p>What additional questions were asked in the real issue?</p> <p>Points of View Compare your summary of points of view (A) during the real issue.</p> <p>Did any of the groups in the real issue change? What reasons could account for this?</p> <p>Was there dissent within the various groups? What was the nature of this dissent?</p> <p>What new facts and figures were brought out in the real issue?</p>	<p>Decision-Making Compare the decision-making process in your simulation (if this was a part of your study) to the actual decision-making process.</p> <p>Who were the decision-makers in each?</p> <p>What factors had the most influence on the decision in each?</p> <p>What did each group "win" and "lose" in the real issue?</p> <p>What compromises were made?</p> <p>Implications of the Decision What provisions are going to be made for followup studies of the proposed action?</p> <p>What future issues or situations might have components similar to this issue?</p> <p>In general, what are the implications of the final decision ...</p> <ul style="list-style-type: none"> ...politically ...economically ...scientifically ...environmentally ...other

C. Retrieve Data:

Students report on questions raised in Activity P. The entire environmental investigation lesson should be discussed in terms of how the students felt about this exercise and whether or not they would recommend it for other students to experience.

CLOSURE How can this process be applied to _____ (name or use a current issue).



A QUICK WAY TO INVESTIGATE AN ENVIRONMENTAL ISSUE

- CONCEPT** Cause/Effect, Change, Interaction, System, Model, Perception, Scale
(perhaps others depending on issue selected)
- PRINCIPLE** In some cases it may not be necessary or desirable to devote the time needed in the previous "Investigation of an Environmental Issue". This may be true when the process used is less important than a capsule analysis of the issue, or when a less complete understanding of the issue is all that is necessary for your purpose. This "quick way" to investigate an environmental issue may then be useful.
- OBJECTIVE** The student will be able to:
- state the issue in his/her own words.
 - identify the main groups and individuals who would be interested or affected by this issue.
 - analyze the major factors affecting the problem.
 - postulate some courses of action to bring improvement to the issue.
 - develop a plan of action for implementation of a proposed solution.
 - summarize the process they used to explore an environmental issue.
- PREPARATION**
1. Do the activity yourself using the attached sample issue on "opossum population increase."
 2. Select an issue for your class.
 3. Select and reproduce copies of newspaper article that will be the basis for your student's understanding of the environmental issue you have chosen.
 4. Reproduce copies of Activity Q.
- MATERIALS NEEDED**
- Copies of the article and lab sheet for each participant
- PROCESSES USED**
- Observe
 - Communicate
 - Infer
 - Interpret data
 - (And others depending on issue and article selected)
- TIME** 60 minutes



DOING THE ACTIVITY

Activity 1 -- Gathering Information

A. Set Stage:

Many times we need ways to analyze environmental issues in order to better understand them. Maybe we want to provide a logical way for our students and citizens to analyze a situation before coming to a conclusion. For the next hour I want to share with you a 'quick way' that will start to do this.

B. Procedure:

1. Distribute a newspaper article and ask participants to read it.
2. Briefly discuss the article and analyze the situation.
3. Distribute Activity Sheet Q and say: "Working in groups of two, discuss the article and complete items one through six."

C. Retrieve Data:

Discuss lab sheet with class, let them complete sheet with information from other groups. Make sure everyone has the data they need to continue.

CLOSURE

Ask groups about difficulties they had with filling out sheet and how they'd go about getting more information.

TRANSITION

Analyzing an issue is only half the solution; the other half comes in identifying actions.

ACTIVITY Q: A Quick Way To Analyze An Environmental Issue 25 min. pairs

1. Read the article and complete the following items. Write the article name, date of publication and publication name here.
2. Impact of issue (Circle appropriate words) Title?

Local	None	Some	A lot
Regional	None	Some	A lot
National	None	Some	A lot
3. List some groups or individuals that would be interested and/or affected by this issue.
4. List at least four additional things you want to find out about this issue and how you would collect and record the information.

Things to find out	Where to find	How to record
1. _____	_____	_____
2. _____	_____	_____
3. _____	_____	_____
4. _____	_____	_____
5. List the major factors that you feel are affecting the problem.
6. List at least three possible courses of action to bring about an improvement or solution to the issue.

Investigating Your Environment
Investigating an Environmental Issue

Activity 2 -- Developing an Action Plan

A. Set Stage:

When most have finished analyzing the first six steps say:

After a person has analyzed the issue and identified some courses of action, the next step is to select one solution or course of action and develop a plan to implement that solution. Let's quickly review the action planning chart, on Activity R.

20 min.
group

ACTIVITY R: Action Planning Chart

1. Suggested course of action from step 6, Activity Q:

2. Action necessary to implement (technological, social, political?)

3. Identify change agents who can help implement this course of action.
Individuals:
Groups:
Agencies:

4. Implementation steps (what must be done, what order, when?)

5. How would you evaluate the effectiveness of your actions?

Investigating Your Environment
Investigating an Environmental Issue 

C. Retrieve Data:

1. Conduct a discussion and make sure the following questions are covered.
 - a. What are the major components of the issue we just analyzed?
 - b. What other information would be necessary before we could determine if our solution(s) were workable?

CLOSURE Summarize how a process like this can be useful. Use it on a school problem if you can.



ACTIVITY A : Describe The Issue

40 min.
individual/groups

Title of Issue: _____

Description of Issue:

What is happening?

Where is it happening? (Past history and events, etc.)

Who is affected?

How are they affected?

What are the impacts of the issue? (Economically, aesthetically, socially, politically, etc.)

What are the possible courses of action about the issue?

Is there an environmental impact statement required and available? Where?

Name, address and telephone number of agency/organization
with major responsibility for final decision and management:



ACTIVITY B: Collect and Record Information

45 min.
individual/groups

List some factors that might contribute to the issue.

Describe what you want to find out about this issue and/or its factors.

Describe the kind of data that needs to be collected.

Information sources about this resource or activity (people, places, reports, etc.).

1.

2.

3.

Based on the information we have read and the things we've discussed, our group would like to find out more about:

1.

2.

3.

Questions we will ask to find out these things are:

1.

2.

3.

4.

In order to find out more about these things, we will make specific observations about:

1.

2.

3.

We will use the following data recording procedures:



ACTIVITY C: Interpret The Information Collected (page 1)

45 min.
individual/group

Management Analysis Matrix

Management Practices Used for this Resource or Activity	Why	Factors to Consider in Managing:		
		Special characteristics of the land of resource (suitabilities) (limitations) (constraints)	Economic Considerations	Effect of current man- agement practices on the total environment



Describe what the collected data tells you about the issue.

List comparisons, contrasts, or cause-and-effect relationships that can be inferred from the collected data.

What big ideas are suggested by the interpretation of this data?

What implications do these big ideas have to environmental management?

Extending the Investigation

List parts of the investigation that can be explored more fully by further data collection.

Describe data that still needs to be collected. (Where? How often? Time of year?)

Describe what might be significant about collecting the additional information.



ACTIVITY D: Analyze The Impact

35 min.
individual/groups

Based on the data you have collected so far, describe the general interest and impact, as you see it, that this issue can have in the following areas.

Area	Impact on Other Nearby Environments	Social Patterns	Economics	Politics	Other
Locally (county, city) Interest Impact					
Regionally (State or states) Interest Impact					
Nationally Interest Impact					
Internationally Interest Impact					

From the chart above, your observations and the analyzing of information about the issue—construct a brief statement which would summarize the general impact of this resource or activity.



ACTIVITY E: List The Possible Interest Groups

35 min.
individual/groups

It is important to identify the groups and individuals who have a right to be involved in investigating, reporting, and solving the issue. List key groups or individuals in the categories below.

<p style="text-align: center;">Who</p> <p>Those groups of individuals interested in the issue.</p> <hr/>	<p style="text-align: center;">Why</p> <hr/>
<p>Those groups or individuals that should be interested in the issue.</p> <hr/>	<p style="text-align: center;">Why</p> <hr/>
<p>Those groups or individuals affected by the issue. (May include some from above.)</p> <hr/>	<p style="text-align: center;">Why</p> <hr/>



ACTIVITY F: Analyze The Interest Groups

30 min.
individual/groups

1. List interest groups and individuals who might be interested in (or affected by) this issue.
2. List questions or concerns each group might have.
3. Check each interest group who would share question or concern.
(From Dr. Mike Giammatteo)

Interest groups and Individuals (list vertically by name)							

Questions/Concerns (place x in each column of group that shares this question or concern)							
1.							
2.							
3.							
4.							
5.							
6.							
7.							
8.							
9.							
10.							
11.							

ACTIVITY G: Summarize The Points Of View Of Interest Groups

25 min.
group

Analyzing the information in Activity H and other information you can gather about the interest groups, complete the following chart:

Interest Group: _____	History of Interests— Past, Present, Future
<u>Concerns they have about the issue</u>	
<u>How they are affected by the problem</u>	
<u>Alternatives they might choose and why</u>	



ACTIVITY H : Develop The Interest Group History

35 min.
group

Complete the following chart for the group you represent.

Your group represents (Is made up of)	Questions or Concerns/Comments
<p>Interests</p> <hr/> <p>Past - Historically, your group has been interested in (supported)</p> <p>Present - At the present time your group is involved in</p> <p>Future - Trends indicate that the future of your group</p>	
<p>How your group is affected by the problem</p> <hr/>	
<p>Additional information from data supplied</p> <hr/>	



ACTIVITY I: Analyze Factors And Alternatives To Present Conditions (Example)

Activity I is designed to brainstorm all possible alternatives. List the factors contributing to the issue. Take each factor and ask: "How can we change this factor (eliminate, modify, substitute) to bring about a change in the issue?" Consider all alternatives, no matter how silly they may seem.)

Factor	How it contributes to the problem or issue	ALTERNATIVES TO ITS PRESENT CONDITION Select one or more alternatives below and describe how the factor might be changed (Elimination Modification Substitution)	Describe how the change will affect the problem or issue
<p>Example: Traffic Management</p> <p>Width of streets</p>	<p>Cause traffic jam</p>	<p>Put in walking or bicycle paths</p> <p>one-way streets</p> <p>Mass transit</p>	<p>Eliminate car traffic, cause changes in working-social patterns</p> <p>Ease congestion because of one-way flow</p>
<p>Everyone start and quit work at same time</p>	<p>Cause traffic jam</p>	<p>Adjust starting, closing, working hours</p>	<p>Minimize number of vehicles, no congestion, less air pollution, etc.</p> <p>Spread out traffic over a longer period of time</p>

40 min.
group

ACTIVITY I: Analyze Factors And Alternatives To Present Conditions

Activity I is designed to brainstorm all possible alternatives. List the factors contributing to the issue. Take each factor and ask: "How can we change this factor (eliminate, modify, substitute) to bring about a change in the issue?" Consider all alternatives, no matter how silly they may seem.)

Factor	How it contributes to the problem or issue	Alternatives to its present condition Select one or more alternatives below and describe how the factor might be changed (Elimination Modification Substitution)	Describe how the change will affect the problem or issue.



ACTIVITY J: Analyze Possible Courses Of Action

30 min.
group

Develop a list of possible courses of action from Activity I and all the other information and data you have collected. List below, analyze advantages and disadvantages of each.

Possible Courses of Action	Advantages	Disadvantages

Based on the interest, needs, and history of your assigned group, select one or more courses of action that your interest group might support.

Before deciding on your final recommendations, your group should analyze these courses of action using the chart in Activity K.



ACTIVITY K: Develop an Action Plan to Implement Your Proposed Recommendations (Example)

Select one of the solutions recommendations, or courses of action suggested by your group. Write it below under "Suggested Solution." Complete the rest of the chart. This Activity can help you determine if your solution is feasible or not, and what course of action you take for its implementation.

Suggested solution (or recommendation or course of action)	Type action necessary to implement your idea	Identify change agents who could help implement your idea	Implementation steps	Evaluation methods How will you follow up and evaluate the effectiveness of your actions?
(Write in solution suggested by the group in Task J)	<p>Technological What kinds of technological action would be necessary to implement this idea?</p> <p>Social What kinds of social action would be necessary to implement this idea?</p> <p>Political What kinds of political action would be necessary to implement this idea?</p>	<p>Individual What kinds of things could be done through individual action?</p> <p>Groups What kinds of things could be done by/through groups? Informal/Formal (organizations)</p> <p>Agencies What kinds of things could be done by/through agencies?</p>	<p>(What must be done?-- in what order?---When?)</p> <p>Steps</p> <p>1.</p> <p>2.</p> <p>3.</p> <p>Target Date</p>	



ACTIVITY K: Develop An Action Plan To Implement Your Proposed Recommendations

Select one of the solutions recommendations, or courses of action suggested by your group. Write it below under "Suggested Solution." Complete the rest of the chart. This Activity can help you determine if your solution is feasible or not, and what course of action you plan to take for its implementation.

Suggested solution (or recommendation or course of action)	Type action necessary to implement your idea	Identify change agents who could help implement your idea	Implementation steps	Evaluation methods How will you follow up and evaluate the effectiveness of your actions?
	Technological	Individual	Steps 1.	
	Social	Groups	2.	
	Political	Agencies	3.	



ACTIVITY L: Make Recommendations By Interest Groups

40 min.
group

We recommend (this action about the issue) _____

because (of these facts) _____

(and these opinions from our group) _____

The following steps would be necessary to implement our recommendation _____

By _____
Interest Group



ACTIVITY M: Establish Criteria To Evaluate Recommendation

25 min.
group

To be used by decision making body. After hearing the presentation, rate the recommendations on the chart below.

Note: There are many ways to make a decision. Voting is only one of them.

Criteria (List items needed to consider in evaluating presentations)	Recommendations by Interest Groups
	Name of Interest Group
	(Rate recommendations against criteria)

Summary of the Decision-makers evaluation and report:



ACTIVITY N : Evaluate The Process

35 min.
individual/group

Respond to the following questions:

1. Group Interaction and Individual participation

- a) How did you feel about your participation as an individual? Is there anything you would change about the way you participated for another time?

- b) What were some factors that helped people to work together in a group?

- c) What things were done to encourage participation by everyone?

- d) Did new leadership emerge during these activities? What factors enabled this to happen?

- e) How did you feel playing a role with which you were only slightly familiar?

- f) What things have you learned about yourself and/or groups that will help you participate better in you real life group decision-making processes?

2. Content and Procedures

- a) In what ways was the decision-making process similar to real decision-making processes in your life? (in our school, in our community)

- b) What techniques were used to convince, persuade, or sell an idea?

- c) What additional information would you like to have had in order to prepare a better presentation or to gain more understanding about the issue?



ACTIVITY O : Analyze Information Sources

45 min.
groups

Examine sources of information about the real issue.

Media (Newspaper, TV, Interview report, etc.)	Source of Information (Who put it out) (Agency, Indiv., Org.)	Title	Date	Purpose of Publication or other Info.	Points of view Expressed



ACTIVITY P: Compare Results (page 1)

35 min.
group

Compare your study of the issue with the actual issue as it develops or after it happened.

Interest Groups

Were the interest groups you identified in your study the same as those actually involved?

Which interest groups were most vocal in your study? In the real issue?

Which questions on your list (Activity B) were actually asked in the real issue?

What additional questions were asked in the real issue?

Points of View

Compare your summary of points of view (Activity G) with the points of view expressed during the real issue.

Did any of the groups in the real issue change their original position as the issue developed? What reasons could account for this?

Was there dissent within the various groups during the issue and following the final decision? What was the nature of this dissent?

What new facts and figures were brought out during the real issue?

Investigating Your Environment
Investigating an Environmental Issue



Decision-Making

Compare the decision-making process in your simulation (if this was a part of your study) to the actual decision-making process.

Who were the decision-makers in each?

What factors had the most influence on the decision in each?

What did each group "win" and "lose" in the real issue?

What compromises were made?

Implications of the Decision

What provisions are going to be made for followup studies of the proposed action?

What future issues or situation might have components similar to this issue?

In general, what are the implications of the final decision . . .

- • • politically
- • • economically
- • • scientifically
- • • environmentally
- • • other



ACTIVITY Q: A Quick Way To Analyze An Environmental Issue

25 min.
pairs

1. Read the article and complete the following items. Write the article name, date of publication and publication name here.

2. Impact of Issue (Circle appropriate words)

Local None Some A lot

Regional None Some A lot

National None Some A lot

Why?

3. List some groups or individuals that would be interested and/or affected by this issue.

4. List at least four additional things you want to find out about this issue and how you would collect and record the information.

Things to find out

Where to find

How to record

1. _____
2. _____
3. _____
4. _____

5. List the major factors that you feel are affecting the problem.

6. List at least three possible courses of action to bring about an improvement or solution to the issue.



ACTIVITY R: Action Planning Chart

1. Suggested course of action (from step 6, Activity Q);
2. Action necessary to implement (technological, social, political?)
3. Identify change agents who can help implement this course of action.
Individuals:

Groups:

Agencies:
4. Implementation steps (what must be done, what order, when?)
5. How would you evaluate the effectiveness of your actions?



Land Use Simulation



BEST COPY AVAILABLE



INTRODUCTION

Many individuals find it difficult to appreciate why some land use decisions are "not right" or "as they should be." Seemingly obvious alternatives appear to be summarily rejected. This activity fosters an understanding of the many factors involved in land use decision making -- political, economical, social and environmental.

THE ACTIVITIES

TIME REQUIRED

Name, record and
classify possible
land uses

60 to 75 minutes

Develop and give
presentations

Analyze character-
istics of simulations

60 minutes

Develop your own
simulation game

COMBINING THE ACTIVITIES

Although the activities in this unit may be done independently it is necessary to combine, name, record and classify possible land uses and develop and give presentations, to make a complete "game".

Analyze "Characteristics of Simulations" may be used as part of the review of the game but it is more effective if it is used as the introductory activity for Develop your own Simulation game.

Note:

The Centerplace City problem has been adapted with permission from the May 1970 Journal of Geography from the article "A Land Use Alternatives Model for upper Elementary Environmental Education" by Dennis Asmussen and Richard Cole, University of Washington.



CURRICULUM RELATIONSHIPS

Social Studies

1. Read about the establishment of your community. Discuss major factors determining growth and the direction of growth.
2. Determine the location of major transportation routes, road and railway and theorize how they may have influenced the location of industrial developments, housing and other facilities.
3. Determine what the current issues and concerns are in your community. Why do these concerns exist?
4. Follow a local current issue through to its conclusion. Attend planning or public meetings held on the issue.

Science

1. Use maps showing features such as topography, drainage, wetlands, floodplains, etc. Determine what effect these may have had on the growth of the community and where housing, industrial facilities, etc., are located.
2. Sample water quality in streams or other bodies of water and infer what effect development in the area may have had on the water quality.
3. Determine what bird and animal species are important to your area. Gather population data on these species. How have numbers changed over time? What affect has this had on the human population? What are the current management policies for the species? How would you change management for the species?

Mathematics

1. Use community or county statistics to determine the cost per person of items such as sewage disposal; garbage disposal, water, law enforcement, and other services
2. Determine percentage of land in the community or county in various types of use, e.g., housing, agriculture, industrial.

Language Arts

1. Write a story describing what the community might be like if the major highway or railroad had bypassed the community. Or, if that has happened, write a comparison of the community before and after.
2. Draft a proposal for locating a needed sanitary landfill and supply supporting arguments.
3. Interview local "oldtimers" about what the county or community looked like when they were youngsters. Try to locate photographs that correspond to that era.

Creative Arts

1. Make a colored map of the community over time. Show the original settlement in one color and then color in growth in different colors showing expansion in 5 to 10 year periods. If you have the skills and materials, use the overlay system to make the maps.
2. Sketch the view you would like to have from your kitchen window. Expand upon this to include the view from the classroom (if you have windows), the view from the front of the school, or before and after sketches if you could improve upon the scene.



LAND USE SIMULATION GAME—CENTERPLACE CITY—NAME, RECORD AND CLASSIFY POSSIBLE LAND USES AND GIVE PRESENTATIONS

CONCEPT	Cause/Effect, Change, Population, Evolution, Interaction, Model
PRINCIPLE	Participants become involved in trying to solve some land use issues for this city. They role play common interests and find out how land use decisions are often made.
OBJECTIVE	<ul style="list-style-type: none">• As a result of this activity, the student will be able to predict or postulate at least three different possible points of view on any given environmental issue.• The student will be able to identify at least 3 factors which would influence a land use decision.• The student will be able to discuss how opposing interests might effect a land use decision.
PREPARATION	<ol style="list-style-type: none">1. Arrange for a room large enough to accommodate five to six tables that will seat up to eight participants per table. The room also needs to accommodate an additional large table with chairs and an easel large enough to be seen from anywhere in the room.2. Look up population figures for the towns in your area, so that Centerplace's population has meaning for the students.3. Arrange for a smaller room nearby to accommodate up to 10 persons, a large table and easel.
MATERIALS NEEDED	<ul style="list-style-type: none">• Large tables (number depends on number of participants)• One chair per participant• One set of four to five different colored markers for each table• One set of markers for facilitators and one set for use in small room• Two easels with easel paper• Two sheets easel paper or newsprint for each table• One roll masking tape or way to fix paper to walls• Populatio figures for local communities• Activity Sheet A: Brainstorming Possible Land Uses, B: Develop & give Presentations, C: County Board Members
PROCESSES USED	<ul style="list-style-type: none">• Observe• Interpret data• Classify• Question• Predict• Infer• Communicate
TIME	60 to 75 minutes



DOING THE ACTIVITY

A. Set Stage:

Review quickly what will take place, i.e. "During this activity we will participate in simulation game concerning land use in a hypothetical community, analyze what we have done and discuss some ideas and ways to develop your own simulation game about local environmental issues or concerns. Techniques used combine elements of simulations, role-playing and games. You will assume roles of decision-makers in a simulated environment and compete for certain objectives according to specified procedures and rules."

B. Procedure:

1. Distribute activity A. Read the problem to the group: "The problem is to identify some possible uses for the one-square mile (640 acres) of county farmland, four miles northwest of the city. It is now available for the city's use."
2. Ask participants to read the information given on the activity sheet and list possible uses of the land to meet the city's needs.
3. You have 10 minutes. Work individually.

ACTIVITY A: Brainstorming Possible Land Uses

10 min.
Individual

"One square mile (640 acres or 259 hectares) of unused county farmland, 4 miles (6.4 km) northwest of the city, is now available for the city's use."

Read the background information for Centerplace City, and then list some possible uses of the vacant farmland.

Background Information Sheet For Centerplace City:

- The population is 250,000 and rapidly increasing.
- The city's boundaries are being extended, but the suburban fringe is expanding even more rapidly.
- The rapid population growth is accompanied by demands for more housing, more jobs, additional city services, and recreational areas.
- The power for industrial uses, adequate public transportation, and a skilled labor force are available.
- The city is located near forests, to the north. The land to the east is devoted mainly to farming.
- The Pipe River is unpolluted and is the source of irrigation water as well as the municipal water supply.
- The river is too small for freight transportation, but logs could be floated on it.
- The gravel bed of the river is appropriate raw material for concrete manufacture.
- The present sewage treatment plant and garbage disposal area are at maximum capacity.
- The citizens of Centerplace are concerned about the maintenance of a scenic regional environment.
- The County Board of Commissioners is the authority for land zoning, and many citizens' groups are being formed to influence zoning decisions.

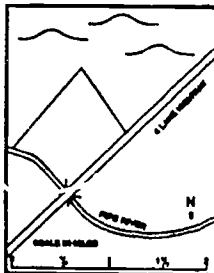
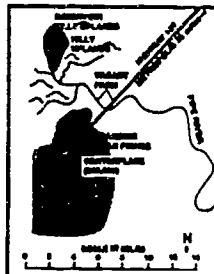

List possible uses of the land

Investigating Your Environment
Land Use Simulation UAS



Investigating Your Environment
Land Use Simulation



408

BEST COPY AVAILABLE

C. Retrieve Data:

When most people have started to write down uses, go ahead and ask question 1.

1. "What are some possible uses for the undeveloped land? As people respond, write all comments just as they are said, don't paraphrase. If they are too wordy, ask: "How shall I write that on the chart?" List all suggestions, specific or general. Number the items to simplify identification later. When you feel you have enough material, ask the next question.
2. Ask "Which of these possible uses are similar?" Designate similar uses by letters, symbols, or colors. When most are designated, or the group seems to run out of thoughts, STOP. Change items among categories if the participants change their minds. Don't get bogged down in the details of grouping, i.e. if some people think one use should be in another category, then put that use in both categories and go on to the next step.
3. Ask "What title could we give to all the items in the same category?" e.g. Recreation, Industrial, Utilities, Housing, Commercial.

D. Procedure:

Develop and Give Presentations
(Activity B)

1. Have the group separate into the number of land use categories. Groups should not be more than eight persons. Assign one of the categories to each group for them to represent. One way to set up groups is to have the total group count off by the number of categories identified.
2. Hand out activity B. Inform participants they have 10 minutes to list and analyze the advantages and disadvantages of possible uses for the vacant land in the assigned category. They may consider those listed on the board plus any other possible uses they can think of in their category. It is important to stress that this activity is to analyze the uses of the land.

ACTIVITY B: Develop and Give Presentations

20 min.
small groups

Group _____ Assigned Category of Land Use _____

Your only task is to analyze and list possible consequences of different land uses within your assigned land use category. Do not decide which is the best use.

Use	Advantages to land/ people/resources	Disadvantages to land/ people/resources

Investigating Your Environment
Land Use Simulation



3. Tell the groups their next activity is to develop a land use plan for the area in their assigned land use category (about 20 minutes)
4. NOTE: See 7 for additional direction after each group has started planning. If all directions are given at first, many groups start drawing a map before considering different land uses.
5. Five minutes into their planning make the following announcements:
 - a. "We have just received word that due to the current workload from reading environmental impact statements the members of the Board of County Commissioners have all been resigned. Each group has one minute to elect one member to represent them on the Board."
 - b. "Will the new Board representatives please follow _____ out of this room?"

6. A staff person takes the new Board to another room, hands out and reviews activity C with them.
 - a. Tell them they have 15 minutes until the meeting begins.
 - b. Have them concentrate on evaluation criteria first.
 - c. Have them elect a chairperson to preside over the group presentations.
 - d. Have chairperson read the announcements at bottom of activity C.

ACTIVITY C: County Board members only 15 min.

"One square mile of unused country farmland, four miles northeast of the city, is now available for the city's use."

1. Using this information, your task is to:
 - a. Develop criteria to evaluate the proposals.
 - b. Develop a system to record your evaluation of each proposal.

Background Information Sheet For Cornerplace City:

The population is 250,000 and rapidly increasing.

The city's boundaries are being extended, but the suburban fringe is expanding even more rapidly.

The rapid population growth is accompanied by demands for more housing, more jobs, additional city services, and recreational areas.

The power for industrial uses, adequate public transportation, and a skilled labor force are available.

The city is located near forests, to the north. The land to the east is devoted mostly to farming.

The Pipe River is unutilized and is the source of irrigation water as well as the municipal water supply.

The river is too small for freight transportation, but logs could be floated on it.

The gravel bed of the river is appropriate raw material for concrete manufacture.

The present sewage treatment plant and garbage disposal area are at maximum capacity.

The citizens of Cornerplace are concerned about the maintenance of a scenic regional environment.

The County Board of Commissioners is the authority for land zoning, and many citizens' groups are being formed to influence zoning decisions.

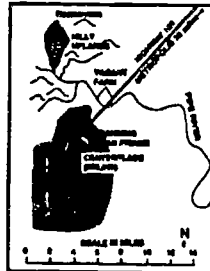

Group Making Presentation (use category)	Criteria to Evaluate Proposal (Rating)					
	1	2	3	4	5	6

Elect a chairperson to preside during the presentations to the group and to run the meeting in an orderly manner. (5 minutes). Announcements to be made by chairperson:

- Because of time constraints, there will be no rebuttal after presentations.
- The board may ask two or three clarifying questions of each group after all presentations.
- You have 3 minutes to give your presentation. You will be given a warning when you have 1 minute left.

7. After the new Board members leave the main room, announce to the planning groups, "You have about 15 minutes to finish your plan and develop a three minute presentation to be made to the County Board of Commissioners. The presentation must include a visual display such as a land use map and more than one person in each group must participate in making the presentation."
 - a. Pass out felt pens and large paper.
 - b. You may have to give some extra time to finish plans and maps.
8. NOTE: Allow 40-50 minutes depending upon number of groups. If you are doing this in a classroom, you can have students develop the presentations one day and present them the next.
9. When all groups are ready, the County Board enters and sits at the front. A time-keeper is appointed to cut off all presentations at three minutes (one minute warning). Chairperson announces criteria on Activity C announcements and adheres to them.
10. When presentations are complete, the Board retires to select the best proposal (5 to 10 minutes).
11. While Board is meeting, each small group develops a list of criteria which they think should be used in choosing among the plans submitted. (See previous page)
12. County Board re-enters the room and reads their criteria aloud.
13. County Board announces their decision and gives their reasons. Board adjourns.
14. NOTE: Person in charge must move rapidly to the next question to avoid shouting matches between losing groups. Have Board members return to the groups who selected them. The main purpose is to evaluate the process, not to get bogged down in the content of the issue.



E. Retrieve Data:

1. Ask participants, "What additional data would you like to have had for planning your group's proposal?" List on board, e.g.: topography, vegetation, economy of the area, railroad, shopping center, adjacent land, climate, soil survey, historical information, flood plain, wildlife, interest of board of control, money available, educational needs, regulations by State, existing zoning, political climate, population information (age, sex, race, jobs).
2. Where would you go to collect information on these topics?
3. Point out to the group that this is one of the most important parts of the activity because it emphasizes that we need a variety of information and data before we can intelligently make a land management or environmental decision to best meet the needs of people and their environment. This list has many of the elements that need to be considered in studying a local environmental issue or concern. It also includes elements of all the curriculum subject areas (social studies, science, language, arts, etc.). Therefore we have to use the total community as a classroom or learning environment to collect the information.
4. If there is time, and it is pertinent to the situation, you may want to ask the following questions.
 - a. Did new leadership emerge during this session? What factors enabled this to happen?
 - b. Did your group work as a team? What did your group do to insure participation by all members of the group?
 - c. Were you assigned to a group or interest you didn't want to represent? How did you feel? Point out that many times we overlook that other people have different needs and ideas and this might be a way to identify them.
5. Discuss any case histories of teachers or groups using this approach. Ask teachers or resource people about computer programs. It is important to do this debriefing step with teachers. Don't do this if you are working with students.

CLOSURE

Use any of the questions in the "Retrieve Data" section to close. You could also have students share how they felt about participating in this activity. One point to be sure to make is that there are alternative solutions to solving specific problems; the "game" proved that!

TRANSITION

In the next activity, you will have the opportunity to look at how simulation games are constructed and to construct your own.



ANALYZE CHARACTERISTICS OF SIMULATIONS AND DEVELOP YOUR OWN SIMULATION GAME

CONCEPT

Cause/Effect, Change, Order, System

PRINCIPLE

This activity provides application of the skills and knowledge experienced in the first activity. After discussion and more exploration, participants see if they can produce their own simulation game.

OBJECTIVE

- The student will be able to identify and describe three component parts of simulation games.
- The student will be able to outline a plan of action for developing a land use simulation or construct a simulation game based on a current environmental issue.
- The student will be able to name and describe at least ten important types of data needed before making a land management decision and describe how that data could affect their life, community and management of the environment.
- The student will be able to identify cause and effect relationships that exist in environmental management.
- The student will be able to describe alternative solutions to solving a specific problem.

PREPARATION

Secure a room large enough to provide adequate working space with large tables. Copy activity sheet for students.

MATERIALS NEEDED

- Copies of newspaper articles on community issues and concerns
- Two easels and easel paper
- Extra pad of easel paper or butcher paper, minimum two sheets per table
- One set, 4 to 5 different colored markers per table, plus one set for facilitators
- One roll masking tape
- Activity Sheet D: Developing a Simulation Game
- Commercially available simulation games for display or computer simulation games such as Oh Deer (optional)

PROCESSES USED

- Question
- Formulate model
- Communicate
- Design experiments
- Control variables
- Interpret data
- Predict

TIME

60 minutes



DOING THE ACTIVITY

A. Set Stage:

"One group of people working with simulation games has identified at least three basic characteristics of most simulation games." As I state each characteristic, think back to our game and see if you can find that characteristic in our game."

1. There is a clearly defined problem.
2. There are factors that influence the decision.
3. There are individuals and groups interested in the decision.

B. Procedure:

1. "The most exciting simulation games are ones people develop themselves, based on local environmental issues in their community, state or region."
2. Can you think of some current environmental issues in your own community around which you could develop a game? List responses on board or paper.
3. For the next 30 minutes work with one or two other people to develop a format for a simulation game based on a local land use issue or topic of your choice. Copies of current newspaper articles are available if you want to use them. At the end of that time, we would like to hear from several of you about what you've developed."
4. Hand out the Activity D to each participant.

ACTIVITY D: Developing a Simulation Game 30 min. small groups

Using a newspaper article about a local environmental land use problem, develop the format of a simulation game, considering the following items:

Identification of the problem or issue to be decided upon.

Identification of some factors having an influence on the decision.

Identification of individual or group roles (those people or groups that will be affected by, or interested in, the problem).

Other things you may want to consider in developing simulation games:

Establishment of conditions for the players (naming procedures, available resources, money, etc.).

Development of specific goals or objectives for players.

Inclusion of limits, or rules for what is permissible behavior (time factors, trading, point system, money allocations, etc.).

Investigating Your Environment
Land Use Simulation 



Investigating Your Environment
Land Use Simulation

C. Retrieve Data

1. Discuss the activity they have been working on. Following are some discussion questions, use the ones which pertain to your situation and to the type of learner you are working with.
 - a. How can you use the techniques in this session in your job? classroom? at home?
 - b. How could a game like this develop decision-making skills in environmental management?
 - c. How can we take this process and use it to involve the public in social and political decision-making action projects in the community?
 - d. What did you think was hard about writing this game? easy? Were there any unexpected obstacles to getting this activity completed?
 - e. What educational value does an activity like this have or, why did I (your teacher) make you do this activity?
 - f. Please share any new learnings or insights from this activity.
 - g. How can we summarize the use of simulation games in environmental interactions?

CLOSURE

Simulation games can help people understand about problems in the environment, develop awareness and concern about those problems and develop skills needed for citizen action and involvement in environmental management. Please evaluate this session in writing. Tell me how you felt about it and if there is any more you would like to do about it.



TEACHER BACKGROUND MATERIALS

GUIDELINES FOR DEVELOPING YOUR OWN SIMULATION GAMES

- I. Develop a set of procedures to be followed in playing the game.
 - A. Goals and/or objectives
 - B. Rules for playing the game
 1. voting procedures
 2. process for recording data
 3. time limits
 4. procedures for presenting data
 - C. Responsibilities of the players
 - D. Provisions for students to collect data, where obtainable, how best to obtain data.

- II. Select a particular land area in your community, for example:
 - A. A vacant lot
 - B. An older building - possibly condemned
 - C. A small park

- III. Establish a land use problem involving the selected area. The land use problem might be developed from a newspaper article from your local newspaper. Examples are listed below:
 - A. An apartment building is being proposed for a large vacant lot that is used for a sand lot ball field.
 - B. A service station is being proposed on a corner across the street from your school.
 - C. A low cost housing area is being proposed on some land next to some more expensive homes.
 - D. A small shopping area is proposed next to a residential area.

- IV. Establish the groups which have a vested interest in the development of the selected land area.
 - A. Residents who own homes near the property, planning commission, apartment building owners, construction workers, store owners near the area, children who play on the lot.
 - B. Oil company representatives, residents, construction workers, parents of the school children, school officials, city planning commission.
 - C. Residents from the more expensive homes, construction workers, contractor, prospective residents of low cost housing, church groups, planning commission.

- V. Identify the possible effects this change could have on the community:
 - A. On taxes for this land and surrounding land
 - B. On land values of the area
 - C. On traffic density and pattern
 - D. On population density and pattern
 - E. On schools, playgrounds, churches, stores of the area
 - F. On wildlife, and other natural environment land, water, air
 - G. On utilities - such as garbage, sewage, electricity



ACTIVITY A: Brainstorming Possible Land Uses

10 min.
Individual

"One square mile (640 acres or 259 hectares) of unused country farmland, 4 miles (6.4 km) northeast of the city, is now available for the city's use."

Read the background information for Centerplace City, and then list some possible uses of the vacant farmland.

Background Information Sheet For Centerplace City:

- The population is 250,000 and rapidly increasing.
- The city's boundaries are being extended, but the suburban fringe is expanding even more rapidly.
- The rapid population growth is accompanied by demands for more housing, more jobs, additional city services, and recreational areas.
- The power for industrial uses, adequate public transportation, and a skilled labor force are available.
- The city is located near forests, to the north. The land to the east is devoted mainly to farming.
- The Pipe River is unpolluted and is the source of irrigation water as well as the municipal water supply.
- The river is too small for freight transportation, but logs could be floated on it.
- The gravel bed of the river is appropriate raw material for concrete manufacture.
- The present sewage treatment plant and garbage disposal area are at maximum capacity.
- The citizens of Centerplace are concerned about the maintenance of a scenic regional environment.
- The County Board of Commissioners is the authority for land zoning, and many citizens' groups are being formed to influence zoning decisions.

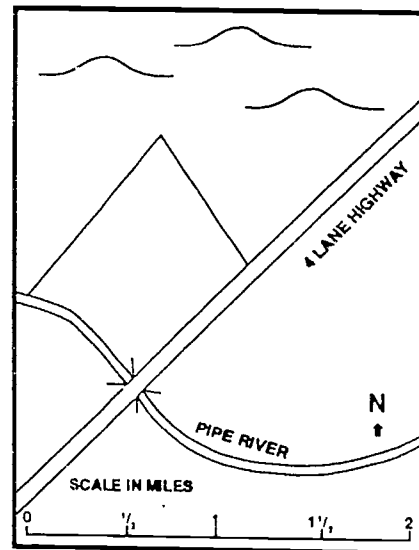
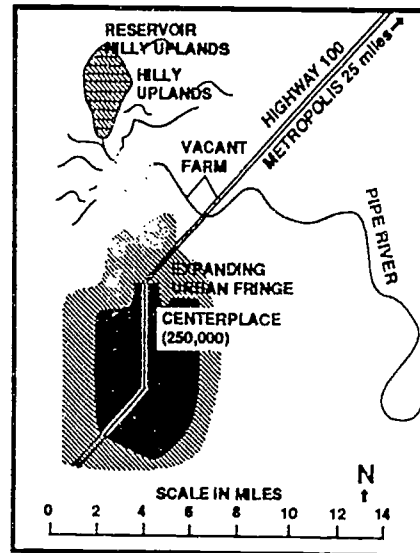

List possible uses of the land



ACTIVITY B: Develop and Give Presentations

20 min.
small groups

Group _____ Assigned Category of Land Use _____

Your only task is to analyze and list possible consequences of different land uses within your assigned land use category. Do not decide which is the best use.

Use	Advantages to land/ people/resources	Disadvantages to land/ people/resources



ACTIVITY C: County Board members only

15 min.

"One square mile of unused country farmland, four miles northeast of the city, is now available for the city's use."

1. Using this information, your task is to:
 - a. Develop criteria to evaluate the proposals.
 - b. Develop a system to record your evaluation of each proposal.

Background Information Sheet For Centerplace City:

The population is 250,000 and rapidly increasing.

The city's boundaries are being extended, but the suburban fringe is expanding even more rapidly.

The rapid population growth is accompanied by demands for more housing, more jobs, additional city services, and recreational areas.

The power for industrial uses, adequate public transportation, and a skilled labor force are available.

The city is located near forests, to the north. The land to the east is devoted mainly to farming.

The Pipe River is unpolluted and is the source of irrigation water as well as the municipal water supply.

The river is too small for freight transportation, but logs could be floated on it.

The gravel bed of the river is appropriate raw material for concrete manufacture.

The present sewage treatment plant and garbage disposal area are at maximum capacity.

The citizens of Centerplace are concerned about the maintenance of a scenic regional environment.

The County Board of Commissioners is the authority for land zoning, and many citizens' groups are being formed to influence zoning decisions.

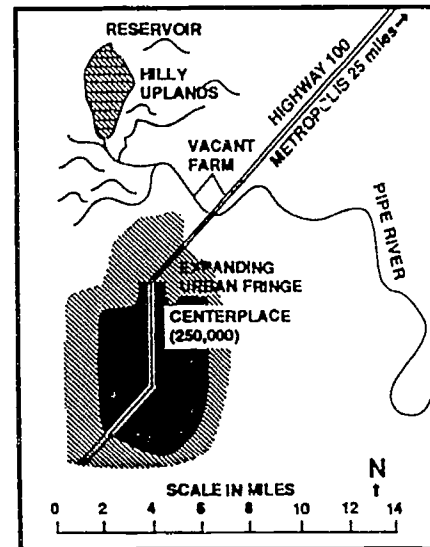

Group Making Presentation (use category)	Criteria to Evaluate Proposal (Rating)					
	1	2	3	4	5	6

Select a chairperson to preside during the presentations to the group and to run the meeting in an orderly manner. (5 minutes). Announcements to be made by chairperson:

- Because of time constraints, there will be no rebuttal after presentations.
- The board may ask two or three clarifying questions of each group after all presentations.
- You have 3 minutes to give your presentation. You will be given a warning when you have 1 minute left.



ACTIVITY D: Developing a Simulation Game

Using a newspaper article about a local environmental land use problem, develop the format of a simulation game, considering the following items:

Identification of the problem or issue to be decided upon.

Identification of some factors having an influence on the decision.

Identification of individual or group roles (those people or groups that will be affected by, or interested in, the problem).

Other things you may want to consider in developing simulation games:

Establishment of conditions for the players (noting procedures, available resources, money, etc.).

Development of specific goals or objectives for players.

Inclusion of limits, or rules for what is permissible behavior (time factors, trading, point system, money allocations, etc.).





BEST COPY AVAILABLE

Investigating Your Environment — Intermountain Region

511



INTRODUCTION

These activities can be used as "sponge" or filler activities, as anticipatory sets for longer lessons, as an introduction to units or theme studies or as experiences from which to write or journal. The activities have been around a long time but don't hesitate to use them. Not everyone has had the opportunity to enjoy them.

You will notice the format is different from other Investigating Your Environment activities. This is because each teacher will have to decide how and when to use these. Hopefully, you will have enough information to fit these into your lessons plans. The concepts and processes are from the National Science Teacher's Association and are replicated in the Oregon Common Curriculum Goals for Science. Listed are obvious concepts and processes which could apply to each lesson depending upon what YOU stress when you use the activity and the purpose for which you are using the activity.

THE ACTIVITIES

TIME REQUIRED

Touch and Feel
Hike

15 to 20 minutes

Color Hike

15 to 20 minutes

Sketching

15 to 30 minutes

Litter We Know

Each item could be done separately for 10 minute activities or this could be developed into an introductory unit to recycling; teacher discretion.



Asphalt Puddles

5 - 10 minutes a day

**Taking a Look at
Air Pollution**

10 to 30 minutes for construction depending upon amount of materials present. 30 minutes to look at final result and discuss.

Mini-Forest

15 to 20 minutes

Weed Patches

20 - 30 minutes

513

2



Investigating Your Environment
School yard Activities

ERIC
Full Text Provided by ERIC

TOUCH AND FEEL HIKE

CONCEPT Change, Interaction, Perception, Population, System

PRINCIPLE • Most activities involved with Investigating Your Environment involve only the sense of sight. This activity explores the sense of touch.

OBJECTIVE • The student will be able to characterize the environment studied using the tactile perceptual mode.

PREPARATION

**MATERIALS
NEEDED:**

- paper
- pencil
- collection boxes (optional)

**PROCESSES
USED**

- classify
- communicate
- hypothesize
- infer
- observe
- predict
- question

TIME: 15 to 20 minutes



DOING THE ACTIVITY (outdoors)

A. Set the Stage

In this lesson, we'll practice our sense of smell. Some of the time, try the activities with your eyes closed.

B. Procedure

Work in pairs

1. Students are led on a walk. At intervals, give the following directions. Students should describe what they find for use later.
2. Find the hairiest leaf around.
3. Find the softest leaf.
4. Find the smoothest rock.
5. Find the roughest twig.
6. Find something cool.
7. Find something warm.
8. Find something bumpy.
9. Find something dry.
10. Think of more feelings you want the student to find and have them ready for the hike.

C. Retrieve Data

Ask students for their responses when you have completed the work, and how they felt when they did the activities with their eyes closed.



COLOR HIKE

CONCEPT

Change, interaction, perception, system

PRINCIPLE

- Although it's the sense people use the most, we often don't "see" things very well. This activity allows participants to look with intensity.

OBJECTIVE

- The student will be able to show that all colors exist in nature.

MATERIALS NEEDED

- pencil
- paper
- Hailstones & Halibut Bones by Mary O'Neill (optional)

PROCESSES USED

- classify
- communicate
- hypothesize
- infer
- observe
- predict
- question

TIME:

15 to 20 minutes



DOING THE ACTIVITY (outdoors)

A. Set the Stage

Take a hike with the students and look for things that are different shades of green. Discourage bringing things back, but encourage students to describe how these green things feel or what they remind them of.

B. Procedure

Working individually or in pairs

1. It is effective to gather in one place and explore shades of green from lightest to darkest or patterns created by the greens.
2. This is also effective for yellow, pink, brown and grey. Yes, you can find lots of pink things in nature! See colors work!

C. Retrieve Data

Ask the students what they've found.

Extension

If you want to extend this activity into a poetry unit, you can have students write color images based on senses. Use O'Neill's book to help. Color images explore all the senses; i.e. Pink smells like.... you may also use the lines "Pink reminds me of..." or "Pink makes me feel like...." to begin or end your color image.



SKETCHING

CONCEPT Evolution, organism, scale, system

PRINCIPLE Comparison is a very powerful learning strategy. In this activity students will use their observation powers to compare trees.

OBJECTIVE The student will be able to compare the shape of two trees using sketching.

PREPARATION

**MATERIALS
NEEDED**

- pens
- pencils
- plain paper
- hard surface, i.e clipboard

**PROCESSES
USED**

- communicate
- define operationally
- formulate models
- infer
- observe
- question

TIME: 15 to 30 minutes depending upon purpose



DOING THE ACTIVITY (outdoors)

A. Set the Stage

"Now we'll focus our attention on looking at trees and what makes them different from one another, by only looking at their shapes."

B. Procedure

1. Find two trees with different shapes. Observe and sketch one tree at a time.
2. Look at the tree from a distance.
3. With your finger, "trace" in the air, the tree's shape. Do this from the ground up and then from the top down.
4. In words, describe the shape of your tree.
5. Make a "telescope" with your hands and look at your tree from a distance. Then make a "picture frame" with your hands and look at your tree.
6. Study the branches and describe how the branches go out from the trunk. Hold your arms to show how the branches branch.
7. Go closer to the tree. How does the perspective change?
8. Get close enough to examine the trunk. Look up into the tree. Describe what you see. How does your perspective change?
9. Now find a comfortable space and sketch your tree.
10. Repeat steps 2 through 9 for the second tree.
11. Teachers, use blind contour drawing if your class knows this technique or you can teach it, to enhance this lesson.
12. You can add color to the sketch by using grass as a crayon or the flower of a dandelion will add yellow. You may also sketch with charcoal from a campfire.

C. Retrieve Data

Have students share their results. Ask "What was the most difficult thing about sketching your trees? the easiest?"



LITTER WE KNOW

- CONCEPT** Cause/effect, change, interaction, organism, perception, quantification, system
- PRINCIPLE** Litter is always something caused by some one else. In this activity, students have an opportunity to analyze litter found and what are the common sources.
- OBJECTIVE**
- The student will be able to define and discuss where different types of litter occur.
- PREPARATION** Make an overhead transparency of the activity sheet.
- MATERIALS NEEDED**
- tags
 - paper
 - pencil
 - "Litter We Know" activity sheet
- PROCESSES USED**
- classify
 - communicate
 - defining operationally
 - hypothesizing
 - infer
 - interpret data
 - measure observe
 - predict
 - question
 - use numbers
- TIME** Each item could be done separately for 10 minute activities or this could be developed into an introductory unit to recycling; teacher discretion.



DOING THE ACTIVITY (indoors, outdoors)

A. Set the Stage

"Litter is all around us. We might be surprised at what we find out about litter and where it's found and where it comes from."

B. Procedure

1. Take a walk on your schoolyard and pick up one sample of litter to bring back to the classroom to share.
2. Is this the same type of litter found in your yard at home? If it is different, discuss the differences. At this point, you may need to define litter and make a distinction between garbage-type litter and naturally occurring litter. Hand out Activity Sheet.

LITTER WE KNOW

COUNT THE KINDS OF LITTER YOU FIND IN EACH PLACE.
COMPLETE THE CHART.

	MY YARD	SCHOOL YARD	NEIGHBORHOOD
GLASS			
METAL			
PAPER			
PLASTIC			

3. Count how many pieces of each different kind of litter you find on your schoolyard and keep a list, e.g. 10 pieces glass, 3 pop cans.

521



4. What kinds of litter did you find the most of? the least of? The class may want to graph their finds.
5. Count how many pieces of each different kind of litter you find in your yard at home and keep a list.
6. What kinds of litter did you find the most of? the least of? You may want to graph this.
7. Count how many pieces of each different kind of litter you find when walking to school, walking through the neighborhood or waiting for the bus. Keep a list. What did you find the most of? the least of? You may want to graph.

C. Retrieve Data

Use an overhead to collect the data and make comparisons. Discuss: Where did you find the most litter? Why do you think this place had the most? Where did you find the least litter? Why do you think this place has the least? Where did you find the most metal? the most glass? the most paper? Why? Other questions will come up, perhaps, like the type of paper or metal. Pursue any questions the students want, if time and resources available. Look for litter in the classroom. What kinds of litter are here? List what you find. Is this the same type of litter as seen outside? Where does this litter come from? What do we do with this litter? How does a classroom remain litter-free and clean. Where does classroom litter go? Find out if you are correct by visiting the custodian. Interview him/her about what s/he does with classroom litter? Is there any way students can help him/her with their job? What would it take to establish a recycling program in your school? Explore and find out. Report to the class. Do you want to undertake such a program?

NOTE: Can Fishing, part of the Lakes and Ponds unit by OBIS, looks like a fun and thought-provoking activity on just what is litter in water. It would be a good activity for a high school biology class.



ASPHALT PUDDLES

- CONCEPT** Cause/effect, change, cycles, equilibrium, interaction, model, quantification, scale, theory
- PRINCIPLE** Something as small as a puddle can teach us a great deal. This activity enables students to look at puddles in new ways.
- OBJECTIVE** The student will be able to define evaporation or contour lines.
- PREPARATION** Locate several puddles suitable for this activity.
- MATERIALS NEEDED**
- chalk
 - paper
 - pencil
 - ruler or tape measure
- PROCESSES USED**
- communicate
 - control variables
 - design experiments
 - hypothesize
 - infer
 - interpret data
 - measure
 - observe
 - predict
 - question
 - use numbers
- TIME:** 5 - 10 minutes a day, number of days determined by what you teach with this activity.



DOING THE ACTIVITY (outdoors)

A. Set the Stage

Even familiar, mundane things such as puddles can provide us with interesting information.

B. Procedure

1. This activity can be used to introduce the principle of evaporation or of contour lines in mapping.
2. Begin this activity early in the day following a heavy rain when puddles remain on sidewalks and the playground. Try to use puddles that are fairly large and shallow. You can also dig and create puddles as needed.
3. Divide the class into groups and assign each to a puddle. Have one person draw a chalk line around the outside edge of the puddle. Students predict what will happen to the puddle throughout the day. List the predictions.
4. Later that day, observe the puddles again and answer, have the puddles changed in any way? Again, use the chalk to make the outer edge of the puddle. Ask what has happened to the water in the puddle? What will happen to this puddle eventually. At this point, you can stop if you are teaching evaporation.
5. If you are teaching contour lines, you will want to continue marking the outside edge until the puddle has almost disappeared so that you have the contour lines marked. Once you have that, use the information to introduce contour lines on maps.
6. Setting up two indoor "puddles" in pans and covering one with plastic wrap will reinforce and extend the evaporation principle. Mark the outside of the pan as water in the open pan evaporates.

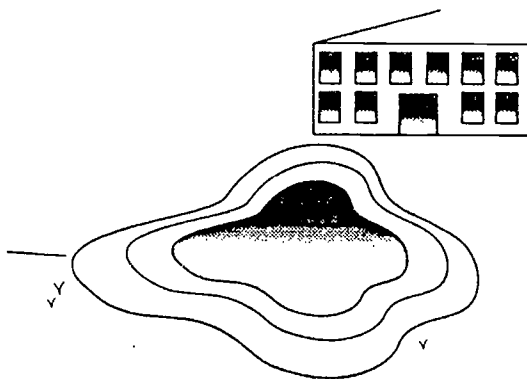

C. Retrieve Data

Ask the students what they learned from this activity, and where else this information might be useful.

TAKING A LOOK AT AIR POLLUTION

- CONCEPT** Cause/effect, change, interaction, organism
- PRINCIPLE** Pollution that isn't visible is difficult to understand. This activity will make some common pollutants visible.
- OBJECTIVE**
- The student will be able to define pollution and discuss where some of the air pollutants come from.
- PREPARATION** Determine how many traps you want each student to make. Also have some ideas in mind where the traps might be placed.
- MATERIALS NEEDED**
- heavy paper or cardboard
 - scissors
 - clear sticky tape
 - string
 - magnifying glass
 - hand lens or microscope
- PROCESSES USED**
- classify
 - communicate
 - control variables
 - hypothesize
 - infer
 - interpret data
 - observe
 - predict
 - question
- TIME** 10 to 30 minutes for construction depending upon amount of materials present. 30 minutes to look at final result and discuss.



DOING THE ACTIVITY (outdoors)

A. Set the Stage

Air is made of gases which we can't see. Smoke is one type of air pollution. The purpose here is to construct "traps which will enable us to see some of the particles which contribute to air pollution.

B. Procedure

1. Cut cardboard strip about 2" x 10" and then cut 3 to 4 holes in each strip. Punch a small hole in one end of the strip and tie a 12" length of string through the hole.
2. Place a long strip of tape down one side of the cardboard covering the holes so that the tape will be sticky on the underside of the holes.
3. Hang these traps by the string in different places indoors and outside. Tie them wherever you think the air might be dirty, e.g. on car bumper, near a wood-burning stove, near a smoker's chair. Label and date each trap so results can be compared.

NOTE: Bigger traps made of clear contact film turned sticky side up and stapled to cardboard could be made for placement in heavy traffic areas in your school.

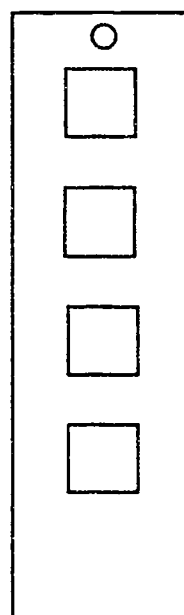

front

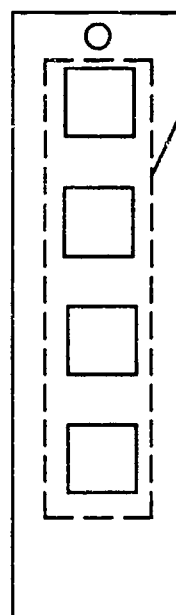

back

strip of transparent tape-sticky side to the front

NOTE: It is easier to cut diamond-shaped holes by bending the strip. Can also punch holes with a paper-punch.

Shape of holes is not important.

C. Retrieve Data

1. After a week, collect all traps and examine the trapped particles with hand lens, magnifying lens or microscope.
2. Discussion: What do you see in the traps? What do you think got caught in the traps? Which places caught the most pollution? the least pollution? Where did the pollution that didn't get caught, go? What colors are present in the traps? Are there any parts of your body that can trap pollution? What can you do about air pollution? Who controls pollution?

Extension: Make a comparison chart or bulletin board showing the continuum of pollution from lowest to highest.



MINI-FOREST

CONCEPT

Cause-Effect, change, cycles, equilibrium, evolution, interaction order, organism, population, quantification, system

PRINCIPLES

A large area of land is not needed to have a quantity of plants and animals. This activity demonstrates that small areas contain much diversity of species.

OBJECTIVE

- The student will be able to draw or describe the many different types of plants and animals that live in/on a small section of ground.

MATERIALS NEEDED

- pencil
- paper
- hand lens
- string (optional)
- coat hanger (optional) bent into a square

PROCESSES USED

- classify
- communicate
- formulate models
- hypothesize
- infer
- measure
- observe
- question

TIME:

15 to 20 minutes



DOING THE ACTIVITY (outdoors)

A. Set the Stage

We're all impressed by big trees, dense underbrush and strange plants. We seldom take time to look at the little things underfoot. In this case, we'll think small.

B. Procedure

1. Students lie on the ground, face down.
2. Students make a circle by stretching out arms in front of them.
3. At this point, they may outline the circle with string, if older, remember the parameters of their circle, or use wire hangers.
4. List at least five different plants inside the circle. Describe, draw or name them. Do you see any animals or evidence of animals within your circle? What else is in the circle?
5. Spread the grass apart and look. Write any additional observations. Use a hand lens if you have one.

C. Retrieve Data

Discuss what happened, journal or whatever to close this activity. If you have a discussion, you might want to make sure the class comes to an understanding of the principle of community as being a place where many plants and animals live together or even a more sophisticated definition for a science class.



WEED PATCHES

- CONCEPT** Cause/effect, change, cycles, equilibrium, evolution, interaction, organism, perception, population, theory
- PRINCIPLES** This activity provides students with an opportunity to inventory and classify a seldom studied environment - a weed patch.
- OBJECTIVE**
- The student will be able to define weed and noxious weed and view these in the context of the plant community.
- PREPARATION** Find a good location in or around the school yard.
- MATERIALS NEEDED**
- pencil
 - data sheet for each student
 - hand lens
 - clipboard
- PROCESSES USED**
- classify
 - communicate
 - hypothesize
 - infer
 - interpret data
 - observe
 - prediction
 - question
- TIME** 20 - 30 minutes

529



DOING THE ACTIVITY (outdoors)

A. Set the Stage

We seldom think that an abandoned field is attractive. It does, however, have some fascinating things, some of which we'll look at today.

B. Procedure

1. Students take Weed Patches Data Sheet to a predetermined area and begin study. Teacher choice as to whether this is an individual activity or grouped in some manner.

2. Allow time for the study. Teacher circulates to keep students on task.

C. Retrieve Data

Ask students

1. "What did you find in your weed patch?"
2. "What were the weeds/noxious plants?"
3. "What is the relationship between weeds and noxious plants?"
4. "What can you say about this particular area?"

Extensions

Include writing riddles, sense poems, color images, haiku, cinquain, diamante, mythology, legends, tall tales or any other form of writing. Art projects may be possible with seeds.

Weed Patches (page 1)

WEED PATCH DATA SHEET

1. Look for different Weed Patches (page 2)

2. Count and record

a. Total plants in _____

b. Plants with few _____

c. Plants with many _____

d. Plants that are _____

e. Plants with flowers _____

f. Plants with seeds _____

g. Describe or draw _____

3. Count and record

a. Total plants in _____

b. Plants with few _____

c. Plants with many _____

d. Plants that are _____

e. Plants with flowers _____

f. Plants with seeds _____

g. Describe or draw _____

4. Are there any plants taller than you? _____ How many? _____

Describe or draw and label these plants: _____

5. Define weed in your own words: _____

Now look the word up. Write the definition: _____

Compare your answers: _____

6. "Noxious" is a word often used to describe weed. What does "noxious" mean? _____

How do you think a plant can be noxious? Cite examples: _____

What do you think is the difference between "weed" and "noxious weed"? _____

Investigating Your Environment
Schoolyard Activities 



TAKING A LOOK AROUND THE SCHOOL - COMMUNITY AND CULTURE

- CONCEPT:** Cause/Effect, change, cycles, evolution, interaction, perception, system
- PRINCIPLE:** Taking a closer look at common aspects of the community can often give new insights to that community.
- OBJECTIVE:**
- The students will be able to draw some conclusions about their area by analyzing their inventories.
- PREPARATION:** Identify an area that has some good diversity.
- PROCESS:**
- classify
 - communicate
 - formulate models
 - hypothesize
 - infer
 - interpret data
 - measure
 - observe
 - predict
 - question
 - using numbers
- MATERIALS NEEDED:**
- paper
 - pencil
 - tapes
 - rulers
 - graph paper
- TIME:** Open ended depending upon where teacher wants to proceed with this. Seems like it would tie to the five themes of geography really well.



DOING THE ACTIVITY

A. Set Stage:

Depending upon the option set the stage by indicating that we'll look with great detail at some pretty common items in our community.

B. Procedure:

- Option 1. Inventory building structures within a given distance from school.
- a. Develop a classification system for building types, i.e. shape, roof shape and type, construction materials
 - b. Develop a means for classifying the age of the buildings.
 - c. Map vacant buildings within a given distance of your school.
1. Determine how long buildings have been vacant by consulting local residents, written records, observing deterioration
 2. What function did the building perform when it was used?
 3. What caused the building to become vacant?
 4. Who owns the building now? Do they have any plans for it? What could it be used for?
- Option 2. Make an inventory of fences within a given distance from school.
- a. 1. What types of fences were found?
 - b. 2. What materials are the fences made of?
 - c. 3. Develop a classification system for the fences observed.
 - d. 4. Develop a chart showing fence type correlated with its most common use.
 - e. 5. If possible, find pieces of discarded fences and construct a display listing uses for each.
 - f. 6. What new types of fencing are now available? Are there any examples of this in the neighborhood? Can you show these materials in some form?
- Option 3. Locate the watershed in which your school is located. What land uses are in that watershed? Are there any conflicts of uses, needs and wants? Can you write a simulation game to help people understand the issues better?
- a. Locate the source of your community's water supply. What changes have occurred in the water supply situation in your community?
 - b. Are there alternative sources of water supply in your community? What and where are they?
 - c. How is water treated in your community - before coming into your home and after leaving it?
- Option 4. Draw maps of your schoolyard. Show the areas important to you, then show major routes for you away from the school to places like work, home and friends homes.



SOUND HIKE (ANY SENSES HIKE)

CONCEPT Change, Interaction, Perception, Population, System

PRINCIPLE Focusing on one sense heightens the sensitivity of that sense.

OBJECTIVE • The students will be able to identify at least 6 different sounds.

PREPARATION

**MATERIALS
NEEDED** • Students need paper and pencil

**PROCESSES:
USED** • classify
• communicate
• question
• hypothesize
• infer
• observe
• predict

TIME: 10 to 15 minutes outdoors. Could be done indoors — creatively



DOING THE ACTIVITY

A. Set Stage:

In this activity, we'll focus on only one of our senses - hearing. By closing our eyes, we often can hear better.

B. Procedure:

1. Take students for a walk, stopping at intervals along the way. Have students close their eyes and concentrate on listening for 30 seconds.
2. They write what they heard. _-
3. Repeat steps 1 and 2, stopping in different spots so varying sounds are heard.

C. Retrieve Data

1. Questions to ask or use: How many different sounds did you hear, did we hear as a group? Which sound was most pleasant to you, why? Does it remind you of some thing else? Which sound was the loudest, quietest, highest, lowest, least pleasant, most prevalent.

Extension

1. You may repeat this hike stressing sight, smell or any of the other senses.
2. The hike need only take 15 minutes yet several class periods of work can spin off this.



LITTER WE KNOW

COUNT THE KINDS OF LITTER YOU FIND IN EACH PLACE.
COMPLETE THE CHART.

	MY YARD	SCHOOL YARD	NEIGHBORHOOD
GLASS			
METAL			
PAPER			
PLASTIC			



WEED PATCH DATA SHEET

1. Look for different colors of plants. Arrange colors from lightest to darkest.

2. Count and record the different plants that are below your knees.

- a. Total plants in all _____
- b. Plants with few leaves _____
- c. Plants with many leaves _____
- d. Plants that are sticky _____
- e. Plants with flowers _____ List flower colors _____

- _____
- f. Plants with seeds or seed pods _____
 - g. Describe or draw and label the different pods:

3. Count and record the different plants that are above your knees.

- a. Total plants in all _____
- b. Plants with few leaves _____
- c. Plants with many leaves _____
- d. Plants that are sticky _____
- e. Plants with flowers _____ List flower colors _____

- _____
- f. Plants with seeds or seed pods _____
 - g. Describe or draw and label the different pods:



Weed Patches (page 2)

4. Are there any plants taller than you? _____ How many? _____
Describe or draw and label these plants:

5. Define weed in your own words: _____

Now look the word up. Write the definition: _____

Compare your answers: _____

6. "Noxious" is a word often used to describe weed. What does "noxious" mean?

How do you think a plant can be noxious? Cite examples: _____

What do you think is the difference between "weed" and "noxious weed"?



Natural Resources in an Urban Environment

BEST COPY AVAILABLE

Investigating Your Environment — Intermountain Region

538



INTRODUCTION

All people, regardless of where they live, are resource users -- natural, human-made, renewable and non-renewable. Many, however, do not understand the origins of the resources they use and depend on. Urban dwellers, especially, are often separated from direct experiences that lead to an acquaintance or understanding of natural resources. Without knowledge or understanding of human impact, both harmful and beneficial, we will continue to experience conflict and confusion over the environment. This activity is only a basic introduction to the fascinating knowledge of the Earth around us!

THE ACTIVITIES

TIME REQUIRED

A Resource of
Many Names

4 hours with discussion

Resource
Management
and Attitudes

3 hours plus 8 minutes.

COMBINING THE ACTIVITIES

These two activities can be done singly. The first activity provides a foundation for the second activity and, if both activities are completed, maximum learning will be experienced by doing the activities in the order presented.

CURRICULUM RELATIONSHIPS

Social Studies

1. Explore landscape architect Ian McHarg's system of resource overlays. How has that technique evolved in the last 25 years? Explain how this technique enhanced our understanding of resource management.
2. Follow a local environmental issue. Collect newspaper articles and other information, interview experts and officials, attend public meetings, participate in the planning. Then prepare a fact sheet, briefing paper or survey to help your community bring the issue to closure.
3. Explore possible work-study commitments with resource management agencies at the local, state and federal levels.
4. Include resource management agencies in career explorations, as classroom speakers or at career fairs or days.



Science

1. Get involved in a school environmental issue, even if it is location of playground equipment. Explore alternatives and offer an alternative for management of the site.
2. Compare the "Scientific Method of Problem Solving" and the method used for land-use planning. How are these methods the same, different? Indicate which steps are similar. Explain why you think this is.
3. Explore construction methods for a simple item such as a bench. What kinds of construction materials are available, include recycled plastic. Compare costs, etc. Try to build this item in several materials for use on the school site.

Mathematics

1. Find out how cost-benefit ratios are applied in environmental issues. Try to use this method on a local environmental issue.
2. Use newspaper advertisements to locate sources of natural resources which are used in building or construction. Compare sources for cost and services.

Language Arts

1. Write and illustrate a "kids" guide to natural resource management.
2. Write articles for the classroom, school or local newspapers about natural resources and personal choice, management, "supermarket syndrome."
3. Read a book by Thor Heyerdahl such as *Kon-Tiki*. Write about his philosophy toward the Earth's resources as found in his book. Does this support the statement he made that is known as the "supermarket syndrome."
4. Read other well-known naturalists work such as John Muir, Sigurd Olson, and Aldo Leopold. Find statements that you feel have become "conservation" philosophy.
5. For elementary or middle school students, add natural resource words to personal spelling lists.

Creative Arts

1. Create a collage or mobile of the different categories of resources discussed in the activities.
2. Create a series of "baseball-type" cards on environmental issues, environmental heroes or environmental resources.



A "RESOURCE" OF MANY NAMES

CONCEPT Change, Interaction, System

PRINCIPLE Natural resources are the basis for life. Rural dwellers are often aware of their dependence upon natural resources. Urban dwellers are often "apart" from the natural environment. These activities are designed to reacquaint all users with knowledge forgotten, taken for granted or possibly, never recognized.

OBJECTIVE

- The student will be able to define natural resource, renewable resource and non-renewable resource and identify their occurrences in their environment.
- The student will be able to trace resources used in everyday items to their original source in the environment.
- The student will be able to describe how s/he feels about resource use in their community.

PREPARATION Gather materials needed. Take several walks in different directions from your school/site to ascertain what your students will see on their walks. If you plan to have students call, you will need telephone access. Prepare instructions for activities E and F ahead of time on flip chart, overhead transparency or poster board.

MATERIALS NEEDED

- Activity cards A- C for each participant.
Activity A: Analyze an Object
Activity B: Classification of Natural Resources
Activity C: Quantities of Natural Resources
- Masking tape
- Markers in a variety of colors
- Flip chart papers
- Local phone books for each group
- Pencils
- Natural objects, one/participant such as rocks, shells, water, soil, antler, bird's nest, cocoon, spider web imprint, etc. Strive for variety and diversity.

PROCESSES USED

- Observe
- Use Numbers
- Hypothesize
- Define Operationally
- Formulate Models
- Classify
- Infer
- Predict
- Question
- Communicate

TIME 4 hours with discussion



DOING THE ACTIVITY (indoors, then outdoors)

A. Set Stage:

In the next few hours (class sessions) we will investigate our use of natural resources. We will discuss the origins of natural resources and how natural resources are classified and used.

B. Procedure:

1. Each participant has five minutes to define "natural resource." (Background - **natural resource**: (1) a feature of the natural environment that is of value in serving human needs. (2) any feature of the natural environment about which choices must be made. (3) must be useful or of value to a culture, i.e. air, water, trees, animals and their relationships and must be basic or primary, not a manufactured or processed.)

chart	Work by yourself (5 minutes)
Write your own definition of a natural resource.	

2. Ask students to share their definitions of "natural resources". Accept all answers, but do not record.
3. Distribute Activity A instructions. Make sure each participant receives an object. Tell the group whether they should work with a partner, alone or in a combination of both. Make sure instructions are understood. 10 minutes.

ACTIVITY A: Analyze an Object

10 min.
Individual

1. List all possible uses you can think of for your object.

2. List all possible uses you can think of for a large amount of your object.

3. List all possible uses you can think of for any part of your object.

Investigating Your Environment
Natural Resources in an Urban Environment

C. Retrieve Data

Facilitator leads a discussion of Activity A. Questions you might want to ask include:

- (a) What are some of the uses of your object?
- (b) Which of the objects seem most important to you? Why?
- (c) Choose one object you feel you could do without? Why?

CLOSURE Now you have a basic understanding of what a natural resource can be. Please explore further how resources are classified.

TRANSITION Now that we've looked at one natural resource, let's see if we can order them in any way.

B. Procedure

1. Hand out Activity B. Participants work alone on the first two parts, then move into groups of three or four to complete the third task in this activity.

ACTIVITY B: Classification of Natural Resources 5 min.
Individual

Write your own definition of a renewable resource.

Write your own definition of a non-renewable resource.

Work in groups of 2 or 4 to classify the objects as renewable or non-renewable. Make sure you have reasons for your classification.

Object	Renewable	Non-renewable	Reasons

Investigating Your Environment
Natural Resources in an Urban Environment 

(Background: non-renewable resource - resources whose total physical quantity does not increase significantly with time. Thus with the total initial supply being limited in quantity, each use must diminish the total stock.

renewable resource - resources whose supply becomes available for use at different intervals in time. The use of present supply flows does not diminish future flows and it is possible to maintain use indefinitely provided the use rate does not exceed flow rate. "Renewable resources" are living organisms and others such as soil and water which are closely associated with and affected by living organisms. Non-renewable resources are non-living materials such as minerals and fuels.)

C. Retrieve Data

Begin a discussion based on Activity B. Possible questions to use are:

- (a) What are some ways you can distinguish between renewable and non-renewable resources? (This helps students examine closer the attributes they used to classify objects.)
- (b) What values are there in distinguishing between renewable and non-renewable resources?
- (c) What makes a resource renewable or non-renewable?

TRANSITION

Let's apply what we've learned in the last hour or so. Hand out Activity C. Go over the instructions with the group. Make sure they understand what they are supposed to do; especially what "relative quantity" means. With younger students, you may need to establish a "relative quantity scale."



B. Procedure

1. This activity takes 15 to 20 minutes. If working with adults, get the next activity ready. If working with children, you know where you should be!
2. **STOP HERE IF YOU NEED TO BREAK THE ACTIVITY.** If you break, then resume your next meeting by looking over Activity C so students can recall where they were. Don't take longer than 10 minutes including time for them to get back together as a group and bond.

15 min.
small groups

ACTIVITY C: Quantities of Natural Resources

Take a walk down one block that is near the school/office. List all natural resources that have been used there. After each natural resource write how it is used, whether it is renewable or non-renewable, and the relative quantity of it on the block. Come back to the room for discussion after your survey is complete.

Natural Resource	How Used?	Renewable	Non-renewable	Relative Quantity

Investigating Your Environment
Natural Resources in an Urban Environment 

3. Once students are back in the room, have them sit in groups and give them paper, marking pens and tape for displaying their finished product. Complete the next Activity in 15 minutes. Display instructions. May need several copies of the instructions if working with a large group.

Work with the group you did Activity C with. (15 minutes)

Make a visual display of the uses and relative quantities of natural resources found in Activity C. Make display any way you want.



4. At the end of 15 minutes, groups display results. Each group has three minutes to explain their chart.
5. Summarize Activities C and previous discussion by asking groups to share on the question, "From our investigation thus far, what can we say about the resources we use?"
6. The next activity takes approximately one hour. Participants work in groups of two or three. Groups may change from previous activities. To each group, distribute local phone books and/or yellow pages.
7. Display the instructions for the next activity around the room. Tell them to work in small groups and this assignment will take about 60 minutes.

chart

Work in small groups. (60 minutes)

**Choose one natural resource from Activity C.
Find out if this resource is available in the community.
Where can it be bought? Where does it come from?
What does it cost? etc...**

Note: This is an assessment of resource supplies in a community or area. If you have access to a telephone, you may want each group to call a couple of the sources they have found. It is not necessary to call! Classroom teachers may expand on this by actually visiting a source, however, that drastically alters the time commitment. Exactly how this activity is conducted depends upon age of participants, the concept attempting to teach and time and resources available.

C. Retrieve Data

A discussion follows when this activity is complete. Possible questions are:

- (a) What did you discover about the natural resource you chose?
- (b) What methods did you use for gathering information?

CLOSURE/ TRANSITION

Thor Heyerdahl has written: "Modern man seems to believe he can get everything he needs from the supermarket and corner drugstore. He doesn't understand that everything has a source in the land or sea, and that he must respect these sources." How do you feel about this statement? This belief that everything comes from the supermarket has been termed the "supermarket syndrome." In what way does the "supermarket syndrome" affect our attitudes and beliefs about natural resources?



RESOURCE MANAGEMENT AND ATTITUDES

- CONCEPT** Cause and Effect, Energy-Matter, Interaction, System, Perception
- PRINCIPLE** By beginning with resources and looking at related environmental issues, one starts by making some decisions about their use of resources. Then a leap from personal decisions to natural resource management guidelines helps one understand that resource use management is a complicated matter, often thought about in simplistic ways.
- OBJECT**
- The student will be able to identify patterns of resource use which involve urban environmental issues.
 - The student will be able to identify the need for active natural resource management guidelines.
 - The student will be able to develop a natural resource management plan using management guidelines.
 - The student will be able to describe what s/he can do to improve resource utilization in his/her community.
 - The student will be able to describe how s/he feels about natural resource management.
- PREPARATION** Gather materials needed.
- MATERIALS NEEDED**
- Activity cards for Activity D: Resource Management Issues, E: Issue Analysis, F: Use of Natural Resources, G: Management Guidelines
 - Flip chart and easel
 - Markers in a variety of colors
 - Highway maps of the state, 1/ group
 - One master map
 - Masking tape
- PROCESSES USED**
- Observe
 - Question
 - Interpret Data
 - Hypothesize
 - Classify
 - Predict
 - Infer
 - Communicate
- TIME** 3 hours plus 8 minutes



DOING THE ACTIVITY (indoors)

A. Set Stage:

We ended the previous session with a quote about the "supermarket syndrome." We will explore urban environmental issues and relate resource use to consumer attitude.

B. Procedure:

1. In the first activity, you and your group will identify five local urban environmental issues.

20 min.
groups

ACTIVITY D: Resource Management Issues

Identify 5 urban environmental issues concerning natural resource utilization in the community. For each issue list the natural resources involved.

Issue	Natural Resources Involved
1. _____	_____ _____ _____
2. _____	_____ _____ _____
3. _____	_____ _____ _____
4. _____	_____ _____ _____
5. _____	_____ _____ _____

Choose one issue from above, and trace the natural resources involved back to their source in the environment.

Investigating Your Environment
Natural Resources in an Urban Environment 

2. Ask each group to share what issue they choose and the results of their tracing the resource back to its environmental source. Ask, "How is the issue you have selected related to the "supermarket syndrome"?"
3. Hand each participant Activity E. Ask them to work by themselves for the next 10 minutes to complete the activity. If it seems like they are done early, begin discussion. If more time seems needed, allot it.

548



C. Retrieve Data

1. Discuss Activity E. Possible questions are:
 - (a) What can you do back home to overcome the supermarket syndrome?
 - (b) How do you feel about resource use in your community?
2. We have raised a lot of questions and feelings about resource use in our communities. The remaining activities will lead us to explore natural resources and how their use can be managed -- for wise use and for resource protection. What does the management of natural resources mean to you?

B. Procedure

1. Distribute Activity F. Ask participants to work by themselves for five minutes, then invite them to join with another to improve their list.

C. Retrieve Data

1. Possible discussion questions are:

(Record all responses on flip-chart).

 - (a) What are some natural resources found in this state?
 - (b) Which of the natural resources are similar. Group those that are similar. Put "A" by those similar, "B" by those in the next group, etc. Do this in front of the group.

ACTIVITY E: Issue Analysis

10 min.
Individual

Describe in writing 3 things you can do in your everyday life to overcome the supermarket syndrome.

Select the one you think would be your best contribution. Describe the benefits of this action:

a. Where you live: _____

b. In your consumer habits: _____

c. Other benefits: _____

Investigating Your Environment
Natural Resources in an Urban Environment



ACTIVITY F: Use of Natural Resources

10 min.
Individual/Group

List some natural resources of the state and how they are used. Keep in mind the major products, industries and businesses of the state.

Natural Resources	How Used?

Investigating Your Environment
Natural Resources in an Urban Environment



- (c) What word can we use to label each group of resources?
- (d) Are there any other resource categories that we should add?

B. Procedure

1. Divide the total group into small groups, one group per category identified in #7. Assign each category and hand out highway maps to each group.
2. Display the instructions for the next activity. Each group has 15 minutes to complete the task.

chart Work in groups. (15 minutes)

Locate on your map where your assigned category of resources can be found. Draw boundaries around these areas. Then mark the boundaries on the master map. Each group should use a different color maker.

C. Retrieve Data

Conduct a discussion. Possible questions are:

- (a) What resource category boundaries overlap?
- (b) What problems occur when boundaries overlap?

B. Procedure

1. Ask the group if they know what "Management Guidelines" are. Discuss for no more than five minutes, then distribute Activity G. Allot 10 minutes for completion.
2. Conduct a discussion of the above activity. Record answers on flip-chart in front of the group. Ask these questions:
 - (a) What are some of your guidelines?
 - (b) Which of the guidelines are similar? Group guidelines that are similar.
 - (c) To develop some general management guidelines, what words can we use to label each group of guidelines?

ACTIVITY G: Management Guidelines

10 min. Individual

Write some guidelines you think are important in managing natural resources.

3. Display instructions for the next activity. Make available pens, easel, paper, tape, etc. Encourage groups to use a visual with their presentation. Allow only 20 minutes for preparation. Each group presentation is only five minutes, but allow eight minutes for transition time.

chart

Work in groups. (20 minutes)

Using the general management guidelines, develop a management plan for all the resource categories. Prepare a five minute presentation for your management plan including a visual display.

C. Retrieve Data

1. Conduct a discussion after all groups have presented and ask:
 - (a) What difficulties do natural resource managers have?
 - (b) What can be said about natural resource management in this present year?
End the discussion of this statement "there is no such thing as a free lunch".
How does this relate to natural resource use and management?

- CLOSURE** Display instructions for the next activity. Give participants 10 minutes to respond and ask them to respond to at least one of the following questions displayed.
- (a) What influence does the urban environment have on natural resource use?
 - (b) What can we conclude about natural resource use today?
 - (c) What can we conclude about resource management today?
 - (d) How can we summarize our discussions and investigations?
 - (e) What methods and processes did we use in our investigation?
- Allow a brief time for statements or questions.

chart

**Describe in writing how you feel about our session today.
Please take the time to answer one of the questions displayed.**



ACTIVITY A : Analyze an Object

10 min.
individual

1. List all possible uses you can think of for your object.

2. List all possible uses you can think of for a large amount of your object.

3. List all possible uses you can think of for any part of your object.



ACTIVITY B: Classification of Natural Resources

5 min.
individual

Write your own definition of a renewable resource.

Write your own definition of a non-renewable resource.

Work in groups of 2 or 4 to classify the objects as renewable or non-renewable.
Make sure you have reasons for your classification.

Object	Renewable	Non-renewable	Reasons



ACTIVITY C: Quantities of Natural Resources

15 min.
small groups

Take a walk down one block that is near this school/site. List all natural resources that have been used there. After each natural resource write how it is used, whether it is renewable or non-renewable, and the relative quantity of it on the block. Come back to the room for discussion after your survey is complete.

Natural Resource	How Used?	Renewable	Non-renewable	Relative Quantity



ACTIVITY D: Resource Management Issues

20 min.
groups

Identify 5 urban environmental issues concerning natural resource utilization in this community. For each issue list the natural resources involved.

Issue	Natural Resources Involved
1. _____ _____	_____ _____
2. _____ _____	_____ _____
3. _____ _____	_____ _____
4. _____ _____	_____ _____
5. _____ _____	_____ _____

Choose one issue from above, and trace the natural resources involved back to their source in the environment.



ACTIVITY E: Issue Analysis

10 min.
individual

Describe in writing 3 things you can do in your everyday life to overcome the supermarket syndrome.

Select the one you think would be your best contribution. Describe the benefits of this action:

a. Where you live: _____

b. In your consumer habits: _____

c. Other benefits: _____



ACTIVITY F: Use of Natural Resources

10 min.
individual/groups

List some natural resources of this state and how they are used. Keep in mind the major products, industries and businesses of this state.

Natural Resources	How Used?

Investigating Your Environment
Natural Resources in an Urban Environment



Developing Environmental Investigations



BEST COPY AVAILABLE

Investigating Your Environment — Intermountain Region



559

INTRODUCTION

An environmental investigation should be designed so that all participants can take an active part at their own level of ability and interest. The investigation should have opportunities for the participant to make observations, collect and record data, make some type of interpretation of data and summarization of how those interpretations relate to the topic.

The following lessons are designed to provide the participant with the necessary background for understanding education by involvement and experience in constructing simple environmental investigations. They are designed to be used with groups of teachers and/or resource personnel interested in producing environmental investigations.

THE ACTIVITIES

The Value of Teaching Process Skills: Survival Values in Learning. A major goal of teaching process skills is to develop the ability for each person to think for themselves.

Developing Activity Cards: Activity cards can promote small group and individual investigations with a minimum of teacher direction. Each participant can move independently at his/her own learning rate.

Developing Instructional Objectives: Today educators are being urged to clarify educational outcomes they hope to achieve through their instructional efforts.

Use Questioning Strategy in Environmental Investigation: The use of certain kinds of questions can help establish a learning climate that will encourage participation, discussion and interaction during the investigation.

A Basic Question Sequence for the Interpretation of Data Process: This question sequence can allow the group to interpret their own observations and recorded data about the topic.

Developing a Lesson Plan for an Environmental Investigation: If you put all the above pieces together you can come up with the start of a lesson plan for an environmental investigation.



THE VALUE OF TEACHING PROCESS SKILLS

A major goal of teaching process skills is to develop the ability within each individual learner to function autonomously at the inquiry and proof level; i.e., the ability to obtain, organize, translate, interpret and apply bodies of knowledge, and to present proof of the validity of the process.

Survival Values in Learning

Used in the Higher Level Thinking Ability Course - N.W.E.R.L. - as an interpretation from Educational Psychology, Cronbach Harcourt Brace & World 1963.

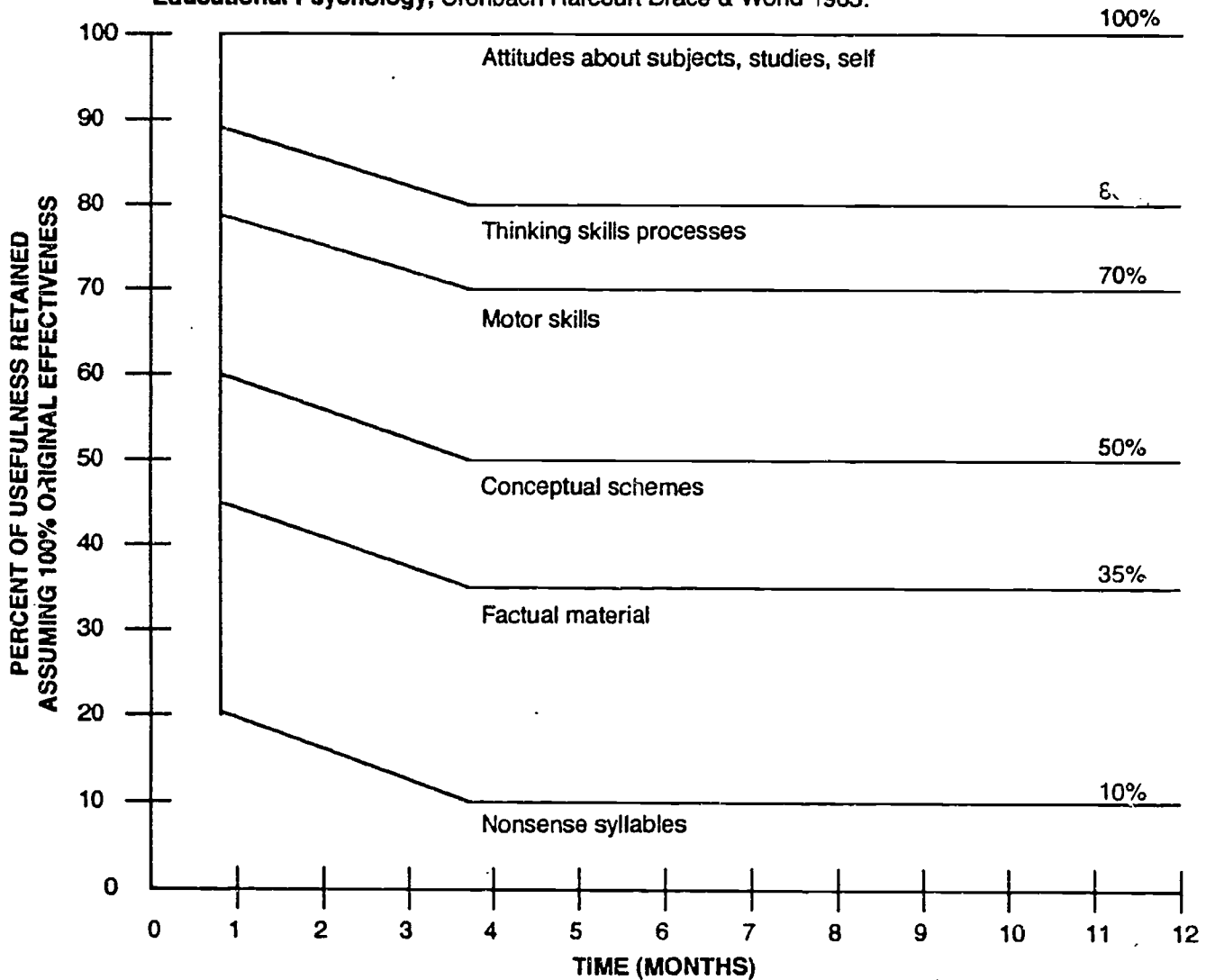

This chart shows the retention rate of different categories of learning. In small groups discuss and answer the following questions.

1. What does this chart say about the retention of learning?
2. What are the implications of this chart to the way we plan learning experiences?



Some Implications about the Chart: Survival Values in Learning.

- This chart relates to what you learn, not to how you learn it.
- Learning some content may not be a very productive use of our time. According to the chart, after 3 months we only remember about 35 percent of the facts and 50 percent of the conceptual schemes.
- We retain up to 70 percent of the ability to manipulate and operate things (machines, tie shoes, write, etc.) 3 months after the learning experience. If the learning experience was designed for us to develop thinking skills and processes (gather, sort, analyze, interpret and provide alternative solutions about problems) we could retain those skills at the 80 percent level of usefulness.
- Therefore, we might assume that people who have developed the ability to think for themselves can collect and analyze factual data, develop a line of reasoning or contribute to the interpretation or solution of a problem or decision. Merely the learning experience deals only with memorizing facts and other information or concepts with no chance for putting that knowledge to work.

Before planning a workshop or other learning experiences, ask yourself:

1. Why am I doing this? (To help people memorize facts, learn concepts or to think for themselves?)
2. How can I structure learning experiences to insure participation and the development of thinking processes along with the use of factual data, etc?

We are now recognizing that if we develop thinking skills and processes of investigation, we may begin to change behaviors. Only by actually involving people in environmental learning experiences can they begin to think about their role in environmental management. We must be concerned with developing environmentally literate persons who can think for themselves.



DEVELOPING ACTIVITY CARDS

In developing an Environmental Investigation Lesson Plan, self-directed activity cards can be a useful tool.

Activity cards are not new and have been used in many ways. A activity card can be simply a card which you write directions for a learning experience.

Some reasons for using Activity Cards include:

- allows for different levels of ability to participate at once.
- easily adjustable - can add or delete activities.
- can promote small group interaction and accomplishment.
- teachers do preparation ahead of time.
- don't feel bound to manual.
- can tailor-make investigations to fit needs of students.
- Makes the learning student dependent and not teacher dependent.

Activity cards can also have the following characteristics:

- Sequential, programmed, assorted, self-directed, personalized, task oriented, etc.
- Provide for a variety of kinds of involvement, communication, feedback.
- Provide alternatives and choices for the learner.
- Can be laminated for wet weather.



Using the following criteria, evaluate the sample task cards below:

1. Does the activity actually *involve* the student with the *environment*? How?
2. Is the activity relevant to the learner in his or her world? (age, level, topic, culture etc.)
3. Does the activity include opportunities for problem solving?
4. Does the activity include opportunities for the learner to collect and record data based on his or her own observations?
5. Does the activity include opportunities for the learner to make his or her own interpretation about the collected data?

SAMPLE TASK CARDS

Circle the # for the criteria present on card

(From an assortment of task cards for a nature trail walk)

Here are two leaves.
 Make a list of all the similarities you find.
 Make a list of all the differences you find.
 (Staple leaf here) (Staple leaf here)
 Leaf 1 Leaf 2

Similarities:
 Differences:

- 1
- 2
- 3
- 4
- 5

(From a sequence of task cards on "Sounds")

Find a noisy place and stay for a little while.
 How do you feel in a noisy place?
 Write a few sentences or a poem to tell how the noisy place makes you feel.

- 1
- 2
- 3
- 4
- 5

(From a sequence of task cards on "Spaces")

Walk around your classroom.
 How do you feel in this place?
 Write or tell about how it makes you feel.

Go outside and stand near the school building.
 Do feel different here than you do inside?
 Write or tell how this space makes you feel.

- 1
- 2
- 3
- 4
- 5

(From a unit of study for a "Supermarket Survey")

In your backyard or schoolyard, bury different kinds of packaging materials. Dig them up at specified intervals of time and compare decomposition rates.

	Alum. Can	Glass Bottle	Plastic	Cardboard	Etc.
Sept.					
Oct.					
Nov.					
Etc.					

- 1
- 2
- 3
- 4
- 5



Construct at least two activity cards on a topic of your choice.

Some suggested Instructions for Cards:

1. Select a topic or theme or a particular environment.
2. Decide on your purposes.
3. Select some activities to accomplish those purposes.
4. Construct activity cards below about the topic or theme you chose.
5. Consider including a variety of:
 - a. types of involvement
 - b. sizes of groups
 - c. lengths of time
 - d. methods of recording or communicating information

Other considerations:

- a. have one specific goal
- b. keep activity brief enough to maintain interest and sequence
- c. color code them by areas of study or ability
- d. keep directions simple
- e. should fit within a time limit
- f. some form of self-evaluation statement
- g. use processes of observing, collecting, recording, and interpreting data



DEVELOPING INSTRUCTIONAL OBJECTIVES

It is important that we be able to distinguish between instructional objectives which are well formed and those which are not. Well formed objectives possess a tremendous advantage over other objectives in that they reduce confusion. This confusion reduction leads to significant dividends in planning instruction and evaluation. The less confusion that surrounds a statement of an educational outcome, the more cues we have regarding what kind of instructional sequence will prove effective. The less ambiguity, the more readily we can devise precise measures to reflect that outcome. Well formed objectives thus constitute a useful mechanism for improving instruction and evaluation.

SOME GUIDELINES FOR DEVELOPING OBJECTIVES OR PERFORMANCE OUTCOMES

1. An objective describes an expected change in the learner's behavior.
2. When the learner has DEMONSTRATED this behavior the objectives have been achieved.
3. An objective is a group of words and symbols which communicate the expectation of the learner so exactly that the others can determine when the learner has achieved it.
4. A meaningful stated objective, then, is one that succeeds in communicating your expectation for the learner.
5. The best objective is the one that excludes the greatest number of possible alternatives to your goal. (No misinterpretation)

CRITERIA TO EVALUATE OBJECTIVES

1. Have you identified who the learner is?
2. Have you described the behavior the learner will demonstrate as evidence that he has achieved the performance task?

Is it measurable action or performance by the learner? (see list of Action Words)

3. Have you stated the conditions you will impose upon the learner when he is demonstrating his mastery of the performance task?

Examples:

- Using the length of his own step he will demonstrate _____
- Given a list of rocks he will distinguish _____
- Given a set of tree samples he will construct a dichotomous key _____
- Using a highway map of his state he will describe _____



OBJECTIVE OR BEHAVIORAL TERMS

The majority of our educational objectives can and should be stated in behavioral terms. It is recognized that there are some meta-objectives which must be more subjectively stated and performance subjectively measured. The terms listed below represent an effort to formulate a list of the most common and applicable terms which have meaning for the teacher developing objectives related to the areas of knowledge, skills and habits, understanding and concerns.

- | | | |
|----------------|----------------|-------------------|
| 1. Describe | 14. Locate | 27. Present |
| 2. Interpret | 15. Express | 28. Discover |
| 3. Observe | 16. Analyze | 29. Support |
| 4. Demonstrate | 17. Apply | 30. Question |
| 5. Sketch | 18. Operate | 31. Create |
| 6. Identify | 19. Illustrate | 32. Calculate |
| 7. Compare | 20. Diagram | 33. Organize |
| 8. Translate | 21. Perform | 34. Develop |
| 9. Contrast | 22. Listen | 35. Recite |
| 10. Relate | 23. Write | 36. Differentiate |
| 11. Generalize | 24. Read | 37. Construct |
| 12. Formulate | 25. Review | 38. Solve |
| 13. Define | 26. Use | 39. List |

Here are nine action words from the American Association for the Advancement of Science that apply to curriculum related activities in the environment. Note the ones that are included in the previous list.

- | | |
|--------------|---|
| Identify | • The individual selects a named or described object by pointing to it, touching it, picking it up. |
| Name | • The individual specifies what an object, event, or relationship is called. |
| Order | • The individual arranges three or more objects or events in a sequence based on a stated property. |
| Describe | • The individual states observable properties sufficient to identify an object, or relationship. |
| Distinguish | • The individual selects an object or event from two or more which might be confused. |
| Construct | • The individual makes a physical object, a drawing or written or verbal statement (such as an inference, hypothesis, or a test of any of these). |
| Demonstrate | • The individual performs a sequence of operations necessary to carry out a procedure. |
| State a Rule | • The individual communicates, verbally or in writing, a relationship or principle that could be used to solve a problem or performs a task. |
| Apply a Rule | • The individual derives an answer to a problem by using a stated relationship or principle. |

Terms to avoid in stating behavioral objectives.

Enjoy	Understand	Know
Appreciate	Like	Grasp
Faith		



USING QUESTIONING STRATEGY IN ENVIRONMENTAL INVESTIGATIONS

One objective in learning is to help people develop thinking skills and processes that will allow them to interpret the data they collect. A lively discussion and a good learning experience will develop if appropriate questions are asked. The use of certain kinds of questions can help establish a learning climate that will encourage individual participation, group interaction, and interpretation of the information collected in the investigation.

Get into groups of 3-4 and answer the following questions about the four questions below.

- A. Which of the four questions below did you feel most comfortable answering?
1 2 3 4 Why?
- B. Which question did you feel least comfortable answering?
1 2 3 4 Why?
- C. Which question allowed for greatest participation?
1 2 3 4 Why?

Questions asked:

- Question #1 What would happen if the rainfall doubled in your state next year?
- Question #2 How many acres of land in your state?
(What is the highest mountain in the United States?)
- Question #3 Why are recreation lands in your state important to the economy?
(What are the reasons for the location of (major city)?)
- Question #4 What are some things you think should be done in Environmental Education in your state?
(In your opinion, what is the major problem facing the environment today? Tell why.)



Question 1 - What would happen if the rainfall doubled in your state next year? This divergent or open type of question provides the opportunity to consider many different systems and try out many answers.

If you ask a question that allows a wide variety of responses, the participation will be more free. This allows more opportunity for creativity and imagination. (What would happen if...? How might....? What do you see....?) Everyone can participate at his or her own level and, since the response depends on the viewpoint of the individual, there are no "wrong" answers.

Question 2 - How many acres of land are in your state? This memory type question calls for remembered content, rote memory, or selective recall.

If you ask a question that has one correct answer, then people will go after the correct answer or the answer they think the leader is looking for. The kind of thinking that is going on is the recall of previously learned information and facts. (Who is...? What is...?)

Question 3 - Why are recreation lands in your state important to the economy? This convergent type of question represents the analysis of given or remembered information. It leads to one set of expected end results or answers.

If you ask a question that focuses on solving a problem or putting several pieces of data together, then the audience has to reason, using given or remembered data. (Why are these things so...? How do you account for...?)

The participant becomes a problem-solver in which the activity is to apply the proper operations at the proper time.

Question 4 - What are some things you think should be done in Environmental Education in your state? This evaluative type question asks the participant to use judgement, value, and choice, and is characterized by its judgmental quality. However, since it also asks for the learner's opinion, there is no one right answer or set of answers. The participant will take the knowledge previously gained in the lesson and relate it to or process it through his or her own frame of reference and set of values.

The type of question you ask then, can affect the learning atmosphere and restrict or motivate the participants to become involved in the discussion. Which of these types of questions have the greatest survival values (of their answers) as we discussed in Activity A.



1. Identify the following questions that are similar. (similar in the kinds of responses they would receive, not in the content)

- ___ A. What is a nuclear reactor?
- ___ B. Why are the demands for energy doubling every 10 years in the U.S.?
- ___ C. How do you account for the decreasing amount of open space in your community?
- ___ D. What do you think is the best use of this land?
- ___ E. Name the largest city in your state?
- ___ F. Should number of coyotes be controlled? Why or why not?
- ___ G. What would happen if all automobiles were banned within your city limits?
- ___ H. How much land has been taken out of agricultural production in the U.S. in the last 5 years?
- ___ I. What effect do trees and shrubs have on noise abatement?
- ___ J. What factors contribute to the traffic congestion problem in your community?
- ___ K. In your opinion, what are the 3 most important problems in your community?
- ___ L. What is the relationship between population density and natural resource allocation?

2. Put the numbers or letters that represent each group identified in the chart below and label each group.

Groups	Label each group of questions using your own names.
--------	---

3. Put your labels in the chart below and describe your groupings.

Kinds of Questions (use the names you gave the groupings)	Characteristics of questions in this group
What does your chart tell you about the use of questions? 1. 2. 3.	



A BASIC QUESTION SEQUENCE FOR THE INTERPRETATION OF DATA PROCESS

It can be important to develop a basic question sequence to allow people to interpret their own observations in the interpretation of data process.

There are four basic question categories that can be used in this process. Select a topic (common to all) about which they should write the questions.

1. *Open Questions*: Open questions are designed to provide an opportunity for *all persons to participate* and to *obtain a body of specific data* which will provide the opportunity to focus on significant points.

This type of question provides an opportunity for every person to become immediately involved in the discussion, regardless of his or her ability or background. It is completely free of the element of "guess what's on my mind." Since the response depends on the viewpoint of the participant there are no wrong answers.

THE CHARACTERISTIC OF THIS QUESTION IS OPENNESS

"What do you see as you look at the hillside?"

"What do you notice about the soil profile?"

NOTE: Interpretation of data may not necessarily begin with an open type question. You may wish to focus immediately upon specific points in the data. In that case, begin the question sequence with a focus question.

2. *Focusing Questions*: The focusing question is an extremely important element in the interpretation of data process. It *focuses on specific points* that will later be compared, contrasted, and related to other points.

Its basic purpose is to focus the attention on specific data as a central point for discussion.

THE CHARACTERISTIC OF THIS QUESTION IS SPECIFICITY

"What are some things that are helping the log decay?"

"What are some things that affect the quality of water?"

3. *Interpretive Questions*: Interpretive questions are designed to compare, contrast, and seek logical relationships between the specific points brought out in the focusing question(s).

The learner is asked to compare and contrast two or more specific points in the data; two or more groups of data; two or more feelings, concepts, or ideas, and express a perceived or inferred relationship between them.

THE CHARACTERISTIC OF THIS QUESTION IS ITS FOCUS ON RELATIONSHIPS

"Are there any of these that seem to belong together?"

"What can you say about the pH of the water from the aquatic life found there?"

"How do you account for the differences between these two areas?"

"Why were the two trees the same age but different in size?"

4. *Summary Questions*: Summary questions are designed to obtain conclusions, summaries and closing.

They occur at the close of a particular discussion and call for a statement which summarizes in a generalized form what has been discussed so the generalization or big idea applies to a variety of situations.

THE CHARACTERISTIC OF THIS QUESTION IS ITS CONCLUSIVENESS

"How could we summarize our discussion about architecture?"

Based on our observation and discussion, what can we say about urban environments?"



DEVELOPING A LESSON PLAN FOR AN ENVIRONMENTAL INVESTIGATION

All the elements of a lesson plan are available to be successful: objectives, task cards, questions strategy, and questioning sequence.

Use the following outline to help guide you through the steps.

Step 1: Objectives

What will the learner be DOING ?	Write:
What CONDITIONS will be imposed?	
How will success be RECOGNIZED ?	

Now write the complete instructional objective below, evaluating it with the criteria above.

572



Step 2: Pre-investigation Questions

Questions, designed for maximum group responses and interaction-What can we find out about the rotten log? What might be important to look at? Consider question strategies.

Evaluation: Will the pre-activity question create interest and motivation to the audience to gather data? Yes No
Are the questions varied? Yes No

Step 3: Task Cards

Directions for gathering data for the investigation:

Data recording for the investigation (type of instruments, charts, graphs, tables, description, etc.):

Evaluation: Does the activity gather data that will help support the purpose? Yes No
Does the activity actually involve learner in collecting and recording data?
Yes No
Does the activity include opportunities for learning to make his own interpretations? Yes No



Step 4: Post Investigation Discussion

Open Question to bring out the "What's" (What did you notice? What did you see?, etc.)

1. _____

Focusing Question on specific points to be compared, contrasted, or related to other points of specific data (How do you account for ..?. Why are these things like that?)

1. _____

2. _____

Interpretive Questions to elicit comparing, contrasting, and relating of points within the field of data-What differences did you notice between rotten logs of the two different trees?

1. _____

2. _____

3. _____

Capstone Question for summarizing generalizations-What can we say about..? How can we summarize what we've done and discussed about the rotten log study?

1. _____

Evaluation: Does the question sequence lead people to make generalizations that coincide with the purpose?

Does each of the questions in the sequence match up with the criteria below?

Open - allow everyone to participate. Get a lot of data.

Focus - focus attention on specific data as a central point for discussion.

Interpretive - seeks relationships. Compare, contrast, relate specific points in the data.

Capstone - call for a statement which summarizes what has been discussed.



Interpreting Your Environment



BEST COPY AVAILABLE

INTRODUCTION

Interpretation is a technique for enhancing information, so that the audience gains more from the experience than a list of unrelated facts. While we most often associate interpretation with parks, museums and historic sites, we can also apply interpretative approaches to other informational or public involvement situations. This session will help participants understand the principles upon which interpretation is based and why we always need to consider the nature and needs of our audience. We will look closely at the elements or building blocks we can use to form our interpretative programs and then explore the various methods available to deliver an intended message. Finally, participants will have the opportunity to design and lead their own interpretative activity.

Rather than simply communicating factual information, it is important for presenters to also reveal meanings and relationships through the use of original objects and illustrative media.

THE ACTIVITIES

TIME REQUIRED

Principles of
Interpretation

45 minutes, with discussion

Consider Your
Audience

45 minutes with discussion

Theme Development

45 minutes with discussion

Interpretive
Methods and
Techniques

45 minutes with discussion

Develop and Conduct
an Interpretive
Activity

60+ minutes



**Evaluate Interpretive
Activities**

45 minutes with discussion

**Style and Delivery
for Interpreters**

45 minutes

COMBINING THE ACTIVITIES

The activities in this unit are displayed singly. Depending upon the time available and the skill of the participants, you may choose to do only one activity or the entire series. For maximum learning, the activities should be experienced in the order listed in the unit, however, other suggestions are:

Suggestion:

Title: Applying "Principles of Interpretation" to "Considering Your Audience" and "Theme Development."

Activity: Read principles of interpretation and discuss what they mean with a partner.

Transition Statement: "Underlying all the principles is a serious consideration of the visitor, your audience. In the next activity, we are going to explore different ways to adjust our thinking and behaviors to the different types of people and situations we may encounter."

Activity: Hand out problem-solving cards. Given the situation on the cards, students should decide how to prepare or modify a program.

Transition Statement: "Now let's change our focus from theory to practice and get into the meat of interpretation."

Activity: Select a theme and inventory the features that relate to it.

SUMMARY QUESTIONS

1. Taken as a whole, how will the interpretive skills we covered today help you in your job?
2. How will the "meanings and relationships" you can reveal to others through interpretation help carry out the mission of your school or agency.

577



PRINCIPLES OF INTERPRETATION

- CONCEPT** Perception, Theory, Interaction
- PRINCIPLE** It's important to examine and understand some basic principles that should govern interpretive development and programs.
- OBJECTIVE** Participants will be able to discuss the basic principles that should govern interpretive development and programs.
- PREPARATION** Select a natural area, if possible, with a variety of vegetative zones nearby. The group size should not exceed 12 for ideal discussion and small group activities. If more than that, add another instructor or have half the class doing something else. If this is an older class simply hand out the same principle to more than one group and collaborate as necessary.
- In advance of the session, write the following definition on a flip chart for use in the discussion.
- “An activity that aims to reveal meanings and relationships through the use of original objects, by firsthand experience and by illustrative media, rather than simply to communicate factual information.”
- Freeman Tilden
- MATERIALS NEEDED**
- Activity Card A : Principles of Interpretation
- PROCESSES USED**
- infer
 - communicate
 - observe
- TIME** 45 minutes, with discussion



DOING THE ACTIVITY (indoors or outdoors)

A. Set the Stage

Say something like the following:

Most of us associate interpretation with parks, museums, and historic sites, but we can also apply interpretive approaches to other informational or public involvement situations. We will discuss the principles upon which interpretation is based and why we always must consider the nature and needs of our audience. We will then look closely at the elements or building blocks we can use to form our interpretive programs and then explore the various methods available to us to deliver our intended messages. Finally, you'll get a chance to design and lead your own interpretive activity using some ideas and skills you learn today.

Interpretation is often very difficult to define or describe. Most often, we resort to listing interpretive activities such as guided walks, campfire programs, or nature trails rather than really defining the term. Before we jump into the methods and mechanics of interpretation, let's look closely at this word and the philosophy behind it.

Post Tilden's definition on wall (previous page) and allow a minute or so for the groups to digest it.

Questions and Discussion:

Take apart each phrase in the definition looking for meaning in the definition, e.g.

1. Why isn't the communication of factual information a sufficient goal in interpretation?
2. What does Tilden mean when he says to reveal meanings and relationships?

Transition: Let's go deeper into these ideas by breaking into pairs to examine some basic principles and goals of interpretation.

B. Procedure

Distribute Activity A . Work in pairs, assign pairs to one of the numbered principles. If you have fewer than 12 people in the group, some will be assigned more than one principle. Direct participants to read over the principle and related goal set out on the activity sheet and discuss with their partners why each principle might be important or useful. Then they should prepare a short summary statement for the group on what this principle means to them. Tell them they have 20 min.

C. Retrieve the data

Each pair chooses one to present their thoughts to the full group (20 minutes).



Questions and Discussion

1. What might be the consequences of failing to consider these six principles in planning your interpretive activities?
2. After reflecting on these principles and philosophies, what does interpretation mean to you now?

NOTE: If your group is all classroom teachers, have them distinguish between interpretation and education all along the way, so that when all activities are completed in this lesson, the teachers can make the distinction and glean from interpretation what might be useful in their classroom (s).

ACTIVITY A: Principles of interpretation

20 min.
pairs

- I. Any interpretation that does not somehow relate what is being displayed or described to something within the personality or experience of the visitor will be sterile. - Tilden
 - To help park visitors understand that the place they're visiting is related to the place they call home.
 - To show the relationship of what is being observed (experienced) to the lives of the observers. - Lewis
- II. Information, as such, is not interpretation. Interpretation is revelation based upon information. But they are entirely different things. However, all interpretation includes information. - Tilden
 - To give accurate, interesting information which forms the foundation for an interpretation of data. - Lewis
- III. Interpretation is an art, which combines many arts, whether the materials presented are scientific, historical or architectural. Any art is in some degree teachable.
 - Knowledge treated imaginatively.
 - Interpreters should "fit into their own artistic appreciation, give form and life to their material, and tell a story rather than recite an inventory" - Tilden
- IV. The chief aim of interpretation is not instruction, but provocation.
 - To give the kind of interpretation which will encourage visitors to figure some things out for themselves.
 - To arouse curiosity and sometimes satisfy it.
 - To conserve park resources through an understanding and consequent appreciation of them.
- V. Interpretation should aim to present a whole rather than a part, and must address itself to the whole person rather than any phase.
 - To help visitors have an inspirational, relaxing, good time.
 - To provide visitors with an escape from the pressures which assault them.
 - To help visitors understand the interrelationships among as many aspects of what is being observed as possible.
- VI. Interpretation addressed to children (say, up to the age of twelve) should not be a dilution of the presentation to adults, but should follow a fundamentally different approach. To be at its best, it will require a separate program.

Investigating Your Environment
Interpreting Your Environment



CLOSURE

Collaborate with your partner - define interpretation and discuss one principle you understand (it should not be your own).

TRANSITION

Interpretation needs an audience - let's explore more about audiences.

550



CONSIDER YOUR AUDIENCE

- CONCEPT** Perception, change, interaction
- PRINCIPLE** It's important to give serious consideration to your audience, the visitor, what experiences they bring with them, and what expectations they may have.
- OBJECTIVE**
- Participants will be able to list various audience considerations in planning for and conducting an interpretive activity.
- PREPARATION** Select a natural area, if possible, with a variety of vegetative zones nearby. The group size should not exceed 12 for ideal discussion and small group activities. However, a teacher knows what s/he can do to make a larger group smaller.
- MATERIALS NEEDED**
- Activity Card B: Considering Your Audience
- PROCESSES USED**
- infer
 - predict
 - communicate
 - observe
 - question
- TIME** 45 minutes with discussion



DOING THE ACTIVITY

A. Set the Stage

Make this transition statement: "Underlying all these principles is a serious consideration of the visitor, your audience. In the next activity, we are going to explore different ways to adjust our thinking and behaviors to the different types of people and situations we may encounter."

B. Procedure

Distribute one or two problem-solving cards to each person while giving these instructions: You are leading an outdoor campfire program that will include the history of your forest area/park. Given the situation or reminder on the card, how will you prepare or modify your program? Take five minutes to jot down your ideas and then we'll share.

ACTIVITY B: Consider Your Audience

5 min.
Individual

1. The group is largely comprised of families with small children.	2. The group is largely comprised of senior citizens.
3. Your forest/park draws people from all over the U.S. and foreign countries.	4. The evening is quite cold and windy, so attendance is sparse.
5. Because it is June, your slide program cannot begin until late when it is substantially dark.	6. People remember 10% of what they hear, 30% of what they see, and 50% of what they do.
7. Questions can be effectively used to help visitors derive meanings.	8. Using a variety of approaches will enhance learning.
9. An organized presentation is more memorable than an unorganized one.	10. People learn best when an experience is close to them in time and space.
11. New learning is built on a foundation of previous knowledge.	12. People learn better when they're actively involved in the learning process.
13. You can't sing, but your supervisor wants your campfire to begin with some songs, and he's there to listen.	14. You can't get the campfire to start and light before you are lost with sticks and marshmallows.
15. You get to the amphitheater only to discover that the electricity doesn't work and you have a slide program.	16. During your talk, a man calls out, "You're wrong, honey! Women rangers don't know nothing. I'm a ranger."
17. It becomes obvious during your program that there's an historian in the audience. You can't answer his questions.	18. About halfway through the slides, the lamp goes out and you don't have an extra.
19. The program is going well, when suddenly a young girl screams "A bear! A bear! How what?"	20. What do you do if someone faints or has an epileptic spell during the program?

Investigating Your Environment
Interpreting Your Environment



532



C. Retrieve the data

Each person presents how they would approach their situation/premise. Allow interaction to evolve as it may because there are no right or wrong answers. Allow up to 30 minutes for sharing.

Question and Discussion

1. Besides its value in learning, why would audience involvement in interpretive programs be so important.
2. Overall, why is "Knowing Your Audience" considered so valuable in interpretation?
3. If heavy teacher audience, ask "how would or could your knowledge of learning styles and teaching strategies to enhance a presentation such as this?"

CLOSURE In partners, write another situation like we just did and share the solution with another partner pair.

TRANSITION Working, worthwhile interpretation stories to develop activities based on themes.



THEME DEVELOPMENT

- CONCEPT** Cause-effect, interaction, perception. Most of the concepts could be themes for the students to develop. As a teacher, with a more advanced class, or as an extension, you could choose a concept, such as “cycles” and have students develop specific interpretive themes within cycles.
- PRINCIPLE** A basic theme is the foundation for interpretive development. But is not enough to “awaken people’s curiosity”. You must present opportunities that the together parts into a “whole”.
- OBJECTIVE**
- Participants will be able to list various themes and select one for further development.
- PREPARATION** Select a natural area, if possible, with a variety of vegetative zones nearby. The group size should not exceed 12 for ideal discussion and small group activities, but allowances can be made.
- MATERIALS NEEDED**
- Activity Card C: Inventorying Interpretive Features
 - Flip chart and marking pens
- PROCESSES USED**
- classify
 - communicate
 - observe
 - infer
 - question
 - interpret data
- TIME** 45 minutes with discussion



DOING THE ACTIVITY (indoors, outdoors)

A. Set the Stage

Now let's change our focus from theory to practice. Whether it's an extensive master plan for a national park or a five minute orientation talk, a basic theme is the foundation for interpretive development. The theme is the central or key idea we want to get across to the visitor. Rather than a broad, sometimes nebulous topic, the theme is a specific concept or objective we wish to communicate clearly to the visitor in a meaningful way. Let's brainstorm together on possible themes so we all get the idea. (NOTE: Here are some themes to start with in case you can't get started: night sounds, plant succession, geology, native american residents and culture, change, cycles in the park, etc.)

Allow 10 minutes to list group ideas on the flip chart. Keep ideas posted through Activity C. NOTE: It is important to record these so they are available throughout the process, don't erase. Invite participation to record all themes on back of the activity for reference once they are home.

B. Procedure

Distribute Activity C and give the following instructions: In teams of two, practice developing a theme using interpretative features you can identify on this site. Select a theme from this list or make up another one of your own and inventory the features on this site that relate to and will help communicate your chosen theme. On the activity card, note each feature and state how it may be used in developing your theme. For example, a rotting log could help visually illustrate the theme of constant change in a forest. During the activity some of you will come upon a supplemental or complementary theme - record it too. Does this remind you of semantic webbing? Give class 10 minutes, expand to 15 if they are still working hard.



ACTIVITY C: Inventory Interpretive Features

10-15 min.
page 586

Our theme is _____	
Features	How They Can Be Used in Theme Development
1.	
2.	
3.	
4.	
5.	
6.	
7.	
8.	
<u>Supplementary or extending themes from the main could be</u>	
1.	
2.	
3.	
4.	
5.	

C. Retrieve the Data

Investigating Your Environment
Interpreting Your Environment 

Have each group summarize their inventory/theme building activity. They may want to add a visual display or matrix, give them time to do this. A lot of ideas will come out here. Give it time.

Use these questions and discussion starters:

1. What observations can we make about this process of inventorying interpretative features?
2. If you kept the same theme, but didn't have the luxury of being right here in the forest, what else could you use as interpretive features or elements of your theme?

CLOSURE List two themes you could develop "back home" and three features you would start with.

TRANSITION You've looked at the audience, you've considered the definition and philosophy of interpretation, how it is time to consider how you will deliver your message.



INTERPRETIVE METHODS AND TECHNIQUES

CONCEPT	Perception, system
PRINCIPLE	It is important to be able to generate new ideas and know the spectrum of interpretive services. It is also important to consider the available technology and how it can help provide pertinent interpretive services.
OBJECTIVE	<ul style="list-style-type: none">• Participants will be able to list several types of interpretive methods - both personal and non-personal - available to the interpreter.
PREPARATION	Select a natural area, if possible, with a variety of vegetative zones nearby. The group size should not exceed 12 for ideal discussion and small group activities, but allowances can be made.
MATERIALS NEEDED	<ul style="list-style-type: none">• Flip charts and marking pens• Collection of interpretive materials
PROCESSES USED	<ul style="list-style-type: none">• classify• communicate• observe• predict
TIME	45 minutes with discussion



DOING THE ACTIVITY (indoors, outdoors)

A. Set the Stage

Quickly review what will take place in the allotted time.

B. Procedure

Set up the flip charts. Give the following directions: Now we'll get down to the nitty gritty and discuss the HOW of interpretation. Let's divide in half and have some friendly competition. Select a recorder, and on the flip chart, list as many interpretive methods or techniques as you can that you have seen or observed. Remember, we have both personal services, such as guided walks, and non-personal services, such as brochures and exhibits. Ready? Set. Go! (End this activity when you see work not being accomplished, monitor closely).

C. Retrieve the Data

After time is called, compare the flip charts side by side. If items appear on both lists, cross them off while asking one member to describe each method or technique. The "winning team" is the one with more methods left than the other.

Next, give the group about 10 minutes to sift through the collection of interpretive materials and samples available, intended to generate and demonstrate the spectrum of interpretive services.

Bring group together to compare lists again and add any methods they forget.

CLOSURE Ask each pair to think creatively and come up with one or two ideas about interpretive methods for the future. Share these with another pair and then list on class list.

TRANSITION Next, it is your opportunity to meld method, theme, and audience and plan an interpretive activity.

538



DEVELOP AND CONDUCT AN INTERPRETIVE ACTIVITY

CONCEPT	System, perception, interaction
PRINCIPLE	It is most beneficial and significant to develop interpretive activities using a basic theme. In fact, it the "job" of an interpreter to use his/her knowledge and intellectual curiosity to develop and present all manner of interpretive activities.
OBJECTIVE	<ul style="list-style-type: none">• Participants will be able to conduct a simple interpretive activity using a basic theme, identified interpretive features or topics, and appropriate structure.
PREPARATION	Select a natural area, if possible, with a variety of vegetative zones nearby. The group size should not exceed 12 for ideal discussion and small group activities, but larger groups can be accommodated.
MATERIALS NEEDED	<ul style="list-style-type: none">• Activity Card D: Developing an Interpretive Activity• Microtrail flags (popsicle sticks, bamboo skewers, something you can write on or flag).• Paper, pens, and possible props
PROCESSES USED	<ul style="list-style-type: none">• observe• infer• classify• hypothesize• interpret data
TIME	60+ minutes



DOING THE ACTIVITY (outdoors)

A. Set the Stage

Quickly review what will take place in the allotted time. Say: Now it's your turn to choose a theme, find interpretive features or select topics, and choose a method to deliver your own interpretive program.

B. Procedure

Hand Activity D Cards and give the following directions: You will have 30 minutes to develop a brief (10-15 minute) interpretive activity that you will share with others. If you wish to conduct a nature walk, try using microtrail flags and lay out a trail that an ant might walk, to save some time. Remember, imagination and enthusiasm are important.

ACTIVITY D: Develop An Interpretive Activity

30 min.
Individual

Using the outline provided below, design a simple, 10-15 minute activity, presentation or demonstration for your "visitors."

THEME:

INTERPRETIVE FEATURES:
OR TOPICS

BODY OF TALK:

1. Introduction (What we're going to do)
2. Theme Development (Do it)
3. Conclusion (What we did)

Theme: _____

Interpretive Features or Topics: _____

Interpretive Method(s) Used: _____

Body of Presentation:

Introduction: _____

Theme Development: _____

Conclusion: _____

Investigating Your Environment
Interpreting Your Environment 



Investigating Your Environment
Interpreting Your Environment

C. Retrieve Data

Facilitator: Allow about 20 minutes

Present your activity to another person. Then listen to their presentation.
If time, listen to some one else's presentation.

Discussion to follow should bring out information on: (7 minutes)

1. What interpretive techniques or methods were chosen?
2. What principle(s) of interpretation were satisfied in your activity?
3. Which of the techniques you experienced satisfied your knowledge or skill needs as a participant?
4. Based on your experience, which technique would you like to be able to use more, or use better?

Let students question and discuss.

CLOSURE Tell another how you will use what you learned in this activity on your work.

TRANSITION It is always useful to objectively evaluate an activity so we know what worked, what needs fixing, and what the next step is. Our next activity is just such an evaluation.



EVALUATE INTERPRETIVE ACTIVITIES

CONCEPT	Perception, interaction
PRINCIPLE	Program design and implementation is incomplete unless evaluation is an integral part of the program. Teachers know this, in business it is called "accountability". A popular poster states "How will you know where you are if you don't know where you began?" - the perfect argument for evaluation.
OBJECTIVE	<ul style="list-style-type: none">• Participants will be able to evaluate interpretive programs and provide useful feedback for themselves and for others.
PREPARATION	Remain in your area.
MATERIALS NEEDED	<ul style="list-style-type: none">• Activity Card E: Evaluate an Interpretive Activity
PROCESSES USED	<ul style="list-style-type: none">• communicate• observe• classify• infer• question
TIME	45 minutes with discussion



DOING THE ACTIVITY (outdoors)

A. Set the Stage

Quickly review what will take place in the next 20 minutes.

B. Procedure

Hand out Activity E. Give the following directions: After conducting your presentation to your small group, ask those who saw your activity to fill out Activity E to provide feedback on your program. Everyone saw at least one activity so all should be working. If time, each person should do a self-evaluation after they see another's evaluation.

20 min.
Individual

ACTIVITY E: Evaluate an Interpretive Activity

Date _____
For _____

1. THEME - Was it clear? Did it evolve through the activity?
2. INTRODUCTION/CONCLUSION - Was it clear when we started and ended?
3. INTERPRETIVE FEATURES? TOPICS - Were they relative, logical, interesting?
4. INTERPRETIVE PRINCIPLES - Were any applied? Which ones? Should some have been applied and weren't?
5. AUDIENCE - How was the audience considered or involved?
6. REVELATION - What meanings and/or relationships were revealed to you?
7. OTHER COMMENTS

Date _____
For _____

1. THEME - Was it clear? Did it evolve through the activity?
2. INTRODUCTION/CONCLUSION - Was it clear when we started and ended?
3. INTERPRETIVE FEATURES? TOPICS - Were they relative, logical, interesting?
4. INTERPRETIVE PRINCIPLES - Were any applied? Which ones? Should some have been applied and weren't?
5. AUDIENCE - How was the audience considered or involved?
6. REVELATION - What meanings and/or relationships were revealed to you?
7. OTHER COMMENTS

Investigating Your Environment
Interpreting Your Environment 

593



Investigating Your Environment
Interpreting Your Environment

C. Retrieve Data

Give each participant time to finish their own self-evaluation, and read other evaluations they received. When group starts to get restless, conduct a discussion, using these questions:

1. What did you learn from developing and conducting your own interpretive program?
2. What additional skills or knowledge might be helpful?
3. In what other ways could you constructively evaluate your own or your colleague's interpretive programs?
4. How did it feel being an interpreter, perhaps for the first time?

CLOSURE Discuss how an evaluation helps in an activity. Come up with an "awful consequence" that could result because you did not evaluate an activity.

TRANSITION Some interpreters (facilitators and teachers) are really, really, good, and some are better than No-Doz[™] while others know what they're talking about but have trouble delivering the message. Why?



STYLE AND DELIVERY FOR INTERPRETERS

CONCEPT	Perception, interaction, system
PRINCIPLE	Certain special and personal qualities contribute to an interpreter's effectiveness. As students complete this activity, they should be able to draw some conclusions about their strengths and what they would like to develop.
OBJECTIVE	<ul style="list-style-type: none">• Participants will be able to identify personal communication styles and characteristics that aid interpreters in program delivery.
PREPARATION	Remain in your area - the natural setting. Teachers, you can use any previous studies in psychology, health or self-esteem to help students do this activity. An inventory of skills, strengths will also be helpful.
MATERIALS NEEDED	<ul style="list-style-type: none">• Activity Card F: The Inspirational Interpreter• Flip charts and markers• tape
PROCESSES USED	<ul style="list-style-type: none">• infer• observe• classify• interpret data• communicate
TIME	45 minutes



DOING THE ACTIVITY

A. Set the Stage

Quickly review what will take place. (about 20 minutes).

B. Procedure

Hand out Activity F and give the following directions: As we grow into our roles as interpreters or as we apply some interpretive principles to our educational roles, we can focus on those special, personal qualities that make a difference in our programs.

Perhaps you have participated in an interpretive program where you were inspired, moved, or really excited by the interpreter. You see the public drawn to such people, probably for a variety of reasons that relate to body language, verbal cues, and delivery style.

What do you think are the personal qualities and delivery styles that are important to cultivate in interpreters? Let's answer that question in our groups. First, work by yourself and come up with as many ideas as possible.

ACTIVITY F: "The Inspirational Interpreter"

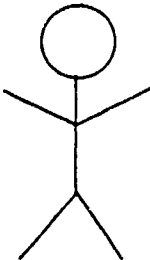
Delivery Style	Body Language
	

Investigating Your Environment
Interpreting Your Environment 



C. Retrieve Data

Using the group chart, each group shares their ideas verbally and visually. Other groups, check off "like" qualities and each successive group adds qualities or expands upon those already offered.

Questions and Discussion

1. In what ways can we practice this aspect of the art of interpretation among our peers? With our students or regular audience?
2. Why is personal enthusiasm and warmth we discussed so important to the effectiveness of our programs? How does this come about?

CLOSURE

Share with your partner one personal trait or one personal area in which you'd like to improve. How will this make you a better interpreter?



ACTIVITY A: Principles of Interpretation

20 min.
pairs

- I. Any interpretation that does not somehow relate what is being displayed or described to something within the personality or experience of the visitor will be sterile. - Tilden
 - To help park visitors understand that the place they're visiting is related to the place they call home.
 - To show the relationship of what is being observed (experienced) to the lives of the observers. - Lewis

- II. Information, as such, is not Interpretation. Interpretation is revelation based upon information. But they are entirely different things. However, all interpretation includes information. - Tilden
 - To give accurate, interesting information which forms the foundation for an interpretation of data. - Lewis

- III. Interpretation is an art, which combines many arts, whether the materials presented are scientific, historical or architectural. Any art is in some degree teachable.
 - Knowledge treated imaginatively.
 - Interpreters should "dip into their own artistic appreciation, give form and life to their material, and tell a story rather than recite an inventory" - Tilden

- IV. The chief aim of Interpretation is not instruction, but provocation.
 - To give the kind of interpretation which will encourage visitors to figure some things out for themselves.
 - To arouse curiosity and sometimes satisfy it.
 - To conserve park resources through an understanding and consequent appreciation of them.

- V. Interpretation should aim to present a whole rather than a part, and must address itself to the whole person rather than any phase.
 - To help visitors have an inspirational, relaxing, good time.
 - To provide visitors with an escape from the pressures which assault them.
 - To help visitors understand the interrelationships among as many aspects of what is being observed as possible.

- VI. Interpretation addressed to children (say, up to the age of twelve) should not be a dilution of the presentation to adults, but should follow a fundamentally different approach. To be at its best, it will require a separate program.



ACTIVITY B: Consider Your Audience

5 min.
individual

- | | |
|---|--|
| 1. The group is largely comprised of families with small children | 2. The group is largely comprised of senior citizens. |
| 3. Your forest/park draws people from all over the U.S. and foreign countries. | 4. The evening is quite cold and windy, so attendance is sparse. |
| 5. Because it is June, your slide program cannot begin until late when it is sufficiently dark. | 6. People remember 10% of what they hear, 50% of what they see, and 90% of what they do. |
| 7. Questions can be effectively used to help visitors derive meanings. | 8. Using a variety of approaches will enhance learning. |
| 9. An organized presentation is more memorable than an unorganized one. | 10. People learn best when an experience is close to them in time and space. |
| 11. New learning is built on a foundation of previous knowledge. | 12. People learn better when they're actively involved in the learning process. |
| 13. You can't sing, but your supervisor wants your campfire to begin with some songs, and he's there to listen. | 14. You can't get the campfire to start and right before you are four kids with sticks and marshmallows. |
| 15. You get to the amphitheater only to discover that the electricity doesn't work and you have a slide program. | 16. During your talk, a man calls out, "You're wrong, honey! Women rangers don't know nuthin'. I'm splittin'." |
| 17. It becomes obvious during your program that there's an historian in the audience. You can't answer his questions. | 18. About halfway through the slides, the lamp goes out and you don't have an extra. |
| 19. The program is going well, when suddenly a young girl screams "A bat! A bat!". Now what? | 20. What do you do if someone faints or has an epileptic spell during the program? |



ACTIVITY C: Inventory Interpretive Features

10-15 min.
pairs

Our theme is _____

Features

How They Can Be Used in Theme Development

1.

2.

3.

4.

5.

6.

7.

8.

Supplementary or extension theme from the main could be

1.

2.

3.

4.

5.



ACTIVITY D: Develop An Interpretive Activity

30 min.
individual

Using the outline provided below, design a simple, 10-15 minute activity, presentation or demonstration for your "visitors."

THEME:

**INTERPRETIVE FEATURES:
OR TOPICS**

BODY OF TALK:

1. Introduction (What we're going to do)
2. Theme Development (Do it)
3. Conclusion (What we did)

Theme: _____

Interpretive Features or Topics: _____

Interpretive Method(s) Used: _____

Body of Presentation:

Introduction: _____

Theme Development: _____

Conclusion _____

ACTIVITY E: Evaluate an Interpretive Activity

20 min.
individual

Date _____
For _____

1. THEME - Was it clear? Did it evolve through the activity?
2. INTRODUCTION/CONCLUSION - Was it clear when we started and ended?
3. INTERPRETIVE FEATURES? TOPICS - Were they relative, logical, interesting?
4. INTERPRETIVE PRINCIPLES - Were any applied? Which ones? Should some have been applied and weren't?
5. AUDIENCE - How was the audience considered or involved?
6. REVELATION - What meanings and/or relationships were revealed to you?
7. OTHER COMMENTS

Date _____
For _____

1. THEME - Was it clear? Did it evolve through the activity?
2. INTRODUCTION/CONCLUSION - Was it clear when we started and ended?
3. INTERPRETIVE FEATURES? TOPICS - Were they relative, logical, interesting?
4. INTERPRETIVE PRINCIPLES - Were any applied? Which ones? Should some have been applied and weren't?
5. AUDIENCE - How was the audience considered or involved?
6. REVELATION - What meanings and/or relationships were revealed to you?
7. OTHER COMMENTS



ACTIVITY F: "The Inspirational Interpreter"

Delivery Style

Body Language

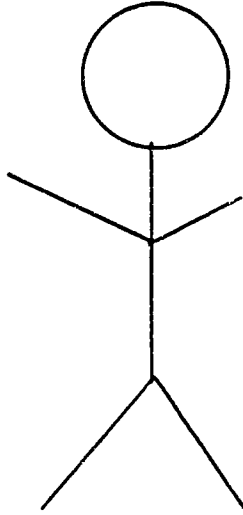

Geologic History



BEST COPY AVAILABLE



Investigating Your Environment — Intermountain Region

INTRODUCTION

An understanding of how our earth's surface evolved, how it has changed, and what the implications are for the future is important. By studying geologic history, students will understand the origin and structure of our earth. They will develop a deeper understanding of geology by investigating the structure of a specific region of the earth's surface. This lesson will help students increase their powers of observation and ability to predict and interpret geologic events. Students use topographical maps, discuss the value of all maps in our society, observe the effects weathering and erosion on our earth's surface and determine human impact on the geologic environment.

THE ACTIVITIES

TIME REQUIRED

Observe and Measure Information on a Topographic Quadrangle	45 minutes
Interpret Data About Local Rock Types	2 hours
Observe and Predict Forces of Weathering and Erosion	30 minutes
Communicate Feeling, Awareness, and Values	30 minutes

COMBINING THE ACTIVITIES

The activities in this unit are displayed singly. Depending upon the time available and the skill of the participants, you may choose to do only one activity or the entire series. For maximum learning, the activities should be experienced in the order listed in the unit, however, other suggestions are:

Suggestion

Title: Observe, Measure, and Interpret Data About Our Earth's Surface by Reading a Topographical Map

Activity: Study the significant features of a topographical map and learn how to read one.

Transition Statement: Let's discuss why a topographic map is useful to us.

Activity: Identify the highest and lowest elevation you can observe from where you are standing and locate the areas on your map.



Transition Statement: Let's compare your actual observations with the features on the map. Now let's take a look specifically at what the land offers by examining rocks in the area.

Activity: Gather rock samples and prepare a dichotomous key representing them.

Transition Statement: By observing the characteristics of these rocks, we can learn about past events in this area.

CURRICULUM RELATIONSHIPS

Social studies and science are most likely to be strong components in the investigation. Math, language arts, and the creative arts can be worked in as the students report on what they found in their initial investigations. The fact that all curriculum areas come into use make these environmental investigations uniquely relevant and motivating. Students can clearly see the usefulness of the various subject matter.

Social Studies

1. Use topographical maps to compare the major topographical land features of your area with an area or a country being studied in social studies (land forms, vegetation, natural resources).
2. Study land ownership boundaries and compare the distribution of natural resources to type of land ownership.

Science

1. Correlate plant communities with features on a topographical map, taking into consideration landforms, climate, waterforms, etc.
2. Study the effect of weather on the natural environment. How does weather directly affect erosion?

Mathematics

1. Learn to use some of the units of measurement in weather calculation; for example, what is "one inch of rain"?
2. Estimate slope distance percent in relation to distances between contour lines.

Language Arts

1. Research and write an article on why change was made from metes and bounds to a systematic grid system of surveying in the United States.
2. Write a paper on how people in this area make a living based on the observations and inferences made from a map study.
3. Develop a chart of proverbs about weather in your area and how it affects the land.

Creative Arts

1. Construct an abstract pattern of a topographical map.
2. Construct a topographical map with a legend.



OBSERVE AND MEASURE INFORMATION ON A TOPOGRAPHICAL MAP

CONCEPT	Quantification, order, scale
PRINCIPLE	Reading a topographical map helps people observe and interpret the environment more easily.
OBJECTIVE	<ul style="list-style-type: none">• Students will be able to read a USGS topographic map and identify the various symbols. They will work in small groups to graph a profile of an area's topography.
PREPARATION	Get topographical maps and make small xeroxed maps of your study areas to distribute to students.
MATERIALS NEEDED	<ul style="list-style-type: none">• Activity A: Read a Topographic Map and B: Graph a Topographic Profile• Copied maps of the study area (if you plan to reuse yearly, laminate the maps)• Guide to topographic symbols• Marking pens, washable
PROCESSES USED	<ul style="list-style-type: none">• formulate models• observe• measure• communicate• use numbers• interpret data• define operationally
TIME	45 minutes



DOING THE ACTIVITY (indoors)

A. Set Stage

“In this activity you will learn to read a topographic or contour map and to interpret the geologic environment. What are some things that you already know about topographic maps?”

B. Procedure

1. Distribute maps and Activity A.
2. Work in pairs.

ACTIVITY A: Read a Topographic Map

25 min.
pairs

30 minutes

Work in groups of 4 or 5.

1. The geologic quadrangle you are studying is _____
2. What year was it published _____
3. The scale of the map is _____
4. The contour interval on this map is _____
5. Identify man-made and natural features on the map and draw the symbol.

Man-made		Natural	
(feature)	(symbol)	(feature)	(symbol)
_____	_____	_____	_____
_____	_____	_____	_____
_____	_____	_____	_____
_____	_____	_____	_____
_____	_____	_____	_____
_____	_____	_____	_____
_____	_____	_____	_____
_____	_____	_____	_____
_____	_____	_____	_____
_____	_____	_____	_____
_____	_____	_____	_____
_____	_____	_____	_____
_____	_____	_____	_____
_____	_____	_____	_____

6. The highest elevation is _____ and the lowest elevation is _____
7. What is the major watershed on the quadrangle? _____

C. Retrieve Data

Students fill out Activity A , and use them in a discussion.

Discuss:

1. What did you find?
2. What is the most significant feature on the map? Why do you think so?
3. How did natural features affect the human development of this area?
4. Why is a topographic map useful?

NOTE: The concept of a watershed should be discussed or demonstrated.

D. Procedure

Now graph a profile of the area's topography. Students should work with a partner to complete the graph. Students use Activity Card B. Allow 30 minutes to complete the assignment. Have them select an area from their contour map.

ACTIVITY B: Graphic Topographic Profile 30 min.
page 7

Example

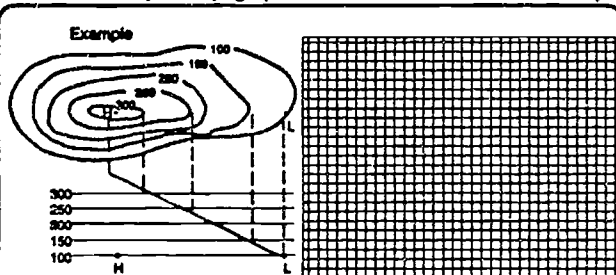

Select an area from your topographic map
Work with one other person.

1. Place an "H" at the highest point and an "L" at the lowest point on your contour map.
2. Connect these two points with a straight line.
3. On the graph paper number along the vertical using the contour interval of the quadrangle. Start with the lowest elevation. What scale will you use.
4. Place an "H" and "L" along the horizontal line equal to the distance on the map.
5. Make points on the graph that correspond in distance (horizontal line) and elevation (vertical line) to the point where your profile line crosses each contour.
6. Sketch the profile along the line between point "H" and "L."

NOTE: If the profile is longer than this graph paper, turn this worksheet sideways.

Investigating Your Environment
Geologic History 

E. Retrieve Data

Using completed Activity Sheet B, conduct a discussion.

1. What problems did you have, if any?
2. What patterns did you notice?
3. What questions do you have about this activity?
4. What scale did you use? Why?

CLOSURE "What have we found out (so far) about topographic maps?"

TRANSITION "Now that we have learned to use a topographic map and draw a topographic profile, let's focus on the rocks that make up some of the landforms we discovered on our maps"

Investigating Your Environment
Geologic History 

INTERPRET DATA ABOUT LOCAL ROCK TYPES

- CONCEPT** Cause/effect, interaction, order, quantification, invariance, replication, fundamental entities
- PRINCIPLE** The earth's crust is composed of many kinds of rocks, each consisting of one or more minerals.
- OBJECTIVE**
- Students will be able to:
 - 1) describe the physical characteristics of rocks
 - 2) prepare a dichotomous key representing rock characteristics
 - 3) demonstrate an ability to test predictions about rock types
- PREPARATION** Select a site where students can work in groups to collect rock samples. The site should offer a variety of rock types within a close range. The site should also have different elevations that are easily observable. (The facilitator should read the activities in this session in advance of selecting the site). Prepare rock samples with freshly broken surfaces for Activity E.
- MATERIALS NEEDED**
- Activity C: Interpret Data About Local Rock Types, D: Dichotomous Key of Rocks, E: Rock Characteristics & Rock Data Sheet
 - information sheet - print duplex
 - maps of the study area
 - guides to topographical symbols
 - marking pens
 - small hammers
 - hand lenses
 - Dilute HCl
- PROCESSES USED**
- observe
 - classify
 - communicate
 - infer
 - interpret data
- TIME** 2 hours



DOING THE ACTIVITY (outdoors)

A. Set Stage

"The earth's crust is made up of many kinds of rocks which consist of one or more minerals. In this activity we will investigate some of the rocks found here on this study site".

B. Procedure

1. Distribute maps and Activity Sheet C.
2. Work in pairs
3. Allow 20 minutes to complete Activity Sheet C.

ACTIVITY C: Interpret Data About Local Rock Types

20 min.
groups

1. Identify the highest and lowest elevation that you can see from where you are standing. Mark these points and your location on the contour map.

2. Are these the same as those indicated on the whole quadrangle? _____

3. Which of the features on the map can be observed from where you are standing?

4. Outline the watershed* containing your study area—identify:

5. Describe man's impact on this area

* Watershed: The region or area drained by a river or stream or, a river and its tributaries

Investigating Your Environment
Geologic History



C. Retrieve Data

Students use the completed Activity Sheet C to discuss their findings. Possible questions to use are:

1. What features did you see from the study area?
2. What features are not shown on the topographical map?
3. What can we say about the topography of this area?
4. Discuss the relationship of human activity to the topography



Investigating Your Environment
Geologic History

TRANSITION

“Now let’s look at the rocks found here. To help us see differences we will be using a two part classification system call a Dichotomous Key.”

D. Procedure

1. Pass out Activity Sheet D.
2. Have each student gather 3 or 4 rock samples
3. Students complete part 1 of Activity D and prepare a Dichotomous key to all samples collected (20 minutes), work in small groups.
4. After 20 minutes, groups gather into large group and go on to part 2 of Activity Sheet D.

30 min.
groups

ACTIVITY D: Dichotomous Key of Rock Types

Dichotomous Chart (20 min.)

1. Each group member should gather three or four rock samples.
2. Prepare a dichotomous chart representing all of the samples collected.
3. Have each group read the descriptions of a sample rock.

Characteristics (10 min.)

1. From the specimens collected have the entire group choose the three most common types of rocks found at the site.

Below each group list the observable characteristics of these rocks.

Rock Type I	Rock Type II	Rock Type III
_____	_____	_____
_____	_____	_____
_____	_____	_____
_____	_____	_____
_____	_____	_____
_____	_____	_____
_____	_____	_____
_____	_____	_____
_____	_____	_____
_____	_____	_____

Optional for Earth Science Students

Based on the rock specimens you found, answer the following:

- a. These rocks were formed by _____
- b. The most common type of rock is _____ which is an example of an _____
(igneous, metamorphic, sedimentary)

E. Retrieve Data

Investigating Your Environment
Geologic History 

Use completed Activity Sheet D to read their descriptions of a sample rock. Possible questions are:

1. What are the characteristics of a rock in this area?
2. What could the rocks in this area tell us about the past events of this area?
3. Under what conditions were these rocks formed?

Investigating Your Environment
Geologic History



TRANSITION

"Now let's examine a freshly broken rock and see what we can find out about it"

F. Procedure

1. Provide students with rock samples that have freshly broken surfaces.
2. Distribute information sheets on rocks and Activity Sheet E.
3. Have students work in groups of 4 or 5 and allow 45 minutes to complete E.

ACTIVITY E: Rock Characteristics 45 min. groups

Use the information on the attached sheet to perform the tests and determine the characteristics of each specimen. Be sure that all tests are performed on a freshly broken surface.

Particle Size (texture)	Color	How does it break	Reaction to H ₂ O	Reaction to HCL	Rock
a.					
b.					
c.					

ACTIVITY E: Rock Data Sheet

List any economic uses you think or know of:

1. _____
2. _____
3. _____

TEXTURE - PARTICLE SIZE		ROCK DESCRIPTION	
Clay - less than .002 mm		Igneous	These rocks are produced through the cooling of molten material. When the cooling process is slow, the rock contains large-sized crystals or the individual minerals.
Silt - .002 - .05 mm		Sedimentary	These rocks are composed of small particles derived from previously existing rocks and deposited in layers upon surfaces of water and plants or upon floors of lakes and oceans.
Sand - .05 - 2.0 mm		Metamorphic	Alteration of previously formed rocks occurs from rock materials from metamorphic heat and pressure. Older igneous or sedimentary rocks can become metamorphic rocks.
Gravel - 2.0 mm - 7.5 cm			
Cobble - 7.5 cm - 25 cm			
Stone - larger than 25 cm			

	ROCK	TEXTURE	DESCRIPTION
IGNEOUS	Granite	Medium to coarse grained crystals	Light colored - white or salmon-pink with dark speckles. A freshly broken surface has glassy specks which reflect light.
	Basalt	Extremely fine grained	Dark colored
	Obsidian	Glassy	Dark - generally black, green or brown. Exhibits conchoidal fracture (like chip off the bottom of a bottle).
SEDIMENTARY	Pumice	Porous, glassy	Light colored, very porous, many small cavities, floats.
	Conglomerates	Coarse	Consolidated gravel and/or sand particles. Light colored. (Resembles cement.)
	Sandstone	Fine	Consolidated sand, variety of colors (resembles mortar), porous.
	Shale	Very fine (microscopic)	Consolidated clay and silt. Any color. Breaks in flat planes
	Limestone	Very fine (microscopic)	Chiefly calcite, generally white or light colored. Fossils may be present. Dilute HCL will cause effervescence.
	Coal	Very fine	Dark, generally brown or black. Derived from plant decomposition. May contain fossils.
METAMORPHIC	Slate	Microscopic, fine grained, smooth	Variety of colors, splits readily into thin sheets. Formed from shale.
	Schist	Flaky, visible particles	Visible flaky minerals. Formed from slightly metamorphosed igneous or sedimentary rocks.
	Gneiss	Coarse grained	Contains both light and dark materials. Parallel streaks. Variety of origins.
	Quartzite	Fine to coarse	Usually light colored, not porous, formed from sandstone or conglomerate.
	Marble	Coarse grained	Many colors, exhibits veining, fossils and bedding described metamorphism. Formed from limestone or dolomite. Dilute HCL will cause effervescence.

G. Retrieve Data

Students use completed Activity Sheet E to report the results of their tests. Possible questions are:

1. What are the results of your tests?
2. What difficulties did you encounter in determining the kind of rock you studied?
3. What does the information tell us about the past events in this area?
4. What might make a rock economically valuable?
5. Based on the economic value of the rocks that we just discussed, what might be the economic value of the whole study area?
6. What are other uses of the rocks and of the area?
7. How could humans use the capability of this area?

CLOSURE Name two things you learned in this lesson. Share those with a partner. Then partners share with another pair, or.

What have we found out about rocks so far?

TRANSITION We have examined rocks and minerals at one point in time. However, chemical and physical forces of weathering are changing them. In the next lesson, we'll look at the interaction of weather and the earth.



OBSERVE AND PREDICT FORCES OF WEATHERING AND EROSION

CONCEPT	Cause/effect, interaction, fundamental entities, change, cycles, force, order
PRINCIPLE	Weather affects our lives every day. By observing certain phenomena, signs of weathering can be used to forecast changes in our environment.
OBJECTIVE	<ul style="list-style-type: none">• Students will be able to 1) understand the relationship between the forces of weathering and erosion, and 2) illustrate a geologic cycle.
PREPARATION	Select a site that has a rock wall, a road cut, or a stream bank.
MATERIALS NEEDED	<ul style="list-style-type: none">• Activity Sheet F: Influences of Weathering• pens or pencils
PROCESSES USED	<ul style="list-style-type: none">• observe• predict• infer• classify• communicate• question• define operationally• interpret data• formulate model
TIME	30 minutes



DOING THE ACTIVITY

A. Set Stage

“Weather affects our lives every day. By observing certain phenomena, signs of weathering can be used to forecast changes in our environment.”

B. Procedure

1. Distribute Activity Sheet F and Influences definitions
2. Work in groups of 2
3. Allow 30 minutes

C. Retrieve Data

Students complete Activity Sheet F and then use it to discuss their findings. Possible discussion questions are:

1. What are some of the relationships between the forces of weathering and erosion?
2. What were some phases (parts) of the geologic cycle that you identified?
3. How might weathering be different on different rock types?
4. What are the benefits of weathering and erosion if any?

ACTIVITY F: Influences of Weathering

30 min.
groups

At a desk, roll, roll out or steam bath:
Observe the material (fels) at the base of the out and answer the following.

1. Where did this material come from? _____

2. What agents have acted upon the material? _____

ACTIVITY F: Influences Definitions

Wes

—

—

—

—

—

—

—

—

—

—

—

—

—

3. Pr

—

—

—

—

4. B.

—

—

—

—

—

—

—

—

—

—

—

—

—

—

—

—

—

—

—

—

—

—

—

—

—

—

—

—

—

—

—

—

—

—

—

—

—

—

—

—

—

—

—

—

—

—

—

EROSION: The group of processes whereby earth or rock material is loosened or dissolved and removed from any part of the earth's surface.
It includes the processes of weathering, solution, corrosion and transportation.
Mechanical wear and transportation are effected by running water, waves, moving ice, winds, which use rock fragments to pound or grind other rocks to powder or sand.
The agents of wind, water and ice are all generated by gravitation forces.

WEATHERING: The physical and chemical disintegration and decomposition of rocks and minerals.
Physical weathering is accomplished by moisture (freezing, thawing, evaporation), temperature change (expansion, and contraction), and root wedging by growing plants.
Chemical weathering is the result of the alteration of minerals within rocks by the action of various chemicals such as acids formed in the environment.
Through this process, rocks are changed in character until they decay, and crumble into soil.

Investigating Your Environment
Geologic History

CLOSURE

In pairs construct a geologic cycle, then compare with others to determine parts common to the cycle.

TRANSITION

People need to think about the environment as more than a resource. This next activity helps us explore our feelings and the values of geology.

616



Investigating Your Environment
Geologic History



COMMUNICATING FEELING, AWARENESS, AND VALUES

CONCEPT	Interaction, perception, cause/effect, change
PRINCIPLE	People have a definite impact on our environment and its natural resources.
OBJECTIVE	<ul style="list-style-type: none">• Students will be able to describe their feelings about human effects on our geologic environment.
PREPARATION	Tell students to think carefully about what they have learned so far and decide how they feel about our responsibility in taking care of our natural environment.
MATERIALS NEEDED	<ul style="list-style-type: none">• Activity Sheet G: Communicate Feelings• pen or pencil
PROCESSES USED	<ul style="list-style-type: none">• communicate• observe• infer• question
TIME	30 minutes



DOING THE ACTIVITY (indoors, outdoors)

A. Set Stage

"People have an impact on our environment and its natural resources and so impact the geology of an area. In this session, you will have the opportunity to spend some time thinking about geology. Even though the two questions are specific to this site, you may communicate general feelings too. Feel free to write, draw, or do both to answer the questions. You have 20 minutes. Please remain silent and work by yourself.

ACTIVITY G: Communicate Feeling, Awareness and Values 20 min.
Individual

What has been this area's impact on men? _____

Describe how you feel about man's impact on this area? _____

B. Retrieve Data

Investigating Your Environment
Geologic History 

When students reassemble - ask for volunteers to share about each question. Discussion begins from sharing. Additional discussion questions:

1. What impact has this area had on people?
2. How might these change in the future?
3. What impacts have people had on this area?
4. How might these change in the future?
5. What are some of your feelings about the human impact you observe?

CLOSURE Does what we do in an environment impact our feelings about the area? Do our feelings about an area impact what environmental impacts we will make on that area?



ACTIVITY A: Read a Topographic Map

25 min.
pairs

30 minutes

Work in groups of 4 or 5.

1. The geologic quadrangle you are studying is _____.
2. What year was it published _____.
3. The scale of the map is _____.
4. The contour interval on this map is _____.
5. Identify man-made and natural features on the map and draw the symbol.

Man-made		Natural	
(feature)	(symbol)	(feature)	(symbol)
_____	_____	_____	_____
_____	_____	_____	_____
_____	_____	_____	_____
_____	_____	_____	_____
_____	_____	_____	_____
_____	_____	_____	_____
_____	_____	_____	_____
_____	_____	_____	_____
_____	_____	_____	_____
_____	_____	_____	_____
_____	_____	_____	_____
_____	_____	_____	_____
_____	_____	_____	_____
_____	_____	_____	_____
_____	_____	_____	_____
_____	_____	_____	_____
_____	_____	_____	_____
_____	_____	_____	_____
_____	_____	_____	_____
_____	_____	_____	_____
_____	_____	_____	_____

6. The highest elevation is _____ and the lowest elevation is _____.
7. What is the major watershed on the quadrangle? _____.

ACTIVITY B: Graphic Topographic Profile

30 min.
pairs

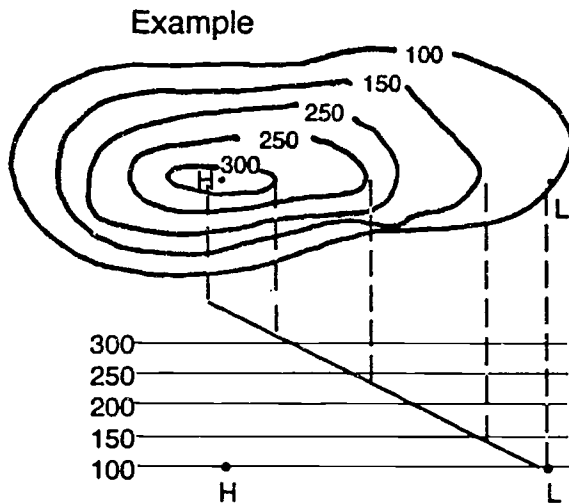

Select an area from your topographic map

Work with one other person.

1. Place an "H" at the highest point and an "L" at the lowest point on your contour map.
2. Connect these two points with a straight line.
3. On the graph paper number along the vertical using the contour interval of the quadrangle. Start with the lowest elevation. What scale will you use.
4. Place an "H" and "L" along the horizontal line equal to the distance on the map.
5. Make points on the graph that correspond in distance (horizontal line) and elevation (vertical line) to the point where your profile line crosses each contour.
6. Sketch the profile along the line between point "H" and "L."

NOTE: If the profile is longer than this graph paper, turn this worksheet sideways.

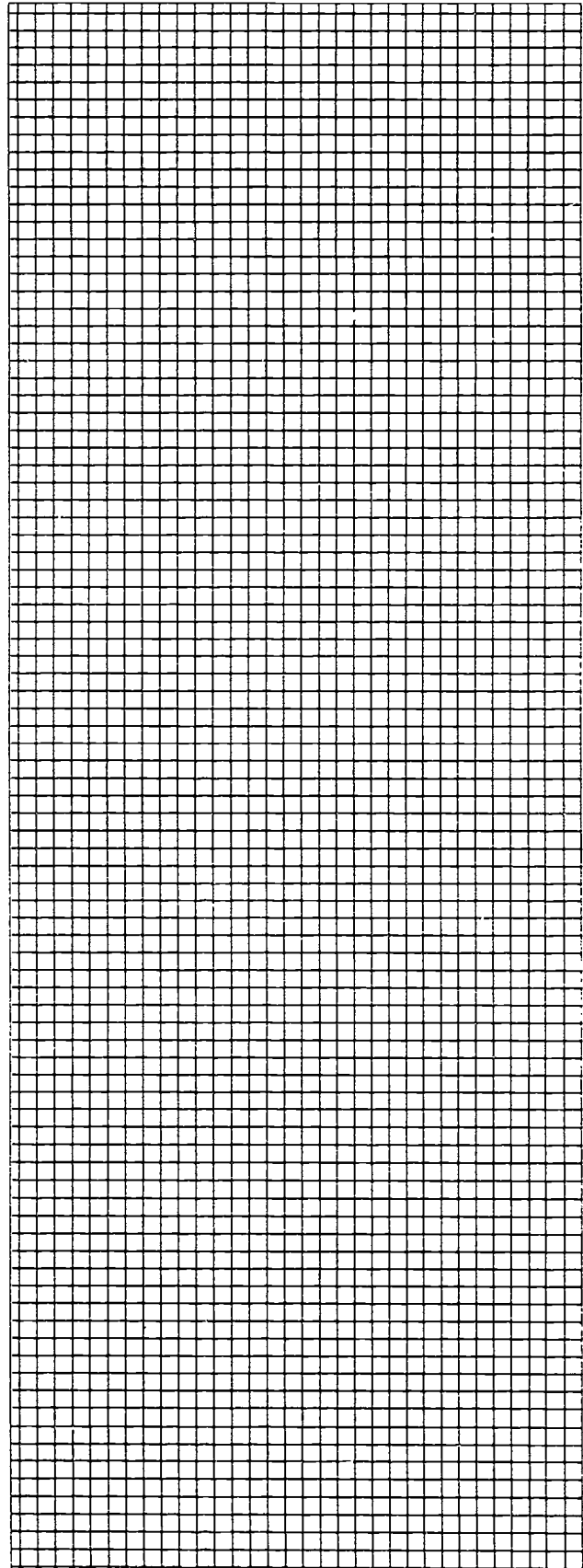

ACTIVITY C: Interpret Data About Local Rock Types

20 min.
groups

1. Identify the highest and lowest elevation that you can see from where you are standing. Mark these points and your location on the contour map.

2. Are these the same as those indicated on the whole quadrangle? _____

3. Which of the features on the map can be observed from where you are standing?

4. Outline the watershed* containing your study area—identify:

5. Describe man's impact on this area

* Watershed: The region or area drained by a river or stream or, a river and its tributaries

ACTIVITY D: Dichotomous Key of Rock Types

30 min.
groups

Dichotomous Chart (20 min.)

1. Each group member should gather three or four rock samples.
2. Prepare a dichotomous chart representing all of the samples collected.
3. Have each group read the descriptions of a sample rock.

Characteristics (10 min.)

1. From the specimens collected have the **entire group** choose the three most common types of rocks found at the site.

Below each group list the observable characteristics of these rocks.

Rock Type I	Rock Type II	Rock Type III
_____	_____	_____
_____	_____	_____
_____	_____	_____
_____	_____	_____
_____	_____	_____
_____	_____	_____
_____	_____	_____
_____	_____	_____
_____	_____	_____
_____	_____	_____
_____	_____	_____
_____	_____	_____
_____	_____	_____
_____	_____	_____
_____	_____	_____
_____	_____	_____

Optional for Earth Science Students

Based on the rock specimens you found, answer the following:

a. These rocks were formed by _____

b. The most common type of rock is _____ which is an example of an _____
(igneous, metamorphic, sedimentary)

ACTIVITY E: Rock Data Sheet

TEXTURE - PARTICLE SIZE		ROCK DESCRIPTION	
Clay -	less than .002 mm	Igneous	These rocks are produced through the cooling of molten material. When the cooling process is slow, the rock contains fair-sized crystals of the individual minerals.
Silt -	.002 - .05 mm	Sedimentary	These rocks are composed of small particles derived from previously existing rocks and deposited in layers upon surfaces of valleys and plains or upon floors of lakes and oceans.
Sand -	.05 - 2.0 mm	Metamorphic	Alteration of previously formed rocks create these rock varieties from tremendous heat and pressure. Either igneous or sedimentary rocks can become metamorphic rocks.
Gravel -	2.0 mm - 7.5 cm		
Cobble -	7.5 cm - 25 cm		
Stone -	larger than 25 cm		

	ROCK	TEXTURE	DESCRIPTION
IGNEOUS	Granite	Medium to coarse grained crystals	Light colored - white or salmon-pink with dark speckles. A freshly broken surface has glassy specks which reflect light.
	Basalt	Extremely fine grained	Dark colored
	Obsidian	Glassy	Dark - generally black, green or brown. Exhibits conchoidal fracture (like chip off the bottom of a bottle).
SEDIMENTARY	Pumice	Porous, glassy	Light colored, very porous, many small cavities, floats.
	Conglomerates	Coarse	Consolidated gravel and/or sand particles. Light colored. (Resembles cement.)
	Sandstone	Fine	Consolidated sand, variety of colors (resembles mortar), porous.
	Shale	Very fine (microscopic)	Consolidated clay and silt. Any color. Breaks in flat planes
	Limestone	Very fine (microscopic)	Chiefly calcite, generally white or light colored. Fossils may be present. Dilute HCL will cause effervescence.
	Coal	Very fine	Dark, generally brown or black. Derived from plant decomposition. May contain fossils.
METAMORPHIC	Slate	Microscopic, fine grained, smooth	Variety of colors, splits readily into thin sheets. Formed from shale.
	Schist	Flaky, visible particles	Visible flaky minerals. Formed from slightly metamorphosized igneous or sedimentary rocks.
	Gneiss	Coarse grained	Contains: both light and dark materials. Parallel streaks. Variety of origins.
	Quartzite	Fine to coarse	Usually light colored, not porous, formed from sandstone or conglomerate.
	Marble	Coarse grained	Many colors, exhibits veining, fossils and bedding destroyed metamorphism. Formed from limestone or dolomite. Dilute HCL will cause effervescence.

ACTIVITY E: Rock Characteristics

45 min.
groups

Use the information on the attached sheet to perform the tests and determine the characteristics of each specimen. Be sure that all tests are performed on a freshly broken surface.

Particle Size (texture)	Color	How does it break	Reaction to H ₂ O	Reaction to HCL	Rock
a.					
b.					
c.					

List any economic uses you think or know of for each rock.

1. _____
2. _____
3. _____

ACTIVITY F: Influences Definitions

EROSION: The group of processes whereby earth or rock material is loosened or dissolved and removed from any part of the earth's surface.

It includes the processes of weathering, solution, corrosion and transportation.

Mechanical wear and transportation are effected by running water, waves, moving ice, winds, which use rock fragments to pound or grind other rocks to powder or sand.

The agents of wind, water and ice are all generated by gravitation forces.

WEATHERING: The physical and chemical disintegration and decomposition of rocks and minerals.

Physical weathering is accomplished by moisture (freezing, thawing, evaporation), temperature change (expansion, and contraction), and root wedging by growing plants.

Chemical weathering is the result of the alteration of minerals within rocks by the action of various chemicals such as acids formed in the environment.

Through this process, rocks are changed in character until they decay, and crumble into soil.

ACTIVITY F: Influences of Weathering

30 min.
groups

At a rock wall, road cut or stream bank:

Observe the material (talus) at the base of the cut and answer the following.

1. Where did this material come from? _____
2. What agents have acted upon the material? _____

Weathering Agent

Result of the Action

_____	_____
_____	_____
_____	_____

Erosion Action (types)

Result of Action

_____	_____
_____	_____
_____	_____

3. Predict what will happen to this material in the future. _____

4. Illustrate the geologic cycle exhibited by this material.

ACTIVITY G: Communicate Feeling, Awareness and Values

20 min.
individual

What has been this area's impact on man? _____

Describe how you feel about man's impact on this area? _____
