

DOCUMENT RESUME

ED 361 202

SE 053 616

TITLE Beyond Earth's Boundaries  
 INSTITUTION National Aeronautics and Space Administration, Kennedy Space Center, FL. John F. Kennedy Space Center.  
 PUB DATE 93  
 NOTE 214p.  
 PUB TYPE Guides - Classroom Use - Teaching Guides (For Teacher) (052)

EDRS PRICE MF01/PC09 Plus Postage.  
 DESCRIPTORS \*Aerospace Education; Astronomy; Earth Science; Elementary Education; Elementary School Science; Elementary School Students; Elementary School Teachers; Physics; Resource Materials; \*Science Activities; Science History; \*Science Instruction; Scientific Concepts; Space Sciences

IDENTIFIERS Astronauts; Space Shuttle; Space Travel

ABSTRACT

This resource for teachers of elementary age students provides a foundation for building a life-long interest in the U.S. space program. It begins with a basic understanding of man's attempt to conquer the air, then moves on to how we expanded into near-Earth space for our benefit. Students learn, through hands-on experiences, from projects performed within the atmosphere and others simulated in space. Major sections include: (1) Aeronautics, (2) Our Galaxy, (3) Propulsion Systems, and (4) Living in Space. The appendixes include a list of aerospace objectives, K-12; descriptions of spin-off technologies; a list of educational programs offered at the Kennedy Space Center (Florida); and photographs. (PR)

\*\*\*\*\*  
 \* Reproductions supplied by EDRS are the best that can be made \*  
 \* from the original document. \*  
 \*\*\*\*\*

SE

ED 361 202

# BEYOND

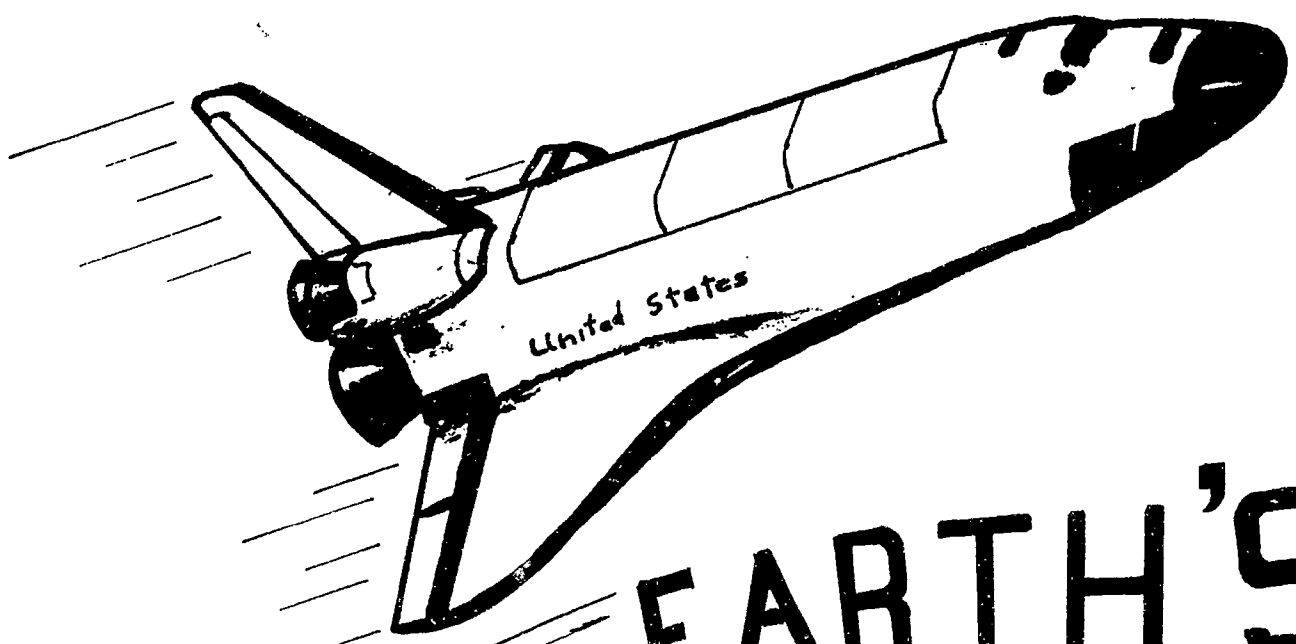

# EARTH'S

# BOUNDARIES

## NASA

National Aeronautics and Space Administration

John F. Kennedy Space Center

U.S. DEPARTMENT OF EDUCATION  
Office of Educational Research and Improvement  
EDUCATIONAL RESOURCES INFORMATION CENTER (ERIC)

- This document has been reproduced as received from the person or organization originating it.
- Minor changes have been made to improve reproduction quality.

• Points of view or opinions stated in this document do not necessarily represent official OERI position or policy.



VF 003 6114



**BEYOND**



**EARTH'S**

**BOUNDARIES**



Beyond Earth's Boundaries  
1993

Selected ideas are reprinted with permission from AVIATION AND SPACE EDUCATION, Jane A. Hodges-Caballero, Copyright© 1986, ISBN: 0-89334-087-1, Library of Congress Catalog Card Number: 85-081658 and AEROSPACE PROJECTS FOR YOUNG CHILDREN, Jane A. Hodges-Caballero, Copyright© 1987, ISBN: 0-89334-100-2, Library of Congress Catalog Card Number: 79-90481. Humanics Limited, Atlanta, GA 30067.



# BEYOND EARTH'S BOUNDARIES

National Aeronautics and  
Space Administration

John F. Kennedy Space Center  
Kennedy Space Center, Florida 32899

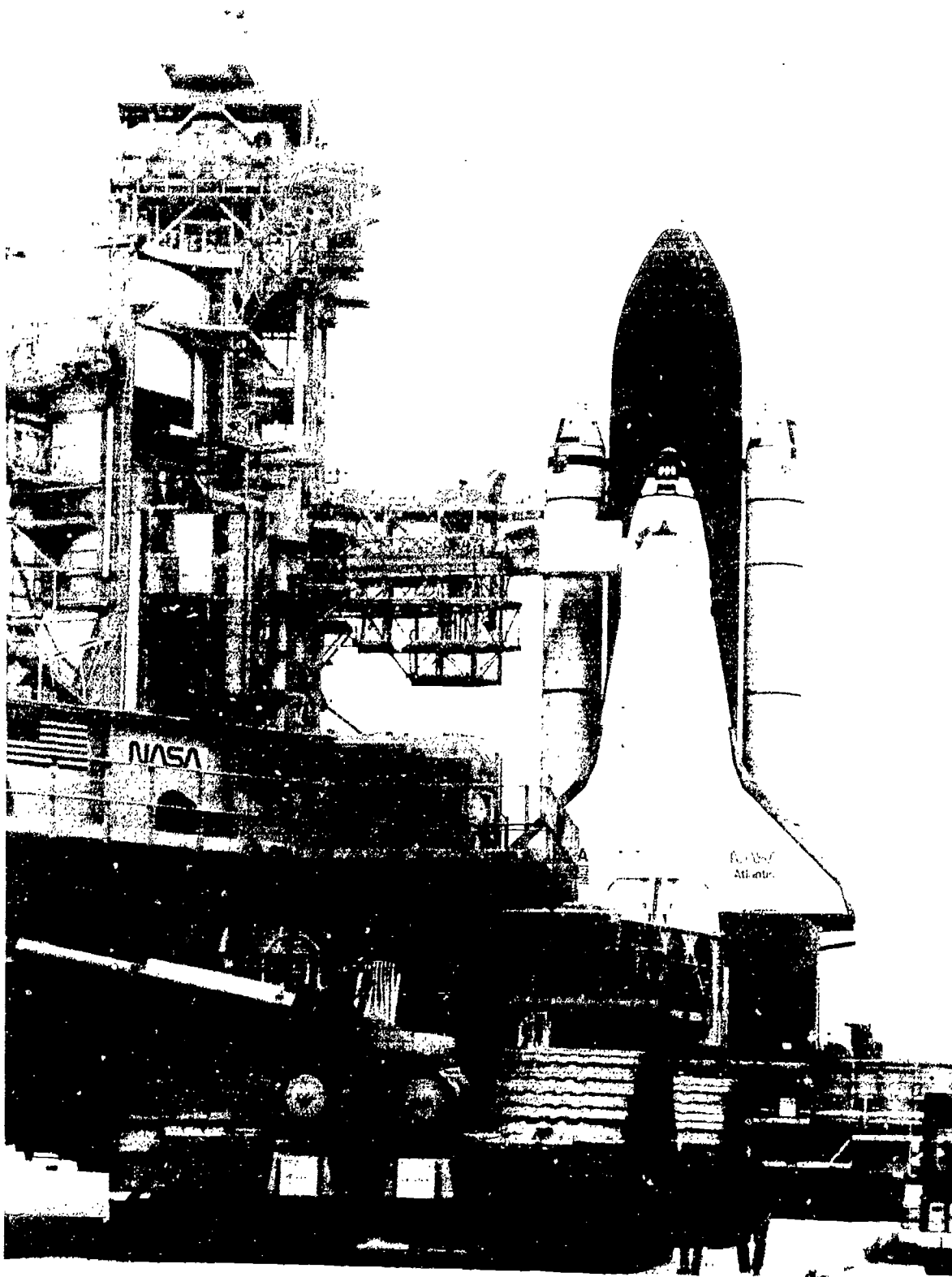

## ACKNOWLEDGEMENTS

Sincere appreciation is extended to Sherry Valdes for her typing, contributions and editorial assistance toward this project. Appreciation is extended to Jim Valdes for the cover design. Thanks are also extended to Mauro Magellen and Jim Valdes for the original art work in this text. Appreciation is extended to Steve Dutczak for typesetting the final version of this text.

## TABLE OF CONTENTS

Title Page	1
Acknowledgements	2
Table of Contents	3
Preface	4
Introduction	5
STOP	6
<b>AERONAUTICS</b>	<b>8</b>
Boomerangs	9
Kites	12
Balloons	15
Flight	22
Air Communication	28
Air Traffic Patterns	32
Can you Find Your Flight?	38
Helicopters	42
Aerospace Pioneers	47
Aviation Careers	51
<b>OUR GALAXY</b>	<b>58</b>
Constellations	59
Moon	63
Solar System	69
<b>PROPULSION SYSTEMS</b>	<b>79</b>
Rockets	80
Shuttle	87
Space Station Freedom	93
Parachutes	97
Retrieval Ships	101
Crawler Transporter	105
<b>LIVING IN SPACE</b>	<b>109</b>
Basic Needs	110
CELSS	113
Astronauts	118
Engineers	129
Space Sensation	138
Weather	141
<b>BIODIVERSITY</b>	<b>147</b>
<b>APPENDIX</b>	<b>152</b>
<b>AEROSPACE OBJECTIVES: Kindergarten to Sixth Grade</b>	<b>153</b>
<b>SPINOFFS</b>	<b>169</b>
<b>SPACE MUSIC</b>	<b>172</b>
<b>NASA CENTERS</b>	<b>176</b>
<b>NASA/KSC Educational Programs</b>	<b>177</b>
<b>LITHOGRAPHS</b>	<b>178</b>
<b>CERTIFICATE OF COMPLETION</b>	<b>186</b>

## PREFACE

**BEYOND EARTH'S BOUNDARIES** provides a foundation for building a life-long interest in our nation's space program. It starts with a basic understanding of man's attempt to conquer the air, then moves on to how we expanded into near-Earth space for our benefit. Students learn, through hands-on experiences, from projects performed within the atmosphere and others simulated in space.

This approach relates to the students by emphasizing those mathematics, science and technology skills with which they are familiar, but motivates their interest through the excitement of aeronautics and space. The imaginations of students can be sparked through the activities set forth in this volume of experiences.

It is hoped that this book will pique a student's interest in a particular subject, and motivate him or her to delve further into that specialty.

If we want our children to dream, to pursue, to discover, we must acquaint them with those subjects that have inspired man since the beginning of time--among them the dream of flying. Gaining knowledge of man's discoveries and accomplishments in aeronautics and space will motivate students to learn more about the vast reaches of the universe beyond our solar system.

Early pioneers in aviation and space encountered, and overcame, great obstacles. Those that await us in the 21st century are equally formidable, and can be overcome only by educated individuals willing to accept the challenge. Our students must become the first in the world in mathematics, science and technology. Only then can we **REACH FOR THE STARS!**

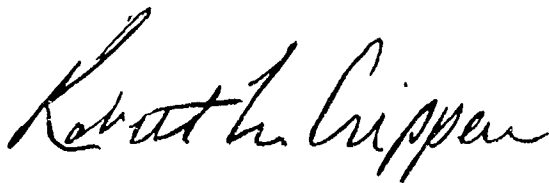

Robert L. Crippen  
Center Director  
Kennedy Space Center  
NASA Astronaut:  
STS-1, STS-7, 41-C, 41-G

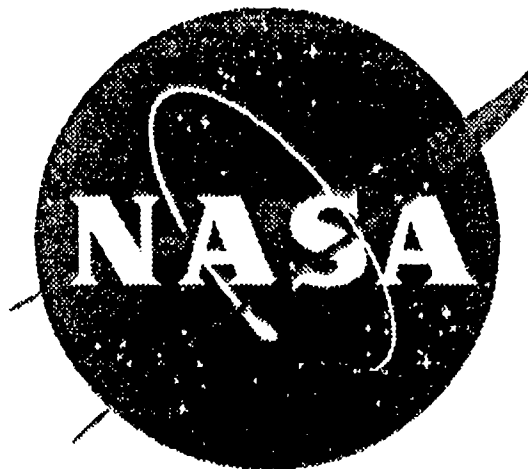



## BEYOND EARTH'S BOUNDARIES

This book is designed as a resource for teachers of elementary age students. The basic philosophy of this curriculum is based on the National Education Goals identified by the Presidential Commission Board and the state governors on April 18, 1991. Special emphasis is placed on Goal Number Four.

1. All children in America will start school ready to learn.
2. The high school graduation rate will increase to at least 90%.
3. American students will leave grades 4, 8, and 12 having demonstrated competency in challenging subject matter including English, mathematics, science, history and geography; and every school in America will ensure that all students learn to use their minds well, so they may be prepared for responsible citizenship, further learning and productive employment in our modern economy.
4. U.S. student's will be first in the world in science and mathematics achievement.
5. Every adult American will be literate and will possess the knowledge and skills necessary to compete in a global economy and exercise the rights and responsibilities of citizenship.
6. Every school in America will be free of drugs and violence and will offer a disciplined environment conducive to learning.

Other national organizations have studied the crisis in American Education and recommended an emphasis be placed on mathematics and science education. The Federal Coordinating Council on Science, Engineering and Technology (preschool-twelfth grade) indicated curriculum reform must reflect emphasis on mathematics and science with problem solving hands-on activities.

The National Curriculum Standards in Science Education appointed national teams to study science curriculum standards, as did the National Standards for Mathematics Education. Again, emphasis is placed on problem solving, reasoning and communication. Technology education must be integrated into the problem solving equation. (International Technology Education Association Models for Technology Education).

The challenges of scope and sequence and coordination is being addressed by the National Science Teachers Association; however, The Project 2001 "Science for All Americans", is more concerned with treating science as a body of developing ideas,

a way of thinking and conducting inquiry, an outlook on the universe and a complex social and cultural enterprise. Students ought to learn education for intrinsic value of knowledge, philosophical value, utility, social responsibility and childhood enrichment.

Another major emphasis has been an analysis of the Labor Force 1988-2000. White women (35.2%) and minorities (33.2%) will occupy 68.% of the workforce. Therefore, an emphasis on all educational programs should reflect this cultural/sexual diversity.

NASA has addressed these national issues in its Vision 21, The NASA Strategic Plan. Providing developmentally appropriate elementary curriculum in aerospace education is one initiative NASA Kennedy Space Center has taken to meet these goals. This document is aimed at the upper elementary student and is an extension of an early childhood edition entitled, ALL ABOARD FOR SPACE. The curriculum activities are based on the following format:

Name

Skill

Procedure

Background Information

File folders are convenient, easy way to develop learning center activities. Covers for the concepts are illustrated, to assist the teacher choosing to use this organizational system. Aerospace education is seldom taught in a comprehensive manner in the schools; therefore, sample aerospace education objectives were correlated to a local district science scope and sequence to provide a basic sample framework. (Brevard County School Board, Florida).

The activities in this book can then be integrated throughout the elementary curriculum as the teacher chooses. The basic four units in any aerospace curriculum should include activities in Aeronautics, Our Galaxy, Propulsion Systems, and Living in Space. In addition, there is great concern about our Planet Earth and our ecosystems. At Kennedy Space Center, the environment receives special attention. About 135,000 of KSC's 140,000 acres serves as a national wildlife refuge.

Now let's begin, and help our students "Reach for the stars!"

*Jane A. Hodges, Ph.D.*

Jane A. Hodges, Ph.D.

Aerospace Specialist

NASA

Kennedy Space Center, FL

# **STOP**

concept introducing pages are to be used by the teacher for folder game covers. They are not to be used for "ditto" coloring sheets for the children.

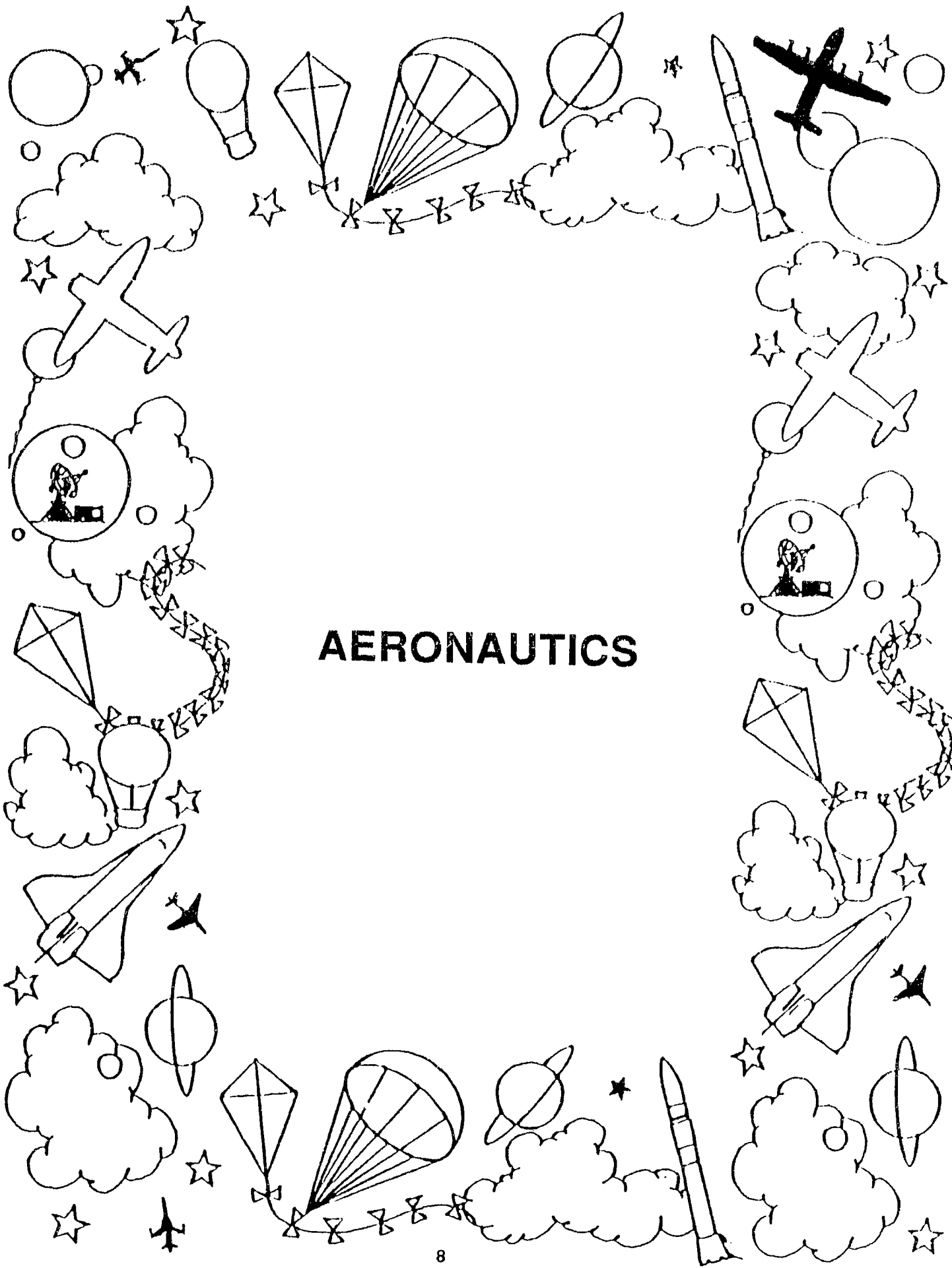

# AERONAUTICS

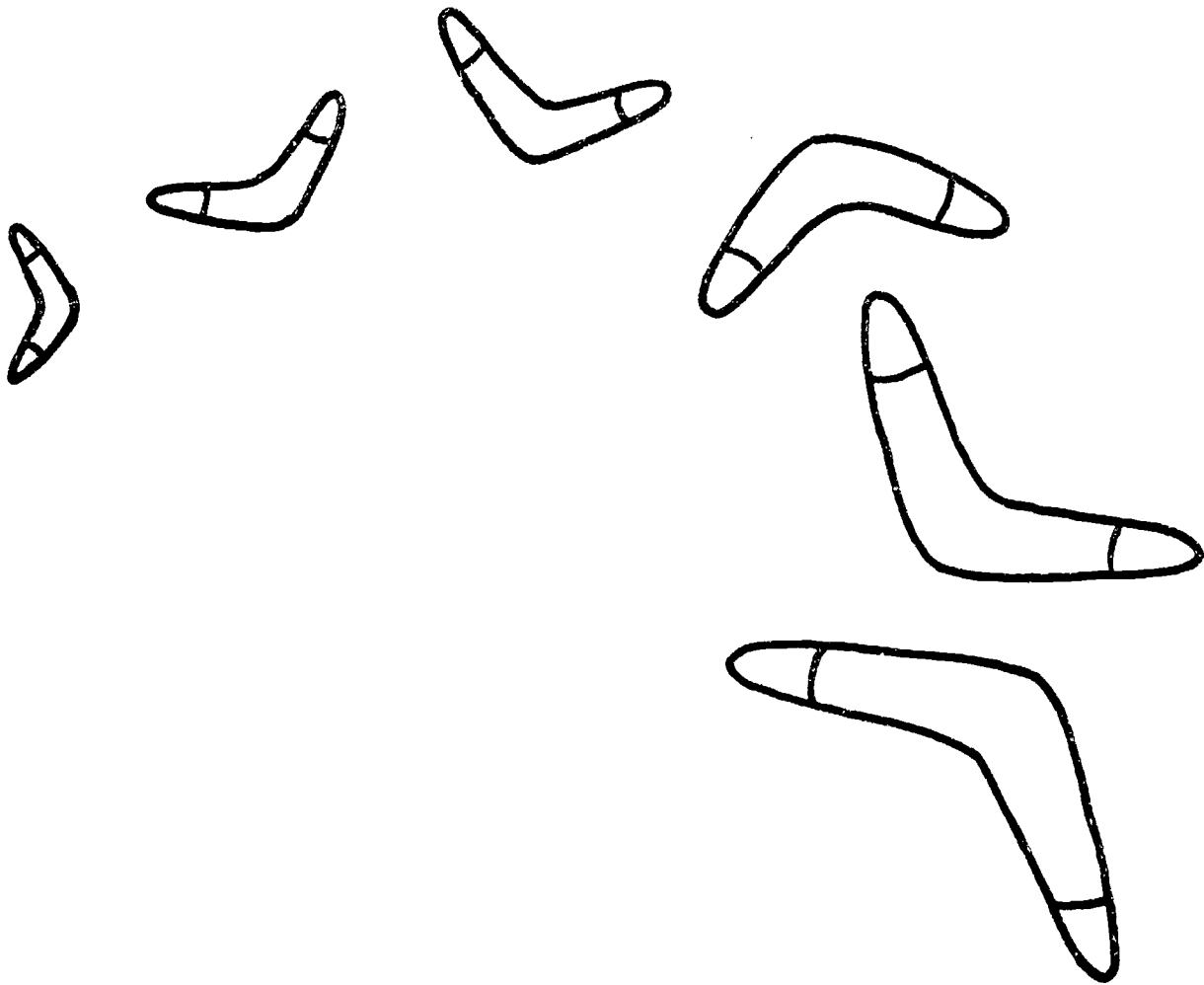

# BOOMERANGS

**NAME:** BOOMERANGS

**SKILL:** SCIENCE, MATH

**PROCEDURE:**

1. Read about boomerangs, then make a small boomerang out of popsicle sticks, tongue depressors or cardboard. See how accurately and how far you can throw a boomerang. Chalk a circle on the ground and see how close classmates can come to the center of the target. Measure the distances.
2. Play boomerang games with classmates.
3. Research the origin of the boomerang.

**BACKGROUND INFORMATION:**

Boomerangs were found more than 10,000 years ago in Australia . Boomerangs were used for killing, sport, ceremonies, and other purposes.

Why does a boomerang return? Simply stated 1) The wing of the boomerang has an airfoil and generates lift. 2) Spinning it produces stability in flight. 3) The spin and forward motion imparted by the thrower causes a gyroscopic action to occur and the boomerang turns and turns and returns. The boomerang can travel 60 miles per hour and spins at 10 revolutions per second.

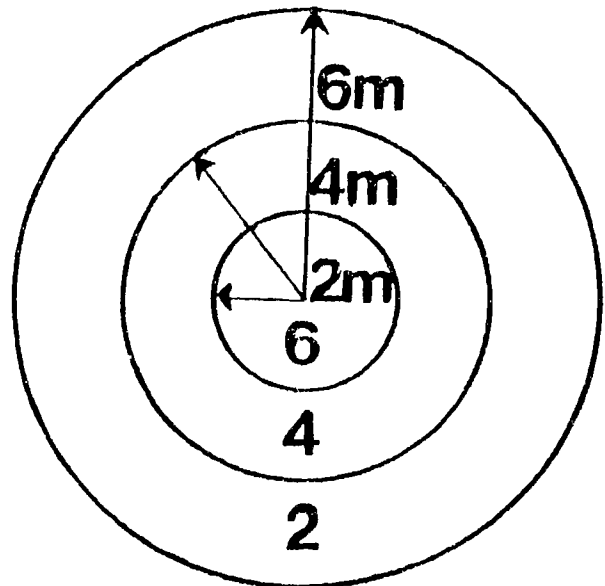
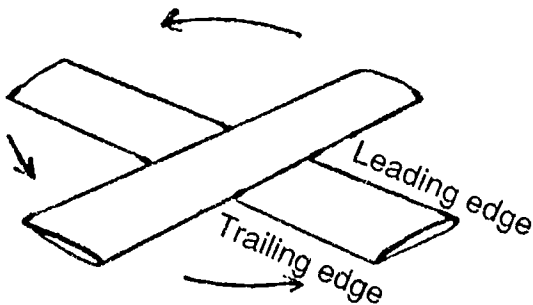

**MATERIALS:** 2 popsicle sticks or 2 tongue depressors  
thread,  
rubber band or glue  
sandpaper

- PROCEDURE:** 1. Round leading edge with sandpaper.
2. Fasten together with rubber band, thread, or glue.
  3. Grasp one vane with fingers and toss with an overhand motion.

**MATERIALS:** index card or piece of cardboard  
scissors and pencil

- PROCEDURE:** 1. Draw the outline of the small boomerang on a piece of cardboard
2. Cut out the boomerang.
  3. Balance the boomerang on your left finger and flick one of the legs sharply with your other finger.

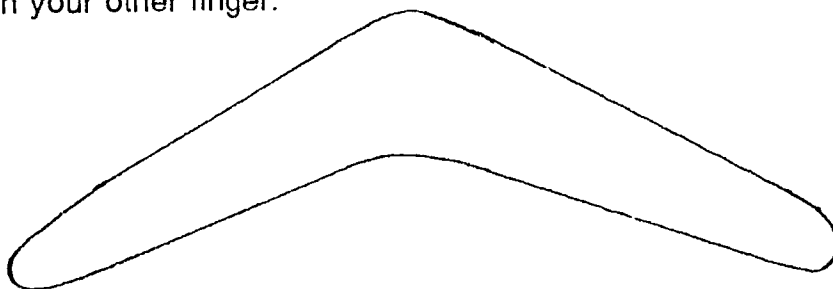

**RULES:**

1. Contestant throws from center circle. If boomerang lands within a circle, the contestant receives 2, 4 or 6 points.
2. If the contestant catches the boomerang anywhere (even outside the circle) he receives a bonus of 4 points.
3. Each contestant gets 10 throws, perfect score is 100.
4. If contestant's feet are in different zones when a catch is made, he receives the average of the score for the circle plus 4 bonus points.
5. If contestant touches the boomerang but fails to catch it, he receives 1 bonus point.

(Based on standard rules of Mudgerabe Creek Emu Racing and Boomerang Throwing Association, Medgeerabe,

# KITES

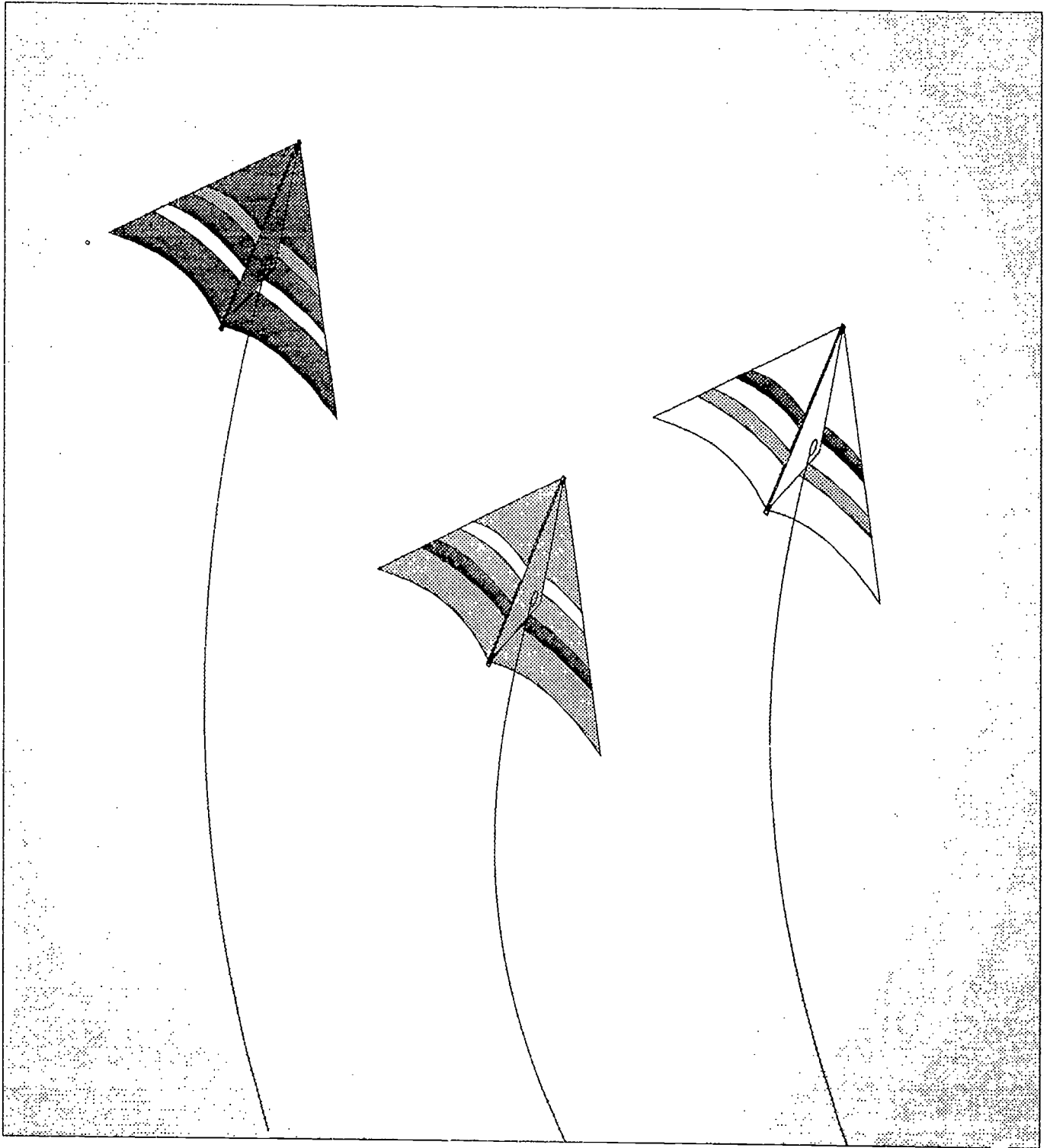



**NAME: KITES**

**SKILL: SCIENCE/MATH**

**PROCEDURE:**

1. Encourage the students to make their own designs and kites, then display small models of the kites on the bulletin board.
2. Using library resources, study the history and different types of kites used by the Chinese, Japanese, Europeans, and Americans.
3. Read the Japanese fable about Tameto (Background information) then illustrate the story.

**BACKGROUND INFORMATION:**

Students need to learn about the effects of air (airfoil) on various flying objects, i.e., kites, boomerangs, balloons, airplanes, helicopters. The Space Shuttle flies differently depending on where it is. It is like a rocket at blast-off, like a spaceship in space (wings have no effect in space), and like a glider with no engine when it returns to the earth's atmosphere. It is like an airplane because it has the flight controls of an airplane.

**KITES**

Despite numerous attempts to build flying machines by different ancient cultures, the oldest and perhaps the most dependable of man's aircraft is the kite. Evidence suggests that the Chinese were flying kites made of silk and bamboo strips as early as 1000 B.C. In Europe, illustrations of kites can be found as early as the fourteenth century. From China, kites eventually made their way to Japan, where they were used in religious and ceremonial functions. Numerous stories are included in Japanese literature of men being carried aloft by kites. One example, describes how Minamoto-Tameto, a famous Samurai warrior, was exiled with his son to the island of Hachijo. Wishing to free his son from imprisonment, Tametomo built a giant kite which was able to carry his son to the mainland and freedom. During the late nineteenth and early twentieth centuries, numerous experiments were undertaken involving manned kites. Yet, despite these experiments, it was not until men experimented with balloons and other lighter-than-air craft that practical flying was achieved by man.

## STRAW KITE

### Materials:

- 7 large drinking straws
- Kite string
- Tissue paper
- Glue
- Scissors
- Crepe paper for tail

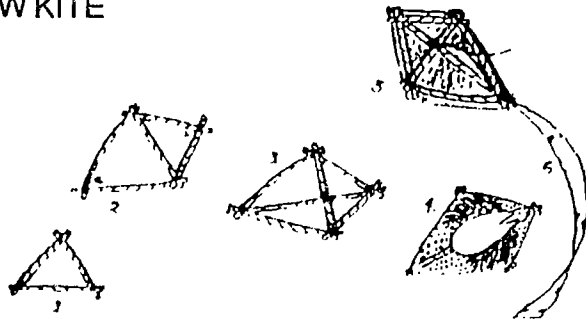

### Procedure:

1. String 3 straws together to form a triangle.
2. Using string, add 2 more straws to form this shape.
3. With the 2 remaining straws, insert (approximately two inches) one straw into the other straw. Use long straw to connect points A and B (see illustration in step 2) with a piece of string.
4. Cover the two triangle areas with tissue paper forming the front of the kite.
5. Make a hole in straw 1/3 from the end, put string through hole attaching one end at this point on the straw, then attach the other end at bottom of straw.
6. Glue on tail--3 ft. X 2 in. wide of crepe paper. If you use cloth for the tail, make the tail only 2 1/2 ft. long.

For best results, adjust the bridle and tail up and down by test flying. This kite can be built in other sizes using the 5 to 6 ratio. The builder may want to bow the crosspiece to reduce the drag. To bow a kite, tie a string to one end of the cross stick, pull the string to the other side of the cross piece. Pull until it bows about 4 inches; tie the string securely.

## STICK KITE

### Materials:

- 2 sticks--one 36 inches long, the other 30 inches long.
- Covering--newspaper, tissue, plastic, cloth
- Kite string
- Glue or tape

### Procedure:

1. Make saw cuts or ridges in the four ends of the sticks. Lash and then glue cross stick about 9 inches from the top.
2. Run string around the outside and tie.
3. Lay the frame on the covering. leaving a margin of 2 inches all around. Glue the edges down over the string.
4. The bridle should be 1 1/2 times the length of the vertical stick. Attach one of the bridle to the stick crossing and the other end to the bottom of the vertical stick. Tie the flying line 4/5 of the distance up from the bottom.
5. Tail: Make a tail by attaching scraps of paper or cloth to a 10 inch string.

B  
A  
L  
L  
O  
O  
N  
S



**NAME: BALLOONS**

**SKILL: SCIENCE**

**PROCEDURE:**

1. Research the history of balloons and ballooning. Write a two page report on the information found and its importance to aeronautics.
2. Study the parts of the balloon and the different patterns of designs, then create your own balloon design pattern.
3. Divide students into groups of four or five. Explain that there will be an international balloon competition in a few days. They will carry a payload of 8 oz. Design the balloon, container for the payload, then launch the balloons. (See aerodynamic packaging).
4. Create a hot air balloon following the directions in this unit. Adhere to the safety precautions!

**BACKGROUND INFORMATION:**

A balloon can rise because a gas is used inside the bag which is much lighter than the air around it. The earliest balloons were filled with heated air. Since hot air is less dense than cold air, the balloon would rise. There is a hole in the top of the balloon to let the hot air molecules escape, making the air inside the balloon lighter. However, the air would soon cool so the ascension of the hot air balloons is short. The Montgolfier brothers experimented with the first hot air balloon. Three months later they were invited to put on a demonstration for King Louis XVI and Marie Antoinette of France. They attached a cage to the balloon which contained a sheep, a rooster, and a duck. The animals stayed aloft eight minutes and traveled a mile and a half. These animals became known as the first passengers in flight! Riding a balloon is a sport for many people who enjoy the thrills and adventures of floating in the air. There is much skill required in locating various currents of air and maintaining the proper altitude to fly with certain paths of air.

## HOT AIR BALLOON

1. Use posterboard or other stiff material to make a gore template as shown in figure 1.
2. Put template on top of 10 sheets of tissue each at least nine feet long. Cut around the template to make the ten gores needed.
3. Decorate the balloon using felt tip pens and/or designs cut from colored tissue. Do not use pens with water soluble ink; it dissolves the tissue.
4. Slide the top gore #1 about a half inch to the side of gore #2 as pictured in figure 2.
5. Carefully fold the margin of gore #2 over gore #1. Now glue that fold of #2 to #1. A glue stick works best.
6. One edge of gore #1 is bonded to one edge of gore #2. Now slide the 1-2 combination about a half inch to the side of gore #3, moving in the opposite direction as before to alternate glued edges. As before, fold the open edge of #3 over #2 and glue. Be careful not to glue the free edge of #1 to #3. Be careful to keep the free edge of #1 free (figure 3).
7. Continue alternating and glueing 4 over 3, 5 over 4, etc. until the only free edges are one on #1 and one #10. Glue these together. The result is a paper bag.
8. Grab about six inches of the ragged looking top, the small end, and tie it with string. Tie a loop in the string.
9. Use two all wire coat hangers to make a loop that will fit inside the base and glue it in by overlapping the tissue about one inch.
10. Using the loop in the string, hang the balloon and inflate it with a hair dryer or small fan. Check for unglued seams, holes and tears and reglue or repair with small bits of tissue.
11. Inflate the balloon using a propane cook stove with a piece of six inch diameter stove pipe over the burner. Two or more people are required for this step. Indoors, three good hair dryers will fly the balloon in a gym. Four is better and three heat guns is even better.
12. When the balloon inflates and begins to be buoyant, you are holding it DOWN, not up, so LET IT GO!

### NOTES:

\*Tissue can be found most anywhere in packs of 10 sheets 20" by 2". These come in many colors but must be joined to form the 9" gores. It is easier to buy a roll of jewelers tissue 20" wide by a hundred or more feet long.

The hoop is made by cutting away the really bent parts bending circular and taping together to fit. Size varies with glue joint overlap.

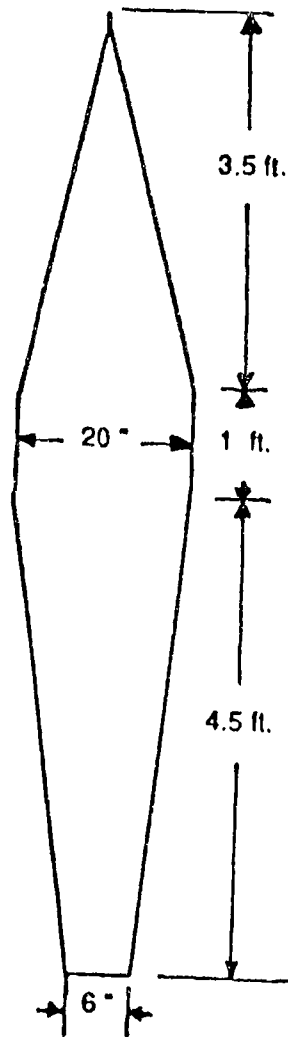
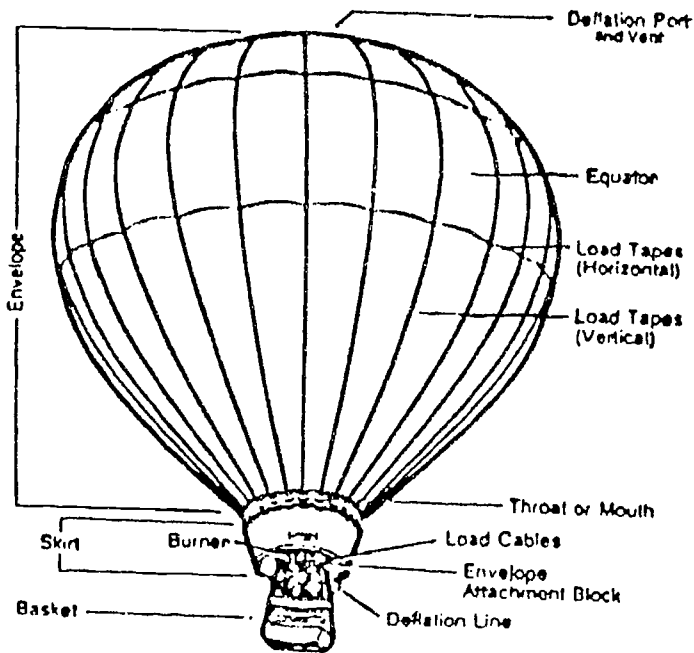

figure 1



figure 2

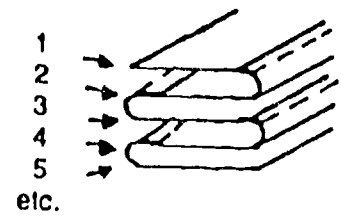
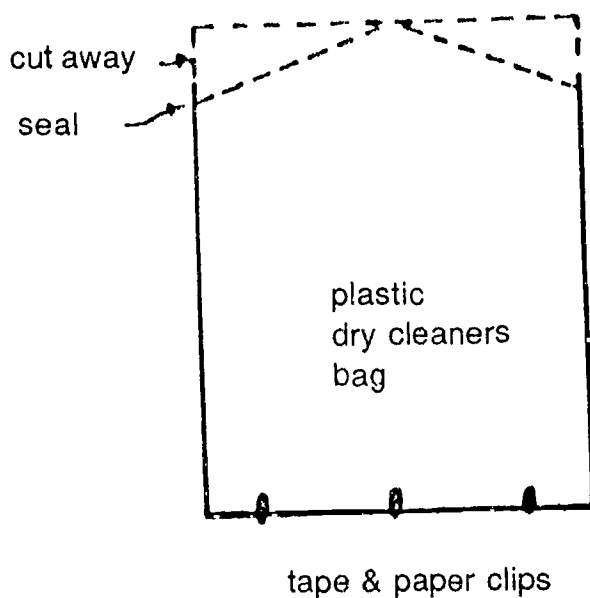

figure 3

LTA stands for lighter-than-air, and refers to hot air balloons, gas balloons, aerostats, and blimps. This hot air balloon is easy to make and is a good indoor demonstration balloon.

Directions:

1. The balloon bag is made from a dry cleaner's plastic bag. Most any other plastic bag is too heavy. The bags from dry cleaners come off a roll and the top has perforations which must be sealed. A hot iron will do a good job if you do not put the hot iron on the plastic itself. Make a newspaper sandwich with the top of the plastic bag between two sheets of newspaper. Iron through the newspaper and the heat will melt the plastic enough to seal the top of the balloon.
2. Using cheap cellophane tape, put a layer around the bottom edge of the balloon. This does two things: it makes the balloon easier to handle, and it adds weight to the bottom to provide a gravity gradient (the heavy end falls).
3. Add four paper clips evenly around the bottom of the balloon. They can be moved to balance out any mass anomalies. One side of the bag is often heavier than the other. And again the mass of the clips adds to the gravity gradient.
4. Using some heat source, fill the balloon with hot air. \*Caution: A propane torch works well if you don't let the flame get close to the plastic. When the air inside the balloon is warmed the balloon will ascend, then descend when the air cools, and it cools quickly. If you are careful, you can reheat the air inside the balloon as it descends.





# BALLOONS

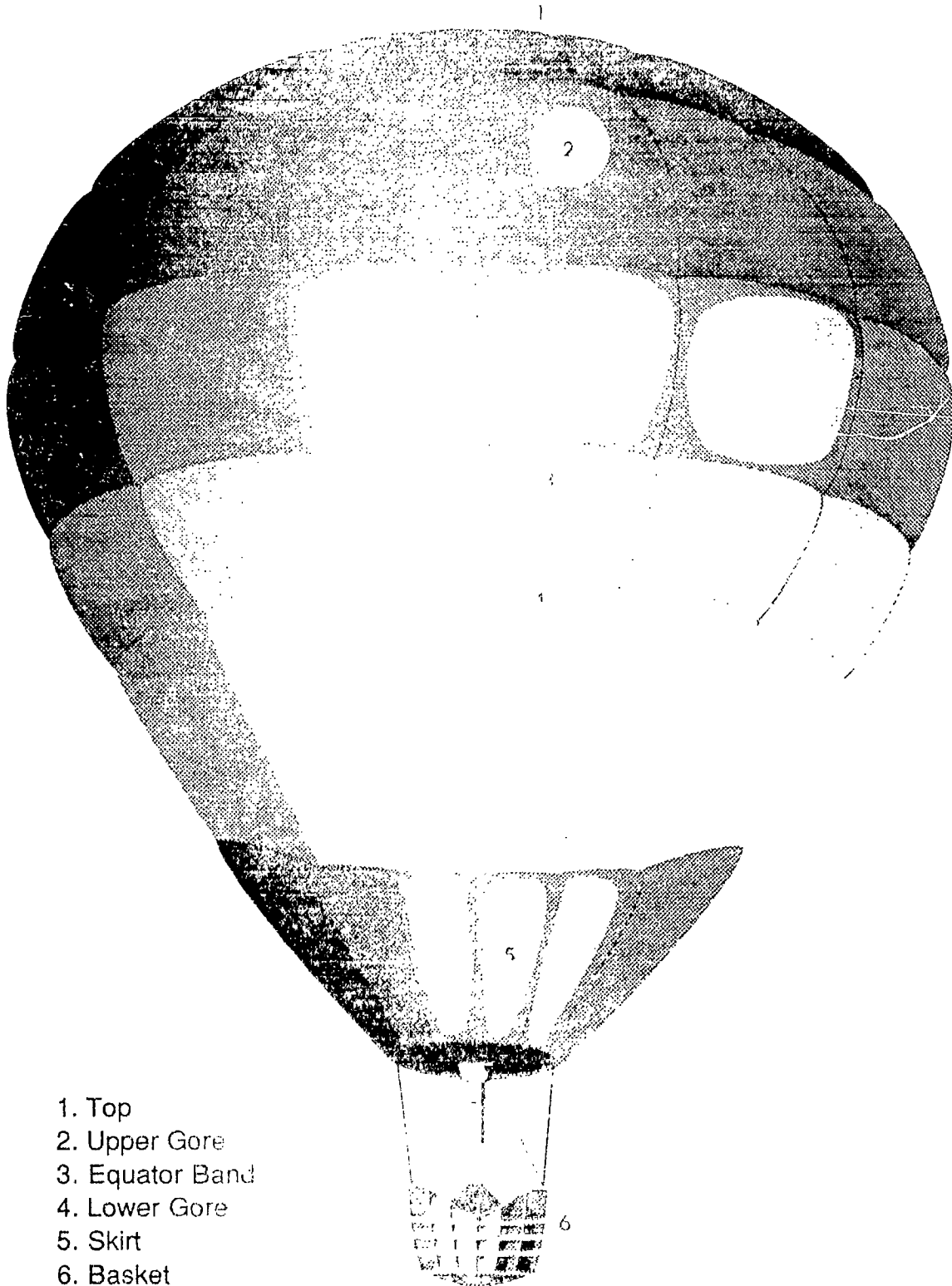

1. Top
2. Upper Gore
3. Equator Band
4. Lower Gore
5. Skirt
6. Basket



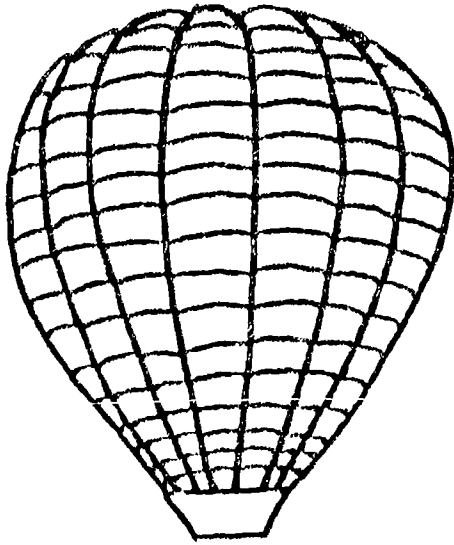

Horizontal

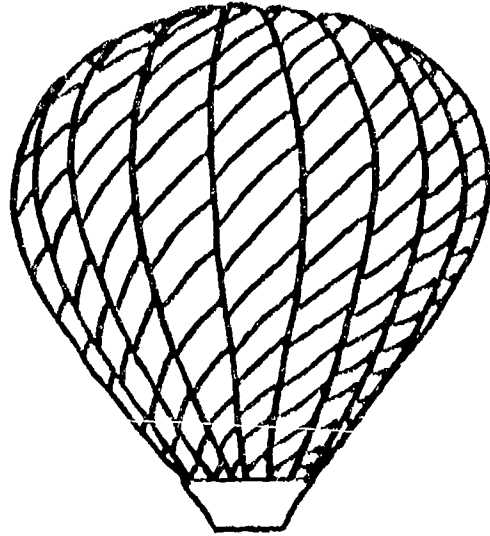

Spiral

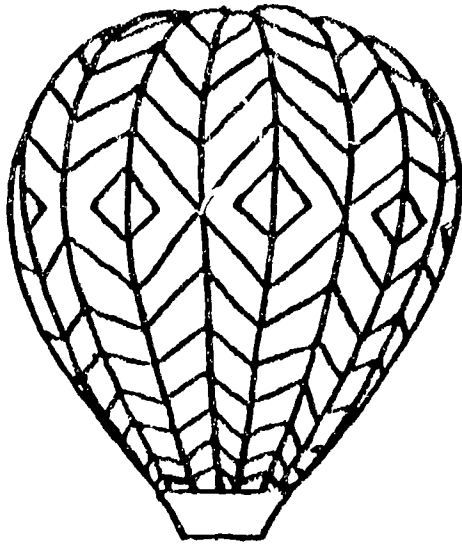

Diamond

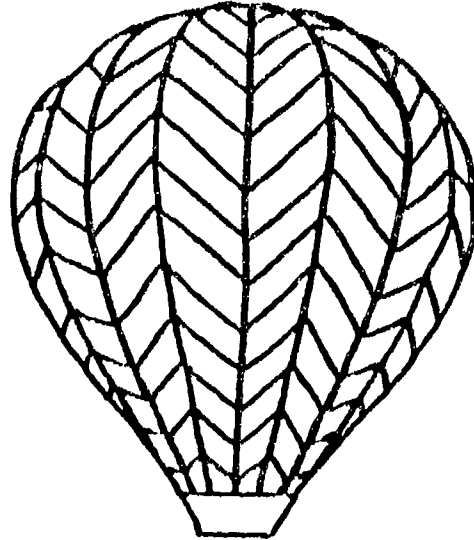

Diagonal

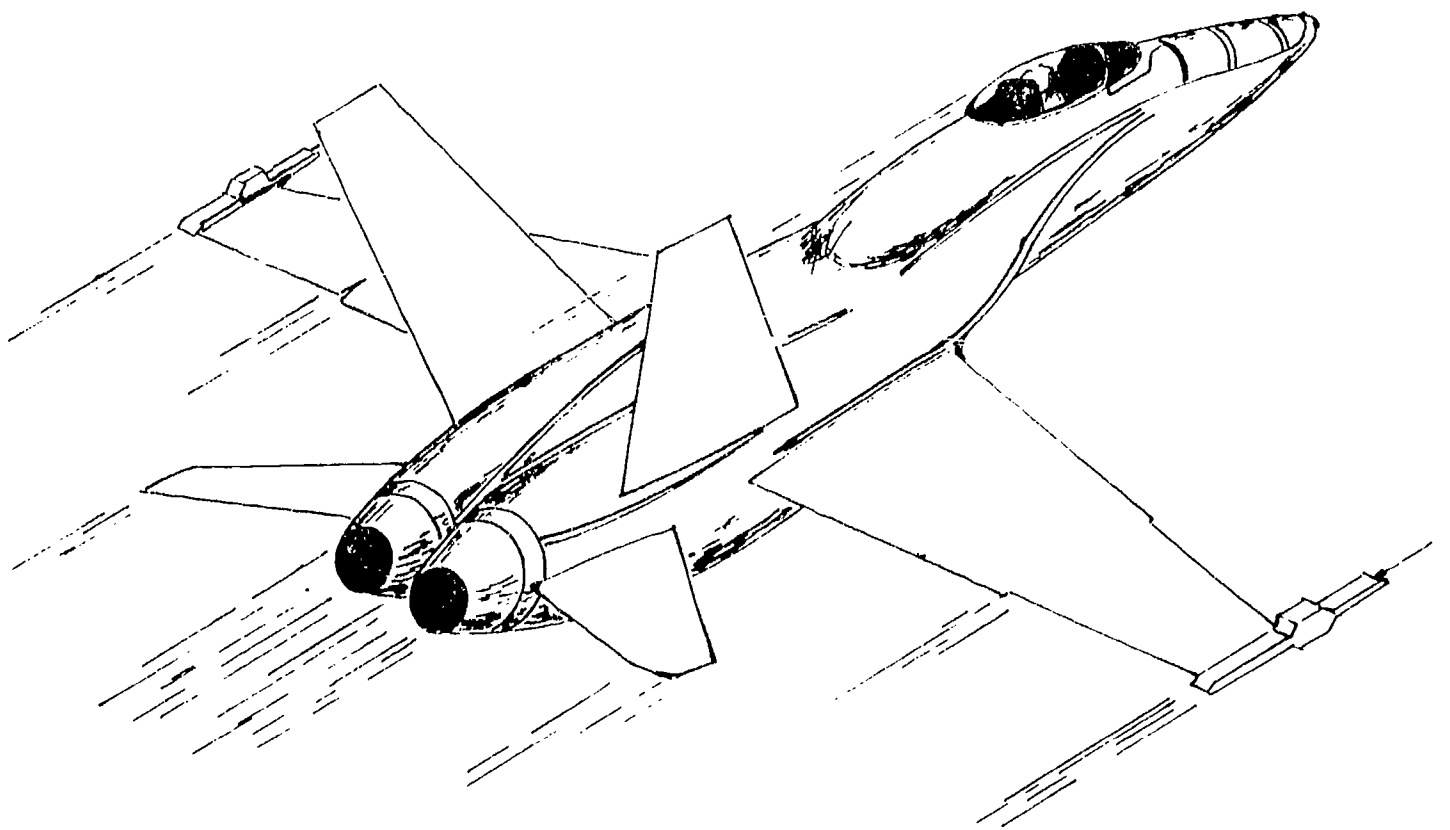

# FLIGHT

**NAME:** AIRPLANE FLIGHT

**SKILL:** SCIENCE, TECHNOLOGY

**PROCEDURE:**

1. Design an airplane body, wing and tail (preferably using a computer aided design program). Transfer the design to cardboard or styrofoam. Fly the plane and see what maneuvers you can make. Change the flight pattern by adjusting the wings, tail, etc.
2. Make the folded paper plane and test fly under the teacher's directions. Experiment with design.
3. Visit the library to read various books about airplanes. Prepare a time line, noting such events as X1 (Yeager), X15 (Crossfield), Mercury 6 (Glenn), Gemini II (Grissom and Young), Apollo 11 (Aldrin, Armstrong, and Collins) and STS-1 (Crippen and Young).
4. Read about Bernoulli's law and perform the experiment. Draw your own airplane, noting where the forces occur.
5. Visit a Civil Air Patrol or Air Force squadron to find out about opportunities relating to aviation.
6. Refer to the information on flying controls and instruments. Review the functions of the parts.
7. Visit a local airport and ask a pilot to show you the parts of the airplane.

**BACKGROUND INFORMATION:**

The important principle to understand as to why an airfoil can produce lift is to consider Bernoulli's law. He proved that where the speed of a moving gas is high, the pressure is low. Where the speed is low, the pressure is high. A simple experiment will help you see how it works to produce lift. Cut a piece of paper two inches wide and seven inches long. Hold it against the chin under your bottom lip with the narrow part. Then blow hard over the top of the paper. The paper rises! What actually happens is the "air in a hurry" on top of the paper has less pressure. The pressure under the paper is greater and lifts the paper up.

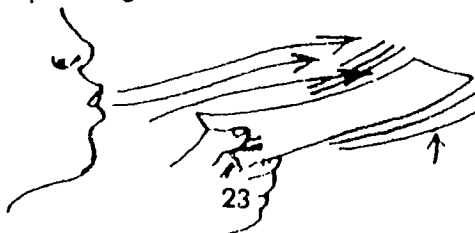

If you take the same paper and just pull it through the air, it will rise again. The wing of an airplane rises when it's pulled through the air by an engine just as the paper is pushed up by greater pressure below. The air moving over the curved wing on top must travel faster to reach the back of the wing. Some of the air goes under the wing also, but they reach the trailing edge at the same time. Therefore, the air pressure on top of the wing is less than the pressure on the bottom of the wing, so the plane lifts up.

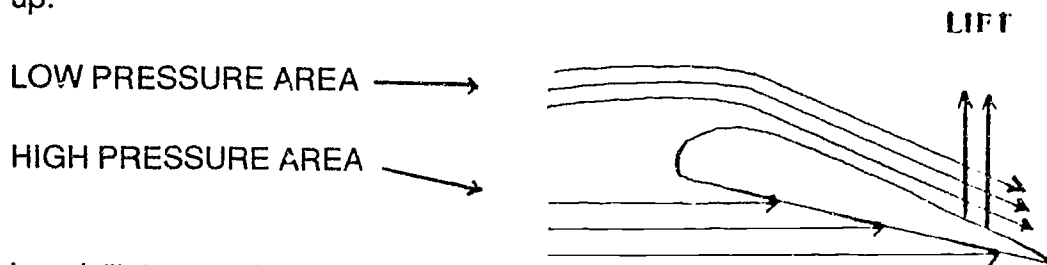

Level flight and Constant Speed

Center of Gravity. CG is the balance point of the aircraft. The CG must be maintained within design limits to have proper control of the aircraft.

Thrust is equal to the drag and acts below the CG to cause a slight lifting action to the nose which mostly overcomes the pitch down tendency caused by the lifting action behind the CF.

Lift is equal to weight and acts behind CG so that aircraft will nose down when power is reduced. Tail load could be up or down depending on the location of the CG and the effect of the combined forces.

Weight always acts toward earth. The direction of the other forces depends on the position of the aircraft.

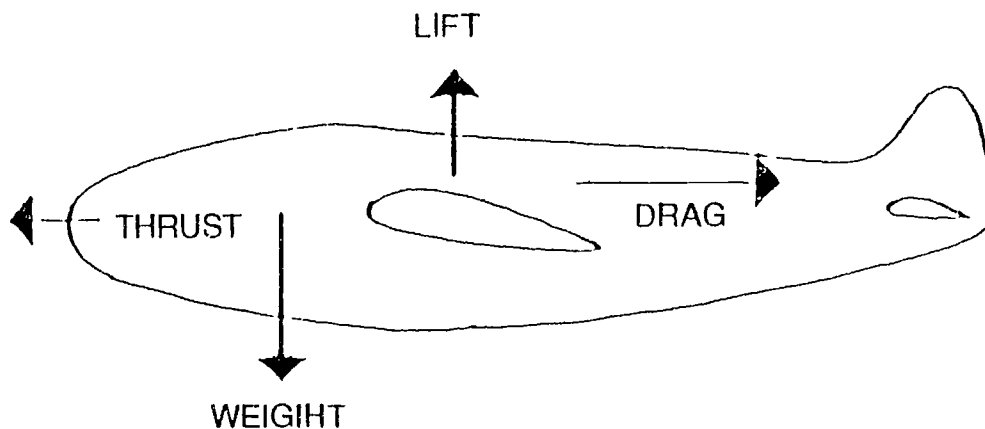

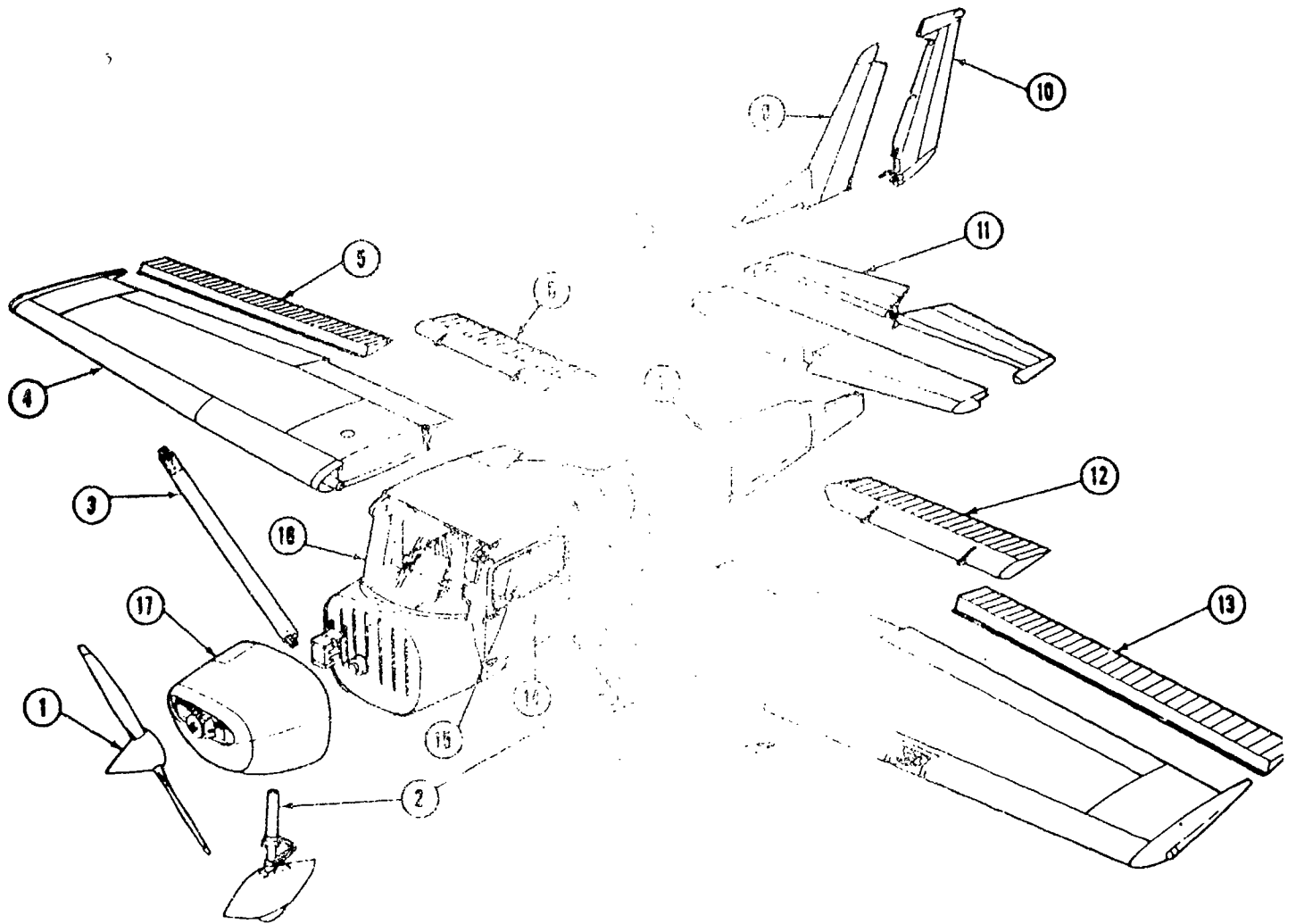

### THE PARTS OF AN AIRPLANE

1. Propeller
2. Landing Gear
3. Wing Strut
4. Wing
5. Right Wing Aileron
6. Right Wing Flap
7. Fuselage
8. Horizontal Stabilizer
9. Fin and Dorsal
10. Rudder
11. Elevator
12. Left Wing Flap
13. Left Wing Aileron
14. Engine
15. Propeller
16. Windshield
17. Landing Gear
18. Landing Gear

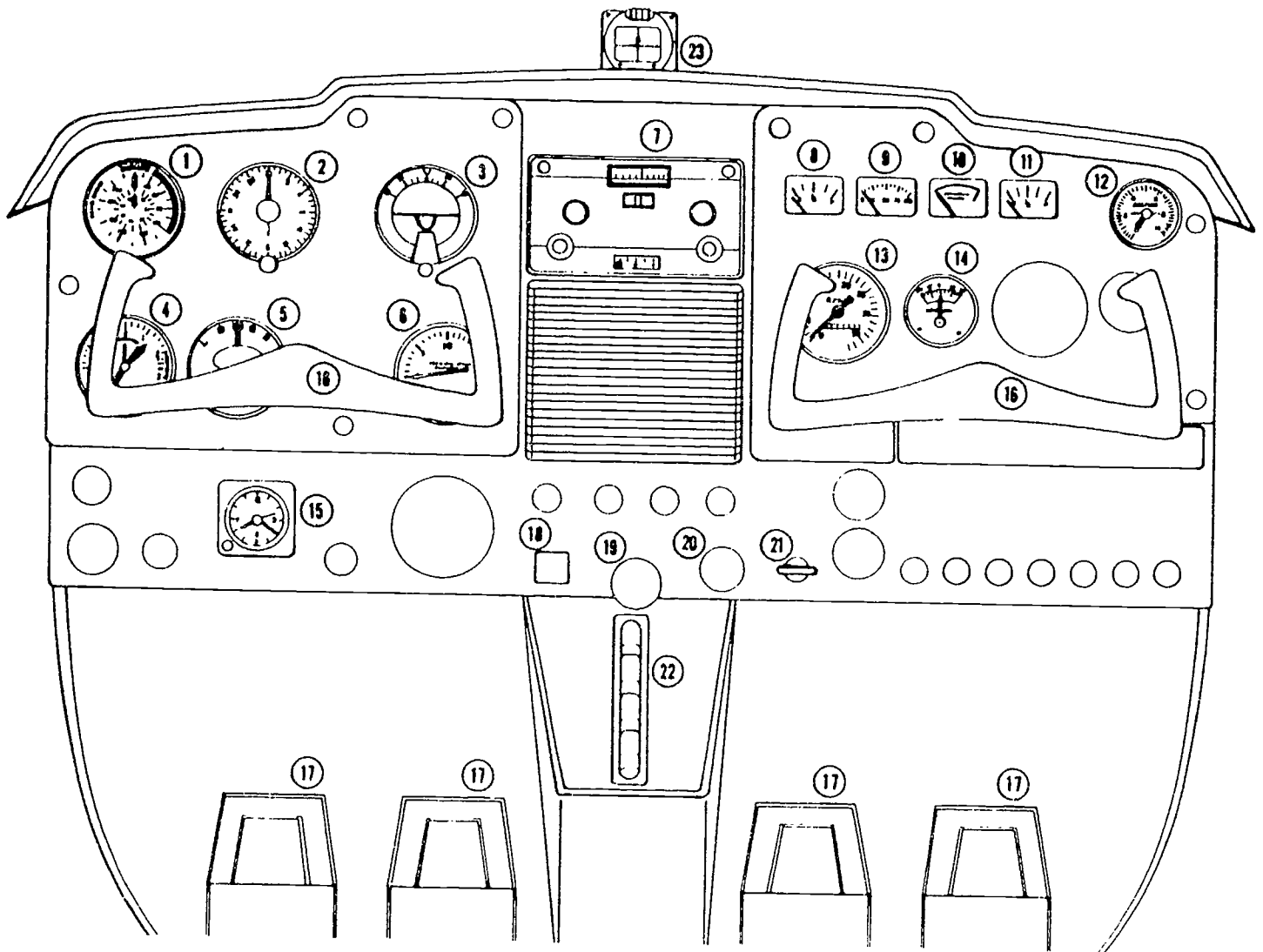

## INSTRUMENT PANEL

- |   |   |
|---|---|
| 1. Airspeed indicator                               | 12. Suction indicator (run by vacuum pump which activates gyroscoptic pump which activates gyroscoptic instruments) |
| 2. Gyroscopic compass                               | 13. Tachometer (measures revolutions per minute Or propeller)   |
| 3. Artificial horizon                               | 14. Battery--generator indicator  |
| 4. Altimeter  | 15. Clock   |
| 5. Turn-and-bank indicator                          | 16. Control wheel (dual)  |
| 6. Vertical speed (rate-of-climb-descent) indicator | 17. Rudder pedals   |
| 7. VHF navigation--communication radio              | 18. Carburator heat control   |
| 8. Fuel gauge (left tank)                           | 19. Throttle control  |
| 9. Oil pressure gauge                               | 20. Fuel-air mixture control  |
| 10. Oil temperature gauge                           | 21. Wing flaps control  |
| 11. Fuel gauge (right tank)                         | 22. Trim tab control  |
|   | 23. Magnetic compass  |

## RING WING AIRCRAFT

Lockheed-Georgia  
Ring Wing design, post  
year 2000 time frame, design  
goal - weight half conventional  
aircraft, better payload.

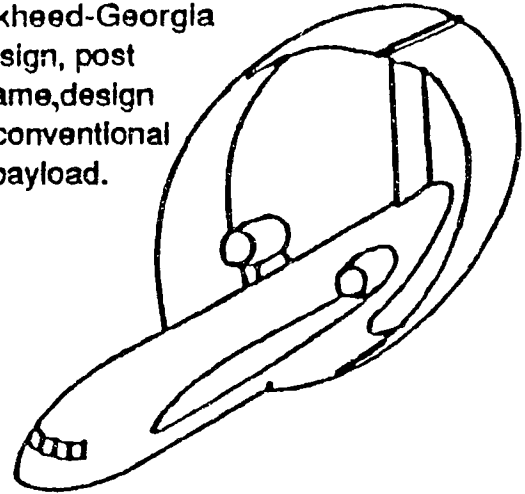
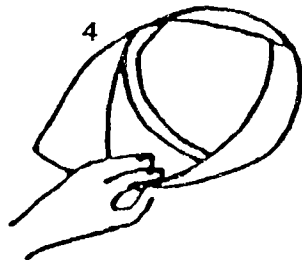
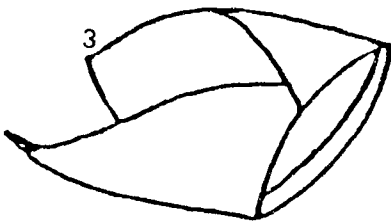
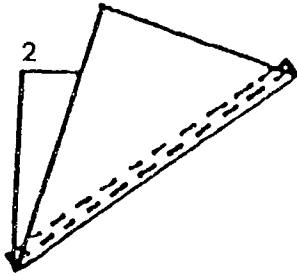
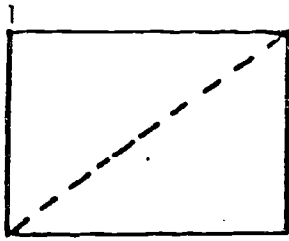

Construction:

1. Fold typing or similar size/weight paper diagonally.
2. Make two or more folds on front, each about one-half inch wide.
3. With the fold on the side, form the paper into a circle. Slip one pointy end into the other.

To fly the Ring Wing, hold with two fingers on top of the "vee", the thumb on bottom, and toss with a smo-o-o-th follow through. Too much speed or the lack of a follow through are no-no's.

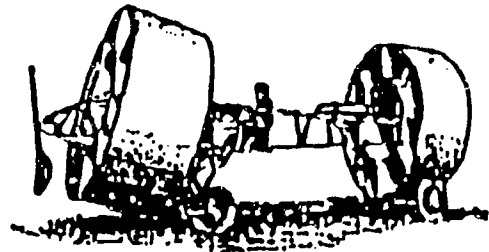

early French Ring Wing design

# Air Communication





**NAME: AIR COMMUNICATION**

**SKILL: MATHEMATICS**

**PROCEDURE:**





































1. Obtain time tables from various airlines and compare their schedules. (Individual airline schedules will be considerably easier to read for lower elementary grades).
2. Plan a trip to a major recreation area or state/national park at least 750 miles away. Find out what flights go there and which is the most economical. Use the worksheet to get quotes from at least three airlines.
3. Obtain an aeronautical chart from a local airport or your State Department of Transportation and compare how it is different from a local road map.
4. Find and explain the symbols on an aeronautical chart. Study the airman's phonetic alphabet.
5. Contact a local flight school and ask to sit in on the first class of an introductory flight course. Observe how the skills learned in this unit are used. Write a summary of the experience.
6. Invite two pilots to speak to your class: one commercial pilot and one military pilot. Ask them to talk about learning to fly, education experiences, and work experiences. Ask for information about flight plans and support personnel.

**BACKGROUND INFORMATION:**

The international language for pilots is English. They use the following phonetic alphabet, especially for aircraft identification.

HANDPRINTING AND PHONETIC ALPHABET

For Communications Operations Courses

	ALFA		NOVEMBER (NO YEM BER)		WUN
	BRAVO (BRAH-VOH)		OSCAR (OSK CAH)		TOO
	CHARLIE (CHAR LEE)		PAPA (PAH PAH)		THUH-REE
	DELTA (DELL, TAH)		QUEBEC (KEH-BECK)		FO-WER
	ECHO (ECK OH)		ROMEO (ROW ME OH)		PI-YIV
	FOXTROT (FOKS TROT)		SIERRA (SEE AIR RAH)		SIX
	GOLF		TANGO (TANG GO)		SEVEN
	HOTEL (HOH TELL)		UNIFORM (YOU NEE FORM)		AT"
	INDIA (IN DEE AH)		VICTOR (VIK TAH)		NINE
	JULIETT (JEW LEE EIT)		WHISKEY (WISS KEY)		ZERO
	KILO (KEY-LOH)		XRAY (ECKS RAY)		THOUSAND THOW-ZAND
	LIMA (LEE-MAH)		YANKEE (YANG KEY)		
	MIKE		ZULU (ZOO LOO)		

FOR ATC INSTRUCTIONAL PURPOSES ONLY

ATC Keesler 0- 1508

DEPARTMENT OF TRANSPORTATION—FEDERAL AVIATION ADMINISTRATION					Form Approved OMB No. 04-R0072		
<b>FLIGHT PLAN</b>							
1. TYPE	2. AIRCRAFT IDENTIFICATION	3. AIRCRAFT TYPE/SPECIAL EQUIPMENT	4. TRUE AIRSPEED	5. DEPARTURE POINT	6. DEPARTURE TIME		7. CRUISING ALTITUDE
	VFR IFR DVFR		KTS		PROPOSED (Z)	ACTUAL (Z)	
9. ROUTE OF FLIGHT							
9. DESTINATION (Name of airport and city)		10. EST. TIME ENROUTE		11. REMARKS			
		HOURS	MINUTES				
12. FUEL ON BOARD		13. ALTERNATE AIRPORT(S)		14. PILOT'S NAME, ADDRESS & TELEPHONE NUMBER & AIRCRAFT HOME BASE			15. NUMBER ABOARD
HOURS	MINUTES						
16. COLOR OF AIRCRAFT				CLOSE VFR FLIGHT PLAN WITH _____ FSS ON ARRIVAL			

FAA Form 7233-1 (5-72)

U.S. GOVERNMENT PRINTING OFFICE

SCALE 1:1,000,000									
WORLD AERONAUTICAL CHARTS									
Nautical Miles 0 10 20 30 40 50 60 70 80 90 100									
Statute Miles 0 10 20 30 40									
<b>PILOT'S PREFLIGHT CHECK LIST</b>									
WEATHER ADVISORIES		ALTERNATE WEATHER		NOTAMS		DATE			
EN ROUTE WEATHER		FORECASTS		AIRSPACE RESTRICTIONS					
DESTINATION WEATHER		WINDS ALOFT		HAZS					
<b>FLIGHT LOG</b>									
DEPARTURE POINT	VOR IDENT.	RADIAL	TO	FROM	LEG REMAINING	TIME	ETA	TAKEOFF	GROUND SPEED
CHECK POINT									
DESTINATION									
TOTAL									
POSITION REPORT: VFR report hourly; IFR as required by ATIS									
ACT. IDENT.	POSITION	TIME	ALT.	WR/VFR	EST NEXT FIX	SUCCESSING FIX	NAME OF	PREFS	
REPORT CONDITIONS ALOFT—CLOUD TOWNS, BASES, LAYERS, VISIBILITY, TURBULENCE, HAZE, ICE, THUNDERSTORMS									
SCALE 1:500,000									
SECTIONAL AERONAUTICAL CHARTS									
Nautical Miles 0 10 20 30 40									
Statute Miles 0 10 20 30 40									

CLOSE FLIGHT PLAN UPON ARRIVAL





**NAME:** AIR TRAFFIC PATTERNS

**SKILLS:** GEOMETRIC PATTERNS AND SHAPES

**PROCEDURES:**

1. Study the diagrams of basic aircraft maneuvers on land. Fold a paper plane or use a model plane to demonstrate the traffic patterns.
2. Research the NASP and compare it to airliners of today.
3. Divide the class into two's by numbering heads. Designate classmate one as the "pilot" and classmate two as the "instructor". Have the students demonstrate the traffic patterns.
4. Read the background information about shuttle landing facility, the largest paved runway in the world. Go to the library and research the length and width of five to ten of the largest commercial landing facilities. Prepare a graph illustrating the different sizes.

**BACKGROUND:**

The paved runway at Kennedy Space Center's shuttle landing facility is concrete and is 15,000 feet long with a 1,000 foot long overrun at each end. The width is 300 feet. It is 16 inches thick in the center over a base of soil cement which is 6 inches thick.

There are 4,848 miles of  $1/4$ " grooves which cross the runway every one and  $1/8$  inches. The grooves, together with the slope of the runway--24 inches from centerline to edge--provide rapid runoff of water from a heavy Florida rain, preventing hydroplaning.

The concrete used in the paving of the landing facility required about 1,000 carloads of cement, 10,000 carloads of crushed limestone and sand aggregate. The facility required approximately 1,350 acres. It was designed as an ecological model for air field construction and environmental impact was held to a minimum.

The orbiter can be guided automatically to a safe landing by a microwave scanning beam landing system, but is usually landed by the mission commander.

## COMMERCIAL LANDING FACILITIES

	Length	Width
London-Heathrow (England)	12,801 ft.	298 ft.
Cologne/Bonn (Germany)	12,467 ft.	197 ft.
JFK International, NY	14,572 ft.	150 ft.
Dallas/Ft. Worth, TX	11,387 ft.	200 ft.
Los Angeles Int'l, CA	12,090 ft.	150 ft.
Orlando Int'l, FL	12,000 ft.	300 ft.
Seattle Tacoma Int'l	11,900 ft.	150 ft.
Zurich, Switzerland	12,139 ft.	197 ft.

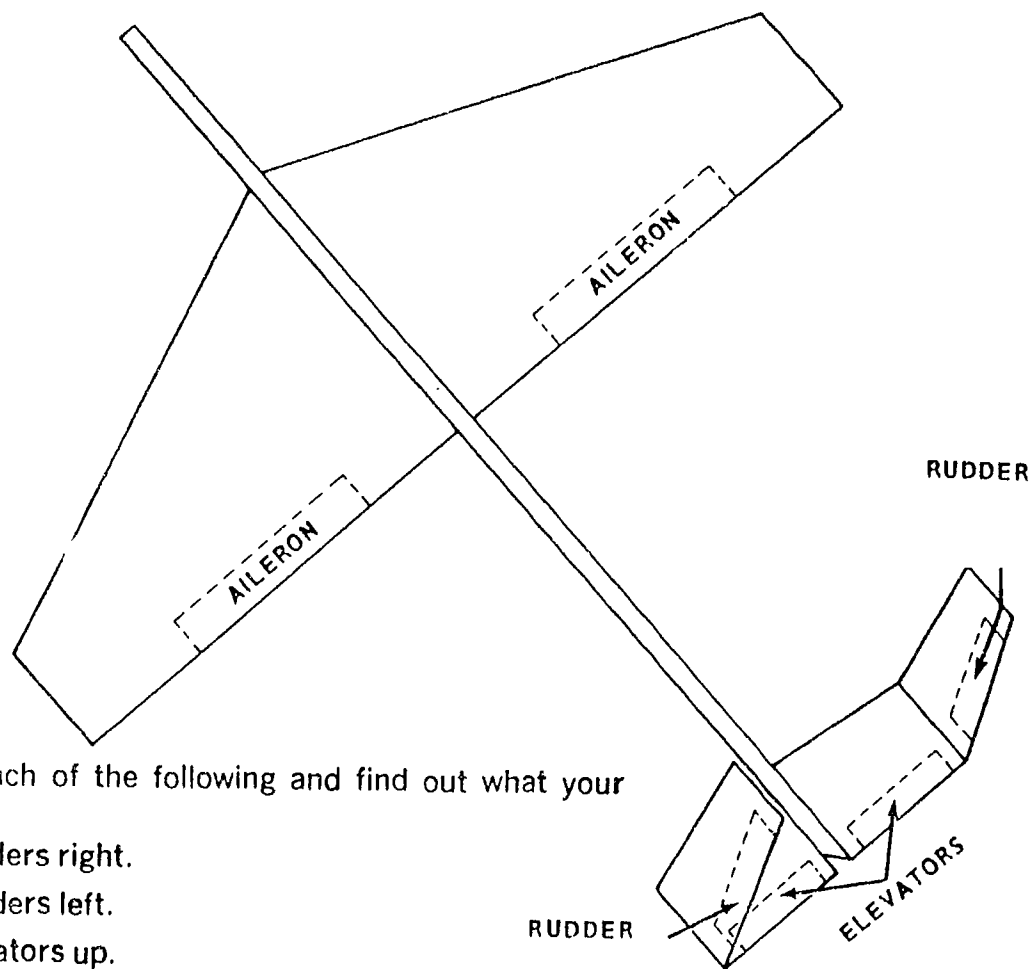

**Investigations:** Try each of the following and find out what your model does:

- Bend both rudders right.
- Bend both rudders left.
- Bend both elevators up.
- Bend both elevators down.
- Bend the right aileron up and the left aileron down.
- Bend the right aileron down and the left aileron up.

What conclusions can you draw from the results of these activities?

## Directions:

1. Cut wing and fuselage from a foam deli tray.
2. Mark elevon hinge with ball point or roller ball pen. Use moderate pressure to score the foam.
3. Cut slot in fuselage so wing fits snugly.
4. Slide wing into slot.
5. Tape a penny on nose to balance.
6. Bend elevons upward as needed.
7. FLY

## STAR GLIDER

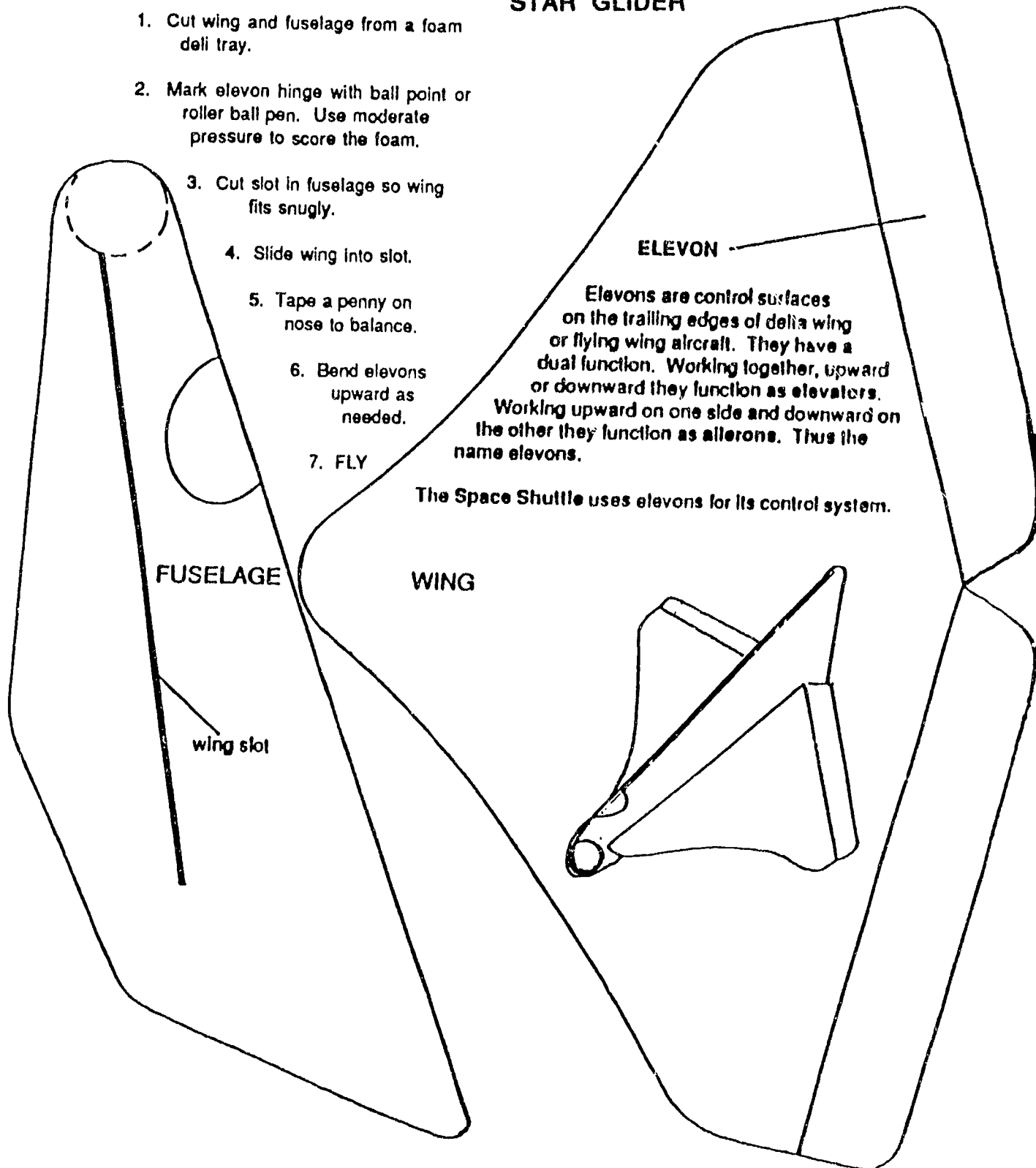

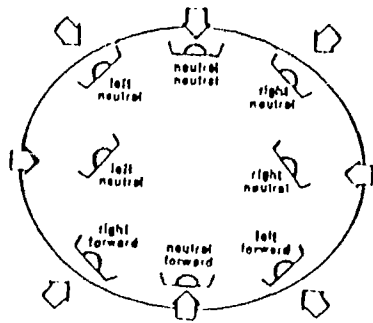

ARROWS INDICATE  
WIND DIRECTION

### Taxi Diagram (tricycle gear aircraft)

#### Standard Traffic Pattern

- |                    |                     |
|--------------------|---------------------|
| A -- Upwind leg    | E -- Base leg       |
| B -- Crosswind leg | F -- Final Approach |
| C -- Downwind Leg  | G -- Departure leg  |
| D -- Key Point     | H -- Entry          |

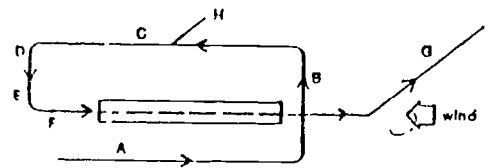

#### S-Turns Across a Road

Chief Objective: To fly two perfect half circles on opposite sides of the road, by varying bank to compensate for the wind.

- X & S - ground speed highest, bank steepest
- R & Z - ground speed lowest, shallowest bank
- Q -- wings level

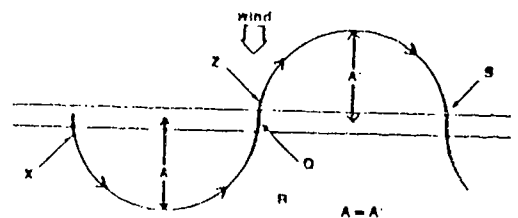

#### Turns About a Point

CHIEF OBJECTIVE: To turn about a point, keeping an equal distance from it, by varying bank.

- A - ground speed medium, bank medium
- B -- ground speed highest, bank steepest
- C - ground speed medium, bank medium
- D -- ground speed lowest, bank shallowest

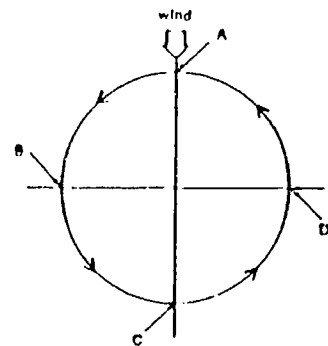

#### Rectangular Course

- |             |              |
|-------------|--------------|
| A -- Medium | E -- Medium  |
| B -- Steep  | F -- Shallow |
| C -- Steep  | G -- Shallow |
| D -- Medium | H -- Medium  |

CHIEF OBJECTIVE: To maintain an equal distance around a rectangle, through a combination of crabbing and bank variation to compensate for the wind.

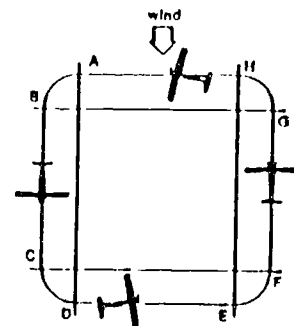

#### Turn About a Point with Constant Bank

CHIEF OBJECTIVE: To show the necessity of varying the bank to compensate for the wind, when attempting to make a turn an equal distance from a point.

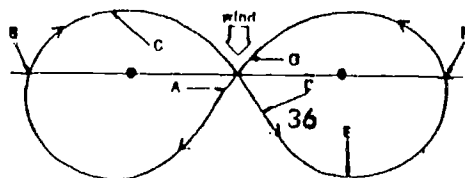



## National Aero-Space Plane

Imagine a sleek research plane that takes off like an airliner from a regular airport runway, then lights up its powerful "scramjet" engines to roar into orbit around Earth. The National Aero-Space Plane Program, conducted by NASA and the Department of Defense, may make that dream a reality. Scientists and engineers are hard at work studying and developing the technology needed for this revolutionary aerospace vehicle. If all goes well, the decision to build an experimental version called "X-30" could come as early as 1993.

In the 21st century, the technology from the National Aero-Space Plane project may produce spaceliners that would give America economical and easy access to orbit, and airliners that could fly high in the atmosphere at nearly 8,000 miles per hour.

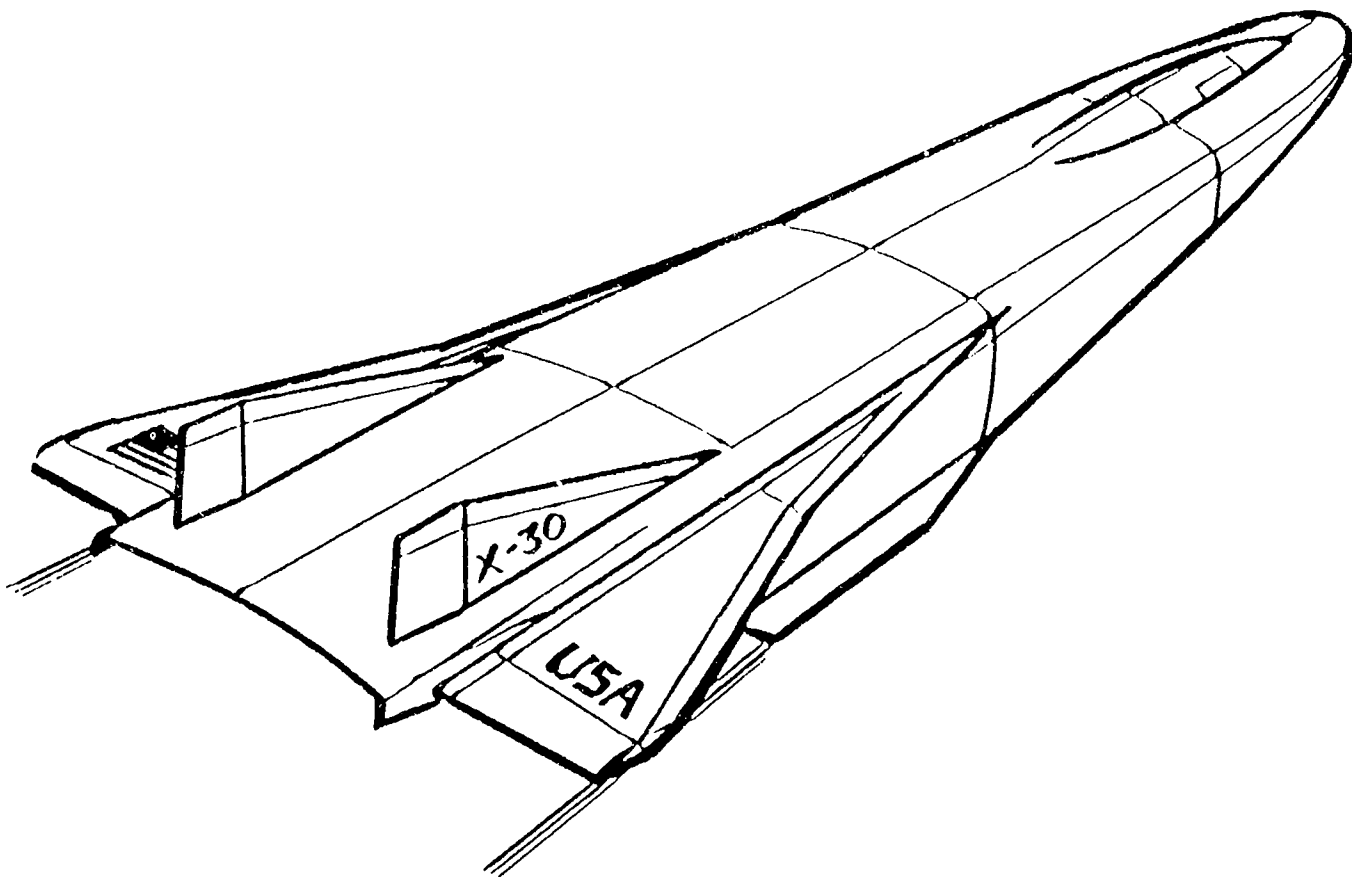

Can you

find your

V W X Y Z

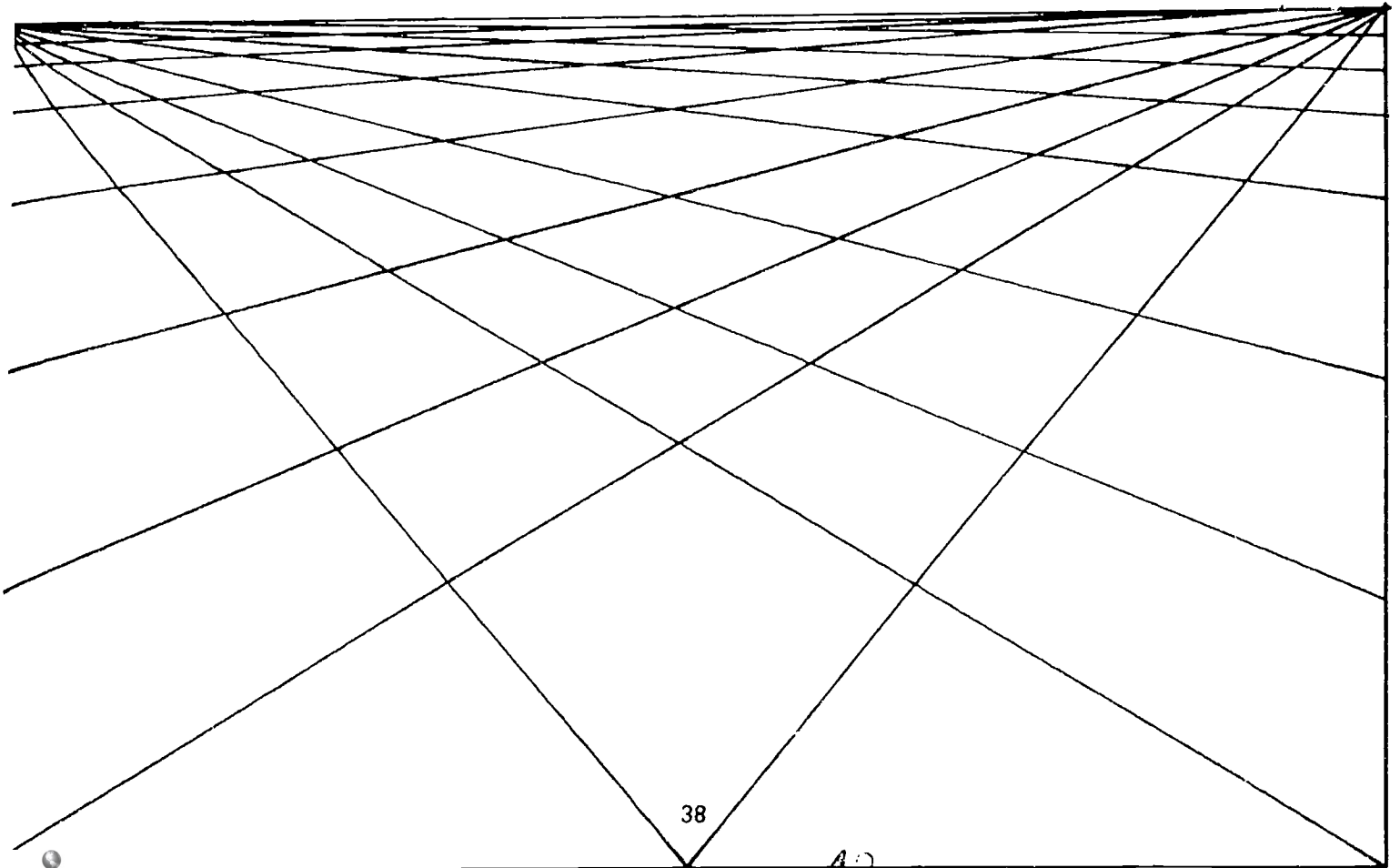

**NAME:** CAN YOU FIND YOUR FLIGHT?

**SKILL:** MATHEMATICS

**PROCEDURE:**

1. Find an old airline ticket or obtain one from a friend, if possible. Read the flight information to see which airline you'll be traveling on.
2. Read the legend on the airport map at Orlando International Airport to locate the concourses and gate numbers.
3. Make a map of your local airport. Include a legend.
4. Survey at least 20 persons at random, making certain that most of them are adults. Ask the following questions and prepare a chart of results.
  - A. What airlines have you traveled on in the last year?
  - B. What was the price of the ticket?
  - C. What was the distance, in miles, to your destination?
  - D. On a scale of 1 to 5, rate the overall service.

**BACKGROUND INFORMATION:**

A place where airplanes can take off and land safely is called an airport. It may be a simple airport, consisting of ground runways, or it may be an elaborate system of concrete or asphalt runways taking up acres of ground. The prevailing wind direction determines how the runways will be built. The airport may be the center of activity around an industrial park.

An airport may be owned by a private individual or a corporation, such as a town. In either case, it is run by a fixed based operator. The operator provides all basic services needed at the airport, including parking for airplanes, taxi-ways to the main runway, fuel supplies, weather information, maps for pilots, and facilities and mechanics to make repairs.



# ORLANDO INTERNATIONAL AIRPORT

One Airport Boulevard, Orlando, Florida 32827-4399 • (407) 825-2001, FAX (407) 857-4079

Gates 1-9

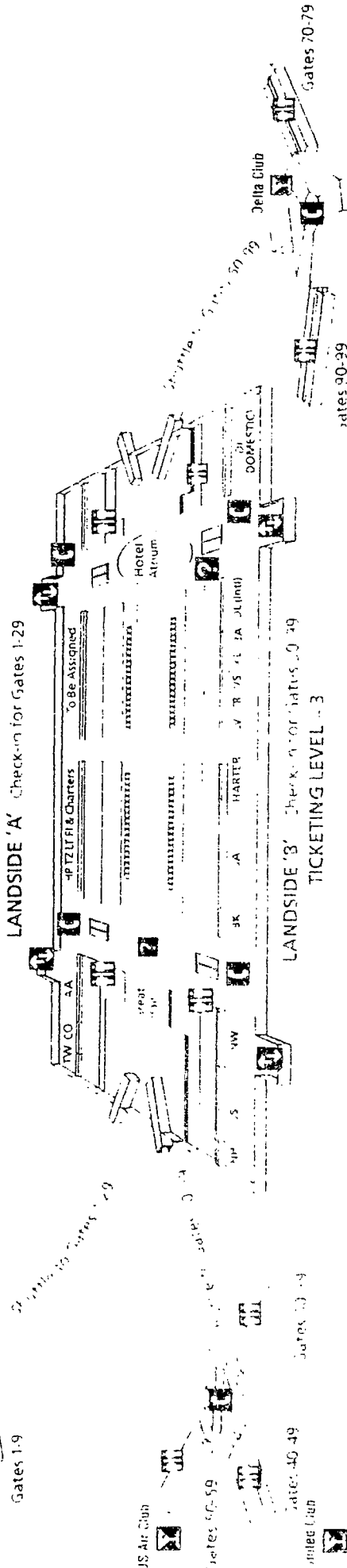

## GATES

Gate	Airline	Phone
Gates 1-9	Allegiant, Delta, Hawaiian, JetBlue, Southwest, Spirit	(407) 825-2000
Gates 10-19	Allegiant, Delta, Hawaiian, JetBlue, Southwest, Spirit	(407) 825-2000
Gates 20-29	Allegiant, Delta, Hawaiian, JetBlue, Southwest, Spirit	(407) 825-2000
Gates 30-39	Allegiant, Delta, Hawaiian, JetBlue, Southwest, Spirit	(407) 825-2000
Gates 40-49	Allegiant, Delta, Hawaiian, JetBlue, Southwest, Spirit	(407) 825-2000
Gates 50-59	Allegiant, Delta, Hawaiian, JetBlue, Southwest, Spirit	(407) 825-2000
Gates 60-69	Allegiant, Delta, Hawaiian, JetBlue, Southwest, Spirit	(407) 825-2000
Gates 70-79	Allegiant, Delta, Hawaiian, JetBlue, Southwest, Spirit	(407) 825-2000
Gates 80-89	Allegiant, Delta, Hawaiian, JetBlue, Southwest, Spirit	(407) 825-2000
Gates 90-99	Allegiant, Delta, Hawaiian, JetBlue, Southwest, Spirit	(407) 825-2000

\*TWA location effective May 1992  
 \*\*International counter, baggage claim  
 \*\*\*Check in at Gate 40  
 Airline locations subject to change.

**Airside**

- Baggage Claim
- Car Rental
- Customs
- Immigration
- Lost & Found
- Post Office
- Taxi
- Ticketing
- Travel Agency
- Waiting Area

**Landside Level 2**

- AT&T
- Business Center
- Information Counters
- Restrooms
- Seating
- Smoking
- Ticketing
- Travel Agency
- Waiting Area

## SAGGAGE CLAIM LEVEL - 2

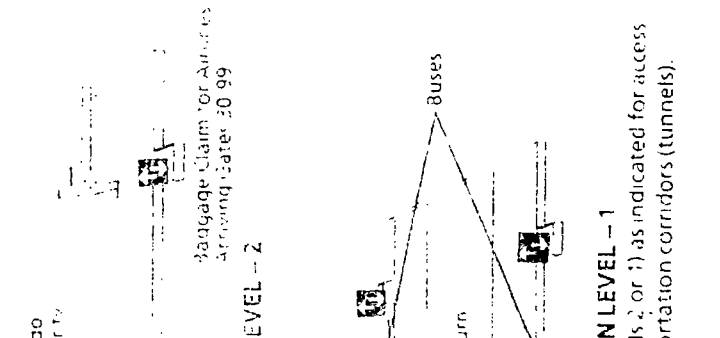

## GROUND TRANSPORTATION LEVEL - 1

Use elevators (levels 3, 2, or 1) or escalators (levels 2 or 1) as indicated for access to the parking garages by way of the transportation corridors (tunnels).

### PARKING GARAGE IDENTIFIERS

CRITTERS "A" GARAGE	CRITTERS "B" GARAGE	TERMINAL TOP GARAGE*
LEVEL 1 ALLIGATORS	LEVEL 1 TROPICAL FISH	LEVEL 4 WADING BIRDS
2 MANATEES	2 FROGS	5 OWLS
3 WILD BOARS	3 PANTHERS	6 FLAMINGOS
4 BEARS	4 ARMADILLOS	7 TURKEYS
5 RACCOONS	5 BRAHMAN'S	8 SEAGULLS
6 TURTLES	6 DEER	9 PELICANS
		10 EAGLES

### MAIN TERMINAL ACCESS:

Follow red "A" or green "B" signs for ticketing/departures, baggage claim/arrivals, and rental car return levels

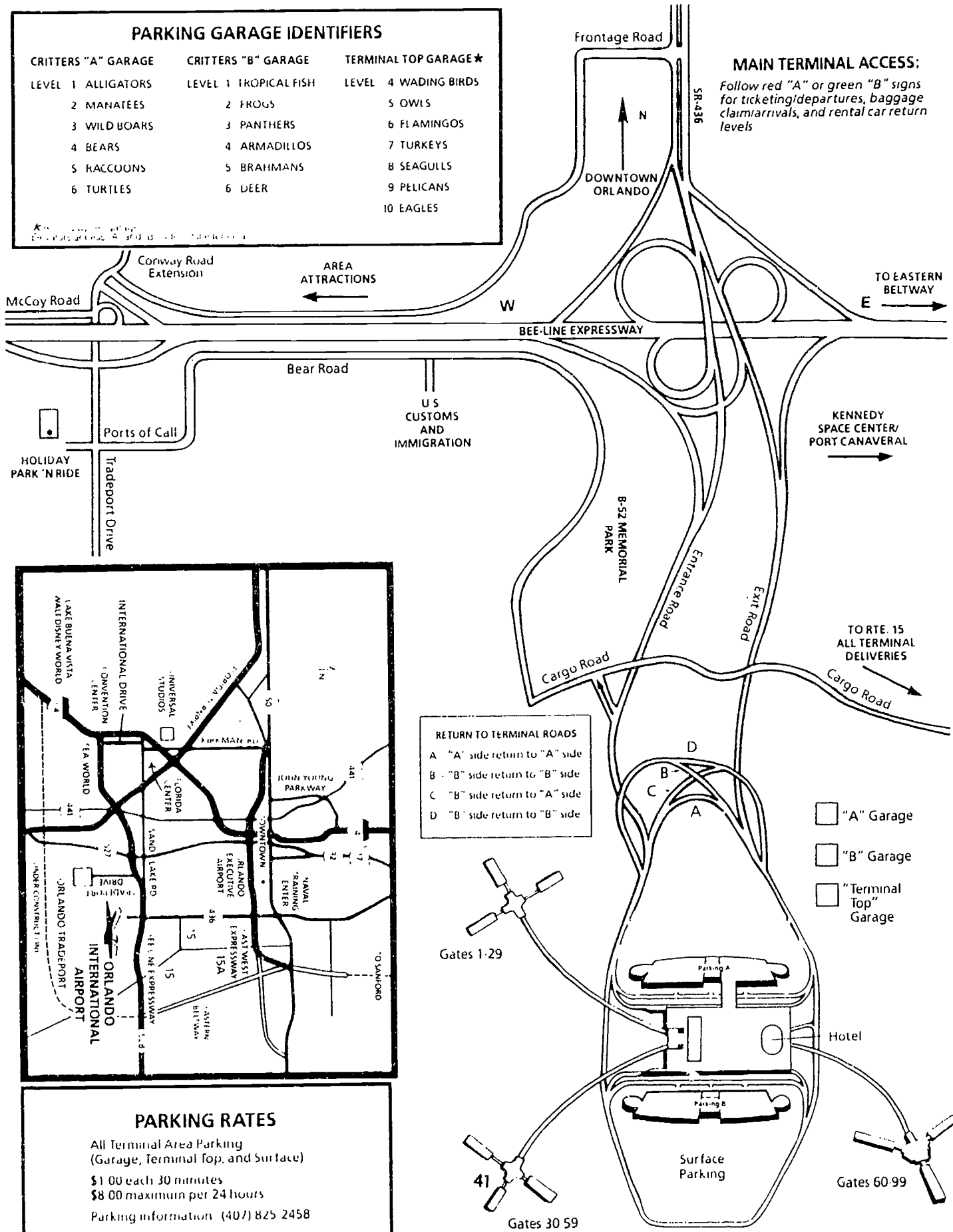

**RETURN TO TERMINAL ROADS**  
 A "A" side return to "A" side  
 B "B" side return to "B" side  
 C "B" side return to "A" side  
 D "B" side return to "B" side

- "A" Garage
- "B" Garage
- "Terminal Top" Garage

**PARKING RATES**  
 All Terminal Area Parking  
 (Garage, Terminal top, and Surface)  
 \$1.00 each 30 minutes  
 \$8.00 maximum per 24 hours  
 Parking information (407) 825 2458

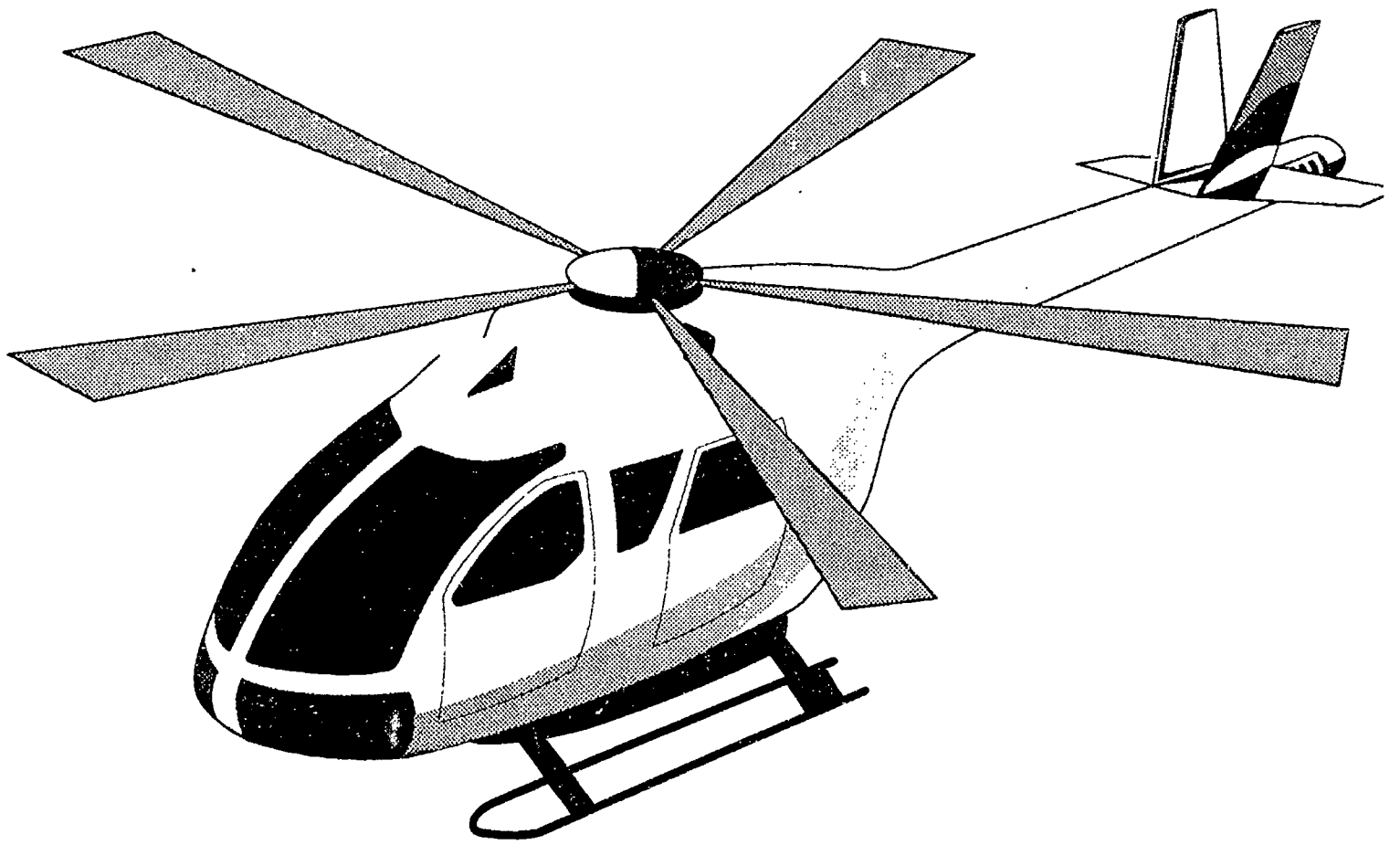

HELICOPTERS

**NAME:** HELICOPTERS

**SKILL:** SCIENCE

**PROCEDURE:**

1. From you own design, make a paper helicopter and see how it flies. Preferably use a computer drawing program such as a computer aided design system.
2. Go to the library and do some research on the uses of helicopters. Write a paper on the various uses of the helicopter.
3. Make a poster/collage displaying various aircraft used in business, industry, government in your area.
4. Visit a local airport or medical hospital with a heliport. Compare it to fixed-wing aircraft.
5. Write the nearest military base in your area for information on the use of helicopters and other fixed-wing aircraft at the facility.

**BACKGROUND INFORMATION:**

A helicopter works much the same as an airplane, except that it has blades instead of wings. The blades on top of the helicopter, called the rotor, provide the lift. The top of the rotor blades are curved and the bottoms are flat. As a result of this design, the air that goes over the top of the blades goes faster then the air on the bottom of the blades. The turning blades then lift the helicopter into the air. The pilot controls by changing the "pitch" or angle on the blades. A helicopter can go up, down, forward, backward, sideways, or hover. A small rotor on the tail turns at right angle to the big rotor. This prevents the tail from swinging in the opposite direction in which the big rotor is turning.

HH3 Helicopters, known as Jolly Green Giants, monitor the launch site prior to the launches of the space shuttle to detect unforeseen situations. Huey helicopters are also available for routine functions, security monitoring and airborne rescue.

## THE ALL-PURPOSE HELICOPTER

The idea of the helicopter was thought of hundreds of years ago. The Chinese made toys which were flying tops with rotors made of feathers. Leonardo da Vinci, (1452 - 1519) a great Italian artist and scientist, drew sketches of a similar flying machine.

Igor I. Sikorsky built the first practical single-rotor helicopter in 1939 and flew it in 1940. He was a Russian engineer who came to this country in 1919. The United States government used many Sikorsky helicopters for its Armed Forces.

The helicopter is an aircraft which can do all kinds of tricks, as well as be an excellent worker. It can go straight up and down, make vertical take offs and landings, fly forward, backward, or sideways. It can turn around completely, and it can even stay in one spot in the air. It has several nick-names, such as whirlybird, eggbeater, and chopper. There is a large, horizontal propeller above the helicopter's body called a rotor, which spins and makes the helicopter fly. The helicopter can do jobs that no other vehicle--air, land or sea--can do. It can speed travellers from a downtown heliport to an airport at the edge of a city. It can hover in the air while its crew lifts a shipwreck victim or a stranded mountain climber to safety. It is used for many rescue missions from accident to hospital, for reporting traffic congestion on highways to radio stations, for police detective work, and for dropping food, clothing, and medical aid to victims of floods and disasters. They can carry from 1 to 30 passengers.

## HELICOPTER

Igor Sikorsky built the first practical single-rotor helicopters in 1939. List the directions in which it can fly:

The whirling blade on the top of the helicopter is called a

Some uses of a helicopter are:

Vocabulary: Vertical  
Horizontal

Other names for this aircraft are:

Answers to "Helicopter" quiz: 1) Vertically, backwards, forward, sideways 2) rotor 3) Lifts shipwreck victims and stranded mountain climbers to safety, rushes accident victims to hospitals, used for observing and reporting traffic conditions, drops food, clothing and medical aid to disaster victims, military operations, convenient for business purposes 4) up and down parallel to the ground 5) Whirlybird, Eggbeater, Chopper.



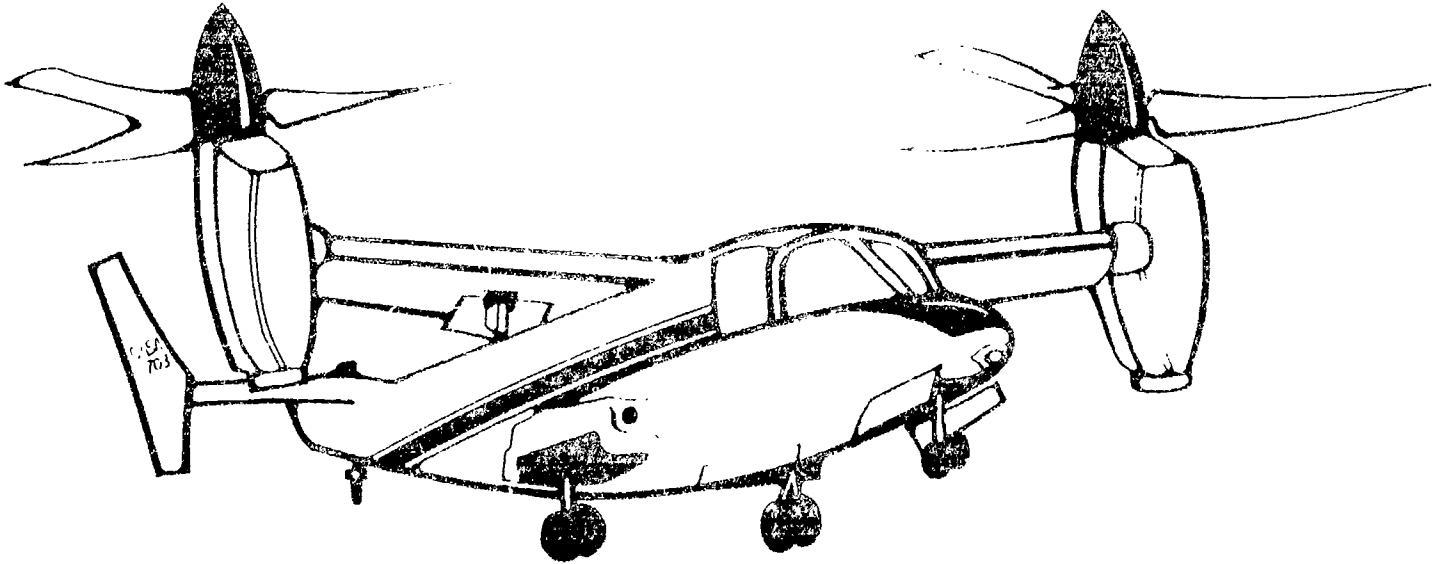

### XV-15 Tilt-Rotor

NASA's remarkable XV-15 Tilt-Rotor combines the best of both helicopters and airplanes in one vehicle. Using powerful engines mounted at the end of each wing, the XV-15 can take off and land vertically. When the pilot wishes to fly straight ahead, he/she simply tilts the engines to a horizontal position in just 12 seconds and zooms away.

Because they would require little runway space and would be relatively quiet, future aircraft based on the XV-15 might be especially useful to relieve congestion at major city airports.

## HELICOPTER

Cut on solid lines.

Bend on dotted lines and secure with a paper clip.

Fold flaps at the top in opposite directions.

Drop the helicopter and watch it twirl.

The child can watch the effects of air on a falling object.

Variation: Make 6 cuts down the sides of a paper cup stopping one inch from the bottom.

Fold the strip outwards.

Flip the helicopter as you would a frisbee.

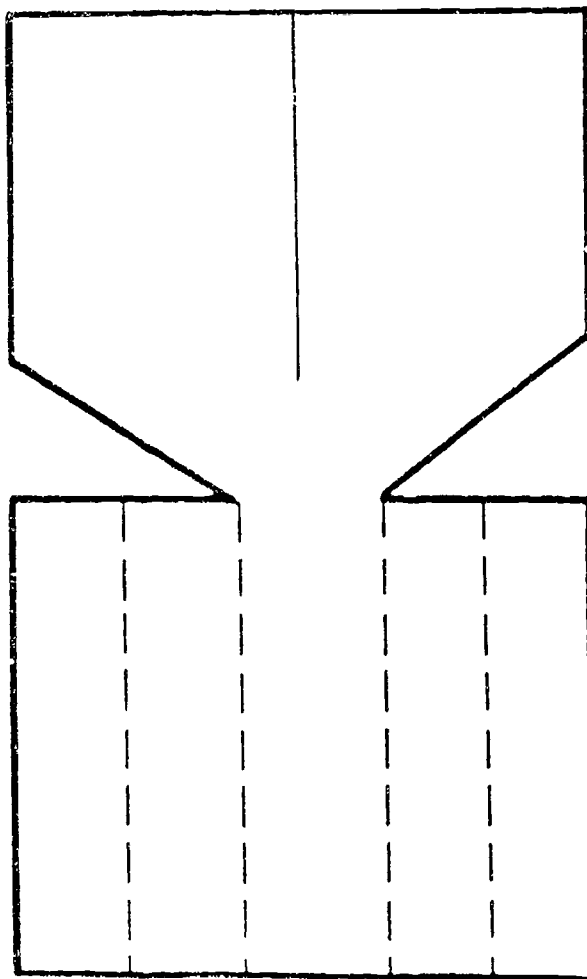

# AEROSPACE

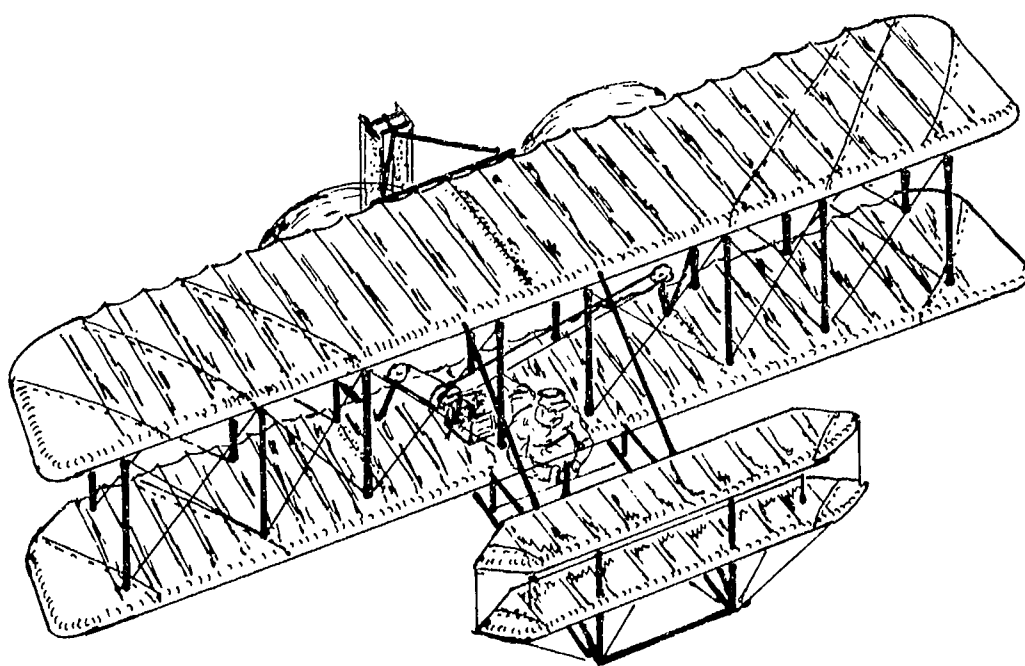

# PIONEERS

**NAME:** PIONEERS

**SKILL:** SCIENCE, HISTORY

**PROCEDURE:**

1. After reading the story of the first air flight, design a "Wanted Poster" for persons to volunteer for the first flight with the Wright Brothers.
2. Write a newspaper account of the First Flight. Discuss how people felt about this in 1903 and what were their hopes and fears. Discuss the present day public awareness of the importance of this flight.
3. Interview your parents, grandparents, or other older relatives about historic events in which they may have participated. Tape record or take notes of the interview and prepare a family time line.
4. Make a class time line of aerospace events, beginning with the Wright Brothers' Flight at Kitty Hawk, NC. Indicate contributions of females and minorities.
5. If possible, invite a military pilot to come speak to your class.

**BACKGROUND INFORMATION:**

After the Wright Brothers flight in 1903 until World War I in 1914, only about 1,000 aircraft existed in the whole world. During the next four years, thousands of aircraft were produced to be used in combat. Mail and passenger service began in 1925. During World War II more aircraft were produced before jets emerged. Today in the United States about one million people fly small airplanes yearly. Many pilots and other aerospace jobs are necessary.

The pilots who fly the Space Shuttle are airplane pilots with 1,000 hours flying jets before they apply for astronaut training. These are military pilots paid by the military according to their service rank whether they fly a small airplane or the shuttle. Some of these pilots are Lt. Colonel Terence (Tom) Henricks, Colonel Frederick Gregory, and Captain Susan Helms. Pictures and information about pilot astronauts can be obtained free by writing NASA. (See Resources). Information about the military pilots organization, Daedalians, can be obtained from Kelly Air Force Base, Bldg. 1660, San Antonio, Texas 78241. Awards, trophies, and youth scholarships are presented to those who work toward the Daedalian goals, i.e. insuring America's preeminence in Air and Space. Upon request, local Daedalians may visit your class to tell you about becoming a pilot.

## A FAMOUS FIRST FLIGHT

As the sun rose on December 17, 1903, a bitter wind blew about 22 to 27 miles per hour by the fishermen's shanties of Kitty Hawk, North Carolina. Kill Devil Hill, four miles south of Kitty Hawk, was barren and dreary.

By noon that day, in that remote corner of America, two obscure bicycle makers, Orville and Wilbur Wright from Dayton, Ohio, had flown four times in a powered airplane. They had fitted a biplane with a 16 horse power motor, giving the aircraft a total weight of 750 pounds. In the first flight, Orville Wright flew at a speed of 30-35 miles per hour, covering a distance of 120 feet in 12 seconds. Later the same day, Wilbur Wright flew the machine a distance of 852 feet in 59 seconds.

After the last flight was completed, a gust of wind tumbled the machine and damaged it enough to call a halt to the experiments. The Wright brothers packed up and went back to Dayton. They had done something that man had been striving towards since recorded history began. Orville and Wilbur Wright later wrote of that first 12 second flight that it was "the first in the history of the world in which a machine carrying a man had raised itself by its own power into the air in free flight, had sailed forward on a level course without reduction of speed, and had finally landed without being wrecked."

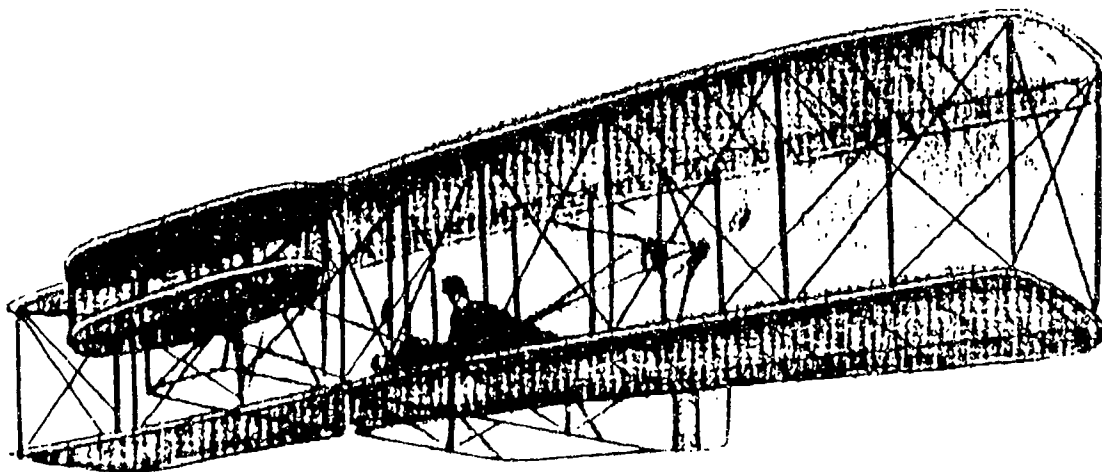

## A FAMOUS FIRST FLIGHT QUIZ

1. Who designed and flew the first powered airplane?
2. When did the flight occur?
3. How long did the first flight last?
4. What did the famous brothers do for a living?
5. Where did the flight take place?
6. What was the distance of the first flight?
7. What was the horse power of the motor?
8. How much did the airplane weight?
9. Was the airplane damaged that day?
10. Explain what happened to the aircraft.

Answers to "A Famous First Flight" 1) Orville and Wilbur Wright 2) December 17, 1903 3) 12 seconds 4) made bicycles 5) Kitty Hawk, North Carolina 6) 120 feet 7) 16 h.p. 8) 750 pounds 9) yes 10) after it was damaged by a gust of wind they packed the airplane and returned it to Dayton, Ohio.

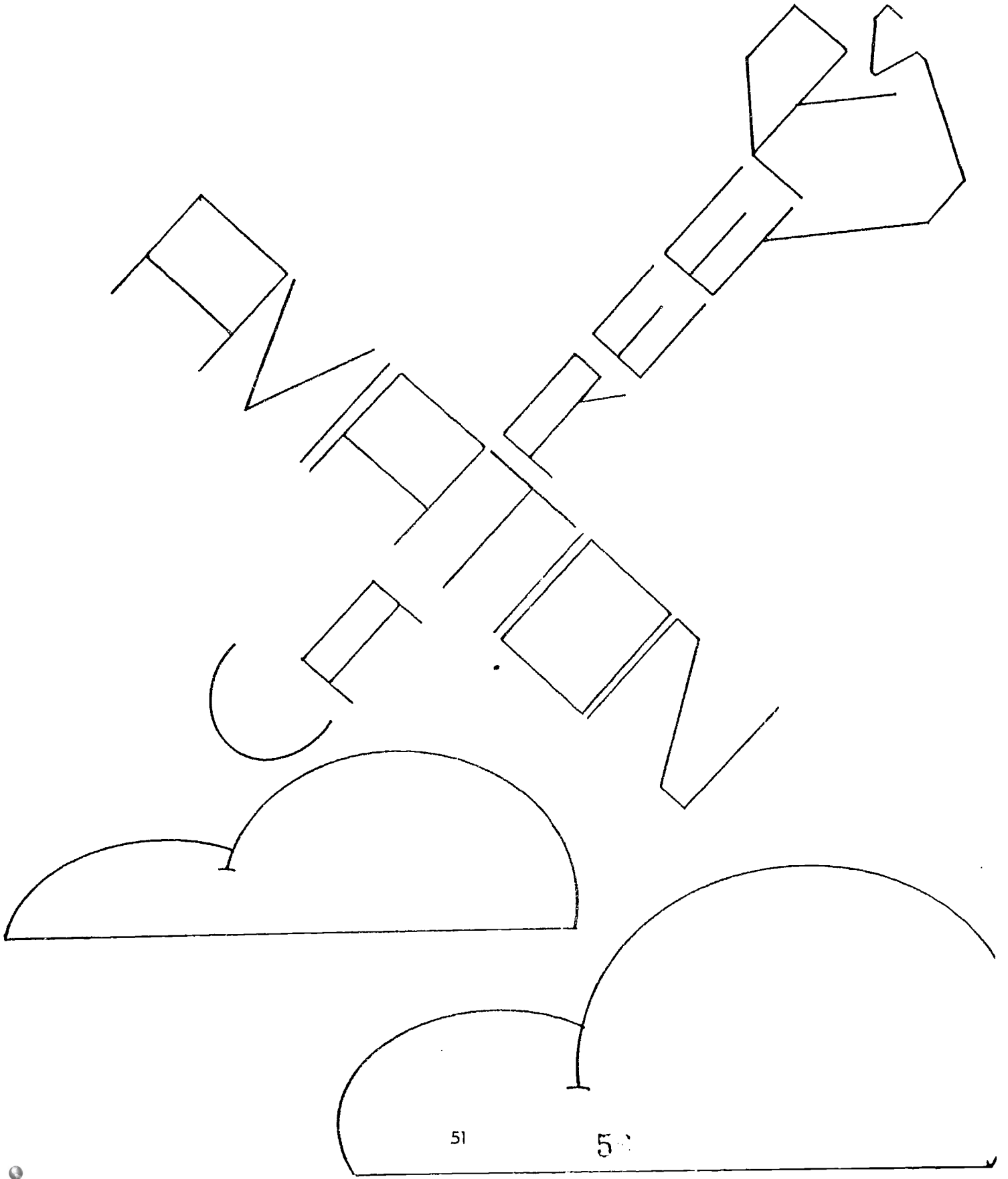

51

52

**NAME:** AVIATION CAREERS

**SKILL:** TECHNOLOGY

**PROCEDURE:**

1. Interview or invite a guest speaker to find out about a particular job career that the class may be interested in.
2. Glue the Career Cards on stiff cardboard or manila paper (file folder). Cut the cards on the solid lines and the dotted lines. See if you can match the person with his career description. Turn the cards face down and play "Concentration".
3. Research the careers of various aerospace pioneers then complete the crossword puzzle and word search games. Using computer technology, create your own games or word puzzles.

**BACKGROUND INFORMATION:**

Beginning with Greek mythology, man has expressed his desire to fly. Legends from Arabia tell of magic carpet rides. In the Middle Ages, man tried to imitate birds.

Our first scientific record of man's desire for flight hardware is recorded in the 1400s through the artist, Leonardo da Vinci. Through his notes and sketches, we have wing devices, ornithopters, helicopters, and parachutes.

In 1782, the Montgolfier brothers build a hot air balloon which drifted five miles in 25 minutes to become the first apparatus to get off the ground. Balloons filled with hydrogen gas were successfully launched later the same year. As the study of flight evolved, it became apparent that fixed wings were best for flight. Thus, in the 1890s, the great pioneer of gliders, Otto Lilienthal of Germany, made more than 2,000 flights.

In 1903, the Wright Brothers built the first powered sustained and controlled flight of a heavier than air vehicle. In 1947 Chuck Yeager broke the sound barrier. In 1962 John Glenn became the first American to orbit the Earth. The first landing on the Moon occurred on July 20, 1969 when Neil Armstrong and Buzz Aldrin stepped on its surface.. In 1981 John Young and Robert Crippen successfully flew the first Space Shuttle. The last launch of 1992 was STS-53 on December 2 with Walker, Cabana, Bluford, Voss and Clifford on board.



Glue the Career Cards on stiff cardboard or manila paper (file folder). Cut the cards on the solid lines and the dotted lines. See if you can match the person with his career description. Turn the cards face down and play "Concentration".

<b>CARGO LOADERS</b>	<p>They put baggage, mail, and supplies on board the plane.</p>
<b>FLIGHT ATTENDANTS</b>	<p>They work in the passenger cabin making sure everyone is comfortable. They serve drinks and meals. They help passengers find their seats and fasten their seatbelts and demonstrate emergency procedures.</p>
<b>COPILOT</b>	<p>Sits in the cockpit with the pilot and helps fly the plane.</p>
<b>FLIGHT ENGINEER</b>	<p>Checks the equipment and makes sure it operates properly during flights. Sits in the cockpit behind the pilots.</p>
<b>PILOT</b>	<p>Sits in the cockpit and flies the plane. This person studies weather maps and files flight plans.</p>

<b>FLIGHT SERVICE SPECIALIST</b>	Talks to the private pilot and gives weather and flying information, and helps plan the flight.
<b>FLIGHT DISPATCHER</b>	Helps the pilot plan the flight.
<b>GROUND CREW</b>	They put fuel in the plane. They also tell the pilot where to park the plane and help the passengers get off the plane.
<b>GROUND CONTROLLER</b>	Controls the airplane on the ground. Tells the pilot where to taxi.
<b>TOWER AIR TRAFFIC CONTROLLER</b>	Gives the pilot permission to take off and land; communicates on a two-way radio; controls air traffic.
<b>AIR ROUTE TRAFFIC CONTROLLER</b>	Watches the plane on the radar screen and tells the pilot where to fly along the airways.
<b>PORTER</b>	Helps the passengers carry their baggage into the terminal.
<b>AIRLINE WORKER AT THE TICKET COUNTER</b>	Sells you your ticket, gives you a boarding pass, checks your baggage.
<b>AIRCRAFT ENGINE MECHANICS</b>	They check the engine and instruments to see if they are working properly on the plane.

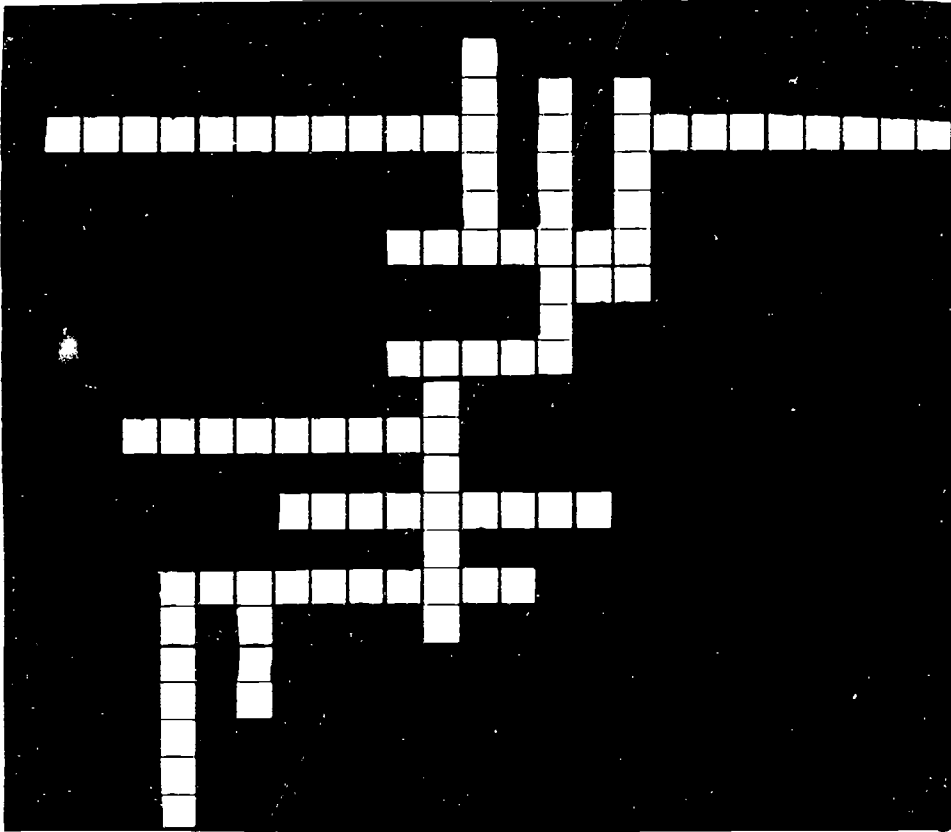

-----  
-----  
THE CLUES

ACROSS

- [ 7 , 12 ] TEST PILOT, X-15
- [ 9 , 10 ] 1ST TO SOLO ATLANTIC
- [ 11 , 14 ] 1ST MAN TO WALK ON MOON
- [ 13 , 11 ] 1ST AMER ASTRONAUT TO ACHIEVE ORBITAL FLIGHT
- [ 16 , 9 ] 1ST WOMAN TO FLY ATLANTIC
- [ 19 , 1 ] LED 1ST BOMBING OF TOKYO
- [ 19 , 13 ] WW I FLYING ACE

DOWN

- [ 1 , 21 ] INVENTOR OF MODERN ROCKETRY
- [ 4 , 19 ] 1ST WOMAN ASTRONAUT ON SHUTTLE
- [ 6 , 14 ] DEVELOPED SATURN V ROCKET
- [ 13 , 11 ] WW II FLYING ACE
- [ 15 , 9 ] 1ST TO BREAK SOUND BARRIER
- [ 16 , 13 ] PILOT OF EAGLE

R N P T L F T J M I C H A E L O C C O L L I N S E J  
 G D O Y M M T R E U E O J V C N U M I X O R X O X  
 I O X F U F L H J Z Q M G Y V G S I N T F R U P H  
 S A L L Y C R I D E V C X F X N S O N E A L T I A  
 P G O L I N D B E R G H F H F E S Y E B W R P E R  
 Z R I X U L J G E H D U Y P R O O I P P A I S E N  
 C R O S S F I E L D P W J B U B B I B G H H G F V  
 V D X O Y H Y L O G F C A D E U M S R X C A H M J  
 S I H U T R E F O E A G J Y S L X A I O E U H I H  
 O P Y F T L J H H T E M P C G F E U D Y Y U H N P  
 I C N B E I J F H Y A P P H A Q C R P S A T E Z G  
 X R P I P U L I B F A P O P A Q A K Z R Z L S A K  
 T K G I G F U B M P I R T I H D C W B N G I H T A  
 Q I M S Y P A Q C M T E L R D U R E I O K B S R W  
 T U U O L G D R C S Y E U O H E N R N I H E Z I I  
 A Y V M D U O P M V M U G C K O D H C T D F O Z R  
 G I K Q Q B M R D A Y V D C V L O I U S O Z I W W  
 S J Y O Z H A W M O T B A O A J O Y V P A W C O Y  
 I N K I P T E J R T B Y E O F V U F Y Y Z D Z I  
 H Y I M L H W U E P N F Z F S L C O O J A K V A R  
 Q R F I I E F B N E U Z S X T O I B H E B V B F M  
 G B E F J X O V K I U K X U S O J I W S V D O W E  
 V N M G P R A C A B U A B X O G W C T A A G V H S  
 V W F G E X I B K M S D D F D W D N V L M R G Z X  
 X S B L J R C J P D D N X X V X I J D D E I W E L

There are 15 words here — can you find them?

**HERE ARE THE WORDS TO LOOK FOR:**

**Amelia Earhart**  
**Chuck Yeager**  
**Gabby Gabreski**  
**John Glenn**  
**Michael Collins**  
**Pappy Boynton**  
**Robert Goddard**  
**Von Braun**

**Buzz Aldrin**  
**Crossfield**  
**Jimmy Doolittle**  
**Lindbergh**  
**Neil Armstrong**  
**Rickenbacker**  
**Sally Ride**

THE ANSWERS

ACROSS

- [7,12] CROSSFIELD
- [9,10] LINDBERGH
- [11,14] ARMSTRONG
- [13,11] GLENN
- [16,9] EARHART
- [19,1] DOOLITTLE
- [19,13] RICKENBACKER

DOWN

- [1,21] GODDARD
- [4,19] RIDE
- [6,14] VON BRAUN
- [13,11] GABRESKI
- [15,9] YEAGER
- [16,13] ALDRIN

```

. . . . . M I C H A E L C O C D L L I N S . .
. . . . . . . . . . . . . . . I . O . . . .
. . . . . . . . . . . . . . . K . T . . . .
S A L L Y C R I D E . . . . . S . N . . . T . .
. . . L I N D B E R G H . . . E . Y . . . R . . R
. . . . . . . . . . . R . O . . . A . E . .
C R O S S F I E L D . . . B . B . . . H . G . .
. . . . . . . . . . . A . E . . . R . A . . .
. . . . . . . . . . . G . Y . . . A . E . N . N
. . . . . . . . . . . E . P . G . E . D . Y . U . N
. . . . . J . Y . F . N . B . R . F . A . E . .
. . . . . I B . A . O . A . A . F . R . L . . .
. . . . . B M F . R . I . D C . B N G . . . .
. . . . . A . . M T . L . D U R E I O . . . .
. . . . . B . . . S Y E . U H E N R N . . . .
. . . . . M . M U G C K O D I I . . . . .
. . . . . R . A . V D C V L O . . . . .
. . . . . A . . . T . A O A J . . . . .
. . . . . P . . . R . B . E O . . . . .
. . . . . L . . . E . N . Z . . . . .
. . . . . I . . . B . E . Z . . . . .
. . . . . E . . . O . . . U . . . . .
. . . . . N . . . F . C . B . . . . .
. . . . . . . . . . . . . . . . . . . . .
. . . . . . . . . . . . . . . . . . . . .
. . . . . R . . . . . . . . . . . . . . .

```





**OUR GALAXY**

# CONSTELLATIONS

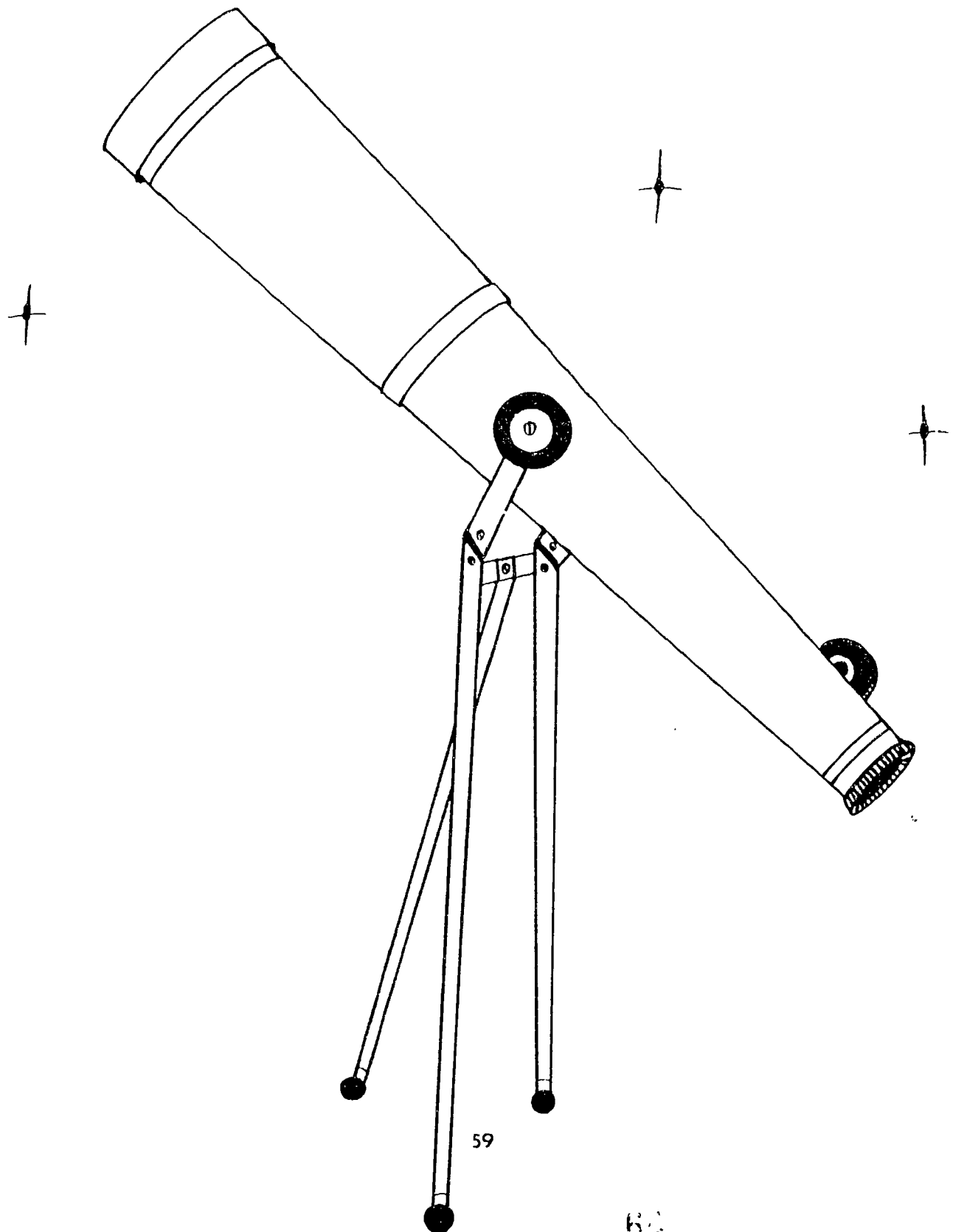

60

**NAME: CONSTELLATIONS**

**SKILL: SCIENCE**

**PROCEDURE:**

1. Read the story of Orion. Study the layout of the stars in the constellations. Look for the constellations outside on a clear night.
2. Visit the library to read about the Greek myths and legends, such as Daedalus, his son Icarus, and the myths of the constellations.
3. Horoscopes are fortunes told by the stars - what is your horoscope sign? Form your constellation with stick-on stars on blue paper, then locate its position in the night sky.
4. Plan a field trip to visit a local planetarium. Learn how the night sky changes during the year and compare the positions of the various constellations.

**BACKGROUND INFORMATION:**

Stars can be seen better in space and they do not twinkle because you don't have to look through the earth's atmosphere. (In fact, you can see 25 times better!) Stars help the Space Shuttle pilot know his position. He can look at the North Star and relate to his position on earth. Stars actually created their light years ago because light travels at 186,000 miles per second. The light that we presently see from the sun left the sun about 8 minutes ago.

**ORION**

Orion is a very prominent and easily recognizable constellation. It has three bright stars, close and in line, which represent his belt; two bright stars to the north, which represent his shoulders; and two more bright stars to the south which represent his legs.

Several dimmer stars just south of the belt form his sword.

Several less prominent stars show one hand holding a shield against Taurus, the bull, which is charging Orion; and the other hand is holding a club (some say it is not a shield, but a lion skin; but it doesn't matter).

The two brightest stars are Betelguese (BET-uhl-jerz) and Rigel (RY-jul).



## THE GREEK MYTH OF ORION, THE HUNTER

There was once a great and handsome hunter named Orion (oh-Rye-un), the son of Poseidon (Neptune).

Orion fell in love with Merope and wanted to marry her. However, her father did not want to give up his daughter, so he blinded Orion in his sleep.

Orion fled to a faraway island where he hoped to have his eyesight restored. His eyesight was restored by the sun's rays. With his eyesight restored, he vowed to return and hunt down the man who blinded him, and marry the girl he loved.

While returning, Orion met Artemis (Diana), daughter of Zeus and sister of Apollo. Since Artemis was also a great hunter, she and Orion became friends and hunted together.

Apollo was protective of his sister and knew of Orion's reputation. When he saw his sister hunting with Orion, he became angry, believing that Artemis was in love with Orion; so Apollo sent a giant scorpion to chase Orion away.

Orion tried to shoot the scorpion with his arrows, but the scorpion was too big. Orion fled into the water to try to get away, hoping the scorpion wouldn't follow; but the scorpion pursued him into the water.

Meanwhile, Apollo convinced his sister, Artemis, that the scorpion was pursuing an evil creature. From a distance, Artemis didn't recognize **Orion**. As Orion and the scorpion approached them, Apollo convinced Artemis to shoot the evil creature (which was really Orion).

Artemis took up her bow and being an excellent hunter, shot an arrow into Orion's head, killing him.

When she found what she had done, she was so aggrieved that she had her father, Zeus, place Orion's image in the sky among the stars, with two dogs, to hunt wild animals forever. (The first wild animal Orion encountered was Taurus, the bull).

When Apollo learned that Orion's image had been placed in the sky, he had his father, Zeus, also place the scorpion in the sky to pursue Orion.

When Artemis learned that the scorpion had also been set in the sky, she begged her father to keep them apart. Zeus agreed to place them at opposite ends of the sky, so that the scorpion and Orion should never appear in the sky at the same time.

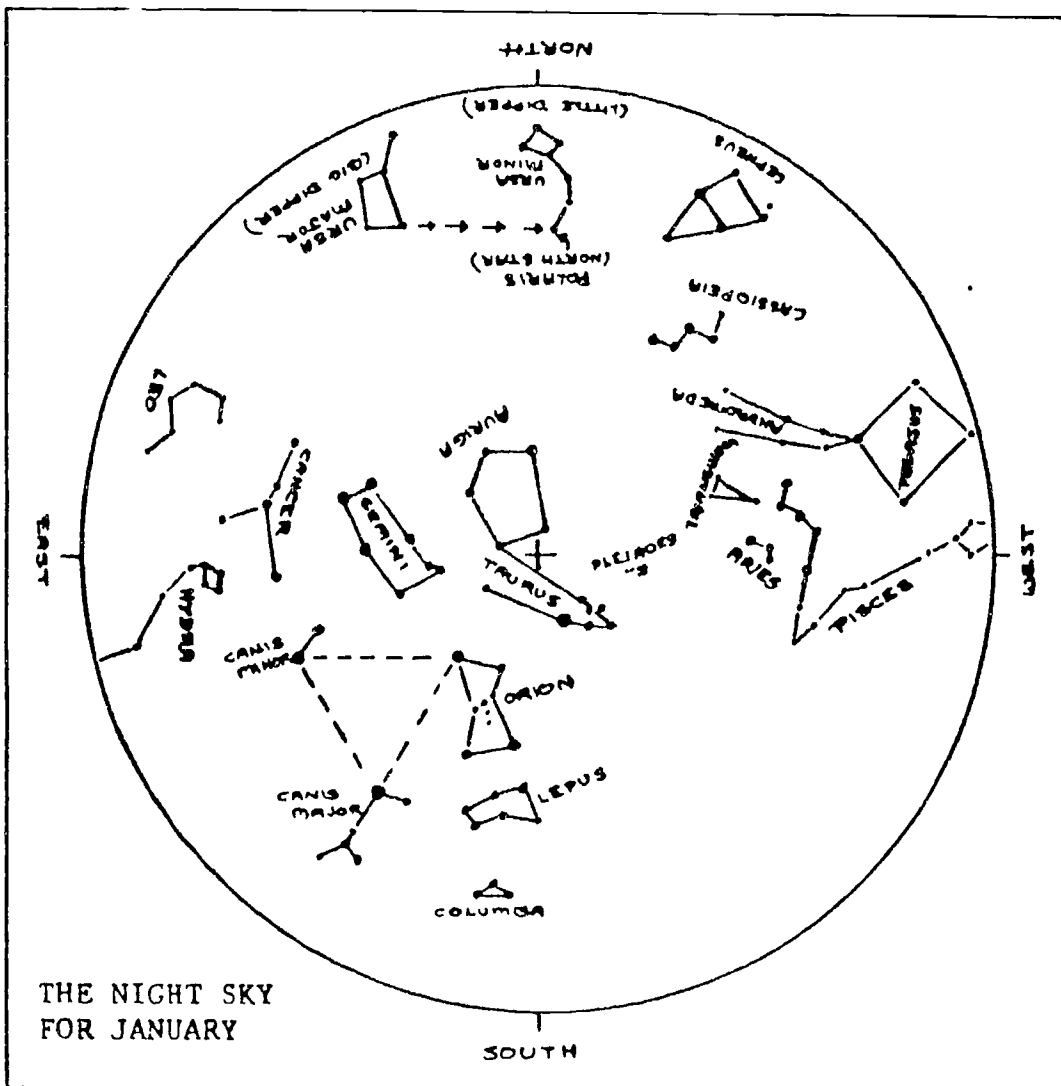
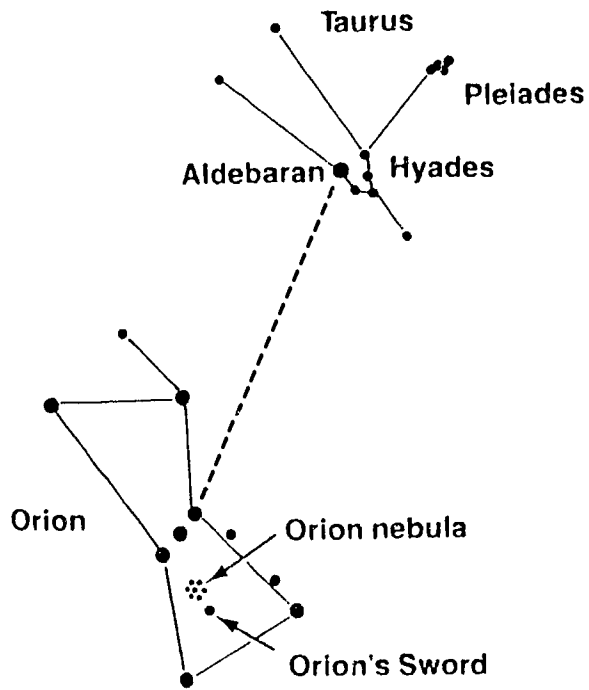

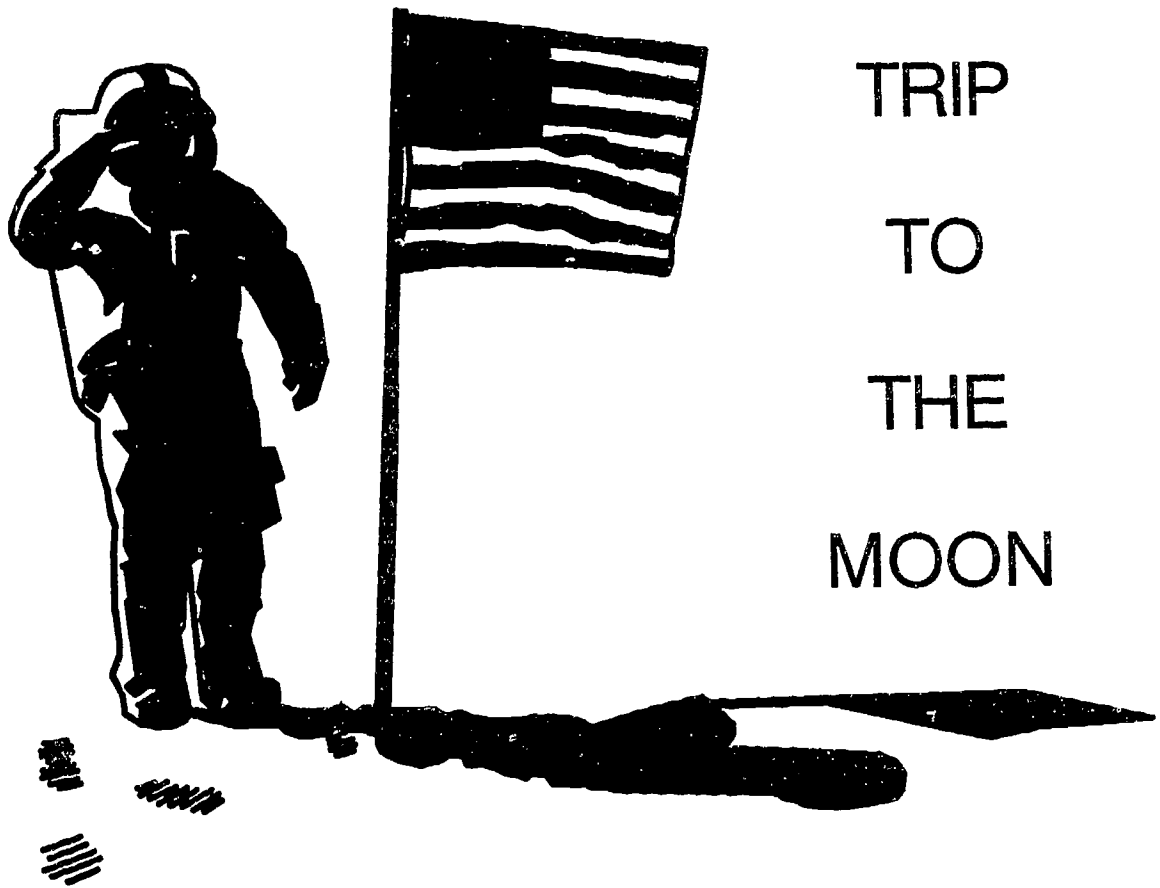

TRIP  
TO  
THE  
MOON

## TRIP TO THE MOON

### SKILL: SCIENCE AND MATHEMATICS

#### PROCEDURE:

1. Students will collect pictures of the moon from various magazines, newspaper articles, etc. and prepare a collage art work for display on a student prepared bulletin board.
2. Students will go to the library and research articles on the moon. Students will prepare a one to two-page report, including the following: origin of the moon, orbit of the moon, surface of the moon, phases of the moon, Apollo landings and discoveries.
3. Show different pictures of the phases of the moon. Use paper plates to illustrate the various phases.

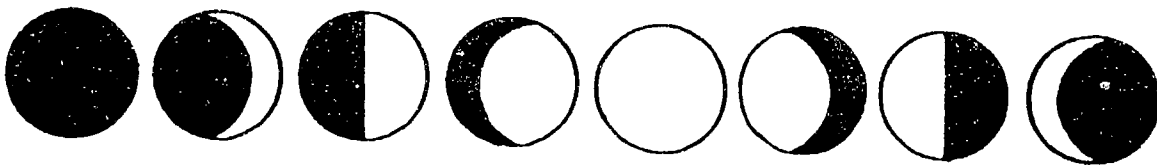

4. Research the ancient beliefs of people that the moon had unusual influence on people. Contrast this with scientific evidence of the effect of gravitational pull on earth.
5. Students will prepare a map of the moon's surface.

Label the following: North, South, East, West, Sea of Tranquility, Sea of Rains, Sea of Serenity, Sea of Clouds, Sea of Crises, Sea of Fertility, Kepler Crater, Carpathian Mountains, Descartes Crater, Langrenus Crater, and Apollo landing sites.

6. Study the men who landed on the moon and their landing locations. Then pretend your mission is stranded. Play the Moon Survival activity.

#### BACKGROUND:

The moon is the earth's only natural satellite. There are several theories about its origin. Scientists once believed that the moon was once part of the earth. However, this proved incorrect when scientists examined rocks brought back by astronauts. The moon rocks contained very large amounts of minerals rarely found on earth.

The moon orbits the earth every 27 days. Because the moon completes one revolution around the earth at the same time it completes one rotation on its axis, we never see but one-half of the moon's surface; thus, the "dark side of the moon". This side was finally seen when a Russian spacecraft circled the moon in 1959.

There are four main phases of the moon: new moon, first quarter, full moon, and last quarter. These phases are a result of the amount of reflected sunlight, since the moon gives off no light of its own.

The moon has no atmosphere and the gravity of the surface of the moon is too weak to hold gases to create an atmosphere. Moon weight is one sixth of what it is on earth. The temperatures vary from 300 degrees on a "lunar day" to 180 degrees below farenheit.

The surface of the moon ranges from tall mountains to hollow areas formed by volcanoes. There are also some flat areas called maria, or seas.

\*Educators should contact their nearest NASA Center for information on obtaining lunar soil samples for their classroom.

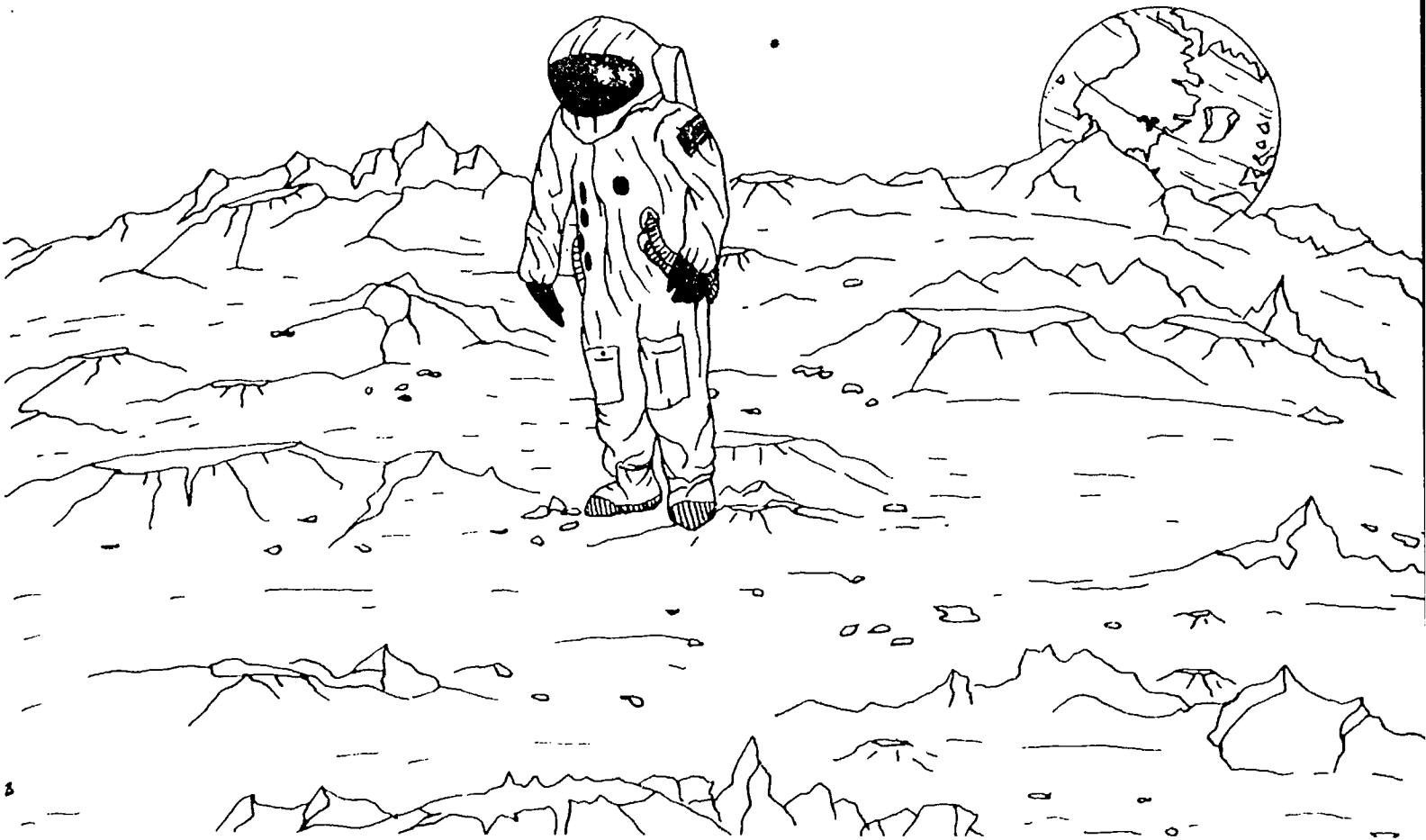

## LUNAR MODULE (L.M.)

The Lunar Module is a buglike cabin set on four spidery legs. It was used to carry two astronauts from Apollo Saturn V to the surface of the moon and return them to the Command Module, which was in lunar orbit. A third crewman remained in orbit aboard the mother ship, and assisted in any way he could. The L.M. had a descent engine which moved it away from Apollo, and slowed it enough so that lunar gravity could take over. Rocket brakes were used from 50,000 feet down through 10,000 feet. From 200 feet above the moon, the astronauts took full charge and maneuvered the L.M. to a good landing spot. The astronauts climbed down the ladder and took television pictures for transmission directly back to earth. The first time out on the lunar surface, with gravity only one-sixth of earth's gravity, the men ventured only about a thousand feet from the L.M. They worked about 3 hours taking geological specimens and then went back inside to eat and rest. After more than 18 1/2 hours on the moon, the L.M.'s ascent engine took the astronauts back to the Apollo with 3,500 pounds of thrust.

## THE MOON

Many stories and superstitions about the moon's powers have been passed from one generation to the other since the beginning of mankind. However, it wasn't until July 20, 1969 that man saw with his own eyes that the moon was not made of cheese! It was on July 16, 1969 that three astronauts, Aldrin, Armstrong and Collins, launched the Apollo 11 flight and successfully made a lunar landing and take off of the lunar module. We can measure the Earth-Moon distance by laser beam from reflectors they placed on the moon.

The moon is approximately 250,000 miles or 400,000 kilometers from Earth. The moon is actually made of rocks of which samples have been taken and returned to Earth to be analyzed. The moon appears to be as old as Earth and its rocks are older than any rocks found so far on earth. The lunar surface is covered with dust or a layer of fine broken-up powder and rubble about 1 to 20 meters deep. This is called lunar soil and contains no water or plant life. The gravity on the moon's surface is only about one-sixth as strong as gravity on earth, so you would weigh only about one-sixth as much on the moon as you do on Earth. There is no oxygen, rain cloud cover, snow or wind. Temperatures range from 212° F. in the daytime to as low as -240° F. at night. Our calendar, which is divided into 12 months, was originally designed by the Egyptians, who counted the number of full moons from one flooding time on the Nile River to the next. Then the number of days were marked between the full moons. To date twelve men have walked on the Moon's surface.

## SUMMARY OF APOLLO/SATURN FLIGHTS

MISSION	LAUNCH	VEHICLE	PAYLOAD	DESCRIPTION
AS-201	2/26/66	SA-201	CSM-009	Launch vehicle and CSM development. Test CSM subsystems and vehicle. Demonstrate reentry adequacy of CM at earth orbital conditions.
AS-203	7/5/66	SA-203	LH2 in SIVB	Vehicle development. Demonstration of control of LH2 by continuous venting in orbit.
AS-202	8/25/66	SA-202	CSM-011	Vehicle and CSM development. Test CSM subsystems, structural integrity and compatibility of space vehicle. Demonstration of propulsion and entry control of G&N system at 8689 meters per second.
Apollo 4	11/9/67	SA-501	CSM-017 LTA-10R	Vehicle and spacecraft development. Demonstration Saturn V vehicle performance and CM entry at lunar return velocity.
Apollo 5	1/22/68	SA-204	LM-1 SLA-7	LM development. Verified operation of LM subsystems, ascent and descent propulsion systems and structures. Evaluate LM staging. Evaluate SIVB-IU orbital performance.
Apollo 6	4/4/68	SA-502	CM-020 SM-014 LTA-2R SLA-9	Vehicle and spacecraft development. Demonstrate Saturn V vehicle performance.
Apollo 7	10/11/68	SA-205	CM-101 SM-101 SLA-5	Manned CSM operations. Duration 10 days, 20 hours.
Apollo 8	12/21/68	SA-503	CM-103 SM-103 LTA-B SLA-11	Lunar orbital mission. Ten lunar orbits. Mission duration 6 days, 3 hours. Manned CSM operations.
Apollo 9	3/3/69	SA-504	CM-104 SM-104 LM-3 SLA-12	Earth orbital mission. Manned CSM/LM operations. Duration 10 days, 1 hour.
Apollo 10	5/18/69	SA-505	CM-106 SM-106 LM-4 SLA-13	Lunar orbital mission. Manned CSM/LM operations. Evaluate LM performance in cislunar and lunar environment following lunar landing profile. Duration 8 days.
Apollo 11	7/16/69	SA-506	CM-107 SM-107 LM-5 SLA-14 EASEP	First manned lunar landing. Lunar surface stay time 21.6 hours. One EVA, 5 man-hours. Duration 8 days, 3.3 hours.
Apollo 12	11/14/69	SA-507	CM-108 SM-108 LM-6 SLA-15 ALSEP	Second manned lunar mission demonstrate point landing capability. Deploy ALSEP 1. Surface stay time 31.5 hours. Two EVAs, 15.5 man-hours. Duration 10 days, 4.6 hours.
Apollo 13	4/11/70	SA-508	CM-109 SM-109 LM-7 SLA-16 ALSEP	Planned third lunar landing. Aborted at 56 hours due to loss of SM cryogenic oxygen and consequent loss of capability to generate electric power and water. Duration 5 days, 22.9 hours.
Apollo 14	1/31/71	SA-509	CM-110 SM-110 LM-8 SLA-17 ALSEP	Third manned lunar landing. Selenological inspection, survey and sampling Fra Mauro formation. Deploy ALSEP. Stay time 33.5 hours. Two EVAs, 18.8 man-hours. Duration 9 days.
Apollo 15	7/26/71	SA-510	CM-112 SM-112 LM-10 SLA-19 LRV-1 ALSEP	Fourth manned lunar landing. Selenological inspection, survey and sampling the Hadley-Apennine Formation. Deploy ALSEP. Three EVAs, 37.1 man-hours. First lunar roving vehicle and direct TV and voice communications with Earth during EVAs. Distance traversed on surface 27.9 km. Duration 12 days, 7.2 hours.
Apollo 16	4/16/72	SA-511	CM-113 SM-113 LM-11 SLA-20 ALSEP LRV 2	Fifth manned lunar mission. Selenological inspection, survey and sampling Descartes Formation. Deploy ALSEP. Second lunar roving vehicle and direct TV and voice communications with Earth during EVA. Stay time 71.2 hours. Distance traversed 26.7 km. Three EVAs, 40.5 man-hours. Far UV camera/spectroscope. Duration 11 days, 1.8 hours.
Apollo 17	12/7/72	SA-512	CM-114 SM-114 LM-12 LRV 3 SLA-21	Sixth manned lunar mission. Selenological inspection, survey and sampling Taurus Littrow area. Deploy ALSEP. Third lunar roving vehicle and direct TV and voice communications with Earth during EVAs. Three EVAs, 66 man-hours. Stay time 75 hours, distance traversed 35 km.

## MOON SURVIVAL

Instructions: You are a member of a space crew originally scheduled to rendezvous with a mother ship on the lighted surface of the moon. Due to mechanical difficulties, however, your ship was forced to land at a spot some 200 miles from the rendezvous point. During re-entry and landing, much of the equipment aboard was damaged and, since survival depends on reaching the mother ship, the most critical items available must be chosen for the 200 mile trip. Below are listed the 15 items left intact and undamaged after landing. Your task is to rank order them in terms of their importance for your crew in allowing them to reach the rendezvous point. Place the number 1 by the most important item, the number 2 by the second most important, and so on through number 15, the least important.

- \_\_\_ Box of matches
- \_\_\_ Food concentrate
- \_\_\_ 50 feet of nylon rope
- \_\_\_ Parachute silk
- \_\_\_ Portable heating unit
- \_\_\_ Two .45 calibre pistols
- \_\_\_ One case dehydrated Pet milk
- \_\_\_ Two 100-pound tanks of oxygen
- \_\_\_ Stellar map (of the moon's surface)
- \_\_\_ Life raft
- \_\_\_ Magnetic compass
- \_\_\_ 5 gallons of water
- \_\_\_ Signal flares
- \_\_\_ First aid kit containing injection needle
- \_\_\_ Solar-powered FM receiver-transmitter

## NASA'S RANKING

- 15 No oxygen to sustain the flame
- 4 Good food source, efficient
- 6 Useful in scaling cliffs, tying together the injured
- 8 Will provide protection from sun's rays
- 13 Useless on dark side, not needed on lighted side
- 11 Possible means of propulsion
- 12 Bulky duplication of food concentrate
- 1 Most pressing need
- 3 Primary means of navigation
- 9 CO2 bottle in raft may be used for propulsion
- 14 Magnetic field on moon is not polarized, worthless
- 2 Replacement for high water loss on light side
- 10 Distress signal when mother ship sighted
- 7 For injecting vitamins--special aperture in suit
- 5 Talk to mother ship, FM needs short range and line of sight





# SOLAR SYSTEM

**NAME:** SOLAR SYSTEM

**SKILL:** SCIENCE

**PROCEDURE:**

1. Read about the planets in the background information, a textbook or encyclopedia.
2. Write real or imaginary stories about the various planets.
3. Visit the library and find out more about the planets. Research how many satellites have been sent into space and which countries have sent up satellites.
4. Make a paper mache, mobile, or model of the sun and planets. Design your own satellite and explain its function.
5. Learn the mythological names of the planets and their moons.
6. Discuss Newton's First Law of Motion, explaining how it keeps a satellite in orbit.
7. Calculate how much you weigh on the various planets.

**BACKGROUND INFORMATION:**

The Space Shuttle and NASA satellites are exploring our solar system. The sun is the center of our solar system and the planets revolve around the sun. Space probes (satellites) have visited other planets. Pictures of the planets can be obtained from NASA (See Resources.)

**Mercury**--closest to the sun; yellow in color; life as we know it isn't possible because there is no air or water and it's too hot or too cold depending on which direction it is facing.

**Venus**--closest to the size of the earth; life isn't possible as we know it; we call it our morning or evening star.

**Earth**--only planet that has life on it; one moon; length of each day is twenty-four hours.

**Mars**--two Viking spacecraft landed on Mars in July and September 1976, found rolling dunes of orange dust and volcanic rocks; water may have been on Mars about a billion years ago or may be underground; took many exciting photographs and performed many experiments.

**Jupiter**--Pioneers 10 and 11 spacecraft visited Jupiter March, 1972 and April, 1973; discovered rings; largest planet with 16 moons. Pioneer 11 went on to Saturn.

**Saturn**--Voyager spacecraft verified 18-21 moons and over 1000 rings on a recent visit to Saturn.

**Uranus**--The Uranus Encounter, by Voyager II, discovered ten additional satellites, bringing the total number of satellites (moons) to fifteen, verified ten rings around Uranus; green in color.

**Neptune**--Voyager II spacecraft visited Neptune last; has two moons that go in opposite directions.

**Pluto**--Orbit is inside Neptune until 1999; one moon, named Charon.

# SOLAR SYSTEM

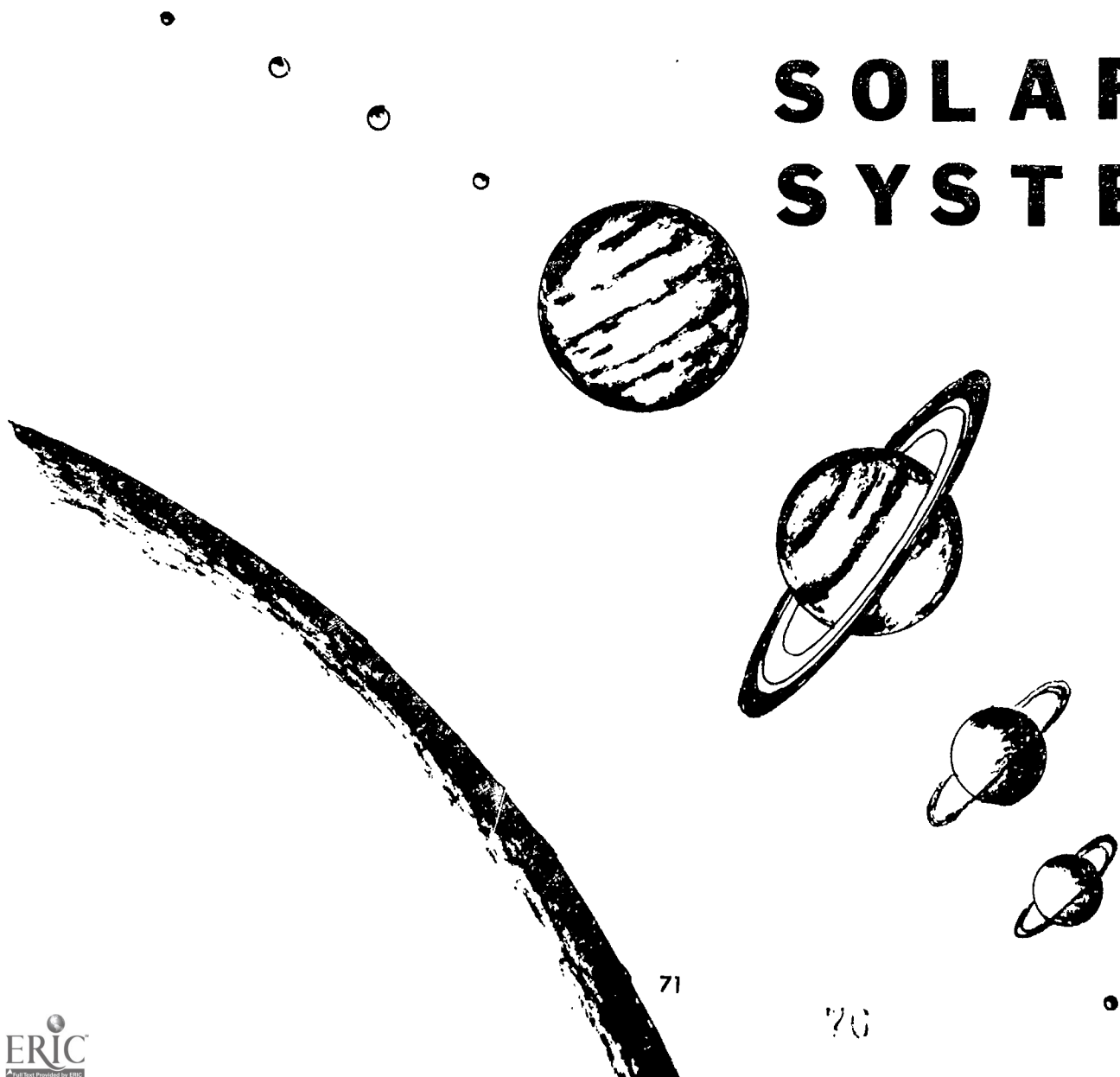

71

70

## PLANET I.Q.

1. Which planet is the largest?
2. Which planet has the most moons?
3. Which planet has rings around it?
4. How many days would it take Jupiter to go around the sun?
5. Which is the brightest planet in the sky?
6. Which planet has a reddish appearance?
7. Which planet is 93 million miles from the sun?
8. Which planet could have a temperature of around 700° Fahrenheit on one side?
9. Can you list the planets in order according to size from the smallest to the largest?

Answers: 1) Jupiter 2) Jupiter 3) Saturn 4) 4380 Earth days 5) Venus 6) Mars 7) Earth 8) Mercury 9) Pluto, Mercury, Mars, Venus, Earth, Neptune, Uranus, Saturn, Jupiter.

## PLANET WEIGHTS

Find out what you would weigh on each of the other planets in the Solar System. Then list the planets in order from least gravity to greatest gravity. Example: Venus' gravity is 0.91 times that of the Earth. If you weighed 100 lbs. on Earth, how much would you weigh on Venus?

Solution  $100 \times .91 = 91$  lbs.

PLANETS	SURFACE GRAVITY	MY WEIGHT	PLANETS FROM LEAST TO GREATEST GRAVITY
Mercury	0.18		
Venus	0.91		
Earth	1.00		
Mars	0.38		
*Jupiter	2.54		
*Saturn	1.07		
*Uranus	0.87		
*Neptune	1.14		
Pluto	0.07		

\*at cloud tops of gas planets\*

## SOLAR SYSTEM NAMES FROM MYTHOLOGY

(Each moon is listed in order, from closest to furthest from its planet)

Sun - (to shine)

Mercury - Roman messenger of the gods, son of Jupiter

Venus - Roman goddess of love and beauty, daughter of Jupiter

Earth - Greek goddess Gaia, (1 moon)

Moon (capitalize)- month

Mars - Roman god of war, son of Jupiter and Juno, (2 moons)

Phobos - fear, son of Mars

Deimos - terror, son of Mars

Asteroids (3,000 named)

Jupiter - Roman ruler of gods, son of Saturn, grandson of Uranus (16 moons, 1 ring) \*  
= Galilean satellite. Most moon names associated with Jupiter.

Adrasteia - a nymph who took care of the infant Jupiter

Melisse - first wife of Jupiter, mother of Minerva

Amaltheia - a goat which nursed the infant Jupiter

Thebe - daughter of Jupiter

\*Io - maiden who loved Jupiter, was turned into a white heifer \*Europa - mistress of Jupiter

\*Ganymede - handsome youth, cup-bearer to Jupiter

\*Callisto - nymph turned into a She-bear

Leda - queen of Sparta, mother of Helen of Troy

Himalia - a nymph of Rhodes, loved by Jupiter

Lysithea - mother of the first Dionysus, daughter of Persephone and Jupiter

Elara - nymph, mother of Typhoeus, Jupiter the father

Ananke - nurse who tended Jupiter as a baby

Carne - with Jupiter, parents of Crete martyr Britomartis Pasiphae - daughter of Jupiter

Sinope - lifetime virtue granted by Jupiter

Saturn - Roman god of the harvest, second ruler of the Universe son of Uranus, father of Jupiter, (18 moons, over 1,000 rings) Most moon names are Titans, siblings of Saturn.

1981 S13 - unnamed

Atlas - son of Iapetus and Clymene, bears heaven and Earth on his shoulders

Prometheus - son of Iapetus

Pandora - a woman made of earth by Vulcan, gift to Epimetheus, had box of human ills

Janus - god of beginnings and doors (January), gave solace to Saturn when overthrown

Epimetheus - son of Iapetus Mimas - one of the giants killed by Mars

Enceladus - child of Uranus and Ge, brother of Saturn

Tethys - goddess of the sea

Telesto - nymph of the cool springs, child of Jupiter and Thetis Calypso - nymph who kept Ulysses prisoner

Dione - mother of Aphrodite, father: Jupiter

Helene - Helen of Troy, daughter of Jupiter and Leda

Rhea - wife of Saturn, her brother

Titan - the first born children of Uranus and Ge, brothers and sisters of Saturn were all Titans

Hyperion - son of Uranus and Ge, A sun god

Iapetus - son of Uranus and Ge, brother of Saturn

Phoebe - goddess of light, sister of Saturn

Uranus - Greek, first ruler of the heavens, father of Saturn, grandfather of Jupiter, (15 moons, 11 rings) Moon names all associated with characters in Shakespearean plays except where noted.

Cordelia - daughter of "King Lear"

Ophelia - daughter of Polonius in "Hamlet"

Blanca - sister of Kate in "Taming of the Shrew"

Cressida - "Troilus and Cressida"

Desdemona - wife of "Othello"

Juliet - "Romeo and Juliet"

Portia - wife of Brutus in "Julius Caesar"

Rosalind - daughter of Prospero in "The Tempest"

Belinda - heroine of Alexander Pope's "Rape of the Lock"

Puck - "A Midsummer's Night Dream"

Miranda - daughter of Prospero in "The Tempest"

Ariel - chief of the sylphs in A. Pope's "Rape of the Lock"

Umbriel - a dusk melancholy sprite in A. Pope's "Rape of the Lock"

Titania - queen of the fairies in "A Midsummer's Night Dream"

Oberon - king of the fairies in "A Midsummer's Night Dream"

Pluto - Roman god of the underworld, brother of Jupiter, (1 moon)

Charon - (pron. Karon) ferryboatman over the river Styx

Neptune - Roman god of the sea, brother of Jupiter, (8 moons; 6 of these have provisional names + , most associated with the sea). 4 rings

- + Naiad - a sea nymph, daughter of Jupiter, goddess of marriage and sacred rites.
  - + Thalassa - god of marriage rights
  - + Despoina - a sea nymph, daughter of Demeter and Poseidon when they were transformed as horses
  - + Galatea - one of the Nereides, a goddess of the sea
  - + Larissa - a goddess, mated with Poseidon to produce Achaëus, Pelasgus 11, and Phthius
  - + Proleus - god of the deep sea, son of Oceanus and Tethys, could transform into many creatures.
- Triton - son of Amphitrite and Neptune  
 Nereid - one of a group of sea nymphs

(Revised 10-25-90, Information verified by the Lunar and Planetary Institute, Houston, TX and The National Geographic Society, Washington, D.C.)

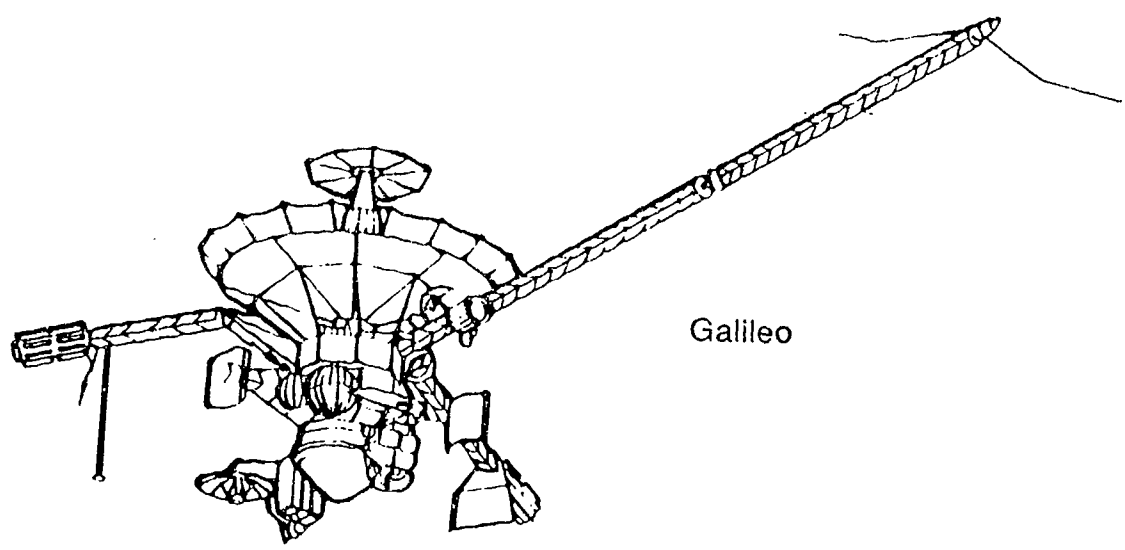

Galileo

Hubble Space Telescope

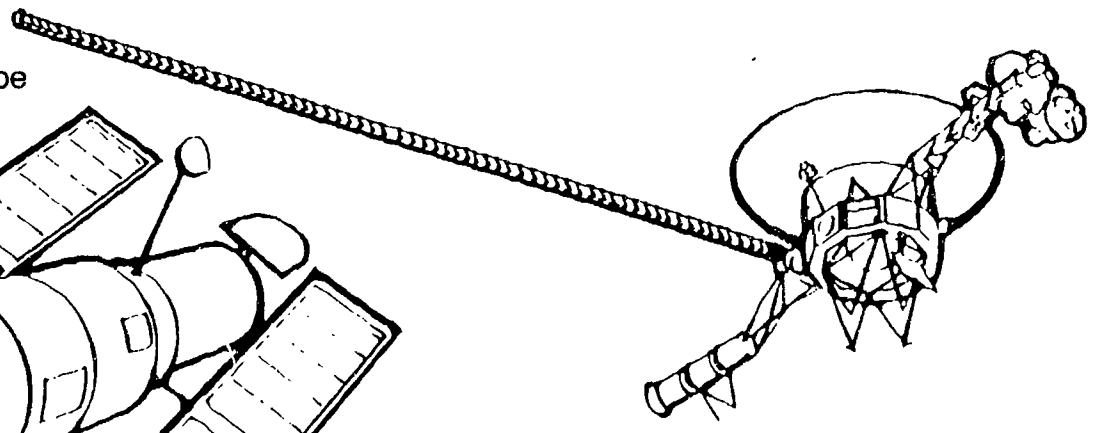
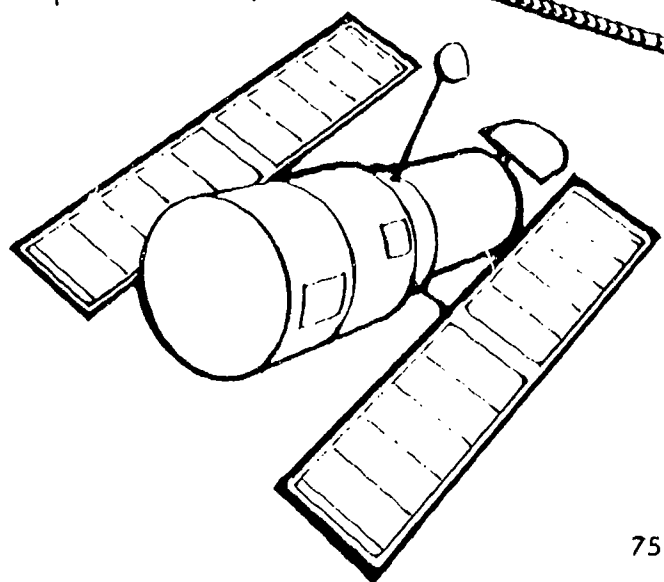

Voyager

## Space Science

### Galileo

The Galileo spacecraft was launched towards Jupiter by the Space Shuttle. It will take nearly six years for Galileo to make the long trip to the largest planet in our solar system. Once it arrives at Jupiter in 1995, Galileo will send a probe into the giant planet's atmosphere to measure the winds and clouds. The probe will last 75 minutes before it is crushed by the tremendous pressure of Jupiter's atmosphere. Although the probe will be gone, the Galileo spacecraft will remain and go into permanent orbit around Jupiter. From its orbit, Galileo will give us continuous views of Jupiter and its Great Red Spot, a tornado which is larger than three Earths and which has been raging for over 300 years. It will also make close fly-bys of the major moons of Jupiter.

### Voyager

Two spacecraft, Voyager 1 and Voyager 2, were launched in 1977 to examine the outer giant gas planets. The spacecraft explored Jupiter's Great Red Spot, Saturn's elegant rings, Uranus' sideways rotation, and Neptune's crazy, backward orbiting moon, Triton. The Voyagers provided us with the most detailed views to date of the outer planets, and helped us to discover many new things. Because these planets are very different from Earth, the photographs taken by these spacecraft have helped us understand the solar system and the differences between the inner and outer planets.

### The Hubble Space Telescope

The Hubble Space Telescope (HST) was launched into space aboard the Shuttle in 1990. HST was designed to help us study the heavens. Above Earth's hazy atmosphere, this space telescope can see planets and stars more clearly. Scientists will be able to see seven times farther into space than ever before. The Hubble Space Telescope instruments relay what they see to people on the ground. Wing-like solar panels turn the Sun's rays into electrical power to run the telescope.



## SATELLITES

One of the most important achievements of NASA's space program is the development and utilization of satellites. What is a satellite and what keeps it going? Newton's First Law of Motion deals with inertia. It states that an object at rest tends to remain at rest. (Also, something that is moving tends to keep moving.) His Second Law deals with acceleration and momentum, and his Third Law states that for every action in one direction there is an equal reaction in the opposite direction.

The First Law explains why a satellite keeps going. Moving things have a tendency to keep moving. This tendency to keep moving is called inertia. Things or forces often get in the way and keep objects from continuing to move once they are started. Friction is one of these counter forces that interferes with inertia. In space there is little to interfere with the movement of the satellite. So the satellite, once it is started, can continue moving. However, if it begins to hit scattered particles of air, meteors, or dust, its orbit will change. It may drop closer to the atmosphere and finally encounter friction from the atmosphere. Then it can be pulled toward the earth where it burns in its downward plunge.

A satellite can reach every point on the earth every 18 days. If two are launched, coverage will occur every nine days. Computers in the satellites can show 30 different shades of infra-red, detect invisible pollution, illegal dumps, opium and marijuana and many, many other things. The retrieval system of the satellites is very interesting. Everything is taped and a number is assigned to frequencies of sound. Two million numbers can be transmitted every second. Persons with perfect pitch monitor the sounds.

Landsat is one of the most important satellites sent into Earth orbit. Landsat goes around the Earth 14 times every 24 hours. One of the remarkable things Landsat has done is to make a coast-to-coast color "picture" of the United States.

This satellite has provided the people of earth with surveys of global conditions and resources. Geologists have studied the Landsat data and discovered how to drill successful water wells near Flagstaff, Arizona. Alaska has been aided by learning about the Cook Inlet and how to best navigate it. Delaware has learned how to best use equipment to contain oil spills. California has used the satellite information to select recreational areas. Forest fire damage was assessed by Landsat in Yolo County, Colorado. Japan used data to monitor pollution on Osaka Bay. The U.S. and other countries received information about faults and fracture zones that helped in selecting locations for nuclear electric power plants and oil and gas pipelines. Inventories of fields of different crops has helped investigators determine crop yield.

## ACTIVITIES

1. Can you find out about other satellites that have been sent into space?
2. How many satellites have been sent into space?
3. What countries have sent up satellites?
4. Draw a picture of a satellite.
5. In order to understand what keeps satellites going, an understanding of gravity, centrifugal force, and inertia are basic elements to experiment with and learn. What is centrifugal force?
6. Demonstrate centrifugal force: Take an old tennis ball, a disk from a Tinker Toy set and a length of twine. Make a small slit in the tennis ball. Tie an oversized knot at the end of the string. Push the knot into the ball. Now you have the ball at the end of the length of string. Slip the other end of the string through the hole in a Tinker Toy disk and hold it in one hand. Now with your other hand, whirl the ball by a stick or dowl pushed into the side of the Tinker Toy. Allow the string to slip through the hole as the ball whirls faster and faster. What happens to the size of the circle or orbit?

As the earth rotates there is another force which works just as the ball did when you whirled it about you. This force tends to throw all objects outward. Scientists call this centrifugal force.

Gravity and centrifugal force are at work when a satellite is in orbit. It works this way. The satellite must be placed in orbit at a speed which is slightly greater than the downward pull of gravity. There must be a balance maintained between the two opposite pulls--the gravity of the earth and the centrifugal force outward--in order to keep the satellite in orbit.

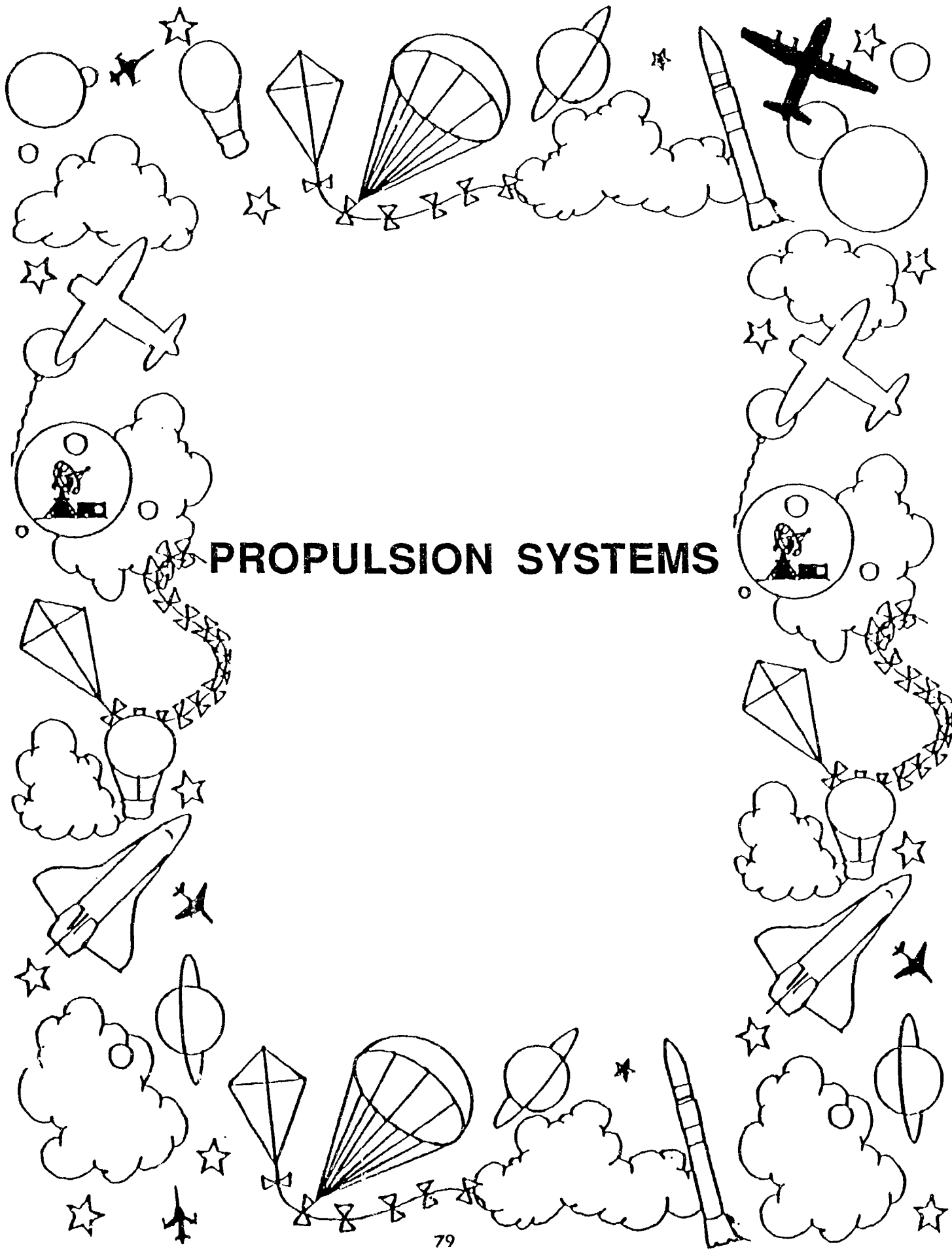

**PROPULSION SYSTEMS**

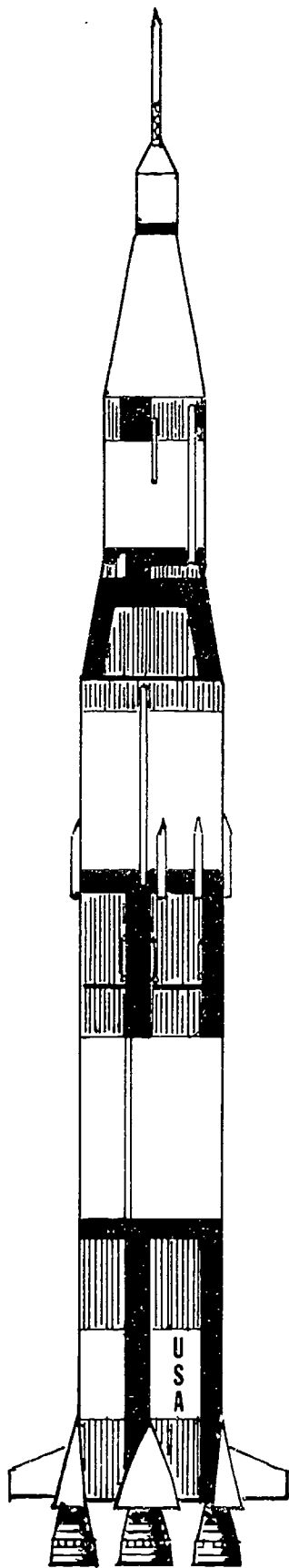

ROCKETRY

**NAME: ROCKETS**

**SKILL: SCIENCE, MATHEMATICS**

**PROCEDURE:**

1. Read the background material on rockets. Write a short one-page report on the history of rockets, including 20th century accomplishments.
2. Research the scientist, Isaac Newton, and write a short summary of what Newton's first two laws of motion demonstrated.
3. Research the library to find out about Robert Goddard, the Father of American Rocketry.
4. Prepare a table on rockets used in the manned space flight program of the United States. Column headings should include: Rocket, Stages, Height, Diameter, Fuel, Thrust, Importance. Refer to the Mercury, Gemini, and Apollo charts for information.

**BACKGROUND:**

After the launch of Sputnik, NASA was established to manage our new space program. Liquid fueled rockets launched satellites into orbit around the earth. The Mercury Program (1961-63) with six manned missions and the Gemini Program (1965-66) with ten manned missions preceded the Apollo Program (1968-72) with 11 missions. During the Apollo program a giant rocket called Saturn V took men to the moon. The Shuttle program uses solid fueled rockets to assist the liquid fueled engines that take the Shuttle into orbit. The solid fueled rockets fall into the ocean and are recovered. The liquid fueled engines return to earth with the Shuttle orbiter.

A rocket is a device shaped like a cylinder that moves at high speed, powered by gases that are forced out of one end. Rockets are considered the oldest form of self-contained propulsion in existence. They were used by the Chinese in warfare in the 1200s against the invading Mongols. Rockets were also used in the War of 1812. They were launched through holes in the sides of ships by the Americans toward the British enemy.

Rockets are driven forward by high-speed gases that blast out the back from narrow tubes. The back blast "kicks" the rocket forward. The rocket carries its own oxygen with it and can go where there is no air. If it is a liquid-fuel rocket, it has a tank of liquid oxygen, called lox, along with it. If it is a rocket burning solid fuel, then a solid chemical containing oxygen is mixed with the fuel. In both cases, no oxygen is needed from the outside air. Therefore, the rocket can go into space.

The rocket is based on the principle called Newton's Third Law of Motion. It states that for every action there is an equal and opposite reaction. You can make a very simple rocket out of a balloon. By filling the balloon completely with air and then letting go, the air is pushed out of the mouth of the balloon and the balloon then "launches" in the opposite direction. Thus, the balloon is a compressed air rocket. This compressed air is a kind of fuel that moves the rocket - a type of propellant. Most rockets use a solid propellant, commonly referred to as the "grain," which is a chemical mixture or compound containing a fuel and oxidizer that burn to produce very hot gases at high pressure. They burn without the introduction of outside oxygen. Solid propellants fall into three basic classes: mono-propellants, double base, and composites.

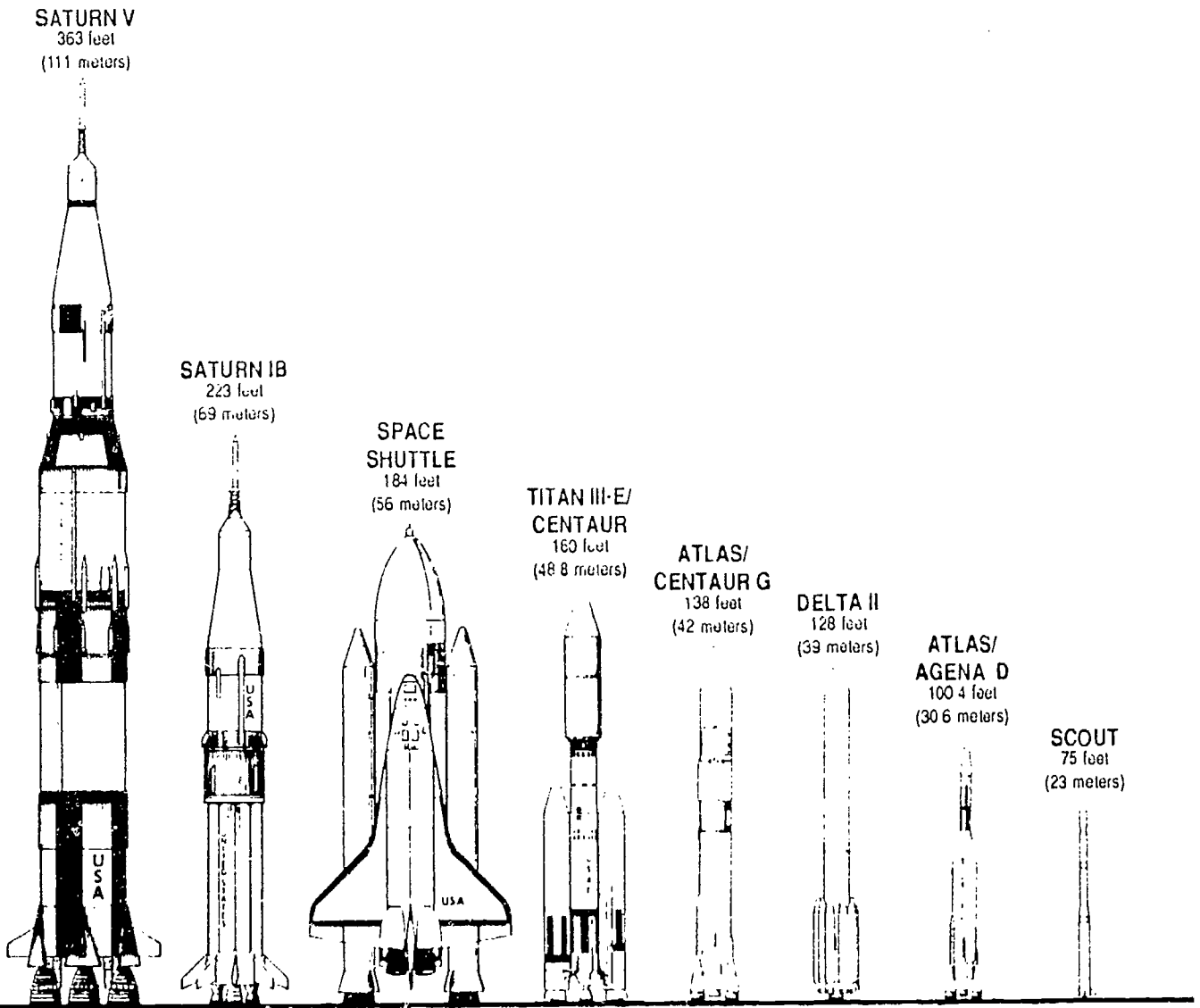

## Mercury, Gemini, and Apollo

The Mercury spacecraft carried the first Americans into space in 1961, 1962, and 1963. Six Mercury astronauts flew into space aboard these cramped, one-person capsules for missions ranging from 15 minutes to 34 hours at a time.

The Gemini spacecraft, an enlarged version of Mercury, carried two persons into Earth orbit. In Gemini, astronauts practiced many of the things that would be necessary for future Apollo missions to the Moon. During ten manned Gemini missions, Americans walked in space for the first time, docked their capsules with other vehicles, and spent up to two weeks in orbit.

The 12-by-12-foot cone-shaped Apollo Command Module was designed to house three American astronauts at a time on their trips to and from the Moon. A four-legged companion spacecraft, called the Lunar Module, was used to actually land two astronauts on the lunar surface and return them back to their mother ship. The third astronaut stayed behind in orbit around the Moon. The first manned lunar landing took place on July 20, 1969.

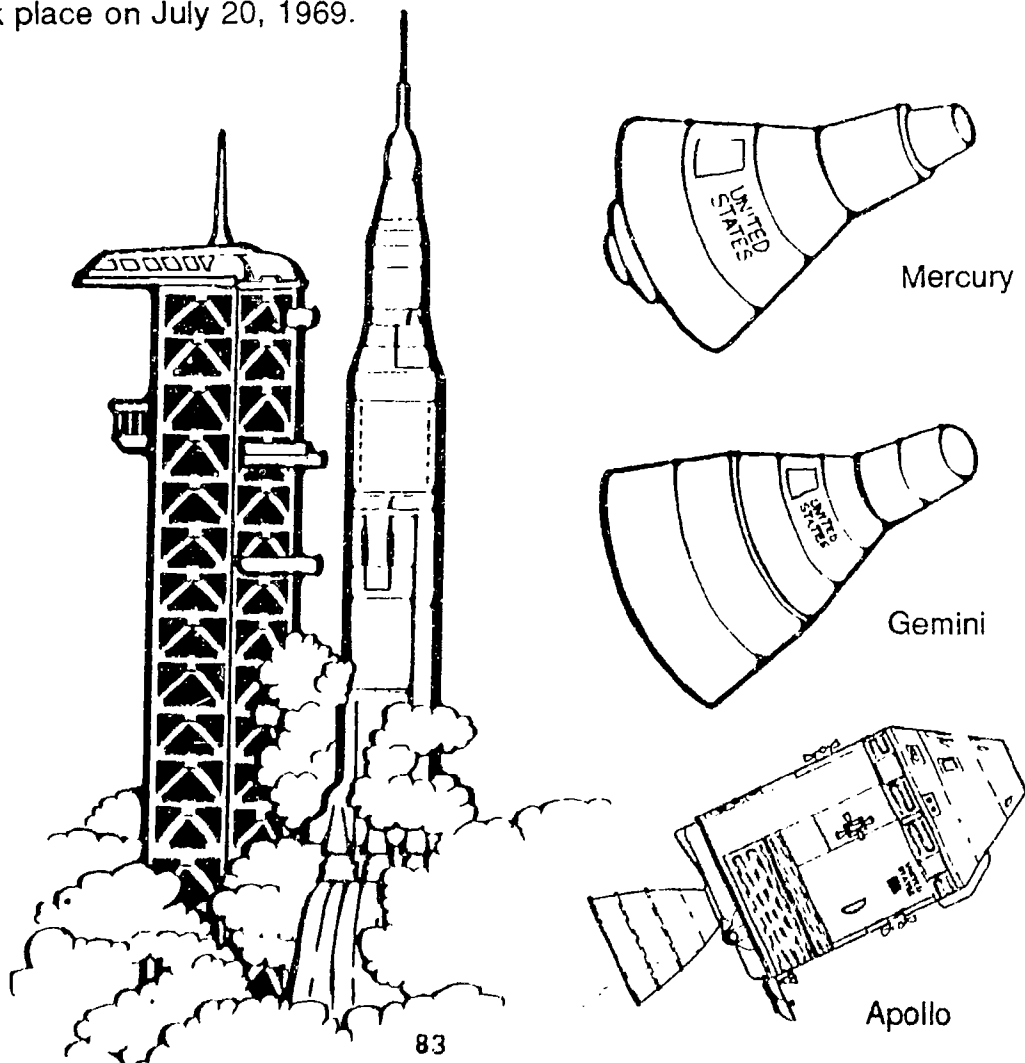

## The Mercury Program

DATE	SPACECRAFT	ASTRONAUTS	#ORBITS
May 5, 1961	Freedom 7	Alan B. Shepard, Jr.	00
Jul. 21, 1961	Liberty Bell 7	Virgil (Gus) Grissom	00
Feb. 20, 1962	Friendship 7	John Glenn, Jr.	03
May 24, 1962	Aurora 7	M. Scott Carpenter	03
Oct. 3, 1962	Sigma 7	Walter (Wally) Schirra, Jr	06
May 15, 1963	Faith 7	L. Gordon (Gordo) Cooper	22

## The Gemini Program

DATE	SPACECRAFT	ASTRONAUTS	#ORBITS
03/23/65	Gemini II	Virgil (Gus) Grissom John M. Young	3
06/03/65	Gemini IV	James McDivitt Edward White	62
08/21/65	Gemini V	L. Gordon (Gordo) Cooper Charles (Pete) Conrad	120
12/04/65	Gemini VII	Frank Borman James Lovell	206
12/15/65	Gemini VI-A	Walter (Wally) Schirra Thomas Stafford	17
03/16/66	Gemini VIII	Neil Armstrong David Scott	65
06/03/66	Gemini IX-A	Thomas Stafford Eugene Cernan	47
07/18/66	Gemini X	John Young Michael Collins	46
09/12/66	Gemini XI	Charles (Pete) Conrad Richard Gordon	47
11/11/66	Gemini XII	James Lovell Edwin (Buzz) Aldrin	63



## The Apollo Lunar Program

**Launch Vehicles: Apollo 7: Saturn I-V  
Apollo 8-17: Saturn V**

LAUNCH/LANDING DATES	MISSION	ASTRONAUTS
10/11-22/68	Apollo 7	Walter (Wally) Schirra, Jr Walter Cunningham Donald Eisele
12/21-27/68	Apollo 8	Frank Borman James Lovell, Jr. William Anders
3/3-13/69	Apollo 9	James McDivitt Russell Schweickart David Scott
5/18-26/69	Apollo 10	Thomas Stafford Eugene Cernan John Young
7/16-24/69	Apollo 11	Neil Armstrong, Jr. Edwin (Buzz) Aldrin, Jr. Michael Collins
11/14-24/69	Apollo 12	Charles (Pete) Conrad Alan Bean Richard Gordon, Jr
4/11-17/70	Apollo 13	James Lovell, Jr. John Swigert, Jr. Fred Haise, Jr.
1/31-2/9/71	Apollo 14	Alan Shepard, Jr. Edgar Mitchell Stuart Roosa
7/26-8/7/71	Apollo 15	David Scott James Irwin Alfred Worden, Jr.
4/16-27/72	Apollo 16	John Young Charles Duke, Jr Thomas Mattingly II
12/7-19/72	Apollo 17	Eugene Cernan Harrison (Jack) Schmitt Ronald Evans

## The Skylab Program

DATES	MISSION	ASTRONAUTS	TOTAL LENGTH
05/25/73- 06/22/73	SL-2	Charles (Pete) Conrad, Jr Joseph Kerwin Paul Weitz	28 days 49 min
07/28/73- 09/25/73	SL-3	Alan Bean Owen Garriot Jack Lousma	59 days 11 hrs 9 min
11/16/73- 02/08/74	SL-4	Gerald Carr Edward Gibson William Pogue	84 days 1 hr 16 min

## Apollo-Soyuz Test Project

### Launch Date

Soyuz: 7/14/75

Apollo: 7/15/75

### Crew

Alexi Leonov  
Valerie Kubasov

Thomas Stafford  
Donald (Deke) Slayton  
Vance Brand

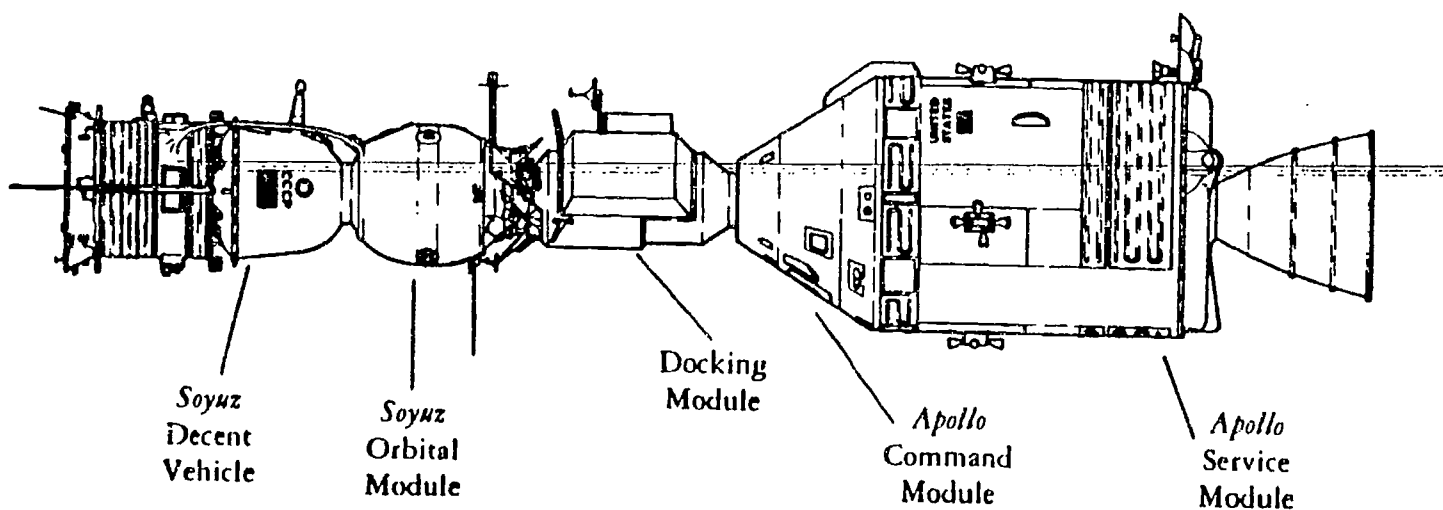

*Apollo-Soyuz*

# SPACE SHUTTLE

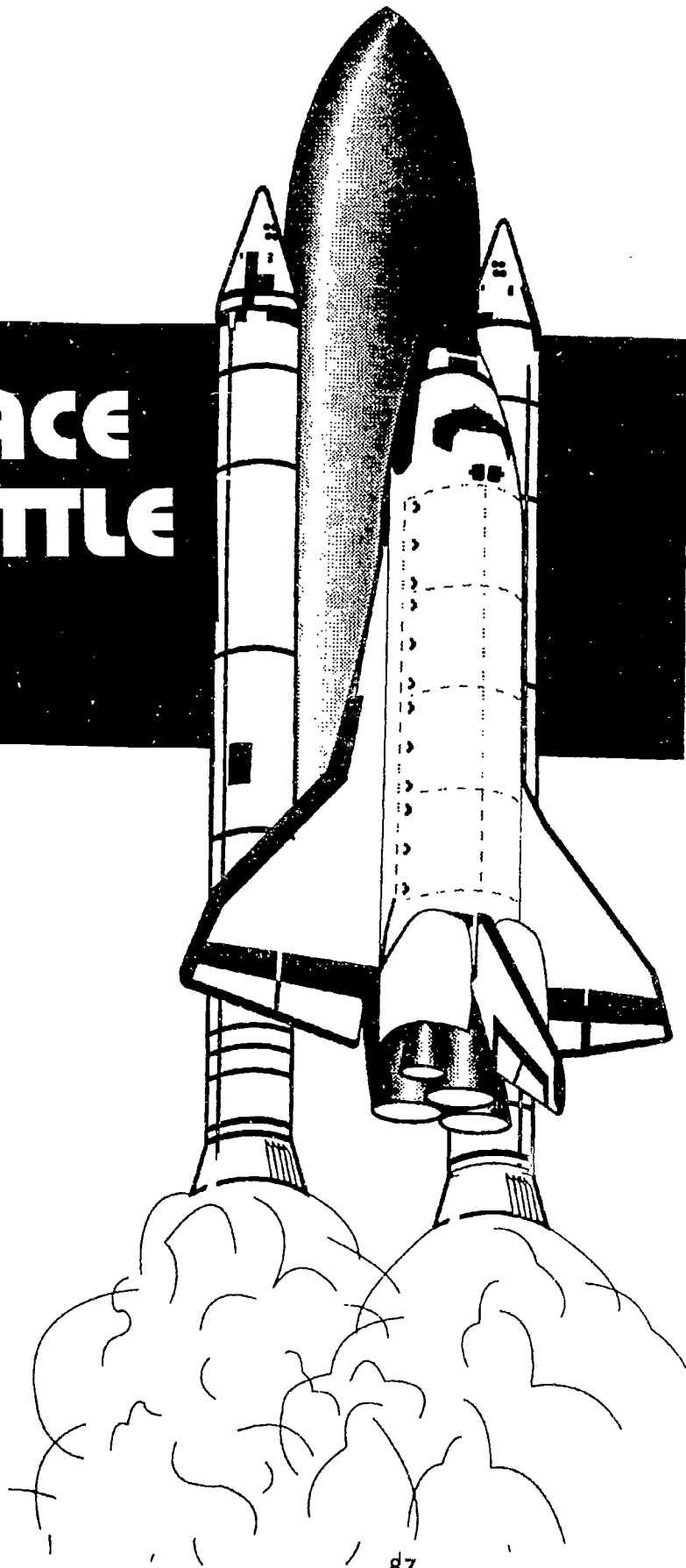

87

92

## SPACE SHUTTLE - A SPACE TRANSPORTATION SYSTEM

The Space Shuttle is a three-part vehicle which has an Orbiter, a liquid propellant external fuel tank, and two solid fuel rocket boosters. The Orbiter, which resembles an airliner, carries the crew and payload to and from orbit. The rest of the system is required to launch the Orbiter into space. The Space Shuttle differs from earlier space vehicles in that the Orbiter and the solid fuel rocket boosters are reusable. Only the external fuel tank is expended on each launch. The assembled Space Shuttle weighs about 4,500,000 pounds at liftoff.

The Space Shuttle fleet is made up of four Orbiters. Selected from sea vessels used in world exploration, the names of the current orbiting Space Shuttle craft are Columbia, Discovery, Atlantis and Endeavour. The Orbiter is a winged spacecraft 122 feet long; 57 feet high, 78-foot wingspan, and has an empty weight of 168,000 to 175,000 pounds. It is about the size and general shape of a DC-9 commercial airliner.

The crew is carried in a two-level cabin in the front section of the Orbiter. The upper level, or flight deck, provides seating for the crew plus all the controls and displays to be used by the crew during the flight. The lower level of the cabin contains passenger seats, the dining area, toilet facilities, sleeping quarters, an air lock, and equipment storage compartments.

The middle section of the Orbiter is a large payload bay equipped to carry and handle a variety of payloads. The payload bay is 15 feet wide and 60 feet long and can carry up to 65,000 pounds into orbit and return 32,000 pounds from orbit. It is flexible enough to provide accommodations for unmanned spacecraft in a variety of shapes and sizes and for fully equipped scientific laboratories, such as the spacelab and modules for space stations.

The rear of the Orbiter consists of various liquid fuel rocket engines. Among these are the three main propulsion engines which are used during launch to carry the Orbiter into space. Each main engine can produce 383,900 pounds of thrust at sea level and 470,000 pounds in the vacuum of space. One unique feature of the Space Shuttle is that the propellants for the main propulsion engines are not carried in the Orbiter but in the external fuel tank underneath the Orbiter. The Orbiter also has orbital maneuvering engines which are used to place it into a precise orbit, maneuver it while in orbit, and function as retrorockets to slow the Orbiter down for reentry and return to Earth from orbit. The propellants for the maneuvering engines are carried in the Orbiter. The complete Orbiter is designed to last for at least 100 flights.

For launch there are two large solid fuel rockets attached to the external fuel tank. These two rockets are ignited at launch and continue to burn for about two minutes.

At an altitude of about 30 miles the solid fuel rocket boosters are jettisoned and parachuted into the ocean. They are recovered and reused.

Each solid fuel rocket booster is 12.2 feet in diameter and 149.1 feet high. They each weight 1,300,000 pounds and produce 3,100,000 pounds of thrust at liftoff. The propellant is a mixture of aluminum powder, aluminum perchlorate powder, and Iron oxide catalyst, held together with a polymer binder.

The external fuel tank is 28.6 feet in diameter, 154 feet long, and weighs a total of 1,667,677 pounds at liftoff. It contains 140,000 gallons of liquid oxygen fuel and 380,000 gallons of liquid hydrogen which are burned in the Orbiter's three main propulsion engines.

The main propulsion engines burn for about 8 minutes, consuming the usable propellants in the external fuel tank. The external fuel tank is jettisoned at an altitude of about 70 miles while traveling over 17,500 miles per hour. It will fall into an uninhabited stretch of the ocean and is the only part of the Space Shuttle system which is not recovered for reuse.

The two solid fuel rocket boosters and the three main engines on the Orbiter provide a total liftoff thrust of over 7,000,000 pounds.

The Space Shuttle is launched like a rocket, and in orbit operates like a spacecraft. When returning to Earth and upon entry into the atmosphere, it sails back like a glider and lands at a designated ground location.

The high cargo capability and major component reusability of the Space Shuttle make it a very economical space vehicle.

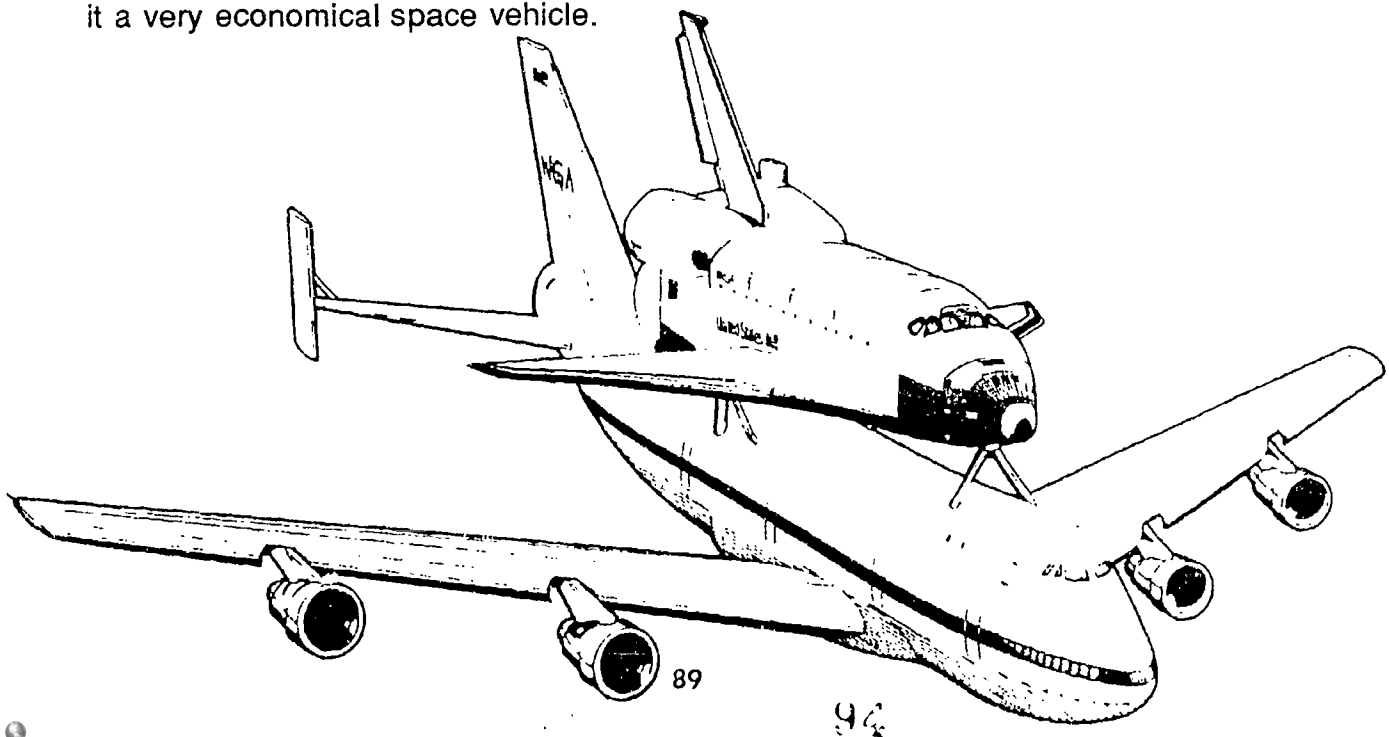

**NAME: SPACE SHUTTLE**

**SKILL: MATH**

**PROCEDURE:**

1. Glue the shuttle pattern onto styrofoam. Follow the directions to assemble the shuttle. Fly the model to see what a smooth landing you can make.
2. Read NASA material about the Mercury, Gemini, Apollo and Skylab space programs which preceded the Space Shuttle.
3. Learn more about the astronauts from the material received from NASA. Refer to Rockets and Astronaut sections.
4. Keep a scrapbook on Shuttle flights occurring during the school year. What were some objectives of the flight? Who were the astronauts?

**BACKGROUND INFORMATION:**

The Space Shuttle is a spacecraft that can be used for many flights into space. It carries people and experiments to Earth orbit. Scientists and engineers ride in the Shuttle and operate experiments in Space. Someday, the Shuttle may carry private citizens to Earth orbit, maybe even you.

The Space Shuttle has four major parts: The Orbiter, the Solid Rocket Boosters (two of them), the External Tank, and the set of three Space Shuttle Main Engines in the rear of the Orbiter. Only the Orbiter and the main engines go into Earth orbit. The other parts are for liftoff and powered flight.

NASA's Marshall Space Flight Center in Huntsville, Alabama, provides the boosters, the External Tank, and the main engines for the Space Shuttle.

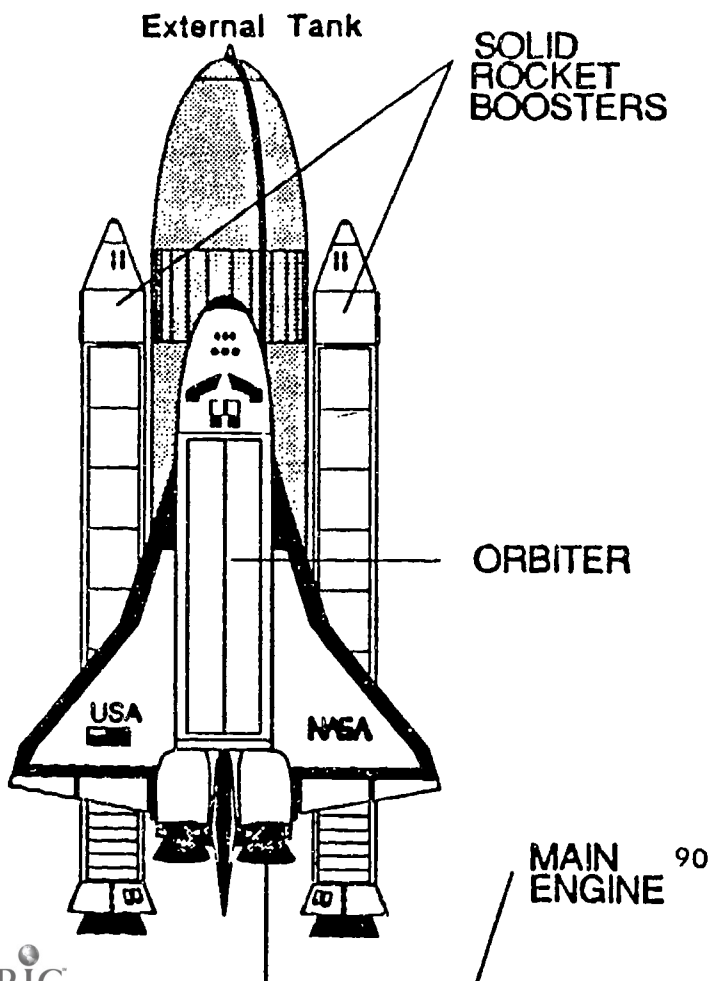

## SPACE SHUTTLE MODEL

Cut out the shuttle pattern and trace on styrofoam meat tray.

Cut out styrofoam shuttle.

Cut the wing slot on the body to hold the front of the wing in place.

Attach paper clip on nose to give weight to insure stability.

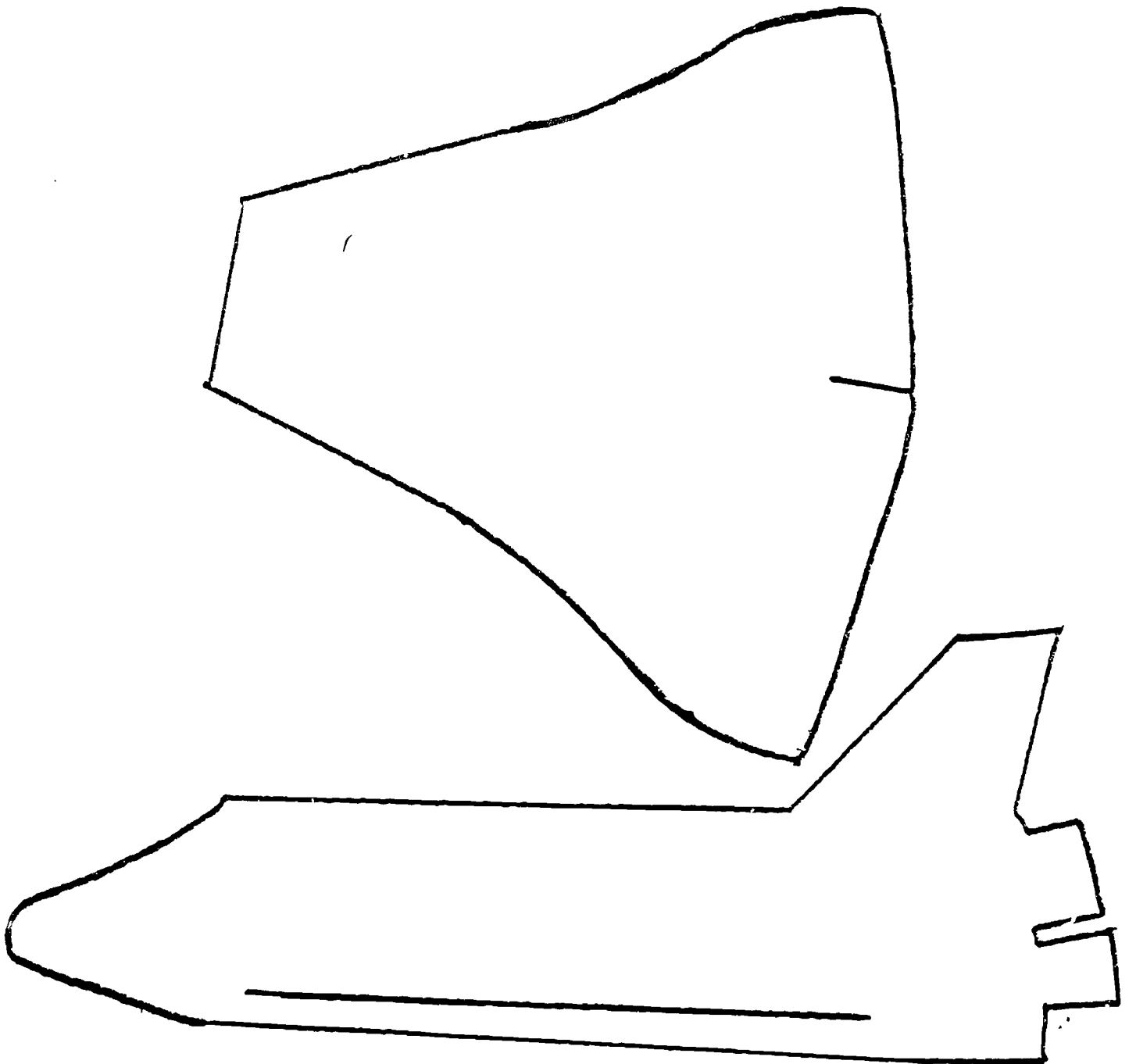

## Space Transportation System

STS-1 (OFT)	Young, Crippen	Apr. 12 to 14, 1981
STS-2 (OFT)	Engle, Truly	Nov. 12 to 14, 1981
STS-3 (OFT)	Lousma, Fullerton	Mar. 22 to 30, 1982
STS-4 (OFT)	Mattingly, Hartsfield	June 27 to July 4, 1982
STS-5	Brand, Overmyer, J. Allen, Lencir	Nov. 11 to 16, 1982
STS-6	Waltz, Bobko, Peterson, Musgrave	Apr. 4 to 9, 1983
STS-7	Crippen, Hauck, Ride, Fabian, Thagard	June 18 to 24, 1983
STS-8	Truly, Brandenstein, D. Gardner, Bluford, W. Thornton	Aug. 30 to Sept. 5, 1983
STS-9	Young, Shaw, Garriott, Parker, Lichtenberg, Merbold	Nov 28 to Dec. 8, 1983
41-B	Brand, R. Gibson, McCandless, McNair, Stewart	Feb. 3 to 11, 1984
41-C	Crippen, Scobee, van Hoften, G. Nelson, Hart	Apr. 6 to 13, 1984
41-D	Hartsfield, Coats, Resnik, Hawley, Mullane, C. Walker	Aug. 30 to Sept. 5, 1984
41-G	Crippen, McBride, Ride, Sullivan, Leestma, Garneau, Scully-Power	Oct. 5 to 13, 1984
51-A	Hauck, D. Walker, D. Gardner, A. Fisher, J. Allen	Nov 8 to 16, 1984
51-C	Mattingly, Shriver, Onizuka, Buchli, Payton	Jan. 24 to 27, 1985
51-D	Bobko, Williams, Seddon, Hoffman, Griggs, C. Walker, Garn	Apr 12 to 19, 1985
51-B	Overmyer, Gregory, Lind, Thagard, W. Thornton, van den Berg, Wang	Apr. 29 to May 6, 1985
51-G	Brandenstein, Creighton, Lucid, Fabian, Nagel, Baudry, Al-Saud	June 17 to 24, 1985
51-F	Fullerton, Bridges, Musgrave, England, Henize, Acton, Bartoe	July 29 to Aug 6, 1985
51-I	Engle, Covey, van Hoften, Lounge, W. Fisher	Aug 27 to Sept.3, 1985
51-J	Bobko, Grabe, Hilmers, Stewart, Palles	Oct 3 to 7, 1985
61-A	Hartsfield, Nagel, Buchli, Bluford, Dunbar, Furrer, Messerschmid, Ockels	Oct. 30 to Nov. 6, 1985
61-B	Shaw, O'Connor, Cleave, Spring, Ross, Neri-Vela, C. Walker	Nov. 26 to Dec. 3, 1985
61-C	Gibson, Bolden, Chang-Diaz, Hawley, G. Nelson, Cenker, B. Nelson	Jan. 12 to 18, 1986
51-L	Scobee, Smith, Resnik, Onizuka, McNair, Jarvis, McAuliffe	Jan. 28, 1986
STS-26	Hauck, Covey, Lounge, G. Nelson, Hilmers	Sept. 29 to Oct. 3, 1988
STS-27	R. Gibson, G. Gardner, Mullane, Ross, Shepherd	Dec. 2 to 6, 1988
STS-29	Coats, Blaha, Bagian, Buchli, Springer	Mar. 13 to 18, 1989
STS-30	D. Walker, Grabe, Thagard, Cleave, Lee	May 4 to 8, 1989
STS-28	Shaw, Richards, Adamson, Leestma, Brown	Aug. 8to 13,1989
STS-34	Williams, McCulley, Chang-Diaz, Lucid, E. Baker	Oct. 18 to 23, 1989
STS-33	F. Gregory, Blaha, Musgrave, Carter, K. Thornton	Nov. 22 to 27, 1989
STS-32	Brandenstein, Wetherbee, Dunbar, Low, Ivins	Jan. 9 to 20, 1990
STS-36	Creighton, Casper, Mullane, Hilmers, Thuot	Feb. 28 to Mar. 4, 1990
STS-31	Shriver, Bolden, Hawley, McCandless, Sullivan	Apr. 24 to 29, 1990
STS-41	Richards, Cabana, Shepherd, Melnick, Akers	Oct. 6 to 10, 1990
STS-38	Covey, Culbertson, Springer, Meade, Gemar	Nov. 15 to 20, 1990
STS-35	Brand, G. Gardner, Hoffman, Lounge, Parker, Durrance, Parise	Dec. 2 to 10, 1990
STS-37	Nagel, Cameron, Ross, Apt, Godwin	Apr. 5 to 11, 1991
STS-39	Coats, Hammond, Bluford, Harbaugh, Hieb, McMonagle, Veach	Apr. 28 to May 6, 1991
STS-40	O'Connor, Gutierrez, Seddon, Blajan, Jernigan, Gaffney, Hughes-Fulford	Jun. 5 to 14, 1991
STS-43	Blaha, M. Baker, Lucid, Adamson, Low	Aug. 2 to 11, 1991
STS-48	Creighton, Reightler, Buchli, Gemar, M. Brown	Sep. 12 to 18, 1991
STS-44	F. Gregory, Henricks, Musgrave, Runco, Jim Voss, Hennen	Nov. 24 to Dec. 1, 1991
STS-42	Grabe, Oswald, Thagard, Hilmers, Readdy, Bondar, Merbold	Jan. 22 to 30, 1992
STS-45	Bolden, Duffy, Sullivan, Leetsma, Foale, Lichtenberg, Frimout	Mar. 23 to Apr 2, 1991
STS-49	Thornton, Melnick, Thuot, Brandenstein, Chilton, Akers, Hieb	May 7 to 16, 1992
STS-50	Richards, Bowersox, Dunbar, Baker, Meade, DeLucas, Trinh	June 25 to Jul 9, 1992
STS-46	Shriver, Allen, Hoffman, Chang-Diaz, Nicollier, Ivins, Malerba	July 31 to Aug 18, 1992
STS-47	Gibson, Brown, Lee, Davis, Apt, Jernison, Mohri	Sept. 12 to 20, 1992
STS-52	Weatherbee, Baker, Shepherd, Jernigan, Veach, MacLean	Oct. 22 to Nov 1, 1992
STS-53	Walker, Cabana, Bluford, Voss, Clifford	Dec. 2 to 9, 1992



# Space Station Freedom

---

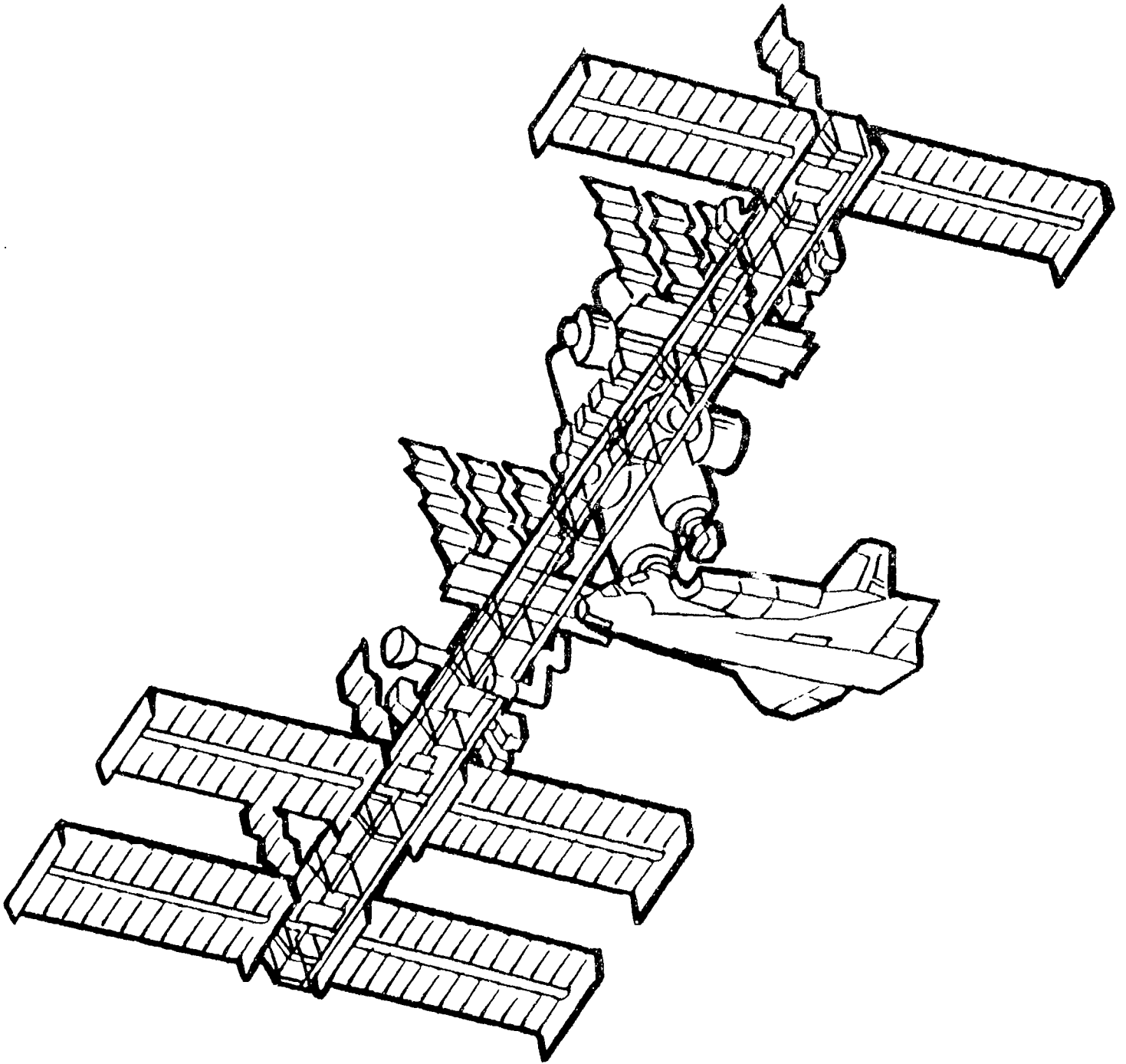

**NAME:** SPACE STATION

**SKILL:** MATH

**PROCEDURE:**

1. Design your own space station, referring to the component parts on the following page. Be sure to consider adequate room, necessities of life, etc.
2. Read Jules Verne's imaginary stories, *Around the World in 80 Days*, *Twenty Thousand Leagues Under the Sea*, and *From Earth to the Moon*.
3. Write an imaginary trip into space, stopping at your space station.

**BACKGROUND INFORMATION:**

The first U.S. "space station" was the Skylab Orbital Workshop launched in 1973. This Workshop was a modified third stage section of the Saturn V moon rocket. It provided a working area for three groups of astronauts who visited the workshop in 1973 and 1974. The last group stayed for over 84 days conducting research and experiments. A large part of the research was the study of the Sun and its interaction with the Earth.

NASA is making plans to build Space Station Freedom, a permanent base in space for astronauts and scientists to live and work. Several European countries, Canada, and Japan are participating with us in the Space Station project. Freedom's crew will perform experiments in the microgravity of space, experiments that cannot be done on Earth. Scientists want to know what happens to people who live in space for a long time. They also want to study how non-living things, like crystals, metals, fluids, and other materials behave in space. They will study Earth, our solar system, and the stars from Space Station Freedom, too. Space tugs for round-trip missions to a future lunar base and large spaceships that will carry human explorers to Mars, could be put together and launched from Freedom. NASA is building Space Station Freedom to help make life better for all Americans, and for our friends.

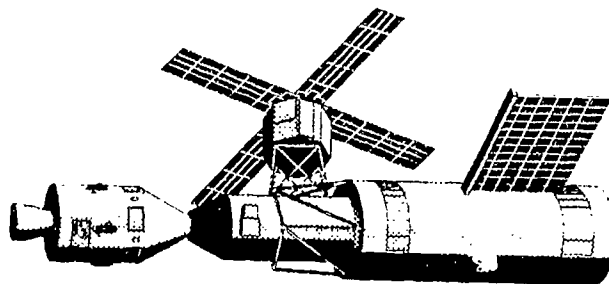

# DESIGN YOUR OWN SPACE STATION

HERE ARE SOME COMPONENT PARTS

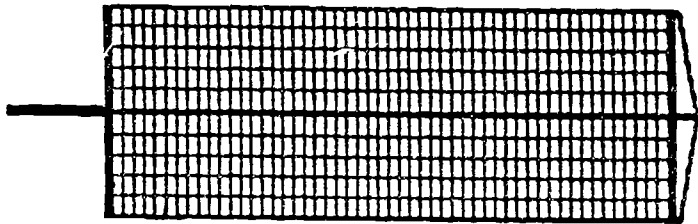

SOLAR PANEL

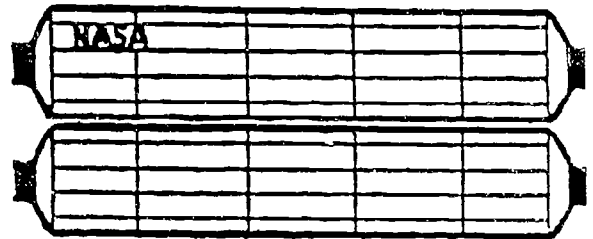

HABITAT MODULE  
OR  
EXPERIMENT MODULE

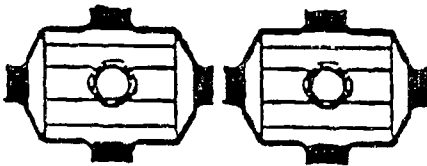

NODES

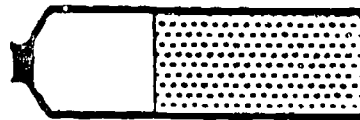

LOGISTICS MODULE  
(RESUPPLY MODULE)

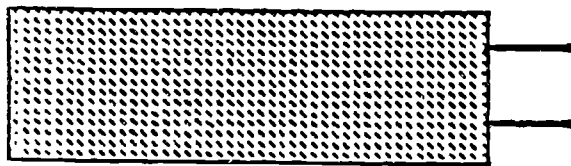

THERMAL RADIATOR

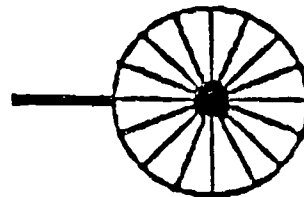

ANTENNA

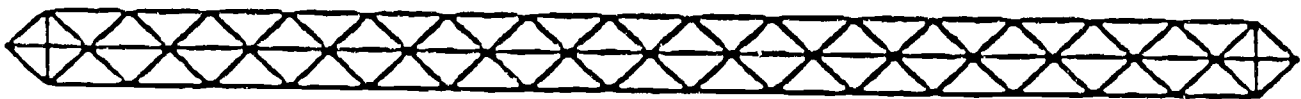

TRUSS / BEAM

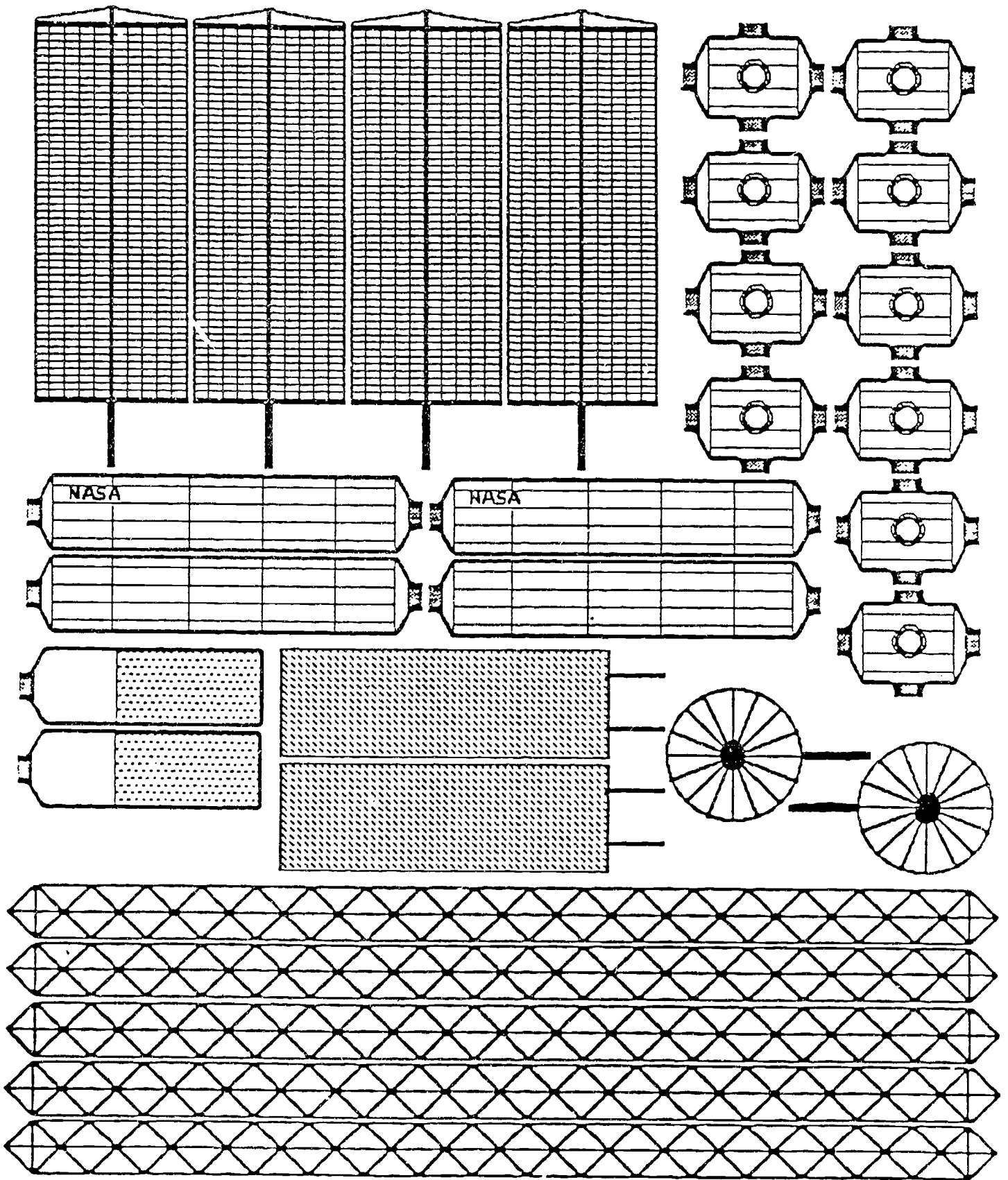

# PARACHUTES

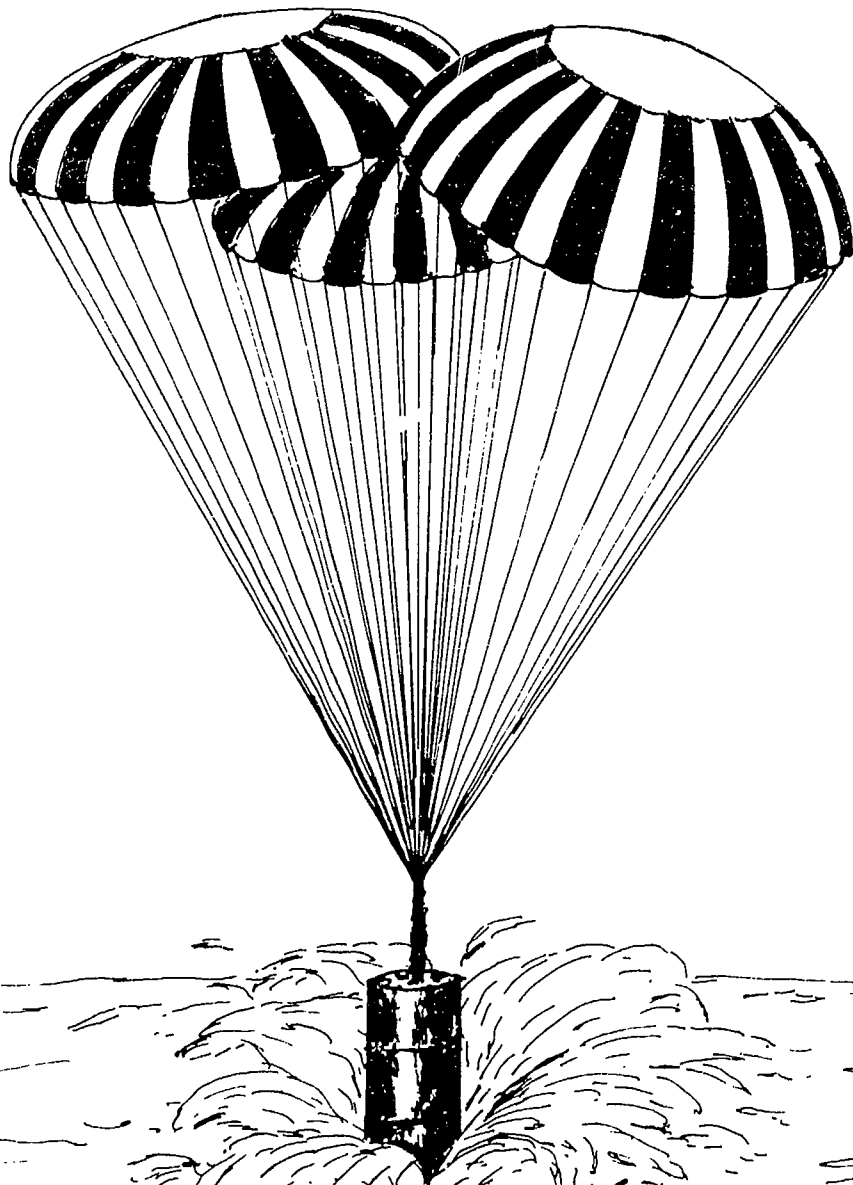

**NAME:** PARACHUTES

**SKILL:** SCIENCE

**PROCEDURE:**

1. The student can make the parachute according to directions, then have the children toss the parachute into the air, observing it as it falls. Children learn about drag as they watch the parachute fall. (Parachutes are also used on some race cars and some aircraft as they land to increase drag and help them stop.)

Parachute Directions: Cut 8" piece of thread. Wrap around 4 corners of paper towel square. Tie the thread ends together with a weight (paper clip). Materials: Kleenex or paper towel square, thread or string, paper clip (weight).

2. Talk about how parachutes are used in the space program. See background information.

3. Study the parachute recovery sequence for the solid rocket boosters and describe, in writing, each stage of the operation.

4. Students are divided into teams of four or five. The students will design a parachute at a cost of less than \$2 to drop an egg from a high place. The students whose egg lands without breaking and is the lowest bid is declared the winner.

**BACKGROUND INFORMATION:**

Parachutes have played a very important part in the recycling of space apparatus. The Apollo capsule used 3 parachutes after it re-entered the atmosphere to slow it down before it hit the water. Parachutes are also used to save your life if an aircraft fails. Packing a chute is a very important activity; because of the safety involved, one must be licensed. However, there is a reserve chute just in case the main chute fails. The Space Shuttle has a parachute which is used to slow it down when it lands. Many people today parachute as a hobby with colorful sport parachutes. They participate in competitions based on style and accuracy.

The solid rocket boosters on the Space Shuttle Transportation System use parachutes to slow the SRBs down to 50 mph on ocean splashdown, which is approximately 160 miles from the launch site. After the boosters separate from the external tank, at approximately 30 miles in altitude, the boosters continue to coast upward before beginning the descent back to earth. The nose cap is pyrotechnically released which, in turn, deploys a pilot parachute. A drogue parachute that has been

pyrotechnically released follows the first parachute. This slows descent and orients the SRB to a vertical position that allows best entry into the water. The drogue chute decelerates the frustum, allowing the main parachutes to be deployed out of the bottom of the frustum. The main parachute then goes through three stages of inflation. Thus the empty solid rocket booster casings are slowed to 50 mph.

Once the solid rocket boosters splash down, the main chutes are separated from the forward skirt. Floats attached to each main chute allow it to be recovered by the retrieval ships, Liberty and Freedom, and their crews. The frustum's descent, which has been slowed down to 40 mph at its splashdown by the drogue parachute, is also retrieved by the ships.

Each retrieval ship has one set of parachutes to reclaim. The divers from the retrieval ships attach a line to one float on each main parachute, which is then drawn onto parachute reels on the ship's deck. The crew then reels in the drogue parachute and lifts the frustum onto the deck. All parachutes are kept covered and wet. The retrieval ships then return to Cape Canaveral Air Force Station's Disassembly Building (Hangar AF). The parachute reels are unloaded onto a trailer and then transported to the Parachute Refurbishment Facility in the Industrial Area of Kennedy Space Center.

### Aerodynamic Packaging

The purpose of the Egg Drop Contest is to provide an opportunity to use science and engineering principles to creatively solve a problem. The contest is an activity you can complete at school with your students. It promotes the development of creativity and problem solving skills and is a great deal of fun.

The objective is to design a container in which one large raw egg can be dropped from a minimum of 30 feet (approximately 3 stories) onto a concrete surface without damage to the egg.

Students will work independently. Students must design their own egg containers, using any materials, shape or design. The container must be no larger than 12 inches in its largest dimension. Parachutes may be used. Students are encouraged to provide a "blueprint" or plans of their container. Targets will be a 6 feet circle. Each container must have a space for an identifying number (to be assigned at competition). Students will drop from a structure of approximately three stories to a hard surface.

Criteria for Judging: Survival, distance from target, design



# BOOSTER TRAJECTORY PROFILE

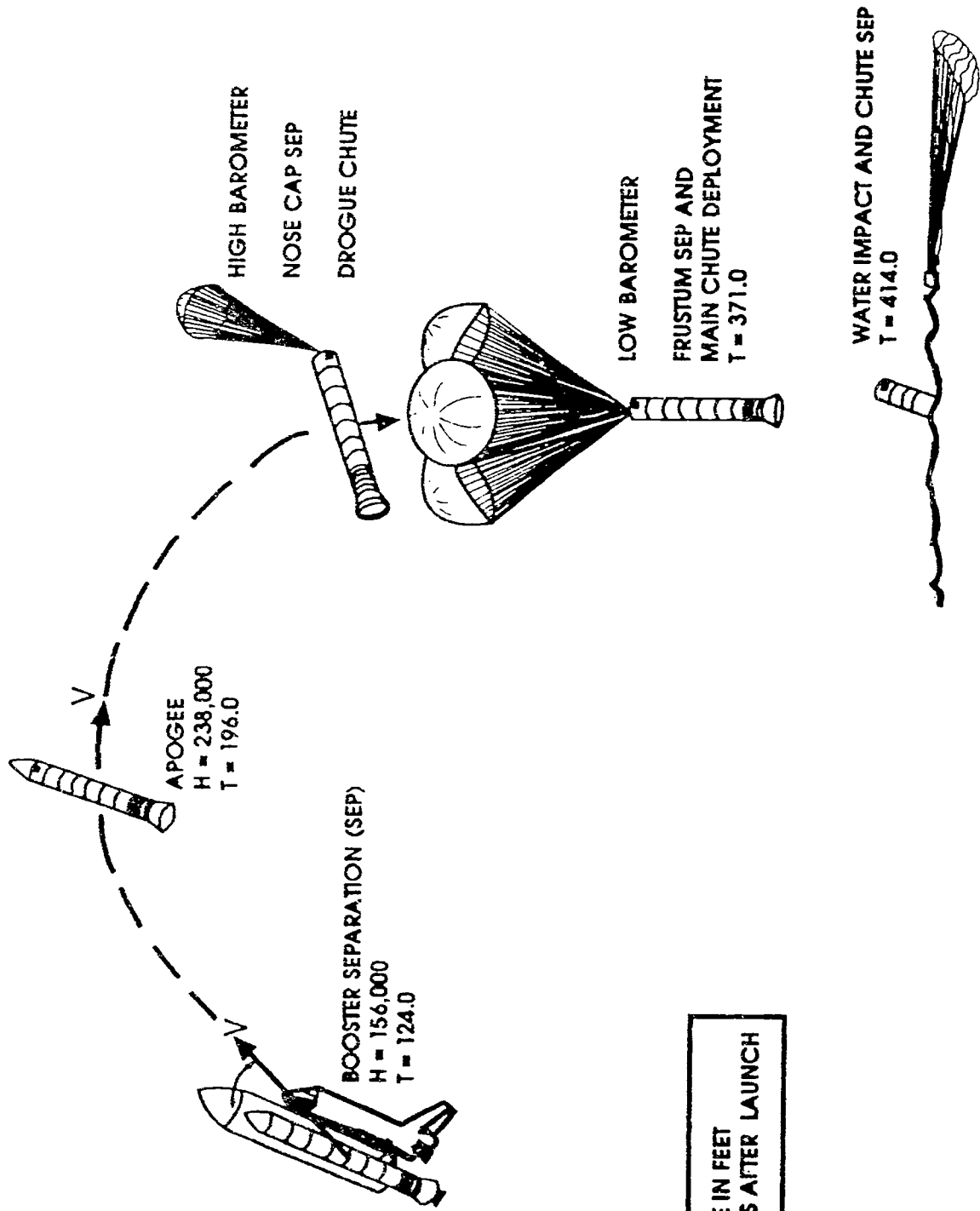

H = ALTITUDE IN FEET  
T = SECONDS AFTER LAUNCH



# RETRIEVAL SHIPS

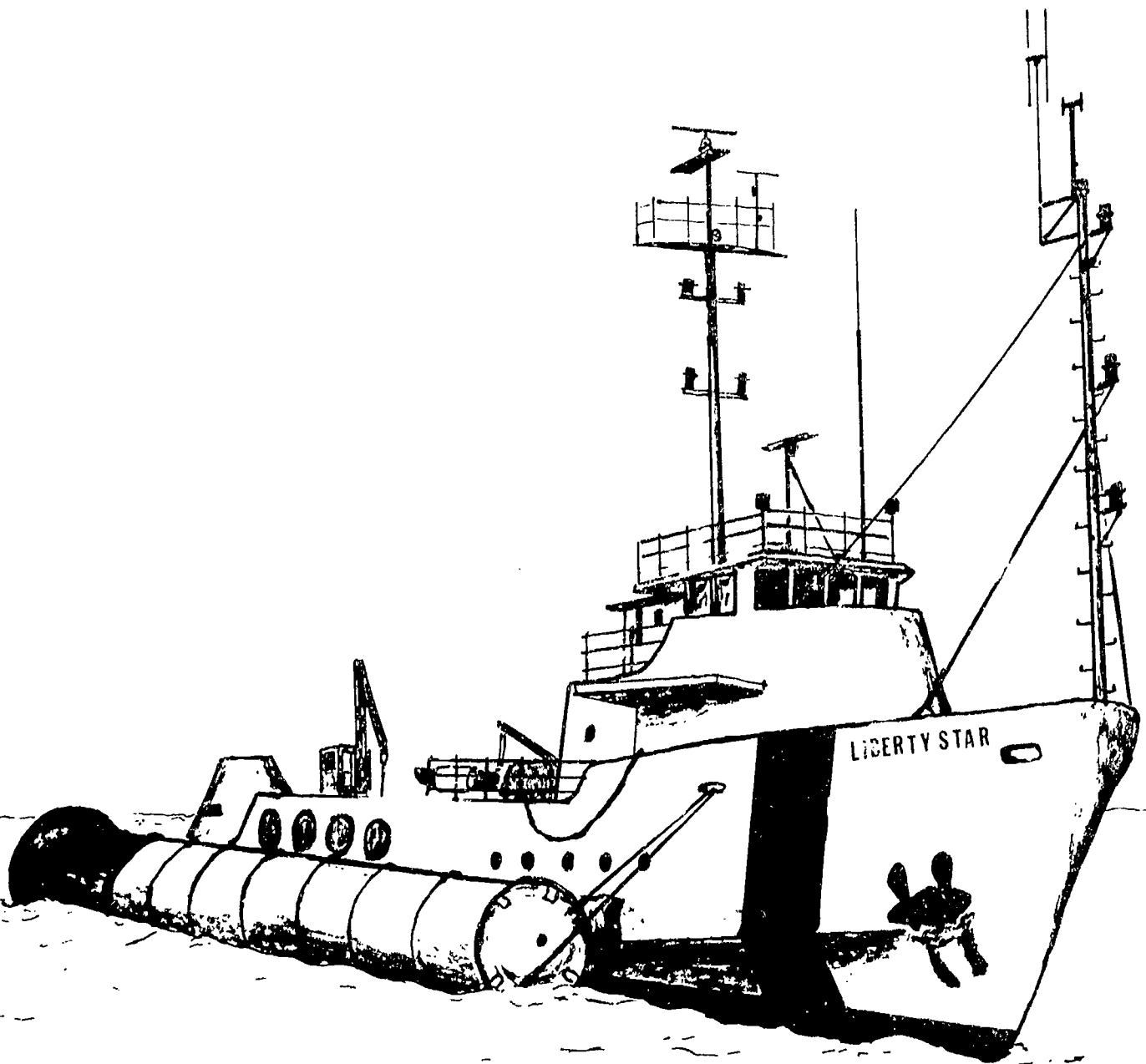

101

107

**NAME:** RETRIEVAL SHIPS

**SKILL:** SCIENCE AND TECHNOLOGY

**PROCEDURE:**

1. Describe the retrieval process of the solid rocket boosters (SRBs). Include where the SRBs are retrieved and the names of the retrieval ships.
2. What is a Loran Chart? Compare it to aeronautical chart.
3. The scuba divers that recover the SRBs must be certified by PADI, Professional Association of Diving Instructors. Research the requirements needed to be a certified scuba diver.
4. How do the retrieval ships protect the endangered manatee?
5. Study the official flag alphabet for nautical communications. Write messages to your friends.

**BACKGROUND INFORMATION:**

When the Space Shuttle's two solid rocket boosters burn out just over two minutes after shuttle liftoff, the empty booster casings separate from the external tank and fall toward the Atlantic Ocean. The casings and associated flight elements are recovered so that they can be reloaded with propellant and reused. The booster casings are retrieved about 258 kilometers (160 miles) downrange by two identical retrieval ships leased by NASA, the Liberty Star and Freedom Star. The ships have water jets instead of propellers in order to protect the endangered manatees found in the surrounding waters.

SRB separation is at 30.8 miles, but momentum continues to carry the spent boosters upward for 70 more seconds, to an altitude of 41.6 miles, before they begin to freefall into the Atlantic. During the fall, the nose cap is jettisoned, and a drogue parachute deploys from the frustum, the truncated cone-shaped structure near the forward end of the boosters. At an altitude of 1.24 miles, the frustums separate from the forward skirts, releasing the three main parachutes on each booster that carry the main sections of the casings down to the sea.

ALPHABET FLAGS			NUMERAL PENNANTS
<p><b>Alfa</b></p> <p>Blue white</p>	<p><b>Kilo</b></p> <p>Blue yellow</p>	<p><b>Uniform</b></p> <p>Red white White Red</p>	<p><b>1</b></p> <p>Red WHITE</p>
<p><b>Bravo</b></p> <p>Red</p>	<p><b>Lima</b></p> <p>Yellow Black Black Yellow</p>	<p><b>Victor</b></p> <p>White Red</p>	<p><b>2</b></p> <p>Blue White</p>
<p><b>Charlie</b></p> <p>Blue White Red White Blue</p>	<p><b>Mike</b></p> <p>Blue White</p>	<p><b>Whis- key</b></p> <p>Red White Blue</p>	<p><b>3</b></p> <p>Red White Blue</p>
<p><b>Delta</b></p> <p>Yellow Blue Yellow</p>	<p><b>Novem- ber</b></p> <p>White Blue</p>	<p><b>Xray</b></p> <p>Blue White</p>	<p><b>4</b></p> <p>White Red</p>
<p><b>Echo</b></p> <p>Blue Red</p>	<p><b>Oscar</b></p> <p>Red Yellow</p>	<p><b>Yankee</b></p> <p>Red White Yellow</p>	<p><b>5</b></p> <p>Yellow Blue</p>

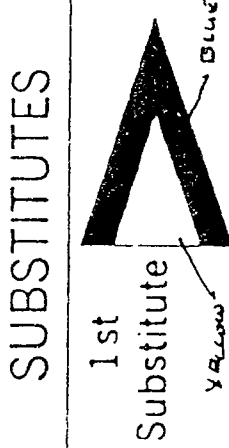
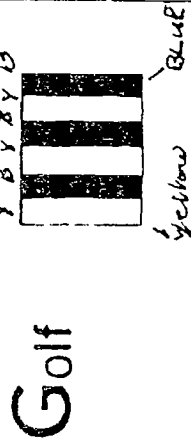
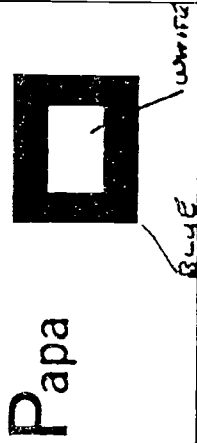
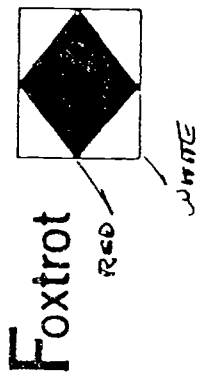

SUBSTITUTES

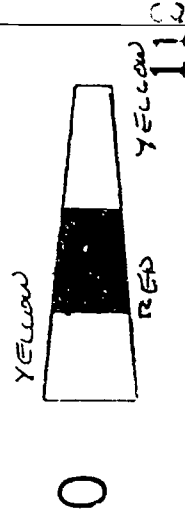
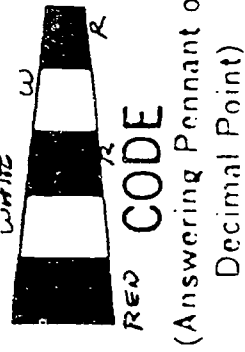
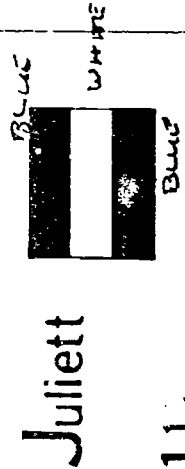
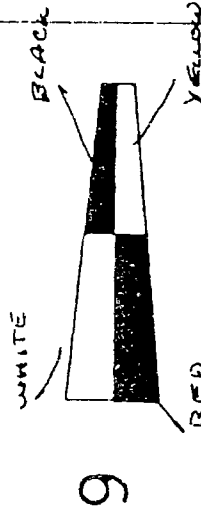
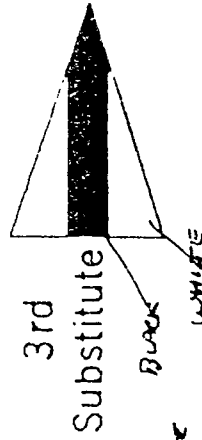
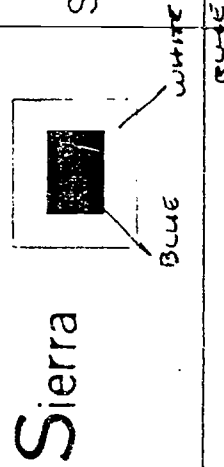
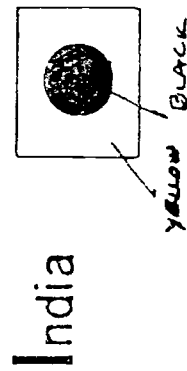
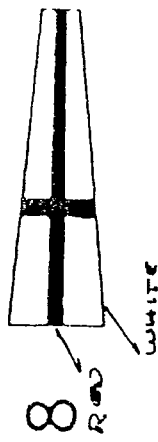
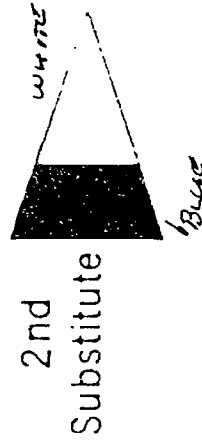
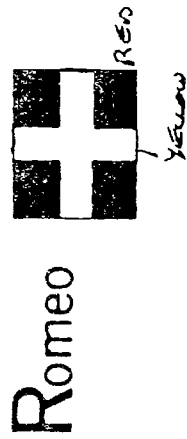
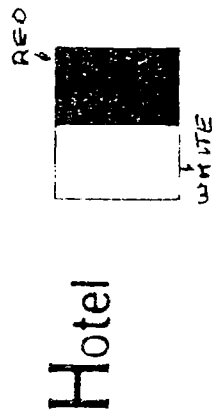

# CRAWLER TRANSPORTER

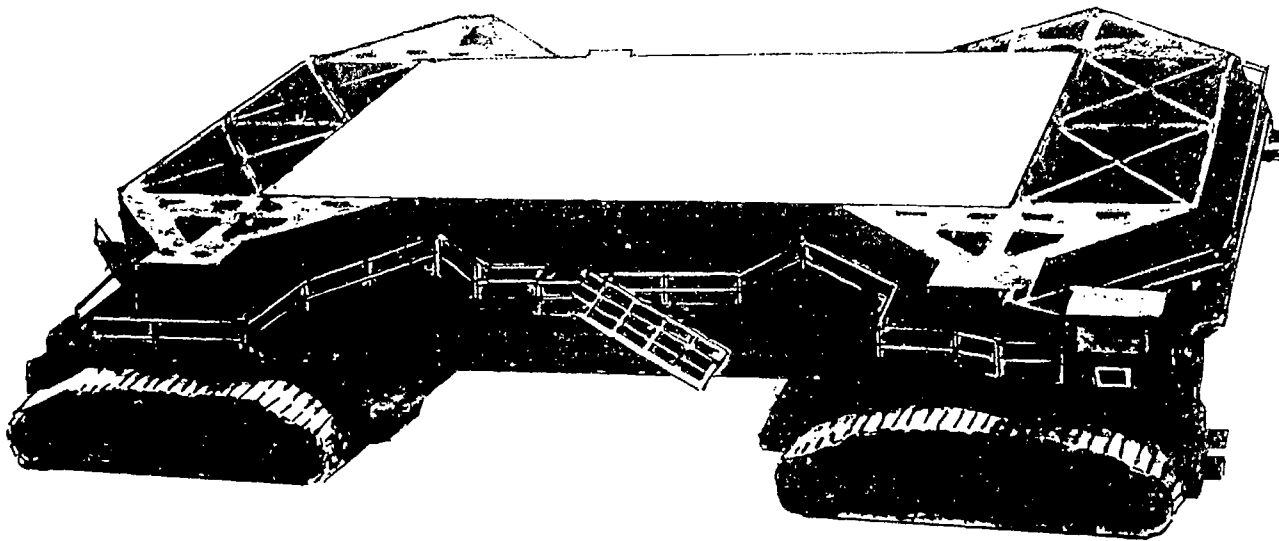

**NAME: CRAWLER TRANSPORTER**

**SKILL: MATH AND TECHNOLOGY**

**PROCEDURE:**

1. Discuss the size of the Crawler Transporter. Compare it to other large land vehicles.
2. Discuss the impact of the Crawler Transporter on the environment. Design concepts of a system that would have less impact, such as a hover craft.
3. Build a model of the crawler. Follow the path of the Crawler from its maintenance facility to the crawler pen then to the Launch pads.

**BACKGROUND INFORMATION:**

The Crawler-Transporter moves a fully assembled Space Shuttle, mounted on a Mobile Launcher Platform, from the Vehicle Assembly Building to the launch pad. The huge tracked vehicles, originally used during the Apollo era, underwent modifications for the Shuttle.

The two Crawlers are about 20 feet high, 131 feet long, and 114 feet wide--about the size of a baseball diamond. Each one weighs about 6 million pounds unloaded. A Crawler has eight tracks, each of which has 57 shoes or cleats. Each shoe weighs approximately one ton.

With the Space Shuttle aboard, the Crawler can creep at a maximum speed of about one mile per hour; unloaded, it can manage about 2 miles per hour.

The Crawler has a leveling system designed to keep the body of the Space Shuttle vertical, while negotiating the 5 percent grade leading to the top of the launch pad. Also, a laser docking system provides pinpoint accuracy when the Crawler and Mobile Launcher Platform are positioned at the launch pad or in the Vehicle Assembly Building.

Two 2,750-horsepower diesel engines power each Crawler. The engines drive four 1,000-kilowatt generators which provide electrical power to 16 traction motors. Operators in cabs on either end steer the giant vehicle.

The Crawlerway is a 130-foot-wide roadway--almost as broad as an eight-lane freeway. The Crawler-Transporters use this for their more than 3-mile trek to one of the launch pads from the Vehicle Assembly Building.

The Crawlerway consists of two 40-foot wide lanes, separated by a 50-foot wide median strip. The Crawlerway has four layers to support the huge weight. The Crawler, Mobile Launcher Platform and Space Shuttle with empty external tank weigh about 17 million pounds. The top layer of the Crawlerway is river gravel about 8 inches thick on straightaway sections. The other layers in descending order are: 4 feet of graded, crushed stone; 2.5 feet of select fill; and 1 foot of compact fill. It takes several hours for the journey from the Vehicle Assembly Building to one of the launch pads. The distance to Pad 39A is about 3.4 miles; to Pad 39B, it is approximately 4.2 miles.

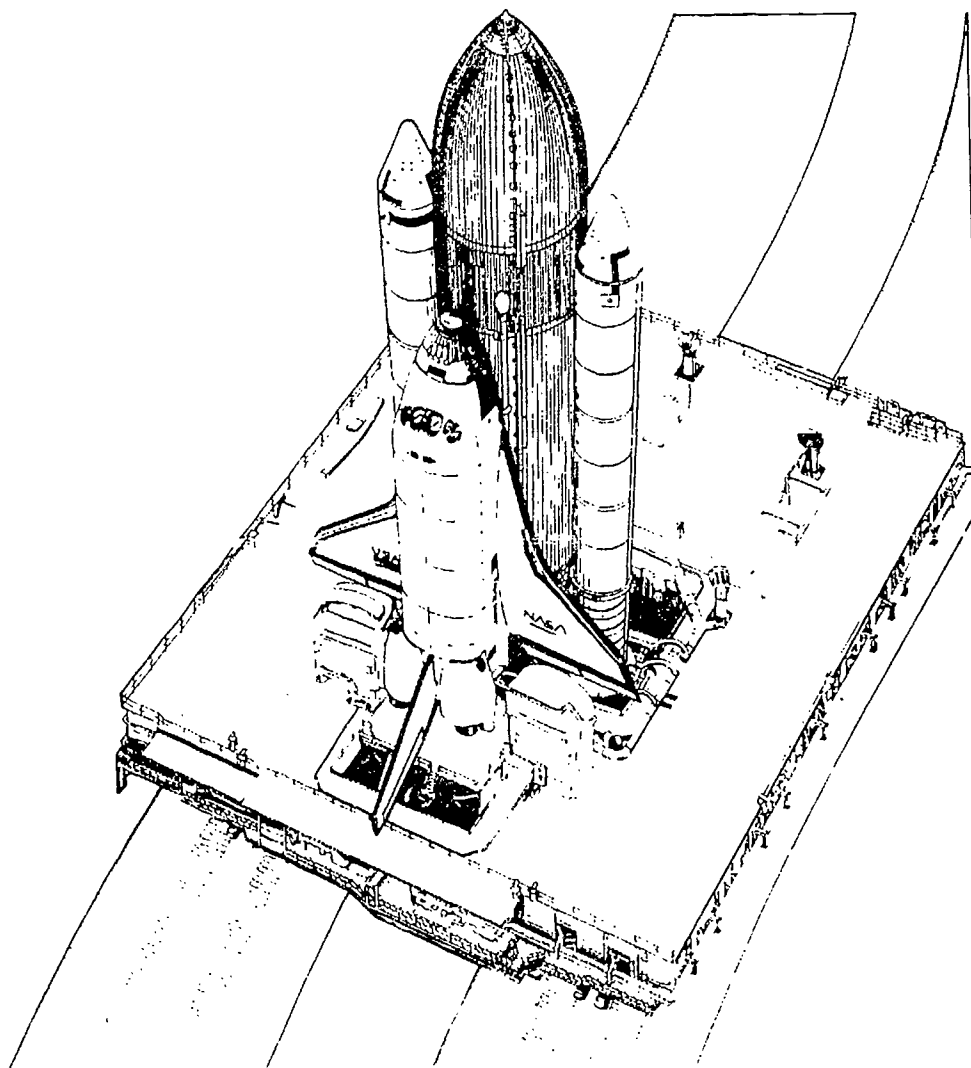

Follow the path of the crawler transporter from the crawler-transporter maintenance bldg to the parking area to Pad A and Pad B

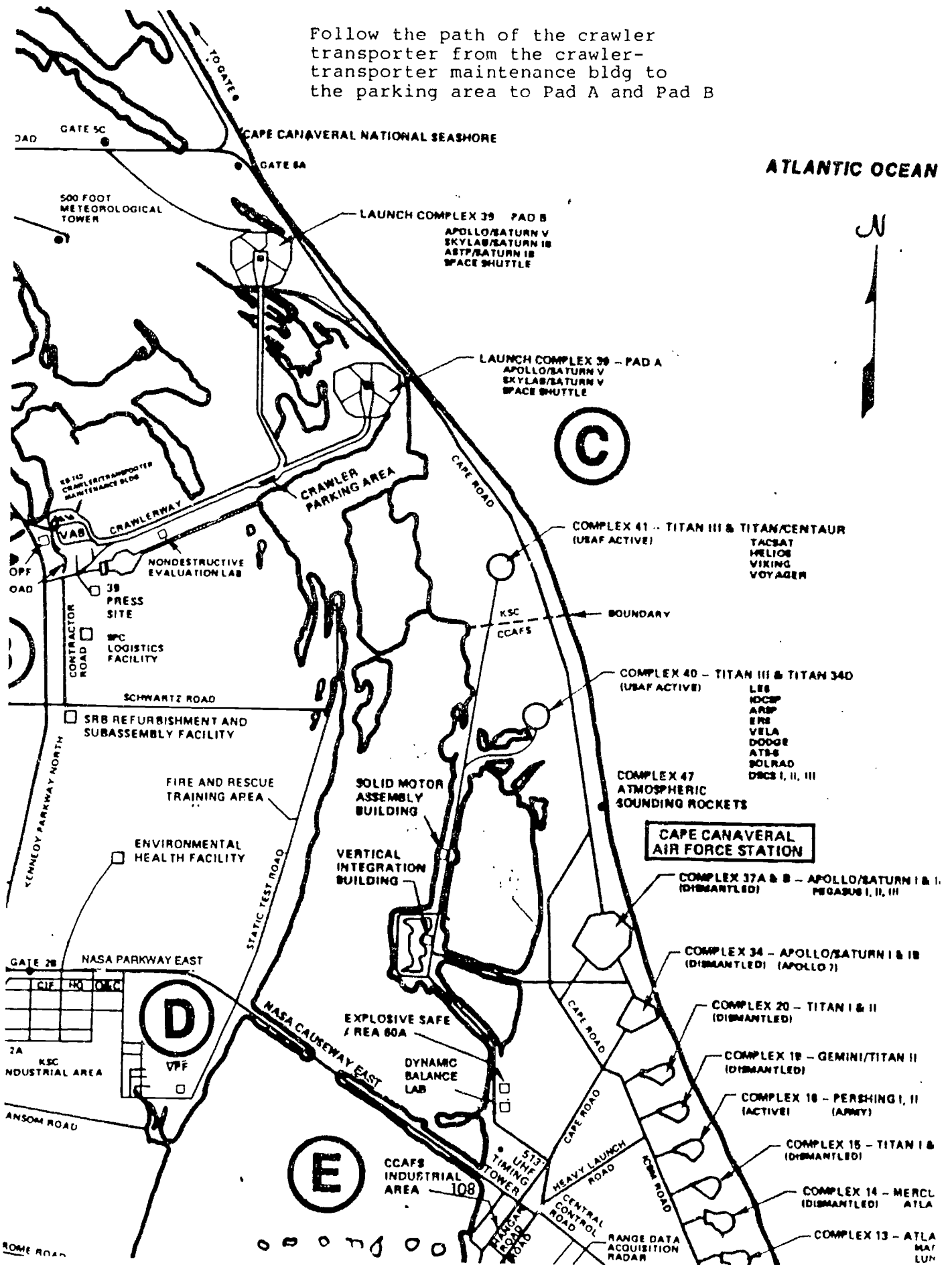



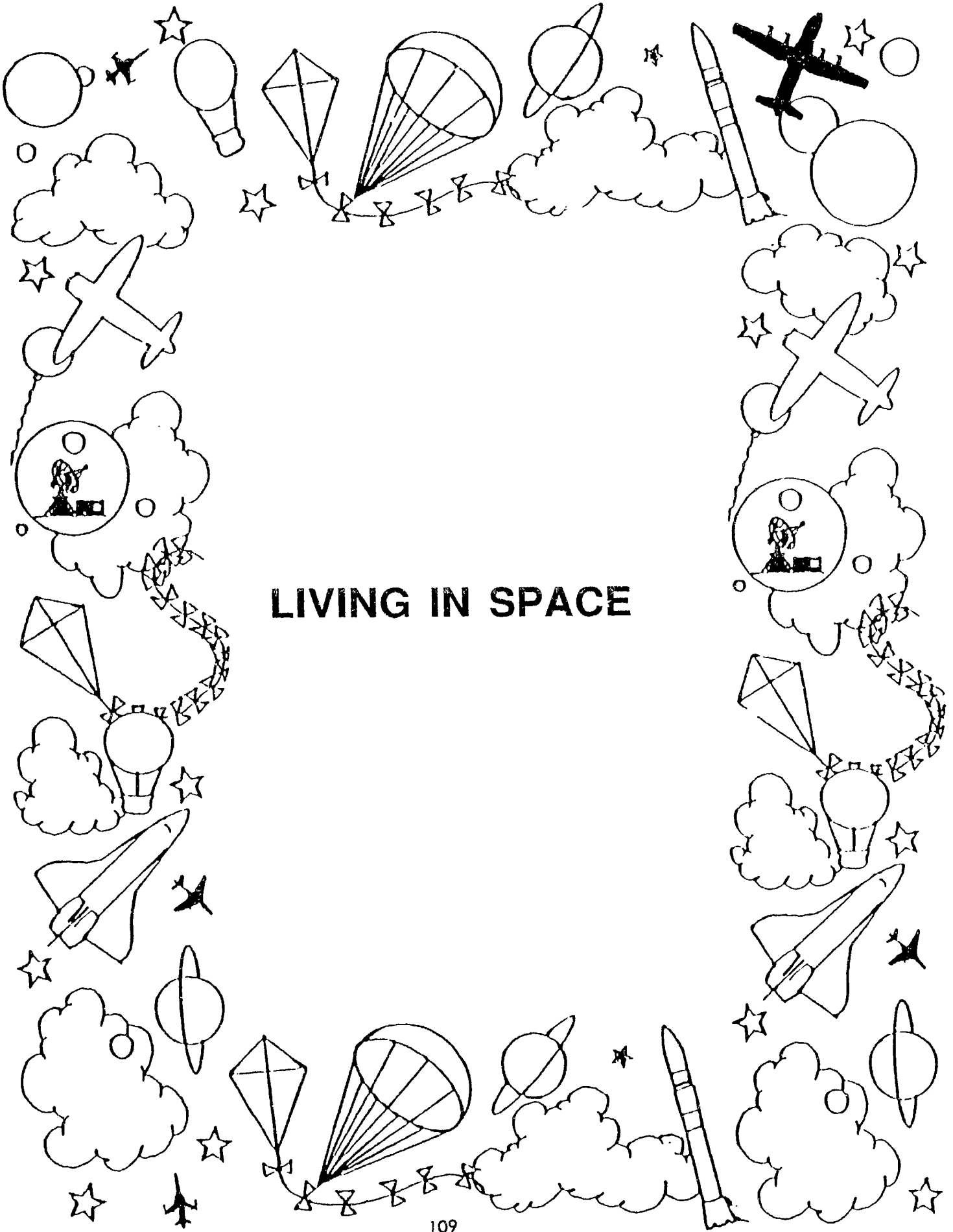

# LIVING IN SPACE

# BASIC NEEDS

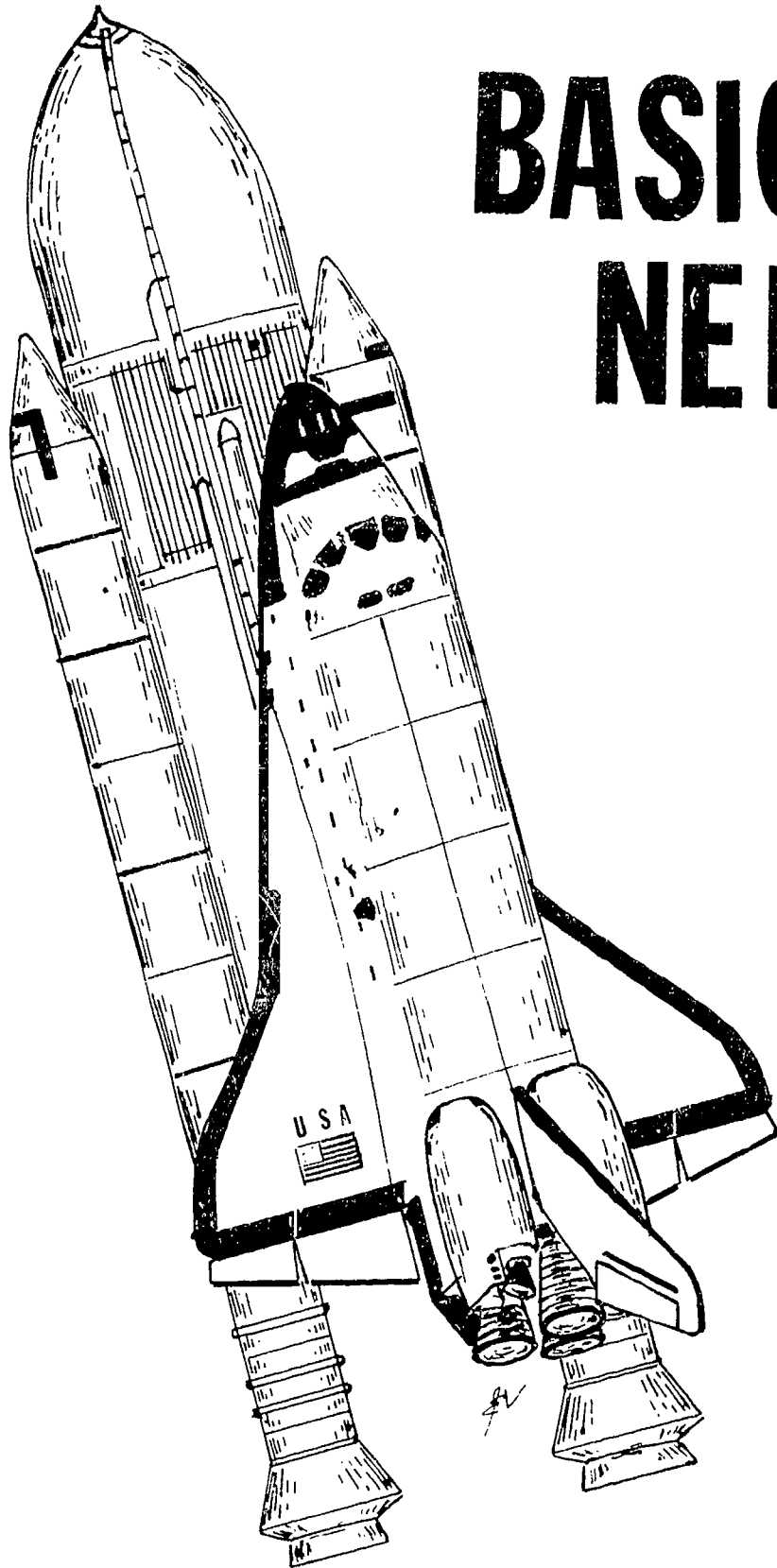

# SHUTTLE

110

118

**NAME:** BASIC NEEDS

**SKILL:** HEALTH AND FOOD AWARENESS

**PROCEDURE:**

1. Read about the kinds of food that are used in space. Look for freeze dried or dried foods in the grocery store.
2. Plan a balanced menu for space flight.
3. To demonstrate the appearance of liquids in space and to depict surface tension, encourage students to blow bubbles using liquid detergents and soda straws.
4. Program a physical fitness program for yourself to enhance your fitness for space--include a record of your diet and exercise program.
5. Indicate the physical requirements required for an applicant to become an astronaut.

**BACKGROUND INFORMATION:**

Menu for Space Shuttle meals are developed from a list of many items and are well-balanced to provide foods from all the recommended food groups including grain products, fruit, vegetables, and protein-rich foods.

**FOOD SYSTEM**

The Orbiter is equipped with food, food storage, and food preparation and dining facilities to provide each crewman with three meals per day plus snacks and an additional 96 hours of contingency food. The food supply and food preparation facilities are designed to accommodate flight variations in the number of crewmen and flight durations ranging from two crewmen for 1 day to seven crewmen for 30 days.

The food consists of individually packaged serving portions of dehydrated, thermostabilized, irradiated intermediate moisture, natural form, and beverage foods. The food system relies heavily on dehydrated food, since water is a byproduct of the fuel cell system onboard the Orbiter. Off-the-shelf thermostabilized cans, flexible pouches, and semirigid plastic containers are used for food packaging.

The menu is a standard 6-day menu instead of the personal-preference types used in previous programs. The menu consists of three meals each day plus additional

snacks and beverages.

The daily menu is designed to provide an average energy intake of 3000 calories for each crewmember. The food system also includes a pantry of foods for snacks and beverages between meals and for individual menu changes. The galley, which is located in the cabin working area, is modular and can be removed for special missions. In addition to cold and hot water dispensers, it is equipped with a pantry, an oven, food serving trays, a personal hygiene station, a water heater, and auxiliary equipment storage areas. The oven is a forced-air convection heater with a maximum temperature of 355K (82° C or 180°F). There are no provisions for food freezers or refrigerators.

Food preparation activities are performed by one crewman 30 to 60 minutes before mealtime. The crewman removes the selected meal from the storage locker, reconstitutes those items that are rehydratable, places the foods to be heated into the galley oven and assembles other food items on the food trays. Meal preparation for a crew of seven can be accomplished by one crewmember in about a 2 minute period. Utensils and trays are the only items that require cleaning after a meal. Cleaning is done with sanitized "wet wipes" that contain a quaternary ammonium compound. As on the Skylab flights, the crewmembers use regular silverware.

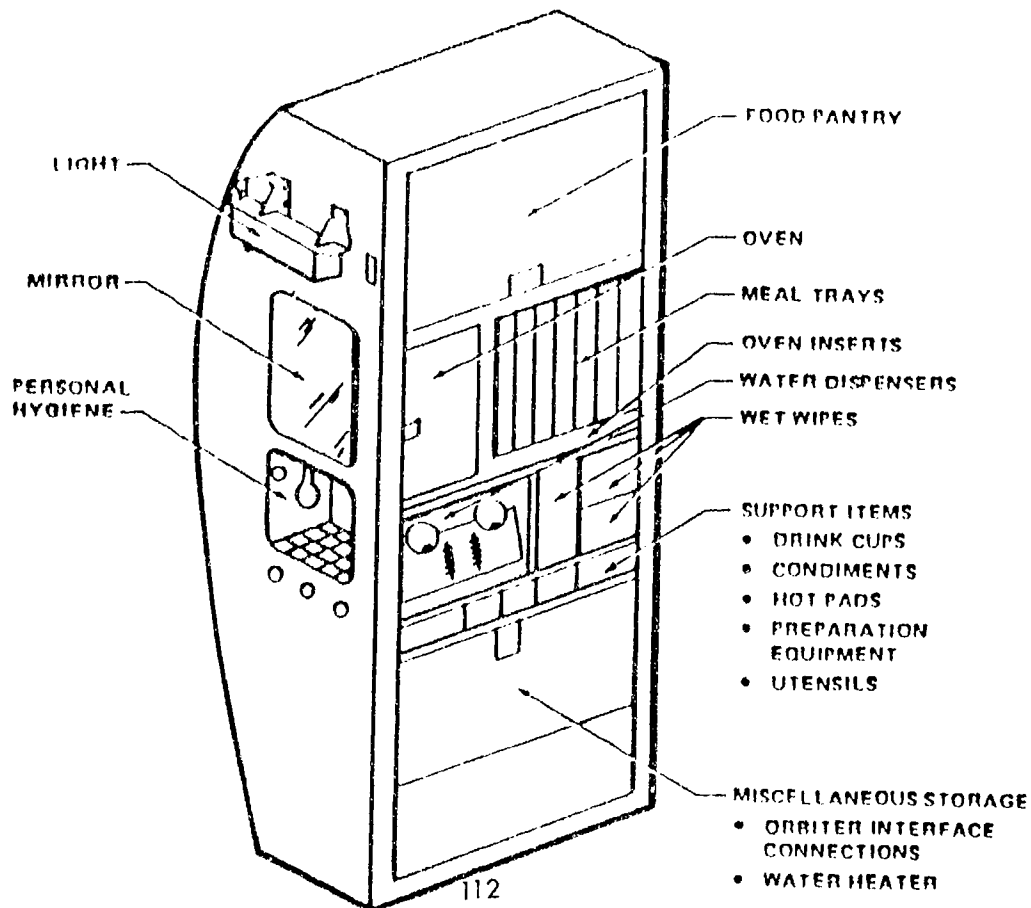

# CELSS

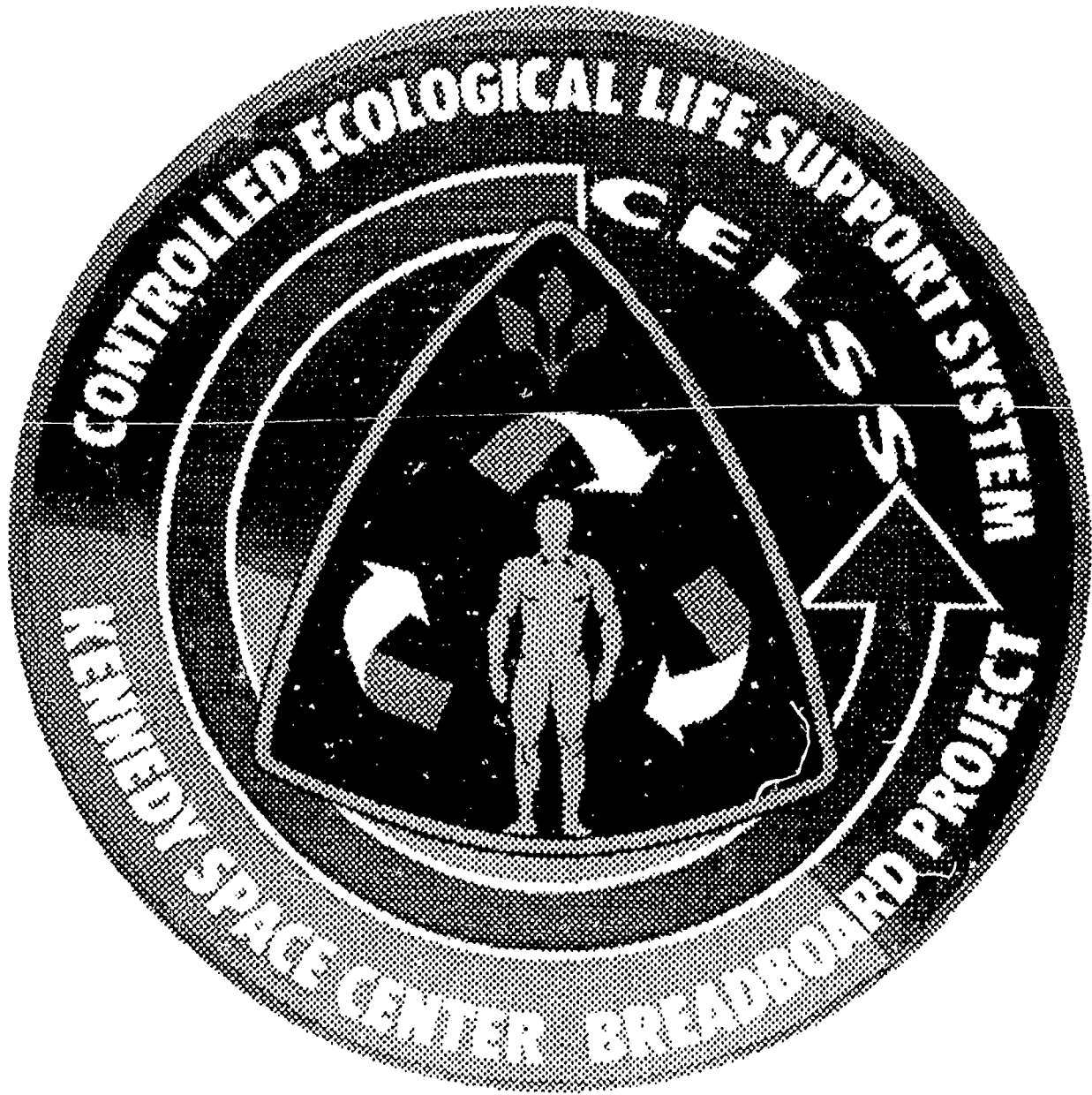

**NAME:** CELSS

**SKILL:** Technology/science

**PROCEDURE:**

1. Have students investigate the requirements for plant growth and discuss which will be available in space in large quantities.
2. Divide students into two groups. Have one group discuss the advantages of a hydroponics plant-growing system over one that grows plants in soil and have the other group discuss the disadvantages.
3. Have students research and develop a bioregenerative system to learn (1) when such a system is perfectly balanced, (2) why even an imperfect system can be highly worthwhile, (3) which two gases must be perfectly controlled in a bioregenerative experiment and why, and (4) three important steps that must be accomplished before a bioregenerative system can approach the ideal of a completely closed-cycle operation.
4. Wheat has a life cycle of 64 days. Have students discuss why this makes it a good crop to grow in the Biomass Production Chamber and then research other crops that have similar cycles.
5. As a class science project, build a small hydroponics system and grow a crop of wheat, Irish or sweet potatoes, soybeans, rice, or sugar beets. Check the nutritional, energy, and gas needs of each plant before making a selection. Design the system to operate in gravity. At the end of the project, do a comparison study to illustrate the changes that would be required to make your system operate in microgravity aboard the Space Station.
6. As a follow-up project, grow two or three different plants and compare the results.

**BACKGROUND INFORMATION:**

**Bioregenerative Life Support Systems and Space Flight**

Plants form the base for all food chains on Earth, and most plants that produce edible products for humans grow in soil. But soil is prohibitively heavy and cannot economically be carried into space. Also, many plants soon consume the nutrients they need in the soil. One way to reduce weight, while still providing a continuous supply of nutrients to plants in space, is a closed-cycle hydroponics system.



In a true hydroponics system, a thin, slowly moving stream of liquid bathes the plant roots, continuously supplying them with both water and nutrients. The leaves absorb carbon dioxide from the air and receive energy from light. The plants grow and produce biomass, some of which is edible fruit, tuber, seed, or stalk. In a fully closed system, the nutrients, water, and gases are supplied as waste products from the creatures who consume the food and recycle the remaining biomass. For example, humans breathe in oxygen and exhale carbon dioxide; plants absorb carbon dioxide and emit oxygen. If enough plants are available, they can provide the complete supply of oxygen needed by a human being. In turn, the plants receive the carbon dioxide they need to grow and produce biomass from human exhalations.

NASA is engaged in experiments to develop a Controlled Ecological Life-Support System, or CELSS. This system would provide basic and continuous life-support requirements, such as food, drinking water, and breathable atmosphere, by using plants as the central recycling component. In turn, the plants would live off human by-products and unused plant matter.

In a perfectly balanced "bioregenerative system," the waste products of the producer are the nutrients of the consumer, and vice-versa. The only item consumed and not replaced is the energy that drives the system. In space near Earth, almost unlimited energy is available from sunlight. Even when a perfect system is not practical, one that approaches the ideal will be more efficient than a system that requires a constant resupply of food, water, and air.

#### CELSS at the Kennedy Space Center

At the Kennedy Space Center (KSC) in Florida, NASA has constructed a prototype facility that may lead the way to a functional CELSS that would be useful in space. One of the first major areas being studied is growing plants in a hydroponics system, where a circulating liquid provides nutrients to plant roots. Parts of this hydroponics system are on display at Disney World near Orlando, in The Land pavilion at EPCOT--Disney's Environmental Prototype Community of Tomorrow. Participating Disney scientists cultivate crops using CELSS equipment, then share the data with NASA.

#### The Biomass Production Chamber

The primary facility for CELSS experiments at KSC is the Biomass Production Chamber (BPC), in the NASA operated Life Sciences Building on Cape Canaveral. The BPC is a large, air-tight steel chamber about 3.5 meters in diameter and 7.5 meters high (see drawing). It was formerly used as a test vessel to check for leaks in Mercury and Gemini spacecraft. It is about the size of the Spacelab module

that files in the cargo bay of the Shuttle. The chamber has two floors, each with two growing shelves, and provides a total growing area of 20 meters. Each floor has eight racks, and each rack supports two banks of sunlamps and two adjustable platforms. An airlock on the second level provides access.

The chamber is one of three parts of a "breadboard project" designed to gather data, rather than to be a fully operational system. Its purpose is to produce food. Later modules will address two additional tasks: food processing--to obtain the maximum edible content from all plant parts; and waste management--to recover and recycle all possible useful solids, liquids, and gases. The information will be valuable for all types of space flight, including the design and operation of food and oxygen production facilities on the Moon and Mars. The simplified diagram illustrates how the food production facility will interact with the other components of a complete system. The BPC will provide specific data on air and water regeneration, plus many other research studies.

Wheat is an excellent crop for a first choice because it has a life cycle of 64 days, which matches the number of trays in the BPC. One tray can be planted each day, and one harvested each day when grown. This procedure enables the other components of a CELSS, such as nutrient storage, liquid and solid regeneration, biomass processing, and gas contaminant control to be easily studied. The labor requirements tend to be uniform for this particular crop, and the loss of one or more trays would not seriously affect the project as a whole.

Investigators have already begun to develop systems for other crops. One goal is to develop a nutrient delivery system that will function effectively in microgravity. Another major step is to place a crew in the gas loop, and measure the actual production and consumption of oxygen and carbon dioxide. The type of plants that best produce oxygen and consume carbon dioxide, and also provide edible products, must be determined. NASA also needs to know how many plants are required to supply food and oxygen for one person. When this data is in hand, the CELSS system can be made more and more "closed"--that is, operating without the input of new materials--to more nearly simulate the complete recycling process.

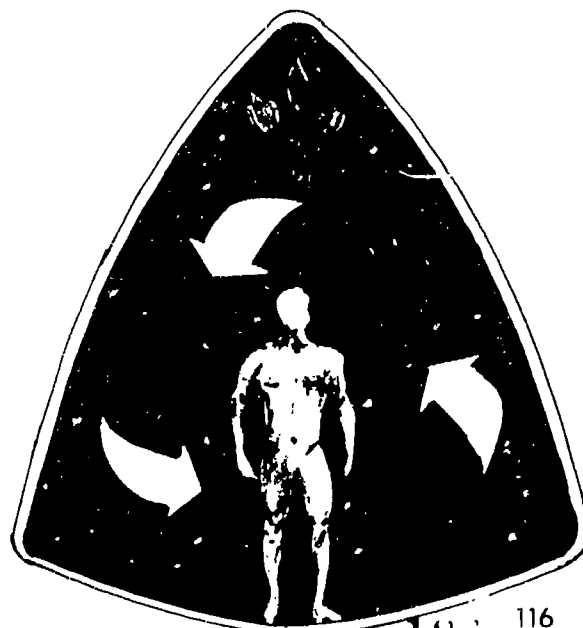



Components visualized for a CEI SS Breadboard Facility

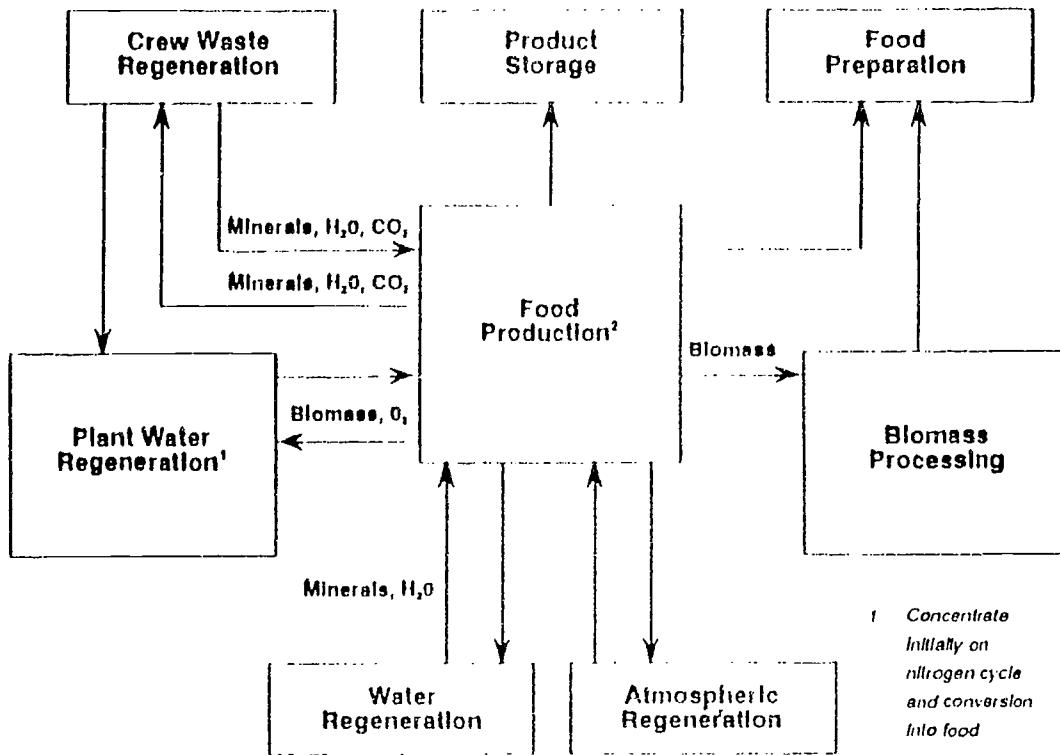

**Monitoring and Control**

- |  |  |
|--|--|
| 1. CO <sub>2</sub> and O <sub>2</sub>                                  | 4. Biomass (lipids, proteins, carbohydrates, and vitamins) |
| 2. O <sub>2</sub> trace contaminants and viable nonedible particulates | 5. Water   |
| 3. Pressure, temperature, and humidity                                 | 6. Major nutrients   |
|  | 7. Energy (i.e., electricity)                              |

1 Concentrate initially on nitrogen cycle and conversion into food

2 Interconnections have been omitted for clarity

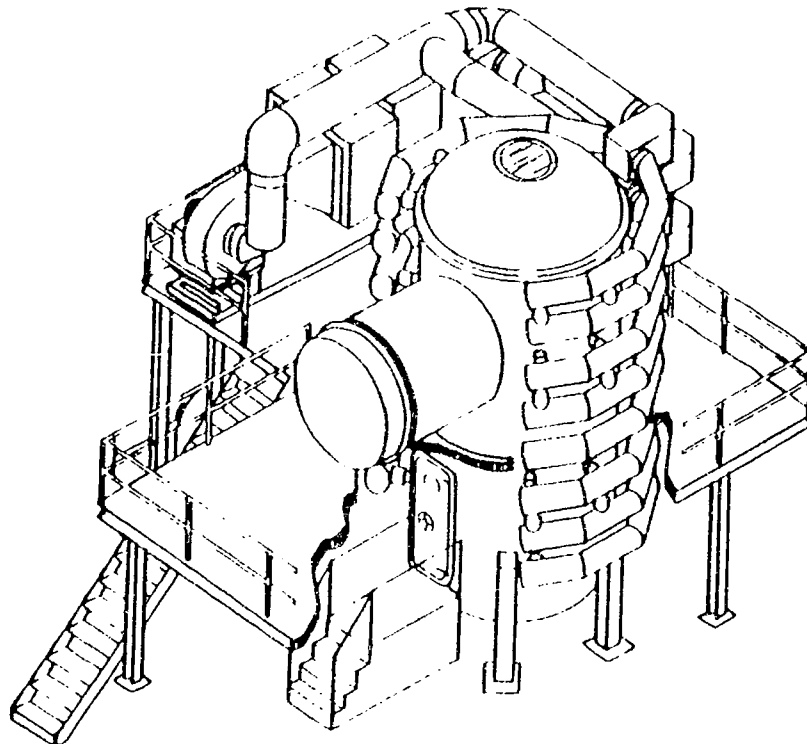

# ASTRONAUTS



118

**NAME: ASTRONAUTS**

**SKILL: SCIENCE AND TECHNOLOGY**

**PROCEDURE:**

1. Study the parts of the space suit. See how many parts you can name correctly.
2. Design your own space suit. Don't forget the vital parts.
3. Security on Kennedy Space Center and other NASA centers is tasked to protect our astronauts and space hardware. Read the American's Creed; discuss its implications.
4. Choose a position on the crew of an upcoming mission. Describe the duties according to the position chosen. Tell why you chose this job. What education background would be required to be best suited for this position?
5. Study the astronauts from each of the Mercury, Gemini, Apollo, Skylab and Shuttle missions. Choose an astronaut and write a biographical sketch.

**BACKGROUND INFORMATION:**

The term astronaut covers several occupations in a highly specialized environment. Astronauts are known as commanders, pilots, mission specialists, and payload specialists. Their duties include deploying and/or retrieving satellites; maintaining onboard equipment and satellites; conducting scientific research; interpreting research data and performing basic crew operations. A commander/pilot flies the spacecraft. The mission specialists conduct the experiments during flight and are skilled in payload operations. The payload specialists perform scientific or technical investigations and are selected by the company or agency whose payload is being flown on that particular mission.

Astronaut candidates are required to have a bachelor's degree from an accredited institution in engineering, biological science, physical science, or mathematics. Applicants must have at least 1,000 hours pilot-in-command time in high-performance jet aircraft. The pilot applicant must be able to pass a NASA Class 1 space flight physical.

The mission specialists are required to hold a bachelor's degree from an accredited institution in engineering, biological or physical science, or mathematics. A majority

of the mission specialists hold several advanced degrees in several different disciplines.

The payload specialists are selected by the companies or agencies whose payloads are on the mission. These individuals usually have been involved with the development of the payload equipment and have trained on the equipment for several years. NASA retains the final selection authority for payload specialists to ensure those chosen are fully qualified and can function as part of the flight crew.

Crew members on active military duty and on loan from the military to NASA receive the normal compensation for the military rank they have attained for their particular service branch. Civilian mission specialists earned an average salary of \$40,000 in 1988. Payload specialists salaries are determined by the company that employs them.

#### **THE AMERICAN'S CREED**

*I believe in the United States of America as a government of the people, by the people, for the people, whose just powers are derived from the consent of the governed; a democracy in a republic; a sovereign Nation of many sovereign States; a perfect union, one and inseparable; established upon those principles of freedom, equality, justice and humanity for which American patriots sacrificed their lives and fortunes.*

*I therefore believe it is my duty to my country to love it, to support its Constitution, to obey its laws, to respect its flag, and to defend it against all enemies.*

Written by William Tyler Page, Clerk of the U.S. House of Representatives, 1917. Accepted by the House on behalf of the American People, April 3, 1918.

## Shuttle Space Suit

Space suits provide astronauts with air to breathe while working in space. The parts of a space suit are: a helmet, a hard upper torso, flexible lower torso, arm assembly, gloves, and boots. These items are worn to protect the astronaut from hot and cold temperatures. They also help them adjust to the different conditions of space.

Each suit has a Primary Life Support System with an air pack and a communication assembly with a built-in radio. Astronauts working outside the Space Shuttle are always in touch with each other and the crew inside.

The Manned Maneuvering Unit (MMU) is a one-person, nitrogen propelled backpack which is attached to the space suit's Primary Life Support System. Using hand controllers, the astronaut can fly around in space to repair and retrieve satellites.

# ASTRONAUTS

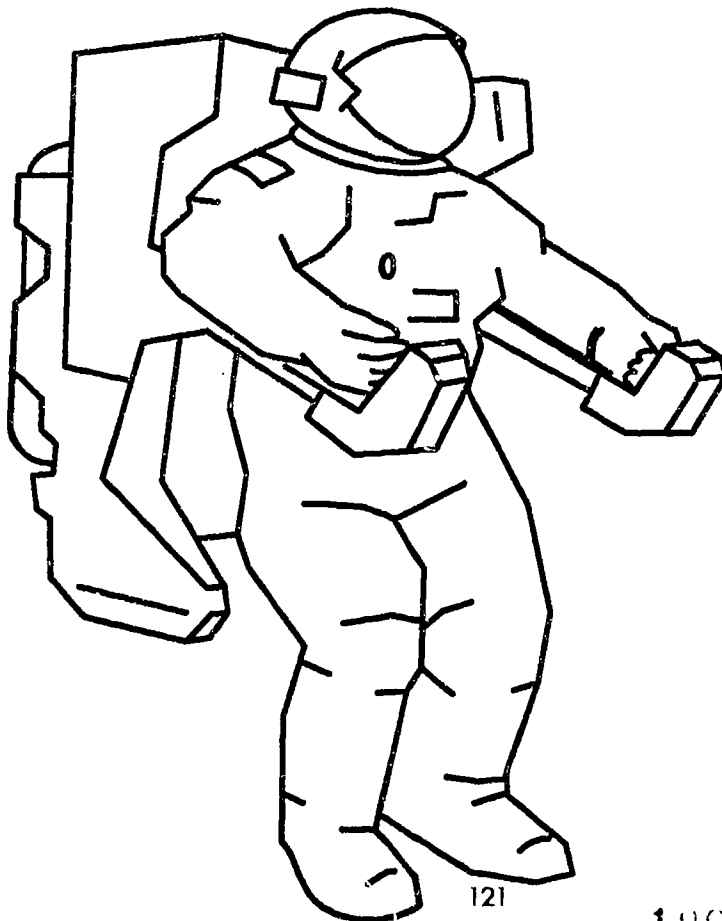

## SPACE SUIT/LIFE SUPPORT SYSTEM OR EXTRAVEHICULAR MOBILITY UNIT

1. Liquid Cooling and Ventilation Garment worn under the pressure and gas garment consists of liquid cooling tubes that maintain desired body temperature.
2. Service and Cooling Umbilical contains communications lines: power, water and oxygen recharge lines and a water drain line. It has a multiple connector at one end which attaches to the EMU.
3. EMU Electrical Harness provides bioinstrumentation and communications connections to the portable life support system.
4. Display and Control Module is a chest mounted control module which contains all external fluid and electrical interfaces, controls and displays.
5. Extravehicular Visor Assembly attaches externally to the helmet. Contains visors which are manually adjusted to shield the astronaut's eyes.
6. Helmet consists of a clear, polycarbonate bubble, neck disconnect and ventilation pad.
7. Arm Assembly contains the shoulder joint and upper arm bearings that permit shoulder mobility as well as the elbow joint and wrist bearing.
8. Gloves contain the wrist disconnect, wrist joint and insulation padding for palms and fingers.
9. Lower Torso consists of the pants, boots and the hip, knee and ankle joints.
10. Hard Upper Torso provides the structural mounting interface for most of the EMU: helmet, arms, lower torso, primary life support subsystem, display and control module, and electrical harness.
11. Primary Life Support System, commonly referred to as the "backpack." This assembly contains the life support subsystem expendables and machinery.
12. Secondary Oxygen Pack mounted to the base of the primary life support subsystem. It contains a 30-minute emergency oxygen supply and a valve and regulator assembly.
13. Contaminant Control Cartridge consists of lithium hydroxide, charcoal, and filters which remove carbon dioxide from the air that the astronaut breathes. It can

be replaced in flight.

14. The Battery provides all electrical power used by the space suit/life support system. It is filled with electrolyte and charged prior to flight. The battery is rechargeable.

15. Airlock Adapter Plate is an EMU storage fixture which is also used as a donning and doffing station.

16. Communications Carrier Assembly consists of a microphone and a headset. Allows the astronaut to talk to the other crewmen in the orbiter or other space suit/life support systems.

17. Insuit Drink Bag stores liquid in the hard upper torso and has a tube projecting up into the helmet to permit the astronaut to drink while suited.

18. Urine Collection Device consists of the adapter tubing, storage bag and disconnect hardware for emptying liquid.

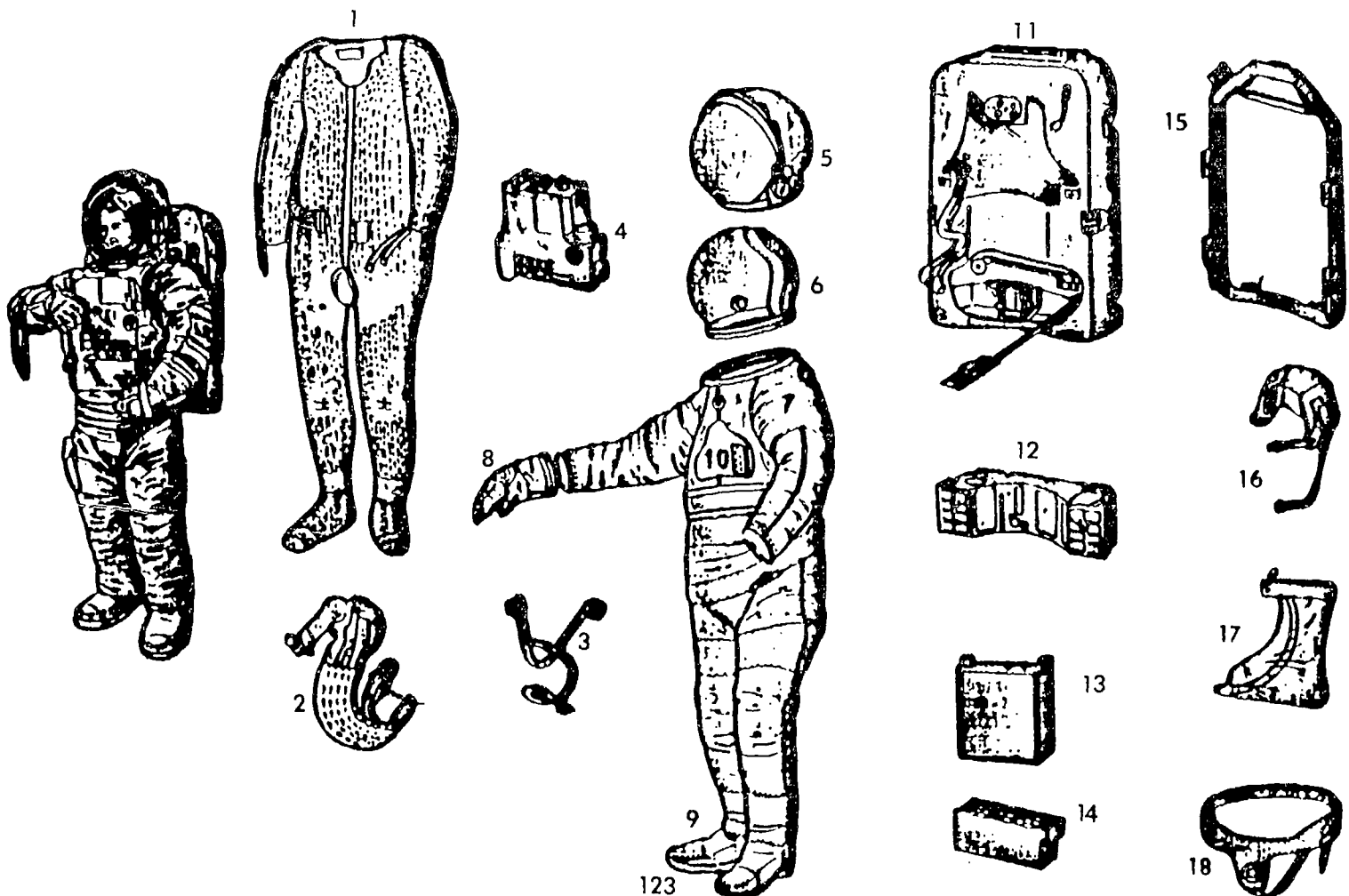

123

## ALPHABETICAL LIST OF ASTRONAUTS

<u>Name</u>	<u>Selection Year</u>	<u>Missions Flown</u>	<u>Status</u>
Adamson, James C.	1984	2	Former
Aldrin, Buzz	1963	2	Former
Akers, Thomas D.	1987	2	Current
Allen, Andrew M.	1987		Current
Allen, Joseph P.	1967	3	Former
Anders, William A.	1963	1	Former
Apl, Jerome	1985	2	Current
Armstrong, Neil A.	1962	2	Former
Bagian, James P.	1980	2	Current
Baker, Ellen S.	1984	2	Current
Baker, Michael A.	1985	2	Current
Bassett, Charles A., II	1963		Deceased
Bean, Alan L.	1963	2	Former
Blaha, John E.	1980	3	Current
Bluford, Guion S., Jr.	1978	4	Current
Bobko, Karol J.	1969	3	Former
Bolden, Charles F., Jr.	1980	2	Current
Borman, Frank	1962	2	Former
Bowersox, Kenneth D.	1987	1	Current
Brand, Vance D.	1966	4	Current
Brandenstein, Daniel C.	1978	4	Current
Bridges, Roy D., Jr.	1980	1	Former
Brown, Curtis L., Jr.	1987		Current
Brown, Mark N.	1984	3	Current
Buchli, James F.	1978	4	Former
Bull, John S.	1966		Former
Bursch, Daniel W.	1990		Current
Cabana, Robert D.	1985	2	Current
Cameron, Kenneth D.	1984	1	Current
Carpenter, M. Scott	1959	1	Former
Carr, Gerald P.	1966	1	Former
Carter, Manley Lanier, Jr.	1984	1	Deceased
Casper, John H.	1984	1	Current
Cernan, Eugene A.	1963	3	Former
Chaffee, Roger B.	1963		Deceased
Chang-Diaz, Franklin R.	1980	3	Current
Chapman, Philip K.	1967		Former
Chiao, Leroy	1990		Current
Chilton, Kevin P.	1987	1	Current
Cleave, Mary L.	1980	2	Former
Clifford, Michael R.	1990	1	Current
Coats, Michael L.	1978	3	Former
Cockrell, Kenneth D.	1990		Current
Collins, Eileen M.	1990		Current
Collins, Michael	1963	2	Former
Conrad, Charles, Jr.	1962	4	Former



<u>Name</u>	<u>Selection Year</u>	<u>Missions Flown</u>	<u>Status</u>
Cooper, L. Gordon, Jr.	1959	2	Former
Covey, Richard O.	1978	3	Current
Creighton, John O.	1978	3	Former
Crippen, Robert L.	1969	4	Former
Culbertson, Frank L., Jr.	1984	1	Current
Cunningham, Walter	1963	1	Former
Davis, N. Jan	1987		Current
Duffy, Brian	1985		Current
Duke, Charles M., Jr.	1966	1	Former
Dunbar, Bonnie J.	1980	3	Current
Eisele, Donn F.	1963	1	Deceased
England, Anthony W.	1967	1	Former
Engle, Joe H.	1966	2	Former
Evans, Ronald E.	1966	1	Deceased
Fabian, John M.	1978	2	Former
Fisher, Anna L.	1978	1	Current
Fisher, William F.	1980	1	Former
Foale, C. Michael	1987		Current
Freeman, Theodore C.	1963		Deceased
Fullerton, Charles G.	1969	2	Former
Gardner, Dale A.	1978	2	Former
Gardner, Guy S.	1980	2	Former
Garriott, Owen K.	1965	2	Former
Gemar, Charles D.	1985	2	Current
Gibson, Edward G.	1965	1	Former
Gibson, Robert L.	1978	4	Current
Givens, Edward G., Jr.	1966		Deceased
Glenn, John H., Jr.	1959	1	Former
Godwin, Linda M.	1985	1	Current
Gordon, Richard F., Jr.	1963	2	Former
Grabe, Ronald J.	1980	3	Current
Graveline, Duane E.	1965		Former
Gregory, Frederick D.	1978	3	Current
Gregory, William G.	1990		Current
Griggs, S. David	1978	1	Deceased
Grissom, Virgil I.	1959	2	Deceased
Gutierrez, Sidney M.	1984	1	Current
Haise, Fred W., Jr.	1966	1	Former
Halsell, James D., Jr.	1990		Current
Hammond, L. Blaine, Jr.	1984	1	Current
Harbaugh, Gregory J.	1987	1	Current
Harris, Bernard A., Jr.	1990		Current
Hart, Terry J.	1978	1	Former
Hartsfield, Henry W., Jr.	1969	3	Current
Hauck, Frederick H.	1978	3	Former
Hawley, Steven A.	1978	3	Former

<u>Name</u>	<u>Selection Year</u>	<u>Missions Flown</u>	<u>Status</u>
Helms, Susan J.	1990		Current
Henize, Karl G.	1967	1	Former
Henricks, Terence T.	1985	1	Current
Hieb, Richard J.	1985	2	Current
Hilmers, David C.	1978	4	Current
Hoffman, Jeffrey A.	1978	3	Current
Holmquest, Donald L.	1967		Former
Irwin, James B.	1966	1	Former
Ivins, Marsha S.	1984	2	Current
Jemison, Mae C.	1987		Current
Jernigan, Tamara E.	1985	1	Current
Jones, Thomas D.	1990		Current
Kerwin, Joseph P.	1965	1	Former
Lee, Mark C.	1984	2	Current
Leestma, David C.	1980	2	Current
Lenoir, William B.	1967	1	Former
Lind, Don L.	1966	1	Former
Llewellyn, John A.	1967		Former
Lounge, John M.	1980	3	Former
Lousma, Jack R.	1966	2	Former
Lovell, James A., Jr.	1962	4	Former
Low, G. David	1984	2	Current
Lucid, Shannon W.	1978	3	Current
Mattingly, Thomas K., II	1966	3	Former
McArthur, William S., Jr.	1990		Current
McBride, Jon A.	1978	1	Former
McCandless, Bruce, II	1966	2	Former
McCulley, Michael J.	1984	1	Former
McDivitt, James A.	1962	2	Former
McMonagle, Donald R.	1987	1	Current
McNair, Ronald E.	1978	2	Deceased
Meade, Carl J.	1985	2	Current
Melnick, Bruce E.	1987	2	Current
Michel, F. Curtis	1965		Former
Mitchell, Edgar D.	1966	1	Former
Muilane, Richard M.	1978	3	Former
Musgrave, F. Story	1967	4	Current
Nagel, Steven R.	1978	3	Current
Nelson, George D.	1978	3	Former
Newman, James H.	1990		Current
Ochoa, Ellen	1990		Current
O'Connor, Bryan D.	1980	2	Former
O'Leary, Brian T.	1967		Former
Onizuka, Ellison S.	1978	2	Deceased

<u>Name</u>	<u>Selection Year</u>	<u>Missions Flown</u>	<u>Status</u>
Oswald, Stephen S.	1985	1	Current
Overmyer, Robert F.	1969	2	Former
Parker, Robert A. R.	1967	2	Former
Peterson, Donald H.	1969	2	Former
Pogue, William R.	1966	1	Former
Precourt, Charles J., Jr.	1990		Current
Readdy, William F.	1987	1	Current
Reightler, Kenneth S., Jr.	1987	1	Current
Resnik, Judith A.	1978	2	Deceased
Richards, Richard N.	1980	3	Current
Ride, Sally K.	1978	2	Former
Roosa, Stuart A.	1966	1	Former
Ross, Jerry L.	1980	3	Current
Runco, Mario, Jr.	1987	1	Current
Schirra, Walter M., Jr.	1959	3	Former
Schmitt, Harrison H.	1965	1	Former
Schweickart, Russell L.	1963	1	Former
Scobee, Francis R.	1978	2	Deceased
Scott, David R.	1963	3	Former
Searfoss, Richard A.	1990		Current
Seddon, Margaret Rhea	1978	2	Current
See, Elliot M., Jr.	1962		Deceased
Sega, Ronald M.	1990		Current
Shaw, Brewster H., Jr.	1978	3	Former
Shepard, Alan B., Jr.	1959	2	Former
Shepherd, William M.	1984	3	Current
Sherlock, Nancy J.	1990		Current
Shriver, Loren J.	1978	3	Current
Slayton, Donald K.	1959	1	Former
Smith, Michael J.	1980	1	Deceased
Spring, Sherwood C.	1980	1	Former
Springer, Robert C.	1980	2	Former
Stafford, Thomas P.	1962	4	Former
Stewart, Robert L.	1978	2	Former
Sullivan, Kathryn D.	1978	2	Current
Swigert, John L., Jr.	1966	1	Deceased
Thagard, Norman E.	1978	4	Current
Thomas, Donald A.	1990		Current
Thorne, Stephen D.	1985		Deceased
Thornton, Kathryn C.	1984	2	Current
Thornton, William E.	1967	2	Current
Thuot, Pierre J.	1985	2	Current
Truly, Richard H.	1969	2	Former
van Hoften, James D. A.	1978	2	Former
Veach, Charles Lacy	1984	2	Current

<u>Name</u>	<u>Selection Year</u>	<u>Missions Flown</u>	<u>Status</u>
Voss, James S.	1987	2	Current
Voss, Janice E.	1990		Current
Walker, David M.	1978	2	Current
Walz, Carl E.	1990		Current
Weitz, Paul J.	1966	2	Current
Wetherbee, James D.	1984		Current
White, Edward H., II	1962	1	Deceased
Wilcutt, Terrence W.	1990		Current
Williams, Clifton C., Jr.	1963	2	Deceased
Williams, Donald E.	1978		Former
Wisoff, Peter J. K.	1990	2	Current
Wolf, David A.	1990		Current
Worden, Alfred M.	1966	1	Former
Young, John W.	1962		Current

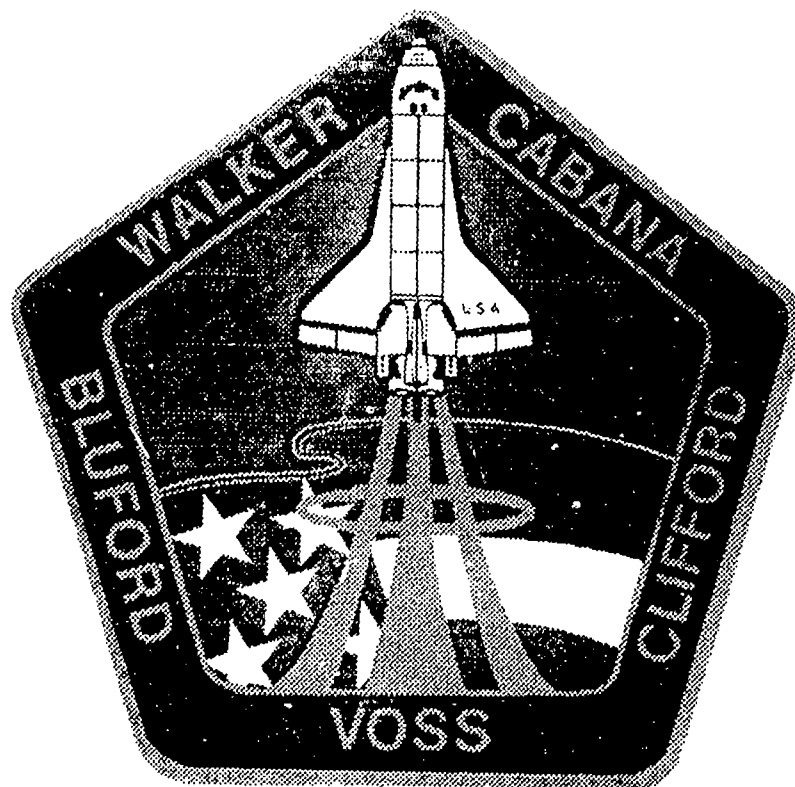

The last launch of 1992 was STS-53 on December 2 with Walker, Cabana, Bluford, Voss and Clifford on board.

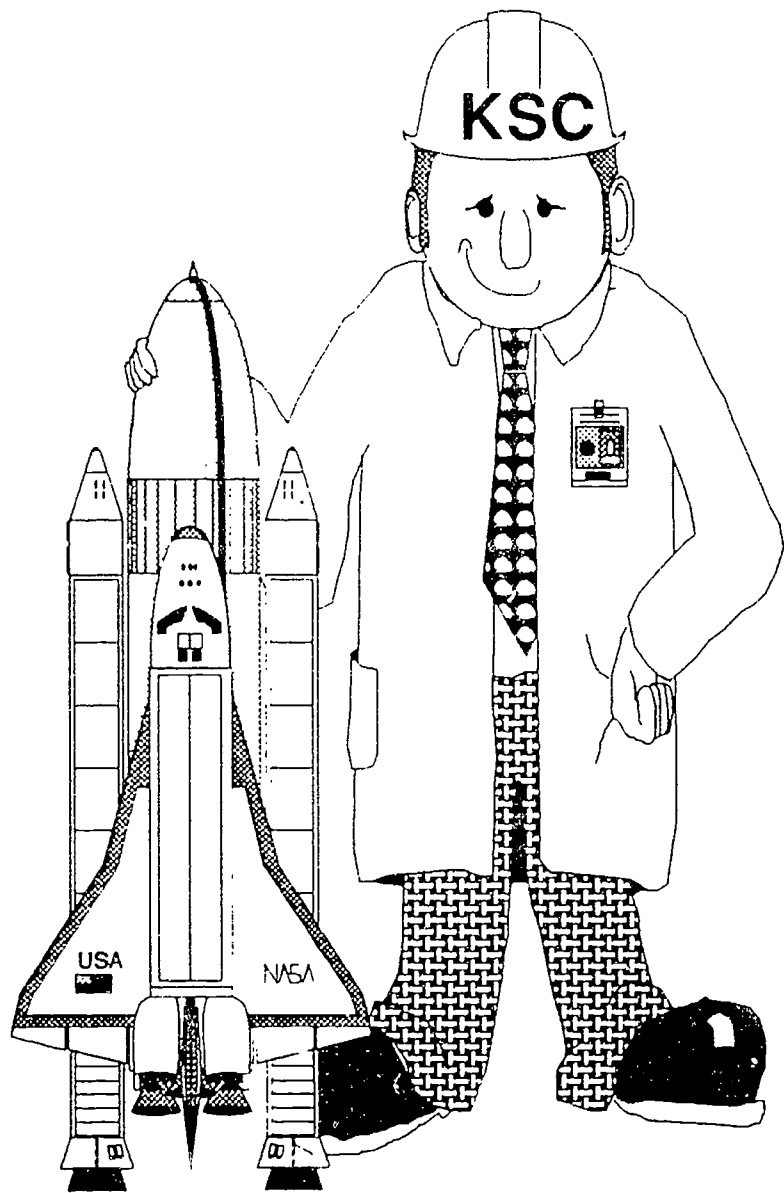

# ENGINEERS

**NAME:** ENGINEERS

**SKILL:** SCIENCE

**PROCEDURE:**

1. Interview or invite an engineer to your classroom.
2. Read about the different categories of engineering professions. Identify the type of career in which you would be most interested.
3. Study the NASA Civilian pay grade and identify various career steps with the corresponding pay grade. Entry pay is based on GPA, grade point average upon graduation from high school or college.
4. Contact various contractor personnel offices and request sample pay scales. Compare to GS employees; include benefits, hours worked, etc.
5. Most engineers at Kennedy Space Center work in the OPF, VAB, LCC and O&C. Read what these "acronyms" represent and locate the building on the KSC map.

(OPF: Orbiter Processing Facility--sophisticated aircraft hangar capable of handling three orbiters in parallel, located west and north of the VAB)

(VAB: Vehicle Assembly Building--second largest building in the world; shuttle buildup operations conducted in this facility, located at the heart of Launch Complex 39)

(LCC: Launch Control Center--contains two primary and two back-up firing rooms, connected to the east side of the VAB)

(O&C: Operations and Check-out facility--facility where the payload is checked out and various lab work is conducted; located next to the headquarters building in the industrial complex)

**BACKGROUND INFORMATION:**

There are many occupations represented in the aerospace industry, but one of the most important is engineering. There are six major engineering directorates throughout NASA/KSC: Shuttle Management and Operations, Safety and Reliability, Biomedical Operations and Research Office, Space Station Project, Engineering Development and Center Support. Each directorate employs various kinds of engineers.

Aerospace Engineers design and develop space vehicles, satellites, missiles, scientific probes, or other related hardware or system. They also oversee the manufacture of prototypes (models).

Electrical and electronics engineers design test apparatus, devise evaluation procedures, develop new and improved devices, recommend equipment design changes, write equipment specifications, direct field operations, maintain equipment, and supervise workers and projects.

Biomedical engineers conduct research into biological aspects of humans or other animals to develop new theories and facts, or test, prove or modify known theories of life systems. They also design support apparatus, using principles of engineering and bio-behavioral sciences. They also develop and design new medical instruments and techniques, such as artificial organs, cardiac pacemakers, or ultrasonic imaging devices. Biomedical engineers recommend equipment design changes and study engineering aspects of bio-medical systems of humans. They also assist medical personnel in observing or treating physical ailments or deformities.

Computer engineering at NASA includes computer system analysts who help define the computer process necessary to turn raw data into useful information, plan the distribution and use of results, and test the working systems in operation. One also consults with other engineering, scientific, or management personnel to define the problem. They study the problem and decide the best way to solve it by using techniques such as cost accounting, sampling, and mathematical model building. They gather the information needed to solve the problem, and design flow charts and diagrams. They recommend the data processing equipment that is to be used and prepare instructions for programmers. They write the results in a non-technical language that managers or customers can understand.

Computer engineering includes software engineers who study problems and determine the steps necessary to solve them. They write out the steps involved in flow chart form and write out details for each step in a computer language.

Mechanical engineers may design new systems in heating, ventilation, air conditioning and refrigeration that are necessary in space habitats. They may design products or systems, or plan and direct engineering personnel in the fabrication of test control apparatus and equipment. They develop methods and procedures for testing products or systems. They direct and coordinate construction and installation activities, and coordinate operation, maintenance, and repair activities to obtain the best use of machines and systems. By re-evaluating field installations and recommending design changes, they eliminate malfunctions.

Industrial engineers design and improve systems of machines, equipment, energy, and workers for maximum productivity. Work responsibilities include developing programs to simplify work flow, economy of worker motions, and layout of units. They plan and oversee plant safety and accident prevention programs, training programs, and the training of other personnel.



Civil engineers plan, design and supervise the construction and maintenance of structures and facilities. In addition, they prepare plans and specifications; estimate costs and requirements of projects; test materials to be used; determine solutions to problems; supervise construction and maintenance; inspect existing or newly constructed projects and recommend repairs; and determine the impact of construction on the environment. Civil engineers often work closely with architects in planning, designing and supervising the construction of buildings.

Chemical engineers conduct research to develop new chemical manufacturing processes. They determine the best method of operations like mixing, crushing, heat transfer, distillation, and oxidation. They oversee workers controlling equipment and make recommendations to management concerning new manufacturing processes, location and/or design of a new plant or modification of an existing plant.

Physicists study the laws of matter and energy and their application to problems in science, engineering, medicine, and industry. Astronomers observe and interpret celestial phenomena. They are concerned with the origin, evaluation, composition, motion, relative position, and size of the solar system. Their duties include devising procedures for conducting research and physical testing of materials; determining physical properties of materials; relating and interpreting research; describing observations and conclusions in mathematical terms; developing theories/laws based on observation and experiments; and developing mathematical tables and charts for navigational and other purposes. They design new optical instruments for observation and supervise scientific activities in research.

Metallurgical and Materials engineers extract, process, and convert metals into useful finished products. Their assignments require conducting research and development; developing processing methods plants; supervising production processes; and selling and servicing metal products.



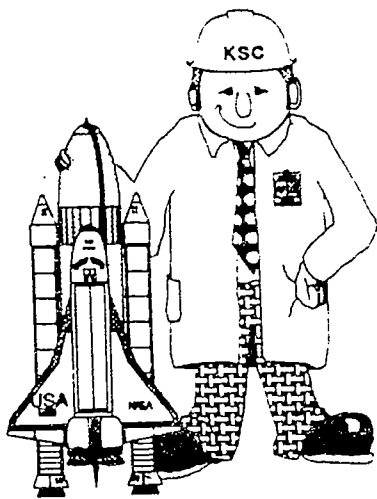

## Who are Engineers?

The broad profession of Engineering is usually broken down into four

basic categories:

- \* Electronic
- \* Mechanical
- \* Chemical
- \* Civil

Other Engineering specialties include:

- Automotive engineering
- \* Aerospace engineering (Aero or Astronautical)
- Agricultural engineering
- Architectural engineering
- Bio-engineering (Bio-medical, Bio-mechanical, Bio-chemical)
- Ceramic engineering
- \* Computer engineering
- Environmental engineering
- Fire protection engineering
- Geological engineering
- Geothermal engineering
- \* Heating, Ventilating, Air-conditioning and Refrigeration engineering
- \* Industrial engineering
- Manufacturing engineering
- \* Materials engineering
- Metallurgy and materials engineering
- Mineral and Mining engineering
- Naval engineering
- Nuclear engineering
- Ocean engineering
- Optical engineering
- Plant engineering
- Plastics engineering
- \* Robotics and Automated systems engineering
- Safety engineering
- \* Software engineering
- Transportation engineering
- \* Specialties at NASA, J.F. Kennedy Space Center, Florida

Engineers are problem solvers. They emphasize the use of math and science to solve problems by these steps:

- \* Identify and define the problem
- \* Analyze the problem
- \* Design and propose solutions
- \* Refine proposals
- \* Solve the problem

Engineering fits into the existing school curriculum in many areas of study:

- \* Science
- \* Math
- \* Computer Science
- \* Mechanical Drawing
- \* Technology Education
- \* Art (Engineering Design)
- \* Social Studies (Engineering's impact on the environment)

**GENERAL SCHEDULE OF ANNUAL RATES BY GRADE**  
*(Providing a 3.7 Percent Increase Effective January 10, 1993)*

GRADE	RATES WITHIN GRADE AND WAITING PERIOD FOR NEXT INCREASE															AMOUNT OF WITHIN-GRADE INCREASE
	52 WEEKS					104 WEEKS					156 WEEKS					
	1	2	3	4	5	6	7	8	9	10						
GS-1	\$11,903	\$12,300	\$12,695	\$13,090	\$13,487	\$13,720	\$14,109	\$14,503	\$14,521	\$14,891	VARIED					
GS-2	13,382	13,701	14,145	14,521	14,633	15,115	15,547	15,979	16,411	16,843	VARIED					
GS-3	14,603	15,090	15,577	16,064	16,551	17,038	17,525	18,012	18,499	18,986	\$487					
GS-4	16,393	16,939	17,485	18,031	18,577	19,123	19,669	20,215	20,761	21,307	546					
GS-5	18,340	18,951	19,562	20,173	20,784	21,395	22,006	22,617	23,228	23,839	611					
GS-6	20,443	21,124	21,805	22,486	23,167	23,848	24,529	25,210	25,891	26,572	681					
GS-7	22,717	23,474	24,231	24,988	25,745	26,502	27,259	28,016	28,773	29,530	757					
GS-8	25,159	25,996	26,837	27,676	28,515	29,354	30,193	31,032	31,871	32,710	839					
GS-9	27,789	28,715	29,641	30,567	31,493	32,419	33,345	34,271	35,197	36,123	926					
GS-10	30,603	31,623	32,643	33,663	34,683	35,703	36,723	37,743	38,763	39,783	1,020					
GS-11	33,623	34,744	35,865	36,986	38,107	39,228	40,349	41,470	42,591	43,712	1,121					
GS-12	40,298	41,641	42,984	44,327	45,670	47,013	48,356	49,699	51,042	52,385	1,343					
GS-13	47,920	49,517	51,114	52,711	54,308	55,905	57,502	59,099	60,696	62,293	1,597					
GS-14	56,627	58,515	60,403	62,291	64,179	66,067	67,955	69,843	71,731	73,619	1,888					
GS-15	66,609	68,829	71,049	73,269	75,489	77,709	79,929	82,149	84,369	86,589	2,220					

**SENIOR EXECUTIVE SERVICE**

ES-1	\$92,900
ES-2	97,400
ES-3	101,800
ES-4	107,300
ES-5	111,800
ES-6	115,700

143

143

## OFFICIAL ADDRESSES OF KENNEDY SPACE CENTER CONTRACTORS

Bionetics Corporation  
BIO-I, Room 3103,0 & C  
Kennedy Space Center, FL 32899  
(407)867-4187

Boeing Aerospace Operations, Inc.  
1355 N. Atlantic Avenue  
Cocoa Beach, Florida 32931  
(407)783-0220

Ivey's Construction, Inc.  
Attn: Wade Ivey  
4060 N. Courtney Parkway  
Merritt Island, FL 32953-8145  
(407) 452-3182

General Dynamics Space Systems  
Attn: F. E. Watkins  
P. O. Box 320999  
Cocoa Beach, FL 32932-0999  
(407) 853-6011

R & E Electronics  
CD & SC Bldg., M6-138  
Kennedy Space Center, FL 32899  
(407) 867-1214/(919)763-4750  
725 Wellington, P.O. Box 7068  
Wilmington, N.C. 28406

HFSI  
Attn: R. L. Bartcher  
HFSI, LCC Bldg., Rm. 2P8  
Kennedy Space Center, FL 32899  
(407) 861-0558  
Construction Corp.  
P. O. Box 1048 (One Malaga St)  
St. Augustine, FL 32085  
(904) 829-3421

Rockwell International Corp.  
Space Transportation Systems Div.  
P. O. Box 21105  
Kennedy Space Center, FL 32815  
Center Street Bldg. Dept. 806 ZK18  
Cape Canaveral, FL 32920  
(407) 799-6871

Bionetics Corporation (Photography)  
P. O. Box 21027  
KSC, FL 32815-0027

McDonnell Douglas Space Systems  
100 McDonnell Douglas Way  
Titusville, FL 32780  
(407) 383-2800

The Haskell Company  
Attn: Greg Ferrell  
111 Riverside Avenue  
Jacksonville, FL 32202-4950  
(904) 791-4683

Hernandez Engineering, Inc.  
355 Indian River Avenue  
Titusville, FL 32796  
(407) 269- 5419

Uwahali Incorporated  
P. O. Box 3200096  
Cocoa Beach, FL 32932-0096  
(407) 867-4090

Harris Space Systems Corporation  
295 Bames Blvd.  
P. O. Box 5000  
Rockledge, FL 32955  
(407) 633-3800

TW Rrecreational Services, Inc.  
Attn: Mr. D. L. Hennessy  
Spaceport USA  
Mailcode: TWRS Kennedy Space  
Center, FL 32899  
(407) 867-1566

USBI Company  
P. O. Box 21212, Mail Code: USBI-HR  
Kennedy Space Center, FL 32815  
(407) 867-9813

Metric Constructors,  
Inc.(CONSTRUCTION)  
(407)453-8493 (Tampa 813-289-0357)

W & J Construction Corporation  
P. O. Box 1779  
Cocoa,Florida 32923-1779  
(407) 632-7660

Goodson Paving, Inc.  
P. O. Box 310  
Sharpes, Florida 32959

Lockheed Corporation  
Attn: Personnel Office  
1100 Lockheed Way  
Titusville, FL 32780  
(407)383-2200

#### SUBCONTRACTORS- LOCKHEED

Bionetic Corporation  
Attn: Lisa Leger  
Mailcode: TBC  
Kennedy Space Center, FL 32899  
(407)867-3253

BAMSI, Inc.  
Attn: Marshall Randall  
Sr. Vice President of Adm.  
P. O. Box 1659  
Titusville, FL 32781-1659  
(407)269-4193

Grumman Technical Services, Inc.  
Attn: Employment Office  
Human Resources Dept.  
1250 Grumman Place  
Titusville, FL 32780  
(407)268-8400

Thiokol Corporation  
Attn: Human Resources  
1425 Chaffee Drive  
Titusville, FL 32780  
(407)268-4813

Johnson Controls World Svcs, Inc.  
7315 N. Atlantic Avenue  
Cape Canaveral, FL 32920  
(407)784-7100

Rocketdyne Div. of Rockwell  
Attn: Alberta Wilson  
Mailcode: ROC- 1 , O&C, Room 1136  
Kennedy Space Center, FL 32899  
(407)867-3227

Unified Services, Inc.  
Attn: J. Kimzie Cowart, Vice President  
Mailcode: USI-SPC  
Kennedy Space Center, PL 32899  
(407)861-0703

Willtech of Florida  
P. O. Box 21052  
Kennedy Space Center, FL 32815

EG&G Florida, Inc.  
Attn: Earl Patrick  
Manager of Employment/EEO  
412 Highpoint Drive  
Cocoa, FL 32926  
(407)631-7300

#### SUBCONTRACTORS-EG&G

Atlantic Technical Services Corp.  
Attn: Alfred Nelson, Project Mgr.  
P. O. Box 21211  
Kennedy Space Center, FL 32815  
(407)867-2413

EGP  
1509 N. Harbor City Blvd.  
Melbourne, FL 32935  
(407)632-1652

New World Services, Inc.  
now (EG&G)  
(407) 631-7300

PBS&J  
Attn: Bonnie Brennan  
1560 Orange Ave., Suite 700  
Winter Park, FL 32789  
(407)647-7275

USAI  
Mailcode: OO  
P. O. Box 21092  
Kennedy Space Center, FL 32815  
(407)867-7297

Wiltech of Florida  
P.O.Box 21052  
Kennedy Space Center, FL 32815  
(407)861-0521

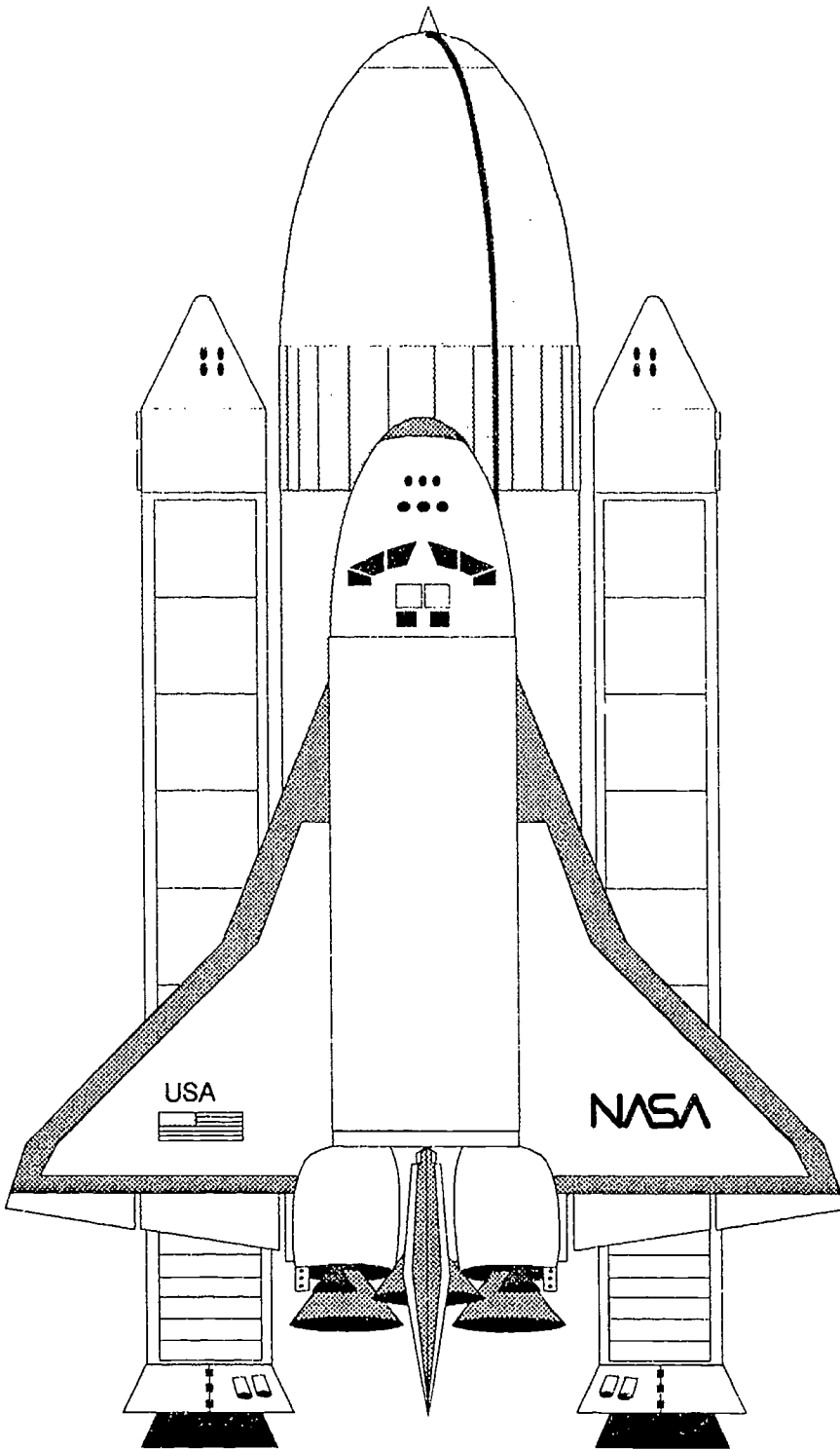

# SPACE SENSATIONS

**NAME:** Space Sensations

**SKILL:** Science, Mathematics and Tehnology

**PROCEDURE:**

1. Sound Waves

- a. Use a board about 18 x 6 inches and attach a set of musical strings using eye bolts. A set of six extra light gauge guitar strings works well. Make some strings longer than others.
- b. Tighten the strings to get different tensions. This is a sound board or simple zither type instrument.
- c. Provide a plectrum for picking the different strings. Students can observe that sound waves will vary depending on the length, gauge and tightness of the string.
- d. A simple slide can be used such as a writing pen to show different sounds. Hold the slide on a string, pick the string, then move the slide to make different sounds.

2. Reaction Time

- a. Tape two or three yard sticks together with clear tape.
- b. One student drops the stick through the open hand of another student starting at the top of the hand.
- c. The second student catches the stick as soon as possible and reads how far the stick has traveled.
- d. See who stops the stick the fastest by recording the shortest distance the stick fell.

3. Sensory Deprivation

- a. Have a student wear a pair of heavy gloves and try to manipulate several pieces of something in an attempt to construct a final product, i.e. connect paper clips together to make a necklace.
- b. Students will gain a knowledge of how much more difficult it is to do things in space while wearing gloves.

4. Peripheral Vision

- a. Take one square of corrugated cardboard and cut it to the shape of a protractor. Support it on a stack of several books and mark the degrees on it in increments of ten along the edge.
- b. Stick the sharp end of a pencil in the cardboard protractor near the edge at zero degrees, leaving the remainder to show on the top of the surface.
- c. As one student positions their nose at the end of the protractor and stares at the pencil, another student moves a block of wood or other object around the edge of the protractor starting at 10 degrees and proceeding to zero degrees.
- d. When the object is first detected the peripheral vision is given in degrees for that

eye. Check each eye separately.

#### 5. Diffraction of Light Rays

- a. Take black and white construction paper and make eight 3 X 5 inch cards.
- b. Use your imagination to make different black and white designs on the cards such as: stripes, stars, circles, etc.
- c. Mount the cards on a poster and place them under a light source (not fluorescent).
- d. View the cards through a prism and watch how light was modified through diffraction.

#### 6. Sensory Deprivation

- a. Place a mystery object in a shoe box and tape it closed.
- b. Ask students to guess what the object is by just listening to the sounds it makes as they tilt the box from side to side.
- c. Students may need clues depending on the difficulty of the object in the box.

#### 7. Depth Perception

- a. Use a dowel or stick of wood 18 inches long and mount it to a piece of board about 6 X 12 inches.
- b. Attach an eye screw at the top end of the dowel and a similar sized bolt to the board with a string about two feet long.
- c. A student can close one eye and try to put the bolt through the eye screw, i.e. thread the needle.
- d. This shows how we need to use both eyes for good depth perception.

### BACKGROUND INFORMATION:

Astronauts need to meet excellent physical requirements to satisfy the job demands created by the weightless environment of space. They often must create or repair things with their own hands, tools and brains while working within the confines of pressurized spacesuits. They must not only possess superior five senses, but be able to use them in conjunction with each other such as eye-hand coordination.

Astronauts need to possess good manual skills and be capable of performing them under challenging circumstances. Since the conditions of space reduce the sensory abilities of astronauts they often must develop hypotheses without having all the facts. Also, they must complete their particular mission assignments and maintain life support equipment while living in microgravity.

A vast amount of formal education, knowledge, and specialized training are required of an astronaut, but these are only some of the requirements of space travelers. They also must have extraordinarily good physical skills and manual abilities that are necessary to perform the duties of an astronaut.





# WEATHER

**NAME:** WEATHER

**SKILL:** SCIENCE

**PROCEDURE:**

1. Study the various cloud symbols. Match the symbol with its corresponding meaning.
2. Study the "Key to Aviation Weather Report" to see how it explains the sky and ceiling and visibility.
3. Read about the different types of clouds. Find the names of the different clouds in the word search game.
4. Watch the weather reports and see if you can identify the cloud formations.
5. Keep a record of your cloud observations, what you predict and the actual weather.
6. Using polyfil or cotton, make models of each of the major cloud types.

**BACKGROUND INFORMATION:**

Although there are no clouds in space, it is very important for our pilots who may be future astronauts to learn about them. As a pilot travels in the air or space, it is often difficult to tell if he/she is up or down when flying into a cloud. Also, a cloud's shape indicates whether he/she is close to the earth's surface or thousands of feet in the sky. Changes in the weather are important to pilots because aircraft and passenger safety is of utmost importance. Sometimes the Space Shuttle does not take off or land because of bad weather.

Clouds are visible vaporous formations in the sky. There are four different types of clouds. Each has its own distinctive characteristics.

**Cumulus** mean "accumulation" or "pile". Cumulus clouds vary in size and grow into huge, puffy white masses. They can be near the earth's surface or tower thousands of feet into the sky. Typically seen on a summer's day, they move swiftly along and cast giant shadows across the land.

**Cumulonimbus** clouds are very dangerous to pilots. They are cumulus clouds which change into dark thunderstorms and are extremely turbulent, formed by rising air currents.

**Cirrus** clouds are in the upper levels of the troposphere, usually between 20,000 and 50,000 feet. They are composed of clouds of ice crystals which have a delicate, curly appearance like feathers. These highest of clouds are usually five to ten miles above the earth.

**Stratus** means spread out. These clouds which appear in the early morning or late evening are nearest the earth when the air is least likely to be moving. These form in layers like fog, and are seldom above 6,500 feet.

**"Alto"** is generally added to designate clouds at intermediate height, usually at levels between 5,000 and 20,000 feet. These could be altocumulus and altostratus.

The term **"cirro"** means curly and is added to the high altitude clouds. Cirrocumulus and cirrostratus are in this group.

Space weather satellites have found out that there is no weather in space because there isn't any air or water. Weather satellites have provided tremendous knowledge about the current and predicted weather. Millions of lives have been saved because of more accurate weather predictions. It is very important to understand weather before blast-off into space. Spacecraft have to blast-off in good weather and it must be predicted that the weather will be good upon reentry. Depending on weather conditions the Shuttle will land at Kennedy Space Center in Florida or Edwards Air Force Base in California. Can you imagine what it would be like to live in space without weather changes?

### Cloud Symbols on a Weather Map

CLEAR      SCATTERED      BROKEN      OBSCURED      OVERCAST

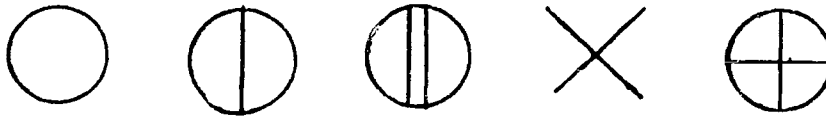

#### KEY TO AVIATION WEATHER REPORTS.....

LOCATION IDENTIFIER AND TYPE OF REPORT	SKY AND CEILING	VISIBILITY WEATHER AND OBSTRUCTION TO VISION	SEA LEVEL PRESSURE	TEMPERATURE AND DEW POINT	WIND	ALTIMETER SETTING	RUNWAY VISUAL RANGE	CODED PIREPS
<b>MKC</b>	<b>150M250</b>	<b>1R-K</b>	<b>132</b>	<b>/58/56</b>	<b>/1807</b>	<b>/993/</b>	<b>R04LVR20V40</b>	<b>/055</b>
<b>SKY AND CEILING</b> Sky cover symbols are in ascending order. Figures preceding symbols are heights in hundreds of feet above station. Sky cover symbols are: O Clear: less than 1 sky cover 0 Scattered: 1 to less than 6 sky cover. 6 Broken: 6 to 9 sky cover. 9 Overcast: More than 9 sky cover. - Thin (When prefixed to the above symbols.) -K Partial obscuration: 1 to less than 10 sky hidden by precipitation or obstruction to vision (bases at surface) X Obscuration: 10 sky hidden by precipitation or obstruction to vision (bases at surface) Letter preceding height of layer identifies ceiling layer and indicates how ceiling height was obtained. Thus: A Aircraft                      B Radiosonde Balloon or Radar. C Balloon (Pilot or ceiling) D Estimated height of cirriform clouds on basis of persistence E Estimated heights of noncirriform clouds M Measured U Height of cirriform ceiling layer unknown. W Indefinite Height of cirriform non-ceiling layer unknown. Immediately following numerical value indicates a varying ceiling		<b>VISIBILITY</b> Reported in Statute Miles and Fractions. (V-Variable) <b>WEATHER AND OBSTRUCTION TO VISION SYMBOLS</b> A Hail                      F Fog                      BW Rain Showers AP Small Hail            GF Ground Fog        S Snow BD Blowing Dust        H Haze                      SD Snow Grains BN Blowing Sand        IC Ice Crystals        SP Snow Pellets BS Blowing Snow        IF Ice Fog                SW Snow Showers D Dust                      K Smoke                T Thunderstorm E Sleet                      L Drizzle                ZL Freezing Drizzle EW Sleet Showers        R Rain                      ZR Freezing Rain Precipitation intensities are indicated thus: - Very Light; - Light; (no sign) Moderate; + Heavy <b>WIND</b> Direction in tens of degrees from true north, speed in knots. 0000 indicates calm. G indicates gusty. Peak speed follows Q or Q when gusts or squalls are reported. The contraction WSHFT followed by local time group in remarks indicates windshift and its time of occurrence. (Knots x 1.15 = statute mi/hr.) EXAMPLES: 3427 340 Degrees, 27 Knots; 3427G40 340 Degrees, 27 Knots Peak speed in gust 40 knots. <b>ALTIMETER SETTING</b> The first figure of the actual altimeter setting is always omitted from the report.			<b>RUNWAY VISUAL RANGE (RVR)</b> RVR is reported from some stations. Extreme values for 10 minutes prior to observation are given in hundreds of feet. Runway identification precedes RVR report. <b>CODED PIREPS</b> Pilot reports of clouds not visible from ground are coded with MSL height data preceding and/or following sky cover symbol to indicate cloud bases and/or tops respectively. <b>DECODED REPORT</b> Kansas City: Record observation, 1500 feet scattered clouds, measured ceiling 2500 feet overcast, visibility 1 mile, light rain, smoke, sea level pressure 1013.1 millibars, temperature 58°F, dewpoint 56°F, wind 180°, 7 knots, altimeter setting 29.93 inches, Runway 04 left, visual range 2000 ft. variable to 4000. Pilot reports top of overcast 3500 feet. (MSL). <b>"TYPE OF REPORT"</b> The omission of type of report data identifies a scheduled record observation for the hour specified in the sequence heading; the time of an out-of-sequence, special observation is given as "S" followed by a time group (24-hour clock GMT) e.g., "PIE 5 0715 PM." A special indicator of significant change in one or more elements. Local reports are identified by "LCL" and a time group. Local are transmitted on local teletypewriter circuits only.			

U.S. DEPARTMENT OF COMMERCE • ENVIRONMENTAL SCIENCE SERVICES ADMINISTRATION • WEATHER BUREAU • Washington, D.C.

#### KEY TO AVIATION WEATHER FORECASTS.....

<p><b>TERMINAL FORECASTS</b> contain information for specific airports on ceiling, cloud heights, cloud amounts, visibility, weather condition and surface wind. They are written in a form similar to the AVIATION WEATHER REPORT.</p> <p><b>CEILING:</b> Identified by the letter "C"  <b>CLOUD HEIGHTS:</b> In hundreds of feet above the station (ground)  <b>CLOUD LAYERS:</b> Stated in ascending order of height  <b>VISIBILITY:</b> In statute miles, but omitted if over 10 miles  <b>SURFACE WIND:</b> In tens of degrees and knots, omitted when less than 10.</p> <p style="text-align: center;"><b>EXAMPLE OF TERMINAL FORECASTS</b></p> <table style="width: 100%;"> <tr> <td style="width: 50%;">                     C1500 ● Ceiling 1500', broken clouds                      240C7004K 32300 Scattered clouds at 2000', ceiling 7000' overcast, visibility 6 miles, smoke, surface wind 320 degrees 30 knots, gusty.                 </td> <td style="width: 50%;">                     O11/20P Clear, visibility one and one-half miles, ground fog.                      CSX1/45+ Sky obscured, vertical visibility 500 ft. visibility one-fourth mile, heavy snow.                 </td> </tr> </table> <p><b>AREA FORECASTS</b> are 12-hour forecasts plus 12 hour <b>OUTLOOKS</b> (18 hour outlook in FA valid of 1300Z) of cloud, weather and frontal conditions for an area the size of several states. Heights of cloud tops, icing, and turbulence are <b>ABOVE SEA LEVEL (ASL)</b>, ceiling heights, <b>ABOVE GROUND LEVEL (AGL)</b>; bases of cloud layers are ASL unless indicated. Area forecasts are amended by SIGMETs or AIRMETs.</p>	C1500 ● Ceiling 1500', broken clouds 240C7004K 32300 Scattered clouds at 2000', ceiling 7000' overcast, visibility 6 miles, smoke, surface wind 320 degrees 30 knots, gusty.	O11/20P Clear, visibility one and one-half miles, ground fog. CSX1/45+ Sky obscured, vertical visibility 500 ft. visibility one-fourth mile, heavy snow.	<p><b>SIGMET or AIRMET</b> warn airmen in flight of potentially hazardous weather such as squall lines, thunderstorms, fog, icing, and turbulence. SIGMET concerns severe and extreme conditions of importance to all aircraft. AIRMET concerns less severe conditions which may be hazardous to some aircraft or to relatively inexperienced pilots. Both are broadcast by FAA on NAVAIID voice channels.</p> <p><b>WINDS AND TEMPERATURES ALOFT (FD) FORECASTS</b> are computer prepared forecasts of wind direction (nearest 10° true N) and speed (knots) for selected flight levels. Temperatures aloft (°C) are included for all levels (≥ 2500 ft. above station elevation) except the 3000-foot level.</p> <p><b>EXAMPLES OF WINDS AND TEMPERATURES ALOFT (FD) FORECASTS:</b></p> <p>FD WPC 131745                      BASED ON 131300Z DATA                      VALID 130000Z FOR USE 1800-0300Z. TEMPS NEG ABV 31000</p> <table style="width: 100%;"> <tr> <td style="text-align: center;">FT</td> <td style="text-align: center;">2000</td> <td style="text-align: center;">4000</td> <td style="text-align: center;">6000</td> <td style="text-align: center;">13000</td> <td style="text-align: center;">18000</td> <td style="text-align: center;">24000</td> <td style="text-align: center;">30000</td> <td style="text-align: center;">34000</td> <td style="text-align: center;">37000</td> </tr> <tr> <td style="text-align: center;">MKS</td> <td style="text-align: center;">3127</td> <td style="text-align: center;">3425-07</td> <td style="text-align: center;">3420-11</td> <td style="text-align: center;">3431-10</td> <td style="text-align: center;">3518-27</td> <td style="text-align: center;">3312-30</td> <td style="text-align: center;">311649</td> <td style="text-align: center;">292451</td> <td style="text-align: center;">283451</td> </tr> <tr> <td style="text-align: center;">JK</td> <td style="text-align: center;">3026</td> <td style="text-align: center;">3327-40</td> <td style="text-align: center;">3334-13</td> <td style="text-align: center;">3333-10</td> <td style="text-align: center;">3120-27</td> <td style="text-align: center;">2923-30</td> <td style="text-align: center;">284240</td> <td style="text-align: center;">285150</td> <td style="text-align: center;">285749</td> </tr> </table> <p>At 6000 foot ASL over JK wind from 330° at 37 knots and temperature minus 8° C.</p> <p style="text-align: center;"><b>PILOTS report in-flight weather to nearest FSS</b></p>	FT	2000	4000	6000	13000	18000	24000	30000	34000	37000	MKS	3127	3425-07	3420-11	3431-10	3518-27	3312-30	311649	292451	283451	JK	3026	3327-40	3334-13	3333-10	3120-27	2923-30	284240	285150	285749
C1500 ● Ceiling 1500', broken clouds 240C7004K 32300 Scattered clouds at 2000', ceiling 7000' overcast, visibility 6 miles, smoke, surface wind 320 degrees 30 knots, gusty.	O11/20P Clear, visibility one and one-half miles, ground fog. CSX1/45+ Sky obscured, vertical visibility 500 ft. visibility one-fourth mile, heavy snow.																																
FT	2000	4000	6000	13000	18000	24000	30000	34000	37000																								
MKS	3127	3425-07	3420-11	3431-10	3518-27	3312-30	311649	292451	283451																								
JK	3026	3327-40	3334-13	3333-10	3120-27	2923-30	284240	285150	285749																								

U.S. DEPARTMENT OF COMMERCE • ENVIRONMENTAL SCIENCE SERVICES ADMINISTRATION • WEATHER BUREAU • Washington, D.C.

For Sale by the Superintendent of Documents, U.S. Government Printing Office, Washington, D.C., 20402

TYPES OF CLOUDS

ETCBFZCIRROSTRATUSAH  
 QCFUYOKDCHCCRLLYNTLQ  
 HQBPMCIRROCUMULUSKTM  
 YPWMTULESHPSXRYUXSOX  
 OTCKJKLALTOSTRATUSCW  
 CMGRWNJOKDRJKWUROBUK  
 EJMCKXXONLMZNVRMGMMM  
 LSF RUEPEPIWHWIDKZRUX  
 BWLEAMQYSWMRCFJMCMLQ  
 WWFHTUUNQUSBFLJHMSUU  
 VSKPTKULTTICUXWWRFSU  
 KCTNPLEGUVUSGSGCZLBH  
 THMRHLPWZSJYFMWEWTTT  
 AUPKANDWGSFNRRHKEGENN  
 TTMDPTOWEBMGOEEIRLGG  
 VSWGXYUUSBJLDJMJEWNH  
 UIXFDAYSHVUBMOIWZHLR  
 BVKALVTDHSTFXQSFAIII  
 YCYRPEAAFXISWFJCPVU  
 EUMEPXLLJLQMSMDXLFZ

THERE ARE 8 WORDS HERE - CAN YOU FIND THEM?

HERE ARE THE ONES TO LOOK FOR

ALTOCUMULUS  
 CIRROSTRATUS  
 CUMULUS

ALTOSTRATUS  
 CIRRUS  
 STRATUS

CIRROCUMULUS  
 CUMULONIMBUS

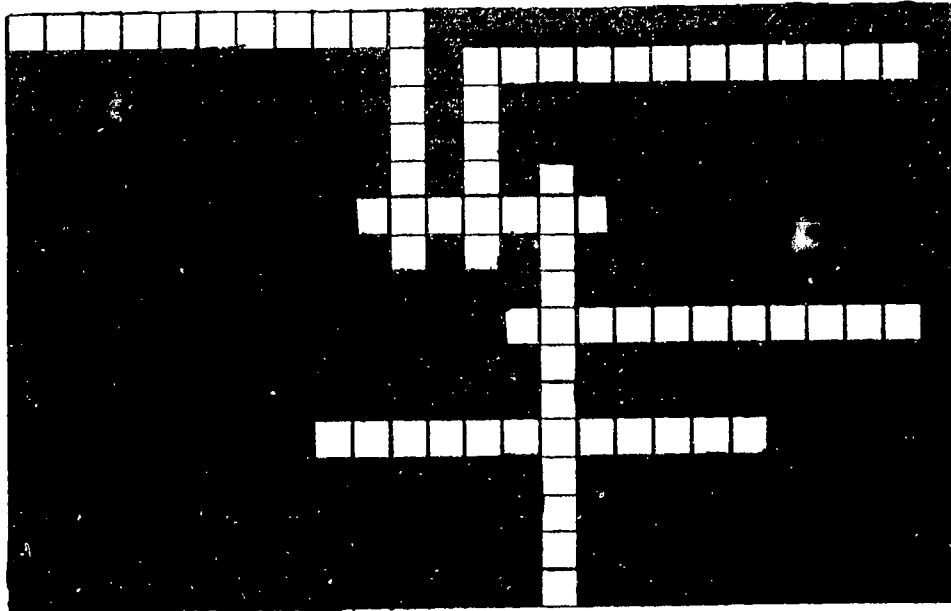

ACROSS

- [ 1 , 1 ] CUMULUS BETWEEN 5,000 TO 20,000 FT
- [ 2 , 13 ] CURLY STRATUS HIGH ALTITUDE CLOUDS
- [ 6 , 10 ] ACCUMULATIONS, PILE, PUFFY
- [ 9 , 14 ] STRATUS BETWEEN 5,000 TO 20,000
- [ 12 , 9 ] CURLY HIGH ALTITUDE CUMULUS

DOWN

- [ 1 , 11 ] FORM LAYERS LIKE FOG, SPREAD OUT
- [ 2 , 13 ] COMPOSED OF ICE CRYSTALS, CURLY
- [ 5 , 15 ] DANGEROUS TO PILOTS, DARK THUNDERSTORMS

BEST COPY AVAILABLE

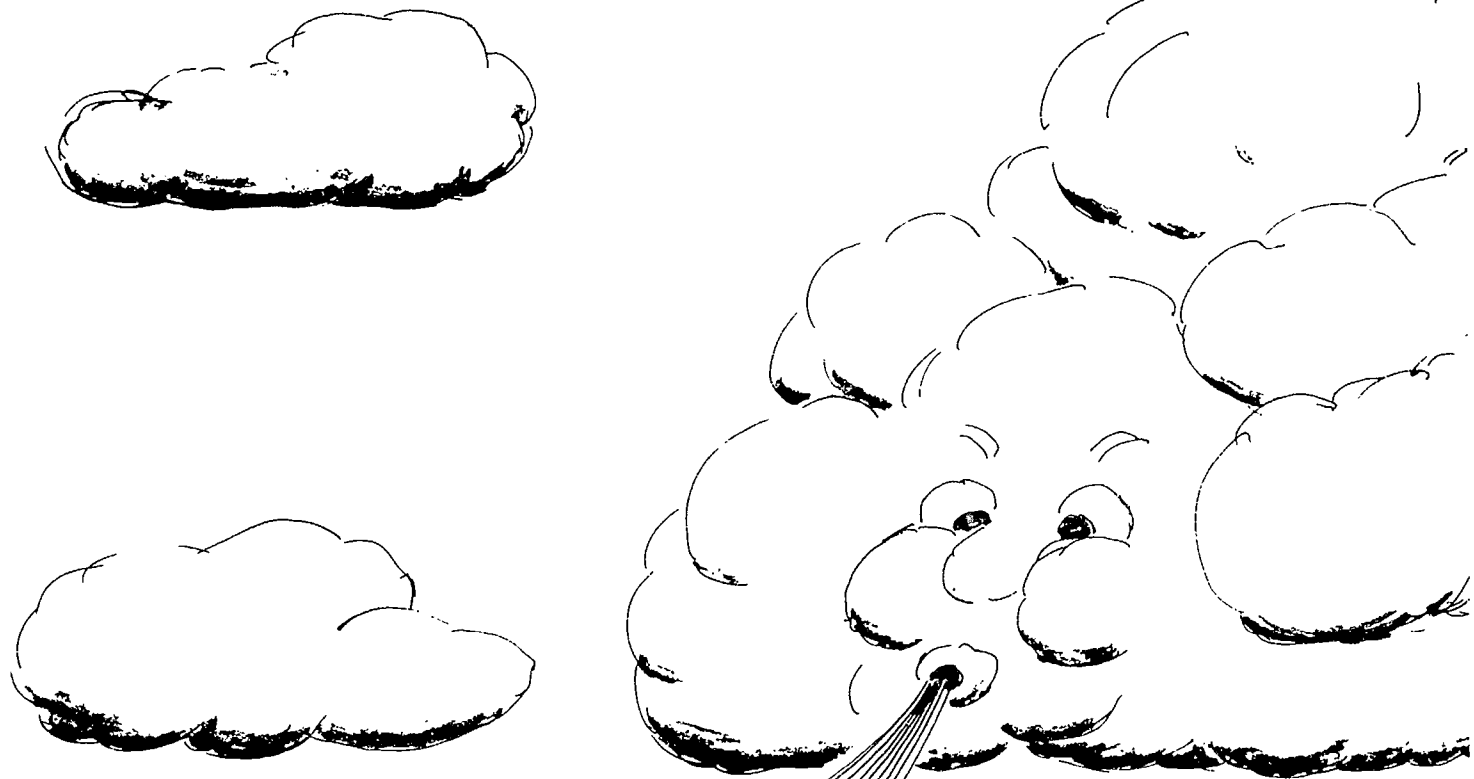

# WEATHER

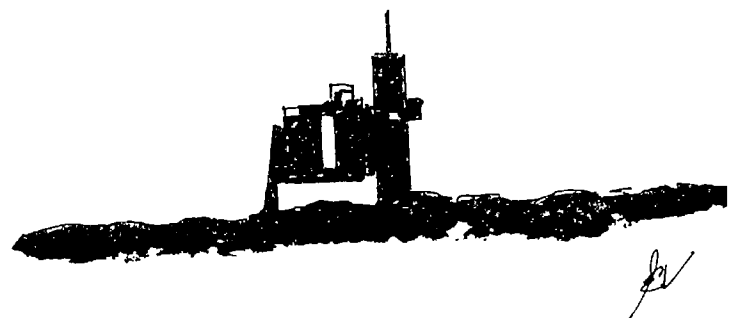

. . C . . . CIRROSTRATUSA .  
 . . . U . . . . . L .  
 . . . M CIRROCUMULUS . T .  
 . . . U . . . . . SO .  
 . . . L ALTOSTRATUSC .  
 . . . O . . . . . R . U .  
 . . . C . . . N . . . . . M .  
 . . . U . . . I . . . I . . . U .  
 . . . M . . . M . C . . . . L .  
 . . . U . . . B . . . . . U .  
 . S . . . . L . . . . U . . . S .  
 . . T . . . . U . . . . S . . . .  
 . . . R . . . . S . . . . . . .  
 . . . A . . . . . . . . . . . .  
 . . . T . . . . . . . . . . . .  
 . . . U . . . . . . . . . . . .  
 . . . . . S . . . . . . . . . . . .  
 . . . . . . . . . . . . . . . . . .  
 . . . . . . . . . . . . . . . . . .  
 . . . . . . . . . . . . . . . . . .  
 . . . . . . . . . . . . . . . . . .  
 . . . . . . . . . . . . . . . . . .  
 . . . . . . . . . . . . . . . . . .  
 . . . . . . . . . . . . . . . . . .  
 . . . . . . . . . . . . . . . . . .  
 . . . . . . . . . . . . . . . . . .  
 . . . . . . . . . . . . . . . . . .  
 . . . . . . . . . . . . . . . . . .  
 . . . . . . . . . . . . . . . . . .  
 . . . . . . . . . . . . . . . . . .  
 . . . . . . . . . . . . . . . . . .  
 . . . . . . . . . . . . . . . . . .  
 . . . . . . . . . . . . . . . . . .

---

THE ANSWERS

ACROSS

[ 1 , 1 ] ALTOCUMULUS  
 [ 2 , 13 ] CIRROSTRATUS  
 [ 6 , 10 ] CUMULUS  
 [ 9 , 14 ] ALTOSTRATUS  
 [ 12 , 9 ] CIRROCUMULUS

DOWN

[ 1 , 11 ] STRATUS  
 [ 2 , 13 ] CIRRUS  
 [ 5 , 15 ] CUMULONIMBUS

---

# BIODIVERSITY

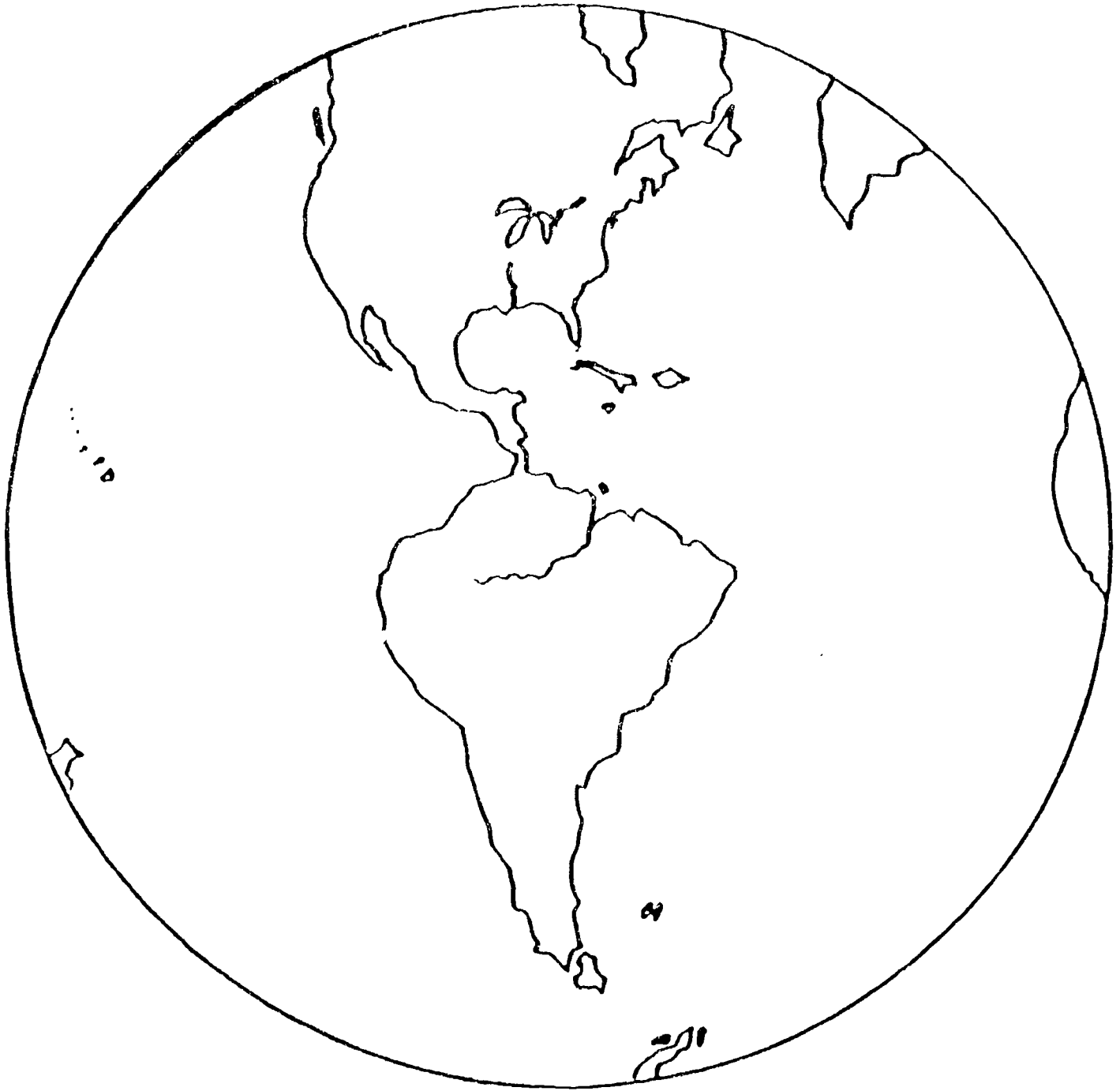

SPECIES OF THE INDIAN RIVER LAGOON AREA  
WHICH ARE CLASSIFIED AS ENDANGERED, THREATENED, OR  
SPECIAL CONCERN

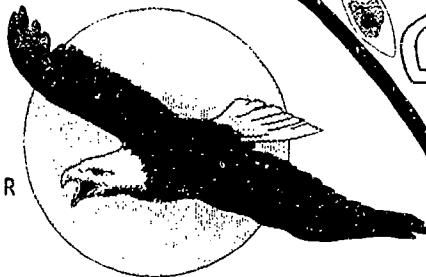

ENDANGERED

Reptiles

Atlantic green turtle  
Atlantic hawksbill turtle  
Atlantic Ridley turtle  
leatherback turtle  
Atlantic salt marsh snake

Birds

wood stork  
peregrine falcon

Mammals

West Indian manatee

SPECIES OF SPECIAL CONCERN

Fishes

common snook  
rivulus

Reptiles

American alligator

Birds

little blue heron  
snowy egret  
tricolor heron  
reddish egret  
roseate spoonbill  
American oystercatcher  
brown pelican  
osprey

THREATENED

Reptiles

Atlantic loggerhead turtle

Birds

bald eagle  
American kestrel  
roseate tern  
least tern

Plants

giant leather fern  
coconut palm  
prickly pear cactus





**NAME:** BIODIVERSITY

**SKILL:** SCIENCE

**PROCEDURE:**

1. Define and discuss the term "ecosystem". Then complete the crossword puzzle as follows:

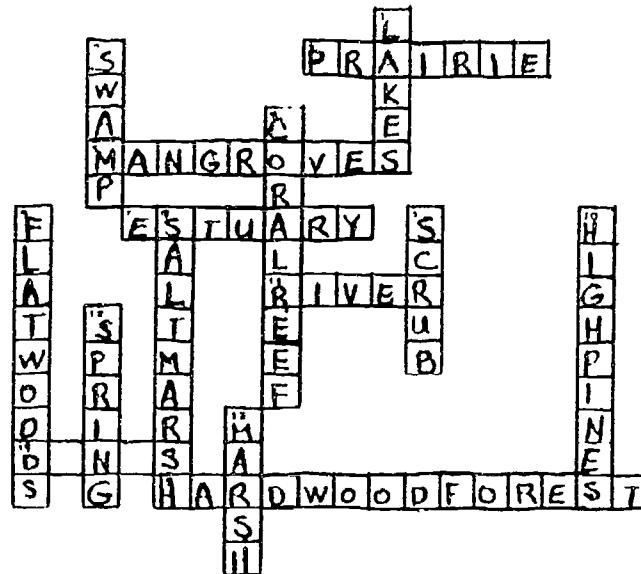

2. Define simile and then complete the Wildlife Simile matching activity.

3. Identify the species and various habitats in your environment. Discuss the impact man has on your environment.

### **BACKGROUND INFORMATION:**

The term BIODIVERSITY has been derived from a combination of the terms BIOLOGICAL and DIVERSITY. It refers to the variety within and between living things and the habitats they live in. The following are three types or levels of biodiversity.

1. Genetic diversity--the variety of genetic materials within a species that allows species and populations to cope with change.
2. Species diversity--The variety of living things within a habitat, ecosystem or region.
3. Ecosystem or habitat diversity--The variety of habitats or ecosystems within a region.

Maintaining healthy ecosystems requires protecting all three levels of biodiversity.

## WILDLIFE SIMILE

A simile is an expression that compares one thing to another thing and the things are usually very different! Most of the time the word like or as is used in the simile. Read each simile and decide if it is true or false. You can use reference books if you wish. Then decide if the phrase described wildlife in a good way or in a bad way.

True or False?

1. Blind as a bat.
2. Grumpy as a bear.
3. Busy as a bee.
4. Daffy as a duck.
5. Cute as a bug in a rug.
6. Slippery as an eel.
7. Sly as a fox.
8. Silly as a goose.
9. Eyes like a hawk.
10. Crazy as a loon.
11. Wise as an owl.
12. Playful as an otter.
13. Proud as a peacock.
14. Slimy as a snake.
15. Dumb as a turkey.
16. Slow as a turtle.

Can you rewrite the similes that show animals in a bad way to similes that show animals in a good way?

(Reprinted with permission from Biodiversity, Florida Solar Energy Center)

## Name That Ecosystem

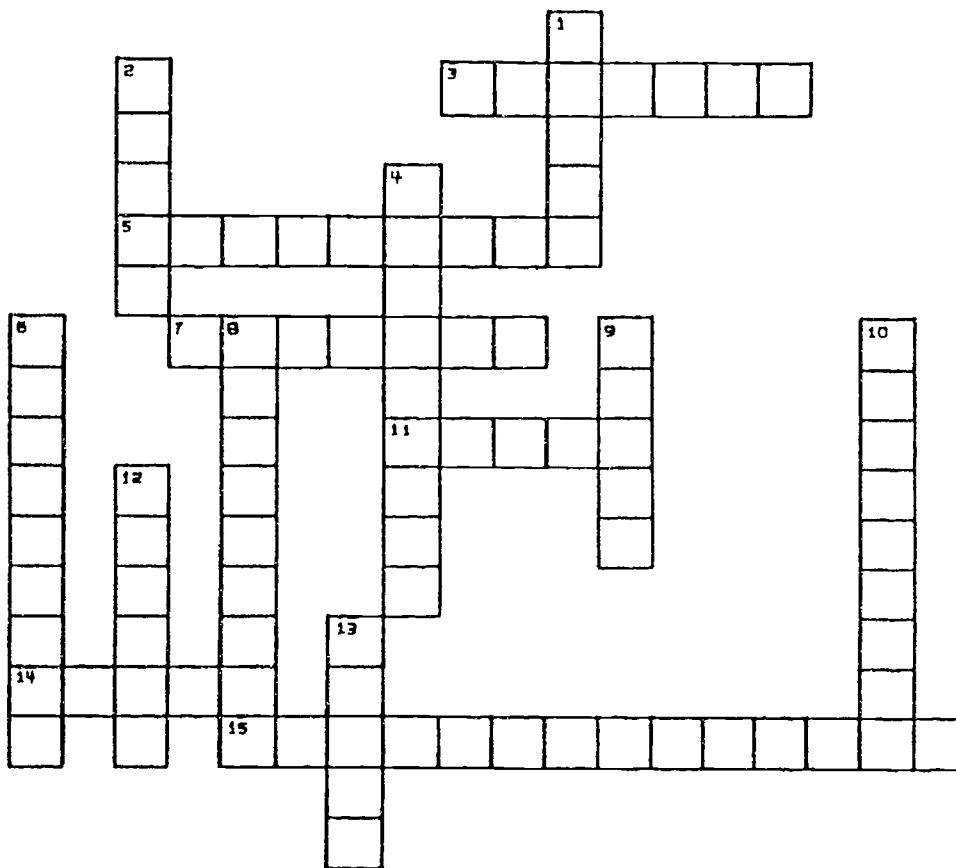

### Across Clues:

3. low flat areas without pine trees
5. trees that grow out into the sea on coastal areas
7. where sand and freshwater mix at inshore marine habitats
11. flowing fresh water
14. mounds of sand formed by wind on the beaches
15. shady places in the hammocks

### Down Clues:

1. body of freshwater
2. forested wetlands
4. offshore marine habitats
6. low flat areas with pine trees
8. grass-like plants in coastal area
9. well drained pine lands growing on old dunes
10. open park-like areas
12. where ~roundwater reaches the earth's surface
13. wetlands with grasses and herbs

(Reprinted with permission from Biodiversity, Florida Solar Energy Center.)

## Appendix

### Kindergarten-Sixth Grade Aerospace Objectives

Spinoffs

Space Music

NASA Centers

NASA /KSC Educational Programs

Lithographs

Apollo 15 Liftoff into Space

Apollo 11 First Human Footprints on the Moon

Space Shuttle Lifts Off into Space

McCandless Flies First Solo in Space: Manned Maneuvering Unit (MMU)

Space Station Freedom Artist Concept

STS-1 (L-R) Young, Crippen

STS-47 (L-R) Davis, Lee, Brown, Gibson, Apt, Jemison, Mohri

## Elementary School Science Objectives in Aerospace

### Grade K

#### Life Science

The student should be able to:

- LK.1 Discuss what living things need to survive.
- LK.2 Discuss why there are no living things on other planets.
- LK.3 Discuss what is needed to sustain life in space habitats.
- LK.4 Discuss what plants need to grow in space.
- LK.5 Discuss how plants (i.e., tomato seeds) adapted to living in space.

#### Earth Science

The student should be able to:

- EK.1 Identify the properties of air and water (i.e. float, sink) as they relate to microgravity environments.
- EK.2 Compare weather conditions on earth with those of other planets.

#### Physical Science

The student should be able to:

- PK.1 Examine properties of objects using the senses and hypothesize if they would be different in microgravity environments.
- PK.2 Classify objects by color, shape, texture and size.
- PK.3 Compare length, weight, and liquid capacity of common objects. Discuss how weight and liquids would be different in microgravity.
- PK.4 Discuss how liquids would be contained in microgravity environments.

#### Materials and Equipment

The student should be able to:

- MK.1 Practice accepted safety procedures manipulating laboratory equipment and materials.
- MK.2 Identify basic apparatus and equipment useful for scientific activities.
- MK.3 Practice proper care for scientific equipment.

## NEWEST Elementary School Science Objective/ Responses in Aerospace

### Life Science

- LK.1 Living things need air, water, food, habitat, light.
- LK.2 Other planets don't sustain life due to lack of wind, lack of rain, extreme temperature.
- LK.3 Some type of apparatus to control temperature of the air and water and food supply.
- LK.4 Plants need controlled temperature and air, water, food (nutrients).
- LK.5 Plants grown in a hydroponic environment seem to do well. Plant experiments involving simulated microgravity environments are also going well. It was reported that the tomato seeds from space germinated faster, however this was not known to be a result of space travel or the condition they were held in prior to space.

### Earth Science

- EK.1 Air and water still are matter, take up space, have weight. A float/sink experiment would not work due to microgravity, not due to changes in the air or water.
- EK.2 It is not known if other planets have wind or rain. Their temperatures are much more extreme than on earth.

### Physical Science

- PK.1 Observations using senses
- PK.2 Senses should not be affected; classification would be no different (with the exception of weight) as long as you had a container to put them in.
- PK.3 Observations by students
- Weight- would appear to be "weightless" in microgravity. Liquid- would have to be contained and controlled in microgravity.
- PK.4 Drinking liquids are in sealed containers; water for washing is in controlled areas that do not allow the waste and water to freely move about. Vacuums are used for waste removal. Astronauts use hoses or water guns and syringes to dispense water.

### Materials and Equipment

- MK.1 Handle materials in a manner that will not harm themselves, the material, or someone else. Follows instruction for handling the materials.
- MK.2 Balance scales, magnifying glass, magnets, funnels, measuring materials, eye droppers, microscopes, etc.
- MK.3 Keep out of mouth, nose, ears, etc. Put things back the way you found them.

# Elementary School Science Objectives in Aerospace

## Grade 1

### Life Science

The student should be able to:

- LI.1 Classify what kinds of plants would be needed in a space environment.
- LI.2 Discuss how plants can be grown in space.
- LI.3 Discuss the results on how plant roots, stems, and leaves responded to long term space environment.
- LI.4 Identify animals that have been in space.
- LI.5 Discuss how animals have adapted in space.
- LI.6 Explain how different body structures helped animals adapt to space environments (i.e., jellyfish).
- LI.7 Explain how the astronauts adapt to short periods of daylight and darkness as they orbit the earth.
- LI.8 Discuss how your senses adapt in microgravity.
- LI.9 Explain how one sense can compensate for the loss of another.
- LI.10 Discuss sources of light in space.

### Earth Science

The student should be able to:

- LI.1 Identify land and water masses from space satellite photographs.
- LI.2 Compare Earth rocks to Moon rocks.
- LI.3 Explain how forces changed the surface of the Earth, Moon and other planets.
- LI.4 Discuss why we need air when we travel outside the Earth's atmosphere.
- LI.5 Investigate the effects of air on objects.
- LI.6 Discuss how water could be located by remote sensing satellites.
- LI.7 Discuss if water has been found on other planets.

### Physical Science

The student should be able to:

- PI.1 Identify several properties of objects using the senses.
- PI.2 Classify groups of objects by two properties.
- PI.3 Classify matter as solid, liquid or gas. Identify which planets contain these forms of matter.
- PI.4 Observe that change takes place and relate to space rocket propulsion systems.
- PI.5 Recognize that motion has occurred.
- PI.6 Observe and identify forces of motion and relate motion on other planets.

### Materials and Equipment

The student should be able to:

- MI.1 Practice accepted safety procedures in manipulating laboratory equipment and materials.
- MI.2 Identify basic apparatus and equipment useful for scientific activities.
- MI.3 Practice proper care for scientific equipment.
- MI.4 Select the appropriate tool for measuring distance, time and temperature.

## NEWEST Elementary School Science Objective/ Responses in Aerospace

### Life Science

- L1.1 Plants that can grow with low light levels and still produce a high nutrient harvest.
- L1.2 Discuss and experiment with hydroponics.
- L1.3 Plants grow up toward light and roots down but because of apparent weightlessness, artificial methods such as centrifugal force will be needed to simulate this.
- L1.4 Monkey, jellyfish, rats, honeybees, cockroaches, spiders
- L1.5 Studies continue at this time.
- L1.6 Animals have not had long enough exposure.
- L1.7 They rely on Houston to keep them on an Earth timetable. Goggles, earplugs, shades, all are used.
- L1.8 Your senses respond almost the same.
- L1.9 The sense is not lost; becomes more acute.
- L1.10 Because shuttle orbits the Earth they will have 45 min of light, 45 min of dark. Artificial light sources will be used.

### Earth Science

- E1.1 Photos made available for identification
- E1.2 Moon rocks cannot come in to contact w/moisture like Earth's do or they will rust. Moon rocks contain many of the same minerals as Earth's.
- E1.3 Plate tectonics theories, extreme temperatures on some, wind erosion on some
- E1.4 Because we are a living organism adapted to living in Earth's atmosphere we must take our own oxygen into the vacuum of space.
- E1.5 Atmospheric pressure experiments
- E1.6 Water gives off a different temperature than land Infrared is used to detect these temperature differences.
- E1.7 Mars has land forms that indicate that water was present at one time. Investigation still continues.

### Physical Science

- P1.1 Color, texture, odor, temperature, weight/mass, sounds, taste
- P1.2 Attribute investigation
- P1.3 Mercury-Solid
  - Venus- Solid gas -molten rock
  - Mars- Volcanic action - molten rock
  - Jupiter, Neptune, Saturn, Uranus- liquid, hydrogen gas, with solid core
  - P Pluto- rock
- P1.4 When solid fuel burns & becomes a gas it becomes a propellant. Hydrogen & oxygen burn to become a "steam Propellant"
- P1.5 Observation
- P1.6 Gravity is directly related to mass therefore you weigh more or less depending on the mass of the planet. on small planets you weigh less on large planets more (ie moon- man weighs 1/6 Earth weight)

### Material & Equipment

- M1.1 Standard safety: Goggles when handling liquids. Care when handling flames. Never put your nose to a container to smell. Never taste in a science lab.
- M1.2 A balance is used to measure mass. A meter stick is used to measure length. A graduated cylinder is used to measure volume.
- M1.3 Equipment should always be stored clean. When using a balance never suddenly force down a single side: never drop. Don't touch slides & lenses.
- M1.4 Distance is measured with a meter stick or trendle wheel. Time is measured with a clock or stop watch. Temperature is measured with a thermometer.



# Elementary School Science Objectives in Aerospace

## Grade 2

### Life Science

The student should be able to:

- L2.1 Discuss conditions needed to germinate seeds in space.
- L2.2 Discuss how plants could be grown without sunlight.
- L2.3 Discuss how a plants life cycle would be affected in a space environment.
- L2.4 Identify plants that produce foods and analyze if they would be appropriate to grow in space.
- L2.5 List foods astronauts could take on board the Shuttle Orbiter.
- L2.6 Describe how foods help the body.
- L2.7 Describe how astronauts prepare their food aboard the Space Shuttle Orbiter.
- L2.8 Describe how a space environment would differ from an earth environment.
- L2.9 Describe how a food chain would work in a space environment.
- L2.10 Predict how man and plants would respond to an environment without changes/seasons.

### Earth Science

The student should be able to:

- E2.1 Describe how weather is formed and how the seasons change.
- E2.2 Identify hurricanes and tornados from space satellite photographs.
- E2.3 Discuss cloud types and weather associated with them.
- E2.4 Demonstrate how wind affects objects that fly (i.e., kites, balloons, aircraft)
- E2.5 Explain how rain and snow affect aircraft.
- E2.6 Identify oceans from satellite photographs.
- E2.7 Compare and contrast oceans and fresh water.
- E2.8 Explain the water cycle and its importance.
- E2.9 Describe how satellite photographs assist in locating resources in the ocean.

### Physical Science

The student should be able to:

- P2.1 Infer if magnets work in space.
- P2.2 Infer if sound waves travel in space.
- P2.3 Describe how astronauts communicate in space.
- P2.4 Describe how water reacts in microgravity.
- P2.5 Explain how objects respond to push and pull motions in microgravity.
- P2.6 Order objects according to measurement.
- P2.7 Explain the importance of using standard measurement in building spacecraft.
- P2.8 Use metric units to measure length.

### Material and Equipment

The student should be able to:

- M2.1 Practice accepted safety procedures in manipulating laboratory equipment and materials.
- M2.2 Identify basic apparatus and equipment useful for scientific activities.
- M2.3 Practice appropriate care for scientific equipment.
- M2.4 Select the appropriate tool for measuring distance, time and temperature.

## NEWEST Elementary School Science Objective/ Responses in Aerospace

### Life Science

- L 2.1 To germinate, seeds need moisture and the proper temperature.
- L 2.2 To grow plants without sunlight, artificial light sources will be necessary.
- L 2.3 Humans will have to control pollination. Because it feels like there is no gravity, the roots and leaves would not grow up and down like they do on earth because of tropisms to light & gravity.
- L 2.4 Wheat and lettuce are being researched for growth in space. A plant must be a high producer of nutrients to be suitable for space use. All waste is recycled.
- L 2.5 Astronauts take almost any food they choose on the space shuttle. Some fresh fruits and vegetables are taken. Dehydrated and packaged foods are also taken.
- L 2.6 The body needs food to provide the basic nutrients for life (protein, carbohydrates, fats, vitamins & minerals, water) Proper foods help the body grow and repair and give it energy.
- L 2.7 Food is prepared by rehydrating dried foods, and some are heated. Most foods are prepackaged in individual servings.
- L 2.8 In space things and people seem to be weightless. Living in the Orbiter requires being confined in a small area. Astronauts are vulnerable while in earth orbit.
- L 2.9 In a contained environment, man would control the food chain by the plants and animals he introduced.
- L 2.10 Because there are areas on earth without season changes (at equator) there would probably be little effect on man or plants. Man can control needs of plants.

58

### Earth Science

- E 2.1 Weather is changed in the earth's atmosphere due to varying moisture and temperature. The seasons change because of the earth's tilt orbit axis, which causes sunlight to be more direct during some parts of the year.
- E 2.2 Photos for identification
- E 2.3 Stratus- blanket coverage, associated with rain Cirrus- high wispy clouds, precede cold fronts Cumulus- Fair weather, possibility of thunderstorms
- E 2.4 Student should know that kites can't fly without wind, balloons are carried by the wind, aircraft can be slowed or sped up by wind.

172

- E 2.5 Rain can cause limited visibility to aircraft. Ice can collect on wings adding extra weight and impeding flying ability.
- E 2.6 Photos for identification
- E 2.7 Oceans and fresh water have different life forms. Oceans contain salt & minerals.
- E 2.8 Through evaporation condensation & precipitation, water cycles from land to air and back. Plants provide a large amount of water in the air.
- E 2.9 Various colors appear on Landsat photos which are interpreted by experts showing Earth's resources.

### Physical Science

- P 2.1 Magnets work in space or a vacuum.
- P 2.2 Sound doesn't travel in space or a vacuum; it must have matter to travel.
- P 2.3 Communication in space is by radio waves.
- P 2.4 Water or liquids will form a sphere in microgravity. Cohesion helps hold the liquids together unless bumped.
- P 2.5 They seem to have no weight so respond readily when a small force is applied.
- P 2.6 Metric measures all have the following prefixes based on 10's (1/1000 Mill, 1/100 Centi, 1/10 Deci, x10 deca, x1000 hecto, x10000Kilo)
- P 2.7 Standard measure makes interchangeable parts and good connections possible. Exact control is necessary.
- P 2.8 The metric unit of length is the meter.

### Material & Equipment

- M 2.1 Standard safety: Goggles when handling liquids. Care when handling flames. Never put your nose to a container to smell. Never taste in a science lab.
- M 2.2 A balance is used to measure mass. A meter stick is used to measure length. A graduated cylinder is used to measure capacity or volume.
- M 2.3 Equipment should always be stored clean. When using a balance never suddenly force down a single side; never drop. Don't touch slides and lenses.
- M 2.4 Distance is measured with a meter stick or treadle wheel. Time is measured with a clock or stop watch. Temperature is measured with a thermometer.

173

## Elementary School Science Objectives in Aerospace

### Grade 3

#### Life Science

The student should be able to:

- L3.1 Describe how the skeletal system is affected by microgravity living.
- L3.2 Describe how the muscular system is affected by microgravity living.
- L3.3 Describe how basic life functions are affected by microgravity living.
- L3.4 Describe how plants respond to light, gravity and water.
- L3.5 Compare how plants would respond in artificial light and microgravity.
- L3.6 Describe how animals have adapted to their space environment.
- L3.7 Explain how the space program (i.e., Kennedy Space Center) helped preserve animals from extinction.

#### Earth Science

The student should be able to:

- E3.1 Describe how Earth's rotation and revolution affect weather phenomena.
- E3.2 Explain how Earth phases would appear from the moon.
- E3.3 Describe the similarities and differences among the planets by reference to NASA missions.
- E3.4 Describe how satellite photographs of the Earth's crust increased our knowledge-base.
- E3.5 Compare rock type formations on Earth with those of other planets.
- E3.6 Identify minerals located on the Moon and other planets.

#### Physical Science

The student should be able to:

- P3.1 Identify the properties of matter.
- P3.2 Describe solids, liquids and gases found on other planets.
- P3.3 Describe physical and chemical changes in matter.
- P3.4 Describe how heat causes matter to expand and change phases.
- P3.5 Describe how heat is measured on other planets.
- P3.6 Describe how a fire could be started on other planets.
- P3.7 Explain what could be used for a fuel substitute in a space environment.

#### Materials and Equipment

The student should be able to:

- M3.1 Practice accepted safety procedures in manipulating laboratory equipment/material.
- M3.2 Identify basic apparatus and equipment useful for scientific activities.
- M3.3 Practice proper care for scientific equipment.
- M3.4 Select the appropriate tool for measuring distance, time and temperature; describe how scientists measured data on other planets.

## NEWEST Elementary School Science Objective/ Responses in Aerospace

### Life Science

- L3.1 Astronauts suffer some bone & muscle deterioration because their bodies don't get the resistance they are used to in gravity.
- L3.2 Astronauts must exercise regularly to counteract the effects of living in a weightless environment.
- L3.3 Air, food & water must be taken to survive prolonged visits in space. All food in space must be nutritious & packaged in individual servings that allow easy manipulation in the weightless environment.
- L3.4 Plants on earth need light & water to survive. Gravity causes roots to grow down & stems & plants, up.
- L3.5 Test are presently being conducted to see how plants respond in artificial light and microgravity. It is an ongoing testing process.
- L3.6 A number of animals, including chimps, dogs, and insects, have been sent to space & tests are run to see how they adapted to their space environment
- L3.7 NASA KSC, is part of the National Wildlife Refuge of Merritt Island and the Canaveral National Seashore. Living on the protected KSC are over 300 endangered species. There is a great concern by NASA Officials, to protect the plants and animals as they build new construction & launch spacecraft.

### Earth Science

- E3.1 The earth's rotation and revolution affect weather phenomena in relation to day/night, seasons, and tides.
- E3.2 The earth would not have the types of phases we are familiar with in regards to the moon.
- E3.3 Through a variety of NASA automated exploration of the solar system a variety of similarities and differences have been documented.
- E3.4 Satellite photographs of the Earth's crust increased our knowledge base of the earths changes & geographic variety.

E3.5 Rock type formations on earth are similar to those of other planets (seen from digitized photography) except on earth they have weathered (eroded)

E3.6 Minerals found in the moon and other planets have been found to have the same organic matter as those from earth.

### Physical Science

- P3.1 The properties of matter are solids, liquids, and gases.
- P3.3 Through experimentation physical & chemical changes would be seen using a variety of materials.
- P3.4 Heat makes the molecules move more rapidly, resulting in expansion and change.
- P3.5 Heat is measured on other planets by computers which measure light spectrum changes.
- P3.6 A fire would not be able to start due to lack of oxygen
- P3.7 Generators & batteries could be used in a space environment.

### Materials and Equipment

- M3.1 Safety rules should be established to be followed. Precautions should include using goggles, gloves, etc.
- M 3.2 Basic apparatus & equipment would include a balance, scales, microscope, magnifying lens, rulers, magnets, and thermometers.
- M3.3 Scientific equipment must be used with care and cleaned & stored after use.

# Elementary School Science Objectives in Aerospace

## Grade 4

### Life Science

The student should be able to:

- L4.1 Describe what types of animals could exist in a space environment.
- L4.2 Hypothesize if vertebrate animals would be affected living in a space environment.
- L4.3 Hypothesize if invertebrate animals would be affected living in a space environment.
- L4.4 Describe how animal living conditions must be adapted to space environments.
- L4.5 Describe how cells would be affected in microgravity.
- L4.6 Describe how carbohydrates, fats, proteins, vitamins and minerals help the body function.
- L4.7 Describe food packaging aboard the Shuttle orbiter and how foods are selected.

### Earth Science

The student should be able to:

- E4.1 Explain why all parts of the Earth's surface are not heated equally.
- E4.2 Describe the weather conditions on planets other than the Earth.
- E4.3 Describe the water conditions on planets other than the Earth.
- E4.4 Describe how NASA determines if there is weather on other planets.
- E4.5 Describe how weathering and erosion affect the Earth's surface.
- E4.6 Explain how earthquakes, volcanos and other forces affect the Earth's surface.

### Physical Science

The student should be able to:

- P4.1 Explain energy sources aboard the orbiter and Space Station.
- P4.2 Explain how magnets react in space.
- P4.3 Explain how electricity is transferred to the Space Transportation System on the launch pad.
- P4.4 Explain light sources in space.
- P4.5 Demonstrate how white light can be produced to combine colors and how light can be separated to produce colors.
- P4.6 Describe the effects of transparent, translucent and opaque objects.
- P4.7 Explain how friction affects kinetic energy.
- P4.8 Describe how the kinetic or potential energy of an objects is affected by a space environment.
- P4.9 Explain how energy can be changed from one form to another.
- P4.10 Describe how sounds waves travel through space.

### Materials and Equipment

The student should be able to:

- M4.1 Practice accepted safety procedures in manipulating laboratory equipment and materials.
- M4.2 Identify basic apparatus and equipment useful for scientific activities.
- M4.3 Practice proper care for scientific equipment.
- M4.4 Select the appropriate tool for measuring distance, time and temperature.
- M4.5 Demonstrate the ability to use standard measuring devices.
- M4.6 Identify the major parts and functions of the microscope and telescope.
- M4.7 Select attire to ensure personal protection while working on various items of space hardware and while living in space.

## NEWEST Elementary School Science Objective/ Responses in Aerospace

### Life Science

- L4.1 Humans, small primates, rodents, fish, insects could live in space.
- L4.2 Muscles would atrophy, blood flow would be different since you do not have as much gravity to overcome; grow taller.
- L4.3 Invertebrates would grow larger due to less gravity, gas flow would change in some, blood flow in those with hearts.
- L4.4 Pressurized cabin, removal of carbon dioxide, provision of Oxygen; waste system provided
- L4.5 A seed is a cell so sprout and roots could not determine up/down
- L4.6 Carbohydrates & fats-energy; proteins building muscles and in digestion; vitamins keep body processes and endocrine system balanced, disease prevention; minerals- build bones transfer of electrolytes.
- L4.7 Freeze dried, vacuum packed, dehydrated-selected from astronaut preference.

### Earth Science

- E4.1 Land and water do not heat at the same rate and earth's rotation, tilt of the earth.
- E4.2 Some have storms, extended days, extreme temperature variations.
- E4.3 There is no water on the other planets.
- E4.4 By observations with satellites and probes.
- E4.5 The Earth's surface has constant changes due to wind and rain erosion and deposition of silt to create deltas.
- E4.6 Volcanos bring rock to the surface, earthquakes increase crack or fault size, push up certain plates, volcanic eruptions destroy landscape and area surrounding it.

### Physical Science

- P4.1 Orbiter turns on engines to move left or right; Space Station is solar powered; the Orbiter leaves payload doors open to allow heat from energy systems to flow out into space.

- P4.2 Magnets still repel and attract in space.
- P4.3 Electricity is plugged into the Florida Power and Light system on the launch pad.
- P4.4 Sun and stars produce light; planets and moon reflect light.
- P4.5 Use a prism and an overhead; Water drops from waterhose; use colors on a spinner or top to produce white light.
- P4.5 Transparent can see clearly through it; translucent can see
- P4.7 Friction causes you to lose some of the kinetic energy
- P4.8 Potential energy is at zero or minimum. Kinetic energy is maximized.
- P4.9 Solar-sun shines on water in pond causes molecules to move faster.
- P4.10 Sound waves don't travel in space because there is no atmosphere for them to travel in.

### Materials and Equipment

- M4.1 Perform in lab using proper safety procedures.
- M4.2 Beakers, metric measuring devices, test tubes, balloons, tubing, water.
- M4.3 Use equipment safely.
- M4.4 Use meter sticks, measuring tapes and light beams for measuring distance. Use stopwatch, clock, sun dial for measuring time. Use thermometer for measuring temperature.
- M4.5 Perform an experiment with measuring as the focus.
- M4.6 Microscope-lens, focus knobs, light source.
- Telescope-lens mirror focusing wheel dish
- M4.7 Astronaut clothing appropriate for the mission or bunny suits for clean rooms.



## Elementary School Science objectives in Aerospace

### Grade 5

#### Life Science

The student should be able to:

- L5.1 Explain how natural resources are affected by the space program.
- L5.2 Identify how the space program's conservation policy protects the natural environment.
- L5.3 Describe how the circulatory system is affected by microgravity.
- L5.4 State that cells use food and oxygen to produce energy and compare how food and oxygen are different in a space environment.
- L5.5 Describe how the respiratory and circulatory systems react differently in microgravity.
- L5.6 Explain how the digestive system is affected by microgravity.
- L5.7 Explain how plants live aboard a space environment. (i.e., Shuttle, Spacelab, etc.)
- L5.8 Use plant classification system to identify appropriate plants to grow in space.
- L5.9 Compare vascular and nonvascular plants.
- L5.10 Explain the fact all food is produced by plants (directly or indirectly); therefore must be produced in a space habitat.
- L5.11 Explain ways people depend on plants in any environment.
- L5.12 Compare fungi, algae, and protozoans with simple organisms classified as plants or animals.
- L5.13 Describe how small living organism are useful in pollution control.
- L5.14 Identify the effect of small living organisms on the body.

#### Earth Science

The student should be able to:

- E5.1 Explain how ocean waters move and how the movement influences weather.
- E5.2 Identify scientific equipment developed as a spinoff of the Space Program that is used to study the ocean.

- E5.3 Describe how resources in the ocean are located by space satellites.
- E5.4 Explain how the space program has helped locate natural resources.

#### Physical Science

- P5.1 Describe the properties of matter.
- P5.2 Describe the relationship of atoms, molecules and elements.
- P5.3 Explain the physical/chemical changes of matter.
- P5.4 Demonstrate how force can cause objects to move or change speed or direction inside the Orbiter.
- P5.5 Demonstrate when work has/has not been done (i.e., exercises in microgravity).
- P5.6 Identify simple machines used in the space program.
- P5.7 Identify machines that can change the size or direction of a force.
- P5.8 Explain how heat affects an object.
- P5.9 Explain the difference between heat and temperature.
- P5.10 Use Fahrenheit and Celsius to measure temperature.
- P5.11 Describe how heat energy travels in space.

#### Materials and Equipment

The student should be able to:

- M5.1 Practice accepted safety procedures in manipulating laboratory equipment and materials.
- M5.2 Identify basic equipment useful for scientific activities.
- M5.3 Practice proper care of scientific equipment.
- M5.4 Select the appropriate tool for measuring distance, time and temperature.
- M5.5 Demonstrate the ability to use standard measuring devices.
- M5.6 Identify the major parts and functions of microscope and telescope.
- M5.7 Select attire to ensure personal protection while working on various space hardware and while living in space.

## NEWEST Elementary School Science Objective/ Responses in Aerospace

### Life Science:

- L 5.1 Through research for the space program, there are many "spinoffs" that have helped to preserve our Natural Resources. Satellites have also spotted oil reserves and climatic changes.
- L 5.2 The Kennedy Space Center is surrounded by a National Wildlife Refuge. Endangered species such as the American Eagle and Manatee are protected by the policies of the space center. The research labs are trying to find a iron replacement to protect the ozone layer.
- L 5.3 Fluids tend to rise above the waist. Blood flow to the lower extremities is reduced. Blood chemistry changes with the loss of potassium and sodium.
- L 5.4 Food in space has to be compatible with life in microgravity. With longer stays in space food producing must be perfected. Oxygen is recycled by the use of filters. There is no room for errors.
- L 5.5 Microgravity affects both the respiratory and circulatory systems. Microgravity affects the gas exchange in the lungs causing imbalances of the electrolytes of the blood and dehydration occurs.
- L 5.6 The digestive system seems to be affected by microgravity with symptoms of motion sickness and nausea. The astronauts of the Apollo program were given anti nausea drugs.
- L 5.7 Plants are grown using hydroponic techniques. There are several designs being tried. Gas content, lighting, and water solutions are closely monitored to maximize results.
- L 5.8 Plants are used that have short harvest cycles, small roots, and are nutritious.
- L 5.9 Vascular Plants (flowering plants with seed covers) are being used for food. Non-Vascular plants, such as algae are being used to feed fish.
- L 5.10 In the food chain, plants are the key for food grown in space.
- L 5.11 People depend on plants either directly by eating them or indirectly by feeding them to animals.

L 5.12 Fungi - heterotrophic organisms that secrete enzymes that promote digestion of large organic molecules outside the cell - then absorbs the breakdown products. Algae - non-vascular plants with no internal transport system. Protozoans - single celled animals.

L 5.13 Some single celled animals can be used to digest oil such as in oil spills. Other organisms can detect pollution problems before they are life threatening to humans.

L 5.14 Identify the effect of small living organisms on the body.  
NOT ENOUGH INFORMATION TO ANSWER THIS OBJECTIVE.

### Earth Science

E 5-1 Because of our atmosphere, the earth is heated unequally. This causes currents in the ocean which in turn influences our weather.

E 5.2 Some of the scientific equipment used in the Space program has also been used to study the bottom of the oceans. Deep sea subs and vessels undergo stresses similar to those in space.

E 5.3 Space shuttles can detect schools of fish. Also weather conditions can be relayed at greater speed.

E 5.4 Land resources can also be detected from the shuttle.

### Physical Science

P 5.1 Physical properties of matter are color, density, hardness, solubility, brittleness, freezing and boiling temperatures. Chemical properties are determined by the reaction of a substance with other substances.

P 5.2 Atoms - smallest particles possessing the properties of an element. Molecules - Smallest particle of substances retaining the properties of that substance; a particle composed of two or more atoms joined by covalent bonds. Elements - fundamental chemical substance from which all other substances are made.



P 5.3 Physical changes of matter - Solid, Liquid, and Gas  
 Chemical changes of matter - Law of conservation - Matter is neither created nor destroyed.

P 5.4 In microgravity, the orbiter and all of its contents are in constant free fall. A force can cause things to move and change direction with minimal effort.

P 5.5 Demonstrate when work has/has not been done (ie. exercises in microgravity) NOT ENOUGH INFORMATION TO ANSWER THIS OBJECTIVE.

P 5.6 Simple machines: Level - the arm of the orbiter  
 Wedge - the shape of the orbiter

P 5.7 Machines that can change size and direction of a force. Thrusters and gyroscopic actions will change direction of a force.

P 5.8 Heat causes the atoms to move faster, increasing the distance between the atoms. Elements expand at different rates.

P 5.9 Heat - The energy produced by the motion of molecules of a substance (total kinetic energy) Temperature - A measure of the tendency of an object to transfer heat to or absorb heat from other objects. (Hotness or coldness of a substance)

P 5.10 Fahrenheit - Temperature scale with freezing point at 32 degrees and boiling point at 212 degrees.  $F=9/5 (C + 32)$   
 Celsius - Temperature scale with freezing point at 0 degrees and boiling point at 100 degrees.  $C=5/9 (F - 32)$

P 5.11 Heat energy traveling in space travels in all directions (ie. the Sun's rays)

### Materials and Equipment

M 5.1 The use of goggles and other safety equipment in the lab. Must know the specifications of each material that is to be handled.

M 5.2 Basic Equipment:  
 Scales, beakers, forceps, Bunsen burners, hot pads, thermometers. Varies from lab to lab.

M 5.3: Reviewing procedures of proper care of equipment,

including setting up, using, cleaning, and storing of equipment.  
 Proper reading of equipment for results of experiments.

### M 5.4 Appropriate tools for measuring

Distance - meter stick or ruler  
 Time - Clock with second hand or digital chronograph  
 Temperature - Celsius thermometers

### M 5.5 Standard measuring units

millimeters    milligrams    milliseconds  
 centimeters    grams    second  
 meters    kilograms    minutes  
 kilometers    hours

### M 5.6 Microscope parts

Convex lenses    Telescope parts  
 eyepiece    Convex lenses  
 stage    eyepiece  
 focus knobs  
 light source

M 5.7 Safety attire for living in space ie. spacesuits life support systems.

# Elementary School Science Objectives in Aerospace

## Grade 6

### Life Science

The student should be able to:

- L6.1 Explain how the endocrine system responds in microgravity.
- L6.2 Identify effects of microgravity on the nervous system.
- L6.3 List plants that would be suitable for reproduction aboard a space station.
- E6.4 List insects, birds, mammals that could reproduce aboard a space station.
- E6.5 Hypothesize the effects of microgravity on heredity.
- E6.6 List nutrients essential for survival during spaceflight.
- L6.7 Explain how to develop an ecosystem in space.
- L6.8 Describe the effects of man on the ecosystem in regards to space exploration.

### Earth Science

The student should be able to:

- E6.1 Compare the satellite photographs of various rock types found on other planets to those found on Earth, i.e., Venus, Mars, Moon.
- E6.2 Explain how satellite photographs show the movement of tectonic plates.
- E6.3 Select the appropriate scientific instrument for recording astronomical observations.
- E6.4 Identify and describe the components of our solar system.
- E6.5 Identify and describe the contributions of space exploration.
- E6.6 Describe how features of the Earth influence climate compare to climate on other planets.
- E6.7 Describe how wind belts are formed and how they influence climate.
- E6.8 Describe how space weather satellites help predict climatic changes.

### Physical Science

The student should be able to:

- P6.1 Define matter.
- P6.2 Compare Earth's atmosphere with that of other planets.
- P6.3 Identify the basic structure of atoms and compare atoms of different elements.
- P6.4 Explain that changes in molecular speed cause changes in states of matter.
- P6.5 Describe how different forms of energy could be used in space vehicles and space habitat.
- P6.6 Explain how people would depend on different kinds of energy in a space habitat.
- P6.7 Explain how man could recycle in a space environment.

### Materials and Equipment

The student should be able to:

- M6.1 Practice accepted safety procedures in manipulating laboratory equipment and materials.
- M6.2 Identify basic apparatus and equipment useful for scientific activities.
- M6.3 Practice proper care for scientific equipment.
- M6.4 Select the appropriate tool for measuring distance, time and temperature.
- M6.5 Demonstrate the ability to use standard measuring devices.
- M6.6 Identify the major parts and functions of the microscope and telescope.
- M6.7 Select attire to ensure personal protection while working on various space hardware and while living in space.

## NEWEST Elementary School Science Objective/ Responses in Aerospace

### Life Science

- L6.1 Body fluids redistribute throughout the entire body.  
 L6.2 No observable effects for short term stays.  
 L6.3 Lettuce, Spinach, Peanuts, Bean Sprouts, Soybeans, Sweet Potatoes, White Potatoes, Wheat, Rice, Radish, are suitable for growth aboard the orbiter.  
 L6.4 All Birds, insects and mammals that could fit in the space station.  
 L6.5 Humans might change some characteristics due to genetic mutation.  
 L6.6 All nutrients in a balanced diet (plus minerals) are essential on spaceflights.  
 L6.7 All necessary life cycles, water cycles and air cycles in a closed environment.  
 L6.8 Pollution in Earth's atmosphere and on the Lithosphere, Garbage floating in space and on the moon. As yet undescribed effects on flora, fauna and water from launches; awareness of pollution problems detected by satellites and orbiting space craft.

### Earth Science

- E6.1 Observe satellite photographs available from NASA.  
 E6.2 Landsat satellites show fractures on Earth's surface where movement has occurred from one photo to the next.  
 E6.3 Depending upon the information needed, radiotelescopes measure radio waves, telescopes measure light waves, x-rays, spectrograph, and laser.  
 E6.4 Sun, local star, 9 planets, and moons large orbiting bodies around the star asteroids, small particles of rock in orbit around the star, Meteoroids, objects moving through our Solar System, usually rock, comets, frozen particles of rock and dust.  
 E6.5 Advances in medicine, technology, environmental awareness and awareness of our own Universe.  
 E6.6 Mountains, valleys, oceans and the atmosphere along with distance from sun and movement of Earth create our climate, the diverse features of the other planets creates a climate different from Earths.

- E6.7 Wind belts are formed by the convection of air on Earth's surface and the Coriolis Effect. This in conjunction with the land forms and curve of Earth create the climate.  
 E6.8 Pictures of clouds and the Earth's surface provide data about temperature, humidity and speed and direction which scientists use to understand and forecast weather.

### Physical Science

- P6.1 Anything that has volume and mass is matter.  
 P6.2 Because of water, earth's atmosphere is completely different from the atmosphere on any other planet.  
 P6.3 Basic structure of the atom is nucleus with protons and neutrons and an electron cloud. Atoms of different elements have a different Atomic number.  
 P6.4 When molecules are stable and moving slowly a solid is created, when molecules begin to speed up and spread apart, a liquid is created, molecules with no definite shape or volume create a gas.  
 P6.5 Solar, X-ray, wind and thermal could be used in space.  
 P6.6 With solar energy the water cycle works, plants grow and food and different processes occur. Heat energy can maintain systems.  
 P6.7 Man can recycle in space environment by filtering the air they breathe to be reused. Package food in edible packaging. Water could be distilled and used again.

### Materials and Equipment

- M6.1 Perform in lab using proper safety procedures.  
 M6.2 Beakers, metric measuring devices, test tubes, balloons, tubing, water.  
 M6.3 Use equipment safely.  
 M6.4 Use meter sticks, measuring tapes and light beams for measuring distance. Use stopwatch, clock, sun dial for measuring time. Use thermometer for measuring temperature.  
 M6.5 Perform an experiment with measuring as the focus.  
 M6.6 Microscope-lens, eyepiece, focus knobs, light source. Telescope-lens mirror focusing wheel, dish.  
 M6.7 Pickout astronaut clothing appropriate for the mission or bunny suits for working in a clean room.

## SPINOFFS

Spinoffs are technologies which have been transferred to uses different than their original application in the aerospace field. More than 30,000 applications of space technology over the past 27 years have been developed.

**Insulin Infusion Pump.** Insulin-dependent diabetics have for years been tied to a rigid schedule in which mealtimes, sleep time and exercise had to be timed to insulin injections. Today, some 12,000 diabetics are free from such lifestyle restrictions through the use of "pump therapy." Pump therapy involves the use of an external pump to deliver insulin continuously at a preprogrammed correct rate.

**Advanced Wheelchair.** More than one million people in the United States rely on wheelchairs for mobility and many of them have difficulty with existing types of chairs. Researchers employed aerospace computerized structural analysis techniques to arrive at the optimum design and used aerospace composite materials which are lighter and stronger than metals.

**Vehicle Controller For The Handicapped.** For the Apollo lunar landings of the early missions, NASA developed a Lunar Rover vehicle to permit exploration of the moon. The rover was designed to allow an astronaut to drive one-handed, using an airplane-like joystick to accelerate, brake and steer the vehicle. That technology is being applied to a system that offers severely handicapped people an opportunity to drive highway vehicles.

**New Window Into The Human Body.** Magnetic Resonance Imaging (MRI) employs magnetic field and radio waves to peer inside the body. MRI enhancement provides invaluable information to diagnostic physicians and surgeons.

**Weather Forecasting.** Another benefit from aerospace advancements has been the forecasting of worldwide weather conditions through meteorological satellites. These satellites, which produce data for the National Weather Service, not only make it possible to understand our environment better, they also help to protect us from its dangers.

**Voice-Controlled Wheelchair And Manipulator.** Based on teleoperator and robot technology developed for space-related programs, a voice-controlled wheelchair and its manipulator have been tested as a possible aid to paralyzed and other severely handicapped persons. A voice-command analyzer translates electrical signals which activate appropriate motors and cause the desired motion of the chair or manipulator.

**Speech Autocuer.** The development of a wearable real-time speech perception aid has the potential to improve the quality of life for many of the 1.8 million deaf people in the United States. This speech analyzer device presents automatically-derived visual cues which, in combination with lip reading, enables accurate speech perception by deaf people.

**Water Recycling.** Research on the use of aquatic plants for the treatment and recycling of wastewater is now over a decade old. This "aquaculture" technique is already serving a number of smaller towns.

**Scratch-Resistant Glasses.** The contribution of space technology to vision wear is a highly abrasion-resistant coating to protect plastic eyeglasses.

**Reading Machine For The Blind.** A device which converts regular inkprint into a readable, vibrating form that is perceptible to the sense of touch enables blind persons to read almost anything in print, not just braille transcriptions. The device is called The OPTACON, or Optical-to-TActicle-CONverter.

**Breathing System For Firefighters.** Firefighting and fire prevention are areas of activity which have benefitted from aerospace spinoffs. This includes a portable firefighting module; protective outer garments for workers in hazardous environments; a broad range of fire-retardant paints and foams; fireblocking coatings for outdoor structures, and a number of types of flame resistant fabrics for use in the home, office or in public transportation vehicles and breathing apparatus worn by firefighters for protection from smoke inhalation injury.

**Advanced Turboprop.** Wind tunnel tests have shown that propfans driven by advanced engines could power commercial transports to speeds comparable with those of existing subsonic jetliners at fuel savings on the order of 30 to 40 percent.

**Dental Braces.** A new type of arch wire material, called Nitinol, is helping to reduce the number of brace changes, due to its exceptional elasticity. It comes from an alloy of nickel and titanium.

**Anti-Corrosion Paint.** The easily applied paint, which incorporates a high ratio of potassium silicate, is water-based, non-toxic, non-flammable and has no organic emissions. In addition, the formulation bonds to steel and, in just 30 minutes, creates a hard ceramic finish with superior adhesion and abrasion resistance.

**Laser Heart Surgery.** One technology transfer from aerospace research that may some day eliminate or significantly reduce the need for coronary bypass surgery is the combined use of lasers and fiber optics. New high-tech instruments are used in

the treatment of a major heart disease, atherosclerosis.

**Remote Sensing.** Remote sensing, a term developed by the Office of the Navy, actually means studying something without really touching it, such as the procedure doctors use with x-rays to study the human body. Remote sensing uses instruments that send rays toward the earth, reflect the rays back, record them and then provide pictures from which scientists can study the layering of the earth's surface. In 1973, as the Apollo-Soyuz earth observations and photography principle investigator, Dr. Farouk El - Baz decided to use satellite photographs to train the Apollo Astronauts. Since deserts are cloud free and vegetation free, they were ideal for studying large areas of terrain to learn about regional colors. The Apollo landings site selection was based on these studies and analyzing the dark (volcanic rocks) and light (original rocks) areas of the lunar surface. Through this basic study of the moon, and remote sensing, we have discovered rivers in the Sahara Desert under the sand, correlations between the surface of Earth and Mars, archeological finds at the Great Pyramid of Egypt, and been able to compare Kuwait before and after Desert Storm to determine the effects on Earth's environment.



## AEROSPACE SONGS

### SUN UP IN THE SKY

I wish I was the sun up in the sky  
I wish I was the sun up in the sky  
If I was the sun up in the sky  
I'd shine on you when you pass by  
I wish I was the sun up in the sky.

I wish I was a winken, blinken star  
I wish I was a winken, blinken star  
If I was a winken, blinken star  
I'd wink on you wherever you are  
I wish I was a winken, blinken star.

I wish I was the moon overhead  
I wish I was the moon overhead  
If I was the moon overhead  
I'd shine on you when you were in bed  
I wish I was the moon overhead.

### 5 IN THE BAG

There were 5 in the bag and the little  
one nagged  
Roll over, roll over  
So they all rolled over and I floated off

Repeat with numbers counting  
backwards

There were none in the bag and the  
little one nagged  
Come back, get in the sack.

### FLIES IN THE CABIN

Flies in the cabin, shoo fly, shoo  
Flies in the cabin, shoo fly, shoo  
Flies in the cabin, shoo fly, shoo  
Shoo, shoo, shoo to my Lou  
Shoo, shoo, shoo to my Lou  
Shoo, shoo, shoo to my Lou  
Shoo to my Lou, my darling.

Dinner in a space ship is gooey, goo,  
goo

Dinner in a space ship is gooey, goo,  
goo

Dinner in a space ship is gooey, goo,  
goo

(CHORUS: Substitute: Sing for flies)

I dropped my meatball (shrimp), what'll  
I do

I dropped my meatball, what'll I do

I dropped my meatball, what'll I do

Roll to my Lou, my darling.

(CHORUS: Substitute: Roll for flies)

It's floating off, over towards you

It's floating off, over towards you

It's floating off, over towards you

Float to my Lou, my darling.

(CHORUS: Substitute: Float for flies)

Open your mouth and chew, chew,  
chew

Open your mouth and chew, chew,  
chew

Open your mouth and chew, chew,  
chew

Chew to my Lou, my darling.

(CHORUS: Substitute: Chew for flies)

## FLOATING IN THE BATHTUB

(CHORUS)

Floating in the bathtub  
Swimming in the pool  
I'm getting ready for astronaut school  
Floating in the bathtub  
Swimming in the pool  
I'll be an astronaut  
'Cause I am so cool.

My mama says her diet is no good  
She wants to go to space with me  
She thinks she can eat all she wants  
And float around weightlessly.

Oh, I'm (CHORUS)

My daddy likes to drive his car fast  
But he's not allowed to speed  
If he rode in my spaceship  
He can go as fast as he pleased.

Oh, I'm (CHORUS)

I'm going to take my dog into space  
He'll like it 'cause there are no fleas.  
But when he gets out to run around  
He's going to miss all those trees.

Oh, I'm (CHORUS)

I'm taking some of my toys with me  
I'll play all night and all day  
When my mom says clean them up  
She'll just see them floating away.

Oh, I'm (CHORUS)

## IN MY ROCKET

10, 9, 8, 7, 6, 5, 4, 3, 2, 1 ... BLAST  
OFF!

In my rocket see me ride  
With my crew by my side  
Watching planets all day long

I'm an astronaut brave and strong.

(CHORUS)

Flying up, flying up, high and away  
Flying up through the sky and away  
Watching planets (EARTH) all day long  
I'm an astronaut brave and strong.

In my shuttle see me glide  
With my crew by my side  
Watching Earth all day long  
I'm an astronaut brave and strong.

(CHORUS)

## CLOUD LULLABY

(Chorus) It's time to sleep

It's time to keep  
A silver cloud with you.  
Come rest your head  
On your soft cloudy bed  
Tomorrow waits for you.

You've got the moonlight on you  
You've got the stars shine, too.  
There's never really a dark time  
Cause there's a light inside of you.

So (Chorus)

(End) Tomorrow waits for you.

## GET ON BOARD

I have a friend you all know  
And (Robert) is his name.  
So get on board, my friends  
So get on board, my friends  
So get on board, my friends  
There's room for many more.

(Substitute student or astronaut  
names, ie. Fred, Jim, John, Mae,  
Marsha, Brewster) Ending line:  
This spaceship is ready to fly.



### MILKY WAY

Well, I woke up before the break of day  
And I said "Let's go to the Milky Way."  
So I jumped into my astronaut suit and  
As the (commander) this is what I'll do:  
I'll put on my helmet  
Put on my suit  
Snap it and zip it  
Put on my boots  
Fly 'em up, fly 'em up, high and away  
Today is the day for the Milky Way  
(Repeat using pilot, mission specialist,  
payload specialist)

### RIDING IN MY SPACE BUGGY

Riding in my space buggy  
Bumping along, I'm bumping along,  
bumping along  
Riding in my space buggy, bumping  
along  
I'm a long way from home.

(CHORUS)

Who misses me, Who misses me  
Who misses me, Oh Mama, Who  
misses me?

Riding in my lunar rover  
Picking up rocks, picking up rocks,  
picking up rocks

Riding in my lunar rover  
I'm a long way from home.

(CHORUS)

Riding in my space ship  
I'm flying home, flying home, flying  
home

Riding in my space ship  
I've a long way to go.

(CHORUS)(To see) Who misses me,  
who misses me

Who misses me, Oh Mama, Who  
misses me?

### JUMPING TO JUPITER

Come on children, jump to Jupiter  
Come on children, jump to Jupiter  
Come on children, jump to Jupiter  
Earli in the morning.

Repeat using motions with planet  
names:

float to Mercury

walk to Venus

roll to Mars

jump to Saturn

fly to Uranus

dance to Neptune

sing to Pluto

back to Earth (Come sit down).

### I LOVE MY MOON

The moon is a great big silver ball  
Hanging in the sky  
But when I try to play with it  
I can't reach up that high.

(CHORUS)

But, oh, I love my moon so  
It makes me think of you  
And when you look up in the sky  
Maybe you'll think of me, too.

The moon is a rocky, bumpy place.  
Without any grass or trees.  
It has no cats and it has no dogs  
And it doesn't have any fleas.

(CHORUS)

The moon is like a piece of cheese  
Floating overhead  
It's yellow and it's full of holes  
But you can't eat it with bread.

(CHORUS)

Yes, I (CHORUS)

## LITTLE WINDOWS

Looking out my little windows  
Looking out upon the Earth  
Looking out my little windows  
Sleeping in my little Earth

### (CHORUS)

Flying in my little spaceship  
As the world goes by so fast  
Looking out my little windows  
Looking down upon my past.

Pushing all the little buttons  
Checking all the little lights  
Watching all the space before me  
Thinking of the many nights  
That I went flying on my spaceship  
As the world goes by so fast  
Looking out my little windows  
Looking down upon my past.

Oh, I love my little windows  
I can see the nights and days  
I can see the sky's a twinkling  
I can see the sun a blaze.

### (CHORUS)

Educators can contact their nearest NASA Teacher Resource Center to copy NASA videos. These songs were correlated with the following videos: STS-44, STS-33, STS-33, STS-49, STS-54, STS-53, Eating and Sleeping in Space, 61-B, STS-33, Eagle has Landed, STS-33, Galileo, 41-C.

Aerospace Songs can be integrated throughout the unit on space. Students in the upper grades can learn these songs then visit lower grade classes and "student teach" the children. Original words and music reprinted with permission from Tonja Evetts Weimer, Space Songs for Young Children, Pearce-Evetts Productions, 624 Ridgeview Dr. Pittsburgh, PA. 15228, 1-800-842-9571. Copyright, 1993.

# NASA Educational Affairs Division Regional Areas

Frank C. Owens  
Director  
Education Division  
NASA Headquarters  
Code FEE  
400 Maryland Ave. SW  
Washington DC 20546  
(202) 453-1110

Eddie Anderson  
Chief, Elementary and  
Secondary Branch  
Education Division  
NASA Headquarters  
Code FEE  
400 Maryland Ave. SW  
Washington DC 20546  
(202) 453-8376

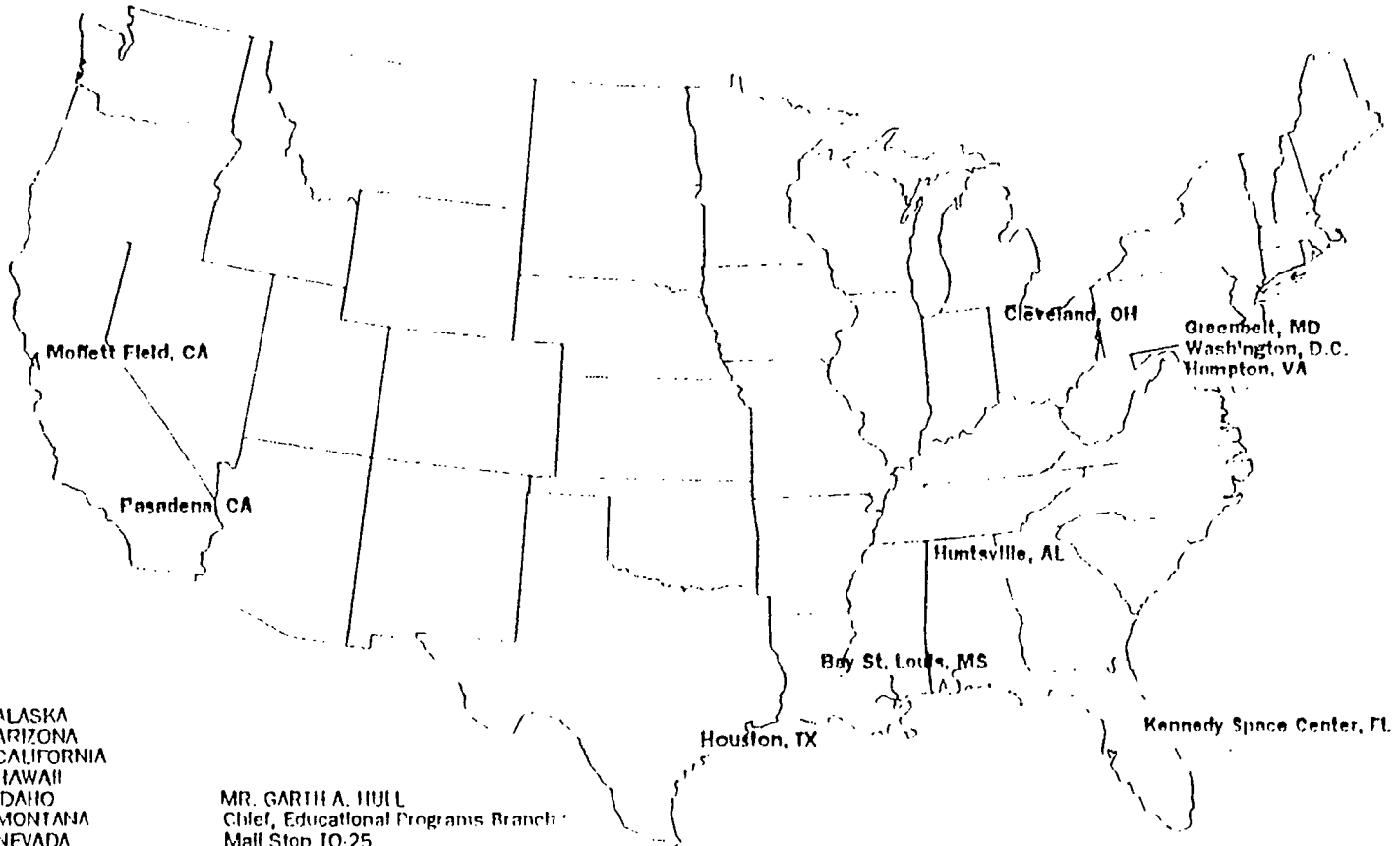

ALASKA  
ARIZONA  
CALIFORNIA  
HAWAII  
IDAHO  
MONTANA  
NEVADA  
OREGON  
UTAH  
WASHINGTON  
WYOMING

MR. GARTH A. HULL  
Chief, Educational Programs Branch  
Mail Stop 10-25  
NASA Ames Research Center  
Moffett Field, CA 94035  
(415) 604 5543  
FAX (415) 604 3445

CONNECTICUT  
DELAWARE  
DISTRICT OF COLUMBIA  
MARYLAND  
MASSACHUSETTS  
NEW HAMPSHIRE  
NEW JERSEY  
NEW YORK  
PENNSYLVANIA  
RHODE ISLAND  
VERMONT

MR. ELVA BAILEY  
Chief, Educational Programs  
Public Affairs Office (130)  
NASA Goddard Space Flight Center  
Greenbelt, MD 20771  
(301) 286 7207  
FAX (301) 286 8142

COLORADO  
KANSAS  
NEBRASKA  
NEW MEXICO  
OKLAHOMA  
SOUTH DAKOTA  
TEXAS

DR. ROBERT W. FITZMAURICE  
Center Education Program Officer  
Public Affairs Office (AP 4)  
NASA Johnson Space Center  
Houston, TX 77058  
(713) 483 1257  
FAX (713) 483 4876

FLORIDA  
GEORGIA  
PUERTO RICO  
VIRGIN ISLANDS

DR. STEVE DUTCZAK  
Chief, Education and Awareness Branch  
Mail Code FA-EAB  
NASA Kennedy Space Center  
(407) 867 4444  
FAX (407) 867 7242

KENTUCKY  
NORTH CAROLINA  
SOUTH CAROLINA  
VIRGINIA  
WEST VIRGINIA

DR. KAREN CREDEUR  
Head, Office of Public Services  
Mail Stop 154  
NASA Langley Research Center  
Hampton, VA 23665 5225  
(804) 864 3307/3312  
FAX (804) 864 3800

ILLINOIS  
INDIANA  
MICHIGAN  
MINNESOTA  
OHIO  
WISCONSIN

DR. LYNN BONDURANT  
Chief, Educational Services Officer  
NASA Lewis Research Center  
21000 Brookpark Road  
Cleveland, OH 44135  
(216) 433 5583  
FAX (216) 433 3344

ALABAMA  
ARKANSAS  
IOWA  
LOUISIANA  
MISSOURI

MR. BILL ANDERSON  
Chief, Education Branch  
NASA Marshall Space Flight Center  
Marshall Space Flight Center, AL 35812  
(205) 544 7391  
FAX (205) 544 5852

MISSISSIPPI

DR. MARCO GIARDINO  
Education Officer  
NASA John C. Stennis Space Center  
Stennis Space Center, MS 39529  
(601) 688 1957  
FAX (601) 688 2739

MR. RICHARD ALVIDREZ  
MANAGER, EDUCATION  
MAIL CODE 180 20 Jet Propulsion Laboratory  
4800 Oak Grove Laboratory  
Pasadena, CA 91109  
(818) 354 8592  
FAX (818) 354 4537

The Jet Propulsion Laboratory (JPL) serves inquiries related to space and planetary exploration and other JPL activities

NASA/KSC offers numerous programs for students and teachers. Below is a listing of some of these programs detailed in the publication entitled *EDUCATIONAL PROGRAMS* (KSC Form 2-203NS).

#### **EDUCATOR PROGRAMS**

Educators Resources Laboratory (ERL) .....  
Film Library .....  
Lunar Sample Education Project .....  
Educator Conferences and Tours .....  
Pre-Teacher Program .....  
In-Service Teacher Programs .....  
Teacher Workshops — NEWMAST and NEWEST .....  
Spacelink .....  
Summer Faculty Fellowship Program .....  
Summer Industrial Fellowship for Teachers (SIFT) .....  
Vocational In-Service and Business Exchange Program (VIBE) .....  
NASA/University Joint Venture (JOVE) .....

#### **STUDENT PROGRAMS**

##### **Elementary Through Pre-College**

Aerospace Education Services Program (AESP) or Spacemobile .....  
Summer Aids .....  
Stay-in-School Program .....  
Summer High School Apprenticeship Research Program (SHARP) .....  
NASA's Unique Resident Tutoring for Up-and-Coming Replacement Engineers (NURTURE) ..  
The KSC Science, Engineering and Research Career Help (SEARCH) Crew Program .....  
Science and Engineering Fairs .....  
Special Programs .....  
Career Shadowing .....  
Pre-College Trainee Program .....  
Federal Junior Fellowship Program (FJFP) .....  
Engineering Concept Institute (ECI) .....  
Volunteer Service Program .....  
KSC Engineers/EAB Partnership .....  
Recycling Center for Educational Materials .....  
Early Childhood/Elementary Students Programs .....  
NASA Alumni League — Kennedy Space Center Chapter .....  
YES--WE CARE! Program .....  
Summer Program for Academic Careers in Engineering (SPACE) .....  
Energizing Minorities for Comprehensive Competency (E>=<MC<sup>2</sup>) .....  
Educational Satellite Broadcasts .....

##### **College Through Post-Graduate**

Clinical and Research Aspects of Aerospace Medicine .....  
Aerospace Medicine Resident Program .....  
Space Life Sciences Training Program (SLSTP) .....  
Technician Cooperative Training Program: Brevard Community College .....  
Clerical Cooperative Training Program .....  
Baccalaureate Cooperative Training Program .....  
M.S. in Engineering Management Program .....  
Science and Engineering Scholars Program .....  
Graduate Student Researchers Program (GSRP) .....  
NASA/USRA University Advanced Design Program .....  
National Space Grant College and Fellowship Program .....  
Resident Research Associateship Program .....

#### **FOR ALL AGES**

Exploration Station .....  
Public Mail .....

## SHUTTLE CREW TAUGHT PHYSICS OF TOYS DURING MISSION

The STS-54 Space Shuttle astronauts taught "Physics of Toys" to elementary level students during their mission launched January 13, 1993.

In addition to their primary payload of a Tracking and Data Relay Satellite, the crew carried a collection of children's toys for this educational project. Through telephone and television links, students at four schools around the country talked with the astronauts while they were in space and discovered how the toys function differently in the classroom compared to those on the Shuttle.

Teachers have used toys to help teach basic and advanced scientific principles and concepts of force, motion, and energy because many toys use these principles to function. By using toys, teachers are able to capture students' interest and to extend their experiences into new learning.

The astronauts, using toys, showed the toy actions independent of the gravity vector, often an important force governing toy performance. Earth orbit provides an ideal classroom to study toys and observe subtle actions that are masked by gravity.

A list of toys flown follows. The toys that were used during the live lessons are the car and track, klacker balls, basketball, magnetic marbles, swimmers, mouse, gravitrons, and balloon helicopter. The entire collection of toys was videotaped for an educational program available from the NASA teacher resource rooms.

### TOY LIST

- (1) Nerf Basketball and (2) Suction cup Hoops
- (2) Darda friction car and (1) Loop track
- (1) Fish swimmer, (1) Frog swimmer, (1) Propeller submarine
- (2) Horseshoes and (1) Stake platform (Velcro target)
- (4) Velcro balls (hook velcro) and target
- (2) Billiard balls (both striped)
- (2) Rubber handballs
- (8) Large and (8) Small magnet Marbles
- (4) Magnetic rings and (1) Lexan post (one foot)
- (1) Flipping mouse ("Rat Stuff")
- (3) Gravitrons, (3) Pull cords, and (1) whiffle ball for triple mounting
- (1) Wooden cup and ball
- (1) Plastic klacker balls
- (1) Balloon helicopter and (2) balloons
- (1) Magnetic Wheelo
- (1) Flapping bird
- (1) Jacob's Ladder
- (1) Gyroscope and string
- (1) Climbing Astronaut
- (1) Dual propeller shaft with (1) large propeller
- (1) Bernoulli blower
- (1) Spring jumper (frog)
- (1) Tippy-top
- (1) Rattlesnake
- (1) Comeback can\*
- (1) Slinky

### PAPER TOYS

- (1) Whirly Twirly\*
- (1) Maple Seed Spinner\*
- (1) Paper Eagle\*
- (1) Topsy Turvy\*
- (3) Flipping grasshoppers and  
(1) grass target\*
- (1) Ring Wing Glider\*
- (1) Paper airplane\*
- (1) Paper boomerang\*
- (1) Flipper\*

\* Toys that can be made by children

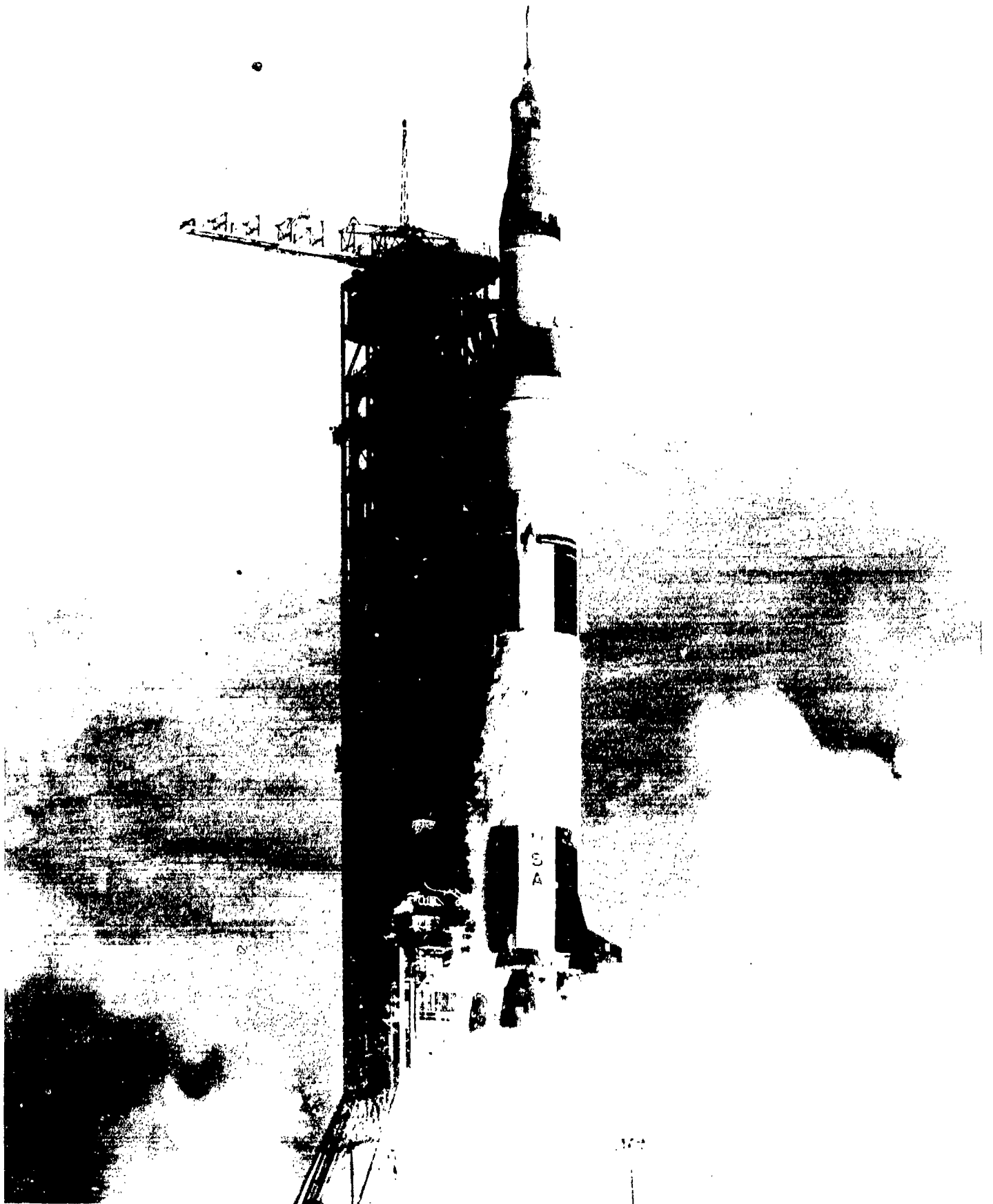

179

212



BEST COPY AVAILABLE

204







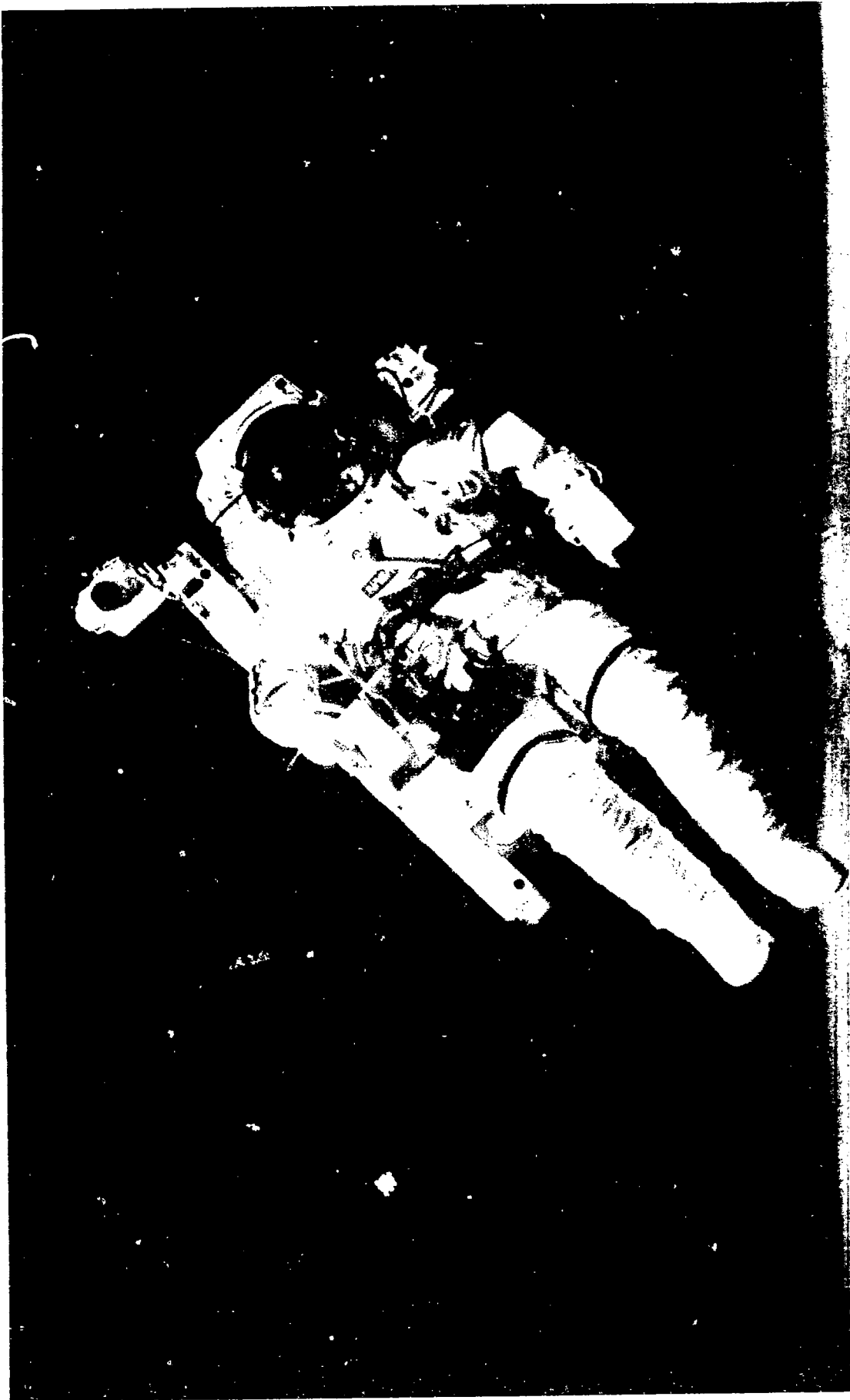



209

208





# AVIATION AND SPACE

## Certificate of Completion

NAME \_\_\_\_\_

I have learned more about aviation and space through mathematics, science, language arts, the humanities and technology and will help others realize the importance of aviation and space in today's world.

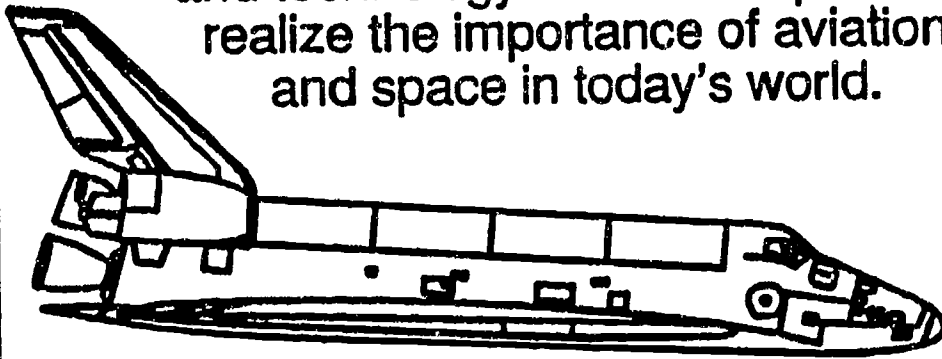

EDUCATION AND AWARENESS  
BRANCH, PUBLIC AFFAIRS  
KENNEDY SPACE CENTER  
FLORIDA

