

DOCUMENT RESUME

ED 360 152

SE 053 425

AUTHOR Lyon, Anne, Ed.
 TITLE TVA--A World of Resources.
 INSTITUTION Memphis State Univ., TN. Center for Environmental Energy Education.; Tennessee Valley Authority, Knoxville.
 PUB DATE 89
 NOTE 747p.
 AVAILABLE FROM Environmental Education Program, Tennessee Valley Authority, Forestry Building, Norris, TN 37828.
 PUB TYPE Guides - Classroom Use - Teaching Guides (For Teacher) (052)

EDRS PRICE MF04/PC30 Plus Postage.
 DESCRIPTORS *Conservation (Environment); Cultural Interrelationships; *Ecology; Energy; *Environmental Education; Forestry; Integrated Activities; *Integrated Curriculum; Interdisciplinary Approach; Junior High Schools; Junior High School Students; *Learning Activities; *Natural Resources; Program Descriptions; Recreation; Science Curriculum; Social Studies; Teaching Guides; Units of Study; Water Resources; Wildlife Management

IDENTIFIERS Air Quality; Concept Maps; *Hands on Experience

ABSTRACT

In studying the earth's natural resources and the systems governing them, students need to understand the interrelationships of resources and ecosystems. This curriculum program for junior high school students investigates the environment as a whole. It is designed to supplement existing school curricula in science and social studies by presenting activities that draw from students the concepts of interdependence, change, adaptation, energy flow, and diversity. The curriculum guide contains eight units of study: (1) Air Resources; (2) Cultural Resources; (3) Energy Resources; (4) Forest Resources; (5) Recreation Resources; (6) Water Resources; (7) Wildlife Resources; and (8) an overview unit on how the curriculum integrates the management of these resources. Each unit consists of an overview and a series of factsheets, a concept map, an activities matrix for factsheet references, students activities, a curriculum rationale, and a glossary of terms. A list of 121 additional Tennessee Valley Authority (TVA) selected references, TVA publications, curricular and book resources, resource materials, and resource organizations is included. (MDH)

 * Reproductions supplied by EDRS are the best that can be made *
 * from the original document. *

TVA -- A World of Resources



TVA is an equal opportunity employer and is committed to ensuring the benefits of programs receiving TVA financial assistance are available to all eligible persons regardless of race, color, national origin, handicap, or age.

Reprinted 1989

TVA/ONRED/LER/86/52

U.S. DEPARTMENT OF EDUCATION
Office of Educational Research and Improvement
EDUCATIONAL RESOURCES INFORMATION
CENTER (ERIC)

This document has been reproduced as received from the person or organization originating it.
 Minor changes have been made to improve reproduction quality.

• Points of view or opinions stated in this document do not necessarily represent official OERI position or policy.

SI 053 425

DISCLAIMER

This document was prepared by TVA and the Center for Environmental and Energy Education at Memphis State University. Neither the preparers, TVA, nor any persons acting on their behalf:

- a. make any warranty or representation, expressed or implied, with respect to the use of any information contained in this document, or that the use of any information, apparatus, method, or process disclosed in this document may not infringe on privately owned rights; or
- b. assume any liabilities with respect to the use of, or for damages resulting from the use of any information, apparatus, method, or process disclosed in this document.

This document does not necessarily reflect the views and policies of TVA. The use of specific brand names or products should not be construed as an endorsement by TVA.

For more information contact:

Environmental Education Program
Tennessee Valley Authority
Forestry Building
Norris, Tennessee 37828
(615) 632-1599

Introduction

In the fast-paced world we live in today, we often forget that we are just a part of the whole system. Our natural world is much like a seamless web with many strands all contributing to its strength and stability. If any of the strands are broken or weakened, the whole web is affected. Everything we do, every change we make, affects our environment. Individually and collectively, our activities ultimately benefit or harm the earth upon which we live.

In studying our natural resources and the systems governing them, it is of utmost importance to begin to understand the interrelationships of these resources and ecosystems. TVA - A WORLD OF RESOURCES investigates the environment as a whole and the effects that changes have on individual resources and ecosystems. This junior high school program is designed to supplement existing school curricula in science and social studies by presenting activities that will draw from students the concepts of interdependence, change, adaptation, energy flow, and diversity.

It is the ultimate goal of this educational program to develop a conservation ethic in students in the Tennessee Valley. It is our aim to help ensure that "future decision makers" in the Valley are equipped with a basic understanding of natural systems and can use this information to make knowledgeable judgements on difficult resource-related issues.

TVA - Environmental
Education Program

Center for Environmental
and Energy Education
Memphis State University



Acknowledgements



Sponsoring TVA Departments and Programs:

Department of Air and
Water Resources
Cultural Resources
Environmental Education
Forest Resources
Information Office
Recreation Resources
Wildlife Resources

TVA - A WORLD OF RESOURCES represents the efforts of many
dedicated professionals in the fields of resource management and
education. It could not have been completed without their tireless
contributions and sincere interest in education.

Concept Development:

Donna Birch
Ron Cleminson

Editors:

Anne Lyon, Editor-in-Chief
Dee Smalley
Carla Taylor

Curriculum Developer:

Roy Clariana

Concept Maps and Rationales:

Bernard Benson
Nancy Bibler
Thomas Bibler

Cover Designer and Illustrator:

Claudia Denton

Production and Layout Design:

Anne Lyon

Proofreaders:

Ashley Mack
Karen Lindebrekke

Word Processors:

Gena Byrd
Mark McNeely



Table of Contents

<u>INTRODUCTION</u>	I-2	<u>ADDITIONAL MATERIALS AVAILABLE</u>	I-22
<u>ACKNOWLEDGEMENTS</u>	I-4	List of Selected References	I-22
<u>TABLE OF CONTENTS</u>	I-6	<u>TVA UNIVERSITY NETWORK CENTERS</u>	I-28
<u>PROGRAM DESCRIPTION</u>		<u>AIR RESOURCES</u>	A-1
<u>TEACHER'S GUIDE</u>		Air Resources Concept Map	A-2
Program Description	I-12	Air Resources Factsheets	A-4
Contents of the Resource Units Matrix	I-12	1. Overview	A-6
Overview and Fact sheets	I-13	2. What Is Air?	A-8
Concept Maps	I-13	3. Where Does It Come From? Where Does It Go?	A-10
Activities	I-13	4. Urban Air	A-12
Glossary	I-13	5. The Burden Of Pollution	A-14
Poster	I-13	6. Acid Rain: An Air Or Water Problem?	A-16
Certificates	I-13	7. Rural Air	A-18
Audiovisual Presentation	I-13	8. Indoor Air And Other New Issues	A-20
	I-14	9. Hazardous Pollutants	A-22
<u>CURRICULUM RATIONALE</u>		Air Resources Activity Matrix	A-24
Air Resources Unit Rationale	I-14	Air Resources Activities	A-26
Cultural Resources Unit Rationale	I-14	The Atmospheric Blanket And Winds	A-26
Energy Resources Unit Rationale	I-15	Compositions About Air Composition	A-30
Forest Resources Unit Rationale	I-16	Temperature Inversions	A-34
Recreation Resources Unit Rationale	I-17	Weather Cycle	A-38
Water Resources Unit Rationale	I-18		
Wildlife Resources Unit Rationale	I-18		
TVA-A World of Resources Unit Rationale	I-19		

Acid Rain Watchers	A-42	Recycling Buildings	C-44
Sulpher Dioxide Dangers	A-46	This Does Not Compute	C-46
The Nose Knows	A-48	Modeling An Indian Dwelling	C-48
Storing Hazardous Materials	A-50		
Carbon Monoxide	A-52	Cultural Resources Glossary	C-52
Smoke Detectors	A-54		
Air Resources Glossary	A-58	<u>ENERGY RESOURCES</u>	E-1
		Energy Resources Concept Map	E-2
<u>CULTURAL RESOURCES</u>		Energy Resources Factsheets	E-4
Cultural Resources Concept Map	C-1	1. Overview	E-6
Cultural Resources Factsheets	C-2	2. History Of Energy	E-8
	C-4	3. The Non-Renewables	E-10
1. Overview	C-6	4. Hydropower	E-12
2. Archeology: The Study Of Human Behavior From Material Remains	C-8	5. Nuclear Power	E-14
3. Prehistoric Land Ownership And Use	C-10	6. Energy Flow In Nature	E-16
4. Indian-White Relations	C-12	7. Energy And Environment	E-18
5. Tennessee Valley Women	C-14	8. Energy Source	E-20
6. Cultural Diversity In The 1930s	C-16	9. Conservation	E-22
7. The Black Experience	C-18	10. Energy Alternatives	E-24
8. Log Buildings	C-20	11. Synfuels	E-26
9. Preservation And Reuse Of Historic Structures	C-22	Energy Resources Activity Matrix	E-28
Cultural Resources Activity Matrix	C-24	Energy Resources Activities	E-30
Cultural Resources Activities	C-26	Meter Matters	E-30
Mining For Gold	C-26	Future Homes	E-34
Games Of The World	C-26	Fuel Eaters	E-38
DUG-OUT	C-26	Trash Energy Alternative	E-42
Wasting Waste	C-30	Solar Energy Alternative	E-46
Log Cabin Day	C-32	Fuel Cell Alternative	E-50
Women's Work Is Never Done	C-34	Insulation	E-52
Separate And Unequal	C-38	Draft-O-Meter	E-54
	C-40	Can A Can Or Recycle	E-56
	C-42	Energy Flow Model	E-60

Energy Resources Glossary

E-62

Recreation Resources Factsheets

R-4

FOREST RESOURCES

Forest Resources Concept Map

F-1

1. Overview
2. Recreation In The Great Outdoors

R-6
R-8

Forest Resources Factsheets

F-2

3. Natural Areas
4. Reservoir Recreation

R-10
R-12
R-14

Forest Resources Factsheets

F-4

5. Valley Streams
6. Trails

R-16
R-18

1. Overview

F-6

7. Special Population Recreation
8. Community Recreation

R-20

2. A Forest Is Many Things

F-8

9. Recreation For Profit
10. Water Safety

R-22
R-24

3. The Development Of A Forest

F-10

4. The Life Cycle Of A Tree

F-12

5. Benefits From The Forest

F-14

6. How Landowners See Their Forest

F-16

7. How Foresters See The Forest

F-18

8. Protection Of Forest Lands

F-20

9. The Future Of Our Forest Land

F-22

Recreation Resources Activity Matrix

R-26

Recreation Resources Activities

R-28

Forest Resources Activity Matrix

F-24

Re-Creation Lands

R-28

Predicting Future Recreation Use

R-30

Picnics Are Fun?

R-32

The Big Picture

R-34

Punching-In Outdoors

R-36

Special Population Recreation

R-38

Valley Vacation

R-40

Water Safety Spotters

R-42

Recreation Resources Glossary

R-44

WATER RESOURCES

WA-1

Water Resources Concept Map

WA-2

Water Resources Factsheets

WA-4

1. Overview

WA-6

2. Groundwater - The Hidden Resource

WA-8

3. Pollution - Natural and Man-made

WA-10

RECREATION RESOURCES

Recreation Resources Concept Map

R-1

R-2

4. Water Quantity - How Much Is Enough?	WA-12
5. Precipitation - The Start of the Cycle	WA-14
6. Water Quality - How Clean Is Clean?	WA-16
7. Rural Water	WA-18
8. Urban Water	WA-20
9. Surface Waters - The Visible Resource	WA-22
Water Resources Activity Matrix	WA-24
Water Resources Activities	WA-26
Water With-In	WA-26
Aquifers And Artesian Wells	WA-30
Aquifers Underfoot	WA-32
Modeling The Mississippi Embayment	WA-34
Modeling The Injection Well	WA-38
Modeling A Toxic Lagoon	WA-40
Water Worldwide	WA-42
Weather Watchers	WA-46
The Super Cycle	WA-50
A Natural Filter	WA-54
Water Resources Glossary	WA-56
<u>WILDLIFE RESOURCES</u>	
Wildlife Resources Concept Map	WI-1
Wildlife Resources Fact Sheets	WI-2
Wildlife Resources Concept Map	WI-4
Wildlife Resources Fact Sheets	WI-6
1. Overview	WI-8
2. Urban Wildlife	WI-10
3. Cavity Nesting Wildlife	WI-12
4. Wildlife Management	WI-14
5. Upland Wildlife	WI-16
6. Raptors (Birds Of Prey)	WI-18
7. Endangered Species	

8. Wetlands Wildlife	WI-20
9. Waterfowl	WI-22
10. Wildlife Habitat	WI-24
Wildlife Resources Activity Matrix	WI-26
Wildlife Resources Activities	WI-28
To Zone Or Not To Zone	WI-28
Let's Build Another Parking Lot	WI-32
A Little Becomes A Lot	WI-36
Game Game	WI-40
Snag Tree Corner	WI-44
Here Today, Here Tomorrow	WI-46
Birdwatching	WI-48
1000-mm Hike	WI-50
Hide Out	WI-52
Pop Bottle Bird Feeders	WI-56
Mind Mapping Urban Wildlife	WI-58
Wildlife Resources Glossary	WI-62

<u>TVA - A WORLD OF RESOURCES</u>	T-1
TVA - A World Of Resources Concept Map	T-2
TVA - A World Of Resources Factsheets	T-4
1. Overview	T-6
2. Creat on And Concept	T-8
3. A Government Laboratory	T-10
4. Agriculture	T-12
5. River Development	T-14
6. Power Supply	T-16
7. Conservation And Solar Energy	T-18
8. Economic Development	T-20
9. Environment And Natural Resources	T-22

TVA - A World Of Resources Activity Matrix	T-24
TVA - A World Of Resources Activities	T-26
The Valley - Yesterday And Today	T-26
A Dam: Youth And Old Age	T-28
Energy Trends	T-30
Introducing New Technology	T-34
Enough River For All?	T-38
"New" MacDonald Has A Farm	T-42
Recycling For Interdependence	T-46
Maintaining The Web	T-48
Water Consumers	T-50

(See Other Resource Unit Glossaries)



Teacher's Guide

TVA - A WORLD OF RESOURCES is designed to teach students in grades 6-8 about resource management. Activities in this program are action oriented and designed to blend into existing science, social studies, and, in some cases, mathematics curricula.

TVA - A WORLD OF RESOURCES units include: air, cultural, energy, forest, recreation, water, and wildlife resources and an overview unit on how TVA integrates the management of these resources.

This program is designed to be flexible and provide students and teachers with "hands on experiences" in resource management. Activities can be presented in any number of sequences since there is no set order of study for the units or for any particular investigation. Each unit can be studied in depth or activities from several units can be combined to focus on a specific issue.

The interrelated nature of the program requires that factsheets from several different units be used as background information for individual activities. This is because individual activities are designed to show how the management of one resource can significantly affect the quality and use of other resources.

Contents of the Resource Units

TVA - A WORLD OF RESOURCES curriculum guide contains eight units of study:

- (1) Air Resources
- (2) Cultural Resources
- (3) Energy Resources
- (4) Forest Resources
- (5) Recreation Resources
- (6) Water Resources
- (7) Wildlife Resources
- (8) TVA - A World of Resources

Each unit consists of an overview and a series of factsheets, a concept map, an activities matrix for factsheet references, student activities, and a glossary of terms. A multi-resource poster and certificates of completion of the TVA - A WORLD OF RESOURCES course of study are available with the curriculum guide. An audiovisual slide/tape program (available on video cassette) entitled "TVA - A World of Resources" is also available on loan from Environmental/Energy Education Centers in the TVA University Network system. Addresses and telephone numbers appear in the TVA University Network Centers section.

Matrix

Each unit contains a matrix which cross-references the unit's activities with the relevant factsheets from other units in the program. Teachers may choose all or some of these factsheets for background information before beginning the activity.

Overview and Factsheets

Each unit contains a factsheet which serves as an overview of the individual resource and its management. In addition, each unit has 8 to 10 other factsheets which discuss the resource and its management in more depth. Teachers may wish to use the factsheets as handouts.

These factsheets provide the needed background information to conduct the activities. Teachers may wish to supplement this information with other resources; however, it is not necessary.

Concept Map

Concept maps show the relationships of each resource to the natural world. They are not intended to be conclusive. These maps are intended to present "loose floating visions of wholeness" which instructors can use to aid them in preparing courses of study from this curriculum guide. (For more information on concept mapping see Writing the Natural Way by Gabriele Lusser Rico, published by J. P. Tarcher, Inc., and distributed by Houghton Mifflin Company, Boston, Massachusetts.)

Activities

There are 8 to 10 interdisciplinary student activities per unit. All activities are designed to be as action oriented as possible and to give students some first-hand experiences in resources management.

Each activity contains: objectives, a list of materials needed to complete the activity, matrix references, teacher preparation and procedure sections, and optional follow-through activities.

Glossary

A glossary of terms is included with each unit to explain terms used in factsheets and activities that may not be familiar.

Poster

A multi-resource poster accompanies the "TVA - A WORLD OF RESOURCES" guide. It can be used to introduce the program and to reinforce the overall concepts of integration and interdependence throughout the program.

Certificates

A classroom set of certificates of completion of TVA - A WORLD OF RESOURCES also accompany the guide. Certificates can be awarded to students who have successfully completed this study of resource management. Certificates are available from TVA's Environmental Education Program, Norris, Tennessee 37828.

Audiovisual Presentation

A 15-minute audiovisual presentation entitled "TVA: A World of Resources" introduces this course of study. This presentation is available in both slide/tape or video cassette through Environmental/Energy Education Centers in TVA's University Network system. Addresses and telephone numbers appear in the TVA University Network section.

Curriculum Rationale



Air Resources Unit Rationale

We live in a sea of constantly moving air on which we depend for life itself. Human civilization has brought about many changes in the atmosphere. Some of these changes are not apparent until they have produced widespread sickness, interference with other natural resources, and even death. Maintaining a high standard of air quality enhances the quality of life for everyone. The earth's atmosphere is complex and its natural variations are worthy of a life-time study. The more we know about the nature of this essential resource, the more easily we can avoid poisoning it.

Intended Learning Outcomes:

1. Students will be able to describe air in terms of its chemical composition, relationship to the earth, and similarity to a living system.
2. Students will understand TVA's interest in air as a resource.
3. Students will describe the earth's four wind belts.
4. Students will appreciate how weather affects the lives of the people of the Tennessee Valley.
5. Students will be able to explain how temperature affects the development and movement of weather systems.
6. Students will understand the connections between the study of weather and air pollution control.

7. Students will be able to list sources of urban air pollution.
8. Students will understand the role of governmental agencies, including TVA, in air quality control.
9. Students will be able to list the five common air pollutants in the Tennessee Valley, their sources, and their health consequences.
10. Students will be able to define acid rain, list its natural and human-related causes, and describe its effect on soil, plants, and animal life.
11. Students will be able to explain why TVA and other governmental agencies are interested in monitoring rural air quality.
12. Students will be able to list and discuss threats to the quality of indoor air.
13. Students will appreciate TVA's role in long-term studies of hazardous air pollutants.

Cultural Resources Unit Rationale

The United States is a relatively young nation, but despite its brief history, it plays a very important role in shaping contemporary attitudes and mores throughout the world. In looking at the Tennessee Valley, we can see in "microcosm" the cultural development of the Nation. The effects of cataclysmic events, such as the Civil War and the Great Depression, can be detailed as can the more subtle influences of geography and economic development. In this unit,

the architecture, geography, and archaeology of the Tennessee Valley are examined in connection with three major population groups: Indians, women, and blacks. Our heritage is explored from the prehistoric period to the present day. In order to understand where we are and who we are, we must look to where we have been.

Intended Learning Outcomes:

1. Students will appreciate the rich heritage evidenced by the cultural resources of the Tennessee Valley.
2. Students will be able to define cultural resources and describe both historic and present day cultural resources in the Valley.
3. Students will be able to describe the effects of the Civil War and the Depression on blacks and women in the Tennessee Valley.
4. Students will appreciate the value of architectural preservation.
5. Students will be able to describe the government's role in the preservation movement in this country.
6. Students will be able to describe what an archaeologist does, explain why he/she does this, and value the results.
7. Students will be able to explain the cultural roots of the White-Indian conflict over land ownership.
8. Utilizing White-Indian conflict as an example, students will be able to describe how diverse cultures interact.
9. Students will understand the diverse roles women have played in the Tennessee Valley.

10. Students will be able to critically examine the common stereotypes of women and blacks in the Valley.
11. Students will understand the complex interplay of economics, geography, and history of the Valley.
12. Students will be able to describe log house construction and differentiate among three types of log houses.

Energy Resources Unit Rationale

Energy surrounds us—without it, life does not exist. Energy affects both the living and nonliving parts of our environment. It comes in renewable and nonrenewable forms. Society's use of energy has changed with technological development. Since all technological processes have energy requirements and impact the environment, it is crucial that decisions about energy development and use be made intelligently. If we remain too dependent on nonrenewable energy sources, for example, our fuel sources will one day be exhausted. The more we learn about energy, the wiser we can be in its use, development, and conservation. Our future depends on an informed, energy-conscious citizenry.

Intended Learning Outcomes:

1. Students will be able to define energy.
2. Students will be able to state and explain the the first two laws of thermodynamics and their applications.
3. Students will understand the historic relationship between the level of technology and the type of energy used, and that the demand and popularity of energy resources vary over time.

4. Students will understand how behavioral changes can affect energy use.
5. Students will understand that no technological process is without environmental impact and will be able to explain how such understanding should affect decisions about energy.
6. Students will be able to define and give examples of renewable and nonrenewable energy sources.
7. Students will be able to discuss the historical rise and fall of hydropower as an energy source.
8. Students will understand how energy is derived from nuclear power and will be able to describe the concerns citizens have about the use of nuclear power.
9. Students will be able to define biosphere, water cycle, photosynthesis, and food chain.
10. Students will be able to explain how the second law of thermodynamics impacts the food chain.
11. Students will be able to describe how energy development affects environmental quality.
12. Students will be able to define potential and kinetic energy and give examples of each.
13. Students will understand why some conversions from one type of energy to another are efficient and some are not, and be able to give examples of each type of conversion.
14. Students will understand the need for energy conservation and be able to list several ways this can be or has been accomplished.
15. Students will be able to list six energy alternatives available today and discuss the future possibilities and problems of each.

Forest Resources Unit Rationale

The forest lands of the Tennessee Valley are vital to the region for many reasons. They produce timber, provide a habitat for wildlife, protect the basins that supply our water, provide recreational opportunities, and enhance the natural environment. Educating future landowners and voters to value the forests and to support wise land management strategies will promote economic growth and improve the quality of life for all who live in the Tennessee Valley.

Intended Learning Outcomes:

1. Students will understand the importance of forest land management in achieving the following goals:
 - a. preserving animal habitats
 - b. providing recreational areas
 - c. producing timber
 - d. protecting watersheds
2. Students will appreciate the importance of timber products to the Tennessee Valley.
3. Students will be able to describe how a forest develops through natural plant succession and be able to give an example of a typical succession pattern in the Tennessee Valley.
4. Students will be able to describe the life cycle of a tree.
5. Students will be able to describe the parts of a tree.
6. Students will be able to describe the life processes of a tree, including photosynthesis, respiration, reproduction, and decomposition.
7. Students will recognize the economic value of proper land management practices to the owner of small woodlands.

8. Students will understand what a watershed is and be able to explain how the forest protects the watershed and our water supply.
9. Students will be able to explain the effects poor timber harvesting practices can have on each of the following areas:
 - a. wildlife protection
 - b. aesthetic quality of the natural environment
 - c. recreational opportunities
 - d. timber production
 - e. protection of watersheds
10. Students will know how a private landowner can ensure that responsible harvesting procedures are carried out on his/her land through a "Timber Sale Contract."
11. Students will appreciate how much a forester needs to know about such subjects as silviculture, ecology, natural succession, and the economic benefits and feasibility of various strategies for land management.

Recreation Resources Unit Rationale

Americans today have more leisure time than ever before. The technological revolution has meant that most Americans' work is more mental than physical. As a result, people are turning to more active types of recreation. The Tennessee Valley is rich in scenic beauty and recreational areas, but this is not an unlimited resource. As more and more people have the time and the desire to utilize the area's recreational opportunities, it becomes increasingly apparent that wise use and management of existing resources are necessities. Educating citizens about recreation will result in informed choices between various land and water uses and will help hold the line against common negative environmental impacts of recreational use such as vandalism, littering, fire, overuse, and pollution.

Education about recreation safety will enhance enjoyment of natural areas and save lives.

Intended Learning Outcomes:

1. Students will understand the concept of recreational carrying capacity, and will be able to explain why it varies throughout time and from area to area.
2. Students will understand the multiuse concept as it applies to forest management.
3. Students will be able to define a natural area and describe its purposes and uses.
4. Students will appreciate the need to make sound decisions concerning fluctuating reservoir water levels for various uses.
5. Students will be able to describe the economic impacts of reservoir and river recreation in the Tennessee Valley.
6. Students will understand why certain areas are designated for specific use and how this relates to problems such as overuse, user conflicts, and vandalism.
7. Students will know what it means for a river to have "national status" and will understand the economic implications of this designation.
8. Students will appreciate why trails are developed and maintained the way they are and how this relates to such problems as increased demand, user conflicts, and the handicapped.
9. Students will describe the needs of the elderly and the handicapped for recreation and will be able to list ways these needs are being addressed in the Tennessee Valley.
10. Students will understand the need for local recreation areas.

11. Students will appreciate the relationship between commercial and recreational enterprises and the natural areas and resources managed by the governments in the Tennessee Valley.
12. Students will appreciate the need for water safety and be able to discuss common safety rules for swimming, boating, and fishing.

Water Resources Unit Rationale

Water is the one element essential to all life on earth; it is a basic component of every living cell. The availability of water has determined the course of civilizations. The Tennessee Valley follows the course of the Tennessee River which, along with the ample rainfall and abundant groundwater typical of the region, provides a generous natural supply of water. In addition, over 50 years of water system development has given the Tennessee Valley a wider variety of water resources than any other inland area of the world. The successful management of this abundant resource is perhaps the most significant factor in the growth of this region. To ensure continued growth, this vital resource must be understood, valued, and protected by the people of the Tennessee Valley.

Intended Learning Outcomes:

1. Students will understand the role groundwater plays in maintaining a water supply in the Tennessee Valley.
2. Students will understand the meaning of aquifer and be able to describe the six types of aquifers in the Tennessee Valley.
3. Students will explain how groundwater acquires impurities.
4. Students will understand that water quality is judged by how well the water serves the purpose for which it is to be used.
5. Students will know the three main purposes reservoirs serve in the TVA system.

6. Students will describe sources of water pollution, natural and people-made.
7. Students will understand why impurities are necessary for drinking water to be healthy.
8. Students will identify the sources of the earth's water supply.
9. Students will understand how societies adapt to the availability of water.
10. Students will explain how fluctuations in rainfall affect life in the Valley.
11. Students will explain how oxygen and other elements in water affect aquatic plant and animal life.
12. Students will understand the differences between rural and urban water needs and problems.
13. Students will know some problems affecting the water supply in reservoirs.
14. Students will understand why the water supply in reservoirs must be protected.

Wildlife Resources Unit Rationale

Human needs must be considered in relation to the total environment if opportunities for "the good life" are to be realized fully. As habitats are destroyed, wildlife suffers, and ultimately people are the losers. In order to combat habitat loss due to competition for the same living space and other problems such as unregulated hunting and trapping, it is necessary for people to be made aware of all the consequences of their actions. After a species has become extinct, there is nothing that can bring it back.

Human civilization affects all wildlife in one way or another, but through education about wildlife resource management, people can learn to assist nature in improving habitats and can ensure that wildlife populations are maintained at levels which maximize the benefits to wild animals and humans.

Intended Learning Outcomes:

1. Students will be able to discuss how various plant and animal species adapt to urban expansion.
2. Students will understand why it is important to consider wildlife management when formulating land development plans.
3. Students will understand how the aging of a developed area will serve the needs of varied wild animal populations.
4. Students will be able to discuss the economics of wildlife management in urban, upland, and wetland settings.
5. Students will be able to explain why it is important to leave den or snag trees in place for wildlife habitat.
6. Students will be able to explain how government and private landowners in the Tennessee Valley work cooperatively to enhance the wildlife of the Valley.
7. Students will be able to explain how wildlife management affects upland wildlife species.
8. Students will be able to describe and give examples of Tennessee Valley raptors and discuss their role in the ecosystem.
9. Students will be able to describe the Endangered Species Act of 1973 and explain why it is significant.
10. Students will be able to explain the role of hunting and trapping in wildlife management.

11. Students will be able to discuss the role of wetlands in the ecosystem, and discuss why restoration of wetlands is important.
12. Students will be able to give examples of Tennessee Valley waterfowl species and discuss their roles in the ecosystem.
13. Students will be able to define habitat and edge effects and discuss the types of habitat common to the Tennessee Valley.

TVA: A World of Resources Unit Rationale

An informed electorate is necessary in a democracy. It is important to know what the conditions were that led to the establishment of TVA so that its accomplishments and problems can be put in perspective. TVA was charged with being a national model for regional development. It is nationally funded and must be nationally accountable. The more people understand about the history of TVA, the better equipped they will be to examine the current issues confronting the agency.

Intended Learning Outcomes:

1. Students will be able to discuss:
 - a. the conditions prevalent in the U.S. that led to TVA's creation
 - b. the roles of George Norris and Franklin Delano Roosevelt in TVA's inception
 - c. the charge given to TVA at its formation
2. Students will be able to discuss the changes in the quality of life in the Tennessee Valley since 1933. From the data, students should be able to list specific improvements in:
 - a. navigation
 - b. production of electricity
 - c. agriculture

- d. tourism
- e. industrial development

3. Students will be able to give reasons for TVA's interest in solar energy and be able to:

- a. distinguish between active and passive solar energy
- b. discuss uses of solar energy

4. Students will be able to explain why each of the following issues is a concern of TVA:

- a. nuclear power
- b. reservoir management
- c. endangered species
- d. land use
- e. air pollution

5. Students will be able to describe the positive contributions made by TVA to the Tennessee Valley.



Additional Materials Available

List of Selected References

1. TVA Publications available through interlibrary loan from:

TVA Technical Library
Tennessee Valley Authority
400 West Summit Hill Drive
Knoxville, Tennessee 37902
(615) 632-3464

A History of the Tennessee Valley Authority, 50th Anniversary Edition,
Tennessee Valley Authority, 999.38 T2925, 1985

A History of the Tennessee Valley Authority, 50th Anniversary Edition,
Tennessee Valley Authority, 999.38 T2925, 1983

A Short History of the Tennessee Valley Authority, 1933-1956, Tennes-
see Valley Authority, 999.38 T2925, 1956

A Short History of the Tennessee Valley Authority, 40th Anniversary of
People in Partnership, Tennessee Valley Authority, 999.38 T2925,
1973

A Student History of TVA, Tennessee Valley Authority, 999.353008
T2924, 1984

Amphibians and Reptiles of Land Between the Lakes, Tennessee
Valley Authority, 999.5981 T29A, 1972

Answers to the Most Frequently Asked Questions About TVA, Tennes-
see Valley Authority, 999.353092 T29A, 1988

Electricity, Tennessee Valley Authority, 999.62131 E385, 1983

Energy Saver Home, Tennessee Valley Authority, 999.692.3T27E, 1981

Evolution and Status of TVA Power System, Tennessee Valley Author-
ity, 999.621312 E935, 1987

Fish and Fishing in TVA Impoundments, Tennessee Valley Authority,
799 E74F, 1950

How Clean is Our Air, Tennessee Valley Authority, 999.62853 H847,
1979

How Clean is Our Air, An Update, Tennessee Valley Authority,
999.62853 H847, 1984

Lichens and Ferns of Land Between the Lakes, Tennessee Valley
Authority, 999589.1 P55L, 1974

Norris Reservation: A Self-Guided Resource Tour, Tennessee Valley
Authority, 999.7965 N858, 1984

Nuclear Power in the Tennessee Valley, Tennessee Valley Authority,
999.621 483 T29N, 1978

Operation Save Our Soil, Tennessee Valley Authority, 999.6314 0615,
1980

Outdoor Recreation for a Growing Nation: TVA's Experience with
Manmade Reservoirs, Tennessee Valley Authority, 999.79 T270,
1961

- Pathway for Floods, Tennessee Valley Authority, 999.6274 P297, 1984
- Preservation is a Use: Experimental Archaeological Site Stabilization in the Tennessee Valley, Tennessee Valley Authority, 999.976 T51P, 1985
- Recreation Resources: 10 Year Action Plan, Tennessee Valley Authority, 999.79 T29RE, 1980
- Residential Energy Alternatives, Tennessee Valley Authority, 697 M15R, 1980
- River Traffic and Industrial Growth, Tennessee Valley Authority, 999.386 T28R, 1976
- Tennessee Valley Authority Annual Reports, 1979 through 1988, Tennessee Valley Authority, 999.38 T29R, 1987
- The First Fifty Years: Changed Land, Changed Lives (The Benchmark Report), Tennessee Valley Authority, 999.3637 F527, 1983
- The New TVA, Tennessee Valley Authority, 999.353008 P25N, 1982
- The Passive Solar Construction Handbook, Tennessee Valley Authority, 690.868 L66P, 1983
- TVA and Regional Development, Tennessee Valley Authority, 999.353008, 1983
- Use Less Electricity and Save Money, Tennessee Valley Authority, 999.33379 U845, 1984
- Where We're Going, Tennessee Valley Authority, 999.353008 W73W, 1986

2. TVA Publications available through TVA offices:

- Catalog of Water Quality Educational Materials, Water Resources Library, TVA, 270 Haney Building, Chattanooga, Tennessee 37402-2801
- Groundwater: A Vital Resource Student Activity Guide, Water Resources Library, TVA, 270 Haney Building, Chattanooga, Tennessee see 37402-2801
- Nest Boxes for Wildlife, limited quantities available from the Environmental Education Program, TVA, Forestry Building, Norris, Tennessee see 37828
- "Nonpoint Water Pollution - A Special Issue," Journal of Soil and Water Conservation, Jan-Feb 1980, Vol. 40, No 1, limited quantities available, Water Resources Library, TVA, 270 Haney Building, Chattanooga, Tennessee 37402-2801
- ### 3. Other Resources
- #### BOOKS
- A Field Guide to the Atmosphere by Vincent Schaffer, Jr. and John A. Day, Houghton Mifflin, Boston, MA, 1981.
- A Guide to Curriculum Planning in Environmental Education, Wisconsin Department of Public Instruction, 125 South Webster Street, Post Office Box 7841, Madison, Wisconsin 53707-7841, 1985
- Blacks in Tennessee 1791-1970 by Lester C. Lemon, University of Tennessee Press, Knoxville, Tennessee, 1981
- Crusade for Justice: The Autobiography of Ida B. Wells by Alfreda M. Duster, University of Chicago Press, Chicago, Illinois, 1970

"Cultural and Historical Perspectives in the Tennessee Valley." Hines poster sets, limited quantities available from the Tennessee Energy Education Network, Roane State Community College, Pellissippi Campus, Box 2294, Knoxville, Tennessee 37933

Energy and the Environment by John M. Fowler, McGraw-Hill Book Company, New York, New York, 1984

Energy Sources. The Wealth of the World by Eugene Ayres and Charles A. Scarlott, McGraw-Hill Book Company, New York, NY, 1952 (reprinted 1969)

Environmental Geology, 4th Edition by Edward A. Keller, Charles E. Merrill Publishing Company, Columbus, Ohio, 1985

Environment Progress and Challenges: EPA's Update, Public Information Center, U.S. EPA (PM21 1B), 401 M Street, SW, Washington, D.C. 20460, 1988

Environmental Science by Charles E. Kupchella and Margaret C. Hyland, Ailyn and Bacon, Inc., Boston, Massachusetts, 1986

Environmental Science: An Introduction by G. Tyler Miller, Jr., Wadsworth Publishing Company, Belmont, California, 1986

Experiments in Meteorology: Investigations for the Amateur Scientist by Leslie Trowbridge, Doubleday, New York, New York, 1973

Forestry in the South by Mobley and Hoskings, Turner E. Smith and Company, Atlanta, Georgia, 1956

Games of the World: How To Make Them, How To Play Them, How They Came To Be by Frederic V. Grunfield, Balantine Books, New York, 1977

How to Plan a Conservation Education Program, The International Institute for Environment and Development, North America World Resources Institute, Massachusetts Avenue, NW, Suite 302, Washington, D.C. 20036, 1988

Indoor Air Quality. Information Handbook: Building System Characteristics, National Technical Information Service, U.S. Department of Commerce Information Service, Springfield, Virginia 22161, 1987

In the Bank... or Up the Chimney: A Dollars and Cents Guide to Energy-Saving Home Improvements, Energy Conservation Now, Office to Policy Development and Research, Division of Energy, Building Technology, and Standards, U.S. Department of Housing and Urban Development, Washington, D.C., 1975

In Their Own Words: A History of the American Negro by Milton Meltzer, 3 volumes: 1619-1865, 1865-1916, and 1916-1966, Thomas Y. Crowell Co., New York, 1964-1967

Managing Municipal Leisure Services edited by Sidney G. Lutz and Edward H. Story, International City Management Association, Washington D.C., 1973

Managing Municipal Leisure Services edited by Sidney G. Lutz, International City Management Association, Washington D.C., 1980

1980 National Survey of Fishing, Hunting, and Wildlife—Associated Recreation, U.S. Department of the Interior and U.S. Department of Commerce, 1982

Natural Resource Conservation: An Ecological Approach, 4th Edition by Oliver S. Owen, MacMillan Publishing Company, New York, New York, 1985

Network: How Energy Links People, Goods, and Services, Interdisciplinary Student/Teacher Materials in Energy, the Environment, and the Economy, U.S. Department of Energy, Office of Consumer Affairs

"Our Fragile Atmosphere: The Greenhouse Effect and Ozone Depletion," EPA Journal, Vol. 12, No. 10, December 1986, Superintendent of Documents, GPO, Washington, D.C. 20402

- People and Natural Resources. Pocketbook for Environmental Awareness. U.S. Youth Conservation Corps, U.S. Forest Service, U.S. Department of Agriculture, U.S. Department of Interior, Washington, D.C., 1985
- Putting "Energy" in Your Course, developed by the participants in the Energy Short Course for Secondary Teachers at Clemson University, U.S. Department of Energy, EU-78-G-05-5802, Summer, 1978
- "Recreation in America." U.S. News and World Report. July 26, 1982 issue, page 47
- Rivers of America, The Tennessee by Donald Davidson, Rinehart & Company, Inc., Boulder, Colorado, 1978
- Roots by Alex Haley, Doubleday, New York, 1976
- "Something New is Happening in the Tennessee Valley," David Freeman, Catalyst 7(1):10-14, 1979
- The Earth, 2nd Edition by Edward J. Tarback and Fredrick K. Lutgens, Charles, E. Merrill Publishing Company, Columbus, Ohio, 1987
- The Harnessed Atom, Nuclear Energy and Electricity. (DOE/NE 0072), Superintendent of Documents, U.S. Government Printing Office, Washington, D.C. 20402
- The Inside Story: A Guide to Indoor Air Quality, Indoor Air Division, Office of Air and Radiation, U.S. Environmental Protection Agency, Washington, D.C. 20460, 1988
- The Lorax by Dr. Seuss, Random House, New York, NY, 1971
- The Tennessee Valley Authority, Marguerite Owen, Praeger Publishers, New York, 1973
- The Third Nationwide Outdoor Recreation Plan, The Assessment. U.S. Department of the Interior, Heritage Conservation and Recreation Service, Washington D.C., 1979
- The Weather Wizard's Cloud Book - How You Can Forecast the Weather Accurately by Reading the Clouds by L. Rubin and J. Duncan, Algonquin Books, Chapel Hill, NC, 1984.
- Transportation and the City. Interdisciplinary Student/Teacher Materials in Energy, the Environment, and the Economy, U.S. Department of Energy and the National Science Teachers Association, 1742 Connecticut Avenue, NW, Washington, D.C. 20009
- Tree Growth by Theodore T. Kozlowski, The Ronald Press Company, New York, 1962
- Two Energy Futures: A National Choice for the 1980s, American Petroleum Institute, Washington D.C., 1983
- Two Energy Futures: National Choices for the 1990's, American Petroleum Institute, Washington D.C., 1986
- TVA: An Approach to the Development of a Region by G. R. Clapp, University of Chicago Press, Chicago, Illinois, 1955
- TVA: Democracy on the March, 20th Anniversary Edition by D.E. Lilienthal, Harper and Row Publishers, Inc., New York, 1953
- TVA: Fifty Years of Grass-Roots Bureaucracy by Edwin C. Hargrove and Paul K. Conkin, University of Illinois Press, Chicago, Illinois, 1983
- Water, The Life Sustaining Resource by Robert Gardner, Julian Messner Publishers, New York, 1982
- Water: The Web of Life by Cynthia A. Hunt and Robert M. Garrels, W.W. Norton & Company, New York, 1972
- Weather - A Guide to Phenomena and Forecasts by Paul E. Lehr, R. Will Burnett, and Herbert S. Zim, A Golden Nature Guide, Simon and Schuster, New York, NY, 1965
- Your Guide to the United States Environmental Protection Agency, U.S. EPA, Office of Public Affairs (A-107), Washington, D.C. 20460, 1987

CURRICULA

- A Guide to Curriculum Planning in Environmental Education, Wisconsin Department of Public Instruction, 125 South Webster Street, Post Office Box 7841, Madison, Wisconsin 53707-7841, 1985
- Alabama Energy Education Idea Book, Environmental and Energy Education Program, Johnson Research Center, University of Alabama in Huntsville, Research Institute, Box 2121, Huntsville, Alabama 35899, 1987
- Aquatic Project Wild, Western Regional Environmental Education Council, Salina Star Route, Boulder, Colorado 80302, 1987
- Aquatic Resource Education Curriculum, AFTMA, Sportfishing Educational Foundation, 1250 Grove Avenue, Burlington, Illinois 60010, 1986
- Away with Waste: A Waste Management Curriculum for Schools, Washington State Department of Ecology, Litter Control and Recycling Program, 4350 150th Avenue, NE, Seattle, Washington 98502, 1984
- Bringing Energy to the People: Washington D.C. and Ghong, Interdisciplinary Student/Teacher Materials in Energy, the Environment, and the Economy, U.S. Department of Energy and the National Science Teachers Association, 1742 Connecticut Avenue, NW, Washington, D.C. 20009
- Energy Conservation Activities for Elementary Grades, Iowa Department of Education, Grimes State Office Building, Des Moines, Iowa 50319-0146
- How to Plan a Conservation Education Program, The International Institute for Environment and Development, North America World Resources Institute, Massachusetts Avenue, NW, Suite 302, Washington, D.C. 20036, 1988
- Iowa Developed Energy Sampler, Iowa Department of Education, Grimes State Office Building, Des Moines, Iowa 50319-0146

Keepers of the Earth: Native American Stories and Environmental Activities for Children, Michael J. Caduto and Joseph Bruchac, Environmental and Cultural Educator, Post Office Box 1052, Norwich, Vermont 05055, 1988

Know Nukes: Controversy in the Classroom, Know Nukes Institute, Antioch/New England Graduate School, Roxbury Street, Keene, New Hampshire 03431, 1985

Learning with Otis: A Conservation Education Activities Book, Ann Holey-Oliphant and Larry Behrens, Conservation Education Unit, Missouri Department of Conservation, Box 180, Jefferson City, Missouri 65102, 1984

Living Lightly on the Planet: A Global Environmental Curriculum Guide, Volumes I and II, Maura O'Connor, Schiltz Audubon Center, 1111 East Brown Deer Road, Milwaukee, Wisconsin 53212, 1987-88

Living in Water, An aquatic science curriculum for grades 4-6, National Aquarium in Baltimore, Pier 3, 501 East Pratt Street, Baltimore, Maryland 21202, 1987

"National Wildlife Week Teachers Guide," National Wildlife Federation, March 18-24, 1984

Project Learning Tree, supplementary activity guide for grades 7 through 12, Project Learning Tree, 1250 Connecticut Avenue, NW, Washington, D.C. 20036, 1986

Project Wild, Western Regional Environmental Education Council, Salina Star Route, Boulder, Colorado 80302, 1983

Resource Guide to Educational Materials About Agriculture: A Project of Agriculture in the Classroom, Agriculture in the Classroom, Room 234-W, U.S. Department of Agriculture, Washington, D.C. 20250

Science Activities in Energy. Department of Energy and the American Museum of Science and Energy, Oak Ridge Associated Universities, Post Office Box 117, Oak Ridge, Tennessee 37820

SCIS Science Curriculum Improvement Study, Rand McNally and Company, Chicago, Illinois:

Communities, 1971

Ecosystems, 1971

Environments, 1970

Life Cycles, 1969

Organisms, 1970

Populations, 1970

Sourcebook on Air Pollution Topics for Grade and High School Teachers, Eileen G. Brennan and John T. McGovern, Air Pollution Control Association, Post Office Box 2861, Pittsburg, Pennsylvania 15230, 1984

Teaching Soil and Water Conservation: A Classroom and Field Guide. U.S. Department of Agriculture, Soil Conservation Service, Post Office Box 2890, Washington, D.C. 20013, 1977

The Class Project from the National Wildlife Federation, 1412 Sixteenth Street, NW, Washington, D.C. 20036, 1982

The Sourcebook: Learning by Design, The Environmental Education Programs of the American Institute of Architects, 1735 New York Avenue, NW, Washington, D.C. 20006-5292, 1981 (revised 1988)

Thinking Globally and Acting Locally: Environmental Teaching Activities, Lori D. Mann and William B. Stapp, ERIC Clearinghouse for Science, Mathematics, and Environmental Education, Ohio State University, 1200 Chambers Road, Third Floor, Columbus, Ohio 43212, 1982

4. Materials

LaMotte Kit
LaMotte Chemical Products Company
P.O. Box 329
Chestertown, Maryland 21620

Water Testing Kits and Equipment
Hach Equipment Company
P.O. Box 389
Loveland, Colorado 80539

5. Organizations

Environmental Protection Agency, Region 4
345 Courtland Street NE
Atlanta, Georgia 30308

EPA's Environmental Monitoring System Laboratory
Triangle Park, North Carolina 27711

National Audubon Society
950 Third Avenue
New York, New York 10022

NDAA, National Weather Service Public Affairs
8060 13th Street, Room 618
Silver Springs, Maryland 20910

The Acid Rain Foundation, Inc.
1630 Blackhawk Hills
St. Paul, Minnesota 55122

U.S. Environmental Protection Agency
Office of Public Affairs (A-107)
Washington, D.C. 20460



TVA University Network Centers

Dr. Bernard Benson, Director
Center for Environmental, Energy
and Science Education
Department of Curriculum and Instruction
The University of Tennessee
Chattanooga, Tennessee 37403
(615) 755-4237/4126

Dr. Race Bergman, Director
Center for Environmental/Energy Education
Department of Education
Middle Tennessee State University
Murfreesboro, Tennessee 37132
(615) 898-2621

Dr. Richard C. Berne, Director
Center for Environmental/Energy Education
School of Arts and Sciences
Western Carolina University
Cullowhee, North Carolina 28723
(704) 227-7476

Dr. Ron Cleminson, Director
Center for Environmental/Energy Education
Department of Curriculum and Instruction
Memphis State University
Memphis, Tennessee 38152
(901) 678-2545

Dr. Maurice Field, Director
Center for Environmental, Energy,
Science, and Mathematics Education
Gooch Building, Room 145
The University of Tennessee at Martin
Martin, Tennessee 38238
(901) 587-7200

Dr. Susan P. Gannaway, Director
Center for Environmental, Energy
and Science Education
Department of Education
North Georgia College
Dahlonega, Georgia 30597-9990
(404) 864-1533

Dr. Earl Gardner, Director
Center for Environmental
and Science Education
Post Office Box 5015
The University of North Alabama
Florence, Alabama 35632
(205) 760-4228

Dr. Ruth Jacquot, Director
Center for Environmental Education
Murray State University
Murray, Kentucky 42071
(502) 762-2499

Mr. Bernard Levine, Director
Environmental/Energy Education
Johnson Research Center
Research Institute Box 212
The University of Alabama in Huntsville
Huntsville, Alabama 35899
(205) 895-6257

Mr. Allan M. O'Neal, Jr., Director
Bear Creek Watershed Environmental
Education Project
Post Office Box 880
Russellville, Alabama 35653
(205) 332-6200

Dr. Margaret Phelps, Director
Center for Environmental/Energy Education
College of Education
Tennessee Technological University
Cookeville, Tennessee 38505
(615) 372-3791

Dr. Doug Ratledge, Director
Cedar Creek Learning Center
c/o Greene County Schools
111 Union Street
Greeneville, Tennessee 37743
(615) 639-4194 (school office)
(615) 638-6100 (Cedar Creek)

Dr. Charles F. Rhyme, Director
Center for Environmental/Energy
and Science Education
School of Science and Technology
Jackson State University
Jackson, Mississippi 39217
(601) 968-2595

Dr. Webb S. Slawson, Director
Center for Environmental/
Energy/Science Education
College of Education
The University of Tennessee
Knoxville, Tennessee 37996-3400
(615) 974-0997

Dr. Terry Wilson, Director
Center for Mathematics, Science
and Environmental Education
Western Kentucky University
Bowling Green, Kentucky 42101
(502) 745-4424

Dr. John Woods, Director
Center for Outdoor Education
Tennessee Wesleyan College
Post Office Box 132
Athens, Tennessee 37303
(615) 745-5087

Air Resources



"Out of the sane, silent, beauteous miracles
that envelope and fuse me -- trees, water,
grass, sunlight, and early frost -- the
one I am looking at most today is sky."

Walt Whitman

Air Resources Concept Map

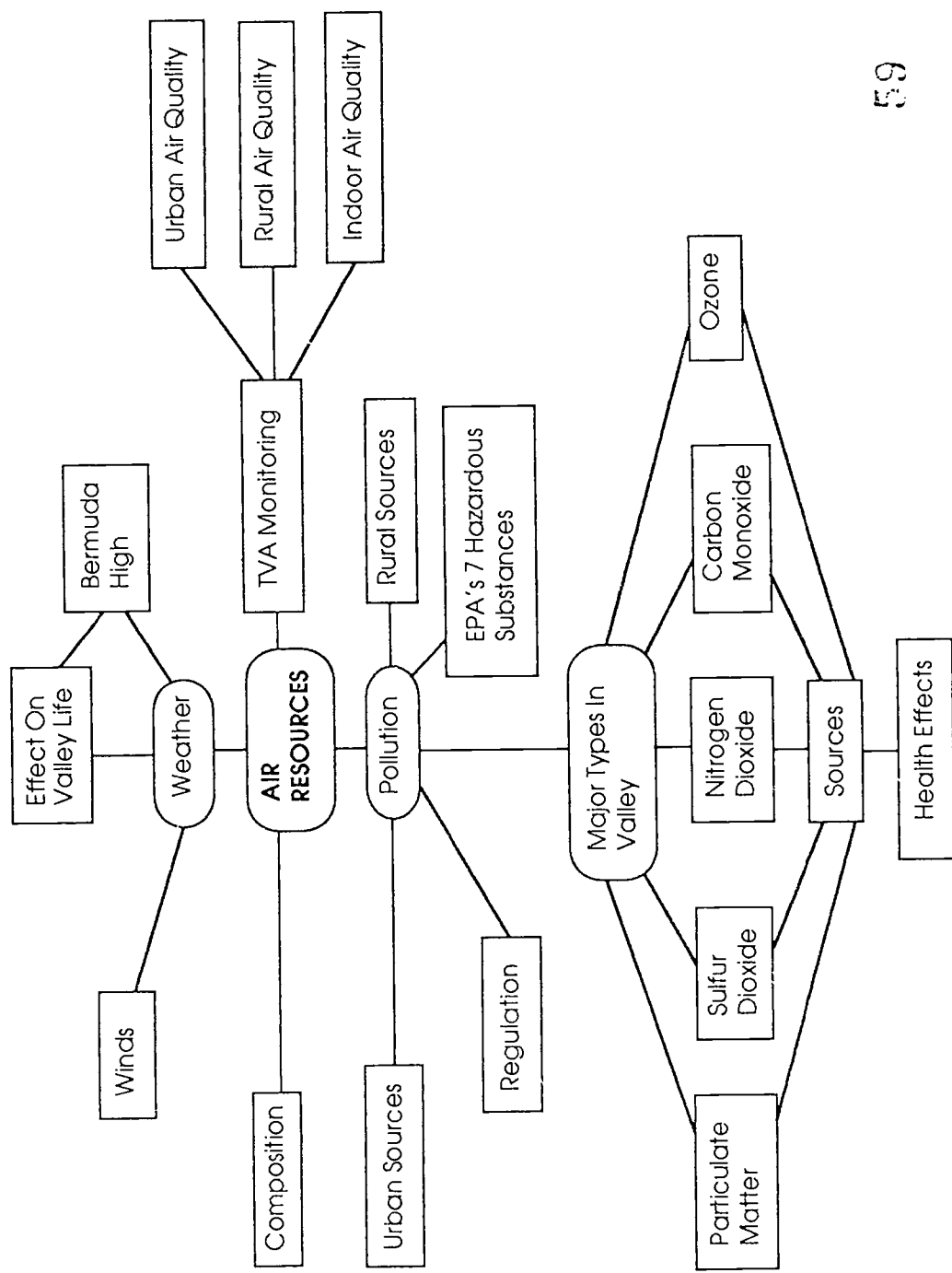



Air Resources Factsheets

1. Overview
2. What Is Air?
3. Where Does It Come From? Where Does It Go?
4. Urban Air
5. The Burden Of Pollution
6. Acid Rain: An Air Or Water Problem?
7. Rural Air
8. Indoor Air And Other New Issues
9. Hazardous Pollutants

1. Overview

Only during the past 20 years or so have the people of the United States begun to understand that air is a resource that can be managed for health and environmental quality. Management of our air means gaining control over industrial emissions and the emissions from individual sources, such as cars and trucks, and temporary sources such as construction projects.

Pollution of the air by certain industrial processes, particularly the burning of coal, has been a concern for many years. Charles Dickens, in his book *Hard Times*, described in graphic detail the blackened air that hung over an English industrial town during the 1800s. He contrasted that air to the cleaner air of the nearby countryside. However, it was not until thousands died because of air pollution, in such cities as London in the 1950s, that the first steps were taken to reduce the poisons that were routinely being emitted into the air we breathe.

Two major sources of harmful emissions became targets for initial action: utilities and industries, and motor vehicles. Steps were first taken to clean up smokestack emissions around power plants and industrial complexes. Attention was then focused on the sulfur oxides emitted from utility, commercial, and industrial stacks. At the same time, devices were developed to cut back on emissions from motor vehicles. It took years and money, but progress was made from the 1960s through the 1980s. The air is generally cleaner today than it was 30 years ago in much of the Nation. In the Tennessee Valley, the same is true. TVA power plants today emit less sulfur than in the early 1970s, and industrial plants have taken steps all across the region to cut back on their contributions to air pollution.

Air quality management is a complex undertaking. It is complicated by the nature of air and by the gases that are commonly

considered its basic components. It is further complicated by the continual chemical changes that take place in the air as it moves from one location to another, and by atmospheric forces. Temperature variations can create complex patterns of air movement.

Air is difficult to define in simple terms. It is mostly nitrogen with oxygen the next most abundant component. All the other gases commonly found in air represent just over one percent of the total.

An air mass is affected by many things as it moves across the earth. Plants, for instance, contribute oxygen as a by-product of photosynthesis. Oceans, lakes, streams, and vegetation contribute water vapor through evaporation and transpiration. In addition, the seas and marshlands contribute sulfur and a variety of salts. Volcanic eruptions can also throw tons of materials high into the atmosphere that remain in the upper air layers for several years, slowly making their way back to earth.

Other natural processes remove various materials from the atmosphere. For example, plants absorb carbon dioxide during photosynthesis, and both plants and animals use oxygen during respiration. Carbon dioxide is also absorbed by water. Rain also washes large amounts of particulate matter from the air. In short, a constant pattern of exchange occurs as air moves across the surface of the earth.

That is just part of the story. As the air moves, chemical changes are taking place. These changes can be beneficial, harmful, or of little or no consequence to the environment. "Acid rain," for instance, has become an issue of serious concern and a real challenge to air resource managers. Acid rain forms when water vapor combines with sulfur and nitrogen compounds to form acids. With this in



mind, let us examine some facts about the air around us, and try to understand what we need to do to protect it.

2. What Is Air?

A vast sea of gases, which sweeps great quantities of materials along in its currents, surrounds the earth. This is earth's atmosphere. It is a layer of air that carries water vapor, clouds, dust, smoke, soot, and a wide variety of chemical compounds. It behaves like a fluid blanket, weighing millions of tons. It presses down on our bodies, extends many miles above the earth's surface, and provides a protective shield against some forms of ultraviolet radiation from the sun. It is constantly in motion, driven by solar energy from the sun and by the gravitational pull of the sun and the moon.

Dry air is a relatively constant mixture of gases, around 78 percent nitrogen and nearly 21 percent oxygen. That leaves just over one percent for all the other gases, including carbon monoxide, carbon dioxide, nitrous oxide, methane, ammonia, and hydrogen sulfide.

As air moves from one place to another, there often is an interaction between the various components of the fluid mixture. For example, water vapor will react with carbon dioxide to form carbonic acid. Sulfur and nitrogen oxides also take part in chemical reactions with water vapor, ozone, and other components leading to the formation of sulfuric and nitric acids. Sunlight sometimes plays an important role in these reactions. It is especially important in the complex chemical processes leading to the formation of ozone. In summary, we have to think of the air about us as a system, always moving, always changing, and always rearranging things along the way.

The Tennessee Valley Authority has a staff which studies the air in the Tennessee Valley. They examine atmospheric chemistry, movement of air currents across the region and elsewhere, and the



nature of materials deposited by the air as it moves from place to place. They also study air quality in cities and rural areas, near power plants, and indoors. They are concerned with the effects that air quality has on the environment and on the health of the people of the Valley.

3. Where Does It Come From? Where Does It Go?



Weather is not easy to understand, but some facts are useful. Weather includes a variety of short-term changes in air pressure, temperature, wind direction, and amounts of water vapor in the air. These changes are generally related to the development and movement of air masses.

An air mass is a body of air that has the same properties as the region over which it develops. For instance, air masses which develop over the equator are very warm, while air masses which form over the polar ice caps are very cool. As a direct result of this condition, one might expect the equatorial zone to become progressively warmer as the years pass, and the polar regions progressively cooler. But such is not the case.

Air movement is strongly influenced by the energy of the sun. If you could see air, an air mass would appear as a large pile. Depending on where this air mass forms, it exerts high or low pressure. Cool, dry, high-pressure air masses form over the regions at higher latitudes (60 degrees centigrade), while warm, moist, low-pressure air masses develop over oceans at lower latitudes (30 degrees centigrade) near the equator. Air masses tend to rotate or spiral. In the northern hemisphere, high-pressure air masses spiral inward in a clockwise motion, while low-pressure air masses spiral outward in a counterclockwise direction. These spiraling air masses form air belts called polar easterlies over the ice caps, westerlies over northern and southern latitudes (between 30-60 degrees centigrade), horse latitudes (at 30 degrees centigrade), trade winds (between 0-30 degrees centigrade), and equatorial doldrums (at 0 degrees centigrade). (See illustration in Air Resources activity "Atmospheric Blankets and Winds"). As the names imply, winds move in either easterly or westerly directions, or not at all in the case of horse latitudes and equatorial doldrums.

Air masses tend to keep their special properties for a long time. When two air masses meet, they tend not to mix. Instead they form a boundary or front. Bad weather is often associated with fronts.

The earth's weather system is not easy to understand and scientists often spend their entire lives just observing and recording weather patterns. But understanding weather is important to scientists who are concerned with air quality and ways to protect it.

Wind speed, wind direction, temperature, humidity, cloudiness, and precipitation all affect the way pollution in the air behaves and how long it will remain in an area. For example, midsummer weather patterns can be especially troublesome in the Valley because of the tendency of the air over the region to become stagnant under the influence of the dominant "Bermuda High." During such hot, hazy days, outdoor air quality conditions can become unhealthy for certain very young and very old individuals with heart or lung problems.

Knowledge of weather patterns in the Valley can provide insight into short- and long-range transportation of air pollution. It helps in understanding why ozone pollution, typically an urban problem, is sometimes found even in rural areas during the summer. By taking into account the weather patterns that are likely to occur, computers can be used to make predictions of the effects of emissions from power plants, industries, transportation sources, and municipal areas.

Weather certainly has a great deal to do with air quality over the Valley region. For these and many other reasons, scientists from the Tennessee Valley Authority have to take weather into account as they study air quality issues.

4. Urban Air

We have always had a powerful influence on all parts of our environment, and the air is no exception. This continues today as populations and commercial and industrial activities increase. Industrialized society, in fact, has had the single greatest human impact on air resources of the world.

Because of the potential health hazards associated with air pollution in large urban centers, a special understanding of city air pollution is needed. This is especially true in a region such as the Tennessee Valley where the major cities more often occupy low-lying areas and where long periods of air stagnation are common during the summer months.

There are many sources of air pollution: motor vehicles, construction activities, pollen from plants, dust generated in the city and from agricultural activities nearby, and thousands of vaporized chemicals, some of them toxic and hazardous.

Sources of pollution are more abundant in major cities than in small towns or rural areas. Sources include: coal-fired power plants; public schools, colleges, universities, hospitals, and other institutions which burn oil as their heat source; office buildings, retail stores, and shopping malls which use fossil fuels as their sources of heat; industrial parks which use fossil fuels not simply to keep workers warm, but as a vital part of many industrial processes; and individual homes, especially where heat is provided by burning oil, natural gas, or wood. All of these sources add to the pollution entering the city's air.

Federal agencies such as the Environmental Protection Agency and state and local regulatory agencies are concerned with the quality

of urban air all across the country. TVA has joined state and local agencies in studies designed to see if residential areas might be affected by hazardous pollutants in the air. State and metropolitan air quality agencies also monitor air quality in some especially troublesome locations to measure the effectiveness of antipollution measures.



5. The Burden Of Pollution



In the Tennessee Valley there are six major kinds of pollutants: particulate matter, sulfur dioxide, nitrogen dioxide, carbon monoxide, lead, and ozone. To deal with these pollution materials, we first have to know something about where they come from, why they are important, and what can be done to bring them under control.

Particles in the air come from many sources: smokestacks and chimneys; cars and trucks traveling the highways and streets; construction activities; and agriculture and forestry operations. Most of the larger particles fall to earth within a short distance of where they are generated. They are far less troublesome to human health than the tiny particles which remain in the air for long periods of time and can be inhaled deep into the lungs.

The largest sources of sulfur dioxide are coal-fired power plants, industrial and commercial boilers burning coal or oil, cement plants, smelters, and petroleum refineries. Sulfur dioxide can cause damage to crops and natural vegetation. It also is associated with health problems for the very young and the elderly. Further, it is a major element in the formation of acid rain, a matter of growing concern in the Valley and around the world.

Nitrogen dioxide comes mainly from automobiles, large coal or oil-burning power plants, and industrial boilers. It also plays a role in the acid rain phenomenon.

Carbon monoxide comes from many sources, but mainly from motor vehicles as a by-product of incomplete combustion. Too much carbon monoxide in our environment can affect the ability of blood to carry oxygen to the cells of our bodies.

Ozone is mostly a summertime problem. It is formed in the atmosphere through the action of the sun on nitrogen oxides, hydrocarbons, and carbon monoxide. High in the atmosphere, ozone provides protection against ultraviolet radiation, but near the earth it can damage farm crops. Millions of dollars are lost each year as trees and plants are damaged, and nylon, rubber, plastics, dyes, and other synthetics deteriorate due to ozone.

Each year millions of dollars are spent to reduce the amount of pollution emitted into the atmosphere. Control devices such as electrostatic precipitators, scrubbers, and catalytic converters are already used to reduce emissions from smokestacks and automobile exhausts. However, even tighter controls may be needed in the future. It is an endless battle, but one that is essential to safeguard human health and the natural environment.

6. Acid Rain: An Air Or Water Problem?



To understand acid rain, we first must understand what an acid is. Acidity is measured on a pH scale which ranges from 1 to 14. A substance with a pH of 7 is considered neutral; that is, it is neither acidic nor alkaline. Measurements below 7 are acidic. The stronger the acid, the lower the number. Vinegar, for instance, has a pH of 3, and lemon juice has a pH of 2. Measurements above 7 are alkaline, or basic. The higher the number, the more alkaline the substance. For example, baking soda has a pH above 8 and ammonia has a pH around 12.

Unpolluted rain is slightly acidic with a pH of 5.0 to 5.2. In the Tennessee Valley, the pH of rain averages around 4.3, which is 5 to 8 times more acidic than unpolluted rain (because pH is a logarithmic measure).

The acid-forming compounds come from natural as well as human-made sources. A volcanic eruption can cause acidic conditions covering half the globe. Decay processes involving both plant and animal materials, which occur in marshes, swamps, and oceans, can also produce chemicals that can increase acidic deposits. Many researchers, however, believe that a major source of increased acid in rainfall is industrial activity such as the burning of fossil fuels like coal, gasoline, fuel oil, and natural gas.

The effects of acid rain are difficult to pinpoint. We know that when a stream or lake becomes too acidic, fish and their food sources are affected. Acid stress can cause fish to die. Small amounts of acid can also affect the ability of fish to reproduce. In addition, acid dissolves materials like aluminum in the soil, and the combination of aluminum and acid often proves fatal to fish and other organisms.

Acid rain is also believed to reduce crop yields and deteriorate buildings and roads. There are indications that acid precipitation also may be causing a reduction in forest production in the Valley region. TVA and other agencies, industrial researchers, and educational institutions are pursuing studies aimed at gaining a greater understanding of acid rain; however, there is much to be done in this field.

Clearly, this is a complex matter, but it is one that is viewed with increasing concern by many world leaders. Since air moves without restriction from region to region, from nation to nation, and from continent to continent, any solution to the problem will require international cooperation.

7. Rural Air

The air around us is never completely pure. It contains many gases and particulate materials that are useful to plants and animals. Plants use the carbon dioxide in air for photosynthesis to produce simple sugars. Plants also absorb water vapor and other elements, such as nitrogen and sulfur, in order to grow and reproduce. Humans breathe the oxygen from the air in order to live.

Not all gases and particulate matter in the air are useful. Many materials carried in the air, such as dust, pollen, smoke, salts, and volatile vapors, serve no particular purpose and cause harm in certain amounts. Because air quality has become an important environmental consideration in our country and around the world, there is a great deal of interest in measuring the various elements in the air. To give these measurements some practical meaning, it is important to have some yardstick for making comparisons. For this reason, TVA and other agencies are involved in rural air monitoring. By making measurements in rural areas as far away as possible from urban and industrial sources of pollution, background levels of potentially troublesome materials can be established.

TVA maintains monitoring stations in the Tennessee Valley to measure how much sulfur dioxide, nitrogen oxides, particulates, acid rain, and ozone are found in the cleaner air in the region. These "trend" stations are located in northern Alabama, western Kentucky, middle Tennessee, eastern Tennessee, and southwestern Virginia. Air quality information from these stations makes it possible to determine the degree to which the air in big cities and near industrial complexes affects human activity. This information, in combination with other data, helps regulatory agencies determine how much emission control is necessary to reduce air pollution.

Measurements of air quality in rural areas can also provide indications of long-term environmental changes in a region. If for instance, a rural station begins to see increasing amounts of a pollutant in the air, Federal and state agencies can use this information to develop the broad-based control measures necessary to improve conditions. Measurements at rural trend stations can also give a great deal of information on long-range transport of pollutants. They can tell us about the quality of the air coming into and leaving the Valley and provide some indication of how pollution sources are affecting air quality. Measurements of rain chemistry can determine whether acid rain is getting worse, better, or holding steady over a period of years.

We are constantly collecting air quality information in the Valley and adding it to the more than 50 years worth of data collected previously. This information is available on request to authorities at every level of government, to industries, to scientific researchers, and to the public.



8. Indoor Air And Other New Issues



Few people think about indoor air pollution. However, increasing numbers of health specialists are becoming concerned about the air in our homes and work places. Since, on the average, we spend more than 80 percent of our time indoors, the quality of indoor air should be important to us. Tobacco smoke, for example, is suspected to be dangerous to our health even if we do not smoke. Fumes from certain types of insulation are also considered hazardous. Indoor air can contain a variety of pollutants.

One of the ways we become aware that the air around us is not pure is through our sense of smell. How many times have you said, or heard someone else say, "That smells good"? Food cooking can give off aromas that make our mouths water. Some people like the smell of a cigar, pipe, or fireplace woodsmoke on a cold winter day. Of course, none of us wants to give up the harmless, pleasant odors around us, but sometimes these odors can mask more harmful pollutants. Unfortunately there are some pollutants that we cannot smell at all, such as carbon monoxide.

TVA became concerned with indoor air quality, in part, as a result of the emphasis placed on tighter insulation of our homes and other buildings. The former TVA-sponsored insulation program promoted insulation as a means of saving energy, especially during heating and air-conditioning seasons. But tighter living quarters can mean less circulation of new air into a building. When air inside is retained longer, it has a longer time in which to accumulate indoor pollutants.

There are several emerging issues that should be kept in mind while thinking about indoor air quality. Inhalable particulates is one. The human breathing passages generally are able to filter out larger

particles and prevent them from reaching the lungs. However, microscopic particles are another matter. They make their way into the deeper parts of the lungs and can cause or aggravate illness in many people. Another indoor air quality issue centers on the effects of woodstoves in homes or in residential neighborhoods. Woodstoves are being used by an increasing number of people in an effort to cut heating bills, but burning wood emits a number of potentially toxic materials.

9. Hazardous Pollutants



Some pollutants are dangerous to human health even in very small amounts. The presence of such materials in the air may be a signal that something needs to be done. So far, the Environmental Protection Agency has listed 7 substances as hazardous air pollutants under the Clean Air Act. These are asbestos, beryllium, mercury, vinyl chloride, benzene, inorganic arsenic, and radionuclides.

Hazardous air pollution is becoming more of a problem year by year due to the creation of more unusual and complex chemicals to serve the needs of new technological industries. Chemical discosal sites and hazardous waste incinerators can also emit hazardous materials. TVA is helping, through various activities, to evaluate hazards and to provide basic standard measures of various substances in the air. Such information is essential to the development of exposure standards or emission control regulations believed necessary to protect human health.

Unfortunately, the number of potentially hazardous chemicals in our environment is almost impossible to estimate. In addition, developing techniques for detecting and measuring these substances is difficult. This is further complicated by the amount of time involved in detecting some effects. Look at cigarette smoking. A healthy person is not likely to be permanently damaged by one cigarette or one package. Continuous smoking over a period of many years, however, can result in the development of cancer, emphysema, or other lung problems.

Hazardous chemicals may affect the body in a similar way. Exposures to small amounts of a chemical may have little or no effect, but, over a long period of time, continuous small exposures may have a serious effect similar to exposures of large amounts of the substance

all at once. For this reason, there is concern not only about exposure to significant amounts of hazardous material over a short period of time but also about repeated exposure to low levels over a period of years. Identifying hazardous substances is further complicated by the lag time between the first exposure and any identifiable damage.

Air Resources Activity Matrix



AIR RESOURCES	AIR RESOURCES	CULTURAL RESOURCES	ENERGY RESOURCES	FOREST RESOURCES	RECREATION RESOURCES	WATER RESOURCES	WILDLIFE RESOURCES	TVA - A WORLD OF RESOURCES
The Atmospheric Blanket and Winds	1,2,3,4		5			9		
Compositions About Air Composition	1,2,3,4,5,6	9	1			6	7	
Temperature Inversions	1,3,5,9		1,4,6			3		9
Weather Cycle	1,3		2,5,6,9			1,5		
Acid Rain Watchers	1,4,5,6,7	9	1,6	8	1,3,5,6,7,8,9	7	9	
Sulfur Dioxide Dangers	6,8,9		3			3		9
The Nose Knows	1,2,4,5,7,8,9			5		3		9
Storing Hazardous Materials	8,9		3			3		
Carbon Monoxide	8,9		3			3		
Smoke Detectors	1,3,4,5,6,7	9	3,6,9	8		3		9

The Atmospheric Blanket And Winds



OBJECTIVES:

(1) Students will research earth's atmosphere. (2) Students will prepare a diagram representing the earth and its atmospheric layer. See AIR RESOURCES matrix for background information.

MATERIALS:

posterboard or newsprint
felt crayons
string
blue felt crayon
globe or photograph of earth from space
cardboard cut out, the shape of a record
old record player

PREPARATION:

Review with students the layers of earth's atmosphere. Ask students to check reference books for information about the atmosphere. Be sure to find out: (1) how far above the earth's surface the atmosphere extends, in kilometers, (2) what the different layers are that make up the earth's atmosphere (like ozone), and (3) the percentage composition of gases and water vapor in each layer.

This activity may be combined with the activity "WATER WORLDWIDE" in the WATER RESOURCES section.

PROCEDURE:

Allow students to work together in groups of 4 or 5. Place a globe, or a photograph of earth from space, in a central location to serve as a model. Students should draw a whole surface view, a cut-away view, as in the diagram provided, or both. The circumference may be drawn by tying a string to a pencil and, by holding the other end of the string in the center, transcribing a circle on the posterboard with the pencil.

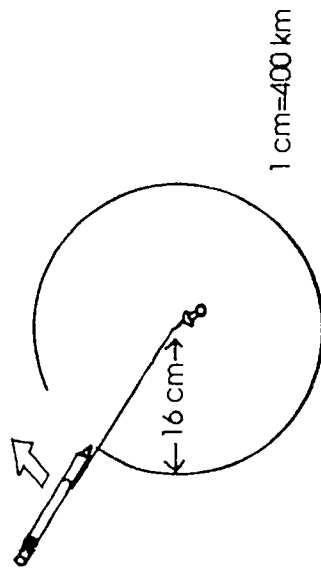

Set the radius of the string at 16cm. The diameter will be 32cm, which gives a scale of 1cm = 400km.

From their research, students should know the depth of the atmosphere. Using a light blue felt crayon, have students add the atmospheric blanket to their earth diagram (about 1 to 3cm thick only). Help each group calculate the correct thickness, using the scale 1cm = 400km. Do this on the board for everyone. Then, discuss with the class the relative thinness of this layer.

Encourage groups to prepare data tables, circle graphs, and bar graphs from the information they have collected, such as percentage composition of gases and of water vapor. Place this information along the borders or in the corners of the poster board. Also, add photographs of clouds and other atmospheric phenomena students have cut out of magazines or other print media. Finally, add the ozone layer. Have each group present its poster to the class.

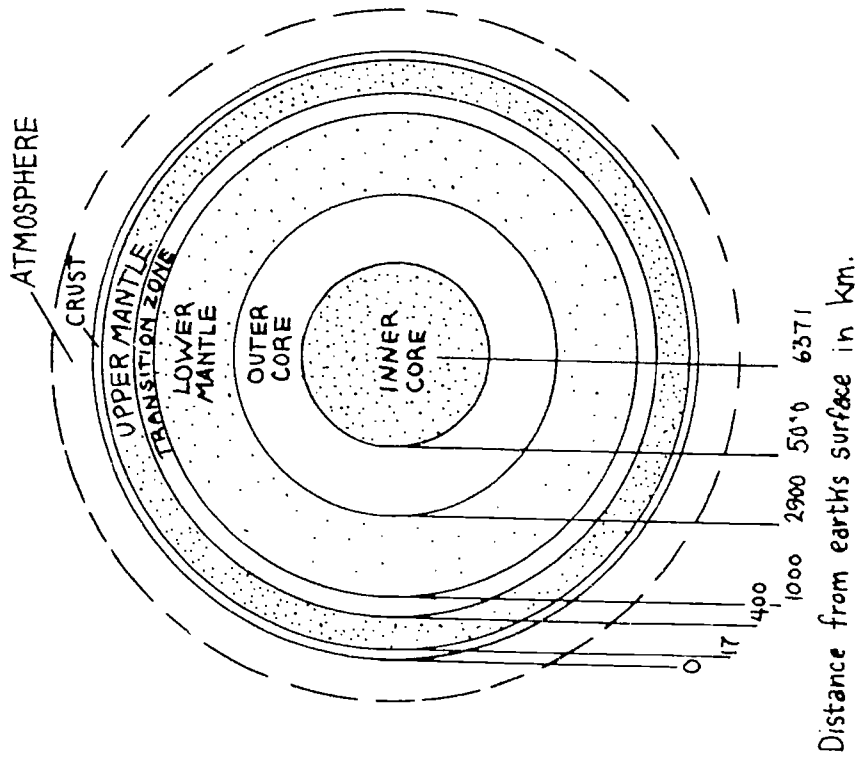

Now, study the diagram "Effects of the Earth's Rotation on Wind Patterns". Explain the major patterns of winds on Earth. Show the importance of sunlight heating the surface and the turning of the Earth in the formation of these wind patterns. Wind deflection is caused by the earth's rotation. To show how this works in the Northern hemisphere, put a cardboard record on the old record player. The center of the record is the axis of the earth. As the record turns, draw a line with a felt crayon from the center hole straightaways to the record (equator) edge. See how the clockwise (easterly) rotating record causes the felt marker line to curve in a counter clockwise (westerly) direction. Now, have students add wind patterns to their posters using the diagram. Note the surface wind direction in their area and the opposite high altitude wind pattern.

FOLLOW THROUGH:

(1) The atmospheric ozone layer worldwide shrank an average of 2.5 percent during the past decade according to the National Aeronautics and Space Administration (NASA). Scientists estimate that for every 1 percent decrease in ozone, an additional 2 percent of the sun's most biologically damaging wavelengths of ultraviolet (UV) radiation reaches the earth's surface. Exposure to elevated UV levels has been linked to cancer. Have the students research this problem. Have them make chemical models to show how chlorofluorocarbons (CFCs) react with ozone to deplete this layer. You might also want to modify the earth diagrams created for this activity to show the hole in the earth's ozone layer.

(2) People often get confused when talking about the ozone problem. There are really two separate problems: (a) depletion of atmospheric ozone in the upper atmosphere; and (b) creation of photochemical smog (ozone) in the lower atmosphere in low lying cities and towns. Have students do research on both. Discuss good and bad ozone.

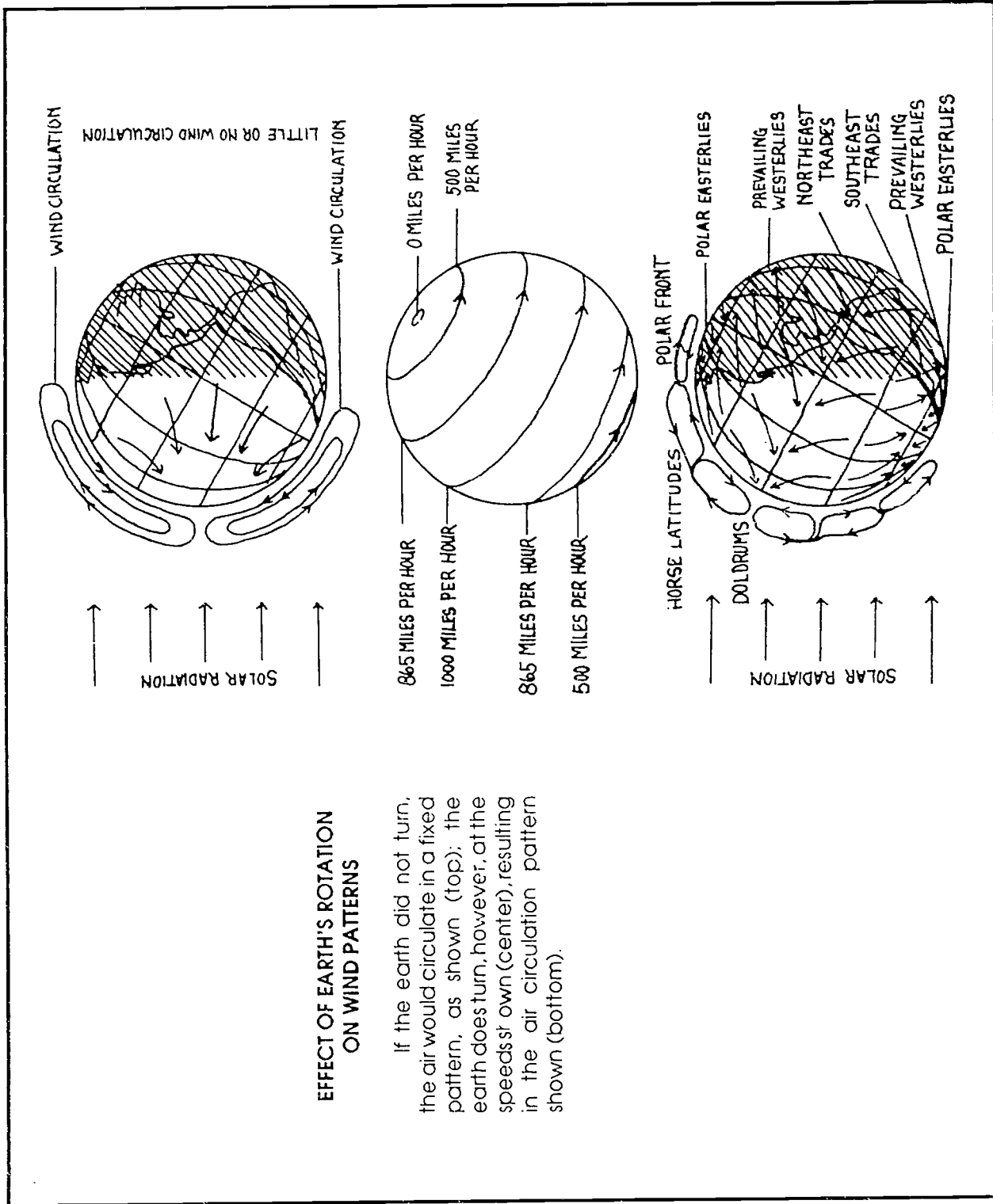

Composition About Air Compositions



OBJECTIVES:

Students will prepare compositions about the "composition" of the earth's atmosphere. See AIR RESOURCES matrix for background information.

MATERIALS:

reference materials

PREPARATION:

Review with students the various information sources available to them such as books, films, interviews, correspondence, and others.

Develop a composition format with the class so that the compositions will be similar and consistent.

Discuss the importance of having the group work together to help one another. Each small group will act as a sounding board to help individual students prepare better compositions. Honesty, helpfulness, and encouragement should be emphasized for the group portion of the work. You might prepare an evaluation, if necessary, to have peers evaluate each other's work in the small groups using the criteria mentioned above.

PROCEDURE:

Divide the class into nine groups. Each group will deal with one of the following topics:

- ACID RAIN
- ASBESTOS
- GREENHOUSE EFFECT
- INDOOR AIR QUALITY
- LEGIONNAIRES' DISEASE
- OZONE HOLE
- RADON
- SMOG

Allow groups to meet and identify information sources. Individuals should begin to research their topics and write a first draft. When the first drafts are complete, give the students these instructions:

- (1) At the next group meeting, pair with a member of another group. Read your composition to that person and ask for comments like: "What parts interested you the most?" and "Which parts would you leave out?". Then have the other person read his/her composition to you while you provide helpful comments. Research your topics more and write a second draft.
- (2) Meet in your original group and allow each member to read the second drafts. Make helpful comments after each person has read. If the paper is interesting enough, then comment on grammar and sentence structure. The writer does not have to accept the group's or any individual's opinion.

Remember: the goal is to give helpful comments. In some cases, it can be helpful to repeat step (1) above if the composition could use a more interesting approach.

- (3) Meet in your original group and work with a partner to check grammar, spelling, and punctuation. Prepare a final copy.
 - (4) Exchange compositions with another group. Read all of their work and choose the best one.
- Allow the best composition from each group to be read to the class.

FOLLOW-THROUGH:

Prepare chemical models (or biological models for the pollen) of the various air pollutants that were researched in this activity. Ask a chemistry teacher about a molecular modeling kit or how to make the models from styrofoam and pipe cleaners.

Have students prepare diagrams, like the one included on petroleum production, refining, and distribution," for each of the air pollutant problems researched. For the substances that are human caused, show possible sources of the substances and possible effects of them. For the naturally occurring substances, make diagrams to show how these substances are cycled through the environment.

PETROLEUM PRODUCTION, REFINING, AND DISTRIBUTION.

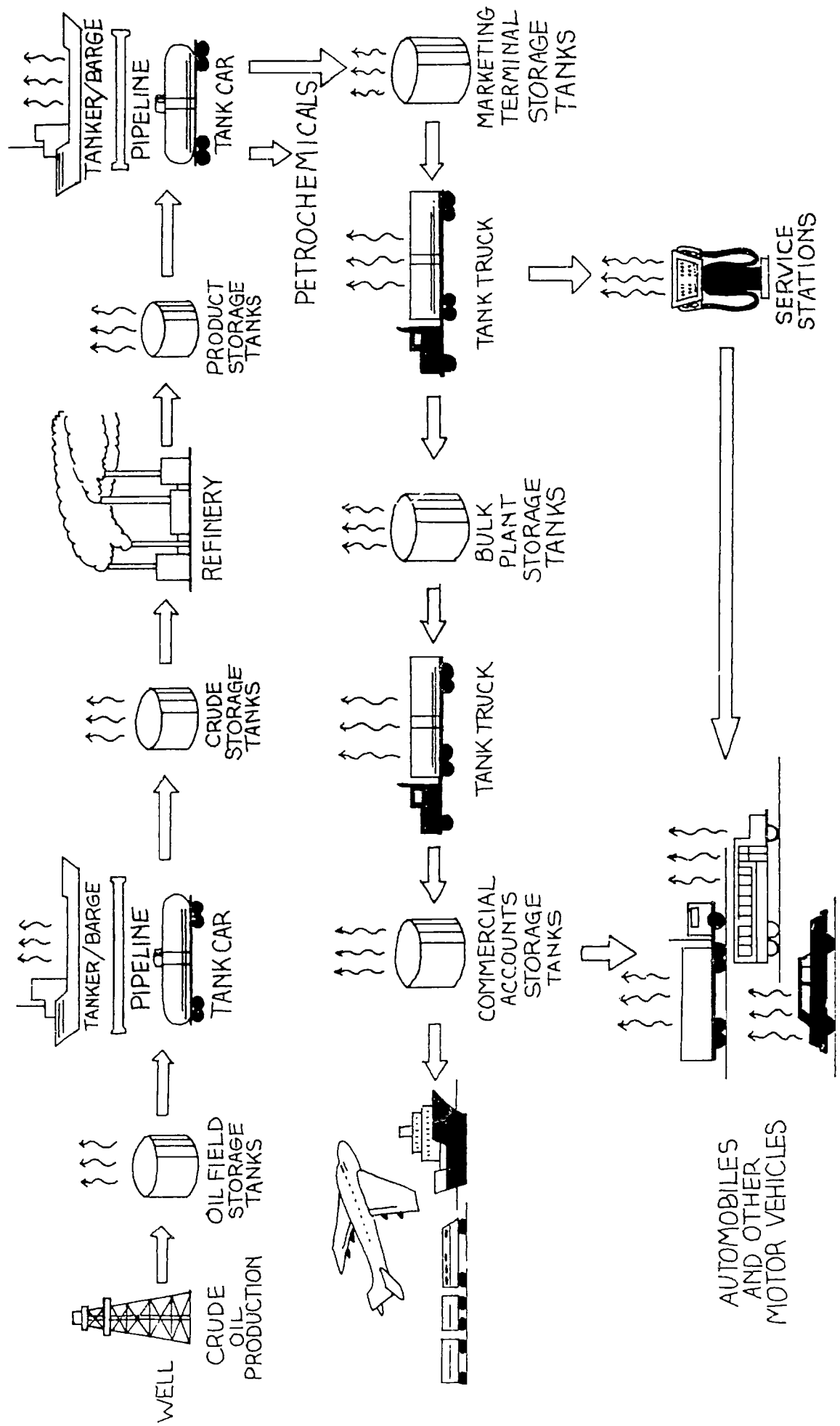

This diagram shows sources of evaporation of volatile, organic compounds.



Temperature Inversions



OBJECTIVES:

Students will observe how an inversion layer can trap pollutants close to the surface of the earth. See AIR RESOURCES matrix for background information.

MATERIALS:

aquarium or cardboard box
tray of ice
cardboard lid
rubber tube
smoke source (matches)
2 thermometers
tape

PREPARATION:

Explain the concept of inversion layer to the class. Generally, the farther from earth's surface, the cooler the air of the atmosphere becomes (see the diagram). Sometimes an inversion layer forms. This happens when a layer of warmer air is on top of a layer of cooler air. An inversion layer can act as a barrier which traps pollutants close to the ground.

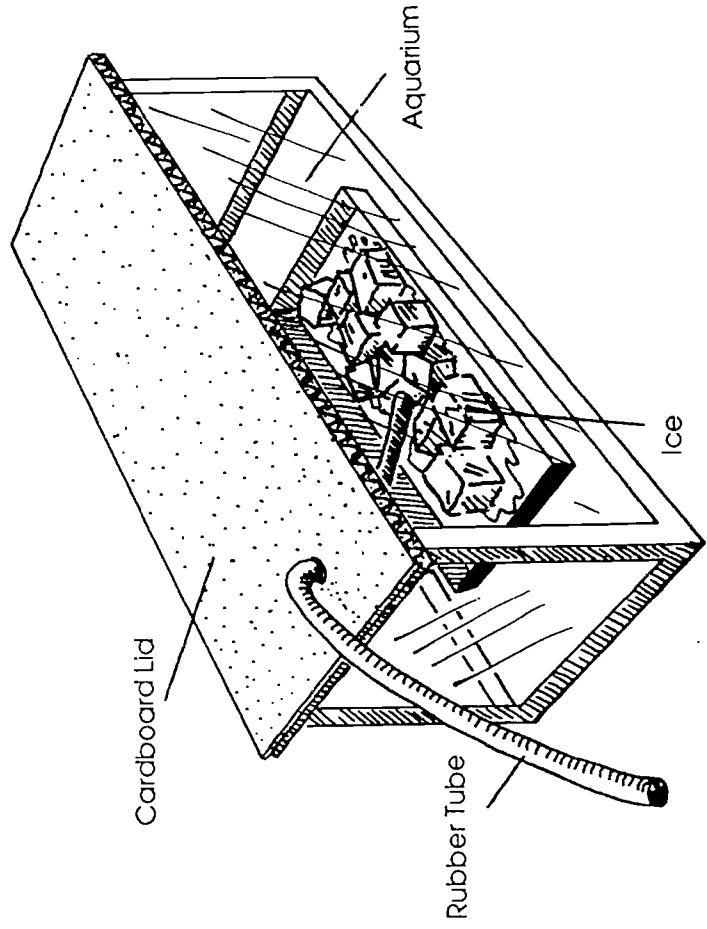
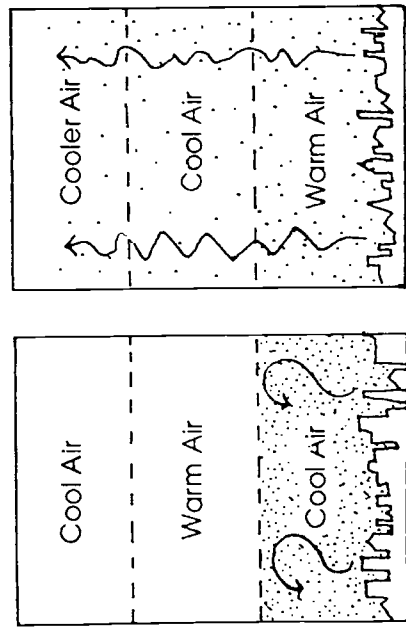

PROCEDURE:

Prepare the system as illustrated or have the students set it up. Students must leave the system undisturbed for at least 10 to 15 minutes to allow a cold layer to form on the bottom of the aquarium. Have the students take an air temperature reading at the top and the bottom of the aquarium. Be sure that the tube is lying on the bottom within the cold layer. Gently blow smoke into the system for students. Have students observe and then draw a diagram of their observations. Ordinarily, the chamber at equilibrium will possess an inversion, with the top temperature being 10°C warmer than the bottom. Blowing warm air into the bottom will trap the cold air between the 2 upper layers. This is what happens in low lying areas; the stagnant front forms a "lid" over the area and traps air pollutants, such as smog, close to the ground.

You may wish to combine this activity with the activity "WEATHER CYCLE." Have half the class prepare this demonstration while the other half of the class does the other demonstration. Switch groups to allow them to perform both activities.

FOLLOW THROUGH:

Share the diagram "Effects of Topography on Air Circulation" with students. How can topography create inversion layers which make certain areas very susceptible to pollution? Do we have inversion layer problems in the Tennessee Valley? What are the effects of inversion layers on health and the economy?

Have the students research ozone (photochemical smog). How can inversion layers make this type of pollution more severe?

EFFECT OF TOPOGRAPHY ON AIR CIRCULATION

Early in the day, the sun's rays do not reach the valley, so the air in it remains cold and air movement is limited (top). By midday, however, heat from the sun reaches the valley, surface air is heated, and air circulation is restored (bottom).

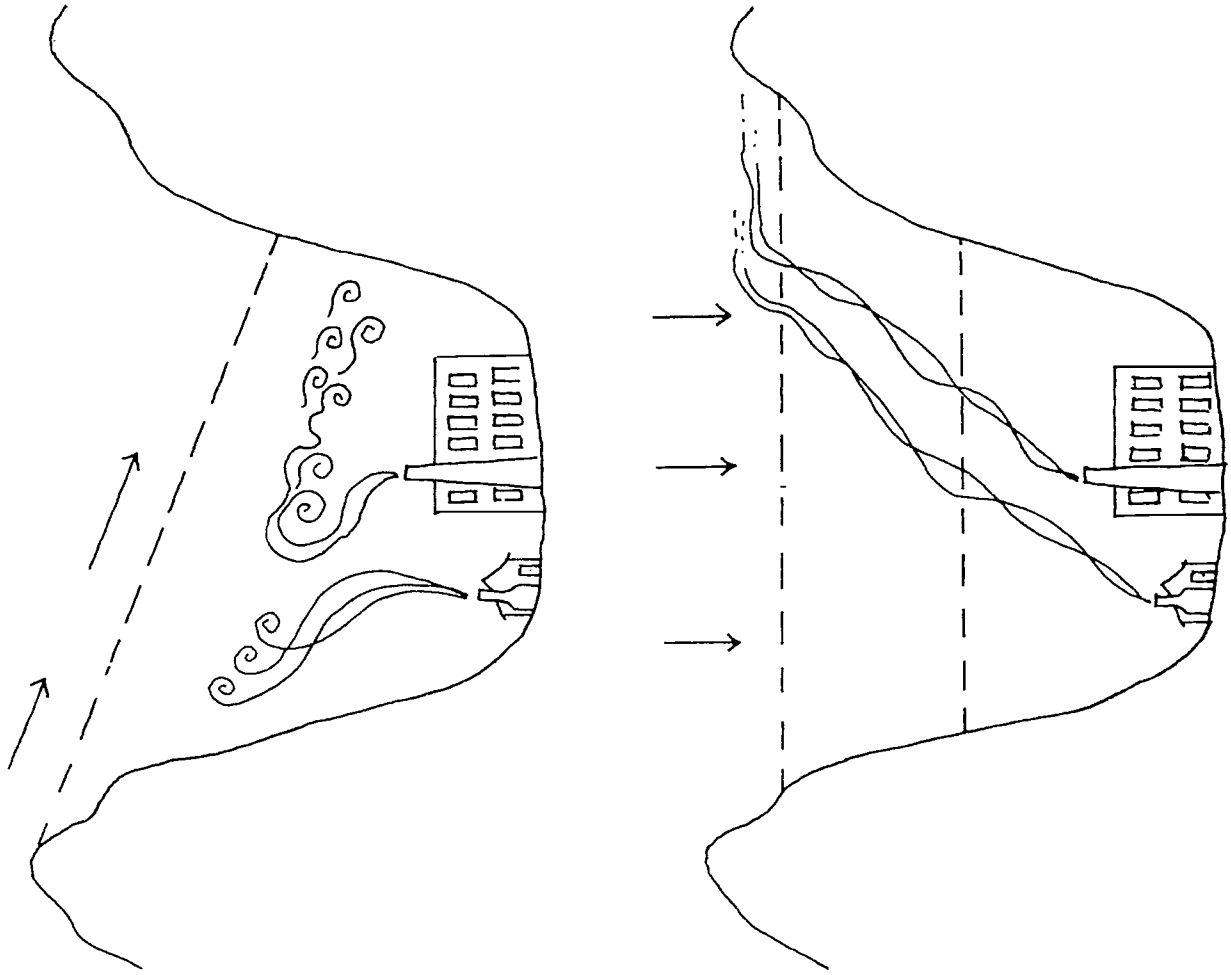

Weather Cycle

OBJECTIVES:

Students will observe the effects of temperature on wind formation. See AIR RESOURCES matrix for background information.

MATERIALS:

150-watt bulbs
cardboard box
tape
plastic food wrap
pan of ice
pan of charcoal
rubber tubing
smoke source (matches)
thermometer
dry ice
sharp point for scraping ice

PREPARATION:

Weather includes a variety of short term changes in heat, pressure, wind, and moisture. All weather changes, however, are brought about by temperature changes in different parts of the atmosphere. Air is mainly heated by contact with the warm earth. When air is warmed, it expands and becomes lighter. When this happens, this layer rises and is replaced by cooler air which flows in under it. This cooler air is then warmed, also rises, and then, too, is replaced by colder air. This circulating movement of warm and cold fluid air masses is called convection. Convection currents cause local winds and breezes

PROCEDURE:

You may wish to combine this activity with the activity "TEMPERATURE INVERSIONS." Have half of the class perform this activity while the other half performs the other activity. Switch groups to allow them to perform both activities. Prepare the materials according to the diagram. Sizes can be approximate. Allow older students to set up the demonstration. Gently blow smoke through the tube in the back while students note the flow of air in the box. (The smoke is used to make the air visible.) Students should draw a diagram of what they observed. Place the two 150-watt bulbs above the box and heat the system for 10 minutes. Gently add smoke, as before, and allow students to note the flow of air in the box. Again, have them draw a

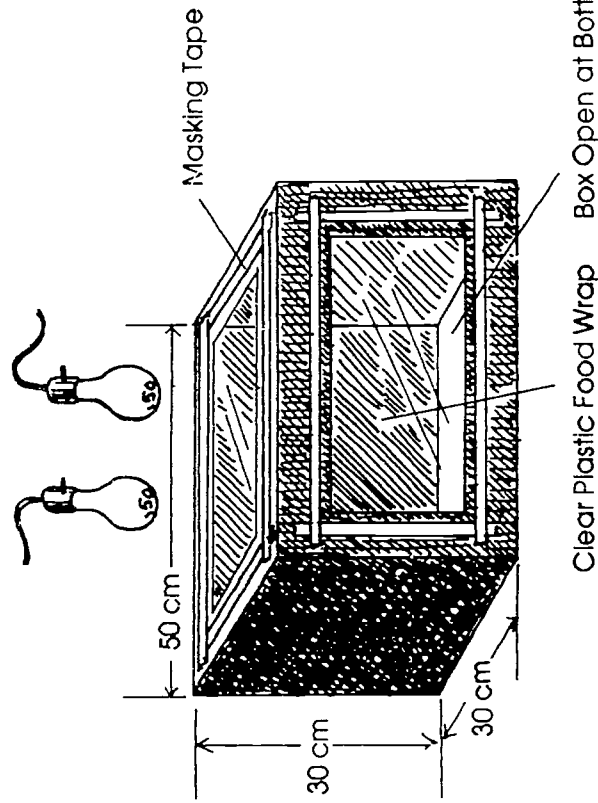

diagram. The students will be observing the affects of heat (convection) on an air mass. The smoke should make the winds visible. Have them take temperature readings in the top, middle, and bottom of the box before each step and record this information.

Turn off the lamp and wait 2 minutes, then blow smoke, as before. Have students note the flow of air and draw a diagram. Have students describe what they have observed and suggest explanations. What were the temperatures in each layer? What role did temperature play in the movement of air masses?

As the bulb heats the ice, water vapor will rise and be trapped in the top of the box. This is a tiny model of a cumulus cloud rising. You may be able to "seed" the cloud by holding a chunk of dry ice, in a gloved hand in the chamber and scratching it with a sharp point so that tiny fragments enter the cloud. This will cause your cloud to either rain or snow depending on the temperature in the box.

Compare this "micro system" to the weather of earth. What are the heat sources that affect air masses? What did the ice in this experiment represent? What is the relationship between heat and water in weather systems?

FOLLOW-THROUGH:

Heat also plays a role in cloud formation and circulation. Have students conduct the following experiment. Fill a quart mason jar with 1/4 cup of water and stretch a large, round, rubber balloon across the mouth of the jar and secure it with rubber bands. (This step requires 2 people.) Then, wait a few minutes and watch what happens. Can you see the balloon bulge? The bulge is caused by water evaporating and adding gas to the air in the jar. Because the rubber band is sealing the jar tight, the moist air cannot escape. If the jar were not air tight, this moist air would leak out and rise, because moist air is actually lighter than relatively dry air.

Under normal conditions, air obtains moisture from transpiration in green plants and when heat from the sun evaporates water in lakes, streams, and oceans. This moist air rises, then slowly cools. Finally, it cools so much that it saturates the air. This is called 100 percent relative humidity. This causes clouds to form, and then, under certain conditions, it rains or snows. This continuous process of evaporation, condensation, and precipitation is called the water cycle.

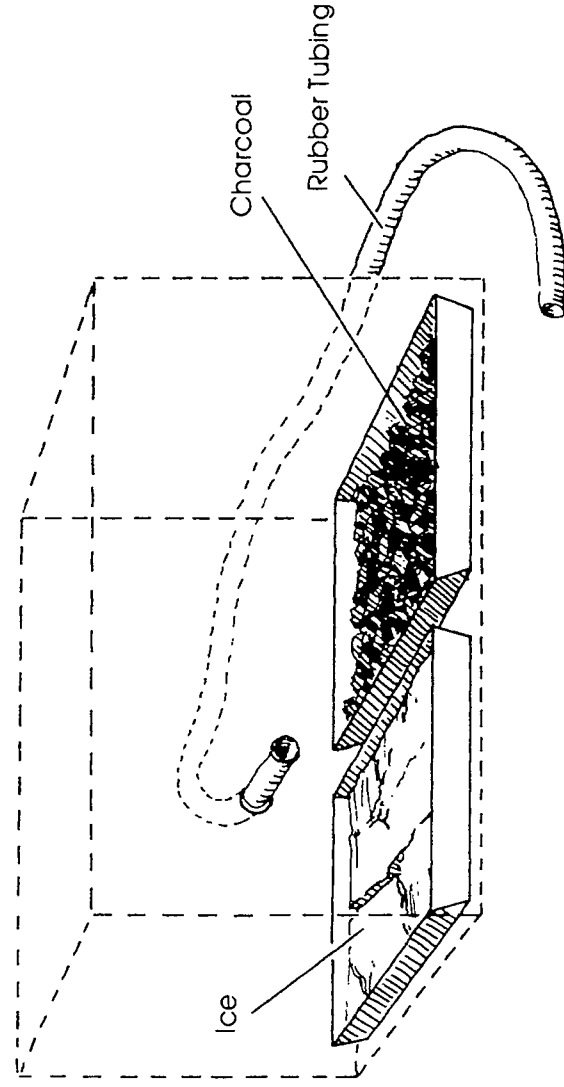

For more information on weather and how to set up your own weather station, see:

Lehr, Paul E., R. Will Burnett, and Herbert S. Zim, Weather - A Guide to Phenomena and Forecasts, A Golden Nature Guide, Simon and Schuster, New York, NY, 1965.

Rubin, L. and J. Duncan, The Weather Wizard's Cloud Book - How You Can Forecast the Weather Accurately by Reading the Clouds, Algonquin Books, Chapel Hill, NC, 1984.

Schaffer, Vincent, Jr. and John A. Day, A Field Guide to the Atmosphere, Houghton Mifflin, Boston, MA, 1981.

Acid Rain Watchers



OBJECTIVES:

(1) Students will collect data on local rainfall pH and particles in the atmosphere. (2) Students will compare their data with data from other schools in the region. See AIR RESOURCES matrix for background information.

MATERIALS:

pH indicator (universal liquid - consult a chemistry textbook or chemistry teacher, or purchase through a biological or science supply company)
small test tubes
microscope slides
petroleum jelly
microscope slide or d hand lens
newsprint
maps of the Tennessee Valley (see address in this activity)
felt crayons
dots or pins (for marking maps)

PREPARATION:

Briefly explain pH. Test the acidity and alkalinity of several common items such as vinegar, soda water, shampoo, detergent, or bicarbonate of soda by simply adding a drop of the pH indicator to a small amount of the test solution. Compare the color formed to a color chart included with the pH indicator (pH test kits are available from any biological or science supply company).

Read Air Factsheet 6. Discuss why acid rain is an important issue to Valley residents.

Then, demonstrate to the class the proper format for the letter that they will write for this activity. Gather addresses of other schools in the Valley to whom your students will write. Find these schools on a large Tennessee Valley Map. Maps can be obtained from:

Map Service Department
TVA
201 Haney Building
Chattanooga, TN 37402-2801

PROCEDURE:

Have students work in small groups of 2 or 3 students per group. After each rainfall, test a sample of the rain with the pH indicator. Keep a record of the data. (See activity "WEATHER WATCHERS.")

Collect data after each rainfall. Record the date, pH, wind direction, temperature, and any other useful information.

Have each group prepare letters to send to other classes in the Valley. The letter should be a request to exchange information with the other schools about the rainfall pH and other weather data in their local area. Perhaps rural schools could select urban schools and vice versa. Be sure to establish a mix—urban versus rural, mountains versus plateau, river town versus nonriver town—but note the differences.

On the Tennessee Valley map, place pins at the location of all corresponding schools. Place newsprint beside the map to record data from other schools as it is received. Continue this activity throughout the year.

A particulate collector can also be made by smearing a layer of petroleum jelly on one side of a clean microscope slide. Place tape on the opposite side and label with a pen or pencil. Place the slide in a safe place at least 7 feet above the ground. Place some slides inside and others outside. Look closely at the slide under a microscope every week, for several weeks. Students should write descriptions of where their slides were placed and what was observed on the slide. You might want to calculate the percent of the slides covered with particles. For example, you might have 1 percent one time and 20 percent another time. What is causing the variation in the amounts of particulates? Where are they coming from? Which particles are from human activity?

Discuss the following questions:

- 1) Is there evidence of acid rain in your local community?
In your region?
- 2) What did you learn about particulate matter?
- 3) Does it vary with location? Why or why not?

FOLLOW-THROUGH:

You may wish to become a part of the National Audubon Society's Citizen's Acid Rain Monitoring Network. Members phone or send the results of their acid rain monitoring data to the Audubon National Headquarters in NYC and mail a postcard of their findings to Bodega Research Lab at the University of California. Members also

receive a monthly newsletter with a map of the U.S. with a pH readings record, and other information about publicizing the acid rain issue and influencing legislation. To find out more about the network write:

National Audubon Society
950 Third Avenue
New York, NY 10022

ACID RAIN DATA CHART	
School Name	Date Reading

TENNESSEE VALLEY MAP

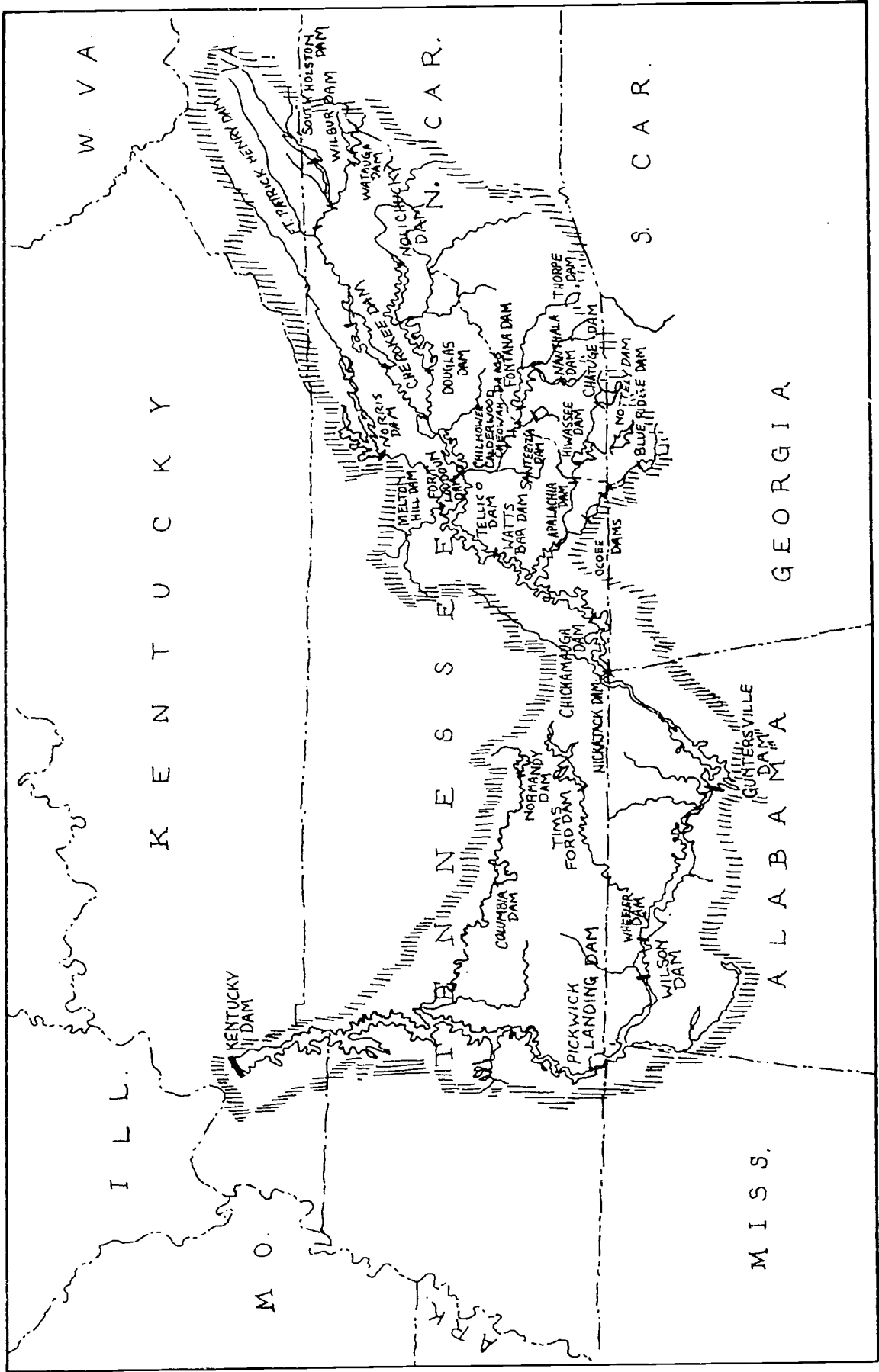

Sulfur Dioxide Dangers



OBJECTIVES:

Students will observe the effects of sulphur dioxide on plant life.
See AIR RESOURCES matrix for background information.

MATERIALS:

large clear plastic bag
tape
green plant in a pot
small beaker
sodium nitrite (2g)
sulfuric acid (5%)
safety goggles

PREPARATION:

Sulfur dioxide, besides having a noxious smell, can interfere with photosynthesis. In this demonstration, there will be a high concentration of sulfur dioxide gas in a closed bag. Because the amount of gas in the bag will be high, effects to the plant will be immediate and severe. **We suggest that the teacher should do this activity as a demonstration only!**

PROCEDURE:

Take the class outside for this demonstration. Wearing safety goggles, place 2 gm of sodium nitrate in the small beaker and place

the beaker and the potted plant inside the plastic bag. Add 2 ml of 5 percent sulfuric acid to the small beaker and seal the bag shut with the tape. If sulfur dioxide gas leaks from the bag (smells like rotten eggs), move the class away until the reaction is completed. Leave the plant in the closed bag at least 10 minutes. Cut the bag open and allow the gas to disperse. After the plant has aired out, take it back to the classroom. **Be sure to wash your hands.**

Allow the class to observe the plant for 2 days and keep a log of their observations. Ask them to note color, leaves, and general health. Provide a second, similar plant to use for comparison. Discuss with the students why sulfur dioxide emissions are regulated to stay below certain levels. Explain that the demonstration used a high

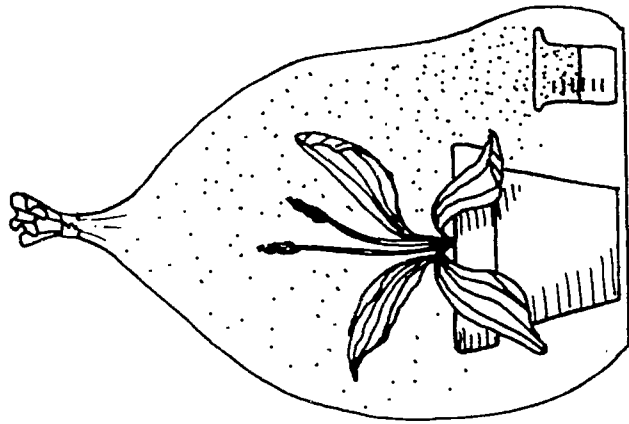

concentration of sulfur dioxide, but under natural conditions, the deterioration of the plant would take more time such as weeks or months. Ask your students: Where does sulfur dioxide come from? Are there any natural sources? How is sulfur dioxide related to acid rain? What can be done to reduce sulfur dioxide emissions? Why do you think TVA maintains a careful watch on the amount of sulfur dioxide produced in the Tennessee Valley?

FOLLOW-THROUGH:

Most sulphur dioxide emissions come from coal burning power plants. In the Tennessee Valley, most coal-fired power plants combat the sulfur emission problem by using low sulfur coal and particulate scrubbers. You might arrange to have your class tour a coal-fired power plant equipped with scrubbers. You might conduct a class project to make the community more aware of sulfur dioxide dangers, acid rain, or other air quality problems. Have students obtain a map of your community and determine where the sulfur dioxide emissions in your community are coming from. Talk with local community officials and the health department to determine what kind of air quality control measures are being implemented in your community. You also might contact the EPA about its Air Quality Control Program. For the address, see the activity "THE NOSE KNOWS."

To find out more about acidic rain and to obtain a catalog of acid rain educational materials, write:

The Acid Rain Foundation, Inc.
1630 Blackhawk Hills
St. Paul, Minnesota 55122

The Nose Knows



OBJECTIVE:

Students will use their sense of smell to detect air pollution in various locations. See AIR RESOURCES matrix for background information.

MATERIALS:

army surplus gas mask or home-made gas mask
cotton
activated charcoal
2 or 3 liter plastic bottle
notebook or newsprint
pencils or felt crayons

PREPARATION:

Prepare the home-made gas mask, as in the diagram. The sense of smell is important for survival for many animals.

Repeated stimuli, odors, are often not smelled because you have become "used to them." By breathing filtered air, your nose will become sensitive again to commonplace odors around you.

PROCEDURE:

Have students breathe through a gas mask for approximately 3 minutes and then, sniff the air. Several gas masks may be purchased, or made, so that several students are able to do the test at

the same time. Ask students to record what they smell. If they can't name the smell, then indicate whether the smell is nice or otherwise. Also, indicate the strength of the smells. Record this information in a notebook, or on newsprint, for the discussion later.

Perform this activity in several locations including:

- the class room
- the gym
- the cafeteria
- a new automobile
- a new building
- a city street
- a country road

Discuss what occurred. Which areas have the most odors? Could you recognize any types of air pollution? Which ones? Did the odors seem to smell good or bad?

Plastic Bottle (remove the bottom)

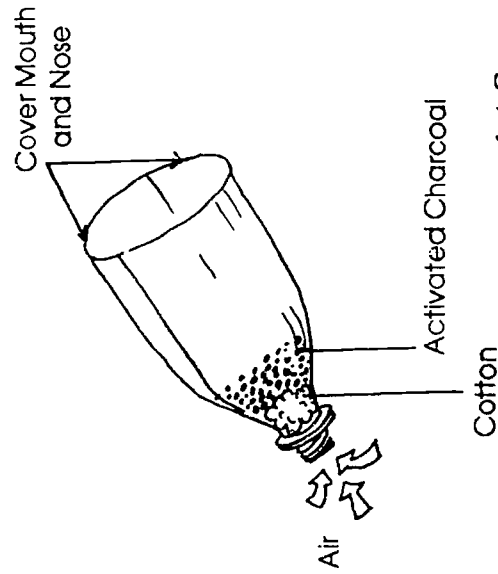

To find out if harmful substances have an odor, have the students conduct research on various air pollutants such as:

- aldehydes
- benzene
- carbon dioxide
- carbon monoxide
- chlorofluorocarbons
- fluorides
- hydrocarbons
- hydrogen sulfide
- lead
- methane
- nitrogen dioxide
- PAN (peroxyacyl or peroxyacetyl nitrate)
- radon
- smog
- sulfur dioxide

Find out if any of these substances have an odor and, if so, what does it smell like? In general, can we rely on our noses to smell harmful chemicals? Also, find out what the likely sources of these pollutants are. Then go back to the places you smelled in this activity. Might some of the things you smelled have been some of these chemicals? Where were they coming from? How might these chemicals affect our health? What is being done to reduce these kinds of air pollution?

FOLLOW-THROUGH:

Write to the EPA and ask them to send you information about their Air Pollution Control Program. Ask them if there is an air quality trend station near you and if your class could arrange a visit to the site. The Tennessee Valley is in EPA Region 4. Their address is:

EPA Region 4
345 Courtland Street NE
Atlanta, Georgia 30308

For general information about air quality, write:

U.S. EPA
Office of Public Affairs (A-107)
Washington D.C. 20460

Storing Hazardous Materials



OBJECTIVE:

Students will simulate how hazardous substances are stored in the human body. See AIR RESOURCES matrix for background information

MATERIALS:

newsprint
poster board
felt crayons
string
research material on 7 hazardous materials mentioned in Air Factsheet 9

PREPARATION:

Read Factsheet 9, "Hazardous Pollutants." Have half of the class research substances that are hazardous to the human body and where these materials are stored in the body. List the seven hazardous materials mentioned in Factsheet 9 and discuss them with the class.

PROCEDURE:

Divide the class into seven groups and have each group research one of the seven hazardous materials mentioned in Factsheet 9. Each group will use the information gathered on how

hazardous particulates or gases enter the body, and where they are stored, during a class simulation activity. Make sure they find out (1) where you come in contact with hazardous materials; (2) what kind of dose you would get from one exposure; and (3) what concentration of the substance would be necessary to cause cancer or death.

To conduct the simulation activity, have the students make posters of each of the organs where hazardous substances are stored. Some examples might include the bones, fat, and the liver. Distribute the "organs" around the room and connect these together with "blood vessels" (string). Students will act as blood and travel through the blood vessels. (See illustration.) Then make cards with each hazardous substance on them and the amount a person would pick up from one exposure.

During the simulation, the "blood" will pick up the hazardous substances at their point of entry into the body and, then, deposit the cards in the organ where it is stored. Let the simulation run through several exposures to each hazardous substance. Make sure hazardous substances have built up in each organ.

Now, discuss the source of each hazardous material and describe where someone could become exposed. Ask the audience to describe why hazardous substances are stored in a particular organ. Are some substances excreted from the body through the action of the kidneys or lungs? What are the health risks associated with exposure to these substances? How can we reduce our exposure to hazardous particulates or gases?

FOLLOW-THROUGH:

After you have completed this activity, invite someone from the local health department, U.S. Center for Disease Control, or U.S. Environmental Protection Agency to visit your class. You could ask them to describe what illnesses are associated with hazardous substances or what the government is doing to control everyone's exposure to these substances. For instance, the EPA administers several acts relating to toxic chemical control including the Toxic Substances Control Act, the Clean Air Act, and the Emergency Planning and Community Right to Know Act.

WHERE ARE THE HAZARDOUS WASTES STORED?

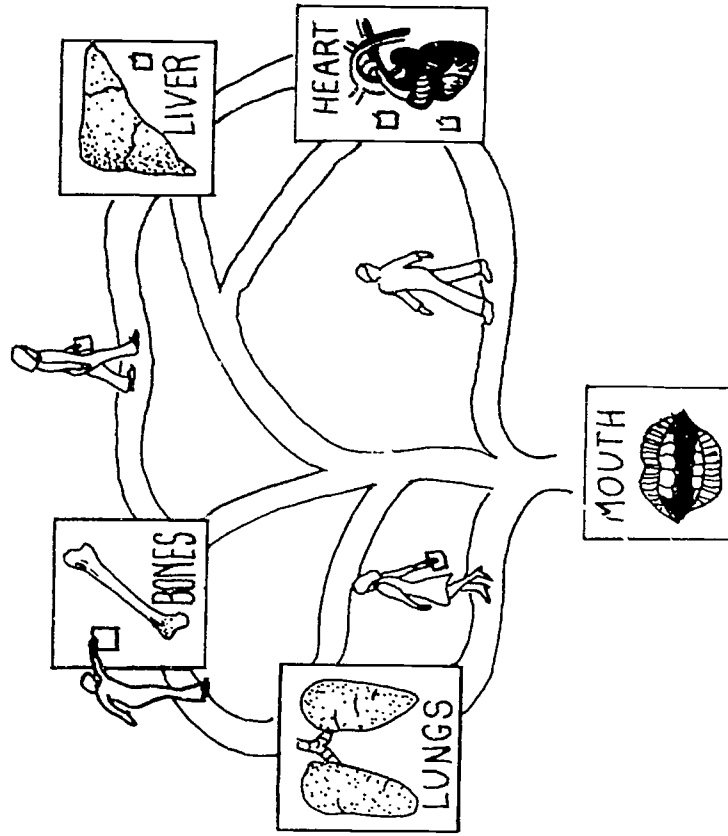

Carbon Monoxide



OBJECTIVES:

Students will simulate carbon monoxide buildup in animals or people. See AIR RESOURCES matrix for background information.

MATERIALS

newsprint
poster board
felt crayons
string
3" x 5" cards, basketballs, building blocks, or
books of the same size
felt board or adhesive cloth
glue
velcro

PREPARATION:

See the activity "STORING HAZARDOUS MATERIALS" for a description and illustration of the simulation.

The human blood stream transports oxygen from the air to the lungs, where it is transported to all other parts of the body. Blood also transports carbon dioxide from the body to the lungs, where it is removed through the nose and mouth. The carrier in blood is hemoglobin. The hemoglobin molecule carries both oxygen and carbon dioxide, but not at the same time. It can only carry one substance at a time.

Carbon monoxide is dangerous because hemoglobin has a higher affinity (liking) for CO than for O₂. If both O₂ and CO are present, the hemoglobin will carry the CO before it carries O₂. Once a hemoglobin molecule picks up CO, the CO will permanently affix itself to the hemoglobin. This makes that hemoglobin molecule permanently unable to exchange O₂ for CO₂. If enough hemoglobin are tied up with CO, a person will suffocate and die.

PROCEDURE:

This activity will simulate the transport of O₂, CO₂, and CO in the human body. Oxygen enters the lungs and is transported to other organs by hemoglobin. Hemoglobin also picks up waste carbon dioxide and removes this by carrying it back to the lungs where it is exhaled through the mouth. Carbon monoxide enters the mouth and, like oxygen, also travels throughout the body, but it is never exhaled. Students will "be" hemoglobin molecules. Create the simulation similar to the one in "STORING HAZARDOUS MATERIALS." Make a poster, or model, of the lungs and other organs where oxygen can be picked up by the "hemoglobin" and carbon dioxide can be deposited. You might want to make posters of each organ out of felt and use colored ping pong balls with velcro on the back as O₂, CO₂, hemoglobin, and CO molecules. The hemoglobin will use the hook side of the velcro, while the O₂, CO₂, and CO will use the loop side. (In this case, students represent the blood which transports the hemoglobin.) To start, put all the oxygen molecules in the lungs. Then, place a reserve of CO₂ molecules in each of the organs. The hemoglobin (students) will begin taking the O₂ from the lungs to other organs. Students can by-pass an organ and stop where they like. When they pick up a CO₂ molecule, it goes directly back to the lungs

where it is tossed out and exchanged for an O_2 molecule. (Oxygen, carbon dioxide, and carbon monoxide molecules could also be represented by cards.)

Begin the simulation by showing normal transport of oxygen to the body and carbon dioxide from the nose and mouth to the lungs, to other organs, and back. Remember, the hemoglobin can carry only one type of molecule at a time. In the lungs, they must drop their carbon dioxide when they pick up oxygen. Place a student in each organ to exchange the delivered O_2 for CO_2 . Also, have someone in the lung exchange the delivered CO_2 for O_2 in the atmosphere.

Now add the carbon monoxide molecules to the system. Instead of exchanging a CO_2 for O_2 at the mouth, toss in a CO molecule. When a hemoglobin picks up a carbon monoxide molecule, it can't put it down; therefore, it can't carry oxygen and carbon dioxide. When the carbon dioxide builds up in the organs, death will rapidly occur. Death in this simulation occurs when about half of the hemoglobin are tied up with CO.

When the simulation is over, ask the class to explain what they have observed. Ask them to explain why carbon monoxide is dangerous to people. Where could you become exposed to a lethal dose of CO?

FOLLOW-THROUGH:

The home is filled with potential sources of carbon monoxide. For instance, a malfunctioning wood stove, furnace, or water heater can cause headaches, nausea, and even death. Other sources include unvented natural gas ranges and tobacco smoke. Have members of the class conduct research about indoor air pollutants and present it to the class. For more information about indoor air pollution, write to the EPA Region 4 Office. (See activity "THE NOSE KNOWS" for the address.)

You might also write:

EPA's Environmental Monitoring System Laboratory
Triangle Park, North Carolina 27711
(919) 541-2912.

Smoke Detectors



OBJECTIVES:

Students will take Ringlemann measurements of smoke in their community. See AIR RESOURCES matrix for background information.

MATERIALS:

3" X 5" index cards

Power's MicroRinglemann handout for each student
community field study area

PREPARATION:

All combustion processes involving the burning of materials composed of carbon, hydrogen, and oxygen will produce only carbon dioxide and water vapor, if combustion is complete. In actual practice, it is usually impossible to burn any fuel completely, even with an excess of air. Thus, particles of unburned carbon are carried along with the gaseous products producing black or various shades of gray discharge from the smokestack.

In 1898, Maximilian Ringlemann devised a series of charts to measure smoke density. A number from 1 to 4 may be assigned to indicate percentage of smoke density. In this activity, students will measure smoke density in the local environment by making field observations. This activity may be combined with the activity "THE NOSE KNOWS" and also ACID RAIN WATCHERS."

PROCEDURE:

Select a suitable site for observing a smoke plume from a factory, powerhouse, school boiler, or other source. Observers should stand between 30 and 300 meters from the smoke. Open sky should be visible behind the smoke—no buildings.

Hold the lower right-hand corner of the Power's MicroRinglemann between the thumb and forefinger with the grids toward you. Face the smoke and hold the card at arms length so that you can see the smoke through the slot in the card. Be sure that the light falling on the card is the same as that falling on the smoke. Record the Ringlemann number on a chart. Repeat the observations every 30 seconds, for 15 minutes.

Record data in a table you have prepared, similar to this one:

Power's MicroRinglemann Grid Numbers	Observations of Each Grid Number	Product: (Grid Number x # Observations)
1	5	5
2	13	26
3	14	42
4	3	12
TOTAL	35	85

Now, return to the classroom and calculate the density of the smoke observed, as shown:

First, determine the average grid number by dividing the total product by the total number of observations.

$$\text{Average Grid Number} = 85/35 = 2.4$$

Next, determine the average density of grid number one (which equals one unit). One grid number has an average smoke density of 20 percent (see chart below). Using this equivalence, the average density of the smoke observed can be calculated by cross multiplication (or similar methods), as demonstrated:

Let X = the unknown density of the smoke observed.

$$\frac{20\% \text{ density}}{\text{Grid \#1}} = \frac{X}{\text{Grid \#2.4}}$$

$$\frac{\text{Grid \#2.4 (20\% density)}}{\text{Grid \#1}} = X$$

48% density = X (note how units cancel)

Therefore, Grid Number **2.4 = 48%** density.

Grid Number	Average Density
1	20%
2	40%
3	60%
4	80%

These data can be charted from day to day to see if smoke output from this source varies. Also, these data could be sent to other schools in return for data from their communities. With this information, you could compare air quality issues in different communities.

Examine the following chart. What are the biggest sources of pollution in the air? Under which category do oil and coal power plants fall? Under which category do home wood fireplaces fall? Do you and the power company have the right to burn as much as you like? If not, what are the limits and who sets these limits? What is being done to control atmospheric pollution?

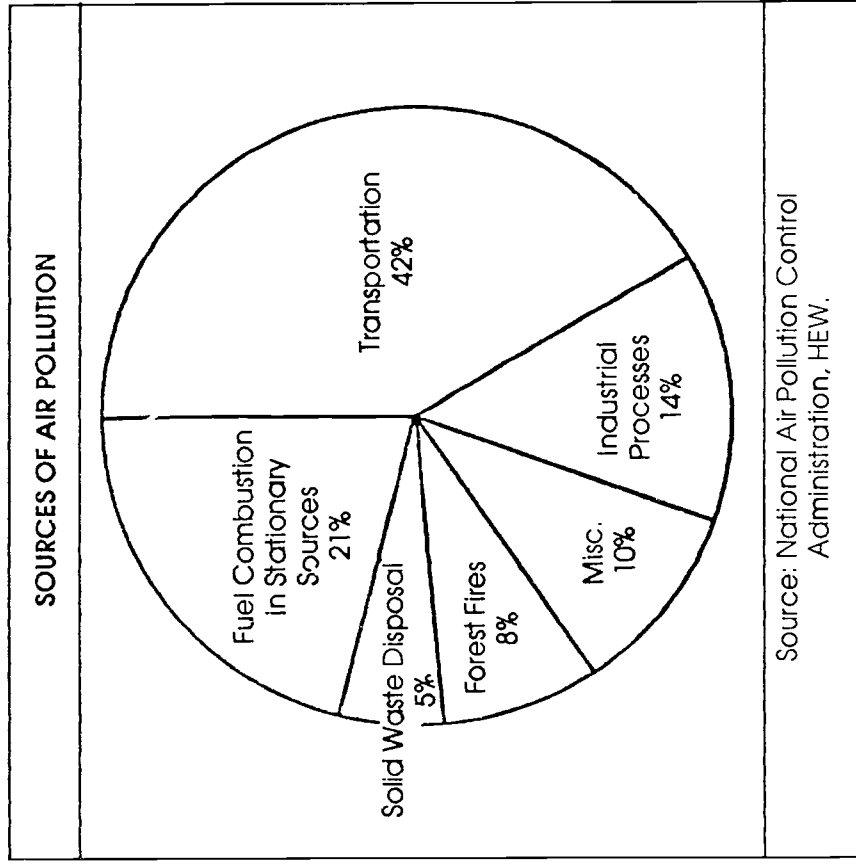

FOLLOW-THROUGH:

(1) Ask several students to research the current theory on the extinction of dinosaurs due to a meteor impact with the earth and a resulting dust cloud that killed the plants that these animals used for food. What are the implications for dust and smoke in the upper atmosphere? Ask students to report to the entire class.

(2) CO₂ is one of many gases present in low concentrations in the earth's atmosphere. However, human activities, particularly CO₂ emission from combustion of carbon-based fuels, are increasing the concentration of CO₂ in the atmosphere. Increased concentrations of CO₂ are believed to create a so-called "greenhouse effect." The greenhouse effect occurs when CO₂ is transparent to incoming short wave radiation from the sun, which absorbs outgoing long wave radiation and re-emits this energy. This leads to a warming of the earth's surface and lower atmosphere. Have the students conduct research about the "greenhouse effect" and the impact of climate changes on sea level, agriculture, and forests. What can be done to combat this problem?

Front side of Power's Ringelmann

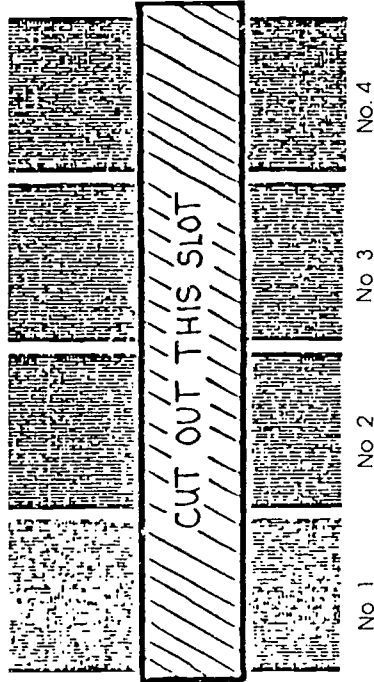

POWER'S MICRORINGELMANN

These grids are a direct facsimile reduction of the standard Ringelmann Chart as issued by the United States Bureau of Mines. Copyright 1954 by McGraw-Hill Publishing Company, Inc. (Publisher of Power) 330 W 42nd St New York 36, N Y
 Price: 35¢ each, discount on quantities

For a copy of POWER'S MICRORINGELMANN order your own from address above

Back side of Power's Ringelmann

Power's MicroRingelmann is an accurate photographic reduction of the standard Ringelmann Smoke Chart as published by the United States Bureau of Mines. For best results, use this card according to the following instructions.



1. Hold chart at arm's length and view smoke through slot provided.
2. Be sure that light shining on chart is the same light that is shining on smoke being examined. For best results, sun should be behind observer.
3. Match smoke as closely as possible with corresponding grid on chart.
4. Enter density of smoke (designated by numbers under each grid) on record sheet; also enter time of each observation.
5. Repeat observations at regular intervals of 1/4 or 1/2 minute.
6. To compute smoke density, use the formula Equivalent units of No. 1 smoke x 0.20 number of observations = percentage smoke density
7. Note and record distance to stack, direction of stack, shape and diameter of stack, and speed and direction of wind

Air Resources Glossary



1. Acid Rain - Sulfur dioxide from industrial and power facilities and nitrogen dioxide from auto emissions mixes with other elements of the atmosphere to form an acid which returns to earth's surface as rain.
2. Aldehydes - Highly reactive organic chemical compounds that are used in the manufacture of resins, dyes, and some acids.
3. Asbestos - Fibrous form of impure magnesium silicate that is used for electrical insulation, fire proofing, and brake linings.
4. Benzene - A clear, colorless, flammable liquid that is used to manufacture DDT, detergents, insecticides, and motor fuels.
5. Bermuda High - A pocket of still air formed when two different air masses, traveling in different directions, meet.
6. Carbon Dioxide (CO₂) - A colorless, odorless gas that is formed during respiration, combustion, and organic decomposition. It is used commercially in carbonated beverages, fire extinguishers, and aerosols.
7. Carbon Monoxide (CO) - A colorless, odorless, toxic gas given off during incomplete combustion, primarily from motor vehicles.
8. Catalytic Converters - A device attached to cars and other vehicles that filters lead out of exhaust gases.
9. Chlorofluorocarbons (CFCs) - Certain chlorine and haloge-

nated hydrocarbons such as refrigerants which, when exposed to ultraviolet light releases chlorine, which then acts as a catalyst to destroy ozone in the upper atmosphere.

10. Clean Air Act - An environmental law enacted by Congress and enforced by the EPA which sets air quality standards.
11. Convection Current - The movement of air upward as a result of heating. These currents tend to disperse air pollutants.
12. Electrostatic Precipitator - A device that separates particulates from gases by neutralizing the charge on these particles.
13. Emergency Planning and Community Right to Know Act - An environmental law enacted by Congress and enforced by EPA that gives citizens access to information about the transportation and use of hazardous materials in or through their community.
14. Fluorides - Very reactive, pungent, colorless gases such as hydrogen fluoride (HF), which can cause plants to develop yellow leaf tips and margins (chlorosis).
15. Greenhouse Effect - The trapping of heat in the atmosphere when outgoing radiation is absorbed by water vapor, carbon dioxide, and photochemical smog (ozone). This causes a rise in atmospheric temperatures.
16. Hemoglobin - The oxygen carrying protein in red blood cells.
17. Hydrocarbons - Compounds that contain hydrogen and carbon.

18. Hydrogen Sulfide (H₂S) - A colorless gas with a very offensive "rotten egg" odor. It is produced during combustion and natural decomposition (sewer gases). It tarnishes metals and blackens paints. In high concentrations, it can cause asphyxiation.
19. Indoor Air Pollution - Particulates and gases found in many buildings and homes which cause health problems. Leading indoor air pollutants include formaldehyde, nitrogen dioxide, asbestos, carbon monoxide, radon, and components of tobacco smoke.
20. Lead - An element emitted into the atmosphere by lead smelters and the burning of coal and leaded gasoline. When lead is inhaled, it can be carried into the blood; it can cause lead poisoning.
21. Legionnaire's Disease - A "pneumonia-like" condition caused by an indoor air pollutant, believed to be bacteria in air conditioning vents. The first episode of this happened in Philadelphia at a Legionnaire convention and the illness was named for this event.
22. Methane (CH₄) - An odorless, colorless, flammable gas that is the major constituent of natural gas.
23. Nitrogen - An element which constitutes nearly four-fifths of the earth's atmosphere. It occurs as a colorless, odorless gas.
24. Nitrogen dioxide (NO₂) - A reddish brown gas given off by incomplete combustion, primarily from larger industrial plants and auto emissions.
25. Ozone (O₃) - A pale blue gas with a sweetish odor occurring in the upper atmosphere that protects the earth from harmful ultraviolet rays of the sun.
26. Ozone Hole - An opening in, or depletion of, the ozone layer in the upper portion of the earth's atmosphere which filters out cancer causing ultraviolet radiation from the sun. CFCs are the main chemical involved in the process.
27. PAN - A group of chemicals known as peroxyacyl nitrates (photochemical oxidants) found in photochemical smog.
28. Particulates - Solid particles or liquid droplets including fumes, smoke, dusts, and aerosols.
29. Photochemical Smog (Ozone) - Ozone in the lower atmosphere, near the earth's surface, which can damage or kill living things. It results when sunlight acts on nitrogen oxides, hydrocarbons, and other chemicals in the air. Automobile exhaust is the major source in urban areas.
30. Pollen Alerts - Alerts issued by the Nation Weather Service or the Center for Disease Control when pollen counts exceed normal levels and may cause health problems in allergy prone persons.
31. Radon - A colorless, naturally occurring, radioactive gas formed by the disintegration of radium.
32. Scrubbers - A filtering device that can be placed in a smokestacks to remove sulfur dioxides and nitrogen oxides.
33. Sulfur Dioxide (SO₂) - A colorless, pungent gas given off during combustion from coal-fired power plants primarily.
34. Toxic Substances Act - An environmental law, enacted by Congress and enforced by the EPA, which regulates the sale, use, and disposal of toxic substances.

35. Trace Atmospheric Gases (argon, neon, helium, xenon) - Naturally occurring elements which comprise less than one percent of the earth's atmosphere.
36. Ultraviolet Radiation (UV) - A type of light ray emitted from the sun (and other sources) that is harmful in large doses. Large doses of ultraviolet radiation cause sunburn and are linked to skin cancer.
37. Weather Cycle - Describes a cycle of changes occurring constantly in the atmosphere such as changes in temperature, moisture, wind velocity, and pressure.

Cultural Resources



BEST COPY AVAILABLE

"It is a tale of a wandering and inconsistent river now become a chain of broad and lovely lakes which people can enjoy, and on which they can depend ... a story of people and how they have worked to create a new Valley."

David E. Lilienthal



Cultural Resources Concept Map

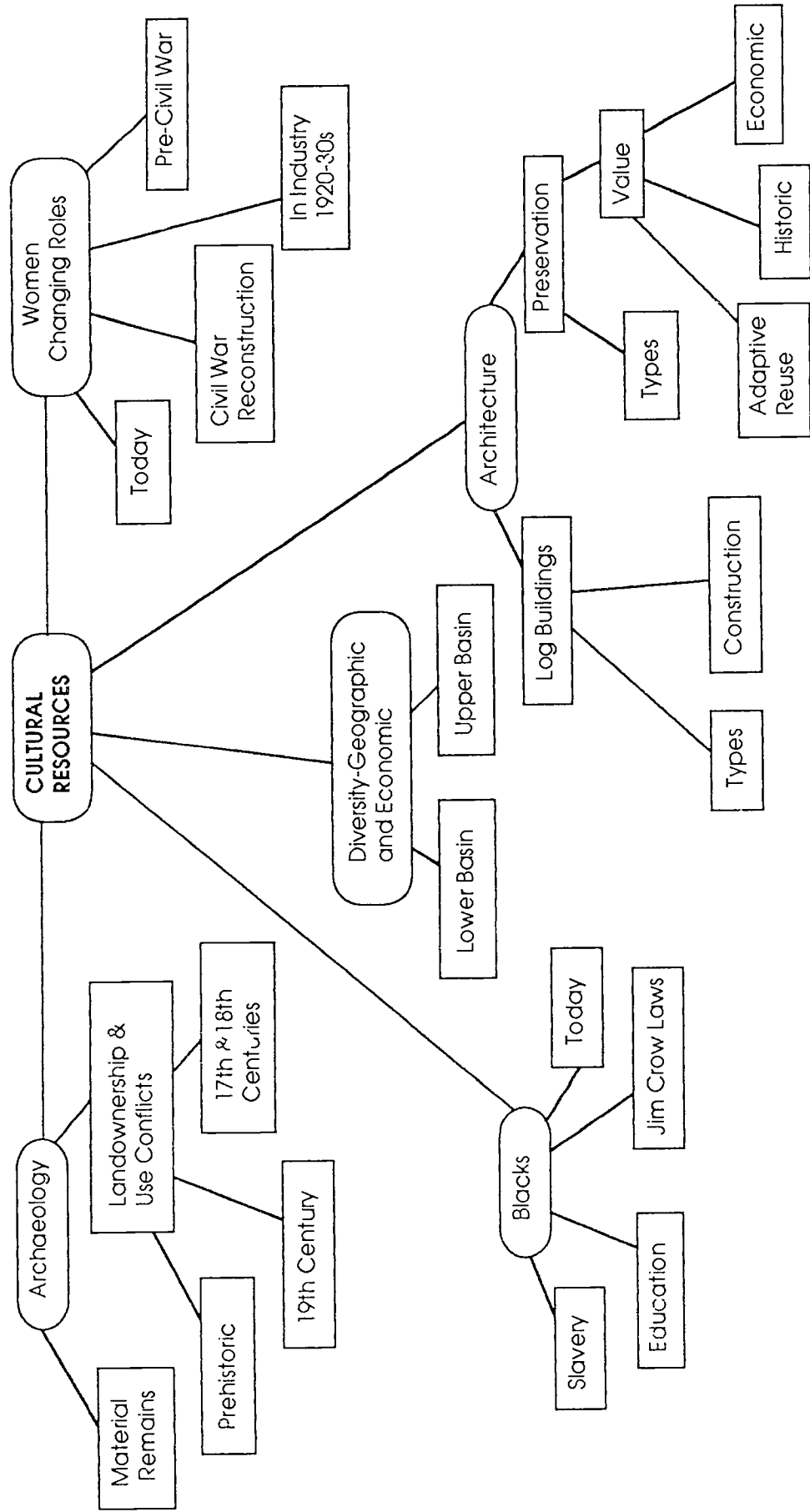

Cultural Resources Factsheets



1. Overview
2. Archaeology: The Study Of Human Behavior From Material Remains
3. Prehistoric Land Ownership And Use
4. Indian-White Relations
5. Tennessee Valley Women
6. Cultural Diversity In The 1930s
7. The Black Experience
8. Log Buildings
9. Preservation And Reuse Of Historic Structures

1. Overview

What comes to mind when you think of a natural resource? Perhaps a pine forest, a brook trout, a coal field, or a limestone quarry? Others might think of places like the mist-capped Smoky Mountains, the cool waters of Reelfoot Lake, the wilderness peninsula of Land Between the Lakes, or even the Tennessee River.

Now think of a cultural resource. What comes to mind? Perhaps a frontier log cabin, a horse-drawn carriage, a steam-driven locomotive, or maybe a plow, a hunting knife, a Civil War rifle, or a banjo? Have you ever visited places like the town of Rugby, the Tellico Blockhouse, the Cherokee Indian Reservation, the Hermitage, Russell Cave National Monument, Shiloh Military Park, or Beale Street in Memphis, Tennessee? These places are enjoyed each year by thousands of people interested in seeing and learning about the past.

A cultural resource comes from human efforts, either by a single person or a group of people. It may be a unique painting or sculpture, a restored section of an old town, or the remnants of a previous culture. However, cultural resources are not necessarily ancient. For example, the Nation's first nuclear reactor in Oak Ridge, Tennessee, is a cultural resource. Cultural resources communicate a sense of our past. By researching and interpreting our rich and varied history, we are able to understand our present culture.

Archaeologists, historic architects, and historians are responsible for the management of cultural resources. They evaluate the significance of cultural resources. For instance, what sites are worthy of protection and preservation? How should they be preserved? Which artifacts should be displayed for the public in museums? Can historic buildings be restored and adapted to other uses? These are just a few of the many questions they face when evaluating the potential of a cultural resource.

Efforts to preserve the homes of national heroes like George Washington's Mount Vernon, Thomas Jefferson's Monticello, and Andrew Jackson's Hermitage (just east of Nashville, TN) date back to the 19th century. But it was not until the passage of the National Historic Preservation Act in 1966 that preservation became a national movement. "The historical and cultural foundations of the Nation," Congress wrote, "should be preserved as a living part of community life and development in order to give a sense of orientation to the American people." Congress went on to say that, "The preservation of this irreplaceable heritage is in the public interest so that its vital legacy will be mandated and enriched for future generations of Americans." Thus, America's cultural roots were to be supported and preserved through legislative action.

The basic administrative tool for carrying out the Act is the National Register of Historic Places (National Register). This is a list kept by the United States Department of the Interior in Washington, D.C. The National Register lists places and things which have historic value on a local, regional, or national scale. It includes sites such as the Tennessee State Capitol in Nashville and Beale Street in Memphis, Tennessee, once the heart and soul of the Nation's rhythm and blues music.

In addition to listing the site, the National Register also contains useful information about the management of the site. It answers questions concerning the site's appearance and state of repair, its historical or architectural importance, and describes why the site is important to preserve.

Although the Department of the Interior is responsible for the National Register, a wide variety of individuals, institutions, and corporations are encouraged to nominate sites. The Federal govern-



ment, under terms of the Act, is required to survey public lands and locate sites eligible for inclusion on the National Register.

Attempts to preserve our heritage are as old as the Nation itself. Cultural resources attempt to capture the rich diversity of our national heritage through places and things symbolizing the unique social patterns characteristic of our past.

2. Archaeology: The Study Of Human Behavior From Material Remains

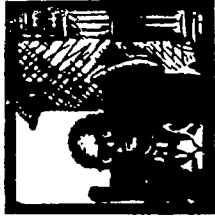

When Europeans came to America, they were met by people already living here. Europeans called these people American Indians. Unlike the television image, most Indians did not ride horses, live in teepees, and shoot bows and arrows. In fact, Indian tribes from different areas of the country varied considerably in their dress, language, and customs. Horses, which evolved in the Western Hemisphere but then became extinct there, were reintroduced to America by Spanish explorers. Indians living on the Great Plains were quick to put these horses to good use. Teepees, often associated with Indians in general, tended to be found mostly on the Great Plains. Southwestern Indians, such as the Pueblos, used multistory, stone, apartment-like buildings, while southeastern Indians, like the Cherokeees, used thatched huts and log cabins. Bows and arrows were really not extensively used until relatively late in American Indian history. For most of the 12,000 years Indians are believed to have inhabited this continent, spears were the primary weapons used for hunting and warfare.

Discovering how Indians lived and where they originally came from is done by excavating, or digging in the ground, to uncover evidence. Early peoples, like people today, sometimes just abandoned their homes. They dropped objects, dumped garbage, painted pictures on cave walls, and buried their dead. As years passed, the abandoned houses and the lost objects were eventually covered by dirt, water, or leaves. Some of these remains decomposed into the soil. Only the harder objects usually remained intact. Archaeology is the study of these artifacts, relics, and other remains.

Archaeologists look for these old sites. When they find one, they carefully remove the layers of earth that cover the remains with shovels and trowels, centimeter by centimeter. As they dig, they also look for areas of discoloration that may show where such things as

wooden objects may have decayed. They also sift the dirt for tiny seeds, bits of bone, and flint. Each of the objects left by these early peoples tells us something about how they lived, what they ate, how they hunted or farmed, and what they wore. Little by little, archaeologists piece all this information together into one big picture.

For example, archaeologists have been able to piece together evidence that humans first came to North America when huge glaciers covered much of the northern part of the continent. These inhabitants are believed to have hunted large, now extinct, mammals such as mammoths and cave bears. After the ice retreated, these people were forced to adapt to a different environment. New sources of food had to be found when the animals they had previously hunted disappeared. Our adaptation to changing conditions, including the ones we cause ourselves, continues today. What archaeologists can tell us about how people adapted to changes in the past may help us understand how and why we are changing today.

3. Prehistoric Land Ownership And Use



When Columbus first came to America, Indians had no understanding of "private property." Europeans believed that they could own land or rent it from someone else, as had been the custom in the old country. Indians, however, did not believe that anyone could own land in this way.

Before the Europeans came, American Indians were heavily dependent on hunting and gathering wild plants for their food. Prior to 1000 B.C. and the development of horticulture, they often moved around from place to place following the harvest times of nuts and berries and the movements of wild animals.

In somewhat later times, Indians also departed from the custom of only owning personal objects, such as spear points and necklaces, and began to own their own family dwellings. They began growing corn, beans, and squash and settling into more permanent communities. They also had communal buildings, owned by everyone, for public meetings and ceremonies (much like today's civic auditoriums) and structures like churches that belonged to specific clans or congregations.

However, the sources of food, like the cornfields, wooded areas, and rivers, were not owned by anyone. They were held in trust by the community as a whole, just as the residents of the United States collectively own all Federal property. Indians within a tribe shared the crops and wild game caught by its hunters, although, it is believed that a good hunter's family would have received a higher percentage of a kill. No man could tell another of the same tribe that he could not hunt on tribal hunting grounds. When food and game were plentiful, several different tribes would hunt in an area, usually without any conflict. But when game was scarce, tribes often protected their

tribal hunting grounds by attacking bands of hunters from tribes outside the area.

When the Europeans first came to America, Indians often agreed to share their hunting grounds either out of simple courtesy or because they feared their guns. The Europeans, having an entirely different notion of ownership, soon began clearing, fencing, and planting crops on the land. Thinking they then owned the land, the early settlers began driving away the Indians who came to hunt. Many wars between the Indians and the early settlers were fought over this issue, which resulted in the eventual decline of Indian populations in the Valley.

4. Indian-White Relations



When Europeans arrived in east Tennessee, they encountered native Americans, not in isolated teepees, but in large towns that contained hundreds and sometimes thousands of people. Enjoying a varied social environment, 18th century Indian life represented the conclusion of 12,000 years of non-European cultural development in America.

Stable communities of Cherokee, Shawnee, Catawba, Chickasaw, and Creek Indians were supported mainly by fields of corn, beans, squash, and other crops grown along the fertile river bottoms of the Tennessee River, or the Tanasee, as the Indians called it, and its tributaries. Hunting, fishing, gathering, and trading added to the food supply.

Religious ceremonies and tribal discussions shaped native American cultures. Dances, stickball, and other community activities provided pleasure. Religious, ceremonial, and civic leaders, medicine men, artisans, laborers, skilled hunters, and fierce warriors, all had their roles in the social system.

Native Americans had adapted to an established a balance with the Valley's natural environment. This way of life would have continued had it not been abruptly changed and rapidly undermined by the European pioneers. At the turn of the 18th century, American pioneers came by force into the region. Armed with Federal land grants, settlers journeyed across the Cumberland Gap and established their roots. These pioneers brought with them a hardy independence and self-reliance that has characterized the region throughout its history.

A complex relationship developed between native Americans and the Europeans. From Indians, white settlers learned about an agricultural crop—corn, a mainstay of the Indian diet. From white men, Indians learned to use new, fearsome weapons. This exchange of goods and knowledge was commonplace in places like the Tellico Blockhouse along the Little Tennessee River.

However, all was not calm. Indians lived in a spiritual relationship with the land that placed them within, rather than above, nature. Whites, on the other hand, believed that Indians used land inefficiently, unable to take full advantage of nature's bounty.

As their numbers grew, American pioneers continued to intrude upon Indian land. Over the course of the next century, several land transactions followed, reducing the Cherokee lands and fueling dissension within the tribe. In 1838, Major General Winfield Scott directed the removal of the Cherokees from east Tennessee to a newly established Federal reservation in Oklahoma. In March 1839, these displaced Cherokee Indians marched the "Trail of Tears" from Tennessee to Oklahoma, leaving 4,000 dead and a small group of fiercely resistant Cherokees—less than 2,000—hidden in the hills of North Carolina. Torn between leaving or resisting white forces of superior strength, the Cherokee Nation had been split in two.

5. Tennessee Valley Women

Women in the Tennessee Valley have often been portrayed by such cartoon figures as Daisy Mae Yakum of Dogpatch, USA, or Aunt Loweezy, wife of moonshining mountaineer Snuffy Smith. History, however, reveals a more complex picture of women in the Tennessee Valley. In the early 19th century, their labor on the pioneer homestead—from childrearing to housekeeping to farming—certainly made a vital contribution to the family. Women were active in religious and political gatherings. Some women even crossed conventional boundaries by working as school teachers or boarding house managers.

This region served as one of the main areas of combat during the Civil War. The war not only created economic hardship but also left Valley homesteads without their traditional patriarchs or sons. New responsibilities, created by war, were placed on women who now had to assume roles traditionally carried out by men. A bloody trail of Civil War casualties meant that, for many women, these responsibilities continued for years after the end of the conflict.

The Civil War also uncovered investment opportunities for northerners who could profit from the Valley's untapped wealth of natural resources. The development of the lumber, coal, and textile industries at the turn of the century had a significant impact on the region in general, and women in particular, especially in the Appalachian Mountains along the eastern edge of the Valley.

Here the traditional family of a rural society was changed by the demands of industrialization. Many women "took" work in textile factories, exchanging farm life for the factory timeclock. As southern laborers grew restless over low pay and poor working conditions, women added their own voices to the sounds of protest. In 1929, they



joined strikes at Elizabethton, Tennessee, and Marion, North Carolina. The reform-minded women then carried their ideas to the workplace, trying to change, through education, what had been difficult to change through direct political action.

Middle and upper middle class women became engaged in activities that led to the suffrage movement. As the 36th state to ratify the women's voting rights amendment to the Constitution in 1920, Tennessee gave the Nation its three-quarters majority required to make Women's Suffrage the law of the land.

Since the Depression in the 1930s, and especially since the end of World War II, the fortunes of the Valley have improved. So has the plight of Valley women. Just as pockets of economic poverty remain in this region, backward attitudes toward women remain, affecting both male behavior toward women and women's status within society. Yet, we now have portraits of progress to place beside conventional images of the past—success stories like Mother Maybelle and the Carter Sisters, Dolly Parton, and Loretta Lynn. Juanita Morris Kreps, the Secretary of Commerce during the Carter administration, and former Kentucky Governor Martha Layne Collins are examples of the entrance of women into a political world formerly monopolized by men. Less glamorous but equally important steps have been taken throughout the workplace as women have traded their gray cotton farm dresses for the tailored clothes of the office. In adapting to these changes, bright new shades of meaning have been added to the richly colorful experience of Valley women.

6. Cultural Diversity In The 1930s



The Tennessee River Valley is a crescent-shaped, 40,000 square-mile basin covering nearly all of Tennessee and parts of six other states, including Virginia, North Carolina, Georgia, Alabama, Mississippi, and Kentucky. Although tied together by the flow of the river, the basin has never been one broad valley, either geographically or socially. Instead, there exists a complex relationship between geography and society, and between environmental and economic conditions.

Upstream From Chattanooga: The Upper Basin

The upper basin, north of Chattanooga, can be broken into three smaller regions. The largest and most heavily populated section is the terrain of narrow valleys separated by rugged hills. These hills ripple southwestward from northeastern Tennessee to the northern eastern tip of Alabama. The area contains many farms as well as the Valley's two largest cities, Knoxville and Chattanooga. These cities have made the Tennessee River and Valley region the major location for manufacturing.

On the eastern flank are the Appalachian Mountains or Blue Ridge region. Around 1900, Appalachian forests were extensively logged, and by the 1930s, these practices had stripped many of the slopes bare. As a result, the Blue Ridge region turned to recreation to stabilize its economy. Proponents in Asheville, North Carolina, encouraged recreational use of the 1.3-million acres of state and national forests, and of the already popular, newly created Great Smoky Mountains National Park.

On the western flank of the ridge and valley section lies the third region, the Cumberland Plateau. This area did not have fertile soil but did have some below-ground natural resources (particu-

164

larly coal). In the 1930s this area was dotted with isolated homesteads, crossroad communities, and coal towns.

Downstream From Chattanooga: The Lower Basin

The rolling, limestone hills of southern Tennessee and northern Alabama have traditionally been the cotton-producing region of the Valley. Before the Civil War, this portion of the Valley most resembled the plantation South. During Reconstruction, the old plantations were chopped into small parcels of land filled by tenant farmers and sharecroppers. By the turn of the century, the region had become bleak with poverty. Debt-ridden farmers filled land that they did not own, possessed little or no capital, and worked with a soil base that was losing its fertility and productivity. In the 1930s the economic and environmental situation worsened.

Along the lower basin's western edge, north of the cotton-producing region, is the Highland Rim—a belt of land with varying fertility. At the turn of the century, the Highland Rim's western edge was the site of extensive oak and hickory lumbering. By the 1920s, however, overcutting had caused a sharp decline in this industry and had left these forests bare and the land badly eroded. Varieties of crops and livestock dominated this land in the 1930s.

West of the Tennessee River, adjoining the Highland Rim, is a third region, the Interior Coastal Plain. This hilly area of poor clay and sandy soils contained some of the most eroded timber and agricultural land in the entire basin. During the Great Depression, the Federal government purchased plots of land within this area in order to reclaim it. Natchez Trace State Park and Forest is one example of the government's efforts.

165

The northern edge of the Highland Rim borders the Nashville basin, a relatively fertile area characterized by areas of pasture, corn, and grains. During the early 1900s, shoe, stove, pencil, and textile factories, as well as whiskey, condensed milk, and chemical processing plants, sprang up throughout the Nashville basin.

Since the late 19th century, northern writers and photographers have portrayed the Tennessee River Valley as a land frozen in time, geographically a part of the United States but not a part of contemporary America. It was a pioneer environment that illustrated what the rest of the country had been like a century ago. This image expressed only part of the region's social and economic conditions. A closer look would have revealed the Tennessee River Valley's rich diversity.

7. The Black Experience

Between the 1790s and the 1850s, white settlers brought enslaved blacks across the Cumberland Plateau in what was then the American frontier. The terrain, economy, and racial attitudes within the region led to a variety of experiences for blacks.

In northern Alabama, select slaves were chosen to work as domestic servants in the "big house," a slave name for their owner's mansion. In east Tennessee, yeomen farmers, a term to describe those farmers who held limited acreage, either worked the fields alone or, if they could afford the expense, owned a few slaves. As for the rest of the South, slaves worked as laborers in Valley cities and towns. Whether servant, field hand, or laborer, a slave's life was restricted by laws and customs that defined him as being part human being and part property.

A few blacks within the Valley enjoyed a measure of freedom. Released from bondage by their white masters, these "free Negroes" represented only a small fraction of the total black population. They had opportunities to earn a living, to own property, to marry, and to raise families. Yet, they too, were denied rights available to adult white males, including the right to vote.

In the years before the Civil War, slaves and freedmen developed a sense of community life distinctly separate from white society. Common bonds were created by family relationships, friends, religious experience, and hardship. From this pre-Civil War environment, the roots of American black culture developed.

In 1865 President Abraham Lincoln's promise of freedom, the Emancipation Proclamation, became a reality. Learning to read and write, to own property, to make choices, and to vote were all possibilities for the first time.



Despite racial conflicts, blacks within the Valley saw some signs of progress. Separate public schools did become available for some black youngsters. During the 1870s and 1880s, black colleges such as Alabama Agricultural and Mechanical State Normal School in Huntsville, were founded in the Valley. Black newspapers were published. The Negro World in Knoxville, the Blade in Chattanooga, and the Gazette in Huntsville were all examples of black newspapers emerging within the Valley between the 1870s and 1900s. These newspapers provided information about black communities that could not be found in the white press.

Post-Civil War hopes for equality soon faded with the rise of "Jim Crow" laws in the late 19th century. These laws established a legal foundation for a racially "separate but equal" society. However, the laws usually meant separate and unequal.

Poorly funded black schools and restrictions upon the black vote led to black migration out of the area throughout the first half of the 20th century. It was again necessary for the Federal government to act if conditions were to change. In the case of Brown vs. Board of Education of Topeka, Kansas (1954), the United States Supreme Court ruled that so-called "separate but equal" schools had forced undue hardships upon blacks. The court found that poorly funded schools and racial segregation were forcing blacks to be second class citizens. This Brown decision soon set in motion a civil rights revolution that dramatically improved opportunities for blacks.

The tension-filled days of the 1950s and 1960s led to laws that have desegregated public schools and other public facilities, allowed blacks to vote in Federal, state, and local elections, and increased minority opportunities in the job market. Although blacks still have to cope with the critical problems of unemployment in the

Valley, they have made giant strides toward realizing the full benefits of American citizenship.

8. Log Buildings

Early settlers found dense forests in the Tennessee Valley. Trees, including oak, poplar, pine, and walnut, had to be cleared to provide open land for farming. Farmers were faced with a major task of removing these giant trees. To dispose of them, some were stacked and burned; others were laid aside to slowly rot. The abundance of trees, and the need to discard them, led to their wide use as building material. Instead of building frame structures for houses and barns, walls were made of solid wood.

Sawmills were not always nearby to provide sawed lumber, especially in newly settled areas. Therefore, log structures were built by hand with only the broadaxe and adze. A broadaxe is a large axe with a broad blade used to shape the log. An adze is an axe-like tool with an arched blade at a right angle to the handle. It is used for dressing or finishing wood.

Log houses varied according to the wealth of the owner. The single-room log cabin of an early settler was often put together quickly and with little care for finished details. The log house of a wealthy owner in a settled community, however, was often as well finished as any frame or masonry house.

Construction of a Log Building

Hewing the Logs — After a tree was felled and branches removed, a broadaxe was used to roughly shape the log. A foot adze was then used to finish the hewn log. A fine smooth finish could be achieved with this tool.

Notching the Logs — Logs were notched in the corners to hold them in place. As logs were stacked, the notches interlocked the walls and

kept them from falling down. Several different types of notches can be found in the region. The full-dovetail notch and the half-dovetail notch were the most complicated. The V, flat, or square notches were less complex but did not provide as strong a structure. The saddle notch was the least skillfully made notch.

Constructing a Log Room — When the size of the building was determined, the logs were cut and notched. After the structure was built, the door and windows were cut. If a weather-tight building was desired, the spaces between the logs were chinked or filled with materials such as wood and rocks. Wet clay was often used to complete the filling.

House Plans — There were three basic house plans—single crib, dogtrot, and saddlebag. Variations of these plans occurred when settlers joined units, added second floors, or combined structures. The single crib is a one-room log house with a fireplace on one gable end and usually a porch across the front and rear.

The dogtrot house plan consisted of two single log cribs with a wide space in between. A continuous roof connected these two log units forming a covered outdoor porch between them. This porch (called a dogtrot) was considered to be an important work space. It provided protection from rain, and snow, and also helped shade the house from the hot summer sun. Fireplace chimneys were located on the two gable end walls.

The third plan, the saddlebag, had two log cribs with a single fireplace chimney between them. The rooms shared the common chimney. Like other house types, there was generally a porch across both the front and rear.



Siding or Weatherboards — To protect the logs and clay chinking from the weather, siding or weatherboards were often nailed to the structure. If not protected, logs would eventually rot away and the clay chinking would wash out.

Riven Shingles or Shakes — To cover the roofs of log buildings, hand-split wood shingles, or shakes, were made from short sections of logs. By using a wooden mallet and a froe (a cleaving tool), shingles were split or riven from the log. In the second half of the 19th century, sawed wood shingles replaced hand-split shakes. By the turn of the century, metal roofs replaced wood shingle roofs. Later, asphalt roofs became common, although hand-split shingles were still used occasionally.

9. Preservation And Reuse Of Historic Structures



There is a wealth of architecture in the Tennessee Valley region that reflects the life and culture of the people. Historic buildings can be found in downtown areas of cities, in residential neighborhoods of towns, and in isolated rural areas. They are part of the history and tradition of the region.

The earliest settlements of this region occurred in the late 18th century and continued through the 1830s as new lands were opened for settlement. The most characteristic type of architecture during this period was log houses and other log farm buildings. As agriculture and commerce developed, small communities and trade centers were established. These settlers built one- and two-story commercial brick buildings which were modified over time as expansion took place. During this same period, a plantation system developed. This architecture was unique to the region, and reflected the wealth and needs of the plantation system. The most noted examples were the great plantation homes, usually designed in the monumental Greek revival style. There are also a few surviving examples of the great barns and slave quarters.

The Civil War destroyed much of the "stylized" architecture. As the economy recovered, new cities emerged and grew. Blocks of large, brick, commercial and warehouse structures were built in trade centers. This was a period of Victorian architecture. Buildings were elaborately ornamented with cast-iron storefronts, arched windows, overhanging roofs supported by large wood brackets, and pressed metal roof cornices. Great city mansions exhibited the color and elaborate detail associated with the Victorian style. Elements of this style were also to be found in rural areas in the "gingerbread" ornamentation on farm houses.

The architectural styles continued to change with the economy of the region. In the early 20th century, the bungalow style and the Colonial Revival house emerged. Commercial buildings reflected the Beaux Arts and Classic Revival styles. There also were examples of Art Deco, Art Moderne, and International styles. The architecture of this period varied considerably and was influenced by intended use, economic conditions, and location. Buildings, whether business, residential, or farm, all reflect the history and culture of the region.

Examples of all Valley architectural styles survive to this day. In some communities there are continuous blocks of original buildings which lend a historic character to the area. Many surviving buildings were built structurally sound and have been well maintained over the years. Others have been rescued, restored, and now serve a new useful purpose. Unfortunately, many historic buildings have been damaged through inappropriate remodeling and alteration, and many have been needlessly bulldozed. New, cheaply built buildings that have very little architectural quality have replaced these buildings. Strip-commercial areas are a prime example of this.

This region has a particularly rich and abundant resource in its buildings, but the historical value of these buildings has not generally been realized. Most of these old buildings are in sound structural condition and to destroy them would be a considerable waste of resources. It would be a waste of (1) labor and materials used in the original construction; (2) money, when you consider that similar buildings would, in many cases, be more costly (cost of demolition plus construction); and (3) time, given that remodeling takes less time than demolition of the old and construction of an entirely new structure.

"Adaptive reuse" is the refurbishing or remodeling of an older building for new uses while preserving and restoring its original architectural character. This allows us to preserve our architectural heritage. The movement has become popular in this country in recent years, giving new life and use to many older buildings. The Federal income tax laws have encouraged this concept through favorable tax credits. The Secretary of the Interior's Standards for Rehabilitation has served as a guideline for restoration projects. These projects have become more numerous and are starting to have a visual impact on our environment. Preserving and restoring these buildings helps emphasize the rich cultural resources of the Tennessee Valley.

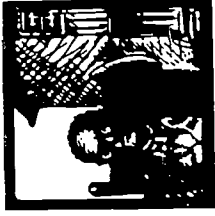

Cultural Resources Activity Matrix

CULTURAL RESOURCES	AIR RESOURCES	CULTURAL RESOURCES	ENERGY RESOURCES	FOREST RESOURCES	RECREATION RESOURCES	WATER RESOURCES	WILDLIFE RESOURCES	TVA-A WORLD OF RESOURCES
Mining For Gold		1,2,3,4,5,6, 7,8,9	2		7			
Games of the World		1,3,4			1,8			
Dug-Out		1,2,3,4,5,6, 7	2,9	9	1,2,8			1
Wasting Waste	5,9	1,2	8,9	5,9	3	2,3,6		7,8,9
Log Cabin Day		8,9						
Woman's Work Is Never Done		5,6						
Separate And Unequal		1,7			9			8
Recycling Buildings	1,4,6	1,2,9	8		1			7
This Does Not Compute		1,6		1,9	1			8
Modelling An Indian Dwelling		1,2,3,8,9	2	1,3	3	2	ALL	

Mining For Gold



OBJECTIVES:

Students will participate in an activity with older citizens or parents to demonstrate the value of resources that exist in this diverse group. See CULTURAL RESOURCES matrix for background information.

MATERIALS:

small-size index cards
Mining for Gold game boards
dice
game markers (made of paper)

PREPARATION:

Today, information is as valuable as gold. Finding it, like searching for gold, may be as difficult as digging an expensive mine shaft or as easy as bending over and picking up a nugget from a mountain stream.

Find senior citizens willing to come to your class or willing to be visited by students. In an urban setting, try retirement villages. In rural school systems, ask students if they have older relatives that might participate. Obtain the proper permission from your principal or supervisor.

Discuss with your class interview techniques and types of courtesy to extend to guests.

Ask students to read through the Cultural Factsheets and pick out topics that most interest them. Send copies of the factsheets to the visitors and brief them on what you want and what they can expect. Give guest speakers or visitors adequate briefing before they arrive.

Topics may include: home remedies, games, folklore, old radio shows, changes they have seen, Indian stories, and so on. Have some research materials on hand for visitors' day.

PROCEDURE:

When the visitors arrive, introduce each one. Form groups so that students can speak to the visitors one-on-one or in small groups. After five minutes, ask the groups to choose one topic that interests them most and to zero in on that topic. Ask each group to develop at least ten trivia questions about its topic. Write each question on the front of an index card and the answer on the back of the same cards. Make at least five sets to use at other tables. Some research may be necessary.

After the groups have finished developing questions, divide the students and visitors into five groups, one for each game board. Distribute the prepared questions and write the topics into some of the spaces left blank on the game board. When a team lands on that space, they must try to answer a question from that topic. When a team has gotten four different topics correct, they can move toward the bottom of the mine. When they reach the bottom of the mine, they must answer one question from a topic chosen by their opponents to win. (Groups may not answer questions that they have written.)

After the groups have finished, ask the visitors to comment on how they felt about visiting the class. Did they enjoy the activity?

After the visitors have left, discuss the visit with students. Did they enjoy this activity? Did they enjoy doing the activity with older people? What one thing is most memorable about this activity? Do they want to do it again?

FOLLOW-THROUGH:

Invite senior citizens to participate in the activities "DUG-OUT," "TO ZONE OR NOT TO ZONE," or "WOMEN'S WORK IS NEVER DONE." They can serve as either participants or resource persons.

MINING FOR GOLD

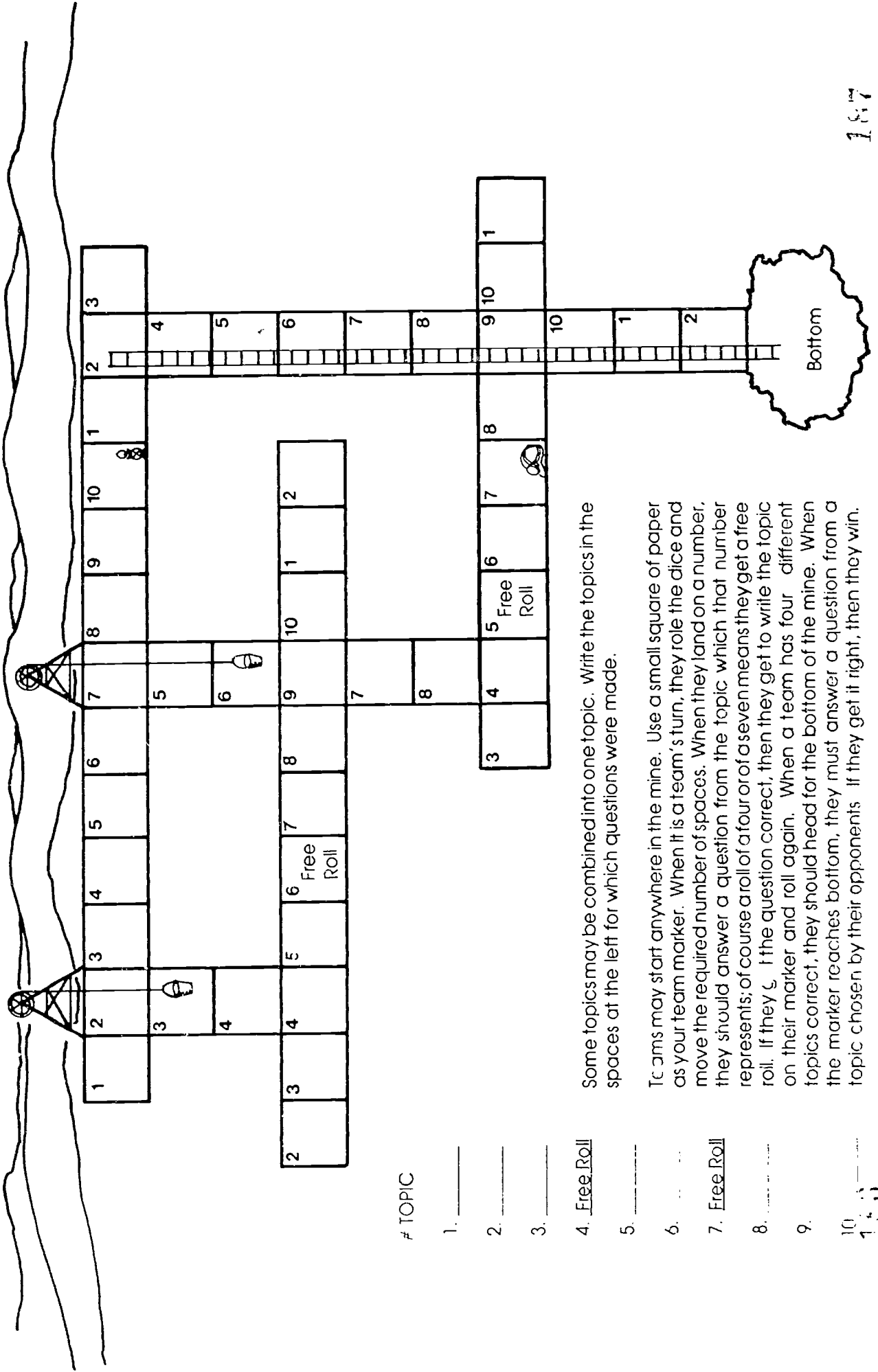

TOPIC

1. _____
2. _____
3. _____
4. Free Roll
5. _____
6. _____
7. Free Roll
8. _____
9. _____
10. _____

Some topics may be combined into one topic. Write the topics in the spaces at the left for which questions were made.

Teams may start anywhere in the mine. Use a small square of paper as your team marker. When it is a team's turn, they roll the dice and move the required number of spaces. When they land on a number, they should answer a question from the topic which that number represents; of course a roll of a four or a seven means they get a free roll. If they land on the question correct, then they get to write the topic on their marker and roll again. When a team has four different topics correct, they should head for the bottom of the mine. When the marker reaches bottom, they must answer a question from a topic chosen by their opponents. If they get it right, then they win.

Games Of The World



OBJECTIVES:

Students will play "Indian Kickball." See CULTURAL RESOURCES matrix for background information.

MATERIALS:

kick ball (or home-made ball at least three inches in diameter; wrap a hard core with string, strips of cloth, or rubber strips.)

PREPARATION:

Thousands of games have developed in different cultures in the past.

This version of "Indian Kickball" comes from the Indians of Mexico. It could easily have been played in the Tennessee Valley by the Indians here and later by pioneer children.

Ask a group of interested students to prepare a report about Indian Kickball and other games of the world.

PROCEDURE:

Form several teams of 3 to 6 students. Each team needs a ball which should be painted or marked to show which team it belongs. Teams may make their own balls.

Lay out an outdoor course with students. The course should be long (at least a football field in length) and covered with such obstacles as trees, shrubs, streams, logs, etc.

Teams form at the starting line. At the signal, all teams advance their ball by kicking it forward—no hands. Team members should stay close together over the course. They function as a cooperative group; no one player should "hog" the ball. The team that gets its ball and all of its players over the finish line first wins.

FOLLOW-THROUGH:

Research other Indian games and play them. Develop a book of games and distribute it to other classes in your school.

Organize a school afternoon of games from other cultures and from the past. Invite parents or other schools to participate.

Investigate Games of the World by Frederic V. Grunfeld, to find other examples of games for your class. (See Additional Resources for bibliography.)

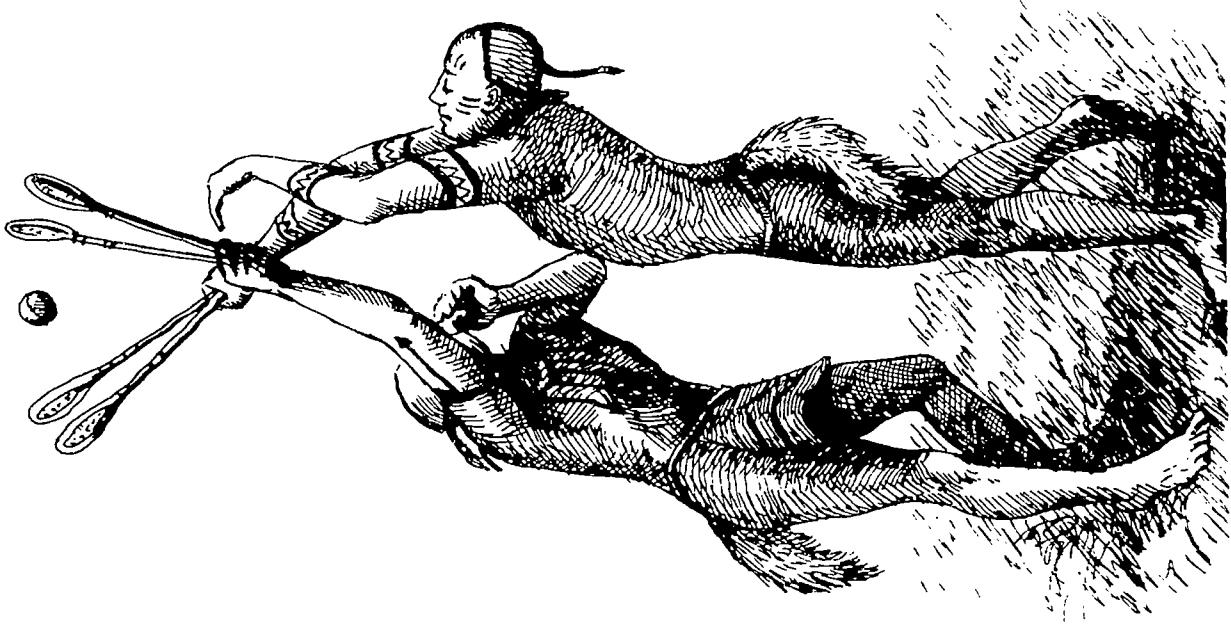

Indian Stickball, or Lacrosse, was another popular Indian game.

Dug-Out



OBJECTIVES:

Students will research cultures of the Valley from various time periods and prepare an exhibit based on a culture studied. See CULTURAL RESOURCES matrix for background information.

MATERIALS:

shoe boxes (or other cardboard boxes)
clean, dry sand to fill the boxes
small spoons or tongue depressors
felt crayons

PREPARATION:

Read through Cultural Factsheet 2. Discuss with the class what "archaeologists" and "anthropologists" are and what they do. In this activity, students will simulate these roles to learn more about another culture.

PROCEDURE:

Divide the class into five groups. Have the groups draw one of the cultures listed below from a hat:

- Indian Culture in the Valley (about 1700)
- Pioneer Culture in the Valley (about 1800)
- Pre-Electrification Culture in the Valley (about 1900)
- Present Culture
- Future Culture in the Valley (2000)

Each group should research its culture. Each group should select items that are important in its culture as artifacts to be discovered later by another group. These items may be the real thing or a model made of paper or other material (for example: paper to represent money). Bury the artifacts in the cardboard box filled with sand in some order which helps to tell a story.

Allow the groups to exchange boxes. Ask the groups to maintain secrecy so they will have to use "maximum brain power" to analyze the materials.

The groups should begin to remove sand from the boxes with the small spoons. Each item should be recorded and drawn on newsprint as it appears. Both side views and above views should be sketched. The groups should be thorough. Any bit of evidence may be important.

Ask the groups to continue until all materials have been excavated. The groups should determine the period of the find and the significance of each artifact, and piece together a story to explain the "dig." Ask each group to present its find and its interpretation. Ask the original group that developed the "dig" to comment on what they had intended.

Which items helped most in identifying the culture? Why? What does it mean to say that something is "characteristic" of a culture or people? How much of the work was factual and how much was guess-work? Did you enjoy this activity?

FOLLOW-THROUGH:

Ask an anthropology instructor from a local university to come and speak to the class on local culture and on their role as a scientist. Solicit information about "digs" in the U.S., and in other countries in which older students may participate at a low cost.

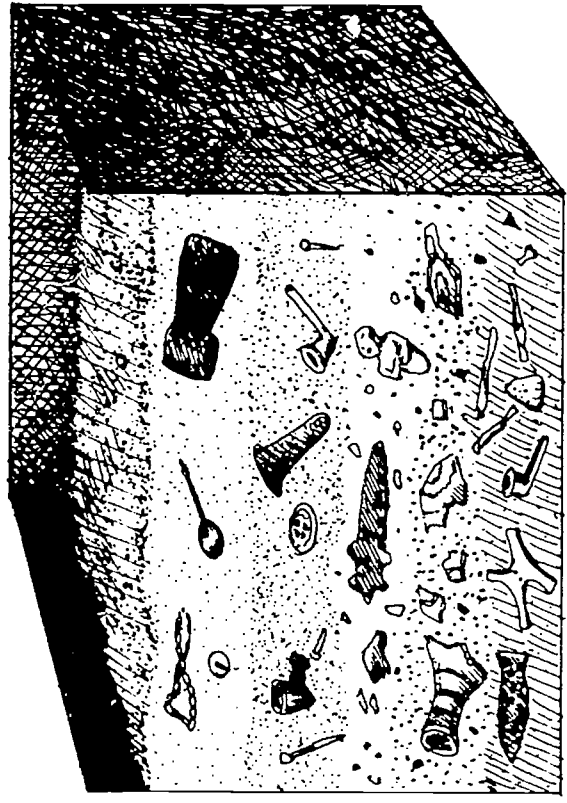

Artifacts are buried in the cardboard box filled with sand in some order which helps to tell a story. Older items go near the bottom, newer items go near the top.

Wasting Waste

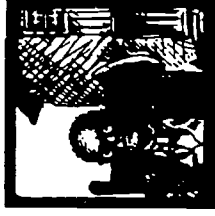

OBJECTIVES:

(1) Students will list materials that are considered waste in our "throw away" society. (2) Students will make a second list of materials that would be considered waste by a society that recycles waste. See CULTURAL RESOURCES matrix for background information.

MATERIALS:

paper
pencil

PROCEDURE:

Begin the activity by having the students brainstorm a list of things that our society throws away every day and write them on newsprint. Use as much newsprint as necessary to make a long detailed list. Title the top of each sheet "WASTE." Include old washing machines, rusty wire, tin roofing sheets, barrels, cans, bottles, bed springs, etc.

Now, read the following:

"Many things can be learned about a culture by examining the things that are discarded as waste by that culture. If we traveled to a developing nation, we would easily see that some things we now consider waste can be quite useful."

Now, list the following words and discuss their meanings with the class. Develop some examples to clarify each one:

- RECYCLABLE WASTE
- REUSABLE WASTE
- BIODEGRADABLE WASTE
- HAZARDOUS OR NOXIOUS WASTE
- BURNABLE WASTE (To generate power)
- WORTHLESS WASTE

After discussing the topics above, divide the class into six groups. Each group will develop one of the topics.

Each group should review the original lists labeled "WASTE." From these lists, each group should list those items that fall within its topic on newsprint. Each group should write its topic at the top of the newsprint.

Allow each group to present its list to the class. Are there many items that can be reused? Are there many totally useless items? Should hazardous materials be stored with other trash?

Remind the class that their own community dump is used as a site of disposal for most of the items on the original list. What attitudes and cultural values does this show? Does wealth cause people to waste more? (Consider a rich country like Sweden that recycles many more items than we do.) Do any students' households keep their waste separate for recycling (like biodegradable in a mulch pile, cans in a box, newspapers bundled for return, bottles kept for return, and so on)? Is it better to stop wasting our waste? How can we do this?

FOLLOW-THROUGH:

Visit a city dump before doing this activity to make it more real for students.

Begin a class recycling program. See the activity "TRASH ENERGY ALTERNATIVES."

STUDENT WORKSHEET

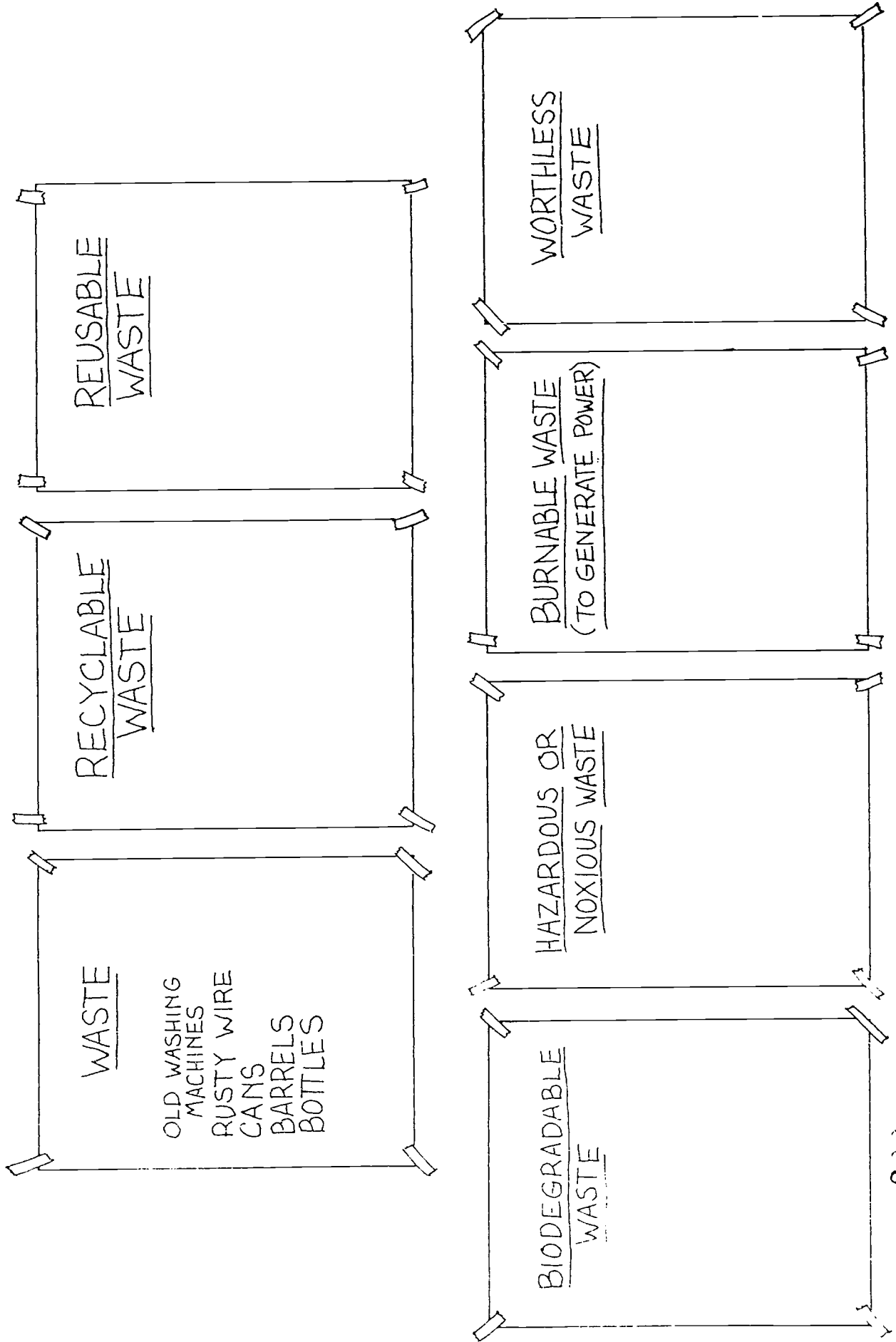

Log Cabin Day



OBJECTIVE:

Students will create and display models of historic log cabin designs and discuss how each is useful. See CULTURAL RESOURCES matrix for background information.

MATERIALS:

toy building logs or other building materials
poster boards
paint and felt crayons

PREPARATION:

Read through Cultural Factsheet 8 to get an idea of how log cabins were designed in the Valley. Students should gather as many pictures, diagrams, and stories about log cabins as they can. Also ask them to question their relatives and friends about the log cabin design and construction of homes they might have lived in.

PROCEDURE:

Ask students, working individually or in pairs, to prepare a posterboard drawing of a traditional log cabin design or a design of their own. Students should list on the poster the reasons for the shape of the cabin and the uses of different rooms.

Now, allow each group to construct a model cabin from the toy logs or other building materials such as popsicle sticks or twigs.

Prepare photographs of each cabin and keep these in a photo album in the class with information about each cabin.

Ask students to describe their log cabin to the class and explain their reasons for designing it as they did.

FOLLOW-THROUGH:

Visit some log cabins in the area. If students in the class have friends and/or relatives who have lived or who currently occupy a log cabin, check and see if they can visit the class or if the class can visit the cabin. Ask students why we don't live in log cabins now. Why did they build log cabins instead of constructing houses like we do today? What are the drawbacks of living in a log cabin?

Have a craftsman come to class and demonstrate the various types of notches mentioned in the factsheets. Discuss why simple or elaborate notches are used in different situations.

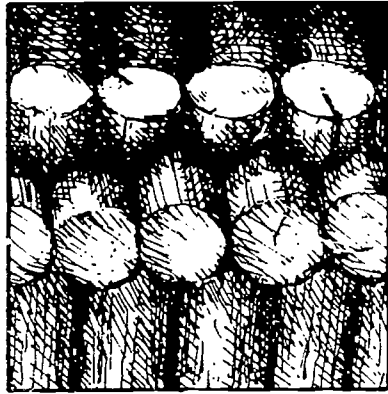

Saddle Notch

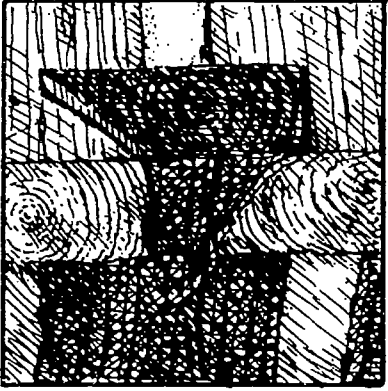

Half-dovetail Notch

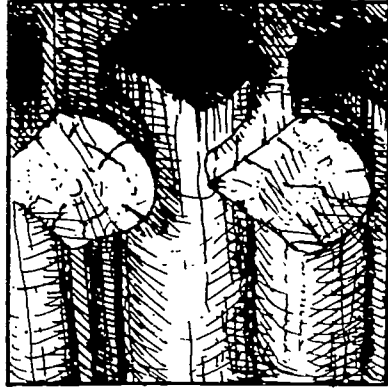

V-Notch

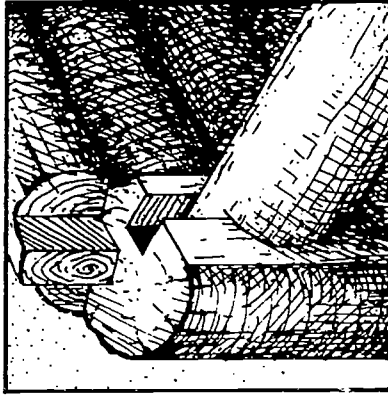

Flat Notch

Woman's Work Is Never Done



OBJECTIVES:

Students will research different tasks women in the Valley performed in the past that were traditionally "Women's Work." See CULTURAL RESOURCES matrix for background information.

MATERIALS:

various materials from home (a visit to a local craft show or museum can generate further ideas)

PREPARATION:

In the Tennessee Valley during the 1930s and before, women were often seen as both a cheap labor source and as second class citizens. In many parts of the world, this is still true today.

In this activity, your class will participate in and observe others performing some of the traditional activities considered to be "women's work." Discuss how physically difficult each task is afterward. This is a great opportunity to invite knowledgeable older citizens into the classroom to serve as content and social resource persons.

PROCEDURE:

Allow students to choose one or more of the activities or types of work listed. Students should research their topics to find out how the

activity is done. Books, trips to visit local artisans, and visits or interviews with older citizens in the community can provide additional information.

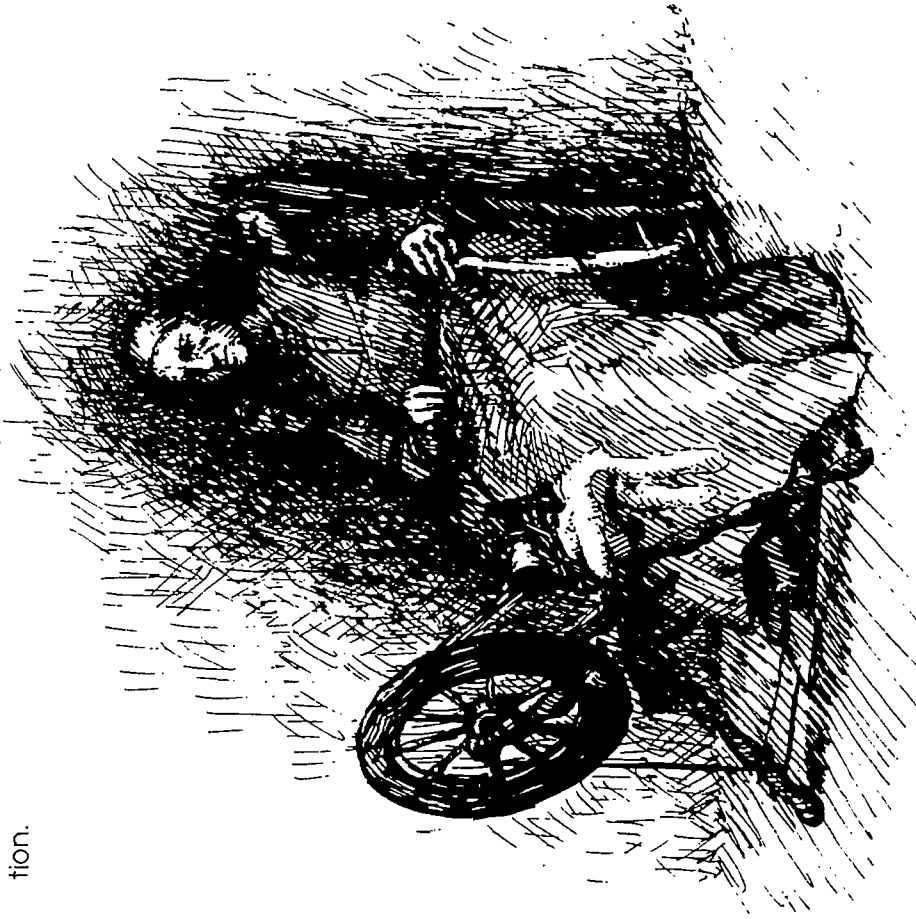

Women spun yarn from lambs wool on spinning wheels.

Possible activities:

1. churning butter
2. carrying or pumping water
3. transporting children and caring for them
4. collecting fuel or firewood
5. keeping a garden
6. house cleaning
7. quilting
8. buying groceries and goods
9. washing, drying, and ironing clothes by hand
10. making soap
11. sewing by hand
12. canning
13. candle making

Once assigned activities are completed, students should present their activities to the class. For example, the student with activity one can churn butter in class. Other students may draw pictures or take photos of the activity.

After the activities are completed, list them on newsprint or chalkboard. Ask students to give each one an "energy rating," with

1 being not too hard, and 10 being very hard work. List "traditional men's work" and rate these.

- How did men's and women's work compare in their energy ratings? Discuss.
- How did electricity improve women's quality of life in terms of easing the traditional work load?
- Compare men's and women's work today? Can you give examples of women's work that is "cheap labor?"
- Ask the class what they think the future holds for women and work. Discuss why students think this.

FOLLOW-THROUGH:

(1) Do this same activity but list activities women perform today. How have women's roles changed or stayed the same? Also have students check local newspapers every day for example articles about women. Post these on the bulletin board, commenting occasionally on any particularly interesting clips. What kind of articles are usually printed? What kind of picture does that paint of women today?

(2) Ask an advanced student to research St. Augustine's position on women and then debate the idea, "Are women human beings?". Aristotle's and Plato's views on women would also make interesting research topics.

Separate And Unequal



OBJECTIVES:

Through simulation, students will experience the unfairness of the "Jim Crow" laws. See CULTURAL RESOURCES matrix for background information.

1. The privileged group is allowed to line up first for lunch and other activities.
2. The "other" group can use only one water fountain and it is the farthest away.
3. Each group can stay only in certain areas of the schoolyard, but the privileged group's area is nicer.
4. The two groups may not talk to each other.
5. (Make your own.)

PREPARATION:

Read through Cultural Factsheet 7 about Jim Crow laws. Discuss with the class what these are. Have students research Jim Crow laws that may have existed in their community or state in the past. Generate a list of Jim Crow laws for your classroom. See procedure below.

Divide the class into two groups with close friends in the same group. Mark the "other" group by having them wear colored bandanas on their arms. Be sure to switch groups after the first day. Ask students to keep a journal during the simulation.

PROCEDURE:

Suggested time line:

Day 1: Discuss and make up some Jim Crow laws for the class. Divide the class into two groups.

Day 2: Group A is the privileged group.

Day 3: Group B is the privileged group.

Day 4: Class discussion.

On the first day, discuss what Jim Crow laws are and have the class make a list of laws for the class. For example:

On the last day hold a class discussion. How did it feel to be in each situation? When did you feel inferior or superior? List three things you liked and three you disliked about this experience. What does the statement "separate and unequal" mean?

FOLLOW-THROUGH:

Carry out this activity over a longer period of time. Have several classes participate. Be sure to keep a diary. Did this activity change your views on racism?

Have students research what Jim Crow laws existed in their community or state. When were they repealed and why? Other research topics could include the "Brown vs. Topeka" verdict, Martin Luther King and the Civil Rights Movement, desegregational busing, and racism.

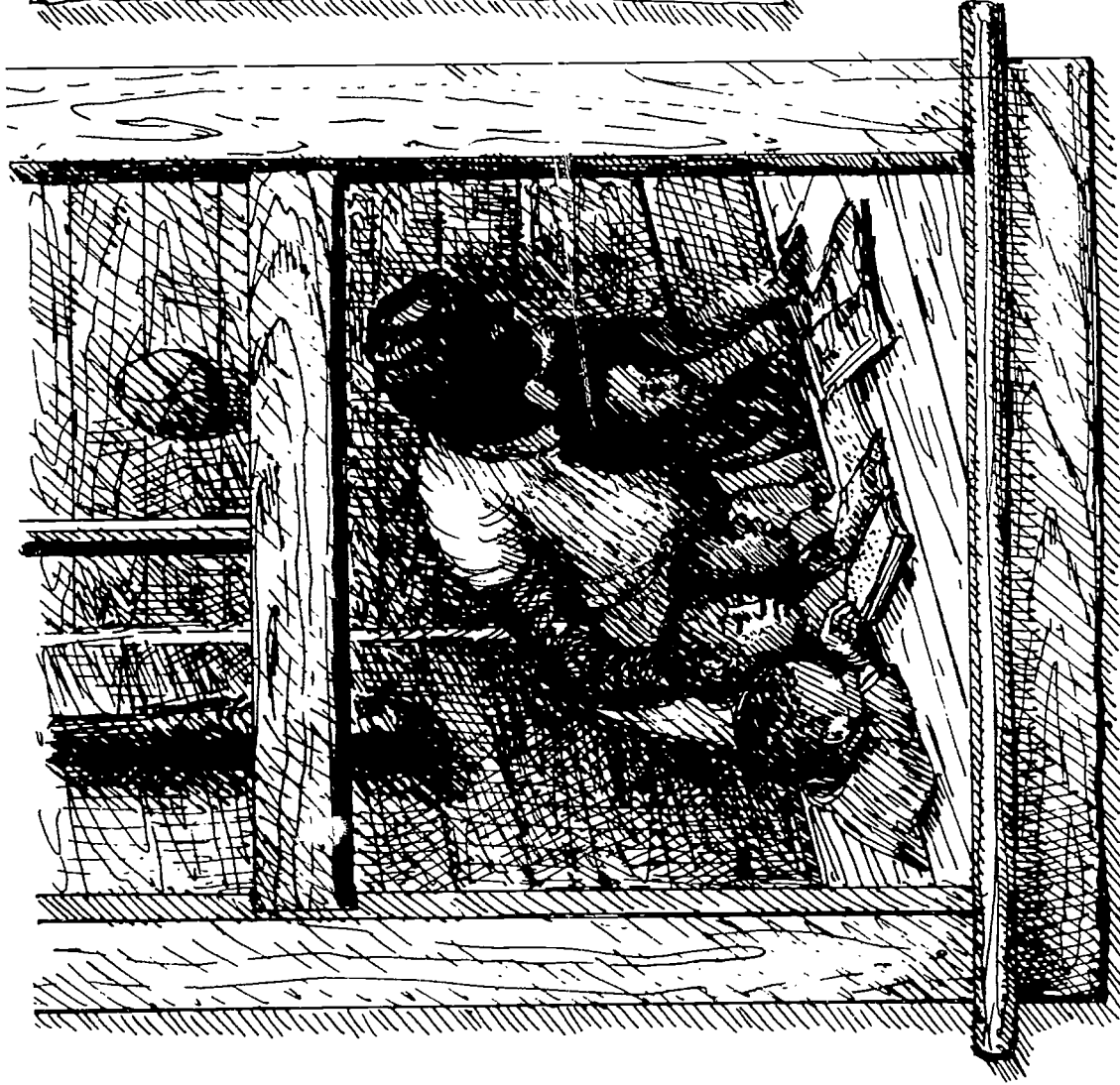

Jim Crow Laws varied from State to State and county to county throughout the Valley.

Colored and white children shall not attend the same school; and no teacher receiving or teaching white and colored pupils in the same school shall be allowed any compensation at all out of the common school funds.
 Georgia Law - 1919

Recycling Buildings



OBJECTIVES:

Students will identify various buildings in the region with cultural significance and make a collage of these buildings. See CULTURAL RESOURCES matrix for background information.

MATERIALS:

pictures (photographs, magazines, etc.)
posterboards
glue

PREPARATION:

After reading Cultural Factsheet 9, have students research and identify various buildings in your area that have cultural and historical significance. Students should take photographs of these buildings. They may also collect photographs from magazines and newspapers of buildings of the same period or style.

PROCEDURE:

Each group of five or six students should develop a poster or collage of the architecture of the buildings they have identified.

When the posters are developed, each group will present the gathered information. Are there any examples of the recycling of buildings in your local community? List reasons why a building should be remodeled rather than torn down for a new building to be built.

FOLLOW-THROUGH:

Simulate a city council meeting in which a decision is being made about whether to save an old building. Make up roles for participants for and against preserving the building and remodeling it.

If a controversy over preserving a building in your community currently exists, have students gather as much information as possible about the situation. They might even be encouraged to attend meetings or interview persons for and against the buildings preservation. Using this information, conduct the simulation city council meeting described above.

Obtain the address of the National Register of Historic Buildings and write to request a list of structures in your area. Then visit one of these and include it in your collage. Interview local residents to determine the folk history of the structure.

Are there any structures in your area that the class could "adopt" and help restore?

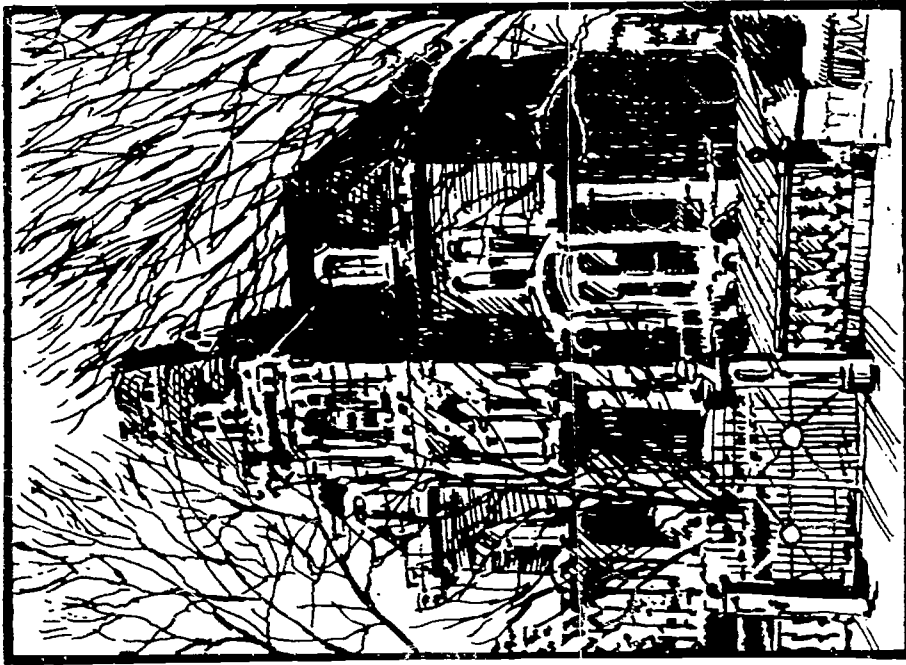

Fontaine House, a French Victorian House
(c. 1870) managed by AP/A

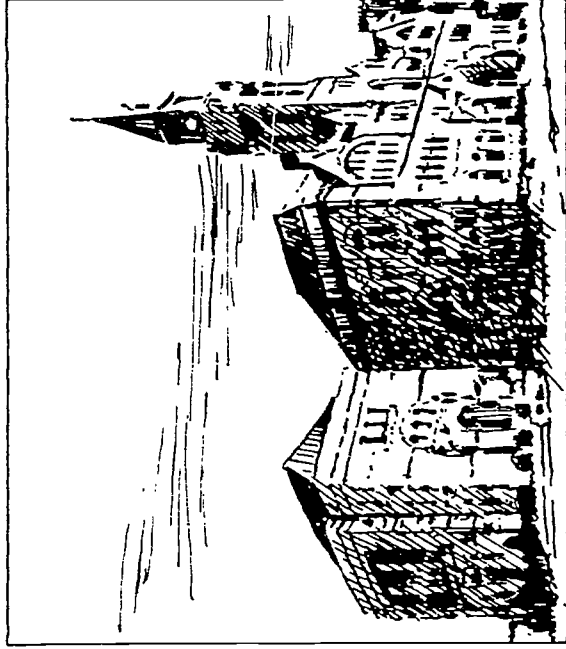

The Customs House in Nashville,
home of the Tennessee Department of Conservation

This Does Not Compute



OBJECTIVES:

Students will write a one-page article about expected changes in our life due to computers. See CULTURAL RESOURCES matrix for background information.

MATERIALS:

newsprint
felt crayons

PREPARATION:

The 1930s was a "hey-day" of industrialization and electrification in the Valley. In fact, electricity was an important factor in the development and maintenance of our industrial society and economy.

Sociologists say that the U.S. industrial society is declining, just as did the agricultural society before it. We are entering an information age and a service economy. In this new age, the effect of computers is analogous to the effect of electricity in the previous time period. Further, computers may be the most important influence in molding this age. It has been said that computers can replace any current use of paper. They can enhance any information or communication system by speeding it up, and they can control any electric device or machine invented in a seemingly intelligent way.

Consider the activities "INTRODUCING NEW TECHNOLOGIES," "ENERGY TRENDS," and "FUTURE HOMES." Also, ask students to read at least one current article about how computers can be used.

PROCEDURE:

Divide the class into groups and assign each group one of the following topics:

1. Any use of paper in the home*
2. Any source of information in the home*
3. Any use of electricity in the home*
4. Any source of communication in the home

(*may require two groups)

Ask each group to brainstorm its topic and make a list on newsprint. After ten minutes, ask each group to present its list. Compile all lists. Number each item as it is presented and remove any duplications.

Now, remake the groups so that there are at least seven smaller groups. Assign each group one-seventh of the topics. For example, if fifty-six items were listed, divide that by the number of small groups: $56/7 = 8$ items. Assign the first eight items to group 1, the next eight items to group 2, and so on.

Ask these small groups to list the items they have been assigned. For each item, they should suggest how computers can replace or enhance that particular item. For example: NEWSPAPERS—computers can instantly present up-to-date news on a video screen, replacing printing and distribution of the newspaper. The computer news would be cheaper and more current than the newspaper. Soon, video monitors will be as thin as a notebook. Just picture people sitting around in a cafe reading the computer bulletins from any city in the world. Ask each group to present its list of ideas on how computers can replace or enhance each of its topics. Summarize and ask if there are any other ideas.

FOLLOW-THROUGH:

Ask students to write a three-paragraph article about how a home, school, or workplace will probably look in the future, using ideas generated in this activity. They may wish to include a sketch, too.

Appoint a committee that has access to school typewriters (or computers) and duplicating machines to collect, edit, and publish these articles in a "FUTURE" newsletter. Better yet, see if you can connect your computer to a video monitor in the library or lunchroom and publish an electronic newsletter.

Modeling An Indian Dwelling



OBJECTIVES:

Students will make a model of an Indian dwelling that flourished in the Valley in the 1400s. See CULTURAL RESOURCES matrix for background information.

MATERIALS:

string
thin burlap material
clay or plaster of paris
sisal bailing twine
sticks about a quarter inch in diameter
collected outside
a shallow pan filled with soil, clay,
or plaster (to serve as a base)
scissors

PREPARATION:

This is a model adapted from a structure at the Chucalisa Indian Village near Memphis, Tennessee. It represents a typical dwelling of an Indian tribe that lived in the Valley whose culture flourished about 1400 A.D. Students may want to research more to find out about diet, customs, and beliefs. The completed structures can then be assembled together into a scene depicting this period in the Valley past. This is a good interest-generating activity and can precede other activities such as "GAMES OF THE WORLD," "FUTURE HOMES," and "THE VALLEY, YESTERDAY AND TODAY," and can be done simultaneously with "LOG CABIN DAY."

PROCEDURE:

Here is the sequence of STEPS in construction (A more detailed description follows.):

1. Collect materials
2. Prepare base
3. Place posts upright into base
4. Place joist poles on uprights
5. Attach roof poles
6. Cover uprights and plaster
7. Thatch roof

Divide the class into several groups of three or four students. The students do not have to follow the plan exactly, but they should adapt it to their own tastes. It should at least resemble the diagrams.

STEP 1

Collect sticks outside; old dried up shrubs or bushes will do. Each group will need about 28 that are 5 inches long and about 30 that are 12 to 16 inches long.

STEP 2

Prepare the base. One way to do this is to put clay or plaster of paris into a shallow aluminum pan that is at least 12 x 14 inches in size.

STEP 3

Stick the 5-inch poles at least a half inch into the clay or plaster of the base in this pattern (right):

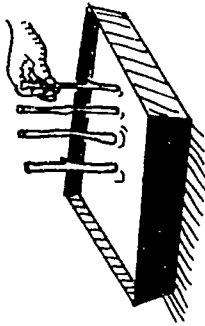

STEP 4

Place the posts about 2 inches apart.

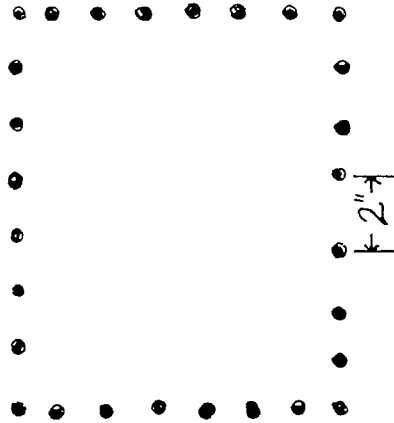

STEP 5

Place joist poles on uprights and tie with string. (front and back first, then both sides).

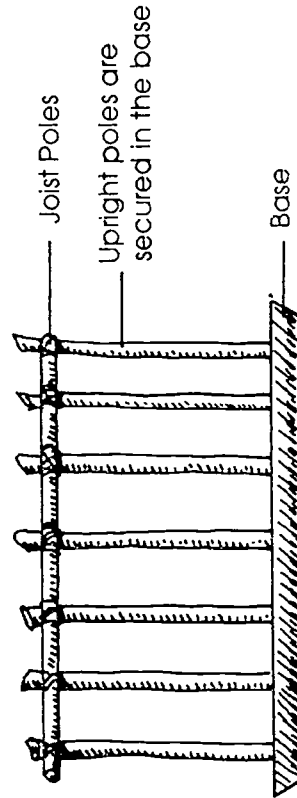

STEP 6

Attach roof poles and tie.

STEP 7

Cut the burlap cloth into strips and tie these to the upright poles. Mix plaster or clay and apply it over the cloth. Leave a place for the doorway.

STEP 8

Cut a piece of sisal bailing twine about 4 inches long and tie near the end, then fray the end to make the thatching bundles. Make more than 50.

Thatch the roof front and sides, leave the back open so that you may look inside the dwellings.

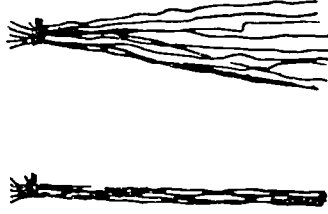

FOLLOW THROUGH:

Several students might be interested in constructing a full-size Native American dwelling. For assistance, contact local Boy Scouts of America leaders. You may want to do a project spin-off, for instance, model an Eskimos house (igloo), a native African home, and so on.

Side

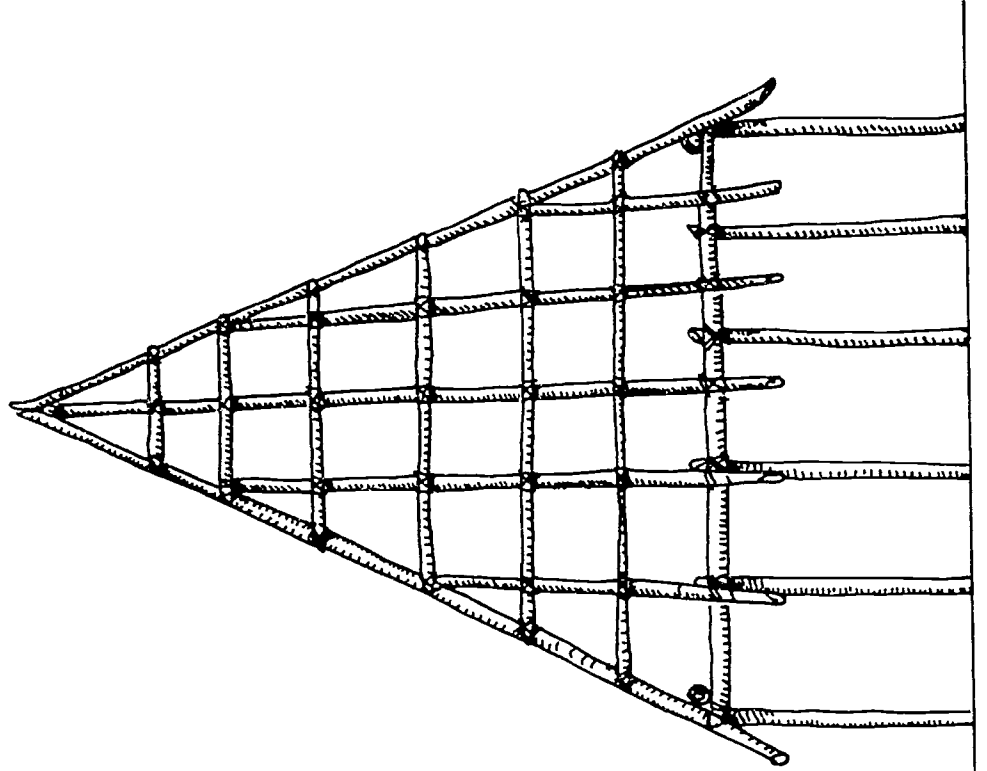

227

Front

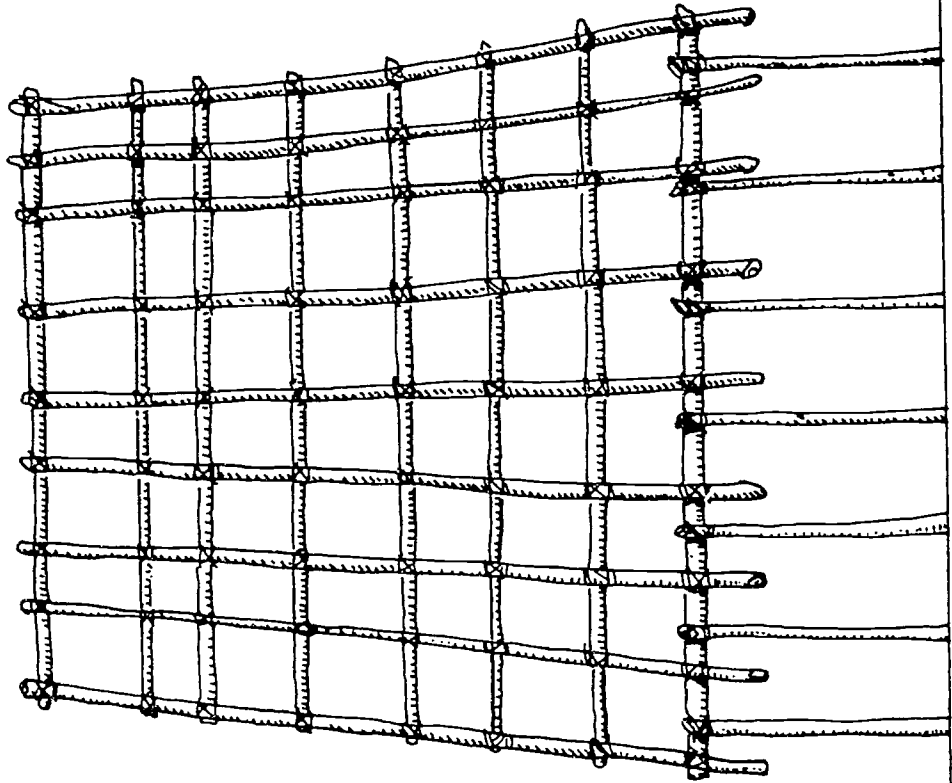

226

C-50

Cultural Resources Glossary



1. Adaptive Reuse - The remodeling of an older building for new uses as well as preserving and restoring its original architectural character.
2. Axze - An axe-like tool with an arched blade at right angles to the handle, used for dressing wood.
3. Anthropologist - A person who studies the origin and physical, social, cultural, and behavioral development of humans.
4. Archaeologist - A person who studies the material evidence remaining of previous human cultures.
5. Broad Axe - An axe with a wide, flat head and a short handle.
6. Civil Rights Movement - A movement led by Martin Luther King, Jr. in the 1960s to win political, economic, and social equality for all peoples, particularly blacks.
7. Desegregation - The abolition of racial separation, especially in schools.
8. Emancipation Proclamation - A document issued by President Lincoln, effective January 1, 1865, declaring freedom for all slaves in the territory still at war with the Union.
9. Free Negroes - Blacks released from bondage by their white masters.
10. Froe - A clearing tool having a heavy blade set at right angles to the handle.
11. Jim Crow Laws - Laws that favored the segregation of blacks.
12. National Register - A list of places, buildings, etc. of historical significance.
13. Racism - The notion that one's own ethnic background (Caucasian, etc.) is superior.
14. Reconstruction - The period of 1865-77 when the Federal government required changes in the southern states before their readmission.
15. Segregation - The separation of races in schools, housing and industry.
16. Suffrage Movement, Women's Suffrage - The protest for women's voting rights in the early 1900s.
17. Yeomen - Farmers who held limited acreage and either worked the fields alone or owned a few slaves.

Energy Resources

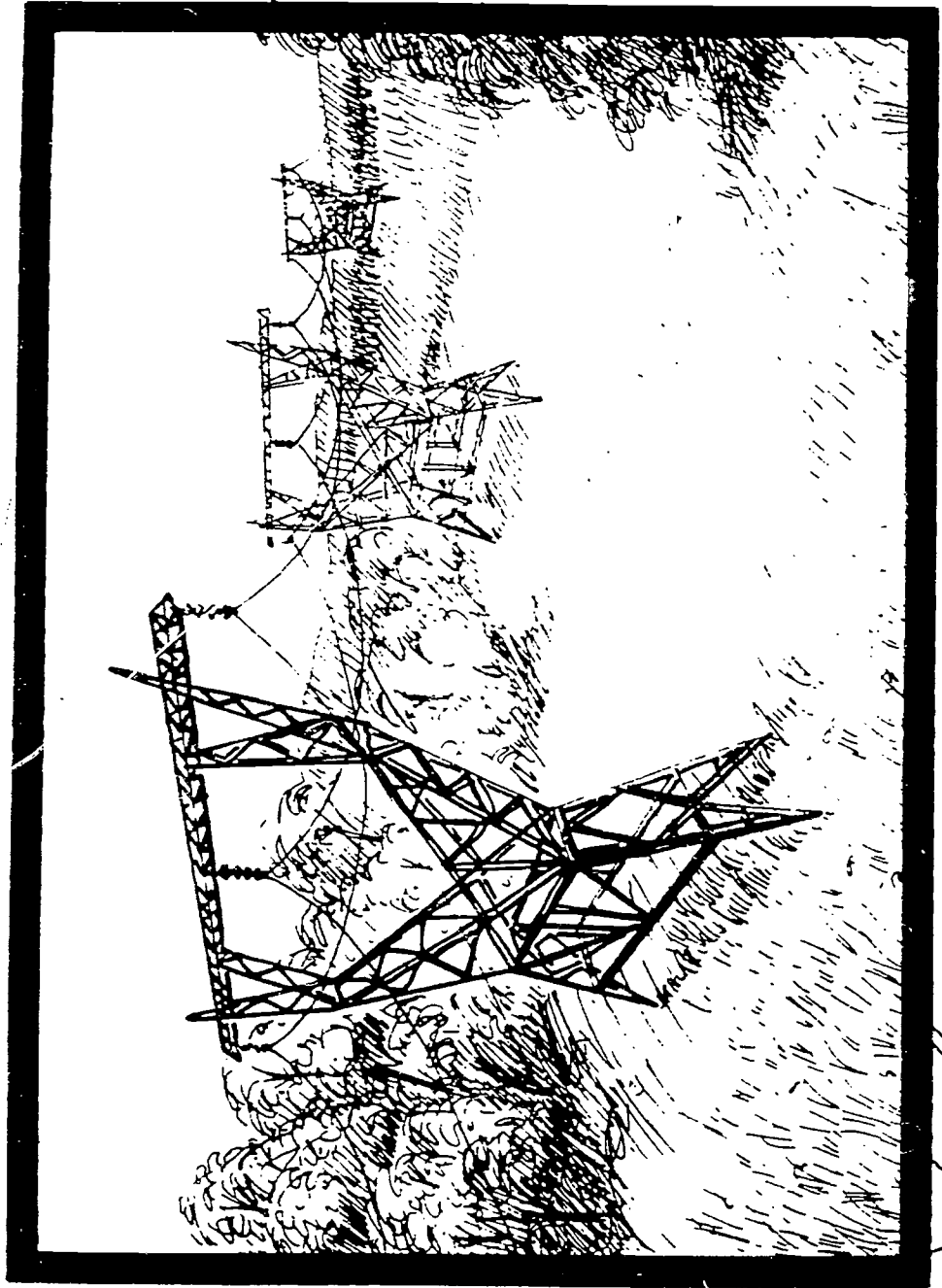

“Impressed forecasting of energy demand, the need for efficient, cleaner production methods, more efficient delivery systems, better results from improved education programs about conservation and more use of nontraditional materials for fuel (from the sun to biomass to garbage) — these trends are planned to help ensure ample but safe energy for the future.”

Benchmark Report

0000

0000

Energy Resources Concept Map

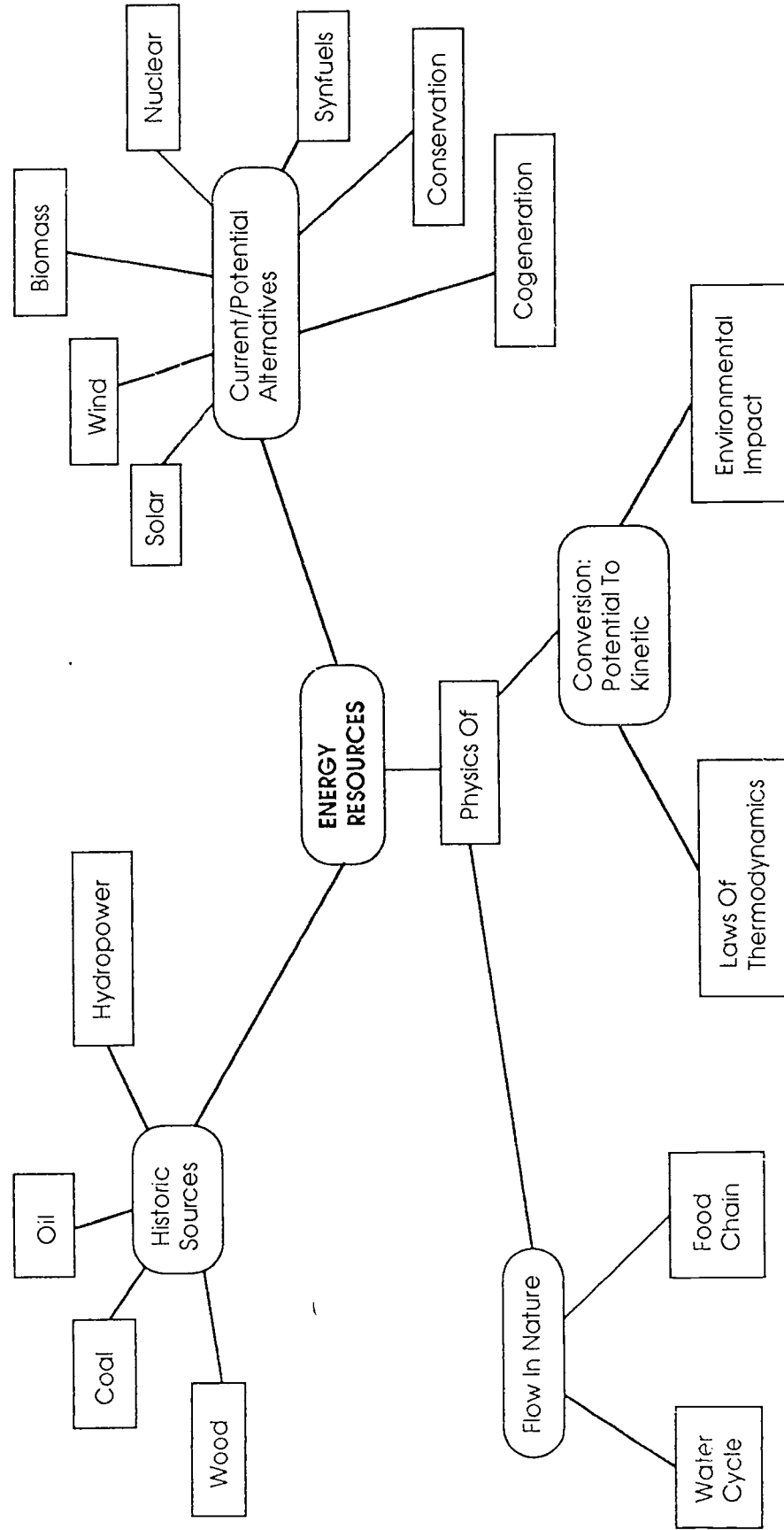

Energy Resources Factsheets



1. Overview
2. History Of Energy
3. The Non-Renewables
4. Hydropower
5. Nuclear Power
6. Energy Flow In Nature
7. Energy And Environment
8. Energy Source
9. Conservation
10. Energy Alternatives
11. Synfuels

1. Overview

Energy exists throughout the universe. It surrounds us as sunshine, powers our mechanical and electrical devices, and satisfies our hunger in the form of food. Life cannot exist without it.

In our environment, plants and animals are linked in a complex web of energy exchanges known as food chains and pyramids. Each illustrates the way the sun's energy is trapped and made available by plants and then passed from organism to organism.

Energy affects the nonliving parts of the environment as well. The sun heats the water which creates the vapor. Vapor forms clouds that eventually rain on the earth, creating water pockets which the sun heats to begin the cycle again.

People have used the natural water cycle to store water and create a potential source of energy. For example, water stored at the top of a dam has potential to produce energy. Energy is defined as "the ability to do work or the capability to produce a change in temperature." At the top of the dam, this ability is unrealized but the potential exists. Released from behind the dam, the water moves quickly, falling with great force, and the movement is work. The water is now active and is producing kinetic energy, referring to the motion. A conversion process is required to change this potential energy of the water into kinetic energy. Burning fuel, water falling turning wheels, and chemical actions are examples of these conversions.

Conversions operate under specific rules. These rules are known as the Laws of Thermodynamics. The first law states, "Energy can neither be created nor destroyed." It can be changed from one form to another; but there will always be the same amount of total energy in the universe.

The second law is sometimes referred to as the energy "tax." Every conversion is "taxed," so no conversion is 100 percent efficient. For example, some energy changes to heat, not all of which can be captured and returned to its usable state. Unusable heat (the tax) is lost during the conversion process. Energy loss increases with the number of conversions made between the primary energy source and its final use.

Energy is also categorized in other ways. Energy resources currently in use, for instance, are classified as either renewable or nonrenewable. Oil, coal, natural gas, and uranium are nonrenewable, primarily because of the natural cycles of their origin. Our use of energy resources has changed throughout history. Wood, a renewable energy source, fueled homes and cooked foods for centuries. As technology advanced, coal replaced wood and gas replaced oil.

Although most of these sources are still in use today, energy use is closely related to the state of technology that is available. Technology may even permit higher efficiency. For example, the amount of electricity used to cook food can be reduced by using a microwave oven instead of a conventional oven. Electricity is also used in space heating, and water heating in the United States. Internationally, however, 25 percent of the world's population still heat and cook with wood. The "developed" resource electricity is generally the most popular for a specific time period; however, history illustrates that the demand and popularity of specific resources change over time.

Given that energy demands and sources change, the existing uses of coal, hydropower, oil, natural gas, and nuclear power may change dramatically. New alternatives will likely play a role in the



future. Synthetic fuels, biomass, wind power, solar power, and methane gas recovery from landfills are potential alternative energy sources. In some cases, the technology has been developed to use these resources. In most, the technology is being actively pursued. All, however, are still limited in their application and probably will not totally replace more traditional energy sources.

Energy use can be affected by human behavior. In recent years, individuals have been very concerned about the supply and cost of energy. Many individuals consider conservation or wise use of energy resources equally important to developing new energy sources. Conservation also tends to lessen the environmental impacts of energy development.

No technological process is without environmental impact. Impacts occur as energy resources are extracted, transported, converted, and used. These impacts are frequently destructive to the environment. Environmental guidelines have been developed to ensure public health and to assist in resource management. Energy extraction will always be costly to the environment. However, balanced management plans are needed to ensure the impacts are temporary and do not cause irreversible damage.

In summary, energy takes a variety of forms and is categorized in different ways. Progress has allowed us to utilize specific energy resources. Technology has permitted more efficient uses of energy resources and promises more opportunities for the future. As our demands for energy increase, our need to safeguard the environment from the impacts of energy use also increases.

2. History Of Energy

Our energy needs have changed and grown with our country, and the sources of energy we are familiar with today are quite different from those of 200 years ago. The introduction of new technology brought radical changes, and the Industrial Revolution of the mid-19th century had a strong influence on the forms of energy used. Unfortunately, the United States moved away from being self-reliant, but an energy crisis in the mid-1970s helped redirect our attention and focus on the need for more energy research and development in our country.

When our country was settled in the 1700s, wood was the major fuel. Since it was often used inefficiently, much of wood's energy literally went up in smoke through home chimneys and industrial smokestacks. To make matters worse, vast forest stands offered no incentive to conserve the resource. Wind and water supplemented wood as a fuel source. Water helped meet transportation needs as well as move the wheels of mills and small-scale manufacturing plants. Wind was harnessed and used to generate energy using windmills.

By the mid-1800s, coal became a major source of fuel in the United States, although it had been mined and used in Europe for almost 200 years. Coal was mined in the Tennessee Valley region, but no one saw the advantages of substituting coal for wood until factories began locating in the Valley and increased the demands for energy. Since half a ton of coal could do the work of more than two tons of wood at half the cost, and was readily available, coal became the logical replacement.

The invention of the automobile and easier methods of removing crude oil from the earth led to another energy age by the early

1900s. Oil and natural gas are still principal energy forms but the 1974 oil crisis brought about a change in overall consumption.

As we can see, the energy choices available to Valley residents have increased over the years, but the oil crisis of the 1970s gave us a chance to examine other available options.

The Tennessee Valley Authority (TVA) began generating electricity to provide energy for development of the Valley first with hydropower, then with coal-fired steam plants, and, more lately, with nuclear plants. Private companies, such as ALCOA, and other government agencies, such as the Department of Energy (DOE) are all working, both independently and with others, to expand the horizons of energy and economic development.

Nuclear power may be the power of the future, but to date, the few plants that have been completed continue to be the focus of controversy. Scheduled construction of new plants has been delayed or cancelled. Safety remains the major concern.

Today, wood is still a valuable natural resource used in the Valley for home and commercial heating. Coal is still being used to supply power for electricity, but research is being done to find ways to extract energy from coal without negative environmental impacts. Oil is still being used for transportation and heating. Research efforts, however, are continuing to help us find U.S. reserves that will make us less dependent on foreign oil. Water continues to be used for transportation and hydropower. While we are still dependent on many of the same energy sources, many alternative forms of energy are being explored, among them solar, geothermal, biomass, and synfuels. It is expected that alternative energy sources will play an even greater role in the future of energy use.



3. The Non-Renewables

In the Tennessee Valley region, coal is the most common fuel, followed by petroleum and natural gas. These three formed when dirt and rocks covered decaying plant and animals. Over millions of years, under the great pressure from layers of heavy earth, these prehistoric plants and animals become part of the earth. They were broken down into separate chemical elements and re-formed into hydrocarbons. These hydrocarbons make up oil, coal, and natural gas.

Oil, coal and natural gas are referred to as fossil fuels and are considered nonrenewable because of the time it takes to create and replace them. The formation of fossil fuels is continuing, but the process is extremely slow. It would take about another 300 million years to produce an amount equal to that which has been built up thus far. Using energy as rapidly as our country does could result in the depletion of all our fossil fuels. That is why fossil fuels are designated non-renewable sources of energy.

By contrast, renewable sources of energy are ones that are constantly or cyclically replenished. Examples would include direct solar energy and indirect sources of solar energy such as biomass and wind power. Renewable energy sources are receiving more emphasis currently as we try to stretch the supply of nonrenewables.

All three types of fossil fuels are found in the Valley, but petroleum and natural gas are present in more limited quantities. Coal is found in varying amounts in every Valley state and is recovered from the earth by deep mining or surface mining. Either form of recovery has safety and environmental drawbacks, and neither technique is cheap.

Until World War I, coal had almost no competition in the United States as the major source of energy. Then cleaner energy sources—hydropower, petroleum, and natural gas—began to be developed and replaced coal as the major energy source.

One of the disadvantages of coal is a shortage of railroad equipment for transportation and distribution. Another detrimental factor is the pollution from erosion and mine spoilage flowing into nearby streams. Mining coal creates many environmental problems, especially strip mining. Since there is more coal readily available today, there is renewed interest in coal as a major fuel. Technical problems of production, uncertainties about labor and materials, and environmental roadblocks are some of the problems that must be overcome in order to use coal to meet fuel needs in this country.

About 90 percent of the electrical energy in the United States is produced with fossil fuels, most of it coal. One of the largest users of coal is the Tennessee Valley Authority, the principal supplier of electricity for the region. In 1985, more than 31.1 million tons of coal were used by TVA at coal-fired plants to produce 73,760 million kilowatt hours of electricity or about 70.4 percent of the total power generated by the agency during the year.

Currently, research is being conducted to extend the life of our non-renewable resources. Atmospheric Fluidized Bed Combustion of coal is a good example. Not only can the pollution be contained, but the potential exists for a nearly "closed" system. The wastes from this process can be used to generate sulfuric acid, gypsum, and as a roadbase. TVA operates a 160-megawatt demonstration plant in Alabama.



Research and development of other renewable resources and better use of non-renewable resources is continuing. Those which are available must be used wisely, and investigation of new technologies that will reduce consumption of non-renewables must be continued.

240

267

4. Hydropower

Leonardo da Vinci called water "the element that knows no rest." Water has provided humans with energy for thousands of years. In the past, hydro, or water power was one of the most important energy sources. Gradually it gave way to other energy sources, primarily fossil fuels, and, within the last decade, nuclear energy.

The need to develop other alternatives to hydropower were twofold:

1. All cost-effective hydropower sites in the Valley have been developed.
2. The tremendous increase in consumption of electricity has forced us to find and use other sources of energy to meet those demands.

Water is the "fuel" for hydropower. Since water is renewable, the amount of energy recoverable from rivers, streams, and lakes is enormous. But not all major waterways can be dammed and used for hydropower. For example, the Mississippi River supplies no hydropower. Its banks are not high enough, and a dam would cause extensive flooding. Watersheds must be able to provide a large storage area and the water level necessary to maintain hydroelectric generators.

In the Valley, engineers are looking at other smaller sources of hydropower, especially some dams that have been retired over the years. With the immense drain on fossil fuels and the cost of constructing new power plants, it may be more economically feasible to reopen these dams or to build new, smaller dams.

Hydropower is generated from water held in a reservoir behind a dam. The water from the reservoir flows through huge, concrete pipes called penstocks and onto the blades of the turbines, causing the turbines to rotate. The amount of water that flows through the turbine blades is controlled by a set of gates which can be opened to different angles, depending upon the amount of water needed. If the gates are closed, no electricity is produced. The major cost of hydropower plants is the construction of the plants. The actual cost for hydropower for 1985 in the Valley was \$193 per kilowatt of installed capacity, and the generation cost was 0.254 cents per kilowatt-hour.

The harnessing of any energy for human use has some environmental effects. Hydropower is almost pollution free, but studies have shown that damming up streams:

- disrupts local plant and animal communities by increasing nitrogen in backed up water.
- can decrease oxygen in streams below dams which creates unhealthy conditions for fish.
- floods croplands; and
- can cause alterations in the use of downstream waters.

Nevertheless, it remains one of the least environmentally damaging sources of electricity.

Pumped-storage plants like the Raccoon Mountain Pumped Storage Facility, near Chattanooga, are a modern outgrowth of hydropower technology. Water is pumped up Raccoon Mountain



from the Tennessee River and then this falling water is used to turn turbines to generate electricity. They use this pumping facility to produce cost-efficient power for peak demands.

Hydropower is an important energy resource in the Valley. In fact, we now use our hydropower plants to meet peak loads. In 1988, TVA provided 9,243 million kilowatt-hours of hydropower to Valley consumers. Like other energy sources, hydropower has advantages and disadvantages. Thus, as our demands for energy increase, so should our concern to reduce or prevent the associated negative environmental impacts.

5. Nuclear Power

If hydropower can be called the first major source of electricity in the Tennessee Valley, then nuclear power can be called the latest major source of energy. Years of testing and study have gone into the development of nuclear energy. December 2, 1942, is known as the birthday of nuclear energy. Since that time, it has developed the potential for producing an enormous amount of electricity. The mid-1970s saw the Valley taking a lead in the plans to build nuclear power plants and use nuclear energy as a major source of electricity because of the oil embargo and the rapid rise in the cost of energy. In recent times, the decrease in the consumption of energy, and numerous unanswered questions have caused the entire nuclear industry to take a closer look at the economic feasibility of nuclear power plants. Many plants in the planning stages, even some in construction phases, have been deferred or cancelled.

Uranium is the fuel for nuclear plants. Like the fossil fuels, uranium is non-renewable. Most deposits of uranium are located in the western United States. Known reserves contain 980,000 tons. On the average, one ton of ore will produce four pounds of U-238, but of that four pounds only 0.7 percent is the sought-after nuclear fuel U-235.

The fuel cycle begins with the mining of ore, followed by milling of the usable ore and, the most difficult step, enrichment of the uranium in a process called gaseous diffusion. The enriched uranium is sent to a fabrication plant and pressed into pellets about 3/8 inch in diameter and 1/2 inch long. The pellets are then inserted end to end into twelve 4-foot-long metal tubes called fuel rods. After being bound together in fuel assemblies, the fuel rods are sent to the power plants. About 200 fuel assemblies are needed per reactor, and one-fourth to one-third are replaced each year.

Nuclear energy is used to produce electricity. Heat energy released from U-235 during bombardment and the splitting of atoms is used to produce steam. This steam is used to rotate turbines which are connected to a generator with rotor and stator coils. The turbines cause rotor coils to rotate as the stator coils remain stationary producing alternating electric current.

There are basically two types of nuclear reactors in the Valley: the Boiling Water Reactor (BWR) and the Pressurized Water Reactor (PWR). In the BWR, water boils inside the pressure vessel and steam produced in the reactor is used directly to drive the turbines. PWRs have three separate systems of pipes or loops for moving heated water. In the PWR, heat is transferred from a primary loop to a steam generator and the steam generated in the secondary loop is sent to the turbines. A third water loop is used to absorb heat from the secondary loop. (See illustrations.)

The most discussed concern of nuclear power is radiation from either the plant itself or the handling of radioactive waste. Although nuclear power plants release small amounts of radiation into the atmosphere, it is much less than natural radiation like radon. Low-level radioactive waste is sealed in steel containers and shipped to licensed disposal sites. The higher level of radioactive waste is usually stored on-site. Another possible risk in nuclear power plants is the accidental release of excessive heat into a river, which could cause serious damage to aquatic life. This hot water is usually first sent to ponds or cooling towers to release the heat through evaporation.

Nuclear power is an important energy resource in the Valley, but nuclear energy has advantages and disadvantages. Nuclear power plants must be managed to make sure that human health and



ecological systems are disturbed as little as possible. Studies and testing are continuously taking place to make sure that these systems are as safe as possible.

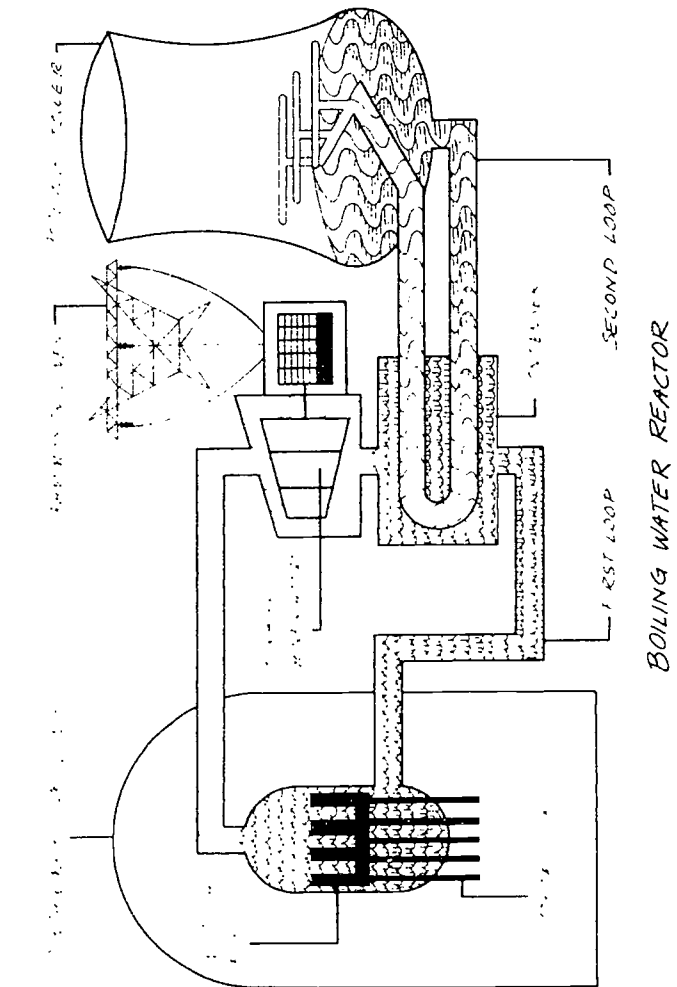
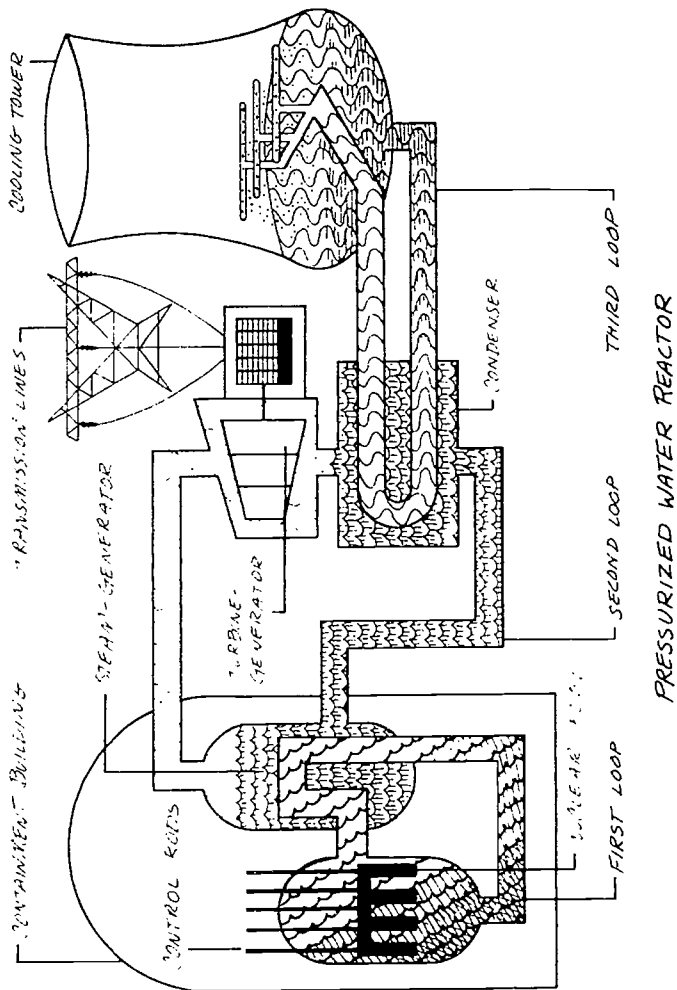

6. Energy Flow In Nature

From space, the earth appears as a blue-green ball surrounded by an aura of air and moisture that seems to glow gently in the sun. From this distance, the atmosphere is visible as a thin film only a few miles thick. This narrow envelope, extending from the upper surface of the soil, contains, as far as we know, every living thing in the universe. It is called the biosphere and is powered by the sun's energy.

Energy is a broad term, but is usually defined as the ability to do work. It is governed by certain laws. The First Law of Thermodynamics states that energy can be neither created nor destroyed. Energy may, however, under certain circumstances, change from one form to another. Light is one form of energy, and when sunlight enters the biosphere, it begins immediately to be changed into other forms of energy and these into still others. It is this cascading flow of energy, changing from form to form, that drives the processes of the natural world.

Perhaps the simplest natural cycle involving sunlight is the water cycle. Open water, heated by the sun, evaporates into a gas and rises into the atmosphere. As it cools, it forms water droplets that fall as rain back to its source. This is a very simple cycle, yet it involves several types of energy. For instance, light, heat, and electrical energy may be discharged as lightning. Water changes the energy state in this process from potential energy in the clouds to the kinetic energy of falling water as it rains.

Plants are energy producers. Plants absorb abiotic (nonliving) substances, such as water, from the soil and carbon dioxide from the air. During photosynthesis, chlorophyll in plant leaves absorbs the light energy of the sun and combines it with water and carbon dioxide

to produce simple sugars. This process is called photosynthesis and is described by the following formulas:

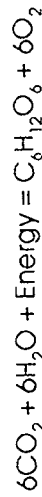

or

Carbon Dioxide + Water + Sunlight = Sugar (or Glucose)
+ Oxygen, in the presence of chlorophyll

Plants use these simple sugars as "food" or energy to carry out other plant processes such as respiration and growth. Not all sugars are consumed. Some simple sugars are converted into complex molecules such as carbohydrates, fats, and proteins and are stored in the plant.

When leaves fall or the entire plant dies, organisms known as decomposers use the plant material as food. In this process, the decomposers reverse the photosynthesis formula and make the basic materials—carbon, hydrogen, and oxygen—available again for use by other plants. In fact, the dark, rich substance we generally know as soil is mostly plant and animal remains in various stages of decomposition.

In theory, the above process forms a complete natural cycle: inorganic substances are used by the producers to manufacture food and plant material which is disassembled by decomposers to be made available to the plants again. In nature, however, this cycle is more complex. For instance, new plant leaves may be eaten by an insect larva, which may be eaten by a songbird, which may in turn be eaten by a larger predator, such as a hawk. This is called a food

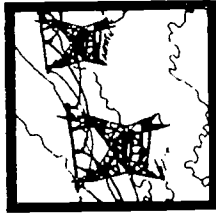

chain. There are many food chains in nature. For instance, a plant might be eaten by a rabbit which is then eaten by a fox. These are just two illustrations of how the sun's energy can be made available by plants and then passed from organism to organism.

In the natural world, the different elements of the energy cycle tend to affect each other in such a way that balance is achieved between the components. This community including abiotic (nonliving) and biotic (living) components is known as an ecosystem. Ecology defines the manner in which energy is distributed in a particular part of the biosphere.

It would seem that these natural cycles, once started, could go on forever, passing energy from component to component and back again. However, this is not possible as stated in the Second Law of Thermodynamics. This law tells us that "when energy is converted from one form to another, some of the usable energy is lost." The Second Law of Thermodynamics helps explain why it takes so many pounds of grass to make one pound of beef, and why it takes so many pounds of beef to make one pound of student. Indeed, for this reason food chains are sometimes shown as food pyramids.

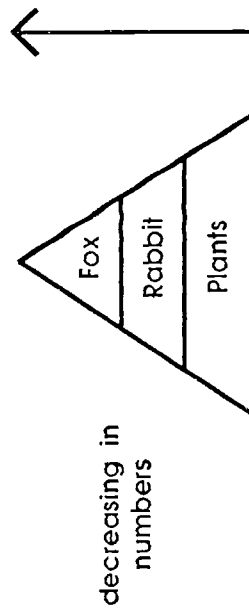

What does this complex energy flow as outlined here, mean to us? People, like rabbits and foxes, are a part of the cycle. The entire

system is connected much like the strands are connected in a spider web. If a strand in a spider web is removed, the whole web is weakened. Understanding the flow of energy is necessary to ensure a quality environment.

7. Energy And Environment

Energy production has a direct impact on our environment from the point of extraction, or removal of the energy source, to the point of converting that source into a usable form of energy.

Plenty of available energy, a high-quality environment, and a strong economic system provide Tennessee Valley residents with a good standard of living. Interaction of these three factors might be looked upon as a seamless web—one with no beginning and no end, where all factors are of equal importance. However, such an interaction must be carefully balanced or the quality of life suffers.

Abundant energy resources are an important part of the Valley's natural resource base. Wise environmental practices contribute to our economy and attract other people who bring more money into the region.

Significant environmental damage was done to parts of the Valley, such as in the Copper Basin of southeastern Tennessee, before the public was made aware of the potential ecological damage. (Copper produced in this region was used in electrical wiring.) Modern technology has now allowed us to reverse some of the damage done. It has also helped us become more efficient in our energy production processes.

One major goal of technology is to increase the efficiency of our society by eliminating waste. A clean environment, however, requires financial investment. Environmental protection laws now require better management of our resources in addition to safeguarding public health and environmental quality.

The production and the use of energy do have certain environmental effects. Sometimes, it is not possible to return an area to the original "pristine condition." Other times, better than original conditions can be achieved, but often trade-offs are required.

Previous environmental disasters have alerted us to the need for careful evaluation before beginning any new development and to the need to continually watch for environmental changes. In the long run, society determines the level of impact it will accept to maintain a balance among environmental, energy, and economic needs. If people are willing to accept poor environmental conditions, improvements are not likely to be made. If environmental quality is demanded, there must be both public and financial support.

Environmental monitoring is a continuous process that is designed to keep an acceptable balance. Environmental protection costs the consumer, but it is necessary to safeguard human health and maintain balance in ecological systems.



8. Energy Source

Every change, whether chemical or physical, involves energy, or the ability to do work. The flight of a bird, the breaking of the earth's crust by a new blade of grass, the burning of wood—all of these actions involve energy.

Energy occurs in two basic forms—potential and kinetic. These forms can be converted from one form to another. Potential energy is either the energy a mass possesses because of its relative position, or it is energy stored and ready to be released. For example, the water held in a reservoir behind a dam is in a position to do work when released by turning a turbine or water wheel. A lump of coal provides no work in its natural state, but when it is burned, it can heat homes, cook food, and produce electricity. When the water is released or the coal is burned, the potential energy is converted or changed to other energy forms such as mechanical, electrical, heat, and radiant (light) energy.

When the conversion process takes place, a portion of the usable energy is lost in the form of heat into the atmosphere. When very little energy is lost during conversion, we say that process is efficient. When a great deal of energy is lost, that conversion process is inefficient. For every 100 units of heat from a gas furnace, 70 units (70 percent) is usable for heat. For every 100 units of light from an incandescent bulb, only 5 units (5 percent) of the light is usable. The other 95 units are lost as heat.

Another example of an efficient versus an inefficient conversion process is burning gasoline to power cars. The internal combustion engine is only 25 to 30 percent efficient. Most of the energy in the gasoline is carried away as unused heat by the radiator and exhaust

system. Because the burning of gasoline for cars is so inefficient, research and new technologies have been developed. The oil crisis in the mid-1970s spurred a tremendous jump in gasoline prices which resulted in the development of cars that get higher miles per gallon (MPG). Larger, heavy cars were replaced with small, light compact cars.

The inefficiency of many conversion processes accounts for many of our energy problems. About one-third of the energy we produce each year through conversion processes is usable energy, while the other two-thirds is lost. It would be difficult to totally eliminate loss; however, ways to capture and reuse lost heat, as well as changing to more efficient systems and products, are being researched.

In summary, there are two laws called the First and Second Laws of Thermodynamics. The first law states energy cannot be created or destroyed but only changed from one form to another (the conversion process), and the total amount of energy in the universe remains the same. The second law states that when energy is converted from one form to another, some of the usable energy is lost (efficiency versus inefficiency).



9. Conservation

Whatever direction this country takes to solve its energy problems, the solution must begin with making better or wiser use of its existing energy resources—conservation. A report on the Energy Project at Harvard Business School concludes that:

"The United States could use 30 to 40 percent less energy than it does, with virtually no penalty in the way Americans live."

Energy conservation directly helps the consumer by lowering total consumption, saving money, and helping stretch scarce energy resources. It indirectly helps by reducing the need for expensive new generating facilities, balancing supply and demand, and lowering costs of operating existing facilities.

Usually energy conservation is simple. Home insulation is a good example. The majority of homes in the Valley were built when energy was inexpensive and before air-conditioning was introduced. When houses were built, little or no insulation was installed. Windows were large with single-glass panes. Doors and windows were loose fitting. All these factors have resulted in tremendous amounts of energy being wasted in Valley homes.

Residential energy makes up 20 percent of the country's energy consumption, with approximately 60 percent of that used for space heating and cooling. Energy-saving steps can reduce energy use in existing homes by 35 to 50 percent. Insulation can be installed in attics where the greatest heat loss takes place, in outside walls and floors, and around heating and air-conditioning ductwork. Storm windows and doors, caulking around window and door frames, and weather-stripping around outside doors can also conserve energy. In addition, learning to read an electric meter can be helpful to consumers in reducing utility bills by enabling them to maintain a daily

record of household power consumption and to understand how much electricity is required for various electrical tasks.

Conservation sometimes means adjusting to conditions around us. People in other parts of the world have always heated their homes to 65 degrees Fahrenheit and would be uncomfortable at a higher setting. Setting thermostats at 68 degrees Fahrenheit, or below in winter and wearing a light jacket or sweater can save dramatically on the heating portion of utility bills. Raising the thermostat to 78 degrees Fahrenheit, or above, in summer can save on cooling costs. Using a ceiling fan or floor fan, in addition to the air conditioner, helps to keep the air moving.

The water heater can account for as much as 20 percent of an annual electric bill. Next to combined heating and air conditioning, it is the greatest energy user in a home. Therefore, cutting hot water use can save energy and money. Running only full wash loads, operating the dishwasher only as needed, and taking short showers rather than tub baths can greatly lower hot water use.

The same conservation measures should be applied to commercial and industrial buildings, which use a sizable portion of the energy produced. Whether it be residential, commercial, or industrial, the investment in energy conservation would bring financial savings over a period of time.

Transportation is a prime conservation target since it accounts for one-fourth of this country's energy consumption. In the Valley, residents are conserving by joining vanpools or carpools, or by riding buses. Besides escaping traffic jams and creating worn nerves, they save on car wear, gasoline, and insurance costs.

Conservation is the conscientious practice of using good technology to extend our dwindling resources. Over time, it has an economic benefit. By decreasing the demand for energy, it reduces the environmental impacts. Conservation is a matter of education and practicing what we have learned. Properly practiced, conservation itself becomes an energy source.

10. Energy Alternatives

When we think of energy, we usually think of oil, coal, or natural gas. These are commonly used, nonrenewable resources that have taken millions of years to form. They cannot be replaced in our lifetime. But the forests, the streams, and even the air contain energy that can be trapped by homeowners and businesses. Even the garbage we create is a possible energy source.

Solar energy is probably the most widely popularized alternative energy source. The amount of solar energy reaching the earth is enormous. In fact, every year, the solar energy contained in the food and fibers we grow in the United States is greater than all the energy in the oil we burn. In the Tennessee Valley, projects have been implemented which use the sun's energy to produce electricity. With fuel costs going up, while nonrenewable energy supplies dwindle, solar energy is becoming an increasingly attractive alternative. Several residential and commercial facilities are using solar photovoltaic conversion units. In these systems, a wafer-like cell of a material like silicon is used to convert the sun's rays to electricity. Currently, the cost is too high and the efficiency too low to make these systems practical.

Solar energy can also be a good way to heat buildings and water. In fact, thousands of residential solar water heating installations have been funded by the Tennessee Valley Authority. Design standards for highly efficient, energy-saving homes and solar homes have been developed and a Valley-wide certification program is in place. By the end of 1982, TVA's energy conservation, solar, and load management activities had reduced the power system's winter peak demand by about 800 megawatts and the summer peak demand by about 300 megawatts. The associated energy savings exceed 1.5 billion kilowatt-hours annually. As a matter of fact, solar

energy can provide a savings for all electricity consumers, not just those whose homes were constructed to utilize solar energy.

Wood heaters are another popular alternative energy device, and as many as 5,000 are in use throughout the Valley. The modern versions of the old wood heaters are more efficient, more convenient, and much safer. Homeowners are finding that they can cut their winter heating bills by 50 percent, or more, through use of the heaters. In addition, forests cover more than half the land area of the Valley, and provide a ready source of fuel.

The stored chemical energy created in vegetation by photosynthesis may also be a promising supplemental fuel. Biomass, or plant material in any form ranging from algae to wood, has a remarkably uniform energy content of about half that of coal. A variety of land and water crops, which might be easily and economically grown for harvesting and burning as fuel material, are being investigated. It is estimated that if an "energy farm" could be designed to convert 3 percent of the solar energy falling on it to useable energy forms. If so, a farm the size of Texas (about 6.5 percent of the total U.S. land area) could fuel all the energy needs of the United States in the near future. There are some problems associated with large-scale energy farming, but even a partial solution could help supply our future energy needs. In the Valley, work is being done to bring existing and new techniques for biomass use to commercial application. They include direct combustion for use in a steam boiler; gasification for use in firing a boiler; and pyrolysis, a process of burning wastes in an oxygen-free chamber and recovering fuel oil, gas, and charcoal.

Landfills across the Valley are bulging with the solid wastes created by homes and business. Studies are underway to determine



how we can make use of our growing volumes of refuse. In Gallatin, Tennessee, the city has built a plant to burn 150 tons of refuse per day. This sharing of heat or steam from a single source, such as a solid waste incinerator, industrial plant, or electric power plant, is called cogeneration. Such systems can use coal, woodchips, municipal waste, or other by-products as fuel. Hospitals, universities, and similar institutions that use both steam and electricity in their operation are candidates for cogeneration projects.

In some parts of the country, wind has been used as an energy source to pump water and drive motors for about as long as wood has been used for heating homes and cooking meals. In the Valley, however, wind has received very little attention, largely because of the lack of wind data. Steps are being taken to assess the wind's energy potential and data are being compiled.

It must be remembered that many of the alternative energy sources are still in the design stage; some have little back-up information or data. For some, there are only limited applications and, on a large scale, they would be economically impractical. Others must be used sparingly until they have been thoroughly tested because of possible damage to the environment.

Despite their drawbacks and shortcomings, alternative energy sources must be considered for our future. The search will continue for renewable sources of energy, as will the study of new resources and the identification of new technologies.

11. Syntuels

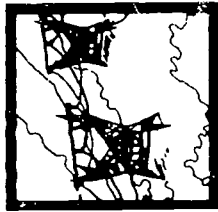

What sort of fuel will cars be using in the year 2000? Will it be the same sort of high-octane gasoline or diesel fuel used now? A blended brew of gasohol, or even straight alcohol? Why not one of those fuels "squeezed" from rocks? Vehicles might be electric and just need to be plugged in occasionally for a recharge.

Whatever that future fuel is, officials in government and industry have begun to realize that the United States may be nearing the time when petroleum will be in short supply and our transportation system can no longer depend on petroleum to keep it going. Two possibilities that will help extend the life of available resources are: (1) improved conservation practices, and (2) development of crude oil substitutes (synthetic fuels or "syntuels").

This country currently produces only a small amount of syntuels. Why don't we know more about syntuel production and availability? First, we haven't had to worry about shortages, and second, we haven't really investigated the possibilities. Also, syntuels are expensive, dirty, and can be potentially damaging to the environment.

What are some of this country's possible sources for syntuels? Coal is one. Unfortunately, chunks of coal cannot run automobiles. However, coal can be made into liquid and gas fuels, similar to oil and natural gas, that can be used for the purpose. All three fossil fuels—coal, petroleum, and gas—are composed of hydrogen and carbon atoms, but coal contains more carbon and less hydrogen than either of the other two. It can be converted into synthetic oil or synthetic natural gas by adding hydrogen to its carbon atoms or by removing carbon, producing a syntuel.

The abundance of the coal deposits in the United States, compared to reserves of oil and natural gas, is one reason for our interest

in syntuels. Research and development efforts aimed at achieving more environmentally and economically acceptable conversion processes have been underway for many years. A demonstration plant for converting coal to gas fuel, which will be burned to produce electricity, is under construction in California.

Syntuels share certain problems with shale oil and coal. Like shale oil, they cannot be produced cheaply enough to compete with conventional energy at today's prices. Construction costs for syntuel plants are high, and the conversion process complex and costly. Since syntuels are made from coal, they have many of the same environmental and safety problems. However, syntuels are cleaner to burn than coal because much of the sulfur is removed in the conversion process.

Synthetic oil and gas are not new. An English document of 1694 describes making "oil out of a kind of stone"—the first known patent for shale oil. Europeans learned to convert coal into flammable gas and used it for lamp oil and fuel for heating during the last century. During World War II, when German oil supplies were cut off, they powered their planes and tanks with liquid fuels made from coal.

Synthetic gas has been around even longer and was used on a limited basis for more than a century before natural gas became readily available. Today, there are two synthetic oil plants in the world. One began operating in the 1950s to supply South Africa with fuel for transportation. In Baltimore, Maryland, the city was lighted by a coal-gas plant as early as 1817. In fact, other American cities followed suit until the 1940s, when many of them converted to electricity or natural gas. Perhaps, in only a few more years, or the span of a generation, we will see the death of one syntuelera and the birth of another.



Energy Resources Activity Matrix

ENERGY RESOURCES	AIR RESOURCES	CULTURAL RESOURCES	ENERGY RESOURCES	FOREST RESOURCES	RECREATION RESOURCES	WATER RESOURCES	WILDLIFE RESOURCES	TVA - A WORLD OF RESOURCES
Mefer Matters			2,3,4,8 9,10					
Future Homes	8	8,9	3,4,6,9,10	6,7,9	1,3,8	2	2,10	7
Fuel Eaters			1,2,3,5,7					7,9
Trash Energy Alternative			1,10	5				9
Solar Cell Alternative			1,10					7
Fuel Cell Alternative	9		1,10					
Insulation	2,8	9	7					7
Draft-O-Meter	8		9					7
Can A Can Or Recycle It?			6,7,9			6		7,8
Energy Flow Model			1,6,8					

Meter Matters

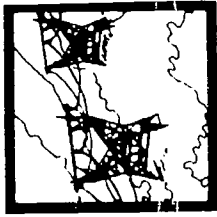

OBJECTIVES:

- (1) Students will record measurements of electric consumption.
- (2) Students will discuss ways to reduce home electrical usage. See ENERGY RESOURCES matrix for background information.

MATERIALS:

- cardboard
- felt crayons
- home electric meter
- publication on how to read your electric meter

PREPARATION:

- Explain how to read an electric meter. Make a cardboard model and let students practice reading the model meter.
- Prepare a handout with meter dials and allow students to fill in the correct numerical value.
- Familiarize the class with electric meters by drawing an example on the board. Ask students where these meters are typically located at their homes.
- For reading electric meters, remember two rules:
 - (a) Meters may have either four or five dials, measuring thousands or tens of thousands of kilowatt-hours. Read the dials from right to left.
 - (b) When one hand is between two numbers, read the smaller number.

READING = 13488
 READING =
 READING =

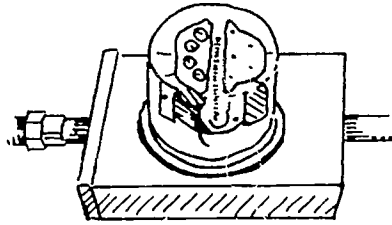

Your Electric Meter is Located on the outside of your house

PROCEDURE:

- Have students read their home meters for a week and record their data. Examine the data together and discuss why some homes use more electricity than others. Calculate the cost per week using the current electric rate for your area (check an electric bill for this information).
 - Brainstorm with students and generate a list of ways students can reduce energy use in their homes. Ask for volunteers to try these energy saving ideas for a week. Compare these meter readings with the data collected earlier and see if there is any reduction in power usage. Calculate the cost savings.
 - Some homes use other forms of energy, in addition to electric power, which reduce the amount of electricity used. Compare a totally electric house with homes that use gas heat or wood-burning stoves. Calculate the total costs of energy for these types of homes (electricity plus cost of wood and so on).

FOLLOW-THROUGH:

Carry out a similar activity for natural gas or wood use. Average the energy sources together by converting to BTUs. (See "TRASH ENERGY ALTERNATIVE ACTIVITY" for BTU conversions.) Now compare different homes. Explain why some homes use more total energy.

Invite a representative from your local power company to discuss power conservation and job opportunities with the power company.

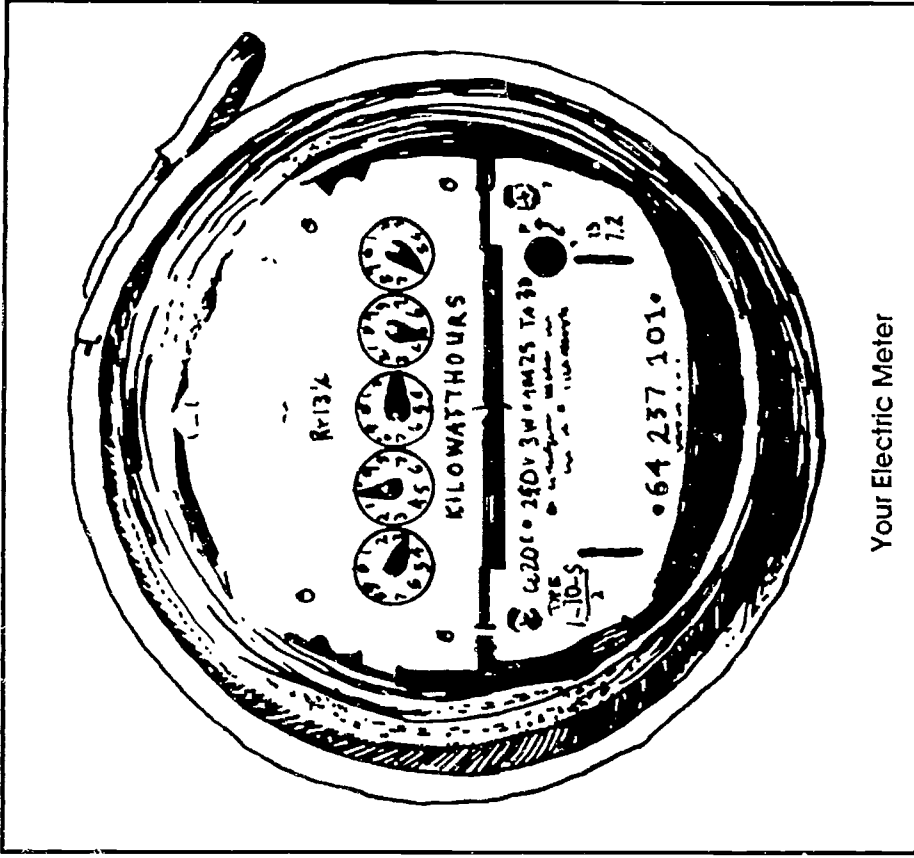

Your Electric Meter

STUDENT WORKSHEET

Practice reading an electric meter

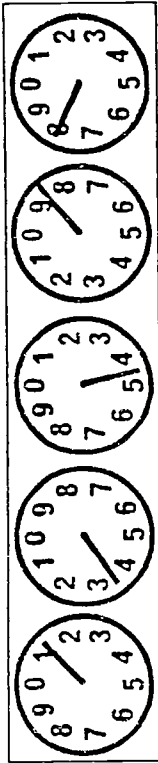

READING = 13488

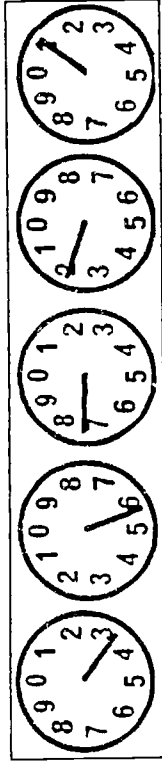

READING = _____

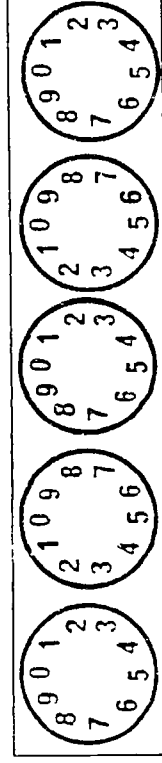

READING = 66190

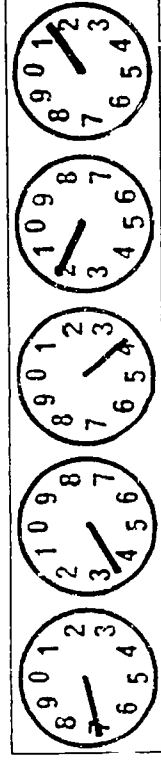

READING = _____

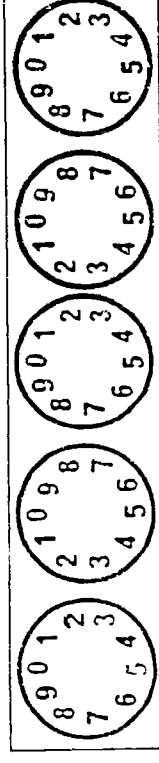

READING = 24713

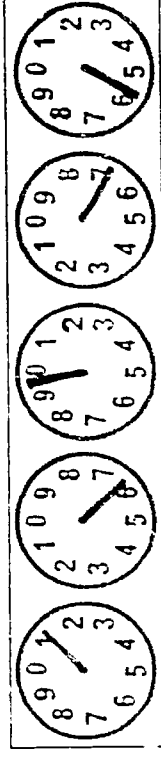

READING = _____

Take meter readings at home

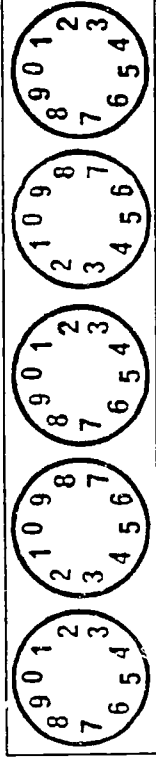

READING = _____ DATE _____

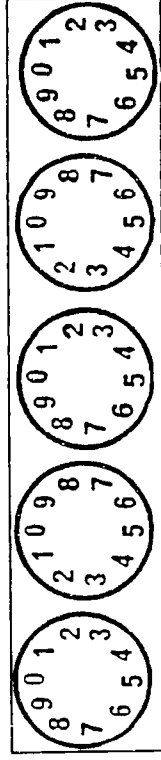

READING = _____ DATE _____

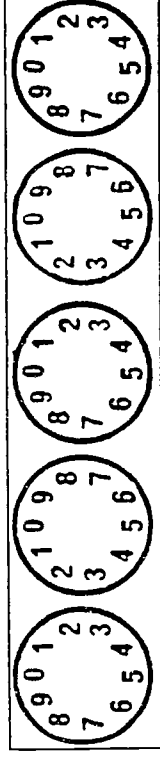

READING = _____ DATE _____

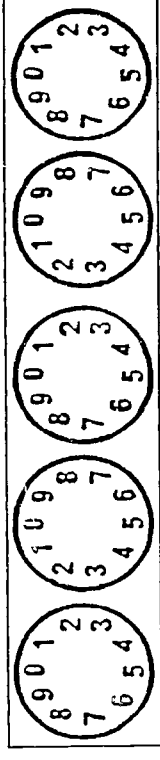

READING = _____ DATE _____

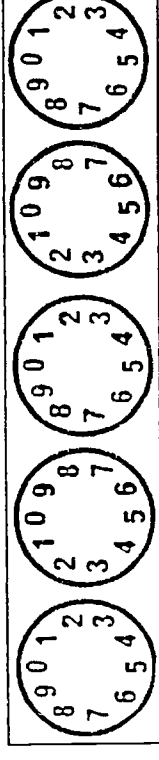

READING = _____ DATE _____

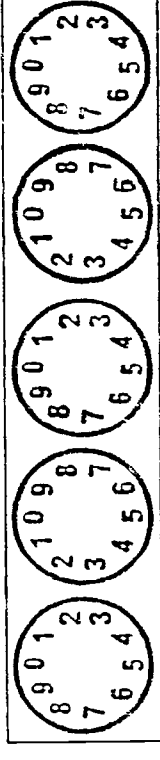

READING = _____ DATE _____

METER MATTERS - STUDENT DATA SHEET

Regular Energy Use

Week 1	S	M	T	W	TH	F	SA
Reading							
Daily kWh Used							
Daily Temp. High/Low							
RUNNING TOTAL kWh							

Week's Average =

Conservative Energy Use

Week 1	S	M	T	W	TH	F	SA
Reading							
Daily kWh Used							
Daily Temp. High/Low							
RUNNING TOTAL kWh							

Week's Average =

Future Homes



OBJECTIVES:

- (1) Students will research current solar energy technology and energy conservation practices in energy efficient homes. (2) Students will draw a model or blueprint of their desired home. See ENERGY RESOURCES matrix for background information.

MATERIALS:

newsprint or posterboards
felt crayons
solar energy references

PREPARATION:

Discuss this activity with students. Work with students to develop a list of resource materials to be used for this activity and where these can be found. Write TVA's technical library and request the "Solar Homes Design Portfolio" through interlibrary loan. Solar home blueprints may also be obtained from libraries, universities, cooperative extension services, architects, local lumber companies, and home builders. Note: The solar energy striking a building in the U.S. is 6 to 10 times the amount of energy needed to heat that building.

PROCEDURE:

Divide the class into groups of four or five students each. Ask the groups to list every possible use of solar energy and conservation

practices used in home building today to make a house energy efficient. Then assign a topic from the list to each member to research further. Have the students gather pictures, if possible, of energy saving devices.

When the group meets again, ask them to use the information gathered in their research to design an energy efficient home. Have them include any data, drawings of devices, or pictures that help explain the house. You may wish to have them build a model of the home or draw a blueprint. Then allow each group to present its house and explain why they designed the home the way they did.

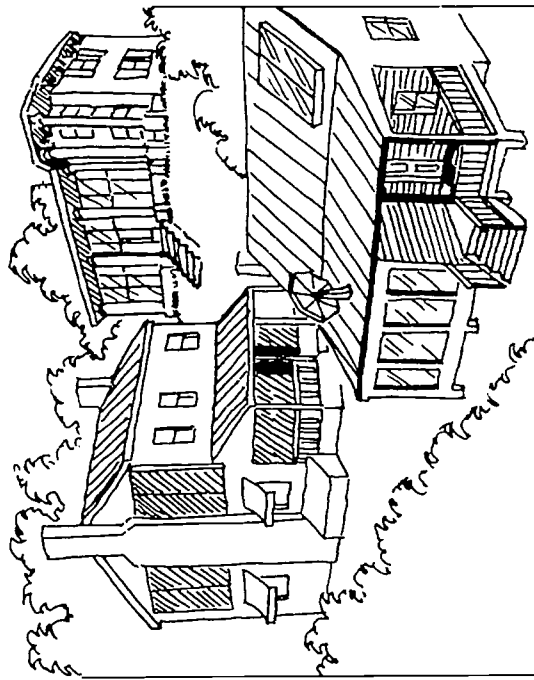

Thermal windows, solar wall heater panels, hot water collectors, solar (photovoltaic) collectors, sunspaces, and thermal curtains are a few of the many ways solar energy can be trapped and used.

WINDOW TREATMENTS TO CONSERVE ENERGY

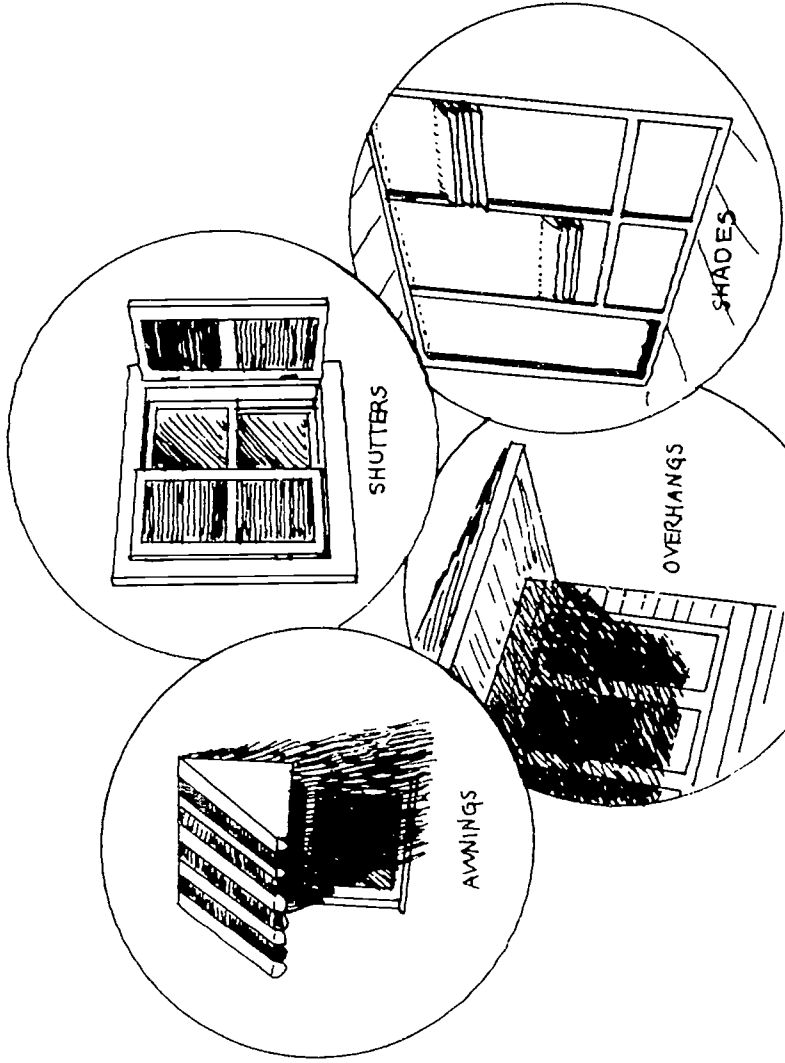

250

250

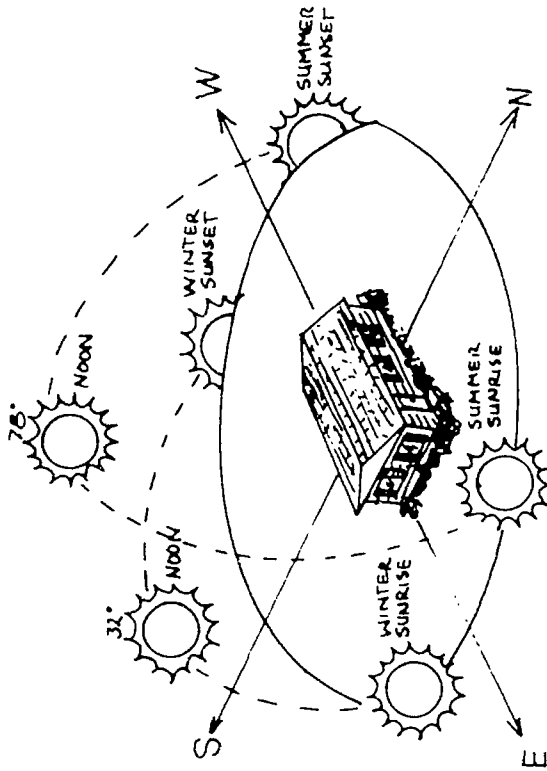

FOLLOW-THROUGH:

Conduct a scavenger hunt in your community. "Energy wise" buildings use a variety of conservation practices to reduce utility costs. Have students make a list of conservation practices used in "energy wise" buildings. Use this list to develop your scavenger hunt. Then divide the class into teams and provide each team with the list and either a polaroid camera with 1 or 2 packs of film or sketch pad and pencils. Each group should use the list to find these buildings in their communities. To prove that they found each, have them either take a photo or draw a picture of the energy saving practice. To prove they have been there, have them submit a map showing the exact location of the building and a statement of why this building is "energy wise." The first group to return with either photos or drawings is the winner.

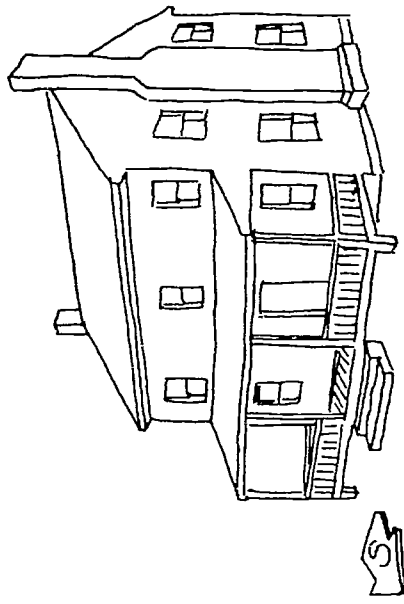

CONVERT AN EXISTING HOME TO SOLAR

If the porchside of this house faces south, it is a natural for solar energy, with a big, south-facing roof and a generous amount of south-facing wall space. Two solar hot water panels, enough for a family of four, fit on the roof. Upstairs, fan-assisted wall heater panels have been installed between the windows. Fans blow the hot air through ducts from the panels into second floor rooms. The front porch has been converted into a Sunspace, with glass on the south-facing walls. The closed-in and insulated east and west walls of the porch have windows that can be opened for ventilation. In the summer, the Sunporch can be shaded with trellises or shades. On winter nights, thermal curtains are drawn over all the windows in the house.

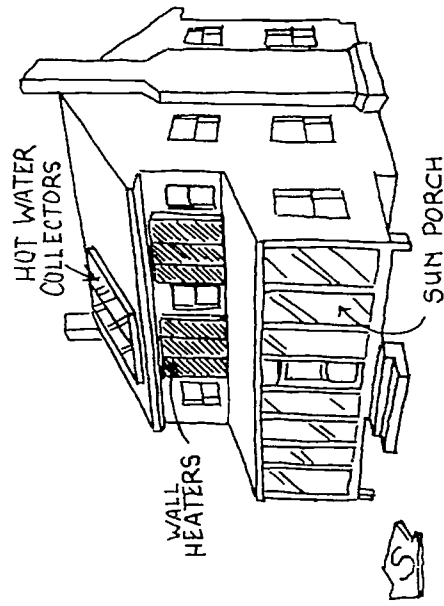

Fuel Eaters



OBJECTIVES:

Students will calculate the amount of time necessary to deplete the world energy supplies at the present rate of consumption. See ENERGY RESOURCES matrix for background information.

MATERIALS:

handout "Energy Content of World Resources" (included in activity)
colored pencils
graph paper

PROCEDURE:

Explain the handout "Energy Content of World Resources" to students. The International System unit of energy is joule. Each exajoules (EJ) is equal to 10^{18} joules (10 raised to the power of 18). Each box is equal to 250 exajoules.

Ask students to count the blocks that represent cumulative world consumption (see figure). Explain that it is this amount of energy that the people of the world will consume in the 25-year period 1975 to 2000. How many blocks are there?

Now, ask students to count the "total" number blocks—uranium, tarsands, oil shale, oil, coal, and natural gas (all blocks for every resource). Then have them count out this number of blocks on a piece of graph paper and draw a line around them. This is the total of world energy resources. Using a colored pencil, color in the boxes equal to cumulative world consumption from 1975-2000. Mark this 2000 AD.

Then switch to another color and, again, color exactly the number of blocks that we consume in a 25-year period (as above). Mark this 2025 A.D. Tell students the uncolored blocks represent the energy that will be left in the year 2025.

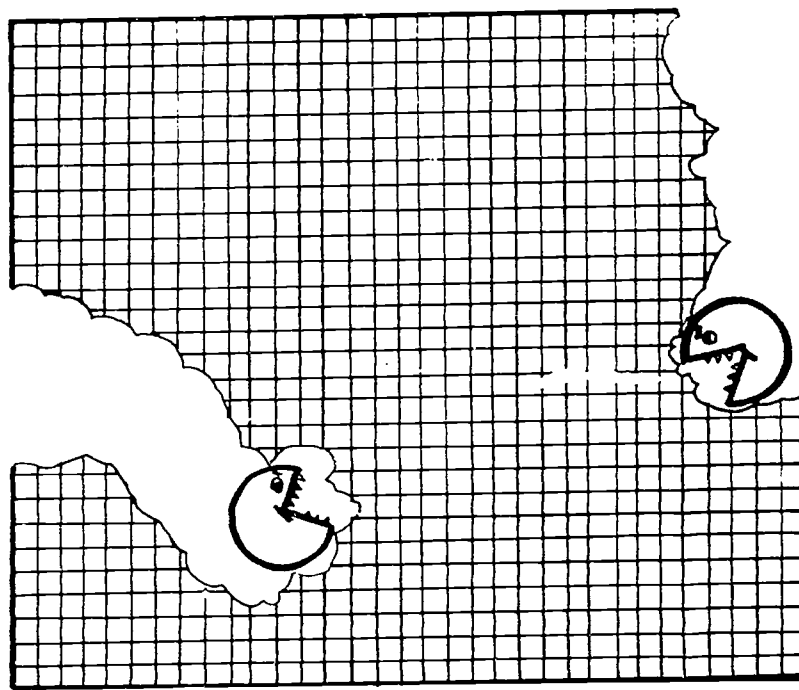

Repeat this process using different colored pencils until all of the energy is used up. What year did this happen? How many years were required to consume all of the energy resources? What kind of resources are not represented in the handout?

Refer to the diagram "World Consumption of Renewable and Nonrenewable Energy Sources for 1984", and the relative amounts of the energy resources listed in the handout. Which of the resources in the handout will be used up the fastest? Which will last the longest (use of all energy resources) if these energy sources are used at 1984 rates? How might an increase in percent use of resources affect the lifespan of our nonrenewable sources?

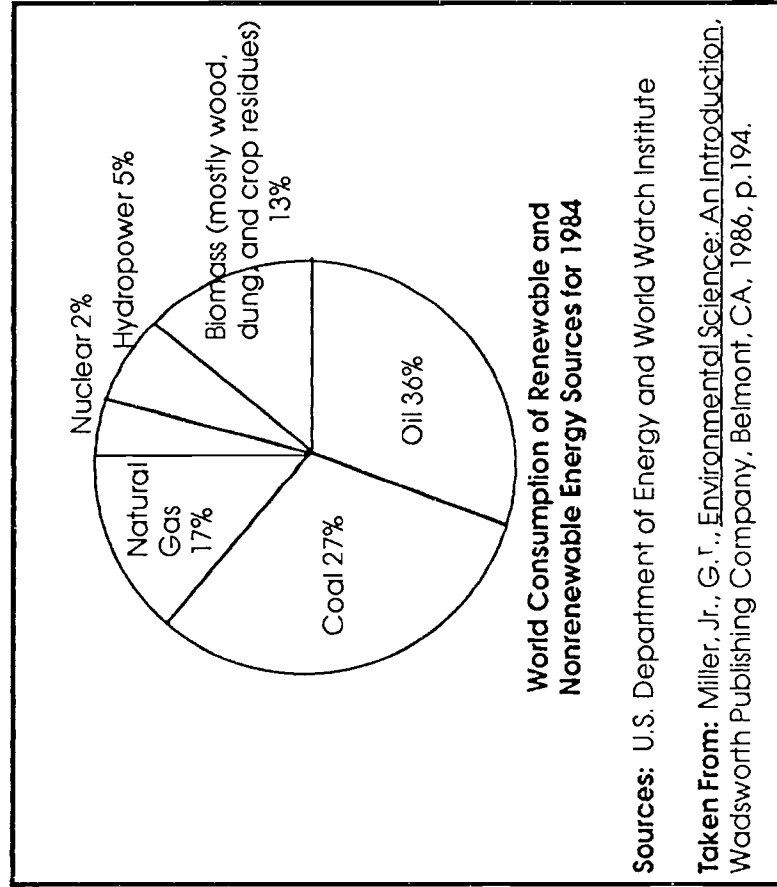

FOLLOW-THROUGH:

Bake a rectangular cake. Ask students to determine its surface area. Let this total area represent the total amount of energy content of world resources. Divide the cake into bites or pieces that equal cumulative world consumption for the past 25-year period. How many pieces of cake are there? Divide the class into groups: parents, children, children's children, and so on, for several generations. Let parents take the first pieces of cake, children the second pieces, and so on. What generation will not have cake? (Have another cake hidden ready for these children that are left out.)

Have interested students find the energy content of the United States resources. How long will these resources last at the present rate of use? If energy use increased each year, how would this fact decrease the expected lifetime of various energy resources? Graph an exponentially increasing energy-use curve.

STUDENT HANDOUT

ENERGY CONTENT OF WORLD RESOURCES

☐ = 250 Exajoules

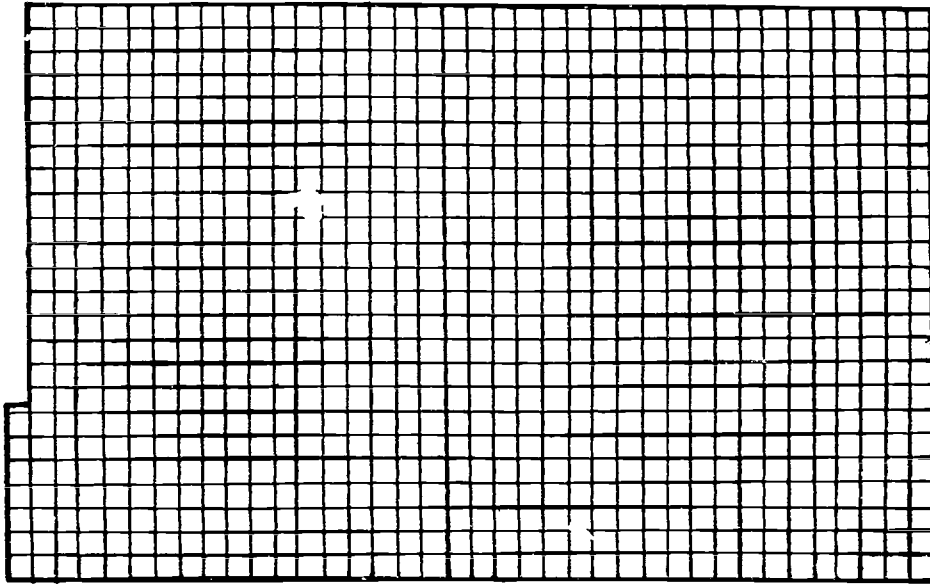
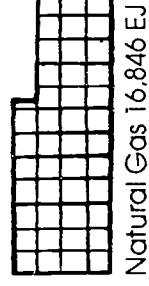
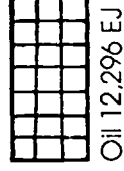
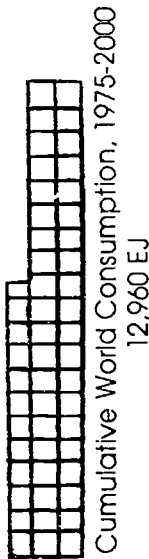

*This figure is very low because it includes only the "reserves" and "probable" resources of uranium. In proportion, U.S. resources in these categories total 1.7 million metric tons or 249 EJ.

Source: U.S. Geologic Survey. Professional Paper 820, 1973.

(Taken from: Fowler, J. M. Energy and the Environment. (New York: McGraw-Hill) 1975.

Trash Energy Alternative



OBJECTIVES:

(1) Students will measure the amount of waste paper the class throws away in a week. (2) Students will determine the BTU's of energy that could be generated if the waste paper was burned to make electricity. See ENERGY RESOURCES matrix for background information.

MATERIALS:

box or drawer
classroom paper trash
bathroom scale or triple-beam balance scale

PREPARATION:

Many of the things that we throw away every day can be burned to produce heat. These things are a source of energy that currently is being wasted. This demonstration will show one way to convert trash into fuel.

PROCEDURE:

Set aside a box or drawer in the classroom and begin to save paper. Weigh the box and record on a data table. When you discard paper, do not crumple it, but place it in the box. At the end of the week, weigh the amount of paper your class has thrown away. Be sure to subtract the weight of the box.

Use the estimate: 1 pound of paper is equal to 5000 BTUs of heat. Convert the weight of paper to BTUs by multiplying the weight in pounds by 5000. For example: 32 lbs. x 5000 = 160,000 BTUs (per week).

Multiply the class figure per week by the number of classes in the school. Then multiply that number by the number of weeks in the school year to determine how many BTUs are being wasted at your school in one school year.

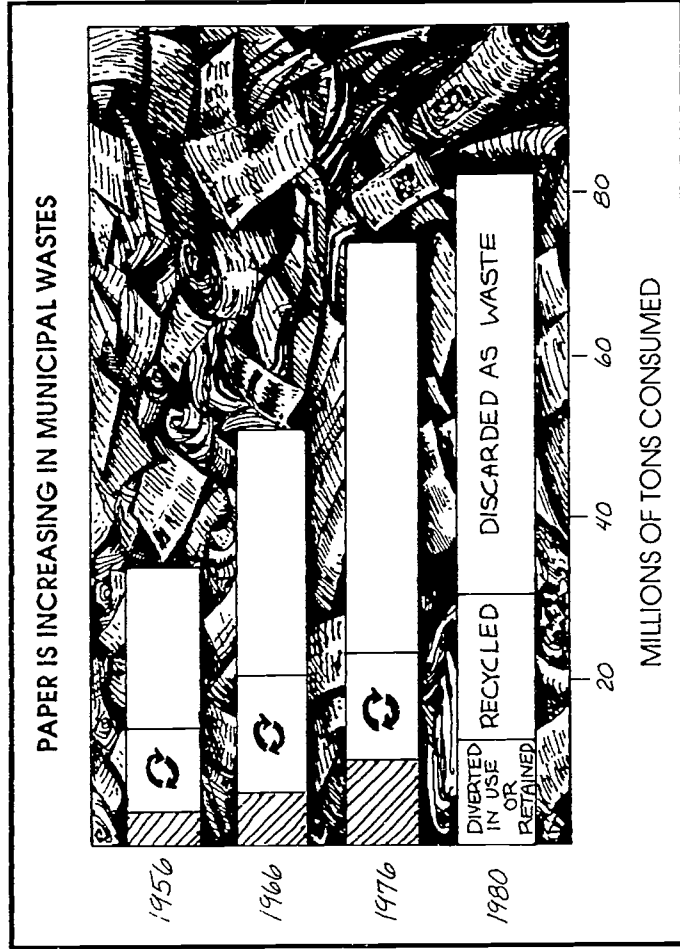

One standard kilowatt-hour is equal to 3412 BTUs of energy. (One BTU is equal to about one match striking.) From the information above, determine how many kilowatt-hours of energy are stored in the paper that is wasted by your school in a year.

Examine the graph "Paper is Increasing in Municipal Wastes" on the previous page. Can you predict the amount of paper waste in 1986 and 1996? Convert the annual figures on the graph into BTUs and kilowatts. Find out how much electricity in BTUs is used each year in the United States. What percentage of this electricity could be produced by burning waste paper?

Use the second illustration to determine how much paper could be recycled. To determine how much paper would be left after recycling, convert the percent to a decimal, multiply it times the BTUs from paper and subtract the amount from the total. This reduces the amount which could be used for electricity. Why then might we want to recycle?

FOLLOW-THROUGH:

Write to Gallatin or Nashville, Tennessee, concerning their solid waste energy facilities which generate electricity. Would co-generation be possible in your town? What are the environmental problems associated with incineration plants?

Electronic or paperless offices will use a large percent of paper in the future. How will this affect the amount of waste paper available to generate electricity? Will this affect waste to energy electric plants like the one in Gallatin or Nashville?

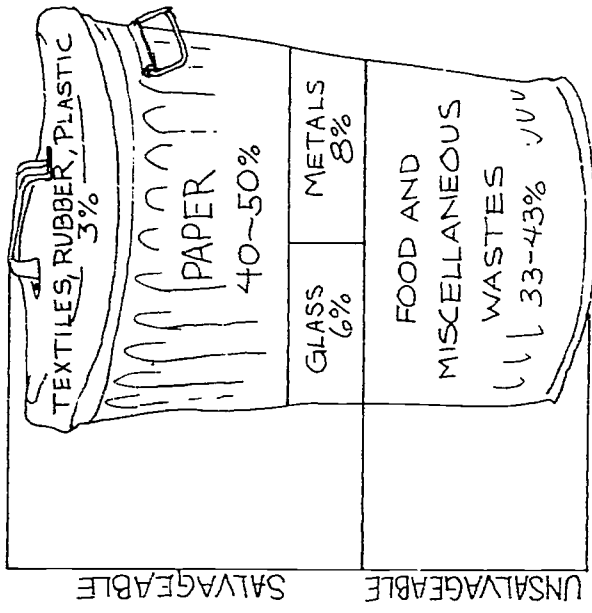

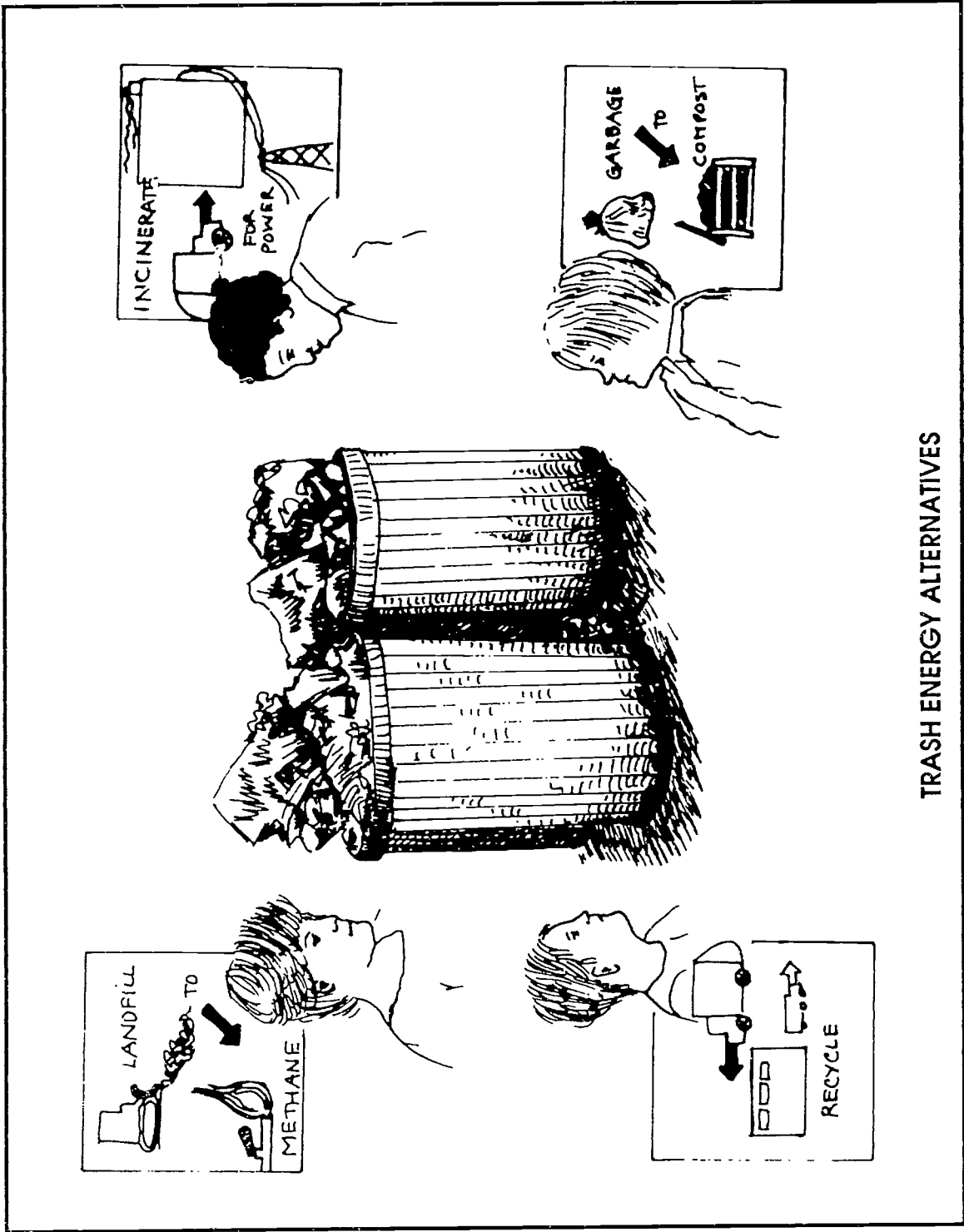

TRASH ENERGY ALTERNATIVES

Solar Energy Alternative



OBJECTIVES:

Students will observe a solar cell producing electricity and discuss large scale applications of this device in electric power production in the United States. See ENERGY RESOURCES matrix for background information.

MATERIALS:

silicon solar cell
 block of wood
 galvanometer or voltage meter
 compass
 cardboard
 small spool of magnet wire (#28 wire or finer)
 two small alligator clamps
 tape
 solder
 flashlight or table lamp
 glass, plastic, or cellophane

PREPARATION:

Attach two 12-inch wires to the solar cell with solder. Tape the cell to the block of wood to secure it so students can handle it conveniently. Set the solar cell aside.

Next, build a simple but very sensitive device, a galvanometer, to show that the cell can actually produce electricity. Making one is easy. Cut and fold two pieces of cardboard and glue them

back-to-back, as shown in the drawing. Lay the compass inside the folded-up side. Then, wind about 100 turns of magnet wire around the compass and cardboard stand. Make sure that coiled wire is wrapped tightly in the center so that it covers as little of the compass as possible. This will make reading the compass easier.

When finished, twist the ends of the coil to keep them from unwinding. Trim these ends to about 12" in length. Then scrape 1/2" of the enamel from the wire tips and install the alligator clamps.

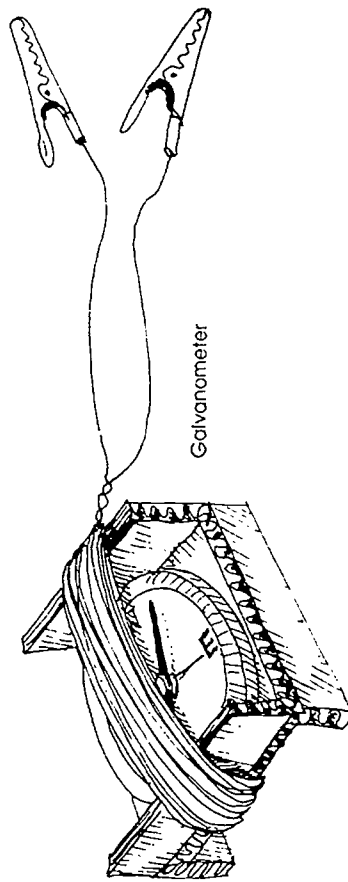

PROCEDURE:

Older students can make the galvanometer. Provide equipment for several small groups.

Connect the silicon solar cell and the galvanometer as shown. Arrange the compass so that the coil lines up with the needle.

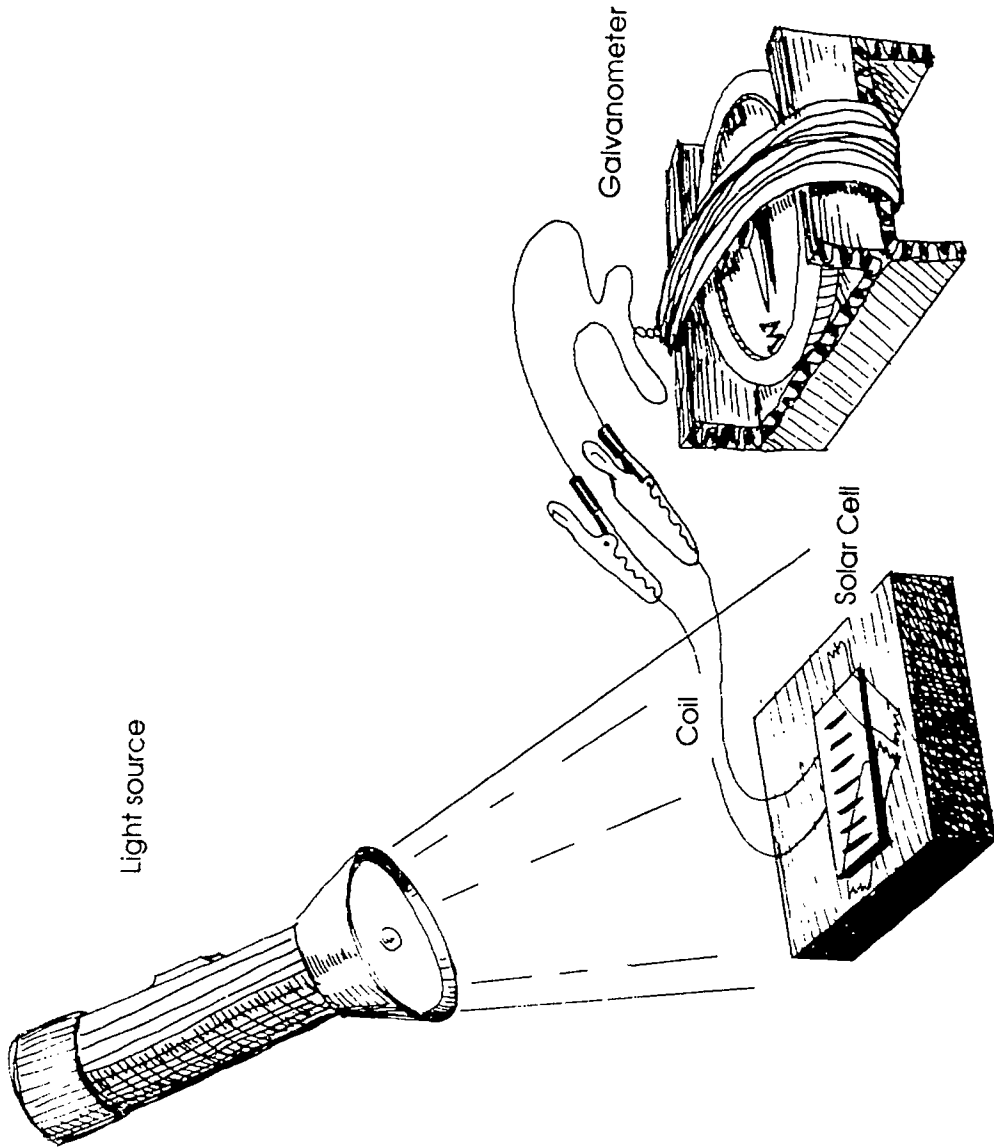

In California, commercial power plants are using solar water collectors to generate electricity and provide this to consumers much like any other power plant. Have students find out more about this new technology (Solar Power Tower). For more information contact the Electric Power Research Institute, P.O. Box 10412, Palo Alto, California 94303 or (415) 855-2000.

When you expose the solar cell to light from the sun, a flashlight, or a table lamp, the compass needle will move. Here's why. The electric current produced by the solar cell flows through the coil and produces a weak magnetic field in the E-W direction. This magnetic field tries to pull the compass needle in that direction. The stronger the electric current, the more it will pull the compass needle in the E-W direction.

Vary the light reaching the silicon solar cell by blocking it with glass, plastic, or colored cellophane. Now ask the students to observe what happens to the compass and record their observations. Use lenses and mirrors to concentrate the light on the solar cell. What effect does this have on the voltage produced? On a cloudy day, you can substitute flood lights for the sun.

Most commercial solar cells come with information on the cost of the solar cell, the efficiency rating, and the expected peak voltages and wattages. Ask students to calculate how many cells would be needed to provide energy for an average size house (about 1000 watts). Using the cost per solar cell, have students multiply to determine the cost of the cells needed to produce this electricity? (Most commercial solar cell projects require larger more expensive solar cells, regulators, converters, and storage devices, however your estimate using the smaller solar cells should give you a "ballpark" estimate.) Why aren't solar cells utilized on a larger scale in the Valley?

FOLLOW-THROUGH:

Ask students to find out more about solar cells—concentrate on efficiency, new technology, energy trends, and other factors that might reduce the cost of using solar cells. Solar cells are used to power satellites. Developing countries are using solar cells in communication to power devices like radios, televisions, and telephones. Farmers in the U.S. are using solar cells to power electric fences and homeowners are using them to power outdoor lights. When might using solar cells on a large scale be economically sound?

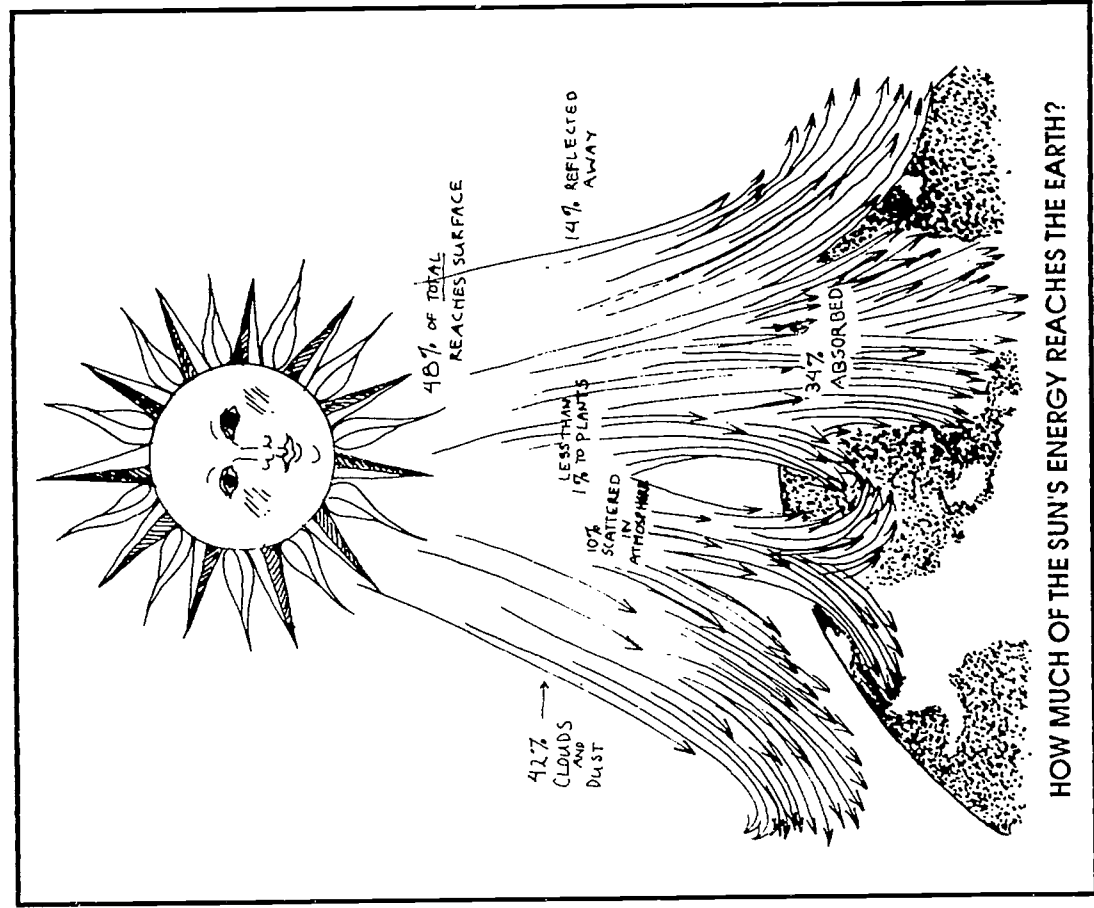

HOW MUCH OF THE SUN'S ENERGY REACHES THE EARTH?

SOLAR HOME HEATING FEASIBILITY

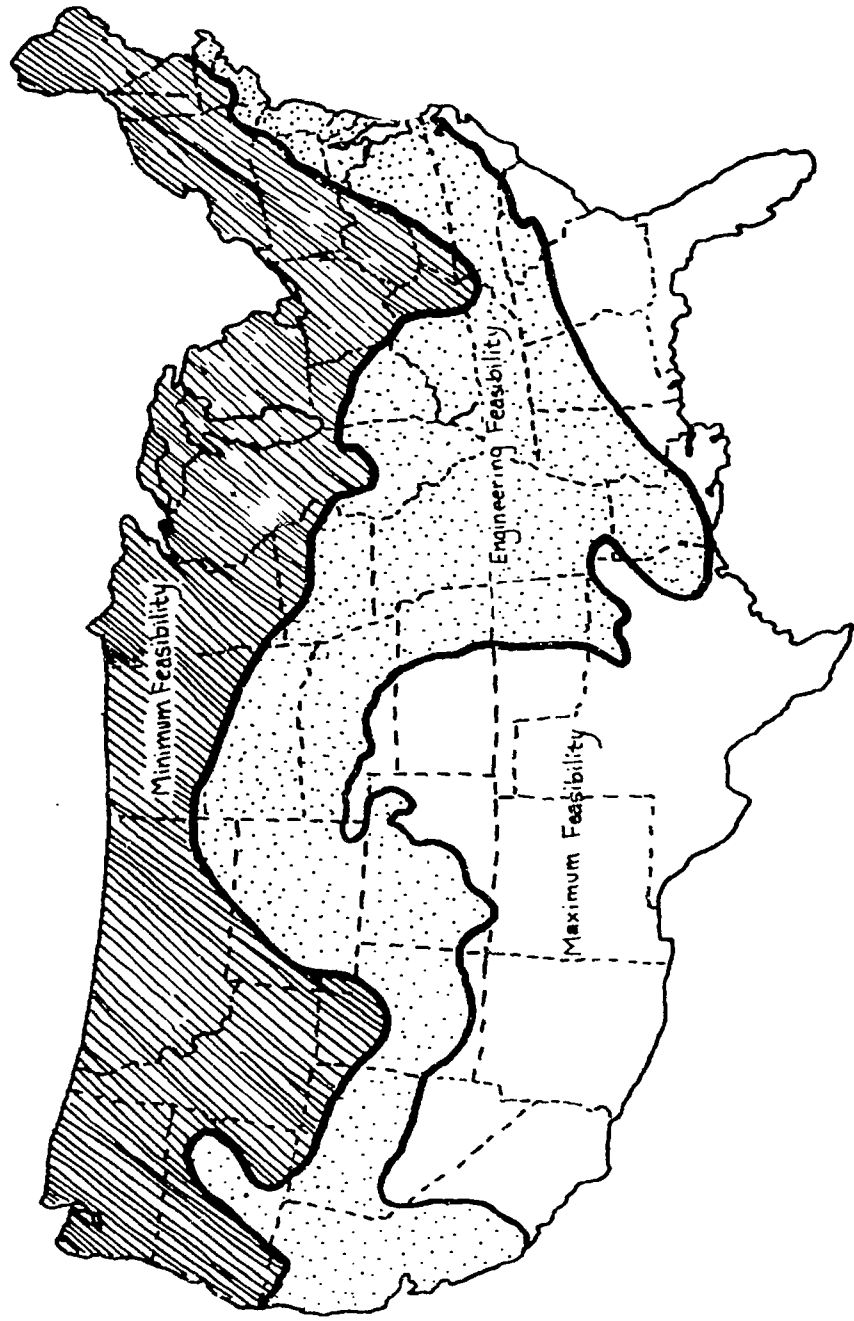

Regions of the different degrees of feasibility of heating houses by solar energy.

Maximum Feasibility - may be entirely heated

Engineering Feasibility - only a portion of heat can be obtained

Minimum Feasibility - only a small part of space heating can be provided

(Information Source: Energy Sources, The Wealth of the World, Ayres and Scarloft (New York: McGraw-Hill, 1952)

Fuel Cell Alternative



OBJECTIVES:

(1) Students will construct a model fuel cell. (2) Students will discuss the role of fuel in our energy future. See ENERGY RESOURCES matrix for background information.

MATERIALS:

nonmetallic mesh tube (plastic hair roller)
 rubber band or string
 thin sheet of metal (zinc or galvanized steel - 9 cm x 5 cm)
 large gauze pad or paper towel
 powdered graphite (one tube of powdered graphite lubricant recommended)
 flour
 salt
 water
 saucer
 galvanometer (see the activity "SOLAR ENERGY ALTERNATIVE")

PREPARATION:

Making a real fuel cell is difficult because the right materials are either dangerous or difficult to get in small quantities. The device in this activity is considered to be a form of fuel cell. It uses zinc as the fuel (one electrode), air as the oxidant (the other electrode), and salt water as the electrolyte.

Ask students to research zinc and hydrogen fuel cells to determine what materials are necessary to make real commercial fuel cells.

PROCEDURE:

First, pour all of the graphite into a mixing container. In a separate container, prepare a mixture of one part flour and four parts water. Add this to the graphite, a little at a time, stirring continuously. Continue until there is a consistency of thick paste, like peanut butter.

Cut two strips as wide as the hair roller and about 18 cm long from the gauze pad. (If you do not have gauze, try a paper towel; fold it into four layers and cut it to size.) Lay one gauze strip down and apply the graphite paste to the first 8 cm. Cover the entire width.

To assemble the air electrode, lay the hair roller on the paste and begin to roll the strip around the roller. Wrap the entire strip onto the roller. Put rubber bands or string around the gauze wrap and set the unit aside to dry (at least 24 hours).

For the zinc electrode, roll the length of the zinc (or galvanized steel) into a tube small enough to fit inside the air electrode (but do not insert it yet). Wrap the second gauze strip around the zinc. After the air electrode has had a chance to dry out, insert the wrapped zinc electrode into the tube core. It should be a snug fit. Prepare the electrolyte by dissolving a tablespoon of salt in two or three tablespoons of hot water and pour into a saucer.

FOLLOW-THROUGH:

How are fuel cells currently being used (space vehicles, remote TVA broadcasting, or home video recorders, etc.)? How might fuel cells be used in the future? What would be some of the advantages of using fuel cells for powering vehicles or providing electricity?

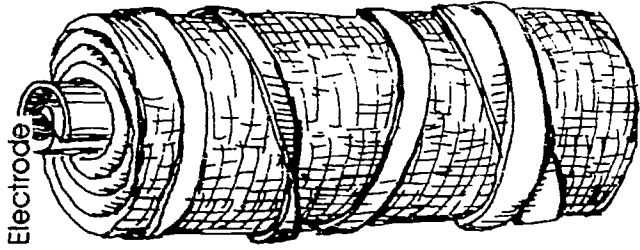

Graphite Soaked Gauze

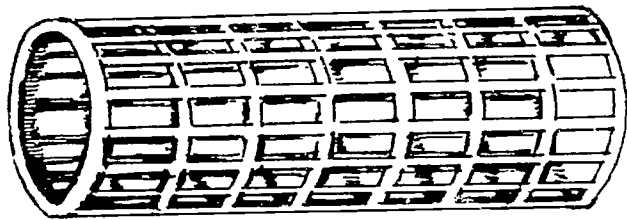

Plastic Hair Roller

To test the battery, clip one of the alligator clips from the galvanometer (see the activity "SOLAR ENERGY ALTERNATIVE" for directions on how to make one) to the top of the zinc electrode. Clip the other to the graphite on the air electrode; this clamp must bite into the graphite. Cut away some of the gauze, if necessary, to ensure such contact. Stand the fuel cell in the saucer. As the salt water soaks into the gauze, electrochemical action should start. Observe what happened to the compass. Is the fuel cell generating electric current? Substitute a dry cell battery for the fuel cell. What effect does this have on the galvanometer? How are D-cell batteries made? Compare a D-cell battery to your fuel cell.

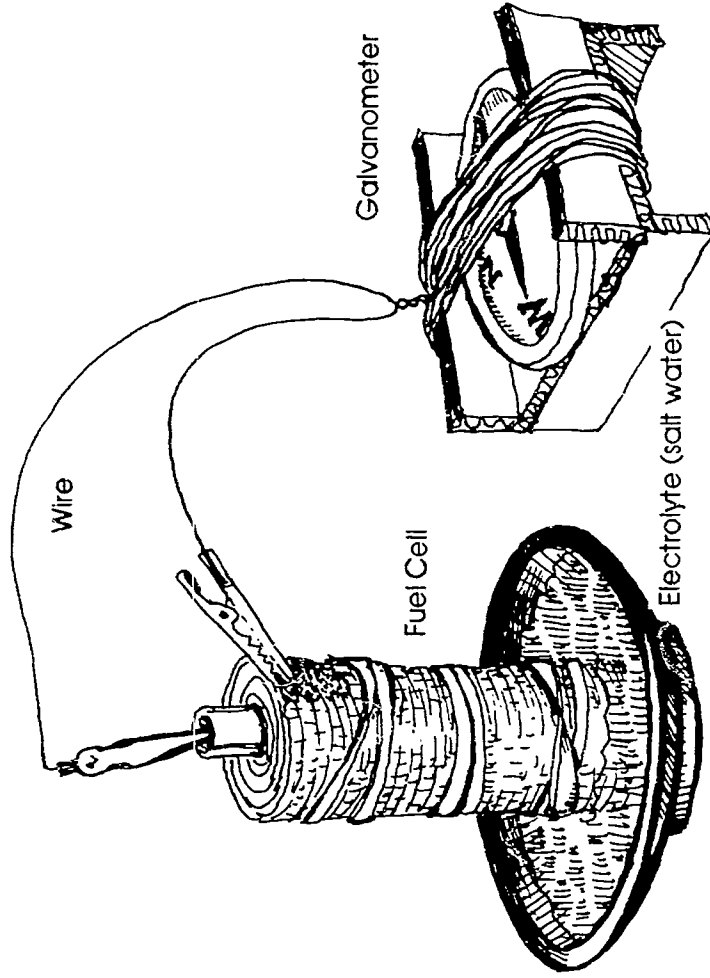

Insulation



OBJECTIVES:

Students will experiment with materials to determine the best insulator. See ENERGY RESOURCES matrix for background information.

PREPARATION:

Prepare boxes by cutting windows in all four sides as shown below. Make several for groups to use. Place the lamp in the center of each box. Plug in the lamps to make sure the bulbs work.

MATERIALS:

100-watt light bulb in a ceramic socket
various materials:
wood, aluminum foil, glass, plastic,
newspaper, cloth, other
thermometers
cardboard box
masking tape
clock

PROCEDURE:

Have students to work in groups. Provide each group with a box and lamp. Then have each group decide which materials they would like to test and predict the insulating ability of that material. Record your predictions to refer to later.

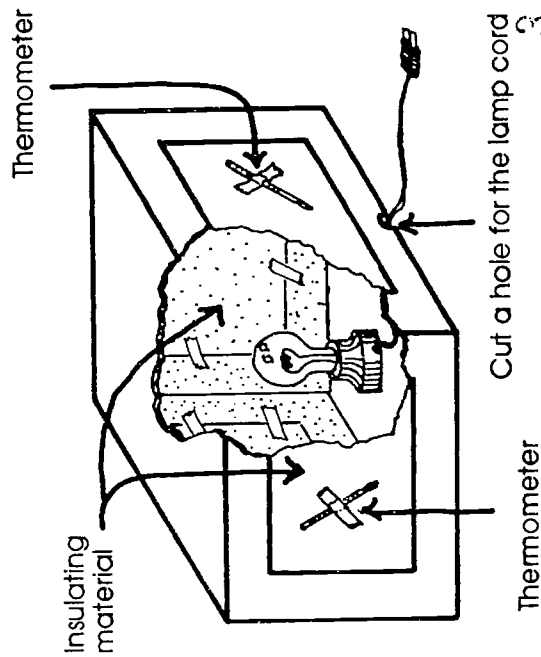
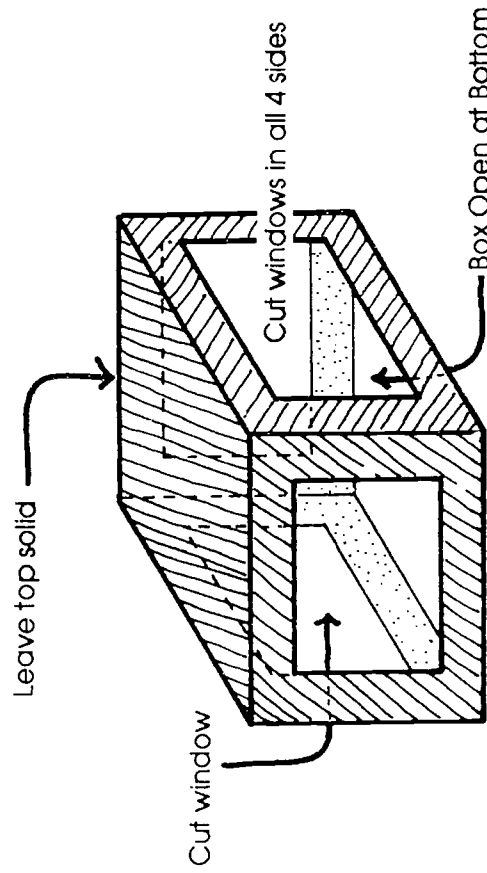

Insert insulating materials over the holes and tape as shown, tape thermometers to the outside of the insulating material, and turn the lamp on for 5 minutes. Record the rise in temperature for each material (See student data chart example at the right).

Discuss the results with the class. Are some materials better insulators of heat than others? Which of the materials was the best insulator? Why is full insulation now required in new houses?

Try making "double layers" of insulation materials with a dead air space between the layers. How does it affect the insulating ability of the material?

FOLLOW-THROUGH:

Have the students investigate what types of insulating materials are used in their homes. What materials were used most commonly? Why? Does the data you gathered in the activity show that the materials commonly used in homes are the best insulators?

Recently, environmentalists have questioned sealing up homes tightly with insulation. Why? (See Air Factsheet, "Indoor Air.")

STUDENT DATA CHART

Material:	Temperature °C	
	Before	After
Wood		
Aluminum foil		
Fiberglass		
Glass		
Metal		
Newspaper		
Clot		

Draft-O-Meter



OBJECTIVES:

Students will conduct investigations to determine energy loss in a given area. See ENERGY RESOURCES matrix for background information.

MATERIALS:

pencils
tape
plastic food wrap
thermometers
reference materials on home energy conservation

PREPARATION:

Make several draft-o-meters for the class to use by cutting 12 cm by 25 cm strips of plastic food wrap. Tape one edge of a strip to each pencil and let the rest hang freely. To test the devices, blow the plastic wrap gently and note how sensitive the wrap is to air movement. Drafts cause either a loss of heat in winter or a loss of "cool" (air conditioning) in summer.

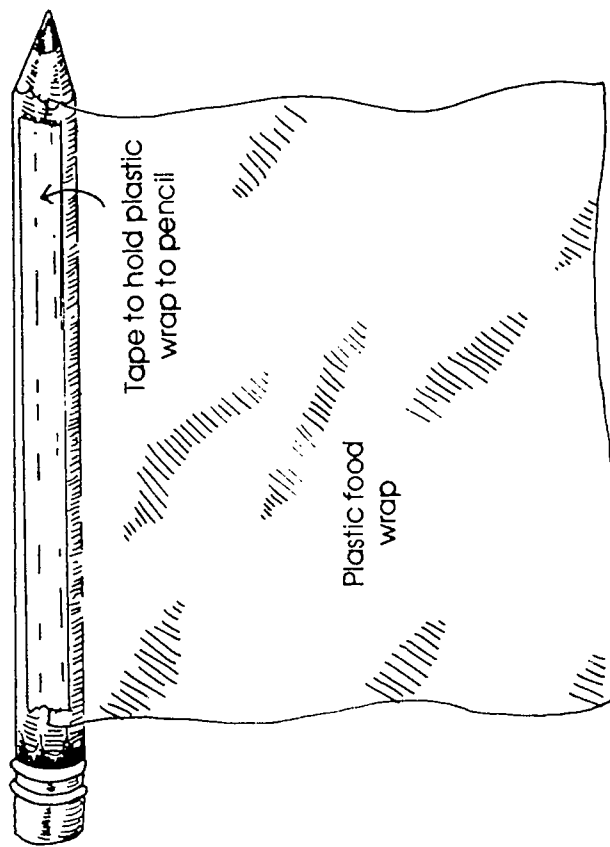

PROCEDURE:

Demonstrate how to use the Draft-O-Meter. Any movement will indicate a draft. You might want to devise your own method for describing the "strength" of the drafts. For example, only a slight movement would be a "small" draft, if the sheet quivers, it would be a "medium" draft, and if the sheet extends out like a flag it would be a "large" draft. Divide students into groups of three. One will record

the data, one will read the thermometer, and one will use the Draft-O-Meter. Have students predict where there might be drafts in your classroom and school building. Have them write this down and then have students test for drafts, have them record their results (see data chart). Where were the strongest drafts? Why? What could be done to prevent it? Have students brainstorm or use reference materials to determine recommendations. Fill this information in on the data table. Discuss the groups results as a class.

STUDENT DATA TABLE

Location	Draft Strength			How could you conserve energy here?
	Small	Medium	Large	
Classroom Window	X			Use rope caulk to seal air leaks.
Classroom Door			X	Keep door closed, roll up towel and lay at bottom of door when closed.

FOLLOW-THROUGH:

Conduct this investigation in their own home or a local business. What could the owner do to decrease drafts and conserve energy?

Can A Can Or Recycle It?



OBJECTIVES:

- (1) Students will perform calculations to determine the amount of energy needed to produce a can. (2) Students will calculate how much energy is saved by recycling a can. See ENERGY RESOURCES matrix for background information.

MATERIALS:

handout - Soup Can Container Energy Cycle (included)

PREPARATION:

Explain what a BTU is. (See "TRASH ENERGY ALTERNATIVE" activity for BTU definition.)

PROCEDURE:

Ask the students to help you draw the energy cycle of a single tin soup can on the blackboard. Begin with mining the tin and follow the can through disposal at a landfill. When they are finished, ask them if they left out any "energy consuming" steps such as transportation or opening the can to? Don't forget the label! Use the handout to add any steps which might have been left out. Then ask the students how they would change the drawing to show how the can could be recycled?

When you are finished doing this, pass out the handout, "Soup Can Container Energy Cycle" provided with the activity. Have them look over the handout carefully. Ask them to tell you what kinds of energy did each step require such as gasoline, electricity (from coal), and so on until you have defined the type of energy for each step in the process.

Then, ask the students to total the BTUs for each type of energy used. First have them total all the BTUs required to make one can and dispose of it in a landfill. Next have them total how many BTUs it would take if the can were recycled. Subtract this amount from the total to landfill the can to determine how many BTUs would be saved recycling one can. What kind of energy in BTUs would be saved by recycling the can?

Using the chart included, "BTU Equivalents," convert the BTUs of energy into their equivalents. For example, if you saved 200 BTUs of gasoline by not having to mine the tin ore, it would equal 200 divided by 124,240 to equal 0.016 gallons of gasoline savings per can. If the cans were recycled and not littered you would save 10 BTUs per can or 50 seconds of walking. Have the students estimate how many tin cans they use in their homes in one week, one month, and one year. Calculate the energy savings if the cans were recycled.

During the World Wars, U.S. citizens were encouraged to recycle their tin cans. Today, tin cans are not recycled because they are made of steel covered with tin and it would take a complex multi-step process to recycle them.

BTU EQUIVALENTS

1 KWh electricity	3,400 BTUs
1 ton coal	26,200,000 BTUs
1 barrel (bbl) fuel oil	5,825,400 BRUs
1bbl crude oil	5,800,000BTUs
1bbl gasoline	124,240 BTUs
1 cubic foot (cu. ft.) natural gas	1,032 BTUs
1 cord wood	20,960,000 BTUs
5 seconds walking	1 BTUs

Recycling one pound of aluminum cans (26 or 27 cans) saves 7.5 kWh of electricity. If the average cost of one kWh was 5.6 cents, how much money could be saved by recycling these cans?

You might want to start your own class recycling center (see Cultural activity "WASTING WASTE").

FOLLOW-THROUGH:

Have the students repeat the activity using a single aluminum can. In 1983, the production of one aluminum can required 6,365 BTUs to mine and transport the ore, to produce the aluminum from the ore, and fabricate the metal into a can. Recycling aluminum requires 92 percent less energy than mining and producing aluminum ore. Use this information and the other information on the Soup Can Container Energy Cycle to make a handout similar to the one provided in this activity. Answer the same questions asked in the activity.

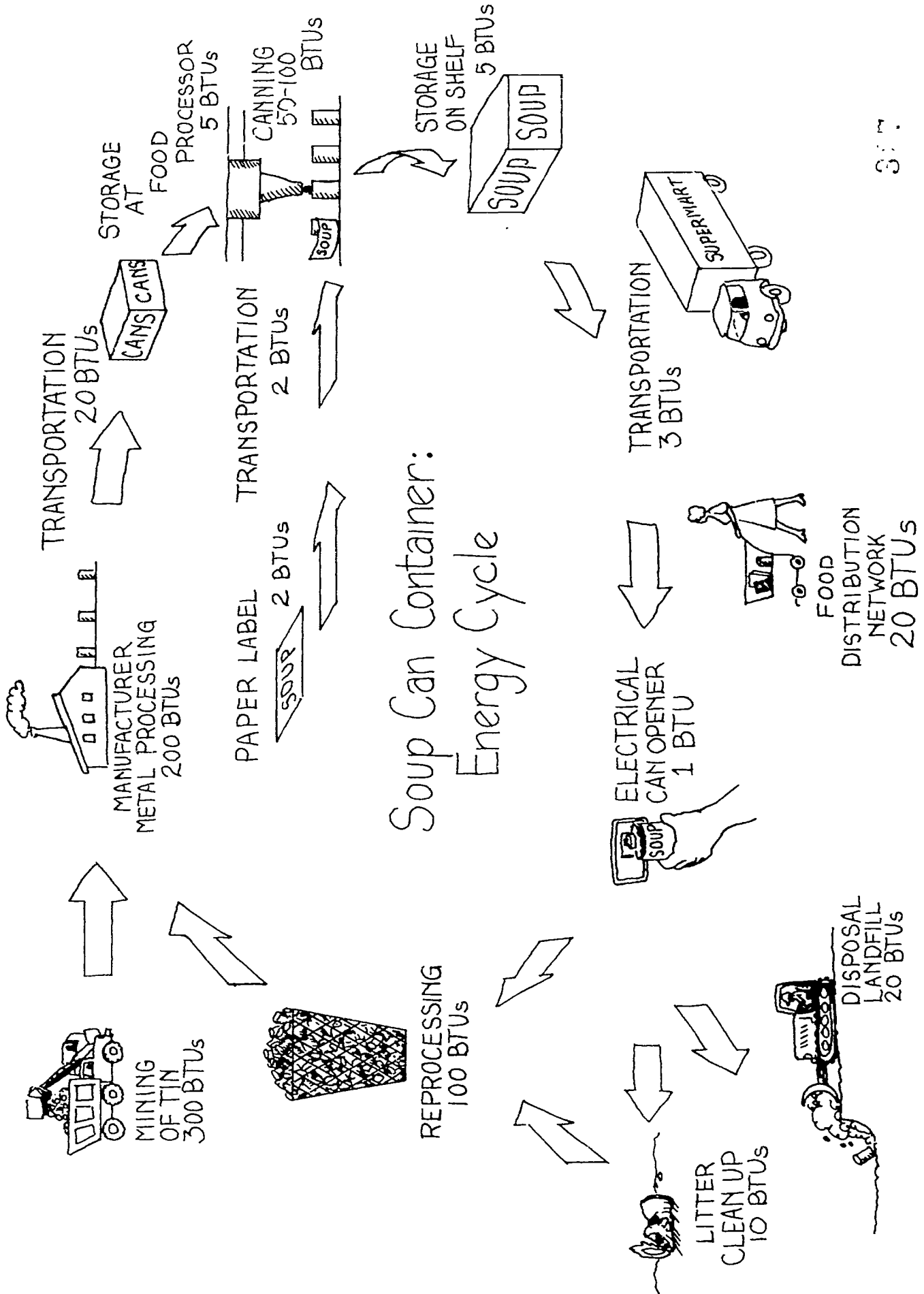

Energy Flow Model



OBJECTIVES:

(1) Students will prepare a model of energy flow using water to represent energy. (2) Students will use the energy flow model to demonstrate the Second Law of Thermodynamics. See ENERGY RESOURCES matrix for background information.

MATERIALS:

2-liter size plastic bottles (remove tops)
ice pick (to punch holes)
pegboard (or cardboard)
glue or tape
large container (or hose)
scissors
felt crayons

PROCEDURE:

Form teams of two or three students each. Students will make the model shown in the diagram by gluing or taping plastic bottles to the piece of pegboard. Punch holes in the sides of the containers so water flows into the container below.

The object of the game is for the team to pour water into the top container only and continue pouring until the bottom container is full. Any water that does not flow into a lower container is lost as energy waste in the sink. The first team to fill its bottom container wins. (If there is only one sink, do this activity outside or time each team and compare times; the team taking the least time wins.)

Hint: More holes near the top will speed a team up, but too many holes will cause the water to dribble out as waste.

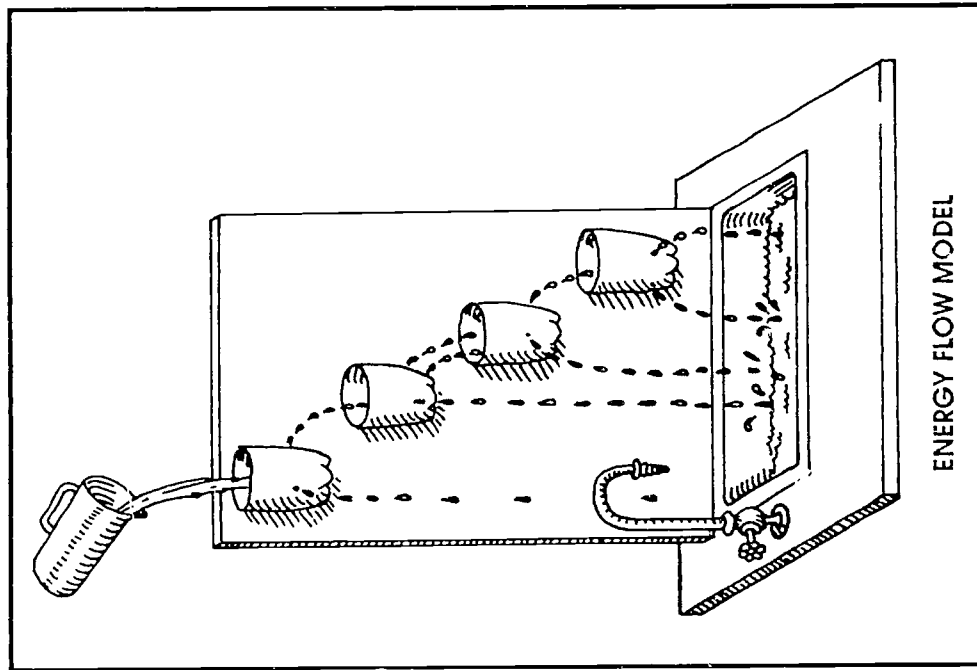

Discuss the results of the activity. How is the bucket full of water like the sun? Why is less energy available at each lower level? All of the energy coming in is eventually wasted in the sink. Draw a diagram or have students draw a diagram from this model to show energy flow through the environment. Why are four levels all that can receive energy in this model? To make this activity more realistic, have students punch one "energy to x" hole that empties into the sink for every hole that can successfully pass water to the next level.

FOLLOW-THROUGH:

Use the model to show energy loss in power generation. Let the first level represent the sun forming plants; the second can be coal to heat; the third level can represent steam to electricity; and the last level can be electricity to light (or heat or other work). Energy is lost throughout the system.

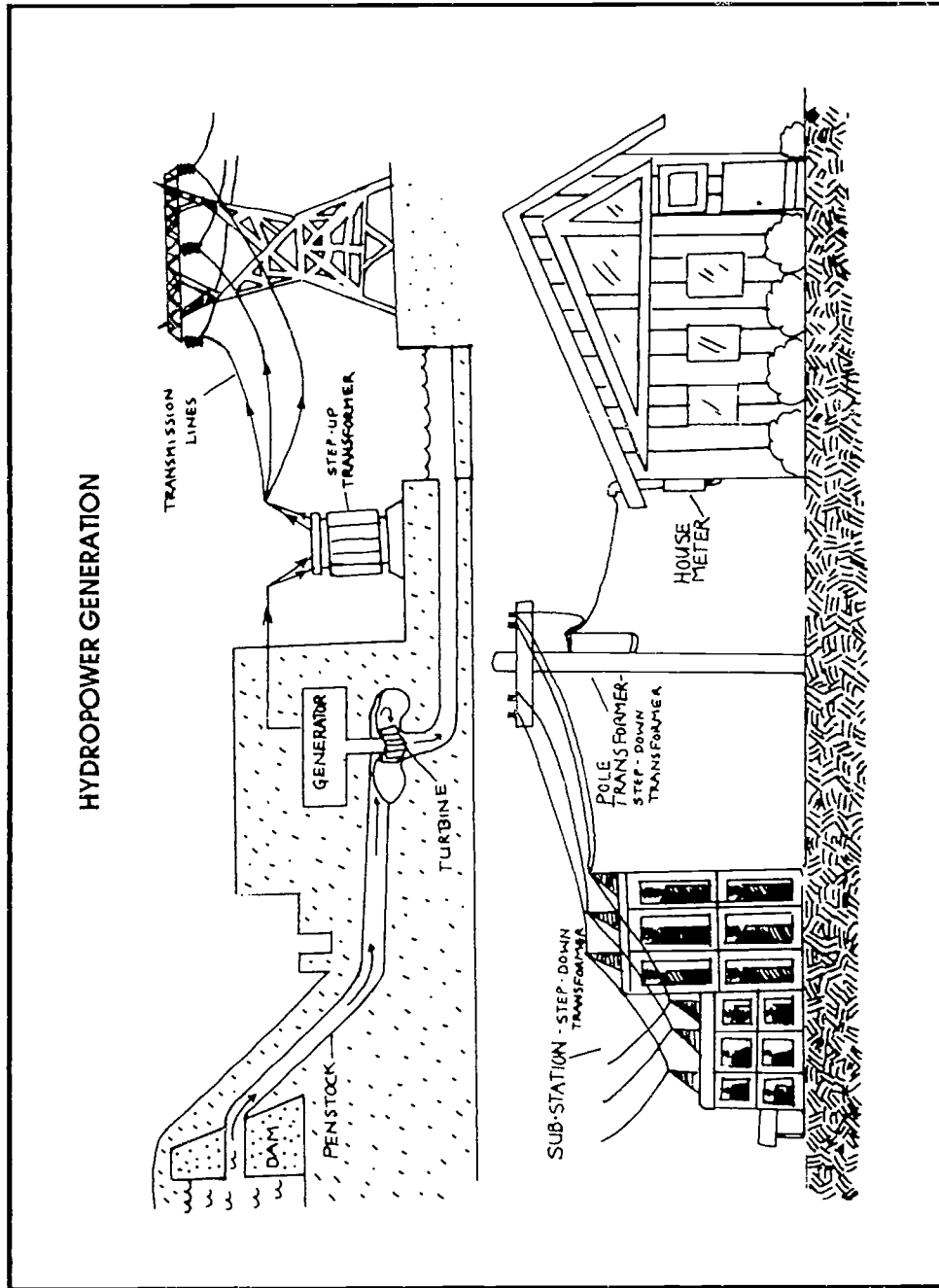

Energy Resources Glossary



1. Abiotic - All physical and non-living factors such as soil, water, and air which influence living things.
2. Biomass - Dry weight of living matter present in a species population. It is expressed in terms of a given area or volume of the habitat.
3. Boiling Water Reactor - A nuclear reactor in which the coolant is water maintained at such a pressure to allow it to boil and form steam.
4. BTU - British thermal unit, one BTU is equal to 1054.5 joules. It is a unit of energy equal to the heat needed to raise one pound of water from 60° to 61° F at a constant pressure of 1 atmosphere.
5. Cogeneration - Providing a contribution of power to another power supply system. Generating in parallel with another generation unit.
6. Consumers - Usually an animal that eats producers for its food.
7. Conversion - Changing from one source of energy to another, such as burning fuel to produce heat, or the force of falling water to turn wheels.
8. Decomposers - Organisms (bacteria, fungi) which convert dead organic materials into inorganic materials.
9. Exajoule - 10¹⁸ joules (i.e., 10 raised to the power of 18).
10. Energy - The ability to do work or the capability to produce a change in temperature.
11. Food chain/pyramid - Transfer of food energy from the source in plants through a series of animals with a repeated eating and being eaten.
12. Fuel Rods - A long, rod-shaped fuel assembly used in nuclear reactors.
13. Gaseous diffusion - A process by which uranium ore is modified for use as fuel in nuclear reactors.
14. Geothermal - Energy produced from the natural heat of the earth.
15. Joule - The International System unit to measure energy.
16. Kilowatt - 1000 watts or 3412 BTUs.
17. Kilowatt-hour - A unit of energy or work equal to 1000 watt-hours.
18. Kinetic energy - The energy a body possesses because of its motion.
19. Nuclear energy - Energy created from the splitting of uranium or tritium atoms.
20. Potential energy - An undeveloped source with the ability or capacity for energy.

21. Pressurized Water Reactor - A nuclear reactor in which water is circulated under enough pressure to prevent it from boiling while serving as a coolant for the uranium fuel. The heated water is then used to produce steam for the power plant.
22. Producers - Green plants which are able to manufacture food from sunlight, water, and simple organic substances.
23. Pyrolysis - The breaking apart of complex molecules into simpler units by the use of heat, as in the pyrolysis of heavy oil to make gasoline or the burning of organic wastes in an oxygen-free chamber to produce fuel oil, gas, and charcoal.
24. Radiant energy - Energy transferred as light or heat.
25. Radiation - The emission of waves from radioactivity in nuclear reactions.
26. Renewable/Nonrenewable - Living resources which have the capability to start over again Nonliving resources which cannot regenerate themselves
27. Rotor - The rotating part of a generator used to produce electricity.
28. Solar incident - The amount of the sun's rays that hit the earth.
29. Stator coils - The stationary part of a generator used to produce electricity.
23. Synfuels - Fuels such as synthetic natural gas and fuel oil produced from coal or sources other than natural gas or crude oil.
24. Watershed - The region draining into a river or system of rivers.
25. Watt - A unit of power in International System equal to one joule per second.
26. Watt-hour - A unit of electrical energy converted or consumed at the rate of 1 watt per hour or 3600 joules.

Forest Resources

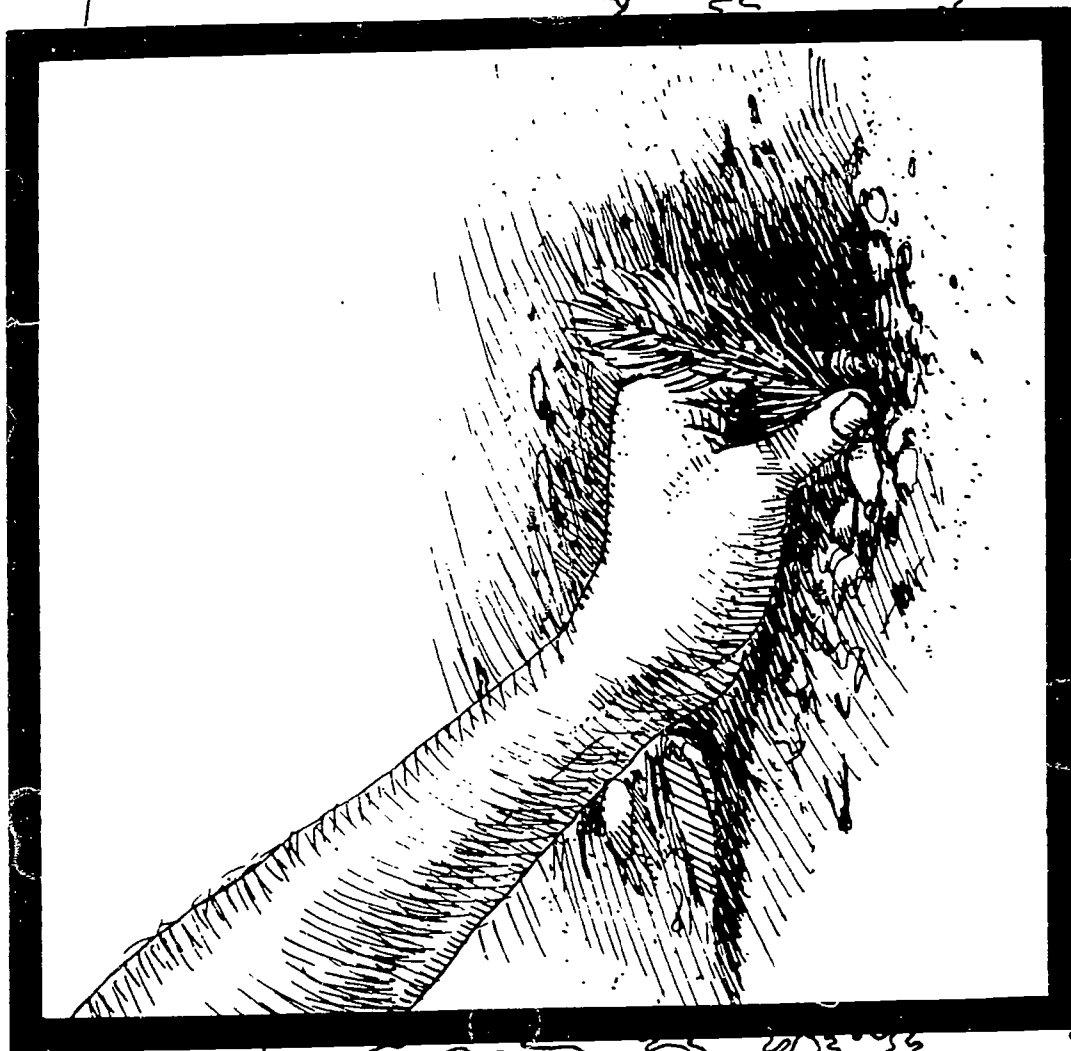

337

BEST COPY AVAILABLE

330

"A diversified forest -- both in types and ages of trees -- is a healthy one. Continued forest health depends on careful management and thoughtful planning to maintain the Valley's forest."

Benchmark Report

Forest Resources Concept Map

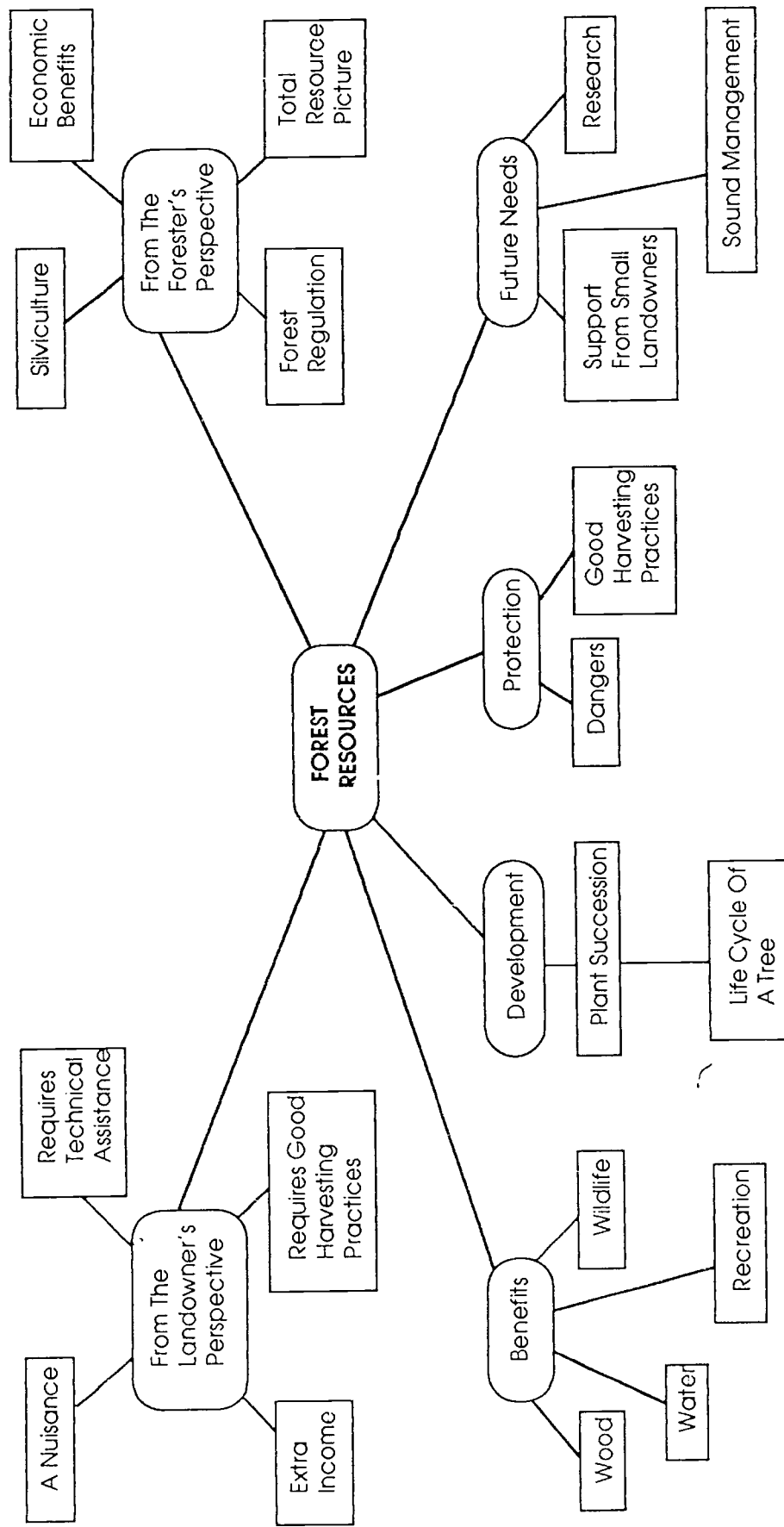

Forest Resources Factsheets



1. Overview
2. A Forest Is Many Things
3. The Development Of A Forest
4. The Life Cycle Of A Tree
5. Benefits From The Forest
6. How Landowners See Their Forests
7. How Foresters See The Forest
8. Protection Of Forest Lands
9. The Future Of Our Forest Land

1. Overview

Forestry is the business of managing forested lands for a variety of products such as timber, clean water, wildlife, and recreational opportunities, to satisfy both the needs of landowners and the public. Through management of forest lands, many of our basic resources can be protected, restored, and renewed.

Forest lands are the basins from which much of our water supply comes. With protection from heavy recreational or vehicular traffic and erosion, forests will continue to provide soil stabilization and clean water.

Forests are homes for many animals such as the squirrel, skunk, opossum, mink, raccoon, woodcock, and rabbit. Insect-eating songbirds thrive at the forest's edge while certain predators, such as hawks and owls, live within our forests feeding upon snakes, frogs, and small mammals.

The forest serves needs for recreation, too, but only through responsible conduct and observance of certain rules and regulations can recreation mix with forestry practices.

Timber production is a major use of our forest lands because of the important material these trees provide for paper products, furniture, building materials, and energy. The harvesting, processing, and marketing of forest products provide hundreds of thousands of jobs in the United States alone. Income from forest lands is significant; however, it depends a great deal upon how well timber stands have been managed. The major goal of forestry is to make the forest useful and productive to society through proper management practices. A managed forest is usually more productive than an unmanaged or mismanaged forest. Foresters use "silvicultural" practices to increase forest productivity. Silviculture is the science of producing and tend-



ing to a forest. Silvicultural practices include ways of controlling the types of tree species in the forest. Depending upon the goals of individual foresters or landowners, trees can be selected and favored to produce wood for specific markets and/or to create habitats for specific wildlife.

The most critical event in forest management occurs when the wood is harvested. All resources of the forest are deeply affected by the method used for removing these trees and the care taken during this activity. For example, the condition of the forest floor after harvesting will determine its ability to store water. Damage to the forest soil by erosion and compaction can affect the growing of trees on forest lands as well as water quality in our streams and rivers. Wildlife habitat, the beauty of forest land, and its use for recreation may be altered significantly depending on the harvesting method used.

Many forest lands are managed to utilize all the available resources for maximum benefit to everyone, using a concept called multiple use. This is not easy to carry out. Many complications can arise between resource use priorities. For example, forested areas provide an excellent environment for such outdoor activities as family camping. However, camping activity can cause soil compaction which may result in poor tree growth. Soil compaction can also lead to surface water runoff which may cause serious erosion problems. Also, some of the best trees for commercial use may be located in those areas most desirable for outdoor play and scenic beauty. Harvesting this valuable timber could ruin the area for public enjoyment.

Professional forest managers try to develop a strategy or management plan which will most likely succeed in meeting

everyone's needs. For instance, if an area contains marketable timber, yet is valuable for recreation and wildlife, forest managers often try to selectively cut the timber at times of the year which will least affect recreational users and wildlife in the area. Balancing the uses of an area for more than one purpose is called multiple-use management.

2. A Forest Is Many Things

The forest is a living community of plants which provides a place or "habitat" where plants and animals can live. It is always changing. It is affected by the natural forces of the earth and the sun, such as weather, as well as to the interaction between the plants and animals living there.

The forest is a vast source of energy. For example, in a single growing season, an acre well stocked with vigorous trees may produce 3 tons of useful wood. However, a crop of wood cannot be grown and harvested in a single year like a crop of corn. It takes many years before young trees mature to a harvestable size. Tomorrow's wood supply is in the trees growing in the forests today.

The forest is a great provider of many of our needs. Resources like wood, water, and wildlife influence the Nation's economy. Our forests also afford us opportunities for recreation, amusement, pleasure and relaxation that nurture the health of our minds, spirits, and bodies. For these reasons, great value is placed on our forest lands.

Wildlife also depends on the forests for habitat. How forests are managed can significantly affect the animals which occupy the area. In fact, any change in the composition of the forest will produce changes in habitat that almost certainly will change some of the species of plants and animals that can live there.

Forests also influence water quality. In heavily forested areas, the streams are normally in a stable condition since the forest vegetation slows down the water that runs off into channels. When water flows are normal, channels tend to be stable and water temperatures fluctuate only a little. But when watersheds are seriously disturbed by improper logging, wild fires, or uncontrolled grazing, the streams can be subjected to much higher waterflow and disturbance of their

channels. When this happens, the aquatic habitat suffers. Insect life is smothered by silt or injured by fast-flowing water. Gravel spawning beds, where fish reproduce, are destroyed. The food-producing ability of the stream is lowered, and the summer temperature of the water is raised. In cases of extreme change, good trout waters, for instance, can become nearly barren of fish.

The removal of forest vegetation may also result in some deterioration of the soil and site. Exposed soil is very susceptible to erosion. Unless the ground is protected by heavy sod or a deep layer of humus and litter, heavy rains can pick up considerable amounts of soil. The result is an accumulation of muddy water in the streams and severely eroded lands. In contrast, if the soil is protected, water can move through the soil more slowly and remain free of sediment.

As you can see, a forest is many things. Forests serve many of our needs for timber, wildlife habitat, recreation, clean water, and erosion control. How these forests are managed can also have far-reaching effects on other resources like water, aquatic life, wildlife, and soil.



3. The Development Of A Forest



Forests can be traced back to stretches of bare rock or bodies of water. In bodies of water, algae and other floating plants collect on top. As these plants die, they sink to the bottom, eventually making the lake or pond more shallow. In time, as the sediment layer gets thicker, aquatic plants which grow with their roots in the bottom and their leaves above the water begin to take over. Over many years the lake or pond then fills in with leaves and sediment in a process of aging called eutrophication. This provides the soil for larger woody plants to grow. Eventually, bottomland hardwood forests either replace or grow around these bodies of water. In bare rock areas, lichens are the first plants to take hold. Fragments of rock broken away by weathering caused by these lichens over time turn into a thin layer of soil which allows mosses to take root. As this process continues, the depth of the soil increases. More moisture is retained, larger plants grow, and forest areas develop. The process in which soil is created and eventually covered, in stages, by various species of plants, is called plant succession. It sometimes takes hundreds of thousands of years before a forest develops.

Wherever the climate is suitable for forests, the area will become forested, over time, through natural plant succession. Fire or wind may destroy native plants and reverse this process but, given time, forests grow back. For instance, if you followed the succession of native plants on a typical abandoned farm in the Tennessee Valley, you would probably find tall weeds growing in the fields the summer after cultivation stops. The next year there might be a little grass beneath the weeds and blackberry seedlings may have begun to grow. At the end of 5 years, the field would be a tangle of briars with some pioneer tree species appearing, such as sassafras, persimmon, eastern red cedar, and others, depending where in the Valley this farm was located. In 10 years, the old field would probably be a

young forest of yellow pine or other species. In time, this area would eventually become an oak-hickory forest.

The rate at which succession occurs depends upon the productivity of the soil, the nearness of a seed source, and the presence of birds and rodents that will carry the heavier seeds of the deciduous species into the pine forests. Succession can be very slow in some areas. It may require two or more complete cycles of pine, from seedlings to mature trees, totaling 100 or more years for the oaks and hickories to become abundant enough to crowd the pine out, assuming there is no interference by people or such natural agents as fire, animals, or disease.

Beyond population centers there are forests which have remained unchanged by human activity. These are the virgin forests. By studying these areas, we can better understand what we have done to forests and can more wisely manage them to our benefit. Almost all our original forests have been permanently removed or harvested which makes it difficult to find undisturbed areas. However, many remaining virgin areas are being protected from all cutting and other man-made alterations so that we can learn from them the nature of our climax or mature forest.

4. The Life Cycle Of A Tree

The life cycle of a tree begins when a seed falls to the ground from another tree. In the spring, when the soil gets warm and moisture is abundant, changes begin to take place in this dormant or inactive seed. Soon the seed sprouts. Growth is fast as the seedling emerges above the ground. This tree is then permanently anchored by its roots, for better or for worse, and has to depend on the nutrients available in the soil and the climatic conditions found in that area. A seedling generally begins its life in a place where its ancestors have been and is well adapted to the existing growing conditions.

Trees are able to grow and enlarge using the sugars formed in a process called photosynthesis. This process uses sunlight, air, and water to build organic compounds. In it, small amounts of carbon dioxide available in the air unite with chlorophyll in the leaf cells. In a chain of reactions, regulated by enzymes, carbon dioxide combines with oxygen and hydrogen in a water molecule to form sugar. This sugar, dextrose, combines with nitrogen to form amino acids. Amino acids are the building blocks of proteins on which all life depends.

Most sugars produced in plants are used in respiration and digestion. Respiration is an inside-cell process in which sugars are converted to release energy. This energy is used by the cells to carry on daily cell functions like photosynthesis. Sugars that are not used are stored. Digestion is a process in which these stored complex sugars are converted into simple sugars using enzymes. At night, when plants are not making sugars, the sugars stored are used for respiration. All of these processes are important because they allow trees to grow.

Plant growth occurs in three distinct regions of the plant—the shoot tips, the roots, and the cambium. The cambium is the growing

zone in the stem. It consists of a single layer of cells which develops into rows of wood cells, or xylem, on the inside and rows of bark cells, or phloem, on the outside of the tree. In the soft inner bark, cells form vertical tubes through which sugar compounds flow from the leaves to storage tissues in the stem and root system. Water flows from the roots to the stem and leaves through specialized woody-type cells. Each year, as the tree grows it expands, leaving distinct growth rings.

The primary product from most trees is the woody stem. In fact, it is the forester's job to make sure the conditions are favorable for maximum growth in the diameter of the tree. Ideal growing conditions produce thick growth rings, while narrow rings, usually indicate less favorable conditions.

Trees reproduce through male and female flowers that are usually found on separate trees (although both flowers can occur on the same tree). Pollen of the male flower fertilizes the ovule of a female flower, which then develops into the seed. Trees produce these seeds for many years. When these seed take root, the life cycle of a new tree begins.

Trees grow old like all other living organisms. Old trees, like old people, struggle with problems of advanced age. Old trees have difficulty with respiration, the annual shoots are not as vigorous, and the cambium produces fewer wood cells. The weakened condition of the tree makes it more susceptible to a variety of diseases and insect pests. For this reason, it is often very difficult to determine why trees die.

When trees die, they fall and begin to decompose. Decomposer plants and animals aid in this process. Eventually the dead tree will become organic matter in the soil which will be used by sprouting tree seedlings to grow into new trees.



5. Benefits From The Forest



The forest provides many benefits to society. With only crude shaping, splitting, or cutting, wood can be used as it comes from the forest for such things as fuel wood, posts, and mine props used to support shafts in mines. With a little processing, it is used as sawed lumber, shingles, railroad ties, veneers, and charcoal. If processed further, it can be used in housing construction, furniture, boats, and pencils. It is also the basic raw material in paper pulp, rayon, and a variety of other products. Whole stands of trees can even be converted into wood chips and be burned to provide the energy for industrial facilities. The forest industry provides many billions of dollars worth of investments and jobs for a large portion of our country's work force.

There are other important functions of the forest. By protecting our watersheds, forests supply individuals and communities with water. What is a watershed? We all live in a watershed. All surface and subsurface water that does not evaporate flows into a basin. Small basins, or small watersheds, drain into larger watersheds. For example, a small creek drains into a larger stream which eventually drains into a large river. It is very important that the smaller watershed areas, where the water supply originates, are protected, particularly from soil erosion. Of course, there are other things which can pollute our water sources further downstream. But in the upstream areas, forests are usually the protective blanket which we must depend on for clean, safe water. Good management of the forest cover in these headwater areas is the best way to protect the water supply.

Another function of some forests in many areas of the country is to produce forage for animals in the form of grasses, weeds, and shrubs. By supporting large numbers of livestock, forest ranges contribute significantly to the Nation's meat, wool, and leather industries. However, not all forests are suitable for grazing. In our

hardwood forests, when the foliage of young trees is eaten, it prevents their growth.

Wildlife and recreation are linked closely with the forests. Wildlife is a natural part of the forest and belongs there just as much as the trees. Managing for wildlife includes many of the same rules as for growing trees. When trees are protected, they provide homes and a source of food for wild animals. To manage for wildlife, we must protect the forest from uncontrolled fires and intensive grazing, harvest the trees wisely, preserve some trees, and develop woodland borders or edges on which wildlife depend. Without wildlife the forest is incomplete. Wildlife makes the forest a more productive, useful, and attractive place for people to use and enjoy.

6. How Landowners See Their Forest



Individual landowners may view forest acreage in totally different ways. Some may feel it is a nuisance to their agricultural needs, while others enjoy providing a home for wildlife or appreciate the forest as an economic asset for timber production. Many owners of small forested areas do not think of their property as having possibilities for regular income. To them, the trees in their woodlands might have no particular value except possibly for fuel wood and fence posts. An offer of a few hundred dollars for all the timber in a small wooded area probably would strike most owners as an unexpected bit of good fortune. Yet, a small forest, even one of only 50 or 60 acres, can be managed to yield a good financial return at regular intervals.

The key to forest profits is, of course, good forest management and good management is within the reach of most owners of small forest properties. Fortunately, more and more private landowners are beginning to recognize the potential value of their woodlands, and the importance of planning management strategies with a professional.

Every forest property has oddities that are key factors in determining the specific requirements for good forest management. This is particularly true of small woodlands, most of which have been cut over so often that uniform forest conditions are the exception rather than the rule. Unlike other crops, trees are not planted, grown and harvested all within short, one or two year cycles. Usually, the landowner must start with what he or she has and make the desired changes gradually, over a period of years. Most individual landowners need competent, technical help in getting forestry activities headed in the right direction, to avoid making mistakes that cannot be remedied for many years.

Small woodlots can provide a variety of economic opportunities. One example of a market for small, nonuniform woodlots is fuelwood. Because of the high cost of energy in recent years, there has been a great demand for fuelwood from our forests. Forest landowners are feeling the pressure from family, friends, and even strangers who wish to cut trees from their properties for fuel consumption. If a management plan were developed for the woodlot, the removal of fuel wood in the form of dead, dying, deformed, and other cull trees would be a tremendous boon for improving the stand and hastening its progress toward being a more productive area.

Important as these small forest holdings are to individual landowners, they are of even greater importance to the Nation's economy. Many of our forest products, certainly in the Tennessee Valley, come from small (less than 500 acres) woodlands.

7. How Foresters See The Forest



Foresters are trained professionals practicing the applied science known as forestry. The purpose of forestry is to make forests permanently useful to all of us. This is accomplished through silviculture, the science of producing and tending a forest. Silviculture is closely related to other natural sciences: plant physiology, agronomy, meteorology, and geology. Since the forest is seen as an area for the study of communities and their natural growth (succession), foresters can determine, through collected ecological information, how and by what means succession can be speeded up, prevented, reversed, or avoided.

A forester knows how the course of natural succession in an area occurs but this does not mean that it should be allowed to continue. A forester's goal is to manage a forest so landowners' wishes are met and the benefits from the forest outweigh the investment. How far a forester can deviate from natural succession in managing a wooded area must be learned from years of experience.

The forester tries, at all times, to be aware of the total resource picture. Good forest management includes plans for wildlife habitat improvement and protection. Also, the protection of forest soils and small drainage channels during logging and other forest activities is very important in controlling floods and supplying clean water for many critical needs. Wherever possible, consideration is given to recreational uses. However, the tremendous demand for wood products dictates that the forester, unless otherwise instructed by the landowner, regard a woodland area as a production site with the potential for a greater volume of useful commodities, if properly managed.

Foresters look to the future. A single tree crop may require 50, 80, 100, even 200 years to mature, but a single crop is not the only concern. Furthermore, we cannot wait a century or more between harvests. Procedures must be developed to assure that some trees can be harvested each year or every few years. This requires foresight and planning. It also requires regulating forest harvest. The forester's basic rule of thumb is to cut an amount of timber each year which is no greater than the amount that grew during the present year. In this way, a sustained yield (measurable quantity) of trees can be harvested indefinitely.

Foresters realize that a sustained yield from our forests depends on more than making plans. It depends on how well each of us, as caretakers of our forests, is able to work with nature and get it to work with us.

8. Protection of Forest Lands

All living communities are subject to change without notice. There is always the danger of fire, insects, and disease. In forests, overgrazing and poor cutting practices can also adversely affect the entire living community. These potentially disastrous events need to be controlled through sound management plans and practices in order to keep the forest productive.

When the settlers first came to this country, the forests were in "virgin," or untouched, condition. Immense wealth was stored in the old trees, but the forest produced very little. A productive forest is a growing forest, one in which the trees are used as they reach maturity. Now that our country is settled and demands for wood and other forest resources have increased, the forest lands of this country are becoming a resource-producing factory instead of an immense storehouse of timber as first seen by the pioneers. Forests are restored by regeneration and growth.

In order to grow properly, the forest must be protected. Protection requires planning and management by both non-professional and professional caretakers. These caretakers are the landowners and foresters who must work together. Of course, each of us has a responsibility to do his/her part in protecting our forest lands. The raw materials and pleasure we receive from the forest lands of this country have significantly increased our standard of living.

Resources of the forest, such as wood and wildlife, are renewable or non-renewable, depending wholly on how these resources are managed. Also, the quantity and quality of water, so critically needed for irrigation, power, industry, navigation, recreation, and public use, are dependent on our activities in the forested watersheds of our country.

Timber harvesting is often criticized because of the apparent damage it does to the forest. However, timber harvesting can be the most valuable method a landowner has to manage for wildlife, recreation, timber, aesthetics, or watershed protection. (See Table.)

Who is responsible for the proper application or method for harvesting the timber crop? Since the landowner is the person who will be affected by the harvesting, he/she is directly responsible. How? The answer is simple. Landowners must use their authority to control harvesting. Too often, landowners sell timber to the highest bidder without considering the impacts the method of harvesting may have on the forest community. The owner has the responsibility, authority, and opportunity to ensure a good harvesting operation through the use of a comprehensive "Timber Sale Contract." In the contract, the owner may specify what trees are to be cut, where roads are to be located, fines for damages to nonharvested trees, rewards for cutting unmarketable trees, and levels of utilization (how much logging debris is left on the site). Unfortunately, these controls may increase the costs of timber harvesting, which will reduce the owner's income from the sale. However, in the long run, this attention to good harvesting procedures will reward the landowner by allowing the residual stand (what is left) to renew itself under better conditions, thus assuring an income from future sales.



ACHIEVING MANAGEMENT OBJECTIVES WITH HARVEST PRACTICES

MANAGEMENT OBJECTIVES	HARVESTING ROLE
Wildlife	<ul style="list-style-type: none"> • Production of browse (sprouts) from stumps • Habitat diversity • Species (tree) preference
Aesthetics	<ul style="list-style-type: none"> • Understory (brush) removal • Species (tree) removal
Recreation	<ul style="list-style-type: none"> • Firewood production • Hazardous tree removal • Campsite preparation — understory removal • Road and trail construction
Timber production	<ul style="list-style-type: none"> • Species and quality (tree) manipulation • Concentration of growth on crop trees • Harvest of crop trees
Watershed protection	<ul style="list-style-type: none"> • Control of water run-off • Fire protection via roads constructed for harvesting

9. The Future Of Our Forest Land



A country's natural resources and how these resources are managed determine a country's wealth and the welfare of its people. One of our country's greatest resources is its forests, which comprise approximately 33 percent of the acreage in the United States. The forest supplies timber, water, livestock forage, wildlife, and, to some, a spiritual strength. So common are the products and services of the forest in every-day living that their presence is often taken for granted and their importance to our existence overlooked. But when one analyzes the relationship of the forests to the Nation's economy and considers all the essential commodities produced from raw materials taken from forest lands, the role our forests play in the lives of people becomes obvious.

Growing timber is the most obvious function of the forest. Timber is the backbone of a large group of industries. However, a majority of our forest acreage, especially in the Tennessee Valley, is in the hands of many individuals who own areas less than 500 acres. Therefore, these small landowners hold the key to the availability of timber and other forest resources for the future. The quantity and quality of the timber and all other forest resources depend upon these landowners because professionals can help only those who want to manage their forests in a sensible manner.

As our non-renewable resources such as metals and petroleum become scarce, industry must turn increasingly to renewable resources, such as trees, for its raw materials. Fortunately, forest products research is identifying many new uses for wood.

The forest is very important to this country's interests. It is so important that America can no longer afford losses from uncontrolled fires, destructive logging methods, and lax reforestation practices. Because of significant progress in the field of forestry, the timber

situation in the Tennessee Valley has improved tremendously. The timber industries offer a good market for materials and services. Thus, the incentive exists for the landowners, both large and small, to begin the most efficient forestry program, as soon as possible, in order to reap financial rewards.

The regeneration and development of the forest and wildlife resources is based upon sound scientific knowledge. However, research must identify procedures and practices which are not only better, but also economically feasible. We have the forest land in the United States to meet our own requirements for timber and to help supply other less fortunate countries. With intelligent management of our forests, we can have a lasting supply of timber and forests to serve our needs indefinitely.



Forest Resources Activity Matrix

	AIR RESOURCES	CULTURAL RESOURCES	ENERGY RESOURCES	FOREST RESOURCES	RECREATION RESOURCES	WATER RESOURCES	WILDLIFE RESOURCES	TVA-A WORLD OF RESOURCES
Board for Boards	3	4,6,9	9	1,2,3,5, 6,7,8	3	6	ALL	8
The Forest Blanket				1,2,5,6,7	3,4,5	3,6		4,9
Where's The Topsoil				1,2,5,6,7	3,4,5	3,6		4,9
Benefits From The Forest	1	1,6,7	2,9	1,2,5,6,7	1,2,3,6	2,6	1,2,3,4, 5,6,7,10	
Tree Hotel	5			1,2			ALL	
Forest Views		6,8	2,9	1,2,3,4, 5,6,7	1,2,3,6	2,6	1,2,3,4 5,6,7,10	
Reading Rings		1		1,2,3,4,5 6,7,8,9				
Nothing Succeeds Like Succession I			1,5	3,4				
Nothing Succeeds Like Succession II		1	1,5	3,4				

Board For Boards



OBJECTIVES:

Students will develop a class bulletin board about a field trip to a forest industries operation. See FOREST RESOURCES matrix for background information.

MATERIALS:

class bulletin board
tape
tacks
colored paper
scissors
felt crayons
lettering
border tape
posterboards

PREPARATION:

Take the class to visit a lumber mill, a forest stand where trees are felled and shipped, or a lumber retailer. Additional information for this activity can come from telephone interviews, letters requesting information, and in-class speakers. This activity will demonstrate that any type of field trip can be summarized by making a bulletin board of the trip afterwards. Have students collect information, pictures, and quotes to add to the class bulletin board. The bulletin board can help students learn and enjoy field trips more by summarizing their experiences. These types of visual displays can also be used to extend the information to the entire school if they are placed on a centrally located bulletin board.

PROCEDURE:

Visit a forest, saw mill, lumber wholesaler, paper mill, or paper distribution warehouse in your area. Perhaps pay a visit to the local newspaper printshop. Use this information and other information gathered through telephone interviews, class speakers, and class research on the topic to develop the bulletin board. Any pictures, printed brochures, and handouts gathered on field trips will be helpful.

Divide the class so that each group will have specific sections of the topic to develop. Arrange for the topic for the board to be "THE CYCLE OF TREE USE" or a similar topic. Divide the topic into "categories" and assign a section to each group. These can include tree planting, forest management, tree harvest, tree processing, transportation, retail sale, use, and disposal. Each group should collect as much information as possible about its topic. Investigate costs, location, time, energy consumption, and so on. The groups should sketch their information and layouts on a posterboard, in pencil, and have photos or examples ready.

Then assign one group to be the central committee whose responsibility is to provide the basic layout for the bulletin board. Their preliminary sketch should be made on a poster board. Allow modification of the sketch as need arises. This committee can also coordinate collection of materials like scissors, tape, and tacks.

Begin to build the board. Cover the board with a basic color of butcher paper. Use colored markers to draw structures, vehicles, and people. Arrows can be drawn to show the order of the cycle.

When completed, allow one person to summarize the information at the board. Then, discuss the importance of trees. Also talk about the tree products used to create the bulletin board.

FOLLOW-THROUGH:

Do a similar activity centered around paper production. Start a student paper-recycling center. Then investigate how the paper collected can be converted into recycled paper. Have the class follow the whole process through until they learn how actual paper is made from the paper they recycled. Directions are included with this activity on how to make your own homemade recycled paper to include in the display. You might have a contest to see who can make the best recycled paper! Take photographs along the way and save letters and all correspondence. Then, make a bulletin board to tell the story or to record progress.

Who Can Make The Best Recycled Paper?

Materials:

- Wirescreen pieces (about 25 cm X 32.5 cm each)
- Blender
- Old newspapers
- Rolling pin
- Starch suspension
- Felt pieces (about 23 cm X 32.5 cm each) (Optional)

Procedures:

- 1) To make a starch suspension: Combine one cup of corn starch with two cups of water. Mix thoroughly before using.
- 2) To Make Paper:
 - Cut or tear a newspaper page into small pieces and soak them in water.
 - Pour off the excess water and place the pieces in a blender.
 - Add three tablespoons of starch suspension and blend at high speed until

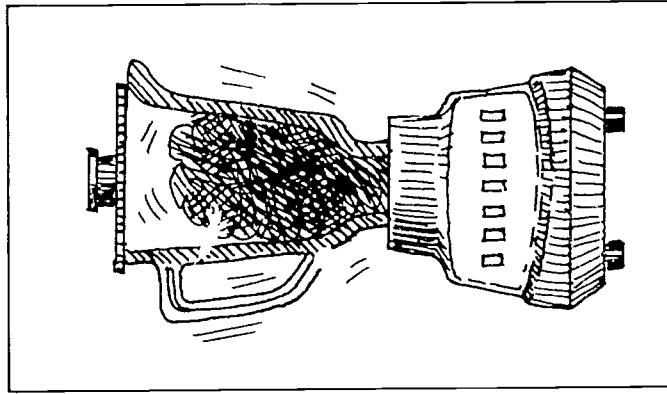

the mixture looks like thick soup.

- Quickly pour the mixture onto a piece of wire screen, spreading it evenly.
- For a smoother-textured paper, allow the mixture to drain on the screen, then cover it with a piece of felt.

- To remove excess liquid, roll the rolling pin over the mixture while it is on the screen. Cover with a piece of felt.
- Turn the screen over on the felt and peel the screen off carefully. Cover the paper with another piece of felt before rolling it.
- To remove excess liquid, roll the rolling pin over the mixture while it is on the screen. Peel off the wet paper and let it dry overnight.

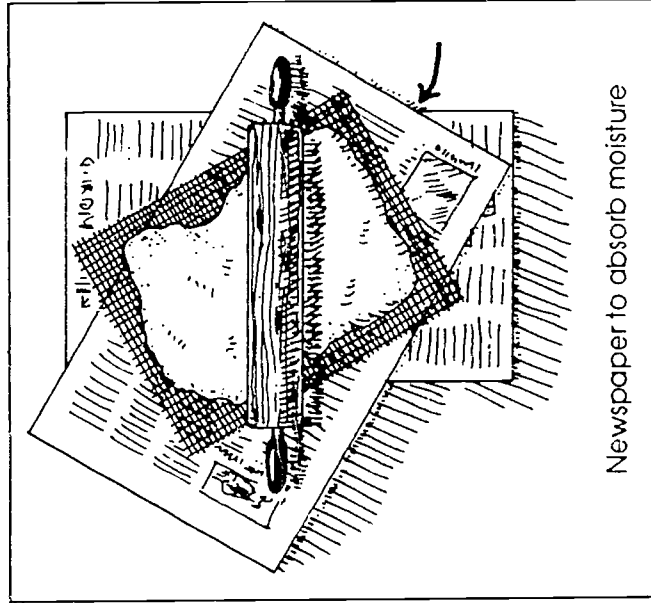

Newspaper to absorb moisture

Set Up Your Contest

Now that you know how to make paper, decide upon contest rules for the class.

Decide Upon Official Contest Rules

- Can you use newspaper only? Are other types of papers allowed, such as homework?
- Can you use only the standard starch suspension? Are there other mixtures allowed?
- What is the minimum or maximum paper thickness?
- May colors be added?
- How many pieces of paper should be made by each student?

The Forest Blanket



OBJECTIVES:

Students will demonstrate how forest cover helps reduce erosion. See FOREST RESOURCES matrix for background information.

MATERIALS:

long narrow box (wood or cardboard)
plastic bag (to line the box)
soil
humus (the upper layer of soil in a forest including leaf materials)
bucket or water hose
water



PREPARATION:

Soil erosion is a serious problem which affects our economy by reducing the productivity of our farmland and increasing costs to process drinking water. Sediments can clog transportation channels for barges and fill reservoirs behind hydroelectric dams. Erosion gullies and sediment-filled streams also take away from the scenic beauty of the environment. Examples of soil erosion are easy to locate. Visit a building under construction or a freshly plowed field and note the gullies that form after a rain.

PROCEDURE:

Have students set up the box outside as shown in the following diagram. Line the box with plastic and fill it with fine soil. Prepare a second box in the same fashion. In the second box, place a layer of humus from the forest on top of the soil layer. Then, pour water from a bucket or hose on each box. Collect the run-off water from each and observe the color and sediment. Students should note and record differences in the two boxes. Discuss the differences noted in the two boxes. Why did these differences occur? Why is the forest important in preventing soil erosion?

FOLLOW THROUGH:

Have the class investigate the community to find examples of soil erosion and examples of methods being used to control soil erosion. Also have the class research environmental laws which govern erosion. What are the laws and who is responsible for enforcing them? Then, look at the results of your community erosion investigation. Are environmental laws being complied with?

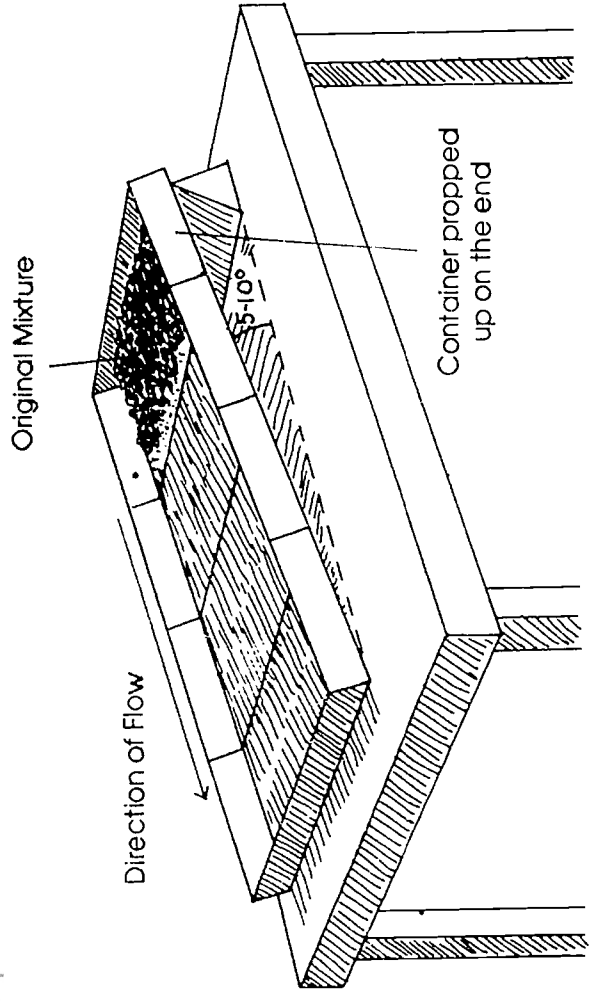

Perform the activity again, but change some of the variables.

For example:

- use a different soil type
- increase or decrease the slope
- use other "blanket" materials such as straw or mulch
- use contour and parallel plowing methods farmers use
- plant grass or some other crop

How does each of these variables affect the amount of soil erosion?

Where's The Topsoil?



OBJECTIVES:

Students will determine the amount of topsoil that erodes and is deposited in a local stream. See FOREST RESOURCES matrix for background information.

MATERIALS:

beakers
coffee filters (other filter papers)
balance (0.1 g)
access to an oven
aluminum pie pan (other pan)

PREPARATION:

Ask the students to read about the Great Dust Bowl of the 1930s. Topsoil erosion has always been a severe problem for some farmers in the Valley region. In addition, techniques to increase production, have sometimes resulted in an actual overall decrease in production because valuable topsoil can be lost using certain practices, such as plowing.

PROCEDURE:

Select a stream or ditch in which there is evidence of silt and silt in the water. Collect a liter of water from several points along the stream. Make sure you collect at least 1 liter per group. Also, make a map of where you collected each sample. If you plan to do the

follow-up activity, conduct it at the same time you collect the samples.

Back in the classroom, determine the mass or weight of the soil lost. Divide the class into groups. Form as many groups as you have liters of water so that each group may have a chance to determine soil mass. To begin, have each group weigh several pieces of filter paper. Determine the average weight of the filter paper by combining the totals of all the filter paper weights and divide by the number of filter papers used. Record this value in a data table. Then place a funnel in a beaker and put one filter paper in the funnel. Pour the entire 1-liter sample through the funnel to collect the stream residue on the filter paper. It may be necessary to stir the sample to assist the flow into the funnel. Place the filtered material in a pie pan and examine the contents. Note your observations.

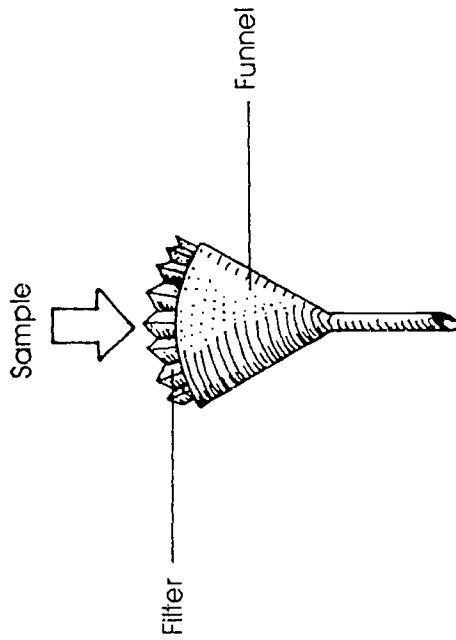

*Note: Add container to collect filtrate.

Dry the contents of the pie pan in an oven for several hours or in the sun for several days. Weigh the dry samples and record these data in a table. Subtract the mass of the filter paper from the mass of the dry sample to determine the mass of the material that was suspended in the stream per liter of water. The results will be in grams per liter. Then, discuss: Where did the soil come from? Once the soil is gone, how can it be replaced? What are some of the conservation practices farmers use to conserve soil?

FOLLOW-THROUGH:

Calculate the volume of water in liters that flows past a point in the river in a 24-hour period and combine this with your erosion data. How much sediment is being transported in the stream? You will need to measure the speed, the depth, and the width of the stream. To determine the speed, tie a fishing float on a light piece of string and tie the other end to a long cane pole. Let the length of string from float to pole be exactly 1 meter. Toss the float into the water a bit upstream and allow it to float downstream at the normal rate of the stream. When the float comes even with the pole, begin timing with a stopwatch. Stop the stopwatch when the string becomes tight. Be sure to hold the pole tip in the same place. Use the formula:

$$\text{Speed} = \frac{\text{distance}}{\text{time}}$$

to calculate speed. Repeat several times and average the results.

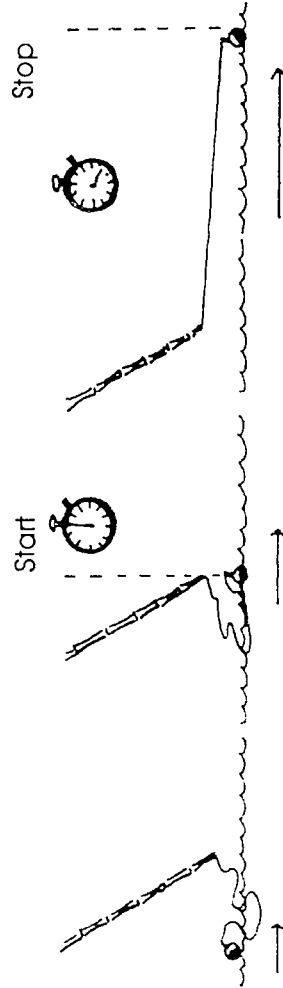

A long pole with a weight can be used to determine the depth. Hold the pole out over the water, allow the weight to sink to the bottom. Immediately raise it straight out of the water and measure the length of wet string. To estimate the width throw a string across and measure the string. Make all measurements in meters.

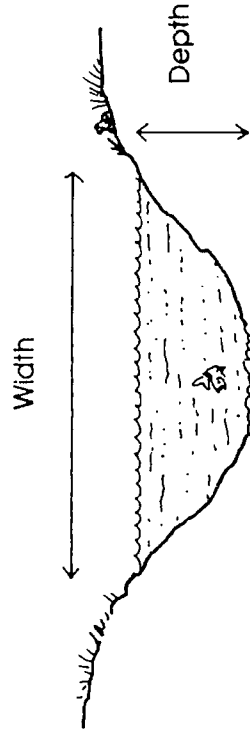

To determine the volume, multiply the depth times the width, and then multiply by 80 percent to account for bottom irregularities. Multiply this figure by the speed, in meters per second. Convert this rate to volume in cubic meters per day. To determine how much sediment is being transported, convert grams per liter into grams per cubic meter. Then multiply by volume in cubic meters per day to get grams of soil loss per day. Because soil loss is usually measured in tons per year, convert your information to tons per year. This figure would only be a rough estimate unless the sediment volume remained constant.

DETERMINING SOIL LOSS FROM EROSION

$$\frac{\text{depth in meters}}{\text{width in meters}} \times 80\% = \frac{\text{volume in cubic meters}}{\text{meters}}$$

$$\frac{\text{volume in cubic meters}}{\text{speed in seconds}} = \frac{\text{volume in cubic meters per second}}{\text{meters per second}}$$

$$\frac{\text{volume in cubic meters per second}}{\frac{60 \text{ seconds}}{1 \text{ minute}} \times \frac{60 \text{ minutes}}{1 \text{ hour}} \times \frac{24 \text{ hours}}{1 \text{ day}}} = \frac{\text{volume in cubic meters per day}}{\text{cubic meters per day}}$$

$$\frac{\text{grams per liter}}{1 \text{ cubic meter}} \times 0.001 \text{ liters} = \frac{\text{grams per cubic meter}}{\text{cubic meter}}$$

$$\frac{\text{volume in cubic meters per day}}{\text{grams per cubic meter}} = \frac{\text{grams soil loss per day}}{\text{grams soil loss per day}}$$

$$\frac{\text{grams}}{1 \text{ ounce}} \times \frac{16 \text{ ounces}}{1 \text{ pound}} \times \frac{2000 \text{ pounds}}{1 \text{ ton}} = \frac{\text{tons of soil loss per day}}{\text{tons of soil loss per day}}$$

$$\frac{\text{tons of soil loss per day}}{\text{year}} \times 365 \text{ days} = \frac{\text{tons of soil loss per year}}{\text{tons of soil loss per year}}$$

Benefits From The Forest



OBJECTIVES:

Students will list forest products. See FOREST RESOURCES matrix for background information.

MATERIALS:

large tree-shaped branch
 Christmas tree stand
 colored paper
 felt crayons
 pipe cleaners
 tape
 glue

PREPARATION:

Read through Forest Factsheet 5. Ask students to collect photographs from magazines and newspapers that demonstrate how we use the forest. These may include products, energy and any other uses of forest and forest products.

PROCEDURE:

Working in teams of four to six, have students develop a list of the benefits from the forest. After the teams have been working for about five minutes, have the first group list on newsprint all of its benefits. Have the second group add to the newsprint any items not

included by the first group. Have all of the groups, in turn, add to the list. On a second piece of newsprint, classify the items into groups such as construction, transportation, recreation, food, etc.

When all the items are listed in a classification group, have the small teams meet again. Assign each team one major classification group. Ask them to list on newsprint all items that fall within their category. Provide one color of paper for each team (for example: recreation benefits = green). Allow the groups to cut out leaf shapes from their paper. On the front of the leaf, put the forest benefit to humans; on the reverse side, paste a photograph that shows the benefit. As a class, discuss how to best balance color and shape before attaching the leaves to the tree using pipe cleaners. Then, place the tree in the stand and decorate.

You might wish to do this as a tree trimming party and invite another class to help. You might also invite members of the community to help. Serve refreshments and explain to the visitors what the tree is all about. You could invite a forester, a forest ranger, and a local businessman associated with the lumber business to participate in the tree trimming activity and ask these resource people to speak briefly to the class about their careers. Senior citizens might also enjoy participating in this activity with students. When completed, display your class tree to the rest of the school or community.

FOLLOW THROUGH:

Have the students inventory the entire classroom. Then ask them to determine if the items consist of or were made using a wood product. Wood products include pulp and paper, particle board, plywood, furniture, flooring, kitchen cabinets, pallets and skids, boxes

and containers, barrels, mirror and picture frames, tool handles, fabricated hardboard products, toilet seats, gum and wood chemicals, travel trailers, piano and organ parts, games and toys, coffins and caskets, and insulation.

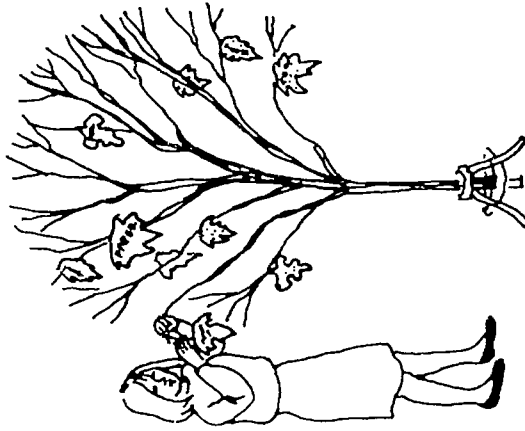
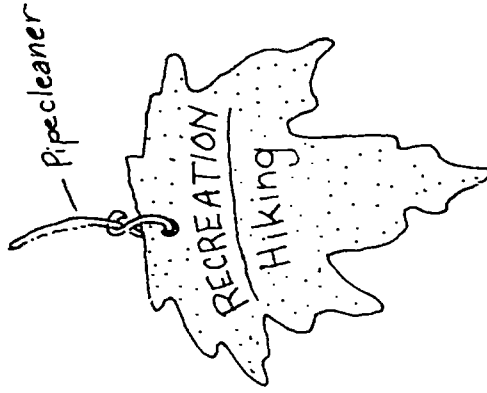

Examples of the benefits of the forest are then hung from the branches which can be displayed in a prominent place.

Tree Hotel



OBJECTIVES:

Students will observe the diversity of wildlife habitat that occurs in one tree. See FOREST RESOURCES matrix for background information.

MATERIALS:

one mature tree
binoculars
hand lens
newsprint
felt crayons
artist's sketch pads
pencils
identification guides (optional)

PREPARATION

Sketch a tree outline on newsprint similar to the tree that you will visit with the class. Divide this tree sketch into five parts:

- 1 - The ground under the tree
- 2 - The trunk up to the first branch
- 3 - The trunk above the first branch
- 4 - The lower two-thirds of the branches
- 5 - The upper one-third of the branches.

PROCEDURE:

Divide the class into five groups and assign each group a section of the tree (see illustration). Have each group brainstorm and list on newsprint the living things that members believe will occupy their part of the tree. For example: lichen on the bark, birds on the branches, earthworms in the soil, and so on. Allow each group to present its list.

Take the groups outside and ask each group to observe and collect data about its portion of the selected tree. Make a list of the living things that occur in that section and sketch each. Note the size, shape, and color, and how many occur in the sections of the tree. Binoculars will be necessary to see the upper branches. Remind the class to record all their observations. You may want to use identification guides to identify what you see.

Back in class, ask the groups to modify the newsprint list to indicate the things actually observed and to compare this list to what they had predicted. Why did these living things occur? Consider the following in answering these questions: Did the tree serve as food or shelter? Could the tree serve other uses to the living thing observed? Does that living thing stay on or near the tree for its whole life? If not, where does it live? Ask each group to present its list and discuss each living thing observed. In which section of the tree did most things occur? Why? Why is this activity called TREE HOTEL?

FOLLOW-THROUGH:

Ask students to redraw the tree on newsprint and use photos or drawings showing the "tenants" of the tree hotel. Have students work together to decide which pictures should be included to create the most attractive display. Consider color and balance. Place the completed newsprint in a prominent place on a bulletin board in your school.

You might also ask a local forester or wildlife biologist to speak to the class about forest management practices to promote wildlife habitats. You could show the speaker your display poster and ask them to comment on and use the poster during their talk.

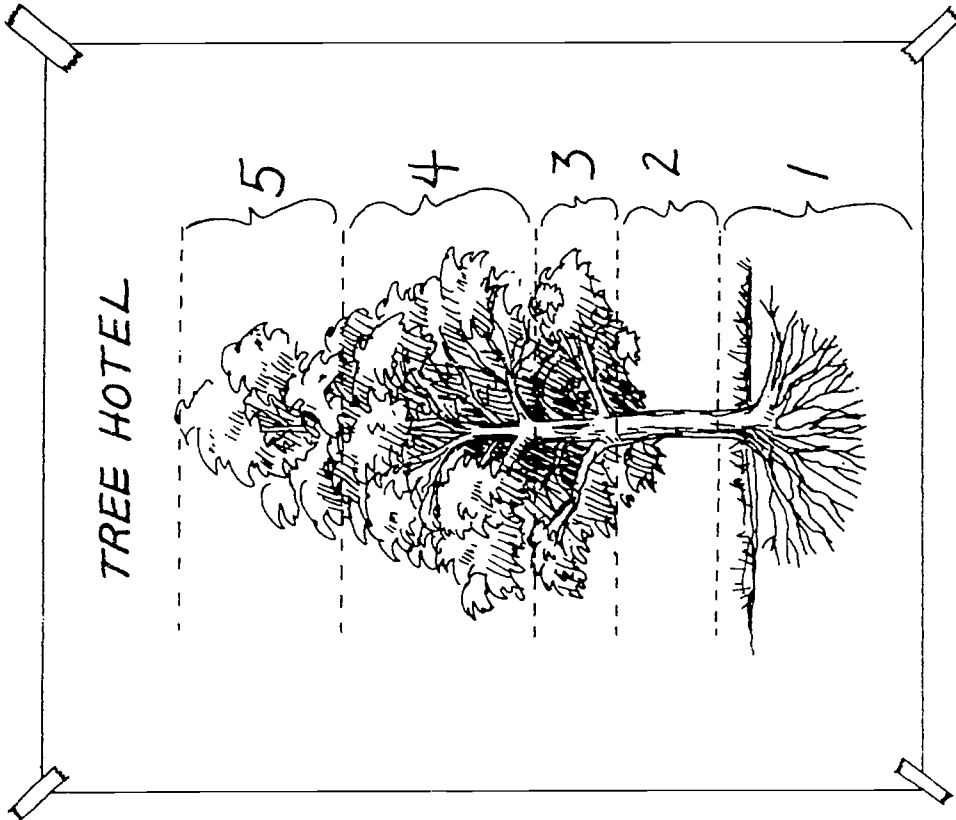

Forest Views



OBJECTIVES:

Students will (1) collect data about locally occurring trees, (2) prepare a poster of one kind of tree, and (3) present information about their trees to the class. See FORESTRY RESOURCES matrix for background information.

MATERIALS:

newsprint or posterboard
glue
felt crayons
simple key to local trees
other reference materials about local trees
leaves from trees selected for study

PREPARATION:

Have students find out the names of trees that they see every day. Many people are interested in naming trees and in knowing some uses of certain trees. In this activity, students will find information about a tree and share this information with the whole class. This will help students appreciate forest resources.

PROCEDURE:

The first step is to generate a list of trees from your area. This list can be developed by brainstorming with the class and added to as students begin to read and ask others about trees. A local forester or

a conservation specialist may be willing to come to class and help in the development of the list. Be sure to add or take away from the list as information becomes available. This shows that our knowledge about something increases as we gather more information about it.

Ask students to work in pairs. Each pair should choose one tree from the list as their tree. Each pair should read about their tree and also ask other people, through letters or interviews, for more information about their tree. Each group will present information to the class and teach the class enough about its tree that the whole class will be able to identify and know some interesting facts about the tree.

The pairs of students should:

1. Make a drawing on newsprint of the outline form of their tree.
2. Collect several leaves from their tree and paste them to the newsprint.
3. Write any interesting facts about the tree (where it can grow, what it can be used for, how tall it grows, how big around it gets, and so on) on the newsprint or on another page of newsprint.

When the students finish their posters have each pair present their posters and give an oral report to the class.

If possible, you may wish to arrange a nature walk where you can have each pair point out their tree to the class.

Round

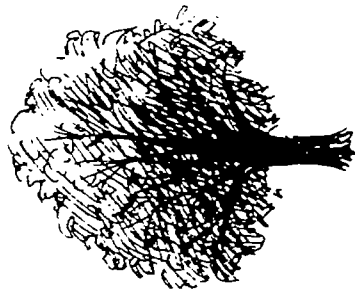

Pyramidal



Vase-shaped

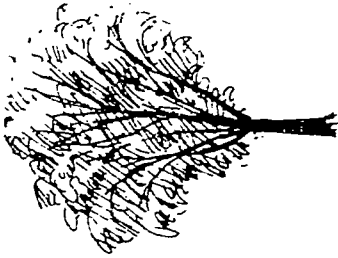

Columnar



FOLLOW-THROUGH:

Trees have some common uses but also some unusual uses. Certain tree barks may be used to make natural dyes; other trees contain chemicals that can be used as medicines. Trees also make some of the best playground equipment. Have students research these and other unusual uses of trees by checking the library for books on trees. Also, ask older relatives how they used trees when they were young.

Reading Rings



OBJECTIVES:

Students will (1) illustrate the life-cycle of a tree in a forest and (2) explain how various factors affect the tree's life-cycle. See FOREST RESOURCE'S matrix for background information.

MATERIALS:

duplications of prepared handouts included with this activity
posterboard or newsprint
felt crayons
simple key to local trees

PREPARATION:

Allow students to read the factsheets and other resources about tree rings. Ask them to find out what tree rings are and how they are formed. Discuss the relationship between a tree's "good" years, when the rings are wide, and its "bad" years, when the rings are narrow. List some causes of "bad" and "good" years.

PROCEDURE:

Divide the class into groups of two to four students each. Give each group a copy of the handout included. Have each group decide which tree ring pattern corresponds to which event. NOTE: All events might not be represented in ring pattern. Have the groups present their ideas and come to a consensus.

Each group should then create an imaginative history of one tree. Draw a large-size ring pattern on newsprint to illustrate the story. Place all the different ring patterns in front of the class and allow students to guess the history of each one. Provide hints if needed.

FOLLOW THROUGH:

Have a committee research the French artist, Henri Matisse. If possible, find some Matisse tree prints to serve as models and inspiration. Give each student a large sheet of white paper, several pieces of construction paper, scissors, and glue. They can then cut out and paste shapes onto the white paper to show their interpretations of the tree shapes they see.



PATTERNS RELATED TO TIME

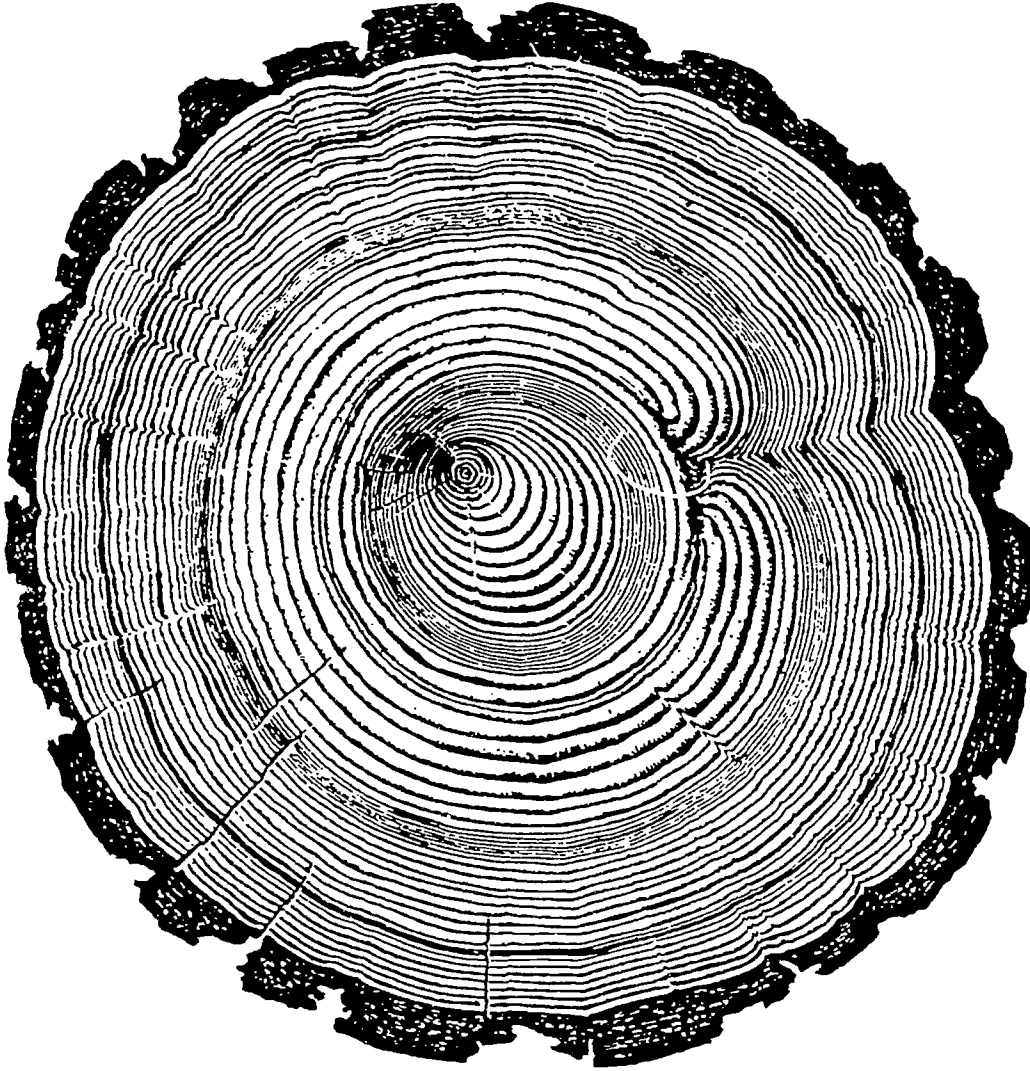
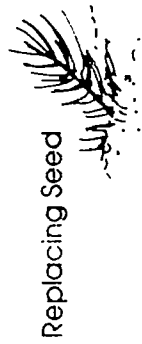
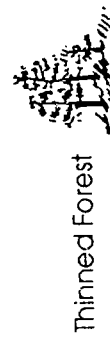
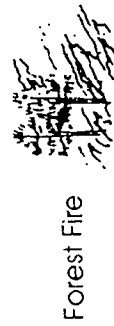
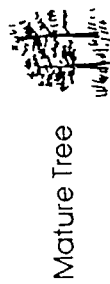

This tree trunk ring pattern shows the yearly growth of the tree and can be used to tell about the past. See if you can match the events shown in the small drawings with the changes in the ring pattern.

Nothing Succeeds Like Succession I



OBJECTIVE:

Students will describe and illustrate the stages of succession. See FOREST RESOURCES matrix for background information.

MATERIALS:

2-liter plastic bottles (tops removed)
soil
aquatic plant
2 cups bird seed
scissors

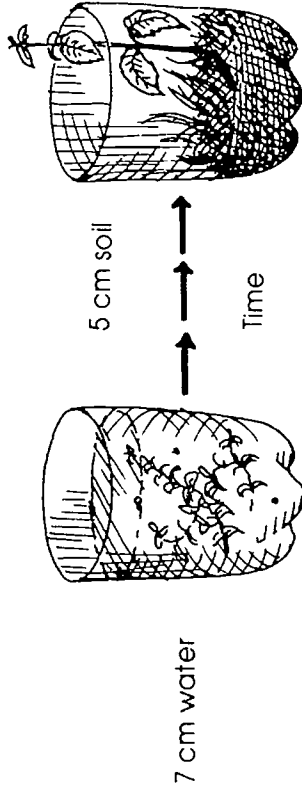

PREPARATION:

Succession is a term that describes the gradual, natural process of one habitat replacing another by building on what the previous "occupants" have left behind. This process is natural and, in many cases, so slow that it remains unnoticed by a casual observer. In this activity, students will be able to see how a swampy area can be succeeded by a forest habitat.

PROCEDURE:

Each student should bring a plastic bottle to school. Use scissors to cut off the top. Add 5 cm of soil and 7 cm water to each jar. Stir and allow to stand overnight. Add an aquatic plant to the bottle and place bottle in a window or beneath a grow lamp for three to four weeks. Do not replace water that evaporates.

Once or twice each week, have students add three or four bird seeds to the bottle and make a drawing of the bottle and its contents. (Note: While there is water in the jar, the seeds will sprout and then rot. As the water evaporates down to the soil, the aquatic plant will die but the bird seeds will now find a suitable environment.) If the soil dries out too much, add a little "rain" occasionally. Add sunflower seeds in the third week to represent "trees."

Have students work in groups of four or five to make a poster of what they saw happen to their "pond" and list what they learned about succession. Have each group present its findings.

FOLLOW-THROUGH:

Place a demonstration bottle in a place where it has light but will not be disturbed. Place a camera on a stand in a position to photograph the succession bottle at one-day intervals. When the project is finished, load the slides into a projector and show rapidly thus creating a "fast motion" movie of succession.

(adapted from "PROJECT WILD")

Nothing Succeeds Like Succession II



OBJECTIVES:

Students will observe succession in a natural setting. See FOREST RESOURCES matrix for background information.

MATERIALS:

camera
meter sticks
field notebooks
pencils
area topographical quadrangle maps
(check with the local geological survey office or library for maps)

PREPARATION:

Find a suitable site for a field trip which clearly shows succession. Examples are: an abandoned farm field or a recently cut forest. Also, locate nearby examples of a mature or climax forest and a farm for comparison. Discuss with students the meaning of plant succession or ecological succession and climax forest. Do the activity "NOTHING SUCCEEDS LIKE SUCCESSION I" before doing this activity.

PROCEDURE:

During the field trip, assign students to groups (for safety). Ask members of a group to watch out for each other. Take a whistle and

arrange a system of signals; for instance: two blasts means.... return to base, etc.

Choose a site where succession is starting. Study a topographical quadrangle map of the area and have students make a map of the area, highlighting several landmarks. Try to determine how long ago people had affected the area directly. Record the number and height of young trees and bushes, and locate these on the map. Look for recent damage by browsing animals and fire. Look for signs of cattle. What is the next step in the succession of this area? What evidence can be found to support this idea?

Make a group journal which will include all information gathered at the site in addition to a sketched map of the area and any photographs you took at the site. Note the stages of succession that can be found in the area. Collect stories from local residents to find out what happened in the area and why. You might want to include photos of group members and residents you have interviewed.

Back in class, have the students place all their group journals in one area to share with other members of the class. Have each group make a presentation to the class on its findings. Ask them what have they learned about succession from this activity?

FOLLOW-THROUGH:

Visit several other sites like lakes, bogs, swamps, reservoirs, and farms. Why do people have to spend a great deal of money and energy preventing succession in these natural areas? How can succession be bad for a hydroelectric power plant?

ZONES IN A POND

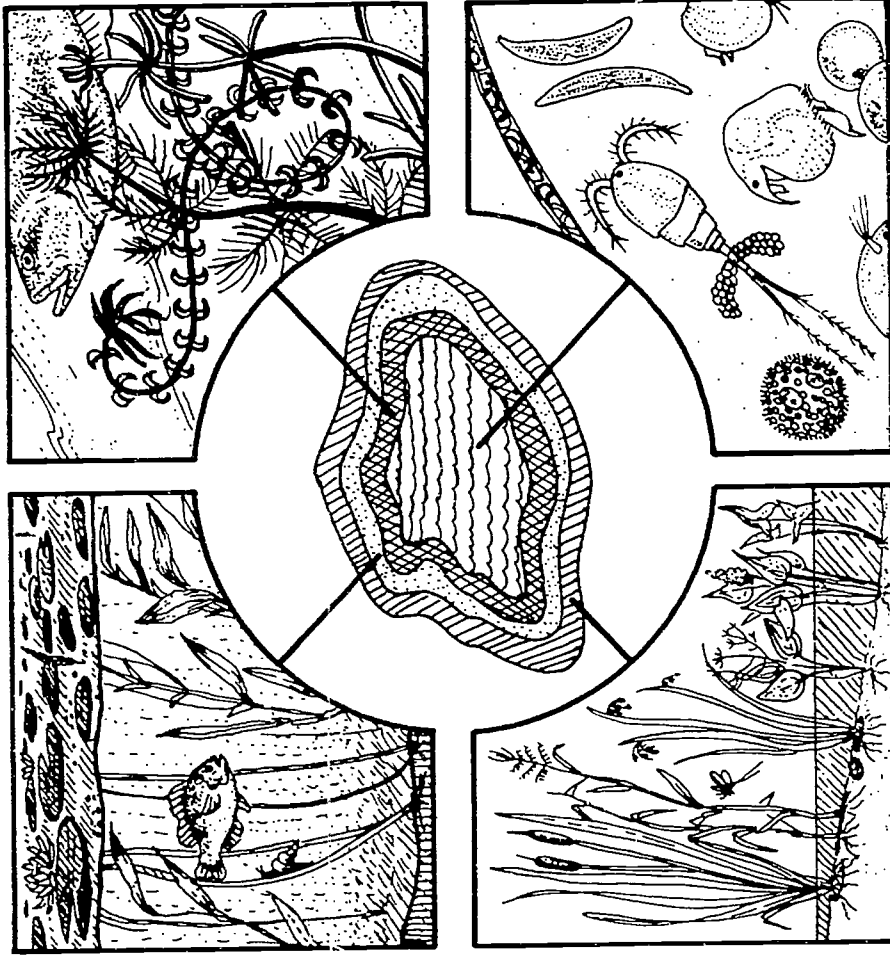

Submersed plant zone

Open water

Floating leaf plant zone

Emergent plant zone

4 17

4 0

Forest Resources Glossary



1. Agromy - The principles and procedures of soil management for field crops and special-purpose plant improvements.
2. Climax forest - The final stage in plant succession.
3. Composition - All the different types of tree species that make up a forest.
4. Cull - To remove undesirable trees.
5. Dormant seed - A temporarily inactive seed.
6. Hardwood - A deciduous tree that loses its leaves. Wood from such trees.
7. Humus - Layers of soil and organic material in a forest floor, the decaying leaves, needles, etc. (litter).
8. Litter - Top layer in forest floor made up of leaves, pine needles, etc.
9. Meteorology - The science concerned with the atmosphere and its phenomena (weather).
10. Multiple-use concept - Managing one area for a variety of uses such as wildlife, recreation, and forestry.
11. Photosynthesis - The process by which green plants convert carbon dioxide and water into simple sugar. Chlorophyll and sunlight are essential to the series of complex chemical reactions involved.
12. Pioneer species - Plants capable of invading bare sites, such as a newly exposed soil surface, and living there until another plant replaces it.
13. Plant communities - A group of plants occupying a certain position in the environment and interacting with each other.
14. Residual stand - A group of trees left standing after a cut has been made.
15. Silviculture - The science of producing and tending a forest.
16. Stand - A group of trees in a forest.
17. Succession - The orderly, gradual and continuous replacement of one plant or animal by another.
18. Understory - Layer formed by the crowns of the plants in a forest.
19. Virgin forests - An original forest undisturbed by people.
20. Watershed - The region draining into a river or system of rivers.

Recreation Resources



411

BEST COPY AVAILABLE

410

"We live beside our lakes. We swim in them, boat on them, fish in them, and get our drinking water from them. Maintaining these appealing havens Valley residents have come to expect, requires careful choices and thoughtful actions."

Benchmark Report

Recreation Resources Concept Map

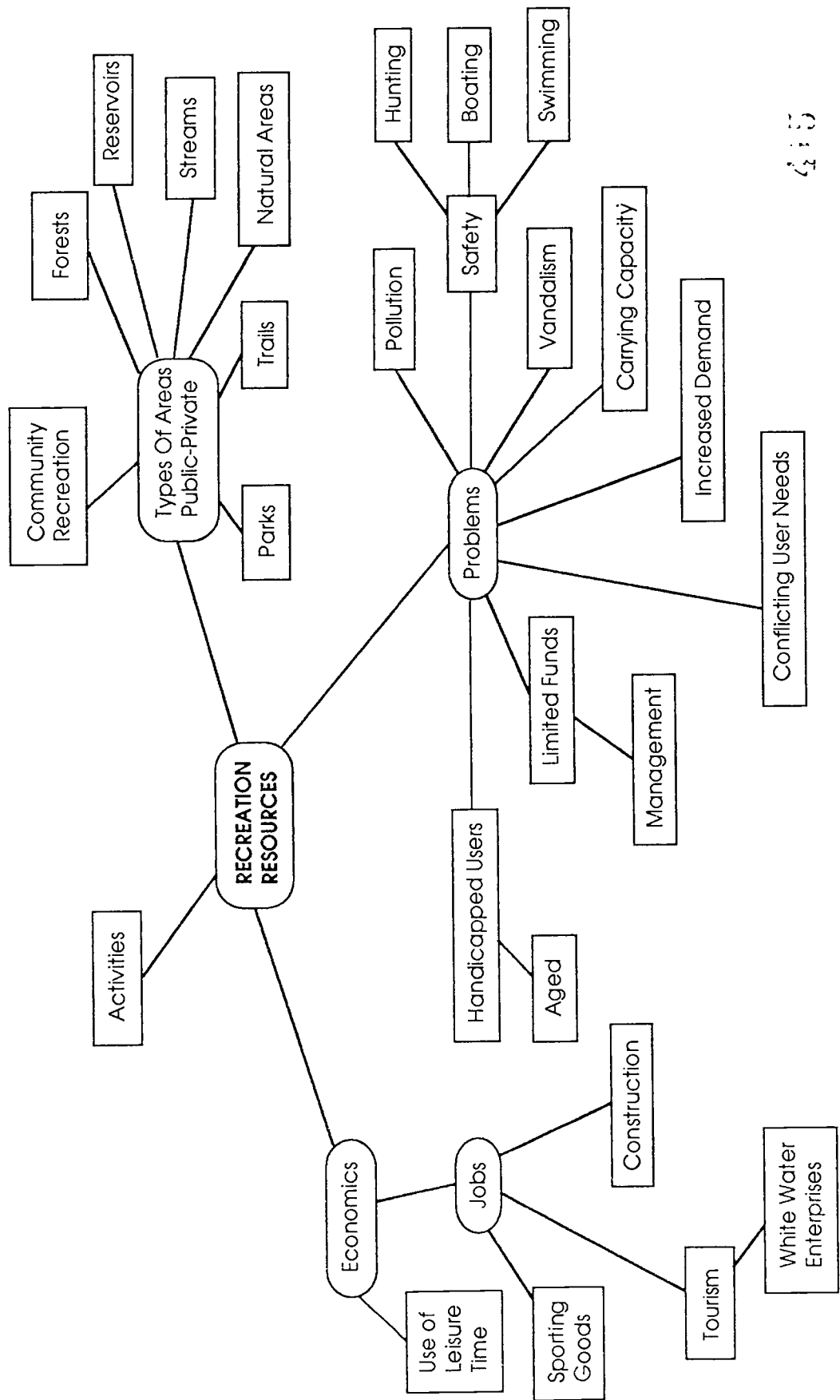



Recreation Resources Factsheets

1. Overview
2. Recreation In The Great Outdoors
3. Natural Areas
4. Reservoir Recreation
5. Valley Streams
6. Trails
7. Special Population Recreation
8. Community Recreation
9. Recreation For Profit
10. Water Safety

1. Overview

Residents of the Tennessee Valley are blessed with an agreeable climate, natural scenic beauty, and abundant animal and plant life. In addition, there are over 600,000 acres of lakes, 11,000 miles of shoreline, 1,800 miles of scenic streams, and 21 million acres of forest, giving the Valley a truly outstanding combination of resources for recreation. Today, we appreciate the benefits of these resources more than ever. They provide a link with our natural and cultural environment, contribute to our physical and mental health, and generate an annual economic growth. It is estimated that at least \$260 billion is spent on leisure activities in the United States.

For many Valley residents, leisure has become an important means of achieving self-improvement and expression. This has resulted in changing patterns of outdoor and indoor recreation. Variations in work patterns, the phenomenon of the two career family, and flexible work schedules are affecting our recreational needs. Business now recognizes the importance of recreation and leisure and its relation to learning, job productivity, health, and many other aspects of life. There is a growing interest in managing one's life so as to prevent illness. This "wellness movement" emphasizes the prevention of illness through exercise, nutrition, and other individual efforts.

Another factor affecting recreation is the economy. It is changing from one based on heavy industry to an economy based on "high-tech" manufacturing, communications, and services. Most Americans no longer engage in heavy physical activity on the job. Fatigue at the end of the working day is more mental than physical. Therefore, we turn to leisure activities for mental relaxation and that "feeling" of physical fitness which comes from the interaction with the natural environment.

With this new awareness, however, come problems like overuse and crowding of our existing recreation resources and conflicts over the use and conservation of land. Until recently, there was little concern about the quantity of outdoor recreational area, particularly in the Valley region where such resources are in seemingly abundant supply. The fact is, the region's supply of land and water resources available for recreation is becoming more limited each year. Unless a method is devised to either expand the supply, shift demand, or use the existing supply more efficiently, there will be a shortage of resources in the future and we will be unable to accommodate all those who wish to "re-create" in an outdoor setting.

The responsibility for a continued supply of resources for recreation lies in the hands of numerous agencies and individuals. This fact, in itself, presents problems concerning the use and preservation of land for recreation. Decisions to use our resources for mining, oil exploration, hunting, fishing, rafting, or forestry are seldom made without having an associated impact on some other resource. Tradeoffs must be made, often to the benefit or at the expense of another resource.

Generally, recreation is viewed as a positive use of our resources and is considered a secondary benefit to most resource management practices. However, there are negative impacts associated with recreation use. These most often occur in the form of vandalism, littering, fire, overuse, and pollution. Many times, areas previously untouched by those problems suffer tremendously after being opened for public recreation. Fortunately, through a better understanding of the delicate balance between people and the environment, we are learning how to use our resources and minimize these problems.



2. Recreation In The Great Outdoors



If you live in the Tennessee Valley, chances are good you have visited the mountains and forests. Perhaps you went camping, picnicking, or hiking, or just for a drive to enjoy the scenery. If you did, you are one of the lucky ones. There are millions of people living in the world who do not have similar areas to enjoy. The wise use of our natural resources, such as forests, for the benefit of all is called conservation. Thus, it is important that we take care of our forests and manage them for a variety of uses. Resource managers call this the "multiple-use concept."

One of the greatest uses of our forested areas is recreation. Many private landowners and companies permit us to enjoy their forested land for hunting, hiking, and studying nature. Some have even developed picnicking, camping, and swimming facilities for us to enjoy, but it is always a good idea to obtain permission before we use these areas.

We ask a great deal of our forests. In addition to recreation, they supply us with wood to build our homes. There are also important economic uses. Forests are an important factor in reducing erosion caused by water and wind. In the process of photosynthesis, trees use carbon dioxide to make food and release oxygen into the air as a "waste" product. Considering all of these important functions of the forest, we should maintain them properly.

Every year, more people seem to visit the mountains and forests for recreational purposes. A forest's recreational carrying capacity is the highest level of recreational use it can withstand while maintaining a constant environmental quality at a reasonable cost. Defining this capacity is like defining how many people one pie will serve—it depends on the size of the servings. For example, your favorite picnic

area may withstand 100 people per day for many years while maintaining a constant level of greenery, quietness, and general pleasantness. But if 200 people were to use this area each day, some of the vegetation would die, the noise level would increase, and there would be a general decline in quality. We need to ask ourselves what we can do to ensure that our forests will be available for visitors in the future.

There are 155 National Forests totaling 188 million acres. In the Valley region, these include: Bankhead National Forest in Alabama, Chattahoochee National Forest in Georgia, Daniel Boone National Forest in Kentucky, Holly Springs National Forest in Mississippi, Nantahala and Pisgah National Forests in North Carolina, Cherokee National Forest in Tennessee, and Jefferson National Forest in Virginia. The National Forests belong to the people of the United States. These lands are under custody of the U.S. Forest Service, an agency of the U.S. Department of Agriculture. On the other hand, the Great Smoky Mountains National Park and the Natchez Trace and Blue Ridge Parkways are under the custody of the National Park Service, an agency of the U.S. Department of the Interior.

3. Natural Areas



Some people spend their recreation time in swimming pools at city recreation centers, playing miniature golf, working out at a health club, going to a movie, or visiting the city library. Others like the quiet solitude of the forest and prefer to "rough it" by getting away from civilization. Few areas of true wilderness exist in the eastern United States. However, many areas do contain such interesting natural features as waterfalls, caves, springs, and stands of virgin forest. Many local, state, Federal, and private programs are designed to identify, preserve, and protect these natural areas for scenic or scientific significance. Natural areas are lands protected in their natural state with as little direct management as possible.

Hiking is one of the most important recreational benefits of natural areas. Careful trail construction is compatible with most natural areas and allows visitors to enjoy them without disturbing plant life. Primitive camping, horseback riding, nature photography, and wildlife observation are other benefits.

Aside from their scenic value, natural areas provide educational opportunities. They are places to learn firsthand about the natural world and offer opportunities for research of various plant and animal life. As population increases, more land is needed to support industry, transportation, agriculture, forest products, energy, and housing. When natural habitats are lost to development, plant and animal species are also lost. Natural areas protect fragile or rare habitats such as bogs, caves, glades, marshes, sinkholes, and the species that have become specifically adapted to live in them. TVA has assisted other agencies in setting aside land to protect sensitive species habitats.

In addition to the activities supported by TVA, the U.S. National Park Service, the U.S. Forest Service, various state agencies, private conservation organizations, businesses, and corporations have all initiated efforts to identify and protect natural areas. In many instances, these groups work together for this purpose. There are over 300 identified natural areas within the Valley currently receiving some degree of protection.

Several problems are involved in the management of natural areas. Water pollution, vandalism, illegal hunting, off-road vehicles, and insect damage are only a few of those problems. Protection requires thoughtful planning, monitoring, cooperation, and education.

4. Reservoir Recreation

Reservoirs differ from lakes. Reservoirs are bodies of water which are collected and stored in natural or artificial lakes. Lakes are large inland bodies of water. In the Tennessee Valley, the reservoir system was created by constructing dams on the Tennessee River and its major tributaries. The dams were built to provide flood control, a navigation channel, electric power production, recreation, and an adequate water supply.

Valley lakes, which provide opportunities for recreation, receive approximately 70 million visitors annually. There are over 110 state and local parks, 400 public access areas, 28 state wildlife management areas, 2 national wildlife refuges, 139 recreational areas, 55 group camps and clubs, and over 300 commercial recreation areas on TVA reservoirs. At reservoirs, the public enjoy boating, camping, swimming, fishing, hiking, hunting, and picnicking in scenic surroundings. To accommodate these needs, campgrounds, picnic areas, boat ramps, restrooms, access roads, and parking areas have been built along the reservoir shorelines.

Increased leisure time such as the shorter workweek and longer vacations and holidays, labor-saving technology, higher salaries, and improved transportation and roads have placed even greater demands on reservoir use. Due to this rapid growth and the lack of public access facilities, reservoirs were becoming overcrowded, unsanitary, and degraded. By 1978, it became evident that a recreation management policy was needed for the TVA reservoir system. Ideas were gathered from everyone concerned, and specific management plans were cooperatively developed to provide a wide range of quality recreation experiences. State and local government agencies also began to develop new management policies for

their parks and other recreational facilities. In addition, local lake residents began forming lake user associations.

Management policies include: designating areas for specific uses such as day use, camping, boat launching, and parking; resident managers on site at major areas; and implementation of fees for overnight camping. These steps were taken to reduce problems related to overuse, user conflicts, and vandalism, and to provide for increased security and supervision.

Recreational use of lakes has also had a variety of economic impacts. Jobs have been created through commercial recreation and significant economic growth has been felt among local businesses that provide food, beverages, supplies, sporting goods, lodging, and recreational equipment. Boat and camper manufacturers have benefited financially from the availability of quality recreational opportunities. Construction companies also benefited from the demand for second homes and primary residences on reservoir property. Tourism attracts visitors outside the Valley to these recreational areas.

Since most reservoir systems have multipurpose objectives, lake levels are fluctuated to meet needs for flood control, navigation, power production, mosquito and/or aquatic plant control, recreation, and water supply. Weather conditions and rainfall ultimately determine lake levels. There are many demands made on the reservoir system and managing it for the benefit of all users is a complex process. For example, lake levels must be lowered to meet power demands and to increase flood control; however, sportsmen need high lake levels for boating. There are conflicts among lake and



stream users since one group prefers full lake levels and the second needs increased streamflows below the dams for fishing, canoeing, kayaking, and boating. TVA reservoir managers seek to achieve a balance by operating the reservoir system for the primary objectives of flood control, navigation, and electric power production, respectively.

Good water quality and proper land management are of great importance to assure that quality recreational opportunities are available. Wise forest management, control of erosion, and proper municipal waste water treatment are essential for the lakes to support fisheries, wildlife habitats, and water-related recreation.

407

5. Valley Streams

Rivers and streams have always been important in America. In the days of the Indians and the fur traders, rivers were an easy way to travel from one village to another and to transport furs to market. In the 1700s and 1800s, rivers were major highways for transporting goods from one city to another. Most large cities in the Tennessee Valley were first established along rivers because they were important trade routes. Rivers also provided the energy to grind corn, wheat, and other grains, and they were eventually harnessed to produce electricity. Today, however, rivers and smaller streams are important for reasons other than work.

In the 1930s, 1940s, and 1950s, some people began canoeing rivers and streams to relax, to explore scenic areas, and to have fun. Today canoeing, rafting, and kayaking are among the fastest growing recreational activities in this country and are expected to continue to increase in popularity. There are approximately 40 different companies in the Valley that provide guided raft trips, rental canoes, or inner tubes. The Tennessee Department of Tourism estimates that \$4.5 million is spent by canoeists and rafters to outfitters on the Ocoee River in Tennessee alone.

Boating isn't the only thing for which streams are popular. Streams in the Tennessee Valley are famous for fishing. There are an estimated 1,230 miles of trout streams in Tennessee. Small mouth bass, spotted bass, white bass, sauger, crappie, and catfish are just a few of the major sport fish. Valley streams are also popular places for swimming and for wildlife observation.

This growing interest in river recreation has helped bring national attention to the preservation of America's most outstanding rivers. In 1968, the National Wild and Scenic Rivers Act was passed.



This act attempts to preserve the Nation's free-flowing streams and rivers by providing immediate protection from damming and other harmful development projects. The Obed River, in Tennessee, is protected through this act and the Big South Fork River, in Tennessee, has been designated a National Recreation River. Tennessee, Virginia, and North Carolina have approximately 129 miles of national, wild and scenic rivers. The act also encourages states to enact their own legislation and develop statewide wild and scenic river programs.

Although many miles of streams in the Valley are not worthy of national river status, many can fulfill the needs of people who want to float and fish, if public access to these rivers is provided. TVA and Federal, state, city, and county governments are working together to provide public access facilities to the rivers of the Valley.

6. Trails

Prior to European settlement, the Indian villages of the Tennessee Valley were linked by a sophisticated network of trails. The Europeans followed these trails during their westward expansion. By the time of the Civil War, these trails had become roads and railroads.

In the early twentieth century, newly formed land-management agencies, such as the U.S. Forest Service, the National Park Service, and the Tennessee Valley Authority, found they needed trails for fire control, resource management, rescue operations, and recreation. At the same time, the Civilian Conservation Corps (CCC), a government program designed to give people work during a time when jobs were not readily available, was also involved in developing trails.

Following World War II, improved economic conditions, educational opportunities, and new technology created a society which had additional leisure time and money. From this point forward, the need for trails and related outdoor facilities began to exceed the demand. Trails were developed to benefit many types of users: elderly persons looking for safe places to stroll, families enjoying bicycle outings, hikers seeking to get away from it all, or horseback riders looking for a remote, scenic setting.

The greatest barrier to developing trails has always been acquiring suitable land. Compared to other areas of the country, however, the Valley region is relatively rich in trails. This is primarily due to the availability of large areas of undeveloped land. The eastern boundary of the Valley includes the Great Smoky Mountains National Park. To the west, the Cumberland Plateau and Highland Rim contain



large areas of undeveloped land, state parks, and natural areas. On the populated floor of the Valley, there are fewer large areas of undeveloped land, but many shorter trails are available.

Most trails have been developed in response to specific public demands; however, there are many reasons to develop more comprehensive plans for trail systems. For instance, in the Valley: (1) The demand is increasing (expected to quadruple by the year 2000) while resources (land and money) are decreasing; (2) user conflicts are growing as more interest groups seek to make use of the same resource; (3) there is an unbalanced geographic distribution of trails with more attention being given to long hiking trails located in the eastern part of the Valley; (4) some groups, such as urban residents, minorities, and the handicapped, have not been included in trail development; and (5) increased participation and improper usage of existing trails threaten security and proper maintenance.

Studies indicate that trails should be: (1) near transportation networks and population centers; (2) in areas to best serve special populations, such as urban residents, children, the aged, and the handicapped; and (3) in areas where recreational and educational programming support facilities which already exist (museums, zoos, interpretive centers, etc.).

Trails have been developed, as needed, for a variety of recreational activities, but only recently has increased emphasis been placed on systematic trail development. Comprehensive plans for trail systems attempt to accommodate the needs of short- and long-distance hikers and back packers, strollers, special populations

(handicapped and elderly), bicyclists, horseback riders, and off-road vehicle users. Coordinating these efforts requires that regional and national organizations work together in trail planning efforts.

Currently there is a growing trend to involve volunteers in the design, construction, and maintenance of trail systems. After all, if users are going to continue to enjoy quality trails, they must participate in the process of developing and maintaining the trail systems.

7. Special Population Recreation



Special populations of both urban and rural areas have been neglected over the years when plans were made for recreational services. Nearly 10 percent of Tennessee Valley residents are elderly, 15 percent are minorities, and 16 percent are considered handicapped. The United States Census Bureau reports that each day 4,000 Americans reach the age of 65. Of over 5,400 visitors to TVA recreation areas surveyed, in 1985-86, about 400 were 65 or older and over 600 were between 56-65 years of age. The White House Conference on Handicapped Individuals estimates that the Nation's handicapped, together, have more than 170 million hours of potential leisure time. Many of these individuals are confined to urban areas where there is no space for an outdoor recreational experience. Although services are offered in indoor facilities to a varying extent, opportunities for a full range of recreational activities are not readily available to most special population users.

Lack of land for outdoor recreation is not the only reason for poor participation by special population groups. Many individuals will not participate because of poor health, fear of getting hurt, architectural barriers, poor lighting, fear of crime, weather, lack of companions, or lack of money. Nevertheless, the needs of these "special" individuals should be met.

Most recreational facilities were built before the Architectural Barriers Act of 1968 and Section 504 of the Rehabilitation Act of 1973. These acts require that organizations using Federal funds make their programs accessible to and usable by handicapped persons. As funds become available, many facilities are being developed and remodeled with structures allowing handicapped persons to participate more fully in activities and programs. In fact, many fishing piers, beaches, shelters, paved trails, campsites, and restrooms have already been developed or remodeled here in the Tennessee Valley.

More and more recreational facilities are beginning to cater to special-needs populations. For instance, on TVA reservoirs each summer, university students are hired to conduct recreation activities free of charge. Activities are specially adapted to meet each special population's need and include: nature arts and crafts, cane pole fishing, canoeing, swimming, sailing, sports, games, and outdoor biology programs. Similar activities are also conducted by other local, state, and Federal organizations, and the number of opportunities for special populations is growing.

In terms of the economy, there is an untapped market for recreational products for use by the disabled. Many companies, realizing this need, are developing products and facilities for use by this population. Special picnic tables and grills are now available for wheelchair users as well as able-bodied individuals. Many facilities are installing TTY and TDD telephone systems for the hearing and speech impaired, and several theaters and auditoriums are installing a variety of amplification systems.

The increasing number of retirees is also expected to affect the economy. People are retiring at an earlier age and receiving a retirement income. This additional money, in combination with increased health awareness, will result in increased purchases of recreational goods and services by the retirement community.

All special population individuals have human needs. If they are to be physically and emotionally healthy, they must continue to have a full range of social and recreational opportunities available to them. All levels of government throughout the Valley are working together to develop the outdoor resources available—state parks, TVA land, lakes, streams, and recreational centers—for special populations. The outdoors provides a setting no classroom can match. It

enables the individual to participate in "total" learning experiences and provides opportunities not available to them elsewhere.

237

430



8. Community Recreation



Community recreational services have played a major role in preserving open space and land resources and have tried to meet the ever-changing leisure needs of Americans. More free time through shorter workweeks, rising incomes, and an increase in health awareness will mean an even greater role for local recreational agencies as we move into the 21st century.

The development of community recreational facilities and organized programs is as much a part of America as motherhood and apple pie. The use of land and water resources for recreation activities predates the beginning of New York's Central Park in 1856. The American Indians provided organized recreation as their youth participated in games of skill. Even the early pioneers found time to relax by engaging in social activities.

Citizens have often expressed their concern for public parks as evidenced by the following excerpt from the New York Packet, August 15, 1785, which was printed as a complaint to the mayor and aldermen from a citizen who signed his name Veritas.... "It is a very general complaint that there is not in this great city, not in its environs, any one proper spot, where its numerous inhabitants can enjoy, with convenience, the exercise that is necessary for health and amusement." Although it took more than 70 years before a major park was developed in New York, the start of an urban park movement had begun. The movement flourished from the late 19th century into the early 20th century producing urban parks in most large cities.

Even though all levels of government are involved in managing recreational lands, the majority of both recreation opportunities and needs remain at the local level. Managers of community recreational programs have the challenge of meeting the needs of a vast

array of participants, from preschoolers to senior citizens, as well as the handicapped and socially disadvantaged.

In order to meet community recreational needs, local agencies set aside and protect open space, develop and manage facilities, and provide structured activities to improve the mind and the body. These agencies are responsible for providing neighborhood and city parks, community centers, nature preserves, zoos, and landscaped gardens. The role of local recreational agencies is becoming more important in maintaining open spaces as the pressures for other development increase.

Recreation not only meets social needs, it also creates business. An estimated \$260 billion was spent on leisure activities in 1982. Its economic importance is apparent in the investments made by new industries; in the increase in a community's tax base resulting from improved property values; and in the jobs created by retail sales of recreation-related products.

Community recreation has always been an important part of American life and will continue to fulfill America's needs as new technologies and recreational products are developed.

9. Recreation For Profit

Interest and participation in recreation has grown dramatically over the last two decades. Increased leisure time, improved transportation, and higher incomes for many citizens are among the factors contributing to this growth. Private businesses have responded with a vast number and variety of recreation-related services and facilities. Motels, restaurants, amusement and theme parks, gift shops, marinas, excursions, bait shops, ski resorts, concession stands, recreational equipment (boats and campers), and campgrounds are just a few examples of equipment and services provided by the private sector. Their role can also be illustrated in other ways. Employment in trades and services increased in the Tennessee Valley from 14.3 percent in 1929, to 41.4 percent of total employment in 1980. Tourist spending in the Valley amounted to a total \$5.5 billion in 1982. These figures show the tremendous economic impact of tourism and recreation-related industries in the region.

Many of the commercial recreation enterprises in the Valley depend upon scenic and natural resources of the region. Examples of this relationship include the recreational attractions in Gatlinburg and Pigeon Forge, Tennessee, and the Great Smoky Mountains National Park. Some 300 commercial enterprises have been developed along the Valley system of reservoirs. Dozens of commercial outfitters provide trips down Valley streams and rivers. A cooperative relationship exists between government agencies and the private sector. Each has a role in providing recreation. Government agencies generally manage resources and provide services that do not lend themselves to operation for profit. The Great Smoky Mountains National Park is an example. In keeping with the primary purpose of this park, the National Park Service (NPS) manages it to protect the resources while providing opportunities for the public to enjoy the park's scenic beauty, such as roads, trails, overlooks, primitive camp-



ing areas, picnic areas, and nature centers. Many park visitors, however, desire additional services and facilities to enhance their visit to the area. Facilities established around the outer edges of the park by the private sector supply these needs.

Another example of the relationship between the private sector and government agencies exists on the TVA reservoir of Kentucky Lake. This vast reservoir contains over 160,000 surface acres of water and has 2,400 miles of shoreline. In managing this resource, TVA tries to maintain good water quality, preserve the scenic character of the shoreline, protect wildlife and fish habitats, and improve navigation. These efforts enhance the overall recreational potential of the lake and complement the 80 commercial recreation areas, including boat docks, resorts, campgrounds, and motels, that have been established around the reservoir.

10. Water Safety

The Tennessee Valley is blessed with an abundance of water resources for swimming, boating, rafting, sailing, and fishing. These resources are within a short distance of anyone wishing to get involved in water recreation and the resources are growing in popularity every year. A recent nationwide survey has shown that swimming was the most popular outdoor activity in the country. Fishing ranked third and boating ranked fifth. With this growing popularity, it becomes more important to understand the potential safety problems related to water recreation.

Each year an average of 55 persons drown in the Tennessee Valley because either they did not know how to swim or they ignored some basic water safety rules. These rules are not very hard to remember but are often overlooked by people who think accidents will never happen to them. Unfortunately, accidents do happen and it is each individual's responsibility to learn to fish, swim, and boat safely.

Learning how to swim is the most important skill to master prior to taking part in any water-related activity. In 1984, 70 percent of the drownings that occurred in the United States happened when the victim had no intention of getting wet. Swimming lessons are offered at the YMCAs, YWCAs, public schools, and local recreation departments. The local Red Cross keeps a list of scheduled learn-to-swim programs and is a good source to check when trying to find a class. In addition to learning how to swim, persons planning to participate in water-related activities should also know the basic safety rules for swimming, boating, and fishing. By remembering and practicing these simple rules, all water recreational activities should be safe and happy experiences.



NOTE

"Each year between 6,000 and 7,000 Americans succumb to needless water deaths. Drowning is the nation's second leading cause of accidental death up to age 44 and the third leading cause of all ages. Most victims are young; 53% are less than 25 years old. 80% are male and over 50% of all drowning victims had been drinking alcoholic beverages or using drugs before entering the water," according to National Safety Council 1983 Survey.

Swimming Safety

These rules are based on common sense and are intended to be the foundation for developing a total awareness of swimming safety.

1. SWIM IN APPROVED AREAS ONLY.
2. DON'T SWIM ALONE.
3. LOOK BEFORE YOU DIVE.
4. DON'T HORSEPLAY.
5. DON'T SWIM IF YOU DON'T FEEL WELL.
6. DON'T USE DRUGS OR ALCOHOL WHILE SWIMMING.
7. DON'T USE INFLATABLE TOYS OR AIR MATTRESSES AS PERSONAL FLOTATION DEVICES (PFD).

8. LEARN THE BASICS OF SELF RESCUE.
9. STAY OUT OF THE WATER DURING ELECTRICAL STORMS.
10. KNOW HOW TO ADMINISTER ARTIFICIAL RESPIRATION.

Boating Safety

Boating offers a chance to get away from every-day cares to a new world of sailing, motorboating, skin diving, canoeing, camping, or picnicking in secluded places. The sensible boater is aware of the legal requirements and the responsibility involved in operating a boat safely.

1. HAVE A PERSONAL FLOTATION DEVICE (PFD) FOR EVERY OCCUPANT.
2. DON'T ANCHOR IN STREAMS BELOW DAMS.
3. USE A TIE STRAP ON FISHING WADERS.
4. BEWARE OF SWIMMERS.
5. NEVER ANCHOR FROM THE REAR OF THE BOAT (STERN) IN MOVING WATER.
6. BE ALERT FOR RISING WATER WHEN WADING OR FISHING BELOW DAMS.
7. WEAR ANKLE TOP BOOTS IN A BOAT.
8. KNOW THE WATER TEMPERATURE.
9. DON'T RIDE ON THE BOW OR SEAT BACKS WHEN IN A BOAT.



Recreation Resources Activity Matrix

RECREATION RESOURCES	AIR RESOURCES	CULTURAL RESOURCES	ENERGY RESOURCES	FOREST RESOURCES	RECREATION RESOURCES	WATER RESOURCES	WILDLIFE RESOURCES	TVA-A WORLD OF RESOURCES
Re-Creation Lands	3	4		2	1,3	5	1	
Predicting Future Recreation Use		3		9	2	4	4,10	8
Picnics Are Fun?		3		1,5,9	1,2,3,4,5 6,7,8,9	1,3,4,9	1,2,3,4,5 6,7,8,9,10	8,9
The Big Picture	4,7	3,4	1	1,2,6,7,9	1,2,3,4,5	9	1,8,9	4
Punching-In Outdoors					4,5,9		1,4	8
Special Population Recreation		1		1	1,2,3,4,5 7,8,9,10			8
Valley Vacation		ALL	4	1,2	ALL	9	ALL	9
Water Safety					10			

Re-Creation Lands



OBJECTIVES:

Students will consider the implications of recreation and wellness by participating in guided imagery. See RECREATION RESOURCES matrix for background information.

MATERIALS:

GRAND CANYON SUITE might be played to set the mood.

PREPARATION:

Note to the Teacher: This activity makes use of an instructional technique called visualization or guided imagery. Brain researchers and learning theorists tell us the technique provides access to ways of processing that facilitate long-term memory and comprehension of concepts. As a teacher using this technique, you read or describe a series of images for your students; with their eyes closed they conjure images in their minds. Leave time between the phrasing of your words for students to visualize the images you are suggesting. Some teachers use guided imagery techniques as a regular part of each teaching day. It is not necessary to use the technique frequently; however, it is a powerful and helpful instructional tool for both teachers and students.

PROCEDURE:

Provide students with the following instructions:

You are to try to imagine the things you will hear me describing. I won't put in all the details—so you must try to see and feel, as clearly as you can, the things I describe.

Now, we are ready to begin. Make yourself comfortable. Don't worry about who is sitting next to you. All of you will have your eyes closed. Just be comfortable, and do your best to imagine the things I will describe. Okay, close your eyes, and imagine what you hear...

It is a late summer's night. There is a coolness in the air. To one side there is a babbling brook...on the other side, a stand of evergreen trees, a forest. You hear the night sounds of summer... Somehow, you can feel the changes in the weather...In the distance the dark sky is broken by bright flashes of lightning...The light is far away...After a long wait a rolling rumble is heard...The lightning gets closer...Suddenly it flashes and lights up the whole night sky...You look for a shelter from the rain...you find a safe place...

The sounds of gentle rain begin to blend with the distant sounds of thunder. There are longer times of quiet between the rumbles of thunder and flashes of lightning. You notice scents in the air, things you can smell and feel...It is quiet for a few moments, now you hear huge and distant rumbles, and now it is quiet again. You begin to hear a new sound...You are not sure what it is...Suddenly the rain is pouring down with a loud rich sound...It rains...and rains...and rains...and then stillness...the storm has passed.

Wait a few seconds; and then tell the students... "Open your eyes..."

Now it is time to find out what the students saw and felt during the guided imagery. There is no need to hear from every student, nor any reason for them to feel pressured to share. Most often, they are eager to describe what they experienced.

After students have shared their descriptions, focus on the feelings they have expressed. Does anyone feel "better" after this experience? Ask students to define "wellness." Relate our recreational lands to wellness at this point. Is there a built-in need in people to experience the outdoors so that even pretending to be outdoors makes us feel better?

FOLLOW-THROUGH:

Ask students to describe any of their recreational experiences, paying particular attention to how they felt before, during, and after the experience. Discuss how summer vacations have become a part of the American way of life.

Research vacations or "holidays" in other countries. For example, there is a recurring national traffic jam all over France during one particular holiday; what is it? Interview a travel agent or ask such a person to come speak to the class about possible recreational experiences and also the boom in travel agent careers.

(adapted from PROJECT WILD)



Predicting Future Recreation Use

OBJECTIVES:

- (1) Students will graph data of estimated visitor-days at U. S. national forests. (2) Students will predict future use of national forests. See RECREATION RESOURCES matrix for background information.

MATERIALS:

- graph paper
- handout of data table
- rulers

PREPARATION:

Change is a constant factor in every component of our society. Collecting and analyzing data to predict future needs and preparing graphs to show trends are ways to anticipate and plan for these future changes.

Distribute the data table and explain the columns of numbers. Point out the missing values and tell the students that their goal is to predict these values accurately as possible. Visitor-days are good indicators of forest use by visitors, because they account for how long visitors stay. A visitor-day equals one person staying 12 hours. (So, if someone stays only 3 hours, this counts as one-fourth of a visitor-day.)

PROCEDURE:

Have each student prepare a line graph with an axis like the examples in the diagram. For younger students, prepare handouts with the axes already drawn in and labelled. Students will probably need to round the number of visitor-days off to the nearest million.

Have students extend their lines through the year 2000. How many visitor-days can be expected in the national forests this year? Write to the Information Office of the U.S. Department of Agriculture and Forest Services in Washington for current data and compare these with your predictions. In what year might the number of visitor-days exceed 300 million? Fill in the data table with your values.

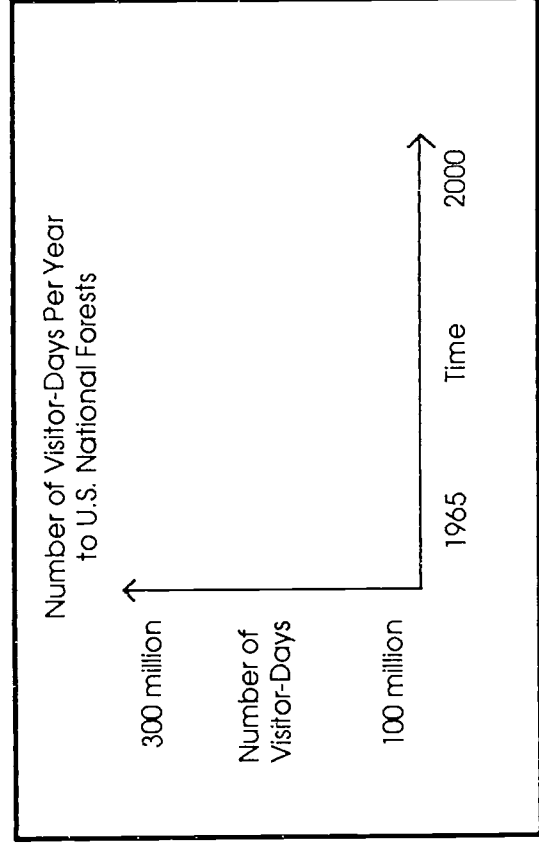

4553

4553

The steepness (slope) of the line reflects the growth in number of visitor-days per year. What does this mean in terms of recreation in the national forests? What are the implications of this for recreation in the U.S.? What are the implications for management and maintenance of our national forests? How might the forests be affected by this apparently continual increase in recreational use?

FOLLOW-THROUGH:

Contact the Information Service Office for Cherokee National Forest for data on one of the Tennessee Valley region's national forests, or contact the supervisor's office of other national forests for some data on recreational use. Prepare a data table like the one given. Draw a line graph with axes labeled like those in the diagram below with an appropriate range for number of visitor-days based on the data.

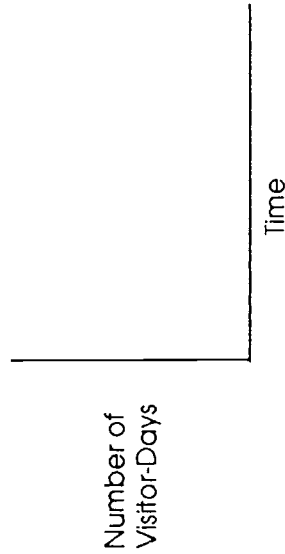

Compare the predictions and slope with those for national forests and discuss how this recreational use of the forest affects the local region.

Make a list of persons in your community with careers in recreation. Contact these persons and ask for interviews, in or out of class, on their perceptions on careers in the recreation field.

Data Table Number of Visitor-Days to U.S. National Forests Per Year	
Year	Number of Visitor-Days
1965	160,336,100
1975	199,200,800
1987	238,458,300
1988	242,315,700
Now	_____
2000	_____
_____	Over 300,000,000

Picnics Are Fun?



OBJECTIVES:

Students will simulate current trends in Tennessee Valley recreation lands and consider possible options. See RECREATION RESOURCES matrix for background information.

MATERIALS:

- 2 pieces of string for fence (each about 20 feet long)
- blue rug to represent water (or a blanket)
- small snack (have each student bring one from home)
- 2 signs (PUBLIC BEACH and PRIVATE PROPERTY)

PROCEDURE:

Set the scene for the activity. Clear an area in the classroom by pushing desks and tables to the sides. (This activity may also be done outside.) Roll out the rug for the lake. Rope two areas off beside the lake and place the signs so that one is a public beach and the other is private property. See the classroom below:

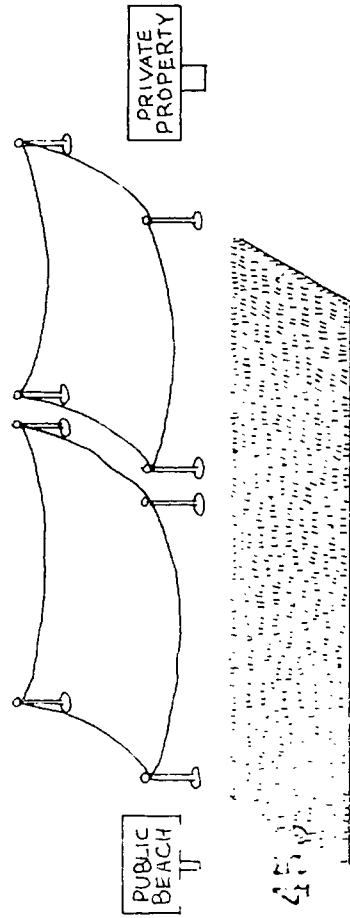

Select three students to be the landowners of the private property. Have these three enter their property and begin their picnic. Choose three more students to be members of the public and have them enter the public beach and begin their picnic. Ask the class to observe the two groups for a few minutes.

After 2 minutes, select three more students to enter the public beach and begin their picnic. Continue at 2-minute intervals until all students are picnicking. (The private owners may invite students to share their property if they want to.) Continue until all students have finished their snacks.

Discussion. Ask students what they observed at the beginning. As the crowd became bigger, how did students feel? What did they think of people on private land? How did landowners feel about the crowded beach?

Some recreation areas are becoming crowded. Discuss options to this problem. Have the class come to a consensus about the three best options for solving this problem.

FOLLOW-THROUGH:

Choose a solution or option generated above and implement it in your local community. Be sure to determine the factors involved in "recreation carrying capacity" first.

The Big Picture



OBJECTIVES:

Students will construct a graph to display land use in the Tennessee Valley. See RECREATION RESOURCES matrix for background information.

MATERIALS:

- colored paper
- scissor
- poster boards
- felt crayons
- ruler

PREPARATION:

In 1978, farms accounted for 13.4 million acres in the Valley with 7.4 million in actual crops. The remaining farmland is in forest and pasture. The total of forested land in the Valley region is about 21 million acres, and there are also 600,000 acres of lakes (0.6 m). This information is summarized in the table.

PROCEDURE:

Form groups of 4 or 5 students per group. Each group should cut squares from the colored paper according to the following table so that 1 square equals 100,000 acres (0.1m). The squares may be either 1 inch on a side or 1 cm on a side. Use yellow (Y), light green (LG), green (G), or blue (B) paper.

Provide the following information to the class groups:

FARM	CROPLAND	7.4 m acres	74 squares (Y)
	FOREST & PASTURE	6.0 m acres	60 squares (LG)
FOREST	NON-FARM	15.0 m acres	150 squares (G)
LAKES		0.6 m acres	6 squares (B)

PHASE I

Graph the above information by placing the squares on a poster board in rows and columns. Trace around the rows with a pencil and then color in the outline to form a bar graph. Label the sides and also name the entire graph.

TENNESSEE VALLEY LAND USE	
CROPLAND	(74 squares)
FOREST & PASTURE	
FOREST	

PHASE 2

Now have each group use the squares to make a representative diagram of the Valley. Let one square now equal 100 acres. This diagram will represent an area that is 1/1000 of the region.

Remember that 1 square is equal to 100 acres. Have each group start with a new posterboard. Place the squares on the board and begin to arrange them to form farms (yellow and light green), forest (green) and lakes (blue). What is the average farm size in your area? If it is 500 acres, then a typical farm should include 5 squares. The squares of paper may be cut into parts to make areas that are smaller than 100 acres. For example: cutting a square in half would produce 50-acre squares. How big are your lakes? Have the group discuss the arrangement of squares to produce the most advantageous conditions for people, being sure to consider farming, recreation, lumber business, etc. Also consider roads, rivers, streams, and towns.

PHASE 3

When your group is satisfied with the reasons for placing the squares, take a second posterboard and draw the land-use layout represented by your group's squares-patterns. Draw in creeks, dams, rivers, roads, and a town. Each group should present its maps to the class. Compare maps and reasons for land use. Do people in the town have access to recreational land? Did you dump the recreational land into one big lump or scatter it through the area? What are the advantages of dumping it into one big reserve? What are the advantages of having farms dispersed through the public lands? What would happen to our public lands if they were not managed? Does your group's map reflect the way that land is actually used in your area? How would you change local land use if you could?

FOLLOW-THROUGH:

Obtain a quadrangle map of your local area and also a county land ownership map. Use this information to determine land use in your local area. How much land is available for recreation in your area? How far do you have to travel to get to it?

Punching-In Outdoors



OBJECTIVES:

Students will list future careers and job opportunities in the recreation field. See RECREATION RESOURCES matrix for background information.

MATERIALS:

posterboard or newsprint
tape
glue
felt crayons

PREPARATION:

Read through the factsheets for this activity. Collect information from them concerning recreation investments, tourist spending, and employment in recreation.

Ask students to collect pictures from magazines and other sources showing businesses and workers.

PROCEDURE:

Brainstorm with students and list recreational businesses and any businesses associated with recreation in the Valley. Examples might include: motels, restaurants, curio shops, and bait shops.

Place the list of recreational business in the front of the room. Read through the list and have the students generate a second list of jobs or careers associated with these businesses. Classify these jobs as public, private, or both.

Divide the class into several groups of 5 or 6 students. Each group member should determine which job or career mentioned might be most interesting. Allow each group to make a poster. Each member of the group can either make a drawing on newsprint or cut out pictures from magazines that exemplify the job they choose and paste this onto the posterboard. Have one member from each group present its poster and tell the job in which each member is interested.

After each group has completed its presentation, review the trends in recreational spending and employment in the Valley. Discuss the effect this will have on the job market.

FOLLOW-THROUGH:

Invite speakers to discuss careers in recreation. The speakers may want to participate in the activity above.

680

680

Special Population Recreation



OBJECTIVES:

Students will develop a sensitivity to the needs of special groups of people in the population by simulating handicaps caused by physical disability or age. See RECREATION RESOURCES matrix for background information.

photos of plants and animals along a trail and take hikers out on the trail. Have the student naturalist treat the photographs as things they are seeing in the wild on the trail.

Choose 10 percent of the class to be elderly, and choose 16 percent to be physically handicapped in various ways. Meet to discuss the types of problems they will portray in the simulation.

MATERIALS:

blindfolds or painted out glasses
wheelchair and crutches
cane
blue rug
20-foot rope
pictures of native plants (dandelions, wildflowers
trees, etc.)
pictures of animals (dogs, cats, bird, salamanders, snakes, etc.)
mural of outdoor scene
obstacles (large rocks, tree branches, aluminum cans, empty
potato chip bags, etc.)

Now visit the "recreational area." Allow some students to act as guides and rangers. Pair up the special group with regular class members. Spend about 10 minutes in the recreational simulation.

After the activity, discuss the feelings of the students and what it is like to be handicapped in a recreational area. What types of obstacles were encountered? Make a list of items that could be considered to make recreational areas more accessible and more enjoyable to special population groups.

FOLLOW-THROUGH:

Make a check list of obstacles to look for and then take a field trip to a nearby recreational area. Decide how useful this site is to members of the population with disabilities. Do this simulation in the recreational area. Discuss with the class their feelings about what it would be like to be in this special group. Develop a rating scale to evaluate accessibility and enjoyability of public recreational areas for special groups. Write letters to other schools in the region, share the scale with them, and ask them to evaluate a recreational site in their area. Construct a table and list as many sites and their scores as possible.

PROCEDURE:

Work with students to develop the classroom into a recreational area simulating the outdoors. Use a blue rug for a pond; rope off a picnic area; hang pictures of plants and animals, and a mural of an outdoor scene. If weather permits, prepare this set-up outside to allow more space to set up the recreational area. Place obstacles on the paths between sites. Encourage students to participate in the set-up. Have one student be a trail naturalist. That student can place

Valley Vacation



OBJECTIVES:

Students will plan a vacation in the Tennessee Valley. See RECREATION RESOURCES matrix for background information.

MATERIALS:

felt crayons (several colors)
road maps of the Valley area (from service stations or automobile associations)
large Valley map
newsprint

PREPARATION:

Planning a vacation is a fun way for students to practice life skills such as planning ahead, budgeting, and setting goals. Also, it increases their knowledge and interest in local and Valley recreation.

PROCEDURE:

Divide the class into groups of 3 to 4 students each. Each group will provide a road map for its use. The group should first discuss what they would like to do or accomplish on their vacation. (Examples: fun, education, learn a new skill, paint a picture, take photos for exhibition or a class, all of these, or others). Students should begin to collect information by writing letters to State Tourist Centers. Students might also wish to call the toll free number 1-800-421-6683 for information about Tennessee State Parks.

In a later class period, allow the groups to set priorities on the information they have collected about recreational areas in the Valley and select a site or sites they would like to visit.

Next comes the planning stage. Students should consider the following: Will they communicate with home, and how often? How much are lodging or camping fees? What types of food will they buy and where they will eat? Do campers need to prepare a menu to buy food? What transportation will be used? What route will be taken? All of this should be written into a budget and estimates for each item computed. For example, if the trip will be 400 miles and you are using a car that get 25 miles to the gallon and gasoline averages \$1.10 per gallon, then the budget should include \$17.60 for gasoline. Add 10 percent to the budget to make sure there is enough money to get there and back.

Each group should write all of this information onto a newsprint sheet to present to the class. In addition, the route should be highlighted on the road map to show the planned route.

Allow each group to share its vacation plans.

FOLLOW-THROUGH:

Have students use the same procedure to plan a "dream vacation" in another part of the USA or in a different country. After students have researched and planned their vacations, present these to the entire class. Let a panel judge the three best "dream vacations." Include planning, location, activities, and other criteria to judge the best vacation.

Also, have students interview a local travel agent to find out how tours are arranged. Have students make presentations to the class on what they learned. Compare the differences in travel agencies.

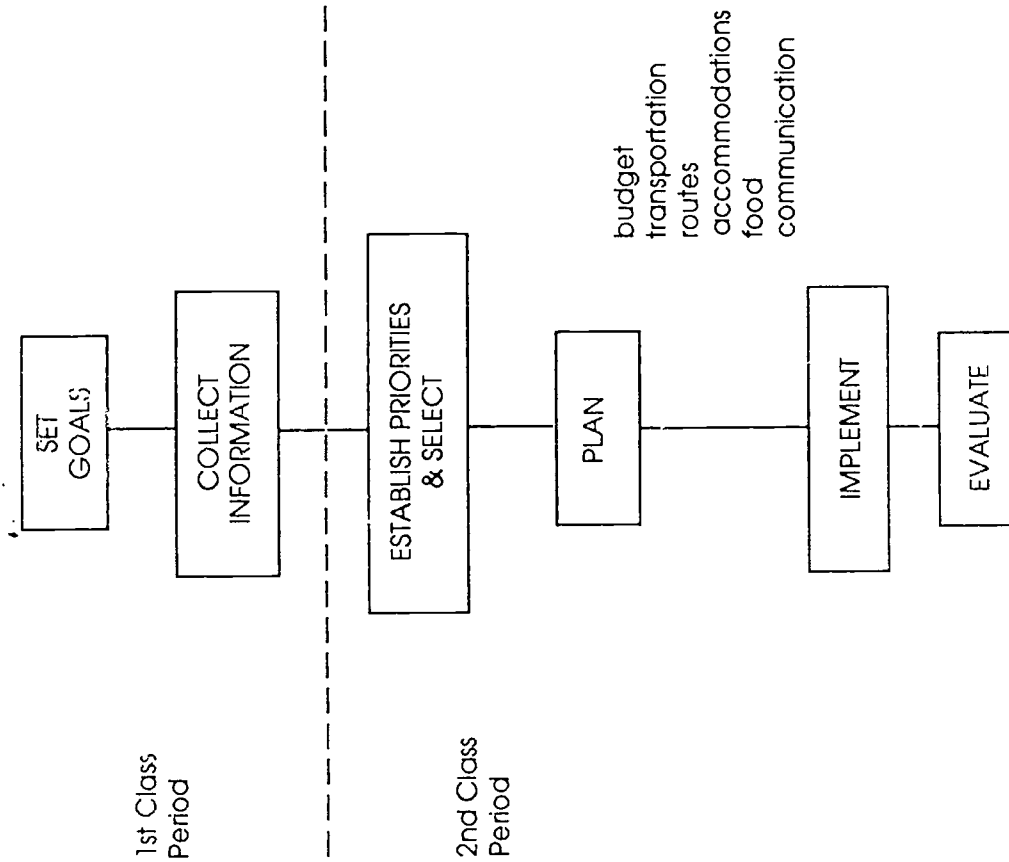

Water Safety Spotters



OBJECTIVES:

Students will make posters dealing with swimming safety, boating safety, and fishing safety. See RECREATION RESOURCES matrix for background information.

MATERIALS:

handouts of Factsheet 10 on "Water Safety"
 newsprint/posterboards
 felt crayons
 tape
 glue
 photographs from magazines of people, boats, and things

PREPARATION:

Water safety knowledge is very critical for anyone who enjoys such watersports as swimming, fishing, skiing, and boating, and even hunting or hiking. Have the students read Factsheet 10 on water safety and make a list of safety points mentioned in the reading for swimming, boating, and fishing.

PROCEDURE:

Divide the class into six groups and assign topics as follows:

TOPICS	GROUPS
swimming safely	1 and 2
boating safely	3 and 4
fishing safely	5 and 6

Ask each group to prepare a newsprint list of safety points for its topic. Make the list as complete as possible. Each group should then make a poster or collage composed of photographs and drawings that includes some safety points. (Example: A boy in a boat without a life jacket.)

When the groups have finished, have them place their posters around the room. Have all groups circulate from poster to poster and identify what is missing from each poster. When all groups have listed the missing items, come together as a large group and note these items to see if the groups were correct.

Place the newsprint list of safety points for each group at the front of the room. Go through each point; ask the class why each point is important.

FOLLOW THROUGH:

Develop safety posters and show these around the school. Have a show of practical art from different classes, centering on water safety. Use votes to choose the winner. Be sure to decide, as

as a class, the criteria for judging and the number of points for each category; for example:

originality.....	30 points maximum
message.....	40 points maximum
neatness.....	10 points
quality.....	10 points
impact.....	30 points
etc.....	__ points



Recreation Resources Glossary

1. Accessibility - Ease of approaching or entering an area or building.
2. Conservation - Wise use of natural resources in a way to assure continued availability for future generations.
3. Multiple use concept - Managing one area for a variety of uses such as wildlife, recreation, and forestry.
4. Natural areas - Lands protected in their natural state with as little direct management as possible.
5. Private sector - People and businesses not associated with the government.
6. Recreational carrying capacity - Highest level of recreational use an area can withstand, while providing a constant level of quality at a reasonable cost.
7. Special populations - Persons of a group that are elderly, physically or mentally handicapped, or from ethnic minorities.
8. Wellness movement - Managing your life so as to prevent illness.
9. Visitor-day - A measurement of public land use. One visitor day is equal to one person staying for 12 hours.

Water Resources



479

478

BEST COPY AVAILABLE



AIM

Association for Information and Image Management

1100 Wayne Avenue, Suite 1100
Silver Spring, Maryland 20910
301 587 8702

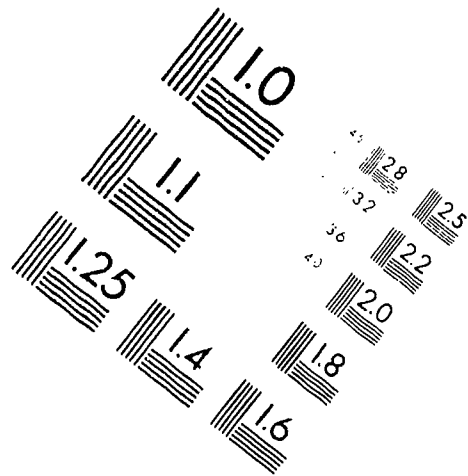
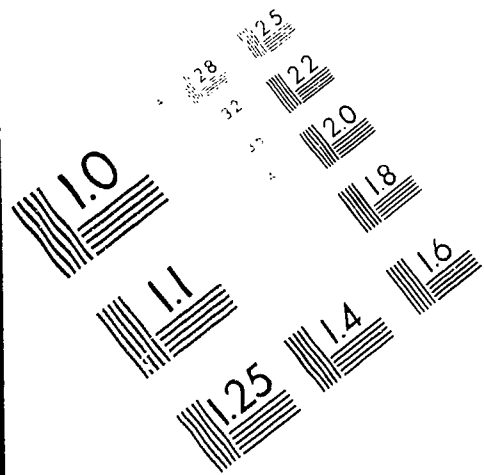

Centimeter

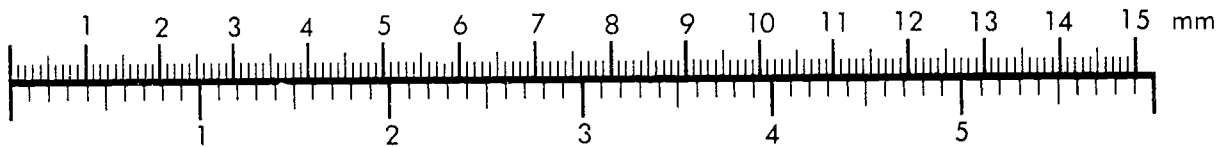

Inches

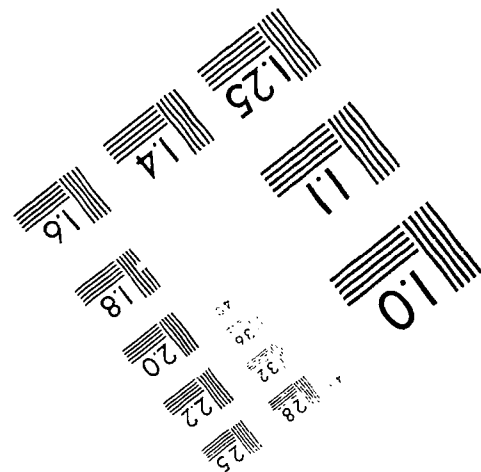
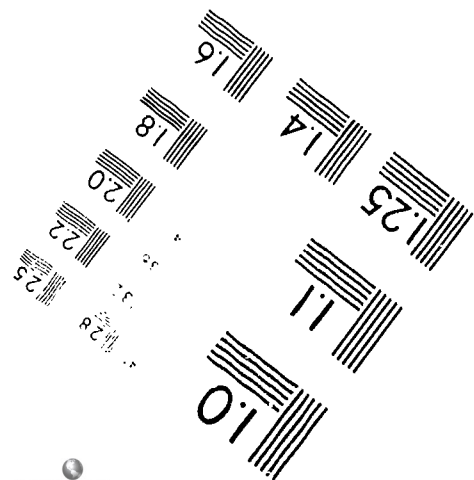
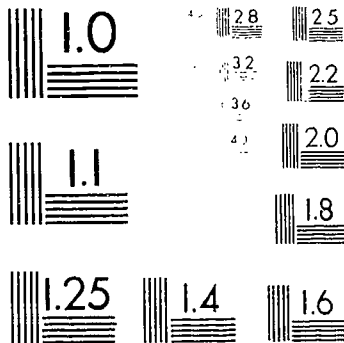

MANUFACTURED TO AIM STANDARDS
BY APPLIED IMAGE, INC.

"Always utterly essential, water can no longer be taken for granted. Polluted and wasted since mankind took over the world, water is with terrible slowness being acknowledged to require very intelligent handling ... if our race is to survive ... whoever mistreats water does so at his own peril."

Peter Briggs

BEST COPY AVAILABLE

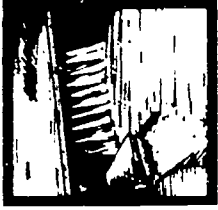

Water Resources Concept Map

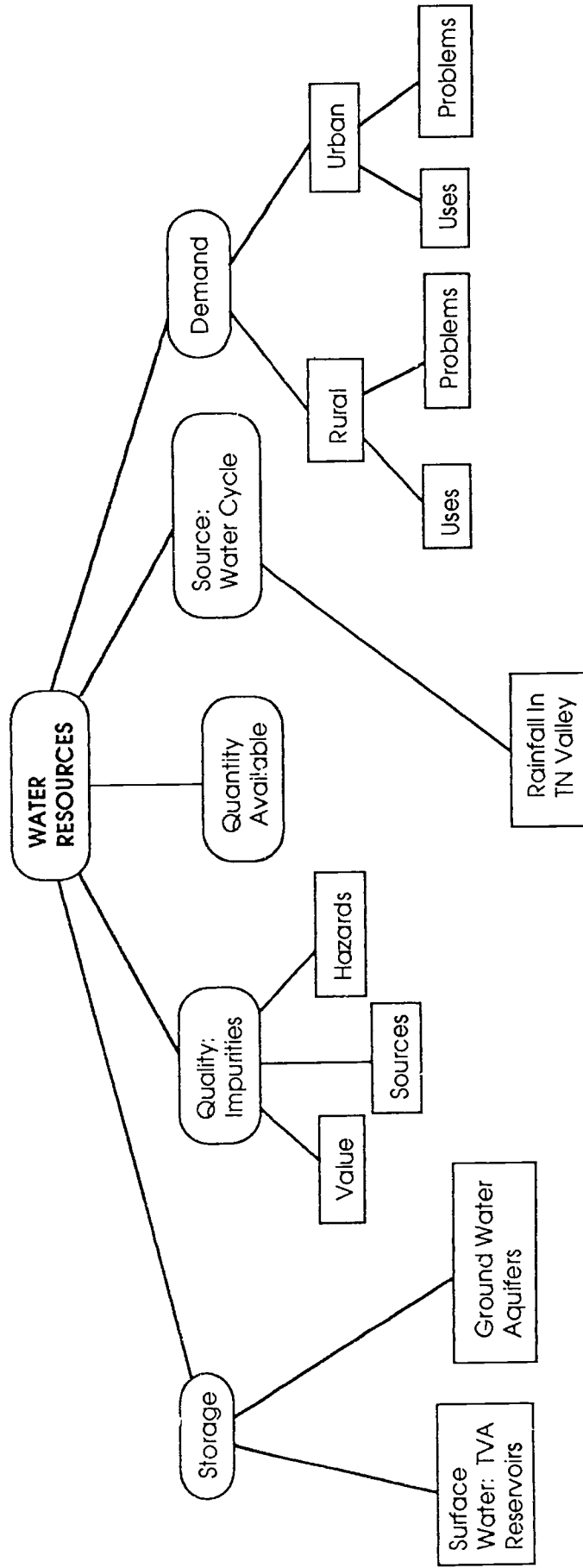

Water Resources Factsheets



1. Overview
2. Groundwater - The Hidden Resource
3. Pollution - Natural And Manmade
4. Water Quantity - How Much Is Enough?
5. Precipitation - The Start Of The Cycle
6. Water Quality - How Clean Is Clean?
7. Rural Water
8. Urban Water
9. Surface Waters - The Visible Resource

1. Overview

Water is the one compound essential to all life on earth. Although the proportion varies from one plant or animal to another, it is a basic component of every living cell. Approximately 70 percent of the human body is water. A tree might be 40 percent water and some other plant, such as an aquatic plant found in the Tennessee Valley, may be 90 percent water or more.

Chemically, water is a simple compound; yet it is one of the most complex natural resources. In its pure state, water is colorless, odorless, and tasteless. Without some natural impurities, it can rob the body of essential minerals and other elements. Healthful drinking water must contain small quantities of dissolved elements such as calcium, phosphorus, strontium, potassium, iron, magnesium, sulfur, chlorine, sodium, and other minerals essential to a person's physical well-being. The fresh water we drink picks up these elements from the air, the rock, and the soil it comes in contact with as it makes its way toward the ocean.

Through the centuries, water has been one of the determining factors in the development of human civilization. The major cities of the world are almost invariably located on the banks of a large river, on the shores of an inland sea or huge lake, or on a seaside location where a safe harbor for large ships is found.

Although the amount of water available varies from one place to another, plant and animal species adapt to the water available in interesting ways. Plants like the cactus are able to store water for long periods and guard against evaporation. Animals such as the camel have special adaptations in their breathing passages that prevent the loss of water. Other animals, such as the kangaroo rat, are able to survive with little or no water; they get what they need from the seeds and roots that they eat in their desert homes. Abundant water



is absolutely necessary for many animals, such as fish, some insects, and amphibians, during all or part of their lives.

Of course, the availability of water has a great deal to do with human lifestyles, too. People at the seashore live differently from those in arid or desert areas of the world; many of these differences are obvious. For example, desert inhabitants move from place to place in search of water; but people who live in areas with plenty of water seldom develop nomadic ways. Among the earliest human engineering developments were systems for the capture, storage, and transportation of water to meet the needs of growing communities.

The Tennessee Valley region provides ample water for most needs. Average rainfall is around 52 inches per year. This varies from as much as 120 inches, in a few spots in the mountains, to 40 inches, or so, just a few miles away. The Valley region is fortunate to have many streams. Along these streams, the Valley's earliest human communities were established.

Today, nine mainstream dams convert the Tennessee River from Knoxville, Tennessee, to Paducah, Kentucky, into a navigable waterway some 650 miles long. Completion of the Tennessee-Tombigbee Waterway has now linked the region directly to Mobile, Alabama, in the Gulf of Mexico. The Tennessee, Ohio, and Mississippi Rivers provide a transportation route joining the Valley with the industrial and agricultural heart of the continent, New Orleans, Louisiana.

Despite fifty years of water system development in the Valley, there are still bright, clear, mountain streams, placid rivers, and creeks

across the region. In addition, large reservoirs create an environment with many characteristics of natural lakes.

However, we see only a small fraction of the total water in the Valley. Beneath the ground, there is 100 times as much water as is found in all the streams and reservoirs of the region. This unseen resource is of concern to TVA and to others responsible for water management in the region.

Healthful water is a complex mix of many elements. However, when certain additional elements are present in too great quantities, the water can become polluted and less desirable in some ways. When the pollution is caused by hazardous or toxic materials, the problem can become a major health hazard. Pollution not only creates undesirable conditions in the water environment, it can also make the water unusable. Cleaning up pollution is more expensive, in many cases, than taking steps to prevent pollution. This is true of surface water, in most places, and certainly is true of groundwater resources. For this reason, it is especially important that the quality of the water resources of the region be maintained using water resource planning, development, and management. Otherwise, it is possible to end up like Coleridge's Ancient Mariner, with "water, water everywhere and not a drop to drink."

2. Groundwater - The Hidden Resource



With all the rivers, creeks, ponds, and reservoirs found in the Tennessee Valley, it's hard to imagine that beneath the surface there is far more water than we see. In fact, there is an estimated 100 times more water underground than in all the rivers and reservoirs of the region.

Groundwater supplies one-third of the public water sources in the Valley. Some communities, including the city of Memphis, Tennessee depend entirely on groundwater, either from wells or large springs. Some have a combination of surface and well water supplies. Many individual families get their water from wells and springs. Because these and other demands sometimes lead to heavy use of groundwater resources, there are areas, like Memphis, Tennessee, and northeast Mississippi, where water shortages could occur in the future unless new sources are found. Some places on the Cumberland Plateau will always face limitations on growth and development because there just isn't enough water for major expansion.

Actually, every stream in the Valley begins with a groundwater source—a spring or group of springs that make up its headwaters. These upland springs provide water at varying rates, from a mere trickle, in some instances, to hundreds of gallons a minute, in others. As the water flows downhill, small streams come together to form larger streams, and rivers join rivers to form even larger rivers. The year-round base flow of streams in the region depends on the output of groundwater sources.

When rainwater soaks into the ground, it continues to move downward until it reaches a zone of saturation. At this point, the water is still moving, but so slowly that, under most natural conditions, the

amount of water in that zone remains constant. These underground areas make up aquifers. In the Valley there are six groups of aquifers.

1. The unconsolidated sediments are found in western Tennessee, Mississippi, and small parts of Alabama and Kentucky. These sand, gravel, silt, and clay sediments have an average depth of almost 3,000 feet and contain large quantities of slow-moving water. Groundwater in this area may take 100 years to travel 50 miles.
2. The horizontal carbonate aquifers with significant overburden are located in the Highland Rim of central Kentucky, central Tennessee, and most of northern Alabama. Groundwater here occurs in aquifers made up of fractures, faults, and bedding planes of carbonate rocks.
3. The horizontal carbonate aquifers without significant overburden are characteristic of the central basin of middle Tennessee. The rock here is almost entirely limestone. Water is found in openings of vertical joints and horizontal bedding planes.
4. The folded and faulted carbonate aquifers with significant overburden provide aquifers in Valley and Ridge Provinces reaching from southwestern Virginia through eastern Tennessee into northern Georgia and Alabama. Openings in the bedrock, such as cavities, fractures, and cracks between layers of rock, provide space for groundwater to accumulate and move.
5. The fractured noncarbonate aquifers with significant overburden are characteristic of the high mountains of southwestern

Virginia, eastern Tennessee, western North Carolina, and northern Georgia. Here water collects along faults and cracks in rock.

6. The fractured noncarbonate aquifers without significant overburden are found in the Cumberland Plateau area of southwestern Virginia, east-central Tennessee, and northern Alabama. Groundwater here is restricted to fractures and joints in bedrock.

An aquifer may be large or small. Some, including their recharge areas, may be no more than a few hundred yards across while others may cover hundreds, or even thousands of square miles. A recharge area is where rainwater soaks into the earth to resupply the aquifer. These may be sinkholes, caves, disappearing streams, or rock outcroppings. As the water moves into the ground, it can pick up many kinds of material from the surface or from the soil through which it passes. The deeper the groundwater moves into the earth, the more minerals it is likely to contain.

Because water quality is so essential to life, it is necessary to take steps to ensure that the underground sources we depend upon will continue to support human, plant, and animal populations.

3. Pollution - Natural And Manmade



In nature, water is never entirely pure. Rain falling from a cloud picks up dust, smoke particles, gases in the atmosphere, pollen, and even bacteria. When rain falls on the roofs of houses and other buildings, on trees and bushes, in the grass, on streets and highways, parking lots, and sidewalks and driveways, it picks up other substances. As it runs along the surface of the ground or soaks into the earth, it collects other materials from rocks and soil. Some materials are filtered out, but others remain in solution and are carried along with the water wherever it goes. Generally, the deeper the water sinks into the ground, the more minerals and other materials it contains.

Differences in mineral contents of water account for the way it looks, tastes, and smells. Sulfur compounds are a problem in the Bear Creek area of northern Alabama, giving water a bad odor at certain times of the year. At both Normandy, in middle Tennessee, and Bear Creek, the water naturally contains troublesome amounts of iron and manganese. This pollution, if not removed by the water treatment plant, causes color problems in household water supplies. Large areas of phosphate rock (salt deposits occurring near the surface of the earth), and minerals such as coal, can pollute water badly enough to affect long stretches of streams. Other natural occurrences, such as earthquakes, volcanic eruptions, and landslides, can cause severe pollution of lakes and streams. Also large populations of wild animals can also contribute to high levels of bacteria in a stream, under certain conditions.

Add to the natural sources of pollution the activities of people and truly hazardous conditions can arise. Just about everything that people do causes some pollution. There is no way to avoid this entirely. There always seems to be something left over that cannot be

used, which becomes waste. When fuels are burned, they produce smoke and gases of various kinds. These gases and smoke eventually come back to earth and find their way into the water somewhere. Also, ashes or other residues from the burning process that become waste can contaminate water supplies.

Many millions of dollars have been spent on facilities that reduce the pollution caused by human activity. Plants have been built to make the water we drink safe, to cut down on wastewater pollution, and to clean up industrial wastes. Laws and regulations have been established to force cities and industries to clean up their wastewater before it is returned to a stream or lake. Still more millions have been spent to clean up polluted stretches of waterways in this region and in the Nation. Progress has been made in many areas.

Even the facilities designed to deal with wastes can become sources of water pollution. Municipal wastewater treatment plants, industrial treatment facilities, septic tanks, landfills, and incinerators often are sources of water pollution. Generally, this occurs when an aging system begins to fail, when it is pushed beyond its capacity, when it is called upon to handle wastes for which it was not designed, or through human error. Accidental spills of toxic or hazardous material are another source of sometimes severe water pollution. These accidents can occur, at any point, during the manufacturing, storing, or hauling of the material.

Other sources of people-made pollution include pesticides and fertilizers used in agriculture, surface mining, forestry practices, and construction activities. The operation of dams and reservoirs can also cause problems when the water released from dams is low in oxygen content. This causes problems for fish and other aquatic life downstream.

4. Water Quantity - How Much Is Enough?

Water's distribution over the earth is tremendously varied. The world's total water supply is estimated to be 330 million cubic miles; 317 million of these are contained in the oceans. Another 9 million cubic miles are locked up in the polar ice caps. Underground, there are approximately 2 million cubic miles of aquifers, with about half of this available for human use. As for the rest, there are 30,000 cubic miles of water in lakes and ponds, 16,000 in soil, 3,100 floating about in the atmosphere, and 300 cubic miles in the rivers of the world.

All of this water is in constant motion. It evaporates from streams, lakes, and oceans or is released by trees, and other plants, through transpiration. It moves about in weather systems, condenses and falls to earth as rain, snow, or ice, and heads downstream toward the ocean, again. Some spots on earth, such as the Hawaiian Islands, get hundreds of inches of rain a year. Other places, such as the Mohave Desert in California, get hardly any rain at all.

Plant and animal life have adapted to most conditions. Desert plants like the cactus, and animals like the kangaroo rat, survive on very little water. Other plants and animals, among them fish and a broad range of aquatic vegetation, cannot live without total water submersion. Humans adapt also, fashioning lifestyles to appropriate patterns of water distribution. From nomad-herding to deep-sea fishing, human communities have thrived by adapting to the characteristics of the water supply.

Some 16 billion tons of water falls, mostly as rain, on the United States every year. This water soaks into the earth, replenishing aquifers, running off into streams, or being used immediately by plants for their growth needs. About one-third of the water flowing in the Nation's streams is withdrawn for a variety of human uses. Around 95 percent of the water used in this country goes into agriculture or

manufacturing. Average water use in the Valley is estimated at 85 gallons per person each day. Of this, only 2 gallons are used for drinking and cooking. The rest is used for bathing, laundry, dishwashing, flushing toilets, washing cars, watering lawns and gardens, and other purposes.

There is plenty of water in the Tennessee Valley. If all the water in rivers and lakes were spread evenly over the State of Tennessee, it would be about a foot deep. Add to this the groundwater available in the region, and Tennessee would be covered to the depth of 100 feet. Unfortunately, the amount of water in the Valley varies a great deal from place to place, making water readily available in some areas and scarce in others. In those places where water is being drawn from underground sources faster than it is being replenished, or where there is a limited supply of water, growth must be planned carefully and economic development must center on activities that do not demand large quantities of water.



5. Precipitation - The Start Of The Cycle



The water cycle is driven by the sun's energy and begins with evaporation. Each year some 122,000 cubic miles of water enters the atmosphere through evaporation, 86 percent of it from the oceans. Only 14 percent comes from rivers, lakes, and ponds. This water vapor is carried by the earth's winds until conditions are right for it to condense and fall back to earth into the ocean.

An average of 32 inches of rain falls worldwide every year. If it fell all at once, the earth would be covered with 3 feet of water. Each day there are 45,000 thunderstorms around the world. Annual rainfall ranges from almost nothing, in the Sahara Desert, to 200 to 600 inches a year, on the south slope of the Himalaya Mountains in India.

The Tennessee Valley has an average of 52 inches of rain a year. This varies from 40 inches, in some mountainous areas in the east, to 120 inches or more, at spots just a few miles away in the same general area of the Valley. As a rule, slightly more rain falls in the western half of the region than in the east, but the difference is essentially insignificant.

The rate at which rain falls is important. Rains are considered light when less than one-tenth of an inch falls during an hour. A rain is designated as moderate when it falls at one-tenth to three-tenths of an inch an hour. Anything over three-tenths of an inch an hour is considered heavy. A localized summer thunderstorm sometimes produces more than five inches of rain during an hour's time. Such storms can produce flash floods, causing creeks to overflow their banks and damage homes or businesses in low-lying areas. Many towns and cities in the Valley are subject to flash flooding, particularly if there has been enough rain prior to a heavy thunderstorm to saturate the ground.

In areas like the Rocky Mountains, snow is far more important than it is in the Tennessee Valley. In the Valley, rain is the dominant form of precipitation. Almost half the annual rain falls from December through April. During these months, vegetation is fairly dormant, and the demand for water on the part of the region's plant life is at a minimum. However, runoff into creeks, rivers, and lakes is at its highest. For these reasons, the winter and early spring months are considered the flood season in the region. The period from January through May also provides most of the rainfall needed to bring the TVA reservoir system up to the desired summer levels.

Valley rainfall follows a pattern that is favorable to agriculture. As a rule, there is ample rain from November through August for planting and bringing crops to maturity. These months average well over four inches each. In September and October, the average rainfall drops to around three inches—just in time for the farmers to get into their fields and harvest their major crops.

6. Water Quality - How Clean Is Clean?



"Clean water," "pure water," "clear water" are some of the terms we use in describing water of good quality. But what do they mean? Pure water, two parts hydrogen and one part oxygen (H_2O), is great in a laboratory but not for plants and animals. Scientists have found that the water from most streams in their natural state contains the proportions of dissolved minerals necessary for human health. On the other hand, drinking absolutely pure water tends to rob the body of the minerals it needs.

Water picks up a broad range of elements: as it moves through its cycle of evaporation, condensation, precipitation, and percolation on its way back to stream, lake, or sea. Water picks up dissolved oxygen and other gases from the air. As water passes over and through rocks and soil, minerals are dissolved into it. Among the desirable elements for human health are iron, copper, strontium, phosphorus, calcium, magnesium, potassium, sulfur, sodium, and chlorine. Too much of any of these elements, of course, can become harmful.

Dissolved oxygen is a major element for the health of aquatic life. Fish, fish food organisms, and the many plants that live in streams, lakes, and the oceans of the world cannot survive without dissolved oxygen. Fish must have oxygen to breathe; however, some need more oxygen in the water than others. Trout, for instance, do best when there is at least five to six parts per million of oxygen in the water. The colder the water, the more dissolved oxygen it is able to store. This may account for the fact that trout prefer colder streams and lakes.

Oxygen also plays a vital role in the life of aquatic plants. During the day, when photosynthesis is taking place, water plants contribute oxygen to the water in which they live. At night, these same plants use

oxygen from the water. Finally, when the plants die, oxygen from the water is consumed in the process of decay.

In addition to dissolved oxygen, many aquatic plants draw all their nourishment from the water. Aquatic plants use nutrients such as nitrogen and phosphorus to manufacture food. Small quantities of these elements are found in water, but most come from fertilizers used on nearby farms, from sewage treatment plant discharges, and from decay processes. The total amount of nutrients found in a stream or lake affects eutrophication. Eutrophication is a process in which mineral and organic nutrient amounts increase and dissolved oxygen decreases. This often reduces animal life but favors plant life. Highly eutrophic waters often produce more of certain forms of plant life than humans consider desirable, like algal blooms.

In summary, water is good when it is compatible with its intended use. For instance, some industrial processes need cleaner water than that which we drink. On the other hand, the water we drink has to have small amounts of essential minerals to be good for us. Good water might be dirty water, too. Farmers, for example, often wash down their animal pens with waste waters. In conclusion, water quality should match use for maximum benefit.

7. Rural Water

Agriculture accounts for approximately 46 percent of the total water used in the United States. Most of the water needed for growing crops in the Tennessee Valley comes from rainfall that occurs during the year. Unlike the southwestern part of the United States where modern farming is totally dependent on vast irrigation projects, water in rural areas of the Valley is pumped from wells and springs and supplies most household, livestock, and poultry needs.

The amount of water required for ordinary farm products is astonishing. Agriculture uses more than 150 billion gallons of water a day in this country. It takes 8 to 10 gallons a day to care for a cow and 15 gallons a day for a horse. It requires approximately 15 to 20 tons of water to put a pound of beef on the dinner table. Producing a single egg requires approximately 120 gallons of water. For every bushel of corn harvested, 10 to 20 tons of water are required. In general, 10 tons of water are needed for each ton of harvested field crops.

People tend to think of water in a rural setting in the same way they think of water anywhere else. Water is used for many of the same things in both rural and urban settings. It is used for drinking, cooking, bathing, laundry, a variety of other cleaning chores, and to meet the needs of plants and animals. A safe and reliable supply, whether from an individual well or spring or small utility, is essential. So, what is the difference?

The main difference comes with managing water in a farm setting. In an agricultural environment, each farm must handle its own water supplies. That means preparing for the rain that falls. It also means pumping water for livestock needs in the barn or feedlot. Most of us do not have to worry at all about how to deal with rain. But on the farm, unless cultivation practices have been properly handled, it



can wash away the soil, robbing the land of fertility. It can wash fertilizers and pesticides into nearby streams, causing pollution. It can carry animal wastes into nearby waters, creating health hazards for those using the water for recreation or household supply.

One of the most difficult water quality problems facing the people of the region and the Nation is in rural water management, much of which centers around agricultural practices. The Tennessee Valley Authority (TVA) and other agencies at the state and Federal levels are trying to deal with severe farmland erosion in the western parts of the Valley. There are also recreational streams all across the region where hazardous levels of bacterial contamination occur as a result of drainage from poultry and livestock concentrations. Additionally, in many rural areas there are thousands of aging septic tanks that no longer operate properly, contributing to stream and lake pollution. Add to this such activities as strip mining for coal and other materials, forestry practices, and other human activities that disturb the earth, and rural water quality problems begin to take on a magnitude that will require special understanding if solutions are to be found.

8. Urban Water

Urban water supplies are consolidated and have to be managed through elaborate utility facilities. Water for homes, businesses, or factories is pumped from streams, reservoirs, lakes, or wells. It is then treated to make it safe for human use and is stored in huge tanks. Finally, it is pumped to customers. Once used, much of it is pumped to a wastewater treatment plant where it is processed and eventually discharged into a nearby lake or stream.

Most urban water is used by industries. For example, industries use more than 150 billion gallons of water a day. Some industrial processes require water treatment even beyond that given to the water we drink. Leather finishing, for instance, requires distilled or demineralized water. For this reason, many large industries independently pump and treat their own water and wastewater and do not use the utilities serving nearby residential areas. Most industries, however, rely on local utilities. Huge quantities of water are required in most industrial processes. About 60 percent of this industrial water is used to generate electric power. Large amounts of water are also used for cooling purposes or in the actual manufacturing process. For instance, textile manufacturers use large quantities of water for washing raw materials and finished products, and in dyeing and bleaching. Manufacturing one automobile takes 100,000 gallons of water. Each average Sunday newspaper requires 280 gallons of water. Producing one ton of steel requires 65,000 gallons. A large papermill can use more water than a city of 50,000 people. In fact, one paper mill in western North Carolina occasionally uses the entire flow of the Pigeon River.

In addition to manufacturing facilities, large amounts of water are required to operate such facilities as laundromats and car wash facilities. Large apartment buildings and individual homes in residential neighborhoods, throughout a city and its outskirts, all require large amounts of water.

All this requires facilities for managing huge amounts of water each day. Such concentrated management can be far more efficient than the scattered systems that serve rural areas of the Valley, but it also can result in special water resource problems. For instance, hundreds of thousands of gallons of treated water are lost every day because of leaking water pipes in the distribution system. This is a problem which will never go away. In fact, it can only become more troublesome as the municipal systems grow older.

Another problem is sewage treatment facilities that cities eventually outgrow. Many older systems are in need of expansion. Cities all across the Valley are threatened by state bans on future residential and industrial expansion if something is not done to increase the capacity of their sewage treatment plants. Unfortunately, there are some small communities which have no wastewater treatment facilities whatsoever. Such conditions threaten streams and reservoirs with pollution unless steps are taken to correct the deficiencies.



9. Surface Waters - The Visible Resource



The most visible feature of the surface waters in Tennessee Valley is the system of reservoirs which have been developed by TVA during the past 50 years. They are often called "The Great Lakes of the South." These reservoirs serve different purposes. First, there are the nine projects of the Tennessee River which create a navigable channel from Knoxville, Tennessee, to Paducah, Kentucky, 650 miles away. Second, there are the giant storage reservoirs on the major tributaries of the Tennessee River. And third, there are the reservoirs, on tributary streams as well as on the main stream, which were built solely for hydroelectric power production.

Most of the major dams in the TVA system are multipurpose projects. They were built to provide navigation on the main river, flood control for the Valley, and hydropower (electricity). In addition, the reservoirs are operated to provide such benefits as recreation, fishing, tourist development, and a quality water supply.

Kentucky Reservoir, because it is about 180 miles long, provides the greatest flood storage capacity, but it benefits the Ohio and Mississippi Rivers as much as, or more than, the Valley. The major flood storage reservoirs in the TVA system are Norris, Douglas, Fontana, and Cherokee.

Most of the main tributaries of the Tennessee River have at least one reservoir on them. These include the Clinch, Holston, French Broad, Little Tennessee, Hiwassee, Elk, and Duck Rivers. Only the Buffalo is without a major dam. The total water flow through the Valley is about 41 billion gallons a day.

The amount of water in streams and reservoirs varies from one period of the year to another. Winter and spring are periods when rainfall is heaviest and these seasons supply most of the water stored

in the TVA water management system. This system consists of 40 major dams. Rainfall during the summer generally keeps water levels in a range suitable for recreation. As a rule, the mainstream reservoirs are filled early in the spring to their summer levels. Tributary reservoirs generally reach summer pool levels by late June or early July. They begin a slow drop in pool level as hydroelectric power is generated during the summer and water is provided to maintain navigation depths in the mainstream. The reservoirs reach their lowest level around January 1 in preparation for storing winter and spring rains.

Reservoirs, unlike lakes, can be managed by storing and releasing water. Reservoir managers, however, face a wide variety of problems which include: maintaining dissolved oxygen in deeper parts of the reservoirs, managing aquatic weeds, monitoring lakefront development, protecting Valley fisheries, and controlling disease-causing mosquitoes and other insects.



Water Resources Activity Matrix

WATER RESOURCES	AIR RESOURCES	CULTURAL RESOURCES	ENERGY RESOURCES	FOREST RESOURCES	RECREATION RESOURCES	WATER RESOURCES	WILDLIFE RESOURCES	TVA - A WORLD OF RESOURCES
Water With-In						1		
Aquifers and Artesian Wells						2,3,4 5,7,8		
Aquifers Underfoot				5		2,5		
Modeling the Mississippi Embayment						1,2		
Modeling the Injection Well			6			1,2,3 6,7,8		
Modeling a Toxic Lagoon			6			1,2,3,6 7,8,9	7,10	4,8,9
Water Worldwide	3		4		4,5	1,2,4,5,9		
Weather Watchers	3,6				4,5	1,2,4,5,9	4,8,9, 10	4
The Super Cycle	1,3,6					5		
A Natural Filter						1,2,6		

509

Water With-In



OBJECTIVES:

Students will determine the approximate percentage of water in living materials. See WATER RESOURCES matrix for background information.

MATERIALS:

plant materials (lettuce, cabbage, spinach, grass)
aluminum pie pans
0.1 g balance
blender
oven (or dry in sun)
plastic bread bags
water
square meter frame (optional)

PREPARATION:

Read Water Factsheet 1.

You may feel fairly solid, but about 65 percent of you is 80 to 90 percent water. Your muscles are about 20 percent water. Your body uses water to digest food, eliminate wastes, and keep your temperature constant. To keep your body running smoothly, you need to take in at least five 8-ounce glasses of water a day. This means the average person consumes up to 16,000 gallons of water in a lifetime.

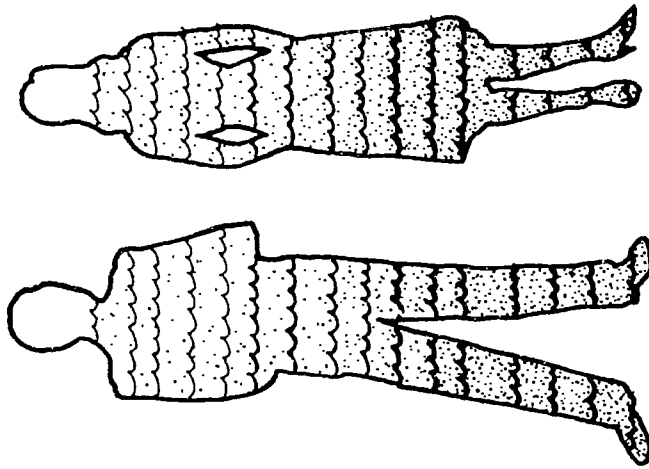

Practice filling in the data sheet with made-up data and do the calculations so students will know how to use the data sheet when they collect the experimental data.

PROCEDURE:

Divide the class into groups of 4 or 5 students. Ask students to collect living leaf materials like lettuce or grass so that each group has about half a plastic bread bag full. Have each group weigh its plant material. Describe what type of plant the leaves are from and where

they were collected. Record information on a data sheet. Weigh aluminum pan and record the mass. Put the plant material in a blender, add a little water, and blend into a paste (this step is optional). Pour the mixture into the aluminum pan and sun dry or dry in a warm oven. Weigh the pan and dry plant mixture the following day. Record weight on student data sheets and complete the calculations. What percent of the plant was water? Did one plant contain a higher percentage of water than another? Why?

FOLLOW-THROUGH:

Many scientists calculate the "biomass" of an area for different reasons. Biomass is the standing crop present at any given time, usually measured in dry weight. Foresters use this biomass to measure tree growth. Farmers use biomass information to predict production of crops or compare production methods, such as fertilizer application rates. Some scientists are studying the use of "biomass" (such as alcohol produced from corn) as an energy source. Ecologists use the information when studying the interrelations between plants and animals in an ecosystem. You can calculate biomass by marking off several 1-square-meter areas and collecting all of the above-ground plant material in this area (no roots). Use the method described in this activity to calculate the dry biomass of each area. Which area produced the most plant material per square meter? Why? What factors might affect production of plant materials? Why is this information important?

STUDENT DATA SHEET

NAME _____

Determine % Water In Plant:

- 1). Describe the plant material collected by your group:
- _____
- _____
- _____
- _____
- _____
- _____

2). Collect data

DATA

weight of plant material before drying _____g.

weight of aluminum pan _____g.

total weight of pan and the dried material _____g.

- 3). Use steps 1 - 4 to determine % water in the living plant material.
- 4). Make a drawing on the back of this sheet showing what happened when the material dried in the sun or the oven.

1). Subtract

$$\frac{\text{pan \& dried material}}{\text{pan only}} \text{ g.} - \frac{\text{pan only}}{\text{pan only}} \text{ g.} = \frac{\text{weight of dry material only}}{\text{weight of dry material only}} \text{ g.}$$

2). Divide

$$\frac{\text{weight of dry material only}}{\text{weight of plant material before drying}} \text{ g.} + \frac{\text{weight of plant material before drying}}{\text{weight of plant material before drying}} \text{ g.} = \frac{\text{fraction that is not water}}{\text{fraction that is not water}}$$

3). Multiply

$$\frac{\text{fraction that is not water}}{\text{fraction that is not water}} \times 100\% = \frac{\text{percent that is not water}}{\text{percent that is not water}} \%$$

4). Subtract

$$100\% - \frac{\text{percent that is not water}}{\text{percent that is not water}} \% = \frac{\text{percent water in the living plant material}}{\text{percent water in the living plant material}} \%$$

Aquifers And Artesian Wells



OBJECTIVES:

Students will construct a model to demonstrate how aquifers and artesian wells are formed. See WATER RESOURCES matrix for background information.

MATERIALS:

two pieces of plexiglass per group (or glass panes)
 plasticine (or clay or playdough)
 in several colors
 fine and coarse aquarium sand
 soda straw
 blue felt crayon

PREPARATION:

Aquifers are underground storage areas for water. They are formed when water movement is stopped by an aquitard (material which resists the flow of water).

PROCEDURE:

Form several groups depending upon the amount of materials available. Place the two plexiglass sheets parallel to each other and use plasticine on the bottom and on two sides to hold the sheets parallel and about 1 cm apart. See the diagram. Older students may be able to do this without help if they have the diagram to follow.

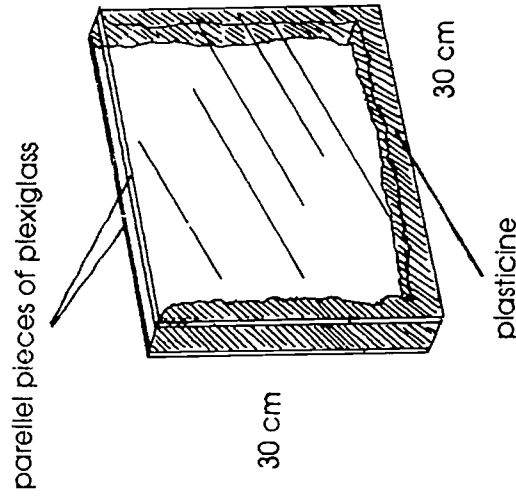

Using sand and playdough, make the model as shown below. Place a straw as the well. Imaginative students may decide to create their own pattern of aquitard and aquifer. Have students draw blue arrows on the plexiglass to indicate the flow of water through the system from the recharge area to the well. Using small labels, label each layer neatly. If made tightly, the systems can be made to work with water by filling an aquifer at the recharge area and noting the water rising in the straw. Ask the students to explain what happened and why. How does this occur naturally?

FOLLOW-THROUGH:

Consult local geologist (state or university) to determine the strata of your local area. Construct a model of the water table in your local area like the model in this activity. Are artesian wells possible in your area? Why?

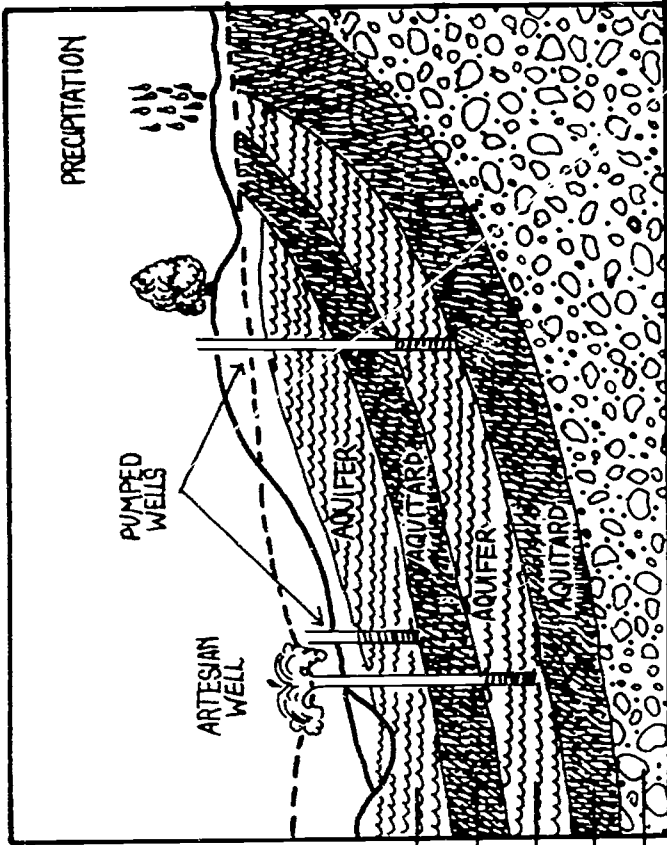

- fine sand
- colored play dough
- fine sand
- colored play dough
- coarse sand

Aquifers Underfoot



OBJECTIVES:

Students will construct a map to show the varied geological structure of the Valley. See WATERRESOURCES matrix for background information.

MATERIALS:

posterboard
felt crayons
highlighters (various colors)

PREPARATION:

Have students read Water Factsheet 2 and discuss the following vocabulary. Allow students to research, if necessary, to find the meanings of these words.

Vocabulary List:

- unconsolidated sand formations
- carbonate aquifers
- fractured non-carbonate aquifers
- regolith
- hydrologic

Remember this activity is designed to spur interest in the variety of underground geology in the Valley, not necessarily to introduce geological vocabulary, so keep it fun!

PROCEDURE:

Divide the class into 5 groups, of 5 or more, and have them research each of the aquifer types in the Tennessee Valley. Copy the map provided for student use.

Have one group develop a map of the Tennessee region on posterboard. Have each group add the region where their aquifer type occurs to that map. Have them add a brief explanation of their aquifer type in the space around the map. You might also add major cities to the map. Have students write letters to the water departments of these cities and ask for information about their city water system. Do they get their communities' water from groundwater or surface water? Use your map to explain why.

FOLLOW-THROUGH:

Find out how to make three-dimensional plaster models. Make a relief map of the TVA region as a semester project. Then, include the data from this activity on your map. You might consider making each aquifer type separately and putting them together in a puzzle. This way you could show what's going on underneath the ground by drawing in the bedrock types on the 4-sides of the 3-dimensional model.

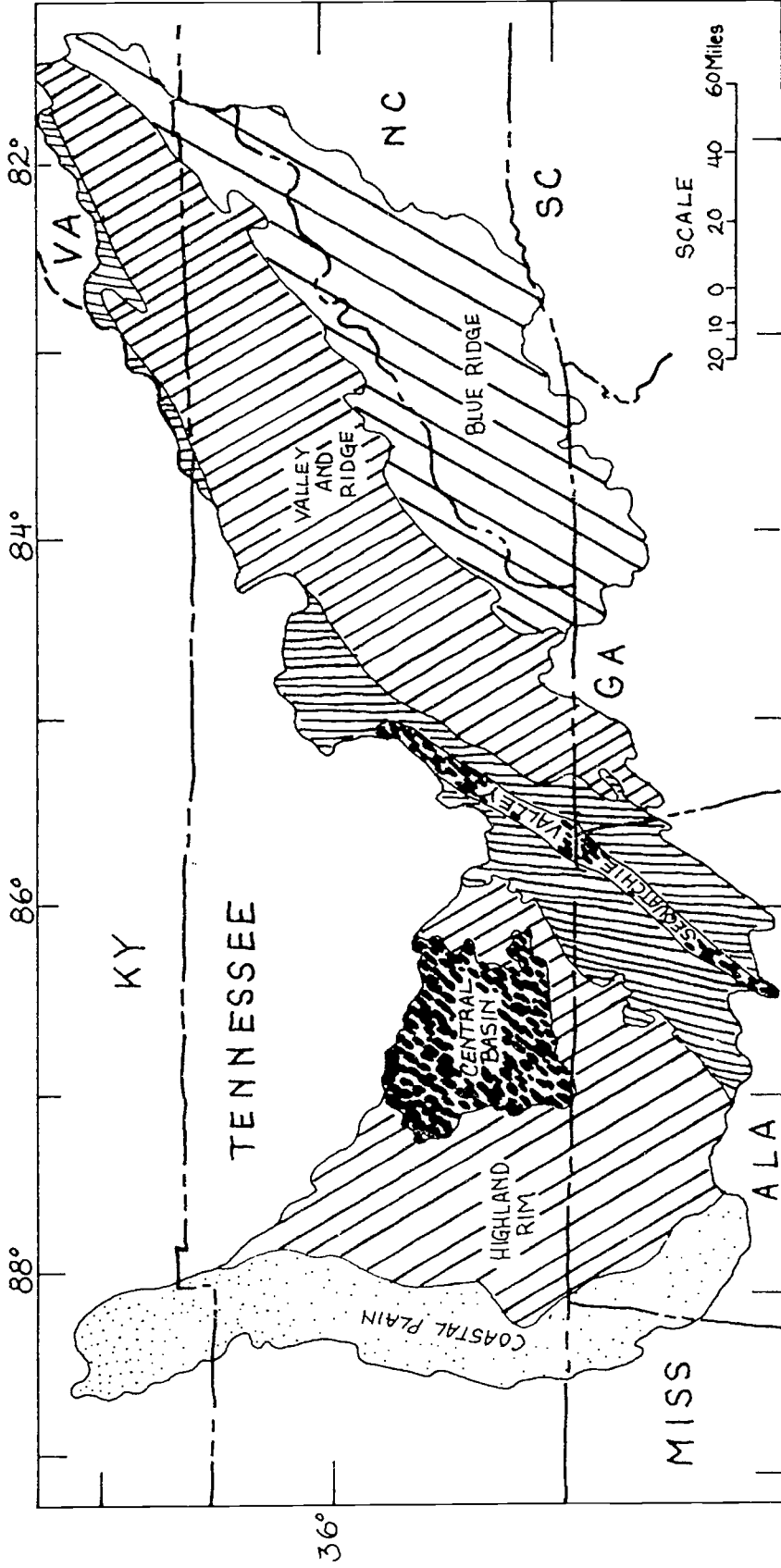

(*Regolith - loose rock material resting in bedrock which is capable of storing water)

Modeling The Mississippi Embayment



OBJECTIVES:

Students will construct a model of the Mississippi Embayment. See WATER RESOURCES matrix for background information.

MATERIALS:

blocks of wood, a cardboard box, or plaster mold (about 6" X 12" X 8")
pencils
colored felt crayons
paint (acrylic or tempera) or spray paint
paint brushes
white glue
fine aquarium sand
flour
corn meal
sugar
white index cards
handout of the Mississippi Embayment (included in the activity)

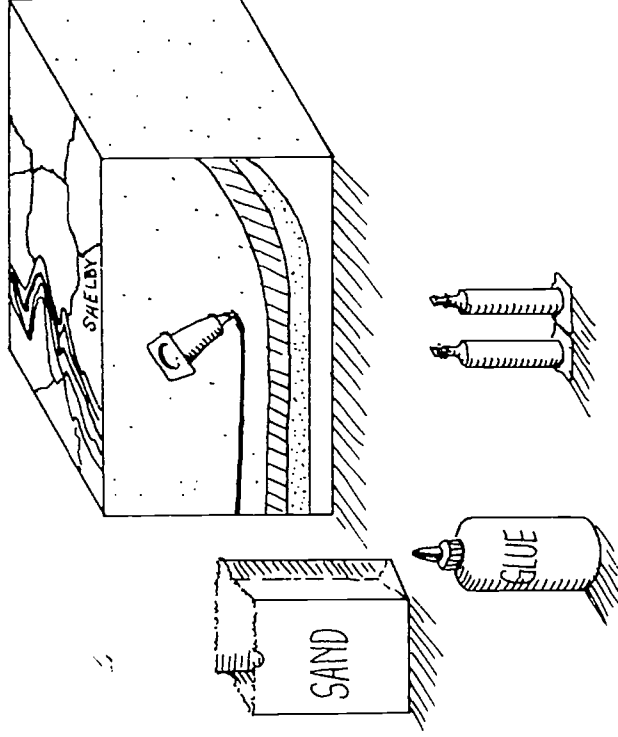

PROCEDURE:

Allow students to work in groups. Each group will draw the cut-away view onto the top and one side of the block with pencils or felt crayons. Use the diagram of the Mississippi Embayment provided to determine zones. Be sure to make the lines proportional. Then, apply glue to one zone and add sand or other material to give the layer a different texture. Let it dry. Now, move to the next zone and use a different material like corn meal. Each zone should have its own color

PREPARATION:

Have the students read Water Factsheet 2. Then, pass out the handout of the Mississippi Embayment and explain its details. Ask students to study the "cut-away" view of the Mississippi Embayment area.

and texture. You can add additional color by painting the layers after the glue dries. Be sure to draw or paint in the county lines and the Mississippi River, too. Make labels of each zone using the index cards, cut them to size, and glue them to the appropriate zone on the model. Using your model and information from the factsheet, what have you learned about aquifers? What kinds of aquifer is present in the Mississippi Embayment?

FOLLOW THROUGH:

Consult geological experts at a local university on the formations occurring below your local area. Use the technique in this activity to create a three-dimensional model of your local area. Indicate the region of aquifers and other strata, like limestone, sandstone, etc.

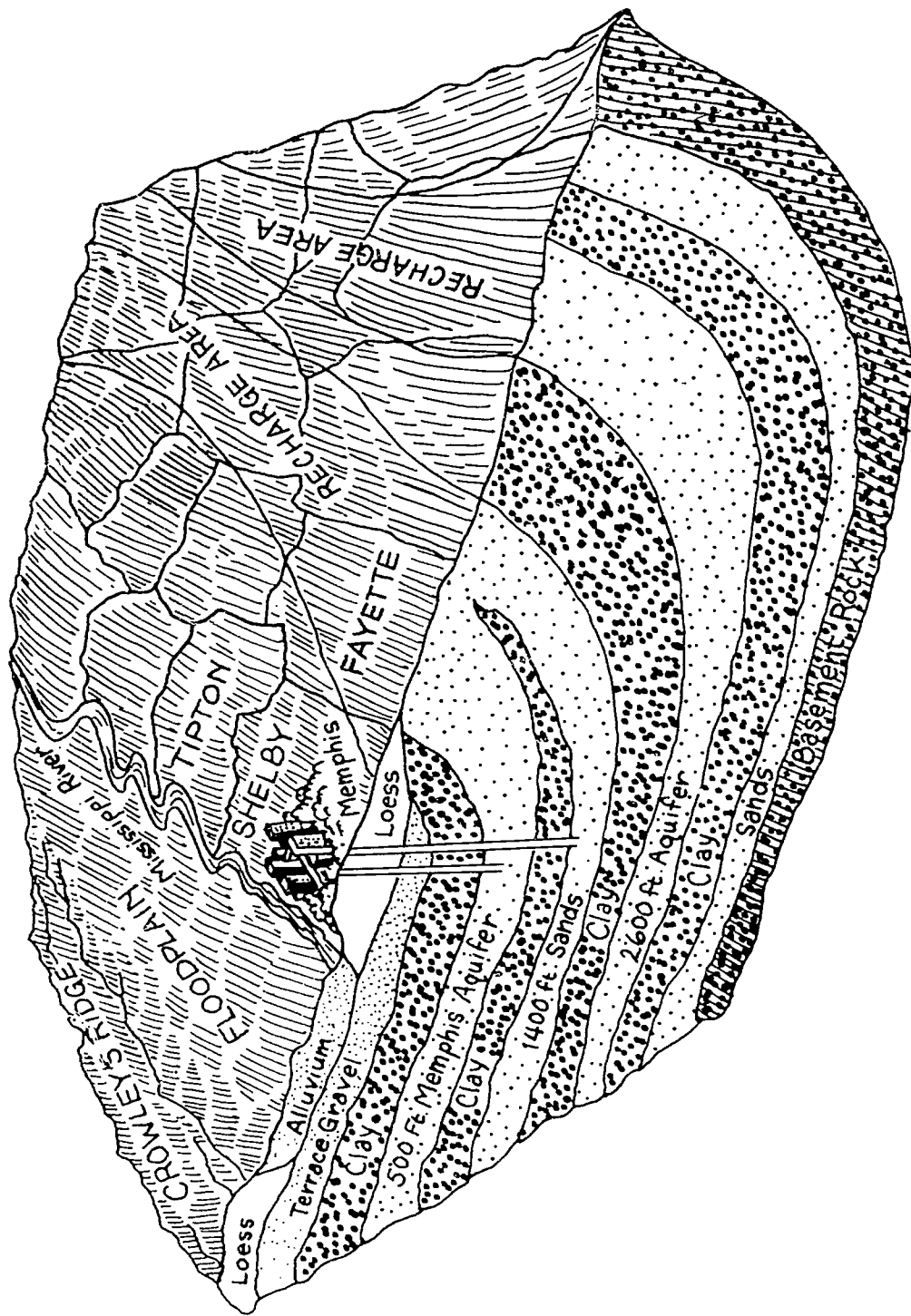

599

MISSISSIPPI EMBAYMENT

598

WA-36

Modeling The Injection Well



OBJECTIVES:

Students will observe the contamination of an aquifer model.
See WATER RESOURCES matrix for background information.

MATERIALS:

10 boxes of unflavored gelatin
phenolphthalein indicator solution
dilute hydrochloric acid or vinegar
plastic straws and/or glass tubes
5 clear containers
heat source

PREPARATION:

Prepare 7 boxes of the gelatin solution according to package directions. Add 10 to 15 drops of phenolphthalein indicator solution to the mixture and stir. Pour a layer 3 inches deep in the bottom of each container. Allow it to set. Prepare the other 3 boxes of gelatin and add 5 to 10 drops of phenolphthalein solution. Add a second layer about 1 inch deep to each. Chill until completely set. Allow older students to prepare their own gelatin models.

Divide the class into 5 groups. Provide an aquifer model and a plastic straw to each of 5 groups. Ask students to use the straw as a drill. Slowly press and turn the straw to drill a hole through the gelatin layers. Stop in the middle of the second layer and remove the clogged straw. Insert a new straw or glass tube and inject several

drops of acid through the straw into the middle zone. Observe the movement of the contaminant through the aquifer model. Record what you observe in words and sketches.

(See the activity "MODELING A TOXIC LAGOON." The activities can be performed together.)

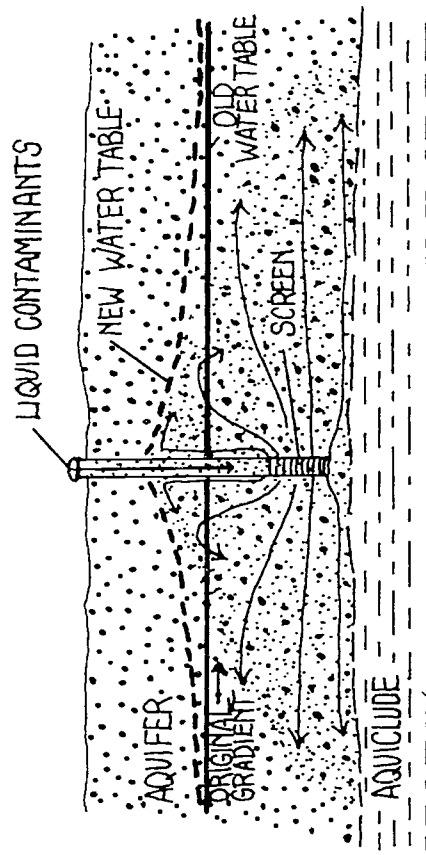

WATER TABLE AQUIFER

How can injected waste enter the water table and contaminate our fresh water?

FOLLOW THROUGH:

Have the class research underground injection or disposal wells. What kind of wastes are injected? What precautions are necessary to protect groundwater? What environmental laws regulate this practice?

Modeling A Toxic Lagoon



OBJECTIVES:

Students will observe the contamination of an aquifer model.
See WATER RESOURCES matrix for background information.

MATERIALS:

10 boxes of unflavored gelatin
phenolphthalein indicator solution
dilute hydrochloric acid or vinegar
5 clear containers
heat source
tablespoons

PREPARATION:

Prepare 7 boxes of the gelatin solution according to package directions. Add 10 to 15 drops of phenolphthalein indicator solution to the mixture and stir. Pour a layer 3 inches deep in the bottom of each container. Allow it to set. Prepare the other 3 boxes of gelatin and add 5 to 10 drops of phenolphthalein solution. Add a second layer about 1 inch deep to each. Chill until completely set. Allow older students to prepare their own gelatin models.

PROCEDURE:

Provide aquifer models for each group. Have students scoop out a tablespoon-size depression in the surface of the model. Add a tablespoon of acid to the depression. Observe the zone of coloration as it moves through the aquifer model. What happens when the acid reaches the zone between the two layers? Make a drawing of what you have observed. Assume the acid represents a hazardous or radioactive substance. How could a toxic lagoon affect groundwater? Can you "clean-up" groundwater? How could you prevent groundwater contamination from toxic lagoons?

FOLLOW-THROUGH:

- Do any of the industries dispose of wastes in a lagoon? What precautions do they take to prevent groundwater contamination?
- (1) Have the students survey local industries in the community.
 - (2) Many livestock operations manage animal waste by temporarily storing it in a lagoon and then applying it to land. You might arrange for your class to visit one of these lagoons. Ask the farmer or soil conservationist how it was constructed to prevent groundwater contamination.
 - (3) Decomposing garbage in landfills can pose environmental problems similar to toxic lagoons when leachate seeps into groundwater. Arrange to visit your landfill. What methods do they use to monitor leachate contamination of groundwater?

TOXIC LAGOON

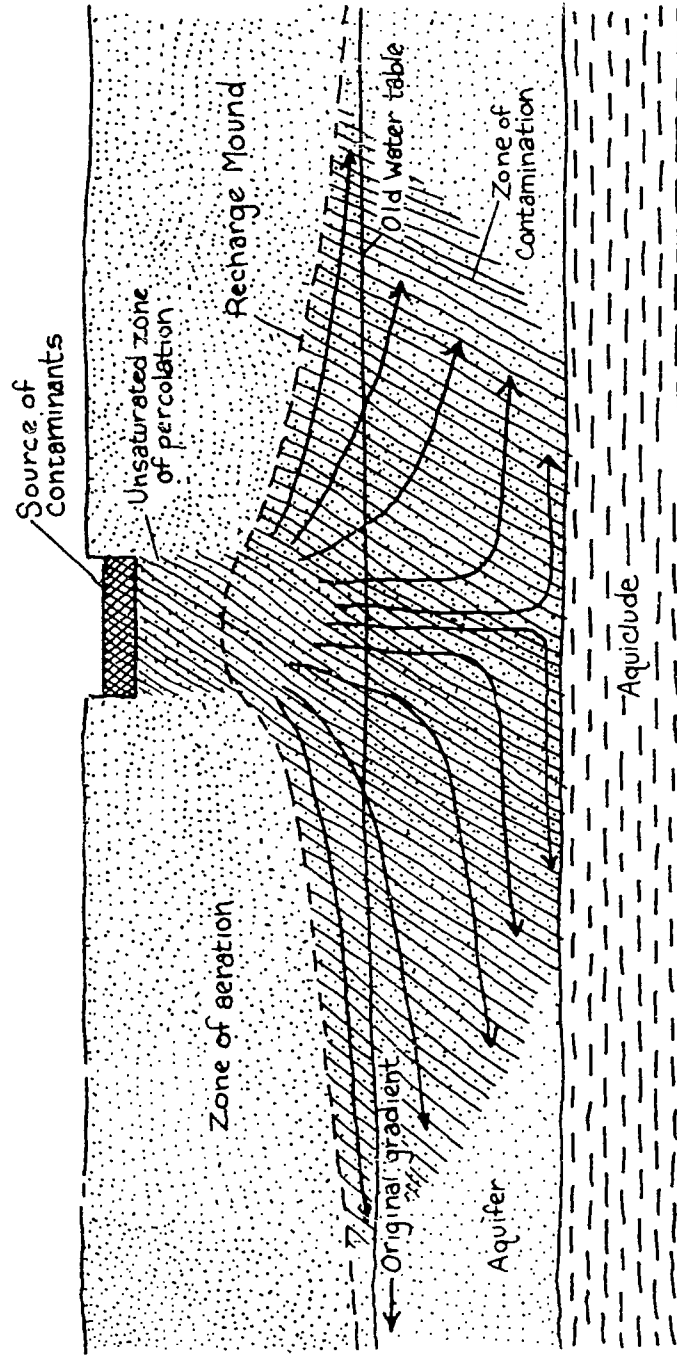

Water Worldwide



OBJECTIVES:

Students will learn how to take a data table and develop a pie graph of this information. See WATER RESOURCES matrix for background information.

MATERIALS:

newsprint or posterboard
felt crayons
globe
ruler
protractor
compass
magazines with worldwide travel advertisements
scissors
glue

PREPARATION:

Read Water Factsheet 4. Help students draw a pie graph to represent the percentage of water worldwide. Encourage students to collect photographs from books and magazines of oceans, rivers, waterfalls, clouds, lakes, polar ice caps, etc.

PROCEDURE

Divide the class into groups of 4 or 5 students. Each group will draw a pie graph using data from the Worldwide Water Distribution

WORLDWIDE WATER DISTRIBUTION

Oceans	317,000,000
Polar ice caps	9,000,000
Underground in aquifers	2,000,000
Lakes and ponds	30,000
In soil	16,000
In the atmosphere	3,100
In rivers	300
TOTAL	330,000,000

Chart on the left side of the posterboard and a illustration of the world on the right side. Have the students use a compass to draw both circles. (See illustration.) Make sure to draw in the center point on the left circle.

To begin, have the students determine what fraction (in decimal form) of the pie or chart each entry would represent. To determine these fractions, have them divide each entry in the chart by the total at the bottom of the chart. The decimal fractions should total 1.0. You may need to round off your numbers.

Have them convert these decimal fractions into degree measurements. To convert to degrees multiply the decimal fractions by 360. For example, $0.5 \times 360^\circ = 180^\circ$.

Next, have the students use a ruler to draw one radius from the center point to the circle's edge. Then, line up the protractor on the radius and line up the center of the protractor's base with the circle's center. Using the degree measurement from the first entry and the protractor, mark the this point on the circle. Now use your ruler to connect the center point with this point. This line is your radius for the

next entry. Repeat this procedure until all entries have been recorded. Be sure to label each piece of the pie with the percent and title of the entry.

The right circle will represent the earth. Using the globe as a model, draw in outlines of the continents. Color in oceans, mountains, polar ice caps, etc. Then label and paste them around the poster. Label the poster "WATER WORLDWIDE." See example included in this activity.

EXAMPLE

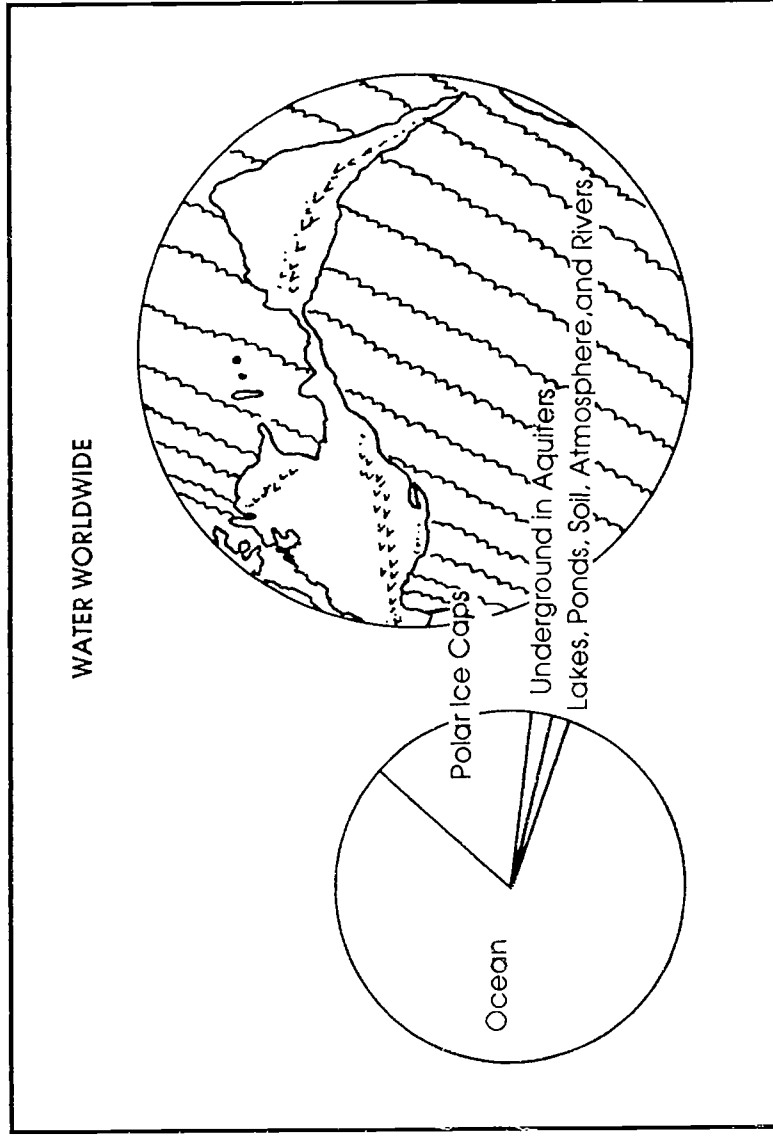

FOLLOW THROUGH:

- (1) Precipitation falls in very different amounts around the earth. In addition to variations in amount, there are variations in time of rainfall, with many areas having wet and dry seasons. All over the world, water supplies and precipitation patterns have a strong influence on economies and cultures. Have students select countries and report on their countries' water situation. For example, Ethiopia, in Africa, continues to experience famine and crop failures due to its desert-like climate and drought.
- (2) Drought conditions in the Tennessee Valley from June, 1984, through April, 1988, resulted in 56 inches less rainfall than normal for that period. How has this drought affected our economy and lifestyles?

Weather Watchers



OBJECTIVES:

Students will measure and keep records of local rainfall. See WATER RESOURCES matrix for background information.

MATERIALS:

Tennessee Valley map
U.S. map
newsprint or posterboard
felt crayons
rain gauge
thermometer

PREPARATION:

Have students research weather stations to decide what type they want to use. The purpose of this activity is to generate interest in rainfall and its regularity in the Valley. This activity may create interest about other portions of the Tennessee Valley and the U.S. and demonstrate to students that letters that letters are a powerful tool for gathering information.

PROCEDURE:

Have students set up a weather station which includes at least a simple rain gauge and a thermometer. Develop a schedule of who will collect and record rainfall, temperature, and other data, at the

same time each day. Then have students write to other classes in the Tennessee Valley area to obtain "weather pals." "Weather pals" should be asked to collect rainfall and temperature data each day for their area and send it to your class each week, for a set period of time. On maps of Tennessee and the U.S., place white tacks to show which cities have been sent letters and red tacks for those that write back. You could keep this activity on-going during the school year. When information is received, put it on a data chart with your classes data.

WEATHER DATA		
Place	Date	
	Temp.	Rainfall
Bearden High Knoxville, TN	82°	0.0

How is the weather different in different parts of the Valley?
Why?

The National Weather Service maintains a volunteer force of weather watchers. Write to them and find out who in your area collects these data. Have them visit the class or arrange a visit to their weather station. Their address is NDAA, National Weather Service Public Affairs, 8060 13th Street, Room 618, Silver Springs, Maryland 20910 or (301) 427-7622.

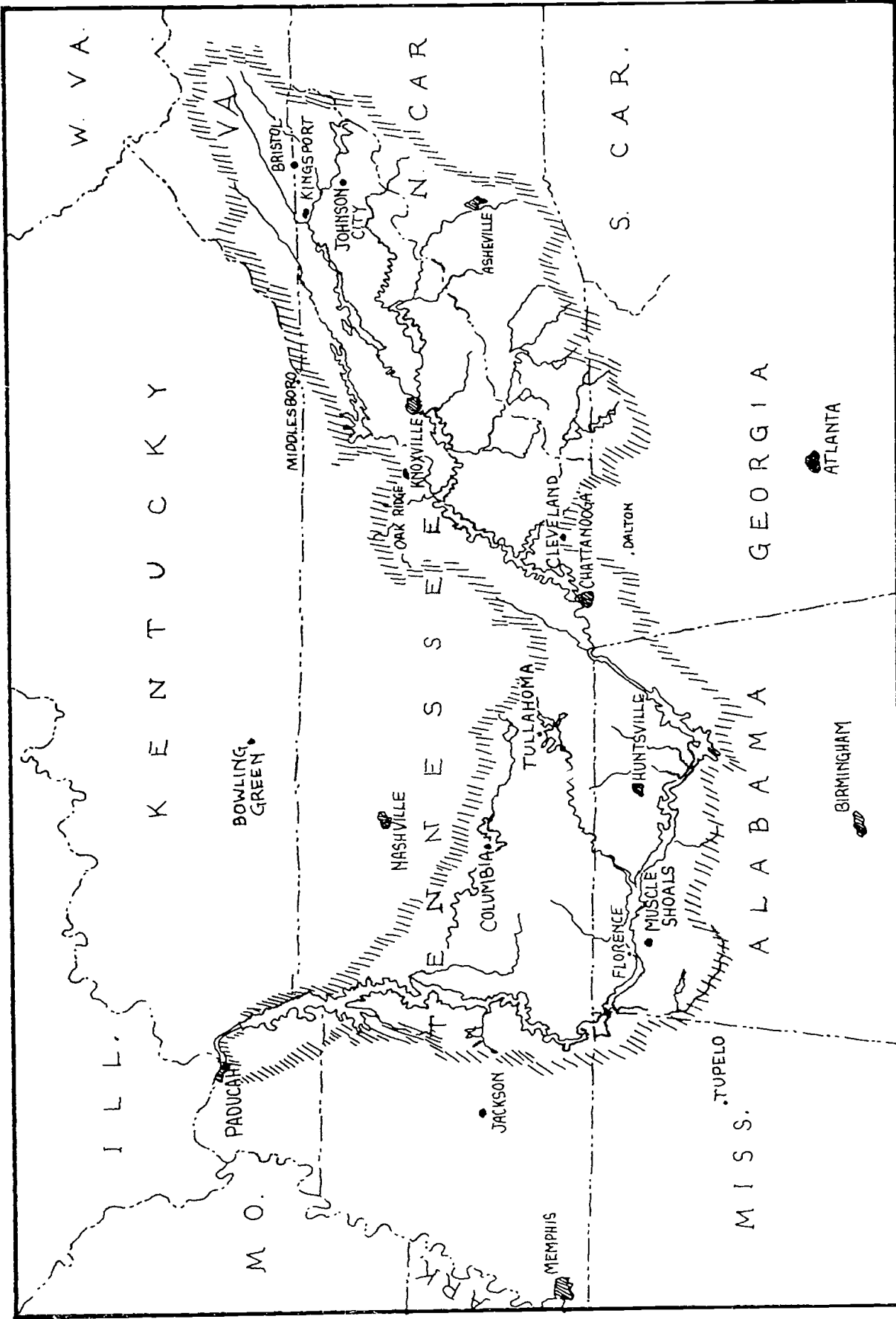

MAJOR CITIES IN TENNESSEE VALLEY

Wind Speed Indicator

Materials needed: clear plastic straw
 small beads of styrofoam from
 crushed cup or packing materials
 balsa wood or corrugated cardboard,
 3 inches by 12 inches
 modeling clay
 2 pearl-end sewing pins
 posterboard
 pipe cleaners (for cleaning)
 rulers

Directions:

Clean and dry straw, using the pipe cleaners, and close-off one end with modeling clay. Make a pinhole in the top of the straw, and drop a notch in the bottom, as shown, and drop in the styrofoam ball. It needs to fit loosely but not fall out the notch. Then attach a posterboard scale, as shown, to the straw and attach this to the balsa wood using sewing pins. To take readings, hold the instrument at arms-length with the notch facing the wind. Air moving into the notch will move the ball to a height proportional to the wind speed. Check with the local weather station for actual wind speeds and use this to adjust the scale on the straw for accuracy.

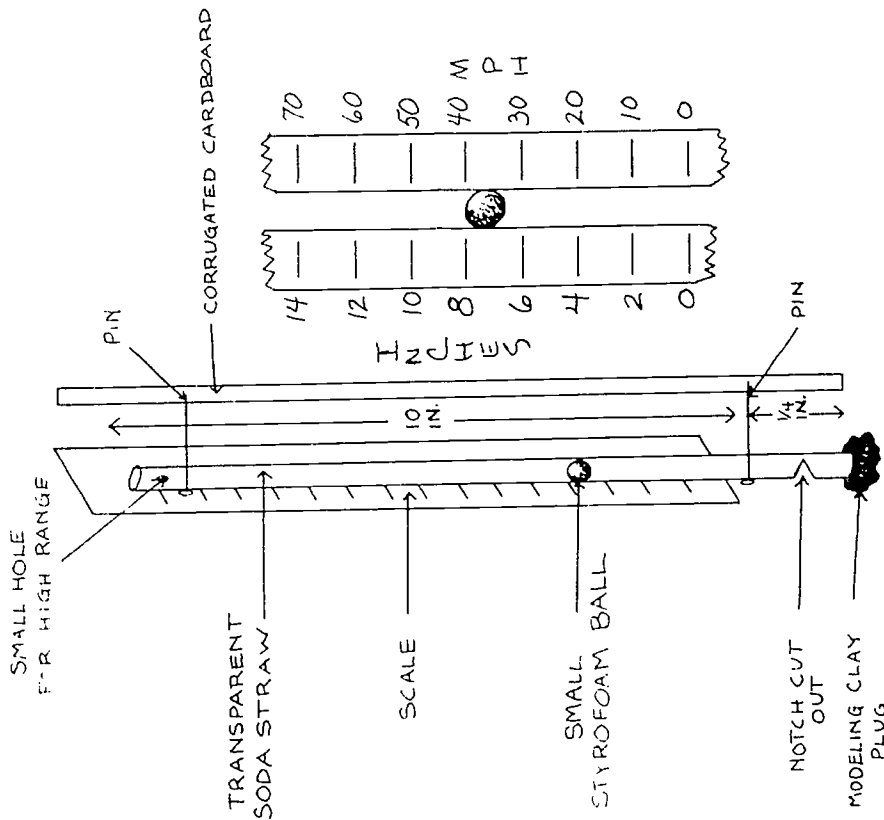

WIND-SPEED INDICATOR

FOLLOW-THROUGH:

Make your own weather instruments like a wind speed indicator and a "hair" hygrometer. (Adapted from Experiments in Meteorology by Leslie W. Trowbridge.)

Simple Hair Hygrometer

Materials needed:

- cardboard milk carton
- 2 inch by 1/2 inch piece of cardboard or posterboard
- 2 small buttons
- 1 large darning needle
- 1 popsicle stick
- epoxy glue
- 1 blond human hair (10 inches, or more, long)
- masking tape
- graph paper
- small mirror

Directions:

Rinse out milk carton and make an "H"-shaped cut, about 2 inches long and 1 inch wide, in one end and cut out openings on the top and side, as shown. Bend the tabs inward and glue one button on each tab with the darning needle passing through the holes to form an axle. Then, glue the mirror to the middle of the needle. When dry, glue one end of the hair to the center of the mirror and let dry. Punch a hole in the other end of the carton, draw the hair through the hole, and tape it down on the outside. Make a scale by gluing the graph paper to the Popsicle stick and labeling the grid in an inverted fashion from 0-20, as shown. Insert this scale into a slit at the end of the carton and tape into place. Glue a 2 inch by 1/2 inch, cardboard sighting bar horizontally, on the top of the scale. To adjust, untape the hair and pull it until the number 10 comes into the center of view on the mirror using the sighting bar. Readings are taken by using the sighting bar and recording the number in view. To calibrate, call the local weather station and check actual readings. Make a chart with your readings and actual humidity. After 4 or 5 readings you should be able to determine humidity using your Simple Hair Hygrometer.

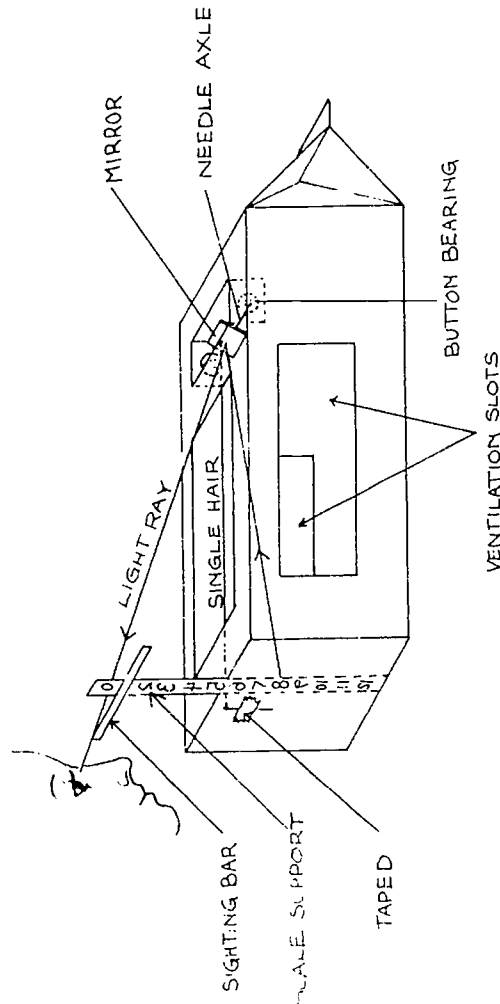

SIMPLE HAIR HYGROMETER

The Super Cycle



OBJECTIVES:

Students will demonstrate the water cycle. See WATER RESOURCES matrix for background information.

MATERIALS:

colored pencils or felt crayons (red, blue, green, yellow)
Handout of water cycle for each student (included)
bottle
plants
soil
water
glass

PREPARATION:

Read Water Factsheet 5. Help students with vocabulary. Stress the meanings of evaporation and transpiration. Perform a demonstration by taking two similar jars; label one evaporation and the other transpiration. Fill both half full of water and mark the level of water on the side of each jar. Place the jar marked transpiration in a terrarium containing soil and a plant. Place the jar marked evaporation in a terrarium containing only soil. Every day mark the jars to indicate the water level; do not add water. Students should record their observations.

PROCEDURE:

On the included handout, "How the Hydrologic Processes Affect the Earth and Its Inhabitants," ask students to show the movement of water using colored arrows. Use **red** for precipitation, **blue** for surface water, **green** for groundwater, and **yellow** for water that is evaporating or transpiring back into the atmosphere.

Discuss the "super" or hydrologic cycle. Where does the energy come from to power this cycle? How are clouds formed? How do plants affect the cycle? How do animals affect the water cycle? Where does water pick up impurities? How? What human activities affect the water cycle?

Build a miniature water cycle in a closed jar or terrarium as shown. Be sure to include soil, water, air, and plants.

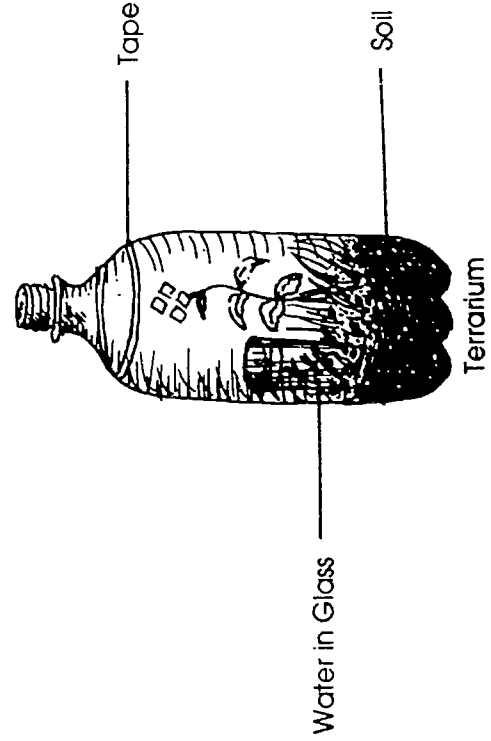

FOLLOW-THROUGH:

Salt is continually dissolved on land surfaces by rain and is then washed into lakes, seas, and oceans, where these salts begin to concentrate. The term used to describe this condition of solid substances being dissolved in the ocean is salinity. For example, the world's oceans contain 34.7 percent dissolved salts (34.7 g/100g sample of water). Salinity is measured in parts per thousand by measuring the concentration of the chloride ion. Salinity (percentage) = $1.80655 \times \text{chlorinity (percentage)}$. Ask students to calculate the salt concentration in the Dead Sea. The chlorine concentration is 149,996 mg/l.

Running water is rarely saline, but occasionally run-off from human activity makes it so. Use a Hach or LaMotte water test kit to measure the salinity (chloride concentration) of fresh water. Research what happens when the salt level in fresh water increases. Then, discuss the implications of this in Valley streams and reservoirs.

HOW HYDROLOGIC PROCESSES AFFECT THE EARTH AND ITS INHABITANTS

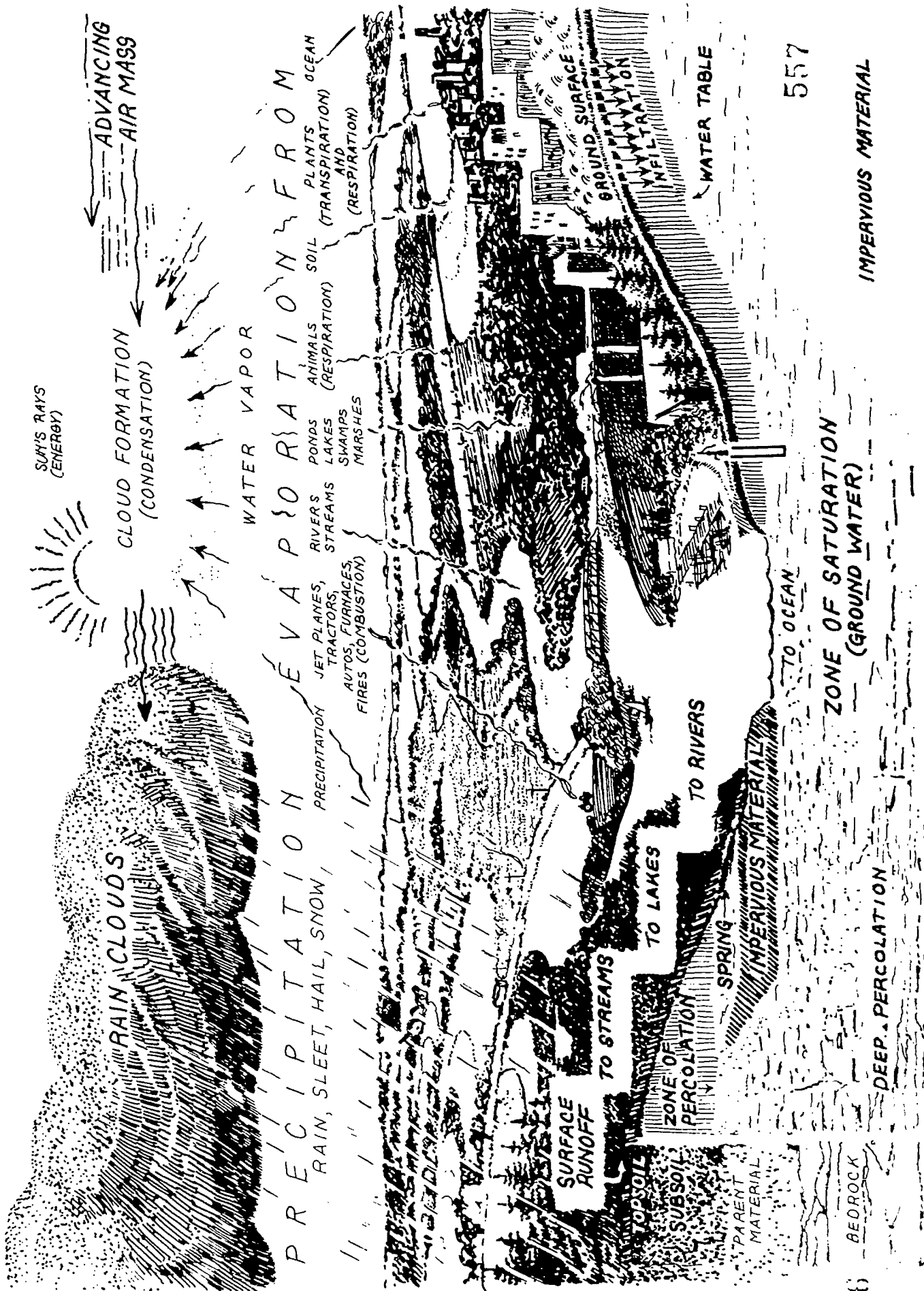

A Natural Filter



OBJECTIVES:

Students will observe the filtering action of the earth by constructing a sand and gravel model. See WATER RESOURCES matrix for background information.

MATERIALS:

several 2-liter, clear, plastic bottles
collander or sieve
fine and coarse aquarium gravel (washed)
fine aquarium sand (washed)
charcoal
cloth rag or cotton plug
scissors

PREPARATION:

Memphis' water supply is drawn from giant, natural reservoirs deep in the earth. The water is held under pressure by about 350 feet of nearly impermeable clay and sand layers. Four water-bearing layers of sand and gravel are situated about 50, 350, 1,400, and 2,600 feet below the ground surface. The water that has taken 3,500 years, or longer, to reach you has not been idle all this time. It has been slowly filtering through the sand and gravel, which has removed some of the harmful bacteria and impurities.

Have the class either examine the model from the activity in the Water Resources Section entitled "MODELING THE MISSISSIPPIE-M-PAYMENT AREA," or copy the handout from that activity.

PROCEDURE:

Have students work together in groups to prepare filter models. First, rinse out a bottle; mark and cut off the bottom. Then, thoroughly rinse the sand and gravel in a collander until the water runs clear. Stuff a loose plug of cotton or cloth into the cap end of the bottle and turn that end down. Fill with 2 inches of fine sand, an inch of crushed charcoal, another sand layer, a fine rock layer, and finally, a coarse gravel layer. (See illustration.) Run about a gallon of tap water through the filter to remove any excess materials and to settle the layers. This model represents layers of the earth which serve as a natural filter.

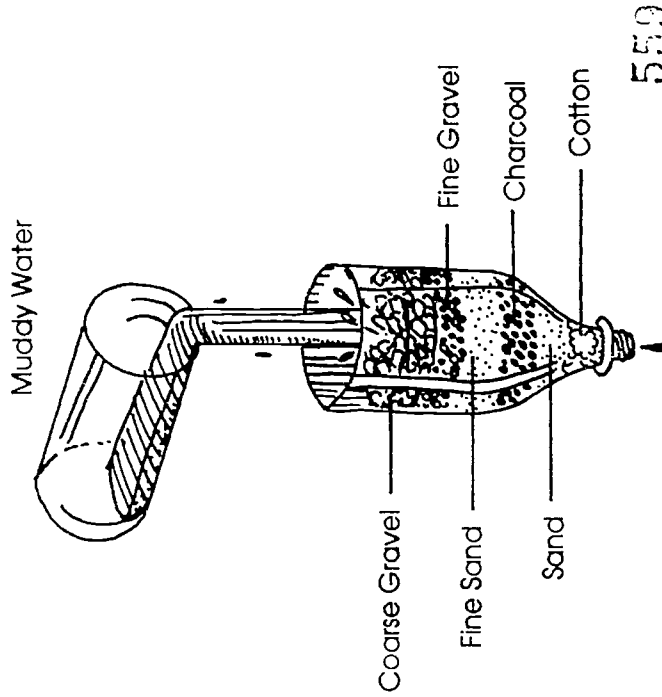

Next, prepare some muddy water that contains dirt, sticks, leaves, etc. Pour the muddy water into the open end and collect it in a clear container, at the bottom. Compare "before" and "after" samples of the water. How did the filter work? Where did the particles collect? Why were different sizes and kinds of particles trapped in different layers? Discuss how this compares to the filtering action of the earth on underground water. Which natural layers of the earth does each layer in your filter represent? (Use the Mississippi Embayment illustration to explain.) How could your filter be improved?

FOLLOW-THROUGH:

People in many parts of the world use filters much like the one you have made. Find out more about this. Local stores sell water filters to attach to your faucets. Explore how these filters work. Your local water treatment plant probably uses a sand filter; take a field trip and learn how it works.

Water Resources Glossary



1. Aquifer - An underground bed of earth, gravel, or porous stone that contains water.
2. Artesian water - Underground water trapped under pressure in a porous layer between non-porous rock layers.
3. Artesian well - A well bored into an artesian aquifer in which the water rises above the top of the water bearing bed.
4. Biomass - The dry weight of living matter.
5. Carbonate aquifers - An aquifer containing dissolved carbon dioxide or carbonate rocks.
6. Condensation - The process of water changing from a gas (water vapor) to a liquid.
7. Dissolved minerals - Minerals that are picked up in water as a result of the water passing over rocks that contain various elements
8. Dissolved oxygen - The amount of oxygen in water. It is necessary for the survival of fish and other aquatic organisms.
9. Embayment - A sedimentary rock formation where one or more of the layers or beds are directed inward (see Mississippi embayment illustration.)
10. Eutrophication - A process of filling in or aging which occurs in lakes when additional nutrients and as nitrogen or phosphorus are added. These additional nutrients usually come from municipal sewage, agricultural fertilizers, and industrial effluents.
11. Evaporation - The process of water changing from a liquid to a gas.
12. Hydrologic Cycle - The complete cycle where water passes from the oceans through the atmosphere, to the land, and back to the ocean.
13. Hydrosphere - The surface water that covers the earth.
14. Injection Well - A well in which fluid (wastes or water) is injected either for disposals or in oil production to force oil into the vicinity of oil producing wells.
15. Lagoon - A shallow pond or lake.
16. Non-Carbonate Aquifers - Aquifers that do not contain carbonate rock formations.
17. Percolation - Downward flow or infiltration of water through the pores or spaces of rock or soil.
18. Precipitation - Water from the atmosphere that falls to the ground as rain, snow, sleet, or hail.
19. Recharge area - An area where rainwater soaks into the earth to resupply the aquifer.

20. Regolith - A layer of rock or unconsolidated rocky debris of any thickness that overlies bedrock and forms the surface of the land.
21. Reservoir - A natural or artificial lake or pond in which water is stored for use.
22. Tributaries - Streams or rivers that flow into a larger stream or river.
23. Transpiration - The release of water vapor through tiny pores in the leaves of plants.
24. Water table - The level underground below which the soil or rocks is saturated with water, sometimes referred to as the upper surface of the saturated zone.
25. Watershed - An area from which water drains and contributes flow to a given place, or point, on a stream or river.
26. Zone of saturation - Rock or soil layer in the earth in which every available space is filled with water.

Wildlife Resources

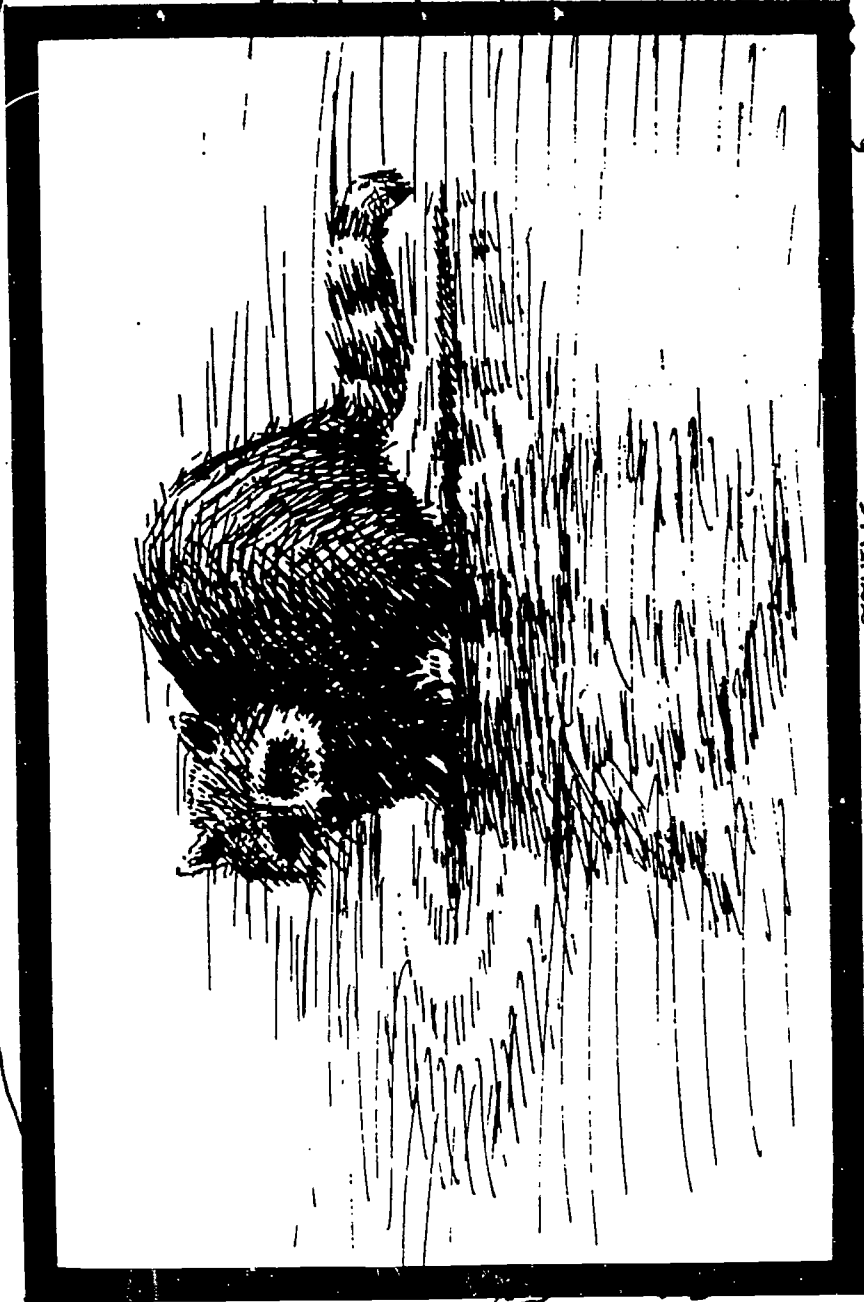

567

BEST COPY AVAILABLE

566

"Some have attempted to justify wildlife in terms of meat, others in terms of personal pleasure, cash...in the interest of science, education, agriculture, art... but few have so far clearly realized that all those factors in a broad social value, and that wildlife is an asset."

Aldo Leopold



Wildlife Resources Concepts Map

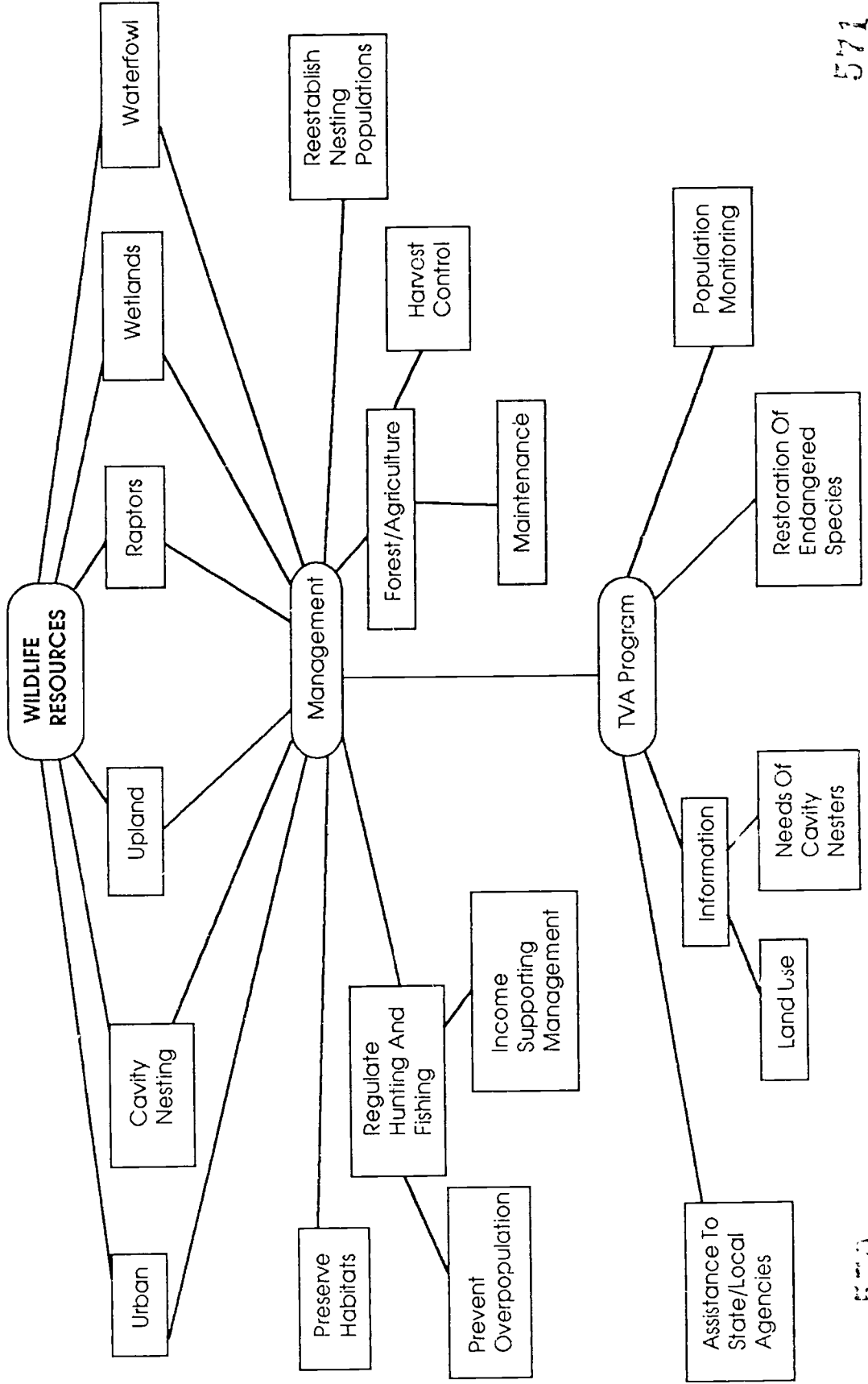

Wildlife Resources Factsheets



1. Overview
2. Urban Wildlife
3. Cavity Nesting Wildlife
4. Wildlife Management
5. Upland Wildlife
6. Raptors (Birds Of Prey)
7. Endangered Species
8. Wetlands Wildlife
9. Waterfowl
10. Wildlife Habitat

572

573

1. Overview

According to a 1980 national survey by the U.S. Fish and Wildlife Service, almost half of all adult Americans, nearly 100 million people, participated in some form of outdoor recreation involving wildlife. These wildlife users, including hunters, trappers, fishermen, birdwatchers, and wildlife photographers, contribute over \$40 billion dollars each year to the Nation's economy.

Wildlife populations have always been important to us. Early settlers in this region relied heavily on wild game as a major source of food. In fact, it was the extensive hunting and trapping of certain animals which led us to study how wildlife could be managed to assure that these animal populations were not driven to extinction.

Hunting is still a valued tradition in the country and many sportsmen are now associated with wildlife conservation. Hunters provide much of the money used to pay for wildlife management programs, and regulated hunting is an important aspect of the management of wildlife populations.

Hunters provide a valuable service by harvesting certain animals to keep their populations in balance with the available habitat. Some species, such as deer, can quickly overpopulate and destroy the habitat that supports them. This is particularly true since such natural predators, like cougars and timber wolves, are no longer available to control deer population growth. Hunting also assures that the habitat will support the remaining animals through the critical winter months when food is in short supply. Those animals that survive the winter provide a healthier stock to repopulate the habitat.

Conservation historians and wildlife professionals agree that regulated hunting and trapping in this country poses no threat to the continued existence of any wildlife species. We can assist nature in

improving wildlife habitat as easily as we can disturb or destroy it. In fact, many species of wild animals are doing well today either because they are able to live in close contact with people and their developed environment or because of good wildlife management programs.

Residents in the Valley, as well as tourists, spend a great deal of time and money hunting or participating in a variety of other wildlife-related activities, from photography to feeding backyard wildlife. Through ecologically sound management practices, these lands can be maintained and improved to produce wildlife for future generations.

The wildlife manager's primary responsibility is to apply the best available scientific methods and information to ensure that wildlife populations are maintained at levels beneficial to the animals and the public.

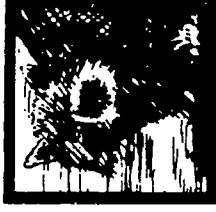

2. Urban Wildlife

Animals are actually very common in cities and towns. They include doves, owls, hawks, woodpeckers, robins, blue jays, cardinals, sparrows, pigeons, rabbits, squirrels, opossums, raccoons, and occasionally white-tailed deer. Small ponds and lakes in urban areas are often filled with a variety of turtles, frogs, and salamanders. Nonpoisonous green, garter, and rat snakes can also be found. Occasionally even poisonous snakes, like copperheads, can be seen in urban areas. Many of these animals have adapted to urban areas as their natural environments have been destroyed.

The expanding human population within the Valley is placing increased demands on all our natural resources. Much of the land chosen for urban development was once productive farmland and forest. Good wildlife management programs should be part of urban planning to provide for these displaced animals. If development results in removal of most or all natural vegetation, it is very important to plant trees, shrubs, grasses, and herbs, as soon as possible, to provide food, cover, and reproductive areas for birds and other wildlife.

As the newly established plant community develops, different animals will come and go as the environment changes. For example, during the first few years, birds will feed on earthworms and other insects in the grassy areas and forage among the shrubs. Later, there will be enough flowers and fruits to attract small mammals and insects. Then reptiles and amphibians which feed on small mammals and insects will move in along with hawks, owls, and other birds of prey. Soon a new wildlife community will be established.

It is important however, to remember that wildlife populations can be severely harmed by free-roaming dogs and cats. These



family pets can be particularly threatening to ground- or shrub-nesting animals, and their young, during the spring and early summer.

Attracting wildlife into urban areas is becoming very popular around the country. Many trees, shrubs, and plants can be planted around the house to attract wildlife. For instance, planting cherry trees in your yard may attract catbirds, brown thrashers, robins, cedar waxwings, evening grosbeaks, and purple finches. Sunflowers attract mockingbirds, cardinals, goldfinches, chickadees, titmice, nuthatches, purple finches, sparrows, and juncos. The U.S. Department of Agriculture sells many pamphlets at a modest cost, that may be helpful. They include:

- Invite Birds To Your Home (SCS 1093)
- Making Land Produce Useful Wildlife (FB-2035)
- More Wildlife Through Soil and Water Conservation (AIB-75)

These publications and possibly others are for sale by: Superintendent of Documents, U.S. Government Printing Office, Washington, D.C. 20402.

You can get further information on plants, soils, and conservation methods from the Soil Conservation Service (SCS). Inquire at the office of your local soil and water conservation district. As part of its assistance to conservation districts, SCS helps people apply many conservation practices that increase wildlife. County agents, commercial nurserymen, landscape architects, and bird societies can also help.

3. Cavity-Nesting Wildlife

Over 85 species of North American birds nest in cavities of dead or dying trees. Cavity-nesting birds in the Valley include wood ducks, wrens, chickadees, titmice, nuthatches, bluebirds, woodpeckers, screech owls, and American kestrels. Many mammals also require tree cavities for shelter and rearing their young. Graysquirrels, flying squirrels, opossums, and raccoons can all be seen frequently in urban areas, parks, and forests, using tree cavities and leaf nests.

Trees that provide nest cavities are commonly referred to as either "snags" or "den" trees. Snags differ from den trees in that they are usually old, dead trees, while "den" trees can be any age of living or dead trees. Only within the last decade has the concept of snag or den tree management evolved as an important aspect of wildlife and forest management. For example, streamside habitats important to wood ducks were often destroyed, causing their populations to decline. Management efforts to reverse these population declines have concentrated on assuring that snag or den trees are not removed during timber management and farming activities. Occasionally, trees are intentionally killed by chemical injection or girdling to provide snags or dens for cavity nesters.

The Tennessee Valley Authority (TVA) provides technical assistance to other Federal, state, and private organizations and individuals regarding the needs of cavity nesters and the impact of certain land use practices on them. One of the most significant cooperative projects undertaken was during the late 1970s. This resulted in over 2,500 wood duck and some 5,000 bluebird nest boxes being placed in areas where naturally occurring nest sites were lacking. These structures can be very important to the survival of an animal species. For example, purple martins now depend almost entirely on people-provided nesting structures.

Foresters and recreation managers are now more aware of the economic benefits from cavity-nesting species. Many cavity-dependent birds are insectivorous and play a major role in the control of insect pests. These benefits easily translate into millions of dollars per year, while the cost is minimal. The continued efforts to help cavity nesters through people-made structures will likely play an important role in the future as natural habitat is lost.



4. Wildlife Management

During the early to mid-1900s, wildlife across the Tennessee Valley suffered sizeable population declines. This was caused by habitat destruction and unregulated hunting and trapping. Today, most of these wildlife populations have now been restored and enhanced, using modern wildlife management techniques.

The combined efforts of wildlife organizations have also resulted in some species of wildlife being present in greater numbers than ever before. Almost 3 million acres of land across the Valley region are now devoted to wildlife management. These and other public lands serve as valuable areas where wildlife and their habitats are being improved and protected through research and better management practices.

Cooperative efforts have also been made to manage wildlife and to improve habitat on private lands across the Valley. Private landowners are receiving assistance in developing plans for managing and protecting wild animals on their lands. This assistance includes the distribution of beneficial wildlife plant materials, such as seed, shrubs, and tree seedlings, and information in the form of articles, pamphlets, and brochures.

TVA's wildlife program has worked to restore wildlife by helping to reestablish populations of river otters, giant Canada geese, wood ducks, bald eagles, peregrine falcons, golden eagles, great egrets, and ospreys. This program focuses on areas of the Valley that have been environmentally changed or disturbed, such as surface or strip mines and land under powerlines.

TVA and other wildlife managers now use computer tools and mapping techniques which assist them in the development of com-

prehensive wildlife management plans. For instance, microcomputer programs are being used, currently, to analyze and report data from regulated deer harvests. High-altitude, color-infrared photographs, taken from aircrafts and satellites, are also being used to monitor what is happening to wildlife as a result of land use projects.

To adequately plan and manage the environment to favor wildlife, wildlife managers must understand the delicate balance between animals and their environment. To do this, wildlife biologists study the ecology. This study of the interrelationship of organisms and their environments helps biologists understand the basic needs of wildlife populations. This helps managers create favorable habitat conditions.

Wild animals have the same basic survival needs as humans. These, of course, include food, water, cover for protection from enemies and weather, and areas where they can reproduce and rear their young in safety. These needs are provided naturally by different kinds and sizes of plants. People-made changes to the landscape can negatively affect the quality of wildlife habitat. Once the habitat is lost, the nameless animals must compete with others occupying similar habitats. If no habitat is found, this could possibly cause permanent loss of the animals or, perhaps, the extinction of the species. For example, large grain fields provide an abundant source of food for field mice, shrews, and other small mammals. This results in more mice and, generally, an increase in the local population of such predatory birds as hawks and owls. Removal of these grain fields, however, would likely result in loss of the field mice, shrews, and small animals and be followed by a decrease in the population of predatory birds.

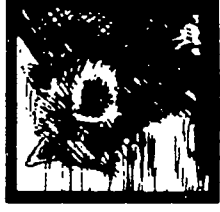

Since the early to mid-1900s, wildlife managers have grown more concerned about the effects of resource development and management activities on wildlife. Improper management techniques and land use practices can result in the destruction or change to wildlife habitat that can have the same negative effect on wildlife as does industrialization and urbanization. On the other hand, certain agricultural and forestry practices can be especially important in enhancing wildlife populations.

5. Upland Wildlife

Upland wildlife are animals that inhabit higher, drier sites that are not seasonally or regularly covered with water. An open water source like a lake or stream is not always necessary for certain upland species since most of their water requirements are met through the plants they eat. Open land species include bobwhite quail, bluebirds, mourning doves, meadowlarks, sparrows, buntings, and cottontail rabbits. Common forest species include wild turkeys, white-tailed deer, gray squirrels, ruffed grouse, woodpeckers, hawks, owls, thrushes, and nuthatches.

Wildlife has always been affected by changes that alter or destroy habitat. In 1949, combined state, local, and Federal government programs were started to improve habitat conditions after it was realized that habitat loss was the primary reason for the decline of most upland wildlife populations. Since these programs began and wildlife use laws and regulations were enacted, public awareness has increased and many wildlife populations have been restored. For example, white-tailed deer in the seven Tennessee Valley states now number over four million, probably higher than ever, and wild turkey populations have made impressive comebacks.

TVA helps the seven Valley states manage approximately three million acres of wildlife management area (WMA) lands. Most of these lands are forested and are managed for upland wildlife, principally white-tailed deer and wild turkeys. The management of these areas generally involves creating favorable habitat conditions by enhancing succession. This includes planting a variety of plants to serve as sources of food, safe areas for reproduction, and protective cover. Forest openings are generally maintained by periodic bush-

hogging, bulldozing, or cutting to create browse (leaf, shoots, and twigs of woody plants) used as food by animals. Also, ponds or waterholes are constructed on sites where surface water is limited to improve habitat conditions for some species.

Open land habitat management techniques include planting important food sources such as berry- and seed-producing plants and various grasses. These areas are maintained by controlled burning, disking, and other agricultural practices. Food production is often further enhanced by planting wildlife food plots or traditional row crops such as corn, sorghum, oats, rye, alfalfa, or soybeans. These areas also provide habitat for ground-nesting birds and small mammals. Occasionally, nesting areas can be improved in forest and open land areas by providing people-made nest boxes.

To manage this valuable resource, care must be taken to avoid creating harmful environmental impacts. Because forests and agricultural land management go hand-in-hand with wildlife management, precautions need to be taken to avoid erosion when cutting roads to harvest timber and disking agricultural fields.

Upland wildlife habitat management activities across the Valley support an economically and ecologically valuable resource. By providing a mix of plants and additional water sources, upland habitats can be successfully improved and wildlife populations enhanced.



6. Raptors (Birds of Prey)

Raptors, or birds of prey, include vultures, owls, kites, hawks, eagles, harriers, falcons, and ospreys. These birds have hooked beaks and, except for the vultures, strong toes and talons. Females are generally larger than males. Most capture their prey alive and eat it freshly killed. Some are powerful fliers and capable of diving through the air in excess of 100 miles per hour to capture prey.

Common species of raptors in the Tennessee Valley include the turkey vulture, black vulture, barred owl, screech owl, great horned owl, red-tailed hawk, and American kestrel. These animals reside here year-round and nest in the area. Other raptors, like the osprey and broad-winged hawk, nest in the valley but winter further south. Bald eagles and peregrine falcons are also considered residents, but rarely nest here. Still others like the northern harrier, golden eagle, and rough-legged hawk can be seen migrating through the area on their way to breed in the northern states and Canada.

In the past, their predatory habits and majestic flight made raptors symbols of courage, power, and freedom. However, misunderstandings regarding their role in the ecosystem, combined with the belief that these birds often preyed upon livestock, made them victims of senseless shootings. Their populations also declined because of timber harvesting practices that removed important nesting trees.

Eagles and ospreys, being mostly fish eaters, suffered reproductive failure due to pesticides that polluted waterways during the 1940s and 1950s. Many other raptors suffered population declines as certain land use practices increased.

In 1913, Congress enacted the Migratory Bird Act. It declared

all migratory game and insectivorous birds:

"...to be within the custody and protection of the Government of the United States..."

and prohibited people from hunting them. Hawks and owls are recognized as being of great economic value to agriculture because of the millions of rodents and insects they eat annually.

Many raptors once nested in the Tennessee Valley, and since the environmental quality has improved, restoration efforts are now returning some of these birds to their former ranges.

Various wildlife programs since the mid-1970s have reestablished nesting populations of osprey, bald eagles, peregrine falcons, and golden eagles. Experience with osprey nesting sites led to the development of the "hacking" process, in 1979. This process involves gradually releasing young birds of prey to the wild with the hope they will return to that site. It has been successful with the osprey, bald and golden eagles, and peregrine falcons. The first bald eagle nest since 1950 was located near Cross Creek National Wildlife Refuge, in Tennessee, in 1983, and the first successful hatched bald eagle in the Southeast was reported nesting at TVA's Land Between The Lakes in April, 1984.

Restoration and monitoring of raptor populations also have considerable value as ecological safeguards, since these sensitive species may provide indications of potential environmental problems to future generations.



7. Endangered Species

The passage of the Endangered Species Act in 1973 gave the United States the power to protect plants and animals from extinction. Under the act, the Secretary of the Interior has powers to protect and conserve all forms of animals and plants considered to be in jeopardy and the Secretary of Commerce has similar authority for protecting and conserving marine life. Congress states, in the preamble to the act, that endangered and threatened species of animals and plants:

"...are of aesthetic, ecological, educational, historical, recreational, and scientific value to the Nation and its people."

The major threat to most species is the destruction of habitats by not controlling land and water development. Habitat is necessary for survival. It provides water, food, reproductive sites, shelter, and enough space for population growth.

Before the arrival of humans, species were becoming extinct at a rate of only one every 1,000 years. By 1950, one species was being lost every 10 years; and by 1980, the rate was one every year. Since the Europeans first came to this country, at least 40 known species of birds and mammals native to the United States have become extinct. As of December 1988, 403 species of birds, mammals, fishes, reptiles (turtles and snakes), amphibians (frogs and salamanders), mollusks (clams and oysters), arthropods (crayfish and insects), and plants have been listed as endangered species in the United States. At that time, 72 species in the Tennessee Valley region were Federally listed

as endangered or threatened and another 234 were being studied for possible listing.

In the Valley, habitats are affected by projects including cutting of wooded areas, water development projects, housing, coal mining operations, and draining of wetlands for agricultural uses. The quality of the remaining habitat is also being affected by such environmental pollutants as acid rain, acid run-off from coal mines, soil erosion, and chemicals found in fertilizers and pesticides. As the human population and future needs for fuel, food, and fiber increase, the problems will likely intensify, resulting in more species becoming threatened.

Various organizations are working together to preserve, restore, and enhance habitats and increase the productivity of the Valley's wildlife. For example, cooperative work has resulted in the establishment of a resident population of approximately 20,000 giant Canada geese, a subspecies once thought to be extinct. Also, work is continuing to reestablish nesting populations of endangered or regionally rare raptors such as ospreys and bald eagles, and wetland mammals such as the river otter.

The greatest danger to wildlife has been, and continues to be, the loss of necessary habitat. The knowledge needed to help many endangered species already exists. Many other species can and will be restored to healthy population levels as efforts continue to maintain and improve habitat through careful planning and thoughtful management practices.



**ENDANGERED SPECIES STATISTICS FOR 201 COUNTY
TENNESSEE VALLEY REGION
1988**

	Endangered	Threatened	Formally Proposed For Listing	Candidate Species For Listing
Vertebrates	17	9	0	51
Invertebrates	28	2	3	83
Plants	12	4	1	100
Total	57	15	4	234

SOURCE: TVA Natural Heritage Program

1988 U.S. ENDANGERED SPECIES			
CATEGORY	ENDANGERED	THREATENED	
Mammals	50	7	
Birds	76	10	
Reptiles	15	18	
Amphibians	5	0	
Fishes	47	30	
Snails	3	5	
Clams	31	0	
Crustaceans	8	1	
Insects	10	7	
Arachnids	3	0	
Plants	155	46	
TOTAL	403	124	

Source: U.S. Department of the Interior

8. Wetlands Wildlife

Wetland wildlife include waterfowl; ospreys; bald eagles; shorebirds, such as snipe, woodcock, sandpipers, yellowlegs, and plovers; wading birds, such as great blue and green-backed herons; and mammals, such as muskrats, beavers, and river otters. These animals depend upon water to support them during much of their lives.

The number of animals present in an area is directly related to the quantity and quality of habitat. Since the early 1970s, the quality of our wetlands has improved as a result of increased efforts through management, conservation, and the passage of Federal legislative acts and executive orders. However, private development results in as much as 18,000 acres of wetlands being lost each year in the Valley.

After decades of decline, many species of wetland wildlife now appear to be making a recovery. An estimated 0.7 to 1.0 million acres of wetlands in the Valley currently help to support a stable winter population of over one-half million waterfowl, several migrating and wintering bald eagles, thousands of shorebirds and wading birds, and many mammal species.

Management practices are also being implemented across the Valley to create new habitats and to improve existing habitats. Wetlands habitat improvement usually involves building water control structures, such as levees, to raise and lower water levels with the seasons. This practice, in combination with planted grain crops, provides a variety of naturally occurring plant and animal food sources and protective cover.



Currently, most wetland wildlife restoration efforts are centered on restoring reproductive populations of animals which have been identified as threatened, endangered, or regionally rare, such as the bald eagle. Working with other Federal and state agencies, TVA has played a role in the restoration of ospreys, bald eagles, golden eagles, and peregrine falcons. These raptors have been "hacked" at various sites across the Valley since 1979. In the past few years, adult river otters have been released in western Kentucky, in the Great Smoky Mountains, and in the Powell River Valley. In fact, the otters released in western Kentucky in 1982 and 1983 have now begun to reproduce naturally and appear to be successfully restored as permanent residents there.

Wetlands are among nature's most productive ecosystems and serve a variety of important and valuable functions, including flood control, sediment control, and replenishment of underground water supplies. Fortunately, wetlands habitats are being preserved and protected now and wildlife is returning to levels of abundance. Continued habitat protection, development, population monitoring, and species restoration programs will still be needed to ensure the future of wetlands wildlife.

9. Waterfowl

Waterfowl includes all species of ducks, geese, mergansers, and swans which share certain similarities like webbed feet, wide flat bills, short legs and tails, and rather long necks. They all live within or near water and depend upon a water-based habitat to provide sufficient living space, food, cover, water of a given quality, and freedom from human disturbance. These habitats include a variety of wetlands such as swamps, marshes, ponds, mudflats, and open water areas.

Habitat requirements of waterfowl species vary considerably. For example, dabbling ducks, like the mallard, require shallow water; diving ducks, like the canvasback, need deeper water; wood ducks prefer timbered waterways; and geese need pasture for grazing.

The Tennessee Valley Authority reservoir system contains over 600,000 acres of water which annually helps to support a migratory population of over one-half million ducks and geese that spend much of the winter in the Valley. Because of the influence of the migratory Mississippi Flyway and available habitat, most of these waterfowl tend to concentrate in western Tennessee and northern Alabama. Giant Canada geese and wood ducks are now the principal resident waterfowl. Both these species were near extinction in the early to mid-1900s. Today, through restoration efforts, giant Canada geese now number over 20,000 in the Valley and wood ducks are considered abundant.

Because of their migratory habitats and dependence upon aquatic habitats throughout the year, it is necessary to establish areas specifically for waterfowl. TVA has provided over 86,000 acres of land and water to the U.S. Fish and Wildlife Service for the development and management of waterfowl. Management of these and

similar locations includes water level fluctuation and such practices as planting, disking, and controlled burning to produce waterfowl food.

Techniques are being used to monitor waterfowl so that more can be learned about their habits and needs. The use of radar equipment for counting migrating waterfowl and other birds helps to determine how often the birds fly into nuclear plant-cooling towers. Also, identification bands from harvested American black ducks are being recovered in an effort to analyze possible reasons for their population decline.

Refuges and some management areas are traditionally managed for waterfowl use. This generally does not prohibit the use of the area for other compatible outdoor recreational activities; however, environmental impacts must be considered. Unwise land-use changes are continuing to erode the quality and quantity of many waterfowl wintering areas. In fact, only one-seventh of these original areas remain in the United States today. For this reason, reservoirs are particularly important wintering grounds for migratory waterfowl and



10. Wildlife Habitat

Habitat includes food, cover, and water that an animal needs to survive and reproduce. More simply, habitat is defined as the area or type of environment in which an organism normally lives. Each species of wildlife has specific habitat requirements and is limited by the quality and quantity of available habitat. The plants and surface water which compose habitats are influenced by complex factors such as temperature, rainfall, sunlight, and the activities of humans.

Some wildlife species depend on a single type of habitat while others depend upon several habitat types. For example, the red-cockaded woodpecker, an endangered species, has a limited population and distribution because it depends on one particular habitat—open, old-age pine woodlands. Unless certain protective measures are taken, poor forestry practices could eliminate such trees, particularly on private lands. Bobwhite quail, on the other hand, require three major vegetative types within their home range. These include grassy cover, grain crops or similar source of food, and forest cover. Quail tend to use "edge" areas where different types of plants are present. The greater the variety of plant life in a given area, the more species of wildlife will be present. This concept of edge effect, or the mixing of habitat types to create edges, can also be very important.

The Tennessee Valley region has a diversity of habitat types, ranging from spruce-fir forest and grassy areas in the east to hardwood bottomlands and cypress wetlands of the western coastal plains of the Mississippi River. More than 300 species of birds and hundreds of species of mammals, reptiles, and amphibians occupy these habitats. Approximately 60 percent of the region is forested, and these areas are composed of numerous tree species. Agricultural lands, pasture, abandoned fields, orchards, road edges, old

homesteads, transmission line rights-of-way, and timber harvest sites add to the diversity of habitats in the Valley.

Habitats are often changed as a result of people-made disturbances or natural occurrences. These changes can be as drastic as a southern Appalachian hillside surface mining operation or as subtle as a decaying oak tree in the forest. They change the characteristics of the environment and force animals to adapt, compete with others occupying similar habitats, or die. As the environment recovers over time, whether through natural plant succession or with human assistance, new plants begin to grow. This newly created habitat will often support or favor species that were not present before the environment was disturbed. This aspect of change and plant succession allows wildlife managers to manipulate habitat to meet the needs of certain species.

Wildlife biologists and concerned land managers must evaluate and predict the impacts of certain land uses on wildlife habitat. For example, logging operations, highway construction, certain agricultural practices, livestock grazing, and some water uses often decrease habitat. The loss of habitat is the major reason for the decline in populations of many species. However, habitat can be improved by foresters, biologists, farmers, and other resource managers working together to develop management plans. When planning a timber harvest, a forester, with assistance from a wildlife biologist, can leave a number of mature live and dead trees standing, to provide food and denning sites for songbirds, squirrels, and raccoons. If animals need more water, it can be provided by constructing a small pond. The vegetation can then be managed to provide the plants that animals prefer to eat or use for other survival purposes.



Wildlife managers must also be concerned with the impact of practices to improve habitat for wildlife. Traditional farming practices, and forest management techniques like road construction, pond dredging, controlled burning to create or maintain open land for wildlife, and other practices that disturb vegetation and soils, must be planned and conducted to have as little effect on the area as possible. Soil erosion, particularly near streams, rivers, and ponds, must be controlled. Burning must be done under favorable weather conditions to avoid uncontrollable wildfires.

The Valley region has a range of topography and a good climate for maintaining many different plants that provide habitats for a diversity of important wildlife. These plants and animals contribute greatly to the quality of human life. Many animals have become endangered as a result of their habitats being lost, changed, or contaminated with people's wastes and pollution. Responsible land managers and decisionmakers are attempting to preserve habitat while developing and wisely using the Valley's natural resources.



Wildlife Resources Activity Matrix

WILDLIFE RESOURCES	AIR RESOURCES	CULTURAL RESOURCES	ENERGY RESOURCES	FOREST RESOURCES	RECREATION RESOURCES	WATER RESOURCES	WILDLIFE RESOURCES	TVA - A WORLD OF RESOURCES
To Zone Or Not To Zone				1,2,6,7,8,9	1,2,3,8,9		1,2,3,4,5,6,7,8,9,10	8,9
Lef's Build Another Parking Lot		3		1,2,6,7,8,9	1,2,3,9	1	1,2,3,4,5,6,7,8,9,10	8,9
A Little Becomes A Lot	5			1,2,5	1,8	3	2,3,4,5,6,7,8,9,10	4
Game Game				1,2,5	1,3		1,4	
Snag Tree Corner				1,2	3		1,3,10	
Here Today, Here Tomorrow	5			5	3	3	1,7,10	9
Bird Watching				1,2	2		1,2,3,4,7,10	
1000mm Hike				2	3		ALL	
Hide Out		6	6	2,9			1,7,10	9
Pop Bottle Bird Feeders							1,2,3,4,10	
Mind Mapping	ANY	ANY	ANY	ANY	ANY	ANY	ANY,2	ANY

To Zone Or Not To Zone

OBJECTIVES:

Through this modified role play, students will understand the importance and complexities of land use planning. See WILDLIFE RESOURCES matrix for background information.

MATERIALS:

copies of Role Descriptions
props for the Role Play (Optional)
classroom set up as a hearing room

PREPARATION:

Land use decisions affecting wildlife have become a familiar issue where housing developments are concerned. The following is an imaginary conflict that corresponds to a real life dilemmas:

Fraterville is a farming community on the west slope of the Cross Mountains. Farmton, a town of 15,000, is the trade center of the area. General Autos is building a new automobile plant in the adjacent county. This will provide 300 new jobs, but housing is very limited. A 200-home subdivision has been proposed for an 80-acre plot of undeveloped land on the south edge of Fraterville. This forested area is bordered by Buck Creek on the west. Buck Creek provides excellent duck hunting. Forty-five species of birds have been sighted in this area, including some rare species. In the spring and fall, the area is used by migrating waterfowl and deer that feed in the area. Many non-game species, such as red fox and flying squirrels, inhabit this land. This 80-acre plot is currently zoned for agriculture and forests

and would have to be rezoned as residential by a vote of the County Commissioners. The subdivision would be on a central water system but each home would have its own septic system.

PROCEDURE:

Hand out the preceding background material to students and discuss it together briefly. Present the suggested time line and explain the activity.

Suggested timeline for this activity:

DAY 1:

- Read background information and select roles.
- Homework—Prepare presentations.

DAY 2:

- Conduct hearing.
- Homework—Write news items and letters to the editor.

DAY 3:

- Continue hearing, including reading of news items and letters to the editor.
- Vote.

On the first day, provide all students with roles. Those without a personal data card will take roles as active observers such as newspaper reporters, outside experts, or concerned citizens. Students should be encouraged to improvise in developing their presentations and questions. Introduce all players and their roles.



On the day of the hearing, the chairperson of the commission is to run the meeting. It is up to him or her to maintain order. All participants must be recognized by the chairperson before they speak.

After all those presenting prepared testimony have spoken and have been questioned, reporters, researchers and concerned citizens will be asked to read their statements, articles, reports, or letters to the editor. After the questions and statements are presented, the commissioners vote and give the reasons for their decisions.

After the vote, discuss the results. Consider the following questions:

- What did we learn about land use decision making?
- Who makes decisions? Who is involved? Who is represented? Who is not? Do all points of view get equal representation?
- What factors most strongly influence land use and planning?
- How were the decisions made in this activity similar or different to what might happen in our community? Other areas? Other parts of the world?
- Do we have a responsibility as citizens to help make land use decisions?
- Why is land-use planning important? How does it affect people, wildlife, and the environment?

FOLLOW-THROUGH:

Have students identify a wildlife, forestry, or environmental issue in their local area, gather data, and develop their own simulation.

Develop a topographical map for this activity. Bring in real expert witnesses. Try to achieve a balance by getting experts from both sides of the issue.

(adapted from PROJECT WILD)

<p><u>PERSONAL DATA CARD</u> Minister - Rev. Michael Martin (County Commissioner)</p> <p>You have been pastor of the Farnton Community Church for fifteen years, and you are respected in the community. You have been on the county commission for many years, but you are hesitant to become involved in controversial issues because members of your congregation support both sides of the issue. You enjoy hunting, fishing, and bird-watching. Your wife is an active member of the Sierra Club.</p>	<p><u>PERSONAL DATA CARD</u> President of Chamber of Commerce - Fred or Ethyl Harris</p> <p>You have been president of the chamber of commerce for years. You own a chain of carry-out stores. You are concerned about the business climate in your community. The chamber recently hired a business consulting firm to evaluate new business potential in Fraterville. Your profits have been steady but not growing. You see this new auto plant as a means to expand your business.</p>
<p><u>PERSONAL DATA CARD</u> Banker - Edward or Jean Murphy (County Commissioner)</p> <p>You are a 35 year old banker. You want to finance new home loans. You are currently president of the Small Business Association and support the rezoning issue.</p>	<p><u>PERSONAL DATA CARD</u> Local Sierra Club President - Oscar or Jan Sparrow</p> <p>You represent over 100 active Sierra Club members and are director of the annual bird count competition. You have a list of 15 rare bird species found in the Buck Creek area. You are 37 years old and will be employed soon at the new auto plant.</p>
<p><u>PERSONAL DATA CARD</u> Land Owner - Sherrie or Daniel Caldwell</p> <p>You are a 63-year-old retired business person. You want to sell your land and move to Florida. You own 25 acres of forested land south of town. This land will net a good cash return if it is rezoned for the subdivision.</p>	<p><u>PERSONAL DATA CARD</u> Hunter - Madeline or Michael Hunter</p> <p>You are a 55-year-old hunter. You have two boys, and hunting has always been an important family activity. You are president of the local Hunting Lodge, and the acres proposed for development contain a prime duck hunting area.</p>
<p><u>PERSONAL DATA CARD</u> Developer - David or Debra Davis</p> <p>You are a wealthy developer in the area and want to buy the land outright. You will make a good profit if the housing needed for the auto plant employees is built. You have a reputation for building prefabricated houses and paying very little attention to landscaping details and construction site clean-up.</p>	<p><u>PERSONAL DATA CARD</u> Lumber Mill Owner - Wallace or Wilma Cramer</p> <p>You own a lumber mill. The wood milled is used locally and transported throughout the state. This new subdivision would be very good for your business.</p>

PERSONAL DATA CARD

Resident - Tom or Mary Floyd

You are 62 years old and living on the land proposed for the subdivision. You have lived on this land for 45 years. Three generations of your family have been raised here. You raise corn and hogs and have a large garden out back. You live in the middle of the area proposed for the housing development. Because of a gambling debt, however, Daniel Caldwell holds the title to your land and could sell your land right out from under you for development.

PERSONAL DATA CARD

Farmer - Fred or Francine Farmer (County Commissioner)

You are the third generation to farm your land. You are proud to tell people that your grandfather was one of the first to settle in Fraterville. Your spread covers 1,200 acres and you have grazing rights to surrounding U.S. Forest Service land. You resent change of any sort and, although you are involved in community affairs, you resent individuals moving into the area who do not share your values. Last winter 3-wheelers came onto the property and destroyed some your crops. Your land would not be rezoned, but the development is adjacent to your property.

PERSONAL DATA CARD

Realtor - John or Jamie Knox (County Commissioner)

You started your business in Fraterville two years ago. Your business is doing well, but your real estate company is not developing this property. You have some question regarding the credibility of the developer, but you generally are in favor of development.

PERSONAL DATA CARD

Merchant - Mainard or Maxine Hull (County Commissioner)

You are 46 years old and own a hardware store. You are also a duck hunter. You would like to sell hardware to all the new home owners, but don't want to have to drive long distances to find a new duck hunting area.

PERSONAL DATA CARD

PERSONAL DATA CARD

PERSONAL DATA CARD

PERSONAL DATA CARD

Let's Build Another Parking Lot



OBJECTIVES:

Students will identify environmental problems associated with land development. See WILDLIFE RESOURCES matrix for background information.

Review with students the elements necessary for a habitat. After discussion, tell students that in this activity they will be simulating wildlife in its habitat.

MATERIALS:

green and blue paper
classroom desks
tables and chairs
5 or 6 large bed sheets or blankets

PROCEDURE:

Divide students into four groups: vegetation (trees, grass, etc.), herbivores (animals that eat plants), carnivores (animals that eat animals), and land developers. The amount of vegetation may vary, but try to establish proportions similar to the following:

- 2 -land developers
- 3 -carnivores
- 9 -herbivores
- 12 -trees or bushes

PREPARATION:

Wildlife habitat is being lost. Wherever an area of land is being paved for a shopping center, divided into lots and excavated for buildings, or plowed to grow crops, many animals lose their homes and, frequently, their sources of food and water. Removing plant material can eliminate the food supply for small animals, resulting in their death or forced relocation to another area. When these animals are gone, animals which feed on them disappear. Removing any link in the food chain can have far reaching effects. Even animals that simply cannot tolerate human activities may disappear. Students can observe this phenomenon near their homes and schools. This process is happening in large, as well as small ecosystems all over the earth.

Establish a large area in the classroom or outside that can be used to simulate the wildlife habitat area before development. The "land developers" are to remain on the sidelines at this time, simply observing the undeveloped land and its wildlife inhabitants. Land developers might also meet on their own nearby, to make plans for development. In fact, they might make their entrance rather suddenly, once the wildlife habitat has been established, to simulate the arrival of heavy construction equipment.

Provide vegetation with:

1. ten green strips of paper to give to herbivores as food; and
2. one piece of blue construction paper to represent water.

Provide each herbivore with:

1. two desks or chairs to use as "shelter",
2. one piece of blue construction paper to represent water; and
3. some of the vegetation portrayed by students.

Provide each carnivore with:

1. one desk or chair to use as a shelter;
2. space equivalent to that used by three herbivores; and
3. one piece of blue construction paper to represent water.

Ask the vegetation to arrange themselves in the space to represent a habitat and place their water at their feet. They cannot move unless they are eaten or developers remove them. They are eaten when herbivores take all ten green strips. Once the vegetation is arranged (3 minutes), have the herbivores to establish their shelters and place their blue strips as a water source (3 minutes). Then have them take some green strips from the vegetation for food. Then ask the carnivores to move into the area to establish their shelter and water sources, keeping an eye on the herbivores as possible food sources (3 minutes). For added interest, have each student identify the kind of animal he or she is and role-play its characteristics. Allow students 3-5 more minutes to consider their relationship to other elements in the environment. Then, start the game with herbivores eating plants and carnivores eating herbivores. "Eaten" players must go to the sidelines and watch. Make sure the water strips are left in place. When an herbivore eats a plant, the herbivore takes the green strips. When the carnivore eats the herbivore, it then takes the green strips.

After 5-10 minutes of the game, it is time for the land developers to enter the picture. These land developers have been given the opportunity to create a housing and shopping area. (They may use from 3 to 7 minutes to construct their development, explaining their actions as they take them.) They are restricted however to a space equivalent to that used by three herbivores. The land developers may use the sheets and blankets to build their development. They

may remove trees represented by the students (without physically hurting the students), shelter (represented by desks), food, and water. Have developers gather the green and blue strips from the displaced vegetation, herbivores, and carnivores.

The game ends when the developers have constructed their development. At the end, count the vegetation, herbivores, and carnivores lost. Look at the blue strips. How has development affected the water sources? How did development affect the vegetation? Herbivores? Carnivores? Would or did any animals left die? From what causes? Could the developers have done anything differently to change the consequences? Ask students to consider and discuss what seemed realistic about the activity and what did not.

FOLLOW-THROUGH:

- 1) Try this activity using an aquatic ecosystem. (See illustration)
- 2) Visit an area in your community proposed for development. Look carefully at the area. Inventory its resources and then using what was learned from this activity, predict the consequences of the proposed development. Ask the questions: Why are some areas more suitable for development than others? What criteria should be used when selecting an area for development?

(adapted from PROJECT WILD)

AQUATIC FOOD PYRAMID

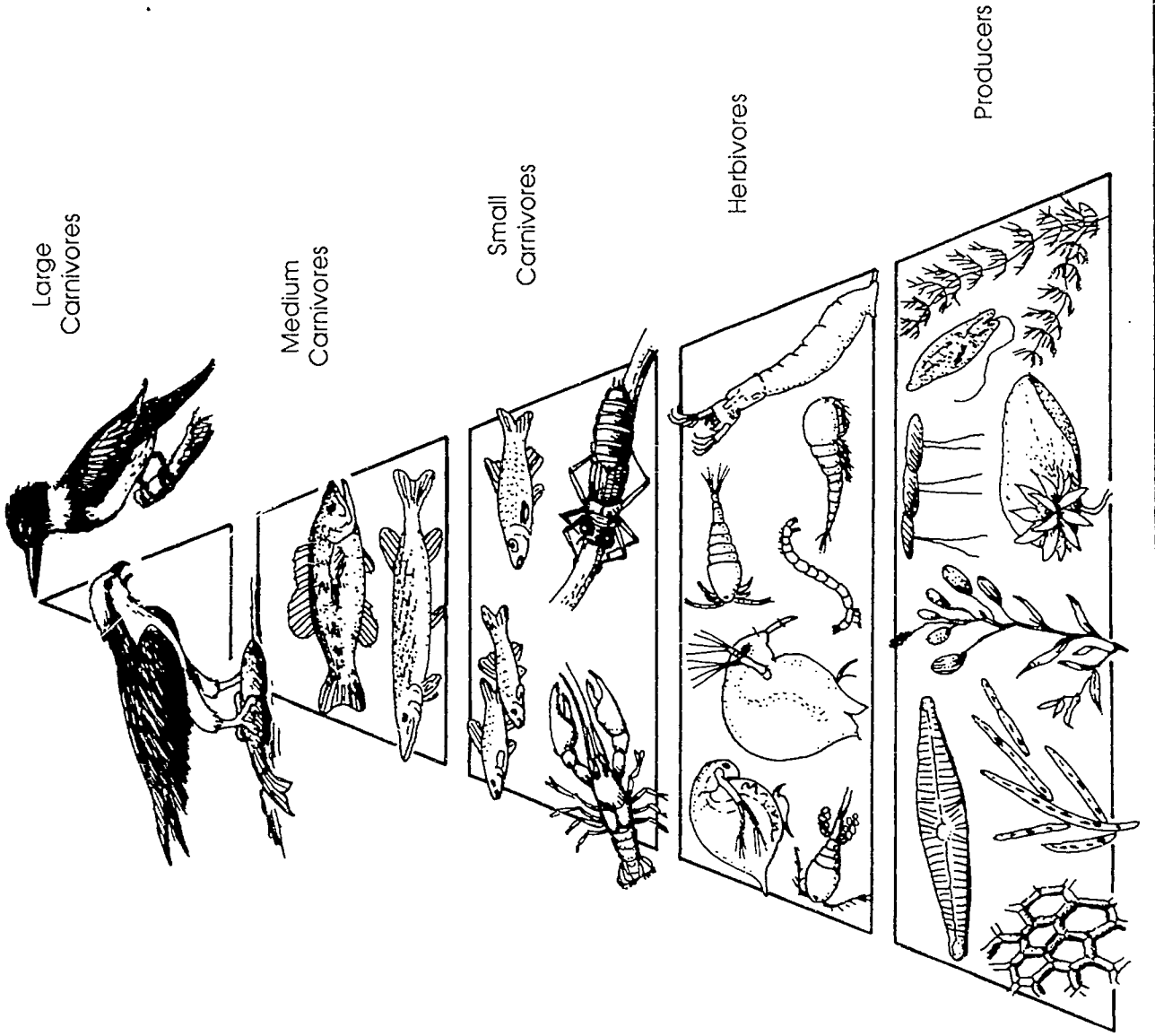

A Little Becomes A Lot



OBJECTIVES:

- (1) Students will describe ways in which pesticides enter the food chain.
- (2) Students will explain the possible effects of pesticides on raptors (birds of prey). See WILDLIFE RESOURCES matrix for background information.

MATERIALS:

small brown paper bags (sandwich size)
 paper strips (1 cm wide by 5 cm long, two thirds white and one third colored)
 red, white, and blue cloth strips for arm bands
 newsprint

PREPARATION:

Develop the concept of the food chain by providing the definition and an example such as:

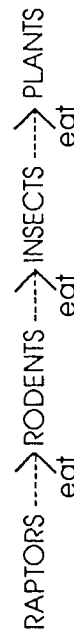

PROCEDURE:

Divide students approximately as follows:

- | | |
|-----------------|-------|
| 1 raptor (hawk) | red |
| 4 rodents | white |
| 18 insects | blue |

Label each student with a colored arm band as indicated above. Randomly distribute the food items (paper strips) in a defined environment. This could be a gym floor or the classroom.

Begin the simulation by allowing the insects to feed. Each insect will use a paper bag to collect the paper strips (food). When the insect is eaten, it may return to the table once and collect another brown paper bag and begin eating again. After the insect is captured twice, it should go to the sidelines and watch.

After about a minute, allow the rodents to begin feeding. The rodents can eat insects by touching the them and saying "I am a rodent!" The rodent then takes the insect's bag of paper strips. (Students might find it more fun to take on a specific identity like a grasshopper, shrew, eagle, or so forth.) After another minute have the raptors start feeding. The raptors will shout "Let me have your bags!" The rodent then hands its bag or bags to the raptor. Eaten rodents should retire to the sidelines and watch. Raptors may begin eating insects too. Let the simulation continue for about 5 minutes.

Put up a sheet of newsprint with the following table:

ANIMAL	NUMBER OF COLORED PIECES	AVERAGE AMOUNT IN ONE INDIVIDUAL
RAPTORS		divided by 1 =
RODENTS		divided by 4 =
INSECTS		divided by 18 =

Have the raptor count the number of colored pieces of paper in the paper sacks he/she collected. Write the number in the left column of the table and also the right column (since there is only one raptor). Have the rodents count the number of colored pieces of paper in their sacks when the simulation stopped. Write this number in the left column and then divide by the total number of rodents (4) to obtain the average amount of colored paper per rodent. Also, have the insects count the colored papers that they just collected. Write the total in the left column and divide by the number of insects (18) to come up with the average per insect. Ask all individuals to remember how many pieces of colored paper they had collected.

Examine the data on the table. Which animal has the highest number of colored pieces (average)? Why is this called "biological magnification?" Ask a student to recall what he or she observed during the simulation. About how many insects did each rodent eat? Is this similar to nature? About how many rodents did the raptor eat? Is this comparable to nature? Can a student explain why the raptor has more colored pieces?

The colored pieces represent pesticide. Inform the students that "pesticide" is represented by the colored paper and the white

paper is regular food. In nature, this pesticide was sprayed onto the crop in order to prevent a lot of damage by the insects. This particular pesticide is one that is poisonous, accumulates in food chains, and stays in the environment for a long time.

All of the insects that were not eaten by rodents may now be considered dead if there is any pesticide—colored paper—in their food bags. Any rodents for which half or more of their food supply was multi-colored would also be considered dead. The hawk will not die at this time; however, it has accumulated so much of the pesticide that the shell of the eggs produced by it and its mate during the nesting season will be too thin and crush under the weight of the bird before hatching.

Talk further with students about what they saw and experienced in this simulation. Ask how food chains seem to work, and how toxic substances can enter the food chain and the variety of results. Mention that sick rodents are easier to catch than healthy ones, and so the amount of pesticide the raptor eats will be even higher from eating rodents with more pesticide.

Ask students for other examples besides those of the insect-rodent-raptor example that might be affected by pesticide.

FOLLOW-THROUGH:

Make an example of a food chain with humans as the final consumer. Show how toxic chemical can enter the chain. Research some toxic substances. See factsheet 9 in the Air Resources Section.

(adapted from PROJECT WILD)

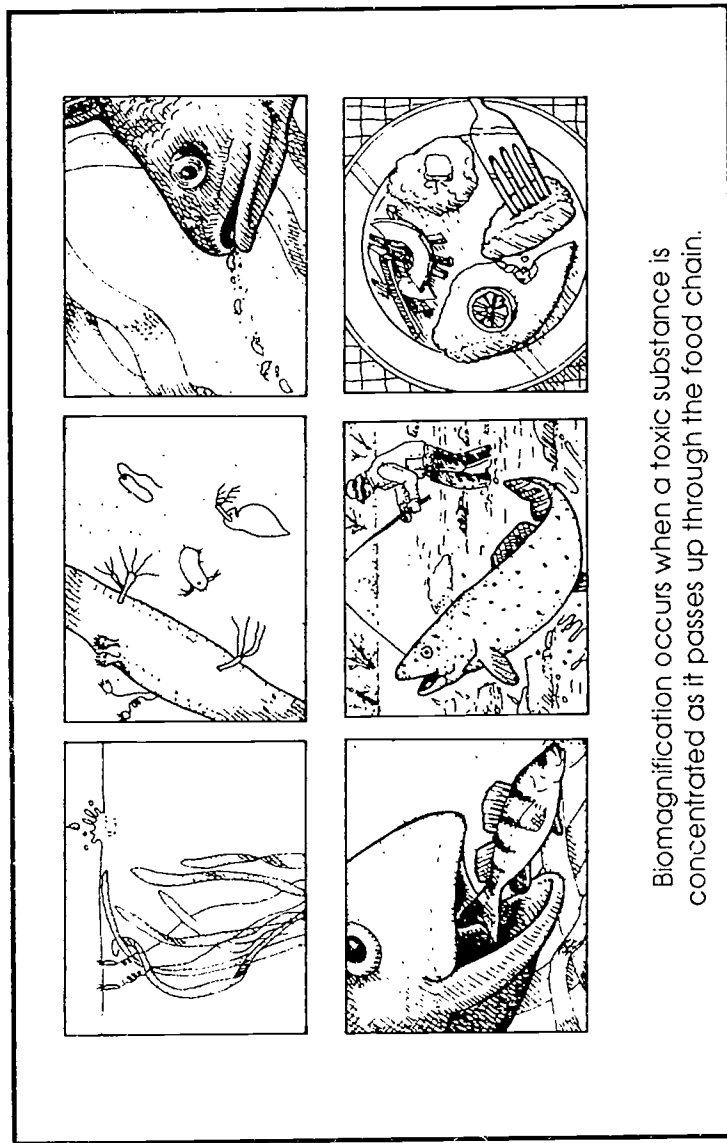

Biomagnification occurs when a toxic substance is concentrated as it passes up through the food chain.

Game Game



OBJECTIVES:

(1) In this simulation, students will make hypothetical decisions about wildlife management, specifically, carrying capacity. (2) Students will identify at least four factors which can affect the size of a wildlife population. See WILDLIFE RESOURCES matrix for background information.

MATERIALS:

paper and pencils
stiff paper to make condition cards
one die per group
newsprint

PREPARATION:

Prepare the 65 game cards called "Condition Cards." Discuss how the game is played after reading through this preparation section. Each team will be composed of no more than four players. Select teams with each having one **decision maker** and **2 or 3 naturalists/statisticians**.

PROCEDURE:

Have the decision makers to sit together at a table. The teacher may serve as the game monitor. The other members of the team are gathered behind their decision maker with newsprint or chalkboard ready to calculate. The monitor shuffles cards, draws a

condition card for each team, and reads it. The decision makers will role a die for their team after each condition card is read and also make final decisions relating to the condition cards. The naturalists/statisticians have several jobs. They must post, in plain sight, the size of the team's herd of deer. To do this, they must accurately calculate the percentage change in their herd after each turn, based upon the condition card and the role of the die by their decision maker. They should also check the accuracy of the other teams' naturalists/statisticians, and if they should detect an error in another team's herd size, that team with the error must roll the die and then multiply by 5 to receive that many angry letters from citizens for their mishandling of information.

The carrying capacity of the habitat is 100 animals; each team begins with 100 deer. The game will continue for 30 turns; the monitor who draws the condition cards should keep track of the number of turns. The game usually takes about 30 minutes. **IMPORTANT:** If at any time a team's herd becomes less than 2 or more than 200, that team must drop out of the game.

Since most wildlife managers have to be sensitive to the public, a lot of unfavorable criticism can be a factor affecting the success of a Wildlife Management Team. For example, hunting is sometimes a controversial issue. In this game, letters, both for and against hunting, are the result. A team will also be disqualified if that team receives more than 200 letters.

After the 30th turn (representing 30 years), the team closest to 100 deer in its herd wins. (The number of letters is not important unless it exceeds 200.)

Wrap up the activity with a class discussion:

1. Is wildlife management necessary?
2. What kinds of management work best? Describe your reasons.
3. Did this game seem realistic?
4. Are there other reasonable ways for controlling population size in order not to exceed the carrying capacity of a given habitat besides hunting?
5. What are some ways that habitat can be improved?

(adapted from PROJECT WILD)

FOLLOW-THROUGH:

Invite a game warden to talk to the class about experiences on the job. Many of your students might hunt or be interested in animals. They may want to meet local wardens to find out what their job is and how they respond to public pressure.

(After playing the game once, students may experiment with making additional cards.)



(Make 5)	<p><u>Population Card</u></p> <p>"This has been an excellent reproduction year. Increase your herd by the percentage equal to five times your roll."</p>	(Make 5)	<p><u>Weather Card</u></p> <p>"_____ (i.e., longer growing season) has had a dramatic positive impact on the survival of the herd. Increase your herd by the percentage equal to your roll."</p>
(Make 10)	<p><u>Population Card</u></p> <p>"This has been an poor reproduction year. Increase your herd by two times your roll."</p>	(Make 5)	<p><u>Pollution Card</u></p> <p>"Toxic substances in food and water supplies have had serious impact on the survival of the herd. Decrease herd by five times your roll."</p>
(Make 10)	<p><u>Habitat Change Card</u></p> <p>"_____ (a natural factor, i.e., trees planted, a pond created) has improved habitat in your area and has increased the carrying capacity by the number of animals equal to three times your roll."</p>	(Make 10)	<p><u>Habitat Change Card</u></p> <p>"_____ (students specify what) has occurred, destroying critical habitat. Decrease herd by three times your roll."</p>
(Make 5)	<p><u>Habitat Change Card</u></p> <p>"_____ (a people-made factor, i.e., a fence put around area, salt blocks or food put out) has improved habitat in your area. Increase your herd by the percentage equal to your roll."</p>	(Make 10)	<p><u>Hunting Card</u></p> <p>"A request for a hunting program has been made. Do you wish to allow hunting in your area?</p> <p>If yes—decrease your herd by the number equal to ten times your roll, and register the number of anti-hunting letters received equal to ten times your roll.</p> <p>If no—record ten times the number rolled as the number of pro-hunting letters received. There is no change in herd size."</p>
(Make 5)	<p><u>Weather Card</u></p> <p>"_____ (i.e., floods, drought) has had a serious negative impact on the survival of the herd. Decrease your herd by the percentage equal to your roll."</p>		

Snag Tree Corner

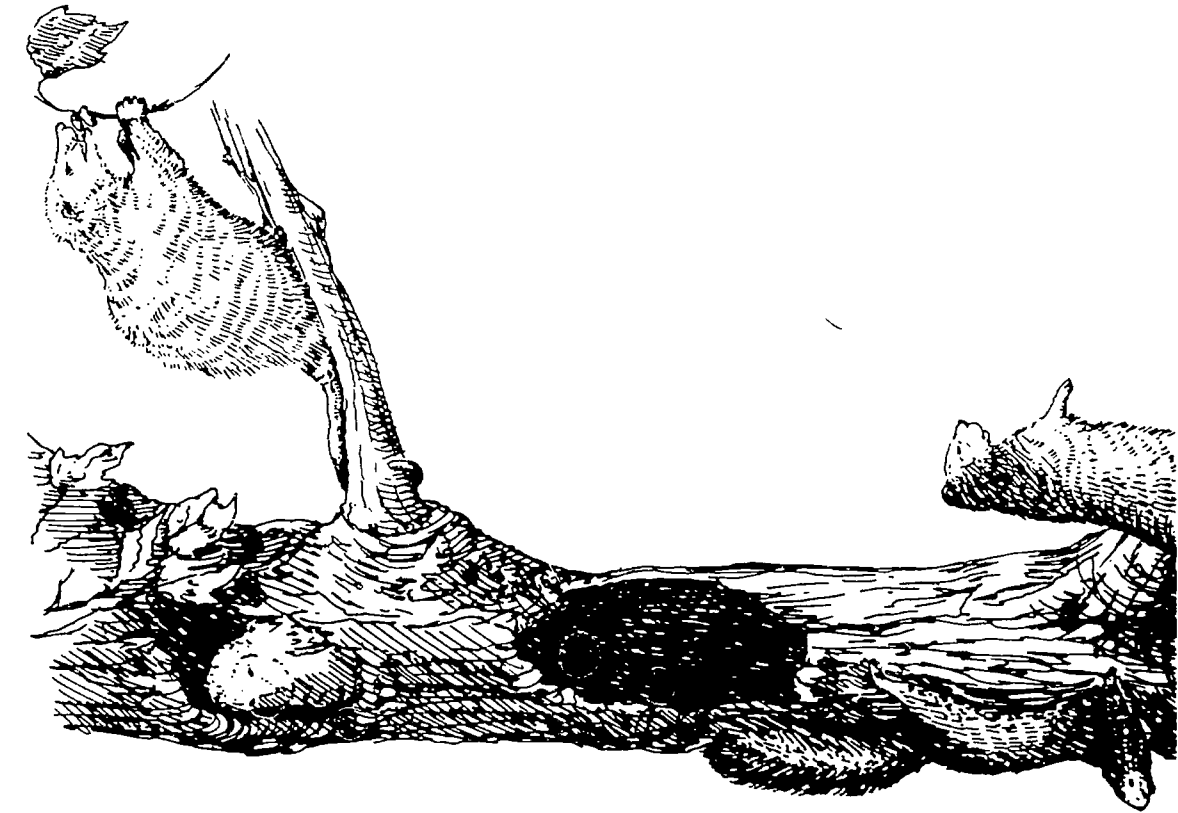

OBJECTIVES:

Students will create a model of forest habitat. See WILDLIFE RESOURCES matrix for background information.

MATERIALS:

part of a snag tree or fallen log (an artificial log can be paper mache over chicken wire) and natural materials (leaves, sticks, dried flowers, grass, lichens)
paper mache and other materials
butcher paper
tape
paints
insect repellent (optional)

PREPARATION:

After reading the factsheet for this activity, visit a local habitat looking for signs of nesting wildlife. This could be combined with the activity "Nothing Succeeds Like Succession II." Take along plastic garbage bags for collecting materials. Collect grasses, lichens, leaves, and sticks to use in the snag tree corner. Look for a fallen tree that could be used as the snag tree. Be sure to get permission to remove materials from the forest. This activity is a class project to make a "natural" corner in your classroom. Place the materials in direct sunshine to drive away any insects. Spray with insect repellent if necessary to prevent infestation of your classroom.

PROCEDURE:

Hang butcher paper from floor to ceiling in one corner of your classroom. Ask students to design, draw, and paint a forest scene on the paper. Set up the snag tree in the corner and add natural materials collected from the forest. Prepare models of wildlife. Also, draw pictures on the mural of wildlife you would expect to find in this habitat.

Ask students to research and prepare oral reports on animals that may be found in your local area. What does the animal eat? What sort of home does the animal have? Is it rare or abundant? Can it live near humans or must it have "wild" lands to survive?

FOLLOW-THROUGH:

Invite local citizens interested in the out-of-doors to attend the presentations. Some may have slide shows, photographs, or live animals they can bring along to show to the class. Also, students might be interested in joining local wildlife clubs.

Here Today, Here Tomorrow



OBJECTIVES:

Students will identify endangered species in the Tennessee Valley region and develop posters to create public awareness. See WILDLIFE RESOURCES matrix for background information.

MATERIALS:

posterboard
felt crayons
glue or tape
conservation magazines such as Audubon, Sierra, Wilderness Society, Nature Conservancy, etc.
scissors

PREPARATION:

Since the year 1600, approximately 300 species of wildlife have become extinct, either directly or indirectly as a result of human activities. In 1988, the U.S. Department of the Interior listed 403 plants and animals in the United States as being endangered. Some experts predict that the loss of species will increase from one species per year worldwide to 100 species per year by the end of this century.

Although extinction is a natural process, human activities in the environment have caused a dramatic increase in its rate. Loss of habitat as a result of human activity is considered to be the most significant cause of species extermination.

A list of endangered species is available from:

Director, Office Of Endangered Species
U.S. Fish And Wildlife Service
U.S. Department Of Interior
Washington, D.C. 20204

PROCEDURE:

Divide students into several committees. Have one group research the definitions of threatened, endangered, rare, and extinct and present this to the class. Have another committee contact your state conservation agency to ask for lists of plants and animals which are classified endangered, critically endangered, threatened, rare, and extinct. Also ask for the reasons for these classifications. Other committees should write the U.S. Dept. of Interior, the National Wildlife Federation, the National Audubon Society, and the Tennessee Valley Authority for information available about species and habitats of concern in your area. Ask the committees to organize their information in poster form to display before the class.

Then, discuss the following questions:

1. What will be the consequences of the disappearance of a species?
2. What are the trade-offs involved?
3. What alternatives are available?

FOLLOW-THROUGH:

- (1) Ask students to identify a plant or animal they want to learn more about. Sponsor a class contest where students create posters honoring endangered species. Display the posters from this activity in your local community.
- (2) Explore how cultural extinction affects us, like the loss of traditional languages and native peoples.
- (3) Have students read and discuss the Dr. Seuss book The Lorax. Ask students to develop their own story about extinction of species.

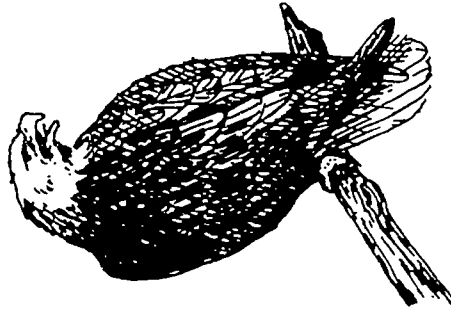

Bald Eagle

Birdwatching



OBJECTIVES:

Students will observe active bird nests and collect field data. See WILDLIFE RESOURCES matrix for background information.

MATERIALS:

field trip in the local community
bird nesting area
field notebook
watch
binoculars (optional)

PREPARATION:

Contact the National Audubon Society for information about the hatching season for different birds in your area. You may want to invite a local expert to come to your class and lead the class on the field trip. This activity should emphasize how a naturalist collects field data through long and tedious observations in the field.

You may want to borrow binoculars and provide a bird identification book from the library for older students.

Be sure to visit the site you plan for the field trip prior to the activity to identify sites where birds are nesting. It is best to select a site you can walk to frequently from your classroom because this activity will require several trips to the site over a relatively short period of time.

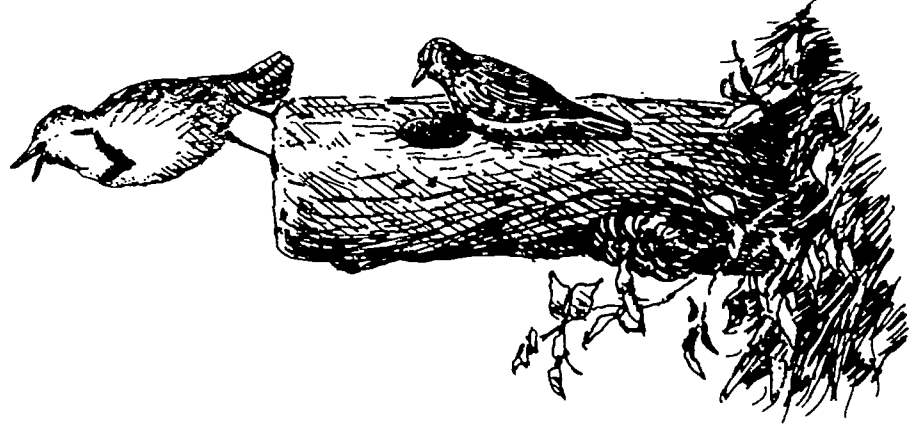

637

PROCEDURE:

Have the class work in pairs. When you get to the field trip site, assign pairs of students to each nesting site or have them search the area more closely for other nests without disturbing those who have been assigned to a nest. Students should find a place where they can watch the nest without disturbing the birds. If there are only a couple of nests in your area, make bigger teams and allow only 2 people at a time to observe the nest. You will have to make several frequent trips to the site to observe the entire process of hatching and raising the young. When you are sure the eggs have hatched, watch the nest for a 30-minute period. Count the number of times the adult birds visit the nest during that period of time. You can be fairly sure the birds are carrying at least one insect of some kind. Keep records of the number of trips made.

In the class, discuss what students observed. How did students feel? Would this be a job that students would like to do as adults?

Calculate the number of insects taken by the birds.

$$\frac{\text{number of trips in 30 mins.}}{X} \times 2 \times \frac{\text{hours of daylight}}{X} = \frac{\text{numbers of insects eaten/day}}{X}$$

This number is an estimate of the total number of insects each pair of birds consumes in a day. Is it more or less than you expected?

FOLLOW-THROUGH:

Identify several bird species and research these. Which prefer insects? Seeds? Popcorn in the park? Ask a local member of a bird-watching club to speak to your class about bird-watching as a hobby.

1000-mm Hike



OBJECTIVES:

- (1) Students will observe smaller members of their environment.
- (2) Students will become aware of the great diversity of habitat found in nature. See WILDLIFE RESOURCES matrix for background information.

MATERIALS:

magnifying lens
1-meter piece of string
popsicle sticks or other small sticks
diverse outdoor site
sketch pad
pencil
identification guides (optional)

PREPARATION:

Students will observe some small living things like grass, fungi, and insects that occur in their area. Provide the common names of common living things they will find so the students will have a "vocabulary" with which to discuss these creatures later. For instance, the student should be able to say, "I saw 3 grasshoppers, 25 houseflies, 3 different mosses..." You may want to provide the class with identification guides to insects, mosses, grasses, wildflowers, and trees.

PROCEDURE:

Provide each student with a 1000-mm piece of string several popsicle sticks, a hand lens, sketch pad, and pencil. Move the class outside to a diverse site. This can include a wooded area, stream, or tall grass. The more "natural" the area the better.

Have each student stretch out his/her string in an area that interests them, then have students use the string as a path. They might wish to tie either end of their strings to a popsicle stick to stake their string in place. No person's strings should overlap. They will begin at one end and proceed to the other, using a lens to carefully observe the ground and area as they go. Ask students to record the various living things they see during their "hike" on their sketch pad. Encourage them to draw pictures and write their impressions down. Older students may want to use guides to identify insects, etc.

Now, ask students to move to a maintained site like a mowed lawn or a parking lot and repeat the 1000-mm hike as before. Record observations.



Ask several students to present their lists. Which area has the greatest variety of living things? What does diversity mean? Which items in the lists can be used as food by other living things? What does the statement "Nature tends towards diversity" mean?
FOLLOW-THROUGH:

In the Gulf of Mexico, junk cars have been dropped into the water to create an "artificial reef" to increase the diversity and provide a home for many different marine species.

Consider how you might be able to increase the diversity of the two areas that you visited in this activity so that more living things can find a home. Which animals would you want to have nearby?

Ask a wildlife manager to visit the class and explain how he/she improves habitats to increase the populations of certain types of animals.

Hide Out



OBJECTIVES:

Students will (1) learn how wildlife has adapted in nature, (2) how wildlife is continuing to adapt to changing conditions, and (3) why certain species become extinct because they fail to adapt to changing conditions. See WILDLIFE RESOURCES matrix for background information.

MATERIALS:

newspaper
scissors
white plain paper
handout for each group (included in activity)
watch with a second hand
pencils

PREPARATION:

Wildlife is highly adapted to live successfully in nature. These adaptations may include coloration, shape and size, behavior, and speed. If we modify the environment so that it is different, these living things may no longer "fit in."

The question is—What value should be placed on our wildlife resources?

PROCEDURE:

Divide the class into groups of four students each. Each group should cut 50 squares about 12 to 15 mm in size from the newspaper to represent wildlife. Spread one sheet of the newspaper on a table or the floor and distribute the squares on this sheet. In section 1 of the handout, record the positions of the squares (wildlife) by placing dots on the handout. Are the animals easy to see?

Select one student to be a predator. Place the predator with his back to the newspaper. When a time keeper says start, the predator should turn around, face the newspaper, and begin to pick up the squares (wildlife) one at a time with one hand only until the timer says stop. The timer should allow the predator to hunt exactly 10 seconds.

In section 2 of the handout, record the positions of the remaining squares as you did in section 1. What percentage of the wildlife squares were taken in 10 seconds? (Divide total number by number taken.)

Now bring in the bulldozers and change the environment by placing sheets of plain white paper over one-half of the newspaper. Redistribute the 50 wildlife squares onto this changed environment. Is it easier to see the wildlife against the plain paper or against the newspaper? Why?

Have the predator hunt for 10 seconds as before. In section 3 of the handout indicate the location of the plain paper and place dots to show positions of the remaining wildlife. What percentage of the wildlife squares were taken in 10 seconds in this changed environment? Were more taken from plain paper or from newspaper? Why?

Replace all 50 wildlife squares and have the predator hunt again, this time for 20 seconds. Record the results in section 4 of the handout. Which environment was more nearly depleted of wildlife squares, plain paper or newspaper?

Discussion. As we develop land, we reduce the natural diversity. What happens to the wildlife there? Why can't the wildlife just stay there in these new conditions? Why don't we find deer in cities? Is it possible to "develop" land and at the same time increase the diversity of the habitat? How can this be done? How much will it cost?

FOLLOW-THROUGH:

Take a field trip to find natural examples of adaptation. Collect and display photographs of examples of species that blend in with their environment, or that have specifically adapted to a particular environment. Under each picture explain why. Post your photographs on the class bulletin board.

	SECTION 1
SECTION 2	SECTION 3
HIDE - OUT	
SECTION 4	
%TAKEN _____	

Pop Bottle Bird Feeders

OBJECTIVES:

Students will construct bird feeders to increase the available food for birds in their area. See WILDLIFE RESOURCES matrix for background information.

MATERIALS:

three 2-liter pop bottles
 7 inch diameter plastic lid with bottle caps (from butter tub or dessert topping)
 baby food jar lid
 all-weather rubber sealant
 8 inches of wire or monofilament fishing line
 small nail
 metal screw or wood screw
 coping saw
 hobby knife
 rubber bands
 ruler
 sunflower or other bird seed

PREPARATION:

Increasing the numbers of beneficial birds can have a positive effect on the environment. The U.S. Fish and Wildlife Director has said, "These bird feeders provide a window on the world that's quick and inexpensive."

650

What types of bird feed attract what types of birds? A report is available for a small fee entitled "Relative Attractiveness of Different Foods at Wildlife Bird Feeders." For a copy, send a check or money order to Superintendent of Documents, U.S. Government Printing Office, Washington, D.C. 20402. Request stock number 024-101-00587-4 and include the title.

PROCEDURE:

1. Obtain two clean bottles and soak off their labels. Remove the plastic bases.
2. With a coping saw, cut vertically through one bottle's mouth down to where the neck "collar" begins. Make a second cut that is slightly above the collar; discard the piece you cut out.
3. Cut the remaining section of the neck and collar from the bottle; leave at least a 1-inch flange of plastic beneath the collar (see diagram). This spout will serve as a feeding hole. The half-round threaded portion will stick inside the bottle to keep seed from falling out.
4. Repeat steps 2 and 3 to make a second spout.
5. Cut two 1-inch-diameter holes opposite each other on the sides of the other bottle. The top of each hole should be at the same height as the top of the plastic base that you removed earlier.
6. Apply sealant around each spout (about the collar). Insert the two spouts in the holes, flange end outwards. The collar and sealant will form a watertight "gasket." Secure with a rubber band until dry.

WI-56

651



7. Using the small nail, make a small hole in the bottom of the bottle in the center of the baby food lid and in the dessert topping lid.
8. Using a screw, attach the two lids to the bottom of the bottle, with the baby food lid on the bottom. The topping lid forms a perch that the baby food lid holds steady.

SUNFLOWER SEED FEEDER

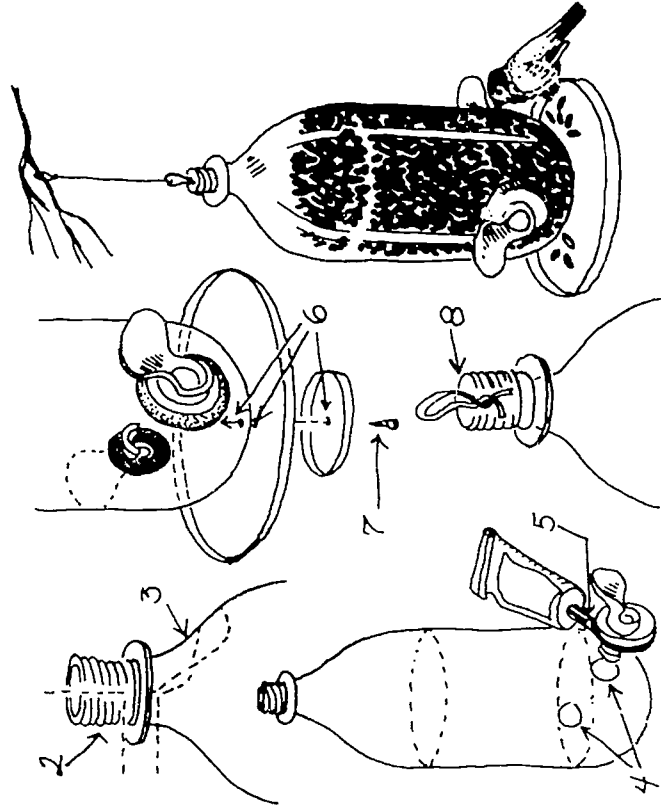

9. Punch two small parallel holes in the bottle cap. String wire or fishing line through the holes and tie into a loop.

10. Fill the bottle with sunflower seeds and hang it up.

FOLLOW-THROUGH:

Try making the thistle-seed feeder shown in the diagram. Experiment with other styles. Consider the type of seed and the type of perch for the birds.

(Adapted from the U.S. Fish and Wildlife Service)

THISTLE SEED FEEDER

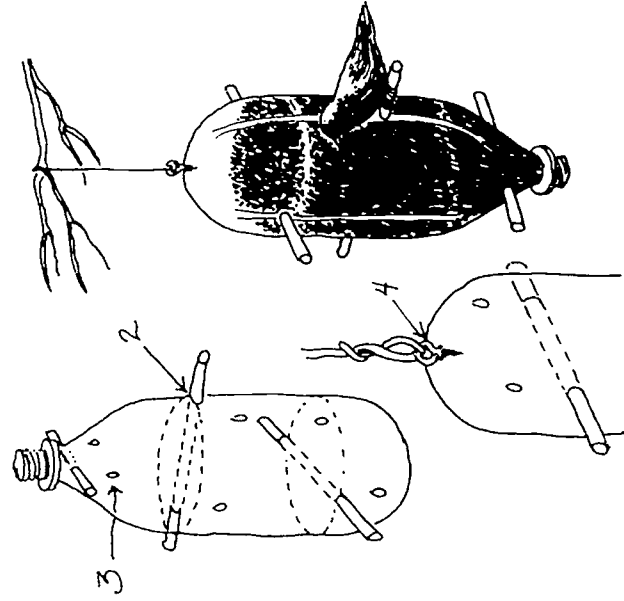

Mind-Mapping Urban Wildlife



OBJECTIVES:

Students will develop note taking ability and text review skills by taking notes from the fact sheet "Urban Wildlife." See WILDLIFE RESOURCES matrix for background information.

MATERIALS:

copies of handout (reverse side)
copies of Wildlife Factsheet 2
newsprint
felt crayons

PREPARATION:

In this activity, students will learn a new way to take and review notes. This technique is based upon current studies of memory and the concept of left-brain/right-brain learning. It is a powerful way to organize materials to be learned by allowing students to immediately see new relationships between ideas and to record this information in a semi-pictorial way for easy recall later.

You begin by writing the central topic in the middle of the paper. Then, place topics in boxes out from the center for each paragraph. Add a few key words, statistics, or descriptors to each of these. You might try to draw very simple pictures for each, but this is not essential.

Immediately after finishing the note taking, review the diagram for 5 minutes. This is very important. A day later spend another 5 to 10 minutes reviewing the diagram. Repeat the next day, and finally use the diagram as a review device for the test. See the mind map example provided in this activity.

PROCEDURE:

Supply students with a copy of Wildlife Factsheet 2. Ask students to read the factsheet and to develop a mind-map. When students have finished, divide them into groups of five or six students per group. Have each group compile their mind-maps into one and write it on newsprint.

Display newsprints and allow students 5 minutes to look at the mind-maps from the other groups. Which mind-map does the class like best? Why? Which is easier to read and review?

If you were given any one of these to use while taking a test, which would you choose? Why?

Now give students a copy of the Urban Wildlife mind-map handout. On this mind-map, choose any two topics opposite each other and see how they relate. For example: Nuisance or Benefit — Urban Environment. When comparing these two, make a list of the animals that are beneficial and a list of those that are a nuisance. Then consider animals which would add property value.

FOLLOW-THROUGH:

Make mind-maps of other factsheets. Remember, for some people, this is an effective way to take notes and remember them. Other people have different learning styles and do best with strictly sequential note taking.

Ask students interested in psychology to research popular books or magazines for articles on left-brain/right-brain thinking and make a presentation to the class.

656

657

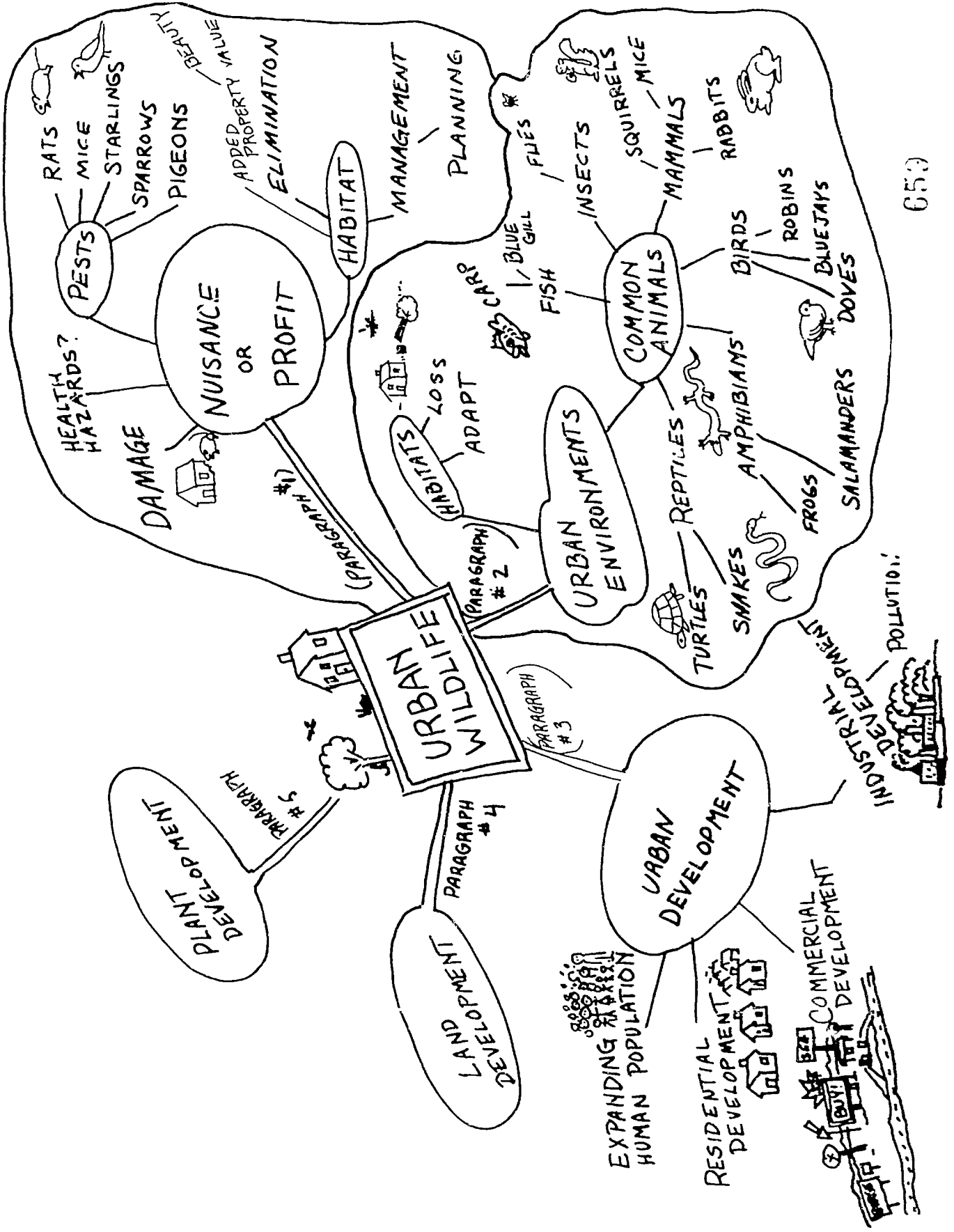

Wildlife Resources Glossary



1. Cavities - Holes in dead or dying trees used by wildlife as sites for nesting, rearing young, and protective cover.
2. Clearcutting - The removal of an entire stand or area of trees.
3. Carnivore - An organism that eats meat.
4. Consumer - An organism that lives off of other organisms. They are usually divided into three groups: primary consumers or herbivores, secondary consumers or carnivores, and microconsumers or decomposers.
5. Den trees (snag trees) - Trees which are considered undesirable for lumber or other wood products which are used by cavity dwelling or nesting wildlife.
6. Deer harvesting - The intentional and regulated hunting of deer by the public to manage populations and provide recreational opportunity.
7. Ecosystem - A natural community of organisms interacting with one another and their environment.
8. Ecology - The study of the relations of living things to one another and the environment.
9. Edge effect - The benefit to wildlife of different kinds of plant communities existing side-by-side (for example, when a meadow is located next to a woodland). Animals tend to frequent these areas because of the diversity of food and shelter.
10. Endangered species - A species which is in danger of extinction throughout all or a significant part of its range.
11. Extinct species - A species which is no longer existing in living form.
12. Exploitation - To take advantage of a resource selfishly and unethically. For example, hunting or trapping without regard to the type or number of animals taken is called "Market Hunting." This practice was made illegal with the establishment of hunting laws and regulations.
13. Girdling - The stripping or gnawing of a section of bark around the trunk of a tree or shrub to kill the plant.
14. Habitat - A space, area, or type of environment that includes water, food, and shelter that an animal needs to survive and reproduce.
15. Hacking - Raising young birds of prey in an enclosed feeding rack placed in their natural environment and then releasing them with the hope they will return to that site to nest and reproduce.
16. Herbivore - An organism that feeds on plants.
17. Insectivore - A plant or animal that eats insects.
18. Migratory - A word describing birds or other animals which make annual or seasonal movements to other geographical locations.

19. Niche - A special place in a community occupied by a certain organism. The role of an organism in its community or habitat.
20. Producers - Green plants that make organic compounds from inorganic substances.
21. Faptors - Birds which are predatory, such as hawks, owls, and eagles, that consume other animals, such as mice, songbirds, and fish.
22. Rare species - A species which is highly valued because it occurs or is uncommon. Often rare species were once abundant and have been reduced in number due to environmental changes.
23. Refuge - A place for birds and other animals which provides food, shelter, and protection from hunters.
24. Succession - The orderly, gradual, and continuous replacement of one kind of plant community by another; the progressive change in plant and animal life over time.
25. Threatened species - A species that is likely to become endangered within the foreseeable future if measures are not taken to prevent it.
26. Watershed - A defined region draining into a stream, lake, river, or system of rivers. The drainage is due to the slope from ridges causing water to flow downward.

TVA - A World Of Resources

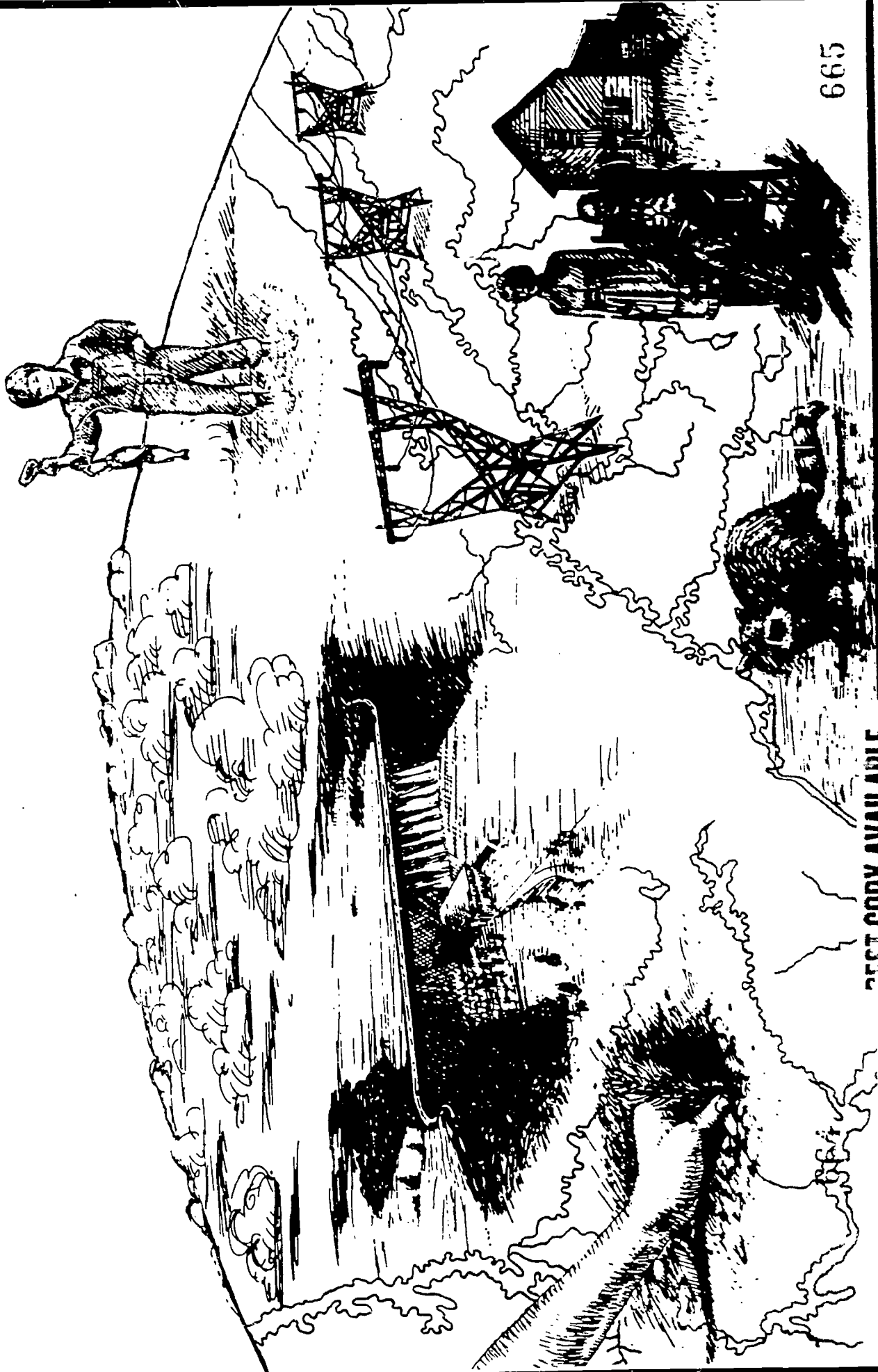

BEST COPY AVAILABLE

"TVA stimulates the regional economy by helping communities, industries, and businesses solve their problems by making the best use of their resources."

Benchmark Report

TVA - A World of Resources Concept Map

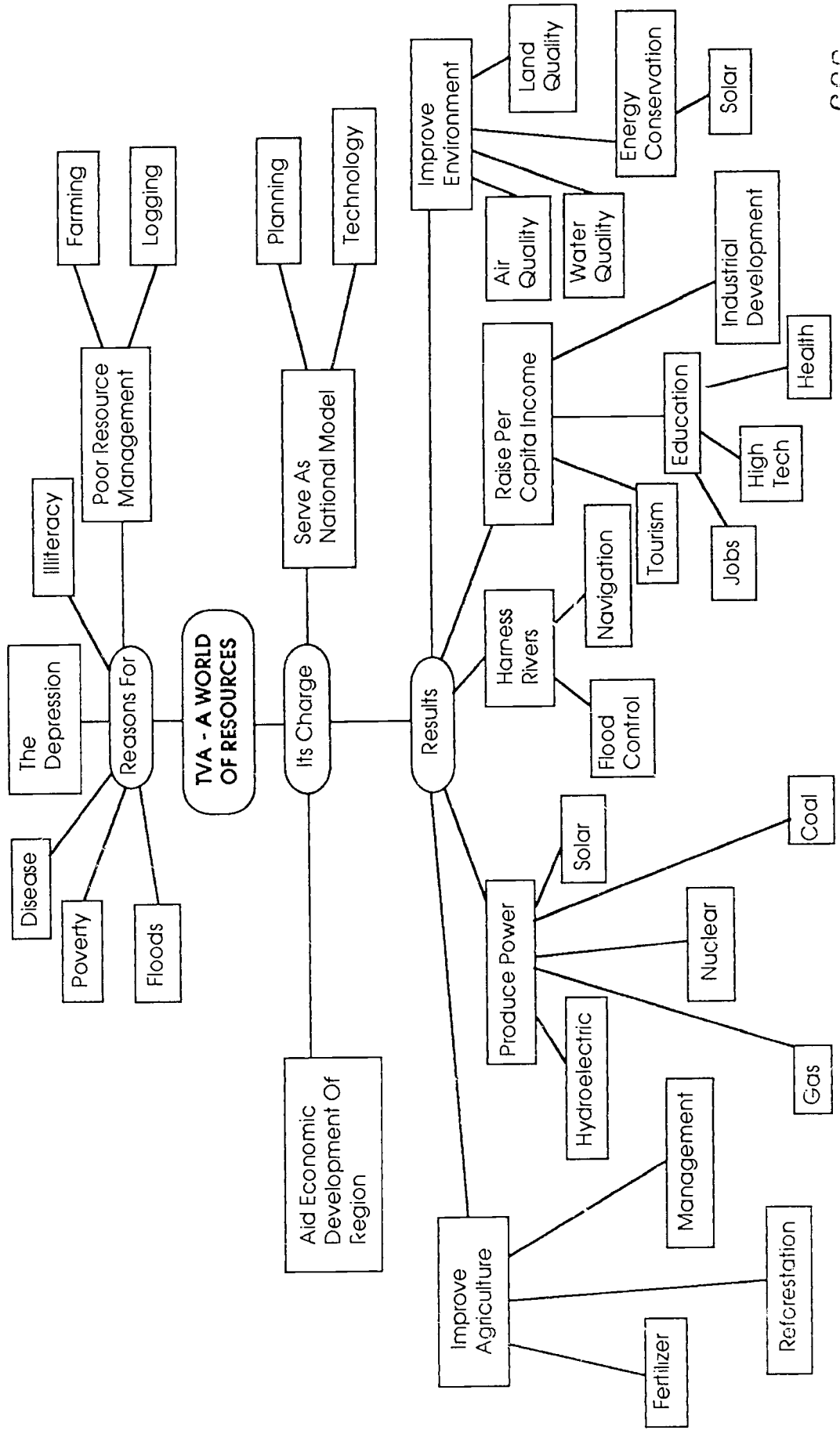

TVA - A World of Resources



1. Overview
2. Creation And Concept
3. A Government Laboratory
4. Agriculture
5. River Development
6. Power Supply
7. Conservation And Solar Energy
8. Economic Development
9. Environment And Natural Resources

670

671

1. Overview



On May 18, 1933, President Franklin D. Roosevelt signed into law legislation that created the Tennessee Valley Authority (TVA). Although the whole Nation was experiencing a terrible depression during that period, the worst conditions existed in the Tennessee Valley. In an area that had once been rich in natural resources, poor farming practices had caused erosion of productive topsoil. Irresponsible logging practices had nearly ruined the Valley's forests and the raging Tennessee River brought devastating floods. The people of the region suffered from poverty, disease, illiteracy, and lack of hope for a better future.

The creation of the Tennessee Valley Authority was a bold experiment in government. Its mission was to plan for "the proper use, conservation, and development of the natural resources of the Tennessee River drainage basin and its adjoining territory for the general social and economic welfare of the nation." TVA was to be an experiment that would turn the Valley into a national laboratory, demonstrating new technology and putting into practice some largely unproven theories about the use of natural resources.

The idea for TVA came from many different sources. The government already owned a large complex of idle chemical plants and a hydroelectric dam at Muscle Shoals, Alabama, which could be used to make fertilizers and to produce electricity. Also under consideration were proposals to develop a whole system of dams and lakes on the Tennessee River to control destructive floods, create a year-round waterway for river transportation, and provide a large new supply of hydroelectric power.

As the reservoirs were being built, TVA began experiments to restore land that had been damaged from improper farming, logging, and mining techniques. Farmers were invited to participate in

agricultural experiments on their own land while TVA developed and distributed better fertilizers. The agency also helped show how a region could replenish its forests and reduce erosion by growing and planting tree seedlings.

Prior to TVA's creation in 1933, the cost of electricity was out of the reach of most people. Using low-cost power produced at hydroelectric dams, TVA cut the price of electricity in half and helped make it available to remote rural areas for the first time. Later, the agency turned to coal-fired and then nuclear plants to meet the region's power requirements. Today, TVA promotes energy conservation as an additional way to satisfy demand for electricity.

Of the many responsibilities assigned to TVA by Congress, the broadest has been to aid the economic development of the region. Over the years, the results of developing the river system, inexpensive electricity, a navigable waterway, and flood-free riverfront industrial sites have contributed significantly to the economic advancement of the Valley. Improved fertilizers and farming practices have also added to the Valley's economic health by increasing agricultural productivity and profitability. Improvement of the region's forests has encouraged wood-product and recreation industries.

TVA has worked closely with Valley states and communities to help develop projects tailored to meet local needs. By offering technical advice and assistance, the agency helps strengthen local economies with a minimum investment of TVA time and money.

The cumulative effect of these and other programs has helped raise Valley per capita income from 46 percent of the national average in 1933 to 77 percent today.

In the decades following passage of the TVA Act, the agency has tried to achieve a delicate balance between development and conservation. It has not always been easy. Today the challenges that face the agency and the world are different from and more complex than those of the 1930s and 1940s. In response to these challenges, TVA has stepped up efforts to promote energy conservation and use of renewable energy resources, protect air and water quality, heal damaged lands, improve wildlife habitats, and encourage responsible use of the earth's limited resources.

2. Creation and Concept



On May 17, 1933, Congress passed legislation to create the Tennessee Valley Authority (TVA) and on May 18, President Roosevelt signed the TVA Act into law. Many Valley residents were not fully aware of the profound effect this new agency would have on their land, their economy, and their lives.

Although ideas about the possible functions of TVA came from many sources, the original concept came into being due to a practical issue: what should the government do with some of its idle facilities? During the 1920s, members of Congress were debating what to do with a large government complex of idle chemical plants and a hydroelectric dam at Muscle Shoals, Alabama. These facilities had been built during World War I to produce nitrates needed to make explosives. After the war, the government no longer needed them for that purpose, but the nitrate plants could easily be converted to make fertilizers for farmers and the dam could produce electricity.

Some people thought the government should operate the facilities while others thought the government should sell them to private companies. Resolution of this issue was difficult and took more than a decade to reach.

One man, who was very determined to use the facilities for the public good, was Senator George W. Norris of Nebraska. Norris, Chairman of the Senate Agriculture and Forestry Committee, was eventually known as the founder of TVA. As Senator Norris and others discussed the possibilities, an idea emerged to develop a regional development program (TVA) that would improve the quality of life in the Tennessee Valley region and serve as a model to the Nation. It was a controversial idea, involving a whole new approach to regional needs.

Engineering studies in the 1920s showed the Tennessee River could be developed with a system of dams and lakes to control destructive floods, create a year-round waterway for river transportation, and provide a large new supply of hydroelectric power. Some congressional leaders also saw the potential for making better use of the land as well, through fertilizer research, agricultural programs, and forestry development. Such programs were to: promote conservation of the region's eroded farmlands; renew over-cut and over-burned forests; and create jobs in business and industry.

In 1933, average personal income in the Valley was less than half of the national average, even though the depression had dropped income levels everywhere. Health and educational levels were also low in the region. Two-thirds of the region's jobs were in agriculture, yet many farms had lost their productive topsoil through poor agricultural methods. Only three farms in one hundred had electricity.

Shortly after his inauguration in 1933, President Roosevelt expressed his support of the idea to create a regional development agency in the Valley. In a letter to Congress, he urged that it be "charged with the broadest duty of planning for the proper use, conservation, and development of the natural resources of the Tennessee River drainage basin and its adjoining territory for the general social and economic welfare of the nation."

He went on to say that development of the Tennessee River "...if envisioned in its entirety, transcends mere power development: it enters the wide fields of flood control, soil erosion, reforestation, elimination from agricultural use of marginal lands, and distribution and diversification of industry."

3. A Governmental "Laboratory"



When President Roosevelt signed the Tennessee Valley Authority Act, he and other supporters hoped the new agency would help solve economic and natural resource problems. They also hoped TVA would demonstrate planning and technology that could benefit other sections of the Nation as well. TVA was to be an experiment that would turn the Tennessee Valley into a national laboratory and put into practice some largely unproven theories about the use of natural resources.

Within a few months of its creation, TVA started construction of Norris Dam, the first in a series of multipurpose dams that would control flooding, generate electric power, and provide reliable navigation for commercial barge traffic.

As the dams were being built, TVA began experiments in search of ways to control erosion on agricultural lands. Working with land-grant colleges, the agency introduced the "Test Demonstration Farm." Across the Valley, farmers were invited to participate in agricultural experiments involving their own land, to learn how to contour plow, terrace, and grow cover crops to hold down the soil. During TVA's first decade, many farmers converted to the new methods. Use of the new techniques began to heal the wounds of erosion and to boost production. On more than 15,000 demonstration farms, production multiplied threefold. TVA developed and distributed better fertilizers for over 50 years. The agency showed the Nation how a region could replenish its forests and reduce erosion by growing and planting tree seedlings.

Important as these and other activities were, the demonstration of new technologies was not TVA's only responsibility as a national laboratory. The agency was intended to be an experiment in government itself.

In President Roosevelt's words, it was to be "a corporation clothed with the power of government but possessed with the flexibility and initiative of a private enterprise." And, unlike other government agencies such as the Forest Service or the Corps of Engineers, which focus attention on individual conservation and development activities, TVA was given the responsibility to consider all the needs of the region it was to serve.

From the beginning, TVA formed partnerships with government agencies, educational institutions, and community groups to achieve its goals. The agency cooperated with local power distributors to provide electricity. It worked with agricultural colleges to improve farming practices. It helped local governments attract industry and it sought public participation in its decision-making processes. Today, TVA has also stepped up efforts to protect air and water quality, correct damage done to the land by mining, improve wildlife habitats, and encourage responsible use of the earth's limited natural resources.

4. Agriculture

When the Tennessee Valley Authority (TVA) was created, it inherited from the Federal Government an idle nitrate plant in Muscle Shoals, Alabama, that had been built during World War I to manufacture explosives. By the Great Depression of the 1930s, however, this plant was no longer needed to produce explosives and it was converted to a center for agricultural research and development.

That plant, and the dam that provided its power, became the cornerstone of TVA. Turning "swords into plowshares," the agency changed the wartime facility into a peacetime center of strength. For more than 50 years now, this National Fertilizer Development Center, with its greenhouses, laboratories, and experimental plants, has created and tested new and better ways to make and use fertilizers.

In 1933, the Tennessee Valley's need for these fertilizers was urgent. Most local farmers were using outdated agricultural practices that robbed the land of necessary nutrients and their topsoil was washing away at alarming rates.

Soon after TVA's creation, agency personnel met with representatives of Valley agricultural colleges to evaluate regional fertilizer needs. Together they decided to promote the use of phosphate fertilizers and an array of new farming systems.

Farmers were suspicious of the new technology at first, but the more adventuresome agreed to try it on a demonstration basis. In return for free TVA fertilizers, the farmers agreed to pay transportation and handling costs, to keep records, to invite their neighbors in for organized tours, and to adopt intensive five-year farm management programs. As the results came in, skeptics were convinced and whole communities volunteered as demonstration sites.

During TVA's first decade, agricultural production levels on more than 15,000 demonstration farms tripled. The grazing season for cattle was lengthened and the land yielded more and better crops.

These early programs were designed to restore soil fertility and control erosion. Later, during the 1940s, the emphasis of TVA's agricultural programs shifted toward helping farmers produce more food. In the 1950s, production practices were stressed in order to increase crop yields and income. In the 1960s, the agency helped farmers become more commercially successful by improving farm management.

By the mid-1970s, the Valley's farmland had shrunk by a third and the number of farm jobs had dropped by more than half. Yet, during that time, average farm size grew substantially, allowing greater efficiency, which resulted in a dramatic increase in the average value of farm products sold per farm. Although there were fewer farm workers, those who remained were more than eight times more productive than the farmers of 50 years earlier. So much progress had been made, in fact, that by 1976, Valley farmers sold about \$485 worth of farm products per acre compared to the national average of \$285.

Farming in the 1980s is a big and complex business. It requires an emphasis on farm management, new crops, weed and pest control, and marketing, as well as improved fertilizers. Although agricultural gains in the Tennessee Valley have been especially dramatic, TVA-developed fertilizers and farming practices have also been applied successfully throughout the United States and in many countries around the world.



5. River Development

The histories of the great rivers show them to be blessings and curses. They create fertile lands and are valuable highways for the movement of goods, but they also rage out from their banks, destroy farms, homes, and factories, and cause death and destruction. This paradox was certainly characteristic of the Tennessee River before the Tennessee Valley Authority (TVA) was created in 1933. One of TVA's most important jobs in its early years was to harness the power of the river.

By passing the TVA Act, the United States Congress paved the way for the world's first comprehensive development of an entire river basin. It was the biggest engineering project ever undertaken. Eventually, TVA's pioneering efforts would create a system of multipurpose dams on the Tennessee River and its tributaries that would provide a variety of benefits.

The primary functions of TVA's hydro system are to control floods and to provide a navigation channel along the entire length of the Tennessee River. A third priority is to generate electric power by releasing water through turbines at the dams.

To perform all these tasks, TVA built a series of high dams on major tributaries and lower dams on the main river. The high dams create large lakes upstream of the main river that can be raised or lowered to meet seasonal demands. For example, in the winter and early spring, when the threat of flooding is greatest, the lakes are lowered to create space to store heavy rain. When the danger passes, this water is released gradually through turbines in the dams to generate electricity. In the summer, when the land is better able to absorb rainfall and reduce runoff into the streams, the lakes are raised to meet recreational demands.

The main river dams create a continuous chain of lakes from Knoxville, Tennessee, to Paducah, Kentucky, on the lower Ohio River. These dams form a "stairway" of lakes and locks that permits barges to overcome the 500-foot difference in elevation between the lowlands of west Kentucky and the foothills of east Tennessee. Like the tributary dams, the main river dams are equipped with turbines and generators to produce electricity.

Since construction of the system began in 1933, these dams have prevented more than \$2 billion in flood damage. This streamflow control on the Tennessee River also helps limit flooding along the Mississippi and Ohio Rivers downstream.

The navigation channel created by the main river dams has enabled commercial freight shippers to save about \$1.3 billion by using relatively low-cost barge shipments on the Tennessee River instead of more expensive overland routes.

Generating facilities at TVA's 29 hydroelectric dams provide about 3.3 million kilowatts of power capacity, an important part of the region's electric power supply. The electricity produced by these dams is the cheapest available because it does not require the purchase of such fuel as the coal, oil, or uranium used at other generating facilities.

A vast tourism industry, unknown before the dams, has become a substantial part of the region's economy, providing recreational opportunities for millions of Americans. More than 100 public parks, 400 access areas and roadside parks, scores of campgrounds, and hundreds of commercial recreation areas now dot the shorelines of TVA lakes.



Industrial development along the Tennessee River waterway has grown to more than \$3.5 billion, providing jobs and millions of payroll dollars to the people of the region. These plants use the developed waterway, flood-free lands, and electric power provided by the TVA program.

Through the years, the needs of the Tennessee Valley have multiplied. More demands, often conflicting with one another, are placed on the river system today than ever before. Water supply, recreation, water quality, fisheries enhancement, and mosquito and aquatic weed control are just a few of the considerations operators of the reservoir system must weigh; and balance. As the Valley becomes more developed, controlling its waters to meet the river requirements in the TVA Act, while balancing conflicting interests, becomes more and more difficult.

Recreation enthusiasts, and those who live along TVA lakes, prefer reservoir levels that are as high as possible for as long as possible in the summer. Others ask for special releases of water from dams to accommodate downstream fishing or whitewater sports. On the other hand, lowering reservoir levels helps control troublesome water weeds that infest the lakes. Raising and lowering reservoirs at certain times also inhibits the breeding of malaria-carrying mosquitoes. All of these needs must be considered. At the same time, TVA engineers must make sure that the reservoirs have enough storage space for flood-causing rains, enough depth for commercial navigation, and, when possible, enough water for hydroelectric generation.

6. Power Supply

The Tennessee Valley Authority (TVA) helped bring about changes in electric power service. When the agency was established in 1933, electricity was too expensive for most people. Few farms in the Valley had electric service and homes in the cities and towns used it mostly for lighting. Electricity became cheaper as hydroelectric dams were built and the price of electricity was cut in half with the advent of TVA. During the 1930's, demand for this cheap electricity spread rapidly and power lines were stretched deep into the countryside for the first time.

To the farmer, electricity meant more than illumination. It thrashed grain, milked cows, and ground corn to feed them. It refrigerated, dried, froze, and cooked food. Electricity pumped the water, washed the clothes, and heated the iron. The availability of cheap power created a larger demand for electrical appliances than anyone had thought possible.

World War II intensified the need for even more power. The war caused a massive acceleration in TVA's dam-building power program with as many as 28,000 workers involved in 12 major projects at one time. When the war ended in 1945, TVA was generating electricity from 9 dams on the main Tennessee River and 12 dams on tributary rivers. Its generating capacity was three times greater than the total power supply of the whole region when the agency was created in 1933. TVA had become the largest electric power producer in the Nation.

In the postwar years, economic growth and improved living standards in the Valley soon created needs for still more power. In 1949, TVA began building a series of large steam plants to produce

electricity from coal. While power from coal was not as cheap as electricity from hydro plants, there were large supplies of low-cost coal available in and near the Valley region.

As TVA continued building plants to keep pace with the growing demand for power, its total capacity to generate electricity grew to 18 million kilowatts by the late 1960s, 14 million of that in coal-burning plants. But the price of coal was increasing and there were other costs facing the agency. In the coalfields, the land was scarred by strip mining, and around the power plants, the air was polluted from the huge amounts of coal being burned.

Meanwhile, technology was offering a new alternative for increasing power supplies—nuclear energy. Between 1966 and 1974, TVA planned and ordered equipment for seven nuclear power plants that would meet future needs if the region's power requirements continued to grow as they had. However, building these nuclear plants was complicated due to the design and construction requirements to make them safe. In many cases, it took ten years or more to build one. There was always the risk that during these very long construction periods there could be a change in the demand for power these projects were to supply. In fact, that is exactly what happened. Today, the growth in power demand is much slower than expected and three of the seven nuclear plants originally planned by TVA have been canceled.

Hydroelectric dams now provide about 14 percent of TVA's total power generation. This is, by far, the cheapest source of power in the system. Coal is TVA's largest source of power, supplying about 55 percent, and nuclear plants are providing an increasing share as additional nuclear units go into operation.



7. Conservation and Solar Energy



In 1970, inflation forced a large increase in electric rates in the Tennessee Valley. Consumers who had taken inexpensive electricity for granted were shocked. The cost per ton of coal rose from \$5 to \$33 in ten years and interest rates and material for labor prices spiraled upward. As a result, utility bills became a hardship for many consumers. New standards of environmental protection added to the costs of providing electricity. The decisions involved in maintaining power supplies while limiting cost increases grew more difficult.

These circumstances created changes in direction and priority. In the late 1970s, the Tennessee Valley Authority (TVA) responded with a series of programs that focused mainly on energy conservation and alternative energy sources. Saving electricity through conservation had become the most economical way to meet new needs because the electricity saved was then available for other uses.

One of TVA's most successful conservation efforts was the Home Insulation Program. Between the 1970s and 1980s, the agency conducted almost 900,000 residential energy surveys to help families save money by pinpointing ways to make their dwellings more energy-efficient. In addition to identifying their needs, TVA lent about \$400 million to Valley residents to finance these home weatherization measures.

Energy conservation became an economic necessity for many. To help the users of large amounts of electricity reduce their power needs and power bills, TVA conducted more than 17,000 energy surveys in commercial and industrial buildings and provided \$2 million in loans for recommended conservation measures.

Several of TVA's former conservation programs encouraged the use of solar energy. To understand its potential usefulness, we must first understand the nature of sunlight. Most forms of power generation use concentrated forms of energy such as coal, oil, natural gas, and uranium. Large amounts of heat can be produced by small quantities of these fuels. Solar energy, on the other hand, is not a concentrated source of energy. It begins in an extremely concentrated form at the surface of the sun, but by the time it travels across space and through the earth's atmosphere, some of the energy has been scattered or lost. Therefore, the use of solar energy is not a practical means of achieving high temperatures. In contrast, however, low-temperature heating is relatively simple for solar energy to achieve. Water heating, and heating and cooling of indoor spaces, are exactly the low-temperature applications for which solar energy is best suited. For that reason, these are the applications TVA has explored and encouraged in the Valley.

Solar energy systems are usually classified in two categories: active and passive. Active solar systems use mechanical devices, such as fans and pumps driven by electricity, to help collect and distribute the sun's energy. Active systems usually heat air or water and perform much like additional appliances in the home. Passive solar design uses only natural means to distribute heat and operates without the assistance of fans or pumps. In passive solar homes, certain structural parts of the house, such as windows and walls, actually become part of the heating and cooling system. The basic principles of passive solar space heating and cooling take advantage of the changing position of the sun in relation to the earth. Passive design allows the low winter sun to penetrate and heat the indoor spaces but shades windows from the high summer sun.

TVA encourages the use of both passive and active solar systems. The agency once offered loans to help people install solar water heaters and works through local banks to finance passive solar additions to existing homes. TVA also promoted solar energy in new homes by offering incentives to builders and by publishing designs for solar homes. In the commercial and industrial area, the agency worked to get solar energy designed into new facilities and renovations, and promoted the use of solar water heaters in commercial establishments.

In 1984, Valley consumers saved more than \$75 million on their electric bills as a direct result of participating in TVA's energy conservation, solar, and other related programs. These programs saved the equivalent of 2.2 billion kilowatt-hours of electrical energy a year for the TVA power system, and played an important role in the agency's commitment to match supply and demand by the most cost-effective methods.

691

690

8. Economic Development



Of the many responsibilities assigned to the Tennessee Valley Authority (TVA) by Congress, the broadest has been the responsibility to aid in the economic development of the region. Inexpensive electricity, a navigable waterway, and flood-free riverfront sites have attracted industries to the Valley region and have added to its economic well-being. Improved fertilizers and farming practices have increased agricultural productivity and profitability, and improvement of the region's forests has encouraged a large wood-products industry.

TVA has worked closely with Valley states and communities to help develop specific projects tailored to meet local needs with local resources. These cooperative efforts have resulted in many successful projects. For example, the agency has worked with individual communities to provide job training, improved water and sewer systems, health education programs, and intensive farm management projects.

Today, TVA's economic development focuses on technical assistance to communities, using development strategies that do not depend on continuing Federal assistance for success. A current example is a program which helps local industries expand their operations and hire unemployed workers. By offering advice in fields such as energy conservation, transportation, and employee training, TVA helps industries strengthen themselves and their local economies with only a small investment of TVA time and money.

TVA also works with regional learning centers to provide job training in sophisticated technical fields. With traditional manufacturing offering fewer new jobs, the need for "high-tech" training becomes increasingly important. In the last few years, thousands of Valley residents have taken advantage of these training programs, enabling many of them to find well-paying jobs.

Another program is designed to concentrate on solving the problems of the poorer, less developed areas of the Valley—those that lag behind both the region and the Nation in economic opportunities. About one-fourth of the Valley's 201 counties can be considered economically disadvantaged and to suffer from several symptoms of poverty. In recent years, TVA has teamed up with about half of these counties to tackle their problems head-on. So far, more than 15,000 new industrial and agricultural jobs have been created through these joint efforts.

TVA also works with local governments in helping them to manage their solid wastes for maximum benefit. It has helped counties in organizing recycling centers where area residents can sell such refuse as cans and paper products that would otherwise be discarded. This approach to managing waste has many benefits. It earns money for the counties and participating residents and conserves the energy required to manufacture such products. Another waste management program demonstrates the use of sewage sludge as fertilizer on agricultural lands. Ordinarily, sewage is treated and made environmentally safe for disposal, then the leftover sludge is burned, buried, or left to accumulate in large pools called lagoons. These methods are expensive and create other problems, such as finding suitable disposal sites. Through this program, TVA is hoping to show that sludge is an effective fertilizer and that cities can save money by giving or selling it to farmers instead of building disposal facilities.

The cumulative effect of these and other programs has helped raise Valley per capita income from 46 percent of the national average in 1933, to 77 percent, today.

9. Environment And Natural Resources



In 1933, President Franklin D. Roosevelt charged the Tennessee Valley Authority (TVA) with "the broadest duty for planning for the proper use, conservation, and development of the natural resources" of the Tennessee Valley region. TVA took the challenge seriously and, in the decades following passage of the TVA Act, the agency has tried to achieve that delicate balance between development and conservation implied by Roosevelt.

The system of dams TVA built to generate electricity, to provide a navigation channel, and to control floods solved many problems but created others. For instance, the agency discovered that the water released from its high dams on tributary streams did not contain enough oxygen and was having an adverse effect on fish and aquatic plant life. The agency's engineers and environmental scientists began exploring ways to put oxygen back in the water. Today, several TVA dams are equipped with systems that inject oxygen into the water as it goes through the hydroelectric generators and discharge it back into the river. In this way, one delicate balance between development and conservation can be achieved.

Similarly, TVA's use of coal is essential to the production of power needs in the Valley. Coal mining also provides jobs to Valley residents, yet the use of coal creates environmental problems. The use of coal affects not only the water, but the air and land as well. When coal is burned in a power plant, pollutants are produced that, if allowed to escape uncontrolled into the air, could cause damage to forests, rivers, wildlife, and buildings. Before the coal even arrives at the power plants, damage can be done to the environment. When coal is removed from the earth by strip mining, the surface of the land is destroyed and some of the exposed coal wastes are carried into nearby streams by the rain. This runoff is acidic and very harmful to aquatic life. It can even pose a threat to humans if it drains into sources of drinking water.

TVA tackled coal problems in several ways. First, it encouraged reclamation of strip-mined areas, even before Federal reclamation laws were passed. Since then, whole mountaintops have been revegetated to limit acid runoff and to restore the land to its former state. Perhaps even more important is TVA's success in reducing pollutants escaping from its coal-burning power plants. In 1984, the agency completed one of the Nation's largest air quality improvement programs. New pollution control methods are now removing more than a million tons of sulfur dioxide from coal plant emissions. TVA continues to explore new and better ways to protect the air resource, including the development of cleaner coal-burning systems.

Agriculture, too, offers examples of the natural tension between development and conservation. To produce more food and earn more money, many farmers plant crops in ways that rob the soil of essential nutrients and leave fields vulnerable to erosion. These problems were particularly widespread during TVA's early years, yet today they persist and are getting worse in some sections of the Valley. By working with individual farmers and sometimes with whole farming communities, TVA has demonstrated the value of using certain fertilizers and alternative cultivation practices. Through such efforts, thousands of farmers have increased their productivity and income while protecting the land that they will hand down to their children.

TVA also has helped reforest almost 2 million acres of land since the 1930s while helping to create a \$2 billion forest products industry that employs more than 45,000 people in the Valley. With 20 million acres of forests in the Valley, TVA is now showing private landowners and forest industries how to use computer-age technology to meet the Nation's increasing demand for paper and other wood products in an effective and environmentally sensitive manner.

In the past half-century, TVA has been involved in countless efforts to manage natural resources wisely. Each has yielded its own rewards. One TVA program that focuses on this is the reservoir land use planning program. Since 1980, TVA has been taking a close look at its own lands and determining how they can best be used. Decisions are based on opinions gathered from the public and on an extensive information base developed by agency scientists, engineers, and economists. This information is used to develop a plan for each TVA reservoir. It identifies plots of land for industrial and residential development, forests, wildlife, agriculture, and recreation. Using these facts and public opinion, TVA is able to better use its lands and provide for future needs.

TVA - A World of Resources Activity Matrix



TVA - A WORLD OF RESOURCES	AIR RESOURCES	CULTURAL RESOURCES	ENERGY RESOURCES	FOREST RESOURCES	RECREATION RESOURCES	WATER RESOURCES	WILDLIFE RESOURCES	TVA - A WORLD OF RESOURCES
The Valley, Yesterday And Today		1,6	1,2,4	1,2,5	1,2,3,4	9	1,2,3,4,5	1,2,5,6
A Dam, Youth And Old Age		1	1,4,6	1,2,3	1,2,3 4,5,10	2,3,4,6 7,8,9	1,4,6,7 8,9,10	1,3,5
Energy Trends		1,2,3,4,5	1,2,9,10	1,2,9		3,6		1,5,6,7,8
Introducing New Technology	8		1,2,4,6 8,9,10		7		4	3,4,6,7,8
Enough River For All			4		1,2,4,5,9	9,10	1,4,7,8	4,5,8
"New" MacDonald Has A Farm	7	1,4,5,6 7,8,9	1,2,8,9	6,7	1,2	7	1,2,3,4,6 7,8,9,10	1,4,6,7, 8,9
Recycling For Interdependence		6	8,9	8				7,8
Maintaining The Web	5		3,6			3		9
Water Consumers		1	4	5	4,5	4,7,8	10	5,9

The Valley - Yesterday and Today



OBJECTIVES:

Students will learn about changes that have taken place in the Tennessee Valley using guided imagery. See TVA-A WORLD OF RESOURCES matrix for background information.

MATERIALS:

newsprint or chalkboard
felt crayons or chalk
duplicated copy of guided imagery passage included in the procedure section
various slides and pictures depicting the Valley yesterday and today

PREPARATION:

Before conducting a guided imagery activity, expose your students to as much information about the topic as possible. Ask students to read through the TVA - A World of Resources and Cultural Resources factsheets for this activity before proceeding. Also, see the activity in the Wildlife Resources section entitled "RECREATION LANDS." Before the activity, show slides and pictures of the Valley yesterday and today to set the mood for students.

PROCEDURE:

Provide students with the following instructions:

You are to try to imagine the things you will hear me describing. I won't put in all of the details—so you must try to see and feel the things I describe as clearly as you can.

Now we are ready to begin. Make yourself comfortable. Don't worry about who is sitting next to you. All of you will have your eyes closed. Just be comfortable and do your best to imagine the things I will describe. Okay, close your eyes and imagine what you hear...

We are taking a trip through time and space. Imagine yourself lifting slowly upward...now begin to move forward out of the room...you are outside...it is becoming dark...and darker...and you begin to move backward in time. Things fly past you in a rapid blur...it is 1980...1970 ...1960...keep going backward in time. It is 1950...1940. It is 1930...you are standing on the bank of the Tennessee River...look down the river...there is an old farmhouse built on stilts...the water is racing under and around it...look all around you...everything is covered by water...there is a boat tied to the porch. With no means to combat steadily rising flood water, Valley residents could only watch as their homes, farms, and businesses were damaged and destroyed. Turn and look back towards the center of the river...there is a chicken coop floating by, only the roof can be seen...look up river, what can you see...

It's time for us to come forward in time. Stay in the same place beside the river. It is 1950...1965...1980 ...now it is present. Look upstream, there is a dam...Move to the dam...look along the

banks...there is a neat home built beside the lake. There is a wooden dock and children are fishing from it...there is a power boat tied to the dock...look downstream... there is a bait shop...there are many people fishing...there go two people in a canoe... look around, what else can you see? Okay, let's come back to the classroom ...now open your eyes."

Ask students to describe what they have seen. Jot down important points that students come up with on newsprint. Allow ample time for everyone to contribute ideas. Then discuss:

- flood control
- agricultural differences
- recreational activities
- electricity generation
- wildlife
- people, cultural differences

What changes have occurred in the Valley in the last 50 years?

FOLLOW THROUGH:

Take an imaginary trip into the future. Allow students to describe the Valley 50 years in the future.

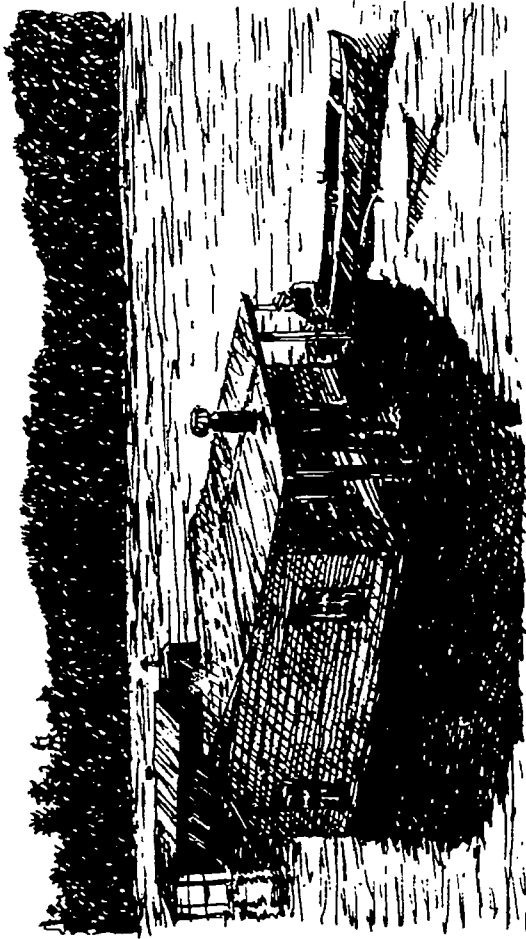

With no means to combat steadily rising flood waters, Valley residents could only watch as their homes, farms, and businesses were damaged or destroyed.

A Dam: Youth and Old Age



OBJECTIVES:

Students will learn one of nature's basic laws: change is inevitable. See TVA - A WORLD OF RESOURCES matrix for background information.

MATERIALS:

overhead transparencies, clear and colored
overhead projector
assorted pens for an overhead
newsprint
poster boards
felt crayons
glue
tape

PREPARATION:

To demonstrate how a dam will fill in with silt, shake a glass jar full of muddy water and then let it settle. Ask the students to describe what they observed. Discuss how siltation at a hydroelectric dam might eventually force it to shut down. Why is control of soil erosion important to a hydroelectric plant?

Have students collect information and photographs of dams. Write a class letter or call TVA's Technical Library and request information about dams in the Tennessee Valley.



PROCEDURE:

Divide the class into groups of three to four students each. Ask each group to develop a graphic representation of the life of a dam from construction through old age. First, have the group draw the dam and the lake in cross-section on poster board. Then tape the left side of 3 or more fold-over transparencies over the poster board drawing. Each fold-over transparency will show the increase in silt in the lake and the changes that occur in fishing, recreation, pollution, farming, forests, wildlife, water quality, transportation, and the generation of electricity. Each fold-over transparency will show changes in a 10 year period. Use felt crayons to draw this information on the transparencies. (See illustration below.)

draw large trees on fold-over clear plastic

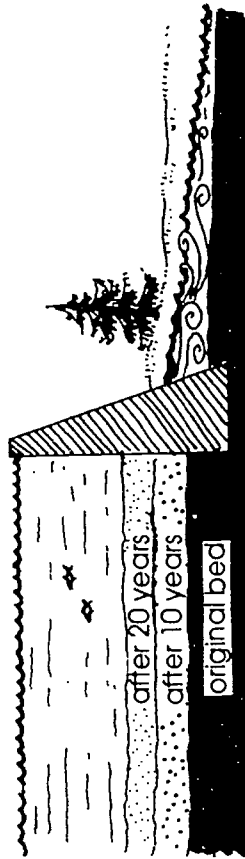

fold it over for 10-year periods

You might want to draw trees, silt, and other changes on separate fold-over transparencies.

You might also want to consider making a collage by pasting photographs of various dams on posterboard along the "time" line.

FOLLOW-THROUGH:

Have the students write a creative article. Specifically, have them become the lake and dam. Ask, "How do you feel as you are being constructed?" "What emotions do you have as a middle-aged dam being fully utilized?" "How do you feel as an old silted-up dam?"

Energy Trends



OBJECTIVES:

Students will describe why there have been changing trends in energy sources over time. See TVA - A WORLD OF RESOURCES matrix for background information.

MATERIALS:

posterboard
felt crayons (several colors, including yellow)

PREPARATION:

Review with students some ways to do research. For instance, list some source such as borrowing books from the library, write for free text materials, consulting experts in history or energy, interviewing senior citizens and also person on the street, and finding old photographs in museums or art galleries.

PROCEDURE:

Divide the class into five groups and assign them the following time periods:

- 1) Indian period (1700s)
- 2) Pioneer period (1800s)
- 3) Pre-electrification period (1900s)
- 4) Present (1980s)
- 5) Future (2030)

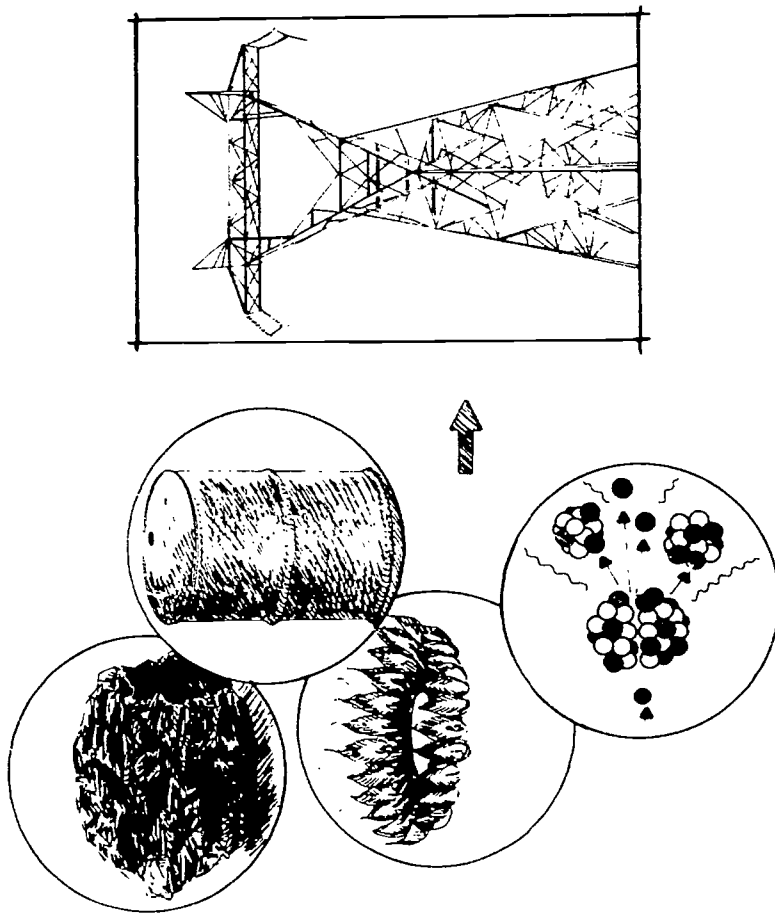

Have each group meet and discuss what kind of energy did you use to:

- travel
- make tools
- heat your home
- obtain food
- light your home
- keep or store food
- wash clothes
- entertain yourself

Have each group list the sources of energy used. Arrange the list from most-used energy source to least-used energy source. Each group will present its list and tell why they ordered the energy sources as they did.

Prepare a chart similar to the following to compile the students' ideas:

Type of Energy	Indian Period	Pioneer Period	Early 1900s	Present	Future

In the left-hand column list the types of energy determined by the students. Examples might include animal power, water power, human power, or electricity. Using a highlighter, color a box for each period when that energy occurs. When finished, you will have a table of energy sources through recent history that looks similar to the following:

Type of Energy	Indian Period	Pioneer Period	Early 1900s	Present	Future
animal power					
human power					
kerosene					
electricity					
etc....					

The "Future" group will probably need more time. If so, complete the table and let them use this data to come up with some other ideas about energy in the future. Summarize the data represented by the chart for the class. Emphasize the continual change in energy use through time.

When the chart is completed, discuss it. Which energy sources occur throughout all periods? Why? Which energy sources may not be available in the future? What will replace them?

This activity can be combined with activities "THE VALLEY YESTERDAY AND TODAY" and "DUG-OUT."

FOLLOW-THROUGH:

Electricity in our society is a commodity. It is produced at one point and then distributed. The power company puts a meter on your house, adds up how much you use each month, and charges you a fee. There has been a shift toward non-point energy capture and production, such as solar, wood, and wind. These forms of energy can be captured at little or no cost after an initial purchase of solar collectors, wood stoves, and wind mills. Research the positive and negative effects of this kind of shift. Also discuss its possibilities and limitations as a widespread energy source. Report to the class.

Introducing New Technology



OBJECTIVES:

Students will develop a strategy to introduce a new technology. See TVA - A WORLD OF RESOURCES matrix for background information.

MATERIALS:

newsprint
felt crayons

PREPARATION:

When fertilizer was introduced to the Valley in the 1930s, farmers were generally reluctant to try it. Examine how TVA introduced fertilizer to farmers and then use this information to suggest how a new technology, like solar electricity, could be introduced.

PROCEDURE:

Have students read TVA - A World of Resources fact sheet 4, "Agriculture," and answer the following questions about agriculture in the Tennessee Valley in the 1930s:

- (1) What were the major problems or needs?
- (2) What was the best solution to these problems?
- (3) What were the major barriers that had to be overcome?
- (4) How did culture and tradition affect the outcome?
- (5) What methods and strategies were used to implement the solution?

Now place pieces of newsprint on the board side-by-side, one titled "1933, Existing Technology: Fertilizer," the second titled "1985, New Technology: Solar Electricity."

Discuss the answers to the four questions. Pay careful attention to question 5, the methods and strategies used. Place this information on the newsprint chart titled "Fertilizer."

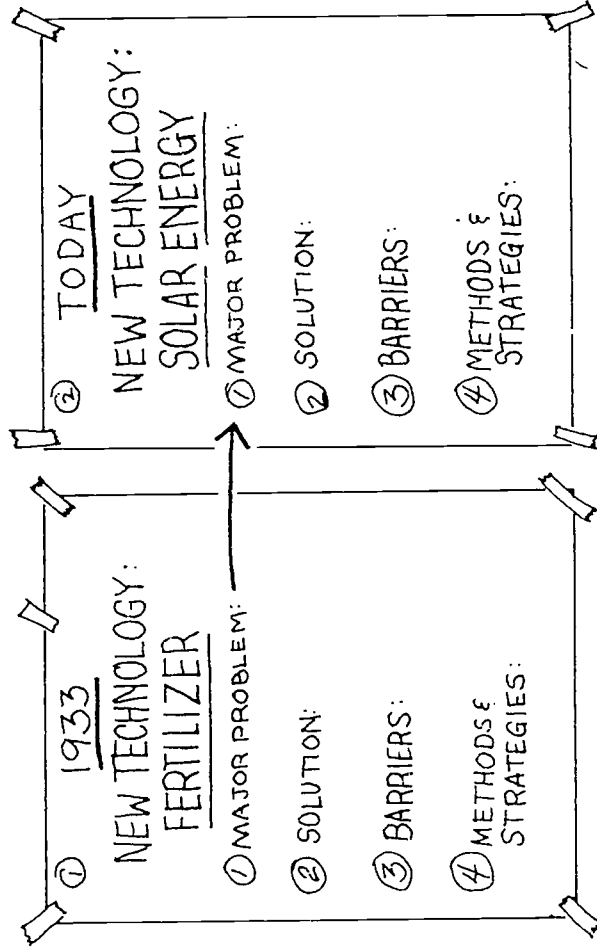

Then, respond to the four questions for newsprint chart on solar energy.

Summarize the results of how this or any new technology may be introduced into a region. What are the possible effects on culture, future energy costs, pollution, forest and wildlife, farming, population trends, jobs, and recreation?

FOLLOW-THROUGH:

What have been the long-term effects of the use of fertilizer in the Tennessee Valley? What new problems were created by its use?

Predict the long-term effects of the solar electric project. What problems may be created?

ALTERNATIVE ENERGY SOURCES

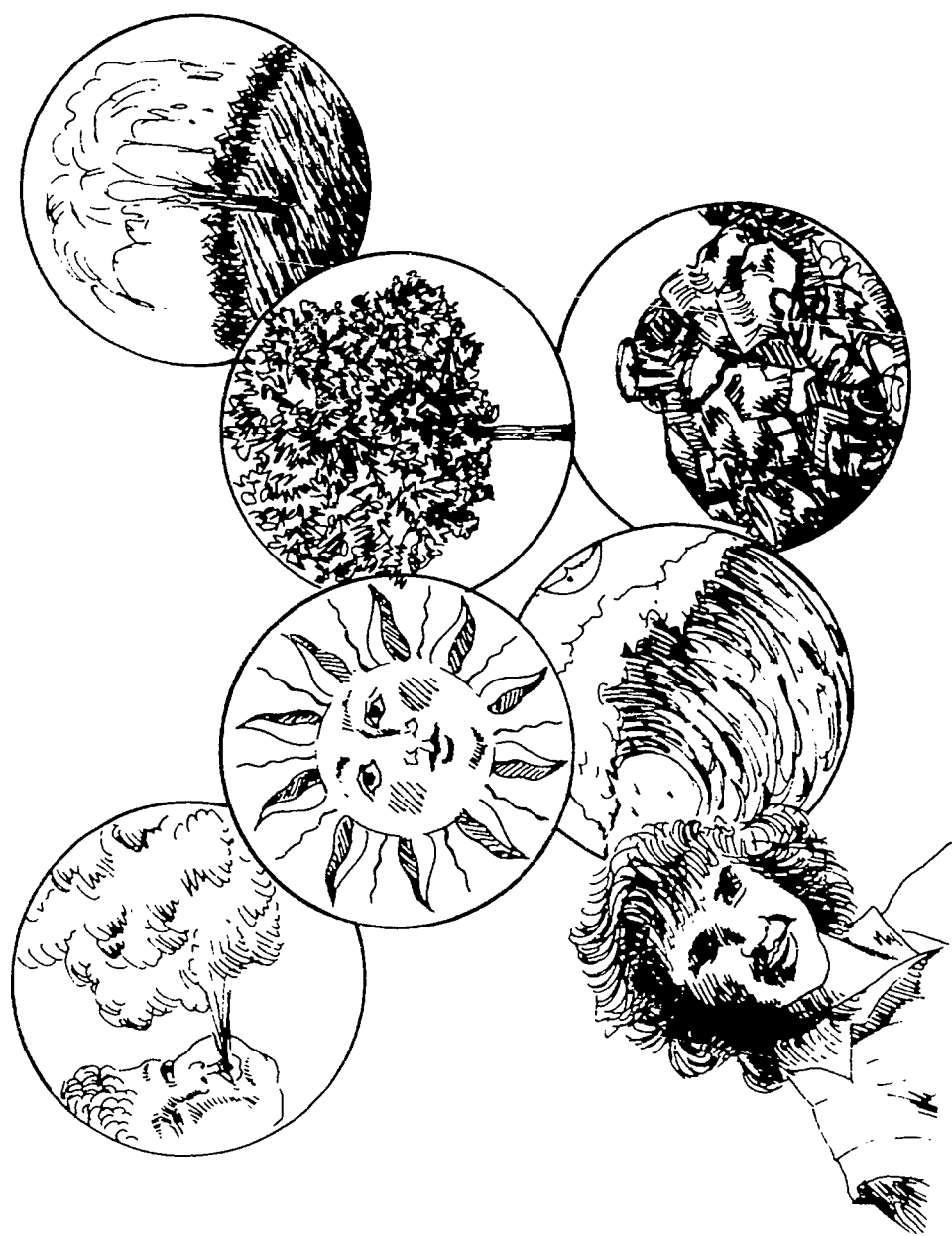

L-R. wind, solar, biomass, geothermal, wave, garbage

Enough River For All



OBJECTIVES:

- (1) Students will list the multiple uses of Valley rivers and reservoirs.
- (2) Students will develop a simulation to express points of view about river and reservoir usage. See TVA - A WORLD OF RESOURCES matrix for background information.

MATERIALS:

newsprint
felt crayons

PREPARATION:

This activity may be used as an introductory activity for many other sections of "TVA: A World of Resources" but may best be used as a summary activity to pull together ideas generated in such activities as: BENEFITS FROM THE FOREST, RECREATION LAND, PREDICTING FUTURE RECREATION LAND USE, TO ZONE OR NOT TO ZONE, THE VALLEY YESTERDAY AND TODAY, and A DAM: YOUTH AND OLD AGE.

PROCEDURE:

Divide the class into five or six groups. Each group will list on newsprint as many uses of the Valley rivers and reservoirs as possible. Allow five minutes.

Each group will briefly present its list to the class. On a separate piece of newsprint, combine the lists prepared by all of the groups as you go along. Have the students list beside each use who the users are. For example, you might have listed recreation. Recreational users might include fisherman, swimmers, boats, canoes, etc. Continue until all groups have made their presentations. After the groups have presented their ideas and formed one long list, begin to read through the long list one item at a time.

Then, tape up 3 or more pieces of newsprint and label them HIGH POOL, LOW POOL, and DOESN'T MATTER. Then go through your list of users and determine whether this user would prefer a high pool, low pool, or doesn't matter. For example: A chemical plant down river from the dam may want the water to flow year round to provide water for its processing and carry away waste by-products. So under LOW POOL RESERVOIR, you should write "Chemical Plant Manager." For recreation, you would list "Dock Owners" under HIGH POOL RESERVOIR and "White Water Canoes" under LOW POOL RESERVOIR. Continue until you have gone through the users list. You may want to add additional users.

We will now use these users and their positions as roles to develop a simulation like the activity "TO ZONE OR NOT TO ZONE" in the Wildlife Resources section.

Suggested timeline for this activity:

DAY 1: List river and reservoir users and develop roles.
Homework: Research personal role.

DAY 2: Conduct simulation and class discussion.

<p><u>HIGH POOL</u></p> <p>LAKE HOMEOWNER</p> <p>_____</p> <p>_____</p> <p>_____</p>	<p><u>LOW POOL</u></p> <p>CHEMICAL PLANT MANAGER</p> <p>WHITE WATER CANOE-ER</p> <p>_____</p> <p>_____</p>	<p><u>DOESN'T MATTER</u></p> <p>_____</p> <p>_____</p> <p>_____</p> <p>_____</p>
--	--	--

Ask students to select a role listed on the newsprint and find out more about that role by interviewing parents and neighbors reading newspapers, newsletters of user groups, and doing library research. Students should name their character and write a brief role description. (The role descriptions provided in the activity "TO ZONE OR NOT TO ZONE" can be used as examples for the students.)

One to three students need to be selected to be reservoir managers. They will make the final decision about whether the lake should be lowered or remain high this summer. One of these students will be the chairperson at a hearing to gather information about reservoir use. Five students for LOWER POOL RESERVOIR and five for HIGH POOL RESERVOIR should be selected to make presentations at the hearing. Everyone should introduce the role before the simulation begins.

On the day of the hearing, the chairperson is to conduct the meeting. It is up to him or her to maintain order. All participants must be recognized by the chairperson before they speak.

After all those presenting prepared testimony or opinions have spoken and have been questioned, other concerned citizens may give statements.

The board should now make a decision about the coming summer reservoir level and support it with reasons.

QUESTIONS TO DISCUSS:

1. What are some things we have learned about use of the rivers and reservoirs of the Valley?
2. What factors influence water use decision-making and planning?
3. What responsibilities do we as citizens have in helping to make water use policy?
4. How could we facilitate this simulation differently next time?
5. Is there enough river for all?

FOLLOW-THROUGH:

Invite a TVA reservoir manager to class, or write and ask how water level decisions are made. Ask what people are involved, and if it is a public or a private decision.

Write the "Save the Piney River" Association in Dickson County for information about water use by the City of Dickson.

Write the Tennessee Valley Authority, Recreation Resources Program, Norris, Tennessee 37828, for information about the Ocoee River and its recreational and other uses.

Check newspaper articles about the drawdown of Reelfoot Lake in the summer of 1985 and the Federal Court Order to block this. What interests are involved on both sides?

"New" MacDonald Has A Farm



OBJECTIVES:

Students will recognize the tremendous impact that electricity has had on the citizens of the Tennessee Valley. See TVA - A WORLD OF RESOURCES matrix for background information.

Have each group present its houses. Summarize how electricity has made house work easier and the quality of life better in the last 50 years.

MATERIALS:

poster board or newsprint
felt crayons

Have students read TVA - A WORLD OF RESOURCES fact sheet 6, "Power Supply." Ask students to make a list of farm chores that one person can do now that once required many laborers.

Ask "What would happen to the farm if the electric power were permanently shut off?" and "How would this affect you?" Also, "If electric costs increase, what will happen to food costs?"

PREPARATION:

Have students investigate what kinds of appliances were used in the 1930s. Also have students look through home economics journals in the library to learn about future technologies in appliances. You may want to have them write EPCOT Center's library in Orlando, Florida about their home of the past, present, and future exhibit.

FOLLOW-THROUGH:

Pretend that you are on a farm 100 years in the future. The farm's power supply is on the farm. There is no soil erosion and also no need to bring in external fertilizer. Look around and describe what would be necessary to make this possible. Where does the energy come from? What sort of appliances and tools are there? What sort of crops are being grown? Discuss your ideas in a small group or write a paper.

PROCEDURE:

Divide the class into groups of five or six students. Have students draw on one newsprint the inside of a farmhouse as they think it might have looked in 1930 and on a second newsprint the inside of a farmhouse in 1980. Be sure to include appliances and other features.

T-43

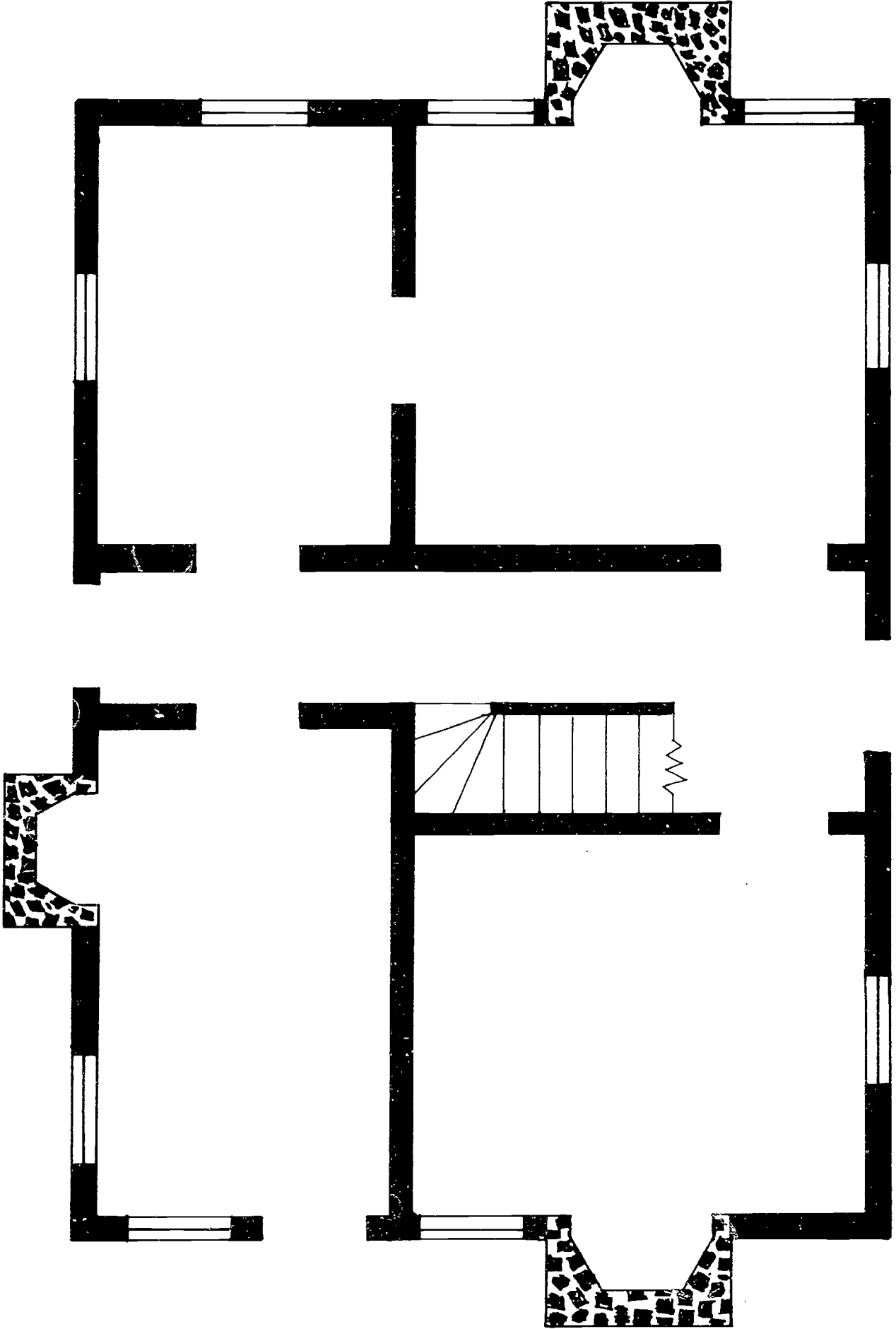

664
1930

728

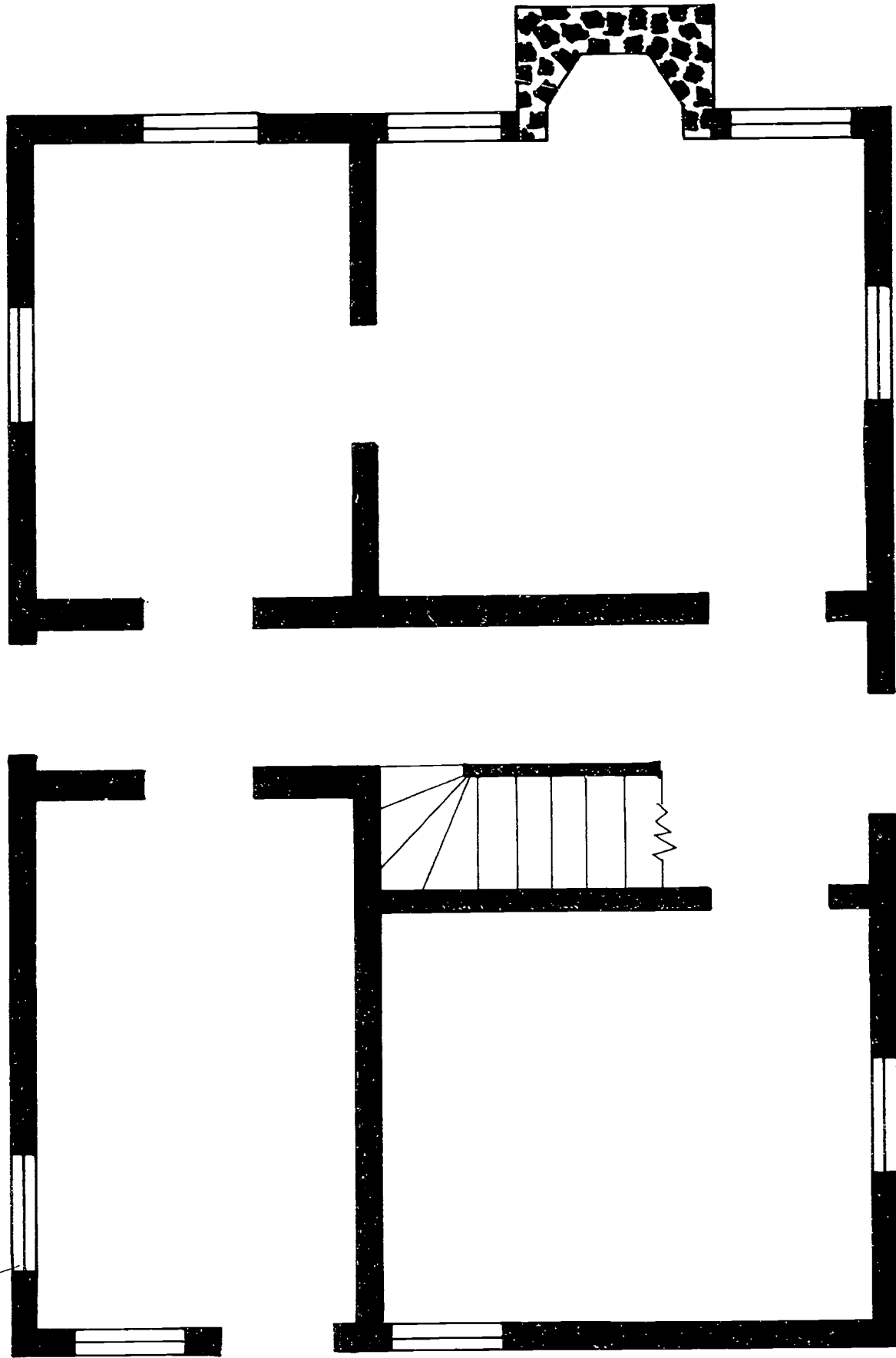

1980
1031

T-44

1030

T-45

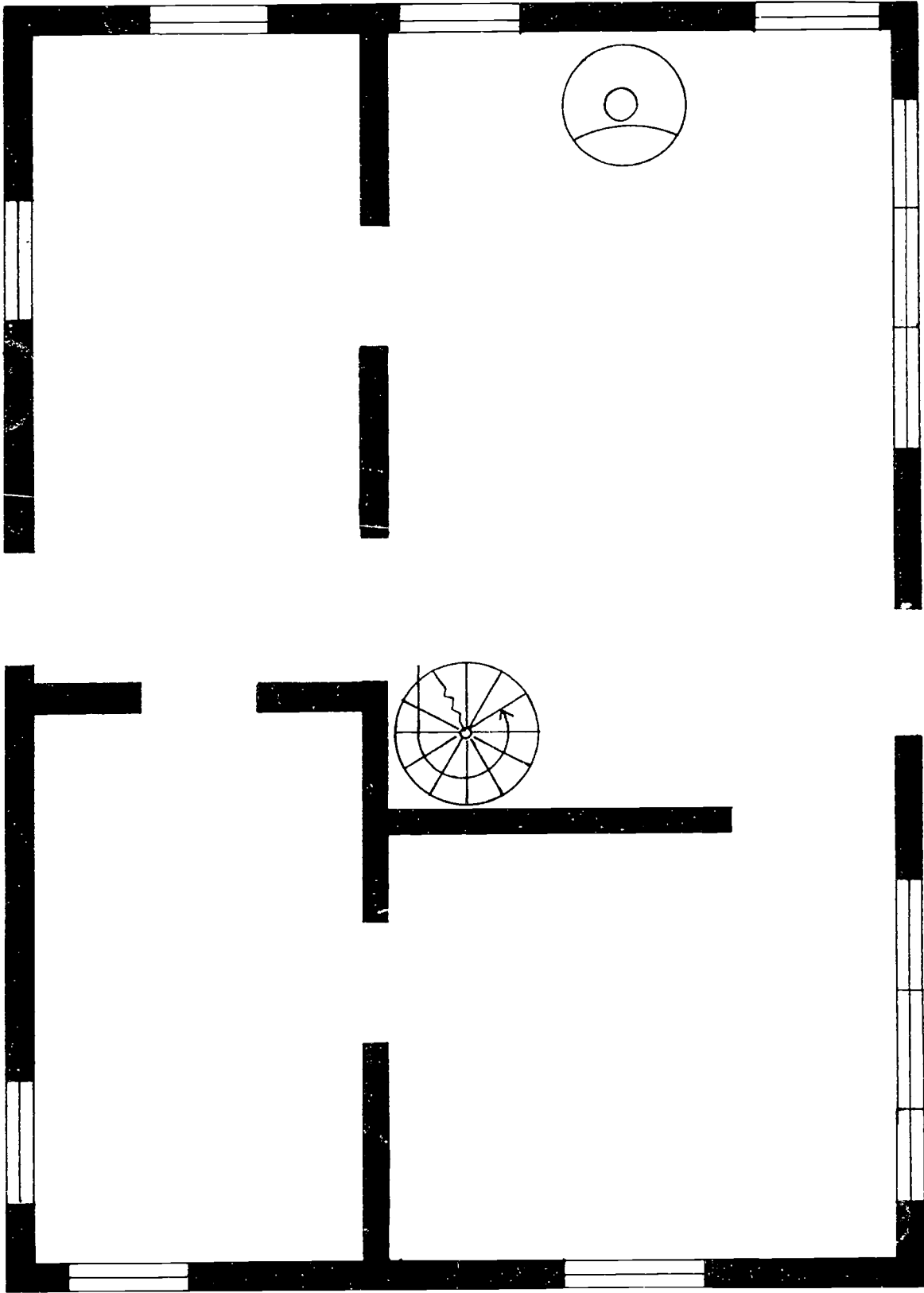

2000 A.D.

733

732



Recycling For Interdependence

OBJECTIVES:

Students will learn about recycling. See TVA - A WORLD OF RESOURCES matrix for background information.

MATERIALS:

- ruler
- litter
- felt crayons
- large cardboard box

PREPARATION:

Ask students to collect information about recycling.

PROCEDURE:

Collect the contents of your class wastebasket for one week, excluding food items. Use a container from the classroom as a unit of measure (such as pans, drawers). Make a bar graph denoting the amount of paper used by the class in one day, in one week. Determine how much would be used in a month and a school year. Then project how much the entire school uses in a day, week, month, and school year.

Conduct the following experiment. Write only on one side of a piece of paper for one week and have the class put all this waste paper in a box. Do not crumple the paper. After only one week of

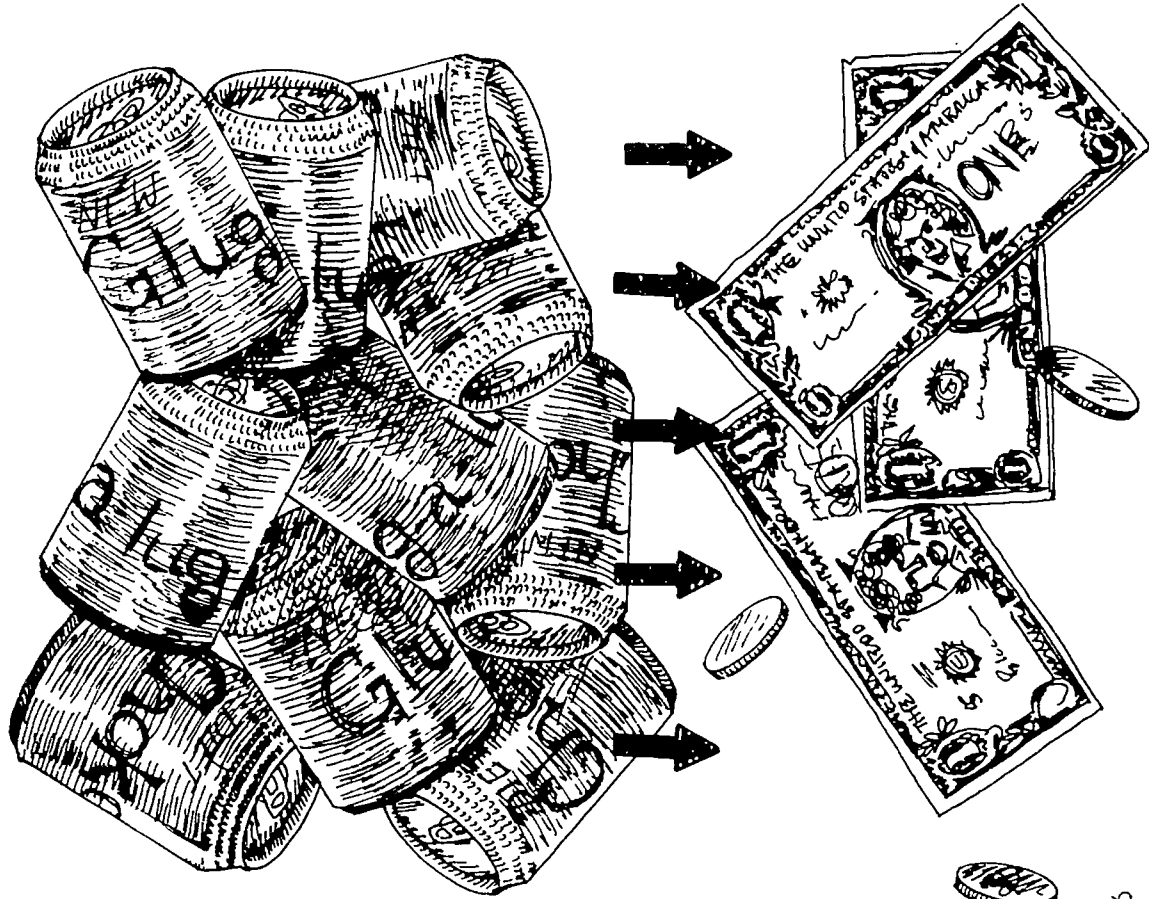

FOLLOW-THROUGH:

(1) Collect litter (newspaper, glass, paper containers, tissue, plastics, aluminum and bimetal cans) in the schoolyard or in the neighborhood and bring it into the classroom. If the neighborhood is fairly clean, bring some litter from home. Divide the class into four groups displaying signs that read "Recyclable," "Reusable," "Non-Recyclable," and "Biodegradable." Allow the groups to sort the litter, choosing what is appropriate for each category. Discuss reasons for the choices. When they finish, groups should make a list of the ways individuals can reduce the amount of solid waste they generate.

(2) If there is a recycling collection station in your area, have the students accompany you when you take the recyclables you collected to the center.

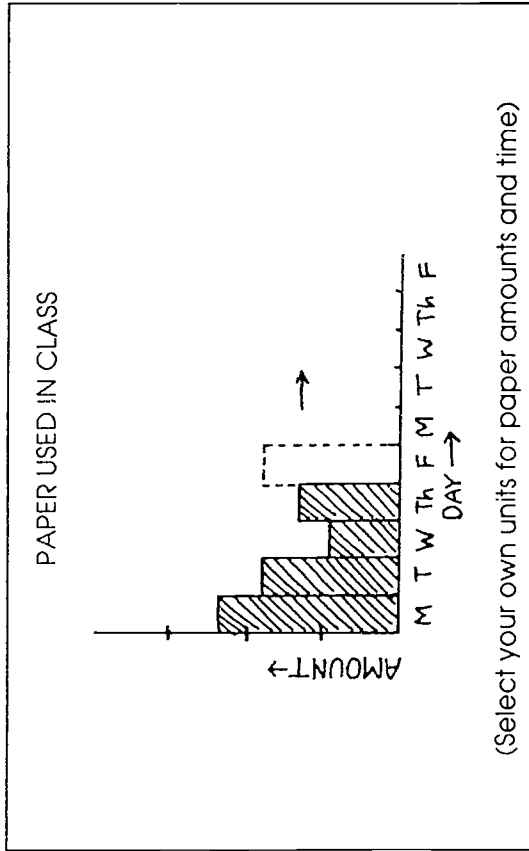

writing only on one side of paper, mark or measure the level of the paper on the side of the box. The second week, have the class use both sides of the paper. Determine whether less paper has been thrown away the second week. Discuss how the class can save paper during the rest of the year.

If this paper were recycled, how would this recycling affect: (1) forests, (2) pollution, (3) soil erosion, (4) power generation, (5) wildlife, and (6) air quality? What can the class do with waste paper? Recycle it? Make paper? (See activity "BOARD FOR BOARDS".)

While you are conducting the paper activity, have students count the bottles and cans used in their household in one week. Figure how much their families would use in one year. Note: The energy lost by not recycling two aluminum cans is equal to the average daily energy use of a person in the developing countries.

Maintaining The Web



OBJECTIVES:

Students will learn how difficult it is to clean up an oil spill and how this could seriously affect the environment. See TVA - A WORLD OF RESOURCES matrix for background information.

MATERIALS:

large pan filled with water
used one-half can motor oil
sawdust, string, cotton, detergent, cornmeal, flour, a feather

PREPARATION:

Students will see a possible consequence of transporting oil for energy.

PROCEDURE:

Have the students to work in small groups. Pour motor oil into a large pan of water. Students will attempt to clean up the oil spill using various materials such as sawdust, string, cotton, cornmeal, etc. Which method works best. Why?

To simulate the affects of oil spills on waterfowl, dip a feather into the oil spill and try to clean the feather afterwards. Describe the oil-covered feather. How would you clean a bird affected by an oil spill? How may the oil spill affect wildlife? Water? Forests? How does the use of oil affect the air we breathe? How do you dispose of the oily water? Can it be recycled? How about pouring it into a sandpit for use in cleaning tools? Discuss other alternatives.

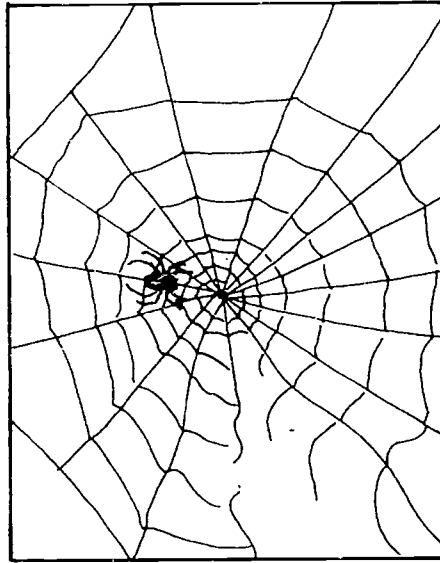

.....If one strand is broken,
the whole web collapses.

FOLLOW-THROUGH:

Contact large oil companies and ask them how they clean up spills. Compare the methods you used to the ones they use. How are they alike? Different? Why? One of the laws of nature states that everything is connected or dependent on everything else. An analogy would be a cobweb: if any one strand is broken, the cobweb comes apart. If this is true, how can the introduction of an unnatural element affect the ecosystem. Research oil spills and how they affect both the ecology and the aesthetics of the area impacted. For example, how did the Exxon oil spill which occurred in Alaska in March 1989 affect wildlife, fishing, and the Alaskan economy?

Water Consumers



OBJECTIVES:

Students will collect data on their water use for one day. See TVA - A WORLD OF RESOURCES matrix for background information.

MATERIALS:

1-gallon plastic milk jugs
or
4-liter plastic soda bottles

PREPARATION:

Most Americans can turn on their faucets and receive all the clean water they want. Water is so often taken for granted, we rarely wonder where the water comes from or how much we use.

It has been estimated that the average American directly uses 87 gallons of water a day. Some estimates go as high as 300 gallons a day in areas where lawn watering is extensive. On the average, such daily activities as drinking and cooking take 2 gallons a day; 5 to 7 gallons are used every time you flush a toilet; 32 gallons are used for bathing, laundry, and dishwashing, and a shower uses water at a rate of about 7 to 9 gallons per minute.

There are also many indirect uses of water. Food production accounts for the majority of fresh water used in the United States. About 150 gallons of water are needed to grow the wheat for one loaf of bread. It takes about 120 gallons of water to produce an egg.

A University of California study estimated that more than 4,500 gallons of water are needed to produce three balanced meals a day for one person.

To meet daily needs, municipal public water systems process a total of about 30 billion gallons of fresh water a day. This amount of water would easily fill a lake 5 miles long, 1 mile wide, and 33 feet deep.

Directly or indirectly, it has been estimated that Americans use an estimated 700 billion gallons of water a day. This represents a figure 18 times greater than the daily amount used in 1900.

Water experts agree that our current water distribution systems and available supply of fresh water cannot support this rate of increase in the future. The elimination of careless and wasteful consumption by each of us will be a positive contribution in the effort to conserve this valuable resource.

PROCEDURE:

Ask students to monitor the water they use in their homes in a single day. Working individually or in teams, students can decide which uses are measurable and develop ideas for monitoring. Some suggestions include measuring water used to brush teeth, wash hands, or take showers by closing the drains and determining the amount used with a standard measuring cup or gallon milk container. Water all the plants in the house and keep track of how much water is used. Fill gallon jugs and label them "cooking only," then determine how much was used at the end of the day. Fill the bathtub using a

gallon jug. Encourage students to look for other water uses in their homes. Add to their estimates the following averages:

Dishwasher	<ul style="list-style-type: none"> • 25 gallons per load
Washing machine	<ul style="list-style-type: none"> • 20 gallons per load
Shower	<ul style="list-style-type: none"> • 7-9 gallons per minute
Toilet	<ul style="list-style-type: none"> • 5-7 gallons per flush

Students can compute their average daily use of water and compare their findings with each other, or estimate daily and weekly averages for specific uses using data collected by all the students. Let students think of ways they can conserve water. Then have them repeat their daily computation. How do these measurements compare to earlier ones?

FOLLOW-THROUGH:

Design a "Community Water Use" exhibit for display in your classroom, school, or a public place such as the town hall, library, or bank. Have students research how water is used in their homes and community, and collect objects that are associated with water use. This might include drinking glasses, soap, hoses, toothbrushes, fishing lures, plumbing fixtures, and cooking utensils. You might also include drawings or photographs of community water uses such as fire hydrants, car washes, municipal swimming pools, and waste water treatment facilities. Encourage students to be creative and construct a modern art "Water Use Sculpture."

Before placing their finished sculpture in a prominent display area, ask students to evaluate the importance of water. What water uses are essential? Which are convenient? Extravagant? If a drought occurred, how could they reduce the amount of water they use?

(Adapted from National Wildlife Federation, "National Wildlife Week Teachers Guide," March 18-24, 1984.)

HOW TO CONSERVE WATER IN YOUR HOME!

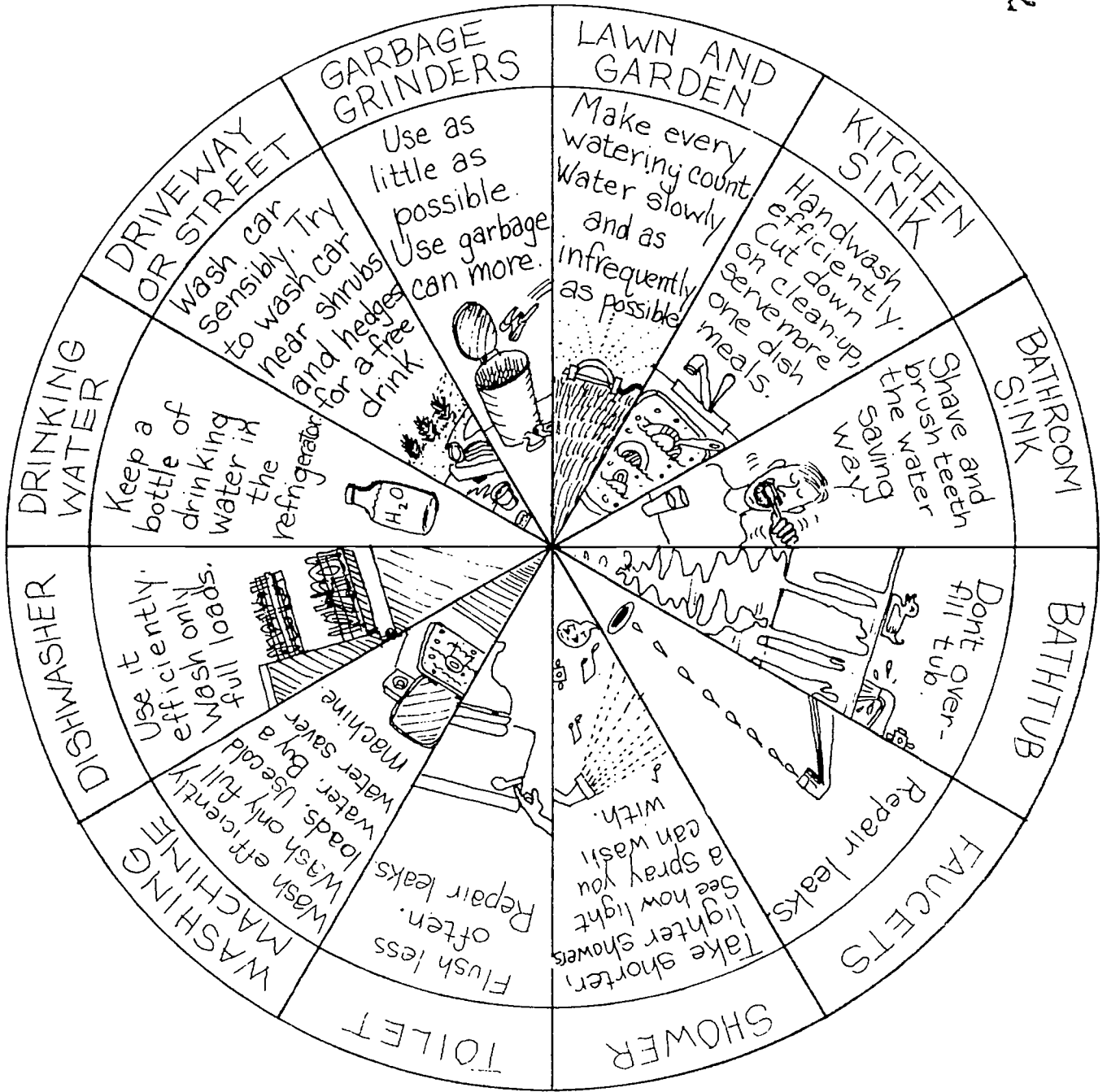

747

59