

DOCUMENT RESUME

ED 359 029

SE 053 279

TITLE Biology AB: An Instructional Course Outline.
 Publication No. SC-928-1987.

INSTITUTION Los Angeles Unified School District, CA. Office of
 Secondary Instruction.

PUB DATE 87

NOTE 334p.; For course outlines in Physics AB and
 Chemistry AB, see SE 053 278 and SE 053 280.

PUB TYPE Guides - Classroom Use - Teaching Guides (For
 Teacher) (052) -- Tests/Evaluation Instruments (160)

EDRS PRICE MF01/PC14 Plus Postage.

DESCRIPTORS Animals; *Biology; Botany; Classification; *Course
 Descriptions; Curriculum Guides; Environment;
 Evolution; Genetics; High Schools; Lesson Plans;
 Plant Identification; Plants (Botany); *Science
 Curriculum; Science Education; *Science Instruction;
 Secondary School Science; Teaching Methods;
 Zoology

IDENTIFIERS California; *California Science Framework; Science
 Process Skills

ABSTRACT

This course of study is aligned with the California State Science Framework and provides students the biology content needed to become scientifically literate and prepared for post-secondary science education. The course of study is divided into four sections. The first section provides an overview of the course and includes a course description, representative objectives, a time line, and the sequence of instructional units. The second section presents the course's 10 instructional units and enumerates the required concepts and skills to be taught. Topics covered by the units are: (1) the nature of biology; (2) the cell; (3) principles of taxonomy; (4) the classification, structure, and function of viruses, monera, protista, and fungi; (5) the classification, structure, and function of plants; (6) the classification, structure, and function of animals; (7) developmental biology; (8) genetics; (9) evolution; and (10) ecology and environment. The third section on lesson planning discusses various teaching strategies that foster scientific ways of thinking and encourage student creativity and curiosity. Ten sample lesson plans identifying specific objectives, instructional activities, practice formats, individual learner differences, and evaluation methods are provided. The fourth section contains four appendices that include: a classroom test of formal operation level including testing and scoring procedures and an answer key; a list of 31 resources; a list of the standards for Biological Science from the "Model Curriculum Standards, Grades Nine through Twelve"; and a copy of the Secondary Science Continuum. (MDH)

 * Reproductions supplied by EDRS are the best that can be made *
 * from the original document. *

"PERMISSION TO REPRODUCE THIS
MATERIAL HAS BEEN GRANTED BY

Anthony A. Cazono
Asst. Superintendent

TO THE EDUCATIONAL RESOURCES
INFORMATION CENTER (ERIC)."

ED359029

BIOLOGY AB

AN INSTRUCTIONAL COURSE OUTLINE

SE053279

U.S. DEPARTMENT OF EDUCATION
Office of Educational Research and Improvement
EDUCATIONAL RESOURCES INFORMATION
CENTER (ERIC)

This document has been reproduced as
received from the person or organization
originating it.
Minor changes have been made to improve
reproduction quality.

Points of view or opinions stated in this do not
necessarily represent official
OERI position or policy.

LOS ANGELES
UNIFIED SCHOOL DISTRICT
Office of Secondary Instruction
Publication No. SC-928 -1987

BIOLOGY AB

AN
INSTRUCTIONAL
COURSE
OUTLINE

LOS ANGELES
UNIFIED SCHOOL DISTRICT
Office of Secondary Instruction
Publication No. SC-928 -1987

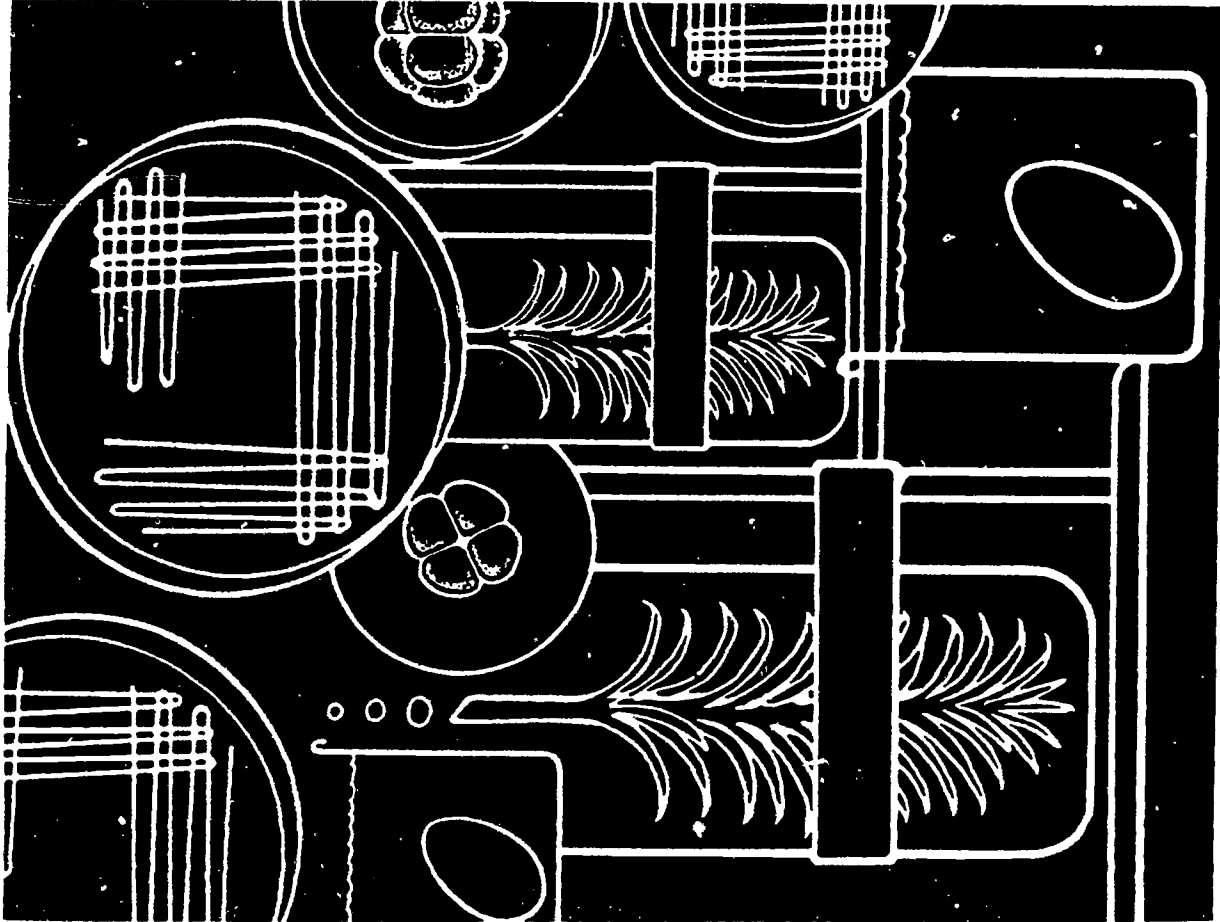

Copyright © 1987

LOS ANGELES UNIFIED SCHOOL DISTRICT

CONTENTS

Foreword	v
Acknowledgments	vi
 SECTION I - OVERVIEW	
How to Use the Instructional Course Outline	2
Summary of Representative Objectives	3
Time Line and Sequence of Units	9
 SECTION II - INSTRUCTIONAL UNITS	
Introduction to Skills and Concepts Required and Developed in Biology AB	12
Unit One: What Is Biology?	24
Unit Two: The Cell	31
Unit Three: Principles of Taxonomy	38
Unit Four: The Viruses, Monera, Protista, and Fungi: Their Classification, Structure, and Function	43
Unit Five: The Plants: Their Classification, Structure, and Function	49
Unit Six: The Animals: Their Classification, Structure, and Function	56
Unit Seven: Developmental Biology	62
Unit Eight: Genetics	66
Unit Nine: Evolution	74
Unit Ten: Ecology and Environment	83
 SECTION III - LESSON PLANNING	
Lesson Planning - Questions and Commentary for Teaching Decisions	90
Teacher Responsibilities	92
The Agenda	94
Guidelines for Assignment of Homework	95
Teaching Strategies	96
Higher Levels of Thinking	97
Learning Modalities	99
Evaluation Procedures	100
Tips for Parents	101

Lesson Plan Format	104
Sample Lesson 1: Scientific Method	105
Sample Lesson 2: The Cell - Laboratory Experiment	108
Sample Lesson 3: Taxonomy - Laboratory Exercise	112
Sample Lesson 4: Protist - Laboratory Exercises	115
Sample Lesson 5: Plant - Laboratory Exercise	125
Sample Lesson 6: Animal - Laboratory Exercise	128
Sample Lesson 7: Embryology - Laboratory Exercise	132
Sample Lesson 8: Genetics Activity	136
Sample Lesson 9: Evolution - Laboratory Activity	139
Sample Lesson 10: Ecology - Laboratory Activity	143

SECTION IV - APPENDICES

Appendix A - Classroom Test of Formal Operations: Testing and Scoring Procedures and Answer Key	148
Appendix B - Resources	171
Appendix C - Summary of Objectives - California Grade 9-12 Model Curriculum Standards	174
Appendix D - Secondary Science Continuum	176

FOREWORD

Scientists acquire and organize knowledge in order to explain natural phenomena and to make it of use to humankind. Through the science instructional program in secondary schools, students develop an understanding that science is a body of knowledge which changes as our understanding increases. Science is comprised of interconnected sets of principles, laws, and theories that explain the known universe and our relationship to it. Students investigate phenomena systematically and acquire and refine information. Outcomes include a greater understanding of how human beings use scientific information essential for comprehending our environment and for reaching solutions to problems of daily living.

Biology AB, a required senior high school course, is intended to assist students in preparing for advanced academic science classes and higher education. It is designed to help students develop a basic knowledge of science as well as appropriate skills, learning processes, and attitudes. These outcomes are emphasized because they are fundamental to good citizenship and effective participation in today's society.

The Biology AB curriculum includes a study of living things with particular emphasis on an investigative approach of units to developing scientific understandings and attitudes. This instructional course outline provides teachers with a time schedule and a sequence of units, required skills and concepts, samples of teacher-directed lesson plans and instructional strategies, and appendices of additional resources.

ACKNOWLEDGMENTS

Gratitude is expressed to those individuals who contributed to the development of this instructional outline by reviewing the content and recommending unit titles and concepts.

The Office of Secondary Instruction is especially grateful to DAVID L. LINCOLN, Science Department Chairperson, Reseda High School, and SHERRY FELICE LINCOLN, who organized the suggestions of teachers and advisors and wrote the instructional course outline.

Sincere appreciation is expressed to GLEN BRATTEN, Teacher, Cleveland High School, who developed and wrote the introductory unit. Appreciation is also expressed to those on the Instructional Planning Committee who developed the outline: JAMES MEYER, Teacher, El Camino High School; MICHAEL MCCONAHEY, Director of Instruction, Birmingham High School; DAVID LINCOLN, Science Department Chairperson, Reseda High School; DOROTHY CHANG-VAN HORN, Coordinator, North Hollywood-Los Angeles Zoo Animal Studies Magnet High School.

Thanks are gratefully extended to the Model Curriculum Standards Committee who reviewed the proposed contents and advised on compliance with the California Grade 9-12 Model Curriculum Standards: MILLICENT ANDERSON, Teacher, Venice High School; PATRICIA C. DUNG, Science Advisor, Senior High Schools Division; DAVID LINCOLN, Science Department Chairperson, Reseda High School; DEANNA McGRUDER, Teacher, Dorsey High School; WILLIAM F. SAMARAS, Teacher, Carson High School; MARY ANN SESMA, Principal, Bell High School; CLAIRE TAMAYOSE, Science Department Chairperson, Roosevelt High School; CONNIE WILLIAMSON-SPARKS Teacher, Kennedy High School.

GERALD J. CARNER
Specialist, Secondary Science
Office of Secondary Instruction

ROSALYN S. HEYMAN
Assistant Superintendent
Office of Secondary Instruction

APPROVED:

LORNA ROUND
Associate Superintendent
Instruction

SECTION I:
OVERVIEW

HOW TO USE THE INSTRUCTIONAL COURSE OUTLINE

Section I of the instructional course outline provides teachers with a summary of representative objectives and a time line and sequence of units. Teachers should read Section I first for an overview of the entire Biology AB course.

Section II provides teachers with the content for the ten instructional units. In addition, these units are prefaced with an introductory unit called "Skills and Concepts Required and Developed in Biology AB." After briefly introducing this unit, teachers should integrate the skills and concepts throughout the course.

Each instructional unit contains a content outline on the left-hand side of the page. The right-hand side of the page lists corresponding skills from the Secondary Science Skills Continuum and standards from the State Model Curriculum Standards, Science. Also indicated on the right column are references to the sample lesson plan provided as a model for the unit and to the related section of the introductory unit.

Section III contains information and strategies necessary for effective lesson planning and one sample lesson plan for each instructional unit. The ten sample lesson plans and instructional strategies follow the teacher-directed lesson format. Appropriate worksheets follow each sample lesson.

Section IV contains the Appendices. Appendix A consists of Dr. Anton E. Lawson's "Classroom Test of Formal Operations," which is reproduced with permission. Appendix B, C, and D include teacher resources, a summary of the State Model Curriculum Standards, Science, and the Secondary Science Skills Continuum, respectively.

SUMMARY OF REPRESENTATIVE OBJECTIVESUnit Title

INTRODUCTION TO SKILLS AND CONCEPTS
REQUIRED AND DEVELOPED IN BIOLOGY AB

Objectives

To assist and develop the student's ability to:

- Assemble and use laboratory apparatus, tools, and materials in a skillful manner; giving due attention to safety measures.
- Develop ability to generate data by observing, recalling, recognizing, identifying, and measuring.
- Prepare a laboratory report.
- Gather information from the library and other appropriate sources.
- Appreciate the importance of technological advances in the biological sciences.
- Use scientific methods in solving problems related to living things.
- Gather, tabulate, and organize pertinent data from a laboratory investigation.
- Apply methods of mathematical analysis to biological investigations.
- Identify factors that may influence a given biological interaction.
- Describe the life processes which are essential to all organisms.

UNIT ONE - WHAT IS BIOLOGY?

Unit Title

UNIT TWO - THE CELL

Objectives

- Recognize the cell as the unit of structure and function of all living things.
- Compare and contrast animal and plant cells.
- Compare and contrast prokaryote and eukaryote cells.
- Distinguish between different kinds of cells.
- Analyze the chemical processes of the cell.
- Describe the processes of osmosis, diffusion, and active transport.
- Demonstrate the process of osmosis.
- Identify and describe science-related careers.
- Describe systems of classification used to sort groups of objects.
- Demonstrate the use of a classification system based on observable characteristics.
- List the steps in the modern binomial system of taxonomy.
- Recognize that all classification systems are based on inherited characteristics.
- Criticize the various schemes for classifying kingdoms.
- Evaluate the relevance of using DNA similarities as a basis for classification.

Unit TitleObjectives

UNIT FOUR - THE VIRUSES, MONERA, PROTISTA,
AND FUNGI: THEIR CLASSIFICATION,
STRUCTURE, AND FUNCTION

- Describe the characteristics of monera, protista, and fungi.
- Assess the ways in which the monera, protista, and fungi affect other living things.
- Discuss the life cycle of the virus.
- Distinguish between those organisms classified as monera, protista, and fungi.
- Report on products of fungi and bacteria which benefit people.
- Appraise the differences between prokaryotes and eukaryotes.
- Recognize career options in microbiology.
- Recognize that groupings of plants are based on structural characteristics which serve to facilitate the study of plants.
- Identify similarities of structure and function among various plant groups.
- Relate the major structural features of plants with their function.
- Describe the steps in photosynthesis.
- Assess the methods of plant reproduction.
- Examine the variety of fruits and nuts.

UNIT FIVE - THE PLANTS: THEIR
CLASSIFICATION, STRUCTURE,
AND FUNCTION

BIOLOGY AB

OVERVIEW

Unit Title

Objectives

UNIT SIX - THE ANIMALS: THEIR
CLASSIFICATION,
STRUCTURE, AND FUNCTION

- List methods of seed dispersal.
- Evaluate and describe science related careers.
- Recognize that groupings of animals are based on structural characteristics and serve to facilitate the study of animals.
- Identify similarities of structure and function among various animal groups which furnish evidence for evolutionary developmental patterns.
- Compare the major groups of animals.
- Describe the major organ systems of animals.
- Define the steps in respiration.
- Recognize related career options.
- List the stages of insect metamorphosis.
- Relate the stages of human development to the stages in other species.
- Organize the stages of human development from conception to death.
- Describe stages of development from zygote to the embryo.
- Discuss career options possible in developmental biology.

UNIT SEVEN - DEVELOPMENTAL BIOLOGY

Unit TitleObjectives

UNIT EIGHT - GENETICS

- Explain the laws of Mendelian genetics.
 - Distinguish between the roles of DNA and RNA in the cell.
 - Compare the processes of mitosis and meiosis.
 - Recognize the uniqueness of the DNA double helix molecule.
 - Diagram the steps of protein synthesis.
 - Evaluate the relative dangers of mutagens in the environment.
 - Debate the merits of genetic counseling.
 - Predict some possible benefits of recombinant DNA technology.
 - Explore career options in genetics.
-
- Analyze the characteristics of the early earth.
 - Distinguish among scientific theories of the origin of life.
 - List the lines of evidence for evolution.
 - Recognize the differences between the theories of Darwin and Lamarck and the modern interpretations of their theories.
 - Recognize the role of DNA in evolution.

UNIT NINE - EVOLUTION

Unit TitleObjectives

- Compare the mechanisms of speciation.
- Examine the fossil evidence for human evolution.
- Identify and describe science-related careers.
- Recognize the dependence of all living things on the abiotic environment.
- Give examples of feeding relationships in a community.
- Assess the effects of various types of pollution on the environment and its inhabitants.
- Describe the major biomes.
- Appreciate the interdependence of living organisms in the environment and the implications for continued survival.
- Identify and describe science-related careers.

UNIT TEN - ECOLOGY AND ENVIRONMENT

TIME LINE AND SEQUENCE OF UNITS

<u>UNIT</u>	<u>TOPICS</u>	<u>NUMBER OF WEEKS ALLOCATED</u>
INTRODUCTION	Skills and Concepts Required and Developed in Biology AB	Integrated throughout the course
ONE	What Is Biology?	2
TWO	The Cell	5
THREE	Principles of Taxonomy	2
FOUR	The Viruses, Monera, Protista, and Fungi: Their Classification, Structure, and Function	4
FIVE	The Plants: Their Classification, Structure, and Function	4
SIX	The Animals: Their Classification, Structure, and Function	5
SEVEN	Developmental Biology	3
EIGHT	Genetics	5
NINE	Evolution	3
TEN	Ecology and Environment	4

SECTION II:
INSTRUCTIONAL UNITS

11

35

34

INTRODUCTION TO SKILLS AND CONCEPTS
REQUIRED AND DEVELOPED IN BIOLOGY ABRepresentative Objectives for the Unit

In accordance with his or her present capacities, the student will grow in ability to:

- Assemble and use laboratory apparatus, tools, and materials in a skillful manner, giving due attention to safety measures.
- Develop ability to generate data by observing, recalling, recognizing, identifying, and measuring.
- Prepare a laboratory report.
- Gather information from the library and other appropriate sources.

ContentI. Introduction

Biology AB has been designed to help students develop concepts about the biological principles that govern life on earth. The classroom has the potential to be a place of great adventure for both students and teachers. How science is taught, i.e., the excitement that it generates within the students, will determine the extent of its impact. The majority of class members will be completing a graduation requirement in science. Scientifically and technologically literate citizens are needed, and this class provides an important opportunity to produce them.

In the presentation of the skills that are fundamental to the understanding of biological science, the teacher has an opportunity to assist students in the development of vital thinking skills and the scientific literacy required for life in the twenty-first century. Cognitive skill development moves from concrete operational to formal theoretical thought. Permitting students to evaluate their misconceptions about biological principles is an effective method to move from concept exploration into concept development and, finally, concept application. In the application phase, the teacher will generally be able to determine whether or not the students are utilizing formal theoretical skills. Because students typically have misconceptions about biological principles, a primary instructional goal is to identify and correct these misconceptions.

ContentII. Cognitive Skill Measurement

Dr. Anton Lawson, Department of Physics, Arizona State University, Tempe, Arizona, has developed and validated a test for teacher observation of student cognitive skill growth in science (See Appendix A). His test is based upon student use of data and capacity to analyze. Little information about specific subject matter content is needed. Use of this test will provide the teacher with an opportunity to measure change in student moving from concrete operational thought to formal theoretical thought. Even a student lacking in skills will show growth during a year of experience in science. Using this test, teachers can more effectively plan lessons emphasizing critical-thinking skills.

Use of the formal operational thought processes opens the door for a development of the scientific method. This logical thought process has influenced the entire world with its approach to problem solving, its technologies, and its philosophy.

The development of literacy in science includes analytical writing ability. To write effectively, the student must know vocabulary and finally must be given the opportunity to write about experiences within the framework of the class. The teacher should provide the student with an effective format for laboratory reports, and then assist the student in using the format. Learners must be given the opportunities to write, edit, rewrite, and receive appropriate feedback from the teacher. Listening, observing, speaking, reading, and writing should be emphasized in all science lessons, including laboratory experiences and teacher demonstrations.

III. Quality Skill Building

All lesson plans in this instructional course outline are in the seven-point teacher-directed lesson plan, the District-approved format. In planning lessons, the teacher should design activities that take into account students' different learning modalities and should ask questions at all levels of Bloom's Taxonomy with an emphasis on higher-level thinking skills.

There is no subject that is as all-encompassing as science in the variety of disciplines it involves. Investigation and hands-on activities are keystones to the learning experience in science. Even desultory students become motivated when they determine their own need to reduce a random approach to education and to develop a structured approach. Students are able to clarify and develop realistic goals and become active participants in the learning process.

Content

Corresponding Skills and Standards for the Student

IV. The Scientific Method

Below are sets of general questions that address the classical parts of the scientific method. Students should be able to answer these questions. Based on answers to these questions, the teacher can determine whether or not the students have misconceptions about biological phenomena.

A. A clear statement of the problem

- What do you believe in? (In relationship to this investigation)
- What are you looking for?
- What do you want to prove?
- What factors and variables must you include?
- What information do you need before you progress?

B. Forming a hypothesis

- What must be included?
- What is the proper wording of a hypothesis?
- Do you need to consider groups or sets of information?
- Do you have some idea of the outcome?
- Do you need a control?
- Have you written the hypothesis in a complete sentence?

4.1.1 Distinguishes between trial and error and controlled investigations.

1.5.1 Recognizes the alternative factors to be considered when examining possible solutions.

1.6.2 Forms opinions only after seeking a variety of data and ideas.

1.7.0 Has a critical, questioning attitude toward inferences, hypotheses, and theories.

ContentCorresponding Skills and Standards for the Student

C. Testing the hypothesis

- Do you know how to set up equipment safely?
- If you are using chemicals, are any of them dangerous?
- What safety precautions must you use at all times in the laboratory?
- If you are working with a laboratory team, does each person know what he or she is supposed to do?
- Do you know what changes you are looking for?
- Have you controlled all variables, except the one you are testing?

D. Gathering and recording data

- Do you know how to group data in several different ways?
- Do you know how to make tables?
- Do you know how to rearrange tables in relationship to variables?

E. Analyzing data

- How do you read graphs?
- How do you move from symbols to complete sentences?
- Do you see trends or patterns?
- How does the data collected from manipulation of the variables compare between experimental and control samples?
- What relationships can be described?

1.8.0 Applies rational and creative thinking processes when trying to find relationships among seemingly unrelated phenomena and when seeking solutions to problems.

2.3.0 Develops ability to apply and evaluate data and generate theories by hypothesizing, predicting, inferring, generalizing, theorizing, explaining, justifying, judging, and interpreting.

Content

F. Reaching the conclusion

- Do you have the ability to write sequentially and logically?
- Does what you write reflect the data that you have collected?
- What other variables must you discuss in your conclusion?
- Have your conclusions and observations changed your belief about these events?
- Is the hypothesis being tested valid?
- Does the hypothesis need to be modified?

V. Responsible Laboratory Activities

The smallest experimental detail that is carefully observed often makes the difference between correct or incorrect correlating of information. Begin by preparing the students for the laboratory. Explain the problems, review equipment set-up, go over the use of chemicals, emphasize safety and cleanliness, and try to anticipate errors before they occur.

Point out that the essence of science is to work out (often in microworlds) the hypothesis upon which many other technologies and discoveries may develop. An important point to make is that many of the classical experiments in biological science are done in the laboratory and not in the field.

Corresponding Skills and Standards for the Student

- 1.6.0 Organizes and reports the results of scientific investigations in an honest and objective manner.
- 1.6.3 Assumes responsibility for reporting results in an honest and objective manner.
- 1.8.2 Applies science problem-solving techniques in everyday life situations.
- 4.1.3 Evaluates procedures in the inquiry process that have been omitted or inadequately performed.

Content

Corresponding Skills and Standards for the Student

- A. Safety is a necessary requirement.
- Ask your students the following:
- Do you know how to handle dangerous chemicals, fires, electrical circuits, gas, chemical spillage, and clean-up?
 - Do you know that broken glass is treacherous?
 - Do you know how to eliminate danger in the lab and maintain a high level of motivation?
 - What is the appropriate first aid in any of the above situations?
- B. The data collected must be accurate, both quantitatively and qualitatively.
- Ask your students the following:
- Do you know what changes are to be observed - e.g., precipitate, color, amount, vapor, size, shape, texture of specimens, and other identifying marks?
 - What is qualitative change versus quantitative change?
- Qualitative change is easier to handle in the lab than is quantitative change. However, once the student crosses the number manipulation barrier, the teacher may well be able to handle quantitative experiments.

- 2.1.1 Examines objects carefully, using a combination of senses to collect and process data; derives meaning from the observation; recognizes the need to use simple instruments to aid the senses in collecting data.
- 2.1.2 Determines the need to repeat observations as a means of improving reliability.
- 2.1.3 Uses measurement procedures to improve accuracy of observations.
- 2.1.4 Identifies changes in properties and rates of change.
- 3.1.1 Manipulates simple materials, apparatus, and equipment in a safe manner.

ContentCorresponding Skills and Standards for the Student

- 3.5.2 Tabulates information and uses tables.
- 3.7.0 Uses the metric system effectively.
- 3.7.1 Counts, uses numbers, and balances objects on an equal-arm balance scale.
- 3.7.2 Measures linear distances, using a metric ruler.
- 3.7.3 Uses a balance to determine the mass of objects.
- 3.7.4 Measures volume of liquids in a graduated cylinder marked in metric units.

C. Acceptance or rejection of the hypothesis is based upon data analysis.

1. Use a null hypothesis on occasion.
2. Instruct students to make a comparison based upon use of the null hypothesis.

ContentCorresponding Skills and Standards for the Student

D. Results of experiments must be recorded and communicated.

Each student is a scientist, albeit a beginning one. He or she can think in formal patterns. A method for developing and communicating results of any experiment is to have students prepare and present the results of experiments in the format of a scientific meeting. Papers are written and then presented orally. This approach will work well only if there is a variety of in the experiments and a diversity of variables. Look for the use of the simple, short, declarative sentence. Students can make use of this type of sentence most effectively in writing descriptions of results. Speaking, listening, reading, and writing are language skills that must all be emphasized in this segment. Of the language skills, writing is the most analytical because it provides graphic representation of mind processes.

E. Appropriate mathematical concepts must be used, including that of the metric system.

Encouraging students to function at the qualitative level in initial concept exploration, aids them in becoming generally more willing to deal with mathematical concepts. In this course these concepts would relate to measurement, ratio, and percentages.

3.6.0 Communicates with others in a manner that is consistent with knowledge.

3.6.2 Explains, either orally or in writing, the methods and procedures involved in carrying out an investigation.

3.5.3 Interprets graphs and displays data graphically.

3.7.0 Uses the metric system effectively.

3.8.0 Applies appropriate mathematical concepts and skills in interpreting data and in solving problems.

3.8.1 Calculates rates from data.

Content

Corresponding Skills and Standards for the Student

The following concepts can be reinforced: measurement in both metric and English systems; units of volume; length; mass; temperature; percentage error; ratio and proportion; graphing; and other visual display methods that are based upon mathematics.

F. Analysis of data must be consistent with conclusions.

Here the teacher and the student are dealing with the thinking processes that permit correlation of observation with known physical principles. Remember that error is going to occur. The student must always be placed in the position of having to deal with real belief systems and to examine the information in relationship with the known values.

Often the teacher can only determine the source of error by talking with the students. The errors may not always relate to arithmetic, but may in fact be intuitive. The teacher can set an admirable model by using the simple words: "I don't know." These words are the essence of science when followed by: "Let's find out!"

4.2.0 Demonstrates understanding of basic generalizations, relationships, and principles.

ContentVI. Library and Research Skills for Investigating Topics of Scientific Interest

- A. The librarian, as a resource person, assists the teacher in selecting appropriate reading material for students.
- B. Reference materials are effective tools to help students reinforce knowledge and skills learned in other classes.
- C. Recent scientific journals, periodicals, newspapers, and science fiction should be available. Often the work of outstanding science fiction writers, such as Madeleine L'Engle, will cause students to pursue a topic with great interest.
- D. Expert opinion is a research tool. The teacher is a readily available expert. If possible, the teacher should also maintain a small resource library. Dictionaries, science encyclopedias, and the Time-Life books are among valuable resources.

Corresponding Skills and Standards for the Student

- 1.5.2 Examines a variety of alternative viewpoints on scientific issues to form opinions about them.
- 1.8.2 Applies science problem-solving techniques in everyday life situations.
- 3.4.0 Gathers needed information which has been generated by others, from a variety of sources appropriate to his or her ability level.
- 3.4.1 Listens to the ideas of others.
- 3.4.2 Gathers information from science textbooks, reference materials, films, and television.
- 3.4.3 Finds sources of information needed to solve a problem related to a specific topic.

ContentCorresponding Skills and Standards for the StudentVII. Providing Opportunities for Students to Correct Misconceptions

Learning about science is a hands-on experience that utilizes formal thought processes. Too frequently, however, instruction in science is separated from learning in other fields. Basic skills learned in other fields must be integrated with instruction in science.

Biology AB provides an opportunity for introduction of information about minorities, women, and handicapped individuals who have overcome barriers to succeed in science.

Students have dealt with the need to resolve questions about biological events, but often incorrectly. The teacher's task is to correct these misconceptions in order to help students develop scientific literacy.

LABORATORY REPORT

The following steps should be included in the preparation of a typical laboratory report. Teachers are encouraged to adapt this form to meet the individual needs of the students.

I. TITLE

Example: The Compound Microscope

II. PURPOSE OR STATEMENT OF THE PROBLEM

Example: The purpose of this investigation is to observe and record specific data about various organisms.

III. HYPOTHESIS

A statement of a hypothesis is useful for experimental investigations.
Example: Light is not a factor involved in plant growth.

IV. MATERIALS

V. PROCEDURE

A step-by-step account of the procedures used in the investigation should be listed.

VI. DATA

The data may be presented in written or graphic form.

VII. ANALYSIS OF RESULTS

Any mathematical treatments need to be described in detail.

III. CONCLUSIONS

The conclusions include several considerations:

- A. Whether the hypothesis was supported or rejected.
- B. The investigator's opinion concerning the data and the results.
- C. Limitations encountered or provided for.
- D. Suggestions for further investigation.

UNIT ONE: WHAT IS BIOLOGY?

Representative Objectives for the Unit

In accordance with his or her present capacities, the student will grow in ability to:

- Appreciate the importance of technological advances in the biological sciences.
- Use scientific methods in solving problems related to living things.
- Gather, tabulate, and organize pertinent data from a laboratory investigation.
- Apply methods of mathematical analysis to biological investigations.
- Identify factors that may influence a given biological interaction.
- Describe the life processes which are essential to all organisms.

Content

- I. Biology is the science that deals with living things.
 - A. The study of biological science has made a tremendous contribution to:
 1. Helping people live longer and healthier lives.
 2. Modern medicine.
 3. The conquest of many diseases.

Corresponding Skills and Standards for the Student

- 1.2.0 Recognizes and reports evidence of order and symmetry in the environment.
- 1.4.0 Takes an active role in solving social problems related to science and technology.
- 1.10.0 Considers science-related careers and makes realistic decisions about preparing for such careers, taking into account abilities, interests, and preparation required.
- 1.10.1 Values the abilities, interests, and preparation required for a science-related career.
- 1.10.2 Assumes responsibility for making a realistic decision about the pursuit of a science-related career.

Content

Corresponding Skills and Standards for the Student

MCS 5 Appreciates the commonality and diversity of animal behavior and distinguishes between inborn and acquired characteristics.

MCS 6 Understands specific behaviors inherent to humans.

MCS 16 Understands that ecology consists of studying how communities of living things interact with and depend upon each other and the physical environment, and that conservation consists of attitudes and actions by man to preserve the natural state of ecosystems.

II. Biological science has assumed a position of enormous importance in modern society. many decisions affecting our future depend upon appropriate interpretations of technological advances in the biological sciences.

A. Some of the special fields of biological science are listed below:

1. Botany - The study of plant life.
2. Zoology - The study of animals.
3. Anatomy - The study of external and internal structures of organisms.
4. Physiology - The study of how organisms carry on their life processes and how they function.
5. Cell Biology - The study of structure and activities of living cells.

1.1.0 Shows curiosity about objects and events.

1.3.0 Appreciates and respects all living organisms, including self and his or her relationship to the environment.

1.4.0 Takes an active role in solving social problems related to science and technology.

Content

- 6. Microbiology - The study of organisms too small to be seen without a microscope.
- 7. Biochemistry - The study of the chemical make-up and processes of organisms.
- 8. Genetics - The study of heredity.
- 9. Ecology - The study of organisms, their interaction with each other, and their environment.
- 10. Evolutionary Biology - The study of how organisms have changed through time.

Corresponding Skills and Standards for the Student

1.10.0 Considers science-related careers and makes realistic decisions about preparing for such careers, taking into account abilities, interests, and preparation required.

1.10.1 Values the abilities, interests, and preparation required for a science-related career.

MCS 1 Understands the structures and function of cells and cell components. This would include a knowledge of the structure and function of the nucleus and the cytoplasm as well as the similarities and differences between plant and animal cells.

MCS 2 Understands the interrelationships among tissues, organs, and systems: cells make up tissues, tissues make up organs, and organs make up systems.

MCS 3 Understands that organisms are categorized by scientists according to similarities and differences in the structure and function of the individual organisms.

MCS 5 Appreciates the commonality and diversity of animal behavior and distinguish between inborn and acquired characteristics.

MCS 9 Understands the complexity of plant development and differentiation.

ContentCorresponding Skills and Standards for the Student

- MCS 15 Understands the theories of evolution, the diversity of life possible through the process of natural selection and mutation; and are aware of the changes that have taken and are taking place in life on earth.
- MCS 16 Understands that ecology consists of studying how communities of living things interact with and depend upon each other and the physical, environment, and that conservation consists of attitudes and actions by man to preserve the natural state of ecosystems.
- MCS 17 Appreciates the importance of technological advances in the fields of agriculture and medicine.
- 4.4.1 Compares the work performed by persons in science occupations
- 4.5.0 Demonstrates knowledge of contributions to science and technology made by men and women of various races and nationalities.
- MCS 17 Appreciate the importance of technological advances in the fields of agriculture and medicine.
- III. Many important biological discoveries have started with a single careful observation.
- A. Alexander Fleming's discovery of penicillin is an example of how a careful observation led to an important biological discovery.

BIOLOGY AB

INSTRUCTIONAL UNIT ONE

ContentCorresponding Skills and Standards for the Student(Introduction to Skills IV: The Scientific Method)

IV. Advances in biological science have been achieved by careful observations, using the scientific method, and applying technologic advances.

A. Many different procedures are part of the scientific method. All of these procedures draw on the following series of logical steps:

1. Defining the problem.
2. Gathering background information.
3. Forming a hypothesis.
4. Testing the hypothesis (experimentation).
5. Recording observations.
6. Forming conclusions.

V. Even though it is difficult to define life, all living organisms have a number of characteristics which nonliving systems do not have. The main features of living organisms include:

- A. Living things are highly ordered.
1. All living matter is produced from simple, nonliving materials.
 2. Every living cell is a highly complex chemical system.
 3. A cell controls and regulates its own activities.

4.0.0 Knowledge.

4.1.0 Demonstrates knowledge of the processes of scientific inquiry.

MCS 17 Appreciates the importance of technological advances in the fields of agriculture and medicine.

(Sample Lesson I: Scientific Method)

4.8.1 Recognizes that a cell is the basic unit of structure and function of a living organism.

4.8.2 Recognizes that all living organisms have the same life processes.

MCS 1 Understands the structures and function of cells and cell components. This would include a knowledge of the structure and function of the nucleus and the cytoplasm as well as the similarities and differences between plant and animal cells.

ContentCorresponding Skills and Standards for the Student

- MCS 4 Identifies roles of animals, plants and protists in web of life.
- MCS 9 Understands the complexity of animal or plant development and differentiation.
- MCS 11 Understands that photosynthesis is the process by which light energy from the sun is used to convert carbon dioxide and water into sugars, storing energy and releasing oxygen, thus renewing the supply of atmospheric oxygen.

(Introduction to Skills VI: Library and Research Skills to Investigate Topics of Topics of Scientific Interest)

- B. Living things take energy from their environment.
1. Living things require energy to stay organized.
 2. Green plants capture the energy of sunlight.
 3. Other organisms get their energy from green plants.
- C. Living things respond actively to their environment.
1. The ability to respond to stimuli is typical of all living organisms.

- 4.8.5 Recognizes that the sun is the source of energy for green plants and is basic to the growth and maintenance of living organisms.
- 4.8.6 Recognizes the importance of energy levels as related to ecosystems.
- 4.8.4 Understands and describes living organisms that grow and develop in different environments.

ContentCorresponding Skills and Standards for the Student

- D. Living things are adapted to their environment.
1. Any change in an organism that makes it better suited to its environment is called adaptation.
- E. Living things develop and grow.
1. The development of a living thing includes all the changes that it undergoes as it matures.
 2. Growth always takes place in a certain way, which is specific for each organism.
- F. Living things reproduce themselves.
1. Reproduction is necessary for the continued existence of a species.
 2. Different species reproduce at different rates. Some bacteria reproduce once every 209 minutes, while some plants reproduce once in a century.

UNIT TWO: THE CELL

Representative Objectives for the Unit:

In accordance with his or her present abilities, the student will grow in ability to:

- Recognize the cell as the unit of structure and function of all living things.
- Compare and contrast animal and plant cells.
- Compare and contrast prokaryote and eukaryote cells.
- Distinguish between different kinds of cells.
- Analyze the chemical processes of the cell.
- Identify the processes of cell division.
- Describe the processes of osmosis, diffusion, and active transport.
- Demonstrate the process of osmosis.
- Identify and describe science-related careers.

Content

- I. The cell theory states that all organisms are made of cells, and all cells come from other cells.

Corresponding Skills and Standards for the Student

- 1.8.1 Attempts spontaneously to describe an object or event that has attracted his or her attention.
- MCS 1 Understands the structures and function of cells and cell components. This would include a knowledge of the structure and function of the nucleus and the cytoplasm as well as the similarities and differences between plant and animal cells.
- 2.2.2 Develops arbitrary classification systems wherein objects can be put into mutually exclusive categories; uses quantitative measurements as criteria for grouping.

Content

Corresponding Skills and Standards for the Student

4.8.1 Recognizes that a cell is the basic unit of structure and function of a living organism.

4.8.9 Recognizes that a living organism is a product of its heredity and environment.

(Introduction to Skills IV: The Scientific Method)

II. The plasma is composed of distinct parts, or organelles, each of which performs a function for cell survival.

3.2.2 Provides an environment for plant and animal life that is conducive to the support of normal life functions.

A. The cell membrane covers the cell and controls passage of materials in and out.

3.4.2 Gathers information from science textbooks, reference materials, science films, and television.

B. The endoplasmic reticulum is a highway for cell materials and a warehouse for cell chemicals.

4.8.1 Recognizes that a cell is the basic unit of structure and function of a living organism.

C. The mitochondria process energy for the cell.

4.8.2 Recognizes that all living organisms have the same life processes.

1. Mitochondria are believed to have a genetic heritage separate from the cell.

4.8.3 Demonstrates a basic knowledge of the structures and functions of the human organism.

2. Mitochondria use the energy of glucose to make ATP.

4.8.10 Recognizes that all forms of life are composed of the same elements in different DNA blueprints.

D. Ribosomes are factory sites for protein synthesis.

E. The Golgi bodies add lipids and package proteins.

Content

- F. Vacuoles are used for cell storage and for digestion of food particles.
- G. Lysosomes store enzymes for extracellular digestion and digestion of the cell itself.
- H. Microtubules and microfilaments are an internal skeleton for the cell.
- I. Chloroplasts change light energy to chemical energy.
- J. Nuclei contain chromosomes which are the ultimate directors of most cell activities.
1. Chromosomes contain DNA.
 2. Chromosomal DNA is copied into RNA, which then directs the manufacture of protein.
- K. Flagella and cilia allow cells to move.
- L. Cilia produce centrioles in animal cells.
- L. Plant cells have cell walls. Animal cells have only a membrane covering.

Corresponding Skills and Standards for the Student

- MCS 1 Understands the structures and function of cells and cell components. This would include a knowledge of the structure and function of the nucleus and the cytoplasm as well as the similarities and differences between plant and animal cells.

(Introduction to Skills VI: Library and Research Skills for Investigating Topics of Scientific Interest)

Content

- III. The cell membrane controls the passage of materials into and out of the cell.
- A. Diffusion is the movement of chemicals from an area of greater concentration to an area of lesser concentration.
 - B. Osmosis is the movement of water molecules across a membrane from an area of greater water concentration to an area of lesser water concentration.
 - C. Active transport is an energy-using process which allows the cell to bring chemicals into or push chemicals out of the cell against the natural flow of osmosis and diffusion or across a membrane normally impermeable to that chemical.

Corresponding Skills and Standards for the Student

- 2.1.4 Identifies changes in properties and rates of change.
- 2.2.1 Perceives similarities and differences in a set of objects, separates a set into groups according to a single characteristic.
- MCS 1 Understands the structures and function of cells and cell components. This would include a knowledge of the structure and function of the nucleus and the cytoplasm as well as similarities and differences between plant and animal cells.
- 4.1.2 Matches names of various processes and products of scientific inquiry with examples.

(Sample Lesson Two: The Egg)

- 4.2.12 Recognizes that classification systems are developed by humans for the use of humans and that they are one way of helping to understand the basic organization and pattern of nature.
- 4.8.11 Understands the relationships of structure and function of living organisms to their environment.

ContentCorresponding Skills and Standards for the Student(Introduction to Skills V: Responsible Laboratory Activities)

- IV. The cell processes energy for its growth and development.
- A. Fermentation, or anaerobic respiration, is a less efficient process than aerobic respiration.
- B. Respiration in the mitochondria involves many chemical steps.
1. The Krebs cycle describes the steps in respiration.
 2. The Krebs cycle begins with glucose and produces carbon dioxide and water plus energy. Most energy from glycolysis and the Krebs cycle is transformed into ATP in the respiratory chain or electron transport system.

4.8.2 Recognizes that all living organisms have the same life processes.

4.8.7 Recognizes that living organisms utilize matter and return it to the environment.

MCS 1 Understands the structures and function of cells and cell components. This would include a knowledge of the structure and function of the nucleus and the cytoplasm as well as the similarities and differences between plant and animal cells.

MCS 10 Understands the factors necessary to sustain plant life. Students will become aware of the complexity and variety of plant processes, some of which are exploited in the field of agriculture and horticulture.

MCS 11 Understands that photosynthesis is the process by which light energy from the sun is used to convert carbon dioxide and water into sugars, storing energy and releasing oxygen, thus renewing the supply of atmospheric oxygen.

Content

Corresponding Skills and Standards for the Student

- V. The cell produces proteins.
 - A. DNA is the master template for RNA.
 - B. RNA is assembled in the nucleolus and then travels to the ribosomes.
 - C. In the ribosomes, varieties of RNA direct the synthesis of proteins from amino acids.

4.8.4 Understands and describes living organisms that grow and develop in different environments.

4.8.9 Recognizes that a living organism is a product of its heredity and environment.

4.8.10 Recognizes that all forms of life are composed of the same elements in different DNA blueprints.

MCS 1 Understands the structures and function of cells and cell components. This would include a knowledge of the structure and function of the nucleus and the cytoplasm as well as the similarities and differences between plant and animal cells.

VI. Mitosis enables cells to make copies of themselves.

4.8.1 Recognizes that a cell is the basic unit of structure and function of a living organism.

4.8.4 Understands and describes living organisms that grow and develop in different environments.

MCS 12 Identifies the processes of mitosis, meiosis, and the rules of DNA and RNA in the replication of cells and in the reproduction of organisms.

Content

Corresponding Skills and Standards for the Student

MCS 13 Understands the structure and function of the reproductive systems of plants and animals, including the role of hormones and auxins.

MCS 14 Understands the principles of genetics and heredity: the passing of traits from parents to offspring.

MCS 15 Understands the theories of evolution, the diversity of life possible through the process of natural selection and mutation, and is aware of the changes that are taking place in life on earth.

(Introduction to Skills VII: Providing Opportunities or Students to Correct Misconceptions)

VII. Many occupations involve the study of cells.

A. Laboratory technicians study cells.

B. A histologist is a scientist who specializes in cells and cell structures.

C. An electron microscope technician prepares specimens and makes pictures of cells and cell parts.

4.4.1 Compares the work performed by persons in related biological science occupations.

4.4.2 Identifies ways in which careers are science-related.

MCS 17 Appreciates the importance of technological advances in the fields of agriculture and medicine.

UNIT THREE: PRINCIPLES OF TAXONOMY

Representative Objectives for the Unit:

In accordance with his or her present capacities, the student will grow in the ability to:

- Describe systems of classification used to sort groups of objects.
- Demonstrate the use of a classification system based on observable characteristics.
- List the steps in the modern binomial system of taxonomy.
- Recognize that all classification systems are based on inherited characteristics.
- Criticize the various schemes for classifying kingdoms.
- Evaluate the relevance of using DNA similarities as a basis for classification.

Content

Corresponding Skills and Standards for the Student

- | | |
|---|---|
| <p>I. Classifying living things is a necessary activity in the study of life.</p> <p>A. In order to study and use organisms, it is necessary that all people recognize them by the same names.</p> <p>B. People in every country of the world recognize the same name for each species.</p> <p>C. Civil laws are written using the scientific names for organisms because those names are universally recognized.</p> | <p>2.2.0 Develops ability to organize data by comparing, classifying, relating, and ordering.</p> <p>4.2.11 Describes systems of classification used to sort a group of miscellaneous objects.</p> <p>4.2.12 Recognizes that classification systems are developed by humans for the use of humans and are one way of helping to understand the basic organization and pattern of nature.</p> <p>MCS 3 Understands that organisms are categorized by scientists according to similarities and differences in the structure and function of the individual organisms.</p> |
|---|---|



Content

- II. Linnaeus founded the modern system of classification.
- A. Every kind of organism is given two names: a genus name which is shared by other closely related species, and a species or specific name.
 - B. All the genus and species names in the system are Latin or Latinized and printed in italic type or underlined.
 - C. The classification system concerns the division of larger groups into smaller and smaller groups.
 - 1. Kingdoms are divided into phyla.
 - 2. Phyla are divided into classes.
 - 3. Classes are divided into orders.
 - 4. Orders are divided into families.
 - 5. Families are divided into genera.
 - 6. Genera are divided into species.

Corresponding Skills and Standards for the Student

- 2.1.1 Examines objects carefully, using a combination of the senses to collect and process data; derives meaning from the observation; recognizes the need to use simple instruments to aid the senses in collecting data.
- 4.2.10 Identifies pairs of objects having similar properties.
- 4.2.11 Describes systems of classification used to sort a group of miscellaneous objects.
- 4.2.12 Recognizes that classification systems are developed by humans for the use of humans and are one way of helping to understand the basic organization and pattern of nature.
- MCS 3 Understands that organisms are categorized by scientists according to similarities and differences in the structure and function of the individual organisms.

ContentCorresponding Skills and Standards for the Student(Introduction to Skills IV: The Scientific Method)

III. Classification is theoretically based on inherited characteristics.

A. It is very difficult to define the concept of species.

1. Members of the same species should produce fertile offspring when mated.
2. Time, distance, and geographic obstacles to contact break down the unity of a species.

B. New techniques of classifying organisms include comparing the number of points at which the DNA of two species is the same.

C. Similar structures in organisms are used to show relationships between the organisms and are reflected in their taxonomy.

1. Analogous organs in different organisms are similar in function, but do not develop from common structures.

2. Homologous organs are similar in origin and structure but may differ in function.

2.2.1 Perceives similarities and differences in a set of objects; separates a set into groups according to a single characteristic.

2.2.2 Develops arbitrary classification systems wherein objects can be put into mutually exclusive categories; uses quantitative measurements as criteria for grouping.

(Sample Lesson III: Using a Dichotomous Key)

4.2.12 Recognizes that classification systems are developed by humans for the use of humans and are one way of helping to understand the basic organization and pattern of nature.

MCS 3 Understands that organisms are categorized by scientists according to similarities and differences in the structure and function of the individual organisms.

MCS 5 Appreciates the commonality and diversity of animal behavior and distinguishes between inborn and acquired characteristics.

MCS 6 Understands specific behaviors inherent to humans.

ContentCorresponding Skills and Standards for the Student

MCS 12 Identifies the processes of mitosis, meiosis, and the rules of DNA and RNA in the replication of cells and in the reproduction of organisms.

MCS 14 Understands the principles of genetics and heredity: the passing of traits from parents to offspring.

(Introduction to Skills VII: Providing Opportunities for Students to Correct Misconceptions)

IV. All scientists do not agree on how to organize the groups of organisms.

A. "Lumpers" put many groups together to show their common characteristics, and "splitters" separate groups into many small divisions to show differences.

B. The two-kingdom system separates all organisms into Plant and Animal kingdoms.

C. The three-kingdom system separates all organisms into Plant, Animal, and Protist kingdoms.

D. The five-kingdom system separates all organisms into Plant, Animal, Protist, Fungi, and Monera kingdoms.

3.3.1 Makes purposeful, objective observations.

3.4.3 Finds sources of information needed to solve a problem related to a specific topic.

4.2.12 Recognizes that classification systems are developed by humans for the use of humans, and are one way of helping to understand the basic organization and pattern of nature.

MCS 3 Understands that organisms are categorized by scientists according to similarities and differences in the structure and function of the individual organisms.

MCS 5 Appreciates the commonality and diversity of animal behavior and distinguishes between inborn and acquired characteristics.

BIOLOGY AB

INSTRUCTIONAL UNIT THREE

Content

V. Jobs such as plant quarantine officer and food inspector require a knowledge of taxonomy.

Corresponding Skills and Standards for the Student(Introduction to Skills IV: The Scientific Method)

- 1.10.1 Values the abilities, interests, and preparation required for a science-related career.
- 1.10.2 Assumes responsibility for making a realistic decision about the pursuit of a science-related career.
- 4.4.2 Identifies ways in which careers are science-related.
- MCS 17 Appreciates the importance of technological advances in the fields of agriculture and medicine.

UNIT FOUR: THE VIRUSES, MONERA, PROTISTA, AND FUNGI:
THEIR CLASSIFICATION, STRUCTURE, AND FUNCTIONRepresentative Objectives for the Unit:

In accordance with his or her present capacities, the student will grow in ability to:

- Describe the characteristics of monera, protista, and fungi.
- Assess the ways in which the monera, protista, and fungi affect other living things.
- Discuss the life cycle of the virus.
- Distinguish between those organisms classified as monera, protista, and fungi.
- Report on products of fungi and bacteria which benefit people.
- Appraise the differences between prokaryotes and eukaryotes.
- Recognize career options in microbiology.

ContentCorresponding Skills and Standards for the Student

- | | |
|---|--|
| <p>I. The viruses are submicroscopic particles that use the cells of organisms to reproduce.</p> <p>A. Viruses are composed of a protein coat and a strand of DNA or RNA.</p> <p>B. Viruses infect all kinds of cells.</p> <p>C. Viruses are responsible for many diseases.</p> <p>D. Viruses are on the borderline between living and nonliving organisms.</p> | <p>2.1.1 Examines objects carefully, using a combination of the senses to collect and process data; derives meaning from the observation; recognizes the need to use simple instruments to aid the senses in collecting data.</p> <p>2.2.1 Perceives similarities and differences in a set of objects; separates a set into groups according to a single characteristic.</p> <p>4.8.1 Recognizes that a cell is the basic unit of structure and function of a living organism.</p> |
|---|--|

Content

Corresponding Skills and Standards for the Student

MCS 1 Understands the structures and function of cells and cell components. This would include a knowledge of the structure and function of the nucleus and the cytoplasm as well as the similarities and differences between plant and animal cells.

MCS 3 Understands that organisms are categorized by scientists according to similarities and differences in the structure and function of the individual organisms.

MCS 17 Appreciates the importance of technological advances in the fields of agriculture and medicine.

(Introduction to Skills VI: Library and Research Skills to Investigate Topics of Scientific Interest)

- II. Monerans are microscopic one-celled prokaryotes. The moneran group consists of bacteria and blue-green algae.
 - A. Some blue-green algae, although simple in structure, inhabit almost every habitat on Earth.
 - 1. Blue-green algae use atmospheric nitrogen and need only a few minerals. They are photosynthetic.
 - 2. Some blue-green algae are enclosed in a jelly-like capsule.

2.1.4 Identifies changes in properties and rates of change.

4.8.2 Recognizes that all living organisms have the same life processes.

4.8.4 Understands and describes living organisms that grow and develop in different environments.

MCS 3 Understands that organisms are categorized by scientists according to similarities and differences in the structure and function of the individual organisms.

ContentCorresponding Skills and Standards for the Student

MCS 4 Identifies roles of animals, plants, and protists in the web of life.

MCS 11 Understands that photosynthesis is the process by which light energy from the sun is used to convert carbon dioxide and water into sugars, storing energy and releasing oxygen, thus renewing the supply of atmospheric oxygen.

MCS 17 Appreciates the importance of technological advances in the fields of agriculture and medicine.

(Sample Lesson IV: Bacteria)

B. Bacteria are everywhere. They have many different modes of living from highly specific parasites to autotrophs.

1. Bacteria cause many diseases.
2. Beneficial bacteria are responsible for the production of many of the foods we eat and materials we use including those produced by genetic engineering.
3. Bacteria help furnish the world with usable nitrogen.
4. In addition to a single chromosome, many bacteria have small bits of DNA called plasmids.
5. Bacteria mutate to form new varieties which may be helpful or harmful to people.

ContentCorresponding Skills and Standards for the Student

- III. The protista are microscopic, one-celled eucaryotes.
- A. The simple algae are one-celled organisms. They include the diatoms, and the dinoflagellates, which produce "red tide."
 - B. The protists are single-celled or colonial forms which include the euglena, amoeba, paramecium, and sporozoans.
 - C. The slime molds are protists which have a life cycle that includes both an ameboid form and a form in which there is a multinucleate mass.
- IV. The fungi are nonmotile, have no chlorophyll, and are either saprophytes or parasites.
- A. The fungi group consists of molds, rusts, mildews, mushrooms, and yeasts.
 - B. The body of the fungi consists of thread-like mycelia and fruiting bodies.

- 4.2.11 Describes systems of classification used to sort a group of miscellaneous objects:
- 4.8.2 Recognizes that all living organisms have the same life processes.
- 4.8.4 Understands and describes living organisms that grow and develop in different environments.
- MCS 3 Understands that organisms are categorized by scientists according to similarities and differences in the structure and function of the individual organisms.
- MCS 4 Identifies roles of animals, plants, and protists in the web of life.
- 4.2.10 Identifies pairs of objects having similar properties.
- 4.8.2 Recognizes that all living organisms have the same life processes.
- 4.8.4 Understands and describes living organisms that grow and develop in different environments.

Content

- C. Many members of the fungi are responsible for returning the chemicals found in living things back to the environment.
- D. Many of the products people eat and use are produced by the fungi.
- F. Many diseases of animals and plants are caused by fungi.
- V. Lichens are a combination of a fungus and an alga.
 - A. Lichens are found in even the harshest environments.
 - B. Lichens are the colonizers of new lands.

Corresponding Skills and Standards for the Student

- | | |
|--------|---|
| MCS 3 | Understands that organisms are categorized by scientists according to similarities and differences in the structure and function of the individual organisms. |
| MCS 4 | Identifies roles of animals, plants, and protists in the web of life. |
| 4.2.10 | Identifies pairs of objects having similar properties. |
| 4.8.2 | Recognizes that all living organisms have the same life processes. |
| MCS 3 | Understands that organisms are categorized by scientists according to similarities and differences in the structure and function of the individual organisms. |
| MCS 4 | Identifies roles of animals, plants, and protists in the web of life. |

Content

Corresponding Skills and Standards for the Student

(Introduction to Skills VII: Providing Opportunities for Students to Correct Misconceptions)

- VI. There are many possible careers in microbiology and medical technology.
 - A. Laboratory technicians make tests to determine the presence or absence of bacteria in samples of body fluids or feces taken from patients.
 - B. Doctors diagnose and treat diseases, some of which are caused by micro-organisms.
 - C. Public health workers design strategies for prevention of disease caused by bacteria, viruses, and protists.
 - D. Commercial microbiologists make products which are useful to all of society.
 - E. Pharmaceutical industry employees include many microbiologists.
 - F. The space industry, soap makers, toy makers, and the food industry all need the expert services of microbiologists and technicians.

- 4.3.1 Gives examples of ways in which the use of scientific knowledge has affected society.
- 4.4.0 Demonstrates knowledge of science-related career opportunities and the preparations needed.
- 4.4.1 Compares the work performed by persons in science occupations.
- 4.6.0 Demonstrates knowledge of the relationships of science to other areas of human endeavor.
- MCS 17 Appreciates the importance of technological advances in the fields of agriculture and medicine.

UNIT FIVE: THE PLANTS: THEIR
CLASSIFICATION, STRUCTURE, AND FUNCTION

Representative Objectives for the Unit:

In accordance with his or her present capacities, the student will grow in ability to:

- Recognize that groupings of plants are based on structural characteristics which serve to facilitate the study of plants.
- Identify similarities of structure and function among various plant groups.
- Relate the major structural features of plants with their functions.
- Describe the steps in photosynthesis.
- Assess the methods of plant reproduction.
- Evaluate and describe science-related careers.
- Examine the variety of fruits and nuts.
- List methods of seed dispersal.

Content

- I. Plants are distinguished by their ability to carry on photosynthesis. They are generally nonmotile.
 - A. The nonvascular plants have no tubes to distribute food and water. They are usually quite small.
 1. Green algae have cells which are very much like those in higher plants. Some species are colonial, which is a bridge between unicellular and multicellular organization.
 2. Brown algae are the commonly seen seaweeds. Brown algae form the Sargasso Sea.
 3. A red alga is the source of agar.

Corresponding Skills and Standards for the Student

- 1.2.1 Relates classification to everyday life situations.
- 2.2.1 Perceives similarities and differences in a set of objects; separates a set into groups according to a single characteristic.
- 2.2.2 Develops arbitrary classification systems wherein objects can be put into mutually exclusive categories; uses quantitative measurements as criteria for grouping.

Content

Corresponding Skills and Standards for the Student

4. The bryophytes are mosses and liverworts. They are small and live on land or in bogs and swamps.

4.8.11 Understands relationships of structure and function of living organisms to their environment.

B. The tracheophytes have a system of tubing to carry water and food to all parts of the plant. They typically have root, stem, and leaf structures.

MCS 3 Understands that organisms are categorized by scientists according to similarities and differences in the structure and function of the individual organisms.

1. Club mosses and horsetails are primitive tracheophytes.
2. Ferns were the food of plant-eating dinosaurs. The sexual reproduction of ferns requires the transfer of gametes through water. The asexual reproduction of ferns involves spores.
3. The gymnosperms produce seed in cones and have needle-like leaves.
4. The angiosperms produce flowers and have seeds which are found within fruits. Many angiosperms are dependent on insects or their vectors for transfer of gametes.
 - a. The monocots produce seeds with one cotyledon.
 - b. The dicots produce seeds with two cotyledons.

3.2.1 Handles plants and animals carefully, following suggested procedures.

3.2.2 Provides an environment for plant and animal life that is conducive to the support of normal life functions.

ContentCorresponding Skills and Standards for the Student(Introduction to Skills VI: Library and Research Skills For Investigating Topics of Scientific Interest)

- | | |
|---|---|
| <p>II. Plants have important structures which allow them to survive.</p> <p>A. Roots allow the plant to have access to water and to maintain an upright posture.</p> <p>B. The stem provides a bridge between the root and the leaves.</p> <p>C. Leaves are the major organs of a plant where photosynthesis takes place.</p> <p>D. Flowers are specialized structures adapted for sexual reproduction of plants.</p> <p>E. Plants have highly developed seeds and fruits which enable species to maintain and enlarge their habitat.</p> | <p>3.3.0 Gathers the information needed for developing or testing inferences and hypotheses by making purposeful, objective observations of things and events.</p> <p>3.4.2 Gathers information from science textbooks, reference materials, science films, and television.</p> <p>4.8.0 Demonstrates general knowledge of science.</p> <p>4.8.1 Recognizes that a cell is the basic unit of structure and function of a living organism.</p> <p>4.8.2 Recognizes that all living organisms have the same life processes.</p> <p>4.8.3 Demonstrates a basic knowledge of the structures and functions of the human organism.</p> <p>4.8.4 Understands and describes living organisms that grow and develop in different environments.</p> <p>4.8.5 Recognizes that the sun is the source of energy for green plants and is basic to the growth and maintenance of living organisms.</p> |
|---|---|

ContentCorresponding Skills and Standards for the Student

- 4.8.6 Recognizes the importance of energy levels as related to ecosystems.
- 4.8.7 Recognizes that living organisms utilize matter and return it to the environment.
- 4.8.9 Recognizes that a living organism is a product of its heredity and environment.
- 4.8.10 Recognizes that all forms of life are composed of the same elements in different DNA blueprints.
- 4.8.11 Understands relationships of structure and function of living organisms to their environment.
- 4.8.12 Recognizes that living organisms have changed over the ages and that some species are now extinct.
- MCS 9 Understands the complexity of animal or plant development and differentiation.
- MCS 10 Understands the factors necessary to sustain plant life. Students will become aware of the complexity and variety of plant processes, some of which are exploited in the field of agriculture and horticulture.
- MCS 11 Understands that photosynthesis is the process by which light energy from the sun is used to convert carbon dioxide and water into sugars, storing energy and releasing oxygen, thus renewing the supply of atmospheric oxygen.

Content

Corresponding Skills and Standards for the Student

(Introduction to Skills V: Responsible Laboratory Activities)

- III. Plants have developed specialized functions for survival.
- A. Plants convert solar energy to chemical energy.
 - 1. Photosynthesis is a chemical process involving many steps.
 - 2. Photosynthesis involves the use of carbon dioxide and water to make glucose.
 - 3. Photosynthesis makes glucose, which is the energy basis for the manufacture of all cell structures.
 - B. Tropisms are responses plants make to their environment.
 - C. Environmental factors limit growth.
 - 1. The limiting factors for plant survival:
 - a. Light
 - b. Water
 - c. Space
 - d. Minerals

- 4.3.3 Identifies types of data valuable in planning environmental changes.
- 4.8.5 Recognizes that the sun is the source of energy for green plants and is basic to the growth and maintenance of living organisms.
- MCS 9 Understands the complexity of animal or plant development and differentiation.
- MCS 10 Understands the factors necessary to sustain plant life. Students will become aware of the complexity and variety of plant processes, some of which are exploited in the field of agriculture and horticulture.
- MCS 11 Understands that photosynthesis is the process by which light energy from the sun is used to convert carbon dioxide and water into sugars, storing energy and releasing oxygen, thus renewing the supply of atmospheric oxygen.
- MCS 15 Understands the theories of evolution, the diversity of life possible through the process of natural selection and mutation and is aware of the changes that have been and are taking place in life on earth.

Content

Corresponding Skills and Standards for the Student

(Sample Lesson V: Plant Production of Oxygen)

(Introduction to Skills IV: The Scientific Method)

- IV. Reproduction enables a species to survive.
 - A. Alternation of generations can produce two distinct forms in one species.
 - B. Sexual reproduction mixes the genes in a gene pool and provides a basis for adaptation.
 - C. There are many adaptations for reproductive processes and seed dispersal.

- 4.8.9 Recognizes that a living organism is a product of its heredity and environment.
- 4.8.11 Understands relationships of structure and function of living organisms to their environment.
- 4.8.12 Recognizes that living organisms have changed over the ages and that some species are now extinct.

MCS 9 Understands the complexity of animal or plant development and differentiation.

MCS 12 Identifies the processes of mitosis, meiosis, and the rules of DNA and RNA in the replication of cells and in the reproduction of organisms.

MCS 14 Understands the principles of genetics and heredity: the passing of traits from parents to offspring.

MCS 15 Understands the theories of evolution, the diversity of life possible through the process of natural selection and mutation, and is aware of the changes that have and are taking place in life on earth.

ContentCorresponding Skills and Standards for the Student(Introduction to Skills VII: Providing Opportunities for Students to Correct Misconceptions)

- V. Many careers involve plants.
 - A. Plant pathologists study plant diseases.
 - B. Agricultural inspectors look for plant pests and diseases.
 - C. Farmers grow plants to provide food and fiber.
 - D. Nursery keepers maintain and grow plants for direct sale.
- 4.4.1 Compares the work performed by persons in science occupations.
- 4.4.2 Identifies ways in which careers are science-related.
- 4.5.1 Matches significant discoveries to persons responsible for them.
- 4.6.1 Identifies how modern techniques of determining the age of specimens contribute to knowledge of earlier civilizations.
- MCS 17 Appreciates the importance of technological advances in the fields of agriculture and medicine.

UNIT SIX: THE ANIMALS: THEIR
CLASSIFICATION, STRUCTURE, AND FUNCTION

Representative Objectives for the Unit:

In accordance with his or her present capacities, the student will grow in ability to:

- Recognize that groupings of animals are based on structural characteristics and serve to facilitate the study of animals.
- Identify similarities of structure and function among various animal groups which furnish evidence for evolutionary developmental patterns.
- Compare the major groups of animals.
- Describe the major organ systems of animals.
- Define the steps in respiration.
- Recognize related career options.

Content

- I. The animal kingdom is divided into major groups called phyla, based on similarities and differences in structural characteristics.
 - A. The invertebrates have no backbone and make up the majority of known animal species.
 1. The porifera are animals with a simple organizational system.
 2. The coelenterata have a sac-like digestive system and stinging cells located on tentacles.
 3. The worms are a group of phyla remarkable for their diversity in structure and niche.
 4. The mollusks are animals with soft bodies.

Corresponding Skills and Standards for the Student

- | | |
|-------|--|
| 2.1.1 | Examines objects carefully, using a combination of the senses to collect and process data; derives meaning from the observation; recognizes the need to use simple instruments to aid the senses in collecting data. |
| 2.2.1 | Perceives similarities and differences in a set of objects; separates a set into groups according to a single characteristic. |
| 2.2.2 | Develops arbitrary classification systems wherein objects can be put into mutually exclusive categories; uses quantitative measurements as criteria for grouping. |
| 3.2.1 | Handles plants and animals carefully, following suggested procedures. |

Content

5. The echinodermata are the spiny-skinned animals.
 6. The arthropods are animals with exoskeletons. There are more kinds of arthropods than there are of any other animal.
- B. The vertebrates are animals with backbones.
1. The fish are a diverse group. Some common characteristics of fish include gills, fins, a two-chambered heart, and scales.
 2. Amphibians represent a bridge between vertebrates of the land and fish. They have no scales, have a three-chambered heart, lack internal temperature regulation, and lay their eggs in aquatic environments.
 3. Reptiles have scales, and a three-chambered heart, lack internal temperature control, and lay their eggs in terrestrial environments.
 4. Birds are animals which have feathers, a four-chambered heart, most birds have upper appendages modified for flight.
 5. Mammals have a four-chambered heart, fur or hair, and feed their young with milk.

Corresponding Skills and Standards for the Student

- 3.3.1 Makes purposeful, objective observations.
- 4.8.11 Understands relationships of structure and function of living organisms to their environment.
- MCS 1 Understands the structures and functions of cells and cell components. This would include a knowledge of the nucleus and the cytoplasm as well as of the similarities and differences between plant and animal cells.
- MCS 3 Understands that organisms are categorized by scientists according to similarities and differences in the structure and function of the individual organisms.
- MCS 13 Understands the structure and function of the reproductive systems of plants and animals, including the roles of hormones and auxins.
- MCS 15 Understands the theories of evolution, the diversity of life possible through the process of natural selection and mutation, and is aware of the changes that have been and are taking place in life on earth.

BIOLOGY AB

INSTRUCTIONAL UNIT SIX

ContentCorresponding Skills and Standards for the Student(Sample Lesson VI: Animal Taxonomy)(Introduction to Skills VI: Library and Research Skills for Investigating Topics of Scientific Interest)

II. Animals have many structural characteristics in common.

A. Animals are organized into cells, tissues, organs, systems, organisms, and communities.

B. Homeostasis is the balanced interaction of parts of an organism required to maintain life.

2.2.1 Perceives similarities and differences in a set of objects; separates a set into groups according to a single characteristic.

4.8.1 Recognizes that a cell is the basic unit of structure and function of a living organism.

4.8.7 Recognizes the importance of energy levels as related to ecosystems.

MCS 2 Understands the interrelationships among tissues, organs, and systems: cells make up tissues, tissues make up organs, and organs make up systems.

MCS 3 Understands that organisms are categorized by scientists according to similarities and differences in the structure and function of the individual organisms.

MCS 7 Understands the structure, function, and maintenance of the major body systems (e.g., digestive, nervous, circulatory, skeletal, muscular, respiratory, reproductive, excretory, endocrine) as well as their component parts and considers the interrelationships among systems.



Content

- III. Physiology deals with animal functions and life processes.
- A. Respiration is the catalytic burning of food with oxygen.
 - B. Metabolism is the total of the body's chemical activities.

Corresponding Skills and Standards for the Student

(Introduction to Skills IV: The Scientific Method)

- 1.3.2 Appreciates the interdependence of living organisms in the natural environment and the implications for continued survival.
- 4.8.3 Demonstrates a basic knowledge of the structures and functions of the human organism.
- 4.8.11 Understands relationships of structure and function of living organisms to their environment.
- MCS 2 Understands the interrelationships among tissues, organs, and systems: cells make up tissues, tissues make up organs, and organs make up systems.
- MCS 7 Understands the structure, function and maintenance of the major body systems (e.g., digestive, nervous, circulatory, skeletal, muscular, respiratory, reproductive, excretory, endocrine) as well as their component parts and considers the interrelationships among systems.

Content

Corresponding Skills and Standards for the Student

- IV. Reproduction is essential to the continuance of animal species.
 - A. Asexual reproduction occurs among many animals. Asexual reproduction produces exact copies of the parent.
 - B. Sexual reproduction promotes variation in animals.
 - C. From fertilization to adulthood, organisms develop with a precise sequence of cell differentiation.

4.8.9 Recognizes that a living organism is a product of its heredity and environment.

4.8.10 Recognizes that all forms of life are composed of the same elements in different DNA blueprints.

MCS 2 Understands the interrelationships among tissues, organs, and systems: cells make up tissues, tissues make up organs, and organs make up systems.

MCS 7 Understands the structure, function and maintenance of the major body systems (e.g., digestive, nervous, circulatory, skeletal, muscular, respiratory, reproductive, excretory, endocrine) as well as their component parts and considers the interrelationships among systems.

MCS 8 Describes the growth and development of humans from conception through old age. The student will discuss the diversity of humans and the variation among growth and development rates.

MCS 12 Identifies the processes of mitosis, meiosis, and the rules of DNA and RNA in the replication of cells and in the reproduction of organisms.

MCS 14 Understands the principles of genetics and heredity: the passing of traits from parents to offspring.

Content

- V. Many careers involve working with animals.
- A. Veterinarians maintain the health of animals and treat animal diseases.
 - B. Dairy farmers raise cows for milk. They feed and take care of animals and keep them in clean and hygienic condition.
 - C. Park rangers supervise large areas of land and manage the plant and animal populations in the park.

Corresponding Skills and Standards for the Student
(Introduction to Skills VII: Providing Opportunities for Students to Correct Misconceptions)

- 4.4.1 Compares the work performed by persons in science occupations.
 - 4.4.2 Identifies ways in which careers are science-related.
 - 4.5.1 Matches significant discoveries to persons responsible for them.
- MCS 17 Students appreciate the importance of technological advances in the fields of agriculture and medicine.

UNIT SEVEN: DEVELOPMENTAL BIOLOGYRepresentative Objectives for the Unit:

In accordance with his or her present capacities, the student will grow in ability to:

- List the stages of insect metamorphosis.
- Relate the stages of human development to the stages in other species.
- Organize the stages of human development from conception to death.
- Describe the stages of development from zygote to the embryo.
- Discuss career options possible in developmental biology.

Content

I. Budding and regeneration are important processes in the lower animals.

A. Animals such as the hydra can reproduce by budding.

B. Many animals can regenerate a part lost during their adult life.

Corresponding Skills and Standards for the Student

- | | |
|-------|---|
| 2.2.1 | Perceives similarities and differences in a set of objects; separates a set into groups according to a single characteristic. |
| 4.1.2 | Matches names of various processes and products of scientific inquiry with examples. |
| 4.8.2 | Recognizes that all living organisms have the same life processes. |
| 4.8.4 | Understands and describes living organisms that grow and develop in different environments. |
| MCS 8 | Describes the growth and development of humans from conception through old age. The student will discuss the diversity of humans and the variations among growth and development rates. |

ContentCorresponding Skills and Standards for the Student

MCS 9 Understands the complexity of animal or plant development and differentiation.

MCS 17 Appreciates the importance of technological advances in the fields of agriculture and medicine.

(Introduction to Skills IV: The Scientific Method)

II. Fission is the most basic form of reproduction among animals. Fission creates two identical organisms.

4.1.2 Matches names of various processes and products of scientific inquiry with examples.

4.2.12 Recognizes that classification systems are developed by humans for use of humans and are one way of helping humans to understand the basic organization and pattern of nature.

MCS 8 Describes the growth and development of humans from conception through old age. The student will discuss the diversity of humans and the variation among growth and development rates.

MCS 9 Understands the complexity of animal or plant development and differentiation.

III. Insects go through a series of developmental steps called metamorphosis.

4.1.2 Matches names of various processes and products of scientific inquiry with examples.

Content

Corresponding Skills and Standards for the Student

(Sample Lesson VII: Sea Urchin Development)

4.8.4 Understands and describes living organisms that grow and develop in different environments.

MCS 9 Understands the complexity of animal or plant development and differentiation.

(Introduction to Skills VII: Providing Opportunities for Students to Correct Misconceptions)

IV. Human developmental biology begins at conception, continues through birth, adolescence, old age, and ends in death.

- A. Humans produce young by sexual reproduction.
 - 1. The male reproductive system is designed for the production of sperm.
 - 2. The female reproductive system produces egg cells and is designed to nurture the young until birth.

B. Egg and sperm unite to form the zygote.

C. Through a series of steps called cleavages, the zygote develops into an embryo.

D. The embryo develops the basic organs and becomes a fetus.

2.2.1 Perceives similarities and differences in a set of objects; separates a set into groups according to a single characteristic.

MCS 8 Describes the growth and development of humans from conception through old age. The student will discuss the diversity of humans and the variations among growth and development rates.

(Introduction to Skills VI: Library and Research Investigate Topics of Scientific Interest)

4.8.2 Recognizes that all living organisms have the same life processes.

4.8.3 Demonstrates a basic knowledge of the structures and functions of the human.

Content

- E. Birth is a critical period at which the baby begins to breathe on its own.
- F. Childhood is a period of growing independence from the mother.
- G. Puberty and adolescence occur when the young human becomes sexually mature and is able to conceive.
- H. Maturity occurs when the person's body maintains its status and does not grow.
- I. Old age is marked by a breakdown of the body. The errors accumulated in DNA replication are not repaired.
- V. There are many career opportunities in developmental biology.
- A. Developmental biologists study the development of organisms from conception to death.
- B. Fish hatchery workers use a knowledge of fish development to rear fish.
- C. Pest control experts have knowledge of insect development in order to recognize various stages of insect life cycles.

Corresponding Skills and Standards for the Student

- 4.8.9 Recognizes that a living organism is a product of its heredity and environment.
- 4.8.10 Recognizes that all forms of life are composed of the same elements in different DNA blueprints.
- 4.8.11 Understands relationships of structure and function of living organisms to their environment.

(Introduction to Skills V: Responsible Laboratory Activities)

- 4.4.1 Compares the work performed by persons in science occupations.
- 4.4.2 Identifies ways in which careers are science-related.
- MCS 8 Describes the growth and development of humans from conception through old age. The student will discuss the diversity of humans and the variations among growth and development rates.
- MCS 9 Understands the complexity of animal or plant development and differentiation.
- MCS 17 Appreciates the importance of technological advances in the fields of agriculture and medicine.

UNIT EIGHT: GENETICSRepresentative Objectives for the Unit:

In accordance with his or her present capacities, the student will grow in ability to:

- Explain the laws of Mendelian genetics.
- Distinguish between the roles of DNA and RNA in the cell.
- Compare the processes of mitosis and meiosis.
- Recognize the uniqueness of the DNA double helix molecule.
- Diagram the steps of protein synthesis.
- Evaluate the relative dangers of mutagens in the environment.
- Debate the merits of genetic counseling.
- Predict some possible benefits of recombinant DNA technology.
- Explore career options in genetics.

ContentCorresponding Skills and Standards for the Student

- | | |
|---|--|
| <p>I. Gregor Mendel founded the science of genetics.</p> <p>A. Various hereditary characteristics are controlled by genes. Genes occur in pairs.</p> <p>B. One gene of a pair may mask or prevent expression of the other gene.</p> <p>C. A pair of genes is separated during the formation of gametes.</p> | <p>1.2.1 Relates classification to everyday life situations.</p> <p>4.8.9 Recognizes that a living organism is a product of its heredity and environment.</p> <p>MCS 5 Appreciates the commonality and diversity of animal behavior and distinguishes between inborn and acquired characteristics.</p> <p>MCS 14 Understands the principles of genetics and heredity: the passing of traits from parents to offspring.</p> |
|---|--|

Content

II. Meiosis is the division of nuclear material. The result is the production of gametes in animals and of gametes and spores in plants.

- A. Mitosis makes copies of chromosomes; this makes possible the process of cell division.
- B. Meiosis deals out the genetic material in new arrangements.

III. DNA is the material of heredity.

- A. The structure of DNA was discovered by Francis Crick and James Watson.
- B. DNA is a double helix molecule of repeating units.
 1. DNA is composed of individual nucleotides made of a sugar, a phosphate group, and one of four bases.

Corresponding Skills and Standards for the Student.

3.5.0 Records observations accurately and organizes data and ideas in ways that improve their usefulness.

MCS 12 Identifies the processes of mitosis and meiosis, and the rules of DNA and RNA in the replication of cells and in the reproduction of organisms.

(Introduction to Skills IV: The Scientific Method)

4.8.2 Recognizes that all living organisms have the same life processes.

4.8.10 Recognizes that all forms of life are composed of the same elements in different DNA blueprints.

4.8.11 Understands relationships of the structure and function of living organisms to their environment.

4.8.12 Recognizes that living organisms have changed over the ages and that some species are now extinct.

MCS 5 Appreciates the commonality and diversity of animal behavior and distinguishes between inborn and acquired characteristics.

Content

Corresponding Skills and Standards for the Student

2. The four bases are adenine, guanine, cytosine, and thymine. They are the basis of a code which carries instructions to make all living things.
3. DNA replicates giving two identical copies of the original.
- C. The genetic code has been broken.
 1. It requires three nucleotides to specify an instruction.
 2. Each instruction, properly translated to RNA, specifies an amino acid.
 3. Some instructions specify "start," "stop," or are repeats of other instructions.
- D. DNA acts as a template for the making of various kinds of RNA.
 1. RNA in the ribosomes assembles amino acids into polypeptide chains which configure into proteins.
 2. All the molecules in the cell that the cell makes are the indirect product of the DNA code.

(Introduction to Skills V: Responsible Laboratory Activities)

- MCS 12 Identifies the processes of mitosis, meiosis, and the rules of DNA and RNA in the replication of cells and in the reproduction of organisms.
- MCS 14 Understands the principles of genetics and heredity: the passing of traits from parents to offspring.
- MCS 15 Understands the theories of evolution, the diversity of life possible through the process of natural selection and mutation and are aware of the changes that have and are taking place in life on earth.
- MCS 17 Appreciates the importance of technological advances in the fields of agriculture and medicine.

ContentCorresponding Skills and Standards for the Student

(Sample Lesson VIII: Extraction of DNA)

(Introduction to Skills V: Responsible Laboratory Activities)

IV. Mutations cause permanent changes in the DNA code and may cause changes in an organism.

A. Factors in the environment can alter DNA.

1. The effects of viruses on cells have been associated with changes in the genetic code.
2. Products produced by smoking tobacco can lead to damage or change in the genetic code of DNA.

3. Many chemicals in the air, water, and on the earth have the potential to cause changes in DNA.
4. Radioactive materials cause changes in DNA.
5. Changes to DNA can be harmful or helpful, but they have greater probability of being harmful.
6. Changes in non-essential DNA, in undecipherable combinations, or in non-reproductive cells have no effect on offspring.

4.2.2 Uses a cause-effect relationship to make a prediction.

4.8.0 Demonstrates general knowledge of science.

4.8.7 Recognizes that living organisms utilize matter and return it to the environment.

(Introduction to Skills Unit VII: Providing Opportunities for Students to Correct Misconceptions)

4.8.9 Recognizes that a living organism is a product of its heredity and environment.

4.8.10 Recognizes that all forms of life are composed of the same elements in different DNA blueprints.

MCS 5 Appreciates the commonality and diversity of animal behavior and distinguishes between inborn and acquired characteristics.

Content

- B. Cancer cells are cells with abnormal DNA.
1. Cancer cells grow rapidly and exhibit uncontrolled reproduction.
 2. Some genes in a cell can change from normal to cancer causing.
- V. The DNA revolution is bringing rapid changes in science and technology.
- A. It is difficult to keep up with the changes because of the rapid development of new ideas, products, and technologies.
 - B. Recombinant DNA technology is mastering the techniques of changing and controlling genes.
 1. New products, such as human insulin and human growth hormone, are being manufactured by inserting human genes into bacteria and other simple organisms.

Corresponding Skills and Standards for the Student

- MCS 9 Understands the complexity of animal or plant development and differentiation.
- MCS 12 Identifies the processes of mitosis, meiosis, and the rules of DNA and RNA in the replication of cells and in the reproduction of organisms.
- MCS 14 Understands the principles of genetics and heredity: the passing of traits from parents to offspring.
- MCS 15 Understands the theories of evolution, the diversity of life possible through the process of natural selection and mutation, and is aware of the changes that have been and are taking place in life on earth.
- 4.8.10 Recognizes that all forms of life are composed of the same elements in different DNA blueprints.
- MCS 12 Identifies the processes of mitosis, meiosis, and the rules of DNA and RNA in the replication of cells and in the reproduction of organisms.
- MCS 15 Understands the theories of evolution, the diversity of life possible through the process of natural selection and mutation and is aware of the changes that have and are taking place in life on earth.

Content

2. New products are being developed through gene manipulation. Some examples include artificial vaccines which protect against more than one disease, and improvements of agricultural products.
3. Plasmids, which are tiny rings of DNA found in bacteria, can have genes of other organisms inserted into the ring. The plasmids can then be inserted into bacteria. The bacterium, and all of its descendants, will produce the product specified by the other organisms' genes.
4. A machine has been devised which makes DNA in whatever codon sequence desired.
- C. Monoclonal antibodies are made from a single cell containing a unique genetic pattern.
 1. Biological tissue culture techniques are used to create many copies of a monoclonal cell.
 2. Commercial products are derived from monoclonal cells.

Corresponding Skills and Standards for the Student

- MCS 17 Appreciates the importance of technological advances in the fields of agriculture and medicine.

(Introduction to Skills VII: Providing Opportunities for Students to Correct Misconceptions)

Content

- VI. Human genetics is the science of genetics applied to people.
- A. Many diseases in people are caused by abnormal genes.
 - B. Doctors can counsel prospective parents on the possibilities of some genetic disorders in their offspring.
 - 1. A number of genetic diseases can be diagnosed before birth.
 - 2. Some genetic diseases may be treatable some day in the future by genetic intervention.
 - C. A karyotype is a picture of a person's chromosomes.

Corresponding Skills and Standards for the Student

- 1.5.0 Weighs alternative scientific, economic, psychological, or social factors when considering possible solutions to some problems.
- 1.8.0 Applies rational and creative thinking processes when trying to find relationships among seemingly unrelated phenomena and when seeking solutions to problems.
- 4.2.12 Recognizes that classification systems are developed by humans for the use of humans and are one way of helping humans to understand the basic organization and pattern of nature.
- 4.8.10 Recognizes that all forms of life are composed of the same elements in different DNA blueprints.
- 4.8.11 Understands relationships of structure and function of living organisms to their environment.
- MCS 6 Understands specific behaviors inherent to humans.
- MCS 9 Understands the complexity of animal or plant development and differentiation.
- MCS 17 Appreciates the importance of technological advances in the fields of agriculture and medicine.

Table of ContentsCorresponding Skills and Standards for the Student(Introduction to Skills V: Responsible Laboratory Activities)

- VII. Many careers are open in the field of genetics.
- A. Genetic counselors give advice to prospective parents.
 - B. Recombinant geneticists make organisms with new features.
 - C. Laboratory technicians manage and monitor experiments in recombinant DNA technology.
 - D. Plant geneticists seek out new and improved crops.

- 4.4.0 Demonstrates knowledge of science-related career opportunities and the preparation needed.
- 4.4.1 Compares the work performed by persons in science occupations.
- 4.4.2 Identifies ways in which careers are science-related.

MCS 17 Appreciates the importance of technological advances in the fields of agriculture and medicine.

(Introduction to Skills VII: Providing Opportunities for Students to Correct Misconceptions)

UNIT NINE: EVOLUTIONRepresentative Objectives for the Unit:

In accordance with his or her present capacities, the student will grow in ability to:

- Analyze the characteristics of the early earth.
- Distinguish between scientific theories of the origin of life.
- List the lines of evidence for evolution.
- Recognize the differences between the theories of Darwin and Lamarck and their modern interpretations.
- Recognize the role of DNA in evolution.
- Compare the mechanisms of speciation.
- Examine the fossil evidence for human evolution.
- Identify and describe science-related careers.

Content

- I. There was a time on earth when there were no living things. Living things later appeared on the earth.
 - A. The Miller-Urey Hypothesis is the most widely accepted scientific theory on the origin of life on earth.
 1. The conditions of the early earth were much different than conditions today.
 2. The conditions of the early earth made possible the formation of amino acids.
 3. Amino acids can form proteins, under the right conditions.
 4. Coacervates are cell-like aggregations of proteins.
 5. Living things, as we recognize them today, began when DNA was formed and began replicating itself.

Corresponding Skills and Standards for the Student

- | | |
|-------|---|
| 1.9.3 | Values the scientific contributions of human beings from varying cultural backgrounds. |
| 2.2.2 | Develops arbitrary classification systems wherein objects can be put into mutually exclusive categories; uses quantitative measurements as criteria for grouping. |
| 2.3.0 | Develops ability to apply and evaluate data and generate theories by hypothesizing, predicting, inferring, generalizing, theorizing, explaining, justifying, judging, and interpreting. |
| 2.3.1 | Examines environmental issues, pointing out contradictions and discrepancies in the positions of various groups. |

ContentCorresponding Skills and Standards for the Student(Introduction to Skills VII: Providing Opportunities for Students to Correct Misconceptions)

MCS 5 Appreciates the commonality and diversity of animal behavior and distinguishes between inborn and acquired characteristics.

MCS 15 Understands the theories of evolution, the diversity of life possible through the process of natural selection and mutation, and is aware of the changes that have been and are taking place in life on earth.

2.3.3 Recognizes contradictions and unusual events.

3.4.2 Gathers information from science textbooks, reference materials, science films, and television.

4.8.0 Demonstrates general knowledge of science.

4.8.5 Recognizes that the sun is the source of energy for green plants and is basic to the growth and maintenance of living organisms.

4.8.9 Recognizes that a living organism is a product of its heredity and environment.

4.8.10 Recognizes that all forms of life are composed of the same elements in different DNA blueprints.

B. The Clay Hypothesis is a new explanation for the origin of life on earth.

1. Just as crystals grow from a "seed," it has been observed that because of the structure and location of some clay minerals, their size increases over time.
2. Some minerals may have incorporated protein molecules in their structure.
3. In time, some of these pre-life forms may have changed to be more protein than clay minerals and even later to have excluded clay minerals.
4. The result of these steps would be living things based on carbon molecules, but with an origin rooted in the inorganic world.

Content

Corresponding Skills and Standards for the Student

II. The study of evolution involves searching for evidence of relationships between organisms.

4.8.7 Recognizes that living organisms utilize matter and return it to the environment.

A. Fossilized organisms are a major source of evidence for evolution.

4.8.11 Understands relationships of structure and function of living organisms to their environment.

1. The kinds of fossils found include:
 - a. Bones
 - b. Teeth
 - c. Fecal material
 - d. Footprints
 - e. Plant remains

4.8.12 Recognizes that living organisms have changed over the ages and that some species are now extinct.

2. The methods of preservation or formation of fossils include:

MCS 15 Understands the theories of evolution, the diversity of life possible through the process of natural selection and mutation and is aware of the changes that have been and are taking place in life on earth.

- a. Covering with tar
- b. Covering and preserving by sediment deposits
- c. Freezing

MCS 17 Appreciates the importance of technological advances in the fields of agriculture and medicine.

3. Some of the methods for dating fossils are:

- a. Using radioactive isotopes
- b. Determining age by sediment layers
- c. Determining age by association with other deposits

Content

B. Comparing the anatomy of living and fossilized organisms is a method of showing relationships between organisms.

C. Comparing the development of organisms can give evidence of their relationships. The obsolete phrase "ONTOGENY RECAPITULATES PHYLOGENY" is an interesting expression which meant that the developmental stages were reflective of evolutionary patterns. It is more accurate to observe that the embryonic development of different organisms goes through similar stages because the organisms are related.

D. Comparing the DNA of different organisms can show relationships.

III. Darwin's Theory of Evolution seeks to explain the variety of life on earth.

A. Darwin studied plants and animals in England and during an around-the-world voyage on the "HMS Beagle."

B. In nature, there are more organisms born than could possibly survive. There is, therefore, a struggle to survive; only the fittest are able to survive and in their turn reproduce and pass favorable genes on to the next generation.

C. Variations exist among organisms. Those varieties which are best adapted to the environment survive.

Corresponding Skills and Standards for the Student

(Introduction to Skills V: Responsible Laboratory Activities)

(Sample Lesson IV: Biochemical Evidence for Evolution)

4.5.1 Matches significant discoveries to persons responsible for them.

4.8.9 Recognizes that a living organism is a product of its heredity and environment.

4.8.12 Recognizes that living organisms have changed over the ages and that some species are now extinct.

MCS 14 Understands the principles of genetics and heredity: the passing of traits from parents to offspring.

Content

D. Lamarck said that animals changed in response to their environment and these acquired characteristics could be passed on to future generations. This theory has been proven false.

- IV. DNA gives the instructions that make an organism.
- A. A single point mutation can make an alteration or variation in an organism.
1. Mutations, such as a slight change in eye color, may have negligible effects.
 2. Diseases, such as the adaptively favored but catastrophic disease of sickle cell anemia, can be caused by a single point mutation.
- B. Gross mutations, such as loss of a chromosome pair or doubling the number of chromosomes, can create a radically different organism or cause death.

Corresponding Skills and Standards for the Student

MCS 15 Understands the theories of evolution and the diversity of life possible through the process of natural selection and mutation and is aware of the changes that are taking and have taken place in life on earth.

(Skills Unit VI: Library and Research Skills to Investigate Topics of Scientific Interest)

4.8.10 Recognizes that all forms of life are composed of the same elements in different DNA blueprints.

4.8.12 Recognizes that living organisms have changed over the ages and that some species are now extinct.

MCS 12 Identifies the processes of mitosis, meiosis, and the rules of DNA and RNA in the replication of cells and in the reproduction of organisms.

MCS 14 Understands the principles of genetics and heredity: the passing of traits from parents to offspring.

MCS 15 Understands the theories of evolution, the diversity of life possible through the process of natural selection and mutation, and is aware of the changes that have been and are taking place in life on earth.

169

ContentCorresponding Skills and Standards for the Student(Introduction to Skills V: Responsible Laboratory Activities)

- V. There are many observable adaptations in nature.
- A. Industrial melanism is an adaptation to human-caused effects on the environment.
 - B. Structural adaptations in organisms enable them to compete more effectively.
 - C. Physiological adaptations enable an organism to deal with its environment by chemical means. An example of this is a koala's ability to eat eucalyptus leaves even though the leaves are poisonous to other organisms.
 - D. Behavioral traits that are inherited and represent an adaptation to the environment.
 - E. Mimicry and warning coloration aid organisms in their survival.

- 4.3.3 Identifies types of data valuable in planning environmental changes.
- 4.8.12 Recognizes that living organisms have changed over the ages and that some species are now extinct.
- MCS 4 Identifies roles of animals, plants, and protists in the web of life.
- MCS 6 Understands specific behaviors inherent to humans.
- MCS 10 Understands the factors necessary to sustain plant life. The student will become aware of the complexity and variety of plant processes, some of which are exploited in the field of agriculture and horticulture.
- MCS 14 Understands the principles of genetics and heredity: the passing of traits from parents to offspring.

ContentCorresponding Skills and Standards for the Student(Introduction to Skills VII: Providing Opportunities for Students to Correct Misconceptions)

VI. New species arise from existing species.

- A. Geographic isolation can cause the formation of new species.
- B. When populations of a species become reproductively isolated, each is likely to accumulate variations which eventually separate the populations into two species.

4.8.3 Demonstrates basic knowledge of the structures and functions of the human organism.

4.8.9 Recognizes that a living organism is a product of its heredity and environment.

MCS 15 Understands the theories of evolution, the diversity of life possible through the process of natural selection and mutation and is aware of the changes that have been and are taking place in life on earth.

MCS 18 Appreciates the wide variety of California's natural areas: the landforms, climates, and conditions that support life.

VII. Human beings are a part of the animal life on earth. Our ancestry begins in animals that resemble, in some ways, extant forms.

- A. There are characteristics which are considered human-like. These characteristics may be shared, wholly or in part, by other organisms.

1. Stereoscopic vision is believed to be an adaptation to living in trees.
2. The prehensile hand is a characteristic shared by many simian species.

4.8.9 Recognizes that a living organism is a product of its heredity and environment.

4.8.10 Recognizes that all forms of life are composed of the same elements in different DNA blueprints.

4.8.11 Understands relationships of structure and function of living organisms to their environment.

Content

3. Bipedal locomotion is walking on two legs without the assistance of the arms.
 4. A large brain, in relationship to body size, is a key characteristic of humans.
 5. Culture is a characteristic of humans and has been only slightly developed in some simians.
- B. No single fossil can be said to be our direct ancestor. Each fossil indicates a set of characteristics. Some of these may be human-like or show a transitional stage between an animal characteristic and a human characteristic.
1. The DNA of humans and chimpanzees differs by only one percent, but that small difference represents every difference between us and the chimps.
 2. The genus Australopithecus comprises a group of species which exhibit primitive human-like characteristics.
 3. Fossil species of the genus Homo have been discovered. These extinct species share many characteristics with humans.
 - a. Homo habilis lived about one-half million years ago.
 - b. Homo erectus walked erect and used fire.

Corresponding Skills and Standards for the Student

- 4.8.12 Recognizes that living organisms have changed over the ages and that some species are now extinct.
- MCS 4 Identifies roles of animals, plants, and protists in the web of life.
- MCS 5 Appreciates the commonality and diversity of animal behavior and distinguishes between inborn and acquired characteristics.
- MCS 6 Understands specific behaviors inherent to humans.
- MCS 7 Understands the structure, function, and maintenance of the major body systems (e.g., digestive, nervous, circulatory, skeletal, muscular, respiratory, reproductive, excretory, endocrine) as well as their component parts and considers the interrelationships among systems.
- MCS 8 Describes the growth and development of humans from conception through old age. The student will discuss the diversity of humans and the variations among growth and development rates.

Content

4. Modern humans include Neanderthal man and Cro-Magnon man. They are separated from us only in time and in slight physical difference.

Corresponding Skills and Standards for the Student

MCS 15 Understands the theories of evolution, the diversity of life possible through the process of natural selection and mutation, and is aware of the changes that have been and are taking place in life on earth.

(Introduction to Skills VII: Providing Opportunities for Students to Correct Misconceptions)

VIII. Many occupations use a knowledge of evolution.

4.4.0 Demonstrates knowledge of science-related career opportunities and the preparation needed.

A. Archeologists study the history of the ancient past.

4.4.1 Compares the work performed by persons in science occupations.

B. Paleobotanists study plants that lived in the past, for many plants relate to human history.

4.4.2 Identifies ways in which careers are science-related.

C. Anthropologists study humans of the past and present, both physically and culturally.

MCS 15 Understands the theories of evolution, the diversity of life possible through the process of natural selection and mutation, and is aware of the changes that have been and are taking place in life on earth.

MCS 17 Appreciates the importance of technological advances in the fields of agriculture and medicine.

UNIT TEN: ECOLOGY AND ENVIRONMENT

Representative Objectives for the Unit:

In accordance with his or her present capacities, the student will grow in ability to:

- Recognize the dependence of all living things on the abiotic environment.
- Give examples of feeding relationships in a community.
- Assess the effects of various types of pollution on the environment and its inhabitants.
- Identify and describe science-related careers.
- Describe the major biomes.
- Appreciate the interdependence of living organisms in the environment and the implication for continued survival.

Content

I. Ecology is the study of how living things interact with each other and with the nonliving factors in their environment.

A. An ecosystem is a community of living things. Scientists study the interactions of living things and the physical environments of ecosystems.

1. An ecosystem may be as small as a drop of water or as large as an ocean.
2. Ecosystems change over time in a succession of different plants and animals.

B. Biomes are large geographic areas which contain a similar pattern of plants and animals. Many of the most interesting and important biomes are found in California.

Corresponding Skills and Standards for the Student

- 2.1.4 Identifies changes in properties and rates of change.
- 2.2.0 Develops ability to organize data by comparing, classifying, relating, and ordering.
- 2.3.1 Examines environmental issues, pointing out contradictions and discrepancies in the positions of various groups.
- 4.3.3 Identifies types of data valuable in planning environmental changes.
- 4.8.6 Recognizes the importance of energy levels as related to ecosystems.

Content

1. Some major biomes are:
 - a. The freshwater environment
 - b. The ocean shore
 - c. The ocean
 - d. The ocean depths
 - e. The temperate forest
 - f. The grasslands
 - g. The desert
 - h. The chaparral
 - i. The tropical rain forest
2. The ocean depths and especially rift zones constitute an exciting new field in which discoveries are being made daily.

*

II. Biotic and abiotic factors control the environment.

- A. Tracing the energy flow in the environment can show us how plants and animals interact.
 1. In every continuing community there must be producers, consumers, and decomposers.
 2. In any environment, all the organisms can be placed in a food chain or food web to show their feeding relationships.

Corresponding Skills and Standards for the Student

4.8.11 Understands relationships of structure and function of living organisms to their environment.

MCS 4 Identifies roles of animals, plants, and protists in the web of life.

MCS 16 Understands that ecology consists of studying how communities of living things interact with and depend upon each other and the physical environment, and that conservation consists of attitudes and actions by man to preserve the natural state of ecosystems.

MCS 18 Appreciates the wide variety of California's natural areas: the landforms, climates, and conditions that support life.

1.3.2 Appreciates the interdependence of living organisms in the natural environment and the implications for continued survival.

2.2.1 Perceives similarities and differences in a set of objects; separates a set into groups according to a single characteristic.

(Introduction to Skills IV: The Scientific Method)

Content

3. In any environment, all the organisms can be arranged in a food pyramid to show relationships in energy use.
4. Any two organisms in a community have an energy-use relationship. Their relationship may be one or more of the following:
 - a. Parasitism
 - b. Commensalism
 - c. Mutualism
 - d. Predator-prey

Corresponding Skills and Standards for the Student

- 2.3.0 Develops ability to apply and evaluate data and generate theories by hypothesizing, predicting, inferring, generalizing, theorizing, explaining, justifying, judging, and interpreting.

(Sample Lesson X: Looking in Your Backyard)

- 3.2.2 Provides an environment for plant and animal life that is conducive to the support of normal life functions.
- 4.8.2 Recognizes that all living organisms have the same life processes.

MCS 5 Appreciates the commonality and diversity of animal behavior and distinguishes between inborn and acquired characteristics.

MCS 10 Understands the factors necessary to sustain plant life. Students will become aware of the complexity and variety of plant processes, some of which are exploited in the field of agriculture and horticulture.

MCS 16 Understands that ecology consists of studying how communities of living things interact with and depend upon each other and the physical environment, and that conservation consists of attitudes and actions by man to preserve the natural state of ecosystems.

Content

Corresponding Skills and Standards for the Student

MCS 18 Appreciates the wide variety of California's natural areas: the landforms, climates, and conditions that support life.

B. The materials found in a community are used over and over again. The processes occur in cycles.

4.8.4 Understands and describes living organisms that grow and develop in different environments.

1. The carbon cycle provides carbon for living things. It includes exchanges among the atmosphere, rocks, and living things.

4.8.5 Recognizes that the sun is the source of energy for green plants and is basic to the growth and maintenance of living organisms.

2. The calcium cycle can take millions of years to return calcium to living things.

4.8.9 Recognizes that a living organism is a product of its heredity and environment.

3. The water cycle provides water for all living things, and habitats for aquatic organisms.

C. Nonliving factors in the environment limit the number and kinds of organisms that can live in a community.

1. The oxygen content of the water controls the numbers and kinds of fish that can live in a stream.

2. The amount of sunlight available limits the number and kinds of plants in a tropical rain forest.

3. Water is a limiting factor in the number and kinds of organisms in a desert community.

Content

III. People are a part of the environment and what we do has effects on the environment.

A. Taking land out of the natural environment for agricultural use can benefit people and have little impact on the environment, or it can be disastrous for wildlife, for the future usefulness of the land, and for the human community.

1. Any change in use of the land must be carefully planned and evaluated.
2. Land damaged by erosion or by chemical pollution does not easily return to its original condition.

B. Pollution is the presence of unwanted materials in our air, water, and on and in our land.

1. In Los Angeles everyone wants to ride in automobiles to work and school, but no one wants to breathe the results in the air.
2. Factories that are carefully designed and built to avoid polluting the environment serve as realistic models of what can be done to improve our environment.
3. Cleaning up after one has made a mess is a much more expensive method of pollution control than not making a mess.

Corresponding Skills and Standards for the Student

1.9.3 Values the scientific contributions of human beings from varying cultural backgrounds.

4.2.12 Recognizes that classification systems are developed by humans for the use of humans and are one way of helping humans to understand the basic organization and pattern of nature.

4.3.0 Demonstrates knowledge of relationships between science and society.

4.8.8 Describes examples of humankind's dependence on and interference with natural ecosystems.

MCS 6 Understands specific behaviors inherent to humans.

MCS 16 Understands that ecology consists of studying how communities of living things interact with and depend upon each other and the physical environment, and that conservation consists of attitudes and actions by man to preserve the natural state of ecosystems.

MCS 17 Appreciates the importance of technological advances in the fields of agriculture and medicine.

Content

- C. Land that is overworked becomes a desert.
1. Great areas of land in Africa are undergoing desertification.
 2. In some places, land has been reclaimed from the desert by careful attention to the needs of the land.
 3. Large areas of the tropical rain forest are being cut and abandoned to erosion.
- IV. Many occupations require a knowledge of ecology.
- A. Range managers see that vast areas of rangeland are properly managed and not subjected to overgrazing by livestock.
 - B. Engineers must build so that the environment is not damaged by their structures or by the products of their factories.
 - C. Marine biologists study the ecological relationships among the organisms of the sea.

Corresponding Skills and Standards for the Student
 (Introduction to Unit VI: Library and Research Skills to Investigate Topics of Scientific Interest)

- 1.10.1 Values the abilities, interests, and preparation required for a science-related career.
- 1.10.2 Assumes responsibility for making a realistic decision about the pursuit of a science-related career.
- 4.4.1 Compares the work performed by persons in science occupations.
- 4.4.2 Identifies ways in which careers are science-related.
- MCS 17 Appreciates the importance of technological advances in the fields of agriculture and medicine.
- MCS 18 Appreciates the wide variety of California's natural areas: the landforms, climate, and conditions that support life.

SECTION III:
LESSON PLANNING

89

190

191



AIM

Association for Information and Image Management

1100 Wayne Avenue Suite 1100
Silver Spring Maryland 20910

301-587-8202

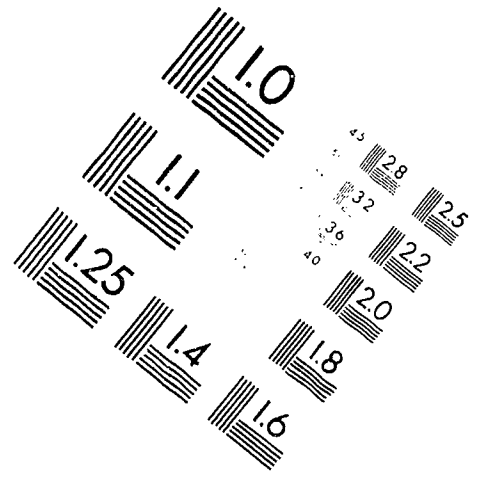
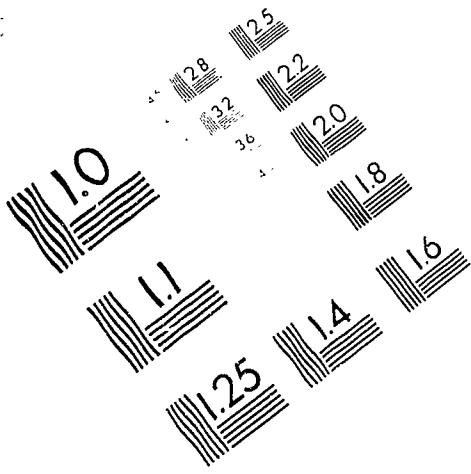

Centimeter



Inches

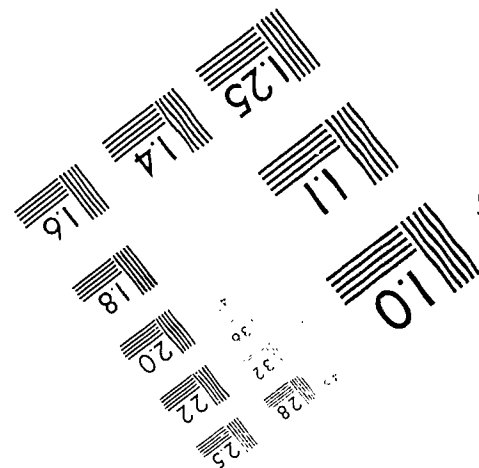
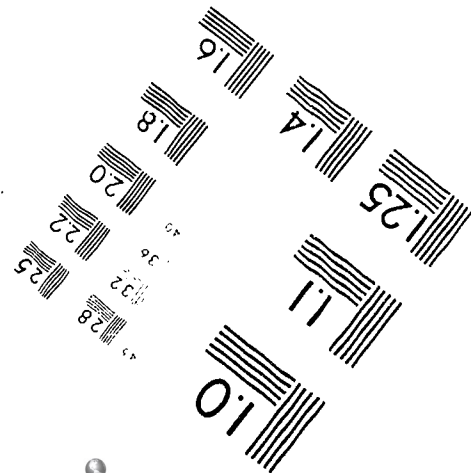
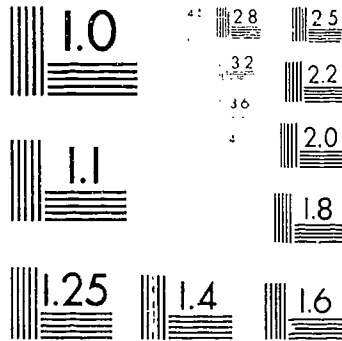

MANUFACTURED TO AIM STANDARDS
BY APPLIED IMAGE, INC.

LESSON PLANNING - QUESTIONS AND COMMENTARY FOR TEACHING DECISIONS

1. What is the specific objective and how will it be presented to the students?

The specific objective tells what students will be able to do by the end of the lesson. It should be a refinement of the broader representative objective selected for the lesson from the course description in the Guidelines for Instruction or from the required course outline. The specific objective may be presented orally or in writing.

2. What is the value to students in achieving the objective?

The teacher explains to the students the importance of achieving the objective and how it relates to past or future learning or their total development. The teacher motivates the students by providing a rationale for achieving the objective.

3. What learning activities are suitable for the students involved and for the specific objective being taught?

The teacher selects or designs initial learning activities--such as a demonstration, a film, a text selection, a lecture, class or small-group discussion, or questions followed by student answers--which fit the ability levels or learning styles of the students. Similarly, the teacher develops initial learning activities which constitute the most efficient means for putting across the particular specific objective.

4. What guided group practice will be provided for the students?

The teacher has the class perform some of the steps leading toward mastery of the specific objective to determine if the students understand the concepts well enough to perform the tasks independently. Student responses give the teacher feedback on the students' degree of understanding.

5. What independent practice or activity will be provided for the students?

The teacher gives the students the opportunity to perform the task stated in the objective with little or no teacher assistance.

6. What are the provisions for individual differences in style of learning?
- a. Remedial or Alternative Activities: The teacher provides other kinds of learning activities for students requiring alternative opportunities to practice the task.
 - b. Enrichment or Supplemental Activities: The teacher provides learning activities for students who were successful and can profit from probing the subject to a greater depth or by extending the subject to other areas.
7. How will the lesson be evaluated?
- To plan learning activities for future lessons, the teacher assesses students' mastery of the skill or skills of the present specific objective.
- The evaluator can be a student, a group of students, or the teacher. An objective test, a subjective test, or a performance test can be used to assess students' ability to perform the objective.

TEACHER RESPONSIBILITIES

The teacher is responsible for creating, maintaining, and fostering a classroom environment and a climate for learning which encourage instructional excellence and achievement. In order to maintain such an environment successfully, the teacher is responsible for:

1. Providing students and parents with a clear statement of instructional objectives, overall goals, and standards of expected progress and achievement.
2. Providing instruction which incorporates a diagnostic-prescriptive program for learning all required skills and concepts.
3. Following the time line as closely as possible, preparing instructional activities for the entire class period, and assisting students in striving for mastery of content and process skills.
4. Having evidence in the classroom of lesson planning to meet the educational needs of the students and the goals of the instructional program.
5. Providing regular instruction and practice in preparing students to take and succeed on tests and other measures of achievement.
6. Maintaining well-defined and consistent classroom standards for academic achievement, citizenship, and work habits.
7. Providing regularly assigned homework designed to reinforce classroom instruction.
8. Providing students and parents with an explanation of the standards used for assigning marks.
9. Providing prompt feedback to students on the results of quizzes, homework, and other class assignments.
10. Recognizing individual student progress and exceptional achievements; displaying student accomplishments and products in the classroom.

TEACHER RESPONSIBILITIES (Continued)

11. Recording a minimum of one grade per week in the rollbook for each student.
12. Keeping parents regularly informed of the educational progress and achievement of the student.
13. Informing parents of outstanding progress and accomplishment.
14. Notifying parents of any signs of significant academic decline in student effort or achievement.
15. Providing parents with suggestions on how to help the student study and complete homework assignments.
16. Inviting administrators, department chairpersons, and fellow teachers to visit the classroom and participate in a sharing of effective and innovative lessons.

THE AGENDA

An agenda, or schedule of class activities, prominently displayed in the classroom, gives immediate directions to the students and prepares them for the day's classwork. The agenda should include an objective, a dispatch activity, scheduled class activities, and homework assignment. The agenda may be written on the chalkboard. Some teachers, particularly teachers who travel from classroom to classroom, prefer to use chart paper that can be easily taped or pinned to a board and quickly removed to be used in a new location. A good way to evaluate an agenda is to ask the question "If a student were absent, could he or she read the agenda and know what happened in the classroom today?"

The dispatch activity is an essential part of the agenda. It should be a short, written, timed exercise that students start as soon as the period begins. Students should be able to complete the dispatch without teacher assistance. The dispatch is used to:

- review and reinforce concepts and ideas previously studied
- start students working immediately upon arrival in class
- preview or introduce new work
- establish a routine
- allow the teacher an opportunity to take care of attendance responsibilities

Below is a sample agenda as it would be written on the board:

AGENDA

Teacher's Name
Biology AB, Period 1
October 17, 1987

Objective: Students will be able to list the characteristics of a cell.
Dispatch: Using your textbook, list the parts of the cell.
Class Work: Discussion of the cell and its relationship to the whole organism.
Independent Work: Pick one kind of cell and write a description of it in detail.
Homework: Find an article about cells in a newspaper or magazine. Paste the article or a copy onto a sheet of notebook paper and use the rest of the sheet to describe how the article relates to what we are studying.

GUIDELINES FOR ASSIGNMENT OF HOMEWORK*

The guidelines that follow should be considered when planning homework assignments:

1. Homework is an important resource for teachers in helping students to learn.
2. Homework may be scheduled when appropriate over an extended period of time, which may include weekends.
3. Homework assignments should be reasonable in length, content, and required resources.
4. Homework should be assigned to reinforce, extend, or enrich areas of subject matter which have been taught.
5. Homework assignments should be related to subject objectives.
6. Homework assignments and due dates should be thoroughly explained by the teacher and understood by the student.
7. Homework, once appropriately assigned by the teacher, becomes the responsibility of the student who should know its content, process, and due date. Homework completed should be submitted to the teacher as required.
8. Completed homework assignments should be acknowledged and/or evaluated by the teacher and reviewed with students when appropriate.

Parents/guardians should be informed of homework schedules, including dates due and time allowance. They should also understand the level of independent work expected of the student and the parental help and involvement required.

*Adapted from Revised Guidelines for Assignment of Homework (Los Angeles Unified School District: Office of Instruction, Bulletin No. 22, February 11, 1986).

TEACHING STRATEGIES

A variety of instructional strategies can enhance the students' growth in both concept and skill development. Examples of these instructional strategies include:

- Teacher-directed lesson with the class investigating the same problem.
- Teacher demonstration with the class observing and recording observations and data.
- Independent study. Students conduct independent research and study concept or process areas. When completed, such individual work provides a basis for class learning projects.
- Team learning situations wherein two to four students function together as a laboratory investigation group. Interaction within and among groups acts both as a stimulus and an information-sharing aid to learning.
- Grouping of lower achieving students with those achieving at a higher level. This permits peer tutoring and interaction which can benefit the less motivated individuals.
- Contract between student and teacher which outlines and prescribes specific tasks to be performed by the student for the fulfillment of certain course requirements.
- Self-paced learning designed for mastery. Assessment is conducted as each student concludes each unit, and the results indicate whether a student is ready to advance to the next unit or experience--a repeated opportunity for the instructor to use a new strategy. Student's mark is based on number of units mastered.
- Library research studies wherein many of the principles learned in laboratory and class activities can be applied to a class, small group (team), or individual project.
- Class presentations by individual or laboratory teams on the outcomes of laboratory investigations which are shared with the class.
- Design and formulation of research projects. Individuals or teams apply the methods, material, and techniques learned to a real experimental investigation.

HIGHER LEVELS OF THINKING

Because questioning is the primary tool in achieving educational goals, teachers will want to be sure their questions are appropriate for the ability level of students and challenge students to higher levels of thinking.

Bloom* classifies six levels of thinking. They are:

- Knowledge (recognition or recall of previously learned material)
- Comprehension (translation or interpretation of data)
- Application (application of past learnings to a new situation)
- Analysis (emphasis on the breakdown of material into constituent parts, the detection of relationships, and the organization of parts)
- Synthesis (organization of separate elements in a new creative structure)
- Evaluation (arrival at value judgments about a material or work)

The levels of thinking are sequential. In other words, each category of thinking is different and builds on lower categories. The categories are arranged from simple to complex and from concrete to abstract.

It is important that all students have many opportunities to answer questions involving every level of thinking. Within each category of thinking there are both simple and complex questions for slow and rapid learners.

Questioning is particularly important during guided group practice in the teacher-directed lesson. Carefully constructed questions using various levels of thinking will help the teacher determine the students' comprehension of new material and assess their readiness to move on to independent practice. Individualization of instruction and remedial or alternative work can be achieved by constructing questions of varying levels of complexity.

Verbs alone do not necessarily determine the level of thinking. A given question may not represent the same task to all students. What may be an analysis question to one student may be a knowledge question to a pupil who has already read and received an explanation of the material. The level of a question depends on how much information the student has already received. If a student is expected to answer a "why" or "how" question by restating an answer provided in the textbook or from the teacher's lecture, the level of thinking is knowledge. If, however, the student has to figure out the answer, not simply remember it, the student is working on a higher level of thinking, such as analysis, synthesis, or evaluation.

*Benjamin S. Bloom: Taxonomy of Educational Objectives: The Classification of Educational Goals, Handbook I: Cognitive Domain, (Longman Inc., New York, 1956).

Six categories of thinking and suggested verbs for teachers are provided below. Teachers will find these helpful in constructing questions and planning lessons. For further classification of learning levels in the affective and psychomotor domains, teachers are referred to Reaching Higher Levels of Thought, Los Angeles Unified School District, Office of Secondary Instruction, Publication No. X-II18, 1982.

MAJOR CATEGORIES AND SUGGESTED VERBS FOR USE IN STATING COGNITIVE OUTCOMES

EVALUATION

Judge
 appraise
 evaluate
 rate
 revise
 score
 assess
 estimate
 choose
 measure
 select
 value

SYNTHESIS

compose
 plan
 propose
 design
 formulate
 arrange
 assemble
 collect
 construct
 create
 set up
 organize
 manage
 prepare

ANALYSIS

distinguish
 analyze
 calculate
 experiment
 test
 compare
 contrast
 criticize
 diagram
 inspect
 debate
 inventory
 question
 relate
 solve
 examine
 categorize

APPLICATION

interpret
 apply
 employ
 use
 demonstrate
 dramatize
 practice
 illustrate
 operate
 schedule
 shop
 sketch

COMPREHENSION

translate
 restate
 discuss
 describe
 recognize
 explain
 express
 identify
 locate
 report
 review
 tell

KNOWLEDGE

define
 repeat
 record
 list
 recall
 name
 relate
 underline

LEARNING MODALITIES

The learning modalities are the sensory channels by which students receive information. The three learning modalities are visual, auditory, and kinesthetic. Classroom instruction should include all three modalities.

A student's dominant modality is the channel through which instruction is processed most efficiently. Teachers can capitalize on learning strengths by determining the students' dominant modalities. Teachers should also assess their own learning styles, since research indicates that teachers tend to teach in their preferred modalities. An awareness of different learning styles will assist the teacher in planning a variety of instructional activities.

Some of the materials and techniques listed below have proved highly effective in designing lessons based on learning modalities.

<u>Visual Learners</u>	<u>Auditory Learners</u>	<u>Kinesthetic Learners</u>
Flash cards	Tapes	Tracing activities
Matching games	Music	Tactile experiences
Puzzles	Rhymes	Felt pens
Dictionaries	Clapping/keeping time	Math manipulatives
Card files	Language master	Plays, art
Overhead projector transparencies	Puppet conversations	Puppet actions
Charts	Rhythm instruments	A-V equipment monitoring
Pictures	Poetry	Demonstrator of tasks
Written directions	Reading aloud	Role playing
Instructional books	Talking about the skills to be learned	Pantomime

EVALUATION PROCEDURES

The evaluation of instruction is an integral part of the educational process. It provides information on what has been accomplished and where to go next. The first phase of evaluation should be diagnostic. The teacher should assess what students know before instruction, and then plan an appropriate course of instruction based on students' knowledge and abilities. In addition to diagnostic pretesting, ongoing evaluation during instruction provides teachers with a record of student progress and indicates the instructional changes that may have to be made in order to plan for maximum achievement. Post-testing assesses how well students have met the objectives at the end of the unit or course. The Secondary Science Continuum provides teachers with a basis for the development of instructional objectives.

The selection or construction of appropriate instruments of evaluation is critical to the measurement process. Test items must measure and reflect instructional objectives. Tests of achievement and problem-solving skills often require advanced reading skills. Therefore, it is recommended that diagrams, graphs, and pictures also be used to evaluate student progress and achievement.

Various measures of evaluation can be used in all phases of science education. Achievement tests assess science knowledge and comprehension. Problem-solving measures are useful for measuring higher cognitive skills such as analysis, synthesis, and evaluation. Motor skills and skill in the application of scientific knowledge can be evaluated in the laboratory setting. Observation and interview techniques are useful in the assessment of such laboratory skills as manipulating materials, setting up experiments, handling and caring for live specimens, and employing safety practices. These measurement techniques allow for immediate feedback to students.

Suggested assessment procedures include the following: teacher-prepared tests; commercially prepared tests; departmental tests; informal and formal assessment of individual and group activities in oral work and discussion; and student-prepared test items which provide reinforcement and the opportunity to apply course content.

TIPS FOR PARENTS

The following are some of the important ways in which parents can provide the proper guidance, motivation, assistance, and nurturing home environment for their student's success and learning in science.

1. Show an active interest in your student's learning activities.

Be a good observer and a good listener. Discuss interests and questions. This will help you learn more about your student's interests, study skills and habits, thinking and reasoning abilities, values, and attitudes.

2. Provide (designate) a quiet work and study area.

Help your student develop a routine that allows time for homework and study activities.

3. Provide materials for learning.

For example, try and have related books, magazines, newspapers, dictionaries, encyclopedias, maps, and a globe available for home study. Not only do these help students complete class assignments, but they also motivate and enhance learning and provide opportunities to experience the satisfaction of independent inquiry and discovery.

4. Read, review, and discuss homework and other class assignments.

Commend efforts and achievements. Make suggestions for improvement, if necessary.

5. Learn together.

Encourage questions and discussion. Plan activities which provide opportunities for practicing and applying science skills and concepts. For example, help your student learn to withhold judgments until sufficient evidence has been secured, to challenge sources of information, and to be open-minded. These efforts will help lead students toward developing essential critical-thinking and reasoning skills as well as toward guiding and preparing them to become humane, rational, understanding, and participating citizens in a democratic society.

6. Share interests and experiences.

In order to assist your student to develop a curiosity and interest about science, discuss with him or her science-related articles and television specials.

7. Encourage use of public as well as school libraries.

Help your student obtain an up-to-date library card and use the library's resources on a regular basis.

8. Plan and make trips and visits to study-related places.

For example plan visits to museums, open houses at universities, and industrial agencies.

9. Become familiar with the teacher's procedures, routine, and expectations.

It is important to know and understand the teacher's and the school's standards regarding homework, grades, citizenship, behavior, and attendance.

10. Discuss student's progress with the teacher.

Meet and discuss with the teacher, on a regular basis, such concerns as your student's progress and achievement level, his or her specific learning needs which can be met through home study, and how your student might receive individualized help if needed.

11. Become familiar with the school's instructional materials and resources.

Consult with the teacher and librarian about the selection of related books, magazines, newspapers, and other materials available for reading. Also, learn about the variety of other instructional resources used by the school.

12. Learn about the school's academic program.

Parental support of the school program is an essential factor in shaping positive attitudes toward education.

13. Become a resource person.

You may wish to offer your services as a community resource person or suggest other community or business resources which may be of service and enrichment to the school's instructional program.

14. Most of all, care.

It is only through the combined and cooperative efforts of school, parents, and community that the necessary support, strength, enrichment, and continued excellence of our public schools will be sustained.

LESSON PLAN FORMAT

Subject or Course:

Teacher:

Representative Objective:

Sending and Receiving Skill(s) Emphasized: Speaking ___ Writing ___ Reading ___ Listening ___ Thinking ___

Thinking Level or Cognitive Level: Knowledge ___ Comprehension ___ Analysis Application ___ Synthesis ___
Evaluation ___

1. Specific Objective and How Presented to Students:

2. Value to Students in Achieving the Objective:

3. Initial Instructional Activity to Teach Objective to Students:

4. Guided Group Practice:

5. Independent Practice or Activity:

6. Provision for Individual Differences in Ways of Learning:

a. Remediation or Alternative Activities:

b. Enrichment or Supplemental Activities:

7. Evaluation:

a. Summary:

b. Homework:

SAMPLE LESSON 1: SCIENTIFIC METHOD

Subject or Course: Biology AB

Representative Objective: To assist and develop the student's ability to prepare a laboratory report.

Sending and Receiving Skill(s) Emphasized: Speaking X Writing X Reading X
Listening X Thinking

Thinking Level or Cognitive Level: Knowledge Comprehension Analysis X
Application X Synthesis Evaluation

1. Specific Objective and How Presented to Students: The student will be able to complete a laboratory report following the steps of problem solving presented in the lesson.
2. Value to Students in Achieving the Objective: The student will gain skills in problem solving that may apply to new situations.
3. Initial Instructional Activity to Teach Objective to Students: The teacher will present the six steps used in problem solving via the scientific method. Given an example such as Alexander Fleming's discovery of penicillin, students will see the importance in following logical steps in solving a problem. The steps are as follows.
 - A. Define the problem.
 - B. Gather background data.
 - C. Form hypothesis.
 - D. Test hypothesis.
 - E. Record observations.
 - F. Form conclusions.
4. Guided Group Practice: Students work in groups of 2 to 4. They are introduced to the laboratory exercise on "PROBLEM SOLVING" sheet with a discussion as to the problem presented in the activity.
5. Independent Practice: Students will complete the laboratory activity after they have been given an introduction. A laboratory report using the steps of the scientific method will be required.
6. Individual Differences and Learning Modalities:
 - a. Remediation/Alternative Activities: Students will re-read the material on the scientific method in the textbook. Small groups will discuss the introduction to the laboratory activity with the teacher.
 - b. Enrichment or Supplemental Activities: Students are asked to design an experiment related to something living. They are to use the steps of the scientific method in their design. A written report and a report to the class are required.
7. Evaluation: Teacher observations of groups during laboratory session.
Teacher evaluation of written reports of laboratory activity.

Name _____

Period _____ Date _____

LABORATORY EXERCISE ON PROBLEM SOLVING

Purpose: The purpose of this investigation is to to gain experience in problem solving.

Materials: Test tube filled with water with cap screwed on tight or with a stopper taped on tight.

Procedures:

1. Place the test tube filled with water lengthwise over the large words, carbon dioxide, shown below.
2. While looking through the test tube, raise the test tube about 3 centimeters above the paper. Describe what happens.

CARBON DIOXIDE

3. Think about what happens and use the steps listed below to try to solve the problem you are presented with.
4. Laboratory write-up:

A. Define the problem: _____

B. Gather background data: _____

C. Form a hypothesis: _____

LABORATORY EXERCISE ON PROBLEM SOLVING (continued)

D. Test the hypothesis: _____

E. Form a conclusion: _____

(OPTIONAL) Design an experiment of your own using living materials.

SAMPLE LESSON 2: THE CELL - LABORATORY EXPERIMENT

Course: Biology AB

Representative Objective: To assist and develop the student's ability to observe the processes of osmosis and diffusion.

Sending and Receiving Skill(s) Emphasized: Speaking___ Writing___ Reading___
Listening___ Thinking X

Thinking Level or Cognitive Level: Knowledge___ Comprehension___ Analysis X
Application___ Synthesis___ Evaluation X

1. Specific Objective: The student will be able to remove the shell from an egg and change the size of the egg with various solutions. The student will be able to predict the results of using other solutions.
2. Value to Student: The student will develop hand-eye coordination, and observational and predictive skills that are useful in real life situations.
3. Initial Instruction/Teacher Presentation: Students are given outlines of the steps of the experiment they will perform and the possible outcomes.
4. Guided Group Practice: Students will be given an opportunity to do a number of experiments with the egg.
5. Independent Practice: The student will change the size of the egg with as many solutions as time allows.
6. Individual Differences and Learning Modalities: Students will be given a choice in the number and type of experiments they do with the egg. Additional practice can be provided to students who do not grasp the concept by having them work with students who do.
 - a. Remediation/Alternative Activities: Students who work rapidly will help students who work slowly. Students will be divided into heterogeneous teams.
 - b. Enrichment/Supplemental Activities: Students who seek greater challenge may use the laboratory exercise entitled "The Advanced Egg."
7. Evaluation: Students will be graded on the preparation of their egg and report. An oral discussion on predictive results will be presented, followed by a quiz.

Name _____

Period _____ Date _____

LABORATORY EXERCISE ON THE EGG

Introduction

Osmosis

Water enters and leaves the cells of our body by passing through the actual cell membranes. The movement of water is called diffusion and the movement of water through a membrane is called osmosis.

Diffusion

Diffusion occurs any time any kind of substance is concentrated in one place and movement of its molecules enables them to travel. If someone wears perfume, it diffuses off the skin into the air, and then into another person's nose.

The odor of an onion is released and diffuses into the air when the onion is cut. A drop of food coloring placed in a gallon of water colors the entire gallon of water without being stirred.

Diffusion always has a direction. Diffusion goes from an area of greater concentration to an area of lesser concentration.

THE EGG

The egg is a wonderful subject for science experiments. It is a single cell, has a hard covering, is covered by a single perfect membrane, can develop into a chicken, and is edible if fertile.

Materials:

- 250-ml beaker or pint jar for each egg
- one pint of vinegar for each egg
- eggs

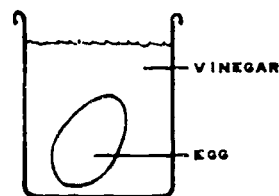

Procedures:

Do not remove the shell first. To remove the shell, place the egg in the beaker and fill the beaker with vinegar. Put the beaker in a refrigerator for 24 hours. Remove the egg from the beaker and, handling it very carefully, rinse it in the sink. At this point the eggs will vary from extremely fragile to rather tough and capable of withstanding being passed around the classroom.

LABORATORY EXERCISE ON THE EGG (continued)

Experiments with the Egg:

You can do any or all of these experiments. Each part is a complete laboratory investigation. The experiments can be done with the same egg reusing it on succeeding days, or you can use several eggs.

1. Place the egg in pure water for 24 hours.
2. Place the egg in white corn syrup for 24 hours.
3. Place the egg in a salt solution which has enough salt in it so that the egg floats.
4. Place the egg in a series of sugar solutions such as 5%, 10%, 20%, 50%.
5. Repeat #1 using a few drops of food coloring.
6. Place the egg in pure cooking oil.
7. Place the egg in liquid dishwashing soap.

Follow-up Questions:

1. What happened to the size of the egg? Was it fatter or thinner?
2. For each experiment, did the water flow into or out of the egg or was there no change?
3. Is there any evidence that something other than water could enter the egg? How would you test for this?

THE ADVANCED EGG

Materials:

any methacrylate or "super glue"
glass medicine droppers
eggs without shells (as prepared above)
glass tubing (1 m or 3 foot section)
rubber tubing
ring stand with clamps
tape
graph paper

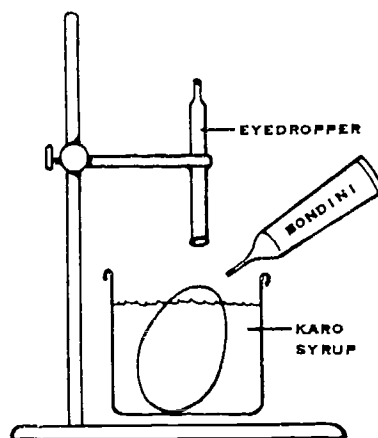

Procedures:

The egg should have the shell removed with no trace of white on it. It is best and safest to soak the egg in white corn syrup for 24 hours before this procedure because it makes the egg membrane looser and less likely to rupture.

Remove the rubber top from a medicine dropper. Position the equipment as shown in the drawing with the dropper a little above the egg. Put a drop of glue around the inside rim of the dropper, then lower it against the egg membrane, and secure it with the ringstand clamp. When it is properly positioned, put another drop of glue around the outside rim of the dropper where it meets the membrane. Allow it to dry for 24 hours.

LABORATORY EXERCISE ON THE EGG (continued)

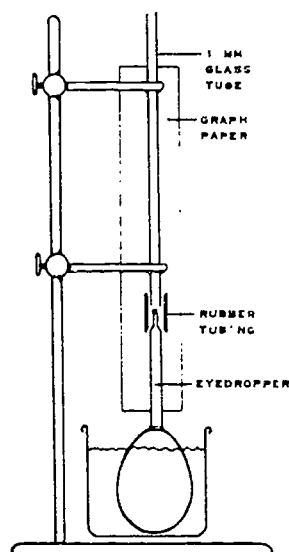

Put 2 or 3 drops of food coloring in the top of the dropper. Place a 5-cm piece of rubber tubing on the top of the dropper. Using an opened paper clip, poke a hole in the egg membrane (inside) the dropper. If the membrane is loose from being soaked in white corn syrup, liquid will not quietly rise. If the egg was very turgid from being in water, you will get a small geyser of egg and food coloring on your hand unless you have the rubber tube well pinched. Insert the long glass tube into the open end of the rubber tubing and clamp it securely to ring stand.

Tape a 1" by 11" piece of graph paper to the glass tube to act as a measuring scale.

Cautions:

This is a tricky procedure requiring steady hands.

This setup is extremely fragile and any movement of the egg or tubing after gluing may cause rupture of the egg membrane.

Experiments:

What you have prepared is an apparatus that shows small differences in osmotic pressure. Each of the following is a variation on that theme:

1. Place fresh tap water in the beaker and record the movement of the liquid through the glass tube at timed intervals. Graph the results.
2. Place concentrated salt water in the beaker and read the level of liquid in the tube. Add water in small quantities to dilute the salt concentration. At each change in concentration, read the new level of liquid in the tubing (allow adequate time).
3. Place cooking oil in the beaker.
4. Place alcohol in the beaker.
5. Instead of using a whole egg, try using just the yolk. The yolk has a complete membrane although it is thinner, more fragile, and dries out easily. This experiment is extremely difficult.

SAMPLE LESSON 3: TAXONOMY - LABORATORY EXERCISE

Course: Biology AB

Representative Objective: To assist and develop the student's ability to categorize common laboratory apparatus through the use of a dichotomous key.

Sending and Receiving Skill(s) Emphasized: Speaking___ Writing___ Reading___
Listening___ Thinking X

Thinking Level or Cognitive Level: Knowledge___ Comprehension___ Analysis X
Application___ Synthesis___ Evaluation___

1. Specific Objective: The student will be able to use a dichotomous key to classify laboratory apparatus.
2. Value to Student: The student will develop hand-eye coordination and observational skills that are useful in real life situations, such as determining features of machined parts.
3. Initial Instruction/Teacher Presentation: Students are given outlines, a printed dichotomous key, and a tray of common laboratory apparatus.
4. Guided Group Practice: Students will be given a practice session consisting of the "keying out" of one item on the tray. Students will work in pairs.
5. Independent Practice: The student will have a 25-minute period to work on the remaining items on the tray.
6. Individual Differences and Learning Modalities: Additional practice can be provided to students who do not grasp the concept by having them work with students who do.
 - a. Remediation/Alternative Activities: Students who work rapidly will help students who work slowly. Students will be divided into heterogeneous teams.
 - b. Enrichment/Supplemental Activities: Students who seek greater challenge will be given the additional assignment of constructing their own dichotomous key for items in one room of their homes.
7. Evaluation: Answers to the items in the tray will be collected and graded. Students will discuss the meaning of the activity, and their knowledge of the purposes and details of the procedure will be an evaluation of the effectiveness of the activity.

Name _____

Period _____ Date _____

LABORATORY EXERCISE ON USING A DICHOTOMOUS KEY

Purpose: The purpose of this exercise is to identify objects on the basis of their characteristics.

Materials:

cafeteria tray
beaker
wood applicator
test tube
Petri dish
toothpick
glass tube
glass rod
slide
coverslip
metric rule

Procedures:

Pick an object from the laboratory tray. While holding it in your hand, start at number one and pick either x or y as the best answer. Go where the directions tell you to go. Proceed with the directions until you reach the letters a through j. Make an answer sheet like the one below and write the proper letter next to each name.

Answer Sheet:

1. beaker _ _ _ _ _
2. wood applicator _ _ _ _ _
3. test tube _ _ _ _ _
4. Petri dish _ _ _ _ _
5. toothpick _ _ _ _ _
6. glass tube _ _ _ _ _
7. glass rod _ _ _ _ _
8. slide _ _ _ _ _
9. coverslip _ _ _ _ _
10. metric rule _ _ _ _ _

THE KEY

- 1x Made of wood-----go to 2
- 1y Not made of wood-----go to 3

- 2x Made of wood and more than 10 cm long-----a
- 2y Made of wood and less than 10 cm long-----b

- 3x Made of plastic-----go to 4
- 3y Not made of plastic-----go to 6

- 4x Small square and flat-----c
- 4y If not-----go to 5

- 5x Long and flat-----d
- 5y Round and dish like-----e

- 6x Flat and rectangular in shape-----f
- 6y If not-----go to 7

- 7x Larger than 1 cm in diameter-----go to 9
- 7y Smaller than 1 cm in diameter-----go to 8

- 8x Solid, has no hole-----g
- 8y Has hole down the center-----h

- 9x Length is more than 5 times the diameter-----i
- 9y Length is less than 5 times the diameter-----j

SAMPLE LESSON 4: PROTIST - LABORATORY EXERCISES

Course: Biology AB

Representative Objective: To assist and develop the student's ability to observe the universal presence of microorganisms in our environment.

Sending and Receiving Skill(s) Emphasized: Speaking___ Writing___ Reading___
Listening___ Thinking X

Thinking Level or Cognitive Level: Knowledge___ Comprehension___ Analysis X
Application___ Synthesis___ Evaluation___

1. Specific Objective: The student will be able to grow bacteria and isolate a pure culture. The student will then test that pure culture for antibiotic sensitivity.
2. Value to Student: The student will develop hand-eye coordination and observational skills that are useful in real life situations, such as sterile laboratory techniques.
3. Initial Instruction/Teacher Presentation: Students are given outlines of the steps of the experiment they will perform and the possible outcomes.
4. Guided Group Practice: Students will have a practice session for development of sterile techniques of bacterial transfer.
5. Independent Practice: Students will be given sterile media and nutrient agar to accomplish the techniques of bacterial transfer.
6. Individual Differences and Learning Modalities: Additional practice can be provided to students who do not grasp the concept by having them work with students who do.
 - a. Remediation/Alternative Activities: Students who work rapidly will help students who work slowly. Students will be divided into heterogeneous teams.
 - b. Enrichment/Supplemental Activities: Students who seek greater challenge will be allowed to screen other materials for antibiotic activity.
7. Evaluation: Students will present Petri dishes showing a single kind of organism and the effects of antibiotic disks. Petri dishes will be graded for sterile technique and completion of assignment. Student answers to written questions will be graded.

Name _____

Period _____ Date _____

SUMMARY OF LABORATORY PARTS

Microorganisms in our environment: Petri dishes are exposed to natural sources of bacteria.

Isolating a pure culture: One of the colonies in the previous experiment is spread out on a sterile Petri dish to get a culture derived from a single ancestor.

Biological magnification: The pure culture from the previous part is grown in broth to increase the number of bacteria.

Testing for antibiotic sensitivity: The bacteria from the broth culture are put in a Petri dish and exposed to antibiotics to see which antibiotics are effective in killing them.

LABORATORY EXERCISE ON MICROORGANISMS IN OUR ENVIRONMENT

Purpose: The purpose of this investigation is to recognize the universal presence of bacteria in our environment.

Materials Needed: (for each team)

Bunsen burner
test tube with 20 ml sterile media
(see Teacher Preparation)
sterile disposable Petri dish
tape or china marking pencil

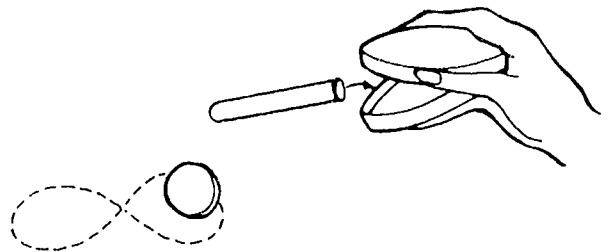

Procedures:

1. Remove the cap or cotton and carefully flame the end of your test tube.
2. Lift the edge of the Petri dish and pour in the sterile medium.
3. Leaving it on the table, rotate the dish around in a figure "8" (very carefully), until the medium covers the entire bottom of the dish. Try not to splash it up the sides.
4. Wait until it is solidified and cool (about 10 minutes).
5. Go outside and expose the dish to something that might have bacteria on it.
Examples:

- a. A kiss
- b. The cafeteria tables
- c. The restroom door handles
- d. Your finger tips

MICROORGANISMS IN OUR ENVIRONMENT (continued)

6. Replace the cover on the dish and seal it with transparent tape so that it cannot be opened again. This guards it against possible exposure to pathogenic organisms.
7. Label the Petri dish bottom with your name(s), date, and what you exposed it to.
8. Place Petri dish in the incubator for 48 hours.

QUESTIONS: Examine the Petri dish carefully.

1. Count the bacterial colonies and note their colors.
2. Count the mold colonies, and describe their colors and forms.
3. Looking at the bacterial colonies in a bright light, report on the "shininess" or gloss of different colonies.

Place the Petri dish in the contaminated trash container.

Name _____

Period _____ Date _____

LABORATORY EXERCISE ON ISOLATING A PURE CULTURE OR CLONING,
BIOLOGICAL REPRODUCTION, AND ANTIBIOTIC SENSITIVITY - PART 1

Purpose: The purpose of this investigation is to make a colony of bacteria from a single ancestor.

Materials:

Bunsen burner
test tube with 20 ml sterile media (see Teacher Preparation)
sterile disposable plastic petri dish
inoculating needle (see Teacher Preparation)
tape or china marking pencil
various pure cultures in broth

Procedures:

1. Remove the cap or cotton and carefully flame the end of your test tube.
2. Lift the edge of the Petri dish and pour in the sterile media.
3. Leaving it on the table, rotate the dish around in a figure "8" until the media covers the whole bottom of the dish.
4. Wait until it is cool and solid.
5. Obtain a vial of pure culture broth.
6. Flame the inoculating needle and then lift the cap of the vial. Touch the needle to the media to cool it.
7. Obtain some of the broth with the sterile inoculating needle.
8. Slightly lift the cover of the new Petri dish and rub the culture broth you are transferring onto the media.
9. Flame the inoculating needle.
10. Slightly lifting the cover of the new Petri dish, touch the sterile inoculating needle to the media to cool it.
11. Rub the inoculating needle through the drop of culture broth and then rub the needle carrying the bacteria in the pattern shown in the illustration.

ILLUSTRATION

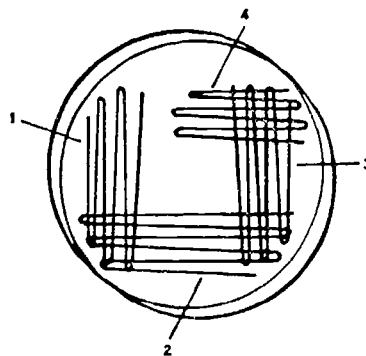

12. Write your name(s) on the new Petri dish bottom and place it in the incubator for 48 hours.

LABORATORY EXERCISE ON ISOLATING A PURE CULTURE OR CLONING,
BIOLOGICAL REPRODUCTION, AND ANTIBIOTIC SENSITIVITY PART 1
(continued)

QUESTIONS: Examine the Petri dish after 48 hours.

1. Look closely at the colony pattern. Is there more than one kind of colony present? Why do you think this is so?
2. Are there places on the Petri dish which seem more likely to be a colony from a single ancestor than those in other places? Why?
3. Are there any colonies which appear to be "like a pie with one slice different than the others?" Describe this colony. (Your teacher may have to help you with an explanation.)
4. Find an isolated colony which seems to be definitely from a single ancestor. Explain the reasons why you chose this colony.

Name _____

Period _____ Date _____

LABORATORY EXERCISE ON ISOLATING A PURE CULTURE OR CLONING,
BIOLOGICAL REPRODUCTION, AND ANTIBIOTIC SENSITIVITY - PART 2

Purpose: The purpose of the investigation is to to grow large numbers of identical bacteria.

Materials:

Bunsen burner
test tube with 25 ml sterile broth (see Teacher Preparation)
inoculating needle (see Teacher Preparation)
tape or china marking pencil

Procedures:

1. Pick the best isolated colony from your Petri dish in the last exercises.
2. Flame the inoculating needle, and then slightly lift the lid of the Petri dish and touch the needle to a clear area of the agar to cool it.
3. With the cooled inoculating needle, pick up your best colony.
4. Remove the plug and flame the top of the broth test tube.
5. Put the inoculating needle which is carrying your colony into the broth, and give it a little shake to loosen it from the inoculating needle.
6. Pull out the inoculating needle, flame the top of the test tube, and put the cap back on. Flame the inoculating needle.
7. Put your name(s) on the broth test tube, and place it in the incubator for 24 hours.
8. Put the old Petri dish in the contaminated trash container.

QUESTIONS:

1. The word "biological magnification" is sometimes used for this exercise. Why is this a good name?
2. What advantages does growing the bacteria in broth have over growing them on agar?

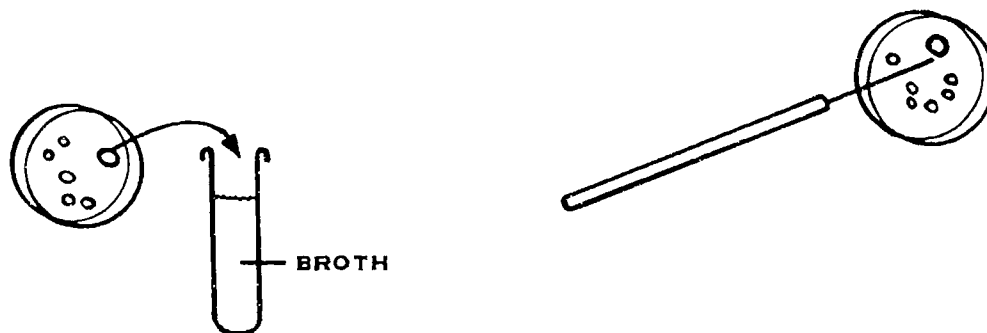

Name _____

Period _____ Date _____

LABORATORY EXERCISE ON ISOLATING A PURE CULTURE OR CLONING,
BIOLOGICAL REPRODUCTION, AND ANTIBIOTIC SENSITIVITY - PART 3

Purpose: The purpose of this investigation is to test a single type of bacteria for antibiotic sensitivity.

Materials:

- Bunsen burner
- test tube with 40 ml sterile media at 37° C
- inoculating needle
- sterile disposable plastic Petri dish
- tape or china marking pencil
- water bath set at 50° C
- antibiotic sources:
 - . antibiotic disks
 - . homemade disks with antibiotic or prepared commercial antibiotic sensitivity disks
 - . antibiotic pills
 - . plant materials which might be antibacterial

Procedures:

1. Mix one-half the broth containing the bacteria with agar media; then, pour it in a Petri dish to harden. The following steps are to be performed carefully and quickly--the agar will be hardening quickly:
 - a. Remove the cap of the broth tube and flame the neck of the tube.
 - b. Remove the cap of the sterile media and flame the neck of the tube.
 - c. Pour one-half of the broth into the sterile media.
 - d. Gently shake the tube to mix the contents.
 - e. Flame the sterile media tube.
 - f. Slightly lifting the edge of a sterile Petri dish, pour the contents of the sterile media tube into the Petri dish.
 - g. Discard the broth tube and the sterile media tube in the contaminated waste pan.
2. Choose some antibiotic sources. Do not heat antibiotics in any way because heat destroys them. Work carefully and keep your work area as clean as possible.
3. Flame the inoculating needle and use it to pick up the antibiotic disk or other antibiotic source. Slightly lift the cover of the cooled Petri dish and place the antibiotic source on the media. If the antibiotic source is a pill or something solid, push down on it.

LABORATORY EXERCISE ON ISOLATING A PURE CULTURE OR CLONING,
BIOLOGICAL REPRODUCTION, AND ANTIBIOTIC SENSITIVITY - PART 3
(continued)

4. You may put one to five antibiotic sources on a Petri dish. You must make a map in your notebook so you can correctly identify the sources tomorrow.
5. Write your name(s) on the bottom of the Petri dish and put it in the incubator for 24 hours.

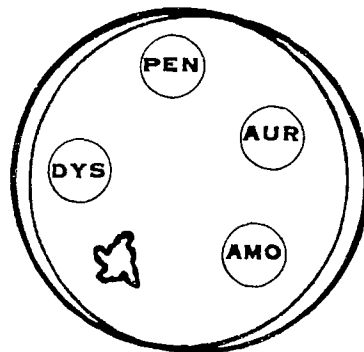

QUESTIONS:

1. Now that the bacteria have grown, they look a little different than those in the other Petri dishes. Describe the colonies and explain the differences.
2. Some of the antibiotic sources show a "zone of inhibition." Describe this zone.
3. Explain why some of the antibiotic sources give a zone of inhibition and some do not.
4. Which antibiotic sources stop the growth of bacteria? Which do not affect growth?
5. Do you think the antibiotics that stopped the growth of your bacteria are effective against all bacteria? Why or why not?
6. How much do the antibiotics diffuse into the media? What are the sizes of their zones of inhibition?
7. Do you see some colonies growing inside the zones of inhibition? What is the probable explanation for these colonies' existence?
8. Are there foreign bacteria in this Petri dish? Explain what may have gone wrong in your sterile techniques to allow these invaders.

TEACHER PREPARATION OF MATERIALS

MATERIAL ACQUISITION: All materials for this laboratory experiment can be obtained from the Science Materials Center, ordered from the supply and equipment catalogs, or acquired from students' homes.

PETRI DISHES: Sterile plastic disposable Petri dishes are available from the Science Materials Center and in the District Supply Catalog.

PREPARING MEDIA: Prepared sterile media can be obtained from the Science Materials Center or it can be easily made. To one liter of water add 23 g of nutrient agar. Heat, stirring constantly until melted. Sterilize before use.

MAKING INOCULATING NEEDLES: Although you can purchase inoculating needles, it is easy to make them using paper clips and glass tubing. The paper clip can be secured in the glass with the Bunsen burner, methacrylate glue, or silicon sealer.

STERILIZING MEDIA: Anything to be sterilized should be put in a pressure cooker for 15 minutes at 15 pounds steam pressure. Carefully read and follow all safety rules regarding your pressure cooker.

STERILIZING CONTAMINATED LABWARE: Everything on which bacteria can or did grow, should be sterilized. Do not let anyone handle contaminated materials until the material has been sterilized. Soaking in a strong phenol solution for several hours is adequate and is the best procedure for plastic Petri dishes prior to disposal. Pressure cooker sterilization is the best method. After sterilization, the labware can be washed in soap and water.

STERILIZING SURFACES: Although you are not working with known pathogens (and never should), it is wise to wash down the laboratory tables with a strong phenol solution or 70% ethyl alcohol after each period.

AVOID MOLDS: You should warn students not to touch, or put themselves in a position to breathe in mold spores. While mold spores are a part of the air in every room, their growth on media makes them highly concentrated. If you wish students to examine them under the microscope--examine them through a sealed Petri dish cover.

WASHING HANDS: Each student should be urged to wash his or her hands with soap and water at the completion of each stage of the laboratory experiment.

MAKING COTTON PLUGS: Cotton should be tightly wrapped to form a plug. A good test for tightness is to hold a plugged test tube by the cotton. If the test tube falls, the cotton is too loose. A superior, but time-consuming alternative, is to wrap cotton plugs with cheese cloth and tie them with thread. These plugs can be used for many years. Caps made from aluminum foil may also be used.

TEACHER PREPARATION OF MATERIALS (continued)

MAKING STERILE MEDIA TUBES: Pour 20 ml of prepared media into each tube, insert cotton plug and sterilize in pressure cooker. On the day of use, melt the contents in a water bath and maintain the temperature at above 50° C. Petri dishes or plates may be quickly prepared by using sterile media from the Science Materials Center, melting media in a water bath on a hot plate, and pouring it into sterile Petri dishes using sterile techniques.

ANTIBIOTIC SOURCES: A number of options are available:

1. The Science Materials Center can supply a variety of prepared antibiotic disks.
2. Disks can be made out of filter paper with a hole punch. The disks should be placed in a glass Petri dish or test tube with plug and sterilized.
 - a. Students can bring in small quantities of antibiotic liquids from home. Disks can be soaked in antibiotic and then used in the experiment.
 - b. Feed and pet stores are often good sources of antibiotics.
 - c. Antibiotic pills or pieces of pills can be placed directly on the freshly poured plate. They should be pushed down firmly with a sterile inoculating needle.
 - d. Materials from nature such as lichen, celery juice (exposed to light), or plant leaves can sometimes be found to contain antibiotic properties. They can be applied directly, or reduced to liquids and used on disks.
 - e. Changes in pH may also inhibit some types of bacteria.

SAMPLE LESSON 5: PLANT - LABORATORY EXERCISE

Course: Biology AB

Representative Objective: To assist and develop student's ability to observe and quantify the relationship between oxygen production and amount of light a plant receives.

Sending and Receiving Skill(s) Emphasized: Speaking___ Writing___ Reading___
Listening___ Thinking X

Thinking Level or Cognitive Level: Knowledge___ Comprehension___ Analysis X
Application___ Synthesis___ Evaluation___

1. Specific Objective: The student will be able to predict oxygen production as a function of light.
2. Value to Student: The student will develop observational and analytical skills useful in real life situations.
3. Initial Instruction/Teacher Presentation: Students are shown the laboratory setup and are instructed on safety with glass and razor blades. The procedure is outlined and the method of preparing elodea is demonstrated.
4. Guided Group Practice: A sample laboratory setup is placed in a conspicuous place. The teacher discusses the use of materials and procedures with students, asking and answering questions.
5. Independent Practice: Students are instructed to follow the procedures, record their data, and predict oxygen production.
6. Individual Differences and Learning Modalities: Additional help can be provided to students who do not grasp the concepts by having them work with students who do.
 - a. Remediation/Alternative Activities: Students who work rapidly will help students who work slowly. Students will be divided into heterogeneous teams.
 - b. Enrichment/Supplemental Activities: Students who show greater interest and ability will be given thermometers and using cold and hot water will investigate temperature as a function of oxygen production in elodea.
7. Evaluation: Students' graphs and the answers to their question sets will be evaluated.

Name _____

Period _____ Date _____

LABORATORY EXERCISE TO DEMONSTRATE HOW PLANTS USE LIGHT TO PRODUCE OXYGEN

Materials:

sprigs of elodea (anacharis)
large test tube
warm water
sodium bicarbonate solution (25 g per liter)
lamp (approximately 40 watt)
tape
sharp, single-edged razor blade
ring stand
metric rule

Procedures:

1. Preparation of elodea: Obtain a piece of elodea about 8 cm long and remove 2 or 3 leaves from the stem end. Cut the stem end with a sharp razor blade at an angle. Lightly crush the stem end.
2. Setting up the experiment: Fill the test tube with warm sodium bicarbonate solution. Place the elodea into it, stem end up. Tape the test tube to the ring stand. Place the lamp 20 cm from the test tube.

ILLUSTRATION

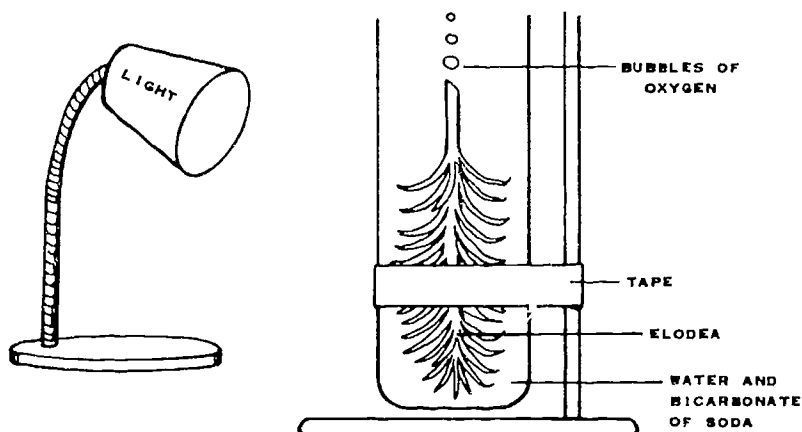

3. Running the experiment:
 - a. Allow several minutes for the experiment to begin working.
 - b. Count the bubbles emerging from the cut stem for 5 minutes and record data.
 - c. Count the bubbles emerging from the cut stem for another 5 minutes and record data.
 - d. Move the lamp to 10-cm distance from the test tube and allow several minutes for the experiment to adjust to the change.
 - e. Count the bubbles emerging from the cut stem for another 5 minutes and record data.

LABORATORY EXERCISE TO DEMONSTRATE HOW PLANTS USE LIGHT TO PRODUCE OXYGEN
(continued)

- f. Count the bubbles emerging from the cut stem for another 5 minutes and record data.
- g. Move the lamp to 5-cm distance from the test tube and allow several minutes for the experiment to adjust to the change.
- h. Count the bubbles emerging from the cut stem for 5 minutes and record data.
- i. Count the bubbles emerging from the cut stem for another 5 minutes and record data.

Evaluation and Analysis:

Prepare a bar graph of your data to show number of bubbles produced. The bar graph should have pairs of bars representing each distance between the lamp and elodea.

Questions:

1. What is being used in this experiment to determine the rate at which photosynthesis is occurring?
2. What is the relationship between oxygen produced and the amount of light?
3. What do you think is the function of the sodium bicarbonate in this experiment?
4. What problems would you have if you tried to put the lamp at a distance of 2.5 cm from the elodea?
5. Does this experiment deal with temperature of the solution?
6. What results would you expect if you used an 80-watt bulb instead of a 40-watt bulb?

SAMPLE LESSON 6: ANIMAL - LABORATORY EXERCISE

Course: Biology AB

Representative Objective: To assist and develop the student's ability to use observation as a tool to find the relationships between animals.

Sending and Receiving Skill(s) Emphasized: Speaking__ Writing__ Reading__
Listening__ Thinking X

Thinking Level or Cognitive Level: Knowledge__ Comprehension__ Analysis X
Application__ Synthesis__ Evaluation__

1. Specific Objective: The student will be able to recognize differences and similarities between representative animal groups.
2. Value to Student: The student will develop observational and organizational skills that are useful in real life situations such as comparison shopping.
3. Initial Instruction/Teacher Presentation: Students are shown various species of animals and asked how specific structures and functions are alike and different. These could include number of legs, body coverings, fluctuations in temperature, and method of bearing young. The concept of taxonomy is introduced, and students are given a key. The teacher explains how a taxonomic key is used.
4. Guided Group Practice: Students are instructed to develop a classification scheme and data table to classify items in their classroom. Using their taxonomic key, students will classify ten items in their classroom.
5. Independent Practice: Twenty stations are set up around the room. One animal species is placed on display at each station. Students work with a partner to classify the specimens into the correct phylum and class, using the key. The instructor monitors student progress.
6. Individual Differences and Learning Modalities: Additional practice can be provided to students who do not grasp the concept by having them work with students who do.
 - a. Remediation/Alternative Activities: Students who work rapidly will help students who work slowly. Students will be divided into heterogeneous teams.
 - b. Enrichment/Supplemental Activities: Specimens of extra, more difficult species will be made available for classifying by those students who seek greater challenges.
7. Evaluation: Students' answer sheets on which organisms have been taxonomically keyed will be evaluated.

Name _____

Period _____ Date _____

LABORATORY EXERCISE ON TAXONOMIC KEYS FOR ANIMAL PHyla

Materials:

- 20 animal specimens
- taxonomic key for each student

Procedures:

Starting with number one, read each couplet (1a & 1b, 2a & 2b), and decide which one fits the organism you are observing. After you have chosen the proper phrase, follow that line to the right and go to the couplet that is given. Again, read both lines of the couplet, and make your choice. Go to the next couplet indicated by the number. Repeat this procedure until you come to the phylum name instead of the number. Write the phylum name and the class, if given, on your paper next to the common name.

TAXONOMIC KEY

- 1a. Worm-like body.....2
- 1b. Any other body.....4

- 2a. If worm is cut in half, shape of cross section of body is round.....3
- 2b. If worm is cut in half, cross section is flat.....Platyhelminthes

- 3a. Round worm, body smooth.....Aschelminthes
- 3b. Round worm, body segmented.....Annelida

- 4a. Body symmetry radial.....5
- 4b. Body symmetry any other way.....6

- 5a. Tentacles present, body soft.....Coelenterata
- 5b. Tentacles absent, body hard and rough.....Echinodermata

- 6a. Exoskeleton, shell, or tentacles.....7
- 6b. Exoskeleton, shell, or tentacles.....8

- 7a. Jointed legs present.....Arthropoda
- 7b. Jointed legs absent.....Mollusca

- 8a. Hair present.....Chordata-Mammalia
- 8b. Hair absent.....9

- 9a. Feathers present.....Chordata-Aves
- 9b. Feathers absent.....10

LABORATORY EXERCISE ON TAXONOMIC KEYS FOR ANIMAL PHYLA (continued)

- 10a. Paired fins present.....Chordata-Osteichthyes
- 10b. Paired fins absent.....11

- 11a. Skin scales present.....Chordata-Reptilia
- 11b. Skin scales absent.....Chordata-Amphibia

Data Table

Specimen #	Phylum Name	Class (if given)

QUESTIONS:

1. What are the most important characteristics that you look for?
2. What characteristics separate the phylum Platyhelminthes from all other phyla?
3. What distinguishes the Aves from all other groups?

TEACHER PREPARATION OF MATERIALS

The animals in this list are only suggestions. You may have many living and preserved organisms which will serve as well. Use several specimens for each category.

PLATYHELMINTHES

- planaria (from Science Materials Center)
- tapeworm

ASCHELMINTHES

- ascaris (from Science Materials Center)

ANNELIDA

- earthworm (from Science Materials Center)
- leech
- nightcrawler (from Science Materials Center)

ECHINODERMATA

- starfish
- sea urchin

COELENTERATA

- sea anemone
- jellyfish
- hydra (from Science Materials Center)

MOI.LUSCA

- snail (from Science Materials Center)
- clam (from Science Materials Center)

ARTHROPODA

- spider
- cricket (from Science Materials Center)
- crab
- crayfish (from Science Materials Center)
- cockroach

CHORDATE-PISCES

- goldfish (from Science Materials Center)

CHORDATE-AMPHIBIA

- frog (from Science Materials Center)
- toad

CHORDATE-REPTILIA

- snake (from Science Materials Center)
- lizard (from Science Materials Center)

CHORDATE-MAMMALIA

- person (use a mirror)
- rat or mouse (from Science Materials Center)
- rabbit

SAMPLE LESSON 7: EMBRYOLOGY - LABORATORY EXERCISE

Course: Biology AB

Representative Objective: To assist and develop the student's ability to observe fertilization and development in sea urchins.

Sending and Receiving Skill(s) Emphasized: Speaking___ Writing___ Reading___
Listening___ Thinking X

Thinking Level or Cognitive Level: Knowledge___ Comprehension___ Analysis X
Application___ Synthesis___ Evaluation___

1. Specific Objective: The student will observe fertilization and early development of sea urchins.
2. Value to Students: Students will develop observational and analytical skills useful in real-life situations.
3. Initial Instruction/Teacher Presentation: Students are shown the laboratory equipment. The procedure is explained and the method of preparing sea urchin gametes is demonstrated.
4. Guided Group Practice: A review and practice in the use of the microscope is given, and students are shown where materials are located.
5. Independent Practice: Students are instructed to follow the procedures and make careful notes and drawings of their observations of sea urchin fertilization and early development. Students are to complete the laboratory follow-up questions.
6. Individual Differences and Learning Modalities: Additional help can be provided to students who do not grasp the concepts or do not have adequate motor skills by having them work with students who do.
 - a. Remediation/Alternative Activities: Students who work rapidly will help students who work slowly. Students will be divided into heterogeneous teams.
 - b. Enrichment/Supplemental Activities: Students who show greater interest and ability will be allowed to come in during lunch and after school to make further observations.
7. Evaluation: Students' drawings, notes on observations, and the answers to their question sets will be evaluated.

Name _____

Period _____ Date _____

LABORATORY EXERCISE OF THE REPRODUCTION AND DEVELOPMENT IN THE SEA URCHIN

Purpose: The purpose of this investigation is to observe the fertilization and development of the sea urchin.

Materials:

gravid male and female sea urchins
filtered sea water
ice
ice tray
0.5 M potassium chloride
hypodermic syringe
Petri dishes
slides and cover slips
droppers
250-ml beaker

Procedures:

1. Inject 1 to 2 ml 0.5 M KCl into 2 or 3 places around the mouth of the sea urchin. Sperm or egg will come out of ducts on the other side (spiny back) of the urchin. A white emission is sperm, a yellow is eggs.
2. If sperm: Turn the urchin mouth side up in a dry Petri dish or on the top of a small beaker and let the sperm collect in the dish. If you put this Petri dish or beaker on a tray of ice, the sperm will remain alive all day.
3. If eggs: turn the urchin mouth side up over a beaker and let the eggs drop into sea water. Let the eggs settle to the bottom and decant the sea water. Refill beaker with sea water and decant again. Fill with sea water and place beaker on a tray of ice. Eggs will remain alive all day.
4. Look at a drop of egg suspension under the microscope, and draw pictures of several eggs.
5. Put a fresh drop of egg suspension under the microscope, and then add a drop of sperm. Describe what happens. Draw a picture of the sperm as it approaches and contacts the egg, and of the egg after the moment of fertilization.
6. After a couple of hours, the fertilized eggs will begin to cleave, and within about 20 hours they will reach the ciliated blastula stage. Draw pictures of as many stages as you can.

Questions:

1. Describe the step-by-step events you observed during fertilization and development. Number your drawings or the stages in the sequence in which development did occur.
2. In what ways do you think this is similar to human development, and in what ways is it different?
3. Thinking back on what you observed, what animals have you studied this year that are similar to one of the stages of development?

DEVELOPMENTAL STAGES OF SEA URCHINS

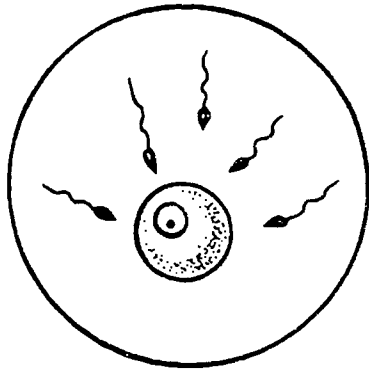

SPERM & EGG

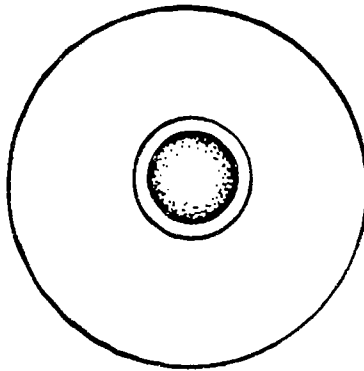

FERTILIZED EGG

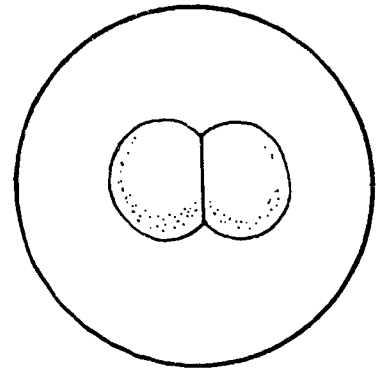

2 CELL STAGE

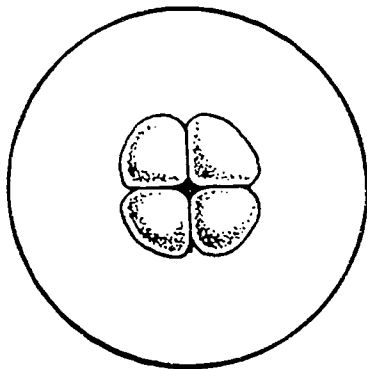

4 CELL STAGE

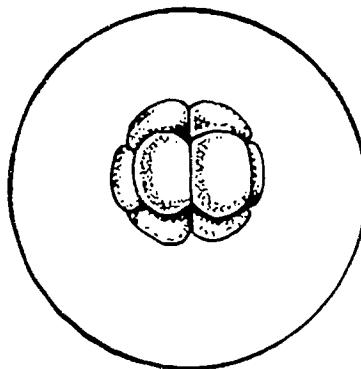

8 CELL STAGE

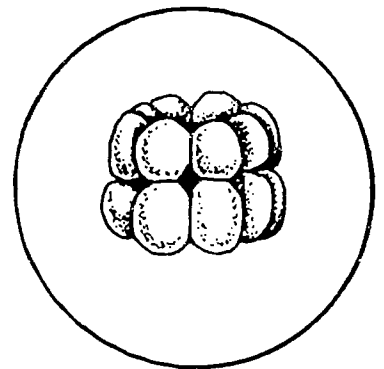

16 32 CELL STAGE
MORULA

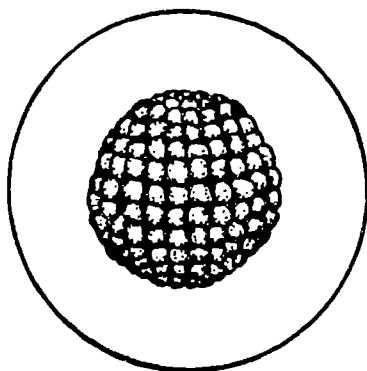

BLASTULA

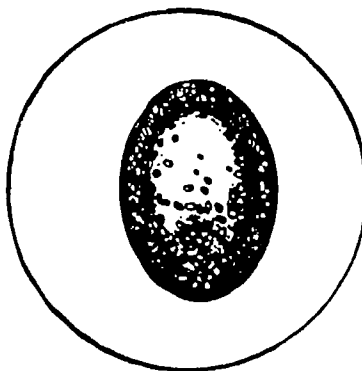

GASTULA

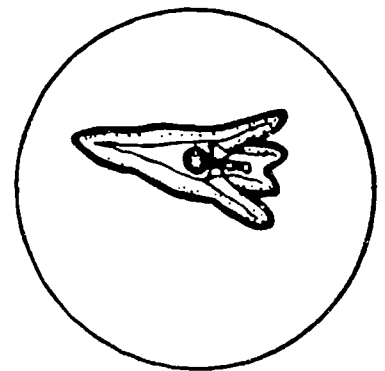

PLUTEUS

LABORATORY EXERCISE OF THE REPRODUCTION AND DEVELOPMENT IN THE SEA URCHIN
(continued)

Notes to the Teacher:

Sea urchins are excellent animals in which to study reproduction and development, because they have external fertilization and development. The stages of development occur very well in ordinary sea water kept in Petri dishes. The sperm and egg can be easily seen through a student microscope and the moment of fertilization is a phenomenal sight. The new urchins can be kept going, and each stage of cleavage can be clearly seen through the blastula stage and beyond.

Sea urchins are available from the Science Materials Center, usually in the spring. The Science Materials Center provides a kit which includes more than enough urchins for a school, the necessary sea water, and all other materials needed for the experiment.

A good idea is to start a colony of urchins at 5 a.m., then each half hour afterwards throughout the day. When period one arrives, the class can start their own colony and observe fertilization. They can use previously prepared colonies to observe successive stages of development.

Artificial sea water can be made as follows (amounts represented in grams per liter of distilled water):

NaCl	23.60
KCl	0.67
MgCl ₂ ·6H ₂ O	10.78
Na ₂ SO ₄	3.98
CaCl ₂	1.00
NaHCO ₃	0.17

The pH of the artificial sea water should be approximately 8 and can be adjusted with NaOH or HCl.

SAMPLE LESSON 8: GENETICS ACTIVITY

Course: Biology AB

Representative Objective: To assist and develop the student's ability to isolate DNA from thymus tissues.

Sending and Receiving Skill(s) Emphasized: Speaking___ Writing___ Reading___
Listening___ Thinking X

Thinking Level or Cognitive Level: Knowledge___ Comprehension___ Analysis X
Application___ Synthesis___ Evaluation___

1. Specific Objective: The student will use a variety of laboratory techniques to extract DNA molecules from thymus tissue.
2. Value to Student: The student will develop observational and analytical skills useful in real life situations.
3. Initial Instruction/Teacher Presentation: Students are shown the laboratory setup and are instructed on safety with glass, razor blades, blenders, and centrifuges. The procedure is outlined and each of the laboratory operations is demonstrated.
4. Guided Group Practice: A practice laboratory exercise conducted without the actual materials is given the day before the laboratory, enabling the students to master each operation.
5. Independent Practice: Students will complete a laboratory experiment to extract DNA molecules from thymus tissue.
6. Individual Differences and Learning Modalities: Additional help can be provided to students who do not grasp the concepts by having them work with students who do.
 - a. Remediation/Alternative Activities: Students who work rapidly will help students who work slowly. Students will be divided into heterogeneous teams.
 - b. Enrichment/Supplemental Activities: Students who show greater interest and ability will be allowed to save their DNA by resuspending it in a buffer solution and storing it in a refrigerator. Students will do experiments of their own design with the DNA.
7. Evaluation: Students will present their DNA for evaluation. Marks will be assigned based on quantity and clarity of the DNA. Questions will be assigned as part of a standard laboratory write-up. Laboratory reports will be evaluated.

Name _____

Period _____ Date _____

LABORATORY EXERCISE OF THE EXTRACTION OF DNA FROM THYMUS TISSUE

Purpose: The purpose of this laboratory exercise is to make use of the properties of the thymus cells and the properties of the DNA molecule itself to isolate DNA.

Materials:

calf thymus	beakers 25-ml, 250-ml, 500-ml
centrifuge tubes	flasks 250-ml
(approximately 10 grams per group)	cork stoppers for flasks
NET solution	Petri dish
SDS solution	blender
TCE trichloroethane (1,1,1 trichloroethane	centrifuge
nonflammable cleaning solvent)	cheesecloth
isopropyl alcohol	ice trays
pipettes	single-edged razor blades
glass stirring rods	

Procedures:

>>>>>If possible, keep solutions cold in an ice tray.<<<<<<

1. Place the thymus tissue in a Petri dish. Measure out 75 ml of NET solution. Pour some of the NET solution into the Petri dish, and with a razor blade, slice the thymus into small pieces. Place the contents of the Petri dish and the remainder of the NET solution into a blender, and blend at low speed for 40 to 50 seconds. Mincing and blending disrupt the tissue, thereby producing a homogenate.
2. Filter the homogenate through a piece of cheesecloth that has been draped over a beaker. It will be necessary to stir the homogenate until only solid pieces of tissue remain.
3. Transfer the filtrate to centrifuge tubes (you may need 2, 3, or 4) and spin at 1500 rpm for 10 minutes. You will have achieved success at this stage if you have a well defined pellet in the bottom of the centrifuge tube.
4. Decant (and discard) the supernatant. The pellet contains thymus cell nuclei and will be the source of the DNA.
5. Add 2 ml of the SDS solution to each pellet. Using a glass stirring rod, loosen each pellet. Combine all the pellets into one 250-ml beaker and add another 30 ml of SDS. Any agglutinated, or un-resuspended material, should be broken up and dispersed with the stirring rod or razor blade.
6. Place a shallow layer of warm tap water in a 500-ml beaker. Carefully place the beaker containing the nuclei into the larger beaker and incubate for 10 minutes.
7. Transfer the nuclear preparation to a 250-ml flask, add 30 ml of TCE, and stopper the flask. Swirl the flask for 10 minutes. (DO NOT SHAKE! Shaking can break the delicate strands of DNA.) The TCE will denature and precipitate any protein present in the sample.
8. Transfer the contents of the flask to centrifuge tubes for 10 minutes at 1500 rpm. Centrifugation will separate the water and the TCE phases, leaving a precipitate at the interface between the two liquids.

THE EXTRACTION OF DNA FROM THYMUS TISSUE (continued)

9. With a pipette, carefully remove the aqueous (top) layer of liquid and transfer to a cold 250-ml beaker.
10. Tilt the beaker, and slowly and carefully pour 10 ml of isopropyl alcohol down the side of the beaker and onto the surface of the aqueous extract. Carefully place the beaker upright on an ice tray.
11. Slender white fibers should soon appear at the interface between the alcohol and the water. Using a glass stirring rod, gently stir the contents of the beaker. While stirring, revolve the rod with your finger tips in the same (clockwise) direction. The DNA fibers should become tangled on the rod and gradually form a spool.

Questions:

1. How are the nuclei separated from the rest of the cell?
2. How are the nuclei disrupted?
3. How is the protein separated from the nucleic acids?
4. What is it about the structure of the DNA molecule that immediately makes you sure that the stringy stuff on the end of the glass rod really is DNA and not some other cell constituent?

Notes to the Teacher:

Calf thymus gland is chosen because thymus glands in calves have large nuclei and are rich in nucleic acids. You can obtain thymus gland tissues from a slaughter house or from a butcher. The fresher the material, the better the activity will work. The usual butcher's term for thymus is sweetbreads. Sometimes sweetbreads will be pancreas rather than thymus glands. The pancreas is a long flat organ. Further specifying neck or throat sweetbreads may help. The thymus gland in adult animals is atrophied and probably would not serve the purpose. If frozen very quickly, thymus can be kept frozen for long periods of time prior to use.

Other parts of animal bodies might also be tried. Bone marrow might be a good candidate, as well as any organ undergoing rapid cell division. Dog testes, obtained from a veterinarian, may be used.

Call the Science Materials Center for assistance in obtaining materials. Some materials may be in their normal stock or may be special ordered.

Students should be taught the use of the centrifuge and the safety precautions involved. It might be a good idea to have one student be responsible for running the centrifuge.

Preparation of Solutions:

NET solution
0.15 M NaCl
50 mM EDTA
30 mM Tris Buffer at pH 8

SDS solution
2% (weight to volume) Sodium dodecyl
sulfate
50 mM EDTA

SAMPLE LESSON 9: EVOLUTION - LABORATORY ACTIVITY

Course: Biology AB

Representative Objective: To assist and develop the student's ability to observe and quantify the relationship between horses, humans, and gorillas.

Sending and Receiving Skill(s) Emphasized: Speaking___ Writing___ Reading___
Listening___ Thinking X

Thinking Level or Cognitive Level: Knowledge___ Comprehension___ Analysis X
Application___ Synthesis___ Evaluation___

1. Specific Objective: The student will be able to analyze the amino acid sequences of different animals and relate their closeness of origin to the number of differences in amino acid sequences.
2. Value to Student: The students will develop observational and analytical skills useful in real life situations.
3. Initial Instruction/Teacher Presentation: Students are instructed in the relationship of DNA to amino acid sequence, and to the meaning of differing sequences in a protein.
4. Guided Group Practice: The procedure is outlined and the method of recording results is demonstrated.
5. Independent Practice: Students are instructed to follow the procedures and record their data.
6. Individual Differences and Learning Modalities: Additional help can be provided to students who do not grasp the concepts by having them work with students who do.
 - a. Remediation/Alternative Activities: Students who work rapidly will help students who work slowly. Students will be divided into heterogeneous teams.
 - b. Enrichment/Supplemental Activities: Students who show greater interest and ability will be given the opportunity to collect amino acid sequence data from other sources, such as Scientific American, and to repeat the experiment with this data.
7. Evaluation: Students' data and questions will be evaluated.

Name _____

Period _____ Date _____

LABORATORY EXERCISE OF BIOCHEMICAL EVIDENCE FOR EVOLUTION

Introduction: One of the most important ways to examine the similarity of two organisms is to look at the chemicals they produce. In this laboratory investigation you will look at a part of the hemoglobin molecule of horse, human, and gorilla.

Hemoglobin, which is responsible for the red color and oxygen transport of blood and many other parts of animals, is made of protein. Protein, in turn, is made of long chains of amino acids. There are more than twenty different amino acids, and they can be arranged in any combination to make proteins. Their arrangement specifies the shape of the animal, how it behaves, or how it functions.

The chemical that has the instructions for the amino acid sequence is DNA. Since DNA is the only chemical in the body which is directly inherited, scientists believe that animals which have similar chains of amino acids have similar DNA, and are thus closely related.

Procedures: On the next page, you will find the amino acid sequence for a part of the hemoglobin molecules of horse, gorilla, and human. Read the sequence from left to right and compare: gorilla and human; horse and human; and gorilla and horse. You must count the differences and fill in the chart below. The three-letter combinations are abbreviations for the names of amino acids.

Sample Sequence

Human	Gly	Thr	Pro
Horse	Gly	Lys	Pro

There is a difference between human and horse in the second position.

DATA:

NUMBER OF AMINO ACID DIFFERENCES	
ANIMAL	DIFFERENCES
gorilla and human	-----
horse and human	-----
gorilla and horse	-----

LABORATORY EXERCISE OF BIOCHEMICAL EVIDENCE FOR EVOLUTION (continued)

Human:	Val	His	Leu	Thr	Pro	Glu	Glu	Lys	Ser	Ala	Val	Thr	Ala	Leu	Try
Gorilla:	Val	His	Leu	Thr	Pro	Glu	Glu	Lys	Ser	Ala	Val	Thr	Ala	Leu	Try
Horse:	Val	Glu	Leu	Ser	Gly	Glu	Glu	Lys	Ala	Ala	Val	Leu	Ala	Leu	Try
Human:	Gly	Lys	Val	Asp	Val	Asp	Glu	Val	Gly	Gly	Glu	Ala	Leu	Gly	Arg
Gorilla:	Gly	Lys	Val	Asp	Val	Asp	Glu	Val	Gly	Gly	Glu	Ala	Leu	Gly	Arg
Horse:	Asp	Lys	Val	Asp	Glu	Glu	Glu	Val	Gly	Gly	Glu	Ala	Leu	Gly	Arg
Human:	Leu	Leu	Val	Val	Tyr	Pro	Try	Thr	Glu	Arg	Phe	Phe	Glu	Ser	Phe
Gorilla:	Leu	Leu	Val	Val	Tyr	Pro	Try	Thr	Glu	Arg	Phe	Phe	Glu	Ser	Phe
Horse:	Leu	Leu	Val	Val	Tyr	Pro	Try	Thr	Glu	Arg	Phe	Phe	Asp	Ser	Phe
Human:	Gly	Asp	Leu	Ser	Thr	Pro	Asp	Ala	Val	Met	Gly	Asp	Pro	Lys	Val
Gorilla:	Gly	Asp	Leu	Ser	Thr	Pro	Asp	Ala	Val	Met	Gly	Asp	Pro	Lys	Val
Horse:	Gly	Asp	Leu	Ser	Asp	Pro	Gly	Ala	Val	Met	Gly	Asp	Pro	Lys	Val
Human:	Lys	Ala	His	Gly	Lys	Lys	Val	Leu	Gly	Ala	Phe	Ser	Asp	Gly	Leu
Gorilla:	Lys	Ala	His	Gly	Lys	Lys	Val	Leu	Gly	Ala	Phe	Ser	Asp	Gly	Leu
Horse:	Lys	Ala	His	Gly	Lys	Lys	Val	Leu	His	Ser	Phe	Gly	Glu	Gly	Val
Human:	Ala	His	Leu	Asp	Asp	Leu	Lys	Gly	Thr	Phe	Ala	Thr	Leu	Ser	Glu
Gorilla:	Ala	His	Leu	Asp	Asp	Leu	Lys	Gly	Thr	Phe	Ala	Thr	Leu	Ser	Glu
Horse:	His	His	Leu	Asp	Asp	Leu	Lys	Gly	Thr	Phe	Ala	Ala	Leu	Ser	Glu
Human:	Leu	His	Cys	Asp	Lys	Leu	His	Val	Asp	Pro	Glu	Asp	Phe	Arg	Leu
Gorilla:	Leu	His	Cys	Asp	Lys	Leu	His	Val	Asp	Pro	Glu	Asp	Phe	Leu	Leu
Horse:	Leu	His	Cys	Asp	Lys	Leu	His	Val	Asp	Pro	Glu	Asp	Phe	Arg	Leu
Human:	Leu	Gly	Asp	Val	Leu	Val	Cys	Val	Leu	Ala	His	His	Phe	Gly	Lys
Gorilla:	Leu	Gly	Asp	Val	Leu	Val	Cys	Val	Leu	Ala	His	His	Phe	Gly	Lys
Horse:	Leu	Gly	Asp	Val	Leu	Ala	Leu	Val	Val	Ala	Arg	His	Phe	Gly	Lys
Human:	Glu	Phe	Thr	Pro	Pro	Val	Glu	Ala	Ala	Tyr	Glu	Lys	Val	Val	Ala
Gorilla:	Glu	Phe	Thr	Pro	Pro	Val	Glu	Ala	Ala	Tyr	Glu	Lys	Val	Val	Ala
Horse:	Asp	Phe	Thr	Pro	Glu	Leu	Glu	Ala	Ser	Tyr	Glu	Lys	Val	Val	Ala
Human:	Gly	Val	Ala	Asp	Ala	Leu	Ala	His	Lys	Tyr	His				
Gorilla:	Gly	Val	Ala	Asp	Ala	Leu	Ala	His	Lys	Tyr	His				
Horse:	Gly	Val	Ala	Asp	Ala	Leu	Ala	His	Lys	Tyr	His				

LABORATORY EXERCISE OF BIOCHEMICAL EVIDENCE FOR EVOLUTION (continued)

Questions:

1. Where is hemoglobin found in animals?
2. Hemoglobin is made up of what components?
3. How many different kinds of amino acids are there in the examples shown for each of these three animals?
4. How similar are human and gorilla hemoglobin?
5. How similar are human and horse hemoglobin?
6. How similar are gorilla and horse hemoglobin?
7. Based on the three previous questions, which do you think is our closer living relative----horse or gorilla?
8. If DNA gives the instructions for the sequence of amino acids, what do you think causes the differences between horse, human, and gorilla? DNA?

SAMPLE LESSON 10: ECOLOGY-LABORATORY ACTIVITY

Course: Biology AB

Representative Objective: To assist and develop the student's ability to observe the variety of living things in a small and familiar area.

Sending and Receiving Skill(s) Emphasized: Speaking___ Writing___ Reading___
Listening___ Thinking X

Thinking Level or Cognitive Level: Knowledge___ Comprehension___ Analysis X
Application___ Synthesis___ Evaluation___

1. Specific Objectives: The student will be able to enter an area and accurately survey the animal and plant life.
2. Value to Student: The student will develop hand-eye coordination and observational skills that are useful in everyday life.
3. Initial Instruction/Teacher Presentation: Students are given outlines of the steps of the experiment they will perform, the outlines are reviewed, and the students are given practical ideas on how to proceed.
4. Guided Group Practice: Students will be given a practice session in class to prepare them for the field trip. Students will work in groups of two. There will be two different groups, and at evaluation they will compare their results.
5. Independent Practice: Students will conduct the field techniques and the mathematical techniques necessary to evaluate their data.
6. Individual Differences and Learning Modalities: Additional practice will be provided to students who do not grasp the concept by having them work with students who do.
 - a. Remediation/Alternative Activities: Students who work rapidly will help students who work slowly. Students will be divided into heterogeneous teams.
 - b. Enrichment/Supplemental Activities: Students who seek greater challenge will be given the additional task of measuring and drawing a plot plan for the areas studied. A further enrichment activity will be the plotting of variable densities of populations of plants and animals on the plot drawing.
7. Evaluation: Students will present reports in the form of written summaries of data and results. Oral presentations will be required of the leaders of each group.

Name _____

Period _____ Date _____

LABORATORY EXERCISE - LOOKING IN YOUR BACKYARD

Purpose: The purpose of this investigation is to recognize the quantity and variety of living things in a community.

Materials:

wire clothes hangers
forceps
plastic bottles or Petri dishes
notebook paper and tape

Procedures:

Group One:

Each Group One (pairs of students) begins by picking one of each kind of plant in the study area. It is not necessary to identify the plant; each can be numbered. Each plant is taped to notebook paper as a key to later identification.

Each Group One throws its wire square into the air and where it lands the group makes a careful count of each kind of plant. An example of this would be: 19 of plant #7; 28 of plant #12.

Group Two:

Each Group Two (pairs of students) will do a survey of animals and animal indicators. Each group should go carefully through the area looking for any signs of animals, such as feces, slime trails from snails, shed skin, feathers, and hairs. A group should turn over rocks and leaves and lightly move away bits of soil. Each item found should be recorded in the notebook. The live things found or seen should not be disturbed. If the find is a spider, it may be picked up with the forceps and put into a jar to examine. The spider should be returned to the exact place it was found. If the animal cannot be named, it should be described, for example: six-legged shiny black creature with tail end held higher than body. Measurements should be given.

LABORATORY EXERCISE - LOOKING IN YOUR BACKYARD (continued)

Evaluating Results:

Group One:

Results should be tabulated as in the following example:

Data:	first toss plant	#1	9
	plant	#3	14
	plant	#4	3

Sample Results: If the area of the wire hanger was one-tenth of a square meter, then multiplying each number by ten would give the density of that plant per square meter.

Example: plant #1 density of 90 plants per square meter.

The density of each species should be averaged so that the overall density of that species in the study area is determined.

Group Two:

The results of the group's findings should be organized into a written report that outlines the numbers, kinds, and locations of the animals found.

Questions:

1. Which plant is the most abundant in the entire area?
2. Which plant is abundant in only certain parts of the study area? Why?
3. Which plant is found least often in this area?
4. What is there about this plant (#3 above) that makes it unsuccessful, in your study area?
5. Would you say your area is a monoculture (all one kind of plant with few strangers) or a polyculture?
6. What animal seems most abundant in the study area?
7. Where were most of the live animals found in the study area?
8. Why do you have to look for hiding places to find items?
9. Do you think that most of the animals are day-living or night-living?
10. When you find an indicator of an animal rather than the animal, is this a secure guess that the animal was there?

NOTES TO THE TEACHER

Prior Preparations:

1. Find a place on or near the school yard that might be interesting to look at in depth. A plain green lawn next to a building will do, but a neglected weed patch is better. Do not pick a place with broken bottles or other dangerous conditions.
2. Bend and form the hangers until they are square and represent some even fraction of a square meter.
3. Describe, in detail, the responsibilities of each student and the code of behavior expected on the field trip.

SECTION IV:
APPENDICES

264

147

263

APPENDIX A

CLASSROOM TEST OF FORMAL OPERATIONS:
TESTING AND SCORING PROCEDURES
AND ANSWER KEY

ANTON E. LAWSON
SCIENCE EDUCATION
DEPARTMENT OF PHYSICS
ARIZONA STATE UNIVERSITY
TEMPE, ARIZONA 85281

This material is based upon research supported by the National Science Foundation under Grant No. SED 74-18950.

Any opinions, findings, conclusions, or recommendations expressed in this publication are those of the author and do not necessarily reflect the views of the National Science Foundation.

CONTENTS

I. Introduction

II. General Testing Procedures

III. Specific Testing Procedures for Each Item

IV. Scoring Procedures

V. Answer Key

268

267



I. Introduction

This fifteen-item test has been developed and validated by Anton Lawson, *Journal of Research in Science Teaching*, 15(1), 11-24, 1978. The purpose of this test is to determine how ready students are for classroom activities involving formal thinking processes and how well students have made the transition from concrete to formal operations. Administration of the test requires apparatus like that described in the instructions. Details of the apparatus are not critical, however, because it is never used by the subjects but merely serves to illustrate the questions. Procedures for each test item are described below and are followed immediately by the material to be included in the students' answer booklets. Also given is the answer key. The item titles and spaces for answers and explanations should be assembled into booklets of one or two items per page, but omitting the answer key, of course. "Example" will be done by the class as a whole to introduce the students to the test procedure and the somewhat unusual form of the responses required.

II. GENERAL TESTING PROCEDURES

1. Students should be seated with empty seats between them if possible.
2. Pass out one test booklet to each student.
3. Provide the students with a general introduction to the test by explaining that the test consists of a number of demonstration items that lead to problems. Solution of the problems involves reasoning or problem-solving strategies that are useful in solving problems in a variety of areas. The test will provide information about how familiar the students are with these strategies. Explain that some of the items are very easy and some quite difficult. Few students would be expected to get them all correct. Indeed, there may be a number of correct solutions to some of the items.
4. Have the students fill in the information on the top right-hand corner of the test booklet and then read the directions.
5. Explain that they will be progressing through the items as a class. This means that some students may finish some items before others and will have to be patient until all (or nearly all) of the other students have finished before going on to the next item.
6. Do the Example Item "The Balancing Beam" with the class (see directions below). Have one student volunteer his answer and his explanation. Explain to the class that their explanations need not be lengthy but they should be complete. In this case, a complete explanation would be: "The weights are the same, so the lengths should also be the same." Give the students time to write down their explanations and proceed to Item 1.
7. After demonstrating Item 1, give the students time to select an answer and justify their selection. Proceed to Item 2 when all but a few students have completed Item 1. You will have to use your own judgment about pacing as you progress through the rest of the items. You must go quickly enough so that the fast students do not become too impatient but you must go slowly enough so that the slower students have ample opportunity to respond. The entire test normally takes 75 to 90 minutes of class time in one long session or two shorter sessions.
8. It is important that the students understand the situations and the questions as best as they can. For this reason, you may need to repeat or rephrase certain questions and items of information for certain students. This is proper, but care must be taken not to provide hints as to the correct solution.

III. SPECIFIC TESTING PROCEDURES FOR EACH ITEM

Example: "The Balancing Beam"

Materials: One balance beam
Two 10-unit hanging weights

Directions: Show the students the balance beam and the two 10-unit hanging weights. Point out the equally spaced marks along the length of the beam and how the beam balances like a teeter-totter when no weights are hung on it. Hang a 10-unit weight on one side of the beam at the 7th mark.

Ask: Where should the other 10-unit weight be hung to make the beam balance?

Item 1: "Pieces of Clay"

Materials: Two balls of clay of equal size, shape, and weight
One balance beam
Two balance pans

Directions: Show the students the two balls of clay. Point out that they are the same size and shape. Demonstrate that they weigh the same by placing them in the balance pans hung equal distances from the fulcrum of the balance beam. Remove the balls of clay from the pans and flatten one of them into a "pancake shape."

Ask: Does the pancake shape piece weigh more now? Do the two pieces weigh the same or does the ball weigh more?

273

274

Item 2: "Metal Weights"

Materials:

Two metal weights of equal volume but different weight (18 and 55 grams)
Two 25-ml graduated cylinders partially filled with colored water
One balance beam
Two balance pans

Directions:

Show the students the metal weights. Point out that they are equal in height and in thickness. Place them on the pans of the balance beam to demonstrate their unequal weights. Point out the cylinders filled with equal amounts of colored water. Slowly lower the lighter weight into one of the cylinders. Note the rise in water level.

Ask:

If the heavier weight were lowered into the other cylinder, would the water level rise higher, the same, or lower than it did in the cylinder with the light weight?

Item 3:

"Plastic Cylinders"

Materials:

One wide plastic cylinder
One narrow plastic cylinder
One jar of colored water

Directions:

Show the students the two plastic cylinders. Point out the different diameters and the equally spaced marks along the front of each. Pour water from the jar into the wide cylinder up to the 4th mark. Pour that water into the narrow cylinder and note that the water rises to the 6th mark. Tell the students to make a record of this information. Pour the water from the narrow cylinder into the jar. Pour water from the jar into the wide cylinder up to the 6th mark.

Ask:

How high would this water rise if it were poured into the narrow cylinder?

Item 4:

"Plastic Cylinders 2"

Materials:

Same as for Item 3

Directions:

Start with empty cylinders. Pour water from the jar up to the 11th mark in the cylinder.

Ask:

How high would this water rise if it were poured into the wide cylinder?

Item 5: "The Pendulum's Length"

Materials:

Three strings numbered 1, 2, 3 suspended from a single support
Strings #1 and #3 are of equal length, string #2 is longer
Two 5-unit weights hung at the end of strings #2 and #3
One 10-unit weight hung at the end of string #1

Directions:

Show the students the three strings and the weights. Attach the weights to the proper strings and explain that this makes three pendulums (just three strings with weights attached to their ends). Point out that pendulum #1 and #3 are the same length while pendulum #2 is longer. Point out that pendulum #2 and #3 have the same weight, but that pendulum #1 has a heavier weight. Swing one of the pendulums and count out loud each time the weight swings back to the release point. Point out that the pendulum seems to take about one second per swing.

Ask:

Suppose you wanted to do an experiment to find out if changing the length of a pendulum changed the amount of time it takes to swing back and forth. Which pendulum or pendulums would you use for the experiment?

Item 6: "The Pendulum's Weight"

Materials:

Same as for Item 4

Directions:

Same as for Item 4

Ask:

Suppose you wanted to do an experiment to find out if changing the weight on the end of the string changed the amount of time the pendulum takes to swing back and forth. Which pendulum or pendulums would you use for the experiment?

Item 7: "The Balancing Beam 1"

Materials:

One balance beam
One 10-unit hanging weight
One 5-unit hanging weight

Directions:

Show the students the balance beam and the two hanging weights. Hang the 10-unit weight 7 marks out from the fulcrum on one side of the beam. Point out that the 10-unit weight is hanging at 7 marks from the center.

Ask:

Where would you hang the 5-unit weight to make the beam balance?

Item 8: "The Balancing Beam 2"

Materials:

One balance beam
One 15-unit hanging weight
One 10-unit hanging weight

Direction:

Show the students the balance beam and the two hanging weights. Hang the 15-unit weight 4 marks out from the fulcrum on one side of the beam. Point out that the 15-unit weight is hanging at 4 marks from the center.

Ask:

Where would you hang the 10-unit weight to make the beam balance?

Item 9:

"The Spheres 1"

Materials:

One ramp
One target sphere
One heavy sphere
One light sphere

Directions:

Show the ramp to the students. Point out that there are three spheres. One sphere is called the target sphere because it sits at the bottom of the ramp and gets hit by the other spheres that are rolled down the ramp. The other spheres (a heavy and a light one) are rolled from one of two positions - a low position half way up the ramp or a high position at the top of the ramp.

Point out the low and high positions on the ramp and demonstrate how the spheres roll down the ramp, hit the target sphere, and cause it to move a certain measurable distance up the other side of the ramp.

Tell the students that you will describe one-half of an experiment with the spheres and the ramp, and they will have to tell you how to complete the experiment. Have the students imagine an experiment in which the light sphere was released from the low position, rolled down the ramp, hit and propelled the target sphere up the other side of the ramp.

Ask:

Which sphere would you release from the high position to find out if the place a sphere is released from, makes a difference in how far the target goes?

Item 10: "The Spheres 2"

Materials:

- One ramp
- One light target sphere
- One heavy target sphere
- One sphere called Metal A
- One sphere called Metal B

Directions:

Point out the light and heavy target spheres and Metal A and Metal B. Tell the students that you will demonstrate an experiment and then ask them a question about the experiment.

Place the heavy target sphere at the bottom of the ramp. Hold Metal A at the high position on the ramp. Tell the students to imagine that Metal A rolls down the ramp and hits the heavy target and that the target moves a certain distance up the other side of the ramp (do not actually release Metal A). Now place the light target sphere at the bottom of the ramp. Hold Metal B at the high position on the ramp. Point out that this is the same position that Metal A was released from. Tell the students to imagine that Metal B rolls down the ramp and hits the light target and that the target moves a certain distance up the other side of the ramp (do not actually release Metal B).

Ask:

Does this experiment prove that Metal B can hit a target farther than Metal A can?

Note: Do not tell the students anything about the relative weights of Metal A and B.

Item 11: "The Metal Box"

Materials: One metal box with four switches, one black button, and a light bulb on it.

Directions: Point out the box, the switches, the light bulb and the black button. Point out that the switches are identified by four colors so that there is a "yellow switch," a "blue switch," a "red switch," and a "green switch." The switches can be flipped into either an "up position" or a "down position." If the correct switch or switches are flipped into the up position, and the black button is pushed, the bulb will light.

Cover the switches and flip the blue and green switches into the up position. Push the button to show the students that the bulb will, in fact, light if the correct switch or switches are flipped. You may need to flip other switches up and down again to assure that the students are not clued as to the correct combination. Flip all switches back to the down position and uncover them.

Explain that the objective of this puzzle is to discover which switch or switches must be flipped to make the light turn on. To do this they would actually need to use the box, but since there is only one box, they can only indicate how they would go about flipping switches to find out.

Show them how to use the symbols y, b, r, g, and the spaces labeled "Your Record" on their booklets by doing the example. Flip switch y (the yellow switch), push the black button, and note that the light remains off.

Explain that on each try the order in which the switches are flipped does not matter. For instance y, r and r, y are the same trial, so they should not write down both.

Item 12: "The Shopping Center"

Materials: Four pictures of stores - a. Barber Shop (B)
b. Discount Store (D)
c. Grocery Store (G)
d. Coffee Shop (C)

Directions: Read the problem out loud. Show the students the four stores. Arrange them in the following way -- B D G C. Show them that this order corresponds to that indicated on the first line in the booklet. This means that the Barber Shop is in the first store location on the left, the Discount Store is in the second store location, the Grocery Store is in the third store location, and the Coffee Shop is in the fourth store location on the right.

Ask: Now write all other possible ways that the stores could be arranged, one arrangement per line. Note that there are extra lines in your booklet.

Item 13: "The Squares"

Materials: One cloth sack
Three yellow wooden squares
Three red wooden squares

Directions: Show the students the sack and the 3 yellow and 3 red wooden squares. Point out that each square is identical in size and shape. Place all the squares into the sack. Shake them up. Reach into the sack and select one piece (the first that you touch). Have the students imagine that you are going to pull this piece out of the sack.

Ask: What are the chances of pulling out a red square on the first try?

Item 14

"Squares and Diamonds 1"

Materials:

One cloth sack
Three red wooden squares
Five blue wooden squares
Four red wooden diamonds
Two yellow wooden diamonds
Three blue wooden diamonds

Directions:

Show the students the cloth sack and the square- and diamond-shaped pieces. Point out that all of the square-shaped pieces are identical in size and shape as are the diamond-shaped pieces. Place all of the pieces into the sack. Shake them up. Reach into the sack and select one piece (the first that you touch). Have the students imagine that you are going to pull this piece out of the sack.

Ask:

What are the chances of pulling out a red piece on the first try?

Item 15:

"Squares and Diamonds 2"

Materials:

Same as for Item 14

Directions:

Shake up the pieces once again. Reach in and select one piece (the first that you touch). Have the students imagine that you are going to pull this piece out of the sack.

Ask:

What are the chances of pulling out a red diamond or a blue diamond on the first try?

239

230

IV. SCORING PROCEDURES

1. Each item is scored either correct or incorrect. Total test scores, therefore, may range from 0 to 15. Scores of 0-5 reflect concrete operational performance on the test. Scores of 6-11 reflect transitional performance and scores of 12-15 reflect formal operational performance.
2. To grade each item, compare the student answers and explanations to those shown on the ANSWER KEY. An item is correct only if the correct box is checked and an adequate explanation is provided.

V. ANSWER KEY

Name _____
Birthdate _____ Month _____ Day _____ Year _____

School _____
Date _____

DIRECTIONS:

For each of the items below, a situation will be demonstrated. Each demonstration will lead to a question or questions for which there are a number of possible answers. For each item you are to check the box of the best answer and explain your choice in the space provided.

Example Item: "The Balancing Beam"

Mark 3
 Mark 7
 Mark 8
 Mark 10

Please explain your choice.

Equal weights should be placed at equal distances from the center.

Item 1: "Pieces of Clay"

- The pancake weighs more.
 The pieces weigh the same.
 The ball weighs more.

Please explain your choice.

You did not add or take away any clay.

Item 2: "Metal Weights":

- The water will rise to a higher level.
 The water will rise to a lower level.
 The water will rise to the same level.

Please explain your choice.

The metal weights are the same size so they will displace equal amounts of water.

Item 3: "Plastic Cylinders 1"

The water will rise to Mark:

- 7 9 Other
 8 10 There is no way of predicting.

Please explain your choice.

$$\frac{4}{6} = \frac{6}{x}$$

$$4x = 36$$

$$x = 9$$

Note: Students do not have to use this method to be considered correct. Any indication of proportioned, rather than additive, reasoning is OK.

Item 4: "Plastic Cylinders 2"

The water will rise to mark:

- 5 1/3 8 1/3
 5 2/3 8 1/2
 7 1/3 9
 7 1/2 Other
 8 There is no way of predicting

Please explain your choice.

$$\frac{4}{6} = \frac{2}{3} = \frac{x}{11}$$

$$6x = 44$$

$$x = \frac{44}{6} \quad x = 7 \frac{1}{3}$$

Item 5: "The Pendulum's Length"

Which pendulum or pendulums would you use for the experiment?

1 and 2

1 and 3

2 and 3

1, 2, and 3

2 only

Please explain your choice.

Everything is the same, except the length, so you can tell if length makes a difference.

Item 6: "The Pendulum's Weight"

Which pendulum or pendulums would you use for the experiment?

1 and 2

1 and 3

2 and 3

1, 2, and 3

3 only

Please explain your choice.

Everything is the same, except weight, so you can tell if weight makes a difference.

Item 7: "The Balancing Beam 1"

Where would you hang the 5-unit to make the beam balance?

- Between Mark 3 and 4 Mark 14
 Mark 7 At the end
 Mark 12

Please explain your choice.

It's half the weight, so it should be twice the distance.

Item 8: "The Balancing Beam 2"

Where would you hang the 10-unit weight to make the beam balance?

- Mark 5 Mark 8
 Mark 6 Mark 9
 Between Mark 6 and 7 Mark 10
 Mark 7 Mark 17

Please explain your choice.

The 10-unit weight is $\frac{2}{3}$ of the 15-unit weight, so it must be placed $\frac{3}{2}$'s as far out. $\frac{3}{2} \times 4 = 6$

Note: If a student uses the formula: $w_1 \times d_1 = w_2 \times d_2$ to solve the problem, this does not indicate the use of formal reasoning. The item should be dropped from consideration.

Item 9: "The Spheres 1"

Which sphere would you release from the high position to find out if the place a sphere is released from makes a difference in how far the target goes?

The heavy sphere

The light sphere

Please explain your choice.

Since the light sphere was released from the low position, it would also have to be released from the high position, or else you could not tell. It would be an unfair test.

Item 10: "The Spheres 2"

Does this experiment prove that Metal B can hit a target farther than Metal A can?

Yes

No

Need more information

Please explain your choice.

The spheres hit targets of different weights so you can't tell anything about the two metals.

Item 11: "The Metal Box"

The objective of this puzzle is to discover which switch or switches must be flipped to make the light turn on.

Example:

	ON	OFF
1.	y	x

y - yellow switch
 b - blue switch
 r - red switch
 g - green switch

Your Record:

1.	y		
2.	r		
3.	b		
4.	g		
5.	y, r		
6.	y, b		
7.	y, g		
8.	r, b		
9.	r, g		
10.	b, g		
11.	y, r, b		21.
12.	y, r, g		22.
13.	y, b, g		23.
14.	r, b, g		24.
15.	y, r, b, g		25.
16.			26.
17.			27.
18.			28.
19.			29.
20.			30.

Note: The combinations need not be in this order to be correct. There must be all 15 and no repetitions.



Item 12: "The Shopping Center"

In a new shopping center, 4 store locations are going to be opened on the ground level.

A Barber Shop, a Discount Store, a Grocery Store, and a Coffee Shop want to move in there. Each one of the stores can choose any one of the 4 locations. Write ALL THE POSSIBLE WAYS that the stores can occupy the 4 locations. Write on the lines below the letter B for Barber Shop, the letter D for Discount Store, the letter G for Grocery Store, and the letter C for Coffee Shop.

<u>BDGC</u>	<u>DBGC</u>	<u>GRCD</u>	<u>CBGD</u>
<u>BDCG</u>	<u>DBC G</u>	<u>GRDC</u>	<u>CBDG</u>
<u>BGCD</u>	<u>DGCB</u>	<u>GDCB</u>	<u>CGBD</u>
<u>BGDC</u>	<u>DGBC</u>	<u>GDBC</u>	<u>CGDB</u>
<u>BCGD</u>	<u>DCGB</u>	<u>G CBD</u>	<u>CDBG</u>
<u>BCDG</u>	<u>DCBG</u>	<u>G CDB</u>	<u>CDGB</u>
_____	_____	_____	_____
_____	_____	_____	_____

Note: The permutations need not be in this order to be correct. There must be all 24 and no repetitions.

Item 13: "The Squares"

Three yellow squares and three red squares are put into a sack. What are the chances of pulling out a red square on the first try?

- 1 out of 1 2 out of 6
 1 out of 2 4 out of 6
 1 out of 3 3 out of 3
 1 out of 6 Other

Please explain your choice.

3 of the 6 squares were red.

$$\frac{3}{6} = \frac{1}{2}$$

Item 14: "Squares and Diamonds 1"

Three red squares, four yellow squares, and five blue squares are put into a sack. Four red diamonds, two yellow diamonds, and three blue diamonds are put into the same sack. What are the chances of pulling out a red piece on the first try?

- 1 out of 1 1 out of 21
 1 out of 2 7 out of 21
 1 out of 3 1 out of 7
 1 out of 4 Other

Please explain your choice.

7 of the 21 pieces are red.

$$\frac{7}{21} = \frac{1}{3}$$

Item 15: "Squares and Diamonds 2"

Three red squares, four yellow squares, and five blue squares are put into a sack. Four red diamonds, two yellow diamonds, and three blue diamonds are put into the same sack. What are the chances of pulling out a red diamond or a blue diamond on the first try?

1 out of 1

8 out of 21

1 out of 2

9 out of 21

1 out of 3

Other

1 out of 4

Please explain your choice.

Four red and three blue diamonds = seven red or blue diamonds.

Seven out of 21 or one of three would be the chances.

300

310

APPENDIX B

RESOURCES

- Administrative Directives and Curricular Information. Los Angeles Unified School District: Office of Instruction, Publication No. SC-863.1, Stock No. 461260.
- Audiovisual Materials Resource List, Secondary Schools Edition. Latest Revision. Los Angeles Unified School District: Audiovisual Services Section.
- Blueprint for Bulletin Boards. Los Angeles Unified School District: Office of Secondary Instruction, Publication No. SC-824, 1983.
- Catalog of Standard Equipment for Elementary, Secondary, and Adult Schools. Latest Revision. Los Angeles Unified School District: Purchasing Branch.
- Catalog of Standard Supplies for Elementary, Secondary, and Adult Schools. Latest Revision. Los Angeles Unified School District: Purchasing Branch.
- Catalog of Films for Secondary and Adult Levels. Latest Revision. Los Angeles Unified School District: Audiovisual Services Section.
- A Collection of Selected Goals and Objectives. Los Angeles Unified School District: Office of Instruction.
- Conservation of Energy, Suggested Activities for Pupils. Los Angeles Unified School District: Instructional Planning Division, Publication No. EC-448. Available from Regional Science Center.
- Evaluation Summary - Science Continuum Assessment, Version 1, 1980; Version 2, 1981. Los Angeles Unified School District: Office of Instruction.
- Guidelines for Assignment of Homework for Elementary and Secondary Schools. Los Angeles Unified School District: Office of Instruction, Publication No. GC-67, 1978.
- Guidelines for Instruction: Science, Secondary School Curriculum. Los Angeles Unified School District: Office of Instruction, Publication No. SC-769.19, 1984.

Instructions for Teachers on the Assessment of the Secondary Science Continuum, Grades 7-12, for Junior and Senior High Schools, 1980-81. Los Angeles Unified School District: Office of Instruction, Publication No. SC-795.

List of Authorized Textbooks, Junior and Senior High Schools and Community Adult Schools. Latest Revision. Los Angeles Unified School District: Textbook Services Section, Publication No. 426.

List of California State Series Textbooks and Prepared Instructional Materials. Latest Revision. Los Angeles Unified School District.

Marking Practices and Procedures for Elementary and Secondary Schools. An Instructional Bulletin. Los Angeles Unified School District: Office of Instruction, Publication No. GC-74, 1978.

Metrics (SI) for the Secondary Classroom. Los Angeles Unified School District: Office of Instruction, Publication No. SC-731, 1976. 186 pp.

Ordering Secondary Science Continuum Assessment Instruments and Support Materials. Latest Revision. Los Angeles Unified School District: Office of Instruction.

Parents and Schools: A Shared Responsibility. Los Angeles Unified School District: Office of Instruction, Publication No. GC-96, 1983.

Precautions with Chemicals. Los Angeles Unified School District: Office of Instruction, Publication No. SC-865, 1984.

Putting Critical Thinking to Work. Los Angeles Unified School District: Office of Instruction, Publication No. EC-501, Stock No. 463180.

Reaching Higher Levels of Thought. Los Angeles Unified School District: Office of Instruction, Publication No. X-118, Stock No. 463320

Safety and Workers Compensation Reference Guide. Los Angeles Unified School District, Sections 2370-45 through 2370-54, 1980.

Science Materials Center Catalog and Loan Equipment List for Senior High Schools, Order Forms and Other Information. Annually Revised. Los Angeles Unified School District: Office of Instruction.

A Statement of Goals. Los Angeles Unified School District: Office of Instruction, Publication No. GC-31, 1975.

Study Center Activity Cards. Los Angeles Unified School District: Office of Instruction, Publication No. GC-32, Stock No. 463640.

Suggested Terminal Objectives: Science, Junior and Senior High Schools. Examples of Instructional Objectives, Together With Samples of Pre- and Post-Test Items. Los Angeles Unified School District: Office of Instruction, Publication No. SC-711.

Teaching the Essential Skills. Los Angeles Unified School District: Office of Instruction, Publication No. GC-82, Stock No. 463818.

Test-Taking Procedures and Techniques for Secondary Schools. Los Angeles Unified School District: Office of Instruction, Publication No. X-116, Stock No. 463897.

The Teaching of Values. Los Angeles Unified School District: Office of Instruction, Publication No. GC-56, Stock No. 463810.

Use Metric! Activities to Help Parents Get the "Feel" of SI Metric Units of Measure. A Teacher's Guide. Revised. Los Angeles Unified School District: Publication No. SC-726, 1979.

We Tried It. We Like It. Successful classroom practices. Los Angeles Unified School District: Office of Instruction, Publication No. GC-77, Stock No. 464415.

APPENDIX CMODEL CURRICULUM STANDARDS, GRADES NINE THROUGH TWELVE:
BIOLOGICAL SCIENCE. CALIFORNIA STATE DEPARTMENT OF EDUCATION, 1985

The following is a list of the standards for Biological Science from Model Curriculum Standards, Grades Nine through Twelve: Biological Science. California State Department of Education, 1985.

Individuals are referred to the entire document as it contains additional information including suggested activities which exemplify each standard.

1. Students understand the structures and functions of cells and cell components. This would include a knowledge of the structure and function of the nucleus and the cytoplasm as well as the similarities and differences between plant and animal cells.
2. Students understand the interrelationships among tissues, organs, and systems: cells make up tissues, tissues make up organs, and organs make up systems.
3. Students understand that organisms are categorized by scientists according to similarities and differences in the structure and function of the individual organisms.
4. Students identify roles of animals, plants, and protists in the web of life.
5. Students appreciate the commonality and diversity of animal behavior and distinguish between inborn and acquired characteristics.
6. Students understand specific behaviors inherent to humans.
7. Students understand the structure, function, and maintenance of the major human body systems (e.g., digestive, nervous, circulatory, skeletal, muscular, respiratory, reproductive, excretory, endocrine) as well as their component parts and consider the interrelationships among systems.
8. Students describe the growth and development of humans from conception through old age. They will discuss the diversity of humans and the variation among growth and development rates.

9. Students understand the complexity of animal or plant development and differentiation.
10. Students understand the factors necessary to sustain plant life. Students will become aware of the complexity and variety of plant processes, some of which are exploited in the field of agriculture and horticulture.
11. Students understand that photosynthesis is the process by which light energy from the sun is used to convert carbon dioxide and water into sugars, storing energy, and releasing oxygen, thus renewing the supply of atmospheric oxygen.
12. Students identify the processes of mitosis, meiosis, and the roles of DNA and RNA in the replication of cells and in the reproduction of organisms.
13. Students understand the structure and function of the reproductive systems of plants and animals, including the role of hormones and auxins.
14. Students understand the principles of genetics and heredity: the passing of traits from parents to offspring.
15. Students understand the theories of evolution, the diversity of life possible through the process of natural selection and mutation, and are aware of the changes that have been and are taking place in life on earth.
16. Students understand that ecology consists of studying how communities of living things interact with and depend upon each other and the physical environment, and that conservation consists of attitudes and actions by man to preserve the natural state of ecosystems.
17. Students appreciate the importance of technological advances in the fields of agriculture and medicine.
18. Students appreciate the wide variety of California's natural areas: the landforms, climates, and conditions that support life.

APPENDIX D:

SECONDARY SCIENCE CONTINUUM

INTRODUCTION TO THE SCIENCE CONTINUUM, GRADES 7-12

PURPOSES

Science is the discipline which involves the acquiring and organizing of knowledge to explain natural phenomena and to increase their usefulness to humankind through the science (emancipatory) program in secondary schools. Students develop an understanding that science is a body of knowledge comprised of interconnected sets of principles, laws, and theories that explain the known universe and our relationship to it. Students use learning processes to systematically investigate phenomena and acquire and refine information. Outcomes include understanding how human beings use scientific information and discoveries to comprehend and practice the pursuit of objective knowledge as a source of truth.

COMPONENTS

The Science Continuum encompasses the four competency strands of attitudes, thinking processes, skills, and knowledge. Within each strand, the continuum includes objectives and the kinds of performance necessary for the student to achieve each objective. However, the continuum does not limit the scope of the science curriculum. Teachers should encourage students to progress to the extent of their interests and abilities. In the continuum, certain symbols are used. Items with a solid dot identify the expectancy level for all students. Those items without dots identify levels above those expected for all students. An open circle in the K-6 column indicates that certain items are first introduced to the student in elementary school.

Attitudes Strand. This strand emphasizes the development of values, aspirations, and attitudes which promote the personal involvement of the individual with the environment and society. The attitudes listed relate to what is hoped students will accomplish, individually, through self-motivation, as a result of science instruction. Positive attitudes toward science and learning are prerequisites to effective learning in other strands.

Objectives of the attitudes strand include the ability of the learner to: internalize scientific attitudes; establish the personal and social relevance of what has been learned about science, scientists, and society; and enjoy and appreciate science.

Thinking Processes Strand. The goal is to help the student develop and apply rational and creative thinking processes. As defined here, these processes refer to the cognitive techniques involved in scientific inquiry as well as those basic to all rational thinking. Such processes as observing, measuring, comparing, and classifying lead to more sophisticated processes, such as inferring, generalizing, and theorizing.

Skills Strand. The goal is to help the student develop and use fundamental skills in the manipulation of materials and equipment, in caring for and handling living organisms, and in gathering, organizing, and communicating information relating to science. Various skills are utilized when the student employs thinking processes to develop a conceptual understanding of the natural environment and collects information through observation, manipulation of materials and apparatus, reading, listening, use of measuring instruments, and handling of living organisms. He or she employs linguistic,

mathematical, graphical, and cabular skills in recording and organizing information.

A major goal of science education is the provision of opportunities for learners to develop and use these manipulative and communicative skills. Many areas of the curriculum relate closely to the skills that are critical to science education. Reading, writing, speaking, and listening skills are all basic to the communication needs of science students. Many of the skills described in the section are essential in a broad spectrum of occupations. For example, people in almost every occupation must be able to obtain, record, process, interpret, and report information and to communicate ideas in a clear, convincing manner. The skills goal is not only critical to science education, but it is also important in the development of competencies necessary for effective citizenship.

Knowledge Strand. The goal is to assist the student in developing knowledge of processes, facts, principles, generalizations, and applications -- the products of science -- and to encourage their use in the interpretation of the natural environment. Acquisition of organized knowledge is a long-range goal of science and science education. Through an understanding of contributing facts, unifying principles, and relevant processes, organized knowledge gradually takes on meaning for the learner. He or she will acquire some knowledge as a by-product of instruction intended to develop attitudes, skills, and thinking processes and will acquire other knowledge as a deliberate result of instruction. At all levels, the knowledge goal must be in balance with and consistent with the other goals of science education.

Four types of knowledge can be highlighted as components of this goal:

- (1) knowledge that enables the learner to communicate the thinking processes and skills of science; (2) knowledge that constitutes broad generalizations which interrelate the many facts, concepts, and principles of all the sciences; (3) knowledge of how science and technology affect society; and (4) knowledge that constitutes the content, basic concepts, and structure of the major disciplines in science.

IMPLEMENTATION

Through the in-service process, the teacher should become fully cognizant of the Science Continuum, its rationale, and its possible use. The goals and objectives of the continuum are basic to all science courses and are consistent with the provisions of AB 65 and the forthcoming State Science Framework. District-developed pretests and posttests are planned to assist teachers in evaluating each student's level of achievement in relation to the Science Continuum. The results of pretests should be used in planning instruction to meet more effectively group and individual needs. In addition, the teacher should formulate a variety of ways to assist the student needing additional instruction.

Approaches to instruction may include:

- Development of learning centers
- Assignment to independent study projects
- Improvement of classroom management

SCIENCE CONTINUUM
GRADES 7-12

SYMBOLS	
—	Awareness/Exposure
- - -	Introduction/Development
0	Assessment/Evaluation
•	Maintenance/Reinforcement

Use of additional instructional resources
Introduction of changes in organization within the science department;
e.g., use of minicourses, team teaching
Expansion of tutoring program
Improvement of counseling

Processes and other tests prepared by the teacher should

Be used to evaluate continuum goals and learner performance objectives
Consist only of items based on performance objectives expected of
all students.

Assess understanding of science concepts rather than reading ability.
Avoid items which are of a controversial nature with respect to individual
religious or political beliefs.

Relate to life situations common to individuals in all cultural groups.
Involve problem statements with supporting data, as expressed in
graphs, tables, pictorials, and other illustrations.
Wherever possible, relate items from skills, thinking processes, and
attitudes objectives to knowledge objectives.

Test items related to attitudes should give the learner an opportunity to utilize
knowledge applicable to the appropriate scientific attitude. This may or may not
reflect the learner's personal attitude.

Test items related to thinking processes should be based on hypothetical problem-
solving experiments and include questions that assess the student's understanding
of scientific methods.

Test items related to skills should include questions about science apparatus,
rules of safety, materials, and equipment common to both biological and physical
sciences. Illustrations should be included.

1.0.0 ATTITUDES

	K	6	7	8	9	10	11	12
SHOWS CURIOSITY ABOUT OBJECTS AND EVENTS								
Shows willingness to examine and organize objects and events in the environment.								
RECOGNIZES AND REPORTS EVIDENCE OF ORDER AND SYMMETRY IN THE ENVIRONMENT								
Relates classification to everyday life situations								
APPRECIATES AND RESPECTS ALL LIVING ORGANISMS, INCLUDING SELF AND HIS/HER RELATIONSHIP TO THE ENVIRONMENT								
Accepts responsibility for the care of living organisms in natural and artificial environments								
1.3.2 Appreciates the interdependence of living organisms in the natural environment and the implications for continued survival								
TAKES AN ACTIVE ROLE IN SOLVING SOCIAL PROBLEMS RELATED TO SCIENCE AND TECHNOLOGY								
Practices conservation in use of food, energy, and materials								
Develops and expresses an opinion on a social issue.								
Seeks to influence the views and behaviors of others with respect to social issues related to science and technology								
WEIGHS ALTERNATIVE SCIENTIFIC, ECONOMIC, PSYCHOLOGICAL, OR SOCIAL FACTORS WHEN CONSIDERING POSSIBLE SOLUTIONS TO SOME PROBLEMS								
Recognizes the alternative factors to be considered when examining possible solutions								
Examines a variety of alternative viewpoints on scientific issues to form opinions about them								

ATTITUDES (CONT 1)

	K	6	7	8	9	10	11	12
ORGANIZES AND REPORTS THE RESULTS OF SCIENTIFIC INVESTIGATIONS IN AN HONEST AND OBJECTIVE MANNER								
1.6.0								
Understands the need to log only those data he/she has actually gathered	0			•				
1.6.1								
Forms opinions only after seeking a variety of data and ideas				•				
1.6.2								
Assumes responsibility for reporting results in an honest and objective manner	0			•				
1.6.3								
HAS A CRITICAL, QUESTIONING ATTITUDE TOWARD INFERENCE, HYPOTHESES, AND THEORIES.								
1.7.0								
1.7.1								
Shows an interest in responding to contradictions between data and theory								
APPLIES RATIONAL AND CREATIVE THINKING PROCESSES WHEN TRYING TO FIND RELATIONSHIPS AMONG SEEMINGLY UNRELATED PHENOMENA AND WHEN SEEKING SOLUTIONS TO PROBLEMS								
1.8.0								
1.8.1								
Attempts spontaneously to describe an object or event that has attracted his/her attention	0			•				
1.8.2								
Applies science problem-solving techniques in everyday life situations	0			•				
RECOGNIZES THE VALUES OF SCIENCE AS A HUMAN ENDEAVOR REPRESENTING ALL RACIAL, ETHNIC, AND CULTURAL BACKGROUNDS								
1.9.0								
1.9.1								
Chooses to gather information and report on the contributions of all cultures to the scientific world	0			•				
1.9.2								
Acknowledges that race, sex, or nationality should not constitute a barrier to scientific study	0			•				
1.9.3								
Values the scientific contributions of human beings from varying cultural backgrounds	0			•				

ATTITUDES (CONT 1)

	K	6	7	8	9	10	11	12
CONSIDERS SCIENCE RELATED CAREERS AND MAKES REALISTIC DECISIONS ABOUT PREPARING FOR SUCH CAREERS, TAKING INTO ACCOUNT ABILITIES, INTERESTS, AND PREPARATION REQUIRED.								
1.10.0								
Values the abilities, interests, and preparation required for a science related career				•				
1.10.1								
Assumes responsibility for making a realistic decision about the pursuit of a science related career								
1.10.2								

THINKING PROCESSES

	K	6	7	8	9	10	11	12
DEVELOPS ABILITY TO GENERATE DATA BY OBSERVING, RECALLING, RECOGNIZING, IDENTIFYING, AND MEASURING.								
2.1.0								
Examines objects carefully, using a combination of senses to collect and process data; derives meaning from the observation, recognizes the need to use simple instruments to aid the senses in collecting data	0			•				
2.1.1								
Determines the need to repeat observations as a means of improving reliability	0			•				
2.1.2								
Uses measurement procedures to improve accuracy of observations	0			•				
2.1.3								
Identifies changes in properties and rates of change	0			•				
2.1.4								
DEVELOPS ABILITY TO ORGANIZE DATA BY COMPARING, CLASSIFYING, RELATING, AND ORDERING.								
2.2.0								
Perceives similarities and differences in a set of objects, separates a set into groups according to a single characteristic.	0			•				
2.2.1								
Develops arbitrary classification systems wherein objects can be put into mutually exclusive categories, uses quantitative measurements as criteria for grouping.								
2.2.2								

THINKING PROCESSES (CONT.)

	K	6	7	8	9	10	11	12
2.3.0 DEVELOPS ABILITY TO APPLY AND EVALUATE DATA AND GENERATE THEORIES BY HYPOTHESIZING, PREDICTING, INFERRING, GENERALIZING, THEORIZING, EXPLAINING, JUSTIFYING, JUDGING, AND INTERPRETING								
2.3.1 Examines environmental issues, pointing out contradictions and discrepancies in the positions of various groups								
2.3.2 Gathers own data to form own point of view, satisfying any former contradictions	0							
2.3.3 Recognizes contradictions and unusual events								
2.3.4 Designs experiments to produce specific data to support or refute a hypothesis								
2.4.0 PARTICIPATES IN SCIENTIFIC INQUIRY AT THE APPROPRIATE LEVEL								
2.4.1 Defines a problem related to an unusual event.								
2.4.2 Identifies data needed to test a hypothesis, designs an experiment to generate the data, records and organizes data, and evaluates the hypothesis in light of new data								

3.0.0 SKILLS

	K	6	7	8	9	10	11	12
3.1.0 ASSEMBLES AND USES LABORATORY APPARATUS, TOOLS AND MATERIALS IN A SKILLFUL MANNER, GIVING DUE ATTENTION TO SAFETY MEASURES								
3.1.1 Manipulates simple materials, apparatus, and equipment in a safe manner	0			•				
3.1.2 Demonstrates growth in the ability to manipulate more complex science materials and equipment			0			•		
3.1.3 Acquires and assembles appropriate science apparatus, materials, and equipment in order to obtain designated data								

SKILLS (CONT.)

	K	6	7	8	9	10	11	12
3.2.0 DEMONSTRATES PROPER TECHNIQUES FOR HANDLING AND CARING FOR LIVING ORGANISMS.								
3.2.1 Handles plants and animals carefully, following suggested procedures	0			•				
3.2.2 Provides an environment for plant and animal life that is conducive to the support of normal life functions.	0			•				
3.3.0 GATHERS THE INFORMATION NEEDED FOR DEVELOPING OR TESTING INFERENCES AND HYPOTHESES BY MAKING PURPOSEFUL, OBJECTIVE OBSERVATIONS OF THINGS AND EVENTS.								
3.3.1 Makes purposeful, objective observations.	0			•				
3.3.2 Determines the timing of a series of events.								
3.4.0 GATHERS NEEDED INFORMATION, WHICH HAS BEEN GENERATED BY OTHERS, FROM A VARIETY OF SOURCES APPROPRIATE TO HIS/HER ABILITY LEVEL.								
3.4.1 Listens to the ideas of others.	0			•				
3.4.2 Gathers information from science textbooks, reference materials, science films, and television.	0			•				
3.4.3 Finds sources of information needed to solve a problem related to a specific topic.	0			•				
3.5.0 RECORDS OBSERVATIONS ACCURATELY AND ORGANIZES DATA AND IDEAS IN WAYS THAT IMPROVE THEIR USEFULNESS								
3.5.1 Orally describes a series of events that have taken place.	0			•				
3.5.2 Tabulates information and uses tables.								
3.5.3 Interprets graphs and displays data graphically.	0							
3.6.0 COMMUNICATES WITH OTHERS IN A MANNER THAT IS CONSISTENT WITH KNOWLEDGE.								
3.6.1 In group settings, orally describes observations and answers questions	0			•				
3.6.2 Explains either orally or in writing, the methods and procedures involved in carrying out an investigation	0							

SKILLS (CONT.)

	K-6	7	8	9	10	11	12
3.7.0							
USES THE METRIC SYSTEM EFFECTIVELY.							
Counts, uses numbers, and balances objects on an equal-arm balance scale.	0		•				
Measures linear distances, using a metric ruler.	0		•				
Uses a balance to determine the mass of objects.	0			•			
Measures volume of liquid in a graduated cylinder marked in metric units.							
3.7.4							
APPLIES APPROPRIATE MATHEMATICAL CONCEPTS AND SKILLS IN INTERPRETING DATA AND IN SOLVING PROBLEMS.							
Calculates rates from data.							
Finds the mean and median of a series of measurements.							
Utilizes exponential notation to express very large and very small numbers.							
Determines degree of precision of measurement and quantities derived from measurements.							
Uses calculators and computers to advantage in manipulating data and solving problems.							
3.8.5							

KNOWLEDGE (CONT.)

	K-6	7	8	9	10	11	12
4.2.0							
DEMONSTRATES UNDERSTANDING OF BASIC GENERALIZATIONS, RELATIONSHIPS, AND PRINCIPLES.							
Identifies simple cause-effect relationships.	0		•				
Uses a cause-effect relationship to make a prediction.	0						
Recognizes that atoms are composed of electrons, protons, neutrons, and other particles.	0				•		
Recognizes that electrons are negatively charged and protons are positively charged.						•	
Illustrates that the number of atomic particles varies with each element.							•
Recognizes that matter is composed of particles which are in constant motion.							•
Describes interaction and reorganization of units of matter and their association with changes of energy.							
Recognizes the uses of fuels.	0		•				
Identifies examples of kinetic and potential energy.							•
Identifies pairs of objects having similar properties.	0		•				
Describes systems of classification used to sort a group of miscellaneous objects.	0		•				
Recognizes that classification systems are developed by humans for the use of humans and are one way of helping to understand the basic organization and pattern of nature.							•
4.2.12							
DEMONSTRATES KNOWLEDGE OF RELATIONSHIPS BETWEEN SCIENCE AND SOCIETY.							
4.3.0							
4.3.1	0		•				
4.3.2							
4.3.3							

4.0.0 KNOWLEDGE

	K-6	7	8	9	10	11	12
4.1.0							
DEMONSTRATES KNOWLEDGE OF THE PROCESSES OF SCIENTIFIC INQUIRY.							
Distinguishes between trial and error and controlled investigations.	0		•				
Matches names of various processes and products of scientific inquiry with examples.							
Evaluates procedures in the inquiry process that have been omitted or inadequately performed.							
4.1.3							

KNOWLEDGE (CONT.)

	K	6	7	8	9	10	11	12
4.4.0	DEMONSTRATES KNOWLEDGE OF SCIENCE-RELATED CAREER OPPORTUNITIES AND THE PREPARATION NEEDED.							
4.4.1	0							
4.4.2	0							
4.5.0	DEMONSTRATES KNOWLEDGE OF CONTRIBUTIONS TO SCIENCE AND TECHNOLOGY MADE BY MEN AND WOMEN OF VARIOUS RACES AND NATIONALITIES							
4.5.1	0							
4.6.0	DEMONSTRATES KNOWLEDGE OF THE RELATIONSHIPS OF SCIENCE TO OTHER AREAS OF HUMAN ENDEAVOR.							
4.6.1								
4.7.0	DEMONSTRATES KNOWLEDGE OF WAYS IN WHICH ATTITUDES, THINKING PROCESSES, AND SKILLS CAN BE RELATED FOR USE IN PERSONAL DECISION-MAKING							
4.7.1	0							
4.7.2								
4.7.3								
4.8.0	DEMONSTRATES GENERAL KNOWLEDGE OF SCIENCE.							
4.8.1	0							
4.8.2	0							
4.8.3	0							
4.8.4	0							
4.8.5	0							

KNOWLEDGE (CONT.)

	K	6	7	8	9	10	11	12
4.8.6	Recognizes the importance of energy levels as related to ecosystems							
4.8.7	0							
4.8.8	Describes examples of humankind's dependence on and interference with natural ecosystems							
4.8.9	0							
4.8.10	Recognizes that all forms of life are composed of the same elements in different DNA blueprints.							
4.8.11								
4.8.12	Recognizes that living organisms have changed over the ages and that some species are now extinct.							
4.8.13	0							
4.8.14	Describes the regular movements of the earth and moon.							
4.8.15	0							
4.8.16	Demonstrates knowledge of basic differences between planets, stars, the solar system, the Milky Way Galaxy, and the known universe.							
4.8.17	0							
4.8.18	Demonstrates knowledge of the effects of moon and sun on ocean tides							
4.8.19	0							
4.8.20	Demonstrates that in chemical or physical changes the total amount of matter remains unchanged.							
4.8.21	Recognizes that in nuclear reactions a loss of matter is a gain in energy. The sum of matter and energy remains constant							

Science Continuum

KNOWLEDGE (CONT.)

	K	6	7	8	9	10	11	12
4.8.22				●		●		
4.8.23								
4.8.24								
4.8.25				●		●		
4.8.26								
4.8.27				●		●		
4.8.28				●		●		
4.8.29								
4.8.30								