

ED 347 927

D 025 690

TITLE Student Profiles 1991. The Second in a Series of Annual Factbooks about Student Participation in California Higher Education.

INSTITUTION California State Postsecondary Education Commission, Sacramento.

REPORT NO CPEC-92-10

PUB DATE Mar 92

NOTE 207p.; For the 1990 profiles, see ED 329 200.

AVAILABLE FROM Publications Office, California Postsecondary Education Commission, Third Floor, 1020 Twelfth St., Sacramento, CA 95814-3985.

PUB TYPE Statistical Data (110)

EDRS PRICE MF01/PC09 Plus Postage.

DESCRIPTORS College Freshmen; *College Students; Community Colleges; Degrees (Academic); Demography; *Educational Trends; *Enrollment Trends; Ethnic Groups; Higher Education; High School Graduates; High Schools; Outcomes of Education; Postsecondary Education; State Surveys; Statistical Data; *Student Characteristics; *Transfer Students; Trend Analysis

IDENTIFIERS *California

ABSTRACT

This factbook presents tabular data on first-time freshmen and transfer students in postsecondary education in California. The report presents data on students in six categories. The first section provides information about all of California's college and university students. The second section contains information about the proportional representation of racial/ethnic groups within the groups of first-time freshmen, transfer students, and baccalaureate degree recipients. The third section includes data that were formerly displayed in the Commission's annual College-Going Rates reports. The fourth section provides information on community college transfers as well as facts about transfer students from the other segments. The fifth section examines student outcomes. The final section provides data on high school graduates and college-going rates by county and on community college transfer students. (GLR)

 * Reproductions supplied by EDRS are the best that can be made *
 * from the original document. *

HEADS-690

U.S. DEPARTMENT OF EDUCATION
Office of Educational Research and Improvement
EDUCATIONAL RESOURCES INFORMATION
CENTER (ERIC)

- This document has been reproduced as received from the person or organization originating it
- Minor changes have been made to improve reproduction quality

• Points of view or opinions stated in this document do not necessarily represent official OERI position or policy

"PERMISSION TO REPRODUCE THIS MATERIAL HAS BEEN GRANTED BY

CA Postsecondary Education

Commission
TO THE EDUCATIONAL RESOURCES
INFORMATION CENTER (ERIC)."

BEST COPY AVAILABLE

Summary

This item is the second edition of *Student Profiles*, which seeks to provide comprehensive information about students in postsecondary education in California. *Student Profiles* contains information on first-time freshmen and transfer students that used to appear in other Commission reports.

The report presents data on students under six categories: (1) All Students, (2) Equity Indexes, (3) First-Time Freshmen and New Students, (4) Transfer Students, (5) Student Outcomes, and (6) Area Specific Student Data. The section on Equity Indexes replaces the "Participation Rate" section of the first edition. The Commission has added this section because of the Commission's ongoing concern with educational equity issues.

Unlike most Commission reports, *Student Profiles* contains little analytic comment about its data. Instead, the Commission encourages readers to use it as the basis for their own analyses.

The Commission discussed this report at its meeting of March 30, 1992. Additional copies may be obtained from the Publications Office of the Commission at (916) 324-4992.

STUDENT PROFILES 1991

*The Second in a Series of Annual Factbooks
About Student Participation
in California Higher Education*

CALIFORNIA POSTSECONDARY EDUCATION COMMISSION
Third Floor • 1020 Twelfth Street • Sacramento, California 95814-3985

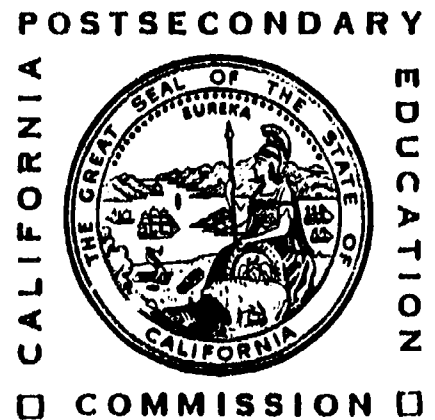



**COMMISSION REPORT 92-10
PUBLISHED MARCH 1992**

Contributing Staff: Marc C. Irish and ZoAnn Laurente.

This report, like other publications of the California Postsecondary Education Commission, is not copyrighted. It may be reproduced in the public interest, but proper attribution to Report 92-10 of the California Postsecondary Education Commission is requested.

Contents

INTRODUCTION	1
Organization of the Profiles	1
Selected Highlights	2
Sources of the Data	3
Categorization of Independent Institutions	4
Caveats	5
Format of Report and Availability of Data	5
Feedback About the Report	5

PROFILES

1. All Students
2. Equity Indexes
3. First-Time Freshmen and New Students
4. Transfer Students
5. Student Outcomes
6. Area Specific Student Data



Introduction

THIS IS the second edition of *Student Profiles*, issued by the California Postsecondary Education Commission to provide comprehensive information about students in postsecondary education in California. *Student Profiles* contains a wide-ranging set of graphs and statistical tables that allows readers to gain an understanding of the characteristics of California students as well as trends in these characteristics, including eligibility for college and university admission, enrollment, transfer, and program completion. Unlike most Commission reports, *Student Profiles* contains little textual comment and analysis about the data. Instead, the Commission hopes that it will provide the basis for such analysis by others.

The primary purposes of *Student Profiles* are five-fold:

1. To provide a context to facilitate policy analysis by presenting a global view of students in California;
2. To permit prompt response to basic inquiries regarding student information;
3. To serve as a basic source of data for research;
4. To function as the Commission's "official" guide to student statistics (that is, by supplying correct, agreed-upon data, even if disagreement exists about how these data might be used in different policy analyses); and
5. To stimulate the production of special topical reports when specific trends in higher education warrant more detailed analysis and description.

Organization of the profiles

Student Profiles is divided into these six sections:

1. All Students

The first section provides information about all of California's college and university students in order

to provide a context for later sections and an overview of how California's student body has changed over the last decade.

2. Equity Indexes

The second section contains information about the proportional representation of racial/ethnic groups within three defined categories: (1) first-time freshmen, (2) transfer students, and (3) baccalaureate degree recipients. These equity indexes provide a measure of the proportional representation of a particular ethnic group with that same group's representation in their appropriate comparison category. For example, the first of the three indexes compares for each major racial/ethnic group the number of first-time freshmen who are 19 years old or under with the total number of public high school graduates for the same year. If the equity index for a particular racial/ethnic group equals 1.0, the proportion of first-time freshmen from that group is identical to the group's proportion of high school graduates. A number less than 1.0 reflects underrepresentation, and a number greater than 1.0 reflects overrepresentation.

The comparison groups for each equity index are as follows:

- *Enrollment Equity Index*: Compares the proportion that any racial/ethnic group represents of a system's enrollment of first-time freshmen who were aged 19 and under with that same group's proportion of all public high school graduates during the same year.
- *Transfer Equity Index*: Compares the proportion that any racial/ethnic group represents of a university's new transfer enrollment with that same group's proportion of credit enrollments in community colleges from four years before.
- *Graduation Equity Index*: Compares the proportion that any racial/ethnic group represents of a system's baccalaureate degree recipients with that same group's proportion of the system's undergraduate enrollment from five years before.

3. *First-Time Freshmen and New Students*

This third section includes data that were formerly displayed in the Commission's annual *College-Going Rates* reports. In addition to information regarding recent high school graduates, data in this section reflects the origin of new students, average age of all first-time freshmen, and sex and ethnic distribution of new students.

4. *Transfer Students*

This fourth section contains information on community college transfers as well as facts about transfer students from the other segments. The Commission previously published this information in its annual *Update of Community College Transfer Statistics*. However, information in this section has been expanded in order to portray a more accurate sense of student flow, including transfers between campuses of the same segment and "reverse transfer" students -- those who begin their higher education in a four-year institution and then transfer to a community college.

5. *Student Outcomes*

The fifth section of this first *Student Profiles* report provides information on student outcomes. Ultimately, the Commission would like to present information beyond simply reporting the number of degrees awarded by California's colleges and universities including graduation rate, student attrition, and persistence information once student-specific data based on unique student identifiers is available. In the absence of student identifiers, the Commission intends to include more information in subsequent *Student Profiles* based on the results of its current student cohort study.

6. *Area Specific Student Data*

The sixth and final section of *Student Profiles* provides information on high school graduates and college-going rates by county and on community college transfer students. These tables were previously published in the Commission's annual *College-Going Rates* report and its annual *Update of Community College Transfer Statistics*, respectively.

Selected highlights

While the Commission encourages readers to develop their own analyses of trends in higher education by using *Student Profiles*, a few trends are highlighted here:

California and the nation

- California continues to enroll a greater proportion of its residents in postsecondary education than the nation at large: 6.1 percent versus 5.4 percent in 1989. This is a trend that has persisted for the last 20 years (Table 1-7).
- A greater proportion of California's postsecondary education students attend public colleges or universities than occurs nationally -- 87.9 percent versus 78.1 percent in 1989. This disparity has existed over the last 20 years (Table 1-6).

California high school students

- While the total number of high school graduates has modestly decreased over the past decade (Table 1-1), the proportional distribution among the Commission's 11 regions has shifted. The Sacramento, San Francisco, Los Angeles, and Orange County regions have declined as a proportion of total high school graduates while the North Central Valley, South Central Valley, Riverside/San Bernardino, and San Diego/Imperial regions have increased as a proportion of total high school graduates (Table 1-8).
- The percentage of public high school graduates who have completed the A-F course pattern, which is necessary to qualify to attend the University of California or the California State University, has increased from 25.5 percent in 1985-86 to 31.4 percent in 1990-91 (Table 6-6).
- Significant regional differences continue in the percentage of public high school graduates who have completed the A-F course pattern. In 1990-91, there ranged from a low of 20.2 percent in the Northern Central Valley region to a high of 37.7 percent in Orange County (Table 1-19).

Characteristics of public college and university students

- Approximately nine out of ten undergraduates at

the University of California attend full-time, while only seven out of ten undergraduates at the California State University do so, as does only one out of every four community college students (Tables 1-2, 1-3, and 1-4).

- Except for four years at the University of California, the proportion of women undergraduates has exceeded their male counterparts in all three systems of public higher education during the past decade (Tables 1-2, 1-3, and 1-4). Women have also outnumbered men in master's and post-baccalaureate programs at the University and the California State University during this time, while the reverse applied for doctoral students and students seeking first professional degrees (Tables 1-14 and 1-15).
- The proportion of undergraduates of color compared to total undergraduates at the University of California and the California State University has increased over the last ten years. During this time, the number of White students has declined slightly at the University and increased slightly at the State University. At the California Community Colleges, the proportion of students of color has increased -- but only because the number of White students has decreased (Tables 1-9, 1-10, and 1-11).
- While the enrollment of historically underrepresented students has increased over the past decade, Black undergraduates have grown the least in comparison to all other racial/ethnic groups at the University of California and the California State University. At the community colleges, the number of Black students actually decreased by 10,400 -- a 10.7 percent decline since 1981 (Tables 1-9, 1-10, and 1-11).

First-time freshmen and transfer students

- The proportion of new undergraduate students (including both first-time freshmen and transfer students) to total undergraduate students at the University, the State University, and the community colleges has decreased over the last ten years. During this same period, the proportion of first-time freshmen compared to transfer students as a component of total undergraduate enrollment, has increased in all three systems (Tables 3-4, 3-6, and 3-7).

- Over the past decade, students from historically underrepresented groups transferred from the community colleges to the University and the State University at lower rates than did White and Asian students (Tables 4-15 and 4-17).
- Over the decade, the proportion of historically underrepresented groups among community college students has continued to be greater than among those community college students who transfer to the University and the State University (Tables 4-10 and 4-12).

Student outcomes

- The University of California awards about one in five of its bachelor's degrees to a student who transferred from a community college. The California State University awards one out of every two bachelor's degrees to a student who transferred from a community college (Tables 5-4 and 5-11).
- Baccalaureate degrees awarded per 1,000 undergraduates has declined for both Black and Latino students over the past decade in the State University and has declined for Latinos in the University during this same period (Tables 5-2, 5-3, 5-9, and 5-10).

Sources of the data

California's colleges and universities are the sources from which the Commission assembles *Student Profiles*. The State's public universities and four-year colleges submit all of their enrollment and degree data to the Commission on machine-readable magnetic computer tape. The California Community Colleges submit their data to their Chancellor's Office, which currently transmits only their enrollment data to the Commission on tape and their degree data on hardcopy survey forms. California's independent colleges and universities submit all of their data to the Commission using hardcopy survey forms generated from the National Center for Education Statistics Integrated Postsecondary Education Data System (IPEDS) of the United States Department of Education.

Categorization of independent institutions

In order to reflect the diversity that exists within California's independent sector of higher education and to facilitate meaningful comparisons with their public-sector counterpart institutions, the Commission arrays data from the State's independent colleges and universities in three groups that are comparable to the public segments. The criteria used by the Commission to establish these groups were (1) the set of high school courses required by the institution for admission; (2) the range of acceptable admission test scores for incoming students; and (3) the minimum high school grade-point average required for admission. The three groups are:

1. Independent institutions with admission standards comparable to the University of California;
2. Independent institutions with admission standards comparable to the California State University; and
3. Two-year independent institutions.

The following list identifies these institutions by their group classification:

Group 1

1. California Institute of Technology
2. Claremont Graduate School
3. Claremont McKenna College
4. Harvey Mudd College
5. Loyola Marymount University
6. Mills College
7. Occidental College
8. Pepperdine University
9. Pitzer College
10. Pomona College
11. Saint Mary's College of California
12. Santa Clara University
13. Scripps College
14. Stanford University
15. Thomas Aquinas College
16. University of the Pacific
17. University of Redlands
18. University of San Diego
19. University of San Francisco
20. University of Southern California
21. Westmont College
22. Whittier College

Group 2

1. Azusa Pacific University
2. Biola University
3. California Baptist College
4. California Lutheran College
5. Chapman College
6. Christ College Irvine
7. Christian Heritage College
8. College of Notre Dame
9. Dominican College of San Rafael
10. Fresno Pacific College
11. Holy Names College
12. Loma Linda University
13. The Master's College
14. Mount Saint Mary's College
15. Point Loma Nazarene College
16. Southern California College
17. United States International University
18. University of La Verne
19. Woodbury University

Group 3

1. American Academy of Dramatic Arts West
2. Brooks College
3. College for Developmental Studies
4. College of Oceaneering
5. Condie Junior College of Business and Technology
6. Don Bosco Technical Institute
7. D-Q University
8. Fashion Institute of Design and Merchandising
9. Marymount College, Palos Verdes
10. National Technical Schools
11. Queen of the Holy Rosary
12. San Francisco College of Mortuary Science

Data from only those independent institutions that have consistently provided data to the Commission over the last ten years have been included in the following tables, in order to allow trend analyses of the independent sector at large.

Finally, because the following information about the independent colleges and universities comes solely from their IPEDS survey forms, which provide data only in aggregate format, the Commission is more limited in how to present it than for public institutions. In addition, those survey forms do not collect all of the information that the Commission

collects through its individual student record data system.

Caveats

Three limitations of all the following data should be noted:

- One is simply that the statistics involve actual numbers of students -- "headcount students" -- rather than calculations of full-time-equivalent students.
 - The second is that while *Student Profiles* includes statistics on students in the State's four major segments of higher education -- the California Community Colleges, the California State University, the University of California, and California's regionally accredited independent institutions -- it does not cover statistics on two other areas of interest to the Commission: (1) the State's private institutions that seldom submit student data to the Commission -- its non-accredited degree-granting colleges and universities, and its non-degree-granting institutions such as business schools and flight-training institutes -- and (2) California students attending college in other states. Both of these types of statistics are needed for *Student Profiles* to present a fully comprehensive picture of college-going behavior on the part of California's young people.
 - Third, data for some years for some independent institutions have been imputed in order to more accurately portray the student characteristics of these institutions.
-

Format of the report and availability of data

The Commission publishes *Student Profiles* in a loose-leaf format to fit in three-ring binders so that additional tables can be added easily to the report. This allows the Commission's staff to provide updates to particular tables on a more timely and regular basis than might otherwise be possible. In addition to the published report itself, the Commission provides the data contained in this report on floppy disk or magnetic computer tape. The data tables and graphics were created using Excel software.

Feedback about the report

Student Profiles is published annually by the Commission as part of its "postsecondary education information clearinghouse" responsibilities. The Commission staff hopes to continue to improve the quality and usefulness of these profiles by soliciting feedback from the systems and others.

The Commission appreciates receiving comments about how to make this report and its other documents more useful as well as feedback about any errors of omission or calculation that should be corrected to make it more accurate. Please send your comments to:

Marc Irish, Director of Information Systems
California Postsecondary Education Commission
1303 J Street, Fifth Floor
Sacramento, CA 95814-2938
Telephone (916) 322-8002

Section 1

All Students

- 1-1 All California Public and Private High School Graduates, 1981 to 1990
- 1-2 Undergraduate (for Credit) Enrollment at the California Community Colleges by Full-Time and Part-Time Status and by Gender, Fall 1981 to Fall 1990
- 1-3 Undergraduate Enrollment at the California State University by Full-Time and Part-Time Status and by Gender, Fall 1981 to Fall 1989
- 1-4 Undergraduate Enrollment at the University of California by Full-Time and Part-Time Status and by Gender, Fall 1981 to Fall 1990
- 1-5 Total Enrollment in California Public Colleges and Universities by Segment, Fall 1971 to Fall 1990
- 1-6 Comparison of Enrollment in Higher Education -- California and the United States, 1970 through 1989
- 1-7 Comparison of Population and Enrollment in Higher Education -- California and the United States, 1970 through 1989
- 1-8 Total California Public and Private High School Graduates by Region, 1981 to 1990
- 1-9 Undergraduate Enrollment by Ethnicity at the University of California, Fall 1981 to Fall 1990
- 1-10 Undergraduate Enrollment by Ethnicity at the California State University Fall 1981 to Fall 1990
- 1-11 Undergraduate (for Credit) Enrollment at the California Community Colleges by Ethnicity, Fall 1981 to Fall 1990
- 1-12 Graduate Enrollment by Student Level at the University of California, Fall 1981 to Fall 1990
- 1-13 Graduate Enrollment by Student Level at the California State University, Fall 1981 to Fall 1990
- 1-14 Graduate Enrollment by Gender at the University of California, Fall 1981 to Fall 1990
- 1-15 Graduate Enrollment by Gender at the California State University, Fall 1981 to Fall 1990
- 1-16 Undergraduate Enrollment at Selected Independent Colleges and Universities, Fall 1981 to Fall 1990

- 1-17 Graduate Enrollment at Group I Independent Institutions, Fall 1981 to Fall 1989
- 1-18 Graduate Enrollment at Group II Independent Institutions, Fall 1981 to Fall 1989
- 1-19 A-F Completion Rates of High School Graduates by Region, 1985-86 Through 1990-91

All California Public and Private High School Graduates, 1981 to 1990

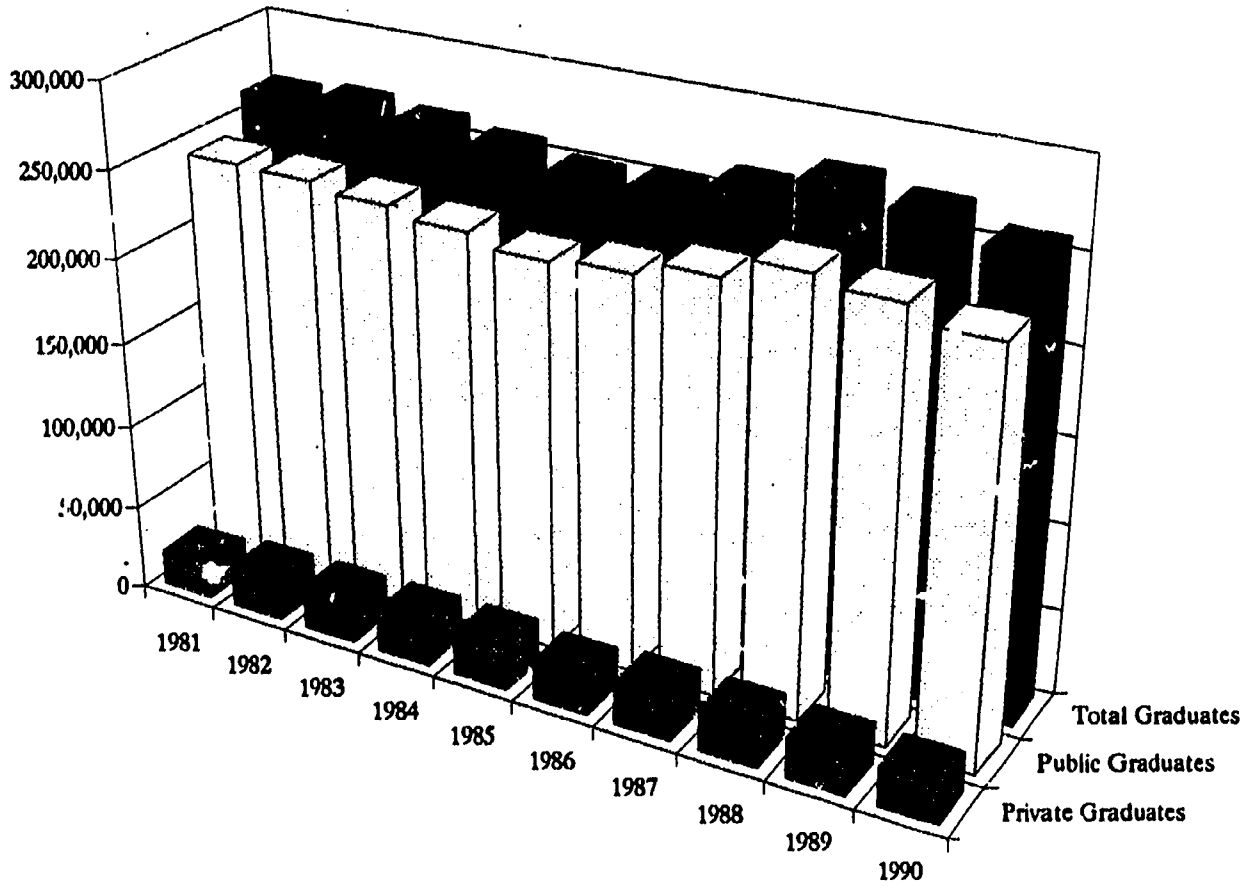

<u>Year</u>	<u>Total High School Graduates</u>	<u>Public High School Graduates</u>	<u>Private High School Graduates</u>
1981	263,392	242,172	21,220
1982	265,924	241,343	24,581
1983	261,994	236,897	25,097
1984	257,633	232,199	25,434
1985	251,143	225,448	25,695
1986	252,150	229,026	23,124
1987	262,921	237,414	25,507
1988	274,812	249,518	25,294
1989	268,983	244,625	24,358
1990	258,949	236,034	22,915

Undergraduate (for Credit) Enrollment at the California Community Colleges, Fall 1981 to Fall 1990

Full-Time and Part-Time Enrollment

Fall Term	Total	Number		Percent	
		Full Time	Part Time	Full Time	Part Time
1981	1,202,682	292,126	910,556	24.3	75.7
1982	1,191,366	308,943	882,423	25.9	74.1
1983	1,087,425	290,175	797,250	26.7	73.3
1984	1,005,576	270,935	734,641	26.9	73.1
1985	1,006,686	261,876	744,810	26.0	74.0
1986	1,046,099	265,526	780,573	25.4	74.6
1987	1,061,014	269,876	791,138	25.4	74.6
1988	1,093,152	276,963	816,189	25.3	74.7
1989	1,136,119	294,866	841,253	26.0	74.0
1990	1,205,565	304,974	900,591	25.3	74.7

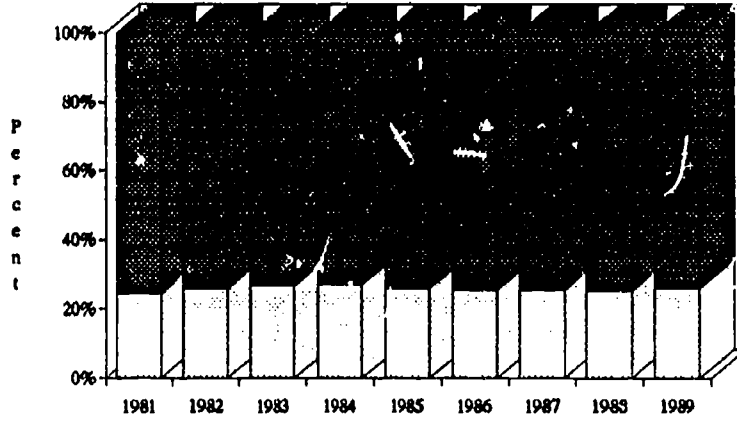

□ Full-Time ■ Part-Time

Undergraduate Enrollment by Gender

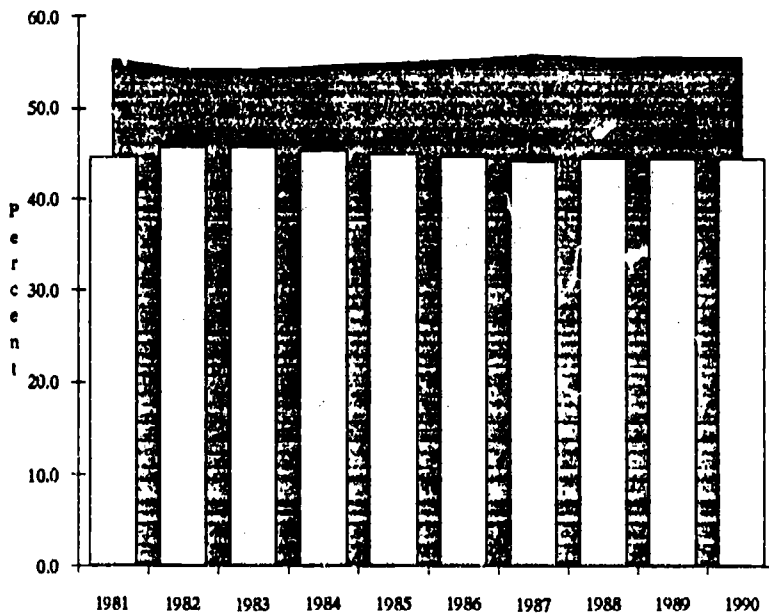

■ Women □ Men

Fall Term	Number		Percent	
	Men	Women	Men	Women
1981	532,535	658,698	44.7	55.3
1982	541,646	641,903	45.8	54.2
1983	494,959	586,195	45.8	54.2
1984	453,365	545,720	45.4	54.6
1985	451,497	550,825	45.0	55.0
1986	465,412	576,395	44.7	55.3
1987	467,511	589,205	44.2	55.8
1988	484,881	604,425	44.5	55.5
1989	503,925	630,189	44.4	55.6
1990	532,578	664,425	44.5	55.5

Undergraduate Enrollment at the California State University, Fall 1981 to Fall 1990

Full-Time and Part-Time Enrollment

Fall Term	Number			Percent	
	Total	Full Time	Part Time	Full Time	Part Time
1981	251,552	178,607	72,945	71.0	29.0
1982	251,137	180,894	70,243	72.0	28.0
1983	253,721	185,540	68,181	73.1	26.9
1984	256,839	185,828	71,011	72.4	27.6
1985	262,759	188,847	73,912	71.9	28.1
1986	266,729	190,350	76,379	71.4	28.6
1987	273,987	194,122	79,865	70.9	29.1
1988	284,929	201,923	83,006	70.9	29.1
1989	289,173	206,336	82,837	71.4	28.6
1990	294,083	209,936	84,147	71.4	28.6

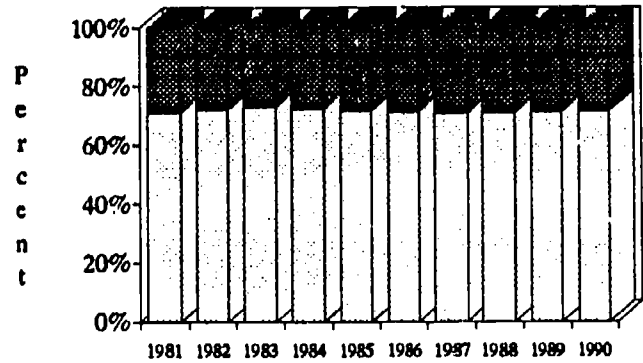

□ Full-Time ■ Part-Time

Undergraduate Enrollment by Gender

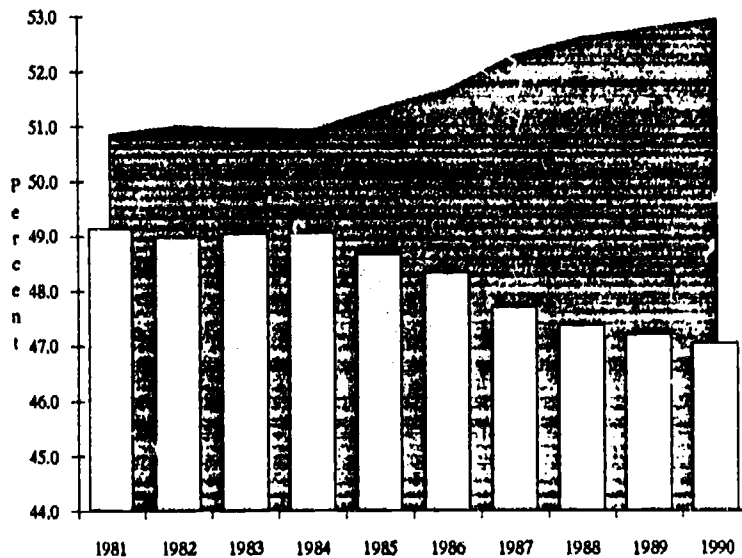

Year	Men	Women	Men	Women
1981	123,614	127,938	49.1	50.9
1982	123,029	128,108	49.0	51.0
1983	124,449	129,272	49.0	51.0
1984	126,014	130,825	49.1	50.9
1985	127,874	134,885	48.7	51.3
1986	128,921	137,808	48.3	51.7
1987	130,713	143,274	47.7	52.3
1988	135,037	149,892	47.4	52.6
1989	136,548	152,625	47.2	52.8
1990	138,396	155,687	47.1	52.9

■ Women □ Men

Undergraduate Enrollment at the University of California, Fall 1981 to Fall 1990

Full-Time and Part-Time Enrollment

Fall Term	Total	Number		Percent	
		Full Time	Part Time	Full Time	Part Time
1981	98,846	90,963	7,883	92.0	8.0
1982	100,751	93,027	7,724	92.3	7.7
1983	103,328	94,865	8,463	91.8	8.2
1984	106,025	96,949	9,076	91.4	8.6
1985	108,988	99,235	9,753	91.1	8.9
1986	112,363	102,866	9,497	91.5	8.5
1987	117,079	105,922	11,157	90.5	9.5
1988	121,001	110,418	10,583	91.3	8.7
1989	123,441	112,534	10,907	91.2	8.8
1990	124,271	114,492	9,779	92.1	7.9

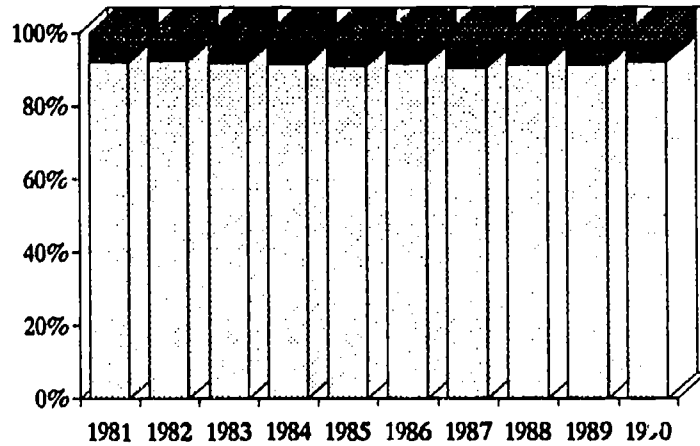

□ Full-Time ■ Part-Time

Undergraduate Enrollment by Gender

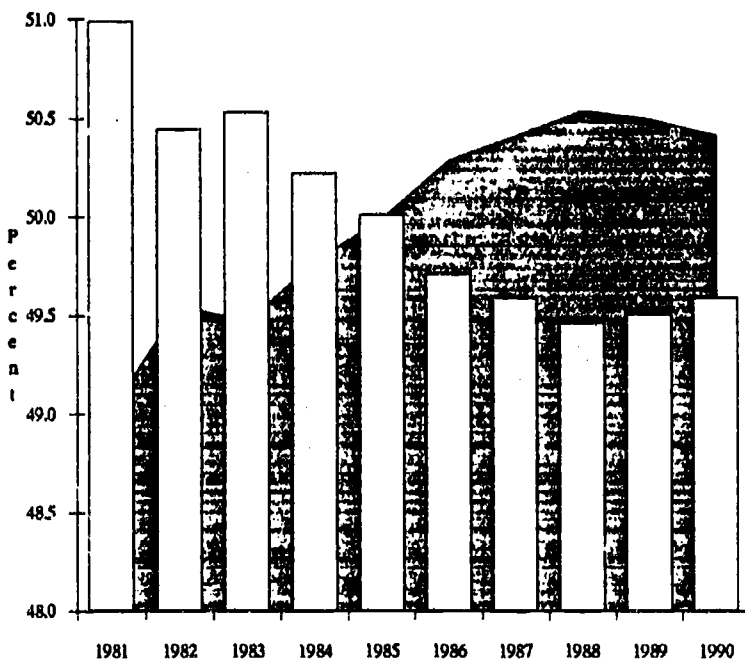

Fall Term	Number		Percent	
	Men	Women	Men	Women
1981	50,401	48,440	51.0	49.0
1982	50,826	49,924	50.4	49.6
1983	52,215	51,111	50.5	49.5
1984	53,251	52,773	50.2	49.8
1985	54,507	54,481	50.0	50.0
1986	55,857	56,506	49.7	50.3
1987	58,061	59,018	49.6	50.4
1988	59,850	61,151	49.5	50.5
1989	61,111	62,330	49.5	50.5
1990	61,625	62,646	49.6	50.4

■ Women □ Men

**Total Enrollment in California Public Colleges and Universities,
Fall 1971 to Fall 1990.**

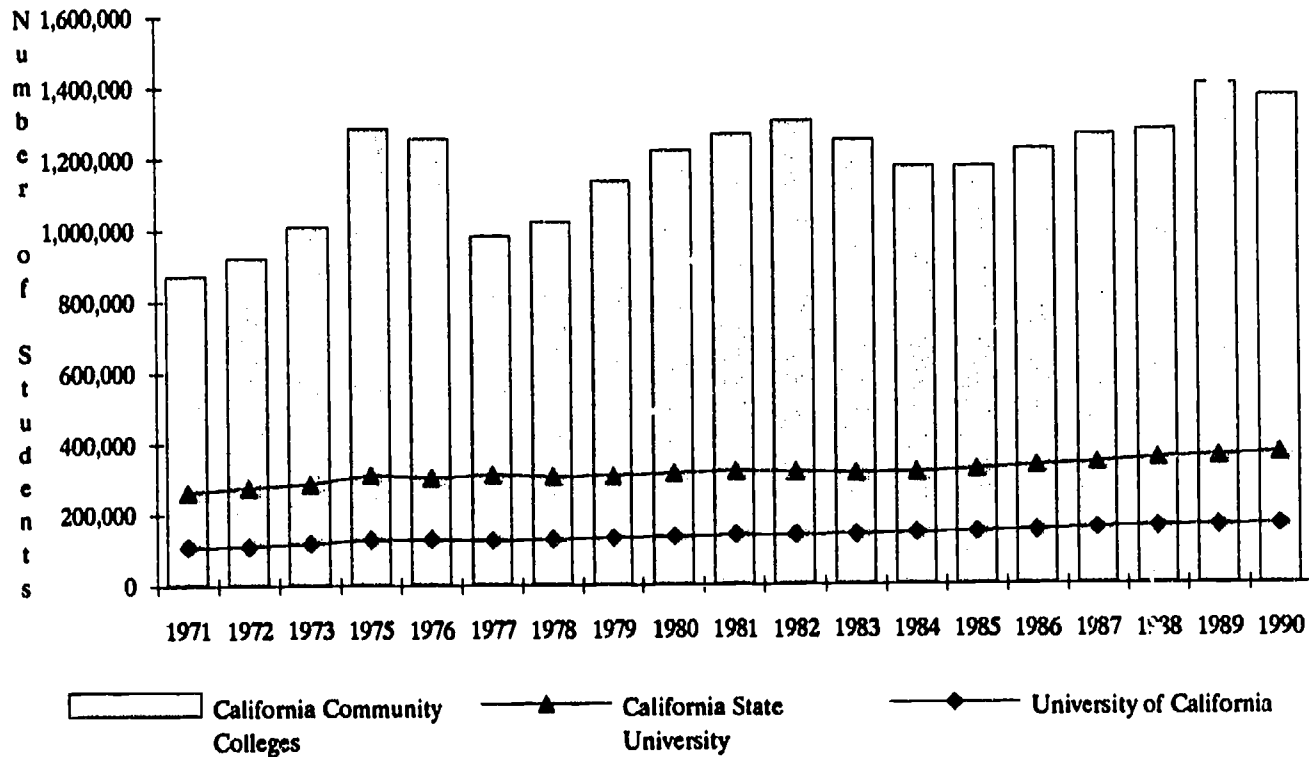

Fall Term	University of California	California State University	California Community Colleges	Total Enrollment
1971	108,033	262,081	873,353	1,243,467
1972	110,578	276,737	921,955	1,309,270
1973	118,854	286,633	1,009,307	1,414,794
1974	122,597	291,542	1,136,478	1,550,617
1975	128,486	310,891	1,284,824	1,724,201
1976	128,648	303,734	1,255,678	1,688,060
1977	126,505	312,380	982,348	1,421,233
1978	127,881	306,175	1,021,378	1,455,434
1979	131,823	306,801	1,137,348	1,575,972
1980	135,668	313,850	1,221,279	1,670,797
1981	138,573	319,665	1,266,724	1,724,862
1982	139,138	315,814	1,304,997	1,759,949
1983	141,289	313,900	1,250,340	1,705,529
1984	144,589	316,005	1,175,649	1,636,243
1985	147,957	324,626	1,176,712	1,649,295
1986	152,065	333,424	1,225,373	1,710,862
1987	157,331	342,776	1,264,409	1,764,516
1988	161,522	355,106	1,277,903	1,794,531
1989	164,605	360,838	1,406,949	1,932,392
1990	166,547	369,053	1,394,563	1,930,163

Comparison of Enrollment in Higher Education --
California and the United States, 1970 through 1989

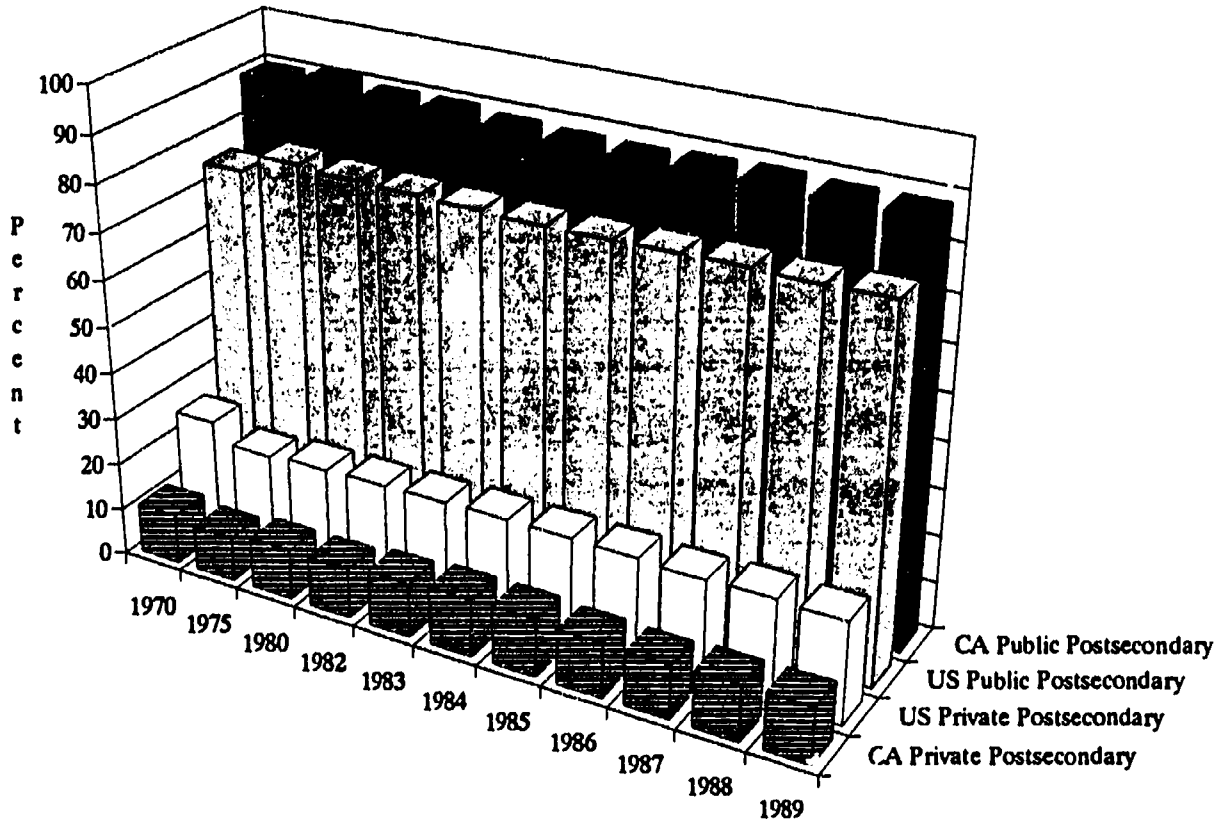

Year	United States (in thousands)				
	Total U.S. Postsecondary Students	Public Postsecondary Students	Percent in Public Institutions	Private Postsecondary Students	Percent in Private Institutions
1970	8,581	6,428	74.9	2,153	25.1
1975	11,185	8,835	79.0	2,350	21.0
1980	12,097	9,457	78.2	2,640	21.8
1982	12,426	9,696	78.0	2,730	22.0
1983	12,465	9,683	77.7	2,782	22.3
1984	12,242	9,477	77.4	2,765	22.6
1985	12,247	9,479	77.4	2,768	22.6
1986	12,505	9,715	77.7	2,790	22.3
1987	12,768	9,975	78.1	2,793	21.9
1988	13,055	10,161	77.8	2,894	22.2
1989	13,458	10,515	78.1	2,943	21.9

Year	California (in thousands)				
	California Postsecondary Students	Public Postsecondary Students	Percent in Public Institutions	Private Postsecondary Students	Percent in Private Institutions
1970	1,257	1,124	89.4	134	10.7
1975	1,788	1,618	90.5	170	9.5
1980	1,791	1,600	89.3	191	10.7
1982	1,843	1,646	89.3	197	10.7
1983	1,731	1,529	88.3	202	11.7
1984	1,665	1,460	87.7	206	12.4
1985	1,650	1,444	87.5	206	12.5
1986	1,728	1,522	88.1	206	11.9
1987	1,788	1,581	88.4	207	11.6
1988	1,754	1,542	87.9	212	12.1
1989	1,745	1,534	87.9	211	12.1

Notes: Enrollment data source is NCES Digest of Education Statistics, 1991.

Comparison of Population and Enrollment in Higher Education --
California and the United States, 1970 through 1989

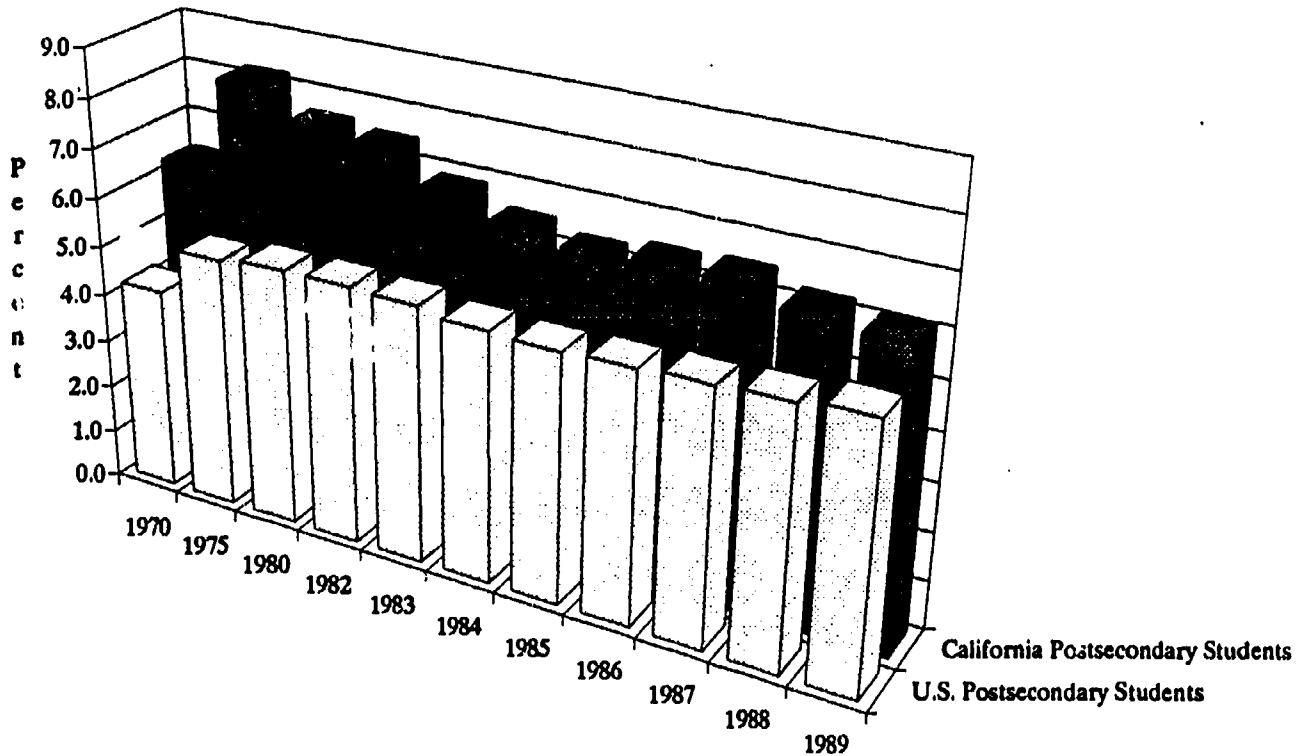

Year	Total U.S. Resident Population (in thousands)	Total U.S. Postsecondary Students (in thousands)	Percent in Postsecondary Education
1970	203,984	8,581	4.2
1975	215,465	11,185	5.2
1980	227,255	12,097	5.3
1982	231,996	12,426	5.4
1983	234,284	12,465	5.3
1984	236,477	12,242	5.2
1985	238,736	12,247	5.1
1986	241,107	12,505	5.2
1987	243,419	12,768	5.2
1988	245,807	13,055	5.3
1989	248,255	13,458	5.4

Year	California Population (in thousands)	California Postsecondary Students (in thousands)	Percent in Postsecondary Education
1970	19,971	1,257	6.3
1975	21,820	1,788	8.2
1980	23,668	1,791	7.6
1982	24,780	1,843	7.4
1983	25,305	1,731	6.8
1984	25,776	1,665	6.5
1985	26,353	1,650	6.3
1986	26,997	1,728	6.4
1987	27,653	1,788	6.5
1988	28,314	1,754	6.2
1989	28,607	1,745	6.1

Notes: Enrollment data source is the NCES Digest of Education Statistics, 1989.
Population data source is the Statistical Abstract of the United States, 1990.

Total California Public and Private High School Graduates by Region, 1981 to 1990

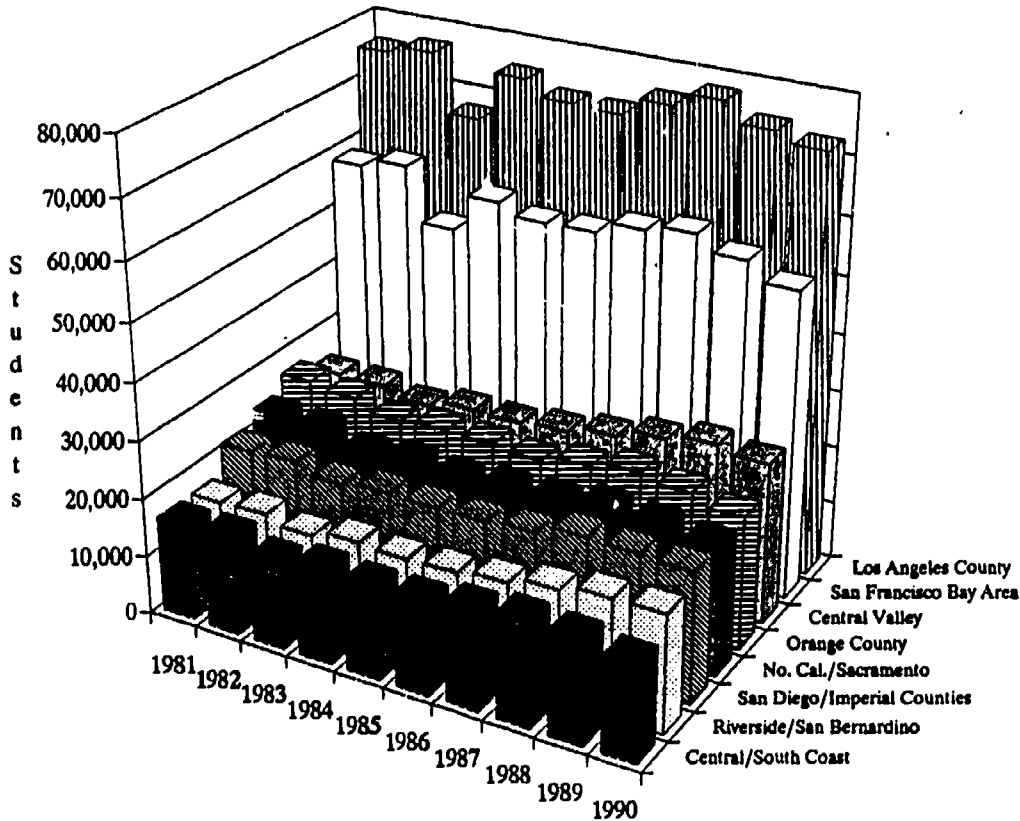

Total California Public and Private High School Graduates by Region, 1981 to 1990

Region	1981	1982	1983	1984	1985	1986	1987	1988	1989	1990
Northern California	9,914	10,082	9,405	9,482	9,328	9,077	9,771	10,130	9,861	9,479
Sacramento Area	13,974	13,648	12,169	12,995	12,476	13,306	12,846	13,658	13,424	12,806
San Francisco Bay Area	58,597	60,076	50,860	57,308	55,511	55,725	57,836	59,009	56,493	53,336
Northern Central Valley	9,584	9,788	9,190	10,039	9,988	10,672	11,162	11,716	12,621	12,055
Southern Central Valley	14,630	14,268	13,471	13,957	13,750	13,908	14,730	15,910	16,280	15,776
Central Coast	5,018	5,068	4,411	4,927	4,926	4,929	5,179	5,620	5,319	5,296
South Coast	11,644	11,891	10,880	11,578	11,124	11,269	12,267	12,791	12,573	11,464
Los Angeles	75,531	76,814	67,019	75,213	72,720	72,422	75,381	77,658	74,390	72,763
Orange	26,590	25,604	23,619	24,244	23,956	23,288	24,605	25,885	24,771	22,993
Riverside/San Bernardino	16,444	16,797	15,529	16,806	16,438	16,623	17,534	19,038	20,202	20,300
San Diego/Imperial	21,466	21,888	20,344	21,084	20,926	20,931	21,610	23,397	23,049	22,681
STATEWIDE TOTAL	263,392	265,924	236,897	257,633	251,143	252,150	262,921	274,812	268,983	258,949

Undergraduate Enrollment by Ethnicity at the University of California, Fall 1981 to Fall 1990

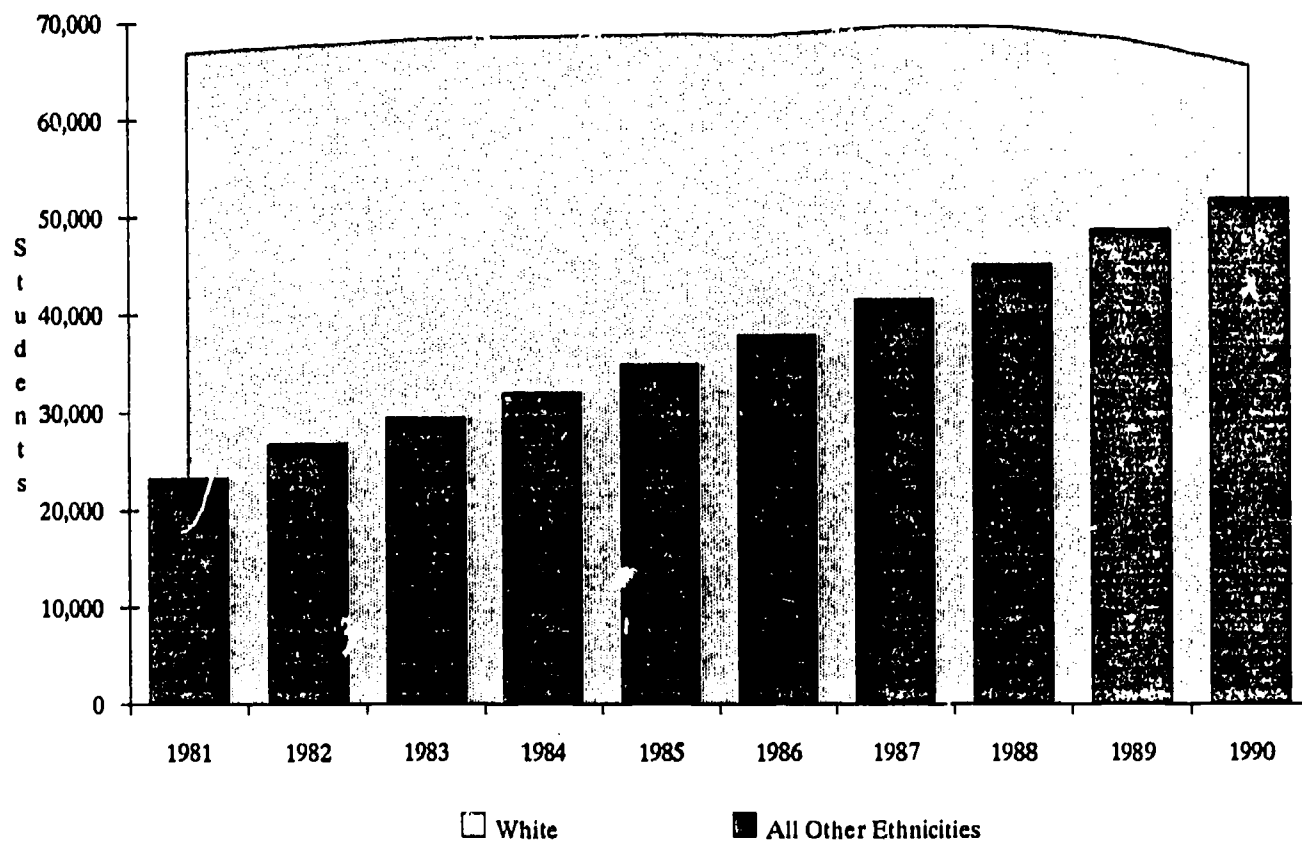

Fall Term	Total Students	Asian/Pacific Islander	Black	Filipino	Latino	Native American	Other	White	Total, Declared Ethnicity	Non-Resident Alien	No Response
1981	98,846	12,048	3,575	1,570	5,364	475	1,726	66,924	91,682	2,445	4,719
1982	100,751	13,207	3,701	1,893	5,701	499	1,821	67,658	94,480	2,435	3,836
1983	103,328	14,481	3,974	2,211	6,285	498	1,987	68,357	97,793	2,208	3,327
1984	106,025	15,615	4,207	2,584	7,049	536	2,059	68,615	100,665	2,205	3,155
1985	108,988	16,719	4,439	2,959	8,143	601	2,040	68,860	103,761	2,254	2,973
1986	111,363	18,113	4,772	3,361	8,949	661	2,008	68,716	106,580	2,450	3,333
1987	117,079	19,696	5,123	3,818	10,234	810	1,839	69,644	111,164	2,374	3,541
1988	121,001	21,247	5,513	4,105	11,600	977	1,681	69,606	114,729	2,601	3,671
1989	123,441	22,993	5,796	4,102	13,071	1,121	1,609	68,187	116,879	2,554	4,008
1990	124,271	25,093	5,622	4,270	14,191	1,206	1,565	65,549	117,496	2,306	4,469
% Change	25.7	108.3	57.3	172.0	164.6	153.9	-9.3	-2.1	28.2	-5.7	-5.3

Undergraduate Enrollment by Ethnicity at the California State University Fall 1981 to Fall 1990

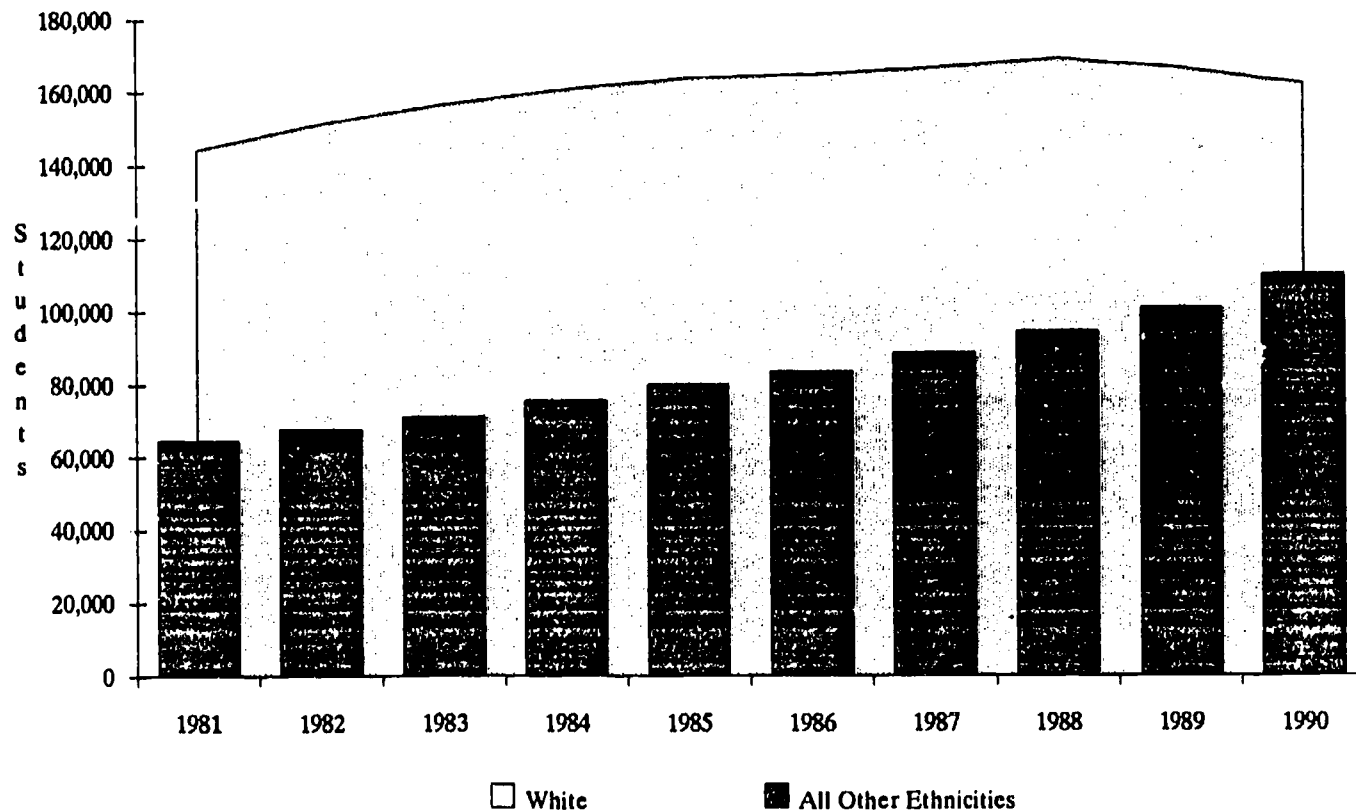

Fall Term	Total Students	Asian/Pacific Islander	Black	Filipino	Latino	Native American	Other	White	Total, Declared Ethnicity	Non-Resident Alien	No Response
1981	251,552	17,625	14,729	3,512	19,096	5,129	4,529	144,161	208,781	7,673	35,098
1982	251,137	20,152	14,567	3,995	20,420	4,083	4,382	151,239	218,838	7,031	25,268
1983	253,421	22,628	14,583	4,334	21,519	3,250	4,670	156,654	227,638	6,867	19,216
1984	256,839	25,477	14,567	4,940	22,778	3,072	4,658	160,599	236,091	6,277	14,471
1985	262,759	27,834	14,414	5,521	24,210	2,957	5,062	163,826	243,824	6,221	12,714
1986	266,729	29,739	14,169	6,195	25,147	2,747	5,325	164,781	248,103	6,610	12,016
1987	273,987	31,525	14,499	6,959	27,309	2,713	5,494	166,561	255,060	7,067	11,860
1988	284,929	33,050	15,065	8,021	29,739	2,652	5,848	169,039	263,414	7,822	13,693
1989	289,173	35,115	15,669	9,095	32,149	2,601	6,227	166,287	267,143	8,246	13,784
1990	294,083	37,121	16,665	10,226	35,658	2,716	7,647	162,104	272,137	8,423	13,523
% Change	16.9	110.6	13.1	191.2	86.7	-47.0	68.8	12.4	30.3	9.8	-61.5

Undergraduate (for Credit) Enrollment at the California Community Colleges by Ethnicity, Fall 1981 to Fall 1990

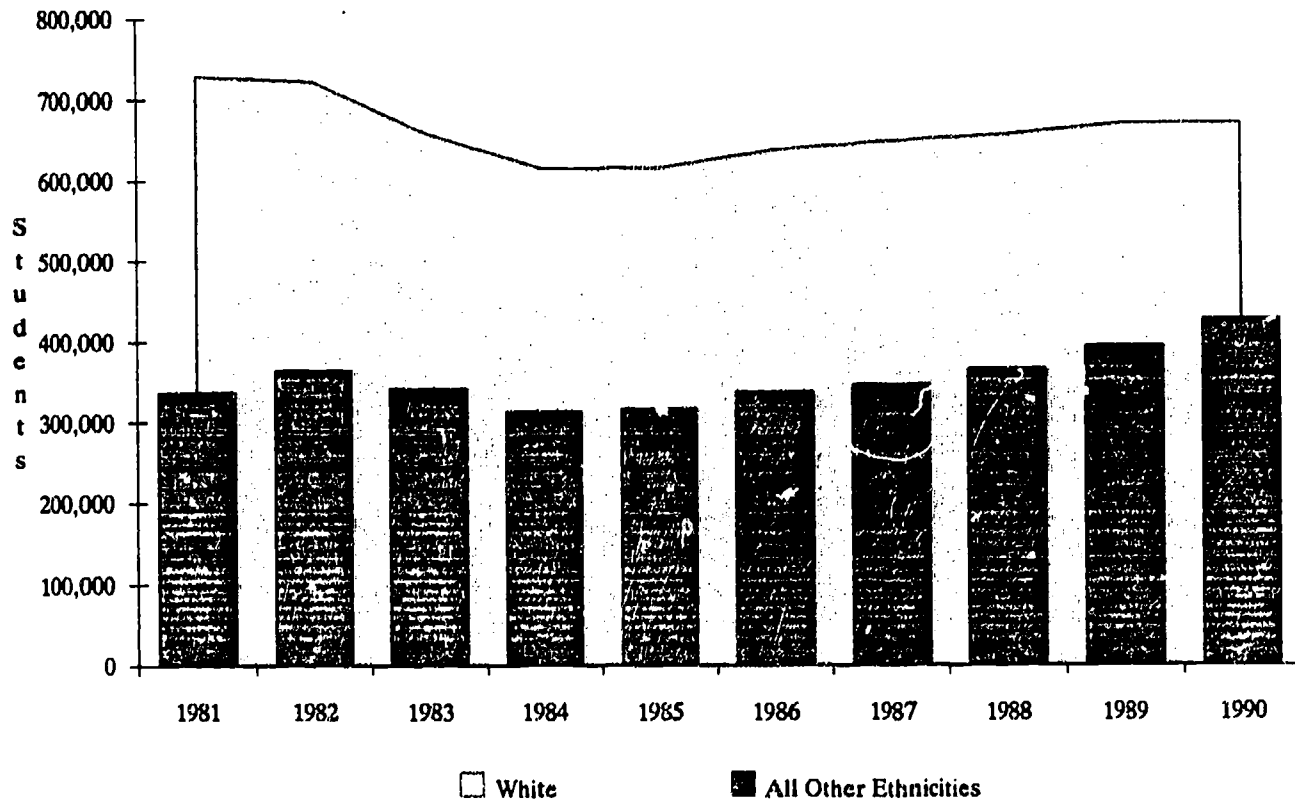

Fall Term	Total Students	Asian/Pacific Islander	Black	Filipino	Latino	Native American	Other	White	Total, Declared Ethnicity	Non-Resident Alien	No Response
1981	1,202,682	55,780	97,503	17,471	124,940	17,799	23,269	728,770	1,065,532	27,429	109,721
1982	1,191,366	66,099	100,787	20,780	131,844	17,401	27,632	721,965	1,086,508	22,267	82,591
1983	1,087,425	67,907	90,851	20,723	119,864	15,962	26,267	657,731	999,305	22,909	65,211
1984	1,005,576	66,825	75,276	21,233	112,632	14,099	23,415	614,124	927,604	21,892	56,080
1985	1,006,686	71,003	72,048	20,851	119,277	13,238	20,344	615,444	932,205	23,139	51,342
1986	1,046,099	75,307	76,786	22,369	129,769	13,649	20,068	637,553	975,501	23,717	46,881
1987	1,061,014	77,389	74,407	25,582	135,640	13,532	19,610	648,381	994,541	25,290	41,183
1988	1,093,152	79,187	76,283	28,370	146,401	14,313	21,469	656,985	1,023,008	29,810	40,334
1989	1,136,119	85,923	80,888	30,556	161,129	14,296	21,709	670,381	1,064,882	36,058	35,179
1990	1,205,565	91,433	87,106	33,842	176,391	19,432	19,229	669,884	1,097,317	53,800	54,448
% Change	0.2	63.9	-10.7	93.7	41.2	0.2	-17.4	-8.1	3.0	96.1	-50.4

Graduate Enrollment at the University of California, Fall 1981 to Fall 1990

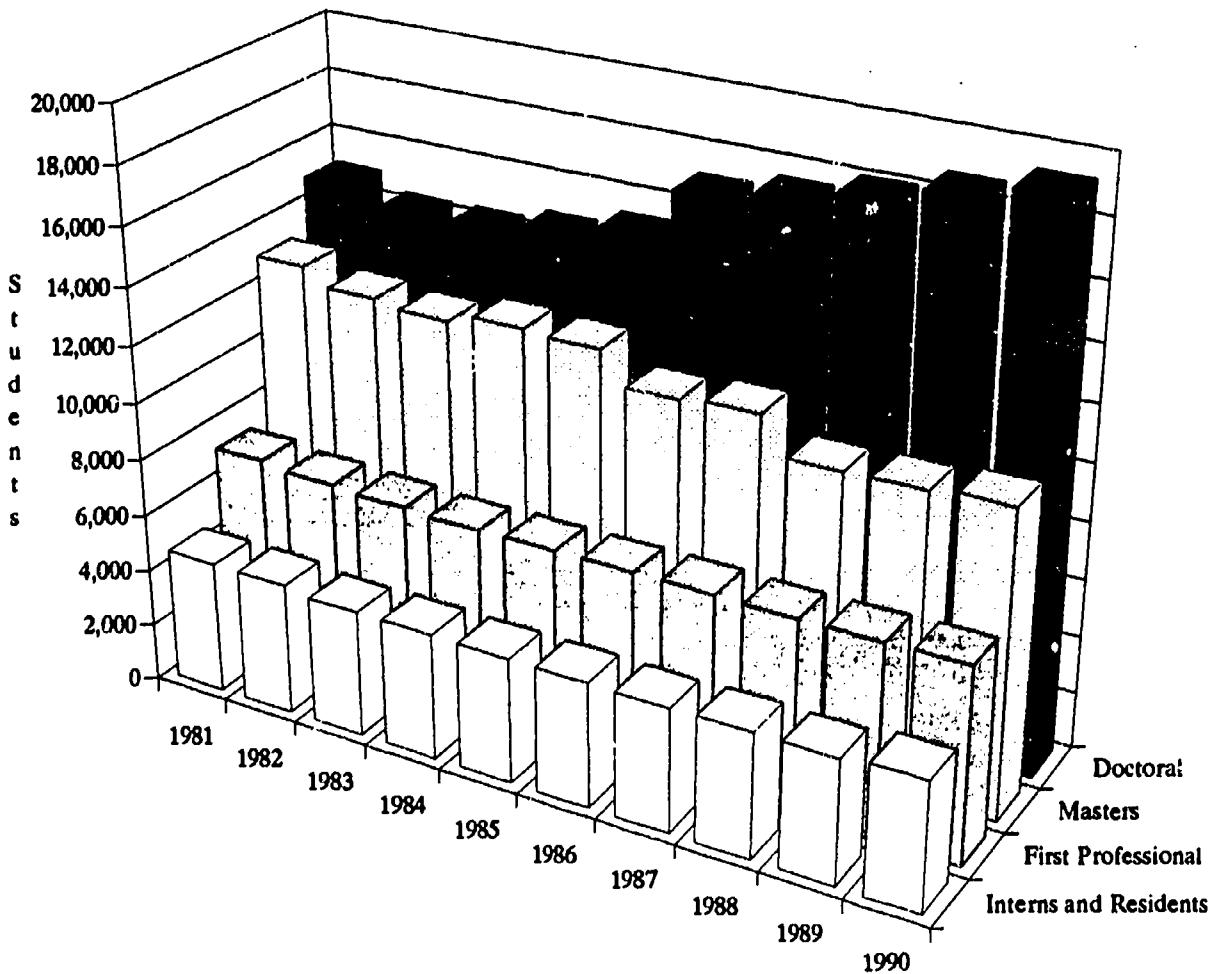

Graduate Enrollment at the University of California, Fall 1981 to Fall 1990

Fall Term	Total Enrollment	Total Academic Enrollment	Number		Percent		Total Academic Percentage	First Professional Enrollment	Interns and Residents Enrollment
			Masters Enrollment	Doctoral Enrollment	Masters Enrollment	Doctoral Enrollment			
1981	39,727	27,938	13,037	14,901	46.7	53.3	70.3	7,163	4,626
1982	38,387	26,786	12,498	14,288	46.7	53.3	69.8	6,987	4,614
1983	37,961	26,645	12,319	14,326	46.2	53.8	70.2	6,878	4,438
1984	38,564	27,343	12,646	14,697	46.2	53.8	70.9	6,790	4,431
1985	38,969	27,776	12,570	15,206	45.3	54.7	71.3	6,799	4,394
1986	39,702	28,505	11,479	17,026	40.3	59.7	71.8	6,809	4,388
1987	40,252	29,091	11,651	17,440	40.1	59.9	72.3	6,810	4,351
1988	39,524	28,376	10,396	17,980	36.6	63.4	71.8	6,748	4,400
1989	40,226	29,067	10,465	18,602	36.0	64.0	72.3	6,785	4,374
1990	41,226	29,848	10,644	19,204	35.7	64.3	72.4	6,828	4,550

Graduate Enrollment at the California State University, Fall 1981 to Fall 1990

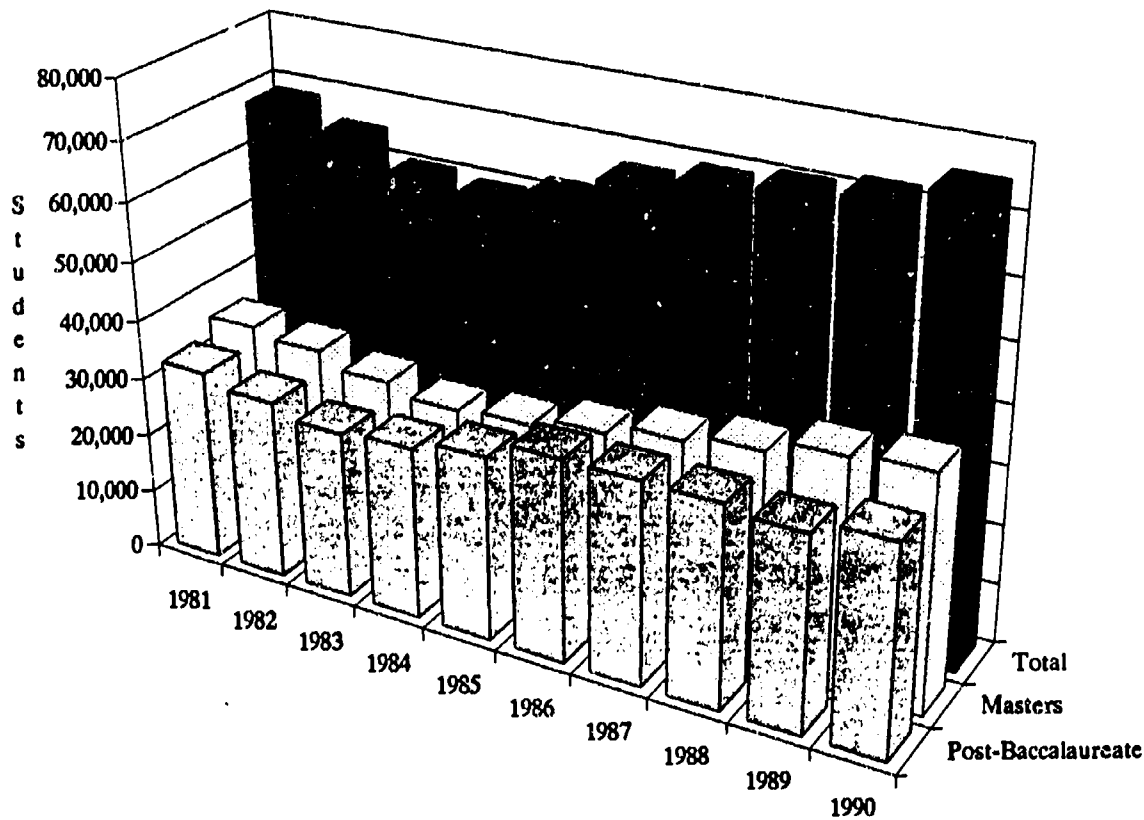

Graduate Enrollment at the California State University, Fall 1980 to Fall 1989.

Fall Term	Total Graduate Enrollment	Number			Percent		
		* Post-Baccalaureate Enrollment	Masters Enrollment	Doctoral Enrollment	* Post-Baccalaureate Enrollment	Masters Enrollment	Doctoral Enrollment
1981	68,013	32,644	35,316	53	48.0	51.9	0.1
1982	64,677	30,570	34,031	76	47.3	52.6	0.1
1983	60,179	28,452	31,692	35	47.3	52.7	0.1
1984	59,166	29,185	29,887	94	49.3	50.5	0.2
1985	61,867	31,150	30,617	100	50.3	49.5	0.2
1986	66,695	34,182	32,417	96	51.3	48.6	0.1
1987	68,789	34,137	34,540	112	49.6	50.2	0.2
1988	70,177	33,975	36,078	124	48.4	51.4	0.2
1989	71,665	32,928	38,579	158	45.9	53.8	0.2
1990	74,970	35,238	39,572	160	47.0	52.8	0.2

Note: Post-baccalaureate includes students who have returned after completion of at least a bachelor's degree to achieve further educational objectives and who are not enrolled in a graduate degree program.

Graduate Enrollment by Gender at the University of California, Fall 1981 to Fall 1990

	Fall 1981	Fall 1982	Fall 1983	Fall 1984	Fall 1985	Fall 1986	Fall 1987	Fall 1988	Fall 1989	Fall 1990	1981 Percent of Total	1990 Percent of Total	Percent Change
Masters													
Domestic Students													
Men	5,479	5,267	5,203	5,322	5,342	4,710	4,880	4,432	4,394	4,437			
Women	5,868	5,460	5,455	5,589	5,552	5,254	5,335	4,692	4,786	4,856			
Total	11,347	10,727	10,658	10,911	10,894	9,964	10,215	9,124	9,180	9,293	87.22	87.31	0.10
Men	48.3	49.1	48.8	48.8	49.0	47.3	47.8	48.6	47.9	47.7			
Women	51.7	50.9	51.2	51.2	51.0	52.7	52.2	51.4	52.1	52.3			
Foreign Students													
Men	1,211	1,265	1,172	1,203	1,167	1,003	926	772	745	823			
Women	451	500	486	531	508	512	510	500	540	521			
Total	1,662	1,765	1,658	1,734	1,675	1,515	1,436	1,272	1,285	1,351	12.78	12.69	-0.65
Men	72	71.7	70.7	69.4	69.7	66.2	64.5	60.7	58.0	61.3			
Women	27.1	28.3	29.3	30.6	30.3	33.8	35.5	39.3	42.0	38.7			
TOTAL Masters Students													
Men	6,690	6,532	6,375	6,525	6,509	5,713	5,806	5,204	5,139	5,265			
Women	6,319	5,960	5,941	6,120	6,060	5,766	5,845	5,192	5,326	5,379			
Total	13,009	12,492	12,316	12,645	12,569	11,479	11,651	10,396	10,465	10,644	100.00	100.00	
Men	51.4	52.3	51.8	51.6	51.8	49.8	49.8	50.1	49.1	49.5			
Women	48.6	47.7	48.2	48.4	48.2	50.2	50.2	49.9	50.9	50.5			
Doctoral													
Domestic Students													
Men	7,742	7,307	7,407	7,321	7,509	8,311	8,348	8,491	8,714	9,021			
Women	4,640	4,469	4,537	4,616	4,823	5,345	5,474	5,677	5,962	6,256			
Total	12,382	11,776	11,944	11,937	12,332	13,656	13,822	14,168	14,676	15,277	83.15	79.55	-4.32
Men	62.5	62.0	62.0	61.3	60.9	60.9	60.4	59.9	59.4	59.0			
Women	37.5	38.0	38.0	38.7	39.1	39.1	39.6	40.1	40.6	41.0			
Foreign Students													
Men	2,000	2,000	1,926	2,210	2,276	2,648	2,789	2,913	2,968	2,952			
Women	510	507	455	550	598	722	829	899	956	975			
Total	2,510	2,507	2,381	2,760	2,874	3,370	3,618	3,812	3,924	3,927	16.85	20.45	21.32
Men	79.7	79.8	80.9	80.1	79.2	78.6	77.1	76.4	75.6	75.2			
Women	20.3	20.2	19.1	19.9	20.8	21.4	22.9	23.6	24.4	24.8			
TOTAL Doctoral Students													
Men	9,742	9,307	9,333	9,531	9,785	10,959	11,137	11,404	11,682	11,973			
Women	5,150	4,976	4,992	5,166	5,421	6,067	6,303	6,576	6,918	7,231			
Total	14,892	14,283	14,325	14,697	15,206	17,026	17,440	17,980	18,600	19,204	100.00		
Men	65.4	65.2	65.2	64.8	64.3	64.4	63.9	63.4	62.8	62.3			
Women	34.6	34.8	34.8	35.2	35.7	35.6	36.1	36.6	37.2	37.7			
First Professional*													
Men	4,519	4,277	4,202	3,966	3,888	3,822	3,727	3,577	3,575	3,598			
Women	2,604	2,654	2,712	2,773	2,839	2,923	2,981	3,060	3,107	3,230			
Total	7,123	6,931	6,914	6,739	6,727	6,745	6,708	6,637	6,682	6,828			
Men	63.4	61.7	60.3	58.9	57.8	56.7	55.6	53.9	53.5	52.7			
Women	36.6	38.3	39.7	41.1	42.2	43.3	44.4	46.1	46.5	47.3			
Interns and Residents*													
Men	3,462	3,381	3,195	3,165	3,060	3,017	2,946	2,937	2,809	3,000			
Women	1,048	1,067	1,150	1,184	1,266	1,301	1,335	1,413	1,504	1,550			
Total	4,510	4,448	4,345	4,349	4,326	4,318	4,281	4,350	4,313	4,550			
Men	76.8	76.0	73.5	72.8	70.7	69.9	68.8	67.5	65.1	65.9			
Women	23.2	24.0	26.5	27.2	29.3	30.1	31.2	32.5	34.9	34.1			

* Does not separate foreign students because the number is too small to be statistically significant.

Graduate Enrollment by Gender at the California State University, Fall 1981 to Fall 1990

	Fall 1981	Fall 1982	Fall 1983	Fall 1984	Fall 1985	Fall 1986	Fall 1987	Fall 1988	Fall 1989	Fall 1990	1981 Percent of Total	1990 Percent of Total	Percent Change
Post-Baccalaureate													
Domestic Students													
Men	12,595	11,862	11,039	11,219	11,581	12,370	11,887	11,725	11,119	11,724			
Women	19,423	18,118	16,883	17,400	19,000	21,283	21,677	21,680	21,233	22,875			
Total	32,018	29,980	27,922	28,619	30,581	33,653	33,564	33,405	32,352	34,599	98.08	98.19	0.11
Men	39.3	39.6	39.5	39.2	37.9	36.8	35.4	35.1	34.4	33.9			
Women	60.7	60.4	60.5	60.8	62.1	63.2	64.6	64.9	65.6	66.1			
Foreign Students													
Men	405	352	308	337	355	312	302	300	289	321			
Women	221	238	222	229	214	217	271	270	287	318			
Total	626	590	530	566	569	529	573	570	576	639	1.92	1.81	5.44
Men	64.7	59.7	58.2	59.5	62.4	59.0	52.7	52.6	50.2	50.2			
Women	35.3	40.3	41.9	40.5	37.6	41.0	47.3	47.4	49.8	49.8			
TOTAL Post-Baccalaureate Students													
Men	13,000	12,214	11,347	11,556	11,936	12,682	12,189	12,025	11,408	12,045			
Women	19,644	18,356	17,105	17,629	19,214	21,500	21,948	21,950	21,520	23,193			
Total	32,644	30,570	28,452	29,185	31,150	34,182	34,137	33,975	32,928	35,238	100.00	100.00	
Men	39.8	40.0	39.9	39.6	38.3	37.1	35.7	35.4	34.6	34.2			
Women	60.2	60.0	60.1	60.4	61.7	62.9	64.3	64.6	65.4	65.8			
Masters													
Domestic Students													
Men	14,190	14,011	13,076	12,155	12,409	13,139	13,762	14,086	15,110	15,533			
Women	18,841	17,905	16,703	15,936	16,303	17,098	18,405	19,580	20,930	21,432			
Total	33,031	31,916	29,779	28,091	28,712	30,237	32,167	33,666	36,040	36,965	93.53	93.41	-0.13
Men	43.0	43.9	43.9	43.3	43.2	43.5	42.8	41.8	41.9	42.0			
Women	57.0	56.1	56.1	56.7	56.8	56.5	57.2	58.2	58.1	58.0			
Foreign Students													
Men	1,441	1,316	1,180	1,101	1,183	1,335	1,442	1,426	1,435	1,460			
Women	844	799	733	695	722	845	931	986	1,101	1,147			
Total	2,285	2,115	1,913	1,796	1,905	2,180	2,373	2,412	2,539	2,607	6.47	6.59	1.82
Men	63.1	62.2	61.7	61.3	62.1	61.2	60.8	59.1	56.5	56.0			
Women	36.9	37.8	38.3	38.7	37.9	38.8	39.2	40.9	43.5	44.0			
TOTAL Masters Students													
Men	15,631	15,327	14,256	13,256	13,592	14,474	15,204	15,512	16,545	16,993			
Women	19,685	18,704	17,436	16,631	17,025	17,943	19,336	20,566	22,034	22,579			
Total	35,316	34,031	31,692	29,887	30,617	32,417	34,540	36,078	38,579	39,572	100.00	100.00	
Men	44.3	45.0	45.0	44.4	44.4	44.6	44.0	43.0	42.9	42.9			
Women	55.7	55.0	55.0	55.6	55.6	55.4	56.0	57.0	57.1	57.1			

**Undergraduate Enrollment at Selected Independent Colleges and Universities,
Fall 1981 to Fall 1990**

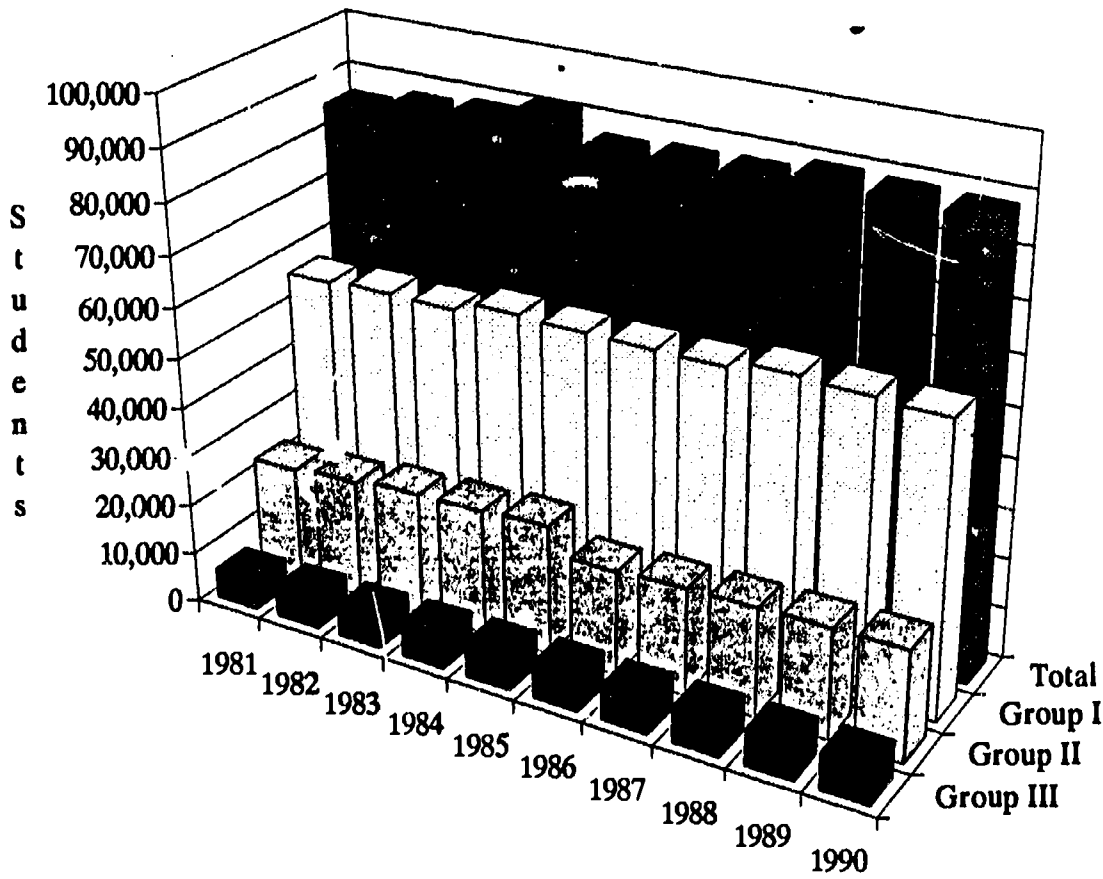

Fall Term	Total Students	Group I Institutions (N = 22)		Group II Institutions (N = 19)		Group III Institutions (N = 12)	
		Institutions	Percent	Institutions	Percent	Institutions	Percent
1981	85,236	56,179	65.9	22,959	26.9	6,098	7.2
1982	87,086	56,801	65.2	23,708	27.2	6,577	7.6
1983	88,119	56,589	64.2	24,963	28.3	6,567	7.5
1984	90,799	58,572	64.5	25,265	27.8	6,962	7.7
1985	86,233	58,166	67.5	25,991	30.1	7,227	8.4
1986	86,752	58,125	67.0	20,840	24.0	7,239	8.3
1987	86,916	57,973	66.7	21,388	24.6	7,308	8.4
1988	88,620	59,456	67.1	21,635	24.4	7,274	8.2
1989	88,216	58,952	66.8	21,890	24.8	7,374	8.4
1990	87,807	58,476	66.6	21,957	25.0	7,374	8.4

Group I Institutions have admission standards comparable to the University of California.
 Group II Institutions have admission standards comparable to the California State University.
 Group III Institutions are two-year colleges.

Graduate Enrollment at Group I Independent Institutions, Fall 1981 to Fall 1990

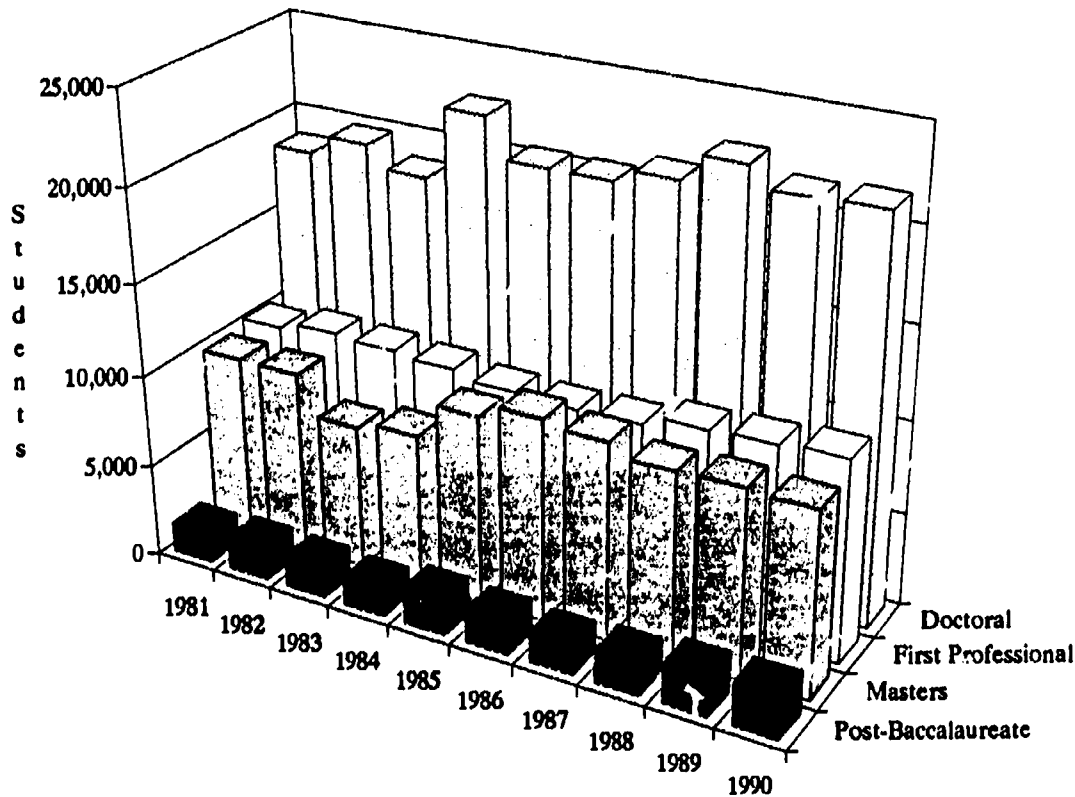

Graduate Enrollment at Group I Independent Institutions, Fall 1981 to Fall 1990

Fall Term	Total Graduate Enrollment	Total Masters & Doctoral Enrollment	Number		Percent		Total Masters & Doctoral Percentage	First Professional Enrollment	* Post-Baccalaureate Enrollment
			Masters Enrollment	Doctoral Enrollment	Masters Enrollment	Doctoral Enrollment			
1981	40,440	28,533	9,887	18,646	34.7	65.3	70.6	10,253	1,654
1982	42,075	29,577	9,862	19,715	33.3	66.7	70.3	10,670	1,828
1983	38,653	26,360	7,777	18,583	29.5	70.5	68.2	10,553	1,740
1984	42,527	30,652	8,217	22,435	26.8	73.2	72.1	10,333	1,542
1985	42,433	30,503	10,157	20,346	33.3	66.7	71.9	9,931	1,999
1986	42,915	31,237	10,896	20,341	34.9	65.1	72.8	9,815	1,863
1987	43,281	31,658	10,613	21,045	33.5	66.5	73.1	9,915	1,708
1988	44,802	32,454	9,983	22,471	30.8	69.2	72.4	10,487	1,861
1989	44,387	31,533	10,091	21,442	32.0	68.0	71.0	10,637	2,217
1990	44,713	31,559	9,955	21,604	31.5	68.5	70.6	10,834	2,320

Note: Post-Baccalaureate includes students who have returned after completion of at least a bachelor's degree to achieve further educational objectives and who are not enrolled in a graduate degree program.

Graduate Enrollment at Group II Independent Institutions, Fall 1981 to Fall 1990

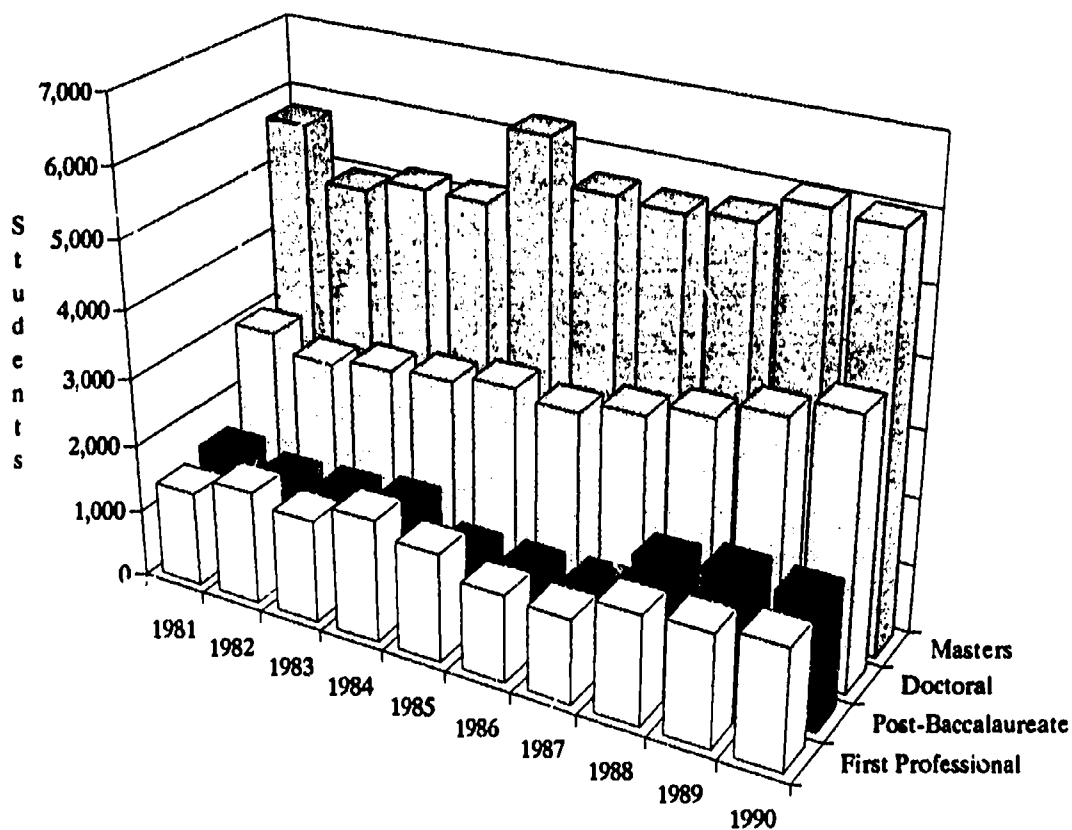

Graduate Enrollment at Group II Independent Institutions, Fall 1981 to Fall 1990

Fall Term	Total Graduate Enrollment	Total Masters & Doctoral Enrollment	Number		Percent		Total Masters & Doctoral Percentage	First Professional Enrollment	* Post-Baccalaureate Enrollment
			Masters Enrollment	Doctoral Enrollment	Masters Enrollment	Doctoral Enrollment			
1981	11,791	8,837	5,742	3,008	65.0	34.0	74.9	1,399	1,536
1982	11,985	8,808	4,969	2,763	56.4	31.4	73.5	1,678	1,397
1983	11,629	8,669	5,171	2,895	59.6	33.4	74.5	1,520	1,440
1984	11,540	8,184	5,173	2,977	63.2	36.4	70.9	1,810	1,536
1985	12,608	9,576	6,275	3,113	65.5	32.5	76.0	1,599	1,093
1986	12,470	9,572	5,645	2,996	59.0	31.3	76.8	1,281	1,100
1987	11,911	9,074	5,600	3,190	61.7	35.2	76.2	1,235	1,123
1988	12,576	9,099	5,685	3,400	62.5	37.4	72.4	1,591	1,757
1989	12,442	8,945	6,058	3,669	67.7	41.0	71.9	1,646	1,886
1990	13,562	9,952	5,997	3,955	60.3	39.7	73.4	1,761	1,849

Note: Post-Baccalaureate includes students who have returned after completion of at least a bachelor's degree to achieve further educational objectives and who are not enrolled in a graduate degree program.

A - F Completion Rates of High School Graduates by Region, 1985-86 Through 1990-91

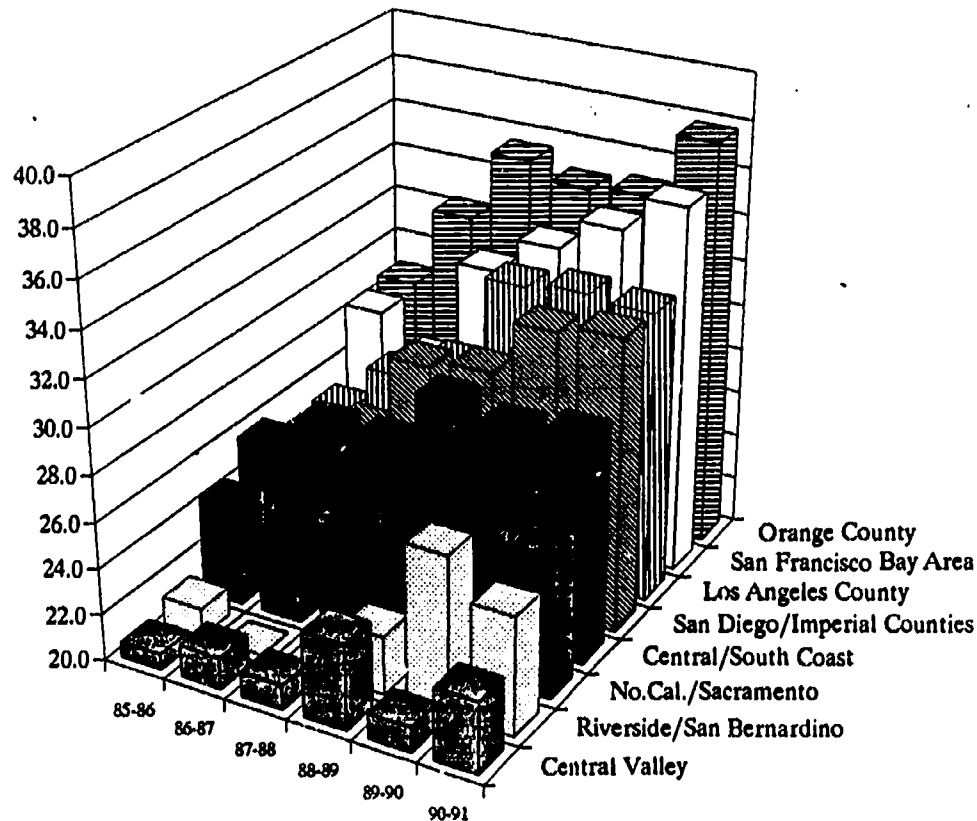

A - F Completion Rates of High School Graduates by Region, 1985-86 Through 1990-91

Region	1985-86	1986-87	1987-88	1988-89	1989-90	1990-91
Northern California	18.4	21.5	23.9	23.2	24.5	23.4
Sacramento Area	30.2	24.9	26.2	27.5	26.7	29.0
San Francisco Bay Area	28.4	26.8	31.5	33.1	34.5	36.0
Northern Central Valley	18.5	21.5	19.2	18.9	18.7	20.2
Southern Central Valley	22.8	21.3	22.9	28.5	23.4	25.9
Central Coast	25.8	26.7	27.0	29.1	28.8	27.9
South Coast	25.7	27.9	27.5	30.4	29.7	31.4
Los Angeles	25.0	27.2	28.4	32.5	32.8	32.6
Orange	28.7	32.3	35.4	34.7	34.9	37.7
Riverside/San Bernardino	21.2	18.5	20.0	22.5	26.8	25.1
San Diego/Imperial	24.8	26.0	29.5	29.9	32.3	32.7
STATEWIDE AVERAGE	25.5	26.0	28.1	30.3	30.6	31.4

- 2-1 Enrollment Equity Indexes for the University of California, the California State University, the California Community Colleges and Combined for All Segments, 1983 Through 1990**
- 2-2 Enrollment Equity Index, 1983 Through 1990**
- 2-3 Transfer Equity Indexes for the University of California, the California State University and Combined for Both Segments, 1985 Through 1990 and Distribution of Community College Credit Enrollment by Ethnicity, 1981 Through 1986**
- 2-4 Transfer Equity Index, 1985 Through 1990**
- 2-5 Graduate Equity Indexes for the University of California, the California State University, the Combined Index for Both Segments, and the Percentage Distribution of the University of California and the California State University Undergraduate Population by Ethnicity, 1985 Through 1990**
- 2-6 Graduate Equity Index, 1985 Through 1990**

Enrollment Equity Indexes* for the University of California, the California State University, the California Community Colleges and Combined for All Public Segments, 1983^ Through 1990

University of California

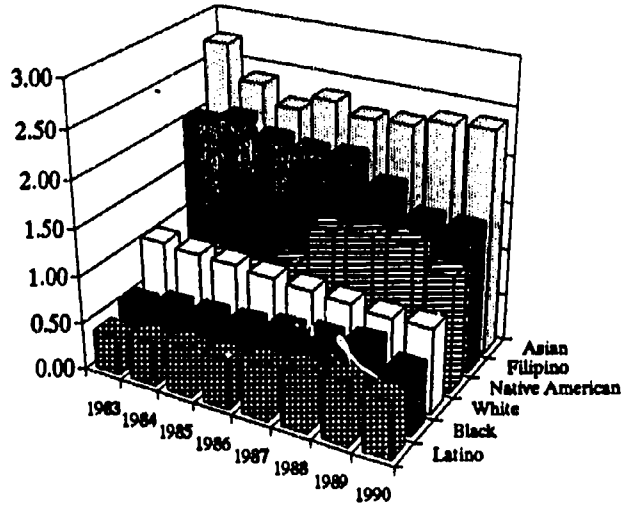

The California State University

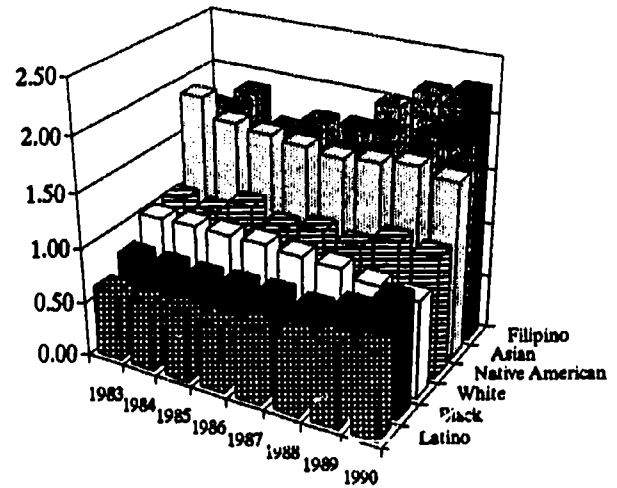

California Community Colleges

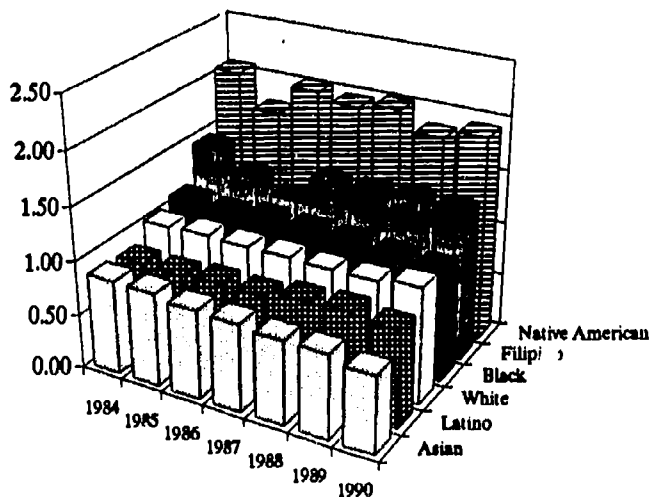

Combined for All Public Segments

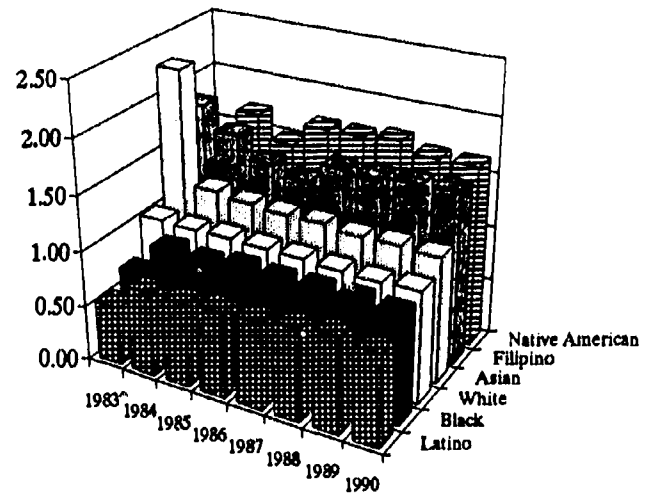

^ Information for 1983 is not available for the California Community Colleges and, therefore, is not included.

* Comparison of a racial/ethnic group's proportion of the total first-time freshmen enrollment with that same group's proportion of the total public high school graduates for the same year. A number less than 1.0 reflects underrepresentation, and a number greater than 1.0 reflects overrepresentation.

Enrollment Equity Index, 1983[^] Through 1990

University of California

	Asian			Black			Filipino			Latino			Native American			White		
	#	%	*	#	%	*	#	%	*	#	%	*	#	%	*	#	%	*
1983	3,291	17.2	2.74	942	4.9	0.54	626	3.3	2.02	1,418	7.4	0.41	97	0.5	0.67	12,733	66.6	1.04
1984	3,370	17.0	2.38	1,075	5.4	0.62	716	3.6	2.13	1,724	8.7	0.48	117	0.6	0.79	12,804	64.7	1.02
1985	3,482	17.3	2.18	1,087	5.4	0.64	795	4.0	1.99	1,966	9.8	0.53	123	0.6	0.75	12,647	62.9	1.01
1986	3,964	19.4	2.34	1,076	5.3	0.66	863	4.2	1.97	2,054	10.1	0.53	137	0.7	0.93	12,308	60.3	0.98
1987	4,164	19.4	2.23	1,219	5.7	0.71	934	4.3	1.98	2,462	11.4	0.59	218	1.0	1.39	12,523	58.2	0.95
1988	4,488	20.6	2.25	1,280	5.9	0.75	908	4.2	1.74	2,730	12.5	0.64	236	1.1	1.44	12,182	55.8	0.93
1989	4,676	22.7	2.34	1,268	6.1	0.81	805	3.9	1.50	2,982	14.4	0.68	236	1.1	1.45	10,678	51.7	0.89
1990	5,118	26.3	2.37	948	4.9	0.66	835	4.3	1.50	2,795	14.3	0.61	192	1.0	1.23	9,612	49.3	0.90

California State University

	Asian			Black			Filipino			Latino			Native American			White		
	#	%	*	#	%	*	#	%	*	#	%	*	#	%	*	#	%	*
1983	2,790	12.0	1.90	1,698	7.3	0.80	639	2.7	1.69	2,674	11.5	0.64	188	0.8	1.06	15,305	65.7	1.02
1984	2,756	12.3	1.72	1,533	6.8	0.79	715	3.2	1.88	2,555	11.4	0.63	172	0.8	1.02	14,693	65.5	1.03
1985	3,258	13.4	1.68	1,593	6.5	0.78	779	3.2	1.61	2,904	11.9	0.64	227	0.9	1.15	15,599	64.0	1.03
1986	3,407	13.7	1.65	1,601	6.4	0.80	941	3.8	1.74	2,934	11.8	0.62	188	0.8	1.04	15,800	63.5	1.03
1987	3,825	14.0	1.61	1,763	6.5	0.81	1,049	3.8	1.75	3,612	13.2	0.68	216	0.8	1.09	16,841	61.7	1.01
1988	4,236	15.0	1.64	1,720	6.1	0.78	1,367	4.8	2.02	3,877	13.7	0.70	219	0.8	1.03	16,862	59.6	0.99
1989	4,560	16.4	1.69	1,854	6.7	0.88	1,578	5.7	2.19	4,489	16.1	0.76	255	0.9	1.16	15,101	54.3	0.93
1990	4,630	17.9	1.62	1,994	7.7	1.05	1,664	6.5	2.26	4,817	18.7	0.80	228	0.9	1.11	12,481	48.4	0.89

California Community Colleges

	Asian			Black			Filipino			Latino			Native American			White		
	#	%	*	#	%	*	#	%	*	#	%	*	#	%	*	#	%	*
1983 [^]																		
1984	5,736	6.3	0.87	8,759	9.5	1.10	2,274	2.5	1.46	14,215	15.5	0.85	1,421	1.6	2.06	59,363	64.7	1.02
1985	6,242	6.8	0.86	8,234	9.0	1.07	2,286	2.5	1.26	14,256	15.6	0.84	1,296	1.4	1.74	59,213	64.7	1.04
1986	6,722	6.8	0.82	8,838	8.9	1.11	2,428	2.5	1.13	16,370	16.6	0.87	1,447	1.5	2.02	63,120	63.8	1.03
1987	6,582	7.0	0.81	8,064	8.6	1.09	2,808	3.0	1.37	15,643	16.7	0.86	1,327	1.4	1.95	59,256	63.3	1.03
1988	7,198	7.1	0.78	8,528	8.4	1.08	3,308	3.3	1.37	18,423	18.2	0.92	1,518	1.5	2.00	62,390	61.6	1.02
1989	7,592	7.5	0.78	8,085	8.0	1.05	3,668	3.6	1.40	20,094	19.9	0.94	1,449	1.4	1.82	60,180	59.5	1.02
1990	6,674	7.9	0.71	6,395	7.6	1.02	3,313	3.9	1.38	17,559	20.8	0.89	1,289	1.5	1.91	49,236	58.3	1.07

Combined

	Asian			Black			Filipino			Latino			Native American			White		
	#	%	*	#	%	*	#	%	*	#	%	*	#	%	*	#	%	*
1983 [^]	6,081	14.3	2.28	2,640	6.2	0.68	1,265	3.0	1.84	4,092	9.7	0.53	285	0.7	0.89	28,038	66.1	1.03
1984	11,862	8.9	1.24	11,367	8.5	0.98	3,705	2.8	1.63	18,494	13.8	0.76	1,710	1.3	1.70	86,860	64.8	1.02
1985	12,982	9.6	1.20	10,914	8.0	0.95	3,860	2.8	1.43	19,126	14.1	0.76	1,646	1.2	1.49	87,459	64.3	1.03
1986	14,093	9.8	1.18	11,515	8.0	0.99	4,232	2.9	1.35	21,358	14.8	0.78	1,772	1.2	1.70	91,228	63.3	1.02
1987	14,571	10.2	1.18	11,046	7.8	0.98	4,791	3.4	1.54	21,717	15.2	0.79	1,761	1.2	1.70	88,620	62.2	1.02
1988	15,922	10.5	1.15	11,528	7.6	0.98	5,583	3.7	1.54	25,030	16.5	0.84	1,973	1.3	1.74	91,434	60.4	1.00
1989	16,828	11.3	1.16	11,207	7.5	0.99	6,051	4.1	1.56	27,565	18.4	0.87	1,940	1.3	1.65	85,959	57.5	0.99
1990	16,422	12.7	1.14	9,300	7.2	0.97	5,812	4.5	1.57	25,171	19.4	0.83	1,709	1.3	1.65	71,329	55.0	1.01

[^] Information for 1983 is not available for the California Community Colleges and, therefore, is not included.

% Indicates the percentage of total enrollment of the racial/ethnic group.

* Comparison of a racial/ethnic group's proportion of the total first-time freshmen enrollment with that same group's proportion of the total public high school graduates for the same year. A number less than 1.0 reflects underrepresentation, and a number greater than 1.0 reflects overrepresentation.

Transfer Equity Indexes* for the University of California, the California State University, and Combined for Both Segments, 1985 Through 1990, and Distribution of Community College Credit Enrollment by Ethnicity, 1981 Through 1986

University of California

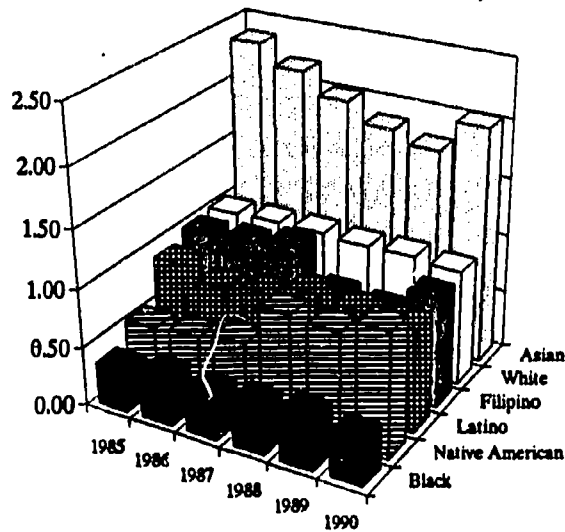

The California State University

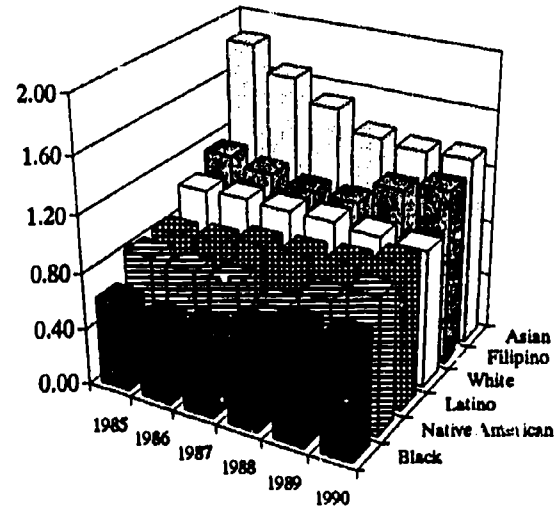

Total Transfers to UC and CSU

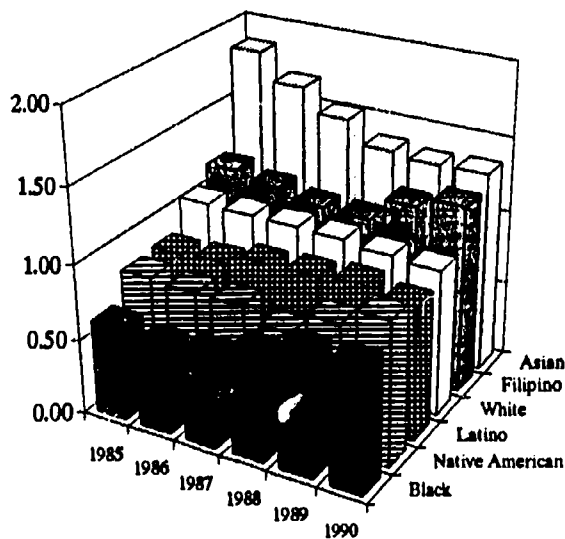

CCC Credit Enrollment

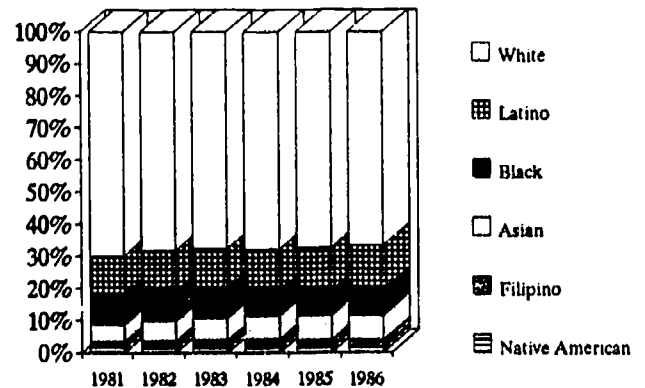

* Comparison of a racial/ethnic group's proportion of the total new transfer enrollment with that same group's proportion of the total credit enrollment in California Community Colleges from four years prior. A number less than 1.0 reflects underrepresentation, and a number greater than 1.0 reflects overrepresentation.

Transfer Equity Index, 1985 Through 1990

Community College Credit Enrollment

	Asian		Black		Filipino		Latino		Native American		White	
	#	%	#	%	#	%	#	%	#	%	#	%
1981	55,780	5.4	97,503	9.4	17,471	1.7	124,940	12.0	17,799	1.7	728,770	69.9
1982	66,059	6.2	100,787	9.5	20,780	2.0	131,844	12.5	17,401	1.6	721,965	68.2
1983	67,907	7.0	90,851	9.3	20,723	2.1	119,864	12.3	15,962	1.6	657,731	67.6
1984	66,825	7.4	75,276	8.3	21,233	2.4	112,632	12.5	14,099	1.6	614,124	67.9
1985	71,003	7.8	72,048	7.9	20,851	2.3	119,277	13.1	13,238	1.5	615,444	67.5
1986	75,307	7.9	76,786	8.0	22,369	2.3	129,769	13.6	13,649	1.4	637,553	66.7

University of California Transfers

	Asian			Black			Filipino			Latino			Native American			White		
	#	%	*	#	%	*	#	%	*	#	%	*	#	%	*	#	%	*
1985	574	12.6	2.36	151	3.3	0.36	75	1.7	0.99	492	10.8	0.90	41	0.9	0.53	3,209	70.7	1.01
1986	591	13.7	2.19	168	3.9	0.41	86	2.0	1.01	431	10.0	0.80	40	0.9	0.56	3,005	69.5	1.02
1987	708	14.0	2.01	183	3.6	0.39	115	2.3	1.07	525	10.4	0.84	51	1.0	0.62	3,466	68.7	1.02
1988	740	13.7	1.85	185	3.4	0.41	95	1.8	0.75	639	11.8	0.95	82	1.5	0.97	3,673	67.8	1.00
1989	780	13.7	1.75	197	3.5	0.44	94	1.7	0.72	680	11.9	0.91	78	1.4	0.94	3,882	68.0	1.01
1990	1,065	15.9	2.02	209	3.1	0.39	147	2.2	0.94	796	11.9	0.88	101	1.5	1.06	4,366	65.3	0.98

California State University Transfers

	Asian			Black			Filipino			Latino			Native American			White		
	#	%	*	#	%	*	#	%	*	#	%	*	#	%	*	#	%	*
1985	2,693	9.9	1.85	1,577	5.8	0.62	525	1.9	1.15	2,718	10.0	0.83	377	1.4	0.81	19,328	71.0	1.02
1986	2,651	10.4	1.67	1,403	5.5	0.58	546	2.1	1.09	2,698	10.6	0.85	332	1.3	0.79	17,859	70.1	1.03
1987	2,721	10.6	1.51	1,475	5.7	0.61	567	2.2	1.03	2,875	11.2	0.91	334	1.3	0.79	17,789	69.1	1.02
1988	2,665	10.1	1.36	1,560	5.9	0.71	636	2.4	1.02	3,019	11.4	0.92	288	1.1	0.70	18,260	69.1	1.02
1989	2,607	10.3	1.33	1,611	6.4	0.81	678	2.7	1.18	3,092	12.3	0.94	312	1.2	0.85	16,932	67.1	0.99
1990	2,759	10.6	1.34	1,717	6.6	0.82	768	2.9	1.25	3,615	13.8	1.02	359	1.4	0.96	16,924	64.7	0.97

Total Transfers to the University of California and the California State University

	Asian			Black			Filipino			Latino			Native American			White		
	#	%	*	#	%	*	#	%	*	#	%	*	#	%	*	#	%	*
1985	3,267	10.3	1.92	1,728	5.4	0.58	600	1.9	1.13	3,210	10.1	0.84	418	1.3	0.77	22,537	71.0	1.01
1986	3,242	10.9	1.74	1,571	5.3	0.55	632	2.1	1.08	3,129	10.5	0.84	372	1.3	0.76	20,864	70.0	1.03
1987	3,429	11.1	1.59	1,658	5.4	0.58	682	2.2	1.04	3,400	11.0	0.90	385	1.3	0.76	21,255	69.0	1.02
1988	3,405	10.7	1.45	1,745	5.5	0.66	731	2.3	0.98	3,658	11.5	0.92	370	1.2	0.75	21,933	68.9	1.01
1989	3,387	11.0	1.41	1,808	5.8	0.74	772	2.5	1.09	3,772	12.2	0.93	390	1.3	0.87	20,814	67.3	1.00
1990	3,824	11.7	1.48	1,926	5.9	0.73	915	2.8	1.19	4,411	13.4	0.99	460	1.4	0.98	21,290	64.9	0.97

% Indicates that racial/ethnic group's percentage representation of total transfers.

* Comparison of a racial/ethnic group's proportion of the total new transfer enrollment with that same group's proportion of the total credit enrollment in California Community Colleges from four (4) years prior. A number less than 1.0 reflects underrepresentation, and a number greater than 1.0 reflects overrepresentation.

Graduate Equity Indexes* for the University of California, the California State University, the Combined Index* for Both Segments, and the Percentage Distribution of the UC and CSU Undergraduate Population by Ethnicity, 1985 Through 1990

University of California

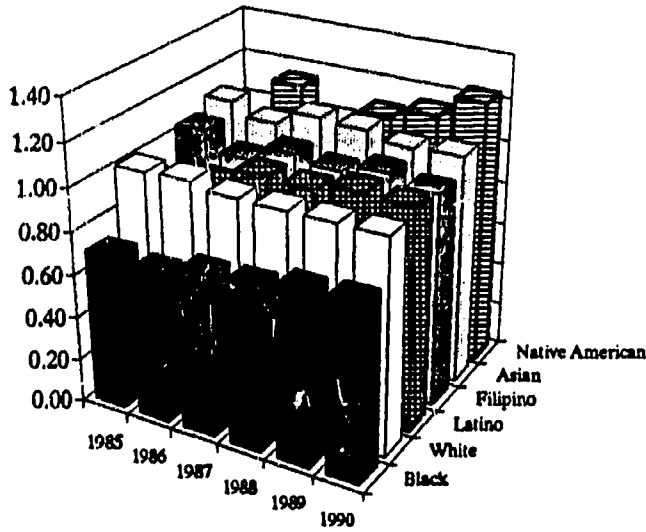

The California State University

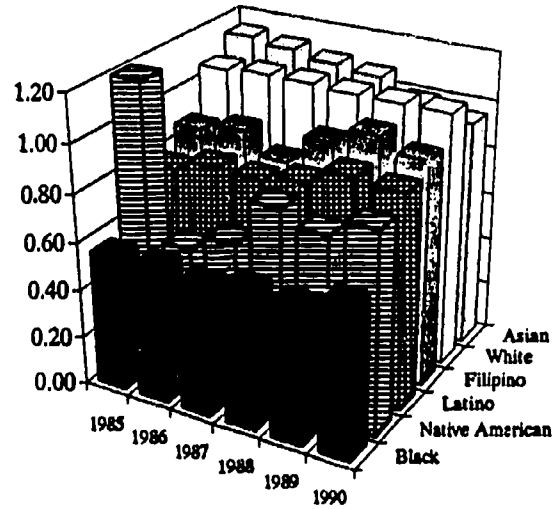

Combined Total Baccalaureate Degree Recipients at UC and CSU

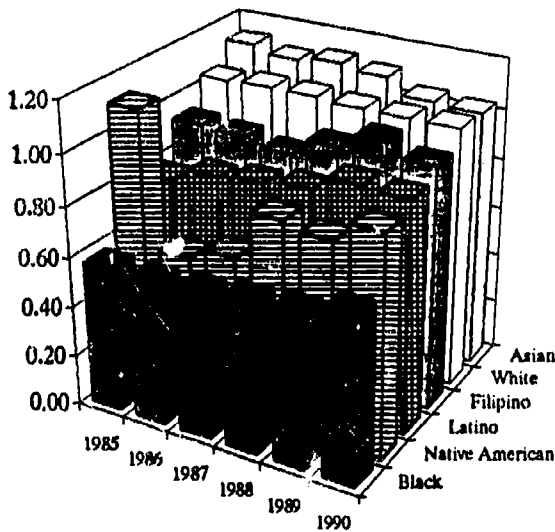

Undergraduate Population Distribution by Ethnicity

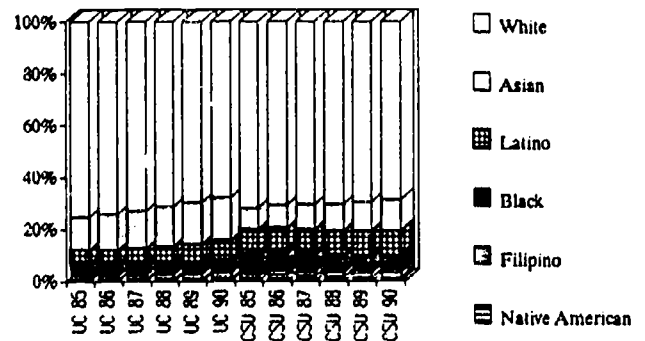

* Comparison of a racial/ethnic group's proportion of the total baccalaureate degree recipients with that same group's proportion of the total undergraduate enrollment in California's public universities from five (5) years prior. A number less than 1.0 reflects underrepresentation, and a number greater than 1.0 reflects overrepresentation.

Graduate Equity Index, 1985 Through 1990

Percentage Representation of Public University Undergraduate Population

	Asian		Black		Filipino		Latino		Native American		White	
	UC	CSU	UC	CSU	UC	CSU	UC	CSU	UC	CSU	UC	CSU
1980	12.5	8.2	4.0	7.6	1.5	1.5	6.1	9.6	0.6	1.4	75.5	71.8
1981	13.7	8.6	4.0	7.2	1.7	1.7	5.9	9.4	0.5	2.5	74.1	70.6
1982	14.3	9.4	4.0	6.8	2.0	1.9	6.2	9.5	0.5	1.9	73.0	70.5
1983	15.1	10.2	4.2	6.5	2.3	1.9	6.6	9.7	0.5	1.5	71.4	70.3
1984	15.8	11.0	4.3	6.3	2.6	2.1	7.2	9.8	0.5	1.3	69.6	69.4
1985	16.4	11.7	4.4	6.0	2.9	2.3	8.0	10.1	0.6	1.2	67.7	68.6

University of California Baccalaureate Degree Recipients

	Asian			Black			Filipino			Latino			Native American			White		
	#	%	*	#	%	*	#	%	*	#	%	*	#	%	*	#	%	*
1985	2,707	13.7	1.10	554	2.8	0.71	307	1.6	1.04	1,031	5.2	0.86	90	0.5	0.83	15,117	76.3	1.01
1986	2,928	14.3	1.04	558	2.7	0.69	336	1.6	0.95	1,104	5.4	0.91	123	0.6	1.14	15,379	75.3	1.02
1987	3,310	15.8	1.11	621	3.0	0.74	436	2.1	1.02	1,296	6.2	1.00	100	0.5	0.88	15,242	72.6	0.99
1988	3,603	16.6	1.10	673	3.1	0.75	497	2.3	0.99	1,402	6.5	0.99	122	0.6	1.08	15,379	71.0	0.99
1989	3,832	16.8	1.06	770	3.4	0.79	616	2.7	1.03	1,691	7.4	1.03	140	0.6	1.13	15,816	69.2	0.99
1990	4,274	17.7	1.07	841	3.5	0.80	696	2.9	0.99	1,987	8.2	1.02	176	0.7	1.23	16,243	67.1	0.99

California State University Baccalaureate Degree Recipients

	Asian			Black			Filipino			Latino			Native American			White		
	#	%	*	#	%	*	#	%	*	#	%	*	#	%	*	#	%	*
1985	3,630	9.4	1.14	1,629	4.2	0.56	519	1.3	0.87	2,838	7.3	0.77	634	1.6	1.20	29,416	76.1	1.06
1986	3,773	9.6	1.12	1,569	4.0	0.56	607	1.6	0.90	3,014	7.7	0.82	546	1.4	0.56	29,610	75.7	1.07
1987	4,100	10.3	1.09	1,469	3.7	0.54	605	1.5	0.81	3,092	7.8	0.81	477	1.2	0.63	30,109	75.6	1.07
1988	4,535	10.9	1.07	1,556	3.7	0.57	759	1.8	0.93	3,392	8.1	0.84	500	1.2	0.82	31,045	74.3	1.06
1989	4,702	10.9	0.99	1,519	3.5	0.56	921	2.1	1.00	3,854	9.0	0.91	433	1.0	0.76	31,573	73.4	1.06
1990	4,792	11.1	0.95	1,621	3.7	0.62	941	2.2	0.94	3,904	9.0	0.89	444	1.0	0.83	31,632	73.0	1.06

Total Baccalaureate Degree Recipients at the University of California and the California State University

	Asian			Black			Filipino			Latino			Native American			White		
	#	%	*	#	%	*	#	%	*	#	%	*	#	%	*	#	%	*
1985	6,337	10.8	1.13	2,183	3.7	0.58	826	1.4	0.93	3,869	6.6	0.78	724	1.2	1.12	44,533	76.2	1.04
1986	6,701	11.3	1.10	2,127	3.6	0.57	943	1.6	0.92	4,118	6.9	0.83	669	1.1	0.59	44,989	75.6	1.05
1987	7,410	12.2	1.12	2,090	3.4	0.58	1,041	1.7	0.89	4,388	7.2	0.85	577	1.0	0.64	45,351	74.5	1.05
1988	8,138	12.8	1.10	2,229	3.5	0.60	1,256	2.0	0.96	4,794	7.6	0.87	622	1.0	0.83	46,424	73.2	1.04
1989	8,534	13.0	1.04	2,289	3.5	0.61	1,537	2.3	1.02	5,545	8.4	0.93	573	0.9	0.80	47,389	72.0	1.04
1990	9,066	13.4	1.03	2,462	3.6	0.66	1,637	2.4	0.97	5,891	8.7	0.92	620	0.9	0.88	47,875	70.9	1.04

% Indicates that racial/ethnic group's percentage representation of total baccalaureate recipients.

* Comparison of a racial/ethnic group's proportion of the total baccalaureate degree recipients with that same group's proportion of the total undergraduate enrollment in California's public universities from five (5) years prior. A number less than 1.0 reflects underrepresentation, and a number greater than 1.0 reflects overrepresentation.

Section 3 First-Time Freshmen and New Students

- 3-1 Comparison of First-Time Freshmen Enrollment in Higher Education -- California and the United States, Fall 1980 through Fall 1988
- 3-2 College-Going Rates of California High School Graduates to California Public Colleges and Universities, Fall 1981 to Fall 1990
- 3-3 First-Time Freshmen Enrolled at the University of California, Fall 1981 to Fall 1990
- 3-4 Distribution of New Students Enrolled at the University of California, Fall 1981 to Fall 1990
- 3-5 First-Time Freshmen Enrolled at the California State University, Fall 1981 to Fall 1990
- 3-6 Distribution of Students Enrolled at the California State University, Fall 1981 to Fall 1990
- 3-7 Distribution of New Students Enrolled (for Credit) at the California Community Colleges, Fall 1981 to Fall 1990
- 3-8 Sources of First-Time Freshmen at the University of California, Fall 1989 and Fall 1990
- 3-9 Sources of First-Time Freshmen at the University of California, Fall 1989 and Fall 1990

Comparison of First-Time Freshmen Enrollment in Higher Education --
California and the United States, Fall 1980 through Fall 1988

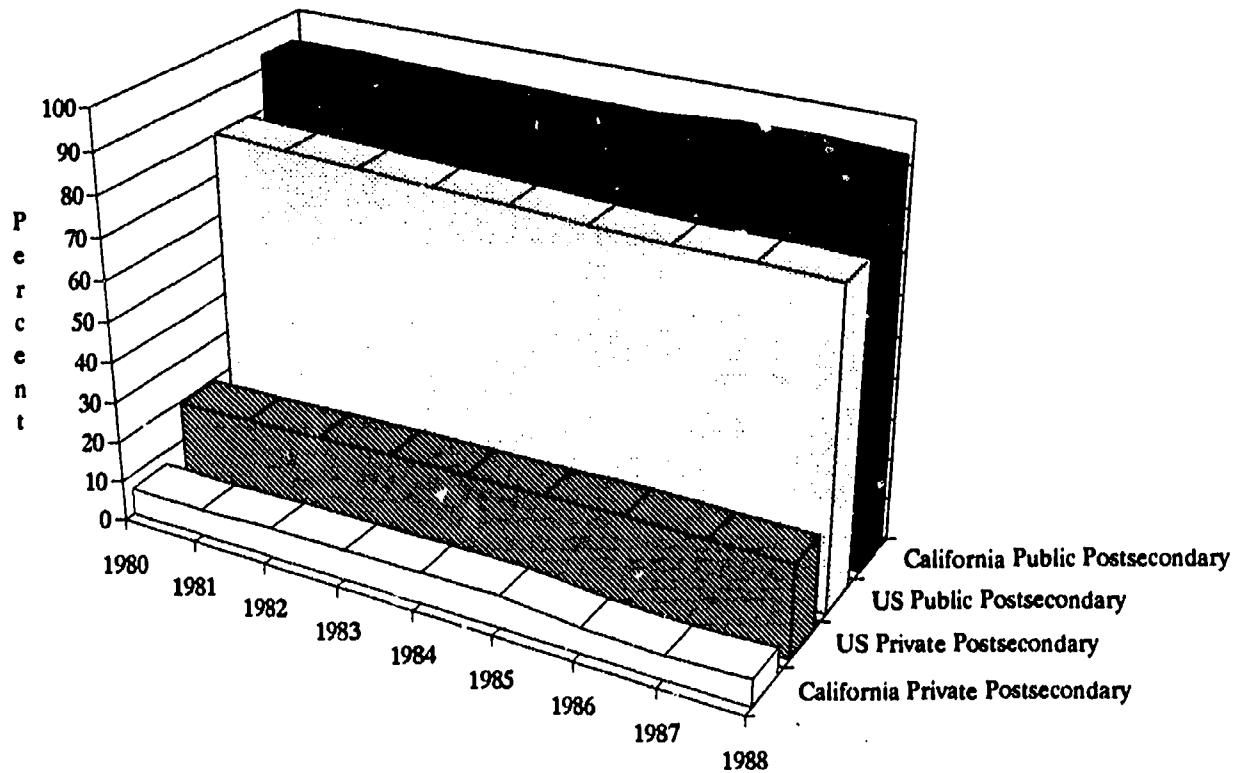

Year	United States (in thousands)				California (in thousands)					
	Total U.S. First-Time Freshmen	Public First-Time Freshmen	Percent in Public Institutions	Private First-Time Freshmen	Percent in Private Institutions	California First-Time Freshmen	Public First-Time Freshmen	Percent in Public Institutions	Private First-time Freshmen	Percent in Private Institutions
1980	2,588	2,079	80.3	509	19.7	348	325	93.4	23	6.6
1981	2,595	2,072	79.8	523	20.2	342	320	93.6	22	6.4
1982	2,505	1,985	79.2	520	20.8	319	296	92.8	23	7.2
1983	2,444	1,918	78.5	526	21.5	284	263	92.6	21	7.4
1984	2,357	1,844	78.2	513	21.8	274	253	92.3	21	7.7
1985	2,292	1,777	77.5	508	22.2	279	257	92.1	22	7.9
1986	2,219	1,711	77.1	509	22.9	286	268	93.7	18	6.3
1987	2,246	1,738	77.4	509	22.7	286	269	94.1	17	5.9
1988	2,376	1,834	77.2	542	22.8	315	294	93.3	21	6.7

Notes: Total Enrollment data source is NCES Digest of Education Statistics, 1990.
California data is from the California Postsecondary Education Commission.

College-Going Rates of California High School Graduates to California Public Colleges and Universities, Fall 1981 to Fall 1990

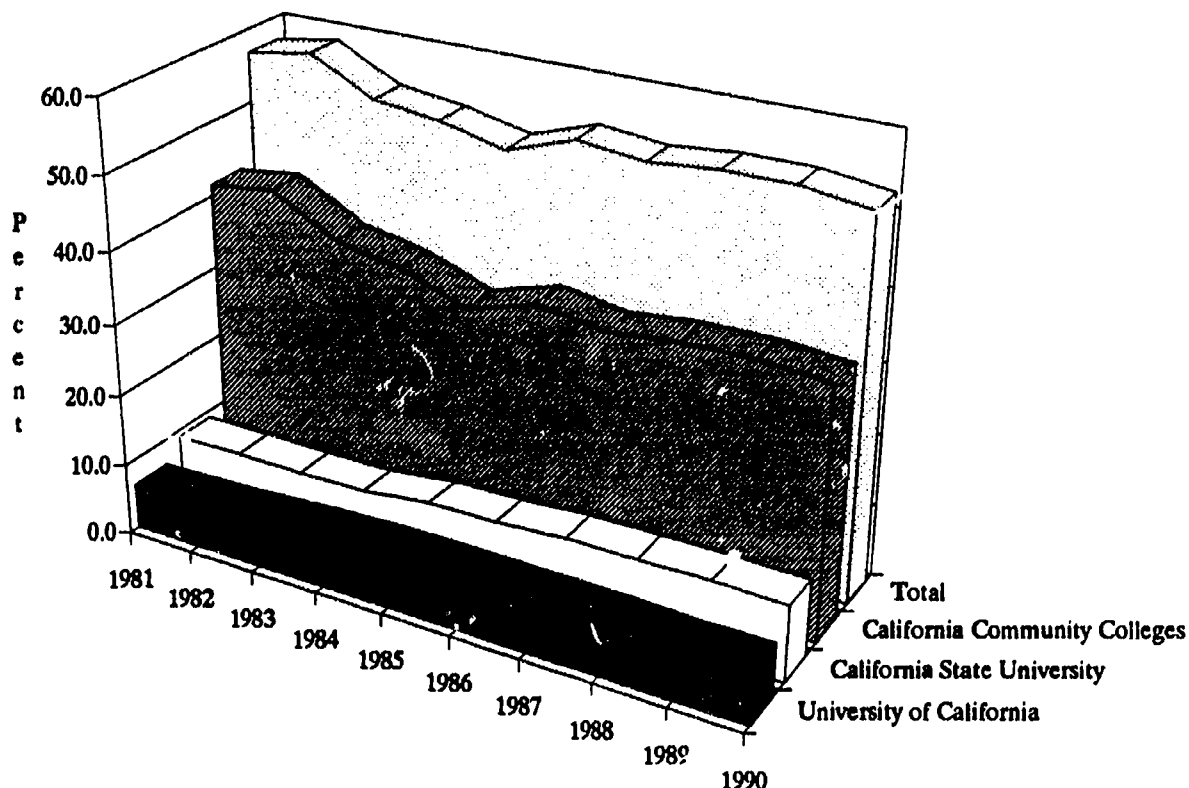

Fall Term	California High School Graduates	University of California	California State University	California Community Colleges	Total
1981	263,392	6.4	9.0	41.6	56.9
1982	265,924	6.5	9.0	42.8	58.3
1983	261,994	7.0	8.9	37.9	53.8
1984	257,633	7.5	8.9	36.3	52.7
1985	251,143	7.7	10.0	32.0	50.7
1986	252,100	7.8	10.1	35.8	53.8
1987	262,921	7.7	10.7	34.5	52.9
1988	274,812	7.6	10.7	35.4	53.8
1989	268,983	7.3	10.8	35.6	53.7
1990	258,949	7.3	10.5	34.7	52.5

First-Time Freshmen Enrolled at the University of California, Fall 1981 to Fall 1990

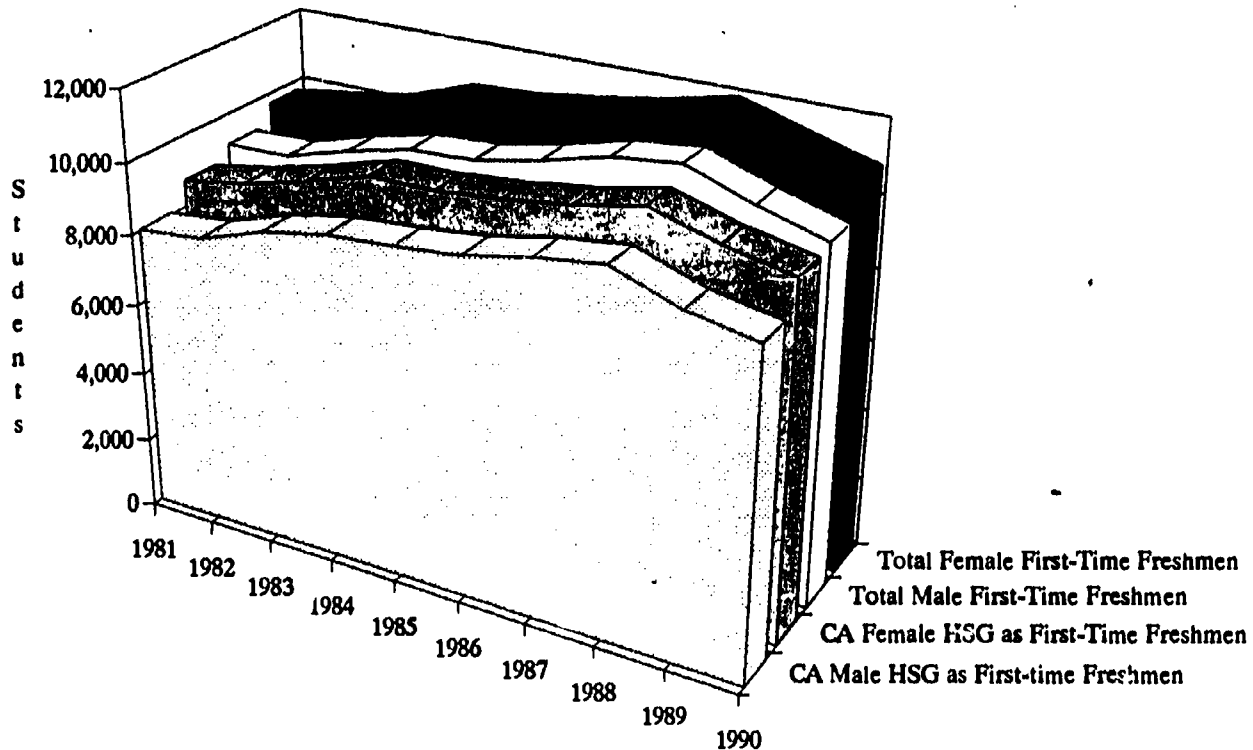

Fall Term	All First-Time Freshmen				
	Number			Percent	
	Total	Men	Women	Men	Women
1981	18,851	9,124	9,727	48.4	51.6
1982	19,127	9,157	9,970	47.9	52.1
1983	19,962	9,678	10,284	48.5	51.5
1984	21,020	10,101	10,919	48.1	51.9
1985	21,192	10,198	10,994	48.1	51.9
1986	21,810	10,573	11,237	48.5	51.5
1987	22,592	11,038	11,554	48.9	51.1
1988	23,197	11,240	11,957	48.5	51.5
1989	21,966	10,585	11,381	48.2	51.8
1990	20,908	10,044	10,864	48.0	52.0

Fall Term	California High School Graduates as First-Time Freshmen				
	Number			Percent	
	Total	Men	Women	Men	Women
1981	16,809	8,061	8,748	48.0	52.0
1982	17,295	8,235	9,060	47.6	52.4
1983	18,323	8,823	9,500	48.2	51.8
1984	19,202	9,167	10,035	47.7	52.3
1985	19,329	9,288	10,041	48.1	51.9
1986	19,707	9,491	10,216	48.2	51.8
1987	20,349	9,875	10,474	48.5	51.5
1988	20,976	10,115	10,861	48.2	51.8
1989	19,739	9,441	10,298	47.8	52.2
1990	19,003	9,084	9,919	47.8	52.2

Note: Figures for First-Time Freshmen include all students aged 19 and under.

Distribution of New Students Enrolled at the University of California,
Fall 1981 to Fall 1990

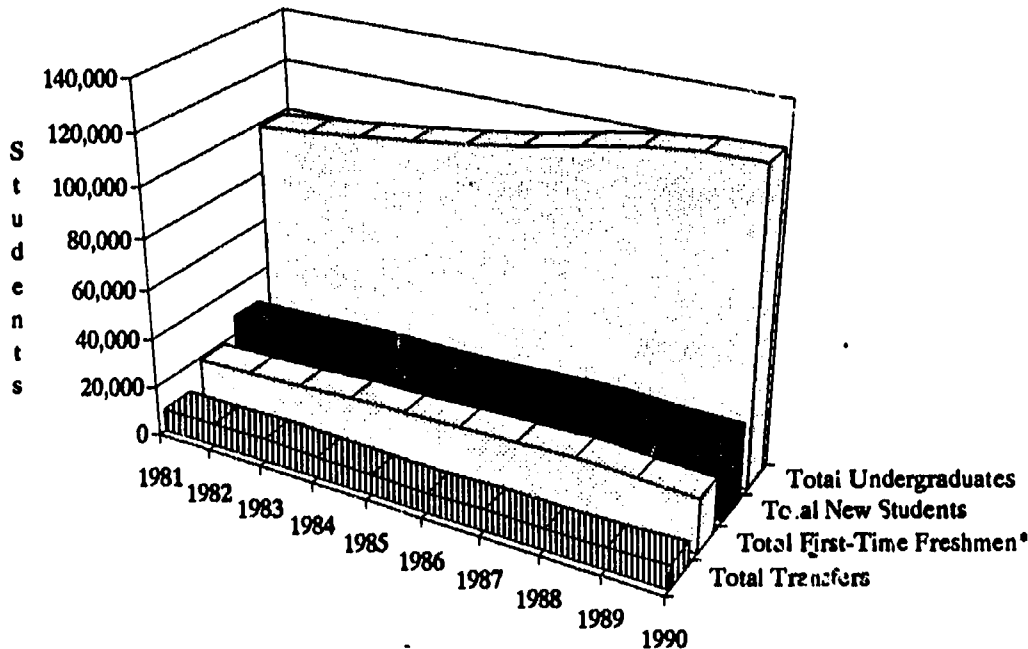

Transfer Students

Fall Term	Total Undergraduates	Total New Students	Total	California Community Colleges	California State University	University of California	Independent Colleges and Universities	Out of State Institutions	Foreign Institutions	First-Time Freshmen*
1981	98,846	28,036	8,836	4,844	988	1,312	475	1,083	134	19,200
1982	100,751	28,287	8,826	5,136	897	1,368	447	874	104	19,461
1983	103,328	29,502	9,195	5,305	908	1,549	421	904	108	20,307
1984	106,025	29,778	8,421	5,257	809	1,218	351	704	82	21,357
1985	108,988	29,554	8,018	4,931	3	1,165	313	716	150	21,536
1986	112,363	29,882	7,645	4,858	728	1,036	313	616	94	22,237
1987	117,079	31,290	8,407	5,465	744	1,118	342	628	110	22,883
1988	121,001	31,782	8,293	5,855	576	966	274	556	66	23,489
1989	123,441	30,496	8,253	6,224	536	768	227	440	58	22,243
1990	124,271	30,634	9,425	7,420	462	790	205	447	101	21,209

Percent

1981	28.4	8.9	4.9	1.0	1.3	0.5	1.1	0.1	19.4
1982	28.1	8.8	5.1	0.9	1.4	0.4	0.9	0.1	19.3
1983	28.6	8.9	5.1	0.9	1.5	0.4	0.9	0.1	19.7
1984	28.1	7.9	5.0	0.8	1.1	0.3	0.7	0.1	20.1
1985	27.1	7.4	4.5	0.7	1.1	0.3	0.7	0.1	19.8
1986	26.6	6.8	4.3	0.6	0.9	0.3	0.5	0.1	19.8
1987	26.7	7.2	4.7	0.6	1.0	0.3	0.5	0.1	19.5
1988	26.3	6.9	4.8	0.5	0.8	0.2	0.5	0.1	19.4
1989	24.7	6.7	5.0	0.4	0.6	0.2	0.4	0.0	18.0
1990	24.7	7.6	6.0	0.4	0.6	0.2	0.4	0.1	17.1

Note: Figures for first-time freshmen include all students regardless of age.

First-Time Freshmen Enrolled at the California State University, Fall 1981 to Fall 1990

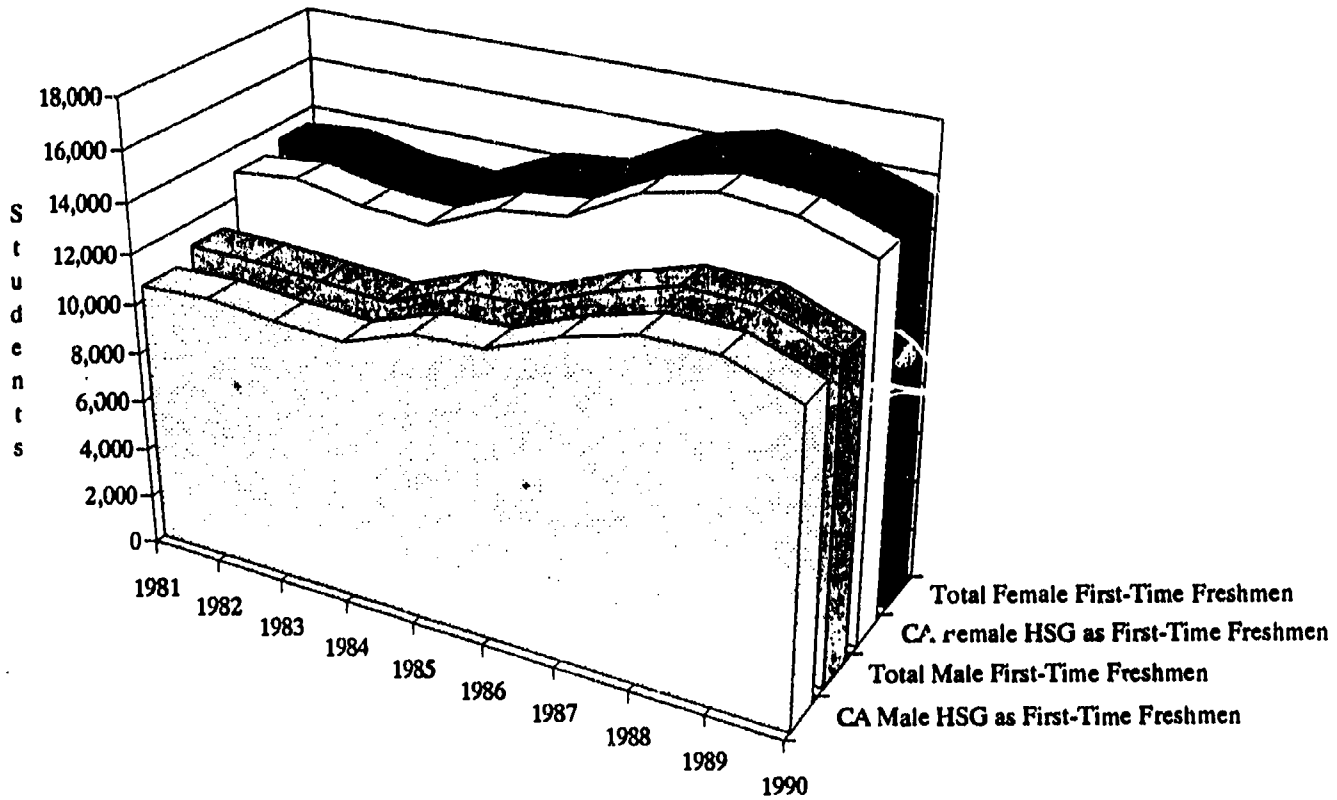

Fall Term	All First-Time Freshmen				
	Total	Number		Percent	
		Men	Women	Men	Women
1981	24,515	11,076	13,439	45.2	54.8
1982	24,733	11,045	13,688	44.7	55.3
1983	24,067	10,882	13,185	45.2	54.8
1984	23,761	10,707	13,054	45.1	54.9
1985	26,088	11,793	14,295	45.2	54.8
1986	26,485	11,885	14,602	44.9	55.1
1987	29,083	13,005	16,078	44.7	55.3
1988	30,580	13,833	16,747	45.2	54.8
1989	30,167	13,777	16,390	45.7	54.3
1990	28,065	12,635	15,430	45.0	55.0

Fall Term	California High School Graduates as First-Time Freshmen				
	Total	Number		Percent	
		Men	Women	Men	Women
1981	23,587	10,559	13,028	44.8	55.2
1982	24,017	10,683	13,334	44.5	55.5
1983	23,250	10,455	12,795	45.0	55.0
1984	22,959	10,316	12,643	44.9	55.1
1985	25,106	11,301	13,805	45.0	55.0
1986	25,523	11,403	14,120	44.7	55.3
1987	28,084	12,513	15,571	44.6	55.4
1988	29,417	13,265	16,152	45.1	54.9
1989	29,116	13,242	15,874	45.5	54.5
1990	27,094	12,182	14,912	45.0	55.0

Note: Figures for First-Time Freshmen include all students aged 19 and under.

Distribution of Students Enrolled at the California State University,
Fall 1981 to Fall 1990

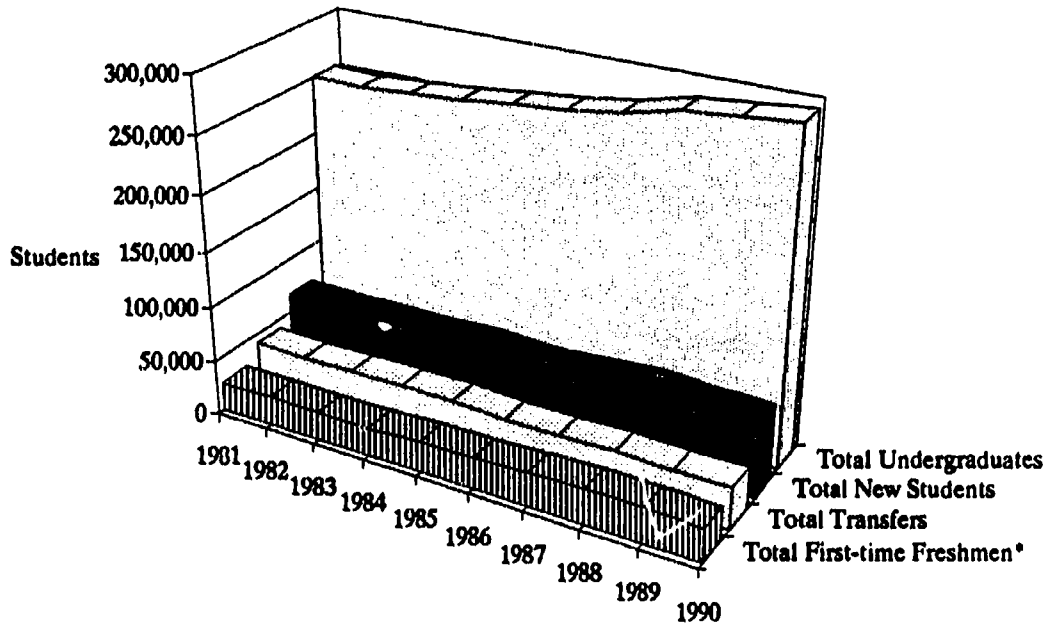

Fall Term	Total Undergraduates	Total New Students	Transfer Students							First-Time Freshmen
			Total	California Community Colleges	California State University	University of California	Independent Colleges and Universities	Out of State Institutions	Foreign Institutions	
1981	251,552	67,028	41,146	30,072	3,809	1,451	1,544	3,647	623	25,882
1982	251,137	65,784	39,780	29,824	3,386	1,357	1,424	3,236	553	26,004
1983	253,721	65,788	40,346	30,274	3,459	1,395	1,305	3,262	651	25,442
1984	256,839	65,288	40,106	30,134	3,508	1,333	1,325	3,277	529	25,182
1985	262,759	67,433	39,945	29,682	3,552	1,321	1,384	3,457	549	27,488
1986	266,729	65,032	37,258	27,761	3,155	1,094	1,323	3,286	639	27,774
1987	273,987	67,747	37,339	28,257	3,138	1,002	1,183	3,169	590	30,408
1988	284,929	70,774	38,762	29,393	3,300	977	1,183	3,239	670	32,012
1989	289,173	68,301	36,788	28,331	2,827	823	1,061	3,004	742	31,513
1990	294,083	67,225	37,542	29,370	2,905	775	1,004	2,824	764	29,583

	Percent									
1981	26.6	16.4	12.0	1.5	0.6	0.6	1.4	0.2	10.3	
1982	26.2	15.8	11.9	1.3	0.5	0.6	1.3	0.2	10.4	
1983	25.9	15.9	11.9	1.4	0.5	0.5	1.3	0.3	10.0	
1984	25.4	15.6	11.7	1.4	0.5	0.5	1.3	0.2	9.8	
1985	25.7	15.2	11.3	1.4	0.5	0.5	1.3	0.2	10.5	
1986	24.4	14.0	10.4	1.2	0.4	0.5	1.2	0.2	10.4	
1987	24.7	13.6	10.3	1.1	0.4	0.4	1.2	0.2	11.1	
1988	24.8	13.6	10.3	1.2	0.3	0.4	1.1	0.2	11.2	
1989	23.6	12.7	9.8	1.0	0.3	0.4	1.0	0.3	10.9	
1990	22.9	12.8	10.0	1.0	0.3	0.3	1.0	0.3	10.1	

Note: Figures for first-time freshmen include all students regardless of age.

Distribution of New Students Enrolled (for Credit) at the California Community Colleges, Fall 1981 to Fall 1990

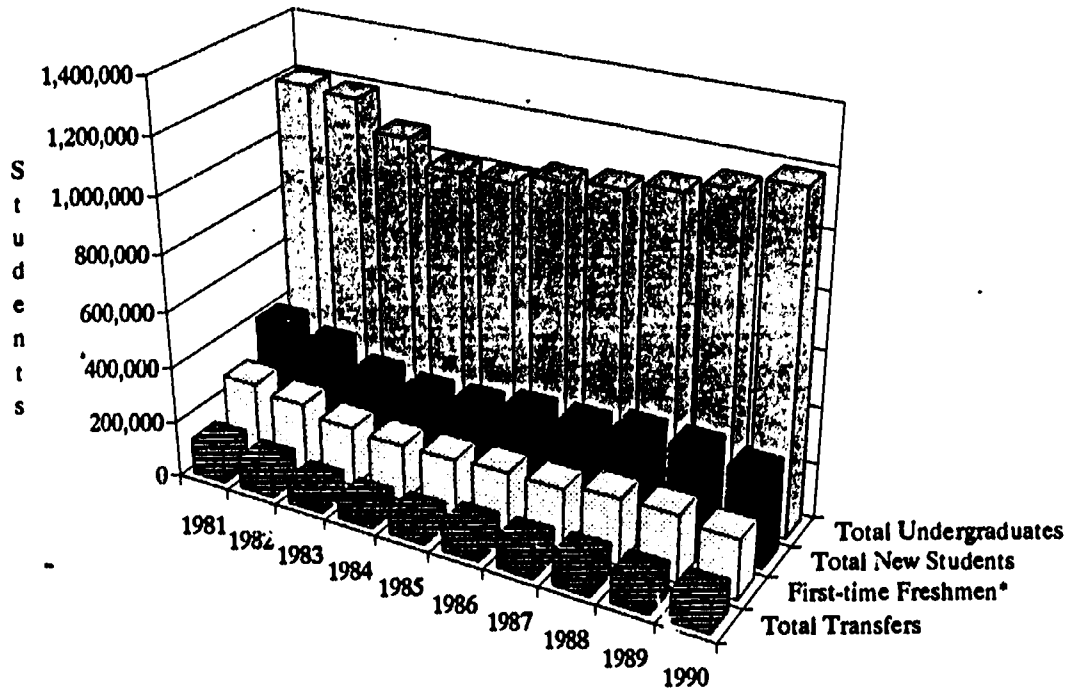

Fall Term	Total Undergraduates	Total New Students	Transfer Students							First-Time Freshmen*
			Total	California Community Colleges	California State University	University of California	Independent Colleges and Universities	Out of State Institutions	Foreign Institutions	
1981	1,202,682	408,370	133,370	58,146	20,456	8,953	8,681	31,624	5,510	275,000
1982	1,191,366	367,874	117,028	52,439	18,416	7,438	7,520	26,395	4,820	250,846
1983	1,087,425	310,144	93,297	43,291	14,521	5,681	5,307	21,295	3,202	216,847
1984	1,005,576	291,077	84,354	39,467	13,678	5,288	5,059	17,931	2,931	206,723
1985	1,006,686	298,237	89,988	41,956	14,845	5,518	5,511	19,235	2,923	208,249
1986	1,046,099	327,552	109,530	49,934	18,505	6,933	6,457	24,167	3,534	218,022
1987	1,061,014	329,740	113,696	50,277	19,754	7,120	6,615	25,986	3,944	216,044
1988	1,093,152	357,462	118,814	52,905	21,032	7,987	6,634	25,826	4,430	238,648
1989	1,136,119	356,389	116,255	50,590	21,350	8,267	6,828	24,324	4,896	240,134
1990	1,186,516	330,530	114,090	53,018	19,664	6,718	6,555	22,824	5,311	216,440

	Percent									
1981		34.0	11.1	4.8	1.7	0.7	0.7	2.6	0.5	22.9
1982		30.9	9.8	4.4	1.5	0.6	0.6	2.2	0.4	21.1
1983		28.5	8.6	4.0	1.3	0.5	0.5	2.0	0.3	19.9
1984		28.9	8.4	3.9	1.4	0.5	0.5	1.8	0.3	20.6
1985		29.6	8.9	4.2	1.5	0.5	0.5	1.9	0.3	20.7
1986		31.3	10.5	4.8	1.8	0.7	0.6	2.3	0.3	20.8
1987		31.1	10.7	4.7	1.9	0.7	0.6	2.4	0.4	20.4
1988		32.7	10.9	4.8	1.9	0.7	0.6	2.4	0.4	21.8
1989		31.4	10.2	4.5	1.9	0.7	0.6	2.1	0.4	21.1
1990		29.1	10.0	4.7	1.7	0.6	0.6	2.0	0.5	19.1

* Note: Figures for first-time freshmen include all students regardless of age.

Sources of First-Time Freshmen at the University of California, Fall 1989 and Fall 1990

County	1989 Freshmen Number and Percent		1989 H.S. Graduates Number and Percent		Difference in Distribution	1990 Freshmen Number and Percent		1990 H.S. Graduates Number and Percent		Difference in Distribution	Difference in Freshmen Distribution 1989 to 1990
UNIVERSITY OF CALIFORNIA, TOTAL											
Alameda County	1,013	5.1	11,706	4.4	-0.78	1,035	5.4	10,847	4.2	-1.26	0.31
Alpine County	0	0.0	0	0.0	0.00	0	0.0	0	0.0	0.00	0.00
Amador County	11	0.1	270	0.1	0.04	9	0.0	241	0.1	0.05	-0.01
Butte County	53	0.3	1,513	0.6	0.29	51	0.3	1,480	0.6	0.30	0.00
Calaveras County	10	0.1	379	0.1	0.09	7	0.0	372	0.1	0.11	-0.01
Colusa County	9	0.0	218	0.1	0.04	5	0.0	214	0.1	0.06	-0.02
Contra Costa County	832	4.2	8,566	3.2	-1.03	872	4.6	7,987	3.1	-1.50	0.37
Del Norte County	3	0.0	201	0.1	0.06	2	0.0	200	0.1	0.07	0.00
El Dorado County	43	0.2	1,139	0.4	0.21	38	0.2	1,119	0.4	0.23	-0.02
Fresno County	273	1.4	6,443	2.4	1.01	265	1.4	6,278	2.4	1.03	0.01
Glenn County	4	0.0	257	0.1	0.08	3	0.0	267	0.1	0.09	0.00
Humboldt County	44	0.2	1,082	0.4	0.18	28	0.1	926	0.4	0.21	-0.08
Imperial County	54	0.3	1,546	0.6	0.30	52	0.3	1,636	0.6	0.36	0.00
Inyo County	4	0.0	233	0.1	0.07	5	0.0	211	0.1	0.06	0.01
Kern County	128	0.6	5,414	2.0	1.36	132	0.7	5,311	2.1	1.36	0.05
Kings County	20	0.1	927	0.3	0.24	18	0.1	957	0.4	0.27	-0.01
Lake County	16	0.1	422	0.2	0.08	11	0.1	451	0.2	0.12	-0.02
Lassen County	5	0.0	258	0.1	0.07	6	0.0	272	0.1	0.07	0.01
Los Angeles County	6,299	31.9	74,390	27.7	-4.25	5,980	31.5	72,763	28.1	-3.37	-0.44
Madera County	23	0.1	963	0.4	0.24	23	0.1	981	0.4	0.26	0.00
Marin County	325	1.6	2,391	0.9	-0.76	312	1.6	2,098	0.8	-0.83	0.00
Mariposa County	6	0.0	143	0.1	0.02	6	0.0	123	0.0	0.02	0.00
Mendocino County	35	0.2	906	0.3	0.16	54	0.3	925	0.4	0.07	0.11
Merced County	43	0.2	1,971	0.7	0.51	57	0.3	2,038	0.8	0.49	0.08
Modoc County	1	0.0	97	0.0	0.03	2	0.0	102	0.0	0.03	0.01
Mono County	4	0.0	81	0.0	0.01	3	0.0	61	0.0	0.01	0.00
Monterey County	200	1.0	2,904	1.1	0.07	190	1.0	2,971	1.1	0.15	-0.01
Napa County	77	0.4	1,083	0.4	0.01	75	0.4	953	0.4	-0.03	0.00
Nevada County	23	0.1	690	0.3	0.14	31	0.2	687	0.3	0.10	0.05
Orange County	2,254	11.4	24,771	9.2	-2.21	2,191	11.5	22,993	8.9	-2.65	0.11
Placer County	72	0.4	1,896	0.7	0.34	84	0.4	1,792	0.7	0.25	0.08
Plumas County	6	0.0	248	0.1	0.06	4	0.0	214	0.1	0.06	-0.01
Riverside County	453	2.3	8,572	2	0.89	475	2.5	8,618	3.3	0.83	0.20
Sacramento County	592	3.0	9,309	3.5	0.46	568	3.0	8,803	3.4	0.41	-0.01
San Benito County	16	0.1	365	0.1	0.05	14	0.1	298	0.1	0.04	-0.01
San Bernardino County	513	2.6	11,630	4.3	1.73	449	2.4	11,682	4.5	2.15	-0.24
San Diego County	1,630	8.3	21,503	8.0	-0.26	1,518	8.0	21,045	8.1	0.14	-0.27
San Francisco County	594	3.0	5,222	1.9	-1.07	584	3.1	6,138	2.4	-0.70	0.06
San Joaquin County	171	0.9	4,521	1.7	0.81	146	0.8	4,252	1.6	0.87	-0.10
San Luis Obispo County	67	0.3	1,678	0.6	0.28	76	0.4	1,501	0.6	0.18	0.06
San Mateo County	541	2.7	5,503	2.0	-0.69	515	2.7	5,031	1.9	-0.77	-0.03
Santa Barbara County	254	1.3	3,282	1.2	-0.07	217	1.1	2,983	1.2	0.01	-0.14
Santa Clara County	1,496	7.6	15,213	5.7	-1.92	1,446	7.6	13,914	5.4	-2.24	0.03
Santa Cruz County	178	0.9	2,050	0.8	-0.14	170	0.9	2,027	0.8	-0.11	-0.01
Shasta County	60	0.3	1,603	0.6	0.29	34	0.2	1,528	0.6	0.41	-0.13
Sierra County	4	0.0	39	0.0	-0.01	3	0.0	41	0.0	0.00	0.00
Siskiyou County	10	0.1	487	0.2	0.13	12	0.1	399	0.2	0.09	0.01
Solano County	165	0.8	3,151	1.2	0.34	129	0.7	3,041	1.2	0.50	-0.16
Sonoma County	214	1.1	3,658	1.4	0.28	220	1.2	3,327	1.3	0.13	0.07
Stanislaus County	122	0.6	3,798	1.4	0.79	103	0.5	3,536	1.4	0.82	-0.08
Sutter County	22	0.1	705	0.3	0.15	15	0.1	645	0.2	0.17	-0.03
Tehama County	13	0.1	476	0.2	0.11	11	0.1	4	0.2	0.13	-0.01
Trinity County	3	0.0	148	0.1	0.04	3	0.0	184	0.1	0.06	0.00
Tulare County	99	0.5	3,263	1.2	0.71	96	0.5	3,019	1.2	0.66	0.00
Tuolumne County	13	0.1	495	0.2	0.12	9	0.0	451	0.2	0.13	-0.02
Ventura County	466	2.4	7,613	2.8	0.47	490	2.6	6,980	2.7	0.12	0.22
Yolo County	142	0.7	1,080	0.4	-0.32	142	0.7	1,092	0.4	-0.33	0.03
Yuba County	13	0.1	511	0.2	0.12	9	0.0	465	0.2	0.13	-0.02
Total	19,741	100.0	268,983	100.0	7.34	19,005	100.0	258,949	100.0	7.34	0.00

Sources of First-Time Freshmen at the California State University, Fall 1989 and Fall 1990

County	1989 Freshmen Number and Percent		1989 H.S. Graduates Number and Percent		Difference in Distribution	1990 Freshmen Number and Percent		1990 H.S. Graduates Number and Percent		Difference in Distribution	Difference in Freshmen Distribution 1989 to 1990
CALIFORNIA STATE UNIVERSITY, TOTAL											
Alameda County	1,527	5.2	11,706	4.4	-0.89	1,318	4.9	10,847	4.2	-0.68	-0.38
Alpine County	0	0.0	0	0.0	0.00	0	0.0	0	0.0	0.00	0.00
Amador County	16	0.1	270	0.1	0.05	15	0.1	241	0.1	0.04	0.00
Butte County	183	0.6	1,513	0.6	-0.07	197	0.7	1,480	0.6	-0.16	0.10
Calaveras County	34	0.1	379	0.1	0.02	20	0.1	372	0.1	0.07	-0.04
Colusa County	37	0.1	218	0.1	-0.05	33	0.1	214	0.1	-0.04	-0.01
Contra Costa County	897	3.1	8,566	3.2	0.10	748	2.8	7,987	3.1	0.32	-0.32
Del Norte County	15	0.1	201	0.1	0.02	13	0.0	200	0.1	0.03	0.00
El Dorado County	116	0.4	1,139	0.4	0.03	116	0.4	1,119	0.4	0.00	0.03
Fresno County	795	2.7	6,443	2.4	-0.34	800	3.0	6,278	2.4	-0.53	0.22
Glenn County	41	0.1	257	0.1	-0.05	48	0.2	267	0.1	-0.07	0.04
Humboldt County	155	0.5	1,082	0.4	-0.13	122	0.5	926	0.4	-0.09	-0.08
Imperial County	54	0.2	1,546	0.6	0.39	65	0.2	1,636	0.6	0.39	0.05
Inyo County	16	0.1	233	0.1	0.03	14	0.1	211	0.1	0.03	0.00
Kern County	416	1.4	5,414	2.0	0.58	404	1.5	5,311	2.1	0.56	0.06
Kings County	54	0.2	927	0.3	0.16	61	0.2	957	0.4	0.14	0.04
Lake County	48	0.2	422	0.2	-0.01	33	0.1	451	0.2	0.05	-0.04
Lassen County	5	0.0	258	0.1	0.08	15	0.1	272	0.1	0.05	0.04
Los Angeles County	9,666	33.2	74,390	27.7	-5.54	9,198	33.9	72,763	28.1	-5.85	0.75
Madera County	93	0.3	963	0.4	0.04	78	0.3	981	0.4	0.09	-0.03
Marin County	304	1.0	2,391	0.9	-0.16	241	0.9	2,098	0.8	-0.08	-0.15
Mariposa County	17	0.1	143	0.1	-0.01	10	0.0	123	0.0	0.01	-0.02
Mendocino County	82	0.3	906	0.3	0.06	75	0.3	925	0.4	0.08	0.00
Merced County	140	0.5	1,971	0.7	0.25	123	0.5	2,038	0.8	0.33	-0.03
Modoc County	6	0.0	97	0.0	0.02	6	0.0	102	0.0	0.02	0.00
Mono County	9	0.0	81	0.0	0.00	9	0.0	61	0.0	-0.01	0.00
Monterey County	222	0.8	2,904	1.1	0.32	235	0.9	2,971	1.1	0.28	0.10
Napa County	84	0.3	1,083	0.4	0.11	93	0.3	953	0.4	0.02	0.05
Nevada County	59	0.2	690	0.3	0.05	73	0.3	687	0.3	0.00	0.07
Orange County	2,798	9.6	24,771	9.2	-0.40	2,533	9.3	22,993	8.9	-0.47	-0.26
Placer County	105	0.4	1,896	0.7	0.27	137	0.5	1,792	0.7	0.19	0.15
Plumas County	26	0.1	248	0.1	0.00	18	0.1	214	0.1	0.02	-0.02
Riverside County	534	1.8	8,572	3.2	1.35	508	1.9	8,618	3.3	1.45	0.04
Sacramento County	796	2.7	9,309	3.5	0.73	756	2.8	8,803	3.4	0.61	0.06
San Benito County	26	0.1	365	0.1	0.05	27	0.1	298	0.1	0.02	0.01
San Bernardino County	993	3.4	11,630	4.3	0.91	1,010	3.7	11,682	4.5	0.78	0.32
San Diego County	1,962	6.7	21,503	8.0	1.26	1,931	7.1	21,045	8.1	1.00	0.39
San Francisco County	1,203	4.1	5,222	1.9	-2.19	1,071	4.0	6,138	2.4	-1.58	-0.18
San Joaquin County	259	0.9	4,521	1.7	0.79	235	0.9	4,252	1.6	0.77	-0.02
San Luis Obispo County	137	0.5	1,678	0.6	0.15	92	0.3	1,501	0.6	0.24	-0.13
San Mateo County	605	2.1	5,503	2.0	-0.03	585	2.2	5,031	1.9	-0.22	0.08
Santa Barbara County	167	0.6	3,282	1.2	0.65	147	0.5	2,983	1.2	0.61	-0.03
Santa Clara County	2,207	7.6	15,213	5.7	-1.92	1,951	7.2	13,914	5.4	-1.83	-0.38
Santa Cruz County	187	0.6	2,050	0.8	0.12	159	0.6	2,027	0.8	0.20	-0.06
Shasta County	90	0.3	1,603	0.6	0.29	62	0.2	1,528	0.6	0.36	-0.08
Sierra County	4	0.0	39	0.0	0.00	0	0.0	41	0.0	0.02	-0.01
Siskiyou County	34	0.1	487	0.2	0.06	27	0.1	399	0.2	0.05	-0.02
Solano County	244	0.8	3,151	1.2	0.33	236	0.9	3,041	1.2	0.30	0.03
Sonoma County	332	1.1	3,658	1.4	0.22	281	1.0	3,327	1.3	0.25	-0.10
Stanislaus County	334	1.1	3,798	1.4	0.26	248	0.9	3,536	1.4	0.45	-0.23
Sutter County	38	0.1	705	0.3	0.13	50	0.2	645	0.2	0.06	0.05
Tehama County	50	0.2	476	0.2	0.01	47	0.2	479	0.2	0.01	0.00
Trinity County	15	0.1	148	0.1	0.00	14	0.1	184	0.1	0.02	0.00
Tulare County	156	0.5	3,263	1.2	0.68	176	0.6	3,019	1.2	0.52	0.11
Tuolumne County	34	0.1	495	0.2	0.07	32	0.1	451	0.2	0.06	0.00
Ventura County	555	1.9	7,613	2.8	0.92	459	1.7	6,980	2.7	1.00	-0.21
Yolo County	105	0.4	1,080	0.4	0.04	117	0.4	1,092	0.4	-0.01	0.07
Yuba County	29	0.1	511	0.2	0.09	22	0.1	465	0.2	0.10	-0.02
Total	29,116	100.0	268,983	100.0	10.82	27,094	100.0	258,949	100.0	10.46	-0.36

Section 4

Transfer Students

- 4-1 California Community College Transfer Students by Segment, Fall 1981 to Fall 1990
- 4-2 Origins of New Undergraduate Transfer Students to the University of California, Fall 1981 to Fall 1990
- 4-3 Origins of New Undergraduate Transfer Students to the California State University, Fall 1981 to Fall 1990
- 4-4 Origins of New Undergraduate Transfer Students to the California Community Colleges, Fall 1981 to Fall 1990
- 4-5 Full-Year Undergraduate Transfer Students Enrolled at the University of California by Segment of Origin, 1981-82 through 1990-91
- 4-6 Full-Year Undergraduate New Transfer Students to the California State University by Segment of Origin, 1981-1982 to 1990-91
- 4-7 Gender of New Undergraduate Transfer Students to the University of California, Fall 1981 to Fall 1990
- 4-8 Gender of New Undergraduate Transfer Students to the California State University, Fall 1981 to Fall 1990
- 4-9 Community College Transfers by Ethnicity to the University of California, Fall 1981 to Fall 1990
- 4-10 Distribution of Total California Community College (Credit) Enrollment and Distribution of New Community College Transfers to the University of California by Ethnicity, Fall 1981 to Fall 1990
- 4-11 Community College Transfers by Ethnicity to the California State University, Fall 1981 to Fall 1990
- 4-12 Distribution of Total California Community College (Credit) Enrollment and Distribution of New Community College Transfers to the California State University by Ethnicity, Fall 1981 to Fall 1990
- 4-13 Change in Share of Community College Transfers by Ethnicity to the University of California, Fall 1981 to Fall 1990
- 4-14 Change in Share of Community College Transfers by Ethnicity to the California State University, Fall 1981 to Fall 1990

- 4-15 Number of Transfer Students (per 1,000 Credit Enrollments) to the University of California by Ethnicity, Fall 1981 to Fall 1990
- 4-16 Displays of the Number of Transfer Students (per 1,000 Credit Enrollments) to the University of California by Ethnicity, Fall 1981 to Fall 1990
- 4-17 Number of Transfer Students (per 1,000 Credit Enrollments) to the California State University by Ethnicity, Fall 1981 to Fall 1990
- 4-18 Displays of the Number of Transfer Students (per 1,000 Credit Enrollments) to the California State University by Ethnicity, Fall 1981 to Fall 1990
- 4-19 Undergraduate Transfer Students by Student Level Enrolled at the University of California, Fall 1981 to Fall 1990
- 4-20 Undergraduate Transfer Students by Student Level Enrolled at the University of California, Fall 1981 to Fall 1990
- 4-21 Undergraduate Transfer Students by Student Level Enrolled at the California State University, Fall 1981 to Fall 1990
- 4-22 Undergraduate Transfer Students by Student Level Enrolled at the California State University, Fall 1981 to Fall 1990
- 4-23 Percentage of Four-Year Public University Enrollments and Bachelor's Degrees Awarded to Students Who Attended a California Community College
- 4-24 Undergraduate Transfer Enrollment at the University of California by Full-Time and Part-Time Status and Gender, Fall 1981 to Fall 1990
- 4-25 Undergraduate Transfer Enrollment at the California State University by Full-Time and Part-Time Status and Gender, Fall 1981 to Fall 1990

California Community College Transfer Students by Segment, Fall 1981 to Fall 1990

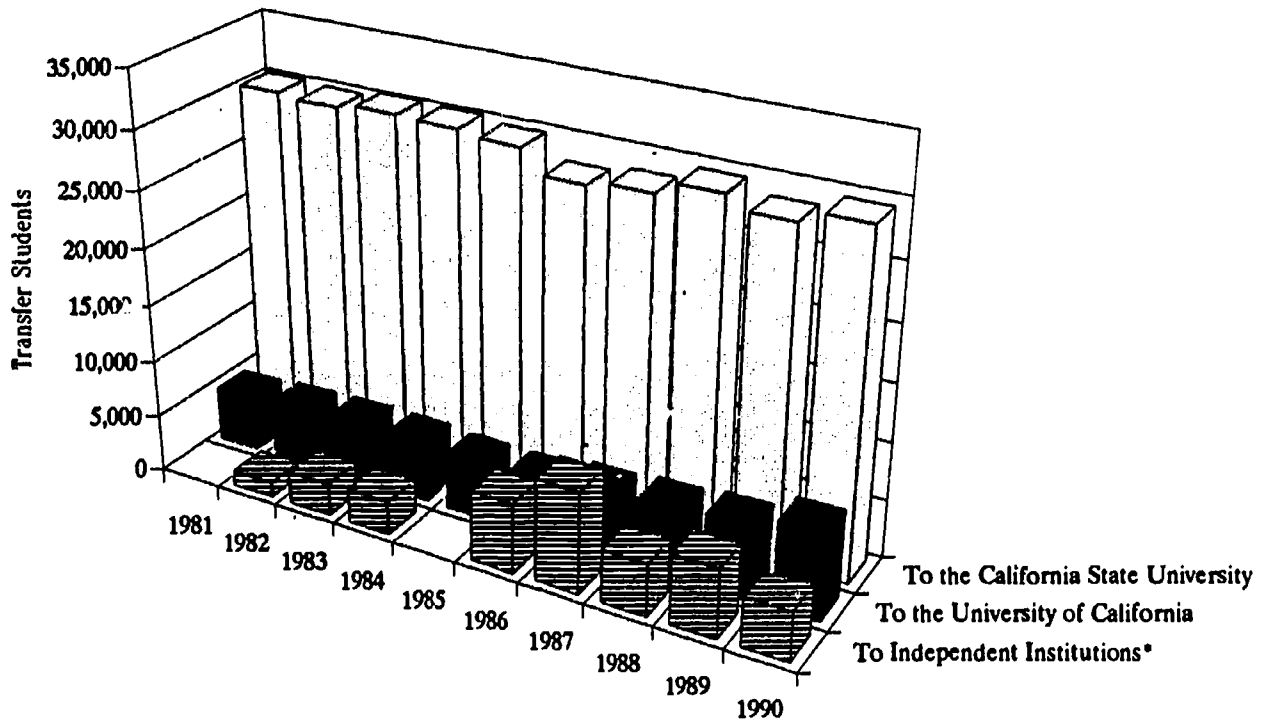

California Community College Transfer Students by Segment, Fall 1981 to Fall 1990

Fall Term	Total Transfer Students	Transfers To			Percentage Distribution		
		University of California	California State University	Independent Institutions *	University of California	California State University	Independent Institutions*
1981	34,919	4,847	30,072	N/A	13.9	86.1	N/A
1982	36,244	5,137	29,824	1,283	14.2	82.3	3.5
1983	38,357	5,307	30,274	2,776	13.8	78.9	7.2
1984	38,265	5,257	30,134	2,874	13.7	78.8	7.5
1985	34,614	4,932	29,682	N/A	14.2	85.8	N/A
1986	38,673	4,861	27,761	6,051	12.6	71.8	15.6
1987	42,477	5,465	28,257	8,755	12.9	66.5	20.6
1988	39,750	5,855	29,393	4,502	14.7	73.9	11.3
1989	40,448	6,224	28,331	5,893	15.4	70.0	14.6
1990	40,995	7,420	29,370	4,205	18.1	71.6	10.3

* A variable number of Independent institutions have reported each year.

Origins of New Undergraduate Transfer Students to the University of California,
Fall 1981 to Fall 1990

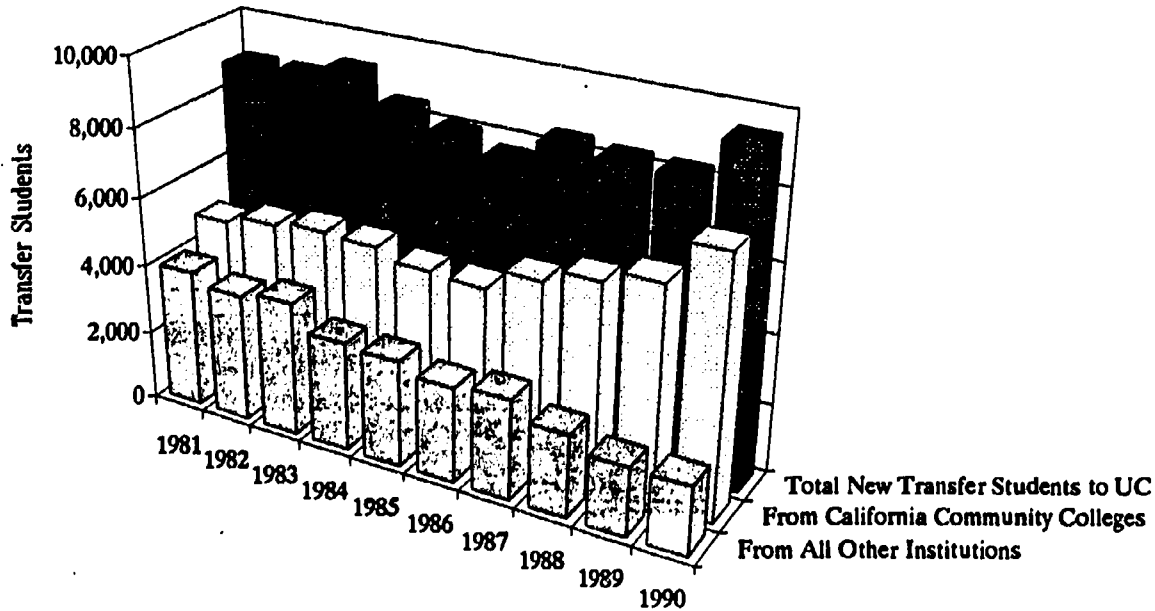

Fall Term	Total Number of New Transfer Students	Number of New Transfer Students by Segment of Origin					
		California Community Colleges	California State University	University of California	Independent Colleges & Universities	Out of State Institutions	Foreign Institutions
1981	8,836	4,844	988	1,312	475	1,083	134
1982	8,826	5,136	897	1,368	447	874	104
1983	9,195	5,305	908	1,549	421	904	108
1984	8,421	5,257	809	1,218	351	704	82
1985	8,018	4,931	743	1,165	313	716	150
1986	7,645	4,858	728	1,036	313	616	94
1987	8,407	5,465	744	1,118	342	628	110
1988	8,293	5,855	576	966	274	556	66
1989	8,253	6,224	536	768	227	440	58
1990	9,425	7,420	462	790	205	447	101

Fall Term	Total	Percent of New Transfer Students by Segment of Origin					
		California Community Colleges	California State University	University of California	Independent Colleges & Universities	Out of State Institutions	Foreign Institutions
1981	100.0	54.8	11.2	14.8	5.4	12.3	1.5
1982	100.0	58.2	10.2	15.5	5.1	9.9	1.2
1983	100.0	57.7	9.9	16.8	4.6	9.8	1.2
1984	100.0	62.4	9.6	14.5	4.2	8.4	1.0
1985	100.0	61.5	9.3	14.5	3.9	8.9	1.9
1986	100.0	63.5	9.5	13.6	4.1	8.1	1.2
1987	100.0	65.0	8.8	13.3	4.1	7.5	1.3
1988	100.0	70.6	6.9	11.6	3.3	6.7	0.8
1989	100.0	75.4	6.5	9.3	2.8	5.3	0.7
1990	100.0	78.7	4.9	8.4	2.2	4.7	1.1

Origins of New Undergraduate Transfer Students to the California State University, Fall 1981 to Fall 1990.

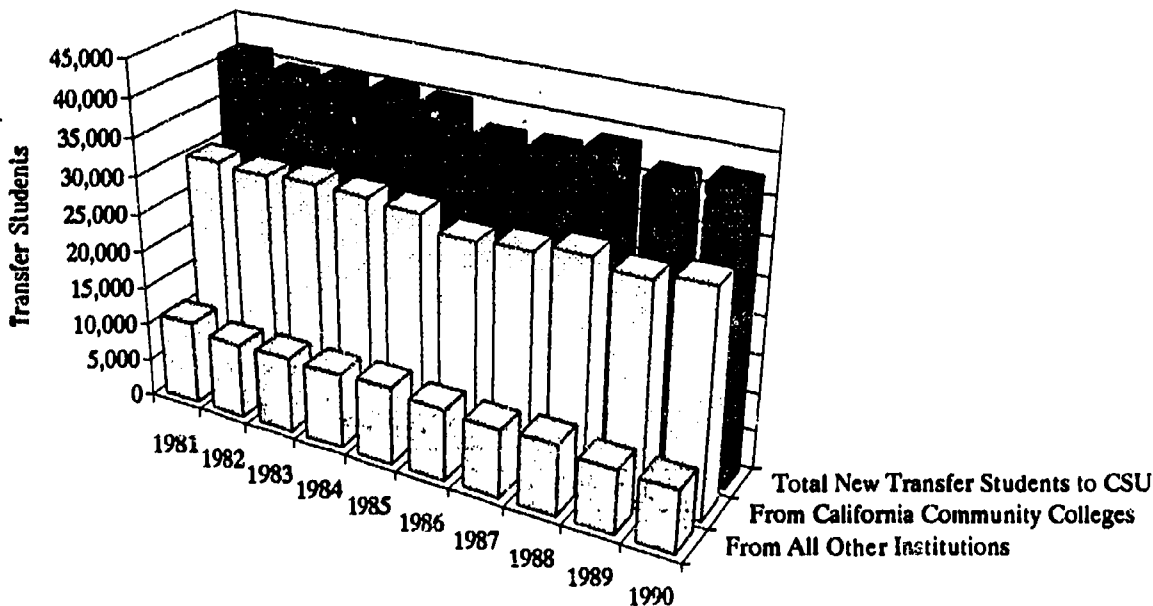

Fall Term	Total Number of New Transfer Students	Number of New Transfer Students by Segment of Origin					
		California Community Colleges	California State University	University of California	Independent Colleges and Universities	Out of State Institutions	Foreign Institutions
1981	41,146	30,072	3,809	1,451	1,544	3,647	623
1982	39,780	29,824	3,386	1,357	1,424	3,236	553
1983	40,346	30,274	3,459	1,395	1,305	3,262	651
1984	40,106	30,134	3,508	1,333	1,325	3,277	529
1985	39,945	29,682	3,552	1,321	1,384	3,457	549
1986	37,258	27,761	3,155	1,094	1,323	3,286	639
1987	37,339	28,257	3,138	1,002	1,183	3,169	590
1988	38,762	29,393	3,300	977	1,183	3,239	670
1989	36,788	28,351	2,827	823	1,061	3,004	742
1990	37,642	29,370	2,905	775	1,004	2,824	764

Percent of New Transfer Students by Segment of Origin							
1981	100.0	73.1	9.3	3.5	3.8	8.9	1.5
1982	100.0	75.0	8.5	3.4	3.6	8.1	1.4
1983	100.0	75.0	8.6	3.5	3.2	8.1	1.6
1984	100.0	75.1	8.7	3.3	3.3	8.2	1.3
1985	100.0	74.3	8.9	3.3	3.5	8.7	1.4
1986	100.0	74.5	8.5	2.9	3.6	8.8	1.7
1987	100.0	75.7	8.4	2.7	3.2	8.5	1.6
1988	100.0	75.8	8.5	2.5	3.1	8.4	1.7
1989	100.0	77.0	7.7	2.2	2.9	8.2	2.0
1990	100.0	78.0	7.7	2.1	2.7	7.5	2.0

Origins of New Undergraduate Transfer Students to the California Community Colleges, Fall 1981 to Fall 1990

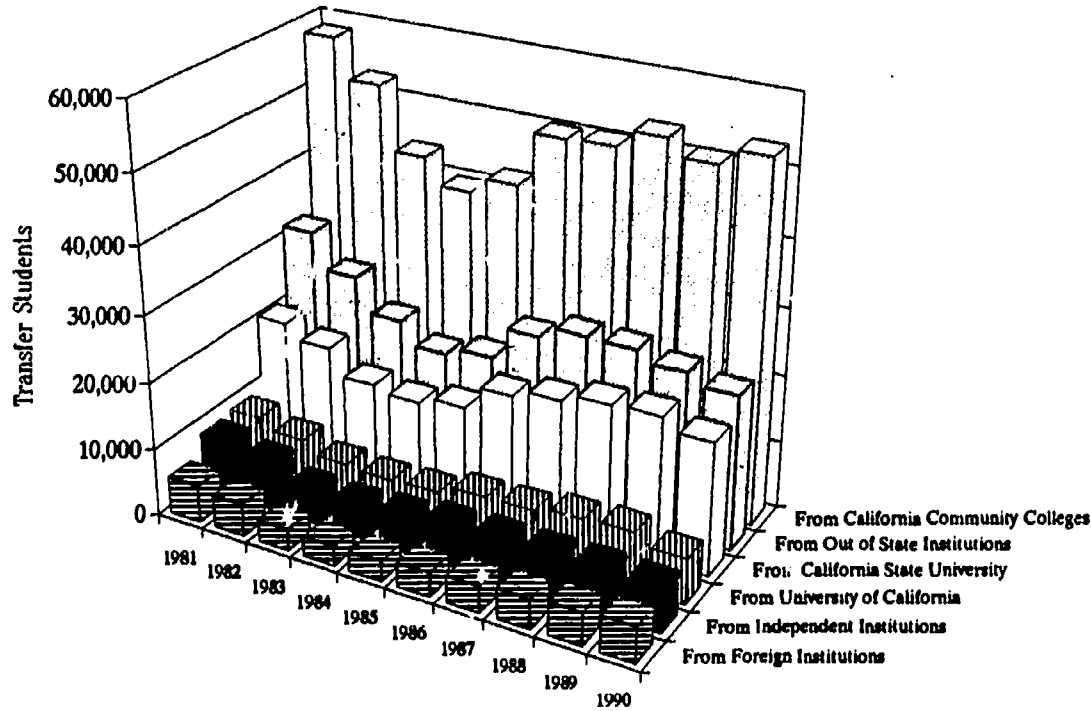

Fall Term	Total Number of New Transfer Students	Number of New Transfer Students by Segment of Origin					
		California Community Colleges	California State University	University of California	Independent Colleges and Universities	Out of State Institutions	Foreign Institutions
1981	133,370	58,146	20,456	8,953	8,681	31,624	5,510
1982	117,028	52,439	18,416	7,438	7,520	26,395	4,820
1983	93,297	43,291	14,521	5,681	5,307	21,295	3,202
1984	84,354	39,467	13,078	5,288	5,059	17,931	2,931
1985	89,988	41,956	14,845	5,518	5,511	19,235	2,923
1986	109,530	49,934	18,505	6,923	6,457	24,167	3,534
1987	113,696	50,277	19,754	7,120	6,615	25,986	3,944
1988	118,814	52,905	21,032	7,987	6,634	25,826	4,430
1989	116,255	50,590	21,350	8,267	6,828	24,324	4,896
1990	114,090	53,018	19,664	6,718	6,555	22,824	5,311

Percent of New Transfer Students by Segment of Origin							
1981	100.0	43.6	15.3	6.7	6.5	23.7	4.1
1982	100.0	44.8	15.7	6.4	6.4	22.6	4.1
1983	100.0	46.4	15.6	6.1	5.7	22.8	3.4
1984	100.0	46.8	16.2	6.3	6.0	21.3	3.5
1985	100.0	46.6	16.5	6.1	6.1	21.4	3.2
1986	100.0	45.6	16.9	6.3	5.9	22.1	3.2
1987	100.0	44.2	17.4	6.3	5.8	22.9	3.5
1988	100.0	44.5	17.7	6.7	5.6	21.7	3.7
1989	100.0	43.5	18.4	7.1	5.9	20.9	4.2
1990	100.0	46.5	17.2	5.9	5.7	20.0	4.7

Full-Year Undergraduate Transfer Students Enrolled at the University of California, 1981-82 through 1990-91

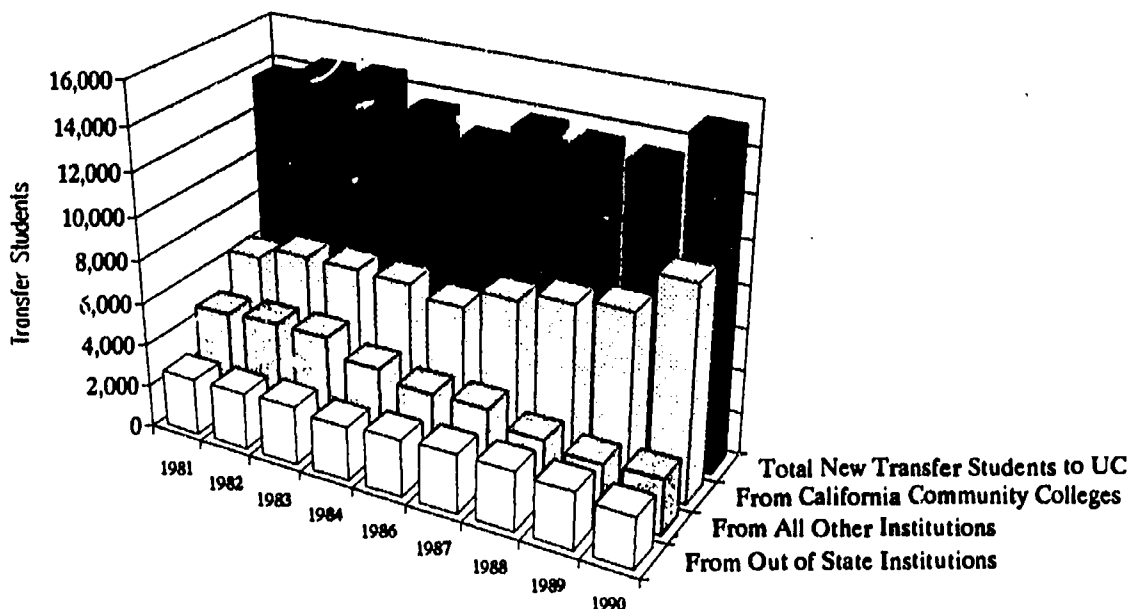

Term	Total Number of Full-Year New Transfer Students	Number of Full-Year New Transfer Students by Segment of Origin					
		California Community Colleges	California State University	University of California	Independent Colleges and Universities	Out of State Institutions	Foreign Institutions
1981-82	13,733	6,363	1,444	2,201	650	2,675	400
1982-83	14,482	6,953	1,392	2,408	658	2,679	392
1983-84	14,615	6,958	1,367	2,478	600	2,789	423
1984-85	13,484	6,891	1,212	1,991	484	2,565	341
1985-86 *	9,823	4,924	738	1,168	310	2,314	369
1986-87	12,680	6,418	1,033	1,729	441	2,706	353
1987-88	13,719	7,349	1,078	1,682	455	2,799	356
1988-89	13,488	7,827	803	1,383	343	2,817	315
1989-90	13,323	8,139	719	1,127	285	2,682	371
1990-91	15,016	10,007	685	1,208	275	2,396	445

Term	Total Number of Full-Year New Transfer Students	Percent of Full-Year New Transfer Students by Segment of Origin					
		California Community Colleges	California State University	University of California	Independent Colleges and Universities	Out of State Institutions	Foreign Institutions
1981-82	100.0	46.3	10.5	16.0	4.7	19.5	2.9
1982-83	100.0	48.0	9.6	16.6	4.5	18.5	2.7
1983-84	100.0	47.6	9.4	17.0	4.1	19.1	2.9
1984-85	100.0	51.1	9.0	14.8	3.6	19.0	2.5
1985-86 *	100.0	50.1	7.5	11.9	3.2	23.6	3.8
1986-87	100.0	50.6	8.1	13.6	3.5	21.3	2.8
1987-88	100.0	53.6	7.9	12.3	3.3	20.4	2.6
1988-89	100.0	58.0	6.0	10.3	2.5	20.9	2.3
1989-90	100.0	61.1	5.4	8.5	2.1	20.1	2.8
1990-91	100.0	66.6	4.6	8.0	1.8	16.0	3.0

* Note: Numbers in this row reflect Fall 1985 enrollments only. Winter and Spring 1986 processing was suspended to prepare for the implementation of a multiple filing system which was introduced in Fall 1986.
 Source: University of California Office of the President.

Full-Year Undergraduate New Transfer Students to the California State University, 1981-82 to 1990-91

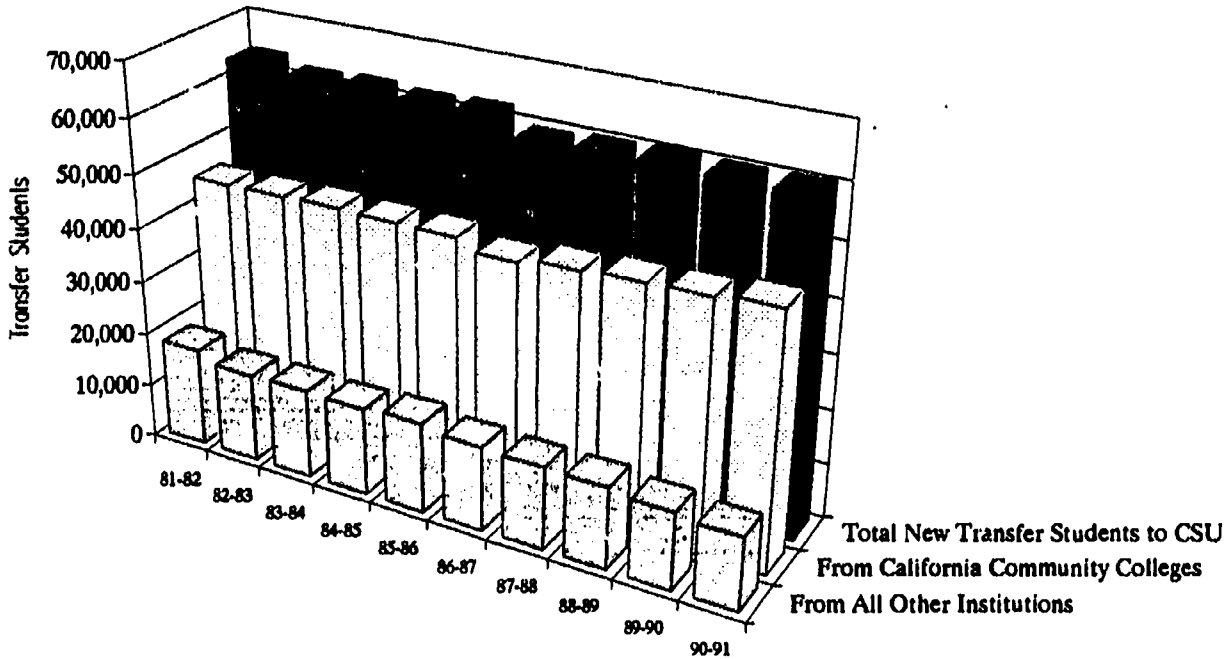

Year	Total Number of Full-Year New Transfer Students	Number of Full-Year New Transfer Students by Segment of Origin					
		California Community Colleges	California State University	University of California	Independent Colleges and Universities	Out of State Institutions	Foreign Institutions
1981-82	63,552	45,283	6,184	2,437	2,658	5,869	1,121
1982-83	61,845	45,400	5,634	2,350	2,267	5,209	985
1983-84	62,250	45,726	5,741	2,374	2,226	5,149	1,034
1984-85	61,752	45,476	5,665	2,221	2,197	5,240	953
1985-86	62,168	45,469	5,750	2,240	2,219	5,500	990
1986-87	59,285	43,666	5,393	1,839	2,120	5,222	1,045
1987-88	59,958	44,701	5,303	1,775	1,949	5,187	1,043
1988-89	60,568	45,402	5,446	1,588	1,783	5,116	1,133
1989-90	60,070	45,724	4,936	1,453	1,787	4,909	1,261
1990-91	60,227	46,678	4,762	1,311	1,654	4,566	1,256

Year	Percent of Full-Year New Transfer Students by Segment of Origin						
	California Community Colleges	California State University	University of California	Independent Colleges and Universities	Out of State Institutions	Foreign Institutions	
1981-82	100.0	71.3	9.7	3.8	4.2	9.2	1.8
1982-83	100.0	73.4	9.1	3.8	3.7	8.4	1.6
1983-84	100.0	73.5	9.2	3.8	3.6	8.3	1.7
1984-85	100.0	73.6	9.2	3.6	3.5	8.5	1.5
1985-86	100.0	73.1	9.2	3.6	3.6	8.8	1.6
1986-87	100.0	73.7	9.1	3.1	3.6	8.8	1.8
1987-88	100.0	74.6	8.8	3.0	3.3	8.7	1.7
1988-89	100.0	75.0	9.0	2.6	3.1	8.4	1.9
1989-90	100.0	76.1	8.2	2.4	3.0	8.2	2.1
1990-91	100.0	77.5	7.9	2.2	2.7	7.6	2.1

Gender of New Undergraduate Transfer Students to the University of California, Fall 1981 to Fall 1990

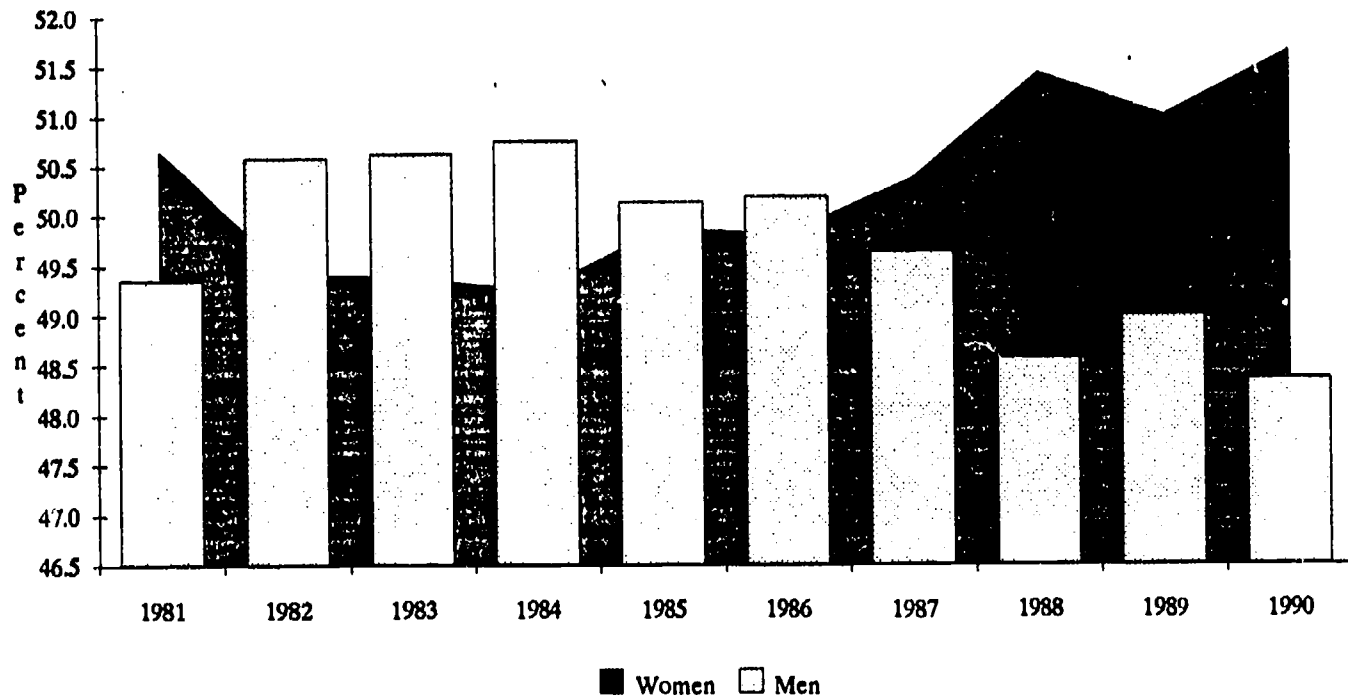

Fall Term	Total Transfer Students		California Community Colleges		California State University		University of California		Independent Colleges and Universities		Out of State Institutions		Foreign Institutions	
	Men	Women	Men	Women	Men	Women	Men	Women	Men	Women	Men	Women	Men	Women
1981	4,361	4,475	2,497	2,347	478	510	591	721	201	274	521	562	73	61
1982	4,464	4,362	2,451	2,451	425	472	670	698	212	235	412	462	60	44
1983	4,655	4,540	2,528	2,528	453	455	707	842	208	213	450	454	60	48
1984	4,274	4,147	2,798	2,459	382	427	567	651	156	195	331	373	40	42
1985	4,020	3,998	2,570	2,361	368	375	526	639	131	182	348	368	77	73
1986	3,837	3,808	2,479	2,379	361	367	500	536	136	177	305	311	56	38
1987	4,173	4,234	2,780	2,685	391	353	490	628	147	195	302	326	63	47
1988	4,028	4,265	2,872	2,983	279	297	448	518	123	151	267	289	39	27
1989	4,044	4,299	3,113	3,111	255	281	340	428	108	119	197	243	31	27
1990	4,558	4,867	3,614	3,806	216	246	354	436	103	102	228	219	43	58

Fall Term	Total Transfer Students		California Community Colleges		California State University		University of California		Independent Colleges and Universities		Out of State Institutions		Foreign Institutions	
	Men (%)	Women (%)	Men (%)	Women (%)	Men (%)	Women (%)	Men (%)	Women (%)	Men (%)	Women (%)	Men (%)	Women (%)	Men (%)	Women (%)
1981	49.4	50.6	51.5	49.5	48.4	51.6	45.0	55.0	42.3	57.7	48.1	51.9	54.5	45.5
1982	50.6	49.4	52.3	47.7	47.4	52.6	49.0	51.0	47.4	52.6	47.1	52.9	57.7	42.3
1983	50.6	49.4	52.3	47.7	49.9	50.1	45.6	54.4	49.4	50.6	49.8	50.2	55.6	44.4
1984	50.8	49.2	53.2	46.8	47.2	52.8	46.6	53.4	44.4	55.6	47.0	53.0	48.8	51.2
1985	50.1	49.9	52.1	47.9	49.5	50.5	45.2	54.8	41.9	58.1	48.6	51.4	51.3	48.7
1986	50.2	49.8	51.0	49.0	49.6	50.4	48.3	51.7	43.5	56.5	49.5	50.5	59.6	40.4
1987	49.6	50.4	50.9	49.1	52.6	47.4	43.8	56.2	43.0	57.0	48.1	51.9	57.3	42.7
1988	48.6	51.4	49.1	50.9	48.4	51.6	46.4	53.6	44.9	55.1	48.0	52.0	59.1	40.9
1989	49.0	51.0	50.0	50.0	47.6	52.4	44.3	55.7	47.6	52.4	44.8	55.2	53.4	46.6
1990	48.4	51.6	48.7	51.3	46.8	53.2	44.8	55.2	50.2	49.8	51.0	49.0	42.6	57.4

Gender of New Undergraduate Transfer Students to the California State University, Fall 1981 to Fall 1990

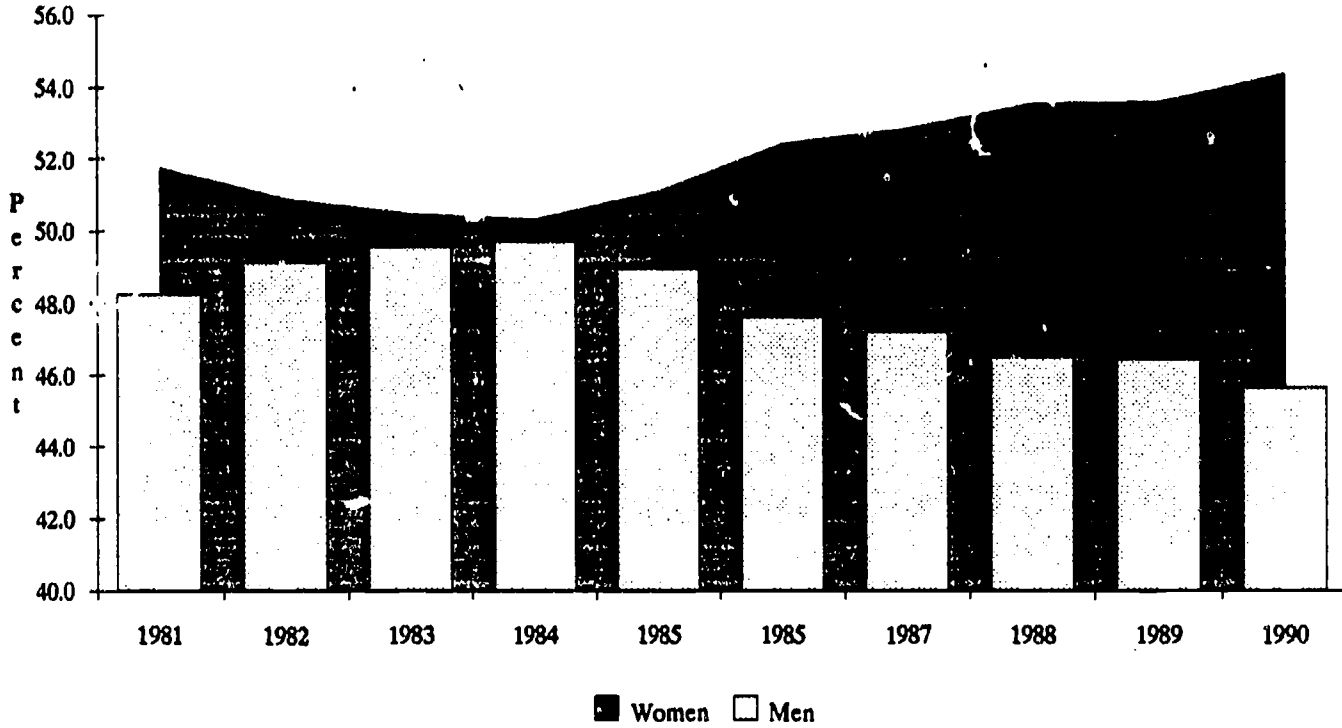

Fall Term	Total Transfer Students		California Community Colleges		California State University		University of California		Independent Colleges and Universities		Out of State Institutions		Foreign Institutions	
	Men	Women	Men	Women	Men	Women	Men	Women	Men	Women	Men	Women	Men	Women
1980	21,037	21,567	15,358	15,169	1,766	2,257	699	836	790	900	2,068	2,096	356	309
1981	19,855	21,291	14,762	15,310	1,661	2,148	652	799	700	844	1,744	1,903	336	287
1982	19,547	20,233	15,005	14,819	1,472	1,914	593	764	647	777	1,529	1,707	301	252
1983	19,992	20,354	15,357	14,917	1,561	1,898	563	832	610	695	1,548	1,714	353	298
1984	19,931	20,175	15,341	14,793	1,568	1,940	612	721	603	722	1,519	1,758	288	241
1985	19,551	20,394	14,819	14,863	1,573	1,979	606	715	606	778	1,667	1,790	280	269
1986	17,733	19,525	13,495	14,266	1,434	1,721	461	633	550	773	1,472	1,814	321	318
1987	17,622	19,717	13,489	14,768	1,419	1,719	436	566	521	662	1,468	1,701	289	301
1988	18,022	20,739	13,870	15,523	1,452	1,847	437	540	499	684	1,447	1,792	317	353
1989	17,085	19,703	13,288	15,043	1,269	1,558	371	452	444	617	1,353	1,651	360	382
1990	17,182	20,460	13,509	15,861	1,294	1,611	346	429	397	607	1,284	1,540	352	412

Fall Term	Total Transfer Students		California Community Colleges		California State University		University of California		Independent Colleges and Universities		Out of State Institutions		Foreign Institutions	
	Men (%)	Women (%)	Men (%)	Women (%)	Men (%)	Women (%)	Men (%)	Women (%)	Men (%)	Women (%)	Men (%)	Women (%)	Men (%)	Women (%)
1981	48.3	51.7	49.1	50.9	43.6	56.4	44.9	55.1	45.3	54.7	47.8	52.2	53.9	46.1
1982	49.1	50.9	50.3	49.7	43.5	56.5	43.7	56.3	45.4	54.6	47.2	52.8	54.4	45.6
1983	49.6	50.4	50.7	49.3	45.1	54.9	40.4	59.6	46.7	53.3	47.5	52.5	54.2	45.8
1984	49.7	50.3	50.9	49.1	44.7	55.3	45.9	54.1	45.5	54.5	46.4	53.6	54.4	45.6
1985	48.9	51.1	49.9	50.1	44.3	55.7	45.9	54.1	43.8	56.2	48.2	51.8	51.0	49.0
1986	47.6	52.4	48.6	51.4	45.5	54.5	42.1	57.9	41.6	58.4	44.8	55.2	50.2	49.8
1987	47.2	52.8	47.7	52.3	45.2	54.8	43.5	56.5	44.0	56.0	46.3	53.7	49.0	51.0
1988	46.5	53.5	47.2	52.8	44.0	56.0	44.7	55.3	42.2	57.8	44.7	55.3	47.3	52.7
1989	46.4	53.6	46.9	53.1	44.9	55.1	45.1	54.9	41.8	58.2	45.0	55.0	48.5	51.5
1990	45.6	54.4	46.0	54.0	44.5	55.5	44.6	55.4	39.5	60.5	45.5	54.5	46.1	53.9

Community College Transfers by Ethnicity to the University of California,
Fall 1981 to Fall 1990

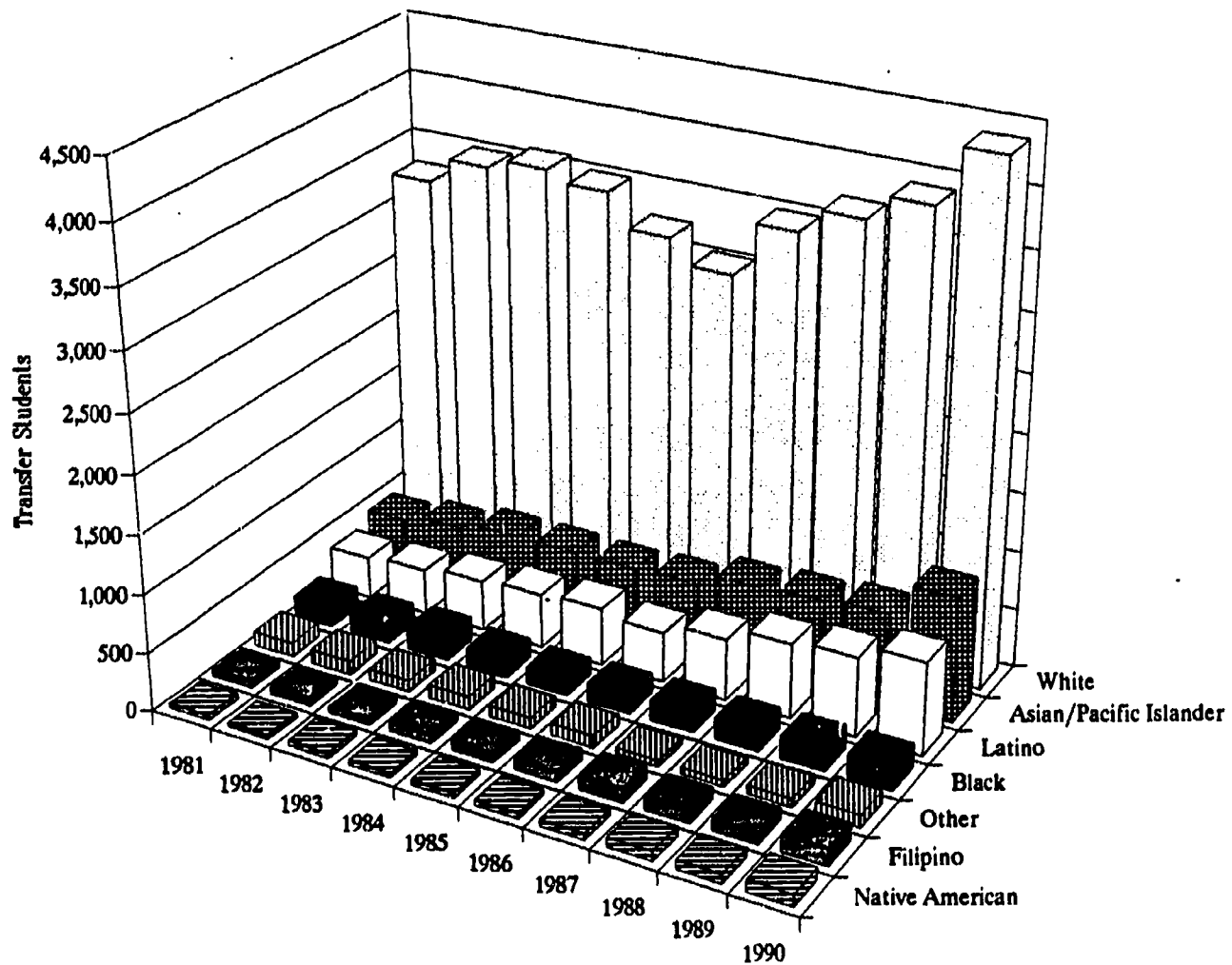

Fall Term	Total Transfer Students	Asian/Pacific Islander	Black	Filipino	Latino	Native American	Other	White	Total, Declared Ethnicity	Non-Resident Alien	No Response
1981	4,844	457	177	54	357	41	120	3,266	4,472	177	195
1982	5,136	519	176	60	389	32	112	3,482	4,770	183	183
1983	5,305	586	204	47	434	43	96	3,568	4,978	150	177
1984	5,257	585	161	72	461	41	113	3,483	4,916	197	144
1985	4,931	574	151	75	492	41	90	3,209	4,632	179	120
1986	4,858	591	168	86	431	40	100	3,005	4,421	221	216
1987	5,465	708	183	115	525	51	53	3,466	5,101	217	147
1988	5,855	740	185	95	639	82	52	3,673	5,466	226	163
1989	6,224	780	197	94	680	78	69	3,882	5,780	229	215
1990	7,420	1,065	209	147	796	101	108	4,366	6,792	300	328
% Change	53.2	133.0	18.1	177.2	123.0	146.3	-10.0	33.7	51.9	69.5	68.2

Distribution of Total California Community College (Credit) Enrollment by Ethnicity, Fall 1981 to Fall 1990

Fall Term	Total (Credit) Students	Asian/Pacific Islander	Black	Filipino	Latino	Native American	Other	White	Total, Declared Ethnicity	Non-Resident Alien	No Response
1981	1,202,682	4.6	8.1	1.5	10.4	1.5	1.9	60.6	88.6	2.3	9.1
1982	1,191,366	5.5	8.5	1.7	11.1	1.5	2.3	60.6	91.2	1.9	6.9
1983	1,087,425	6.2	8.4	1.9	11.0	1.5	2.3	60.5	91.9	2.1	6.0
1984	1,005,576	6.6	7.5	2.1	11.2	1.4	2.3	61.1	92.2	2.2	5.6
1985	1,006,686	7.1	7.2	2.1	11.8	1.3	2.0	61.1	92.6	2.3	5.1
1986	1,046,099	7.2	7.3	2.1	12.4	1.3	1.9	60.9	93.3	2.3	4.5
1987	1,061,014	7.3	7.0	2.4	12.8	1.3	1.8	61.1	93.7	2.4	3.9
1988	1,093,152	7.2	7.0	2.6	13.4	1.3	2.0	60.1	93.6	2.7	3.7
1989	1,136,119	7.6	7.1	2.7	14.2	1.3	1.9	59.0	93.7	3.2	3.1
1990	1,205,119	7.6	7.2	2.8	14.6	1.6	1.6	55.6	91.0	4.5	4.5

Distribution of New Community College Transfers to the University of California by Ethnicity, Fall 1981 to Fall 1990

Fall Term	Total Transfer Student	Asian/Pacific Islander	Black	Filipino	Latino	Native American	Other	White	Total, Declared Ethnicity	Non-Resident Alien	No Response
1981	4,844	9.4	3.7	1.1	7.4	0.8	2.5	67.4	92.3	3.7	4.0
1982	5,136	10.1	3.4	1.2	7.6	0.6	2.2	67.8	92.9	3.6	3.6
1983	5,305	11.0	3.8	0.9	8.2	0.8	1.8	67.3	93.8	2.8	3.3
1984	5,257	11.1	3.1	1.4	8.8	0.8	2.1	66.3	93.5	3.7	2.7
1985	4,931	11.6	3.1	1.5	10.0	0.8	1.8	65.1	93.9	3.6	2.4
1986	4,858	12.2	3.5	1.8	8.9	0.8	2.1	61.9	91.0	4.5	4.4
1987	5,465	13.0	3.3	2.1	9.6	0.9	1.0	63.4	93.3	4.0	2.7
1988	5,855	12.6	3.2	1.6	10.9	1.4	0.9	62.7	93.4	3.9	2.8
1989	6,224	12.5	3.2	1.5	10.9	1.3	1.1	62.4	92.9	3.7	3.5
1990	7,420	14.4	2.8	2.0	10.7	1.4	1.5	58.8	91.5	4.0	4.4

Difference Between California Community College (Credit) Enrollment Ethnic Distribution and Ethnic Distribution of California Community College Transfer Students to the University of California.

Fall Term	Asian/Pacific Islander	Black	Filipino	Latino	Native American	Other	White	Total, Declared Ethnicity	Non-Resident Alien	No Response
1981	4.8	-4.4	-0.4	-3.0	-0.7	0.6	6.8	3.7	1.4	-5.1
1982	4.6	-5.1	-0.5	-3.5	-0.9	-0.1	7.2	1.7	1.7	-3.3
1983	4.8	-4.6	-1.0	-2.8	-0.7	-0.5	6.8	1.9	0.7	-2.7
1984	4.5	-4.4	-0.7	-2.4	-0.6	-0.2	5.2	1.3	1.5	-2.9
1985	4.5	-4.1	-0.6	-1.8	-0.5	-0.2	4.0	1.3	1.3	-2.7
1986	5.0	-3.8	-0.3	-3.5	-0.5	0.2	1.0	-2.3	2.2	-0.1
1987	5.7	-3.7	-0.3	-3.2	-0.4	-0.8	2.3	-0.4	1.6	-1.2
1988	5.4	-3.8	-1.0	-2.5	0.1	-1.1	2.6	-0.2	1.2	-0.9
1989	4.9	-3.9	-1.2	-3.3	0.0	-0.8	3.4	-0.8	0.5	0.4
1990	6.8	-4.4	-0.8	-3.9	-0.3	-0.1	3.3	0.5	-0.4	-0.1
Average Difference	5.1	-4.2	-0.7	-3.0	-0.4	-0.3	4.3	0.7	1.2	-1.9

Community College Transfers by Ethnicity to the California State University,
Fall 1981 to Fall 1990

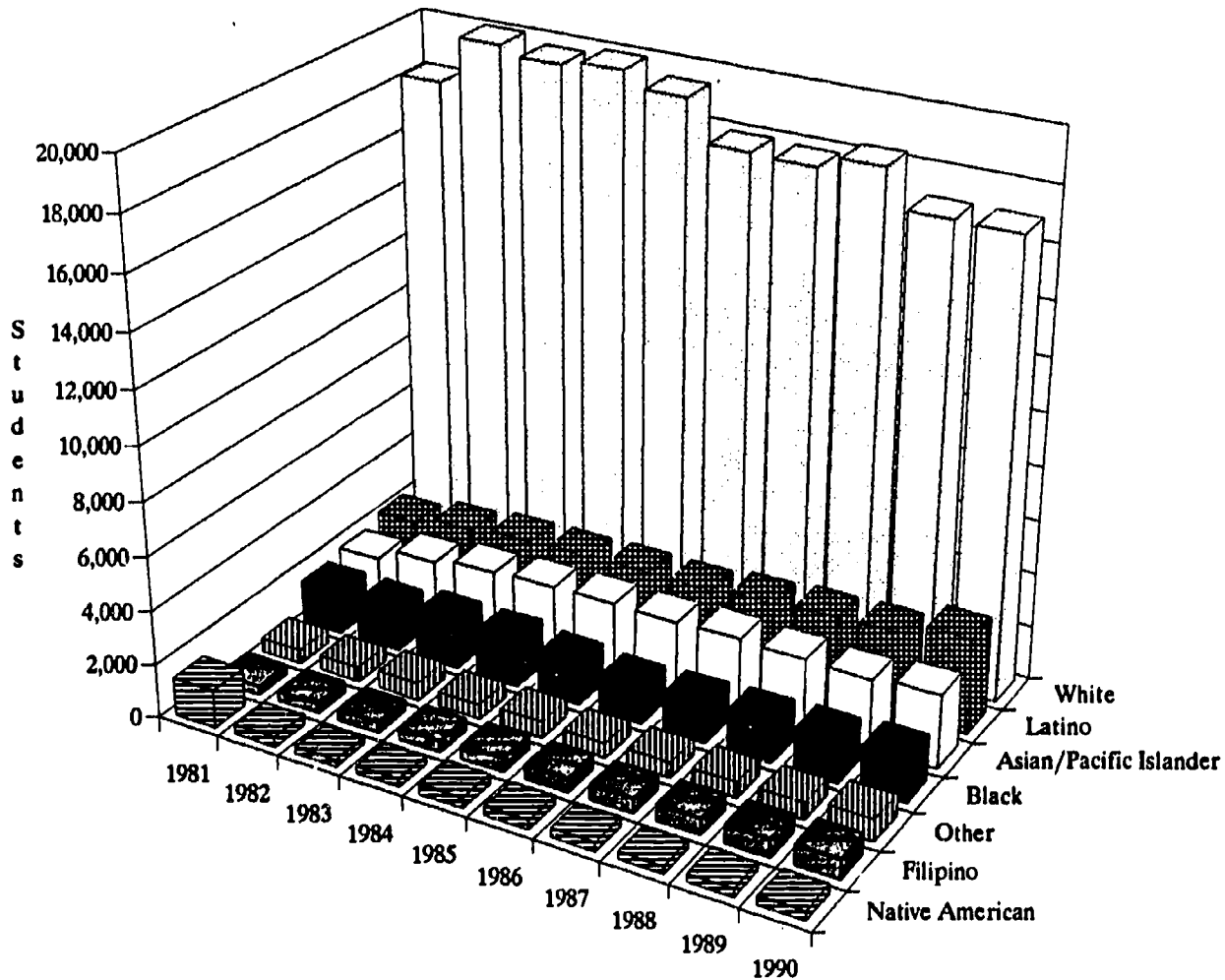

Fall Term	Total Transfer Students	Asian/Pacific Islander	Black	Filipino	Latino	Native American	Other	White	Total, Declared Ethnicity	Non-Resident Alien	No Response
1981	30,072	1,801	1,615	340	2,147	1,417	541	18,206	26,067	585	3,420
1982	29,824	2,309	1,593	379	2,467	371	547	19,955	27,621	524	1,679
1983	30,274	2,541	1,790	401	2,644	257	630	19,648	27,911	490	1,872
1984	30,134	2,649	1,769	446	2,695	294	550	19,876	28,279	462	1,393
1985	29,682	2,693	1,577	525	2,718	377	631	19,328	27,849	535	1,298
1986	27,761	2,651	1,403	546	2,698	332	547	17,859	26,036	579	1,146
1987	28,257	2,721	1,475	567	2,875	334	578	17,789	26,339	624	1,294
1988	29,393	2,665	1,560	636	3,019	288	602	18,260	27,030	665	1,698
1989	28,331	2,607	1,611	678	3,092	312	628	16,932	25,860	653	1,818
1990	29,370	2,759	1,717	768	3,615	359	822	16,924	26,964	644	1,762
% Change	-2.3	53.2	6.3	125.9	68.4	-74.7	51.9	-7.0	3.4	10.1	-48.5

Distribution of Total California Community College (Credit) Enrollment by Ethnicity, Fall 1981 to Fall 1990

Fall Term	Total (Credit) Students	Asian/Pacific Islander	Black	Filipino	Latino	Native American	Other	White	Total, Declared Ethnicity	Non-Resident Alien	No Response
1981	1,202,682	4.6	8.1	1.5	10.4	1.5	1.9	60.6	88.6	2.3	9.1
1982	1,191,366	5.5	8.5	1.7	11.1	1.5	2.3	60.6	91.2	1.9	6.9
1983	1,087,425	6.2	8.4	1.9	11.0	1.5	2.4	60.5	91.9	2.1	6.0
1984	1,005,576	6.6	7.5	2.1	11.2	1.4	2.3	61.1	92.2	2.2	5.6
1985	1,006,686	7.1	7.2	2.1	11.8	1.3	2.0	61.1	92.6	2.3	5.1
1986	1,046,099	7.2	7.3	2.3	12.4	1.3	1.9	60.9	93.3	2.3	4.5
1987	1,061,014	7.3	7.0	2.3	12.3	1.3	1.8	61.1	93.7	2.4	3.9
1988	1,093,152	7.2	7.0	2.6	13.4	1.3	2.0	60.1	93.6	2.7	3.7
1989	1,136,119	7.6	7.1	2.7	14.2	1.3	1.9	59.0	93.7	3.2	3.1
1990	1,207,565	7.6	7.2	2.8	14.6	1.6	1.6	55.6	91.0	4.5	4.5

Distribution of New Community College Transfers to the California State University by Ethnicity, Fall 1981 to Fall 1990

Fall Term	Total Students	Asian/Pacific Islander	Black	Filipino	Latino	Native American	Other	White	Total, Declared Ethnicity	Non-Resident Alien	No Response
1981	30,072	6.0	5.4	1.1	7.1	4.7	1.8	60.5	86.7	1.9	11.4
1982	29,824	7.7	5.3	1.5	8.3	1.2	1.8	66.9	92.6	1.8	5.6
1983	30,274	8.4	5.9	1.7	8.7	0.8	2.1	64.9	92.2	1.6	6.2
1984	30,154	8.8	5.9	1.5	8.9	1.0	1.8	66.0	93.8	1.5	4.6
1985	29,682	9.1	5.3	1.8	9.2	1.3	2.1	65.1	93.8	1.8	4.4
1986	27,761	9.5	5.1	2.0	9.7	1.2	2.0	64.3	93.8	2.1	4.1
1987	28,257	9.6	5.2	2.0	10.2	1.2	2.0	63.0	93.2	2.2	4.6
1988	29,393	9.1	5.3	2.2	10.3	1.0	2.0	62.1	92.0	2.3	5.8
1989	28,331	9.2	5.7	2.4	10.9	1.1	2.2	59.8	91.3	2.3	6.4
1990	29,570	9.4	5.8	2.6	12.3	1.2	2.8	57.6	91.8	2.2	6.0

Difference Between California Community College (Credit) Enrollment Ethnic Distribution and Ethnic Distribution of California Community College Transfer Students to the California State University

Fall Term	Asian/Pacific Islander	Black	Filipino	Latino	Native American	Other	White	Total, Declared Ethnicity	Non-Resident Alien	No Response
1981	1.4	-2.7	-0.4	-3.3	3.2	-0.1	-0.1	-1.9	-0.4	2.3
1982	2.2	-3.2	-0.4	-2.8	-0.3	-0.5	6.3	1.4	-0.1	-1.3
1983	2.2	-2.5	-0.6	-2.3	-0.7	-0.3	4.4	0.3	-0.5	0.2
1984	2.2	-1.6	-0.6	-2.3	-0.4	-0.5	4.9	1.6	-0.7	-1.0
1985	2.0	-1.9	-0.3	-2.6	0.0	0.1	4.0	1.2	-0.5	-0.7
1986	2.3	-2.2	-0.1	-2.7	-0.1	0.1	3.4	0.5	-0.2	-0.4
1987	2.3	-1.8	-0.4	-2.6	-0.1	0.2	1.9	-0.5	-0.2	0.7
1988	1.9	-1.7	-0.4	-3.1	-0.3	0.0	2.0	-1.6	-0.4	2.1
1989	1.6	-1.4	-0.3	-3.3	-0.2	0.3	0.8	-2.4	-0.9	3.3
1990	1.8	-1.4	-0.2	-2.3	-0.4	1.2	2.0	0.8	-2.3	1.5
Average Difference	2.0	-2.0	-0.4	-2.7	0.1	0.0	3.0	-0.1	-0.6	0.7

Community College Transfers by Ethnicity to the University of California,
Fall 1981 to Fall 1990

Change in Share of Community College Transfer Students as a Percentage of Transfer
by Ethnicity, Fall 1981 to Fall 1990

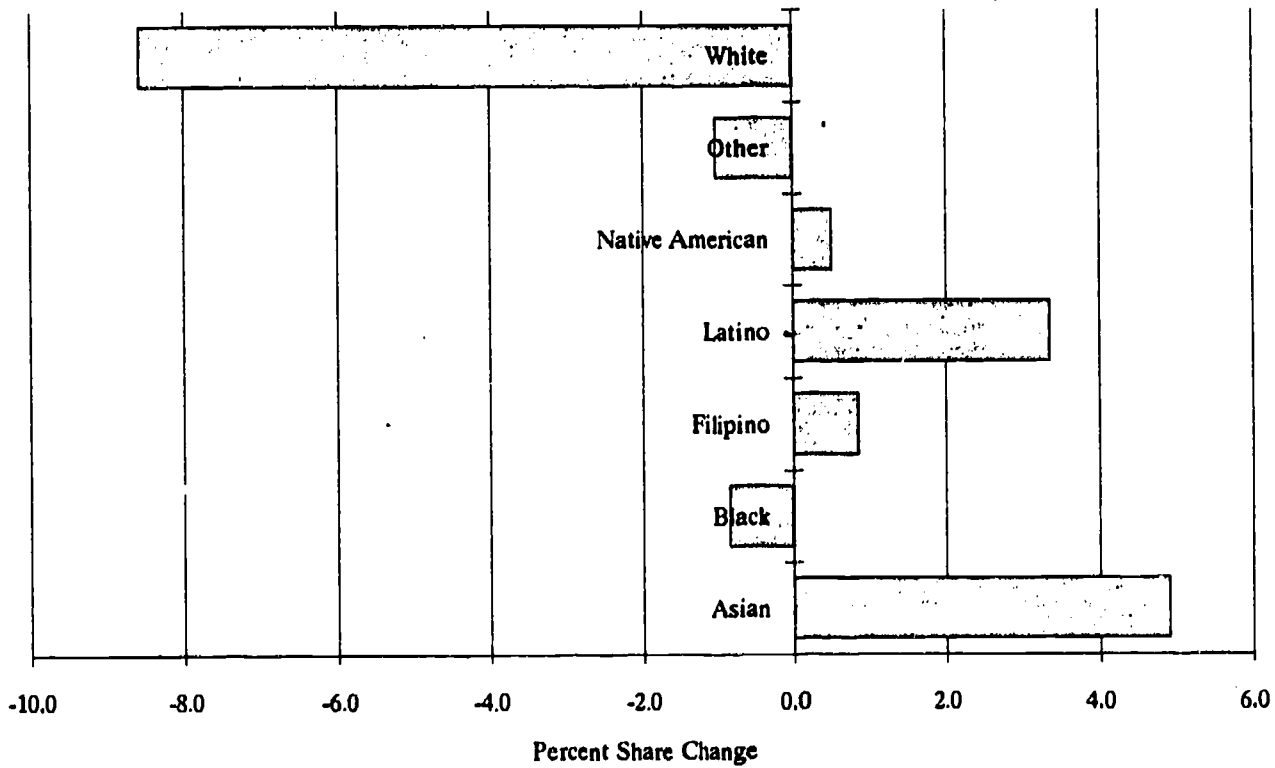

Fall Term	Total Transfer Students	Asian/Pacific Islander	Black	Filipino	Latino	Native American	Other	White	Total, Declared Ethnicity	Non-Resident Alien	No Response
1981	4,844	457	177	54	357	41	120	3,266	4,472	177	195
1982	5,136	519	176	60	389	32	112	3,482	4,770	183	183
1983	5,305	586	204	47	434	43	96	3,568	4,978	150	177
1984	5,257	585	161	72	461	41	113	3,483	4,916	197	144
1985	4,931	574	151	75	492	41	90	3,209	4,632	179	120
1986	4,858	591	168	86	431	40	100	3,005	4,421	221	216
1987	5,465	708	183	115	525	51	53	3,466	5,101	217	147
1988	5,855	740	185	95	639	82	52	3,673	5,466	226	163
1989	6,224	780	197	94	680	78	69	3,882	5,780	229	215
1990	7,420	1,065	209	147	796	101	108	4,366	6,792	300	328
% Share Change		4.9	-0.8	0.9	3.4	0.5	-1.0	-8.6		0.4	0.4

Community College Transfers by Ethnicity to the California State University,
Fall 1981 to Fall 1990

Change in Share of Community College Transfer Students as a Percentage of Transfer
by Ethnicity, Fall 1981 to Fall 1990

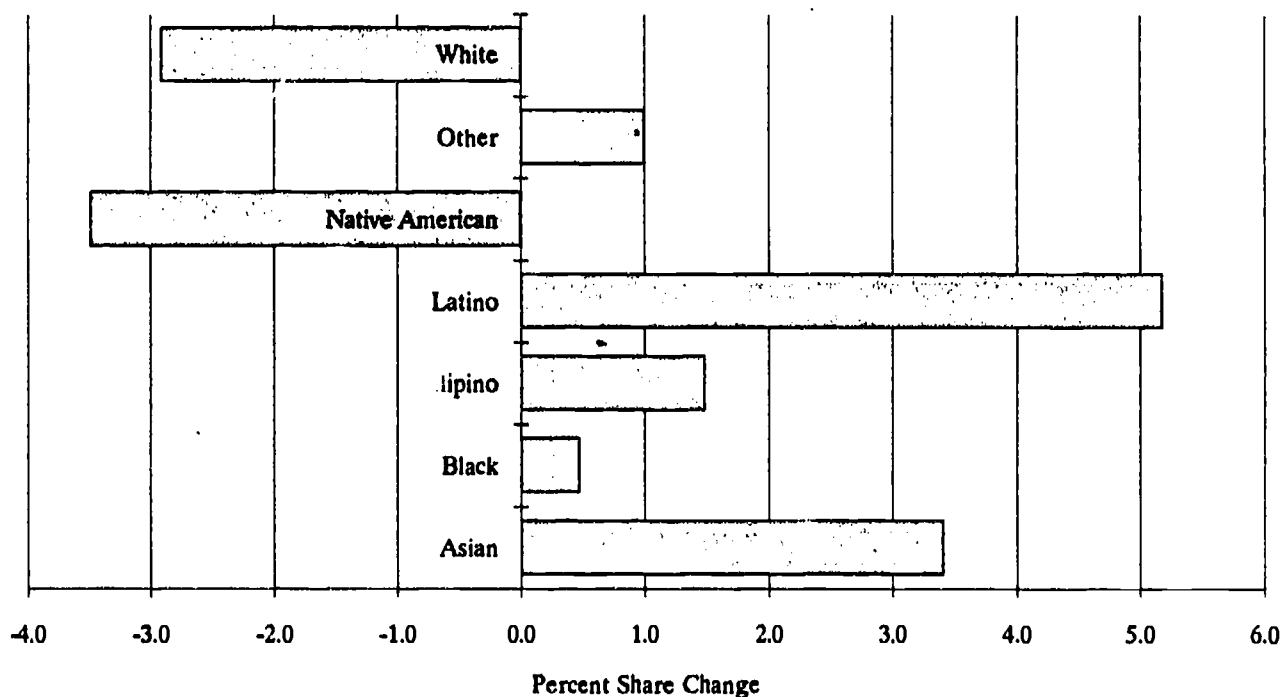

Fall Term	Total Transfer Students	Asian/Pacific Islander	Black	Filipino	Latino	Native American	Other	White	Total, Declared Ethnicity	Non-Resident Alien	No Response
1981	30,072	1,801	1,615	340	2,147	1,417	541	18,206	26,067	585	3,420
1982	29,824	2,309	1,593	379	2,467	371	547	19,955	27,621	524	1,679
1983	30,274	2,541	1,790	401	2,644	257	630	19,648	27,911	490	1,873
1984	30,134	2,649	1,769	446	2,695	294	550	19,876	28,279	462	1,393
1985	29,682	2,693	1,577	525	2,718	377	631	19,328	27,849	535	1,298
1986	27,761	2,651	1,403	546	2,698	332	547	17,859	26,036	579	1,146
1987	28,257	2,721	1,475	567	2,875	334	578	17,789	26,339	624	1,294
1988	29,393	2,665	1,560	636	3,019	288	602	18,260	27,030	665	1,698
1989	28,331	2,607	1,611	678	3,092	312	628	16,932	25,860	653	1,818
1990	29,370	2,759	1,717	768	3,615	359	822	16,924	26,964	644	1,762

% Share Change	3.4	0.5	1.5	5.2	-3.5	1.0	-2.9	-1.9	-11.4
----------------	-----	-----	-----	-----	------	-----	------	------	-------

Total California Community College (Credit) Enrollment by Ethnicity, Fall 1981 to Fall 1990

Fall Term	Total (Credit) Students	Asian/Pacific Islander	Black	Filipino	Latino	Native American	Other	White	Total Declared Ethnicity	Non-Resident Alien	No Response
1981	1,202,682	55,780	97,503	17,471	124,940	17,799	23,269	728,770	1,065,532	27,429	109,721
1982	1,191,366	66,099	100,787	20,780	131,844	17,401	27,632	721,965	1,086,508	22,267	82,591
1983	1,087,425	67,907	90,851	20,723	119,864	15,962	26,267	657,731	999,305	22,909	65,211
1984	1,005,576	66,825	75,276	21,233	112,632	14,099	23,415	614,124	927,604	21,892	56,080
1985	1,006,786	71,003	72,048	20,851	119,277	13,238	20,344	615,444	932,205	23,139	51,342
1986	1,046,099	75,307	76,786	22,369	129,769	13,649	20,068	637,553	975,501	23,717	46,881
1987	1,061,014	77,389	74,407	25,582	135,640	13,532	19,610	648,381	994,541	25,290	41,183
1988	1,093,152	79,187	76,283	28,370	144,401	14,313	21,469	656,985	1,023,008	29,610	40,334
1989	1,136,119	85,923	80,888	30,556	161,129	14,296	21,709	670,381	1,064,882	30,058	35,179
1990	1,205,565	91,433	87,106	33,842	176,391	19,432	19,229	669,884	1,097,317	53,800	54,448

New Community College Transfers to the University of California by Ethnicity, Fall 1981 to Fall 1990

Fall Term	Total Transfer Students	Asian/Pacific Islander	Black	Filipino	Latino	Native American	Other	White	Total Declared Ethnicity	Non-Resident Alien	No Response
1981	4,844	457	177	54	357	41	120	3,266	4,472	177	195
1982	5,136	519	176	60	389	32	112	3,482	4,770	183	183
1983	5,305	586	204	47	434	43	96	3,568	4,978	150	177
1984	5,257	585	161	72	461	41	113	3,483	4,916	197	144
1985	4,931	574	151	71	492	41	90	3,209	4,632	179	120
1986	4,858	591	168	86	431	40	100	3,005	4,421	221	216
1987	5,465	708	183	115	525	51	53	3,466	5,101	217	147
1988	5,855	740	185	95	639	82	52	3,673	5,466	226	163
1989	6,271	780	197	94	680	78	69	3,882	5,780	229	215
1990	7,420	1,065	209	147	796	101	108	4,366	6,792	300	323

Number of Transfer Students (per 1,000 Credit Enrollments) to the University of California by Ethnicity, Fall 1981 to Fall 1990

Fall Term	Total Transfer Students (per 1,000)	Asian/Pacific Islander (per 1,000)	Black (per 1,000)	Filipino (per 1,000)	Latino (per 1,000)	Native American (per 1,000)	Other (per 1,000)	White (per 1,000)	Total Declared Ethnicity (per 1,000)	Non-Resident Alien (per 1,000)	No Response (per 1,000)
1981	4.03	8.19	1.82	3.09	2.86	2.30	5.16	4.48	4.20	6.45	1.78
1982	4.31	7.85	1.75	2.89	2.95	1.84	4.05	4.82	4.39	8.22	2.22
1983	4.87	8.63	2.25	2.27	3.62	2.69	3.65	5.42	4.98	6.55	2.71
1984	5.23	8.75	2.14	3.39	4.09	2.91	4.83	5.67	5.30	9.00	2.57
1985	4.90	8.08	2.10	3.60	4.12	3.10	4.42	5.21	4.97	7.74	2.34
1986	4.64	7.85	2.19	3.84	3.32	2.93	4.98	4.71	4.53	9.32	4.61
1987	5.15	9.15	2.46	4.50	3.87	3.77	2.70	5.35	5.13	8.58	3.57
1988	5.36	9.34	2.43	3.35	4.36	5.73	2.42	5.59	5.34	7.58	4.04
1989	5.48	9.08	2.44	3.08	4.22	5.46	3.18	5.79	5.43	6.35	6.11
1990	6.15	11.65	2.40	4.34	4.51	5.20	5.62	6.52	6.19	5.58	6.02

Number of Transfer Students (per 1,000 Credit Enrollments) to the University of California
by Ethnicity, Fall 1981 to Fall 1990

All Ethnicities (except Native American and Other)

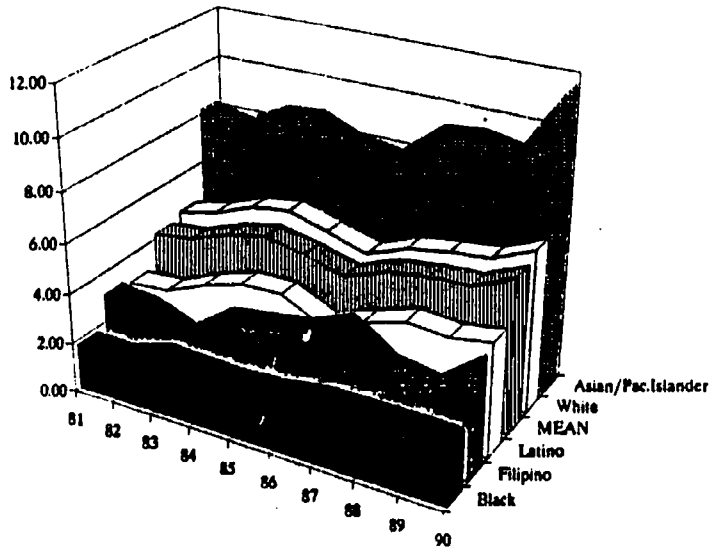

Asian/Pacific Islander

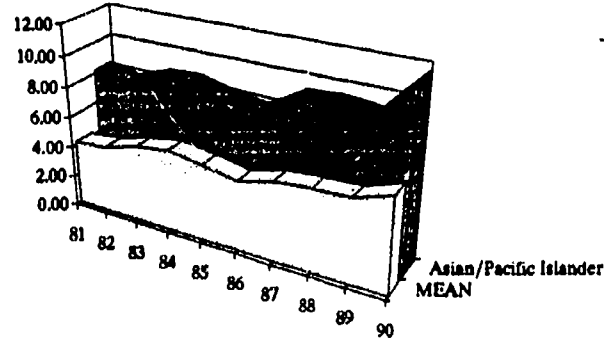

White

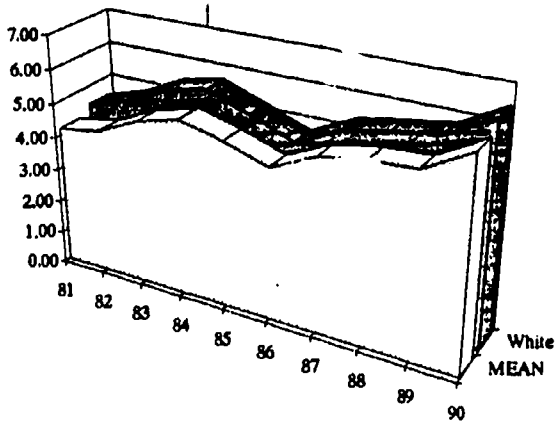

Latino

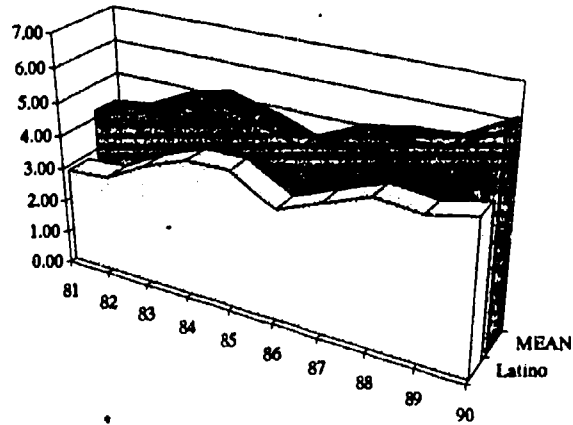

Filipino

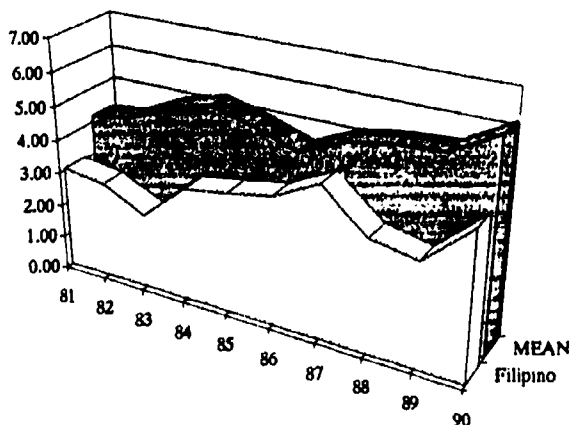

Black

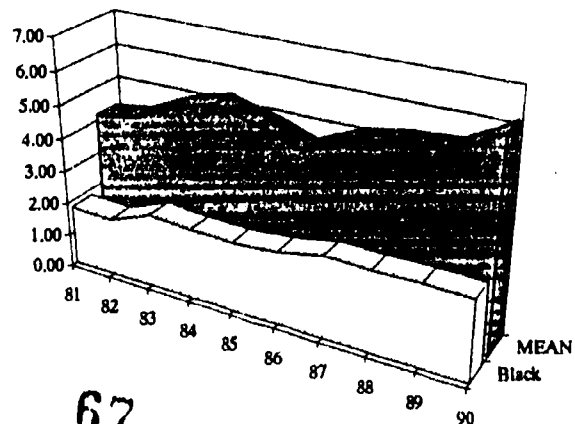

Total California Community College (Credit) Enrollment by Ethnicity, Fall 1981 to Fall 1990

Fall Term	Total (Credit) Students	Asian/Pacific Islander	Black	Filipino	Latino	Native American	Other	White	Total, Declared Ethnicity	Non-Resident Alien	No Response
1981	1,202,682	55,780	97,503	17,471	124,940	17,799	23,269	728,770	1,065,532	27,429	109,721
1982	1,191,366	66,099	100,787	20,780	131,844	17,401	27,632	721,965	1,086,508	22,267	82,591
1983	1,087,425	67,907	90,851	20,723	119,864	15,962	26,267	657,731	999,305	22,909	65,211
1984	1,005,576	66,825	75,276	21,233	112,632	14,099	23,415	614,124	927,604	21,892	56,080
1985	1,006,686	71,003	72,048	20,851	119,277	13,238	20,344	615,444	932,205	23,139	51,342
1986	1,046,099	75,307	76,786	22,369	129,769	13,649	20,068	637,553	975,501	23,717	46,881
1987	1,061,014	77,389	74,407	25,582	135,640	13,532	19,610	648,381	994,541	25,290	41,183
1988	1,093,152	79,187	76,283	28,370	146,401	14,313	21,469	656,985	1,023,008	29,810	40,334
1989	1,136,119	85,923	80,888	30,556	161,129	14,296	21,709	670,381	1,064,882	36,058	35,179
1990	1,205,565	91,433	87,106	33,842	176,391	19,432	19,229	669,884	1,097,317	53,800	54,448

New Community College Transfers to the California State University by Ethnicity, Fall 1981 to Fall 1990

Fall Term	Total Transfer Students	Asian/Pacific Islander	Black	Filipino	Latino	Native American	Other	White	Total, Declared Ethnicity	Non-Resident Alien	No Response
1981	30,072	1,801	1,615	340	2,147	1,417	541	18,206	26,067	585	3,420
1982	29,824	2,309	1,593	379	2,467	371	547	19,955	27,621	524	1,679
1983	30,274	2,541	1,790	401	2,644	257	630	19,648	27,911	490	1,873
1984	30,134	2,649	1,769	446	2,695	294	550	19,876	28,279	462	1,393
1985	29,682	2,693	1,577	525	2,718	377	631	19,328	27,849	535	1,298
1986	27,761	2,651	1,403	546	2,698	332	547	17,859	26,036	579	1,146
1987	28,257	2,711	1,475	567	2,875	334	578	17,789	26,339	624	1,294
1988	29,393	2,665	1,560	636	3,019	288	602	18,260	27,030	665	1,698
1989	28,331	2,607	1,611	678	3,092	312	628	16,932	25,860	653	1,818
1990	29,370	2,759	1,717	768	3,615	359	822	16,924	26,964	644	1,762

Number of Transfer Students (per 1,000 Credit Enrollments) to the California State University by Ethnicity, Fall 1981 to Fall 1990

Fall Term	Total Transfer Students (per 1,000)	Asian/Pacific Islander (per 1,000)	Black (per 1,000)	Filipino (per 1,000)	Latino (per 1,000)	Native American (per 1,000)	Other (per 1,000)	White (per 1,000)	Total, Declared Ethnicity (per 1,000)	Non-Resident Alien (per 1,000)	No Response (per 1,000)
1981	25.00	32.29	16.56	19.46	17.18	79.61	23.25	24.98	24.46	21.33	31.17
1982	25.03	34.93	15.81	18.24	18.71	21.32	19.80	27.64	25.42	23.53	20.33
1983	27.84	37.42	19.70	19.35	22.06	16.10	23.98	29.87	27.93	21.39	28.72
1984	29.97	39.64	23.50	21.01	23.93	20.85	23.49	32.36	30.49	21.10	24.84
1985	29.48	37.93	21.89	25.18	22.79	28.48	31.02	31.40	29.87	23.12	25.28
1986	26.54	35.20	18.27	24.41	20.79	24.32	27.26	28.01	26.69	24.41	24.44
1987	26.63	35.16	19.82	22.16	21.20	24.68	29.47	27.44	26.48	24.67	31.42
1988	26.89	33.65	20.45	22.42	20.62	20.12	28.04	27.79	26.42	22.31	42.10
1989	24.94	30.34	19.92	22.19	19.19	21.82	28.93	25.26	24.28	18.11	51.68
1990	24.36	30.18	19.71	22.69	20.49	18.47	42.75	25.26	24.57	11.97	32.36

Number of Transfer Students (per 1,000 Credit Enrollments) to the California State University
by Ethnicity, Fall 1981 to Fall 1990

All Ethnicities (Except Native American and Other)

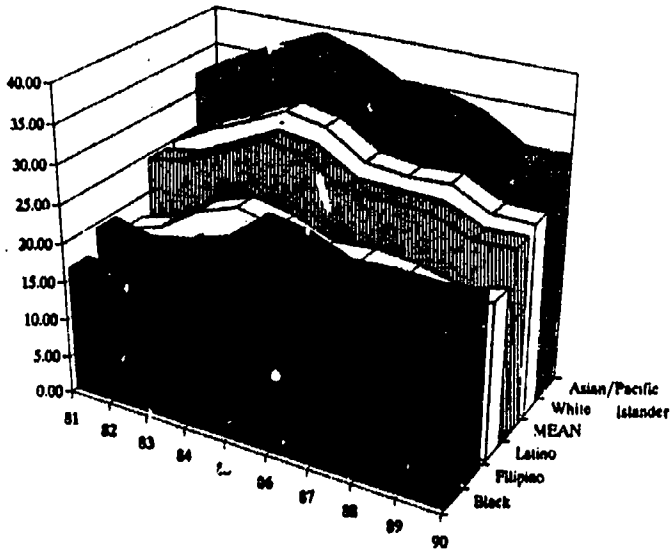

Asian/Pacific Islanders

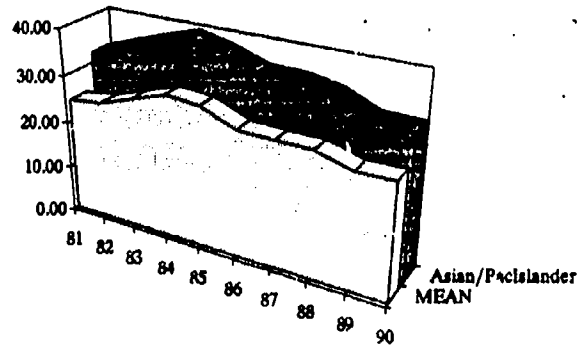

White

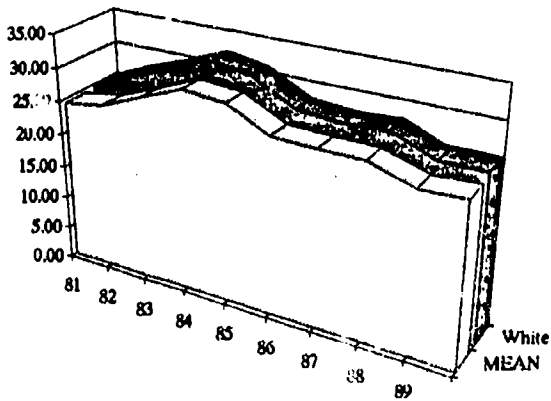

Latino

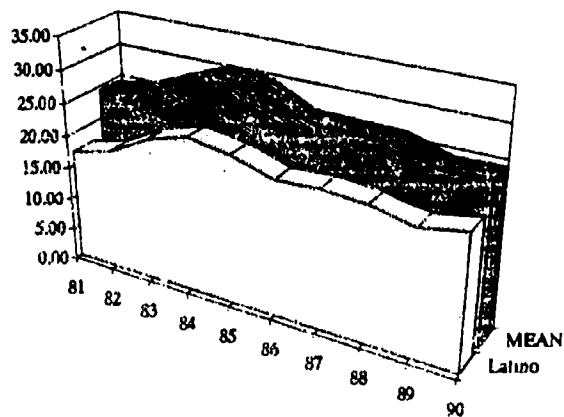

Filipino

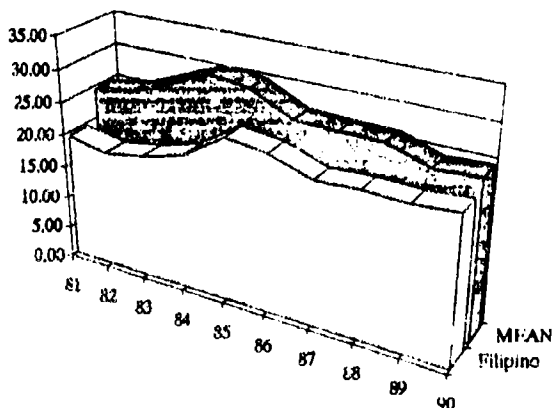

Black

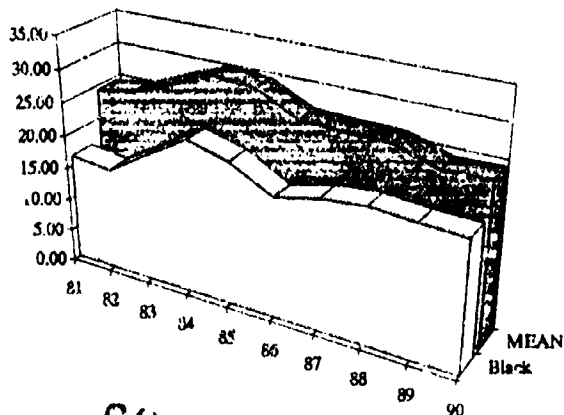

Undergraduate Transfer Students by Student Level Enrolled at the University of California, Fall 1981 to Fall 1990

Student Level	Fall Term	Total Transfer Students	California Community Colleges	California State University	University of California	Independent Colleges and Universities	Out of State Institutions	Foreign Institutions	
Freshmen	1981	700	398	90	150	62	0	0	
	1982	782	457	111	155	59	0	0	
	1983	956	559	122	193	82	0	0	
	1984	743	448	97	140	58	0	0	
	1985	543	315	72	117	39	0	0	
	1986	742	437	88	169	48	0	0	
	1987	746	453	95	140	58	0	0	
	1988	732	492	79	125	36	0	0	
	1989	525	348	68	76	33	0	0	
	1990	694	547	47	75	25	0	0	
	Sophomore	1981	2,443	1,343	285	352	112	316	35
		1982	3,229	1,750	350	531	188	372	38
		1983	3,250	1,830	309	577	136	373	25
1984		3,047	1,865	272	443	138	303	26	
1985		2,757	1,688	235	444	120	246	24	
1986		2,605	1,648	241	326	117	251	22	
1987		2,725	1,824	222	316	116	221	26	
1988		2,475	1,760	163	228	94	204	26	
1989		2,734	2,041	167	252	83	180	11	
1990		2,905	2,250	148	230	71	173	33	
Junior		1981	5,182	3,005	543	678	245	664	47
	1982	4,379	2,851	385	536	169	418	20	
	1983	4,477	2,819	403	624	171	432	28	
	1984	4,233	2,850	381	506	136	327	33	
	1985	4,245	2,837	370	486	132	384	36	
	1986	3,977	2,688	353	470	135	308	23	
	1987	4,610	3,109	371	578	153	357	42	
	1988	4,816	3,511	299	540	127	308	31	
	1989	4,747	3,742	266	379	100	225	35	
	1990	5,528	4,493	227	431	95	238	44	
	Senior	1981	511	98	70	132	56	103	52
1982		436	78	51	146	31	84	46	
1983		512	97	74	155	32	99	55	
1984		398	94	59	129	19	74	23	
1985		473	91	66	118	22	86	90	
1986		321	85	46	71	13	57	49	
1987		297	79	56	84	15	21	42	
1988		270	92	35	73	17	44	9	
1989		247	93	35	61	11	35	12	
1990		298	130	40	54	14	36	24	

Undergraduate Transfer Students by Student Level Enrolled at the University of California, Fall 1981 to Fall 1990

Student Level	Fall Term	Total Transfer Students	California Community Colleges	California State University	University of California	Independent Colleges and Universities	Out of State Institutions	Foreign Institutions
Percent Distribution								
Freshmen	1981	7.9	8.2	9.1	11.4	13.1	0.0	0.0
	1982	8.9	8.9	12.4	11.3	13.2	0.0	0.0
	1983	10.4	10.5	13.4	12.5	19.5	0.0	0.0
	1984	8.8	8.5	12.0	11.5	16.5	0.0	0.0
	1985	6.8	6.4	9.7	10.0	12.5	0.0	0.0
	1986	9.7	9.0	12.1	16.3	15.3	0.0	0.0
	1987	8.9	8.3	12.8	12.5	17.0	0.0	0.0
	1988	8.8	8.4	13.7	12.9	13.1	0.0	0.0
	1989	6.4	5.6	12.7	9.9	14.5	0.0	0.0
	1990	7.4	7.4	10.2	9.5	12.2	0.0	0.0
Sophomore	1981	27.6	27.7	28.8	26.8	23.6	29.2	26.1
	1982	36.6	34.1	39.0	38.8	42.1	42.6	36.5
	1983	35.3	34.5	34.0	37.2	32.3	41.3	23.1
	1984	36.2	35.5	33.6	36.4	39.3	43.0	31.7
	1985	34.4	34.2	31.6	38.1	38.3	34.4	16.0
	1986	34.1	33.9	33.1	31.5	37.4	40.7	23.4
	1987	32.5	33.4	29.8	28.3	33.9	36.9	23.6
	1988	29.8	30.1	28.3	23.6	34.3	36.7	39.4
	1989	33.1	32.8	31.2	32.8	36.6	40.9	19.0
	1990	30.8	30.3	32.0	29.1	34.6	38.7	32.7
Junior	1981	58.6	62.0	55.0	51.7	51.6	61.3	35.1
	1982	49.6	55.5	42.9	39.2	37.8	47.8	19.2
	1983	48.7	53.1	44.4	40.3	40.6	47.8	25.9
	1984	50.3	54.2	47.1	41.5	38.7	46.4	40.2
	1985	52.9	57.5	49.8	41.7	42.2	53.6	24.0
	1986	52.0	55.3	48.5	45.4	43.1	50.0	24.5
	1987	55.0	56.9	49.9	51.7	44.7	59.6	38.2
	1988	58.1	60.0	51.9	55.9	46.4	55.4	47.0
	1989	57.5	60.1	49.6	49.3	44.1	51.1	60.3
	1990	58.7	60.6	49.1	54.6	46.3	53.2	43.6
Senior	1981	5.8	2.0	7.1	10.1	11.8	9.5	38.8
	1982	4.9	1.5	5.7	10.7	6.9	9.6	44.2
	1983	5.6	1.8	8.1	10.0	7.6	11.0	50.9
	1984	4.7	1.8	7.3	10.6	5.4	10.5	28.0
	1985	5.9	1.8	8.9	10.1	7.0	12.0	60.0
	1986	4.2	1.7	6.3	6.9	4.2	9.3	52.1
	1987	3.5	1.4	7.5	7.5	4.4	3.5	38.2
	1988	3.3	1.6	6.1	7.6	6.2	7.9	13.6
	1989	3.0	1.5	6.5	7.9	4.8	8.0	20.7
	1990	3.2	1.8	8.7	6.8	6.8	8.1	23.8

**Undergraduate Transfer Students by Student Level Enrolled
at the California State University, Fall 1981 to Fall 1990**

Student Level	Fall Term	Total Transfer Students	California Community Colleges	California State University	University of California	Independent Colleges and Universities	Out of State Institutions	Foreign Institutions
Freshmen	1981	5,192	3,314	643	285	275	552	123
	1982	4,364	2,757	521	274	239	454	119
	1983	4,379	2,764	564	258	218	452	123
	1984	4,046	2,448	557	246	221	449	125
	1985	4,135	2,395	575	300	236	506	123
	1986	3,437	1,938	510	224	216	420	129
	1987	3,236	1,889	473	197	189	372	116
	1988	3,605	2,126	527	196	198	445	117
	1989	3,354	1,982	462	143	162	466	151
	1990	3,126	1,817	435	143	174	389	168
Sophomore	1981	11,560	8,769	897	429	444	867	154
	1982	11,224	8,698	767	407	425	819	108
	1983	10,222	7,648	791	437	361	829	156
	1984	10,389	7,839	813	381	382	860	114
	1985	10,847	8,277	746	385	416	916	107
	1986	9,902	7,497	681	343	411	835	135
	1987	9,646	7,474	650	289	341	779	113
	1988	10,015	7,681	719	287	346	819	163
	1989	9,782	7,654	646	259	326	725	172
	1990	9,698	7,781	588	207	298	666	158
Junior	1981	21,401	16,992	1,486	474	613	1,605	231
	1982	21,426	17,316	1,373	476	579	1,456	226
	1983	22,794	18,658	1,364	496	547	1,468	261
	1984	22,632	18,656	1,363	489	526	1,389	209
	1985	21,984	17,877	1,424	446	528	1,487	222
	1986	21,094	17,244	1,212	367	510	1,477	284
	1987	21,554	17,749	1,237	358	471	1,490	249
	1988	22,323	18,443	1,274	348	482	1,470	306
	1989	20,868	17,486	1,083	286	425	1,274	314
	1990	21,596	18,195	1,198	286	369	1,234	314
Senior	1981	2,993	997	783	263	212	623	115
	1982	2,766	1,053	725	200	181	507	100
	1983	2,951	1,204	740	204	179	513	111
	1984	3,039	1,191	775	217	196	579	81
	1985	2,979	1,133	807	190	204	548	97
	1986	2,825	1,082	752	160	186	554	91
	1987	2,903	1,145	778	158	182	528	112
	1988	2,819	1,145	780	146	157	505	88
	1989	2,784	1,209	636	135	148	539	117
	1990	3,222	1,577	684	139	163	535	124

**Undergraduate Transfer Students by Student Level Enrolled
at the California State University, Fall 1981 to Fall 1990**

Student Level	Fall Term	Total Transfer Students	California Community Colleges	California State University	University of California	Independent Colleges and Universities	Out of State Institutions	Foreign Institutions
			Percent Distribution					
Freshmen	1981	12.6	11.0	16.9	19.6	17.8	15.1	19.7
	1982	11.0	9.2	15.4	20.2	16.8	14.0	21.5
	1983	10.9	9.1	16.3	18.5	16.7	13.9	18.9
	1984	10.1	8.1	15.9	18.5	16.7	13.7	23.6
	1985	10.4	8.1	16.2	22.7	17.1	14.6	22.4
	1986	9.2	7.0	16.2	20.5	16.3	12.8	20.2
	1987	8.7	6.7	15.1	19.7	16.0	11.7	19.7
	1988	9.3	7.2	16.0	20.1	16.7	13.7	16.9
	1989	9.1	7.0	16.3	17.4	15.3	15.5	18.7
	1990	8.3	6.2	15.0	18.5	17.3	13.8	22.0
	Sophomore	1981	28.1	29.2	23.5	29.6	28.8	23.8
1982		28.2	29.2	22.7	30.0	29.8	25.3	19.5
1983		25.3	25.3	22.9	31.3	27.7	25.4	24.0
1984		25.9	26.0	23.2	28.6	28.8	26.2	21.6
1985		27.2	27.9	21.0	29.1	30.1	26.5	19.5
1986		26.6	27.0	21.6	31.4	31.1	25.4	21.1
1987		25.8	26.5	20.7	28.8	28.8	24.6	19.2
1988		25.8	26.1	21.8	29.4	29.2	25.3	24.3
1989		26.6	27.0	22.9	31.5	30.7	24.1	23.2
1990		25.8	26.5	20.2	26.7	29.7	23.6	20.7
Junior		1981	52.0	56.5	39.0	32.7	39.7	44.0
	1982	53.9	58.1	40.5	35.1	40.7	45.0	40.9
	1983	56.5	61.6	39.4	35.6	41.9	45.0	40.1
	1984	56.4	61.9	38.9	36.7	39.7	42.4	39.5
	1985	55.0	60.2	40.1	33.8	38.2	33.0	40.4
	1986	56.6	62.1	38.4	33.5	38.5	44.9	44.4
	1987	57.7	62.8	39.4	35.7	39.8	47.0	42.2
	1988	57.6	62.7	38.6	35.6	40.7	45.4	45.7
	1989	56.7	61.7	38.3	34.8	40.1	42.4	42.3
	1990	57.4	62.0	41.2	36.9	36.8	43.7	41.1
	Senior	1981	7.3	3.3	20.6	18.1	13.7	17.1
1982		7.0	3.5	21.4	14.7	12.7	15.7	18.1
1983		7.3	4.0	21.4	14.6	13.7	15.7	17.1
1984		7.6	4.0	22.1	16.3	14.8	17.7	15.3
1985		7.5	3.8	22.7	14.4	14.7	15.9	17.7
1986		7.6	3.9	23.8	14.6	14.1	16.9	14.2
1987		7.8	4.1	24.8	15.8	15.4	16.7	19.0
1988		7.3	3.9	23.6	14.9	13.3	15.6	13.1
1989		7.6	4.3	22.5	16.4	13.9	17.9	15.8
1990		8.6	5.4	23.5	17.9	16.2	18.9	16.2

Percentage of Four-Year Public University Enrollments and Bachelor's Degrees Awarded to Students Who Attended a California Community College

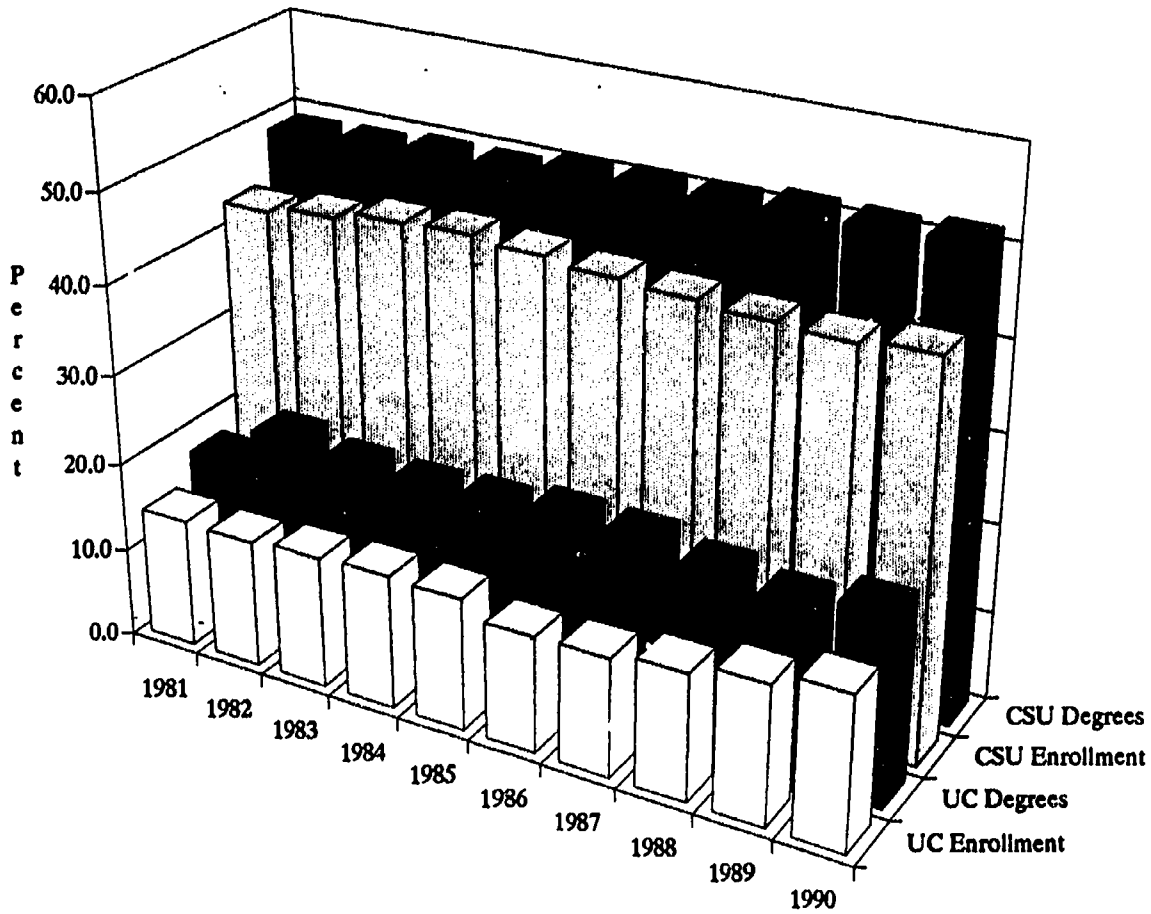

	University of California		California State University	
	Undergraduate Enrollment	Bachelor's Degrees	Undergraduate Enrollment	Bachelor's Degrees
1981	14.6	17.7	43.2	48.8
1982	14.4	22.2	44.1	49.0
1983	14.9	21.0	45.2	49.5
1984	15.2	20.7	45.5	49.4
1985	15.0	21.0	45.0	50.4
1986	13.2	21.9	44.4	50.7
1987	13.4	21.7	44.0	50.7
1988	14.3	20.5	43.5	51.3
1989	15.7	19.5	43.2	51.2
1990	17.3	21.1	43.9	51.6

Undergraduate Transfer Enrollment at the University of California, Fall 1981 to Fall 1990

Full-Time and Part-Time Enrollment

Fall Term	Total	Number		Percent	
		Full Time	Part Time	Full Time	Part Time
1981	4,844	4,468	376	92.2	7.8
1982	5,136	4,724	412	92.0	8.0
1983	5,305	4,805	500	90.6	9.4
1984	5,257	4,833	424	91.9	8.1
1985	4,931	4,539	392	92.1	7.9
1986	4,858	4,476	382	92.1	7.9
1987	5,465	4,932	533	90.2	9.8
1988	5,855	5,361	494	91.6	8.4
1989	6,224	5,711	513	91.8	8.2
1990	7,420	6,880	540	92.7	7.3

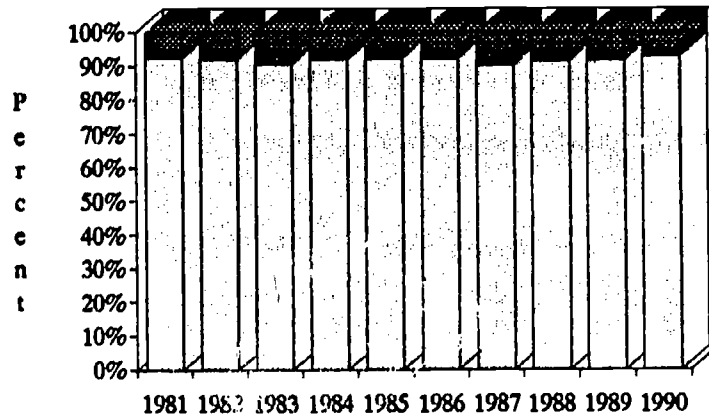

□ Full-Time ■ Part-Time

Undergraduate Enrollment by Gender

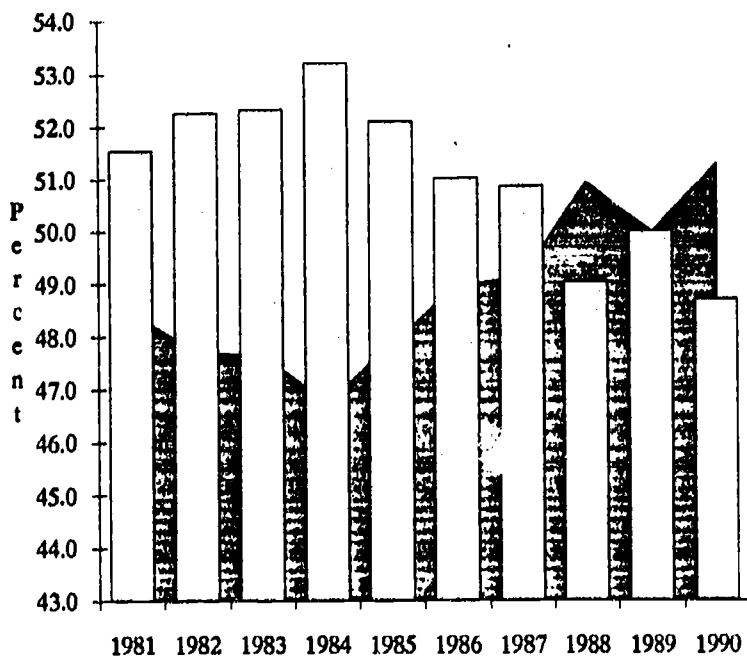

■ Women □ Men

Fall Term	Number		Percent	
	Men	Women	Men	Women
1981	2,497	2,347	51.5	48.5
1982	2,685	2,451	52.3	47.7
1983	2,777	2,528	52.3	47.7
1984	2,798	2,459	53.2	46.8
1985	2,570	2,361	52.1	47.9
1986	2,479	2,379	51.0	49.0
1987	2,780	2,685	50.9	49.1
1988	2,872	2,983	49.1	50.9
1989	3,113	3,111	50.0	50.0
1990	3,614	3,806	48.7	51.3

Undergraduate Transfer Enrollment at the California State University, Fall 1981 to Fall 1990

Full-Time and Part-Time Enrollment

Fall Term	Total	Number		Percent	
		Full Time	Part Time	Full Time	Part Time
1981	30,072	20,332	9,240	69.3	30.7
1982	29,824	20,965	8,859	70.3	29.7
1983	30,274	21,570	8,704	71.2	28.8
1984	30,134	21,267	8,867	70.6	29.4
1985	29,682	20,519	9,163	69.1	30.9
1986	27,761	18,990	8,771	68.4	31.6
1987	28,257	19,065	9,192	67.5	32.5
1988	28,393	19,967	9,426	67.9	32.1
1989	28,331	19,414	8,917	68.5	31.5
1990	29,370	20,106	9,264	68.5	31.5

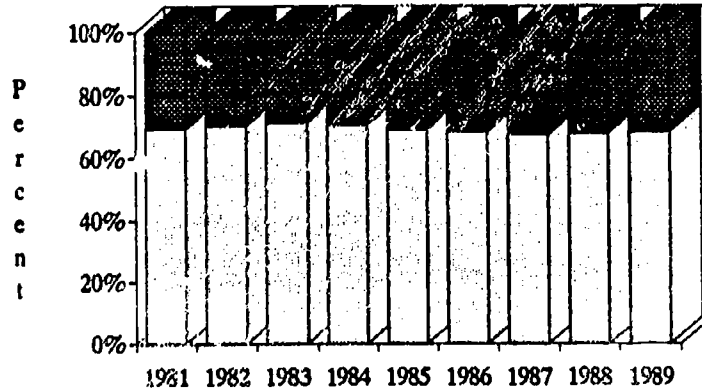

□ Full-Time ■ Part-Time

Undergraduate Enrollment by Gender

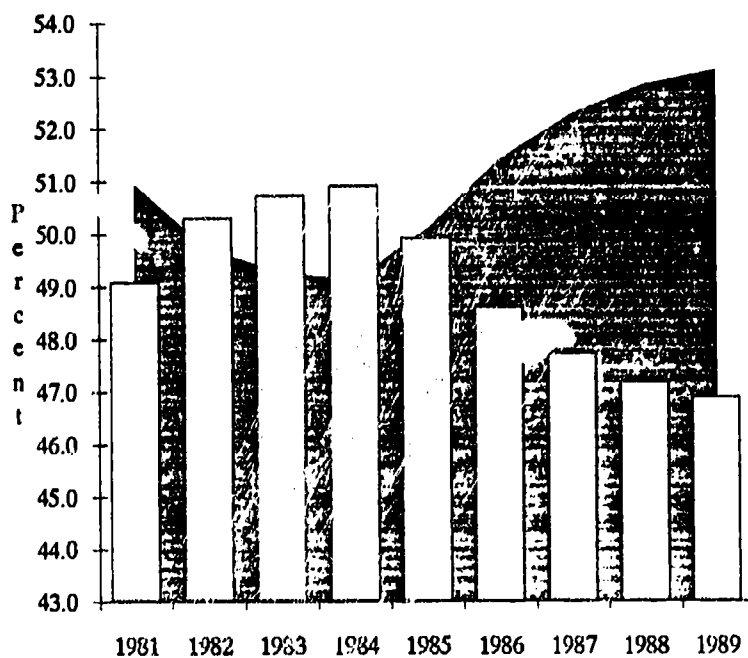

Fall Term	Number		Percent	
	Men	Women	Men	Women
1981	14,762	15,310	49.1	50.9
1982	15,005	14,819	50.3	49.7
1983	15,357	14,917	50.7	49.3
1984	15,341	14,793	50.9	49.1
1985	14,819	14,863	49.9	50.1
1986	13,495	14,266	48.6	51.4
1987	13,489	14,768	47.7	52.3
1988	13,870	15,523	47.2	52.8
1989	13,288	15,043	46.9	53.1
1990	13,509	15,861	46.0	54.0

■ Women □ Men

- 5-1 Degrees and Certificates Awarded at the University of California, 1980-81 through 1989-90
- 5-2 Total Undergraduate Enrollment at the University of California by Ethnicity, Fall 1981 to Fall 1990, and Bachelor's Degrees Awarded by Ethnicity, 1981-1990.
- 5-3 Degree Rate as a Function of Undergraduate Enrollment at the University of California, 1981 to 1990
- 5-4 Bachelor's Degrees Awarded at the University of California by Ethnicity, and Bachelor's Degrees Awarded to Students at the University of California who Transferred from a California Community College by Ethnicity, 1981 to 1990
- 5-5 Baccalaureate Degrees Awarded at the University of California by Discipline Division, Fall 1981 to Fall 1990
- 5-6 Master's Degrees Awarded at the University of California by Discipline Division, Fall 1981 to Fall 1990
- 5-7 Doctoral and First Professional Degrees Awarded at the University of California by Discipline Division, Fall 1981 to Fall 1990
- 5-8 Degrees Awarded at the California State University, 1980-81 through 1989-90
- 5-9 Total Undergraduate Enrollment at the California State University by Ethnicity, Fall 1981 to Fall 1990, and Bachelor's Degrees Awarded by Ethnicity, 1981-1990
- 5-10 Degree Rate as a Function of Undergraduate Enrollment at the California State University, 1981 to 1990
- 5-11 Bachelor's Degrees Awarded at the California State University by Ethnicity, 1981 to 1990, and Bachelor's Degrees Awarded at the California State University who Transferred from a California Community College by Ethnicity, 1981-1990
- 5-12 Baccalaureate Degrees Awarded at the California State University by Discipline Division, Fall 1981 to Fall 1990
- 5-13 Master's Degrees Awarded at the California State University by Discipline Division, Fall 1981 to Fall 1990

Degrees and Certificates Awarded at the University of California, 1980-81 through 1989-90.

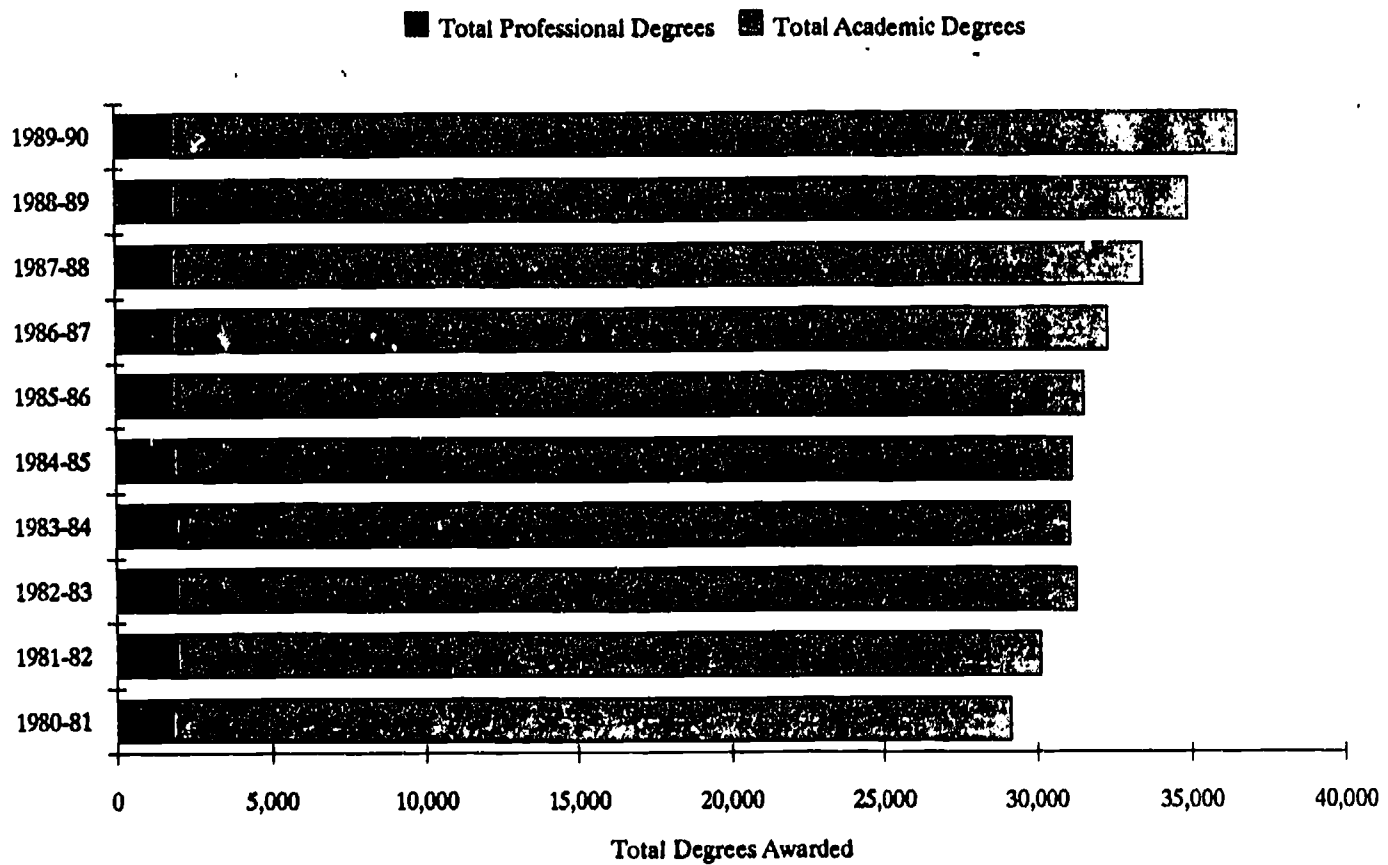

Degrees and Certificates Awarded at the University of California, 1980-81 Through 1989-90

Degree Type	1980-81	1981-82	1982-83	1983-84	1984-85	1985-86	1986-87	1987-88	1988-89	1989-90
Bachelors Degree	19,733	20,229	21,337	21,376	21,583	22,109	22,755	23,466	24,761	26,261
Masters Degree	5,569	5,979	5,954	5,752	5,751	5,608	5,751	5,893	6,054	6,148
Doctorate	2,111	1,983	2,084	2,064	2,012	2,065	2,023	2,297	2,307	2,311
Total Academic Degrees	27,413	28,191	29,375	29,192	29,346	29,782	30,529	31,656	33,122	34,720
Dentistry	176	223	207	209	199	184	193	197	172	165
Medicine	567	625	622	640	616	612	612	611	618	627
Optometry	59	69	62	70	63	64	59	63	67	67
Veterinary Medicine	85	127	120	123	134	125	107	122	121	118
Law	781	819	841	783	751	714	765	754	758	770
Pharmacy	113	94	101	107	98	109	111	99	111	118
Total Professional Degrees	1,781	1,957	1,953	1,932	1,861	1,808	1,847	1,846	1,847	1,865
Other Degrees & Certificates	835	847	822	801	734	812	752	780	761	750
Total Degrees and Awards	30,029	30,995	32,150	31,925	31,941	32,402	33,128	34,282	35,730	37,335

Total Undergraduate Enrollment at the University of California by Ethnicity, Fall 1981 to Fall 1990.

Fall Term	Total Undergraduates	Asian/Pacific Islander	Black	Filipino	Latino	Native American	Other	White	Total, Declared Ethnicity	Non-Resident Alien	No Response
1981	98,846	12,048	3,575	1,570	5,364	475	1,726	66,924	91,682	2,445	4,719
1982	100,751	13,207	3,701	1,893	5,701	499	1,821	67,658	94,480	2,435	3,836
1983	103,328	14,481	3,974	2,211	6,285	498	1,987	68,357	97,793	2,208	3,327
1984	106,025	15,615	4,207	2,584	7,049	536	2,059	68,615	100,665	2,205	3,155
1985	108,988	16,719	4,439	2,959	8,143	601	2,040	68,860	103,761	2,254	2,973
1986	112,363	18,113	4,702	3,361	8,949	661	2,008	68,716	106,580	2,450	3,333
1987	117,079	19,696	5,023	3,818	10,234	810	1,839	69,644	111,164	2,374	3,541
1988	121,001	21,247	5,513	4,105	11,600	977	1,681	69,606	114,729	2,601	3,671
1989	123,441	22,993	5,796	4,102	13,071	1,121	1,609	68,187	116,879	2,554	4,008
1990	124,271	25,093	5,622	4,270	14,191	1,206	1,565	65,549	117,496	2,306	4,469

Bachelor's Degrees Awarded at the University of California by Ethnicity, 1981 to 1990.

Term	Total Students	Asian/Pacific Islander	Black	Filipino	Latino	Native American	Other	White	Total, Declared Ethnicity	Non-Resident Alien	No Response
1981	19,730	1,953	469	134	799	100	1,824	13,077	18,356	413	964
1982	20,223	2,129	447	164	828	83	1,083	14,218	18,952	468	809
1983	21,337	2,466	506	216	970	106	644	15,072	19,980	561	796
1984	21,376	2,518	520	242	995	84	669	15,236	20,264	495	617
1985	21,583	2,777	554	307	1,031	90	505	15,117	20,311	521	751
1986	22,109	2,928	558	336	1,104	123	493	15,379	20,921	518	670
1987	22,755	3,310	621	436	1,296	100	428	15,242	21,433	496	826
1988	23,466	3,603	673	497	1,402	122	449	15,379	22,125	450	891
1989	24,761	3,832	770	616	1,691	140	451	15,816	23,316	536	909
1990	26,261	4,274	841	696	1,987	176	429	16,243	24,646	621	994

Degree Rate as a Function of Undergraduate Enrollment at the University of California, 1981 to 1990.

Fall Term	Total Students (per 1,000)	Asian/Pacific Islander (per 1,000)	Black (per 1,000)	Filipino (per 1,000)	Latino (per 1,000)	Native American (per 1,000)	Other (per 1,000)	White (per 1,000)	Total, Declared Ethnicity (per 1,000)	Non-Resident Alien (per 1,000)	No Response (per 1,000)
1981	199.63	162.10	131.19	85.35	148.96	210.53	1056.78	195.40	200.21	168.92	204.28
1982	200.78	161.20	120.78	86.63	145.24	166.33	594.73	210.15	200.59	192.20	210.90
1983	206.50	170.29	127.33	97.69	154.34	212.85	324.11	220.49	204.31	254.08	239.25
1984	201.61	161.26	123.60	93.65	141.15	156.72	324.92	222.05	201.30	224.49	195.56
1985	198.03	161.91	124.80	103.75	126.61	149.75	247.55	219.53	195.75	231.14	252.61
1986	196.76	161.65	116.93	99.97	123.37	186.08	245.52	223.81	196.29	211.43	201.02
1987	194.36	168.05	121.22	114.20	126.64	123.46	232.74	218.86	192.81	208.93	233.27
1988	193.93	169.58	122.08	121.07	120.86	124.87	267.10	220.94	192.85	173.01	242.71
1989	200.59	166.66	132.85	150.17	129.37	124.89	280.30	231.95	199.49	209.87	226.80
1990	211.32	170.33	149.59	163.00	140.02	145.94	274.12	247.80	209.76	269.30	222.42

Degree Rate as a Function of Undergraduate Enrollment at the University of California, 1981 to 1990

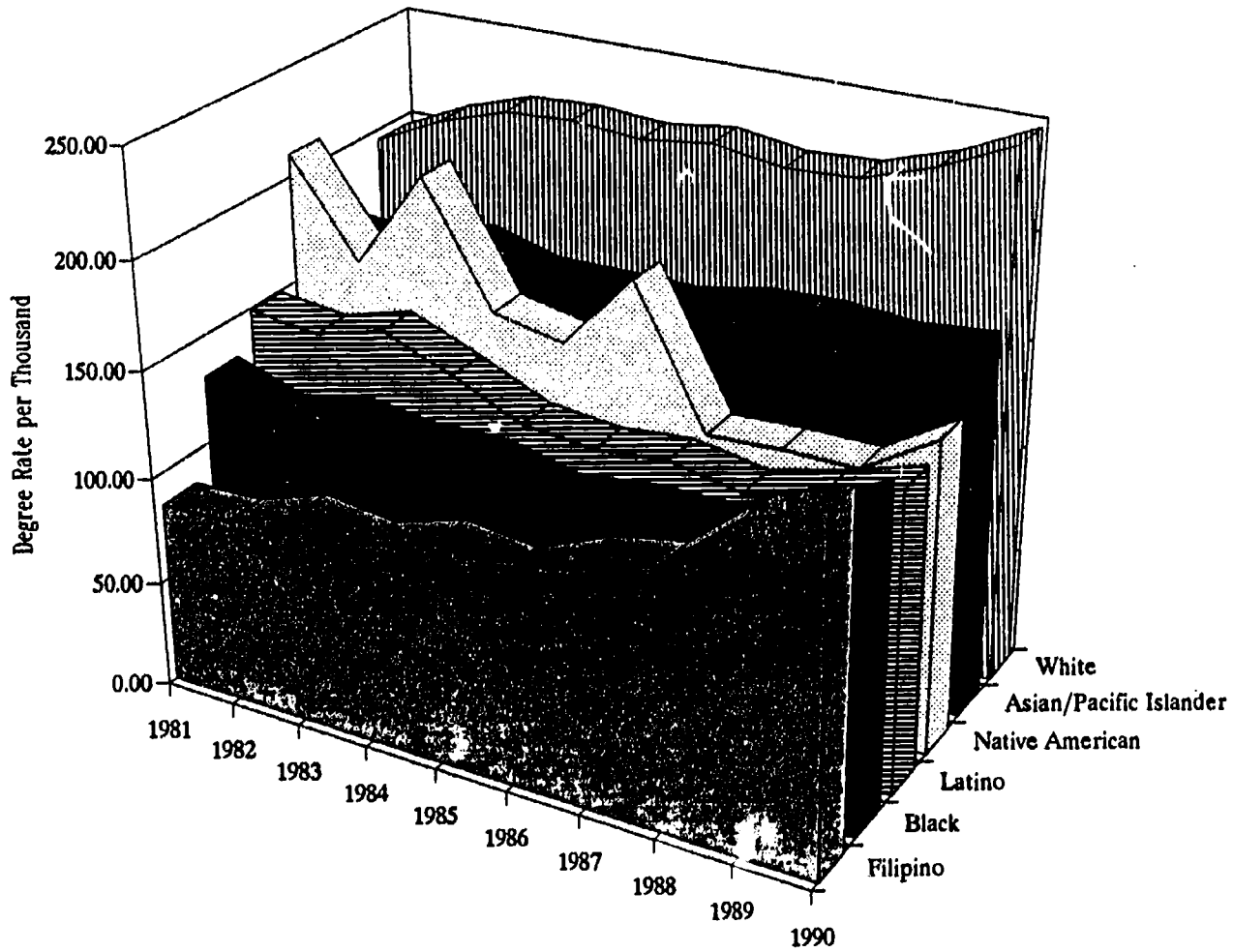

Degree Rate as a Function of Undergraduate Enrollment at the University of California, 1981 to 1990

Fall Term	Total Students (per 1,000)	Asian/Pacific Islander (per 1,000)	Black (per 1,000)	Filipino (per 1,000)	Latino (per 1,000)	Native American (per 1,000)	Other (per 1,000)	White (per 1,000)	Total, Declared Ethnicity (per 1,000)	Non-Resident Alien (per 1,000)	No Response (per 1,000)
1981	199.63	162.10	131.19	85.35	148.96	210.53	1056.78	195.40	200.21	168.92	204.28
1982	200.78	161.20	120.78	86.63	145.24	166.33	594.73	210.15	200.59	192.20	210.90
1983	206.50	170.29	127.33	97.69	154.34	212.85	324.11	220.49	204.31	254.08	239.25
1984	201.61	161.26	123.60	93.65	141.15	156.72	324.92	222.05	201.30	224.49	195.56
1985	198.03	161.91	124.80	103.75	126.61	149.75	247.55	219.53	195.75	231.14	252.61
1986	196.76	161.65	116.93	99.97	123.37	186.08	245.52	223.81	196.29	211.43	201.02
1987	194.36	168.05	121.22	114.20	126.64	123.46	232.74	218.86	192.81	208.93	233.27
1988	193.93	169.58	122.08	121.07	120.86	124.87	267.10	220.94	192.85	173.01	242.71
1989	200.59	166.66	132.85	150.17	129.37	124.89	280.30	231.95	199.49	209.87	226.80
1990	211.32	170.33	149.59	163.00	140.02	145.94	274.12	247.80	209.76	269.30	222.42

Bachelor's Degrees Awarded at the University of California by Ethnicity, 1981 to 1990.

Term	Total	Asian/ Pacific Islander	Black	Filip'no	Latino	Native American	Other	White	Total, Declared Ethnicity	Non- Resident Alien	No Response
1981	19,733	1,953	469	134	799	100	1,824	13,077	18,356	413	964
1982	20,229	2,129	447	164	828	83	1,083	14,218	18,952	468	809
1983	21,337	2,466	506	216	970	106	644	15,072	19,980	561	796
1984	21,376	2,518	520	242	995	84	669	15,236	20,264	495	617
1985	21,583	2,707	554	307	1,031	90	505	15,117	20,311	521	751
1986	22,109	2,928	558	336	1,104	123	493	15,379	20,921	518	670
1987	22,755	3,310	621	436	1,296	100	428	15,242	21,433	496	826
1988	23,466	3,603	673	497	1,402	122	449	15,379	22,125	450	891
1989	24,761	3,832	770	616	1,691	140	451	15,816	23,316	536	909
1990	26,261	4,274	841	696	1,987	176	429	16,243	24,646	621	994

**Bachelor's Degrees Awarded to Students at the University of California
Who Transferred from the California Community Colleges
by Ethnicity, 1981 to 1990.**

Term	Total Students	Asian/ Pacific Islander	Black	Filipino	Latino	Native American	Other	White	Total, Declared Ethnicity	Non- Resident Alien	No Response
1981	3,497	356	96	27	190	31	90	2,471	3,261	117	119
1982	4,483	443	108	34	221	26	187	3,175	4,194	125	164
1983	4,486	464	113	41	268	36	154	3,096	4,172	147	167
1984	4,434	460	110	38	257	28	139	3,143	4,175	125	134
1985	4,525	481	111	42	287	18	99	3,170	4,208	145	172
1986	4,851	538	116	36	295	33	101	3,405	4,524	180	147
1987	4,943	596	124	52	375	35	115	3,329	4,626	151	166
1988	4,804	542	113	64	346	41	119	3,269	4,494	135	175
1989	4,833	590	134	75	408	44	31	3,150	4,482	170	181
1990	5,548	709	125	78	493	53	73	3,616	5,147	212	189

**Percentage of Degrees Awarded to Students at the University of California
Who Transferred from the California Community Colleges
by Ethnicity, 1981 to 1990.**

Fall Term	Total Transfer Students	Asian/ Pacific Islander	Black	Filipino	Latino	Native American	Other	White	Total, Declared Ethnicity	Non- Resident Alien	No Response
1981	17.7	18.2	20.5	20.1	23.8	31.0	4.9	18.9	17.8	28.3	12.3
1982	22.2	20.8	24.2	20.7	26.7	31.3	17.3	22.3	22.1	26.7	20.3
1983	21.0	18.8	22.3	19.0	27.6	34.0	23.9	20.5	20.9	26.2	21.0
1984	20.7	18.3	21.2	15.7	25.8	33.3	20.8	20.6	20.6	25.3	21.7
1985	21.0	17.8	20.0	13.7	27.8	20.0	19.6	21.0	20.7	27.8	22.9
1986	21.9	18.4	20.8	10.7	26.7	26.8	20.5	22.1	21.6	34.7	21.9
1987	21.7	18.0	20.0	11.9	28.9	35.0	26.9	21.8	21.6	30.4	20.1
1988	20.5	15.0	16.8	12.9	24.7	33.6	26.5	21.3	20.3	30.0	19.6
1989	19.5	15.4	17.4	12.2	24.1	31.4	18.0	19.9	19.2	31.7	19.9
1990	21.1	16.6	14.9	11.2	24.8	30.1	17.0	22.3	20.9	34.1	19.0

**Undergraduate and Graduate Degrees Awarded at the University of California
by Discipline Division, Fall 1981 to Fall 1990**

	1981	1982	1983	1984	1985	1986	1987	1988	1989	1990
Baccalaureate Degrees										
Agribusiness and Agricultural Production	19	187	253	253	254	270	224	246	260	224
Agricultural Sciences	461	255	271	270	237	185	166	161	133	103
Renewable Natural Resources	179	326	311	282	230	186	161	176	151	152
Architecture and Environmental Design	309	297	296	253	221	225	224	200	238	246
Area and Ethnic Studies	137	131	155	119	123	129	140	160	202	270
Business and Management	923	908	948	935	984	1,040	1,008	980	1,053	1,090
Communications	348	427	451	477	462	401	411	448	513	577
Computer and Information Sciences	325	509	562	608	640	645	524	510	427	458
Education	136	135	122	114	69	75	84	90	97	71
Engineering	1,900	1,968	2,066	2,062	1,911	1,831	2,034	1,889	1,995	2,074
Foreign Languages	426	408	410	354	391	422	389	412	440	445
Allied Health	39	56	35	40	45	43	47	47	43	16
Health Sciences	501	402	433	329	345	308	317	293	273	276
Home Economics	90	211	184	185	161	167	149	163	153	154
Law	1	41	48	52	104	133	116	148	149	207
Letters	1,084	1,209	1,282	1,305	1,428	1,416	1,503	1,583	1,867	2,120
Liberal/General Studies	170	229	291	306	340	374	503	462	209	134
Life Sciences	2,346	2,178	2,431	2,495	2,667	2,662	2,660	2,875	2,803	2,954
Mathematics	370	419	536	624	767	885	886	807	695	614
Multi/Interdisciplinary Studies	1,711	1,583	1,679	1,575	1,630	1,654	1,704	1,774	1,913	2,228
Philosophy and Religion	174	153	194	168	166	159	167	203	215	251
Physical Sciences	642	698	768	780	820	809	752	693	693	625
Psychology	1,571	1,588	1,592	1,649	1,590	1,704	1,906	1,918	2,219	2,372
Public Affairs	130	112	113	86	73	61	94	69	75	90
Social Sciences	4,472	4,539	4,609	4,823	4,805	5,236	5,458	5,893	6,604	7,175
Visual and Performing Arts	1,248	1,241	1,265	1,201	1,114	1,081	1,122	1,245	1,339	1,329

**Percentage of Undergraduate and Graduate Degrees Awarded at the University of California
by Discipline Division, Fall 1981 to Fall 1990**

	1981	1982	1983	1984	1985	1986	1987	1988	1989	1990
Baccalaureate Degrees										
Agribusiness and Agricultural Production	0.10	0.93	1.19	1.19	1.18	1.72	0.98	1.05	1.05	0.85
Agricultural Sciences	2.34	1.26	1.27	1.26	1.10	0.84	0.73	0.69	0.54	0.39
Renewable Natural Resources	0.91	1.61	1.46	1.32	1.07	0.84	0.71	0.75	0.61	0.58
Architecture and Environmental Design	1.57	1.47	1.39	1.19	1.02	1.02	0.98	0.85	0.96	0.94
Area and Ethnic Studies	0.70	0.65	0.73	0.56	0.57	0.58	0.62	0.68	0.82	1.03
Business and Management	4.68	4.49	4.45	4.38	4.56	4.71	4.43	4.18	4.25	4.15
Communications	1.77	2.11	2.12	2.23	2.14	1.81	1.81	1.91	2.07	2.20
Computer and Information Sciences	1.65	2.52	2.64	2.85	2.97	2.92	2.30	2.18	1.72	1.74
Education	0.69	0.67	0.57	0.53	0.32	0.34	0.37	0.38	0.39	0.27
Engineering	9.64	9.74	9.70	9.66	8.86	8.28	8.94	8.06	8.06	7.90
Foreign Languages	2.16	2.02	1.92	1.66	1.81	1.91	1.71	1.76	1.78	1.69
Allied Health	0.20	0.28	0.16	0.19	0.21	0.19	0.21	0.20	0.17	0.06
Health Sciences	2.54	1.99	2.03	1.54	1.60	1.39	1.39	1.25	1.10	1.05
Home Economics	0.46	1.04	0.86	0.87	0.75	0.76	0.65	0.70	0.62	0.59
Law	0.01	0.20	0.23	0.24	0.48	0.60	0.51	0.63	0.60	0.79
Letters	5.50	5.98	6.02	6.11	6.62	6.41	6.61	6.75	7.54	8.07
Liberal/General Studies	0.86	1.13	1.37	1.43	1.58	1.69	2.21	1.97	0.84	0.51
Life Sciences	11.90	10.78	11.41	11.69	12.36	12.04	11.69	12.26	11.32	11.25
Mathematics	1.88	2.07	2.52	2.92	3.55	4.00	3.89	3.44	2.81	2.34
Multi/Interdisciplinary Studies	8.68	7.83	7.88	7.38	7.55	7.48	7.49	7.57	7.73	8.49
Philosophy and Religion	0.88	0.76	0.91	0.79	0.77	0.72	0.73	0.87	0.87	0.96
Physical Sciences	3.26	3.45	3.60	3.65	3.80	3.66	3.31	2.96	2.80	2.38
Psychology	7.97	7.86	7.47	7.73	7.37	7.71	8.38	8.18	8.96	9.03
Public Affairs	0.66	0.55	0.53	0.40	0.34	0.28	0.41	0.29	0.30	0.34
Social Sciences	22.69	22.46	21.63	22.60	22.27	23.69	23.99	25.14	26.67	27.33
Visual and Performing Arts	6.33	6.14	5.94	5.63	5.16	4.89	4.93	5.31	5.41	5.06

Undergraduate and Graduate Degrees Awarded at the University of California
by Discipline Division, Fall 1981 to Fall 1990

	1981	1982	1983	1984	1985	1986	1987	1988	1989	1990
Master's Degrees										
Agribusiness and Agricultural Production	15	35	39	37	41	26	38	35	38	39
Agricultural Sciences	149	128	134	115	97	103	88	95	67	72
Renewable Natural Resources	5	29	15	10	24	22	19	21	15	14
Architecture and Environmental Design	280	269	221	242	253	204	229	247	285	264
Area and Ethnic Studies	45	54	72	55	48	68	60	61	59	66
Business and Management	864	936	1,005	923	872	875	959	996	1,050	1,085
Communications	25	10	17	29	15	19	35	33	33	43
Computer and Information Sciences	133	161	134	160	161	152	133	152	162	148
Education	232	270	266	216	242	275	317	355	340	388
Engineering	856	1,006	934	960	960	893	897	938	933	888
Foreign Languages	118	113	103	115	123	115	111	115	94	103
Allied Health	1	8	16	21	22	12	9	14	11	10
Health Sciences	730	638	730	772	697	725	691	673	737	818
Home Economics	11	9	12	11	8	9	10	6	4	6
Law	23	43	21	27	32	39	33	41	30	24
Letters	186	198	182	193	148	185	194	200	205	200
Library and Archival Sciences	128	111	131	113	126	131	148	167	166	171
Life Sciences	273	264	281	243	244	238	263	239	245	228
Mathematics	109	128	139	96	113	128	135	131	147	165
Multi-/Interdisciplinary Studies	83	142	150	91	102	108	60	29	24	20
Parks and Recreation	0	11	11	7	6	4	6	8	13	6
Philosophy and Religion	18	28	39	25	28	24	19	37	32	29
Physical Sciences	272	280	241	263	302	242	268	294	271	275
Psychology	61	61	51	68	71	58	66	61	71	51
Public Affairs	176	181	162	150	179	150	166	182	197	154
Social Sciences	421	480	452	405	488	437	452	465	496	550
Visual and Performing Arts	351	366	351	354	327	316	303	298	328	331

Percentage of Undergraduate and Graduate Degrees Awarded at the University of California
by Discipline Division, Fall 1981 to Fall 1990

	1981	1982	1983	1984	1985	1986	1987	1988	1989	1990
Master's Degrees										
Agribusiness and Agricultural Production	0.27	0.59	0.66	0.65	0.72	0.47	0.67	0.59	0.63	0.63
Agricultural Sciences	2.68	2.15	2.27	2.02	1.69	1.85	1.54	1.61	1.11	1.17
Renewable Natural Resources	0.09	0.49	0.25	0.18	0.42	0.40	0.33	0.36	0.25	0.23
Architecture and Environmental Design	5.03	4.51	3.74	4.24	4.42	3.67	4.01	4.19	4.71	4.29
Area and Ethnic Studies	0.81	0.90	1.22	0.96	0.84	1.22	1.05	1.04	0.97	1.07
Business and Management	15.53	15.69	17.01	16.19	15.22	15.74	16.80	16.90	17.35	17.65
Communications	0.45	0.17	0.29	0.51	0.26	0.34	0.61	0.56	0.55	0.70
Computer and Information Sciences	2.39	2.70	2.27	2.81	2.81	2.73	2.33	2.58	2.68	2.41
Education	4.17	4.66	4.50	3.79	4.22	4.95	5.55	6.02	5.62	6.31
Engineering	15.38	16.86	15.81	16.84	16.76	16.07	15.71	15.92	15.41	14.44
Foreign Languages	2.12	1.89	1.74	2.02	2.15	2.07	1.94	1.95	1.55	1.68
Allied Health	0.02	0.13	0.27	0.37	0.38	0.22	0.16	0.24	0.18	0.16
Health Sciences	13.12	10.69	12.35	13.54	12.17	13.04	12.10	11.42	12.18	13.31
Home Economics	0.20	0.15	0.20	0.19	0.14	0.16	0.18	0.10	0.07	0.10
Law	0.41	0.72	0.36	0.47	0.56	0.70	0.58	0.70	0.50	0.39
Letters	3.34	3.32	3.08	3.39	2.58	3.33	3.40	3.39	3.39	3.25
Library and Archival Sciences	2.30	1.86	2.22	1.98	2.20	2.36	2.59	2.83	2.74	2.78
Life Sciences	4.91	4.42	4.76	4.26	4.26	4.28	4.51	4.06	4.05	3.71
Mathematics	1.96	2.15	2.35	1.68	1.97	2.30	2.36	2.22	2.43	2.68
Multi-/Interdisciplinary Studies	1.49	2.38	2.54	1.60	1.78	1.94	1.05	0.49	0.40	0.33
Parks and Recreation	0.00	0.18	0.19	0.12	0.10	0.07	0.11	0.14	0.21	0.10
Philosophy and Religion	0.32	0.47	0.66	0.41	0.49	0.43	0.33	0.63	0.53	0.47
Physical Sciences	4.89	4.69	4.08	4.61	5.27	4.35	4.69	4.99	4.48	4.47
Psychology	1.10	1.02	0.86	1.19	1.24	1.04	1.16	1.04	1.17	0.83
Public Affairs	3.16	3.03	2.74	2.63	3.12	2.70	2.91	3.09	3.25	2.50
Social Sciences	7.57	8.04	7.65	7.10	8.52	7.86	7.92	7.89	8.19	8.95
Visual and Performing Arts	6.31	6.13	5.94	6.21	5.71	5.69	5.31	5.06	5.42	5.38

**Undergraduate and Graduate Degrees Awarded at the University of California
by Discipline Division, Fall 1981 to Fall 1990**

	1981	1982	1983	1984	1985	1986	1987	1988	1989	1990
Doctorate Degrees										
Agribusiness and Agricultural Production	10	11	14	16	13	12	11	15	14	13
Agricultural Sciences	34	19	28	35	27	23	19	23	25	24
Renewable Natural Resources	0	5	6	2	6	6	5	3	21	15
Architecture and Environmental Design	11	21	13	9	14	16	19	15	15	17
Area and Ethnic Studies	8	8	6	6	8	18	7	9	8	14
Business and Management	31	28	25	35	19	28	33	43	33	33
Computer and Information Sciences	40	28	40	30	31	41	39	57	54	62
Education	148	145	134	133	122	118	119	107	131	105
Engineering	258	246	275	255	233	265	269	348	373	381
Foreign Languages	52	42	55	52	44	57	61	51	59	66
Allied Health	0	6	9	3	8	9	0	0	0	0
Health Sciences	55	56	63	81	71	76	63	85	123	108
Law	2	1	0	2	1	1	5	4	4	6
Letters	107	84	97	98	107	87	111	114	92	118
Liberal/General Studies	0	1	1	2	1	2	0	1	2	2
Library and Archival Sciences	4	5	5	2	5	5	3	2	9	3
Life Sciences	429	403	418	406	391	415	368	449	424	389
Mathematics	76	66	59	82	81	73	79	87	91	70
Multi/Interdisciplinary Studies	41	49	48	53	51	44	45	45	31	38
Philosophy and Religion	22	20	19	19	16	21	19	23	18	12
Physical Sciences	311	334	334	335	352	351	351	379	363	380
Psychology	107	87	108	79	88	79	75	82	74	101
Public Affairs	19	18	16	17	7	11	14	10	11	15
Social Sciences	295	253	258	250	275	272	262	293	283	285
Visual and Performing Arts	49	35	37	48	39	32	46	51	49	54
First Professional Degrees										
Health Sciences	1000	1,138	1,109	1,149	1,110	1,094	1,082	1,092	1,089	1,095
Law	781	792	806	774	736	701	765	754	758	770
Multi/Interdisciplinary Studies	0	0	38	9	15	13	0	0	0	0

**Percentage of Undergraduate and Graduate Degrees Awarded at the University of California
by Discipline Division, Fall 1981 to Fall 1990**

	1981	1982	1983	1984	1985	1986	1987	1988	1989	1990
Doctorate Degrees										
Agribusiness and Agricultural Production	0.47	0.56	0.68	0.78	0.65	0.58	0.54	0.65	0.61	0.56
Agricultural Sciences	1.61	0.96	1.35	1.71	1.34	1.12	0.94	1.00	1.08	1.04
Renewable Natural Resources	0.00	0.25	0.29	0.10	0.30	0.29	0.25	0.13	0.91	0.65
Architecture and Environmental Design	0.52	1.07	0.63	0.44	0.70	0.78	0.94	0.65	0.65	0.74
Area and Ethnic Studies	0.38	0.41	0.29	0.29	0.40	0.87	0.35	0.39	0.35	0.61
Business and Management	1.47	1.42	1.21	1.71	0.95	1.36	1.63	1.87	1.43	1.43
Computer and Information Sciences	1.90	1.42	1.93	1.46	1.54	1.99	1.93	2.48	2.34	2.68
Education	7.02	7.36	6.48	6.49	6.07	5.72	5.88	4.66	5.68	4.54
Engineering	12.23	12.48	13.30	12.44	11.59	12.85	13.30	15.16	16.17	16.49
Foreign Languages	2.47	2.13	2.66	2.54	2.19	2.76	3.02	2.22	2.56	2.86
Allied Health	0.00	0.30	0.44	0.15	0.40	0.44	0.00	0.00	0.00	0.00
Health Sciences	2.61	2.84	3.05	3.95	3.53	3.69	3.11	3.70	5.33	4.67
Law	0.09	0.05	0.00	0.10	0.05	0.05	0.25	0.17	0.17	0.26
Letters	5.07	4.26	4.69	4.78	5.32	4.22	5.49	4.97	3.99	5.11
Liberal/General Studies	0.00	0.05	0.05	0.10	0.05	0.10	0.00	0.04	0.09	0.09
Library and Archival Sciences	0.19	0.25	0.24	0.10	0.25	0.24	0.15	0.09	0.39	0.13
Life Sciences	20.34	20.45	20.21	19.80	19.45	20.13	18.19	19.56	18.38	16.83
Mathematics	3.60	3.35	2.85	4.00	4.03	3.54	3.91	3.79	3.94	3.03
Multi/Interdisciplinary Studies	1.94	2.49	2.32	2.59	2.54	2.13	2.22	1.96	1.34	1.64
Philosophy and Religion	1.04	1.01	0.92	0.93	0.80	1.02	0.94	1.00	0.78	0.52
Physical Sciences	14.75	16.95	16.15	16.34	17.51	17.02	17.35	16.51	15.73	16.44
Psychology	5.07	4.41	5.22	3.85	4.38	3.83	3.71	3.57	3.21	4.37
Public Affairs	0.90	0.91	0.77	0.83	0.35	0.53	0.69	0.44	0.48	0.65
Social Sciences	13.99	12.84	12.48	12.20	13.68	13.19	12.95	12.76	12.27	12.33
Visual and Performing Arts	2.32	1.78	1.79	2.34	1.94	1.55	2.27	2.22	2.12	2.34
First Professional Degrees										
Health Sciences	56.15	58.96	56.78	59.47	59.65	60.51	58.58	59.15	58.96	58.71
Law	43.85	41.04	41.27	40.06	39.55	38.77	41.42	40.85	41.04	41.29
Multi/Interdisciplinary Studies	0.00	0.00	1.95	0.47	0.81	0.72	0.00	0.00	0.00	0.00

Degrees Awarded at the California State University, 1980-81 through 1989-90

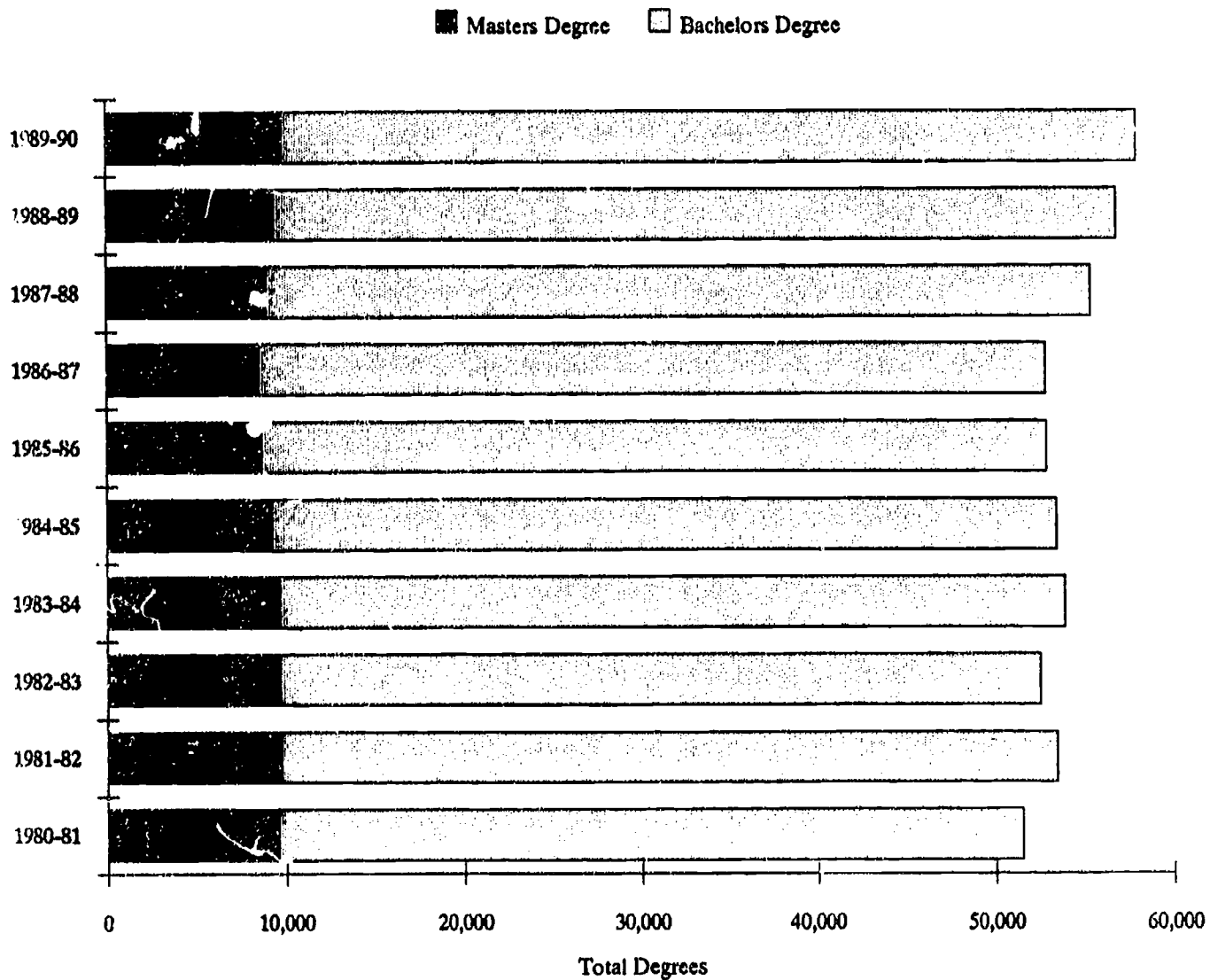

Degrees Awarded at the California State University, 1980-81 Through 1989-90

Degree Type	1980-81	1981-82	1982-83	1983-84	1984-85	1985-86	1986-87	1987-88	1988-89	1989-90
Bachelors Degree	41,993	43,711	42,956	44,274	44,292	44,292	44,374	46,446	47,459	48,105
Masters Degree	9,545	9,755	9,627	9,614	9,179	8,645	8,510	8,960	9,381	9,850
Doctorate	6	6	11	14	8	12	27	19	14	12
Total Degrees Awarded	51,544	53,472	52,594	53,902	53,479	52,949	52,911	55,425	56,854	57,967

Total Undergraduate Enrollment at the California State University by Ethnicity, Fall 1981 to Fall 1990

Fall Term	Total Undergraduates	Asian/Pacific Islander	Black	Filipino	Latino	Native American	Other	White	Total, Declared Ethnicity	Non-Resident Alien	No Response
1981	251,552	17,625	14,729	3,512	19,096	5,129	4,529	144,161	208,781	7,673	35,098
1982	251,137	20,152	14,567	3,995	20,420	4,083	4,382	151,239	218,838	7,031	25,268
1983	253,721	22,628	14,583	4,334	21,519	3,250	4,670	156,654	227,638	6,867	19,216
1984	256,839	25,477	14,567	4,940	22,778	3,072	4,658	160,599	236,091	6,277	14,471
1985	262,759	27,834	14,414	5,521	24,210	2,957	5,062	163,826	243,824	6,221	12,714
1986	266,729	29,739	14,169	6,195	25,147	2,747	5,325	164,781	248,103	6,610	12,016
1987	273,987	31,525	14,499	6,959	27,309	2,713	5,494	166,561	255,060	7,067	11,860
1988	284,929	33,050	15,065	8,021	29,739	2,652	5,848	169,039	263,414	7,822	13,693
1989	289,173	38,943	15,044	8,890	35,089	3,095	6,428	161,108	268,597	7,255	13,321
1990	294,083	37,121	16,665	10,226	35,658	2,716	7,647	162,104	272,137	8,423	13,523

Bachelor's Degrees Awarded at the California State University by Ethnicity, 1981 to 1990

Term	Total Students	Asian/Pacific Islander	Black	Filipino	Latino	Native American	Other	White	Total, Declared Ethnicity	Non-Resident Alien	No Response
1981	41,993	2,398	1,689	409	2,309	417	975	24,699	32,896	2,372	6,725
1982	43,711	2,658	1,715	389	2,473	444	871	25,766	34,316	2,374	7,021
1983	42,956	2,821	1,595	420	2,500	475	696	26,671	35,177	2,342	5,437
1984	44,274	3,187	1,670	528	2,769	661	649	28,503	37,967	2,314	3,993
1985	44,292	3,630	1,629	519	2,838	634	688	29,416	39,354	1,482	3,456
1986	44,292	3,773	1,569	607	3,014	546	737	29,610	39,856	1,428	3,008
1987	44,374	4,100	1,469	605	3,092	477	742	30,109	40,594	1,462	2,318
1988	46,446	4,535	1,556	759	3,392	500	841	31,045	42,628	1,410	2,408
1989	47,459	4,702	1,519	921	3,854	433	813	31,573	43,815	1,509	2,135
1990	48,105	4,786	1,621	940	3,902	444	896	31,626	44,215	1,628	2,262

Degree Rate as a Function of Undergraduate Enrollment at the California State University, 1981 to 1990

Fall Term	Total Students (per 1,000)	Asian/Pacific Islander (per 1,000)	Black (per 1,000)	Filipino (per 1,000)	Latino (per 1,000)	Native American (per 1,000)	Other (per 1,000)	White (per 1,000)	Total, Declared Ethnicity (per 1,000)	Non-Resident Alien (per 1,000)	No Response (per 1,000)
1981	166.94	136.06	114.67	116.46	120.92	81.30	215.28	171.33	157.56	309.14	191.61
1982	174.05	131.90	117.73	97.37	121.11	108.74	198.77	170.37	156.81	337.65	277.86
1983	169.30	124.67	109.37	96.91	116.18	146.15	149.04	170.25	154.53	341.05	282.94
1984	172.38	125.09	114.64	106.88	121.56	215.17	139.33	177.48	160.82	368.65	275.93
1985	168.57	130.42	113.02	94.00	117.22	214.41	135.91	179.56	161.40	238.23	271.83
1986	166.06	126.87	110.73	97.98	119.86	198.76	138.40	179.69	160.64	216.04	250.33
1987	161.96	130.06	101.32	86.94	113.22	175.82	135.06	180.77	159.15	206.88	195.45
1988	163.01	137.22	103.29	94.63	114.06	188.54	143.81	183.66	161.83	180.26	175.86
1989	164.12	120.74	100.97	103.60	109.83	139.90	126.48	195.97	163.13	207.99	160.27
1990	163.58	128.93	97.27	91.92	109.43	163.48	117.17	195.10	162.47	193.28	167.27

Degree Rate as a Function of Undergraduate Enrollment at the California State University, 1981 to 1990

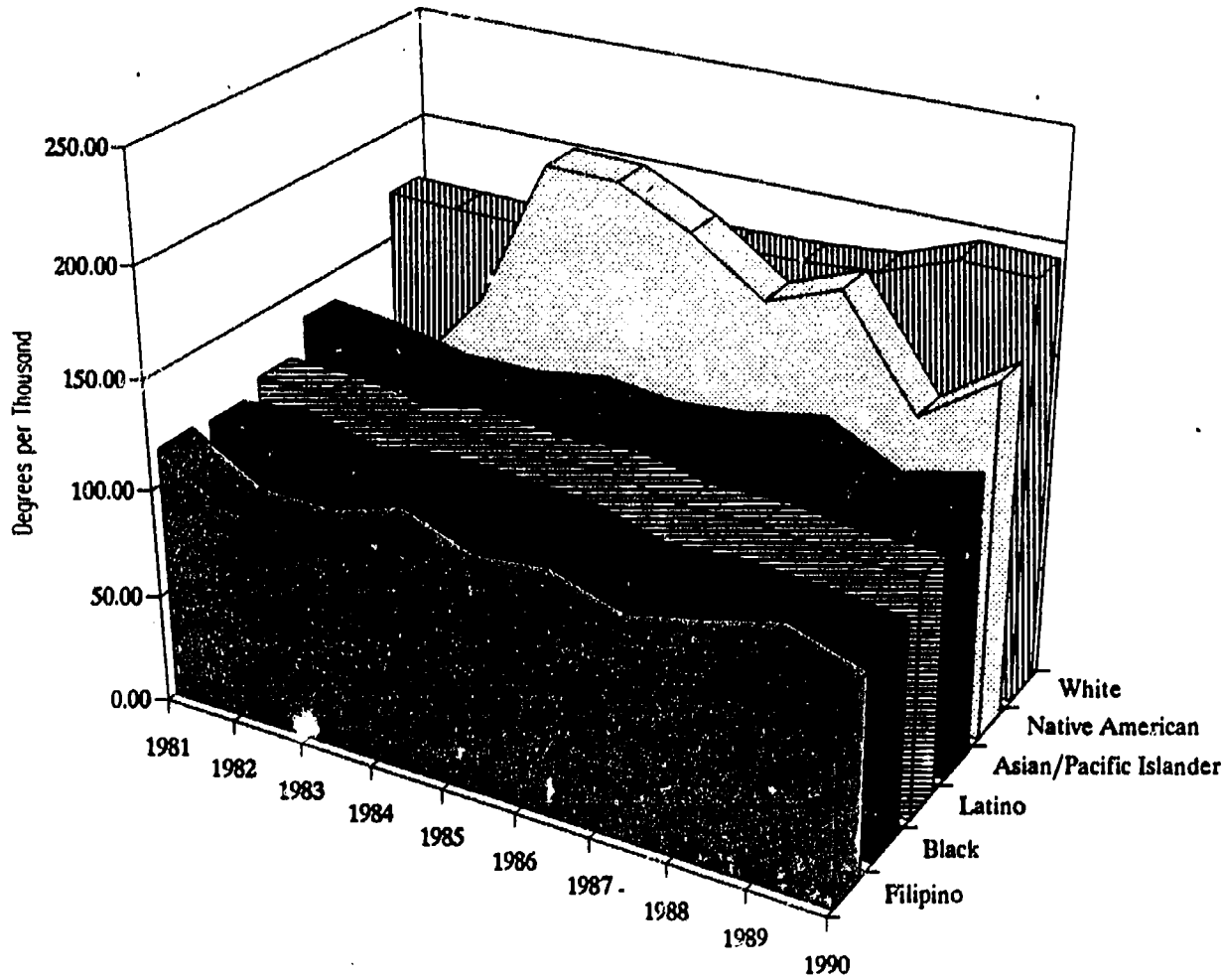

Degree Rate as a Function of Undergraduate Enrollment at the California State University, 1981 to 1990

Fall Term	Total Students (per 1,000)	Asian/ Pacific Islander (per 1,000)	Black (per 1,000)	Filipino (per 1,000)	Latino (per 1,000)	Native American (per 1,000)	Other (per 1,000)	White (per 1,000)	Total, Declared Ethnicity (per 1,000)	Non- Resident Alien (per 1,000)	No Response (per 1,000)
1981	166.94	136.06	114.67	116.45	120.92	81.30	215.28	171.33	157.56	309.14	191.61
1982	174.05	131.90	117.73	97.37	121.11	108.74	198.77	170.37	156.81	337.65	277.86
1983	169.30	124.67	109.37	96.91	116.18	146.15	149.04	170.25	154.53	341.05	282.94
1984	172.38	125.09	114.64	106.88	121.56	215.17	139.33	177.48	160.82	368.65	275.93
1985	168.57	130.42	113.02	94.00	117.22	214.41	135.91	179.56	161.40	238.23	271.83
1986	166.06	126.87	110.73	97.98	119.86	198.76	138.40	179.69	160.64	216.04	250.33
1987	161.96	130.06	101.32	66.94	113.22	175.82	135.06	180.77	159.15	206.88	195.45
1988	163.01	137.22	103.29		114.06	188.54	143.81	183.66	161.83	180.26	175.86
1989	164.12	120.74	100.97	103.60	109.83	139.90	126.48	195.97	163.13	207.99	160.27
1990	163.58	128.93	97.27	91.92	109.43	163.48	117.17	195.10	162.47	193.28	167.27

Bachelor's Degrees Awarded at the California State University by Ethnicity, 1981 to 1990.

Term	Total	Asiar/ Pacific Islander	Black	Filipino	Latino	Native American	Other	White	Total, Declared Ethnicity	Non- Resident Alien	No Response
1981	41,993	2,398	1,689	409	2,309	417	975	24,699	32,896	2,372	6,725
1982	43,711	2,658	1,715	389	2,473	444	871	25,766	34,316	2,374	7,021
1983	42,956	2,821	1,595	420	2,500	475	696	26,670	35,177	2,342	5,437
1984	44,274	3,187	1,670	528	2,769	661	649	28,503	37,967	2,314	3,993
1985	44,292	3,630	1,629	519	2,838	634	688	29,416	39,354	1,482	3,456
1986	44,292	3,773	1,569	607	3,014	546	737	29,610	39,856	1,428	3,008
1987	44,374	4,100	1,469	605	3,092	477	742	30,109	40,594	1,462	2,318
1988	46,446	4,535	1,556	759	3,392	500	841	31,045	42,628	1,410	2,408
1989	47,459	4,702	1,519	921	3,854	433	813	31,573	43,815	1,509	2,135
1990	48,105	4,786	1,621	940	3,902	444	896	31,626	44,215	1,628	2,262

Bachelor's Degrees Awarded to Students at the California State University Who Transferred from the California Community Colleges by Ethnicity, 1981 to 1990.

Term	Total	Asian/ Pacific Islander	Black	Filipino	Latino	Native American	Other	White	Total, Declared Ethnicity	Non- Resident Alien	No Response
1981	20,508	1,138	846	205	1,251	231	490	12,657	16,818	568	3,122
1982	21,412	1,265	835	187	1,351	223	442	13,005	17,308	644	3,460
1983	21,284	1,361	788	183	1,345	249	333	13,790	18,049	595	2,640
1984	21,878	1,489	808	233	1,505	382	319	14,643	19,379	537	1,962
1985	22,333	1,663	790	220	1,488	372	342	15,395	20,270	441	1,622
1986	22,434	1,780	773	278	1,665	276	375	15,358	20,505	459	1,470
1987	22,491	1,944	710	279	1,691	231	398	15,615	20,868	488	1,135
1988	23,810	2,168	769	330	1,825	275	426	16,302	22,095	492	1,223
1989	24,310	2,263	712	415	2,055	237	425	16,523	22,630	559	1,121
1990	24,830	2,197	807	392	2,182	249	475	16,687	22,989	640	1,201

Percentage of Degrees Awarded to Students at the California State University Who Transferred from the California Community Colleges by Ethnicity, 1981 to 1990.

Fa'' Term	Total	Asian/ Pacific Islander	Black	Filipino	Latino	Native American	Other	White	Total, Declared Ethnicity	Non- Resident Alien	No Response
1981	48.8	47.5	50.1	50.1	54.2	55.4	50.3	51.2	51.1	23.9	46.4
1982	49.0	47.6	48.7	48.1	54.6	50.2	50.7	50.5	50.4	27.1	49.3
1983	49.5	48.2	49.4	43.6	53.8	52.4	47.8	51.7	51.5	25.4	48.6
1984	49.4	46.7	48.4	44.1	54.4	57.8	49.2	51.4	51.0	23.2	49.1
1985	50.4	45.8	48.5	42.4	52.4	58.7	49.7	52.3	51.5	29.8	46.9
1986	50.7	47.2	49.3	45.8	55.2	50.5	50.9	51.9	51.4	32.1	48.9
1987	50.7	47.4	48.3	44.1	54.7	48.4	53.6	51.9	51.4	33.4	49.0
1988	51.3	47.8	49.4	43.5	53.8	55.0	50.7	52.5	51.8	34.9	50.8
1989	51.2	48.1	46.9	45.1	53.3	54.7	52.3	52.3	51.6	37.0	52.5
1990	51.6	45.9	49.8	41.7	55.9	56.1	53.0	52.8	52.0	39.3	53.1

**Undergraduate and Graduate Degrees Awarded at the
California State University by Discipline Division, Fall 1981 to Fall 1990**

	1981	1982	1983	1984	1985	1986	1987	1988	1989	1990
Baccalaureate Degrees										
Agribusiness and Agricultural Production	275	468	537	531	581	561	623	378	340	346
Agricultural Sciences	758	797	736	700	594	566	430	434	341	300
Renewable Natural Resources	336	341	308	252	220	239	151	146	160	150
Architecture and Environmental Design	355	385	376	340	389	348	324	351	363	380
Area and Ethnic Studies	194	217	195	198	130	135	136	119	120	136
Business and Management	9,855	83	11,523	11,873	12,076	11,856	11,955	12,430	12,882	12,517
Communications	1,794	2,041	2,241	2,546	2,527	2,541	2,612	2,745	2,807	2,781
Computer and Information Sciences	517	630	881	1,207	1,519	1,694	1,770	1,518	1,525	1,365
Education	2,436	2,247	2,066	2,052	1,833	1,827	1,733	1,877	2,042	2,036
Engineering	2,457	4,832	5,193	5,338	8,391	5,513	5,726	3,901	3,589	3,503
Engineering-Related Technologies	797	866	924	918	1,023	985	946	1,056	958	770
Foreign Languages	477	464	398	417	455	376	357	386	447	393
Allied Health	263	311	252	203	197	200	192	171	174	168
Health Sciences	2,203	2,217	2,125	2,069	1,929	2,007	1,860	1,797	1,757	1,774
Home Economics	1,005	917	826	780	853	867	801	905	781	797
Letters	1,451	1,442	1,337	1,446	1,535	1,569	1,689	1,742	1,988	2,280
Liberal/General Studies	2,482	2,554	2,318	2,405	2,536	2,564	2,828	3,463	3,959	4,395
Life Sciences	1,486	1,570	1,304	1,354	1,258	1,292	1,292	1,312	1,153	1,275
Mathematics	396	354	425	446	567	606	669	630	558	534
Multi/Interdisciplinary Studies	431	388	366	332	321	318	322	336	403	386
Parks and Recreation	670	655	508	452	423	412	391	365	444	377
Philosophy and Religion	194	183	161	154	167	141	148	139	136	158
Physical Sciences	767	768	780	729	816	801	780	690	628	593
Psychology	2,275	2,245	2,222	2,269	2,087	2,190	2,162	2,325	2,418	2,744
Protective Services	939	838	707	779	712	771	765	816	854	910
Public Affairs	1,059	931	829	820	701	678	701	728	783	856
Social Sciences	3,666	3,698	3,509	3,666	3,439	3,361	3,358	3,617	3,894	4,262
Visual and Performing Arts	2,390	2,265	2,169	2,264	2,118	1,923	1,872	2,009	1,904	1,865

**Percentage of Undergraduate and Graduate Degrees Awarded at the California State University
by Discipline Division, Fall 1981 to Fall 1990**

	1981	1982	1983	1984	1985	1986	1987	1988	1989	1990
Baccalaureate Degrees										
Agribusiness and Agricultural Production	0.66	1.02	1.19	1.14	1.18	1.21	1.34	0.81	0.72	0.72
Agricultural Sciences	1.81	1.74	1.63	1.50	1.20	1.22	0.92	0.94	0.72	0.62
Renewable Natural Resources	0.80	0.74	0.68	0.54	0.45	0.52	0.32	0.31	0.34	0.31
Architecture and Environmental Design	0.85	0.84	0.83	0.73	0.79	0.75	0.70	0.76	0.77	0.79
Area and Ethnic Studies	0.46	0.47	0.43	0.43	0.26	0.29	0.29	0.26	0.25	0.28
Business and Management	23.50	24.41	25.48	25.51	24.45	25.58	25.66	26.80	27.17	26.05
Communications	4.28	4.46	4.96	5.47	5.12	5.48	5.61	5.92	5.92	5.79
Computer and Information Sciences	1.23	1.38	1.95	2.59	3.08	3.66	3.80	3.27	3.22	2.84
Education	5.81	4.91	4.57	4.41	3.71	3.94	3.72	4.05	4.31	4.24
Engineering	5.86	10.55	11.70	11.47	16.99	11.90	12.29	8.41	7.57	7.29
Engineering-Related Technologies	1.90	1.89	2.04	1.97	2.07	2.13	2.03	2.28	2.02	1.60
Foreign Languages	1.14	1.01	0.88	0.90	0.92	0.81	0.77	0.83	0.93	0.82
Allied Health	0.63	0.68	0.56	0.44	0.40	0.43	0.41	0.37	0.37	0.35
Health Sciences	5.25	4.84	4.70	4.45	3.91	4.33	3.99	3.87	3.71	3.69
Home Economics	2.40	2.00	1.83	1.68	1.73	1.87	1.72	1.95	1.65	1.66
Letters	3.46	3.15	2.96	3.11	3.11	3.39	3.63	3.76	4.19	4.74
Liberal/General Studies	5.92	5.58	5.13	5.17	5.13	5.53	6.07	7.47	8.35	9.15
Life Sciences	3.54	3.43	2.88	2.91	2.55	2.79	2.77	2.83	2.43	2.65
Mathematics	0.94	0.77	0.94	0.96	1.15	1.31	1.44	1.36	1.18	1.11
Multi/Interdisciplinary Studies	1.03	0.85	0.81	0.71	0.65	0.69	0.69	0.72	0.85	0.80
Parks and Recreation	1.60	1.43	1.12	0.97	0.86	0.89	0.84	0.79	0.94	0.78
Philosophy and Religion	0.46	0.40	0.36	0.33	0.34	0.30	0.32	0.30	0.29	0.33
Physical Sciences	1.83	1.68	1.73	1.57	1.65	1.73	1.67	1.60	1.32	1.23
Psychology	5.43	4.90	4.91	4.88	4.22	4.73	4.64	5.01	5.10	5.71
Protective Services	2.24	1.83	1.56	1.67	1.44	1.66	1.64	1.76	1.80	1.89
Public Affairs	2.53	2.03	1.83	1.76	1.42	1.46	1.50	1.57	1.65	1.78
Social Sciences	8.74	8.07	7.76	7.88	6.96	7.25	7.21	7.80	8.21	8.87
Visual and Performing Arts	5.70	4.94	4.80	4.86	4.29	4.15	4.02	4.33	4.02	3.88

**Undergraduate and Graduate Degrees Awarded at the California State University
by Discipline Division, Fall 1981 to Fall 1990**

	1981	1982	1983	1984	1985	1986	1987	1988	1989	1990
Master's Degrees										
Agribusiness and Agricultural Production	0	35	39	37	41	28	40	4	2	2
Agricultural Sciences	92	116	122	106	83	69	63	63	59	56
Renewable Natural Resources	23	26	26	20	31	24	26	42	31	34
Architecture and Environmental Design	82	93	96	87	64	73	53	67	66	56
Area and Ethnic Studies	42	28	33	20	16	16	14	12	11	26
Business and Management	1,193	1,318	1,385	1,524	1,389	1,285	1,366	1,471	1,564	1,661
Communications	66	87	70	76	70	104	79	91	90	121
Computer and Information Sciences	127	155	197	188	200	230	218	220	247	257
Education	3,250	3,307	3,188	3,112	2,864	2,613	2,459	2,613	2,792	2,847
Engineering	428	1,438	1,385	1,450	1,458	1,431	1,399	570	622	610
Foreign Languages	82	89	65	66	48	53	51	64	74	76
Allied Health	155	137	113	67	80	79	65	49	46	59
Health Sciences	574	540	535	630	570	564	535	528	542	597
Home Economics	142	154	134	142	123	115	103	88	111	77
Letters	386	407	400	426	464	411	400	439	453	533
Liberal/General Studies	21	28	8	35	33	16	8	8	44	62
Library and Archival Sciences	60	76	73	55	57	55	77	96	76	103
Life Sciences	230	219	239	227	163	178	167	155	156	150
Mathematics	41	62	56	63	58	73	60	97	91	97
Multi/Interdisciplinary Studies	104	148	135	136	136	139	152	132	115	145
Parks and Recreation	54	43	44	31	31	38	30	25	26	33
Philosophy and Religion	16	8	14	11	7	8	9	8	14	13
Physical Sciences	140	170	160	155	145	149	165	166	159	182
Psychology	546	527	476	496	516	460	456	380	404	430
Protective Services	50	37	27	20	29	22	31	38	27	44
Public Affairs	790	745	740	707	785	642	749	818	931	896
Social Sciences	398	346	407	349	341	280	283	325	279	325
Visual and Performing Arts	453	457	433	375	378	409	378	391	349	358

**Percentage of Undergraduate and Graduate Degrees Awarded at the California State University
by Discipline Division, Fall 1981 to Fall 1990**

	1981	1982	1983	1984	1985	1986	1987	1988	1989	1990
Master's Degrees										
Agribusiness and Agricultural Production	0.00	0.32	0.37	0.35	0.40	0.29	0.42	0.04	0.02	0.00
Agricultural Sciences	0.96	1.07	1.15	1.00	0.82	0.72	0.67	0.70	0.63	0.57
Renewable Natural Resources	0.24	0.24	0.25	0.19	0.30	0.25	0.28	0.47	0.33	0.35
Architecture and Environmental Design	0.86	0.86	0.91	0.82	0.63	0.76	0.56	0.75	0.70	0.57
Area and Ethnic Studies	0.44	0.26	0.31	0.19	0.16	0.17	0.15	0.13	0.12	0.26
Business and Management	12.50	12.11	13.07	14.36	13.64	13.44	14.48	16.42	16.67	16.86
Communications	0.69	0.81	0.66	0.72	0.69	1.09	0.84	1.02	0.96	1.23
Computer and Information Sciences	1.33	1.44	1.86	1.77	1.96	2.40	2.31	2.46	2.63	2.61
Education	34.05	30.63	30.08	29.33	28.13	27.32	26.06	29.16	29.76	28.90
Engineering	4.48	13.32	13.07	13.67	14.32	14.96	14.83	6.36	6.63	6.19
Foreign Languages	0.86	0.82	0.61	0.62	0.47	0.55	0.54	0.71	0.79	0.77
Allied Health	1.62	1.27	1.07	0.63	0.79	0.83	0.69	0.55	0.49	0.60
Health Sciences	6.01	5.00	5.05	5.94	5.60	5.90	5.67	5.89	5.78	6.06
Home Economics	1.49	1.43	1.26	1.34	1.21	1.20	1.09	0.98	1.18	0.78
Letters	4.04	3.77	3.77	4.01	4.56	4.30	4.24	4.90	4.83	5.41
Liberal/General Studies	0.22	0.26	0.08	0.33	0.32	0.17	0.08	0.09	0.47	0.63
Library and Archival Sciences	0.63	0.70	0.69	0.52	0.56	0.58	0.82	1.07	0.81	1.05
Life Sciences	2.41	2.03	2.25	2.14	1.60	1.86	1.77	1.73	1.66	1.52
Mathematics	0.43	0.57	0.53	0.59	0.57	0.76	0.64	1.08	0.97	0.98
Multi/Interdisciplinary Studies	1.09	1.37	1.27	1.28	1.34	1.45	1.61	1.47	1.23	1.47
Parks and Recreation	0.57	0.40	0.42	0.29	0.30	0.40	0.32	0.28	0.28	0.34
Philosophy and Religion	0.17	0.07	0.13	0.10	0.07	0.08	0.10	0.09	0.15	0.13
Physical Sciences	1.47	1.57	1.51	1.46	1.42	1.56	1.75	1.85	1.69	1.85
Psychology	5.72	4.88	4.49	4.67	5.07	4.81	4.83	4.24	4.31	4.37
Protective Services	0.52	0.34	0.25	0.19	0.28	0.23	0.33	0.42	0.29	0.45
Public Affairs	8.28	6.90	6.98	6.66	7.71	6.71	7.94	9.13	9.92	9.10
Social Sciences	4.17	3.20	3.84	3.29	5	2.93	3.00	3.63	2.97	3.30
Visual and Performing Arts	4.75	4.23	4.08	3.53	3.11	4.28	4.01	4.36	3.72	3.63

Section 6

Area Specific Student Data

- 6-1 **Number of Recent Public and Private High School Graduates and Percent Enrolling in Each Segment of California Higher Education by County and Year, 1981 Through 1990**
- 6-2 **Sex and Ethnic Distribution of 1989-90 California Public High School Graduates by County, and of Fall 1990 First-Time Freshmen from Public High Schools at the University of California, the California State University, and the California Community Colleges by County**
- 6-3 **Flow of Transfer Students from California Community College Districts and Colleges to the University of California, the California State University and Regionally Accredited Independent Colleges and Universities, Fall Term and Full-Year, 1982-83 Through 1990-91**
- 6-4 **Ethnic Distribution of Community College Transfer Students to the University of California and the California State University, Fall 1988, Fall 1989 and Fall 1990**
- 6-5 **Public and Private High School Graduates by Region, 1980 to 1990**
- 6-6 **A-F Completion Rates of High School Graduates by County and by Region, 1985-86 Through 1990-91**

**Number of Recent Public and Private High School Graduates
and Percent Enrolling in Each Segment of California Higher Education
by County and Year, 1981 Through 1990.**

County	Year	Number of High School Graduates	Percentage Enrolling as Freshmen					Grand Total
			University of California	California State University	California Community Colleges	Total Public Institutions	Independent Institutions	
Alameda								
	1981	12,154	8.0	9.1	37.0	54.0	2.5	56.5
	1982	12,278	8.0	10.1	42.0	60.1	2.1	62.2
	1983	11,848	8.5	10.0	37.9	56.4	2.4	58.8
	1984	11,750	8.4	10.5	36.5	55.5	2.4	57.9
	1985	11,486	8.0	10.3	34.8	53.0	3.4	56.4
	1986	12,066	7.8	10.6	35.5	54.0	2.3	56.3
	1987	11,743	8.6	11.6	38.2	58.4	2.9	61.3
	1988	12,417	9.3	11.7	37.4	58.4	2.5	60.9
	1989	11,706	8.6	13.0	38.3	60.0	1.0	61.0
	1990	10,847	9.5	12.2	40.1	61.8	1.5	63.3
Alpine								
	1981	0	0.0	0.0	0.0	0.0	0.0	0.0
	1982	0	0.0	0.0	0.0	0.0	0.0	0.0
	1983	7	0.0	0.0	42.9	42.9	0.0	42.9
	1984	0	0.0	0.0	0.0	0.0	0.0	0.0
	1985	0	0.0	0.0	0.0	0.0	0.0	0.0
	1986	0	0.0	0.0	0.0	0.0	0.0	0.0
	1987	0	0.0	0.0	0.0	0.0	0.0	0.0
	1988	0	0.0	0.0	0.0	0.0	0.0	0.0
	1989	0	0.0	0.0	0.0	0.0	0.0	0.0
	1990	0	0.0	0.0	0.0	0.0	0.0	0.0
Amador								
	1981	197	2.5	8.1	31.0	41.6	4.1	45.7
	1982	226	1.8	6.2	24.3	32.3	4.0	36.3
	1983	193	4.1	12.4	33.7	50.3	4.1	54.4
	1984	230	1.7	5.7	41.3	48.7	3.0	51.7
	1985	199	7.0	6.0	52.3	65.3	0.1	65.4
	1986	275	5.1	4.7	36.4	46.2	1.1	47.3
	1987	241	2.1	5.8	28.2	36.1	0.8	36.9
	1988	268	7.8	7.1	17.9	32.8	0.8	33.6
	1989	270	4.1	5.9	31.5	41.5	0.0	41.5
	1990	241	3.7	6.2	32.3	42.7	3.3	46.1
Butte								
	1981	1,491	2.9	13.3	3.4	19.6	2.4	22.0
	1982	1,492	2.0	13.1	13.4	28.5	1.7	30.2
	1983	1,495	3.1	11.7	14.0	28.8	1.5	30.3
	1984	1,409	3.2	12.8	24.2	40.2	1.0	41.2
	1985	1,432	3.8	15.2	24.2	43.2	0.4	43.6
	1986	1,346	3.6	13.8	33.8	51.3	2.9	54.2
	1987	1,453	4.6	17.5	24.4	46.5	2.5	49.0
	1988	1,431	3.6	15.2	31.2	50.1	1.5	51.6
	1989	1,513	3.5	12.1	33.0	48.6	1.4	50.0
	1990	1,480	3.4	12.8	29.9	46.1	1.6	47.8

**Number of Recent Public and Private High School Graduates
and Percent Enrolling in Each Segment of California Higher Education
by County and Year, 1981 Through 1990.**

County	Year	Number of High School Graduates	Percentage Enrolling as Freshmen					Grand Total
			University of California	California State University	California Community Colleges	Total Public Institutions	Independent Institutions	
Calaveras								
	1981	89	1.0	7.6	39.8	48.4	0.7	49.1
	1982	293	4.8	8.2	33.1	46.1	1.4	47.5
	1983	305	2.6	6.2	40.0	48.9	4.3	53.2
	1984	307	2.9	7.5	31.3	41.7	2.3	44.0
	1985	293	2.7	9.2	21.0	32.9	0.2	34.0
	1986	351	4.0	8.0	19.1	31.1	1.4	32.5
	1987	346	1.4	10.4	25.7	37.0	4.9	42.5
	1988	377	3.2	6.9	17.0	27.1	2.5	29.6
	1989	379	2.6	9.0	23.5	35.1	0.8	35.9
	1990	372	1.9	5.4	33.1	40.3	1.9	42.2
Colusa								
	1981	204	2.9	10.0	35.3	49.0	0.0	49.0
	1982	178	1.1	8.4	40.4	50.0	0.0	50.0
	1983	153	5.2	9.8	36.6	51.6	0.0	51.6
	1984	180	4.4	12.2	29.4	46.0	0.0	46.1
	1985	162	6.8	9.3	29.0	45.1	0.0	45.1
	1986	169	1.2	8.9	43.8	53.8	0.0	53.8
	1987	191	4.7	9.9	29.8	44.5	0.0	44.5
	1988	184	3.8	9.8	28.8	42.4	1.6	44.0
	1989	218	4.1	17.0	23.9	45.0	0.5	45.4
	1990	200	2.5	16.5	24.0	43.0	1.0	44.0
Contra Costa								
	1981	8,747	10.5	8.1	44.4	63.0	3.3	66.3
	1982	8,768	10.7	8.0	45.1	63.8	2.6	66.4
	1983	8,348	11.7	7.8	42.6	62.1	3.5	65.6
	1984	8,428	11.6	8.2	38.9	58.7	3.2	61.9
	1985	7,861	11.3	10.1	45.5	66.9	2.4	69.3
	1986	8,092	11.0	9.1	53.5	73.6	3.7	77.3
	1987	8,820	10.1	9.9	36.9	57.0	3.6	60.6
	1988	9,085	11.0	9.7	36.0	56.7	3.0	59.7
	1989	8,566	9.7	10.5	41.5	61.7	1.9	63.5
	1990	7,987	10.9	9.4	40.2	60.5	1.5	62.0
Del Norte								
	1981	197	1.0	7.1	28.4	36.5	1.0	37.5
	1982	218	0.9	8.7	25.2	34.9	0.0	34.9
	1983	215	2.8	3.7	19.5	26.0	0.9	26.9
	1984	177	1.1	5.1	18.1	24.3	0.6	24.9
	1985	188	0.5	6.9	29.3	36.7	0.1	36.8
	1986	167	0.0	6.0	40.1	46.1	1.8	47.9
	1987	176	1.1	9.1	30.1	40.3	2.3	42.6
	1988	188	3.7	5.9	23.4	33.0	1.1	34.1
	1989	201	1.5	7.5	28.4	37.3	1.0	38.3
	1990	200	1.0	6.5	20.5	28.0	0.5	28.5

***Number of Recent Public and Private High School Graduates
and Percent Enrolling in Each Segment of California Higher Education
by County and Year, 1981 Through 1990.***

County	Year	Number of High School Graduates	Percentage Enrolling as Freshmen					Grand Total
			University of California	California State University	California Community Colleges	Total Public Institutions	Independent Institutions	
El Dorado								
	1981	1,016	4.6	8.3	54.2	67.1	2.8	69.9
	1982	971	3.7	8.4	38.3	50.5	1.0	51.5
	1983	964	4.4	7.5	35.6	47.4	0.7	48.1
	1984	1,042	3.6	8.7	40.9	53.3	0.6	53.9
	1985	1,045	3.7	10.2	38.1	52.1	0.5	52.6
	1986	1,138	3.4	10.5	40.5	54.5	2.2	56.7
	1987	1,027	4.6	10.8	39.9	55.3	2.8	58.1
	1988	1,213	3.4	10.6	36.3	50.2	2.1	52.3
	1989	1,139	3.8	10.2	39.7	53.6	1.1	54.7
	1990	1,119	3.4	10.4	39.7	53.4	1.1	54.5
Fresno								
	1981	6,260	2.7	14.3	4.1	21.1	1.4	22.5
	1982	6,284	2.5	13.6	39.3	55.4	2.1	57.5
	1983	6,098	2.6	13.6	32.9	49.2	2.3	51.5
	1984	6,161	2.9	12.3	34.4	49.6	1.8	51.4
	1985	5,919	3.1	13.2	36.5	52.8	1.2	54.0
	1986	5,868	4.0	13.8	37.0	54.7	2.1	56.8
	1987	5,989	4.6	14.3	37.9	56.7	2.8	59.5
	1988	6,492	4.3	13.4	38.8	56.5	1.3	57.8
	1989	6,443	4.2	12.3	39.9	56.5	1.8	58.3
	1990	6,278	4.2	12.7	39.2	56.2	1.2	57.3
Glenn								
	1981	292	1.0	7.5	5.1	13.7	1.4	15.1
	1982	322	4.0	8.1	18.3	30.4	1.6	32.0
	1983	290	2.4	9.3	20.7	32.4	1.7	34.1
	1984	263	3.8	11.8	23.2	38.8	0.8	39.6
	1985	253	1.2	13.8	32.0	47.0	0.1	47.1
	1986	238	5.0	15.5	29.8	50.4	1.3	51.7
	1987	245	0.8	17.6	22.0	40.4	2.4	42.8
	1988	289	1.7	14.5	29.8	46.0	2.1	48.1
	1989	257	1.6	16.0	30.7	48.2	0.8	49.0
	1990	267	1.1	18.0	23.2	42.3	1.1	43.4
Humboldt								
	1981	1,199	2.5	10.2	44.9	57.5	1.3	58.8
	1982	1,171	3.1	10.0	37.8	50.9	1.4	52.3
	1983	1,105	2.6	10.8	32.9	46.3	2.5	48.8
	1984	1,072	2.6	8.7	16.1	27.4	2.1	29.5
	1985	978	3.7	12.1	37.5	53.3	0.3	53.6
	1986	975	2.9	13.9	37.0	53.8	1.9	55.7
	1987	1,048	5.1	10.8	36.7	52.6	2.7	55.3
	1988	1,103	3.6	14.1	31.0	48.7	1.4	50.1
	1989	1,082	4.1	14.3	39.3	57.7	1.2	58.9
	1990	926	3.0	13.2	35.2	51.4	1.5	52.9

***Number of Recent Public and Private High School Graduates
and Percent Enrolling in Each Segment of California Higher Education
by County and Year, 1981 Through 1990.***

County	Year	Number of High School Graduates	Percentage Enrolling as Freshmen					Grand Total
			University of California	California State University	California Community Colleges	Total Public Institutions	Independent Institutions	
Imperial								
	1981	1,358	3.0	3.3	36.4	42.7	1.4	44.1
	1982	1,306	2.5	3.1	44.9	50.6	2.3	52.9
	1983	1,262	4.0	4.1	41.2	49.3	1.5	50.8
	1984	1,323	3.5	3.8	58.9	66.1	1.4	67.5
	1985	1,355	3.1	3.5	12.9	19.5	0.3	19.8
	1986	1,321	3.0	3.3	49.4	55.7	1.1	56.8
	1987	1,307	3.6	2.9	44.3	50.8	2.7	53.5
	1988	1,380	2.8	3.8	46.5	53.0	1.2	54.2
	1989	1,546	3.5	3.5	39.8	46.8	0.8	47.7
	1990	1,636	3.2	4.0	9.4	16.5	0.8	17.3
Inyo								
	1981	216	3.2	10.2	34.7	48.1	1.9	50.0
	1982	267	2.2	9.4	28.5	40.1	5.6	45.7
	1983	233	3.4	11.6	26.6	41.6	1.3	42.9
	1984	244	4.9	8.2	36.1	49.2	1.6	50.8
	1985	201	4.0	11.4	30.8	46.3	0.1	46.4
	1986	219	8.2	6.8	36.5	51.6	3.6	55.2
	1987	236	3.4	7.2	30.5	41.1	2.1	43.2
	1988	252	4.8	9.9	27.8	42.5	1.2	43.7
	1989	233	1.7	6.9	19.3	27.9	2.6	30.5
	1990	211	2.4	6.6	25.6	34.6	3.3	37.9
Kern								
	1981	4,283	2.3	7.4	43.8	53.6	2.8	56.4
	1982	4,075	2.7	6.7	40.4	49.8	1.5	51.3
	1983	4,034	2.3	5.7	32.4	40.4	2.0	42.4
	1984	3,915	2.9	7.2	32.7	42.8	2.3	45.1
	1985	4,079	3.1	8.9	37.4	49.4	1.2	50.6
	1986	4,171	3.4	8.0	42.7	54.0	2.5	56.5
	1987	4,632	3.3	8.7	30.6	42.6	2.2	44.8
	1988	5,068	2.9	8.0	35.6	46.4	1.8	48.2
	1989	5,414	2.4	7.7	38.5	48.6	1.2	49.8
	1990	5,311	2.5	7.6	42.1	52.2	1.1	53.3
Kings								
	1981	888	2.0	7.7	43.5	53.2	2.1	55.3
	1982	899	1.4	5.9	44.5	51.8	2.3	54.1
	1983	856	3.2	6.2	45.2	54.6	1.6	56.2
	1984	843	3.1	8.4	40.3	51.8	1.1	52.9
	1985	852	1.6	5.4	39.9	46.9	0.2	47.1
	1986	834	2.0	6.2	36.8	45.1	2.6	47.7
	1987	837	1.3	7.0	36.3	44.7	1.7	46.4
	1988	913	2.5	7.6	35.8	45.9	1.2	47.1
	1989	927	2.2	5.8	38.2	46.2	1.5	47.7
	1990	957	1.9	6.4	25.5	33.8	2.3	36.1

*Number of Recent Public and Private High School Graduates
and Percent Enrolling in Each Segment of California Higher Education
by County and Year, 1981 Through 1990.*

County	Year	Number of High School Graduates	Percentage Enrolling as Freshmen					Grand Total
			University of California	California State University	California Community Colleges	Total Public Institutions	Independent Institutions	
Lake								
	1981	376	1.9	5.3	43.1	50.3	2.1	52.4
	1982	403	2.0	6.0	42.2	50.1	1.0	51.1
	1983	416	2.2	5.0	32.0	39.2	0.7	39.9
	1984	389	3.3	4.1	23.7	31.1	1.0	32.1
	1985	408	2.5	6.6	34.6	43.6	0.1	43.7
	1986	374	3.5	6.4	41.7	51.6	2.7	54.3
	1987	410	3.4	8.8	30.0	42.2	0.5	42.7
	1988	474	3.2	7.2	22.2	32.5	1.1	33.6
	1989	422	3.8	11.4	27.0	42.2	1.4	43.6
	1990	451	2.4	7.3	25.7	35.5	1.8	37.3
Lassen								
	1981	302	1.7	3.3	43.0	48.0	1.1	49.1
	1982	300	1.7	4.0	44.3	50.0	0.3	50.3
	1983	306	1.0	3.3	45.8	50.0	0.7	50.7
	1984	240	1.3	4.2	44.6	50.0	0.8	50.8
	1985	259	1.9	3.9	42.5	48.3	0.1	48.4
	1986	275	1.5	5.1	53.5	60.0	1.1	61.1
	1987	297	2.0	8.4	37.7	48.1	1.3	49.4
	1988	312	1.3	1.9	40.4	43.6	0.6	44.2
	1989	258	1.9	1.9	29.1	32.9	1.2	34.1
	1990	272	2.2	5.5	34.2	41.9	0.7	42.6
Los Angeles								
	1981	75,531	7.2	10.4	39.2	56.7	4.2	60.9
	1982	76,814	7.3	10.6	40.6	58.6	4.4	63.0
	1983	76,822	7.6	10.1	35.8	53.6	4.3	57.9
	1984	75,213	8.1	10.0	32.6	50.7	4.0	54.7
	1985	72,720	8.7	11.2	32.6	52.5	3.4	55.9
	1986	72,422	8.7	11.5	36.4	56.6	4.3	60.9
	1987	75,381	8.7	12.2	32.0	52.9	3.9	56.8
	1988	77,658	8.4	12.2	33.6	54.2	3.8	58.0
	1989	74,390	8.5	13.0	32.8	54.3	2.3	56.6
	1990	72,763	8.2	12.6	32.8	53.6	2.4	56.0
Madera								
	1981	711	1.5	8.7	17.3	27.6	1.5	29.1
	1982	577	2.4	14.0	47.0	63.4	3.1	66.5
	1983	606	1.0	10.4	28.1	39.4	1.8	41.2
	1984	641	1.4	10.0	34.2	45.6	1.6	47.2
	1985	683	2.2	10.0	34.7	46.9	0.2	47.1
	1986	774	1.6	9.4	27.0	38.0	1.7	39.7
	1987	887	2.0	8.9	25.4	36.3	1.7	38.0
	1988	887	2.1	10.0	31.8	44.0	1.8	45.8
	1989	963	2.4	9.7	28.1	40.2	1.0	41.2
	1990	981	2.3	8.0	30.8	41.1	0.7	41.8

**Number of Recent Public and Private High School Graduates
and Percent Enrolling in Each Segment of California Higher Education
by County and Year, 1981 Through 1990.**

County	Year	Number of High School Graduates	Percentage Enrolling as Freshmen					Grand Total
			University of California	California State University	California Community Colleges	Total Public Institutions	Independent Institutions	
Marin								
	1981	3,277	13.2	7.7	40.1	61.0	3.7	64.7
	1982	2,983	13.1	8.0	34.5	55.6	4.0	59.6
	1983	2,940	15.4	8.8	26.1	50.3	3.2	53.5
	1984	2,750	17.7	8.8	29.5	56.0	3.9	59.9
	1985	2,616	16.7	10.7	31.2	58.5	1.5	60.0
	1986	2,539	16.7	11.5	32.7	60.9	4.8	65.7
	1987	2,583	14.8	11.9	29.4	56.0	4.6	60.6
	1988	2,597	14.0	13.1	31.5	58.6	4.6	63.2
	1989	2,391	13.6	12.7	33.0	59.3	3.2	62.5
	1990	2,098	14.9	11.5	12.4	38.8	2.6	41.4
Mariposa								
	1981	109	3.7	11.9	48.6	64.2	0.0	64.2
	1982	121	5.0	6.6	48.8	60.3	0.0	60.3
	1983	136	1.5	7.4	36.0	44.9	0.0	44.9
	1984	140	2.1	7.1	35.7	45.0	0.0	45.0
	1985	162	4.9	8.0	32.1	45.1	0.0	45.1
	1986	135	3.0	7.4	26.7	37.0	0.0	37.0
	1987	117	3.4	6.8	29.9	40.2	0.0	40.2
	1988	135	3.7	6.7	30.4	40.7	2.2	42.9
	1989	143	4.2	11.9	26.6	42.7	4.9	47.6
	1990	123	4.9	8.1	34.1	47.2	2.4	49.6
Mendocino								
	1981	899	4.0	8.7	44.7	57.4	1.5	58.9
	1982	868	4.0	7.4	37.6	49.0	1.8	50.8
	1983	773	3.4	10.7	28.6	42.7	2.5	45.2
	1984	869	4.6	9.4	31.3	45.3	3.1	48.4
	1985	804	3.7	9.7	39.1	52.5	0.4	52.9
	1986	883	4.8	8.8	38.1	51.6	3.0	54.6
	1987	934	5.2	7.8	27.0	40.0	3.4	43.4
	1988	1,005	5.0	8.5	23.3	36.7	2.8	39.5
	1989	906	3.9	9.1	36.1	49.0	1.4	50.4
	1990	925	5.8	8.1	34.3	48.2	1.5	49.7
Merced								
	1981	1,813	2.2	6.2	55.3	63.7	1.4	65.1
	1982	1,564	2.4	7.4	56.8	66.6	1.0	67.6
	1983	1,679	2.3	8.9	39.5	50.8	1.2	52.0
	1984	1,717	2.5	8.2	38.8	49.6	0.6	50.2
	1985	1,792	2.1	8.1	37.3	47.5	0.3	47.8
	1986	1,831	1.6	6.6	36.2	44.3	1.5	45.8
	1987	1,935	2.5	8.9	34.0	45.4	1.6	47.0
	1988	1,860	2.3	7.7	34.1	44.1	0.9	45.0
	1989	1,971	2.2	7.1	35.4	44.7	0.5	45.2
	1990	2,038	2.8	6.0	37.7	46.6	0.8	47.4

**Number of Recent Public and Private High School Graduates
and Percent Enrolling in Each Segment of California Higher Education
by County and Year, 1981 Through 1990.**

County	Year	Number of High School Graduates	Percentage Enrolling as Freshmen					Grand Total
			University of California	California State University	California Community Colleges	Total Public Institutions	Independent Institutions	
Modoc								
	1981	132	0.0	7.6	30.3	37.9	0.0	37.9
	1982	145	0.0	4.1	37.2	41.4	0.0	41.4
	1983	135	0.7	8.9	24.4	34.1	0.0	34.1
	1984	135	0.7	3.7	14.8	19.3	0.0	19.3
	1985	117	2.6	8.5	25.6	36.8	0.0	36.8
	1986	113	0.9	9.7	15.0	25.7	0.0	25.7
	1987	112	0.0	7.1	25.9	33.0	0.0	33.0
	1988	94	2.1	7.4	84.0	93.6	0.0	93.6
	1989	97	1.0	4.1	23.7	28.9	0.0	28.9
	1990	102	1.0	2.0	17.6	20.6	0.0	20.6
Mono								
	1981	94	2.1	4.3	48.9	55.3	0.0	55.3
	1982	80	5.0	10.0	37.5	52.5	0.0	52.5
	1983	88	5.7	6.8	18.2	30.7	0.0	30.7
	1984	81	7.4	9.9	33.3	50.6	0.0	50.6
	1985	59	10.2	10.2	27.1	47.5	0.0	47.5
	1986	85	11.8	14.1	22.4	48.2	0.0	48.2
	1987	79	3.8	19.0	54.4	77.2	0.0	77.2
	1988	82	8.5	13.4	24.4	46.3	9.8	56.1
	1989	81	4.9	11.1	28.4	44.4	4.9	49.4
	1990	61	4.9	14.8	26.2	45.9	6.6	52.5
Monterey								
	1981	2,686	6.1	5.7	46.0	57.8	4.0	61.8
	1982	2,803	5.6	4.0	45.9	55.4	3.4	58.8
	1983	2,795	5.4	4.8	35.2	45.5	3.5	49.0
	1984	2,742	7.1	4.6	31.5	43.3	2.9	46.2
	1985	2,711	6.0	4.9	38.6	49.6	1.2	50.8
	1986	2,661	7.6	6.6	34.5	48.6	4.1	52.7
	1987	2,775	6.8	6.2	36.5	49.5	3.8	53.3
	1988	3,064	7.4	6.3	28.0	41.7	5.1	46.8
	1989	2,904	6.9	7.6	34.1	48.6	1.8	50.4
	1990	2,971	6.4	7.9	33.9	48.2	2.2	50.4
Napa								
	1981	1,191	5.0	5.1	66.6	76.7	6.0	82.7
	1982	1,212	6.4	4.8	64.8	75.9	6.7	82.6
	1983	1,203	5.8	6.4	30.3	42.5	4.1	46.6
	1984	1,124	7.7	5.8	14.9	28.4	2.2	30.6
	1985	946	8.5	9.0	37.7	55.2	1.3	56.5
	1986	986	7.2	10.3	37.1	54.7	6.8	61.5
	1987	1,000	7.3	9.4	36.6	53.3	10.1	63.4
	1988	1,054	9.1	8.9	32.7	50.8	4.2	55.0
	1989	1,083	7.1	7.8	39.8	54.7	2.8	57.4
	1990	953	7.9	9.8	28.0	45.6	4.9	50.6

*Number of Recent Public and Private High School Graduates
and Percent Enrolling in Each Segment of California Higher Education
by County and Year, 1981 Through 1990.*

County	Year	Number of High School Graduates	Percentage Enrolling as Freshmen					Grand Total
			University of California	California State University	California Community Colleges	Total Public Institutions	Independent Institutions	
Nevada								
	1981	611	2.5	3.9	38.8	45.2	1.6	46.8
	1982	694	4.3	4.5	31.7	40.5	1.2	41.7
	1983	592	4.4	7.1	39.2	50.7	1.5	52.2
	1984	569	6.5	7.9	39.5	54.0	2.1	56.1
	1985	653	5.5	8.1	35.5	49.2	0.2	49.4
	1986	633	3.8	9.0	37.6	50.4	2.5	52.9
	1987	728	5.8	7.4	37.0	50.1	2.5	52.6
	1988	773	5.3	6.6	29.2	41.1	1.4	42.5
	1989	690	3.3	8.6	42.6	54.5	2.2	56.7
	1990	687	4.5	10.6	38.0	53.1	2.0	55.2
Orange								
	1981	26,590	6.9	10.1	46.7	63.7	3.1	66.8
	1982	25,604	7.2	10.6	45.1	62.9	3.3	66.2
	1983	25,196	8.4	10.1	41.7	60.2	3.4	63.6
	1984	24,244	8.9	9.7	40.2	58.8	3.0	61.8
	1985	23,956	9.3	11.6	40.0	60.9	4.5	65.4
	1986	23,288	9.8	12.0	40.9	62.7	3.9	66.6
	1987	24,605	9.4	12.6	38.7	60.7	3.6	64.3
	1988	25,885	9.5	12.1	36.9	58.6	3.3	61.9
	1989	24,771	7.8	11.3	40.0	59.1	2.4	61.5
	1990	22,993	9.5	11.0	25.5	46.0	2.5	48.6
Placer								
	1981	2,012	2.5	4.6	43.4	50.5	1.4	51.9
	1982	1,863	2.8	4.9	38.4	46.2	1.4	47.6
	1983	1,803	3.8	5.7	40.0	49.5	2.1	51.6
	1984	1,842	3.7	5.8	40.3	49.9	1.7	51.6
	1985	1,777	3.9	6.9	39.4	50.1	0.1	50.2
	1986	1,857	4.4	7.1	38.8	50.2	2.4	52.6
	1987	1,820	3.6	8.6	40.5	52.8	2.9	55.7
	1988	1,858	5.1	8.8	37.3	51.2	2.3	53.5
	1989	1,896	3.8	5.5	44.7	54.0	1.3	55.3
	1990	1,792	4.7	7.6	43.5	55.9	1.3	57.2
Plumas								
	1981	280	5.0	6.8	43.2	55.0	2.9	57.9
	1982	276	2.2	5.1	28.3	35.5	1.1	36.6
	1983	242	1.7	6.2	37.2	45.0	2.5	47.5
	1984	252	3.6	8.3	44.0	56.0	0.8	56.8
	1985	247	3.6	6.5	53.0	63.2	0.1	63.3
	1986	249	3.6	8.8	51.4	63.9	2.4	66.3
	1987	251	4.0	12.4	46.6	62.9	4.0	66.9
	1988	240	3.3	5.4	33.8	42.5	3.8	46.3
	1989	248	2.4	10.5	25.4	38.3	0.8	39.1
	1990	214	1.9	8.4	34.1	44.4	1.9	46.3

*Number of Recent Public and Private High School Graduates
and Percent Enrolling in Each Segment of California Higher Education
by County and Year, 1981 Through 1990.*

County	Year	Number of High School Graduates	Percentage Enrolling as Freshmen					Grand Total
			University of California	California State University	California Community Colleges	Total Public Institutions	Independent Institutions	
Riverside								
	1981	6,832	5.1	4.9	45.1	55.2	1.9	57.1
	1982	6,961	5.0	4.5	40.6	50.1	1.8	51.9
	1983	6,883	5.1	4.2	36.6	46.0	2.4	48.4
	1984	7,104	5.8	4.7	33.5	43.9	2.5	46.4
	1985	6,893	5.7	5.6	25.5	36.9	2.6	39.5
	1986	7,091	5.8	6.1	32.8	44.6	1.5	46.1
	1987	7,518	5.3	6.3	27.6	39.3	2.2	41.5
	1988	8,108	5.7	6.2	23.4	35.2	2.0	37.2
	1989	8,572	5.3	6.2	22.9	34.4	1.4	35.8
	1990	8,618	5.5	5.9	31.2	42.6	2.0	44.6
Sacramento								
	1981	9,739	4.5	9.3	43.9	57.7	2.0	59.7
	1982	9,555	4.1	8.6	41.2	54.0	2.0	56.0
	1983	9,046	5.9	9.0	38.9	53.8	1.9	55.7
	1984	9,029	6.3	8.1	37.9	52.2	2.1	54.3
	1985	8,527	6.2	9.7	39.3	55.3	2.4	57.7
	1986	9,213	6.1	8.0	40.7	54.8	2.4	57.2
	1987	8,851	6.5	8.9	42.9	58.3	2.9	61.2
	1988	9,470	5.9	8.6	36.7	51.2	2.4	53.6
	1989	9,309	6.3	8.3	41.6	56.2	1.2	57.4
	1990	8,803	6.4	8.4	46.3	61.2	1.7	62.9
San Benito								
	1981	275	3.3	8.7	41.1	53.1	5.8	58.9
	1982	233	3.9	3.4	41.6	48.9	4.3	53.2
	1983	309	1.6	5.5	35.3	42.4	2.3	44.7
	1984	277	2.2	5.8	28.2	36.1	2.5	38.6
	1985	306	2.0	5.2	24.2	31.4	0.1	31.5
	1986	306	3.6	4.6	35.0	43.1	3.2	46.3
	1987	338	5.0	10.1	22.2	37.3	0.6	37.9
	1988	354	6.2	10.5	23.4	40.1	2.0	42.1
	1989	365	4.4	7.1	37.8	49.3	0.3	49.6
	1990	298	4.7	9.1	43.6	57.4	1.0	58.4
San Bernardino								
	1981	9,612	3.1	7.3	43.2	53.6	2.7	56.3
	1982	9,836	3.5	6.9	48.2	58.6	2.5	61.1
	1983	9,568	3.4	6.7	40.4	50.5	2.8	53.3
	1984	9,702	3.6	7.1	35.2	45.9	2.0	47.9
	1985	9,545	4.2	6.8	31.7	42.7	1.2	43.9
	1986	9,532	4.4	8.3	30.5	43.2	2.5	45.7
	1987	10,016	4.6	8.0	35.1	47.7	2.2	49.9
	1988	10,930	4.2	8.5	34.1	46.8	1.9	48.7
	1989	11,630	4.4	8.5	30.5	43.4	1.6	45.0
	1990	11,682	3.8	8.6	30.1	42.6	2.4	45.0

*Number of Recent Public and Private High School Graduates
and Percent Enrolling in Each Segment of California Higher Education
by County and Year, 1981 Through 1990.*

County	Year	Number of High School Graduates	Percentage Enrolling as Freshmen					Grand Total
			University of California	California State University	California Community Colleges	Total Public Institutions	Independent Institutions	
San Diego								
	1981	20,108	6.9	7.8	39.0	53.7	3.5	57.2
	1982	20,582	7.0	7.4	35.4	49.8	3.6	53.4
	1983	20,652	7.2	7.8	36.9	51.9	3.2	55.1
	1984	19,761	8.1	8.5	30.7	47.4	3.8	51.2
	1985	19,571	8.2	8.8	36.3	53.3	3.5	56.8
	1986	19,610	8.8	8.8	39.5	57.2	2.9	60.1
	1987	20,303	8.7	10.1	32.1	50.9	3.7	54.6
	1988	22,017	7.9	9.1	32.4	49.4	3.1	52.5
	1989	21,503	7.6	9.1	37.2	53.9	2.9	56.7
	1990	21,045	7.2	9.2	35.5	51.9	2.7	54.6
San Francisco								
	1981	4,931	10.3	14.7	39.2	64.2	3.9	68.1
	1982	5,378	10.7	13.9	41.3	65.9	4.3	70.2
	1983	5,527	11.9	13.2	33.9	59.0	4.7	63.7
	1984	5,405	11.6	15.3	38.7	65.7	4.4	70.1
	1985	5,729	11.0	16.3	35.4	62.7	1.4	64.1
	1986	5,682	9.8	16.2	36.0	62.1	3.5	65.6
	1987	6,102	9.5	16.1	32.8	58.4	4.1	62.5
	1988	5,445	12.1	20.7	30.4	63.3	3.9	67.2
	1989	5,222	11.4	23.0	35.0	69.4	2.5	71.9
	1990	6,138	9.5	17.4	26.1	53.0	1.6	54.7
San Joaquin								
	1981	3,183	4.0	4.7	58.6	67.3	4.5	71.8
	1982	3,716	3.5	4.6	56.5	64.7	3.4	68.1
	1983	3,534	3.4	3.8	42.7	49.9	4.0	53.9
	1984	3,662	3.4	5.1	30.1	38.6	3.5	42.1
	1985	3,601	4.0	4.5	38.7	47.2	1.5	48.7
	1986	3,893	4.4	5.0	18.8	28.2	2.9	31.1
	1987	3,936	3.8	4.5	23.3	31.7	4.9	36.6
	1988	4,347	4.3	6.5	27.3	38.1	2.8	40.9
	1989	4,521	3.8	5.7	48.1	57.6	0.8	58.3
	1990	4,252	3.4	5.5	45.3	54.3	2.8	57.0
San Luis Obispo								
	1981	1,359	3.2	9.9	49.0	62.1	1.5	63.6
	1982	1,482	2.8	8.5	42.9	54.3	1.5	55.8
	1983	1,463	2.7	10.4	34.9	48.0	2.3	50.3
	1984	1,501	3.6	11.1	34.7	49.4	1.9	51.3
	1985	1,317	5.1	11.0	42.7	58.8	0.4	59.2
	1986	1,445	5.3	10.3	38.6	54.3	2.0	56.3
	1987	1,653	3.6	10.0	34.4	48.1	2.9	51.0
	1988	1,583	4.1	11.8	42.5	58.4	1.9	60.3
	1989	1,678	4.0	8.2	41.2	53.4	1.1	54.5
	1990	1,501	5.1	6.1	39.8	51.0	1.7	52.6

***Number of Recent Public and Private High School Graduates
and Percent Enrolling in Each Segment of California Higher Education
by County and Year, 1981 Through 1990.***

County	Year	Number of High School Graduates	Percentage Enrolling as Freshmen					Grand Total
			University of California	California State University	California Community Colleges	Total Public Institutions	Independent Institutions	
San Mateo								
	1981	6,327	8.5	9.1	6.0	23.5	3.9	27.4
	1982	6,497	8.7	8.6	36.3	53.6	4.1	57.7
	1983	6,333	8.9	7.7	39.7	56.2	4.6	60.8
	1984	6,105	10.1	8.3	45.5	63.8	4.0	67.8
	1985	5,763	9.3	9.3	49.4	68.0	3.0	71.0
	1986	5,405	9.9	9.9	53.7	73.5	5.4	78.9
	1987	5,712	9.9	10.1	49.0	69.0	4.9	73.9
	1988	5,889	9.3	11.4	48.0	68.7	4.1	72.8
	1989	5,503	9.8	11.0	47.4	68.2	2.2	70.4
	1990	5,031	10.2	11.6	20.0	41.8	2.4	44.3
Santa Barbara								
	1981	3,546	8.6	5.5	51.1	65.2	2.9	68.1
	1982	3,589	7.8	4.9	55.4	68.1	2.4	70.5
	1983	3,459	8.8	5.2	36.5	50.6	3.5	54.1
	1984	3,363	9.2	5.7	37.6	52.6	2.8	55.4
	1985	3,139	9.8	5.7	39.2	54.7	1.6	56.3
	1986	3,138	9.8	4.7	45.4	59.8	3.5	63.3
	1987	3,338	7.3	6.3	38.5	52.2	3.4	55.6
	1988	3,479	7.9	5.1	39.2	52.3	3.6	55.9
	1989	3,282	7.7	5.1	27.7	40.5	2.3	42.8
	1990	2,983	7.3	4.9	23.0	35.2	2.2	37.4
Santa Clara								
	1981	15,830	8.4	11.2	32.2	51.8	4.1	55.9
	1982	16,739	8.1	12.0	24.0	44.1	4.3	48.4
	1983	15,927	8.8	11.6	38.9	59.3	4.2	63.5
	1984	15,649	9.2	10.9	30.5	50.7	3.8	54.5
	1985	15,222	10.1	13.2	30.0	53.3	5.3	58.6
	1986	15,110	10.0	13.0	37.5	60.5	4.1	64.6
	1987	15,518	10.6	13.9	36.1	60.5	3.9	64.4
	1988	15,710	10.5	14.1	33.7	58.2	3.8	62.0
	1989	15,213	9.8	14.5	31.8	56.2	2.0	58.1
	1990	13,914	10.4	14.0	41.4	65.8	2.1	67.9
Santa Cruz								
	1981	2,057	4.7	5.3	46.7	56.7	2.6	59.3
	1982	2,032	6.5	4.8	42.6	54.0	3.5	57.5
	1983	1,944	8.0	5.7	43.7	57.4	3.2	60.6
	1984	1,908	8.3	5.2	40.5	54.0	3.3	57.3
	1985	1,909	9.6	7.0	39.4	56.0	0.6	56.6
	1986	1,962	8.3	8.2	45.5	61.9	4.7	66.6
	1987	2,066	9.1	8.6	43.7	61.3	2.8	64.1
	1988	2,202	10.0	8.5	40.0	58.4	3.0	61.4
	1989	2,050	8.7	9.1	39.7	57.5	3.7	61.2
	1990	2,027	8.4	7.8	41.7	58.0	4.0	62.0

***Number of Recent Public and Private High School Graduates
and Percent Enrolling in Each Segment of California Higher Education
by County and Year, 1981 Through 1990.***

County	Year	Number of High School Graduates	Percentage Enrolling as Freshmen					Grand Total
			University of California	California State University	California Community Colleges	Total Public Institutions	Independent Institutions	
Shasta								
	1981	1,536	1.7	3.3	77.3	82.2	1.3	83.5
	1982	1,587	2.8	4.0	40.8	47.7	1.2	48.9
	1983	1,533	2.0	4.7	40.6	47.4	0.9	48.3
	1984	1,607	2.1	3.4	39.1	44.6	1.0	45.6
	1985	1,564	2.4	4.8	34.7	41.9	0.4	42.3
	1986	1,455	2.7	4.3	41.2	48.2	1.8	50.0
	1987	1,606	3.4	4.4	33.9	41.7	2.3	44.0
	1988	1,675	3.2	5.4	33.9	42.4	1.2	43.6
	1989	1,603	3.7	5.6	35.2	44.6	1.7	46.4
	1990	1,528	2.2	4.1	14.6	30.9	1.3	22.2
Sierra								
	1981	46	0.0	4.3	19.6	23.9	0.0	23.9
	1982	52	1.9	5.8	26.9	34.6	0.0	34.6
	1983	59	5.1	5.1	18.6	28.8	0.0	23.8
	1984	45	0.0	2.2	20.0	22.2	0.0	22.2
	1985	54	3.7	11.1	16.7	31.5	0.0	31.5
	1986	45	4.4	8.9	33.3	46.7	0.0	46.7
	1987	41	2.4	17.1	17.1	36.6	0.0	36.6
	1988	53	3.8	15.1	30.2	49.1	5.8	54.9
	1989	39	10.3	10.3	17.9	38.5	0.0	38.5
	1990	41	7.3	0.0	46.3	53.7	4.9	58.5
Siskiyou								
	1981	471	2.1	5.7	49.5	57.3	1.6	58.9
	1982	508	2.6	5.3	47.2	55.1	1.2	56.3
	1983	490	3.3	6.1	36.7	46.1	1.0	47.1
	1984	464	1.7	6.3	37.3	45.3	1.3	46.6
	1985	469	3.0	7.5	46.5	56.9	0.1	57.0
	1986	450	3.1	8.0	46.0	57.1	2.2	59.3
	1987	473	3.8	7.4	37.2	48.4	2.7	51.1
	1988	485	3.7	7.2	35.5	46.4	2.1	48.5
	1989	487	2.1	7.4	37.0	46.4	1.2	47.6
	1990	399	3.3	7.8	40.4	51.4	2.0	53.4
Solano								
	1981	2,717	4.9	5.2	41.4	51.5	1.8	53.3
	1982	2,755	4.4	5.7	41.8	51.9	1.4	53.3
	1983	2,679	5.2	5.3	38.1	48.6	1.6	50.2
	1984	2,707	5.8	5.2	31.8	42.7	1.4	44.1
	1985	2,673	6.3	6.5	30.6	43.4	0.6	44.0
	1986	2,536	7.1	7.8	33.7	48.6	1.7	50.3
	1987	2,773	6.6	6.7	33.0	46.4	1.9	48.3
	1988	3,103	6.0	7.1	33.1	46.2	1.5	47.7
	1989	3,151	5.3	8.1	41.0	54.4	0.7	55.1
	1990	3,041	4.2	8.1	41.1	53.4	0.7	54.1

**Number of Recent Public and Private High School Graduates
and Percent Enrolling in Each Segment of California Higher Education
by County and Year, 1981 Through 1990.**

County	Year	Number of High School Graduates	Percentage Enrolling as Freshmen					Grand Total
			University of California	California State University	California Community Colleges	Total Public Institutions	Independent Institutions	
Sonoma								
	1981	3,423	4.0	4.0	44.2	52.2	2.1	54.3
	1982	3,466	4.3	4.4	38.3	47.0	2.0	49.0
	1983	3,443	4.7	5.2	44.5	54.4	2.0	56.4
	1984	3,390	5.0	5.1	25.1	35.2	1.6	36.8
	1985	3,215	5.1	6.6	35.7	47.4	1.1	48.5
	1986	3,309	5.2	7.0	27.6	39.8	2.3	42.1
	1987	3,585	5.6	6.3	21.1	33.1	2.3	35.4
	1988	3,709	5.1	8.0	32.5	45.6	3.9	49.5
	1989	3,658	5.9	9.1	48.9	63.9	2.1	66.0
	1990	3,327	6.6	8.4	42.3	57.3	2.2	59.5
Stanislaus								
	1981	2,805	1.6	5.8	43.1	50.6	2.1	52.7
	1982	2,805	2.6	7.6	42.7	53.0	1.8	54.8
	1983	2,838	3.0	6.9	37.3	47.2	1.7	48.9
	1984	2,849	3.1	7.2	32.8	43.1	1.6	44.7
	1985	2,806	3.2	7.7	35.0	46.0	0.9	46.9
	1986	2,881	3.3	8.9	32.9	45.1	1.7	46.8
	1987	3,198	3.4	8.2	26.9	38.5	2.9	41.4
	1988	3,287	3.5	7.8	33.2	44.5	1.9	46.4
	1989	3,798	3.2	8.8	35.9	47.9	1.2	49.1
	1990	3,536	2.9	7.0	26.8	36.7	1.1	37.8
Sutter								
	1981	722	1.9	7.2	41.3	50.4	0.8	51.2
	1982	676	4.7	5.0	43.0	52.8	1.0	53.8
	1983	678	4.3	8.4	33.8	46.5	1.6	48.1
	1984	675	5.5	8.1	33.9	47.6	0.6	48.2
	1985	638	4.5	7.7	37.6	49.8	0.1	49.9
	1986	627	4.1	4.8	43.1	52.0	1.6	53.6
	1987	672	4.3	8.8	40.9	54.0	1.9	55.9
	1988	698	4.6	9.5	32.5	46.6	2.0	48.6
	1989	705	3.1	5.4	33.8	42.3	0.7	43.0
	1990	645	2.3	7.8	35.7	45.7	0.3	46.0
Tehama								
	1981	572	1.7	8.9	51.6	62.2	1.4	63.6
	1982	560	1.6	6.6	35.0	43.2	1.4	44.6
	1983	514	2.5	8.0	30.5	41.1	1.9	43.0
	1984	553	2.0	8.9	30.6	41.4	0.9	42.3
	1985	490	2.9	7.3	31.0	41.2	0.1	41.3
	1986	488	1.8	8.4	34.0	44.3	2.4	46.7
	1987	516	3.3	10.3	29.7	43.2	3.1	46.3
	1988	505	2.0	12.3	25.7	40.0	1.4	41.4
	1989	476	2.7	10.5	33.4	46.6	0.8	47.5
	1990	479	2.3	9.8	16.1	28.2	1.7	29.9

*Number of Recent Public and Private High School Graduates
and Percent Enrolling in Each Segment of California Higher Education
by County and Year, 1981 Through 1990.*

County	Year	Number of High School Graduates	Percentage Enrolling as Freshmen					Grand Total
			University of California	California State University	California Community Colleges	Total Public Institutions	Independent Institutions	
Trinity								
	1981	99	3.0	18.2	101.0	122.2	0.0	122.2
	1982	142	1.4	6.3	36.6	44.4	0.0	44.4
	1983	163	0.6	8.6	30.1	39.3	0.0	39.3
	1984	150	2.0	8.0	24.0	34.0	0.0	34.0
	1985	169	3.6	7.1	21.3	32.0	0.0	32.0
	1986	217	0.5	7.4	13.8	21.7	0.0	21.7
	1987	147	2.0	12.2	24.5	38.8	0.0	38.8
	1988	173	1.2	7.5	17.3	26.0	1.2	27.2
	1989	148	2.0	10.1	25.7	37.8	1.4	39.2
	1990	184	1.6	7.6	11.4	20.7	1.1	21.7
Tulare								
	1981	2,983	1.6	3.8	40.8	46.2	1.4	47.6
	1982	2,743	1.3	3.8	47.0	52.2	1.2	53.4
	1983	2,742	1.7	3.9	37.1	42.7	1.7	44.4
	1984	2,794	2.1	4.3	42.7	49.1	1.7	50.8
	1985	2,699	2.2	4.6	45.2	51.9	0.4	52.3
	1986	2,816	2.9	4.0	41.3	48.3	2.3	50.6
	1987	3,036	2.8	4.8	36.9	44.5	2.0	46.5
	1988	3,185	3.0	4.7	39.6	47.4	1.5	48.9
	1989	3,263	3.0	4.8	43.1	50.9	1.3	52.3
	1990	3,019	3.2	5.8	39.6	48.6	1.2	49.9
Tuolumne								
	1981	383	2.1	4.7	42.8	49.6	1.8	51.4
	1982	399	4.0	4.0	48.6	56.6	1.8	58.4
	1983	450	2.4	7.1	37.8	47.3	1.6	48.9
	1984	412	1.5	6.3	51.2	59.0	1.7	60.7
	1985	393	3.8	8.9	28.5	41.2	0.2	41.4
	1986	447	2.7	9.6	31.1	43.4	3.5	46.9
	1987	423	2.6	6.4	31.0	40.0	3.1	43.1
	1988	473	2.3	7.4	27.7	37.4	2.9	40.3
	1989	495	2.6	6.9	35.2	44.6	2.0	46.7
	1990	451	2.0	7.1	24.6	33.7	2.0	35.7
Ventura								
	1981	6,739	4.5	5.6	45.4	55.6	2.8	58.4
	1982	6,820	4.9	5.8	45.6	56.3	2.1	58.4
	1983	6,982	5.3	5.7	38.1	49.1	3.2	52.3
	1984	6,714	6.9	6.6	40.3	53.8	2.2	56.0
	1985	6,668	7.0	7.3	39.2	53.5	2.6	56.1
	1986	6,686	7.5	7.4	41.4	56.3	2.6	58.9
	1987	7,276	6.6	6.9	29.9	43.3	2.8	46.1
	1988	7,729	6.3	8.3	26.2	40.9	1.9	42.8
	1989	7,613	6.1	7.3	36.5	49.9	2.1	52.0
	1990	6,980	7.0	6.6	34.5	48.1	2.8	50.9

***Number of Recent Public and Private High School Graduates
and Percent Enrolling in Each Segment of California Higher Education
by County and Year, 1981 Through 1990.***

County	Year	Number of High School Graduates	Percentage Enrolling as Freshmen					Grand Total
			University of California	California State University	California Community Colleges	Total Public Institutions	Independent Institutions	
Yolo								
	1981	1,207	12.3	10.0	36.9	59.2	1.3	60.5
	1982	1,259	12.1	9.5	34.0	55.6	1.7	57.3
	1983	1,188	10.5	10.6	33.7	54.8	1.6	56.4
	1984	1,082	13.1	9.8	32.7	55.6	2.9	58.5
	1985	1,127	13.0	10.2	30.3	53.5	0.3	53.8
	1986	1,098	14.7	11.1	34.9	60.7	1.2	61.9
	1987	1,148	14.7	10.5	32.3	57.6	3.1	60.7
	1988	1,117	13.8	11.0	24.9	49.7	2.7	52.4
	1989	1,080	13.6	10.6	32.2	56.5	1.6	58.1
	1990	1,092	13.3	11.1	32.0	56.3	1.8	58.2
Yuba								
	1981	485	2.5	3.7	47.4	53.6	3.5	57.1
	1982	490	1.8	3.3	40.0	45.1	1.0	46.1
	1983	452	2.4	5.3	41.8	49.6	2.4	52.0
	1984	433	3.9	4.2	38.1	46.2	1.8	48.0
	1985	443	2.7	5.4	37.9	46.0	0.2	46.2
	1986	373	2.4	9.1	47.5	59.0	4.8	63.8
	1987	471	2.3	6.4	41.8	50.5	1.3	51.8
	1988	448	2.7	6.5	32.1	41.3	0.7	42.0
	1989	511	2.5	5.7	30.9	39.1	1.0	40.1
	1990	465	1.9	4.7	26.9	33.5	0.4	34.0
TOTAL								
	1981	263,392	6.4	9.0	41.6	56.9	3.3	60.2
	1982	265,924	6.5	9.0	42.8	58.5	3.2	61.5
	1983	261,994	7.0	8.9	37.9	53.8	3.4	57.2
	1984	257,633	7.5	8.9	36.3	52.7	3.3	56.0
	1985	251,143	7.7	10.0	33.0	50.7	3.0	53.7
	1986	252,150	7.8	10.1	35.8	53.8	3.4	57.2
	1987	262,921	7.7	10.7	34.5	52.9	3.4	56.3
	1988	274,812	7.6	10.7	0.0	18.3	3.3	21.6
	1989	268,983	7.3	10.8	35.6	53.7	2.0	55.7
	1990	258,949	7.3	10.5	34.7	52.5	2.1	54.6

**Sex and Ethnic Distribution of 1989-90 California Public High School Graduates by County,
and of Fall 1990 First-Time Freshmen at the University of California,
the California State University, and the California Community Colleges by County.**

County and Segment	Sex	Total	Asian/ Pacific Islander	Black	Filipino	Native American		White	Sub- Total	Non-Resident No		
						Latino	American			Other	Alien	Response
ALAMEDA												
High School	Number											
	Men	4,786	752	744	275	501	35	2,479	4,786			
	Women	4,938	692	906	248	558	45	2,489	4,938			
	Total	9,724	1,444	1,650	523	1,059	80	4,968	9,724			
	Percent											
	Total			14.8	17.0	5.4	10.9	0.8	51.1			
University of California	Number											
	Men	399	119	30	25	29	5	162	370	8	2	19
	Women	404	126	52	11	39	5	146	379	8	2	15
	Total	803	245	82	36	68	10	308	749	16	4	34
	Percent											
	Total			32.7	10.9	4.8	9.1	1.3	41.1			
The California State University	Number											
	Men	513	106	53	53	45	2	212	471	15	2	25
	Women	639	120	118	51	59	2	245	595	21	0	23
	Total	1,152	226	171	104	104	4	457	1,066	36	2	48
	Percent											
	Total			21.2	16.0	9.8	9.8	0.4	42.9			
California Community Colleges	Number											
	Men	1,782	235	256	124	213	27	798	1,653	49	43	37
	Women	1,916	204	320	122	256	22	864	1,788	54	51	23
	Total	3,698	439	576	246	469	49	1,662	3,441	103	94	60
	Percent											
	Total			12.8	16.7	7.1	13.6	1.4	48.3			

Sex and Ethnic Distribution of 1989-90 California Public High School Graduates by County, and of Fall 1990 First-Time Freshmen at the University of California, the California State University, and the California Community Colleges by County.

County and Segment	Sex	Total	Ethnicity					Sub-Total	Residency			
			Asian/Pacific Islander	Black	Filipino	Latino American	White		Other	Non-Resident Alien	No Response	
AMADOR												
High School	Number											
	Men	128	1	4	0	7	2	114	128			
	Women	113	2	0	0	2	1	108	113			
	Total	241	3	4	0	9	3	222	241			
	Percent											
	Total			1.2	1.7	0.0	3.7	1.2	92.1			
University of California	Number											
	Men	4	0	0	0	0	0	3	3	1	0	0
	Women	4	0	1	0	0	0	3	4	0	0	0
	Total	8	0	1	0	0	0	6	7	1	0	0
	Percent											
	Total			0.0	14.3	0.0	0.0	0.0	85.7			
The California State University	Number											
	Men	6	0	0	0	1	1	4	6	0	0	0
	Women	9	1	0	0	0	0	8	9	0	0	0
	Total	15	1	0	0	1	1	12	15	0	0	0
	Percent											
	Total			6.7	0.0	0.0	6.7	6.7	80.0			
California Community Colleges	Number											
	Men	19	0	1	0	1	0	16	18	1	0	0
	Women	22	0	0	0	0	2	19	21	0	1	0
	Total	41	0	1	0	1	2	35	39	1	1	0
	Percent											
	Total			0.0	2.6	0.0	2.6	5.1	89.7			

*Sex and Ethnic Distribution of 1989-90 California Public High School Graduates by County,
and of Fall 1990 First-Time Freshmen at the University of California,
the California State University, and the California Community Colleges by County.*

County and Segment	Sex	Total	Asian/ Pacific Islander	Black	Filipino	Latino	Native American	White	Sub- Total	Other	Non- Resident Alien	No Response	
BUTTE													
High School	Men	704	32	8	Number			14	611	704			
	Women	748	23	8	2	37	13	50	652	748			
	Total	1,452	55	16	4	87	27	1,263	1,452				
	Men		4.5	1.1	Percent			2.0	86.8				
	Women		3.1	1.1	0.3	5.3	1.7	87.2					
	Total		3.8	1.1	0.3	6.0	1.9	87.0					
University of California	Men	22	2	0	Number			0	12	16	0	1	5
	Women	29	1	0	0	2	0	4	22	27	1	0	1
	Total	51	3	0	0	6	0	34	43	43	1	1	6
	Men		12.5	0.0	Percent			0.0	75.0				
	Women		3.7	0.0	0.0	12.5	0.0	81.5					
	Total		7.0	0.0	0.0	14.0	0.0	79.1					
The California State University	Men	95	5	2	Number			6	74	90	3	1	1
	Women	101	5	2	0	6	3	12	77	97	2	1	1
	Total	196	10	4	0	18	4	151	187	187	5	2	2
	Men		5.6	2.2	Percent			3.3	82.2				
	Women		5.2	2.1	0.0	6.7	1.0	79.4					
	Total		5.3	2.1	0.0	9.6	2.1	80.7					
California Community Colleges	Men	203	6	4	Number			17	160	191	1	5	6
	Women	223	2	0	3	17	4	19	191	219	0	2	2
	Total	426	8	4	3	36	8	351	410	410	1	7	8
	Men		3.1	2.1	Percent			2.1	83.8				
	Women		0.9	0.0	1.4	8.9	1.8	87.2					
	Total		2.0	1.0	0.7	8.8	2.0	85.6					

Sex and Ethnic Distribution of 1989-90 California Public High School Graduates by County, and of Fall 1990 First-Time Freshmen at the University of California, the California State University, and the California Community Colleges by County.

County and Segment	Sex	Total	Asian/ Pacific Islander	Black	Filipino	Native Latino American	White	Sub- Total	Non- Resident Other	No Alien Response		
CALAVERAS												
Number												
High School	Men	171	3	2	0	11	2	153	171			
	Women	201	0	1	0	15	4	181	201			
	Total	372	3	3	0	26	6	334	372			
Percent												
High School	Men		1.8	1.2	0.0	6.4	1.2	89.5				
	Women		0.0	0.5	0.0	7.5	2.0	90.0				
	Total		0.8	0.8	0.0	7.0	1.6	89.8				
Number												
University of California	Men	5	0	0	0	0	0	5	5	0	0	0
	Women	2	0	0	0	0	0	2	2	0	0	0
	Total	7	0	0	0	0	0	7	7	0	0	0
Percent												
University of California	Men		0.0	0.0	0.0	0.0	0.0	100.0				
	Women		0.0	0.0	0.0	0.0	0.0	100.0				
	Total		0.0	0.0	0.0	0.0	0.0	100.0				
Number												
The California State University	Men	9	0	1	0	0	0	8	9	0	0	0
	Women	11	0	0	0	0	0	11	11	0	0	0
	Total	20	0	1	0	0	0	19	20	0	0	0
Percent												
The California State University	Men		0.0	11.1	0.0	0.0	0.0	88.9				
	Women		0.0	0.0	0.0	0.0	0.0	100.0				
	Total		0.0	5.0	0.0	0.0	0.0	95.0				
Number												
California Community Colleges	Men	43	0	0	0	6	2	34	42	0	1	0
	Women	42	0	0	0	2	1	37	40	1	1	0
	Total	85	0	0	0	8	3	71	82	1	2	0
Percent												
California Community Colleges	Men		0.0	0.0	0.0	14.3	4.8	81.0				
	Women		0.0	0.0	0.0	5.0	2.5	92.5				
	Total		0.0	0.0	0.0	9.8	3.7	86.6				

Sex and Ethnic Distribution of 1989-90 California Public High School Graduates by County, and of Fall 1990 First-Time Freshmen at the University of California, the California State University, and the California Community Colleges by County.

County and Segment	Sex	Total	Asian/ Pacific Islander	Black	Filipino	Native Latino American	White	Sub- Total	Non- Resident Other	Alien	No Response
COLUSA											
Number											
High School	Men	103	2	1	3	36	0	61	103		
	Women	111	8	0	0	22	0	81	111		
	Total	214	10	1	3	58	0	142	214		
Percent											
	Men		1.9	1.0	2.9	35.0	0.0	59.2			
	Women		7.2	0.0	0.0	19.8	0.0	73.0			
	Total		4.7	0.5	1.4	27.1	0.0	66.4			
Number											
University of California	Men	2	0	0	0	1	0	1	2	0	0
	Women	3	0	0	0	1	0	2	3	0	0
	Total	5	0	0	0	2	0	3	5	0	0
Percent											
	Men		0.0	0.0	0.0	50.0	0.0	50.0			
	Women		0.0	0.0	0.0	33.3	0.0	66.7			
	Total		0.0	0.0	0.0	40.0	0.0	60.0			
Number											
The California State University	Men	19	2	1	0	10	0	6	19	0	0
	Women	14	0	0	0	5	0	8	13	1	0
	Total	33	2	1	0	15	0	14	32	1	0
Percent											
	Men		10.5	5.3	0.0	52.6	0.0	31.6			
	Women		0.0	0.0	0.0	38.5	0.0	61.5			
	Total		6.3	3.1	0.0	46.9	0.0	43.8			
Number											
California Community Colleges	Men	15	0	0	0	1	0	9	10	0	5
	Women	22	0	0	0	0	0	6	6	0	16
	Total	37	0	0	0	1	0	15	16	0	21
Percent											
	Men		0.0	0.0	0.0	10.0	0.0	90.0			
	Women		0.0	0.0	0.0	0.0	0.0	100.0			
	Total		0.0	0.0	0.0	6.3	0.0	93.8			

Sex and Ethnic Distribution of 1989-90 California Public High School Graduates by County, and of Fall 1990 First-Time Freshmen at the University of California, the California State University, and the California Community Colleges by County.

County and Segment	Sex	Total	Asian/ Pacific Islander	Black	Filipino	Native Latino American	White	Sub- Total	Non- Resident Other	Alien	No Response	
CONTRA COSTA												
High School			Number									
	Men	3,658	363	331	115	310	16	2,523	3,658			
	Women	3,730	316	422	111	307	15	2,559	3,730			
	Total	7,388	679	753	226	617	31	5,082	7,388			
			Percent									
	Men		9.9	9.0	3.1	8.5	0.4	69.0				
	Women		8.5	11.3	3.0	8.2	0.4	68.6				
	Total		9.2	10.2	3.1	8.4	0.4	68.8				
University of California			Number									
	Men	393	89	4	6	35	3	231	368	2	4	19
	Women	398	63	27	10	31	3	247	381	3	1	13
	Total	791	152	31	16	66	6	478	749	5	5	32
			Percent									
	Men		24.2	1.1	1.6	9.5	0.8	62.8				
	Women		16.5	7.1	2.6	8.1	0.8	64.8				
	Total		20.3	4.1	2.1	8.8	0.8	63.8				
The California State University			Number									
	Men	291	29	14	13	20	3	192	271	6	2	12
	Women	374	32	27	20	23	1	255	358	8	1	7
	Total	665	61	41	33	43	4	447	629	14	3	19
			Percent									
	Men		10.7	5.2	4.8	7.4	1.1	70.8				
	Women		8.9	7.5	5.6	6.4	0.3	71.2				
	Total		9.7	6.5	5.2	6.8	0.6	71.1				
California Community Colleges			Number									
	Men	1,406	115	105	66	116	14	943	1,359	9	12	26
	Women	1,440	104	117	59	126	14	981	1,401	4	19	16
	Total	2,846	219	222	125	242	28	1,924	2,760	13	31	42
			Percent									
	Men		8.5	7.7	4.9	8.5	1.0	69.4				
	Women		7.4	8.4	4.2	9.0	1.0	70.0				
	Total		7.9	8.0	4.5	8.8	1.0	69.7				

Sex and Ethnic Distribution of 1989-90 California Public High School Graduates by County, and of Fall 1990 First-Time Freshmen at the University of California, the California State University, and the California Community Colleges by County.

County and Segment	Sex	Total	Asian/ Pacific Islander	Black	Filipino	Native Latino American	White	Sub- Total	Other	Non- Resident Alien	No Response
DEL NORTE											
Number											
High School	Men	106	3	1	0	7	15	80	106		
	Women	94	0	0	0	8	14	72	94		
	Total	200	3	1	0	15	29	152	200		
Percent											
	Men		2.8	0.9	0.0	6.6	14.2	75.5			
	Women		0.0	0.0	0.0	8.5	14.9	76.6			
	Total		1.5	0.5	0.0	7.5	14.5	76.0			
Number											
University of California	Men	0	0	0	0	0	0	0	0	0	0
	Women	2	0	0	0	0	0	2	2	0	0
	Total	2	0	0	0	0	0	2	2	0	0
Percent											
	Men		0.0	0.0	0.0	0.0	0.0	0.0			
	Women		0.0	0.0	0.0	0.0	0.0	100.0			
	Total		0.0	0.0	0.0	0.0	0.0	100.0			
Number											
The California State University	Men	9	1	0	0	0	0	7	8	1	0
	Women	4	0	0	0	0	1	3	4	0	0
	Total	13	1	0	0	0	1	10	12	1	0
Percent											
	Men		12.5	0.0	0.0	0.0	0.0	87.5			
	Women		0.0	0.0	0.0	0.0	25.0	75.0			
	Total		8.3	0.0	0.0	0.0	8.3	83.3			
Number											
California Community Colleges	Men	15	0	1	0	1	2	10	14	0	0
	Women	20	1	0	0	2	2	17	17	0	1
	Total	35	1	1	0	3	4	22	31	0	1
Percent											
	Men		0.0	7.1	0.0	7.1	14.3	71.4			
	Women		5.9	0.0	0.0	11.8	11.8	70.6			
	Total		3.2	3.2	0.0	9.7	12.9	71.0			

Sex and Ethnic Distribution of 1989-90 California Public High School Graduates by County, and of Fall 1990 First-Time Freshmen at the University of California, the California State University, and the California Community Colleges by County.

County and Segment	Sex	Total	Asian/ Pacific Islander	Black	Filipino	Native Latino American	White	Sub- Total	Non- Resident Other	Alien	No Response	
EL DORADO												
Number												
High School	Men	539	8	1	2	18	6	504	539			
	Women	574	7	1	11	15	8	532	574			
	Total	1,113	15	2	13	33	14	1,036	1,113			
Percent												
	Men		1.5	0.2	0.4	3.3	1.1	93.5				
	Women		1.2	0.2	1.9	2.6	1.4	92.7				
	Total		1.3	0.2	1.2	3.0	1.3	93.1				
Number												
University of California	Men	21	0	0	0	0	1	17	18	0	0	3
	Women	17	0	1	0	0	1	13	15	0	0	2
	Total	38	0	1	0	0	2	30	33	0	0	5
Percent												
	Men		0.0	0.0	0.0	0.0	5.6	94.4				
	Women		0.0	6.7	0.0	0.0	6.7	86.7				
	Total		0.0	3.0	0.0	0.0	6.1	90.9				
Number												
The California State University	Men	50	2	0	1	2	1	43	49	0	0	1
	Women	66	2	0	0	3	0	58	63	1	0	2
	Total	116	4	0	1	5	1	101	112	1	0	3
Percent												
	Men		4.1	0.0	2.0	4.1	2.0	87.8				
	Women		3.2	0.0	0.0	4.8	0.0	92.1				
	Total		3.6	0.0	0.9	4.5	0.9	90.2				
Number												
California Community Colleges	Men	186	2	0	2	7	3	168	182	2	1	1
	Women	208	6	1	2	13	4	180	206	2	0	0
	Total	394	8	1	4	20	7	348	388	4	1	1
Percent												
	Men		1.1	0.0	1.1	3.8	1.6	92.3				
	Women		2.9	0.5	1.0	6.3	1.9	87.4				
	Total		2.1	0.3	1.0	5.2	1.8	89.7				

Sex and Ethnic Distribution of 1989-90 California Public High School Graduates by County, and of Fall 1990 First-Time Freshmen at the University of California, the California State University, and the California Community Colleges by County.

County and Segment	Sex	Total	Asian/ Pacific Islander	Black	Filipino	Native Latino American	White	Sub- Total	Non- Resident Other	Alien	No Response	
FRESNO												
Number												
High School	Men	2,971	338	134	13	1,005	25	1,456	2,971			
	Women	3,026	256	149	28	1,055	27	1,511	3,026			
	Total	5,997	594	283	41	2,060	52	2,967	5,997			
Percent												
	Men		11.4	4.5	0.4	33.8	0.8	49.0				
	Women		8.5	4.9	0.9	34.9	0.9	49.9				
	Total		9.9	4.7	0.7	34.4	0.9	49.5				
Number												
University of California	Men	121	28	4	2	23	2	49	108	0	3	10
	Women	128	22	5	4	29	7	56	123	3	0	2
	Total	249	50	9	6	52	9	105	231	3	3	12
Percent												
	Men		25.9	3.7	1.9	21.3	1.9	45.4				
	Women		17.9	4.1	3.3	23.6	5.7	45.5				
	Total		21.6	3.9	2.6	22.5	3.9	45.5				
Number												
The California State University	Men	316	71	7	1	80	4	136	299	8	1	8
	Women	434	51	18	5	119	7	196	396	13	8	17
	Total	750	122	25	6	199	11	332	695	21	9	25
Percent												
	Men		23.7	2.3	0.3	26.8	1.3	45.5				
	Women		12.9	4.5	1.3	30.1	1.8	49.5				
	Total		17.6	3.6	0.9	28.6	1.6	47.8				
Number												
California Community Colleges	Men	1,116	52	65	7	332	17	559	1,032	29	25	30
	Women	1,222	48	74	19	383	19	588	1,131	30	21	40
	Total	2,338	100	139	26	715	36	1,147	2,163	59	46	70
Percent												
	Men		5.0	6.3	0.7	32.2	1.6	54.2				
	Women		4.2	6.5	1.7	33.9	1.7	52.0				
	Total		4.6	6.4	1.2	33.1	1.7	53.0				

Sex and Ethnic Distribution of 1989-90 California Public High School Graduates by County, and of Fall 1990 First-Time Freshmen at the University of California, the California State University, and the California Community Colleges by County.

County and Segment	Sex	Total	Asian/ Pacific Islander	Black	Filipino	Latino	Native American	White	Sub- Total	Other	Non- Resident Alien	No Response
GLENN												
Number												
High School	Men	138	2	4	0	21	1	110	138			
	Women	129	6	2	0	19	1	101	129			
	Total	267	8	6	0	40	2	211	267			
Percent												
	Men		1.4	2.9	0.0	15.2	0.7	79.7				
	Women		4.7	1.6	0.0	14.7	0.8	78.3				
	Total		3.0	2.2	0.0	15.0	0.7	79.0				
Number												
University of California	Men	0	0	0	0	0	0	0	0	0	0	0
	Women	3	0	0	0	0	1	2	3	0	0	0
	Total	3	0	0	0	0	1	2	3	0	0	0
Percent												
	Men		0.0	0.0	0.0	0.0	0.0	0.0				
	Women		0.0	0.0	0.0	0.0	33.3	66.7				
	Total		0.0	0.0	0.0	0.0	33.3	66.7				
Number												
The California State University	Men	17	0	2	0	3	0	11	16	0	0	1
	Women	31	0	0	0	11	1	18	30	0	0	1
	Total	48	0	2	0	14	1	29	46	0	0	2
Percent												
	Men		0.0	12.5	0.0	18.8	0.0	68.8				
	Women		0.0	0.0	0.0	36.7	3.3	60.0				
	Total		0.0	4.3	0.0	30.4	2.2	63.0				
Number												
California Community Colleges	Men	31	0	0	0	4	0	24	28	0	0	3
	Women	23	1	0	0	2	0	19	22	0	0	1
	Total	54	1	0	0	6	0	43	50	0	0	4
Percent												
	Men		0.0	0.0	0.0	14.3	0.0	85.7				
	Women		4.5	0.0	0.0	9.1	0.0	86.4				
	Total		2.0	0.0	0.0	12.0	0.0	86.0				

Sex and Ethnic Distribution of 1989-90 California Public High School Graduates by County, and of Fall 1990 First-Time Freshmen at the University of California, the California State University, and the California Community Colleges by County.

County and Segment	Sex	Total	Asian/ Pacific Islander	Black	Filipino	Native Latino American	White	Sub- Total	Other	Non- Resident Alien	No Response	
HUMBOLDT												
Number												
High School	Men	437	5	3	1	12	32	384	437			
	Women	449	6	1	2	19	43	378	449			
	Total	886	11	4	3	31	75	762	886			
Percent												
	Men		1.1	0.7	0.2	2.7	7.3	87.9				
	Women		1.3	0.2	0.4	4.2	9.6	84.2				
	Total		1.2	0.5	0.3	3.5	8.5	86.0				
Number												
University of California	Men	15	0	0	0	1	1	13	15	0	0	0
	Women	13	1	0	0	1	0	11	13	0	0	0
	Total	28	1	0	0	2	1	24	28	0	0	0
Percent												
	Men		0.0	0.0	0.0	6.7	6.7	86.7				
	Women		7.7	0.0	0.0	7.7	0.0	84.6				
	Total		3.6	0.0	0.0	7.1	3.6	85.7				
Number												
The California State University	Men	49	1	1	0	2	2	37	43	1	1	4
	Women	66	1	1	0	7	8	46	63	1	0	2
	Total	115	2	2	0	9	10	83	106	2	1	6
Percent												
	Men		2.3	2.3	0.0	4.7	4.7	86.0				
	Women		1.6	1.6	0.0	11.1	12.7	73.0				
	Total		1.9	1.9	0.0	8.5	9.4	78.3				
Number												
California Community Colleges	Men	133	0	0	0	5	4	117	126	1	0	6
	Women	155	2	0	1	3	8	129	143	2	2	8
	Total	288	2	0	1	8	12	246	269	3	2	14
Percent												
	Men		0.0	0.0	0.0	4.0	3.2	92.9				
	Women		1.4	0.0	0.7	2.1	5.6	90.2				
	Total		0.7	0.0	0.4	3.0	4.5	91.4				

Sex and Ethnic Distribution of 1989-90 California Public High School Graduates by County, and of Fall 1990 First-Time Freshmen at the University of California, the California State University, and the California Community Colleges by County.

County and Segment	Sex	Total	Asian/ Pacific Islander	Black	Filipino	Latino	Native American	White	Sub- Total	Other	Non- Resident Alien	No Response
IMPERIAL												
Number												
High School	Men	741	15	14	6	558	12	136	741			
	Women	828	11	10	5	637	8	157	828			
	Total	1,569	26	24	11	1,195	20	293	1,569			
Percent												
High School	Men		2.0	1.9	0.8	75.3	1.6	18.4				
	Women		1.3	1.2	0.6	76.9	1.0	19.0				
	Total		1.7	1.5	0.7	76.2	1.3	18.7				
Number												
University of California	Men	22	2	0	1	17	0	1	21	0	0	1
	Women	27	2	0	0	18	0	7	27	0	0	0
	Total	49	4	0	1	35	0	8	48	0	0	1
Percent												
University of California	Men		9.5	0.0	4.8	81.0	0.0	4.8				
	Women		7.4	0.0	0.0	66.7	0.0	25.9				
	Total		8.3	0.0	2.1	72.9	0.0	16.7				
Number												
The California State Universi /	Men	28	1	0	1	17	0	7	26	2	0	0
	Women	35	2	0	2	22	0	8	34	1	0	0
	Total	63	3	0	3	39	0	15	60	3	0	0
Percent												
The California State Universi /	Men		3.8	0.0	3.8	65.4	0.0	26.9				
	Women		5.9	0.0	5.9	64.7	0.0	23.5				
	Total		5.0	0.0	5.0	65.0	0.0	25.0				
Number												
California Community Colleges	Men	69	0	1	0	30	34	3	68	0	0	1
	Women	69	0	0	0	25	36	4	65	1	1	2
	Total	138	0	1	0	55	70	7	133	1	1	3
Percent												
California Community Colleges	Men		0.0	1.5	0.0	44.1	50.0	4.4				
	Women		0.0	0.0	0.0	38.5	55.4	6.2				
	Total		0.0	0.8	0.0	41.4	52.6	5.3				

**Sex and Ethnic Distribution of 1989-90 California Public High School Graduates by County,
and of Fall 1990 First-Time Freshmen at the University of California,
the California State University, and the California Community Colleges by County.**

County and Segment	Sex	Total	Asian/ Pacific Islander	Black	Filipino	Native		White	Sub- Total	Non-Resident		
						Latino	American			Other	Alien	No Response
INYO												
High School					Number							
	Men	100	2	0	0	5	15	78	100			
	Women	109	1	0	0	4	8	96	109			
	Total	209	3	0	0	9	23	174	209			
					Percent							
	Men		2.0	0.0	0.0	5.0	15.0	78.0				
	Women		0.9	0.0	0.0	3.7	7.3	88.1				
	Total		1.4	0.0	0.0	4.3	11.0	83.3				
University of California												
University of California					Number							
	Men	2	0	0	0	0	0	2	2	0	0	0
	Women	3	0	0	0	0	0	2	2	0	0	1
	Total	5	0	0	0	0	0	4	4	0	0	1
					Percent							
	Men		0.0	0.0	0.0	0.0	0.0	100.0				
	Women		0.0	0.0	0.0	0.0	0.0	100.0				
	Total		0.0	0.0	0.0	0.0	0.0	100.0				
The California State University												
The California State University					Number							
	Men	7	0	0	0	1	0	6	7	0	0	0
	Women	7	0	0	0	1	0	5	6	1	0	0
	Total	14	0	0	0	2	0	11	13	1	0	0
					Percent							
	Men		0.0	0.0	0.0	14.3	0.0	85.7				
	Women		0.0	0.0	0.0	16.7	0.0	83.3				
	Total		0.0	0.0	0.0	15.4	0.0	84.6				
California Community Colleges												
California Community Colleges					Number							
	Men	26	0	0	1	1	1	22	25	0	0	1
	Women	17	0	0	1	2	3	11	17	0	0	0
	Total	43	0	0	2	3	4	33	42	0	0	1
					Percent							
	Men		0.0	0.0	4.0	4.0	4.0	88.0				
	Women		0.0	0.0	5.9	11.8	17.6	64.7				
	Total		0.0	0.0	4.8	7.1	9.5	78.6				

Sex and Ethnic Distribution of 1989-90 California Public High School Graduates by County, and of Fall 1990 First-Time Freshmen at the University of California, the California State University, and the California Community Colleges by County.

County and Segment	Sex	Total	Asian/ Pacific Islander	Black	Filipino	Native Latino American	White	Sub- Total	Other	Non- Resident Alien	No Response	
KERN												
High School	Number											
	Men	2,478	69	135	48	683	34	1,509	2,478			
	Women	2,654	60	148	59	784	35	1,568	2,654			
	Total	5,132	129	283	107	1,467	69	3,077	5,132			
	Percent											
	Total			2.5	5.5	2.1	28.6	1.3	60.0			
University of California	Number											
	Men	59	13	2	0	12	0	30	57	1	0	1
	Women	64	6	0	2	16	0	37	61	1	0	2
	Total	123	19	2	2	28	0	67	118	2	0	3
	Percent											
	Total			16.1	1.7	1.7	23.7	0.0	56.8			
The California State University	Number											
	Men	160	7	7	7	40	1	84	146	7	3	4
	Women	213	6	17	10	60	4	105	202	2	0	9
	Total	373	13	24	17	100	5	189	348	9	3	13
	Percent											
	Total			3.7	6.9	4.9	28.7	1.4	54.3			
California Community Colleges	Number											
	Men	1,045	25	57	20	239	35	634	1,010	18	13	4
	Women	1,134	29	54	16	229	29	738	1,095	25	11	3
	Total	2,179	54	111	36	468	64	1,372	2,105	43	24	7
	Percent											
	Total			2.6	5.3	1.7	22.2	3.0	65.2			

**Sex and Ethnic Distribution of 1989-90 California Public High School Graduates by County,
and of Fall 1990 First-Time Freshmen at the University of California,
the California State University, and the California Community Colleges by County.**

County and Segment	Sex	Total	Ethnicity					Sub-Total	Non-Resident				
			Asian/ Pacific Islander	Black	Filipino	Latino American	White		Other	Alien	No Response		
KINGS													
High School	Number												
	Men	468	10	22	16	145	1	274	468				
	Women	467	17	25	16	152	1	256	467				
	Total	935	27	47	32	297	2	530	935				
	Percent												
	Men			2.1	4.7	3.4	31.0	0.2	58.5				
	Women			3.6	5.4	3.4	32.5	0.2	54.8				
	Total			2.9	5.0	3.4	31.8	0.2	56.7				
	Number												
	University of California	Men	8	3	1	0	1	0	3	8	0	0	0
		Women	10	0	0	1	2	0	7	10	0	0	0
		Total	18	3	1	1	3	0	10	18	0	0	0
Percent													
Men			37.5	12.5	0.0	12.5	0.0	37.5					
Women			0.0	0.0	10.0	20.0	0.0	70.0					
Total			16.7	5.6	5.6	16.7	0.0	55.6					
Number													
The California State University	Men	25	1	1	1	3	0	14	20	3	0	2	
	Women	35	2	0	4	13	0	14	33	0	1	1	
	Total	60	3	1	5	16	0	28	53	3	1	3	
Percent													
Men			5.0	5.0	5.0	15.0	0.0	70.0					
Women			6.1	0.0	12.1	39.4	0.0	42.4					
Total			5.7	1.9	9.4	30.2	0.0	52.8					
Number													
California Community Colleges	Men	112	0	6	2	30	3	63	104	5	0	3	
	Women	124	3	10	7	36	5	55	116	4	0	4	
	Total	236	3	16	9	66	8	118	220	9	0	7	
Percent													
Men			0.0	5.8	1.9	28.8	2.9	60.6					
Women			2.6	8.6	6.0	31.0	4.3	47.4					
Total			1.4	7.3	4.1	30.0	3.6	53.6					

Sex and Ethnic Distribution of 1989-90 California Public High School Graduates by County, and of Fall 1990 First-Time Freshmen at the University of California, the California State University, and the California Community Colleges by County.

County and Segment	Sex	Total	Asian/ Pacific Islander	Black	Filipino	Native Latino American	White	Sub- Total	Other	Non- Resident Alien	No Response	
LAKE												
High School					Number							
	Men	245	2	6	1	25	9	202	245			
	Women	203	5	8	1	11	5	173	203			
	Total	448	7	14	2	36	14	375	448			
						Percent						
	Men			0.8	2.4	0.4	10.2	3.7	82.4			
Women			2.5	3.9	0.5	5.4	2.5	85.2				
Total			1.6	3.1	0.4	8.0	3.1	83.7				
University of California					Number							
	Men	4	0	0	0	0	0	4	4	0	0	
	Women	7	1	0	1	1	0	2	6	0	0	
	Total	11	1	0	1	1	0	7	10	0	0	
						Percent						
	Men			0.0	0.0	0.0	0.0	0.0	100.0			
Women			16.7	0.0	16.7	16.7	0.0	50.0				
Total			10.0	0.0	10.0	10.0	0.0	70.0				
The California State University					Number							
	Men	18	0	0	1	2	2	12	17	0	0	
	Women	15	0	1	0	4	0	10	15	0	0	
	Total	33	0	1	1	6	2	22	32	0	0	
						Percent						
	Men			0.0	0.0	5.9	11.8	11.8	70.6			
Women			0.0	6.7	0.0	26.7	0.0	66.7				
Total			0.0	3.1	3.1	18.8	6.3	68.8				
California Community Colleges					Number							
	Men	52	0	2	0	3	4	30	39	0	0	
	Women	42	1	2	0	1	2	18	24	1	1	
	Total	94	1	4	0	4	6	48	63	1	1	
						Percent						
	Men			0.0	5.1	0.0	7.7	10.3	76.9			
Women			4.2	8.3	0.0	4.2	8.3	75.0				
Total			1.6	6.3	0.0	6.3	9.5	76.2				

Sex and Ethnic Distribution of 1989-90 California Public High School Graduates by County, and of Fall 1990 First-Time Freshmen at the University of California, the California State University, and the California Community Colleges by County.

County and Segment	Sex	Total	Asian/ Pacific Islander	Black	Filipino	Native Latino American	White	Sub- Total	Other	Non- Resident Alien	No Response		
LASSEN													
High School			Number										
	Men	121	2	7	0	9	2	101	121				
	Women	145	2	2	0	7	8	126	145				
	Total	266	4	9	0	16	10	227	266				
			Percent										
	Men		1.7	5.8	0.0	7.4	1.7	83.5					
	Women		1.4	1.4	0.0	4.8	5.5	86.9					
	Total		1.5	3.4	0.0	6.0	3.8	85.3					
University of California			Number										
	Men	3	0	0	0	0	0	1	1	0	0	2	
	Women	3	0	0	0	0	0	3	3	0	0	0	
	Total	6	0	0	0	0	0	4	4	0	0	2	
			Percent										
	Men		0.0	0.0	0.0	0.0	0.0	100.0					
	Women		0.0	0.0	0.0	0.0	0.0	100.0					
	Total		0.0	0.0	0.0	0.0	0.0	100.0					
The California State University			Number										
	Men	6	0	0	0	0	0	6	6	0	0	0	
	Women	9	0	0	0	0	1	8	9	0	0	0	
	Total	15	0	0	0	0	1	14	15	0	0	0	
			Percent										
	Men		0.0	0.0	0.0	0.0	0.0	100.0					
	Women		0.0	0.0	0.0	0.0	11.1	88.9					
	Total		0.0	0.0	0.0	0.0	6.7	93.3					
California Community Colleges			Number										
	Men	38	0	1	3	1	0	33	38	0	0	0	
	Women	51	1	2	2	1	1	43	50	1	0	0	
	Total	89	1	3	5	2	1	76	88	1	0	0	
			Percent										
	Men		0.0	2.6	7.9	2.6	0.0	86.8					
	Women		2.0	4.0	4.0	2.0	2.0	86.0					
	Total		1.1	3.4	5.7	2.3	1.1	86.4					

Sex and Ethnic Distribution of 1989-90 California Public High School Graduates by County, and of Fall 1990 First-Time Freshmen at the University of California, the California State University, and the California Community Colleges by County.

County and Segment	Sex	Total	Asian/ Pacific Islander	Black	Filipino	Latino	Native American	White	Sub- Total	Other	Non- Resident Alien	No Response
LOS ANGELES												
Number												
High School	Men	30,905	4,513	3,149	799	10,956	131	11,357	30,905			
	Women	32,441	4,471	3,893	862	11,616	74	11,525	32,441			
	Total	63,346	8,984	7,042	1,661	22,572	205	22,882	63,346			
Percent												
	Men		14.6	10.2	2.6	35.5	0.4	36.7				
	Women		13.8	12.0	2.7	35.8	0.2	35.5				
	Total		14.2	11.1	2.6	35.6	0.3	36.1				
Number												
University of California	Men	2,278	901	112	83	327	9	690	2,122	16	35	105
	Women	2,452	879	174	104	447	14	688	2,306	19	40	87
	Total	4,730	1,780	286	187	774	23	1,378	4,428	35	75	192
Percent												
	Men		42.5	5.3	3.9	15.4	0.4	32.5				
	Women		38.1	7.5	4.5	19.4	0.6	29.8				
	Total		40.2	6.5	4.2	17.5	0.5	31.1				
Number												
The California State University	Men	3,430	842	334	176	801	16	915	3,084	96	123	127
	Women	4,128	942	552	198	977	22	1,090	3,781	121	105	121
	Total	7,558	1,784	886	374	1,778	38	2,005	6,865	217	228	248
Percent												
	Men		27.3	10.8	5.7	26.0	0.5	29.7				
	Women		24.9	14.6	5.2	25.8	0.6	28.8				
	Total		26.0	12.9	5.4	25.9	0.6	29.2				
Number												
California Community Colleges	Men	11,067	1,041	1,253	402	3,154	66	3,779	9,695	175	604	593
	Women	11,279	864	1,376	432	3,454	76	3,772	9,974	184	590	531
	Total	22,346	1,905	2,629	834	6,608	142	7,551	19,669	359	1,194	1,124
Percent												
	Men		10.7	12.9	4.1	32.5	0.7	39.0				
	Women		8.7	13.8	4.3	34.6	0.8	37.8				
	Total		9.7	13.4	4.2	33.5	0.7	38.4				

124

**Sex and Ethnic Distribution of 1989-90 California Public High School Graduates by County,
and of Fall 1990 First-Time Freshmen at the University of California,
the California State University, and the California Community Colleges by County.**

County and Segment	Sex	Total	Ethnicity					Sub-Total	Non-Resident			
			Asian/Pacific Islander	Black	Filipino	Latino American	White		Other	Alien	No Response	
MADERA												
High School	Number											
	Men	432	6	18	1	145	5	257	432			
	Women	546	6	11	0	212	9	308	546			
	Total	978	12	29	1	357	14	565	978			
	Percent											
	Total			1.2	3.0	0.1	36.5	1.4	57.8			
University of California	Number											
	Men	9	1	0	0	4	0	4	9	0	0	0
	Women	14	0	1	0	6	1	6	14	0	0	0
	Total	23	1	1	0	10	1	10	23	0	0	0
	Percent											
	Total			4.3	4.3	0.0	43.5	4.3	43.5			
The California State University	Number											
	Men	29	0	0	1	12	0	14	27	0	0	2
	Women	49	0	1	1	20	0	24	46	0	2	1
	Total	78	0	1	2	32	0	38	73	0	2	3
	Percent											
	Total			0.0	1.4	2.7	43.8	0.0	52.1			
California Community Colleges	Number											
	Men	113	0	6	1	29	3	68	107	3	2	1
	Women	175	1	5	1	53	3	94	157	4	12	2
	Total	288	1	11	2	82	6	162	264	7	14	3
	Percent											
	Total			0.4	4.2	0.8	31.1	2.3	61.4			

*Sex and Ethnic Distribution of 1989-90 California Public High School Graduates by County,
and of Fall 1990 First-Time Freshmen at the University of California,
the California State University, and the California Community Colleges by County.*

County and Segment	Sex	Total	Asian/ Pacific Islander	Black	Filipino	Native Latino American	White	Sub- Total	Other	Non- Resident Alien	No Response	
MARIN												
High School			Number									
	Men	860	41	25	1	43	1	749	860			
	Women	827	37	28	1	37	1	723	827			
	Total	1,687	78	53	2	80	2	1,472	1,687			
			Percent									
	Men		4.8	2.9	0.1	5.0	0.1	87.1				
	Women		4.5	3.4	0.1	4.5	0.1	87.4				
	Total		4.6	3.1	0.1	4.7	0.1	87.3				
University of California			Number									
	Men	117	3	0	1	7	1	93	105	4	0	8
	Women	124	10	2	0	6	2	95	115	1	1	7
	Total	241	13	2	1	13	3	198	220	5	1	15
			Percent									
	Men		2.9	0.0	1.0	6.7	1.0	88.6				
	Women		8.7	1.7	0.0	5.2	1.7	82.6				
	Total		5.9	0.9	0.5	5.9	1.4	85.5				
The California State University			Number									
	Men	86	7	2	0	3	0	66	78	2	0	6
	Women	107	5	2	0	4	1	92	104	1	0	2
	Total	193	12	4	0	7	1	158	182	3	0	8
			Percent									
	Men		9.0	2.6	0.0	3.8	0.0	84.6				
	Women		4.8	1.9	0.0	3.8	1.0	88.5				
	Total		6.6	2.2	0.0	3.8	0.5	86.8				
California Community Colleges			Number									
	Men	103	3	3	2	6	0	87	101	2	0	0
	Women	95	2	0	2	5	0	84	93	1	1	0
	Total	198	5	3	4	11	0	171	194	3	1	0
			Percent									
	Men		3.0	3.0	2.0	5.9	0.0	86.1				
	Women		2.2	0.0	2.2	5.4	0.0	90.3				
	Total		2.6	1.5	2.1	5.7	0.0	88.1				

Sex and Ethnic Distribution of 1989-90 California Public High School Graduates by County, and of Fall 1990 First-Time Freshmen at the University of California, the California State University, and the California Community Colleges by County.

County and Segment	Sex	Total	Asian/ Pacific Islander	Black	Filipino	Native Latino American	White	Sub- Total	Other	Non- Resident Alien	No response
MARIPOSA											
High School	Men	50	1	0	0	2	2	45	50		
	Women	72	3	0	2	1	4	62	72		
	Total	122	4	0	2	3	6	107	122		
Number											
Men			2.0	0.0	0.0	4.0	4.0	90.0			
Women			4.2	0.0	2.8	1.4	5.6	86.1			
Total			3.3	0.0	1.6	2.5	4.9	87.7			
Percent											
University of California											
University of California	Men	2	0	0	0	0	0	2	2	0	0
	Women	4	0	0	0	0	0	3	3	0	0
	Total	6	0	0	0	0	0	5	5	0	0
Number											
Men			0.0	0.0	0.0	0.0	0.0	100.0			
Women			0.0	0.0	0.0	0.0	0.0	100.0			
Total			0.0	0.0	0.0	0.0	0.0	100.0			
Percent											
The California State University											
The California State University	Men	1	0	0	0	0	0	1	1	0	0
	Women	9	1	0	0	0	1	6	8	1	0
	Total	10	1	0	0	0	1	7	9	1	0
Number											
Men			0.0	0.0	0.0	0.0	0.0	100.0			
Women			12.5	0.0	0.0	0.0	12.5	75.0			
Total			11.1	0.0	0.0	0.0	11.1	77.8			
Percent											
California Community Colleges											
California Community Colleges	Men	15	0	0	0	0	1	13	14	1	0
	Women	23	2	0	0	0	1	19	22	0	0
	Total	38	2	0	0	0	2	32	36	1	0
Number											
Men			0.0	0.0	0.0	0.0	7.1	92.9			
Women			9.1	0.0	0.0	0.0	4.5	86.4			
Total			5.6	0.0	0.0	0.0	5.6	88.9			
Percent											

Sex and Ethnic Distribution of 1989-90 California Public High School Graduates by County, and of Fall 1990 First-Time Freshmen at the University of California, the California State University, and the California Community Colleges by County.

County and Segment	Sex	Total	Asian/ Pacific Islander	Black	Filipino	Native		White	Sub- Total	Non-Resident No		
						Latino	American			Other	Alien	Response
MENDOCINO												
High School	Number											
	Men	463	3	9	1	30	21	399	463			
	Women	458	3	2	1	31	24	397	458			
	Total	921	6	11	2	61	45	796	921			
	Percent											
	Total			0.6	1.9	0.2	6.5	4.5	86.2			
<hr/>												
University of California	Number											
	Men	30	1	0	0	0	0	26	27	0	0	3
	Women	24	0	0	1	0	0	18	19	2	1	2
	Total	54	1	0	1	0	0	44	46	2	1	5
	Percent											
	Total			3.7	0.0	0.0	0.0	0.0	96.3			
<hr/>												
The California State University	Number											
	Men	28	0	0	0	4	2	19	25	0	0	3
	Women	47	0	0	0	6	1	38	45	1	0	1
	Total	75	0	0	0	10	3	57	70	1	0	4
	Percent											
	Total			0.0	0.0	0.0	16.0	8.0	76.0			
<hr/>												
California Community Colleges	Number											
	Men	120	2	1	0	7	9	95	114	2	2	2
	Women	158	0	1	1	10	9	133	154	0	0	4
	Total	278	2	2	1	17	18	228	268	2	2	6
	Percent											
	Total			1.8	0.9	0.0	6.1	7.9	83.3			

*Sex and Ethnic Distribution of 1989-90 California Public High School Graduates by County,
and of Fall 1990 First-Time Freshmen at the University of California,
the California State University, and the California Community Colleges by County.*

County and Segment	Sex	Total	Asian/ Pacific Islander	Black	Filipino	Native Latino American	White	Sub- Total	Other	Non- Resident Alien	No Response	
MONO												
Number												
High School	Men	33	0	0	0	0	1	32	33			
	Women	27	0	0	0	2	1	24	27			
	Total	60	0	0	0	2	2	56	60			
Percent												
	Men		0.0	0.0	0.0	0.0	3.0	97.0				
	Women		0.0	0.0	0.0	7.4	3.7	88.9				
	Total		0.0	0.0	0.0	3.3	3.3	93.3				
Number												
University of California	Men	1	0	0	0	0	0	1	1	0	0	
	Women	2	0	0	0	0	0	2	2	0	0	
	Total	3	0	0	0	0	0	3	3	0	0	
Percent												
	Men		0.0	0.0	0.0	0.0	0.0	100.0				
	Women		0.0	0.0	0.0	0.0	0.0	100.0				
	Total		0.0	0.0	0.0	0.0	0.0	100.0				
Number												
The California State University	Men	4	0	0	0	0	0	4	4	0	0	
	Women	4	0	0	0	0	0	3	3	1	0	
	Total	8	0	0	0	0	0	7	7	1	0	
Percent												
	Men		0.0	0.0	0.0	0.0	0.0	100.0				
	Women		0.0	0.0	0.0	0.0	0.0	100.0				
	Total		0.0	0.0	0.0	0.0	0.0	100.0				
Number												
California Community Colleges	Men	10	0	0	0	0	1	8	9	0	0	
	Women	7	0	0	0	3	0	4	7	0	0	
	Total	17	0	0	0	3	1	12	16	0	0	
Percent												
	Men		0.0	0.0	0.0	0.0	11.1	88.9				
	Women		0.0	0.0	0.0	42.9	0.0	57.1				
	Total		0.0	0.0	0.0	18.8	6.3	75.0				

Sex and Ethnic Distribution of 1989-90 California Public High School Graduates by County, and of Fall 1990 First-Time Freshmen at the University of California, the California State University, and the California Community Colleges by County.

County and Segment	Sex	Total	Asian/ Pacific Islander	Black	Filipino	Native Latino American	White	Sub- Total	Other	Non- Resident Alien	No Response	
MERCED												
High School	Number											
	Men	1,008	109	54	10	323	6	506	1,008			
	Women	1,019	89	59	12	309	3	547	1,019			
	Total	2,027	198	113	22	632	9	1,053	2,027			
	Percent											
	Total			9.8	5.6	1.1	31.2	0.4	51.9			
University of California	Number											
	Men	30	6	1	2	8	0	13	30	0	0	0
	Women	27	7	3	0	4	0	13	27	0	0	0
	Total	57	13	4	2	12	0	26	57	0	0	0
	Percent											
	Total			22.8	7.0	3.5	21.1	0.0	45.6			
The California State University	Number											
	Men	49	7	3	1	10	0	26	47	2	0	0
	Women	73	5	4	1	22	1	35	68	4	0	1
	Total	122	12	7	2	32	1	61	115	6	0	1
	Percent											
	Total			10.4	6.1	1.7	27.8	0.9	53.0			
California Community Colleges	Number											
	Men	386	27	18	2	85	3	199	334	1	41	10
	Women	375	26	26	5	83	3	171	314	9	43	9
	Total	761	53	44	7	168	6	370	648	10	84	19
	Percent											
	Total			8.2	6.8	1.1	25.9	0.9	57.1			

**Sex and Ethnic Distribution of 1989-90 California Public High School Graduates by County,
and of Fall 1990 First-Time Freshmen at the University of California,
the California State University, and the California Community Colleges by County.**

County and Segment	Sex	Total	Asian/ Pacific Islander	Black	Filipino	Native Latino American	White	Sub- Total	Non- Resident Other	Alien	No Response
MODOC											
High School					Number						
	Men	60	0	0	0	4	2	54	60		
	Women	42	0	0	0	2	3	37	42		
	Total	102	0	0	0	6	5	91	102		
					Percent						
	Men		0.0	0.0	0.0	6.7	3.3	90.0			
	Women		0.0	0.0	0.0	4.8	7.1	88.1			
	Total		0.0	0.0	0.0	5.9	4.9	89.2			
University of California											
University of California					Number						
	Men	0	0	0	0	0	0	0	0	0	0
	Women	1	0	0	0	0	0	1	1	0	0
	Total	1	0	0	0	0	0	1	1	0	0
					Percent						
	Men		0.0	0.0	0.0	0.0	0.0	0.0			
	Women		0.0	0.0	0.0	0.0	0.0	100.0			
	Total		0.0	0.0	0.0	0.0	0.0	100.0			
The California State University											
The California State University					Number						
	Men	0	0	0	0	0	0	0	0	0	0
	Women	2	0	0	0	0	0	2	2	0	0
	Total	2	0	0	0	0	0	2	2	0	0
					Percent						
	Men		0.0	0.0	0.0	0.0	0.0	0.0			
	Women		0.0	0.0	0.0	0.0	0.0	100.0			
	Total		0.0	0.0	0.0	0.0	0.0	100.0			
California Community Colleges											
California Community Colleges					Number						
	Men	4	1	0	1	1	0	1	4	0	0
	Women	6	0	0	0	0	0	6	6	0	0
	Total	10	1	0	1	1	0	7	10	0	0
					Percent						
	Men		25.0	0.0	25.0	25.0	0.0	25.0			
	Women		0.0	0.0	0.0	0.0	0.0	100.0			
	Total		10.0	0.0	10.0	10.0	0.0	70.0			

Sex and Ethnic Distribution of 1989-90 California Public High School Graduates by County, and of Fall 1990 First-Time Freshmen at the University of California, the California State University, and the California Community Colleges by County.

County and Segment	Sex	Total	Asian/ Pacific Islander	Black	Filipino	Latino	Native American	White	Sub- Total	Other	Non- Resident Alien	No Response
MONTEREY												
Number												
High School	Men	1,284	87	66	69	434	13	615	1,284			
	Women	1,279	81	71	53	465	7	602	1,279			
	Total	2,563	168	137	122	899	20	1,217	2,563			
Percent												
	Men		6.8	5.1	5.4	33.8	1.0	47.9				
	Women		6.3	5.6	4.1	36.4	0.5	47.1				
	Total		6.6	5.3	4.8	35.1	0.8	47.5				
Number												
University of California	Men	56	3	2	0	18	0	28	51	2	0	3
	Women	76	7	5	4	31	0	26	73	0	0	3
	Total	132	10	7	4	49	0	54	124	2	0	6
Percent												
	Men		5.9	3.9	0.0	35.3	0.0	54.9				
	Women		9.6	6.8	5.5	42.5	0.0	35.6				
	Total		8.1	5.6	3.2	39.5	0.0	43.5				
Number												
The California State University	Men	99	10	4	8	25	0	43	90	2	0	7
	Women	90	6	4	2	26	2	44	84	3	1	2
	Total	189	16	8	10	51	2	87	174	5	1	9
Percent												
	Men		11.1	4.4	8.9	27.8	0.0	47.8				
	Women		7.1	4.8	2.4	31.0	2.4	52.4				
	Total		9.2	4.6	5.7	29.3	1.1	50.0				
Number												
California Community Colleges	Men	429	23	39	33	138	5	177	415	9	3	2
	Women	444	26	21	34	139	9	196	425	6	6	7
	Total	873	49	60	67	277	14	373	840	15	9	9
Percent												
	Men		5.5	9.4	8.0	33.3	1.2	42.7				
	Women		6.1	4.9	8.0	32.7	2.1	46.1				
	Total		5.8	7.1	8.0	33.0	1.7	44.4				

Sex and Ethnic Distribution of 1989-90 California Public High School Graduates by County, and of Fall 1990 First-Time Freshmen at the University of California, the California State University, and the California Community Colleges by County.

County and Segment	Sex	Total	Asian/ Pacific Islander	Black	Filipino	Native Latino American	White	Sub- Total	Other	Non- Resident Alien	No Response	
NAPA												
Number												
High School	Men	425	7	9	9	62	1	337	425			
	Women	377	12	0	2	46	4	313	377			
	Total	802	19	9	11	108	5	650	802			
Percent												
	Men		1.6	2.1	2.1	14.6	0.2	79.3				
	Women		3.2	0.0	0.5	12.2	1.1	83.0				
	Total		2.4	1.1	1.4	13.5	0.6	81.0				
Number												
University of California	Men	24	1	0	0	3	0	18	22	1	0	1
	Women	28	3	0	0	1	0	23	27	0	0	1
	Total	52	4	0	0	4	0	41	49	1	0	2
Percent												
	Men		4.5	0.0	0.0	13.6	0.0	81.8				
	Women		11.1	0.0	0.0	3.7	0.0	85.2				
	Total		8.2	0.0	0.0	8.2	0.0	83.7				
Number												
The California State University	Men	35	0	2	2	6	0	23	33	0	0	2
	Women	36	1	0	1	2	0	32	36	0	0	0
	Total	71	1	2	3	8	0	55	69	0	0	2
Percent												
	Men		0.0	6.1	6.1	18.2	0.0	69.7				
	Women		2.8	0.0	2.8	5.6	0.0	88.9				
	Total		1.4	2.9	4.3	11.6	0.0	79.7				
Number												
California Community Colleges	Men	113	3	1	2	7	1	93	107	1	5	0
	Women	91	5	1	0	10	4	65	85	0	6	0
	Total	204	8	2	2	17	5	158	192	1	11	0
Percent												
	Men		2.8	0.9	1.9	6.5	0.9	86.9				
	Women		5.9	1.2	0.0	11.8	4.7	76.5				
	Total		4.2	1.0	1.0	8.9	2.6	82.3				

Sex and Ethnic Distribution of 1989-90 California Public High School Graduates by County, and of Fall 1990 First-Time Freshmen at the University of California, the California State University, and the California Community Colleges by County.

County and Segment	Sex	Total	Asian/ Pacific Islander	Black	Filipino	Native		White	Sub- Total	Non- Resident No		
						Latino	American			Other	Alien	Response
NEVADA												
High School	Number											
	Men	331	2	1	0	5	1	322	331			
	Women	334	1	0	0	7	4	322	334			
	Total	665	3	1	0	12	5	644	665			
	Percent											
	Total			0.6	0.3	0.0	1.5	0.3	97.3			
Men			0.3	0.0	0.0	2.1	1.2	96.4				
Women			0.5	0.2	0.0	1.8	0.8	96.8				
<hr/>												
University of California	Number											
	Men	18	0	0	0	0	0	17	17	0	0	1
	Women	11	0	0	0	0	0	11	11	0	0	0
	Total	29	0	0	0	0	0	28	28	0	0	1
	Percent											
	Total			0.0	0.0	0.0	0.0	0.0	100.0			
Men			0.0	0.0	0.0	0.0	0.0	100.0				
Women			0.0	0.0	0.0	0.0	0.0	100.0				
<hr/>												
The California State University	Number											
	Men	22	1	1	0	0	0	19	21	1	0	0
	Women	49	0	0	0	4	0	44	48	0	0	1
	Total	71	1	1	0	4	0	63	69	1	0	1
	Percent											
	Total			4.8	4.8	0.0	0.0	0.0	90.5			
Men			0.0	0.0	0.0	8.3	0.0	91.7				
Women			1.4	1.4	0.0	5.8	0.0	91.3				
<hr/>												
California Community Colleges	Number											
	Men	105	2	0	2	6	3	88	101	1	0	3
	Women	114	2	0	1	3	2	97	105	0	0	9
	Total	219	4	0	3	9	5	185	206	1	0	12
	Percent											
	Total			2.0	0.0	2.0	5.9	3.0	87.1			
Men			1.9	0.0	1.0	2.9	1.9	92.4				
Women			1.9	0.0	1.5	4.4	2.4	89.8				
Total												

**Sex and Ethnic Distribution of 1989-90 California Public High School Graduates by County,
and of Fall 1990 First-Time Freshmen at the University of California,
the California State University, and the California Community Colleges by County.**

County and Segment	Sex	Total	Ethnicity					Sub-Total	Residence			
			Asian/ Pacific Islander	Black	Filipino	Native Latino American	White		Other	Non-Resident Alien	No Response	
ORANGE												
High School	Number											
	Men	10,651	1,759	182	125	1,588	123	6,874	10,651			
	Women	10,862	1,602	165	88	1,712	107	7,188	10,862			
	Total	21,513	3,361	347	213	3,300	230	14,062	21,513			
Percent												
	Men		16.5	1.7	1.2	14.9	1.2	64.5				
	Women		14.7	1.5	0.8	15.8	1.0	66.2				
	Total		15.6	1.6	1.0	15.3	1.1	65.4				
University of California	Number											
	Men	993	387	12	14	69	7	459	948	10	10	25
	Women	1,018	375	16	17	76	12	471	967	12	7	32
	Total	2,011	762	28	31	145	19	930	1,915	22	17	57
Percent												
	Men		40.8	1.3	1.5	7.3	0.7	48.4				
	Women		38.8	1.7	1.8	7.9	1.2	48.7				
	Total		39.8	1.5	1.6	7.6	1.0	48.6				
The California State University	Number											
	Men	1,039	284	17	24	90	7	561	983	16	22	18
	Women	1,263	285	26	35	120	13	714	1,193	28	12	30
	Total	2,302	569	43	59	210	20	1,275	2,176	44	34	48
Percent												
	Men		28.9	1.7	2.4	9.2	0.7	57.1				
	Women		23.9	2.2	2.9	10.1	1.1	59.8				
	Total		26.1	2.0	2.7	9.7	0.9	58.6				
California Community Colleges	Number											
	Men	4,466	377	74	78	605	77	2,782	3,993	50	336	87
	Women	4,624	281	65	60	680	61	3,048	4,195	61	285	83
	Total	9,090	658	139	138	1,285	138	5,830	8,188	111	621	170
Percent												
	Men		9.4	1.9	2.0	15.2	1.9	69.7				
	Women		6.7	1.5	1.4	16.2	1.5	72.7				
	Total		8.0	1.7	1.7	15.7	1.7	71.2				

Sex and Ethnic Distribution of 1989-90 California Public High School Graduates by County, and of Fall 1990 First-Time Freshmen at the University of California, the California State University, and the California Community Colleges by County.

County and Segment	Sex	Total	Ethnicity					Sub-Total	Non-Resident			
			Asian/Pacific Islander	Black	Filipino	Latino American	White		Other	Alien	No Response	
PLACER												
High School	Number											
	Men	882	12	7	1	43	8	811	882			
	Women	898	28	16	2	34	5	813	898			
	Total	1,780	40	23	3	77	13	1,624	1,780			
Percent												
Men			1.4	0.8	0.1	4.9	0.9	92.0				
Women			3.1	1.8	0.2	3.8	0.6	90.5				
Total			2.2	1.3	0.2	4.3	0.7	91.2				
<hr/>												
University of California	Number											
	Men	32	2	0	0	2	3	23	30	0	0	2
	Women	52	5	0	0	5	2	37	49	1	0	2
	Total	84	7	0	0	7	5	60	79	1	0	4
Percent												
Men			6.7	0.0	0.0	6.7	10.0	76.7				
Women			10.2	0.0	0.0	10.2	4.1	75.5				
Total			8.9	0.0	0.0	8.9	6.3	75.9				
<hr/>												
The California State University	Number											
	Men	55	3	1	2	7	1	35	49	1	0	5
	Women	82	5	0	0	7	0	67	79	1	0	2
	Total	137	8	1	2	14	1	102	128	2	0	7
Percent												
Men			6.1	2.0	4.1	14.3	2.0	71.4				
Women			6.3	0.0	0.0	8.9	0.0	84.8				
Total			6.3	0.8	1.6	10.9	0.8	79.7				
<hr/>												
California Community Colleges	Number											
	Men	336	4	3	1	12	7	305	332	3	0	1
	Women	393	9	1	1	34	5	334	384	6	1	2
	Total	729	13	4	2	46	12	639	716	9	1	3
Percent												
Men			1.2	0.9	0.3	3.6	2.1	91.9				
Women			2.3	0.3	0.3	8.9	1.3	87.0				
Total			1.8	0.6	0.3	6.4	1.7	89.2				

***Sex and Ethnic Distribution of 1989-90 California Public High School Graduates by County,
and of Fall 1990 First-Time Freshmen at the University of California,
the California State University, and the California Community Colleges by County.***

County and Segment	Sex	Total	Asian/ Pacific Islander	Black	Filipino	Latino American	Native White	Sub- Total	Other	Non- Resident Alien	No Response		
PLUMAS													
High School	Number												
	Men	122	1	1	0	3	4	113					
	Women	92	1	1	0	3	7	80					
	Total	214	2	2	0	6	11	193					
	Percent												
	Men			0.8	0.8	0.0	2.5	3.3	92.6				
	Women			1.1	1.1	0.0	3.3	7.6	87.0				
	Total			0.9	0.9	0.0	2.8	5.1	90.2				
	University of California	Number											
		Men	1	0	0	0	0	0	1	1	0	0	0
		Women	3	1	0	0	1	0	1	3	0	0	0
		Total	4	1	0	0	1	0	2	4	0	0	0
Percent													
Men				0.0	0.0	0.0	0.0	0.0	100.0				
Women				33.3	0.0	0.0	33.3	0.0	33.3				
Total				25.0	0.0	0.0	25.0	0.0	50.0				
The California State University		Number											
		Men	11	0	0	0	0	0	11	11	0	0	0
		Women	7	0	0	0	0	1	6	7	0	0	0
		Total	18	0	0	0	0	1	17	18	0	0	0
	Percent												
	Men			0.0	0.0	0.0	0.0	0.0	100.0				
	Women			0.0	0.0	0.0	0.0	14.3	85.7				
	Total			0.0	0.0	0.0	0.0	5.6	94.4				
	California Community Colleges	Number											
		Men	30	1	0	0	0	0	28	29	0	0	1
		Women	35	0	0	0	2	0	30	32	3	0	0
		Total	65	1	0	0	2	0	58	61	3	0	1
Percent													
Men				3.4	0.0	0.0	0.0	0.0	96.6				
Women				0.0	0.0	0.0	6.3	0.0	93.8				
Total				1.6	0.0	0.0	3.3	0.0	95.1				

Sex and Ethnic Distribution of 1989-90 California Public High School Graduates by County, and of Fall 1990 First-Time Freshmen at the University of California, the California State University, and the California Community Colleges by County.

County and Segment	Sex	Total	Asian/ Pacific Islander	Black	Filipino	Latino	Native American	White	Sub- Total	Non- Resident Other	Alien	No Response
RIVERSIDE												
Number												
High School	Men	3,863	168	284	31	1,054	21	2,305	3,863			
	Women	4,402	176	312	37	1,163	30	2,684	4,402			
	Total	8,265	344	596	68	2,217	51	4,989	8,265			
Percent												
High School	Men		4.3	7.4	0.8	27.3	0.5	59.7				
	Women		4.0	7.1	0.8	26.4	0.7	61.0				
	Total		4.2	7.2	0.8	26.8	0.6	60.4				
Number												
University of California	Men	192	30	11	5	33	2	100	181	2	2	7
	Women	247	44	11	11	43	7	121	237	3	1	6
	Total	439	74	22	16	76	9	221	418	5	3	13
Percent												
University of California	Men		16.6	6.1	2.8	18.2	1.1	55.2				
	Women		18.6	4.6	4.6	18.1	3.0	51.1				
	Total		17.7	5.3	3.8	18.2	2.2	52.9				
Number												
The California State University	Men	198	19	17	2	42	2	104	186	8	2	2
	Women	270	13	26	6	62	2	151	260	5	1	4
	Total	468	32	43	8	104	4	255	446	13	3	6
Percent												
The California State University	Men		10.2	9.1	1.1	22.6	1.1	55.9				
	Women		5.0	10.0	2.3	23.8	0.8	58.1				
	Total		7.2	9.6	1.8	23.3	0.9	57.2				
Number												
California Community Colleges	Men	1,205	41	97	16	268	13	700	1,135	20	26	24
	Women	1,332	25	89	26	307	15	798	1,260	18	25	29
	Total	2,537	66	186	42	575	28	1,498	2,395	38	51	53
Percent												
California Community Colleges	Men		3.6	8.5	1.4	23.6	1.1	61.7				
	Women		2.0	7.1	2.1	24.4	1.2	63.3				
	Total		2.8	7.8	1.8	24.0	1.2	62.5				

Sex and Ethnic Distribution of 1989-90 California Public High School Graduates by County, and of Fall 1990 First-Time Freshmen at the University of California, the California State University, and the California Community Colleges by County.

County and Segment	Sex	Total	Asian/ Pacific Islander	Black	Filipino	Native Latino American	White	Sub- Total	Non- Resident Other	Alien	No Response	
SACRAMENTO												
High School	Number											
	Men	3,884	488	438	84	382	43	2,449	3,884			
	Women	4,243	492	506	76	476	39	2,654	4,243			
	Total	8,127	980	944	160	858	82	5,103	8,127			
Percent												
	Men		12.6	11.3	2.2	9.8	1.1	63.1				
	Women		11.6	11.9	1.8	11.2	0.9	62.6				
	Total		12.1	11.6	2.0	10.6	1.0	62.8				
University of California	Number											
	Men	214	55	7	9	19	6	101	197	2	1	14
	Women	259	77	23	8	28	4	109	244	5	2	8
	Total	473	127	30	17	47	10	210	441	7	3	22
Percent												
	Men		27.9	3.6	4.6	9.6	3.0	51.3				
	Women		29.5	9.4	3.3	11.5	1.6	44.7				
	Total		28.8	6.8	3.9	10.7	2.3	47.6				
The California State University	Number											
	Men	279	43	23	11	15	2	167	261	5	1	12
	Women	338	62	29	8	24	4	191	318	5	2	13
	Total	617	105	52	19	39	6	358	579	10	3	25
Percent												
	Men		16.5	8.8	4.2	5.7	0.8	64.0				
	Women		19.5	9.1	2.5	7.5	1.3	60.1				
	Total		18.1	9.0	3.3	6.7	1.0	61.8				
California Community Colleges	Number											
	Men	1,662	209	195	40	138	39	954	1,575	42	33	12
	Women	1,783	165	187	42	185	30	1,083	1,692	45	31	15
	Total	3,445	374	382	82	323	69	2,037	3,267	87	64	27
Percent												
	Men		13.3	12.4	2.5	8.8	2.5	60.6				
	Women		9.8	11.1	2.5	10.9	1.8	64.0				
	Total		11.4	11.7	2.5	9.9	2.1	62.4				

Sex and Ethnic Distribution of 1989-90 California Public High School Graduates by County, and of Fall 1990 First-Time Freshmen at the University of California, the California State University, and the California Community Colleges by County.

County and Segment	Sex	Total	Asian/ Pacific Islander	Black	Filipino	Native		White	Sub- Total	Non-Resident		
						American				Other	Alien	No Response
SAN BENITO												
High School						Number						
	Men	150	2	2	3	80	0	63	150			
	Women	145	2	0	0	80	0	63	145			
	Total	295	4	2	3	160	0	126	295			
						Percent						
	Men		1.3	1.3	2.0	53.3	0.0	42.0				
	Women		1.4	0.0	0.0	55.2	0.0	43.4				
	Total		1.4	0.7	1.0	54.2	0.0	42.7				
University of California						Number						
	Men	7	0	0	0	3	0	3	6	1	0	0
	Women	7	0	0	0	5	0	2	7	0	0	0
	Total	14	0	0	0	8	0	5	13	1	0	0
						Percent						
	Men		0.0	0.0	0.0	50.0	0.0	50.0				
	Women		0.0	0.0	0.0	71.4	0.0	28.6				
	Total		0.0	0.0	0.0	61.5	0.0	38.5				
The California State University						Number						
	Men	6	0	0	1	4	0	1	6	0	0	0
	Women	21	0	0	0	14	0	7	21	0	0	0
	Total	27	0	0	1	18	0	8	27	0	0	0
						Percent						
	Men		0.0	0.0	16.7	66.7	0.0	16.7				
	Women		0.0	0.0	0.0	44.7	0.0	33.3				
	Total		0.0	0.0	3.7	60.7	0.0	29.6				
California Community Colleges						Number						
	Men	68	1	1	0	34	0	25	61	1	1	5
	Women	59	0	0	0	25	0	27	52	2	1	4
	Total	127	1	1	0	59	0	52	113	3	2	9
						Percent						
	Men		1.6	1.6	0.0	55.7	0.0	41.0				
	Women		0.0	0.0	0.0	48.1	0.0	51.9				
	Total		0.9	0.9	0.0	52.2	0.0	46.0				

110

Sex and Ethnic Distribution of 1989-90 California Public High School Graduates by County, and of Fall 1990 First-Time Freshmen at the University of California, the California State University, and the California Community Colleges by County.

County and Segment	Sex	Total	Asian/ Pacific Islander	Black	Filipino	Native Latino American	White	Sub- Total	Other	Non- Resident Alien	No Response
SAN BERNARDINO											
Number											
High School	Men	5,352	246	454	35	1,232	48	3,337	5,352		
	Women	5,883	273	525	46	1,452	42	3,545	5,883		
	Total	11,235	519	979	81	2,684	90	6,882	11,235		
Percent											
	Men		4.6	8.5	0.7	23.0	0.9	62.4			
	Women		4.6	8.9	0.8	24.7	0.7	60.3			
	Total		4.6	8.7	0.7	23.9	0.8	61.3			
Number											
University of California	Men	170	35	13	2	20	4	88	162	4	0
	Women	259	40	23	8	49	1	125	246	5	1
	Total	429	75	36	10	69	5	213	408	9	1
Percent											
	Men		21.6	8.0	1.2	12.3	2.5	54.3			
	Women		16.3	9.3	3.3	19.9	0.4	50.8			
	Total		18.4	8.8	2.5	16.9	1.2	52.2			
Number											
The California State University	Men	424	37	34	11	63	5	242	397	10	1
	Women	514	45	46	11	96	5	282	485	10	0
	Total	938	82	80	22	164	10	524	882	20	1
Percent											
	Men		9.3	8.6	2.8	17.1	1.3	61.0			
	Women		9.3	9.5	2.3	19.8	1.0	58.1			
	Total		9.3	9.1	2.5	18.6	1.1	59.4			
Number											
California Community Colleges	Men	1,584	47	132	18	343	15	917	1,472	13	21
	Women	1,737	60	153	27	377	19	996	1,632	13	15
	Total	3,321	107	285	45	720	34	1,913	3,104	26	36
Percent											
	Men		3.2	9.0	1.2	23.3	1.0	62.3			
	Women		3.7	9.4	1.7	23.1	1.2	61.0			
	Total		3.4	9.2	1.4	23.2	1.1	61.6			

**Sex and Ethnic Distribution of 1989-90 California Public High School Graduates by County,
and of Fall 1990 First-Time Freshmen at the University of California,
the California State University, and the California Community Colleges by County.**

County and Segment	Sex	Total	Native					Sub-Total	Non-Resident			
			Asian/ Pacific Islander	Black	Filipino	Latino	American		White	Other	Alien	No Response
SAN DIEGO												
High School			Number									
	Men	9,694	703	584	597	1,968	60	5,782	9,694			
	Women	9,966	659	794	599	2,019	43	5,852	9,966			
	Total	19,660	1,362	1,378	1,196	3,987	103	11,634	19,660			
			Percent									
	Men		7.3	6.0	6.2	20.3	0.6	59.6				
	Women		6.6	8.0	6.0	20.3	0.4	58.7				
	Total		6.9	7.0	6.1	20.3	0.5	59.2				
University of California												
University of California			Number									
	Men	644	100	21	34	90	4	357	606	6	4	28
	Women	741	101	32	71	96	5	394	699	18	3	21
	Total	1,385	201	53	105	186	9	751	1,305	24	7	49
			Percent									
	Men		16.5	3.5	5.6	14.9	0.7	58.9				
	Women		14.4	4.6	10.2	13.7	0.7	56.4				
	Total		15.4	4.1	8.0	14.3	0.7	57.5				
The California State University												
The California State University			Number									
	Men	829	108	35	121	117	4	393	778	34	7	10
	Women	950	94	62	109	144	11	478	898	41	6	5
	Total	1,779	202	97	230	261	15	871	1,676	75	13	15
			Percent									
	Men		13.9	4.5	15.6	15.0	0.5	50.5				
	Women		10.5	6.9	12.1	16.0	1.2	53.2				
	Total		12.1	5.8	13.7	15.6	0.9	52.0				
California Community Colleges												
California Community Colleges			Number									
	Men	3,540	199	172	221	741	41	2,001	3,375	61	80	24
	Women	3,606	174	168	167	784	39	2,097	3,429	78	68	31
	Total	7,146	373	340	388	1,525	80	4,098	6,804	139	148	55
			Percent									
	Men		5.9	5.1	6.5	22.0	1.2	59.3				
	Women		5.1	4.9	4.9	22.9	1.1	61.2				
	Total		5.5	5.0	5.7	22.4	1.2	60.2				

Sex and Ethnic Distribution of 1989-90 California Public High School Graduates by County, and of Fall 1990 First-Time Freshmen at the University of California, the California State University, and the California Community Colleges by County.

County and Segment	Sex	Total	Asian/ Pacific Islander	Black	Filipino	Native Latino American	White	Sub- Total	Non- Resident Other	Alien	No Response	
SAN FRANCISCO												
High School			Number									
	Men	2,796	1,228	486	261	495	21	305	2,796			
	Women	1,961	921	250	190	268	4	328	1,961			
	Total	4,757	2,149	736	451	763	25	633	4,757			
			Percent									
	Men		43.9	17.4	9.3	17.7	0.8	10.9				
	Women		47.0	12.7	9.7	13.7	0.2	16.7				
	Total		45.2	15.5	9.5	16.0	0.5	13.3				
University of California			Number									
	Men	150	92	4	10	15	0	21	142	1	2	5
	Women	218	105	10	13	27	0	45	200	3	5	10
	Total	368	197	14	23	42	0	66	342	4	7	15
			Percent									
	Men		64.8	2.8	7.0	10.6	0.0	14.8				
	Women		52.5	5.0	6.5	13.5	0.0	22.5				
	Total		57.6	4.1	6.7	12.3	0.0	19.3				
The California State University			Number									
	Men	311	187	23	23	20	4	31	288	7	11	5
	Women	426	222	41	49	42	0	39	393	14	14	5
	Total	737	409	64	72	62	4	70	681	21	25	10
			Percent									
	Men		64.9	8.0	8.0	6.9	1.4	10.8				
	Women		56.5	10.4	12.5	10.7	0.0	9.9				
	Total		60.1	9.4	10.6	9.1	0.6	10.3				
California Community Colleges			Number									
	Men	581	302	57	39	48	1	70	517	5	42	17
	Women	525	245	51	48	64	6	56	470	5	40	10
	Total	1,106	547	108	87	112	7	126	987	10	82	27
			Percent									
	Men		58.4	11.0	7.5	9.3	0.2	13.5				
	Women		52.1	10.9	10.2	13.6	1.3	11.9				
	Total		55.4	10.9	8.8	11.3	0.7	12.8				

Sex and Ethnic Distribution of 1989-90 California Public High School Graduates by County, and of Fall 1990 First-Time Freshmen at the University of California, the California State University, and the California Community Colleges by County.

County and Segment	Sex	Total	Asian/ Pacific Islander	Black	Filipino	Latino	Native American	White	Sub- Total	Other	Non- Resident Alien	No Response
SAN JOAQUIN												
High School			Number									
	Men	2,008	287	84	63	378	16	1,180	2,008			
	Women	1,980	249	99	78	380	20	1,154	1,980			
	Total	3,988	536	183	141	758	36	2,334	3,988			
			Percent									
	Men		14.3	4.2	3.1	18.8	0.8	58.8				
	Women		12.6	5.0	3.9	19.2	1.0	58.3				
	Total		13.4	4.6	3.5	19.0	0.9	58.5				
University of California			Number									
	Men	70	21	1	2	3	1	39	67	2	0	1
	Women	64	16	6	5	8	1	26	62	0	0	2
	Total	134	37	7	7	11	2	65	129	2	0	3
			Percent									
	Men		31.3	1.5	3.0	4.5	1.5	58.2				
	Women		25.8	9.7	8.1	12.9	1.6	41.9				
	Total		28.7	5.4	5.4	8.5	1.6	50.4				
The California State University			Number									
	Men	95	14	5	1	11	1	55	87	2	1	5
	Women	123	14	3	4	23	2	70	116	2	0	5
	Total	218	28	8	5	34	3	125	203	4	1	10
			Percent									
	Men		16.1	5.7	1.1	12.6	1.1	63.2				
	Women		12.1	2.6	3.4	19.8	1.7	60.3				
	Total		13.8	3.9	2.5	16.7	1.5	61.6				
California Community Colleges			Number									
	Men	849	96	34	39	159	18	431	777	11	31	30
	Women	863	76	37	46	154	13	457	783	6	37	37
	Total	1,712	172	71	85	313	31	888	1,560	17	68	67
			Percent									
	Men		12.4	4.4	5.0	20.5	2.3	55.5				
	Women		9.7	4.7	5.9	19.7	1.7	58.4				
	Total		11.0	4.6	5.4	20.1	2.0	56.9				

Sex and Ethnic Distribution of 1989-90 California Public High School Graduates by County, and of Fall 1990 First-Time Freshmen at the University of California, the California State University, and the California Community Colleges by County.

County and Segment	Sex	Total	Asian/ Pacific Islander	Black	Filipino	Native Latino American	White	Sub- Total	Non- Resident Other	Alien	No Response	
SAN LUIS OBISPO												
Number												
High School	Men	753	22	9	10	86	1	625	753			
	Women	700	13	5	13	64	1	604	700			
	Total	1,453	35	14	23	150	2	1,229	1,453			
Percent												
	Men		2.9	1.2	1.3	11.4	0.1	83.0				
	Women		1.9	0.7	1.9	9.1	0.1	86.3				
	Total		2.4	1.0	1.6	10.3	0.1	84.6				
Number												
University of California	Men	39	3	0	0	6	0	28	37	0	0	2
	Women	33	3	0	0	9	0	18	30	1	0	2
	Total	72	6	0	0	15	0	46	67	1	0	4
Percent												
	Men		8.1	0.0	0.0	16.2	0.0	75.7				
	Women		10.0	0.0	0.0	30.0	0.0	60.0				
	Total		9.0	0.0	0.0	22.4	0.0	68.7				
Number												
The California State University	Men	47	1	0	0	9	1	33	44	0	0	3
	Women	42	2	0	2	7	1	29	41	0	0	1
	Total	89	3	0	2	16	2	62	85	0	0	4
Percent												
	Men		2.3	0.0	0.0	20.5	2.3	75.0				
	Women		4.9	0.0	4.9	17.1	2.4	70.7				
	Total		3.5	0.0	2.4	18.8	2.4	72.9				
Number												
California Community Colleges	Men	280	4	5	2	29	2	228	270	7	3	0
	Women	291	3	4	6	20	5	249	287	2	2	0
	Total	571	7	9	8	49	7	477	557	9	5	0
Percent												
	Men		1.5	1.9	0.7	10.7	0.7	84.4				
	Women		1.0	1.4	2.1	7.0	1.7	86.8				
	Total		1.3	1.6	1.4	8.8	1.3	85.6				

**Sex and Ethnic Distribution of 1989-90 California Public High School Graduates by County,
and of Fall 1990 First-Time Freshmen at the University of California,
the California State University, and the California Community Colleges by County.**

County and Segment	Sex	Total	Ethnicity					Sub-Total	Non-Resident			
			Asian/ Pacific Islander	Black	Filipino	Latino American	White		Other	Alien	No Response	
SAN MATEO												
High School	Number											
	Men	2,084	310	135	192	306	3	1,138	2,084			
	Women	2,261	327	127	225	316	4	1,262	2,261			
	Total	4,345	637	262	417	622	7	2,400	4,345			
	Percent											
	Total			14.7	6.0	9.6	14.3	0.2	55.2			
University of California	Number											
	Men	184	42	6	11	19	1	86	165	2	3	14
	Women	217	43	6	12	21	2	111	195	3	3	16
	Total	401	85	12	23	40	3	197	360	5	6	30
	Percent											
	Total			23.6	3.3	6.4	11.1	0.8	54.7			
The California State University	Number											
	Men	214	36	6	30	17	1	103	193	12	5	4
	Women	292	38	9	29	43	2	144	265	10	5	12
	Total	506	74	15	59	60	3	247	458	22	10	16
	Percent											
	Total			16.2	3.3	12.9	13.1	0.7	53.9			
California Community Colleges	Number											
	Men	886	97	58	94	130	13	455	847	14	16	9
	Women	902	111	51	91	124	4	478	859	13	17	13
	Total	1,788	208	109	185	254	17	933	1,706	27	33	22
	Percent											
	Total			12.2	6.4	10.8	14.9	1.0	54.7			

Sex and Ethnic Distribution of 1989-90 California Public High School Graduates by County, and of Fall 1990 First-Time Freshmen at the University of California, the California State University, and the California Community Colleges by County.

County and Segment	Sex	Total	Asian/ Pacific Islander	Black	Filipino	Native Latino American	White	Sub- Total	Non- Resident Other	No Alien Response		
SANTA BARBARA												
High School					Number							
	Men	1,347	41	56	26	374	8	842	1,347			
	Women	1,316	48	47	36	391	8	786	1,316			
	Total	2,663	89	103	62	765	16	1,628	2,663			
					Percent							
	Men		3.0	4.2	1.9	27.8	0.6	62.5				
	Women		3.6	3.6	2.7	29.7	0.6	59.7				
	Total		3.3	3.9	2.3	28.7	0.6	61.1				
University of California					Number							
	Men	90	6	3	1	9	0	63	82	2	1	5
	Women	92	7	3	0	16	0	56	82	3	1	6
	Total	182	13	6	1	25	0	119	164	5	2	11
					Percent							
	Men		7.3	3.7	1.2	11.0	0.0	76.8				
	Women		8.5	3.7	0.0	19.5	0.0	68.3				
	Total		7.9	3.7	0.6	15.2	0.0	72.6				
The California State University					Number							
	Men	62	3	1	3	11	0	41	59	1	1	1
	Women	62	2	2	2	13	1	39	59	2	0	1
	Total	124	5	3	5	24	1	80	118	3	1	2
					Percent							
	Men		5.1	1.7	5.1	18.6	0.0	69.5				
	Women		3.4	3.4	3.4	22.0	1.7	66.1				
	Total		4.2	2.5	4.2	20.3	0.8	67.8				
California Community Colleges					Number							
	Men	336	14	17	2	78	2	210	323	3	8	2
	Women	294	10	3	4	77	3	182	279	3	10	2
	Total	630	24	20	6	155	5	392	602	6	18	4
					Percent							
	Men		4.3	5.3	0.6	24.1	0.6	65.0				
	Women		3.6	1.1	1.4	27.6	1.1	65.2				
	Total		4.0	3.3	1.0	25.7	0.8	65.1				

*Sex and Ethnic Distribution of 1989-90 California Public High School Graduates by County,
and of Fall 1990 First-Time Freshmen at the University of California,
the California State University, and the California Community Colleges by County.*

County and Segment	Sex	Total	Asian/ Pacific Islander	Black	Filipino	Native Latino American	White	Sub- Total	Other	Non- Resident Alien	No Response	
SANTA CLARA												
Number												
High School	Men	6,242	1,247	246	278	1,055	53	3,363	6,242			
	Women	6,301	1,098	304	275	1,177	55	3,392	6,301			
	Total	12,543	2,345	550	553	2,232	108	6,755	12,543			
Percent												
	Men		20.0	3.9	4.5	16.9	0.8	53.9				
	Women		17.4	4.8	4.4	18.7	0.9	53.8				
	Total		18.7	4.4	4.4	17.8	0.9	53.9				
Number												
University of California	Men	558	197	18	18	30	8	250	521	6	7	24
	Women	643	199	16	20	70	3	289	597	9	6	31
	Total	1,201	396	34	38	100	11	539	1,118	15	13	55
Percent												
	Men		37.8	3.5	3.5	5.8	1.5	43.0				
	Women		33.3	2.7	3.4	11.7	0.5	48.4				
	Total		35.4	3.0	3.4	8.9	1.0	48.2				
Number												
The California State University	Men	780	224	23	50	75	3	350	725	19	11	25
	Women	887	224	31	51	108	5	402	821	27	7	32
	Total	1,667	448	54	101	183	8	752	1,546	46	18	57
Percent												
	Men		30.9	3.2	6.9	10.3	0.4	48.3				
	Women		27.3	3.8	6.2	13.2	0.6	49.0				
	Total		29.0	3.5	6.5	11.8	0.5	48.6				
Number												
California Community Colleges	Men	2,752	402	103	126	402	20	1,386	2,439	32	37	244
	Women	2,583	325	78	122	390	23	1,343	2,281	29	32	241
	Total	5,335	727	181	248	792	43	2,729	4,720	61	69	485
Percent												
	Men		16.5	4.2	5.2	16.5	0.8	56.8				
	Women		14.2	3.4	5.3	17.1	1.0	58.9				
	Total		15.4	3.8	5.3	16.8	0.9	57.8				

**Sex and Ethnic Distribution of 1989-90 California Public High School Graduates by County,
and of Fall 1990 First-Time Freshmen at the University of California,
the California State University, and the California Community Colleges by County.**

County and Segment	Sex	Total	Asian/ Pacific Islander	Black	Filipino	Latino American	Native White	Sub- Total	Other	Non- Resident Alien	No Response	
SANTA CRUZ												
High School					Number							
	Men	976	23	12	11	213	3	714	976			
	Women	844	21	6	14	187	1	615	844			
	Total	1,820	44	18	25	400	4	1,329	1,820			
					Percent							
	Men		2.4	1.2	1.1	21.8	0.3	73.2				
	Women		2.5	0.7	1.7	22.2	0.1	72.9				
	Total		2.4	1.0	1.4	22.0	0.2	73.0				
University of California					Number							
	Men	79	8	4	0	8	1	52	73	1	0	5
	Women	83	5	3	1	12	1	58	80	0	0	3
	Total	162	13	7	1	20	2	110	153	1	0	8
					Percent							
	Men		11.0	5.5	0.0	11.0	1.4	71.2				
	Women		6.3	3.8	1.3	15.0	1.3	72.5				
	Total		8.5	4.6	0.7	13.1	1.3	71.9				
The California State University					Number							
	Men	68	3	2	2	13	0	45	65	0	0	3
	Women	69	0	0	2	8	0	54	64	2	0	3
	Total	137	3	2	4	21	0	99	129	2	0	6
					Percent							
	Men		4.6	3.1	3.1	20.0	0.0	69.2				
	Women		0.0	0.0	3.1	12.5	0.0	84.4				
	Total		2.3	1.6	3.1	16.3	0.0	76.7				
California Community Colleges					Number							
	Men	397	11	6	4	86	6	274	387	2	6	2
	Women	364	12	5	6	82	0	251	356	2	6	0
	Total	761	23	11	10	168	6	525	743	4	12	2
					Percent							
	Men		2.8	1.6	1.0	22.2	1.6	70.8				
	Women		3.4	1.4	1.7	23.0	0.0	70.5				
	Total		3.1	1.5	1.3	22.6	0.8	70.7				

**Sex and Ethnic Distribution of 1989-90 California Public High School Graduates by County,
and of Fall 1990 First-Time Freshmen at the University of California,
the California State University, and the California Community Colleges by County.**

County and Segment	Sex	Total	Asian/ Pacific Islander	Black	Filipino	Latino	Native American	White	Sub- Total	Other	Non- Resident Alien	No Response
SHASTA												
High School					Number							
	Men	711	17	3	0	17	45	629	711			
	Women	724	9	5	0	16	44	650	724			
	Total	1,435	26	8	0	33	89	1,279	1,435			
					Percent							
	Men		2.4	0.4	0.0	2.4	6.3	88.5				
	Women		1.2	0.7	0.0	2.2	6.1	89.8				
	Total		1.8	0.6	0.0	2.3	6.2	89.1				
University of California					Number							
	Men	13	0	0	0	1	2	9	12	0	0	1
	Women	21	0	1	0	1	0	19	21	0	0	0
	Total	34	0	1	0	2	2	28	33	0	0	1
					Percent							
	Men		0.0	0.0	0.0	8.3	16.7	75.0				
	Women		0.0	4.8	0.0	4.8	0.0	90.5				
	Total		0.0	3.0	0.0	6.1	6.1	84.8				
The California State University					Number							
	Men	28	0	0	0	3	0	25	28	0	0	0
	Women	33	0	1	0	3	0	28	32	1	0	0
	Total	61	0	1	0	6	0	53	60	1	0	0
					Percent							
	Men		0.0	0.0	0.0	10.7	0.0	89.3				
	Women		0.0	3.1	0.0	9.4	0.0	87.5				
	Total		0.0	1.7	0.0	10.0	0.0	88.3				
California Community Colleges					Number							
	Men	102	3	1	2	6	5	78	95	1	0	6
	Women	91	1	0	0	5	2	81	89	0	0	2
	Total	193	4	1	2	11	7	159	184	1	0	8
					Percent							
	Men		3.2	1.1	2.1	6.3	5.3	82.1				
	Women		1.1	0.0	0.0	5.6	2.2	91.0				
	Total		2.2	0.5	1.1	6.0	3.8	86.4				

150

Sex and Ethnic Distribution of 1989-90 California Public High School Graduates by County, and of Fall 1990 First-Time Freshmen at the University of California, the California State University, and the California Community Colleges by County.

County and Segment	Sex	Total	Asian/ Pacific Islander	Black	Filipino	Native Latino American	White	Sub- Total	Other	Non- Resident Alien	No Response	
SIERRA												
High School	Number											
	Men	26	0	0	0	2	0	24	26			
	Women	15	0	0	0	3	0	12	15			
	Total	41	0	0	0	5	0	36	41			
	Percent											
	Men			0.0	0.0	0.0	7.7	0.0	92.3			
	Women			0.0	0.0	0.0	20.0	0.0	80.0			
	Total			0.0	0.0	0.0	12.2	0.0	87.8			
	University of California	Number										
		Men	1	0	0	0	0	0	1	1	0	0
		Women	2	0	0	0	0	1	1	2	0	0
		Total	3	0	0	0	0	1	2	3	0	0
Percent												
Men				0.0	0.0	0.0	0.0	0.0	33.3			
Women				0.0	0.0	0.0	0.0	50.0	50.0			
Total				0.0	0.0	0.0	0.0	33.3	66.7			
The California State University		Number										
		Men	0	0	0	0	0	0	0	0	0	0
		Women	0	0	0	0	0	0	0	0	0	0
		Total	0	0	0	0	0	0	0	0	0	0
	Percent											
	Men			0.0	0.0	0.0	0.0	0.0	0.0			
	Women			0.0	0.0	0.0	0.0	0.0	0.0			
	Total			0.0	0.0	0.0	0.0	0.0	0.0			
	California Community Colleges	Number										
		Men	12	0	0	0	1	0	10	11	0	0
		Women	4	0	0	1	0	0	2	3	0	0
		Total	16	0	0	1	1	0	12	14	0	0
Percent												
Men				0.0	0.0	0.0	9.1	0.0	90.9			
Women				0.0	0.0	33.3	0.0	0.0	66.7			
Total				0.0	0.0	7.1	7.1	0.0	85.7			

Sex and Ethnic Distribution of 1989-90 California Public High School Graduates by County, and of Fall 1990 First-Time Freshmen at the University of California, the California State University, and the California Community Colleges by County.

County and Segment	Sex	Total	Asian/ Pacific Islander	Black	Filipino	Native		White	Sub- Total	Non- Resident		
						Latino	American			Other	Alien	No Response
SISKIYOU												
High School	Number											
	Men	203	5	5	0	16	5	172	203			
	Women	196	4	5	1	15	9	162	196			
	Total	399	9	10	1	31	14	334	399			
	Percent											
	Total			2.3	2.5	0.3	7.8	3.5	83.7			
University of California	Number											
	Men	7	0	0	0	0	0	6	6	1	0	0
	Women	6	0	0	0	0	0	6	6	0	0	0
	Total	13	0	0	0	0	0	12	12	1	0	0
	Percent											
	Total			0.0	0.0	0.0	0.0	0.0	100.0			
The California State University	Number											
	Men	10	0	0	0	1	0	9	10	0	0	0
	Women	21	0	0	0	0	2	16	18	1	0	2
	Total	31	0	0	0	1	2	25	28	1	0	2
	Percent											
	Total			0.0	0.0	0.0	3.6	7.1	89.3			
California Community Colleges	Number											
	Men	76	4	2	0	5	3	56	70	0	0	6
	Women	72	0	5	0	5	3	54	67	0	2	3
	Total	148	4	7	0	10	6	110	137	0	2	9
	Percent											
	Total			2.9	5.1	0.0	7.3	4.4	80.3			

152

**Sex and Ethnic Distribution of 1989-90 California Public High School Graduates by County,
and of Fall 1990 First-Time Freshmen at the University of California,
the California State University, and the California Community Colleges by County.**

County and Segment	Sex	Total	Asian/ Pacific Islander	Black	Filipino	Native Latino American	White	Sub- Total	Other	Non- Resident Alien	No Response	
SOLANO												
Number												
High School	Men	1,377	79	198	130	160	12	798	1,377			
	Women	1,503	83	244	153	174	13	836	1,503			
	Total	2,880	162	442	283	334	25	1,634	2,880			
Percent												
	Men		5.7	14.4	9.4	11.5	0.9	58.0				
	Women		5.5	16.2	10.2	11.6	0.9	55.6				
	Total		5.6	15.3	9.8	11.6	0.9	56.7				
Number												
University of California	Men	51	5	3	4	6	0	28	46	1	0	4
	Women	63	11	2	8	12	1	26	60	0	0	3
	Total	114	16	5	12	18	1	54	106	1	0	7
Percent												
	Men		10.9	6.5	8.7	13.0	0.0	60.9				
	Women		18.3	3.3	13.3	20.0	1.7	43.3				
	Total		15.1	4.7	11.3	17.0	0.9	50.9				
Number												
The California State University	Men	90	2	5	14	10	0	56	87	2	0	1
	Women	131	9	15	15	20	3	61	123	4	0	4
	Total	221	11	20	29	30	3	117	210	6	0	5
Percent												
	Men		2.3	5.7	16.1	11.5	0.0	64.4				
	Women		7.3	12.2	12.2	16.3	2.4	49.6				
	Total		5.2	9.5	13.8	14.3	1.4	55.7				
Number												
California Community Colleges	Men	455	18	62	55	49	4	250	438	5	9	3
	Women	538	26	77	47	57	9	294	518	9	7	4
	Total	993	44	139	102	114	13	544	956	14	16	7
Percent												
	Men		4.1	14.2	12.6	11.2	0.9	57.1				
	Women		5.0	14.9	9.1	12.5	1.7	56.8				
	Total		4.6	14.5	10.7	11.9	1.4	56.9				

Sex and Ethnic Distribution of 1989-90 California Public High School Graduates by County, and of Fall 1990 First-Time Freshmen at the University of California, the California State University, and the California Community Colleges by County.

County and Segment	Sex	Total	Asian/ Pacific Islander	Black	Native			Sub- Total	Non- Resident			
					Filipino	Latino American	White		Other	Alien	No Response	
SONOMA												
High School	Number											
	Men	1,521	59	25	5	124	8	1,300	1,521			
	Women	1,440	38	22	7	120	5	1,248	1,440			
	Total	2,961	97	47	12	244	13	2,548	2,961			
	Percent											
	Total			3.3	1.6	0.4	8.2	0.4	86.1			
University of California	Number											
	Men	90	13	1	2	3	2	64	85	0	0	5
	Women	99	6	2	1	4	1	83	97	0	0	2
	Total	189	19	3	3	7	3	147	182	0	0	7
	Percent											
	Total			10.4	1.6	1.6	3.8	1.6	80.8			
The California State University	Number											
	Men	107	6	1	1	13	1	82	104	0	1	2
	Women	124	5	5	3	10	6	88	117	0	2	5
	Total	231	11	6	4	23	7	170	221	0	3	7
	Percent											
	Total			5.0	2.7	1.8	10.4	3.2	76.9			
California Community Colleges	Number											
	Men	594	19	12	4	51	6	486	578	3	9	4
	Women	614	24	7	6	33	10	520	600	5	7	2
	Total	1,208	43	19	10	84	16	1,006	1,178	8	16	6
	Percent											
	Total			3.7	1.6	0.8	7.1	1.4	85.4			

**Sex and Ethnic Distribution of 1989-90 California Public High School Graduates by County,
and of Fall 1990 First-Time Freshmen at the University of California,
the California State University, and the California Community Colleges by County.**

County and Segment	Sex	Total	Ethnicity					Sub-Total	Residency			
			Asian/ Pacific Islander	Black	Filipino	Native Latino American	White		Other	Non-Resident Alien	No Response	
STANISLAUS												
High School	Men	1,710	140	37	7	321	14	1,191	1,710			
	Women	1,656	113	26	20	352	12	1,133	1,656			
	Total	3,366	253	63	27	673	26	2,324	3,366			
			Number									
	Men		8.2	2.2	0.4	18.8	0.8	69.6				
	Women		6.8	1.6	1.2	21.3	0.7	68.4				
	Total		7.5	1.9	0.8	20.0	0.8	69.0				
			Percent									
University of California	Men	51	10	0	1	5	1	31	48	1	0	2
	Women	44	6	1	0	8	1	27	43	1	0	0
	Total	95	16	1	1	13	2	58	91	2	0	2
			Number									
	Men		20.8	0.0	2.1	10.4	2.1	64.6				
	Women		14.0	2.3	0.0	18.6	2.3	62.8				
	Total		17.6	1.1	1.1	14.3	2.2	63.7				
			Percent									
The California State University	Men	98	6	3	0	24	4	57	94	3	0	1
	Women	134	6	4	1	31	0	81	123	6	0	5
	Total	232	12	7	1	55	4	138	217	9	0	6
			Number									
	Men		6.4	3.2	0.0	25.5	4.3	60.6				
	Women		4.9	3.3	0.8	25.2	0.0	65.9				
	Total		5.5	3.2	0.5	25.3	1.8	63.6				
			Percent									
California Community Colleges	Men	425	11	11	6	56	2	276	362	2	44	17
	Women	464	5	4	2	66	10	316	403	0	49	12
	Total	889	16	15	8	122	12	592	765	2	93	29
			Number									
	Men		3.0	3.0	1.7	15.5	0.6	76.2				
	Women		1.2	1.0	0.5	16.4	2.5	78.4				
	Total		2.1	2.0	1.0	15.9	1.6	77.4				
			Percent									

Sex and Ethnic Distribution of 1989-90 California Public High School Graduates by County, and of Fall 1990 First-Time Freshmen at the University of California, the California State University, and the California Community Colleges by County.

County and Segment	Sex	Total	Asian/ Pacific Islander	Black	Filipino	Native Latino American	White	Sub- Total	Other	Non- Resident Alien	No Response	
SUTTER												
Number												
High School	Men	313	63	7	0	45	0	198	313			
	Women	314	39	4	0	47	0	224	314			
	Total	627	102	11	0	92	0	422	627			
Percent												
	Men		20.1	2.2	0.0	14.4	0.0	63.3				
	Women		12.4	1.3	0.0	15.0	0.0	71.3				
	Total		16.3	1.8	0.0	14.7	0.0	67.3				
Number												
University of California	Men	13	2	0	0	2	0	9	13	0	0	
	Women	2	0	0	0	0	0	2	2	0	0	
	Total	15	2	0	0	2	0	11	15	0	0	
Percent												
	Men		15.4	0.0	0.0	15.4	0.0	69.2				
	Women		0.0	0.0	0.0	0.0	0.0	100.0				
	Total		13.3	0.0	0.0	13.3	0.0	73.3				
Number												
The California State University	Men	21	5	0	0	1	1	11	18	2	0	
	Women	28	5	0	0	8	0	14	27	0	0	
	Total	49	10	0	0	9	1	25	45	2	0	
Percent												
	Men		27.8	0.0	0.0	5.6	5.6	61.1				
	Women		18.5	0.0	0.0	29.6	0.0	51.9				
	Total		22.2	0.0	0.0	20.0	2.2	55.6				
Number												
California Community Colleges	Men	105	1	1	0	1	0	9	12	0	0	
	Women	190	1	0	0	1	0	4	6	0	0	
	Total	205	2	1	0	2	0	13	18	0	0	
Percent												
	Men		8.3	8.3	0.0	8.3	0.0	75.0				
	Women		16.7	0.0	0.0	16.7	0.0	66.7				
	Total		11.1	5.6	0.0	11.1	0.0	72.2				

Sex and Ethnic Distribution of 1989-90 California Public High School Graduates by County, and of Fall 1990 First-Time Freshmen at the University of California, the California State University, and the California Community Colleges by County.

County and Segment	Sex	Total	Asian/ Pacific Islander	Black	Filipino	Native Latino American	White	Sub- Total	Other	Non- Resident Alien	No Response	
TEHAMA												
High School			Number									
	Men	225	1	1	0	13	13	197	225			
	Women	226	7	1	0	29	6	183	226			
	Total	451	8	2	0	42	19	380	451			
			Percent									
	Men		0.4	0.4	0.0	5.8	5.8	87.6				
	Women		3.1	0.4	0.0	12.8	2.7	81.0				
	Total		1.8	0.4	0.0	9.3	4.2	84.3				
University of California			Number									
	Men	2	0	0	0	0	0	2	2	0	0	
	Women	4	0	0	0	0	0	4	4	0	0	
	Total	6	0	0	0	0	0	6	6	0	0	
			Percent									
	Men		0.0	0.0	0.0	0.0	0.0	100.0				
	Women		0.0	0.0	0.0	0.0	0.0	100.0				
	Total		0.0	0.0	0.0	0.0	0.0	100.0				
The California State University			Number									
	Men	17	0	0	0	1	1	15	17	0	0	
	Women	25	3	0	0	5	0	17	25	0	0	
	Total	42	3	0	0	6	1	32	42	0	0	
			Percent									
	Men		0.0	0.0	0.0	5.9	5.9	88.2				
	Women		12.0	0.0	0.0	20.0	0.0	68.0				
	Total		7.1	0.0	0.0	14.3	2.4	76.2				
California Community Colleges			Number									
	Men	30	0	0	0	1	5	24	30	0	0	
	Women	34	0	0	0	4	1	28	33	0	1	
	Total	64	0	0	0	5	6	52	63	0	1	
			Percent									
	Men		0.0	0.0	0.0	3.3	16.7	80.0				
	Women		0.0	0.0	0.0	12.1	3.0	84.8				
	Total		0.0	0.0	0.0	7.9	9.5	82.5				

Sex and Ethnic Distribution of 1989-90 California Public High School Graduates by County, and of Fall 1990 First-Time Freshmen at the University of California, the California State University, and the California Community Colleges by County.

County and Segment	Sex	Total	Asian/ Pacific Islander	Black	Filipino	Native Latino American	White	Sub- Total	Non- Resident Other	Alien	No Response
TRINITY											
High School											
					Number						
	Men	97	0	0	0	3	8	86	97		
	Women	87	1	0	1	3	2	80	87		
	Total	184	1	0	1	6	10	166	184		
					Percent						
	Men		0.0	0.0	0.0	3.1	8.2	88.7			
	Women		1.1	0.0	1.1	3.4	2.3	92.0			
	Total		0.5	0.0	0.5	3.3	5.4	90.2			
University of California											
					Number						
	Men	0	0	0	0	0	0	0	0	0	0
	Women	3	0	0	0	0	1	2	3	0	0
	Total	3	0	0	0	0	1	2	3	0	0
					Percent						
	Men		0.0	0.0	0.0	0.0	0.0	0.0			
	Women		0.0	0.0	0.0	0.0	33.3	66.7			
	Total		0.0	0.0	0.0	0.0	33.3	66.7			
The California State University											
					Number						
	Men	6	0	0	0	0	1	5	6	0	0
	Women	8	0	0	0	0	0	8	8	0	0
	Total	14	0	0	0	0	1	13	14	0	0
					Percent						
	Men		0.0	0.0	0.0	0.0	16.7	83.3			
	Women		0.0	0.0	0.0	0.0	0.0	100.0			
	Total		0.0	0.0	0.0	0.0	7.1	92.9			
California Community Colleges											
					Number						
	Men	10	0	0	0	0	1	9	10	0	0
	Women	7	0	0	0	0	1	6	7	0	0
	Total	17	0	0	0	0	2	15	17	0	0
					Percent						
	Men		0.0	0.0	0.0	0.0	10.0	90.0			
	Women		0.0	0.0	0.0	0.0	14.3	85.7			
	Total		0.0	0.0	0.0	0.0	11.8	88.2			

155

Sex and Ethnic Distribution of 1989-90 California Public High School Graduates by County, and of Fall 1990 First-Time Freshmen at the University of California, the California State University, and the California Community Colleges by County.

County and Segment	Sex	Total	Asian/ Pacific Islander	Black	Filipino	Native Latino American	White	Sub- Total	Non- Resident Other	Alien	No Response
TULARE											
High School											
						Number					
	Men	1,515	61	32	10	569	11	832	1,515		
	Women	1,482	51	12	19	519	13	868	1,482		
	Total	2,997	112	44	29	1,088	24	1,700	2,997		
						Percent					
Men			4.0	2.1	0.7	37.6	0.7	54.9			
Women			3.4	0.8	1.3	35.0	0.9	58.6			
Total			3.7	1.5	1.0	36.3	0.8	56.7			
University of California											
						Number					
	Men	58	4	1	3	20	2	25	55	3	0
	Women	38	7	0	2	10	0	19	38	0	0
	Total	96	11	1	5	30	2	44	93	3	0
						Percent					
Men			7.3	1.8	5.5	36.4	3.6	45.5			
Women			18.4	0.0	5.3	26.3	0.0	50.0			
Total			11.8	1.1	5.4	32.3	2.2	47.3			
The California State University											
						Number					
	Men	67	6	0	1	22	1	33	63	4	0
	Women	106	5	2	1	38	2	54	102	2	2
	Total	173	11	2	2	60	3	87	165	6	2
						Percent					
Men			9.5	0.0	1.6	34.9	1.6	52.4			
Women			4.9	2.0	1.0	37.3	2.0	52.9			
Total			6.7	1.2	1.2	36.4	1.8	52.7			
California Community Colleges											
						Number					
	Men	571	19	13	5	191	10	279	517	28	9
	Women	613	13	9	9	218	12	306	567	30	5
	Total	1,184	32	22	14	409	22	585	1,084	58	14
						Percent					
Men			3.7	2.5	1.0	36.9	1.9	54.0			
Women			2.3	1.6	1.6	38.4	2.1	54.0			
Total			3.0	2.0	1.3	37.7	2.0	54.0			

Sex and Ethnic Distribution of 1989-90 California Public High School Graduates by County, and of Fall 1990 First-Time Freshmen at the University of California, the California State University, and the California Community Colleges by County.

County and Segment	Sex	Total	Asian/ Pacific Islander	Black	Filipino	Latino	Native American	White	Sub- Total	Other	Non- Resident Alien	No Response
TUOLUMNE												
Number												
High School	Men	211	4	1	2	12	8	184	211			
	Women	224	1	1	10	12	7	193	224			
	Total	435	5	2	12	24	15	377	435			
Percent												
	Men		1.9	0.5	0.9	5.7	3.8	87.2				
	Women		0.4	0.4	4.5	5.4	3.1	86.2				
	Total		1.1	0.5	2.8	5.5	3.4	86.7				
Number												
University of California	Men	4	0	0	0	1	0	2	3	0	0	1
	Women	5	0	0	0	0	0	5	5	0	0	0
	Total	9	0	0	0	1	0	7	8	0	0	1
Percent												
	Men		0.0	0.0	0.0	33.3	0.0	66.7				
	Women		0.0	0.0	0.0	0.0	0.0	100.0				
	Total		0.0	0.0	0.0	12.5	0.0	87.5				
Number												
The California State University	Men	10	0	0	0	2	0	8	10	0	0	0
	Women	21	0	0	0	1	1	16	18	0	0	3
	Total	31	0	0	0	3	1	24	28	0	0	3
Percent												
	Men		0.0	0.0	0.0	20.0	0.0	80.0				
	Women		0.0	0.0	0.0	5.6	5.6	88.9				
	Total		0.0	0.0	0.0	10.7	3.6	85.7				
Number												
California Community Colleges	Men	51	1	1	0	6	2	41	51	0	0	0
	Women	41	1	0	0	3	1	36	41	0	0	0
	Total	92	2	1	0	9	3	77	92	0	0	0
Percent												
	Men		2.0	2.0	0.0	11.8	3.9	80.4				
	Women		2.4	0.0	0.0	7.3	2.4	87.8				
	Total		2.2	1.1	0.0	9.8	3.3	83.7				

Sex and Ethnic Distribution of 1989-90 California Public High School Graduates by County, and of Fall 1990 First-Time Freshmen at the University of California, the California State University, and the California Community Colleges by County.

County and Segment	Sex	Total	Asian/ Pacific Islander	Black	Filipino	Native American		White	Sub- Total	Non-Resident		
						Latino	American			Other	Alien	No Response
VENTURA												
High School	Number											
	Men	3,194	143	76	83	724	32	2,136	3,194			
	Women	3,167	127	73	95	683	25	2,164	3,167			
	Total	6,361	270	149	178	1,407	57	4,300	6,361			
	Percent											
	Total			4.2	2.3	2.8	22.1	0.9	67.6			
University of California	Number											
	Men	206	39	0	5	24	4	129	201	0	1	4
	Women	215	26	5	13	29	4	129	206	6	0	3
	Total	421	65	5	18	53	8	258	407	6	1	7
	Percent											
	Total			16.0	1.2	4.4	13.0	2.0	63.4			
The California State University	Number											
	Men	205	16	3	14	20	0	134	187	7	1	10
	Women	192	16	4	13	26	0	122	181	1	2	8
	Total	397	32	7	27	46	0	256	368	8	3	18
	Percent											
	Total			8.7	1.9	7.3	12.5	0.0	69.6			
California Community Colleges	Number											
	Men	1,180	46	30	23	166	14	801	1,080	12	71	17
	Women	1,064	26	26	14	152	10	756	984	9	58	13
	Total	2,244	72	56	37	318	24	1,557	2,064	21	129	30
	Percent											
	Total			3.5	2.7	1.8	15.4	1.2	75.4			

***Sex and Ethnic Distribution of 1989-90 California Public High School Graduates by County,
and of Fall 1990 First-Time Freshmen at the University of California,
the California State University, and the California Community Colleges by County.***

County and Segment	Sex	Total	Ethnicity					Sub-Total	Non-Resident			
			Asian/ Pacific Islander	Black	Filipino	Latino American	White		Other	Alien	No Response	
YOLG												
High School	Number											
	Men	524	44	10	2	129	6	333	524			
	Women	564	38	13	5	143	6	359	564			
	Total	1,088	82	23	7	272	12	692	1,088			
	Percent											
	Total			7.5	2.1	0.6	25.0	1.1	63.6			
University of California	Number											
	Men	68	13	0	0	4	1	47	65	0	1	2
	Women	77	11	1	5	13	0	40	70	1	1	5
	Total	145	24	1	5	17	1	87	135	1	2	7
	Percent											
	Total			17.3	0.7	3.7	12.6	0.7	64.4			
The California State University	Number											
	Men	54	7	3	0	11	1	24	46	4	1	3
	Women	67	4	1	0	17	0	39	61	2	0	4
	Total	121	11	4	0	28	1	63	107	6	1	7
	Percent											
	Total			10.3	3.7	0.0	26.2	0.9	58.9			
California Community Colleges	Number											
	Men	175	5	2	2	30	2	89	130	5	1	39
	Women	161	5	2	2	20	4	79	112	4	0	45
	Total	336	10	4	4	50	6	168	242	9	1	84
	Percent											
	Total			4.1	1.7	1.7	20.7	2.5	69.4			

Sex and Ethnic Distribution of 1989-90 California Public High School Graduates by County, and of Fall 1990 First-Time Freshmen at the University of California, the California State University, and the California Community Colleges by County.

County and Segment	Sex	Total	Asian/ Pacific Islander	Black	Filipino	Native Latino American	White	Sub- Total	Other	Non- Resident Alien	No Response
YUBA											
High School					Number						
	Men	239	31	9	2	36	10	151	239		
	Women	226	23	10	2	21	17	153	226		
	Total	465	54	19	4	57	27	304	465		
					Percent						
	Men		13.0	3.8	0.8	15.1	4.2	63.2			
	Women		10.2	4.4	0.9	9.3	7.5	67.7			
	Total		11.6	4.1	0.9	12.3	5.8	65.4			
University of California					Number						
	Men	6	0	0	1	1	0	4	6	0	0
	Women	3	0	0	0	0	0	3	3	0	0
	Total	9	0	0	1	1	0	7	9	0	0
					Percent						
	Men		0.0	0.0	16.7	16.7	0.0	66.7			
	Women		0.0	0.0	0.0	0.0	0.0	100.0			
	Total		0.0	0.0	11.1	11.1	0.0	77.8			
The California State University					Number						
	Men	8	3	1	1	0	0	1	6	2	0
	Women	14	0	1	0	1	2	7	11	2	0
	Total	22	3	2	1	1	2	8	17	4	1
					Percent						
	Men		50.0	16.7	16.7	0.0	0.0	16.7			
	Women		0.0	9.1	0.0	9.1	18.2	63.6			
	Total		17.6	11.8	5.9	5.9	11.8	47.1			
California Community Colleges					Number						
	Men	48	0	0	0	0	1	7	8	2	38
	Women	59	0	0	0	0	0	5	5	0	54
	Total	107	0	0	0	0	1	12	13	2	92
					Percent						
	Men		0.0	0.0	0.0	0.0	12.5	87.5			
	Women		0.0	0.0	0.0	0.0	0.0	100.0			
	Total		0.0	0.0	0.0	0.0	7.7	92.3			



**Sex and Ethnic Distribution of 1989-90 California Public High School Graduates by County,
and of Fall 1990 First-Time Freshmen at the University of California,
the California State University, and the California Community Colleges by County.**

County and Segment	Sex	Total	Asian/ Pacific Islander	Black	Filipino	Latino	Native American	White	Sub- Total	Non- Resident Other	Alien	No Response
STATEWIDE TOTAL												
Number												
High School	Men	116,417	13,562	8,132	3,330	26,822	991	63,580	116,417			
	Women	119,617	12,559	9,320	3,408	28,252	893	65,185	119,617			
	Total	236,034	26,121	17,452	6,738	55,074	1,884	128,765	236,034			
Percent												
	Men		11.6	7.0	2.9	23.0	0.9	54.6				
	Women		10.5	7.8	2.8	23.6	0.7	54.5				
	Total		11.1	7.4	2.9	23.3	0.8	54.6				
Number												
University of California	Men	7,638	2,236	261	242	881	71	3,454	7,145	80	77	336
	Women	8,398	2,211	432	333	1,181	80	3,680	7,917	109	75	297
	Total	16,036	4,447	693	575	2,062	151	7,134	15,062	189	152	633
Percent												
	Men		31.3	3.7	3.4	12.3	1.0	48.3				
	Women		27.9	5.5	4.2	14.9	1.0	46.5				
	Total		29.5	4.6	3.8	13.7	1.0	47.4				
Number												
The California State University	Men	10,546	2,106	638	578	1,700	78	4,621	9,721	288	198	339
	Women	12,915	2,242	1,055	636	2,271	117	5,709	12,030	349	170	366
	Total	23,461	4,348	1,693	1,214	3,971	195	10,330	21,751	637	368	705
Percent												
	Men		21.7	6.6	5.9	17.5	0.8	47.5				
	Women		18.6	8.8	5.3	18.9	1.0	47.5				
	Total		20.0	7.8	5.6	18.3	0.9	47.5				
Number												
California Community Colleges	Men	41,562	3,469	2,909	1,447	8,076	551	21,412	37,864	632	1,539	1,527
	Women	42,750	2,928	3,032	1,435	8,737	545	22,452	39,129	672	1,466	1,483
	Total	84,312	6,397	5,941	2,882	16,813	1,096	43,864	76,993	1,304	3,005	3,010
Percent												
	Men		9.2	7.7	3.8	21.3	1.5	56.5				
	Women		7.5	7.7	3.7	22.3	1.4	57.4				
	Total		8.3	7.7	3.7	21.8	1.4	57.0				

*Flow of Transfer Students from California Community College Districts and Colleges
to the University of California, the California State University
and Regionally Accredited Independent Colleges and Universities,
Fall Term and Full-Year, 1982-83 Through 1990-91*

District, College, Year	Number of Transfers to:				
	University of California		The California State University		Independent Institutions
	Fall	Full Year	Fall	Full Year	Fall
Allan Hancock Joint Community College District					
Allan Hancock College					
1982-83	28		166	248	6
1983-84	34		159	257	11
1984-85	35		162	271	7
1985-86	35		141	237	
1986-87	24	36	146	242	35
1987-88	24	40	137	259	36
1988-89	27	36	142	263	12
1989-90	24	27	156	291	25
1990-91	25	33	142	246	19

Antelope Valley Community College District

Antelope Valley College					
Year	UC	CSU	Ind	UC	Ind
1982-83	16		105	150	6
1983-84	21		137	184	20
1984-85	31		134	191	18
1985-86	23		147	198	
1986-87	18	23	108	160	15
1987-88	19	29	122	187	29
1988-89	38	43	130	179	21
1989-90	27	33	163	237	20
1990-91	32	36	147	212	10

Barstow Community College District

Barstow College					
Year	UC	CSU	Ind	UC	Ind
1982-83	1		21	28	0
1983-84	3		19	30	0
1984-85	5		20	39	2
1985-86	3		30	43	
1986-87	2	2	25	35	11
1987-88	2	3	22	34	15
1988-89	3	3	27	44	5
1989-90	4	4	25	33	3
1990-91	7	7	22	30	4

Butte Community College District

Butte College					
Year	UC	CSU	Ind	UC	Ind
1982-83	16		406	639	4
1983-84	8		401	612	14
1984-85	8		345	534	3
1985-86	15		410	555	
1986-87	7	9	323	527	17
1987-88	10	12	366	573	21
1988-89	6	8	385	602	10
1989-90	10	14	364	596	21
1990-91	17	23	408	571	10

District, College, Year	Number of Transfers to:				
	University of California		The California State University		Independent Institutions
	Fall	Full Year	Fall	Full Year	Fall
Cabrillo Community College District					
Cabrillo College					
1982-83	161		265	382	13
1983-84	169		264	384	16
1984-85	179		227	342	28
1985-86	153		232	339	
1986-87	151	220	253	357	25
1987-88	143	228	236	342	24
1988-89	164	279	254	402	29
1989-90	150	224	253	384	35
1990-91	232	334	281	409	17

Cerritos Community College District

Cerritos College					
Year	UC	CSU	Ind	UC	Ind
1982-83	38		555	797	18
1983-84	28		522	800	36
1984-85	48		481	730	36
1985-86	38		434	698	
1986-87	30	41	427	728	75
1987-88	41	57	449	746	114
1988-89	44	57	415	677	55
1989-90	50	60	390	699	89
1990-91	55	72	435	746	55

Chaffey Community College District

Chaffey College					
Year	UC	CSU	Ind	UC	Ind
1982-83	27		281	436	5
1983-84	35		280	464	40
1984-85	24		275	443	25
1985-86	24		261	447	
1986-87	26	44	276	455	39
1987-88	13	27	247	443	43
1988-89	23	31	248	435	33
1989-90	39	52	250	438	26
1990-91	37	61	276	491	27

Citrus Community College District

Citrus College					
Year	UC	CSU	Ind	UC	Ind
1982-83	25		241	361	5
1983-84	21		263	371	58
1984-85	22		243	359	18
1985-86	24		205	373	
1986-87	26	35	214	353	57
1987-88	21	31	220	379	67
1988-89	31	40	194	323	28
1989-90	26	30	204	351	32
1990-91	24	29	220	386	20

**Flow of Transfer Students from California Community College Districts and Colleges
to the University of California, the California State University
and Regionally Accredited Independent Colleges and Universities,
Fall Term and Full-Year, 1982-83 Through 1990-91**

District, College, Year	Number of Transfers to:				
	University of California		The California State University		Independent Institutions
	Fall	Full Year	Fall	Full Year	

Desert Community College District**College of the Desert**

1982-83	15		98	136	5
1983-84	19		111	157	16
1984-85	31		118	161	21
1985-86	20		107	160	
1986-87	16	29	128	191	84
1987-88	24	26	130	201	127
1988-89	19	26	127	180	29
1989-90	37	37	138	211	45
1990-91	24	30	154	222	38

Coast Community College District**Coastline Community College**

1982-83	7		56	75	14
1983-84	3		46	64	21
1984-85	4		39	72	2
1985-86	1		43	74	
1986-87	3	4	39	59	51
1987-88	7	9	34	67	77
1988-89	9	9	23	43	34
1989-90	7	9	23	49	46
1990-91	7	10	29	58	25

Golden West College

1982-83	62		515	755	14
1983-84	76		528	779	39
1984-85	58		502	764	30
1985-86	61		487	770	
1986-87	68	84	423	691	63
1987-88	41	65	421	713	143
1988-89	74	93	422	643	80
1989-90	73	90	336	588	90
1990-91	75	101	337	642	71

Orange Coast College

1982-83	219		915	1,316	50
1983-84	251		926	1,377	130
1984-85	225		903	1,352	65
1985-86	165		791	1,248	
1986-87	207	267	802	1,263	167
1987-88	280	352	845	1,315	287
1988-89	261	358	817	1,279	148
1989-90	267	355		1,266	189
1990-91	344	506	737	1,232	104

District, College, Year	Number of Transfers to:				
	University of California		The California State University		Independent Institutions
	Fall	Full Year	Fall	Full Year	

College of the Sequoias Community College District**College of the Sequoias**

1982-83	34		310	420	18
1983-84	27		303	423	27
1984-85	42		319	414	17
1985-86	23		321	416	
1986-87	30	34	363	493	42
1987-88	39	48	311	434	36
1988-89	48	58	353	496	23
1989-90	30	37	391	537	51
1990-91	31	36	322	456	23

Compton Community College District**Compton Community College**

1982-83	5		154	223	5
1983-84	6		92	162	10
1984-85	4		100	150	7
1985-86	11		84	135	
1986-87	6	8	88	137	13
1987-88	4	7	93	128	19
1988-89	4	4	67	120	10
1989-90	7	7	68	125	14
1990-91	5	6	109	181	8

Contra Costa Community College District**Contra Costa College**

1982-83	24		147	216	14
1983-84	31		147	212	8
1984-85	28		130	201	13
1985-86	26		129	200	
1986-87	26	34	141	207	27
1987-88	30	36	115	182	18
1988-89	20	41	131	203	19
1989-90	28	44	104	158	19
1990-91	56	76	116	182	11

Diablo Valley College

1982-83	238		810	1,147	23
1983-84	213		766	1,138	78
1984-85	212		804	1,157	84
1985-86	216		329	1,221	
1986-87	243	373	767	1,115	109
1987-88	260	373	739	1,185	104
1988-89	307	454	873	1,334	90
1989-90	297	446	837	1,348	98
1990-91	403	597	773	1,249	91

*Flow of Transfer Students from California Community College Districts and Colleges
to the University of California, the California State University
and Regionally Accredited Independent Colleges and Universities,
Fall Term and Full-Year, 1982-83 Through 1990-91*

District, College, Year	Number of Transfers to:				
	University of California		The California State University		Independent Institutions
	Fall	Full Year	Fall	Full Year	Fall

Contra Costa Community College District**Los Medanos College**

1982-83	4		67	88	8
1983-84	6		69	98	5
1984-85	9		87	123	8
1985-86	9		65	96	
1986-87	8	11	60	99	12
1987-88	18	21	73	116	8
1988-89	17	21	81	114	9
1989-90	14	21	67	116	12
1990-91	21	25	92	135	10

El Camino Community College District**El Camino College**

1982-83	136		830	1,250	20
1983-84	125		799	1,202	134
1984-85	122		774	1,152	123
1985-86	150		838	1,235	
1986-87	143	190	740	1,193	179
1987-88	123	178	794	1,224	276
1988-89	147	201	780	1,150	143
1989-90	147	174	598	987	168
1990-91	208	282	701	1,122	76

Feather River Community College District**Feather River College**

1982-83	5		24	33	2
1983-84	2		24	30	2
1984-85	5		24	27	0
1985-86	0		29	38	
1986-87	2	2	30	43	12
1987-88	4	4	19	26	2
1988-89	1	1	16	20	2
1989-90	1	1	14	22	0
1990-91	1	2	15	20	0

Foothill-De Anza Community College District**De Anza College**

1982-83	132		604	898	16
1983-84	122		655	921	43
1984-85	96		661	1,006	23
1985-86	97		637	964	
1986-87	139	189	623	963	87
1987-88	122	184	641	923	90
1988-89	176	251	819	1,213	115
1989-90	211	281	918	1,295	88
1990-91	228	323	796	1,174	63

District, College, Year	Number of Transfers to:				
	University of California		The California State University		Independent Institutions
	Fall	Full Year	Fall	Full Year	Fall

Foothill-De Anza Community College District**Foothill College**

1982-83	127		374	560	58
1983-84	127		390	554	54
1984-85	118		357	566	18
1985-86	116		398	602	
1986-87	117	161	379	556	85
1987-88	106	160	330	476	79
1988-89	102	142	365	529	72
1989-90	122	163	359	546	87
1990-91	140	195	294	468	36

Fremont-Newark Community College District**Ohlone College**

1982-83	25		237	347	9
1983-84	33		252	352	14
1984-85	23		245	324	19
1985-86	26		250	343	
1986-87	33	39	201	316	25
1987-88	31	42	237	356	29
1988-89	39	45	272	419	27
1989-90	46	53	284	421	32
1990-91	34	38	229	347	18

Gavilan Joint Community College District**Gavilan College**

1982-83	10		76	110	6
1983-84	17		78	115	12
1984-85	17		86	112	8
1985-86	14		77	103	
1986-87	14	16	101	130	8
1987-88	10	14	106	124	8
1988-89	14	18	88	136	10
1989-90	21	23	124	152	11
1990-91	20	25	110	147	5

Glendale Community College District**Glendale Community College**

1982-83	50		303	533	34
1983-84	69		344	525	66
1984-85	71		398	617	62
1985-86	48		362	565	
1986-87	55	73	376	599	75
1987-88	52	77	369	561	106
1988-89	64	85	338	515	94
1989-90	79	93	307	500	124
1990-91	109	133	346	574	55

*Flow of Transfer Students from California Community College Districts and Colleges
to the University of California, the California State University
and Regionally Accredited Independent Colleges and Universities,
Fall Term and Full-Year, 1982-83 Through 1990-91*

District, College, Year	Number of Transfers to:				Independent Institutions
	University of California		The California State University		
	Fall	Full Year	Fall	Full Year	

Grossmont-Cuyamaca Community College District**Cuyamaca College**

1982-83	3		45	66	2
1983-84	3		44	63	2
1984-85	1		46	57	2
1985-86	1		30	49	
1986-87	2	8	32	59	45
1987-88	5	6	43	61	72
1988-89	4	5	31	50	27
1989-90	0	2	27	52	34
1990-91	8	14	47	89	36

Grossmont College

1982-83	69		435	838	31
1983-84	57		552	902	45
1984-85	42		522	835	107
1985-86	50		474	846	
1986-87	64	94	419	898	213
1987-88	62	97	528	1,032	511
1988-89	59	82	546	1,016	157
1989-90	87	112	541	1,004	233
1990-91	91	152	593	1,110	211

Hartnell Community College District**Hartnell College**

1982-83	40		181	238	3
1983-84	27		197	250	12
1984-85	38		189	252	17
1985-86	31		185	238	
1986-87	28	37	145	205	24
1987-88	26	30	181	231	26
1988-89	35	46	216	307	23
1989-90	45	54	201	293	15
1990-91	23	31	174	261	12

Imperial Community College District**Imperial Valley College**

1982-83	16		127	165	2
1983-84	14		128	170	6
1984-85	15		122	161	4
1985-86	10		136	181	
1986-87	10	11	107	143	16
1987-88	15	15	93	149	19
1988-89	11	14	102	136	13
1989-90	9	9	125	180	18
1990-91	13	13	157	212	16

District, College, Year	Number of Transfers to:				Independent Institutions
	University of California		The California State University		
	Fall	Full Year	Fall	Full Year	

Kern Community College District**Bakersfield College**

1982-83			333	528	10
1983-84	28		338	525	17
1984-85	25		370	537	10
1985-86	27		391	579	
1986-87	32	40	360	548	26
1987-88	27	35	351	560	26
1988-89	19	29	419	603	29
1989-90	31	37	397	637	39
1990-91	31	39	372	628	20

Cerro Coso Community College

1982-83	3		34	47	0
1983-84	8		43	53	0
1984-85	4		37	48	1
1985-86	6		33	45	
1986-87	6	6	33	49	12
1987-88	11	14	36	47	12
1988-89	8	13	34	46	32
1989-90	2	3	37	69	14
1990-91	4	6	36	55	5

Porterville College

1982-83	6		82	106	3
1983-84	10		78	99	8
1984-85	3		69	83	11
1985-86	2		62	83	
1986-87	4	4	66	91	6
1987-88	4	7	82	102	9
1988-89	8	9	57	76	8
1989-90	3	3	46	70	7
1990-91	2	3	67	87	3

Lake Tahoe Community College District**Lake Tahoe Community College**

1982-83	2		19	30	0
1983-84	5		18	27	0
1984-85	8		33	40	1
1985-86	2		20	28	
1986-87	5	8	18	21	7
1987-88	4	6	16	27	2
1988-89	3	4	21	27	3
1989-90	0	3	30	41	0
1990-91	4	6	25	31	1

*Flow of Transfer Students from California Community College Districts and Colleges
to the University of California, the California State University
and Regionally Accredited Independent Colleges and Universities,
Fall Term and Full-Year, 1982-83 Through 1990-91*

District, College, Year	Number of Transfers to:				
	University of California		The California State University		Independent Institutions
	Fall	Full Year	Fall	Full Year	Fall

Lassen Community College District**Lassen College**

1982-83	6		57	75	2
1983-84	7		59	72	1
1984-85	2		43	48	1
1985-86	2		45	56	
1986-87	1	2	61	75	6
1987-88	5	7	51	65	6
1988-89	4	5	47	62	4
1989-90	2	3	48	54	9
1990-91	7	7	35	50	6

Long Beach Community College District**Long Beach City College**

1982-83	52		646	915	12
1983-84	32		637	939	42
1984-85	59		512	807	35
1985-86	41		567	900	
1986-87	44	58	478	789	85
1987-88	49	61	524	865	159
1988-89	60	81	488	786	58
1989-90	59	79	458	804	89
1990-91	66	79	488	778	63

Los Angeles Community College District**East Los Angeles College**

1982-83	46		338	626	13
1983-84	50		351	593	37
1984-85	38		360	646	35
1985-86	30		299	568	
1986-87	35	40	270	485	51
1987-88	42	54	329	544	63
1988-89	54	67	228	438	49
1989-90	57	61	282	497	45
1990-91	78	96	326	562	20

Los Angeles City College

1982-83	83		427	780	18
1983-84	88		407	736	53
1984-85	54		336	601	67
1985-86	54		351	655	
1986-87	46	63	307	562	134
1987-88	53	88	316	542	212
1988-89	52	89	304	512	78
1989-90	67	84	309	518	90
1990-91	66	96	329	533	61

District, College, Year	Number of Transfers to:				
	University of California		The California State University		Independent Institutions
	Fall	Full Year	Fall	Full Year	Fall

Los Angeles Harbor College

1982-83	42		355	523	15
1983-84	47		351	493	36
1984-85	30		337	514	51
1985-86	25		232	377	
1986-87	19	30	247	388	37
1987-88	25	33	236	377	83
1988-89	27	31	233	358	32
1989-90	37	45	228	360	46
1990-91	36	47	232	347	32

Los Angeles Mission College

1982-83	4		38	68	2
1983-84	3		41	57	8
1984-85	10		42	60	5
1985-86	1		34	49	
1986-87	4	5	39	57	21
1987-88	2	2	23	59	34
1988-89	2	3	43	66	7
1989-90	4	4	56	102	10
1990-91	4	5	42	69	13

Los Angeles Pierce College

1982-83	118		838	1,281	35
1983-84	117		741	1,143	40
1984-85	113		752	1,218	55
1985-86	98		722	1,122	
1986-87	66	112	653	1,011	68
1987-88	66	112	605	943	139
1988-89	89	120	639	923	75
1989-90	131	159	504	865	115
1990-91	137	187	602	970	53

Los Angeles Southwest College

1982-83	4		173	199	3
1983-84	5		129	184	10
1984-85	5		110	195	8
1985-86	1		74	136	
1986-87	3	3	81	128	6
1987-88	1	1	51	83	20
1988-89	1	2	61	101	5
1989-90	1	1	62	104	14
1990-91	8	9	85	127	4

**Flow of Transfer Students from California Community College Districts and Colleges
to the University of California, the California State University
and Regionally Accredited Independent Colleges and Universities,
Fall Term and Full-Year, 1982-83 Through 1990-91**

District, College, Year	Number of Transfers to:				
	University of California		The California State University		Independent Institutions
	Fall	Full Year	Fall	Full Year	

Los Angeles Community College District**Los Angeles Trade-Technical College**

1982-83	7		121	199	4
1983-84	7		136	235	13
1984-85	4		123	208	10
1985-86	5		123	199	
1986-87	5	5	86	170	27
1987-88	2	4	108	185	36
1988-89	2	4	84	152	28
1989-90	4	4	97	151	29
1990-91	3	5	90	163	15

Los Angeles Valley College

1982-83	96		562	903	18
1983-84	93		513	809	61
1984-85	81		494	814	37
1985-86	71		482	743	
1986-87	67	112	420	691	55
1987-88	66	112	445	722	89
1988-89	88	126	444	654	53
1989-90	105	129	444	692	86
1990-91	94	140	476	760	68

West Los Angeles College

1982-83	30		199	303	11
1983-84	37		166	260	26
1984-85	13		140	228	25
1985-86	21		118	209	
1986-87	23	30	94	159	36
1987-88	18	29	110	168	66
1988-89	28	37	122	218	49
1989-90	27	35	131	222	32
1990-91	21	29	168	260	34

Los Rios Community College District**American River College**

1982-83	122		763	1,247	11
1983-84	131		726	1,199	29
1984-85	172		719	1,108	68
1985-86	148		756	1,140	
1986-87	134	162	678	1,102	196
1987-88	165	203	718	1,132	312
1988-89	201	257	763	1,142	105
1989-90	161	199	690	1,075	139
1990-91	194	225	789	1,194	109

District, College, Year	Number of Transfers to:				
	University of California		The California State University		Independent Institutions
	Fall	Full Year	Fall	Full Year	

Cosumnes River College

1982-83	9		164	243	4
1983-84	21		151	231	13
1984-85	24		154	226	20
1985-86	20		134	185	
1986-87	17	22	152	232	41
1987-88	28	29	143	211	76
1988-89	32	39	169	256	32
1989-90	29	39	166	252	52
1990-91	35	40	171	278	29

Sacramento City College

1982-83	126		565	896	10
1983-84	101		540	914	22
1984-85	111		588	896	103
1985-86	149		587	895	
1986-87	94	128	505	804	104
1987-88	115	145	477	790	165
1988-89	140	180	559	826	79
1989-90	129	169	536	813	93
1990-91	147	190	560	854	70

Marin Community College District**College of Marin**

1982-83	83		278	430	29
1983-84	84		269	404	27
1984-85	86		273	421	60
1985-86	62		284	415	
1986-87	68	105	239	360	28
1987-88	83	134	225	368	54
1988-89	72	122	225	339	49
1989-90	115	155	260	405	51
1990-91	114	188	246	391	10

Indian Valley College (Closed 1985)

1982-83	11		93	128	4
1983-84	6		92	136	7
1984-85	5		71	114	13
1985-86	3		58	72	
1986-87	2	2	23	32	4
1987-88	1	1	16	28	3
1988-89		1	10	13	3
1989-90			8	11	2
1990-91	2	2	8	8	0

*Flow of Transfer Students from California Community College Districts and Colleges
to the University of California, the California State University
and Regionally Accredited Independent Colleges and Universities,
Fall Term and Full-Year, 1982-83 Through 1990-91*

District, College, Year	Number of Transfers to:				
	University of California		The California State University		Independent Institutions
	Fall	Full Year	Fall	Full Year	

Mendocino-Lake Community College District**Mendocino College**

1982-83	3		54	70	0
1983-84	4		48	61	3
1984-85	7		43	56	2
1985-86	3		42	58	
1986-87	2	2	58	74	7
1987-88	4	5	42	63	11
1988-89	5	5	47	75	2
1989-90	1	1	72	96	8
1990-91	3	4	70	90	5

Merced Community College District**Merced College**

1982-83	21		245	333	4
1983-84	16		243	324	6
1984-85	11		233	313	13
1985-86	16		223	312	
1986-87	9	9	239	335	26
1987-88	18	21	248	348	31
1988-89	20	20	242	324	34
1989-90	27	35	246	350	29
1990-91	28	35	219	335	19

Mira Costa Community College District**Mira Costa College**

1982-83	38		67	114	8
1983-84	33		78	105	11
1984-85	24		97	135	25
1985-86	18		85	139	
1986-87	28	42	87	124	149
1987-88	25	39	96	161	195
1988-89	26	34	98	153	52
1989-90	36	48	130	224	96
1990-91	58	84	180	284	73

Monterey Peninsula Community College District**Monterey Peninsula College**

1982-83	65		175	243	6
1983-84	66		192	272	25
1984-85	68		166	253	27
1985-86	61		200	288	
1986-87	61	87	153	217	48
1987-88	52	83	145	234	48
1988-89	58	83	187	262	38
1989-90	43	57	159	227	38
1990-91	58	70	180	297	23

District, College, Year	Number of Transfers to:				
	University of California		The California State University		Independent Institutions
	Fall	Full Year	Fall	Full Year	

Mt. San Antonio Community College District**Mt. San Antonio College**

1982-83	36		567	920	24
1983-84	36		583	926	64
1984-85	57		595	957	43
1985-86	43		610	1,021	
1986-87	51	69	560	931	60
1987-88	61	80	550	960	89
1988-89	57	73	548	949	47
1989-90	52	69	558	961	70
1990-91	86	101	514	939	58

Mt. San Jacinto Community College District**Mt. San Jacinto College**

1982-83	11		43	59	3
1983-84	13		51	71	6
1984-85	17		57	75	3
1985-86	19		51	75	
1986-87	14	21	62	84	10
1987-88	14	23	52	79	18
1988-89	9	18	72	98	4
1989-90	7	14	48	78	6
1990-91	17	21	61	96	17

Napa Valley Community College District**Napa Valley College**

1982-83	36		150	191	8
1983-84	36		177	233	8
1984-85	48		166	205	13
1985-86	25		152	200	
1986-87	23	30	141	192	16
1987-88	27	35	138	186	27
1988-89	27	36	135	166	32
1989-90	26	28	148	203	47
1990-91	24	33	139	184	16

North Orange County Community College District**Cypress College**

1982-83	37		383	552	13
1983-84	30		382	577	29
1984-85	32		432	646	57
1985-86	41		385	650	
1986-87	39	49	407	633	46
1987-88	33	50	395	655	95
1988-89	36	55	356	626	41
1989-90	48	65	353	641	65
1990-91	55	75	354	623	45

**Flow of Transfer Students from California Community College Districts and Colleges
to the University of California, the California State University
and Regionally Accredited Independent Colleges and Universities,
Fall Term and Full-Year, 1982-83 Through 1990-91**

District, College, Year	Number of Transfers to:			
	University of California		The California State University	Independent Institutions
	Fall	Full Year	Fall	Full Year

North Orange County Community College District**Fullerton College**

1982-83	65		726	1,062	31
1983-84	63		744	1,165	59
1984-85	57		724	1,132	45
1985-86	59		737	1,182	
1986-87	63	84	694	1,142	85
1987-88	54	71	669	1,112	149
1988-89	57	72	696	1,124	92
1989-90	74	109	635	1,102	110
1990-91	95	139	650	1,126	78

Palo Verde Community College District**Palo Verde College**

1982-83	2		1	2	0
1983-84	0		4	5	0
1984-85	0		3	6	0
1985-86	0		8	12	
1986-87	1	1	2	5	44
1987-88	2	2	12	14	9
1988-89	4	4	6	12	2
1989-90	1	1	9	12	2
1990-91	2	2	0	0	1

Palomar Community College District**Palomar College**

1982-83	97		332	566	21
1983-84	116		427	625	50
1984-85	115		459	601	83
1985-86	91		367	552	
1986-87	70	93	322	521	173
1987-88	99	130	412	630	438
1988-89	94	122	438	664	123
1989-90	91	120	457	707	208
1990-91	107	155	487	782	151

Pasadena Area Community College District**Pasadena City College**

1982-83	127		617	988	38
1983-84	119		704	1,091	156
1984-85	141		662	967	138
1985-86	111		657	1,036	
1986-87	123	166	625	1,083	155
1987-88	161	207	656	1,121	232
1988-89	140	182	615	1,055	125
1989-90	145	173	617	1,070	211
1990-91	192	242	621	1,102	47

District, College, Year	Number of Transfers to:			
	University of California		The California State University	Independent Institutions
	Fall	Full Year	Fall	Full Year

Ferrelta Community College District**College of Alameda**

1982-83	42		159	249	4
1983-84	51		141	226	20
1984-85	40		108	179	20
1985-86	30		108	184	
1986-87	35	64	102	189	37
1987-88	38	58	100	183	35
1988-89	31	52	120	185	22
1989-90	45	63	100	185	19
1990-91	45	73	108	193	41

Laney College

1982-83	29		145	248	13
1983-84	32		148	240	18
1984-85	38		170	275	22
1985-86	52		144	223	
1986-87	53	87	155	234	62
1987-88	68	102	140	232	28
1988-89	73	117	167	232	20
1989-90	75	123	162	236	29
1990-91	69	112	132	219	15

Merritt College

1982-83	45		187	265	6
1983-84	51		174	274	21
1984-85	49		160	239	27
1985-86	41		131	199	
1986-87	38	63	140	209	36
1987-88	54	73	128	198	27
1988-89	32	56	126	197	15
1989-90	33	46	120	178	18
1990-91	29	49	90	143	9

Vista College

1982-83	1		7	15	2
1983-84	4		10	14	1
1984-85	2		9	14	1
1985-86	2		13	25	
1986-87	2	4	13	22	1
1987-88	1	4	4	9	1
1988-89	7	10	12	19	0
1989-90	4	6	7	14	8
1990-91	3	7	10	19	0

*Flow of Transfer Students from California Community College Districts and Colleges
to the University of California, the California State University
and Regionally Accredited Independent Colleges and Universities,
Fall Term and Full-Year, 1982-83 Through 1990-91*

District, College, Year	Number of Transfers to:				
	University of California		The California State University		Independent Institutions
	Fall	Full Year	Fall	Full Year	Fall

Rancho Santiago Community College District

Rancho Santiago College

1982-83	30		341	520	17
1983-84	51		356	555	34
1984-85	47		302	481	31
1985-86	50		337	574	
1986-87	44	53	337	540	91
1987-88	46	53	320	547	145
1988-89	61	82	356	549	68
1989-90	41	67	298	492	88
1990-91	68	85	316	552	60

Redwoods Community College District

College of the Redwoods

1982-83	11		210	336	3
1983-84	13		262	359	11
1984-85	15		200	307	6
1985-86	14		285	391	
1986-87	7	7	196	281	16
1987-88	8	15	236	321	18
1988-89	18	22	241	354	9
1989-90	16	20	238	329	13
1990-91	23	28	202	296	8

Rio Hondo Community College District

Rio Hondo College

1982-83	20		258	377	29
1983-84	14		200	327	33
1984-85	15		234	364	15
1985-86	21		213	361	
1986-87	24	26	268	419	46
1987-88	17	22	230	356	71
1988-89	17	17	241	371	37
1989-90	19	21	168	312	46
1990-91	25	38	181	329	20

Riverside Community College District

Riverside Community College

1982-83	110		337	490	12
1983-84	104		342	505	33
1984-85	96		314	450	15
1985-86	116		331	479	
1986-87	94	125	292	455	55
1987-88	98	162	345	520	80
1988-89	113	170	352	528	38
1989-90	119	150	348	542	74
1990-91	149	178	440	653	41

District, College, Year	Number of Transfers to:				
	University of California		The California State University		Independent Institutions
	Fall	Full Year	Fall	Full Year	Fall

Saddleback Community College District

Irvine Valley College (since 1985)

1982-83					
1983-84					
1984-85					
1985-86					5
1986-87	25	31	29	44	
1987-88	52	66	42	73	1
1988-89	32	61	41	74	3
1989-90	51	77	64	105	8
1990-91	80	129	80	146	13

Saddleback College

1982-83	120		445	667	32
1983-84	147		509	743	65
1984-85	138		552	819	60
1985-86	142		532	824	
1986-87	132	182	463	729	194
1987-88	174	228	453	692	325
1988-89	138	185	519	774	133
1989-90	150	200	438	765	172
1990-91	178	246	494	806	134

San Bernardino Community College District

Crafton Hills College

1982-83	21		108	151	2
1983-84	15		113	158	13
1984-85	27		112	148	7
1985-86	19		110	148	
1986-87	14	17	109	144	16
1987-88	10	16	97	140	29
1988-89	17	25	114	159	10
1989-90	13	17	116	151	33
1990-91	20	22	134	190	24

San Bernardino Valley College

1982-83	54		363	556	3
1983-84	40		348	482	14
1984-85	35		349	520	17
1985-86	33		332	499	
1986-87	21	27	239	365	89
1987-88	25	35	294	449	57
1988-89	16	25	277	392	22
1989-90	20	26	306	443	44
1990-91	24	29	280	398	22

*Flow of Transfer Students from California Community College Districts and Colleges
to the University of California, the California State University
and Regionally Accredited Independent Colleges and Universities,
Fall Term and Full-Year, 1982-83 Through 1990-91*

District, College, Year	Number of Transfers to:				Independent Institutions
	University of California		The California State University		
	Fall	Full Year	Fall	Full Year	
San Diego Community College District					
San Diego City College					
1982-83	73		231	396	12
1983-84	86		280	434	32
1984-85	51		264	385	142
1985-86	54		204	350	
1986-87	39	74	229	384	140
1987-88	48	72	221	427	291
1988-89	41	58	271	438	102
1989-90	37	47	241	413	119
1990-91	48	58	218	378	341

District, College, Year	Number of Transfers to:				Independent Institutions
	University of California		The California State University		
	Fall	Full Year	Fall	Full Year	
San Diego Mesa College					
1982-83	95		587	1,025	66
1983-84	90		643	999	63
1984-85	102		655	1,001	84
1985-86	123		539	966	
1986-87	138	214	483	933	249
1987-88	143	200	519	935	255
1988-89	167	231	537	1,000	86
1989-90	213	279	574	1,100	181
1990-91	270	326	714	1,224	140

District, College, Year	Number of Transfers to:				Independent Institutions
	University of California		The California State University		
	Fall	Full Year	Fall	Full Year	
San Diego Miramar College					
1982-83	5		20	46	6
1983-84	4		38	52	?
1984-85	4		30	48	16
1985-86	5		39	64	
1986-87	5	9	31	56	48
1987-88	10	13	38	74	50
1988-89	6	9	33	65	20
1989-90	14	16	41	88	35
1990-91	13	15	58	103	47

District, College, Year	Number of Transfers to:				Independent Institutions
	University of California		The California State University		
	Fall	Full Year	Fall	Full Year	
San Francisco Community College District					
City College of San Francisco					
1982-83	105		805	1,284	
1983-84	118		855	1,325	
1984-85	114		784	1,265	
1985-86	92		914	1,374	
1986-87	105	176	808	1,287	97
1987-88	160	235	690	1,270	85
1988-89	156	245	810	1,280	53
1989-90	151	231	780	1,379	69
1990-91	185	285	795	1,344	25

District, College, Year	Number of Transfers to:				Independent Institutions
	University of California		The California State University		
	Fall	Full Year	Fall	Full Year	
San Joaquin Delta Community College District					
San Joaquin Delta College					
1982-83	94		539	699	
1983-84	83		471	655	
1984-85	81		532	700	
1985-86	68		516	738	
1986-87	74	89	494	691	147
1987-88	78	93	466	640	220
1988-89	91	113	552	765	157
1989-90	91	106	527	705	103
1990-91	83	95	537	752	123

District, College, Year	Number of Transfers to:				Independent Institutions
	University of California		The California State University		
	Fall	Full Year	Fall	Full Year	
San Jose Community College District					
Evergreen Valley College					
1982-83	9		151	239	6
1983-84	15		173	296	8
1984-85	21		189	303	4
1985-86	12		176	267	
1986-87	20	24	162	280	15
1987-88	14	20	157	254	19
1988-89	17	25	196	318	18
1989-90	8	15	182	312	16
1990-91	21	30	181	295	18

District, College, Year	Number of Transfers to:				Independent Institutions
	University of California		The California State University		
	Fall	Full Year	Fall	Full Year	
San Jose City College					
1982-83	16		228	355	5
1983-84	14		222	356	16
1984-85	7		226	366	11
1985-86	5		212	325	
1986-87	15	21	187	294	30
1987-88	5	11	210	320	42
1988-89	17	22	212	309	35
1989-90	13	18	203	312	23
1990-91	11	19	204	297	30

District, College, Year	Number of Transfers to:				Independent Institutions
	University of California		The California State University		
	Fall	Full Year	Fall	Full Year	
San Luis Obispo County Community College District					
Cuesta College					
1982-83	22		255	522	7
1983-84	11		297	554	14
1984-85	19		276	573	19
1985-86	19		214	492	
1986-87	22	23	196	453	25
1987-88	25	37	206	513	38
1988-89	28	38	210	571	14
1989-90	24	31	224	628	27
1990-91	27	34	273	593	16

*Flow of Transfer Students from California Community College Districts and Colleges
to the University of California, the California State University
and Regionally Accredited Independent Colleges and Universities,
Fall Term and Full-Year, 1982-83 Through 1990-91*

District, College, Year	Number of Transfers to:				
	University of California		The California State University		Independent Institutions
	Fall	Full Year	Fall	Full Year	

San Mateo County Community College District**Canada College**

1982-83	28		165	224	23
1983-84	29		145	214	18
1984-85	30		169	231	12
1985-86	24		159	233	
1986-87	21	27	115	184	31
1987-88	29	33	137	187	25
1988-89	18	22	131	192	27
1989-90	16	22	125	183	30
1990-91	26	28	103	158	7

College of San Mateo

1982-83	101		524	772	32
1983-84	109		543	798	38
1984-85	119		548	804	54
1985-86	117		578	806	
1986-87	83	115	575	820	70
1987-88	96	129	493	763	63
1988-89	124	157	506	760	64
1989-90	134	153	512	762	70
1990-91	123	155	443	648	20

Skyline College

1982-83	18		193	290	3
1983-84	21		165	242	11
1984-85	6		170	256	13
1985-86	12		197	280	
1986-87	17	21	177	278	27
1987-88	23	25	180	280	29
1988-89	19	23	193	307	23
1989-90	28	34	162	274	38
1990-91	23	28	202	308	12

Santa Barbara Community College District**Santa Barbara City College**

1982-83	215		218	294	
1983-84	281		213	291	
1984-85	251		235	339	
1985-86	245		226	320	
1986-87	227	315	209	306	55
1987-88	309	493	214	304	53
1988-89	266	393	231	343	46
1989-90	353	509	213	321	70
1990-91	401	618	262	360	51

District, College, Year	Number of Transfers to:				
	University of California		The California State University		Independent Institutions
	Fall	Full Year	Fall	Full Year	

Santa Clarita Community College District**College of the Canyons**

1982-83	18		110	171	2
1983-84	9		107	159	7
1984-85	18		100	163	7
1985-86	11		133	190	
1986-87	15	22	142	207	20
1987-88	15	21	121	212	23
1988-89	18	27	133	199	22
1989-90	22	32	130	210	35
1990-91	26	39	151	237	12

Santa Monica Community College District**Santa Monica College**

1982-83	224		419	626	59
1983-84	214		395	622	113
1984-85	205		446	696	116
1985-86	274		480	692	
1986-87	253	372	493	733	137
1987-88	302	474	504	798	236
1988-89	351	508	530	791	170
1989-90	337	450	466	792	183
1990-91	424	528	462	758	60

Shasta-Tehema-Trinity Joint Community College District**Shasta College**

1982-83	29		252	341	7
1983-84	30		265	326	8
1984-85	25		263	359	16
1985-86	28		327	417	
1986-87	21	23	245	342	16
1987-88	19	24	324	424	22
1988-89	23	31	289	379	6
1989-90	24	25	267	358	30
1990-91	25	28	300	361	53

Sierra Joint Community College District**Sierra College**

1982-83	32		310	474	2
1983-84	42		354	505	14
1984-85	55		361	510	31
1985-86	53		378	565	
1986-87	36	48	335	511	45
1987-88	46	60	374	555	87
1988-89	68	85	389	562	36
1989-90	57	83	363	553	50
1990-91	74	98	400	575	45

*Flow of Transfer Students from California Community College Districts and Colleges
to the University of California, the California State University
and Regionally Accredited Independent Colleges and Universities,
Fall Term and Full-Year, 1982-83 Through 1990-91*

District, College, Year	Number of Transfers to:				
	University of California		The California State University		Independent Institutions
	Fall	Full Year	Fall	Full Year	

Siskiyou Joint Community College District

College of the Siskiyous

1982-83	6		69	90	1
1983-84	7		65	77	4
1984-85	11		65	81	2
1985-86	8		69	81	
1986-87	9	12	50	66	2
1987-88	9	10	51	69	7
1988-89	7	12	59	72	8
1989-90	11	12	59	62	1
1990-91	16	18	61	77	2

Solano County Community College District

Solano Community College

1982-83	34		153	254	2
1983-84	47		167	260	17
1984-85	39		192	281	13
1985-86	46		200	291	
1986-87	39	51	163	224	37
1987-88	41	61	174	271	48
1988-89	44	65	183	275	34
1989-90	42	63	184	279	32
1990-91	55	81	223	335	20

Sonoma County Community College District

Santa Rosa Junior College

1982-83	84		556	808	17
1983-84	77		589	835	30
1984-85	84		641	852	33
1985-86	99		675	940	
1986-87	90	115	655	889	45
1987-88	87	100	675	962	48
1988-89	117	140	635	901	34
1989-90	155	189	582	862	41
1990-91	176	212	614	856	23

South County Community College District

Chabot College

1982-83	64		472	772	21
1983-84	74		535	844	30
1984-85	88		535	845	27
1985-86	74		522	848	
1986-87	81	116	535	858	71
1987-88	102	135	484	805	67
1988-89	84	118	531	893	53
1989-90	105	140	614	976	53
1990-91	118	159	588	966	33

District, College, Year	Number of Transfers to:				
	University of California		The California State University		Independent Institutions
	Fall	Full Year	Fall	Full Year	

South County Community College District

Las Positas College

1982-83					
1983-84					
1984-85					
1985-86					
1986-87					
1987-88					
1988-89					
1989-90					
1990-91					

Southwestern Community College District

Southwestern College

1982-83	24		245	417	11
1983-84	30		250	432	28
1984-85	37		292	417	60
1985-86	23		242	381	
1986-87	36	46	222	393	432
1987-88	41	55	293	468	437
1988-89	35	55	294	471	118
1989-90	42	49	309	508	216
1990-91	46	53	321	568	191

State Center Community College District

Fresno City College

1982-83	15		609	953	17
1983-84	12		535	902	26
1984-85	16		615	973	20
1985-86	19		711	1,065	
1986-87	18	25	671	1,035	47
1987-88	33	42	721	1,085	85
1988-89	34	60	709	1,098	48
1989-90	52	68	728	1,137	102
1990-91	76	87	735	1,103	54

Kings River Community College

1982-83	9		155	215	0
1983-84	6		163	207	8
1984-85	3		137	178	3
1985-86	4		132	169	
1986-87	5	5	131	175	20
1987-88	1	3	131	178	17
1988-89	6	7	105	151	11
1989-90	9	9	106	157	30
1990-91	8	9	121	185	16

Flow of Transfer Students from California Community College Districts and Colleges to the University of California, the California State University and Regionally Accredited Independent Colleges and Universities, Fall Term and Full-Year, 1982-83 Through 1990-91

District, College, Year	Number of Transfers to:				
	University of California		The California State University		Independent Institutions
	Fall	Full Year	Fall	Full Year	Fall

Ventura County Community College District

Moorpark College

1982-83	63		291	415	11
1983-84	70		308	474	33
1984-85	70		338	464	34
1985-86	82		346	500	
1986-87	68	85	316	48	35
1987-88	67	95	357	497	100
1988-89	61	77	372	526	44
1989-90	85	96	359	560	55
1990-91	80	102	369	539	81

Oxnard College

1982-83	15		39	51	2
1983-84	19		37	50	5
1984-85	10		44	51	3
1985-86	16		28	42	
1986-87	7	14	45	69	9
1987-88	16	25	37	57	17
1988-89	14	17	63	81	10
1989-90	20	21	52	72	8
1990-91	12	20	95	127	9

Ventura College

1982-83	131		280	413	19
1983-84	132		299	412	38
1984-85	135		332	456	20
1985-86	113		291	411	
1986-87	115	155	308	431	50
1987-88	126	193	259	387	70
1988-89	131	180	340	476	32
1989-90	99	108	289	422	52
1990-91	106	128	334	485	47

Victor Valley Community College District

Victor Valley College

1982-83	7		74	92	1
1983-84	7		87	133	5
1984-85	11		99	137	5
1985-86	10		86	126	
1986-87	12	14	74	104	8
1987-88	9	10	108	151	22
1988-89	10	10	106	176	6
1989-90	11	11	96	157	9
1990-91	14	14	110	167	15

District, College, Year	Number of Transfers to:				
	University of California		The California State University		Independent Institutions
	Fall	Full Year	Fall	Full Year	Fall

West Hills Community College District

West Hills College

1982-83	0		65	81	2
1983-84	1		45	63	3
1984-85	4		53	64	3
1985-86	0		41	57	
1986-87	0	3	49	71	6
1987-88	5	5	69	88	15
1988-89	2	2	59	78	11
1989-90	2	2	54	73	16
1990-91	1	1	63	84	4

West Kern Community College District

Taft College

1982-83	3		23	36	0
1983-84	1		24	36	3
1984-85	2		40	52	5
1985-86	3		33	42	
1986-87	4	4	46	62	4
1987-88	1	1	51	66	4
1988-89	2	3	41	51	2
1989-90	0	1	41	52	0
1990-91	0	0	28	38	2

West Valley-Mission Community College District

Mission College

1982-83	7		85	141	1
1983-84	6		102	186	11
1984-85	19		120	200	4
1985-86	7		99	191	
1986-87	16	22	127	222	8
1987-88	16	20	128	210	11
1988-89	11	16	177	257	25
1989-90	13	15	144	218	13
1990-91	14	18	133	214	14

West Valley College

1982-83	93		675	967	56
1983-84	108		609	939	49
1984-85	88		630	976	43
1985-86	63		643	939	
1986-87	74	100	587	917	36
1987-88	73	99	607	888	51
1988-89	64	79	567	840	47
1989-90	41	51	457	681	72
1990-91	84	104	474	702	40

Flow of Transfer Students from California Community College Districts and Colleges to the University of California, the California State University and Regionally Accredited Independent Colleges and Universities, Fall Term and Full-Year, 1982-83 Through 1990-91

District, College, Year	Number of Transfers to:				
	University of California		The California State University		Independent Institutions
	Fall	Full Year	Fall	Full Year	Fall

Yosemite Community College District

Columbia College

1982-83	8		60	75	5
1983-84	6		62	74	2
1984-85	7		68	86	6
1985-86	10		57	70	
1986-87	4	5	29	41	3
1987-88	6	6	45	57	3
1988-89	6	7	49	65	12
1989-90	4	5	42	61	9
1990-91	8	10	40	56	6

Modesto Junior College

1982-83	42		423	599	10
1983-84	40		438	617	22
1984-85	52		444	643	12
1985-86	31		432	625	
1986-87	23	32	419	621	31
1987-88	49	64	435	647	69
1988-89	48	63	427	636	53
1989-90	35	47	409	642	48
1990-91	43	54	393	634	26

District, College, Year	Number of Transfers to:				
	University of California		The California State University		Independent Institutions
	Fall	Full Year	Fall	Full Year	Fall

Yuba Community College District

Yuba College

1982-83	16		240	307	3
1983-84	27		225	307	69
1984-85	34		269	355	3
1985-86	17		226	305	
1986-87	23	27	214	296	32
1987-88	20	27	211	291	35
1988-89	42	47	234	303	15
1989-90	17	23	202	313	28
1990-91	22	31	214	282	15

Statewide Total

1982-83	5,137	0	29,824	45,400	1,283
1983-84	5,307	0	30,274	45,726	2,776
1984-85	5,257	0	30,134	45,476	2,874
1985-86	4,932	0	29,682	45,469	0
1986-87	4,861	6,754	27,761	43,666	6,051
1987-88	5,465	7,713	28,257	44,701	8,755
1988-89	5,855	8,145	29,393	45,402	4,502
1989-90	6,224	8,164	28,331	45,724	5,893
1990-91	7,420	10,032	29,370	46,678	4,205

*Ethnic Distribution of Community College Transfer Students
to the University of California and the California State University,
Fall 1988, Fall 1989 and Fall 1990.*

		Asian/ Pacific Islander	Black	Filipino	Latino	Native American	White	Known Ethnicity Total	Non Resident Alien	No Response	Other	Grand Total
Allan Hancock Joint Community College District												
Allan Hancock College												
1988	UC	1	1	1	4	0	18	25	0	0	2	27
	CSU	10	6	1	13	0	100	130	2	7	3	142
1989	UC	2	0	1	1	1	18	23	0	0	1	24
	CSU	6	2	4	15	1	114	142	2	6	6	156
1990	UC	1	0	0	3	0	19	23	1	1	0	25
	CSU	5	9	6	15	1	97	133	0	7	2	142
Antelope Valley Community College District												
Antelope Valley College												
1988	UC	2	4	1	2	0	29	38	0	0	0	38
	CSU	3	5	2	11	0	98	119	0	4	7	130
1989	UC	5	3	2	1	0	16	27	0	0	0	27
	CSU	2	2	3	14	3	127	151	1	5	5	163
1990	UC	2	2	2	5	0	17	28	1	2	1	32
	CSU	6	6	2	10	2	106	132	2	11	2	147
Barstow Community College District												
Barstow College												
1988	UC	0	1	0	1	0	1	3	0	0	0	3
	CSU	1	1	0	10	0	10	22	2	3	0	27
1989	UC	1	0	0	1	0	1	3	1	0	0	4
	CSU	1	2	0	3	0	18	24	0	1	0	25
1990	UC	0	0	0	2	1	4	7	0	0	0	7
	CSU	0	5	1	4	0	9	19	0	2	1	22
Butte Community College District												
Butte College												
1988	UC	0	0	0	0	0	6	6	0	0	0	6
	CSU	6	5	1	12	8	331	363	2	12	8	385
1989	UC	0	0	0	2	0	7	9	0	1	0	10
	CSU	10	3	1	15	8	309	346	5	6	7	364
1990	UC	2	0	0	0	0	15	17	0	0	0	17
	CSU	9	9	1	22	4	339	384	4	11	9	408
Cabrillo Community College District												
Cabrillo College												
1988	UC	5	1	1	6	2	134	149	4	11	0	164
	CSU	10	1	3	22	5	189	230	6	13	5	254
1989	UC	2	1	0	17	2	117	139	2	7	2	150
	CSU	6	4	0	21	3	192	226	3	15	9	253
1990	UC	4	3	2	17	3	184	213	4	11	4	232
	CSU	10	4	4	23	5	192	238	3	32	8	281

*Ethnic Distribution of Community College Transfer Students
to the University of California and the California State University,
Fall 1988, Fall 1989 and Fall 1990.*

		Asian/ Pacific Islander	Black	Filipino	Latino	Native American	White	Known Ethnicity Total	Non Resident Alien	No Response	Other	Grand Total
Cerritos Community College District												
Cerritos College												
1988	UC	4	1	5	17	0	14	41	2	1	0	44
	CSU	60	13	24	103	3	212	415	8	15	11	449
1989	UC	16	1	2	14	0	13	46	3	0	1	50
	CSU	45	27	15	107	5	171	363	16	26	10	415
1990	UC	17	2	3	12	0	13	47	7	1	0	55
	CSU	58	30	15	115	6	170	394	10	23	8	435
Chaffey Community College District												
Chaffey College												
1988	UC	2	2	0	3	0	14	21	2	0	0	23
	CSU	13	14	1	22	2	173	225	8	7	8	248
1989	UC	3	4	1	7	1	20	36	1	2	0	39
	CSU	11	11	4	28	0	169	223	8	14	5	250
1990	UC	5	0	1	6	2	18	32	0	3	2	37
	CSU	8	17	3	50	1	172	251	7	15	3	276
Citrus Community College District												
Citrus College												
1988	UC	2	0	0	6	1	18	27	2	2	0	31
	CSU	6	8	3	17	0	129	172	8	11	3	194
1989	UC	3	0	0	2	1	19	25	1	0	0	26
	CSU	11	9	4	26	4	120	174	14	11	5	204
1990	UC	3	1	0	1	1	11	17	3	4	0	24
	CSU	12	10	5	33	7	123	190	14	11	5	220
Coachella Valley Community College District												
College of the Desert												
1988	UC	0	0	0	6	0	13	19	0	0	0	19
	CSU	1	3	1	17	0	95	117	4	5	1	127
1989	UC	0	0	0	7	3	23	33	1	1	2	37
	CSU	2	3	2	23	2	89	121	0	11	6	138
1990	UC	0	1	0	5	0	15	21	0	2	1	24
	CSU	2	8	2	27	?	105	146	0	6	2	154
Coast Community College District												
Coastline Community College												
1988	UC	3	0	0	1	0	4	8	0	1	0	9
	CSU	2	0	0	1	0	18	21	0	1	1	23
1989	UC	0	0	0	1	1	5	7	0	0	0	7
	CSU	1	0	1	1	0	18	21	0	1	1	23
1990	UC	3	0	0	0	0	4	7	0	0	0	7
	CSU	4	1	0	1	1	20	27	0	2	0	29

***Ethnic Distribution of Community College Transfer Students
to the University of California and the California State University,
Fall 1988, Fall 1989 and Fall 1990.***

		Asian/ Pacific Islander	Black	Filipino	Latino	Native American	White	Known Ethnicity Total	Non Resident Alien	No Response	Other	Grand Total
Golden West College												
1988	UC	18	0	1	8	1	43	71	1	2	0	74
	CSU	88	3	6	22	5	275	399	4	18	1	422
1989	UC	23	2	0	1	0	39	65	4	4	0	73
	CSU	51	1	3	14	4	237	310	7	12	7	336
1990	UC	20	0	1	7	1	42	71	2	2	0	75
	CSU	58	5	3	20	10	220	316	6	12	3	337
Orange Coast College												
1988	UC	31	2	0	17	3	195	248	5	6	2	261
	CSU	89	6	7	46	12	606	766	6	34	11	817
1989	UC	34	2	3	22	3	184	248	9	6	4	267
	CSU	90	8	12	47	9	531	697	5	54	16	772
1990	UC	42	1	1	28	8	230	310	15	15	4	344
	CSU	79	5	5	47	13	513	662	7	50	18	737
College of the Sequoias Community College District												
College of the Sequoias												
1988	UC	3	1	0	4	2	33	43	0	1	4	48
	CSU	7	6	2	43	4	256	318	2	20	13	353
1989	UC	1	3	1	5	0	18	28	0	1	1	30
	CSU	9	7	2	54	4	272	348	2	22	19	391
1990	UC	0	0	0	9	5	14	28	0	1	2	31
	CSU	14	11	5	59	4	188	281	0	27	14	322
Compton Community College District												
Compton Community College												
1988	UC	0	1	0	1	0	0	2	2	0	0	4
	CSU	2	45	0	5	0	4	56	5	4	2	67
1989	UC	0	4	1	0	0	0	5	2	0	0	7
	CSU	3	44	0	8	0	4	59	3	3	3	68
1990	UC	1	1	0	2	0	1	5	0	0	0	5
	CSU	4	70	1	17	0	4	96	7	5	1	109
Contra Costa Community College District												
Contra Costa College												
1988	UC	1	4	0	1	0	8	14	6	0	0	20
	CSU	14	25	4	11	3	54	111	3	13	4	131
1989	UC	6	3	0	3	1	12	25	1	0	2	28
	CSU	13	34	5	7	1	39	99	0	3	2	104
1990	UC	12	11	0	9	2	15	49	4	2	1	56
	CSU	11	34	7	10	2	39	103	4	6	3	116

*Ethnic Distribution of Community College Transfer Students
to the University of California and the California State University,
Fall 1988, Fall 1989 and Fall 1990.*

		Asian/ Pacific Islander	Black	Filipino	Latino	Native American	White	Known Ethnicity Total	Non Resident Alien	No Response	Other	Grand Total
Diablo Valley College												
1988	UC	32	4	7	18	5	226	292	4	9	2	307
	CSU	50	27	19	47	7	649	799	6	52	16	873
1989	UC	43	3	2	23	3	202	276	9	10	2	297
	CSU	48	14	20	47	6	625	760	9	55	13	837
1990	UC	38	10	18	26	8	264	364	8	24	7	403
	CSU	43	11	28	49	4	558	693	8	51	21	773
Los Medanos College												
1988	UC	4	0	1	1	0	11	17	0	0	0	17
	CSU	2	8	3	10	0	51	74	1	5	1	81
1989	UC	0	0	0	4	1	9	14	0	0	0	14
	CSU	3	4	0	6	1	45	59	0	7	1	67
1990	UC	2	0	1	4	0	12	19	0	1	1	21
	CSU	2	4	3	8	2	65	84	0	6	2	92
El Camino Community College District												
El Camino College												
1988	UC	29	8	2	16	0	80	135	7	4	1	147
	CSU	111	88	18	72	8	406	703	14	46	17	780
1989	UC	26	10	3	22	2	75	138	6	2	1	147
	CSU	77	78	9	70	7	307	542	13	33	10	598
1990	UC	49	8	2	20	0	113	192	7	6	3	208
	CSU	76	102	27	86	9	343	643	10	35	13	701
Feather River Community College District												
Feather River College												
1988	UC	0	0	0	0	0	1	1	0	0	0	1
	CSU	0	0	0	0	1	15	16	0	0	0	16
1989	UC	0	0	0	0	0	1	1	0	0	0	1
	CSU	0	0	0	0	0	13	13	0	1	0	14
1990	UC	0	0	0	0	0	1	1	0	0	0	1
	CSU	1	1	0	1	1	10	14	0	1	0	15
Foothill-De Anza Community College District												
De Anza College												
1988	UC	50	5	1	11	3	87	157	13	5	1	176
	CSU	117	15	29	50	3	525	739	15	51	14	819
1989	UC	55	4	3	8	1	118	189	11	8	3	211
	CSU	144	16	37	56	5	575	833	7	53	25	918
1990	UC	54	3	4	19	1	119	200	12	12	4	228
	CSU	147	28	24	53	3	457	712	16	51	17	796

*Ethnic Distribution of Community College Transfer Students
to the University of California and the California State University,
Fall 1988, Fall 1989 and Fall 1990.*

		Asian/ Pacific Islander	Black	Filipino	Latino	Native American	White	Known Ethnicity Total	Non Resident Allen	No Response	Other	Grand Total
Foothill College												
1988	UC	9	2	0	3	0	79	93	4	3	2	102
	CSU	23	17	1	20	2	251	314	16	28	7	365
1989	UC	16	4	0	8	0	75	103	12	4	2	122
	CSU	21	10	8	26	1	235	301	20	31	7	359
1990	UC	14	3	5	5	0	92	119	9	10	2	140
	CSU	22	7	4	15	3	193	244	13	25	12	294
Fremont-Newark Community College District												
Ohlone College												
1988	UC	8	1	0	3	1	20	33	2	3	1	39
	CSU	21	5	8	22	4	184	244	9	11	8	272
1989	UC	9	0	1	5	0	24	39	3	3	1	46
	CSU	26	12	8	23	4	190	263	5	12	4	284
1990	UC	6	0	0	5	1	21	33	1	0	0	34
	CSU	13	8	10	22	1	145	199	3	18	9	229
Gavilan Joint Community College District												
Gavilan College												
1988	UC	0	0	0	5	0	8	13	1	0	0	14
	CSU	2	0	1	20	0	52	75	3	8	2	88
1989	UC	1	0	0	4	0	15	20	1	0	0	21
	CSU	4	2	0	30	1	77	114	0	7	3	124
1990	UC	1	0	0	4	0	15	20	0	0	0	20
	CSU	3	1	2	26	4	66	102	1	5	2	110
Glendale Community College District												
Glendale Community College												
1988	UC	10	1	1	11	4	29	56	6	1	1	64
	CSU	33	12	16	39	3	182	285	23	13	17	338
1989	UC	9	2	0	16	0	45	72	4	3	0	79
	CSU	31	1	22	44	1	150	249	27	15	16	307
1990	UC	28	1	4	15	0	46	84	5	8	2	109
	CSU	42	5	14	66	5	156	288	15	19	24	346
Grossmont Community College District												
Cuyamaca College												
1988	UC	0	0	0	2	0	2	4	0	0	0	4
	CSU	3	1	0	3	1	19	27	0	3	1	31
1989	UC	0	0	0	0	0	0	0	0	0	0	0
	CSU	2	2	0	0	2	19	24	1	2	0	27
1990	UC	1	0	0	1	0	6	8	0	0	0	8
	CSU	3	1	0	6	1	28	39	3	0	5	47

*Ethnic Distribution of Community College Transfer Students
to the University of California and the California State University,
Fall 1988, Fall 1989 and Fall 1990.*

		Asian/ Pacific Islander	Black	Filipino	Latino	Native American	White	Known Ethnicity Total	Non Resident Alien	No Response	Other	Grand Total
Grossmont College												
1988	UC	2	1	0	4	2	45	54	2	1	2	59
	CSU	18	11	11	38	1	410	489	19	29	9	546
1989	UC	4	1	2	6	1	69	83	2	2	0	87
	CSU	20	9	7	29	8	412	485	15	24	17	541
1990	UC	4	3	1	7	3	67	85	2	4	0	91
	CSU	16	18	10	47	12	423	526	20	10	37	593
Hartnell Community College District												
Hartnell College												
1988	UC	2	1	2	10	1	15	31	1	2	1	35
	CSU	12	5	9	40	1	131	198	5	6	7	216
1989	UC	4	0	3	16	0	18	41	3	1	0	45
	CSU	7	5	10	43	5	108	178	5	16	2	201
1990	UC	1	0	0	5	0	15	21	1	0	1	23
	CSU	13	5	7	41	3	92	161	0	11	2	174
Imperial Community College District												
Imperial Valley College												
1988	UC	2	0	0	8	0	0	10	0	0	1	11
	CSU	1	1	1	55	0	39	97	0	2	3	102
1989	UC	0	0	1	5	0	1	7	0	2	0	9
	CSU	0	0	0	78	0	38	116	2	4	3	125
1990	UC	1	0	0	9	0	2	12	0	0	1	13
	CSU	4	3	1	98	1	43	150	1	1	5	157
Kern Community College District												
Bakersfield College												
1988	UC	0	0	0	4	0	14	18	0	1	0	19
	CSU	11	15	4	50	8	305	393	2	16	8	419
1989	UC	3	1	2	3	1	20	30	0	1	0	31
	CSU	16	24	4	57	11	253	365	2	20	10	397
1990	UC	6	1	0	2	0	17	26	2	2	1	31
	CSU	10	23	4	47	9	245	338	2	23	10	372
Cerro Coso Community College												
1988	UC	1	0	0	0	0	7	8	0	0	0	8
	CSU	0	2	0	0	0	31	33	0	1	0	34
1989	UC	0	0	0	0	0	1	1	0	1	0	2
	CSU	1	3	1	1	2	28	36	0	1	0	37
1990	UC	1	0	0	0	0	3	4	0	0	0	4
	CSU	0	0	0	1	0	35	36	0	0	0	36

*Ethnic Distribution of Community College Transfer Students
to the University of California and the California State University,
Fall 1988, Fall 1989 and Fall 1990.*

		Asian/ Pacific Islander	Black	Filipino	Latino	Native American	White	Known Ethnicity Total	Non Resident Alien	No Response	Other	Grand Total
Porterville College												
1988	UC	0	0	0	1	1	5	7	0	1	0	8
	CSU	1	2	0	11	0	41	55	1	0	1	57
1989	UC	0	0	0	0	0	2	2	1	0	0	3
	CSU	1	1	1	9	4	28	44	0	1	1	46
1990	UC	0	0	0	1	0	1	2	0	0	0	2
	CSU	1	0	0	10	2	47	60	0	4	3	67
Lake Tahoe Community College District												
Lake Tahoe Community College												
1988	UC	0	0	0	0	0	3	3	0	0	0	3
	CSU	0	0	1	1	0	16	18	0	2	1	21
1989	UC	0	0	0	0	0	0	0	0	0	0	0
	CSU	1	0	0	1	0	27	29	0	1	0	30
1990	UC	0	0	0	0	0	4	4	0	0	0	4
	CSU	0	1	0	1	1	18	21	0	4	0	25
Lassen Community College District												
Lassen College												
1988	UC	0	0	0	0	0	4	4	0	0	0	4
	CSU	0	3	0	0	0	41	44	1	1	1	47
1989	UC	0	1	0	1	0	0	2	0	0	0	2
	CSU	0	2	0	3	7	28	40	5	2	1	48
1990	UC	0	0	0	1	1	5	7	0	0	0	7
	CSU	1	0	0	2	3	22	28	5	1	1	35
Long Beach Community College District												
Long Beach City College												
1988	UC	8	5	0	7	1	38	59	0	0	1	60
	CSU	73	43	23	36	5	267	447	4	27	10	488
1989	UC	11	5	1	8	0	27	52	3	4	0	59
	CSU	80	42	19	41	3	244	429	3	20	6	458
1990	UC	6	3	3	12	2	34	60	3	3	0	66
	CSU	71	44	17	45	2	262	441	4	32	11	488
Los Angeles Community College District												
East Los Angeles College												
1988	UC	7	0	1	35	0	3	46	7	1	0	54
	CSU	49	3	1	122	1	12	188	23	12	5	228
1989	UC	9	0	2	36	0	1	48	7	2	0	57
	CSU	46	10	3	170	1	17	247	20	11	4	282
1990	UC	15	2	2	42	2	3	66	11	1	0	78
	CSU	53	8	7	209	1	15	293	19	13	1	326

*Ethnic Distribution of Community College Transfer Students
to the University of California and the California State University,
Fall 1988, Fall 1989 and Fall 1990.*

		Asian/ Pacific Islander	Black	Filipino	Latino	Native Americar.	White	Known Ethnicity Total	Non Resident Alien	No Response	Other	Grand Total
Los Angeles City College												
1988	UC	17	4	3	8	0	20	52	0	0	0	52
	CSU	54	58	11	60	1	60	244	21	27	12	304
1989	UC	25	3	3	18	1	14	62	4	1	0	67
	CSU	55	58	17	66	0	52	248	28	24	9	309
1990	UC	21	9	5	11	0	17	63	2	1	0	66
	CSU	64	69	20	39	0	45	287	14	16	10	327
Los Angeles Harbor College												
1988	UC	5	4	1	1	0	16	27	0	0	0	27
	CSU	17	30	13	35	1	107	203	4	22	4	233
1989	UC	4	2	3	3	0	24	36	1	0	0	37
	CSU	15	32	11	40	0	105	203	6	18	1	228
1990	UC	5	2	0	6	1	20	34	1	0	1	36
	CSU	15	33	9	35	2	99	193	11	21	7	232
Los Angeles Mission College												
1988	UC	0	0	0	0	0	1	1	0	1	0	2
	CSU	1	3	0	17	0	16	37	2	2	2	43
1989	UC	0	2	0	1	0	0	3	0	1	0	4
	CSU	3	10	0	17	0	24	54	1	1	0	56
1990	UC	1	0	1	0	0	2	4	0	0	0	4
	CSU	2	4	1	18	0	14	39	0	2	1	42
Los Angeles Pierce College												
1988	UC	9	2	1	5	2	61	80	7	2	0	89
	CSU	49	12	5	37	4	464	571	14	44	10	639
1989	UC	13	4	1	12	1	91	122	6	2	1	131
	CSU	56	9	5	48	11	310	439	20	34	11	504
1990	UC	18	4	1	9	2	83	117	7	12	1	137
	CSU	53	17	9	53	5	381	518	21	52	11	602
Los Angeles Southwest College												
1988	UC	0	1	0	0	0	0	1	0	0	0	1
	CSU	1	51	0	0	0	5	57	0	3	1	61
1989	UC	0	1	0	0	0	0	1	0	0	0	1
	CSU	2	54	0	1	0	3	60	0	1	1	62
1990	UC	0	6	0	0	0	1	7	1	0	0	8
	CSU	1	66	0	6	3	3	79	0	5	1	85
Los Angeles Trade-Technical College												
1988	UC	0	1	0	0	0	1	2	0	0	0	2
	CSU	13	34	3	21	1	3	75	3	5	1	84
1989	UC	2	2	0	0	0	0	4	0	0	0	4
	CSU	9	43	1	24	0	4	81	2	10	4	97
1990	UC	0	1	0	1	0	0	2	0	1	0	3
	CSU	11	41	2	25	1	0	82	5	2	1	90

*Ethnic Distribution of Community College Transfer Students
to the University of California and the California State University,
Fall 1988, Fall 1989 and Fall 1990.*

		Asian/ Pacific Islander	Black	Filipino	Latino	Native American	White	Known Ethnicity Total	Non Resident Alien	No Response	Other	Grand Total
Los Angeles Valley College												
1988	UC	13	2	1	11	2	52	81	3	2	2	88
	CSU	47	23	13	54	2	241	380	9	39	17	445
1989	UC	7	5	0	10	3	68	93	5	6	1	105
	CSU	36	25	13	50	4	224	352	17	30	14	413
1990	UC	12	2	3	10	3	53	83	2	8	1	94
	CSU	33	34	8	72	5	257	409	13	43	11	476
West Los Angeles College												
1988	UC	11	4	1	3	0	7	26	0	2	0	28
	CSU	10	61	1	5	0	27	104	4	8	6	122
1989	UC	2	6	1	2	1	12	24	2	1	0	27
	CSU	8	57	2	14	2	24	107	9	13	2	131
1990	UC	6	4	0	1	1	7	19	1	1	0	21
	CSU	7	93	1	9	1	39	150	6	7	5	168
Los Rios Community College District												
American River College												
1988	UC	19	6	3	18	6	143	195	2	3	1	201
	CSU	35	21	7	31	10	590	694	4	50	15	763
1989	UC	17	3	1	12	3	121	157	1	1	2	161
	CSU	11	34	8	33	4	516	606	3	61	20	690
1990	UC	18	5	4	11	2	140	180	4	5	5	194
	CSU	34	29	9	44	11	581	708	5	62	14	789
Cosumnes River College												
1988	UC	2	3	0	2	1	22	30	0	1	1	32
	CSU	11	9	4	9	1	119	153	0	13	3	169
1989	UC	5	2	0	6	1	14	28	0	1	0	29
	CSU	5	18	7	13	2	103	148	1	15	2	166
1990	UC	7	3	0	4	3	17	34	0	1	0	35
	CSU	7	20	3	12	3	104	149	4	15	3	171
Sacramento City College												
1988	UC	45	9	2	18	0	57	131	5	3	1	140
	CSU	89	27	9	52	7	277	467	38	41	13	559
1989	UC	25	6	2	13	1	72	119	4	5	1	129
	CSU	37	61	6	54	8	233	399	21	108	8	536
1990	UC	33	7	1	12	4	70	127	14	6	0	147
	CSU	94	57	20	67	6	234	478	19	43	20	560

***Ethnic Distribution of Community College Transfer Students
to the University of California and the California State University,
Fall 1988, Fall 1989 and Fall 1990.***

		Asian/ Pacific Islander	Black	Filipino	Latino	Native American	White	Known Ethnicity Total	Non Resident Alien	No Response	Other	Grand Total
Marin Community College District												
College of Marin												
1988	UC	2	0	0	3	2	61	68	4	0	0	72
	CSU	9	7	0	11	1	177	205	4	14	2	225
1989	UC	7	0	0	7	0	87	101	4	9	1	115
	CSU	14	13	1	19	4	182	233	4	21	2	260
1990	UC	5	0	1	7	0	86	99	5	8	2	114
	CSU	10	11	1	8	3	177	210	2	21	13	246
Indian Valley College (Closed 1985)												
1988	UC	0	0	0	0	0	0	0	0	0	0	0
	CSU	0	0	0	0	0	9	9	0	1	0	10
1989	UC	0	0	0	0	0	0	0	0	0	0	0
	CSU	0	0	0	0	1	7	8	0	0	0	8
1990	UC	0	0	0	0	0	2	2	0	0	0	2
	CSU	0	0	0	2	1	4	7	0	1	0	8
Mendocino-Lake Community College District												
Mendocino College												
1988	UC	0	0	0	0	0	5	5	0	0	0	5
	CSU	1	0	0	2	2	39	44	0	2	1	47
1989	UC	0	0	0	0	0	0	0	0	1	0	1
	CSU	2	1	0	5	2	52	62	0	8	2	72
1990	UC	0	0	0	0	0	3	3	0	0	0	3
	CSU	1	0	2	8	1	53	65	0	4	1	70
Merced Community College District												
Merced College												
1988	UC	0	0	0	6	1	13	20	0	0	0	20
	CSU	15	19	3	25	0	150	212	12	9	9	242
1989	UC	2	3	0	3	0	18	26	1	0	0	27
	CSU	13	16	5	30	7	154	225	5	9	7	246
1990	UC	1	0	2	4	0	17	24	0	2	2	28
	CSU	14	18	2	39	2	126	201	0	16	2	219
Mira Costa Community College District												
Mira Costa College												
1988	UC	3	2	1	2	0	18	26	0	0	0	26
	CSU	1	3	0	6	0	77	87	0	7	4	98
1989	UC	1	1	0	1	1	30	34	0	2	0	36
	CSU	4	4	2	12	1	93	116	1	9	4	130
1990	UC	4	2	1	5	0	42	54	0	2	2	58
	CSU	2	8	0	15	2	144	171	0	4	5	180

*Ethnic Distribution of Community College Transfer Students
to the University of California and the California State University,
Fall 1988, Fall 1989 and Fall 1990.*

		Asian/ Pacific Islander	Black	Filipino	Latino	Native American	White	Known Ethnicity Total	Non Resident Alien	No Response	Other	Grand Total
Monterey Peninsula Community College District												
Monterey Peninsula College												
1988	UC	1	1	2	2	3	39	48	5	4	1	58
	CSU	13	15	6	4	4	121	165	2	14	6	187
1989	UC	5	3	0	3	1	26	38	4	1	0	43
	CSU	16	10	5	7	1	99	133	4	12	5	159
1990	UC	9	1	0	5	0	33	48	4	5	1	58
	CSU	23	13	8	9	2	100	162	5	10	3	180
Mt. San Antonio Community College District												
Mt. San Antonio College												
1988	UC	6	3	1	25	0	18	53	3	0	1	57
	CSU	48	27	20	106	7	281	489	20	25	14	548
1989	UC	2	2	4	16	2	23	49	1	2	0	52
	CSU	48	32	18	123	3	275	504	13	30	11	558
1990	UC	21	4	7	18	0	29	79	5	1	1	86
	CSU	52	27	21	104	5	251	460	13	30	11	514
Mt. San Jacinto Community College District												
Mt. San Jacinto College												
1988	UC	1	0	0	3	0	4	8	0	1	0	9
	CSU	1	5	0	10	1	50	67	0	3	2	72
1989	UC	0	0	0	1	1	5	7	0	0	0	7
	CSU	1	3	1	4	0	38	47	0	1	0	48
1990	UC	1	2	0	1	0	11	15	1	1	0	17
	CSU	1	1	0	7	0	46	55	1	2	3	61
Napa Valley Community College District												
Napa Valley College												
1988	UC	0	0	1	2	0	12	25	2	0	0	27
	CSU	6	2	3	11	1	101	124	1	7	3	135
1989	UC	0	0	0	3	0	21	24	1	1	0	26
	CSU	1	4	6	8	1	112	132	1	14	1	148
1990	UC	1	0	1	1	0	20	23	0	1	0	24
	CSU	4	2	10	7	0	100	123	2	10	4	139
North Orange County Community College District												
Cypress College												
1988	UC	10	1	0	4	1	16	32	3	0	1	36
	CSU	45	0	6	33	1	242	331	5	14	6	356
1989	UC	15	0	2	3	0	24	44	2	2	0	48
	CSU	36	8	9	31	2	230	316	2	26	9	353
1990	UC	16	2	3	3	0	24	48	2	4	1	55
	CSU	48	8	16	31	4	212	319	7	16	12	354

***Ethnic Distribution of Community College Transfer Students
to the University of California and the California State University,
Fall 1988, Fall 1989 and Fall 1990.***

		Asian/ Pacific Islander	Black	Filipino	Latino	Native American	White	Known Ethnicity Total	Non Resident Alien	No Response	Other	Grand Total
Fullerton College												
1988	UC	12	3	0	3	1	36	55	2	0	0	57
	CSU	66	9	6	87	5	479	652	2	32	10	696
1989	UC	11	0	1	13	1	43	69	1	2	2	74
	CSU	61	9	8	69	6	439	592	3	31	9	635
1990	UC	28	0	1	11	0	50	90	2	0	3	95
	CSU	74	10	8	68	8	414	582	12	45	11	650
Palo Verde Community College District												
Palo Verde College												
1988	UC	0	0	0	0	0	4	4	0	0	0	4
	CSU	0	0	0	3	0	3	6	0	0	0	6
1989	UC	0	0	0	0	0	1	1	0	0	0	1
	CSU	1	2	0	1	0	5	9	0	0	0	9
1990	UC	0	0	0	1	0	1	2	0	0	0	2
	CSU	0	0	0	0	0	0	0	0	0	0	0
Palomar Community College District												
Palomar College												
1988	UC	8	2	1	6	0	66	83	4	6	1	94
	CSU	11	5	4	33	1	351	405	8	21	4	438
1989	UC	9	1	0	9	0	69	88	0	2	1	91
	CSU	16	6	7	35	2	351	417	6	23	11	457
1990	UC	0	2	1	12	1	77	101	3	3	0	107
	CSU	20	10	8	48	6	359	451	7	21	8	487
Pasadena Area Community College District												
Pasadena City College												
1988	UC	29	4	0	24	1	60	118	17	3	2	140
	CSU	125	56	13	77	5	241	517	42	40	16	615
1989	UC	34	7	0	25	1	62	129	11	3	2	145
	CSU	157	41	17	83	1	227	526	42	31	18	617
1990	UC	56	8	1	26	2	74	167	17	5	3	192
	CSU	169	28	14	98	4	216	529	51	25	16	621
Peralta Community College District												
College of Alameda												
1988	UC	4	10	0	0	0	14	28	1	2	0	31
	CSU	17	43	3	7	1	35	106	3	8	3	120
1989	UC	9	10	1	1	0	23	44	0	1	0	45
	CSU	16	31	5	5	0	25	82	3	8	7	100
1990	UC	10	7	1	5	0	20	43	0	2	0	45
	CSU	23	34	3	8	0	24	92	2	7	7	108

***Ethnic Distribution of Community College Transfer Students
to the University of California and the California State University,
Fall 1988, Fall 1989 and Fall 1990.***

		Asian/ Pacific Islander	Black	Filipino	Latino	Native American	White	Known Ethnicity Total	Non Resident Alien	No Response	Other	Grand Total
Laney College												
1988	UC	16	6	1	5	1	38	67	3	3	0	73
	CSU	37	59	6	9	0	38	149	6	11	1	167
1989	UC	18	8	0	3	2	37	68	2	4	1	75
	CSU	48	54	3	1	1	33	140	2	17	3	162
1990	UC	19	5	2	9	0	29	64	2	2	1	69
	CSU	23	42	1	2	3	42	113	1	11	7	132
Merritt College												
1988	UC	6	3	1	2	0	17	29	1	2	0	32
	CSU	39	35	2	7	1	23	107	1	15	3	126
1989	UC	10	4	0	1	0	17	32	0	1	0	33
	CSU	27	42	6	4	3	28	110	1	8	1	120
1990	UC	5	2	0	2	0	17	26	1	1	1	29
	CSU	9	32	4	5	0	32	82	0	5	3	90
Vista College												
1988	UC	0	1	0	0	0	5	6	0	1	0	7
	CSU	0	0	0	0	0	10	10	0	2	0	12
1989	UC	0	0	0	0	0	4	4	0	0	0	4
	CSU	1	1	0	0	0	4	6	0	1	0	7
1990	UC	0	1	0	0	0	5	6	0	3	1	10
	CSU	0	0	0	0	0	3	3	0	0	0	3
Rancho Santiago Community College District												
Santa Ana College												
1988	UC	13	0	3	12	1	27	56	3	2	0	61
	CSU	72	11	3	36	4	196	322	22	8	4	356
1989	UC	12	2	0	6	1	17	38	1	2	0	41
	CSU	53	11	0	38	3	151	256	23	18	1	298
1990	UC	27	3	0	6	0	21	57	8	3	0	68
	CSU	61	6	5	48	2	140	262	28	18	8	316
Redwoods Community College District												
College of the Redwoods												
1988	UC	0	0	0	0	0	17	17	0	0	1	18
	CSU	1	4	0	12	11	188	216	1	22	2	241
1989	UC	1	1	0	1	0	12	15	0	1	0	16
	CSU	2	4	1	6	9	193	215	0	22	1	238
1990	UC	1	0	0	3	1	17	22	0	0	1	23
	CSU	4	2	0	7	9	152	174	0	24	4	202

*Ethnic Distribution of Community College Transfer Students
to the University of California and the California State University,
Fall 1988, Fall 1989 and Fall 1990.*

		Asian/ Pacific Islander	Black	Filipino	Latino	Native American	White	Known Ethnicity Total	Non Resident Alien	No Response	Other	Grand Total
Rio Hondo Community College District												
Rio Hondo College												
1988	UC	2	0	0	12	0	3	17	0	0	0	17
	CSU	22	1	3	109	0	78	213	14	7	7	241
1989	UC	3	1	1	9	0	4	18	0	1	0	19
	CSU	12	3	2	75	0	54	146	9	9	4	168
1990	UC	4	1	1	10	0	4	20	4	0	1	25
	CSU	25	2	1	94	0	36	158	9	7	7	181
Riverside Community College District												
Riverside Community College												
1988	UC	10	5	2	10	4	76	107	2	4	0	113
	CSU	10	34	3	27	1	256	331	5	12	4	352
1989	UC	5	8	1	12	4	78	108	7	4	0	119
	CSU	16	37	4	32	6	224	319	4	22	3	348
1990	UC	20	10	2	18	1	88	139	2	4	4	149
	CSU	21	38	6	64	4	269	402	6	21	11	440
Saddleback Community College District												
Irvine Valley College												
1988	UC	4	1	1	3	1	19	29	2	1	0	32
	CSU	4	0	1	4	2	25	36	0	2	3	41
1989	UC	4	1	1	2	3	35	46	4	0	1	51
	CSU	5	1	1	2	0	49	58	3	0	3	64
1990	UC	17	1	2	6	0	44	70	3	5	2	80
	CSU	3	2	1	3	0	57	66	3	9	2	80
Saddleback College												
1988	UC	9	3	0	11	0	109	132	2	3	1	138
	CSU	18	6	5	32	8	417	486	1	24	8	519
1989	UC	15	0	0	17	1	111	144	3	1	2	150
	CSU	17	5	8	27	3	346	406	4	24	4	438
1990	UC	12	1	2	11	2	139	167	1	8	2	178
	CSU	21	10	8	27	9	378	453	7	22	12	494
San Bernardino Community College District												
Crafton Hills College												
1988	UC	1	1	0	1	0	13	16	1	0	0	17
	CSU	1	4	0	8	2	91	106	0	5	3	114
1989	UC	1	0	0	0	0	10	11	1	1	0	13
	CSU	1	1	0	9	0	93	104	2	7	3	116
1990	UC	0	1	0	3	0	14	18	0	2	0	20
	CSU	1	4	1	10	2	109	127	1	5	1	134

*Ethnic Distribution of Community College Transfer Students
to the University of California and the California State University,
Fall 1988, Fall 1989 and Fall 1990.*

		Asian/ Pacific Islander	Black	Filipino	Latino	Native American	Whites	Known Ethnicity Total	Non Resident Alien	No Response	Other	Grand Total
San Bernardino Valley College												
1988	UC	1	4	0	2	0	9	16	0	0	0	16
	CSU	14	32	2	37	1	168	254	8	9	6	277
1989	UC	1	2	0	6	0	11	20	0	0	0	20
	CSU	22	41	6	46	3	151	269	9	22	6	306
1990	UC	4	4	0	8	1	6	23	1	0	0	24
	CSU	15	38	3	52	1	149	258	2	13	7	280
San Diego Community College District												
San Diego City College												
1988	UC	3	2	0	11	1	19	36	3	1	1	41
	CSU	33	42	7	28	4	132	246	9	12	4	271
1989	UC	2	2	0	5	2	21	32	0	3	2	37
	CSU	22	43	9	30	3	104	211	9	16	5	241
1990	UC	4	9	0	5	1	25	44	0	4	0	48
	CSU	21	24	10	35	2	93	165	7	3	23	218
San Diego Mesa College												
1988	UC	23	4	7	16	2	109	161	2	3	1	167
	CSU	48	16	20	46	7	351	488	7	34	8	537
1989	UC	23	4	3	12	1	153	196	7	6	4	213
	CSU	54	24	25	40	10	380	533	4	27	10	574
1990	UC	31	7	4	23	3	180	248	8	11	3	270
	CSU	58	39	28	59	12	441	637	18	14	45	714
San Diego Miramar College												
1988	UC	1	0	1	1	0	4	7	1	0	0	8
	CSU	3	2	3	0	0	24	32	0	1	0	33
1989	UC	2	1	0	2	0	8	13	0	1	0	14
	CSU	4	0	6	1	0	25	36	1	4	0	41
1990	UC	0	0	1	2	0	8	11	1	1	0	13
	CSU	4	1	3	2	3	40	53	0	1	4	58
San Francisco Community College District												
City College of San Francisco												
1988	UC	52	5	4	9	2	59	131	15	9	1	156
	CSU	310	51	49	53	4	212	679	39	71	21	810
1989	UC	54	5	4	13	2	57	135	7	9	0	151
	CSU	313	56	40	52	1	177	639	39	79	23	780
1990	UC	84	4	5	7	1	62	163	12	8	2	185
	CSU	297	55	51	54	6	207	670	32	68	25	795

*Ethnic Distribution of Community College Transfer Students
to the University of California and the California State University,
Fall 1988, Fall 1989 and Fall 1990.*

		Asian/ Pacific Islander	Black	Filipino	Latino	Native American	White	Known Ethnicity Total	Non Resident Alien	No Response	Other	Grand Total
San Joaquin Delta Community College District												
San Joaquin Delta College												
1988	UC	12	3	1	17	2	52	87	2	2	0	9
	CSU	44	20	13	57	9	350	493	12	40	7	552
1989	UC	11	1	2	16	0	57	87	2	2	0	91
	CSU	23	15	11	60	9	339	457	8	44	18	527
1990	UC	14	1	2	13	4	47	81	1	0	1	83
	CSU	56	14	19	76	6	308	479	10	32	16	537
San Jose Community College District												
Evergreen Valley College												
1988	UC	7	0	0	2	0	6	15	0	2	0	17
	CSU	48	10	18	33	2	63	174	3	11	8	196
1989	UC	3	0	1	1	0	2	7	0	1	0	8
	CSU	66	10	11	21	0	55	163	2	8	9	182
1990	UC	6	1	2	2	0	6	17	1	3	0	21
	CSU	55	3	14	35	1	56	164	6	4	7	181
San Jose City College												
1988	UC	6	1	1	1	1	7	17	0	0	0	17
	CSU	27	22	2	27	3	109	190	5	11	6	212
1989	UC	3	1	0	3	0	4	11	1	1	0	13
	CSU	21	16	7	25	2	101	172	4	22	5	203
1990	UC	2	0	0	2	0	5	9	1	1	0	11
	CSU	31	13	1	35	2	89	171	7	18	8	204
San Luis Obispo County Community College District												
Cuesta College												
1988	UC	0	1	0	0	0	26	27	0	1	0	28
	CSU	3	1	2	13	0	178	197	2	6	5	210
1989	UC	1	0	0	2	0	20	23	0	1	0	24
	CSU	4	0	1	17	2	176	200	3	18	3	224
1990	UC	2	0	0	0	1	22	25	1	1	0	27
	CSU	4	4	5	22	1	208	244	3	20	6	273
San Mateo County Community College District												
Canada College												
1988	UC	1	0	0	2	1	11	15	3	0	0	18
	CSU	8	10	0	12	2	80	112	7	8	4	131
1989	UC	0	2	0	1	0	8	11	4	1	0	16
	CSU	7	6	4	10	0	80	107	4	10	4	125
1990	UC	2	0	1	3	0	15	21	3	1	1	26
	CSU	8	5	1	10	2	62	88	5	8	2	103

*Ethnic Distribution of Community College Transfer Students
to the University of California and the California State University,
Fall 1988, Fall 1989 and Fall 1990.*

		Asian/ Pacific Islander	Black	Filipino	Latino	Native American	White	Known Ethnicity Total	Non Resident Alien	No Response	Other	Grand Total
College of San Mateo												
1988	UC	19	1	4	15	0	75	114	6	2	2	124
	CSU	47	11	14	42	2	327	443	6	44	13	506
1989	UC	24	2	9	10	0	72	117	5	10	2	134
	CSU	47	18	21	37	0	316	439	15	43	15	512
1990	UC	24	2	2	11	0	68	107	6	5	5	123
	CSU	48	13	14	42	4	263	384	11	32	16	443
Skyline College												
1988	UC	6	0	2	3	1	6	18	0	0	1	19
	CSU	23	10	15	33	3	74	158	7	20	8	193
1989	UC	4	0	1	3	0	14	22	2	3	1	28
	CSU	15	14	13	24	1	80	147	7	7	1	162
1990	UC	7	2	0	4	0	9	22	0	1	0	23
	CSU	26	13	23	24	2	77	165	13	15	9	202
Santa Barbara Community College District												
Santa Barbara City College												
1988	UC	10	3	2	24	5	205	249	3	12	2	266
	CSU	2	6	1	17	2	186	214	1	12	4	231
1989	UC	7	5	1	32	5	282	332	4	11	6	353
	CSU	6	2	1	12	1	173	195	4	14	0	213
1990	UC	13	3	3	34	1	313	367	12	14	8	401
	CSU	8	2	6	39	4	190	249	1	10	2	262
Santa Clarita Community College District												
College of the Canyons												
1988	UC	1	0	0	1	0	13	15	1	2	0	18
	CSU	2	4	0	8	4	103	121	1	9	2	133
1989	UC	0	0	0	1	2	19	22	0	0	0	22
	CSU	2	1	1	12	1	105	122	1	5	2	130
1990	UC	1	1	0	2	0	22	26	0	0	0	26
	CSU	5	2	0	12	1	113	133	3	13	2	151
Santa Monica Community College District												
Santa Monica College												
1988	UC	39	17	5	32	1	220	314	30	7	0	351
	CSU	54	59	10	45	6	275	449	40	26	15	530
1989	UC	31	11	4	28	4	211	289	37	9	2	337
	CSU	47	48	4	43	3	231	376	42	32	16	466
1990	UC	50	13	7	35	4	251	360	43	17	4	424
	CSU	40	44	10	42	9	245	390	28	29	15	462

*Ethnic Distribution of Community College Transfer Students
to the University of California and the California State University,
Fall 1988, Fall 1989 and Fall 1990.*

		Asian/ Pacific Islander	Black	Filipino	Latino	Native American	White	Known Ethnicity Total	Non Resident Alien	No Response	Other	Grand Total
Shasta-Tehema-Trinity Joint Community College District												
Shasta College												
1988	UC	0	1	0	2	1	19	23	0	0	0	23
	CSU	3	1	1	6	3	261	275	0	10	4	289
1989	UC	0	0	0	1	0	23	24	0	0	0	24
	CSU	2	2	2	10	9	226	251	0	12	4	267
1990	UC	1	0	0	1	2	20	24	0	0	1	25
	CSU	4	4	0	15	8	255	286	0	12	2	300
Sierra Joint Community College District												
Sierra College												
1988	UC	1	0	1	2	2	61	67	0	1	0	68
	CSU	6	2	0	18	4	335	365	0	21	3	389
1989	UC	1	0	1	1	1	50	54	0	2	1	57
	CSU	5	2	2	13	1	310	333	0	23	7	363
1990	UC	2	0	0	4	2	63	71	0	2	1	74
	CSU	7	2	2	9	0	338	358	0	33	9	400
Siskiyou Joint Community College District												
College of the Siskiyou												
1988	UC	0	0	1	0	0	6	7	0	0	0	7
	CSU	0	3	0	7	0	45	55	1	2	1	59
1989	UC	0	0	0	0	0	10	10	1	0	0	11
	CSU	1	2	1	4	1	45	54	1	4	0	59
1990	UC	3	0	0	2	1	7	13	2	1	0	16
	CSU	1	1	0	6	1	49	58	0	0	3	61
Solano County Community College District												
Solano Community College												
1988	UC	4	2	4	2	0	31	43	0	1	0	44
	CSU	7	17	17	13	2	108	164	0	16	3	183
1989	UC	1	5	2	4	1	27	40	0	0	2	42
	CSU	7	14	18	9	4	110	162	0	16	6	184
1990	UC	4	3	8	4	1	30	50	1	2	2	55
	CSU	16	28	19	14	2	122	201	2	12	8	223
Sonoma County Community College District												
Santa Rosa Junior College												
1988	UC	1	0	0	3	1	104	109	2	5	1	117
	CSU	13	9	4	42	6	509	583	2	46	4	635
1989	UC	5	2	1	4	2	130	144	0	8	3	155
	CSU	17	8	2	19	7	471	524	2	46	10	582
1990	UC	12	1	3	8	2	137	163	3	8	2	176
	CSU	19	7	1	24	10	481	542	5	55	12	614

*Ethnic Distribution of Community College Transfer Students
to the University of California and the California State University,
Fall 1988, Fall 1989 and Fall 1990.*

		Asian/ Pacific Islander	Black	Filipino	Latino	Native American	White	Known Ethnicity Total	Non Resident Alien	No Response	Other	Grand Total
South County Community College District												
Chabot College												
1988	UC	9	2	3	7	1	49	71	4	5	4	84
	CSU	46	32	28	49	5	325	485	6	24	16	531
1989	UC	19	0	4	10	2	64	99	2	3	1	105
	CSU	69	45	41	48	7	354	564	12	26	12	614
1990	UC	17	1	7	17	0	58	100	7	11	0	118
	CSU	84	26	36	51	8	324	529	10	38	11	588
Southwestern Community College District												
Southwestern College												
1988	UC	3	1	3	9	1	17	34	1	0	0	35
	CSU	15	14	45	80	1	117	272	6	10	6	294
1989	UC	5	3	2	13	0	18	47	0	0	1	42
	CSU	15	24	34	99	4	105	281	4	19	5	309
1990	UC	5	3	3	19	0	11	41	2	2	1	46
	CSU	4	13	48	106	2	119	292	1	2	26	321
State Center Community College District												
Fresno City College												
1988	UC	1	2	0	7	3	21	34	0	0	0	34
	CSU	32	38	6	114	11	409	610	19	68	12	709
1989	UC	5	2	0	7	3	30	47	2	2	1	52
	CSU	51	38	3	139	15	400	646	19	41	22	728
1990	UC	12	1	2	15	2	40	72	1	3	0	76
	CSU	48	34	5	138	11	409	645	20	52	18	735
Kings River Community College												
1988	UC	1	1	0	1	0	3	6	0	0	0	6
	CSU	9	0	2	24	2	55	92	0	10	3	105
1989	UC	0	0	0	2	0	6	8	0	0	1	9
	CSU	3	2	2	30	1	60	98	1	5	2	106
1990	UC	3	0	0	2	0	1	6	1	1	0	8
	CSU	5	2	1	36	4	61	109	1	10	1	121
Ventura County Community College District												
Moorpark College												
1988	UC	3	1	0	8	0	43	55	2	4	0	61
	CSU	12	5	1	21	2	312	353	0	16	3	372
1989	UC	2	1	0	7	0	69	79	0	5	1	85
	CSU	12	6	3	25	1	281	328	1	23	7	359
1990	UC	2	0	1	8	3	58	72	0	8	0	80
	CSU	13	7	2	31	8	280	341	0	20	8	369

*Ethnic Distribution of Community College Transfer Students
to the University of California and the California State University,
Fall 1988, Fall 1989 and Fall 1990.*

		Asian, Pacific Islander	Black	Filipino	Latino	Native American	White	Known Ethnicity Total	Non Resident Alien	No Response	Other	Grand Total
Oxnard College												
1988	UC	2	1	1	3	0	4	11	2	1	0	14
	CSU	6	8	5	16	1	21	57	0	6	0	63
1989	UC	3	1	1	8	0	6	19	1	0	0	20
	CSU	5	2	4	20	0	15	46	1	5	0	52
1990	UC	0	1	2	8	0	1	12	0	0	0	12
	CSU	5	6	13	34	0	30	88	3	3	1	95
Ventura College												
1988	UC	5	0	3	22	2	96	128	1	2	0	131
	CSU	13	8	6	52	3	238	320	0	18	2	340
1989	UC	4	3	2	16	1	68	94	0	5	0	99
	CSU	16	3	0	46	3	198	266	2	19	2	289
1990	UC	2	1	1	22	5	70	101	0	5	0	106
	CSU	17	5	12	62	2	205	303	1	20	10	334
Victor Valley Community College District												
Victor Valley College												
1988	UC	1	0	0	2	0	7	10	0	0	0	10
	CSU	0	6	2	13	1	81	103	2	0	1	106
1989	UC	2	1	0	0	0	8	11	0	0	0	11
	CSU	1	5	2	3	1	73	85	4	4	3	96
1990	UC	0	0	0	3	0	11	14	0	0	0	14
	CSU	4	8	1	5	1	79	98	0	7	5	110
West Hills Community College District												
West Hills College												
1988	UC	0	0	0	0	0	2	2	0	0	0	2
	CSU	2	3	0	10	0	38	53	0	5	1	59
1989	UC	0	0	0	0	0	2	2	0	0	0	2
	CSU	4	1	0	9	1	34	49	0	3	2	54
1990	UC	1	0	0	0	0	0	1	0	0	0	1
	CSU	1	4	1	14	2	33	55	1	5	2	63
West Kern Community College District												
Taft College												
1988	UC	0	0	0	0	0	2	2	0	0	0	2
	CSU	0	1	0	3	0	36	40	0	0	1	41
1989	UC	0	0	0	0	0	0	0	0	0	0	0
	CSU	1	5	1	2	1	31	41	0	0	0	41
1990	UC	0	0	0	0	0	0	0	0	0	0	0
	CSU	1	2	0	1	1	21	26	0	2	0	28

*Ethnic Distribution of Community College Transfer Students
to the University of California and the California State University,
Fall 1988, Fall 1989 and Fall 1990.*

		Asian/ Pacific Islander	Black	Filipino	Latino	Native American	White	Known Ethnicity Total	Non Resident Allen	No Response	Other	Grand Total
West Valley-Mission Community College District												
Mission College												
1988	UC	4	2	1	0	0	2	9	1	1	0	11
	CSU	46	9	12	23	2	62	154	5	12	6	177
1989	UC	6	0	3	1	0	2	12	0	1	0	13
	CSU	53	8	11	12	0	50	134	3	5	2	144
1990	UC	6	0	0	1	0	5	12	1	1	0	14
	CSU	31	14	9	12	1	51	118	2	9	4	133
West Valley College												
1988	UC	22	0	0	3	0	33	58	4	1	1	64
	CSU	45	8	5	39	4	408	509	14	37	7	567
1989	UC	9	1	0	2	1	24	37	2	2	0	41
	CSU	50	9	3	24	6	322	414	11	25	7	457
1990	UC	16	0	0	10	1	51	78	0	5	1	84
	CSU	58	5	7	27	3	330	430	7	27	10	474
Yosemite Community College District												
Columbia College												
1988	UC	0	0	0	0	0	6	6	0	0	0	6
	CSU	0	1	0	6	1	39	47	0	2	0	49
1989	UC	0	0	0	0	0	4	4	0	0	0	4
	CSU	1	1	0	1	2	33	38	0	2	2	42
1990	UC	1	0	0	2	0	3	6	0	1	1	8
	CSU	0	2	0	5	2	27	36	0	2	2	40
Modesto Junior College												
1988	UC	1	0	1	5	0	39	46	0	0	2	48
	CSU	17	3	2	41	9	326	398	3	18	8	427
1989	UC	3	0	0	6	0	20	29	0	3	3	35
	CSU	19	5	0	40	4	302	370	5	20	14	409
1990	UC	5	0	0	2	1	32	40	1	1	1	43
	CSU	24	3	1	37	5	280	350	5	29	9	393
Yuba Community College District												
Yuba College												
1988	UC	7	3	0	9	1	20	40	0	0	2	42
	CSU	12	6	0	16	8	171	213	2	13	6	234
1989	UC	1	0	0	1	0	14	16	0	1	0	17
	CSU	8	6	1	25	9	140	189	0	10	3	202
1990	UC	4	0	0	1	1	12	18	1	1	2	22
	CSU	10	8	1	22	3	155	199	2	9	4	214

*Ethnic Distribution of Community College Transfer Students
to the University of California and the California State University,
Fall 1988, Fall 1989 and Fall 1990.*

		Asian/ Pacific Islander	Black	Filipino	Latino	Native American	White	Known Ethnicity Total	Non Resident Alien	No Response	Other	Grand Total
Statewide Total												
1988	UC	740	185	95	639	82	3,673	5,414	226	163	52	5,855
	CSU	2,665	1,560	636	3,019	288	18,260	26,428	665	1,698	602	29,393
1989	UC	780	197	94	680	78	3,882	5,711	229	215	69	6,224
	CSU	2,607	1,611	678	3,092	312	16,932	25,232	653	1,818	628	28,331
1990	UC	1,065	209	147	796	101	4,366	6,684	300	328	108	7,420
	CSU	2,759	1,717	768	3,615	359	16,924	26,142	644	1,762	822	29,370

20

County	1980			1981			1982			1983		
	Public	Private	Total	Public	Private	Total	Public	Private	Total	Public	Private	Total
Northern California												
Butte	1,480	21	1,501	1,471	20	1,491	1,470	22	1,492	1,491	4	1,495
Colusa	192	0	192	204	0	204	178	0	178	153	0	153
Del Norte	184	0	184	197	0	197	216	2	218	214	1	215
Glenn	300	0	300	292	0	292	322	0	322	290	0	290
Humboldt	1,279	69	1,348	1,133	66	1,199	1,117	54	1,171	1,072	33	1,105
Lake	378	1	379	375	1	376	403	0	403	415	1	416
Lassen	273	1	274	301	1	302	300	0	300	303	3	306
Mendocino	832	11	843	889	10	899	867	1	868	766	7	773
Modoc	133	6	139	126	6	132	128	17	145	126	9	135
Nevada	481	48	529	565	46	611	642	52	694	551	41	592
Plumas	261	24	285	257	23	280	254	22	276	220	22	242
Shasta	1,520	18	1,538	1,519	17	1,536	1,557	30	1,587	1,506	27	1,533
Sierra	52	0	52	46	0	46	52	0	52	59	0	59
Siskiyou	502	0	502	471	0	471	508	0	508	489	1	490
Sutter	718	0	718	722	0	722	676	0	676	663	15	678
Tehama	493	40	533	534	38	572	520	40	560	473	41	514
Trinity	191	0	191	99	0	99	142	0	142	163	0	163
Yuba	502	1	503	484	1	485	488	2	490	451	1	452
Total	9,771	240	10,011	9,685	229	9,914	9,840	242	10,082	9,405	206	9,611
Sacramento Area												
El Dorado	913	0	913	1,016	0	1,016	963	8	971	955	9	964
Placer	1,787	40	1,827	1,974	38	2,012	1,842	21	1,863	1,781	22	1,803
Sacramento	9,023	869	9,892	8,912	827	9,739	8,698	857	9,555	8,251	795	9,046
Yolo	1,234	6	1,240	1,201	6	1,207	1,255	4	1,259	1,182	6	1,188
Total	12,957	915	13,872	13,103	871	13,974	12,758	890	13,648	12,169	832	13,001
San Francisco Bay Area												
Alameda	11,611	1,325	12,936	10,894	1,260	12,154	10,883	1,395	12,278	10,454	1,394	11,848
Contra Costa	8,296	533	8,829	8,240	507	8,747	8,125	643	8,768	7,690	658	8,348
Marin	2,744	363	3,107	2,932	345	3,277	2,498	485	2,983	2,547	393	2,940
Napa	1,123	171	1,294	1,028	163	1,191	1,057	155	1,212	1,020	183	1,203
San Francisco	3,468	1,896	5,364	3,128	1,803	4,931	3,495	1,883	5,378	3,593	1,934	5,527
San Mateo	6,320	654	6,974	5,705	622	6,327	5,674	823	6,497	5,533	800	6,333
Santa Clara	15,188	1,477	16,665	14,425	1,405	15,830	15,353	1,386	16,739	14,465	1,462	15,927
Solano	2,543	163	2,706	2,562	155	2,717	2,581	174	2,755	2,519	160	2,679
Sonoma	3,036	451	3,487	2,994	429	3,423	3,055	411	3,466	3,039	404	3,443
Total	54,329	7,033	61,362	51,908	6,689	58,597	52,721	7,355	60,076	50,860	7,388	58,248
Northern Central Valley												
Alpine	12	0	12	0	0	0	0	0	0	7	0	7
Amador	223	0	223	197	0	197	226	0	226	193	0	193
Calaveras	323	0	323	289	0	289	293	0	293	305	0	305
Madera	566	6	572	705	6	711	574	3	577	605	1	606
Mariposa	145	2	147	107	2	109	120	1	121	136	0	136
Merced	1,787	2	1,789	1,811	2	1,813	1,556	8	1,564	1,668	11	1,679
Mono	78	0	78	94	0	94	80	0	80	88	0	88
San Joaquin	3,452	109	3,561	3,079	104	3,183	3,366	347	3,713	3,145	389	3,534
Stanislaus	3,018	222	3,240	2,594	211	2,805	2,589	226	2,815	2,611	227	2,838
Tuolumne	418	13	431	371	12	383	391	8	399	432	18	450
Total	10,022	354	10,376	9,247	337	9,584	9,195	593	9,788	9,190	646	9,836
Southern Central Valley												
Fresno	6,305	262	6,567	6,011	249	6,260	5,913	371	6,284	5,771	327	6,098
Inyo	227	0	227	216	0	216	267	0	267	231	2	233
Kern	4,429	162	4,591	4,129	154	4,283	3,907	168	4,075	3,893	141	4,034
Kings	885	26	911	863	25	888	874	25	899	843	13	856
Tulare	2,790	0	2,790	2,983	0	2,983	2,743	0	2,743	2,723	9	2,742
Total	14,636	450	15,086	14,202	428	14,630	13,704	564	14,268	13,471	492	13,963
Central Coast												
Monterey	2,490	248	2,738	2,450	236	2,686	2,427	376	2,803	2,430	365	2,795
San Benito	265	0	265	275	0	275	228	5	233	308	1	309
Santa Cruz	1,686	332	2,018	1,741	316	2,057	1,759	273	2,032	1,673	271	1,944
Total	4,441	580	5,021	4,466	552	5,018	4,414	654	5,068	4,411	637	5,048
South Coast												
San Luis Obispo	1,580	5	1,585	1,354	5	1,359	1,467	15	1,482	1,429	34	1,463
Santa Barbara	3,485	315	3,800	3,246	300	3,546	3,178	411	3,589	3,076	383	3,459
Ventura	6,321	469	6,790	6,293	446	6,739	6,217	603	6,820	6,375	607	6,982
Total	11,386	789	12,175	10,893	751	11,644	10,862	1,029	11,891	10,880	1,024	11,904
Los Angeles												
Orange	24,184	1,486	25,670	25,177	1,413	26,590	24,194	1,410	25,604	23,619	1,577	25,196
Riverside/San Bernardino												
Riverside	6,413	378	6,791	6,472	360	6,832	6,579	382	6,961	6,505	378	6,883
San Bernardino	9,306	417	9,723	9,215	397	9,612	9,383	453	9,836	9,024	544	9,568
Total	15,719	795	16,514	15,687	757	16,444	15,962	835	16,797	15,529	922	16,451
San Diego/Imperial												
Imperial	1,274	35	1,309	1,325	33	1,358	1,258	48	1,306	1,209	53	1,262
San Diego	19,472	1,108	20,580	19,054	1,054	20,108	19,259	1,323	20,582	19,135	1,517	20,652
Total	20,746	1,143	21,889	20,379	1,087	21,466	20,517	1,371	21,888	20,344	1,570	21,914
STATEWIDE TOTAL	249,217	22,307	271,524	242,172	21,220	263,392	241,343	24,581	265,924	236,897	25,097	261,994

County	1984			1985			1986			1987		
	Public	Private	Total	Public	Private	Total	Public	Private	Total	Public	Private	Total
Northern California												
Butte	1,399	10	1,409	1,422	10	1,432	1,340	6	1,346	1,443	10	1,453
Colusa	180	0	180	162	0	162	168	1	169	190	1	191
Del Norte	173	4	177	186	2	188	164	3	167	176	0	176
Glenn	263	0	263	253	0	253	236	2	238	242	3	245
Humboldt	1,010	62	1,072	941	37	978	930	45	975	1,000	48	1,048
Lake	38	0	38	408	0	408	374	0	374	410	0	410
Lassen	238	2	240	256	3	259	271	4	275	293	4	297
Mendocino	862	7	869	804	0	804	882	1	883	933	1	934
Modoc	127	8	135	115	2	117	113	0	113	109	3	112
Nevada	519	50	569	612	41	653	611	22	633	680	48	728
Plumas	229	23	252	220	27	247	217	32	249	251	0	251
Shasta	1,567	40	1,607	1,522	42	1,564	1,414	41	1,455	1,560	46	1,606
Sierra	45	0	45	54	0	54	45	0	45	41	0	41
Siskiyou	463	1	464	469	0	469	450	0	450	472	1	473
Sutter	645	30	675	607	31	638	612	15	627	662	10	672
Tehama	507	46	553	436	54	490	446	42	488	473	43	516
Trinity	150	0	150	168	1	169	217	0	217	147	0	147
Yuba	427	6	433	443	0	443	373	0	373	465	6	471
Total	9,193	289	9,482	9,078	250	9,328	8,863	214	9,077	9,547	224	9,771
Sacramento Area												
El Dorado	1,035	7	1,042	1,043	2	1,045	1,125	13	1,138	1,020	7	1,027
Placer	1,820	22	1,842	1,747	30	1,777	1,842	15	1,857	1,802	18	1,820
Sacramento	8,192	837	9,029	7,689	838	8,527	8,426	787	9,213	8,039	812	8,851
Yolo	1,078	4	1,082	1,121	6	1,127	1,066	32	1,098	1,143	5	1,148
Total	12,125	870	12,995	11,600	876	12,476	12,459	847	13,306	12,004	842	12,846
San Francisco Bay Area												
Alameda	10,372	1,378	11,750	10,106	1,380	11,486	10,821	1,245	12,066	10,421	1,322	11,743
Contra Costa	7,729	699	8,428	7,184	677	7,861	7,421	671	8,092	8,084	736	8,820
Marin	2,335	415	2,750	2,187	429	2,616	2,138	401	2,539	2,137	446	2,583
Napa	943	181	1,124	761	185	946	802	184	986	818	182	1,000
San Francisco	3,526	1,879	5,405	3,943	1,786	5,729	3,951	1,731	5,682	4,370	1,732	6,102
San Mateo	5,306	799	6,105	5,050	713	5,763	5,009	396	5,405	4,971	741	5,712
Santa Clara	14,202	1,447	15,649	13,680	1,542	15,222	13,634	1,476	15,110	14,019	1,499	15,518
Solano	2,538	169	2,707	2,491	182	2,673	2,454	82	2,536	2,688	85	2,773
Sonoma	2,942	448	3,390	2,851	364	3,215	2,961	348	3,309	3,216	369	3,585
Total	49,893	7,415	57,308	48,253	7,258	55,511	49,191	6,534	55,725	50,724	7,112	57,836
Northern Central Valley												
Alpine	0	0	0	0	0	0	0	0	0	0	0	0
Amador	230	0	230	199	0	199	275	0	275	241	0	241
Calaveras	307	0	307	293	0	293	351	0	351	346	0	346
Madera	640	1	641	676	7	683	773	1	774	886	1	887
Mariposa	140	0	140	162	0	162	135	0	135	117	0	117
Merced	1,712	5	1,717	1,785	7	1,792	1,828	3	1,831	1,929	6	1,935
Mono	80	1	81	59	0	59	84	1	85	78	1	79
San Joaquin	3,310	352	3,662	3,264	337	3,601	3,566	327	3,893	3,661	275	3,936
Stanislaus	2,654	155	2,849	2,572	234	2,806	2,751	130	2,881	2,997	201	3,198
Tuolumne	394	18	412	377	16	393	426	21	447	403	20	423
Total	9,467	572	10,039	9,387	601	9,988	10,189	483	10,672	10,658	504	11,162
Southern Central Valley												
Fresno	5,796	365	6,161	5,589	330	5,919	5,540	328	5,868	5,667	322	5,989
Inyo	242	2	244	201	0	201	215	4	219	232	4	236
Kern	3,724	191	3,915	3,904	175	4,079	3,984	187	4,171	4,426	206	4,632
Kings	827	16	843	833	19	852	813	21	834	809	28	837
Tulare	2,792	2	2,794	2,694	5	2,699	2,795	21	2,816	3,009	27	3,036
Total	13,381	576	13,957	13,221	529	13,750	13,347	561	13,908	14,143	587	14,730
Central Coast												
Monterey	2,357	385	2,742	2,320	391	2,711	2,360	301	2,661	2,376	399	2,775
San Benito	274	3	277	306	0	306	298	8	306	337	1	338
Santa Cruz	1,638	270	1,908	1,664	245	1,909	1,712	250	1,962	1,810	256	2,066
Total	4,269	658	4,927	4,290	636	4,926	4,370	559	4,929	4,523	656	5,179
South Coast												
San Luis Obispo	1,466	35	1,501	1,290	27	1,317	1,415	30	1,445	1,568	85	1,653
Santa Barbara	1,914	449	3,363	2,654	485	3,139	2,785	353	3,138	2,934	404	3,338
Ventura	6,088	626	6,714	6,059	609	6,668	6,143	543	6,686	6,626	650	7,276
Total	10,468	1,110	11,578	10,003	1,121	11,124	10,343	926	11,269	11,128	1,139	12,267
Los Angeles												
Los Angeles	65,319	9,894	75,213	62,621	10,099	72,720	63,207	9,215	72,422	65,035	10,346	75,381
Orange	22,597	1,647	24,244	22,275	1,681	23,956	21,722	1,566	23,288	22,869	1,736	24,605
Riverside/San Bernardino												
Riverside	6,700	404	7,104	6,478	415	6,893	6,718	373	7,091	7,047	471	7,518
San Bernardino	9,275	427	9,702	9,114	431	9,545	9,102	430	9,532	9,561	455	10,016
Total	15,975	831	16,806	15,592	846	16,438	15,820	803	16,623	16,608	926	17,534
San Diego/Imperial												
Imperial	1,270	53	1,323	1,305	50	1,355	1,275	46	1,321	1,256	51	1,307
San Diego	18,242	1,519	19,761	17,823	1,748	19,571	18,240	1,370	19,610	18,919	1,384	20,303
Total	19,512	1,572	21,084	19,128	1,798	20,926	19,515	1,416	20,931	20,175	1,435	21,610
STATEWIDE TOTAL	232,199	25,434	257,633	225,448	25,695	251,143	229,026	23,124	252,150	237,414	25,507	262,921

County	1988			1989			1990			1991		
	Public	Private	Total	Public	Private	Total	Public	Private	Total	Public	Private	Total
Northern California												
Butte	1,471	10	1,431	1,492	21	1,513	1,452	28	1,480			
Colusa	184	0	184	215	3	218	214	0	214			
Del Norte	188	0	188	201	0	201	200	0	200			
Glenn	289	0	289	257	0	257	267	0	267			
Humboldt	1,059	44	1,103	1,035	17	1,082	886	40	926			
Lake	474	0	474	422	0	422	448	3	451			
Lassen	302	10	312	257	1	258	266	6	272			
Mendocino	1,003	2	1,005	903	3	906	921	4	925			
Modoc	94	0	94	95	2	97	102	0	102			
Nevada	727	46	773	667	23	690	665	22	687			
Plumas	240	0	240	248	0	248	214	0	214			
Shasta	1,605	70	1,675	1,538	65	1,603	1,435	93	1,528			
Sierra	53	0	53	39	0	39	41	0	41			
Siskiyou	482	3	485	486	1	487	399	0	399			
Sutter	669	29	698	687	18	705	627	18	645			
Tehama	469	36	505	452	24	476	451	28	479			
Trinity	173	0	173	147	1	148	184	0	184			
Yuba	448	0	448	511	0	511	465	0	465			
Total	9,880	250	10,130	9,652	209	9,861	9,237	242	9,479			
Sacramento Area												
El Dorado	1,207	6	1,213	1,134	5	1,139	1,113	6	1,119			
Placer	1,851	7	1,858	1,885	11	1,896	1,780	12	1,792			
Sacramento	8,665	805	9,470	8,501	808	9,309	8,127	676	8,803			
Yuba	1,115	2	1,117	1,078	2	1,080	1,088	4	1,092			
Total	12,838	820	13,658	12,598	826	13,424	12,108	698	12,806			
San Francisco Bay Area												
Alameda	11,171	1,246	12,417	10,477	1,229	11,706	9,724	1,123	10,847			
Contra Costa	8,375	710	9,085	7,926	640	8,566	7,363	599	7,962			
Marin	2,159	438	2,597	1,992	399	2,391	1,687	411	2,098			
Napa	884	170	1,054	920	163	1,083	802	151	953			
San Francisco	4,045	1,400	5,445	3,602	1,620	5,222	4,757	1,381	6,138			
San Mateo	5,132	757	5,889	4,800	703	5,503	4,345	686	5,031			
Santa Clara	14,168	1,542	15,710	13,727	1,486	15,213	12,543	1,371	13,914			
Solano	2,928	175	3,103	2,986	165	3,151	2,880	161	3,041			
Sonoma	3,261	448	3,709	3,265	393	3,658	2,961	366	3,327			
Total	52,123	6,886	59,009	49,695	6,798	56,493	47,087	6,249	53,336			
Northern Central Valley												
Alpine	0	0	0	0	0	0	0	0	0			
Amador	268	0	268	270	0	270	241	0	241			
Calaveras	377	0	377	379	0	379	372	0	372			
Madera	883	4	887	900	0	900	978	3	981			
Mariposa	135	0	135	143	0	143	122	1	123			
Merced	1,852	8	1,860	1,965	6	1,971	2,027	11	2,038			
Mono	81	1	82	80	1	81	60	1	61			
San Joaquin	4,033	314	4,347	4,252	269	4,521	3,988	264	4,252			
Stanislaus	3,068	219	3,287	3,597	201	3,798	3,366	170	3,536			
Tuolumne	461	12	473	474	21	495	435	16	451			
Total	11,158	558	11,716	12,123	498	12,621	11,589	466	12,055			
Southern Central Valley												
Fresno	6,159	333	6,492	6,182	261	6,443	5,997	281	6,278			
Inyo	249	3	252	230	3	233	209	2	211			
Kern	4,870	198	5,068	5,241	173	5,414	5,132	179	5,311			
Kings	888	25	913	902	25	927	935	22	957			
Tulare	3,173	12	3,185	3,243	20	3,263	2,997	22	3,019			
Total	15,339	571	15,910	15,798	482	16,280	15,270	506	15,776			
Central Coast												
Monterey	2,639	425	3,064	2,518	386	2,904	2,563	408	2,971			
San Benito	349	5	354	365	0	365	295	3	298			
Santa Cruz	1,992	210	2,202	1,850	200	2,050	1,820	207	2,027			
Total	4,980	640	5,620	4,733	586	5,319	4,678	618	5,296			
South Coast												
San Luis Obispo	1,524	59	1,583	1,622	56	1,678	1,453	48	1,501			
Santa Barbara	3,116	363	3,479	2,917	365	3,282	2,663	320	2,983			
Ventura	7,090	639	7,729	6,975	638	7,613	6,361	619	6,980			
Total	11,730	1,061	12,791	11,514	1,059	12,573	10,477	987	11,464			
Los Angeles												
Orange	2,183	1,702	25,885	23,119	1,652	24,771	21,513	1,480	22,993			
Riverside/San Bernardino												
Riverside	7,309	299	8,108	8,189	383	8,572	8,265	353	8,618			
San Bernardino	10,451	479	10,930	11,131	499	11,630	11,235	447	11,682			
Total	18,260	778	19,038	19,320	882	20,202	19,500	800	20,300			
San Diego/Imperial												
Imperial	1,324	56	1,380	1,494	52	1,546	1,569	67	1,636			
San Diego	20,575	1,442	22,017	20,158	1,345	21,503	19,660	1,385	21,045			
Total	21,899	1,498	23,397	21,652	1,397	23,049	21,229	1,452	22,681			
STATEWIDE TOTAL	249,518	25,294	274,812	244,625	24,358	268,983	236,034	22,915	258,949			

A - F Completion Rate of High School Graduates by County and by Region
1985-86 Through 1990-91

Region	County	1985-86			1986-87			1987-88		
		Total Graduates	Total A-F Completions	Percent	Total Graduates	Total A-F Completions	Percent	Total Graduates	Total A-F Completions	Percent
3	Alameda	10,106	2,217	21.9	10,821	2,359	21.8	10,421	2,974	28.5
4	Alpine	0	0	0.0	0	0	0.0	0	0	0.0
4	Amador	199	41	20.6	275	46	16.7	241	56	23.2
1	Butte	1,422	244	17.2	1,340	285	21.3	1,443	363	25.2
4	Calaveras	293	50	17.1	351	55	15.7	346	61	17.6
1	Colusa	162	46	28.4	168	29	17.3	190	32	16.8
3	Contra Costa	7,184	2,254	31.4	7,421	2,170	29.2	8,084	2,575	31.9
1	Del Norte	186	27	14.5	164	16	9.8	176	9	5.1
2	El Dorado	1,043	320	30.7	1,125	257	22.8	1,020	268	26.3
5	Fresno	5,589	1,261	22.6	5,540	1,374	24.8	5,667	1,338	23.6
1	Glenn	253	36	14.2	236	37	15.7	242	50	20.7
1	Humboldt	941	101	10.7	930	196	21.1	1,000	223	22.3
11	Imperial	1,305	199	15.2	1,275	280	22.0	1,256	200	15.9
5	Inyo	201	105	52.2	215	87	40.5	232	105	45.3
5	Kern	3,904	720	18.4	3,984	698	17.5	4,426	997	22.5
5	Kings	833	118	14.2	813	140	17.2	809	121	15.0
1	Lake	408	48	11.8	374	68	18.2	410	98	23.9
1	Lassen	256	38	14.8	271	62	22.9	293	89	30.4
8	Los Angeles	62,621	15,650	25.0	63,207	17,203	27.2	65,035	18,447	28.4
4	Madera	676	146	21.6	773	171	22.1	886	122	13.8
3	Marin	2,187	787	36.0	2,138	746	34.9	2,137	857	40.1
4	Mariposa	162	37	22.8	135	27	20.0	117	19	16.2
1	Mendocino	804	141	17.5	882	139	15.8	933	210	22.5
4	Merced	1,785	191	10.7	1,828	260	14.2	1,929	169	8.8
1	Modoc	115	24	20.9	113	13	11.5	109	30	27.5
4	Mono	59	12	20.3	84	35	41.7	78	33	42.3
6	Monterey	2,320	466	20.1	2,360	502	21.3	2,376	464	19.5
3	Napa	761	256	33.6	802	173	21.6	818	184	22.5
1	Nevada	612	184	30.1	611	174	28.5	680	170	25.0
9	Orange	22,275	6,387	28.7	21,722	7,023	32.3	22,869	8,096	35.4
2	Placer	1,747	600	34.3	1,842	503	27.3	1,802	537	29.8
1	Plumas	220	35	15.9	217	71	32.7	251	71	28.3
10	Riverside	6,478	1,359	21.0	6,718	1,335	19.9	7,047	1,422	20.2
2	Sacramento	7,689	2,257	29.4	8,426	2,012	23.9	8,039	1,927	24.0
6	San Benito	306	64	20.9	298	115	38.6	337	74	22.0
10	San Bernardino	9,114	1,954	21.4	9,102	1,588	17.4	9,561	1,904	19.9
11	San Diego	17,823	4,546	25.5	18,240	4,797	26.3	18,919	5,748	30.4
3	San Francisco	3,943	1,321	33.5	3,951	1,401	35.5	4,370	1,647	37.7
4	San Joaquin	3,264	530	16.2	3,566	721	20.2	3,661	712	19.4
7	San Luis Obispo	1,290	250	19.4	1,415	320	22.6	1,568	342	21.8
3	San Mateo	5,050	1,600	31.7	5,009	1,433	28.6	4,971	1,451	29.2
7	Santa Barbara	2,654	709	26.7	2,785	746	26.8	2,934	774	26.4
3	Santa Clara	13,680	4,307	31.5	13,634	3,980	29.2	14,019	4,770	34.0
6	Santa Cruz	1,664	575	34.6	1,712	548	32.0	1,810	681	37.6
1	Shasta	1,522	386	25.4	1,414	401	28.4	1,560	472	30.3
1	Sierra	54	17	31.5	45	12	26.7	41	19	46.3
1	Siskiyou	469	89	19.0	450	83	18.4	472	105	22.2
3	Solano	2,491	508	20.4	2,454	603	24.6	2,688	605	22.5
3	Sonoma	2,851	457	16.0	2,961	339	11.4	3,216	907	28.2
4	Stanislaus	2,572	639	24.8	2,751	800	29.1	2,997	800	26.7
1	Sutter	607	132	21.7	612	155	25.3	662	176	26.6
1	Tehama	436	66	15.1	446	85	19.1	473	84	17.8
1	Trinity	168	12	7.1	217	30	13.8	147	32	21.8
5	Tulare	1,694	580	34.2	2,795	543	19.4	3,009	671	22.3
4	Tuolumne	377	93	24.7	426	77	18.1	403	74	18.4
7	Ventura	6,059	1,612	26.6	6,143	1,824	29.7	6,626	1,942	29.3
2	Yolo	1,121	325	29.0	1,066	327	30.7	1,143	411	36.0
1	Yuba	443	47	10.6	373	48	12.9	465	48	10.3
STATE TOTAL		224,448	57,176	25.5	229,026	59,522	26.0	237,414	66,766	28.1

A - F Completion Rate of High School Graduates by County and by Region
1985-86 Through 1990-91

Region	County	1988-89			1989-90			1990-91		
		Total Graduates	Total A-F Completions	Percent	Total Graduates	Total A-F Completions	Percent	Total Graduates	Total A-F Completions	Percent
3	Alameda	11,171	3,045	27.3	10,472	3,401	33.3	9,724	3,316	34.1
4	Alpine		0	0.0	0	0	0.0	0	0	0.0
4	Amador		62	23.1	270	28	10.4	241	25	10.4
1	Butte		410	28.9	1,492	370	24.8	1,452	374	25.8
4	Calaveras		71	18.8	379	71	18.7	372	58	15.6
1	Colusa		48	26.1	215	39	18.1	214	49	22.9
3	Contra Costa	8,375	2,787	33.3	7,926	3,018	38.1	7,388	2,587	35.0
1	Del Norte	188	28	14.9	201	26	12.9	200	21	10.5
2	El Dorado	1,207	335	27.8	1,134	351	31.0	1,113	341	30.6
5	Fresno	6,159	1,731	28.1	6,182	1,711	27.7	5,997	1,768	29.5
1	Glenn	289	54	18.7	257	55	21.4	267	60	22.5
1	Humboldt	1,059	204	19.3	1,035	217	21.0	886	200	22.6
11	Imperial	1,324	211	15.9	1,494	269	18.0	1,569	332	21.2
5	Inyo	249	109	43.8	230	63	27.4	209	82	39.2
5	Kern	4,870	1,754	36.0	5,241	1,114	21.3	5,132	1,243	24.2
5	Kings	888	187	21.1	902	187	20.7	935	181	19.4
1	Lake	474	76	16.0	422	128	30.3	448	108	24.1
1	Lassen	302	69	22.8	257	45	17.5	266	68	25.6
8	Los Angeles	67,128	21,820	32.5	64,425	21,104	32.8	63,346	20,646	32.6
4	Madera	883	249	28.2	963	231	24.0	978	228	23.3
3	Marin	2,159	974	45.1	1,992	897	45.0	1,687	776	46.0
4	Mariposa	135	11	8.1	143	31	21.7	122	27	22.1
1	Mendocino	1,003	254	25.3	903	217	24.0	921	194	21.1
4	Merced	1,852	219	11.8	1,965	236	12.0	2,027	296	14.6
1	Modoc	94	25	26.6	95	16	16.8	102	15	14.7
4	Mono	81	33	40.7	80	39	48.8	60	26	43.3
6	Monterey	2,639	607	23.0	2,518	600	23.8	2,563	664	25.9
3	Napa	884	206	23.3	920	189	20.5	802	246	30.7
1	Nevada	727	166	22.8	667	213	31.9	665	218	32.8
9	Orange	24,183	8,403	34.7	23,119	8,076	34.9	21,513	8,107	37.7
2	Placer	1,851	638	34.5	1,885	555	29.4	1,780	461	25.9
1	Plumas	240	62	25.8	248	61	24.6	214	63	29.4
10	Riverside	7,809	1,582	20.3	8,189	2,173	26.5	8,265	2,155	26.1
2	Sacramento	8,665	2,170	25.0	8,501	2,068	24.3	8,127	2,306	28.4
6	San Benito	349	109	31.2	365	123	33.7	295	77	26.1
10	San Bernardino	10,451	2,532	24.2	11,131	3,012	27.1	11,235	2,748	24.5
11	San Diego	20,575	6,347	30.8	20,158	6,717	33.3	19,660	6,600	33.6
3	San Francisco	4,045	1,758	43.5	3,602	1,613	44.8	4,757	1,962	41.2
4	San Joaquin	4,033	654	16.2	4,252	734	17.3	3,988	773	19.4
7	San Luis Obispo	1,524	497	32.6	1,622	405	25.0	1,453	401	27.6
3	San Mateo	5,132	1,704	33.2	4,800	1,648	34.3	4,345	1,702	39.2
7	Santa Barbara	3,116	863	27.7	2,917	865	29.7	2,663	805	30.2
3	Santa Clara	14,168	5,267	37.2	13,727	4,660	33.9	12,543	4,827	38.5
6	Santa Cruz	1,992	735	36.9	1,850	638	34.5	1,820	565	31.0
1	Shasta	1,605	448	27.9	1,538	473	30.8	1,435	369	25.7
1	Sierra	53	17	32.1	39	9	23.1	41	16	39.0
1	Siskiyou	482	100	20.7	486	115	23.7	399	86	21.6
3	Solano	2,928	618	21.1	2,986	689	23.1	2,880	672	23.3
3	Sonoma	3,261	919	28.2	3,265	937	28.7	2,961	863	29.1
4	Stanislaus	3,068	699	22.8	3,597	818	22.7	3,366	806	23.9
1	Sutter	669	171	25.6	687	166	24.2	627	145	23.1
1	Tehama	469	66	14.1	452	89	19.7	451	66	14.6
1	Trinity	173	38	22.0	147	41	27.9	184	40	21.7
5	Tulare	3,173	590	18.6	3,243	626	19.3	2,997	674	22.5
4	Tuolumne	46	111	24.1	474	78	16.5	435	103	23.7
7	Ventura	7,090	2,204	31.1	6,975	2,148	30.8	6,361	2,087	32.8
2	Yolo	1,115	384	34.4	1,078	391	36.3	1,088	399	36.7
1	Yuba	418	61	13.6	511	82	16.0	465	71	15.3
STATE TOTAL		249,518	75,492	30.3	244,624	74,966	30.6	236,034	74,098	31.4

CALIFORNIA POSTSECONDARY EDUCATION COMMISSION

THE California Postsecondary Education Commission is a citizen board established in 1974 by the Legislature and Governor to coordinate the efforts of California's colleges and universities and to provide independent, non-partisan policy analysis and recommendations to the Governor and Legislature.

Members of the Commission

The Commission consists of 17 members. Nine represent the general public, with three each appointed for six-year terms by the Governor, the Senate Rules Committee, and the Speaker of the Assembly. Six others represent the major segments of postsecondary education in California. Two student members will be appointed by the Governor.

As of January 1992, the Commissioners representing the general public are:

Helen Z. Hansen, Long Beach; *Chair*
Henry Der, San Francisco; *Vice Chair*
Mim Andelson, Los Angeles
C. Thomæ; Dean, Long Beach
Rosalind K. Goddard, Los Angeles
Mari-Luci Jaramillo, Emeryville
Lowell J. Paige, El Macero
Mike Roos, Los Angeles
Stephen P. Teale, M.D., Modesto

Representatives of the segments are:

William T. Bagley, San Francisco; appointed by the Regents of the University of California;

Joseph D. Carrabino, Los Angeles; appointed by the California State Board of Education;

Timothy P. Haidinger, Rancho Santa Fe; appointed by the Board of Governors of the California Community Colleges;

Ted J. Saenger, San Francisco; appointed by the Trustees of the California State University; and

Harry Wugalter, Ventura; appointed by the Council for Private Postsecondary and Vocational Education.

The position of representative of California's independent colleges and universities is currently vacant, as are those of the two student representatives.

Functions of the Commission

The Commission is charged by the Legislature and Governor to "assure the effective utilization of public postsecondary education resources, thereby eliminating waste and unnecessary duplication, and to promote diversity, innovation, and responsiveness to student and societal needs."

To this end, the Commission conducts independent reviews of matters affecting the 2,600 institutions of postsecondary education in California, including community colleges, four-year colleges, universities, and professional and occupational schools.

As an advisory body to the Legislature and Governor, the Commission does not govern or administer any institutions, nor does it approve, authorize, or accredit any of them. Instead, it performs its specific duties of planning, evaluation, and coordination by cooperating with other State agencies and non-governmental groups that perform those other governing, administrative, and assessment functions.

Operation of the Commission

The Commission holds regular meetings throughout the year at which it debates and takes action on staff studies and takes positions on proposed legislation affecting education beyond the high school in California. By law, its meetings are open to the public. Requests to speak at a meeting may be made by writing the Commission in advance or by submitting a request before the start of the meeting.

The Commission's day-to-day work is carried out by its staff in Sacramento, under the guidance of its executive director, Warren H. Fox, Ph.D., who is appointed by the Commission.

The Commission issues some 20 to 30 reports each year on major issues confronting California postsecondary education, and it makes these publications available without charge while supplies last.

Further information about the Commission and its publications may be obtained from the Commission offices at 1303 J Street, Fifth Floor, Sacramento, CA 98514-2938; telephone (916) 445-7933.

STUDENT PROFILES, 1991

California Postsecondary Education Commission Report 92-10

Student Profiles, 1992

ONE of a series of reports published by the Commission as part of its planning and coordinating responsibilities. Additional copies may be obtained without charge from the Publications Office, California Postsecondary Education Commission, Third Floor, 1020 Twelfth Street, Sacramento, California 95814-3985.

Recent reports of the Commission include:

91-13 California's Capacity to Prepare Registered Nurses: A Preliminary Inquiry Prepared for the Legislature in Response to Assembly Bill 1055 (Chapter 924, Statutes of 1990) (September 1991)

91-14 Supplemental Report on Academic Salaries, 1990-91: A Report to the Governor and Legislature in Response to Senate Concurrent Resolution No. 51 (1965) and Supplemental Language to the 1979, 1981, and 1990 Budget Acts (September 1991)

91-15 Approval of Las Positas College in Livermore: A Report to the Governor and Legislature on the Development of Las Positas College -- Formerly the Livermore Education Center of Chabot College (September 1991)

91-16 Update on Long-Range Planning Activities: Report of the Executive Director, September 16, 1991 (September 1991)

91-17 The Role, Structure, and Operation of the Commission: A Preliminary Response to Senate Bill 2374 (October 1991)

91-18 1991-92 Plan of Work for the California Postsecondary Education Commission: Major Studies and Other Commission Activities (October 1991)

91-19 Reauthorization of the Higher Education Act of 1965 as Amended: A Report to California's Congressional Delegation Summarizing Consensus in California's Higher Education Community Regarding Proposed Revisions of the Act (December 1991)

91-20 Student Fees, Access, and Quality: Prospects and Issues for the 1992-93 Budget Process (December 1991)

91-21 Legislative and State Budget Priorities of the Commission, 1992: A Report of the California Postsecondary Education Commission (December 1991)

91-22 Proposed Construction of the Western Nevada County Center, Sierra Joint Community College District: A Report to the Governor and Legislature in Response to a Request for Capital Funds for a Permanent Off-Campus Center in the Grass Valley/Nevada City Area (December 1991)

92-1 Final Report on the Effectiveness of Intersegmental Student Preparation Programs: The Third Report to the Legislature in Response to Item 6420-0011-001 of the 1988-89 Budget Act (January 1992)

92-2 Assessing Campus Climate: Feasibility of Developing an Educational Equity Assessment System (January 1992)

92-3 California's Joint Doctoral Programs: A Report on Doctoral Programs Offered by Campuses of the California State University with Campuses of the University of California and the Claremont Graduate School (January 1992)

92-4 Prospects for Long-Range Capital Planning in California Public Higher Education: A Preliminary Review. A Staff Report to the California Postsecondary Education Commission (January 1992)

92-5 Current Methods and Future Prospects for Funding California Public Higher Education: The First in A Series of Reports on Funding California's Colleges and Universities into the Twenty-First Century (March 1992)

92-6 Commission Comments on the Systems' Preliminary Funding Gap Reports: A Report to the Legislature and the Governor in Response to Supplemental Report Language of the 1991 Budget Act (March 1992)

92-7 Analyses of Options and Alternatives for California Higher Education: Comments by the Staff of the California Postsecondary Education Commission on Current Proposals for Change in California's Public Colleges and Universities (March 1992)

92-8 Faculty Salaries in California's Public Universities, 1992-93: A Report to the Legislature and Governor in Response to Senate Concurrent Resolution No. 51 (1965) (March 1992)

92-9 Fiscal Profiles, 1992: The Second in a Series of Handbooks about the Financing of California Postsecondary Education (March 1992)

92-10 Student Profiles, 1991: The Second in a Series of Annual Factbooks About Student Participation in California Higher Education (March 1992)

92-11 Meeting the Educational Needs of the New Californians: A Report to Governor Wilson and the California Legislature in Response to Assembly Concurrent Resolution 128 (1990) (March 1992)

92-12 Analysis of the 1992-93 Governor's Budget: A Staff Report to the California Postsecondary Education Commission (March 1992)

Report 92-10