

ED 346 255

CE 061 257

AUTHOR Copeland, Scott
 TITLE Columbia/Willamette Skill Builders Consortium. Final Performance Report. Appendix 5A: Oregon Cutting Systems and Warn Industries, Inc. Basic Math/Shop Math and Computer Basics. Instructors' Reports and Sample Curriculum Materials.

INSTITUTION Clackamas Community Coll., Oregon City, Oreg.
 SPONS AGENCY Office of Vocational and Adult Education (ED), Washington, DC. National Workplace Literacy Program.

PUB DATE 30 Jan 92
 CONTRACT V198A00158-90
 NOTE 336p.; For final report, see CE 061 256. Handwritten evaluations may not reproduce well.

PUB TYPE Reports - Descriptive (141) -- Guides - Classroom Use - Teaching Guides (For Teacher) (052)

EDRS PRICE MF01/PC14 Plus Postage.
 DESCRIPTORS Adult Basic Education; Adult Literacy; Community Colleges; *Computer Literacy; Cooperative Programs; Curriculum Development; Educational Cooperation; *Inplant Programs; Labor Force Development; *Literacy Education; Manufacturing Industry; *Mathematics Instruction; Needs Assessment; Participant Satisfaction; Program Development; Program Evaluation; *Program Implementation; School Business Relationship; Student Recruitment; Two Year Colleges

IDENTIFIERS Oregon; *Workplace Literacy

ABSTRACT

Workplace literacy projects were established at Warn Industries, a winch and hubcap maker, and Oregon Cutting Systems (OCS), a producer of cutting edges supplying the timber industry by Clackamas Community College (Oregon). At Warn, project staff developed functional context materials, delivered instruction to a math class, and implemented a basic computer class. At OCS, staff taught basic math and basic computer classes. The best recruitment ideas at OCS were a combination of offering a popular subject, keeping the class to 9 hours, and providing enough information so that people could screen themselves in and out. The combination of paying the employees to take classes and paying them for improved skills motivated Warn employees. (Other contents of the report include demographic data, sample workplace literacy audit forms, pre-post-test summaries and samples, and completed participant evaluation forms. Part 2 of this report contains the curricula. The OCS and Warn math class curriculum contains problems and exercises. Separate curricula are provided for the OCS and Warn computer basics classes. Both are in a programmed note package format.) (YLB)

 * Reproductions supplied by EDRS are the best that can be made *
 * from the original document. *

ED 346 255

THE COLUMBIA-WILLAMETTE SKILL BUILDERS CONSORTIUM

National Workplace Literacy Program (84.198)
U.S. Department of Education

FINAL PERFORMANCE REPORT

Submitted by
Portland Community College
12000 S.W. 49th Avenue
Portland, Oregon 97219

APPENDIX V. Instructors' Reports and Sample Curriculum Materials

A. Clackamas Community College:

Oregon Cutting Systems - Scott Copeland

Basic Math
Computer Basics

Warn Industries, Inc. - Scott Copeland

Shop Math
Computer Basics

U.S. DEPARTMENT OF EDUCATION
Office of Educational Research and Improvement
EDUCATIONAL RESOURCES INFORMATION
CENTER (ERIC)

This document has been reproduced as received from the person or organization originating it.

Minor changes have been made to improve reproduction quality.

Points of view or opinions stated in this document do not necessarily represent official OERI position or policy.

CFE 061 257

COLUMBIA/WILLAMETTE SKILLBUILDERS

GRANT REPORT

CLACKAMAS COMMUNITY COLLEGE

PART ONE:

INTRODUCTION
DEMOGRAPHICS
RECRUITMENT
ASSESSMENT
EVALUATION

**Clackamas Community College
19600 S Molalla Ave
Oregon City, Oregon 97045**

**Helen Humphreys, Coordinator
Scott Copeland, Instructor
January 30, 1992**

for the

Columbia/Willamette Skillbuilders Consortium

**cc: Steve Reder, Northwest Regional Education Laboratory
Dian Connett, Dean of Student Services, CCC
Gale Long for ODONS, Oregon Cutting Systems
Toni McConnell, Warn Industries
Helen Humphreys, coordinator
Scott Copeland, instructor**

INTRODUCTION

*

A SHORT HISTORY OF THREE WORKPLACE LITERACY PROJECTS: LOSING AND GAINING BUSINESS PARTNERS.

Our first business partner was the local giant Precision Cast Parts Company which makes parts for the Challenger nose cone and Boeing airplane parts among other products. We had the enthusiastic support from the company president and the manager of human relations to set a literacy project in their Titanium plant. They knew exactly what department they wanted us to work with. Helen Humphreys and Mary Craven spent three days doing a basic skills audit including twelve interviews with workers. The team leader of the production line was behind the project and wanted to help as much as he could. We were invigorated by the scope and importance of the basic skills problem.

The company had a production and safety problem having to do with the inability of the production line workers to do the math ratio and proportions necessary to change the pH in acid baths. The production line where this was happening was a small but important link in production. Also errors in calculations could result in faulty product and in environmental and personal safety issues.

despite the perfect workplace literacy scenario, we were not able to set up even one class. We were stonewalled: we would set up meetings that managers didn't come to, we didn't get return calls, we couldn't get a classroom reserved. What happened? We can only speculate, but during this time the company was assessed a huge fine for environmental pollution, and our production line may have been involved. Also during this period every manager in the company was reassigned or let go. We lost our sympathetic HR manager one day before the project was to start. The new HR manager not only was in the dark about the project, but she had neither time or knowledge to supervise it. The company president still voiced support of the idea, but we finally came to an understanding with him that can be summarized as "maybe next time."

The impact of losing Precision Cast Parts eight months into the project was sickening but not fatal. We not only lost the project but also we lost two of the three college faculty initially interested in workplace literacy; they were disheartened and went on to greener pastures. We had also endured some criticism from our customized contracts department (EMD). EMD had arranged many management training projects for Precision Cast Parts and felt we were offering a service for free that they could charge for.

Luckily, I had a contact at an interesting, small company less than two miles from our learning lab. Warn Industries, a winch and hubcap maker was already interested in workplace literacy. The short version of our relationship was that we

officially pulled out of Precision Cast Parts on a Wednesday, I contacted Warn's HR manager on Friday and we started classes Tuesday. We have had a warm and mutually beneficial relationship with Warn and its employees for the balance of the project. In fact, Warn hired our workplace literacy instructor as a full time employee!

In the meantime, Oregon Cutting Systems had agreed to be our second business partner. They are an international company producing cutting edges for all kinds of industries but in Oregon they specialize in supplying the timber industry. Our education laboratory (Targeted Learning Center) had a long relationship with OCS. We had found OCS to be interested in the education of all its employees. They even had a quality circle (ODONS) whose special interest was employee education. ODONS wanted to set up a miniature Targeted Learning Center at OCS for the purpose of reaching people with the lowest literacy levels in a format that would neither frighten nor jeopardize their jobs. We surveyed the population for educational interest with excellent response. We found a significant number of responses from the population were targeting but getting them to come to a class held on the work site was a different story. The people who were low in reading and math or who wanted to get a GED would come to Targeted Learning Center with its relative anonymity, but they would not come to classes or tutoring at their worksite. Even writing and business English classes didn't draw enough people to justify continuing. Our most enthusiastic response was for computer basics, including keyboarding. OCS is a very computer oriented company but most of their inhouse training is for higher applications. Evidently, there was a layer of people who needed some help jumping in to the computer world. Our relationship with the ODONS committee has been pleasant and stimulating. They have never lost sight of their vision nor lost their compassion and concern for those peers who work under the handicap of illiteracy.

Teacher Narrative: Warn Shop Math

Initial Contact:

Warn had begun a math class for the basic skills learner prior to our involvement. We convinced them that, with the aid of the grant, we could develop functional context materials for the class and deliver instruction. They were eager to do this.

Development:

Initially 30 hours were spent performing literacy task analysis on math tasks performed in the plant. Later, 10 hours were spent surveying needs and prioritizing instructional objectives. Throughout the project, another 20 hours was spent in task analysis and needs assessment activity. Curriculum development took approximately 120 hours. Development of pre-tests/ post-tests and administrative tasks took about 30 hours initially and weekly administrative and individual consultation averaged 3 to 5 hours per week.

Delivery of Instruction:

I took over the class immediately and incorporated the new materials as soon as they were ready. The class meets for 1 hour, two times per week. Class activities involve discussion of skill applications on the job, worksheets modeled after actual tasks and on-one-one or small group demonstrations of the skills. The course is open exit and most workers finish after about 20 hours of instruction. The post-test scores are quite high.

The typical learner either has forgotten math skills learned in school or never really understood the concepts and how math relates to on-the-job problem solving.

Evaluation:

Response has been very favorable (see evaluation comments). One problem has arisen in that some employees do not expect to be cross-trained to the extent that we expected when selecting the critical tasks. We plan to develop another class for the "non-shop" worker this year.

Many students have praised the class as being easy and practical. Supervisor response has been positive as well.

Teacher Narrative: Warn Basic Computer

Initial Contact:

The company expressed concerns that many workers were intimidated by computers and wished to see a basic skills class taught on computers. Initially, it seemed that many workers would soon be asked to perform tasks on PC's and the Novell network. The goal of instruction was to make employees more comfortable around computers and more fluent with the concepts and terminology.

Development:

I spent 20 hours with personnel that were newly competent on PC's and the network. I spent 10 hours with the companies trainers and information services people. Several task analysis were conducted and a list of competencies were developed. From this list, a 16 hour curriculum was developed (approx. 80 hours). A screening system with a pretest was devised to allow the classes to have a homogenous level of knowledge and skills. The company took over the screening process and did not pay attention to knowledge levels or needs when assigning workers to the class. Seven laptop computers were set up for class and take home

work.

Delivery of Instruction:

The classes met for 1 hour twice a week for an average of 16 hours of class time. Many students stayed after to ask specific questions related to problems they were working on. An extra session was set up for workers who missed too many classes to keep up. For four weeks, a group of 4 workers came to a class to work on applications they were using for work tasks.

The sessions began with a discussion of vocabulary and whenever possible, an application of the vocabulary or concept was done on the laptops. Each worker was involved in a project on a word processor or spreadsheet. The company's logistical limitations precluded the desired time on the network and their mainframe system (AMAPS). Not being able to access these two systems was a disappointment to many students (see the evaluations). But several classes did deal with the concepts and ideas behind the systems.

Evaluation:

In many classes, workers shared laptops and worked together on projects. For the initially intimidated, this worked well, they were never alone. For the more competent user, having to share a computer was viewed as a negative aspect of the class. These workers also felt the course was "too basic." Had the initial screening process been utilized these problems would have been averted.

A post test was conducted with the group of workers who were the initial target of the course (little or no computer knowledge/skill). The pre/post progress and comments on the evaluations indicate that our objective was met. A group of workers is now more comfortable around computers and has a significant grasp of the terminology and concepts involved.

Teacher Narrative: OCS Basic Computer

Initial Contact:

Initial interest in some other basic skills courses was sagging at OCS. The idea of doing a basic computer course was due in part to earlier success with the class a Warn. A gap existed in OCS's computer training system that involved some basic computer skills and keyboard ability. Before one can progress in computer training at OCS, they must type 15 wpm or faster. Discussions with several of their

in-house trainers also indicated a need for students to possess a more complete understanding of the concepts and terminology used with PC's.

Development:

An audit was conducted with four In-house Instructors and two students who had gone through some courses and became competent with computers on the job. Each Interview yielded a list of competencies that a basic computer course at OCS should address. This information was used to develop a curriculum which included time spent with vocabulary and on the computers with a spreadsheet and word processor. Time and Instruction in keyboarding was also provided.

Delivery:

Each session involved discussion and hands on participation. Several projects were used to give the students a chance to work with the applications. The company provided PC's in a lab with a datavue. It was a wonderful instructional environment. An assistant was utilized to allow as much one-on-one as possible. The course was brief, 9 hours, but indications are that many of the students will be enrolling in more courses in early '92.

Evaluation:

Two survey formats were used (see evaluations). Both indicated the class was a success. The company has agreed to include the class in future offerings in their training system. A supervisors ' survey has not been returned yet.

Teacher Narrative: OCS Basic Math

Initial Contact:

I took over this class after the initial development. We pursued the idea of developing functional context materials with this group but got little response. The students had a clear idea of their need and we worked with what had.

Development:

No further development was done, except to secure some texts that addressed the students' needs.

Delivery:

The course was more of a study group with never more than three or four in attendance. Work was generally self study from a variety of texts (a machine math

and SPC text were used as well). Group discussion was utilized whenever more than one worker was working on similar skills.

Evaluation:

Comments are all favorable. The company is still trying to collect the participant's post surveys. Some data was included in the interim report.

DEMOGRAPHICS

Demographic Summary

Course Title: OCS worker-learners-Basic Skills
Company/Site: Targeted Learning Center

14

1. Age Distribution

18 or younger: 19 to 25 yrs.: 1 26 to 36: 2 36 to 50: 8 51 to 65: 3 65 or older: 0

2. Ethnic/Race Groups

White: 12 Black: 1 Indian: 0 Hispanic: 1 Other: 1 ASIAN

3. Gender Male: 3 Female: 12

4. Marital Status (Single and Head of Household overlap)

Single: 4 Married 7 Head of Household: 4

5. Tenure

Less than 1 yr.: 0 1 to 2 yrs: 1 3 to 5 yrs: 2 6 to 10 yrs: 1 over 10 yrs: 7

6. and 7.: answers vary widely, raw data is available.

8. School completion

below grade 8: 0 8: 0 9: 0 10: 2 11: 0 12: 6 GED: 1

Degrees Yes: 0 No: 2 AA: 0 BS/BA: 0 MS/MA: 0

3 some college
3 no data

9. Reasons for attending

- 8 :improve job performance
- 8 :qualify for future job postings
- 9 :further my education
- 8 :personal goals
- 2 :find out more about this kind of training
- 1 :to become more active in company training programs
- 0 :other (see attached summaries)

10. Best way to learn

- 4 :Read about it
- 2 :Listen to presentations or talks
- 7 :Have someone show and tell me
- 0 :other

See summaries for other comments

Demographic Summary

Course Title: OCS - Computer Basics
Company/Site: OCS Dogwood lab

52

1. Age Distribution

18 or younger: 0 19 to 25 yrs.: 3 26 to 36: 14 36 to 50: 21 51 to 65: 13 65 or older: 1

2. Ethnic/Race Groups

White: 47 Black: 2 Indian: 0 Hispanic: 3 Other: 0

3. Gender

Male: 21 Female: 31

4. Marital Status (Single and Head of Household overlap)

Single: 17 Married: 32 Head of Household: 2

5. Tenure

Less than 1 yr.: 1 1 to 2 yrs: 6 3 to 5 yrs: 6 6 to 10 yrs: 4 over 10 yrs: 28

6. and 7.: answers vary widely, raw data is available.

8. School completion

below grade 8: 0 8: 0 9: 0 10: 0 11: 3 12: 23 GED: 5

Degrees Yes: 1 No: 40 AA: 5 BS/BA: 4 MS/MA: 0

8 with some college classes
13 with more than 1 year of college

9. Reasons for attending

29: improve job performance
14: qualify for future job postings.
38: further my education
36: personal goals
13: find out more about this kind of training
13: to become more active in company training programs
2: other (see attached summaries)

10. Best way to learn 7: Read about it
2: Listen to presentations or talks
42: Have someone show and tell me
1: other

Demographic Summary

Course Title: Warn - Computer Basics

134

Company/Site: Warn Industries using college laptops

1. Age Distribution

18 or younger: 0 19 to 25 yrs.: 9 26 to 36: 46 36 to 50: 65 51 to 65: 13 65 or older: 1

2. Ethnic/Race Groups

White: 124 Black: 1 Indian: 0 Hispanic: 4 Other: 4 (ASIAN)

3. Gender

Male: 89 Female: 45

4. Marital Status (Single and Head of Household overlap)

Single: 43 Married 84 Head of Household: 15

5. Tenure

Less than 1 yr.: 8 1 to 2 yrs: 25 3 to 5 yrs: 21 6 to 10 yrs: 33 over 10 yrs: 47

6. and 7.: answers vary widely, raw data is available.

8. School completion

below grade 8: 1 8: 0 9: 2 10: 2 11: 4 12: 75 GED: 8

Degrees Yes: 1 No: 110 AA: 10 BS/BA: 5 MS/MA: 0

11 some college
31 more than one year
of college.

9. Reasons for attending

106: improve job performance

56: qualify for future job postings

102: further my education

70: personal goals

10: find out more about this kind of training

34: to become more active in company training programs

4: other (see attached summaries)

10. Best way to learn

19: Read about it

14: Listen to presentations or talks

94: Have someone show and tell me

4: other

See summaries for other comments

Demographic Summary

Course Title: Warn Shop Math
Company/Site: Warn

79

1. Age Distribution

18 or younger: \emptyset 19 to 25 yrs.: 12 26 to 36: 33 36 to 50: 26 51 to 65: 7 65 or older: 1

2. Ethnic/Race Groups

White: 71 Black: 2 Indian: 1 Hispanic: 3 Other: 3

3. Gender Male: 46 Female: 33

4. Marital Status (Single and Head of Household overlap)

Single: 26 Married 50 Head of Household: 4

5. Tenure

Less than 1 yr.: 11 1 to 2 yrs: 19 3 to 5 yrs: 20 6 to 10 yrs: 15 over 10 yrs: 13

6. and 7.: answers vary widely, raw data is available.

8. School completion

below grade 8: 1 8: \emptyset 9: 2 10: 1 11: 3 12: 54 GED: 4

Degrees Yes: 2 No: 70 AA: 1 BS/BA: \emptyset MS/MA: \emptyset

9. Reasons for attending

- 41 :improve job performance
- 42 :qualify for future job postings
- 55 :further my education
- 35 :personal goals
- 3 :find out more about this kind of training
- 37 :to become more active in company training programs
- \emptyset :other (see attached summaries) (Brush up, math)

10. Best way to learn 20:Read about it
11 :Listen to presentations or talks
44 :Have someone show and tell me
1 :other

Demographic Summary

Course Title: *Warrn workers-learners-Basic skills*
Company/Site: *Targeted Learning Center*

5

1. Age Distribution

18 or younger: 0 19 to 25 yrs.: 0 26 to 36: 0 36 to 50: 5 51 to 65: 0 65 or older: 0

2. Ethnic/Race Groups

White: 4 Black: Indian: Hispanic: Other: 1 Asian

3. Gender Male: 2 Female: 3

4. Marital Status (Single and Head of Household overlap)

Single: Married 5 Head of Household: 1

5. Tenure

Less than 1 yr.: 0 1 to 2 yrs: 2 3 to 5 yrs: 0 6 to 10 yrs: 2 over 10 yrs: 1

6. and 7.: answers vary widely, raw data is available.

8. School completion

below grade 8: 0 8: 1 9: 1 10: 11: 12: 1 GED: 2

Degrees Yes: 0 No: 5 AA: BS/BA: MS/MA:

9. Reasons for attending

- 4 :improve job performance
- 2 :qualify for future job postings
- 5 :further my education
- 3 :personal goals
- :find out more about this kind of training
- :to become more active in company training programs
- :other (see attached summaries)

10. Best way to learn 1 :Read about it
1 :Listen to presentations or talks
3 :Have someone show and tell me
0 :other

See summaries for other comments

SAMPLE OF REGISTRATION FORMS

REGISTRATION FORM

I. Personal Information

Name _____

Current Address:

Telephone Number: _____ Birthdate: 2-8-48

1. What is your age group?

16-18yrs. 19-25yrs. 26-36yrs. 36-50yrs. 51-65yrs. 65-yrs.

2. What is your ethnic group?

1. X White 2. Black 3. Indian 4. Hispanic 5. Other

3. What is your gender? 1. X Male 2. Female

4. Circle: Single Married Head of Household

II. Employment Information:

Extension No. # 4498 Mailbox Electric Shop

I am an outside vendor, working for Oregon Electric, which has a control job with oregon systems

5. How long have you worked for this company?

less than 1 year 1-2yrs. 3-5yrs. 6-10 yrs. more than 10 years

6. What is your job title? Electrician

7. How long have you worked in this job title? 1973
(beginning date)

III. Training and Education Information:

8. What is the last grade you complete in school?

below 8 8 9 10 11 12 GED
1/2 year
1 yr college more than 1 yr. college

Have you earned any college degrees?

1. Yes 2. No 3. Associates 4. Bachelors 5. Masters

9. Which of the following are your reasons for attending this class? (You may mark up to three answers.)

- a. To improve my job performance.
- b. To qualify for future job postings.
- c. To further my education.
- d. To meet personal goals.
- e. To find out more about this training.
- f. To become more active in company training programs
- g. Other _____

10. Which way do you BEST like to get information about something you need to know more about? (Please mark only one answer.)

- 1. Read about it.
- 2. Listen to presentations or talks about it.
- 3. Have someone show and tell you about it.
- 4. Other (Describe)

11. Did you choose to take this class? 1. Yes 2. No

12. What do you expect to get from this class?

A higher level of math ability.

REGISTRATION FORM

I. Personal Information

Name _____

Current Address _____

Telephone Number: _____ Birthdate: 11/28/50

1. What is your age group?

16-18yrs.

19-25yrs.

26-36yrs.

 X
36-50yrs.

51-65yrs.

65-yrs.

2. What is your ethnic group?

1. X White 2. Black 3. Indian 4. Hispanic 5. Other

3. What is your gender? 1. X Male 2. Female

4. Circle: Single Married Head of Household

II. Employment Information:

Extension No. # _____ Mailbox 89

5. How long have you worked for this company?

less than 1 year

1-2yrs.

 X
3-5yrs.

6-10 yrs.

more than 10 years

6. What is your job title? ASSYLT OPER.

7. How long have you worked in this job title? aug 88
(beginning date)

III. Training and Education Information:

8. What is the last grade you complete in school?

below 8

 8

 9

 10

 11

 X
 12

GED

1 yr college

more than 1 yr. college

Have you earned any college degrees?

1. Yes 2. X No 3. Associates 4. Bachelors 5. Masters

90

9. Which of the following are your reasons for attending this class? (You may mark up to three answers.)

- a. To improve my job performance.
- b. To qualify for future job postings.
- c. To further my education.
- d. To meet personal goals.
- e. To find out more about this training.
- f. To become more active in company training programs
- g. Other _____

10. Which way do you BEST like to get information about something you need to know more about? (Please mark only one answer.)

- 1. Read about it.
- 2. Listen to presentations or talks about it.
- 3. Have someone show and tell you about it.
- 4. Other (Describe)

11. Did you choose to take this class? 1. Yes 2. No

12. What do you expect to get from this class?

I expect this to help me when I start my college course in manufacturing technology

REGISTRATION FORM

I. Personal Information

Name _____

Current Address:

Telephone Number: _____ Birthdate: 8/10/62

1. What is your age group?

16-18yrs.

19-25yrs.

 X
26-36yrs.

36-50yrs.

51-65yrs.

65-yrs.

2. What is your ethnic group?

1. X White 2. Black 3. Indian 4. Hispanic 5. Other

3. What is your gender? 1. X Male 2. Female

4. Circle: Single Married Head of Household

II. Employment Information:

Extension No.# _____ Mailbox _____

5. How long have you worked for this company?

 X
less than 1 year

1-2yrs.

3-5yrs.

6-10 yrs.

more than 10 years

6. What is your job title? CHRONIC TANK OPERATOR

7. How long have you worked in this job title? 2/26/61
(beginning date)

III. Training and Education Information:

8. What is the last grade you complete in school?

below 8

 8

 9

 10

 X
11

 12

GED

1 yr college

more than 1 yr. college

Have you earned any college degrees?

1. Yes 2. No 3. Associates 4. Bachelors 5. Masters

9. Which of the following are your reasons for attending this class? (You may mark up to three answers.)

- a. To improve my job performance.
- b. To qualify for future job postings.
- c. To further my education.
- d. To meet personal goals.
- e. To find out more about this training.
- f. To become more active in company training programs
- g. Other ARCHIVE SKILLS

10. Which way do you BEST like to get information about something you need to know more about? (Please mark only one answer.)

- 1. Read about it.
- 2. Listen to presentations or talks about it.
- 3. Have someone show and tell you about it.
- 4. Other (Describe)

11. Did you choose to take this class? 1. Yes 2. No

12. What do you expect to get from this class?

TO BECOME BETTER WITH MY MATH SKILLS

REGISTRATION FORM

I. Personal Information

Name _____

Current Address:

Telephone Number: _____ Birthdate: 10/17/50

1. What is your age group?

 X
16-18yrs. 19-25yrs. 26-36yrs. 36-50yrs. 51-65yrs. 65-yrs.

2. What is your ethnic group?

1. X White 2. ___ Black 3. ___ Indian 4. ___ Hispanic 5. ___ Other

3. What is your gender? 1. ___ Male 2. X Female

4. Circle: Single Married Head of Household

II. Employment Information:

Extension No. # _____ Mailbox _____

5. How long have you worked for this company?

 X
less than 1 year 1-2yrs. 3-5yrs. 6-10 yrs. more than 10 years

6. What is your job title? Machine Operator

7. How long have you worked in this job title? May 1978
(beginning date)

III. Training and Education Information:

8. What is the last grade you complete in school?

 X
below 8 8 9 10 11 12 GED

1 yr college more than 1 yr. college

Have you earned any college degrees?

1. ___ Yes 2. X No 3. ___ Associates 4. ___ Bachelors 5. ___ Masters



9. Which of the following are your reasons for attending this class? (You may mark up to three answers.)

- a. To improve my job performance.
- b. To qualify for future job postings.
- c. To further my education.
- d. To meet personal goals.
- e. To find out more about this training.
- f. To become more active in company training programs
- g. Other _____

10. Which way do you BEST like to get information about something you need to know more about? (Please mark only one answer.)

- 1. Read about it.
- 2. Listen to presentations or talks about it.
- 3. Have someone show and tell you about it.
- 4. Other (Describe)

11. Did you choose to take this class? 1. Yes 2. No

12. What do you expect to get from this class?

*To learn and advance in a skill that
needs improvement.*

WPL 1/15/91

POST-PROGRAM PARTICIPANT

Survey Sheet

Directions: Please answer each question below. The information you give will be used to evaluate and help improve the course materials you have used.

I. Background Information:

1. How long have you worked at this company? 5 years
2. How long have you done this kind of work? 20 years
3. How long have you worked in your present position? 20 years
4. What is your job title? Electrician
5. What is your age? 42
6. What is your sex? MALE FEMALE

II. Course Information:

7. What can you do now that you couldn't do before taking this course?
WORK BETTER WITH FRACTIONS AND DECIMALS
8. How many classes have you attended so far? (this year or?)
5 classes. 1990/1991
9. Has this course helped you meet or work toward any of your personal goals?
 YES NO

(If you checked yes, please answer the next part of the question)

In what way? A BETTER UNDERSTANDING OF MATH

Figure 6-3

10. Circle one number in each row across to show how you would rate each item.

Example:

I love country music	5	4	3	2	1	I can't stand country music
<hr/>						
<u>How would you rate this program?</u>						
Very interesting to me	5	4	3	2	1	Boring to me
Very useful to me on the job	5	4	3	2	1	Totally useless to me on the job
Much too difficult for me	5	4	3	2	1	Much too easy for me
Very useful to me outside work	5	4	3	2	1	Totally useless to me outside of work
Exactly what I expected	5	4	3	2	1	Not at all what I expected
<hr/>						
<u>How would you rate the materials?</u>						
Hard to learn and confusing for me	5	4	3	2	1	Easy to learn and simple for me

11. ~~Would you~~ recommend this course to a co-worker or friend?

Yes No

Why or why not? _____

12. If you could change anything about this program, what would it be?

— MORE CHALK BOARD WORK AS A GROUP

Thank you for taking time to help evaluate this course. Your answers will be very useful in trying to make it better.



Figure 6-3, continued

**POST-PROGRAM PARTICIPANT
Survey Sheet**

Directions: Please answer each question below. The information you give will be used to evaluate and help improve the course materials you have used.

I. Background Information:

1. How long have you worked at this company? NA
2. How long have you done this kind of work? NA
3. How long have you worked in your present position? NA
4. What is your job title? Home maker
5. What is your age? 37
6. What is your sex? MALE FEMALE

II. Course Information:

7. What can you do now that you couldn't do before taking this course?
I've learned how to multiply + divide fractions with a better understanding by canceling and inventing. Also I've got a better grasp of decimals.
8. How many classes have you attended so far?
8 classes.
9. Has this course helped you meet or work toward any of your personal goals?
 YES NO

(If you checked yes, please answer the next part of the question)

In what way? In cooking + sewing. I use lots of fractions and its easier to figure amounts if recipes are changed or extra fabric is used. Also the time that I take in computing the problems, is quicker.

Figure 6-3

10. Circle one number in each row across to show how you would rate each item.

Example:

I love country music 5 4 3 2 1 I can't stand country music

How would you rate this program?

Very interesting to me 5 4 3 2 1 Boring to me

Very useful to me on the job 5 4 3 2 1 Totally useless to me on the job

Much too difficult for me 5 4 3 2 1 Much too easy for me

Very useful to me outside work 5 4 3 2 1 Totally useless to me outside of work

Exactly what I expected 5 4 3 2 1 Not at all what I expected

How would you rate the materials?

Hard to learn and confusing for me 5 4 3 2 1 Easy to learn and simple for me

11. Would you recommend this course to a co-worker or friend?

YES No

Why or why not? Because the instructor is easy to work with and really takes the time to make sure you really understand.

12. If you could change anything about this program, what would it be?

It seems like you just got started and its over. Its really fun to learn. Mrs. Romano has made this class a real pleasure to take.

Thank you for taking time to help evaluate this course. Your answers will be very useful in trying to make it better.



Instructor Anecdotal Report Form

Instructor N. Romano Plant Location OCS

Date anecdote occurred 2/11/91

Characteristics of participant:

Sex M Approximate age 43 Race _____

Job classification Electrician Seniority with plant 5 yrs.

Please describe in the space below comments made by this participant about how he or she is applying the content of instruction to job or to everyday life situations. Please be as specific as you can, providing participant quotes if possible.

Mike sd. his math skills have improved - when calculating amp loads - process^{has} speeded up. . . it's easier.

Instructor N. Romano Plant Location OCS

Date anecdote occurred 2/11/91

Characteristics of participant:

Sex F Approximate age 37 Race _____

Job title wife of worker Seniority with plant _____

Please describe in the space below comments made by this participant about how he or she is applying the content of instruction to job or to everyday life situations. Please be as specific as you can, providing participant quotes if possible.

When figuring things up - like balancing check, taxes, etc. - it's going faster. In the kitchen - for measuring in recipes it's faster & easier.

Instructor Anecdotal Report Form

Instructor J. Romano Plant Location OCS

Date anecdote occurred Between 1-14 & 1/30/91

Characteristics of participant:

Sex M Approximate age 42 Race Caucasian

Job classification Electrician Seniority with plant 1yr. 3 mos.

Please describe in the space below comments made by this participant about how he or she is applying the content of instruction to job or to everyday life situations. Please be as specific as you can, providing participant quotes if possible.

Louis does a lot of simple math calculations as part of his job - bending pipe, etc. "I've noticed that they go faster now cause I'm not using my fingers." "I've also noticed that since I started this job I'm feeling better about myself & that's got to help."

Instructor _____ Plant Location _____

Date anecdote occurred _____

Characteristics of participant:

Sex _____ Approximate age _____ Race _____

Job title _____ Seniority with plant _____

Please describe in the space below comments made by this participant about how he or she is applying the content of instruction to job or to everyday life situations. Please be as specific as you can, providing participant quotes if possible.

Warm

Completed during the

REGISTRATION FORM

I. Personal Information

Name: _____

Current Address: _____

Telephone Number: _____

Birthdate: 4-22-41

1. What is your age group?

16-18yrs.

19-25yrs.

26-36yrs.

X
36-50yrs.

51-65yrs.

65+yrs.

2. What is your ethnic group?

1. X White

2. Black

3. Indian

4. Hispanic

5. Other

3. What is your gender?

1. X Male

2. Female

4. Circle: Single

Married

Head of Household

II. Employment Information:

Extension No. # _____

Mailbox _____

5. How long have you worked for this company?

less than 1 year

1-2yrs.

3-5yrs.

6-10 yrs.

X
more than 10 years

6. What is your job title? TEAM MEMBER

7. How long have you worked in this job title? 2 yrs
(beginning date)

III. Training and Education Information:

8. What is the last grade you complete in school?

below 8

8

9

10

11

12

GED

1 yr college

more than 1 yr. college

Have you earned any college degrees?

1. Yes

2. X No

3. Associates

4. Bachelors

5. Masters

RECEIVED

9. Which of the following are your reasons for attending this class? (You may mark up to three answers.)

- a. To improve my job performance.
- b. To qualify for future job postings.
- c. To further my education.
- d. To meet personal goals.
- e. To find out more about this training.
- f. To become more active in company training programs
- g. Other _____

10. Which way do you BEST like to get information about something you need to know more about? (Please mark only one answer.)

- 1. Read about it.
- 2. Listen to presentations or talks about it.
- 3. Have someone show and tell you about it.
- 4. Other (Describe)

11. Did you choose to take this class? 1. Yes 2. No

12. What do you expect to get from this class?

G.E.D.

WPL 1/15/91

Warn

Completed with instructor

REGISTRATION FORM

I. Personal Information

Name: _____

Current Address: _____

Telephone Number: _____

Birthdate: 6-14-47

1. What is your age group?

16-18yrs.

19-25yrs.

26-36yrs.

X

36-50yrs.

51-65yrs.

65-yrs.

2. What is your ethnic group?

1. X White

2. ___ Black

3. ___ Indian

4. ___ Hispanic

5. ___ Other

3. What is your gender?

1. X Male

2. ___ Female

4. Circle: Single

Married

Head of Household

II. Employment Information:

Extension No. # _____ Mailbox _____

5. How long have you worked for this company?

less than 1 year

X
1.2yrs.

3-5yrs.

6-10 yrs.

more than 10 years

6. What is your job title? Mounting System

7. How long have you worked in this job title? August 1990
(beginning date)

III. Training and Education Information:

8. What is the last grade you complete in school?

below 8

8

X
9

10

11

12

GED

1 yr college

more than 1 yr. college

Have you earned any college degrees?

1. ___ Yes

2. X No

3. ___ Associates

4. ___ Bachelors

5. ___ Masters



9. Which of the following are your reasons for attending this class? (You may mark up to three answers.)

- a. To improve my job performance.
- b. To qualify for future job postings.
- c. To further my education.
- d. To meet personal goals.
- e. To find out more about this training.
- f. To become more active in company training programs
- g. Other _____

10. Which way do you BEST like to get information about something you need to know more about? (Please mark only one answer.)

- 1. Read about it.
- 2. Listen to presentations or talks about it.
- 3. Have someone show and tell you about it.
- 4. Other (Describe)

11. Did you choose to take this class? 1. Yes 2. No

12. What do you expect to get from this class?

*To better my education in reading
and writing and to get my GED.*

WPL 1/15/91

Warm

PHONE INTERVIEW

REGISTRATION FORM

I. Personal Information

Name: _____

Current Address: _____

Telephone Number: _____ Birthdate: 5-31-55

1. What is your age group?

16-18yrs. 19-25yrs. 26-36yrs. 36-50yrs. 51-65yrs. 65+yrs.

2. What is your ethnic group?
1. X White 2. Black 3. Indian 4. Hispanic 5. Other

3. What is your gender? 1. Male 2. X Female

4. Circle: Single Married Head of Household

II. Employment Information:

Extension No. # _____ Mailbox _____

5. How long have you worked for this company?

less than 1 year 1-2yrs. 3-5yrs. 6-10 yrs. more than 10 years

6. What is your job title? MANAGER

7. How long have you worked in this job title? 6 yrs.
(beginning date)

III. Training and Education Information:

8. What is the last grade you complete in school?

below 8 8 9 10 11 12 GED

1 yr college more than 1 yr. college

Have you earned any college degrees?
1. Yes 2. No 3. Associates 4. Bachelors 5. Masters



9. Which of the following are your reasons for attending this class? (You may mark up to three answers.)

- a. To improve my job performance.
- b. To qualify for future job postings.
- c. To further my education.
- d. To meet personal goals.
- e. To find out more about this training.
- f. To become more active in company training programs
- g. Other _____

10. Which way do you BEST like to get information about something you need to know more about? (Please mark only one answer.)

- 1. Read about it.
- 2. Listen to presentations or talks about it.
- 3. Have someone show and tell you about it.
- 4. Other (Describe)

11. Did you choose to take this class? 1. Yes 2. No

12. What do you expect to get from this class? .

GED

WPL 1/15/91

REGISTRATION FORM

I. Personal Information

Name _____

Current Address:

Telephone Number: _____

Birthdate: 8-3-51

1. What is your age group?
 _____ X _____
 16-18yrs. 19-25yrs. 26-36yrs. 36-50yrs. 51-65yrs. 65-yrs.

2. What is your ethnic group?
 1. ___ White 2. ___ Black 3. ___ Indian 4. ___ Hispanic 5. X Other Oriental

3. What is your gender? 1. ___ Male 2: X Female

4. Circle: Single Married Head of Household

II. Employment Information:

Extension No. # 158 Mailbox _____

5. How long have you worked for this company?
 _____ X _____
 less than 1 year 1-2yrs. 3-5yrs. 6-10 yrs. more than 10 years

6. What is your job title? assembly

7. How long have you worked in this job title? 2 years
 (beginning date)

III. Training and Education Information:

8. What is the last grade you complete in school?
 _____ X _____
 below 8 8 9 10 11 12 GED

 1 yr college more than 1 yr. college

Have you earned any college degrees?
 1. ___ Yes 2. X No 3. ___ Associates 4. ___ Bachelors 5. ___ Masters

9. Which of the following are your reasons for attending this class? (You may mark up to three answers.)

- a. To improve my job performance.
- b. To qualify for future job postings.
- c. To further my education.
- d. To meet personal goals.
- e. To find out more about this training.
- f. To become more active in company training programs
- g. Other _____

10. Which way do you BEST like to get information about something you need to know more about? (Please mark only one answer.)

- 1. Read about it.
- 2. Listen to presentations or talks about it.
- 3. Have someone show and tell you about it.
- 4. Other (Describe)

11. Did you choose to take this class? 1. Yes 2. No

12. What do you expect to get from this class?

GED

REGISTRATION FORM

I. Personal Information

Name _____

Current Address:

Telephone Number: _____ Birthdate: 02-27-52

1. What is your age group?
 X
16-18yrs. 19-25yrs. 26-36yrs. 36-50yrs. 51-65yrs. 65+yrs.

2. What is your ethnic group?
1. X White 2. Black 3. Indian 4. Hispanic 5. Other

3. What is your gender? 1. Male 2. X Female

4. Circle: Single Married Head of Household

II. Employment Information:

Extension No. # 259 Mailbox _____

5. How long have you worked for this company?
 X
less than 1 year 1-2yrs. 3-5yrs. 6-10 yrs. more than 10 years

6. What is your job title? Assembler

7. How long have you worked in this job title? 8 yrs
(beginning date)

III. Training and Education Information:

8. What is the last grade you complete in school?
 X
below 8 8 9 10 11 12 GED

1 yr college more than 1 yr. college

Have you earned any college degrees?
1. Yes 2. No 3. Associates 4. Bachelors 5. Masters

9. Which of the following are your reasons for attending this class? (You may mark up to three answers.)

- a. To improve my job performance.
- b. To qualify for future job postings.
- c. To further my education.
- d. To meet personal goals.
- e. To find out more about this training.
- f. To become more active in company training programs
- g. Other _____

10. Which way do you BEST like to get information about something you need to know more about? (Please mark only one answer.)

- 1. Read about it.
- 2. Listen to presentations or talks about it.
- 3. Have someone show and tell you about it.
- 4. Other (Describe)

11. Did you choose to take this class? 1. Yes 2. No

12. What do you expect to get from this class?

Hopefully to get my GED & I did.

RECRUITMENT

Recruitment Ideas We Tried at Warn Industries

- 1. Took over existing classes and redesigned them for individualized learning.**
- 2. Gave math books to 75 students for coming to class.**
- 3. Offered TLC as alternate educational site.**
- 4. Advised our liason committee that our instructor needed to interact with employees "on the floor" immediatly.**
- 5. Offered the same services to adult family members.**
- 6. Offered to pay for childcare.**
- 7. Company paid workers 2 hours a week training time to come to class.**
- 8. Company increases wage per skill block (which includes basic skills).**

Recruitment Ideas We Tried at Oregon Cutting Systems

- 1. Met with every management team so that they could recruit students from within their teams.**
- 2. Met with most production teams so that they could see and hear the teachers.**
- 3. Set up a booth on college recruitment day at OCS.**
- 4. Gave a speech with a video and overheads at every break.**
- 5. Posters**
- 6. Table top tents in the lunch rooms.**
- 7. One on One recruitment by ODON (quality circle) members.**
- 8. Peer group recruitment. We asked each classmember to recruit someone.**
- 9. OCS newsletter articles-2.**
- 10. Survey of interest areas and barriers to class attendance of the entire plant.**
- 11. Video using employees and former employees.**
- 12. Childcare costs would be covered by the grant.**
- 13. Audit--we met interested employees while we were interviewing.**
- 14. Family members--we offered the same services to family members.**
- 15. Tie in with other classes especially the SPC math and those people who didn't have keyboarding skills to take computer classes.**
- 16. Paid tuition to off-site location (TLC)**
- 17. Stressed Confidentiality at every recruitment attempt.**
- 18. Pay envelopes- we stuffed recruitment flyers in every pay envelope.**

EVALUATION OF RECRUITMENT TECHNIQUES

OCS. The best recruitment ideas at Oregon Cutting Systems were a combination of offering a popular subject (according to a survey), keeping it to nine hours, and giving enough information about it so that people could screen themselves in and out. The most popular class in terms of numbers of recruits was Keyboarding /Basic Computers. The computer class was popular initially because we let the employees check out laptop computers to take home. The class gained in popularity even when we were giving the classes too often to check out the computers. The next most popular was basic skills at Targeting Center. However the math class had some loyal members who stuck with it for the entire life of the grant.

Ideas that didn't work were childcare reimbursement-not a single taker; the speech-only two recruits out of the 1,700 who saw it; and the newsletter articles-not a single recruit.

Ideas that yielded some recruits and should be considered again were: including family members, one-on-one recruitment, and the combination of table top tents in the lunchroom and posters.

WARN. All of the recruiting techniques worked at Warn except one. Again, childcare reimbursement wasn't used by even one parent even though there are many employees with young children. We deduce that the combination of paying the employees to take classes, plus paying employees for improved skills motivated the Warn employees. They loved checking out the laptop computers: the computers went home with employees 140 times!

ASSESSMENT

SAMPLE OF WORKPLACE LITERACY AUDIT FORMS

PERSONAL DATA

NAME

JOB TITLE

M OR F

TIME W/OMARK

TIME ON THIS JOB

READING SKILLS

1. Read understand/write abbreviations
2. Read understand/write abbreviations
3. Read words on switches and dials
4. Follow simple written directions
(1-2 steps)
5. Determine complex directions
(3+ steps)
6. Determine the meaning of a word
from context
7. Do you need to find and use
reference material
8. Alphabetize
9. Apply information from reading to
practical situations (labels, directions
manuals, memos, warning posters, house-
keeping, accident precaution)
10. Read and interpret information on maps,
charts, graphs, diagrams, blueprints,
schematic drawings
11. Use an index, glossary, table of contents,
appendices
12. Do you think the reading required on this
job is easier or harder than the Oregonian
newspaper.
13. Other

WRITING SKILLS

1. Record observations
2. Proofread for spelling, grammatical, punctuation and numerical errors
3. Write or print legibly
4. Record dates, times, numbers, phone messages, abbreviations, symbols
5. Spell technical words
6. Use correct spelling-general vocabulary
7. What kinds of answers do you need to give on forms? (words/paragraphs numbers/abbreviations/correct grammar)
8. What kinds of composing do you do (reports/summary/minutes of meetings/memos/evaluations/critiques/methods or procedures in sequential order)

MATHEMATICAL SKILLS

1. Read and work with whole numbers (Place value, rounding)
2. Find averages
3. Read and write simple fractions = $\frac{1}{4}$, $\frac{1}{2}$
4. Read and write less used fractions = $\frac{1}{7}$, $\frac{1}{10}$, $\frac{1}{23}$
5. Read and add & subtract, multiply, and divide fractions
6. Figure out which fractions are smallest or largest
7. Round whole numbers and decimals to nearest thousandth and ten thousandth
8. Read and work with decimals place/value, rounding +, -, x, divide - (subtract)
9. Figure which decimals are smallest or largest
10. Read a conversion table (decimals, to fractions & percents)
11. Work with percents (% of defects or gain sharing ratio)
12. What do you have to find out from graphs

13. Do you have to plot graphs
14. Make linear measurements - English system (ft, in)
15. Make weight measurements - English system (lbs, oz)
16. Calculate volume measurements - English system (cubic units, (cylinders or liquids)
17. Convert from one English unit to another
18. Make linear measurements - Metric
19. Make weight measurements - Metric system
20. Make volume measurements - Metric system
21. Convert from one metric unit to another.
22. Convert metric to English (and reverse)
23. How do you use military time
24. How do you use standard time
25. Read a Fahrenheit thermometer
26. Read a Celsius thermometer
27. Recognize parallel & perpendicular lines
28. Measure angles
29. Calculate perimeter, area and volume
30. Find circumference (given formula)
31. Estimate quantity, length, weight, volume or time
32. Plot numbers on a graph

MISCELLANEOUS

1. Use ratios (1 part to 5 parts)
2. Use powers and square roots
3. Find missing number in proportion (defects per thousand)
4. Use a calculator, vernier, caliper, micrometer or ?
5. Understand the order of operations (control charts)
6. negative and positive numbers

7. powers
8. solve multiple or sequential math problems (#parts: #people x hours)

VERBAL AND LISTENING SKILLS

1. Use formal correct grammar and pronunciation
2. Give directions or explain procedures to others
3. Distinguish between fact and opinion
4. What kind of communication skills do you need to work here?

ATTITUDIAL/BEHAVIORAL SKILLS

1. Do you need team work for this job? If so what are some important components?
2. What kind of problem solving do you do on this job?
3. Which of these is the most common way an individual learns new information about this job.
 1. hearing
 2. reading
 3. observing
4. What is the most confusing thing about this job?

COMPUTERS

1. Do you have to know how to use the computer keyboard (use the enter key, delete, shift, etc.)
2. Do you have to know how to type more than a few words per minute
3. What software programs do you work with....
4. Do you use the number pad on your PC
5. Do you need to use a floppy disk or the Network (OPIC system)
6. Do you use a scanner, a CRT
7. Do you have to know computer vocabulary (key in response, cursor, AIT, enter menu)

GENERAL JOB SKILLS

1. What kinds of behavior cause a person to lose an entry level job?
(can't keep up, drug & alcohol problems, attendance, child care problems, poor people skills, can't problem solve, other)
2. What job skills will be needed in the future for this same position

PRE & POST TEST SUMMARIES

and

PRE & POST TEST SAMPLES

Shop Math Pre Post Difference

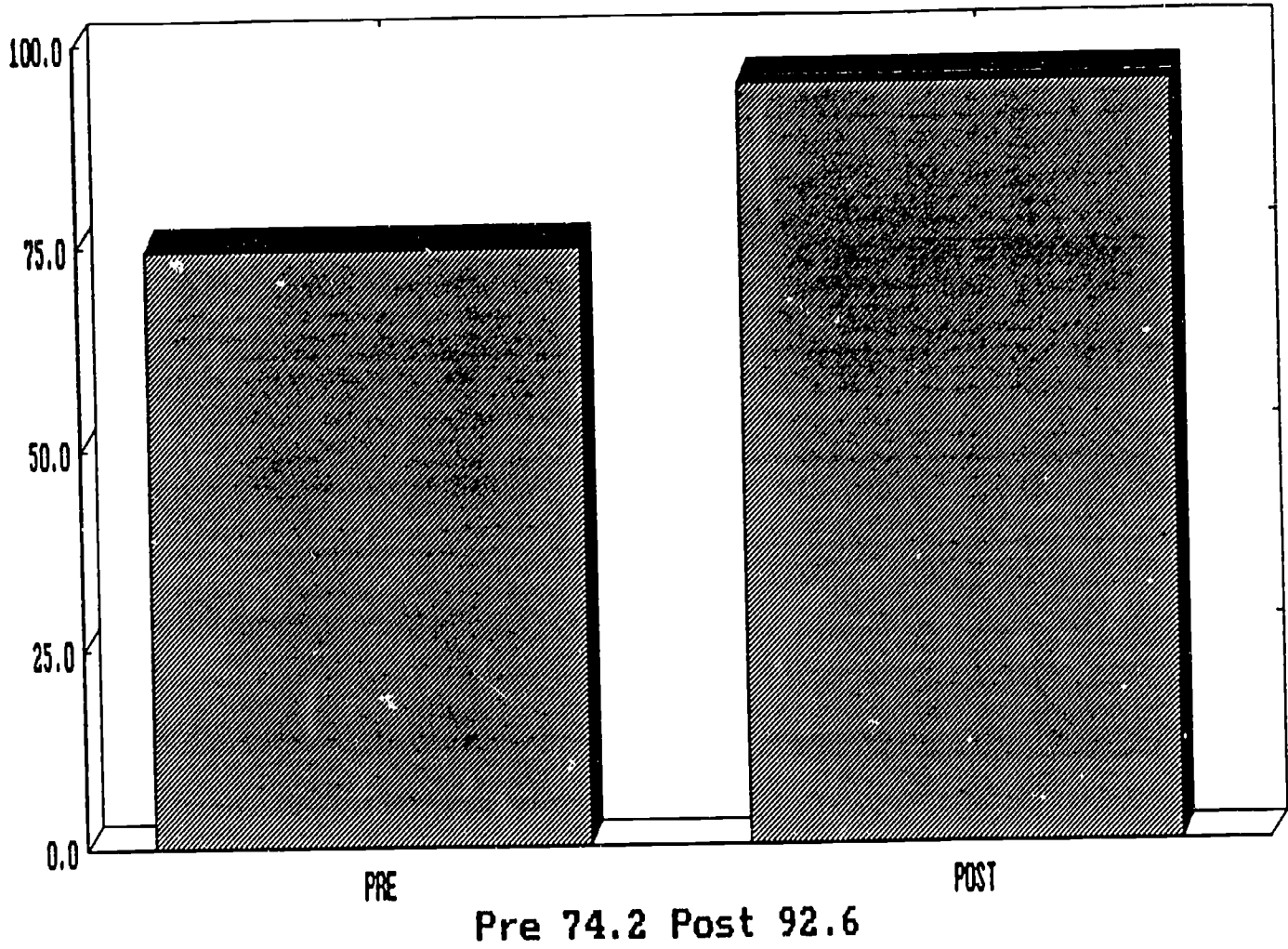

Warn Shop Math Pre-Post

85	100	15
80	86	6
75	100	25
55	73	18
70	100	30
75	86	11
65	93	28
80	100	20
90	93	3
85	100	15
90	100	10
55	93	38
70	93	23
55	93	38
85	100	15
85	86	1
60	100	40
80	100	20
50	100	50
90	100	10
85	100	15
75	100	25
88	87	-1
75	93	18
83	100	17
83	93	10
29	80	51
67	93	26
88	100	12

mean 20.31034
 std 13.14928
 t= 8.318
 p< 0.0001

Warn Computer Basics Pre Post Scores

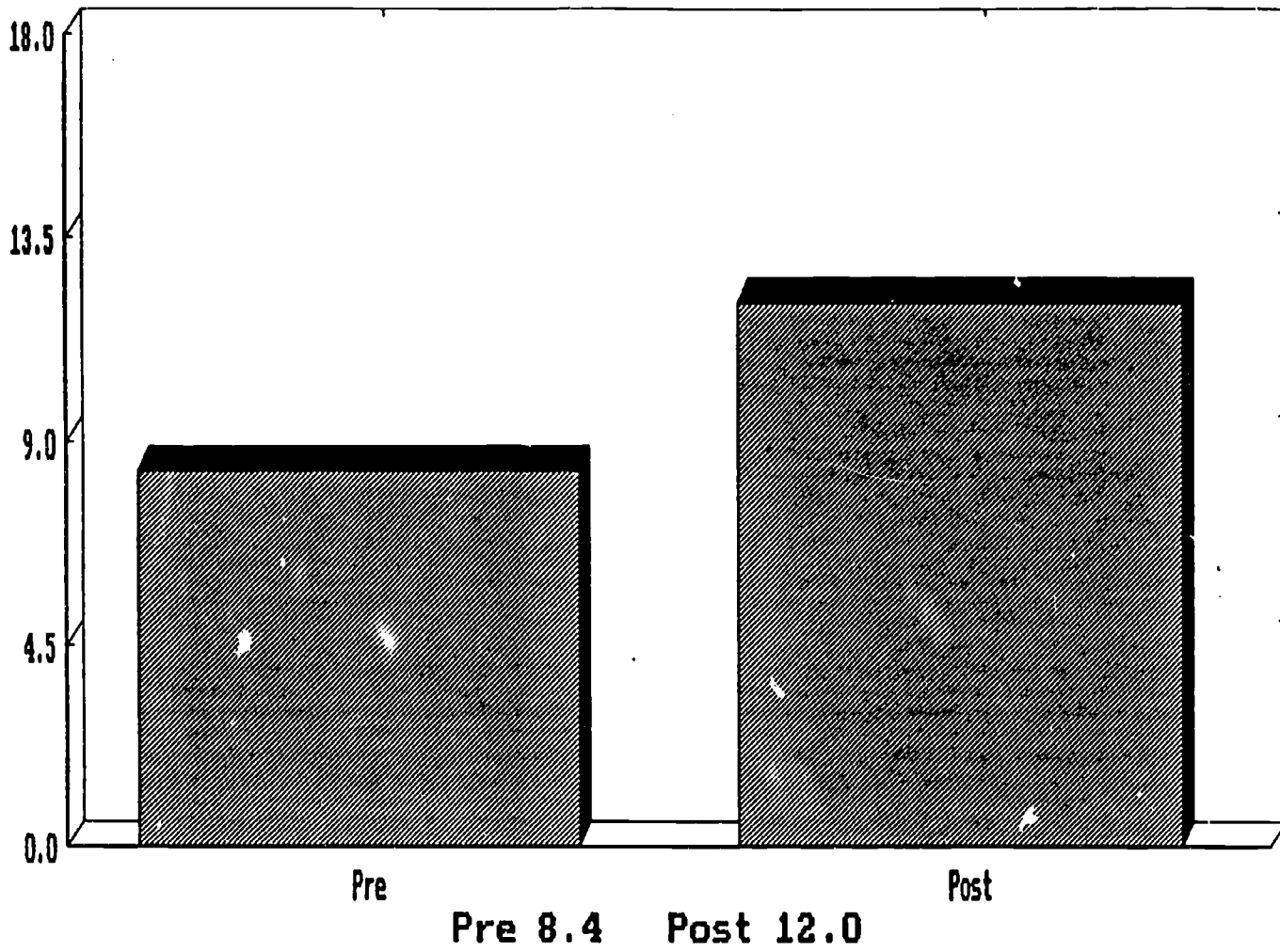

Warn Computer Basics Pre-Post

11	14	3
4	16	12
7	11	4
9	15	6
9	14	5
8	13	5
9	15	6
10	14	4
7	11	4
9	11	2
10	9	-1
7	12	5
9	10	1
9	13	4
4	16	12
7	14	7
1	10	9
6	10	4
8	11	3
8	12	4
7	12	5
10	15	5
7	11	4
11	12	1
3	7	4
10	10	0
8	11	3
11	14	3
7	11	4
11	10	-1
8	6	-2
11	8	-3
10	11	1
9	15	6
10	8	-2
10	16	6
10	11	1
9	14	5
10	11	1
9	17	8
10	12	2

mean	3.658536
std.	3.273021
t=	7.157
p<	0.0001

Computer Basics Evaluation Test

(this test is for evaluation purposes only: it does not have any effect on your job or pay for knowledge)

Name: _____

Team: _____

Date: _____

Job title: _____

Circle the answer that you believe is correct.

1. If you turn a PC on and it tells you there is a non-system disk error, this means that..
 - a. you simply need to turn it off then turn it on again.
 - b. you need to have a technician find the problem before you can use the machine.
 - c. the disk in drive A must be removed and then you strike a key to continue.
 - d. the main frame has been connected and you cannot use a disk.

2. Most commands are sent to the computer by..
 - a. using the "enter" key or the "return" key.
 - b. typing the word "enter" or "go."
 - c. using the "escape" or "go" key.
 - d. using the key that has the asterisk (*) on it.

3. If you get "lost", the best way to find your way again is to..
 - a. turn off the computer and turn it back on again.
 - b. type the word "dir" to get directions.
 - c. enter an "escape", "f1," or type menu to get back to a menu.
 - d. use the "sys req" key to allow you to request help.

4. When you see this on your screen: C:\DATA
it means that you are..
 - a. into the AMAPS data directory.
 - b. being requested to enter data.
 - c. in a data area on the network.
 - d. in a subdirectory named 'DATA' on your hard drive.

5. The thing to remember about "files" is that...
- a. they are permanent, you can't do any harm to them
 - b. they are not programs, only data.
 - c. they are named by the computer, not you.
 - d. they can be changed by what you do.
6. The files are stored...
- a. on a memory chip in the computer.
 - b. on a floppy disk, hard disk or tape.
 - c. on a ROM disk, CPU disk or hyper disk.
 - d. in the collector bank on the mainframe.
7. Programs are...
- a. files that the computer can load and run.
 - b. built into the memory of the computer.
 - c. loaded by "booting" the computer.
 - d. part of the hardware on the PC or mainframe.
8. You start a program by..
- a. typing "goto.." and the name of the program.
 - b. selecting its number off of the menu.
 - c. "booting" it when you are ready.
 - d. sending a request to mainframe for a program run.
9. To copy or delete a file on any computer including your own, you must..
- a. simply issue the correct command.
 - b. get a clearance from the network operator.
 - c. save it first or it won't let you delete or copy.
 - d. get a special password from Information Services.

10. You can operate a computer (PC) without DOS on it if you...

- a. get on the network.
- b. log on the mainframe.
- c. only use menus.
- d. you must have DOS on your PC

11. If you wanted to prepare a table of numbers and be able to change totals, calculations or figure "what if?" you should use....

- a. the word processor in table mode.
- b. a spreadsheet.
- c. a database.
- d. a desktop publisher.

12. Letters and memos are easy to produce and change if you use a...

- a. word processor.
- b. a spreadsheet in text mode.
- c. a database in memo mode.
- d. a desktop publisher.

13. Keeping records for personnel, maintenance or reports where you may want to look at the records in several ways should be done with a...

- a. word processor in file mode.
- b. a spreadsheet.
- c. a database.
- d. a desktop publisher.

14. The PC is often hooked into another system... it is

- a. the network but not into AMAPS.
- b. AMAPS but not the network.
- c. the network or the mainframe (AMAPS).
- d. the SPC and CNC national databank.

15. If you bring a disk from home to copy programs onto the network directories, the disk should be checked for...
- a. illegal disk formats.
 - b. problems with disk directories.
 - c. viruses hidden in non-commercially supplied programs.
 - d. the correct number bytes for network operations.
16. If a program tells you to use "F2" to save your work, this means...
- a. enter a capital F then a 2 then return.
 - b. find the key at the top or side that shows an F2 and use it.
 - c. enter a 2 then a capital F then return.
 - d. enter an escape, then hit the 2 key very fast.
17. If you want a quick copy of what is on the screen to be printed out...
- a. exit to DOS and use the copy command
 - b. don't exit to DOS, use the F6 key
 - c. use the Ctrl key, then enter a "C"
 - d. use the shift key and the PrtSc key.
18. The network can be used for communication purposes, this is done with...
- a. the AMAPS phone utility.
 - b. the small speakers and a voice simulator.
 - c. the electronic mail system.
 - d. a phone module in Word Perfect

Answer yes, no or not sure...

- a. Have you had other computer training this year (besides the class on the laptops)? _____
- b. If you have had other computer training, did anything from the laptop class help you in the other training? _____
- Any Comments on computer training in general? _____
-

Check off the things **you know** that you can do...

- Boot the computer and run an application.
- Copy or Delete a File.
- Find a subdirectory and look at the files in it.
- Know if you are in DOS, a program or the network.
- Use electronic mail.
- Use the function keys as instructed to in a program.
- Format a floppy disk.
- Set up and maintain subdirectories.
- Find a help screen, or get help you need from the manual.
- Decide what software will do the work you need to do.
- Rename or move a file.
- Use the Network menu AND pathminder to organize and do your work.
- Perform some type of transaction on AMAPS.

PERCENTAGE REVIEW

Name _____

Date _____

1. What is .65 written as a percent?	2. What is the decimal form of 12.5%?
3. Change $\frac{1}{8}$ to a decimal.	4. Change $\frac{3}{4}$ to a percent.
5. Change $\frac{2}{3}$ to a percent.	6. What percent of 10 is six?
7. Change 90% to a fraction in the lowest terms.	8. What is 75% of 800?
9. Andrea sold a house for \$75,000. If she got a 5% commission, how much did she make?	10. Jeff had $33\frac{1}{3}$ of his salary taken out for taxes. If he made \$24,000 one year, how much did he receive in cash that year?
11. Kim bought a \$36 dress marked down 20%. How much did she pay for the dress?	

DIRECTIONS: CHANGE THE FOLLOWING DECIMALS TO PERCENTS.

- | | | |
|----------------|-----------------|-----------------|
| 1) .10 = _____ | 4) 1.00 = _____ | 7) .125 = _____ |
| 2) .50 = _____ | 5) .01 = _____ | 8) .085 = _____ |
| 3) .15 = _____ | 6) .05 = _____ | 9) 3.75 = _____ |

DIRECTIONS: CHANGE THE FOLLOWING FRACTIONS TO PERCENTS.

- | | | |
|---------------------------|----------------------------|----------------------------|
| 10) $\frac{1}{2}$ = _____ | 13) $\frac{3}{7}$ = _____ | 16) $\frac{1}{3}$ = _____ |
| 11) $\frac{1}{4}$ = _____ | 14) $\frac{5}{8}$ = _____ | 17) $\frac{5}{12}$ = _____ |
| 12) $\frac{4}{5}$ = _____ | 15) $\frac{3}{16}$ = _____ | 18) $\frac{2}{3}$ = _____ |

DIRECTIONS: CHANGE THE FOLLOWING PERCENTS TO DECIMALS.

- | | | |
|-----------------|------------------|------------------------------|
| 19) 12% = _____ | 23) 200% = _____ | 27) 1500% = _____ |
| 20) 75% = _____ | 24) .7% = _____ | 28) .07% = _____ |
| 21) 6% = _____ | 25) .1% = _____ | 29) $\frac{1}{2}$ % = _____ |
| 22) 3% = _____ | 26) 1.4% = _____ | 30) $5\frac{1}{4}$ % = _____ |

DIRECTIONS: CHANGE THE FOLLOWING PERCENTS TO FRACTIONS.

- | | | |
|-------------------------------|--------------------------------|-------------------------------|
| 31) 25% = _____ | 35) $87\frac{1}{2}$ % = _____ | 39) $3\frac{3}{4}$ % = _____ |
| 32) $33\frac{1}{3}$ % = _____ | 36) 125% = _____ | 40) $16\frac{2}{3}$ % = _____ |
| 33) $12\frac{1}{2}$ % = _____ | 37) $116\frac{2}{3}$ % = _____ | 41) 75% = _____ |
| 34) $6\frac{1}{4}$ % = _____ | 38) $\frac{1}{2}$ % = _____ | 42) $66\frac{2}{3}$ % = _____ |

ITEM 6-26
MATH-INTEREST PROBLEMS

TRAINEE'S NAME _____
INSTRUCTOR _____

SCORE _____
CRITERION 8

- _____ 1. What is the interest on 500 dollars at 5% for one year?
- _____ 2. What is the interest on 750 dollars at 6% for 2 months?
- _____ 3. What is the interest on 100 dollars at $5\frac{3}{4}\%$ for 3 years?
- _____ 4. What is the interest on 1500 dollars at 6% for 60 days?
- _____ 5. What is the interest on 10,000 dollars at $2\frac{1}{2}\%$ for 18 months?
- _____ 6. What is the interest on 60 dollars at $5\frac{1}{3}\%$ for 6 months?
- _____ 7. How much money must be invested to earn 120 dollars interest at 6% in one year?
- _____ 8. What is the principal if the interest is 50 dollars; and the rate, 5%; and the time, 24 months?
- _____ 9. What rate of interest is charged if the interest is 90 dollars; and the principal 1,800 dollars; and the time is one year?
- _____ 10. What is the time on a note for 1,200 dollars at 6% that has a charge of 36 dollars interest?
- _____ 11. Find the amount after 2 years of 500 dollars at 4% compounded annually.
- _____ 12. Find the amount after 1 year of 100 dollars at 6% compounded semiannually.

AHE:CEB
JN:gm
2:4:72

DIRECTIONS: Change the following percents to decimals.

1) 20% = _____	3) 82.5% = _____	5) .75% = _____
2) 100% = _____	4) 5.9% = _____	

DIRECTIONS: Change the following percents to common fractions:

6) $33\frac{1}{3}\%$ = _____	7) $12\frac{1}{2}\%$ = _____
------------------------------	------------------------------

DIRECTIONS: Find the following percentages.

8) 5% of 340 = _____	10) $33\frac{1}{3}\%$ of 540 = _____
9) 25% of 280 = _____	11) 110% of 448 = _____

DIRECTIONS: Find the following percents.

12) 8 is what percent of 16? _____	14) 250 is what percent of 75? _____
13) 7 is what percent of 35? _____	

DIRECTIONS: Find the whole amount of the following.

15) 50% of what number is 6? _____	17) 150% of what number is 240? _____
16) $66\frac{2}{3}\%$ of what number is 82? _____	

DIRECTIONS: Find the new amount in each of the following.

18) 300 increased by 25% = _____	19) 900 decreased by 15% = _____
----------------------------------	----------------------------------

DIRECTIONS: Find the percent of increase or decrease.

20) From 6 to 9 is an increase of _____ %.
21) From 120 to 80 is a decrease of _____ %.

DIRECTIONS: Find the amount of discount and the net price.

22) \$150 less 20% = _____ Amount of discount. _____ Net price.
23) \$80 less 25% = _____ Amount of discount. _____ Net price.

DIRECTIONS: Find the amount of discount and the rate of discount.

24) Original Price is....\$75.00 Sale price is..... <u>50.00</u> Amount of discount is _____	25) Original price is....\$160.00 Sale price is..... <u>120.00</u> Amount of discount is _____
--	--

ITEM 6-20

NAME _____

MATH-ROUNDING OFF NUMBERS

SCORE _____

DIRECTIONS: Round each of the following to the nearest cent.

1. \$.125 = _____

2. \$.625 = _____

3. .333 = _____

DIRECTIONS: Round each of the following to the nearest whole quantity indicated in parentheses.

4. 240 (hundred) is _____

15. 0.25602 (thousandth) is _____

5. 250 (hundred) is _____

16. 25.6025 (thousandth) is _____

6. 260 (hundred) is _____

17. 25.6025 (unit) is _____

7. 243 (ten) is _____

18. 101.52 (unit) is _____

8. 245 (ten) is _____

19. 109.56 (ten) is _____

9. 249 (ten) is _____

20. 105 (ten) is _____

10. 2.49 (tenth) is _____

21. 2,625,175 (million) is _____

11. 2.45 (tenth) is _____

22. 2,356,999 (million) is _____

12. 2.43 (tenth) is _____

23. 3.56762 (ten thousandth) is _____

13. 0.245 (tenth) is _____

24. 3.56768 (ten thousandth) is _____

14. 25,602 (thousand) is _____

25. 0.5676253 (millionth) is _____

EVALUATION

WARN EMPLOYEES
AT
TARGETED LEARNING CENTER
FOR
BASIC SKILLS

TLC instructional activities: Learner Survey
 December 30, 1991 at 10:22 p.m.

X1_ X2_ X3_ X5_ X7_Do_now	X8_How_Many	X What_Way
2 15 2 40 f I can understand how to read/write a little bit.	1 1/2 years	y Improving my learning skills
20 35 17 50 m More knowledgeable of math		y It has shown that I need to further
2 16 1 44 m read better and write better	2 years	y It helped me at work, at home and e
6 6 6 36 f I improved my basic skills to get my GED	pre-tests at TLC	y I got my GED!
8 8 8 39 f I have more confidence in myself.	3 terms	y Taking more classes,not afraid to d

Is do or Rec Why or	IsChange	RACE COMMENT	OR
1 1 1 1 1 y Because many places require a GED.	I don't have anything to change about it.	Orise Reading level has increased to 5th grade level	
1 1 1 1 1 y	Program good, more one on one would be nice.	white Has passed 4 out of 5 GED tests.	
1 1 1 1 1 y I wasn't embarrassed to take class, everyone was nice to me.	Nothing	white	1
1 1 1 1 1 y Makes you feel better about yourself.	Nothing	white	1
1 1 1 1 1 y Feels good to accomplish something, like getting a GED	Nothing, had plenty of time, could work at your own pace.	white	Met

TLC
72

73

POST-PROGRAM PARTICIPANT

Survey Sheet

Directions: Please answer each question below. The information you give will be used to evaluate and help improve the course materials you have used.

I. Background Information:

1. How long have you worked at this company? 2 years
2. How long have you done this kind of work? 16 years
3. How long have you worked in your present position? 1 year
4. What is your job title? mounting system
5. What is your age? 44
6. What is your sex? MALE FEMALE

II. Course Information:

7. What can you do now that you couldn't do before taking this course?
read better and write better
8. How many classes have you attended so far?
2 years classes.
9. Has this course helped you meet or work toward any of your personal goals?
 Yes No

(If you checked yes, please answer the next part of the question)

In what way? It helped me at work, at home and everywhere.

10. Circle one number in each row across to show how you would rate each item.

Example:

I love country music ⑤ 4 3 2 1 I can't stand country music

How would you rate this program?

Very interesting to me ⑤ 4 3 2 1 Boring to me

Very useful to me on the job ⑤ 4 3 2 1 Totally useless to me on the job

Much too difficult for me 5 4 ③ 2 1 Much too easy for me

Very useful to me outside work ⑤ 4 3 2 1 Totally useless to me outside of work

Exactly what I expected ⑤ 4 3 2 1 Not at all what I expected

How would you rate the materials?

Hard to learn and confusing for me 5 4 ③ 2 1 Easy to learn and simple for me

11. Would you recommend this course to a co-worker or friend?

YES NO

Why or why not? *Because I felt I was not embarrassed taking this course and everybody was nice to me.*

12. If you could change anything about this program, what would it be?

Nothing

Thank you for taking time to help evaluate this course. Your answers will be very useful in trying to make it better.

Instructor Humphreys Plant Location TLC

Date anecdote occurred 1/1/88

Characteristics of participant:

Sex M Approximate age 44 Race White

Job title mounting systems Seniority with plant 2 yrs

Please describe in the space below comments made by this participant about how he or she is applying the content of instruction to job or to everyday life situations. Please be as specific as you can, providing participant quotes if possible.

"It helped me at work,
at home and everywhere."

"I can read the work orders
by myself"

"I'm trying to read - more and more."

Reading - (non reader)

GED (long term goal)

POST-PROGRAM PARTICIPANT
Survey Sheet

Directions: Please answer each question below. The information you give will be used to evaluate and help improve the course materials you have used.

I. Background Information:

- 1. How long have you worked at this company? 2 years
- 2. How long have you done this kind of work? 15 years
- 3. How long have you worked in your present position? 2 years
- 4. What is your job title? assembly
- 5. What is your age? 40
- 6. What is your sex? MALE FEMALE

II. Course Information:

- 7. What can you do now that you couldn't do before taking this course?
I can understand how to read and write a little bit.
- 8. How many classes have you attended so far?
1 1/2 years
classes.
- 9. Has this course helped you meet or work toward any of your personal goals?
 Yes No

(If you checked yes, please answer the next part of the question)

In what way?
Improving my learning skills.



10. Circle one number in each row across to show how you would rate each item.

Example:

I love country music (5) 4 3 2 1 I can't stand country music

How would you rate this program?

Very interesting to me (5) 4 3 2 1 Boring to me

Very useful to me on the job (5) 4 3 2 1 Totally useless to me on the job

Much too difficult for me 5 4 (3) 2 1 Much too easy for me

Very useful to me outside work (5) 4 3 2 1 Totally useless to me outside of work

Exactly what I expected (5) 4 3 2 1 Not at all what I expected

How would you rate the materials?

Hard to learn and confusing for me 5 4 (3) 2 1 Easy to learn and simple for me

11. Would you recommend this course to a co-worker or friend?

YES No

Why or why not? *Because many places require a CED*

12. If you could change anything about this program, what would it be?

I don't have anything to change about it.

Thank you for taking time to help evaluate this course. Your answers will be very useful in trying to make it better.

Instructor Anecdotal Report Form

Instructor Humphreys / O'Neil Plant Location TLC

Date anecdote occurred _____

Characteristics of participant:

Sex F Approximate age 41 Race Oriental (ESL)

Job classification assembly Seniority with plant 2 years

Please describe in the space below comments made by this participant about how he or she is applying the content of instruction to job or to everyday life situations. Please be as specific as you can, providing participant quotes if possible.

reading level has increased to
5th grade level

GED

POST-PROGRAM PARTICIPANT

Survey Sheet

Directions: Please answer each question below. The information you give will be used to evaluate and help improve the course materials you have used.

I. Background Information:

1. How long have you worked at this company? 6 years
2. How long have you done this kind of work? 6 years
3. How long have you worked in your present position? 6 years
4. What is your job title? MACHINIST
5. What is your age? 36
6. What is your sex? MALE FEMALE

II. Course Information:

7. What can you do now that you couldn't do before taking this course?

I improved my basic skills
to get my GED

8. How many classes have you attended so far?

0 classes. took pre tests at TLC

9. Has this course helped you meet or work toward any of your personal goals?

YES NO

(If you checked yes, please answer the next part of the question)

In what way?

"I got my GED!"

10. Circle one number in each row across to show how you would rate each item.

Example:

I love country music 5 4 3 2 1 I can't stand country music

How would you rate this program?

Very interesting to me (5) 4 3 2 1 Boring to me

Very useful to me on the job (5) 4 3 2 1 Totally useless to me on the job

Much too difficult for me 5 4 (3) 2 1 Much too easy for me

Very useful to me outside work (5) 4 3 2 1 Totally useless to me outside of work

Exactly what I expected (5) 4 3 2 1 Not at all what I expected

How would you rate the materials?

Hard to learn and confusing for me 5 (4) 3 2 1 Easy to learn and simple for me

11. Would you recommend this course to a co-worker or friend?

 X
Yes No

Why or why not:

makes you feel better about yourself

12. If you could change anything about this program, what would it be?

Nothing

Thank you for taking time to help evaluate this course. Your answers will be very useful in trying to make it better.

Instructor Humphreys Plant Location TLC

Date anecdote occurred 5/1/07

Characteristics of participant:

Sex F Approximate age 36 Race White

Job title Machinist Seniority with plant 6 years

Please describe in the space below comments made by this participant about how he or she is applying the content of instruction to job or to everyday life situations. Please be as specific as you can, providing participant quotes if possible.

"I got my GED!"

GED

POST-PROGRAM PARTICIPANT

Survey Sheet

Directions: Please answer each question below. The information you give will be used to evaluate and help improve the course materials you have used.

I. Background Information:

1. How long have you worked at this company? _____ 20 YR _____
2. How long have you done this kind of work? _____ 35 YRS _____
3. How long have you worked in your present position? _____ 17 1/2 _____
4. What is your job title? _____ TEAM MEMBER _____
5. What is your age? 50
6. What is your sex? MALE FEMALE

II. Course Information:

7. What can you do now that you couldn't do before taking this course?

MORE KNOWLEDGE OF MATH

8. How many classes have you attended so far?

1 classes.

9. Has this course helped you meet or work toward any of your personal goals?

YES No

(If you checked yes, please answer the next part of the question)

In what way?

IT HAS SHOWN THAT I NEED TO FURTHER MY EDUCATION.

10. Circle one number in each row across to show how you would rate each item.

Example:

I love country music 5 4 3 2 1 I can't stand country music

How would you rate this program?

Very interesting to me 5 4 3 2 1 Boring to me

Very useful to me on the job 5 4 3 2 1 Totally useless to me on the job

Much too difficult for me 5 4 3 2 1 Much too easy for me

Very useful to me outside work 5 4 3 2 1 Totally useless to me outside of work

Exactly what I expected 5 4 3 2 1 Not at all what I expected

How would you rate the materials?

Hard to learn and confusing for me 5 4 3 2 1 Easy to learn and simple for me

11. Would you recommend this course to a co-worker or friend?

YES NO

Why or why not?

12. If you could change anything about this program, what would it be?

MORE ONE ON ONE WOULD BE NICE.
OVERALL THE PROGRAM HAS BEEN GOOD.

Thank you for taking time to help evaluate this course. Your answers will be very useful in trying to make it better.

THANK YOU

POST-PROGRAM PARTICIPANT

Survey Sheet

Directions: Please answer each question below. The information you give will be used to evaluate and help improve the course materials you have used.

I. Background Information:

1. How long have you worked at this company? 8 years
2. How long have you done this kind of work? 8 years
3. How long have you worked in your present position? 8 years
4. What is your job title? Assembler
5. What is your age? 39
6. What is your sex? MALE FEMALE

II. Course Information:

7. What can you do now that you couldn't do before taking this course?

I have more confidence in myself

8. How many classes have you attended so far?

3 classes. 3 terms

9. Has this course helped you meet or work toward any of your personal goals?

YES NO

(If you checked yes, please answer the next part of the question)

In what way?

I'm taking more classes at work and am not afraid to do more things instead of staying in the background.

Instructor Humphreys Plant Location TLC
J. O'Neil

Date anecdote occurred _____

Characteristics of participant:

Sex M Approximate age 50 Race White

Job title Team member Seniority with plant 20 years

Please describe in the space below comments made by this participant about how he or she is applying the content of instruction to job or to everyday life situations. Please be as specific as you can, providing participant quotes if possible.

Has passed 4 out of 5 GED tests.

GED

10. Circle one number in each row across to show how you would rate each item.

Example:

I love country music 5 4 3 2 1 I can't stand country music

How would you rate this program?

Very interesting to me 5 4 (3) 2 1 Boring to me

Very useful to me on the job (5) 4 3 2 1 Totally useless to me on the job

Much too difficult for me 5 (4) 3 2 1 Much too easy for me

Very useful to me outside work (5) 4 3 2 1 Totally useless to me outside of work

Exactly what I expected (5) 4 3 2 1 Not at all what I expected

How would you rate the materials?

Hard to learn and confusing for me 5 4 3 2 (1) Easy to learn and simple for me

11. Would you recommend this course to a co-worker or friend?

Yes No

Why or why not:

It feels good when you accomplish something like getting a GED - & to know you can do something if you try.

12. If you could change anything about this program, what would it be?

Nothing really cause you had plenty of time & could work at your own pace.

I thank you for taking time to help evaluate this course. Your answers will be very useful in trying to make it better.

Instructor Anecdotal Report Form

Instructor Humphreys/CNell Plant Location TLC
Date anecdote occurred _____

Characteristics of participant:

Sex F Approximate age 39 Race White
Job classification Assembler Seniority with plant _____

Please describe in the space below comments made by this participant about how he or she is applying the content of instruction to job or to everyday life situations. Please be as specific as you can, providing participant quotes if possible.

"I'm taking more classes at work and am not afraid to do more things instead of staying in the background. (Is team spokesperson)"

3(E) - (Completed)

OREGON CUTTING SYSTEMS EMPLOYEES
AT
TARGETED LEARNING CENTER
FOR
BASIC SKILLS

POST-PROGRAM PARTICIPANT

Survey Sheet

Directions: Please answer each question below. The information you give will be used to evaluate and help improve the course materials you have used.

I. Background Information:

1. How long have you worked at this company? 10⁺ years
2. How long have you done this kind of work? 10⁺ year
3. How long have you worked in your present position? 1⁺ year
4. What is your job title? Quality technician
5. What is your age? 45
6. What is your sex? MALE FEMALE

II. Course Information:

7. What can you do now that you couldn't do before taking this course?
I had forgotten some of my algebra & it did refresh me on formulas which I use a lot at work
8. How many classes have you attended so far?
1⁺ term
_ classes.
9. Has this course helped you meet or work toward any of your personal goals? YES NO

(If you checked yes, please answer the next part of the question)

In what way?

to be able to take the test in October - I felt secure enough And also to help my daughter with algebra & geometry

10. Circle one number in each row across to show how you would rate each item.

Example:

I love country music 5 4 3 2 1 I can't stand country music

How would you rate this program?

Very interesting to me (5) 4 3 2 1 Boring to me

Very useful to me on the job (5) 4 3 2 1 Totally useless to me on the job

Much too difficult for me 5 4 (3) 2 1 Much too easy for me

Very useful to me outside work 5 4 (3) 2 1 Totally useless to me outside of work

Exactly what I expected 5 (4) 3 2 1 Not at all what I expected

How would you rate the materials?

Hard to learn and confusing for me 5 4 3 2 (1) Easy to learn and simple for me

11. Would you recommend this course to a co-worker or friend?

X _____
 YES No

Why or why not: *It was helpful and of benefit to me.*

12. If you could change anything about this program, what would it be?

Program itself is good. I do feel that students should try to solve a problem on their own before asking for help -

I thank you for taking time to help evaluate this course. Your answers will be very useful in trying to make it better. *!!*

learn to work independent

REGISTRATION FORM

I. Personal Information

Name: --

Current Address:

Telephone Number:

Birthdate: 5-7-46

1. What is your age group?

16-18yrs. 19-25yrs. 26-36yrs. 36-50yrs. 51-65yrs. 65+yrs.

2. What is your ethnic group?

1. White 2. X Black 3. Indian 4. Hispanic 5. Other

3. What is your gender? 1. Male 2. X Female

4. Circle: Single Married Head of Household

II. Employment Information:

Extension No. # 4319 Mailbox

5. How long have you worked for this company?

less than 1 year 1-2yrs. 3-5yrs. 6-10 yrs. more than 10 years

6. What is your job title? Quality Technician

7. How long have you worked in this job title? 1+ yr.
(beginning date)

III. Training and Education Information:

8. What is the last grade you complete in school?

below 8 8 9 10 11 12 GED

1 yr college more than 1 yr. college

some college courses

Have you earned any college degrees?

1. Yes 2. No 3. Associates 4. Bachelors 5. Masters

Instructor Anecdotal Report Form

Instructor Humphreys/ONEIL Plant Location TLC
Date anecdote occurred _____

Characteristics of participant:

Sex F Approximate age 45 Race Black
Job classification Quality Technician Seniority with plant 10+ years

Please describe in the space below comments made by this participant about how he or she is applying the content of instruction to job or to everyday life situations. Please be as specific as you can, providing participant quotes if possible.

"I felt secure enough to take the test." (October 1991 - awaiting results which should be known in December 1991).

Quality Technician Certification

Instructor Anecdotal Report Form

Instructor Humphreys Plant Location TLC

Date anecdote occurred JUN

Characteristics of participant:

Sex F Approximate age 44 Race White

Job classification N/A Seniority with plant N/A - attended TLC because husband was emp'd at C.

Please describe in the space below comments made by this participant about how he or she is applying the content of instruction to job or to everyday life situations. Please be as specific as you can, providing participant quotes if possible.

"It's taught me that I can do these computers and got me thinking that I can go to school in something in that line."

Skills improvement

10. Circle one number in each row across to show how you would rate each item.

Example:

I love country music 5 4 3 2 1 I can't stand country music

How would you rate this program?

Very interesting to me 5 4 3 2 1 Boring to me

Very useful to me 5 4 3 2 1 ~~Totally useless to me on the job~~

Much too difficult for me 5 4 3 2 1 Much too easy for me

Very useful to me outside work 5 4 3 2 1 Totally useless to me outside of work

Exactly what I expected 5 4 3 2 1 Not at all what I expected

How would you rate the materials?

Hard to learn and confusing for me 5 4 3 2 1 Easy to learn and simple for me

11. Would you recommend this course to a co-worker or friend?

YES NO

Why or why not:

you handled it well the atmosphere was right

12. If you could change anything about this program, what would it be?

Extend it more into other classes with the computer

I thank you for taking time to help evaluate this course. Your answers will be very useful in trying to make it better.

POST-PROGRAM PARTICIPANT

Survey Sheet

Directions: Please answer each question below. The information you give will be used to evaluate and help improve the course materials you have used.

I. Background Information: *na*

1. How long have you worked at this company? _____
2. How long have you done this kind of work? _____
3. How long have you worked in your present position? _____
4. What is your job title? _____
5. What is your age? _____
6. What is your sex? _____
 MALE FEMALE

II. Course Information:

7. What can you do now that you couldn't do before taking this course?

type on the computer

8. How many classes have you attended so far?

0 0 0
 _____ classes. *1 term*

9. Has this course helped you meet or work toward any of your personal goals?

YES No

(If you checked yes, please answer the next part of the question)

In what way? *It's taught me that I can do those computers & got me thinking that I can go to school in something in that line.*

9. Which of the following are your reasons for attending this class? (You may mark up to three answers.)

- a. To improve my job performance.
- b. To qualify for future job postings.
- c. To further my education.
- d. To meet personal goals.
- e. To find out more about this training.
- f. To become more active in company training programs
- g. Other _____

10. Which way do you BEST like to get information about something you need to know more about? (Please mark only one answer.)

- 1. Read about it.
- 2. Listen to presentations or talks about it.
- 3. Have someone show and tell you about it.
- 4. Other (Describe)

11. Did you choose to take this class? 1. Yes 2. No

12. What do you expect to get from this class?

*To improve on my math skills
& get ready to pass the test
for Quality Technician Certification*

REGISTRATION FORM

I. Personal Information

Name: _____

Current Address: _____

Telephone Number: _____

Birthdate: 4-14-47

1. What is your age group?

16-18yrs.

19-25yrs.

26-35yrs.

X
36-50yrs.

51-65yrs.

65-yrs.

2. What is your ethnic group?

1. X White 2. Black 3. Indian 4. Hispanic 5. Other

3. What is your gender? 1. Male 2. X Female

4. Circle: Single Married Head of Household

II. Employment Information:

enrolled because husband was employed at CCS

Extension No. # _____ Mailbox _____

5. How long have you worked for this company?

less than 1 year

1-2yrs.

3-5yrs.

6-10 yrs.

more than 10 years

6. What is your job title? _____

7. How long have you worked in this job title? _____
(beginning date)

III. Training and Education Information:

8. What is the last grade you complete in school?

below 8

8

9

10

11

12

GED

1 yr college

more than 1 yr. college

Have you earned any college degrees?

1. Yes 2. X No 3. Associates 4. Bachelors 5. Masters

9. Which of the following are your reasons for attending this class? (You may mark up to three answers.)

- a. To improve my job performance.
- b. To qualify for future job postings.
- c. To further my education.
- d. To meet personal goals.
- e. To find out more about this training.
- f. To become more active in company training programs
- g. Other _____

10. Which way do you BEST like to get information about something you need to know more about? (Please mark only one answer.)

- 1. Read about it.
- 2. Listen to presentations or talks about it.
- 3. Have someone show and tell you about it.
- 4. Other (Describe)

11. Did you choose to take this class? 1. Yes 2. No

12. What do you expect to get from this class?

to learn to type on a computer

POST-PROGRAM PARTICIPANT

Survey Sheet

Directions: Please answer each question below. The information you give will be used to evaluate and help improve the course materials you have used.

I. Background Information:

1. How long have you worked at this company? _____
2. How long have you done this kind of work? _____
3. How long have you worked in your present position? _____
4. What is your job title? _____
5. What is your age? 57
6. What is your sex? MALE FEMALE

II. Course Information:

7. What can you do now that you couldn't do before taking this course?

I can read & write much better with English

8. How many classes have you attended so far?

Several years on and off

9. Has this course helped you meet or work toward any of your personal goals?

YES NO

(If you checked yes, please answer the next part of the question)

In what way?

I feel self esteem. I feel good to myself I get a little more education - more confidence.

10. Circle one number in each row across to show how you would rate each item.

Example:

I love country music 5 4 3 2 1 I can't stand country music

How would you rate this program?

Very interesting to me 5 4 3 2 1 Boring to me

Very useful to me on the job 5 4 3 2 1 Totally useless to me on the job

Much too difficult for me 5 4 3 2 1 Much too easy for me

Very useful to me outside work 5 4 3 2 1 Totally useless to me outside of work

Exactly what I expected 5 4 3 2 1 Not at all what I expected

How would you rate the materials?

Hard to learn and confusing for me 5 4 3 2 1 Easy to learn and simple for me

11. Would you recommend this course to a co-worker or friend?

YES No

Why or why not?

It helps everyday in life - you can cope better in society & in your job.

12. If you could change anything about this program, what would it be?

I was satisfied because they were close and everything was OK

Thank you for taking time to help evaluate this course. Your answers will be very useful in trying to make it better.

111

REGISTRATION FORM

I. Personal Information

Name _____

Current Address: _____

Telephone Number: _____

Birthdate: 3-1-34

1. What is your age group?

16-18yrs.

19-25yrs.

26-36yrs.

36-50yrs.

X
51-65yrs.

65-yrs.

2. What is your ethnic group?

1. White

2. Black

3. Indian

4. Hispanic

5. X Other

ASIAN

3. What is your gender? 1. Male 2. X Female

4. Circle: Single Married Head of Household

II. Employment Information:

Extension No. # _____ Mailbox _____

5. How long have you worked for this company?

less than 1 year

1-2yrs.

3-5yrs.

X
6-10 yrs.

more than 10 years

6. What is your job title? manufacturing worker

7. How long have you worked in this job title? 8 yrs
(beginning date)

III. Training and Education Information:

8. What is the last grade you complete in school?

below 8

8

9

10

11

X
12

GED

1 yr college

more than 1 yr. college

Have you earned any college degrees?

1. Yes

2. No

3. Associates

4. Bachelors

5. Masters

Instructor Humphreys Plant Location TLC
Date anecdote occurred 5/1/02

Characteristics of participant:

Sex F Approximate age 57 Race ASIAN
Job title Manufacturing Worker Seniority with plant 8 years

Please describe in the space below comments made by this participant about how he or she is applying the content of instruction to job or to everyday life situations. Please be as specific as you can, providing participant quotes if possible.

"I can read and write much better with English."

SKILLS IMPROVEMENT - ESL

POST-PROGRAM PARTICIPANT

Survey Sheet

Directions: Please answer each question below. The information you give will be used to evaluate and help improve the course materials you have used.

I. Background Information:

1. How long have you worked at this company? 10+ yrs.
2. How long have you done this kind of work? 10+ yrs.
3. How long have you worked in your present position? 1 yr
4. What is your job title? Quality Specialist
5. What is your age? 44
6. What is your sex? MALE FEMALE

II. Course Information:

7. What can you do now that you couldn't do before taking this course?

Am a quality specialist

8. How many classes have you attended so far?

1 classes.

1 term

9. Has this course helped you meet or work toward any of your personal goals?

YES

No

(If you checked yes, please answer the next part of the question)

In what way?

passed test I was studying for

9. Which of the following are your reasons for attending this class? (You may mark up to three answers.)

- a. To improve my job performance.
- b. To qualify for future job postings.
- c. To further my education.
- d. To meet personal goals.
- e. To find out more about this training.
- f. To become more active in company training programs
- g. Other _____

10. Which way do you BEST like to get information about something you need to know more about? (Please mark only one answer.)

- 1. Read about it.
- 2. Listen to presentations or talks about it.
- 3. Have someone show and tell you about it.
- 4. Other (Describe)

11. Did you choose to take this class? 1. Yes 2. No

12. What do you expect to get from this class?

wanted to get ready to go into
Junior College

10. Circle one number in each row across to show how you would rate each item.

Example:

I love country music	5	4	3	2	1	I can't stand country music
<hr/>						
<u>How would you rate this program?</u>						
Very interesting to me	5	4	3	2	1	Boring to me
<hr/>						
Very useful to me on the job	5	4	3	2	1	Totally useless to me on the job
<hr/>						
Much too difficult for me	5	4	3	2	1	Much too easy for me
<hr/>						
Very useful to me outside work	5	4	3	2	1	Totally useless to me outside of work
<hr/>						
Exactly what I expected	5	4	3	2	1	Not at all what I expected

How would you rate the materials?

Hard to learn and confusing for me	5	4	3	2	1	Easy to learn and simple for me
------------------------------------	---	---	---	---	---	---------------------------------

11. Would you recommend this course to a co-worker or friend?

YES No

Why or why not? *Very helpful*

12. If you could change anything about this program, what would it be?

nothing

I thank you for taking time to help evaluate this course. Your answers will be very useful in trying to make it better.



Instructor Anecdotal Report Form

Instructor Humphreys Plant Location OCS
Date anecdote occurred O'NEIL

Characteristics of participant:

Sex F Approximate age 44 Race White

Job classification Quality Specialist Seniority with plant 10+ yrs

Please describe in the space below comments made by this participant about how he or she is applying the content of instruction to job or to everyday life situations. Please be as specific as you can, providing participant quotes if possible.

was able to pass test to become
certified in Quality Technology

Skills Improvement

REGISTRATION FORM

I. Personal Information

Name _____

Current Address:

Telephone Number:

Birthdate: 8-14-47

1. What is your age group?

16-18yrs.

19-25yrs.

26-36yrs.

X
36-50yrs.

51-65yrs.

65+yrs.

2. What is your ethnic group?

1. X White 2. Black 3. Indian 4. Hispanic 5. Other

3. What is your gender? 1. Male 2. X Female

4. Circle: Single Married Head of Household

II. Employment Information:

Extension No. # 2202 Mailbox _____

5. How long have you worked for this company?

less than 1 year

1-2yrs.

3-5yrs.

6-10 yrs.

X
more than 10 years

6. What is your job title? Quality Specialist

7. How long have you worked in this job title? 1 yr.
(beginning date)

III. Training and Education Information:

8. What is the last grade you complete in school?

below 8

8

9

10

11

X
12

GED

1 yr college

more than 1 yr. college

Have you earned any college degrees?

1. Yes 2. No 3. Associates 4. Bachelors 5. Masters

9. Which of the following are your reasons for attending this class? (You may mark up to three answers.)

- a. To improve my job performance.
- b. To qualify for future job postings.
- c. To further my education.
- d. To meet personal goals.
- e. To find out more about this training.
- f. To become more active in company training programs
- g. Other _____

10. Which way do you BEST like to get information about something you need to know more about? (Please mark only one answer.)

- 1. Read about it.
- 2. Listen to presentations or talks about it.
- 3. Have someone show and tell you about it.
- 4. Other (Describe)

11. Did you choose to take this class? 1. Yes 2. No

12. What do you expect to get from this class?

*Pass the test for quality
control specialists*

WPL 1/15/91

POST-PROGRAM PARTICIPANT

Survey Sheet

Directions: Please answer each question below. The information you give will be used to evaluate and help improve the course materials you have used.

I. Background Information:

1. How long have you worked at this company? 1 1/2 yrs
2. How long have you done this kind of work? 1 1/2 yrs
3. How long have you worked in your present position? 1 1/2 yrs.
4. What is your job title? MS /
5. What is your age? 20
6. What is your sex? MALE FEMALE

II. Course Information:

7. What can you do now that you couldn't do before taking this course?

type

8. How many classes have you attended so far?

1 classes.

1 term

9. Has this course helped you meet or work toward any of your personal goals?

YES

No

(If you checked yes, please answer the next part of the question)

In what way?

In Presenting formal letters - now they're typed

10. Circle one number in each row across to show how you would rate each item.

Example:

I love country music 5 4 3 2 1 I can't stand country music

How would you rate this program?

Very interesting to me 5 4 3 2 1 Boring to me

Very useful to me on the job 5 4 3 2 1 Totally useless to me on the job

Much too difficult for me 5 4 3 2 ~~1~~ Much too easy for me

Very useful to me outside work 5 4 3 2 1 Totally useless to me outside of work

Exactly what I expected 5 4 3 2 1 Not at all what I expected

How would you rate the materials?

Hard to learn and confusing for me 5 4 3 2 1 Easy to learn and simple for me

11. Would you recommend this course to a co-worker or friend?

YES NO

Why or why not: *Helps you build self confidence & present yourself professionally*

12. If you could change anything about this program, what would it be?

Sound on man's

I thank you for taking time to help evaluate this course. Your answers will be very useful in trying to make it better.

111



REGISTRATION FORM

I. Personal Information

Name _____

Current Address _____

Telephone Number: _____

Birthdate: 12-28-71

1. What is your age group?

16-18yrs.

19-25yrs.

26-36yrs.

36-50yrs.

51-65yrs.

65-yrs.

2. What is your ethnic group?

1. White

2. ___ Black

3. ___ Indian

4. ___ Hispanic

5. ___ Other

3. What is your gender?

1. Male

2. ___ Female

4. Circle: Single Married Head of Household

II. Employment Information:

Extension No. # 2272 Mailbox _____

5. How long have you worked for this company?

less than 1 year

1-2yrs.

3-5yrs.

6-10 yrs.

more than 10 years

6. What is your job title? MS 1

7. How long have you worked in this job title? 1 1/2 yrs.
(beginning date)

III. Training and Education Information:

8. What is the last grade you complete in school?

below 8

8

9

10

11

12

GED

1 yr college

more than 1 yr. college

Have you earned any college degrees?

1. ___ Yes

2. ___ No

3. ___ Associates

4. ___ Bachelors

5. ___ Masters

Instructor Humphreys Plant Location TLC
Date anecdote occurred J. O'Neil

Characteristics of participant:

Sex M Approximate age 20 Race White

Job title MSI Seniority with plant 1 1/2 yrs

Please describe in the space below comments made by this participant about how he or she is applying the content of instruction to job or to everyday life situations. Please be as specific as you can, providing participant quotes if possible.

Knowledge of typing and (computer
(letters are now typed)
"Helps you build self-confidence
and present yourself
professionally."

Skills improvement

POST-PROGRAM PARTICIPANT

Survey Sheet

Directions: Please answer each question below. The information you give will be used to evaluate and help improve the course materials you have used.

I. Background Information:

1. How long have you worked at this company? 10 yrs⁺
2. How long have you done this kind of work? 10 yrs⁺
3. How long have you worked in your present position? 7 yrs
4. What is your job title? manufacturing specialist 2
5. What is your age? 43
6. What is your sex? MALE FEMALE

II. Course Information:

7. What can you do now that you couldn't do before taking this course?
Have more confidence in my English skills
8. How many classes have you attended so far?
1 classes. 1 term
9. Has this course helped you meet or work toward any of your personal goals?
 YES NO

(If you checked yes, please answer the next part of the question)

In what way?

So that I could go on to other courses.

9. Which of the following are your reasons for attending this class? (You may mark up to three answers.)

- a. To improve my job performance.
- b. To qualify for future job postings.
- c. To further my education.
- d. To meet personal goals.
- e. To find out more about this training.
- f. To become more active in company training programs
- g. Other _____

10. Which way do you BEST like to get information about something you need to know more about? (Please mark only one answer.)

- 1. Read about it.
- 2. Listen to presentations or talks about it.
- 3. Have someone show and tell you about it.
- 4. Other (Describe)

11. Did you choose to take this class? 1. Yes 2. No

12. What do you expect to get from this class?

Knowledge of typin & computers

10. Circle one number in each row across to show how you would rate each item.

Example:

I love country music 5 4 3 2 1 I can't stand country music

How would you rate this program?

Very interesting to me 5 4 3 2 1 Boring to me

Very useful to me on the job 5 4 3 2 1 Totally useless to me on the job

Much too difficult for me 5 4 3 2 1 Much too easy for me

Very useful to me outside work 5 4 3 2 1 Totally useless to me outside of work

Exactly what I expected 5 4 3 2 1 Not at all what I expected

How would you rate the materials?

Hard to learn and confusing for me 5 4 3 2 1 Easy to learn and simple for me *helpful*

11. Would you recommend this course to a co-worker or friend?

 X
 YES No

Why or why not:

Because I found it very helpful.

12. If you could change anything about this program, what would it be?

I wouldn't change a thing.

Thank you for taking time to help evaluate this course. Your answers will be very useful in trying to make it better.

Instructor Humphreys Plant Location TLC

Date anecdote occurred 10/11/01

Characteristics of participant:

Sex F Approximate age 43 Race White

Job title Manufacturing Specialist Seniority with plant 10 years

Please describe in the space below comments made by this participant about how he or she is applying the content of instruction to job or to everyday life situations. Please be as specific as you can, providing participant quotes if possible.

"I have more confidence in my English skills so I can go on to other classes."

skills improvement

065.

PHILIP L. ...

REGISTRATION FORM

I. Personal Information

Name _____

Current Address:

Telephone Number:

Birthdate: 3-31-48

1. What is your age group?

16-18yrs.

19-25yrs.

26-36yrs.

X
36-50yrs.

51-65yrs.

65-yrs.

2. What is your ethnic group?

1. X White 2. Black 3. Indian 4. Hispanic 5. Other

3. What is your gender? 1. Male 2. X Female

4. Circle: Single Married Head of Household

II. Employment Information:

Extension No. # 653-4663 Mailbox _____

5. How long have you worked for this company?

less than 1 year

1-2yrs.

3-5yrs.

6-10 yrs.

X
more than 10 years

6. What is your job title? manufacturing specialist

7. How long have you worked in this job title? 1980
(beginning date)

III. Training and Education Information:

8. What is the last grade you complete in school?

below 8

8

9

10

11

X
12

GED

1 yr college

more than 1 yr. college

Have you earned any college degrees?

1. Yes 2. X No 3. Associates 4. Bachelors 5. Masters

9. Which of the following are your reasons for attending this class? (You may mark up to three answers.)

- a. To improve my job performance.
- b. To qualify for future job postings.
- c. To further my education.
- d. To meet personal goals.
- e. To find out more about this training.
- f. To become more active in company training programs
- g. Other _____

10. Which way do you BEST like to get information about something you need to know more about? (Please mark only one answer.)

- 1. Read about it.
- 2. Listen to presentations or talks about it.
- 3. Have someone show and tell you about it.
- 4. Other (Describe)

11. Did you choose to take this class? 1. Yes 2. No

12. What do you expect to get from this class?

Upgrade English, reading, writing
and Spelling skills

WPL 1/15/91

WARN INDUSTRIES EMPLOYEES
AT
WARN
FOR
SHOP MATH

CLASS 1

Survey Results

- Column 1: Course code- Wasm Shop Math
- Column 2: Tenure with company
- Column 3: Sex
- Column 4: Age
- Column 5: Race

Code for Questions 1 to 5: y=yes, n=no, u=uncertain or left blank.
 Code for Statement numbers 6 to 10: a=agree, d=disagree, n=not sure.

Questions

1. Can you solve problems that you couldn't solve before taking the class?
2. Do you think the the skills laarsed in this class will help you in your job?
3. Do you think the course has (or will) help(ed) you meet any of your personal goals?
4. Would you recommend the course to a fellow-employee or friend?
5. Were the materials and workbooks helpful?

Statements

6. The course was too hard.
7. The course will help me on the job.
8. The course will help me outside of work.
9. The course was confusing at times.
10. The teacher made it easy to learn.
11. I would like another class taught this way.

Cour	Year	S	Age	Ra	Question #					Class could be better if...	Statements #									
					1	2	3	4	5		6	7	8	9	10	11				
WNSM	1	f	20		n	y	n	y	y	Don't know	d	a	d	d	e					
WNSM	1	m	33		y	n	n	y	y	Just a different type of math	d	a	d	d	a	e				
WNSM	1	F	40	W	y	y	y	y	u	more work done on board in each math step	d	a	e	a	a	a				
WNSM	2	m	40	c	y	y	y	y	y	better ventilated room, stale air	d	a	e	a	a					
WNSM	2	f	40	as	y	y	y	y	y		n	a	e	d	e					
WNSM	3	m	21	c	y	n	y	y	y	Self-paced class	d	a	e	e	e					
WNSM	4	f	36	c	y	n	y	y	y	It was great I thought	d	a	e	e	e					
WNSM	4	m	42	W	Y	y	y	y	y	can't think of anything	d	a	e	e	e					
WNSM	5	m	37	c	y	u	y	y	y	More indepth, extend into alg, or offer alg. after this one										e
WNSM	5	m	34	c	y	u	u	y	y	Class on how to use a calculator in depth	d	a	d	d	e					
WNSM	6	m	27	c	y	y	y	y	y	nothing	d	a	e	d	a	e				
WNSM	6	f	27	c	y	y	y	y	y	more work packets, mix up problems in the packets	d	a	e	d	a	e				
WNSM	7	m	25	c	u	y	y	y	y	Nothing	d	a	e	e	e					
WNSM	7	m	38	w	y	y	y	y	y	nothing	d	a	e	d	a	e				
WNSM	7	f	27	w	y	n	y	y	y	discuss more in class	d	a	e	e	e					
WNSM	7	m	36	w	y	y	y	y	y		d	e	d	e	d	e				
WNSM	13	f	60	c	y	n	u	y	y	Studying without the distractions of people talking	d	a	e	e	e					
WNSM	20	m	61	c	y	y	y	y	y	instructor very good, consider gives certs for completion	d	a	e	d	e	a				

Survey Results

- Column 1: Course code- ~~Warn Shop-Math~~ *Computer Basics*
- Column 2: Tenure with company
- Column 3: Sex
- Column 4: Age
- Column 5: Race

Code for Questions 1 to 5: y=yes, n=no, u=uncertain or left blank.
 Code for Statement numbers 6 to 10: a=agree, d=disagree, n=not sure.

Questions

1. Can you solve problems that you couldn't solve before taking the class?
2. Do you think the skills learned in this class will help you in your job?
3. Do you think the course has (or will) help(ed) you meet any of your personal goals?
4. Would you recommend the course to a fellow-employee or friend?
5. Were the materials and workbooks helpful?

Statements

6. The course was too hard.
7. The course will help me on the job.
8. The course will help me outside of work.
9. The course was confusing at times.
10. The teacher made it easy to learn.
11. I would like another class taught this way.

Cour	Year	S	Age	Ra	Question #					Statements #						
					1	2	3	4	5	6	7	8	9	10	11	
					Class could be better if...											
8	0	m	26	w	n	y	y	y								
8	8	m	26	w	u	y	y	y	y	More computers, one for each person.	d	a	a	a	a	a
10	10	f	41	c	y	n	y	y	u	We need to learn more AMAPS	d	d	d	d	d	d
10	10	m	44	w	y	y	y	y	y	smaller classes, so enough computers, individual help	d	a	a	n	a	a
11	11	f	32	b	y	y	y	y	y	Teach us what we need to know in Assembly, inventory, parts etc	d	a	a	d	a	a
11	1	m	28	c	y	y	y	y		Longer to work on more specific items	d	a	a	d	a	a
12	12	m	0	c	y	y	y	y	y	Make classes longer, PC for each student	d	n	n	d	a	n
12	12	m	31	w	y	y		y		more in-depth	d	a	a	d	a	a
13	22	m	45	c	y	y	y	y	y	To go through materials faster, probably fine for other student	d	a	a	d	a	a
13	13	f	60	w	Y	n	u	y	y	Have a computer for everyone to work on	n	d	n	a	n	n
13	13	f	0	c	y		n	y	y		n	n	n	a	a	a
13	0	m	35	w	n	n	n	y	y	more hands on computer	d	n	n	a	a	n
13	26	m	51	w	y	y	u	y	y	Make it longer						
14	1	m	38	w	y	y	y	y	y	Nothing						
15	15	f	61	c	y	u	u	y	y	More hands on experience with PC's	d	a	a	d	a	a
18	28	m	49	w	y	y	y	y	y	Longer class time more computers in class, more time on topics	n	a	a	a	n	n
18	4	m	39	c	y	y	y	y	y	PC for each student	d	a	a	a	a	a
18	25	m	46	c	y	y	y	y	y	To have access to AMAPS for use in the shop	n	a	a	a	a	n
18	32	m	56	c	y	y	y	y	y	Typing 15 WPM should be a prerequisite	d	a	a	a	n	d
18	28	m	49	w	y	y	y	y	y	More time in class, on computers on each topic, more computers	n	a	a	a	n	n
20	29	m	49	c	y	y	y	y	y	Allow more time, more hands on examples	d	a	n	d	a	a
20	6	m	41	c	y	y	y	y	y	Nothing	d	a	a	a	a	a
21	0	m	62	w	y	u	y	y	y	have computers available to practice on	d	n	a	d	a	a
24	20	m	45	j	n	y	y	y	n	Teach DOS	D	a	a	d	a	n
24	14	m	42	w	y	y	y	y	y	More computers per class	d	a	n	d	a	a
25	0	m	57	w	y	y	y	y	y		d	a	d	a	a	a
27	4	m	48	w	Y	y	u	u	y		n	a	a	a	a	a
29	29	m	49	w		u	n	y	n		d	n	a	d	a	a

Survey Results

Column 1: Course code- ~~Warn 3804~~ *Computer Basics*
Column 2: Tenure with company
Column 3: Sex
Column 4: Age
Column 5: Race

Code for Questions 1 to 5: y=yes, n=no, u=uncertain or left blank.
Code for Statement numbers 6 to 10: a=agree, d=disagree, n=not sure.

Questions

- 1. Can you solve problems that you couldn't solve before taking the class?
- 2. Do you think the the skills learned in this class will help you in your job?
- 3. Do you think the course has (or will) help(ed) you meet any of your personal goals?
- 4. Would you recommend the course to a fellow-employee or friend?
- 5. Were the materials and workbooks helpful?

Statements

- 6. The course was too hard.
- 7. The course will help me on the job.
- 8. The course will help me outside of work.
- 9. The course was confusing at times.
- 10. The teacher made it easy to learn.
- 11. I would like another class taught this way.

Table with columns: Question #, Cour, Year, S, Age, Ra, 1, 2, 3, 4, 5, Class could be better if..., Statements #, 6, 7, 8, 9, 10, 11. Rows contain survey data for 20 different entries.

Summaries of Supervisor Evaluation

SHOP MATH PARTICIPANTS

LEADERNAME	CLASS	Partipants name...	A	B	C	D
	WNSM		3	3	3	4
	WNSM		3	3	2	3
	WNSM		3	3	2	4
	WNSM		3	3	3	3
	WNSM		3	3	2	2
	WNSM		4	4	3	4
	WNSM		3	4	3	4
	WNSM		3	4	3	4
	WNSM		3	4	3	4
	WNSM		3	4	3	4
	WNSM		3	4	3	4
	WNSM		3	4	3	4
	WNSM		3	4	3	4
	WNSM		3	3	3	3
	WNSM		4	3	3	5
	WNSM		4	4	3	4
	WNSM		3	3	2	3
	WNSM		3	3	3	3
	WNSM		3	3	2	3
	WNSM		3	3	2	3
	WNSM		3	3	2	3
	WNSM		3	3	2	3
	WNSM		3	3	2	3
	WNSM		3	3	2	3
	WNSM		3	3	2	3
	WNSM		3	3	3	3
	WNSM		4	3	3	3
	WNSM		3	3	3	3
	WNSM		3	3	3	3
	wnsM		3	3	3	3
	wnsM		3	3	3	3
	wnsM		3	3	3	4
	wnsM		3	3	3	4

Question A: Production 5: greatly improved down to 1, greatly decreased, with 3:

Question B: Quality 5: greatly improved down to 1, greatly decreased, with 3: st

Question C: Future Plans 3: Better, 2: The Same 1: Worse

Question D: Coop/Problem Solving 5: greatly improved down to 1, greatly decrease

Averages, Question A: 3.1
 Question B: 3.2
 Question C: 2.6
 Question D: 3.3

Course Evaluation

You do not need to write your name on this form.

How long have you worked at this company? _____

How long have you done this type of work? _____

What is your job title or position? _____

What is your sex? M or F (circle one).

What is your age? _____ What is your Race? _____

Your Answers are Kept Confidential

Only write your Name on this if want to be contacted

What type of problems can you solve that you couldn't before taking the class?

Do you think the skills you learned in this class will help you in your job? Why, or why not? How?

Do you think the course has (or will) help you meet any of your personal goals? Why, or why not? How

Would you recommend the course to a fellow-employee or friend? Why or why not?

Were the materials and workbooks helpful? What was good or bad about the materials used in this course?

If you could change the course in any way, what would you suggest we do to make it a better class?

Circle the answer that best applies...

Circle one:

- The course was too hard agree not sure disagree
- The course will help me on the job agree not sure disagree
- The course will help me outside of work agree not sure disagree
- The course was confusing at times agree not sure disagree
- The teacher made it easy for me to learn agree not sure disagree
- I would like another class taught this way agree not sure disagree

Use the back of this form if you wish to make further comments or suggestions.

Thank you for your help. You will help us make this a better course.

LEADER'S EVALUATION OF TRAINING EFFECTS
ON THEIR TEAMS

SAMPLE

Leader's Name: _____
 Today's Date: _____
 Course Name: _____

Below you will find an evaluation matrix. Now that the first year's courses have been completed, how would you rate their effects on the participants that you lead? Use key below:

NAME	PRODUCT- ION	QUALITY	FUTURE PLANS	CO-OPERATION AND PROBLEM SOLVING
████████████████████	5 4 3 2 1	5 4 3 2 1	3 2 1	5 4 3 2 1
████████████████████	5 4 3 2 1	5 4 3 2 1	3 2 1	5 4 3 2 1
████████████████████	5 4 3 2 1	5 4 3 2 1	3 2 1	5 4 3 2 1
████████████████████	5 4 3 2 1	5 4 3 2 1	3 2 1	5 4 3 2 1
	5 4 3 2 1	5 4 3 2 1	3 2 1	5 4 3 2 1
	5 4 3 2 1	5 4 3 2 1	3 2 1	5 4 3 2 1
	5 4 3 2 1	5 4 3 2 1	3 2 1	5 4 3 2 1

KEY:

Production:

5 = Greatly Increased 4 = Somewhat Increased 3 = Stayed the Same
 2 = Somewhat Decreased 1 = Greatly Decreased

Quality:

5 = Greatly Improved 4 = Somewhat Improved 3 = Stayed the Same
 2 = A few more errors 1 = Many more errors

Future Plans:

After completing the program, when new technical equipment or training comes to your department, do you think your employees will be able to handle it

3 = Better 2 = The Same 1 = Worse

Co-operation or Problem Solving:

5 = A Lot 4 = Some 3 = Same amount as before program
 2 = Little 1 = None

Overall:

Since your employees participated in the program, do you feel your job as a leader has become

5 = Much Easier 4 = Somewhat Easier 3 = Same as Before
 2 = Somewhat More Difficult 1 = Much More Difficult

Please give an example: _____

Comments on the Supervisors' Evaluation Form

Regarding Shop Math

Required paper work accuracy has improved somewhat.

No Noticeable Change

...learned to do inventory transactions and cycle counting/...training has been helpful in new duties.

...(easier) because I don't have to spend time working with X on problems, he can do now.

Simple math...time cards, production jobs, pulling materials for jobs.

WARN INDUSTRIES EMPLOYEES
AT
WARN
FOR
COMPUTER BASICS

S Age Ra "What type of problems can you solve that couldn't before..."

- f 28 w Hands on experience on spreadsheet was nice
- f 23 c know how to change things in Word Perfect, spreadsheet
- f 39 w How to use a spreadsheet
- m 28 a
- f 32 w I know a little more than I did before
- m 23 w I can better understand a computer now.
- m 39 c More comfortable with computers
- F 65 W typing skill improved, operations of computer
- m 36 h Not so much problem solving, have wider knowledge, skill
- f 25 c Understanding the questions the computer is asking
- m 36 c How to get help when running applications
- m 39 w Not sure without more use of Computer
- f 36 c Knew nothing about computers before class
- m 22 w some wordprocessing or spreadsheets
- f 36 c How to use all aspects of a PC
- m 27 w How to work with PC's
- f 44 w Can turn on computer and do some work on it
- m 32 c
- m 27 w all kinds of things using a spread sheet
- f 44 c Can do memos by myself
- m 30 w Could not even turn on computer before class
- f 30 a Can now do basic navigation and basic work
- M 30 W run word processors and spreadsheets
- m 36 w No previous experience on PC's
- f 39 c changing descriptions, programs
- f 44 w
- m 51 w Made it easier to run programs, ie, WP, spreadsheet
- m 26 w
- m 26 w It was only basic operation of computer, no problem solving
- f 41 c Typing, easy to correct, spreadsheets
- m 44 w Doing spreadsheet calculation, graphs
- f 32 b How to turn on computer, how to use computer files
- m 28 c Now have some background in computers
- m 0 c understanding computers
- m 31 w I know how to get around in a computer, helped a lot
- m 45 c Can do own projects without help, memos, graphs, charts
- f 60 w How to get computer started
- f 0 c Turning computers on, margins, deleting etc.
- m 35 w
- m 51 w Can do basic things to operate and use computer
- m 38 w How to use spreadsheet, WP, formatting disk
- f 61 c How to use a PC
- m 49 w make work better more enjoyable
- m 39 c Using directories and floppies
- m 46 c Turning on comp, Word Perfect, how comp works
- m 56 c can access computer without doing damage to it
- m 49 w understanding comp, can make work better, more enjoyable
- m 49 c How to get into computer
- m 41 c Run a PC now fairly confident
- m 62 w Can use Word Perfect, spreadsheet on IBM
- m 45 j None
- m 42 w understand new programs easier
- m 57 w how to get in and out of work in process
- m 48 w Word Perfect
- m 49 w

S Age Ra Do you think the skills will help you in your job

f 28 w possibly spreadsheet, not sure if we will use it

f 23 c Helps me find my way around the computer

f 39 w Will help to find information

m 28 a

f 32 w I know a little more about computers

m 23 w I don't use computer in job anymore

m 39 c Applications, speed through the system

F 65 W hope to be able to make labels and other jobs

m 36 h Computer skills always a plus for careers

f 25 c Can now relate to terms, use computer more

m 36 c Don't use at work

m 39 w Maybe in future, now job leaves little time.

f 36 c Will have to use one at work, not afraid anymore

m 22 w little bit now, more in the future, everything comput

f 36 c when I was a Team Leader, not so much now

m 27 w Possibly in the future

f 44 w Can trace parts on computer

m 32 c sometime down the road

m 27 w down the road when I get enough training to do what I

f 44 c Basic understanding, working knowledge of computers

m 30 w Somewhere down the road

f 30 a Hope it will become part of my job

M 30 W doesn't relate

m 36 w Better understand computers and work with them

f 39 c Barcode labels, eventually finding if part is in stock

f 44 w eventually

m 51 w Won't need so much help running computer at work

m 26 w Still working in assembly

m 26 w It will give me more skills.

f 41 c don't use those kind in work applications

m 44 w Because computer will become integral part of my job

f 32 b I can now be asked to do computer work

m 28 c

m 0 c in the future

m 31 w I won't be afraid to use one

m 45 c Increasingly becoming a part of my job, learned terms

f 60 w The computers are different

f 0 c

m 35 w

m 51 w In future job will be using more computers

m 38 w Computers are being used more, need to keep up

f 61 c

m 49 w for record keeping and problem solving

m 39 c with a little more time and practice

m 46 c Using computers for inventory, information when need

m 56 c Able to create data files for collection of tools

m 49 w For record keeping and problem solving

m 49 c Increasingly becoming a part of my job to use them

m 41 c we're going to be using PC's more often

m 62 w Just feel better about using an IBM PC

m 45 j

m 42 w Access to programs that solve problems

m 57 w

m 48 w Learned to use more than just amaps

m 49 w Will help in future change, job opportunities

S Age Ra ...help you meet any of your personal goals?

- f 28 w it helped me learn more about spreadsheets
- f 23 c Got me interested in taking other computer classes
- f 39 w to be able to complete a drafting degree
- m 28 a
- f 32 w
- m 23 w have gotten more interested in computers
- m 39 c Speed
- F 65 W wanted to operate a computer for years/self confid.
- m 36 h more computer literate, speak computer ease better
- f 25 c Have always found computer hard to use, until now
- m 36 c Help me be more comp literate, with future plans
- m 39 w To be computer friendly
- f 36 c Always good to gain more knowledge
- m 22 w
- f 36 c For personal use at home, setting up pers finances
- m 27 w not really
- f 44 w Can use comp at home, not be afraid of it
- m 32 c Learning to use computers
- m 27 w
- f 44 c Take on more responsibility at work
- m 30 w I would like more time to work with it
- f 30 a Feel better about working with PC's
- M 30 W better interact with computers
- m 36 w at least a step in the right direction
- f 39 c better understand comp, different functions, uses
- f 44 w
- m 51 w Helped me to reach goal of learning more about comp
- m 26 w Hope to be an engineer in the future
- m 26 w Starting new team, will be using computers in job.
- f 41 c If I plan to move around
- m 44 w Plan to buy computer for use in home business
- f 32 b Says something to WARN about my dependablty, raises
- m 28 c
- m 0 c
- m 31 w
- m 45 c Helped become more adept on computers
- f 60 w I would like to learn more about computers
- f 0 c not enough training in computer
- m 35 w too basic
- m 51 w Class should be longer
- m 38 w Machines I use are being run by computers
- f 61 c
- m 49 w what they can do to delp you at work
- m 39 c Learning PC skills is one of my goals
- m 46 c Will help in personal goals, work, knowledge
- m 56 c I won't be computer illiterate
- m 49 w understanding comp and how they can help you at work
- m 49 c
- m 41 c
- m 62 w Feel better about using computer
- m 45 j
- rr. 42 w More relaxed and confident with computers
- m 57 w understand smart cam better
- m 48 w Application change when company is in Powersoft
- m 49 w

S Age Ra ...recommend this course to a fellow employee or co-worker?

- f 28 w if they don't know anything about computers
- f 23 c Helps get you familiar with computer
- f 39 w Everyone should know the basics
- m 28 a
- f 32 w Because it covers the basics
- m 23 w It was fun
- m 39 c Only if they had a PC and planned to use daily
- F 65 W enjoyed it, sense of accomplishment
- m 36 h Help them to gain basic understanding of computers
- f 25 c Nice refresher, introductory course
- m 36 c Was a fun and informative class
- m 39 w to become familiar with computer
- f 36 c Very informative
- m 22 w good learning opportunity
- f 36 c it is fun, helps you be comfortable around PC's
- m 27 w If they don't know anything about computers
- f 44 w Can help you understand and not be afraid on comp
- m 32 c It's a good basics class
- m 27 w unless the class was more related to Warn, rec. com
- f 44 c so many are computer ignorant and afraid of them
- m 30 w Well presented, not too fast paced
- f 30 a It's a good basic course
- M 30 W it's fun
- m 36 w For basic understanding of computers
- f 39 c Gives selfconfidence when working with computers
- f 44 w good for basic info
- m 51 w Helps learning the computer so much easier
- m 26 w Teaches good skills for changes in the work place
- m 26 w If they had very little knowledge about computers.
- f 41 c It's just nice to know
- m 44 w If not familiar with computer, good starting place
- f 32 b Scott helps alot,he encourages you to make up class
- m 28 c
- m 0 c
- m 31 w if they don't know anything about computers, a help
- m 45 c Helps teach comp in a friendly environment
- f 60 w It will help you realize what a computer is about
- f 0 c
- m 35 w if they know nothing about computers
- m 51 w If he needs the basics
- m 38 w Need to know computers to keep up
- f 61 c It's always good to learn new projects
- m 49 w can make your work easier
- m 39 c It starts out basic enough for even raw beginner
- m 46 c For job related uses PFK etc.
- m 56 c Because it covers the basic fundamentals
- m 49 w it can make your work easier
- m 49 c
- m 41 c
- m 62 w To help them feel better about using PC
- m 45 j Only if they don't already know about computers
- m 42 w Vital tool in understanding growth power
- m 57 w
- m 48 w Skills learned have to be practiced
- m 49 w Excellent class for those who have little knwldge

S Age Ra ...mat'ls and workbooks helpful?

- f 28 w workbook and material were helpful to me
- f 23 c They were helpful
- f 39 w Some of material could have easier to follow
- m 28 a
- f 32 w
- m 23 w not enough information to get in/out of programs
- m 39 c Boring typing in all the definitions
- F 65 W need more detail
- m 36 h Material good, but needed more information
- f 25 c Helpful to have all materials, agenda at beginning
- m 36 c Materials were developed thru this course
- m 39 w everything was useful
- f 36 c Good having own PC to work with
- m 22 w didn't help much, class time was most beneficial
- f 36 c If you had time to read them
- m 27 w Don't like looking up list of words with no suggestio
- f 44 w
- m 32 c
- m 27 w more work sheets, more hands on
- f 44 c Helpful if vocabulary lists in the first class
- m 30 w
- f 30 a Very organized, like step by step workbook
- M 30 W need notes writtne in book for us, not for us to do
- m 36 w
- f 39 c Need materials at beginning of class
- f 44 w
- m 51 w Altho not fancy, very appropriate for begining course
- m 26 w
- m 26 w The materials were very clear.
- f 41 c He couldn't find a lot of definitions
- m 44 w instructions quite detailed, some hard to find
- f 32 b helped to introduce computers to a new afraid student
- m 28 c
- m 0 c
- m 31 w I got more out of listening to the teacher
- m 45 c Experimental materials, got better as time went on
- f 60 w They told what things were, Scott helped explain them
- f 0 c
- m 35 w
- m 51 w
- m 38 w Enough help on material to learn basics
- f 61 c
- m 49 w but not to much in depth if you in a problem (sic)
- m 39 c essential
- m 46 c Helpful, but lacked help in using AMAPS
- m 56 c Were helpful, could be more concise
- m 49 w Wrkbks give general idea, but not if you have a probl
- m 49 c Less writing makes it easier to keep up with instruct
- m 41 c
- m 62 w But most written comp directions aren't complete
- m 45 j Basic DOS should be taught
- m 42 w Easy to understand and follow
- m 57 w
- m 48 w Good because it was written in common language
- m 49 w Cumbersome

Comment 1: Are You More Comfortable Around Computers?

Basic understandin of PC's

249	
249 Hub	Never used one before, understand them a little more
249 Team	Not afraid of messing something up, more familiar
350	I know more about their operation
350 A	I now know how to get started
8274 RV	Know more about what computer is able to do
A/M Hubs	Because I can do more things
Accessories	Easier to navigate
Accessories	Understand more of the keyboard functions
Carrier Call	a little, but I understand the basic
CSR	Understand terminology that is used in field
Flange Mount 350A	Didn't know anything before
Flange Mt	Move around programs better,
Flange MT	I can't kill them as easy as I earlier thought
Flange Mt.	I am not afraid I will destroy something
Flange Mt. Nissan	Not afraid of hurting programs anymore
Human Resources	understand the lingo
Human Resources	Better understanding of the lingo
M 249	Just an intro class, need repetition to remember
M 249	Understanding that I can be productive with them
M 249	In's and out's have been explained
M236	Wasn't uncomfortable before
M236	Before class, worried about losing data, doing damage
M249	
Maintenance	Was basically a refresher course for me
Mounting System	Need more hands on experience to feel comfortable
Mounting Systems	Feel qualified to tackle PC
Nissan Hub	More comfortable, more confident
Quicker	Never used WP, spreadsheet before
Rounds	Practice on PC help feel more comfortable, familiar
RV	Because I know I can't hurt it, like to buy one
RV	Better understanding of how they work
RV	Was scared of computer before taking class
RV	Before I was afraid I would mess something up
RV	I know more about them
RV	Can do over if I didn't do it right the first time
RV Winch	Didn't know anything before
RV (Service)	Will only feel comfortable through experience
RV Winch	Know terminology, functions better, do productive work
RV Winch	Because I had not worked with computers before
RV Winch	Unless you format, its hard to do serious damage
RV Winch	
RV Winch	More familiar with them
RV Winch	Knew nothing about them before
RV Winch	More familiar with programs
RV Winch Mid Size	Was a brush up on things that I had learned before
Shift Linkage	I like them
Ssangyong	My notes and the teacher make me more comfortable
Tool and Die	Knew most that was taught
Tool Crib/Tool Grinding	Better understanding of how to communicate with PC
Tool Grinding	
Tool Grinding	But will increase when I can put this training to use
Tool Grinding 494	Can turn one on, but didn't learn to use AMAPS

Comment 2: Are you more familiar with the words and terms...?

Team	the basic terms
249	But we really don't use the terms
249 Hub	Didn't use the terms before taking the class.
249 Team	Learned definitions of common terms
350	I can use them...
350 A	Need more time on most things
8274 RV	simply because they are explained in class
A/M Hubs	Being exposed to them and the answers from Scott
Accessories	Not really important to me
Accessories	understand hcv to move thru menus more freely
Carrier Call	Know a little more than I did before
CSR	When using AMAPS, only don't have the same programs
Flange Mount 350A	Didn't know anything before
Flange Mt	Helpful if I want to buy my own computer
Flange MT	
Flange Mt.	We worked on vocabulary words
Flange Mt. Nissan	
Human Resources	usable not technical
Human Resources	Real basics given, usable information, not tech
M 249	Very interesting, hard to remember without repetitn
M 249	As long as I can use PC's I will be comfortable
M 249	learned terms not used before
M236	Normally work with AMAPS, taught me more about PC's
M236	Now I am comfortable with terms at a novice level
M249	
Maintenance	Especially with the spreadsheet program
Mounting System	Better understanding what others talk about, meaning
Mounting Systems	Before I knew nothing about PC's
Nissan Hub	Nice to learn exactly what I was doing, terms
Quicker	
Rounds	Become more familiar, comfortable
RV	But have to refer to wordlist, am reading about them
RV	Has a language all its own
RV	Didn't know any of the lanuage before taking class
RV	I know what they mean and do
RV	feels much better to have worked with them
RV	
RV Winch	Didn't know any terminology before
RV (Service)	Because it was explained
RV Winch	Class focused on terms and definitions
RV Winch	
RV Winch	Through use of the terms and the meanings
RV Winch	
RV Winch	Was previously computer literate
RV Winch	
RV Winch	Basic background of computers
RV Winch Mid Size	The terms were explained very well
Shift Linkage	I am learning the computer languages
Ssangyong	Learned new terms, good handouts, notes
Tool and Die	Knew most that was taught
Tool Crib/Tool Grinding	Have become more familiar with abbreviated words
Tool Grinding	
Tool Grinding	Now understand what the terms mean
Tool Grinding 494	Didn't know anything about them before

Comment 3: Has the class helped you interact...more effective...?

Team	a little
249	
249 Hub	Haven't had the chance to use computers much.
249 Team	More comfortable
350	I feel more confident about going into a word proc..
350 A	Learned you have to answer it's choices
8274 RV	Bought computer since class, have taught myself more
A/M Hubs	Haven't had the chance to apply the skills
Accessories	
Accessories	Before class, didn't understand the keys functions
Carrier Call	Some
CSR	Can learn how to use program step by step
Flange Mount 350A	Know what keys to get help
Flange Mt	able to change bar code label without fear of hurting
Flange MT	Now I know some terms that I have heard talked about
Flange Mt.	I am not afraid to use them
Flange Mt. Nissan	Can use without double checking everything I do
Human Resources	
Human Resources	??
M 249	
M 249	By knowing basic commands, able to produce work
M 249	learned WP, spreadsheet on IBM
M236	not really
M236	Learned what they do, how to get around on them
M249	
Maintenance	Knew the other programs, spreadsheet was most helpful
Mounting System	Can have information no more than one area at a time
Mounting Systems	
Nissan Hub	Know more about how to operate comp, more effective
Quicker	The more hands on experience the more you learn
Rounds	Hands on experience is my way of learning
RV	Haven't had the chance to yet
RV	Less fear
RV	I don't know
RV	
RV	know more about them
RV	
RV Winch	Given me more confidence
RV (Service)	Only through experience
RV Winch	Less intimidated around PC, comfortable seeking help
RV Winch	
RV Winch	
RV Winch	
RV Winch	
RV Winch	know WP, Lotus and DOS more effectively
RV Winch	Too basic
RV Winch	can navigate in computers easier
RV Winch Mid Size	How to get around on computer and what they can do
Shift Linkage	Have basic skills to write a file, make a spreadsheet
Ssangyong	Introduced to computer, now have tools to learn more
Tool and Die	
Tool Crib/Tool Grinding	Better understanding of language, applications, job
Tool Grinding	
Tool Grinding	But not as effective as I would like
Tool Grinding 494	Helped with Word Perfect, spreadsheets, but need AMA

Comment 4: ...understand ... better team member?

Team	the technology is very helpful
249	We all share the work on the computer
249 Hub	Other than having more skills to offer.
249 Team	Have knowledge if needed about computers
350	have improved typing and self confidence
350 A	Possibly, if I understood all about computers
8274 RV	Things learned in class, not applicable to my job
A/M Hubs	The more skilled you are the more complete your tea
Accessories	Charts, spreadsheets etc.
Accessories	helps you work on and save important information
Carrier Call	If I had more time on them
CSR	Able to program more info that is related to work
Flange Mount 350A	had to ask other people for help before class
Flange Mt	Be able to look up stock to see if it's in
Flange MT	
Flange Mt.	Have more access to information about parts
Flange Mt. Nissan	
Human Resources	use time more efficiently
Human Resources	Use time more efficeintly
M 249	But need much more training
M 249	Class increased my ability to be flexible
M 249	Don't use computer too often on job
M236	
M236	haven't used them, but may need to in the future
M249	
Maintenance	Can do more at faster pace for team members
Mounting System	Making records easier to be kept, storing informatio
Mounting Systems	
Nissan Hub	Computer will make our jobs easier
Quicker	Don't use it now but may be helpful in the future
Rounds	Word Perfect and spreadsheet could be helpful
RV	Computer make things more efficient
RV	But it still takes a lot more time than I have
RV	If I could entor jobs, boss would have less work
RV	
RV	Can do more on the system now
RV	
RV Winch	
RV (Service)	Have a better understanding of what is going on
RV Winch	Already realized importance before class
RV Winch	
RV Winch	They can store information everyone can access
RV Winch	
RV Winch	We all need to be as familiar with them as we can
RV Winch	Has nothing to do with my job
RV Winch	Don't have to ask other people for help
RV Winch Mid Size	Gave some ideas on how to store and use stats
Shift Linkage	There are terminals, standlones, servers, network
Ssangyong	Don't feel afraid now when team leader is helping m
Tool and Die	
Tool Crib/Tool Grinding	Can make computer do work for us if feed right info
Tool Grinding	I knew nothing before
Tool Grinding	Can see where we can be more effective in our dept
Tool Grinding 494	Making programs for team use, inventory, tool contro

Comment 5: What can you do now as a result...?

Team	Basicly work with PC's
249	Not ask for as much help
249 Hub	Learned more than I can explain in this space.
249 Team	Basics, use WP, possibly spreadsheet
350	about to start WordStar (on home computer
350 A	Get it started
8274 RV	Good beginning for teaching myself more
A/M Hubs	All course topics
Accessories	Use my computer effectively
Accessories	Practice with PC for future job skills
Carrier Call	Undrstd little better how work,solve problems mysel
CSR	Word Perfect, spreadsheet
Flange Mount 350A	Start computer, find program, store work, print
Flange Mt	Get in,out of A drive, delete words,find files etc.
Flange MT	Spreadsheets, Word Perfect in a very basic manner
Flange Mt.	Get info from system, use Word Perfect, spreadsheet
Flange Mt. Nissan	Spreadsheet, word processing, get around on compute
Human Resources	bring up network and use various programs
Human Resources	Bring up network, beginning to use various programs
M 249	
M 249	Be able to log in and do simple work
M 249	Get in and out of WP and spreadsheet
M236	Work with PC's
M236	Less intimidated,know more about programs, usage
M249	Turn on comp, run programs, load disk
Maintenance	Do more with spreadsheet than I could before
Mounting System	Help make problem solving easier by using spreadshe
Mounting Systems	Use a PC
Nissan Hub	Utilize files better, general understanding of DOS
Quicker	Manipulate system, more familiar with WP, Lotus
Rounds	Easier to use computer
RV	Practice on all programs without fear of hurting it
RV	Use floppies
RV	Documents on Word Perfect, spreadsheets
RV	I know the basics about getting around on computer
RV	Work on WP, spreadsheets
RV	I can run a spreadsheet
RV Winch	sit an a PC and run it (somewhat)
RV (Service)	
RV Winch	Producing own memos,letters without help from secrt
RV Winch	Do basic computer functions
RV Winch	
RV Winch	
RV Winch	Better understanding of WP, Lotus, DOS
RV Winch	Explain DOS
RV Winch	Navigate programs, extract information easier
RV Winch Mid Size	Use files, store, rename, create,WP, spreadsheet
Shift Linkage	Have to learn how to use WP, database, Lotus better
Ssangyong	Take on computer responsibilities on my team
Tool and Die	
Tool Crib/Tool Grinding	Further my education, know what programs are availb
Tool Grinding	Do the basics
Tool Grinding	Do Word Perfect with minimal amount of problems
Tool Grinding 494	turning on small PC, Word Perfect, formating disks

Supervisors' Evaluation of the Computer Basics Class

TEAM LEADER	PARTICIPANTS	A	B	C	D
	WNCB	3	3	2	3
	WNCB	3	3	3	4
	WNCB	4	4	2	4
	WNCB	3	3	3	3
	WNCB	3	4	3	3
	WNCB	4	3	3	4
	WNCB	4	4	3	4
	WNCB	4	4	3	5
	WNCB	4	4	3	5
	WNCB	4	3	2	4
	WNCB	3	3	3	3
	WNCB	3	3	2	3
	WNCB	3	3	2	3
	WNCB	3	3	3	3
	WNCB	3	3	3	3
	WNCB	4	4	2	4
	WNCB	4	4	3	3
	WNCB	4	3	3	4
	WNCB	4	4	3	4

Question A: Production 5: greatly improved down to 1, greatly decreased, with 3:

Question B: Quality 5: greatly improved down to 1, greatly decreased, with 3: st

Question C: Future Plans 3: Better, 2: The Same 1: Worse

Question D: Coop/Problem Solving 5: greatly improved down to 1, greatly decrease

Averages, Question A: 3.5
 Question B: 3.4
 Question C: 2.6
 Question D: 3.6

Questionnaire For Employees that
have taken the Computer Basics
Class...

Name: _____

Team: _____

(the next page has an evaluation that does not require you give your name)

Please answer the following questions...

1. Since taking the class, are you more comfortable around computers? Explain why or why not.

2. Since taking the class, are you more familiar with the words and terms used in referring to computers? Explain why or why not.

3. Has the class helped you learn to interact with computers in a more effective way?

If so, How?

4. Did the class help you understand how computers can be used to make you a better worker/team member? Explain.

5. What can you do now as a result of having been in the class?

6. What things should be changed to make the class better?

Please return this questionnaire and the Course Evaluation to Toni M. in HR-Training as soon as possible.

Comments on the Supervisors' Evaluation Form

Regarding Computer Basics

(I) don't have to take the time to show basic computer skills.

...Helped to gain confidence in using computers in general.

...X is more frustrated, needs one-on-one training.

...how much will be retained by the time opportunity presents itself is questionable.

...will make record keeping...data collection somewhat easier.

...X has been contributing more and more...don't know whether it is the training or TEI...

(easier) memos, meeting notices and minutes produced.

OREGON CUTTING SYSTEMS EMPLOYEES
AT
OCS
FOR
COMPUTER BASICS

142

OCS TRAINING CRITIQUE FORM

PURPOSE OF CRITIQUE: Continual improvement of training classes and processes.
Thanks for your assistance.

CLASS TITLE Computer Basics DATE 6-13-91
INSTRUCTOR (S) Scott Cleveland

1) Were your overall expectations met for this class?
1 2 3 4 5 6
not at all very little somewhat reasonably well definitely beyond expectations
If you did not rate a 5 or 6, what could have been done differently to achieve a 5 or 6 rating?

2) Please rate the overall appropriateness and quality of the training materials (or manual) you received for this class.
1 2 3 4 5 6
not at all very little somewhat reasonably appropriate definitely beyond expectations
If you did not rate a 5 or 6, what could have been done differently to achieve a 5 or 6 rating?

3) Were you contacted regarding this class in a timely manner?
1 2 3 4 5 6
not at all very little somewhat reasonably well definitely beyond expectations
If you did not rate a 5 or 6, what could have been done differently to achieve a 5 or 6 rating?

4) How appropriate was the day & time of this class(es)?
1 2 3 4 5 6
not at all very little somewhat reasonably well definitely beyond expectations
Comments: _____

5) How would you rate the importance of this subject to your job?
1 2 3 4 5 6
not at all very little somewhat reasonably imp. definitely imp. extremely imp.
Comments: My job deals very little with computers at this time.

SEE BACK PLEASE



6) Given opportunities, how effectively could you use what was taught in class?

1 2 3 4 5 6
not at all very little somewhat reasonably well definitely very effectively

If you did not rate a 5 or 6, why? Probably could use a little more practice.

7) Rate the instructors' ability as a teacher (HOW class was taught)?

1 2 3 4 5 6
very low low fair high very high excellent

If you did not rate a 5 or 6, what could have been done differently to achieve a 5 or 6 rating?

8) Rate the degree of instructor's expertise/knowledge (on this subject).

1 2 3 4 5 6
very low low fair high very high excellent

If you did not rate a 5 or 6, what could have been done differently to achieve a 5 or 6 rating?

9) Please rate overall training.

1 2 3 4 5 6
very low low fair high very high excellent

If you did not rate a 5 or 6, what could have been done differently to achieve a 5 or 6 rating?

10) WHAT classes would you like to see offered at OCS?

Word processing

ocs college classes only

11) What impact did OCS College (having classes held here at work) have on you taking this course?

1 2 3 4 5 6
none at all very little somewhat reasonable impact definite impact extreme impact

Comments: _____

12) What impact did the payment method (payroll deduction at the end) and the cost (to you) have in your choice to take this class?

1 2 3 4 5 6
none at all very little somewhat reasonable impact definite impact extreme impact

Comments: _____

OCS TRAINING CRITIQUE FORM

PURPOSE OF CRITIQUE: Continual improvement of training classes and processes.
Thanks for your assistance.

CLASS TITLE Basic Computer DATE 6-15-91
INSTRUCTOR (S) Scott England

1) Were your overall expectations met for this class?
1 2 3 4 5 6
not at all very little somewhat reasonably well definitely beyond expectations
If you did not rate a 5 or 6, what could have been done differently to achieve a 5 or 6 rating?

This is good for some that don't know anything or know little about computers to slow if some have little experience

2) Please rate the overall appropriateness and quality of the training materials (or manual) you received for this class.
1 2 3 4 5 6
not at all very little somewhat reasonably appropriate definitely beyond expectations
If you did not rate a 5 or 6, what could have been done differently to achieve a 5 or 6 rating?

Could have some explanation of terms so student can listen and not be writing so much

3) Were you contacted regarding this class in a timely manner?
1 2 3 4 5 6
not at all very little somewhat reasonably well definitely beyond expectations
If you did not rate a 5 or 6, what could have been done differently to achieve a 5 or 6 rating?

4) How appropriate was the day & time of this class(es)?
1 2 3 4 5 6
not at all very little somewhat reasonably well definitely beyond expectations
Comments: Sat. afternoon not good

5) How would you rate the importance of this subject to your job?
1 2 3 4 5 6
not at all very little somewhat reasonably imp. definitely imp. extremely imp.
Comments: _____

SEE BACK PLEASE



6) Given opportunities, how effectively could you use what was taught in class?

1 2 3 4 5 6
not at all very little somewhat reasonably well definitely very effectively
If you did not rate a 5 or 6, why? with lot more practice

7) Rate the instructors' ability as a teacher (HOW class was taught)?

1 2 3 4 5 6
very low low fair high very high excellent
If you did not rate a 5 or 6, what could have been done differently to achieve a 5 or 6 rating?

Both Instructors Sometimes
Talking at same time and saying diff. things
no confusing

8) Rate the degree of instructor's expertise/knowledge (on this subject).

1 2 3 4 5 6
very low low fair high very high excellent
If you did not rate a 5 or 6, what could have been done differently to achieve a 5 or 6 rating?

9) Please rate overall training.

1 2 3 4 5 6
very low low fair high very high excellent
If you did not rate a 5 or 6, what could have been done differently to achieve a 5 or 6 rating?

10) WHAT classes would you like to see offered at OCS?

ocs college classes only

11) What impact did OCS College (having classes held here at work) have on you taking this course?

1 2 3 4 5 6
none at all very little somewhat reasonable impact definite impact extreme impact

Comments: _____

12) What impact did the payment method (payroll deduction at the end) and the cost (to you) have in your choice to take this class?

1 2 3 4 5 6
none at all very little somewhat reasonable impact definite impact extreme impact

Comments: _____

JE

OCS TRAINING CRITIQUE FORM

PURPOSE OF CRITIQUE: Continual improvement of training classes and processes.
Thanks for your assistance.

CLASS TITLE Computer Basics DATE 6-15
INSTRUCTOR (S) Scott Copeland

1) Were your overall expectations met for this class?
1 2 3 4 5 6
not at all very little somewhat reasonably well definitely beyond expectations
If you did not rate a 5 or 6, what could have been done differently to achieve a 5 or 6 rating?

2) Please rate the overall appropriateness and quality of the training materials (or manual) you received for this class.
1 2 3 4 5 6
not at all very little somewhat reasonably appropriate definitely beyond expectations
If you did not rate a 5 or 6, what could have been done differently to achieve a 5 or 6 rating?

3) Were you contacted regarding this class in a timely manner?
1 2 3 4 5 6
not at all very little somewhat reasonably well definitely beyond expectations
If you did not rate a 5 or 6, what could have been done differently to achieve a 5 or 6 rating?
I was notified of the class ~~at~~ about a week ahead. More time would have been better

4) How appropriate was the day & time of this class(es)?
1 2 3 4 5 6
not at all very little somewhat reasonably well definitely beyond expectations
Comments: I have scheduling problems so it was hard to come at the same time each week.

5) How would you rate the importance of this subject to your job?
1 2 3 4 5 6
not at all very little somewhat reasonably imp. definitely imp. extremely imp.
Comments: I am not yet in a position that I need to use a computer but hope to be soon

SEE BACK PLEASE

6) Given opportunities, how effectively could you use what was taught in class?

1 2 3 4 5 6
not at all very little somewhat reasonably well definitely very effectively

If you did not rate a 5 or 6, why? _____

7) Rate the instructors' ability as a teacher (HOW class was taught)?

1 2 3 4 5 6
very low low fair high very high excellent

If you did not rate a 5 or 6, what could have been done differently to achieve a 5 or 6 rating?

8) Rate the degree of instructor's expertise/knowledge (on this subject).

1 2 3 4 5 6
very low low fair high very high excellent

If you did not rate a 5 or 6, what could have been done differently to achieve a 5 or 6 rating?

9) Please rate overall training.

1 2 3 4 5 6
very low low fair high very high excellent

If you did not rate a 5 or 6, what could have been done differently to achieve a 5 or 6 rating?

10) WHAT classes would you like to see offered at OCS?

more 'general' basic computer classes (like this).
A 'Sampler' class, if we don't know what's Ave

ocs college classes only

11) What impact did OCS College (having classes held here at work) have on you taking this course?

1 2 3 4 5 6
none at all very little somewhat reasonable impact definite impact extreme impact

Comments: I would not have signed up for
the class elsewhere

12) What impact did the payment method (payroll deduction at the end) and the cost (to you) have in your choice to take this class?

1 2 3 4 5 6
none at all very little somewhat reasonable impact definite impact extreme impact

Comments: N/A

OCS TRAINING CRITIQUE FORM

PURPOSE OF CRITIQUE: Continual improvement of training classes and processes.
Thanks for your assistance.

CLASS TITLE COMPUTER BASICS DATE 6/15/91
INSTRUCTOR (S) SEPT COPPELLAW

1) Were your overall expectations met for this class?

1 2 3 4 5 6
not at all very little somewhat reasonably well definitely beyond expectations
If you did not rate a 5 or 6, what could have been done differently to achieve a 5 or 6 rating?

2) Please rate the overall appropriateness and quality of the training materials (or manual) you received for this class.

1 2 3 4 5 6
not at all very little somewhat reasonably appropriate definitely beyond expectations
If you did not rate a 5 or 6, what could have been done differently to achieve a 5 or 6 rating?

3) Were you contacted regarding this class in a timely manner?

1 2 3 4 5 6
not at all very little somewhat reasonably well definitely beyond expectations
If you did not rate a 5 or 6, what could have been done differently to achieve a 5 or 6 rating?

4) How appropriate was the day & time of this class(es)?

1 2 3 4 5 6
not at all very little somewhat reasonably well definitely beyond expectations

Comments: _____

5) How would you rate the importance of this subject to your job?

1 2 3 4 5 6
not at all very little somewhat reasonably imp. definitely imp. extremely imp.

Comments: _____

SEE BACK PLEASE



6) Given opportunities, how effectively could you use what was taught in class?

1 2 3 4 5 6
not at all very little somewhat reasonably well definitely very effectively

If you did not rate a 5 or 6, why? _____

7) Rate the instructors' ability as a teacher (HOW class was taught)?

1 2 3 4 5 6
very low low fair high very high excellent

If you did not rate a 5 or 6, what could have been done differently to achieve a 5 or 6 rating?

8) Rate the degree of instructor's expertise/knowledge (on this subject).

1 2 3 4 5 6
very low low fair high very high excellent

If you did not rate a 5 or 6, what could have been done differently to achieve a 5 or 6 rating?

9) Please rate overall training.

1 2 3 4 5 6
very low low fair high very high excellent

If you did not rate a 5 or 6, what could have been done differently to achieve a 5 or 6 rating?

10) WHAT classes would you like to see offered at OCS?

ocs college classes only

11) What impact did OCS College (having classes held here at work) have on you taking this course?

1 2 3 4 5 6
none at all very little somewhat reasonable impact definite impact extreme impact

Comments: _____

12) What impact did the payment method (payroll deduction at the end) and the cost (to you) have in your choice to take this class?

1 2 3 4 5 6
none at all very little somewhat reasonable impact definite impact extreme impact

Comments: _____

OCS TRAINING CRITIQUE FORM

PURPOSE OF CRITIQUE: Continual improvement of training classes and processes.
Thanks for your assistance.

CLASS TITLE Computer Basic DATE 6-18-91
INSTRUCTOR (S) Scott E. DeLano

1) Were your overall expectations met for this class?
1 2 3 4 5 6
not at all very little somewhat reasonably well definitely beyond expectations
If you did not rate a 5 or 6, what could have been done differently to achieve a 5 or 6 rating?

2) Please rate the overall appropriateness and quality of the training materials (or manual) you received for this class.
1 2 3 4 5 6
not at all very little somewhat reasonably appropriate definitely beyond expectations
If you did not rate a 5 or 6, what could have been done differently to achieve a 5 or 6 rating?

3) Were you contacted regarding this class in a timely manner?
1 2 3 4 5 6
not at all very little somewhat reasonably well definitely beyond expectations
If you did not rate a 5 or 6, what could have been done differently to achieve a 5 or 6 rating?

4) How appropriate was the day & time of this class(es)?
1 2 3 4 5 6
not at all very little somewhat reasonably well definitely beyond expectations
Comments: _____

5) How would you rate the importance of this subject to your job?
1 2 3 4 5 6
not at all very little somewhat reasonably imp. definitely imp. extremely imp.
Comments: It could have been longer - more
than three Saturdays

SEE BACK PLEASE

6) Given opportunities, how effectively could you use what was taught in class?

1 2 3 4 5 6
not at all very little somewhat reasonably well definitely very effectively

If you did not rate a 5 or 6, why? _____

7) Rate the instructors' ability as a teacher (HOW class was taught)?

1 2 3 4 5 6
very low low fair high very high excellent

If you did not rate a 5 or 6, what could have been done differently to achieve a 5 or 6 rating?

8) Rate the degree of instructor's expertise/knowledge (on this subject).

1 2 3 4 5 6
very low low fair high very high excellent

If you did not rate a 5 or 6, what could have been done differently to achieve a 5 or 6 rating?

9) Please rate overall training.

1 2 3 4 5 6
very low low fair high very high excellent

If you did not rate a 5 or 6, what could have been done differently to achieve a 5 or 6 rating?

10) WHAT classes would you like to see offered at OCS?

_____ OCS college classes only _____

11) What impact did OCS College (having classes held here at work) have on you taking this course?

1 2 3 4 5 6
none at all very little somewhat reasonable impact definite impact extreme impact

Comments: _____

12) What impact did the payment method (payroll deduction at the end) and the cost (to you) have in your choice to take this class?

1 2 3 4 5 6
none at all very little somewhat reasonable impact definite impact extreme impact

Comments: _____

OCS TRAINING CRITIQUE FORM

PURPOSE OF CRITIQUE: Continual improvement of training classes and processes.
Thanks for your assistance.

CLASS TITLE Computer BASIC DATE 6-15-91
INSTRUCTOR (S) SCOTT LOPELANCI

1) Were your overall expectations met for this class?

1 2 3 4 5 6
not at all very little somewhat reasonably well definitely beyond expectations
If you did not rate a 5 or 6, what could have been done differently to achieve a 5 or 6 rating?

2) Please rate the overall appropriateness and quality of the training materials (or manual) you received for this class.

1 2 3 4 5 6
not at all very little somewhat reasonably appropriate definitely beyond expectations
If you did not rate a 5 or 6, what could have been done differently to achieve a 5 or 6 rating?

3) Were you contacted regarding this class in a timely manner?

1 2 3 4 5 6
not at all very little somewhat reasonably well definitely beyond expectations
If you did not rate a 5 or 6, what could have been done differently to achieve a 5 or 6 rating?

4) How appropriate was the day & time of this class(es)?

1 2 3 4 5 6
not at all very little somewhat reasonably well definitely beyond expectations

Comments: _____

5) How would you rate the importance of this subject to your job?

1 2 3 4 5 6
not at all very little somewhat reasonably imp. definitely imp. extremely imp.

Comments: _____

SEE BACK PLEASE

6) Given opportunities, how effectively could you use what was taught in class?

1 2 3 4 5 6
not at all very little somewhat reasonably well definitely very effectively

If you did not rate a 5 or 6, why? _____

7) Rate the instructors' ability as a teacher (HOW class was taught)?

1 2 3 4 5 6
very low low fair high very high excellent

If you did not rate a 5 or 6, what could have been done differently to achieve a 5 or 6 rating?

8) Rate the degree of instructor's expertise/knowledge (on this subject).

1 2 3 4 5 6
very low low fair high very high excellent

If you did not rate a 5 or 6, what could have been done differently to achieve a 5 or 6 rating?

9) Please rate overall training.

1 2 3 4 5 6
very low low fair high very high excellent

If you did not rate a 5 or 6, what could have been done differently to achieve a 5 or 6 rating?

10) WHAT classes would you like to see offered at OCS?

Classes to continue BASIC COMPUTERS

ocs college classes only

11) What impact did OCS College (having classes held here at work) have on you taking this course?

1 2 3 4 5 6
none at all very little somewhat reasonable impact definite impact extreme impact

Comments: _____

12) What impact did the payment method (payroll deduction at the end) and the cost (to you) have in your choice to take this class?

1 2 3 4 5 6
none at all very little somewhat reasonable impact definite impact extreme impact

Comments: _____

OCS TRAINING CRITIQUE FORM

PURPOSE OF CRITIQUE: Continual improvement of training classes and processes.
Thanks for your assistance.

CLASS TITLE COMPUTER BASICS DATE 6-15-91
INSTRUCTOR (S) SCOTT COYLAND

1) Were your overall expectations met for this class?

1 2 3 4 5 6
not at all very little somewhat reasonably well definitely beyond expectations

If you did not rate a 5 or 6, what could have been done differently to achieve a 5 or 6 rating?

2) Please rate the overall appropriateness and quality of the training materials (or manual) you received for this class.

1 2 3 4 5 6
not at all very little somewhat reasonably appropriate definitely beyond expectations

If you did not rate a 5 or 6, what could have been done differently to achieve a 5 or 6 rating?

3) Were you contacted regarding this class in a timely manner?

1 2 3 4 5 6
not at all very little somewhat reasonably well definitely beyond expectations

If you did not rate a 5 or 6, what could have been done differently to achieve a 5 or 6 rating?

4) How appropriate was the day & time of this class(es)?

1 2 3 4 5 6
not at all very little somewhat reasonably well definitely beyond expectations

Comments: _____

5) How would you rate the importance of this subject to your job?

1 2 3 4 5 6
not at all very little somewhat reasonably imp. definitely imp. extremely imp.

Comments: _____

SEE BACK PLEASE

6) Given opportunities, how effectively could you use what was taught in class?

1 2 3 4 5 6
not at all very little somewhat reasonably well definitely very effectively

If you did not rate a 5 or 6, why? _____

7) Rate the instructors' ability as a teacher (HOW class was taught)?

1 2 3 4 5 6
very low low fair high very high excellent

If you did not rate a 5 or 6, what could have been done differently to achieve a 5 or 6 rating?

8) Rate the degree of instructor's expertise/knowledge (on this subject).

1 2 3 4 5 6
very low low fair high very high excellent

If you did not rate a 5 or 6, what could have been done differently to achieve a 5 or 6 rating?

9) Please rate overall training.

1 2 3 4 5 6
very low low fair high very high excellent

If you did not rate a 5 or 6, what could have been done differently to achieve a 5 or 6 rating?

10) WHAT classes would you like to see offered at OCS?

CLASSES AFTER COMPUTER BASICS

ocs college classes only

11) What impact did OCS College (having classes held here at work) have on you taking this course?

1 2 3 4 5 6
none at all very little somewhat reasonable impact definite impact extreme impact

Comments: _____

12) What impact did the payment method (payroll deduction at the end) and the cost (to you) have in your choice to take this class?

1 2 3 4 5 6
none at all very little somewhat reasonable impact definite impact extreme impact

Comments: _____

OCS TRAINING CRITIQUE FORM

PURPOSE OF CRITIQUE: Continual improvement of training classes and processes.
Thanks for your assistance.

CLASS TITLE COMPUTER BASICS DATE 6-15-91
INSTRUCTOR (S) SCOTT COPELAND

1) Were your overall expectations met for this class?
1 2 3 4 5 6
not at all very little somewhat reasonably well definitely beyond expectations
If you did not rate a 5 or 6, what could have been done differently to achieve a 5 or 6 rating?

2) Please rate the overall appropriateness and quality of the training materials (or manual) you received for this class.
1 2 3 4 5 6
not at all very little somewhat reasonably appropriate definitely beyond expectations
If you did not rate a 5 or 6, what could have been done differently to achieve a 5 or 6 rating?

3) Were you contacted regarding this class in a timely manner?
1 2 3 4 5 6
not at all very little somewhat reasonably well definitely beyond expectations
If you did not rate a 5 or 6, what could have been done differently to achieve a 5 or 6 rating?

4) How appropriate was the day & time of this class(es)?
1 2 3 4 5 6
not at all very little somewhat reasonably well definitely beyond expectations
Comments: _____

5) How would you rate the importance of this subject to your job?
1 2 3 4 5 6
not at all very little somewhat reasonably imp. definitely imp. extremely imp.
Comments: _____

SEE BACK PLEASE

- 6) Given opportunities, how effectively could you use what was taught in class?

1 2 3 4 5 6
not at all very little somewhat reasonably well definitely very effectively

If you did not rate a 5 or 6, why? _____

- 7) Rate the instructors' ability as a teacher (HOW class was taught)?

1 2 3 4 5 6
very low low fair high very high excellent

If you did not rate a 5 or 6, what could have been done differently to achieve a 5 or 6 rating?

- 8) Rate the degree of instructor's expertise/knowledge (on this subject).

1 2 3 4 5 6
very low low fair high very high excellent

If you did not rate a 5 or 6, what could have been done differently to achieve a 5 or 6 rating?

- 9) Please rate overall training.

1 2 3 4 5 6
very low low fair high very high excellent

If you did not rate a 5 or 6, what could have been done differently to achieve a 5 or 6 rating?

- 10) WHAT classes would you like to see offered at OCS?

MORE COMPUTER CLASSES
TYPEWRITING
SPELLING

ocs college classes only

- 11) What impact did OCS College (having classes held here at work) have on you taking this course?

1 2 3 4 5 6
none at all very little somewhat reasonable impact definite impact extreme impact

Comments: _____

- 12) What impact did the payment method (payroll deduction at the end) and the cost (to you) have in your choice to take this class?

1 2 3 4 5 6
none at all very little somewhat reasonable impact definite impact extreme impact

Comments: _____

OCS TRAINING CRITIQUE FORM

PURPOSE OF CRITIQUE: Continual improvement of training classes and processes.
Thanks for your assistance.

CLASS TITLE COMPUTER BASICS DATE 6/15/91
INSTRUCTOR (S) SCOTT COPELAND

1) Were your overall expectations met for this class?
1 2 3 4 5 6
not at all very little somewhat reasonably well definitely beyond expectations
If you did not rate a 5 or 6, what could have been done differently to achieve a 5 or 6 rating?

2) Please rate the overall appropriateness and quality of the training materials (or manual) you received for this class.
1 2 3 4 5 6
not at all very little somewhat reasonably appropriate definitely beyond expectations
If you did not rate a 5 or 6, what could have been done differently to achieve a 5 or 6 rating?

3) Were you contacted regarding this class in a timely manner?
1 2 3 4 5 6
not at all very little somewhat reasonably well definitely beyond expectations
If you did not rate a 5 or 6, what could have been done differently to achieve a 5 or 6 rating?

4) How appropriate was the day & time of this class(es)?
1 2 3 4 5 6
not at all very little somewhat reasonably well definitely beyond expectations
Comments: _____

5) How would you rate the importance of this subject to your job?
1 2 3 4 5 6
not at all very little somewhat reasonably imp. definitely imp. extremely imp.
Comments: _____

SEE BACK PLEASE

6) Given opportunities, how effectively could you use what was taught in class?

1 2 3 4 5 6
not at all very little somewhat reasonably well definitely very effectively

If you did not rate a 5 or 6, why? _____

7) Rate the instructors' ability as a teacher (HOW class was taught)?

1 2 3 4 5 6
very low low fair high very high excellent

If you did not rate a 5 or 6, what could have been done differently to achieve a 5 or 6 rating?

8) Rate the degree of instructor's expertise/knowledge (on this subject).

1 2 3 4 5 6
very low low fair high very high excellent

If you did not rate a 5 or 6, what could have been done differently to achieve a 5 or 6 rating?

9) Please rate overall training.

1 2 3 4 5 6
very low low fair high very high excellent

If you did not rate a 5 or 6, what could have been done differently to achieve a 5 or 6 rating?

10) WHAT classes would you like to see offered at OCS?

BASIC COMPUTER CLASSES (HANDS ON AS WELL AS NOVICE) DN UP TO THIS POINTS ADVANCED

ocs college classes only

11) What impact did OCS College (having classes held here at work) have on you taking this course?

1 2 3 4 5 6
none at all very little somewhat reasonable impact definite impact extreme impact

Comments: _____

12) What impact did the payment method (payroll deduction at the end) and the cost (to you) have in your choice to take this class?

1 2 3 4 5 6
none at all very little somewhat reasonable impact definite impact extreme impact

Comments: _____

OCS TRAINING CRITIQUE FORM

PURPOSE OF CRITIQUE: *Continual improvement of training classes and processes.
Thanks for your assistance.*

CLASS TITLE Computer Basics DATE 6-15-91
INSTRUCTOR (S) Scott

1) Were your overall expectations met for this class?
1 2 3 4 5 6
not at all very little somewhat reasonably well definitely beyond expectations
If you did not rate a 5 or 6, what could have been done differently to achieve a 5 or 6 rating?

2) Please rate the overall appropriateness and quality of the training materials (or manual) you received for this class.
1 2 3 4 5 6
not at all very little somewhat reasonably appropriate definitely beyond expectations
If you did not rate a 5 or 6, what could have been done differently to achieve a 5 or 6 rating?

3) Were you contacted regarding this class in a timely manner?
1 2 3 4 5 6
not at all very little somewhat reasonably well definitely beyond expectations
If you did not rate a 5 or 6, what could have been done differently to achieve a 5 or 6 rating?

4) How appropriate was the day & time of this class(es)?
1 2 3 4 5 6
not at all very little somewhat reasonably well definitely beyond expectations
Comments: _____

5) How would you rate the importance of this subject to your job?
1 2 3 4 5 6
not at all very little somewhat reasonably imp. definitely imp. extremely imp.
Comments: _____

SEE BACK PLEASE

6) Given opportunities, how effectively could you use what was taught in class?

1 _____ 2 _____ 3 _____ 4 (4) _____ 5 _____ 6 _____
not at all very little somewhat reasonably well definitely very effectively

If you did not rate a 5 or 6, why? _____

7) Rate the instructors' ability as a teacher (HOW class was taught)?

1 _____ 2 _____ 3 _____ 4 _____ 5 (5) _____ 6 _____
very low low fair high very high excellent

If you did not rate a 5 or 6, what could have been done differently to achieve a 5 or 6 rating?

8) Rate the degree of instructor's expertise/knowledge (on this subject).

1 _____ 2 _____ 3 _____ 4 _____ 5 (5) _____ 6 _____
very low low fair high very high excellent

If you did not rate a 5 or 6, what could have been done differently to achieve a 5 or 6 rating?

9) Please rate overall training.

1 _____ 2 _____ 3 _____ 4 _____ 5 (5) _____ 6 _____
very low low fair high very high excellent

If you did not rate a 5 or 6, what could have been done differently to achieve a 5 or 6 rating?

10) WHAT classes would you like to see offered at OCS?

~~ocs college classes only~~

11) What impact did OCS College (having classes held here at work) have on you taking this course?

1 _____ 2 _____ 3 _____ 4 _____ 5 (5) _____ 6 _____
none at all very little somewhat reasonable impact definite impact extreme impact

Comments: _____

12) What impact did the payment method (payroll deduction at the end) and the cost (to you) have in your choice to take this class?

1 _____ 2 _____ 3 _____ 4 _____ 5 _____ 6 (6) _____
none at all very little somewhat reasonable impact definite impact extreme impact

Comments: CLASS WAS FREE _____



OCS TRAINING CRITIQUE FORM

PURPOSE OF CRITIQUE: Continual improvement of training classes and processes.
Thanks for your assistance.

CLASS TITLE Impute Basic
INSTRUCTOR (S) Scott Upeland

DATE 6-12-91

1) Were your overall expectations met for this class?

1 2 3 4 5 6
not at all very little somewhat reasonably well definitely beyond expectations

If you did not rate a 5 or 6, what could have been done differently to achieve a 5 or 6 rating?

2) Please rate the overall appropriateness and quality of the training materials (or manual) you received for this class.

1 2 3 4 5 6
not at all very little somewhat reasonably appropriate definitely beyond expectations

If you did not rate a 5 or 6, what could have been done differently to achieve a 5 or 6 rating?

more written detail

3) Were you contacted regarding this class in a timely manner?

1 2 3 4 5 6
not at all very little somewhat reasonably well definitely beyond expectations

If you did not rate a 5 or 6, what could have been done differently to achieve a 5 or 6 rating?

heard about it just 1 wk before class started

4) How appropriate was the day & time of this class(es)?

1 2 3 4 5 6
not at all very little somewhat reasonably well definitely beyond expectations

Comments: _____

5) How would you rate the importance of this subject to your job?

1 2 3 4 5 6
not at all very little somewhat reasonably imp. definitely imp. extremely imp.

Comments: _____

SEE BACK PLEASE

6) Given opportunities, how effectively could you use what was taught in class?

1 _____ 2 _____ 3 _____ 4 _____ 5 _____ 6 _____
 not at all very little somewhat reasonably well definitely very effectively

If you did not rate a 5 or 6, why? *depending on what opportunities are offered in working place*

7) Rate the instructors' ability as a teacher (if W class was taught)?

1 _____ 2 _____ 3 _____ 4 _____ 5 _____ 6 _____
 very low low fair high very high excellent

If you did not rate a 5 or 6, what could have been done differently to achieve a 5 or 6 rating?

8) Rate the degree of instructor's expertise/knowledge (on this subject).

1 _____ 2 _____ 3 _____ 4 _____ 5 _____ 6 _____
 very low low fair high very high excellent

If you did not rate a 5 or 6, what could have been done differently to achieve a 5 or 6 rating?

9) Please rate overall training.

1 _____ 2 _____ 3 _____ 4 _____ 5 _____ 6 _____
 very low low fair high very high excellent

If you did not rate a 5 or 6, what could have been done differently to achieve a 5 or 6 rating?

10) WHAT classes would you like to see offered at OCS?

~~ocs college classes only~~

11) What impact did OCS College (having classes held here at work) have on you taking this course?

1 _____ 2 _____ 3 _____ 4 _____ 5 _____ 6 _____
 none at all very little somewhat reasonable impact definite impact extreme impact

Comments: _____

12) What impact did the payment method (payroll deduction at the end) and the cost (to you) have in your choice to take this class?

1 _____ 2 _____ 3 _____ 4 _____ 5 _____ 6 _____
 none at all very little somewhat reasonable impact definite impact extreme impact

Comments: _____

OCS TRAINING CRITIQUE FORM

PURPOSE OF CRITIQUE: Continual improvement of training classes and processes.
Thanks for your assistance.

CLASS TITLE Basic Computer DATE 6-16-81
INSTRUCTOR (S) Scott Cape Land

1) Were your overall expectations met for this class?
1 2 3 4 5 6
not at all very little somewhat reasonably well definitely beyond expectations
If you did not rate a 5 or 6, what could have been done differently to achieve a 5 or 6 rating?
I involved more computer work for class to understand better or just keep interested.

2) Please rate the overall appropriateness and quality of the training materials (or manual) you received for this class.
1 2 3 4 5 6
not at all very little somewhat reasonably appropriate definitely beyond expectations
If you did not rate a 5 or 6, what could have been done differently to achieve a 5 or 6 rating?

3) Were you contacted regarding this class in a timely manner?
1 2 3 4 5 6
not at all very little somewhat reasonably well definitely beyond expectations
If you did not rate a 5 or 6, what could have been done differently to achieve a 5 or 6 rating?
Two days before the first class.

4) How appropriate was the day & time of this class(es)?
1 2 3 4 5 6
not at all very little somewhat reasonably well definitely beyond expectations
Comments: Should've been earlier not in middle of day.

5) How would you rate the importance of this subject to your job?
1 2 3 4 5 6
not at all very little somewhat reasonably imp. definitely imp. extremely imp.
Comments: Doesn't involve my job at all.

SEE BACK PLEASE

6) Given opportunities, how effectively could you use what was taught in class?

1 _____ 2 _____ 3 _____ 4 _____ 5 _____ 6 _____
not at all very little somewhat reasonably well definitely very effectively

If you did not rate a 5 or 6, why? Would need a real computer class.

7) Rate the instructors' ability as a teacher (HOW class was taught)?

1 _____ 2 _____ 3 _____ 4 _____ 5 _____ 6 _____
very low low fair high very high excellent

If you did not rate a 5 or 6, what could have been done differently to achieve a 5 or 6 rating?

Would explain something else while getting help from assistant and leave you behind.

8) Rate the degree of instructor's expertise/knowledge (on this subject).

1 _____ 2 _____ 3 _____ 4 _____ 5 _____ 6 _____
very low low fair high very high excellent

If you did not rate a 5 or 6, what could have been done differently to achieve a 5 or 6 rating?

9) Please rate overall training.

1 _____ 2 _____ 3 _____ 4 _____ 5 _____ 6 _____
very low low fair high very high excellent

If you did not rate a 5 or 6, what could have been done differently to achieve a 5 or 6 rating?

10) WHAT classes would you like to see offered at OCS?

_____ OCS college classes only _____
11) What impact did OCS College (having classes held here at work) have on you taking this course?

1 _____ 2 _____ 3 _____ 4 _____ 5 _____ 6 _____
none at all very little somewhat reasonable impact definite impact extreme impact

Comments: _____

12) What impact did the payment method (payroll deduction at the end) and the cost (to you) have in your choice to take this class?

1 _____ 2 _____ 3 _____ 4 _____ 5 _____ 6 _____
none at all very little somewhat reasonable impact definite impact extreme impact

Comments: _____

OCS TRAINING CRITIQUE FORM

PURPOSE OF CRITIQUE: *Continual improvement of training classes and processes.
Thanks for your assistance.*

CLASS TITLE Computer Basics DATE 6/15/91
INSTRUCTOR (S) Scott Copeland

1) Were your overall expectations met for this class?

1 2 3 4 5 6
not at all very little somewhat reasonably well definitely beyond expectations

If you did not rate a 5 or 6 what could have been done differently to achieve a 5 or 6 rating?

2) Please rate the overall appropriateness and quality of the training materials (or manual) you received for this class.

1 2 3 4 5 6
not at all very little somewhat reasonably appropriate definitely beyond expectations

If you did not rate a 5 or 6, what could have been done differently to achieve a 5 or 6 rating?

3) Were you contacted regarding this class in a timely manner?

1 2 3 4 5 6
not at all very little somewhat reasonably well definitely beyond expectations

If you did not rate a 5 or 6, what could have been done differently to achieve a 5 or 6 rating?

4) How appropriate was the day & time of this class(es)?

1 2 3 4 5 6
not at all very little somewhat reasonably well definitely beyond expectations

Comments: _____

5) How would you rate the importance of this subject to your job?

1 2 3 4 5 6
not at all very little somewhat reasonably imp. definitely imp. extremely imp.

Comments: _____

SEE BACK PLEASE

6) Given opportunities, how effectively could you use what was taught in class?

1 2 3 4 5 6
not at all very little somewhat reasonably well definitely very effectively

If you did not rate a 5 or 6, why? I would need a lot more practice

7) Rate the instructors' ability as a teacher (HOW class was taught)?

1 2 3 4 5 6
very low low fair high very high excellent

If you did not rate a 5 or 6, what could have been done differently to achieve a 5 or 6 rating?

8) Rate the degree of instructor's expertise/knowledge (on this subject)

1 2 3 4 5 6
very low low fair high very high excellent

If you did not rate a 5 or 6, what could have been done differently to achieve a 5 or 6 rating?

9) Please rate overall training.

1 2 3 4 5 6
very low low fair high very high excellent

If you did not rate a 5 or 6, what could have been done differently to achieve a 5 or 6 rating?

10) WHAT classes would you like to see offered at OCS?

Word Perfect

ocs college classes only

11) What impact did OCS College (having classes held here at work) have on you taking this course?

1 2 3 4 5 6
none at all very little somewhat reasonable impact definite impact extreme impact

Comments: _____

12) What impact did the payment method (payroll deduction at the end) and the cost (to you) have in your choice to take this class?

1 2 3 4 5 6
none at all very little somewhat reasonable impact definite impact extreme impact

Comments: _____



BASIC COMPUTER

RATING SCALE: 1 - 6 (LOW/NO/POOR --- HIGH/DEFINITELY/EXCELLENT)

	Expectations Met? ?#1	Manual/Mats. ?#2	Contacted Timely? ?#3	Appropriate Day/Time? ?#4	Importance to Job? ?#5	Could use effect? ?#6	Instruct. Ability How? ?#7	Instruct. expertise /knowl? ?#8	Rate Overall Training ?#9	Impact OCSC? ?#11	Impact Paymt Method? ?#12
#1	5	6	6	5	5	5	6	6	6	6	
#2	5	4	5	5	5	4	5	5	5	4	1
#3	5	5	5	4	5	4	5	5	6	5	1
#4	5	5	5	4	3	5	5	6	6		
#5	5	5	5	5	5	5	6	6	5	4	
#6	4	5	5	5	1						
#7	5	5	5	4	5	4	5	5	5	6	5
#8	3	5	6	5	5	5	5	5	5	6	6
#9	2	5	4	4	4	4	5	5	5	5	2
#10	5	5	5	5	3	4	5	5	5	1	
#11	5	5	6	5	4	6	6	5	6		
#12	4	5	5	4	3	4	4	4	4		
#13	6	6	5	5	5	5	6	6	6	1	1

170

/RNC{?} ~ {end} {down} ~ {right}

169

1	0	0	0	0	1	0	0	0	0	2	3
2	1	0	0	0	0	0	0	0	0	0	1

BASIC COMPUTER

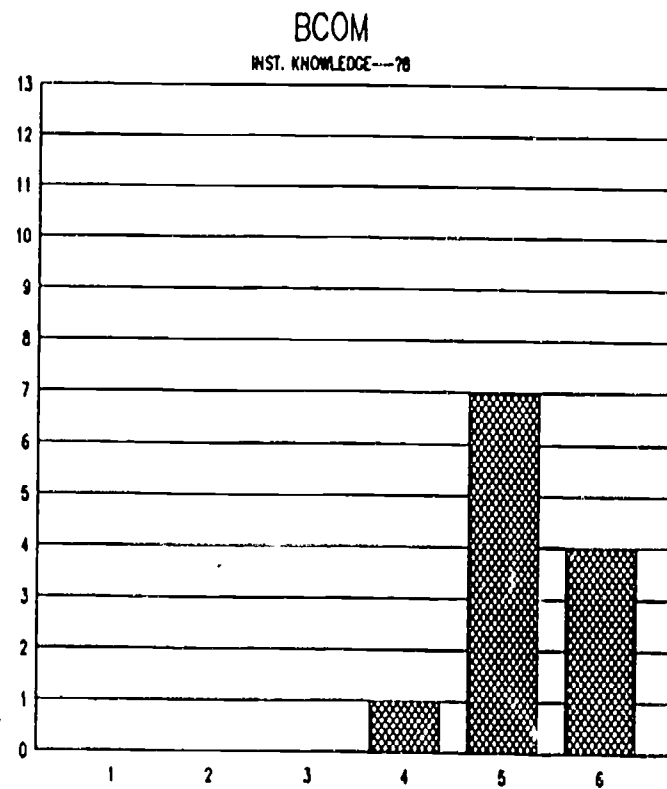
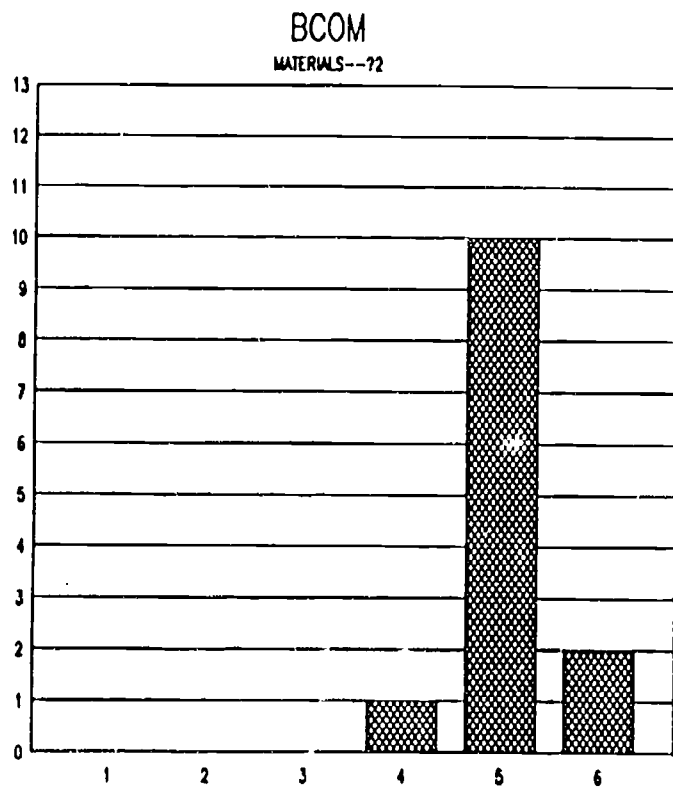
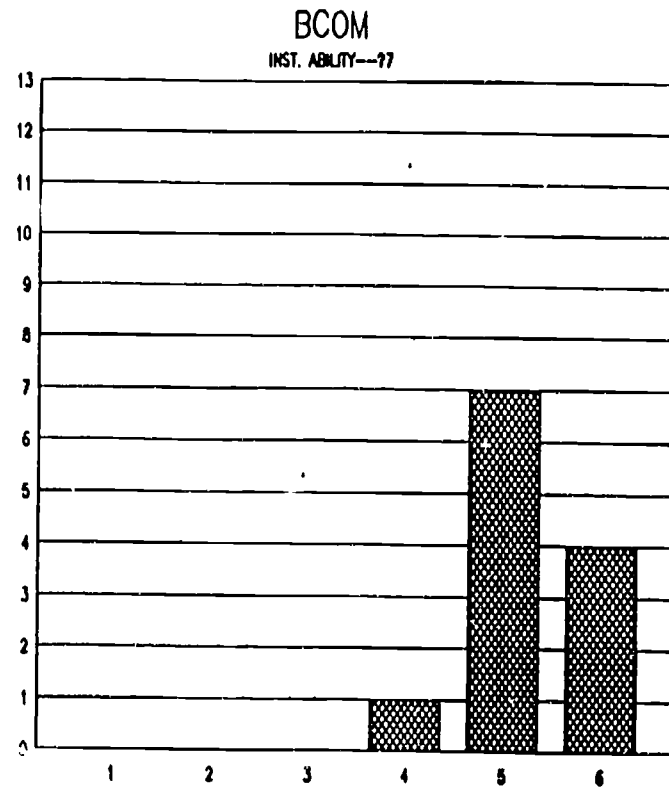
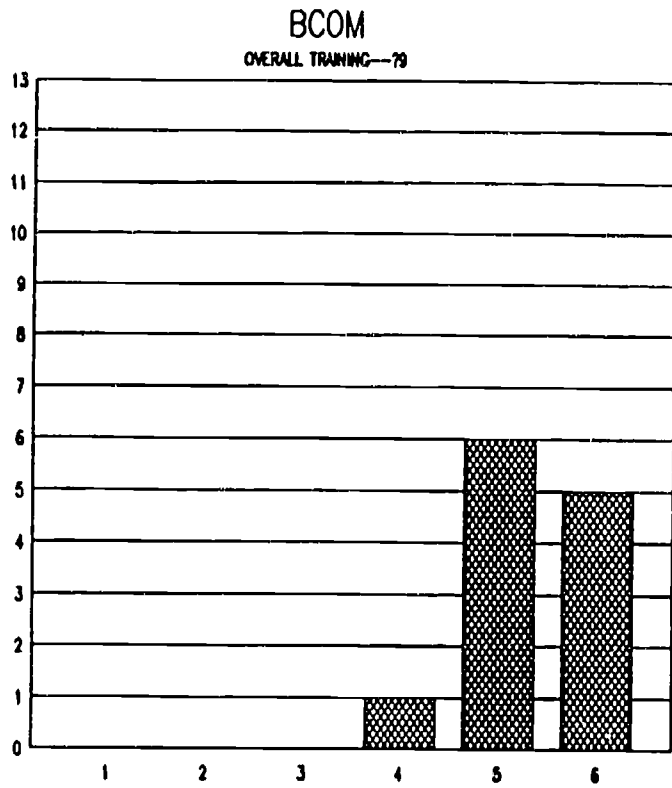

BASIC COMPUTER

BCOM
EXPECTATIONS—71

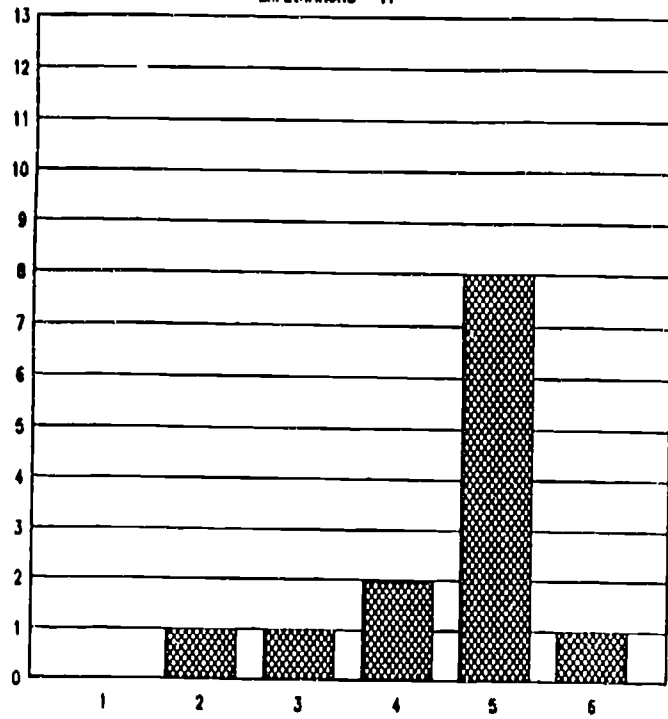

BCOM
JOB IMPORTANCE—75

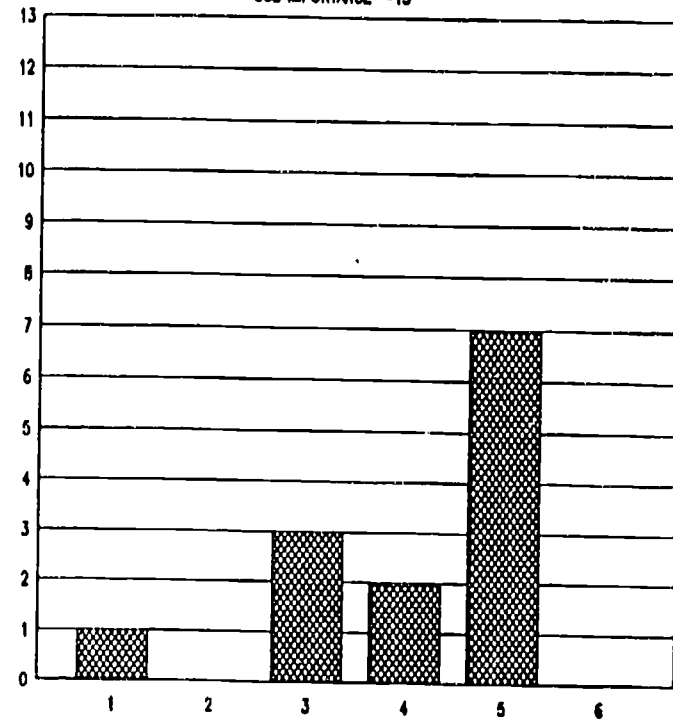

BCOM
USE EFFECTIVELY—76

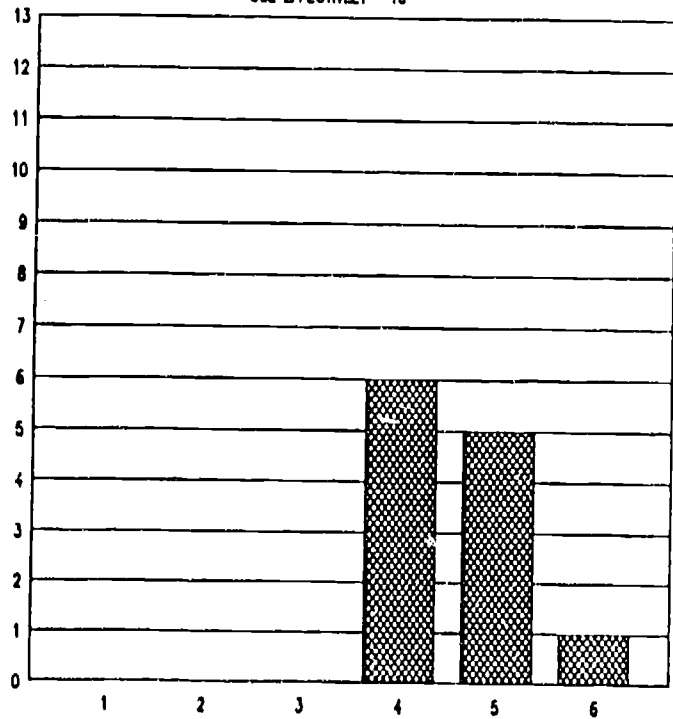

BCOM
IMPACT ● OCS—711

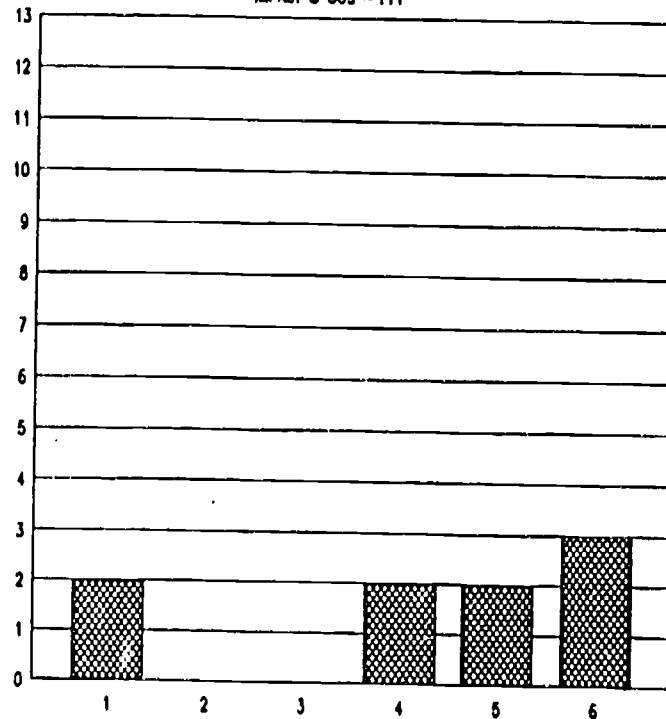

Compilation of Survey to Computer Basics Participants

Question #1 (been able to use...) Comments	Have you taken other courses	if yes, did this course help you
2	n	0
2	n	0
2	n	0
3 How about windows, OS 2.2 and MAC systems	n	0
2	n	0
2 It helped me with other classes I took	y	1
3 This would be very valuable to my position	y	1
2	n	0
3	n	0
2 had some basic skills, course was informative, enhanced my knowly	n	0
2 I'm not afraid of it anymore	n	0
2	n	0
2 Helped in using new method of computer at work	n	0
2	n	0
2	n	0
3	n	0
2 Has helped me be more confident with our new reporting system	n	0
2	n	0
2 Mostly dept. computer is used for labor reporting	y	1
2 Gave me a better understanding	n	0
3 Applied the knowledge away from work	n	0
2	n	0
4	n	0
2	n	0

Compilation of Survey to Computer Basics Participants

Do you plan to take other computer courses at OCS: Comments	Did being in the course encourage you to plan to take more courses?
1	y
0	y
4 Presently I don't use a computer very much	y
3	
1	y
2	y
1	y
2	y
3	y
3	y
1	y
0 Don't know yet	y
3	y
2	y
2	y
3	y
3 I need to now which one I can take.	y
2	y
2	y
3 When the right courses are offered	y
2	y
3	y
1	y
3	y
4	y

Evaluation of Computer Basics Course

To: _____

Please help us follow-up on the effectiveness of this training course. Answer each question as best you can. If a question does not apply to you, just leave it blank.

1. Have you been able to use any of the knowledge or skills you learned in this course?

1.	2.	3.	4.
I've used it a lot	I've used it a little	I haven't had a chance to use it	I won't be able to use it

Comments: _____

2. Have you taken any other computer classes since taking this course?

Yes? No?

If yes, what course(s): _____

If you have taken other courses, did this course help you in another course?

1.	2.	3.	4.
It helped me a lot	It helped me a little	It didn't really help	It left me confused

Comments: _____

3. Do you plan to take other courses in computers at OCS?

1.	2.	3.	4.
I'm enrolling in January	I plan to take one soon	I plan to take one eventually	I may not take one

Comments: _____

Did being in the Computer Basics class encourage you to plan to take more classes?

Yes? No? Explain: _____

4. May we contact your supervisor to ask them a few questions about how the class may have affected your performance on the job?

Okay?

Not Okay?

Please Return this Survey to Lynn Cox in the Training office as soon as possible,
Thank you.

Comment 6: What should be...make the class better?

Team	Focus on less topics
249	Need to learn more of our AMAPS system
249 Hub	More computers, or less students in class.
249 Team	Nothing
350	Make class longer
350 A	Have table of contents and pages # on handouts
8274 RV	Class was fine
A/M Hubs	Design a class that lets people go at own pace
Accessories	Shorter overall term
Accessories	Have more free time to use the PC
Carrier Call	None
CSR	
Flange Mount 350A	More computers
Flange Mt	more time on computer, not having to team up
Flange MT	More weeks of class, more specific areas
Flange Mt.	Teach us about our new system
Flange Mt. Nissan	Get more computers
Human Resources	class area is very uncomfortable
Human Resources	Area where it is held, very uncomfortable
M 249	Hard to take notes and listen, pages need # system
M 249	Have more class like the last one, doing work alone
M 249	I think it is fine the way it is
M236	Smaller classes with one person per terminal
M236	Wouldnt change material used,would extend class tim
M249	Longer class time, one PC per person
Maintenance	Great for beginners, needed faster pace for me
Mounting System	More class time, computers for each student
Mounting Systems	More time to use the PC
Nissan Hub	Make it 1 hour each of instruction, lab
Quicker	More hands on experience, home-work worksheets
Rounds	Class cancelations should be minimized, more PCs
RV	One comp per person,using programs on real projects
RV	Little more quiet time in class to do work
RV	Course could have been longer, too fast
RV	More indepth
RV	Not applicable
RV	I like it the way it was
RV Winch	Additional computers to be used during class
RV (Service)	Can't think of anything
RV Winch	Move at faster pace, more terminals available
RV Winch	More computers, more time
RV Winch	
RV Winch	Class is too short
RV Winch	
RV Winch	More hands on experience with computer
RV Winch	one computer per person, not several
RV Winch Mid Size	More time to use what you are learning
Shift Linkage	
Ssangyong	Learn inventory, reject parts, parts to floor etc
Tool and Die	More class time, teach Basic DOS
Tool Crib/Tool Grinding	Handouts at beginning, teach one topic at a time
Tool Grinding	Just fine, could be longer
Tool Grinding	Typing 15 WPM beneficial, easier to keep up
Tool Grinding 494	How to find part #'s, tooling used on parts, AMAPS

Comments on the Computer Basics Post Test

...I will remember and improve skills. ...just need to use my skills.

I feel more comfortable, I know it won't bite me.

Training needs to be ongoing.

...it opened a door and now I need to know more.

More hands on training.

If you don't have the opportunity...it is very hard to remember.

...found the class very, very helpful.

...good presentations...I don't feel so intimidated by the terminals.

...at least 20 wpm should be a prerequisite.

Should dwell on the system (AMAPS) here at Warn.

...moved too slow for me...group by knowledge or experience.

Evaluation of Computer Basics Course

To:

Please help us follow-up on the effectiveness of this training course. Answer each question as best you can. If a question does not apply to you, just leave it blank.

1. Have you been able to use any of the knowledge or skills you learned in this course?

- 1. I've used it a lot
- 2. I've used it a little
- 3. I haven't had a chance to use it
- 4. I won't be able to use it

Comments: I'M NOT AFRAID OF IT ANYMORE

2. Have you taken any other computer classes since taking this course?

Yes? No?

If yes, what course(s): _____

If you have taken other courses, did this course help you in another course?

- 1. It helped me a lot
- 2. It helped me a little
- 3. It didn't really help
- 4. It left me confused

Comments: _____

3. Do you plan to take other courses in computers at OCS?

- 1. I'm enrolling in January
- 2. I plan to take one soon
- 3. I plan to take one eventually
- 4. I may not take one

Comments: DON'T KNOW YET

Did being in the Computer Basics class encourage you to plan to take more classes?

Yes? No? Explain: IT BROUGHT ME THRU MOST OF THE FOG

4. May we contact your supervisor to ask them a few questions about how the class may have affected your performance on the job?

Okay?

Not Okay?

Please Return this Survey to Lynn Cox in the Training office as soon as possible, Thank you.

Evaluation of Computer Basics Course

To:

Please help us follow-up on the effectiveness of this training course. Answer each question as best you can. If a question does not apply to you, just leave it blank.

1. Have you been able to use any of the knowledge or skills you learned in this course?

- 1. I've used it a lot
- 2. I've used it a little
- 3. I haven't had a chance to use it
- 4. I won't be able to use it

Comments: *I had some basic skills but this course was informative and I did learn several features that enhanced my knowledge*

2. Have you taken any other computer classes since taking this course?

Yes? No?

If yes, what course(s): _____

If you have taken other courses, did this course help you in another course?

- 1. It helped me a lot
- 2. It helped me a little
- 3. It didn't really help
- 4. It left me confused

Comments: _____

3. Do you plan to take other courses in computers at OCS?

- 1. I'm enrolling in January
- 2. I plan to take one soon
- 3. I plan to take one eventually
- 4. I may not take one

Comments: _____

Did being in the Computer Basics class encourage you to plan to take more classes?

Yes? No? Explain: *Course was well taught - took a lot of the "mystery" out of computer language and did encourage me to proceed in training.*

4. May we contact your supervisor to ask them a few questions about how the class may have affected your performance on the job?

Okay? Not Okay?

Please Return this Survey to Lynn Cox in the Training office as soon as possible, Thank you.



Evaluation of Computer Basics Course

To:

Please help us follow-up on the effectiveness of this training course. Answer each question as best you can. If a question does not apply to you, just leave it blank.

1. Have you been able to use any of the knowledge or skills you learned in this course?

1. I've used it a lot 2. I've used it a little 3. I haven't had a chance to use it 4. I won't be able to use it

Comments: *It has helped me to be more confident with our new reporting system.*

2. Have you taken any other computer classes since taking this course?

Yes? No?

If yes, what course(s): _____

If you have taken other courses, did this course help you in another course?

1. It helped me a lot 2. It helped me a little 3. It didn't really help 4. It left me confused

Comments: _____

3. Do you plan to take other courses in computers at CUS?

1. I'm enrolling in January 2. I plan to take one soon 3. I plan to take one eventually 4. I may not take one

Comments: _____

Did being in the Computer Basics class encourage you to plan to take more classes?

Yes? No? Explain: *It showed me I have some aptitude for computers and also a real liking.*

4. May we contact your supervisor to ask them a few questions about how the class may have affected your performance on the job?

Okay? Not Okay?

Please Return this Survey to Lynn Cox in the Training office as soon as possible, Thank you.

Evaluation of Computer Basics Course

To:

Please help us follow-up on the effectiveness of this training course. Answer each question as best you can. If a question does not apply to you, just leave it blank.

1. Have you been able to use any of the knowledge or skills you learned in this course?

1. I've used it a lot 2. I've used it a little 3. I haven't had a chance to use it 4. I won't be able to use it

Comments: HAS HELPED IN USING THE NEW METHOD OF ON THE JOB USE OF THE COMPUTER

2. Have you taken any other computer classes since taking this course?

Yes? No?

If yes, what course(s): _____

If you have taken other courses, did this course help you in another course?

1. It helped me a lot 2. It helped me a little 3. It didn't really help 4. It left me confused

Comments: _____

3. Do you plan to take other courses in computers at OCS?

1. I'm enrolling in January 2. I plan to take one soon 3. I plan to take one eventually 4. I may not take one

Comments: _____

Did being in the Computer Basics class encourage you to plan to take more classes?

Yes? No? Explain: FOUND THAT I LIKED AND ENJOYED THE CLASS

4. May we contact your supervisor to ask them a few questions about how the class may have affected your performance on the job?

Okay?

Not Okay?

Please Return this Survey to Lynn Cox in the Training office as soon as possible,
Thank you.

Evaluation of Computer Basics Course

To: _____

Please help us follow-up on the effectiveness of this training course. Answer each question as best you can. If a question does not apply to you, just leave it blank.

1. Have you been able to use any of the knowledge or skills you learned in this course?

- | | | | |
|--------------------|-----------------------|----------------------------------|---------------------------|
| 1. | 2. | 3. | 4. |
| I've used it a lot | I've used it a little | I haven't had a chance to use it | I won't be able to use it |

Comments: _____

2. Have you taken any other computer classes since taking this course?

Yes? No?

If yes, what course(s): _____

If you have taken other courses, did this course help you in another course?

- | | | | |
|--------------------|-----------------------|-----------------------|---------------------|
| 1. | 2. | 3. | 4. |
| It helped me a lot | It helped me a little | It didn't really help | It left me confused |

Comments: _____

3. Do you plan to take other courses in computers at OCS?

- | | | | |
|--------------------------|-------------------------|-------------------------------|--------------------|
| 1. | 2. | 3. | 4. |
| I'm enrolling in January | I plan to take one soon | I plan to take one eventually | I may not take one |

Comments: _____

Did being in the Computer Basics class encourage you to plan to take more classes?

Yes? No? Explain: It would if I enjoyed working with computers - but I still don't care for them. But your class did help me a lot to

4. May we contact your supervisor to ask them a few questions about how the class may have affected your performance on the job? understand more about them.

Okay?

Not Okay? Chrome. I guess you could if you had the right job. But I don't - so I just use it a little.

Please Return this Survey to Lynn Cox in the Training office as soon as possible,

Thank you.

I don't like copy machines or vending machines or the computer in my new truck either.

It's just too impersonal to me. But it was a great class - Thanks!

OREGON CUTTING SYSTEMS EMPLOYEES
AT
OCS
FOR
MATH

155

AG R S S S T ED D r r r r r r r B C Class Cte Expect

3 1 1 y a 4	9 2 n a y y a y e	3 1 WNSM	20 Refresh my math skills
3 1 1 y a 2	6 2 y n y y e n n	3 1 WNSM	0 Improve math skills.
4 1 1 y a 2	6 2 y y n n n n a	3 1 WNSM	0 Improve job performance. Qualify for future position
3 1 1 y a 1	6 2 y e n n a y y	3 1 WNSM	20
0 1 1 y a 5	6 2 y a y y n a n	3 1 WNSM	0 Refresh memory.
3 3 2 y a 7	6 0 y y s a n n n	3 1 WNSM	20 To improve my math skills and learn how it's done.
3 4 3 y a 7	9 0 y a y n a y n	1 1 WNSM	20 Better understanding of fractions and decimals.
5 1 1 y a 5	9 2 n a y y n y n	3 1 WNSM	20 Refreshment of math and to gain focusing of the mind.
4 1 1 y 5	6 2 y y y n n u	1 1 WNSM	20 Better grasp of math and application in mfg. shop.
3 1 1 y a 1	6 2 y a n a y y	3 1 WNSM	20 To see if I need to brush up on some levels of math.
3 1 2 n y a 2	6 2 n y a y n y n	3 1 WNSM	20 To be able to improve my math skills.
4 1 2 y a 1	6 2 y y n n n y n	2 1 WNSM	20 More education, plus more oties in Wern Industries.
3 1 1 y a 2	6 2 y y y a a y a	3 1 WNSM	20
4 5 2 n y a 2	0 2 y y y y y y n	3 1 WNSM	20
3 1 1 y a 4	6 2 y y y n a n n	3 1 WNSM	20 To improve my math skills
5 1 2 o y a 1	6 1 y y y n n y n	2 1 WNSM	20 Upgrade and refresh my memory.
4 1 1 y a 3	6 2 n y y n n n	1 1 WNSM	20 Basic shop math to help with blueprint reading.
2 1 1 y a 2	6 2 y y y n n n n	3 1 WNSM	20 Further knowledge.
5 1 1 y a a 5	6 2	0 0 WNSM	20
4 1 2 n y a 4	4 2 n n y y n y a	1 1 WNSM	20
3 1 1 y a 2	6 2 y y y y n y a	1 1 WNSM	20 Better math skills.
3 1 2 n o y 3	9 3 n a o y a y	3 1 WNSM	20 Math understanding
3 1 2 y a 4	6 3 n y a n n y n	3 1 WNSM	20 Learn more about fraction & percents
2 4 1 y a 2	4 2 y n y a n y a	2 1 WNSM	20 Use a calculator at home and work.
4 1 1 n y a 5	6 2 n n y y n y n	2 1 WNSM	20 Refresh memory about math in classroom format.
4 1 2 n y a 2	6 2 n n y y a n n	3 1 WNSM	20
3 1 2 y a 4	6 2 n y y y a n n	3 1 WNSM	20 Refreshen forgotten math skills.
6 1 2 n y a 2	6 2 y n n n n n n	3 1 WNSM	20 Education
4 1 2 n y a 5	6 2 y y y n n n	2 1 WNSM	20 Learn how to work with fractions and percentages.
5 1 1 y a 3	7 2 n a y y a y a	3 1 WNSM	20 A full knowledge of how to use fractions and percent.
5 1 2 y a 5	6 2 a y y a n y n	3 1 WNSM	20 Knowledge on what I have studied
4 5 1 o y a 3	9 2 y a y a n y a	2 1 WNSM	20 Improve
3 1 1 n y a 5	6 2 n n y n n y a	3 1 WNSM	20
5 1 1 n y a 5	7 2 n n n n n y y	1 1 WNSM	20 Learn more about math.
4 1 1 y a 3	6 0 y y y n n n	1 1 WNSM	20 A better understanding about math, (perc. and fract.)
4 1 1 n y n 1	8 2 y y y n n n	3 1 WNSM	20 Learn more than I already know.
3 1 1 y n n 9	6 2 n y y n n y n	3 1 WNSM	20 Better math skills to use in other classes.
3 1 2 n y a 3	6 2 y n n n n n n	1 1 WNSM	0
3 1 2 n v a 2	6 2 n n y y n y n	1 1 WNSM	0 Improve my math skills--mainly fractions.
4 1 2 n y a 5	6 2 n n y n n n n	3 1 WNSM	0 Basic fundamentals of math
4 1 1 n y a 2	7 2 n y y n n y n	3 1 WNSM	20 Better my math skills and get into GDT class.
3 1 1 y a 3	6 2 n y n y n y	1 1 WNSM	20 improve math skills and prepare for more training
3 1 1 n y n 4	6 1 y y y n y y	3 1 WNSM	0 Refresh my memory on how to do fractions.
3 1 1 n y o 3	9 2 y y y n n y	3 1 WNSM	20 Improve education and be a computer drafter.
3 1 2 y n n 4	6 2 y y n n n y n	3 1 WNSM	20 Refresh my memory on basic math skills.
3 1 1 n y n 1	6 2 n y y n n y n	3 1 WNSM	20 passed
4 2 1 n y n 3	3 2 n y y n n y n	1 1 WNSM	20 Improve my math
2 1 2 y n n 1	8 2 y y y n n n n	3 1 WNSM	20 Catch up on math skills. Increase job skills re: math
4 1 1 n y n 2	6 0 n y n n y n	3 1 WNSM	20 Better at math.
4 1 2 n y n 2	6 2 y a n y n n n	3 1 WNSM	20 Education in math was appreciated in any school years
3 1 2 y n n 4	6 2 n n y y n n n	2 1 WNSM	0 Better knowledge of fractions and percents.
2 1 2 y n n 2	6 2 n y y o n y n	2 1 WNSM	20 further my knowledge in math. better myself
4 1 2 n y a 2	6 2 y y y n n n n	1 1 WNSM	20 Better understanding of the calculator
3 1 1 o y n 4	7 2 y y y n n n n	3 1 WNSM	0 Refresh old math skills and learn new ones.
2 1 1 y n n 2	6 2 n n y n n n n	3 1 WNSM	20 Improve my personal math skills.



AG B S S S T ED D r r r r r r B C Class Cla Expect

AG	B	S	S	S	T	ED	D	r	r	r	r	r	r	B	C	Class	Cl	Expect
3	1	2	a	y	n	3	5	2	y	y	y	n	n	3	1	WNSM	20	Further my knowledge and receive credit toward G.E.D.
4	1	2	a	y	n	5	4	2	a	y	n	n	n	1	1	WNSM	20	Hopefully to remember how to do them.
2	1	2	y	e	n	1	6	2	y	y	n	n	n	1	1	WNSM	20	Knowledge of working on computers and how they work.
4	1	2	a	y	n	1	6	2	y	y	y	n	y	2	1	WNSM	20	Renew math skills to take future classes.
2	1	2	y	n	3	9	2	n	n	a	y	n	n	0	1	WNSM	20	
3	1	2	y	n	3	5	2	y	y	n	n	a	n	3	1	WNSM	0	Mainly to improve my education for better jobs.
2	1	1	a	y	n	4	3	2	a	y	n	n	n	1	1	WNSM	20	
5	1	1	y	n	3	6	2	y	a	y	n	n	y	3	1	WNSM	20	More understanding in self and in training with co.
2	1	1	a	y	n	4	6	2	y	n	n	n	n	3	1	WNSM	20	More math skills.
3	1	1	a	y	n	3	9	2	a	a	y	n	n	1	1	WNSM	20	Improve my math skills.
2	1	1	y	n	1	6	2	y	a	y	n	n	n	4	1	WNSM	0	General math skills to move to higher classes.
4	1	1	a	y	n	1	6	2	y	n	y	n	n	3	1	WNSM	20	Brian back a few things I forgot.
4	1	2	a	y	n	5	0	0						0	0	WNSM	20	
1	2	2	y	n	4	6	2	y	y	y	y	y	y	1	1	WNSM	20	I expect to achieve the math skills that I need.
2	1	1	y	n	3	6	2	y	y	n	n	n	n	1	1	WNSM	20	refresh my knowledge on basic math skills
4	1	2				4	1	0	n	n	y	n	n	1	1	WNSM	20	
4	4	1	n	y	n	5	6	1	n	n	y	n	n	3	1	WNSM	20	
2	1	1	y	n	3	5	2	a	y	n	n	n	n	1	1	WNSM	20	Better education in math skills.
3	1	2	y	n	4	6	2	n	n	y	n	n	n	3	1	WNSM	20	Key understanding of math
4	1	1	n	y	n	3	6	2	n	y	n	y	n	2	1	WNSM	20	Review. More familiar with proper formulae for prob.
3	1	2	n	y	n	2	6	2	n	y	n	n	n	2	1	WNSM	20	will help me brush up..job openings easier
3	1	1	n	y	n	3	8	2	n	n	y	n	n	1	1	WNSM	20	Better understanding of math.
2	1	1	n	y	n	4	6	2	y	n	n	y	n	3	1	WNSM	20	Brush up on my skills.
3	1	2	n	y	n	3	6	2	y	n	n	n	n	3	1	WNSM	0	Better math skills

PRIMARY SORT FIELD: ClassName

SELECTION CRITERIA:
(ClassName="WNSM")



Course Evaluation

You do not need to write your name on this form.

How long have you worked at this company? _____

How long have you done this type of work? _____

What is your job title or position? _____

What is your sex? M or F (circle one).

What is your age? _____ What is your Race? _____

Your Answers are
Kept Confidential

Only write your
Name on this if
want to be con-
tacted

What type of problems can you solve that you couldn't before taking the class?

Do you think the skills you learned in this class will help you in your job? Why, or why not? How?

Do you think the course has (or will) help you meet any of your personal goals? Why, or why not? How

Would you recommend the course to a fellow-employee or friend? Why or why not?

Were the materials and workbooks helpful? What was good or bad about the materials used in this course?

If you could change the course in any way, what would you suggest we do to make it a better class?

Circle the answer that best applies...

Circle one:

- | | | | |
|---|-------|----------|----------|
| -The course was too hard | agree | not sure | disagree |
| -The course will help me on the job | agree | not sure | disagree |
| -The course will help me outside of work | agree | not sure | disagree |
| -The course was confusing at times | agree | not sure | disagree |
| -The teacher made it easy for me to learn | agree | not sure | disagree |
| -I would like another class taught this way | agree | not sure | disagree |

Use the back of this form if you wish to make further comments or suggestions.

Thank you for your help. You will help us make this a better course.

OCS SUPERVISOR EVALUATIONS

RETURN TO:
LYNN COX (8)

Supervisor's Survey
of
Worker's Participation in Training

To: _____

Regarding: Participation of _____ in a recent training program.

Please help us evaluate the effectiveness of training programs by completing this survey. The worker listed above has participated in a Basic Computer class this last year. Your answers can help us evaluate the overall benefits of this training effort. You may or may not have a lot to go on in answering some of the questions. Just answer as you see best. Thank You.

1. Were you aware that this worker took a basic computer class? Yes () No
2. Does this worker use the computer (of any kind) to complete work tasks? Yes () No

If the answer to #2 is no, skip down to #5.

3. Have you noticed any improvement in this worker's skill or ability to perform tasks on the computer?

- | | | | |
|---------------------|------------------|---------------------------|----------------|
| 1. | 2. | 3. | 4. |
| A great improvement | Some Improvement | No noticeable improvement | Somewhat worse |

Comments: _____

4. Have you noticed any improvement in this worker's knowledge or understanding of the computer?

- | | | | |
|---------------------|------------------|---------------------------|----------------|
| 1. | 2. | 3. | 4. |
| A great improvement | Some Improvement | No noticeable improvement | Somewhat worse |

Comments: _____

5. Do you feel that this worker will be of more value to you and the company by having participated in the Basic Computer course?

- | | | | |
|--------------|----------|-------------------|------------|
| 1. | 2. | 3. | 4. |
| Very Much So | Somewhat | It is hard to say | Not Likely |

Comments: _____

Please Route this survey to Lynn Cox in Training at your earliest convenience.
Thank You for your participation.

RETURN TO:
LYNN COX (8)

Supervisor's Survey
of
Worker's Participation in Training

To: _____

Regarding: Participation of _____ in a recent training program.

Please help us evaluate the effectiveness of training programs by completing this survey. The worker listed above has participated in a Basic Computer class this last year. Your answers can help us evaluate the overall benefits of this training effort. You may or may not have a lot to go on in answering some of the questions. Just answer as you see best. Thank You.

- 1. Were you aware that this worker took a basic computer class? Yes () No ?
- 2. Does this worker use the computer (of any kind) to complete work tasks? Yes No ()

If the answer to #2 is no, skip down to #5.

3. Have you noticed any improvement in this worker's skill or ability to perform tasks on the computer?

- 1. A great improvement
- 2. Some Improvement
- 3. No noticeable improvement
- 4. Somewhat worse

Comments: Simple Tasks Repetitive Labor and Production

4. Have you noticed any improvement in this worker's knowledge or understanding of the computer?

- 1. A great improvement
- 2. Some Improvement
- 3. No noticeable improvement
- 4. Somewhat worse

Comments: SAME AS 3

5. Do you feel that this worker will be of more value to you and the company by having participated in the Basic Computer course?

- 1. Very Much So
- 2. Somewhat
- 3. It is hard to say
- 4. Not Likely

Comments: A person is looking into the Computer field this

Please Route this survey to Lynn Cox in Training at your earliest convenience.

Thank You for your participation. Training will have value to the Co.

RETURN TO:
LYNN COX (8)

Supervisor's Survey
of
Worker's Participation in Training

To:

Regarding: Participation of _____ in a recent training program.

Please help us evaluate the effectiveness of training programs by completing this survey. The worker listed above has participated in a Basic Computer class this last year. Your answers can help us evaluate the overall benefits of this training effort. You may or may not have a lot to go on in answering some of the questions. Just answer as you see best. Thank You.

1. Were you aware that this worker took a basic computer class? Yes () No ()
2. Does this worker use the computer (of any kind) to complete work tasks? Yes () No ()

If the answer to #2 is no, skip down to #5.

3. Have you noticed any improvement in this worker's skill or ability to perform tasks on the computer?
1. A great improvement 2. Some Improvement 3. No noticeable improvement 4. Somewhat worse

Comments: _____

4. Have you noticed any improvement in this worker's knowledge or understanding of the computer?
1. A great improvement 2. Some Improvement 3. No noticeable improvement 4. Somewhat worse

Comments: _____

5. Do you feel that this worker will be of more value to you and the company by having participated in the Basic Computer course?

1. Very Much So 2. Somewhat 3. It is hard to say 4. Not Likely

Comments: _____

Please Route this survey to Lynn Cox in Training at your earliest convenience.
Thank You for your participation.

RETURN TO:
LYNN COX (8)

Supervisor's Survey
of
Worker's Participation in Training

To: _____

Regarding: Participation of _____ in a recent training program.

Please help us evaluate the effectiveness of training programs by completing this survey. The worker listed above has participated in a Basic Computer class this last year. Your answers can help us evaluate the overall benefits of this training effort. You may or may not have a lot to go on in answering some of the questions. Just answer as you see best. Thank You.

1. Were you aware that this worker took a basic computer class? Yes () No
2. Does this worker use the computer (of any kind) to complete work tasks? Yes No ()

If the answer to #2 is no, skip down to #5.

3. Have you noticed any improvement in this worker's skill or ability to perform tasks on the computer?

1. A great improvement 2. Some Improvement 3. No noticeable improvement 4. Somewhat worse

Comments: _____

4. Have you noticed any improvement in this worker's knowledge or understanding of the computer?

1. A great improvement 2. Some Improvement 3. No noticeable improvement 4. Somewhat worse

Comments: _____

5. Do you feel that this worker will be of more value to you and the company by having participated in the Basic Computer course?

1. Very Much So 2. Somewhat 3. It is hard to say 4. Not Likely

Comments: _____

Please Route this survey to Lynn Cox in Training at your earliest convenience.
Thank You for your participation.

RETURN TO:
LYNN COX (8)

Supervisor's Survey
of
Worker's Participation in Training

To: _____

Regarding: Participation of _____ in a recent training program.

Please help us evaluate the effectiveness of training programs by completing this survey. The worker listed above has participated in a Basic Computer class this last year. Your answers can help us evaluate the overall benefits of this training effort. You may or may not have a lot to go on in answering some of the questions. Just answer as you see best. Thank You.

- 1. Were you aware that this worker took a basic computer class? Yes (X) No ()
- 2. Does this worker use the computer (of any kind) to complete work tasks? Yes (X) No ()

If the answer to #2 is no, skip down to #5.

3. Have you noticed any improvement in this worker's skill or ability to perform tasks on the computer?

- | | | | |
|---------------------|------------------|---------------------------|----------------|
| 1. | 2. | 3. | 4. |
| A great improvement | Some Improvement | No noticeable improvement | Somewhat worse |

Comments: Just finished class

4. Have you noticed any improvement in this worker's knowledge or understanding of the computer?

- | | | | |
|---------------------|------------------|---------------------------|----------------|
| 1. | 2. | 3. | 4. |
| A great improvement | Some Improvement | No noticeable improvement | Somewhat worse |

Comments: _____

5. Do you feel that this worker will be of more value to you and the company by having participated in the Basic Computer course?

- | | | | |
|--------------|----------|-------------------|------------|
| 1. | 2. | 3. | 4. |
| Very Much So | Somewhat | It is hard to say | Not Likely |

Comments: Data is a significant part of medical services

Please Route this survey to Lynn Cox in Training at your earliest convenience.
Thank You for your participation.

RETURN TO:
LYNN COX (8)

Supervisor's Survey
of
Worker's Participation in Training

To: _____

Regarding: Participation of _____ in a recent training program.

Please help us evaluate the effectiveness of training programs by completing this survey. The worker listed above has participated in a Basic Computer class this last year. Your answers can help us evaluate the overall benefits of this training effort. You may or may not have a lot to go on in answering some of the questions. Just answer as you see best. Thank You.

1. Were you aware that this worker took a basic computer class? Yes () No (✓)
2. Does this worker use the computer (of any kind) to complete work tasks? Yes () No (✓)

If the answer to #2 is no, skip down to #5.

3. Have you noticed any improvement in this worker's skill or ability to perform tasks on the computer?

1.	2.	3.	4.
A great improvement	Some Improvement	No noticeable improvement	Somewhat worse

Comments: _____

4. Have you noticed any improvement in this worker's knowledge or understanding of the computer?

1.	2.	3.	4.
A great improvement	Some Improvement	No noticeable improvement	Somewhat worse

Comments: _____

5. Do you feel that this worker will be of more value to you and the company by having participated in the Basic Computer course?

1.	2.	3.	4.
Very Much So	Somewhat	It is hard to say	Not Likely

Comments: _____

Please Route this survey to Lynn Cox in Training at your earliest convenience.
Thank You for your participation.

COLUMBIA/WILLAMETTE SKILLBUILDERS

GRANT REPORT

CLACKAMAS COMMUNITY COLLEGE

PART TWO:

CURRICULUM

CURRICULUM
OCS AND WARN
MATH CLASS

Change and Check Tolerance:

The width of the groove is .061" .
Is it in tolerance? _____

The diameter(left) is 1.511" .
Is it in tolerance? _____
(in this case, \pm .04 mm)

$.061" + .03937 = \underline{\hspace{1cm}} \text{ mm}$
Is this within \pm 0.12 mm? _____

$1.511" + .039370 = \underline{\hspace{1cm}} \text{ mm}$
Is this within \pm 0.04 mm? _____

Rules to Remember

To change a millimeter (mm) measure to inches:

$\text{MM} \times .039370 = \text{INCHES}$

To change inches to (mm) measure:

$\text{INCHES} + .039370 = \text{MM}$

More practice:

1. The spec calls for a hole to be 9.525 mm . What size drill bit is this?
2. The distance of a cut needs to be 1.87 mm . How far is this in inches.
3. An outside diameter needs to be 33.2 mm \pm 0.12 mm . You measure it at 1.305" . Is in tolerance?

Note: If you are not currently using millimeters (metrics), do not try to memorize all these steps. Just make sure you understand how the "conversions" work. If you get the "big picture," when you do get into metrics, it will go easy for you.



METRIC EQUIVALENT				Inches	mm	Inches	mm	Inches	mm	Inches	mm	Inches	mm
Inches	mm	Inches	mm	0.190	4.826	0.380	9.652	0.570	14.478	0.760	19.304	0.890	22.606
0.0001	0.0025	0.010	0.254	0.200	5.080	0.390	9.906	0.580	14.732	0.770	19.558	0.900	22.860
0.0002	0.0051	0.020	0.508	0.210	5.334	0.400	10.160	0.590	14.986	0.780	19.812	0.910	23.114
0.0003	0.0076	0.030	0.762	0.220	5.588	0.410	10.414	0.600	15.240	0.790	20.066	0.920	23.368
0.0004	0.0102	0.040	1.016	0.230	5.842	0.420	10.668	0.610	15.494	0.800	20.320	0.930	23.622
0.0005	0.0127	0.050	1.270	0.240	6.096	0.430	10.922	0.620	15.748	0.810	20.574	0.940	23.876
0.0006	0.0152	0.060	1.524	0.250	6.350	0.440	11.176	0.630	16.002	0.820	20.828	0.950	24.130
0.0007	0.0178	0.070	1.778	0.260	6.604	0.450	11.430	0.640	16.256	0.830	21.082	0.960	24.384
0.0008	0.0203	0.080	2.032	0.270	6.858	0.460	11.684	0.650	16.510	0.840	21.336	0.970	24.638
0.0009	0.0229	0.090	2.286	0.280	7.112	0.470	11.938	0.660	16.764	0.850	21.590	0.980	24.892
0.001	0.025	0.100	2.540	0.290	7.366	0.480	12.192	0.670	17.018	0.860	21.844	0.990	25.146
0.002	0.051	0.110	2.794	0.300	7.620	0.490	12.446	0.680	17.272	0.870	22.098	1.000	25.400
0.003	0.076	0.120	3.048	0.310	7.874	0.500	12.700	0.690	17.526	0.880	22.352		
0.004	0.102	0.130	3.302	0.320	8.128	0.510	12.954	0.700	17.780				
0.005	0.127	0.140	3.556	0.330	8.382	0.520	13.208	0.710	18.034				
0.006	0.152	0.150	3.810	0.340	8.636	0.530	13.462	0.720	18.288				
0.007	0.178	0.160	4.064	0.350	8.890	0.540	13.716	0.730	18.542				
0.008	0.203	0.170	4.318	0.360	9.144	0.550	13.970	0.740	18.796				
0.009	0.229	0.180	4.572	0.370	9.398	0.560	14.224	0.750	19.050				

Example: 0.8564 inch in mm.
 0.850 = 21.590
 0.006 = .152
 0.0004 = .0102
 0.8564 in. = 21.7522 mm.



Different Kinds of Percentage Problems
Help Each Other Find the Answers

Problem: Your team produced 2006 parts, but 6 were defective. What is your percent defective?

$$\begin{array}{l} \text{Part:} \underline{\hspace{2cm}} \hspace{1cm} \% \\ \text{Whole:} \hspace{1cm} = \hspace{1cm} 100 \end{array}$$

Same Type of Problem: You check out springs for receiving, out of 1250 springs 53 are not acceptable. What is the percent rejected?

$$\begin{array}{l} \text{Part:} \underline{\hspace{2cm}} \hspace{1cm} \% \\ \text{Whole:} \hspace{1cm} = \hspace{1cm} 100 \end{array}$$

Another kind of problem: Your team has decided that any shipment of dials that is more than 3% defective must be rejected. You count a sample of 64 dials. How many can be defective?

$$\begin{array}{l} \text{Part:} \underline{\hspace{2cm}} \hspace{1cm} \% \\ \text{Whole:} \hspace{1cm} = \hspace{1cm} 100 \end{array}$$

A similar problem: You expect a 12% discount on a shipment that would normally cost \$2235.50. The billing lists your amount due as \$2045.00. Did you get the right discount?

$$\begin{array}{l} \text{Part:} \underline{\hspace{2cm}} \hspace{1cm} \% \\ \text{Whole:} \hspace{1cm} = \hspace{1cm} 100 \end{array}$$

One different problem: Your team has done well to reach 97% orders shipped to new orders. You shipped \$120,500, how much were the new orders. (Hint: orders shipped "to" or "of" new orders = 97%)

$$\begin{array}{l} \text{Part:} \underline{\hspace{2cm}} \hspace{1cm} \% \\ \text{Whole:} \hspace{1cm} = \hspace{1cm} 100 \end{array}$$

Figure out the percentage of a sample
That is defective using division and
the calculator.

Jill needs to check out some hub bodies her team is purchasing.

In Receiving, she picks up the invoice and the "characteristics/results" sheet. On the invoice, it usually tells her how many she needs to look at for a sample to inspect. She could find out how many to sample for this lot by using the "zero defects chart."

See the following pages, If the invoice does not show how many to take for a sample, Jill will find how many she needs to sample using the "zero defects chart." She also looks at the "characteristics/results" sheet to see what the spud diameter should be. This is what she wants to inspect.

On the zero defects chart, she only uses one column. It's the column of numbers with the arrow above it. She finds the number in that column for a sample size needed for the lot size she has.

She counts out enough hubs for a sample, then measures the spud diameter. Three hubs have spud diameter that is too large.

Jill needs to figure out the percentage defective in order to fill in the DMR (Discrepant Material Report).

The pages after the chart and characteristics/results sheet show how Jill finds the percentage defective and fills in a DMR.

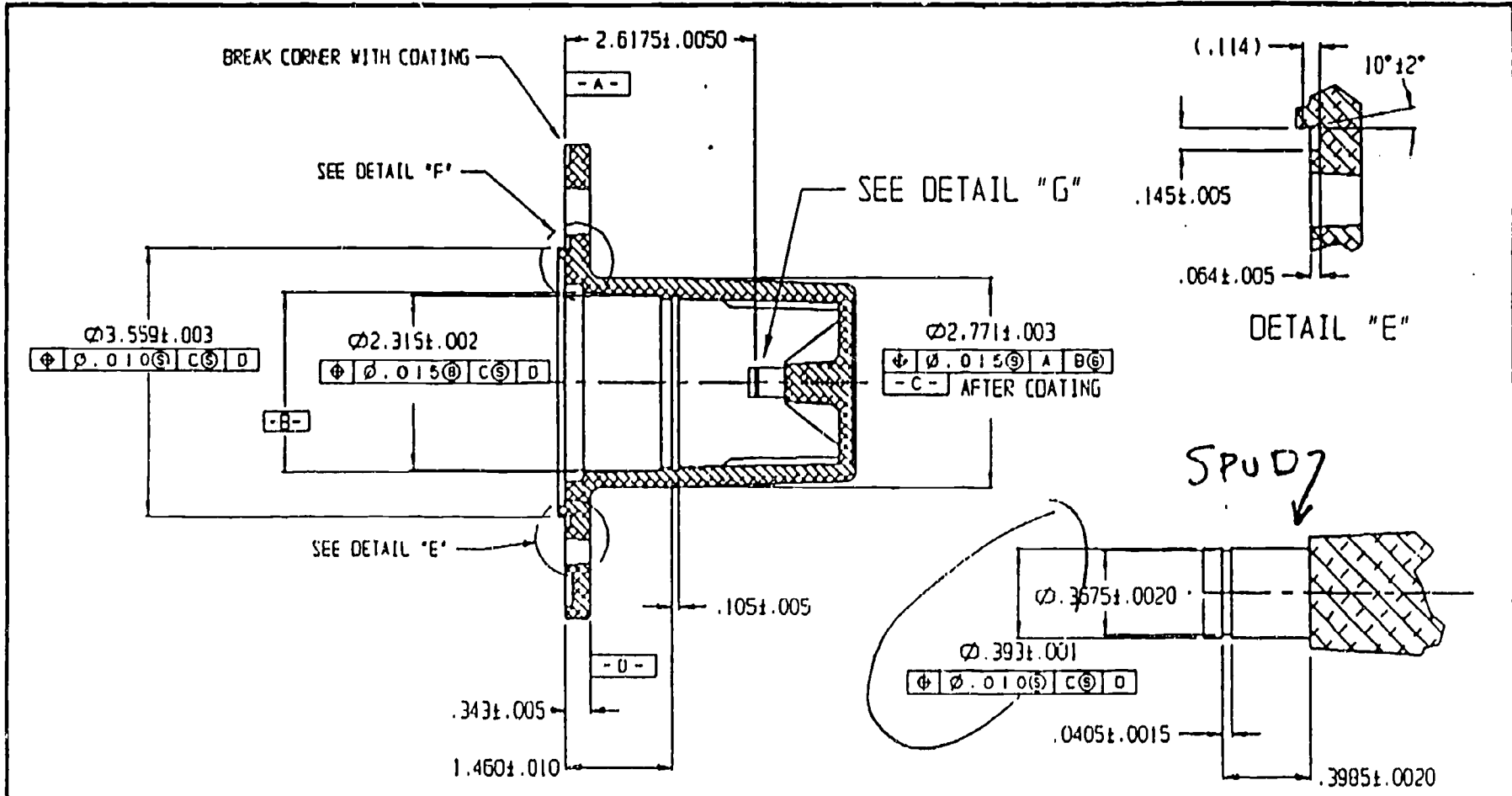

- NOTES: (unless otherwise noted)
1. DATUM 'D' SURFACE LOCATION BETWEEN 5.60 AND 6.00 DIA.
 2. COAT PER YARN SPECIFICATION 24431.

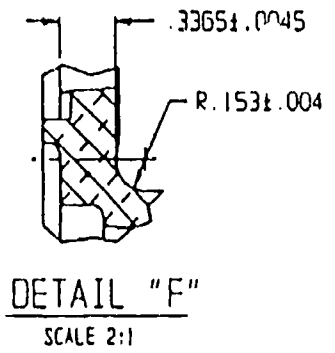

00 10299	REVISE .114 DIMENSION TO REF	A.P.
AO 9912	RELEASE	KIP
DESCRIPTION OF CHANGE		
WAPII WARTH INDUSTRIES, INC.		
DIMENSIONS UNLESS OTHERWISE SPECIFIED IN MILLIMETERS		
DIMENSIONS IN MILLIMETERS USE IN THESE UNLESS OTHERWISE SPECIFIED		
UNSPECIFIED TOLERANCES		
OF PLACE OR 1001	OF PLACE OR 17 01	
OF PLACE OR 17 01	OF PLACE OR 17 01	
OF PLACE OR 17 01	OF PLACE OR 17 01	
OF PLACE OR 17 01	OF PLACE OR 17 01	
OF PLACE OR 17 01	OF PLACE OR 17 01	
CASTING 26039		
BODY, HUB		
DATE	BY	BY
8/8/90	KIP	
1:1	SHEET 1 OF 1	26104

CHARACTERISTICS / RESULTS

NAME: BODY, HUB

5740

IF NUMBER	BUILD-REV	INSP DATE	INSP BY	LOT SIZE	SAMPLE SIZE	.393+/- .001
609	FØ	12-2	29	620	19	.393 .394
7612	FØ	12-19	29	560	19	.393 .396

she writes the highest and lowest in here ↗

section from the "characteristics/results" sheet. This sheet is used every time this part is inspected at receiving.

The Zero Defects Chart:

Use this copy of the Zero Defects Chart. Jill can find how many to sample by finding the lot size, and going over to the hi-lighted column and find the sample size needed for that lot size. This time, her lot size was 560.

LOT SIZE	SAMPLE SIZE ONLY USE THIS COLUMN																
	.0103	.0153	.0253	.0403	.0653	.103	.153	.253	.403	.653	1.03	1.53	2.53	4.03	6.53	10.0	
2 to 8	A	A	A	A	A	A	A	A	A	A	A	A	5	3	2		
9 to 15	A	A	A	A	A	A	A	A	A	A	13	3	5	3	2		
16 to 25	A	A	A	A	A	A	A	A	A	20	13	3	5	3	3		
26 to 50	A	A	A	A	A	A	A	A	32	20	13	3	5	5	5		
51 to 90	A	A	A	A	A	A	80	50	32	20	13	3	7	6	5		
91 to 150	A	A	A	A	A	125	80	50	32	20	13	12	11	7	6		
151 to 280	A	A	A	A	200	125	80	50	32	20	20	19	13	10	7		
281 to 500	A	A	A	315	200	125	80	50	43	47	29	21	16	11	9		
501 to 1200	A	800	500	315	200	125	80	75	73	47	34	27	19	15	11		
1201 to 3200	1250	800	500	315	200	125	120	116	73	53	42	35	23	13	13		
3201 to 10,000	1250	800	500	315	200	192	189	116	86	68	50	38	29	22	15		
10,001 to 35,000	1250	800	500	315	300	294	189	135	108	77	60	46	33	29	15		
35,001 to 150,000	1250	800	500	490	476	294	218	170	123	96	74	56	40	29	15		
150,001 to 500,000	1250	800	750	715	476	345	270	200	156	119	90	64	40	29	15		
500,001 and over	1250	1200	1112	715	556	435	303	244	189	143	102	64	40	29	15		

USE THIS COLUMN

Turn to the next page to see how Jill will determine the percent defective.



Jill

Jill figures out the percentage defective for this sample...

First: She has a lot size of 560, she knows this from the invoice and she counts them to (by box) be sure.

Then: She finds that she needs to "sample" 19 of the hub bodies. She gets this from the Zero Defects chart, or, if the instructions on the invoice showed how many to sample.

Then: After she measured 19, checking the spud diameter, she found that 3 had a diameter that was too large, up to .396 (+.003).

So: She divides 3 by 19 and multiplies the answer by 100 to get a percentage defective. She enters this on the DMR.

$$3 \div 19 \times 100 = 15.79 \text{ or } 16\%$$

Now: She can fill in the results section of the DMR. See the sample below.

The Run/Lot Qty. (in this case, it's how many are being received) is 560, the sample qty. is 19. She measured them and 3 had to be rejected. Note how she fills in the form. The Run/Lot Qty. Accepted and Rejected is figured by the Quality People. They'll fill in that part.

RUN/LOT QTY.	SAMPLE QTY.	SAMPLE ACCPTED	SAMPLE REJ.	LOT ACCPTED	LOT REJ
560	19	16	3		
INSPECTION RESULTS					
ITEM	DEFECT CHARACTERISTIC	SPECIFICATION	OBS/MEASURED DEFECT	% DEFECT	
1	O.S. SPUD DIM	.393 +/- .001	Tapered - up to +.002	16%	

On the next page, practice finding the percent defective and filling in the DMR.

A sample of 33 brass dials are inspected from a lot of 11,000. Out of the 33 you inspect, 14 have paint missing in the lettering... What is the percent defective? Write in your answer under % DEFECT.

RUN/LOT QTY. 11,000	SAMPLE QTY. 33	SAMPLE ACCPTED 19	SAMPLE REJ. 14	LOT ACCPTED	LOT REJ
------------------------	-------------------	----------------------	-------------------	-------------	---------

INSPECTION RESULTS				
ITEM	DEFECT CHARACTERISTIC	SPECIFICATION	OBS/MEASURED DEFECT	% DEFECT
1	VISUAL. Lettering		Paint Missing in Lettering	

On some flange blocks, the whole lot of 1725 is sampled and 213 are found to be off-center line up to nearly .165" ... What is the percent defective? Fill in the Inspection Results section.

RUN/LOT QTY.	SAMPLE QTY.	SAMPLE ACCPTED	SAMPLE REJ.	LOT ACCPTED	LOT REJ
--------------	-------------	----------------	-------------	-------------	---------

INSPECTION RESULTS				
ITEM	DEFECT CHARACTERISTIC	SPECIFICATION	OBS/MEASURED DEFECT	% DEFECT
1	DIMENSION.	Symultric	OFF CENTER	

On another lot of hub bodies, the spud diameter is tapered, not even. The taper is up to .002" over specification on all 19 of the 19 you sample. The lot was 620 hub bodies and quality tells you they will reject the entire lot. Fill in the Inspection Results Section...

RUN/LOT QTY.	SAMPLE QTY.	SAMPLE ACCPTED	SAMPLE REJ.	LOT ACCPTED	LOT REJ
--------------	-------------	----------------	-------------	-------------	---------

INSPECTION RESULTS				
ITEM	DEFECT CHARACTERISTIC	SPECIFICATION	OBS/MEASURED DEFECT	% DEFECT

Finding the percentage of rejects to complete a P-Chart

Jerri is charting defects as her team assembles aftermarket hubs. Each reject is set aside, then at the end of the job, she counts how many rejects there are of each type.

For the Job dated 3/15:

She adds up the rejects of each type to figure the REJ. TOTAL.

She divides the total by the BUILD QTY: $7 \div 2015 = \underline{\hspace{2cm}}$

She multiplies this by 100 to make the decimal a % : $\times 100$
 $= \underline{\hspace{2cm}}\%$

Then she enters this on the PERCENTAGE LINE---

DATE BUILT	3/15	3-16	3/19	3-20	3-21
MPS JOB	35412	35413	38410	38411	38413
BUILD QTY	2015	2000	1009	1015	2004
REJ. TOTAL	7				
PERCENTAGE	.35				
CASTING-----	-----	-----	-----	-----	-----
POROSITY	2	1	-	1	3
CRACKS/PIT	-	2	-	2	-
FLASH	1	-	2	1	-
PLATING-----	-----	-----	-----	-----	-----
PEELING	3	-	-	-	1
BUFF/DULL	1	1	1	3	3

Finish chart for Patti by adding the rejects and finding the % .
 ←
 ←

"DEFECT CAP/BODY REJECT REPORT"

ASHB-AKHE PROD CODE

DATE COMPLETED

7-18

PARENT ITEM P.N. 19406

CAP/BODY P.N. 19007

	6-12	6-15	6-16	6-22	6-29	7-02	7-3	7-16	7-17	7-17
DATE BUILT	6-12	6-15	6-16	6-22	6-29	7-02	7-3	7-16	7-17	7-17
MPS JOB	2555	2555	2555	2555	2555	2555	2555	2555	2555	2555
BUILD QTY	1015	2000	2006	1000	2000	1000	2004	2000	1000	2000
REJ. TOTAL	9	6								
PERCENTAGE	.99	.3								
CASTING										
POROSITY	5					1			1	3
CRACKS/PIT				2		1				
FLASH		1					3	2		2
LINES/LETT									1	
DECAL SURF										
DEFECT LEG			1		1					
PLATING										
BARE SPOTS		2						1		
PEELING	3			1			1	1		1
BUFF/MAT						2			2	
BUFF/DULL							1			
RWK PLTNG					4			2		
BARE DIAL							1			
PAINT										
BARE SPOTS				1	1				1	
ROUGH			2			1		1		2
CARD BOARD										
DENT										
DENT/FIT				1				3		1
DENT/COS	1				3					
SCRATCHES		3	6							
MACHINING										
OUT/ROUND										
NOT MACH										
BAD SPUD										
NO PINHOLE										
LETTERS										

CODE	TOTAL
3	10
0	3
0	
3	
0	
0	
1	
2	
0	
1	
2	
0	
1	
2	
0	
100	
120	
120	
3	
2	
0	
3	
2	
0	

CAP/BODY DEFECT CHART

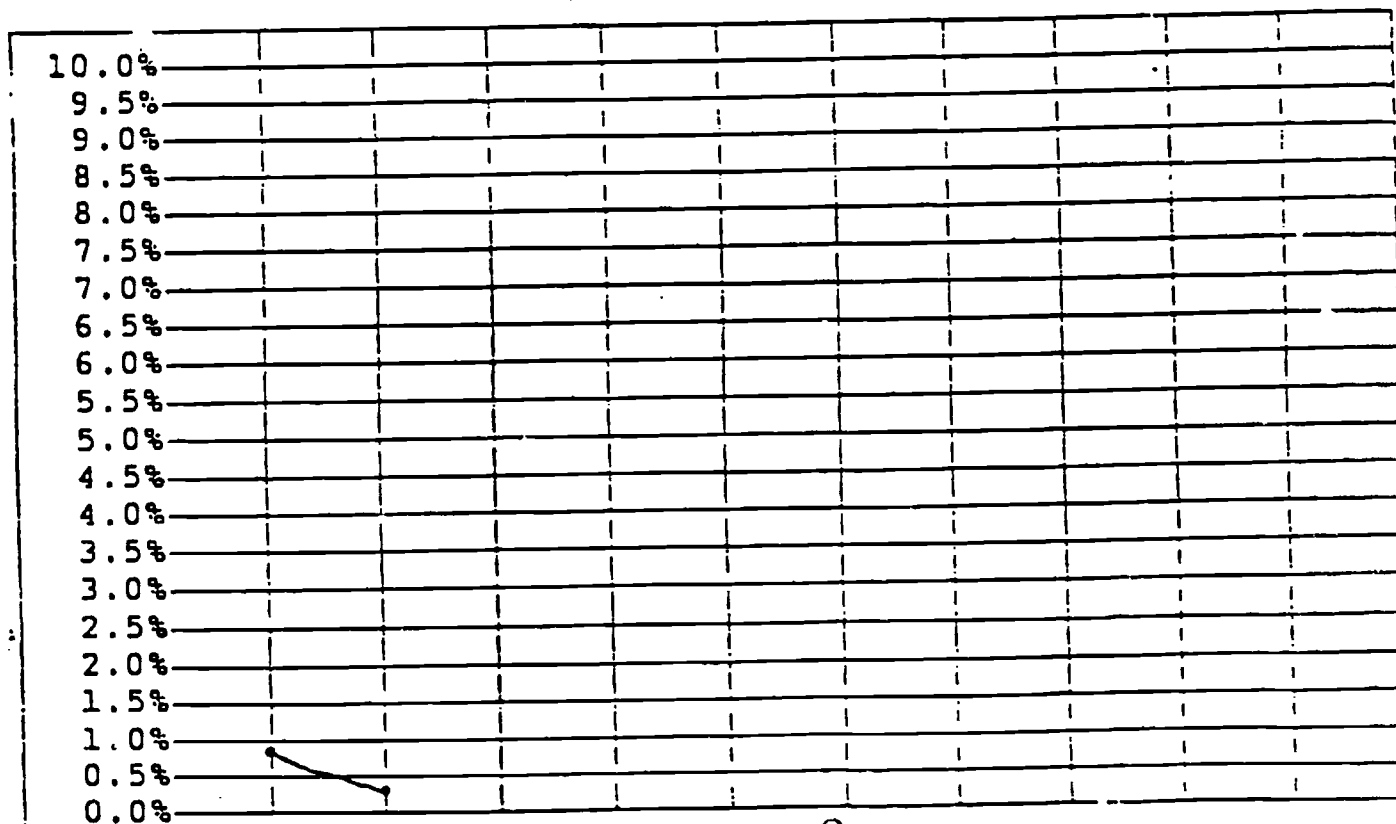

*Final
Pre
Chart*

OVER-



Using percentages to compare the teams' monthly shipments to the plan amount.

Tom is working on some numbers for his team leader. He needs to figure how his team doing compared to others in shipments compared to plan amounts.

Tom realizes that the different teams have different factors to contend with, so the comparison is only a general view of how his team is doing.

He figures the percentage of shipments to plan by dividing the shipments by the plan amounts. Then he multiplies that by 100 to get it in percentage form.

This percent will be below 100% if the shipments are less than plan. It will be above 100% if the shipments are more than the plan.

The report from the last day of the month is on the next page.

Use this formula to finish the percentages for each team...

$$\frac{\text{Shipments M-T-D}}{\text{Plan amount}} \times 100 = \text{Percentage of shipments to plan amount}$$

Now, Tom's team leader asks him to figure the percentage of shipments to orders. He can use the same formula...

$$\frac{\text{Shipments M-T-D}}{\text{Orders M-T-D}} \times 100 = \text{Percentage of shipments to plan amount}$$

Write the percentages along the right side of each column. Tom started them, just finish them using these formulas.

WARN INDUSTRIES
28-Sep-90

PRODUCT LINE	PLAN	SHIPMENTS		ORDERS	
		DAILY	M-T-D	DAILY	M-T-D
LANGYONG	0	0	0	0	0
COMMERCIAL/IND.	91,000	1,203	108,137	1,014	107,291
RANGE MOUNT	1,422,572	229,679	1,547,048	111	1,819,510
236	192,498	52,228	422,563	6,841	412,609
241	241,180	32,552	227,142	20,365	221,425
251	0	0	0-	0	0-
SHIFT LINKAGE	0	0	0-	0	0-
SALES & MARKETING	13,750	0	17,560	(8)	17,217
ITEM SUBTOTAL	1,961,000	315,661	2,322,451	28,324	2,578,052
COVER	102,800	(1,672)	29,431	245	32,498
ACCESSORIES	165,600	2,628	122,273	29,783	156,116
MOUNTING KITS	331,000	12,529	213,193	52,199	310,583
DECKOR	52,600	624	17,041	1,030	20,625
WINCH	1,888,500	32,063	1,327,762	324,891	1,860,441
UTILITY	163,600	41,154	274,388	21,501	264,915
AFTERMARKET HUBS	365,900	2,783	231,421	55,278	254,994
AFTERMARKET SUBTOTAL	3,070,000	90,111	2,215,509	484,927	2,900,172
TOTAL	5,031,000	405,772	4,537,959	513,251	5,478,224
PLANNED SHIPMENTS/ORDERS - TO DATE			5,031,000		5,031,000
OVER (UNDER) PLANNED SHIPMENTS/ORDERS			(\$493,041)		\$447,224
BACKORDERS - DOMESTIC					1,689,894
BACKORDERS - INTERNATIONAL					700,097
BACKORDERS - TOTAL					\$2,389,992
MANUFACTURING OVERHEAD ABSORBED					578,423
ASSEMBLY OVERHEAD ABSORBED					250,273
LOCAL OVERHEAD ABSORBED					828,696
PLANNED OVERHEAD ABSORPTION TOTAL			855,000		855,000
OVER (UNDER) PLANNED ABSORPTION					(\$26,304)
DAILY INVENTORY (LESS WORK IN PROCESS)					\$5,997,084
WORKING DAYS			19		19

Finding the percentage of rejects to complete a P-Chart

Jerri is charting defects as her team assembles aftermarket hubs. Each reject is set aside, then at the end of the job, she counts how many rejects there are of each type.

For the Job dated 3/15:

She adds up the rejects of each type to figure the REJ. TOTAL.

She divides the total by the BUILD QTY: $7 \div 2015 = \underline{\hspace{2cm}}$

She multiplies this by 100 to make the decimal a % : $\times 100 = \underline{\hspace{2cm}}\%$

Then she enters this on the PERCENTAGE LINE---

DATE BUILT	3/15	3-16	3/19	3-20	3-21
MPS JOB	35412	35413	38410	38411	38413
BUILD QTY	2015	2000	1009	1015	2004
REJ. TOTAL	7				
PERCENTAGE	.35				
CASTING-----	-----	-----	-----	-----	-----
POROSITY	2	1	-	1	3
CRACKS/PIT	-	2	-	2	-
FLASH	1	-	2	1	-
PLATING-----	-----	-----	-----	-----	-----
PEELING	3	-	-	-	1
BUFF/DULL	1	1	1	3	3

Finish chart for Patti by adding the rejects and finding the %.

Finish the P-Chart by charting the percent of defects and totaling each type of defect.

The next pages have two p-charts that need to be finished. Find the percentage defective like before, then, "chart" the percent on the defect chart across the bottom of the page.

Jerri started these charts by marking a dot on the line below each job that is across from the percentage numbers along the left edge of the page....

Then she connects the dots to show what is happening with defects on the jobs her team is doing.

This is what her chart looks like...

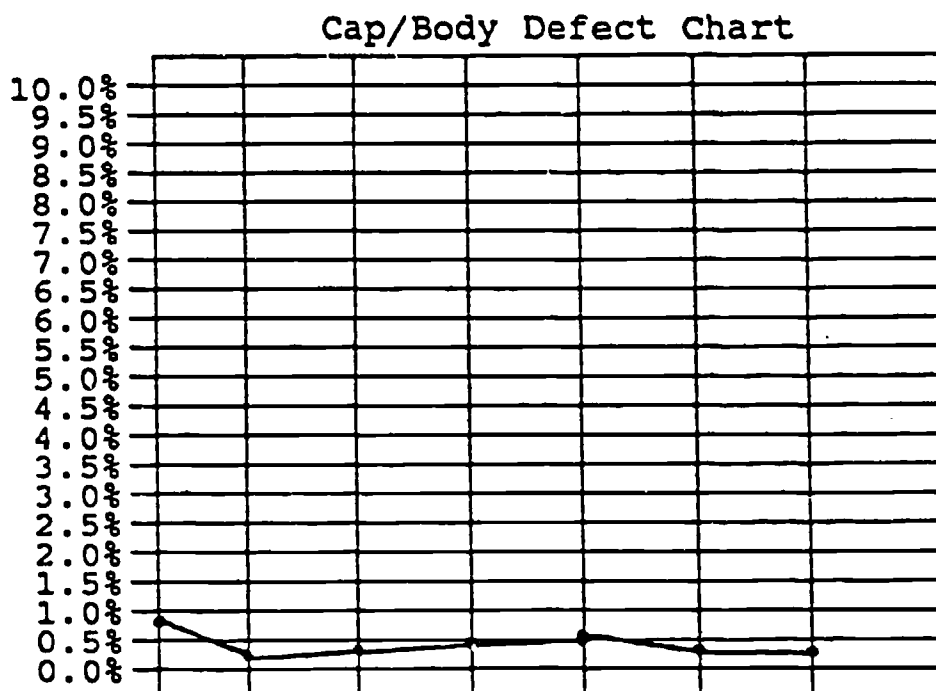

Then, for each type of defect, she adds every row across, then puts the total in the column along the right side of the page.

Note the charts on the next pages. She started the totals, you can finish them.

PARENT ITEM P.N. 19402

CAP/BODY P.N. 19453

H

10-27

DATE BUILT	10-2	10-3	10-6	10-7	10-12	10-13	10-14	10-21	10-27	10-28
MPS JOB	3550	3550	3550	3713	3817	3917	35410	37522	36715	3630
BUILD QTY	2000	2007	1000	1000	2000	2000	1000	1004	1000	2000
REJ. TOTAL	9	9	3							
PERCENTAGE	.4	.4	.3							
CASTING										
POROSITY	3			1						
CRACKS/PIT			1			3		1		1
FLASH	1				4					
LINES/LETT		2					1		1	
DECAL SURF				1						
DEFECT LEG										
PLATING										
BARE SPOTS	2		1		2		2			3
PEELING				1						
BUFF/MAT		3				4				
BUFF/DULL					1					
RWK PLTNG								3		
BARE DIAL										
PAINT										
BARE SPOTS	1									
ROUGH		2		1				1		
CARD BOARD					1					
DENT										
DENT/FIT	1									6
DENT/COS						1				
SCRATCHES			1							
MACHINING										
OUT/ROUND										
NOT MACH								1		
BAD SPUD										
NO PINHOLE										
LETTERS		1								

CODE	TOTAL
3	4
0	6
0	5
3	
0	
0	
1	
2	
0	
1	
2	
0	
1	
2	
0	
100	
120	
120	
3	
2	
0	
3	
2	
0	

CAP/BODY DEFECT CHART

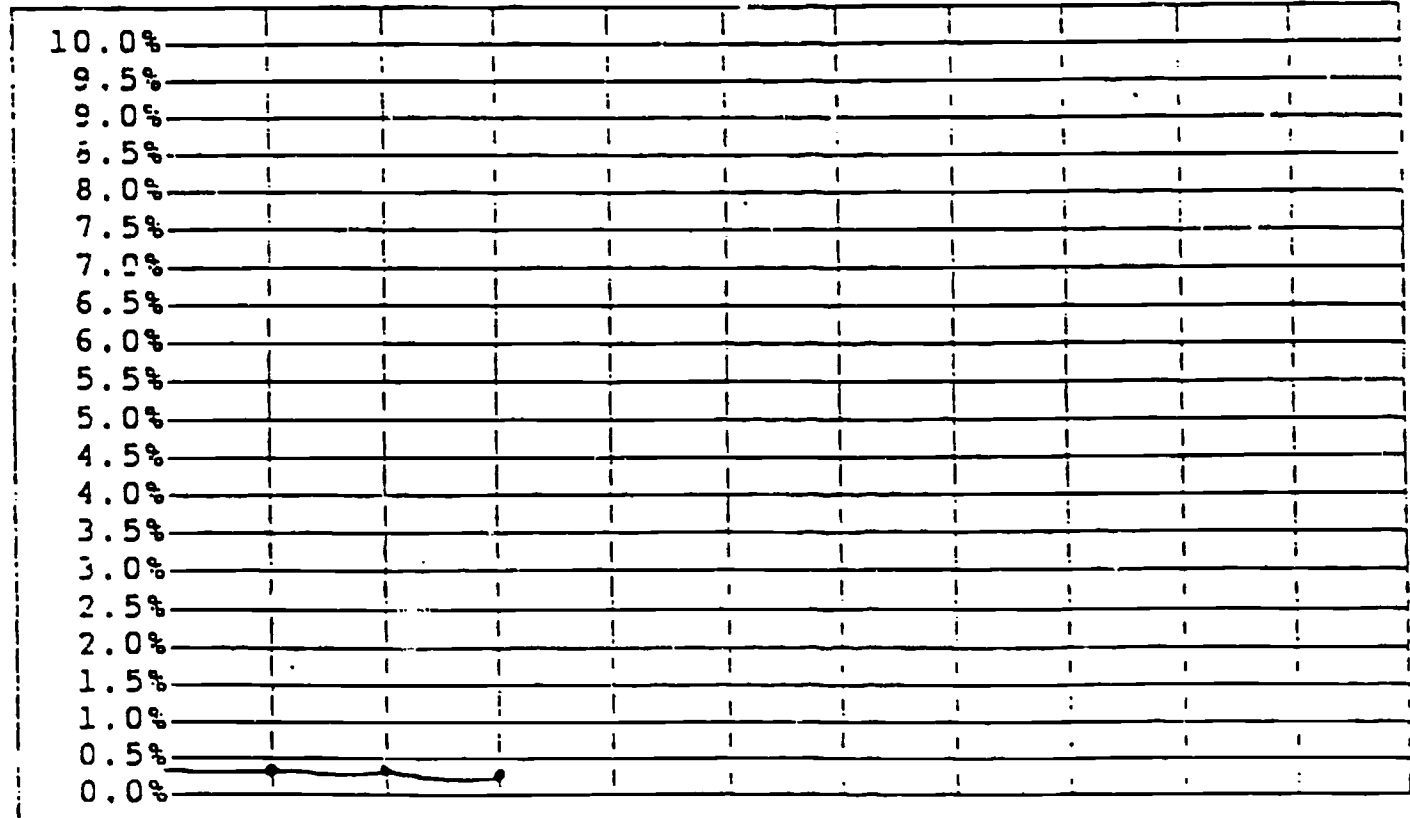

finish the Chart

OVER-



PARENT ITEM P.N. 19406

CAP/BODY P.N. 19407

DATE BUILT	6-12	6-15	6-16	6-22	6-29	7-02	7-3	7-16	7-17	7-17
MPS JOB	3623	36427	36427	36711	36711	35612	35613	37729	36211	37631
BUILD QTY	1015	2000	2006	1005	2000	1009	2014	2000	1003	2002
REJ. TOTAL	9	6								
PERCENTAGE	.9	.3								
CASTING										
FOROSITY	5					1			1	3
CRACKS/PIT				2		1				
FLASH		1			1		3	2		2
LINES/LETT									1	
DECAL SURF										
DEFECT LEG			1		1					
PLATING										
BARE SPOTS		2						1		
PEELING	3			1			1	1		1
BUFF/MAT						2			2	
BUFF/DULL							1			
RWK PLTNG								2		
BARE DIAL				4			1			
PAINT										
BARE SPOTS				1	1				1	
ROUGH			2			1		1		2
CARD BOARD										
DENT										
DENT/FIT				1			3			1
DENT/COS	1				3					
SCRATCHES		3	6							
MACHINING										
OUT/ROUND										
NOT MACH										
BAD SPUD										
NO PINHOLE										
LETTERS										

CODE	TOTAL
3	10
0	3
0	
3	
0	
0	
1	
2	
0	
1	
2	
0	
1	
2	
0	
100	
120	
120	
3	
2	
0	
3	
2	
0	

CAP/BODY DEFECT CHART

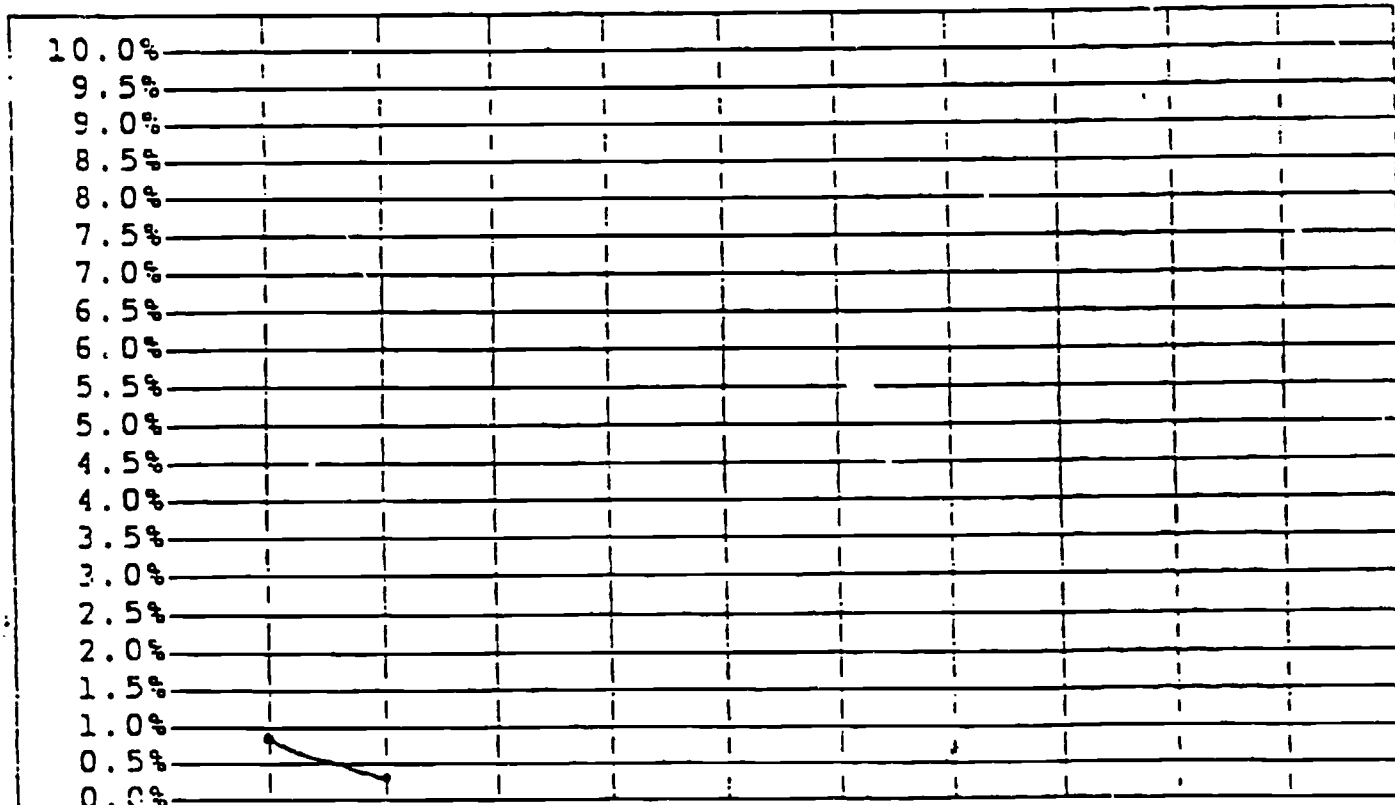

finish the chart

OVER



Running Totals: Find When a Tool Limit is Reached

Cutting Tools need to be serviced after reaching the "tool limit." When planning a job, Phyllis checks the broach (a cutting tool) record to see if she can finish the job before exceeding the "tool limit."

Look at the Record on the next page...

This how she figures if she can run the job:

First, she looks for the row on the broach record that shows her when the tool was last sharpened.

Next, she checks the "tool limit," and the amount she plans to run on this job.

Now, she adds the tool limit number to the running total that was listed the last time the broach (tool) was sharpened.

Then she takes that total and subtracts the current (last entry) running total.

If this answer is less than the amount she needs to run for her job, she will reach the tool limit before the job is done.

The broach team can inspect the broach and determine if it is wise to exceed the limit. If not, they will need to replace the broach in order to finish the job.

Phyllis is planning to run a job for 3150 parts. See how she figures it on the next page.

INDIVIDUAL BROACH RECORD

TOOL NO. 776422		DASH NO. -2	DATE OF MFG. 12-6-91		MANUFACTURER GBC			ORIGINAL TOOTH THICKNESS	
BRIEF DESCRIPTION 12 POT				LOCATION CAB # E	MATERIAL	CARD NO.	LENGTH OF CUT	FORCE REQ'D. LBS.	MAX. PRESSURE READING
				DRAWER # 2		2			TOOL LIMIT 7000
DATE	SHIFT	EMP. NO.	SET UP	PART NO.	MFG. NO.	NO. PCS. RUN	RUNNING TOTAL	REMARKS	
							7541	<i>Carried from Card 1</i>	
	1	62		9523	57683	471	8017		
	2	29	29	9523	57683	739	8756	<i>Pulled and Sharpened</i>	
	1	62		9523	57683	421	9177		
	1	121		9523	57683	863	10040	<i>END of Job</i>	
	2	29	62	9523	57662	712	10752		
	1	121		9523	57662	941	11693	<i>Remove Life buildup</i>	
	2	29		9523	57662	716	12409		
	1	171		9523	57662	872	13281		
	1	62		9523	57662	401	13682		

➔ Here's how she figures it...

The broach was last sharpened at 8756.

She adds 7000, (the tool limit) to 8756 to get 15756.

She subtracts the current running total (13682) from 15756 and gets 2074.

8756
+ 7000
15756
15756
- 13682
2074

This tells her she can only run 2074 of the 3150 she needs to run before she reaches the tool limit. She knows that she'll need to contact the tool department during the run so they can check the broach.

On the following two pages are more broach records... figure out if you will hit the tool limit: on the first tool you will want to run 2000 pcs. on the second one, 1450. Which one(s) will exceed the tool limit?

Determine the amount of stock needed to complete a job. Using addition, subtraction, the material list and the Stock Status Inquiry.

Mary is starting a new job and is checking the materials to see what she will need.

Problem: The job material list shows that Mary needs 235 EA. of item number 0002592900. See REQ-QTY on the list.

ITEM NUMBER	ITEM DESCRIPTION	UM	REQ-QTY	CMP TYP	ISS CTL
0001333000	REMOTE CONTROL ASSY,12FT	EA	235	S	2
0002155400	DRUM GROUP, 5/16X80 WR	EA	235	S	1
0002592900	CONTROL, WN, 12VDC, 4 SOL	EA	235	S	1
0009520800	GEAR RING ARGENT	EA	235	S	1

The Stock Status By Item screen shows how many are "on hand" or "OH." (OH is on hand in the stock room, an "FS" would indicate the material is available from floor stock) .

Mary checks the screen to see if there are enough of these parts on hand...

STKS INQ

*** STOCK STATUS BY ITEM ***

Item Number: 0002592900

Detail Option:

Desc: CONTROL, WN 12VDC, 4 SOL

U/M: EA 117 / OH _____

Text: _____

Planner: SC _____

Rcpt Mix: YES

Will Mary need more more of this part? If so, how many will she need to backorder?

See the next page to see how she works it out.

Mary works it out...

She knows that she needs... _____ to do the job. (QTY-REQ).
She knows that there are...(-) _____ on hand (OH) in stock.
= _____ to back order.

If there are more OH (on hand) than QTY-REQ (for the job), she won't even subtract, she knows she has enough.

Mary can double check her calculation,

She takes the number to order... _____
She adds the number OH (on hand)... + _____
She comes up with the QTY-REQ (how much she needs).. = _____

If the material is on hand (OH), she can get it from the stock room and it will not need to be back ordered.

Jack is starting a new job and is checking the materials to see what he will need.

Problem: The job material list shows that Jack needs 129 EA. of item number 0001383100. See REQ-QTY on the list.

ITEM NUMBER	ITEM DESCRIPTION	UM	REQ-QTY	CMP TYP	ISS CTL
0001382700	RING,RETAINING (RS-168)	EA	129	S	2
0001383100	BUSHING,DRUM,NYLON	EA	129	S	2
0002592900	CONTROL,WN,12VDC,4 SOL	EA	129	S	1
0009520800	GEAR RING ARGENT	EA	129	S	1

The Stock Status By Item screen shows how many are "on hand" or "OH." (OH is on hand in a stock room, an "FS" would indicate the material is available from floor stock) .

Jack checks the screen to see if there are enough of these parts on hand...

STKS INQ

*** STOCK STATUS BY ITEM ***

Item Number: 0001383100

Detail Option:

Desc: BUSHING DRUM,NYLON U/M: EA 85 / FS 25/OH

Text: _____

Planner: SC

Rcpt Mbr: YES

Will

Will Jack need more more of this part? If so, how many will come from floor stock (FS) and how much will he need to request from stock? (OH) Will any need to be backordered? If so, how much for this order?

Mark is starting a new job and is checking the materials to see what he will need.

Problem: The job material list shows that Mark needs 325 EA. of item number 0001382700. See REQ-QTY on the list.

ITEM NUMBER	ITEM DESCRIPTION	UM	REQ-QTY	CMP TYP	ISS CTL
0001382700	RING,RETAINING (RS-168)	EA	325	S	2
0002155400	DRUM GROUP, 5/16X80 WR	EA	325	S	1
0002592900	CONTROL,WN,12VDC,4 SOL	EA	325	S	1
0009520800	GEAR RING ARGENT	EA	325	S	1

The Stock Status By Item screen shows how many are "on hand" or "OH." (OH is on hand in *the* stock room, an "FS" would indicate the material is available from floor stock).

Mark checks the screen to see if there are enough of these parts on hand...

STKS INQ

*** STOCK STATUS BY ITEM ***

Item Number: 0001382700

Detail Option:

Desc: RING,RETAINING(RS-168)

U/M: EA 300 / FS 200/OH

Text: _____

Planner: SC _____

Rcpt Mbr: YES

Will

Mark need more more of this part? If so, how many will come from floor stock (FS) and how much will he need to request from stock? (OH) Will any need to be backordered? If so, how much for this order?

Jack is starting a new job and is checking the materials to see what he will need.

Figure out how much material is needed for item number 0009520800 and see if there will be enough.

ITEM NUMBER	ITEM DESCRIPTION	UM	REQ-QTY	CMP TYP	ISS CTL
0001382700	RING,RETAINING (RS-168)	EA	155	S	2
0001383100	BUSHING,DRUM,NYLON	EA	155	S	2
0002592900	CONTROL,WN,12VDC,4 SOL	EA	155	S	1
0009520800	GEAR RING ARGENT	EA	155	S	1

The Stock Status By Item screen shows how many are "on hand" or "OH." (OH is on hand in stock room, an "FS" would indicate the material is available from floor stock) .

Jack checks the screen to see if there are enough of these parts on hand...

```

STKS INQ
*** STOCK STATUS BY ITEM ***

Item Number: 0009520800          Detail Option:
Desc: GEAR RING ARGENT        U/M: EA   125 / FS 225/OH
Text: _____                Planner: SC
                                   Rcpt Mix: YES
    
```

Will
 Jack need more more of this part? If so, how many will *come* from floor stock (FS) and how much will he need to request from stock? (OH). *Will* any need to be backordered? If so, how much for this order?
 .. much will be left in OH after he gets the material he needs?

Calculate the Fractional Dimensions

Work these problems together in class. Use the print on the next page to solve the problems.

1. Suppose you need to inspect this part. You are told to make sure the bracket is the right length between point A and point B.

How far is it from point A to B? (within $\frac{3}{16}$ ths of an inch).

2. How far should it be from point A to the outer edge of the large hole (point G) ? (Hint: from the middle of the hole to the edge of the bracket is shown as $1\frac{1}{2}$ R, or a radius of $1\frac{1}{2}$ inches).

3. What distance should it be from the middle of hole E to the edge (point F)?

4. How far from the middle of hole E to the edge (point H)?

1734

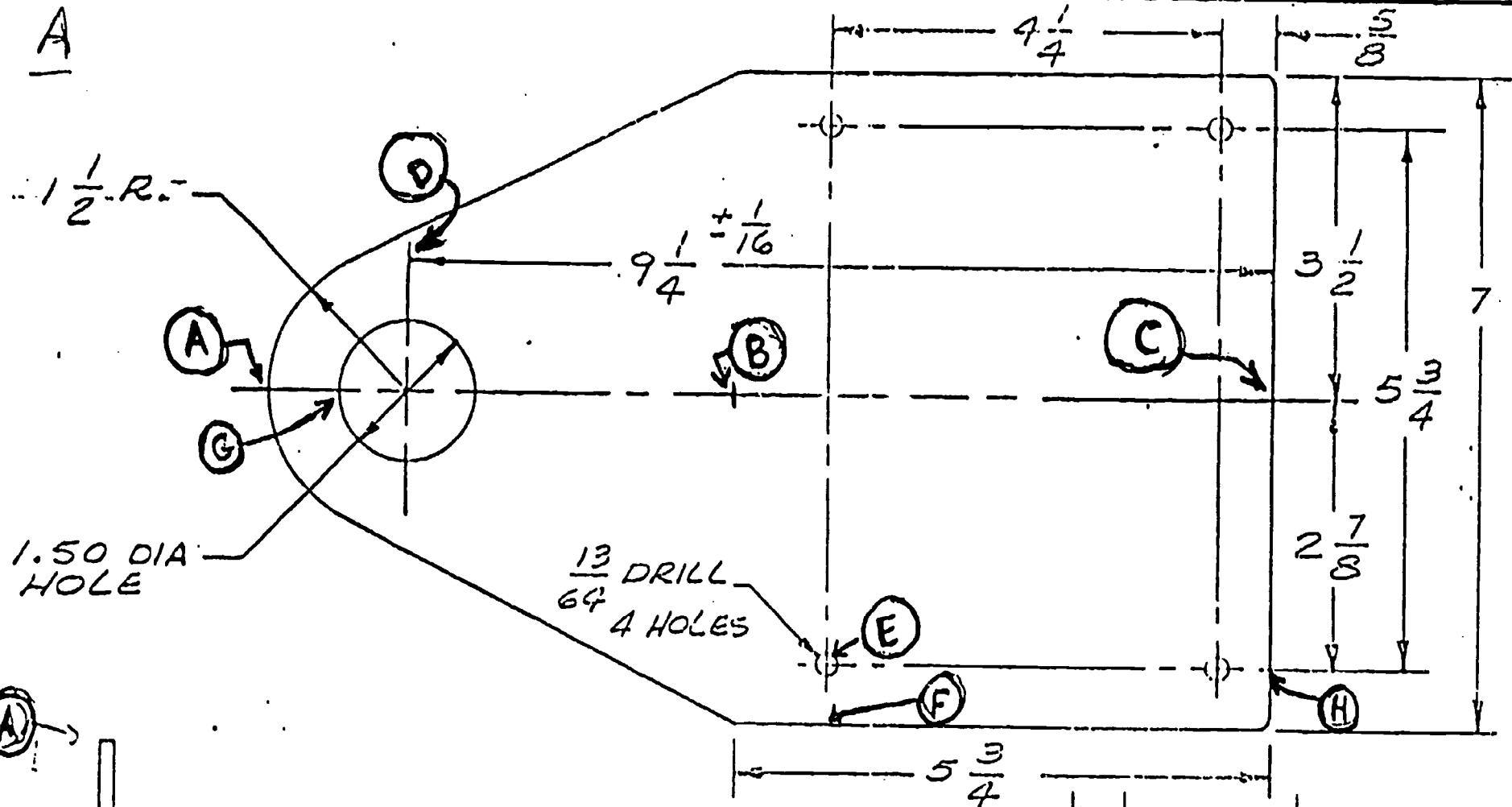

DEVELOPMENT

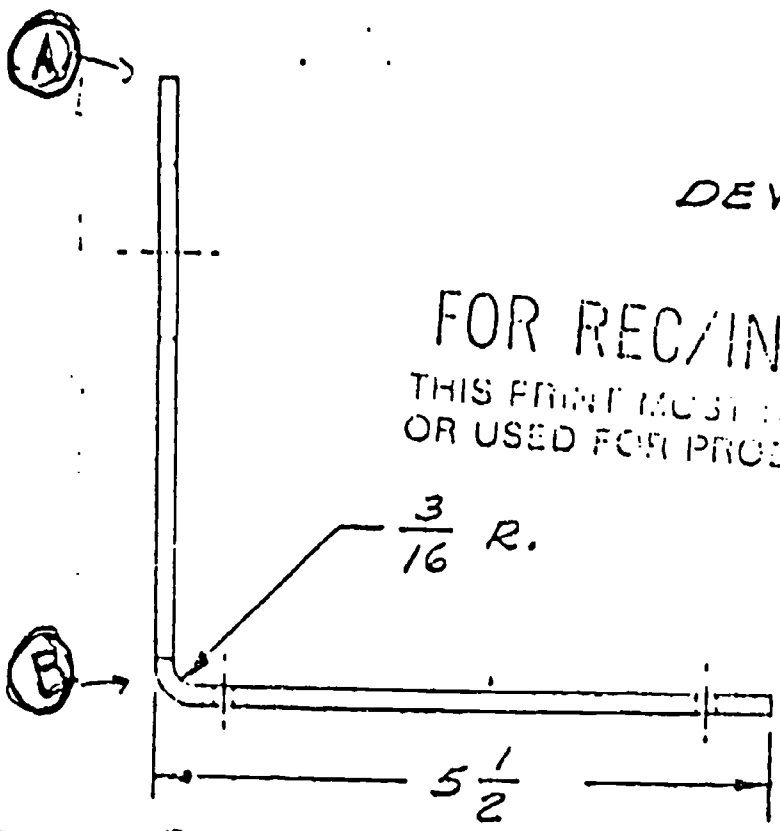

FOR REC/INSP USE ONLY
 THIS PRINT MUST NOT BE DUPLICATED
 OR USED FOR PRODUCTION PURPOSES

1275	R.S. 116A (.117) H.R. 54# 1020		
ITEM	PART NO.	DESCRIPTION	QTY. U/M

WARN-BELLEVUE STDS.
 REMOVE ALL BURRS: .010 MAX. C/R
 UNLESS OTHERWISE NOTED: FINISH $\sqrt{125}$, ANGLES $\pm 1^\circ$
 TOL: .00 = $\pm .010$.000 = $\pm .003$ FRACTIONS $\pm 1/64$

DATE 8-6-71	SCALE 1/2	NEXT ASS'Y
DRAWN BY AP	CHK'D	APP'D

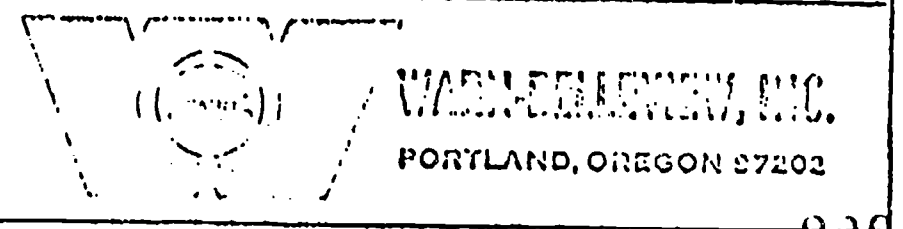

TITLE BRACKET-STAND, DISP'AY	NO. 734
------------------------------------	------------

1	EN	11	1	8-6-71	AP
---	----	----	---	--------	----

Figure Out the Fractions...

The Shipping Box shown on the print is used for many products. The print shows four ways to pack the box for different sizes of inner boxes. Use the print and your skill with fractions to solve these problems.

1) The packing for M35 and M37 (see "A" on the print) shows three boxes laid $4\frac{1}{2}$ " across and one laid $5\frac{1}{8}$ " across. The shipping box is $18\frac{1}{2}$ " across (inside dimension, see top of print). Will these boxes fit into the shipping box packed this way?

2) The packing for M10, M11... (see "B" on the print) allows a space (FILL) in the center of the shipping box. Marketing wants to send a promo package along with the orders. The package is currently in a box that is 2" wide, 10" long and 10" high. Will this box fit in this fill space? If not, what size of a box would?

3) The packing for M9 and M14 (look at "C" on the print) allows some space across the length. How much room is left after loading the inner boxes in?

Shipping Box Problems

4) With the box loaded with M5 or M7 boxes (see "D" on the print), How much room is left at either end of the box? (length and width).

5) A freight trailer has some space available for shipping some of these boxes. The space 28 feet long and 7 feet across. You will not be stacking these so the height is not a problem. How many shipping boxes will fit in this trailer space? (Check the outside dimensions on the print, use length = $18 \frac{11}{16}$ " and width = $10 \frac{3}{8}$ ") Hint: drawing a picture may help.

1144

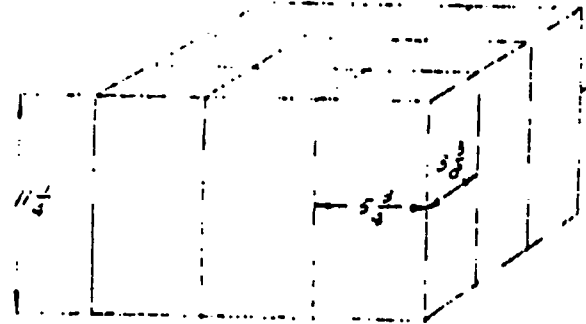
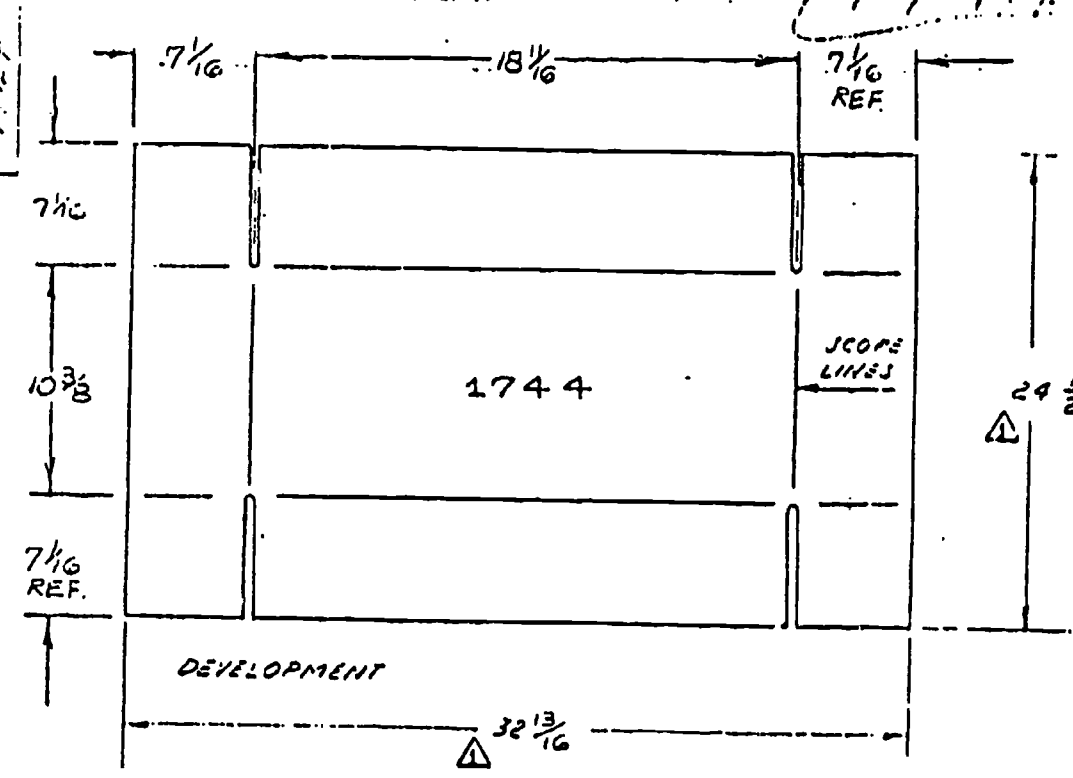
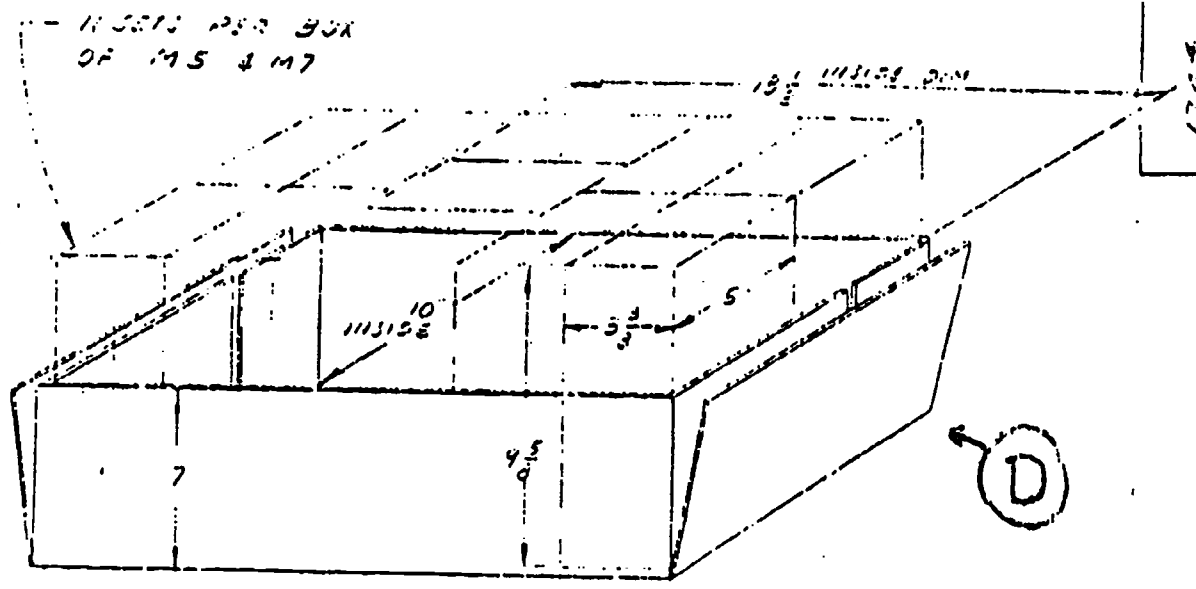

(C)

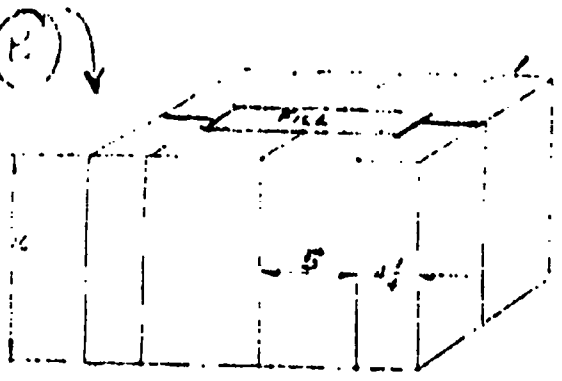

(E)

8 SETS PER BOX OF M12, M14, M11, M15, M15A, M21, M22, M23, M26, M27, M31, M31A

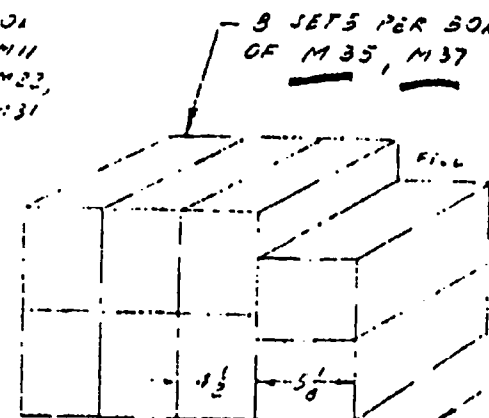

(A)

8 SETS PER BOX OF M35, M37

HEAT TREAT NONE
 REMOVE ALL BURRS
 TOL FINISHES \pm .015 LIMIT AS NOTED
 ORIGINAL \pm .020

MATERIAL:
 CORRUGATED CARDBOARD
 BURSTING TEST 350 LBS/SQ. INCH
 MIN. COMB. WT. 180 LBS/M SQ. FT FACING
 SIZE LIMIT 100"
 GROSS WT. LT., 120 LBS

USED ON: M5, M7, M9, M10, M14A, M11, M14, M15, M15A, M21, M22, M23, M26, M27, M31, M31A, M35, M37, M51, M57

REVISIONS			WARR 1459 CS		
NO	DATE	BY	SEATTLE 98 WARR		
1	8-3-53	J.P.	SHIPPING BOX - BOTTOM		
2			WARR M.I. ?		
3			DRAWN BY	SCALE	MATERIAL
4			CHK'D	DATE	NOTE
5			TRACED	APP'D	DRAWING NO
					1744

RELEASED

239

FOR REC/INSP USE ONLY
 THIS PRINT MUST NOT BE DUPLICATED
 OR USED FOR PRODUCTION PURPOSES

230

More Conversions to Decimals to Solve Measurement Problems.

Why?

Layout and Box measurements will be in fractions. Figuring out how you can use a box or area will require to multiply or divide measurements.

If you remember the rules for multiplying and dividing fractions, it might be faster to work with the measurements as fractions. But many workers find it easier to convert fractions into decimals before dividing or multiplying.

Convert Fractions to find out how many parts or objects will fit in an area...

Why? Boxes or Work cell areas are measured in feet, inches and fractions of an inch. With constant changes, you will need to help your team figure out problems like: "will it fit?"

See the print "B." It's the bottom of the shipping box used for several different parts.

Question: Your team has a new product that fits into a box that is $4 \frac{3}{4}$ inches wide and $4 \frac{1}{2}$ inches thick (how long it is doesn't matter since the shipping box is made to cover the top and bottom of your boxes...see the print).

How many of these boxes can you fit into the shipping box?

The print shows that the shipping box is $18 \frac{1}{2}$ inches long and 10 inches across.

With the longest side of your box along the longest side of the shipping box, you can get 3 across with room left over...

$$18 \frac{1}{2} \text{ divided by } 4 \frac{3}{4} \quad \text{or} \quad 18.5 \text{ divided by } 4.75 = 3.89$$

If you pack it this way, you could get two rows in since...

$$10 \text{ divided by } 4 \frac{1}{2} \quad \text{or} \quad 10 \text{ divided by } 4.5 = 2.22$$

So you could get six in the whole box... (look at the print and picture; three in a row along the $18 \frac{1}{2}$ inch side, and two rows).

Is there a better way to pack it?

Try the short side ($4 \frac{1}{2}$) along the long side of the shipping box.

$$18.5 \text{ divided by } 4.5 = 4.111 \quad , \text{ so four could go in this way..}$$

You can now get ($10 \text{ divided by } 4.75 = 2.105$) two rows in with 4 in each row, so you will get 8 into the shipping box this way.

How many if your box is $3 \frac{3}{4}$ inch by $4 \frac{1}{4}$?

How many if your box is $5 \frac{3}{8}$ inch by $3 \frac{1}{4}$?

This is not handed out but discussed w/ overhead 231 of print

Help each other solve these problems.
 Work in class using rulers or gages provided.

1. These bars must be 1.25" long with a tolerance of +/- .125"

How long can a bar be, and still be in tolerance
 (acceptable)? How Short?

Measure and circle the bars that are not in tolerance...



2. What percent defective do you have with the sample of bars above?

3. If a part can be .393" in diameter +/- .003", how large can the diameter be and still be in tolerance (acceptable)?

How small can it be?

4. You measure ten of these parts (from question #3) and get these measures...

.392 .389 .394 .390 .393 .398 .396
 .391 .393 .395

How many must be rejected? what % defective would you have?

5. The length of a bar must be 2.2250" +/- .005" Circle the ones that are not in tolerance...

2.2211 2.2191 2.2201 2.2310 2.2299

Metric Madness...

A "meter" is a little longer than a yard... it's 39.37 inches while a yard is 36 inches.

Meters are the standard for the "Metric" system. Metrics are used in most other countries instead of feet and inches.

A yard might look like this....



Each foot has 12 inches, so 3 feet makes one yard.

A meter is more like this...



It takes 1000 "millimeters" or "mm" to make a meter.

Millimeters are much smaller than inches so they are good for precise measurement. With millimeters and meters, you never have fractions of an inch, it's always decimals.

For example... One inch equals 25.4 mm (millimeters)...

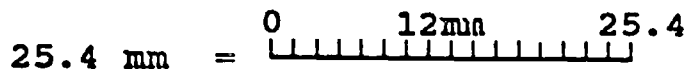
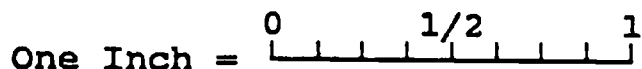

And... One mm = .039370 inch

(Its very small, compared to an inch.)

To change a metric measure into a decimal inch, just multiply the mm by .03937

Making Millimeters (mm) into Inches

* One inch is equal to 25.4 mm and one mm is equal to .039370 of an inch.

* If you have a gear that should have an inside diameter of 25.4 mm, how many inches is this diameter?

* You can turn a Millimeter, (mm) into decimal inches so you can measure them with your micrometer or calipers. Here's how...

Suppose the gear should have an inside diameter of 26 mm . If you multiply that by .03937, you get exactly 1.02362 inches, or just over one inch. Since it takes 25.4 mm to make an inch, it makes sense that 26 mm is slightly more than one inch.

Convert the Dimensions on the Print for a Korean Hub.
See the print on the next page.

Overall length :	32.55mm x .039370 =	_____ "
Width of groove:	1.68mm x .039370 =	_____ "
Diameter(left) :	38.10mm x .039370 =	_____ "

Suppose you measure the overall length and get 1.292" . Will this be "in tolerance?"

Check the tolerance by changing the inches to mm.

You can change inches to mm by reversing the steps above. Just divide the inches by .03937 to find out how many mm you have.

Now you compare this to the spec, which is 32.55mm ± 0.12 .

(± 0.12 is the tolerance for all these)

Is the overall length in tolerance? _____
(it should be no longer than 32.67mm)

Change 1.292 inches to mm...
1.292 ÷ .039370 = _____ mm

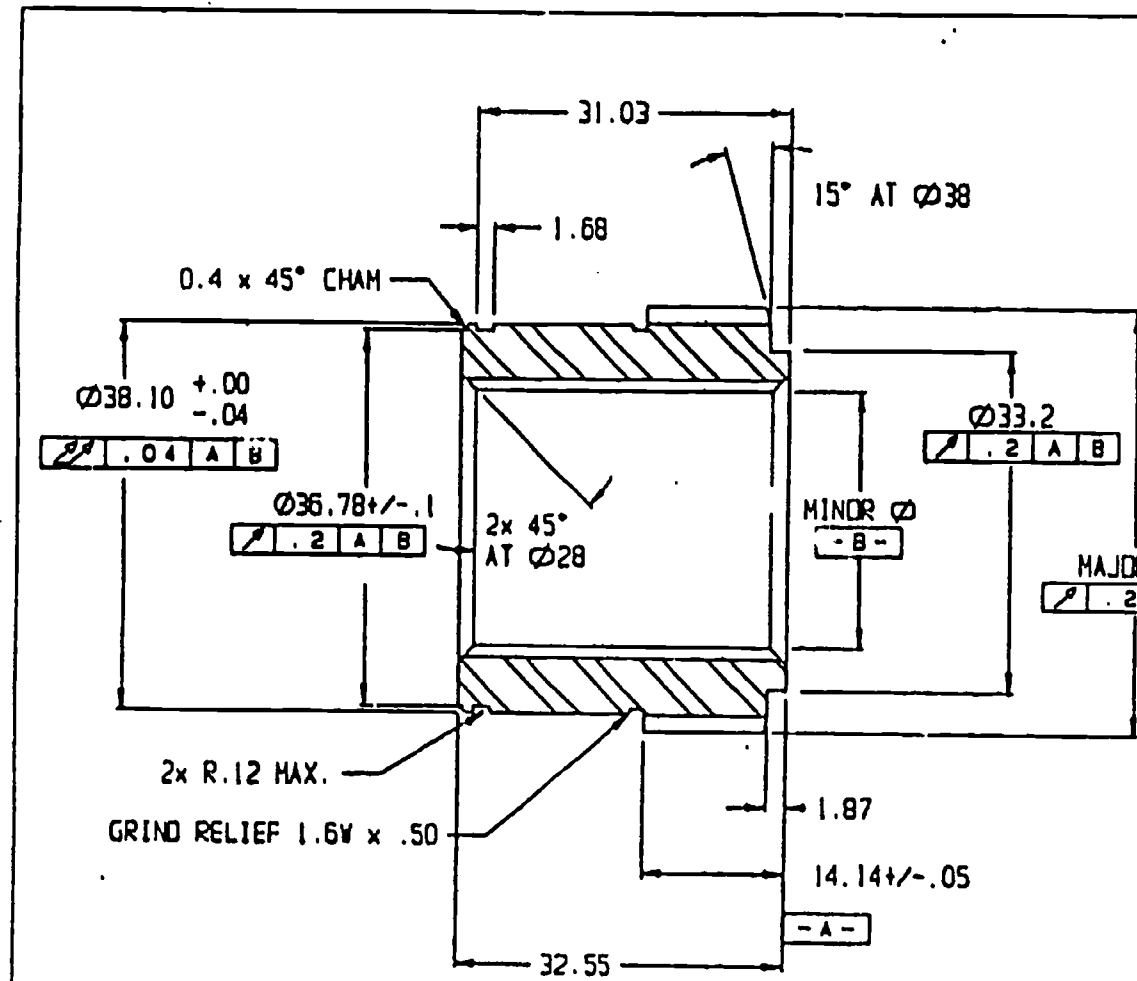

NOTES: (unless otherwise specified)

- 1) HEAT TREAT: THROUGH HARDEN TO ROCKWELL 'C' 35-40
- 2) EDGE BREAK: .35 MAXIMUM
- 3) RADII AND FILLETS TO BE .75 MAXIMUM
- 4) INTERNAL SPLINE PER WARN SPEC. 26488
- 5) EXTERNAL SPLINE PER WARN SPEC. 21197

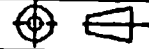
30	10568	CHG.0 MATL FROM 1144 TO 86L20	
AD	10058-2	RELEASE	
REV E.N. NO		DESCRIPTION OF CHANGE	REV
REVISIONS			
 WARN INDUSTRIES, INC. 13270 S. E. PHEASANT COURT MILWAUKIE, OREGON 97222			
DIMENSIONS AND TOLERANCES IN ACCORDANCE WITH ANSI Y14.5M-1982			
THIRD ANGLE PROJECTION		A331(86L20)	
DIMENSIONS <input checked="" type="checkbox"/> MILLIMETERS ARE IN <input type="checkbox"/> INCHES			
UNSPECIFIED TOLERANCES		GEAR, DRIVE, INNER	
ONE PLACE DEC. (X.X) ± 0.25 TWO PLACE DEC. (X.XX) ± 0.12 THREE PLACE DEC. (X.XXX) \pm FOUR PLACE DEC. (X.XXXX) \pm ANGULAR \pm			
DATE	6-22-90	DESIGNED BY	C. WILSON
SCALE	2:1	SHEET	1 OF 1
		OR	B
			26484

Figuring the Control limit for the
P-Chart (% defect chart).

Control limits are to be drawn across the charts so the team can see when the percentage defective is usually high. To figure out where the control limit should be drawn, Jerri will work some formulas. These formulas determine the typical percentage of defects, then set a point that indicates when a high percentage is "untypical" and needs immediate attention.

Jerri will use a completed P-Chart to figure a control limit for the next chart. She uses a calculator with a square root function.

The formulas look a little confusing at first, but Jerri has worked them enough she could do it with out even looking at the formulas. She is careful to take it one step at a time and double checks her work just in case she entered something wrong onto the calculator.

First, she needs to figure the average percentage of defects they had or all the jobs on the last chart.

This is called \bar{p} , or p bar. This is the formula...

$$\bar{p} = \frac{\text{Total defective}}{\text{Total units built}} \times 100$$

Using every job on the sheet, she adds up the total defective, the total built and divides the total defective by the total built. She multiplies this by 100 to make it a percentage. p bar is the average percentage defective.

Then, she needs to figure \bar{n} , or n bar. This average number built on each job. She goes to the last chart and adds up the total number built and counts the total number of jobs. She divides to get n bar:

$$\bar{n} = \frac{\text{total number built}}{\text{total number of jobs}}$$

To figure the control limit, she needs to know s . This represents the "standard deviation." That's just a technical way of showing the typical amount of variation there is in the percentage of defects. This number is used so that the control limit will show the team when a very "untypical" number of defects are found.

Jerri will add $3s$ ($3 \times s$) to \bar{p} and this will be the upper control limit. The lower control limit is not important since zero percent defective is not a problem.

On the next page, Jerri will figure out s using a formula. Then she will add it to p bar to get the control limit.

The formula to get s , so she can find the control limit is..

$$s = \sqrt{\frac{\bar{p}(1-\bar{p})}{\bar{n}}}$$

Jerri always figures what is inside the parenthesis first, so she figures $(1-\bar{p})$. Then, she multiplies this by \bar{p} . Now, she can divide this answer by \bar{n} . Now, she needs to get the square root of this number so she uses the square root key on the calculator.

Now, Jerri add $3s$ ($3 \times s$) to \bar{p} and gets the control limit.

$$\bar{p} + 3s = \text{UCL}$$

Use the p-chart dated 7-18 to find the control limit to use on the chart dated 10-23. Remember to use all the jobs on the chart to get the totals for \bar{p} and \bar{n} .

Total number defective: _____

(total across the chart, all jobs)

Total units built: _____

$\bar{p} =$ _____

$$(\bar{p} = \frac{\text{\# defective}}{\text{\# built}} \times 100)$$

$\bar{n} =$ _____

$$(\bar{n} = \frac{\text{\# built}}{\text{\# of jobs}})$$

$s =$ _____

(use formula at top of this page)

UCL = _____

$$(\bar{p} + 3s)$$

Draw a line for the limit on chart dated 10-23. (Find the value on the chart that is the same as UCL, then draw your control limit line from left to right across the page. Now, when the percentage defective is higher than this amount, the team knows that the number of defects is unusually high and action will be taken to determine and correct the problem.

For more practice, use the chart dated 10-23 to figure control limits for a new chart. You always use previous charts to figure control limits for new charts.

Using addition, subtraction and division
to fill out a Statistical Control Chart.

Pat is charting dial torque. She takes a sample of 5 every hour (as specified in the process sheets), and tests the torque on these five.

She writes the amount of torque (in pounds) for each hub tested in a column that looks like this...

DIAL TORQUE								
SUB GROUPS		1	2	3	4	5	6	7
S	1	10.0						
A	2	8.5						
K	3	8.0						
P	4	9.5						
L	5	11.0						
E								
SUM		47.0						
AVERAGE		9.4						
RANGE		3.0						

Finding the "Sum."

Then she adds up all the torque readings in that column and enters the total in the box at the bottom. The row is titled "sum." This is the "sum" total of the torque for the hub dials she tested. For this set, 47.0.

Finding the "Average"

Then she finds out the "Average" dial torque measured for this sample of hubs. She divides the sum by the number of dials in her sample. She enters this, the average, in the box under the sum.

Finding the "Range"

The range is the difference between the highest reading and the lowest. The highest torque was 11.0 pounds and the lowest was 8.0 pounds, she takes 11.0 and subtracts 8.0 and gets three for the range. She enters this in the box under the average.

Charting the Average and Range on the Statistical
Control Chart.

Notice Pat's chart on the opposite page.

On the chart that Pat is working on, the average was set at 10.5. This means that 10.5 is at the middle of the scale along the right column of the chart.

Each mark up and down the scale is half pound difference. The scale starts at 7.0 at the bottom and goes up to 14.0 at the top.

Across the bottom of the page is another chart for the range. It doesn't have an average set at the middle. It goes from 0 to 8.

Pat needs to plot the average on the top chart and the range on the bottom one.

After Pat figures the average and the range, she "charts" the average by marking a spot on the scale under the column of numbers for the sample she just did.

The spot is below her numbers and across from the point on the scale that indicates how high or low the average was.

As she works, she will take a sample of 5 hubs every two hours and check them. Each time, she figures the sum, average and range and writes in the numbers.

Then she always enters a mark below the numbers that is across from the point on the scale that is equal to the average for that sample of hubs.

At the bottom of the page, another chart is for charting the range. She looks at the scale for it (in the right lower corner of the page) and marks the range for each sample.

Notice how Pat connects the marks on each chart so she can see when the average or range are beginning to get out of line or out of "control."

SUB. GROUPS

Chart the average and range on the Statistical Control Chart.

	1	2	3	4	5
S	11.0	10.0	9.0	10.5	
A	9.0	10.0	9.0	9.0	
M	8.5	9.0	8.5	8.5	
P	8.5	10.5	9.0	10.0	
Z	10.0	8.0	8.5	10.0	
L	47.0	47.5	44.0		
E	9.4	9.5	8.8		
SUM	2.5	2.5	.5		
AVERAGE					
RANGE					

Pat Measures the torque on 5 hubs and writes in the readings in the 5 boxes.

In the 6th box, she figures the sum by adding up all five readings.

Below that, she enters the average that she figured by dividing the sum by the number in the sample (always 5).

Now she enters the range in the next box. She got this by taking the highest reading (11.0) and subtracting the lowest (8.5).

She finds the point on the Average scale that equals or closest to the average she got for this sample of hubs.

She marks a spot on the line below the rest of her numbers, and across from the point on the scale that equals her average for the sample.

She finds the point on the range scale for her range and marks a spot on the line for it.

Then she connects the marks so she can see if the average and range are staying in line or in "control."

If the lines show a trend heading too high up or down, she notifies the other team members and they figure out where the problem is.

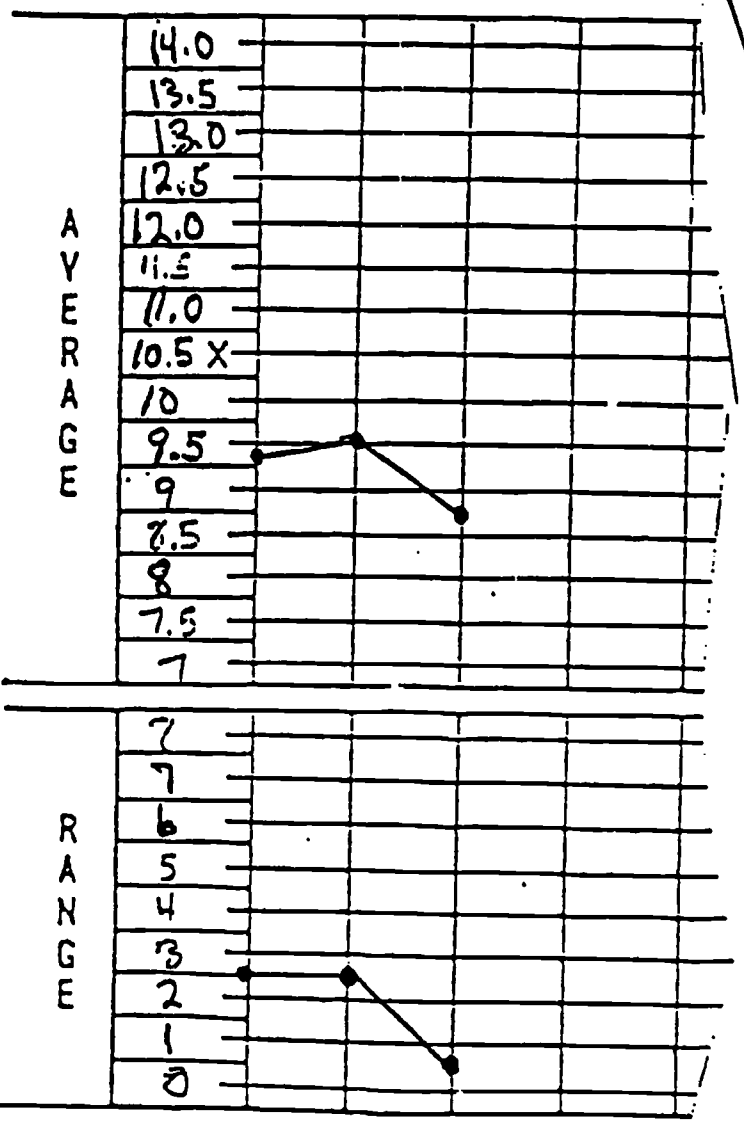

finish sample or (Sub group) 4 for Pat

STATISTICAL CONTROL CHART AVERAGE AND RANGE

$$\bar{x} = \frac{\text{sum of average}}{\text{no. of sub grc}}$$

Control Limits on

$$UCL\bar{x} = \bar{x} + (A_2 \times \bar{R}) =$$

$$LCL\bar{x} = \bar{x} - (A_2 \times \bar{R}) =$$

$$\bar{R} = \frac{\text{sum of ranges}}{\text{no. of sub grou}}$$

ORIGINATOR _____

DATE _____

PART NO. _____

REV. NO. _____

PART NAME _____

OPERATION _____

NO. PCS. _____

SUB GROUPS	1-10		1-14		1-15		1-15		1-16		1-17		1-18	
	24	24	33	33	33	29	33	33	29					
1	8.5	7.5	9.5	10.5	11.5	8.5	9.0	9.5	11.5					
2	9.5	9.0	9.5	9.5	8.0	11.0	10.5	11.0	9.5					
3	8.0	11.0	10.0	9.0	9.0	9.5	9.5	12.0	12.5					
4	9.0	10.5	10.5	11.0	8.5	12.0	11.5	10.5	12.0					
5	10.5	9.5	8.5	9.5	10.5	10.5	12.0	11.5	10.5					
SUM														
AVERAGE														
RANGE														

12.5													
12.0													
11.5													
11.0													
10.5													
10.0													
9.5													
9.0 X													
7.5													
8.0													
7.5													
7.0													
6.5													
6.0													

7.0													
6.0													
5.0													
7.0													
3.0													
2.0													
1.0													
0													

212

Using Formulas to figure the Control limits on the Statistical Control Charts.

On the Control Charts, Sandi uses a hi-lite pen to mark the "control limits" for the average and for the range.

These help the team see when the average or the range may be getting out of control. Sandi figures out where these lines should go by using the numbers from the last chart and working some formulas. She also works the formulas to find out what average (number) should be at the middle of the average scale on the new chart.

The formulas that Sandi uses look complicated because they have special letters and statistical symbols in them. All they really are is several addition, subtraction and division problems.

Any time Sandi sees a letter or symbol, she knows that she will find a number to take its place in the formula. She won't calculate any letters... so she doesn't let it bother her.

If you take your time and double check your calculations, you shouldn't have any trouble finding these numbers.

Always remember this about formulas: take them one step at a time.

Most formulas use a fraction, like this...

$$\bar{X} = \frac{\text{sum (total) of averages}}{\text{number of samples}}$$

This formula works like this... Sandi divides the number on the top part of the fraction by the number on the bottom and she gets a value for \bar{X} (the average of all the averages).

Formulas also use parentheses (). This just means that you should work the calculation inside of the parentheses first, before you work any other parts of the formula...

$$UCLx = \bar{X} + (A \times \bar{R})$$

Sandi will figure out what numbers to use for \bar{X} , A and \bar{R} , then she will use them to work out the problem. She does the part in parentheses first, $A \times \bar{R}$, then she will add that to \bar{X} to find out what $UCLx$ is (the upper control limit on the average).

The formulas are easy after some practice. The hardest part is adding up a lot of numbers to find out what numbers are used to replace the letters or symbols.

The first thing Sandi does is find the value for \bar{X} . This is the "average of the averages." She will use this number in her formulas, and she will use it as the middle point on the average scale of the new chart.

An \bar{X} indicates a number that is an average, like the average torque of dials tested on 5 hubs. The word "mean" also is used to indicate the average.

An \bar{X} indicates a number that is an average of several averages.

To get the average for a sample, you added up all five readings or measurements, then took that total and divided it by 5, the number of measurements you had. That gave you average torque for the sample.

To get the average of averages or \bar{X} , you add up all the averages and that total is called the "sum" (or total) of averages, then you divide that by the number of samples that you have.

Sandi totaled up the Sum of Averages from the last chart (see charts on following pages), and got a total 448.7. She divides this by 30 since there are 30 samples (subgroups) on the chart.

Her formula work out like this...

$$\bar{X} = \frac{\text{Sum of Averages} = 448.7}{\text{number of samples} = 30}$$

So $\bar{X} = 448.7$ divided by 30 = 14.96, the average of averages.

She uses this number in her formulas and as the mid point for the average scale on the new chart.

Now, Sandi wants to find the average of the ranges, or \bar{R} . She will need this to work out the formulas for the control limits.

She uses this formula....

$$\bar{R} = \frac{\text{sum (total) of the ranges}}{\text{number of samples (subgroups)}}$$

To work this formula, she adds up all the range numbers from the chart. This gives her the "sum of the ranges."

Then she divides that by 30, the number of samples (or subgroups) that are on that chart. (There are usually 30 samples on all of these charts).

She gets 46 for the sum of the ranges and divides it by 30 (samples) and gets 1.53, this is the average of the ranges or \bar{R} .

Now, Sandi is ready to work the formulas to find the upper and lower control limits. The upper limit is called UCLx and the lower limit is called LCLx. When these are figured and drawn in on the new chart, they will show the team when a sample's average is too high or low and indicate that there is a quality problem to check into.

These are the formulas...

$$\begin{aligned} \text{UCLx} &= \bar{X} + (A \times \bar{R}) \\ \text{LCLx} &= \bar{X} - (A \times \bar{R}) \end{aligned}$$

She does the $(A \times R)$ first, it will be the same for both formulas. She gets a number for A from the box in the upper left hand corner of the chart. She always has a sample size of 5, so A is always .557 for these charts. (see the box on the chart).

-She got 1.53 for \bar{R} so she multiplies 1.53 by .557 and gets .88 .

-Now, she adds this (like the first formula shows) to \bar{X} to get UCLx.

-She subtracts the .88 from \bar{X} to get LCLx (see the second formula).

The upper control limit is 15.84 and the lower limit is 14.08

Now she can draw lines across the average chart to show where the control limits are. When the averages get close or trend toward either limit, the team knows there may be a problem.

Now, Sandi does another formula to find the control limit for the range chart.

AVERAGE AND RANGE

ORIGINATOR 249 Hub Line DATE _____
 PART NO. _____ REV. NO. _____
 PART NAME 276
 OPERATION Dist. to repair NO. PCS. 50 per hr

Control Limits on Average:
 $UCL\bar{X} = \bar{X} + (A_1 \times \bar{R}) = \text{---} + \text{---} = \text{---}$
 $LCL\bar{X} = \bar{X} - (A_1 \times \bar{R}) = \text{---} - \text{---} = \text{---}$
 $\bar{R} = \frac{\text{sum of ranges}}{\text{no. of sub groups}} = \text{---}$

Sample Size	A ₁	D ₄	d ₁
2	1.880	3.268	1.128
3	1.023	2.574	1.693
4	.729	2.282	2.059
5	.577	2.114	2.326
6	.483	2.004	2.534

Control Limits on Average:
 $UCL\bar{X} = \bar{X} + (A_1 \times \bar{R}) = \text{---} + \text{---} = \text{---}$
 $LCL\bar{X} = \bar{X} - (A_1 \times \bar{R}) = \text{---} - \text{---} = \text{---}$
 $\bar{R} = \frac{\text{sum of}}{\text{no. of sub groups}} = \text{---}$
 Control Limits on Range:
 $UCLR = D_4 \times \bar{R} = \text{---}$

Lock to-Free

SUB GROUPS	Control Limits on Range: $UCLR = D_4 \times \bar{R} = \text{---}$														Control Limits on Range: $UCLR = D_4 \times \bar{R} = \text{---}$															
	1	2	3	4	5	6	7	8	9	10	11	12	13	14	15	16	17	18	19	20	21	22	23	24	25	26	27	(28)	29	30
S	11.0	10.0	9.5	10.5	10.0	9.5	10.0	9.0	9.0	9.0	10.5	9.0	7.0	6.5	5.5	5.5	9.5	9.0	10.0	10.0	8.5	8.5	9.5	9.5	8.5	8.5	9.5	9.5	9.5	11.0
A	9.5	10.0	9.5	8.5	8.5	9.5	9.5	11.5	8.0	9.5	9.5	8.5	8.0	8.0	9.0	9.5	9.5	10.5	10.5	8.5	8.5	9.5	9.0	10.0	9.0	9.5	9.0	9.5	11.0	
M	9.5	10.5	9.0	10.0	9.0	10.5	10.0	12.5	10.0	9.0	9.5	9.5	9.0	8.0	9.0	9.5	9.5	10.5	10.5	8.5	8.5	9.5	9.0	10.0	9.5	9.0	10.0	10.0	9.0	
P	10.0	9.5	9.5	10.0	10.5	10.5	10.0	10.0	10.0	10.0	10.0	10.0	6.0	8.5	10.0	9.0	9.0	10.0	9.5	9.5	9.5	9.5	9.0	9.0	9.0	9.0	9.5	10.0	9.0	
Z	47.0	47.5	44.0	45.0	45.5	45.0	45.5	55.0	40.0	46.0	41.5	47.5	39.0	41.5	43.5	44.0	44.0	47.0	52.0	43.5	43.5	43.5	44.0	43.5	43.5	43.5	43.5	43.5	43.5	
E	9.4	9.5	9.5	9.6	9.1	9.2	9.1	11.0	8.0	9.2	9.9	9.5	7.8	8.5	8.7	8.2	9.2	9.2	10.1	10.1	8.7	9.1	8.7	9.3	8.8	8.7	9.0	9.7	8.3	
SUM/AVERAGE	9.4	9.5	9.5	9.6	9.1	9.2	9.1	11.0	8.0	9.2	9.9	9.5	7.8	8.5	8.7	8.2	9.2	9.2	10.1	10.1	8.7	9.1	8.7	9.3	8.8	8.7	9.0	9.7	8.3	
RANGE	2.5	2.0	1.5	2.0	1.5	3.0	2.0	3.5	13.0	1.5	2.0	1.5	3.0	2.5	1.0	1.5	1.0	1.5	1.5	1.5	1.0	1.5	1.0	2.0	1.0	1.0	1.5	2.5		

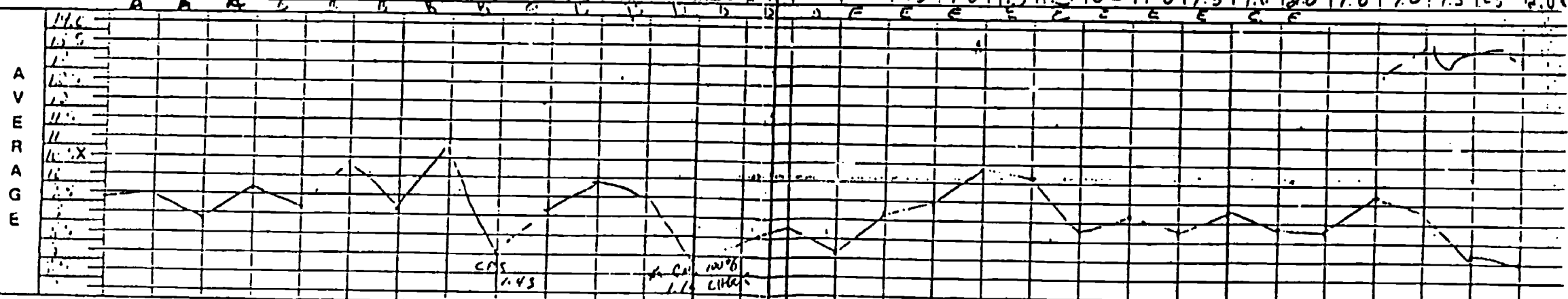

248
B. Line = 1

STATISTICAL CONTROL CHART
AVERAGE AND RANGE

ORIGINATOR _____ DATE 8-1-90
 PART NO. _____ REV. NO. _____
 PART NAME LYR Hub Assembly
 OPERATION Drill Screw Torque NO. PCS 5 per pc

$\bar{\bar{x}} = \frac{\text{sum of averages}}{\text{no. of sub groups}} = \frac{4487}{30} = 14.96$

Control Limits on Average:

$UCL_{\bar{x}} = \bar{\bar{x}} + (A_1 \bar{R}) = 14.96 + 1.30(1.53) = 15.96$

$LCL_{\bar{x}} = \bar{\bar{x}} - (A_1 \bar{R}) = 14.96 - 1.30(1.53) = 13.96$

Sample Size	A_1	D_4	d_2
2	1.880	3.268	1.128
3	1.023	2.574	1.693
4	.729	2.282	2.059
5	.577	2.114	2.326
6	.483	2.004	2.534

Machine Capability = $6 \times \frac{\bar{R}}{\sigma_1} = 6 \times \dots$

Drawing Specification = _____

Capability Ratio = $\frac{\text{Machine Capability}}{\text{Total Print Tolerance}}$

$\bar{R} = \frac{\text{sum of ranges}}{\text{no. of sub groups}} = \frac{46}{30} = 1.53$

Control Limits on Range:

$UCL_R = D_4 \bar{R} = 3.23$

Process is in control Yes

SUB GROUPS	1	2	3	4	5	6	7	8	9	10	11	12	13	14	15	16	17	18	19	20	21	22	23	24	25	26	27	28	29	30
1	15.0	15.0	16.0	16.0	16.0	14.0	14.0	15.0	15.0	14.0	14.0	14.0	15.0	16.0	15.0	15.0	15.0	15.0	15.0	15.0	16.0	18.0	15.0	15.0	15.0	15.0	15.0	15.0	14.0	14.0
2	15.0	15.0	15.0	14.0	15.0	15.0	15.0	15.0	16.0	14.0	15.0	16.0	14.0	16.0	15.0	14.0	16.0	15.0	15.0	15.0	15.0	17.0	15.0	15.0	15.0	15.0	15.0	14.0	14.0	14.0
3	14.0	14.0	15.0	14.0	15.0	15.0	15.0	15.0	15.0	15.0	15.0	15.0	15.0	17.0	17.0	15.0	16.0	15.0	15.0	15.0	15.0	15.0	15.0	16.0	15.0	14.0	15.0	14.0	14.0	14.0
4	15.0	15.0	17.0	15.0	15.0	15.0	15.0	16.0	14.0	15.0	15.0	15.0	15.0	17.0	15.0	15.0	15.0	15.0	15.0	15.0	15.0	15.0	14.0	15.0	14.0	14.0	14.0	14.0	14.0	14.0
5	15.0	15.0	17.0	15.0	15.0	15.0	14.0	15.0	15.0	16.0	15.0	15.0	15.0	15.0	15.0	15.0	15.0	16.0	14.0	15.0	15.0	17.0	15.0	14.0	14.0	14.0	14.0	15.0	15.0	14.0
SUM	74.0	74.0	74.0	74.0	74.0	74.0	73.0	76.0	75.0	74.0	73.0	75.0	75.0	79.0	76.0	75.0	76.0	77.0	75.0	77.0	78.0	77.0	74.0	74.0	74.0	73.0	73.0	72.0	71.0	71.0
AVERAGE	14.8	14.8	16.0	14.8	15.2	14.8	14.6	15.2	15.0	14.8	14.6	15.4	15.0	15.8	15.2	15.0	15.0	15.4	15.0	15.4	16.2	14.8	14.8	14.8	14.8	14.8	14.8	14.8	14.8	14.8
RANGE	1.0	1.0	2.0	2.0	1.0	1.0	1.0	2.0	2.0	2.0	1.0	2.0	2.0	2.0	1.0	2.0	1.0	1.0	2.0	2.0	1.0	4.0	1.0	2.0	2.0	1.0	1.0	1.0	1.0	2.0

UCL \bar{x} 16.2
 $\bar{\bar{x}}$ 14.96
 LCL \bar{x} 13.96
 UCL R 3.5
 \bar{R} 1.53



STATISTICAL CONTROL CHART AVERAGE AND RANGE

$$\bar{x} = \frac{\text{sum of averages}}{\text{no. of sub groups}}$$

Control Limits on

$$UCL\bar{x} = \bar{x} + (A_2 \times \bar{R}) = \underline{\hspace{2cm}}$$

$$LCL\bar{x} = \bar{x} - (A_2 \times \bar{R}) = \underline{\hspace{2cm}}$$

$$\bar{R} = \frac{\text{sum of ranges}}{\text{no. of sub groups}}$$

ORIGINATOR _____ DATE _____
 PART NO. _____ REV. NO. _____
 PART NAME _____
 OPERATION _____ NO. PCS. _____

Chart #3

SUB GROUPS		1	2	3	4	5	6	7	8	9	10	11	12
S	1												
A	2												
M	3												
P	4												
L	5												
E	6												
SUM OR													
AVERAGE													
RANGE													

limits

ENTER The Control

Set X as \bar{x}

from is. chart

Each Line is a half pound (.5)

AVERAGE

RANGE

254

Revised by Doc

CNC: Getting the Big Picture

This is being revised:
2 problems
- Orientation of specific machines varies (X, Y, Z)
- Too much text need a manipulator

Warn's Machines are usually equipped with Computerized Numeric Controls or CNC. This is a tool that helps the operator make very precise adjustments and work the parts as needed to be in specification.

The machine works by moving the "tool," (the bit or part that will actually cut the metal) left or right and towards or away from the operator.

These moves bring the tool in to the metal that is turning. A "program" tells the machine how far to move and in which directions. With the program, the machine can "automatically" move the cutting tool in towards the metal (a gear or some other part).

To keep it simple (even though it seems confusing at first), the machine uses a number line system with two lines. One line, called "Z," measures the moves a tool is making from left to right (or right to left on some machines). The other line is called "X", it measures the moves the tool makes toward or away from the operator. Operators that use CNC say it's easier if you picture the X and Z lines like this...

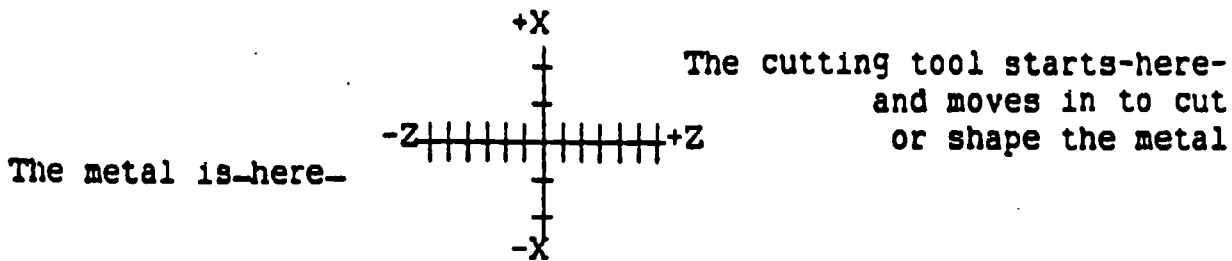

(some machines are different! but the idea is the same)

Any time the tool is moving to the left, it is moving toward -Z, to the right, it is going toward +Z.

Any time the tool is moving toward you, it is moving toward -X and if it going away from you, it is moving toward +X.

The operator needs to change how far the tool will go in either direction. She (or he) does this by making an "offset." Because of the wearing out of the tool, or changes in the programs, the operator will make an offset so the tool moves in and makes the right cut.

The amount of the change is figured by measuring the first part that is machined (or cut) and finding out how close it is to specifications.

If it is not in specification, the operator makes the offset to compensate for how far off it is. Maybe the Outside Diameter (OD) is too large. The tool needs to come in and cut a little more off. Or maybe the OD is too small, the tool is coming in too close so it needs to be adjusted or "offset."

T.A. was done on one of those make: of machine
The machine's reviewed
this: X Y Z orientation widely across machines since
251

WarnMath/CNC numbers/ in-class problem.

Problem: A tool is moving in too far on a piece of metal and needs to be adjusted. By moving in so far, the diameter of the metal, in this case a ring gear, is too small, too much is being cut off.

Skills to Apply: Find the difference between the specified diameter and the diameter that actually is cut. Then adjust the machine to account for that difference. This skill involves adding or subtracting positive and negative decimal numbers. Then, you can adjust the machine's program by changing an "offset" to change the amount of movement.

Problem Solving Steps: Kevin checked the outside diameter of the ring gear and found it to be 7.418 inches. The specification requires it to be 7.420 +/- (plus or minus .001 of an inch).

Outside Diameter is too small...

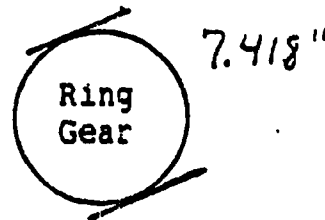

He takes it off and measures it across:

Kevin wants to change the movement of the tool so that the diameter is larger by .002 of an inch. On a round piece of metal, if the tool movement is changed by .001 of an inch, the result will be a change in diameter of the metal of .002 of an inch. This is because the tool cuts off (OR LEAVES on .001 of an inch as Kevin wants) as the metal is turning. The result is .001 of an inch is cut off both sides. So when the diameter is checked, a total change of .002 has resulted.

Kevin's machine allows him to enter a change of .002 and the computer in the machine will split the amount in half to cut off .001 as the machine is turning the metal. All he needs to do is figure what the diameter is and what it should be, and find the difference so he can adjust.

(The tool moves toward Kevin along "X" toward the "-X" . When it moves in too far, it will take off too much metal. Kevin wants to change the program with an "offset" of .002" . Then, the tool will not go quite as far.)

Looking at the gear sideways, as it sits in the machine:

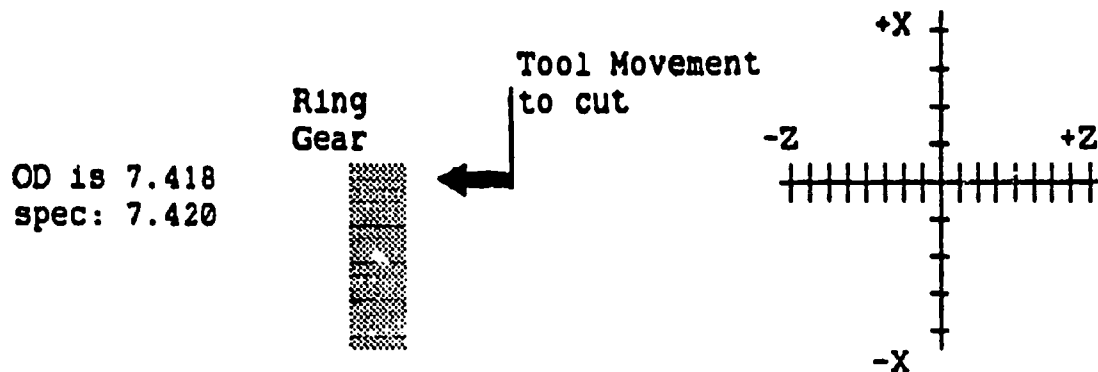

He measures the outside diameter and it's 7.418 inches. This is not within the +/- .001 inch tolerance, so he will adjust the machine. He figures that 18 is 2 less than twenty (he ignores the 7.4 inches and just works with the thousandths of an inch) so he wants to change the tool movement by .002 of an inch. The tool moves toward him on the "x" axis so he pushes the x button and adds .002" .

This causes the tool to stop at a point that is not quite as far on the negative X axis (-X) so less metal is taken off the gear. This will leave a larger diameter. Kevin expects the diameter to be right about 7.420 "

WarnMath/CNC numbers/ problems

Problem: When the gear, or other metal work is measured and it is not within the specified tolerance range, the machine operator makes an "offset" like Kevin did for the diameter on the last page.

Each Offset number relates to a command in the program. By giving an offset of X : .002 (Or 0.0020 as the machine sees it), when the program sees offset number 21 (see below), it will change how far it moves from X toward -X. On Kevin's machine, the offsets are at Zero until he makes a change. The display on the machine looks like this...

Wear Offset	X	Z
21	0.0020	0.0000
22	0.0000	0.0000

(Wear Offset is also called "assignable")

He selects number 21 since this offset controls the diameter of his ring gear. He enters an X = .002 and "offsets" the program so the machine will not go as far on X.

Since the tool movement that cuts down the diameter is toward -X, a positive offset will change (by reducing) the distance the tool moves toward -X.

Skills to Apply: Finding the difference between what the machine is cutting and what the specifications call for. Then adjusting X (Z is covered later) to offset the tool so that the part is cut to specification.

Problem Solving Steps:

Suppose Kevin measured the gear and this time the diameter was 7.423 " Now what should he do?

This time his problem is that the tool is not coming far enough on X toward -X. So he can get it come farther by pushing the -X button and entering .003 .

Now the display will look like this

Wear	X	Z
21	-0.0030	0.0000
22	0.0000	0.0000

For "Z", the tool is moving from right to left (or left to right on some machines).

Kevin finds that the tool does not come far enough to the left, or towards -Z. He can increase how far it comes by pushing the -Z and entering a number. After measuring a part, he sees that the tool should come over about .0500 " farther to take off the metal all the way across. He does this and the display now looks like this...

Wear	X	Z
21	-0.0030	- 0.0500
22	0.0000	0.0000

Offset problems:

1. Your machine is going too far to the left (toward -Z) and cuts a groove that is .225 " deep on the part. The spec calls for the groove to be .222 " deep. What would your offset be? The program will recognize this as offset #6. Write it in on the "display"...

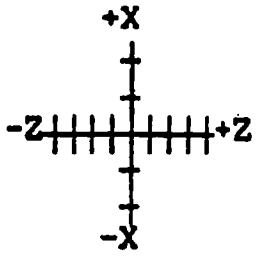

Wear/Assignable Offset	X	Z
04	0.0000	0.0010
05	-0.0021	0.0000
06	0.0000	_____?

2. You check the inside diameter of a gear and find that it is 2.8785" . The spec calls for it to be 2.880 +/- .003" . Do you need to adjust?

3. Later, you check again and find that the inside diameter is now 2.8715". How much of an offset should you make? (the tool needs to move farther toward +X in order to increase the inside diameter on this part.) Write in the display, for offset # 34 .

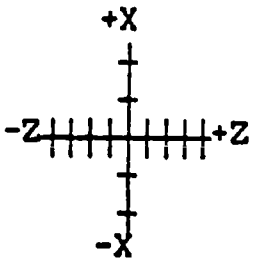

Wear/Assignable Offset	X	Z
33	0.0050	0.0010
34	_____?	0.0030
35	0.0022	0.0000

4. Your machine gets a new tool and it will cut a gear's outside diameter down to 4.3345 " You need a diameter of 4.310 " . The tool needs to come farther down toward -X . What would the offset be? (the offset number is #3).

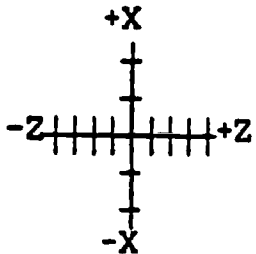

Wear/Assignable Offset	X	Z
05	_____?	0.0010
06	0.0000	0.0035
07	0.0012	0.0000

5. You want your tool to come farther to the left so it will cut off .002 " of the outside diameter. You measure the gear and figure that the tool needs to come left .0500 to cut off across the whole gear. Enter the correct offset as Offset number 6.

Wear/Assignable Offset	X	Z
05	0.0000	0.0050
06	0.0020	_____?
07	0.0012	0.0000

Looking Down on a Machine operation, X is back and forth, Z is across

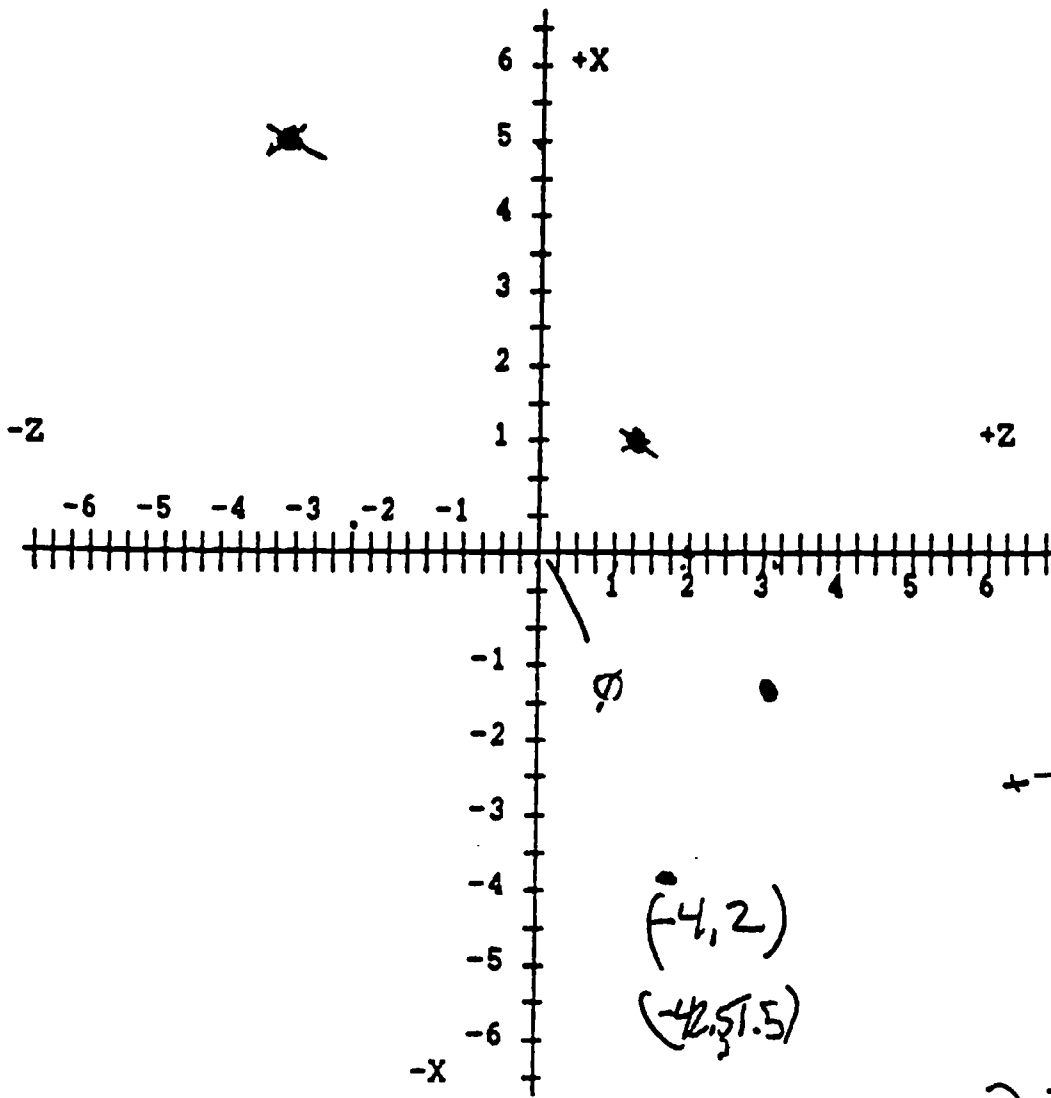

$$\begin{array}{r} 2.00 \\ \times 0.50 \\ \hline 1.50 \end{array}$$

$$+2 + \textcircled{.50} = 1.50$$

$$-2.50$$

$(-4, 2)$
 $(-4, 1.5)$

$$2 + -2.5 = ?$$

$$-4$$

$$6 \div 3 = 2$$

- 1) Mark a point where X= 1 and Z= 1.
where X= -1 and Z= 3.
where X= 5 and Z= -3.5

2) What is 3 + 4 ? (look at the Z or X lines...)

3) What is -2 + -1 ? **3** 4) What is -5 divided by 2 ? **2.5**

5) If a tool is at X= -4 and Z= 2, and you change the position by adding -.50 to Z and subtracting .25 from X, where will the tool be? (look at the lines).

X = -4.25
Z = +1.50

Looking Down on a Machine operation, X is back and forth, Z is across

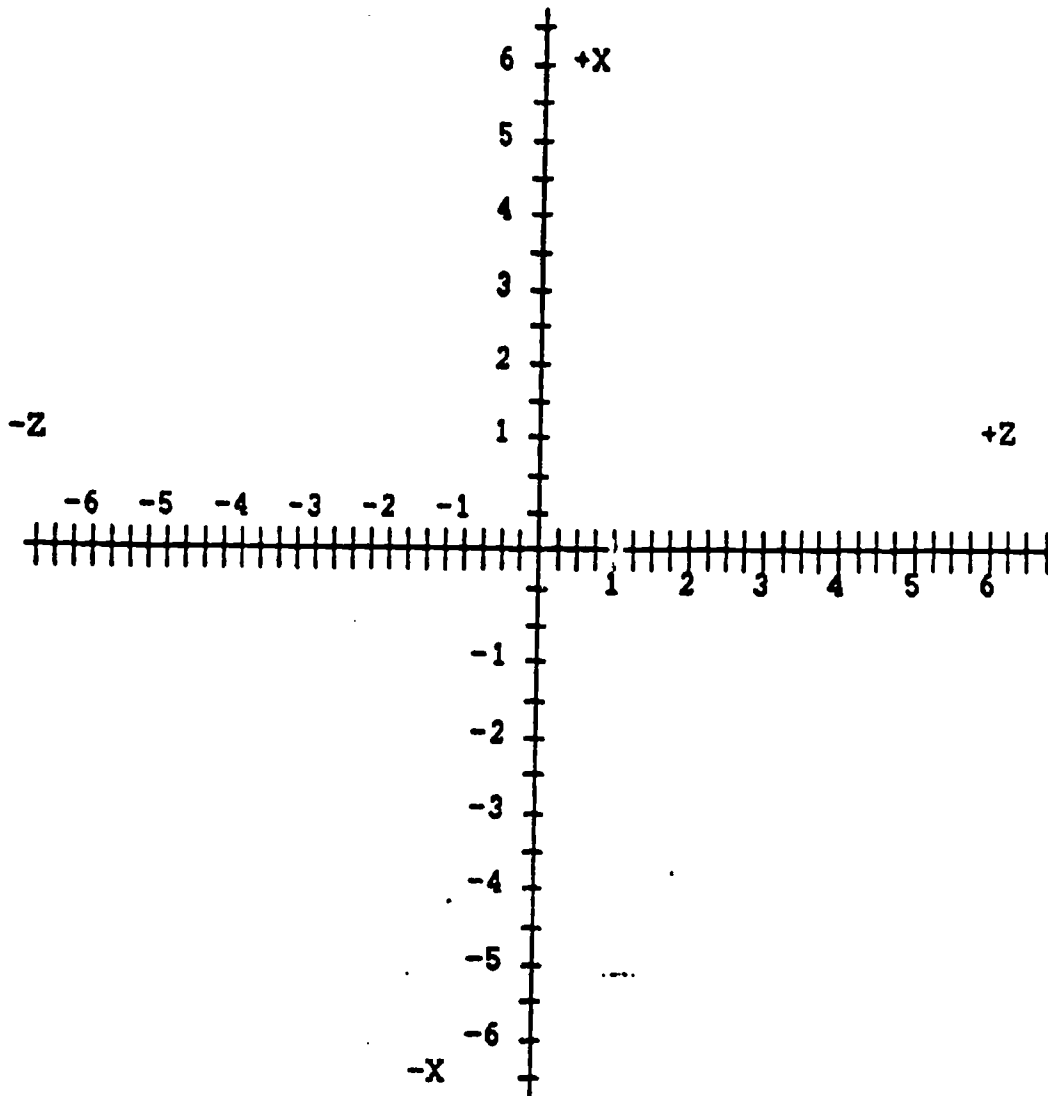

This Calculator

1. What is $6.0021 + -.2345$? 5.7676
2. Add -1.0091 to 3.3350 : 2.3259
3. What is -1.2050×3 ? -3.615
4. What is -5.5000 divided by -2.0 (think about this one): 2.75

USED
AS
OVERHEAD

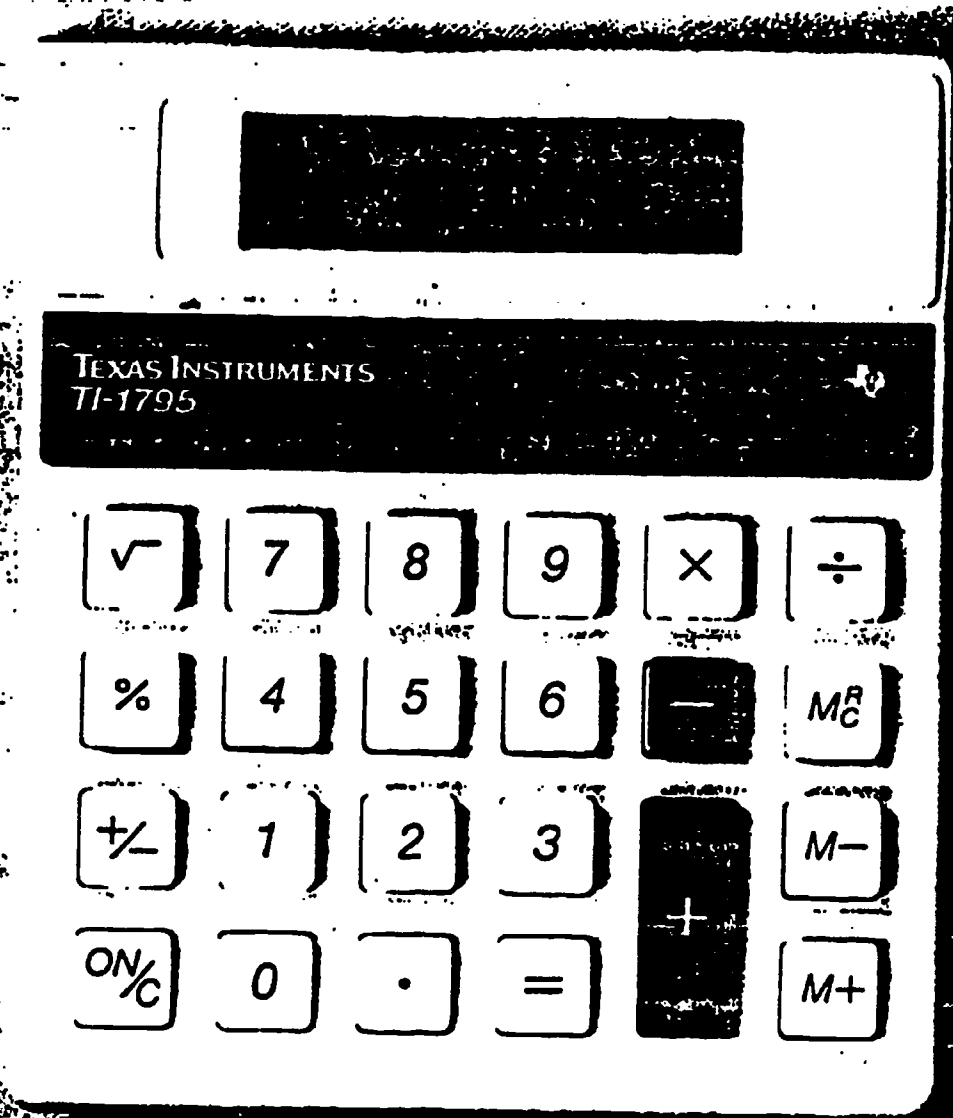

**CURRICULUM
OCS
COMPUTER BASICS**

259

Cutting Through to Computer Competency

• 1991: OCS, TLC: This programmed note package was developed for exclusive use of Oregon Cutting Systems. The development was funded by Grants from the US Dept. of Labor and US Dept. of Education along with funds from Clackamas Community College.

Some Introductory Comments...

The goal of the class...

A few requests and guidelines...

You must ask questions...

About your notes...

Do it again, and again...

The need for patience...

What want your ideas and suggestions...

Cutting Through: The Computer Inside and Out

Use these sheets to take notes...

First we'll look at the computer, inside and out.

This is an older computer, but all the parts are much like the new ones.

Several areas you want to look at...

1. Input:

2. Output:

3. Processing:

4. Storage:

Other comments:

(In a little while, we'll come back and discuss all these words in more detail, but whenever you have a question, go ahead and ask!)

What Happens When You Turn it On?

1. It (the computer,) looks for instructions...
2. It tries to find the instructions stored in a "File" somewhere...
3. It finds the instructions and "loads" them into "memory"...
4. These "instructions" are called "DOS"...
5. "DOS" needs instructions from you, or from a "program"...
6. All "PC's", use DOS. Many PC's are set up or "configured" so that you don't need to know "DOS."

Other Comments:

Let's Turn on the Computer...

Several things can go wrong when you try to "start up the system"...

But, nothing serious. Short of dropping or throwing the machine, you cannot hurt it.

Just Two Rules to remember when turning a computer on and off...

- ☛ Remove any "floppy disks" before turning a machine on or off.
- ☛ After you turn a computer off, let it "slow down" for a few seconds before turning it back on again.

Now, Let's turn them on...

Some things to check if you have a problem...

1. Is everything plugged in?
2. Is the "power strip" or box turned on... look for a red or yellow lighted switch.
3. Are the monitor, printer or any other "Peripherals" turned on?

What you see on the computer screen next depends on how that particular computer has been "set up" or "configured."

What does it mean?

Now, Let's talk about all these words
we've been hearing so much...

Applications/Programs

Files

Backup

Filenames

Boot/Booting/ReBoot

Fixed Disk (Hard Disk)

Bit/Bytes(& Megabytes)

Hardware vs. Software

Character

Load/Loading/Run

Compatible

Memory

Command/Prompt

Operating System

Configure

Output

CPU/Processor

RAM/ROM

Data-Processing

Stand-Alone

Disk Drive

Text/Numerical Data

Disk/Diskette

Word Wrap

DOS

Mega-Hertz (MHz)

Format

Discussion of Applications:

What Can You *Do* With a Computer?

Let's talk about things you or I may want to use a computer for...

"Word Processing" (it can chop up words)

"SpreadSheets" (no, it can't make your beds, but your numbers will line up nice)

"DataBase" (File Cabinets, without the mess)

"Statistics/Graphics Packages" (for you quality folks, tell it and show it "like it is.")

"Household Applications" (no more checkbook errors?, track investments, schedules...)

"Tutorials" (Learn about nearly anything, typing with Mavis or...)

"Programming Languages" (When you have a special job that no other software can do)

Getting Around on the Keyboard

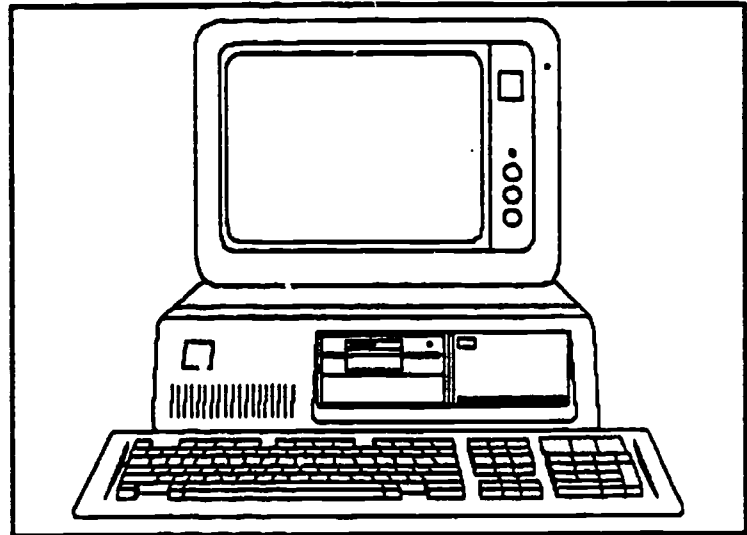

Let's look at the Keyboard...

"Alphanumeric Keys"...

"Cursor Keys"...

"Editing Keys"...

"Function Keys"...

"Hard Keys/Lock Keys"...

Let's Talk about Programs and "Input"

Unfortunately, nearly every program (or type of software) has it's own way of getting input from the "user" (that's you).

It would be nice if we could say "anytime you want to 'exit' a program just..."

CR Anytime... save

There is no standard for "input." So you need to learn about the different ways some programs will want you to input your "commands."

We'll look at two ways of dealing with the programs...

1) Menus:

- a) making a choice...
- b) several ways to make a choice...
- c) menus in a menu...

2) Function Keys and Combinations of Keys:

- a) The F keys...
- b) Combinations of keys...
- c) Problems with fast or fat fingers...

Let's Practice "Input" with a Word Processor.

We're Going to "load" Professional Write (also called "Pro Write").

Then we're going to "type" or "edit" a "document."

This will give you a chance to see how a program gets "input" from you, the user.

Once you've selected Pro Write off the "network's" Main Menu, create this document... (the instructor will walk you through this).

OCS is Cutting Through to Computer Competency!

Today's technology utilizes computers in nearly every type of job. Oregon Cutting Systems has always been a leader in areas involving technological innovation. Computer Technology is no exception. From the machines to the maintenance schedules, computers are making work more accurate and efficient.

Now you can learn to make the computer work for you. OCS offers a wide range of computer courses. You can learn to utilize computers to make your letters and memos perfect (they'll even check your spelling!). Or, you can analyze sets of numbers in a "what if?" situation. File Cabinets are nice if you know how they were originally "set up." But with computer filing systems, any number of "set ups" are possible and you can find anything with the touch of few keys.

DON'T PUT IT OFF! Get into the computer revolution now by signing up for the OCS College computer course that meets your needs. You've seen and learned a lot already with the changes at OCS. Now, get on "Cutting Edge" by sharpening your skills in computers. Check the bulletin boards for a schedule of courses starting soon.

Use This Page Make Notes on Your
Input/Editing Keys in PRO WRITE

To center a title Line...

F4 FORMAT
Ctrl-X

To move around...

To delete "frontwards"...

To delete "backwards"...

To insert a letter or word...

To delete a letter or word...

To make a tab at the beginning of a paragraph...

To start a new paragraph or line...

To lock the "caps"...

To make a word "Boldface"...

Ctrl B
Ctrl U

To check spelling...

To "save" and "exit"...

Other things to remember...

F1 - Help

What about "Files?"

What they are...

When to "save"...

What to call it (the "filename" and "file extension"...))

Where to Save...

When you are going to "Exit"...

Some different strategies...

Updating:

Several Versions:

The Key: Thinking it through

What can go wrong...

The computer takes you literally...

What About Numbers?
Let's Look at *SpreadSheets*.

We're going to "load" and "run" Lotus 123...

This software (program) is great for working with numbers...

We're going to work on the expense sheet you see on the page below...

The spreadsheet will do all the math for us...

The instructor will walk you through each step. Then, we will go back over it...

<i>Travel Expense Data</i>						
<i>Month:</i>	<i>Miles Traveled</i>	<i>Gas</i>	<i>Parking/Tolls</i>	<i>Meals</i>	<i>Lodging</i>	<i>Totals</i>
<i>January</i>	1289	51.56	12.25	216.25	71.61	
<i>February</i>	1674	62.64	15.50	228.43	102.23	
<i>March</i>	1328	54.45	9.50	190.24	67.80	
<i>April</i>	1888	64.65	17.25	232.97	111.31	
<i>May</i>	1255	53.49	11.20	180.12	55.50	
<i>June</i>	1440	59.37	12.75	191.32	89.97	
<i>Totals:</i>						

SpreadSheets: Common Keys and Steps to Working With the Numbers...

Note: Most Spreadsheets use the same type of "commands" and procedures to "input" information. The major differences will be in how they look on the screen and several ways they use to "say the same thing..."

The WorkSheet Layout...

▷ Once you are in the program (after the initial screen, you may need to "hit any key to continue") you have a blank sheet with a frame across the top and right sides...

Across the top or bottom are some "options" or commands...

As you type in numbers, words or formulas, what you type will show up at the top of the screen. Then when you hit "enter," it will go in the "cell" that is "highlighted" with your cursor. Numbers and words you see, formulas are "hidden."

A B C D E F G H I J K

1 {the top left cell is called "A1," next to it is

2 B1 and below it is A2..

3

4

5 this "x" x is in D5. Somewhere, way off to the

6 lower Right is a cell called FZ999, (after Z, the

7 columns are AA, AB... and so on... depending on how

8 large the program is.}

9

More on SpreadSheets: Common Keys
and Steps to Working With the
Numbers...

Getting where you want to go...

Putting the numbers in...

Putting in the words, titles or labels...

Putting in Formulas so you don't have to do as much work...

Some "Rules"

Thinking it through

Getting at the "Commands"...

Saving your work...

Finding and getting your work back...

There's Always *Help!*

Some things to remember when you start to work with computers...

Don't spend long periods of time on one problem. It may not be your fault...

Get Help...

Get Help from the program...

In Pro Write:

In Lotus:

In other programs:

Get Help from the Manual (they are difficult but necessary)...

Where to look and what to get:

How to use the thing without reading more than ever wanted to know...

Get Help from your Local Experts (they are eager to help you)...

Who to call...

When to call...

Other Resources and options...

Other Topics and Things to Remember...

Keeping it all straight...

Some typical problems...

Recognizing Screens and looking at prompts...

Housekeeping...

Deleting...

Disk Space Management...

Consideration for others...

Courtesy, Honesty and Safety...

Beg, Borrow or...?

Avoiding Viruses...

Thinking of Buying?

Look at your needs:

Find someone to help:

What to do Next?

Think about these questions...

What can I use a computer for...

at work:

at home:

What I really need to know how to do is...

I could start by...

Taking classes on _____ then:

Seeing a demonstration on:

Reading more about:

Talking to _____ about:

Be sure to turn in a course evaluation. Thanks for giving your time and energy for this class!

C8

3M

BRIEFLY

Software delayed
in IBM bid against
rival's Windows

NEW YORK — International Business Machines Corp. will not meet its year-end deadline for a new version of software it touted earlier this year as better than Windows, Microsoft Corp.'s hot-selling personal computer software, an industry official said Monday.

At the same time, IBM said it will sharply curtail a division that develops PC software. The division was set up three years ago to give IBM a larger presence in the burgeoning market.

The news adds up to more setbacks for the world's largest computer maker in the software field, analysts said.

Software has become increasingly important as computers become more like interchangeable commodities, because software is a major way a computer maker can distinguish its machines from another brand. It also is more profitable than most computer hardware.

But so far, success has eluded IBM's PC software division.

IBM, Apple facing Microsoft's brave new world

PERSONAL COMPUTERS

By PETER H. LEWIS
New York Times News Service

SAN JOSE, Calif. — The contract was a foot thick, indicating the complexity of the deal signed earlier this month by Apple Computer Inc. and the International Business Machines Corp.

Reduced to essentials, Apple and IBM have agreed that they must join forces if they are to salvage any meaningful role in the personal-computer industry of the 21st century.

The two biggest PC makers vowed to work together to develop a generation of powerful business computers and an operating system for them. They hope to be done by the mid-1990s — meaning it will be years before the main results of the alliance are evident, if the effort does not collapse under its weight before then.

Apple and IBM virtually have nothing in common except a challenge: keeping Microsoft Corp. at bay and shifting the power center of the industry away from software and back to hardware. It is a profound and fundamental struggle.

"Unless both companies, IBM in particular, embark now on a five-year campaign to sink the armada of clones, they will never make a profit again in desktop computing," said Richard Shaffer, editor and publisher of Technologic, an industry newsletter. "They have to do something to restore profitability in the box business."

The key, many in the industry believe, is to wrest power from Microsoft. The Redmond, Wash., company wrote the operating software that controls more than 50

million personal computers. These machines usually are known as IBM compatibles, but a more accurate name would be Microsoft DOS or Microsoft Windows compatibles.

When businesses go shopping, their first criterion for computers is that the machines must be capable of running the software already in use at the office. Companies invest far more money in software, software development and training than they do in the hardware that runs it. And DOS and Windows have become the standards for business computing.

Boldly defying former partner IBM, which had staked its future on the OS/2 operating system, Microsoft has sold millions of cop-

ies of Windows in the last year. Apple, with its Macintosh operating system, and IBM, with OS/2, are committed to a different path.

Once a company decides on the software, the hardware that runs it becomes a commodity. Apple's Macintoshes cannot run Windows; so Macintosh is shut out of the mainstream as long as Microsoft rules the market.

IBM's PS/2 computers can run Windows, but IBM has not been able to demonstrate that its computers are superior to rival machines that cost less. In other words, software — Microsoft's in particular — controls IBM's fate.

"Microsoft has won" the battle for control of the industry, Jonathan Seybold, president of Seybold Seminars Inc., said at the Seybold Conference on Desktop Publishing, held here early this month.

BYE BYE



5500AT™ *Leading TECHNOLOGY*
PERSONAL COMPUTER BY LEADING TECHNOLOGY
IBM COMPATIBLE
 • 1 Mb RAM (expandable to 4 Mb) • 1.2 Mb and 1.44 Mb floppy disk drives • 40 Mb IDE hard disk drive (28 ms) • 1458V™ 14" color VGA monitor • 12 MHz 286.
FREE HYPERDOS AND LOTUS WORKS

\$1149

6800SX™ *Leading TECHNOLOGY*
PERSONAL COMPUTER by LEADING TECHNOLOGY
IBM COMPATIBLE
 • 1 Mb RAM (expandable to 8 Mb) • 1.2 Mb and 1.44 Mb floppy disc drive • 40 Mb IDE hard disc drive (28 ms) • 1458V™ 14" color VGA monitor • 13 MHz 386SX
FREE HYPERDOS AND LOTUS WORKS

\$1495

Leading TECHNOLOGY
6816SX™
PERSONAL COMPUTER IBM COMPATIBLE
 • 2Mb RAM • 1.2 5.25" Floppy • 1/44 3.5" Floppy • 100 Mb Hard Drive • 1451V 4171 VGA color monitor, 16 MHz 386sx
FREE WINDOWS, LOTUS WORKS, MODEM, MOUSE AND HYPERDOS

\$1895

7000DX™ *Leading TECHNOLOGY*
PERSONAL COMP by LEADING TECHN
IBM COMPATIBLE
 • Intel 386™ DX, 25 MHz, 251 (64 KB, CACHE memory) VGA color monitor, 28 1428 hard drive (One 1.2 Mb 5.25 MB 3.5" floppy) **FREE MOUSE, LOTUS WORKS AND WINDOWS**

\$2195

250

251

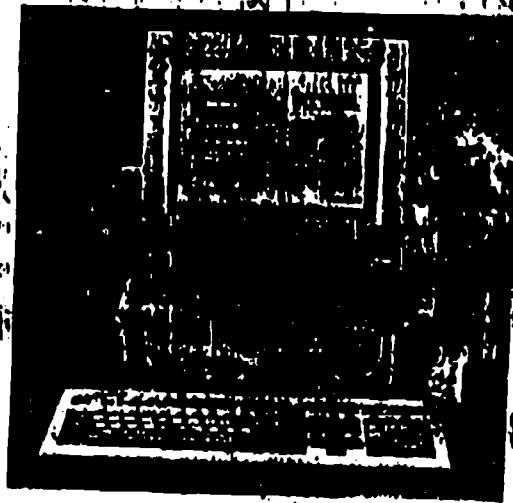

5500AT™

Computer

286AT • 40 MB Hard Drive
5.25" & 3.5" Floppy Drive • 1 MB RAM
2 Serial, 1 Parallel • MS DOS 4.01 •
HyperDOS™ • Lotus Works™

\$797

Only \$27 a month

1458V Monitor \$247
14" Color VGA Display

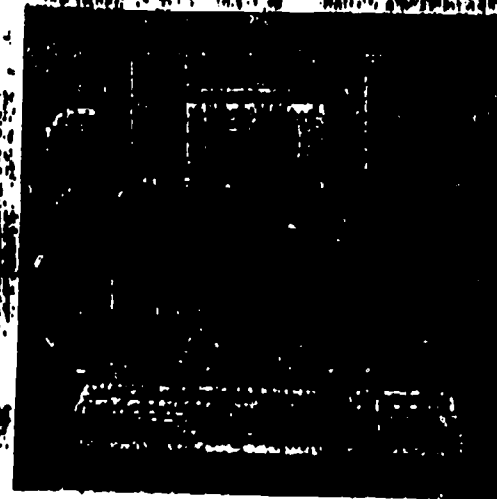

6800SX™

Computer

386™ SX • 40 MB Hard Drive
3.5" & 5.25" Floppy Drive
1MB RAM • 1 Serial, 1 Parallel, Mouse Port
MS DOS 4.01 • Lotus Works™ • HyperDOS™

\$1197

Only \$40 a month

1458V Monitor \$247
14" Color VGA Display



Model 6816SX

Computer

68000SX™ / 80386™ SX • 100 MB Hard Drive
3.5" & 5.25" Floppy Drive • 1MB RAM
1 Serial, 1 Parallel, 1 Mouse Port • Modem Mouse
• Windows 3.0™ • MS DOS 4.01 • Lotus Works™
• HyperDOS™

\$1597

Only \$54 a month

1451V Monitor \$257
14" Color VGA Display

HYUNDAI

Oregon's Largest Hyundai Dealer,
Will Not Be Undersold!

SUPER-286E Plus System

- 2 Meg Hard Drive
- 2 Meg RAM
- 3 Meg Floppy
- 16-Meg Monitor and Card
- MS-DOS 4.01 and GW-Basic
- 18-Month Warranty



896
Retail \$1650

SPECIAL! SUPER-386SE • 386SX16

- Special Bundle Includes
- Hyundai Super-386SE
- 16MHz of power, 2 Meg
- RAM, a 42 Meg Hard Disk,
- 1.2 Meg Floppy and:
- VGA color card
- VGA color monitor
- 18-month Warranty
- Local Service
- Satisfaction Guarantee

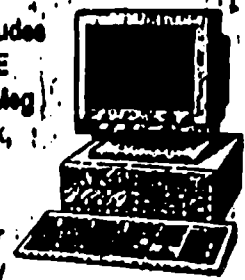

1396 (Retail \$1650)

SUPER-386N • 25MHz 386

- 2 Meg Hard Drive
- 2K Cache Memory
- 2 Meg RAM
- 2 Meg Floppy
- 16-Meg VGA Card
- 16-Meg VGA Mono Monitor
- MS-DOS 4.01 and GW-Basic
- 18-Month Warranty
- FREE Mouse

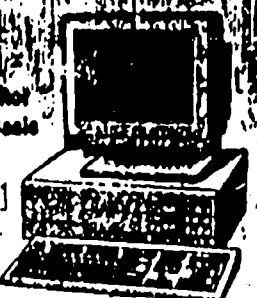

1695

ERIC

AST COMPUTERS

Bravo 486/25 Bundle

- Nearly twice as fast as a 386/33
- 2 MB RAM (Expandable to 16 MB)
- AST Hi-Res Super VGA
- Color Monitor
- 1.2 Meg Floppy
- 80 MB HD
- Microsoft Mouse
- Windows 3.0

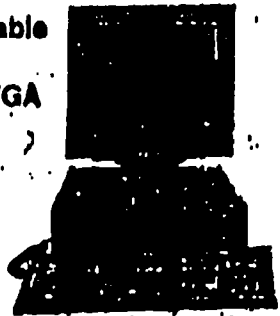

Model 838

\$3995

AST Premium® Exec™ 386SX/20MHz Notebook

- Only 7 lbs.!
- Paper-white VGA
- 2 Meg RAM
- 20 Meg HD
- 3.5" FD

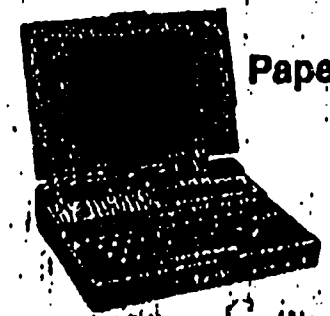

Model 23V

\$2595
(Also 40 and 60 Meg HD)



AST, AST logo and AST Premium registered and Exec trademark of AST Research, Inc. All other product names are trademarks or registered trademarks of their respective companies.

LEADING EDGE®

AFFORDABLE 386 POWER!

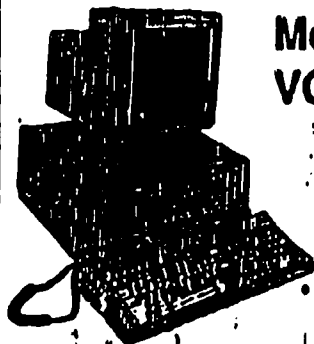

Model D3/SX VGA System

- 386SX/16MHz
- 1 Meg RAM
- 40 Meg Hard Disk
- VGA Video Card
- VGA Mono Monitor
- Microsoft Works
- 20-month Warranty
- MS-DOS 3.3

\$995

Model D3/33

- 386 / 33MHz
- 2 Meg RAM
- 40 Meg Hard Disk
- 32K Cache Memory
- VGA Video Card
- VGA Mono Monitor
- 20-month Warranty
- MS-DOS 4.01



LEADING EDGE®
a Datacube Telecom company

\$1895

*OmniTek strives to offer the lowest computer prices in the Northwest on these products! In the event that a lower written quote is obtained, we will meet or beat it!!
Prices and coupons in this ad are NOT retroactive
VISA/MC add 3% • Financing available on approved credit

CLEARANCE!!

Visit the
"Clearance Corner"
at our Southeast Store!



Monitors
from \$49!!

Printers
from \$90!!

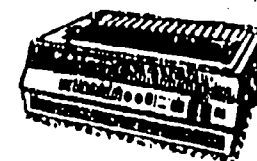

Computers
from \$350!!

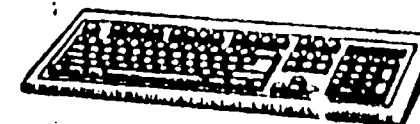

Keyboards from \$10!!

PANASONIC

Oregon's Largest Panasonic Dealer Will Not Be Undersold!
KX-P2624 **Panasonic**
Office Automation

- The silent dot matrix
- 11 internal fonts
- 300 cpi
- Full carriage

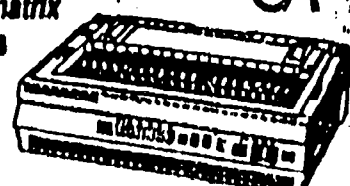

\$469

Would You Buy a
Computer From a
Furniture Store?
Buy From Experts
and Save \$100!!



- 16MHz 386SX
- 1 MB RAM
- 1.2 & 1.44 floppies
- 40 Meg Hard Drive
- 14" VGA Monitor

\$1295

NETWORKS

WANT TO CONNECT
YOUR COMPUTERS?



OmniTek offers
sales and
support for
networks.
Call for Details.

HIGH-PERFORMANCE LAPTOP PCs

Laptopbook-Size With Built-In Hard Drive

MS-DOS and DeskMate® Software Included
 640K, Expandable to 1.64MB
 Built-in 20MB Hard Drive
 Lightweight—Only 6.0 lbs.

NEW! Tandy 1500 HD. A truly portable (only 12.2 x 10 x 1.7") PC compatible. Features include a built-in hard drive with MS-DOS for running today's most popular programs. Since the 1500 HD comes with DeskMate software and the DeskMate Graphical User Interface® already installed, you can begin coming right away. Choose from any of DeskMate's ten productivity applications including word processing, spreadsheet and more. "Power on" lets you know if the power is on while lid is closed. Caps Lock and Control keys are reachable to configure the keyboard for your convenience. With a 10 MHz processor. **\$1999** (MSRP available)
 1506 ... Low As \$61 Per Month
 NI Rechargeable/Replaceable Battery, 25-3526 ... 49.95
 NI 2400-bps Internal Modem, 3528 ... 199.85

Get 20MB, 286 Performance In a PC-Compatible Laptop

Tandy 2800 HD. A 12 MHz 80C286 microprocessor and 8 MB of memory let you process spreadsheets and graphics fast. A built-in 20MB hard drive lets you access pro-

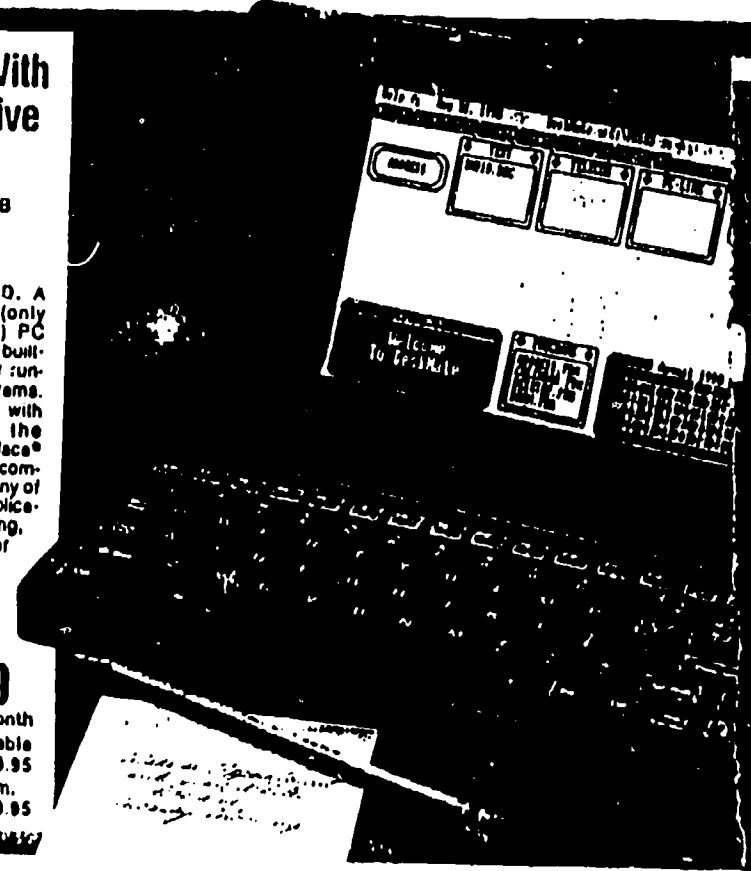

ALL EPSON Printers Are On Sale Now!



Both Computers Include Lotus® Works Integrated Software A \$150 Value
 Plus, both include 1-year in-home/on-site service by AT&T. Free analysis and on-site technical support!



Powerful, Yet Simple-To-Learn!

Built-in Fax & Modem Board

SAVES 100%

PACKARD BELL

YOUR WHOLESALE COMPUTER PARTS STORE

JULY 4TH SPECIAL
 25 MHZ, 1 MEG. VGA,
 COLOUR, 45 MB HD
\$1175.00



10357 SW Canyon Rd.
 Beaverton, OR 97005

643-2079

FAX 643-2350 M-F 9-7
 SAT & SUN 11-4



COMPLETE SYSTEMS

45 Mb Hard Drive
 1.2 or 1.4 floppy disk, 1 MEG RAM, VGA monitor, 2S/1P/1G, 101 keyboard, 16 bit VGA card.

89 Mb Hard Drive
 2 MEG RAM, 1.2 or 1.44 floppy, VGA monitor, 2S/1P/1G, 101 keyboard, 16 bit VGA card.

124 Mb Hard Drive
 4 MEG RAM, 1.2 or 1.44 floppy, VGA monitor, 16 bit VGA card, 2S/1P/1G, 101 keyboard.

286-12	\$955
286-20	\$1015
386 SX-16	\$1095
386 SX-20	\$1327

5% OFF Complete Systems
 Not Valid With Other Discounts
10% OFF All Parts

386-25	\$1495
386-33	\$1820
486-25	\$2401
486-33	\$2726

Free with complete systems: Free mouse, 1 year limited warranty on parts & labor, free cleaning every 6 months for one year, 24 hour burn-in.

BASIC SYSTEMS

Include:
 1 Mb RAM, 1.2 or 1.44 floppy, IDE controller card, 2S/1P/1G ports, 101 keyboard, 24 hour burn-in, 1 year limited warranty on parts & labor, free cleaning every 6 months for a year.

286-12	\$399
286-20	\$425
386 SX-16	\$566
386 SX-20	\$634
386-25	\$755
386-33	\$936
486-25	\$1520
486-33	\$1845

BAREBONE SYSTEMS

Case, power supply and motherboard:

286-12	\$177
286-20	\$199
386 SX-16	\$342
386 SX-20	\$409
386-25	\$530
386-33	\$639
486-25	\$1296
486-33	\$1845

MOTHERBOARD PARTS

286-12	\$95
286-20	\$120
386 SX-16	\$265
386 SX-20	\$325
386-25	\$450
386-33	\$560
486-25	\$1150

CASES

Tower	\$155
Baby Tower	\$85

MISC

2400 B Modem	\$75
Floppy Disk AT-XT Controller	\$20
Genius 3-Button Mouse	\$27
MFM Controller H/F	\$30
IDE Controller H/F	\$12
Floppy Drive	\$71
Math Co.(287-10)	\$129
Math Co.(387-25)	\$270
Math Co.(387-33)	\$337
Math Co.(387sx-16)	\$238

★ ★ ★ ★ ★ OFFER EXP

**Available Now At
 AsterTech**

6.33 MHz/64K Cache
\$799.00
 only

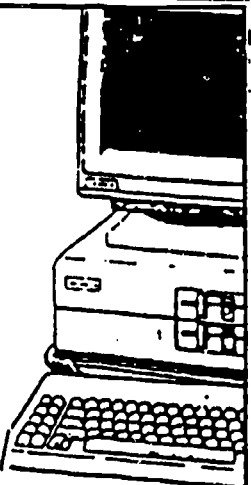

System includes: 1 MB RAM, 1.2 or 1.44 floppy, IDE controller card, 2S/1P/1G ports, 101 keyboard, 24 hour burn-in, 1 year limited warranty on parts & labor, free cleaning every 6 months for a year.

6.33 MHz	\$369
16MHz	\$549
20MHz	\$749
64K Cache	\$1599

Block North of Canyon Road in Beaverton

Up Grade

43 MB Hard Drive	\$209
89 MB Hard Drive	\$359
110 MB Hard Drive	\$409
200 MB Hard Drive	\$749
1 meg RAM	\$65
1.44 FLOPPY	\$69



FINANCING AVAILABLE

PRICE EXPLOSION!!!

Because of our high NATIONAL business volume we're able to offer our lowest system prices ever!

systems below priced as shown with 1MB RAM

286-12	\$695
386SX-16	\$845
386SX-20	\$895

Upgrades (with System Purchase only)
 Super VGA (requires 2800) \$300
 Standard VGA (requires 2800) \$200
 105MB Hard Drive \$195

386-25 SUPER VGA
 28 dot pitch

- 25MHz CPU, 42MB Hard Drive
- 1MB RAM, exp. to 16MB
- 14" Super VGA Color Monitor
- 16 Bit VGA Card, 512K VRAM
- 1.2 MB Floppy Drive
- Serial/ Parallel/ Game Ports

\$1295.00 Limited Time!!

386-33MHz
Power User System
 same as 386-25 SUPER VGA, with

- 4MB RAM, 1.2 AND 1.4 floppy
- 105 MB Hard Drive, 19ms
- 64K Cache, exp. to 128K

\$1895.00



486-33 ISA
 SUPER VGA, 4MB RAM
 120 MB Hard Drive, 18ms
 64K Cache, exp. to 256K
\$2995.00

Since 1984, Quality Service, Locations Nationwide

Lucky Computer Co

10773 SW Beaverton-Hillsdale Hwy. HOURS: 9am to 6pm

YOUR WHOLESALE COMPUTER PARTS STORE



Independence Day



Friday, June 29
Saturday, June 30
10:00 - 6:00

SAVINGS!

Alpha Computers, Inc.

Beaverton • Lake Oswego



Most competitive prices
on HP products!

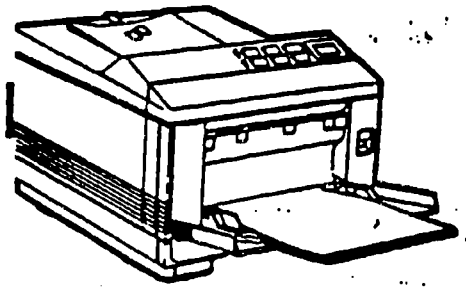

- ☆ Most affordable HP LaserJet printer
- ☆ Wide range of HP LaserJet software and font support
- ☆ Publication-quality output
- ☆ Fast, 4-ppm printing

JULY MS-DOS CLASSES

Advanced Lotus 123	July 1
Beginning WordPerfect	July 2,18
Introduction to PC	July 3
Beginning Windows	July 8
Beginning Lotus 123	July 9
Intro to DOS & HD	July 10,13
Excel for Windows I	July 11
Intermediate WordPerfect	July 12
Advanced WordPerfect	July 15
Word for Windows I	July 17
Intermediate Lotus 123	July 19
Beginning Paradox	July 22

Most classes run from 9:00 a.m. - 4:00 p.m.; call Alpha's training department at 620-7000

Connecting Point
COMPUTER CENTERS

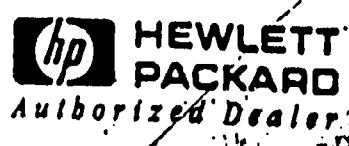

Lake Oswego
Kruse Meadows
15150 SW Bangy Road
Lake Oswego, OR 97035
(503) 620-7000

ALPHA COMPUTERS, INC.

Alpha Computers
is the *only* Apple authorized
Training Center in Oregon!

Beaverton
Beaverton Town Square
11635 SW Beaverton-Fallsdale Hwy.
Beaverton, OR 97005
(503) 644-9122

**It's a COMPLETE System!
Look At What You Get:**

- 16 MHz, 32-Bit 386SX Processor
- 1 Full Megabyte of RAM
- 40-Megabyte Hard Disk
- 1.2MB 5¼" Floppy Drive
- 1.44MB 3½" Disk Drive
- 14" 640 x 480 VGA Color Monitor (.31 Dot Pitch)
- 16-Bit VGA Card With 256K of RAM
- 1 Parallel Port/2 Serial Ports/1 Mouse Port
- 101-Key Extended Keyboard
- MS DOS 3.31 and GW-BASIC
- Exclusive 'Plain English' DAK Manual
- Toll-Free Technical Support
- FREE 1 Year On-Site Service

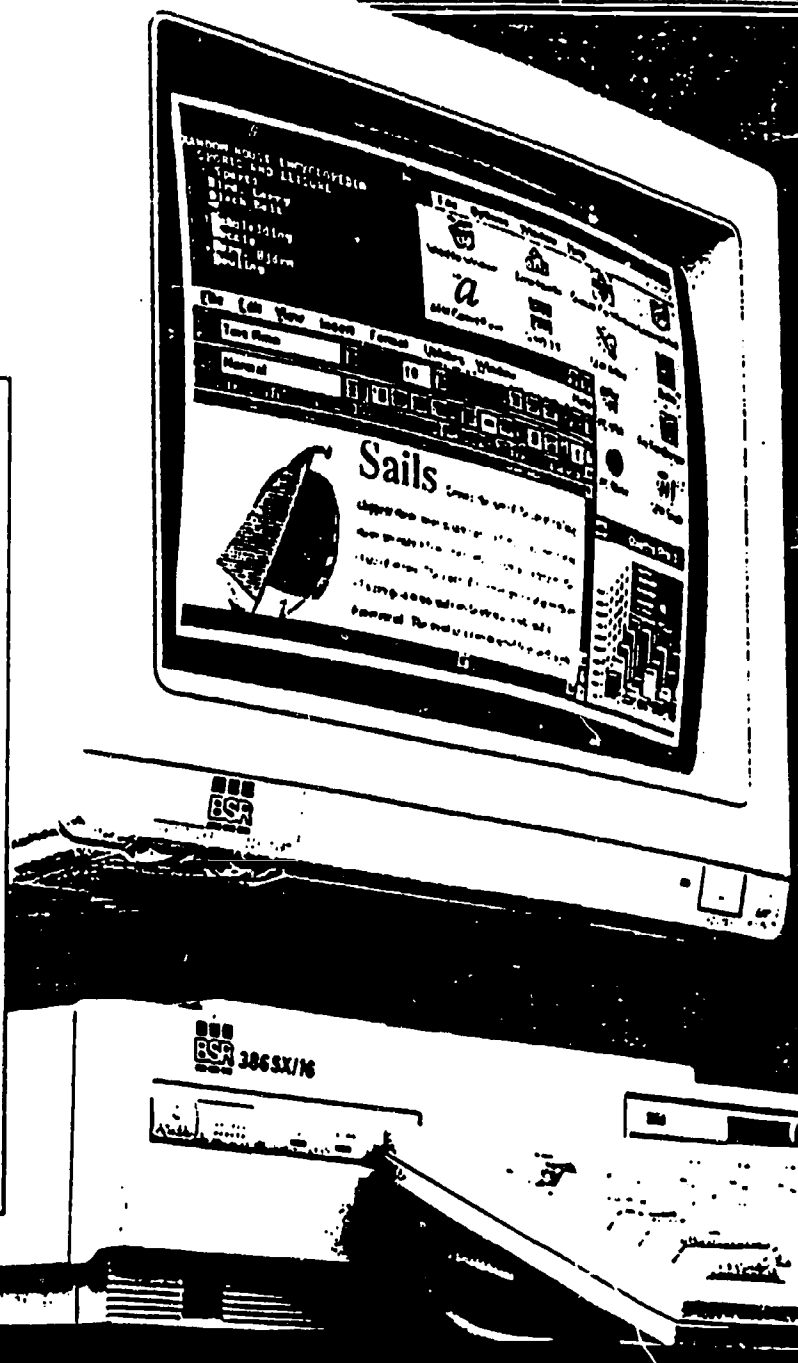

It's revolutionary computing power. Plus, with optional Windows 3.0, you can use several programs at once. Here I'm using Windows, NEW Word for Windows, NEW Quattro Pro 3.0 and the Random House Encyclopedia.

386SX Corporate Give-away?

Jump on the corporate bandwagon! To build the BSR brand name in Fortune 500 companies (who often buy dozens of computers) DAK has the green light to slash the price of this FULLY LOADED 386SX computer system—with OR without \$149 Windows 3.0, \$495 Word for Windows and \$495 Quattro Pro 3.0. But, no one told me I couldn't offer this special corporate deal to all DAKonians. So, until I hear otherwise, this 386SX corporate powerhouse is yours for a price-shattering \$1,399 with OR without adding the 3 programs mentioned above (PLUS 17 other top name-brand programs AND a 3-button mouse) for an incredible bonus price that has the computer industry reeling.

By Drew Kaplan

Smash high computer prices! Other name-brand 386SX computers comparable to this one (complete with a full meg of RAM, 40MB hard drive, both 5¼" and 3½" disk drives and a true .31 dot pitch 14" color VGA monitor), sell for \$1,999 to \$2,499.

But, thanks to a special promotion aimed at corporate America, you can grab this fully loaded BSR 386SX computer system for as much as \$1,100 less!

Plus, you can also grab a breakthrough software package containing \$149 Windows 3.0, the newest \$495 Word for Windows, the newest \$495 Quattro Pro 3.0 and 17 other powerful name-brand programs (a \$3,683 total value) for an industry-shocking \$399.

But, forget prices for a moment. It's the quality and dependability of this incredible 386SX computer that's really important.

SUPERIOR 386SX PERFORMANCE

It's fast. Really fast. You'll rocket through

work at a blinding 386SX microprocessor like 286 computers twice the information.

But, blind it's a story. You see, memory capacity RAM barrier through powerfully.

You see, with program like Microsoft unleash all the power of this computer (8 megs) of high speed and me beyond the ability.

Just wait till the world of 32-bit speed and me beyond the ability.

You can act on programs at the computer users can you can transfer forth between were using one.

It's incredible your word processing and back instantly using your word.

JUST LOADED

It's loaded. It was specially designed for business work!

Look At All You Can Get With Your BSR 386SX Computer

Plus, Look At All You Can Get For Just \$399

- \$149 Windows 3.0
- \$495 Word for Windows
- \$495 Quattro Pro 3.0
- \$495 GEM Artline
- \$249 Reflex 2.0
- \$ 99 Adobe Type Manager
- \$ 99 Grammatik Windows
- \$ 59 Microsoft Productivity Pack
- \$119 Random House Encyclopedia
- \$299 GEM Graph
- \$ 59 Key Sales Letters
- \$ 59 Key Business Letters
- \$249 Key Form Designer Plus
- \$ 49 Key Form Pac
- \$ 59 Word Finder
- \$245 Key Mailer 2000
- \$ 99 Key Dictionary
- \$ 69 Keyboard/Keypad Trainer
- \$ 69 PC USA
- \$ 69 PC Globe
- \$ 99 BSR 3-Button Mouse

I think I've put together the greatest software bonus package EVER OFFERED in the history of the computer industry!

Here's why. DAK is, as I write, the ONLY company authorized by Microsoft to include the flagship of their line, \$495 Word for Windows, in a special bonus software package.

It's a great compliment to both DAK and the BSR 386SX computer. But, amazing Word for Windows is just the beginning. **YOU GET \$3,683 WORTH OF SOFTWARE FOR JUST \$399**

These are TOP programs. You get \$149 Windows 3.0, \$495 Word for Windows, \$495 Quattro Pro 3.0, \$99 Adobe Type Manager and \$249 Reflex 2.0 just to name a few!

Plus, look at this. I visited my local Egg-head Discount Software store and Quattro 3.0 was 'discounted' to \$399**. Word for Windows was \$339**. And, Windows 3.0 was \$99**. That's a total of \$839** for just these 3 programs alone!

But, YOU can get the same 3 top-of-the-line programs above PLUS 17 other name brand programs PLUS a bonus BSR 3-button mouse for literally pennies on the dollar!

It's a total value of \$3,683. But, when you acquire your 386SX computer it's all yours for just \$399. Now let's dive in and take a quick look at everything you'll get in this amazing software bonus package.

Windows 3.0 (\$149 Value). It's the new standard. Windows 3.0 has revolutionized computing. Before Windows, we had to memorize and key in complex DOS commands. Plus, we were limited to using only one program at a time.

But, now that's all changed. With Win-

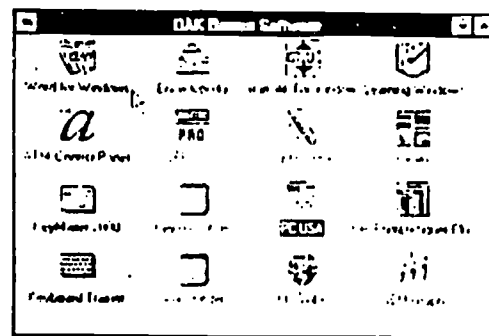

Forget complex DOS commands. Windows 3.0 is incredibly easy to use. Simply point and click your mouse on the program or (X)S application you desire. Windows 3.0, your 386SX computer will become both incredibly easy to use and many, many times more powerful.

In fact, Windows 3.0 obliterates the 640K barrier once and for all. So you can upgrade to 2, 4 even 8 megs of RAM, and Windows can use every ounce of memory.

Plus, with Windows 3.0 you can copy files, format diskettes, see a directory of your files and run programs without even touching your keyboard!

It's great! Instead of having to memorize complicated DOS commands and type in tendon-stretching key combinations, you simply click a mouse on a little picture (called an icon) or an easy pull-down menu.

Basically, Windows pulls all your programs together into one big, easy-to-use program. And, with Windows' advanced memory power, you can actually run two or more programs simultaneously.

So, for example, if you're writing a letter (Next Page Please...)

multi-tasking power for just \$79**.

Both 5¼" AND 3½" Floppy Drives (Standard). You get not one, but TWO floppy drives with your BSR 386SX computer.

First, there's a 1.2MB, high-density 5¼" floppy disk drive. You can store nearly 4

density 3½" floppy disk drive. So you'll never have a compatibility problem if you switch floppies between your 386SX and the latest IBM computers or even 1.44MB and 720K laptop computers.

4 Expansion Slots (Standard). With its 4 expansion slots (3 available), your 386SX will grow with you. You'll have plenty of room to add a voice mail/fax/modem card, a scanner card and more.

Serial, Parallel and Mouse Ports (Standard). You'll have two serial ports to use with serial devices. You get a parallel port for printer hook-up. And, there's even a bus mouse port. (Keep reading for a great deal on the latest BSR 3-button bus mouse.)

101-Key Extended Keyboard (Standard). Whether you 'hunt & peck' or type 90 words per minute, you'll really appreciate the tactile feedback of this full extended keyboard complete with separate arrow/cursor keys. It's a joy to your fingers.

MS DOS 3.31 and GW-BASIC (Standard). The latest MS DOS 3.31 obliterates the 32 meg hard disk size limitation. So you can use your 40 meg (or optional 80 meg) hard drive without partitions.

Clock/Calendar with Battery Back-Up and More. This extraordinary IBM-compatible computer has a clock/calendar with battery backup, a front panel reset switch, 80387 math co-processor socket, 8MHz/16MHz switching and much more.

Whew! That's A LOT of computer fire- (Next Page Please...)

plete arsenal full of work-annihilating industrial features at your fingertips.

14" VGA Monitor (Standard). With its phenomenal 640 x 480 (.31 dot pitch), slide-like resolution, this easy-on-the-eyes, non-glare 14" color VGA monitor is the most brilliant I've ever seen. Just wait till you see its palette of 256,000 colors.

Note: Lately I've been seeing 'bargain' computers with VGA monitors that are only .42 or .51 dot pitch. Don't be misled.

.42 and .51 dot pitch monitors cost a lot less than the .31 dot pitch color VGA monitor that you get with this BSR 386SX computer. Plus, their resolution is fuzzy, hard on your eyes and noticeably inferior. Always insist on a .31 dot pitch monitor.

40-Megabyte Hard Drive (Standard). With your super-fast, 28-millisecond, 40-megabyte hard drive, you'll have the informational storage power of over 110 traditional floppy disks to save all of your work and programs with plenty of room to spare.

Plus, if you're running a business or simply need all the storage space you can get, you can upgrade to a colossal 80-megabyte hard drive for just \$199**.

Full Megabyte of RAM (Standard). You'll have plenty of power to run even the most massive memory-devouring programs with the included 1 megabyte of high-speed RAM. Plus, you can upgrade to a total of 2 megabytes of RAM for virtually unlimited

COMPUTER SCAM ALERT!
Browse through the computer magazines and you'll find ads for 386SX computers that, on the surface, may appear to beat DAK's price.
But, if you read those ads closely, you'll usually find that these so-called 386SX systems would be UNUSABLE if you ordered them without expensive upgrades.
Last week, I found an ad in PC Magazine offering a '386SX' for slightly less than DAK's price. But, when I scrutinized the fine print, I found that it had NO monitor, NO video card and NO hard drive. Plus, it had just one floppy drive and just 512K of RAM.
So, whether you acquire your computer from DAK or get it somewhere else, ALWAYS, ALWAYS pay very close attention to what you're REALLY getting (and what you're not) for your money.

times more information on a 1.2MB floppy than you can on a standard 360K floppy.

Of course, you can still use and exchange 360K floppies with less sophisticated computer users than yourself.

Plus, you also get the latest 1.44MB high-

Understanding the Technology

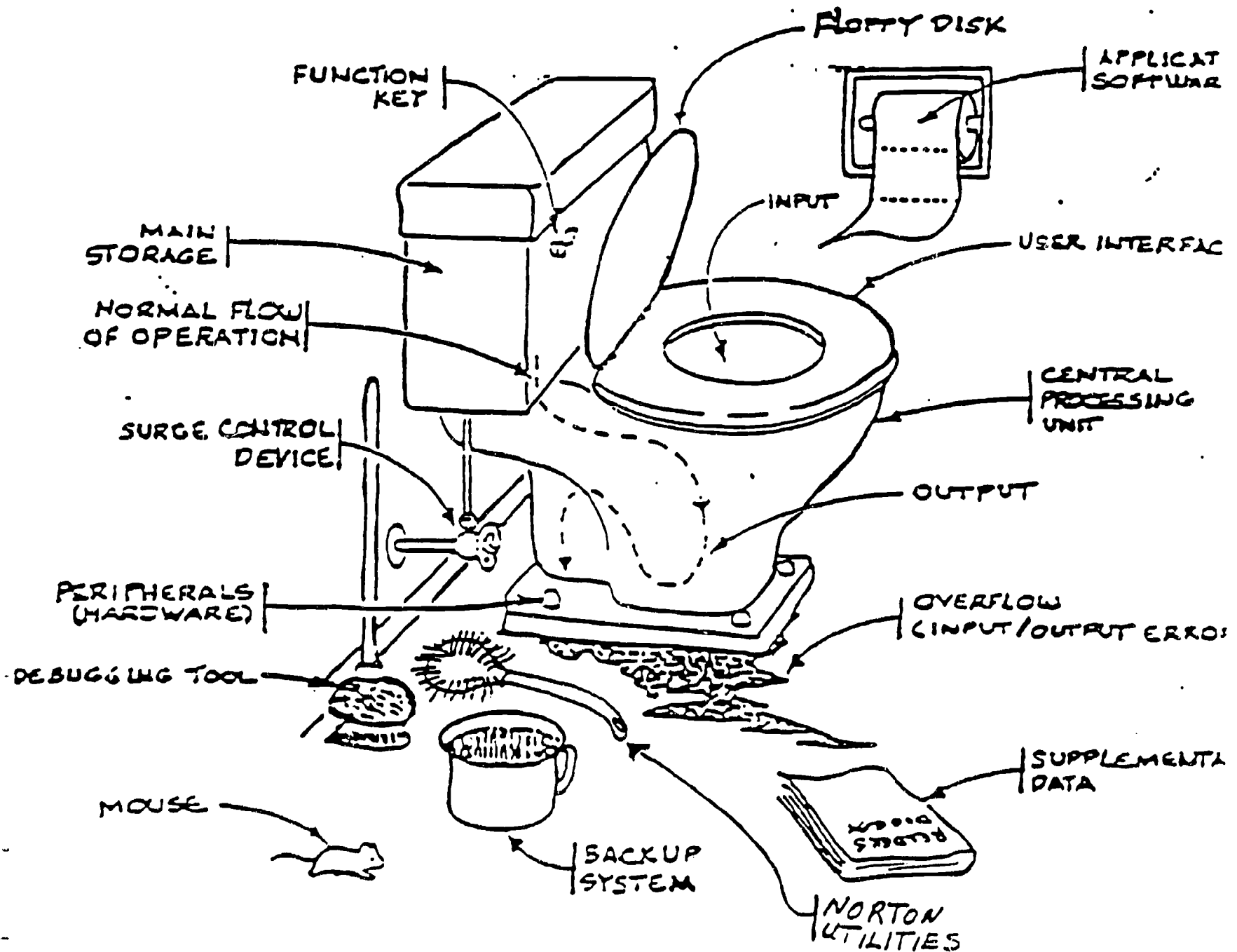

**CURRICULUM
WARN
COMPUTER BASICS**

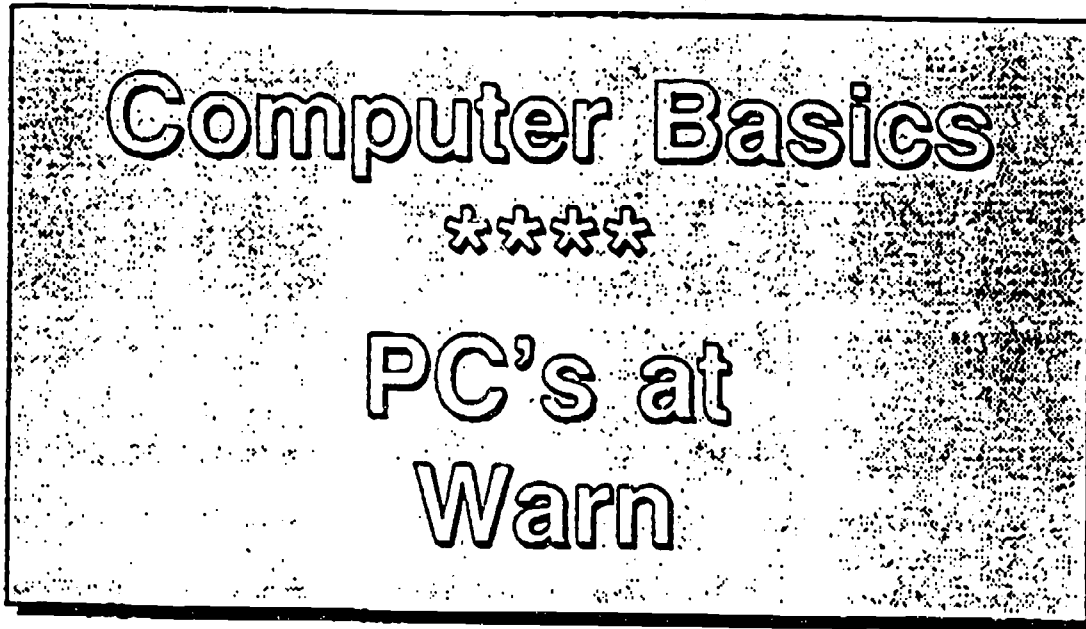

© 1991: Warn, TLC: This programmed note package was developed for exclusive use of Warn Industries. The development was funded by Grants from the US Dept. of Labor and US Dept. of Education along with funds from Clackamas Community College.

Before We Get Started...

The goal of the class...

A few suggestions and requests...

You need to ask questions...

About your notebook...

Only practice makes perfect

The need for patience...

We want your ideas and suggestions...

The Computer Inside and Out

First we'll look at the computer, inside and out.

This is an older computer, but all the parts work just like the new ones.

Several areas we want to look at...

- 1. Input:

- 2. Output:

- 3. Processing:

- 4. Storage:

Other comments:

(We'll come back and discuss all these words in more detail, but whenever you have a question, go ahead and ask!)

What Happens When You Turn it On?

1. It (the computer,) doesn't know what to do...
2. It tries to find "operating" instructions stored in a "File" somewhere...
3. It finds the instructions and "loads" them into "memory"...
4. These "instructions" are called "DOS"...
5. "DOS" needs input from you, or from a "program"...
6. All "PC's", use DOS. Many PC's are set up or "configured" so that you don't need to know "DOS." The Warn Network allows you to operate the PC without knowing anything about DOS.

Other Comments:

Let's Turn on the Computer...

Several things can go wrong when you try to "start up the system"...

But, nothing serious.

Just Two Rules to remember when turning a computer on and off...

- ☛ Remove any "floppy disks" before turning a machine on or off.
- ☛ After you turn a computer off, let it "slow down" for a few seconds before turning it back on again. Don't take a disk out or put one in while turning the computer on or off!

Now, Let's turn them on...

Some things to check if you have a problem...

1. Is everything plugged in?
2. Is the "power strip" or box turned on... look for a red or yellow lighted switch.
3. Are the monitor, printer or any other "Peripherals" turned on?

What you see on the computer screen next depends on how that particular computer has been "set up" or "configured."

What types of Computers and Computer Systems are Found at Warn?

PC's are everywhere, but some are more than just a PC...

"Terminals" are everywhere, but they are "dumb" and depend on being wired into "MainFrame.":

The Network: A "Server" and many PC's that can work together...

Some PC's are bigger and dedicated to special tasks...

Even many of the machines have their own computers built in...



• 1/2 words
 - Homework

Now, Let's talk about all these words we've been hearing so much...

To 12:31

What does it mean?

Applications/Programs

DOS

Backup

Files

Boot/Booting/ReBoot

Filenames

Bit/Bytes(& Megabytes)

Fixed Disk (Hard Disk)

Character

Hardware vs. Software

Compatible

Load/Loading

Command

Memory

Configure

Operating System

CPU

Prompt

Data

RAM/ROM

Disk Drive

Stand-Alone

Disk/Diskette

Text-Numbers

Density

Discussion of Applications:**What Can You Do With a Computer?**

Let's talk about things you or I may want to use a computer for...

"Word Processing" (For Warn Letters, Lists, Reports, Memos...)

"SpreadSheets" (Team Budgets, Calculation of any type of numbers)

"DataBase" (File Cabinets, Client-Customer-Vendor Data, Maintenance Records...)

"Statistics/Graphics Packages" (for quality tracking and charts or graphs for presentation.)

"Household Applications" (no more checkbook errors!, track investments, inventory, schedules...)

"Tutorials" (Learn about anything from how to use a program to how to type faster.)

"Programming Languages" (If you need a custom program to do a unique job, like instructing a computer to operate a Warn Machine.)

Getting Around on the Keyboard

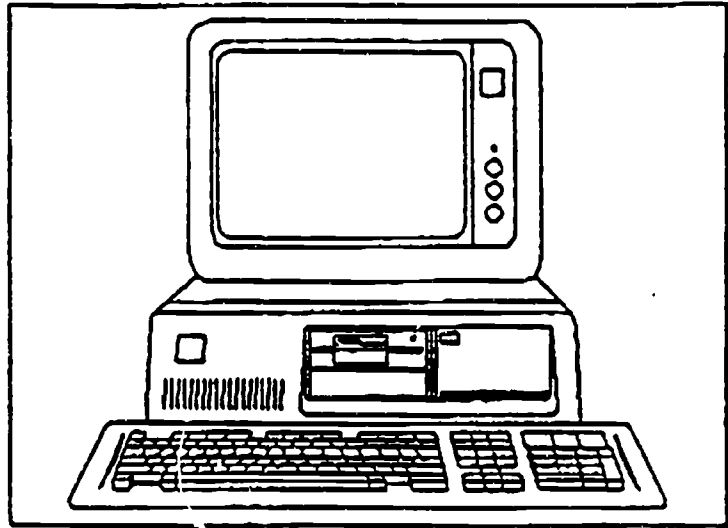

Let's look at the Keyboard...

"Typewriter Keys"...

"Cursor Keys"...

"Editing Keys"...

"Function Keys and Combinations with ALT or CTRL"...

Some of the other keys...

Let's Talk about Programs and "Input":

Unfortunately, nearly every program (or type of software) has it's own way of getting input from the "user" (that's you).

It would be nice if we could say "anytime you want to 'exit' a program just..."

There is no standard for "input." So you need to learn about the different ways some programs will want you to input your "commands."

We'll look at two ways of dealing with the programs...

1) Menus:

- a) making a choice...
- b) several ways to make a choice...
- c) menus in a menu...

2) Prompts and Commands

- a) The DOS prompt...
- b) Program prompts, function keys and command lines...
- c) Problems with fast fingers...

Let's Practice "Input" with a Word Processor.

We're Going to "load" Word Perfect...

Then we're going to "type" or "edit" a "document."

This will give you a chance to see how a program gets "input" from you, the user.

How we load Word Perfect depends on the computers we are using. If we are on the "network", we will "select" Word Perfect from the Main Menu. We are going to create this document and make some changes in it...

(the instructor will walk you through this).

Wam Industries Utilizes Computers Throughout the Business

No matter what job you have, computers are headed your way. In order to save time and reduce errors, computers will be used extensively in the manufacturing environment.

Wam Industries uses a variety of computers to perform a wide range of tasks. A "Mainframe" system utilizes an "integrated" software system to track materials, production, accounting and other product related information. "PC's" are used to generate memos, reports and handle many types of "number crunching" jobs. A "network" is set up to allow many PC's to share information and resources.

A worker can add value and productivity to the team by being competent on several types of computer tasks. You will find that computers, while frustrating at first, can be fun and save you a tremendous amount of time.

Use This Page Make Notes on Your
Input/Editing Keys in Word Perfect

- To get into the program...
- To move around...
- To delete "frontwards"...
- To delete "backwards"...
- To insert a letter or word...
- To delete a letter or word...
- To make a tab at the beginning of a paragraph...
- To start a new paragraph...
- To lock the "caps"...
- To make a word "Boldface"...
- To "save" and "exit"...
- To "bring up" or retrieve your work...
- Other things to remember...

Let's look at some more words and see
what they mean...

Go to WP FS

Backup:

Backspace:

Carriage Return (enter key):

Centering:

Delete:

Directory:

Document (File/Data):

Edit:

ESCAPE Key:

Exit:

Format (text):

Format (disk):

Margins:

Num Lock:

Page Break:

PageUp/PageDown:

~~^Pr Sc (Print Screen):~~

Print/Hard Copy:

Save:

Scroll Lock:

Other Things to Remember...

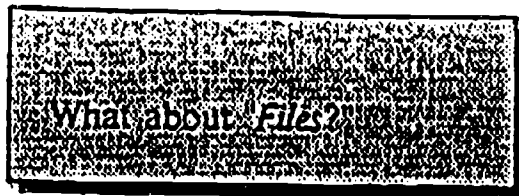

What they are...

When to "save"...

What to call it (the "filename" and "file extension"...

Where to Save...

When you are going to "Exit"...

Some different strategies...

Updating:

Several Versions:

The Key: Thinking it through

What can go wrong...

The computer takes you literally...

What About Numbers?
Let's Look at *SpreadSheets*.

We're going to "load" and "run" Lotus 123 (or a similar spreadsheet...

This software (program) is great for working with numbers...

We're going to work on the expense sheet you see on the page below...

The spreadsheet will do all the math for us...

The instructor will walk you through each step. Then, we will go back over it...

Team	Plan Amount \$	Actual Shipped \$	Percent to Plan
SuperHubs	154,000.00	166,874.50	
JitWinch	112,345.00	123,762.33	
Singasyong	134,320.00	136,569.72	
RoBoGear	103,200.00	98,345.22	
Faston	132,450.00	141,347.98	
Totals:			

On the next two pages, we'll look at some of the steps used in working on spreadsheets.

**SpreadSheets: Common Keys and Steps
to Working With the Numbers**

Note: Most Spreadsheets use the same type of "commands" and procedures to "input" information. The major differences will be in how they look on the screen and several ways they use to "say the same thing..."

The WorkSheet Layout...

► Once you are in the program (after the initial screen, you may need to "hit any key to continue") you have a blank sheet with a frame across the top and right sides...

Across the top or bottom are some "options" or commands...

As you type in numbers, words or formulas, what you type will show up at the top of the screen. Then when you hit "enter," it will go in the "cell" that is "highlighted" with your cursor. Numbers and words you see, formulas are "hidden."

	A	B	C	D	E	F	G	H	I	J	K
1											
2											
3											
4											
5											
6											
7											
8											
9											

{the top left cell is called "A1," next to it is B1 and below it is A2..}

this "x"  x is in D5. Somewhere, way off to the lower right is a cell called FZ999, (after Z, the columns are AA, AB... and so on... depending on how large the program is.)

More on SpreadSheets: Common Keys
and Steps to Working With the
Numbers...

Getting where you want to go...

Putting the numbers in...

Putting in the words, titles or labels...

Putting in Formulas so you don't have to do as much work...

Some "Rules"

Thinking it through

Getting at the "Commands"...

Saving your work...

Finding and getting your work back...

Other Topics and Things to Remember...

There's Always Help!

Some things to remember when you start to work with computers...

Don't spend long periods of time on one problem. It may not be your fault...

Get Help...

Get Help from the program...

In Pro Write:

In Lotus:

In other programs:

Get Help from the Manual (they are difficult but necessary)...

Where to look and what to get:

How to use the thing without reading more than ever wanted to know...

Get Help from your Local Experts (they are eager to help you)...

Who to call...

• When to call...

Other Resources and options...

Vocabulary terms for Warn Computer Basics

=====

386 }

386sx } Model of 'processor' in the computer...indicates relative speed.

486 }

Applications- programs, software, instructions for you to use with the computer to do typical computer tasks.

Assembly Language- a code, using numbers, used to 'program' a computer to do work.

AT 286} Model of 'processor'... AT was the name IBM used, then others picked up on it.

Autoexec. A 'file' with 'commands that the computer 'automatically' executes when you turn it on.

Backup- make an extra copy, 'just in Case'

BASIC- a programming language: allows you to tell the computer what you want it to do. Easy(?) to learn.

Batch- a group of commands that are run together to do some work.

Batch files-the place the batch of commands is stored on disk.

Baud-a rate (or speed) of information transfer between computer and other destinations(phone,printer...).

Boot, Booting, Boot up- to turn on the computer and have it load the 'operating system.'

C, Pascal-two other common programming languages, very flexible, harder to learn.

Cache- a memory system that speeds up disk operations-lets you find things faster.

CAD-Computer Aided Design... for drafters and engineers, lets them use the computer to improve or change designs.

Card-or 'Board'-electronic components on a piece of plastic (card) that can be installed or removed.

CD-A 'DOS' command you use to 'Change Directory'

Clone-A computer, or computer accessory designed to work just like a major name brand computer or accessory.

Co-processor, Math chip-an optional piece of electronic hardware that will speed up numeric calculations.

Cold Boot-a boot when the computer has been turned off then is turned on.

Command-an instruction from you, or your answer to a question the computer program is asking.

- Command line-the place on the screen you need to "be at" when you give the computer a command.
- Communications-the process of one computer sending or receiving information from another computer.
- Compatible-this means two or more components or programs will "work together"
- Copy-to make an identical file on another disk, for someone else or for safe keeping.
- Copy protected-software is often "protected" so you can't make copies to give to your friends.
- Crash-a general term to explain that the computer quit working or you had to turn it off.
- Cursor-the little line or box flashing on the screen. It tells you "where you are."
- Cursor pad-or "Arrow" keys- they move you around by using a left, right, up or down arrow on the keyboard.
- Database (DBMS)-An electronic file cabinet system, for storing, sorting and generating reports from "file" information.
- Del-short for delete... used to delete a letter, number or word: OR, to delete-erase a "file" off the disk.
- Density-How "dense" a disk is formatted determines how much can be stored on it.
- Desktop publisher-A type of software that lets you create very nice documents for publishing your materials.
- Dir-short for "Directory."
- Directory- The directory is a list of what you have stored on a disk.
- Disk drive- The part of the computer that you put your disk into so you can get or store your information.
- Diskcopy- A DOS command that lets you copy everything on one disk to another disk.
- Diskspace- How much "room" you have on a disk to store or save your information.
- DOS. MS-DOS, PC-DOS- Different Terms for "Operating Systems," or the "instructions, rules and procedures" to operate.
- Dot Matrix Printer- prints to paper by printing tiny dots shaped into letters, numbers or symbols.
- Editing Keys (backspace, Ins)-the keys you use to "fix" your mistakes or make your work better.
- Electronic Mail System (EMS)-on the "network," a way to send and receive messages or information.

Enter or Return-The same on most computers, the key with the word "enter" or "return" and a arrow pointing left.

Erase-to remove information from a disk, permanently.

Exit-the term used to describe "leaving" a program, or quitting your work.

Expanded Memory System-a way to upgrade a computer so it can do more work at one time or run new, larger programs.

Fax-Modem card- an accessory you can add that allows you to send or receive information by phone lines or FAX.

File- a "place" on disk where your information is kept. A file could hold a report, memos or sets of numbers.

File extension- when you name a file, you can put a 3 letter word or code on the end of it to remind you what it is.

File Maintenance- the process of making sure you delete files you don't need or store them out of the way of others.

Filename- a name you give to your work so that the computer knows what you want to call it when you save it.

Floppy Disk- a plastic storage device that you slide in and out of the computer. For saving your information or data.

Format-Can be to format text(margins, centering etc.)or to format your disks(so your computer can read and write on it).

Function Keys- the keys across the top of most computers..F1 F2 ...up to F10 or F12. Used to perform various "functions".

Glossary- the place in the back of a manual or book to look to find out what they mean when they use technical words.

Graphics- the computer's ability to make pictures, designs or animation.

Hard disk- a "disk" inside the computer for storing large programs or large amounts of information: Also the "C: drive."

Hardware- a general term to describe any of the physical-electronic components. See Software.

Input-Output- various ways to get information into or out of your computer (keyboards, disks, printers, monitors, etc.).

Integrated- several computers and/or programs that "work together" by sharing information (production-accounting marketing)

Interface- a box or hardware that allows two components (that would not be compatible) to work together.

Joystick- an input device common to home video game-type computers. Could work on any computer.

Keyboard- the typewriter style input that lets you type in words, numbers etc.

Keypad- a separate set of buttons (keys) that lets you enter numbers or special information.

Laptop- a PC that is small and portable, fits on your lap.

Laser printer- the printer that fuses the letters, numbers or symbols right on to the paper for a sharp, clear image.

Load, run- to start up a program. you are actually loading a copy of the program into "memory."

Log in/out- you must sign in and out on most computers that are sharing information. Often a password is needed.

Lotus, Symphony, Excel- "SpreadSheet" programs that let you "crunch" (calculate) sets of numbers. Good for "What if?"

Mainframe\HP-Warn's large computer that runs AMAPS or PowerSoft. Other computers or terminals are "on line" with it.

Megabyte- A million bytes or characters of information. A measuring standard for memory and storage.

Memory- the area in the computer where the computer does its work. It must be able to remember data while it works.

Menus- an easy to use method of letting you look at the screen and choose one of several different options.

Milliseconds-or MS, a fraction of a second, used to rate how fast a disk drive can retrieve or save information.

Modem- an accessory that allows your computer to send or get information over phone lines.

Monitor- the screen or display, looks like a TV screen.

Monochrome, CGA, EGA, VGA, SVGA- different types of monitors, denoting color and quality of resolution.

Motherboard- the main section of hardware across the bottom of the inside of the computer, where most processing occurs.

Mouse- input device that lets you move the cursor around the screen very quickly and make a choice by clicking a button.

Network- a system of computers that are connected together to share programs and information.

Non-system disk-when you leave a regular disk in the drive and turn on the computer, you will get a Non-System Disk error.

Operating Systems- the rules, procedures and information the computer needs before it can operate, usually called "DOS."

OS/2 UNIX- Different types of "Operating Systems" used by larger or different kinds of computers.

Pagemaker- A desktop publishing program. Lets you design nice pages for presentation or publication.

Parallel- information moves faster when a device is "parallel" in runs together along parallel circuits. See "Serial".

Password- a special word or phrase that you are given or make up that allows only you to use certain areas on a computer.

PC- Personal Computer, most computers that are small enough to sit on a desk are considered PC's.

Peripherals- all the different things you hook up to a computer, printers, monitors, modems, etc.

Plotter- a unique type of printer that uses pens and allows you to make designs or perform drafting.

Ports, bus- the slots or connectors on the back of the computer for hooking up peripherals.

Power switch- the on and off switch.

Prompt-a message or symbol that indicates the computer is waiting for your input or a decision.

RAM-Random Access Memory,the "Memory," or place where the computer loads information and programs while its working.

Reset- usually a button on the computer that starts the computer from scratch. Use only when you really get stuck.

ROM-Read Only Memory,-Memory that is ready and is read by the computer when it first comes on. It is not changeable.

Save- to make a copy of your work on the disk. So you can come back and work on it later as needed.

Scanner- an accessory that allows you to "import" words, numbers or pictures by scanning a "hard copy" (off of paper).

Screens- a term referring to different areas in a software/program that let you do different types of things in the program.

Serial- information moves slower, in a line sequentially as opposed to "parallel."

Software- Programs and information that is changeable. As opposed to "hardware" that stays the same.

Spreadsheet-a type of program\software

Standalone- refers to a computer that is able to do work without being hooked to another computer.

Subdirectory- an area in a directory for storing files that are common or related to each other.

Terminal- a keyboard and monitor that are connected to a main computer somewhere else. Can't Standalone.

Tracks, Sectors- the way a computer divides a disk up for storing information. Not a concern unless disk goes bad.

Turbo- a button or hardware that makes the computer go faster.

Tutorial- a program or book that lets the computer teach you how to do something.

User support- People you can call who are supposed to be able to answer any question you have about the programs.

Utility- a program that lets you use your computer in a more efficient way. Many varieties of utilities.

Ventura- like PageMaker, but more extensive and powerful. Makes nice pages for presentation and publishing.

Warm Boot- when you restart the computer without turning it off. Usually by pushing the reset button.

Wildcard- when you are looking for information on disk or in a search program, the * can be used to say "anything."

Windows- a program that allows you to run several programs at once and use a mouse to quickly move around and work.

WordPerfect(WP)- the most well-known of the powerful word processors. All of your class materials are developed in WP.

Wordprocessor-a program that lets you generate and enhance text in the form of memos, letters, reports, lists, notes.

Write protection-You move a piece of plastic at the corner of your disk, then it is "write protected." You can't mess it up.

*What You Need to Know to..
"Just Get By" using a Spread
Sheet*

Before You Get Started...

► Know what commands are needed to "bring up" the spreadsheet program you plan to use. Usually you will choose it off a Menu. Sometimes you will need to type in one or more commands to bring it up.

(on our computers, after time and date, just type: 3 <then enter>)

► While spreadsheets differ, several basic commands are common to nearly all the major programs. When you understand these commands, you will be able to use the Help screens or a manual to get more specific instructions.

► You should have an idea or project when you sit down at the spreadsheet. It is much easier to learn how they work if you have an idea of the type of problems you need to solve.

Notes:

The WorkSheet Layout...

- ▷ Once you are in the program (after the initial screen, you may need to "hit any key to continue") you have a blank sheet with a frame across the top and right sides...

Across the top or bottom are some "options" or commands...

As you type in numbers, words or formulas, what you type will show up at the top of the screen. Then when you hit "enter," it will go in the "cell" that is "highlighted" with your cursor. Numbers and words you see, formulas are "hidden."

	A	B	C	D	E	F	G	H	I	J	K
1											
2											
3											
4											
5				x							
6											
7											
8											
9											

{the top left cell is called "A1," next to it is B1 and below it is A2..}

this "x" is in D5. Somewhere, way off to the lower right is a cell called FZ999, (after Z, the columns are AA, AB... and so on... depending on how large the program is.)

Notes:

Putting Numbers and Words into the SpreadSheet...

▶ Move your cursor to the "cell" where you want the numbers or words to go. Use the arrow keys, or, hit F5 to let you "Goto" a cell when you enter the name of the cell you want.

▶ Then just type in the number or words that you want. What you type shows up on the top of the worksheet, and after you type it in and hit "enter," it will show up in the cell you have chosen.

▶ Numbers may be "truncated" (shortened) to fit in the cell but the value is "remembered" just as you typed it in.

▶ Words may be longer than the cell or "column width." What you type in will just "dump" into the next cell to the right.

How to Leave the Program, or go back to DOS.

If you have not saved your work and need to, be sure to do it before leaving the spreadsheet program. For instructions, see "Saving Your Work."

Hit the "Slash" Key - / to give you a list of options. The last option is usually the "Exit" or Quit option. Move to it with the cursor and hit enter, or hit "E" for exit, (or Q for Quit).

Notes:

Putting A Formula in for Calculating in the SpreadSheet...

► Move your cursor to the "cell" where you want the answer to the formula or calculation to go.

► Type in the formula or calculation by putting it into parentheses (). You must have the left parenthesis as the first thing you type in or the spreadsheet will think you are trying to enter numbers or words.

► Spreadsheets can use "functions" like... @SUM(A1..A10) to calculate totals or other functions of numbers. For these, the "@" symbol is the first thing you type in. Then you use parentheses to tell it where the numbers should come from.

► Once you have numbers in certain cells, if you want the spreadsheet to do a calculation, you refer to the cell name in a formula... (A1 + A2).. if the number in A1 is 14 and the number in A2 is 3, anywhere you have the formula: (A1 + A2) , the spreadsheet will give you 17, or, the total of whatever numbers you may put into A1 and A2.

► You can use the + and the - signs to add and subtract. Use the * symbol to multiply and the / symbol to divide...

to multiply the number in A1 by the number in A2: (A1*A2)

to divide the number in A1 by the number in A2: (A1/A2)

☛ Note: the spreadsheet doesn't care if you use capitol or lower case letters.

A1 is the same as a1 and a2 is the same as A2.

Notes:

Copying Cells to Save Time Entering Numbers or Formula...

(These steps are covered in class, Don't try to follow them if you haven't seen this done in class yet.)

Note: Understanding the difference between copying "from" and "to" is important. There are two steps to this process.

Step 1: What "cell" to copy "From"?

► Move your cursor to the "cell" that has numbers, words or a formula you want to use in another cell.

► Hit the "slash key"... it has the / symbol on it. This brings up a list of commands and options you can use. One of the commands will be a copy command or a copy cell command. Choose this command by moving the cursor to it and hitting "enter," or just entering a letter "C" for "Copy."

► Once you select the copy command, the spreadsheet wants to know what cell you want to copy from. It usually will have the cell listed that your cursor was on when you entered the / to get to the commands. If the cell listed is the one you want to copy from, you just "enter" to accept it.

► When telling the spreadsheet which cell you want to copy from, you may want to copy a "range" of cells. In this case, you would want to tell the spreadsheet to copy the information for all the cells between two points.

You can do this when it asks you which cell(s) you want to copy from. If you wanted to copy all the formulas (or numbers or words) from cell B3 to cell B10, you would enter... B3..B10 when it asks you what cells to copy from. The two periods let the spreadsheet know you want to copy everything between B3 and B10. Then you just enter "enter."

Notes:

Step 2: What "cell(s)" to copy "to"...

► Now, the spreadsheet asks you what cell(s) you want to copy to. You answer the questions the same way as when it was asking you what cells you wanted to copy "from". If you want to copy to only one cell, say cell D3, you would enter D3..D3. If you wanted to copy to a range of cells, such as every cell from D3 to D10, just enter D3..D10. After you enter the cells you want to copy to, when you hit "enter," the spreadsheet will copy your formulas or information to those cells.

☛ Short Cut...

When the spreadsheet wants to know which cells to copy from and which cells to copy to, you can use your arrow keys to "show it" what you want.

Instead of entering D3, move the cursor (with your arrow keys) to D3. Then just hit "enter" if that is the only cell you are copying to or from. If you want to copy from or to a row or column of cells, move to the first cell, say D3, hit the period to "Anchor" the cursor at D3, then move with the arrows down to D10 or wherever you want to copy to or from.

When you hit "enter," the spreadsheet will see the area you want to copy to or from and it will follow your directions.

Notes:

Saving Your Work...

► Hit the slash / key. You will get a list of several commands and options. Choose the option called "File." Then you can choose an option called "Save" or "Store." You will be asked to give your "worksheet" a name. Use a "A:" (no quotes) to start out the name, this will save your work on your floppy disk. Give a name no longer than eight characters long. Don't use a period or "extension" on the end of the name. The spreadsheet will save your work with this name.

Retrieving Work that You have Saved, to work on some more...

► Hit the slash / key. You will get a list of several commands and options. Choose the File option. Then choose Retrieve. The screen will show the worksheets that are on the hard drive. Since you want to find your's on the floppy drive, type in an "A:" then it show you a directory of the worksheets on the floppy drive. Highlight the worksheet you want and hit enter. This will bring you back to where you left off last on your worksheet.

Notes:

What you need to know to "just get by" in Word Perfect

How to start the program:

- When you see the DOS prompt...

Like

C:\>_ or it may have a name in the prompt: C:\USER>_

Just type in.. WP{then "enter"}

- Or, if you get a menu when you turn on the computer, just select the number for Word Perfect, or, on some menus you move the "highlight" with the arrow keys then hit "enter".

Network Menu:

1. Word Perfect
2. Spreadsheets
3. Data Bases
4. Utilities

Enter the number, or highlight your choice and hit {enter}

- You may get a message such as "Are other copies of WordPerfect currently running?" On our computers just answer "no" by hitting the N.

- If you get a message such as "old backup copy exists..." On our computers you will just delete it by hitting the number 2 or letter D.

Word Perfect: Notes and Reminders...

These pages can be used as they are, or you can add your notes on the blank pages.

Be sure to come in and ask for assistance if any of this is unclear.

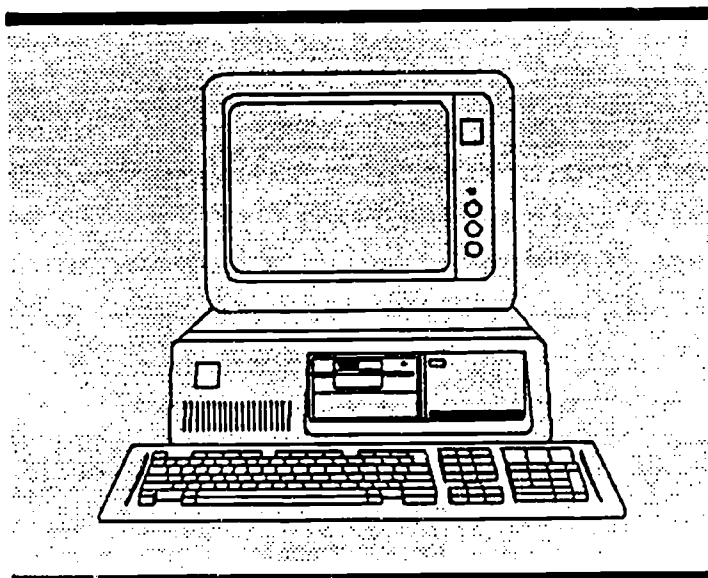

WordPerfect: How to get the program started.

On the Laptops...

1. Put your disk in first, then, from the Menu, pick choice number 2 and hit <enter>.

2. If you get one of these questions, answer with these choices...

"Other Copies...running?" Your Answer: No or N

"Old Backup Copy Exists..." Your Answer: Delete or 2

3. When you get a blank screen (except for the position numbers in the bottom right), you are ready to begin a new document. If you are starting from scratch, just start typing.

On the Network...

1. Choose F1 after the computer has been turned on and is listing the four choices (F1 is the choose to get on the network).

2. Enter your login name and password. The network shows you a data screen with your account information, the location of your printer and lets you know if you have any mail messages. To get to your choices, just hit enter.

3. A list of choices appears and Word Perfect is choice "0." Just highlight it and hit enter.

On other computers...

Usually, you can get Word Perfect by typing WP at the DOS prompt. So if you sit down at a different computer and you know it has Word Perfect, When you see a prompt like this...

```
C:\>_
```

Just type in WP and hit <enter>. If this doesn't work, you'll need more details from someone who uses that computer for Word Perfect.

Word Perfect: Making Changes

(Use the arrow or cursor keys to move to the words or letters you want to change).

1. Use the delete key to get rid of words or letters that are in front of your cursor.
2. Use the backspace key to get rid of letters or words that are behind your cursor.
3. Use the enter key to add a blank line.
4. To get rid of blank space or blank lines, move to the beginning of the spaces or line and hit the delete key. You may need to hit it several times, but don't get carried away.
5. To add extra lines or blank space, use the enter key every time you want to end a paragraph or add a blank line. If you hit enter several times it will give you more blank space.

To make words or sentences look different when printed...

Use ALT F4 to "block" the words you want to change. Do it like this...

-Go to the beginning of the word or words and hold the ALT key and hit the F4 key. This turns on the "block on" feature. Move the arrow keys to the right and "block" the word or words you want to change.

-Once you block the word or words, you can change the size or appearance by hitting CTRL-F8. (Hold control and hit F8).

-CTRL-F8 lets you choose size or appearance, choose by numbers. You will then get some more options for specific size or appearance changes. Some examples are Bold, Large, Underline and other changes.

-After you make the change, the block disappears and you may not notice any change unless you print it out to paper or "view document" (see the next page).

Word Perfect: Saving Your Work

(See the last page if you want to save the work as you "exit" or quit Word Perfect)

Saving the work as you go:

- If you want to "save" your work as you go, (a good idea if the power goes out occasionally) hit the F10 key. You will be asked for the name of the document. If the name that WP gives you is the one you want, then hit [enter], otherwise, type in a new name.
-

One thing to remember...

If WP puts a name for you to approve or change, don't answer with a Y or N. Only use the Y or the N when WP is asking you "Yes or No."

How to find and "retrieve" your work so you can work on it:

(this is when you come back at a later time and want to pick up where you left off.

- If you are at the "blank" screen (WP is loaded and you are ready to "bring up" your work (file or document), make sure the "cursor" is in the upper left hand corner of the display and that if you have typed any lines, spaces or letters that you have deleted them.

- Now, hit the F5 key. WP will ask you "where" you want to look for your work. You will have your work on a disk in the "A Drive" so if WP shows you "A:*.*" in the lower left corner, just hit [enter] and it will show you a list of documents (or files) that you can choose from.

- If you only want to "look" at one of documents listed, just highlight the one you want by moving to it with the "arrow" keys and hitting the [enter]. While "looking" you can go back to the list by hitting F7

- If you want to "retrieve" the document so you can work on it, pick the one you want by moving to it with the "arrow" keys and hitting the number 1 or an R for "retrieve."

Word Perfect: F-keys to remember...

Get Help use F3:

When you use F3, you hit the F3 key, then a letter of the alphabet that will take you to the topic you need help with. (Word Perfect tells you this when you hit F3).

For example, to find out about changing margins, hit F3 then the letter 'm' for margins. A list of topics starting with the letter 'm' is on the left side of the screen. Over on the right side, the screen list the keys you need to use to change the margins (for left and right margins, the list shows...

SHFT-F8, 1,7 this means you hold the shift and hit F8 then hit choice 1 then choice 7.)

Remember this! Before you try to change the margins or make any changes you must 'exit help' by hitting the enter key. Until you do this you will stay *in help* until you hit enter.

Look at the disk, and file options using F5...

Hit the F5 key and in the lower left corner it shows the disk directory (dir) Word Perfect is ready to show you. You can change this to "C:" or leave it as it is then hit <enter>.

The screen shows a list of all the files on the disk or in that directory.

Normally, you can retrieve by highlighting and hitting "1" to retrieve.

But you can also delete, copy or move files by choosing one of the other choices.

Use F7 to get out...

F7 is like an escape key, it lets you get out of what you are doing. F1 also lets you cancel an action but you must use F7 to leave the program.

Word Perfect: Printing and Leaving the program

How to Print out your work to the printer:

Hit shift F7 (push the shift key and while it's pushed down, push F7 key. The Print menu comes up. You must make sure the printer is online and is ready with paper. Check the Print menu for the "Select Printer" line.

The printer shown must be the printer you have ready for your computer. You can change it by hitting "S" then choosing the correct printer.

Now you can choose 1 or 2 to print either the whole document or just one page (the page you were just working on). Choose 6 if you want to "view" how it will look before printing.

How to "Get Out" or leave Word Perfect :

Hit the F7 key, it's one of the function keys across the top or left side of your keyboard.

WP, (Word Perfect) asks you if you want to **save document? Yes (no)**, (your work, would you want to save it?).

if you don't need to save any work you've done, just hit N for "no." Then WP will ask you if you want to **"Exit WP? No (Yes)"** Just hit Y for yes to leave (get out of) the program.

if want to save your work, hit a "Y" for "Yes." Then WP asks you **"Document to be saved:"** At this point, you either type in a name you want to use to identify the work (the "file" you are working on) or, it may have a name already there if you have given the work (file) a name in the past.

To accept this name, just hit [enter]. Otherwise, type in a new name for this file.

Now, it may ask you if you want to **"replace"** the document. If you want to **"update"** the document with the new work, then yes, you do want to **"replace."** If you want this to be a new document, different than one you worked on before, then hit N for "no" and type in a new name.

Now, it asks you if you want to **"Exit WP?"** Just hit Y for yes, or N if you want to start working on another document.

Notes on Networking

1. To get onto the network, you need two things...

One: A PC that is connected to the "server" by a cable.

Two: A "user name" that identifies who you are and "where" your areas are in the computer.

2. About Security...

Your Account...

Your "area" and other's areas...

You cannot "damage" the work of others while on the network.

3. The "Log in"...

Passwords...

4. Selecting programs from the "menus"

What you can choose...

More about the Network

5. Other options you can choose from the "Menus"

Electronic Mail and Messages

PathMinder

6. "Where are you?"

7. Getting at other things through Pathminder...

8. Housekeeping...

9. "Safe" Computing... "Viruses"...

8274 COMPLETES SCRAP ANALYSIS

by Scot Davidson

On September 24, members of the 8274 Cell met to develop a new procedure of scrap analysis. The team holds all scrap parts over a one month period. As a group, they evaluate all scrap parts through inspection to determine defects. This is set into a Pareto chart for analysis and action.

The first analysis revealed this Pareto:

TOP QUALITY PROBLEMS 8274 for Sept 91

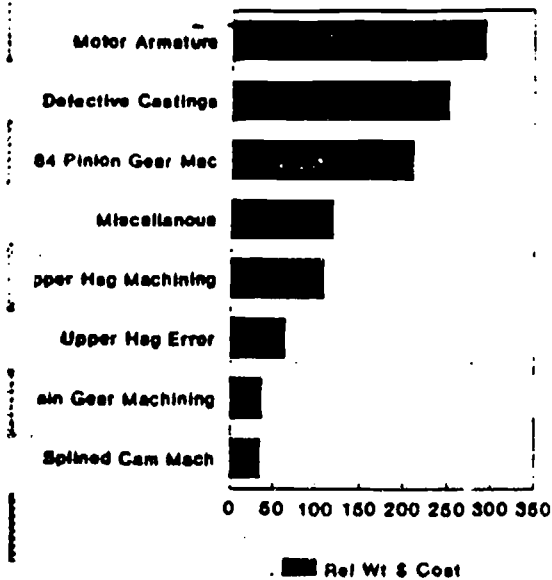

The group agreed to tackle the top four problems. Each problem was assigned to a team member for a Quality Improvement Project. The goal is to eliminate these problems and eliminate the waste.

Key observations in the first session:

Outside supplier's process is the likely cause of our number one scrap problem. Working with the supplier can reduce the cost of this defect.

Many other hidden costs are caused by scrap. Disassembly, cost of accounting, costs of additional scrap parts, cost of handling and disposal all add to a bigger waste than seen on the surface.

WGVW
CURRICULUM
COMPUTER

Mike's View



As we move into the 1990's and beyond, one of the most important areas of involvement for all citizens of the world is the environment. Warn is no exception.

We need to continuously focus on the fact that, at Warn, protecting the environment is a high priority. We are pledged to eliminate or reduce our use of toxic substances and our generation of hazardous wastes wherever possible. When waste cannot be avoided, we are committed to recycling, treatment and disposal in ways that minimize undesirable effects on the air, water and land.

It is our responsibility to uphold and fulfill these ideals, not only as individuals, but as a corporate member of the community in which we live. I urge each and everyone of you to do your utmost to participate with us in helping to protect the environment for future generations.



*For information on the...
...direct...*

Do you have a question for Mike? Give him a call or drop him a line through intercompany mail. He'll be happy to discuss any question that you may have.

10/1/91 - M. WPC