

DOCUMENT RESUME

ED 344 000

CE 060 701

TITLE State of Wisconsin Commercial Drivers License Instructor's Manual.

INSTITUTION Madison Area Technical Coll., Wis.

SPONS AGENCY Wisconsin Motor Carriers Association, Madison.; Wisconsin State Board of Vocational, Technical, and Adult Education, Madison.; Wisconsin State Dept. of Transportation, Madison.

PUB DATE 91

NOTE 629p.

PUB TYPE Guides - Classroom Use - Teaching Guides (For Teacher) (052)

EDRS PRICE MF03/PC26 Plus Postage.

DESCRIPTORS Course Content; \*Driver Education; Hazardous Materials; Postsecondary Education; \*State Legislation; State Standards; \*Teaching Methods; Test Items; \*Traffic Safety; Transparencies; \*Transportation; Units of Study

IDENTIFIERS Bus Drivers; Truck Drivers; \*Wisconsin

ABSTRACT

This instructor's manual contains seven units for a course to prepare students to pass the Wisconsin Commercial Driver's License test. The units cover the following: (1) introduction (rules and laws); (2) vehicle inspection; (3) transporting cargo safely; (4) transporting passengers; (5) air brakes; (6) combination vehicles; and (7) introduction to hazardous materials. Units include information sheets, teaching tips, sample tests, and transparencies with suggested dialog. Answer keys are provided. (KC)

\*\*\*\*\*  
 \* Reproductions supplied by EDRS are the best that can be made \*  
 \* from the original document. \*  
 \*\*\*\*\*

# State of Wisconsin Commercial Drivers License Instructor's Manual

ED344000

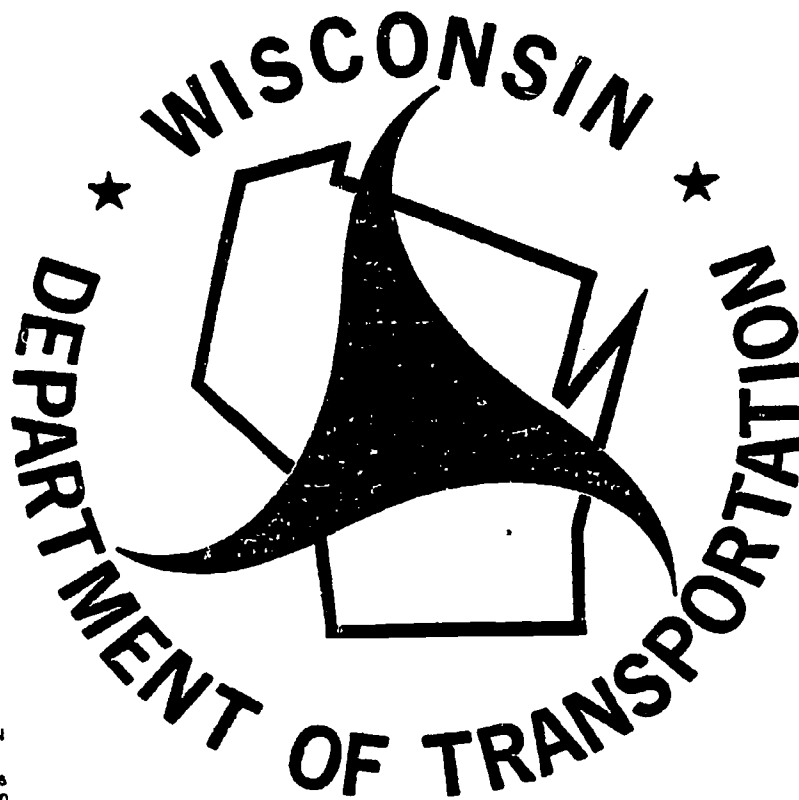

U.S. DEPARTMENT OF EDUCATION  
Office of Educational Research and Improvement  
EDUCATIONAL RESOURCES INFORMATION  
CENTER (ERIC)

- This document has been reproduced as received from the person or organization originating it
- Minor changes have been made to improve reproduction quality

- Points of view or opinions stated in this document do not necessarily represent official OERI position or policy

"PERMISSION TO REPRODUCE THIS MATERIAL HAS BEEN GRANTED BY

*L. H. Math...*

TO THE EDUCATIONAL RESOURCES INFORMATION CENTER (ERIC)."

A Project of:  
 The Wisconsin Board of  
 Vocational, Technical and Adult Education  
 The Wisconsin Department of Transportation and  
 The Wisconsin Motor Carriers Association

**BEST COPY AVAILABLE**

PREPARED BY:  
MADISON AREA TECHNICAL COLLEGE  
Madison Wisconsin 53704

CF 060 701

# TABLE OF CONTENTS

**UNIT/  
SUB UNIT      TOPIC**

**PAGE NO.**

## **UNIT 1: INTRODUCTION**

**Endorsement  
Waivers  
BAC Rules  
Summary of Key Points  
1989 Wisconsin Act 105**

## **UNIT 2: VEHICLE INSPECTION**

**2.1 Vehicle Inspection  
2.2 Basic Control  
Sample Test (2.2)  
2.3 Shifting  
2.4 Seeing Sample Test (2.4)  
2.5 Communicating  
2.6 Controlling Speed  
Sample Test (2.6)  
2.7 Managing Space  
Sample Test (2.7)  
2.8 Night Driving  
Sample Test (2.8)  
2.9 Winter Driving  
Sample Test (2.9)  
2.10 Hot Weather Driving  
Sample Test (2.10)  
2.11 Mountain Driving  
Sample Test (2.11)  
2.12 Seeing Hazards  
2.13 Emergencies  
Sample Test (2.14)  
2.14 Skid Control and Recovery  
Sample Test (2.14)  
2.15 Accident Procedures  
Sample Test (2.15)  
2.16 Fires  
Sample Test (2.16)  
2.17 Staying Alert  
Sample Test (2.17)  
2.18 Hazardous Materials  
Sample Test**

## **Unit 3: TRANSPORTING CARGO SAFELY**

**3.1 Inspecting  
3.2 Weight and Balance  
    Legal Weight Limits  
3.3 Securing Cargo  
Sample Test (3)  
3.4 Tank Vehicles**

**TABLE OF CONTENTS  
CONT'D**

Sample Test (3.4)  
3.5 Other Cargo Needing Special Attention

**Unit 4: TRANSPORTING PASSENGERS**

4.1 Endorsements  
4.2 Vehicle Classes  
4.3 Bus Types  
4.4 Who is a Bus Driver?  
4.5 Pre-Trip Inspection  
4.6 Seven Step Pre-Trip  
4.7 Pre-Trip Bus Inspection  
4.8 Final Check  
4.9 Loading and Trip Start  
4.10 In-Trip (VSI)  
4.11 Steering  
4.12 Night Driving  
4.13 Post-Trip (VSI)  
4.14 Hazardous Materials  
4.15 Bus Driver Reminder  
Sample Test (4)

**UNIT 5: AIR BRAKES**

Sample Test (5)

**UNIT 6: COMBINATION VEHICLES**

6.1 Driving Combination  
Vehicles Safely  
6.2 Combination Vehicle,  
Air Brakes  
6.3 Coupling and Uncoupling  
Sample Test (6.3)  
6.4 Double/Triples  
Sample Test (6.4)

**UNIT 7: INTRODUCTION TO  
HAZARDOUS MATERIALS**

7.1 Intent of the Regulations  
7.2 Transporting Hazardous Materials  
7.3 Communication Rules  
7.4 Loading and Unloading  
7.5 Bulk Tank Marking, Loading and  
Unloading  
7.6 Hazardous Materials, Driving  
and Parking Rules  
7.7 Hazardous Materials Emergencies  
Samples Test (7)



# **INTRODUCTORY NOTES**

**Knowledgeable**

**Enthusiastic**

**Sincere**

**Positive Attitude**

**People Oriented**

**Good Listener**

## **INSTRUCTOR**

The instructor must have a thorough understanding of the material to be presented the material must be organized in a logical manner so that the presentation builds from the know to the unknown using knowledge already acquired as a building block for new knowledge.

Enthusiasm breeds enthusiasm. The instructor must enjoy teaching and the sharing of new knowledge. The trainee should feel "If he/she is excited about it than i should be too".

As an instructor it is your responsibility to provide honest feed back to the trainee. The feedback should be honest but tempered with compassion. The trainee should feel that they can and will succeed. Avoid criticism, don't correct in front of others and never blame the trainee. If the student failed to learn maybe the instructor failed to teach.

The instructor must lead the group. As instructors our opinions should be positive towards GDL. Its good for the driver, their employers, the public. The group should look at the positive side (How it will be good for them.) Not the negative side.

Learn the names of the individuals in the group. Instructors must enjoy people. They must be able to recognize fear, uncertainty and anxiousness in the trainee. They must be patient and flexible. Not everyone learns at the same pace. Instructors must supply positive reinforcement and encouragement. Compliment when appropriate.

In order to answer a question we must first hear the question. Good listening skills are essential to good instructors. We must always strive to answer any questions completely and honestly. Don't do all the talking, ask questions of individuals at the group. Listen to see if they comprehend.

# TEST ANXIETY

Text anxiety is:

## CAUSES OF TEST ANXIETY

## OVERCOMING TEST ANXIETY

It's the worry or fear caused by having to take the CDL test. Many commercial drivers fear the loss of their livelihood because of failing the CDL test.

- **Mental Distraction** - unable to concentrate and easily distracted by noise, spouse, kids, etc.
- **Physical Symptoms** - "butterflies" in the stomach, sweaty palms, headaches, etc.
- **Mental Blocks** - unable to think about what you are doing.

The largest causes of the CDL test anxiety is FEAR OF FAILURE. Drivers are convincing themselves that:

- they never did well taking tests, so they will do poorly on this one.
- they have a very low reading and comprehension level.
- the CDL test can only be passed by college grads.
- they will lose their driving job.

All of these causes of anxiety are of the negative nature. If someone keeps telling themselves that they are no good and are doing to do poorly, they will.

**YOU CAN BEAT TEST ANXIETY IF YOU LEARN TO BELIEVE IN YOURSELF!**

The first thing that must be done is to have a positive attitude. I can do it! **YOU CAN BEAT TEST ANXIETY IF YOU LEARN TO BELIEVE IN YOURSELF.**

States that have been issuing CDL's have discovered that about 20% of drivers fail some part of the CDL test the first time (most of those never studied). Of those 20% that failed when they retook the test 98% passed.

In Wisconsin, if you currently have a Wisconsin Chauffeur license and fail any of the Knowledge Tests, you will NOT lose your driving privileges. You will be issued an Instructional Permit which will allow you to continue driving for six months. So within that six month period, you must retake and pass any of the tests that were failed.

Another task that must be done is to study. Individuals learn differently. Some people will be able to just read the manual and pass the test. Other people will need tutoring. Some people will use media (as audio tapes or video tapes). Other people learn better in the classroom setting. Whatever method works for you — use it. But remember **YOU MUST STUDY**. By studying and knowing the material, your attitude will also improve.

When you are studying or taking the test, if your shoulders are tense or your back hurts, or you feel grouchy, you are under stress. You must learn to relax. Several things that can be done to reduce stress and relax are:

**Deep Breathing.** While sitting, lying down or standing, close your eyes and breathe in slowly. Let the breath out for a count of 5-10 seconds. Take ten of these super-relaxers any time you feel tense.

**Stretching.** Practice simple stretches such as the "neck stretch." (Stretch your neck by gently rolling your head in a half circle, starting at one side, then dropping your chin to your chest, then to the other side.)

**Eat Well.** All kinds of physical activity (walking, running, etc.) help to reduce stress.

**Talk.** Take the time to talk with a friend, mate or child. Express feelings you might have been holding in. Listen to your partner.

**Laugh.** See a funny movie or spend time with a funny friend.

**Do something you like to do.** Enjoy yourself.

Now that you can relax and you have studied for the CDL test, it is the morning of the test. Get up early, then you don't have to rush.

**Do a few simple exercises.**

**Take a shower or bath.** This freshens you both mentally and physically.

**Take a last glance at your notes.**

**Eat a leisurely breakfast of good food.**

**Leave early enough for the test so that you don't have to rush.** Don't leave so early that you have too much time to waste and worry about the test.

**The CDL test will be questions with four multiple choice answers to choose from. Only one answer will be correct. Hints for taking this type of test are:**

**Carefully read the directions and mark your answer sheet in the proper place.**

**Read the question carefully to make sure you know what it is asking. Look for words such as "NOT".**

**Eliminate the choices that are obviously wrong.**

**Select the best of the choices that are left.**

**If the question is too hard, go on and come back to it. Several of the other questions may help you answer the hard ones.**

**Answer ALL questions even if you must guess at several. You must get 80% correct so you will not be punished for guessing.**

# **INTRODUCTION CDL CURRICULUM**

## **INTRODUCTORY TRANSPARENCY**

## **TRANSPARENCY A - EMPLOYER REQUIREMENTS**

## **TRANSPARENCY B - DRIVER REQUIREMENTS**

## **TRANSPARENCY C - CLASSIFICATIONS**

## **TRANSPARENCY D - ENDORSEMENTS**

The Wisconsin Commercial Driver License (CDL) Law went into effect on December 20, 1989. The act establishes a classified driver license system and implements the federal Commercial Motor Vehicle Safety Act of 1986. The law is intended to reduce or prevent commercial motor vehicle accidents and injuries. Under this law, the federal government requires states to test and license commercial vehicles following certain guidelines.

The law also requires employers to: not knowingly employ drivers with more than one license or whose licenses are suspended, revoked, or cancelled, and to ask prospective employees for 10 years of employment history.

Drivers are required to: have only one license by July 1, 1987, report convictions to employer and state licensing agency, notify employers of suspensions and revocations, and provide prospective employers with 10 years of employment history.

The new law changed the definition of chauffeur to any person who:

1. Is employed to drive a motor vehicle;
2. Who, when employed, operates a vehicle for 20 or more hours each week;  
or
3. Drives a vehicle used as a public carrier of "persons or property" for hire.

Therefore, even if you have not been required to have a chauffeur license in the past, if you are hired to drive a commercial motor vehicle effective January 1, 1991, you must have a chauffeur license or a Commercial Driver License.

Effective January 1, 1991, Wisconsin will have a classified licensing system. Class A vehicles will be combination commercial motor vehicles over 26,000 pounds, provided the towed unit is over 10,000 pounds. Class B vehicles are single commercial motor vehicles over 26,000 pounds towing trailers under 10,001 pounds. Class C vehicles are any vehicles or combination of vehicles that meets neither definition of Class A or B but is designed to carry 16 or more people, including the driver or used to transport hazardous materials. Class D includes all other vehicles not included in Classes A, B, C or including regular passenger cars and light trucks. Class M vehicles are Type 1 motorcycles.

The endorsements for classified licenses are:

- S - School Bus
- P - Passenger
- H- Hazardous materials
- N- Cargo tank
- T - Double or triple trailers
- X - Combination hazmat and tanker

## **TRANSPARENCY E - WAIVERS**

The classified license also has an air brake restriction for those vehicles that do not have air brakes. Applicants for an unrestricted CDL must be at least 21 years old and meet all federal medical standards. However, applicants over 18 years of age who meet state medical standards may receive a restricted CDL, limited to driving a commercial motor vehicle only inside Wisconsin and not in interstate commerce. Applicants for driver licenses will be required to furnish their social security numbers. The social security number will not appear on the driver license document but will be used to identify driver records between states.

Beginning January 1, 1991, 6-month permits allowing highway operation will be available to learners who have passed the CDL knowledge test. Instruction permits are also available to drivers with chauffeur licenses who have not passed the knowledge test but have passed the road test or have been grandfathered. After March 31, 1992, every person driving a commercial motor vehicle or school bus under an instruction permit must be accompanied by a person with a CDL. The person accompanying the learner must be either a licensed driving instructor or a person over 25 years old with 2 years of licensed experience driving in the same class of commercial motor vehicle.

In Wisconsin, the following people are waived from having to obtain a CDL:

1. Firefighters operating properly equipped emergency vehicles.
2. Farmers operating vehicles they own or lease, transporting agricultural products or machinery (within 150 miles of the farm).
3. Drivers operating recreational vehicles they own or lease (not used in commercial activity).

Under the federal law, no commercial motor vehicle driver may possess more than one driver license. States will exchange information on commercial driver license applicants through the newly created Commercial Driver License Information System (CDLIS) to prevent issuing a license to a person already licensed or disqualified in another state.

Under this new license, all applicants for a driver license must pass a road test in the same class of vehicle they plan to drive. Only the license endorsements for driving a school bus or commercial motor vehicle carrying passengers require that the applicant pass a road test in a school bus or passenger carrying vehicle; other endorsements just require a written test. All licenses will be renewed every 4 years. No new tests will be administered at renewal except an abbreviated written and road test for school bus drivers and a written test for those transporting hazardous materials.

Testing for all commercial driver licenses will begin January 1, 1991. All applicants for commercial driver licenses will be required to take a knowledge test; there will be additional knowledge tests for each endorsement and air brakes.



## **TRANSPARENCY F - GRANDFATHERING**

We estimate that approximately 80% of the commercial driver applicants will qualify to be "grandfathered" from the road test. Drivers with two years of experience driving the same class of commercial vehicle will be grandfathered unless the applicant:

1. Held multiple licenses in the previous 2 years; or
2. Had a license or operating privilege revoked, suspended, or cancelled in the previous two years; or
3. Was convicted of any "disqualifying" or serious traffic offense, in a commercial or non-commercial motor vehicle in the past two years; or
4. Violated any traffic control law except parking violations in connection with a traffic accident; or
5. Was at fault in any motor vehicle accident.

## **TRANSPARENCY G - DISQUALIFICATIONS**

Conviction of the following offenses (in any state) results in a 1 year disqualification for the 1st offense (3 years if transporting hazardous materials) and a lifetime disqualification on the 2nd offense:

1. OWI in a commercial motor vehicle; or
2. BAC of 0.04 or more in a commercial motor vehicle; or
3. Knowingly or willfully leaving the scene of an accident involving a commercial motor vehicle; or
4. Use of a commercial motor vehicle in commission of a felony; or
5. Refusing chemical testing.

A lifetime disqualification may be reduced to a 10 year time period if appropriate corrective action is taken.

## **TRANSPARENCY H - SERIOUS TRAFFIC VIOLATIONS**

Serious traffic violations include:

1. Speeding 15 MPH over posted limits in a commercial motor vehicle; or
2. Violating a traffic control law in a commercial motor vehicle in connection with a fatal accident; or
3. Conviction for reckless driving in a commercial motor vehicle; or
4. Conviction for improper or erratic lane change, illegal passing, or following too closely in a commercial motor vehicle.

Conviction of 2 "serious traffic violations" for violations committed in a 3 year period results in a 60 day disqualification; 3 "serious traffic violations" in 3 years results in a 120 day disqualification.

## **TRANSPARENCY I - BAC RULES**

The federal law defines a commercial motor vehicle operator with a BAC level of 0.04 or above as "operating under the influence." The driver will then be ordered "out of service" for 24 hours when apprehended. If a driver is convicted of having a BAC level between 0.04 and 0.999, he/she will be disqualified from driving commercial motor vehicles. Fines, forfeitures and penalties are identical to the OWI penalties, but there will be no demerit points, administrative suspension, or assessment if the offense involves a BAC below 0.1. A commercial motor vehicle driver with a BAC of .10 or more remains subject to the present OWI laws and penalties associated with the law. Effective 12-20-89, a person arrested and convicted for OWI in

**TRANSPARENCY J -  
THIRD PARTY TESTING**

**TRANSPARENCY M -  
TESTING PROPOSAL**

Wisconsin will have all prior offenses counted regardless of in what state or when the prior offenses occurred.

An occupational license is available for any vehicle the person was authorized to operate before suspension/revocation except a disqualified driver may not receive an occupational license to operate a commercial motor vehicle. If you lose your operating privilege in a private vehicle, you may apply for an occupational CDL.

DOT may contract with third parties such as employers, state vocational-technical schools and other public agencies to give required behind-the-wheel tests. Road tests administered by third parties will be identical to the road tests conducted by DOT, and third party testers will be required to meet the same standards and qualifications as DOT examiners.

The fee for a 4-year commercial driver license will be \$32. This fee will include any endorsements applied for at the time of license issuance. Later endorsements will require a fee of \$5. The fee for a road test in a commercial motor vehicle is \$20. The fee for all school bus road tests is \$5.

**CDL KNOWLEDGE TESTING (Proposal)**

- Essex Knowledge Test
- Core Test - 50 questions
- Air Brake Test - 25 questions
- Combination Vehicle Test - 20 questions
- Passenger Vehicle Test - 20 questions
- Double / Triple Trailer Test - 20 questions
- Tank Vehicle Test - 20 questions
- Hazardous Material Test - 30 questions
- School Bus Test - 15 questions
- Motorcycle Test - 30 questions
- ★ Begin Testing September 90
- ★ 80% Needed To Pass - Including Sign Test
- ★ Alternative Testing
- ★ Waiting Time - One Day

**WISCONSIN'S  
COMMERCIAL DRIVER LICENSING  
PROJECT**

Department of Transportation  
Bureau of Driver Licensing



## EMPLOYER REQUIREMENTS

- Not knowingly employ drivers with more than one license
- Not knowingly employ drivers whose licenses are suspended, revoked or
- Ask prospective employees for 10 years of employment history

## DRIVER REQUIREMENTS

- One license only by July 1, 1987
- Report convictions to employer and state licensing agency
- Notify employer of suspensions, revocations
- Provide prospective employer with 10 years of employment history

## WISCONSIN CLASSIFICATIONS

Classes proposed to include all drivers

- |         |  |
|---------|--|
| Class A | Combination vehicles with GCWR of 26,001 pounds or more  |
| Class B | Single vehicles with GVWR of 26,001 pounds or more   |
| Class C | Commercial vehicles less than 26,001 pounds transporting hazardous materials requiring placarding, or designed to carry 16 or more people including the driver |
| Class D | Non-Commercial vehicles less than 26,001 pounds  |
| Class M | Motorcycles  |

## WISCONSIN WAIVERS

- Firefighters operating properly equipped emergency vehicles.
- Farmers operating vehicles they own or lease, transporting agricultural products or machinery within 150 miles of the farm (excludes for hire transport)
- Drivers operating recreational vehicles they own or lease (not used in commercial activity)

## WISCONSIN ENDORSEMENTS

- |   |                               |
|---|-------------------------------|
| T | Double/Triple Trailers        |
| P | Passengers                    |
| N | Tank Vehicles                 |
| H | Hazardous Materials           |
| X | Hazardous Materials + Tankers |
| S | School Bus                    |

## WHO CAN BE GRANDFATHERED?

DRIVERS MAY BE WAIVED FROM THE SKILLS TEST IF IN THE 2 YEARS PRIOR TO APPLYING FOR A CDL:

1. They have been driving a CMV regularly.
2. They have not held multiple licenses.
3. They have not had any license suspended, revoked or cancelled.
4. They have not had convictions for any of the disqualifying offenses or serious traffic violations in any vehicle.
5. They have not been at fault in any accident.

*The knowledge test cannot be waived!*

## DISQUALIFICATIONS

### Major Offenses

#### Convictions in a CMV

- OWI
- BAC (.04)
- Knowingly and willfully leaving the scene of an accident
- Refusing a chemical test
- Felony involving the use of a CMV
- Use of a CMV to make, dispense, or distribute drugs (lifetime disqualification for 1st offense)

**Penalty**

- 1 year for 1st offense
- 3 years for 1st offense for persons with HAZMAT endorsement
- Lifetime disqualification for subsequent convictions

**DISQUALIFICATIONS  
Serious Traffic Violations**

**Convictions in a CMV**

- Speeding Excess (15 MPH over limit)
- Reckless Driving
- Improper Lane Change/Improper Passing
- Following Too Closely
- Convictions arising from fatal accident

**Penalty**

- 60 days for second offense in 3 years
- 120 days for third offense in 3 years

**BAC RULES**

- Any measurable, detectable BAC or consuming alcohol within 4 hours of going on duty  
24 hours Out of Service
- BAC .04 to .099  
24 hours Out of Service  
1 year loss of commercial privilege
- BAC .10 or greater  
24 hours Out of Service  
1 year loss of commercial privilege  
Other state OWI penalties

### **THIRD PARTY TESTING**

Wisconsin CDL law authorizes the Department of Transportation to contract with third parties such as employers, vocational-technical schools, and other public agencies to perform behind-the-wheel testing.

**ALL KNOWLEDGE TESTS MUST BE ADMINISTERED BY AUTHORIZED DOT PERSONNEL.**

### **SUMMARY OF WISCONSIN'S CDL LEGISLATION**

- One license by January 1, 1990
- Classified license system for all drivers:
  - \* A, B, and C commercial classes
  - \* D and M for regular vehicles and motorcycles
- All commercial drivers to be retested by 4/1/92
  - \* Most drivers will not need to take skills test
  - \* All drivers will have to take knowledge test
  - \* Testing begins 1/1/91
- Organizations may contract with DOT to test their own drivers
- Instruction permits required for those learning to drive a commercial vehicle

### **SUMMARY OF WISCONSIN'S CDL LEGISLATION (continued)**

- Firefighters and most farmers waived from testing and licensing requirements
- New .04 BAC standard will apply to all operators of commercial vehicles (including waived groups)
- Suspensions for OWI or points in a CMV will take both "regular" and "commercial" privileges;
  - \* if OWI was in regular vehicle, driver can apply to DOT for an occupational license
- New disqualifications apply when commercial driver is convicted of certain offenses in commercial vehicle; No occupational license will be available.

# SUMMARY OF KEY POINTS OF THE MOTOR CARRIER SAFETY BILL

1989 Wisconsin Act 105  
(Assembly Bill 605 with Amendments)

## INDEX

SECTION	NUMBER
Age and Physical Qualifications	9
Air Brake Restriction	15
BAC of 0.04	22
CDLIS	11
"Chauffeur" definition	2
"Classified" Driver Licenses	13
"Consolidated" License	12
"Commercial Motor Vehicle" definition	3
Disqualifying Offenses	18
Effective Dates	29
Endorsements	14
Falsifying Information	21
Fees	30
"Grandfathering"	17
Identification Requirements	6
Instruction Permits	7
MATTSON	24
"Not a Drop"	23
Occupationals	25
One License requirement	10
Organ Donor Card	27
Penalties	20
Purpose of the Bill	1
"Resident" definition	4
"Road Testing"	16
School Bus Licenses	26
Serious Traffic Violations	19
"Sponsorship" changes	5
Third Party Testing	28
Vehicle Groups	
Waivers	8

This information has been collected to help you answer our customer's questions about Act 105. If you cannot find the information you need, please call Luvonn Endres at 266-2237 or Alice Weiss at 266-7386. Alice and Luvonn will help your customer or refer them to Program Development staff.

# SUMMARY OF KEY POINTS OF THE MOTOR CARRIER SAFETY BILL

1989 Wisconsin Act 105  
(Assembly Bill 605 with Amendments)

## 1. Purpose of the Bill

This act establishes a classified driver license system and implements the federal Commercial Motor Vehicle Safety Act of 1986 (49 USC 2701 to 2716). The bill is intended to reduce or prevent commercial motor vehicle accidents, fatalities and injuries by:

- A. Permitting commercial drivers to hold only one driver license
- B. Strengthening the licensing and testing standards for commercial motor vehicle drivers.
- C. Disqualifying commercial drivers convicted of certain major offenses or who repeatedly commit serious traffic violations.

**2. What is a "Chauffeur?"**

**Effective December 20, 1989** - A chauffeur includes every person, including a vehicle owner who:

- A. Is employed to drive a motor vehicle, or;
- B. Who, when employed, operates a truck for 20 or more hours each week, or;
- C. Drives a vehicle used as a public carrier of "persons or property for hire."

**Effective January 1, 1991** - A chauffeur includes every person who operates a Commercial Motor Vehicle on the highway.

**NOTE:** Exceptions are defined in the Motor Vehicle law book (343.01 [(a) 1-8 (pages 109 and 110)]).

**3. What is a "Commercial Motor Vehicle?"**

A motor vehicle designed or used to transport property or passengers is a commercial motor vehicle if:

- A. The vehicle has a gross vehicle weight rating ("GVWR"), or gross combination weight rating, actual or registered weight of over 26,000 pounds; or,
- B. The vehicle is transporting hazardous materials of the type or in amounts that require placarding.
- C. The vehicle is designed or used to transport 16 or more persons counting the driver.

**4. What is a "Resident?"**

Beginning 12/20/89, a resident is someone whose home and "principle residence" is in Wisconsin. The law explains that home is the place where the adult "has the intention of returning" (343.01 (2) (g)).

A child is a resident if he/she lives with a parent or guardian who is a resident, is attending and living at a Wisconsin school, is a foreign-exchange student living with a host family in Wisconsin, is living with a relative or adult other than parent or legal guardian (with parents consent), or is on active duty with the armed services.

**5. What is new about sponsorship?**

The law has become more specific about who under age 18 can file insurance and choose not to have a sponsor.

- A. A person under age 18 is not required to have a sponsor sign for them if he/she is not living with parents and is a full time student or is earning a living.
- B. Other exceptions will be laid out by Administrative Rule rather than in the statutes themselves.

**6. Identification Requirements for all Driver License Applicants.**

Applicants for driver licenses will be required to furnish their social security numbers. The social security number will not appear on the driver license document but will be used to identify driver records between states. (These requirements may be waived for religious reasons.) In addition, the bill will allow the DOT to acquire biometric data (such as digitized finger prints or retinal patterns). Federal Highways Administration (FHWA) will issue the standards for required biometric identification data in 1990.

7. **Instruction Permits.** Beginning 1/1/91, 6-month permits allowing high way operation are available to learners who have passed the CDL knowledge test. Instruction permits are also available to drivers with "chauffeur" licenses who do not pass the knowledge test, but pass the skills test or are "grandfathered."

After March 31, 1992, every person driving a commercial motor vehicle or school bus under an instruction permit must be accompanied by a person with a CDL. The person accompanying the learner must be either a licensed driving instructor or a person over 25 years old with 2 years of licensed experience driving in the same class of commercial motor vehicle.

8. **Waivers.** Federal law allows states the option to waive certain kinds of drivers from the requirement to obtain a CDL. In Wisconsin, fire fighters, recreational vehicle drivers and farmers may not need a CDL but will remain subject to the alcohol prohibitions that apply to all commercial motor vehicle drivers.

- A. **Fire fighters** will not need a CDL to drive properly equipped emergency equipment.
- B. The driver of **recreational vehicles**, such as a motor home, fifth wheel mobile home or touring mobile home will not need a CDL, provided the driver owns or leases the vehicle and it is not being used in connection with any commercial activity.
- C. A **farmer** will not need a CDL to drive a commercial motor vehicle owned or leased by the farmer, provided the vehicle is not used "for hire," is transporting farm supplies, produce or machinery to or from the farm and is within 150 miles of the farm. The farm supplies that a farmer may transport without a CDL may include hazardous materials.

A farmer driving a vehicle with double or triple trailers, or designed to carry 16 or more passengers must first obtain a CDL with proper endorsements.

9. **Age and Physical Qualifications.** Applicants for an unrestricted CDL must be at least 21 years old and meet all federal physical qualifications. However, applicants over 18 and persons who meet state physical standards may receive a **restricted CDL**, limited to driving a commercial motor vehicle only inside Wisconsin and not in **interstate commerce**.

10. **The one license requirement.** Under federal law, no commercial motor vehicle driver may possess more than one driver license. States will exchange information on commercial driver license applicants through the newly created Commercial Driver License Information System ("CDLIS") to prevent issuing a license to a person already licensed or disqualified in another state. Wisconsin will eliminate the present separate chauffeur and school bus license documents in 1990 and will adopt a single "classified" license system for **all** drivers in 1991.

11. **What is CDLIS?** The Motor Carrier Safety Act mandates a Commercial Driver License Information System (CDLIS). This system "connects" all 50 states and the District of Columbia. Each time a license (Commercial Driver License - CDL) is issued or updated, the system must be checked to verify driver status before issuing. It is similar to the National Driver Register.



12. **The "Consolidated" License.** Wisconsin will begin to eliminate its present multiple licenses starting on 1/1/90. Any driver holding a combination of regular, chauffeur or school bus licenses may choose to exchange them for a photo-license that consolidates the multiple licenses into a single license document. The current non-photo chauffeur and school bus licenses will be gradually replaced during renewals. Only drivers choosing to renew by mail will receive the old-style "paper" licenses, and none of these will be valid after 3/31/92. Issuance of a single classified driver license will begin 1/1/91. By 4/1/92, the federal deadline, all of the current and consolidated licenses will have been replaced by a classified driver license that meets federal standards.
13. **The "Classified" Driver License.** Early in 1991, issuance of a new kind of driver license begins. A driver's "classified" license will list each of the five classes of motor vehicles the person is authorized to drive along with the endorsements and restrictions each driver needs.
- A. **"Class A"** for the combination commercial motor vehicles over 26,000 pounds, provided the towed unit is over 10,000 pounds
  - B. **"Class B"** for the single commercial motor vehicles over 26,000 pounds and such vehicles towing trailers under 10,001 pounds
  - C. **"Class C"** for any vehicles or combination of vehicles that meet neither definition of class A nor B but are designed to carry 16 or more passengers or used to transport hazardous materials
  - D. **"Class D"** for all other vehicles not included in classes A, B, C, or M, including regular passenger cars and light trucks
  - E. **"Class M"** for type 1 motorcycles
14. **Endorsements for Classified Licenses.** For certain types of operation, persons will take special tests in addition to the standard license testing and receive special license endorsements showing they have qualified to drive. The endorsements are:
- A. School buses "S"
  - B. Passengers "P"
  - C. Hazardous materials "H"
  - D. Cargo tank "N"
  - E. Double or triple trailers "T"
  - F. Combination HazMat and tanker "X"
15. **Air Brake Restriction.** Drivers who pass special knowledge tests concerning air brake systems and pass the behind-the-wheel test in a commercial motor vehicle equipped with air brakes will receive a CDL without an air brake restriction. Licenses with an air brake restriction are only valid for operating commercial motor vehicles that do not have air brakes.
16. **"Road Testing."** Present law requires only automobile drivers, school bus drivers and motorcycle operators to pass road tests in the type of vehicle they plan to drive. In the future, all applicants for a driver license must pass a road test in the same class of vehicle as they plan to drive. The license endorsements for driving a school bus or a commercial motor vehicle carrying passengers require that the applicant pass a road test in a school bus or passenger-carrying vehicle. When the commercial driver license program begins in early 1991, many experienced drivers will qualify to be "grandfathered," and will not need to take these road tests.



17. **“Grandfathering.”** DOT estimates that road tests may be waived for approximately 80% of Wisconsin commercial motor vehicle drivers (160,000 out of about 200,000 drivers). Federal law allows Wisconsin to waive road tests for CDL applicants with 2 years experience driving the same class/type of commercial motor vehicle, unless the applicant:
- A. Held multiple licenses in the previous 2 years
  - B. Had a license or operating privilege revoked, suspended, or cancelled in the previous 2 years.
  - C. Was convicted of any “disqualifying” or serious traffic offense, in commercial or non-commercial motor vehicle, in the past 2 years
  - D. Violated any traffic control law (except parking violations) in connection with a traffic accident
  - E. Was at fault in any motor vehicle accident

Drivers who have already passed road tests in the same class of commercial motor vehicles, including Wisconsin school bus drivers, do not need the 2 years of experience to qualify for “grandfathering.” The knowledge test required for all CDL applicants cannot be waived.

18. **Disqualifying Offenses.** Conviction of the following offenses (in any state) results in 1 year disqualification for 1st offense (3 years if transporting hazardous materials) and a lifetime disqualification on 2nd offense:
- A. OWI in a commercial motor vehicle
  - B. BAC of 0.04% or more in a commercial motor vehicle
  - C. Knowingly and willfully leaving the scene of an accident involving a commercial motor vehicle
  - D. Use of a commercial motor vehicle in commission of a felony
  - E. Refusing chemical testing
19. **“Serious Traffic Violations.”**
- A. Speeding 15 mph over posted limits in a commercial motor vehicle
  - B. Violating a traffic control law in a commercial motor vehicle in connection with a fatal accident
  - C. Conviction for reckless driving in a commercial motor vehicle
  - D. Conviction for improper or erratic lane change, illegal passing, or following too closely in a commercial motor vehicle
20. **“Serious Traffic Violations” Penalty = Disqualification.** Conviction of 2 “serious traffic violations” for violations in a commercial motor vehicle committed in a 3 year period results in a 60 day disqualification; 3 “serious traffic violations” in 3 years results in 120 day disqualification.
21. **Falsifying Information.** Knowingly falsifying information or certifications when making an application for a CDL may result in a disqualification or license cancellation, revocation or suspension for at least 60 days, plus any other penalties under state law.

**22. 0.04 BAC.** After 1/1/91, commercial motor vehicle drivers must obey regulations on the use of alcohol and controlled substances similar to the federal regulations that already apply to the crews of commercial aircraft, trains and ships. The alcohol regulations include a new and lower OWI "per se" level. Federal law defines a commercial motor vehicle operator with BAC of 0.04 or more as "operating under the influence." The driver must be immediately ordered "out of service" for 24 hours when apprehended. A driver convicted of this violation will be disqualified from driving commercial motor vehicles. Fines, forfeitures and jail penalties for a BAC of 0.04% to 0.1% are identical to the current OWI penalties, but there will be no demerit points, administrative suspension or assessment if the offense involves only a BAC below 0.1%. A commercial motor vehicle driver with a BAC of 0.1% or more remains subject to the present OWI laws, including administrative suspension and automatic license revocation or suspension upon conviction.

**23. "Not a Drop" for CMV Operators.** After 1/1/91, commercial motor vehicle operators in possession of alcohol while on duty, on duty within 4 hours of consuming alcohol or having any measured alcohol concentration above zero must be immediately ordered "out of service" and issued a citation. Conviction for this offense results in a \$10 forfeiture but will not cause demerit points to be assessed or any license suspension, revocation or disqualification. The 24 hour out-of-service orders are reported to the DOT and recorded on the driver's record.

**24. MATTSON and OWI.** Beginning 12/20/89, a person arrested and convicted for OWI in Wisconsin (on or after 12/20/89), will have all prior offenses on record counted regardless of when or where the prior offenses occurred, even those which occurred in Minnesota.

**25. Occupational Licensing.** An occupational license is available for any vehicle the person was authorized to operate before suspension/revocation, except the occupational license does not allow a disqualified driver to operate a commercial motor vehicle.

*Waiting periods, restrictions and requirements are the same as in present law. However, the 15 day waiting period before an occupational license may be issued to a person whose license was revoked or suspended after accumulating 12 demerit points in a 1 year period is eliminated.*

Special provision allows DOT, instead of the courts, to issue an occupational license to a CDI holder whose license was revoked or suspended for OWI while operating a non-commercial motor vehicle or for demerit points.

**26. School Bus Licenses.** The CDL bill continues to require school bus drivers in Wisconsin to meet the same special standards as present law. Drivers will be tested when they first apply for a school bus endorsement and must also pass the knowledge tests and an abbreviated skills test every 4 years to renew their school bus endorsements.

Wisconsin will not continue issuing school bus licenses to residents of neighboring states, but will honor a school bus license issued by other states.

- 27. New Organ Donor Card for Commercial Driver Licenses.** A description of the different classes of vehicles and of each of the class, endorsement and restriction codes will occupy all the space on the reverse side of the commercial driver license document. An organ donor form will be printed on an organ donor card that may be attached to the back of the CDL by an adhesive strip. On driver licenses that do not authorize the operating of commercial motor vehicles, the organ donor information will continue to appear on the back of the license document. The space to affix an "organ donor" sticker will be moved to the face of the license document.
- 28. Third Party Testing.** The Wisconsin Department of Transportation may contract with third parties such as employers, state vocational-technical schools and other public agencies to perform required behind-the-wheel testing. Road tests by such third parties will be identical to the road tests conducted by the DOT and the third party testers will meet the same qualifications and training standards as the DOT's license examiners.
- 29. Effective dates.** *The CDL program will go into effect in three stages over a period of approximately 30 months.*
- A. 12/20/89 (Act 105 goes into effect.), the interim consolidated license will be announced and we should be issuing them by 1/1/90.
  - B. *On January 1, 1991, the CDL license system is created.* Road testing in the appropriate class vehicle will begin about this time. Existing "chauffeur" licenses are then valid only for operating commercial motor vehicles. Replacement of the separate school bus license by a school bus endorsement begins. Technical changes necessary to implement the CDL program requirements are made to statutory definitions and to existing statutes concerning evidence of blood alcohol concentrations below 0.1% and 0.05% BAC.
  - C. *On April 1, 1992, the CDL program is completed by full implementation of the federal disqualification provisions.* The former chauffeur license is repealed. Instruction permits may be used to drive a commercial motor vehicle only if the permittee is accompanied by another person holding a CDL. Federal highway funds will not be withheld from a state which fully complies with the federal Commercial Motor Vehicle Safety Act by 4/1/92.
- 30. Driver License Fees.** The licensing fees for drivers of automobiles and other non-commercial motor vehicles will remain unchanged. A temporary \$2 increase in the fees for chauffeur and school bus licenses will offset the costs of providing the interim "consolidated" driver license until 1991. The fee for a commercial driver license will be \$32 for a four year license. The CDL fee is lower than the present combined fees for a regular and chauffeur license over four years (\$33). The \$32 fee will include any endorsements for which the person applies at the time of license issuance. A commercial driver license may also be "upgraded" later to add authorization to drive additional classes or types of vehicle for \$5 each. When the particular license upgrade requires a road test, an additional road test fee will be charged.

*The fee for a road test in a commercial motor vehicle is \$20. The fee for a road test in a non-commercial motor vehicle continues to be \$5. The road test fee for all school buses, regardless of size, is \$5.*

# **VEHICLE INSPECTION**

## **Unit 2.1**

**Video Tape:**

# **BASIC CONTROL**

## **Unit 2.2**

**VISUAL 2.2.1**

**Must inspect a vehicle because:**  
**Safety (most important)**  
**Legal Requirement**

**Three (3) types of inspection**

- 1. Pre-trip**
- 2. Driving**
  - A. 1st 25 miles**
  - B. Every 150 miles or 3 hours**
- 3. Post trip**

**"Commercial Drivers License Pre-trip Vehicle Inspection"**

**To drive a vehicle safely, you must be able to control its speed and direction. Safe operation of a commercial vehicle requires skill in four areas:**

- 1. Accelerating**
- 2. Steering**
- 3. Shifting Gears**
- 4. Braking**

**Always remember two basic rules:**

- Wear your seatbelt while you drive; and,**
- Always apply the parking brake when you leave the vehicle.**

**Let's talk about proper acceleration. Don't allow the truck to roll back when you start off. Proper coordination of clutch, brake, and accelerator controls is a must.**

**Release the brakes only when you are certain you will not roll back, but don't drag out the clutch release process. Proper coordination of the controls is the key.**

**As the vehicle starts to move forward, pull ahead smoothly and gradually. Hard take-offs can damage the vehicle's drive train. If the vehicle is a combination vehicle, damage to the coupling device may result.**

**When traction is limited, sudden take-offs may cause the drive wheels to spin. You may lose control. If the wheels begin to spin, ease up on the throttle.**

**Always hold the wheel properly. Use two hands, keeping them on opposite sides of the wheel toward the top. Keep a firm grasp, in case the tires hit something which might pull the wheel from your hands. Keep your thumbs from inside the wheel.**

# Sample Test

## Vehicle Inspection Unit 2.1

1. Which statement is correct?
  - A. The minimum amount of tread depth needed on a steering tire is 2/32 inch.
  - B. Radial and bias tires should not be used together.
  - C. A vehicle can be declared "out of service" if 1/8 or more leaf springs are missing or broken.
  - D. Commercial vehicles must have a fire extinguisher, warning devices, and first aid kit.
  
2. When checking hydraulic brakes, there should be firm pressure on the brake pedal after pumping the brakes how many times?
  - A. 1
  - B. 2
  - C. 3
  - D. 5
  
3. When the driver moves the vehicle forward slowly and applies the brakes, the driver is checking the:
  - A. parking brake.
  - B. service brakes.
  - C. speedometer.
  - D. both A and B
  
4. Which one of these is NOT a steering component?
  - A. Drag link
  - B. Pitman arm
  - C. Shackle
  - D. Tie rod
  
5. Which one is NOT part of the suspension?
  - A. Shock absorber
  - B. Shackle
  - C. Torque rod
  - D. Cam roller



## **VISUAL 2.2.2**

An obvious question which comes to mind is, "Which way do I turn the wheel?" Remember, with a car or straight truck, the wheel is turned in the direction you wish the rear to go. With a trailer, the opposite is true. With a trailer, turn the wheel in the direction opposite to the direction you wish the rear to go. As the trailer starts to turn, turn the wheel back to follow the trailer and control the angle between tractor and trailer.

## **VISUAL 2.2.3**

A few tips on how to back with maximum safety. Whenever possible, direct the rear toward the driver's side of the vehicle. This approach affords maximum visibility.

Never go "Blindside" unless there is no other approach possible. Go around the block if necessary to avoid a blindside approach. The extra effort is worth it when you consider how much more safely you can operate by simply seeing where you are going as you back up.

Always back up in as straight of a line as possible. If a straight line is not possible, use a flat arc as your approach path. Avoid sharp approaches, and "dogleg" type approaches.

Remember, a truck does not "Spin on a dime." You must have space in which to operate. A straight line approach cuts down on the movement from side to side of your vehicle, and requires you to take less space.

With less movement from side to side, there is also less chance of hitting something beside you.

Keep your speed down. This will allow you to spot mistakes and problems and will give you an opportunity to correct them before they become too serious. Correct mistakes and problems as soon as you spot them. Don't let the mistake or problem become serious by simply not acting to correct it.

When necessary, make corrections by pulling the vehicle ahead. Know when to reposition the vehicle and how to reposition.

Use the mirrors properly. Use the correct mirror at the correct time. Know what is behind you and around you at all times.

Select your path before you begin. Check to see if there are any hazards around or behind the vehicle. Look at overhead clearances. Look under the vehicle as well.

Many times a helper might be necessary. Use a helper if one is available. The helper can see into your blindspots, which is why having someone else to help can be so important.

## **VISUAL 2.2.3**

When using a helper, always be able to see them. Never back up when the helper is out of sight. Before backing up, arrange the signals you will use. Use hand signals, not voice signals. Be sure you agree on the signal to use to indicate a stop.

These tips for accelerating, steering, and backing work well for all types of vehicles. The emphasis should always be on safety, regardless of what you drive. A few common sense principles go a long way toward making your operation a safe operation.

The best rule for safe backing is to avoid backing altogether. Obviously this is impossible, so the next best approach is to always be certain you are aware, and in total control.

Tractor-trailers have a greater off-track than straight trucks. In fact, tractor-trailers have two off-tracks. There is an off-track of the rear wheels of the tractor. There is an even greater off-track of the rear wheels of the trailer.

### Steering Handhold

#### DRIVER'S SIDE BACKING

THINK OF THE WHEEL AS A CLOCK. PLACE YOUR LEFT HAND BETWEEN THE EIGHT AND TEN O'CLOCK POSITIONS AND YOUR RIGHT HAND BETWEEN THE TWO AND FOUR O'CLOCK POSITIONS. THIS DOUBLE GRIP HELPS YOU MAINTAIN CONTROL OF YOUR TRUCK.

Visual 2.2.1

Visual 2.2.2

# ● Sample Test

## Basic Control Unit 2.2

1. The most important hand signal that a driver and a helper can use when backing is:
  - A. direction to steer.
  - B. direction the rear of the trailer should travel
  - C. stop
  - D. distance to dock
  
2. When backing, back toward the driver's side because:
  - A. It is easier to see.
  - B. It is easier to steer.
  - C. You can use hand signals easier.
  - D. all of the above
  
3. The driver knows when to shift by:
  - A. speed.
  - B. engine sounds.
  - C. engine RPM's.
  - D. all of the above



# **SHIFTING**

## **Unit 2.3.1**

Correct shifting of gears is certainly one of the most important keys to proper vehicle operation. Perhaps no other single aspect of operation contributes more to overall smooth operation.

Correct shifting is also important for safety. If you are not in the proper gear for conditions, you are not in total control of your vehicle. Let's consider some of the factors which apply to the shifting of gears.

Most commercial trucks are equipped with manual transmissions. Proper shifting requires that the gear be changed using a double action on the clutch.

This technique is strongly recommended by all transmission manufacturers and by all transmission repair specialists. These are the people who should know. Failure to double clutch is improper shifting.

Learning to shift properly requires practice. The basic requirement is coordination, or simply the ability to do various tasks at the right time, in the right order, and at the right speed.

When learning to shift, remember one fact: it is the vehicle, far more so than the driver, which dictates when and how to shift.

The basic method of shifting up is as follows:

1. Release accelerator, depress clutch, and shift to neutral, all at the same time.
2. Release clutch.
3. Pause a moment to allow the engine RPM to drop. For smooth shifting, the rpm should drop to the point where they will be when the shift is complete.
4. Depress clutch, and shift into higher gear, at the same time.
5. Release clutch, and depress accelerator, at the same time.

Perhaps the key to learning how to shift up smoothly is learning to allow the engine speed to fall properly as the gear stick passes through neutral.

Move the stick too fast, and RPM will not fall enough and the shift will be rough; move the stick too slow, and RPM will drop too far to allow entry into higher gear. The exact speed will always depend on the situation.

While learning "how" to shift may seem difficult, learning "when" to shift is the real task of any driver. There are several signals to tell you when to shift.

One signal is engine speed. The gears must be shifted so as to keep the engine within a range specified by the manufacturer. Read the tachometer to know engine speed.

## VISUAL 2.3.2

Use "Progressive" shifting techniques if possible. Progressive shifting means using as few RPM as possible to move the truck, all the while keeping the engine within its range.

With progressive shifting, the point in the range at which you shift becomes higher as you move up in the gears.

Another signal is road speed. Learn how the gears and road speeds match. Then you may shift by the speedometer as well as by the tachometer.

Using either signal, you will soon learn to "Hear" the engine, and learn to "Feel" the engine. You will learn to recognize when it is pulling, and when it is lugging.

Now let's talk about downshifting. The principles are the same, but downshifting is often much more difficult.

The basic method of downshifting is as follows:

1. Release the accelerator, depress the clutch, and shift to neutral, all at the same time.
2. Release clutch.
3. Rev the engine to increase the engine speed to the point where it will be when the shift is complete.
4. Push in clutch, and shift to lower gear at the same time.
5. Release clutch, and depress accelerator at the same time.

Downshifting, as with up-shifting, requires coordination. The actions must be taken at the proper times, in the proper combinations, and must be performed at the proper speed.

Perhaps the key to smooth downshifting is the proper use of the rev to build engine speed, and the proper coordination of the gear stick movement with the rev.

By building the engine speed with the rev, the driver matches engine speed with the higher engine speed required for the lower gear.

As with up-shifting, certain signals will tell you when to downshift. Again, the truck far more than the driver decides when it is time to shift. You must always listen to these signals and be in the proper gear for conditions.

Certain situations demand special attention to the shifting process. One such condition is going down hills. Shift down before starting down a hill. This both slows the truck, and places the vehicle in a lower gear to help hold back the truck.

Be sure to be in a gear which is low enough — usually a lower gear than the one used to climb the hill. You should never attempt to downshift after starting down a steep hill, for you may get stuck in neutral.

**Another situation calling for special attention is shifting and curves. Shift down before entering the curve. This will stabilize the vehicle in the curve, and allow you to speed up out of the curve.**

**Many trucks, especially straight trucks, are equipped with multi-speed rear axles. These are usually controlled by a knob or button on the gear stick.**

**Learn how to use these extra gears, for otherwise you will not use all the gears your truck has. This may cause you to be in the wrong gear much of the time.**

**Some commercial vehicles have automatic transmissions. When driving these vehicles, you should shift into a lower gear or range when you go down a steep grade the same as you do with a manual transmission.**

**You downshift an automatic transmission for the same reason you downshift a manual transmission, to help hold back the vehicle. With both automatics and manual transmissions, you must not downshift and allow the engine to exceed a safe level of RPM.**

**Many vehicles have retarder devices to help slow the truck. There are several varieties of retarders such as exhaust, engine, hydraulic, and electric. All retarders may be controlled by the driver. Some retarders may be adjusted by the driver so as to overall adjust braking effect.**

**One word of caution regarding the use of retarders: Avoid their use on slick roads, for they may cause the drive tires to skid, thus causing you to lose control. Turn the retarder off when the road is slick.**

**Many drivers drive for years and never pick up some of the most basic points which apply to shifting. Remember, you must have a "feel" for shifting, and this comes only through both practice and understanding.**

## **Basic Method For Shifting Up**

**VISUAL 2.3.1**

## **DOWNSHIFTING**

**VISUAL 2.3.2**

Most heavy vehicles with manual transmissions require double clutching to change gears. This is the basic method:

1. Release the accelerator (gas pedal), push in the clutch and shift to neutral at the same time.
2. Release clutch.
3. Let the engine and gears slow down to the rpm required for the next gear. (This takes practice.)
4. Push in the clutch and shift to the higher gear at the same time.
5. Release clutch and press accelerator at the same time.

Downshifting, like upshifting, requires knowing when to shift. Use either the tachometer or the speedometer and downshift at the right rpm or road speed.

### **Special Conditions Where You Should Downshift**

Before starting down a hill, slow down and shift down to a speed that you can control without using the brakes hard. Otherwise, the brakes can get hot and lose their braking power. Downshift before starting down the hill. Make sure you are in a low enough gear.

### **Shifting Gears: Manual Transmissions**

Shifting gears properly is important. If you cannot get your vehicle into the right gear while driving, you will have less control of it.

# Sample Test

## Shifting Gears Unit 2.3

1. The sequence used when upshifting using the double clutching technique
  - A. Clutch in, neutral, release clutch, clutch in, shift.
  - B. Clutch in, neutral, release clutch, rev engine, clutch in, shift.
  - C. Clutch in, shift, release clutch.
  - D. Release accelerator, shift, (no clutch is used).
  
2. Drivers know when to shift by:
  - A. Engine sound.
  - B. Engine rpms.
  - C. Road speed.
  - D. All of the above.
  
3. Retarders should be used when:
  - A. Going down grade.
  - B. It is icy and snow covered.
  - C. It is wet out.
  - D. All of the above.

# **COMMERCIAL DRIVERS LICENSE PREPARATION COURSE**

## **Seeing**

### **Unit 2.4**

#### **VISUAL 2.4.1**

#### **VISUAL 2.4.2**

#### **VISUAL 2.4.3**

Regardless of whether you are driving the family car or one of the larger vehicles of the road, drivers all share one basic requirement for safety: We must be able to see everything around our vehicle.

Proper seeing is really a habit. In this section, we will talk about some of the things you can do to develop the seeing habits we must have to be safe drivers.

One thing to remember is that we must keep our eyes moving at all times. But keeping our eyes moving is not enough.

As we look around, our eyes are constantly giving our brain input about traffic around us but it takes time for us to realize what we are seeing. Therefore, we must build in a reaction time.

Our vehicles travel in six dimensions of space: top, underside, back, front, left and right. This means that a good driver must be able to know what is around them at all times. In order to do this, we must use our eyes intelligently.

We should be looking ahead of our vehicle for at least 12 to 15 seconds, depending on road conditions. In city driving, this amounts to looking ahead a full city block. On the open road, this means we will be looking ahead a quarter mile.

Looking ahead this distance will allow us to see hazards that will affect us immediately or in the very near future. A visual lead time of 12 to 15 seconds will give us time to make the necessary changes that the situation may call for.

What are some of the things we should be looking for? We should look for traffic situations. Be looking for brake lights which may indicate a situation which is developing. Be alert for traffic controls. Make predictions about what will happen next, but be careful to make the correct, safe prediction.

By seeing things early, we can prepare ourselves. If we're ready, we can deal with nearly all situations. The situations which we don't see and which catch us by surprise are the ones which will cause us problems.

We should look for road conditions. What is the condition of the road? Is the road ahead covered with ice? Are there scattered icy spots? Be alert for road features. Don't let anything catch you by surprise.

We realize that we cannot see everything around us at once. Therefore, we must not focus our attention in one place too long. Two seconds is the longest we should look at any object or in any single direction. When you look ahead 12 to 15 seconds, be careful not to park your eyes in any one place.

We must be looking to the sides and rear as well as toward the front. We must make regular checks using our mirrors. We must be checking both traffic and our vehicle. A good rule of thumb is to check your mirrors every five seconds or so.

**Be looking for vehicles which will enter our blind spots. If we constantly watch for vehicles behind us, we will not be surprised when they suddenly materialize in a blind spot.**

**When we check our vehicle, we should look for problems with our tires. We should check our cargo. Look for straps which have loosened or pieces of the load which are in danger of breaking free.**

**There are special situations which call for special use of the mirrors. Let's take a look at a few.**

**When we check traffic, we must check what is on either side of our vehicle in case we must make a sudden lane change. Even lane changes which are planned in advance must be done using the mirrors.**

**Look before making the first move to leave your lane. Look after you have signaled to be sure the way is still open. Right after you have started to change lanes, look a second time to be sure the way is still open. Then take a look after the lane change is complete.**

**Look in your mirror each time you make a turn. Look before merging to be sure you have enough room to fit in traffic. When you're in a tight spot, take as many extra looks in your mirrors as you need to be safe.**

**Proper use of mirrors means that you look in the correct mirror at the correct time. Be able to understand what you see in the mirrors. Take quick looks. Remember the two second rule for seeing. If you look for more than two seconds, you're staring.**

**Finally, understand the difference between what you see in a flat mirror and what you see in a convex or fisheye or spot mirror. Everything seems smaller in a convex mirror. Everything also seems further away. Know how to read the mirrors accurately. Don't use convex mirrors to judge distance.**

**By learning how to see, we may help ourselves become safer drivers. Remember, proper seeing is really the application of good seeing habits. The development of good habits requires a lot of work on the part of the driver. It's the bad habits which come easy.**

### **VISUAL 2.4.3**

# Sample Test

Seeing  
Unit 2.4

1. How far ahead should you be looking at 55 mph?

- A. 5 vehicle lengths
- B. 6 vehicle lengths
- C. one block
- D. 1/4 mile

2. Always look ahead at least:

- A. 5 - 7 seconds.
- B. 6 - 8 seconds.
- C. 10 - 12 seconds.
- D. 12 - 15 seconds.

3. When using mirrors:

- A. Compensate for distortions in convex mirrors.
- B. Use all mirrors.
- C. Be aware of blind spots.
- D. all of the above



# **COMMERCIAL DRIVERS LICENSE PREPARATION COURSE**

## **Communicating**

### **Unit 2.5**

#### **VISUAL 2.5.1**

When we drive, we must communicate with the drivers of other vehicles. When we communicate, we are making known two things. First, we communicate our intention. Second, we communicate our presence.

When we turn, we must signal our intention to do so. There are three good rules for using turn signals.

**One:** Use the signal early. Letting others know what you intend to do often will give you the opportunity to complete your maneuver.

**Two:** Signal continuously. Don't cancel the signal halfway through the maneuver. Keep both hands on the wheel.

**Three:** Cancel the signal when the turn is complete. If you leave the signal on after the maneuver is complete, other drivers will be confused. Confusion is always a recipe for problems.

Communication is required for safe lane changing.

Put on the signal before making your move. Then change lanes slowly, so the driver who failed to see your signal may react.

It's a good idea to signal when slowing down. A few light taps on the brake pedal will activate the brake lights and get the message across. If you must drive on the road at very slow speeds, use your emergency flashers.

To warn drivers behind you of danger ahead, again use the brake lights. The size of your vehicle makes it difficult to see around it, so a little help to those behind is often a good idea.

When you face a tight maneuver which requires slow speeds, again, tap your brakes to warn the drivers behind you.

If you are required to stop on the road such as buses must do when coming to a train track, again, give some advance warning.

One thing you should not do is direct traffic with your vehicle signals. This is especially true for signaling when it is safe to pass. If you give signals and there is a problem, you may be liable for damages.

At times, we communicate not to tell what we intend to do, but rather to indicate our presence.

Let's look at a few situations when this is the case.

When passing, make sure the other driver sees you and knows what you are doing. Tap the horn lightly if local law allows it, but be careful not to startle anyone. This could cause an accident. At night, you could quickly flash your lights.

Whenever visibility is limited, communicate to show others your presence. When it's snowing, or foggy, or simply when the light is poor, turn on your headlights. Don't use only your clearance lights. And remember, high beams bother people in the day as well as at night.

At times, it will be necessary to use your horn to make sure others see you. But be careful; as we've said, if you startle someone with a blast from your horn, you may cause an accident.

Finally, when you are stopped either on or beside the road, you must let other drivers know of your presence. One way to do this is to use your emergency flashers. When you stop, put on the flashers immediately.

In addition to the flashers, it may be necessary to place reflective devices around the vehicle if you are stopped for more than 10 minutes. The most common kind of device in use today is the orange triangle.

Where you place the devices depends on the situation. On a two lane road, place one device 10 feet behind the vehicle, another 100 feet behind the vehicle, and the third 100 feet in front of the vehicle toward oncoming traffic.

On a four lane road, the devices all go behind the vehicle toward approaching traffic. The distances are 10 feet, 100 feet, and 200 feet.

When you stop below the crest of a hill or near a curve, you must place the devices so that approaching traffic will have a 500 feet warning.

Two final words about warning devices. The sequence in which you place the devices and then remove them should always be such that other drivers have maximum warning of your vehicle's presence. And finally, use the devices to protect yourself as you put them in place.

If we properly communicate with the other drivers on the road, confusion should be held to a minimum, and we should have the maximum opportunity to accomplish our objectives.

# Sample Test

## Communicating Unit 2.5

1. You stop on the right shoulder of a level two-way traffic highway. Where should you place the emergency reflectors.
  - A. 10 feet in front, 10 feet to the rear, and 100 feet to the rear
  - B. 100 feet in front, 10 feet to the rear, and 100 feet to the rear
  - C. 10 feet to the rear, 100 feet to the rear, 200 feet to the rear
  - D. 10 feet to the front, 100 feet to the rear, and 500 feet to the rear

# COMMERCIAL DRIVERS LICENSE PREPARATION COURSE

## Controlling Speed Unit 2.6

### VISUAL 2.6.1

Let me ask a question to begin our study of speed control:

Q: What are two forces that control speed?

A: The legal limit or road conditions (whichever is lower in terms of mph)

The legal speed is the maximum speed allowed. This can be by statute (example: unposted residential area) or by a posted sign. The road condition speed is the maximum legal speed adjusted for adverse conditions such as traction, curves, visibility, traffic, or driving surface and terrain.

**REMEMBER:** Driving above these limits is a major cause of fatal crashes.

Once a vehicle is in motion, it will continue in motion until acted upon by an opposing force. The faster the speed, the greater the opposing force needed to stop the vehicle. This force can be shown in terms of average time and average distance traveled. We refer to it as total stopping distance.

Q: What elements make up "Total Stopping Distance?"

A: Perception Distance  
+ Reaction Distance  
+ Braking Distance  
Total Stopping Distance

Let's take a minute to define these elements:

1. Perception distance. This is the distance the vehicle travels from when the driver sees the hazard until the brain recognizes it. For the alert driver, it is about 3/4 of a second. At 55 mph, you travel 60 feet in 3/4 second.
2. Reaction distance. This is the distance traveled from the time the driver's brain tells their foot to move from the accelerator until the foot is actually pushing the brake pedal. The average driver has a reaction time of 3/4 second — an additional 60 feet traveled at 55 mph.
3. Braking distance. This is the distance the vehicle will travel before reaching a stopped position once the brakes are put on. Braking distance includes brake lag and maximum brake. Brake lag is the amount of time between applying the foot valve until the brakes reach maximum efficiency. Then maximum brake is the time needed to reach the stopped position. At 55 mph on dry pavement with good brakes, it can take a heavy vehicle about 170 feet to stop. This takes about 4.5 seconds.
4. Total stopping distance. In terms of feet/seconds this is the total or sum of perception distance plus reaction distance plus braking distance. So, at 55 mph, it will take about 6 seconds to stop. The vehicle will travel about 290 feet. (pd = 60') + (rd = 60') = (bd = 170') = 290 feet.

11

**Q:** Does anyone know how to calculate the distance traveled in  $3/4$  of a second by using the mph speed shown on the speedometer?

**A:** This can be done by taking the first digit shown on the speedometer and adding it to the speed the vehicle is traveling. In our example just mentioned, we stated the vehicle traveled 60 feet in  $3/4$  of a second. Remember, we were traveling at 55 mph. In this example, both digits are 5's but we're concerned with the ten's digit which is the first 5 when read left to right. So take this 5 and add it to the speed of 55. The sum is  $55 + 5 = 60$  or 60' traveled in  $3/4$  second.

Let's try it at 65 mph. First we take the first digit when read from left to right.

**Q:** What is it?

**A:** Six (6). That's correct.

**Q:** Now what do we do?

**A:** That's correct. We add this six to the speed the vehicle is traveling.

**Q:** What is our speed?

**A:** 65 mph is correct. So when we add  $6 + 65$ , we get 71.

**Q:** What does this tell us?

**A:** The vehicle will travel 71 feet in  $3/4$  seconds at 65 mph. Good!

Speed has a great effect on stopping distance. When vehicle speed is doubled, the stopping distance is about four times as great. This also means the vehicle will have four times the destructive power in a crash. Braking distance can be reduced a lot just by slowing down a little.

It is important we realize that, in addition to speed, total stopping distance will be determined by several factors affecting the elements just stated. Vehicle weight, mechanical condition of the equipment, braking system, tires, weight and type of cargo plus weather and road conditions all play a major part in determining the vehicle's total stopping distance. Added weight will require the brakes to work harder in order to stop the vehicle, but heavy vehicles are designed to work best when fully loaded. Empty trucks require greater stopping distances due to lost traction from the bounding of the wheels. (Buses are not usually affected this way.)

**REMEMBER:** It must be every driver's goal to maintain rolling traction, and keep the front ahead of the rear of the vehicle. Avoiding wheel lockup is one way to achieve this goal! A spinning or skidding wheel tries to lead. Maintain rolling traction!

Slower speeds are required on slippery surfaces. Wet roads can double stopping distances so the driver must reduce speed by about one-third on a wet road. When driving on packed snow, reduce speed by one-half or more. While driving on a surface covered by ice, reduce speed to a crawl and stop driving as soon as you can safely do so.

It is necessary for the driver to readily identify the signs of slippery surfaces in order to properly adjust the vehicle's speed. The driver must look for:

1. Shaded areas
2. Bridges
3. Melting ice
4. Black ice
5. Vehicle ice
6. Slick roads just after rain begins
7. Hydroplaning

1. **REMEMBER:** Shaded parts of the road will remain slippery long after open areas have melted.
2. **REMEMBER:** The surface of a bridge will freeze before the road will when the temperature is dropping. Always use extreme care when the temperature is close to the freezing point (32 degrees F).
3. **REMEMBER:** Melting ice or wet ice is much more slippery than ice that is not wet. So be on the lookout for the slightest melting conditions.
4. **REMEMBER:** Black ice is a thin layer of ice that is clear enough to allow the road surface to be seen underneath it, and will give that surface a wet look. Any time the surface temperature is at a point where it causes freezing, watch out for black ice and adjust the vehicle's speed accordingly.
5. **REMEMBER:** To look for ice forming on the vehicle simply by opening a window and feeling the front of the mirror, mirror support, or antenna. If ice can be found here, then the road surface is probably starting to ice up. Also, watch for wheel spray or the lack of wheel spray. When the road looks wet and there appears to be no wheel spray, chances are ice will be on the road surface.
6. **REMEMBER:** To also adjust the vehicle's speed just after rain begins because this is when road oils are washed to the surface, making the road very slippery until the rain has had time to wash the oil away.
7. **REMEMBER:** Hydroplaning occurs when the tires are lifted off the road's surface by water or slush present on the road's surface. It's like water skiing. When this happens the tires have little or no traction. The driver may not be able to steer or brake.
8. Control can be regained by releasing the accelerator and pushing in the clutch. This will slow the vehicle while allowing the wheels to turn freely. Avoid using the brake to slow down. If the drive wheels start to skid, push in the clutch to let them turn freely. This helps to maintain rolling traction while keeping the front ahead of the rear of the vehicle.



Hydroplaning can happen from a thin layer of surface water or at a speed as low as 30 mph if more water is present. Low tire pressure, as well as worn tire tread, both contribute to hydroplaning. The grooves in a tire carry away the water; if they aren't deep enough, the water cannot be carried away. Beware of puddles. The water is often deep enough to cause hydroplaning.

When drivers approach a curve, they must consider additional factors before entering, while driving through, and after leaving it.

1. **ENTERING:** The vehicle's speed must be adjusted before the curve. Be alert for road signs (speed limit, curve signs). The proper speed is needed for two important reasons: A) If a curve is attempted at a speed too fast, the wheels can lose their traction, causing the driver to lose control. The vehicle will fail to remain on the road surface and continue straight ahead or skid off the road. B) The wheels may keep their traction but the vehicle roll over. Tests have shown that trucks with a high center of gravity can roll over at the speed limit for a curve. Know your cargo and drive accordingly. We'll talk more about cargo in a few minutes.
2. **IN THE CURVE:** Brake before the curve. When the vehicle has entered the curve, braking will be very dangerous. It is easy for wheels to lock up, resulting in a skid. It is necessary to maintain a safe speed; always avoid exceeding the posted speed limit. Never go into a curve at a speed higher than the posted speed limit, and use the proper gear. The proper gear is one that will let the vehicle accelerate slightly in the curve, helping the driver maintain control.
3. **AFTER:** Leaving the curve, the driver will resume a safe driving speed while continuing safe driving practices.

**SIGHT DISTANCE AND SPEED:** Always drive at a speed that will allow the vehicle to stop once a hazard has been identified. Fog, rain, or other conditions require the driver to slow down. At night, slow down while headlights are on low beam. Make sure the speed is not over-driving the headlights even when using high beams.

**ROLL-ON, TRAFFIC FLOW:** Driving in heavy traffic requires flow! This means, the safest speed is the speed of other vehicles. There is less of a chance for a collision when vehicles going in the same direction are being driven at the same speed as long as it is a safe and legal speed. Maintain a good space cushion by keeping a safe following distance.

**RE...MBER:** Avoid using speed as a tool for catching up for lost time. If you're off schedule when you leave, plan to arrive late. When speed is used to get to a destination sooner, very little time will be gained. When tempted to speed, think of these risks:

1. More passing = greater chance for a crash;
2. More tiring = greater chance for a crash;
3. More braking = greater chance for a crash.



Ask yourself if it's worth it.

**Q: What's your answer?**

**A: No. Definitely not worth the risk. Going with the flow of traffic is safer and easier.**

**DOWNGRADES:** A slow and controlled speed is a necessary condition for going down long, steep hills safely. Brakes can overheat when worked for too long of a period. The braking power can fade to a point of total brake failure.

The safety minded driver will shift the vehicle's transmission to a low gear **BEFORE** starting down the grade. Watch for hill signs and check the brakes before starting down. Once the proper gear has been selected, apply **STEADY** pressure on the brake pedal while descending the grade.

**MOUNTAIN DOWNGRADES:** Maintain a driving situation that avoids brake fading. Brake fading happens when the driver has to apply the brakes harder and harder to get the same stopping power, or the brakes overheat to the point of total failure. When this occurs, the force of gravity will have a major part in determining the vehicle's speed. At this point, the driver cannot slow down or stop.

These dangers can be avoided by driving slowly on downgrades. Using lower gears help to keep the vehicle in control while allowing the brakes to work properly.

This concept must be used whether the vehicle has an automatic or a manual transmission. Always **BE IN THE RIGHT GEAR BEFORE STARTING DOWN THE HILL.** Shifting a manual transmission on downgrades can result in shifting into neutral and being unable to get the transmission into any gear. Also known as: missing a gear, blown shift, or roller coaster ride. When this happens, the benefit of engine braking is lost resulting in coasting at an illegal and dangerous speed.

**RULE OF THUMB:** In order to select the proper gear for downgrades, the driver must consider the facts associated with modern trucks such as low friction parts and streamlined shapes, along with more powerful engines. It is necessary to modify the old rule of "go down in the same gear needed to go up" to the new rule of "drive down in a lower gear than needed to drive up!" Find out what is right for your vehicle.

The recommended way to use your brakes is to go slow enough for them to get rid of the heat generated while being activated. Use a light, but steady, brake pedal pressure in order to keep the vehicle's speed from increasing. Brake drums cool very slowly. For this reason, letting up on the brakes from time to time will not allow the cooling necessary to prevent overheating. Therefore, select the right gear, go slow enough, and maintain a light, steady pressure on the brakes.

**ESCAPE RAMPS:** Are designed for run-away vehicles to slow them safely without injuring driver or passengers. These ramps are often made of loose, soft material (pea gravel), sometimes designed in combination with an upgrade. Know where these ramps are. Watch for the signs on your route.

Escape ramps save lives, equipment, and cargo. Use them if you lose your brakes. They can be an important emergency method for controlling vehicle speed.

# Sample Test

## Controlling Speed Unit 2.6

1. When driving on a wet road and the speed limit is 55 mph, you should travel about:  
A. 35  
B. 40  
C. 45  
D. 50
2. The distance your vehicle travels while your brain tells your foot to move until it presses on the brake pedal is called:  
A. reaction distance.  
B. braking distance.  
C. perception distance.  
D. stopping distance.
3. The reaction time for an alert driver is about:  
A. 0.4 seconds.  
B. 0.5 seconds.  
C. 0.75 seconds.  
D. 1.5 seconds.
4. Which vehicle has the longest stopping distance?  
A. bobtail tractor  
B. tractor and loaded semi-trailer  
C. tractor and empty semi-trailer  
D. passenger car
5. When going down a downgrade:  
A. Downshift before starting down.  
B. Pump the brakes if you must slow down.  
C. Start brake if you must slow down.  
D. Downshift if after you crest the hill.
6. When going around a curve:  
A. Shift up a gear before the curve.  
B. Shift up a gear in the curve.  
C. Be in a gear that will let you accelerate slightly.  
D. Brake while going around the curve.
7. Hydroplaning:  
A. is when the tire loses contact with the road.  
B. can be eliminated by accelerating.  
C. is more likely to occur with new tires.  
D. is more likely to occur with high tire air pressure.

8. Slippery conditions occur:

- A. when ice forms on the vehicle.
- B. in shaded areas after a thaw.
- C. just after it starts to rain.
- D. all of the above

9. If the speed is doubled, it takes as much as \_\_\_\_\_ times the distance to stop.

- A. 2
- B. 2.5
- C. 3
- D. 4

10. On icy roads, reduce speed:

- A. by 1/2.
- B. by 1/4.
- C. by 1/3.
- D. to a crawl and stop as soon as you can.

11. To regain control when the vehicle starts to hydroplane:

- A. Accelerate.
- B. Release the accelerator and push in the clutch.
- C. Stab brake.
- D. Control brake.

12. When driving in fog at night and you can only see 100 feet ahead, you must be able to stop within:

- A. 50 feet.
- B. 75 feet.
- C. 100 feet.
- D. 500 feet.

13. If the speed limit is 55 mph and the traffic is going at 40 mph, a safe speed for you to travel is:

- A. 35 mph.
- B. 40 mph.
- C. 50 mph.
- D. 55 mph.

# **COMMERCIAL DRIVERS LICENSE REPARATION COURSE**

## **Managing Space Unit 2.7**

### **Visual 2.7.1**

### **VISUAL 2.7.2**

To be a safe driver, you must have a cushion of space around your vehicle. This space gives you time to think and act when you encounter a problem.

To make sure you have the space to think and act when you need it, you must learn to manage the space around your vehicle. While this is true for all vehicles, it is especially true for large commercial vehicles.

The most important space around your vehicle is the space in front. You need this space simply to stop your vehicle.

The most common accident involving large vehicles is one vehicle hitting the vehicle ahead of it. The most common reason for doing this is simply following the vehicle ahead too closely.

How much space in front of you is enough? That depends on the situation and conditions.

If your speed is less than 40 mph, you need one second of interval for every 10 feet of your vehicle's length. For speeds over 40 mph, you must add an additional second.

For example, at 35 mph, a 40 foot vehicle will need 4 seconds of interval between it and the vehicle ahead of it. At 45 mph, that same vehicle will require 5 seconds of interval.

What do we mean when we talk about interval? Interval is the time your vehicle needs to travel the space between it and the vehicle in front of it.

How do we determine this interval for any given situation? It's simple. Look at the vehicle in front of you and begin to count off seconds as it passes some fixed point on or along the road.

Continue counting until your vehicle arrives at the same point. This is the time interval between the two vehicles.

Remember, allow yourself enough room in front of your vehicle to be able to stop safely. Do this by following the rule we have explained.

When situations are especially bad, such as when the roads are slick or when visibility is limited, remember to allow yourself even more extra time.

We must also manage the space behind our vehicle. While we can't stop someone from tailgating us, there are several things we can do to make the situation safer.

For one thing, keep to the right. This is especially true when going uphill. Keeping to the right will make it easier for other vehicles to pass us. Keeping to the right will hold up faster traffic as little as possible.

**There are other things you can do to safely deal with tailgaters. Avoid quick moves. Make all maneuvers as slowly and as far ahead as possible.**

**Increase the distance in front of your own vehicle. This will allow you to most easily avoid those quick moves which might cause problems if the vehicle behind you is too close. Greater distance ahead means that you have additional time to think and react.**

**Don't speed up when you're being tailgated. It's safer to be tailgated at slower speeds. Also, don't play games which might confuse or frustrate the person behind you and lead to dumb acts.**

**As drivers of large vehicles, we must manage the space to our sides. We can do this by staying in the center of our lane. This will give us as much clearance as possible in tight situations.**

**Also, avoid traveling beside other vehicles. When two vehicles travel beside one another, both vehicles lose their safety space cushion. Neither vehicle may be able to change lanes if necessary to avoid an accident.**

**When traveling in traffic, try to find an open space to position your vehicle. In heavy traffic, simply do the best you can. Sometimes it might be better to speed up or slow a little to help other drivers see you.**

**A special problem with regard to space to the side is the problem which strong winds present. A strong cross wind can blow your vehicle into the lane beside you. Be alert for this if your vehicle is light, and in special situations such as coming out of tunnels.**

**As the driver of a large vehicle, you must consider the space above your vehicle. Don't assume posted heights are correct. Repaving a road or a buildup of snow can take several inches off a posted height.**

**The weight of a vehicle affects its height. Dropping off a load of freight can raise your vehicle two inches or more. If you cleared a bridge on your way in to unload, don't assume you'll clear it on your way out.**

**Sometimes a road surface can cause your vehicle to tilt. Be alert to this as you drive along the side of the road to avoid being tipped into tree limbs or bridge supports.**

**Check heights before backing into an area. Look for wires, branches, and parts of buildings.**

**Finally, if there is any question in your mind as to safe clearance, go slowly. Be prepared to stop. The best thing is to see the low clearance in time to somehow go around it.**

**Many drivers forget about the space under their vehicles. Remember the difference between a loaded and an empty vehicle. Be careful when crossing railroad tracks or crowned roads. Be careful when operating off the road. If you're not careful, your vehicle might get hung up from below.**

**Drivers of large vehicles must be especially mindful of the space around their vehicles when they turn. Let's look at a few tips to help you manage this space when you turn. We'll talk about right turns first.**

**First of all, go slowly. This will help you avoid problems.**

**VISUAL 2.7.4**

**If you must swing wide to make a turn, do so as you complete the turn. Keep the rear of your vehicle as close to the curb as possible to help prevent other drivers from passing you on the right. If the end of your vehicle swings too far to the left, a vehicle might slip into your blindspot.**

**VISUAL 2.7.3**

**If you must cross into an oncoming lane, let traffic go by first. Never back up, for your vision will be limited and you may hit something.**

**VISUAL 2.7.5**

**For left turns, don't begin the turn until you have reached the center of the intersection. If you turn too soon, the rear of your vehicle may hit another vehicle because of the short track the rear of your vehicle always follows.**

**VISUAL 2.7.6**

**If there are two lanes turning left, take the outside lane. This will give you as much space as possible, and will keep your blindside under control.**

**VISUAL 2.7.7**

**A final space which you must control is the space you take to enter or cross traffic. Because your vehicle is slower than other traffic, you will need a much larger opening in traffic than you'd need in a car.**

**If your vehicle is loaded, you'll need even more space, since your vehicle will be even slower.**

**Whenever you start into traffic or across traffic, be sure you have the space necessary to complete the maneuver. Any time we lose the necessary space around our vehicle, there is a serious risk of an accident.**



# Sample Test

## Managing Speed Unit 2.7

1. What should the minimum following distance be for a 50 foot vehicle traveling 35 mph?
  - A. 35 feet
  - B. 50 feet
  - C. 3.5 seconds
  - D. 5 seconds
  
2. When a vehicle tailgates, you:
  - A. Increase your following distance.
  - B. Flash your brake lights.
  - C. Hit the brakes.
  - D. Change lanes.
  
3. During strong winds:
  - A. Travel next to other vehicles.
  - B. Decrease following distance.
  - C. Lighter vehicles are affected more.
  - D. all of the above
  
4. The minimum following distance for a 60 foot long vehicle traveling 55 mph is:
  - A. 5 truck lengths.
  - B. 6 truck lengths.
  - C. 5 seconds.
  - D. 7 seconds.
  
5. If you must swing wide to make a right turn:
  - A. Turn wide as you start the turn.
  - B. Turn wide as you complete the turn.
  - C. Turn wide so other traffic has to back up.
  - D. Use a helper to stop traffic.

# **COMMERCIAL DRIVERS LICENSE PREPARATION COURSE**

## **Night Driving Unit 2.8**

Driving at night is far more dangerous than driving during the day. You can't see hazards as well, so you have less time to respond after you finally do see something which you must avoid.

The problems of night driving fall into three areas:

- The driver
- The roadway; and
- The vehicle.

Let's take a look at how problems in these three areas make safe driving at night far more of a challenge.

Let's look first AT DRIVER RELATED problems. Obviously people can't see as well at night as they can during the day. Since proper seeing is essential for safe driving, whenever seeing is diminished, safety is threatened.

A common problem people have when they drive at night is dealing with the glare of lights both from other vehicles and from sources beside the road. This is especially a problem for older drivers.

The glare of lights can lead to a temporary blindness. If you are blinded for no more than two seconds by glare, you may have real problems. In two seconds at 55 mph, you can go more than 150 feet. Driving blind for even such a short period of time can be especially dangerous.

The best way to avoid being blinded is to avoid looking directly into bright lights. Look toward the right side of the road. Looking to the side for a moment or two is much better than being blinded.

Another problem which is driver related stems from the fact that it is much easier to be tired and less alert at night. We've seen how fatigue and lack of alertness can affect your driving. This is especially a problem if you have been driving for a long time. If you get sleepy, get some rest. There's no substitute for rest.

One of the night driving problems which is related to the roadway is the fact that many areas will simply not be well lit. Less light means that you will see less, and thus you will be at greater risk. You will not see hazards as well when the light is poor or nonexistent.

Even if there are lights, it's likely that the lights will be confusing. When lighting is poor or confusing, you must drive more slowly. You must be able to stop within the distance you can see ahead.

A special problem is the problem of drunk drivers. Be especially watchful around the closing time for bars and taverns. Watch the way other drivers drive. Look for tell tale signs of a drunk driver such as weaving or straddling lines.

**Problems which are related to the vehicle include problems which stem from your headlights. Even when working perfectly, headlights simply don't provide the light we need for safe operation.**

**With low beams, we can see about 250 feet. With high beams, we can see about 350 - 500 feet.**

**To be able to stop within the distance we can see with our headlights, we must adjust our speed. Whenever our stopping distance exceeds our vision, we are in serious danger of hitting something.**

**Specific problems with headlights include lights which don't work, or lights which are dirty or obscured. Make sure the lights are adjusted so they offer you maximum benefit while not blinding other drivers.**

**The same points can be made about all other lights on our vehicle directionals and brake lights are especially important at night. At night, other drivers must clearly understand your intentions. Brake lights and turn signals allow them to know what you are about to do.**

**Clean windshields and other glass are vital for night driving. Glass which is dirty or streaked might blind you with its own glare, or block your vision with dirt, insects, or streaks. Clean your glass both inside and out.**

**When you must drive at night, follow a few simple procedures. Make sure you are rested and ready to drive. Use some common sense. Take off your sunglasses and clean your lenses if you wear regular glasses. Pay attention to pre-trip inspections. Find problems with the vehicle before you shove off.**

**Try to avoid blinding others with your lights. Be alert to the needs of others. Dim your lights within 500 feet of an oncoming vehicle and when following another vehicle within the same distance.**

**As we've said, avoid being blinded yourself. Don't look directly into glare. Don't get into little wars with vehicles which fail to dim their lights. If you raise your beams, you might only blind them and increase the chances of their hitting you.**

**Use high beams whenever you can. Get the maximum visibility from your lights. Why drive with low beams except when you have to?**

**Keep the inside of your cab dim. Don't let inside lights get too bright. This simply makes it harder to see outside.**

**And finally, always know if you are getting sleepy. If you get sleepy, don't try to push ahead. If you look or feel sleepy and continue to drive, you are placing yourself at great risk of an accident. Stop at a safe place and sleep.**

## **VISUAL 2.8.1**

# ● Sample Test

**Driving at Night**  
**Unit 2.8**

1. With low beams, you can see about:
  - A. 200 feet.
  - B. 250 feet.
  - C. 500 feet.
  - D. 1000 feet.
  
2. With high beams, you can see about:
  - A. 200 feet.
  - B. 250 feet.
  - C. 500 feet.
  - D. 1000 feet.
  
3. When driving at night:
  - A. Keep interior lights bright.
  - B. Use low beams whenever possible.
  - C. Avoid glare from oncoming vehicles.
  - D. all of the above

# **Winter Driving**

## **Unit 2.9**

### **VISUAL 2.9.1**

The subject of winter driving should be a subject of special interest to all drivers of commercial vehicles in Wisconsin. To ensure the safest operation possible, drivers must pay extra attention to their vehicles and must know techniques for cold weather driving.

Driver must have vehicles ready for driving. A thorough vehicle inspection is essential.

### **VISUAL 2.9.2**

Make sure the cooling system is full and that there is adequate antifreeze in the system.

### **VISUAL 2.9.3**

Make sure the heater and defroster are working. Safe driving is impossible without defrosters that work.

### **VISUAL 2.9.4**

Make sure that the wipers and windshield washers work properly. Stop and repair if necessary.

### **VISUAL 2.9.5**

Never try to drive in winter without the proper tire tread depth. Vehicle control is especially difficult without adequate tire tread. For front tires, the requirement is at least 4/32" in all grooves. For all other tires, the requirement is at least 2/32".

### **VISUAL 2.9.6**

At times, tire chains may be required. Make sure the chains are the correct size. Inspect the chains for broken hooks and worn or broken cross links.

### **VISUAL 2.9.7**

Make sure lights work properly. Keep lights and reflectors clean and unobscured by snow, mud, or road salt. Check lights often.

For maximum visibility, keep glass clean and free of snow and ice buildup. Ice scrapers may be needed.

### **VISUAL 2.9.8**

Keep snow and ice from building up on steps and catwalks. Always use the three point method for climbing up and down. Do not jump. If the vehicle has shutters or a winterfront, make certain that the air flow through the radiator is appropriate for weather conditions.

### **VISUAL 2.9.9**

Make sure shutters don't clog up with ice. Make sure winterfronts aren't closed too tightly.

### **VISUAL 2.9.10**

Check the exhaust system for leaks. With the windows up much of the poor ventilation may make you sleepy. If there's an exhaust leak, you may be overcome by carbon monoxide. This is especially true if you are forced to wait for the weather to improve or roads to be cleared.

**VISUAL 2.9.11**

Now let's look at some driving techniques which will help when you're driving in winter conditions.

Perhaps the best thing to keep in mind is to slow down. Train yourself to act in slow motion, but keep your thoughts moving at their regular pace. Take your time. Make turns, stops, and all maneuvers in slow motion, as gently and slowly as possible.

The key word is adjustment. You must make adjustments in everything you do. Stop at the first safe place.

You must start the vehicle rolling more gently than normal or the tires may start to spin.

Adjust your turning and braking. Again, the key is to do everything gently. Overbraking and oversteering will likely lead to skids and loss of control.

Adjust the speed to conditions. Don't be accelerating one moment and braking the next. Keep speeds down and steady. Don't use the engine brake.

Be alert to road conditions such as bridges or shady areas. Remember that when the temperature is around freezing is when wet or snow and ice covered roads are the slickest.

Increase the spaces around your vehicle. Keep away from other vehicles as much as possible.

Learn to look far enough ahead to anticipate traffic situations which might require a reaction on your part.

Keep in mind the problems which may occur from the brakes on your vehicle becoming wet. Wet brakes might pull to one side or cause a jackknife if you have a combination vehicle.

Do what you can to keep brakes as dry as possible. Avoid driving through deep puddles if possible, but if you have no choice, take the following steps to protect your brakes.

As you go through the water, apply the brakes gently. This will close the space between the shoes and the drums and will help keep out water, sand, or grit. Use the brakes gently to avoid a lock-up which might cause a skid.

When clear of the water, keep the brakes lightly applied to dry them. Remember, keep the pressure light, and don't hold it too long.

Make a test stop when safe to do so. Be alert for grabbing and pulling. If the brakes don't seem right, dry them some more.

**VISUAL 2.9.12**

**VISUAL 2.9.13**

**VISUAL 2.9.14**

# Sample Test

## Driving in Winter Unit 2.9

1. When driving through deep water:
  - a. Keep a light pressure on the brakes
  - b. Travel through slowly.
  - c. Keep light pressure on the brakes for a short distance when out of the water.
  - d. all of the above
  
2. On a road that has glare ice on it:
  - a. Use rear brakes only.
  - b. Stop driving as soon as it is safe to do so.
  - c. Use retarders.
  - d. all of the above
  
3. When driving during winter months:
  - a. Adjust speed according to conditions.
  - b. If you can't see out of the windshield, reduce speed by 1/2.
  - c. Drive alongside other vehicles.
  - d. all of the above



## **Hot Weather Driving**

### **Unit 2.10**

#### **VISUAL 2.10.1**

Just as with driving in winter conditions, driving in very hot weather makes extra demands on both drivers and equipment. Through proper vehicle inspections, drivers may eliminate many problems before they arise. Following a few simple driving techniques will help keep problems to a minimum.

#### **VISUAL 2.10.2**

When you inspect your vehicle in hot weather, pay special attention to its tires. A good idea is to check them every two hours or 100 miles.

A key point to inspect with regard to tires is air pressure. The pressure must be right before the tire is driven, for it naturally increases as the tire is driven.

Don't remove air to decrease pressure. Under inflation is the primary cause of heat build-up in tires, and heat is the primary cause of tire failure. If the pressure is right before the tire is driven, the build-up which will naturally occur should be within normal limits.

#### **VISUAL 2.10.3**

A tire may become too hot. If a tire becomes too hot to touch, stop until it cools. Watch retreads for signs of failure such as partial separation.

#### **VISUAL 2.10.4**

Also, watch for tread separation on recaps.

#### **VISUAL 2.10.5**

Make sure that the engine has the proper level of oil and coolant. Both oil and coolant help keep engine temperatures down.

If the vehicle has a sight glass through which you can check the coolant, it will be possible to monitor the coolant quite easily. If the vehicle is not equipped with a sight glass, then be very careful when checking the coolant.

#### **VISUAL 2.10.6**

To avoid burning yourself when checking the coolant level:

- Shut off the engine and let it cool.
- Protect your hands with gloves or a cloth.
- Turn the radiator cap slowly to the first stop. This will allow the pressure to release.
- Step back as the pressure is released. When the pressure seems to be released, remove the cap.
- Check the coolant level, and add if necessary.
- Return the cap and make sure it is tight.

Other parts of the vehicle which require special attention in hot weather are belts and hoses.

**VISUAL 2.10.7**

A loose belt may not turn the water pump sufficiently and may result in overheating. Check the belts for tightness and make sure there are no signs of wear such as cracking and fraying.

**VISUAL 2.10.8**

Make sure the hoses are in good condition. Look for cracks and loose connections. Hoses which fail can ruin an engine in a very short time.

**VISUAL 2.10.9**

While driving, monitor the various temperature gauges. Pay special attention to engine coolant and engine oil temperature gauges. In hot weather, watch these gauges quite closely to prevent or hold problems to a minimum.

Adjust driving when temperatures start to rise on the gauges. When you notice a rise in temperature, slow down.

A rise in temperature is the vehicle's way of saying it's working too hard. Slowing down will cool the engine and save the vehicle's tires.

Keep alert for places where tar has bled from the highway pavement. Look for shiny spots of tar on the road surface. It can be slippery.

Driving in very hot weather makes demands on both the driver and the vehicle. Through proper preparation and intelligent driving techniques, the driver can limit problems as much as possible.

## ● **Sample Test**

### **Driving In Very Hot Weather Unit 2.10**

1. **Tires during hot weather should:**
  - a. **be checked every 200 miles or 4 hours.**
  - b. **have 10% less air pressure.**
  - c. **not be run if they are too hot to touch.**
  - d. **all of the above**
  
2. **Engine oil not only lubricates the engine but also:**
  - a. **adds necessary weight to the steering axle.**
  - b. **must be added to the coolant to lubricate the water pump.**
  - c. **helps cool the engine.**
  - d. **is injected into the air brake system.**
  
3. **If coolant must be added to a hot engine that does not have a recovery tank:**
  - a. **Have engine idling at high idle.**
  - b. **Have engine idling at low idle.**
  - c. **Wait until the engine is cooled.**
  - d. **Only add coolant through the sight glass.**
  
4. **High heat increases the chances of:**
  - a. **engine failures.**
  - b. **tire failures.**
  - c. **tire fires.**
  - d. **all of the above**

# **Mountain Driving**

## **Unit 2.11**

### **VISUAL 2.11.1**

### **VISUAL 2.11.2**

### **VISUAL 2.11.3**

### **VISUAL 2.11.4**

### **VISUAL 2.11.5**

### **VISUAL 2.11.6**

When you drive in mountains or down a downgrade, the challenge is in holding back the vehicle while the law of gravity and the force of the load push the vehicle faster and faster. The driver must keep the vehicle under control without overheating the brakes.

In this section, we will talk about what you can do to make sure you always maintain maximum control over your vehicle.

The best thing you can do to help hold back the vehicle and not overheat its brakes is to use a lower gear to descend steep hills. The lower gear will transfer some of the work of slowing the vehicle from the brakes to the engine and transmission.

When you select a lower gear, you must do so before starting down the grade. If you try to downshift while going downhill, you might end up in neutral. If this were to happen, the entire burden of slowing the vehicle would rest with the brakes, and in many cases, the brakes will not be able to do the job.

Never go down a hill in neutral. This is both dangerous and illegal.

An old rule of thumb was to use the same gear to go down a hill that you used to go up. Newer trucks are more aerodynamic resulting in less friction. Now a driver should use a lower gear to go down a hill than used to go up.

Selecting the proper gear depends on the severity of the grade, the load, and the ability of the vehicle to withstand the forces pushing it faster and faster downhill. Know what is right for your vehicle.

Know how to use the brakes for maximum braking and minimum heat build-up. Heat is an unavoidable byproduct of braking. Excessive heat can cause the brakes to either fade or fail altogether.

As brakes are used, heat expands the brake drums. As the drums expand, more braking pressure must be applied. This is brake fade. In some cases, brake fade may reach the point where the brakes will simply not hold at all.

The proper braking technique for hills is to be going slowly enough so that light, steady brake applications keep the speed under control. If you go slow enough, the brakes will get rid of the heat which develops.

The technique of hitting the brakes hard, then releasing them in the belief that the heat generated will escape is mistaken. The hard applications will generate more heat than can escape. Also, the repeated heavy applications will use up air supply more quickly than steady light applications.

It is a good idea to know if there are escape ramps on the grades which you drive. These ramps are built to slow a vehicle whose brakes have failed. If brakes fail, use the ramps. If you suspect you have problems, use the ramps. There is nothing illegal about using a ramp when there is an emergency.

Even if there are no special ramps, and your vehicle loses its brakes, look for some path of escape which you can take to slow and stop the vehicle as smoothly as possible. It is better to drive off into the median or into a field than to go out of control.

# **Sample Test**

## **Mountain Driving Unit 2.11**

1. When driving a truck with a manual transmission, the recommended gear going down a downgrade would be:
  - a. the same as going up.
  - b. a gear lower than going up.
  - c. a gear higher than going up.
  - d. neutral.
  
2. When downshifting for a downgrade:
  - a. Shift before the vehicle starts to go down.
  - b. Shift after the vehicle starts to go down.
  - c. Shift when the engine reaches 200 rpms over the governed rpm.
  - d. Always select a low range gear.
  
3. When going down a grade:
  - a. Go slow.
  - b. Be in a low gear so the power train can assist in keeping speeds low.
  - c. Use a light steady pressure on brakes if braking is required.
  - d. all of the above
  
4. Escape ramps:
  - a. help stop runaway vehicles.
  - b. can only be used by trucks greater than 26,001 lbs.
  - c. when used, do severe damage to vehicles.
  - d. all of the above

# **COMMERCIAL DRIVERS LICENSE PREPARATION COURSE**

## **Seeing Hazards**

### **Unit 2.12**

As we drive, we must constantly be alert for hazards. We have already talked about the importance of proper seeing habits. Perhaps we should now consider precisely what types of hazards we should be looking for. Let's take a look at some of the specific things for which we should be looking.

Before going too far, let's define the word, "hazard." A hazard is any road condition or road user which might be a possible danger. If the danger becomes actual, then it is no longer a hazard, but rather an emergency.

Remember what we said about being prepared. If we are prepared to deal with hazards, and if we deal with them properly, then a hazard should not become an emergency.

Learning to recognize hazards requires experience. We have to be able to say whether an object or an individual which we see represents a hazard.

We must be able to predict what an individual or object will do to be able to make this decision.

We must first recognize their presence, then predict what will happen, then prepare ourselves to act.

Hazards usually fall into one of two classes. One class of hazard may be called road hazards. These include the condition of the road itself, conditions such as sharp drop offs, sharp curves, poorly designed ramps or other road features, and foreign objects which are in the road.

Activities around the road such as construction may also be considered road hazards.

When we encounter these sorts of hazards, we must recognize the possible dangers and be ready to react. If we fail to recognize that certain conditions represent hazards, we will be unable to take the actions necessary to prevent a hazard from becoming an emergency.

The other class of hazard are the people who we may find on or around the roadway. Of course this includes other drivers and road users such as pedestrians.

When we talk about other road users, there are a number of clues to help us decide whether they represent hazards. For instance, if a person's vision is blocked, we may well assume that person is a hazard.

We should watch for vehicles, pedestrians, and bicyclists that are partially hidden.

There are a large number of situations and times when other people (drivers, cyclists, pedestrians) on or around the roadway may be distracted. We should be especially alert around children, construction workers, disabled vehicles, accident scenes and confused drivers.

Impaired drivers are a big concern. Both drunk and drugged drivers need to be watched for.

# **Emergencies**

## **Unit 2.13**

### **VISUAL 2.13.1**

### **VISUAL 2.13.2**

### **VISUAL 2.13.3**

### **VISUAL 2.13.4**

### **VISUAL 2.13.5**

### **VISUAL 2.13.6**

**A driver's body movement is a clue as to what he/she is going to do next. Watch where other drivers are looking.**

**We always need to be alert and have a plan to avoid the mistakes of others.**

**Two types of emergencies are: traffic emergencies which occur when two vehicles are about to collide and vehicle emergencies which occur when a mechanical part of the vehicle fails. A vehicle emergency can lead to a traffic emergency.**

**The practices discussed here can help deal with these emergencies. When an emergency occurs, your chances of avoiding a crash depend upon what action is taken.**

**It is important to remember that stopping or attempting to stop is not always the safest response to an obstacle or hazard in your path. Steering away from the hazard may be a better option. You can almost always turn to miss an obstacle more quickly than you can stop for it.**

**Drivers of top-heavy vehicles and drivers with multiple trailers must remember how easy it is to roll over these vehicles. These drivers must consider this when responding to an emergency.**

**Drivers must keep both hands on the steering wheel. Also keep a firm grip on the wheel. When steering around a hazard, it may have to be quick, but it must be smooth.**

**A 3-9 o'clock hand position is recommended.**

**When making a quick emergency steering maneuver:**

- 1. Do not apply the brakes while turning. It is easy to lock the wheels if overbraking occurs. A locked wheel results in a skid which reduces control of the vehicle.**
- 2. Turn the wheel only enough to clear the object. The further you turn, the greater your chances of rolling over. Limit steering as much as possible.**
- 3. Be prepared to countersteer. Countersteering means to turn the wheel back after you have avoided a hazard. Unless you are prepared to countersteer, you probably will not be able to do it quickly enough. Consider the initial steering and the countersteering as a single maneuver.**

**If this is "HOW" to steer, perhaps the next question is "WHERE" to steer. Almost always, a move to your right is best, especially if an oncoming vehicle has drifted into your lane. Since the proper travel lane is the right lane, you should be able to move right. Always have an escape route. If you have been using mirrors properly, you will know which lanes are available to use.**

**Another advantage to moving right is that in many cases, you may use the shoulder of the road. Most highway shoulders will support a large vehicle. Highway shoulders are an excellent escape route.**



If you use the shoulder, stay there until you bring the vehicle to a stop. Then signal and return to the travel lane.

Even if you have a vehicle to your right, it may still be better to steer right than to risk a head-on collision with an oncoming vehicle. While this is a difficult situation, at least you will not force the vehicle beside you into oncoming traffic.

There may be times when you must leave the road to avoid a collision. If you must do this, there are several things you can do to help control the vehicle.

One thing you can do is avoid using the brakes until your speed has dropped to around 20 mph. Then brake gently, to avoid skids.

Improper braking decreases control and maintaining as much control as possible will be vital after leaving the road.

Try to keep one set of wheels on the pavement. This will help stabilize the vehicle until you can bring it safely to a stop.

Sometimes you will have to bring the vehicle back onto the road before you can stop. In these situations, use the following procedure:

1. Hold the wheel tightly, and steer sharply back onto the road. Coming back onto the road gently might allow the tires to "grab" the edge of the pavement and might cost you control.
2. When both front tires are back on the road, countersteer immediately. Again, it will be best if you combine the two steering moves into a single move.

For those situations when you must stop quickly and evasive steering is not an option, there are two techniques which will help stop as quickly as possible, and which will help stop in a straight line.

One method is called "controlled braking" or squeeze braking. Using this technique, apply the brakes as hard as possible without locking the brakes.

Keep steering to a minimum as you use controlled braking. If you must make a large steering input, release the brakes to do so. Then reapply when steering is complete.

Another technique is called "stab braking." Using this technique, apply the brakes hard until they lock. When they lock, release the brakes. When the wheels start turning again, reapply the brakes again until they lock once more.

One final word about braking. Emergency braking does not mean simply hitting the brakes as hard as you possibly can. This would only cause a skid and skids rob you of both control and braking ability.

Emergency braking really means "smart" braking.

Another emergency situation with which drivers must be prepared to deal is the possibility that brakes might fail. Here we will discuss only hydraulic brakes. Air brakes are discussed in a separate section.

**VISUAL 2.13.7**

**VISUAL 2.13.8**

**VISUAL 2.13.9**

**VISUAL 2.13.10**

**Hydraulic brakes usually fail for one of two reasons:**

- 1. Loss of hydraulic pressure**
- 2. Brake fade on long downgrades**

**If the system will not build up pressure, or if the brake pedal feels spongy under your foot or goes all the way to the floor, you have several options:**

**Perhaps first, you can try to downshift if the conditions allow it. This will help hold you back.**

**Pumping the brakes will usually generate enough hydraulic pressure to operate the brakes.**

**Use the parking or emergency brake. When using the brake, the release button must be pressed in. This allows you to modify braking pressure.**

**You may use the emergency brake in this situation because the parking and emergency brakes in a hydraulic system are separate from the regular service brake system.**

**If all else fails, look for an escape route. Find something you can use to somehow slow the vehicle. Perhaps you can rub the vehicle against a hill. Perhaps you will find a field into which you can drive. If you are going to have an accident, it is better to have it at a slow speed.**

**When brakes fail on downgrades, your best hope is to use an escape ramp. Escape ramps are built to slow and stop vehicles which are no longer able to stop themselves. They use a combination of soft sand or gravel, and uphill grades.**

**If no ramp is available, you must find your own escape route. It is important not to give up. Do not jump from the vehicle. Find something which will slow it down. Look for a field or a road which turns uphill, or anything relatively soft which you can use to break the momentum of your vehicle.**

**A final emergency situation which we will discuss is sudden tire failure. This might be an actual tire blowout or simply a tire which goes flat in a hurry.**

**The tire failure which drivers fear most is failure of the steering tires. While this situation receives the most driver attention, failure of any tire can result in loss of control of the vehicle.**

**The first thing you must do when your vehicle experiences tire failure is simply recognize the failure. You must act fast to retain control of your vehicle, so quick recognition is essential.**

**There are several indicators of tire failure:**

**One indicator will be the sound of the tire itself as it fails. Often this will be a tremendous bang. Many times, the bang will be your first indication that a tire has failed.**

**Another indicator is feel. If a front tire has failed, you will feel it through the steering wheel. The steering wheel will most likely pull suddenly to one side, the side with the failed tire.**

**If a drive tire has failed, you may feel vibration through the seat. If a trailer tire has failed, you may feel it in the seat, or you may not feel it at all. If the entire vehicle seems to shake or thump more than what seems normal, check the tires.**

**After you detect a tire failure, act quickly and decisively:**

- 1. The first thing you must do is grip the wheel firmly and maintain steady steering. If a front tire fails, the steering wheel may be wrenched from your grasp unless you hold it firmly.**
- 2. Stay off the brakes.**
- 3. You must also hit the accelerator. You must hit it hard, so the truck will resist the tendency to pull to one side or the other.**

**The purpose of accelerating is not to build up speed, but rather to resist the new force pulling you to the side.**

**After recognizing the failure, stabilizing the steering, and resisting the pull to the side, let the truck slow gradually.**

**DO NOT HIT THE BRAKES, at least until the truck has slowed significantly. Hitting the brakes is the worst thing you can do, unless you are about to run into something.**

**After the truck has stopped, inspect your tires.**

# Sample Test

## Emergencies Unit 2.13

1. The proper hand position on the steering wheel is:
  - a. both hands together, near the top.
  - b. both hands together, near the bottom.
  - c. hands on opposite sides of the steering wheel as 9-3.
  - d. one hand at 10 o'clock and the other hand on the shifter.
  
2. Stab braking:
  - a. involves releasing the brakes only after wheel lock-up.
  - b. involves a steady pressure on the brake pedal without wheel lock-up.
  - c. should not be used when it is slippery.
  - d. should only be used when it is slippery.
  
3. When a tire failure occurs:
  - a. stab brake immediately.
  - b. steer quickly onto the shoulder.
  - c. stay off the brakes until the vehicle has slowed down.
  - d. use hard emergency braking.
  
4. When steering to avoid a crash:
  - a. apply brakes while turning.
  - b. accelerate while turning.
  - c. steer using the one hand method.
  - d. steer only what is needed to clear the hazard.
  
5. If you need to leave the road during an emergency situation:
  - a. try to get all wheels off the pavement.
  - b. brake hard while leaving the pavement.
  - c. avoid braking until your speed has dropped to about 20 mph.
  - d. accelerate slightly while steering.
  
6. If the steering wheel starts to vibrate:
  - a. you may have a front tire failure.
  - b. you may have a rear tire failure.
  - c. the power steering belt broke.
  - d. the front wheel spacer came loose.
  
7. With the loss of hydraulic brake pressure for a vehicle with hydraulic brakes:
  - a. The brake pedal will feel "hard" and not move.
  - b. Pumping the brakes may help.
  - c. Using the hand valve will increase the pressure.
  - d. will increase when the engine retarder is shut off.

# **Skid Control and Recovery**

## **Unit 2.14**

### **VISUAL 2.14.1**

### **VISUAL 2.14.2**

### **VISUAL 2.14.3**

### **Visual 2.14.4**

At certain times and under certain conditions, it is possible that the tires of a vehicle may lose contact with the road surface. When this happens, the result is a skid.

Any tire or group of tires may skid but the result is always the same: a loss of control of the vehicle.

One rule of driving to keep in mind is that for maximum control, the wheels of a vehicle must be turning as freely as possible. Anything causing the wheels to turn less freely deprives the driver of some measure of control over that wheel.

Trailer skids are discussed in the manual section on combination vehicles. Much of what is discussed here also applies to trailer skids.

A skid can come about in one of four ways. In all these situations, the tires lose their grip on the road.

1. **Overbraking.** Applying the brakes too hard for conditions locks up the wheels causing the tires to skid. Retarder devices may also cause this kind of skid when used under the wrong conditions.
2. **Oversteering.** This results when the wheels are turned more sharply than the vehicle can turn.
3. **Overacceleration.** This results when too much power is sent to the drive wheels, causing them to spin.
4. **Excessive Speed.** This is the cause of most skids and results when drivers simply drive too fast for conditions.

By adjusting for conditions, a driver will not overbrake or overaccelerate or oversteer. Making the proper and necessary adjustments is the key to avoiding skids.

Let's discuss several different types of skids. The first skid is the front wheel. Causes of front wheel skids are:

- Brakes out of adjustment
- Oil or grease on brake linings
- Not enough weight on the front wheels
- Speed

(Slide the toy truck down the table.) It goes straight because there is less friction between a sliding wheel and the road surface than a rolling wheel and the road surface. A sliding wheel will always try to lead.

**VISUAL 2.14.5**

**VISUAL 2.14.6**

**VISUAL 2.14.7**

**What do you do to get out of this type of skid? Get off the brakes. Allow the wheels to start rolling. The front of the vehicle will travel in a straight line until the tires regain rolling traction.**

**Drive wheel skids are caused by:**

- **Overbraking**
- **Poor or no brakes on the front wheels**
- **Overacceleration**

**(Slide the toy truck down the table.)**

**To regain control of this type of skid:**

- **Release the brakes. Allow the wheels to regain rolling traction.**
- **Steer in the direction you want the vehicle to travel. Select a reference down the road and steer toward it.**
- **Countersteer. After the vehicle straightens out, steer the wheel back to keep the vehicle from continuing to turn.**

**Skids are relatively easy to control if they are detected early and the proper corrective steps are taken. But no matter how easy the problem may be to correct, a far better approach to dealing with the problem is to avoid the skid in the first place.**

**Making the proper adjustments for conditions and the proper use of the accelerator and brake controls are the best ways to avoid skids. If a skid does take place, keep the wheels turning as freely as possible, and steer in the direction you wish to go.**

**Sample Test**  
**Skid Control and Recovery**  
**Unit 2.14**

1. To recover from a drive wheel skid:
  - a. Stop braking.
  - b. Steer quickly.
  - c. Countersteer.
  - d. all of the above
  
2. When a vehicle gets into a front wheel skid, it will:
  - a. slide sideways and spin out.
  - b. travel straight ahead.
  - c. travel in the direction that the steering wheels are turned.
  - d. cause the rear of the vehicle to come around.
  
3. Which of the following does NOT cause skidding:
  - a. overaccelerating
  - b. overclutching
  - c. oversteering
  - d. overbraking



# ● Accident Procedures

## Unit 2.15

### Visual 2.15.1

If you are involved in an accident with any vehicle, you have several responsibilities. As a driver, you have certain responsibilities.

### Visual 2.15.2

The basic steps to be taken at any accident are:

1. Protect the area.
2. Notify authorities.
3. Care for the injured.

### Visual 2.15.3

When we say, "Protect the area," we mean take steps to prevent further accidents from happening. When you are involved in an accident, or when you come upon an accident, there are several steps which will help prevent further accidents.

1. Move your vehicle to the side of the road if possible. This will allow traffic to move.
2. If you are not involved in the accident but are stopping only to help, park away from the scene. Don't add to the congestion at the scene.
3. Put on your flashers to alert other drivers.

### Visual 2.15.4

Set out reflective devices to warn other drivers and attempt to control the flow of traffic toward the immediate accident scene. As you do this, always keep your own safety in mind.

After the area is protected, notify authorities. Use your CB radio if you have one. If you do have one, use it before getting out of your vehicle. Get the word out fast.

Either phone yourself, or send someone else to phone. Make sure you have accurate information to identify the accident location. Be able to report if there are injuries involved.

### Visual 2.15.5

Part of your responsibility is to offer reasonable assistance to the injured. If there is someone present who is qualified to offer aid, help this person, but do not get in the way. If there is no one present who is qualified, assist the best you can. The Good Samaritan law protects people who are not trained in helping the injured but help to the best of their ability. It is a good idea to ask the person if they want help if that person is conscious.

**These principles may be summarized as:**

- 1. Don't move the injured person unless the situation dictates it for their own safety.**
- 2. Check to see if the injured person is breathing.**
- 3. Stop heavy bleeding by use of direct pressure to the wound.**
- 4. Keep the injured person warm and calm.**

**Remember, at all times you must conduct yourself properly. Accident scenes are often high stress situations. You help no one by losing control of yourself.**

**Whether you are involved in an accident, or you simply come upon an accident, you have certain responsibilities. These responsibilities apply to how you act and to what you should do. Get as much information as possible. Do not offer statements to the media or other bystanders.**

**Always remember, your actions may either save those individuals who are injured or protect others from injury.**

**Sample Test**  
**Accident Procedures**  
**Unit 2.15**

1. At an accident scene:
  - a. Never move the injured.
  - b. Keep the injured cool.
  - c. Stop bleeding.
  - d. all of the above
  
2. At an accident scene:
  - a. Park near the scene.
  - b. Block traffic until emergency help arrives.
  - c. Warn traffic by using four-way flashers and setting up emergency reflectors.
  - d. all of the above

**Fires**  
**Unit 2.16**  
**Visual 2.16.1**

**Visual 2.16.2**

Vehicle fires are a common form of vehicle emergency. All fires require three things: fuel, oxygen and heat. When these three elements are present in the proper combination, a fire may result. Add any of these three to an existing fire and the fire will become worse. Take away any one of these three and a fire will die.

There are many causes of vehicle fires.

Fires often result following accidents. Many times at an accident fuel will spill. This creates a dangerous situation. If there is a fuel spill, careless use of flares or smoking in the area may result in a fire.

Fuel leaking onto the exhaust system may be a problem. Even smoking while fueling a vehicle is dangerous and also against the law. Improper fueling techniques and loose fuel fittings may cause fires.

Many fires result from problems with the load. This is especially true for flammable cargo. Cargo which is improperly sealed, or loaded or ventilated may spontaneously burst into flame.

Sometimes a fire will start in the electrical system. Shorts in the wiring resulting from damaged insulation or loose connections may become especially hot, hot enough to cause fire.

The driver must also pay attention to the vehicle's tires. Underinflated tires or tires which run flat may become hot enough to burst into flames. Dual tires which touch also may produce enough heat to cause a fire.

**Visual 2.16.3**

Following a few relatively simple procedures may prevent many of the most common vehicle fires. Properly performed pretrip inspections will detect such problems as fuel leaks, flat tires and faulty wiring.

Inspections performed enroute will uncover conditions which develop as you go through your trip. Watch tires as you drive. When you stop, check them. Also be alert for leaks which might develop in the fuel system or in the exhaust.

Monitor all parts of your vehicle as you drive. Read gauges, looking for overheating. Be alert for indicators of heat such as the smell from smoldering wires. Be alert for signs of brake drag.

Another way to prevent fires is to follow proper operating procedures. Follow proper fueling procedures. Use the brakes properly. If you use flares, use them carefully, following recommended safety procedures.

If you do experience a fire, know what to do. If you attempt to fight the fire with the improper technique, you may simply make the matter worse. Do nothing which will contribute to the three requirements of a fire: fuel, oxygen and heat.

**Visual 2.16.4**

**What steps should you take if your vehicle catches fire? The first step in fighting a fire is to pull off the road into a safe place. Keep the vehicle in the open, away from buildings, trees and other vehicles. You don't want to make matters worse by setting on fire whatever may be around you. Don't pull into a service station.**

**As soon as you stop the vehicle, notify the authorities.**

**After you have stopped, make sure the fire doesn't spread. If the fire is in the trailer, remove the tractor. If the fire is around the engine, remember to turn the engine off.**

**Don't open the hood or raise the cab if you can avoid it. Opening the hood or raising the cab would help the fire to spread, for the fire would then have a better source of oxygen.**

**Don't open van doors. You want to keep the amount of oxygen that a fire gets to a minimum.**

**Visual 2.16.5**

**Use the proper type of fire extinguisher. A Type B:C is required in a commercial vehicle. That type is designed to extinguish electrical and burning liquids. Type A:B:C also will extinguish wood, paper and cloth.**

**Water may be used on burning wood, paper and cloth, but don't use water on an electrical or gasoline fire.**

**A burning tire needs to be cooled. Water also works well for this.**

**Visual 2.16.6**

**Keep as far away from the fire as possible. Aim the fire extinguisher at the base of the fire, not at the flames. Stand upwind of the fire. This will help keep smoke and flame away from you and will help direct the extinguisher toward the fire.**

**Continue fighting the fire until you are certain it is out. Don't be fooled by what seems to be the absence of flames. Many times a fire can restart itself.**

**Try to extinguish a fire only if you know what you are doing and can do so safely. It makes no sense at all to lose your life simply to save a piece of equipment.**

# **Sample Test**

## **Fires**

### **Unit 2.15**

1. Which of the following fires can be put out with water?
  - a. gasoline
  - b. electrical
  - c. tire
  - d. all of the above
  
2. When a fire occurs:
  - a. keep trailer doors closed if fire is in the trailer.
  - b. open hood if fire is in the engine compartment.
  - c. aim fire extinguisher at the flame.
  - d. all of the above
  
3. When using a fire extinguisher:
  - a. aim at the flame.
  - b. stand upwind.
  - c. stand close.
  - d. all of the above
  
4. When a fire occurs:
  - a. stop in an open area.
  - b. stop where water is available as at a service station.
  - c. stop near other vehicles so other people can help.
  - d. any of the above

## **Staying Alert**

### **Unit 2.17**

#### **Visual 2.17.1**

**Driving a vehicle for long hours is tiring and difficult work. Under these circumstances even the best drivers will become less alert.**

**As you become increasingly tired, it is more and more likely that you will face safety problems. Safety may be compromised as drivers attempt to do more than they are capable of.**

**Yet long hours of driving are typical of commercial vehicle operation. Since this is a fact of life, how may a driver meet the expectations of the job yet still operate alertly, safely?**

#### **Visual 2.17.2**

**Perhaps the most important thing a driver can do is to simply get enough sleep. Pace yourself; don't start long trips when you are already tired.**

**Don't attempt to do more than you safely can. Know your limits and be honest with yourself. The more tired you are, the less alert you will be and the more likely it will be that you have an accident.**

**Many large vehicle accidents occur between midnight and 6:00 a.m. These are the hours when most people are accustomed to sleeping. Your body conditions itself to sleep during these hours. Avoid driving at these hours if you can. A million and a half dollar study is being done right now. It is studying fatigue in the trucking industry. At the end of the four year study in 1994, there may be some changes in the 10 hour on, 8 hour off regulation. Avoid driving anytime when your body tells you it's actually time to be asleep. Pushing ahead to finish a trip during these times can be very dangerous.**

**Avoid taking medicine which may make you sleepy. Many medicines will have warning labels advising you not to drive while taking the medicine. Take these warnings seriously. It is better to suffer the effects of a cold than try to overcome the effects of the medicine.**

**One simple trick to help keep yourself alert is to keep the cab of the vehicle cool. A warm cab may make you drowsy. Keep a window or vent cracked or use the air conditioner. Try to keep fresh air circulating through the cab.**

**Take frequent breaks. It is best to take them before you feel tired or sleepy. Move around outside the cab. Try to get some exercise. Remember, eating may actually make you more drowsy, so don't eat large meals when you suspect you may be getting tired.**

**Sometimes no matter what you do, you will still become sleepy. If you get sleepy but keep pushing on, you are risking an accident.**

**This is far more dangerous than most drivers think. What can you do if you become sleepy?**



### Visual 2.17.3

**The best thing to do is sleep. If you are sleepy, nothing substitutes for sleep. Don't try to put off the inevitable. It is better to sleep when you are sleepy than to wait and only make yourself more tired.**

**If you are sleepy but you can't stop for the night, pull over for a nap. Even a short nap will do you more good than spending time in a truckstop or cafe.**

**Don't rely on drugs to keep you alert. They may help keep you awake for a while but they won't keep you alert and they won't substitute for sleep. Eventually you will be more tired than if you had not taken them in the first place.**

**Drivers of commercial vehicles must understand the dangers of combining driving with the use of alcohol. There are any number of falsehoods and myths in this area.**

**One myth is that alcohol increases your ability to drive. The truth is that alcohol will make you less alert and will reduce your ability to drive safely. Another belief is that some people are not affected by alcohol, that they can drink a lot and show no effects. This is not true. Everyone who drinks is affected by alcohol.**

**Eating a lot before drinking will not help. Food will not keep you from getting drunk.**

**Coffee and fresh air will not help you sober up. The only thing which will sober you up is the passage of time.**

**Another myth is that beer will not affect you as much as liquor or wine. This is not true either. A few beers have the same effect as a few shots or a few glasses of wine.**

**A twelve ounce beer has the same alcohol as a five and a half ounce glass of wine and an ounce and a half shot of 80 proof liquor.**

**Alcohol works by doing straight from the stomach into the blood. The liver removes about two ounces of alcohol per hour. Only by controlling the amount of alcohol consumed can a person control the amount of alcohol which will enter the blood.**

**A person has no control at all over how fast the body is able to get rid of alcohol, the alcohol will accumulate in your blood and your driving will be affected.**

**The amount of alcohol in your blood is usually measured by the Blood Alcohol Concentration level or BAC.**

**BAC is determined by the amount of alcohol you drink, how fast you drink and by your weight. If you drink more, you'll have a higher BAC. Drink fast and you'll have a higher BAC faster. If you are small, alcohol will produce a higher BAC. Alcohol also affects women differently than men.**

**As BAC increases, the brain is quickly affected. The first part to be affected controls judgment and self control. This will keep a drinker from realizing he/she is getting drunk. Also, judgement and self control are essential for safe driving.**

### Visual 2.17.4

**As BAC continues to increase, muscle control, vision and coordination are affected more and more. Eventually a person will pass out.**

**Visual 2.17.5  
Visual 2.17.6**

**What are some of the driving errors which will result from drinking and driving? Increased reaction time is one. Coordination problems such as quick, jerky starts and straddling lanes are other problems. Weaving, driving too fast or too slow, failure to signal, and missing traffic controls are all common problems. These effects increase chances of a crash and of losing your driver's license. Accident statistics indicate this.**

**In addition to alcohol, other drugs affect your driving. Illegal drugs are increasingly common. Drivers of commercial vehicles are prohibited by law from possessing these drugs or being under the influence while on duty.**

**Visual 2.17.7**

**BAC of a trace to 0.04 means an automatic 24 hours out of service. BAC of 0.04 or greater while operating a commercial vehicle means the driver is legally drunk.**

**Visual 2.17.8**

**Legal drugs, either prescription or over the counter may also make the driver unsafe to drive. Controlled drugs may be used by a driver only if a doctor informs the driver that the drug will not affect driving ability.**

**Pay attention to warning labels. Stay away from illegal drugs. Don't use drugs to hide or delay the effects of fatigue. Don't mix drugs and don't mix alcohol with drugs.**

**Visual 2.17.9**

**The use of drugs and alcohol has serious repercussions for the driver of a commercial vehicle. The possibility of death, injury, jail, law suits and the loss of your driving career are all reason enough to reconsider their use when you drive. From time to time you may become so ill while driving that you may become unable to operate your vehicle safely. If this happens, you must stop driving. However, in the case of an emergency, you may continue to drive to the nearest place where you may safely stop.**

**In an emergency, you will have to ask yourself, "What is safer, stopping where I am, or driving to the nearest safe place?". You must always do whatever is safer.**

## **Sample Test**

### **Staying Alert and Fit to Drive Unit 2.17**

1. Which of these statements about drinking alcohol is true?
  - a. 12 ounces of beer, five ounces of wine and 1-1/2 ounces of liquor have about the same effect on the driver.
  - b. Coffee and fresh air will help sober up a drinker.
  - c. Not everyone who drinks is affected by alcohol.
  - d. all of the above
  
2. Which of these statements about drugs is true?
  - a. No drugs can be used while driving.
  - b. Any prescription drug can be used while driving.
  - c. Misuse of drugs may mean the end of a person's driving career.
  - d. all of the above

# **Hazardous Materials**

## **Unit 2.18**

### **Visual 2.18.1**

### **Visual 2.18.2**

### **Visual 2.18.3**

### **Visual 2.18.4**

### **Visual 2.18.5**

### **Visual 2.18.6**

### **Visual 2.18.7**

All drivers should know something about hazardous materials. You must be able to recognize hazardous materials, and you must know whether you can haul it without a Hazardous Materials endorsement on your CDL.

Those items and substances defined as hazardous material are listed in the Federal Hazardous Materials Table on Page 7-21. These substances are regarded as a special threat to health and safety.

When hauling hazardous materials you must follow rules pertaining to handling and transportation. The purpose of these rules are to:

- contain the product
- communicate the risk
- ensure safe drivers and equipment

What does it mean to contain the product? This means simply to protect drivers and others from unsafe contact with potentially deadly substances.

These containment rules include rules regarding packaging, loading, transporting and the handling of bulk tanks.

What does it mean to communicate the risk? This means to let everyone who might come into contact with a particular substance know of the dangers associated with that substance.

These communication rules are the rules regarding paperwork, placards and labels.

The dangers or risks of hazardous materials are classified into 22 hazard classes. Each class has its own risks. The classes are given on Page 2-49 of the driver's manual.

The official name and hazard class of a given substance may be found by looking up that substance in the Hazardous Material Table. This name must appear on the shipping papers.

Similar words must appear on a label on the containers used to hold the substance. If a label will not fit on the container, then a tab must be attached.

Following an accident, the driver may not be able to help authorities identify the substances contained on the truck. Police and fire fighters must know the substances so they may prevent further injury or damage.

To help authorities identify the substances on your vehicle, the shipping papers must be readily accessible.

**Visual 2.18.8**

This may be done in one of several ways. You may tab the papers for quick access or place them on top of other shipping papers.

In addition, you must:

1. keep the shipping papers in a pocket on the driver's door, or
2. keep them in clear view and within reach while driving, or
3. keep them on the driver's seat when you are away from the truck.

Handling the papers in these ways will allow fire and police personnel to identify the substances on a truck, even when the driver is unable to do so or is away from the vehicle.

**Visual 2.18.9**  
**Visual 2.18.10**

Sometimes drivers use placards to communicate the risks of the substances on their trucks. There are 19 types of placards shown in the chart at the end of Section 7 of this manual. The person who loads the truck must place the placards on the front, rear and sides of the vehicle.

**Visual 2.18.11**

Not all vehicles carrying hazardous materials must have placards. The rules about placards are given in Section 7. If you have no Hazardous Material endorsement on your CDL, you may drive a vehicle not requiring placards.

Placards, paperwork and labels all help communicate the risks associated with particular substances.

The third reason for hazardous material rules is to ensure the safety standards of the drivers who haul hazardous materials and of the equipment they use. To ensure the standards of the drivers, the CDL rules are strict as to who may haul hazardous materials.

To be qualified to haul hazardous materials, you must take a test on the material contained in Section 7 of the manual. If you intend to haul hazardous materials in the tank in excess of 1000 gallons, you will need a tank endorsement as well.

Remember, never haul a load requiring placards unless you have a hazardous materials endorsement on your CDL.

**Sample Test**  
**Hazardous Materials**  
**Unit 2.18**

1. If you do not have a Hazardous Materials endorsement on your CDL, you can drive a vehicle hauling hazardous materials when:
  - a. not crossing a state line.
  - b. the vehicle does not require placards.
  - c. a person with a hazardous material endorsement is present in the vehicle.
  - d. all of the above
  
2. Hazardous Materials are marked by:
  - a. two placards on the shipping papers.
  - b. two placards on the outside of the vehicle.
  - c. four placards on the outside of the vehicle.
  - d. three hazardous materials labels on the container.
  
3. Which statement is NOT an intent of the hazardous materials rule?
  - a. contain the product
  - b. weight restrictions
  - c. communicate the risk
  - d. ensure safe drivers
  
4. Information about the hazardous cargo can be found on the:
  - a. shipping papers.
  - b. labels.
  - c. placards.
  - d. all of the above

## **Transporting Cargo Safely Unit 3**

**Visual 3.0.1**

**Visual 3.0.2**

**Visual 3.1.**

## **Inspecting Unit 3.1**

**Visual 3.1.1**

**Visual 3.1.2**

Since commercial drivers transport various types of cargo, they must understand basic safety rules. The driver is always responsible for the inspecting, recognizing overloads, and securement of the cargo.

During the pre-trip inspection check for overloads, weight balance and securement.

The cargo must again be inspected within the first 25 miles. The cargo must then be checked:

- after three hours or 150 miles of driving
- after every break

Sealed trailers cannot be inspected inside. Drivers must still check for weight limits.



## ● **Weight and Balance**

### **Unit 3.2**

**Visual 3.2.1**

**Visual 3.2.2**

## ● **Legal Weight Limits**

### **Unit 3.2**

**Visual 3.2.3**

**Visual 3.2.4**

**Visual 3.2.5**

**Visual 3.2.6**

**Visual 3.2.7**

There are several weight definitions that drivers must be aware of:

- **Gross Vehicle Weight (GVW):** The total weight of a single vehicle plus its load.
- **Gross Combination Weight (GCW):** The total weight of a powered unit plus trailer(s) plus the cargo.
- **Gross Vehicle Weight Rating (GVWR):** The maximum GCW specified by the manufacturer for a single vehicle plus its load.
- **Gross Combination Weight Rating (GCWR):** The maximum GCW specified by the manufacturer for a specific combination of vehicles plus its load.
- **Axle Weight:** The weight transmitted to the ground by one axle or one set of axles.
- **Tire Load:** The maximum safe weight a tire can carry at a specified pressure. This rating is stated on the side of each tire.
- **Suspension Systems:** Suspension systems have a manufacturer's weight capacity rating.
- **Coupling Device Capacity:** Coupling devices are rated for a maximum weight they can pull and/or carry.

Not all states have the same weight limits. For example, the maximum amount of weight on a single axle is 20,000 pounds and the maximum amount of gross combination weight is 80,000 pounds in Wisconsin. Wisconsin CDL holders must not only know the Wisconsin weight limits but any state's weight limits where they operate.

**Overloaded vehicles:**

- have steering problems
- have an increased braking distance
- travel slowly up grades and speed going down grades

During adverse weather or in mountains, a legal load may be too heavy.

Keep the load as low as possible. A high center of gravity load such as hanging meat means that the vehicle may tip over easier. This is true during curves and quick steering maneuvers.

Also, balance the load both side to side and front to rear. Too much weight on the steering axle can cause hard steering. Not enough weight on the steering axle can cause unsafe steering. Not enough weight on the drive axle can cause poor traction.

## **Securing Cargo**

### **Unit 3.3**

**Visual 3.3.1**

**Visual 3.3.2**

**Visual 3.3.3**

**Visual 3.3.4**

**Visual 3.3.5**

**Visual 3.3.6**

**Blocking and bracing are used to secure cargo.**

**On flatbed trailers, tiedowns are used to keep the cargo from moving. Tiedowns must be strong enough to lift one and one half times the weight of the piece of cargo tied down. All tiedown equipment including ropes, straps, chains, winches, ratches, etc., must be the proper type and attached to the vehicle correctly.**

**At least one tiedown is needed every 10 feet. A minimum of two tiedowns must be used.**

**Trailer header boards or tractor headache racks must be strong enough to block the forward movement of the load.**

**Certain cargo must be covered to:**

- protect people from spilled cargo**
- protect cargo from bad weather**
- keep covers tight and from flapping**

**Sample Test**  
**Transporting Cargo Safety**  
**Unit 3**

1. To prevent cargo from shifting there should be at least one tiedown every:
  - a. 10 feet.
  - b. 15 feet.
  - c. 20 feet.
  - d. 25 feet.
  
2. When tiedowns are required the minimum needed are:
  - a. one.
  - b. two.
  - c. four.
  - d. five.
  
3. The load should be:
  - a. to the front.
  - b. to the rear.
  - c. equally balanced front and rear.
  - d. towards the front and somewhat on the right side.
  
4. Inspect the cargo and securement during pre-trip inspection. Also inspect the cargo and securement:
  - a. within 25 miles of start of trip.
  - b. after three hours or 150 miles.
  - c. after every break.
  - d. all of the above

# **Tank Vehicles**

## **Unit 3.4**

**Visual 3.4.1**

**Visual 3.4.2**

**Visual 3.4.3**

**Visual 3.4.4**

**Visual 3.4.5**

**Visual 3.4.6**

**Visual 3.4.7**

**Visual 3.4.8**

**Visual 3.4.9**

### **Tank Endorsement**

A tank vehicle is a vehicle used to transport any liquid or liquified gaseous material in a permanently attached tank or a portable tank having a capacity of 1000 gallons or more.

Tankers generally have a high center of gravity. These top heavy vehicles roll over easier. Posted speed limits may be too high for tankers. Take curves below the posted speed limit.

The movement of liquid forward, backward or sideways is called surge. If the surge is forward while stopping, it will affect the handling and increase the stopping distance. On a slippery surface, the surge could move a stopped vehicle into an intersection. The surge or wave tends to move the vehicle in the direction that the wave is moving.

To help eliminate this surge, some tankers have separate compartments. When loading and unloading these smaller tanks, be aware of weight distribution.

Baffled liquid tankers have bulkheads in them with holes that let liquid flow through. These baffles help to control the forward and rearward surge but not the side-to-side surge.

Unbaffled tankers are sometimes referred to as smooth bore tankers. Be careful when starting and stopping.

As liquids warm up they expand. Room for this expansion is required when loading. This is called outage.

Other vehicles or cargo that have the same characteristics as tankers are:

- dry bulk tankers
- hanging meat
- livestock

The same precautions must be taken as driving tankers.

Oversize loads require special permits. Driving may be limited to certain times. Special signs, lights or escort may be required.

Some liquids are heavier than others. A tanker may be larger than the amount of liquid it can haul. The amount of liquid that can be hauled depends on:

- amount of liquid expansion
- the weight of the liquid
- legal weight limits

**Sample Test**  
**Tank Endorsement**  
**Unit 3.4**

1. A tank endorsement is required if the vehicle has:
  - a. a permanently mounted 1000 gallon tank or more.
  - b. any tank without baffles.
  - c. any tank having a capacity of 1000 gallons or more
  - d. any tank having a capacity of 10,000 gallons or more
  
2. On curves, tankers:
  - a. should travel at the same speed as the rest of the traffic.
  - b. should travel the posted speed limit.
  - c. should travel less than the posted speed limit.
  - d. be in a low range gear BEFORE the curve.
  
3. Bulkheads:
  - a. divide tanks into smaller compartments.
  - b. eliminate side to side surge.
  - c. reduce outage by 10%.
  - d. lower the center of gravity in tankers.
  
4. To reduce surge:
  - a. use a tank with baffles or bulkheads.
  - b. unload center compartments first.
  - c. double the outage.
  - d. use a smooth bore tank.
  
5. The amount of liquid to load on a tank does NOT depend on:
  - a. outage.
  - b. surge.
  - c. density of liquid.
  - d. legal weight limit.
  
6. A tanker that is baffled:
  - a. controls surge
  - b. controls outage
  - c. used to haul dry freight
  - d. has bulk heads with holes in them

## **Other Cargo Needing Special Attention Unit 3.5**

**Visual 3.5.1**

**Visual 3.5.2**

**Visual 3.5.3**

**Visual 3.5.4**

**Visual 3.5.5**

**Visual 3.5.6**

**Several other specialized trucks were drivers must have special skills are:**

- dry bulk tanks**
- hanging meat**
- livestock**
- oversize loads**

**Dry bulk tanks have a high center of gravity and load shifts present special problems.**

**Hanging meat has many of the same characteristics as a liquid tanker.**

**Livestock, if allowed to move, will cause a very unstable situation. Use false bulkheads to keep livestock bunched together.**

**Oversize loads may need special permits, signs, escorts, etc. All of these specialized cargo need special driving skills.**

## ● **Transporting Passengers Unit 4**

### **Endorsements Unit 4.1**

### **VEHICLE CLASSES Unit 4.2**

### **BUS TYPES Unit 4.3**

### **Visual 4.1**

### **WHO IS A BUS DRIVER? Unit 4.4**

To operate some commercial motor vehicles (CMV) you may need an endorsement code added to a CDL (a letter of the alphabet). This means that there is an addition to your CDL which lets you operate certain types of CMVs. For example, drivers who intend to operate a tanker, double/triple trailer, vehicles carrying hazardous material, or buses designed to carry 16 or more persons must have an endorsement on their CDL. Here is how it works.

Under the CDL system there are three basic vehicle classes - A, B, and C. Class A includes all combination vehicles like tractor-trailer rigs. Class B Vehicles are straight trucks and large buses including articulated (the body can bend) buses. Class C includes CMVs under 26,000 pounds, like small buses and smaller trucks pulling a trailer. A driver with a Class A license would need a passenger vehicle endorsement(P) to operate a tractor-trailer bus.

#### **General Categories**

A bus is a self-propelled (contains its own engine) rubber-tired vehicle which is meant to carry large numbers of people. It operates on streets and roads. The Act of 1986 refers to a bus as a passenger vehicle. Under federal rules, a passenger vehicle is one that transports 16 or more passengers, including the driver.

The five general groups of buses are intercity buses, transit buses, suburban buses, school buses, and passenger vans.

#### **WHAT IS A BUS?**

Any commercial motor vehicle designed to seat and carry 16 or more passengers, including the driver.

All bus drivers must have a commercial driver's license (CDL).

Some states have stricter requirements. For example, California requires you to have a CDL if your vehicle carries 10 or more persons.

*Bus drivers must have a commercial driver's license before they can receive a passenger endorsement. To get the endorsement you must pass Section 2, 3 and 4, and also if your bus has air brakes you must pass Section 5.*

The federal law defines bus driver as a person who operates any vehicle designed to seat more than 15 person, including the driver. Bus drivers must have a commercial driver's license. You are not classed as a bus driver if you carry only family members on personal trips. you are a commercial bus driver if you transport people who are not members of your family in a bus.



### ARE YOU A BUS DRIVER?

The state law states that you are legally a bus driver if you transport passengers in any vehicle designed to seat more than 15, including the driver. All bus drivers must have a commercial driver's license. You are a bus driver even if you only:

- Drive a school bus.
- Transport passengers for nonprofit groups, such as church groups, school, scouting groups, senior citizen centers.
- Drive a hotel or car rental shuttle that seats more than 15.
- Drive an airport limousine that seats more than 15.

You are not a commercial bus driver if you only transport family members for non-business purposes, even if your vehicle seats more than 15.

**Note:** Some states may have stricter laws. For example, California requires a CDL to transport more than 10 passengers.

Safety is the most important and obvious reason for vehicle inspection.

Make sure these things are in good working order before driving.

- Service brake including air hose coupling if your bus has trailer or semi-trailer
- Parking brake (remember to test this)
- Steering mechanism (no more than 2 inches play in a 20 inch wheel)
- Lights and reflectors
- Tire 4/32" on front (no recaps) 2/32" on rear
- Horn and windshield wipers
- Rear-vision mirror
- Coupling device wheels and rims. Also check the exterior of the bus for general conditions or damage.

What is the condition of your bus? A seven (7) step inspection will provide the answer:

1. Approach checks: as you approach the vehicle, look at its overall condition. Check for fuel, oil, or water leaks and for damage:
2. Check the engine compartment: Raise the hood or cab, or open the engine compartment door, and complete the inspection.
3. Start the engine and check inside the vehicle: get in, start the engine warm up, and check the controls and instruments. Check the condition of all emergency equipment (fire extinguisher, electrical fuses, reflective triangles, etc.).
4. Check lights: Put on the parking brakes (choke wheels if you have to), get out and check high/low headlights and four-way warning flashers.

## PRE-TRIP INSPECTION

Unit 4.5

## SEVEN STEP PRE-TRIP (VSI)

Unit 4.6

Visual 4.3

## **PRE-TRIP BUS INSPECTION**

Unit 4.7

5. **Conduct walkaround inspection:** turn off headlights and four-way flashers, turn on marker, clearance, and ID lights, put on right turn signal and then walk around the vehicle and inspect it.
6. **Check lights:** Turn off all lights, turn on left turn signal and stop lights (you may need a helper). Make sure they work
7. **Check brake system:** Get in, turn lights on/off as required for driving. Do brake system tests and a final instrument check.

### **SEVEN-STEP PRE-TRIP INSPECTION CHECKLIST**

1. **Approach Vehicle - Look for Leaks**
2. **Check Under Hood or Cab**
3. **Start Engine and Check Inside Cab**
4. **Check Headlights and Warning Lights**
5. **Conduct Walkaround Inspection**
6. **Check Signal Lights**
7. **Check Air Brake System**

Before driving your bus, make sure it is safe. During the predrive inspection, check defects reported by previous drivers. If the defects reported earlier have been fixed, sign the previous driver's report. This is your statement that the defects reported earlier have been fixed.

Make sure these things are in good working order before driving.

- Service Brakes, including air hose coupling if your bus has a trailer or semitrailer
- Parking brake
- Steering mechanism
- Lighting devices and reflectors
- Tires (front wheels must not have recapped or regrooved tires)
- Horn
- Windshield wiper or wipers
- Rear-vision mirror or mirrors
- Coupling devices
- Wheels and rims

As you check the outside of the bus, close any open emergency exits. Also close any open Baggage, restroom, service, or engine access panels before driving.

People sometimes damage empty buses. Always check the inside of the bus before driving it to be sure it is safe for the riders. Aisles and stairs must always be clear. The following parts of your bus must be in safe working condition.

- Each handhold and railing
- Floor covering
- Signaling devices, including the restroom emergency buzzer if the bus has a restroom
- Emergency exit handles

The seats must be safe for riders. All seats must be securely fastened to the bus. There is one exception to this rule. A charter bus carrying farm workers may have as many as eight folding seats in the aisle.

Never drive with an open emergency door or window. The "Emergency Exit" sign on an emergency door must be clearly visible at all times. If there is a red emergency door light, it must work. Turn it on every time you use your outside light.

You may lock some emergency roof hatches in a partly open position for fresh air. Do not leave them open as a regular practice. Keep in mind the bus' need for higher clearance while driving with them open.

Make sure your bus has a fire extinguisher and the emergency reflectors required by law. The bus must also have spare electrical fuses unless it has circuit breakers.

*The driver's seat should have a seat belt. Always use it for safety.*

*Always wear your seat belt*

Visual 4.4

## **FINAL CHECK**

Unit 4.8

### **Final Check**

- Check for all required papers, trip manifests, permits, etc.
- Secure all loose articles in cab (they might interfere with operation of the controls or hit you in a crash).

This completes the pre-trip inspection.

**IF YOU FIND ANYTHING THAT IS NOT SAFE DURING THE PRE-TRIP INSPECTION, GET IT FIXED. FEDERAL AND STATE LAWS FORBID OPERATING AN UNSAFE VEHICLE.**

# LOADING AND TRIP START

Unit 4.9

## IN-TRIP (VSI)

Unit 4.10

### Important Note

Visual 4.5

Visual 4.6

Visual 4.7

Do not allow riders to leave carry-on baggage in a doorway or aisle. Be sure there is nothing in the aisle that may trip riders. Secure baggage and freight in ways that avoid damage and:

- Allow the driver to move freely and easily.
- Allow riders to exit by any window or door in an emergency.
- Protect riders from injury if carry-ons fall or shift position.

### Inspection During a Trip

Check vehicle operation regularly. You should check:

- Instruments.
- Air pressure gauge (if you have air brakes).
- Temperature gauges.
- Pressure gauges.
- Ammeter/voltmeter.
- Tires.
- Cargo and cargo covers.

If you see, hear, smell, or feel anything that may mean trouble, check it out.

### Safety Inspection

Truck drivers should inspect after the first 25 miles of a trip and every 150 miles or every 3 hours (whichever comes first) after. Check these:

- Cargo doors and/or cargo securement
- Tires - Enough air pressure and not overheated
- Brakes - not overheated (put back of hand near brake drums to test)
- Coupling devices

Passengers many times damage busses. Always check the interior of the bus: the hand-hold and railing, floor covering, signaling devices including the restroom emergency buzzer, and emergency exit handles.

All seats must be securely fastened to the bus. The one exception to the rule is a charter bus carrying agricultural workers may have up to 8 temporary holding seats in the aisle.

You must never drive with an open emergency exit door or window. The emergency exit sign must be clearly visible and if there is a light, it must work.

Make sure you have a charged fire extinguisher and emergency reflectors. You must also have spare buses if your bus is equipped with them. Make sure the driver's seat has a seat belt and use it.

Be careful so the carry-on baggage is not left where it might endanger the driver or other passengers, or may be blocking any windows or doors. Also be sure that none of the baggage may fall on anyone.

# **STEERING**

## **Unit 4.11**

### **Visual 4.8**

# **NIGHT DRIVING**

## **Unit 4.12**

### **Visual 4.9**

### **Visual 4.10**

# **POST-TRIP (VSI)**

## **Unit 4.13**

Steering a large truck, tractor-trailer, or bus requires special skills. This is mainly due to their length. Hold the wheel correctly. Allow for "off-tracking" as you steer.

Think of a wheel as a clock. Place your left hand between the eight and the ten o'clock positions and your right between the two and four o'clock positions. This double grip helps you maintain control of your bus.

### **Hold the wheel right**

Your grip on the wheel should be firm. If you hit a curb or pothole, the wheel could pull away from your hands unless you have a firm hold. Sit with your

Driving at night is more dangerous. More than half of all traffic accidents happen at night. Drivers do not see hazards as soon as they do in daylight, so they have less time to act. Drivers caught by surprise are less able to avoid a crash.

The problems of night driving involve the driver, the roadway, and the vehicle.

### **Night Driving Checklist**

#### **The Driver**

- Clean Glasses
- Do Not Wear Sunglasses
- Be Rested

#### **The Roadway**

- Plan Your Route
- Know Location of Rest Stops
- Know where Nighttime Hazards Are Ramps, Roadside Bars
- Be Extra Careful on Unfamiliar Roads

#### **The Vehicle**

- Perform Pre-trip Inspection
- Check All Lights
- Use Flashlights

### **Rear/Front Lights on School Bus**

### **Post-trip Inspection and Report**

You may have to write a report each day on the condition of the vehicle(s) you drove. Report anything affecting safety or that can possibly lead to a mechanical breakdown.

The vehicle inspection report tells the vehicle owner about problems that may need fixing. Keep a copy of your report in the vehicle for one day. In that way, the next driver can learn about any problems you have found.

# HAZARDOUS MATERIALS

## Unit 4.14

### Visual 4.11

Watch for cargo or baggage containing hazardous material. Most hazardous material cannot be carried on a bus.

The Federal Hazardous Materials Table shows which materials are hazardous. They pose a risk to health, safety, and property during transportation. The rules require shippers to mark containers of hazardous material with the material's name, ID number, and a hazard label. There are 22 different 4-inch diamond-shaped hazard labels.

#### Examples of warning labels

**DO NOT** transport any hazardous material unless you are sure the rules allow it. Watch for diamond-shaped labels.

Buses may carry small-arms ammunition labeled ORM-D, emergency hospital supplies, and drugs. Buses can also carry small amounts of certain other hazardous materials if the shipper cannot send them any other way. Buses must never carry:

- Class A poison, liquid Class B poison, tear gas, or irritating materials.
- More than 100 pounds of Solid Class B poisons.
- Explosives in the space occupied by people; the exception is small arms ammunition.
- Radioactive materials (which are labeled) in the space occupied by people.
- More than a total of 500 pounds of allowed hazardous materials. You also cannot carry more than 100 pounds of any one class of hazardous material.

Riders sometimes board a bus with an unlabeled hazardous material. They may not know it is unsafe. Do not allow riders to carry on common hazards such as car batteries or gasoline.

The driver must be extremely careful of hazardous materials (most of which cannot be carried on a bus).

The Federal Hazardous Materials Table has 22 different 4-inch diamond shape hazard labels. Do not transport any of these unless you are sure the rules allow it. **IT IS BETTER TO BE SAFE THAN SORRY.**

Buses can carry small arm ammunition labels ORM-D, emergency supplies and drugs.

Class A poison such as liquid gas and poisonous tear gas . . . .

More than 100 pounds of solid Class B poison explosives in the passenger compartment labeled radioactive material in passenger components. More than 500 pounds total or 100 of any one class.

Passengers sometimes enter the bus with unlabeled hazardous material. Do not let riders carry on car batteries or gasoline.

### Visual 4.12

### Visual 4.13

### Visual 4.14



# **BUS DRIVER REMINDER**

## **UNIT 4.15**

No rider may stand in front of the back of the driver's seat. Buses designed to allow standing must have a 2-inch line on the floor or some other means of showing riders where they cannot stand. This is the standee line. All standee riders must stay behind it.

When you stop the bus, you should announce the:

- Location.
- Reason for stopping.
- Next departure time.
- Bus number.

Remind the riders to take carry-ons with them if they get off the bus. You should also tell them where to reclaim their checked luggage. If the aisle is on a lower level than the seats, remind them of that.

Never leave your bus unattended without setting the parking brakes. Your bus might roll away and cause injury and damage.

### **Railroad crossing**

Stop at drawbridges: Stop at drawbridges that do not have a signal light or traffic control attendant. Stop at least 50 feet before the draw of the bridge. Make sure the draw is completely closed before crossing it.

The driver must not let any rider stand forward of the driver's seat. All buses allowing standing must have a stand line.

When arriving at your stop be sure to announce your location, the reason of your stopping (a stop or end of line), and the next departure time or bus number. Ask all passengers to watch their step as they get off and to take all carry-ons.

Passenger supervision can be more trying for some drivers than anything else. The best way to handle this is to explain the rules about radios, tape players, smoking or drinking before the start of the trip. You may need to remind passengers as you drive about this rule. Also be sure to tell them to be careful about getting on or off the bus.

You may have a drunk or disruptive passenger. Your foremost concern is to ensure your safety and that of the other passengers. Do not discharge such a rider where it would be unsafe for them.

Most bus crashes happen at intersections. Use extreme caution at all times. Also be aware that many drivers do not wish to follow you and will try to cut you off. You must never assume that other drivers will wait for you or yield the right of way. Drive defensively!!

**Visual 4.15**

**Visual 4.16**

**Visual 4.17**

**Visual 4.18**



**Visual 4.19**

Most bus accidents on curves result from too much speed (even in good weather). Every curve has a safe speed, but remember the posted speed is safe for conventional vehicles but not always for a bus. The rule of thumb is that if the bus leans, **SLOW DOWN**.

**Visual 4.20**

You must stop your bus at all railroad crossings. Between 15 and 50 feet before crossing, listen and look both ways.

**Visual 4.21**

If your bus has a manual transmission do not change gears on the tracks.

**Visual 4.22**

You must stop at all drawbridges that do not have a signal light or attendant.

Stop at least 50 feet before the draw of the bridge.

Inspect your bus after your shift and at each stop. You must make a written report of all defects. Also check the seats and interior of the bus.

**Visual 4.23**

Do not fuel the bus with passengers aboard unless absolutely necessary, and then remind them not to smoke or light any material or litter.

Be careful not to talk to riders when driving as it is very distracting.

Use extreme caution when towing or pushing any bus. Attempt to do it when there are no passengers aboard.

Some transit buses have a brake and accelerator latch system that holds the brake in when the door is open. This is a safety switch, **NOT A PARKING BRAKE**.

**Sample Test**  
**Transporting Passengers**  
**Unit 4**

1. On a bus, recap tires can be used on:
  - A. the front wheels.
  - B. the rear wheels.
  - C. all wheels.
  - D. cannot be used.
2. All of the following are required on a bus, except:
  - A. a fire extinguisher.
  - B. reflective triangles.
  - C. spare bulbs.
  - D. first aid kits.
3. The maximum amount of hazardous material a bus may transport is:
  - A. 1,000 lbs.
  - A. 500 lbs.
  - A. 100 lbs.
  - A. 0 lbs.
4. When a bus is in operation:
  - A. the emergency door must be closed.
  - b. no one must be standing ahead of the standee line.
  - C. driver seat belt must be used.
  - D. all of the above.
5. When stopping at a railroad crossing:
  - A. be within 15 feet.
  - B. stay back at least 50 feet.
  - C. stoop between 15 and 50 feet.
  - D. both A & B.
6. The bus may have up to eight folding seats if.
  - A. the age of all passengers is over 21.
  - B. the age of all passengers is under the age of 21.
  - C. it is a charter bus.
  - D. transporting agricultural workers.
7.
  - A. it is in a building with passengers on board.
  - B. anytime passengers are on board.
  - C. the emergency door is closed.
  - D. both A & C.
8. If there is a disruptive passengers on board:
  - A. discharge that person immediately.
  - B. you can not discharge the person.
  - C. must discharge that person at the next scheduled stop.
  - D. do not discharge that person when it would be unsafe.

## **This Section Covers**

Definition of a Bus  
Pretrip Inspection  
Loading  
Safe Driving with Buses

### **Pretrip Inspection**

### **Vehicle Systems**

### **Access Doors & Panels**

### **Bus Interior**

Bus driver must have a commercial driver's license if they drive a vehicle designed to seat more than 15 persons, including the driver. However, you are not considered a bus driver if you only carry family members for personal reasons.

Bus drivers must have a passenger endorsement on their commercial driver's license. To get the endorsement you must pass a written test on Sections 2, 3, and 4 of this manual. (If your bus has air brakes, you must also pass a written test on Section 5.) You must also pass the performance tests required for the class of vehicle you drive. This section has information you must know to drive a bus safely.

Before driving your bus, make sure it is safe. During the pretrip inspection check defects reported by previous drivers. Only if defects reported earlier have been fixed, should you sign the previous driver's report. This is your certification that the defects reported earlier have been fixed.

Make sure these things are in good working order before driving

- Service brakes, including air hose couplings  
(if your bus has a trailer or semi-trailer)
- Parking brake
- Steering mechanism
- Lights and reflectors
- Tires (front wheels must not have recapped or regrooved tires)
- Horn
- Windshield wiper or wipers
- Rear-vision mirror or mirrors
- Coupling devices
- Wheels and rims

As you check the outside of the bus, close any open emergency exits. Also close any open access panels (for baggage, restroom service, engine, etc) before driving.

People sometimes damage unattended buses. Always check the interior of the bus before driving to ensure rider safety. Aisles and stairwells must always be clear. The following parts of your bus must be in safe working condition

- each handhold and railing
- floor covering
- signaling devices, including the restroom emergency buzzer,  
if the bus has a restroom
- emergency exit handles

Forbidden Hazardous Materials

Standee Line

At Your Destination

The seats must be safe for riders. All seats must be securely fastened to the bus. There is one exception to this rule. A charter bus carrying agricultural workers may have up to 8 temporary folding seats in the aisle. Never drive with an open emergency exit door or window. The "Emergency Exit" sign on an emergency door must be clearly visible. If there is a red emergency door light, it must work. Turn it on at night or any other time you use your outside lights.

## Roof Hatches

You may lock some emergency roof hatches in a partly open position for fresh air. So not leave them open as a regular practice. Keep in mind the bus's higher clearance while driving with them open.

Make sure your bus has the fire extinguisher and emergency reflectors required by law. The bus must also have spare electrical fuses unless equipped with circuit breakers.

## Use Your Seatbelt!

The driver's seat should have a seat belt. Always use it for safety.

## Loading and Trip Start

Do not allow riders to leave carry-on baggage in a doorway or aisle. There should be nothing in the aisle that might trip other riders. Secure baggage and freight in ways that avoid damage and

allow the driver to move freely and easily

allow riders to exit by any window or door in an emergency

protect riders from injury if carry-ons fall or shift

## Hazardous Material

Watch for cargo or baggage containing hazardous materials. Most hazardous materials cannot be carried on a bus.

The Federal Hazardous Materials Table shows which materials are hazardous. They pose a risk to health, safety, and property during transportation. The rules require shippers to mark containers of hazardous material with the material's name, ID number, and hazard label. There are 22 different 4 inch diamond shaped hazard labels like the examples shown in the Figure below. A chart showing all the labels is at the back of this manual. Watch for the diamond shaped labels. Do not transport any hazardous material unless you are sure the rules allow it.

## Examples of Labels

## **Forbidden Hazardous Materials**

Buses may carry small-arms ammunition labeled ORM-D, emergency hospital supplies and drugs. You can carry small amounts of some other hazardous materials if the shipper cannot send them any other way. Buses must never carry

- Class A poison, liquid Class B poison, tear gas irritating material
- more than 100 pounds of solid Class B poisons
- explosives in the space occupied by people, except small arms ammunition
- labeled radioactive materials in the space occupied by people
- more than 500 pounds total of allowed hazardous materials, and no more than 100 pounds of any one class

Riders sometimes board a bus with an unlabeled hazardous material. They may not know it is unsafe. Do not allow riders to carry on common hazards such as car batteries or gasoline.

## **Standee Line**

No rider may stand forward of the rear of the driver's seat. Buses designed to allow standing must have a 2 inch line on the floor or some other means of showing riders where they can not stand. This is called the standee line. All standing riders must stay behind it.

## **At Your Destination**

When arriving at the destination or intermediate stops announce

- the location,
- reason for stopping,
- next departure time, and
- bus number

Remind riders to take carry-ons with them if they get off the bus. If the aisle is on a lower level than the seats, remind riders of the step-down. It is best to tell them before coming to a complete stop.

Charter bus drivers should not allow riders on the bus until departure time. This will help prevent theft or vandalism of the bus.

## **On The Road Passenger Supervision**

Passenger supervision while driving. Many charter and intercity carriers have passenger comfort and safety rules. Mention rules about smoking, drinking, or use of radio & tape players at the start of the trip. Explaining the rules at the start will help to avoid trouble later on.

While driving, scan the interior of your bus as well as the road ahead, to the sides, and to the rear. You may have to remind riders about rules, or to keep arms and heads inside the bus.

## At Stops

Riders can stumble when getting on or off and when the bus starts or stops. Caution riders to watch their step when leaving the bus. Wait for them to sit down or brace themselves before starting. Starting and stopping should be as smooth as possible to avoid rider injury.

Occasionally, you may have a drunk or disruptive rider. You must ensure this rider's safety as well as that of others. Don't discharge such riders where it would be unsafe for them. It may be safer at the next scheduled stop, or a well lighted area where there are other people. Many carriers have guidelines for handling disruptive riders.

## Common Accidents

The most common bus crashes. Bus crashes often happen at intersections. Use caution, even if a signal or stop sign controls other traffic. School and mass transit buses sometimes scrape off mirrors or hit passing vehicles when pulling out from a bus stop. Remember the clearance your bus needs, and watch for poles and tree limbs at stops. Know the size of the gap your bus needs to accelerate and merge with traffic. Wait for the gap to open before leaving the stop. Never assume other drivers will brake to give you room when you signal or start to pull out.

## Speed on Curves

Crashes on curves kill people and destroy buses. They result from excessive speed, often when rain or snow has made the road slippery. Every banked curve has a safe "design speed." In good weather, the posted speed is safe for cars, but it may roll over; with poor traction it might slide off the curve. Reduce speed for curves! If your bus leans toward the outside on a banked curve, you are driving too fast.

## Railroad Crossings

Stop at RR crossings. Stop your bus between 15 and 50 feet before railroad crossings. Listen and look in both directions for trains. You should open your forward door if it improves your ability to see or hear an approaching train. Before crossing after a train has passed, make sure there isn't another train coming in the other direction on other tracks. If your bus has a manual transmission, don't change gears while crossing the tracks.

You do not have to stop, but must slow down and carefully check for other vehicles

- at street car crossings,
- at railroad tracks used only for industrial switching within a business district,
- where a policeman or flagman is directing traffic,
- if a traffic signal shows green, and
- at crossings marked "exempt crossing"

## **Drawbridges**

## **After-Trip Vehicle Inspection**

## **Prohibited Practices**

## **Use of Brake-Door Interlocks**

Stop at drawbridges. Stop at drawbridges that do not have a signal light or traffic control attendant. Stop at least 50 feet before the draw of the bridge. Look to make sure the draw is completely closed before crossing. You do not need to stop, but must

- slow down and make sure it's safe, when
- there is a traffic light showing green
- the bridge has an attendant or traffic officer that controls traffic whenever the bridge opens

Inspect your bus at the end of each shift. If you work for an interstate carrier, you must complete a written inspection report for each bus driven. The report must specify each bus and list any defect that would affect safety or result in a breakdown. If there are not defects, the report should say so.

Riders sometimes damage safety related parts such as hand-holds, seats, emergency exits, and windows. If you report this damage at the end of a shift, mechanics can make repairs before the bus goes out again. Mass transit drivers should also make sure passenger signaling devices and brake-door interlocks work properly.

Avoid fueling your bus with riders on board unless absolutely necessary. Never refuel in a closed building with riders on board.

Don't talk with riders, or engage in any other distracting activity, while driving.

Do not tow or push a disabled bus with riders aboard either vehicle, unless getting off would be unsafe. Only tow or push the bus to the nearest safe spot to discharge passengers. Follow your employer's guidelines on towing or pushing disabled buses.

Urban mass transit coaches may have a brake and accelerator interlock system. The interlock applies the brakes and holds the throttle in idle position when the rear door is open. The interlock releases when you close the rear door. Do not use this safety feature in place of the parking brake.



# School Bus Drivers

This section provides additional information for school bus drivers transporting children and handicapped persons.

You must have a school bus endorsement if you drive a vehicle (painted school bus colors) transporting:

- Pupils to or from school, or points designated by the school.
- Handicapped or elderly persons in connection with any transportation assistance program.

For further clarification, contact the personnel at your nearest Motor Vehicle Services Center.

## Test

To operate a school bus, drivers must have Passenger and School Bus endorsements. The first part of Chapter 4 outlines the information you need to qualify for a Commercial Driver License with a passenger endorsement. In addition, you will take a special school bus knowledge test based on information in this section and pass a driving test in a school bus. Prepare for the knowledge exams by studying the information included in section 2 thru 4.

Anyone taking a driving exam in a bus that is a CMV without air brakes will be restricted from operating a bus with air brakes.

If you take the driving exam in a bus designed to carry fewer than 16 passengers (including the driver), you will be restricted to driving a bus of this size.

## Additional Requirements

There are additional driver requirements for a school bus endorsements. To qualify for the endorsements, school bus drivers must:

- Be 21 years old. (If you are under 21 years of age and want to drive a school bus, you will be restricted to intrastate operation.)
- Not have been convicted of reckless driving, operating a motor vehicle while under the influence of an intoxicant or controlled substance within the 2 year period immediately preceding the date of application.
- Not have been convicted of a felony or offense against public morals within the past 5 years.
- Have sufficient use of both hands and the foot normally used to operate the foot brake and accelerator safely.
- Have at least 20/40 vision corrected or uncorrected in each eye, have a minimum of 70 degrees field of vision in each eye and be able to identify traffic signal colors.

## Knowledge Tests

## School Bus Rules

Be able to hear a forced whisper at five feet with or without a hearing aid.

Pass a special physical examination based on requirements drawn up by the Department, taken within the last 3 months.

You will have to take one or more knowledge tests for the CDL, depending on the class vehicle and endorsements necessary. The knowledge tests may be taken at any Motor Vehicle Customer Services Center without appointment. If you need information about which tests you need to take and an estimate of the time they may require, call before going. Call to schedule an appointment for the skills test. Most but not all stations will conduct the skills test for class A vehicles.

- In addition to knowing and obeying general traffic rules applicable to all busses and large vehicles, school bus drivers must comply with these rules and procedures.
- Keep doors closed when moving, except when crossing railroad tracks.
- Transport authorized passengers only.
- Keep aisles, stair wells, and steps clear of book bags, band instruments, etc.
- Conduct a complete inspection prior to each trip. (See "Pre-Trip Inspection," in Section 4.1.)
- Keep children out of the back row of seats except when the bus is filled. Sitting near the front of the bus provides greater protection in rear end collisions.
- Seat students with special needs near the driver.
- Keep students seated when the bus is moving unless they are going to a door before stopping or to their seat immediately after loading.
- Prohibit smoking when children are on the bus.
- Maintain a time schedule but not at the expense of safety.
- Use approved routes and pickup or discharge points.
- Follow approved routes except in emergency.
- NEVER leave the bus unattended with the engine running and the keys in the ignition.
- Wear the safety belt.

A challenging task facing school bus drivers is getting children to accept part of the responsibility for their safety on the bus. Establishing a positive relationship between the driver and the passengers helps gain this cooperation.

Drivers should:

**INSTRUCT** students on the hazards that are part of riding the bus or crossing the road.

**INSTRUCT** them how to protect themselves in a crash and the proper evacuation procedures.

**REMINDE** children to continually follow safety procedures.

**INFORM** them of expected, acceptable behavior.

**HANDLE** disciplinary problems as they occur.

Maintaining proper discipline on the school bus reduces distractions and allows the driver to give full attention to driving. Students' behavior must not distract the driver or interfere with safety of other passengers.

Local school boards develop the rules for student behavior. Copies of the rules should be distributed to students and their parents. Rule enforcement is a responsibility shared by the school bus driver, school officials and parents.

#### **Student Pick-Up and Discharge**

Most student injuries occur at pick-up or discharge points. When the students are off the bus, the driver has little or no control over their safety.

Select pickup and discharge points carefully. Report those sites that are dangerous to local School Boards. Other drivers should be able to see the bus in plenty of time.

#### **Using Flashing Red Warning Lights**

A school bus has no special right-of-way privileges on highways except when picking up or discharging students. When you stop, you must use the flashing red warning lights and the stop arm.

All vehicles must stop no closer than 20 feet to a stopped school bus with flashing red warning lights and stop arm extended. The only exception is vehicles traveling in the opposite direction on a divided highway. Do not use flashing red warning lights where both sides of the road have curb and sidewalk, unless required by local ordinance.

## **Supervising Students**

## **Safety Tips**

School bus drivers are responsible for reporting incidents of drivers who do not stop for flashing red lights and an extended stop arm to appropriate enforcement agencies. Note time and location, license number, color and type of vehicle, weather and road conditions.

Any school bus driver approaching the front or rear of a stopped school bus that is displaying flashing red warning lights shall also display its flashing red warning lights while stopped. These are stopping and loading/unloading procedure guidelines:

- Turn flashing red warning lights on at least 100 feet before the stop or sooner if conditions warrant.
- Determine if other drivers have observed flashing red warning lights and have time to stop.
- Stop in the farthest right driving lane.
- Activate the stop arm only after the bus has stopped and before opening the door.
- Use the stop arm only when the flashing red warning lights are used.
- Shift to neutral and apply foot brake to prevent the bus from accidentally moving.
- Recheck traffic.
- Open the door and count the students as they leave the bus
- Students living on left side of road wait 10-12 feet in front of the bus.
- Those living on the right should move away from the bus immediately.
- Recheck mirrors.

After determining when it is safe to cross, give a clear hand signal to students while keeping a lookout for traffic. Choose a predetermined signal such as sounding the horn to warn if there is danger. Choose a signal that will not be misunderstood by the other drivers.

- Re-count the students who have been discharged.
- When you have accounted for all students, retract the stop arm and turn off signals.
- Check crossover mirror before starting.
- Proceed when traffic allows.

1 1 1

**Note:** Use the same procedure guidelines for loading students except instruct them to wait for a signal before crossing the road to the bus. Inform new students and remind all students of proper procedure at the beginning of each school year.

Do not use the flashing red warning lights when operating a school bus to transport adults or when a school bus is being used for non-school functions. When the bus is used for these situations, cover the words, "school bus" on the front and rear of the bus.

#### **Without Flashing Red Warning Lights**

If you are loading or discharging students in areas where flashing red warning lights are not required, follow these procedures:

- Activate the yellow hazard lights at least 100 feet before the stop.
- Move over to the right curb.
- Observe traffic carefully.
- Tell students to stand away from the road when waiting to board and to move away from the bus immediately after they get off.
- Instruct students who must cross the street to go to the cross walk and wait until it is safe to proceed.
- When students are safely aboard or unloaded, turn off the hazard warning lights and use the left turn signal to re-enter traffic. Teach students these procedures. Work with parents to promote safety.

#### **Pick-up / Discharge On School Grounds**

The pickup and discharge of students at the school grounds requires special planning to prevent injuries to children. Some rules for operating your school bus on school grounds are:

- Arrive before students are in the loading area at dismissal time.
- Drive slowly in and near the school area.
- Never back a bus on school grounds.
- Come to a complete stop before discharging students.
- Shift to neutral and apply foot brake.
- Supervise loading/unloading.

## White Strobe Lights

## Backing a School Bus

## Turning Around

- after boarding students, move out carefully.
- Do not pass other buses, remain in line.
- Maintain proper following distance behind other buses.

The flashing white strobe light is optional equipment that increases visibility in all types of weather. Its use does not require motorists to stop.

See Wisconsin Administrative code (Trans 110 and 300) for additional information.

Never back a school bus unless it is absolutely necessary, and then only if it is safe. The bus's size and design severely limit the driver's ability to see. Many school bus accidents occur while backing.

If you must back, know what is behind the bus. Ask a responsible student to move to the back seat of the bus and act as a guide. If no responsible student is available, the driver should walk around the bus before backing.

Like backing, turning around in a driveway is done only when necessary. Plan routes to reduce the need for this maneuver.

If you must turn around in a driveway, there are two methods. The driver is responsible for making the choice after evaluating the conditions. When pulling into a driveway:

- Signal the turn.
- Check traffic and yield to oncoming vehicles.
- Pull into the drive until the bus is straight.
- Pick up students before backing.
- Check traffic carefully.
- Use hazard warning lights.

When discharging students make sure they are safe before backing onto the highway. When backing into a driveway:

- Drive past the driveway and allow enough space to maneuver.
- Load students before backing into the driveway.
- Check traffic carefully. Allow traffic to pass.
- Use hazard warning lights.
- Back into drive.
- Discharge students after backing.
- Check traffic and yield to oncoming vehicles.
- Proceed out of the drive.

Either method requires some backing and seriously limits your ability to see. Never back when children are near.

### **Railroad Crossings**

All school buses must stop at railroad crossings unless the tracks are posted "exempt" or "abandoned." The procedure for stopping at railroad crossings is:

- Check traffic before slowing.
- Turn on yellow hazard lamps at least 100 feet before the stop.
- Stop in the farthest right driving lane, no closer than 15 nor further than 50 feet from the nearest rails.
- Shift to neutral and use foot brake to prevent the bus from moving.
- Ask passengers to be quiet.
- Open the service door (or driver's side window on the vehicles without driver controlled service door) and listen carefully.
- Look left, then right.
- Recheck again. Never rely on railroad mechanical flashing lights.
- Select the lowest gear that will permit crossing the tracks without shifting.

The service door may be closed after the front wheels clear the first set of tracks. As soon as the tracks are crossed and before shifting gears, the service door must be closed. Turn off yellow lights when you return to normal speed.



## Handling Emergencies

When crossing multiple tracks, stop between the tracks when there is more than 15 feet between the front and rear of the bus and any tracks.

School bus drivers should prepare for unexpected situations. Carry emergency cards listing telephone numbers for the sheriff, local police, school officials, ambulance service and garage.

If possible, do not leave the children unattended. Give the card to two responsible children who will go for help. Select and train several students for this responsibility. Two way radios are valuable in emergency situations.

Following a crash or break-down, the school bus driver must decide whether to evacuate the students. They may be safer on the bus. If evacuation is necessary, select a safe place and supervise the unloading.

It is extremely important that the bus is visible in the event of a break-down or crash. To maximize your bus visibility:

- Move off the roadway if possible.
- Activate the hazard lights and after dark, turn on the parking and clearance lights.
- Set out traffic warning devices.

Then account for all of your students and administer necessary first aid. Report school bus crashes immediately to a local law enforcement agency.

## Fire

In the event of a fire from a collision or an equipment malfunction, follow this procedure:

- Evacuate the students.
- Set out traffic warning devices.
- Send two responsible children for help with the emergency cards.
- Attempt to put the fire with the extinguisher.

## Evacuation Procedures

## **Transporting Handicapped Persons**

Use the school grounds to conduct an evacuation drill using the front door on the school grounds. To practice a drill using the service door and emergency exit, find an area where there is no traffic.

In an evacuation, calm the students and give them instructions. If the driver is unable to conduct the evacuation because of an injury, the school patrol members should take over.

**Front door evacuation procedure is:**

- Student in the front seat exit first followed by those in the right front seat.
- Continue alternating from the front to the rear of the bus until all students are off.

**Rear door evacuation procedure is:**

- Assign two patrol members or older children to exit first and help the others out of the door.
- Students in the left rear seat exit first followed by those in the right rear seat.
- Continue alternating until all students are off the bus.

If possible, use both doors for evacuation. Start at both doors alternating as above. Have the students assemble in one location immediately after the evacuation. Do not allow students to cross the road or re-enter the bus. Always account for all of the students.

Transporting persons with special needs or physical disabilities requires patience and understanding. Follow your company guidelines. Some general rules are:

- When raising or lowering persons on the power ramp, hold onto the wheel chair.
- Secure the wheel chair first and then the occupant.
- Know an individual's special health or behavioral problems.
- Practice vehicle evacuation.

Establish an understanding with the parents, guardians or other care givers on their involvement in loading and unloading the person at home. Work with the parents and school officials to determine the location for pick up and discharge. Do not leave your bus unattended to assist a person with special needs unless the engine is shut off and the keys are removed from the ignition.

## **Pre-Trip Inspection**

Each driver is required and may be held accountable, for making a pre-trip check of the bus to determine whether or not the vehicle is safe to operate on the highway. Review Chapter 2 of this manual for detailed information on pre-trip check inspection. Additionally school bus drivers must:

- Check stop arm control
- Check operation of emergency door and buzzer.
- Activate headlights, hazard warning lights and red flashers, leave activated for exterior inspection.

You as a driver will be evaluated by the driver license personnel on the inspection of the vehicle at the time of examination for original or renewal of your school bus license. You may use the CDL check list as a guide when being evaluated.

Driver license examining personnel will complete an examination report for school bus driver applicants. This report is to be returned to the school bus owner or contractor by the driver taking the examination.

# **Air Brakes**

## **Unit 5**

Many commercial vehicles are equipped with air brakes. If you want to operate these vehicles you will need to pass the knowledge test for air brakes.

The material discussed in this section deals with air brakes in general. If you wish to pull a trailer which is equipped with air brakes, you will have to study the material in Section 6 as well. Section 6 deals with certain aspects of air brakes which apply only to combination vehicles.

Air brake systems are actually three brake systems combined. First, there is the service brake system. This system applies and releases the brakes in normal driving situations.

A second system is the parking brake system. This system applies and releases parking brakes when you operate the parking brake controls.

The third system is the emergency brake system. This system uses part of the service and parking brake systems to stop the vehicle in emergency situations following a brake system failure.

When you slow or stop your vehicle in everyday use, you use the service brakes. These brakes are operated when you use certain controls which open certain valves. When these valves are open, compressed air is sent to the brake parts. The force of the compressed air drives brake shoes against brake drums.

When you secure your vehicle with the parking brake, you operate a control which cuts off a supply of compressed air to certain areas of the brake system. With the air supply removed, powerful springs are allowed to expand. The force of these springs drives brake shoes against brake drums and secures the vehicle in place.

When your vehicle experiences an air loss, these same springs expand. The results are the same as when you apply the parking brake: the springs expand, and the brakes are applied.

The major difference between the parking brake system and the emergency brake system in newer vehicles is that when you park the vehicle and set the parking brakes, you deliberately dump the air supply from the system by operating the parking brake control. This deliberate loss of air allows the springs to expand. In an emergency, the loss of air is not deliberate, but the system functions essentially the same: air is lost, and the springs expand, thus applying the brakes.

Now that we have taken a look at the three systems which make up an air brake system, let's take a look at some of the mechanical parts which make up the three systems.

The first part to consider is the compressor. The compressor takes air from the atmosphere and compresses it into air storage tanks for use in operating the brakes. These tanks are also known as reservoirs.

Visual 5.1

The power to run the compressor comes from the engine by way of either belts or gears. The compressor is actually a small motor, and like any motor it must be both cooled and lubricated.

The compressor may be cooled either by air or by the engine cooling system. The compressor may have its own oil supply, or it may share oil with the engine. If the compressor has its own oil, then you must check the oil level the same as you would check the oil in any other motor, or in other words, before operating it.

All air compressors have governors which tell the compressor when to compress air, and when to stop. When the air pressure rises to a present level, the governor tells the compressor to "Cut Out." This is usually around 125 psi. At the "Cut Out" point, the compressor stops pumping air.

When the air pressure falls to the "Cut In" point, the governor tells the compressor to start pumping air once again to rebuild pressure. This point is around 100 psi.

Another part of the air brake system is the storage tanks which hold the air compressed by the compressor.

The number of tanks and the size of the tanks will vary between vehicles. But while the number and size will vary, all storage tanks hold enough air to operate the brakes several times even if the compressor fails.

Compressed air usually has some water and compressor oil in it which is bad for the system. In winter the water might freeze and interfere with the operation of the brakes. The oil might interfere with the operation of the many valves which control the movement of air through the system.

This water and oil tend to collect in the bottoms of the reservoir tanks, and especially in the tank closest to the compressor. To ensure the proper operation of the system, this oil and water must be removed from the system on a regular basis.

To allow this water and oil to be removed, reservoir tanks have drain valves. These valves fall into two categories.

Some valves are manually operated. Each day the driver must open these valves to allow the oil and water to escape. The driver opens the valve by either turning the valve handle a quarter turn, or by pulling a cable which opens the valve.

Another type of valve is an automatic valve. These valves may also be operated manually. To help prevent the valve from freezing in cold weather, these automatic valves often have electric heating devices.

Some brake systems have an alcohol evaporator added to the system as an extra precaution against freeze up in the valves and lines. An alcohol evaporator adds alcohol to the air system to help eliminate water from the system. The alcohol level in the evaporator must be checked on a daily basis. Even with an evaporator, daily air tank drainage is necessary, unless the system drains automatically.

## Visual 5.2

### Visual 5.3

To protect the air system from a failure of either the governor or compressor, a safety valve is installed in the tank nearest to the compressor.

Should the air pressure rise too high, usually to around 150 psi, the safety valve will open to allow pressure to escape. When this happens it means something is wrong with the air system, and you should seek the help of a mechanic.

### Visual 5.4

A part of the air brake system with which you are well acquainted is the brake pedal. Other names for the brake pedal are foot valve or treadle valve. When you hit the foot pedal, you open a valve and allow air to leave the storage tanks and go to the brakes. By pushing harder on the pedal, you transmit more air and apply the brakes with even more force.

Repeatedly hitting the brake pedal allows air to leave the tanks and the rest of the system faster than the compressor can replace it. The loss of too much air will prevent the system from operating properly.

As you push the foot pedal, two forces push back against your foot. One force comes from a spring built into the pedal. The other force is the force of the air going to the brakes. These two forces allow you to feel how much pressure is being applied to the brakes.

The parts of the brake system which we have discussed so far are all located away from the wheels. Those parts which are located close to the wheels are known as the foundation brakes.

Foundation brakes include brake shoes, brake drums and the various brake parts associated with the brake chambers.

Brake drums are located on each end of the vehicle's axles, inside the wheels. When you use the brakes, the brake shoes and brake linings are pushed against the inside of the drum. The friction of the shoes pushing against the drums is what causes the vehicle to slow or stop.

This friction also produces heat. Sometimes this heat can damage the drum. How much heat the brakes create depends on how long and hard the brakes are applied. Too much heat can damage the drums or otherwise cause the brakes to fail.

### Visual 5.5

Perhaps the most common form of foundation brake is what is called "S-Cam Brakes." When you push the brake pedal, air is sent to the brake chambers.

This air pushes out the chambers a rod called a push rod. One end of the push rod is attached to a slack adjuster.

### Visual 5.6

As the push rod is pushed out and the slack adjuster moves with it, the slack adjuster twists what is known as an S-Cam.

The end of the S-Cam opposite the slack adjuster is shaped like the letter "s". As the S-Cam twists, the letter "s" twists with it. The twisting "s" spreads apart the brake shoes, driving them against the drums and creating the friction necessary to slow or stop the vehicle.



When you release the brake pedal, the push rod returns to the brake chamber, and the slack adjuster moves in response. The S-Cam twists back, and the "s" twists also. As the "s" twists back, the brake shoes are pulled away from the drums by springs and the wheels again roll freely.

Another form of foundation air brake is what is called a "wedge brake." In this form of brake the push rod pushes a wedge directly between the ends of two brake shoes. This wedge drives apart the shoes and drives them into the drums, thus creating the necessary friction.

Wedge brakes may have one or two brake chambers, pushing at one or two ends of the brake shoes. Wedge brakes may be self-adjusting or they may require manual adjustment.

Some vehicles have air-operated disc brakes as their foundation brakes. In these brakes compressed air acts on a push rod and slack adjuster just as with the S-Cam system. But instead of an S-Cam, disc brakes rely on what is called a "power screw."

The slack adjuster turns the power screw which clamps together the ends of a caliper. This caliper is shaped much like a large C-clamp. As the caliper closes, it closes against a disc or rotor thus creating friction.

As we have said, the most common foundation air brake found in commercial vehicles is the s-cam brake.

All vehicles equipped with air brakes must have pressure gauges attached to their reservoir tanks. Drivers of air brake equipped vehicles must always know how much air pressure the tanks contain. Vehicles equipped with dual brake systems, which we will discuss in a few minutes, will have either two gauges, or one gauge with two needles.

Some vehicles have what is known as an application gauge. This gauge tells the driver how much air pressure is being directed to the brakes and thus the force of brake application.

Application gauges tell the driver of a vehicle several important bits of information about his brake system. If while descending a steep hill increasing amounts of application are required to maintain roughly equal braking, it means the brakes have begun to "fade" from the heat which has been created. In other words, the hot brakes are not working well.

Also, the need for increased force of application might indicate that the brakes are out of adjustment, that there are air leaks, or that there may be a mechanical problem with the brakes.

All vehicles with air brakes must have warning devices to alert the driver to a loss of air pressure. A signal which you can see must activate before the air pressure falls below 60 psi. On older vehicles the alarm must come on at one half the compressor cut-out pressure. In addition to a visual warning device, a buzzer or bell might sound.

120

Visual 5.7

Visual 5.8



## Visual 5.9

Some vehicles have warning devices called "wig wags." These are mechanical arms which drop into view when the pressure drops below 60 psi. An automatic wig wag will return to position when the pressure returns. The manual variety must be pushed back into position and will not stay there until pressure is above 60 psi.

Some large buses have warning devices which activate at 80-85 psi rather than 60 psi.

Just as in a car, there must be a means for drivers behind you to know you have hit the brakes. In air brake equipped vehicles a pressure sensitive switch activates the vehicle's brake lights. Air pressure in the air lines activates the switch.

## Visual 5.10

Some vehicles made before 1975 have a manual front brake limiting valve which was designed to limit the braking force of the front axles. The control is often on the dashboard and is usually marked "normal" and "slippery."

To operate this system, the driver would place the control in the position appropriate for conditions.

The logic of these devices was that by limiting front wheel braking the possibility of front wheel skids would also be limited. The problem is that by limiting the braking force, the stopping ability of the vehicle is naturally reduced as well.

Tests have shown that front wheel braking is good under all conditions. Front wheel skids due to braking are not likely even on ice. The extra braking ability of having all your brakes operating as fully as necessary is well worth the small risk of a front wheel skid. If your vehicle has a manual brake limiting device, keep it in the normal position.

Many vehicles have automatic front brake limiting devices. These devices limit front wheel braking except when the brakes are applied with hard force, usually 60 psi or more application force. By allowing the brakes to operate fully when called upon, these devices are an improvement over the old limiting devices.

We have already talked about the three systems which make up a complete air brake system. Now let's take a look at a particular type of brake which usually serves as the parking and emergency brakes. This type of brake is known as a spring brake.

All trucks and buses must have parking and emergency brakes which operate by mechanical means rather than the force of compressed air. The problem with relying on compressed air to keep brakes applied is that whenever the air is lost there is no force to hold the brakes.

The mechanical force most often used is the force of powerful springs. When the parking and emergency brakes are not in use, compressed air holds these springs closed.

When the parking brakes are applied or when there is an emergency loss of air, the removal of this compressed air allows the spring to expand. The force of the spring is what holds the brake shoe against the drum.

We have already talked some about these brakes and how they operate. It's important to understand that the air used to control these springs is held separately from the air used to operate the service brakes in normal situations.

Spring brakes will fully apply when the air pressure drops to about 20 to 45 psi. Most often the range is from 20 to 30 psi. The safe thing for a driver to do when there is a drop in air pressure is to stop as soon as possible, before the air pressure reaches this level and the springs fully apply.

When the springs apply fully, you will not be able to control the vehicle's braking force. To maintain maximum control, a driver should always be able to control the force with which the vehicle stops.

For spring brakes to work properly, the brakes on the vehicle must be in proper adjustment. If the brakes are not in adjustment, neither the service or spring brakes will work properly.

Let's take a look at the parking brake controls found on air brake equipped vehicles. On newer vehicles you apply the brakes with a diamond shaped, yellow, push/pull knob located on the dash.

Pulling the knob out removes the supply of air to the springs and allows the spring to expand, thus applying the brakes. Pushing in the knob directs compressed air to the springs, closing the, and releasing the brakes. On older vehicles you may find a lever instead of a knob.

Remember, never leave your vehicle without first applying the parking brake.

A word of caution regarding the use of parking brakes. Don't apply the service brakes when the spring brakes are applied. The combined force of the spring and the service air may damage the brake parts. When the spring brakes are applied, keep your foot off the brake pedal.

On some vehicles you will find a modulating valve. This spring loaded valve allows you to control the flow of air to the spring brake and thus control the braking force. This valve is useful, because if the spring brakes simply pop on fully applied, you may have difficulty controlling the vehicle. When you park a vehicle with a modulating valve, move the control as far as it will go, then lock it in position.

Sometimes after air pressure is lost and the spring brakes apply, it may be useful to be able to move the vehicle a short distance to a safer place. Some vehicles have a separate air tank which can be used to release the spring brakes in these situations.

On the dash will be a spring loaded button which pops back into the "out" position when you release it. When you press the button, air is released from this separate tank and is fed to the spring brake, closing it, and allowing you to move the vehicle. Releasing the button applies the spring brake once again.

When using this button, you must carefully plan your moves, since there is only enough air in the tank for the control to be used a few times. If you're not careful, you may wind up in a dangerous location when you use the last of the separate air supply.

Visual 5.11

## Visual 5.12

Most newer vehicles with air brakes have what is called dual brake systems. These vehicles have dual air brake systems which use a single set of controls. Each system will have its own tanks, hoses, lines and foundation brakes. These are called the primary and secondary brake systems.

One system will operate the service brakes on one axle or set of axles, while the other system will operate the remaining brakes. Typically the primary system operates the rear brakes, while the secondary operates the front. Sometimes the secondary system will operate the brakes on one rear axle if there are more than one.

Thus if one system fails, you will still be able to operate the brakes of the other system and stop the vehicle. Each system is simply the backup for the other.

As we have said earlier, these vehicles will have either two air gauges or a single gauge with two needles. As you operate a vehicle with dual systems, you should note the pressure in each system. You need a minimum of 100 psi in each system.

Each system must operate as though it was the only system on the truck. This means that warning buzzers, lights and pressures must be watched for each.

If you notice a pressure drop in one system, pull over. Low pressure in one system means that system will not operate properly and that you are driving with less than full braking ability. You must never drive with less than full braking ability.

Vehicles which are equipped with air brakes require special attention when it comes to inspections. The inspections which must be performed on an air brake system were discussed in the section pertaining to inspections in general.

In general, the inspections fall into three areas. First, those parts around the engine which must be inspected. This means the compressor, and the belts (if applicable) and hoses and lines around the compressor.

Secondly, the condition of the individual brake parts must be checked as you walk around the vehicle. Look for such things as loose, worn or contaminated brake linings. Check the slack adjusters to see if the brake adjustment is correct. Check the condition of the drums, the chambers and the various hoses.

The final step in a brake inspection process is to make sure everything functions as it should. Test warning devices and spring brakes. Test service brakes, both the foot and the trailer control valve if you have one.

Make sure the compressor builds up air properly and that the governor is properly adjusted. Finally, check the system for leaks.

For additional information, refer to the manual section on inspections or refer back to the material presented in our discussion.

Now that we've looked at how an air brake system operates, some of the parts included in an air brake system and the correct method to inspect an air brake system, let's look at driving techniques which are best for air brake equipped vehicles.

For normal stops in normal situations, apply pressure on the foot pedal smoothly and as evenly as possible. Moderate the pressure to ensure smooth, safe stops. If you have a manual transmission, push in the clutch just as the engine rpm is about to drop to idle.

In emergency situations, your objectives are to brake so that you retain control of the steering and so that your vehicle stays in a straight line, if possible. You can achieve these goals in two ways.

One method is controlled braking. We discussed controlled braking when we discussed emergencies. Remember, apply the brakes as hard as possible without locking the wheels. Don't steer and brake together. If you feel a skid, let up on the pedal.

The other method is stab braking. We've discussed this technique also. Remember, hit the brakes as hard as you can, then release them when you feel the wheels lock up. As soon as the wheels start rolling again, hit the brakes as hard as you can once more. Make sure the wheels are rolling again before you return to the brake pedal.

We've talked about speed and stopping distance in our discussion on speed control. With air brakes there's an extra consideration to figure into the equation.

Air brakes do not work instantly. When you hit the brakes there is a slight lag in the reaction of the brakes. This is simply the time it takes the air to go through the system, but you have to keep the delay in mind when you figure the distance necessary to stop the vehicle.

This delay is called "brake lag." The distance the vehicle travels during brake lag is called brake lag distance.

Thus, with air brakes total stopping distance is comprised of four factors:

1. Perception Distance
2. Reaction Distance
3. Brake Lag Distance, and
4. Effective Braking Distance

At 55 mph, brake lag distance is approximately 32 feet. Drivers must not forget the delay factor. Sometimes 32 feet might be the difference between hitting a hazard or stopping safely.

A subject of great importance to the drivers of commercial vehicles is the matter of how to drive safely down steep grades. The problems drivers face in this area are primarily heat buildup around the brakes and the depletion of the vehicle's air supply.

Heat buildup will lead to brake fade which is when a given amount of air offers less and less braking force. As more and more air is used to maintain braking force, the air supply might possibly become exhausted. Brake fade may become so extreme that the brakes will simply not slow you down.

To avoid these problems, go down steep or long grades using a low gear. This will allow the engine to help hold back the vehicle. The proper brake applications for these situations are light, steady applications. These applications along with the use of lower gears will hold vehicle speed down and will minimize heat buildup and air pressure loss.

The idea that hitting the brakes hard, then releasing them will allow them to cool is simply wrong. Brakes cool slowly, so the time between applications does nothing at all to help prevent overheating.

Hitting the brakes hard, then releasing them actually produces more heat than light, steady applications.

A final word about downhill braking. An absolute requirement is that the vehicle's brakes be properly adjusted and that the brakes be in balance. Brakes which are not balanced will force one or more brakes to do more than their share, and might lead to a failure of these brakes. Brake balance can be tested and corrected by air brake mechanics.

One thing to pay special attention to as you drive is your vehicle's low air pressure warning device. If the device ever comes on, pull over and stop as quickly as possible. It's very important to stop while the vehicle still has some air pressure remaining and before the spring brakes apply.

Waiting for the spring brakes to apply to stop the truck is wrong for two reasons. For one, since spring brakes often are not found on all axles, you will be attempting to stop the vehicle with less than its full braking capability. This will mean a much longer stopping distance.

The other problem with using spring brakes in this manner is that usually the driver will not be able to control braking force when the spring brakes apply. If this were to happen on slick roads, the vehicle might skid due to overbraking. Use the foot pedal whenever possible to stop the vehicle.

Finally, let's talk just a moment about the use of parking brakes. Whenever you are away from the vehicle you must secure it from moving. Usually this means you must use the parking brakes. However there are several situations when it may be better not to use the parking brake.

Avoid use of the parking brakes if the brakes are very hot. The excessive heat may harm the shoes and drums. Allow hot brakes to cool before applying the parking brake. Use wheel chocks to hold the vehicle in place.

Avoid using the parking brakes if the brakes are wet. In cold weather wet brake shoes can freeze to the drums and make it difficult for the brakes to release. If your brakes are wet, use them lightly while driving to warm them and dry them.



**Air brakes offer a safe method of slowing and stopping large, heavy commercial vehicles. But as with any mechanical system, air brakes require attention and proper maintenance. Air brakes also require drivers to follow certain driving techniques for maximum operating safety. Understanding both the parts of the system and the operating principles mentioned here will contribute greatly to safe operations.**

**Sample Test**  
**CDL AIR BRAKE**  
**Unit 5**

1. When driving down a long grade, it is best to:
  - a. apply light brakes, then release and reapply when your speed builds back up.
  - b. apply strong brake pressure in a pumping action.
  - c. apply light, steady pressure all the way down the grade.
  - d. kick the transmission out of gear and only brake when needed.
  
2. The application air gauge shows:
  - a. total air pressure in air system.
  - b. amount of pressure currently being applied by brake pedal.
  - c. how much air has been used since beginning the trip.
  - d. none of the above
  
3. The low air pressure warning will activate at approximately:
  - a. 60 psi.
  - b. 30 psi.
  - c. 20 psi.
  - d. 80 psi.
  
4. If you experience a severe air loss and the service brake system is no longer working, which brake system is used to stop the vehicle?
  - a. parking brake system
  - b. interlock air lock system
  - c. service brake system
  - d. emergency brake system
  
5. Air tanks should be drained at least:
  - a. daily.
  - b. weekly.
  - c. after each dispatch.
  - d. every 4 hours.
  
6. An alcohol evaporator:
  - a. injects alcohol into the air lines to help prevent freezing.
  - b. is used instead of an air dryer.
  - c. removes alcohol from air lines.
  - d. should be used only on hydraulic brake systems.
  
7. The air compressor governor determines:
  - a. amount of air sent to brakes when brake pedal is depressed.
  - b. how fast the air compressor is allowed to run.
  - c. the cut-in and cut-out pressure.
  - d. all of the above
  
8. If you experience a sudden drop in the air system, you should:
  - a. continue driving and say an effective prayer.
  - b. continue driving but only to the next repair shop.
  - c. keep your eye on the gauge and hope it will build the pressure back up.
  - d. stop immediately when safe to do so.



**Sample Test - Cont'd**

**CDL AIR BRAKE**

**Unit 5**

9. At approximately 20 - 45 psi:
  - a. the low air pressure buzzer will activate.
  - b. spring brakes will apply automatically.
  - c. nothing unusual will happen.
  - d. the air compressor governor will quit working.
  
10. Vehicles equipped with air brakes must have:
  - a. at least 2 air tanks, one on tractor and one on trailer.
  - b. an air pressure gauge.
  - c. a dual air brake system.
  - d. automatic air drains.
  
11. When a driver depresses the brake pedal, what air brake system is he using?
  - a. service brakes
  - b. emergency brakes
  - c. parking brakes
  - d. both a and b
  
12. Emergency brakes are activated by:
  - a. the brake pedal.
  - b. the "S" Cam.
  - c. a loss of air pressure.
  - d. all of the above
  
13. Which of the following is the most common foundation brake found on commercial vehicles?
  - a. wedge and drum
  - b. disc
  - c. "S" Cam drum
  - d. none of the above
  
14. If the air system develops a leak, which of the following prevents the air from escaping out of the system?
  - a. air compressor
  - b. emergency brake system
  - c. the emergency relay valve
  - d. the one-way check valve
  
15. The spring brakes, or emergency braking system:
  - a. will always work.
  - b. will work only if the brakes are adjusted properly.
  - c. cannot be tested by one person during a pre-trip inspection.
  - d. will work properly, regardless of the brake adjustment.

# Combination Vehicles

## Unit 6

### Visual 6.0.1

# Driving Combination Vehicles Safely

## Unit 6.1

### Visual 6.6.1

### Visual 6.1.2

### Visual 6.1.3

### Visual 6.1.4

To obtain a Class A CDL License in Wisconsin the knowledge test must be taken along with the Combination of Vehicle Test. If the combination of vehicle being operated has air brakes, the air brake test must also be taken. This unit covers just the minimum knowledge needed for driving a combination vehicle.

A combination vehicle is any combination of vehicles with a gross combination weight rating of 26,001 pounds or more provided that the trailer(s) being towed is in excess of 10,000 pounds. Drivers of combination vehicles must have additional knowledge and skill of other vehicles also. Let's discuss some important safety factors that apply mainly to combination vehicles.

Driving combination vehicles requires additional knowledge and driving skill. The heavier loads as well as the high center of gravity of many loads present problems. Rollover of loaded combination vehicles is a major factor during vehicle crashes.

A video tape entitled "Rollover" has been produced that shows the causes of rolling over combination vehicles. At this time we will view that tape.

Let's review the important concepts related to rollover.

- Drive slowly around curves, on and off ramps, etc.
- Avoid any quick steering.
- Keep loads low; the center of gravity should be as low as possible.
- Load the load in the center of the vehicle.
- Fully loaded vehicles are 10 times more likely to roll over in a crash than an empty one.
- Make sure the load is secure.
- Steer smoothly.

Improper steering may result in a "crack the whip" action. The more trailers, the greater the whipping action.

To keep this crack the whip action to a minimum:

- Follow at a safe distance — at least one second for each ten feet of your vehicle length, plus add another second if over 40 mph.
- Look far down the road.
- Slow down before a turn.
- Don't over drive headlights.

Start braking early so only minimum braking is required. Large combination vehicles that are empty may take longer to stop than loaded ones. The braking system on trucks is designed for when they are fully loaded. When empty, the stiff suspension and strong brakes tend to lock up the wheels which increase stopping distances.

Tests have shown that bobtail tractors can be very hard to stop. It may take them farther to stop than a tractor trailer fully loaded.

(Slide trucks down the inclined table.)

When wheels lock up, they slide. A skidding wheel has less resistance on the pavement than a rolling one. These sliding wheels will tend to lead. If the tractor drive wheels lock up, the rear of the tractor will start to come around. If the trailer wheels lock up, the rear of the trailer will come around. This is also true for bobtail tractors.

#### Visual 6.1.5

To recover from any of these skids, the tires must regain rolling traction with the pavement. Release the brakes. The trailer should follow the tractor once the trailer tires regain rolling friction. Do not use the hand brake to straighten out the trailer. Some steering may be necessary. Select a reference point in front of the vehicle and keep steering towards it.

#### Visual 6.1.6

The longer the trailer, the greater the off-tracking; where the rear wheels follow a different path than the front wheels.

Position the truck so when going around a corner, the rear wheels do not run over the curb, pedestrians, other vehicles, etc. If you cannot complete your turn without entering another traffic lane, turn wide as you complete the turn. Do not swing wide before starting the turn.

## Combination Vehicle, Air Brakes

### Unit 6.2

#### Visual 6.2.1

During the air brakes section, Section 5, various air brake components were discussed and air brake safety checks were gone through. That unit focused on single vehicles. Let us focus on some additional components found on combination vehicles.

#### Visual 6.2.2

Trailer hand valve, also called the trolley valve or Johnson bar, is an optional valve that operates just the trailer brakes. It should only be used when checking trailer brakes. It should not be used when driving or for parking.

#### Visual 6.2.3

Tractor protection valves keep air in the tractor or truck in case the trailer breaks away or develops a bad air leak. The tractor protection valve is controlled by the trailer air supply valve inside the cab. At 20-45 psi the valve will close automatically. The tractor protection valve stops the air from flowing out of the tractor air system. When this happens, the emergency brakes on the trailer will come on.

#### Visual 6.2.4

The trailer air supply valve is a red eight sided knob that controls the tractor protection valve. When depressed, the tractor protection valve opens and air travels to the trailer air tank. When air pressure drops to between 20 and 45 psi, the trailer air supply knob will pop out and close the tractor protection valve. This is the emergency position. The normal position is when the knob is in.

**Visual 6.2.5**

There are two air lines between the tractor and the trailer — the Service Line and the Emergency Line.

The service line (blue — control line) has air when either the front brake is applied or the hand brake is applied. The harder either of these brakes are applied the more air flows through the lines. If a major leak occurs in the service line, it will not be noticed until the brakes are applied. If too much air is lost in the air system, the trailer emergency brakes will go on.

**Visual 6.2.6**

Emergency air lines (red) — When the trailer air supply knob is pushed in, air flows through the tractor protection valve through the red emergency air line into the trailer air tank. Loss of air in the emergency air line causes the trailer emergency brakes to go on.

**Visual 6.2.7**

Glad Hands are the metal connectors that connect the air lines to the trailer. Make sure the glad hand seals are in good condition. When the air lines are uncoupled, connect them to the dummy couplers so water and dirt do not get into the air system.

**Visual 6.2.8**

When air flows down the trailer emergency air line, the air enters the trailer air tank(s). Drain the air tanks daily.

Trailers built before 1975 and many converter dollies do not have spring brakes. If the air lines would get crossed, you could drive but the trailer may not have any brakes. This could be very unsafe.

## **COUPLING AND UNCOUPLING**

### **Unit 6.3**

#### **Visual 6.3.1**

Drivers must develop a safe routine for coupling and uncoupling trailers. Following is a video tape on the proper technique.

When the combination vehicle is coupled, there are safety items that the driver must do in addition to a noncombination vehicle.

## **Sample Test**

### **Combination Vehicle, Air Brakes Unit 6.3**

1. Use the trailer hand valve:
  - a. to test trailer brakes.
  - b. for parking.
  - c. to recover from a trailer jackknife.
  - d. all of the above
  
2. When air pressure gets low (20-45 psi), what valve closes?
  - a. limiting
  - b. tractor protection
  - c. relay
  - d. quick release
  
3. If a major air loss occurs in the trailer brake system:
  - a. the trailer emergency brakes will engage.
  - b. the trailer air supply control will go to the emergency position.
  - c. the tractor protection valve will close.
  - d. All of these will occur.
  
4. The blue color air line that carries air from the foot brake and hand brake to the trailer is called the:
  - a. service line.
  - b. control line.
  - c. signal line.
  - d. all of the above
  
5. The metal air couplers at the end of the air lines are called:
  - a. dummy couplers.
  - b. relay couplers.
  - c. glad hands.
  - d. pigtails.
  
6. When inspecting the 5th wheel before coupling:
  - a. there should be no grease (lubrication) on it.
  - b. jaws should be closed.
  - c. it should be tilted toward the front of the tractor.
  - d. the safety unlocking handle should be in the automatic position.

# **Double/Triples**

## **UNIT 6.4**

To obtain a double/triples endorsement, a written test is required but not a skills test.

Many of the test questions for the double/triple endorsement are from UNIT 6, Combination Vehicles. At this time we will review that material.

Now let's continue with the material on Coupling Twin Trailers. To do this we will view the Double/Triple Section on the "No Nonsense CDL" video tape.

# Sample Test

## Doubles/Triples

### Unit 6.4

1. Which trailer should be the front trailer?
  - a. widest
  - b. highest
  - c. heaviest
  - d. longest
  
2. Before coupling the second trailer to the dolly, why drive the tractor close to the trailer, connect the emergency line, and charge the air tank?
  - a. to set the springs on the trailer springs brakes
  - b. to apply the emergency brakes for trailers that do not have spring brakes
  - c. to apply the trailer parking brakes for trailers that have spring brakes
  - d. to keep the dolly pole from flying up
  
3. If air does not come out of the emergency line at the rear of the last trailer:
  - a. the tractor parking brake is on.
  - b. the tractor parking brake is off.
  - c. the front brake is not depressed.
  - d. the emergency shut off valve on the first trailer is not open.
  
4. When uncoupling the second trailer:
  - a. uncouple the second trailer from the dolly before uncoupling the dolly from the first trailer.
  - b. do not uncouple any air lines until after the dolly is uncoupled from the first trailer.
  - c. unhook the dolly from the first trailer first.
  - d. lower both landing gears of the second trailer and the dolly at the same time.



# Introduction to Hazardous Materials

## Unit 7

### Intent of the Regulations Unit 7.1

#### Visual 7.1.1

**Contain the Material:** Containment deals with how to properly package a hazardous material. Containment rules also address how to load, transport and unload bulk tanks.

**Communicate the Risk:** The driver and the public have a right to know the risks associated with a hazardous material. For that reason shippers must put warning labels on packages of hazardous materials. Drivers must also put placards on their vehicles to warn people about the contents of the vehicle.

**Assure Safe Drivers and Equipment:** Drivers are required to pass a written test showing that they can recognize hazardous materials shipments. Drivers must also demonstrate knowledge on how to safely load shipments, correctly placard a vehicle and safely transport shipments of hazardous materials.

**Drivers are required to do a pre-trip inspection of their vehicles before and during their trips. Unsafe equipment must not be driven until the repairs have been made.**

*Law enforcement officers may stop and inspect the driver and the vehicle for any violations of the rules.*

#### Visual HM1

In this section we will cover hazardous materials. We will discuss the regulations and the individual responsibilities of the shipper, driver and carrier.

**Q:** What is a Hazardous Material?

**A:** According to Code of Federal Regulations 49 (CFR49) Section 171.8, a Hazardous Material is a substance or a material, including a hazardous substance, which has been determined by the Secretary of Transportation to be capable of posing an unreasonable risk to health, safety and property when transported in commerce, and has been so designated. **NOTE:** Hazardous substances and hazardous wastes are hazardous materials.

**Q:** Who must have a hazardous material endorsement on their commercial driver's license?

#### Visual HM2

**Visual HM3**

**A:** Anyone who drives any type of vehicle which requires placards must have a hazardous materials endorsement on their CDL. In order to get a hazardous materials endorsement you must pass a written test on Section 7 of the Commercial Driver's License Manual. The manual contains all the information necessary to pass the test. However, most drivers who work with hazardous materials as part of their job will require additional training from their employer. For example, drivers who transport flammable cryogenic liquids or highway route controlled quantities of radioactive material must have special training. The driver must carry a dated certificate of training signed by the employer. Drivers must have had training within the last two years.

**Visual 7.2.1**

The shipper, carrier and driver are all responsible for the safe transportation of hazardous materials shipments. During this unit we will discuss "who does what."

The shipper generates the shipment and identifies which mode of transportation will best service their needs. The shipment can move by truck, rail, air or water.

**Visual 7.2.2**

It is the responsibility of the shipper to properly prepare the shipping paper for the hazardous material shipment. The shipper must identify the products, proper shipping name, hazard class and identification number. The shipper is also responsible for correct packaging, correct labels, markings and proper placards. The shipper must certify on the shipping paper that he/she has prepared the shipment in accordance with regulations.

If the cargo tank is supplied to you or your employer, you are not required to have a signed shippers certification.

**Visual 7.2.3**

It is the carrier's responsibility to safely transport the hazardous material. Other carrier responsibilities include verifying that the shipper has correctly named, labeled and marked the shipment. The carrier must not transport any shipment which does not meet these requirements. In the event of an accident or incident involving a hazardous materials shipment, the carrier must report it to the proper government agency.

**Visual 7.2.4**

The driver must also make sure that the shipper has identified, marked and labeled the product. Although the shipper has the initial responsibility, the carrier and driver must verify that the shipper has complied with the regulations. The driver may not accept a leaking container. During the loading of a hazardous materials shipment the placards must be placed on the vehicle. Before the driver moves the vehicle he/she must assure this has been done. If not, the driver is responsible for affixing the placards. The driver must safely transport the shipment without delay following all special rules about transporting hazardous materials. During transportation, the shipping papers must be accessible to the driver and authorities.

# Communication Rules

## Unit 7.3

### Visual 7.3.1

Some words and phrases have special meanings when talking about hazardous materials. The meanings may differ from common use. The glossary at the end of Unit 7 contains the meaning of many words and phrases used when working with hazardous materials.

A materials hazard class reflects the risk associated with it. There are 22 different hazard classes. Some examples of a hazard class would be: Corrosive Material, Explosive A, Flammable Liquid, etc.

### Visual 7.3.2

Each person who offers a hazardous material for transportation shall describe the hazardous material on the shipping paper (Sec. 172.200 of the Hazardous Material Guide).

The shipping paper describes a shipment of hazardous material. Each item description on the shipping paper shows the materials hazard class. Shipping orders, bills of lading, and manifests are all shipping papers.

In the event of an accident or a leak involving hazardous materials shipments, it is vital that first response personnel have access to the information regarding the shipment. The driver may be incapacitated and not able to speak. Therefore, there are some rules as to where the shipping papers are kept during transportation as well as when the vehicle is parked.

### Visual 7.3.3

Whenever hazardous materials shipping papers are carried with other papers they must either be tabbed or placed on top of the stack. The driver must carry the shipping papers in a pouch on the driver's door or in clear view while driving. The driver must be able to reach the shipping papers while restrained by a seat belt. If the driver leaves the vehicle, he/she must place the shipping papers on the driver's seat or in a pouch on the driver's door.

The labels are diamond shaped and identify the hazard class of the material contained. In the event the label will not fit on the package, for example, a gas cylinder, the label must be put on a tag and the tag must be attached to the cylinder.

### Visual 7.3.5

Placards are signs which are placed on the vehicle. Placards are used to warn others of hazardous cargo.

### Visual 7.3.6

A placarded vehicle must display four identical placards. They must be placed on the front, rear, left and right side of the vehicle. Placards must be readable from all four directions.

### Visual 7.3.7

The two main lists used by shippers, carriers, and drivers are the hazardous materials table and the list of hazardous substances and reportable quantities.

Some products appear on both lists and other products only appear on one. Always check both lists. When using the list of hazardous substances and reportable quantities, if the hazardous substance has a star next to its name, the substance will also be listed in the Hazardous Materials Table.

Visual 7.3.8

This is an example of the Hazardous Materials Table. The first column tells which shipping mode the entry affects. The next four columns show each material's shipping name, hazard class, ID number and required labels. Please note, if the word forbidden appears in column 3, you must NOT transport this material.

Visual 7.3.9

Some products are called Hazardous Substances. The DOT and EPA want to know about spills of Hazardous Substances. The reportable quantity of a Hazardous Substance can be found in the list of Hazardous Substances and Reportable quantities. The shipper must identify the "RQ" on the shipping paper. The RQ may appear before or after the basic item description. The driver or employer must report any spill of a reportable quantity of these substances.

Visual 7.3.10

Some materials may pose multiple risks. For example, a corrosive material may also produce toxic vapors. These materials may require two placards. If the words "Inhalation Hazard" appears on the shipping paper or package, the rules require poison placards.

Visual 7.3.11

The shipping paper for a hazardous material must include page numbers if the shipping paper has more than one page. For example, page 2 of 3. The first page must include the total number of pages. The shipping paper must properly describe the hazardous material. The shipping paper must also have a "shippers certification" signed by the shipper, saying he/she prepared the shipment according to the regulations.

Visual 7.3.12

Under some circumstances, the shipping papers may describe both hazardous and non hazardous materials. If that is the case, then the hazardous materials must either be described first, highlighted in a contrasting color, or identified by an "X" placed before the shipping name in a column captioned "HM." If the shipment is a reportable quantity, the letters "RQ" may be used instead of an "X."

Visual 7.3.13

When describing hazardous materials, the basic description includes the proper shipping name, hazard class and identification number, in that order.

Visual 7.3.14

The shipping name, hazard class, and ID number must not be abbreviated. The description must also show the total quantity, unit of measure and the letters RQ if a reportable quantity. Allowable abbreviations would include the type and unit of measurement. Non hazardous materials may not be described by using a hazard class or ID number.

Visual 7.3.15

The shipper must identify hazardous waste shipments by putting the word "waste" before the name of the material. As in this example: Waste Acetone, Flammable Liquid, UN1090.

Visual 7.3.16

Another required entry on the shipping paper is a certification by the shipper that the shipment is properly classed, packed, marked, and labeled and in proper condition for transport. This "shippers certification" statement, however, is not required when the hazardous material is offered for highway transport if it is in a cargo tank supplied by the carrier, or when the material is transported by the shipper operating as a private carrier.

**Visual 7.3.17**

The shipper may print required markings directly on the package, an attached label or tag. When required, the shipper will put the following on the package: the name and address of the shipper or consignee, the hazardous materials shipping name and ID number, and the labels required. Products which have an RQ or inhalation hazard will have that information on the package.

**Visual 7.3.18**

Drivers must learn to recognize shipments of hazardous materials. The first step is to read the shipping papers. If there is a hazardous material listed, it can only appear in one of several ways. First, the material must be described correctly using the proper shipping name, hazard class, and ID number. Second, the entry can be highlighted, or one with an "X" or "RQ" in the HM column.

Some other clues may tip you off to a hazardous materials shipment: What type of business is the shipper in? Are there placarded tanks on the premises? Are there warning labels on the packages? Did you receive any special handling instructions? For example, a Material Safety Data Sheet (MSDS).

**Visual 7.3.19**

Hazardous waste shipments require a signed copy of the uniform hazardous waste manifest. The hazardous waste manifest must contain the name and EPA registration number of the shipper and carrier. The destination must also appear on the manifest.

Waste shipments can only be delivered to another registered carrier or treatment facility. After you deliver the shipment, keep your copy of the manifest. Each copy must have all the needed signatures and dates, including those of the person to whom you delivered the waste.

**Visual 7.3.20**

Before moving a vehicle which contains hazardous materials, you must determine if it requires placards. To make this decision, you must know the shipments hazard class, the amount shipped and the total weight of all hazardous materials in your vehicle. Some hazardous materials required placards no matter how much is being shipped.

If your vehicle requires placards, they must appear on both ends and both sides. Each placard must be easily seen from the direction it faces and at least 3" away from any other markings. The placard should be placed so the words or numbers are level and read from left to right. Placard Table Number 1 identifies those materials which require placards no matter how little is being transported. For example, if your vehicle contains any amount of:

*Class A Explosives*

*Class B Explosives*

*Poison A*

*Flammable Solid (labeled dangerous when wet)*



# ● Loading and Unloading

## Unit 7.4

### Visual 7.4.1

### Visual 7.4.2

Extra care must be taken whenever you load or unload hazardous material. The first step is to make sure your vehicle will not move. Set your parking brake and check your wheels. You should do all you can to prevent damage to the containers. Don't use hooks or any tool that might rupture the containers. Some products are more susceptible to heat than others. Whenever possible, load hazardous materials away from heat sources. Watch for signs of leaking or damaged containers. Never load or transport leaking containers.

Never transport leaking containers! Whenever you load or unload a hazardous material you must keep fire away. Do not allow people to smoke. You must never smoke around explosives, oxidizers or flammables.

Drivers should always check their loads to insure that all the containers, and / or packages have been properly secured. Floor bracing, loading straps or load locks should be used to prevent containers from movement in transit. Extra care should be taken if the containers have valves or other types of fittings.

A few other important things to remember: Do not open packages between points of origin and destination. Never transfer the contents of one package to another.

There are special cargo heater rules for loading explosives, flammable liquid and flammable gas. These rules usually forbid the use of cargo heaters including automatic cargo heater /air conditioner units.

You cannot have overhang or tailgate loads of explosives, flammable solids or oxidizing materials. These loads must be loaded into closed cargo space unless all the packages are fire and water resistant or covered with a fire and water resistant tarp.

### Visual 7.4.3

**— You must disable cargo heaters. Disconnect the power sources of the heaters. Drain the fuel tanks of the heaters.**

**— There must be no sharp points that can damage the cargo. Look for bolts, screws, nails, broken side panels and broken floor boards.**

**— Use a floor lining with Class A or Class B explosives. The floors must be tight. The liner must not contain steel or iron.**

**Use extra care to protect explosives.** Never use hooks, or other metal tools. Never drop, throw or roll the shipment. Protect packages that contain explosives from other cargo that could damage them.

**Do not transfer a Class A or Class B explosive from one truck to another on a public roadway except in an emergency.** If safety requires an emergency transfer, set out red warning reflectors, flags or electric lanterns. You must warn other highway users.

Visual 7.4.4

Never transport damaged packages of explosives. Do not accept a package shows any dampness or an oil stain.

*Class A explosives may never be transported in triple trailers. Class A explosives are also prohibited from combination vehicles if one of the following conditions exist:*

- There is a placarded cargo tank in the combination, or*
- The other vehicle in the combination contains:*
  - initiating explosives*
  - radioactive materials labeled "Yellow III"*
  - Class A or Class B poisons*
  - hazardous materials in a portable tank.*

Visual 7.4.5

*Care must be taken when loading corrosive materials. If loading by hand, load breakage containers of corrosive liquid one by one. Keep them right side up. Avoid dropping or rolling the containers. The floor surface should be even. Only stack carboys (a bottle or container that holds from 5-15 gallons of liquid) if the lower tiers can bear the weight of the upper tiers safely.*

*Nitric acid must not be loaded above any other product. Do not stack more than two high.*

*Charged storage batteries must be loaded so that their liquid will not spill and no other cargo will fall against or short circuit them.*

Visual 7.4.6

*When you transport compressed gases including cryogenic liquids and your truck does not have racks to hold the cylinders, the floor of the cargo space must be flat. The cylinders must be secured from movement. One way to accomplish this is to place the cylinders in racks which are attached to the vehicle. The cylinders can also be held upright or laying down flat and braced or placed in boxes that will keep them from turning over.*

*Poison A or irritants should never be transported in containers with meter connections. The driver should never carry any package labeled poison, poison gas or irritant in the cab, sleeper or with any food material for human or animal consumption.*

Visual 7.4.7

*Some packages of radioactive materials bear a number called the "transportation index." The transportation index tells the degree of control needed during transportation.*

Visual 7.4.8

*Some products may not be loaded in the same cargo space with other products. They must be loaded separately. The segregation and separation chart lists those products that must not be loaded together.*



# Bulk Tank Marking, Loading and Unloading

## Unit 7.5

### Visual 7.5.1

There are two types of tanks used in the transportation of hazardous material — the cargo tank and the portable tank. The difference is that a cargo tank is permanently attached to the vehicle and a portable tank is not. Portable tanks are loaded or unloaded and then put on a vehicle for transportation.

### Visual 7.5.2

*Cargo tanks and portable tanks must display ID numbers identifying their contents.* Product ID numbers can be found in Column 3A of the Hazardous Materials Table.

The rules require black four inch numbers on orange panels, DOT placards or a white diamond shaped background if no placards are required. Some cargo tanks require retest dates to be displayed. A portable tank must also show the lessee or owner's name. They must also show the shipping name and ID number of the contents on two opposing sides. The letters must be at least two inches tall. If the tank holds more than 1000 gallons, the ID number must appear on the front, rear, left and right sides of the tank.

### Visual 7.5.3

The person in charge of loading and unloading a cargo tank must be sure someone is always watching. The person watching the loading or unloading must:

- have a clear view of the cargo tank
- be within 25 feet of the tank
- know the procedures to follow in an emergency, and
- be authorized to move the cargo tank and able to do so.

### Visual 7.5.4

**Warning:** *Before moving a tank with hazardous materials, all valves and manholes must be closed.*

### Visual 7.5.5

The only time you can run your engine during loading or unloading a flammable liquid is when the tractor pump is used to fill or empty the tank. During each process, the tank must be grounded before opening the filling hole, and maintain the ground until after the closing the filling hole.

### Visual 7.5.6

Loading and unloading compressed gas tanks requires that:

- the discharge valves be closed off
- the engine be turned off
- the wheels be chocked

# Hazardous Materials Driving and Parking Rules

## Unit 7.6

### Visual 7.6.1

Never park with EXPLOSIVES A or EXPLOSIVES B within 5 feet of the travelled part of the road. Unless your work requires it, do not park within 300 feet of:

- a bridge, tunnel or building
- a place where people gather
- an open fire

If you must park to do your job, do so only briefly. Do not park on private property without the owner's permission. Whenever a vehicle carrying explosive A or B is parked, someone must watch the vehicle. You may let someone else watch it for you only if your vehicle is on the shipper, carrier or consignee's property.

Some locations have a government approved parking area for explosives. That area is called a safe haven. You can leave your vehicle unattended in a safe haven

### Visual 7.6.2

Placarded vehicles that are not carrying explosives may park within 5 feet of the traveled portion of the road only if their work requires it. Someone must always watch the vehicle when parked on a public roadway or shoulder. Do not uncouple a trailer and leave it with hazardous material on a public street. Do not park within 300 feet of an open fire.

### Visual 7.6.3

Attendance is defined as:

- in the vehicle, awake, and not in the sleeper berth or within 100 feet of the vehicle and have it within clear view
- aware of the hazards
- know what to do in emergencies, and
- be able to move the vehicle if needed.

### Visual 7.6.4

In the event of an accident or a breakdown never use flame producing warning devices around a:

- tank used for flammable liquid or flammable gas (whether loaded or empty)
- vehicle loaded with

**EXPLOSIVES A FLAMMABLE LIQUID  
EXPLOSIVES B FLAMMABLE GAS**

### Visual 7.6.5

State and local authorities are becoming more restrictive about which roads they will allow hazardous materials to travel. These restrictions change frequently and in some cases require a special permit. As a driver you are responsible for obtaining any required permits and determining which route you can take. Make sure you have all the required papers before you start your trip.

**Visual 7.6.6**

Placarded vehicles must avoid heavily populated areas, crowds, tunnels, narrow streets and alleys. Use a city bypass or alternate route even if it is longer inconvenient.

**Visual 7.6.7**

Placarded vehicles must avoid open flames and fires. Do not drive by an open fire unless you can pass safely without stopping.

If transporting Class A or Class B Explosives, you must have a written route plan and follow that plan. Carriers prepare the route plan in advance and give the driver a copy. You may plan the route yourself if you pick up the explosives at a location other than your employer's terminal. Write out the plan in advance. Keep a copy of it with you while transporting the explosives. Deliver shipments of explosives only to authorized persons or leave them in locked rooms designed for explosives storage.

A carrier must choose the safest route to transport placarded radioactive material. After choosing the route, the carrier must tell the driver about the radioactive materials and show the route to be taken.

**Visual 7.6.8**

Do not smoke within 25 feet of a placarded tank used for flammable liquids or gases. Also do not smoke or carry a lighted cigarette, cigar or pipe within 25 feet of any vehicle which contains:

EXPLOSIVES    OXIDIZERS    FLAMMABLES

**Visual 7.6.9**

Before you can fuel a placarded vehicle the engine must be turned off and there must be someone at the point where the tank is being filled.

**Visual 7.6.10**

The power unit of placarded vehicles must have a fire extinguisher with a UL rating of 10 B:C or more.

**Visual 7.6.11**

Make sure your tires are properly inflated. Check placarded vehicles with dual tires at the start of each trip and when you park. You must stop and check the tires every two hours or 100 miles, whichever is less. The only acceptable way to check tire pressure is to use a tire pressure gauge.

Do not drive with a tire that is leaking or flat except to the nearest safe place to fix it. Remove any overheated tire. Place it a safe distance from your vehicle. Don't drive until you correct the cause of the overheating.

Rules pertaining to parking still apply when checking, repairing or replacing tires.

**Visual 7.6.12**

Do not take a hazardous material shipment without a properly prepared shipping paper. A shipping paper for hazardous material must always be easily recognized. Other people must be able to find it quickly after an accident.

- Clearly distinguish hazardous material shipping papers from others by tabbing them or keeping them on top of the stack of papers.
- When you are behind the wheel, keep shipping papers within your reach (with your seat belt on) or in a pouch on the driver's door. They must be easily seen by someone entering the cab.
- When not behind the wheel, leave shipping papers in the driver's door pouch or on the driver's seat.

**Visual 7.6.13**

A carrier must give each driver transporting Class A or Class B explosives a copy of FMCSR, Part 397. The carrier must also give written instructions on what to do if delayed or in an accident. The written instructions must include:

- the names and telephone numbers of people to contact (including carrier agents or shippers)
- the nature of the explosives transported
- the precautions to take in emergencies such as fires, accidents or leaks.

You must be familiar with and have in your possession while driving:

- the shipping papers.
- the written emergency instructions
- a written route plan
- a copy of FMCSR 397

**Visual 7.6.14**

A driver transporting chlorine in cargo tanks must have an approved gas mask in the vehicle. The driver must also have an emergency kit for controlling leaks in dome cover plate fittings on the cargo tank.

Stop before crossing a railroad if you vehicle:

- is placarded, or
- carries any amount of chlorine, or
- has cargo tanks, whether loaded or empty, used for hazardous materials

Vehicles required to stop at railroad crossings must STOP no closer than 15 feet nor further than 50 feet from the nearest rail.

# **Hazardous Materials Emergencies**

## **Unit 7.7**

### **Visual 7.7.1**

### **Visual 7.7.2**

### **Visual 7.7.3**

### **Visual 7.7.4**

### **Visual 7.7.5**

### **Visual 7.7.6**

The Department of Transportation has a guidebook for fire fighters, police and industry personnel. The guidebook tells them what to do first to protect themselves and the public from hazardous materials. The guide is indexed by shipping name and hazardous materials ID number. Emergency personnel look for these items on the shipping paper. That is why it is vital that the shipping name, ID number, label and placards are correct.

As a professional driver, your job at the scene of an accident is to:

- *Keep people away from the area.*
- *Limit the spread of material, only if you can safely do so.*
- *Communicate the danger to emergency response personnel.*

It is important to remember that people should be kept far away and upwind. Follow this checklist.

1. *Check to see that your driving partner is OK.*
2. *Keep shipping papers with you.*
3. *Warn others of the danger.*
4. *Send for help.*
5. *Follow your employer's instructions.*

You might have to control minor truck fires on the road. However, unless you have the training and equipment to do so safely, don't fight hazardous materials fires.

You should send someone for help. If possible try to prevent the fire from spreading by using your fire extinguisher (UL 10 B:C required). Never open the trailer doors if they are hot. This could cause the fire to flare up. In order to assist firefighters and emergency personnel you should take the shipping papers with you when you leave the truck. The First Response Emergency Personnel will need them to know how to handle this fire. Remember to warn other people of the danger and keep them away.

If you discover a cargo leak, identify the material by using shipping papers, labels or package location. Do not touch any leaking material. Many people under the stress of handling an accident or leak forget and injure themselves this way. Do not try to identify material or find the source of a leak by smell. Many toxic gases destroy one's sense of smell. They can injure or kill you even if they don't smell. Do not eat, drink or smoke around a leak or spill.

If hazardous material is spilling from your vehicle, do not move it any more than safety requires. You may move off the road and away from places where people gather, if doing so serves safety. Only move your vehicle if you can do so without danger to yourself or others.

Never continue driving with hazardous material leaking from your vehicle to find a phone booth, truck stop, help or similar reason. Remember that the carrier pays for the cleanup of contaminated parking lots, roadways, and drainage ditches. The costs are enormous, so don't leave a lengthy trail of contamination. If hazardous material is spilling from your vehicle:

- *park it*
- *secure the area*
- *stay there*
- *send someone else for help*

When sending someone for help, write down this information:

- *a description of the emergency*
- *your exact location and direction of travel*
- *your name, the carrier's name and the name of the community or city where your terminal is located*
- *the shipping name, hazard class and ID number of the material if you know them.*

Listing this information will give the person you send the correct information for the emergency response team.

Never move your vehicle if doing so will cause contamination or damage the vehicle. Keep downwind and away from roadside rests, truck stops, cafes and businesses. Never try to repack leaking containers.

Unless you have the training and equipment to repair leaks safely, don't try it. Call your dispatcher or supervisor for instructions and, if needed, emergency personnel.

**Explosives.** If your vehicle breaks down or is in an accident while carrying explosives, warn others of the danger. Keep bystanders away. Do not allow smoking or open fire near the vehicle.

Remove all explosives before pulling apart vehicles involved in a collision. Place the explosives at least 200 feet from the vehicles and occupied buildings. If there is a fire, warn everyone of the danger of explosion. Stay a safe distance away.

Whenever a placarded vehicle is involved in an accident, breakdown, spill, or has a leak, the following guidelines should be used.

**Flammable Liquids:** Prevent bystanders from gathering. Warn people of the danger. Keep them from smoking.

Never transport a leaking cargo tank farther than needed to reach a safe place. If safe to do so, get off the roadway. Don't transfer flammable liquid from one vehicle to another on a public roadway except in emergency.

**Flammable Solids and Oxidizing Materials:** Warn other of the fire hazard. Do not open smoldering packages of flammable solids. Remove them from the vehicle if you can safely do so. Gather and remove any broken packages if safe to do so. Also remove unbroken packages if it will decrease the fire hazard.

Visual 7.7.7

Visual 7.7.8



**Corrosive Materials:** Avoid further damage or injury when handling the containers. Parts of the vehicle exposed to a corrosive liquid must be thoroughly washed with water. Wash out the interior as soon after unloading as possible before reloading the vehicle.

If further transportation of a leaking tank would be unsafe, get off the road. If safe to do so, try to contain any liquid leaking from the vehicle. Keep spectators away from the liquid and its flames. Do everything possible to prevent injury to other highway users.

**Compressed Gases:** Only permit those involved in removing the hazard or wreckage to get close. You must notify the shipper of the compressed gas of any accident.

Unless you are fueling machinery used in road construction or maintenance, do not transfer a flammable compressed gas from one tank to another on any public roadway.

**Poisons:** You must protect yourself, other people and property from harm. Remember that many products classed as poison are also flammable. If you think a leaking poison liquid or gas might be flammable, take the added precautions needed for flammable liquids or gases. Do not allow smoking, open flame, or welding. Warn others of the hazards of fire, of inhaling vapors or coming in contact with the poison.

**Radioactive Materials:** If a leak or broken package involves radioactive material, tell your dispatcher or supervisor as soon as possible. If there is a spill or if an internal container might be damaged, do not touch or inhale the material. Do not use the vehicle until it is cleaned and checked with a survey meter.

### Visual 7.7.9

The National Response Center helps coordinate emergency response to chemical hazards. They are a resource to the local police and fire fighters. The person in charge of a vehicle involved in an accident may have to phone the National Response Center. This call will be in addition to any made to police or fire fighters. You or your employer must phone when any of the following occur as a direct result of a hazardous materials incident:

- a person is killed
- a person receives injuries requiring hospitalization
- estimated carrier or other property damage exceeds \$50,000

### Visual 7.7.10

The Chemical Transportation Emergency Center (CHEMTREC) in Washington also has a 24 hour toll free line. CHEMTREC was created to provide emergency personnel with technical information about the physical properties of hazardous products. The National Response Center and CHEMTREC are in close communication. If you call either one, they will tell the other about the problem when appropriate.



## Sample Questions

### Hazardous Materials Unit 7

1. Who needs a hazardous materials endorsement on their commercial driver's license?
  - a. tank drivers
  - b. all drivers
  - c. drivers of vehicles which require placards
  - d. both a and c
  
2. A vehicle containing enough hazardous materials to require placards must have:
  - a. two (one on each end).
  - b. two (one on each side).
  - c. four (two on the front and two on the rear).
  - d. four (front, rear and both sides).
  
3. Drivers must placard their vehicles to:
  - a. warn others of the risk.
  - b. contain the material.
  - c. assure safe equipment.
  - d. it's the shipper's rules.
  
4. Which of the following is not a shipping paper?
  - a. waste manifest
  - b. transport index
  - c. bill of lading
  - d. shipping orders
  
5. Which of these statements is not true?
  - a. Any material that is forbidden in the hazardous materials table can only be transported with government escorts.
  - b. The letters "RQ" mean "Reportable Quantity."
  - c. You or your employer must report any spill of a reportable quantity.
  - d. Some hazardous material may be listed in both the Hazardous Materials Table and the list of Hazardous Substances and Reportable Quantities.
  
6. Hazardous Material shipping papers are not required to include:
  - a. page numbers.
  - b. product description.
  - c. shipper's certification.
  - d. the HM column.
  
7. It is the driver's responsibility to:
  - a. recognize hazardous materials shipments.
  - b. label the packages of hazardous material.
  - c. assure the vehicle has been placarded.
  - d. both a and c
  
8. Before loading or unloading explosives you must:
  - a. turn off your engine.
  - b. disable cargo heaters.
  - c. fuel your cargo heaters.
  - d. both a and b

9. No one may smoke within 25 feet of any vehicle which contains explosives or:
- oxidizers.
  - flammables.
  - compressed gases.
  - both a and b
10. Class A explosives must not be transported in a combination vehicle if the vehicle includes:
- a placarded cargo tank.
  - a 280 inch wheel base trailer.
  - a 27 foot trailer.
  - none of the above
11. The transport index of a radioactive material:
- is another way of writing the weight of the package.
  - tells the degree of control needed during transportation.
  - is just for the shipper.
  - both a and b
12. Which of the following statements is false?
- Compressed gas cylinders may be loaded in boxes that will keep them from turning over.
  - Poison may be loaded with animal or human food if the poison package is overpacked in an approved way.
  - You may not load charged storage batteries in the same vehicle with Explosives A.
  - Always use a stainless steel floor lining with Class A or B explosives.
13. Do not park hazardous materials within \_\_\_\_ feet of an open flame.
- 200
  - 300
  - 500
  - 250
14. When transporting hazardous materials you must check your tires:
- at the beginning of the trip.
  - when you park.
  - every two hours or 100 miles, whichever comes first.
  - all of the above
15. The DOT has a guidebook for firefighters, police and industry personnel. That book is called:
- DOT Guidebook.
  - FMCSR.
  - Emergency Response Guidebook.
  - List of Hazardous Substances and Reportable Quantities.

# CDL KNOWLEDGE TESTING

## (Proposal)

- **Essex Knowledge Tests**
- **Core Test - 50 questions**
- **Air Brake Test - 25 questions**
- **Combination Vehicle Test - 20 questions**
- **Passenger Vehicle Test - 20 questions**
- **Double/Triple Trailer Test - 20 questions**
- **Tank Vehicle Test - 20 questions**
- **Hazardous Material Test - 30 questions**
- **School Bus Test - 15 questions**
- **Motorcycle Test - 30 questions**
- ***Begin Testing September 90***
- ***80% needed to pass - including sign test***
- ***Alternative testing***
- ***Waiting time - One day***

**Visual M**

**THINK OF THE WHEEL AS A CLOCK. PLACE YOUR LEFT HAND BETWEEN THE EIGHT AND TEN O'CLOCK POSITIONS AND YOUR RIGHT HAND BETWEEN THE TWO AND FOUR O'CLOCK POSITIONS. THIS DOUBLE GRIP HELPS YOU MAINTAIN CONTROL OF YOUR TRUCK.**

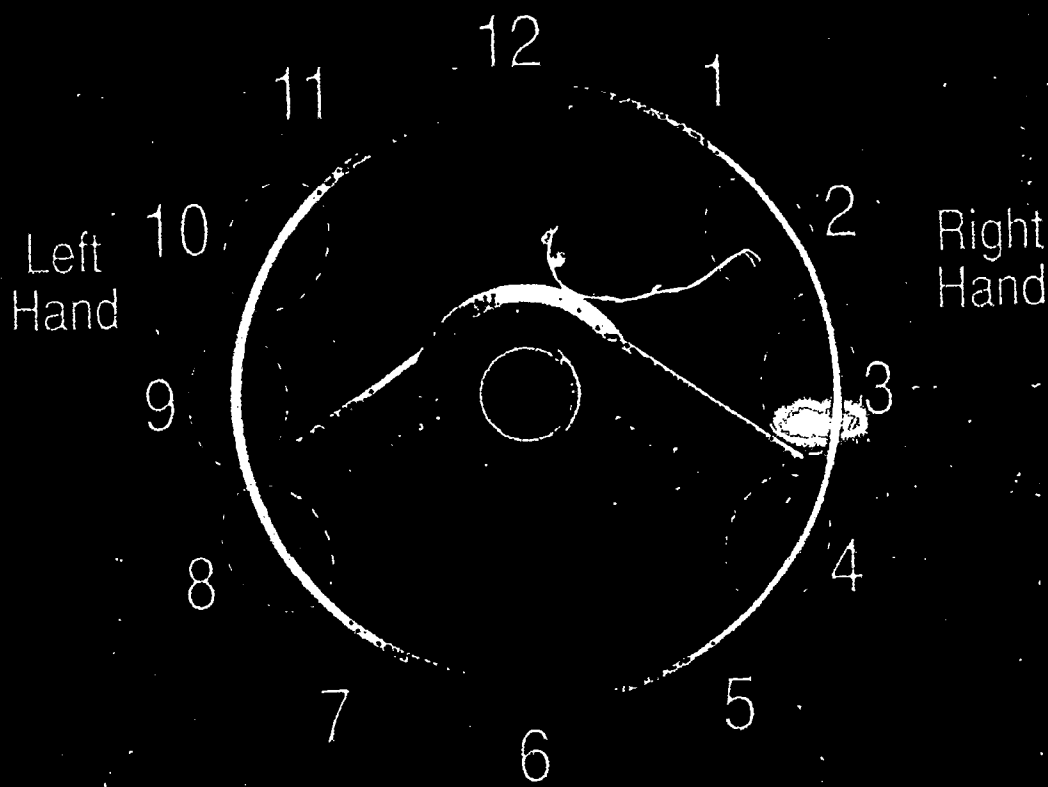

**FIGURE NO. 2.2.1: STEERING HANDHOLD**

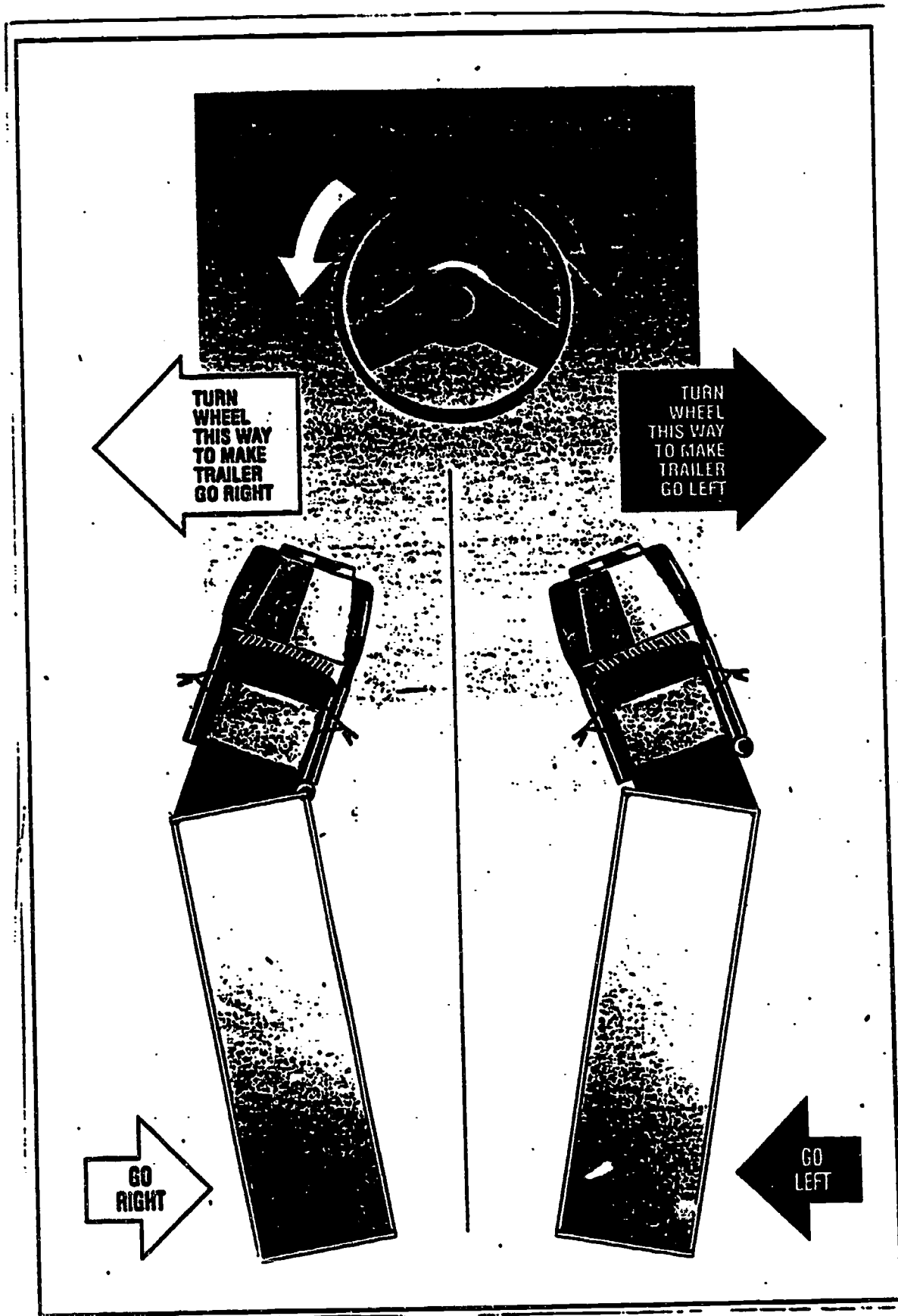

FIGURE NO. 2.2.2: BACKING A TRAILER

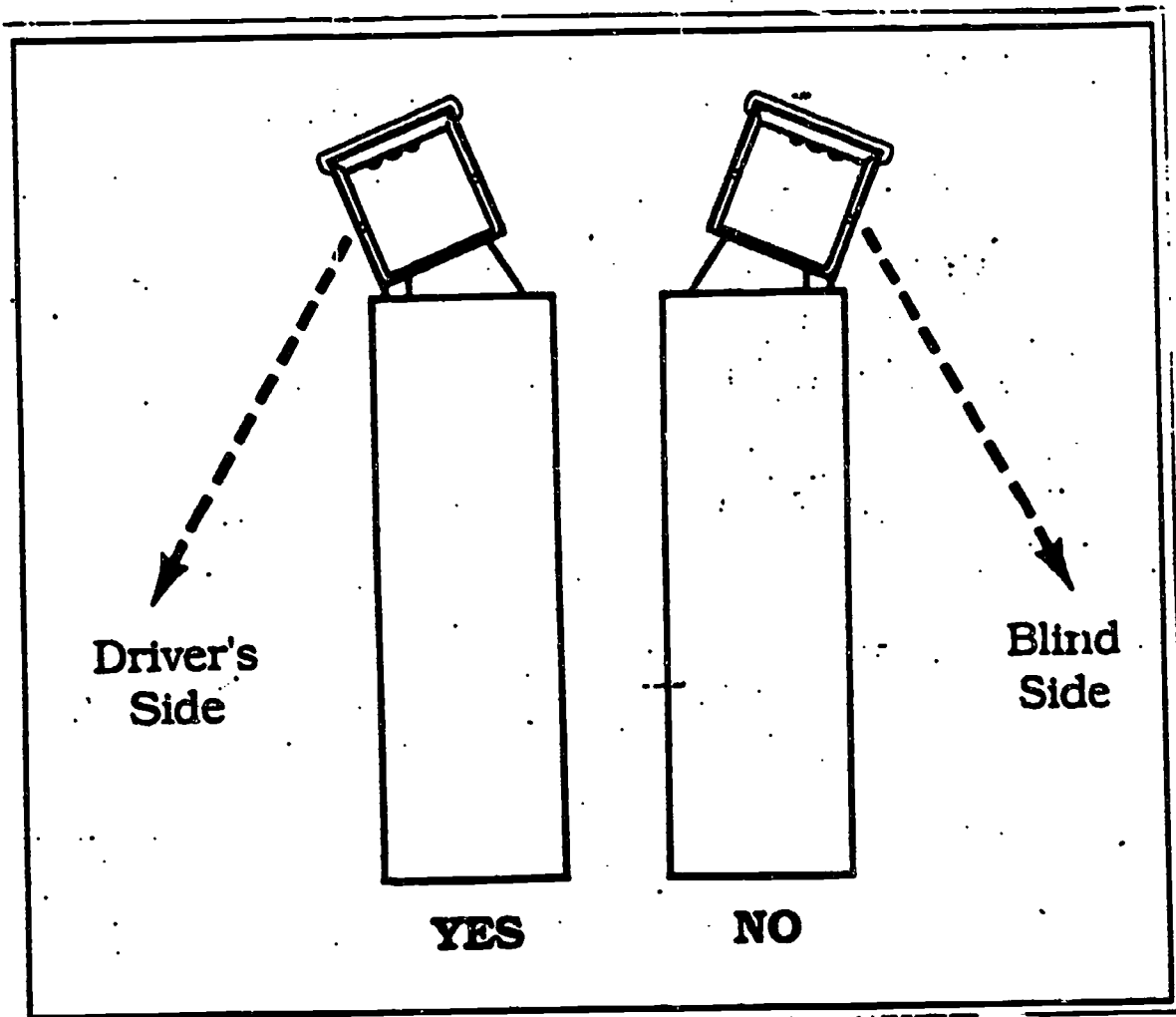
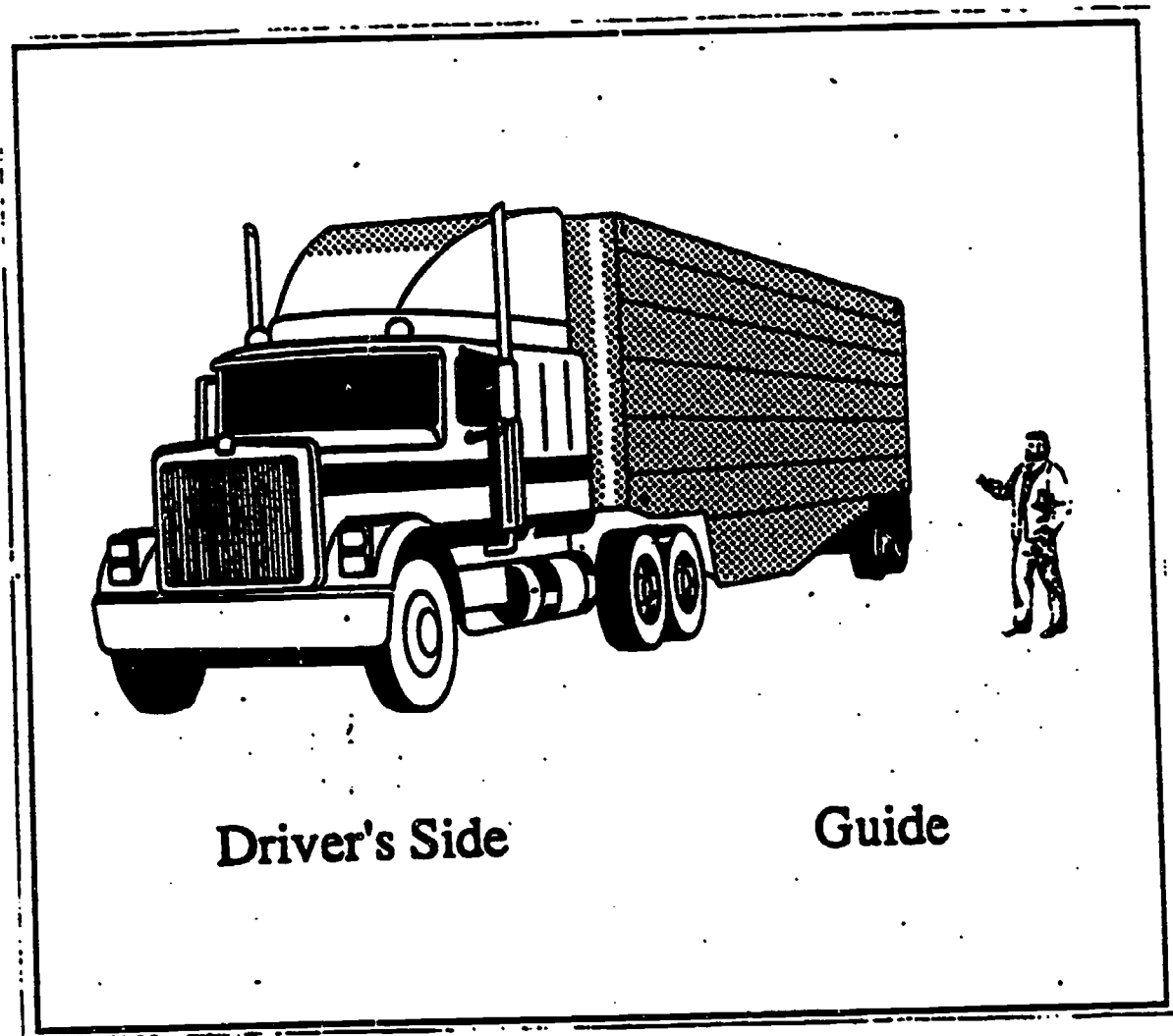





FIGURE NO. 2.2.3: DRIVERS SIDE BACKING





**FIGURE NO. 2.24: GUIDE STANKS ON THE DRIVER'S SIDE**



Step	Clutch 	Accelerator 	Stickshift 	
1	Depress	Release	Shift to Neutral	First Shift
2	Release			
3	Depress		Shift to Next Gear	Second Shift
4	Release	Depress		

VISUAL FROM P. 101 2.3.1: DOUBLE CLUTCHING: UPSHIFT

What to Do:

Step	Clutch 	Accelerator 	Stickshift 	
1	Depress	Release	Shift to Neutral	First Shift
2	Release			
3		Depress		Rev
4	Depress	Release	Shift to Next Gear	Second Shift
5	Release			

VISUAL 2.3.2: DOWNSHIFTING

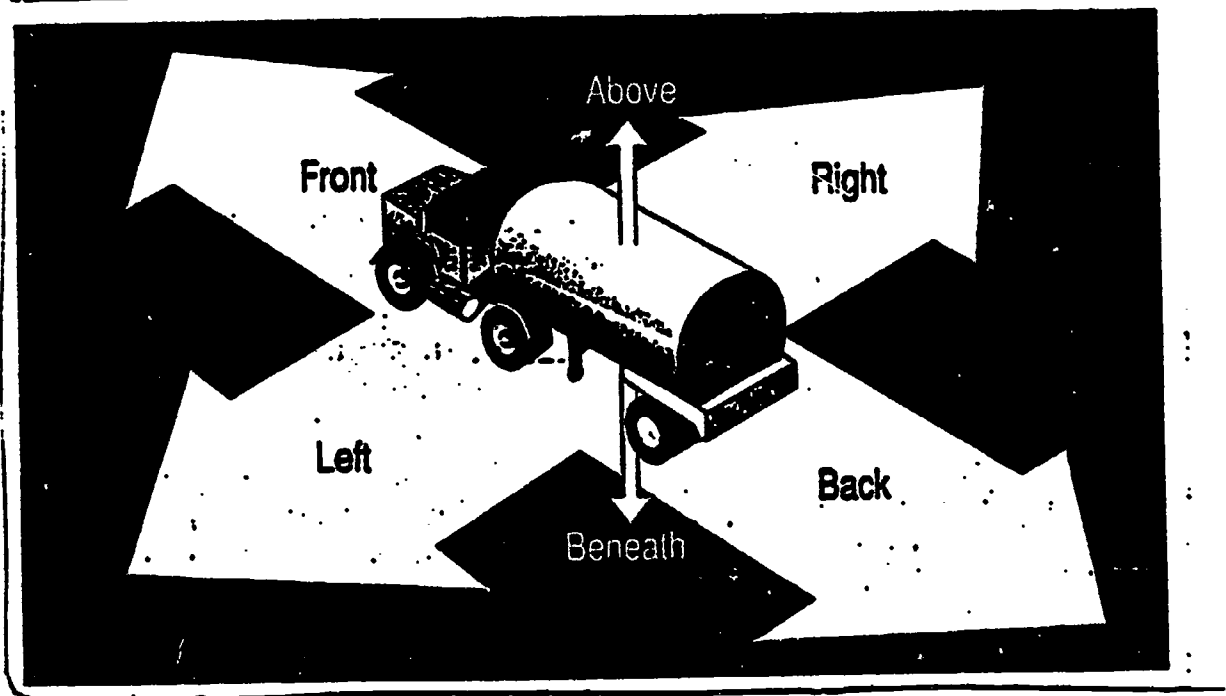

**VISUAL 24.1: SPACE CUSHION**

Maintain a 12 second visual lead.

At the middle of one block be looking beyond the middle of the next block.

**VISUAL 2.4.2: LOOKING AHEAD**

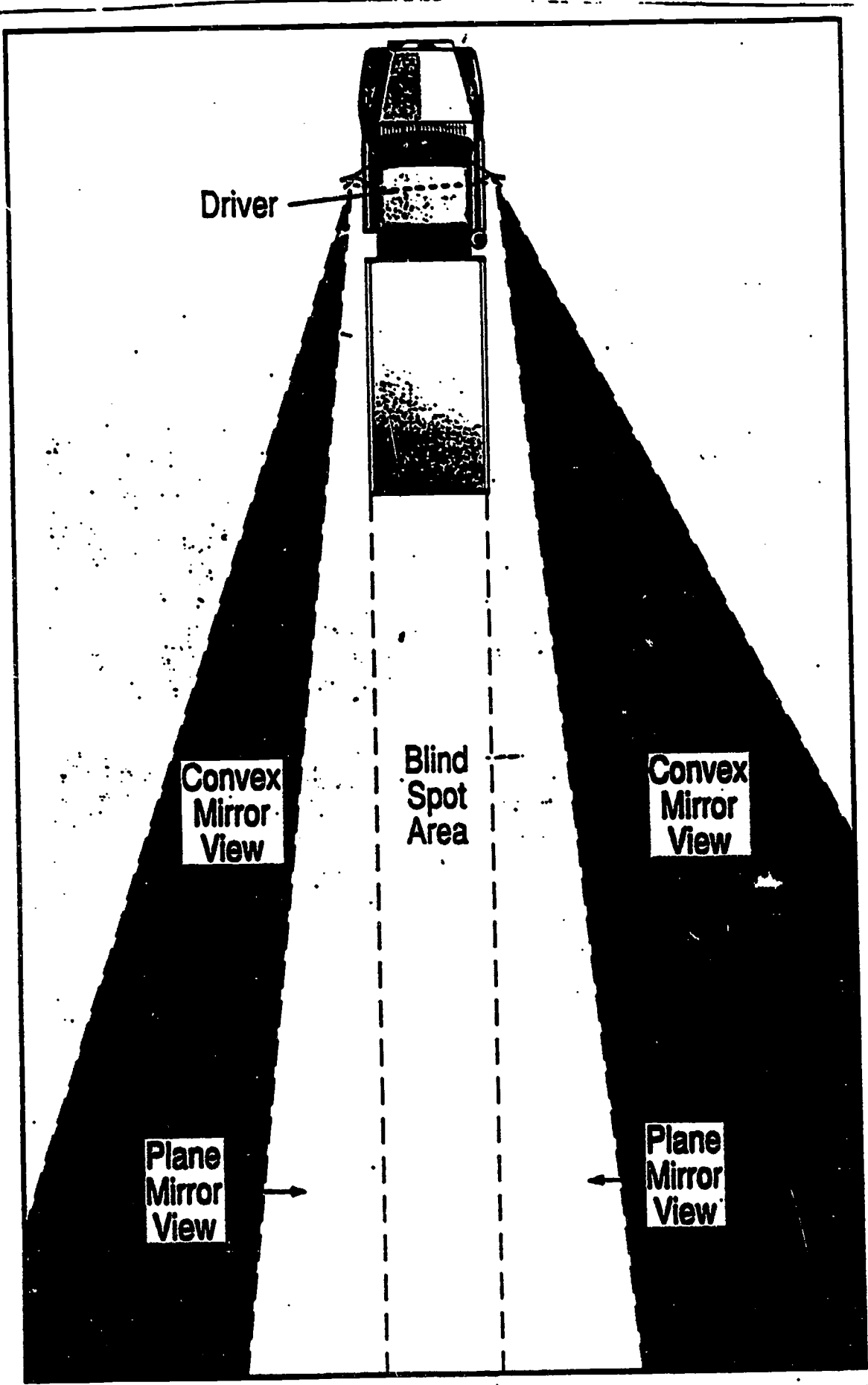

VISUAL 2.4.3: FIELD OF VISION USING A CONVEX MIRROR

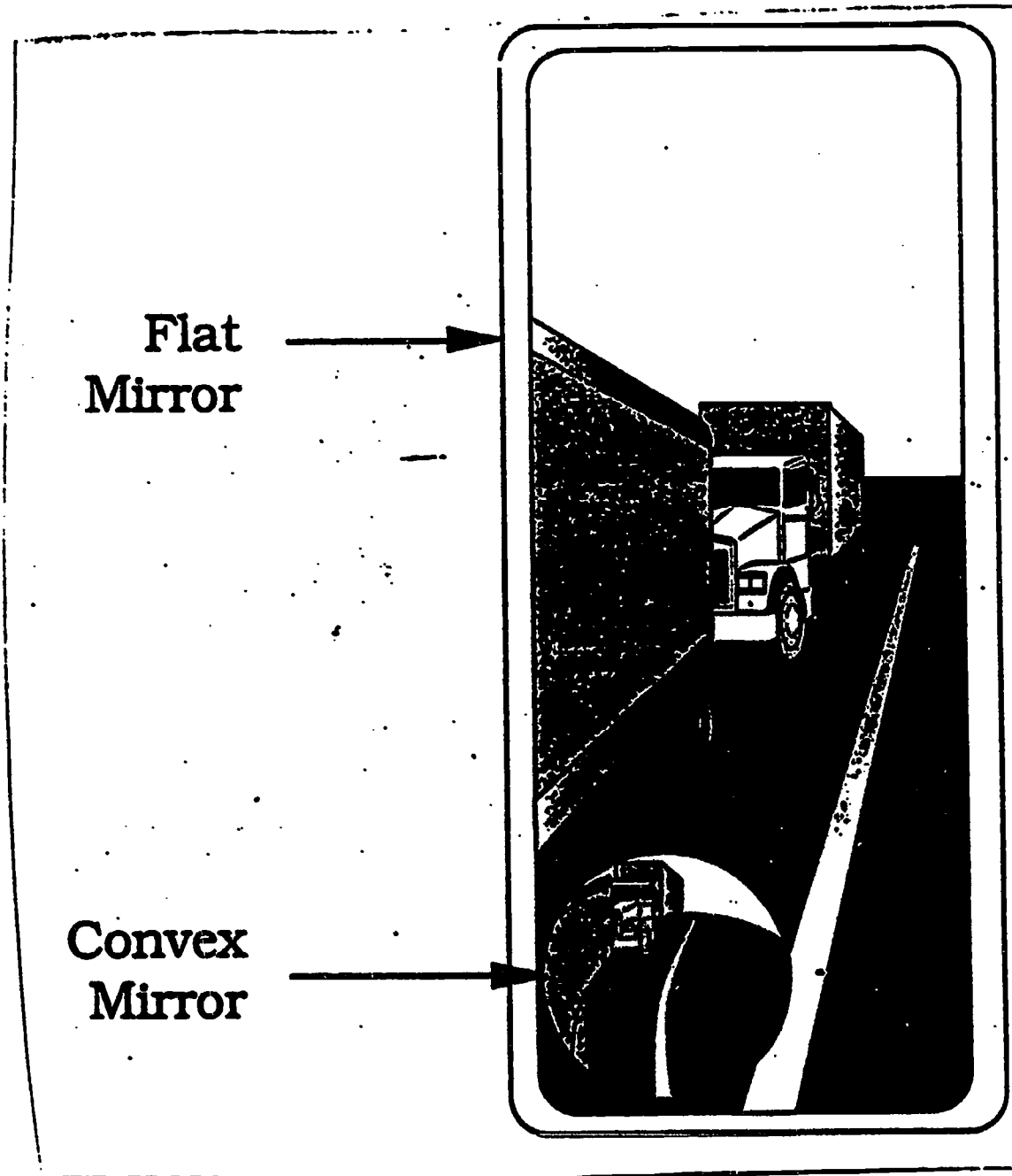

VISUAL 2.4.4: DISTORTION OF CONVEX MIRRORS

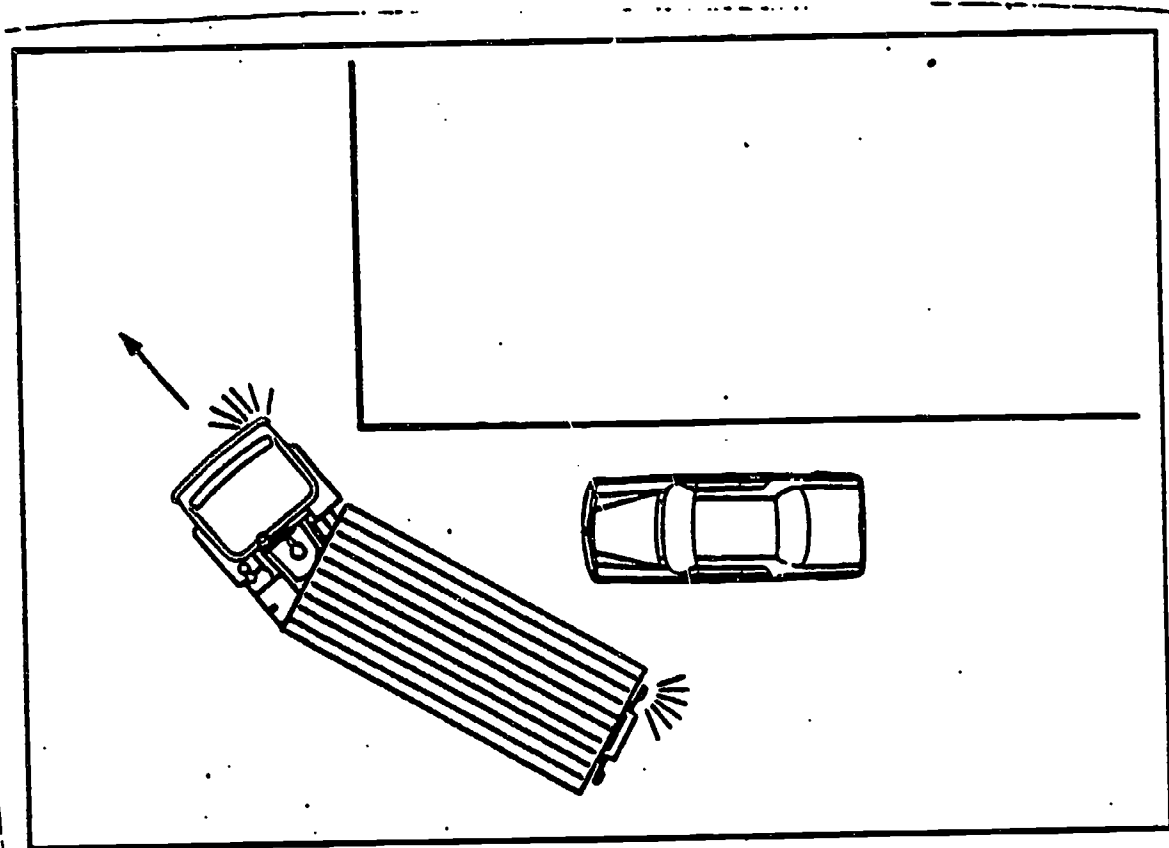

**VISUAL 2.5.1: MAKING A RIGHT TURN FROM THE WRONG POSITION**

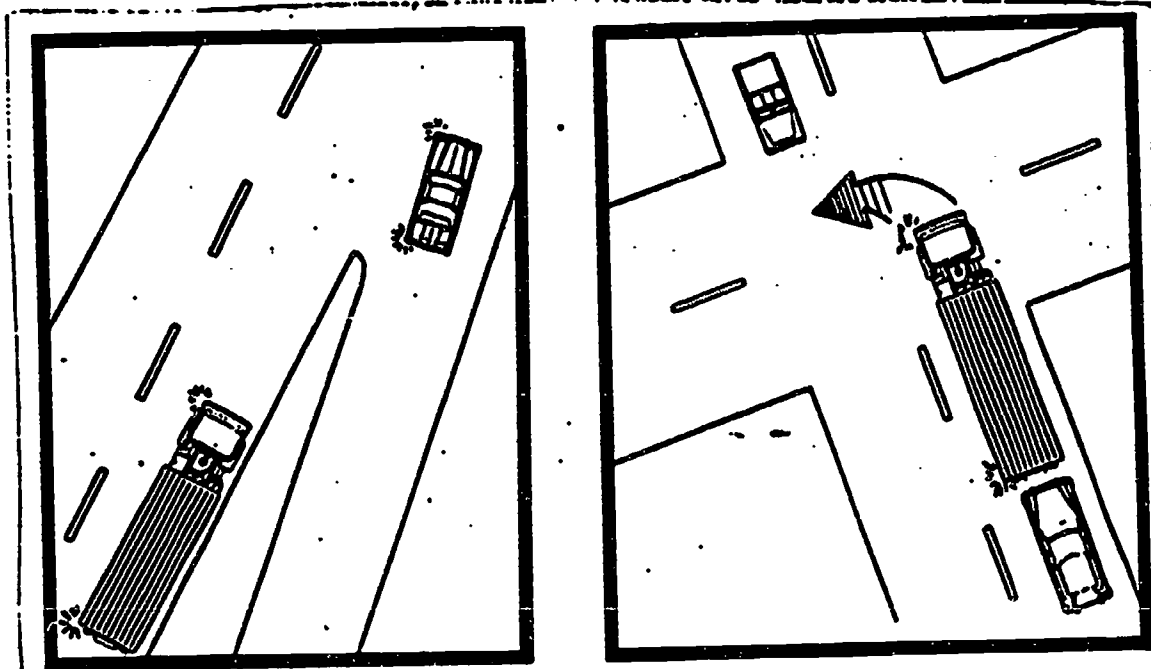

**When Changing Lanes, Merging, Passing, or Turning**

**VISUAL 2.5.2: COMMUNICATE YOUR INTENT**



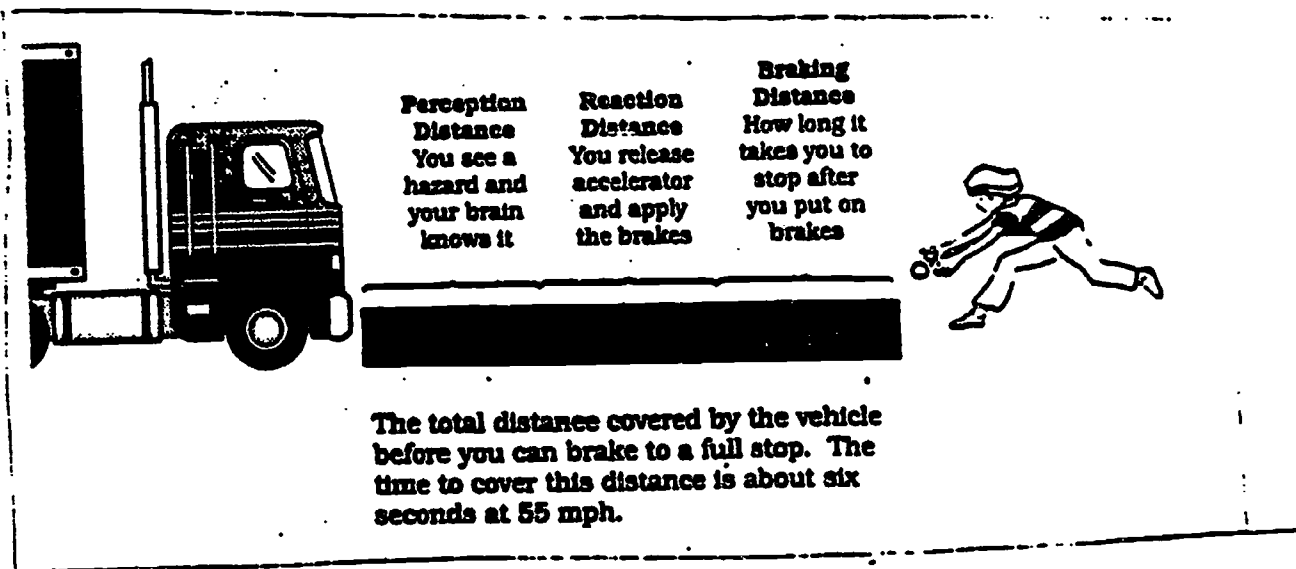

**VISUAL 2.6.1: TOTAL STOPPING DISTANCE**

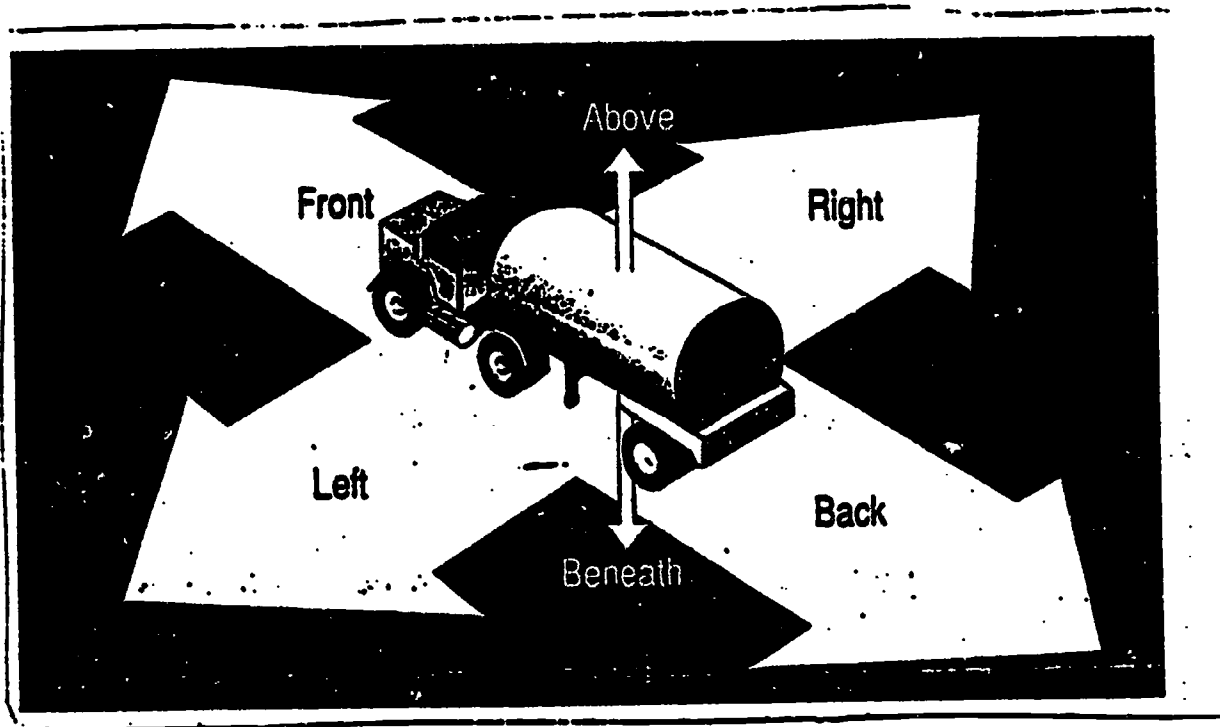

**VISUAL 2.7.1: SPACE CUSHION**

- 1 Second Required for Each 10 Feet of Vehicle Length at Speeds Under 40 MPH
- Above 40 MPH Use Same Formula, Then Add 1 Second for the Additional Speed

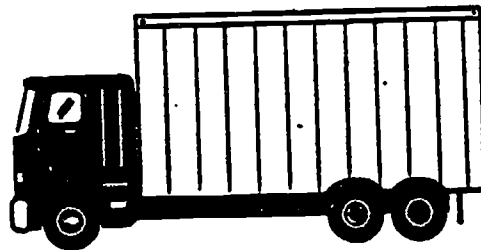

40 FOOT TRUCK = 4 SECONDS

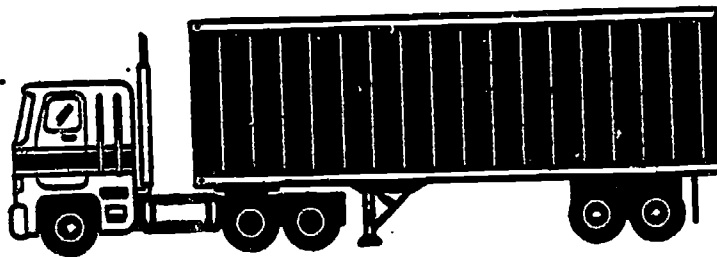

60 FOOT TRUCK (TRACTOR-TRAILER) = 7 SECONDS

VISUAL 2.7.2: FORMULA FOR SAFE FOLLOWING DISTANCE

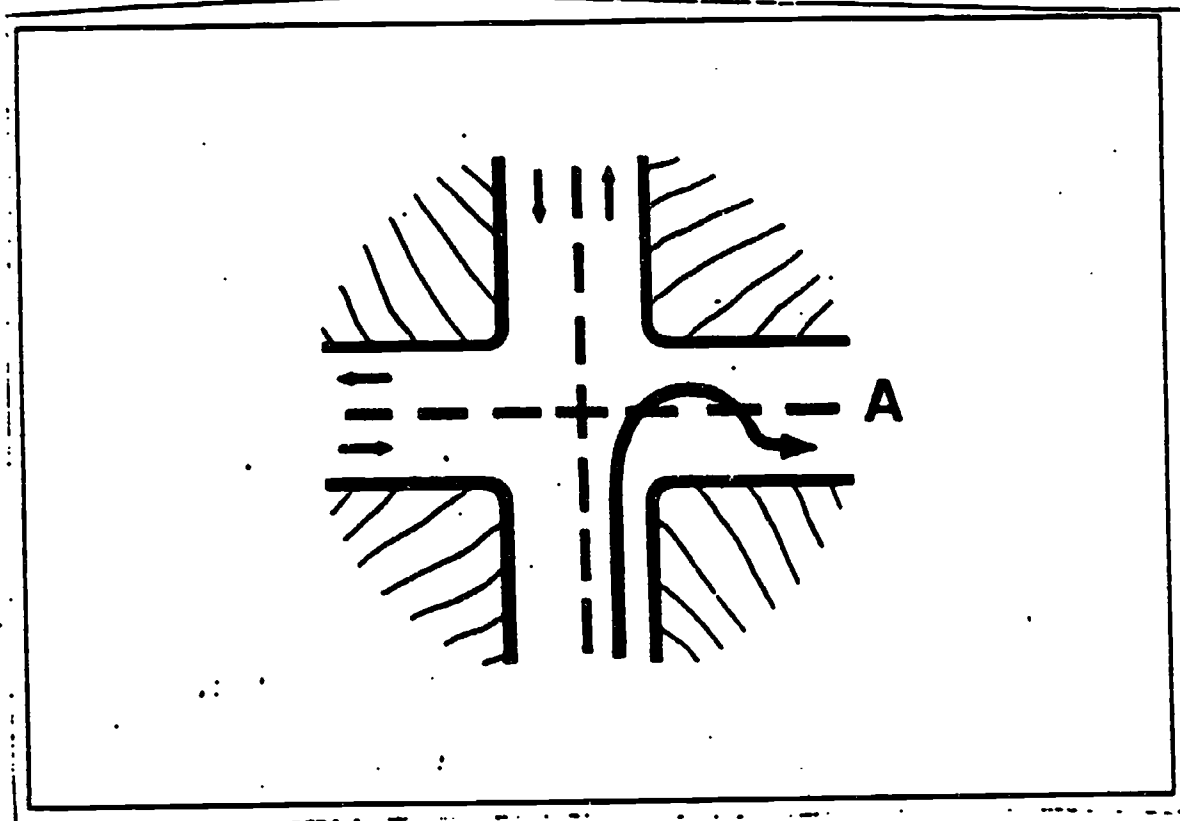

VISUAL 2.7.4: RIGHT TURN-DO THIS

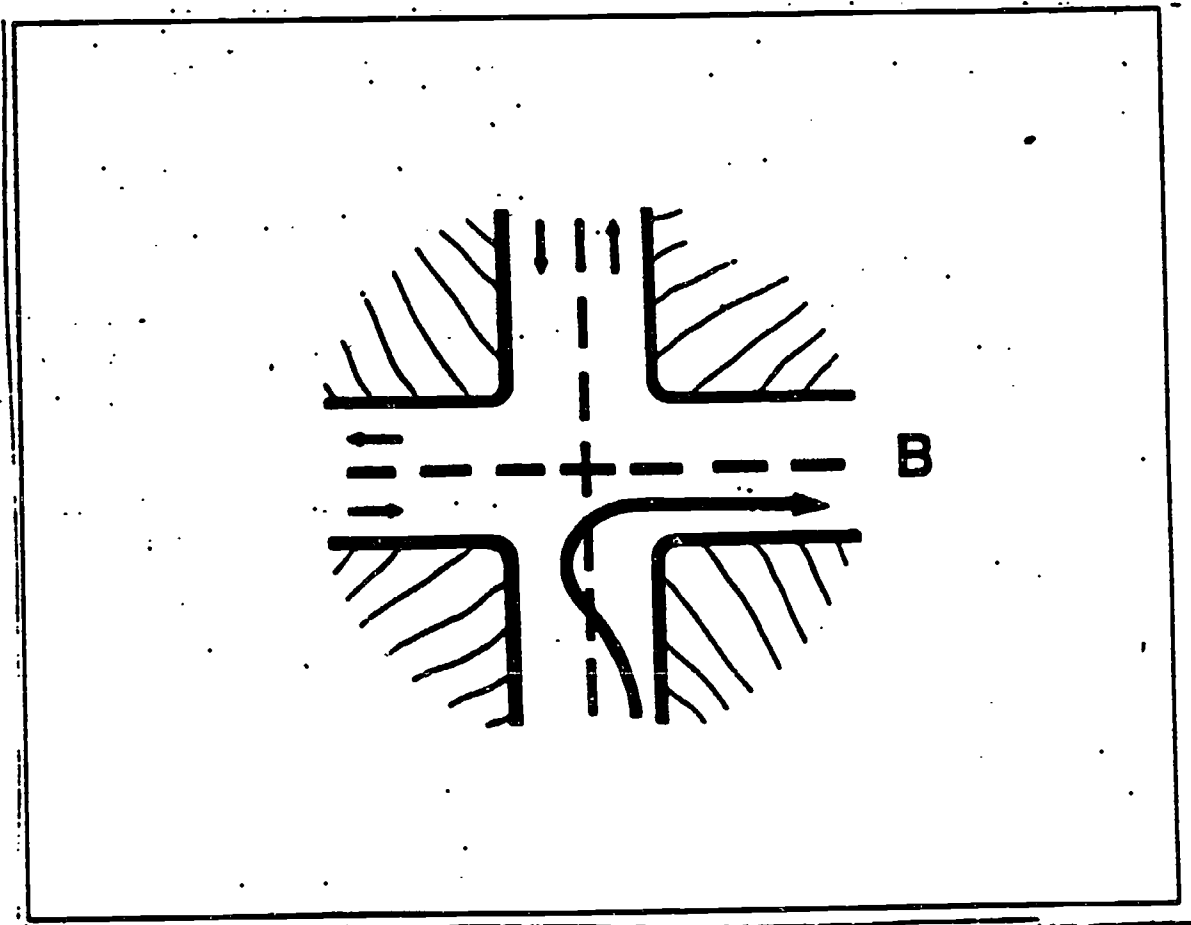

VISUAL 2.7.3: RIGHT TURN-DO NOT DO THIS

## RIGHT TURNS

Improper right turns are a leading cause of accidents. Here is a set of steps to reduce accidents:

1. Plan Ahead - Look at the turn before you get there. Set up for your turn.
2. Signal Your Turn
3. Check Right Mirror - Leave sufficient clearance from all obstacles without drifting out of your lane.
4. Have the unit in the gear that you will make the turn in.
5. Turn the wheel right when the trailer is halfway past the stationary object (telephone pole, car, or curb).
6. Proceed into the turn, checking the mirrors for clearance.
7. Assume the proper lane (the lane closest to the curb).
8. Adjust speed accordingly.

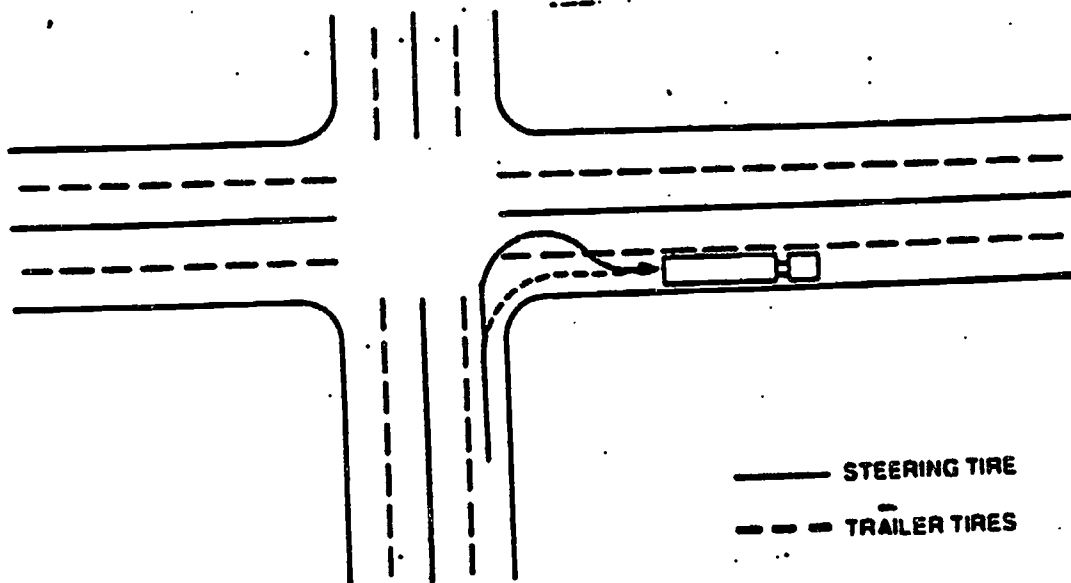

VISUAL 2.7.5: RIGHT TURN SUMMARY

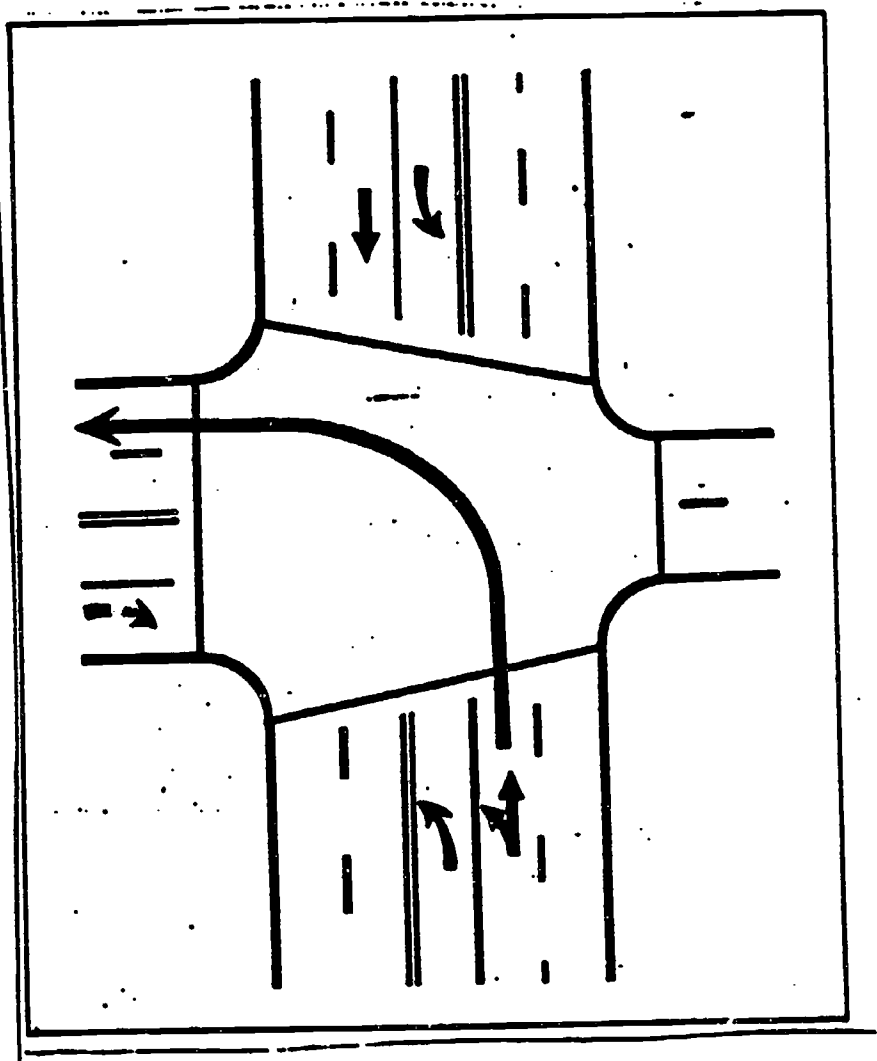

VISUAL 2.7.6: LEFT TURN LANES

## LEFT TURNS

You have greater visibility making left turns than you have in right turns.

Once again, there is a set of steps to reduce accidents

1. Move into the left turning lane in advance
2. Signal your intentions
3. Have the unit in the gear you will make the turn in.
4. Yield to oncoming traffic.
5. Turn the wheel when the trailer is halfway past the stationary object (center line, island, etc.)
6. Assume the proper lane (left lane, farthest from the curb).
7. Reduce speed.
8. Signal and move to the right lane.

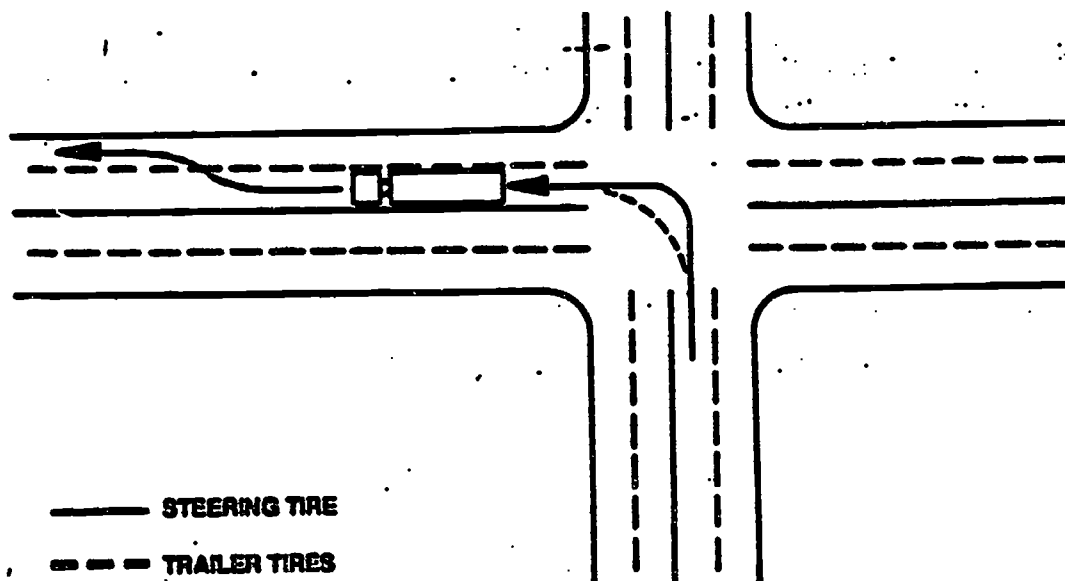

VISUAL 2.7.7: LEFT TURN SUMMARY



## **Night Driving Checklist**

### **The Driver**

- *Clean Glasses*
- *Do Not Wear Sunglasses*
- *Be Rested*

### **The Roadway**

- *Plan Your Route*
- *Know Location of Rest Stops*
- *Know Where Nighttime Hazards Are  
(Ramps, Roadside Bars)*
- *Be Extra Careful on Unfamiliar Roads*

### **The Vehicle**

- *Perform Pre-trip Inspection*
- *Check All Lights*
- *Use Flashlights*

VISUAL 2.8.1: NIGHT DRIVING CHECKLIST

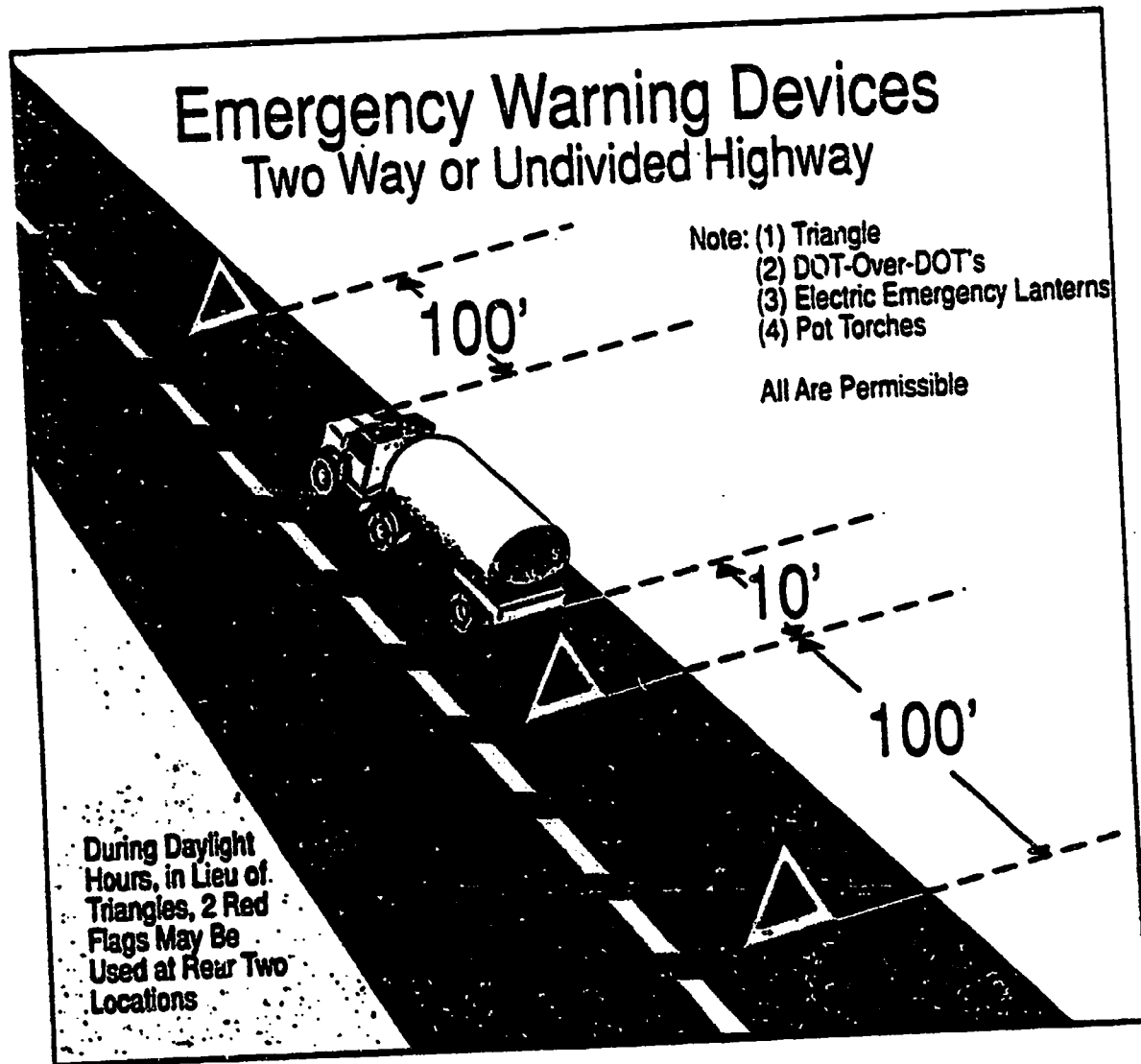

**VISUAL 2.5.3: PLACING WARNING MARKERS CORRECTLY ON AN UNDIVIDED HIGHWAY**

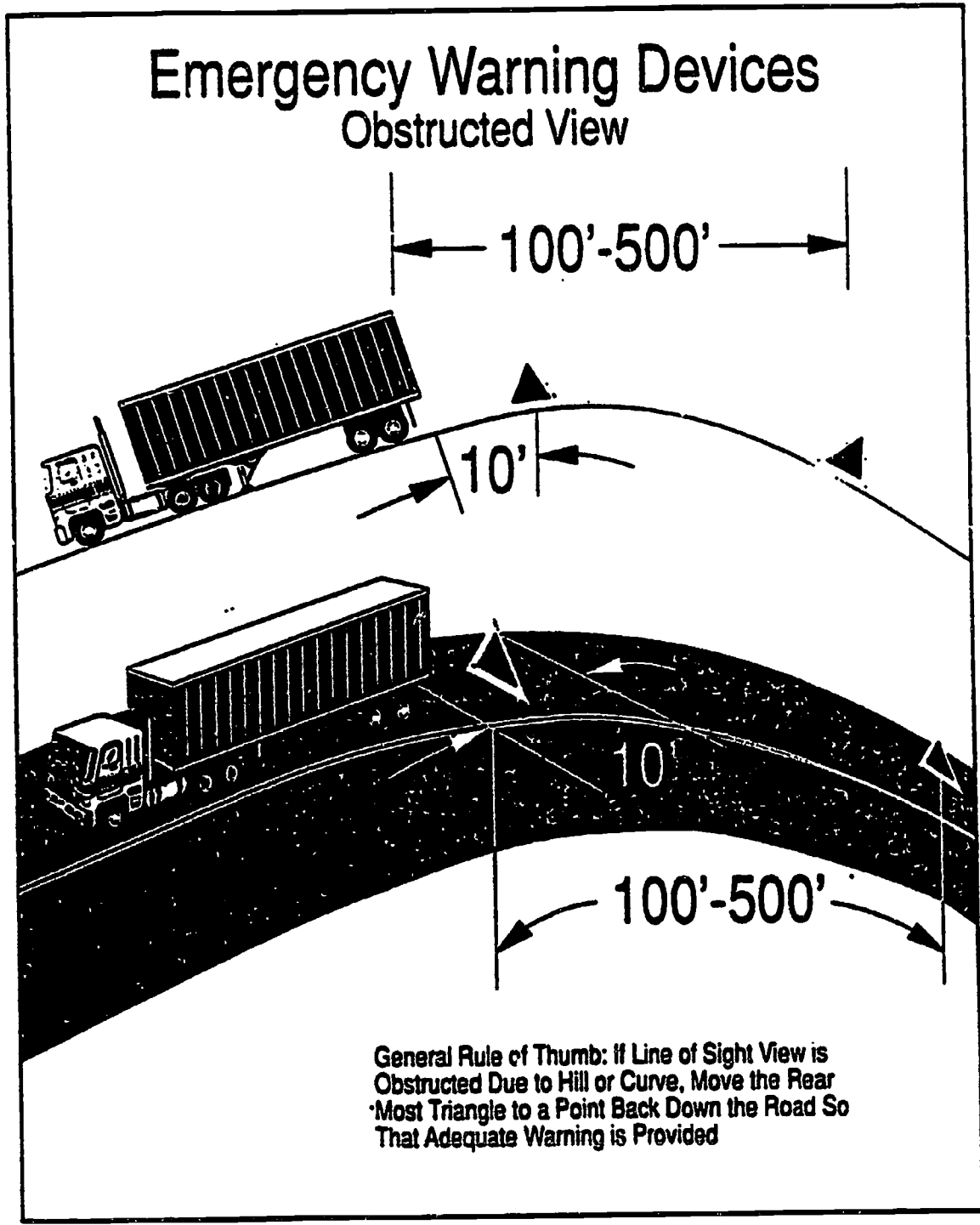

**VISUAL 2.5.4: PLACING WARNING MARKERS WHEN THERE IS AN OBSTACLE IN THE LINE OF VIEW**

## Emergency Warning Devices One Way or Divided Highway

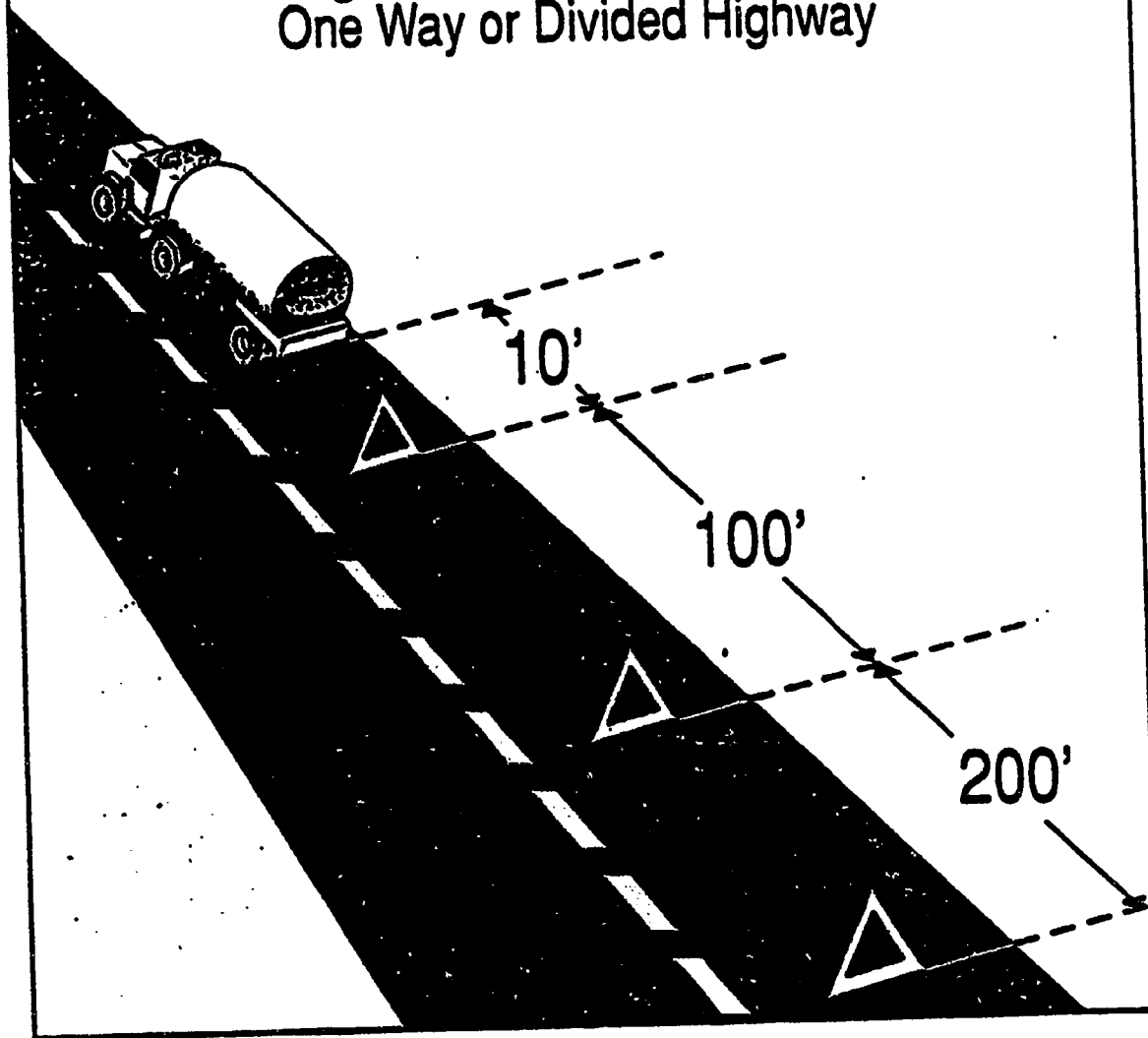

VISUAL 2.5.5: PLACING WARNING MARKERS WHEN STOPPED  
ON A DIVIDED HIGHWAY

# WINTER DRIVING

## UNIT 2.9

175

**2.9.1**

176

# Check Coolant System



177

2.9.2

178

# Check Heater and Defroster

2.9.3

180

179



**Check wipers and  
windshield washer**

**Use an antifreeze liquid**

**STOP - fix if necessary**

**2.9.4**

151

152

# TIRES

**Front - 4/32"**

**Others - 2/32"**

**2.9.5**

153

154

# TIRE CHAINS

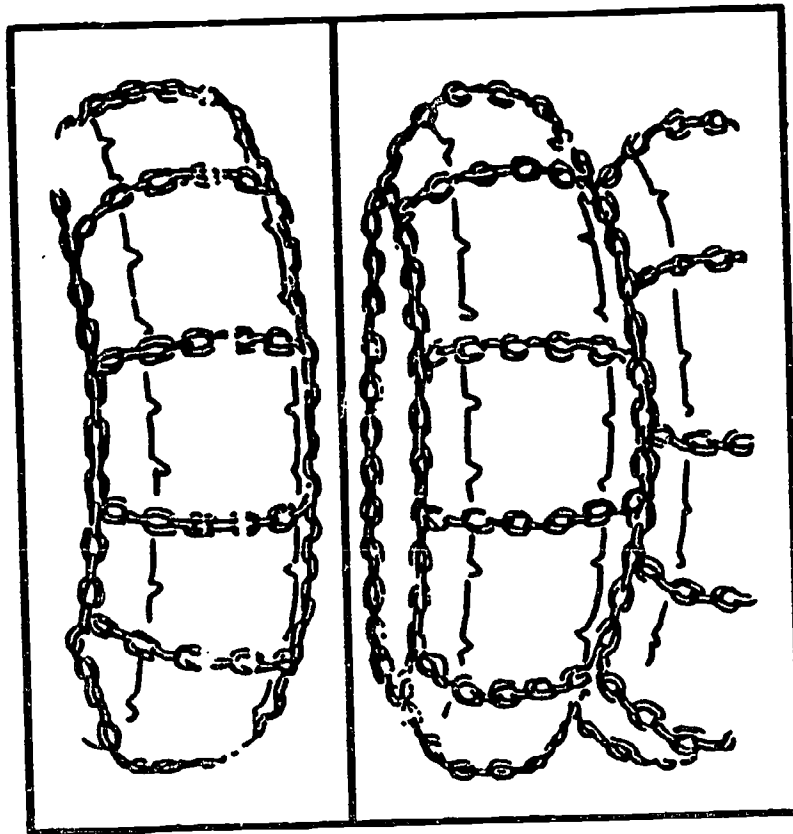

# Lights Reflectors Glass

**- Keep clean -**

**- Ice scrapers -**

**2.9.7**

# **Steps & Catwalks**

**Keep clean**

**Don't jump**

**2.9.8**

# Shutters & Winterfront

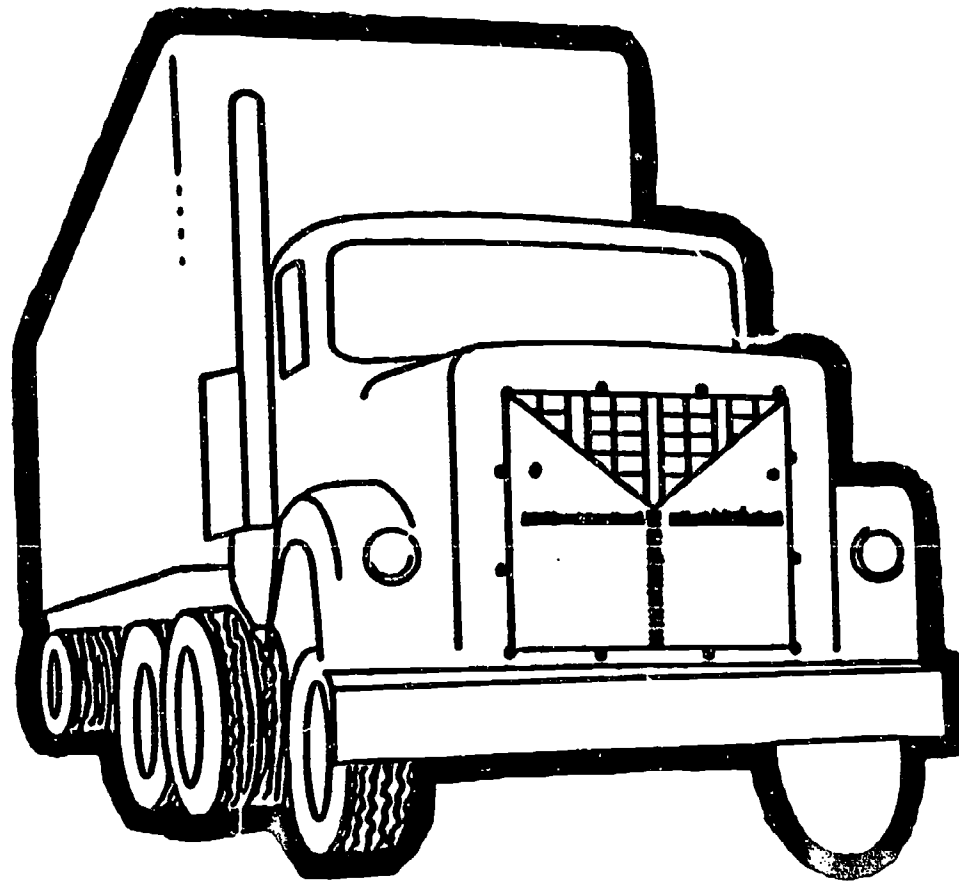

191

2.9.9

192

# Check Exhaust

**2.9.10**

193

194



**Slow  
&  
Gently**

**If very slippery - stop at  
first safe place**

**When temperature  
is near 32 °F**

**Ice is the slipperiest**

**2.9.12**

138

137

# **Wet Brakes May Present Problems**

**2.9.13**

189

20

# When Driving Through Water

- **Slow**
- **Light braking while going through**
- **Dry brakes when through**
- **Test**

**2.9.14**

# **HOT WEATHER DRIVING**

## **UNIT 2.10**

**2.10.1**

2.3

2.4

# **TIRES**

**Check every**

- **2 hours**

**or**

- **100 miles**

**Proper air pressure**

**2.10.2**

**206**

**TIRES**

**Hot - can't touch**

**STOP**

**2.10.3**

2:7

2:8

**TIRES**

**Recap**

**Separation**

**2.10.4**

209

210



**CHECK**

**Engine oil level**

**Coolant level**

211

**2.10.5**

212

# Checking hot coolant level

- **Shut off engine**
- **Gloves**
- **Turn slowly**
- **Step back**

**2.10.6**

214

# Check Belts

**1/2 - 3/4" deflection**

**2.10.7**

215

216

# Check Hoses

**2.10.8**

217

218

# WHEN DRIVING

- **Monitor gauges**
- **Tar**

**2,10.9**

219

220

# **MOUNTAIN DRIVING**

## **UNIT 2.11**

**2.11.1**

221

222

**Downshift to a lower gear**

**BEFORE**

**Starting downgrade**

**2.11.2**

# **BRAKE FADE**

**Increase stopping  
distance**

**2.11.3**

235

236



# **PROPER BRAKING TECHNIQUE**

**Go slow so a light  
steady braking  
application keeps  
speed down.**

**2.11.4**

# **STAB BRAKING**

- **Brakes cool slowly**
- **Air pressure decreases**
- **Going slow using light**

**Steady braking is better**

# ESCAPE RAMPS

Use them

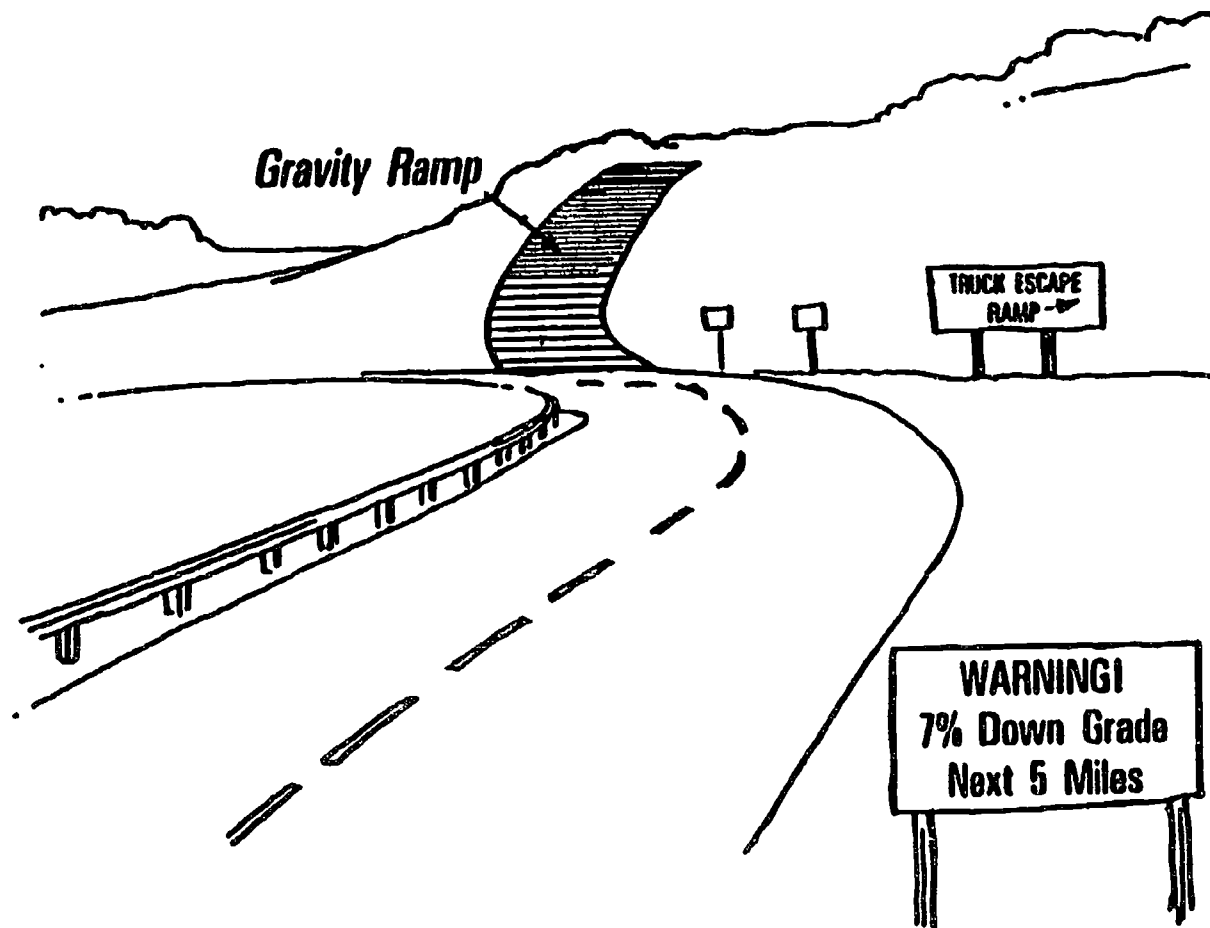

2.11.6

# Question #1

## Truck Escape Ramps

- a) Can only be used by tractor - trailer combinations
- b) When used, do extensive physical damage to vehicle
- c) Should be used when needed
- d) Both B & C

2.11.7

# **EMERGENCIES**

## **UNIT 2.13**

### **2.13.1**

235

236

# TRAFFIC EMERGENCIES

# VEHICLE EMERGENCIES

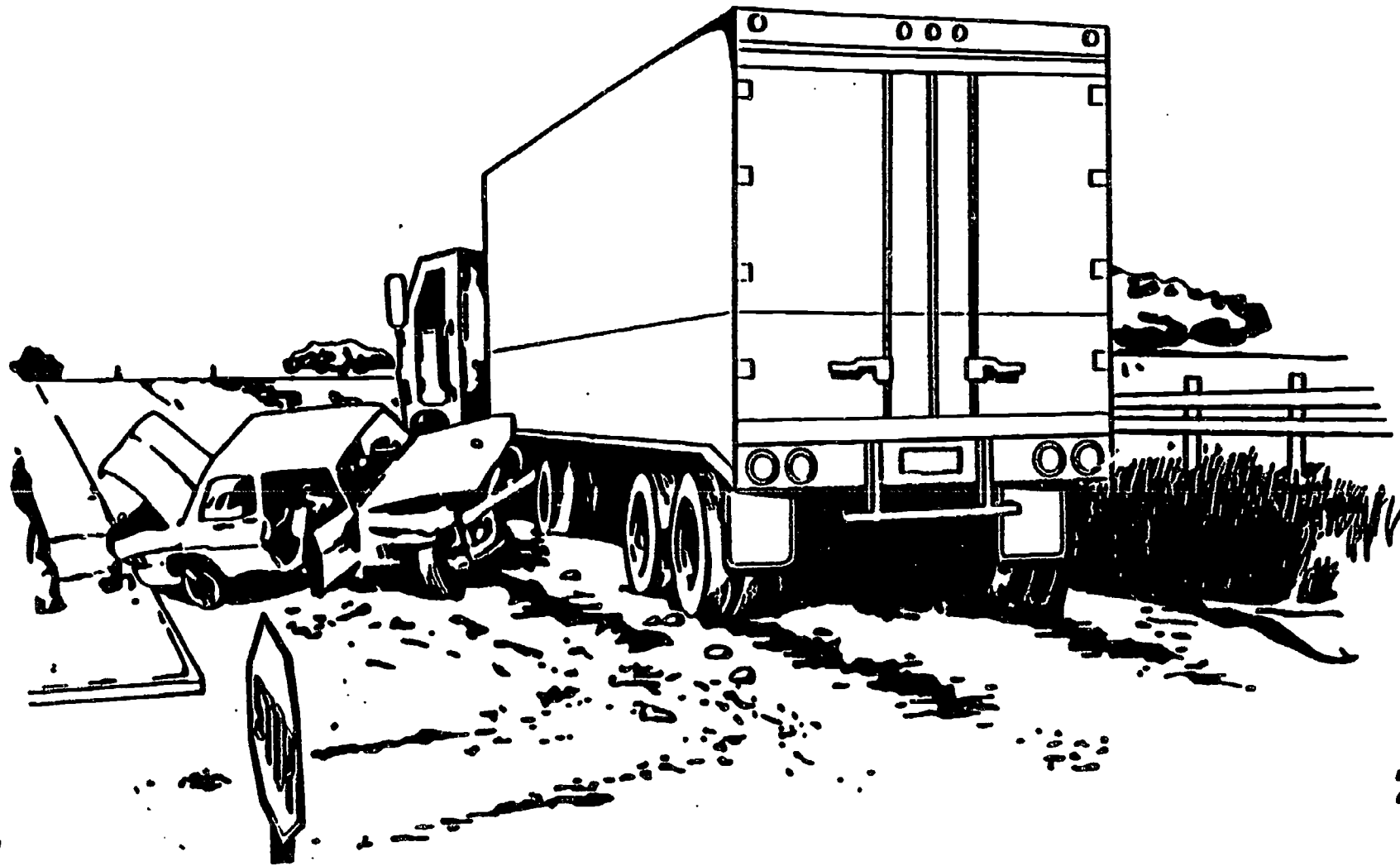

**Steering around a  
hazard may be safer  
than braking**

**2.13.3**

239

210

# HAND POSITION

9 - 3

2.13.4

211

212



# WHEN QUICK STEERING

- **Do not apply brakes**
- **Steer only enough to clear the hazard**
- **Countersteer**

**2.13.5**

214

213

# WHERE TO STEER

- **Generally to right**
- **Shoulders of roads**
- **When pulling onto shoulders -  
stay until vehicle stops**
- **Slow until 20 mph  
before braking**

2.13.6

216

# **RETURNING TO ROAD WITHOUT STOPPING**

- **Hold wheel tightly**
- **Steer sharply**
- **Countersteer**

**2.13.7**

# **BRAKING TECHNIQUES**

- **Controlled braking  
(Squeeze)**
- **Stab Braking**

**2.13.8**

219

250

**Emergency braking  
does not mean  
braking hard and  
locking up the brakes**

**2.13.9**

# **FAILURE OF HYDRAULIC BRAKES**

- **Down shift**
- **Pump the brakes**
- **Parking or emergency brake**
- **Escape route**

**2.13.10**

254

# TIRE FAILURE

- **Recognize**
  - **Sound**
  - **Feel**
  - **Vibration**
- **Grip Wheel**
- **Off Brakes**
- **Check tires**

**2.13.11**

# **SKID CONTROL & RECOVERY**

## **UNIT 2.14**

**2.14.1**

257

258



# **SKID**

**Whenever tire loses  
traction on the road**

**2.14.2**

259

260

# **SKIDS HAPPEN**

- **Overbraking**
- **Oversteering**
- **Overacceleration**
- **Excess speed**

**2.14.3**

# SKIDS

## Front wheel

2.14.4

263

264

# SKIDS

## Front Wheel

- **Get off the brakes**
- **Slow down -  
do not lock brakes**

**2.14.5**

# **SKIDS**

## **Drive wheel**

**2.14.6**

267

268

# SKIDS

## Wheel

- **Release the brakes**
- **Steer**
- **Countersteer**
- **Depress the clutch**

**2.14.7**

# **Question #1**

**A skid can be caused by**

**a) Hard acceleration**

**b) Hard braking**

**c) Sharp turning**

**d) All of the above**

**2.14.8**

# **Accident Procedures**

## **UNIT 2.15**

**2.15.1**

273

274



# **At An Accident Scene**

- **Protect the scene**
- **Notify authorities**
- **Care for injured**

**2.15.2**

# Protect the Scene

- **Move your vehicle to side**
- **Park away from scene**
- **Reflective triangles**

**2.15.3**

# **Notify Authorities**

**2.15.4**

279

250

# Help Injured

- **Don't move unless necessary**
- **Breathing**
- **Stop bleeding**
- **Keep warm**

**2.15.5**

# **Accident Procedures**

## **Question #1**

**When you come upon an accident scene are you going to help?**

- A) Park as close to the scene as possible to help protect it**
- B) Put on the 4-way flashers or set up reflective triangles**
- C) Keep injured cool**
- D) Stop bleeding by applying direct pressure to the wound**

**2.15.6**

# FIRES

## UNIT 2.16

**2.16.1**

255

256

# CAUSES OF VEHICLE FIRES

- **Accident scenes**
- **Fuel spills or improper fueling techniques**
- **Cargo**
- **Electrical**
- **Tires**
  - **Underinflated**
  - **Flat**
  - **Duals touching**

**2.16.2**

# **FIRE PREVENTION**

- **Pretrip inspections**
- **Enroute inspections**
- **Good monitoring habits**

**2.16.3**



# **IN CASE OF FIRE**

**Pull off road**

**Notify authorities**

**Contain the fire**

**2.16.4**

# USE THE RIGHT FIRE EXTINGUISHER

- **B:C type for**
  - **electrical**
  - **burning liquids**
- **A:B:C type for**
  - **same as B:C type**
  - **wood**
  - **paper**
  - **cloth**
- **Use water on**
  - **wood**
  - **paper**
  - **cloth**
  - **tires**
- **Do NOT use water**
  - **electrical**
  - **gasoline**

2.16.5

# PUTTING FIRE OUT

**Know how extinguisher works**

**Keep far away**

**Aim at base**

**Upwind**

**Don't stop**

**Extinguish only if know what to do**

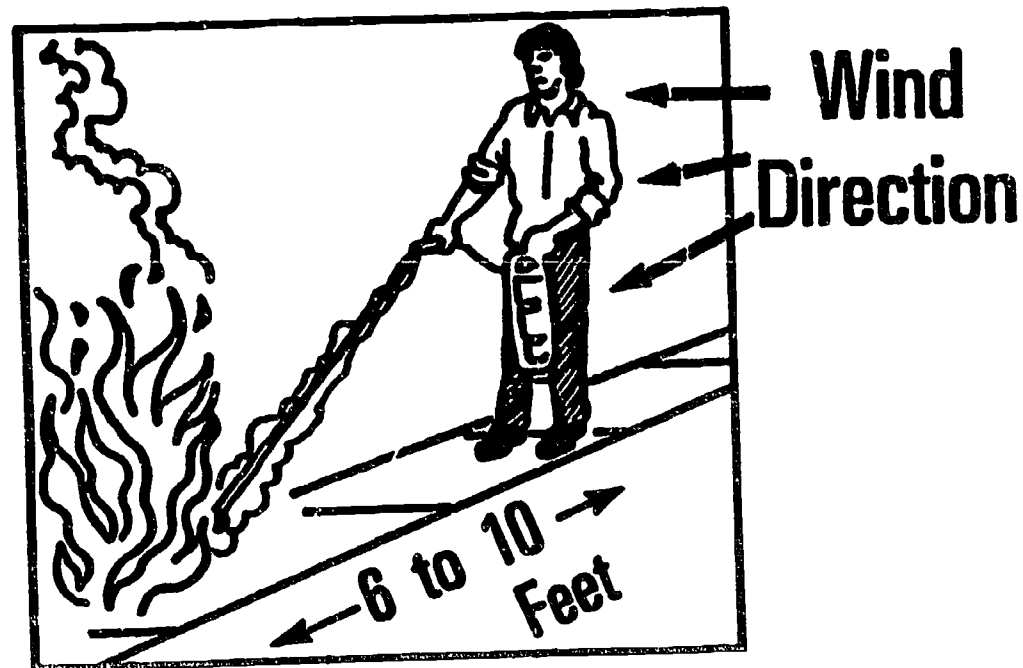

2.16.6

296

295

# STAYING ALERT

## UNIT 2.17

2.17.1

297

298

# **STAY ALERT**

**Enough sleep**

**Schedule trips**

**Avoid medication**

**Keep cool**

**Take breaks**

**Nap**

**Avoid drugs & alcohol**

**2.17.2**

**300**

# ALCOHOL MYTHS

**Improves driving skills**

**All people are affected**

**Eating helps**

**Coffee & fresh air helps**

**Beer affects are less**

- 12 oz. beer
- 5 oz. wine
- 1 and 1/2 oz. liquor

*They're All the Same*



1 1/2 oz. Liquor

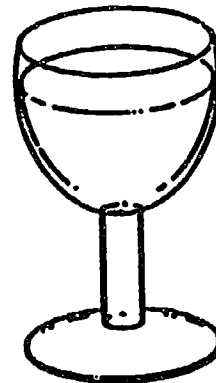

5 oz. Glass of Wine



12 oz. Can of Beer

# **B A C**

**Blood alcohol concentration**

**Amount drank**

**Fast Drinking**

**Body weight**

**2.17.4**

# ALCOHOL AFFECTS BRAIN

**Quickly**  
**Judgement**  
**Self control**  
**Muscle control**  
**Vision**  
**Coordination**  
**Reaction time**

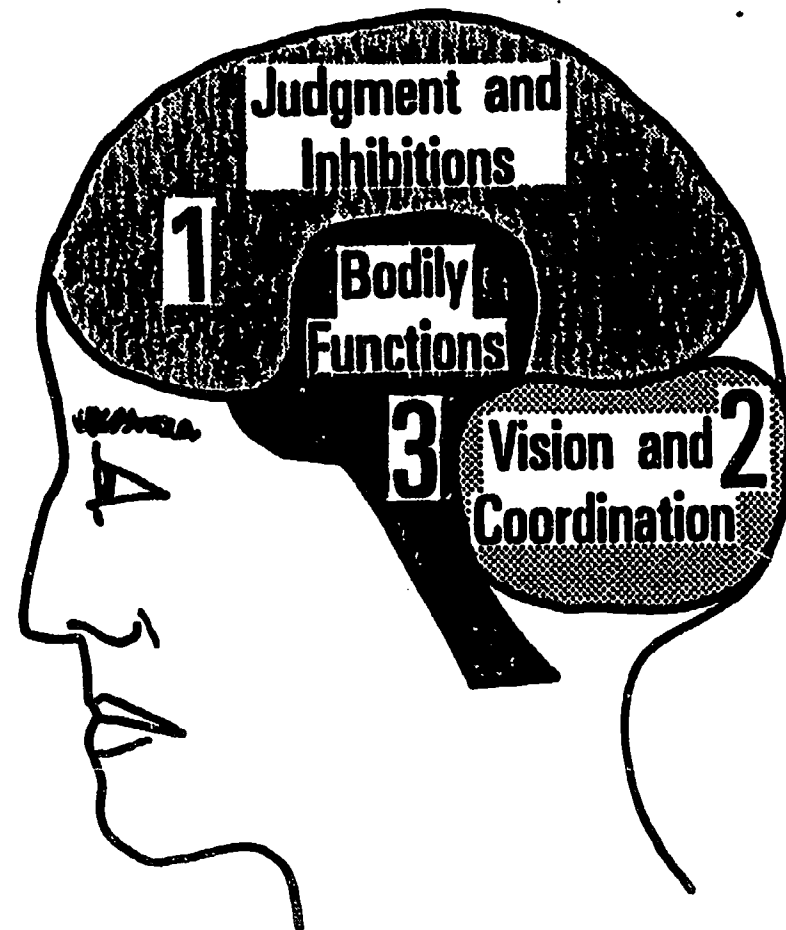



# **Affects Driving**

**Reaction Time**

**Too fast or too slow**

**Wrong lanes**

**Hit curbs**

**Weaving**

**Straddling lanes**

**Quick, jerky starts**

**Poor signaling**

**Not stopping**

**Improper passing**

**Statistics show drinking  
drivers have a greater  
chance for a crash.**

**B.A.C. of a trace to 0.04  
24 hours "Out of Service"**

**B.A.C. of 0.04 or greater  
Legally Drunk**

**2.17.8**

311

312

**Law prohibits possession or  
under the influence of**

**controlled substances**

**bennies**

**pep pills**

**amphetamines**

**narcotics**

**prescription & over-the-counter  
drugs causing drowsiness or  
unsafe driving**

# **1st offense**

**License lost for 1 year  
unless placarded - then 3 years**

# **2nd offense**

**Life!**

3.5

2.17.10

318

# **HAZARDOUS MATERIALS**

## **UNIT 2.18**

**2.18.1**

3.7

318

**All commercial drivers must recognize hazardous cargo and if it can be hauled without the "H" endorsement.**

**2.18.2**

319

320

# **Why H.M. Rules?**

**Contain the product**

**Communicate the risk**

**Ensure safe drivers & equipment**

**2.18.3**

321

322



# **Containment Rules**

**Packaging**

**Loading**

**Transporting**

**Handling of bulk tanks**

**2.18.4**

323

324

# Communication

**Paperwork**

**Placards**

**Labels**

**2.18.5**

325

326

"RQ" means that this is a reportable quantity

Proper shipping name from Column 2 of the Hazardous Materials Table

Hazard Class from Column 3 of the Table

ID Number from the Hazardous Materials Table

**SHIPPING PAPER**  
Page 1 of 1

**TO:** Waters R Us  
88 Valley Street  
Silicon Junction, CA

**FROM:** Essex Corporation  
5775 Dawson Avenue  
Goleta, CA 93117

QTY	HM	DESCRIPTION	WEIGHT
1 cyl	RQ	Phosgene, Polson A, UN1076	25 lbs

This is to certify that the above named materials are properly classified, described, packaged, marked and labeled, and are in proper condition for transportation according to the applicable regulations of the Department of Transportation.

**Shipper:** Essex Corp      **Carrier:** Knuckle Bros.  
**Per:** Shultz      **Per:**  
**Date:** 6/27/88      **Date:**

327

2.18.6

328

# DOT Hazardous Materials Warning Labels

## DOMESTIC PLACARDING

Illustration numbers in each square (1) through (18) refer to TABLES 1 and 2 below.

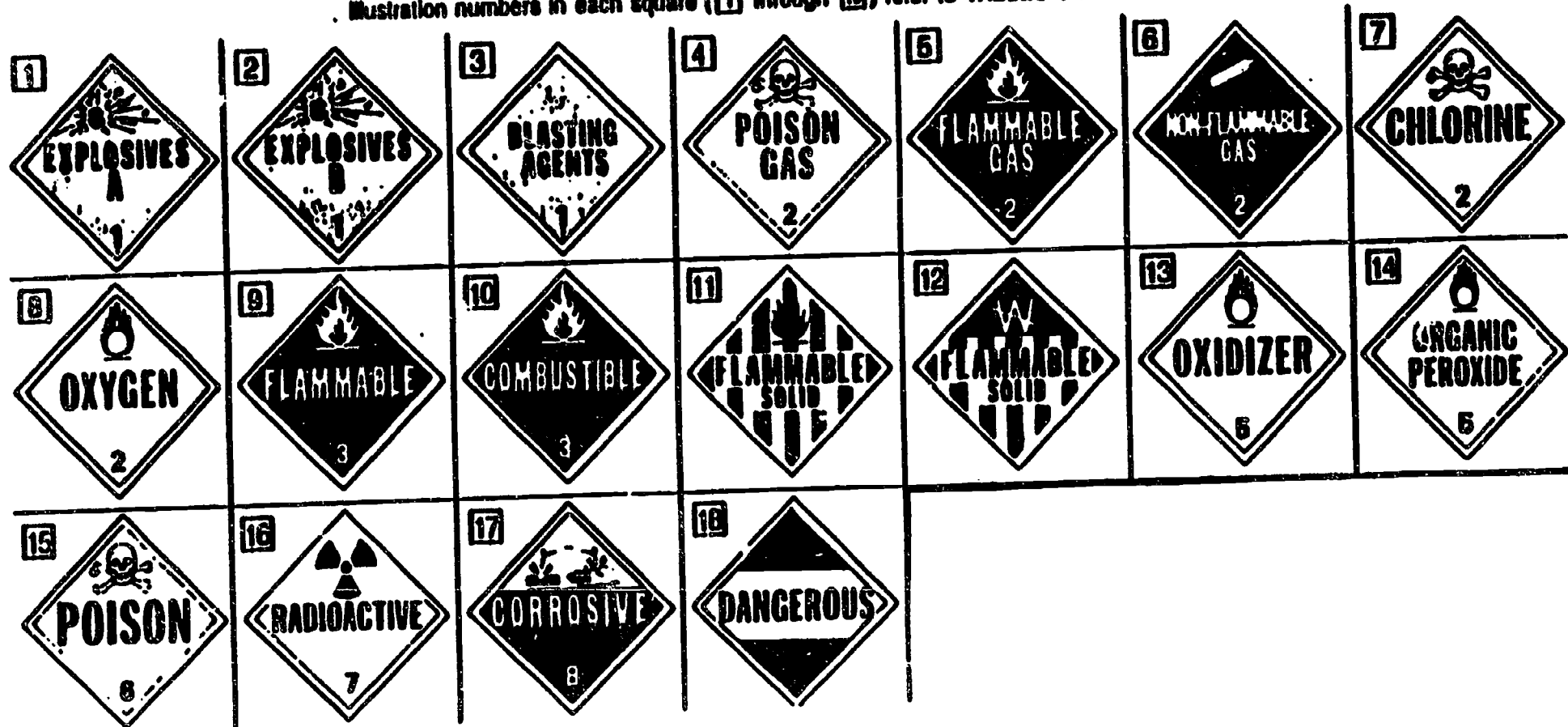

2.18.7

3.2.0

3.3.0

# H.M. Papers

- **TAB**
- **Place on top**
- **Door pocket**
- **In view while driving**
- **Driver's seat**

# Placards

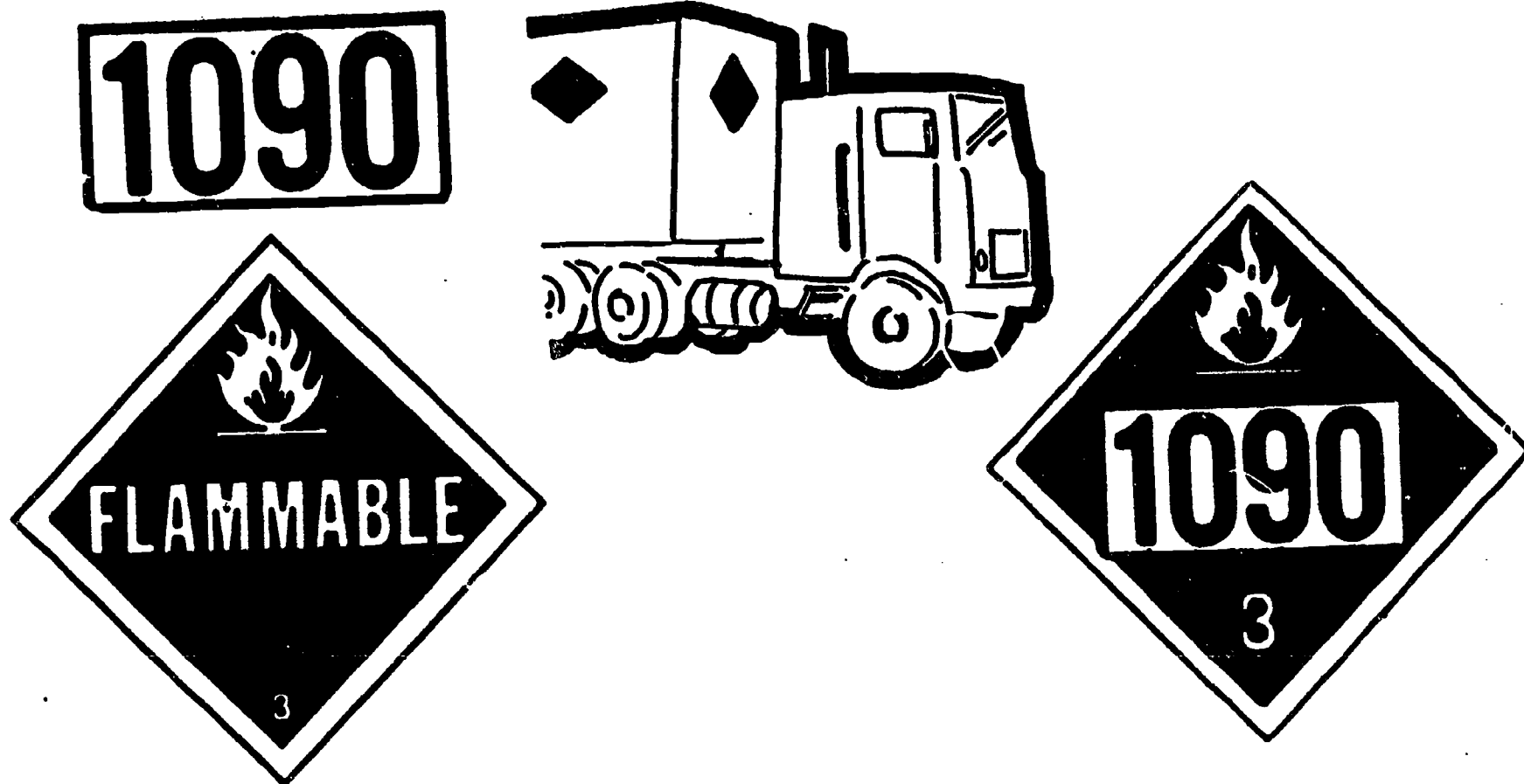

2.18.9

333

334

# Placard Placement

Hazardous Material identification numbers may be displayed on placards or orange panels.

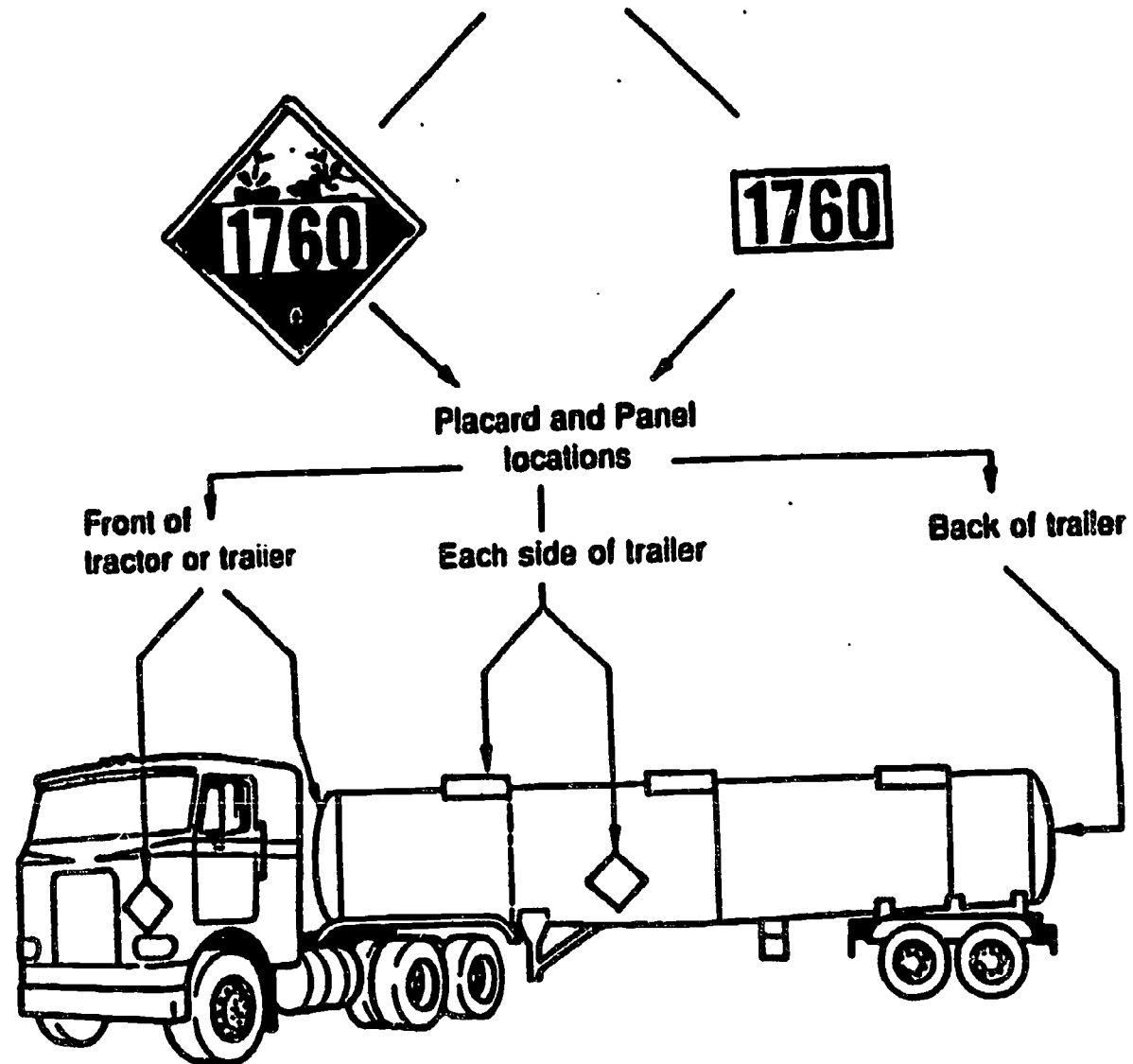

3.35

2.18.10

3.36

**You may NOT drive a vehicle  
requiring placards if you do  
not have the hazardous  
material endorsement**

**2.18.11**

337

335



# **Transporting Cargo Safely**

## **Section 3**

**3.0.1**

339

310

# **Driver Responsible**

- **Inspecting**
- **Recognizing**
- **Securement**

**3.0.2**

# Inspecting Cargo

## UNIT 3.1

**3.1.1**

313

314

**Inspect**

**Pre-trip**

**1<sup>st</sup> 25 miles**

**3 hours or 150 miles**

**After every break**

# **Weight & Balance**

## **UNIT 3.2**

**3.2.1**

317

318

# **DEFINITIONS**

**GVW - Single Vehicle Total**

**GCW - Combination Total**

**GVWR - Manufacturer GVW**

**GCWR - Manufacturer GCW**

**Axle Weight**

**Tire Load**

**Suspension System**

**Coupling Device**

**3.2.2**

# **WEIGHT LIMITS**

**Single Axle - 20,000 lbs.**

**Gross Combination - 80,000 lbs.**

**Drivers are responsible**

**3.2.3**

# **OVER LOAD EFFECTS**

**Steering**

**Increase braking distance**

**Slow upgrades**

**Speed downgrades**

**Overworked brakes**



**Bad weather  
or mountains**

**legal loads may be  
too much**

**3.2.5**

355

356

# BALANCE LOAD

WRONG

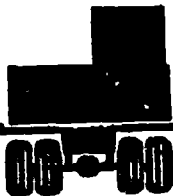

RIGHT

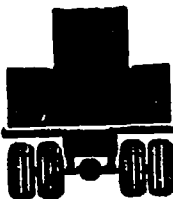

RIGHT

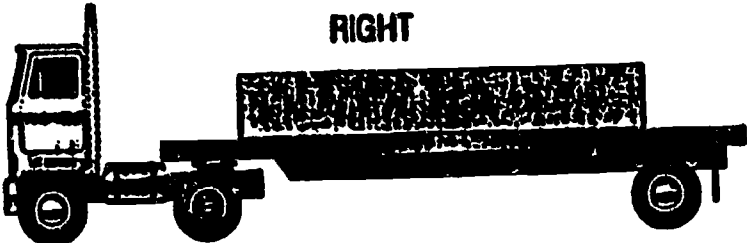

WRONG

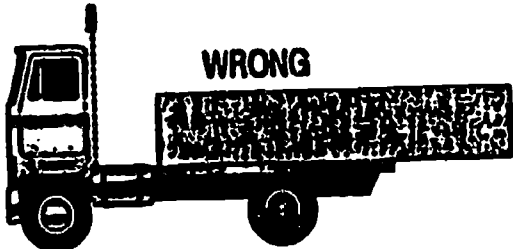

RIGHT



WRONG

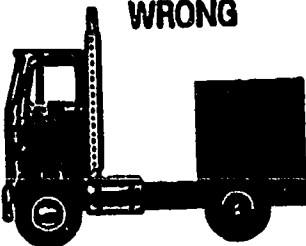

RIGHT



WRONG



**Overweight on steering**  
**hard steering**

**Underweight steering**  
**unsafe steering**

**Underweight drives**  
**Poor traction**

# Securing Cargo

## UNIT 3.3

**3.3.1**

361

362

**BLOCKING -**  
**Keep from sliding**

**BRACING -**  
**Keep from movement**

# TIEDOWNS



365

3.3.3

366

# **TIEDOWNS**

**1 and 1/2 times the weight**

**One tiedown every 10 feet**

367

**3.3.4**

368

# **HEADER BOARDS AND HEADACHE RACKS**

## **Stop forward movement**

369

**3.3.5**

370



**Cover Cargo**  
**Protect People**  
**Protect From Weather**

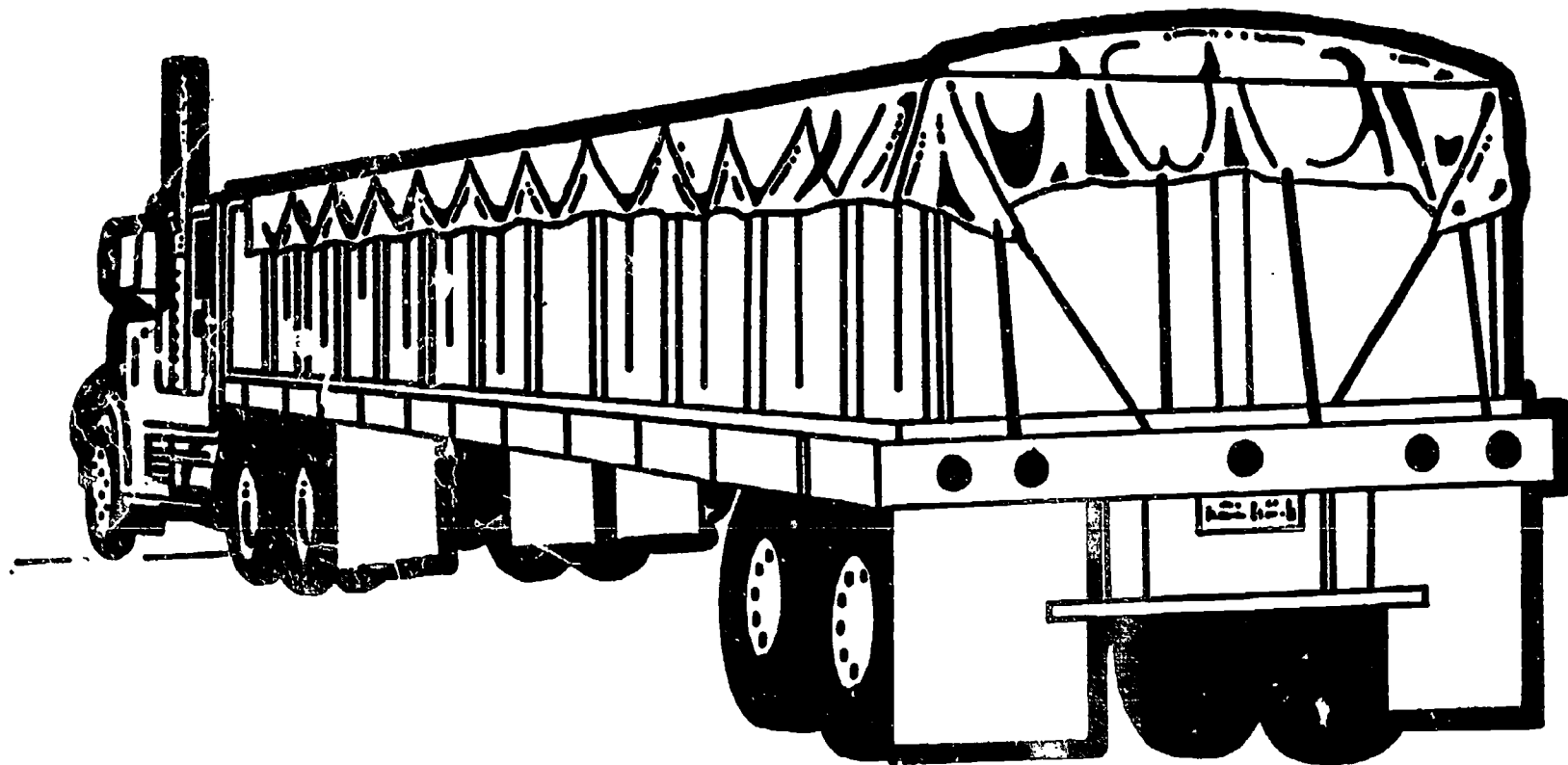

371

**3.3.6**

372

# Tank Vehicles

## UNIT 3.4

**3.4.1**

373

374

# **TANK VEHICLE**

**Hauling 1,000 Gallons or More of  
Liquid Gaseous Liquid**

**Special Driving Skills Required**

# HIGH CENTER OF GRAVITY

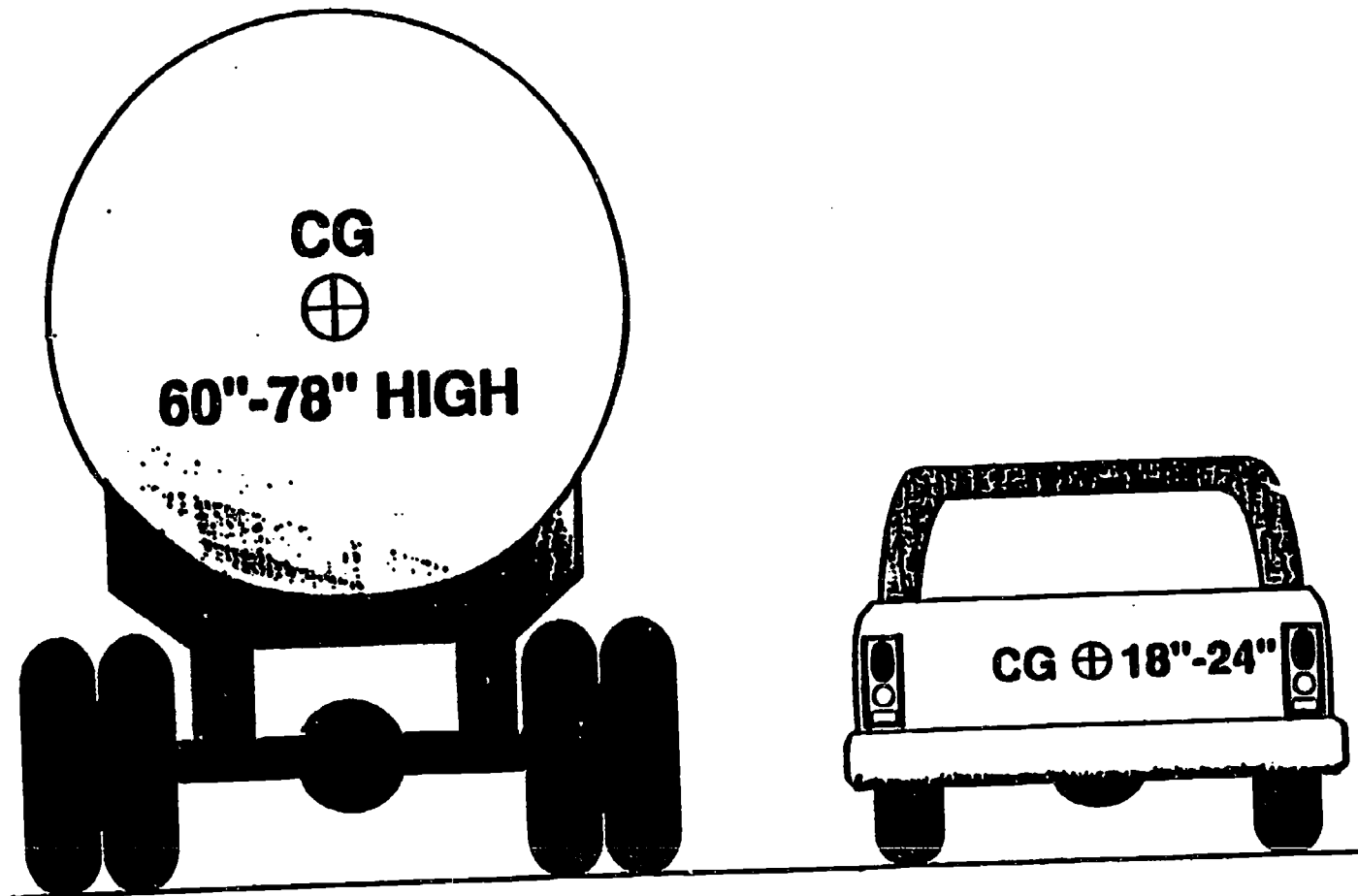

**Rollover easier**

**Slow for curves**

# **SURGE**

**Movement of Liquid**

**Forward - Stopping**

**Rearward - Acceleration**

**Side-to-side - Steering**

**3.4.4**

**Unloading smaller  
tanks on a larger tanker**

**be aware of the  
weight distribution**

# BAFFLED TANKS

Holes in bulkheads

Help forward and rearward surge  
but not side-to-side

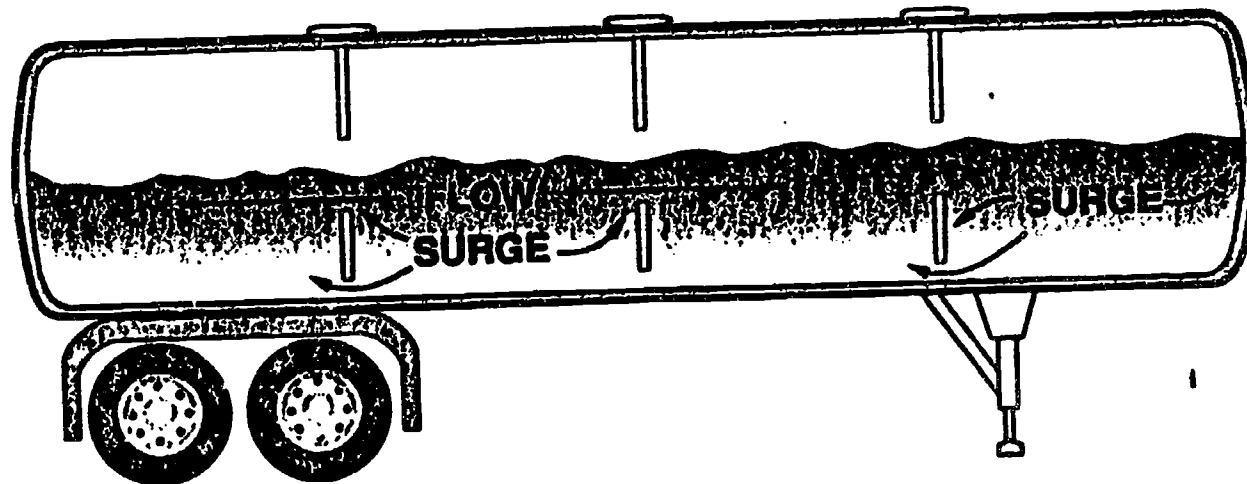

353

3.4.6

354

# UNBAFFLED TANKERS or SMOOTH BORE TANKER

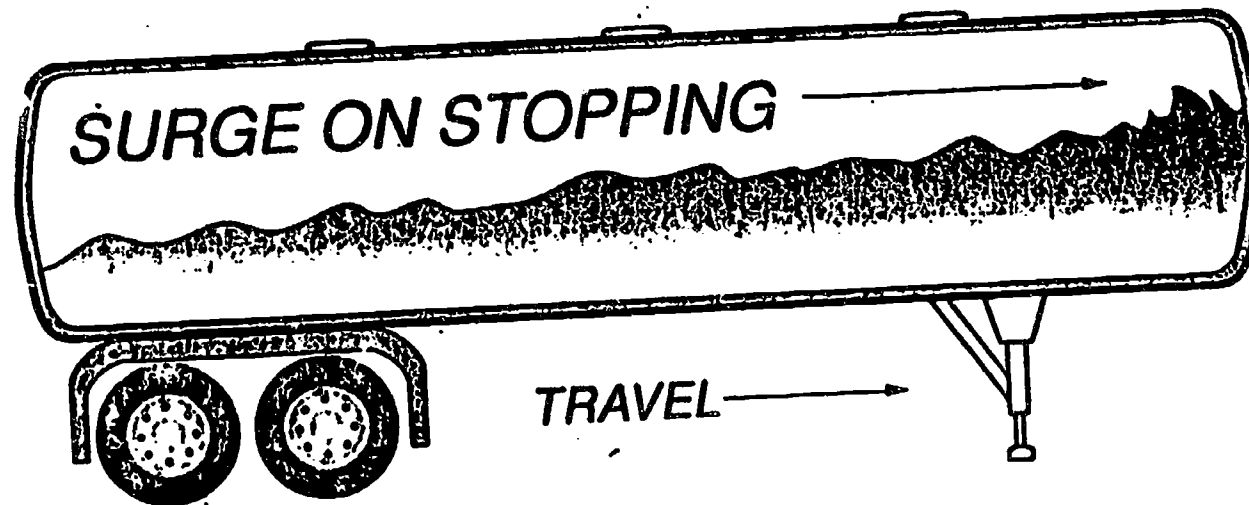

**Be careful  
especially starting & stopping**



# OUTAGE

## Space needed of Liquid Expansion

357

**3.4.8**

358

# **Amount in Tanker Depends on**

**Expansion**

**Weight of liquid**

**Weight limits**

# Other Cargo Needing Special Attention

## UNIT 3.5

3.5.1

301

302

**Dry bulk tanks**

**Hanging meat**

**Livestock**

**Oversize**

**3.5.2**

# Dry Bulk Tank

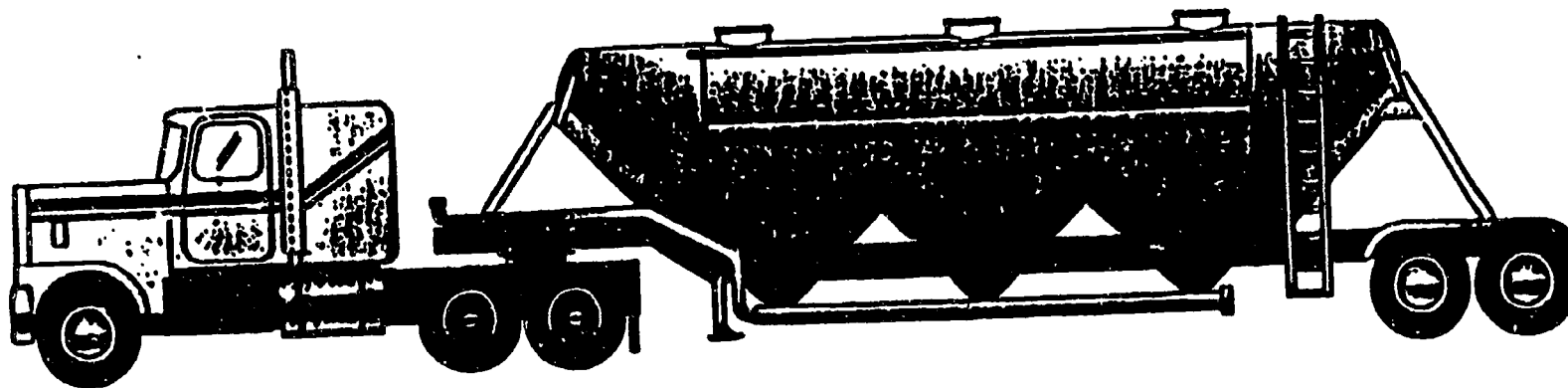

3:5

3.5.3

398

# Hanging Meat

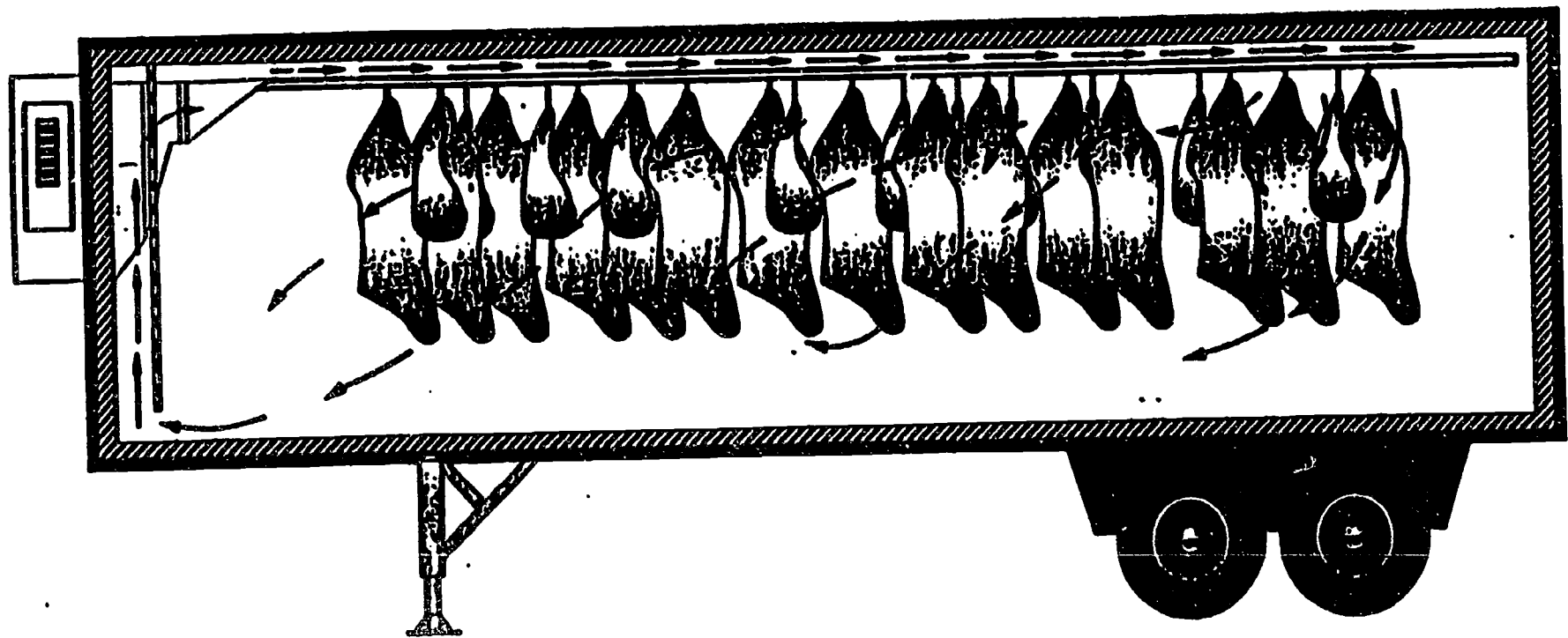

3.5.4

397

398

# Livestock

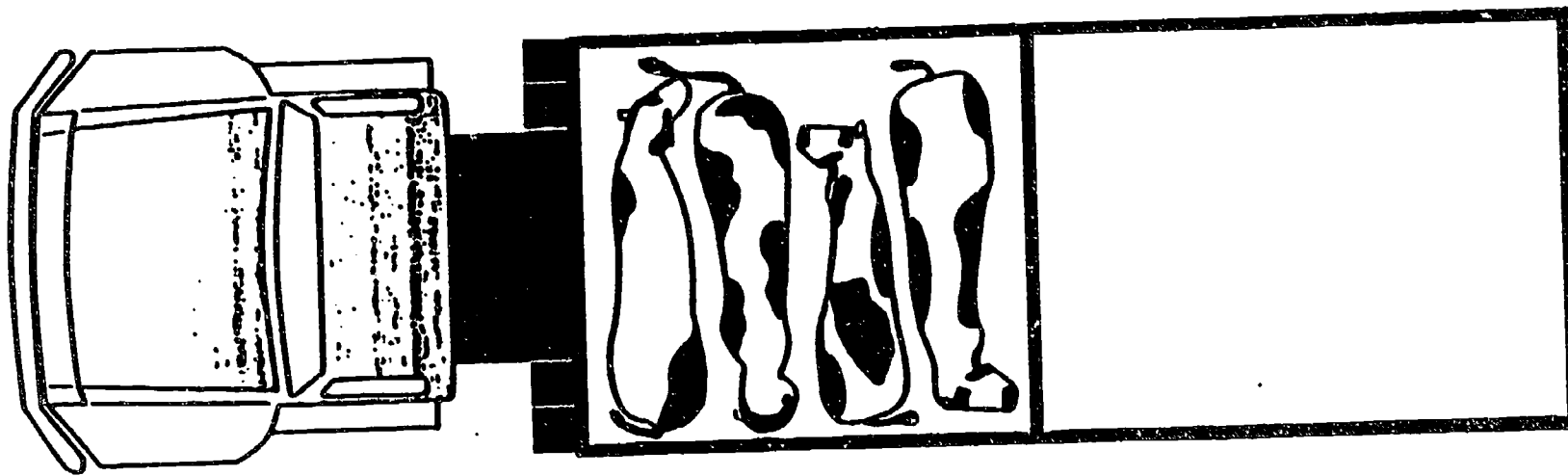

3.5.5

309

4 (1)

**Over Size**

**3.5.6**

411

402



## WHAT IS A BUS?

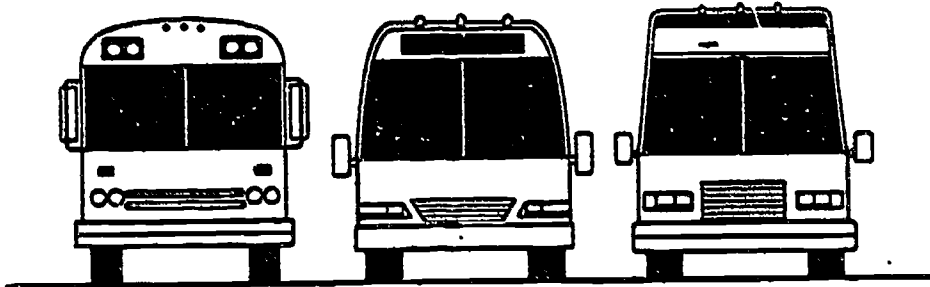

**ANY COMMERCIAL MOTOR VEHICLE  
DESIGNED TO SEAT AND CARRY 16 OR  
MORE PASSENGERS, INCLUDING THE  
DRIVER.**

**ALL BUS DRIVERS MUST HAVE A  
COMMERCIAL DRIVER'S LICENSE (CDL).**

**VISUAL 4.1: DEFINITION OF A BUS**

**SOME STATES HAVE STRICTER REQUIREMENTS.  
FOR EXAMPLE, CALIFORNIA REQUIRES YOU TO  
HAVE A CDL IF YOUR VEHICLE CARRIES 10 OR  
MORE PERSONS.**

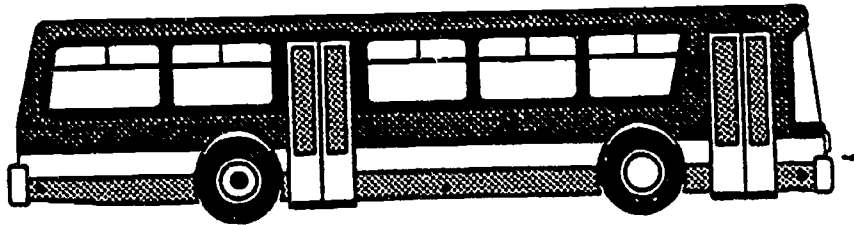

## ARE YOU A BUS DRIVER?

The federal law states that you are legally a bus driver if you transport passengers in any vehicle designed to seat more than 15, including the driver. All bus drivers must have a commercial driver's license. You are a bus driver even if you only:

- Drive a school bus.
- Transport passengers for nonprofit groups, such as church groups, schools, scouting groups, senior citizen centers.
- Drive a hotel or car rental shuttle that seats more than 15.
- Drive an airport limousine that seats more than 15.

You are not a commercial bus driver if you only transport family members for nonbusiness purposes, even if your vehicle seats more than 15.

**Note:** Some states may have stricter laws. For example, California requires a CDL to transport more than 10 passengers.

VISUAL 4.2: ARE YOU A BUS DRIVER?

## **SEVEN-STEP PRE-TRIP INSPECTION CHECKLIST**

- 1. Approach Vehicle — Look for Leaks**
- 2. Check Under Hood or Cab**
- 3. Start Engine and Check Inside Cab**
- 4. Check Headlights and Warning Lights**
- 5. Conduct Walkaround Inspection**
- 6. Check Signal Lights**
- 7. Check Air Brake System**

**VISUAL 4.3: SEVEN-STEP PRE-TRIP INSPECTION CHECKLIST**

The driver's seat should have a seat belt. Always use it for safety.

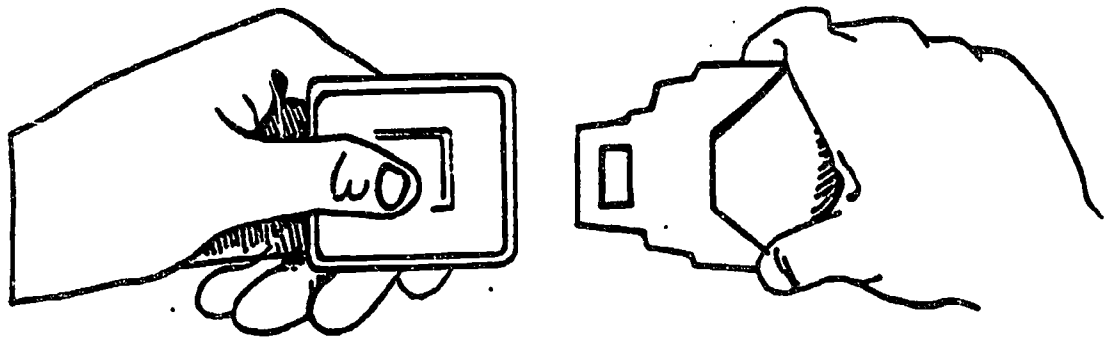

VISUAL 4.4: ALWAYS WEAR YOUR SEAT BELT

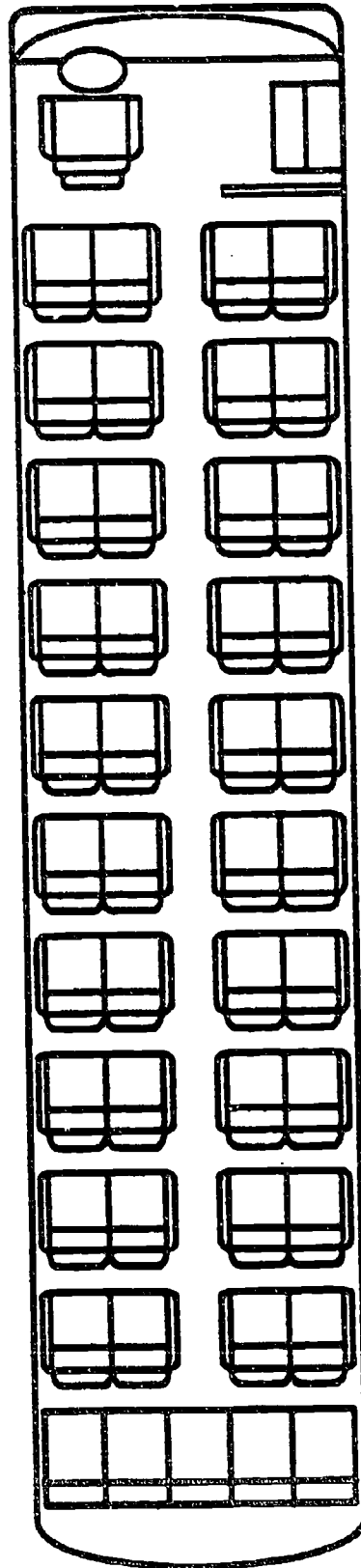

VISUAL 4.5: BUS SEATING

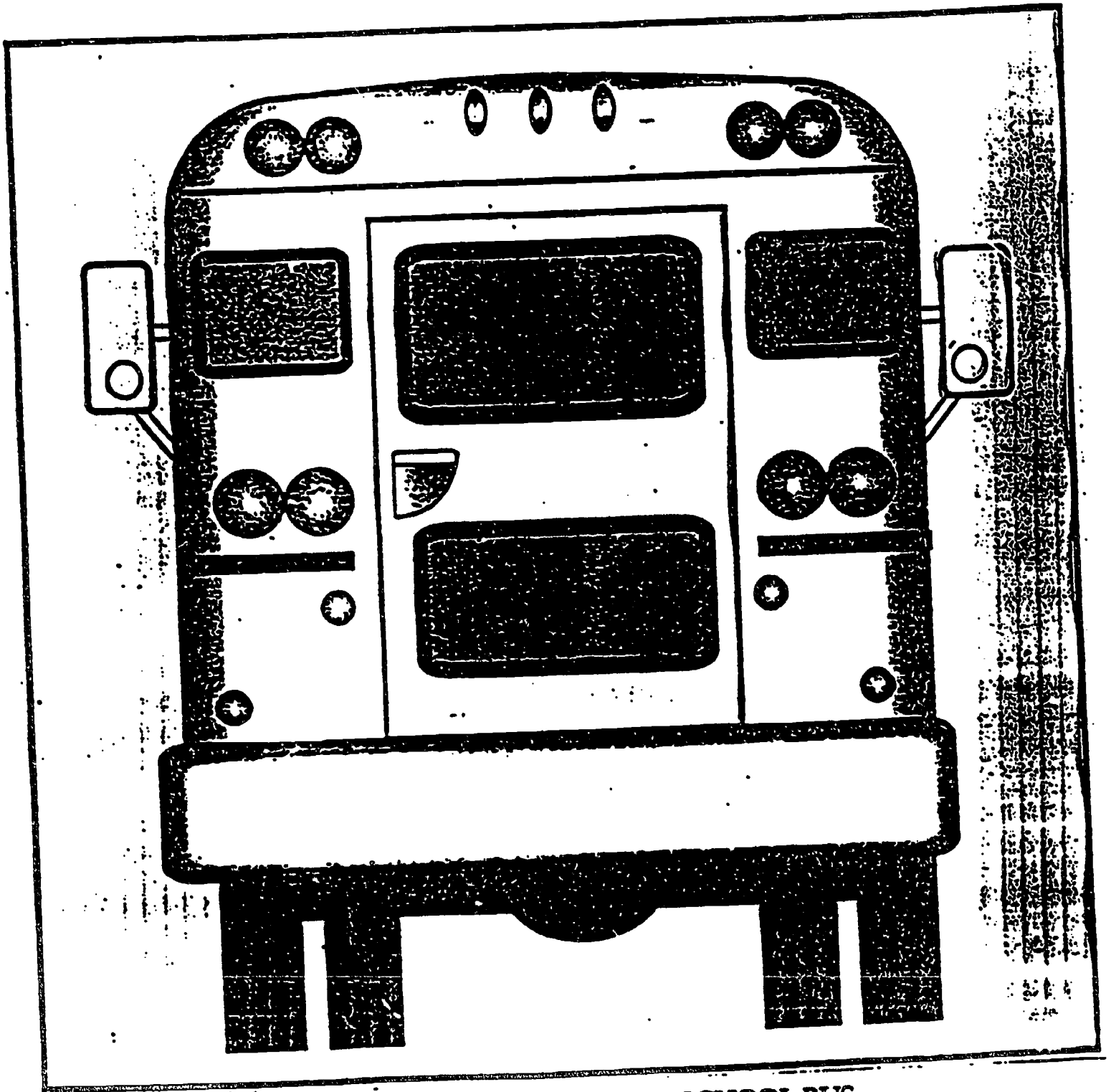

VISUAL 4.6: REAR VIEW OF SCHOOL BUS

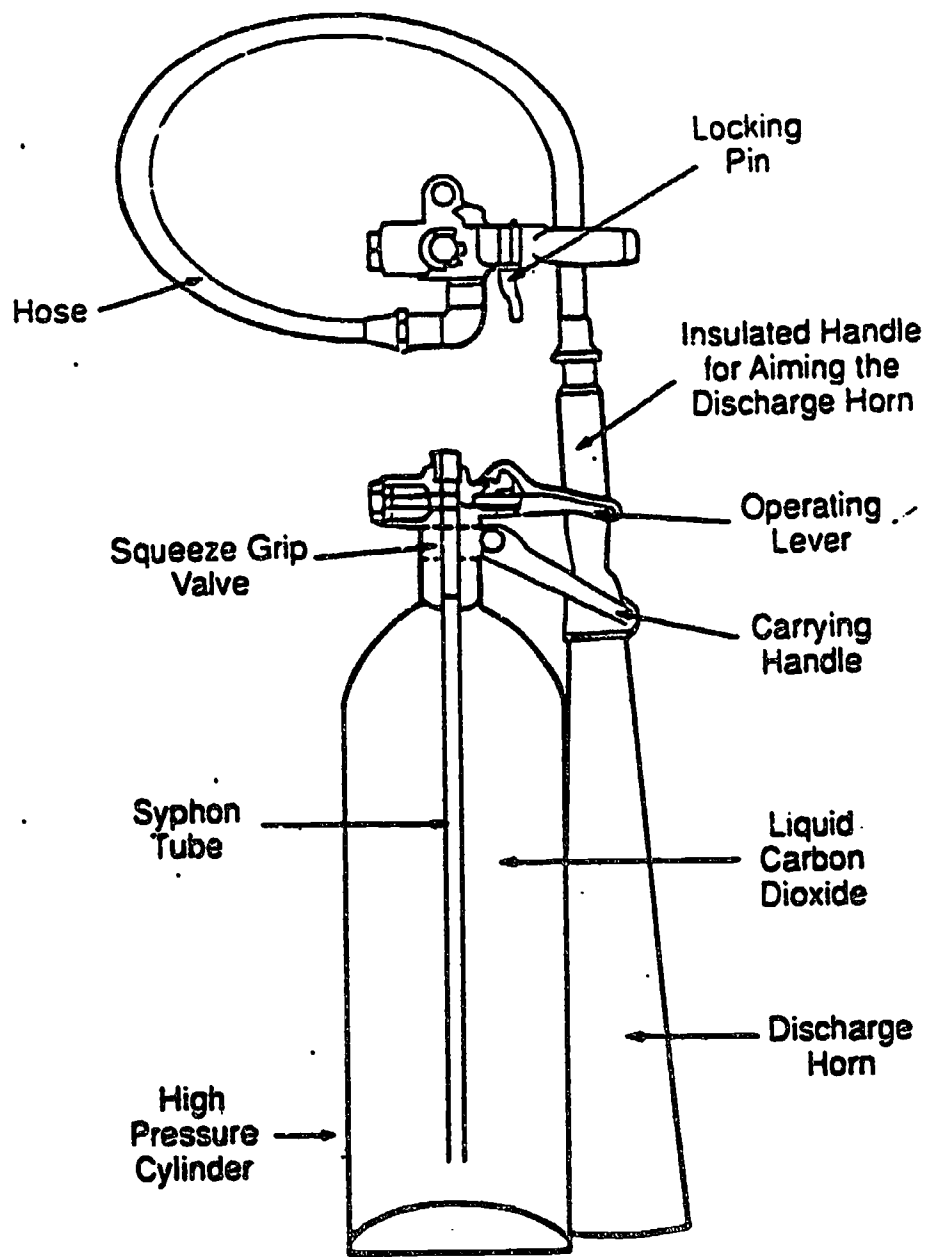

VISUAL 4.7: FIRE EXTINGUISHER

**THINK OF THE WHEEL AS A CLOCK. PLACE YOUR LEFT HAND BETWEEN THE EIGHT AND TEN O'CLOCK POSITIONS AND YOUR RIGHT HAND BETWEEN THE TWO AND FOUR O'CLOCK POSITIONS. THIS DOUBLE GRIP HELPS YOU MAINTAIN CONTROL OF YOUR BUS.**

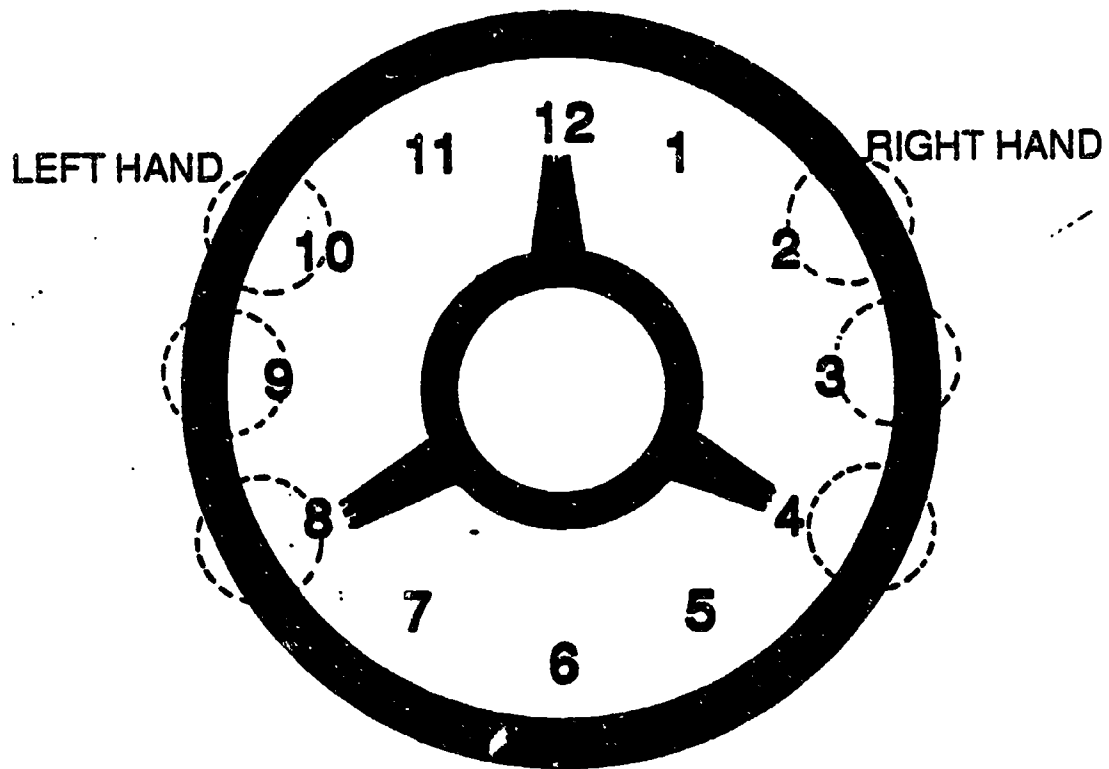

**VISUAL 4.8: STEERING HANDHOLD**



## ***Night Driving Checklist***

### ***The Driver***

- *Clean Glasses*
- *Do Not Wear Sunglasses*
- *Be Rested*

### ***The Roadway***

- *Plan Your Route*
- *Know Location of Rest Stops*
- *Know Where Nighttime Hazards Are*  
*Ramps, Roadside Bars*
- *Be Extra Careful on Unfamiliar Roads*

### ***The Vehicle***

- *Perform Pre-trip Inspection*
- *Check All Lights*
- *Use Flashlights*

VISUAL 4.9: NIGHT DRIVING CHECKLIST

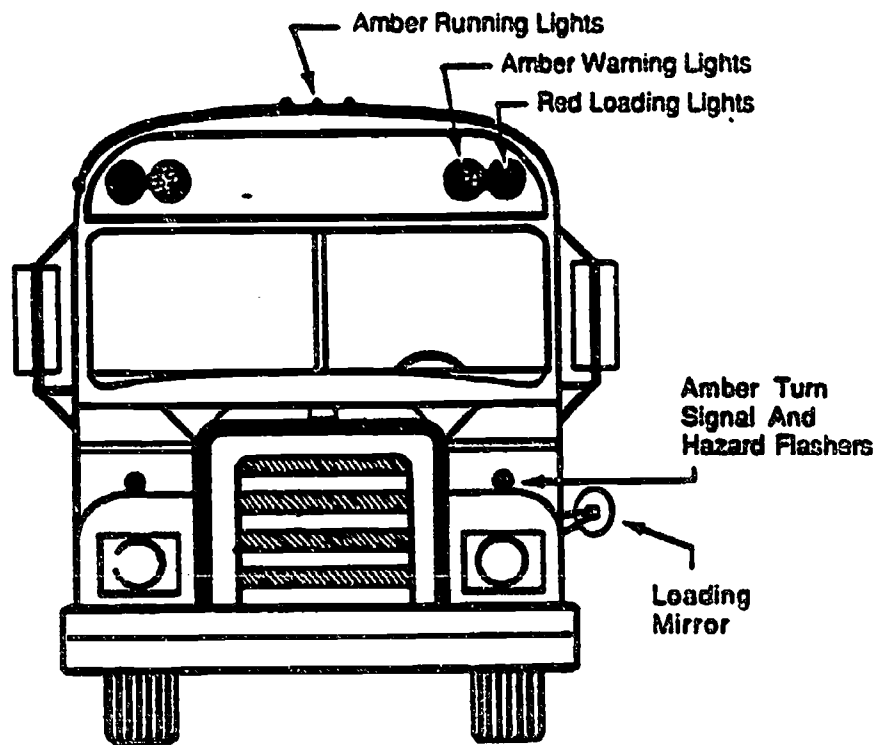
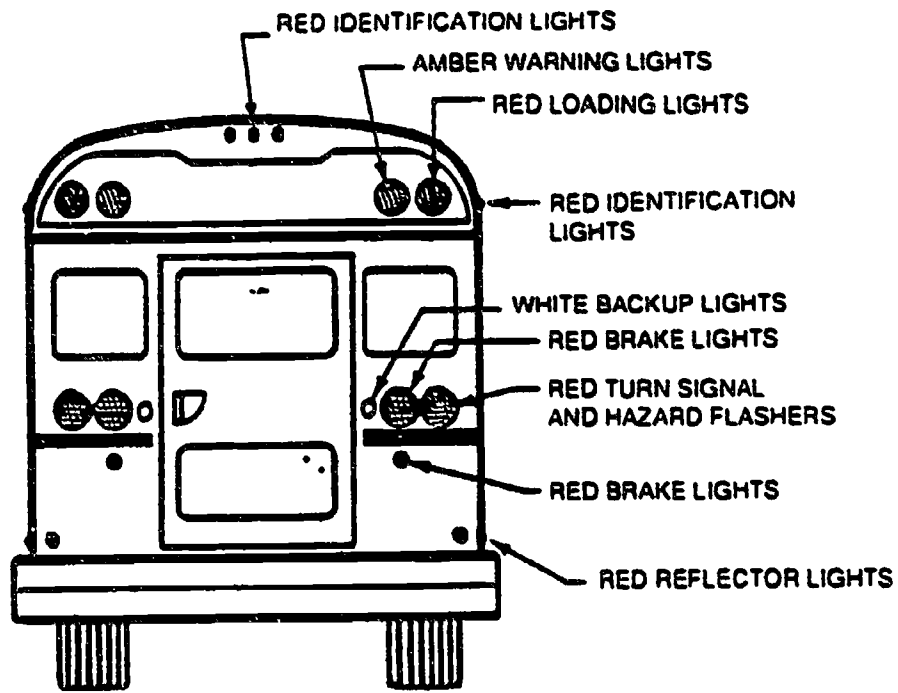

VISUAL4.10: LIGHTS ON SCHOOL BUS

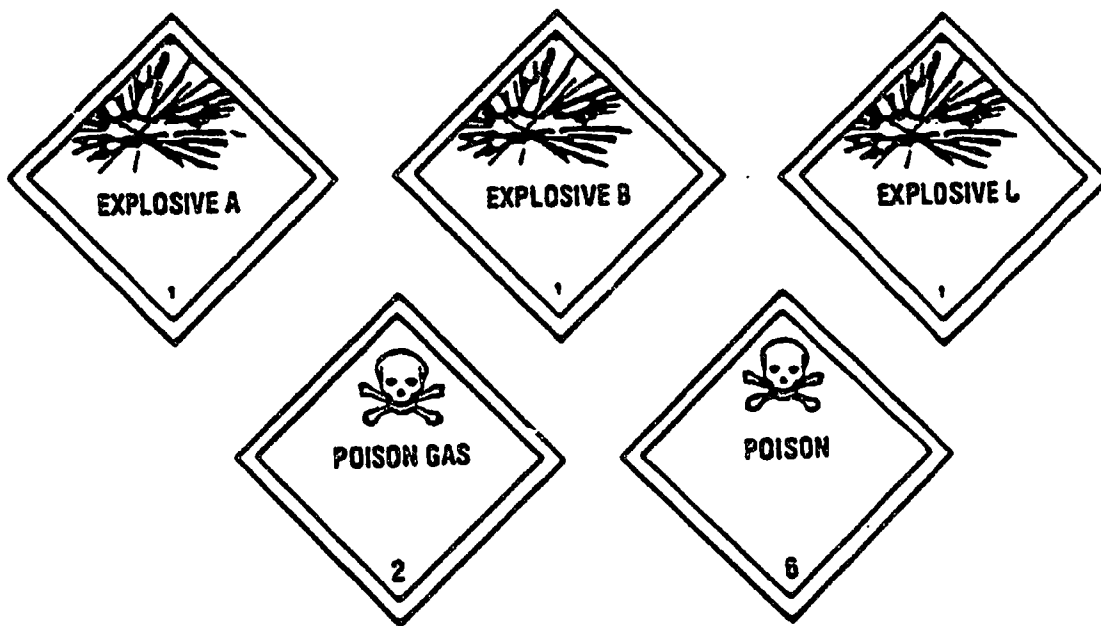

VISUAL 4.11: EXAMPLES OF WARNING LABELS

EXPLOSIVE A  
EXPLOSIVE B  
EXPLOSIVE C  
POISON A  
POISON B  
ORM-A  
ORM-B  
ORM-C  
ORM-D  
ORM-E  
OXIDIZER

COMBUSTIBLE LIQUID  
NONFLAMMABLE GAS  
ORGANIC PEROXIDE  
IRRITATING MATERIAL  
FLAMMABLE SOLID  
FLAMMABLE LIQUID  
ETIOLOGIC AGENTS  
BLASTING AGENTS  
RADIOACTIVE MATERIAL  
CORROSIVE MATERIAL  
FLAMMABLE GAS

VISUAL 4.12:

**DANGER!**

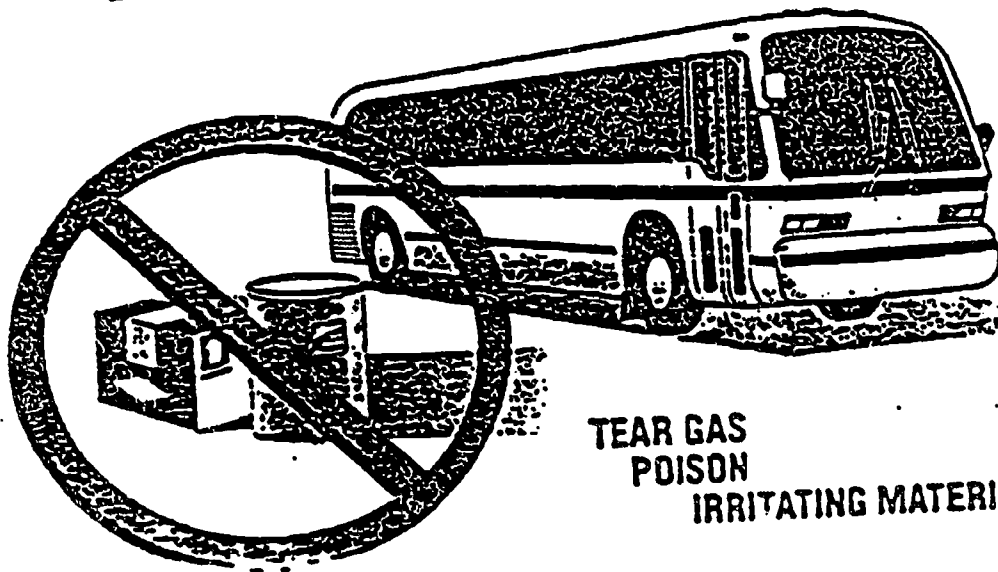

TEAR GAS  
POISON  
IRRITATING MATERIAL

VISUAL 4.13:

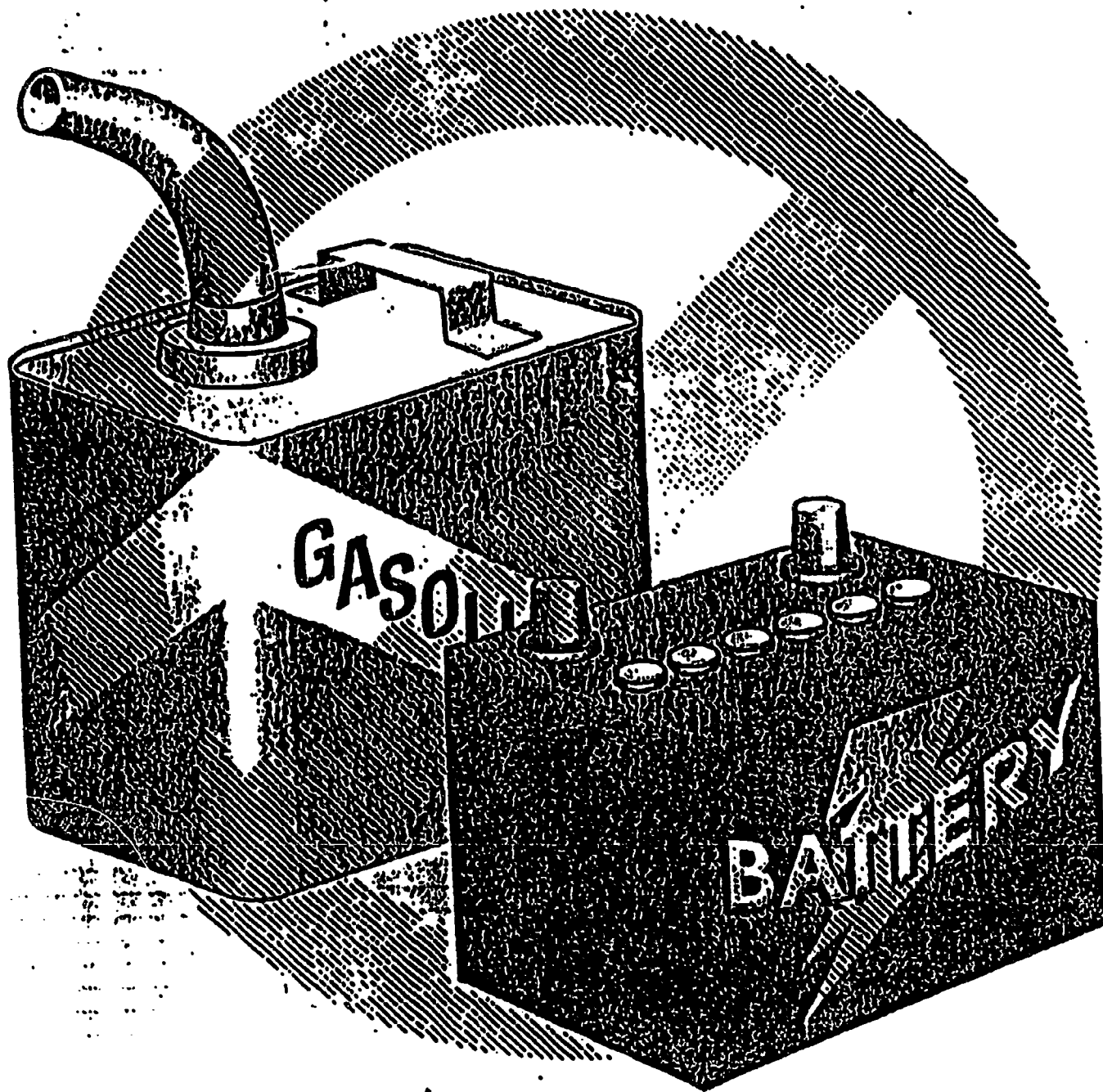

VISUAL 4.14:

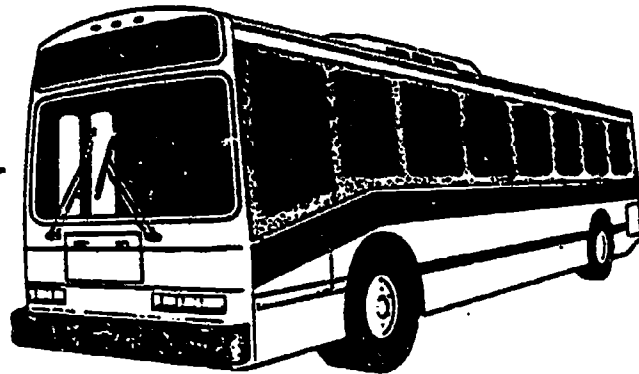

**NEVER LEAVE YOUR  
BUS UNATTENDED  
WITHOUT SETTING THE  
PARKING BRAKES.**

**YOUR BUS MIGHT  
ROLL AWAY AND  
CAUSE INJURY  
AND DAMAGE.**

**VISUAL 4.15: NEVER LEAVE YOUR BUS WITHOUT  
APPLYING THE PARKING BRAKES.**

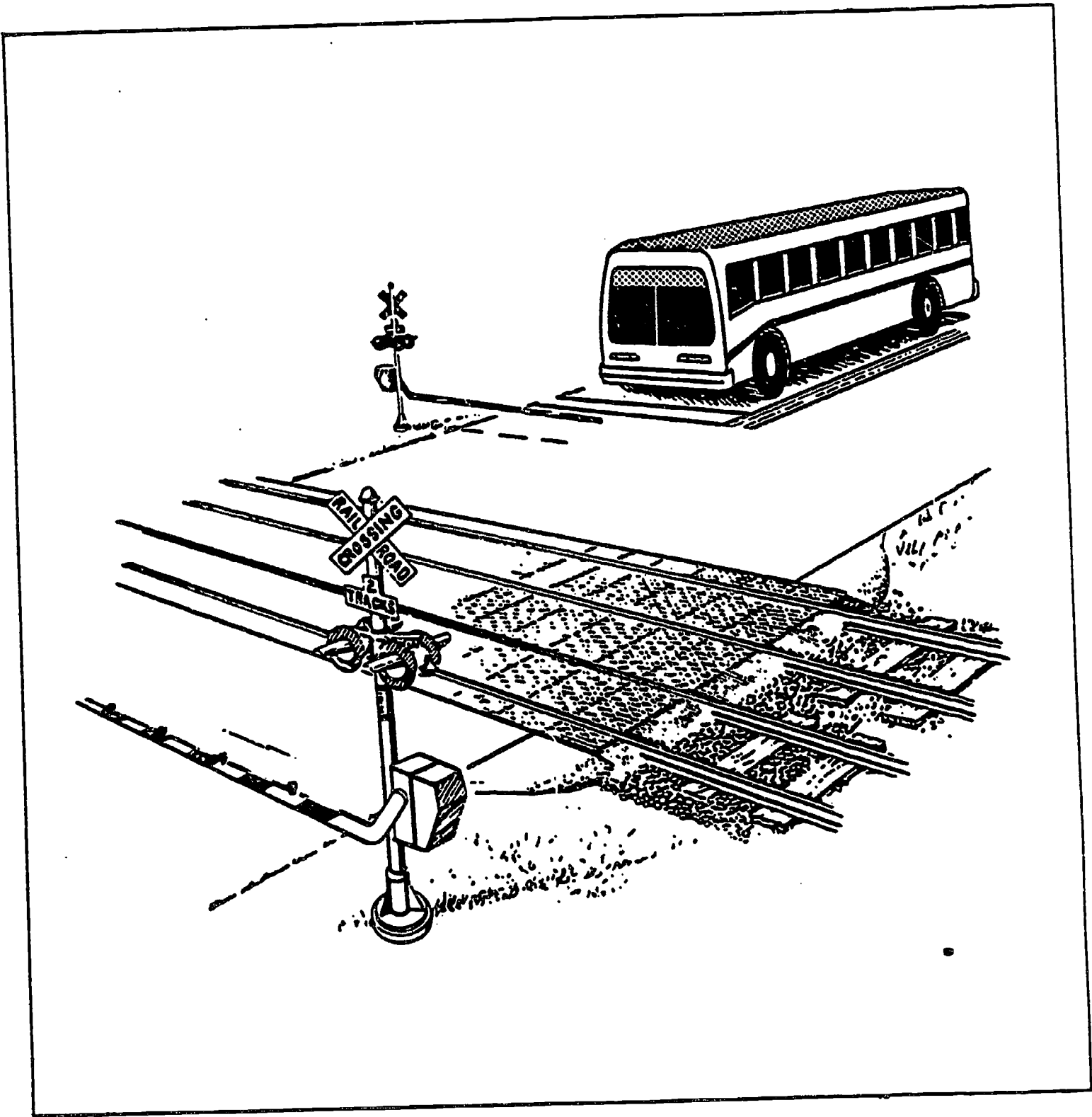

VISUAL 4.16: RAILROAD CROSSING



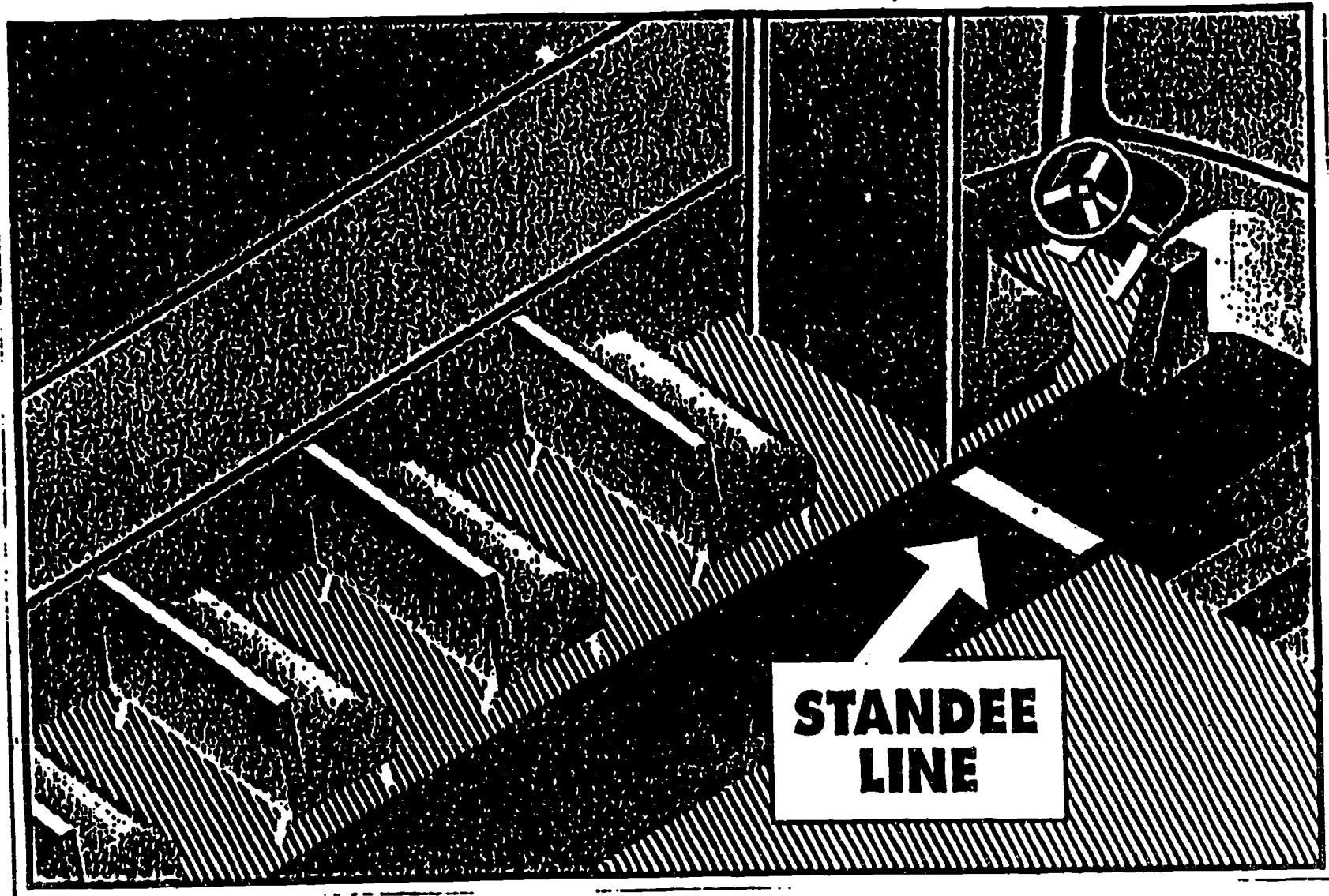

VISUAL 4.17:

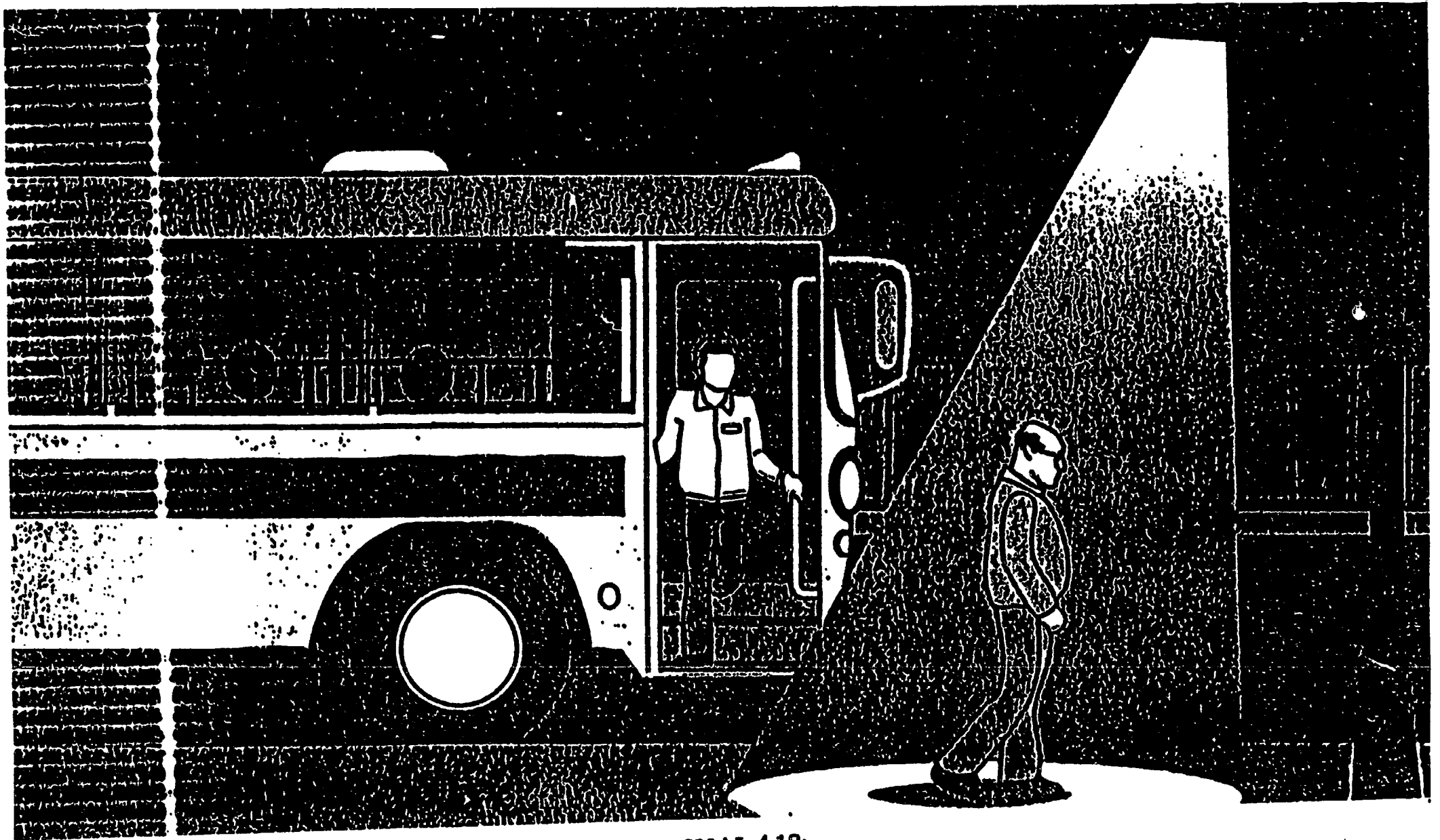

VISUAL 4.18:

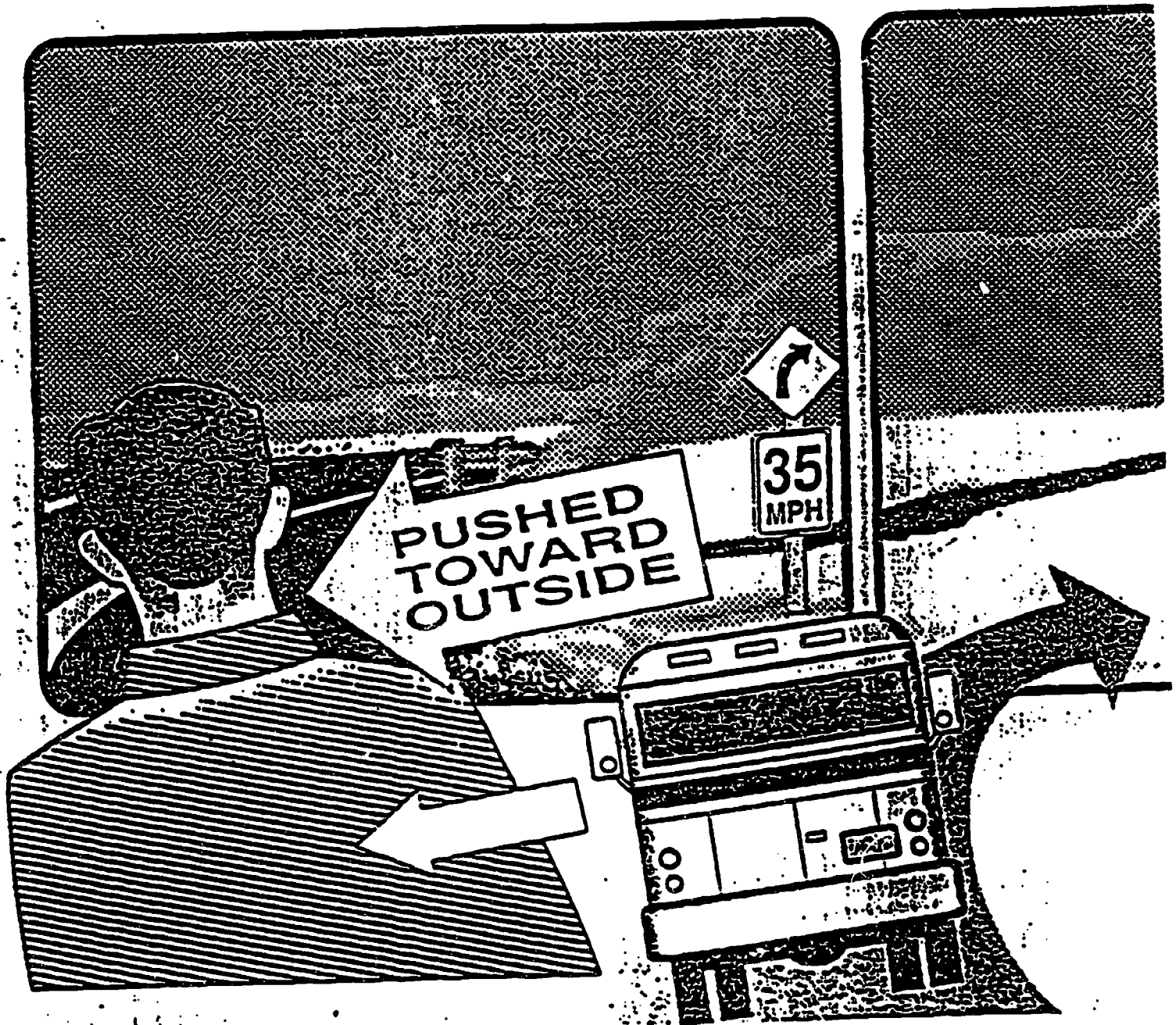

OUTSIDE  
OF CURVE

INSIDE  
OF CURVE

VISUAL 4.19:

# RAILROAD CROSSING

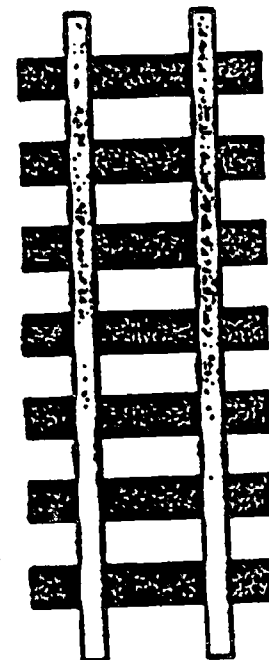
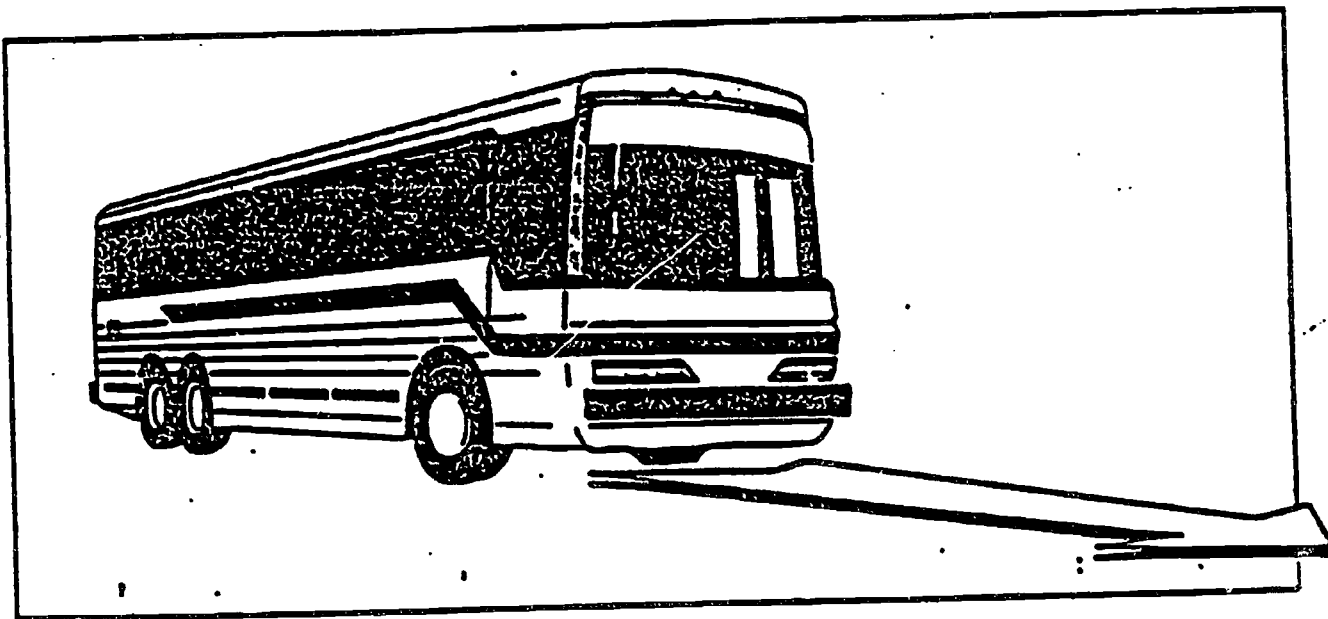

Make a full, complete stop, no closer than 15 feet or farther than 50 feet from the track.

VISUAL 4.20:



# DO NOT SHIFT GEARS WHILE CROSSING TRACKS

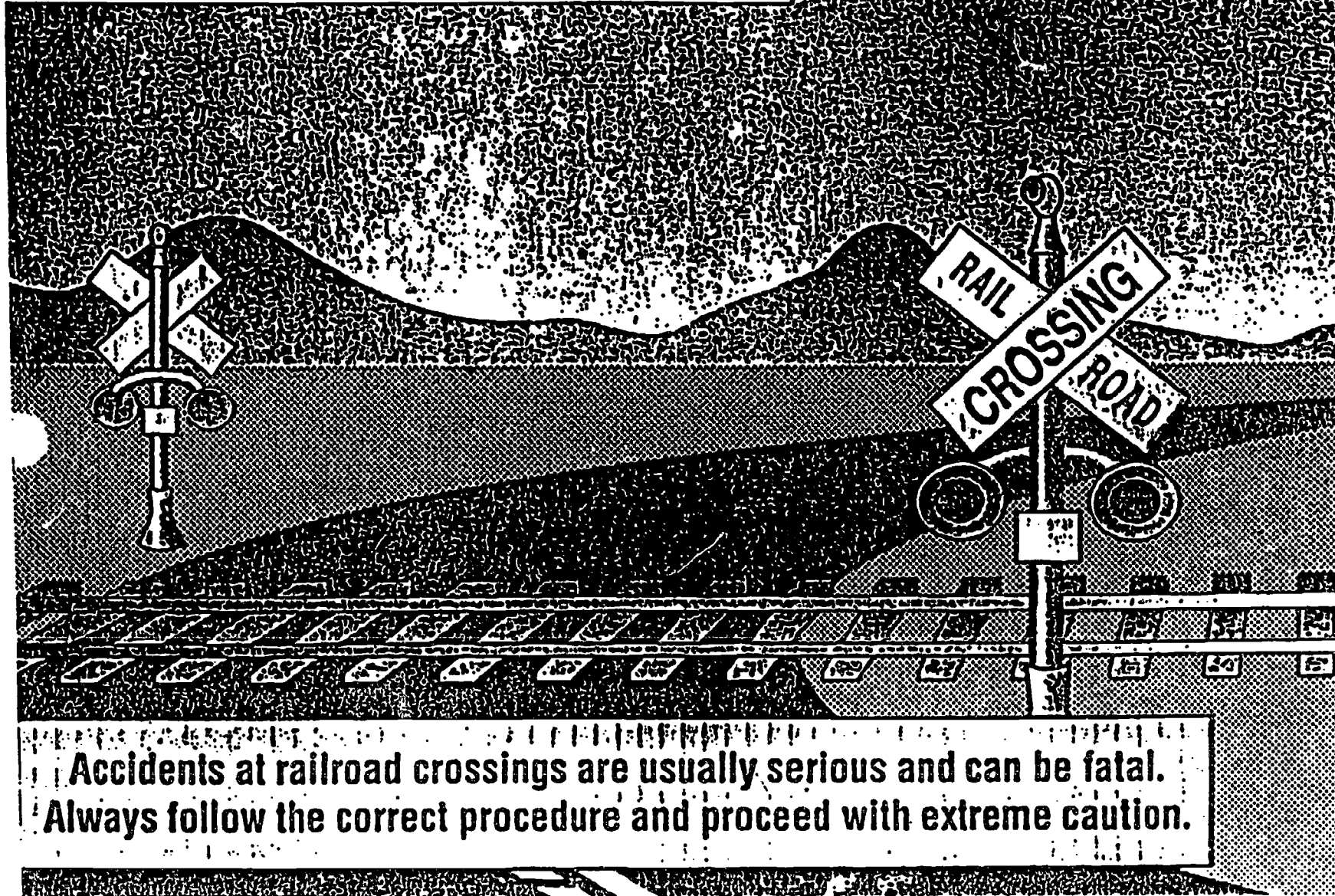

Accidents at railroad crossings are usually serious and can be fatal.  
Always follow the correct procedure and proceed with extreme caution.

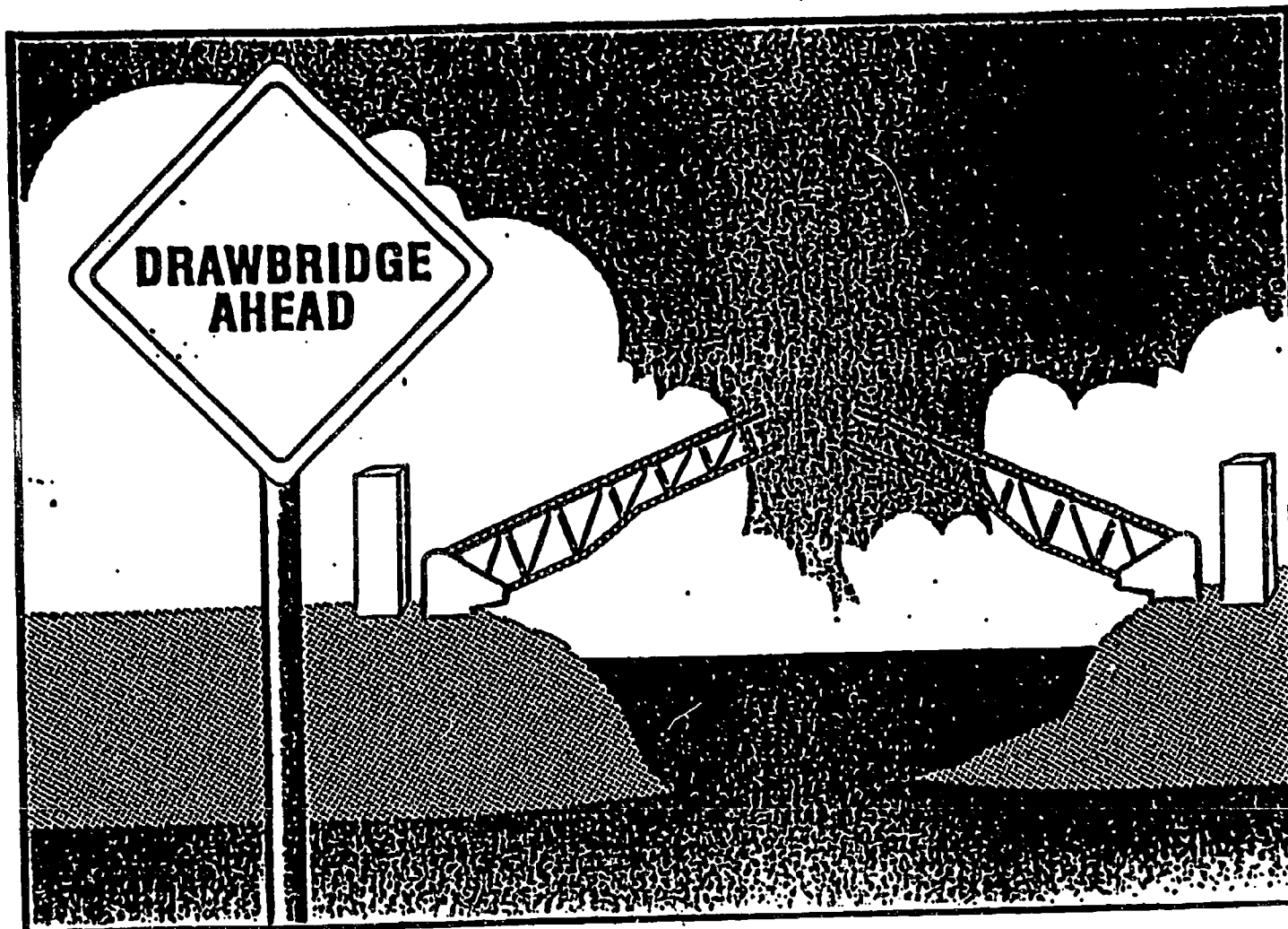

VISUAL 4.22:

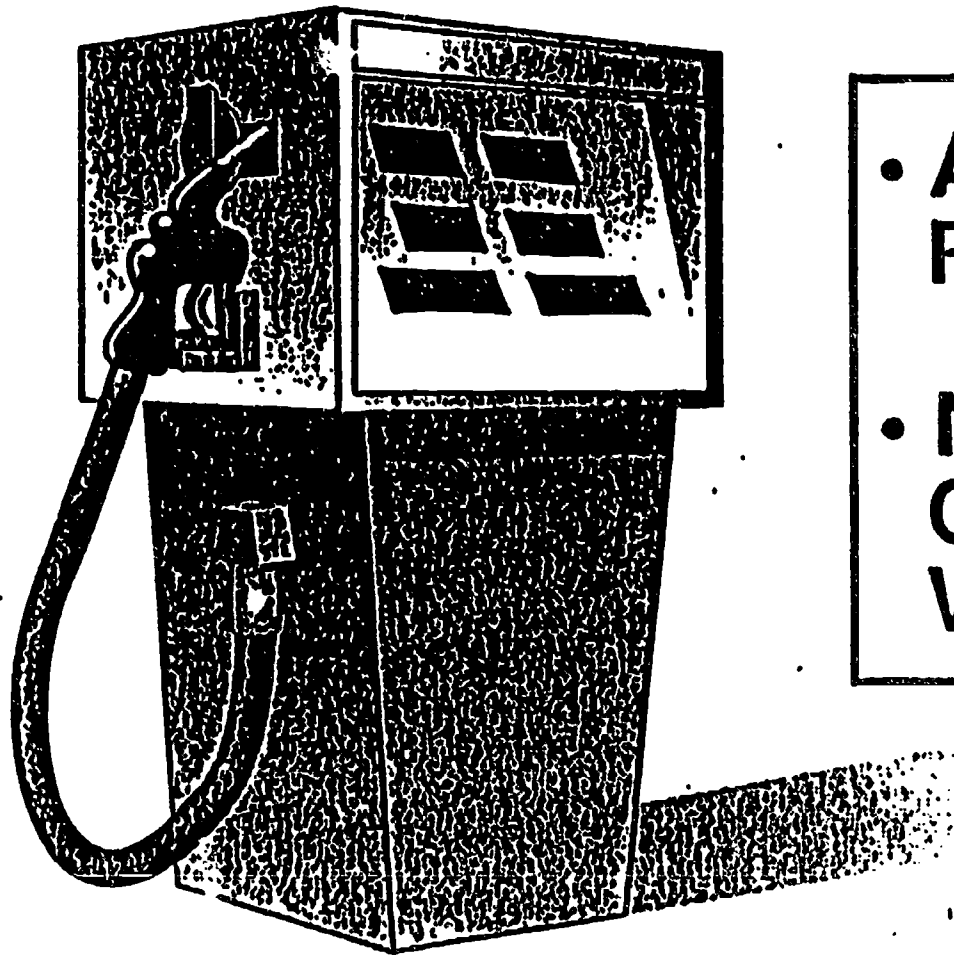

- **AVOID FUELING WITH RIDERS ABOARD**
- **NEVER REFUEL IN A CLOSED BUILDING WITH RIDERS ABOARD**

VISUAL 4.23:

# Air Compressor

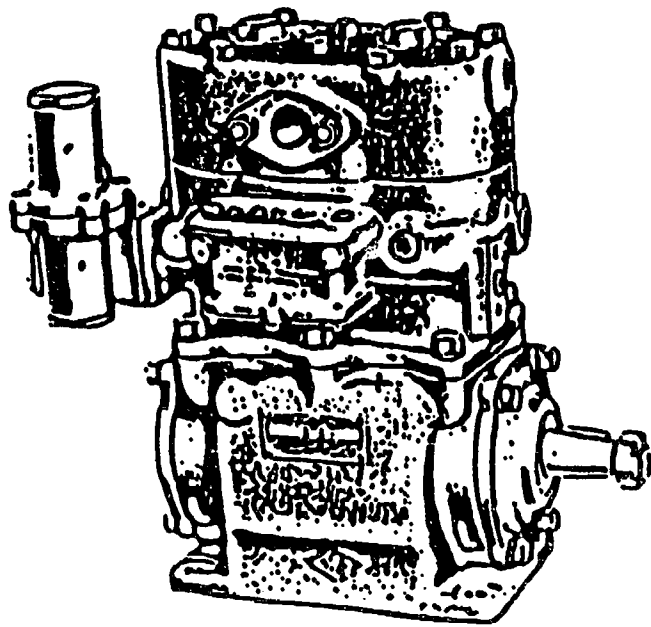

432

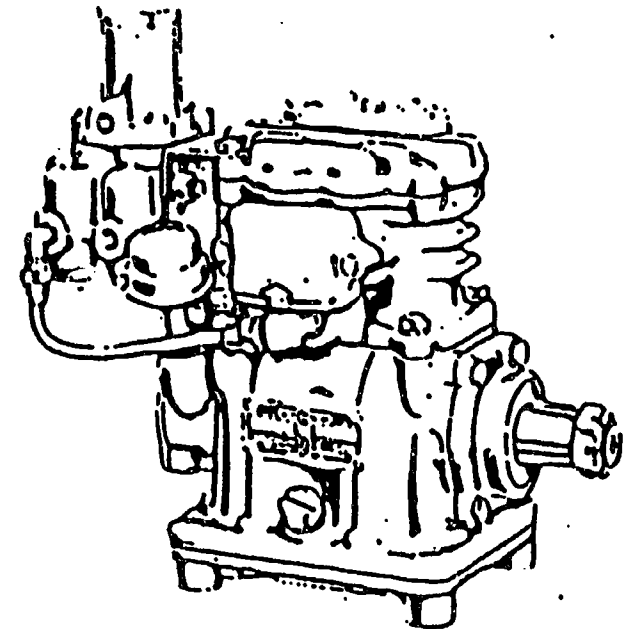
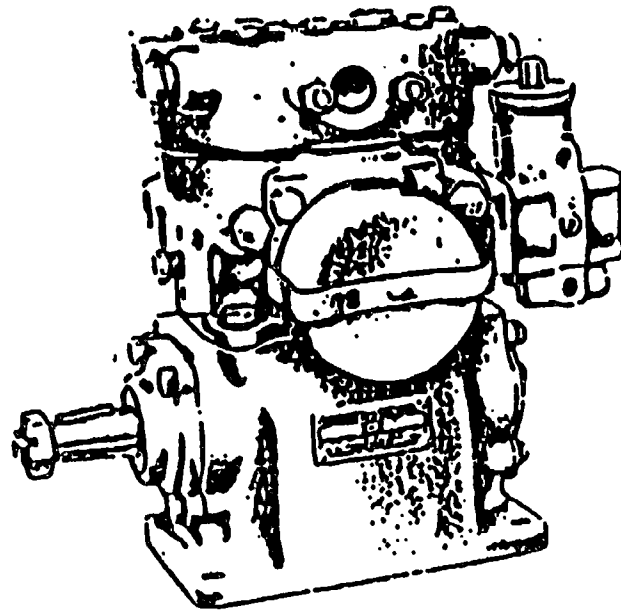

5.1

433



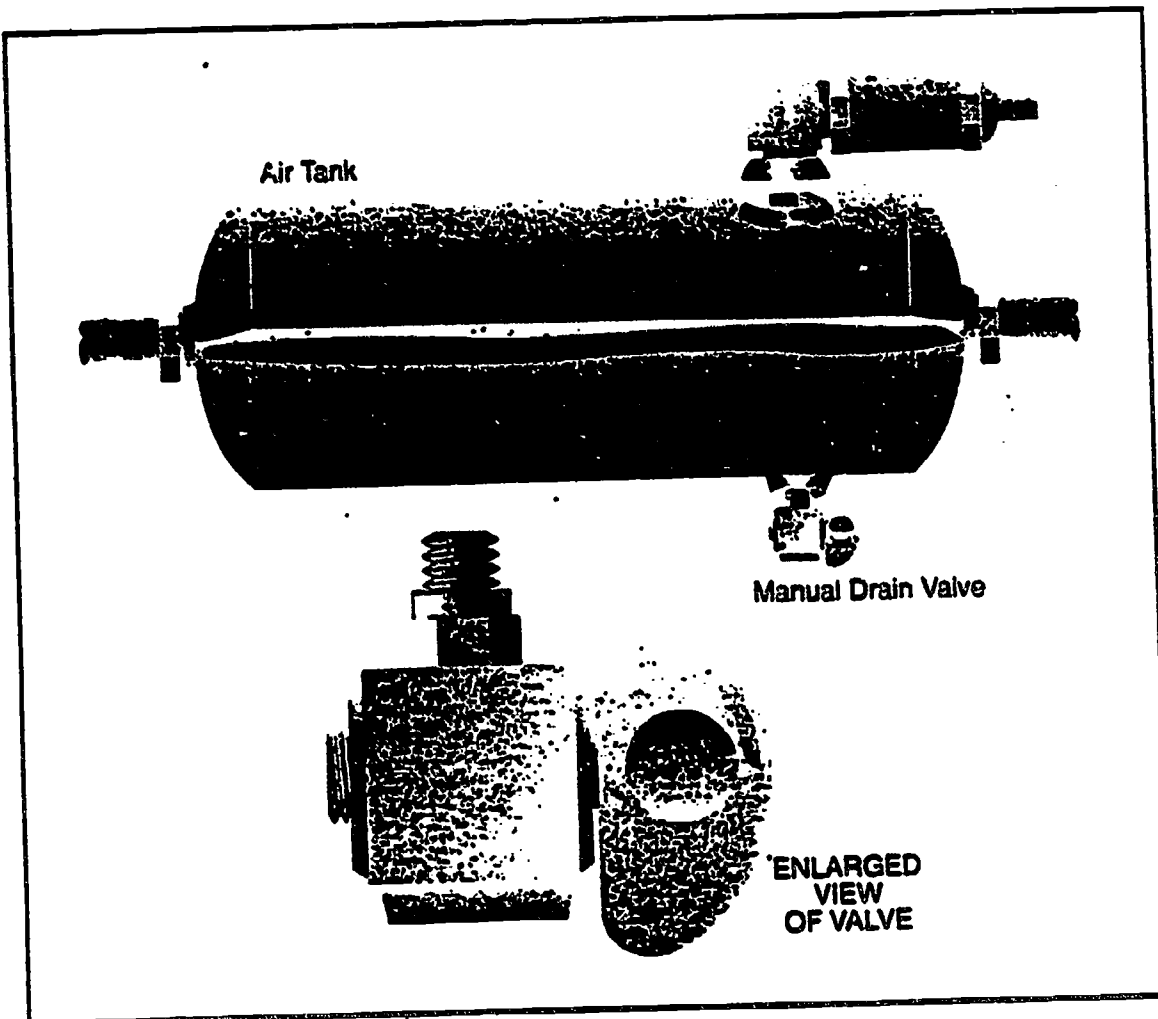

VISUAL 5 2: MANUAL DRAIN VALVE

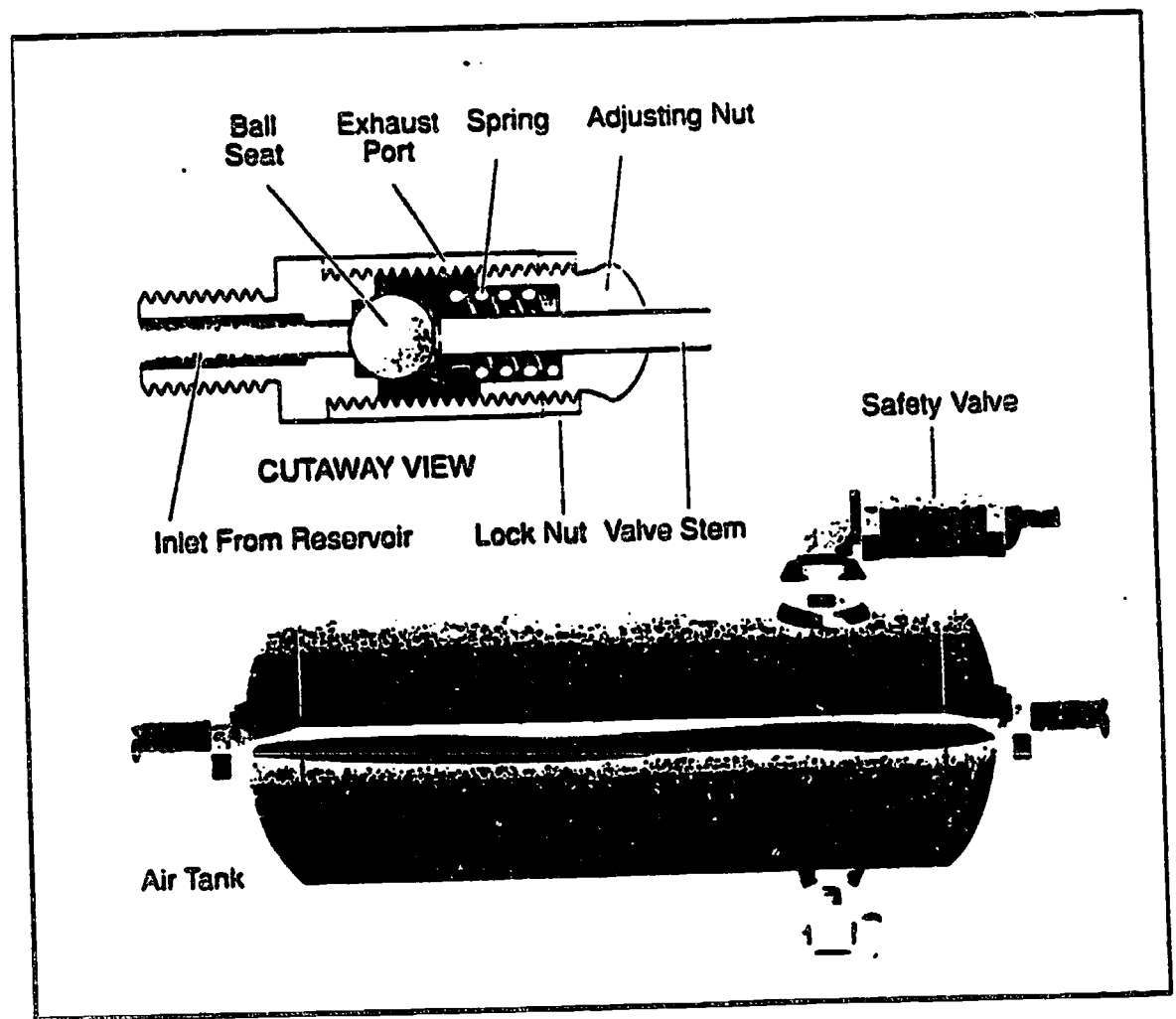

VISUAL 5.3: SAFETY VALVE

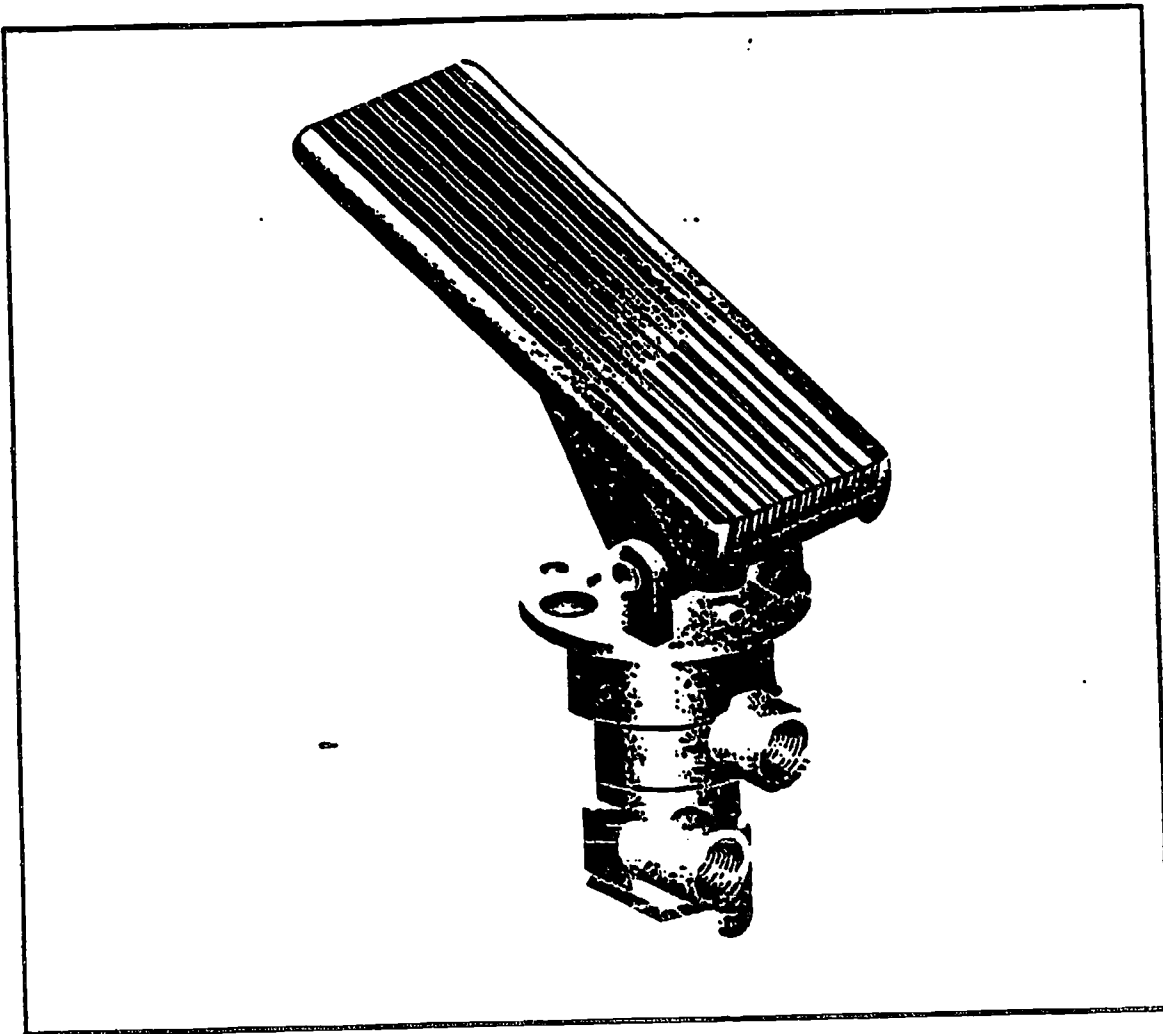

VISUAL 5.4: FOOT VALVE-THE BRAKE PEDAL

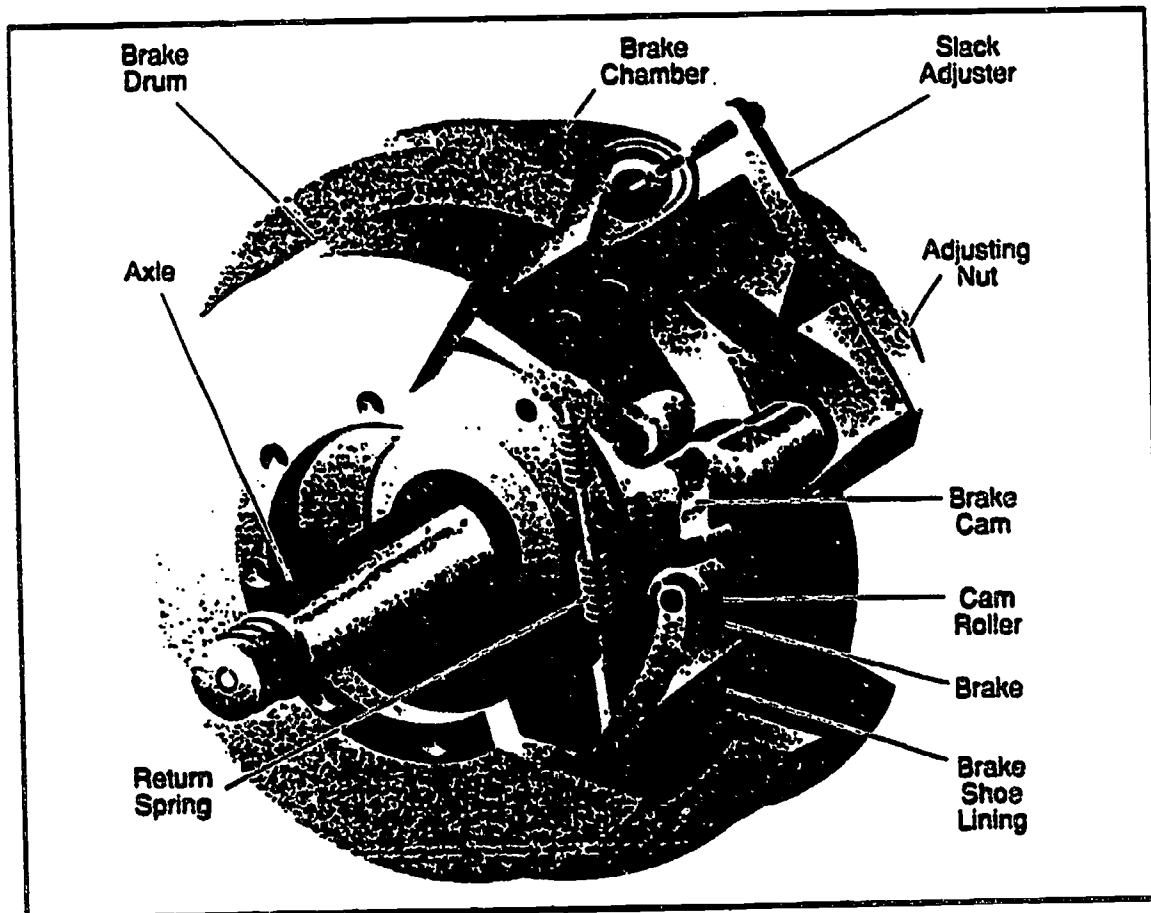

VISUAL 5.5: S-CAM DRUM BRAKE

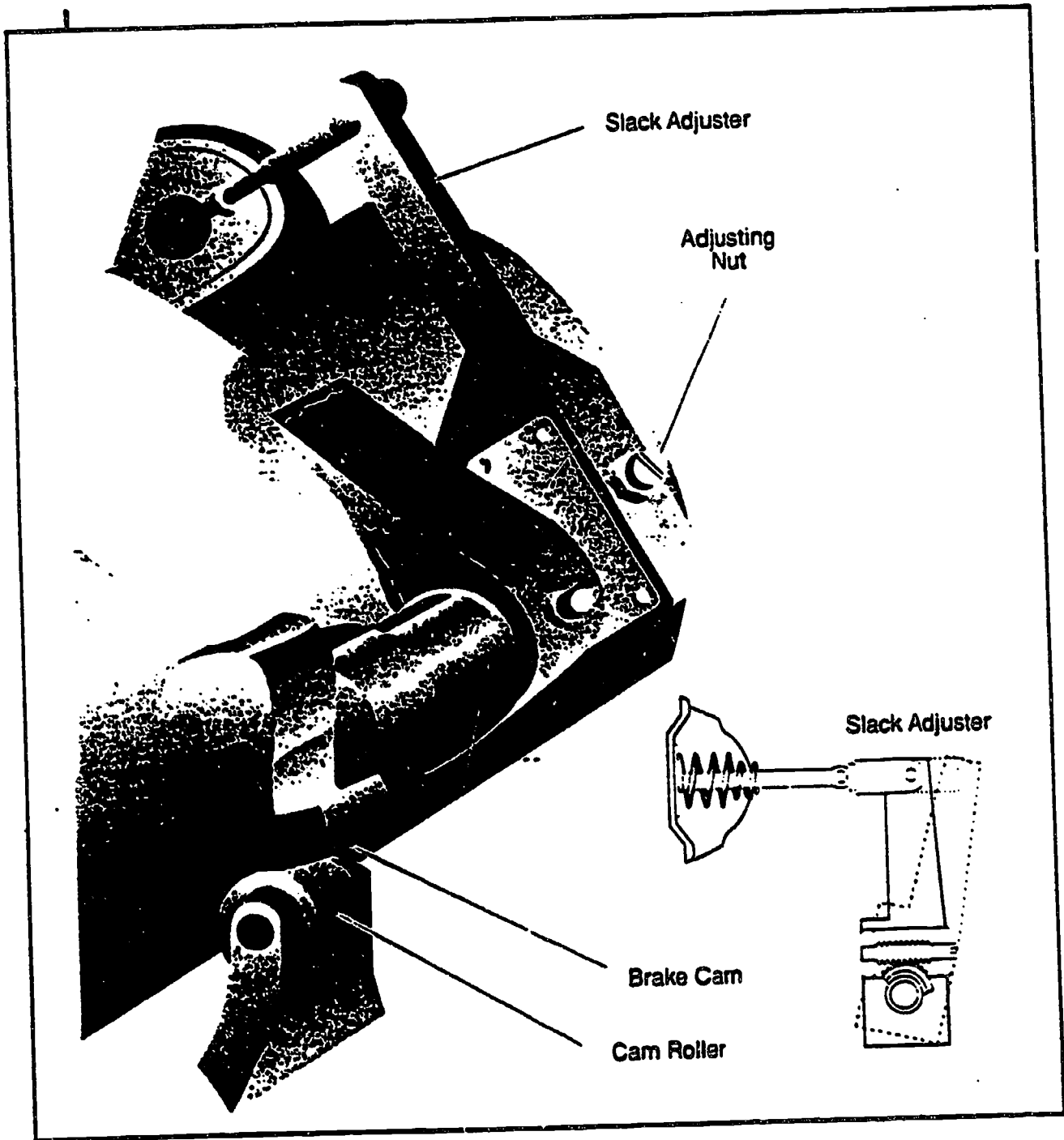

VISUAL 5.6: MANUAL SLACK ADJUSTER

The air pressure gauge indicates the usable air supply you have for items such as air brakes, windshield wipers, etc. Normal operating range of your air pressure gauge is 90 to 120 pounds per square inch (psi). Your gauge must indicate at least 90 pounds before moving the vehicle. As you drive and use the air systems, your gauge will normally fluctuate up and down between 90 and 120 pounds. At 90 pounds the compressor should start to bring the system back to full capacity (120 pounds). When this level is obtained the compressor should shut off. If the air pressure should drop below 90 pounds without apparent cause, such as overusing the brakes, the system should be checked.

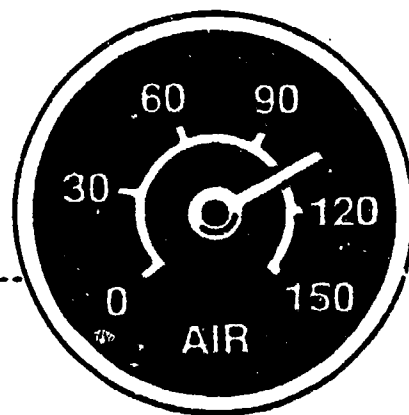

VISUAL 5.7: AIR PRESSURE GAUGE

The air application gauge, which is not available on all tractors, indicates the amount of air being used at any one time when brakes are applied.

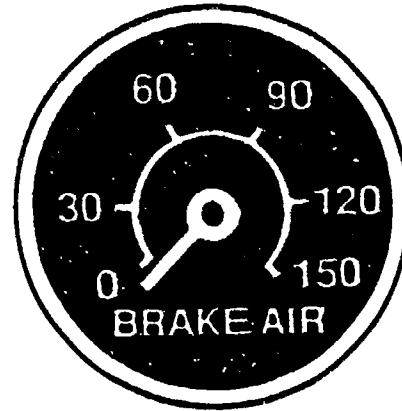

VISUAL 5.8: APPLICATION PRESSURE GAUGE

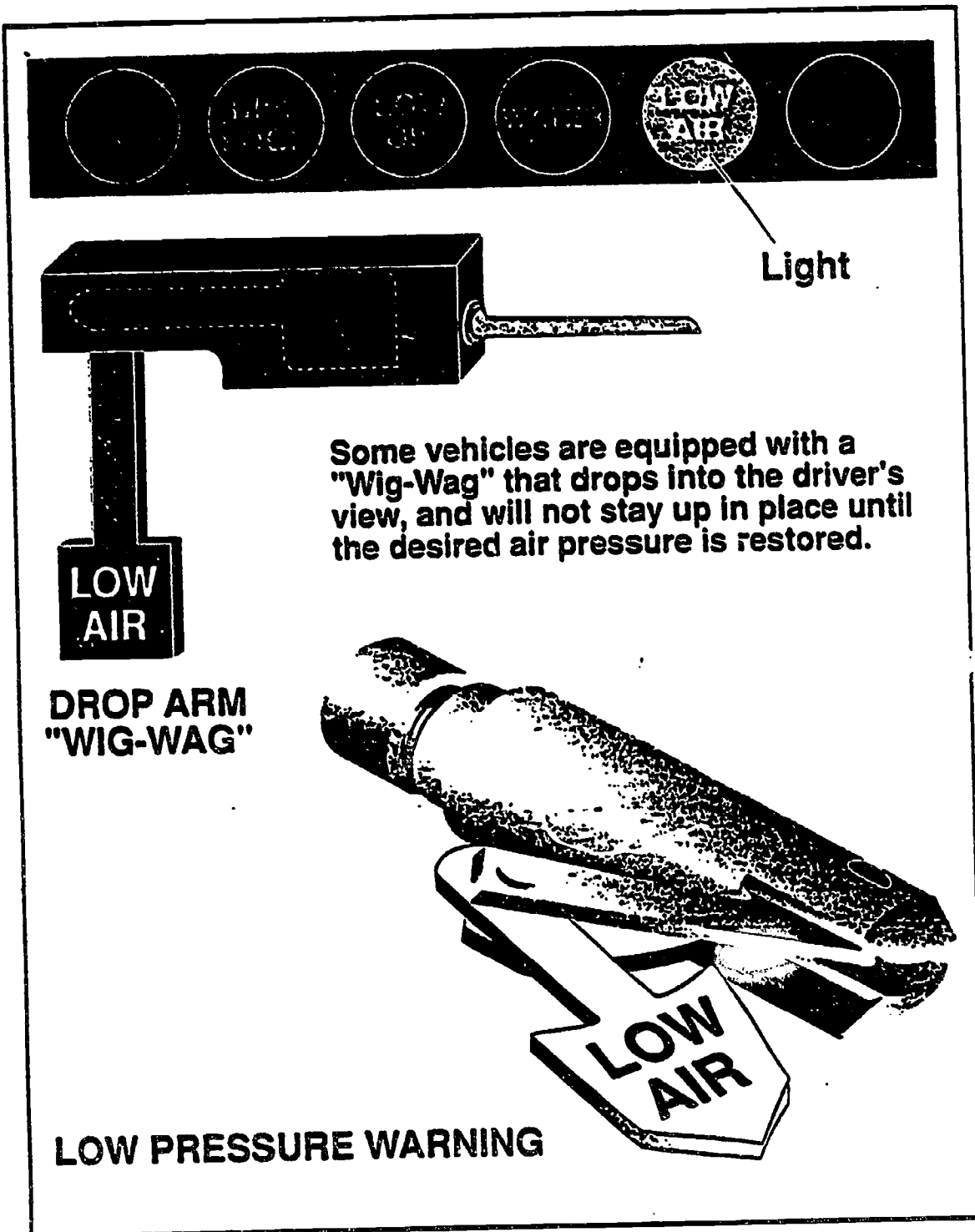

Some vehicles are equipped with a "Wig-Wag" that drops into the driver's view, and will not stay in place until the desired air pressure is restored.

**DROP ARM  
'WIG-WAG'**

**LOW PRESSURE WARNING**

VISUAL 5.0- LOW PRESSURE WARNING DEVICE



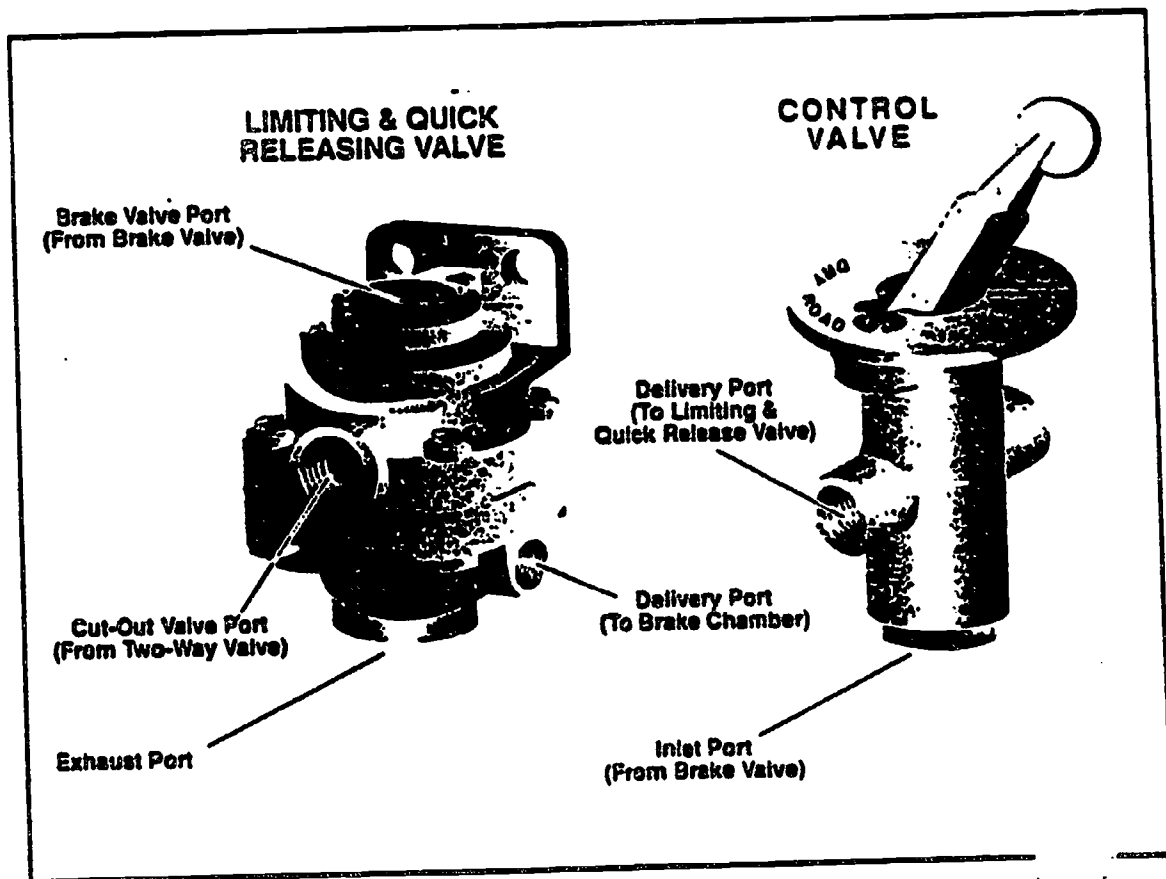

VISUAL 5.10: FRONT BRAKE LIMITING VALVE

To the right of the driver on the control panel are two push-pull type valves. The top knob is termed the **System Parking Brake Valve**, or parking brake, and is yellow. When pulled, the brakes will actuate for the entire unit. This is the brake which you would use for parking at all times. When pushed in, all brakes release and the vehicle is ready for movement. The knob on the bottom, colored red, is called the **Trailer Air Supply Valve**. When this knob is pulled, only the trailer brakes are applied. When hooking to a new trailer, this valve must be depressed to release your trailer brakes before driving. When you bob-tail, this button should be pulled to keep the air from leaking out of the lines on the back of your tractor.



**VISUAL 5.11: PARKING BRAKE AND TRAILER AIR SUPPLY**

Perception Distance  
 Reaction Distance  
 Brake Lag Distance  
 + Effective Braking Distance  

---

**TOTAL STOPPING DISTANCE**

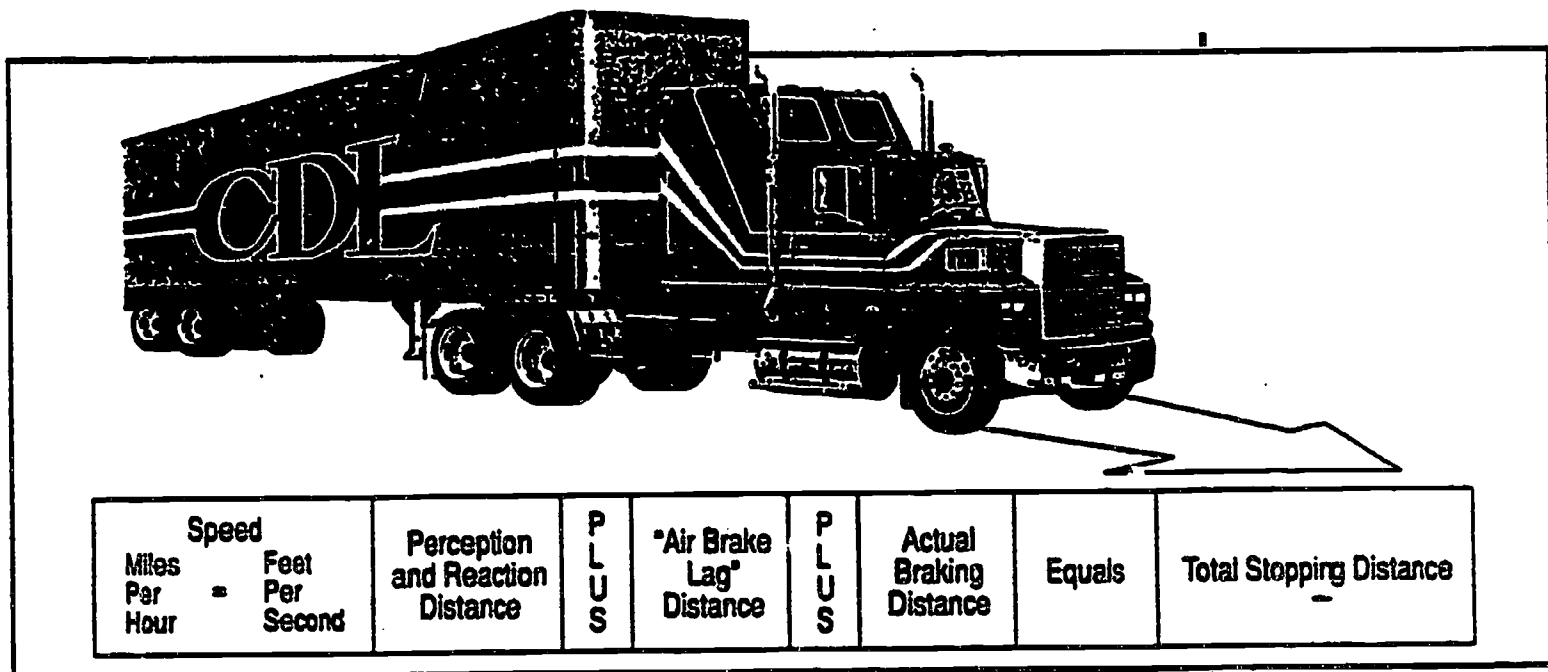

**VISUAL 5.13: TOTAL STOPPING DISTANCE**

# TRUCK/TRACTOR SYSTEM

# TRAILER SYSTEM

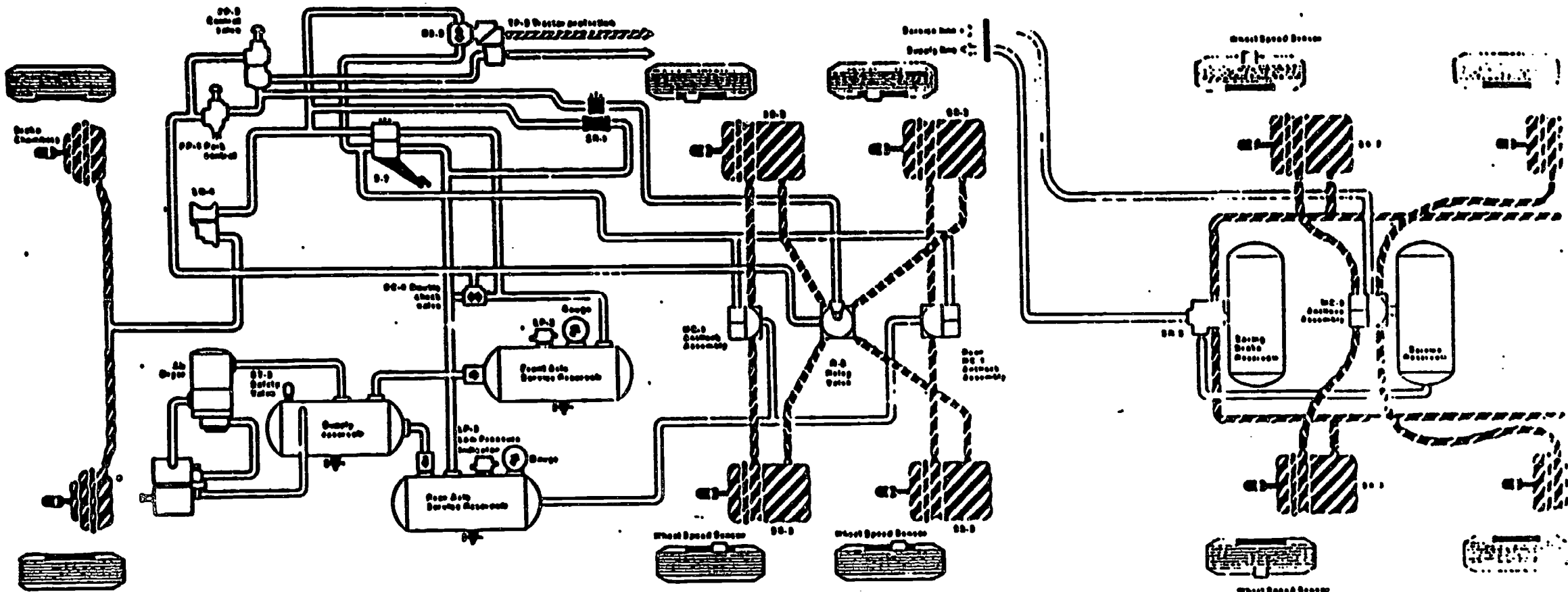

TYPICAL "121" DUAL  
TRACTOR/TRAILER AIR BRAKE SYSTEM

445

446

# Combination Vehicles

## SECTION 6

417

6.0.1

418

# **ROLL OVER**

**Slow on curves, ramps, etc.**

**Avoid quick steering**

**Center of gravity low**

**Load in center of vehicle**

**Load secure**

**Smooth steering**

# Rearward Amplification

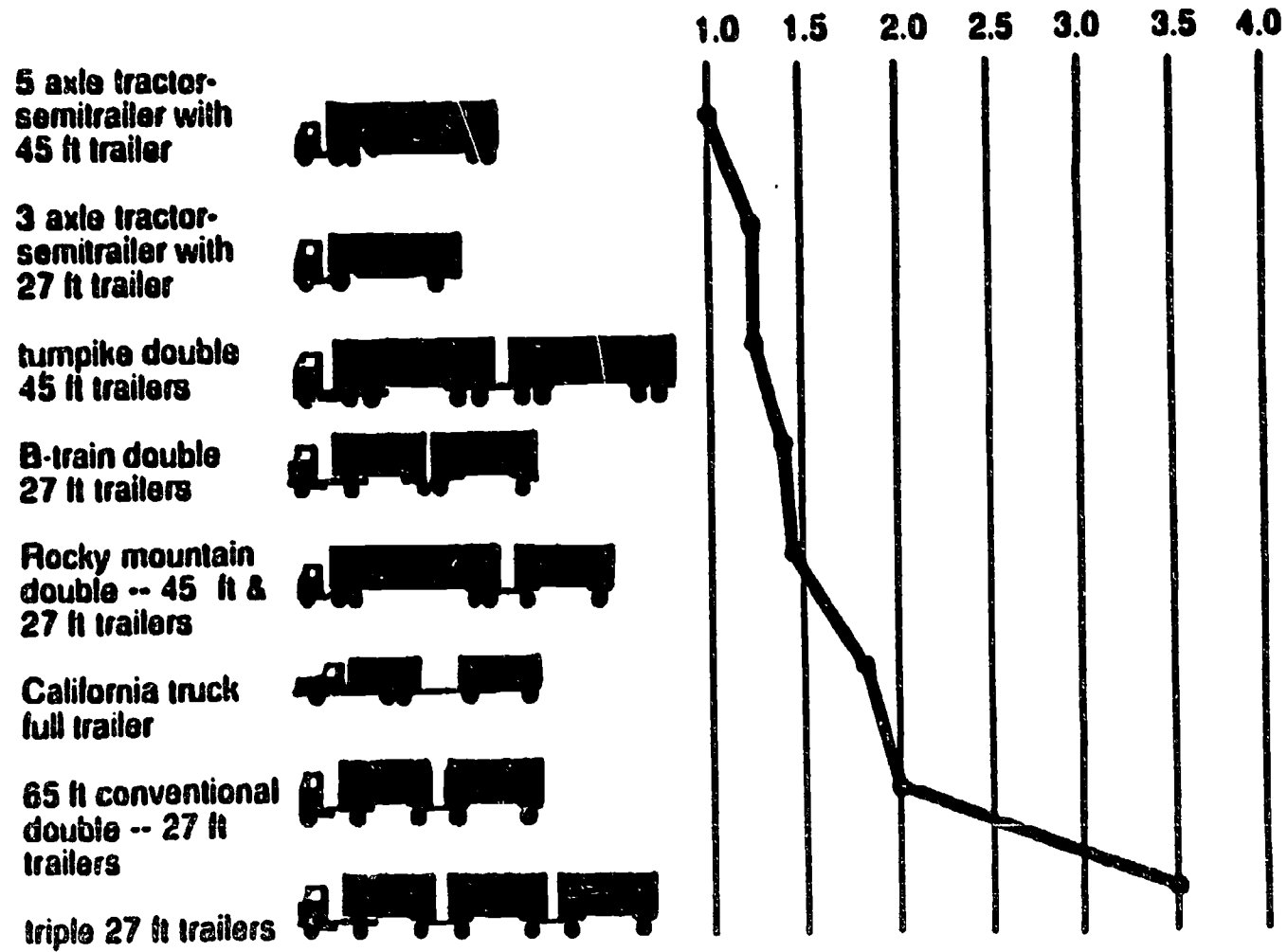

6.1.2

# **Reduce the Crack the Whip Action By**

**Increase following distance**

- **1 second for every 10 feet under 40 mph**
- **Add one second over 40 mph**

**Look far ahead**

**Slow before turning**

**Don't over drive headlights**



# BRAKING DISTANCES

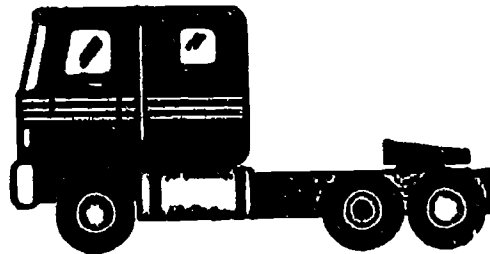

VS

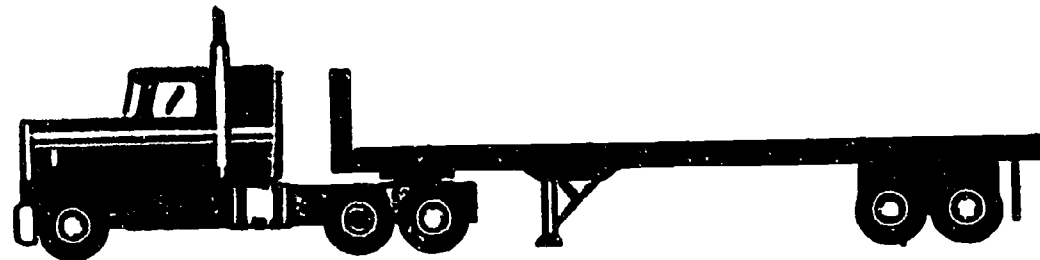

VS

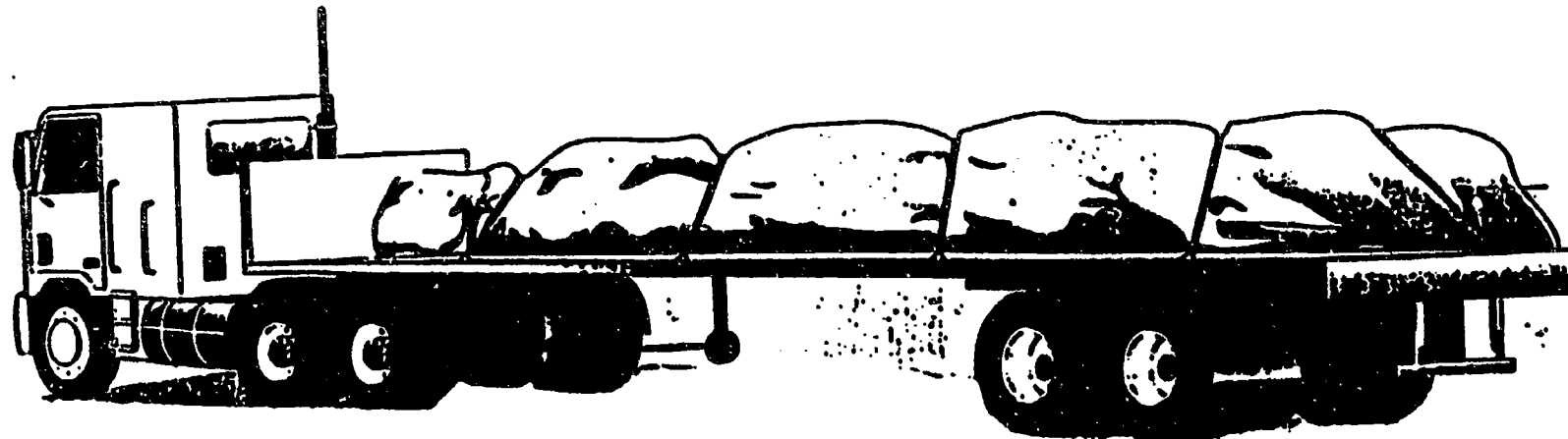

# Recovery from Skids

**Off brakes**

**Steer**

**Tires must regain rolling traction**

# OFF TRACKING

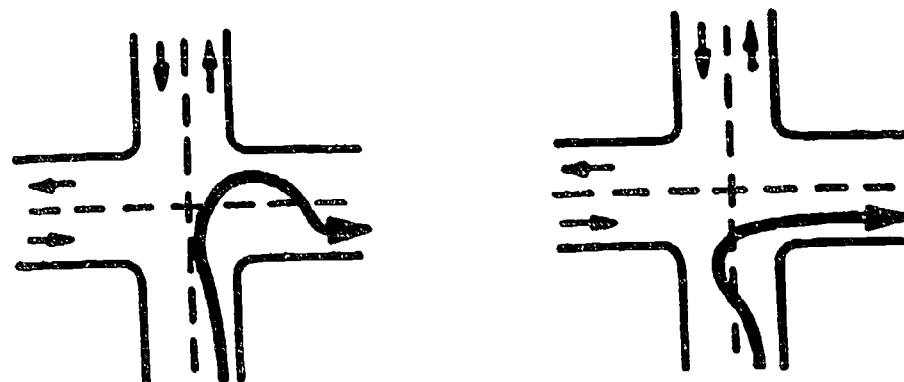
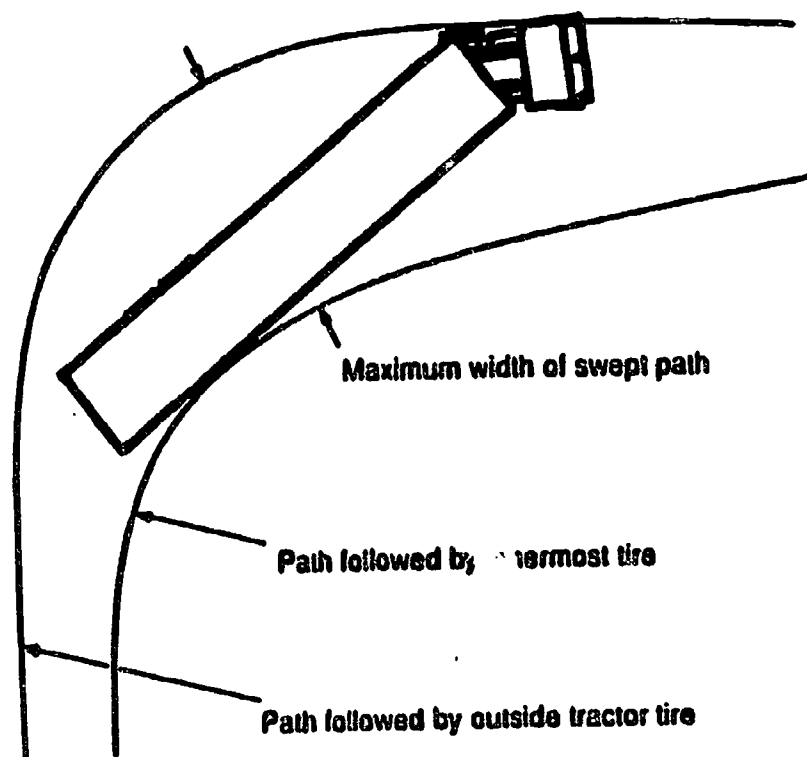

459

6.1.6  
460

# **Combination Vehicle and Brakes**

## **SECTION 6.2**

461

**6.2.1**

462

# Hand Valve

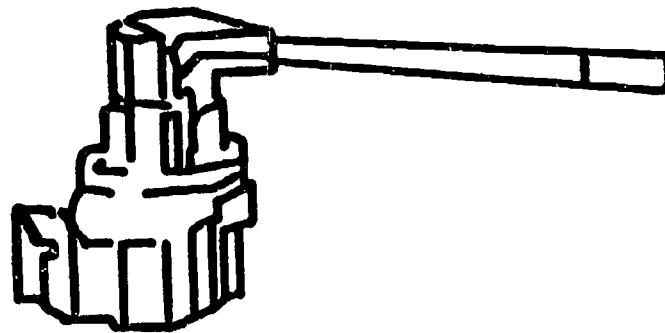

**Only use to test trailer**

**Brakes**

**Do not use for**

**Parking**

**Slowing down**

**Recovery from slides**

# Tractor Protection Valve

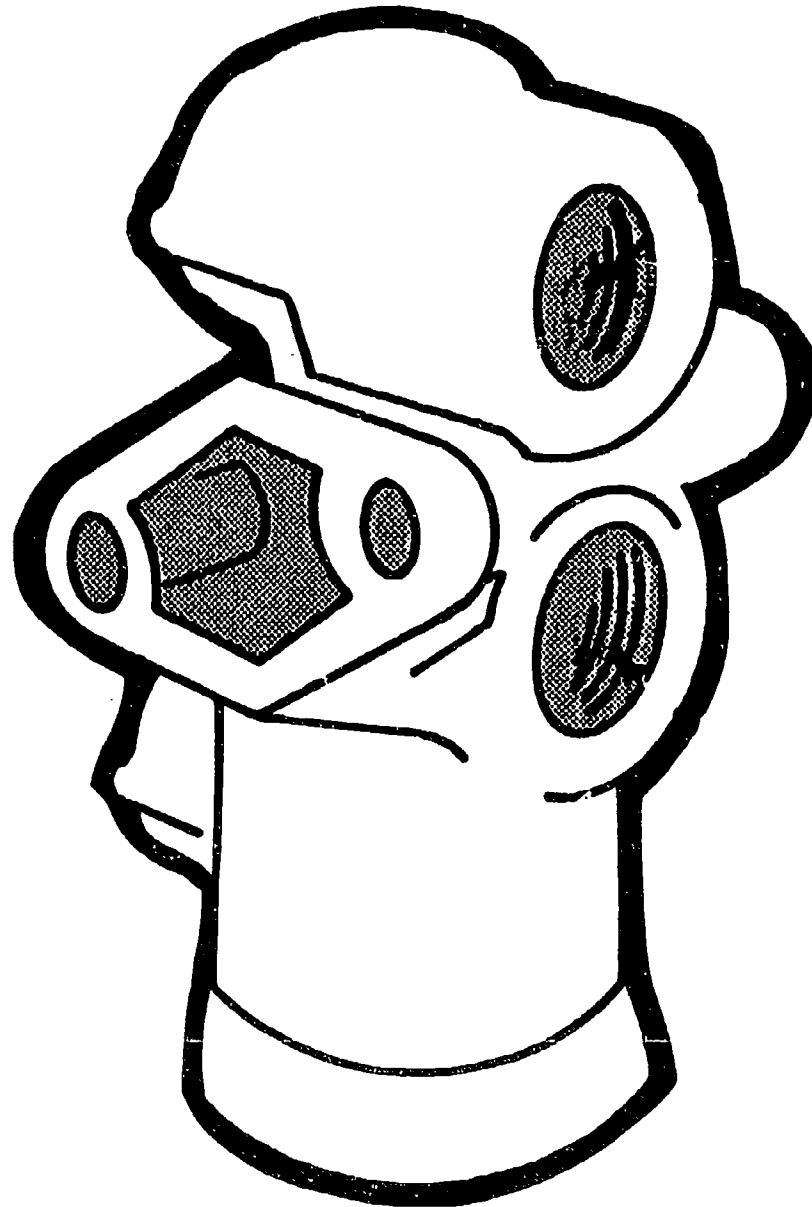

**Closes at 20-45 PSI**

465

6.2.3

468

# Trailer Air Supply Control



**NORMAL** - when pulling a trailer

**EMERGENCY** - apply trailer brakes

# **Service Air Line**

**Blue in color**

**Air when brakes depressed**

**If leak - not know until brakes on**

**If much air lost - trailer brakes will set**



# **Emergency Air Line**

**Red**

**When trailer air supply knob  
depressed**

**Major air lost - trailer emergency  
brakes will set**

# Gland Hands

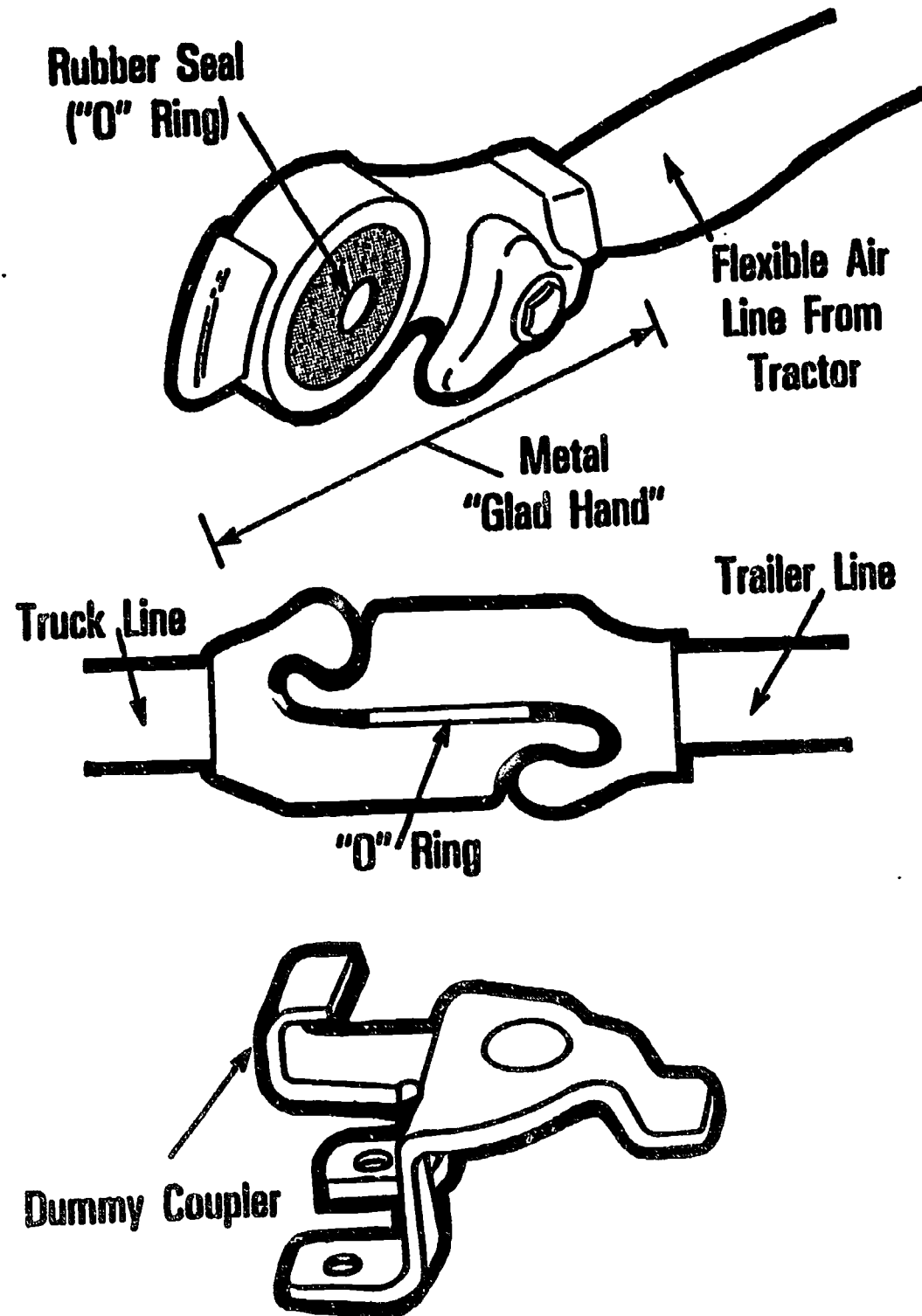

# Air Tanks

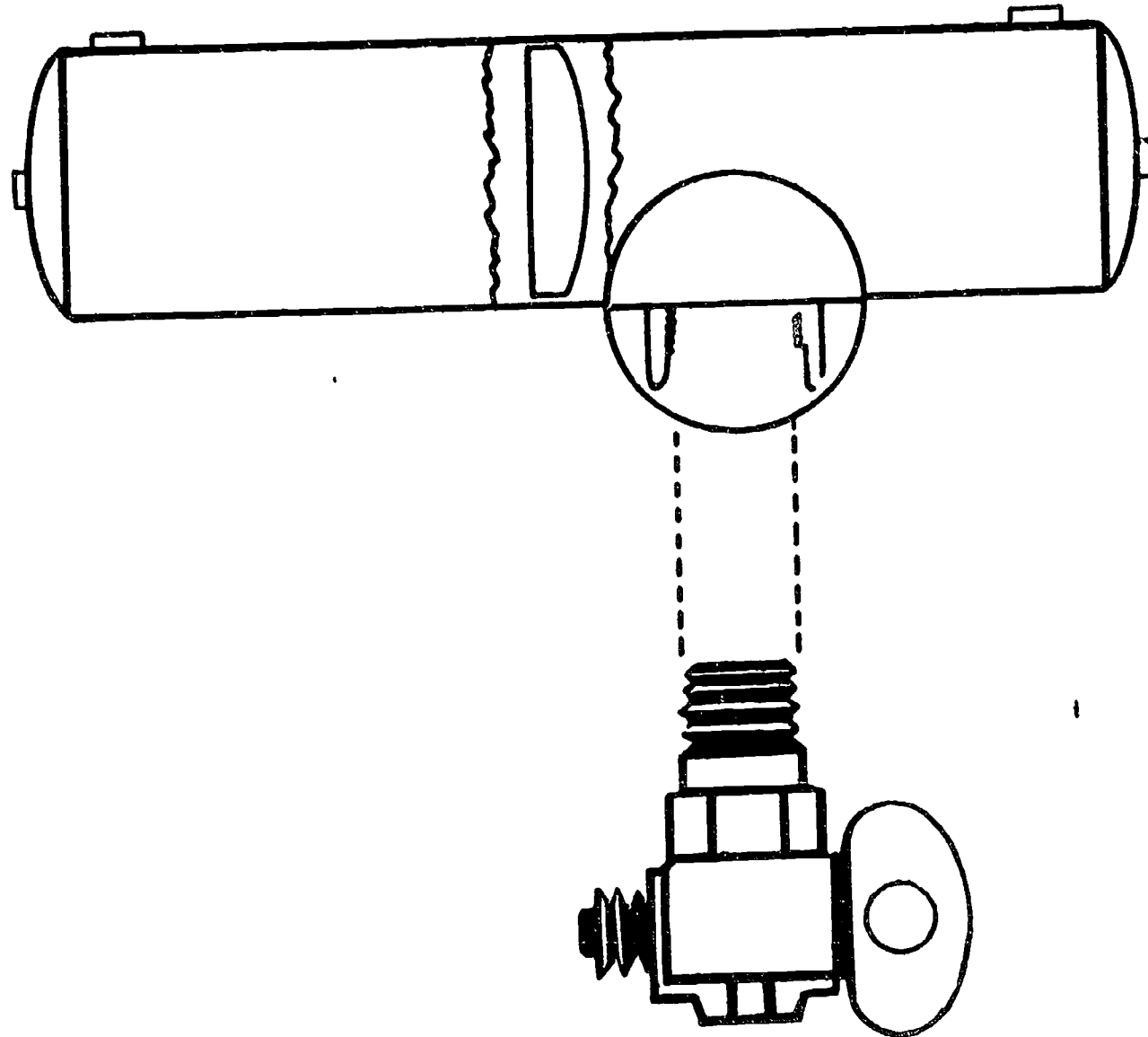

475

6.2.8

476

# Additional Safety Checks

## **Coupling System Areas**

- **Check fifth wheel (lower).**
  - Securely mounted to frame.
  - No missing, damaged parts.
  - Enough grease.
  - No visible space between upper and lower fifth wheel.
  - Locking jaws around the shank, not the head of kingpin.
  - Release arm properly seated and safety latch/lock engaged.
- **Fifth wheel (upper).**
  - Glide plate securely mounted to trailer frame.
  - Kingpin not damaged.
- **Air and electric lines to trailer.**
  - Electrical cord firmly plugged in and secured.
  - Air lines properly connected to glad hands, no air leaks, properly secured with enough slack for turns.
  - All lines free from damage.
- **Sliding fifth wheel.**
  - Slide not damaged or parts missing.
  - Properly greased.
  - All locking pins present and locked in place.
  - If air powered -- no air leaks.
  - Check that fifth wheel is not so far forward that tractor frame will hit landing gear, or cab hit the trailer, during turns.

## **Landing Gear**

- Fully raised, no missing parts, not bent or otherwise damaged.
- Crank handle in place and secured.
- If power operated, no air or hydraulic leaks.

6.2.9

# Hazardous Materials

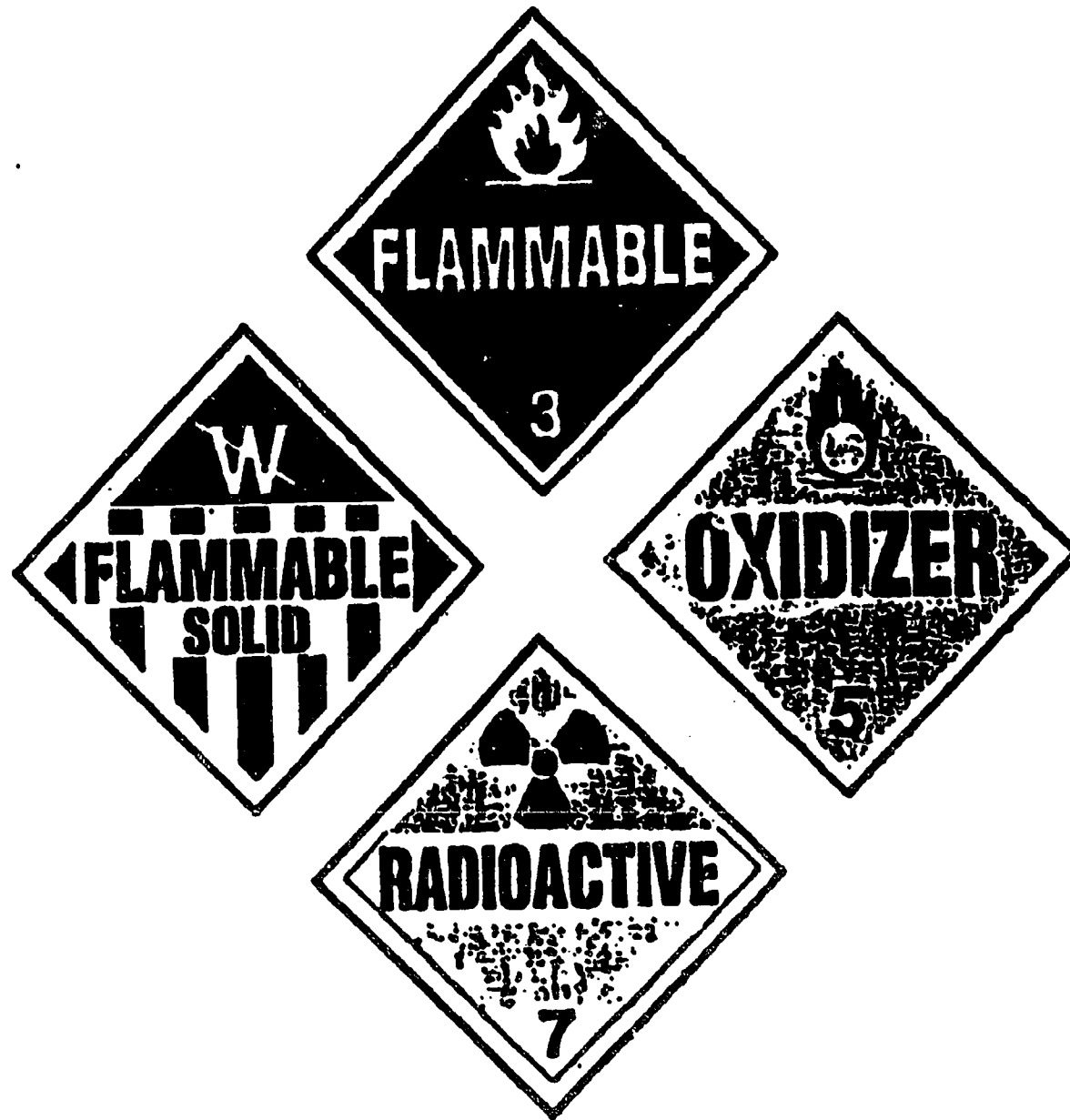

479

HM1

450

**Any material that poses  
an unreasonable risk to  
health, safety and property  
during transportation**

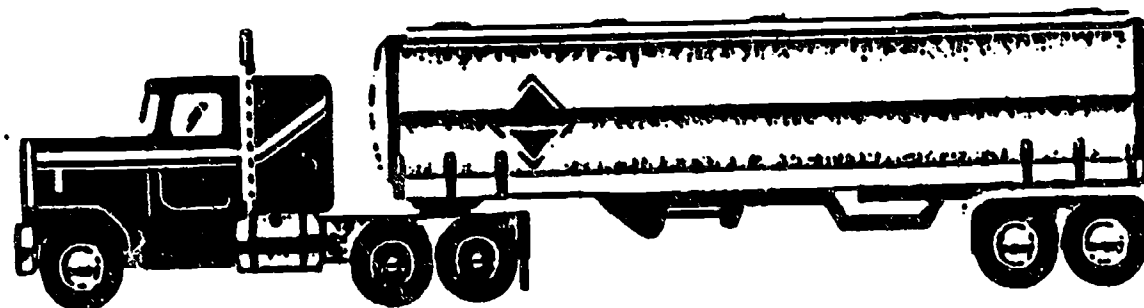

**If your vehicle requires placards,  
you must have a hazardous  
material endorsement on your  
CDL**

**HM3**

# **Interest of the Regulations**

- **Contain the material**
- **Communicate the risk**
- **Assure safe drivers  
and equipment**

**7.1.1**

455

456



- **Shipper**

- **Carrier**

- **Driver**

7.2.1

457

458

- **Proper shipping name**
- **Hazard class**
- **ID number**
- **Correct packaging**
- **Package labels and markings**
- **Placards**
- **Shippers certification**

**7.2.2**

- **Transportation**
- **Verifies the shipper has correctly:**

**Named  
Labeled  
Marked**

- **Refuses improper shipments**
- **Accident and incident reporting**

**7.2.3**

- **Verification**
- **Refuses leaking shipments**
- **Placards**
- **Safe transportation**
- **Rules & Regulations**
- **Shipping papers**

**7.2.4**

# Hazard Class

- **Reflect the risk**
- **22 different classes**

**7.3.1**

# Shipping Paper

- **Describes the material**
- **Must be accessible**

**7.3.2**

497

498

# **Accessibility**

- **Tabbed**
- **On top**
- **Within reach**

**7.3.3**

499

510

# Package Labels



**Compressed  
Gas  
Cylinder**

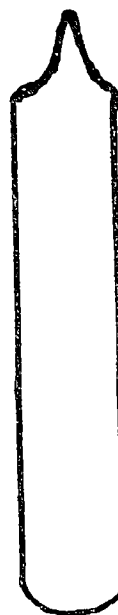

**Label  
or  
Tag**

501

7.3.4

502



# Placard

**Diamond shaped  
warning sign**



5-3

7.3.5

504

Hazardous Material Identification numbers may be displayed on placards or orange panels.



1760

Placard and Panel locations

Front of tractor or trailer

Each side of trailer

Back of trailer

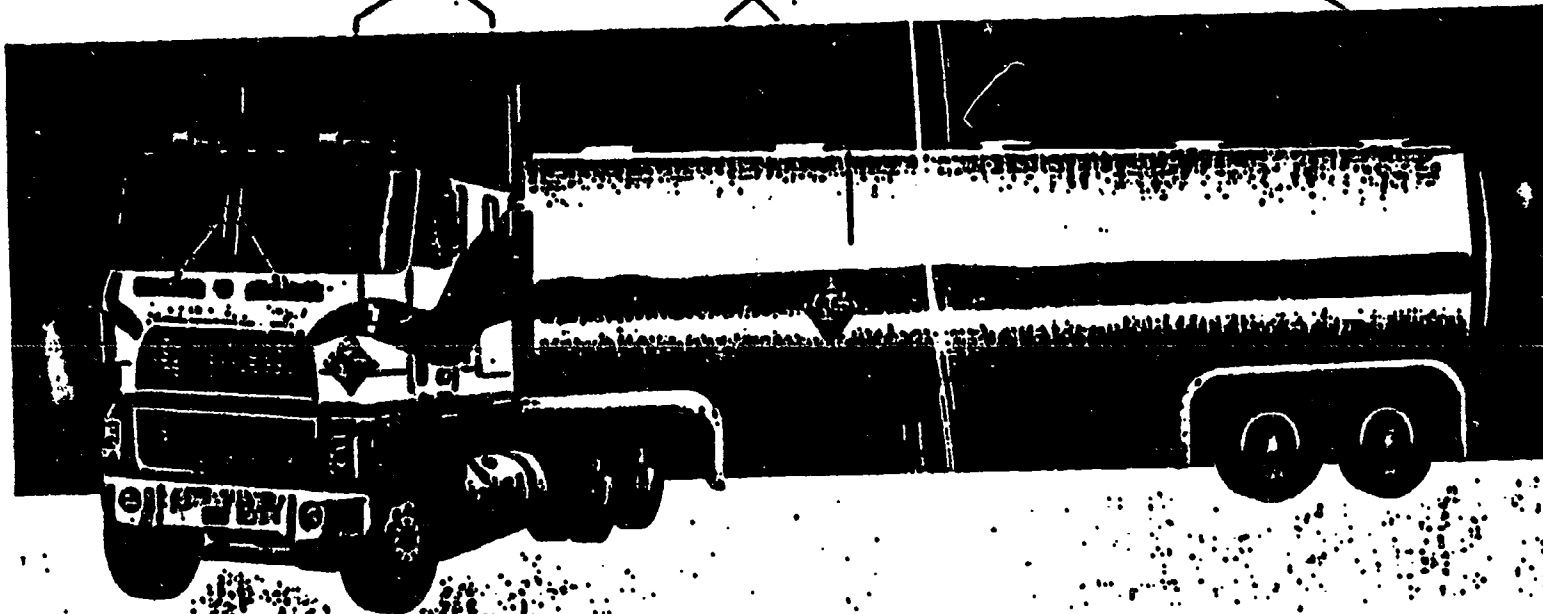

- **Hazardous material table**
- **List of hazardous substances and reportable quantities**

# Hazardous Materials Table

(1) (2) +/ Hazardous materials Descriptions and Proper A/ shipping names W	(3) Hazard class	(3A) Identification number	(4) Label(s) required
<p>Carbolic acid, liquid (Liquid tar acid containing over 50% pheno). See Phenol, liquid</p> <p>Carbon bisulfide, or Carbon disulfide</p> <p>Carbon dioxide</p>	<p>Flammable liquid</p> <p>Nonflammable</p>	<p>UN1131</p> <p>UN1013</p>	<p>Flammable liquid</p> <p>Nonflammable</p>

**Never transport a material that is listed as forbidden under Column 3**

<b>LIST OF HAZARDOUS SUBSTANCES AND REPORTABLE QUANTITIES</b>		
<b>Hazardous Substance</b>	<b>Synonyms</b>	<b>Reportable Quantity (RQ) Pounds (Kilograms)</b>
Phenyl mercaptan @ .....	Benzinethiol .....	100 (45.4)
.....	Thiophenol .....	100 (45.4)
Phenylmercuric acetate .....	Mercury, (acetate-O) phenyl .....	100 (45.4)
N-Phenylthioacetate .....	Thiourea, phenyl .....	10 (4.54)
Phorate .....	Phosphorodithioic acid, O,O-diethyl S-(ethylthio), methyl ester ..	10 (4.54)
Phosgene .....	Carbonyl chloride .....	100 (45.4)
Phosphine .....	Hydrogen phosphide .....	5000 (2270)
Phosphoric acid .....	.....	100 (45.4)
Phosphoric acid, diethyl p-nitrophenyl ester ..	Diethyl-p-nitrophenyl phosphate .....	1 (0.454)
Phosphoric acid, lead salt .....	Lead phosphate .....	1 (0.454)

**Spilled RQ must be reported  
to the DOT & EPA**

**7.3.9**

# Inhalation Hazard Requires



513

7.3.10

514

# **Shipping Paper Must Include**

- **Page numbers**
- **Total pages**
- **Proper description**
- **Signed shippers certification**

# **Hazardous Materials Must Be:**

- **Described first**
- **Highlighted**
- **Identified by an "X" or "RQ"  
in the HM column**



# **Basic Description**

- **Proper shipping name**
- **Hazard class**
- **Identification number**

**"Must be in the order"**

"RQ" means that this is a reportable quantity

Proper shipping name from Column 2 of the Hazardous Materials Table

Hazard Class from Column 3 of the Table

ID Number from the Hazardous Materials Table

**SHIPPING PAPER**  
Page 1 of 1

**TO:** Waters R Us  
88 Valley Street  
Silicon Junction, CA

**FROM:** Essex Corporation  
5775 Dawson Avenue  
Goleta, CA 93117

QTY	HM	DESCRIPTION	WEIGHT
1 cyl	RQ	Phosgene, Poison A, UN1076	25 lbs

This is to certify that the above named materials are properly classified, described, packaged, marked and labeled, and are in proper condition for transportation according to the applicable regulations of the Department of Transportation.

**Shipper:** Essex Corp      **Carrier:** Knuckle Bros.  
**Per:** Shultz      **Per:**  
**Date:** 6/27/88      **Date:**

521

7.3.14

522

**"Waste" Acetone,  
Flammable Liquid,  
UN1090**

**7.3.15**

523

524

# Shipper Certification

**Shipper's certification - a statement on a shipping paper, signed by the shipper, saying he/she prepared the shipment properly according to law.**

**"This is to certify that the above named materials are properly classified, described, packaged, marked and labeled, and are in proper condition for transportation according to the applicable regulations of the Department of transportation."**

525

**7.3.16**

526

- **Name and address of shipper or consignee**
- **Proper shipping name and ID number**
- **Required labels**

**7.3.17**

537

528

# **To Recognize Hazardous Materials**

- **Read the shipping papers**

**7.3.18**

529

530

**Hazardous waste  
shipments must have  
a signed uniform  
waste manifest**

**7.3.19**

531

532

# Placards

- **Must be placed on both ends and both sides**
- **Attached to the vehicle during loading**
- **Identify the correct hazard class**

7.3.20



# Loading

- **Secure unit**
- **Correct tools**
- **Avoid heat sources**
- **Reject leaking containers**

7.4.1

535

536

- **No smoking**
- **No open flames**



**Explosives - Oxidizers - Flammables**

# WHEN LOADING EXPLOSIVES

- **Engine off**
- **Disable heaters**
- **No sharp points**
- **Use floor lining for Class A & B explosives**
- **Use extra care**
- **No hooks**
- **No metal tools**

# No Class A Explosives an

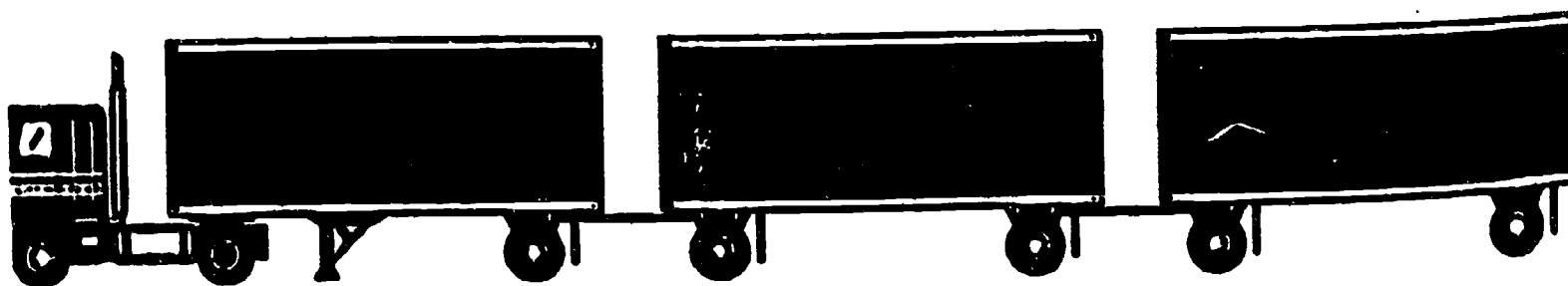

Or combinations of

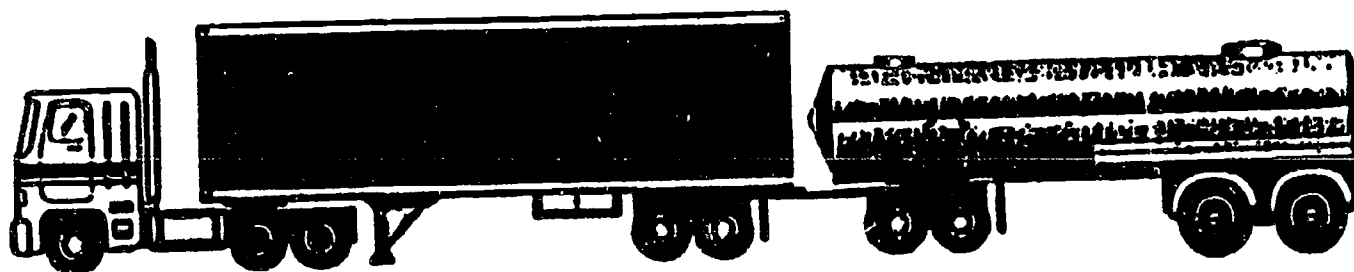

7.4.4

# **Corrosive liquids never load above or next to:**

- **Class A or B explosives**
- **Flammable solids**
- **Oxidizing material**

# **Cylinders Must Be**

- **Held upright or lying down flat and braced; or**
- **In racks attached to the vehicle; or**
- **In boxes that will keep them from turning over.**

# Radioactive Materials

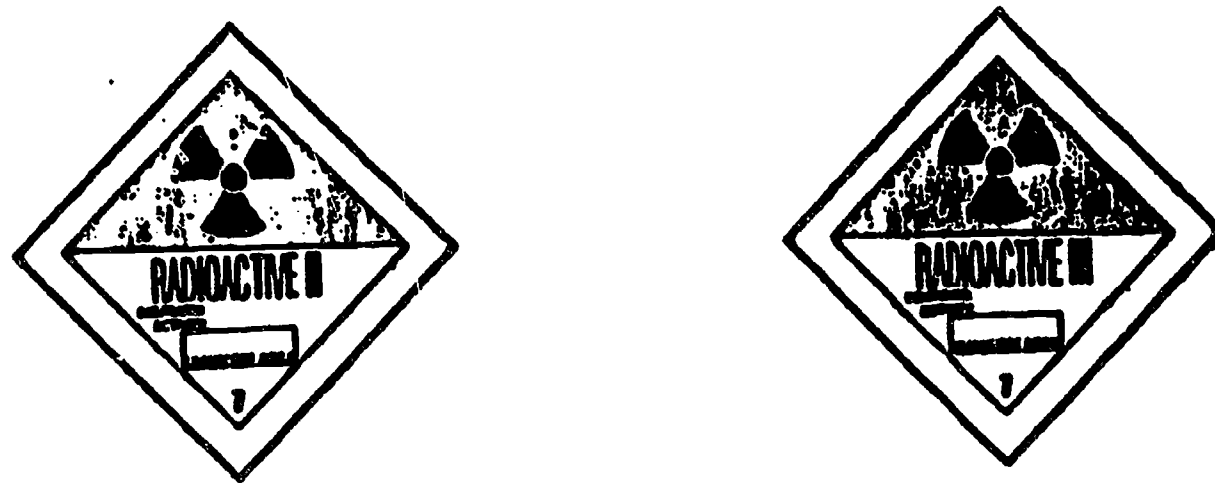

**The total transport index  
of all packages in a single  
vehicle must not exceed 50.**

**7.4.7**

**DO NOT LOAD**

**Poison labeled  
material**

**Poison A**

**IN THE SAME VEHICLE WITH**

**Animal or human food unless  
the poison package is over  
packed in an approved way.**

**Oxidizers, flammables,  
corrosives, organic peroxides**



# Bulk Tank Marking, Loading and Unloading

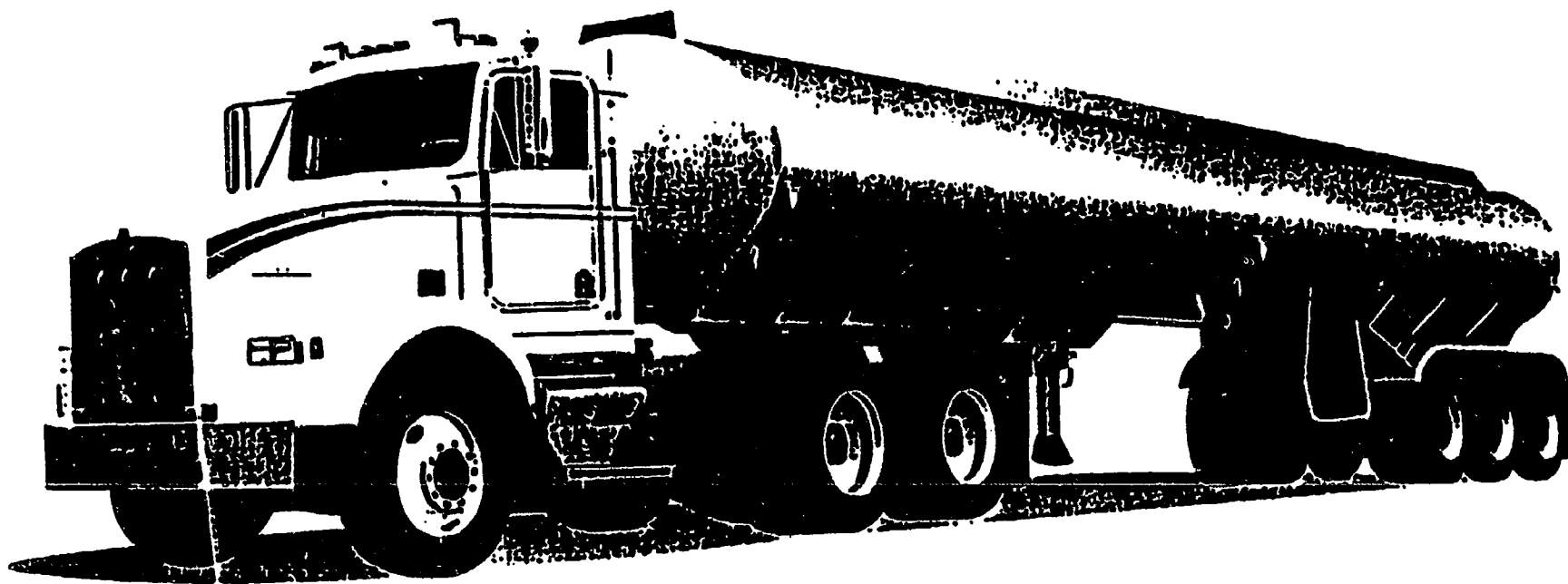

551

7.5.1

552

# Tank Markings

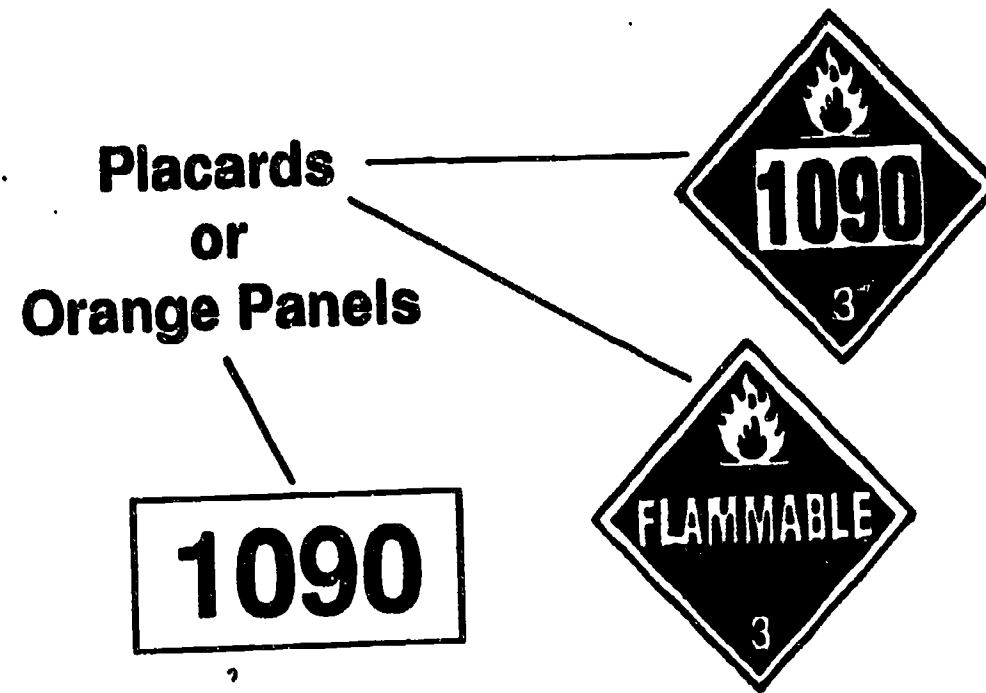

**Portable tanks and cargo tanks require ID numbers and placards.**

# Tank Loading

- **Clear view**
- **Within 25 feet**
- **Aware of the hazards**
- **Know emergency procedures**
- **Authorized and able to move tank**

**7.5.3**

**Cargo tanks must be attended during loading and unloading**

**They must be:**

- **Knowledgeable**
- **Authorized to move the vehicle**

**Warning - All valves and manholes must be closed before moving**

# Loading and Unloading Flammable Liquids



- **Engine off**
- **Tank grounded**

# **Loading and Unloading Compressed Gas**

- **Discharge valves must be closed**
- **Engine off**
- **Wheels must be chocked**

**Never park Explosives A or Explosives B closer than 5 feet to the traveled part of the road. Do not park within 300 feet of:**

- **A bridge.**
- **A tunnel.**
- **A building.**
- **A place where people gather.**
- **An open fire.**

# **Placarded Vehicle Parking**

- Never park within 300 feet of an open fire**
- Must have someone in attendance if parked within 5 feet of the traveled part of the road**



- **Awake (not in the sleeper)**
- **Within 100 feet with a clear view**
- **Aware of the hazards**
- **Know what to do in an emergency**
- **Able to move the vehicle**

**7.6.3**

**NO**

## **Flares, fuses, burning signals**

- **Around empty or loaded tanks used for flammable liquids or flammable gas.**
- **Vehicles loaded with**

**Explosives A or B  
Flammable Liquid  
Flammable Gas**

**7.6.4**

# ROUTE RESTRICTIONS



## Drivers responsibilities:

- Obtain required permits
- Determine correct route

# **Placarded Vehicles Must Avoid**

- **Populated areas**
- **Crowds**
- **Tunnels**
- **Narrow streets and alleys**

**Never drive a placarded  
vehicle near an open fire  
unless you can pass  
safely without stopping.**

575

7.6.7

576



- **Within 25 feet of a placarded tank used for flammable liquids or gases**

**Do not smoke or carry a lighted cigar, cigarette or pipe within 25 feet of any vehicle which contains:**

- **Explosives**
- **Oxidizers**
- **Flammables**

# Refueling

- **Engine off**
- **Some one must always be at the nozzle controlling the flow**

# Minimum UL Rating 10 B:C

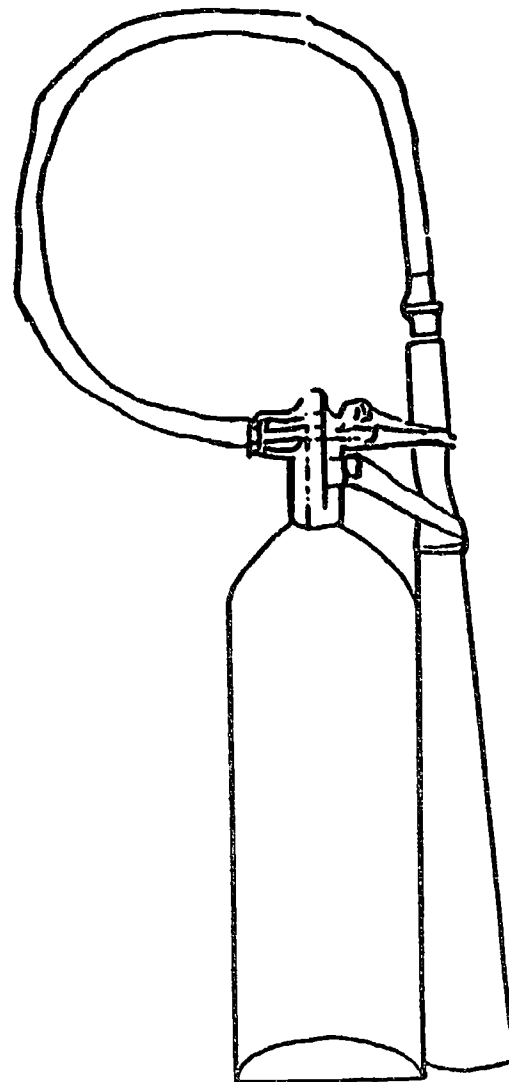

551

**7.6.10**

552



# TIRES

**Must be:**

- **Properly inflated**
- **Checked at specific intervals**
- **Removed if overheated**

**Do not drive with a flat or  
leaking tire**

# Shipping Papers

- **Tabbed or on top**
- **Within reach**
- **In a pouch on the driver's door**

## When vehicle is unattended

- **On the driver's seat**
- **In a pouch on the driver's door**

# Class A or B Explosives



**The driver must understand and have with him or her:**

- **Shipping papers**
- **Written emergency instructions.**
- **Written route plan.**
- **Copy of FMCSR Part 397.**

# **Driver Requirements for Transporting Chlorine**

- **Approved gas mask**
- **Emergency kit for leaks**
- **Stop at all RR crossings**

**Loaded or empty**

# Hazardous Materials Emergencies

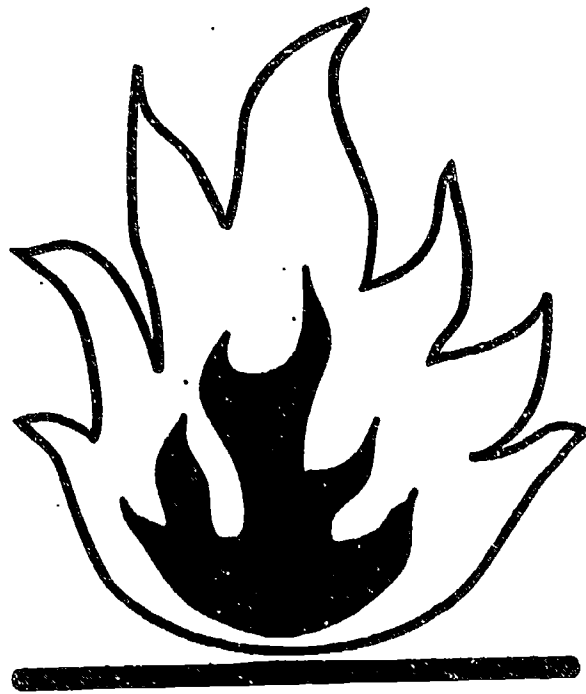

**No Smoking**  
**Warn Others**  
**Keep People Away**  
**Avoid Contact or Inhaling**

591

7.7.1

592

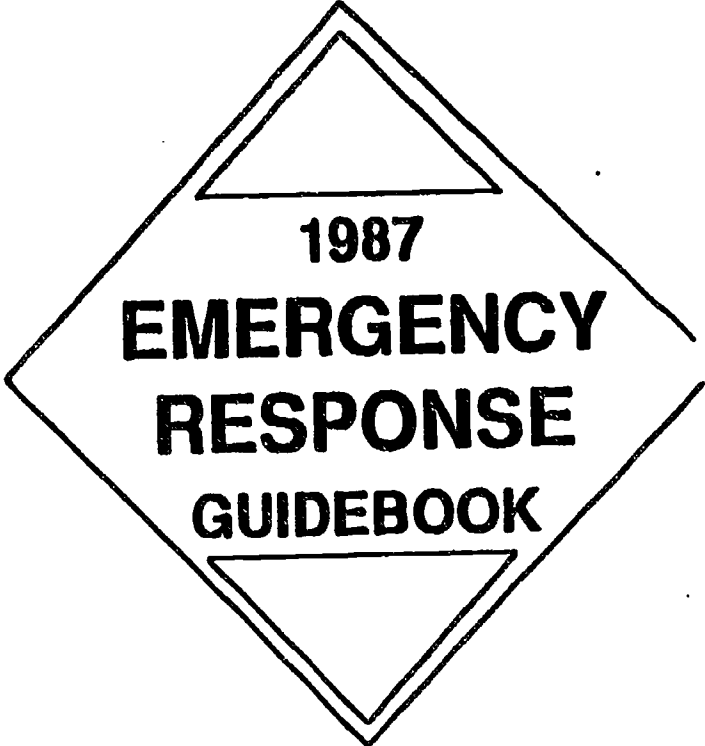

**1987  
EMERGENCY  
RESPONSE  
GUIDEBOOK**

**GUIDEBOOK  
FOR  
INITIAL RESPONSE TO  
HAZARDOUS  
MATERIALS  
INCIDENTS**

593

594 <sup>7.7.2</sup>

# **Accidents/Incidents**

- **Keep people away**
- **If safe, contain the material**
- **Communicate the danger**

# **Follow this Checklist:**

- **Check on your partner**
- **Keep the shipping papers**
- **Keep people far away  
and upwind**
- **Warn others of danger**
- **Send for help**
- **Follow employer's instructions**



# **Hazardous Materials Fires**

**The driver should:**

- **Send for help**
- **Prevent the fire from spreading**
- **Have the shipping papers**
- **Keep bystanders away**

# LEAKS

- **Avoid contact**
- **Do not move the vehicle any more than safety requires it**
- **Send for help**
- **Never try to repack leaking containers**
- **Call your supervisor**

# **Accidents or Breakdowns**

## **Transporting Explosives:**

- **Warn others**
- **Keep bystanders away**
- **No smoking or open flame**
- **Maintain at least 200 feet**

**From other vehicles or occupied buildings**

**7.7.7**

# **Placarded vehicles involved in an accident or a break down should follow these general guidelines:**

- **Warn others of the danger**
- **Keep bystanders away**
- **Send someone for help**
- **Do not allow smoking or open flames**
- **Do not open doors, containers, etc.**
- **Do not move any further than necessary**
- **Avoid vapors and contact**
- **Notify your supervisor**

**National Response Center  
coordinates emergency response  
involving chemical hazards.**

**800-424-8802**

**Must be called if:**

- **A person is killed**
- **Someone is hospitalized**
- **Damage in excess of \$50,000**

# **Chem Trec**

**Provides emergency personnel  
with technical information about  
the physical properties of  
hazardous products.**

**800-424-9300**

**AAMV Anet/CDLIS**

**Paul Helkowski 608-266-0753**

**Madison**

**Administrative Rule Trans 327**

**Insp. Supv. Terry Bengtson 715-839-3809**

**Insp. Supv. John J. Smith 414-929-3712**

**Insp. Supv. Janice M. Ward 608-269-2500**

**Insp. Supv. Robert E. Barnett 608-246-3238**

**Insp. Supv. Lyle Walheim 608-266-0305**

**Insp. Supv. Steve Gasper 608-266-0264**

**Sgt. Eric L. Erickson 715-635-2141**

**Insp. Supv. David J. Lutze 608-372-5998**

**Insp. Supv. James P. Cmeyla 414-785-4704**

**Insp. Supv. David M. Pfeuffer 414-785-4721**

**Insp. Supv. Darroll G. Peterson 715-845-1143**

**Eau Claire  
Fond du Lac  
Fort McCoy  
Madison**

**Spooner  
Tomah  
Waukesha**

**Wausau**

**Citations Issued By Another State For Not Having  
CDL**

**Capt. Marsha Wiley 608-267-9522**

**Insp. Supv. Lyle Walheim 608-266-0305**

**Insp. Supv. Steve Gasper 608-266-0264**

**Madison**

**Disqualifiers**

**Al Johnson 608-266-1483**

**Kent Buehler 608-266-2266**

**Mary Jackson 608-267-2086**

**Madison**

**Hazardous Materials**

**Lyle Walheim 608-266-0305**

**Madison**

**Medical Requirements**

**DMV Medical Review Section 608-266-2327**

**Madison**

**Manuals**

**Dianne Maglio Terry 608-266-6943**

**Madison**

**Occupationals**

**Rick Kleist 608-266-2267**

**Jane Rouleau 608-267-5080**

**Bob Tribbey 414-548-5611**

**Madison**

**Waukesha**

**Testing**

**Jane Rouleau 608-267-5080**

**Wes Geringer 608-266-0614**

**Donald Reincke 608-755-2003**

**Madison**

**Beloit**

**Third Party Testing**

**Wes Geringer 608-266-0614**

**Sue Foster 608-266-1499**

**Dennis Nussbaum 608-246-7540**

**Madison**

## COMMERCIAL DRIVER LICENSE

### CONTACT PEOPLE

#### General Information (By City)

**Appleton**  
**Beaver Dam**  
**Beloit**  
**Eau Claire**  
**Eikhorn**  
**Fond du Lac**

**Green Bay**

**Janesville**  
**Kenosha**  
**LaCrosse**  
**Madison**

**Manitowoc**  
**Marshfield**  
**Milwaukee**

**Oshkosh**  
**Platteville**  
**Portage**  
**Racine**  
**Rhineland**  
**Rice Lake**

**Sheboygan**  
**Stevens Point**  
**Superior**  
**Tomah**

**Waukesha**

**Wausau**

**West Bend**  
**Wisconsin Rapids**

Glenn Johnson 414-832-2722  
Donald Reincke 608-755-2008  
Donald Reincke 608-755-2008  
Donald Shilts 715-836-2802  
Larry Jabs 414-723-2059 or 414-548-5848  
Gary Guenther 414-929-3720  
Diana Dunham 414-929-3721  
Linda Lewis 414-497-4313  
Michael Ashmore 414-497-4312  
Donald Reincke 608-755-2008  
Larry Jabs 414-656-7141  
Wayne Close 608-372-6882  
Dennis Nussbaum 608-246-7540  
Keith Brockmiller 608-266-7661  
Harold Thummel 608-266-0054  
Bonnie Phaneuf 608-267-7783  
Jennifer Liddicoat 608-267-9558  
Darlene Jensen 608-266-8693  
Kay James 608-266-0598  
Joan Van Horn 608-267-2351  
Dale Lambrecht 414-459-4052  
Richard Redding 715-345-5322  
Donald Brieger 414-227-4890  
Hazel Wills 414-227-4659  
Gary Patterman 414-438-4594  
John Bonlender 414-438-4594  
Tim Sturtevant 414-768-7166  
Abe Kaalele 414-423-7747  
Diana Dunham 414-929-3721  
Glenn Green 608-742-4999  
Glenn Green 608-742-4999  
Douglas Niles 414-636-3590  
Richard Steffek 715-359-7398  
Richard Gietzel 715-234-8088  
Marvin Doubek 715-234-8088  
Dale Lambrecht 414-459-4052  
Richard Redding 715-345-5322  
Marvin Doubek 715-234-8088  
John Walsh 608-372-6882  
Wayne Close 608-372-6882  
Bob Tribbey 414-548-5611  
Mary Veith 414-548-5848  
Lawrence Jandrin 715-359-7398  
Richard Steffek 715-359-7398  
Diana Dunham 414-929-3721  
Richard Redding 715-345-5322



# DRIVER LICENSE KNOWLEDGE TESTS

Wisconsin Department of Transportation

LV3630-00

**FOR OFFICE USE**  
EXAM DATE

LOCATION

Examiner Badge No.

First Name		Last Name	
Home Address (Street or P.O.)		City	Zip
Date of Birth	Social Security Number	Driver License Number	

**FOR OFFICE USE**

LICENSE CLASS (circle applicable)	A	B	C	D	M	OCC	TESTS (circle applicable)			CPL Tests							
							DPR	CYC	SPR	GK	AIR	COMB	TANK	HAZ	D/T	PASS	SB

## REGULAR TEST

Darken the circle of the correct answer.  
EXAMPLE: 1 ● (B) (C)

- |               |                |                |                |
|---------------|----------------|----------------|----------------|
| 1 (A) (B) (C) | 11 (A) (B) (C) | 21 (A) (B) (C) | 31 (A) (B) (C) |
| 2 (A) (B) (C) | 12 (A) (B) (C) | 22 (A) (B) (C) | 32 (A) (B) (C) |
| 3 (A) (B) (C) | 13 (A) (B) (C) | 23 (A) (B) (C) | 33 (A) (B) (C) |
| 4 (A) (B) (C) | 14 (A) (B) (C) | 24 (A) (B) (C) | 34 (A) (B) (C) |
| 5 (A) (B) (C) | 15 (A) (B) (C) | 25 (A) (B) (C) | 35 (A) (B) (C) |
| 6 (A) (B) (C) | 16 (A) (B) (C) | 26 (A) (B) (C) | 36 (A) (B) (C) |
| 7 (A) (B) (C) | 17 (A) (B) (C) | 27 (A) (B) (C) | 37 (A) (B) (C) |
| 8 (A) (B) (C) | 18 (A) (B) (C) | 28 (A) (B) (C) | 38 (A) (B) (C) |
| 9 (A) (B) (C) | 19 (A) (B) (C) | 29 (A) (B) (C) | 39 (A) (B) (C) |
| (A) (B) (C)   | 20 (A) (B) (C) | 30 (A) (B) (C) | 40 (A) (B) (C) |

## SIGN TEST

Match the number of the sign with the following descriptions.

- |                       |                              |
|-----------------------|------------------------------|
| — School Zone         | — Do Not Enter               |
| — School Crossing     | — No Passing                 |
| — Divided Highway     | — Right Lane Ends            |
| — Two-Way Highway     | — Intersection               |
| — No U-Turn           | — No Right Turn              |
| — Keep Right          | — Merging Traffic From Right |
| — Railroad Warning    | — Yield Right of Way         |
| — Pedestrian Crossing |                              |
| — Stop                |                              |

**FOR OFFICE USE**

Series \_\_\_\_\_ No. Missed \_\_\_\_\_ Satisfactory \_\_\_\_\_  
Unsatisfactory \_\_\_\_\_

**FOR OFFICE USE**

Series \_\_\_\_\_ Satisfactory \_\_\_\_\_  
No. Missed \_\_\_\_\_ Unsatisfactory \_\_\_\_\_

## CYCLE OR SPECIAL RESTRICTED TEST

Darken the circle of the correct answer.  
EXAMPLE: 1 ● (B) (C)

- |                |                |                |
|----------------|----------------|----------------|
| 1 (A) (B) (C)  | 11 (A) (B) (C) | 21 (A) (B) (C) |
| 2 (A) (B) (C)  | 12 (A) (B) (C) | 22 (A) (B) (C) |
| 3 (A) (B) (C)  | 13 (A) (B) (C) | 23 (A) (B) (C) |
| 4 (A) (B) (C)  | 14 (A) (B) (C) | 24 (A) (B) (C) |
| 5 (A) (B) (C)  | 15 (A) (B) (C) | 25 (A) (B) (C) |
| 6 (A) (B) (C)  | 16 (A) (B) (C) | 26 (A) (B) (C) |
| 7 (A) (B) (C)  | 17 (A) (B) (C) | 27 (A) (B) (C) |
| 8 (A) (B) (C)  | 18 (A) (B) (C) | 28 (A) (B) (C) |
| 9 (A) (B) (C)  | 19 (A) (B) (C) | 29 (A) (B) (C) |
| 10 (A) (B) (C) | 20 (A) (B) (C) | 30 (A) (B) (C) |

## SIGN TEST

Match the number of the sign with the following descriptions.

- |                       |                              |
|-----------------------|------------------------------|
| — School Zone         | — Do Not Enter               |
| — School Crossing     | — No Passing                 |
| — Divided Highway     | — Right Lane Ends            |
| — Two-Way Highway     | — Intersection               |
| — No U-Turn           | — No Right Turn              |
| — Keep Right          | — Merging Traffic From Right |
| — Railroad Warning    | — Yield Right of Way         |
| — Pedestrian Crossing |                              |
| — Stop                |                              |

**FOR OFFICE USE**

Series \_\_\_\_\_ No. Missed \_\_\_\_\_ Satisfactory \_\_\_\_\_  
Unsatisfactory \_\_\_\_\_

**FOR OFFICE USE**

Series \_\_\_\_\_ Satisfactory \_\_\_\_\_  
No. Missed \_\_\_\_\_ Unsatisfactory \_\_\_\_\_

**COMMERCIAL  
DRIVER LICENSE  
KNOWLEDGE TESTS**

Darken the circle of the correct answer  
EXAMPLE: 1 ● (B) (C) (D)

General Knowledge

- |                    |                    |                             |                     |                            |                            |                     |
|--------------------|--------------------|-----------------------------|---------------------|----------------------------|----------------------------|---------------------|
| 1 (A) (B) (C) (D)  | 29 (A) (B) (C) (D) | 57 (A) (B) (C) (D)          | 85 (A) (B) (C) (D)  | 113 (A) (B) (C) (D)        | 144 (A) (B) (C) (D)        | 175 (A) (B) (C) (D) |
| 2 (A) (B) (C) (D)  | 30 (A) (B) (C) (D) | 58 (A) (B) (C) (D)          | 86 (A) (B) (C) (D)  | 114 (A) (B) (C) (D)        | 145 (A) (B) (C) (D)        | 176 (A) (B) (C) (D) |
| 3 (A) (B) (C) (D)  | 31 (A) (B) (C) (D) | 59 (A) (B) (C) (D)          | 87 (A) (B) (C) (D)  | 115 (A) (B) (C) (D)        | <u>Passenger/Taxi</u>      | 177 (A) (B) (C) (D) |
| 4 (A) (B) (C) (D)  | 32 (A) (B) (C) (D) | 60 (A) (B) (C) (D)          | 88 (A) (B) (C) (D)  | <u>Hazardous Materials</u> | 146 (A) (B) (C) (D)        | 178 (A) (B) (C) (D) |
| 5 (A) (B) (C) (D)  | 33 (A) (B) (C) (D) | 61 (A) (B) (C) (D)          | 89 (A) (B) (C) (D)  | 116 (A) (B) (C) (D)        | 147 (A) (B) (C) (D)        | 179 (A) (B) (C) (D) |
| 6 (A) (B) (C) (D)  | 34 (A) (B) (C) (D) | 62 (A) (B) (C) (D)          | 90 (A) (B) (C) (D)  | 117 (A) (B) (C) (D)        | 148 (A) (B) (C) (D)        | 180 (A) (B) (C) (D) |
| 7 (A) (B) (C) (D)  | 35 (A) (B) (C) (D) | 63 (A) (B) (C) (D)          | 91 (A) (B) (C) (D)  | 118 (A) (B) (C) (D)        | 149 (A) (B) (C) (D)        | 181 (A) (B) (C) (D) |
| 8 (A) (B) (C) (D)  | 36 (A) (B) (C) (D) | 64 (A) (B) (C) (D)          | 92 (A) (B) (C) (D)  | 119 (A) (B) (C) (D)        | 150 (A) (B) (C) (D)        | 182 (A) (B) (C) (D) |
| 9 (A) (B) (C) (D)  | 37 (A) (B) (C) (D) | 65 (A) (B) (C) (D)          | 93 (A) (B) (C) (D)  | 120 (A) (B) (C) (D)        | 151 (A) (B) (C) (D)        | 183 (A) (B) (C) (D) |
| 10 (A) (B) (C) (D) | 38 (A) (B) (C) (D) | 66 (A) (B) (C) (D)          | 94 (A) (B) (C) (D)  | 121 (A) (B) (C) (D)        | 152 (A) (B) (C) (D)        | 184 (A) (B) (C) (D) |
| 11 (A) (B) (C) (D) | 39 (A) (B) (C) (D) | 67 (A) (B) (C) (D)          | 95 (A) (B) (C) (D)  | 122 (A) (B) (C) (D)        | 153 (A) (B) (C) (D)        | 185 (A) (B) (C) (D) |
| 12 (A) (B) (C) (D) | 40 (A) (B) (C) (D) | 68 (A) (B) (C) (D)          | <u>Tanker</u>       | 123 (A) (B) (C) (D)        | 154 (A) (B) (C) (D)        | <u>School Bus</u>   |
| 13 (A) (B) (C) (D) | 41 (A) (B) (C) (D) | 69 (A) (B) (C) (D)          | 96 (A) (B) (C) (D)  | 124 (A) (B) (C) (D)        | 155 (A) (B) (C) (D)        | 186 (A) (B) (C) (D) |
| 14 (A) (B) (C) (D) | 42 (A) (B) (C) (D) | 70 (A) (B) (C) (D)          | 97 (A) (B) (C) (D)  | 125 (A) (B) (C) (D)        | 156 (A) (B) (C) (D)        | 187 (A) (B) (C) (D) |
| 15 (A) (B) (C) (D) | 43 (A) (B) (C) (D) | 71 (A) (B) (C) (D)          | 98 (A) (B) (C) (D)  | 126 (A) (B) (C) (D)        | 157 (A) (B) (C) (D)        | 188 (A) (B) (C) (D) |
| 16 (A) (B) (C) (D) | 44 (A) (B) (C) (D) | 72 (A) (B) (C) (D)          | 99 (A) (B) (C) (D)  | 127 (A) (B) (C) (D)        | 158 (A) (B) (C) (D)        | 189 (A) (B) (C) (D) |
| 17 (A) (B) (C) (D) | 45 (A) (B) (C) (D) | 73 (A) (B) (C) (D)          | 100 (A) (B) (C) (D) | 128 (A) (B) (C) (D)        | 159 (A) (B) (C) (D)        | 190 (A) (B) (C) (D) |
| 18 (A) (B) (C) (D) | 46 (A) (B) (C) (D) | 74 (A) (B) (C) (D)          | 101 (A) (B) (C) (D) | 129 (A) (B) (C) (D)        | 160 (A) (B) (C) (D)        | 191 (A) (B) (C) (D) |
| 19 (A) (B) (C) (D) | 47 (A) (B) (C) (D) | 75 (A) (B) (C) (D)          | 102 (A) (B) (C) (D) | 130 (A) (B) (C) (D)        | 161 (A) (B) (C) (D)        | 192 (A) (B) (C) (D) |
| 20 (A) (B) (C) (D) | 48 (A) (B) (C) (D) | <u>Combination Vehicles</u> | 103 (A) (B) (C) (D) | 131 (A) (B) (C) (D)        | 162 (A) (B) (C) (D)        | 193 (A) (B) (C) (D) |
| 21 (A) (B) (C) (D) | 49 (A) (B) (C) (D) | 76 (A) (B) (C) (D)          | 104 (A) (B) (C) (D) | 132 (A) (B) (C) (D)        | 163 (A) (B) (C) (D)        | 194 (A) (B) (C) (D) |
| 22 (A) (B) (C) (D) | 50 (A) (B) (C) (D) | 77 (A) (B) (C) (D)          | 105 (A) (B) (C) (D) | 133 (A) (B) (C) (D)        | 164 (A) (B) (C) (D)        | 195 (A) (B) (C) (D) |
| 23 (A) (B) (C) (D) | <u>Air Permits</u> | 78 (A) (B) (C) (D)          | 106 (A) (B) (C) (D) | 134 (A) (B) (C) (D)        | 165 (A) (B) (C) (D)        | 196 (A) (B) (C) (D) |
| 24 (A) (B) (C) (D) | 51 (A) (B) (C) (D) | 79 (A) (B) (C) (D)          | 107 (A) (B) (C) (D) | 135 (A) (B) (C) (D)        | <u>Passenger Transport</u> | 197 (A) (B) (C) (D) |
| 25 (A) (B) (C) (D) | 52 (A) (B) (C) (D) | 80 (A) (B) (C) (D)          | 108 (A) (B) (C) (D) | 136 (A) (B) (C) (D)        | 166 (A) (B) (C) (D)        | 198 (A) (B) (C) (D) |
| 26 (A) (B) (C) (D) | 53 (A) (B) (C) (D) | 81 (A) (B) (C) (D)          | 109 (A) (B) (C) (D) | 137 (A) (B) (C) (D)        | 167 (A) (B) (C) (D)        | 199 (A) (B) (C) (D) |
| 27 (A) (B) (C) (D) | 54 (A) (B) (C) (D) | 82 (A) (B) (C) (D)          | 110 (A) (B) (C) (D) | 138 (A) (B) (C) (D)        | 168 (A) (B) (C) (D)        | 200 (A) (B) (C) (D) |
| 28 (A) (B) (C) (D) | 55 (A) (B) (C) (D) | 83 (A) (B) (C) (D)          | 111 (A) (B) (C) (D) | 139 (A) (B) (C) (D)        | 169 (A) (B) (C) (D)        |                     |
|                    | 56 (A) (B) (C) (D) | 84 (A) (B) (C) (D)          | 112 (A) (B) (C) (D) | 140 (A) (B) (C) (D)        | 170 (A) (B) (C) (D)        |                     |
|                    |                    |                             | 113 (A) (B) (C) (D) | 141 (A) (B) (C) (D)        | 171 (A) (B) (C) (D)        |                     |
|                    |                    |                             | 114 (A) (B) (C) (D) | 142 (A) (B) (C) (D)        | 172 (A) (B) (C) (D)        |                     |
|                    |                    |                             | 115 (A) (B) (C) (D) | 143 (A) (B) (C) (D)        | 173 (A) (B) (C) (D)        |                     |
|                    |                    |                             | 116 (A) (B) (C) (D) | 144 (A) (B) (C) (D)        | 174 (A) (B) (C) (D)        |                     |
|                    |                    |                             | 117 (A) (B) (C) (D) |                            |                            |                     |
|                    |                    |                             | 118 (A) (B) (C) (D) |                            |                            |                     |
|                    |                    |                             | 119 (A) (B) (C) (D) |                            |                            |                     |
|                    |                    |                             | 120 (A) (B) (C) (D) |                            |                            |                     |
|                    |                    |                             | 121 (A) (B) (C) (D) |                            |                            |                     |
|                    |                    |                             | 122 (A) (B) (C) (D) |                            |                            |                     |
|                    |                    |                             | 123 (A) (B) (C) (D) |                            |                            |                     |
|                    |                    |                             | 124 (A) (B) (C) (D) |                            |                            |                     |
|                    |                    |                             | 125 (A) (B) (C) (D) |                            |                            |                     |
|                    |                    |                             | 126 (A) (B) (C) (D) |                            |                            |                     |
|                    |                    |                             | 127 (A) (B) (C) (D) |                            |                            |                     |
|                    |                    |                             | 128 (A) (B) (C) (D) |                            |                            |                     |
|                    |                    |                             | 129 (A) (B) (C) (D) |                            |                            |                     |
|                    |                    |                             | 130 (A) (B) (C) (D) |                            |                            |                     |
|                    |                    |                             | 131 (A) (B) (C) (D) |                            |                            |                     |
|                    |                    |                             | 132 (A) (B) (C) (D) |                            |                            |                     |
|                    |                    |                             | 133 (A) (B) (C) (D) |                            |                            |                     |
|                    |                    |                             | 134 (A) (B) (C) (D) |                            |                            |                     |
|                    |                    |                             | 135 (A) (B) (C) (D) |                            |                            |                     |
|                    |                    |                             | 136 (A) (B) (C) (D) |                            |                            |                     |
|                    |                    |                             | 137 (A) (B) (C) (D) |                            |                            |                     |
|                    |                    |                             | 138 (A) (B) (C) (D) |                            |                            |                     |
|                    |                    |                             | 139 (A) (B) (C) (D) |                            |                            |                     |
|                    |                    |                             | 140 (A) (B) (C) (D) |                            |                            |                     |
|                    |                    |                             | 141 (A) (B) (C) (D) |                            |                            |                     |
|                    |                    |                             | 142 (A) (B) (C) (D) |                            |                            |                     |
|                    |                    |                             | 143 (A) (B) (C) (D) |                            |                            |                     |
|                    |                    |                             | 144 (A) (B) (C) (D) |                            |                            |                     |
|                    |                    |                             | 145 (A) (B) (C) (D) |                            |                            |                     |
|                    |                    |                             | 146 (A) (B) (C) (D) |                            |                            |                     |
|                    |                    |                             | 147 (A) (B) (C) (D) |                            |                            |                     |
|                    |                    |                             | 148 (A) (B) (C) (D) |                            |                            |                     |
|                    |                    |                             | 149 (A) (B) (C) (D) |                            |                            |                     |
|                    |                    |                             | 150 (A) (B) (C) (D) |                            |                            |                     |
|                    |                    |                             | 151 (A) (B) (C) (D) |                            |                            |                     |
|                    |                    |                             | 152 (A) (B) (C) (D) |                            |                            |                     |
|                    |                    |                             | 153 (A) (B) (C) (D) |                            |                            |                     |
|                    |                    |                             | 154 (A) (B) (C) (D) |                            |                            |                     |
|                    |                    |                             | 155 (A) (B) (C) (D) |                            |                            |                     |
|                    |                    |                             | 156 (A) (B) (C) (D) |                            |                            |                     |
|                    |                    |                             | 157 (A) (B) (C) (D) |                            |                            |                     |
|                    |                    |                             | 158 (A) (B) (C) (D) |                            |                            |                     |
|                    |                    |                             | 159 (A) (B) (C) (D) |                            |                            |                     |
|                    |                    |                             | 160 (A) (B) (C) (D) |                            |                            |                     |
|                    |                    |                             | 161 (A) (B) (C) (D) |                            |                            |                     |
|                    |                    |                             | 162 (A) (B) (C) (D) |                            |                            |                     |
|                    |                    |                             | 163 (A) (B) (C) (D) |                            |                            |                     |
|                    |                    |                             | 164 (A) (B) (C) (D) |                            |                            |                     |
|                    |                    |                             | 165 (A) (B) (C) (D) |                            |                            |                     |
|                    |                    |                             | 166 (A) (B) (C) (D) |                            |                            |                     |
|                    |                    |                             | 167 (A) (B) (C) (D) |                            |                            |                     |
|                    |                    |                             | 168 (A) (B) (C) (D) |                            |                            |                     |
|                    |                    |                             | 169 (A) (B) (C) (D) |                            |                            |                     |
|                    |                    |                             | 170 (A) (B) (C) (D) |                            |                            |                     |
|                    |                    |                             | 171 (A) (B) (C) (D) |                            |                            |                     |
|                    |                    |                             | 172 (A) (B) (C) (D) |                            |                            |                     |
|                    |                    |                             | 173 (A) (B) (C) (D) |                            |                            |                     |
|                    |                    |                             | 174 (A) (B) (C) (D) |                            |                            |                     |

FOR OFFICE USE

- > 10 f GK \_\_\_\_\_
- > 5 f Air \_\_\_\_\_
- > 4 f Comb \_\_\_\_\_
- > 4 f Tank \_\_\_\_\_
- > 6 f Haz \_\_\_\_\_
- > 4 f D/T \_\_\_\_\_
- > 4 f Pass \_\_\_\_\_
- > 3 f SB \_\_\_\_\_

**The application for a commercial driver license will ask this question:**

- Do you meet all the driver qualifications in 49 CFR 391?**

**If yes, present your federal medical card to the licensing staff.**

---

**All applicants for  
CDL's will need  
to certify whether  
they meet the  
Federal Qualifications  
for driving.**

---

**All applicants will need to:**

**✓ complete a vision screening in the motor vehicle service center**

**or**

**✓ bring in a report from a vision specialist.**

**The federal card is acceptable,  
if:**

- ✓ A licensed doctor  
of medicine or  
o s t e o p a t h y  
signed the card.**
  
  - ✓ The exam date is  
within the last 24  
months.**
-

**If the applicant doesn't present the federal card, the CDL will have restrictions:**

- ✓ Intrastate operation only**
  - ✓ 100 mile radius of home office or the official worksite of the vehicle**
-

**Applicants for a Sor P  
endorsement must:**

**✓ present their federal  
medical card**

**or**

**✓ file a WI medical  
report**



**All CDL applicants must answer questions on the driver license application about:**

- ✓ Brain injury**
  - ✓ Diabetes**
  - ✓ Heart disease**
  - ✓ Lung disease**
  - ✓ Mental illness**
  - ✓ Muscle or nerve disease**
  - ✓ Seizure disorder**
  - ✓ Stroke**
-

**For an unrestricted CDL, the applicant must have:**

- ✓ 20/40 visual acuity in each eye**
  - ✓ 70 degrees field of vision in each eye**
-

## Times for testing

CDL testing is performed at customer service centers in 46 Wisconsin cities. Below is a list of test sites, dates and times for the next few months.

DESIRED TEST CITY	TEST LOCATION	TEST DATES AND TIMES
ANTIGO	Technical Institute Forest Avenue	Sept. & Oct. 1-3-5 Wed. 5:15 pm - 8:15 pm
APPLETON	Northland Mall 720 W. Northland Avenue	Sept. 8 & 20, Oct. 4 & 10 8:30 - 8:30pm Sept. 22 & 29, Oct. 13 & 27 8:00 - 11:00am Oct. 20th - 8:00 am
ARCADIA	Ashley Furniture 305 Madison Street	
SARASCO	UW Campus 1008 Connie Road	Nov. 3rd - 8:00 am
BEAVER DAM	Moraine Park Tech. College 700 Gould Street Room 201 & 202	Sept. 8th - Oct. 27th Saturdays - 8:00 am
BLACK RIVER FALLS	American Legion Bldg. Hwy. 54 West	Oct. 16th - 8:30 pm
DARLINGTON	High School Auditorium 11838 Center Hill Road	Nov. 3rd - 8:00 am
DODGEVILLE	City Hall 100 E. Fountain St.	Oct. 18th - 7 pm
EAU CLAIRE	Exam Station 3115 Melby Road	Sept. 22nd & Oct. 13th Saturday - 8:00 am
ELKHORN	Gateway Technical Institute 400 South Hwy. H Room 306	Sept. 15th - Oct. 13th Saturdays - 8:15 am
FENNIMORE	Vocational School (VTAS) Bronson Boulevard	Oct. 20th - 8:00 am
D DU LAC	Exam Station 833 S. Rolling Meadows	Sept. 15th - Oct. 6th Saturdays - 8:00 am
FRIENDSHIP	Adams/Marquette Elec. Coop. 401 Lake Street	Oct. 10th - 8:30 pm
GREEN BAY	Department of Transportation 942 Vanderpennen Way	Sept. 12 & 26, Oct. 10 & 24 8:30 pm - 8:30 pm Sept. 22 & 29, Oct. 13 & 27 8:00 - 11:00am Oct. 6th - 9:00 am
HILLSBORO	Freman's Community Center 205 Mill Street	
JANESVILLE	Blackhawk Tech. College 6004 Prairie Road Room 2509 - 2511	Sept. 8th - Oct. 27th Saturdays - 8:00 am
KENOSHA	Gateway Technical Institute 3520 30th Avenue, Room 330	Sept. 15th - Oct. 13th Saturdays - 8:15 am
LA CROSSE	UW Business Ed. Bldg. 405 N. 6th Street	Oct. 13th - 8:00 am
MADISON	Madison Area Tech. College 3350 Anderson Street Room 350	Sept. 8th - Oct. 27th Saturdays - 8:00 am
MANITOWOC	Adult Learning Center 1401 Clark St.	Sept. 15th - Oct. 6th Saturdays - 8:00 am
MARSHFIELD	503 S. Cherry Avenue	Sept. & Oct. 2-4 Friday 8:00 pm - 8:30 pm Oct. 18th - 8:30 pm
MAUSTON	Juneau Co. Courthouse 220 La Crosse Street	
MILWAUKEE	NW Driver Licensing Station 7301 W. Mill Road	Saturdays - 2 sessions 1st check-in 8:00 am 2nd check-in 10:00 am
MILWAUKEE	SW Driver Licensing Station 5500 W. Grange Avenue	Saturdays - 2 sessions 1st check-in 8:00 am 2nd check-in 10:00 am
NEILLSVILLE	Neillsville High School Multi-Media Room (PIT)	Oct. 22nd - 8:00 pm
OSH	Exam Station 2301 Omro Road	Sept. 22nd - Oct. 13th Saturdays - 8:00 am
PLATTEVILLE	High School Commons 710 E. Madison	Nov. 7th - 7:00 pm

PORTAGE	John Muir Middle School 2800 Woodcrest Drive	Dec. 1st - 8:00 am
PRAIRIE DU CHIEN	High School Auditorium 800 E. Crawford	Oct. 19th - 8:30 pm
RACINE	Gateway Technical Institute 1001 South Main St. Lake Bldg., Room 115	Sept. 15th - Oct. 13th Saturdays - 8:15 am
REEDSBURG	National Guard Armory 549 S. Dewey Avenue	Oct. 27th - 8:00 am
RHINELANDER	Highway's Building Hanson Lake Road	Sept. & Oct. Every Mon. 9:30 am - 8:00 pm
RICE LAKE	Exam Station 737 West Avenue	Sept. 22nd & Oct. 13th Saturday - 8:00 am
RICHLAND CENTER	UW Campus Hwy. 14 West	Oct. 10th - 6:30 pm
SAUK CITY	Community Center 730 Monroe Street	Nov. 28th - 5:00 pm
SHEBOYGAN	Exam Station 3803 Kohler Memorial Dr.	Sept. 15th - Oct. 6th Saturdays - 8:00 am
STEVENS POINT	Y.M.C.A. 1924 Briggs Street	Sept. & Oct. 2-4 Tues. 5:15 pm - 8:00 pm
SUPERIOR	Exam Station 1701 N. 4th St.	Sept. 22nd & Oct. 13th Saturday - 8:00 am
TOMAH	Masonic Lodge 520 E. Saratoga	Oct. 23rd - 8:30 pm
VIROQUA	National Guard Armory Draon Street	Oct. 20th - 9:00 am
WATERTOWN	Madison Area Tech. College - Watertown Room 4 1300 W. Main Street, Hwy 19	Sept. 8th - Oct. 27th Saturdays - 8:00 am
WAUKESHA	Waukesha County Tech. College Business Occupational Bldg. 800 Main Street, Room 8218 Pewaukee	Sept. 15th - Oct. 13th Saturdays - 8:00 am
WAUPACA	1300 E. Royalton	Sept. & Oct. 1-3 Mon. 5:30 pm - 8:30 pm
WAUSAU	DOT/DNR Building 5301 Rib Mt. Drive	Sept. & Oct. 1-3 Wed. 5:00 pm - 8:00 pm
WEST BEND	New Exam Station 1516 W. Paradise Drive	Oct. 6th - Oct. 27th Saturdays - 8:00 am
WISCONSIN RAPIDS	Highway's Building 1991 2nd Avenue South	Sept. & Oct. 2-4 Mon. 8:00 pm - 8:00 pm

## CDL training tapes available

A training program developed by the Pennsylvania Department of Transportation to help drivers prepare for the written portion of the CDL test is now available on loan or for sale. Four videotapes, providing 4 and a half hours of instruction, follow the Wisconsin CDL manual. To borrow, contact the UW-Extension Traffic Information Center at the address below and ask for number 16810. To purchase for \$50, make check payable to the UW Extension and send to 432 N. Lake St., Room 741, Madison 53706.

Transportation Information Center  
University of Wisconsin-Madison  
432 North Lake Street, Room 741  
Madison, WI 53706

If you have questions or topics that you would like to see addressed in this newsletter, write to:  
Bureau of Driver Services, Room 351  
P.O. Box 7917  
Madison, WI 53707-7917

Cross-Reference to CDL Test Answers

101 - 200

8/01/90  
SERIES A

101	2-42 (7)	126	7-17 (1)	151	6-16 (2)	176	2-24 (2,5)
102	3-5 (2)	127	7-15 (8,9)	152	2-22 (2)	177	2-23 (5)
103	3-5 (1)	128	7-18 (5)	153	2-23 (5)	178	4-4 (5)
104	3-5 (4)	129	7-16 (9)	154	2-30 (9)	179	2-4 (2) 4-2 (4)
105	2-39 (6-8)	130	7-10 (1)	155	6-16 (2)	180	2-23 (6)
106	3-5 (1)	131	7-16 (7)	156	6-12 (7)	181	4-5 (4)
107	2-22 (2)	132	7-17 (5)	157	5-8 (7-9)	182	2-12 (8) 4-2 (5)
108	2-41 (7-11)	133	7-17 (4)	158	6-1 (6,7) 6-2 (1,2)	183	4-5 (6)
109	2-38 (4)	134	7-11 (9)	159	2-16 (12) 2-17 (1)	184	4-3 (3)
110	3-4 (6)	135	7-12 (10)	160	2-41 (7)	185	4-2 (1)
111	2-39 (1)	136	7-16 (1)	161	2-21 (1) 6-2 (3)	186	4-12 (4)
112	3-4 (7)	137	7-12 (8)	162	2-22 (3) 2-27(11) 2-28(1)	187	4-9 (2)
113	3-5 (1)	138	7-1 (4)	163	5-4 (7)	188	4-13 (3)
114	3-4 (8)	139	7-15 (6)	164	6-14 (1)	189	4-14 (3)
115	2-21 (1) 6-2 (3)	140	7-12 (9) 7-13 (3)	165	6-7 (7) 6-13 (3)	190	4-8 (6)
116	7-19 (4)	141	7-16 (5)	166	4-3 (1)	191	4-7 (3)
117	7-4 (3)	142	7-8 (4)	167	2-20 (4)	192	4-11 (7)
118	7-8 (3)	143	7-16 (8)	168	2-2 (1) 4-1 (4)	193	4-9 (2,3)
119	7-7 (2)	144	7-15 (7)	169	2-16 (12) 2-17 (1)	194	4-9 (2)
120	7-11 (2)	145	7-17 (6,8) 7-18(1,3) 7-19(3)	170	2-22 (2)	195	4-9 (2)
121	7-15 (5)	146	2-23 (6)	171	4-1 (5)	196	4-13 (9)
122	7-1 (6)	147	6-12 (8)	172	2-2 (3) 2-27(11) 2-28(1)	197	4-11 (10,1) 4-12 (1)
123	7-2 (4)	148	2-16 (2,4)	173	2-35 (5) 2-36 (5,11)	198	4-12 (4)
124	7-4 (1)	149	2-33 (6,7)	174	4-2 (6)	199	4-15 (2)
125	7-7 (3,5)	150	6-13 (3)	175	4-4 (2)	200	4-8 (9)

**Cross-Reference To CDL Test Answers  
OR, Where Do You Find That In The Book ?**

1 -100

8/01/90  
SERIES A

Partial paragraphs and graphics counted as paragraphs. Answers can often be found in several places in manual (not all listed here).

?	Page	(Par)								
1	2-34	(1,2)	26	2-39	(9)	51	5-5	(7)	76	6-11 (1)
2	2-41	(12)	27	2-26	(2)	52	5-8	(10)	77	6-9 (5)
							5-9	(1)		
3	2-20	(5)	28	2-29	(1)	53	5-2	(3)	78	6-7 (4)
	2-33	(5)								
4	2-18	(7)	29	2-36	(10)	54	5-6	(4)	79	5-7 (7)
5	2-15	(5)	30	2-7	(1)	55	5-7	(7)	80	6-9 (1)
6	2-8	(2)	31	2-33	(4)	56	5-1	(3)	81	6-5 (7)
7	2-16	(4)	32	2-15	(9)	57	5-4	(9)	82	6-8 (3)
8	2-30	(9)	33	2-21	(3)	58	5-2	(7)	83	6-6 (2)
										6-9 (6)
9	2-41	(9,10)	34	2-25	(3)	59	5-5	(3)	84	6-5 (8)
	2-42	(7)								
10	2-31	(3)	35	2-47	(5,8)	60	5-1	(7)	85	6-7 (8)
				2-48	(3)					
11	2-48	(1-3)	36	2-12	(4)	61	5-9	(7)	86	6-10 (4)
12	2-21	(3)	37	2-22	(4)	62	5-6	(6)	87	6-10 (2)
13	2-38	(2)	38	2-44	(10)	63	5-2	(1,4)	88	6-9 (6,7)
							5-10	(3)		
14	2-49	(2)	39	3-1	(9)	64	5-9	(3)	89	6-7 (2)
	2-50	(2)		3-2	(7-9)					
15	2-39	(3)	40	2-43	(8-10)	65	5-2	(5)	90	6-1 (4,5)
16	2-16	(10)	41	2-38	(4)	66	5-4	(2)	91	6-9 (6)
	2-17	(2,3)								
17	2-44	(10)	42	2-2	(1)	67	5-8	(7)	92	6-6 (1,5)
18	2-23	(5)	43	2-13	(9)	68	5-4	(1)	93	6-10 (4)
19	2-28	(1)	44	2-19	(1)	69	5-8	(3)	94	6-9 (4)
20	2-13	(2)	45	2-2	(3)	70	5-4	(3)	95	6-7 (1)
				2-3	(1)					
21	2-50	(3)	46	2-17	(10)	71	5-8	(9)	96	2-34 (2)
22	2-40	(11)	47	2-14	(7)	72	5-4	(9)	97	2-38 (5)
	2-41	(1,2)		2-15	(2)					
23	2-46	(1)	48	2-33	(7)	73	5-5	(4)	98	2-21 (3)
							5-10	(1)		
24	2-42	(3-5)	49	2-22	(3)	74	5-2	(6)	99	3-5 (3)
							5-9	(4,5)		
25	2-24	(6)	50	3-2	(10)	75	5-2	(1)	100	2-28 (1)

## CDL STUDY GUIDE 9/11/90

Partial paragraphs and graphics counted as paragraphs. Answers can often be found in several places in manual (not all listed here).

?	Page	(Par)									
1	2-34	(7)	26	2-39	(1)	51	5-7	(7)	76	6-10	(4)
2	2-20	(3)	27	2-46	(3)	52	5-9	(3)	77	6-9	(6)
3	2-19	(1)	28	2-26	(1)	53	5-4	(1)	78	6-9	(6,7)
4	2-19	(3)	29	2-48	(3)	54	5-1	(3)	79	6-9	(6)
5	2-12	(9)	30	2-31	(1)	55	5-2	(5)	80	6-9	(7)
6	2-42	(7)	31	2-34	(1,2)	56	5-2	(1)	81	6-10	(2-4)
7	3-5	(6,7)	32	2-40	(6)	57	5-8	(3)	82	6-9	(4)
8	2-35	(2)	33	2-15	(5)	58	5-9	(4,5)	83	6-1	(4)
9	2-22	(2)	34	2-31	(4)	59	5-6	(3)	84	6-10	(4)
9	2-18	(1,3,8)	34	2-32	(2,5)	60	5-4	(9)	85	6-2	(3)
10	3-2	(11)	35	2-28	(1)	61	5-9	(1)	86	6-6	(5)
11	2-41	(5)	36	2-8, 2-9,		62	5-3	(1)	87	6-8	(6)
12	2-26	(3)	37	2-10		63	5-10	(1)	88	6-7	(4)
13	2-46	(5)	37	2-13	(9,13)	64	5-8	(9)	89	6-11	(1)
14	2-16	(9)	37	2-14	(1,2)	65	5-4	(9)	90	6-8	(3)
15	2-2	(4)	37	2-29	(6)	66	5-7	(2)	91	6-7	(1)
16	2-4	(1)	38	2-39	(6,7)	67	5-2	(4)	92	6-5	(7)
16	2-40	(2)	39	2-41	(12)	68	5-2	(7,8)	93	5-7	(7)
17	2-2	(1)	40	2-43	(4)	69	5-5	(7)	94	6-7	(8)
18	2-33	(1)	41	2-19	(2)	70	5-6	(6)	95	6-9	(1)
18	2-33	(5)	42	2-33	(4)	71	5-9	(7)	96	2-42	(7)
19	2-38	(5)	43	2-15	(8)	72	5-1	(7)	97	3-5	(4)
20	2-31	(6)	44	2-16	(4)	73	5-5	(3)	98	2-22	(2)
21	2-12	(8)	45	2-21	(12)	74	5-4	(1)	99	2-39	(1)
22	2-38	(4)	46	2-24	(1)	75	5-8	(7)	100	2-41	(8-10)
23	2-2	(2)	47	2-24	(7)						
24	2-50	(3)	48	2-30	(11)						
25	2-47	(5)	49	2-44	(10)						
			50	3-1	(2)						

?	Page	(Par)									
101	2-27	(11)	126	7-4	(1)	151	6-12	(7)	176	4-1	(4)
	2-28	(1)									
102	2-38	(5)	127	7-1	(4)	152	2-38	(6)	177	4-5	(4)
103	3-5	(1)	128	7-9	(1)	153	6-14	(1)	178	4-2	(4)
104	2-39	(6)	129	7-15	(1)	154	2-41	(7)	179	4-2	(1)
							6-3	(4)			
105	3-5	(3)	130	7-12	(8)	155	2-24	(2, 4-5)	180	4-5	(6)
106	3-4	(5)	131	7-1	(5)	156	6-12	(8)	181	4-3	(3)
107	3-5	(1)	132	7-18	(1)	157	2-17	(7)	182	2-35	(7)
108	2-38	(4)	133	7-1	(7)	158	6-1	(7)	183	4-5	(1)
							6-2	(1)			
109	3-5	(1)	134	7-16	(9)	159	6-13	(3)	184	4-2	(5)
110	3-4	(7)	135	7-8	(7)	160	6-15	(5)	185	2-23	(5)
111	3-5	(2)	136	7-9	(6)	161	6-5	(3-5)	186	4-11	(10)
										4-12	(1)
112	2-21	(1)	137	7-7	(2)	162	6-13	(3)	187	4-14	(3)
113	3-4	(8)	138	7-17	(2)	163	2-23	(5)	188	4-9	(2)
114	2-21	(3)	139	7-12	(10)	164	6-1	(6-7)	189	4-8	(6)
							6-2	(1)			
115	2-34	(2)	140	7-2	(5)	165	2-31	(1)	190	4-8	(7-9)
	2-40	(7)									
116	7-17	(3)	141	7-6	(1)	166	2-22	(2)	191	4-12	(4)
117	7-5	(2)	142	7-15	(7)	167	4-4	(2)	192	4-7	(3)
										4-15	(2)
118	7-11	(10)	143	7-19	(2)	168	2-16	(2)	193	4-11	(7)
119	7-16	(4)	144	7-15	(6)	169	4-3	(1)	194	4-8	(15)
										4-9	(2)
120	7-2	(6)	145	7-14	(5)	170	2-27	(11)	195	4-12	(4)
							2-28	(1)			
121	7-17	(5)	146	6-7	(8)	171	4-2	(6)	196	4-9	(2)
122	7-7	(3)	147	6-2	(5)	172	2-16	(12)	197	4-7	(3)
							2-17	(1)			
123	7-12	(3)	148	6-4	(1, 3)	173	4-1	(6)	198	4-9	(2)
124	7-16	(8)	149	2-22	(2)	174	2-17	(7)	199	4-13	(3)
125	7-16	(6)	150	2-20	(4)	175	4-3	(2)	200	4-13	(9)



## CDL AIR BRAKE TEST

1. When driving down a long grade; it is best to:
  - A. Apply light brakes; then release and reapply when your speed builds back up
  - B. Apply strong brake pressure in a pumping action
  - C. Apply light steady pressure all the way down the grade
  - D. Kick the transmission out of gear and only brake when needed
2. The application air gauge shows:
  - A. Total air pressure in air system
  - B. Amount of pressure currently being applied by brake pedal
  - C. How much air has been used since beginning the trip
  - D. None of the above
3. The low air pressure warning will activate at approximately:
  - A. 60 psi
  - B. 30 psi
  - C. 20 psi
  - D. 80 psi
4. If you experience a severe air loss and the service brake system is no longer working; which brake system is used to stop the vehicle?
  - A. Parking brake system
  - B. Interlock air lock system
  - C. Service brake system
  - D. Emergency brake system
5. Air tanks should be drained at least:
  - A. Daily
  - B. Weekly
  - C. After each dispatch
  - D. Every 4 hours
6. An alcohol evaporator:
  - A. Injects alcohol into the air lines to help prevent freezing
  - B. Is used instead of an air dryer
  - C. Removes alcohol from air lines
  - D. Should be used only on hydraulic brake systems
7. The air compressor governor determines:
  - A. Amount of air sent to brakes when brake pedal is depressed
  - B. How fast the air compressor is allowed to run
  - C. The cut-in and cut-out pressure
  - D. All of the above
8. If you experience a sudden drop in the air system; you should:
  - A. Continue driving and say an effective prayer
  - B. Continue driving but only to the next repair shop
  - C. Keep your eye on the gauge and hope it will build the pressure back up
  - D. Stop immediately when safe to do so



9. At approximately 20-45 psi:
- A. The low air pressure buzzer will activate
  - B. Spring brakes will apply automatically
  - C. Nothing unusual will happen
  - D. The air compressor governor will quit working
10. Vehicles equipped with air brakes must have:
- A. At least two air tanks; one on tractor and one on trailer
  - B. An air pressure gauge
  - C. A dual air brake system
  - D. Automatic air drains
11. When a driver depresses the brake pedal; what air brake system is he using?
- A. Service brakes
  - B. Emergency brakes
  - C. Parking brakes
  - D. Both A and B
12. Emergency brakes are activated:
- A. By the brake pedal
  - B. By the "S" Cam
  - C. By a loss of air pressure
  - D. All of the above
13. Which of the following is the most common foundation brake found on commercial vehicles?
- A. Wedge and drum
  - B. Disc
  - C. "S" Cam drum
  - D. None of the above
14. If the air system develops a leak; which of the following prevents the air from escaping out of the system?
- A. Air compressor
  - B. Emergency brake system
  - C. The emergency relay valve
  - D. The one-way check valve
15. The spring brakes; or emergency braking system:
- A. Will always work
  - B. Will work only if the brakes are adjusted properly
  - C. Cannot be tested by one person during a pre-trip inspection
  - D. Will work properly; regardless of the brake adjustment