

DOCUMENT RESUME

ED 330 882

CE 057 715

TITLE Rescue Manual. Module 8.  
 INSTITUTION Ohio State Univ., Columbus. Instructional Materials Lab.  
 PUB DATE 89  
 NOTE 72p.; For related modules, see CE 057 708-717. Photographs may not reproduce well.  
 AVAILABLE FROM Instructional Materials Laboratory, Ohio State University, 842 West Goodale Blvd., Columbus, OH 43212 (\$8.50; set of 10, \$33.00).  
 PUB TYPE Guides - Classroom Use - Instructional Materials (For Learner) (051)

EDRS PRICE MF01/PC03 Plus Postage.  
 DESCRIPTORS \*Accidents; \*Emergency Programs; \*Emergency Squad Personnel; First Aid; Learning Modules; Occupational Safety and Health; Postsecondary Education; \*Rescue; Safety; Safety Education  
 IDENTIFIERS \*Aircraft; \*Helicopters

ABSTRACT

This learner manual for rescuers covers the current techniques or practices required in the rescue service. The eighth of 10 modules contains 6 chapters: (1) trench rescue; (2) shoring and tunneling techniques; (3) farm accident rescue; (4) wilderness search and rescue; (5) aircraft rescue; and (6) helicopter information. Key points, an introduction, and conclusion accompany substantive material in each chapter. (NLA)

\*\*\*\*\*  
 \* Reproductions supplied by EDRS are the best that can be made \*  
 \* from the original document. \*  
 \*\*\*\*\*

# RESCUE MANUAL

U.S. DEPARTMENT OF EDUCATION  
Office of Educational Research and Improvement  
EDUCATIONAL RESOURCES INFORMATION  
CENTER (ERIC)

This document has been reproduced as received from the person or organization originating it.  
Minor changes have been made to improve reproduction quality.

Points of view or opinions stated in this document do not necessarily represent official OERI position or policy.

"PERMISSION TO REPRODUCE THIS MATERIAL HAS BEEN GRANTED BY

*A. Scuffs*

TO THE EDUCATIONAL RESOURCES INFORMATION CENTER (ERIC)."

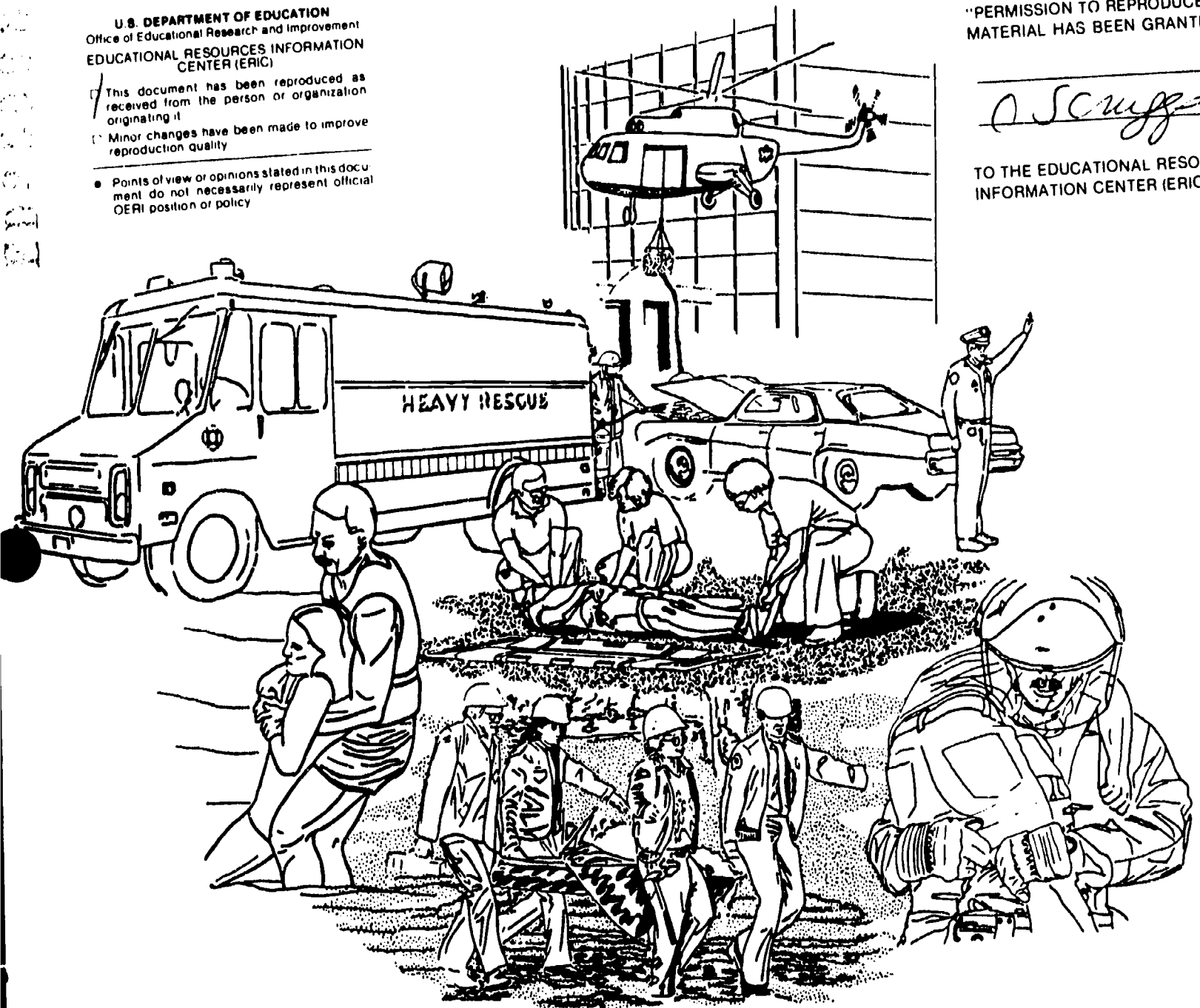

## MODULE 8

Trench Rescue  
Shoring and Tunneling Techniques  
Farm Accident Rescue

Wilderness Search and Rescue  
Aircraft Rescue  
Helicopter Information

**BEST COPY AVAILABLE**

2

**INSTRUCTIONAL MATERIALS LABORATORY**  
THE OHIO STATE UNIVERSITY  
COLUMBUS, OHIO 43210

Copyright 1989 by The Ohio State University. All rights reserved.

Edited and distributed by the  
Instructional Materials Laboratory  
The Ohio State University  
College of Education  
Columbus, Ohio 43210

Rescue operations may subject both rescuer and victim to the possibility of injury or death. Rescuers must understand the nature and effect of each rescue technique, and practice techniques regularly, using this text to enhance their learning. The materials and information presented here are intended only as a learning aid, and are no substitute for training. Expert opinions, recommendations, and guidelines change as research and experience refine procedures. This text includes the most up-to-date information from rescuers working in the field.

Specialized procedures require demonstration and training by subject-matter experts. It is not likely that a rescuer will become proficient in all rescue operations. Most rescuers develop proficiency in only a few areas but may be familiar with several others.

This text suggests procedures and explains how to do them. The techniques given are guidelines only. Each department should incorporate its own procedures and address local needs.

**Nondiscrimination Policy** — The policy of The Ohio State University, both traditionally and currently, is that discrimination against any individual for reasons of race, color, creed, religion, national origin, sex, age, handicap, or Vietnam-era veteran status is specifically prohibited. Title IX of the Education Amendments of 1972 prohibits sex discrimination and Section 504 of the Rehabilitation Act of 1973 prohibits discrimination on the basis of handicap in education programs and activities. Accordingly, equal access to employment opportunities, admissions, education programs, and all other University activities is extended to all persons, and the University promotes equal opportunity through a positive and continuing affirmative action program.

# **RESCUE MANUAL**

**INSTRUCTIONAL MATERIALS LABORATORY  
THE OHIO STATE UNIVERSITY  
COLUMBUS, OHIO 43210**

## ACKNOWLEDGEMENT

Acknowledgment is extended to the following persons for their willingness to share their knowledge and expertise and for authoring information presented in this module:

### Trench Rescue

Louis Vargo, Fire Chief, Mt. Pleasant Fire Department, Mt. Pleasant, Ohio

### Shoring and Tunneling Techniques

Louis Vargo, Fire Chief, Mt. Pleasant Fire Department, Mt. Pleasant, Ohio

### Farm Accident Rescue

Albert Pugh, Professor Emeritus, The Ohio State University, Columbus, Ohio

### Wilderness Search and Rescue

Charles Foster, Ohio Department of Natural Resources (ODNR), Division of Forestry, Columbus, Ohio

### Aircraft Rescue

Tom Beverly, Columbus Division of Fire, Columbus, Ohio

### Helicopter Information

Larry Young, Aviation Management Training Specialist, and the Office of Aircraft Services, Department of the Interior, Boise, Idaho

## FOREWORD

The intent of this manual for rescuers is to provide the latest instructional content and serve as an up-to-date, comprehensive source of information covering the current techniques or practices required in the rescue service. To help in this endeavor, an instructor's manual has been developed to be used in conjunction with this learner's manual. The manual has been produced in a series of modules to facilitate future revisions more rapidly and cost effectively.

The instructor's manual follows the key points identified in the text. Chapters have been included in the text which exceed those printed in any other resource. These include managing and operating the emergency vehicle, rope rescue techniques, industrial rescue, farm accident rescue, and various water emergency procedures, among others.

That the rescue profession is a dangerous and challenging career is a recognized fact. It is our hope that this text will help the rescuer meet the challenges of the rescue service in a safe and professional manner.

Tom Hines  
Director  
Instructional Materials Laboratory  
College of Education  
The Ohio State University

## PREFACE

The Ohio State University Instructional Materials Laboratory has played a major role in the training of public safety personnel through the development of text materials for many years. Due to the advances in the rescue techniques, it became apparent that the existing text was obsolete. Upon the advice of many knowledgeable people in the rescue service, the Instructional Materials Laboratory initiated the development of a new text that would be easily updated, and address the needs of the rescuer. To this end, an editorial review board representing a broad spectrum of individuals in the various phases of the research profession was convened to determine what topics this text should address. The culmination of this effort is the Rescue Manual. It is hoped that this text will be useful to not only the new rescuer but will serve as a reference source for the experienced rescuer.

Joyce Leimbach  
Curriculum Consultant  
College of Education  
The Ohio State University

Ronald Slane  
Technical Consultant  
College of Education  
The Ohio State University

# MODULE 8

## TABLE OF CONTENTS

Trench Rescue.....	1
Shoring and Tunneling Techniques.....	7
Farm Accident Rescue.....	19
Wilderness Search and Rescue.....	49
Aircraft Rescue.....	57
Helicopter Information.....	63

## MODULE CONTENTS

The 1989 Rescue Manual has been grouped into ten modules in accordance with the recommendations from the Rescue Editorial Board.

### Module 1

Introduction  
Occupational Stresses in Rescue Operations  
Size-up  
Critique  
Reporting and Recordkeeping  
Tools and Equipment for Rescue Operations  
Planning for Emergency Operations  
Incident Command System  
Mass Casualty Planning  
Dealing with Natural Disasters

### Module 2

Patient Care and Handling Techniques  
Rescue Carries and Drags  
Emergency Vehicle Operation  
Self-Contained Breathing Apparatus  
Protective Clothing

### Module 3

Forcible Entry  
Structure Search and Rescue  
Rescue Operations Involving Electricity  
Cutting Torches

### Module 4

Construction and Characteristics of Rescue Rope  
Knots, Bends, and Hitches  
Critical Angles  
Belay Systems  
Raising Systems  
Rigging  
Using the Brake-Bar Rack for Rope Rescue  
Rope Rescue Techniques  
Aerial Ladder and Aerial Platform Rescue

### Module 5

Hazardous Materials

### Module 6

Industrial Rescue  
Rescue From a Confined Space  
Extrication From Heavy Equipment  
Rescue Operations Involving Elevators

### Module 7

Extrication From Vehicles

### Module 8

Trench Rescue  
Shoring and Tunneling Techniques  
Farm Accident Rescue  
Wilderness Search and Rescue  
Aircraft Rescue  
Helicopter Information

### Module 9

Ice Characteristics  
River Characteristics and Tactics for Rescue  
Water Rescue Techniques  
Water Rescue/Recovery Operations  
Dive Operations  
Water Rescue Equipment  
Water Rescue Safety Tips

### Module 10

Glossary  
Appendix

---

## PUBLIC SAFETY SERVICES PUBLICATIONS AVAILABLE

For ordering and pricing information contact:

Instructional Materials Laboratory  
The Ohio State University  
842 W. Goodale Blvd.  
Columbus, Ohio 43212  
Phone (614) 221-4950



# TRENCH RESCUE

## KEY POINTS

- Trench rescue incidents
- Equipment needed for trench rescue
- Hazards encountered in trench rescue
- Executing a trench rescue

## INTRODUCTION

Fire fighters, EMTs, and rescue personnel respond to many emergencies during their daily work routine. However, incidents involving cave-ins and trench rescues are rare occurrences that require special training. Even though trenches and ditches can be found in every city, town, or rural area, rescuers are seldom given specialized training in procedures for such emergencies. Pipelines, sewage systems, and excavation areas are a part of the American landscape, and fire fighters in every community must be prepared to handle incidents requiring trench rescue techniques, even though incidents of this kind are rare. This chapter will attempt to show ways to adapt equipment and develop rescue techniques to prepare for such emergencies.

## TRENCH RESCUE INCIDENTS

Preplanning for a trench rescue is virtually impossible, since most trenches are created as part of a temporary construction process. A trench that is present today may be filled in next week. OSHA requires that any trench greater than five feet deep must be made safe with shoring; however, since trenches are temporary, some contractors do not take the time to shore and others are just inexperienced. Improperly shored trenches may cave in. Other factors that may lead to trench cave-ins include loose or sandy soil, soil that has been piled too close to the edge of the trench, weather conditions such as rain or thawing ground, seepage of natural water, and the weight of heavy-construction equipment or its vibration in operation.

### Resources for Trench Rescue

Since trench rescues are rare, a resource directory

may be the most valuable item available to the rescuer. In addition to the usual listings, a fire department resource directory should include the names and telephone numbers of contractors who specialize in trench work. They are the local experts who will be able to provide valuable assistance with equipment such as cranes, backhoes, shoring equipment, and air compressors in an emergency situation. Remember that the supervisors, engineers, and workers at the rescue site can provide expertise, even when under stress during an incident. Listings should also include lumber yards that have plywood, lumber, and nails that may be needed. It is also important to have the name of each company's contact person with a telephone number for work and residence.

It is important to scan the community to find providers of equipment that can be obtained for trench rescue operations. Review the city, county, and state agencies for equipment available from water, street, and sewage departments.

## EQUIPMENT FOR TRENCH RESCUE

**Ditch jacks.** Ditch jacks or screw jacks can be used to support sheeting material. Several may be required for one major trench rescue (see Figure 1). Ditch jacks can also be used as pneumatic or hydraulic tools.

**Tool kits.** Most fire departments carry a variety of hand tools that are necessary in trench rescue operations. It is especially important to have a variety of shovels available. A military-type shovel (see Figure 2) should be included.

**Saws.** Rescue saws, chain saws, circular saws, and hand saws may be used to cut sheeting and shoring material.



Figure 1. Ditch Jack



Figure 2. Collapsible Shovel

**Smoke ejectors.** In the absence of blowers, smoke ejectors can be used to ventilate a ditch or trench. Smoke ejectors with ducts will be especially useful.

**Airbags.** Airbags have a limited use in trench rescue operations; however, they can be used to fill a void between the trench wall and the sheeting. When using an airbag, care must be taken not to place too much pressure on the sheeting, which can cause the collapse of the shoring.

**Gas monitoring devices.** Any trench, especially those greater than five feet deep, is considered a confined space. Before entering a confined space during a rescue operation, gas monitoring devices should be used to insure that oxygen levels are adequate and lethal gases are not present (see Figure 3).

**Fire service ladders.** Fire service ladders can be used to help support the weight of a rescuer working close to a trench. The rescuer's weight will



Figure 3. Gas Monitoring Device

be distributed over the length of the ladder, which should be placed parallel to the trench. Roof and attic ladders can be used to enter the trench.

**Portable Pumps.** Depending on the amount of water in a trench from natural seepage or from a water pipe break, it may be necessary to have the water evacuated before a rescue can be executed. The weight of a fire engine positioned close to the trench will jeopardize the rescue, portable pumps should be used to evacuate the water.

### Hazards in Trench Rescue Operations

As in any rescue operation, potential hazards in trench rescues must be eliminated immediately after sizing up the situation. Electrical wires must be removed from the area if they pose a potential problem to the rescuer. If a water line is leaking it must be controlled, either by the rescue personnel or by the local water company. In the event of a gas line leak, the gas company must be called to shut the line down and eliminate all ignition sources.

In trench rescues, the greatest danger to the victim and the rescuers is a further cave-in. Traffic should be controlled on all sides of the trench. All bystanders and any equipment not essential to the rescue operation must be removed from the area. Any unnecessary weight on the edges of the trench should be safely removed if possible. If it is determined that moving equipment may jeopardize the operation, the equipment may be left, but steps must be taken to support the weight of the equipment to prevent a further cave-in.

A hazard zone determined by the ground and its stability should be established surrounding the entrapment. This zone will vary with the trench and

the surrounding area. The boundaries must be marked with traffic cones or barrier tape, and all personnel must be made aware of who is permitted inside the hazard zone. Only personnel assisting with the rescue operations should be allowed to enter. Policing this area from all directions is necessary for a safe, effective rescue.

## THE RESCUE

Only when hazards have been removed and adequate equipment and personnel are in place should the rescue process begin. The incident commander should establish a command post outside the hazard zone where consultation with engineers, contractors, municipal officials, and others can take place. A staging area for equipment and supplies should be established, along with a work area where shoring and sheeting can be cut and prepared for use.

### Preparing the Trench

Before rescuers enter the trench, ladders or 4' x 8' sheets of plywood should be placed alongside the trench, giving the rescuers a base from which to work. If dirt or rocks leave an uneven footing, flat shovels should be used to level the area.

The trench should be ventilated and air quality should be monitored prior to and throughout the rescue. The trench should be measured and the shoring should be cut to fit. Once the sheeting is cut, a 2" x 10" or 2" x 12" should be nailed upright to the center of the sheeting for all jacks or shoring to be attached. If plywood is used, it should be 1" or more in thickness. A piece of 2" x 4" x 10" should then be placed across the 2" x 10" and nailed at ground level, in the middle (if the depth is greater than five feet), and at one foot from the bottom (see Figure 4). The sheeting should then be placed on both sides of the trench.

An attic or roof ladder should then be placed in the trench and a rescuer with a lifeline attached should enter the trench to waist level. A ditch jack should be placed in the top 2" x 4" support and secured by the rescuer. The rescuer should be aided by other rescuers who lower the jack into place by using short pieces of rope. The rescuer should then place jacks on the middle and lower supports (see Figure 5).

If shoring is used, the distance between the two pieces of sheeting should be measured and 4" x 4" shore cut to fit. This shore should be placed on the

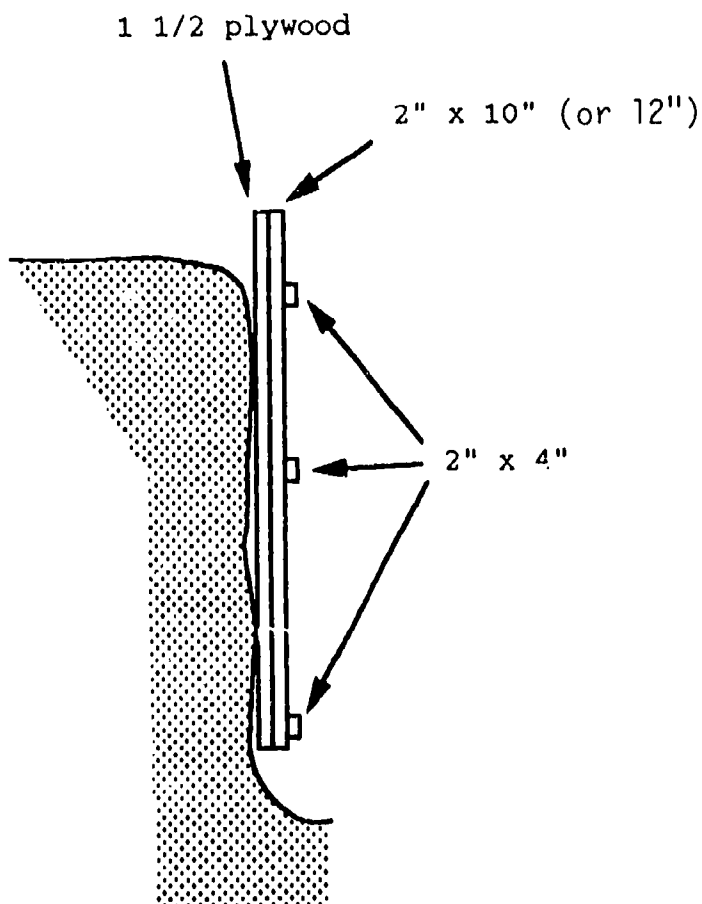

Figure 4. Shoring Against a Wall

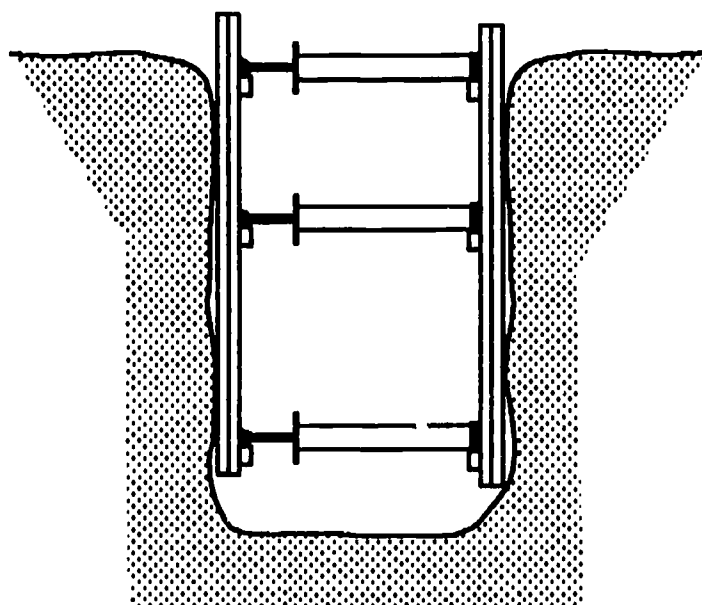

Figure 5. Supporting Jacks

upper support and secured by driving two opposing wood wedges between the shore and the sheeting (see Figure 6). When fitted, the wedges should be nailed into place and another 2" x 4" nailed on top of the shore to secure it. Similar procedures should be used for the middle and lower supports.

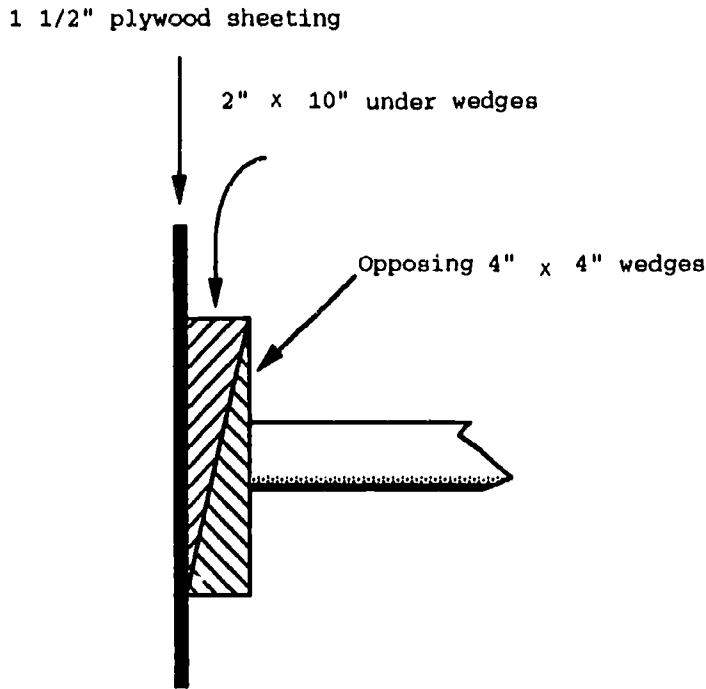

Figure 6. Wedges Used to Support Shoring

### Reaching the Victim

Sufficient sheeting and shoring should be placed to allow safe working room for the rescuers on all sides of the victim. If the victim is completely covered by soil or debris, work carefully at the bottom of the trench with the feet placed wide apart so that in the event the rescuer is standing on the victim, excessive pressure will not be placed on the victim's body. Carefully remove soil or debris from the area around the victim in buckets on ropes. Shovels may be used to remove the majority of the soil, but upon reaching the victim, use special trench shovels and dig by hand. Once the victim is uncovered, begin preparation for his removal from the trench.

The first effort should be concentrated on removing the soil from the area around the victim's head and chest as quickly as possible. Administer oxygen as soon as it is feasible.

The amount of emergency care administered in the trench will depend upon the situation and the extent of the victim's injuries. Temporary splints may be applied. **Spinal immobilization is warranted on all rescues.**

The method of removal from the trench will depend upon the amount of shoring required and the extent of the victim's injuries. The victim should be secured on a long backboard or in a Stokes basket. Whether this is possible will depend upon the situation and the available room to work in the trench.

It may be necessary to use wristlets or a body harness with ropes to pull the victim out of the trench. Improvisation may be needed at this point. Training and previous experience will help the incident commander determine the exact rescue method. Raising the victim horizontally may be physically impossible if the opening between the shoring is too narrow for the stokes basket. If there is enough room, a four-point raise may be used. Caution is necessary, since this requires four rescuers at the top of the trench, which will add a fair amount of weight to the edges of the trench.

If the victim is to be raised vertically, a ladder assist can be used. The victim should be carried to the entry ladder and a rope attached to the top of the backboard or stretcher. The ladder is used as a guide while the victim is raised.

If necessary, the incident commander should request a ladder company to assist in the rescue. The aerial ladder rescue technique discussed in the chapter on aerial rescue may be used in this situation. Extreme caution is required in using this technique. One person must be in constant communication with the truck operator to assure safe removal of the victim. The best technique is to suspend a pulley from the fly of the aerial ladder and use ropes to lift the victim manually. This technique allows rescuers to be elevated above the trench, so that excessive weight is not placed on the sides of the trench.

Since the victim may have to be carried over rough terrain, the rescuers must carry the victim very carefully. At least four rescuers should carry the victim. If possible, one person should lead the way to alert the rescuers to any uneven ground or hazards.

Once the victim is removed from the trench and taken to a safe area nearby, emergency care should be administered. An assessment of the victim should be conducted and appropriate treatment administered.

The rescue is not complete until all the rescuers have left the safety zone. If the shoring is to be dismantled, a reverse setup procedure should be used. Once the bottom shores are removed from the trench, the rescuers should leave the trench so the top shores and the sheeting can be removed. After all equipment is removed and the rescuers are out of the hazard zone, the rescue can be considered complete.

Since many agencies are usually involved in a trench rescue, a critique of the rescue should be

conducted with everyone involved in the operations. A written report should be filed for future reference.

## CONCLUSION

The need for a trench rescue can occur in any community, but few fire departments house all of the necessary equipment. The incident commander must know where to get the necessary resources and how to get them quickly. Working together as a team, merging all of the available equipment and expertise, can assure that the rescue is performed quickly and efficiently. As in all rescues operations, emphasis must be placed on safety, both for the victim and the rescuer.

# SHORING AND TUNNELING TECHNIQUES

## KEY POINTS

- Identifying types of collapses and voids
- Recognizing signs of potential building collapse
- Managing the scene, i.e., danger zone and hazards
- Locating a victim
- Tunneling through debris
- Shafting and tunneling to a void
- Timbering and lining a tunnel
- Trenching
- Breaching walls
- Shoring techniques
- Strutting
- Handling debris

## INTRODUCTION

One of the most difficult rescues is reaching a victim trapped in a building, a structural collapse, or a cave-in of the earth. Shoring and tunneling techniques are primary methods used to reach trapped victims. A victim can be trapped anywhere in the debris. Victims usually have few or minor injuries, because the voids formed in the debris often provide some space and protection. Victims who have serious injuries, however, are often in unstable condition. The first step rescuers must perform at the scene is to assess the situation and establish a route of entry and exit. When a victim is trapped in debris, every precaution must be taken to prevent the possibility of further collapse or cave-in.

## BUILDING COLLAPSE

Building collapse can be caused by fire damage, explosion, age deterioration, decomposition of the structural material, high winds, storms, or by the nature of the construction of the building. Cave-ins can occur from construction at a building site, or changes in the terrain, such as those caused by water run-off.

The incident commander must assess the situation, establish a thorough rescue plan, and maintain a coordinated effort throughout the entire rescue.

Teamwork is essential in this type of rescue operation.

Many emergencies require tunneling and shoring techniques to reach victims trapped in pipes, wells, or sewer lines. Provide a safe work area for the rescuers as well as for the victim.

If the rescue plan requires tunneling and shoring, do it rapidly, but do not sacrifice safety for speed. Execute only the amount of shoring and tunneling required for the safe removal of the victims and the rescuers. **Do not** attempt to restore a structure to its original condition during the rescue.

A minor accident may require only the use of a minimal amount of equipment. To expedite procedures at a major accident it may be necessary to use a highly-skilled operator for each piece of equipment. Rescue personnel must address this issue during preplanning.

## Types of Collapses

The biggest danger that exists when a building has been weakened by an explosion, a fire, or a storm is total collapse. The type of collapse can vary depending on the construction of the building and the types of materials used in its construction. The incident commander should evaluate the building construction and the materials when sizing up and planning the rescue. Weaknesses and strengths in the building construction should be noted and treated accordingly.

When a building collapses, it is usually in one of three ways. Most commonly, a wall parts from the building, falling at a right angle to the building (see Figure 7). In this type of collapse, the debris falls at least the distance of the height of the building. It is common for debris to fall a greater distance as it comes apart and makes contact with the ground.

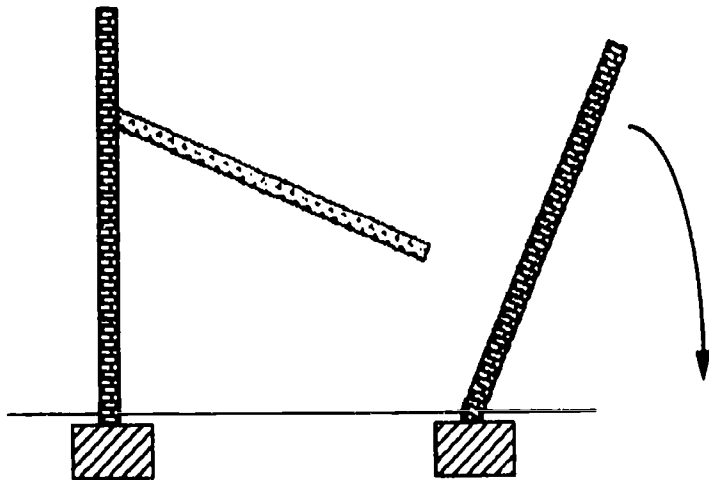

Figure 7. Right-Angle Wall Collapse

Another type of building collapse is when a wall comes apart in sections to the ground. Some pieces fall inward while others fall to the outside of the structure (see Figure 8). This type of collapse is particularly dangerous to all the rescuers, whether inside or outside the building.

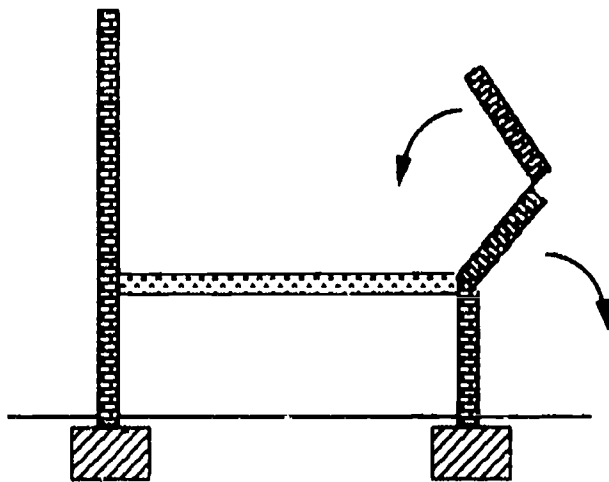

Figure 8. Sections of a Wall Collapse

The third type of building collapse is when a wall falls apart in pieces. The wall falls directly to the ground, piling debris at its base (see Figure 9).

A partial building collapse can also occur. Such a collapse can include the false front of a building, a section of concrete trim, an exterior sign, equipment

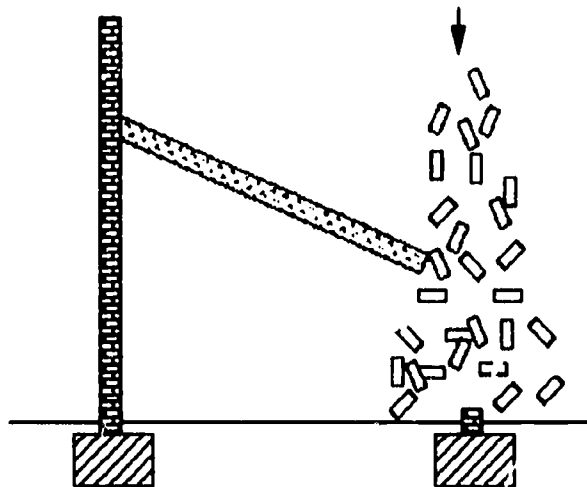

Figure 9. Pieces of a Wall Collapse

attached to a building, a porch, an overhang, or a fire escape. Even though the main building is still intact, a falling part may trap a victim. The incident commander must pay attention to all parts of the building, watching all building components during the rescue.

When a wall collapses, the remainder of the building, especially the floors, may follow. When a floor falls, voids can form in a particular pattern. When sizing up the rescue operation, pay special attention to the voids. It is not uncommon to find live victims with only minor injuries in such voids.

### Types of Voids

Various types of voids are formed as a wall collapses. The type of collapse, along with characteristics of the building's construction, determine the shape and size of the void formed. If only one wall collapses, it is possible that the floor will remain intact and attached to the opposite wall. If this occurs, a lean-to collapse is formed. With this type of collapse and void, a large open area is found underneath the floor (see Figure 10).

If the floor remains intact but comes apart from both walls, the floors and ceilings will pile on top of each other. This type of void is referred to as a pancake collapse and will leave only small spaces in the debris (see Figure 11).

Two other types of voids, the V-shaped void and the tent-shaped void, are formed when a collapse involves an interior wall supporting the floors. The V-shaped collapse occurs when the floor remains attached to the exterior walls and comes apart from the interior walls, when an interior wall collapses, or when the floor collapses in the middle (see Figure

12). This type of collapse leaves two large voids under the floor at the exterior walls.

Just the opposite occurs with the tent-shaped void. This void forms under the floor at the interior walls.

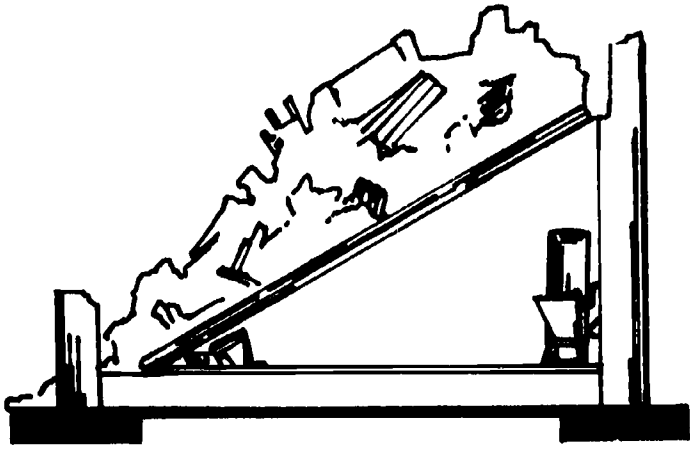

Figure 10. Open Area Under a Floor (Lean-to Collapse)

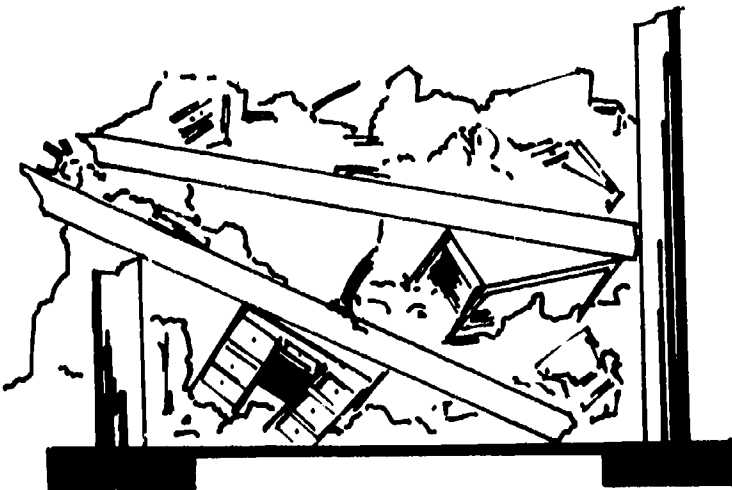

Figure 11. Pancake Collapse

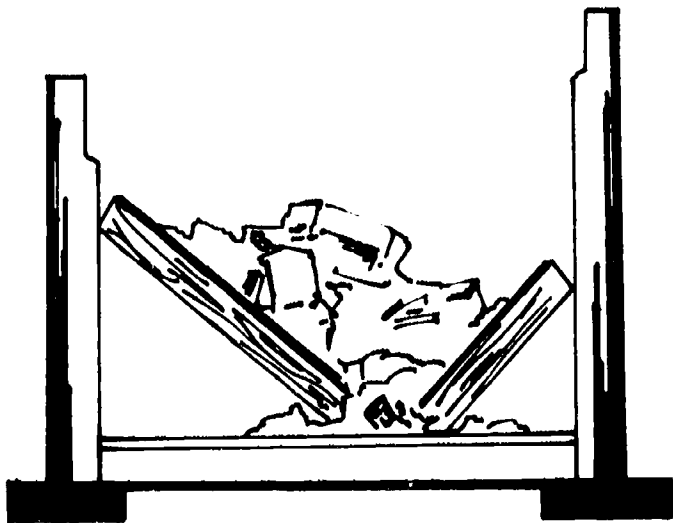

Figure 12. V-shaped Collapse

The tent-shaped void occurs when the exterior walls collapse and the floor remains attached to the interior walls.

### Resources

Each department involved in rescue operations should develop a resource manual that includes the names, addresses, and phone numbers of providers of equipment that may be needed to assist in a building collapse, an accident requiring a trench for rescue, or a cave-in rescue operation.

Assistance from building contractors who have heavy equipment is very important in the event of a building collapse. It may be necessary to move tons of concrete and debris quickly. Large cranes, payloaders, and trucks are necessary to execute such operations. The incident commander must have equipment available and must coordinate the efforts of the contractors once they arrive at the emergency scene.

In the event of a cave-in or an entrapment in a pipe or storm line where tunneling may be necessary, a mining or tunneling company can provide expertise in rescue procedures. Surveyors can also provide assistance in directing the construction of a secondary shaft into a mine shaft where a victim is entrapped.

### Signs of Potential Building Collapse

During a rescue operation in or around any collapsed structure, or one that has been weakened and has the potential of collapsing, (e.g., due to explosion or fire), the incident commander must look for signs of potential building collapse. Watch for walls that are bowing inward or outward, unstable floors, expanding cracks, falling bricks or roofing material, run-off from fire streams coming through the joints of masonry walls, floor joists pulling away from walls, steel columns losing their integrity, or a large volume of fire in a large old building. Buildings that have deteriorated with age are especially prone to collapse.

## MANAGING THE SCENE

### Scene Management—Danger Zone

The danger zone is an area surrounding the building that is the same distance away from the building foundation as the height of the building. Establish the zone with the right-angle collapse in mind. The



right-angle collapse causes the largest area of debris fall.

During any rescue operation, establish a danger zone that is clearly identified and controlled by rescuers. Mark specific boundaries with tape or a utility rope. This zone must be identified at the scene of any cave-in or collapse, or where there is the danger of a structural collapse.

Monitor the danger zone so only a minimum number of personnel may enter. In some instances, it may be necessary to attach lifelines to all personnel entering the danger zone. Position a safety officer at the zone entrance to monitor the personnel inside.

### Hazards

The incident commander must be sure that all hazards have been removed or controlled prior to starting the rescue operation. No rescuers should be allowed to enter the danger zone until the hazards have been removed. The following concerns must be addressed before official rescue operations can begin.

**Electricity.** Shut off all electricity and lock out at the main control panel. If this is impossible, notify the electric company to shut off the power at the electric pole. If this is not done, rescuers may encounter live wires and power sources in debris, and electrocution is possible. See the chapter on electricity and rescue operations for further information.

**Gas.** The rescuer or the gas company must shut off all natural gas utility lines at the street level. There is the possibility that a gas line may be broken during a collapse, allowing pockets of gas to accumulate. It is mandatory to use an explosimeter and gas monitors when entering such an area.

**Water.** Control the main water lines supplying a building. The incident commander must decide whether the water main should be shut off at the street level or at a sector valve in the building. The incident commander must realize that shutting off water at the street level may disable automatic fire suppression systems within the building.

**Ventilation.** Consider any void a confined space, especially those below ground level. Assure an adequate oxygen level before entering the area. If sufficient oxygen is not present, equip all personnel with full protective clothing and SCBAs.

The area must be ventilated and fresh air supplied by fans or smoke ejectors used as blowers. Smoke and dust can accumulate in these areas, making it difficult to carry out rescue operations. Maintaining

a constant air flow prevents smoke and dust from accumulating. In the event of entrapment in a well, pipe, or similar structure, lower a fresh air or oxygen line to the victim's level to maintain an adequate oxygen level.

**Fire.** Eliminate all ignition sources prior to starting rescue operations. Pay special attention to commercial sites and industrial equipment that use open flames or contain pilot lights.

In the event the rescue operation is at a fire scene, the incident commander in charge of the rescue must coordinate all rescue efforts with the fire chief. If the fire is not under control, hose lines and a fire attack must be established to protect the rescue operation. Pay attention to the water run-off. Construct dikes to prevent water accumulation in areas where victims may be trapped. In all rescue operations at a fire scene, keep a charged hose line readily available.

**Lighting.** Provide portable lighting at the rescue site. Even if the rescue operation occurs during the day, voids can be dark. Rescue operations can be difficult or impossible until adequate lighting is established. Use portable lights with explosion-proof connectors to illuminate darkened areas.

## LOCATING A VICTIM

Once the incident commander has established a rescue plan, the resources have been established and notified, and all hazards have been removed, it is time to locate the victims. In the original size-up, other people at the site, construction supervisors, building operators, or other victims should be questioned about the number and location of victims. Preplanning information and floor plans of the building are very helpful.

Rescuers will find it difficult to locate the victims when other emergency activities are happening simultaneously. Make the rescue scene as quiet as possible so rescuers can listen for cries of help. If any cries are heard, establish voice communication with the victim immediately. Trapped victims may be able to provide valuable information as to their location, possible dangers, the number of victims, and the extent of their injuries.

If voice communication is not established, size up the damage and look for voids. Focus rescue efforts on the voids, since there is a greater chance for survival in a void than under dense debris.

In the event of entrapment in a pipe, well, or cave-in, lower an explosion-proof flashlight into the pipe or debris to locate and identify victims. It is important to establish the victim's location as precisely as possible. It may be necessary to cautiously dig a secondary parallel shaft and tunnel with a horizontal shaft.

## DEBRIS TUNNELING

### Tunneling Through Debris

Use tunneling to reach casualties buried in debris when an exact location is known. It is slow, dangerous work. Undertake it only after all other methods have been explored. Carry out tunneling from the lowest possible level, but do not use it for general search. Occasionally tunneling may be used to reach a point, such as a void under a floor, where further search needs to be conducted, but it is used primarily for connecting existing voids.

### Shafting and Tunneling to a Void

A tunnel must be of sufficient size to permit rescuers to transport casualties. Tunnels as small as 30 inches wide and 36 inches high have proven satisfactory for rescue work. Whenever possible, drive tunnels along a wall, or between a wall and a concrete floor. To simplify the framing required, do not construct a tunnel with an abrupt turn.

Constructing a vertical shaft is considered a form of tunneling for vertical or diagonal access. Usually these shafts are made through earth after debris has been cleared from the surface. They are often made to reach a point where a basement wall must be breached. Do not sink shafts where water or gas lines enter a building. Avoid soil or gravel known to be carrying water.

Debris tunneling is quite different from tunneling through undisturbed earth, although strutting and bracing are necessary in both methods. The speed at which a debris tunnel can be constructed varies with the type of debris and the size and the length of the tunnel required. Because debris is often unstable and key beams have to be left in place, the shape and path of a tunnel as it passes through the debris often becomes irregular. A definite pattern of timbering, such as that used in a tunnel through earth, may not be possible.

The size of timbers used for bracing is determined by the nature of the job, and the equipment and

materials available. Because of the uncertain weight that shoring timbers must support, it is always better to use heavy timbers rather than timbers that may be too light.

In debris tunneling, keep constant watch for key timbers, beams, and girders. Disturbing these structures could move the pile of debris and collapse the tunnel. To avoid any accidental movement, place a prop under horizontal pieces, leaving enough space for the passage of both rescuers and stretchers. Brace everything in the tunnel as the work proceeds to help prevent accidents. Time spent in careful bracing is not wasted when compared to the time needed to reconstruct a collapsed tunnel.

When piles of debris are large, it may be advantageous to sink a shaft to reach a basement level or a basement opening, and then tunnel horizontally to reach a victim (see Figure 13). Even though the materials in the area appear to be solid, the sides of the shaft must always be braced and timbered, with the timbers wedged securely in place.

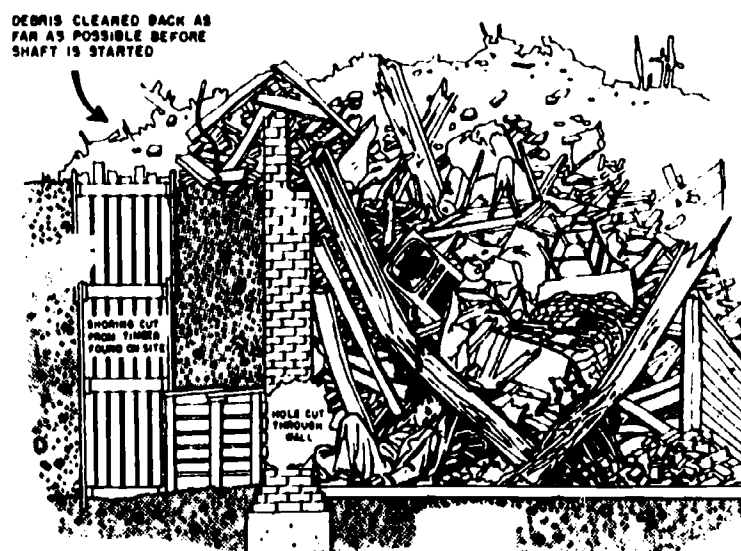

Figure 13. Shafting and Tunneling to Reach a Void

### Timbering and Lining a Tunnel

Use frames and forepoling to construct a debris tunnel. The frames are the primary supporting elements of the tunnel. Prefabricate them outside the tunnel and place them in position as the work progresses. Forepoling is planks or boards driven between the collar and crowbar of one frame and extending beyond the next frame into the debris. Material needed to timber and line a debris tunnel can usually be found in the wreckage.

Figure 14 shows a longitudinal section and a cross section of a frame tunnel using the forepole method.

## DEBRIS TUNNELING CONSTRUCTION OF TUNNEL

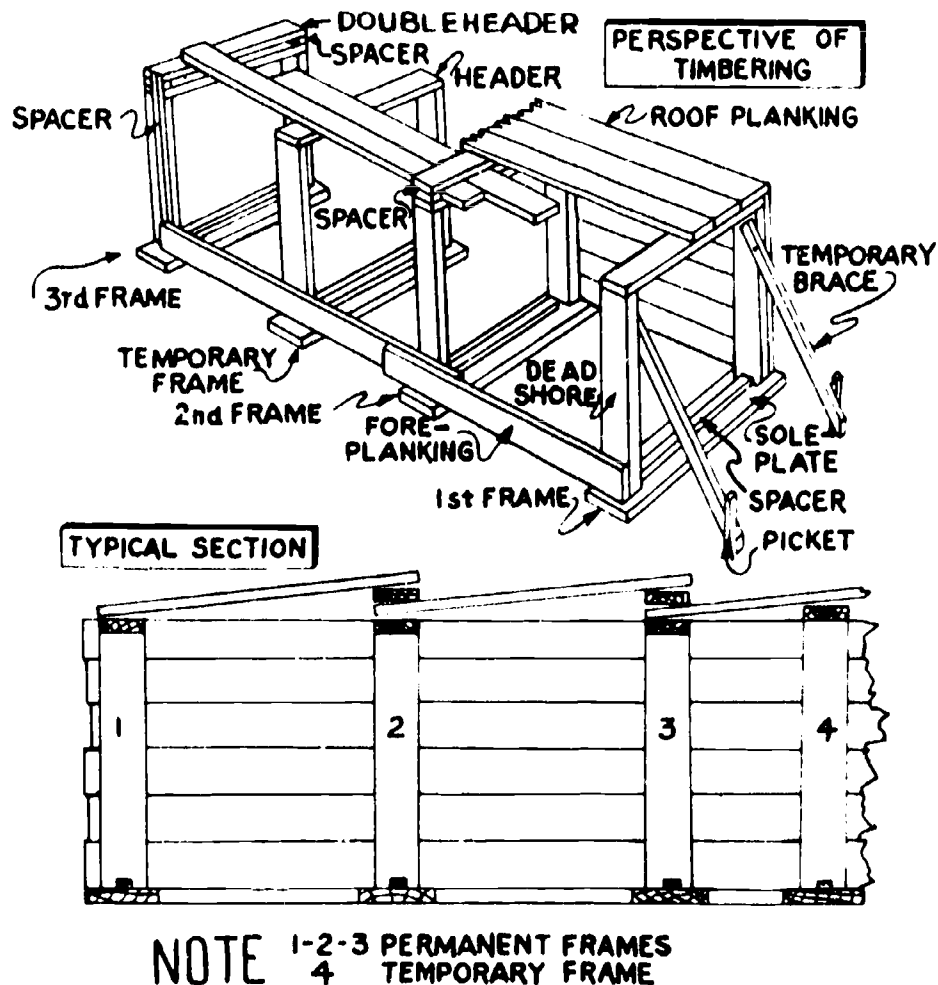

Figure 14. Tunnel Construction Using the Forepole Method

To start the tunnel, construct three frames. The first frame does not require a collar or spacer blocks at the top, nor do any of the temporary frames. The second and third frames, and all other permanent frames in the tunnel, require 2-inch spacer blocks and a collar piece set on top of the crowbar. Set frame No. 3 against a cleared vertical face of debris with frames No. 1 and 2 solidly braced at approximately 3 foot intervals. Then brace frame No. 1 diagonally to a stake driven solidly into the ground, about 2 to 3 feet in front of each strut. Once the frames are in place, cover the top of the structure from frame No. 1 to frame No. 3 with long pieces of lumber, such as floor joists, roofing, or flooring. (Beyond frame No. 3, forepoles need to be long enough to overlap only from one frame to the next.)

Line the sides in the same manner as the roof of

the tunnel, driving boards between the frame struts and the rubble. To insure stability of the tunnel thus far completed, pile debris against the sides and over the top. When completed, cover the frames completely with the exception of the first frame and the diagonal braces.

When debris is removed about 2 feet beyond the third frame, the load on the forepoles may make it necessary to construct a temporary frame under them until enough debris is removed to permit construction of a permanent frame. Remove the temporary frame after the permanent frame is properly braced and lined. Repeat this procedure until the tunnel is completed.

The debris of a demolished structure usually includes small rubble and dust that trickles through the timbers. The escape of this material can disturb

the mass of debris, causing internal movement. Board the tunnel through small loose debris as closely as possible.

Rectangular framing has certain disadvantages in debris tunneling. Since frames are not rigid, unbalanced side pressures can cause them to collapse. In some instances, in short debris tunnels, small cross sections can be driven into the debris to form a closed triangle, using heavy planks keyed together at the ends (see Figure 15).

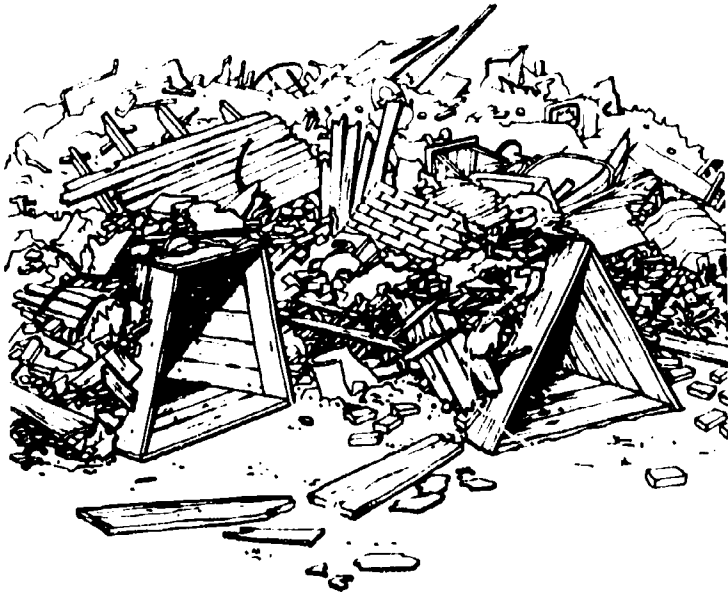

Figure 15. Triangular Tunnels

Regardless of the method used, the strutting or lining in a debris tunnel must be rigid and tightly wedged to keep the lining in position and prevent it from being broken by the impact of shifting or moving debris.

When there is doubt about the quickest means of access to a victim, try two or more methods at the same time. For example, reach a basement simultaneously through one or more tunnels, and through a shaft constructed from the outside.

Consider several different approaches to remove a victim from under a collapsed basement wall, or from a basement still intact but with exits closed by debris. For example, it may be necessary to break through the wall from an adjacent basement to reach a lean-to void. Clear debris from a utility tunnel or coal chute to enter the area. In a rescue where ground floors have not collapsed, clear a small area either by tunneling along the floor, or removing debris and cutting a hole in the floor to gain entrance to the basement (see Figure 16). Where a floor has fallen and the basement ceiling is completely collapsed,



Figure 16. Tunneling to Gain Entrance

dig a sloping tunnel from the edge of the debris downward toward the floor of the basement (see Figure 17). A shaft may be sunk next to a building and into the ground along the basement wall, through which a hole in the basement wall can be made for entry (see Figure 18). Another situation may involve a basement ceiling that has collapsed so that a solid mass of debris is revealed when a hole is cut through the outer wall. In this case, construct a trench or tunnel along the outer face of the wall, and drive a hole into the wall at another point.

If a floor has collapsed forming a V-shaped void, drive a tunnel through the debris from the first void toward the opposite wall in an effort to reach the second void. Remember, debris tunneling is one of the hardest jobs in rescue work and should be un-

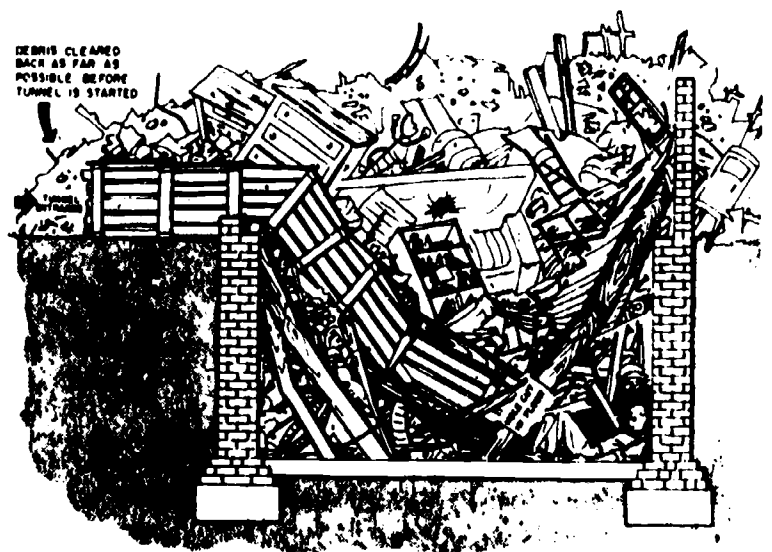

Figure 17. Tunneling to Reach a Void

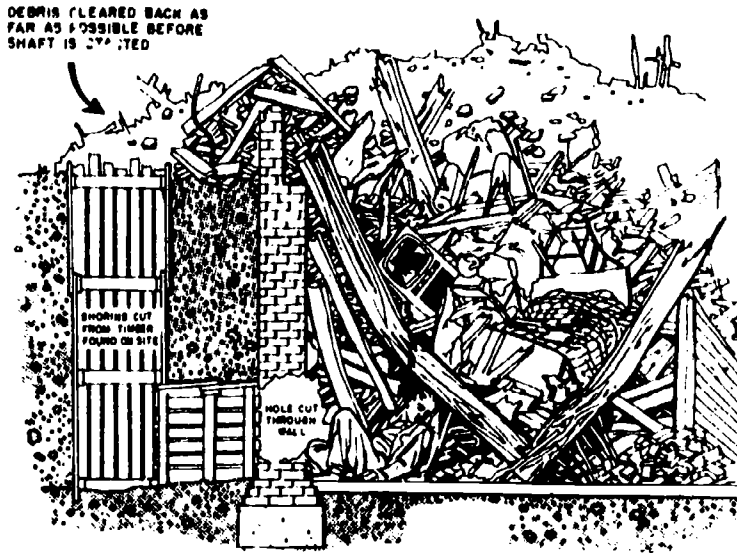

Figure 18. Shafting and Tunneling to Reach a Void

undertaken only when other means of gaining access are impractical.

Whenever a rescue worker is using an SCBA inside a tunnel, maintain communication to the outside. Use a lifeline as a means of communicating. This line can also be used to locate a worker in case the tunnel collapses. When a person collapses in a toxic atmosphere only a short distance into a tunnel, he or she can be pulled out by the lifeline. Do not pull a collapsed person a long distance or around corners because the facepiece can become dislodged, leaving the person without mask protection. If a worker becomes unconscious, that worker should be carried to safety by fellow workers.

## Trenching

If the debris is not piled too high, it is frequently faster to dig an open trench than construct a tunnel. Trenching and tunneling operations can sometimes be combined using a trench to extend into the debris until a tunnel becomes more practical (see Figure 19).

To trench through debris, remove the larger pieces of timber, stones, or other objects from the face of the pile nearest the object. Next, clear a way into the debris by shoveling and other hand methods, removing the minimum amount of material necessary to provide a safe passageway.

Trenching can be dangerous. If a trench collapses, the worker has little chance of avoiding injury. To avoid collapse or dangerous movement of the sides of a trench, use some method of retaining the side-walls, such as bracing. One method is to drive sufficient sheet-piling (usually lumber found at the site)

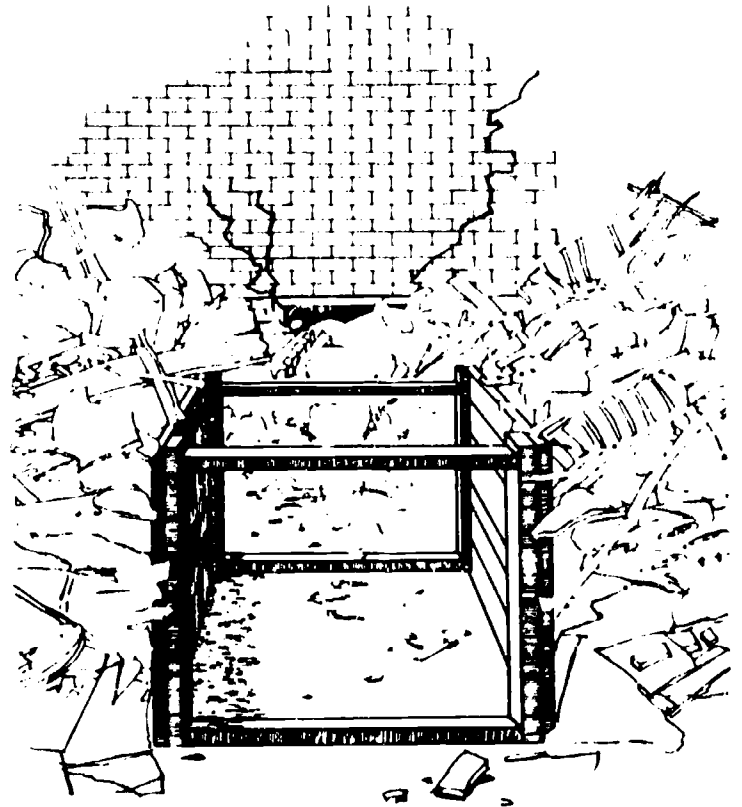

Figure 19. Preliminary Trenching

into the ground. Provide additional support by applying horizontal bracing using the sheet piling, and screw or hydraulic jacks if available, or by using wooden struts between the two retaining walls.

Pile materials removed from a trench at a safe distance from the edge so they do not fall back into the trench or have to be moved. The size of the trench is determined by its purpose and the nature of the debris.

Trenching is used to reach a specific point, not for general clearance. Rescuers may start two or more trenches simultaneously to the same given point, since it is not always possible to determine the fastest route.

## Breaching Walls

Many different types of construction are found in rescue operations. These include walls made of brick with lime mortar, brick made with cement mortar, stone, concrete, or concrete blocks.

When cutting through walls or floors of large buildings, locate sections of the structures where cutting can be done quickly and safely. When cutting through walls be sure that support beams and columns are not weakened. After a building has been subjected to a bomb blast, the parts left standing may appear to be sound, when in fact they have been badly

shaken and are cracked. When cutting away wall sections with air hammers, take care to prevent further collapse.

Openings large enough for rescue purposes usually can be made in brick walls without the danger of more of the masonry falling. Remove the bricks so the opening is arch-shaped.

Concrete walls and floors are difficult to cut through, especially when they are reinforced. Pavement breakers or other power tools are helpful, but it may be necessary to call a city engineering department for such equipment. When cutting through walls and floors (except concrete), cut a small portion at a time and then enlarge it. When working with concrete, it is better to cut around the edge of the section to be removed. If the concrete has reinforcing bars, cut them with a hacksaw or a torch, allowing the material to be removed in one piece. If a torch is used, be sure explosive gases are not present so flammable materials do not ignite. Keep a charged hoseline nearby in case of fire.

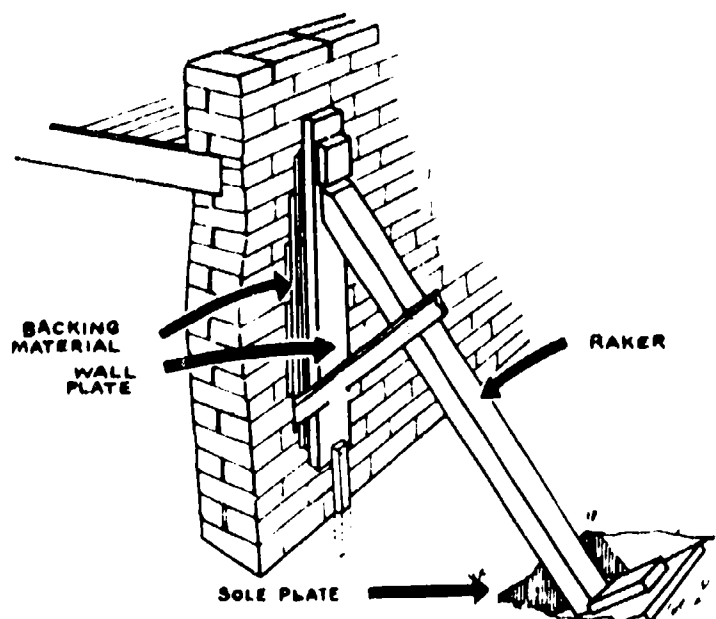

Figure 20. Raking Shore

bulging wall, back it with timbers to provide continuous support.

Construct rakers with square timbers. The number required varies from one to four, depending on the height of the wall to be supported and the number of floors carried by the wall. Use information in Table 1 as a guide to the number of rakers and the size of the timbers required for shores of different heights.

Height of shore (feet)	Number of rakers	Cross-sectional area of raker built up to approximate square section (square inches)
20 to 30	1	25
30 to 40	2	36
40 to 50	3	50
Over 50	4	80

Table 1. Guide for the Use of Rakers

Construct one raker for each floor carried by the wall. The raker should be set so its foot forms a 60° to 70° angle at ground level. Arrange each raker so its center line meets at a common point with the center lines of the wall and floor, thus carrying the floor load directly on the shore.

Next, nail a cleat to the wallplate where it meets the head of each raker. Secure the wallplate to prevent it from sliding upward as the rakers are tightened into place. When working with a masonry

## SHORING

For rescue operations, shoring is defined as the erection of a series of timbers to stabilize a wall or to prevent further collapse of a damaged structure that could endanger the rescue operations. Only temporary shoring should be done by rescuers. Permanent shoring is the responsibility of the engineering services.

Do not use shoring to restore structural elements to their original position. Any attempt to force beams, sections of floors, or walls back into place may cause further collapse and damage. Use the bars, wedges, and jacks gradually and cautiously to prevent shock to a structure while securing shores in position.

## SHORING TECHNIQUES

### Raking Shore

If a wall is bulging or out of plumb, use shores to brace the wall or hold it in position, especially if excavating or tunneling is being conducted next to it. This type of shoring is called a bracing, pushing, or raking shore (see Figure 20). The principal parts include a wallplate, a raker, and a soleplate.

If possible, the wallplate should be continuous throughout the shore length. When used against a

wall, secure the plate by extending cleats through an opening or by nailing it into the window frame. If there are no openings, secure the wallplate by driving nails or small metal pins into the mortar joints or small holes in the masonry. A masonry wall that needs to be shored is dangerous, and drilling or nailing into the wall must be done with extreme caution.

Place footings (platforms upon which lower ends of the rakers rest) to help distribute the weight of a heavy load. The size of a footing depends on the resisting power of the soil. Place the footing at a right angle to each raker, if possible.

Place soleplates to take the thrust of the raker at an angle exceeding a right angle, so it becomes a right angle when the raker is tightened. Do not tighten the raker with a hammer. Instead, cut a small notch in the foot of the raker and use a pry bar in the notch to tighten it (see Figure 21).

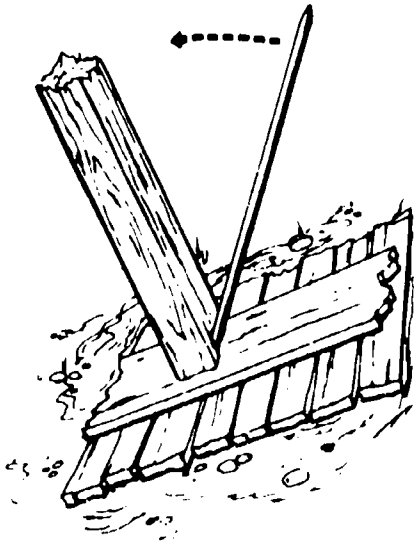

Figure 21. Raker Set Using a Pry Bar

Evacuate surrounding soft ground and slope the bottom of the hole toward the unsafe wall to provide the proper angle to the soleplate. When on hard ground, build up the soleplate to the required angle and spike or wedge it in place.

After placing the cleat on the wallplate and securing it to the wall, raise the top of the raker to the cleat and place the foot on the soleplate. Then gently force the whole structure into place. Nail a cleat to the soleplate at the foot of the raker to secure it.

Install struts or braces to prevent any movement of the foot of the wallplate, and to help prevent it from sliding upward under the strain. Spike struts

to the raker and to the wallplate.

When supporting a wall, place wallplates and rakers at 8 foot to 12 foot intervals, depending on the circumstances of the collapse, the type of wall construction, and the degree of damage.

### Flying Shore

Use a flying shore to brace a damaged wall when a sound adjacent wall can be used as a means of support (see Figure 22). The principal parts include the horizontal beams, wallplates, and struts. Other items include cleats, wedges, and straining pieces.

To erect the flying shore, nail the cleats on the wallplate. Use one pair to support the horizontal beam or shore, and the others to support the struts.

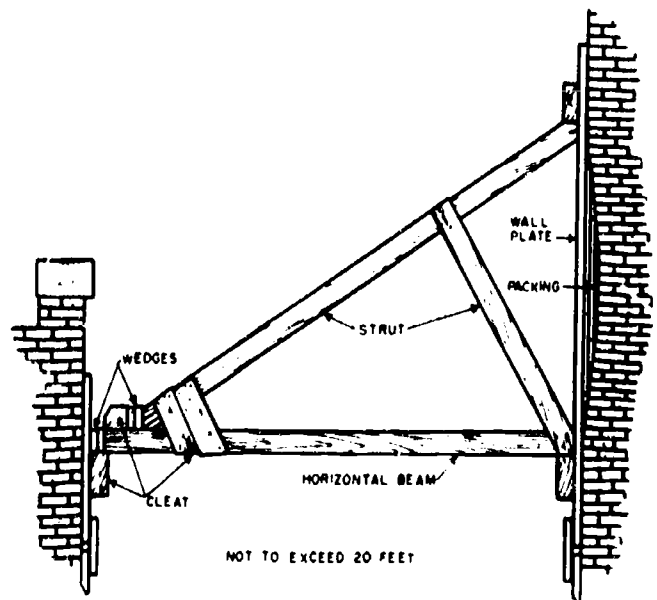
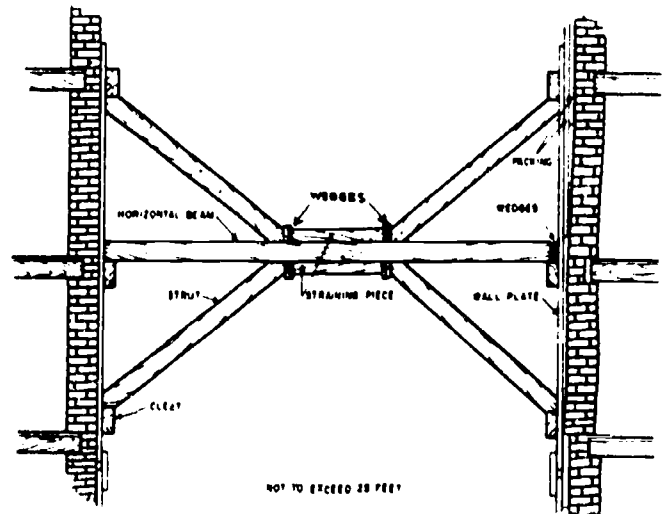

Figure 22. Flying Shores

Set the struts at an angle not greater than  $45^\circ$  to the horizontal beam and keep them apart with straining pieces. The length of the straining pieces is determined by the length of the horizontal beam.

Before erecting a flying shore, make a layout of the job to determine the measurements and angles necessary. Holding the wallplates in position, place the horizontal beam on the center cleats and tighten with wedges and shims inserted between the shore and the wallplates. Next, place the struts and straining pieces into position to provide continuous bearing.

Place flying shores along a wall at 8 foot to 12 foot intervals, depending on the situation, type of wall, and the degree of damage. They are not recommended for use between two walls separated by more than 25 feet.

Frequently a weakened foundation or damage to the lower portion of the wall will make it unstable. Causes of instability in a structure subjected to blast may vary. Since there is no standard method of approach, plan carefully in situations requiring shoring and the supporting of walls and floors. The lower part of the wall and its footing or foundation must carry the entire weight of the structure above it. If damaged by a blast or by removal of an adjacent supporting structure, a wall may buckle or crumble. Therefore, bracing or shoring applied to the lower parts of the wall should be stronger than corresponding work applied to the upper portions.

### Dead or Vertical Shore

Use a dead or vertical shore to carry the vertical dead load of a wall or floor (see Figure 23). The principal parts include the strut, the soleplate, and the headpiece. Struts should be made of square timber, and heavy enough to carry the maximum expected load.

It is difficult to estimate what load a strut must be capable of carrying and to gauge what load the strut timber can support; however, when strutting a damaged building, the four following principles apply.

1. For a given size of timber, the shorter the strut, the greater the load it can carry.
2. A strut of square cross section is stronger than a rectangular one of the same cross-sectional area.
3. A strut is much stronger in service if its ends are cut so they fit square to the soleplate and the headpiece.

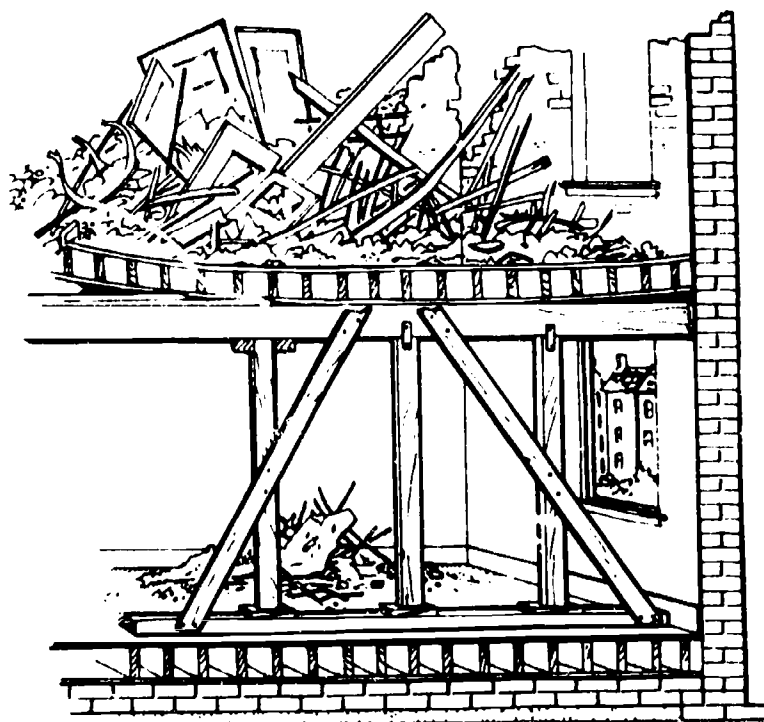

Figure 23. Dead or Vertical Shore

4. Struts should always be made a little heavier than necessary. The size used is determined by the weight and height of the wall or floor to be supported.

Set folding wedges under the strut and drive the strut into position with the wedges until it just takes the weight and no more. Do not drive wedges tighter, since it would lift the wall or floor being supported and might cause more damage to the building.

Make the soleplate as long and as wide as practical to spread the load over a sizable area. Do not place the soleplate on a cellar arch or timber floor if there is doubt that the arch or floor can carry the load. In such cases, the soleplate must be supported from below. When struts are used on an upper floor of a building, repeat the strutting on all the floors so the load has a solid foundation. An exception to this is when a strut can be supported on a heavy beam in a part of the building that has not suffered much damage.

The headpiece should have approximately the same cross section as the strut, but the load to be carried is a factor in determining the size. Also, the distance of the span between the struts where two struts are used is a factor. Keep this span as small as possible. The smaller the span, the greater the load the headpiece can carry.



## Strutting

Use strutting to strengthen the window and door frames when they are declared unsafe due to cracked or damaged walls. Two methods of strengthening such openings are shown in figure 24.

Many methods of strutting can be used, but sufficient room must be left between the struts to carry out a rescue.

Wear gloves when handling the debris to prevent injuries to the hands. Remove debris using baskets, buckets, and wheelbarrows to an area clear of the

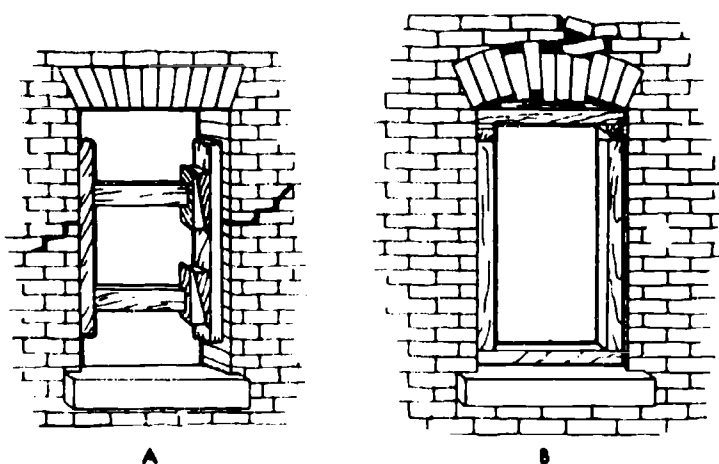

Figure 24. Strutting a Window Opening

damaged building. Only when it is reasonably certain that the rubble or portions of buildings to be removed do not conceal more victims, should cranes, power shovels, and bulldozers be used for clearing debris. The incident commander should direct all heavy-equipment operations. If it is necessary to pile debris in the street, avoid blocking traffic. Mark all debris that has been moved for future reference.

Rescuers, with the help of police must exercise constant vigilance to prevent disorganized and unsupervised groups from digging at random in the area. Do not climb unnecessarily over piles of debris. Any disturbance can cause further collapse, making the rescue more difficult and decreasing a victim's chance of survival.

## HANDLING DEBRIS

Use shovels, picks, and other standard hand tools in debris removal only when the location of a casualty or victim is definitely known and all other people have been accounted for. It is sometimes difficult to recognize a body trapped in debris. Use tools, especially picks, with great care to avoid further

injury to a victim. Remove debris close to a casualty's known or expected location by hand only.

Wear gloves when handling the debris to prevent injuries to the hands. Remove debris using baskets, buckets, and wheelbarrows to an area clear of the damaged building. Only when it is reasonably certain that the rubble or portions of buildings to be removed do not conceal more victims, should cranes, power shovels, and bulldozers be used for clearing debris. The incident commander should direct all heavy-equipment operations. If it is necessary to pile debris in the street, avoid blocking traffic. Mark all debris that has been moved for future reference.

Rescuers, with the help of police must exercise constant vigilance to prevent disorganized and unsupervised groups from digging at random in the area. Do not climb unnecessarily over piles of debris. Any disturbance can cause further collapse, making the rescue more difficult and decreasing a victim's chance of survival.

## CONCLUSION

Shoring and tunneling techniques are very important in rescue procedures involving a cave-in or a collapse. Like many rescue operations, improvise to execute rescue shoring and tunneling procedures that are effective as well as safe. Many rescue procedures involve a high level of risk, but the safety of the rescuers, any victims, and curious bystanders must always prevail.

## FARM ACCIDENT RESCUE

### KEY POINTS

- General rescue principles for farm rescue operations
- Rescue procedures for accidents involving tractors
- Rescue procedures for accidents involving power-take-off shafts
- Rescue procedures for accidents involving hydraulically-operated equipment
- Rescue procedures for accidents involving augers or rotating beaters
- Rescue procedures for accidents involving augers or elevators
- Rescue procedures for accidents involving electricity
- Rescue procedures for accidents involving harvesting equipment (balers and combines)
- Rescue procedures for accidents involving grain bins
- Rescue procedures for accidents involving silos
- Rescue precautions for working with silos and silo gas exposures
- Rescue procedures for silo fires
- Dealing with hay mows and hay mow fires
- Rescue procedures for accidents involving manure storage
- The dangers of anhydrous ammonia
- Dealing with agricultural chemical fires
- Dealing with pesticides

### INTRODUCTION

Farming can be a very rewarding occupation but it presents some serious potential hazards. It often involves an entire family, including children, along with several employees, all encountering a wide variety of job hazards. Farm machinery is designed to take in, process, treat, convey, grind, and/or dispense agricultural crops and materials. In addition to the potential hazards with machinery, farm workers come in contact with hazardous chemicals, gases, and toxic atmospheres in a farming operation. Agriculture is basically an industry without structure with a limited number of regulations requiring workers to follow safety procedures or keep equipment in good repair. Seldom does a farming operation involve a management or safety engineer. Safety equipment is expensive and using it properly with all guards in place often slows a job. Farmers work long days under stress and fatigue, and often during an illness, to get the job done simply because of weather conditions, or a crop is at the peak of harvest.

Some farm accident victims are found hours after an accident occurs because they often work alone,

isolated from other people. These factors, plus climate and terrain considerations, often make a farm rescue a unique experience for the rescuers.

The intent of the information presented in this text is to familiarize emergency personnel and rescuers with some potential farm accident situations and techniques that can be used to rescue a victim safely. The safety of the rescue personnel is as important as saving the victim. Precautions are noted throughout the text to reduce the chance of having another victim during a farm rescue.

Rescuing a victim from a farm accident can be similar to rescuing a victim from a vehicle accident, an accident involving hazardous materials, or a high place. The major difference is the accident location and the ruggedness of the equipment involved. In some cases, because of the terrain or the accident location, equipment must be hand-carried to the scene.

The actual extrication may call for more than the assessment of where and how to apply the tools to remove the victim. It may require the disassembly of a farm machine, which usually takes much longer than routine rescue operations. Assistance can come

from a local farm machinery dealer or neighboring farmers who are familiar with the equipment.

## GENERAL RESCUE PROCEDURES

Each farm accident is unique because it usually involves a variety of machinery and structures that have been built by the farmer. An incident commander needs to direct the total rescue operation. The following procedure is suggested:

1. Establish a hazard area.

This area gives the rescuers a specific area to work in and also prevents bystanders from interfering with the rescue. It can reduce injuries from potential hazards such as fire, inhalation of toxic substances, or those caused by structural collapse.

2. Stabilize the equipment and/or structural condition.

Equipment such as a tractor, combine, or other piece of machinery must be stabilized before checking the victim or removing any parts from the equipment. Make sure the equipment will not shift or collapse or that the release of a spring will not cause injury or hamper the rescue operations.

3. Care for the victim.

- A. Open airway
- B. Restore breathing
- C. Restore circulation (perform CPR)
- D. Control bleeding and administer necessary first aid

4. Provide psychological support.

Remain with the victim during the rescue. Remove family members from the rescue area so they do not interfere with the rescue and/or treatment of the victim. They may be concerned about the amount of time required to stabilize the victim before transport.

5. Conduct the rescue.

The incident commander should direct the rescue, assessing the entire situation before attempting any action. Before removing equipment or spreading parts, recheck the equipment to be sure it will not shift or collapse. If additional information or tools are needed, do not hesitate to call for help.

If the victim is seriously injured, such as having an amputated hand, arm, or leg, or a head injury

that requires prompt medical care, consider calling a helicopter for immediate transport. In case of an amputation, do not delay transporting the victim while looking for amputated tissue. Wrap tissue in a moistened towel, place it in a clean plastic bag, and take it to the hospital. Place the package on ice but make sure it does not freeze. Notify the hospital that the amputated tissue is being transported (see Figure 25).

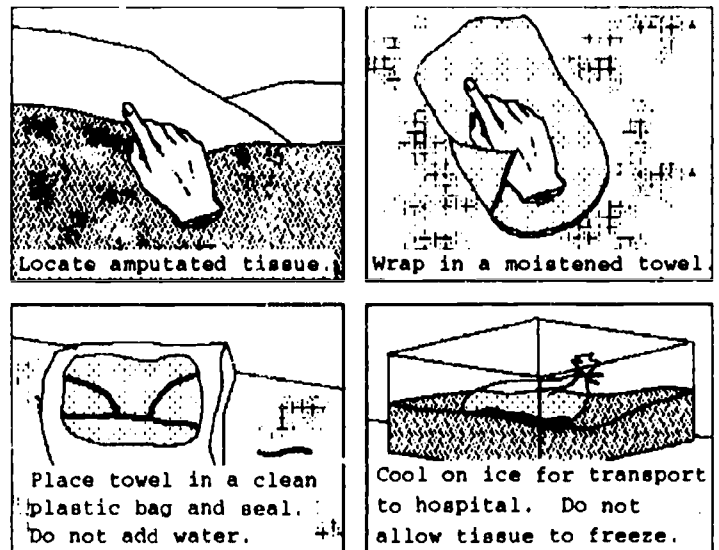

Figure 25. Caring for Amputated Parts

Occasionally, during extrication procedures, it is simpler and faster to disassemble a piece of farm machinery to free an entangled victim. Seek the advice of a nearby farm machinery dealer, it may be more efficient than the "trial and error" method, particularly if complex machinery is involved with which the rescuers are not familiar.

### Rescue Procedures for Accidents Involving Tractors

Since many tractor accidents result in fatalities, entrapments, or serious injuries, it is important for both emergency medical and rescue personnel to respond to any farm accident involving a tractor. Fire is always a threat in any tractor overturn if a large amount of gasoline or diesel fuel is spilled (see Figure 26). Do not permit smoking near the accident site and keep curious onlookers away from the site. Consider alternative extrication methods before using oxy-acetylene cutting equipment. **NOTE:** Keep a charged 1-1/2" fire hose and an ABC-type chemical fire extinguisher available for emergency use.

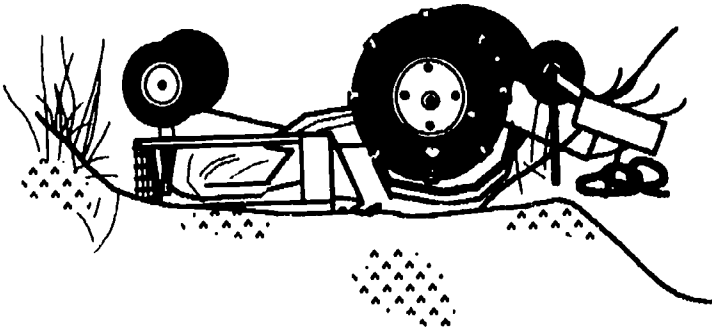

Figure 26. Overturned Tractor

Be sure the tractor engine is turned off. If the engine is gasoline-powered (check for spark plugs and distributor), try to find the ignition switch on the control panel near the steering wheel and turn it to the off position. Movement of the rear wheels could restart the engine if the ignition switch is in the on position. The engine can also be shut off by disconnecting the high-voltage wire running between the coil and the distributor. If gasoline is leaking, clear all flammable vapors emitting from the distributor by using a short discharge from a CO<sub>2</sub> fire extinguisher.

Diesel engines can be difficult to shut off for people unfamiliar with tractors and engines. Again, as with the gasoline-powered tractor, try to find the shut-off key or the fuel shut-off knob (often red in color) usually located on the control panel. On some tractors, simply turning the key shuts off the engine. On others, the fuel shut-off knob needs to be moved into the off position (see Figure 27).

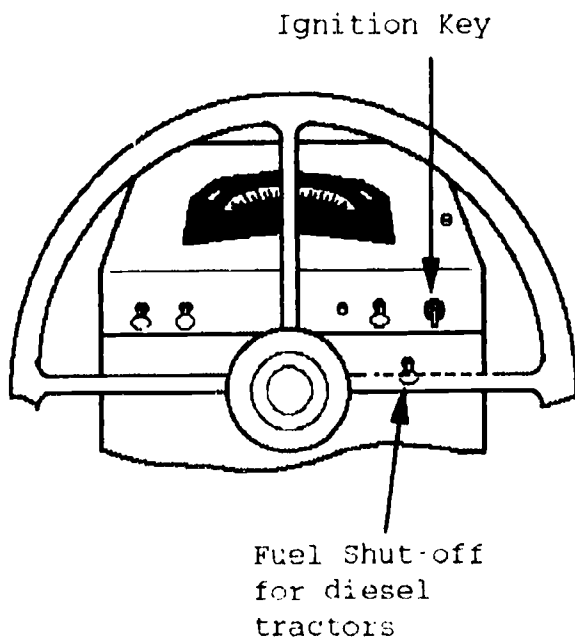

Figure 27. Tractor Panel

If the key or shut-off knob cannot be located or does not stop the engine when moved to the off position, move the throttle lever into the idle position. The throttle lever is usually located directly beneath or beside the steering wheel. If none of the above procedures are successful, stop a diesel engine by manually operating the fuel shut-off lever on the fuel injection pump. As a last resort, stop the air intake by discharging a CO<sub>2</sub> fire extinguisher or stuffing a rag into the air intake or air cleaner of the engine. However, remember that a dry chemical extinguisher may not plug the air cleaner sufficiently to stop the engine (see Figure 28).

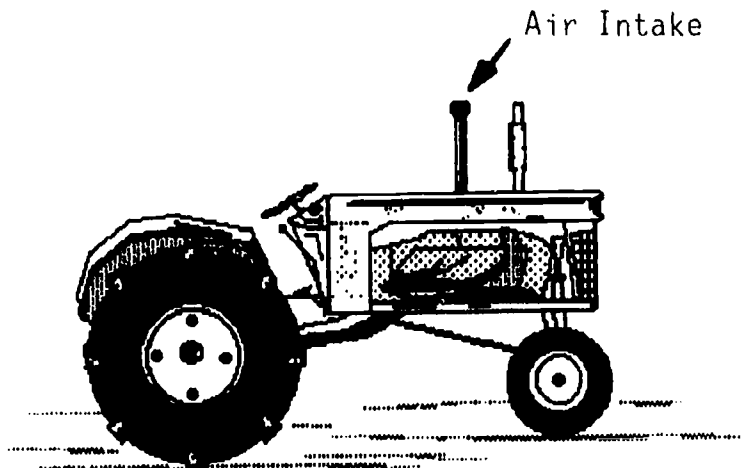

Figure 28. Discharge CO<sub>2</sub> Into the Air Intake

The method used to remove a victim from under the tractor depends on how much of the victim's body is pinned, the condition of the soil, and the size of the tractor. If the ground is soft, it may be possible to free the victim from under the tractor simply by hand digging the soil away from the victim. In any case, always block or crib the tractor to be sure that removal of the soil does not cause the tractor to tip more, causing further injury to the victim or endanger the rescuers (see Figure 29).

High pressure air bags can be used very effectively to lift a tractor on soft ground or in unstable areas. Stack two bags on top of cribbing for greater lift. Use cribbing as the tractor is lifted. If the tractor is large (15,000 to 30,000 lbs.), lift it with another tractor or a tow truck. Lift rather than roll the tractor away from the victim. When a tractor is rolled by raising one side, the other side may sink farther into the ground, crushing the victim even more. If the tractor must be rolled, block it carefully to reduce settling of the lower side. Securely fasten the chain or cable to the axle on the side opposite

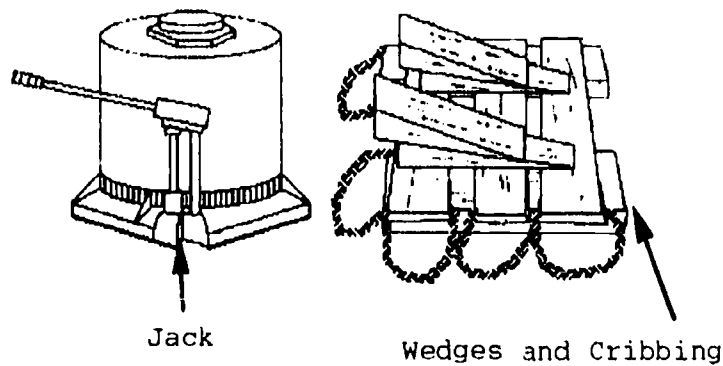

Figure 29. Cribbing, Wedges, and Jack

the tow truck. Drape tarps over the chains fastened with tension, so if a chain breaks, it drops to the ground instead of whipping wildly about in the air.

Check to be sure that the capsized tractor will not slip sideways. As an added precaution, chock the rear wheels with a wedge or block. Again, make certain that the engine cannot start. Place wood cribbing under the tractor as it is lifted. Do not use concrete blocks for support; they may break during the lift. During the lift, have extra rescuers stand back at least one length of any lifting cables or chains to prevent serious injury should the cable or chains break. Do not use a nylon rope because it stretches too much to give a positive pull.

A rescue-hydraulic-lifting unit (5- to 12-ton capacity) can be used to lift a tractor since only a part of the weight of the tractor must be lifted. Two or 3' of solid blocking is required to allow the jack to reach an axle or another solid part of the tractor. Block the axle on both sides to prevent the tractor from rocking onto the victim. Also, dig the soil away from under the victim's arm or a leg to reduce the height the tractor must be lifted. If the victim is pinned under one side of a small tractor, as a last resort, use eight to ten people to move the tractor enough to allow the victim to be pulled free. Block the tractor so the rear wheel does not slip, allowing the tractor's weight to be transferred onto the victim.

## TRACTOR POWER TAKE-OFF (PTO) SHAFT

The power take-off (PTO) shaft transfers power from the tractor to trailing equipment or stationary implements. All farm tractors are designed to operate the PTO shaft at either 540 or 1000 revolutions per minute. Universal standards suggest that the PTO

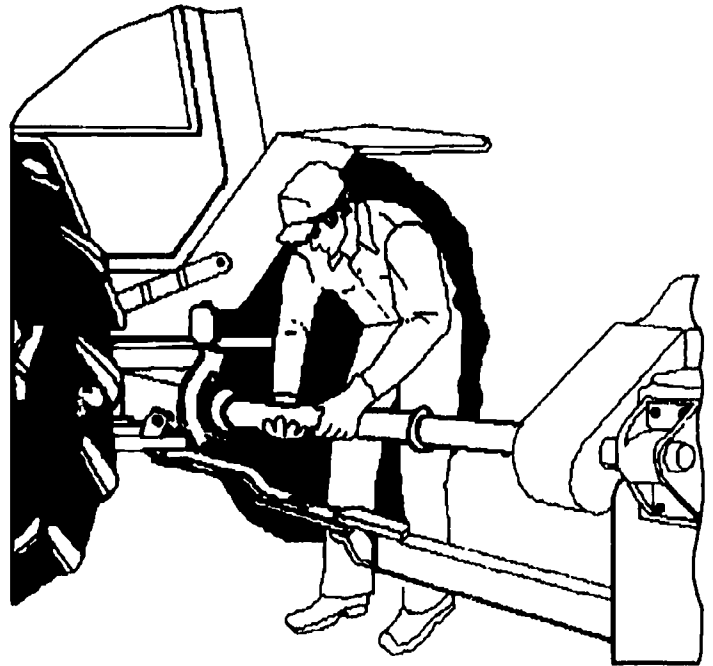

Figure 30. Power Take-off Hooked to Tractor

operate in a clockwise direction when facing the tractor from the rear (see Figures 30 and 31).

## Rescue Procedures for Accidents Involving a PTO

When performing a rescue where a power take-off is involved, use the procedures as follows:

1. Block the implement so it is firmly supported throughout the rescue. Be sure the tractor engine cannot start. On some models, turning the PTO shaft will start the engine.
2. Attempt to telescope apart the two ends of the shaft. The locking pin on the front yoke must be firmly depressed before the yoke will slide off the tractor-stub shaft. Sometimes the PTO shaft cannot be telescoped together enough to remove the yoke from the tractor stub shaft. In that case, try to roll the tractor ahead either to pull the PTO shaft apart or to slide the stub shaft out of the front yoke. Often the yoke is difficult to remove from the tractor stub shaft and a pry bar may be needed to force the yoke backward. Some PTO shafts are constructed in one piece and do not telescope. This type of shaft may have to be cut or disassembled at either end to free the victim.
3. In most cases, neither the tractor PTO stub shaft nor the implement drive are designed to allow the PTO shaft to be turned backward to remove a victim. Consider disassembling the

Spring-loaded pin connecting PTO to tractor. Depress to slide yoke off shaft.

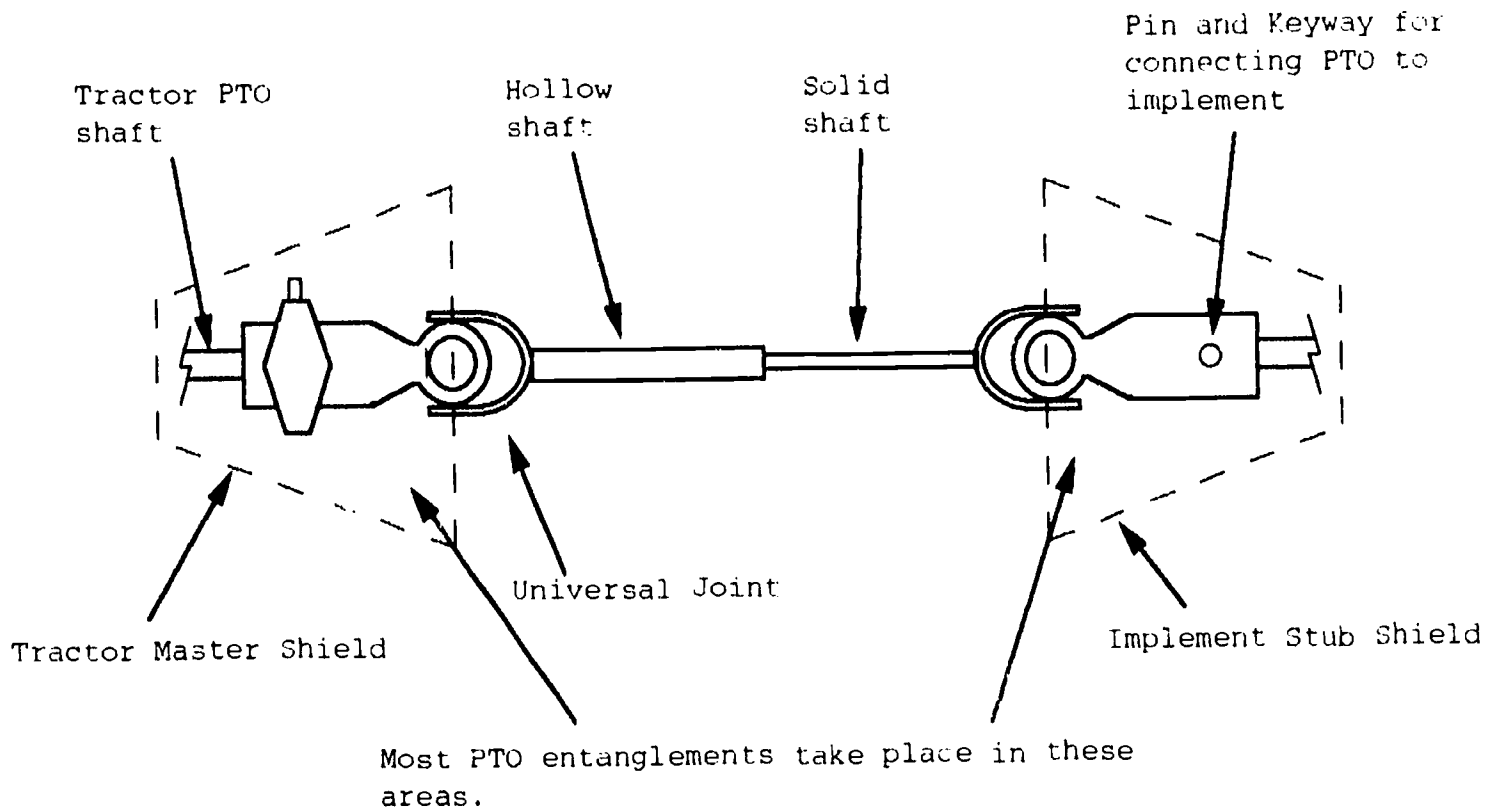

Figure 31. Power Take-off Shaft Diagram

- slip clutch or removing the shear pin, if the trailing equipment is so equipped.
4. Once the PTO is free to turn, use a large pipe wrench on the shaft (not on the external rotating shield) or a pry bar slipped through the yoke at the end of the shaft to slowly rotate it.
  5. If only the victim's clothing is wrapped around the shaft, cut the entangled clothing with a razor or a sharp knife. If the victim is bodily entangled, it may be better to transport the stabilized victim with part of the shaft. A surgeon can then complete the extrication in the hospital facility.
  6. Spine and neck injuries are common when a victim becomes entangled in the PTO drive-line. Stabilize the victim's cervical spine before transporting. See the chapter on patient care and handling for further information.
  7. The PTO shaft may be under load and need to be cut. Be careful that it does not suddenly snap free, injuring the victim or a rescuer.

## HYDRAULICALLY-OPERATED EQUIPMENT

Hydraulic systems are commonly found on many types of agricultural equipment. An engine or motor is used to drive a hydraulic pump that forces oil from a reservoir through hydraulic lines to a hydraulic cylinder or drive mechanism (see Figure 32). Hydraulic systems are used to lift an implement such as a plow, change the position of implement components such as a combine header or a bulldozer blade, operate remote hydraulic motors, and assist in steering and braking. Do not attempt to lift any part of the equipment with the hydraulic system. The hoses in the system may have reversed and rescuers can end up crushing the victim.

### Rescue Procedures Involving Hydraulically-operated Equipment

Follow the procedures suggested when rescuing a victim caught in hydraulically-operated equipment.

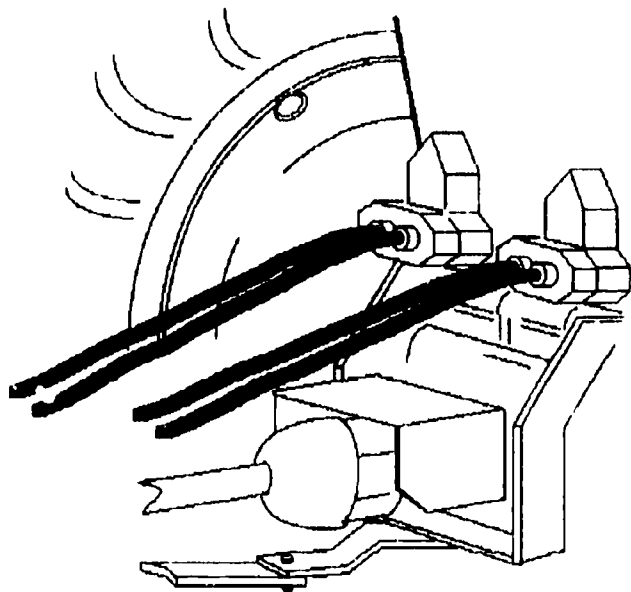

Figure 32. Hydraulic Lines

1. Turn the engine off if it is still running. Always assume that the entire hydraulic system, including the hoses, is under pressure. Fluid trapped in hoses and cylinders, especially on hot days, can exceed a pressure of 2,000 lbs. per square inch.
2. Treat hydraulic fluid as a flammable liquid. Avoid open flames and sparks if spilled fluid is present. Have a charged fire hose (1-½" minimum) or ABC chemical-type extinguisher available during the extrication.
3. Use rescue air bags to lift a machine. Use cribbing during a lift to prevent further injury. Stack two bags to produce a greater lift if cribbing is not available.
4. Sometimes it is easier and safer to dig the victim out from under the equipment when the equipment cannot be lifted. If hand digging, block the equipment to be sure it cannot fall backward onto the victim.
5. Secure or shore up the equipment before attempting to release the pressure of the load. Once the pressure is released, the total hydraulic system can become inoperable and parts held by the hydraulic pressure can collapse and/or change position. Secure the components using jacks, locks, or the pins sometimes built into the equipment.
6. If pressure cannot be released by the controls, disconnect the hydraulic hose at the tractor. Most hydraulic couplings are disconnected by pushing the sliding collar on the coupling (the couplings are similar to those found in com-

pressed air lines). Then strike the end of the male coupling against a hard surface to open the one-way valve to allow trapped fluid to bleed off. Cover the end of the coupling with a rag in case hot fluid is released.

7. If the couplings are inaccessible, bleed the hydraulic line by opening the connections at the hydraulic cylinder with two wrenches. Fire fighters must wear full turnout gear during this procedure.
8. Cut the hydraulic hoses only as a last resort. Large amounts of hot fluid will spill, creating a potential fire hazard. If the fluid is under pressure it will spray over a wide area, possibly contaminating open injuries or causing burns.

**NOTE:** Hydraulic hoses are constructed of steel webbing covered with rubber and cannot be cut with a knife. Use a hacksaw or large bolt cutter to cut through the webbing.

If a truck or a trailer bed has collapsed on a victim, it may be necessary to remove part of the truck load before high pressure air bags or portable jacks can safely lift the bed.

If anyone's skin has been penetrated by high-pressure hydraulic fluid, the person should be checked by a physician. This type of injury is difficult to treat if proper care is not given immediately.

## AUGER WAGONS AND SELF-UNLOADING WAGONS

Self-unloading and auger wagons are used in agriculture operations to transport and unload grain, silage, loose forage, stover, and other loose materials. Operated by the power-take-off shaft from the tractor or a remotely controlled motor, the wagon components operate with considerable force and speed. The most frequent accidents involving these wagons are injuries or entanglements in belts, chains, gears, and other drive-line components (see Figure 33).

In some accidents, the aggressive action of the augers and rotating beaters used to convey and break up the material being handled have completely dismembered victims.

### Rescue Procedures for Accidents Involving an Auger or a Rotating Beater

Follow the procedures suggested when rescuing a victim caught in an auger or a rotating beater.

1. Turn off any equipment that may be running, i.e., an elevator, portable auger, silage blower,

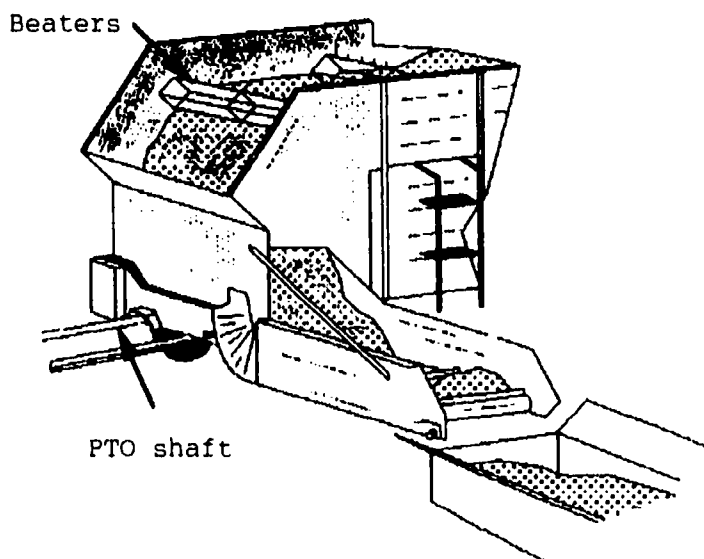

Figure 33. Self-unloading Wagon

or tractor used with a self-unloading auger wagon (see Figure 34).

2. If the entanglement involves belts or chains, cut them with bolt cutters. Nearly all rubber belts used for agricultural machinery contain numerous strands of tough steel wire that cannot be cut with a regular knife. In situations where a chain is too heavy for the cutters, locate the master link (similar to that found on a bicycle chain) and separate it with a pair of pliers or a screwdriver.
3. If necessary, and only if the victim is minimally caught or pinched, disconnect the PTO. Using

a large pipe wrench, turn the PTO clockwise while facing the wagon. Sometimes the PTO shaft can be disconnected from the tractor and turned at right angles so the shaft itself can be used as a lever to reverse the mechanism.

4. If the PTO cannot be turned, trace the drive train to the auger or beater. Look for hinges and latches that allow the housing or guard to be opened to give access to the drive assembly. Try to reverse the auger by turning the auger shaft with a large pipe wrench. Cut or disconnect the drive chain or belt with bolt cutters.
5. If it is not possible to reverse the equipment, remove the auger or beater from the machine. Stabilize the equipment before any parts are removed. Use an air chisel to remove any shielding or housing, and cut the chain drive connected to the auger.
6. Consider dismantling the auger housing at the end opposite the power drive connection since it has less metal parts. If the end can be freed, either manually or with a hoist, try to lift the auger to free the victim. Proceed slowly and cautiously so that parts of the equipment do not collapse.
7. If it is not possible to dismantle the shaft and the housing, try springing the shaft from the end housing using power equipment and pry bars. Use an air chisel if prying does not work. As a last resort, use an oxy-acetylene torch to cut both ends free. If the oxy-acetylene torch is used, it is important to watch for a fire.

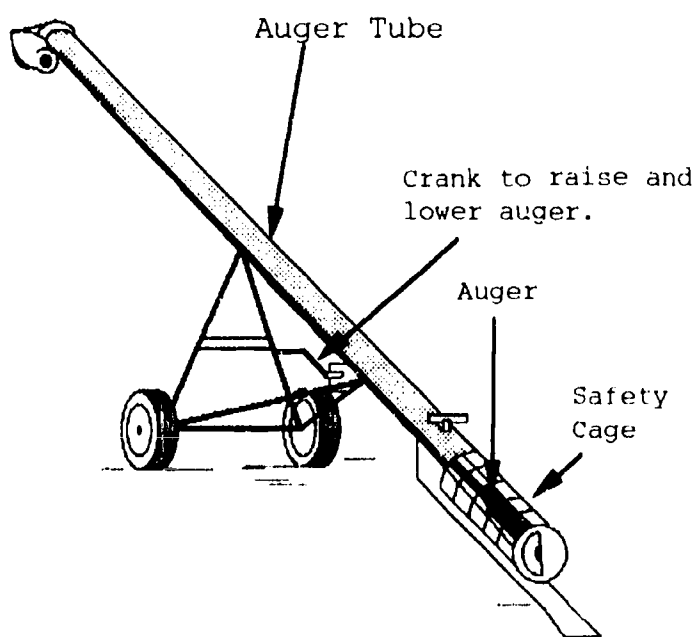

Figure 34. Portable Auger

### Rescue Procedures for Accidents Involving Augers or Elevators

Follow the procedures suggested when performing a rescue involving an elevator.

1. Secure each piece of equipment involved in the accident to be sure that no component can be accidentally started. Shut off the tractor's engine and remove the key, lock-out or tape-guard the electric motor switches, or remove the spark plug wires from small gasoline engines.
2. If the auger or truck is in the related position, watch for overhead power lines. If possible, lower the auger to increase its stability (see Figures 35 and 36).

**NOTE:** An auger loaded with grain may weigh several thousand pounds, so lower it carefully. If operated incorrectly, the lifting mechanism



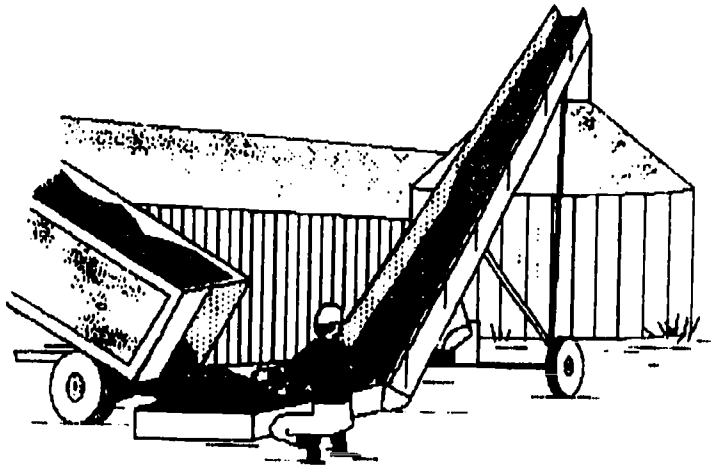

Figure 35. Elevator

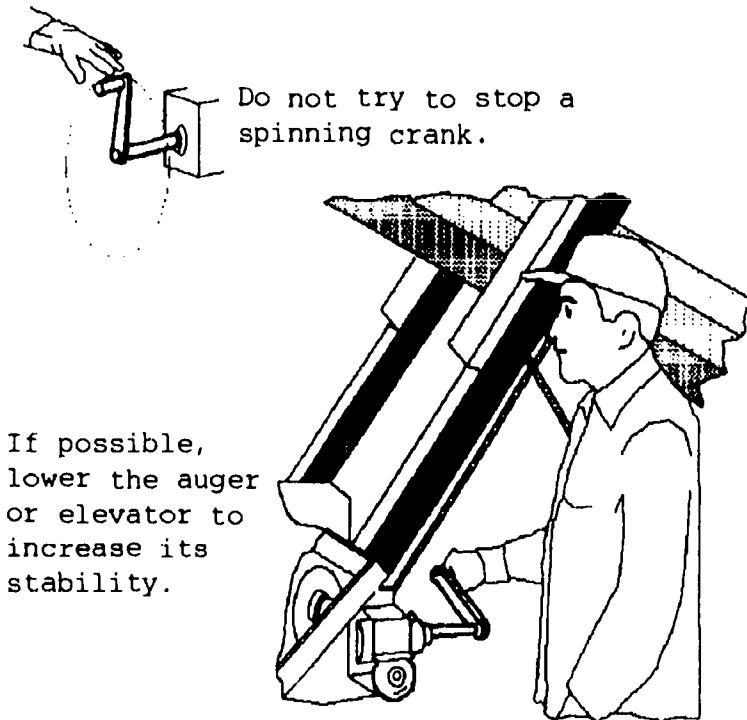

Figure 36. Lowering an Auger

could disengage and cause the auger to suddenly collapse.

3. If the victim has suffered severe lacerations or an amputation there will be considerable blood loss. Give first aid for life-threatening injuries such as severe bleeding.
4. If there has been an amputation, amputated tissue may be inside the auger tube. Check the outlet of the auger for signs of amputated tissue. Attempt to reverse the auger **only** if the tissue is visible or known to have penetrated into the auger a short distance (2 to 4 feet). This tissue can be damaged more if the auger is reversed. Turn the auger slowly in the normal direction

of rotation and retrieve the tissue at the outlet end.

**NOTE:** Do not use the normal power source to turn the auger. Have someone observe the outlet to prevent the amputated tissue from jamming against the end place of the auger tube.

5. In the case of an amputation, transport the victim immediately. Do not delay transporting the victim while looking for amputated tissue. Wrap tissue in a moistened towel, place it in a clean plastic bag, and take it to the hospital. Place the package on ice, but make sure it does not freeze. Notify the hospital that the amputated tissue is being transported.
6. If an entangled limb is still attached to the victim, cut the auger tube from around the auger screw and the limb. Avoid reversing the auger; in most cases, this would amputate the limb.
7. One way to remove the entangled limb is to cut 2' to 4' up each side of the auger tube with an air chisel. Then cut across the top to expose the auger screw and the limb. Be sure the victim and rescuers are protected from flying metal while cutting the metal.

The entangled limb may be severely stretched, so be sure it will not be further injured when cutting the tube. Once the auger screw and limb are exposed there will be less danger of causing additional injury during extrication. Cut the auger screw above the limb, then lift the limb and the auger screw away from the tube.

8. In cases where a victim is severely entangled, it may be best to support both ends of the auger assembly and cut off 4' to 6' of the inlet end. Once the end has been cut off, it may be possible to slide the auger screw and the entangled limb from the tube. If this is not possible, transport the victim and the auger section to the hospital so the auger can be removed by a surgeon.

**NOTE:** Extricating a victim who is severely entangled in an auger should be under direct supervision of a physician or an advanced life-support team at the scene of the accident.

## ELECTRICAL ACCIDENTS

Most electrocutions and electrical injuries on a farm are from contact with overhead power lines.

Grain augers, hay elevators, aluminum ladders, radio antennae and irrigation equipment are often involved. Many overhead power line accidents involve two or more people working together at the time of contact, setting up an antenna, moving an auger, or performing other tasks that require more than one person.

### Rescue Procedures for Accidents Involving Electricity

In the event of a high-voltage line accident, call the utility company immediately. Secure the accident site until assistance arrives. Only if the response time could be dangerously long, should an unskilled person attempt an electrical rescue.

**NOTE:** The safety precautions listed are not sufficient for protection when working with high-voltage, high-tension lines. In most cases, however, high-tension lines are not found on farms where augers and elevators are used. Follow the procedures suggested when performing a rescue involving an electrical accident.

1. Always assume that any downed power line or any piece of equipment in direct contact with a power line is fully energized. If a victim is in contact with the power line or energized equipment, do not touch his or her body. Use a "hot stick" to remove the line or to push or pull the victim away (see Figure 37). If there is no "hot stick" available, use a piece of dry, nonconductive rope (polypropylene) to tow away the victim or the wire (see Figure 38).
2. Once the victim is freed from electrical contact, check the victim's breathing and begin basic life support. Bleeding is usually not a problem, even though there may be wounds on the victim's body.

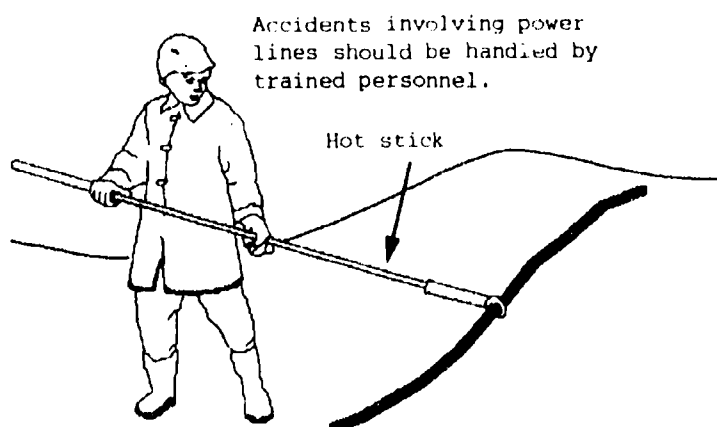

Figure 37. Hot Stick

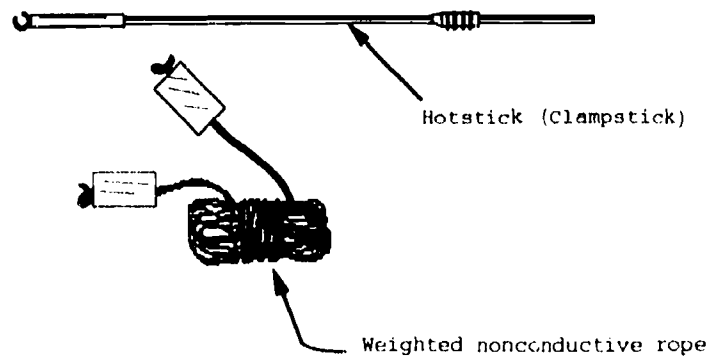

Figure 38. Nonconductive Rope

3. Regardless of how the victim feels, any person receiving a high voltage electrical shock should be examined by a physician.

**NOTE:** For further information, see the chapter on Rescue Operations Involving Electricity.

## HARVESTING EQUIPMENT

### Balers

A baler is a large complex piece of equipment used to compact hay and straw into dense, easy-to-handle bundles. Conventional balers form rectangular 50- to 150-pound bales that are held together by twine or wire (see Figure 39). Round balers roll the crop into a 1000- to 1500-pound cylinder-shaped bale. The knotting mechanism and pick-up assembly on the conventional baler are responsible for most injuries and the tying mechanism can cause a problem on the small round baler. Entanglement in the pick-up assembly, or the belts or chains used to

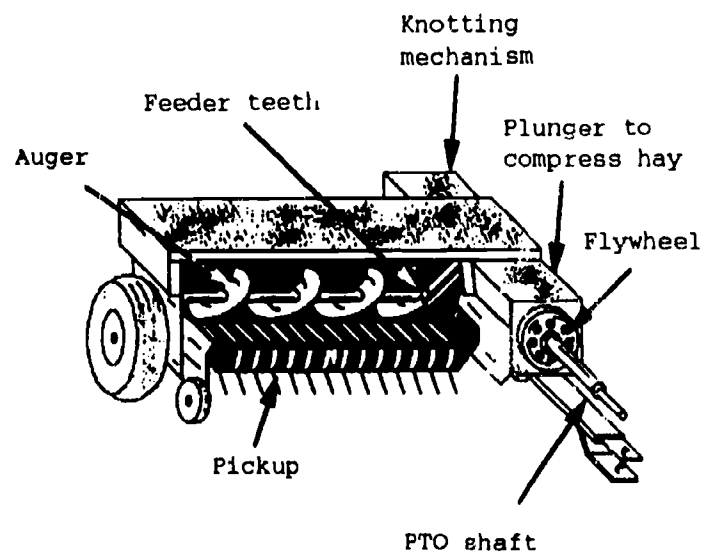

Figure 39. Conventional Baler

compress the foliage comprise most mishaps with round balers (see Figure 40).

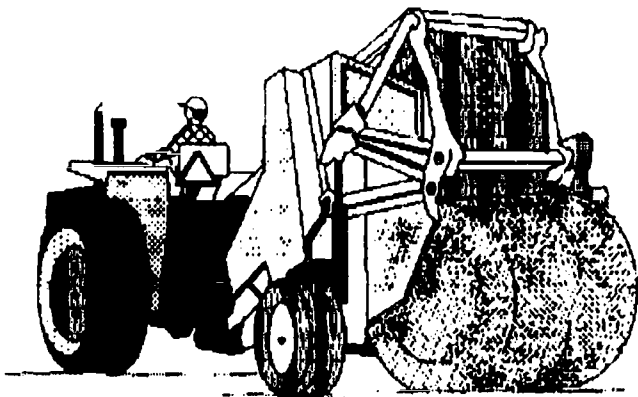

Figure 40. Round Baler Baler

### Rescue Procedures for Accidents Involving Conventional Balers

Follow the procedures suggested when rescuing a victim caught in a conventional baler.

1. Turn off the tractor's engine. Secure each piece of equipment involved in the accident to be sure it cannot be started accidentally. Either shut off the baler and remove the key, lock-out or tape-guard the electric motor switches, or remove the spark plug wires from small gasoline engines.
2. If a hand and arm has been entangled in the knotting mechanism, disassemble the mechanism to release the limb. A mechanic with experience working on baling equipment can disassemble a knotter quickly. If a mechanic is not available, close examination of the knotter components make disassembly procedures apparent. (Check the tool box on the baler or the twine box for an operator's manual).
3. In some cases the victim may be entangled in the cross auger found on the pick-up assembly of the balers. This type auger is usually supported on one end only and can be easily removed. Block the pick-up mechanism to keep it from moving during extrication.
4. Once the PTO shaft is disconnected from the tractor the moving components on most conventional balers can be reversed. Rotate the large fly wheel at the front of the baler counterclockwise. Never use power from the tractor to attempt extrication.
5. Entanglement in the pick-up assembly may involve puncture wounds caused by the pick-up

tines. Use a heavy bolt cutter to cut off any tines embedded in the victim. Use a vise grip to hold the tine when cutting. This procedure is recommended because removal of the tines can cause severe hemorrhaging.

6. A physician should be on the scene at complex entanglements to supervise life-support procedures during extrication.
7. Use the cutting torch or power saw with utmost caution. Have a charged hose line (1-1/2" minimum) and an ABC fire extinguisher on hand during the extrication in case of fire. Remove all hay from inside the baler as well as any loose hay surrounding the baler and tractor.

### Rescue Procedures for Accidents Involving Round Balers

Follow the procedures suggested when rescuing a victim caught in a round baler.

1. Turn off the tractor's engine and block any parts that may shift and cause further injury.
2. Victims entangled in the belts or chains that form the hay into a bale may have been pulled into the mechanism so tightly that they have difficulty breathing. To relieve the pressure, cut the belts with a sharp knife or saw. Remove the hay surrounding the victim to reduce the pressure on the victim.
3. Rollers used to compress the crop as it passes from the pick-up into the bale chamber are spring-loaded. Loosen the spring or hydraulic pressure on one of the rollers to release the tension of the spring.
4. Since several power springs are used to keep the belts under tension, disassemble the unit with extreme caution. Sudden release of the stored energy in one of the springs could cause serious injury.
5. The risk of fire is continually present throughout this type of rescue. Remove all loose hay from the area. Keep a fire extinguisher nearby during the extrication.

### Rescue Procedures for Accidents Involving Combine Equipment

Most combine injuries occur when clothing, fingers, hands, or legs are caught in the belts of the combine. Burns, severe cuts, and occasional amputations can happen using a combine.

### Releasing a Victim Caught in a Belt

Follow the procedures suggested when rescuing a victim caught in a belt of a combine.

1. Turn off the combine engine. Secure each piece of equipment involved in the accident to be sure that it cannot be started accidentally. Either turn the combine ignition switch to the off position and remove the key, lock-out or tape-guard electric motor switches, or remove the spark plug wires.
2. Free the victim by cutting the belt with bolt cutters or a hacksaw.

### Rescuing a Victim Caught in a Grain-tank Auger of a Combine

1. A victim who is minimally caught in a grain-tank auger can sometimes be released by reversing the mechanism by hand or by using a pipe wrench. On most combines the drive train must be disconnected before the auger can be reversed.
2. If the victim is severely entangled, remove the auger from the combine. Disconnect the auger's drive train before removing it from the combine.
3. Try to dismantle the auger bearing housing at the end opposite the drive train. Once the auger is freed, slowly lift it by hand or with a hoist.
4. If the auger cannot be released, try to spring the auger shaft free with a rescue tool. If all else fails, cut both ends and carefully hoist the auger free.

### Rescuing a Victim Pinned Under the Header of a Combine

Follow the procedures suggested when rescuing a victim pinned under the header of a combine.

1. If the ground is soft, it may be possible to dig the soil away from under the victim. Block the header to prevent the soil from settling.
2. It may be necessary to lift the header with a hydraulic jack or high-pressure air bags. If the header is locked in place, lift the combine along with the header. High-pressure air bags can be used to lift the combine header. The header can be lifted separately once the hydraulic hoses at the lift cylinders have been disconnected.

## CORN PICKERS

Every year a few farmers are pulled into corn pickers and seriously injured. An accident like this

occurs when a farmer tries to pull a plug of corn stalks or a piece of trash from a running machine (see Figure 41). Once the plug breaks loose, the snapping rolls can carry the plug and a limb into the machine (see Figure 42).

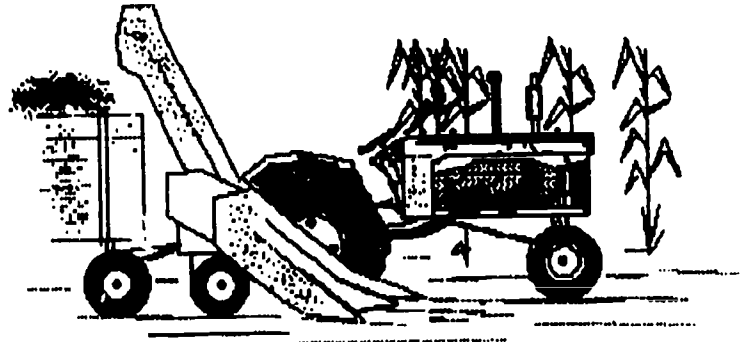
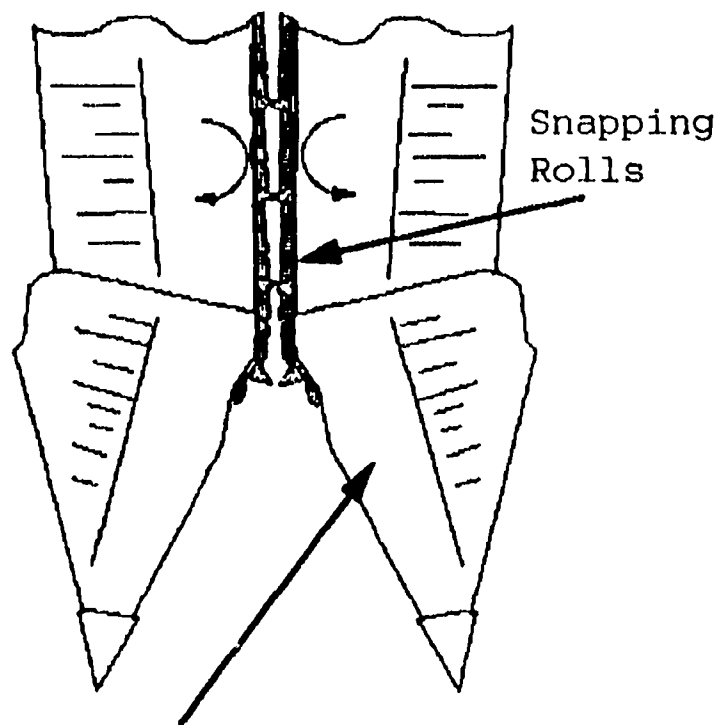

Figure 41. Corn Picker



Corn Picker

Figure 42. Snapping Rolls of a Corn Picker

Follow these procedures when performing a rescue involving a corn picker.

1. Turn off the engine. Disconnect the PTO if the picker is a tractor-towed unit.
2. Use high-pressure air bags to spread apart the snapping rolls. Use tapered wedges (soft wood) to hold the rolls apart while the air bags are

being inflated. Power spreaders can also be used to spread apart the snapping rolls.

3. To free a hand caught in the husking bed roller, use a pry bar to release the tension. It may be necessary to use cutting tools.
4. It may be necessary to call a machinery dealer or neighboring farmer to help dismantle the corn picker.

## GRAIN BINS

Generally, few dangers are generated from stored grain, but flowing grain can lead to suffocation and entrapment. Grain bins that appear relatively safe can become the scene of death and entrapment. In addition, grain transport equipment, commercial elevators, and equipment used at the grain-processing facilities have also been involved in numerous accidents.

### Rescue Procedures for Accidents Involving Grain Bins

Follow the procedures suggested when rescuing a victim in a grain bin.

1. Always assume that a victim entrapped in grain (even if completely submerged) is alive. Successful rescues have taken place with a victim completely engulfed in 10 feet of grain for more than two hours. There have been unnecessary deaths when access to the victim could have been expedited if the rescuers had performed the rescue as if the victim was still alive.
2. If a victim is trapped in grain, do not start the unloading auger or open the gravity flow gate for any reason. This can cause the victim to be drawn into the unloading auger, or become wedged in the opening, causing further injury.
3. When there is evidence of spoiled or caked grain, always have three rescuers involved: two outside the bin and one inside (see Figure 43). The rescuer in the bin should wear a body (parachute) harness and be tied with safety rope to the two rescuers outside. The outside rescuers should be capable of lifting the rescuer in the bin without entering the bin.
4. Dust or mold spores from spoiled grain can cause severe allergic reactions in some individuals. Wear respiratory protection to filter out dust and mold spores when working in a bin of spoiled grain. A paper dust mask is usually sufficient. If rescuers begin to exhibit shortness

Always use safety harnesses.

Crusted grain can conceal a void.

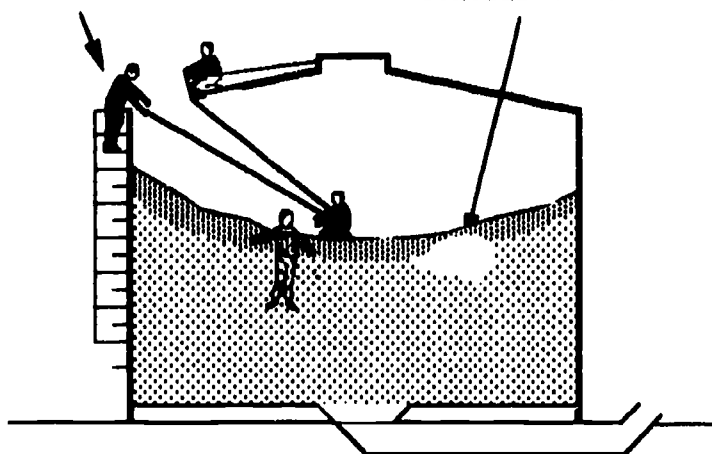

Figure 43. Rescuing a Victim Trapped in a Grain Bin

of breath, tightness in the chest, or dizziness, they should leave the area and be kept under observation. Severe reactions to grain dust or mold often require hospitalization. Allergic reactions can be delayed for several hours.

### Rescue Procedures for a Victim Completely Submerged in a Grain Bin

Follow the procedures suggested when rescuing a victim who is completely submerged in a grain bin.

1. Start the aeration fan to circulate air through the grain. The operation of an aeration fan can provide an air supply to the completely submerged victim.  
**NOTE:** Check to be sure the drier is not connected to the aeration fan. Do not start the drier.
2. If a victim is completely submerged, remove the grain from the bin in a rapid orderly manner. Efforts to dig out a buried victim from inside the bin have proven worthless due to the large amount of grain involved and the nature of grain to back-flow.  
To remove grain rapidly, uniformly cut large openings around the base of the bin, releasing the grain. Cut the openings in the metal skin of the bin with an abrasive saw, an air chisel, or a cutting torch (see Figure 44). This procedure greatly reduces the time needed to remove the grain and gain access to the victim.  
**NOTE:** Only use a cutting torch when no other equipment is available, and watch for a fire.
3. Cut emergency openings 4' to 6' off the ground to reduce grain building up around the outside

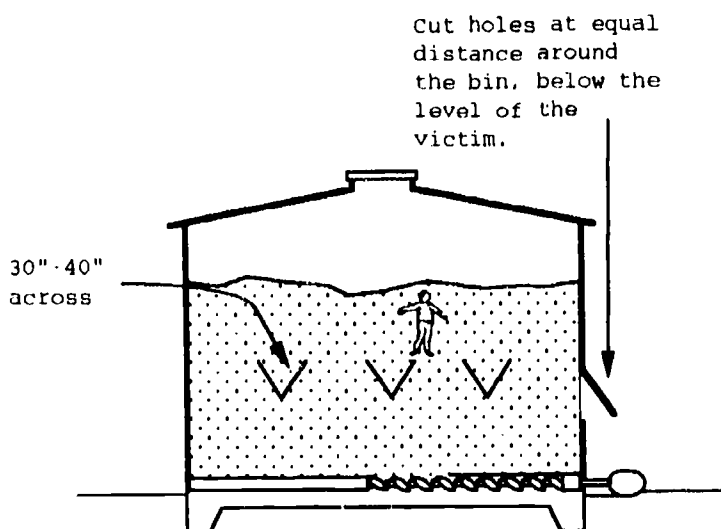

Figure 44. Releasing Grain from Bottom of a Bin

of the bin and blocking the flow. Make V-shaped cuts, 30" to 40" across. These cuts form a valve which, when bent up, allow the grain to flow freely. When bent back, they slow or stop the flow of the grain. This allows the rescuers to control the flow and protect the workers inside the bin from being drawn into a rapid flow of grain.

4. Grain should be removed equally from all sides. The structure will not hold the grain pressure if the grain builds up only on one side.

### Rescue Procedure for a Victim Partially-submerged in a Grain Bin

Follow the procedures suggested when a rescue involves a victim who is partially-submerged in a grain bin.

1. If possible, lower a rescuer into the grain bin to reassure the victim and attempt to attach a harness or lifeline to the victim. **Do not try to pull the victim free using ropes or the harness.** The tremendous drag created by the grain will likely cause further injury. The lifeline is used to reassure the victim and prevent further sinking.
2. Check the victim's airway for lodged grain, and if the victim suffers difficulty in breathing, administer oxygen if available. Sometimes a victim experiences difficulty breathing during a panic attack or while struggling to work free of the grain, rather than from pressure on the respiratory system.
3. If there is a danger of more grain falling and further covering the victim, construct a shield

around the victim using a sheet of plywood or metal. It may be necessary to remove part of the roof to get rescue materials inside the bin. Once the shield is in place, begin to dig the victim out by scooping the grain from inside the shielded area. Use a sheet of plywood or a few boards to construct a work platform for the rescuers.

4. If materials are not available or these procedures fail, use the procedure identified previously to lower the grain to rescue a completely-submerged victim.

### Rescue Procedures for Victims Entrapped in a Grain-Transport Vehicle

Entrapment in a grain transport vehicle usually presents fewer problems than entrapment in large grain-storage facilities. Rapidly remove the grain surrounding the victim by cutting open the sides of the vehicle. This removes most of the grain. Do not use the gravity flow opening on a gravity unloading vehicle. Victims, especially children, are apt to be drawn deeper into the grain or become wedged in the opening.

### Rescue Procedures for Victims Trapped in a Silo

The round vertical silo, used to preserve and store livestock feed, is a common sight on many farms. Silos vary in circumference and height, and also by the type of construction and design. Construction can be of poured concrete or concrete stave, sheet metal, or wooden stave. Some silos have a roof, while others are open at the top (see Figure 45).

Another type of silo on some farms is a large sealed structure that is usually painted dark blue. This type has an unloading mechanism built into the bottom and a small vent or access door at the top that can be closed to exclude air. This sealed silo is specifically designed as an oxygen-limiting structure. **Self-contained breathing equipment is required for anyone entering this type of silo.** Enter either through the roof access door or vent, or the bottom access door that is used to service the loading mechanism. Some silos of this design have a bar over the access door that needs to be removed.

Open silos may have an electrically-operated unloading device that rests on top of the silage (see Figure 46). The unloader circles around the silo,

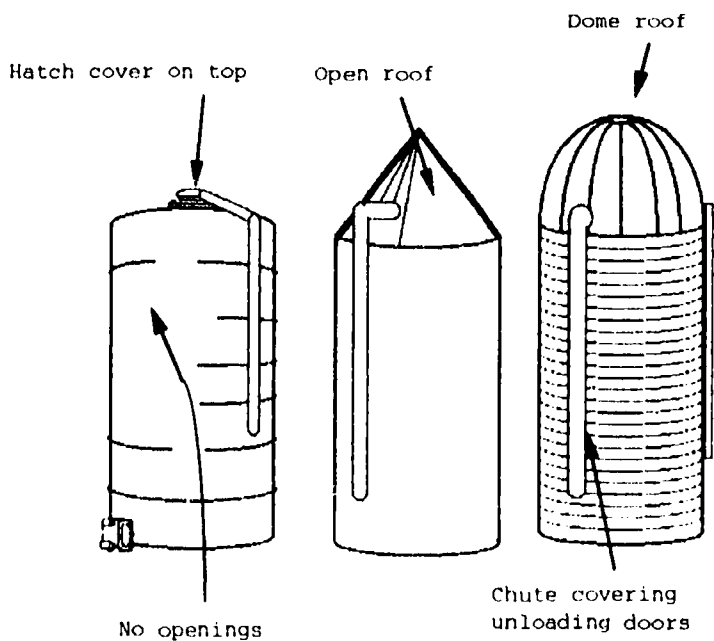

Figure 45. Types of Silos

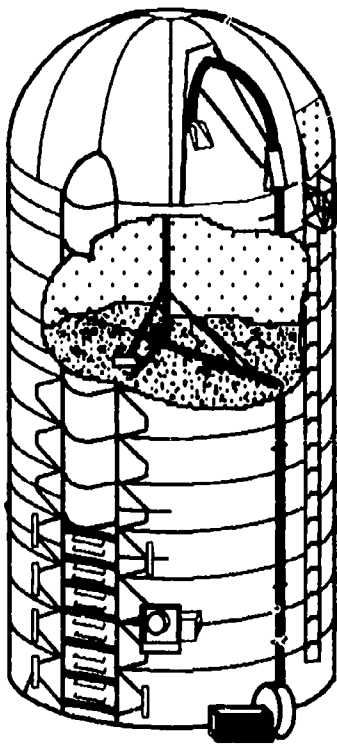

Figure 46. Typical Top-unloading Conventional Silo

chops off a thin layer of silage, and blows it down a closed chute to feed livestock. This chute often covers a series of doors along the side of the silo.

If a silo unloader is in use, the chute will be blocked by the ejection tubing. Both the ejection tubing extending into the chute and the unloading mechanism can be raised by ropes, pulleys, and hoists that are a part of the unloading mechanism. In

addition, silos usually have an external ladder on the opposite side of the chute. It is used to attach the loading pipes from a silage blower. These ladders are normally located 8 to 10 feet from the ground.

Silo rescues are necessary in four situations: the victim falls into the silo, has had a heart attack while in the silo, is overcome with toxic gas while in the silo, or is caught in the silo's unloading mechanism. In each situation, the victim may not be able to descend the enclosed chute ladder and may require extrication by rescuers using a litter, backboard, body sling, or harness.

## GASES FOUND IN A SILO

Silage is formed by a natural chemical fermentation which takes place in chopped forage shortly after it is placed in the silo. As the silage ferments, a variety of gases, including carbon dioxide, methane, and nitrogen dioxide are released. Carbon dioxide can cause suffocation in concentrations of 30% or higher — a situation that is unlikely to occur in a silo. Methane is present in very small concentrations in silos for the first two weeks after silage has been placed in a silo.

The inhalation of nitrogen dioxide may cause death or permanent lung damage, even in low concentrations (see Figure 47). Nitrogen dioxide is heavier than air so it tends to collect at the surface of the silage and flow down the chute into adjoining feed rooms and other low areas at the base of the silo. Silo gas has a strong bleach odor and may appear as low-lying yellow, red, or dark brown fumes in the silo filling area.

Silo gas can persist for two or three weeks after crops have been placed in the silo. The greatest danger, especially with corn, occurs one to three

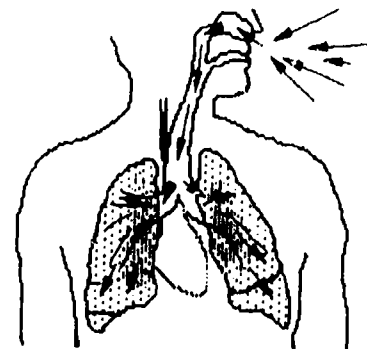

Figure 47. Respiratory Tract and Lungs Affected by Silo Gas

days after the harvest. Two or three weeks after filling, it is unlikely that more silo gas will be produced. A potential hazard still remains, however, usually when the silo is opened for unloading.

Silo gas causes severe irritation of the upper respiratory tract and may lead to inflammation of the lungs. The victim may feel little immediate pain or discomfort. A person may inhale silo gas for a short time period noticing no immediate ill effects, but may go to bed several hours later and die during sleep from fluid collecting in the lungs. If a person survives silo-gas inhalation, a relapse, with symptoms similar to pneumonia, can occur one to two weeks after an initial recovery.

The majority of people who develop initial silo-gas poisoning symptoms usually develop further symptoms and complications. It is extremely important that a victim of silo-gas exposure seek immediate medical attention regardless of the degree of exposure or symptoms.

## RESCUE PROCEDURES WHEN WORKING WITH SILO-GAS EXPOSURE

1. Use caution when rescuing victims in and around silos, especially if the silos have been filled within the past three weeks. If silo gas is present or suspected, use self-contained breathing apparatus (SCBA) (see Figure 48); gas masks do not protect against silo gas. Assume there is deficient oxygen and use breathing apparatus

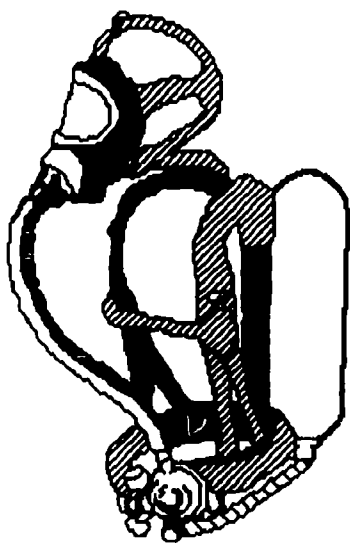

Figure 48. Self-contained Breathing Apparatus

inside any sealed silo regardless of the time of year or the type of rescue being performed.

- When it is not possible to climb the enclosed silo chute with an air pack, use an air line. Attach the self-contained breathing equipment to tag lines and pull them up the chute once a rescuer has entered the silo with an air line. If an air line is not available, the silo may have to be climbed from the outside and the rescuers lowered into the silo through the roof opening.
2. Always use lifelines when entering a silo in which silo gas is suspected to be present.
  3. Provide immediate medical attention if the victim is found lying on the surface of grain that is emitting gas. If possible, lift the victim off the surface where the gas concentration is greatest.
  4. If an extra self-contained breathing apparatus is available, put it on the victim and try to move air into the victim's lungs. In some cases the victim may be able to walk out of the silo rather than be taken out on a stretcher.
  5. Exercise caution when climbing on a silo ladder, and always use a life belt and hook, since the rungs of the enclosed chute ladder double as door handles and do not provide secure footing. Often, some are broken or missing. Also, the external ladders may suffer weather or mechanical damage. The lifeline is a necessity.
  6. Rescue workers exposed to silo gas should be immediately relieved from duty and receive medical attention. Respiratory problems caused by exposure to silo gas are sometimes difficult to diagnose. Symptoms to watch for include difficult breathing, coughing, and wheezing.

### Rescue Procedures for a Victim Trapped in a Silo Unloader

When rescuing someone trapped in silage-unloading equipment, note these items:

1. There is usually no need to use breathing apparatus during the winter months unless the silo is the sealed type.
2. The surface of the silage is usually firm enough to walk on.
3. Silage clinging to the walls could fall and injure the victim or the rescuer.
4. A seriously injured person will probably have to be lifted over the top of the silo by rescuers using a rope and backboard, litter, or body sling.



5. Rescue personnel should know the height of the tallest silo in the local area and have enough rescue rope (see rope section for type and size) to lift a victim out of the silo, regardless of the level of the silage in the silo.

Follow the procedures suggested for accidents involving a victim caught in a silo unloader:

1. To remove a victim from inside the silo, use two rescue teams: one operating outside the silo and one operating inside the silo. Two-way radio communication is essential in silo rescue operations.
2. Locate the main power control for the unloader and secure it (preferably with a padlock) before entering the silo. If the switch cannot be locked, have someone guard it or secure it with tape (see Figure 49). Be certain it is kept in the off position during any rescue attempt from the silo or during extrication from the unloading mechanism.

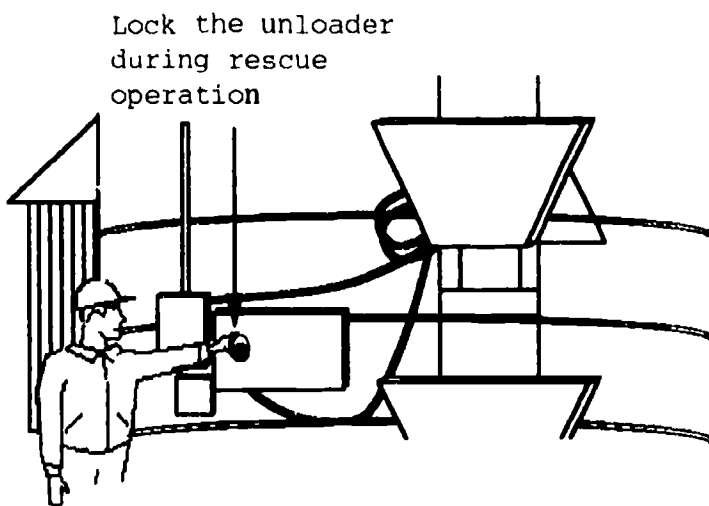

Figure 49. Locking the Unloader

3. If a victim is caught in the unloading mechanism, study the equipment to plan the best method of extrication. Tools will have to be hoisted up the enclosed chute using tag lines or dropped by a tag line from the top of the silo.
4. The inside rescue team should secure the victim in a litter, backboard, or body sling, depending on the victim's injuries or the situation.
5. Be sure to carry enough rope to the top of the silo for the rescue. In most cases, it is not possible to take a victim down the enclosed chute. The rescuers stationed outside the silo should prepare to lift the victim up from the

inside and lower the victim down the outside of the silo using the following procedure.

- a. Lash a 16' to 18' ladder securely to the outside silo ladder or to the silo structure so it extends at least 8' above the silo rim. The backboard must clear the top of the silo (see Figure 50).

NOTE: Rig a pulley or snatch-block to the top of the ladder and run the rescue line through it before lashing the ladder to the silo top. Drop part of the rescue line inside the silo to the rescue team stationed inside. Then drop the remainder of the rescue line to the ground.

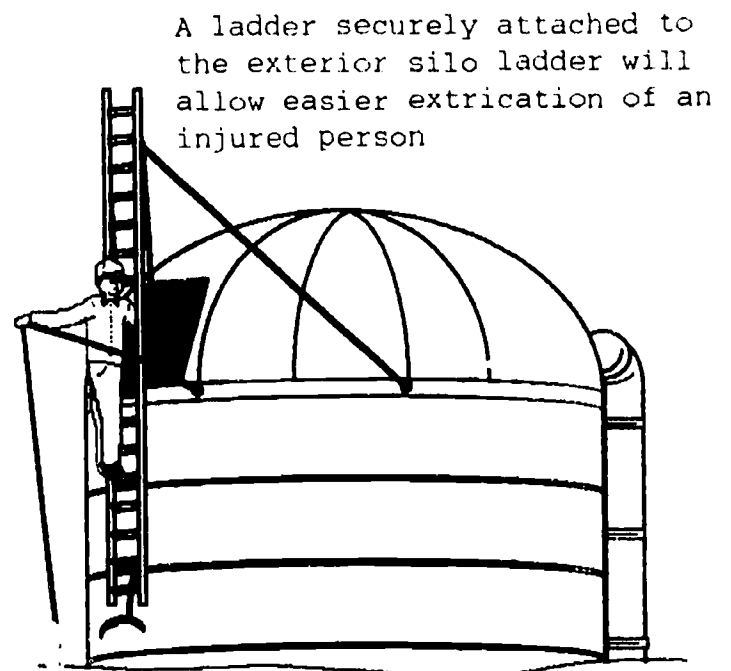

Figure 50. Rigging the Ladder

- b. Attach a rescue line to the victim.
- c. Rig another pulley to the base of the silo directly under the ladder lashed onto the top. Run the rescue line through this pulley and drop to members of the rescue team stationed on the ground.
- d. Most silos have an access door or opening in the top or roof; it is either at or near the outside ladder. If this opening is not large enough to pass the victim through easily, enlarge it or cut a new opening. Cut metal caps with an air chisel or a power saw.

Use a wrecking bar or a power saw to tear apart a wooden roof. Since weather may have caused the wooden structures to rot, rescuers should watch for weakened areas. Rescuers stationed at the base of

the silo should wear protective headgear to prevent injury from falling debris.

- e. Pull the victim from inside the silo. A rescuer at the top of the silo should maneuver the backboard from the inside to the outside of the silo and start the descent to the ground. The victim's ascent from inside the silo and descent to the ground should be assisted and secured by two tag lines fastened to the backboard, litter, or harness (see Figure 51).

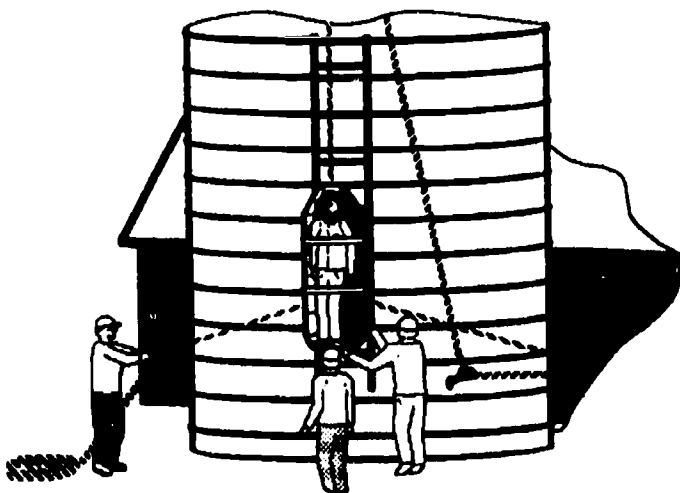

Figure 51. Lowering the Backboard

- f. Set up sufficient lighting both inside and outside the silo during night rescue operations. Tall silos are difficult to light and require extra equipment.
- g. The incident commander should be stationed at the top of the silo. This point gives visual and verbal access to rescuers working inside and outside the silo via a two-way radio.

### Rescue Procedures for a Victim Trapped in a Three-Silo Setup

When rescuing a victim from a three-silo setup, use a two-line system or two separate single-line systems. Use separated anchor points for each system for safety.

In the event shown, two separate single rope systems are incorporated into a lowering, belaying and hauling, and a belaying system. Figure 52 shows a lowering system with double pulleys at the top and bottom of the ladder. A second line, the belaying

line, is rigged into the double pulleys but using a separate belay anchor point.

Once a rescuer has been lowered to the victim, rig the belay system into a hauling system as shown in Figure 52 or Figure 53. The lowering line, shown in Figure 54, now becomes the belay system for the hauling system.

**NOTE:** Extra large carabiners are wide enough to go over a ladder rung. **Never set up a system on a ladder rung. A ladder rung cannot hold the added weight.** Use webbing around the ladder siderails and over the rungs to hang the system.

**Remember, a system is only as strong as its weakest point!!!**

### Silo Fires

**NOTE:** The information presented here is for fire fighters involved in farm accident rescue procedures.

#### Causes of Silo Fires

Plant material continues to "breathe" for a short time after it is cut. This respiration produces some heat when the material is in a storage area. In the process of producing acids necessary to ensile the material in a silo, organisms also produce heat. If the material is wet, the water in the forage conducts the heat from the mass of material and spontaneous combustion does not occur. If the material is dry, (below 20% moisture) the microorganisms are relatively inactive, so little heat is produced and again, spontaneous combustion does not occur.

A hay crop that is too wet (above 25% moisture) when placed into a mow, or too dry (below 40% moisture) when placed into a silo, produces heat rapidly. If the mow or silo is large and the heat loss is restricted, the internal temperature rises. As the temperature rises above 130° Fahrenheit, a chemical reaction called the Maillard Reaction occurs and may sustain itself. The heat kills the microorganisms at 250° to 400° Fahrenheit and begins to break down the hay crop by a chemical reaction called pyrolysis. The Maillard Reaction does not require oxygen, but the flammable gases produced by pyrolysis are at a temperature above their ignition point. When they come into contact with oxygen, these gases ignite.

Recent efforts have demonstrated that most silo fires can be extinguished by only a few fire fighters,

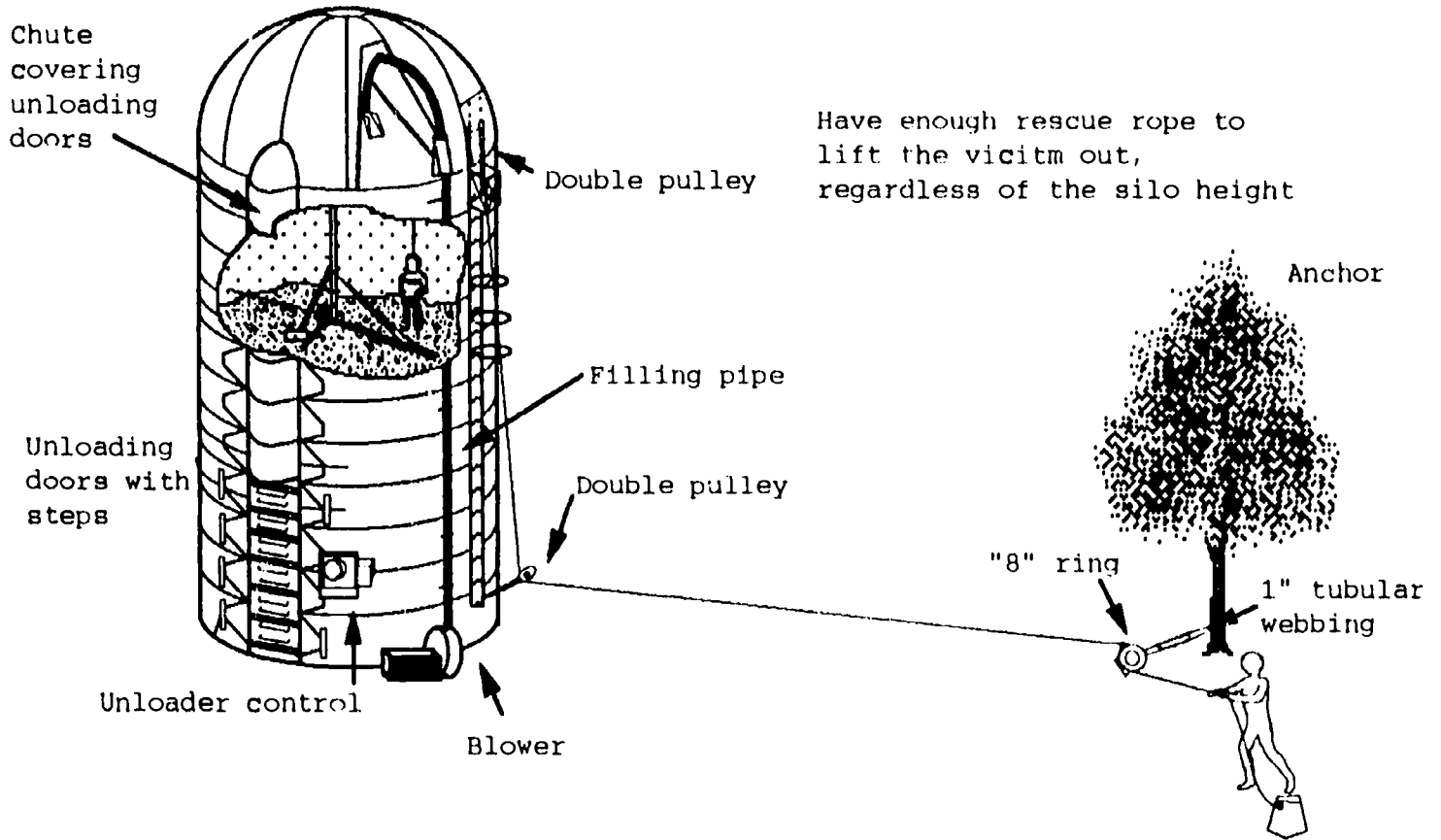

Figure 52. Lowering and Belaying System

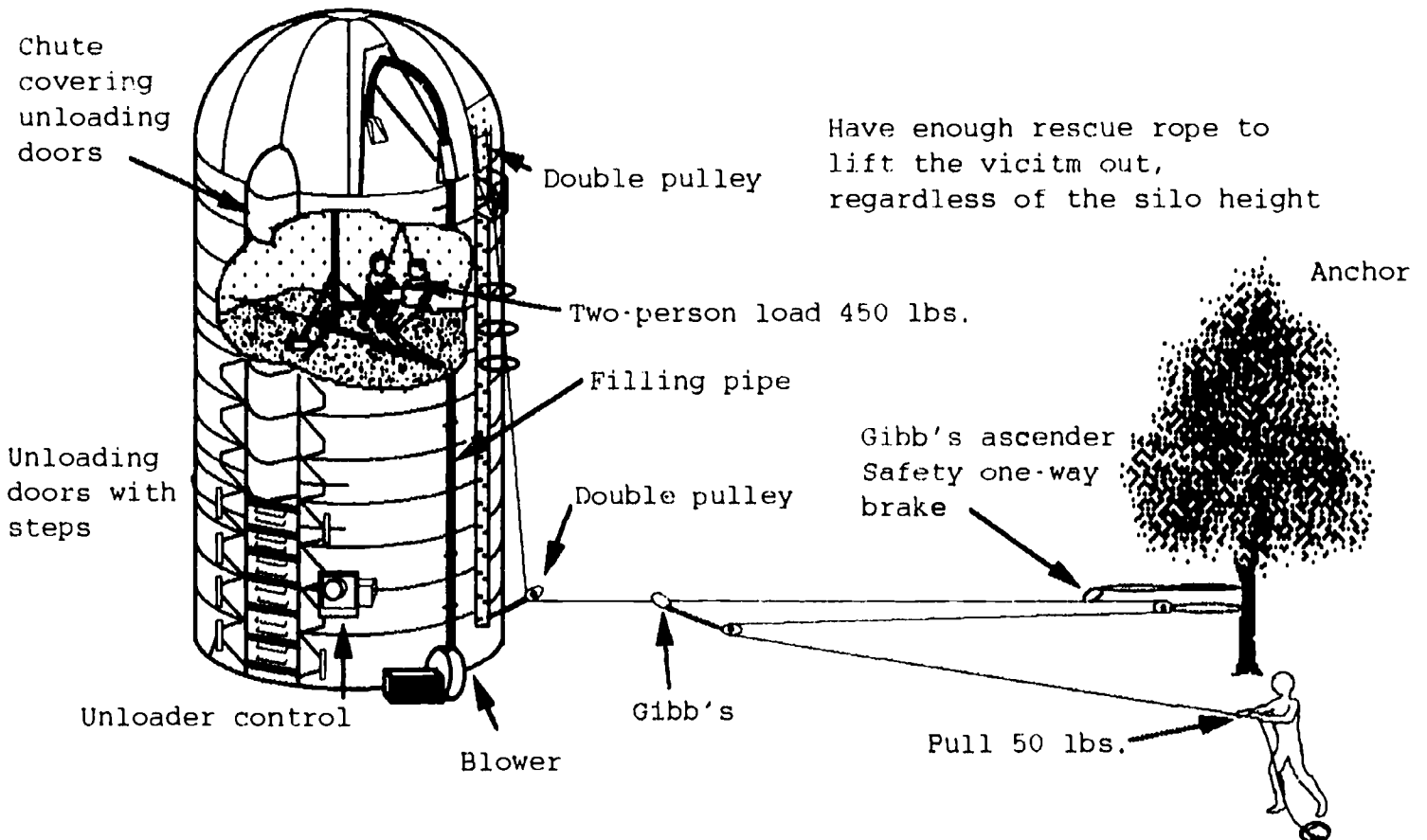

Figure 53. Hauling System, "Z" Drag

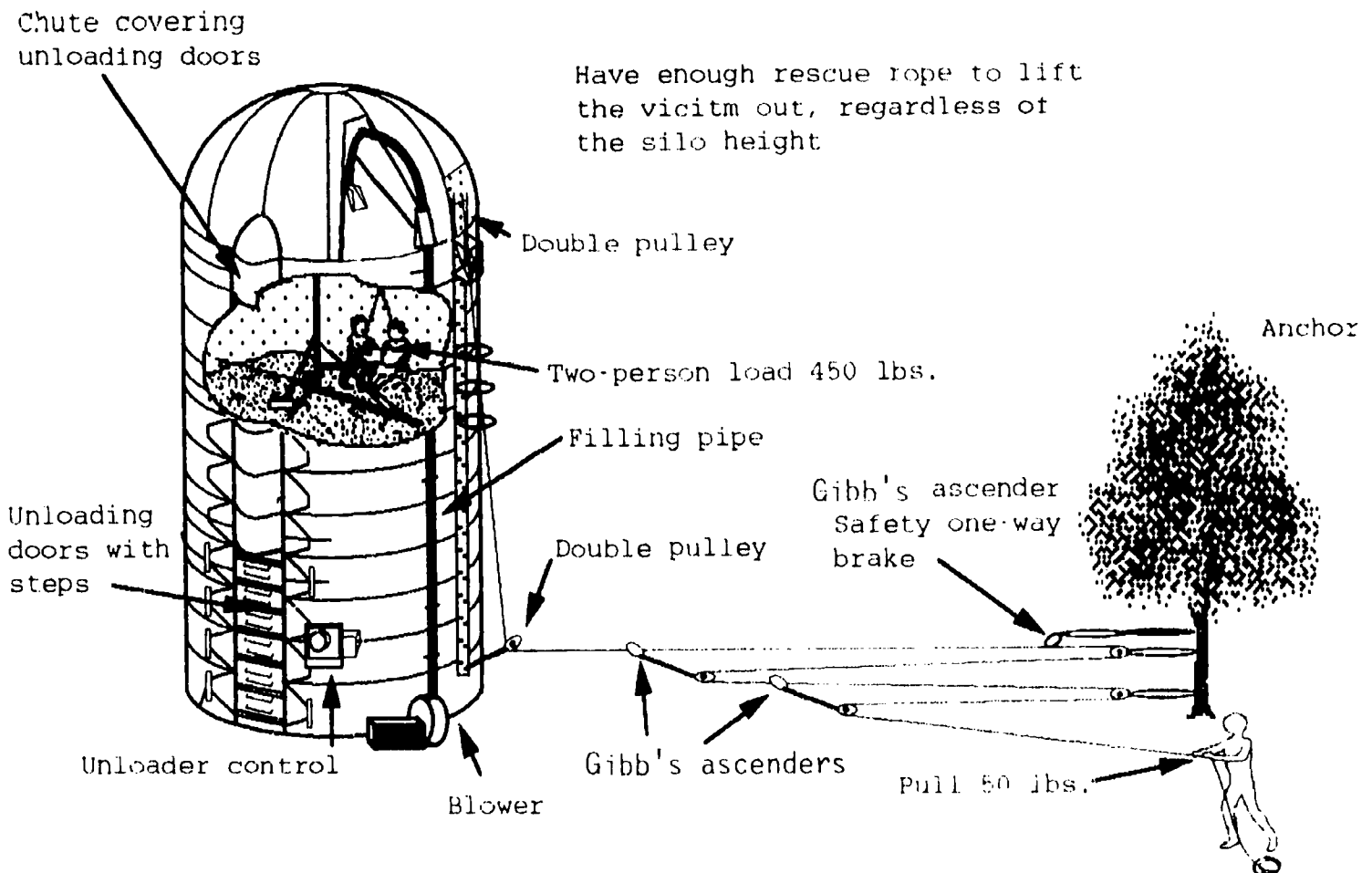

Figure 54. Hauling System, Stacked "Z" Drag

with minimum risk, and using only a minimal extinguishing agent. The procedures for extinguishment vary with each fire, but general guidelines are given below.

**Extinguishment Procedures for Conventional Silo Fires**

Follow the procedures suggested to extinguish a conventional silo fire.

1. Usually there is ample time to analyze the fire at the scene. Rarely is there a significant flame or an immediate threat to other buildings. Usually the silage is glowing red with an occasional flame like the flame found in a charcoal fire. Most fires occur in the top ten feet of silage. Fires usually originate near the unloading doors because of air leaks, but a fire can occur at any point where the ensiled material is too dry.

If the fire is only suspected, that is, only light puffs of smoke are visible with no glowing embers, every person that goes up the chute

should wear an SCBA to assess the situation.

If considerable smoke is pouring out of the silo or a silo chute, or red hot embers are falling down the chute, fire fighters are required to wear full turnout gear along with self-contained breathing apparatus.

2. Whether a fire is known to exist or is just suspected, do not step directly into the silage. Lay a ladder across the silage with one end placed on the unloading door frame. The ladder distributes weight over a larger area and minimizes the risk of falling into a cavity that may have been created by the fire.

Each person entering the silo should wear a rope harness with the lifeline attached to a beam or a structure above. Station a rescuer on the silo blower platform or chute to observe the interior of the silo.

3. If an established fire is in progress, saturate it with water from the silo-blower platform or from the silo chute. All fire fighters on the

scene should be dressed in full turnout gear.

As with any fire in an enclosed area, a considerable amount of gas, smoke, and steam belches from the fire when it is hit with water. Remove as many unloading doors and coverings as possible to allow the gases to escape. If a fire is only suspected, or if a burned cavity can be seen but there is no flaming fire, saturation is not necessary.

4. Find the exact location of the fire with a probe and lower a thermometer suspended on a wire into the probe to obtain temperature readings (see Figure 55).

Take several temperature readings starting near any obvious hot spots, usually somewhere in the top 10' of silage. Gradually probe outward toward the silo walls. Several hot spots may exist because the fire follows air pockets to support itself.

If the temperature readings are near 180°F or higher, the material eventually burns. Temperature readings from 140° to 170°F may indicate that the silage is heating, or that residual heat from a hot spot is being conducted through the silage. Check temperatures every two or three hours at this stage. Temperatures below 140°F indicate no heating problems.

5. Once the extent and location of the fire is established, slowly and methodically inject small streams of water directly into the hot areas via the probe (see Figure 56). Inject water in a single spot for several seconds up to a few minutes before moving it to another location.

Because the holes in the perforated tip of the probe are only 3/16" in diameter, use the smallest hoseline available. In many cases, water may be injected from the silo chute, particularly if a hatch door has burned through. Be prepared

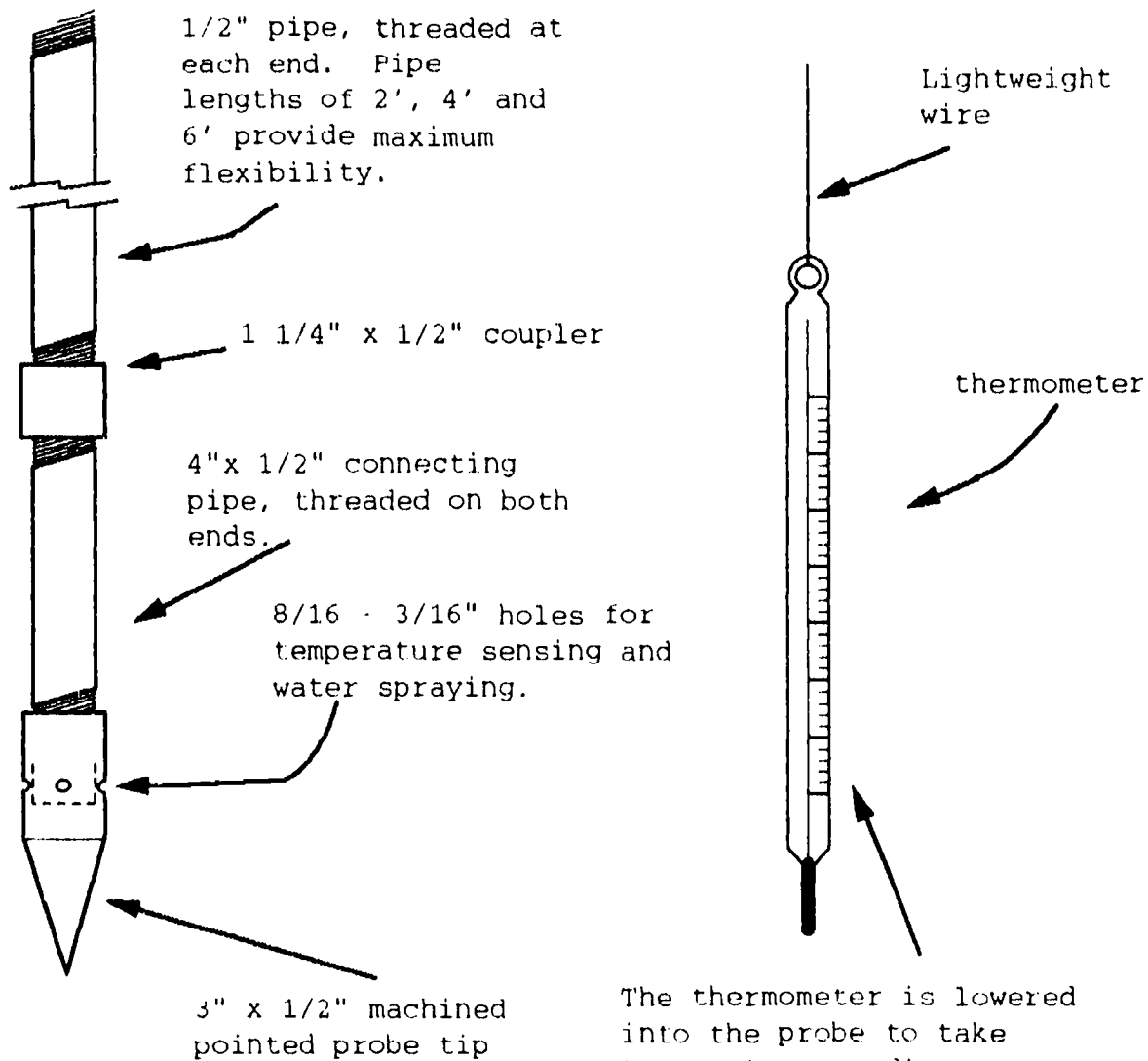

Figure 55. Probe and Thermometer

for a considerable amount of smoke and steam to blow backward when the water is injected.

The fire fighter operating the injection probe must wear full turnout gear. Station a second fire fighter, also dressed in full turnout gear, inside the silo chute to help handle the hose and stand by as a safety backup.

Fire fighters may be concerned about creating a **water-gas reaction** and causing an explosion when they inject the water into burning silage. This is not a concern for a fire in a conventional silo. The few explosions that have been reported from silage fires have all been in oxygen-limited silos where the explosive gases were trapped and could not escape. Even in these cases, it is not certain if the explosions were caused by water-gas reactions.

6. Unload damaged silage. Overheated silage loses its nutritional value, the top layers of the wet silage spoil, and any hot spots missed in the extinguishment of the fire might reignite.



Figure 56. Injecting Water Through the Probe

### Extinguishing Fires in an Oxygen-Limiting Silo

A fire in an oxygen-limiting silo is potentially hazardous. Extinguishing techniques can cause a devastating explosion. Explosive gases found in an oxygen-limiting silo fire can produce heat or flame to ignite the gas. The only thing preventing an explosion may be insufficient oxygen.

Do not do anything that increases the level of oxygen inside the silo. Opening the top hatch to dump water or foam might allow enough oxygen to be pulled in to put the gases into the explosive range. Even air within the water droplets and foam

particles can increase the oxygen level.

Some silos have valves specifically designed to inject gases for fire control. Inject liquid nitrogen or carbon dioxide into the silo to displace oxygen and cool the fire. Drill a small hole in the silo wall and hook a tube or probe to the gas line to allow the nitrogen or carbon dioxide to enter the silo. Be careful that additional oxygen is not pulled into the silo when performing this process. If a fire should occur in an oxygen-limiting silo, call the dealer-distributor for assistance.

Do not touch an open roof hatch if there is any smoke or steam coming out of the top of the silo, or if the silo is shaking or rumbling. If the silo is quiet and no visible smoke has been seen for several hours, it should be safe to close the top hatch cover but do not secure it. If gas pressure subsequently builds beyond the relief capacity of the breather valve, the unlatched cover lifts to relieve the pressure.

### Hay Mows

Chemical preservatives are sometimes added to damp hay as it is placed in the mow. When it reaches 240°F, hay treated with preservatives containing ethoxyquin and butylated hydroxytoluene (BHT) produces hydrogen cyanide gas. Take extreme caution when fighting a hay fire treated with these chemicals since hydrogen cyanide can be deadly if inhaled. Additives that contain propionic acid do not produce hydrogen cyanide during a fire.

### Temperatures in Hay Mows

Where hot spots or pockets are suspected, they may be located quickly by using a thermometer probe that can be easily constructed on site. Cut a groove in the side and near one end of a 3/4" wooden rod. Use electrical tape to secure a glass thermometer with a range up to 212°F in the groove of the rod. Sharpen the end of the wooden rod to aid penetration into the hay mass.

Measure the temperature in the hay at different points by forcing the probe into the hay, leaving it for a minute or two, then quickly withdrawing and reading the thermometer. A danger is that the hole made by the probe forms a duct through which air can readily enter the hay. Use the probe only at a few definite places and always recheck in the same hole. Insert a similar size stick in the hole to close it in between readings. If the hay temperature becomes excessively high, plug the holes to prevent air from entering.

## DANGEROUS TEMPERATURE POINTS IN THE HEATING OF HAY

- 190° Remove hay rapidly to safe distance. Hay may heat to several degrees above 200°F without ignition; however, the hay should be removed at 190°F. Call for fire department protection during the removal. Remove animals, equipment, and tools from adjoining structures before removing the hay.
- 180° Call the local fire department and make immediate provisions for standby fire service. Also, notify the insurance agent, who will gladly cooperate and make arrangements for additional protective service.
- 175° Watch for hot spots or pockets of heat 175°F. Above this temperature, keep all doors and other openings closed to prevent drafts.
- 170° Maintain constant vigilance of the hay mow, periodically taking temperature readings and looking for potential hot spots.
- 160° Take precaution! If a barn is equipped with an automatic temperature alarm, it will sound at this point, giving sufficient time to prepare for removing the hay.
- 150° Maintain a careful watch, 150°F signifies the danger zone. Up to this point, temperatures are not considered abnormal but anything above 125°F is unusual.

**CAUTION: Mows that have heated to a high temperature are dangerous to walk on because the rescuers may fall into a burning pocket. If necessary to enter the mow, place long planks to form walkways. Check these conditions in teams of two in case of an accident.**

To cool a hay fire, saturate with water. Then remove the hot hay. Be ready to quench any flames that might develop when air comes into contact with the hay being removed. Deposit the hot and charred hay a safe distance away from the buildings in case the flames ignite.

### Manure Storage

Liquid manure storage systems are used on farms. They include the three following types:

1. Large tanks located directly under the livestock housing area.
2. Open lagoons or ponds located near livestock housing areas.

3. Silo-type structures used as above-ground storage.

There are hazards to both people and animals when livestock waste is stored in large quantities. The most obvious hazard is the possibility of falling into the open storage and drowning (see Figure 57).

A serious danger is present when manure is stored below the livestock housing area (see Figures 58 and 59). The manure releases various toxic gases caused

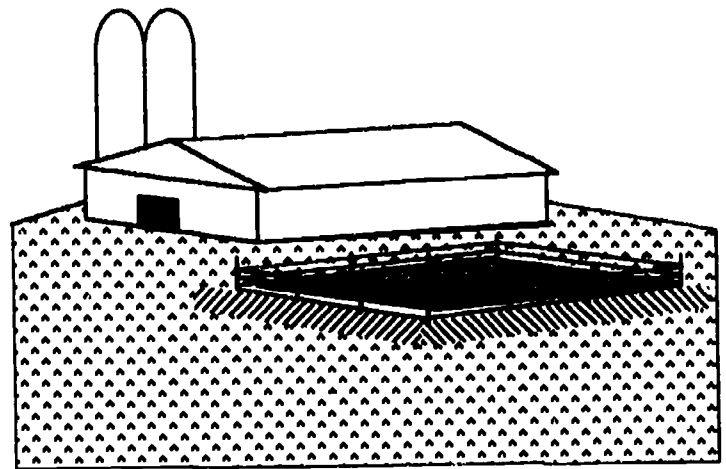

Figure 57. Manure Pond

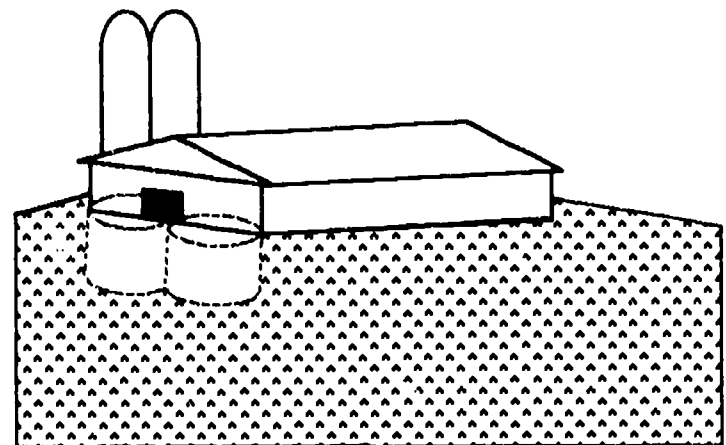

Figure 58. Below Ground Manure Storage

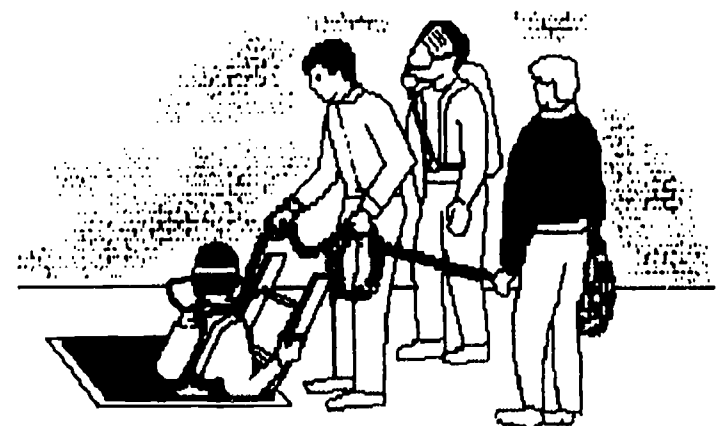

Figure 59. Entering a Manure Storage Facility

by bacterial action. Agitating the liquid, which is often done before emptying the storage, causes a more rapid release of gas. The common gases emitted include ammonia, carbon dioxide, methane, and hydrogen sulfide (see Table 2).

**Ammonia (NH<sub>3</sub>)** is a strong alkali with a common household ammonia odor. Ammonia, when inhaled in small concentrations, can severely irritate the respiratory system. In high concentrations it can be fatal. If contact is made with this ammonia, flush the irritated skin or eyes with large quantities of water.

**Carbon dioxide (CO<sub>2</sub>)** is an odorless, non-toxic gas. At a 30% or higher concentration it can cause death by suffocation since it replaces the oxygen available for breathing.

**Methane (CH<sub>4</sub>)** is a highly flammable, non-toxic gas. Confinement buildings can be blown off their foundations when a concentration of methane gas is pocketed beneath the structure and ignited by sparks. Take caution if welding needs to be done on or near the tank. Asphyxiation is also possible in a confined space with a high concentration (5 to 15%) of methane. Methane is extremely difficult to detect without a gas detection instrument because it is odorless. Suspect its presence in all manure storage areas.

**Hydrogen sulfide (H<sub>2</sub>S)** is a very poisonous gas and emits a readily recognizable "rotten egg" odor. In high concentrations, H<sub>2</sub>S deadens the sense of smell, so do not assume it is gone just because it cannot be smelled after a few minutes. It is the most dangerous by-product of manure decomposition. Death caused by respiratory paralysis can occur with little or no warning when a concentration of 1,000 parts per million is inhaled. Both carbon dioxide and hydrogen sulfide are heavier than air, and usually settle in low areas of the storage facility and remain in high concentrations even after ventilation.

Table 2. Gases Emitted from a Manure Pond

### Rescue Procedures for an Accident Victim in a Liquid Manure Storage Facility

1. Use extreme caution when undertaking any rescue attempt in and around a livestock facility

with liquid manure storage. Wear a self-contained breathing unit whenever working near the pit. Never enter a manure storage pit without a supply of air, a lifeline, and assistance from a backup crew.

2. Ventilate the facility as quickly as possible by opening windows and doors, activating the facility's ventilation system, or by using smoke-evacuation equipment.

### Open Manure Pond

The danger of toxic gases does not exist in open manure, but the surface crust of this type storage is deceiving. The crust may look solid and may even have weeds growing on its surface, but it will not support a person's weight. If a person is in an open manure storage, use a small boat with a dragline to remove him or her.

## ANHYDROUS AMMONIA

Anhydrous ammonia is pure ammonia (anhydrous means without water) used as a nitrogen fertilizer. It contains 82% nitrogen and 18% hydrogen. At ordinary temperatures it is a colorless gas, but under pressure it changes into a liquid. Agricultural ammonia is transported, stored, and handled in pressurized tanks in a liquid form.

Because anhydrous ammonia is completely devoid of water, it absorbs water from the skin at an amazing speed. In addition, anhydrous ammonia is a strong alkali that can cause painful skin burns and, due to its low boiling point, burn by freezing.

Mild exposure to anhydrous ammonia can cause irritation to the eyes, nose, and lungs. Prolonged exposure can result in suffocation. Even small amounts of water near an anhydrous leak may absorb enough ammonia to cause irritation and blindness if splashed into the eyes. This gas does have a sharp irritating odor that gives a warning of its presence (see Figure 60).

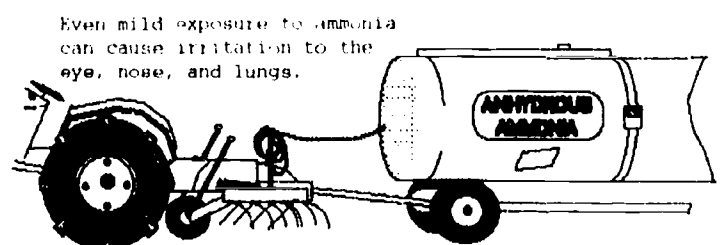

Figure 60. Anhydrous Ammonia



When a person is exposed to anhydrous ammonia, treat the specific injury as follows:

### Eye Injury

1. If the victim is wearing contact lenses, remove them immediately, hold the eyelids open, and flush with water continuously for at least 15 minutes. Ten gallons of water will provide a pencil-sized stream of water for fifteen minutes (see Figure 61).

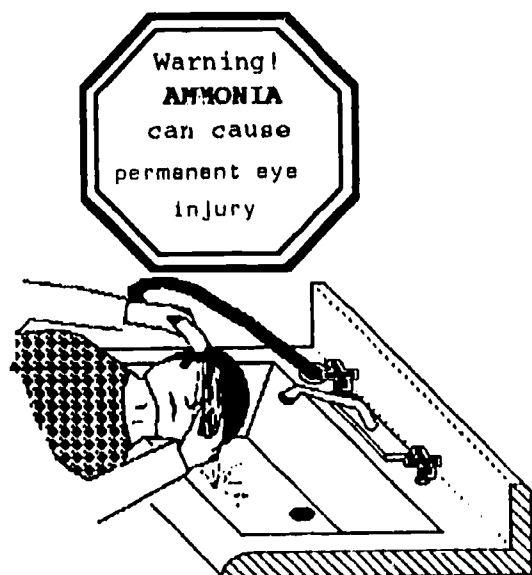

Figure 61. Flushing Irritated Eyes

2. If there is a delay in transferring the victim for medical care, continue eye irrigation for another 15 minutes or as long as the eyes burn.

### Nose, Throat, and Respiratory Injury

1. Flush the nose and throat with water for 15 minutes. Be careful the victim does not choke.
2. If the victim can swallow, encourage him or her to drink some type of citrus drink, such as lemonade or a fruit juice. Ammonia is caustic and the acidity of the fruit juice counteracts its effect.
3. If the victim has been overcome by the ammonia fumes and has stopped breathing, administer basic life support immediately.
4. Move the victim to an area free of ammonia fumes. Place the victim in a reclining position with the head and shoulders elevated.
5. Administer oxygen; it has been found useful in treating inhalation exposure to ammonia fumes.

### Skin Injury

1. Flush the affected area with water for at least 15 minutes. Allow burned area to remain open to the air. Do not apply any salve or ointment (see Figure 62).

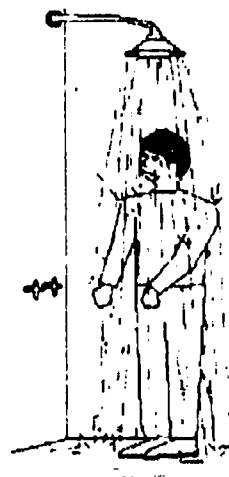

Figure 62. Shower After Exposure to Ammonia

2. A splash of anhydrous ammonia can freeze clothing to the skin almost instantly, so do not remove clothing at the onset of exposure. Wet the clothing and body to thaw them and then remove the clothing. Discard the clothing since it holds anhydrous ammonia in the fibers.
3. Transport victim to a medical care facility.

### Accident Site Precautions

Follow the suggested precautions when working with anhydrous ammonia.

1. Wear self-contained breathing apparatus, eye protection, and rubber gloves when working at the site of an ammonia spill.
2. Approach the accident site from an upwind direction.
3. If there is any possibility that escaping ammonia fumes will enter a populated area, start evacuation procedures immediately.
4. Apply water using a fog nozzle to control or disperse the ammonia fumes.

## AGRICULTURAL CHEMICAL FIRES

Pesticides (herbicides, insecticides, and fungicides), fertilizers (ammonium nitrate), sanitizers (calcium hypochlorite), acids (battery acid), and

explosives are commonly used and stored on agricultural facilities. Each agricultural chemical alone cannot cause a fire, but the nature of the chemical composition of each makes some of them highly flammable or even explosive. When burned or heated many chemicals produce highly toxic smoke and vapors. It is extremely important to know the hazards associated with chemicals used in agriculture and to take protective measures when fighting fires that involve these chemicals (see Figure 63).

- d. Face shields, goggles, or respirator equipment to protect the eyes and face
- e. Self-contained breathing equipment

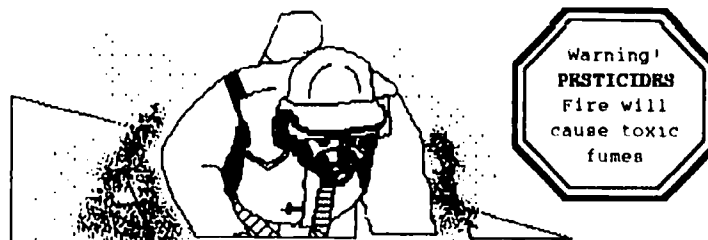

Figure 64. Pesticide Warning

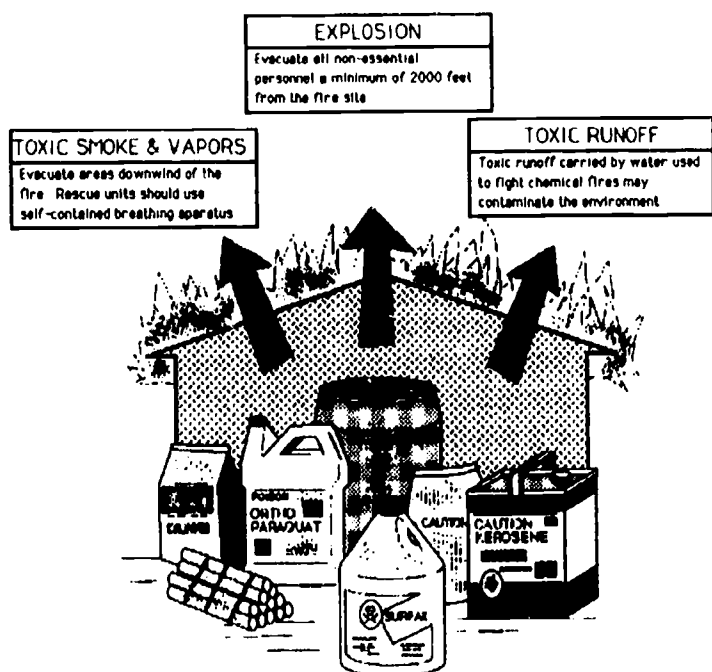

Figure 63. Chemicals and Their Hazards

### Procedures for Fighting a Chemical Fire

Follow the suggested procedures when fighting a chemical fire (see Figure 64).

1. Contact the owner or operator of the facility involved in the fire. Attempt to determine the contents of the facility. Identify any toxic or explosive chemicals present.
2. Alert the hospital (and local poison control center) of the possibility of victims exposed to toxic chemicals and/or fumes. Inform medical personnel of the specific chemicals involved.
3. When dealing with rescue and clean-up, wear protective clothing including the following:
  - a. Liquid-proof raincoat
  - b. Wide-brimmed, waterproof hat
  - c. Unlined neoprene gloves and boots (place sleeves and trouser legs outside the gloves and boots)
4. Remove from duty any rescue personnel and workers not wearing respiratory protection. If they have been exposed to fumes or smoke, check for possible poisoning. Poisoning symptoms include the following: headache, giddiness, blurred vision, coughing, tightness of chest, salivation, twitching, or lack of pupil contraction when exposed to bright light.
 

Symptoms can be delayed up to 12 hours. Some chemical symptoms can be delayed several days. Clothing can retain toxic fumes and endanger personnel when they remove their self-contained breathing apparatus.
5. Thoroughly and immediately wash any person who has been in contact with toxic or unknown chemicals with detergent and a large amount of water. It is particularly important to treat immediately anyone exposed to organo-phosphates. Do not wait for symptoms to appear.
 

Organophosphate poisoning symptoms may be mistaken for heat exhaustion or smoke inhalation. An exposed victim should have a cholinesterase test after exposure to organophosphates. Be sure to provide a label from the chemical container describing the chemical to those conducting the test and giving treatment.
6. Attack a chemical fire from upwind or crosswind using a soft stream of water to avoid tearing open paper containers (see Figure 65).
7. Avoid using large volumes of water to keep runoff and potential pollution to a minimum. If necessary, dike the area to contain the contaminated water.
8. Consider letting the building burn if it is separate from other toxic materials. Ventilate the building to aid combustion and reduce the volume of dangerous toxic smoke.

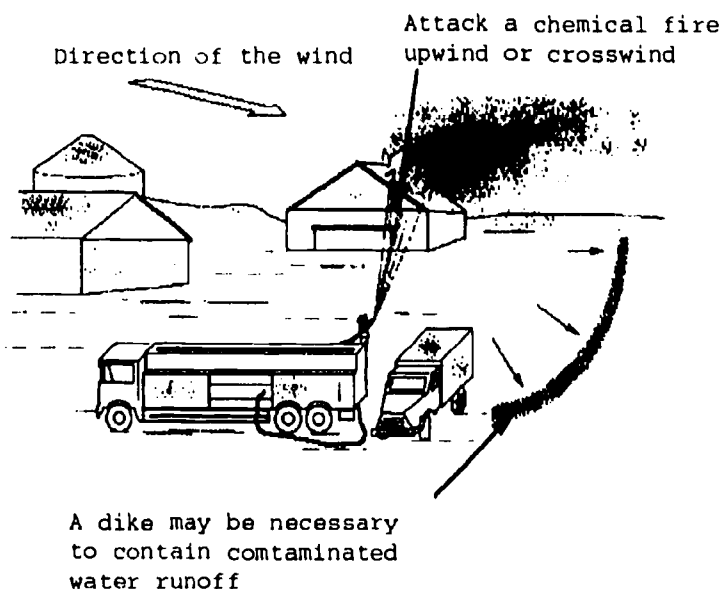

Figure 65. Attacking a Chemical Fire

9. Notify state and local public health officials. Post warning signs and ropeoff the burned area and runoff areas to prevent unauthorized entry. Identify the local hazardous materials response team and chemical manufacturers for help dealing with the emergencies. Contact CHEMTREC (1-800-424-9300) for additional advice (see Figure 66).

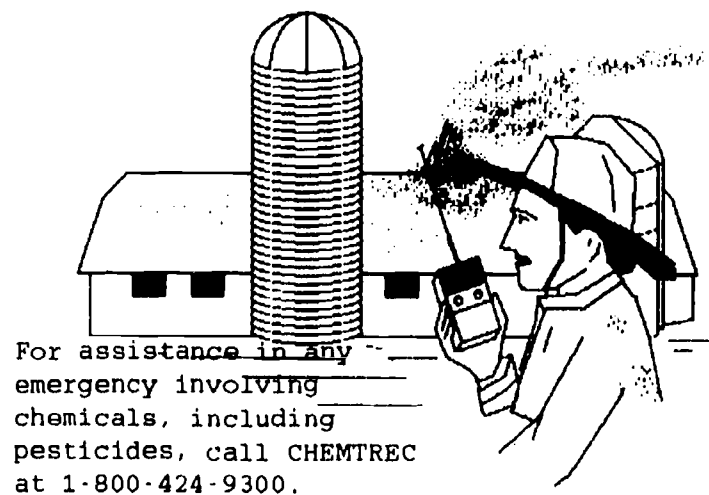

Figure 66. Assistance in Chemical Emergencies

### Procedures for Decontamination

Once the fire has been extinguished contact chemical companies for assistance with decontamination procedures. If available, contact an expert decontamination team or a hazardous materials response team for assistance. If such a team is not available, a person familiar with pesticides should direct the

cleanup operation using the following procedure:

1. Neutralize and absorb toxic chemicals by covering them, by twice their volume, with lime, a special clay absorbative material, or soda ash. Dampen the material slightly. Spray standing walls, joists, and other surfaces that cannot be easily reached, with a lime solution mixed at a rate of 50 pounds of lime per 100 gallons of water. Close off the area for 24 hours, being careful not to track pesticides out of the area.
2. Neutralize runoff water by adding large quantities of soda ash. Pump standing water immediately into disposable containers for disposal into an approved dumping area.
3. Be sure that all personnel involved understand the toxic nature of the debris and are properly clothed and provided with adequate respiratory protection.
4. Use mechanized loaders, dump trucks, etc., to minimize human contact with the contaminated materials. Avoid raising dust.
5. Absorb excess liquid with lime, sawdust, or clay. Do not wash any material into a waterway or sewer system without official authorization from public health officials.
6. Transport debris to an approved dumping area in tight, metal-bodied dump trucks or tightly-covered containers. Moisten or cover the load with a disposable cover to control any dust. To prevent spills, do not overload the trucks.

Anyone involved in a chemical fire or a decontamination procedure should remove any traces of toxic chemicals by bathing in large volumes of soap and water. Be particularly careful to clean under the fingernails. If leather-soled shoes are worn, check for absorbed pesticides. Wash the respirator and all personal and protective clothing. Do not contaminate the inside of the respirator with chemicals deposited on the outside. Install a new cartridge in the respirator. Watch for pesticide poisoning symptoms several hours or days after exposure.

### Pesticide Accidents and Spills

Assume any spilled pesticide is highly toxic, flammable, and explosive, until proven otherwise. At the accident scene, wear a liquid-proof raincoat, a wide-brimmed hat, and unlined neoprene gloves and boots. Fumigants such as methyl bromide, are readily absorbed by neoprene. Check the label to see if fumigants are involved. Place sleeves and trouser legs outside the gloves and boots. Protect the eyes and

face with face shields or goggles. If vapors or odors are evident, use a self-contained breathing apparatus.

Use the following suggested procedure to treat victims involved in exposure to pesticides:

1. Remove contaminated clothing from the victim if injuries are not too severe. Then use a detergent and water to wash the pesticide from the skin.
2. Immediately read the label on the pesticide container to check the toxicity of the product and the suggested first aid in case of inhalation. Take the label or the container with the victim to a physician or a hospital. If possible, radio the physician or hospital with this information so they can be prepared to treat the victim.
3. Call the chemical manufacturer, CHEMTREC (1-800-424-9300), or the local poison control center for further treatment information.
4. Keep people away from spilled chemicals by roping off the area. Do not leave the accident scene unless someone remains in the area to warn people of the potential danger.
5. Confine the spill if it starts to spread by forming a dike with sand or soil to contain the material. Use an absorbent material (such as soil, sawdust, or a special product designed for this purpose) to soak up the spill. Shovel all contaminated material into a leak-proof container and dispose of it at an approved site. Do not hose down the area since this spreads the chemical.
6. If a major pesticide spill occurs, keep people away, give first aid if needed, and confine the spill. Always call the chemical manufacturer or CHEMTREC. Call the highway patrol or the sheriff for help if a major pesticide spill occurs on a highway. Do not leave the site until responsible assistance arrives.
7. If water is contaminated, notify the regional, state, or federal water quality or water pollution authorities, state health officials, and the state fish and game agency.

## SUGGESTED TOOLS FOR FARM RESCUE

Many tools listed are used by rescue departments for other rescue operations.

### Power Spreader Unit

- 1 power unit
- 1-32' hydraulic hose

- 24 - 2 oz. bottles oil additive
- 1 - 2 gallon UL listed gasoline safety can with hose/funnel attachment
- 1 spare spark plug and necessary wrench
- 1 quart hydraulic fluid
- 1 spare power plant recoiler unit with rope
- 2 each clevis link/shackle unit with pins
- 2 - 12' x 1/2" case hardened steel chain with grab hooks at each end
- 1 pair spreader unit training tips with pins
- 1 spare pin for the spreader unit
- 1 spare pin for the shackle unit

It is recommended that the power spreader unit, cutter unit, and hydraulic hoses be stored preconnected.

### Rescue Air Bag System

- 1 each air bag unit with accessory components
- 1 - 20' x 1", 7000 lbs. capacity nylon strap with ratchet protective caps for bag nipples
- 40 - 4" x 4" x 18" hardwood cribbing blocks
- 18 - 4" x 4" x 48" hardwood cribbing blocks
- 2 - 36" x 36" open-weave steel-mesh base plates or 2 - 36" x 36" x 3/4" plywood sheet-base plates
- 10 - 45 cubic foot compressed air cylinders (2216 psi) or equivalent air supply source

It is recommended that the air source, regulator, control unit, and all hoses be stored preconnected.

### Remote Controlled Hydraulic Jack Unit

Note: 10-ton capacity unit preferred

- 2 hydraulic pumps
- 2 - 10" hydraulic rams (10-ton)
- 1 each - 5", 10", 18", and 30" extension tube
- 2 double male adapters
- 2 double female adapters
- 5 lock-on connections
- 9 locking pins
- 1 slip-lock adjustable extension
- 2 serrated heads
- 2 - 90 degree vee heads
- 2 wedge heads
- 2 rubber flex heads
- 2 flat bases
- 1 plunger toe
- 1 cylinder toe
- 1 chain pull plate
- 2 - 8' x 3/8" diameter chains with grab hook on one end only
- 1 - 10" x 3/8" diameter chain shortener
- 1 clamp head (some units use a two-piece head/toe attachment)

**Cribbing Blocks (most can be stored)**

- 18 - 2" x 4" x 18" hardwood blocks
- 10 - 4" x 4" x 48" hardwood blocks
- 10 - 4" x 18" wedge blocks (softwood)
- 10 - 2" x 6" x 18" hardwood blocks

**Forcible Entry Tools**

- 1 - 6 lb. flat head axe with 36" fiberglass handle
- 1 - 6 lb. pick head axe with 36" fiberglass handle
- 2 Halligan-type entry bars
- 1 pry-axe type entry bar
- 1 - 8 lb. sledge hammer
- 2 baling hooks (hay hooks)
- 1 - 66" pry bar
- 1 - 36" bolt cutter tool

**Cutting Tools**

- 4 hacksaws, 12" one-piece frame type with shatterproof blades
- 10 spare shatterproof hacksaw blades
- 2 squirt cans with light weight cutting oil
- 1 pair tin snips
- 1 air chisel, 300 psi unit preferable
- 2 air chisel double panel cutting chisel bits
- 2 air chisel flat chisel cutting bits, 8" to 11"
- 4 - 45 cubic feet air cylinders (2216 psi) or equivalent
- 1 electric or pneumatic reciprocating saw
- 12 reciprocating saw blades, shatterproof type
- 1 can-opener type metal cutting tool
- 2 pair industrial quality ear muff protective devices
- 1 - 24" chain saw with support accessories
- 1 oxy-acetylene cutting torch outfit with accessories
- 1 rotary power saw with support accessories

**Pulling Tools**

- 2 hand winch tools, 2-ton capacity
- 2 - 9/32" or 3/8" x 10' length alloy chains
- 2 - 9/32" or 3/8" x 12' length alloy chains
- 2 - 9/32" or 3/8" x 15' length alloy chains

All chains should have grab hooks at each end.

**Ropes and Rigging**

- 2 - 300' nylon kernmantle lifelines, 1/2" or 5/8"
- 2 - 150' nylon kernmantle lifelines, 1/2" or 5/8"
- 2 - 100' nylon kernmantle accessory lines, 3/8"
- 1 - 100' polypropylene, 1/2"

- 15 rated carabiners
- 2 full body rescue harnesses with safety lines
- 3 rated pulley snatch block tools
- Assorted quantity of 1" nylon webbing straps

**Hand Tools**

- 2 utility type knives
- 1 - 12" adjustable wrench
- 1 - 8" adjustable wrench
- 1 - 1/2" drive socket wrench set, standard and metric
- 1 - 6" x 3/16" flat bladed screwdriver
- 1 - 8" x 3/8" flat bladed screwdriver
- 1 Phillips head screwdriver
- 1 channel lock pliers
- 1 - 10" vise grips with wire cutter feature
- 2 - 3 lb. mallets
- 2 - 12" pry bars
- 2 automatic spring-loaded center punches
- 1 solid type center punch
- 2 - 1" x 12" long cold chisels
- 1 finger ring cutter tool
- 2 - 24" ripping type crow bars
- 1 - 12' x 1" tape measure
- 1 - 3/8" chainbinder
- 2 stainless steel scissors with serrated blades
- 1 carpenter leather tool pouch with waist belt

**Safety/Control Tools**

- 2 package golf tees for temporary leak stoppages
- 12 - 30-minute road flares
- 1 - 5-gallon oil-absorbent material (quantity at firehouse)
- 100 - 3/8" x 18" square industrial type oil-absorbent pads
- 8 PVC fluorescent orange traffic cones
- 2 - 3" x 60' rolls of duct tape
- 2 large 100% wool fire safety blankets
- 1 - 12' x 20' salvage cover
- 1 - 24' wide push broom
- 1 scoop shovel
- 3 handlights
- 3 - 10 lb. ABC-type dry chemical fire extinguishers
- Portable generator and lights for night extrication

**Other Tools**

- 2 - 50' x 12-gauge extension cords with ground
- 1 - 8' folding ladder
- 1 - 8' fiberglass pike pole

- 1 - 36" closet hook pike pole
- 3 - 7000 lb. capacity mechanical jacks
- 1 - 12 ton capacity hydraulic jack
- Self-contained breathing apparatus (SCBA) units for use in silos, manure pits, and confined spaces

**Training**

Training in farm rescue operations is important. Training should include practice runs to selected farm sites, tours of farm operations, and other opportunities to become acquainted with various agricultural hazards.

Owners of agribusiness firms are usually cooperative in providing specialized instruction concerning the products or services available to emergency units. Most farm implement dealers and/or their service personnel can contribute effective and detailed instruction on the hazards associated with various pieces of farm equipment. Farm equipment mechanics can provide considerable insight into the best way to dismantle the more common machines.

Most agricultural chemical suppliers are willing to share facilities for inspection and preemergency planning activities. Chemical suppliers also provide a good source of information concerning the safe handling of farm chemicals and procedures to follow in the event of a chemical spill or a fire.

Another source of information on farm hazards and accidents is the state Cooperative Extension or Farm Safety Specialist who promotes farm safety and is knowledgeable of the circumstances surrounding most types of accidents at agricultural facilities. The Safety Specialist may also have information on educational materials useful in training activities.

The following materials contain further information pertinent to agricultural accidents and rescue techniques.

**Agricultural Operator Control Symbols**

New farm tractors, combines and other self-propelled agricultural equipment have universal operator control symbols so farmers can readily locate and operate the various controls. These symbols could also assist rescue personnel in an accident. Quickly locating the fuel shut-off or operating a remote hydraulic system might contribute to a successful rescue.

**NOTE:** These symbols are generally not found on older agricultural equipment (see Figures 67 & 68).

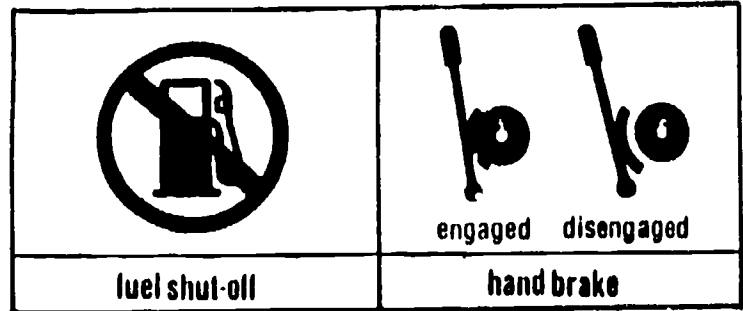

Figure 67. Dashboard Controls



Figure 68. Operational Controls

**SIGNAL WORDS**

**CAUTION** is used for general reminders of good safety practices or to direct attention to unsafe practices.

**WARNING** denotes a specific potential hazard.

**DANGER** denotes the most serious potential hazard.

## WILDERNESS SEARCH AND RESCUE

### KEY POINTS

- The importance of a preplan
- Components of preplanning
- Three kinds of searches
- The roles of rescue and medical personnel
- Defense of the statement "The safety of the rescue team always comes first."
- The importance of crowd control
- Functions of a follow-up report
- The elements of preplanning, operations, safety, and follow-up in the case histories

### INTRODUCTION

Wilderness rescue sounds exciting and glamorous; however, it is also hard work. People can get hurt or lost in the great outdoors in many ways. Logging, hunting, falls from cliffs, all-terrain-vehicle accidents, and disorientation and exposure all claim victims every year. The lack of good roads, the difficulty of communication, and the distance to a good medical facility make wilderness rescue especially challenging, although physical and psychological traumas are the same for victims everywhere.

Even in states with very few roadless expanses, rescue personnel need to be familiar with wilderness-rescue techniques. Finding a toddler who has wandered into a 160-acre soybean field can necessitate an organized search and rescue effort.

The need for a wilderness search may not arise as often as other problems encountered by rescuers. But when an emergency does occur, it is important to understand preplanning, search and rescue procedures, follow-up, and safety concerns. It is assumed in this manual that most rescuers are familiar with specific techniques, such as first aid, two-way radio operation, rappelling, and map reading.

### PREPLANNING FOR A WILDERNESS SEARCH AND RESCUE

One of the more difficult tasks in a search and rescue operation is to coordinate the efforts of three

or four agencies and the volunteer personnel involved. A search and rescue effort may involve a deputy sheriff, one or more volunteer fire departments, a helicopter rescue operation, a county emergency medical service, two or more forest rangers, and a dog team.

Advance preparation is the best way to deal with a complex wilderness rescue operation. Preplanning can be boring and is easy to neglect; however, the success of a search and rescue operation can be dependent upon the preplanning that has taken place.

The foundation of a preplan is a list of resources, people and agencies that can be called to help in search and rescue operations. The name, address, telephone number, type of equipment or service, jurisdiction, and any other useful information should be kept on file by each person or agency that might be of assistance in search and rescue operations. The list should detail who can provide aircraft assistance, who can perform cliff rescue procedures, who has bloodhounds, who can be called for assistance, etc.

The function of various personnel must be clearly identified. An on-duty paramedic cannot afford to spend a day in the woods searching for a lost child when life-threatening emergencies need his or her attention. Likewise, volunteers and Boy Scouts should not be administering prehospital care. The type of service offered and the jurisdiction of each agency involved should be clearly defined.

Familiarity with the area where search and rescue efforts may be needed is very important. Topographical maps should be on file and the Incident Commander should know how to read them. If it is not

possible to have all maps on file, the names of people and agencies who have such maps and know how to use them should be readily available. Search and rescue personnel should make a point of knowing the area. For example, when engaged in recreational activities in wilderness areas, it is a good idea to keep the question of search and rescue access in mind. A rescuer who is hiking in a ravine might ponder about how to rescue a victim with a broken leg from the ravine. Practicing this kind of thinking can make similar search or rescue procedures easier.

Training with other agencies is a must. Joint training allows personnel to practice with equipment that sits idle for long periods of time and possibly even with equipment belonging to other agencies. Agencies can update each other on equipment availability and new techniques.

Rescuer personnel should train for specific situations. The techniques learned in this training can be tailored to fit local conditions. In the conduct of a simulated search or rescue, many unforeseen details can be addressed. In a simulated situation, an Incident Commander should be identified, as well as people who can be depended upon to act independently. Simulated rescue operations are a good time to review procedures such as how to approach a helicopter safely, how to get into a harness for a rappel, how to handle a victim with a broken back, and how to tie a victim into a stokes basket that will be lifted vertically. It is better to work these situations out during a training session rather than in the middle of the woods under adverse conditions.

Search and rescue equipment must be organized and stored so that it is accessible. Any faulty equipment should be repaired or replaced. Rescue equipment should never be used for general, nonemergency activities.

Finally, communication is a vital concern in preplanning. The communication system is used to receive or call for help; to contact other agencies; and to coordinate the two-way radio traffic. Initially, the victim or victim's friends must be able to contact the agency. Local residents and other agencies must be aware of the existence of each agency and its telephone number so that a call can be made in case of an emergency. The agency must have somebody on duty to answer these calls. A full-time dispatcher or a pager system can work well. The telephone is also a useful tool for the initial contact for mutual aid among all emergency agencies.

Field operations are best run through two-way radio systems. Multiband radios allow different agen-

cies to communicate with each other. A radio link to a dispatcher with a telephone may be necessary for communications with a second agency. Whether it is a base station, a mobile unit, or a hand-held unit, the two-way radio can be so useful that it is tempting to overuse it. Too much radio traffic can block vital contacts and become useless to everybody. For this reason it is advisable when performing larger operations to designate one person as the clearinghouse for radio communications. Important traffic should be routed through this person and unimportant traffic should be held for transmission after the emergency.

Preplanning is an ongoing process. As new agencies, new materials, equipment, techniques and roadways replace older ones, search and rescue plans must be revised. Rescue personnel must also remember that no plan is comprehensive; nearly every emergency effort involves some type of improvisation.

## THE SEARCH AND RESCUE

Sometimes victims are just lost, but often they are injured as well. In either case, they cannot be helped until they are located.

A search begins with obtaining pertinent information from the informant while the search is being organized. The informant should remain available, and his or her name, address, and telephone number must be taken and kept on file. A checklist of information to be obtained is included and should be kept by the telephone. Searchers will need the name of the lost person, a description of physical characteristics, an idea of what the lost person was doing, and a description of the area to search. If the missing person is a juvenile, the law requires that the county sheriff be notified. (See State Park Separated/Missing Child Checklist)

The first rescuer on the scene should take along the following equipment: two-way radio, first-aid gear, a flashlight, and a map. Additional gear may be required depending upon local conditions.

A "hasty search" can be made by checking trails, roads, and points of interest, such as streams, lookout points, and campgrounds. Searchers should look for signs, such as tracks and clothing, and should talk to people encountered in the search area. While this is happening, a "passive search" can be established with people stationed at trailheads, parking lots, and other key locations. The idea of a passive search is to let the victim find the searcher.



As time passes, a lost person can travel farther and farther away. Consider the following: in one hour, a person walking only one mile-per-hour can theoretically be anywhere within a 3.1 square-mile area. In two hours, this area increases to 12.6 square miles. In three hours it is 28.3 square miles. If people are quickly stationed during the passive search, they may confine the search area and keep it from growing. If a dog team begins searching quickly, it is more likely to pick up the scent and further restrict the search area.

If all else fails, a "grid search" can be attempted. A grid search is a time-consuming effort in which a long line of people stationed 20-60' apart, criss-cross small areas of land looking for any information that can be found about the lost person. As this method can take days, other methods usually succeed first.

Searchers should circulate descriptions and photographs of the lost person. Lights, noise, and a bonfire may be used to assist rescuers where and when appropriate. Aerial searches and dog teams can be used. This is where an up-to-date record of agencies, pertaining with these agencies, and knowledge of the area and the terrain can be helpful.

Local people are usually very good sources of information about the terrain, especially during an actual search or rescue. However, care must be taken that the information provided is of use to emergency personnel. Keep in mind that the local resident may not be aware of the technical limitations of the emergency equipment and rescue techniques. Pickup trucks and four-wheel drive vehicles can go where fire trucks cannot. Likewise, an agile 18 year-old can crawl through cracks in rocks where a stokes basket cannot be taken.

Many rescues involve an injured person. If the rescue crew is fortunate, one of the victim's friends or a witness can lead the rescue crew to the victim. The crew should follow the informant to the site. A rescuer who takes shortcuts to the informant's location may often find that the informant has not identified the location correctly. A search must be initiated if no one can identify where an injured victim is located.

Once the victim has been located, rescue operations can begin; rescue personnel should plan the rescue. Care of the victim including the decision to call a helicopter rescue EMS unit, will generally be the job of the emergency medical technician. The job of the rescue crew will be to get the paramedics

and equipment to the victim, and to set up a system to get the victim to the ambulance or rescue helicopter.

Some first aid may be necessary before the paramedics arrive, but unless there is extreme danger to the victim or rescuers, such efforts should be kept to a minimum. The following rules should be observed: 1) Do not move the victim. 2) The victim's airway should be kept open. 3) Severe bleeding should be stopped. 4) A blanket may be draped over the victim to conserve body heat. 5) Vital signs can be monitored. Splinting fractures, bandaging, and other medical treatment should be left to the emergency medical personnel. The paramedic may ask a rescuer for help, but the rescuer should not attempt to help unless asked.

## MANAGING

Wilderness search and rescue efforts in many states are small in scope. However, even small operations need organization. Organizing along the lines of the National Interagency Incident Management System can provide structure to any size operation. Searchers who get lost chasing "hot leads" without checking with the Incident Commander (or his staff in a large emergency) are useless. Such efforts could require another search. If no one is in charge, an operation can fall apart. Even in a small operation everyone must understand who is in charge and must report to that person.

During a very small search the Incident Commander will probably take an active part in the search. During larger search operations, the Incident Commander will have to delegate areas of responsibility and oversee work on assigned tasks. For example: one person can do a hasty search while another organizes and executes a passive search. A third person can search with dogs while a fourth sits with the family and friends to keep them up-to-date on search operations and obtain further information about the lost person. It may also be necessary to have a person assigned to coordinate radio traffic. Obviously, some jobs can be combined, depending on the emergency.

Rescue operations should be similarly managed. Emergency medical service personnel must be available to give prehospital care to the victim. A small group of volunteers should move as close to the victim as possible with a four-wheel drive vehicle to assist with moving the victim. Other personnel may

be needed to guide the landing of a helicopter EMS unit.

Some rescue situations may demand special knowledge in making decisions, for example: how far into an abandoned coal mine should unskilled searchers follow a track?

### Evaluating Urgency

Different situations demand various levels of response. The report of a body lying at the bottom of a cliff in a pool of blood should result in an all-out emergency response. The report that a 32-year-old man is a day late returning from a one-week hunting trip also requires a response, but not with lights and siren. Some of the factors that determine the level of urgency are indicated on the "Evaluating Urgency for Search and Rescue" sheet which can be used to determine the relative urgency of a situation (see Table 3).

The evaluation guide is meant to be used only as a guide. Many factors influence any search and rescue decision. There are important factors unique to many emergencies that may not be measured on the rating chart.

## SAFETY CONCERNS FOR WILDERNESS SEARCH AND RESCUE

It has been said that the safety of the rescue team always comes first. This seems to run counter to human instinct. The "golden hour," the time between an injury or accident and the trauma care that is most critical to the victim's survival, is usually already gone by the time rescuers arrive on the scene. Speed is essential. When the victim is hanging by the fingertips from the cliff below you, it is difficult to methodically unravel a long rope, tie a proper harness (complete with an extra safety loop), tie a proper anchor, secure a hardhat, and/or put on leather rope gloves before rappelling down. But the safety of the rescuer is actually critical to the safety of the victim.

Flying through intersections with flashing lights and a siren without checking for traffic may cause a second emergency. Driving an ambulance back a washed-out log road may result in the vehicle getting stuck or breaking an axle. What use is it to the victim to wait for a second ambulance? Safe procedures must prevail in each rescue operation.

Rate each factor on a scale of 1 to 3 (1 = high risk, 2 = medium risk, 3 = low risk)

- \_\_\_\_\_ Age (very young or old = 1)
- \_\_\_\_\_ Medical condition
- \_\_\_\_\_ Number of subjects
- \_\_\_\_\_ Weather profile
- \_\_\_\_\_ Equipment profile (light clothing + bad weather = 1)
- \_\_\_\_\_ Subject experience
- \_\_\_\_\_ Terrain hazards
- \_\_\_\_\_ History of incidents (lost subject, suicidal = 1)
- \_\_\_\_\_ History of false alarms
- \_\_\_\_\_ Total

The lower the total, the greater the emergency.

8-12 Emergency Response

13-18 Measured Response

19-24 Evaluate (Should anything be done at this time?)

25-27 Search situation or missing person (not lost)

Table 3. Evaluating Urgency for Search and Rescue

A good search and rescue team has the equipment to do the job and knows how to use it. They waste no moves. However, they take no shortcuts either. Necessitating a second rescue is of no help to anybody.

### Crowd Control

Often conditions that injure a person in the wilderness remain ready to claim new victims. In populated areas, an accident a mile off the road can draw such a crowd that crowd control may become necessary. Even the press can get in the way. The rescue crew can usually do a better job with fewer

people in the way. It is best to designate people to control the crowd. All bystanders should be kept away from hazards and out of the way of the rescue effort.

Many times, the most difficult people to handle are the family and friends of the victim. They may require special attention and should be kept informed so they do not get unduly alarmed.

Bystanders can be a good source of information. They may know how the accident occurred, the name, address, and age of the victim, and health information about the victim.

Members of the press often ask a lot of questions during a rescue operation. While it is important for the public to know what is happening, it is best to refer reporters to the Incident Commander. Hurried comments made under stress can result in embarrassment when they come out in print.

## FOLLOW-UP

Follow-up is an important part of a search and rescue operation. Writing a report can aid in analysis of the operation. Critiques of past rescues can be helpful in planning and executing further search and rescue operations. Reports can also be useful in dealing with law enforcement investigations and liable actions, and can provide a rationale for improving agency operations.

Prompt cleanup, repair, and storage of rescue equipment after an operation is a must. Search and rescue teams must be prepared to answer a call at a moment's notice.

## CONCLUSION

Wilderness search and rescue operations most often occur off the beaten track, away from populated areas. Most occur far from roads, telephones, electricity, and hospitals. Emergency efforts tend to involve multiple agencies, since it is unlikely that any one agency has the capability to handle every aspect of a search and rescue. Effective preplanning can eliminate hurried search and rescue efforts that waste valuable time and cause mass confusion. It is necessary for each agency to know its role in a search or rescue procedure. A file of all agencies noting each agency's equipment availability and capabilities should be kept. Each agency's personnel will be familiar with a local area. Training with other agencies will develop teamwork and keep everybody up-

to-date on equipment. Communication networks function better if designed in advance to fit local conditions.

During an emergency, efforts must be organized. A search may consist of up to three stages: a "hasty search" that actively pursues the lost person, a "passive search" that limits the search area and allows the lost person to work his way out to rescue personnel, and a "grid search" that systematically combs the search area.

Once the person is found, he or she may need medical help and rescue as well. The role of the rescue crew is to get medical personnel to the victim and to transport the victim safely to the ambulance or helicopter. Follow-up consists of good record keeping and equipment maintenance.

Each rescue operation is unique with the type of emergency, the weather, the terrain, personnel availability, and available equipment all playing part. Designating an operation leader, obtaining cooperation with other agencies, training in advance, and maintaining good equipment will lead most search and rescue efforts to successful results.

Two case histories follow that are designed to put the above material into context.

## CASE HISTORY 1

The following is a reconstruction of an actual rescue. Names and details have been changed for instructional purposes.

3:10 p.m. October 16, 1986

Sarah McKinley, age 20, is celebrating her birthday with her friend, Jack Davis, in a state nature preserve. The couple has been moving off the established trail since lunch.

3:11 p.m.

McKinley slips over a 90-foot cliff, calling to her friend as she goes over the edge. He looks up as she goes over, and a moment later he hears her body hit below. He races for help.

3:20 p.m.

Davis runs up to Nature Preserve Officer Barns asking for help. Barns immediately investigates. After spotting McKinley at the bottom of the cliff, the officer calls the state park headquarters on a portable two-way radio.

3:35 p.m.

The state park dispatches park officers to come to the scene with ropes, a stokes basket, a backboard,

a portable winch, and first-aid gear. The county emergency medical service is called. The state forest headquarters is called for backup, because park and forestry personnel train together and frequently help each other.

3:50 p.m.

Forest Officer Frost arrives on the scene with rappelling gear and a first-aid pack. It is determined that the victim can best be reached by rappelling. While Frost sets up a rappel line, Barns, who is an EMT-A, harnesses up to descend. Frost calls for another forest officer, Morris, for backup.

4:00 p.m.

Barns reaches McKinley. Incredibly, she is still alive and starting to regain consciousness. Park officers arrive with rescue gear. Topside, county EMS paramedics arrive to prepare the rappel to the victim. Other park and forest officers rig the winch and rope to extract the victim from the bottom of the cliff. Morris, also an EMT-A arrives and prepares to rappel.

4:05 p.m.

Barns has ascertained that McKinley has a broken left humerus, lacerated chin, bloody nose, and face abrasions. Vitals are: BP = 70/50, P = 60 even, R = 20. (It is found out later that she also has a lacerated liver and lacerated spleen.) A wire splint is put on her left arm. Her face is bandaged. A Philadelphia collar is put on her neck. She is put into MAST trousers (left uninflated for the time being). She is strapped onto a backboard and into the stokes basket. Two attempts are made to start IV's; both are unsuccessful. Paramedics request an EMS rescue helicopter. Park Officer Smith relays the call to the state park dispatcher who calls the EMS rescue helicopter for transport.

4:20 p.m.

Frost leaves the rescue scene to help land the EMS rescue helicopter in a softball diamond near the preserve. A check is made for overhead wires, flares are laid out, and the helicopter is guided in via two-way radio.

4:25 p.m.

The helicopter lands. The officer takes the helicopter medics to the rescue scene. The victim, now conscious and in pain, is lifted out of the hollow.

4:40 p.m.

The victim is carried out of the woods to a service road, transferred to an ambulance, driven to the ball

diamond, transferred to the helicopter, and flown to a trauma center at the hospital.

6:00 p.m.

Ropes, winch, webbing, and other gear have been separated. Preliminary reports have been written. Tomorrow the ropes will be washed and dried to be put back into the rescue packs, ready for the next emergency.

## CASE HISTORY 2

The following is a reconstruction of an actual search. Names and details have been changed for instructional purposes.

6:30 p.m. March 5, 1987

State Park Officer Smith logs an older model Ford still parked in the Old Man's Cave parking lot. He runs the license plate through the county sheriff's office. It comes back to a Bob Rugby of Toledo, Ohio. No wants/warrants.

7:30 p.m.

Smith notices the car is still in the parking lot. Perhaps it is nothing but car trouble. Perhaps Rugby is lost or hurt. Smith calls the Rugby residence. He discovers Rugby had recently been under the care of a psychiatrist and has suicidal tendencies. He went out for a haircut this morning in Toledo and has not returned. Smith immediately calls the Chief Ranger who then calls the Park Manager. It is decided that a search is in order. Rugby's parents leave Toledo for Old Man's Cave.

7:45 p.m.

Other personnel are called in to help: Park and Forest Rangers and a search/track/rescue dog team.

8:00 p.m.

It is believed that a passive search is pointless; Rugby has been known to hide from such efforts in the past. The car is searched for more information. The waterfalls, water holes, dripline of the cliffs, and other steep inclines where a person could jump off in a suicide attempt are searched. Nothing is found. Even the dog team does not find any clues in the gorge.

11:30 p.m.

It is determined that Rugby is not in the immediate vicinity of the cliffs, and further search would probably be fruitless and even dangerous. A search in daylight might provide information that

flashlights cannot. Park Manager Browne decides to let the dog team and other officer go home.

12:00 midnight

Shifts change. Browne notices a light in the woods across from his residence. The light should not be there. This area appears to be about one mile through the woods from the parking lot at Old Man's Cave.

1:00 a.m. March 6, 1987

Browne and chief ranger discover Rugby with a large campfire and an empty whiskey bottle camped alone on the hillside where the light was spotted. Rugby is inebriated and not very happy to be found.

2:30 a.m.

Rugby is turned over to his parents.

## USE OF HELICOPTER FOR SEARCH OR RESCUE OPERATIONS

### Preparing a Landing Zone

The landing zone should be at least 60 feet in diameter, level, (no slope), and clear of wires, emergency vehicles, buildings, debris, and other obstacles, and at least 150 feet away from the victim, scene, and bystanders. If possible, it should be established at such a location as to prevent the helicopter from overflying the scene during its landing approach.

**Landing Zone markings, Day:** use the rotating beacons of emergency vehicles to help the pilot locate the landing site. If possible, mark the landing zone perimeter with chalk, lime, or fluorescent flags.

**Landing Zone Markings, Night:** Use the rotating beacon and or low beam headlights of emergency vehicles to help the pilot locate the landing site. Mark the landing zone perimeter with flares as shown in the diagram. Be careful the flares do not blow away into dry grass and weeds and start a fire. **Do not** shine lights directly at the aircraft. **Do** search for wires and other obstructions thoroughly prior to arrival of the EMS helicopter.

### General Safety Procedures

1. Expect a wind of 60 to 70 mph near the landing helicopter. Bystanders' eyes should be protected from debris that may be thrown up by the rotor-wash. All bystanders must turn their

backs to the helicopter during takeoff and landing.

2. Fire and police/security personnel should be on hand, if possible, for safety, crowd control, and protection of the helicopter.
3. **No one** should enter the landing zone until after the helicopter rotor blades have come to a **complete stop**. The helicopter should **never** be approached while blades are in motion.
4. The helicopter should **always** be approached from the **front**. At **no** time is anyone permitted near the tail of the aircraft.
5. Approaches into the landing area can be made once personnel are signaled to do so by the pilot.
6. No smoking within 150' of the landing zone.
7. No running within 150' of the landing zone.
8. The flight team is responsible for loading and unloading both victim and equipment. Other personnel should **not** approach the landing zone unless requested by the helicopter team. Do not bring the victim or equipment to the helicopter. Let the flight crew come to the scene.
9. Only members of the EMS helicopter crew may open or close aircraft doors.
10. For hospital transfers:  
The hospital should provide a wheeled stretcher without sheets and, if possible, without padding to accommodate the helicopter's stretcher. The hospital is responsible for providing ground transportation of the flight team and victim to and from the hospital.

## AIRCRAFT RESCUE

### KEY POINTS

- Ground traffic control at the aircraft crash scene
- Approaching aircraft wreckage
- Entering a downed aircraft
- Special crash situations
- Triage procedures
- Safeguarding the aircraft crash scene
- Role of the National Transportation Safety Board (NTSB)
- Fires unique to aircraft crashes

### INTRODUCTION

The aviation industry is constantly striving to reduce aircraft accidents through flight safety programs, inspections, and improved maintenance procedures. However, in spite of the many programs, aircraft accidents may occasionally occur at any time or place. Fire departments and rescue personnel play a vital role in the sequence of events following an aircraft accident. Speed and accuracy in reporting and responding to such accidents is of utmost importance.

Teamwork among all rescuers involved can minimize the loss of life and property, and in the case of military aircraft, provide protection and preservation of classified defense information and equipment. Aircraft rescue can involve specialized techniques, such as water rescue procedures, if the aircraft is forced down in water; wilderness search and rescue, if the plane is downed in a rural area; or the principles of vehicle extrication, when trapped victims need to be freed of the wreckage.

When receiving the initial report of an aircraft crash, the dispatcher should attempt to obtain as many facts as possible. Information should include the aircraft type, its size, the fuel load (jet fuel weighs 6.7 pounds per gallon), the number of persons on board, the presence of any hazardous materials, and if possible, the wind direction and velocity at the time of the emergency.

### THE AIRCRAFT CRASH SITED

#### Ground Traffic Control

Ground traffic control is the responsibility of the

law enforcement agency that is called to respond. Upon arrival at the scene, the law enforcement representative should report to the incident command post. There the incident commander (or the designated person) and the law enforcement representative should establish a restricted area around the incident. There should be only one point of entry into and exit from the site. Only authorized personnel carrying proper identification should be permitted to enter the restricted area. Ground traffic control should be in place until all rescue operations have been completed.

#### Approaching the Scene

Approach the aircraft crash site from the windward side at an angle. Approach the aircraft itself from either side at an angle.

If the crash site is in an area that is overgrown with high grass or brush, avoid approaching in a vehicle along the same path as the aircraft took after first hitting the ground. It is possible for survivors to have been thrown in this area where they might be run over by a rescue vehicle. If this is the only route of entry, approach on foot.

In the event a military aircraft has crashed, approach with caution; it is possible that highly explosive weapons may be on board. The presence of nuclear weapons in an aircraft presents no greater hazard than the presence of highly explosive materials; except for the possibility of exposure to a chemical or radiation hazard. Always wear protective clothing and a self-contained breathing apparatus. Keep all bystanders clear of the crash site.

Heat from engines can ignite fuel vapors up to 20 minutes after the engines are shut down.

## Entering the Downed Aircraft

The crash of a small, propeller-driven aircraft can be treated much like an automobile accident. There is usually less room to work inside a cockpit than in an automobile, but standard rescue tools can be used in a similar manner. These include hydraulic tools, the porta-power, air chisels, air bags, and other tools. The use of gasoline-powered rescue tools is discouraged due to the potential fire hazard. In many situations, a porta-power may be the tool to use, since its movement, although much slower than that of the hydraulic jaws, is more exact. Also, there will be less shifting of major structures when this device is used. Always follow the manufacturer's instructions for operating all tools to prevent further injuries.

Care must be taken to prevent shifting the plane and spilling fuel from damaged fuel tanks. Use shoring and blocking to stabilize the aircraft before rescue operations are started. Windows and doors can be removed as in automobile extrication.

Large commercial airliners are often surrounded by flammable liquids. In addition to the fuel hazards, rescuers will encounter alcohol (used for windshield washers), pressurized oxygen, 115-volt electrical wiring, and toxic hydraulic fluids (pressurized up to 3000 psi). Act with extra caution when working near flammable products.

If the fuselage is not broken during the crash, direct rescue efforts toward opening doors and emergency window exits. Usually the doors must be pushed inward slightly before they can be pulled open.

If the cabin is pressurized, the fuselage may need to be ventilated before entry. When entering through an emergency window exit, care must be taken to prevent injuring passengers, since most window exits open inward and can fall onto them. Most airliner doors, if they are opened from the outside, have been modified to prevent deployment of the emergency rescue slides. Place ladders and open the doors with caution, in case the equipment malfunctions and a slide or stairway is deployed.

An emergency slide or stairway may already be activated, but may be unusable if the position of the aircraft is such that one side or end is lower than the other. If the nose gear is not extended, the front of the plane will be too low and the front slides will be too flat, while the rear slides may be too steep or may not even reach the ground. Escaping passengers, once on the ground at the base of the slide, can often provide assistance to others.

## Cutting Into an Aircraft

If it is necessary to cut through the exterior metal of an aircraft, cut three windows before or aft of a door. These areas are usually free from dangerous lines. If possible, use an air chisel to peel back the outer skin and determine a safe area that can be cut. Shoring, air bags, hydraulic rescue tools, air chisels, and other tools may be used to assist as long as proper attention is given to the fire hazard. Make a large opening by cutting along both sides and the top of the aircraft; then fold the flap outward.

## Accessing a DC-9 or Boeing 727 Airstar

When attempting to gain access to a DC-9 or a Boeing 727 Airstar, remember, these aircraft have built-in explosive charges located in the rear of the plane. The charges are designed to create an access to the aircraft by blasting the tail-cone approximately 50' to the rear of the aircraft and then allowing a slide to deploy. This cone can be jettisoned by persons inside the aircraft or by pulling a lanyard located on the rear of the fuselage.

The lanyard on the Boeing 727 Airstar, like in the DC-9 tail cone, is located in the rear of the aircraft and can be operated from the inside or the outside. If the aircraft is not sitting on its landing gear, this aft stairway will be useless. Be very cautious when working around the rear of the plane, since the exits could be operated from inside at any time. Open the exit to ventilate the fuselage and facilitate the opening of other doors if the aircraft is pressurized.

A small, corporate-type jet aircraft presents the same basic hazards to rescuers as a large airliner. The main difference is that there are usually fewer passengers on board.

Attempting to break a window with an axe can be extremely dangerous. Aircraft windows are often made of multi-layers of plastic and/or glass, and tools usually bounce off the surface. It is best to gain access through available openings when possible.

## SPECIAL CRASH SITUATIONS

### Nose-Gear Collapse

A nose-gear collapse may present some unique rescue problems. On some single-engine aircraft, collapse of the nose gear will crush fuel components in the engine compartment, creating fuel spills and possible fires.

On a larger aircraft, upon impact, emergency slides may no longer operate properly due to a tail-high altitude. Slides on the forward section may lie too flat, creating congestion where passengers and crew members escape. Rescuers positioned adjacent to the slides can assist passengers, speed up the procedure, and help reduce injuries.

### **Main-Gear Collapse**

When a single main-gear collapses, the aircraft may go out of control and either ground loop or veer off the runway. Emergency slides may collapse too flat on one side, creating congestion, or extremely steep on the opposite side, causing injuries as the victims escape.

### **Fire in a Hydraulic System**

When a fire occurs in a plane's hydraulic system, use a dry chemical agent for extinguishment. This type of fire involves a petroleum-based fluid stored in a confined space and must be treated cautiously. **CAUTION:** Many jet aircraft use an hydraulic fluid that breaks down when heated, creating a vapor and causing severe irritation to the eyes and respiratory tract. The high pressure found in some aircraft hydraulic systems (up to 3000-4000 psi), combined with this vapor, creates a safety hazard.

### **No-Gear or Belly Landing**

When an aircraft lands with no landing gear, considerable damage will be done to the undercarriage, propellers (if so equipped), and possibly the wings. Such a landing creates friction, causing heat and sparks. If no fuel leaks occur, there is less chance of fire, and the passengers and crew members may survive with few injuries.

When an aircraft lands with no landing gear or on its belly, emergency slides are usually positioned flat to the ground, creating congestion as victims try to escape on the slides. Rescuers positioned at the base and sides of the slide can assist passengers off the slide.

### **Wheel Fire**

Overheated brakes are common to aircraft. As a safety precaution, jet aircraft are normally equipped with fusible plugs that deflate the tire when the tire reaches a temperature of 350°F to 400°F. Pilots usually use the propeller wash to cool the wheel areas.

In the event of a fire, position the equipment and workforce so that the approach to the wheel assembly is directly from the front or rear of the aircraft and never from the side. Hydraulic fluid, oils, and grease may be ignited due to extreme heat, which if left unchecked, creates a class D fire. If grease, oil, or rubber are involved in the flame, make the fire attack with a dry chemical agent. If necessary, fire fighters may use a smoke ejector to cool the wheels; however, once magnesium is involved, a class D agent must be used.

### **Cabin Fires**

Fires in an aircraft cabin may be caused by electrical failure, cabin heater malfunctions, or human negligence. The intensity of the fire will depend on preburn time, the fuel supply, draft conditions, the combustible contents of interior cabin materials, and the personal effects of passengers and crew members.

An unoccupied aircraft left closed-up for a period of time (such as an overnighter at an airport) creates a special problem. A cabin fire that has smoldered for hours in a tightly-closed, unventilated, aircraft, creates an explosive situation. Keep in mind the rules of ventilation for long, narrow structures. Purge flammable gases by venting on either the leeward side of the aircraft or from above prior to attack on the fire. Fires behind paneling may require removal of large sections of the paneling to effect extinguishment.

## **TRIAGE PROCEDURES**

Triage is started by the first rescuers to arrive at the scene. The first rescuer to gain access to the aircraft should attempt to remove the victims from the imminent danger of death, from explosion, heat, or toxic gases. In a large aircraft disaster with the possibility of a large number of people involved more rescuers will be needed to suppress a fire, rescue the victims, and maintain and secure the area.

### **Rescue of Survivors**

Rescuing survivors is the first action to be taken at the scene of an aircraft crash.

If the aircraft is on fire, establish and maintain a rescue path on the windward side until the rescue has been completed. Time is of the essence in most aircraft rescues since aircraft skins can withstand only about ninety seconds of flame impingement before failing.



Once the rescue has been made, or recognized as impossible, keep all personnel clear of the crash site. Establish a restricted-access area with a perimeter of at least 1500 feet to safeguard the accident site. Search the entire area for survivors who may have been thrown free of the aircraft and are wandering about in a dazed condition.

When practical, cover the aircraft identification or "N" number (usually located on the tail) so it is not identifiable on a newscast until the victim's family members can be notified by the proper authorities.

### Primary Triage

The initial triage should be performed by the fire fighters. The fire fighters should first control the fire scene, and second remove the passengers from in and around the crash site. Upon entering the aircraft, begin the triage procedure with a quick assessment of which victims should be handled first. Handle victims who have a chance of living if cared for quickly. Fire fighters should remove these victims immediately and place them at least 200 yards upwind of the aircraft at a secondary triage point.

Due to the possibility that hundreds of people may be injured by an aircraft disaster, fire fighters cannot be concerned with the basic rescue techniques used for victims of automobile accidents. There is not time to assess each victim for broken bones or respiratory difficulty. All victims must be moved from the aircraft to the secondary triage point as quickly as possible.

### Secondary Triage

At the secondary triage point, another decision must be made as to which victims will be removed to the next receiving point. At the secondary triage point, deal with the victims' airway management, breathing, and circulation, and examine victims for life-threatening situations. Once initial assessments have been made, categorize victims for transport. To prevent reexamination of deceased victims, attach triage tags as soon as practical.

### Emergency Care of Survivors

Emergency care must be administered to all survivors, even those who exhibit no physical injuries; the majority will be suffering from shock. When the danger of fire or explosion exists, victims must be removed to a safe area. If a victim must be dragged, drag by the long axis of the body. See the chapter on rescue carries and drags.

Severe lacerations and fractures are common in aircraft accidents; however, due to extreme stress and fear, rescuers must also be aware of possible strokes and heart attacks. Rescuers dealing with an aircraft crash usually are faced with a multitude of severe injuries and illnesses.

### Fatalities

Exact knowledge of the position of all dead victims in the aircraft and in the general area of the wreckage is important. This information may furnish valuable help in the identification of the accident victims or in establishing the cause of injuries or death. In the event of fatalities, do not move remains or portions thereof from their position at the accident scene nor take the remains to the morgue without prior approval from the incident commander.

The investigating officials may request the assistance of the rescuer and fire department personnel in tagging or staking the location of a victim's body or portion thereof. The usual procedure is to drive a stake into the ground near the remains and tag both the remains and the stake. Record information on both tags, stating any identification information and the location of the remains. Once permission to remove the dead has been given, the stakes should remain properly tagged and in place to show as nearly as possible the original crash scene and the exact location of each body or portion thereof.

Investigations following an aircraft crash may continue for weeks or months. The crash scene may need to be reviewed many times. The scene must remain the same until all investigations are completed.

### Safeguard the Area

Until responsible officials arrive at the scene, it will be the duty of the rescue personnel to make sure no wreckage is moved. However, if a part of the wreckage presents a hazard to life or property, make necessary removal or adjustments.

Keep all bystanders beyond the safe perimeter and enforce a no-smoking policy. The hazard of volatile fuels is always present at the aircraft crash scene.

### The National Transportation Safety Board (NTSB)

The National Transportation Safety Board (NTSB) investigates any multiple fatality in a civil aircraft accident. The NTSB safety team is on 24-hour call

and will be enroute to an accident scene within two-hours of notification.

The NTSB Congress determines the probable cause of all civil aircraft accidents and operates under the direct authority of the United States government. It has the power to conduct a hearing and take testimony from anyone involved, including fire and rescue personnel.

The crash scene must remain secured until released by the NTSB. This could encompass many acres of debris. Once the scene is secured, fire and rescue personnel should be prepared to be interviewed by investigators. Investigators will need to know the following information: (1) the type of equipment used for rescue and fire fighting operations and its effectiveness; (2) how the alarm was received; (3) the type of medical treatment given; and (4) when an emergency plan for the area was put into effect and how often it was tested.

Investigators may also ask about the extent of the victims' injuries, and the victim's location and position when rescued. The responsibility for initial scene security is that of the first responding unit. Once victims have been cared for and the fire hazard is minimized, scene security is a must.

When the investigators arrive, it is likely they will divide into two groups; one to deal with the passengers and the crew, and one to study the dynamics of the crash. The dynamics include the altitude, the speed at impact, the stopping distance, the distribution of the wreckage, and the probable cause of the accident.

## CONCLUSION

Aircraft crashes are not common and each has unique situations and problems. It is not possible to address every problem that could be encountered during an aircraft crash; however, some basic techniques and cautions have been presented in this text. It is recommended that if rescuers are located in an area where an aircraft crash is likely, a considerable amount of preplanning should be done by the emergency personnel to prepare for such an event. However, planes are not selective about crash sites; any rescue department could be faced with the possibility of an air crash and must be familiar with the hazards encountered and tactics used in an aircraft rescue.

## HELICOPTER INFORMATION

### KEY POINTS

- Precautions for safe helicopter operations
- Flight plans
- Ground precautions
- Takeoff and landing
- Refueling the aircraft
- Flight precautions
- Helicopter capabilities and limitations
- Helicopter terminology
- Importance of density altitude
- Helicopter loading
- Personal protection equipment

### INTRODUCTION

The helicopter can be a potentially dangerous machine and requires clear thinking and continuous practice of safe operations by all personnel who work with it. The helicopter has been used for years as a valuable resource in a variety of uses. Rescuers must be aware of inherent hazards and practice principles to insure safe operations when using a helicopter in rescue operations.

### PRECAUTIONS FOR SAFE HELICOPTER OPERATIONS

Only necessary flights should be permitted. Pilots must never carry unauthorized or unnecessary passengers or cargo. Helicopter operations must comply with the safety rules for aerial operations and practices prescribed for specialized helicopter operations in an agency's manual, and those written in the Federal, State, and OSHA standards. Safety training provided for ground personnel must include items requiring special care in and around helicopters on the ground and in the air.

The pilot is responsible for the safety of the helicopter and the passengers at all times. The pilot must know the hazards, limitations, and safety features of the aircraft.

Operation of the helicopter at night is permitted only after the requirements in the Federal Aviation

Association (FAA) regulations have been met. Helicopter pilot-duty limitations and flight-time limitations must be followed at all times.

If possible personnel trained in helicopter operations should be stationed at each helicopter landing area to supervise loading operations and enforce safety regulations. Only qualified and trained ground-crew personnel should be used during hover hookups. The crew must be briefed by the pilot prior to the start of any hover hookup operation. Emergency procedures must be established between the pilot and the ground crew. Any accident must be reported immediately to responsible authorities.

### FLIGHT PLANS

Flight plans are required for all flights except local training and maintenance test flights within a 25-mile radius of the base of operations for all flights conducted by U.S. Department of Interior (DOI) aircraft. An FAA or equivalent agency flight plan following established procedures is required. The flight plan should state the names of all people on board, the destination of the aircraft, the type and color of the aircraft, the aircraft's N-number, the amount of fuel available, the time of departure, and the return time.

FAA statistics indicate that survivors of an initial aircraft crash have twice the chance of surviving if the aircraft is on a flight plan. The length of time

for the first search and rescue personnel to arrive at the scene of the crash depends on the type of flight plan filed.

## GROUND PRECAUTIONS

Never approach a helicopter without the pilot's knowledge and approval. **Never** enter the landing area until the helicopter has completed landing and the pilot has indicated it is safe to approach the helicopter.

When approaching, approach in a crouched position from the front or side and in full view of the pilot since the main rotor blades can tip below the six-foot level. Do not approach a helicopter from an area where the ground is higher than where the helicopter is standing or hovering. Main rotors can easily reach below head height on the uphill side of a landing area or on a moderate slope. Also, never run when approaching or leaving a helicopter.

When walking in front of a helicopter, be sure not to strike any part of the helicopter such as pitot tube, antenna, or mirrors with the body or any cargo. Be sure to keep all long-handled tools clear of the rotor system. It is recommended to never load or unload any object over four feet in length when the blades are turning. Keep the landing area clear of all unauthorized personnel and also clear of light materials that may blow. All personnel must stay 50 feet from a running helicopter unless required to go nearer.

### Cargo

The pilot must be aware of any baggage or cargo being placed in the helicopter. The correct weight of all personnel, cargo, and equipment must be known by the pilot before the flight. The cargo packages should be weighed separately so the pilot can know how to distribute the weight evenly.

Explosives, flammables, and other hazardous materials can be transported only when the pilot and government personnel have complied with DOI Aviation Transport of Hazardous Materials Handbook (351 DM) or HMR Part 175, CFR 49. If regulations are not followed, all involved parties can be cited by the U.S. Department of Transportation.

Secure all cargo in external racks by attaching tie-down cords through the handles. Never leave loose tie-down cords in cargo racks. **Never stand erect on cargo racks or on the door sill.**

## TAKEOFF AND LANDING

When entering a helicopter, hold on to the door to prevent the wind from slamming it against the helicopter. Do not use the door to hold the body weight or as a lift to pull the body into the aircraft. Place a foot on the step first and enter the passenger compartment with the head and shoulders before placing another foot inside. Front-seat passengers and their equipment must remain clear of all flight controls.

Do not use the sliding windows or air-vent holes on the helicopter to close the doors since they are easily broken. Close doors gently, **do not slam**. Secure all papers and materials that may interfere with flight controls.

**A shoulder harness is required for all front-seat passengers.** Before takeoff, fasten and adjust the seatbelt and shoulder harness. Keep seat belts fastened until the landing is completed. Know how to unfasten the belts before takeoff.

After landing, unfasten the seatbelt and refasten it (on the seat) before getting out of the helicopter. **Never allow an unfastened seatbelt to hang outside of the door.** A seatbelt left outside the door during flight can cause extensive damage to the aircraft.

All personnel working near a helicopter must wear hearing protection, goggles, and a hardhat with chin straps to comply with OSHA regulations. All pilots, crew members, and DOI employees must wear fire-retardant clothing, approved aviation helmets, and other protective equipment as required by departmental policy.

## REFUELING THE AIRCRAFT

The following procedures must be observed when refueling a helicopter at a landing area.

- shut off the engine and stop the rotor blades
- ground the helicopter and fuel containers
- permit no passengers on board the aircraft
- permit no smoking
- permit no unauthorized personnel within 50 feet
- have a fire extinguisher readily available

## FLIGHT PRECAUTIONS

All passengers should locate the emergency exits, first-aid kit, emergency locator transmitter (ELT),

fire extinguisher, and survival gear. These items should be used only in an emergency; however, passengers should be familiar with their location and instructions for use. These items are required on all DOI contract aircraft. Rental aircraft may or may not have a survival or first-aid kit.

All passengers must keep all safety belts fastened and not move around during flight unless absolutely necessary. Cigarette smoking is allowed during flight at the pilot's discretion. No smoking is permitted during takeoff or landing, or within 50 feet of heliports.

All passengers should remain alert for hazards, particularly electric power lines and telephone lines, and inform the pilot of their presence. Passengers should assist the pilot **only when requested** in watching the tail rotor clearance during a rough field landing.

Passengers must keep the body, any equipment, and the seatbelt clear of the controls at all times. Passengers must never request a pilot to perform a mission for which he or she, or the aircraft has not been approved.

The pilot is the person who approves all missions, and his or her word is final as to whether a flight can be made. Do not put any undue pressure on the pilot to fly in adverse weather conditions. Undue influence to go beyond a pilot's limitations may result in an accident. **Stop the flight if there is a concern that the crew and passenger's lives are endangered.**

Wind restrictions are established to ensure safe and successful helicopter flights. Helicopter operations are discontinued when winds exceed established limitations or any time the pilot decides that the wind conditions are such that the safety of continuing flight operations is in question. Radio communications or hand signals should be used to aid the pilot determine wind direction. Other methods of indicating wind direction and speed include to suspend cloth or paper streamers or a wind sock in the air.

Always be prepared for a sudden emergency landing while in flight. Wear all personal protective gear, keep the seatbelt snug, keep clear of all controls, secure loose gear, and check the emergency-exit locations. During an emergency landing assume the proper seating position to reduce the risk of injury.

## HELICOPTER CAPABILITIES AND LIMITATIONS

The helicopter's ability to operate from a restricted

area and to remain hovered above a selected spot are perhaps its greatest attributes. When a helicopter is managed by trained personnel, it is as safe as any aircraft used.

To properly manage a helicopter for safe and efficient use, the basic characteristics, capabilities, and limitations must be known. A helicopter derives its ability to fly from one or more power-driven rotating air foils or rotors; hence it is called a rotary-wing aircraft.

## HELICOPTER TERMINOLOGY

It is important for persons involved with helicopter use to be familiar with the common terms used in helicopter operations.

*Ground effect* occurs when the blade-tip vortices contact the ground. This causes the vortices to run outward from the aircraft and not recirculate through the rotor system. Ground effect has the apparent result of increasing lift or decreasing power requirements by allowing more of the rotor blade to pass through undisturbed air rather than through recirculating vortices. Ground effect begins at an altitude of one rotor blade radius and increases until the aircraft is on the ground.

*Hover-in-Ground-Effect (HIGE)* is achieved when the helicopter is hovering within one rotor diameter of the ground.

*Hovering-Out-of-Ground Effect (HOGE)* occurs whenever a helicopter hovers greater than one rotor diameter above the ground. If a helicopter is hovering at five feet above a rock shelf on the side of a mountain, then moves laterally to clear the shelf it passes from HIGE to HOGE.

During a hovering flight, air enters the main rotor system from above and is pushed down and outward in all directions from the helicopter. By selecting a landing site that allows the pilot to approach into the wind and terminate the approach during hover-in-ground-effect conditions, the safety of the operation is increased.

*Translational lift* refers to a lift that is gained when translating from a hover into forward flight. This additional lift is gained at about 18 mph and caused by the extra volume of air passing through the rotor system.

*Autorotation* refers to a nonpowered flight condition with the rotor system maintaining required flight RPM. The rotor RPM is maintained by the airflow moving upward through the rotors. The RPM of the rotor system can also be thought of as inertia and is used as the helicopter nears the ground to check the rate of descent and to effect a landing.

A *freewheeling unit* is a built-in safety device which makes it possible to autorotate. This device releases the drive of the main rotor blades from the engine drive in the event of engine failure. During autorotation, the pilot adjusts the pitch on the main rotor blades so that the blades continue to turn as the helicopter is gliding downward. During autorotation the blades turn in a manner similar to a windmill. The main rotor blades continue to turn as fast without engine power as they do with engine power and the pilot must continue to maintain complete control of the aircraft.

The sequence of events in which a helicopter enters autorotation descent without engine power is as follows:

1. The helicopter enters an autorotative descent and is in a stabilized autorotative flight.
2. As the aircraft approaches the landing area, the pilot flares the helicopter by gently lifting the nose. This slows the **forward and downward speeds**.
3. By this time during the autorotation, most forward motion of the helicopter has stopped.
4. The pilot now uses stored blade inertia to cushion the aircraft onto the landing area.
5. The helicopter touches down on the landing area and the autorotation is completed.

*Height-velocity curve* is a chart developed from flight tests for each type of helicopter that shows the comparative combination of air speed and altitude required to execute a safe, autorotational landing (usually about 475' AGL at zero air speed for light helicopters.)

### Density Altitude

Density altitude is a given block of air with a measured pressure and temperature translated to an "altitude above sea level" for use in figuring its capability to support an aircraft in flight. Relative humidity has some additional effect, but not to the extent that it affects the calculation for a flight load. Three factors in varying degrees, pressure, temperature, and humidity affect density altitude. The following conditions affect density altitude.

- If the pressure is changed 10 points, i.e., from 29.92" to 30.02" hg., there will be an altitude reading change of 100'.
- If the temperature is changed 10 points, i.e., from 70° to 80° on the same altitude reading, the density altitude will change 500'.

- If the relative humidity is changed 10 points, i.e., from 20% to 30%, the density altitude will be affected by only another 10' to 15'.

### HOW DENSITY ALTITUDE AFFECTS AIRCRAFT AND FLIGHT

The only altitude an aircraft knows or uses as far as performance is concerned is density altitude. This air reduces the lifting capability of aircraft by loss of lift for the wing and less oxygen available for the power plant. For example, it is comparable to the decreased performance of an automobile engine due to lack of oxygen in higher altitudes.

Helicopters rely on the movement of a rotary wing through the air at a speed sufficient to create enough lift to become airborne. Since the helicopter is a rotary wing aircraft and starts into flight vertically, the pilot cannot extend a ground run to increase the speed of the rotary wing through the air.

Also, the craft is operating at a fixed allowed rotor speed, which cannot be increased to compensate for the thinner air found at higher density altitudes. The gross weight of the helicopter must be reduced to a point where a fixed rotor system is capable of lifting the helicopter into flight. This can be accomplished only by reducing the fuel supply or the payload, or both.

### HELICOPTER LOADING

**Center-of-gravity (CG) effect.** Consideration of CG limitations is important in the loading of all aircraft, but is critical in a helicopter. In a fixed-wing aircraft, the load is balanced over a horizontal wing area and has a comparatively wide range. It is important to properly secure all materials loaded on or in a helicopter. In a helicopter the load is carried under a single point like a pendulum; therefore, very little out-of-CG loading can affect the controllability of the helicopter.

#### Helicopter Loads and Weight Definitions

**Certified Gross Weight.** This is the maximum total weight that a helicopter is certificated to carry by the FAA standards to safely perform flight at sea level on a standard day. It makes no allowance for weight reductions at higher altitudes. It is also

considered as the total weight of the aircraft existing on any one flight.

**Empty Weight.** This term refers to the total weight of the helicopter including the structure, the powerplant, all fixed equipment, all fixed ballast, unusable fuel, undrainable oil, total quantity of engine coolant, and total quantity of hydraulic fluid.

**Equipped Weight.** This term refers to the empty weight of the aircraft plus the weight of accessories required for the mission, plus the weight of the oil.

**Useful load.** This term refers to the helicopter's adjusted gross weight minus the equipped weight is called the useful load.

**Payload.** This term refers to the weight of passengers and cargo that can be carried for any mission. The payload weight does not include the weight of pilot(s) and fuel.

### Helicopter Load Calculation; Fixed Amount Method

1. **Destination base.** Read altimeter when set to 29.92.
2. **Destination base.** Use mean sea level elevation.
3. **Helicopter equipped weight.** Empty weight of aircraft plus weight of accessories required for the mission plus weight of oil. Recorded on the aircraft data card and in the aircraft's logbook.
4. **Flight crew weight.** Weight of the pilot and any additional crew members plus their personal gear.
5. **Fuel.** Av gas = 6.0 lbs./gal. Jet fuel (JP) = 7 lbs./gal. Weight of fuel times the number of gallons in aircraft.
6. **Operating weight.** Add items 3, 4, and 5.
7. **Computed gross weight.** Obtained weight from aircraft Hover-in-Ground-Effect (HIGE) Chart using External Load Chart if available. Sling load missions and adverse terrain, weather, etc., flights are computed from aircraft Hover-Out-of-Ground (HOGE) Charts.
8. **Weight reduction.** Enter applicable weight reduction for helicopter model as shown on weight-reduction chart.
9. **Adjusted weight.** Item 7 minus item 8.
10. **Takeoff and landing limits.** Enter applicable takeoff and landing limit as found in LIMITATIONS section of aircraft's manual.

11. **Selected weight.** If line 9 is greater than line 10, line 9 may be used for JETTISONABLE loads. However, the lowest weight, line 9 or 10, will be used for NONJETTISONABLE loads.
12. **Operating weight.** Item 6.
13. **Allowable load.** The maximum allowable weight (passenger and/or cargo) that can be carried for the mission.
14. **Passengers and/or cargo.** Enter passenger weights and/or type and weights of cargo. Manifest all passengers by name for each flight.
15. **Actual payload.** Total of all weights listed in item 14.
16. **Actual gross weight.** The total of weights in items 12 and 15.

## DOI REQUIREMENTS

### Personal Protective Equipment (PPE)

Personal protective equipment refers to the protective equipment an individual brings to the flight but does not include equipment or devices installed on the aircraft or furnished as a part of the aircraft equipment. Personal protective equipment includes, but is not necessarily limited to, boots, gloves, protective headgear, and fire-retardant clothing.

### Requirements for Wearing PPE

All personnel (pilots, crew members, and passengers) are required to wear the following PPE during replanned "special use" activity flights:

- Aviator's protective helmet (the pilot's and crew member's helmets must have communications capability; passengers may have helmets without communication capability).
- Fire-retardant clothing.
- All-leather boots which extend above the ankle.
- All-leather or combination leather and "Nomex" gloves.

Personal flotation devices are required to be worn by all occupants of single-engine aircraft and be readily available for use by occupants of multiengine aircraft when flying over water which is beyond a gliding distance to the shoreline. If the estimated water temperature is 50°F or less, all single-engine aircraft occupants must wear antiexposure suits and

all multiengine occupants must have the suits readily available.

Exceptions to PPE requirements on "special use" activities include the following:

- Fire-retardant clothing is not required for spray or overwater flights.
- Fire crews are not required to wear PPE when being transported between designated landing sites on a fire ground.
- Leather boots are not required for overwater flights or when they are not conducive to the person's working environment, such as in snow or water, and if the supervisor determines that other types of boots are necessary to perform the project.

**NOTE:** Crew members and passengers must be informed of the additional hazard in the event of an aircraft crash fire.

### Special Use

"Special use" activities are types of operations which require special considerations to protect personnel due to the nature of the operations. Besides special pilot qualifications and aircraft equipment, the use of personal protective equipment is required.

U.S. Army records indicate that many deaths and injuries in aviation accidents are caused by not wearing or improperly wearing personal protective clothing. Lives have been saved or personnel have received less serious injuries when wearing personal protective equipment.

An aviator's helmet that is fitted and worn properly gives excellent head protection. It not only protects the head from blows, but also gives hearing protection and protects the eyes.

Helicopter operations requiring all personnel (pilots, passengers, and crew members) aboard the aircraft to wear PPE include the following:

1. Helicopters with Class B or C external loads (slung loads, etc.)
2. Night-vision goggle operations
3. Hoversite missions
4. Rappelling operations
5. Animal herding
6. Offshore navigation (vessel or platform landings)
7. Flights conducted below 500' above ground level
8. Operations around a fire perimeter

9. Helitack
10. Water/retardant applications
11. Dispensing of flammable liquids, flares, or ignition devices
12. Animal damage control operations
13. Flights where any takeoff or landing requires special pilot techniques due to terrain, obstacles, or surface conditions

### Fire-Retardant Clothing

The primary purpose of fire-retardant clothing is to provide protection from burns in the event an aircraft crash involves a post-crash fire. Fire-retardant clothing provides a barrier to the heat and flames that can eliminate or minimize burns. Burns are usually broken down into three categories.

1. First-degree burns are the least serious, e.g., bad sunburn. It can be painful but seldom causes serious problems.
2. Second-degree burns are characterized by blistering of the skin. These take a lot longer to heal and there is danger from infection if the blisters break.
3. Third-degree burns are the most serious. Skin tissue is actually destroyed and charred. The burned area is extremely susceptible to infection. Burns of this type can take two or more years to heal.

### CONCLUSION

Helicopters can be very useful in rescue operations. However, prior to using the aircraft in rescue procedures the personnel utilizing helicopter services must be knowledgeable about their use and be familiar with federal and state regulations.