

DOCUMENT RESUME

ED 330 879

CE 057 712

TITLE Rescue Manual. Module 5.
 INSTITUTION Ohio State Univ., Columbus. Instructional Materials Lab.
 PUB DATE 89
 NOTE 51p.; For related modules, see CE 057 708-717. Photographs may not reproduce well.
 AVAILABLE FROM Instructional Materials Laboratory, Ohio State University, 842 West Goodale Blvd., Columbus, OH 43212 (\$8.00; set of 10, \$33.00).
 PUB TYPE Guides - Classroom Use - Instructional Materials (For Learner) (051)

EDRS PRICE MF01/PC03 Plus Postage.
 DESCRIPTORS Accidents; *Emergency Programs; *Emergency Squad Personnel; First Aid; *Hazardous Materials; Learning Modules; Occupational Safety and Health; Postsecondary Education; *Rescue; Safety; Safety Education

ABSTRACT

This learner manual for rescuers covers the current techniques or practices required in the rescue service. The fifth of 10 modules contains information on hazardous materials. Key points, an introduction, and conclusion accompany substantive material in this module. In addition, the module contains a Department of Transportation guide chart on hazardous materials marking, labeling, and placarding. (NLA)

 * Reproductions supplied by EDRS are the best that can be made *
 * from the original document. *

RESCUE MANUAL

U.S. DEPARTMENT OF EDUCATION
Office of Educational Research and Improvement
EDUCATIONAL RESOURCES INFORMATION
CENTER (ERIC)

This document has been reproduced as
received from the person or organization
originating it

Minor changes have been made to improve
reproduction quality

• Points of view or opinions stated in this docu-
ment do not necessarily represent official
OERI position or policy

"PERMISSION TO REPRODUCE THIS
MATERIAL HAS BEEN GRANTED BY

Scrymgeour

TO THE EDUCATIONAL RESOURCES
INFORMATION CENTER (ERIC)."

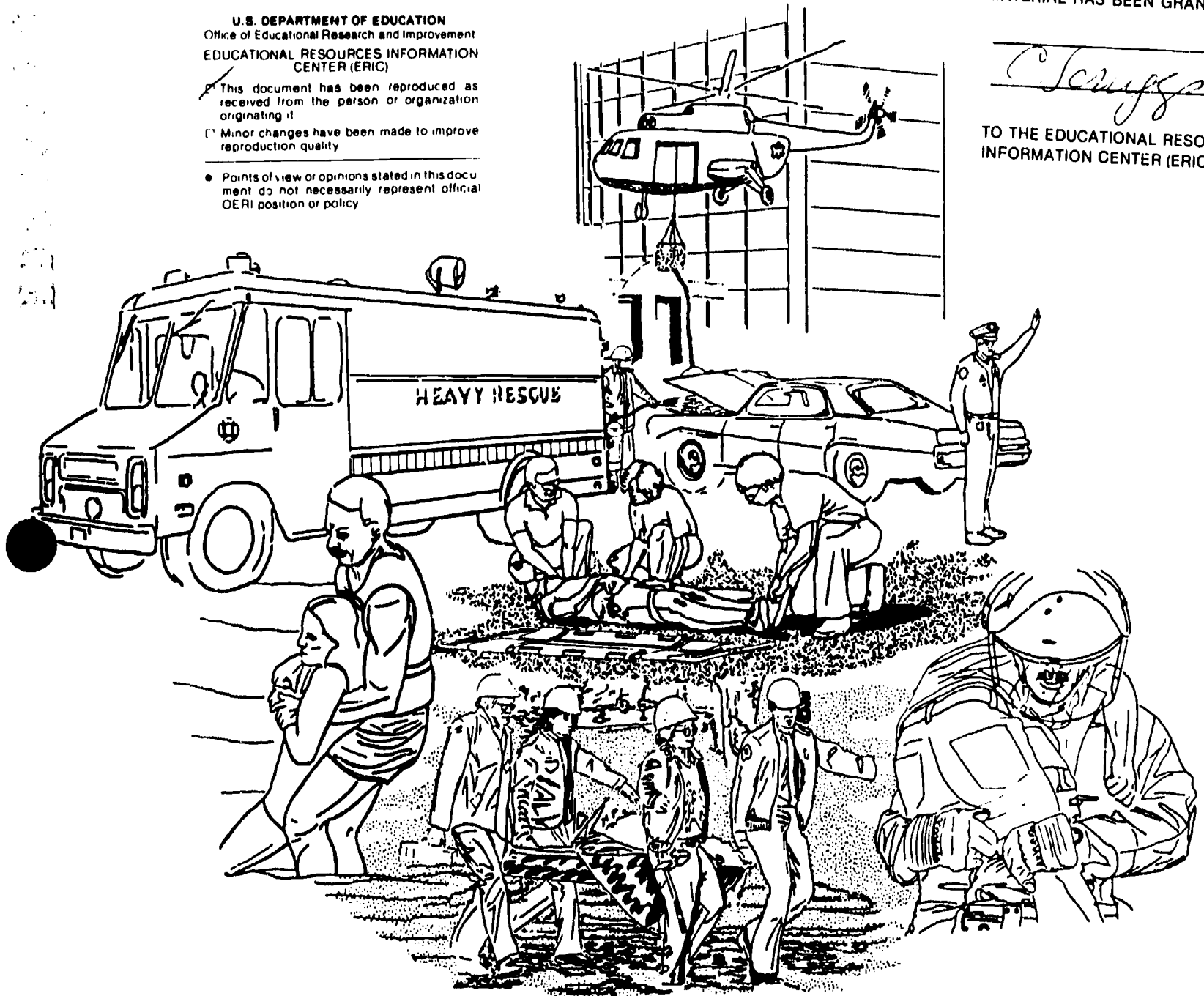

MODULE 5

Hazardous Materials

BEST COPY AVAILABLE

2

INSTRUCTIONAL MATERIALS LABORATORY
THE OHIO STATE UNIVERSITY
COLUMBUS, OHIO 43210

CF 057 712

Copyright 1989 by The Ohio State University. All rights reserved.

Edited and distributed by the
Instructional Materials Laboratory
The Ohio State University
College of Education
Columbus, Ohio 43210

Rescue operations may subject both rescuer and victim to the possibility of injury or death. Rescuers must understand the nature and effect of each rescue technique, and practice techniques regularly, using this text to enhance their learning. The materials and information presented here are intended only as a learning aid, and are no substitute for training. Expert opinions, recommendations, and guidelines change as research and experience refine procedures. This text includes the most up-to-date information from rescuers working in the field.

Specialized procedures require demonstration and training by subject-matter experts. It is not likely that a rescuer will become proficient in all rescue operations. Most rescuers develop proficiency in only a few areas but may be familiar with several others.

This text suggests procedures and explains how to do them. The techniques given are guidelines only. Each department should incorporate its own procedures and address local needs.

Nondiscrimination Policy The policy of The Ohio State University, both traditionally and currently, is that discrimination against any individual for reasons of race, color, creed, religion, national origin, sex, age, handicap, or Vietnam-era veteran status is specifically prohibited. Title IX of the Education Amendments of 1972 prohibits sex discrimination and Section 504 of the Rehabilitation Act of 1973 prohibits discrimination on the basis of handicap in education programs and activities. Accordingly, equal access to employment opportunities, admissions, education programs, and all other University activities is extended to all persons, and the University promotes equal opportunity through a positive and continuing affirmative action program.

RESCUE MANUAL

**INSTRUCTIONAL MATERIALS LABORATORY
THE OHIO STATE UNIVERSITY
COLUMBUS, OHIO 43210**

ACKNOWLEDGMENT

Acknowledgment is extended to the following persons for their willingness to share their knowledge and expertise and for authoring information presented in this module:

Hazardous Materials

**Hazardous Materials Bureau, Ohio Department of Commerce, Division of State Fire Marshal,
Reynoldsburg, Ohio**

Willie L. Beaver, Chief, Hazardous Materials Bureau, Reynoldsburg, Ohio

David Bowman, Hazardous Materials Coordinator, Hazardous Materials Bureau, Reynoldsburg, Ohio

**Tom Forbes, Technical Consultant, Bureau of Underground Storage Tank Regulations (BUSTR),
Reynoldsburg, Ohio**

**Steve Parsons, Hazardous Materials Technician, Hazardous Materials Technician, Hazardous Material
Bureau, Reynoldsburg, Ohio**

FOREWORD

The intent of this manual for rescuers is to provide the latest instructional content and serve as an up-to-date, comprehensive source of information covering the current techniques or practices required in the rescue service. To help in this endeavor, an instructor's manual has been developed to be used in conjunction with this learner's manual. The manual has been produced in a series of modules to facilitate future revisions more rapidly and cost effectively.

The instructor's manual follows the key points identified in the text. Chapters have been included in the text which exceed those printed in any other resource. These include managing and operating the emergency vehicle, rope rescue techniques, industrial rescue, farm accident rescue, and various water emergency procedures, among others.

That the rescue profession is a dangerous and challenging career is a recognized fact. It is our hope that this text will help the rescuer meet the challenges of the rescue service in a safe and professional manner.

Tom Hines
Director
Instructional Materials Laboratory
College of Education
The Ohio State University

PREFACE

The Ohio State University Instructional Materials Laboratory has played a major role in the training of public safety personnel through the development of text materials for many years. Due to the advances in the rescue techniques, it became apparent that the existing text was obsolete. Upon the advice of many knowledgeable people in the rescue service, the Instructional Materials Laboratory initiated the development of a new text that would be easily updated, and address the needs of the rescuer. To this end, an editorial review board representing a broad spectrum of individuals in the various phases of the research profession was convened to determine what topics this text should address. The culmination of this effort is the Rescue Manual. It is hoped that this text will be useful to not only the new rescuer but will serve as a reference source for the experienced rescuer.

Joyce Leimbach
Curriculum Consultant
College of Education
The Ohio State University

Ronald Slane
Technical Consultant
College of Education
The Ohio State University

MODULE 5

TABLE OF CONTENTS

Hazardous Materials.. ..	1
--------------------------	---

MODULE CONTENTS

The 1989 Rescue Manual has been grouped into ten modules in accordance with the recommendations from the Rescue Editorial Board.

Module 1

Introduction
Occupational Stresses in Rescue Operations
Size-up
Critique
Reporting and Recordkeeping
Tools and Equipment for Rescue Operations
Planning for Emergency Operations
Incident Command System
Dealing with Natural Disasters

Module 2

Patient Care and Handling Techniques
Rescue Carries and Drags
Emergency Vehicle Operation
Self-Contained Breathing Apparatus
Protective Clothing

Module 3

Forcible Entry
Structure Search and Rescue
Rescue Operations Involving Electricity
Cutting Torches

Module 4

Construction and Characteristics of Rescue Rope
Knots, Bends, and Hitches
Critical Angles
Raising Systems
Rigging
Using the Brake-Bar Rack for Rope Rescue
Rope Rescue Techniques
Aerial Ladder and Aerial Platform Rescue

Module 5

Hazardous Materials

Module 6

Industrial Rescue
Rescue From a Confined Space
Extrication From Heavy Equipment
Rescue Operations Involving Elevators

Module 7

Extrication From Vehicles

Module 8

Trench Rescue
Shoring and Tunneling Techniques
Farm Accident Rescue
Wilderness Search and Rescue
Aircraft Rescue
Helicopter Information

Module 9

Ice Characteristics
River Characteristics and Tactics for Rescue
Water Rescue Techniques
Water Rescue/Recovery Operations
Dive Operations
Water Rescue Equipment
Water Rescue Safety Tips

Module 10

Glossary
Appendix

PUBLIC SAFETY SERVICES PUBLICATIONS AVAILABLE

For ordering and pricing information contact:

Instructional Materials Laboratory
The Ohio State University
842 West Goodale Boulevard
Columbus, Ohio 43212
Phone (614) 221-4950

HAZARDOUS MATERIALS

KEY POINTS

- National Fire Protection Association (NFPA) standards for handling hazardous materials
- The Superfund Amendments and Reauthorization Act (SARA) Title III Consolidated Chemical List
- The physical states for hazardous materials
- Identifying hazardous materials in transport
- Preplanning
- Preparing response plan
- Organizing cleanup after an incident
- NFPA 704 system
- Personal protective equipment
- Forms and checklists required at a hazardous materials incident
- Materials Safety Data Sheets (MSDS)
- Definitions of fire hazard properties
- Identifications of hazardous materials
- NFPA 704 marking system
- Descriptions of hazard classes
- United Nations classes
- Pesticides

INTRODUCTION

Rescuers have been dealing with hazardous materials in life-threatening situations for many years. Today's technology continually presents rescuers with changing problems. There is no easy way to deal with a hazardous material incident; however, with accurate information, good preplanning, an incident command system, and up-to-date training, rescuers can successfully perform safe and professional rescues involving hazardous materials. Rescuers need to be prepared to effectively handle a hazardous-materials incident to prevent the loss of life and property, and prevent environmental damage, or at least control the incident to minimize losses.

It is impossible to provide all the information needed to deal with every chemical in use today; however, the information presented can help rescuers make logical decisions in an incident involving hazardous materials. Once an accurate identification of the problem has been made, appropriate action (offensive or defensive) can be taken. There is no reason good enough to sacrifice the life of a rescuer in rescue efforts. Rescuers are of no value to the life

and property they are trying to protect if they end up losing their life.

NFPA STANDARDS

The key points for this module are taken from the proposed **NFPA Standard 472, Professional Competence of Responders to Hazardous Materials Incidents**, 1988 Edition. This information provides rescuers with information to comply with the local, state, and federal standards, and the training requirements addressed in the regulations. To meet the minimum guidelines it will be necessary to have access to the latest published NFPA Standards.

2-1 GENERAL

- 2-1.1 First responders are divided into two levels of competency; First Responder Awareness and First Responder Operational. First responders at the awareness level "shall" be trained to meet all of the requirements of Section 2-2 found in NFPA Standard 472. The first re-

sponder at the operational level "shall" be trained to meet all of the requirements of Section 2-2 and Section 2-3 found in NFPA Standard 472. All first responders "shall" receive training to meet federal Occupational Safety and Health Administration (OSHA) and Environmental Protection Agency (EPA) requirements, whichever is appropriate for their jurisdiction.

2-2 FIRST RESPONDER AWARENESS LEVEL

2-2.1 The goal at the first responder awareness level is to provide those persons, who in the course of their normal duties may be the first on the scene of a hazardous materials incident, with the following competencies to help them to act in a safe manner when confronted with a hazardous materials incident:

- a. An understanding of what hazardous materials are and the risks associated with them in an incident.
- b. An understanding of the potential outcomes associated with an emergency created when hazardous materials are present.
- c. Recognize the presence of hazardous materials in an emergency.
- d. The ability to identify hazardous materials and determine basic hazard and response information.
- e. An understanding of the role of the first responder on the scene of a hazardous materials incident as identified in the local contingency plan for hazardous materials incidents.
- f. Realize the need for additional resources and make appropriate notifications.
- g. Initiate scene management (incident command system, isolate immediate site, deny entry, and evacuate).
There are three other levels of competency that rescuers need to be aware of:

1. The goal of the **first responder operational level** is to know basic hazard and risk assessment techniques, select and use proper personal protective clothing, understand basic hazardous materials terms, and perform basic hazardous materials control, containment and/or confinement operations within their resource capabilities, understand basic decontamination procedures, and perform basic record keeping and expand the Incident Command System.
2. The **hazardous materials technician level** is the next step in the hazardous materials training structure. The technician will be competent and able to respond to and take appropriate actions to handle, from an operational standpoint, the correct tactics, strategies, and procedures necessary for a successful end to a hazardous materials incident.
3. The **hazardous materials specialist level** is the highest level of competency addressed at this time for an emergency responder. This person will be highly skilled in the areas of chemistry, site safety, risk assessment, incident command, decontamination procedures, and incident termination. This is an advanced position with a great deal of responsibility in an incident involving hazardous materials.

DEFINITIONS FOR HAZARDOUS MATERIALS

There are many definitions of hazardous materials. For the purposes of information presented, the following definitions are used:

A definition used in NFPA 472 lists a hazardous material (substance/wastes) as:

A hazardous substance (gas, liquid, or solid) capable of creating harm to people, property, and the environment.

It must be understood that each section of industry, transportation, manufacturers of goods, and the different regulatory agencies use definitions of hazardous materials that are specific to their area of responsibility. To be familiar with those definitions rescuers must review the resources that are used in those specific industries (See Appendices A, B, and C in Module 10 of the Rescue Manual for resource information).

Superfund Amendments and Reauthorization Act (SARA) Title III Consolidated Chemical List

The consolidated chemical list includes chemicals subject to reporting requirements under TITLE III of the Superfund Amendments and Reauthorization Act of 1986 (SARA). It has been prepared to help firms that handle chemicals determine whether reports need to be submitted under Sections 304 or under 313 of TITLE III and, identify which reports need to be submitted for a specified chemical.

All chemicals subject to the reporting requirements in section 311 and 312 of SARA TITLE III are not specified in this consolidated list. The hazardous chemicals for which material safety data sheets (MSDS) must be developed under Occupational Safety and Health Act (OSHA) hazard communication standards are identified by broad criteria, rather than enumeration. There are over 50,000 such substances that satisfy the criteria. For further detail refer to 29 Code of Federal Regulations (CFR) 1910.1200.

The list includes chemicals referenced under the four federal statutory provisions as follows:

1. **Superfund Amendments and Reauthorization Act (SARA)**. SARA Section 302 extremely hazardous substances. The presence of which, in sufficient quantities, requires certain emergency planning activities to be conducted. Releases of these substances are also subject to reporting under Section 304 of TITLE III. The final rule was published on April 22, 1987 (52 FOR 13378).
2. **Comprehensive Environmental Response Compensation, and Liability Act (CERCLA) Hazardous Substances [reportable quantity (RQ)] Chemicals**. Releases of which are subject to reporting under the Comprehensive Environmental Response, Compensation, and Liability Act of 1980 (CERCLA, or "SUPERFUND"). Such releases are also subject to reporting under Section 304 of TITLE III. CERCLA Hazardous Substances, and their reportable quantities (RQ) are listed in 40 CFR Part 302, table 302.4.
3. **SARA Section 313 Toxic Chemicals, Emissions or Releases of which must be reported annually as part of SARA TITLE III's Community Right-to-Know provisions**. The proposed Section 313 rule containing these chemicals was published on June 4, 1987 (52 FR 21152).

4. **Resource Conservation and Recovery Act (RCRA)**. RCRA Hazardous Wastes from the P and U Lists only (40 CFR 261.33), which consist of alphabetized lists of specific chemicals. RCRA Hazardous Wastes consisting of waste streams on the F and K lists are not included: such waste streams are CERCLA Hazardous Substances. This listing is provided as an indicator to companies that they may already have data on a specific chemical that can be used for the TITLE III reporting purposes.

Basic Physical States of Hazardous Materials

There are three basic physical states of hazardous materials (see Figures 1 thru 3).



Figure 1. Solids (Sodium Metal)

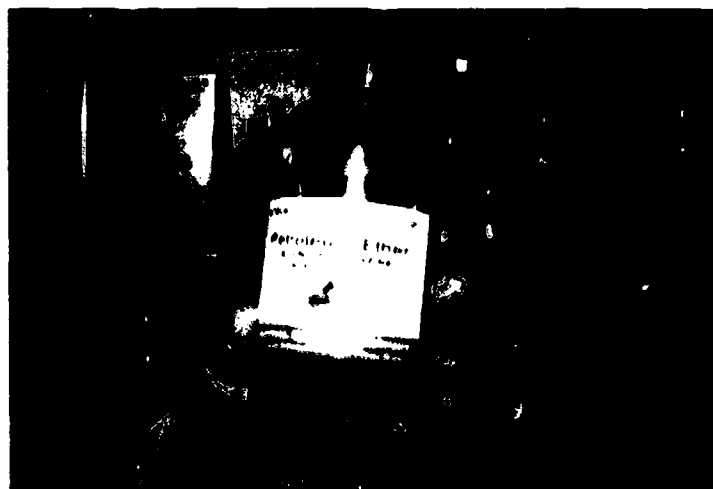

Figure 2. Liquids (Petroleum Ether)



Figure 3. Gases (Propane Gas)

The term "normal physical form" can be misleading because of the many materials shipped and used for different purposes. For example, hydrogen or oxygen is often shipped as a liquid in large, insulated tank trucks (see Figure 4), however; a first responder can encounter oxygen shipped as a compressed gas in both large and small cylinders (see Figure 5). An emergency responder must be aware of the different forms a material can take and for safety purposes must be able to recognize the difference.



Figure 4. Liquid Oxygen Tank Truck

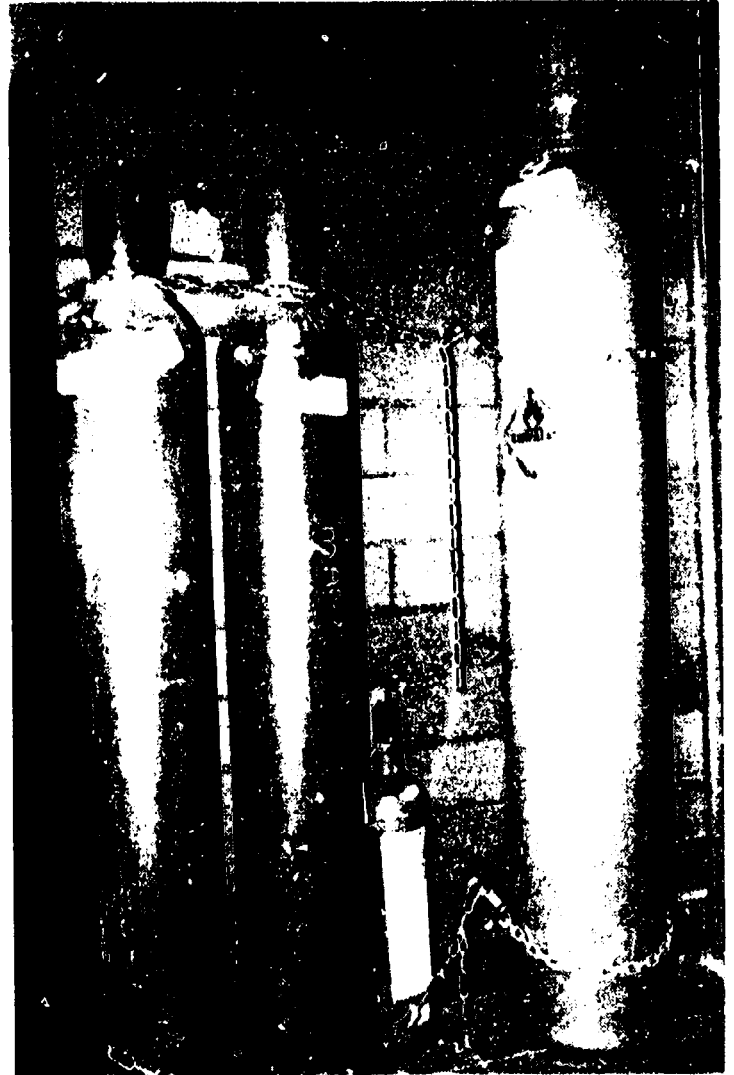

Figure 5. Compressed Gas Cylinders

Many methods can be used to identify the hazardous materials encountered in a transportation emergency. **Do not rush into any environment until the threatening material has been identified.** 49 CFR PARTS 100-199 address packaging, container requirements, and the placards and labels. One method of identification that rescuers should become familiar with is the United Nations placard and labeling system (see DOT's Full Color Insert in This Module). This system lists nine hazard classes that include the following: explosives, gases, flammable liquids, flammable solids, oxidizers, poisons, radioactive materials, corrosives, other regulated materials (ORMs). For definition of each see Figure 6.

United Nations Classes

UN Class 1 Explosives

DOT Class A. Primary hazard of detonation. Materials are sensitive to shock, heat, and contamination. Examples: dynamite and blasting caps

DOT Class B. Materials subject to rapid combustion or deflagration. Not as sensitive as Class A. Examples: special fireworks and flash powders

DOT Class C. Contain smaller quantities of materials found in Class A and B explosives. Examples: other fireworks and small arms ammunition

Blasting agents. Relative insensitive substances such as ammonium nitrate when contaminated with organic substances.

UN Class 2 Gases

DOT Flammable gases Gases that will burn when mixed with air in favorable concentrations such as propane.

Nonflammable gases Any compressed gas other than a flammable compressed gas.

Poison gas Class A Poison which is immediately dangerous to life and health such as cyanide.

Oxygen Liquid Oxygen (LOX) in excess of 1,000 pounds.

Chlorine Chlorine in excess of 110 pounds.

UN Class 3 Flammable Liquids

DOT Flammable liquids Liquids with a flash point below 100° F such as gasoline.

Combustible liquids Liquids with a flash point greater than 100° F.

Pyrophoric liquids Liquids that ignite spontaneously in air at or below 130° F.

UN Class 4 Flammable Solids

DOT Flammable solids Solids capable of spontaneous combustion or easily ignited such as matches and sulfur.

Flammable solids, water reactant Solids that when in contact with water can initiate or increase intensity such as the alkaline metals.

Figure 6. Definitions of Hazard Classes

UN Class 5 Oxidizers	
DOT Oxidizers	Materials that yield oxygen to support combustion such as chlorate and nitrates.
Organic peroxides	Unstable materials that contain oxygen and carbon and can easily detonate such as benzoyl peroxide.
UN Class 6 Poisons	
DOT Poison B	Materials that pose a serious threat to life or health such as some pesticides.
Irritants	Materials that give off highly irritating fumes when burning or exposed to air such as tear gas.
Etiologic or Infectious Organisms	Living organisms that pose health hazards to humans such as polio virus.
UN Class 7 Radioactive Materials	
DOT Radioactive I	0.5 or less millirems per hour
Radioactive II	No more than 1 millirem per hour at 3 feet
Radioactive III	More than 50 millirems per hour at external points of its container or more than 1 millirem per hour at three feet.
UN Class 8 Corrosives	
DOT Corrosives	Materials that damage skin or other substances in contact such as sulfuric acid.
UN Class 9 Other Regulated Materials (ORMs)	
DOT Other Regulated Materials (ORMs)	A variety of other materials with vary) lng types of hazards not found in the first 8 classes. Examples are: hazardous wastes and a variety of medicines and industrial byproducts.

Figure 6. (cont.) Definitions of Hazard Classes

DEALING WITH A HAZARDOUS—MATERIALS INCIDENT

When a hazardous materials incident occurs in a community, three basic questions must be answered (see Figure 7).

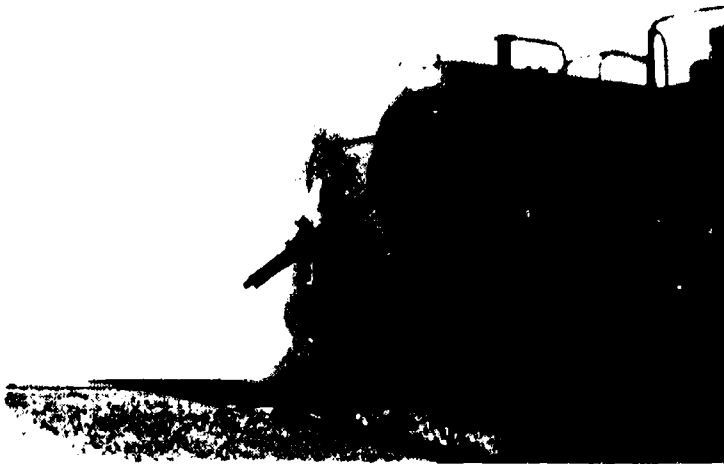

Figure 7. Hazardous Materials Incident

1. Can the materials cause harm? If so, the reaction may be thermal, radioactive, asphyxiation, chemical, etiologic or mechanical. Citizens may also suffer psychological effects.
2. Can a rescue department handle the incident or is outside assistance needed?
3. Does this incident require the use of specialized equipment?

Each agency should develop a series of operational guidelines which can be used to handle an incident. One of the most important considerations is to identify who is in charge of the incident. Supervision of the incident is determined by local and state laws. If the law requires the local fire chief to be in charge, the chief must assume the responsibility for all decision-making, and proceed to delegate activities. When an agency arrives at the emergency scene the person in charge must report directly to the incident commander for directions.

Preplanning Before an Emergency Occurs

Each community should develop a hazardous-materials incident plan that identifies each local agency that will participate in an incident. The plan should identify which local agency and supervisor has the

responsibility to make the decisions. All responding agencies must be made aware who is in charge of the emergency.

Each community should develop a preplan for dealing with potential hazardous materials incidents to include emergencies that could occur at area facilities, localities, or institutions such as: storage facilities, manufacturing plants, waste operations, retail stores, railroad routes and train yards, highways, pipelines, waterways, and airports. To be prepared the community should conduct drills using all concerned agencies, and review and revise procedures as necessary. Once the preplan is in place the community leaders should meet with responding agencies to develop a reciprocal training program so each agency understands the potential problems (see Figure 8a thru 8d).

INITIAL RESPONSE GUIDELINES INCORPORATED INTO A PREPLAN

The following steps should be done to prepare for a hazardous-materials incident.

1. Sizeup
 - a. Review the preplan and update as necessary
 - b. Evaluate approach positions, including alternate routes; instruct rescuers to stay out of hazardous areas until identification of the material can be made
 - c. Stay uphill and upwind of the substance in question
 - d. Perform a complete size-up including hazard identification, evacuation logistics, exposures, water supply, special equipment requirements, and identification of private protection systems available
2. Hazard Identification
 - a. Determine the nature of the problem. Identify if it is a spill, leak, or fire, and if the product involved is a solid, liquid, or gas.
 - b. Check the transporting vehicle for a placard.
 - c. Check the product container for a label.
 - d. Check the shape and size of the product container.
 - e. Check the color of the product container; it may be a key to its contents.
 - f. Check the accompanying shipping papers for the product name or identification number.

- g. Check to see if the transporting carrier or the receiving facility uses the NFPA 704 Identification System, if so is it visible?
- h. Check for an information source with first

responder information at the entrance to the receiving facility.

- i. Check for a vehicle operator or a representative of the product manufacturer at the scene.

PREPLANNING CHECKLIST

LOCATION?

1. PRIMARY ACCESS?
2. SECONDARY?
3. OBSTRUCTIONS?

EXPOSURES

1. RESCUE - PEOPLE IN FACILITY? DAY _____ NIGHT _____
2. SPECIAL RESCUE PROBLEMS?
3. LIFE EXPOSURES IN ADJACENT AREAS TO PROPERTY?
4. EVACUATION OR SHELTERING PROBLEMS?
5. STRUCTURES ADJACENT TO PROPERTY AND ANY SPECIAL PROTECTION PROBLEMS?
6. EXTERIOR UTILITY PROBLEMS?
 - SEWERS
 - STORM SEWERS
 - TELEPHONE LINES
 - POWER LINES (VOLTAGE)
 - NATURAL GAS OR PROPANE
 - OTHER

8a

FACILITY

1. SIZE OF STRUCTURE?
2. TYPE OF CONSTRUCTION?
3. TYPE OF ROOF?
4. LOCATION OF EXITS?
5. PRIVATE FIRE PROTECTION SYSTEM?
6. UTILITIES?
7. SECURITY SYSTEMS?
8. ACCESS PROBLEMS DAY/NIGHT?
9. WHERE DO FLOOR DRAINS AND SEWER GO?

WATER SUPPLY

1. LOCATION OF HYDRANTS/FLOW?
2. PONDS AND OTHER WATER SOURCES?
3. IS WATER SHUTTLE NEEDED? YES _____ NO _____ IF YES, WHAT SHOULD THE INITIAL ALARM BE?

8b

CONTENTS OF FACILITY

1. MATERIAL NAME
- HAZARD
- LOCATION
- AMOUNT
2. MATERIAL NAME
- HAZARD
- LOCATION
- AMOUNT
3. MATERIAL NAME
- HAZARD
- LOCATION
- AMOUNT
4. MATERIAL NAME
- HAZARD
- LOCATION
- AMOUNT
5. MATERIAL NAME
- HAZARD
- LOCATION
- AMOUNT
6. DO THE AMOUNTS IN STORAGE VARY BY SEASON?

8c

TOPOGRAPHY AND ENVIRONMENTAL CONCERNS

1. WHERE WILL RUNOFF OF FIRE OPERATIONS GO?
2. WILL DIKING HELP? YES _____ NO _____ IF YES WHERE SHOULD DIKES BE CONSTRUCTED?
3. HOW WILL DIKES BE CONSTRUCTED?
4. WHERE WILL DIKING MATERIALS COME FROM?
- CONTACT DAY/NIGHT
5. IS THE WIND A FACTOR?
6. WHAT SPECIAL OPERATIONS ARE NEEDED IN WINTER?
7. WHAT SPECIAL EQUIPMENT MAY BE NEEDED FOR A PROBLEM AT THIS FACILITY? WHERE CAN IT BE OBTAINED?

PERSONNEL OR AGENCIES TO CONTACT.

1.
2.
3.
4.
5.
6.
7.
8.

8d

Figure 8a thru 8d. Preplanning Checklist

STABILIZING THE INCIDENT

Reference Sources

The following references can be contacted for information and assistance.

- CHEMTREC 1-800-424-9300
- The National Response Center 1-800-424-8802
- National resources identified on a local response plan
- State agencies identified in a preplan
- Local resources identified in a preplan
- Reference guides identified in a preplan

See Appendix "B" in Module 10 of the Rescue Manual for other resources.

Incident Command Post

- Establish an incident command post and make sure that all federal, state, and local agencies are aware of its location. Mark it so that it can be clearly seen.
- Notify state agencies as required
- Require supervisors for all agencies operating on the scene to report to the incident command post.
- Ensure that only orders from the incident commander are followed. Have all information from the reference sources and advisors sent directly to the incident commander.
- Make sure that communications from the incident commander are relayed to all those in the command post.
- Review and revise the plan of action as new information is received at the command post.

Tactical Decisions

The following tactical decisions must be made by the incident commander.

- Decide how to control the leak, spill, or fire. A defensive posture may be the best in some situations.
- Decide if evacuation is necessary. If it is, determine the scope, which agencies are responsible for the tasks, and establish a method to monitor the areas evacuated. The incident commander

must rely on others at the command post to accomplish this task.

- Decide if the emergency warrants the withdrawal of emergency forces.
- Decide if medical assistance is needed; if necessary activate a medical-disaster plan.
- Protect exposures. Remember, ground water is an exposure with a liquid or solid spill. Check drainage and sewers for indications of runoff problems. Check wind velocity and direction to determine if the gas or products of combustion pose a threat downwind.
- Decide if any closed container is exposed to fire. If so, apply large volumes of water (500 gpm minimum) at the point where the flame strikes the container. Monitor the time. A closed container exposed to flame can result in a BLEVE (boiling liquid expanding vapor explosion), if this happens apply water to the container quickly.
- Ensure that the attack positions of emergency response personnel are safe. Use unattended streams wherever possible. If an uninterrupted flow of water is not available for at least one hour, consider defensive tactics concentrating on evacuation procedures. Make necessary changes in the attack plan as new information is received.

CLEANUP OF THE AREA

Legal Aspects

The incident commander and rescuers all must be familiar with or have access to the government regulations regarding cleanup and containment of hazardous materials involved in the incident. Rescuers must be able to identify the organizations that can provide assistance.

Logistics

The following concerns must be dealt with immediately.

- Identification of product-transfer equipment
- Identification of transportation vehicles
- Identification of dump sites
- Maintaining security of the site
- Identification of special absorption materials
- Identification of special protective clothing needed

Decontamination

Rescuers must be familiar with the following decontamination regulations and procedures.

- Identify decontamination procedures for equipment and personnel
- Maintain disposal of runoff water
- Control decontamination at the spill site

Restoration of Services

Once an incident is controlled, take the following steps to restore community services.

- Plan with the utility companies for restoring services
- Plan for water supply testing
- Plan for soil testing
- Plan for termination of evacuation and reopening of roads

NFPA 704 SYSTEM

The increased use of a variety of chemicals that have introduced problems other than flammability in our society have led to the need for a simple hazard-identification system. The purpose of this system is to provide information to individuals concerned with fires occurring in an industrial plant, storage location, or similar area.

The NFPA 704 system classifies the hazards of a materials in three categories; health, flammability, and reactivity. It indicates the order of severity in each category of five divisions ranging from "Four" indicating a severe hazard, to "Zero" indicating no special hazard. Approximately 35 inherent and environmental hazards of materials that could affect fire fighting operations have been evaluated. The five degrees give the required information. For such a system to be effective it must be simple and easily understood.

HAZARDOUS MATERIALS AND THE BODY

There are four primary routes for a material to enter the human system; absorption, ingestion, inhalation, and injection. Protecting the eyes is a primary concern. The emergency responder must take appropriate precautions to prevent hazardous materials from entering the body.

PROTECTIVE CLOTHING

An appointed safety officer must insure that the proper level of protective clothing is worn by each rescuer. The clothing must be compatible with the hazardous material(s) encountered.

There are three major classes of protective clothing.

1. **Structural.** Structural protective clothing refers to the minimum basic protective clothing that must be worn when encountering any structural fire (see Figure 9).



Figure 9. Structural Fire Gear

2. **Specialized high temperature.** Specialized high temperature clothing is used for protection from extreme thermal dangers.
3. **Chemical.** Chemical clothing is used in an incident involving toxic chemicals. Chemical clothing is available in non-encapsulated (see

Figure 10) and encapsulated suits (see Figure 11).

Other terminology referring to levels of protection is used by federal, state, and local response organizations. The most popular identification system is Level D, C, B, and A.

HAZARDOUS MATERIALS

RESPONSE UNIT



Figure 10. Non-Encapsulated Suit

HAZARDOUS MATERIALS

RESPONSE UNIT



Figure 11. Encapsulated Suit

PERSONAL PROTECTIVE EQUIPMENT

Level D Clothing (see Figure 12)

- Coveralls
- Gloves*
- Boots, chemical resistant
- Boot covers, disposable*
- Safety glasses or goggles
- Hard hat with face shield*
- Escape mask*
- *Optional

Section Criteria

- No inhaled toxic substances
- No potential for contamination



Figure 12. Level D Clothing

Level C Clothing (see Figure 13)

- Full-face, air-purifying respirator
- Chemical resistant clothing
- Inner clothing
- Gloves chemical resistant, (2 pair)
- Boots, chemical resistant
- Boot covers, disposable*
- Hard hat with faceshield*
- Escape mask*
- *Optional

Selection Criteria

- Air purifying respirator limitations
- Small area of unprotected skin allowed

Level B Clothing and Equipment (see Figure 14)

- Pressure-demand SCBA
- Chemical resistant clothing
- Inner clothing
- Gloves, chemical resistant (2 pair)
- Boots, chemical resistant
- Boot covers, disposable*
- Hard hat with face shield*
- *Optional

Section Criteria

- Highest level of respiratory protection needed
- Small area of unprotected skin allowed

HAZARDOUS MATERIALS
RESPONSE UNIT

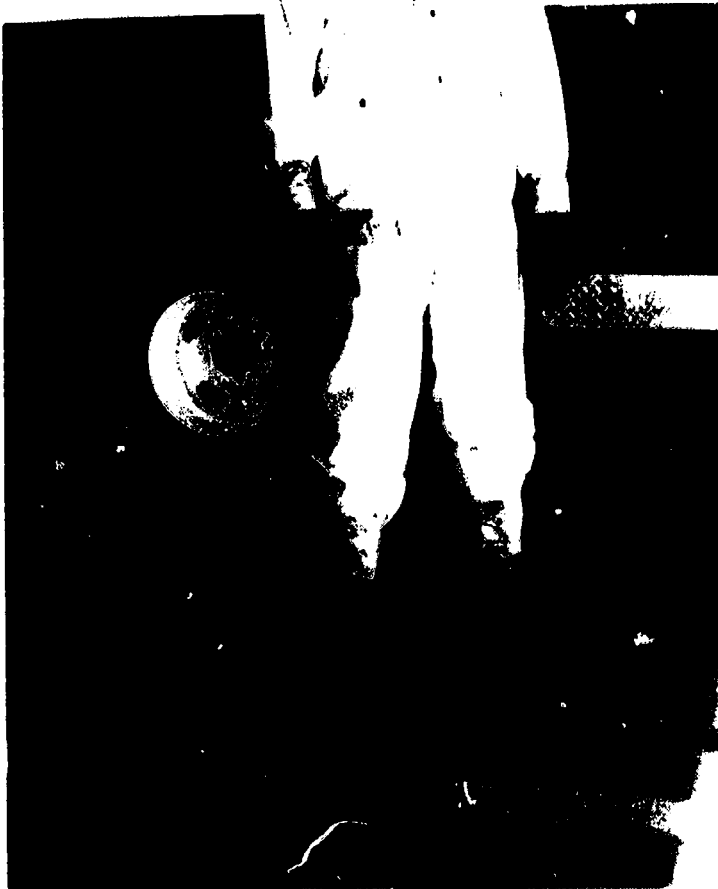

Figure 13. Level C Clothing

HAZARDOUS MATERIALS
RESPONSE UNIT

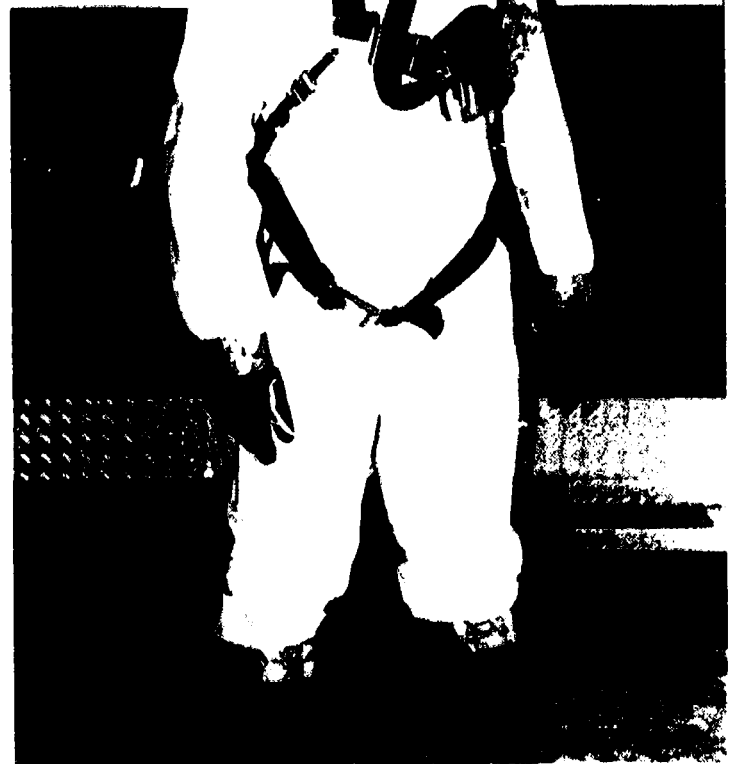

Figure 14. Level B Clothing and Equipment

Level A Clothing and Equipment

(see Figure 15)

Pressure-demand SCBA

Fully encapsulating chemical resistant suit

Inner clothing

Gloves, chemical resistant (2 pair)

Boots, chemical resistant

Boot covers, disposable*

Suit cover, disposable*

Hard hat*

*Optional

Selection Criteria

Highest level of respiratory protection needed

No unprotected skin allowed

This information is provided to familiarize rescuers with the terminology used in the field. It is not intended to be used to train rescuers in the use of the different levels of protective clothing. Specialized training is needed to be proficient in the use of equipment needed in a hazardous materials incident. Once a rescuer is trained, practice drills should be conducted routinely.



Figure 15. Level A Clothing and Equipment

BEST COPY AVAILABLE

FORMS AND CHECKLISTS REQUIRED AT A HAZARDOUS MATERIALS INCIDENT

Forms and checklists must be used at the scene of a hazardous-materials incident. During an actual hazardous-materials incident, it is difficult to re-

member all the actions necessary. The use of pre-printed forms and checklists save time at the scene of an emergency, and hours of research after the incident (see Figures 16 through 27). Develop or acquire forms and checklists before an emergency occurs.

Sample Forms and Checklists

HAZARDOUS MATERIALS INCIDENT CHECKLIST

LOCATION _____ TIME _____ DATE _____ TEMP. _____

CHEMICAL _____ UN# _____ WEATHER _____ WIND _____

ITEM	Y	N	OTHER
Initial Report			
Identify the Material			
Shipped and Lot Number			
Identify the Cause			
Life Hazard			
Flammability			
Toxicity			
Toxic Exposure			
Reactive			
Explosive			
Extinguish with Heat Agent			
Other Hazards			
Notify Team			
Public Information Efforts			
Isolation Area			
Decontamination Line			
Remove and Store Contaminated			
Isolate Area and Sign			
Use Appropriate PPE			
Notify Police			
Notify Fire Department			
Notify State			
Notify Mutual Aid			
Notify Hospital			
Notify State Health Dept			
State Fire Marshal			
Emergency Management Agency (EMA)			
Environmental Health Dept Agency			
State Agencies			
Law Enforcement			
Water Treatment Plant			
Utility Companies			
Transportation			
Public Information			
Documentation			

TIME _____

Figure 16. Hazardous Materials Incident Checklist

STATE FIRE MARSHAL/HAZARDOUS MATERIALS BUREAU
TRANSPORTATION INCIDENT REPORT

Sample

Report completed by _____ Agency _____
Location _____ Township _____ County _____
Date _____ Time _____ AM/PM Report number _____
Type situation found _____
Method of receiving alarm _____ Disposition or action taken _____

UN/NA # _____ Shipping name(s) _____
Placards _____ Labels _____
Manifest # _____ Amount contained _____
Amount lost or not contained _____
Type and Form _____

Shipper _____ Address _____
Phone (____) _____
Carrier _____ Address _____
Phone (____) _____
Consignee _____ Address _____
Phone (____) _____
Owner/transporter _____ Address _____
Phone (____) _____

Driver's Name _____ SSN: _____ OL: _____
OL State _____ OL Type _____ Medical Card _____
Driver's Address _____ City _____ State _____ Zip _____

Unit 1- Make _____ Year _____ V.I/N. _____
Tractor Lic. _____ State _____ Truck No. _____
Condition _____

Unit 2- Make _____ Year _____ V.I.N. _____
Tractor License _____ State _____ Trailer No. _____
Type trailer _____ M.C. # _____
Stamp _____ Condition _____

Law enforcement agency _____ Investigating officer _____
Fire department _____ O.I.C. _____
Squad _____ O.I.C. _____
Cleanup contractor _____ In Charge _____
Wrecker _____ In Charge _____
State personnel: SP _____ FM _____ EPA _____ PUCO _____
DOT _____ Other _____

Disposition:
Injuries _____ Transported _____
Citations issued to _____ By _____

Time log: Call received _____ Enroute _____ On scene _____
Departed scene _____ Back in quarters _____

Remarks _____

Supplement attached Y/N Photos Y/N

Figure 17. Transportation Incident Report

FIRE MARSHAL/HAZARDOUS MATERIALS BUREAU
FIXED SITE INCIDENT REPORT

Sample

Report completed by _____ Agency _____
Location _____ Township _____ County _____
Date _____ Time _____ AM/PM Report number _____
Method of receiving alarm _____ Disposition or action taken _____

Facility owner _____
Address _____ Phone () _____
General property use _____ Specific property use _____

Number Injuries: Fire service _____ Other emer. _____ Civilian _____
Number Fatalities: Fire service _____ Other emer. _____ Civilian _____
Number Fire service personnel on scene _____ Engines _____
Aerial apparatus _____ Haz. mat. _____ EMS _____
Other _____ Fire Department in charge _____
Fire department O.I.C. _____ Title _____

Condition upon arrival of first unit _____
Area of origin _____
Equip. involved in ignition _____ year _____ make _____
model _____ serial no. _____

Construction type _____ No. of stories _____ Level of origin _____
Structure status _____ No. of occupants at time of incident _____
Structure evacuated Yes/No Other evacuated Yes/No How many people? _____
Evacuated taken to _____
Damage estimate: Structure _____ Contents _____ Other _____

CHEMICALS INVOLVED: QUANTITY AND DISPOSITION

Chemical	Amount	Disposition
_____	_____	_____
_____	_____	_____
_____	_____	_____
_____	_____	_____
_____	_____	_____
_____	_____	_____

Incident commander _____
Squad _____ O.I.C. _____
Cleanup contractor _____ In Charge _____
State personnel: SP _____ FM _____ EPA _____ PUCO _____
DOT _____ Other _____

Time log: Call received _____ Enroute _____ On scene _____
Departed scene _____ Back in quarters _____

Remarks _____

Supplements attached Yes/No Photos Reports

Figure 18. Fixed-site Incident Report



STATE FIRE MARSHAL/HAZARDOUS MATERIALS BUREAU
CHEMICAL DISPOSAL REPORT AND LIABILITY RELEASE

Sample

Report completed by _____ Agency _____
Location _____ Township _____ County _____
Date _____ Time _____ AM/PM report number _____
Disposal requested by _____
Agency _____ Address _____
City _____ Phone (_____)

CHEMICALS INVOLVED: AMOUNTS AND METHODS OF DISPOSAL

<u>Chemical</u>	<u>Amount</u>	<u>Method of disposal</u>
_____	_____	_____
_____	_____	_____
_____	_____	_____
_____	_____	_____
_____	_____	_____

Location of disposal _____
Personnel Assisting _____

AGREEMENT

The DIVISION OF STATE FIRE MARSHAL, HAZARDOUS MATERIALS BUREAU offers to provide assistance upon request to fire departments, agencies, and individuals involved in hazardous materials incidents and the handling of hazardous materials as well as provide hazardous materials response training for such fire departments, agencies, and individuals subject to the following conditions:

1. The DIVISION OF STATE FIRE MARSHAL, HAZARDOUS MATERIALS BUREAU assumes no liability and shall not be subjected to suit of any nature, kind, or description whatsoever, including costs and expenses for or on account of any loss or damage to property, real or personal, owned or possessed by the fire department, agency, or individual or any injury to such fire department personnel, agency personnel, or individual.

2. I _____ (the below listed fire department, agency, or individual) did notify the EPA and did obtain permission for the State Fire Marshal's Office to burn or to detonate the unstable chemicals in question. I talked to _____ of the EPA Time: _____ Date: _____. I also understand a notification letter of completion of this job will be mailed to the EPA.

Name: (Fire Department, Agency, or Representative) _____
Address _____ Phone (_____)
Hazardous materials representative _____
Date _____

Emergency declared Yes/No EPA Initially notified _____
Completion letter sent to EPA (Date) _____

Time enroute _____ On scene _____ Completed _____
Time returned to quarters _____

Supplements attached Yes/No Photo/Videos Yes/No Remarks _____

Figure 19. Disposal Report





U.S. Department of
Transportation

Research and
Special Programs
Administration



DOT CHART 9

Hazardous Materials Marking, Labeling & Placarding Guide

This Marking, Labeling and Placarding Guide will assist shippers, carriers, fire departments, police, emergency response personnel, and others in complying with, and enforcing the regulations governing the safe transport of hazardous materials by highway, rail, water and air.

The information and illustrations presented in this Guide are intended to serve as an introduction to regulations governing hazardous materials transportation. The Guide should be read in conjunction with the Hazardous Materials Regulations (HMR: 49 CFR 100-199). Published annually, and amended periodically, the HMR are the key to compliance and contain the information needed to comply with the requirements for the safe transport of hazardous materials.

Hazardous materials markings, labels, placards, and shipping papers serve to communicate the hazards posed by materials in transportation. Hazard communication is the key to effective emergency response, and is also used to alert transportation workers and the general public of the presence of hazardous materials, insure that non-compatible materials are not loaded together in the same transport vehicle, and provide the necessary information for reporting hazardous materials incidents. The purpose of this Guide is to explain and identify the markings, labels and placards which appear on packages, freight containers and transport vehicles containing hazardous materials.

Marking regulations (Section 172.300) require information, specific to the hazardous material, to be "marked" on the outside of the package. Examples of the information required to be marked on the package are the proper shipping name, identification number and consignor's or consignee's name. For how markings required by the HMR are to be applied to a package, see Section 172.304. For exceptions to the marking requirements and additional marking requirements, see Section 172.300. This chart does not attempt to cover all the marking requirements. In particular this chart does not contain any information related to specification packaging markings addressed in the Parts 178 and 179 of 49 CFR. For further details on required markings, consult the appropriate sections in the HMR.

The Labeling of a package of hazardous material is specific to the hazard class of the material. The Hazardous Material Tables, Section 172.101 and 172.102, identify the proper label(s) for the hazardous material listed. In some cases, a hazardous material will meet the definition of two or more hazard classes. In these instances, the additional labeling requirements of Section 172.402 must be met. Labels, when required, must be placed next to the marked proper shipping name (Section 172.406). The requirements for labels can be found in Section 172.400-172.450.

Placards represent the hazard class(es) of the material(s) contained within the freight container, motor vehicle or rail car. The requirements for placarding are contained in Section 172.500-172.558. NOTE: This document is for general guidance only and is not a substitute for the requirements of 49 CFR 100-199.

Response begins with identification.

A transport vehicle carrying 1 package of Radioactive Material labeled Yellow III, 500 pounds of Flammable Liquid and 600 pounds of Corrosive Materials would be placarded with both RADIOACTIVE and DANGEROUS placards.

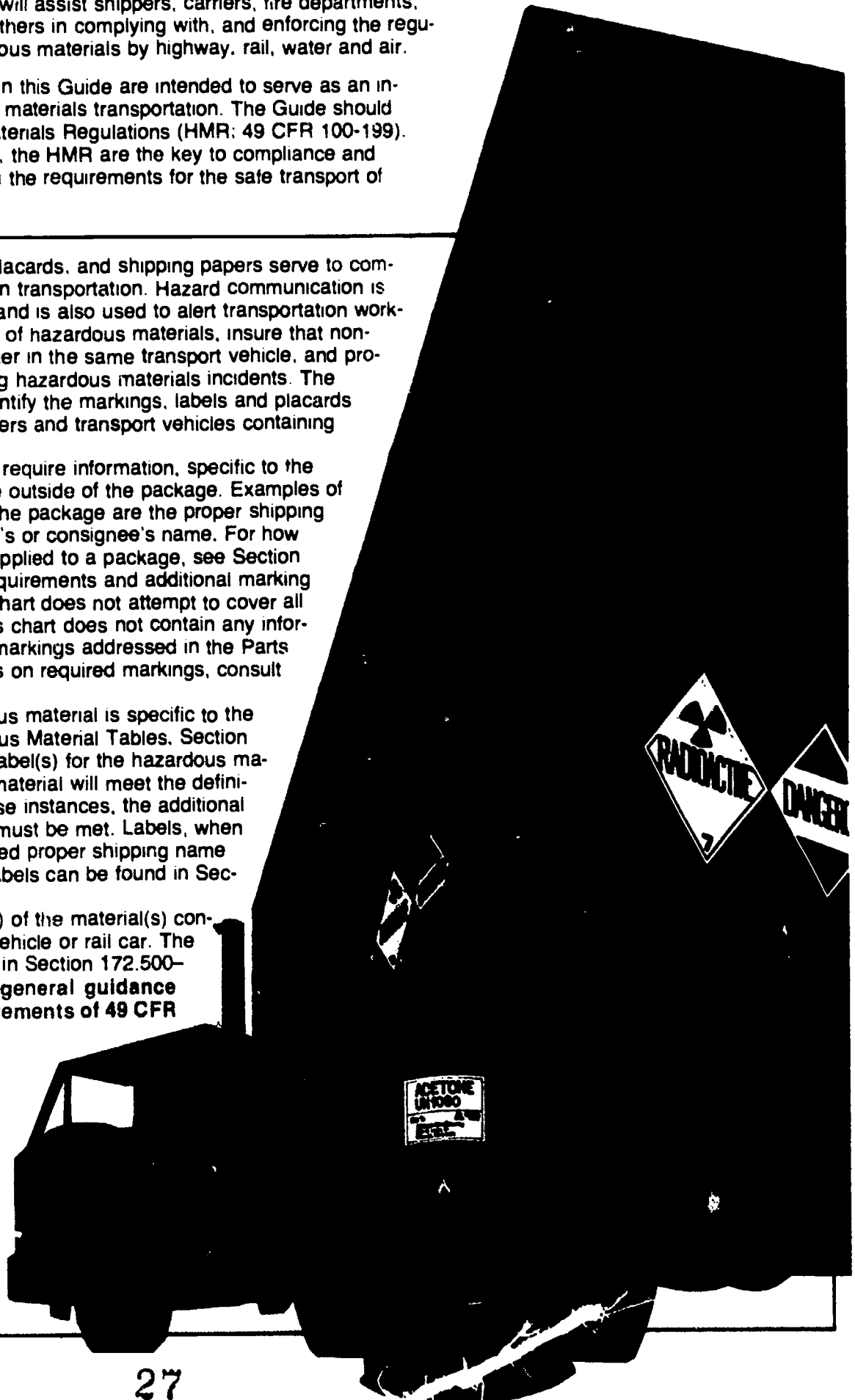

Hazardous Materials Warning Labels

DOMESTIC LABELING

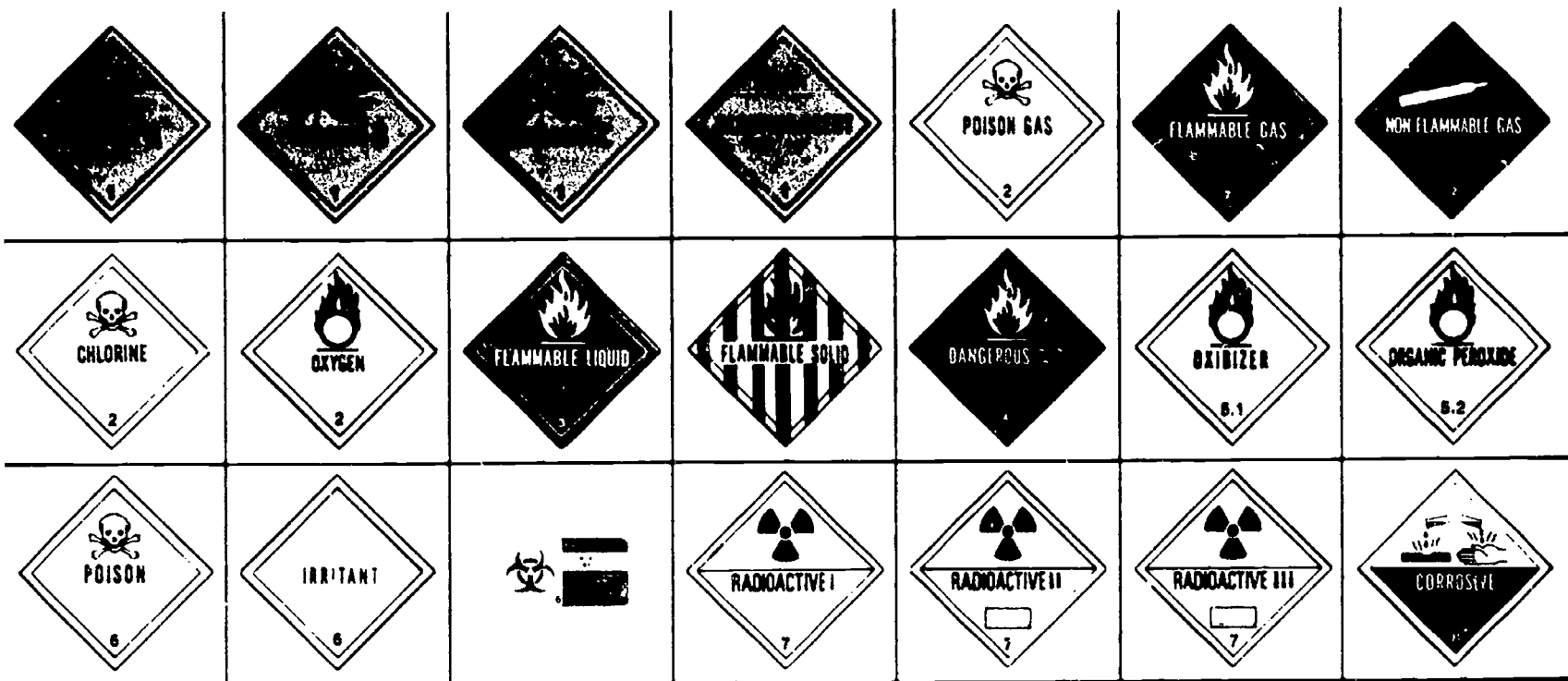

General Guidelines on Use of Labels (CFR, Title 49, Transportation, Parts 100-177)

- Labels illustrated above are normally for domestic shipments. However, some air carriers may require the use of International Civil Aviation Organization (ICAO) labels.
- Domestic Warning Labels may display UN Class Number, Division Number (and Compatibility Group for Explosives only) [Sec. 172.407(g)].
- Any person who offers a hazardous material for transportation MUST label the package, if required [Sec. 172.400(a)].
- The Hazardous Materials Tables, Sec. 172.101 and 172.102, identify the proper label(s) for the hazardous materials listed.
- Label(s), when required, must be printed on or affixed to the surface of the package near the proper shipping name [Sec. 172.406(a)].
- When two or more different labels are required, display them next to each other [Sec. 172.406(c)].
- Labels may be affixed to packages (even when not required by regulations) provided each label represents a hazard of the material in the package [Sec. 172.401].

**Check the Appropriate Regulations
Domestic or International Shipment**

Additional Markings and Labels

HANDLING LABELS

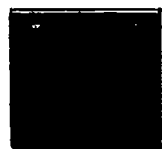

Cargo Aircraft Only
172.402(b)



172.316

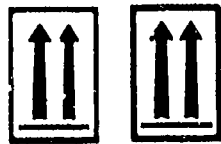

172.312(a)(c)

Package
Orientation
Markings

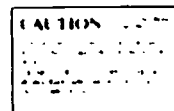

Bung Label
172.402(e)

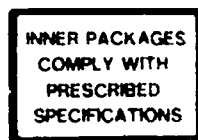

173.25(a)(4)

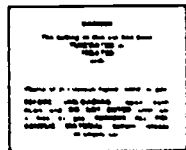

Fumigation
173.9

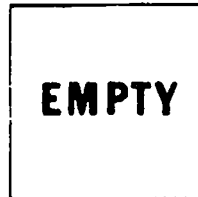

173.427

Here are a few additional markings and labels pertaining to the transport of hazardous materials. The section number shown with each item refers to the appropriate section in the HMR. The Hazardous Materials Tables, Section 172.101 and 172.102, identify the proper shipping name, hazard class, identification number, required label(s) and packaging sections.

Poisonous Materials



172.505



172.301

Materials which meet the inhalation toxicity criteria specified in Section 173.3a(b)(2), have additional communication standards prescribed by the HMR. First, the words "Poison-Inhalation Hazard" must be entered on the shipping paper, as required by Section 172.203(k)(4), for any primary capacity units with a capacity greater than one liter. Second, packages of 110 gallons or less capacity must be marked "Inhalation Hazard" in accordance with Section 172.301(a). Lastly, transport vehicles, freight containers and portable tanks subject to the shipping paper requirements contained in Section 172.203(k)(4) must be placarded with POISON placards in addition to the placards required by Section 172.504. For additional information and exceptions to these communication requirements, see the referenced sections in the HMR.

Hazardous Materials Warning Placards

DOMESTIC PLACARDING

Illustration numbers in each square refer to Tables 1 and 2 below

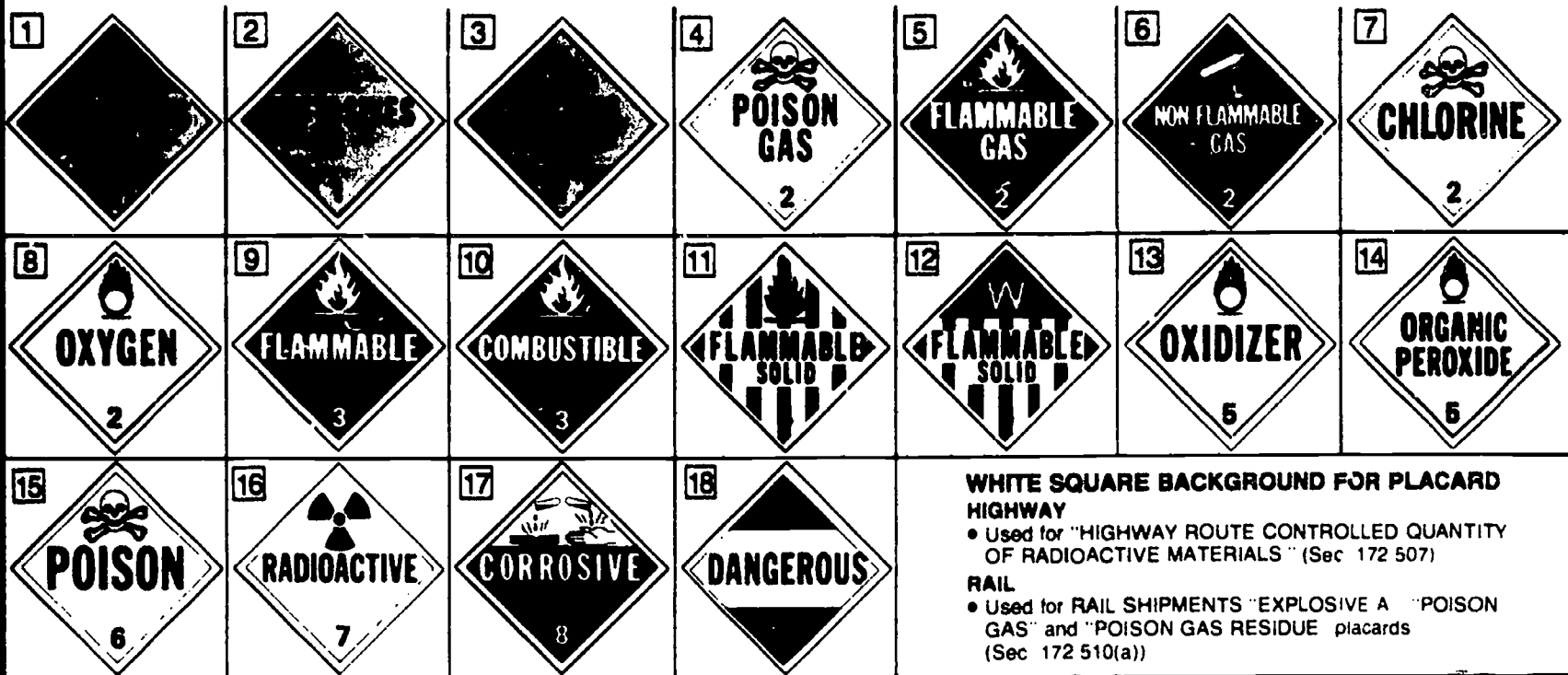

Guidelines

(CFR, Title 49, Transportation, Parts 100-177)

- Placard any transport vehicle, freight container, or rail car containing any quantity of material listed in Table 1
- Materials which are shipped in portable tanks, cargo tanks, or tank cars must be placarded when they contain any quantity of Table 1 and/or Table 2 material
- Motor vehicles or freight containers containing packages which are subject to the "Poison-Inhalation Hazard" shipping paper description of Section 172.203(k)(4), must be placarded POISON in addition to the placards required by Section 172.504 (see Section 172.505)
- When the gross weight of all hazardous material covered in TABLE 2 is less than 1000 pounds, no placard is required on a transport vehicle or freight container
- Placard freight containers 640 cubic feet or more containing any quantity of hazardous material classes listed in TABLES 1 and/or 2 when offered for transportation by air or water (see Section 172.512(a)). Under 640 cubic feet see Section 172.512(b)

TABLE 1

Hazard Classes	No.
Class A explosives	1
Class B explosives	2
Poison A	4
Flammable solid (DANGEROUS WHEN WET label only)	12
Radioactive material (YELLOW III label)	16
Radioactive material Uranium hexafluoride fissile (Containing more than 10% U235)	16 & 17
Uranium hexafluoride, low-specific activity (Containing 10% or less U235)	16 & 17

Note: For details on the use of Tables 1 and 2, see Sec 172.504 (see footnotes at bottom of tables)

TABLE 2

Hazard Classes	No.
Class C explosives	18
Blasting agent	3
Nonflammable gas	6
Nonflammable gas (Chlorine)	7
Nonflammable gas (Fluorine)	15
Nonflammable gas (Oxygen, cryogenic liquid)	8
Flammable gas	5
Combustible liquid	10
Flammable liquid	9
Flammable solid	11
Oxidizer	13
Organic peroxide	14
Poison B	15
Corrosive material	17
Irritating material	18

UN or NA Identification Numbers

MUST BE DISPLAYED ON TANK CARS, CARGO TANKS, PORTABLE TANKS AND BULK PACKAGINGS

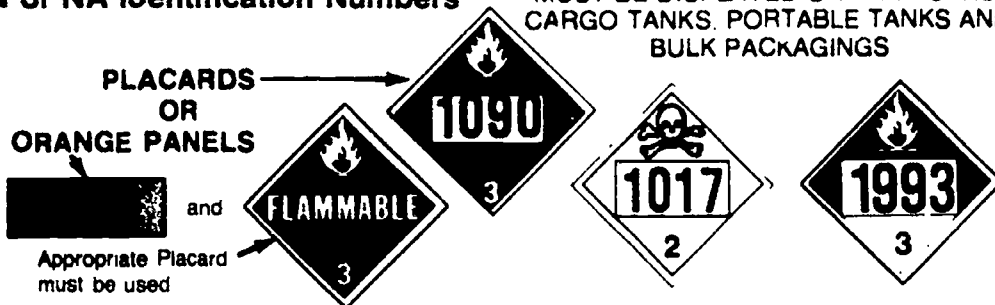

- When hazardous materials are transported in Tank Cars (Section 172.330), Cargo Tanks (Section 172.328), Portable Tanks (Section 172.326) or Bulk Packagings (Section 172.331), UN or NA numbers must be displayed on placards, orange panels or, when authorized, plain white square-on-point configuration
- UN (United Nations) or NA (North American) numbers are found in the Hazardous Materials Tables Sections 172.101 and 172.102
- Identification numbers may not be displayed on "POISON GAS," "RADIOACTIVE" or "EXPLOSIVE A," "EXPLOSIVE B," "BLASTING AGENTS," or "DANGEROUS" placards (See Section 172.334)
- In lieu of the orange panel, identification numbers may be placed on plain white square-on-point configuration when there is no placard specified for the hazard class (e.g., ORM-A, B, C, D, or E) or where the identification number may not be displayed on the placard. See Section 172.336(b) for additional provisions and specifications
- When the identification number is displayed on a placard the UN hazard class number must be displayed in the lower corner of each placard (see Section 172.332 (c)(3))
- Specifications of size and color of the Orange Panel can be found in Section 172.332(b)
- NA numbers are used only in the USA and Canada

Additional Placarding Guidelines



A transport vehicle or freight container containing two or more classes of material requiring different placards specified in Table 2 may be placarded DANGEROUS in place of the separate placards specified for each of those classes of material specified in Table 2. However, when 5000 pounds or more of one class of material is loaded therein at one loading facility, the placard specified for that class must be applied. This exception, provided in Section 172.504(b), does not apply to portable tanks, tank cars, or cargo tanks.

CAUTION: Check each shipment for compliance with the appropriate hazardous materials regulations — Proper Classification, Packaging, Marking, Labeling, Placarding, Documentation — prior to offering for shipment

Examples of Canadian and International Placards and Labels

The shipment of hazardous materials internationally is governed by one or more regulatory bodies with regulations that may be similar to domestic regulations or radically different. Canada, for example, has adopted wordless placards and labels because their country is bilingual. Canada also requires cargo and rail tanks to use retro-reflective placarding. However, Canada and the United States have reciprocity regarding the use of wordless and worded placards and labels.

Several international organizations govern the transportation of hazardous materials according to the mode of transportation. If a shipment is going by water, the International Maritime Organization (IMO) has authority. The International Civil Aviation Organization (ICAO) is concerned about the safe shipment of dangerous goods

(i.e., hazardous materials) by air. Transport Canada (TC) is the Canadian counterpart to the U.S. Department of Transportation (DOT).

The United Nations publishes "Recommendations for the Transport of Dangerous Goods," a publication that is used by many nations of the world when promulgating regulations. Since the safe transport of hazardous materials is of concern to people everywhere, the work done by the United Nations is of critical importance world-wide. Labels and placards used in the Canadian, IMO, and ICAO regulations are generally based on the U.N. Recommendations, although Canada has some labels and placard designs that vary from the U.N. White borders are optional on International Placards

Examples of Wordless Placards and Labels

Pictured here are typical wordless placards and labels required for use in Canada and many other countries around the world



Examples of International and Canadian Placards and Labels

Spontaneously Combustible and Keep Away From Food placards and labels are used internationally and in Canada. The Corrosive Gas placard and label are used exclusively in Canada. Most placards and labels used internationally are similar (color and symbols) to those required by DOT regulations

UN Class Numbers

- Class 1: Explosives
- Class 2: Gases (compressed, liquified or dissolved under pressure)
- Class 3: Flammable liquids
- Class 4: Flammable solids or substances
- Class 5: Oxidizing substances, Division 5.1, Oxidizing substances or agents, Division 5.2, Organic peroxides
- Class 6: Poisonous and infectious substances
- Class 7: Radioactive substances
- Class 8: Corrosives
- Class 9: Misc. dangerous substances

Examples of Explosive Labels

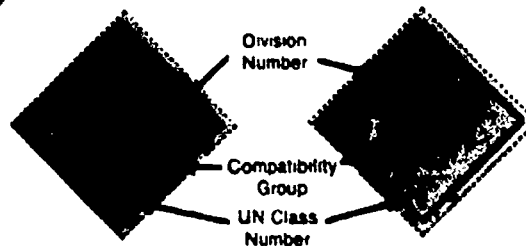

The Numercal Designation represents the Class or Division. Alphabetical Designation represents the Compatibility Group (for Explosives only). Division Numbers and Compatibility Group combinations can result in over 30 different "Explosives" labels (see IMDG Code/ICAO)

For complete details, refer to one or more of the following:

- Code of Federal Regulations, Title 49, Transportation Parts 100-199. [All modes]
- International Civil Aviation Organization (ICAO) Technical Instructions for the Safe Transport of Dangerous Goods by Air [Air]
- International Maritime Organization (IMO) Dangerous Goods Code [Water]
- "Transportation of Dangerous Goods Regulations" of Transport Canada. [All Modes]



U.S. Department of Transportation
**Research and Special Programs
Administration**

Copies of this Chart can be obtained by writing
OHMT/DHM-51, Washington, D.C. 20590.

SUIT DONNING CHECKLIST

Check suit compatibility
 Remove all badges, name bars, pins, etc.
 Remove and secure all personal property (billfold, rings, watches)
 Remove glasses or contact lenses
 Check soles of shoes for sharp objects
 Put on disposable suit or coveralls
 Put on inner gloves
 Don SCBA: check air pressure (don't hook up facepiece) turn on tank
 Put legs in encapsulated suit
 Put on outer boots (if applicable)
 Hookup SCBA facepiece
 Get upper body into suit
 Put on suit gloves
 Put on outer gloves (if applicable)
 Zip suit
 Secure fasteners
 Velcro outer suit
 Recheck suit
 Suit # _____
 Name _____
 Time in _____
 Time out _____
 COMMENTS:

Figure 24. Suit Donning Checklist

**STATE FIRE MARSHAL
 HAZARDOUS MATERIALS BUREAU
 Vital Information Sheet**

Name _____ SSN _____
 Address _____
 Phone _____
 Date of Birth _____ Blood type _____
 Physician _____
 Physician's address _____
 Physician's phone number (_____) _____
 List of current medical conditions/status _____

 List of medication being taken _____

 Person to be notified in case of accident or illness
 Name _____ Relationship _____
 Address _____
 Phone (_____) _____

Figure 25. Vital Information Sheet

PERSONAL MEDICAL MONITORING RECORD FOR HAZARDOUS MATERIALS RESPONSE

NAME _____ FIVE FEET _____
 HEIGHT _____ TYPE OF RESPONSE _____
 LEVEL OF CONTAMINATION _____
 DECONTAMINATION EXPOSURE (SEE _____)

DATE				
WEIGHT				
TEMP				
PULSE				
BES				
TECH				
TYPE				
ORIENTAL STATE				
ENTRY TIME				
EXIT TIME				
TOTAL TIME				

CHEMICAL EXPOSURE TO _____

 NOTE SIGNIFICANT EXPOSURE _____
 AVAILABLE EXPOSURE _____
 RECOMMENDED MEDICAL FOLLOWUP _____
 TEST COMPLETE _____ LOCATION _____
 RESULTS _____
 REMARKS _____

Figure 26. Personal Medical Monitoring Record

PERSONAL RECORD OF TOXIC/HAZARDOUS SUBSTANCE EXPOSURE

Name _____
 1. Incident _____
 2. Date, Time, and Location of Incident _____
 3. Description of Incident _____
 4. Type of substance(s) exposed _____
 5. Estimated amount and type of exposure _____
 6. Initial first aid _____
 7. Date and time of medical treatment _____
 8. Name of physician _____
 9. Name of hospital/clinic _____
 10. Name of physician _____
 11. Name of hospital/clinic _____
 12. Name of physician _____
 13. Name of hospital/clinic _____
 14. Name of physician _____
 15. Name of hospital/clinic _____
 16. Name of physician _____

Other observations (nature of physical contact, amount, etc.) _____

The latency period for cancer and cancer-related diseases is often 5-10 years; therefore, this form should be retained during the victim's career and after retirement to insure proper documentation.

Figure 27. Personal Record of Toxic or Hazardous Substance Exposure

MATERIAL SAFETY DATA SHEETS (MSDS)

A Material Safety Data Sheet (MSDS) value is for preplanning before an emergency occurs (see

Figure 28). The data on a MSDS helps with decisions such as offensive and defensive tactics, extinguishing agents to be used, plans for approach, levels of protection, and identification of outside resources.

Material Safety Data Sheet

From Genium's Reference Collection
Genium Publishing Corporation
1145 Catalyn Street
Schenectady, NY 12303-1836 USA
(518) 377-8855



No. 433

ETHYLENE OXIDE
(Revision A)
Issued: May 1980
Revised: August 1988

SECTION 1. MATERIAL IDENTIFICATION			26	
Material Name: ETHYLENE OXIDE			 NFPA	
Description (Origin/Uses): Used primarily as a chemical intermediate in the manufacture of antifreeze, polyester resins, and nonionic surfactants, specialty solvents; used as a sterilizing agent (diluted with about 90% of an inert gas) in health care applications.				
Other Designations: Oxirane; C ₂ H ₄ O; CAS No. 0075-21-8			HMIS H 2 R 1 F 4 I 4 R 3 S 3 PPG* K 4 *See sect. 8	
Manufacturer: Contact your supplier or distributor. Consult the latest edition of the <i>Chemicalweek Buyers' Guide</i> (Genium ref. 73) for a list of suppliers.				
SECTION 2. INGREDIENTS AND HAZARDS		%	EXPOSURE LIMITS	
Ethylene Oxide, CAS No. 0075-21-8		Ca 100	OSHA Action Level 8-Hr TWA: 0.5 ppm OSHA PEL 8 Hr TWA: 1 ppm STEL: 10 ppm ACGIH TLV, 1987-88 TLV-TWA: 1 ppm, 2 mg/m ³ NIOSH REL 8 Hr TWA: < 0.1 ppm (0.18 mg/m ³) 10-Min Ceiling per Day: 5 ppm, 9 mg/m ³ Toxicity Data* Human, Inhalation, TC ₁₀ : 12500 ppmv/10 Seconds	
*See NIOSH, <i>RIECS</i> (KX2450000), for extensive additional data with references to irritative, reproductive, tumorigenic, and mutagenic effects.				
SECTION 3. PHYSICAL DATA				
Boiling Point: 50.9°F (10.5°C) Specific Gravity (H ₂ O = 1): 0.9 Vapor Density (Air = 1): 1.5		Water Solubility (%): 100 Molecular Weight: 45 Grams/Mole Melting Point: -168°F (-111°C)		
Appearance and Odor: A colorless gas; irritating, etherlike odor that is usually detectable at approximately 700 ppm.				
SECTION 4. FIRE AND EXPLOSION DATA			LOWER	UPPER
Flash Point and Method °F (-18°C)	Autoignition Temperature °F	Flammability Limits in Air % by Volume	3	100
Extinguishing Media: Use "alcohol" foam, dry chemical, or carbon dioxide. Water is not recommended because it is not effective until the dilution of ethylene oxide reaches a ratio of at least 22 to 1. If feasible, try to shut off the flow of gas. With a direct water spray, cool fire-exposed pipelines, holding tanks, cylinders, etc., that contain ethylene oxide. Unusual Fire or Explosion Hazards: This gas is dangerously explosive and flammable over an extremely large range of concentrations in air. Its vapor may travel along surfaces to reach distant, low-lying sources of ignition and flash back. Special Fire-fighting Procedures: Wear a self-contained breathing apparatus (SCBA) with a full facepiece operated in the pressure demand or positive-pressure mode. Fight fires from explosion-proof (remote) or unmanned locations. Use care in selecting equipment (see sect. 5, Conditions to Avoid). *The autoignition temperature depends upon whether or not the ethylene oxide is pure or mixed with air (pure, 1058°F [570°C]; mixture, 804°F [429°C]).				
SECTION 5. REACTIVITY DATA				
Ethylene oxide is stable in closed, airtight, pressurized containers at room temperature under normal storage and handling conditions. It can undergo hazardous polymerization if it reacts with certain catalysts. Chemical Incompatibilities: Ethylene oxide is very reactive. It reacts with active catalysts that promote explosive, heat-producing self-polymerization. These initiators include potassium; anhydrous chlorides of tin, aluminum, and iron; alcohols; mercaptans; copper; the pure oxides of iron or aluminum; magnesium perchlorate; acids; and bases such as KOH and NaOH. It reacts with hydrochloric acid (HCl) to form highly toxic ethylene chlorohydrin. Ethylene oxide can be absorbed by rubber and leather and some plastics and coatings. Conditions to Avoid: Prevent contact with incompatible chemicals. Active catalysts and/or initiators of polymerization must not be mixed with this material. Prevent all exposures to any and all sources of ignition such as open flame, lighted tobacco products, electrical or mechanical sparks, etc. Hazardous Products of Decomposition: Carbon monoxide can be produced during ethylene oxide fires.				

Copyright © 1988 Genium Publishing Corporation.
Any commercial use or reproduction without the publisher's permission is prohibited.

Figure 28. Sample MSDS Sheet

BEST COPY AVAILABLE

32

No. 433 ETHYLENE OXIDE 8/88

SECTION 6. HEALTH HAZARD INFORMATION

Ethylene oxide is listed as a suspected human carcinogen by the ACGIH.

Summary of Risks: Aqueous solutions of ethylene oxide are very irritating to the skin; erythema, blistering, and vesiculation appear from 1 to 5 hours after skin contact. When used as a sterilizing agent, this material is absorbed by rubber, plastic, and leather articles; severe skin irritation can result from wearing such articles. Inhalation of this gas can cause headache, dizziness, nausea, vomiting, difficulty in breathing, depression of the central nervous system (CNS), and irritation of the upper respiratory tract (URT). Cancer, stomach cancer, leukemia, and circulatory/blood diseases are health effects reportedly linked to exposure to ethylene oxide.

Medical Conditions Aggravated by Long-Term Exposure: None reported. **Target Organs:** Eyes, blood, respiratory system, liver, kidneys, and CNS. Administer preplacement and periodic medical exams emphasizing these target organs as well as the reproductive system. **Primary Entry:** Inhalation, skin contact. **Acute Effects:** Irritation of the URT, skin, and eyes.

Chronic Effects: Possible cancer.

FIRST AID

Eyes: Immediately flush eyes, including under the eyelids, gently but thoroughly with plenty of running water for at least 15 minutes.

Skin: Treat for possible skin burns and/or frostbite damage (cryogenic injury). **Inhalation:** Remove exposed person to fresh air;

restore and/or support his or her breathing as needed. Observe for pulmonary edema; treat accordingly. **Ingestion:** Unlikely.

GET MEDICAL HELP (IN PLANT, PARAMEDIC, COMMUNITY) FOR ALL EXPOSURES. Seek prompt medical assistance for further treatment, observation, and support after first aid. If a significant level of ethylene oxide has been inhaled, hospitalization and observation for 72 hours for delayed pulmonary edema is recommended.

SECTION 7. SPILL, LEAK, AND DISPOSAL PROCEDURES

Spill/Leak: Treat any ethylene oxide gas leak as an emergency. Preplan for leaks and make these preparations known to all relevant personnel. Notify safety personnel, evacuate all nonessential personnel, provide maximum explosion-proof ventilation, and eliminate all sources of ignition immediately. Cleanup personnel must have protection against contact with and inhalation of vapor (see sect. 8). Try to shut off the flow of ethylene oxide gas. **Waste Disposal:** Contact your supplier or a licensed contractor for detailed recommendations. Follow Federal, state, and local regulations.

OSHA Designations

Specifically Regulated Substance (29 CFR 1910.1047)

EPA Designations (40 CFR 302.4)

RCRA Hazardous Waste, No. U115

CERCLA Hazardous Substance, Reportable Quantity: 1 lb. (0.454 kg.), per Resource Conservation and Recovery Act (RCRA), section 3001

SECTION 8. SPECIAL PROTECTION INFORMATION

Goggles: Always wear protective eyeglasses or chemical safety goggles. If splashing of aqueous ethylene oxide solutions may occur, wear a full face shield as a supplementary protective measure. Follow OSHA eye- and face-protection regulations (29 CFR 1910.133).

Respirator: Wear a NIOSH-approved respirator per the *NIOSH Pocket Guide to Chemical Hazards* for the maximum-use concentrations and/or the exposure limits cited in section 2. Follow OSHA respirator regulations (29 CFR 1910.134). For emergency or nonroutine use (leaks or cleaning reactor vessels and storage tanks), wear an SCBA with a full facepiece operated in the pressure-demand or positive-pressure mode. **Warning:** Air-purifying respirators will *not* protect workers in oxygen-deficient atmospheres. **Other:** Wear impervious gloves; boots; aprons; head covers; and clean, impervious, body-covering clothing to prevent any possibility of skin contact. All clothing must be flame resistant.

Ventilation: Install and operate general and local ventilation systems powerful enough to maintain airborne levels of ethylene oxide below the OSHA PEL standards cited in section 2. Make all ventilation systems of maximum explosion-proof design (nonsparking, electrically grounded and bonded, etc.) **Safety Stations:** Make eyewash stations, washing facilities, and safety showers available in areas of use and handling. **Contaminated Equipment:** Contact lenses pose a special hazard; soft lenses may absorb irritants and all lenses concentrate them. Do *not* wear contact lenses in any work area. **Other:** Design all engineering systems to be explosion-proof in any area where this gas may occur. **Comments:** Practice good personal hygiene; always wash thoroughly after using this material. Avoid transferring it from your hands to your mouth while eating, drinking, or smoking. Do *not* eat, drink, or smoke in any work area. Use care in selecting equipment (see sect. 5, Conditions to Avoid).

SECTION 9. SPECIAL PRECAUTIONS AND COMMENTS

Storage Segregation: Store ethylene oxide in a cool, dry, well-ventilated area away from incompatible chemicals (see sect. 5) and any source of ignition. Outside or detached storage is necessary. Store the cylinders upright, secure them tightly, do not drag or slide them, and move them in a carefully supervised manner with a suitable hand truck. **Special Handling/Storage:** Ethylene oxide is shipped/stored as a pressurized gas in cylinders or tank cars. Protect containers against physical damage and regularly inspect them for cracks, leaks, or faulty valves. Electrically ground and bond all systems used in shipping/transferring operations to prevent static sparks that can cause explosions. Monitor inventory; don't store this material for longer than 60 days. Monitor purity specifications that may indicate the degree of molecular rearrangement/polymerization of this material, particularly if it has been stored for more than 60 days. Obtain detailed handling, shipping, and storage information from your supplier. **Engineering Controls:** Make all engineering systems of maximum explosion-proof design. Use this gas in closed engineering systems. Ground and purge all pipelines with nitrogen before and after using ethylene oxide. **Comments:** Perform all operations with ethylene oxide carefully to prevent its accidental ignition. Keep the valve-protection cap in place until immediately before using it. Insert a check valve or trap into the transferral line to prevent a dangerous backflow of material into the original container. Use pressure-reducing regulators when connecting a container to a lower-pressure piping system.

Transportation Data (49 CFR 172.101-2)

DOT Shipping Name: Ethylene Oxide
DOT Hazard Class: Flammable Liquid

DOT Label: Flammable Liquid
DOT ID No. UN1040

IMO Label: Flammable Gas and Poison Gas
IMO Class: 2.1

References: 1, 2, 12, 73, 84-94, 100, 103.

Judgments as to the suitability of information herein for purchaser's purposes are necessarily purchaser's responsibility. Therefore, although reasonable care has been taken in the preparation of such information, Genium Publishing Corp extends no warranties, makes no representations and assumes no responsibility as to the accuracy or suitability of such information for application to purchaser's intended purposes or for consequences of its use.

Prepared by PJ Igoe, BS

Industrial Hygiene Review: DJ Wilson, CIH

Medical Review: MJ Hardies, MD

Copyright © 1988 Genium Publishing Corporation.
Any commercial use or reproduction without the publisher's permission is prohibited.

Figure 28. (cont.) Sample MSDS Sheet

The MSDS is not meant to be intimidating. It is used to gather pertinent information to help in an emergency response. The terminology on a data sheet can be confusing. Rescuers must become familiar

with the data sheets (see Figure 29). The National Fire Academy Program, Hazardous Materials Course on incident analysis is readily available and includes information on data sheets and the terminology used.

HAZARDOUS MATERIALS DATA SHEET

Shipping name _____ DOT hazard class _____
 Chemical formula _____ DOT ID # _____ STCC # _____
 CAS # _____ NFPA 704 _____ - _____ - _____

Physical form _____ color _____
 ODOR _____ other _____

Specific gravity _____ Vapor density _____
 Molecular weight _____ Expansion ration _____ to _____
 Boiling point _____ °F Melting point _____ °F
 Solubility: In water Yes - No Degree of solubility _____

TLV/TWA _____ ppm (Hg/M³) STEL _____ ppm (Hg/M³) IDLH _____ ppm (Hg/M³)
 Absorption hazard Yes - No Skin Yes - No Eyes Yes - No
 Chronic hazard: CARCINOGEN yes - no MUTAGEN yes - no TERATOGEN yes - no
 Hazard to aquatic life: yes - no
 Other _____
 Decontamination procedure _____
 First aid _____ Antidote _____

Flash point _____ °F AUTO IGNITION TEMPERATURE _____ °F
 Flammable range: LEL _____ % UEL _____ %
 Toxic products of combustion _____
 Heat reactivity information _____
 Possible extinguishing agents _____

Reactive with what _____
 Neutralizing agents _____

Public evacuation distance _____
 Level of protective clothing _____
 Compatible with what type suits _____

SPECIAL INFO:

Figure 29. Sample Hazardous Materials Data Sheet

The MSDS can also be used by emergency medical personnel or the local hospital. The more pre-emergency information available, the better the care that can be provided during an emergency. If an area has a highly-threatening industry or includes a highly-traveled transportation route, evaluate the materials that may be encountered.

The following definitions should be known by rescuers.

DEFINITIONS OF FIRE HAZARD PROPERTIES

Boiling point (BP) is the temperature at which the vapor pressure of a liquid is equal to the atmospheric pressure of the air.

OR

The temperature at which a liquid becomes a gas at the maximum possible rate. For more complete and the most current definitions it is necessary to have the most current copy of the NFPA Standards.

Flammable (explosive) limits

In the case of gases or vapors which form flammable mixtures with air or oxygen, (gases and vapors may form flammable mixtures in atmospheres other than air or oxygen, as for example hydrogen in chlorine.) There is a minimum concentration of vapor in air or oxygen below which propagation of flame does not occur on contact with a source of ignition. There is also a maximum proportion of vapor or gas in air above which propagation of flame does not occur. These boundary-line mixtures of vapor or gas with air, which if ignited will just propagate flame, are known as the "lower and upper flammable or explosive limits", and are usually expressed in terms of percentage by volume of gas or vapor in air.

Flash point

The flash point of a substance is the minimum temperature at which it gives off sufficient vapor to form an ignitable mixture with the air near the surface of the liquid or within the vessel used. By "ignitable mixture" is meant a mixture within the flammable range (between upper and lower limits) that is capable of the propagation of flame away from the source of ignition when ignited. By "propagation of flame" is meant the spread of flame from the source of ignition through a flammable mixture.

Ignition temperature

Ignition temperature of a substance, whether solid, liquid, or gaseous, is the minimum temperature required to initiate or cause self-sustained combustion in the absence of any source of ignition.

Specific gravity

The specific gravity of a substance is the ratio of the weight of the substance to the weight of the same volume of another substance. Temperature affects the volume of liquids, and temperature and pressure affect the volume of gases. It is therefore necessary to make corrections for effects of temperature and pressure when making accurate specific gravity determinations.

Specific gravity, as commonly used, refers to the ratio of a substance to the weight of an equal volume of water. In a few cases, such as fuel oils, where percentage composition of the substance varies, specific gravity information is given as greater than 1 (>) or less than 1 (<).

Vapor density

Vapor density is the weight of a volume of pure vapor of gas (with no air present) compared to the weight of an equal volume of dry air at the same temperature and pressure. It is calculated as the ratio of the molecular weight of the gas to the average molecular weight of air, 29. A vapor density figure less than 1 indicates that the vapor is lighter than air and will tend to rise in a relatively calm atmosphere. A figure greater than 1 indicates that the vapor is heavier than air and may travel at low levels for a considerable distance to a source of ignition and flash back (if the vapor is flammable).

Water solubility

The ability of a substance to blend uniformly with water (by percent by weight or parts per million).

Information on the degree to which a flammable liquid is soluble in water is useful in determining effective extinguishing agents and methods. Alcohol-resistant type foam, for example, is usually recommended for water-soluble flammable liquids. Also, water-soluble flammable liquids may be extinguished by dilution, although this method is not commonly used because of the amount of water required to make most liquids nonflammable, and there may be danger of frothing with this method, if the burning liquid is heated to over 212 degrees F (100 degrees C).

IDENTIFICATION OF HAZARDOUS MATERIALS

The major factor in the initial fire fighting, rescue, or other operations involving a dangerous hazardous-materials incident is to identify the hazardous material involved. Fire fighters and others responding to accidents, fires, spills, and other emergency scenes are frequently injured at such sites. A major concern is the failure to properly identify the situation and recognize that a hazardous material is involved.

Several methods and resources can be used to determine if an emergency scene involves a hazardous material. The following information offers basic resource information to assist in identifying the materials involved. Information included are the NFiPA 704 identification system for fixed-site hazardous-materials locations, military fixed-site symbols, descriptions of the nine classes of hazardous materials and several examples for each class, placard information, labeling information, hazardous materials packaging, and the types of shipping papers.

IDENTIFY NFiPA

NFiPA 701 Marking System

The NFiPA 704 marking system identifies the hazards of materials in three categories: health, flammability, and reactivity. Numbers or values are assigned in each category with relative weight given per degree of hazard. The NFiPA 704 system is used primarily at fixed sites such as warehouses and fixed tank-type facilities. The NFiPA 704 system is not meant to identify a product, but is to be used as an initial contact point for an incident commander to recognize the possibility that hazardous materials involvement exists, and to give an indication of the relative hazard that may exist. Upon alert to a 704 symbol, an incident commander should recognize the need to further use resources to identify the products involved.

The system uses a diamond-shaped symbol with four sections which are color coded: blue indicates a health hazard, red indicates a flammability hazard, yellow indicates a reactivity hazard, and white provides additional information or instructions. The blue, red, and yellow diamonds are given a number value from 0-4 which indicates their relative hazard level with 0 being of lesser severity and 4 being of

the greatest severity. The white diamond indicates special information or instructions such as water reactive, oxidizer, polymerization, radiation, special extinguishing agent, or any needed protective equipment (see Figure 30).

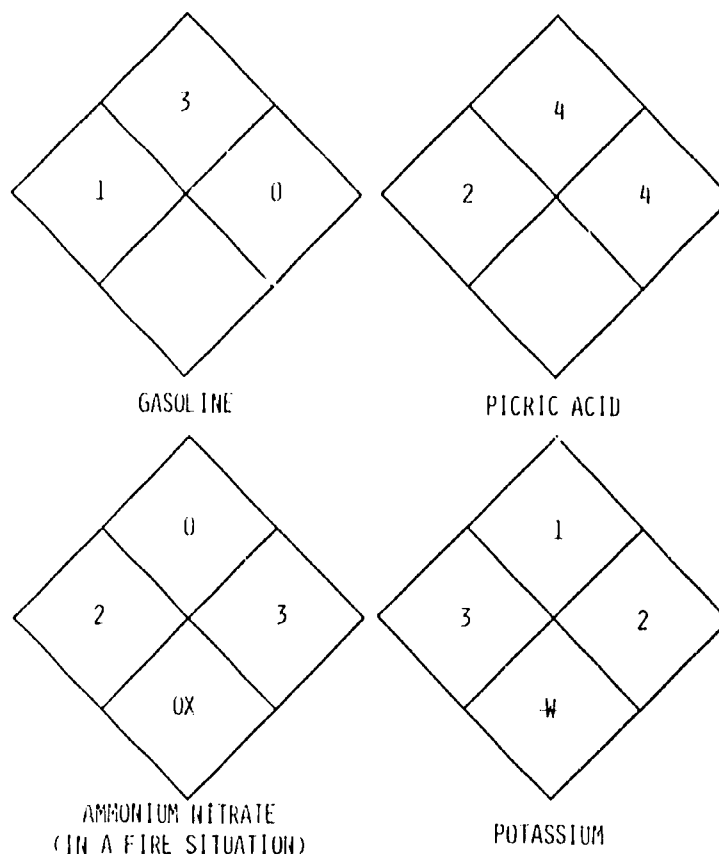

Figure 30. Sample NFiPA Diamonds

Descriptions of Hazard Classes

Health. A blue background located on the LEFT QUADRANT of the symbol describes relative health hazards and probable severity of the hazard to personnel.

"0" value indicates that the material, upon exposure under fire conditions offers no hazard beyond that of an ordinary combustible product.

"1" indicates that the material, upon exposure, causes irritation but only minor residual injury even if no treatment is rendered. This degree includes products which under fire conditions give off irritating combustion products and materials, which upon skin contact cause irritation without destruction of tissue.

"2" includes materials which upon intense or continued exposure causes temporary incapacitation or possible residual injuries unless prompt medical attention is given. This class includes materials which give off highly irritating combustion products and

materials which either under fire conditions or normal conditions give off toxic vapors which lack prior warning properties.

"3" indicates materials which upon short exposures causes serious temporary or residual injury even though prompt medical treatment is given. This degree includes materials which give off highly toxic combustion products and materials corrosive to living tissue or toxic by skin absorption.

"4" is the highest degree of severity and includes materials which on a very short exposure cause death or major residual injury even though prompt medical treatment is given and includes products that are to dangerous if approached without specialized equipment. Further, severity class 4 under fire conditions or normal conditions give off extremely hazardous gases and cause severe life hazard through inhalation or absorption.

Flammability. A red background located in the UPPER QUADRANT of the symbol indicates degree of hazards which are rated in accordance with their susceptibility to burn.

"0" includes materials which by themselves are normally stable, even under fire exposure conditions and are not reactive to water.

"1" includes materials which are normally unstable and readily undergo violent chemical changes, but do not detonate. This degree includes materials which can undergo chemical change with rapid release of energy at normal temperatures and pressures or which can undergo violent chemical change at elevated temperatures and react violently to water, or which may form potential an explosive mixture when mixed with water.

"2" includes materials which are normally unstable and readily undergo violent chemical change, but do not detonate. This degree includes materials which can undergo chemical changes with a rapid release of energy at normal temperatures and pressures or which can undergo violent chemical changes at elevated temperatures and pressures. It also includes those materials which may react violently when mixed with water and form potentially explosive mixtures.

"3" includes materials which can be ignited in most temperature conditions. Water is usually ineffective due to the low flash points.

"4" includes materials which are very flammable gases or highly volatile flammable liquids.

Reactivity. A yellow background and located in the RIGHT QUADRANT of the symbol indicates the relative degree of hazard ranked according to

ease, rate, and quantity of energy release.

"0" indicates materials which are normally stable, even under fire exposure. These materials are normally stable, but can become unstable at elevated temperatures and pressures or may react with water with some releases, or may react with water with some release of energy but not violently.

"1" indicates materials which are normally unstable and readily undergo violent chemical changes but do not detonate. This degree includes materials which can undergo chemical change with rapid release of energy at normal temperatures and pressures, or pressures. The degree also includes materials which may react violently when mixed with water and form potentially explosive mixtures.

"2" includes materials which are normally unstable and readily undergo violent chemical change but do not detonate. This degree includes materials which can undergo chemical change with rapid release of energy at normal temperatures and pressures, or can undergo violent chemical changes at elevated temperatures and pressures. It also includes materials which may react violently when mixed with water or which may form potentially explosive mixtures with water.

"3" includes materials which are capable of detonation or of explosive decomposition or reaction but require a strong initiating source or must be heated under confinement before initiation. This degree includes materials which are sensitive to thermal or mechanical shock at elevated temperatures and pressures or react explosively when mixed with water without requiring heat or confinement.

"4" includes materials which are readily capable of detonation or of explosive decomposition or explosive reaction at normal temperatures and pressures. This degree includes materials sensitive to mechanical or localized thermal shock at normal temperatures and pressures.

Special Hazard. A white background and located in the LOWER QUADRANT. Special hazards as symbolized by a W with a slash through the center \mathcal{W} and indicate that the material has a special reactivity with water, OXY meaning that the material possesses oxidizing properties, or a radioactivity symbol indicating the material possesses radioactivity hazards.

Using the NFiPA 704 system in conjunction with NFiPA Standard 49 yields important information concerning material properties and hazards possible of the present chemical. The 704 system does not

in itself identify a specific product, but assists in giving an incident commander a direction for determining a safe approach in the initial phase of handling a hazardous materials incident and further lead to chemical or technical references (see Figure 31).

HAZARDOUS

Figure 31. Fire Protection Guide on Hazardous Materials

Military Markings

The U.S. Military has a marking system meant to alert potential responders to hazards similar to the NFPA 704 system (see Figure 32). This system is applied to transportation systems as well as fixed sites. The 704 system is used primarily for fixed sites.

The military system addresses seven subjects. The first three symbols are found at fixed sites.

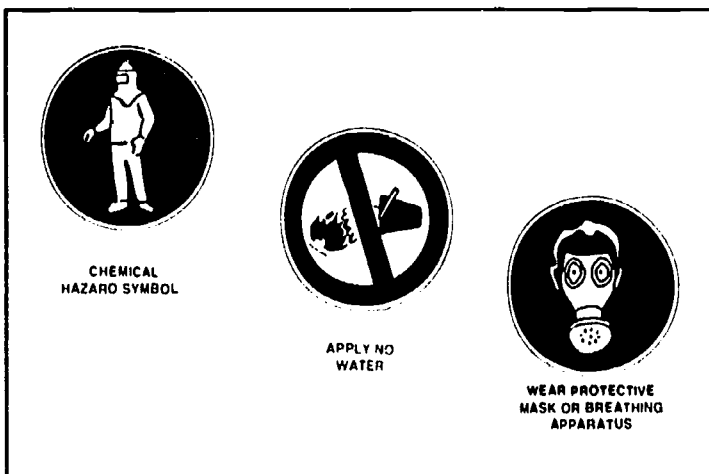

Figure 32. Symbols Found at Fixed Sites

The remaining four symbols indicate detonation or fire hazards (see Figure 33).

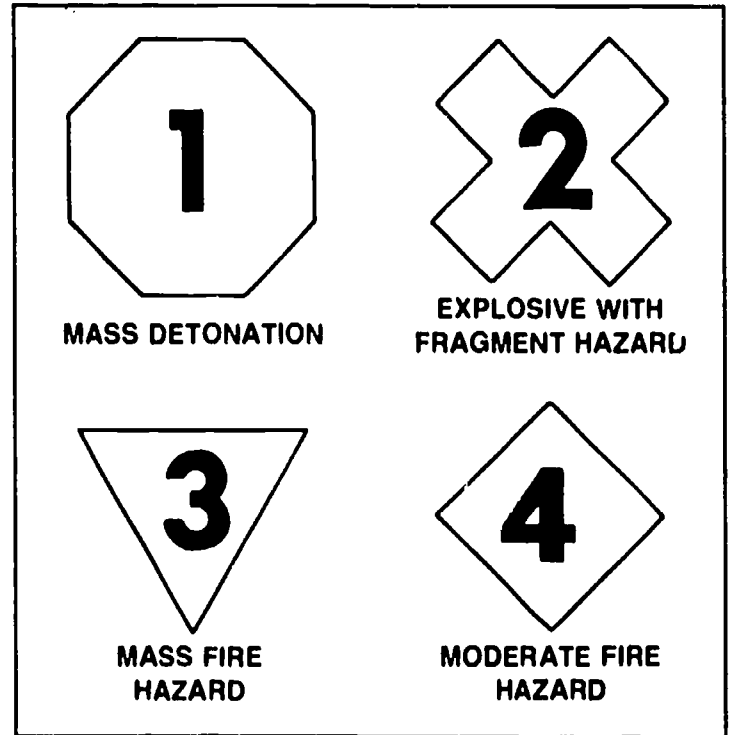

Figure 33. Symbols Indicating Detonation or Fire Hazards

The Canadian Military Force use a system similar to the U.S. Military (see Figure 34). It addresses the classes of explosives as follows:

- Class 1 Explosives. Mass detonation potential on flame contact
- Class 2 Explosives. Readily ignitable with or without explosion
- Class 3 Explosives. Possible mass detonation potential after flame contact for a period of time
- Class 4 Explosives. No mass explosion risk, but burns intensely with dense, possibly toxic smoke
- Class 5 Explosives. Containing toxic substances
- Class 6 Explosives. Increasing frequency of explosion potential after being in contact with flame for some time. Fragment hazard and limited blast risk present
- Class 7 Explosives. Combined corrosive, flammable, and toxic risk present
- Class 8 Explosives. Radiological hazard added
- Class MP. Metallic powders

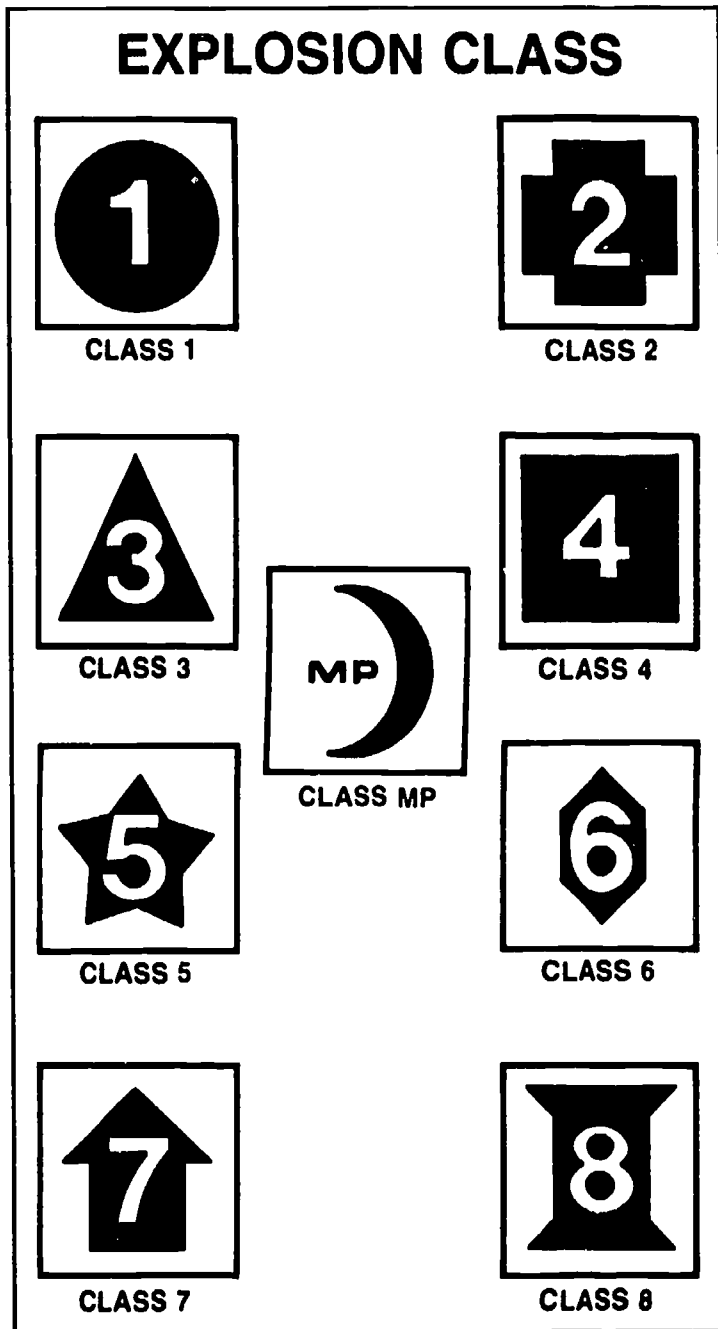

Figure 34. Canadian Military Explosives Marking System

Shipping and Transportation Identification Systems

Several sources have attempted to develop standard methods to identify classes of hazardous materials and provide a standard labeling method so that any agency confronted with incident can identify the general hazard category.

The most common system of identification is one required by the U.S. Department of Transportation (DOT) per Code of Federal Regulations, (CFR) Part 49. The system used by the United States and Can-

ada was developed through the United Nations. It involves the use of picture placards or labels and a system of four-digit code numbers which represent specific commodities. The United Nations/North American System includes a number system of 1-9 which encompasses the general classes of hazardous materials.

- Class 1 — Explosives
- Class 2 — Gases
- Class 3 — Flammable Liquids
- Class 4 — Flammable Solids
- Class 5 — Oxidizers
- Class 6 — Poisons and Infectious Materials
- Class 7 — Radioactive Materials
- Class 8 — Corrosives
- Class 9 — Other Regulated Materials (ORMs)

The commodity 4-digit identification number is assigned for various substances and is required to be displayed on transportation containers and not at fixed-site locations. The NFPA 704 labeling system is required for fixed-site location. The 4-digit identification number is used in reference publications to assist in identifying specific products. Of particular importance is the use of the 4-digit identification number in the U.S. Department of Transportation Emergency Response Guide (see Figure 35). The response guide identifies products by several methods including the 4-digit ID number and the name of the material.

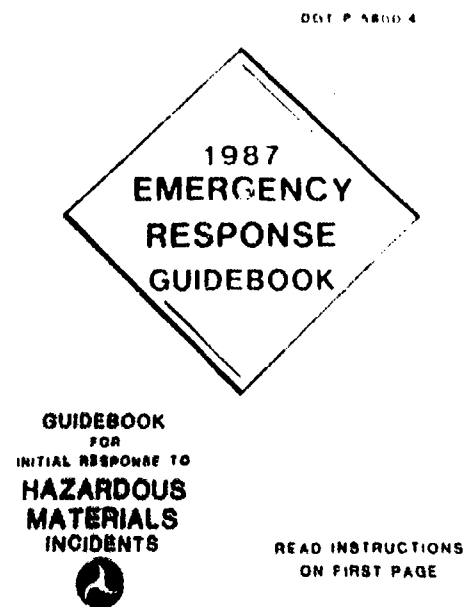

Figure 35. Emergency Response Guide

After a product is identified using the DOT guide, a reference is made to a guide number which gives information immediately that can be used to control an incident. The guide page will give information concerning; potential hazards, such as fire or explosion hazards, and health hazards and emergency action covering fire or spill or leak conditions. Specific instructions for the use of the guide should be included in in-service training for all personnel responsible for the initial response to the scene of a hazardous-materials incident.

A copy of the DOT guidebook must be available in every public safety department, fire apparatus, and law enforcement vehicle. The guide is only a quick reference and further technical research is indicated. It is not intended for the purpose of technical research.

The U.S. Department of Transportation has assigned subclasses to the United Nations Classes. The subclasses are indicated on the DOT labels and placards and include the U.N. Classifications number on the lower portion of the placard of label.

HAZARDOUS MATERIALS

There are nine classes of hazardous materials. The five following classifications of Class A explosives, Class B explosives, Poison A, Flammable Solids (Dangerous When Wet label only), Radioactive Yellow III must have a placard regardless of quantity. A 1,000 pound limit affects placarding of most other materials when transported by motor vehicles or in freight containers. That means that for materials in the category of the 1,000-pound rule, placarding is not required when gross weight of the product is less than 1,000 pounds. Placarding of any cargo tank is required. The guidelines discussed are in general and are not intended to be all inclusive. Further information concerning labeling and placarding, and their respective requirements can be found in Code of Federal Regulations (CFR) Part 49.

PESTICIDES

Emergency incidents involving a variety of pesticides occur frequently. The most effective method to identify the involved product is to locate an intact, undamaged package of the pesticide and read the label.

The information on the label states information about the level of danger encountered by exposure.

A label contains a warning statement in bold print such as, CAUTION, WARNING, or DANGER. They will be in an ascending order of danger and provide a key to the correct method to handle the material.

Other information included on the label is the product name, chemical contents, precautionary statements, manufacturer's name, registration number, and a physician's statement to medical personnel regarding treatment methods.

The substance identification method is vital to initiating prompt and correct measures for size-up, decision-making, and proper emergency operations at an incident site; however, each system has limitations.

When using the NFPA 704 system only the major characteristics of materials are involved. The NFPA's *Fire Protection Guide to Hazardous Materials* includes possible reactions to certain chemicals, but cannot include all the possible factors involved in chemical reactions. The most learned toxicologists can only predict what reactions take place in given circumstances.

When using labels and placards, it is presumed that the material was packaged and loaded, and placarded or labeled correctly in compliance with all laws; however, experience indicates that this is not always true. Dangerous cargos occasionally go unplacarded. Loads are also changed or varied without placard changes. It is also possible to find 999 pounds of material on a load that is not required to be placarded according to the DOT 1,000 pound rule.

If all necessary placarding is performed correctly and what appears to be on a load or in a package is what is present, the first responder can look at the package and identify the material with regard to the general or specific class, or the specific material being dealt with. However, material identification is difficult under the most ideal conditions.

During a transportation or a fixed-site incident conditions are seldom ideal. Frequently rescuers must remain at a safe distance until accurate identification of the materials involved is confirmed. Emergency incidents involving hazardous materials are different than normal emergency situations encountered where an immediate approach can be made to assess the situation. The label or placard is often difficult to see from the safe recommended distance of 1,000'.

Even with binoculars or a spotting telescope, a placard or UN number may be difficult to read when a cargo tanker is on its side or upside down, or



Figure 36. Fixed-Site Incident

numerous rail-tankers are piled together in the middle of a train derailment.

Two methods are recommended for accurate identification of materials.

- (1) Fixed-site incidents remain in one location. Preplanning the site yields valuable information. A rescuer has the opportunity to see what materials are used at the site and where they are stored or used. The rescuer can evaluate the materials and gather technical information before an incident happens, and in many cases, correct a problem to prevent an incident.
- (2) Transportation incidents do not have the benefit of fixed-site incidents in that an accident can take place anytime or at any location and may be influenced by outside factors. Transportation incidents can be preplanned by performing a community-risk assessment, locations can be identified projecting where transportation incidents may happen and what effect they could pose on the surroundings, and what can be done to reduce the negative affects. The primary consideration in any transportation incident is to locate the shipping papers. Reading the shipping papers is always the preferred method to identify the specific materials involved. For further information, see chapters on farm accident rescue and rescue from a confined space.

Fixed-Site Incident

Information that can be gained by preplanning includes (see Figure 36):

Presence of special hazards which may not be visible

at the time of an incident (see Figure 37).

Know what materials are stored in the facility and the exact location of each, including key information needed during an emergency such as utility connections and shut offs, exits, and means that haz-



Figure 37. Chemical Storage Room

ardous materials can escape packages. Proper preplanning can provide substance identification and the quantity on hand. It can provide overall information to accurately identify what will be encountered without having to place personnel in dangerous situations.

A vast amount of information can be obtained in advance with regard to chemicals on hand from personnel on site who are familiar with the materials.

Numerous forms can be completed in advance (see Figures 38 and 39).

HAZARDOUS SUBSTANCE DATA SHEET

NAME OF SUBSTANCE _____

COMMON _____ CHEMICAL _____

I. Physical/Chemical Properties

SOURCE

Normal physical state	_____ gas _____ liquid _____ solid _____	
Molecular weight	_____	_____
Density	_____	gm/ml _____
Specific gravity	_____ @ _____	°F/°C _____
Solubility: Water (ppm)	_____ @ _____	°F/°C _____
Solubility: _____	_____ @ _____	°F/°C _____
Boiling point	_____	°F/°C _____
Melting point	_____	°F/°C _____
Vapor pressure (mmHg)	_____ @ _____	°F/°C _____
Vapor density	_____ @ _____	°F/°C _____
Flash point OC/CC	_____	°F/°C _____
Other:	_____	_____

II. Hazardous Characteristics

A. TOXICOLOGICAL HAZARD

HAZARD

CONCENTRATIONS

SOURCE

Inhalation	Yes No	_____	_____
Ingestion	Yes No	_____	_____
Skin/eye absorption	Yes No	_____	_____
Skin/eye contact	Yes No	_____	_____
Carcinogenic	Yes No	_____	_____
Teratogenic	Yes No	_____	_____
Mutagenic	Yes No	_____	_____
Aquatic	Yes No	_____	_____
Other:	Yes No	_____	_____

B. Fire Hazard

HAZARD

CONCENTRATIONS

SOURCE

Combustibility	Yes No	_____	_____
Toxic byproducts:	Yes No	_____	_____
Other: _____	Yes No	_____	_____
_____	Yes No	_____	_____
Flammable/Explosive	Yes No	_____	_____
LFL/LEL		_____	_____
UFL/UEL		_____	_____

C. Reactivity Hazard

HAZARD

CONCENTRATIONS

SOURCE

Water	Yes No	_____	_____
Other: _____	Yes No	_____	_____

Figure 38. Hazardous Substance Data Sheet

D. Corrosive Hazard	HAZARD	pH	SOURCE
Acid	Yes No	_____	_____
Base	Yes No	_____	_____
Neutralizing agent:	Yes No	_____	_____
_____		_____	_____
E. Radioactive Hazard	HAZARD	EXPOSURE RATE	SOURCE
Background	Yes No	_____	_____
Alpha particles	Yes No	_____	_____
Beta particles	Yes No	_____	_____
Gamma radiation	Yes No	_____	_____

III. INCIDENT RELATED

Quantity involved _____

Release information _____

Monitoring/sampling recommended _____

IV. RECOMMENDED PROTECTION

Public _____

Environment _____

Worker _____

V. RECOMMENDED SITE CONTROL

Exclusion zone _____

Contamination reduction zone _____

Support zone _____

Figure 38. (cont.) Hazardous Substance Data Sheet

RECOGNITION AND IDENTIFICATION ELEMENTS THAT CAN BE MADE DURING PREPLANNING

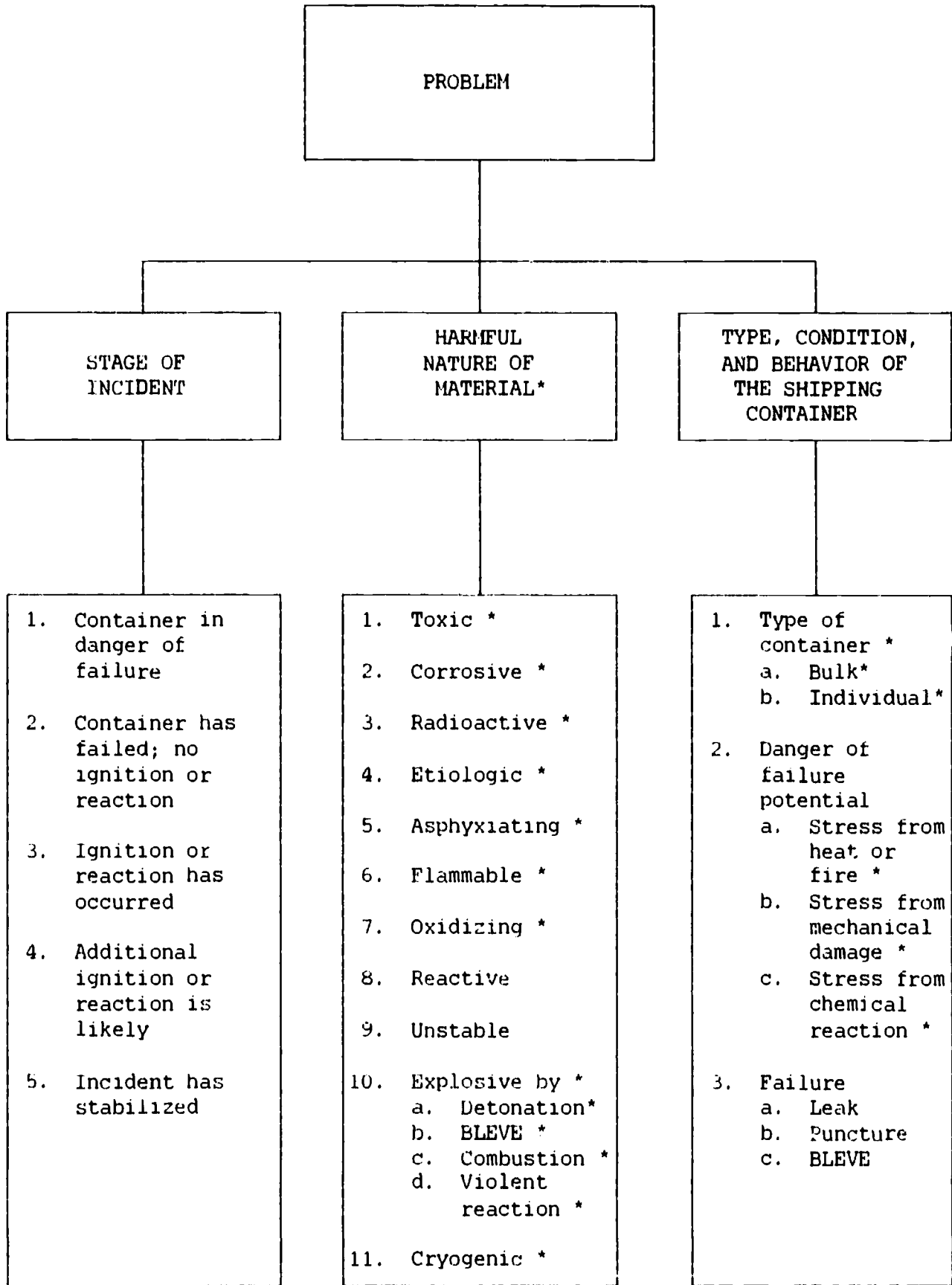

Figure 39. Preplanning Flowchart

Identification of Materials Being Transported

To identify materials in any transportation accident involving hazardous-materials, read the ship-

ping papers. The U.S. Department of Transportation defines the shipping papers as bills of lading, the manifest, shipping orders, or other shipping documents containing specific information about the materials being transported (see Figure 40).

STRAIGHT BILL OF LADING

Shipper no. _____

Carrier no. _____

NEUTRAL TRANSPORT INC.
(Name of Carrier)

Date _____

TO: Consignee		CONTINUE POSTER CO.		FROM: Shipper		KILEON PRODUCT INC.	
Street		4142 CAT ST.		Street		KABOOM BLVD.	
Destination		KITTYLITTER, TEXAS 92015		Origin		CARBON HILL, OHIO 43111	
Route				Vehicle number 007			
No. of Units & Container Type	HM	DESCRIPTION AND CLASSIFICATION (Proper shipping name, class and identification number per 172.101, 172.202, 172.203)	UN# or NA#	TOTAL QUALITY (Weight, Volume Gallons, etc.)	WEIGHT (Subject to correction)	RATE	Charges (For carrier use only)
3 drums	X	Corrosive material 1, 2, 3, 6-Tetrahydrobenzaldehyde	2498	520 gal	10,920 lbs	9	INVOICE
5 carboys	RD	Mercuric nitrate oxidizer	1625	200 gal	2,000 lbs	5	INVOICE
5 pails	X	Flammable liquid N.O.S.	1993	25 gal	175 lbs	9	\$62.77
5 pails	X	Formaldehyde solution ORM-A	2209	25 gal	152 lbs	1	INVOICE
Placards tendered: Yes <input checked="" type="checkbox"/> No <input type="checkbox"/>			Remit COD to address				

Figure 40. Straight Bill of Lading

When hazardous materials and nonhazardous materials appear on the same shipping paper, the hazardous material must be entered first by description or in a clearly contrasting color; or preceded by an "X" or "RQ" in a column marked "HM".

The four-digit identification number required for each listed hazardous material will be preceded by a NA (North American) or UN (United Nations) prefix such as, UN 1993 or NA 1247. In addition, the shipping names must be quoted from the DOT Hazardous Materials regulations.

Shipping papers are to always include: the name of the material being shipped, its hazard class, the four-digit ID number, and the name of the shipper. For highway shipments, shipping papers are usually located in the driver's cab. Shipping papers must be clearly labeled as hazardous materials and within the driver's reach when at the wheel. They should be kept readily visible in the driver's doorholder, or placed on the driver's seat when the driver is absent from the vehicle.

For rail shipments, shipping papers are required to be carried by an official train crew member. Regulated vessels such as barges must have shipping papers onboard and in the possession of the tow vessel master (see Figure 41)



Figure 41. Barge Papers

Shipping Containers and Vessel Shapes

At times identification by a formal identification system is impossible. Safe site entry is prohibitive until a positive plan of action is in place and events such as explosions, fires, or other unusual circumstances prevent getting close to the site for visual observation are under control:

- Many times a general category or class of materials can be identified by descriptions of containers, packages, or vessels.
- Often a train crew notices a derailment situation before they evacuate the scene.
- A truck driver may be able to offer information following an accident.
- Frequently a witness to an accident can give an eyewitness account as to what was seen at an accident.

Basic diagrams and pictures are used to identify shapes of containers (see Figure 42). Illustrations can assist in providing specific information when combined with other identifying information to accurately determine a substance's identity.



Figure 42. Photo of Container Shapes

Transportation Containers

It is important to be able to recognize shapes of vehicles on the highway which may be transporting hazardous materials. Such information can be used to assist with materials identification purposes. Combining information from shipping papers, placards or labels, identification names or numbers, and eye witnesses, a rescuer can often make an educated decision as to what an accident situation may involve.

There are given profiles for recognized classifications of dangerous cargo containers. Any container displayed may or may not be loaded with hazardous materials, but as a rescuer at a hazardous-materials incident, the first concern is safety and site security. It must be assumed that the worst scenario is present and the unknown material is potentially hazardous.

The diagrams describe various classifications of containers and give a general description for valve locations for the different styles. The diagrams illustrate how the valves may be situated when the container is not in a normal position, such as on its side or upside down. Rescuers must have a general knowledge of how the container may react when in an unnatural position or involved in an accident.

Rail Tank Cars

Tank cars can be divided into several categories: pressure tank cars, non-pressure tank cars, cryogenic liquid tank cars, multi-unit tank cars, high-pressure tank cars, pneumatically unloaded covered hopper cars, or wooden tank cars.

Usually, pressure tank cars are used to transport nonflammable and flammable gases, or poison A; however, they can transport other materials including: ethylene oxide, pyrophoric liquids, NOS sodium metal, motor fuel antiknock compound, bromine, anhydrous hydrogen fluoride, or acrolein.

Pressure tank cars range in capacity from 4,000 to 45,000 gallons. Tank test pressures range from 100 to 600 psi (see Figure 43).

Pressure Tank Car Table							
Class	Material	Insulation	Test pressure	Safety relief device required	Valve setting	Vent setting	Notes
DOT-105	Steel/ Aluminum	Required	100	Valve	75	n/a	No bottom outlet or washout only one opening in tank.
			200	Valve	150		
			300	Valve	225		
					*247.5		
			400	Valve	300		
			500	Valve	375		
DOT-109	Steel/ Aluminum	Optional	100	Valve	75	n/a	No bottom outlet optional bottom washout.
			200	Valve	150		
			300	Valve	225		
DOT-112	Steel	None	200	Valve	150	n/a	No bottom outlet or washout, retrofit package possible.
			340	Valve	225		
					*280.5		
			400	Valve	300		
DOT-114	Steel	None	500	Valve	375	n/a	Similar to DOT-112; optional bottom outlet, retrofit package possible.
			340	Valve	255		
					*280.5		
DOT-120	Steel/ Aluminum	Required	200	Valve	150	n/a	Similar to DOT-105; optional bottom outlet.
			300	Valve	225		
			400	Valve	300		
			500	Valve	375		
			600	Valve	450		

Notes: (*) refers to valve setting for certain commodities such as liquefied petroleum gas; butadiene; anhydrous ammonia; methylacetylene-propadiene, stabilized; chlorodifluoromethane; and vinyl chloride.

Figure 43. Pressurized Tank Car Table

Pressure tank car tanks are cylindrical in shape and of welded construction. The heads of pressure tank car tanks are convex. Pressure tank cars are top loading, provided with a manway on top of the tank of sufficient size to permit access to the interior, a manway plate for the mounting of all valves, and gauging and sampling devices, and a protective housing or bonnet, approximately 18-24" high and 30-36" in diameter.

Pressure tank cars may be insulated and thermally protected. Pressure tank cars without insulation or jacketed thermal protection have the top two-thirds of the tank painted white. Some pressure tank cars including those transporting flammable gases and anhydrous ammonia have been retrofitted with one or more of the following: head-puncture resistance which protects the lower portion of the heads against punctures; and thermal protection—either jacketed or sprayed-on (see Figure 44).

NON-PRESSURE TANK CARS

Non-pressure tank-car tanks are cylindrical in shape with formed, convex heads. The tanks may be compartmentalized with each compartment handled as a separate tank. Compartments vary in capacity and may each be used to transport a different material. Non-pressure tank cars may be insulated and are provided with a minimum of one manway or one expansion dome with a manway to allow access to the interior of the tank. Each compartment has an external fitting for filling or emptying the tank. In addition, each one has the required safety devices (see Figure 45).

To visually differentiate between pressure and non-pressure tank cars, check the fittings on top of the tank. Non-pressure tank cars have visible fittings or an expansion dome. Pressure tank cars have all fittings located under one single protective housing

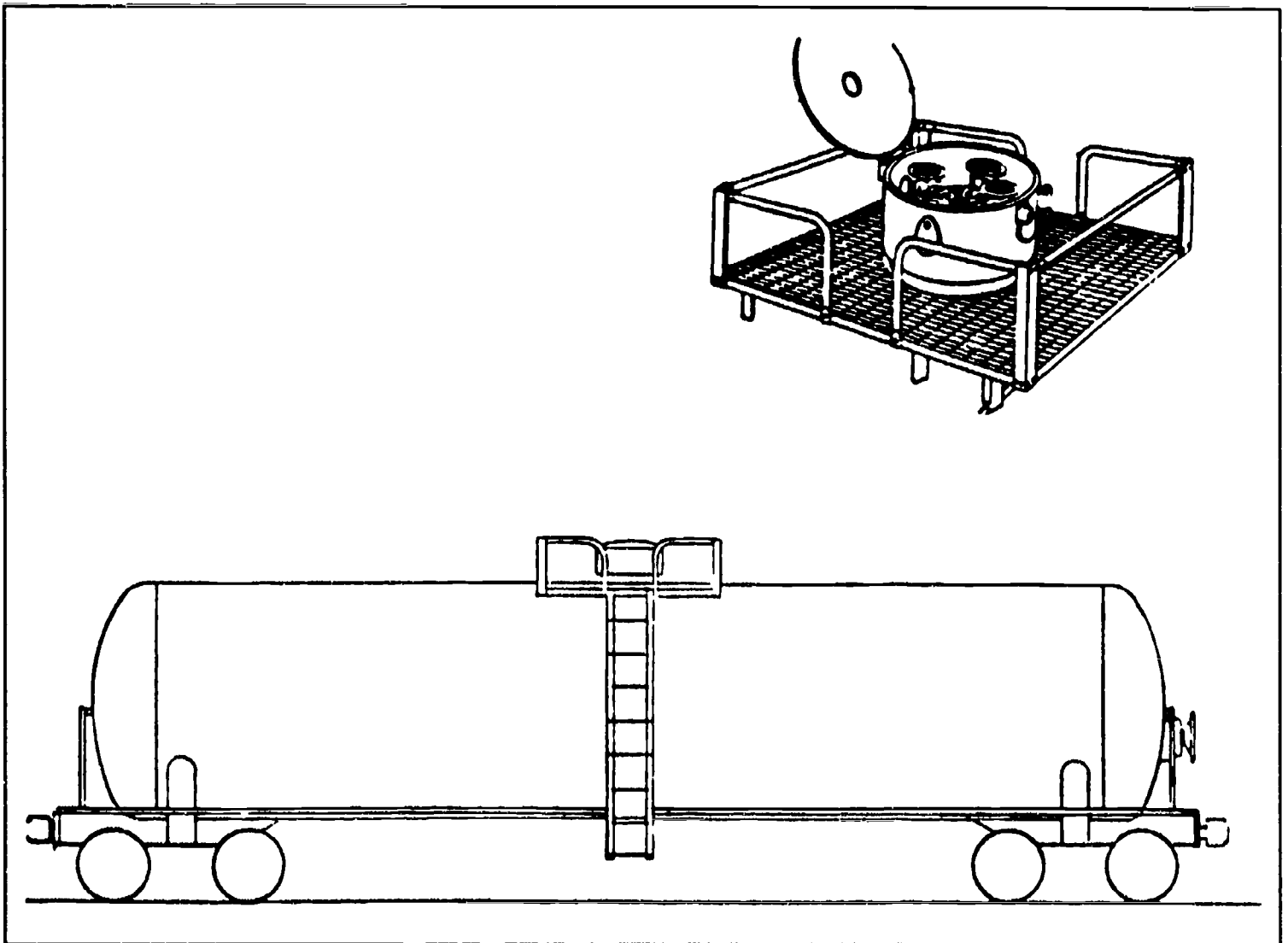

Figure 44. Pressurized Tank Car

Nonpressure tank cars							
Class	Material	Insulation	Test pressure	Safety relief device required	Valve setting	Vent setting	Notes
(with expansion dome)							
DOT-103	Steel/ Aluminum/ Stainless steel/ Nickel	Optional	60	Either	35	60	Optional bottom outlet
DOT-104	Steel	Required	60	Either	35	60	Similar to DOT-103; optional bottom outlet
AAR-201	Aluminum	Optional	35	Either	15	17	Similar to DOT-103; optional bottom outlet
AAR-203	Steel	Optional	60	Either	35	45	Similar to DOT-103; optional bottom outlet
(without expansion dome)							
DOT-111	Steel/ Aluminum	Optional	60 100	Either Either	35 75	60 100	Optional bottom outlet and bottom washout
AAR-211	Steel/ Stainless steel/ Aluminum	Optional	60 100	Either Either	35 75	60 100	
DOT-115	Steel/ Stainless steel/ Aluminum	Required	60	Either	35	45	Tank within a tank; lighter inner tank, heavier outer tank, heavy insulation
AAR-206	Steel/ Stainless steel/ Aluminum	Required	60	Either	35	45	Similar to DOT-115; tank within a tank; lighter inner tank, heavier outer tank, heavy insulation
Notes: Either a safety relief valve or safety vent or both is required depending on the specification and the commodity being transported.							

Figure 45. Non-pressurized Tank Car Table

or expansion dome (see Figure 46). There are exceptions such as: non-pressure tank cars used to transport nitric acid are constructed with a protective housing which appears to be twice as tall as a

normal pressure housing. Other pressure tank cars have a safety valve located outside the protective housing or expansion dome, while some may have an auxiliary pressure manway (see Figure 47).

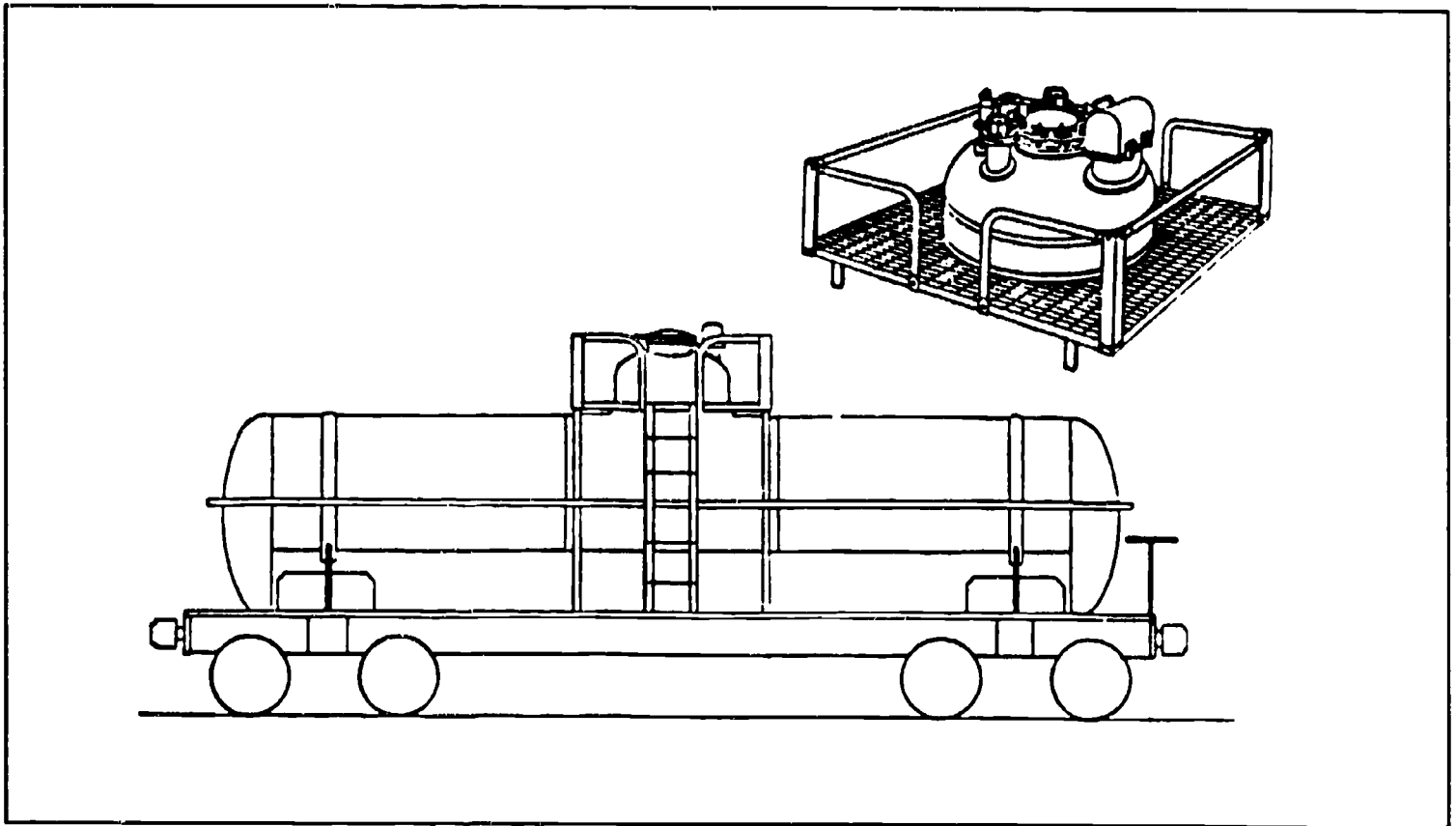

Figure 46. Non-pressure Tank Car with Expansion Dome

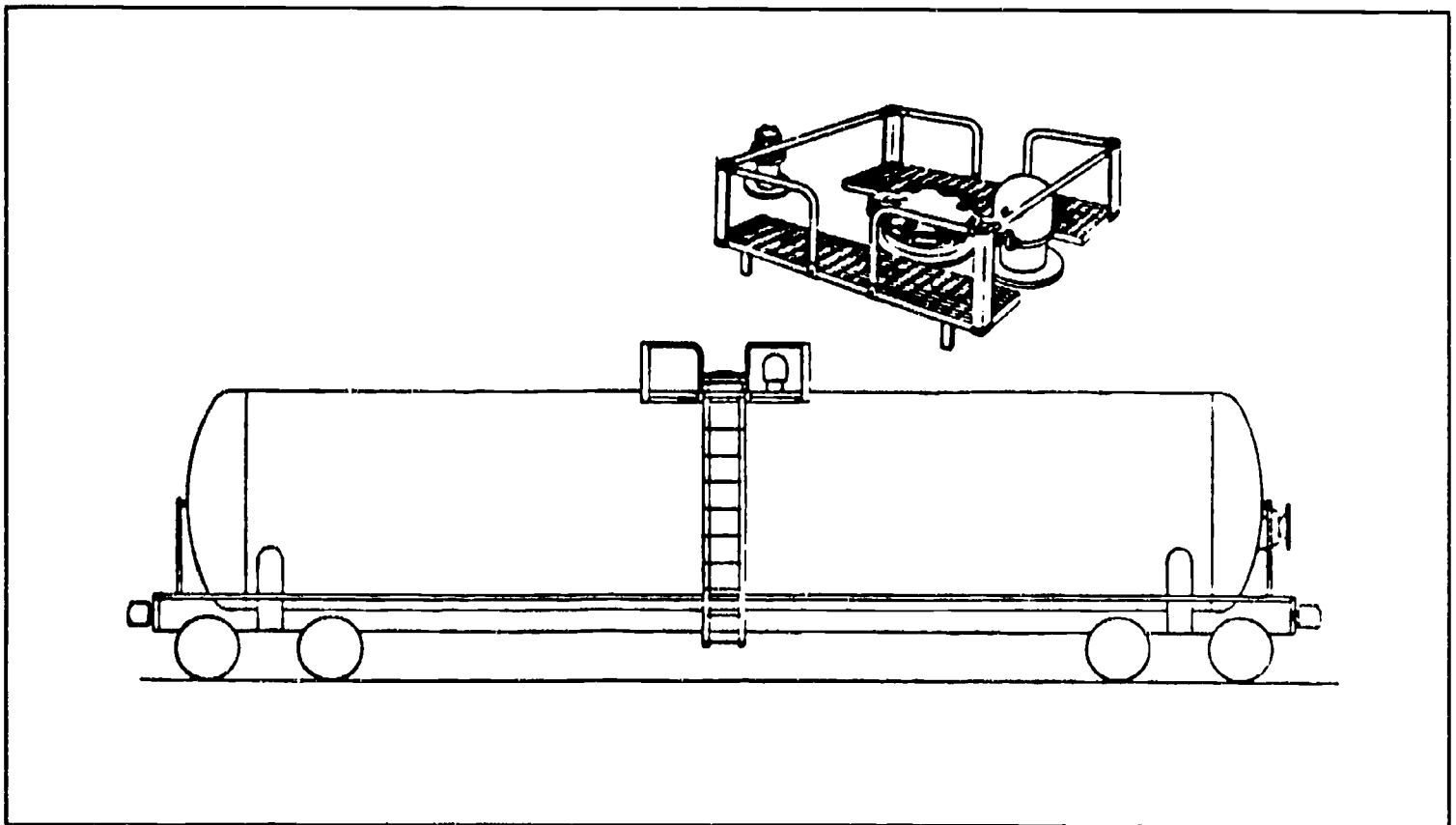

Figure 47. Non-pressure Tank Car Without Expansion Dome

Some tanks cars are dedicated to transport a specific material. When a tank car is dedicated to one material, either the Department of Transportation or the Association of American Railroads requires the material name to be stenciled in 4-inch lettering on the car. Requirements for labeling change periodically. An update can be obtained by contacting the Association of American Railroads. Below is a list of current material names stenciled on tank cars:

Acrolein
Anhydrous Ammonia
Bromine
Butadiene
Chlorine
Chloroprene (When in a DOT 115A specification tank car)
Difluoroethane *
Difluoromonochloromethane *
Dimethylamine, Anhydrous
Dimethyl Ether
Ethylene Oxide
Formic Acid
Fused Potassium Nitrate and Sodium Nitrate
Hydrocyanic Acid
Hydrofluoric AcidHydrogen Chloride
Hydrogen Fluoride
Hydrogen Peroxide
Hydrogen Sulfide
Liquified Hydrogen
Liquified Hydrocarbon Gas and Liquified Petroleum Gas (can also be stenciled Propane, Butane, Propylene, Ethylene)
Methyl Acetylene Propadiene Stabilized
Methyl Chloride
Methyl Mercaptan
Methyl Chloride, Methylene Chloride Mixture
Monomethylamine, Anhydrous
Motor Fuel Antiknock Compound or Antiknock Compound
Nitric Acid
Nitrogen Tetroxide
Nitrogen Tetroxide, Nitric Oxide Mixture
Phosphorus
Sulfur Trioxide
Trifluoroethoethylene *
Trimethylamine, Anhydrous
Vinyl Chloride
Vinyl Fluoride Inhibited
Vinyl Methyl Ether Inhibited

* May be labeled DISPERSANT GAS or REFRIGERANT GAS in lieu of name. Only flammable refrigerant or dispersant gases are stenciled.