

ED 330 809

CE 057 462

AUTHOR Anderson, Gary A.
TITLE Floral Design and Marketing.
INSTITUTION Ohio State Univ., Columbus. Agricultural Curriculum Materials Service.
SPONS AGENCY Ohio State Dept. of Education, Columbus. Agricultural Education Service.
PUB DATE 88
NOTE 858p.; Photographs will not reproduce well.
AVAILABLE FROM Ohio Agricultural Education Curriculum Materials Service, 254 Agricultural Administration Bldg., Ohio State University, 2120 Fyffe Road, Columbus, OH 43210-1099 .
PUB TYPE Books (010) -- Guides - Classroom Use - Instructional Materials (For Learner) (051)

EDRS PRICE MF05/PC35 Plus Postage.
DESCRIPTORS Adult Education; Advertising; *Agricultural Education; Design; *Distributive Education; *Floriculture; *Marketing; *Ornamental Horticulture Occupations; Plant Identification; Postsecondary Education; Salesmanship; Sales Occupations; *Sales Workers
IDENTIFIERS *Floral Designers; Florists

ABSTRACT

This profusely illustrated, 32 chapter book surveys retail floriculture and makes a current statement of the industry. It can be used by students pursuing individualized study, in a classroom with instructor reinforcement and demonstrations, and by a former student or flower shop employee as a refresher tool and reference. Principles of flower arranging are explained and applied. Identification of floral material and supplies commonly found in flower shops is explained with illustrations. Information on care, handling, and selling of flowers is provided. Suggested activities in each chapter provide hands-on exercises. Following an introduction, chapter topics are: elements of design; cut flowers and foliage; mechanics, supplies, and safety; body flowers; bud vases and rose bowls; decorating potted plants; mass arrangements; line and line-mass arrangements; accessories, bases, and backgrounds; dried flowers; silk and other permanent flowers; table settings; wedding floral design; sympathy flowers; living plant groupings; novelty arrangements; special occasions and holidays; period arrangements; contemporary arrangements; retail floriculture industry; sales and service; wrapping and packaging floral products; pricing floral products; organization and efficiency; store displays; conditioning and storing cut flowers; care of living plants; delivery; advertising and promotion; and keeping current with the industry. Lists of resource organizations and periodicals and 64 references are appended. Both black and white and color photographs illustrate the text. (YLB)

ED330809

CE 057462

Floral Design and Marketing

Gary A. Anderson

U.S. DEPARTMENT OF EDUCATION
Office of Educational Research and Improvement
EDUCATIONAL RESOURCES INFORMATION
CENTER (ERIC)

This document has been reproduced as
received from the person or organization
originating it.

Minor changes have been made to improve
reproduction quality.

Points of view or opinions stated in this docu-
ment do not necessarily represent official
OERI position or policy.

"PERMISSION TO REPRODUCE THIS
MATERIAL HAS BEEN GRANTED BY

R. Roediger

TO THE EDUCATIONAL RESOURCES
INFORMATION CENTER (ERIC)."

John H. Davis, Assistant Director
Vocational and Career Education,
Agricultural Education Service
Ohio Department of Education

Roger D. Roediger, Director
Ohio Agricultural Education
Curriculum Materials Service
The Ohio State University

Library of Congress No. 90-621762

Copyright ©, 1988

Ohio Agricultural Education Curriculum Materials Service
The Ohio State University

All rights reserved

Ohio Agricultural Education Curriculum Materials Service
The Ohio State University
Room 254, 2120 Fyffe Road
Columbus, Ohio 43210

1988

The Ohio Agricultural Education Curriculum Materials Service, as a part of The Ohio State University, is an equal opportunity employer and does not discriminate against any individual for reasons of race, color, creed, religion, national origin, sex, or handicap. All instructional materials are available to all potential clientele on a non-discriminatory basis without regard to race, color, creed, religion, national origin, sex, or handicap.

Trade or brand names mentioned in this text are supplied with the understanding that no discrimination or endorsement by the Ohio Agricultural Education Curriculum Materials Service is implied or intended.

CONTENTS

Chapter		Chapter	
1	Introduction	17	Living Plant Groupings
Color Plate I		18	Novelty Arrangements
2	Elements of Design	19	Special Occasions and Holidays
3	Principles of Design	20	Period Arrangements
4	Cut Flowers and Foliage	21	Contemporary Arrangements
5	Mechanics, Supplies, and Safety	22	The Retail Floriculture Industry
6	Body Flowers	23	Sales and Service
7	Bud Vases and Rose Bowls	24	Wrapping and Packaging Floral Products
8	Decorating Potted Plants	25	Pricing Floral Products
Color Plate II		26	Organization and Efficiency
9	Mass Arrangements	27	Store Displays
10	Line and Line-Mass Arrangements	Color Plate IV	
11	Accessories, Bases and Backgrounds	28	Conditioning and Storing Cut Flowers
12	Dried Flowers	29	Care of Living Plants
13	Silk and Other Permanent Flowers	30	Delivery
14	Table Settings	31	Advertising and Promotion
15	Wedding Floral Design	32	Keeping Current with the Industry
Color Plate III		References	
16	Sympathy Flowers		

Preface

This book is designed to survey the area of retail floriculture and make a current statement of the industry. The subject matter includes an interesting blend of art, science and business. Time tested principles of flower arranging are explained and applied in exercises that will enable the beginning designer to comprehend them. Identification of floral material and supplies commonly found in flower shops is clearly made with illustrations. Information on care and handling as well as suggestions for selling flowers is treated with a straight-forward approach that can be understood by those preparing for a career in flower shops.

This book can be used in many ways and at different levels as individual situations require. A great deal of knowledge can be gained from the wealth of illustrations. For students pursuing an individualized study, clear directions starting at the ground level will allow them to build a working knowledge of retail floriculture. In the classroom the ideas can be reinforced, demonstrated and expanded upon by the instructor. For a former student of the subject or a flower shop employee needing a review, the book will serve as a valuable refresher tool and reference.

The book is intended to be motivational while presenting a realistic picture of arranging and selling flowers and plants. Suggested activities are located in each chapter to provide hands-on exercises that will provide the experience and practice necessary to master the concepts presented. It is hoped that all readers will be challenged to put forth a dedicated effort to expand their knowledge, express their creativity, strive for perfection, and develop an appreciation for the many ways flowers can be enjoyed.

Gary A. Anderson

Acknowledgments

A great number of individuals have generously contributed to the preparation of this book. The initial research to determine the need for a new retail floriculture manual was done by Mr. James Scott, now an area supervisor with the Ohio Department of Education. A statewide advisory committee was appointed to provide input for the project. Thanks is extended to the following committee members for their suggestions, support and review of the final draft.

Dr. Gary Anderson, OSU/ATI, Wooster
Mr. Jim Bлек, Westerville South HS, Westerville
Mr. Gene Houser, Eastland JVS, Groveport
Ms. Arlene Mercer, Natural Accents Florist, Marysville
Mr. Bob Niemeyer, Apollo JVS, Lima
Mr. James Scott, State Department of Education, Columbus
Mr. Dennis Waldman, Plain Local HS, North Canton
Ms. Karen Wellbaum, Montgomery County JVS, Clayton

The two-year project of preparing the book for publication was supervised by Dr. Roger Roediger, Director, Ohio Agricultural Education Curriculum Materials Service, The Ohio State University. Editing and layout was done by Muriel N. King, whose scholarly attention to detail and willingness to venture into the realm of graphic design resulted in this creative and exciting presentation. Special thanks to my wife, Cheryl Anderson, who spent countless hours helping to write and type the original manuscript. She also shared her artistic talent in rendering all the drawings included in this book. Color Plate I-1 and the cover design were done by Ail the King's Men.

Appreciation is extended to all individuals, organizations and businesses who in any way contributed to the arrangements, settings and photography involved. A wide variety of styles is presented ranging from very traditional to contemporary so that the reader will gain an appreciation of the diversity of the art. I have tried to take the student into the work room, the office and the sales area of a retail flower shop. Some arrangements are shown as they would be used in the home and public places. Hopefully a total picture is created which captures the scope of the retail floriculture industry and entices interested individuals to pursue this rewarding career opportunity.

Nearly all the pictures in this book were taken during the preparation of the manuscript with the purpose of illustrating the major points being presented. A number of opportunities for photographing the work of outstanding nationally known designers became available through the professional programs offered by The Ohio Florists' Association. Other special situations for photography included a filming session by Smithers-Oasis at The Agricultural Technical Institute, the Ohio State Fair Professional Design Show, the ATI Flower and Bridal Show, the Cleveland Home and Flower Show, and flower shows at the Garden Center of Greater Cleveland and Kingwood Center, Mansfield.

Recognition is given to the following businesses in Ohio where photographs were taken.

Alexander's Flowers	Cleveland
Architectural Greenery	Akron
Boulevard Gardens	Portsmouth
The Bouquet Shop	Wooster
Buehler's Flower Shop	Wooster
Corn-patt-ibles	Wooster
Connell's Flowers	Columbus
De Santis Florist and Gift	Columbus
Don Johnson Flowers and Gifts	Lima
Engel's Wholesale Florist	Columbus
The Flower Garden	Portsmouth
The Flower Gazebo	Findlay
Flowers by Davids Square	Columbus
Hemmerly's	Marion
John Anderson Florist	Canton
Kiefer's Floral	Coshocton
Maple Lee Flowers	Worthington
Murray Funeral Home	Lodi
Parkhurst's Flower Gallery	Medina
Schley's Greenhouse	West Salem
United Wholesale Florist	Canton

Special thanks to the following designers whose artistic arrangement of materials is represented in this book.

Marie Ackerman, AIFD	Oklahoma City, OK
Allen Beck, AIFD	Newport Beach, CA
Jim Blied	Columbus, OH
James Bridenbaugh,	Kent, OH
AAF, PFCI	
Noreen Drake	Columbus, OH
Diana Ferich, AIFD	Columbus, OH
Hitomi Gilliam, AIFD	British Columbia, CN
David Hale	Columbus, OH
Els Hazenberg	The Netherlands
Jacqueline Headecker	Ontario, CN
Roger Houseman	Columbus, OH
Don Johnson, AIFD	Lima, OH
Connie Lyon, AIFD	Findlay, OH
Keith Mueller, AIFD	Cincinnati, OH
Teresa Paniello	Wooster, OH
Alan Parkhurst, AIFD	Medina, OH
C. Michael Polychrones,	Springfield, VA
AAF, AIFD, PFCI	
Jerry Prokuski	Mendota, IL
Roger Roe	Dayton, OH
Rosemarie Schweitzer	Dover, OH
Julia Smetzer	Columbus, OH
Joseph Smith, AIFD	Nashville, TN
Perry Walston, AIFD	Houston, TX
Robert Wietholter	Bluffton, IN
Julie Wilkinson,	Minneapolis, MN
AIFD, PFCI	

Additional thanks to the following individuals who have contributed in special ways.

Agricultural Technical Institute personnel-Teresa Paniello,
 Robert McMahon, Kenneth Cochran, Ladonna Whitt,
 Dan Snyder, Beverly Winner
 Mr. and Mrs. Kenneth Cochran
 Mrs. Carol Correll
 Mrs. Mary Gresser
 Mr. and Mrs. Richard Kauffman
 Mr. and Mrs. Charles Lee
 Mrs. Lucille Parry

While many of the photographs were taken by the author, credit also goes to the following for their photographic contributions.

Dr. Thomas Bowman
Lora Yan Chen
Charles Correll
Malcom Emmons
Teresa Parello
Dr. Roger Roediger
Thomas Taylor

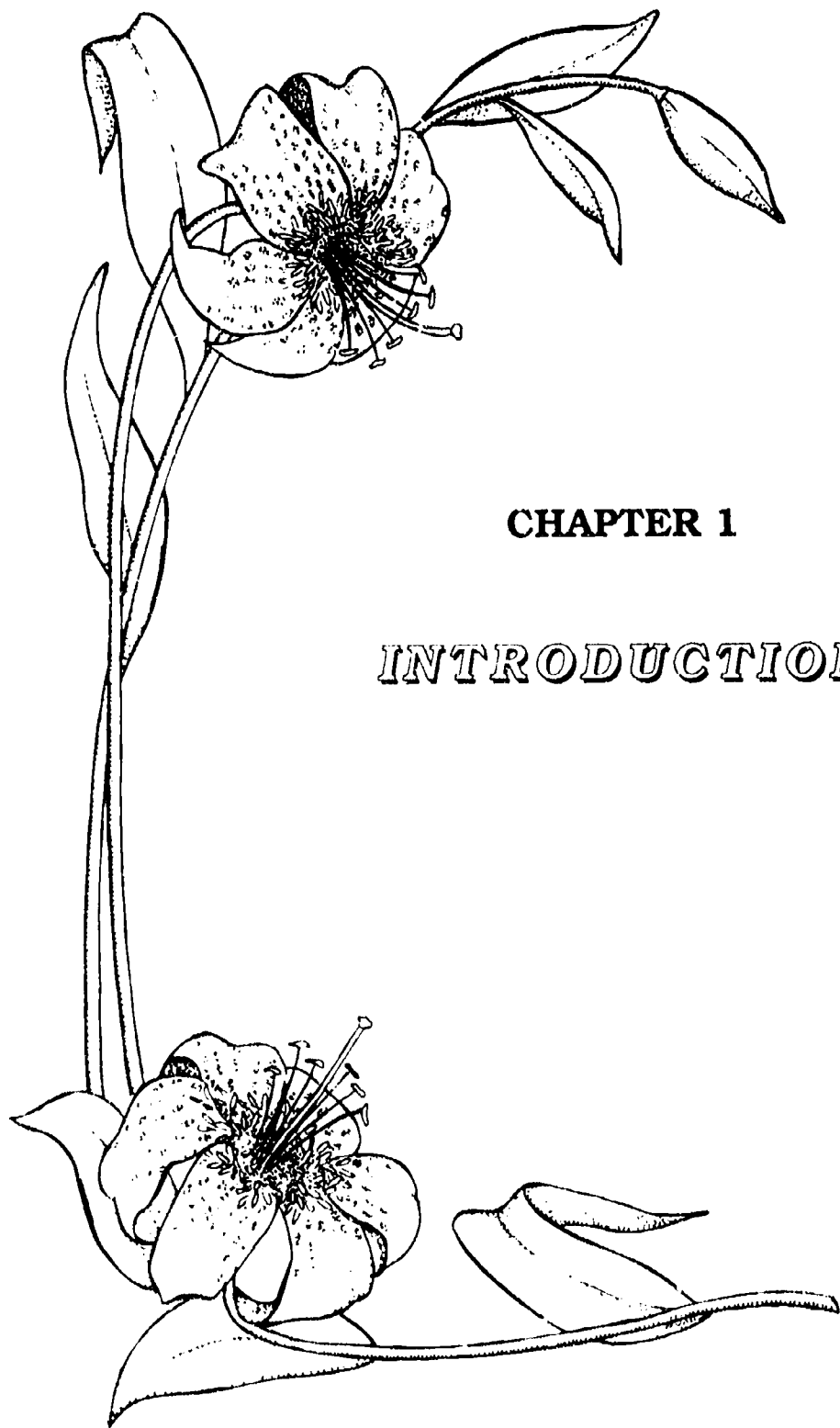
About the Author

Dr. Gary Anderson has taught floral design and marketing for over 20 years. Currently he is chairman of the Horticultural Industries Division at The Ohio State University's Agricultural Technical Institute in Wooster.

He graduated Phi Beta Kappa from the University of Michigan and holds both M.S. and Ph.D. degrees in horticulture from Michigan State University. He has lectured widely in the area of floral design, written for several state and national publications, and designed for numerous university and civic functions. Dr. Anderson has won several *Best of Show* awards in flower shows and judged many competitions including the Ohio State Fair Professional Design Show, the Ohio Florist Short Course Design Contest, National Junior Horticultural Association State and National demonstrations, FTD regional America's Cup contest, and the Cleveland Home and Flower Show. Also he was awarded the Ohio State Honorary FFA Degree.

Dr. Anderson is an advisor and advisory board member for the Ohio Junior Horticultural Association and member of the Ohio Florists' Association retail short course committee, decorations committee and education committee. He is chairman of the annual Spring Garden Preview presented by students of the Agricultural Technical Institute. He also established the Ohio State University/Agricultural Technical Institute Student Chapter of FTD and the widely acclaimed ATI Flower and Bridal Show.

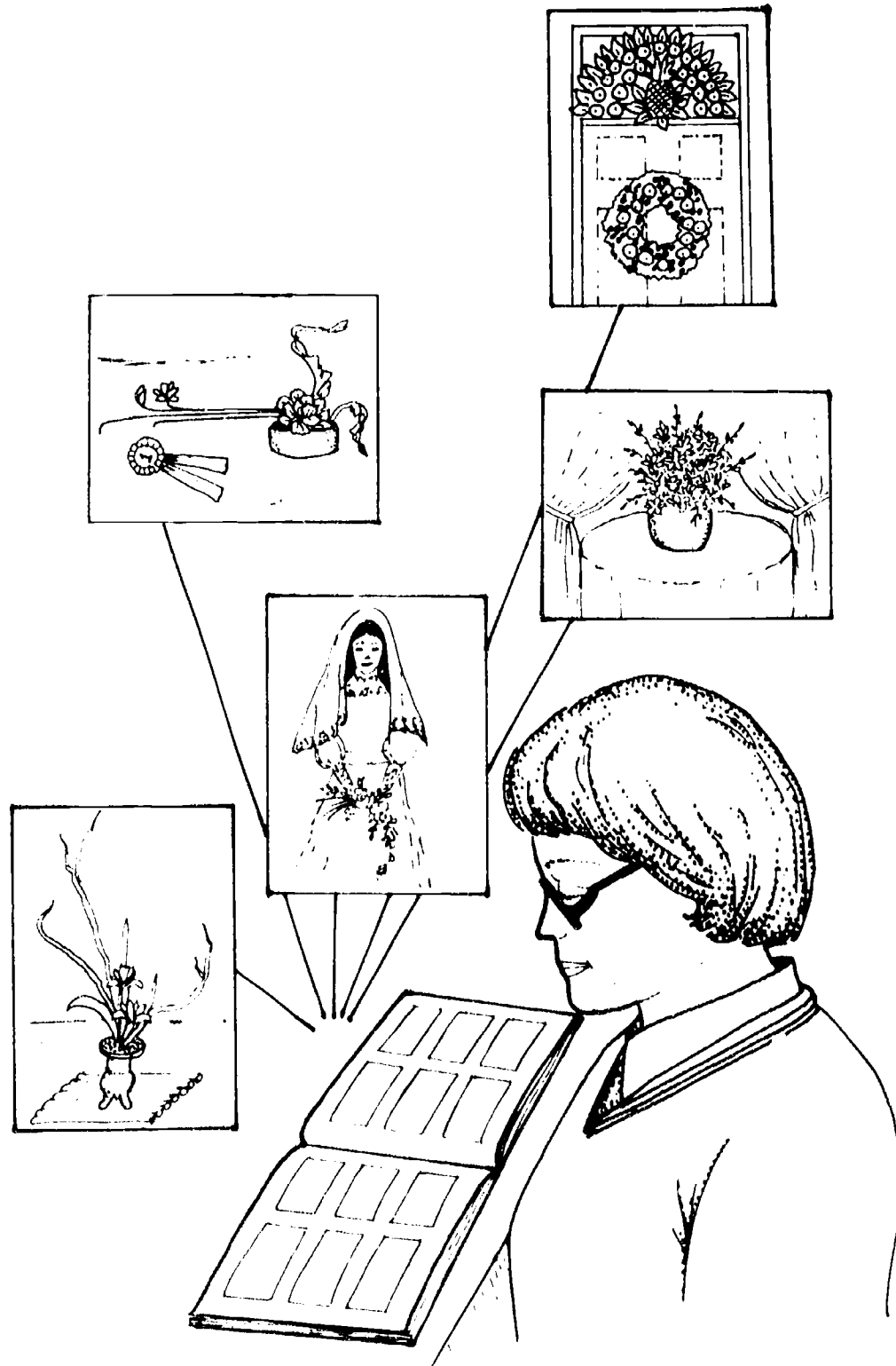
Dr. Anderson is a member of the American Society for Horticultural Science, the American Horticultural Society and the Ohio Florist Association. He has traveled in Europe, South America and the Caribbean as well as in Canada, Mexico and the U.S. He has given many programs for garden clubs, written a chapter for *Exhibitors and Judges Handbook* of The Ohio Association of Garden Clubs, and taught study courses for The Garden Club of Ohio.



CHAPTER 1

INTRODUCTION





Ideas about flower arranging come from personal observations of flowers

DISCOVERING YOUR CONCEPTS OF FLORAL DESIGN

Every field of endeavor has its starting point. As you embark on your study of floral design and marketing, you begin with a set of uniquely personal ideas about design based on your background and experiences up to now. These ideas are not static, but will change over time as you become more aware of what to look for in floral designs and gain more practical skill in arranging flowers. If you are motivated to become a skilled designer, and if you are willing to practice, the reward can be an ever-increasing ability to express yourself artistically and creatively with flowers.

Let's think about what may have influenced your ideas on flower arranging. Where have you seen flowers used? What bouquet or arrangement do you remember that especially impressed you?

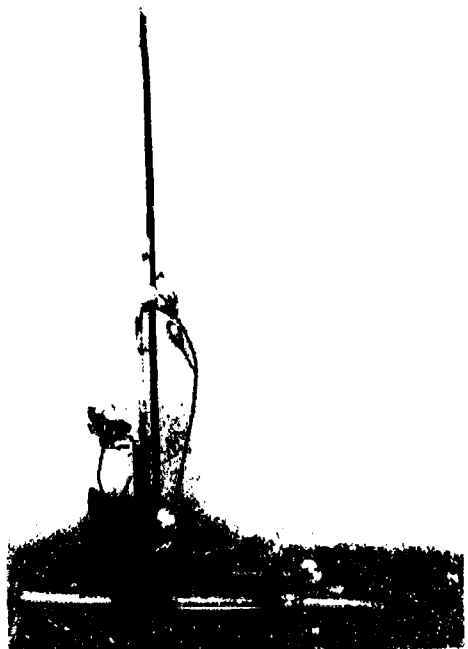
SUGGESTED STUDENT ACTIVITY

Write down at least five situations in which you remember seeing flowers used. After each, write briefly what your reaction was to these flowers. Share these thoughts with the other students as your teacher leads the discussion.

Do you find that different class members react in different ways to flowers in the same situation? Do you find that some people remember seeing many more flowers than others do?



THE TRADITIONAL LOOK



THE ORIENTAL LOOK





THE CONTEMPORARY LOOK

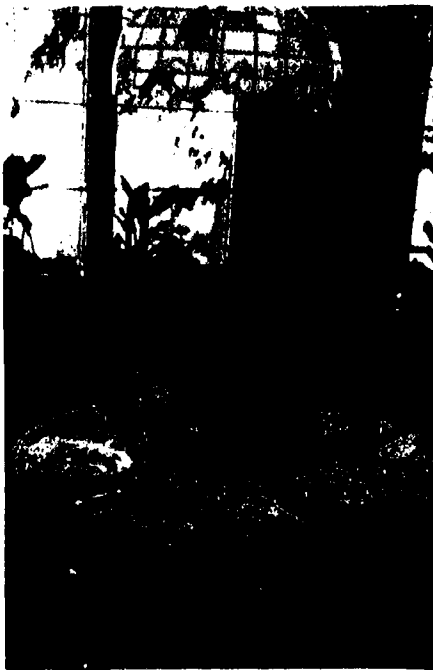
Just like you, customers who buy and use flowers will have preconceived ideas about them, based on their different experiences. They may be shopping for floral products that are not the same as those you would buy. Therefore, people who arrange and sell flowers for others must be sensitive to the preferences of the customers. Even though many customers have no more formal training in floral design than you have today, they still have ideas about what they will or won't buy. Flower shops both large and small must keep in mind customer wishes as well as their own concepts of design.

Let's continue to explore the factors that may have influenced your personal concepts of floral design. Here is a list of some specific examples of places and occasions where flowers may be seen. How many of these can you relate to? How do you think the flowers you saw in these situations have affected your ideas on flower arranging? (See Color Plate II-1.)

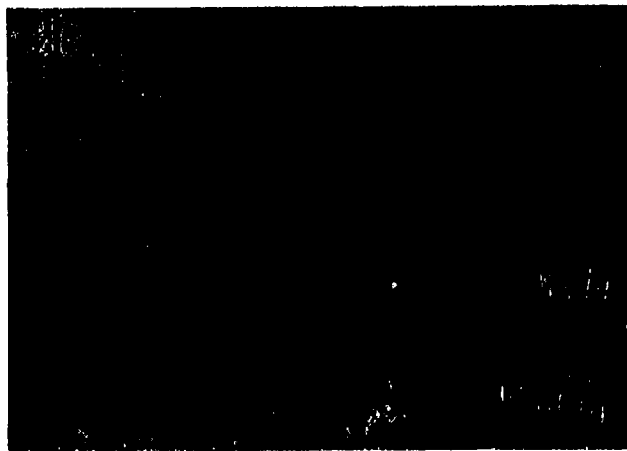
Flowers Used In the Home

At Home

* centerpiece for a special dinner



On the table



On the mantel



On the piano

- * dried arrangement on the fireplace mantel
- * simple vase of garden flowers on end table or desk
- * crock filled with field flowers or interesting weeds on a porch table
- * Christmas wreath or swag on the door
- * florist arrangement delivered for a special occasion like a birthday party, anniversary or holiday
- * small bouquet or loose bunch of flowers brought home "just to show I care"

At Church

- * weekly flowers on the altar
- * lavish flower arrangements, bouquets and candelabras for a wedding
- * sympathy flowers for a funeral

At Parties

- * corsages and clutch bouquets at a dance or prom
- * a dozen long-stemmed roses given to an honored guest
- * candle centerpieces at individual small tables, or floral pieces on a buffet table or near the punch bowl
- * creative suspended arrangement from the ceiling, or floating arrangement in the swimming pool at a lavish party

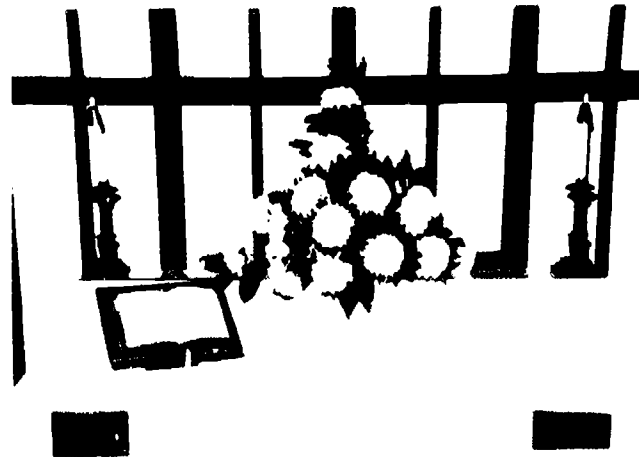
Church Flowers



Cross decorated at Easter



Wedding Flowers



Weekly altar flowers



Party Flowers - At a tea

Party Flowers



Birthday party



Reception



Flowers in
Public Buildings



In the Hospital

- * planter, bud vase or potted plant for adult patient
- * chrysanthemum clown or poodle dog or animal planter for a sick child
- * arrangements in the hospital's gift shop

In the Media

- * advertisement on television for a special bouquet being promoted by a florist wire service organization
- * spectacular show of flowers used on floats in the Tournament of Roses Parade
- * tasteful placement of flowers on a conference table in a magazine picture showing some current event
- * wedding flowers described or pictured in newspaper articles, bride's magazines or television shows

At Businesses

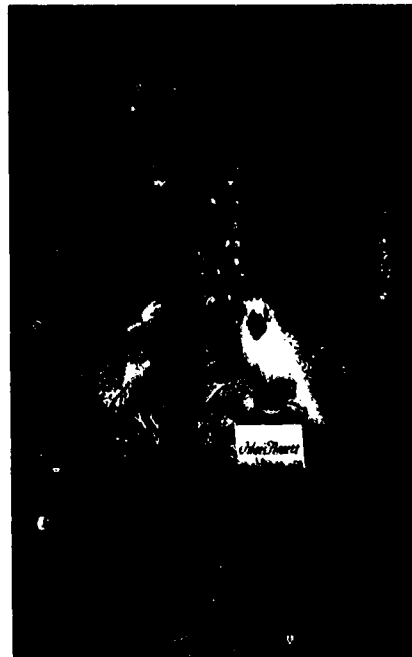
- * creative seasonal window display at your area florist
- * arrangement sent to the grand opening of a bank, restaurant or store
- * silk or dried arrangements in a furniture store or interior design studio
- * holiday corsages in the grocery produce section

At Flower Shows

- * large Victorian mass arrangement entered in a state or local fair
- * modern-looking interpretive arrangements at a fair flower show or show sponsored by a local garden club
- * display of creative arrangements by florists at a large city home and flower show
- * new European designs described by a floral commentator at a professional design show



Flower Shops



Flower Shows



Cut off one-third block of soaked floral foam.



Use water-proof tape to secure floral foam to container.

SUGGESTED STUDENT ACTIVITY

To demonstrate that your concept of design is based on past experiences and may be different from that of other class members, work entirely on your own to create an arrangement that is pleasing to you. Use the containers and flowers provided by your instructor.

Materials suggested for each student:

design compote
 1/3 block floral foam
 narrow waterproof tape
 knife
 1/2 bunch pompon mums
 1/4 bunch leatherleaf
 1/6 bunch purple statice
 or assortment of available flowers
 and foliage

Your instructor will have soaked the floral foam in water and will demonstrate how to cut it, place it in the container, and secure it with the waterproof tape. You will also be advised on proper and safe use of the knife.

Working independently, create an arrangement of your choice. If an assortment of materials is available, or if you are allowed to cut from a garden or field area, select those flowers and foliages which you feel look good together and with the container you are using. As you work on your arrangement, start thinking about what occasion it could be used for and where it might be placed. Think about the choices you had in the selection of flowers and their placement in the arrangement. Why did you make the choices you did?

After all arrangements are completed, contribute to a class discussion by explaining to the other students what is especially pleasing to you about the arrangement you designed, and where you think your arrangement might be used. Don't feel shy or intimidated! Today there is no "right" or "wrong." You are discovering your own personal concepts of design; just like the customer in a flower shop, you are entitled to your own opinion.

**SUGGESTED
INSTRUCTOR ACTIVITY**

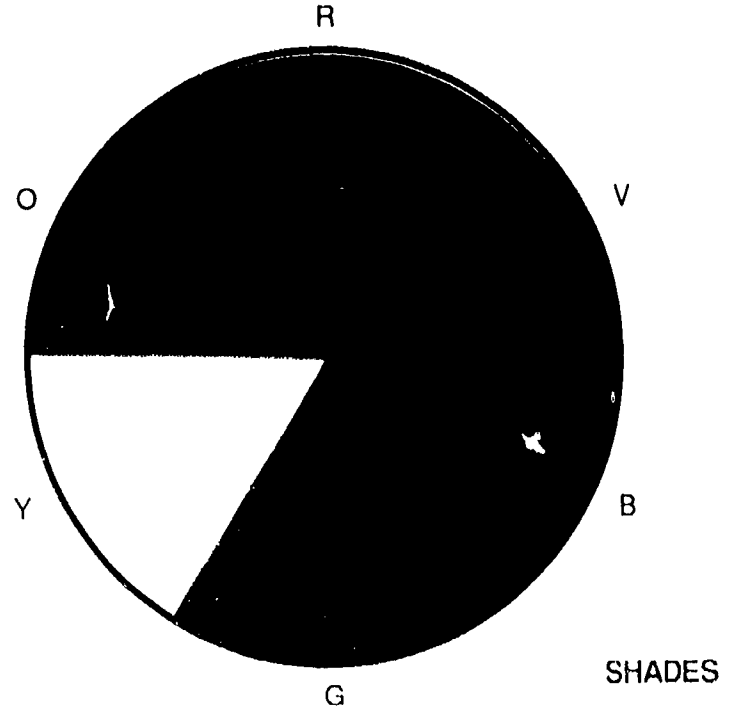
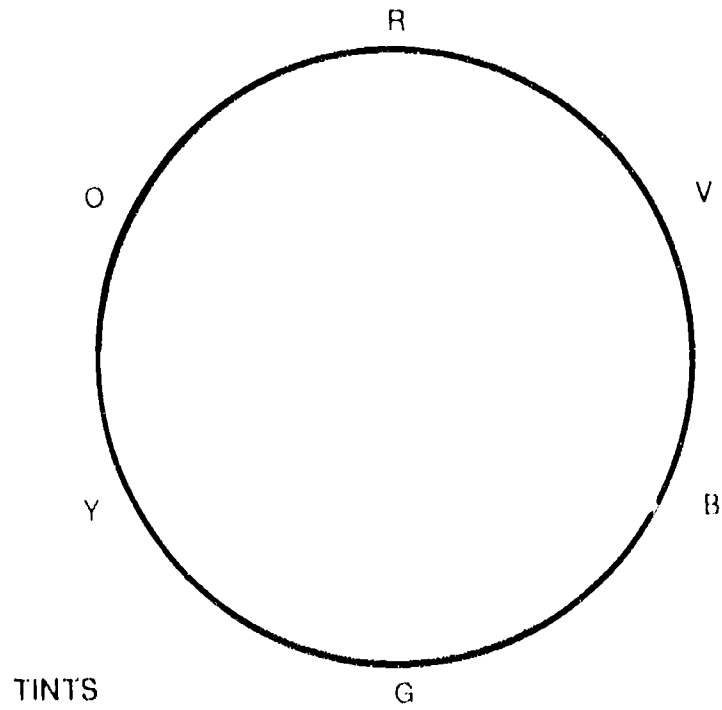
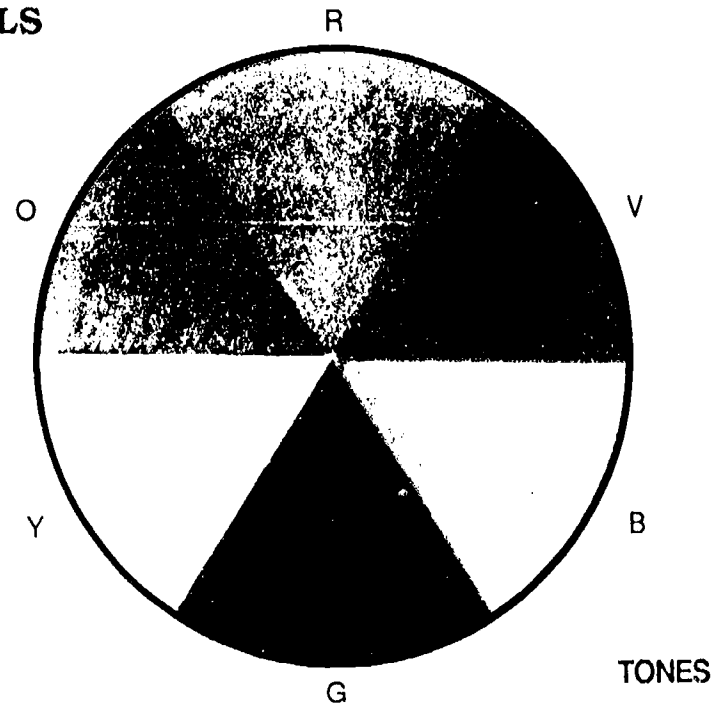
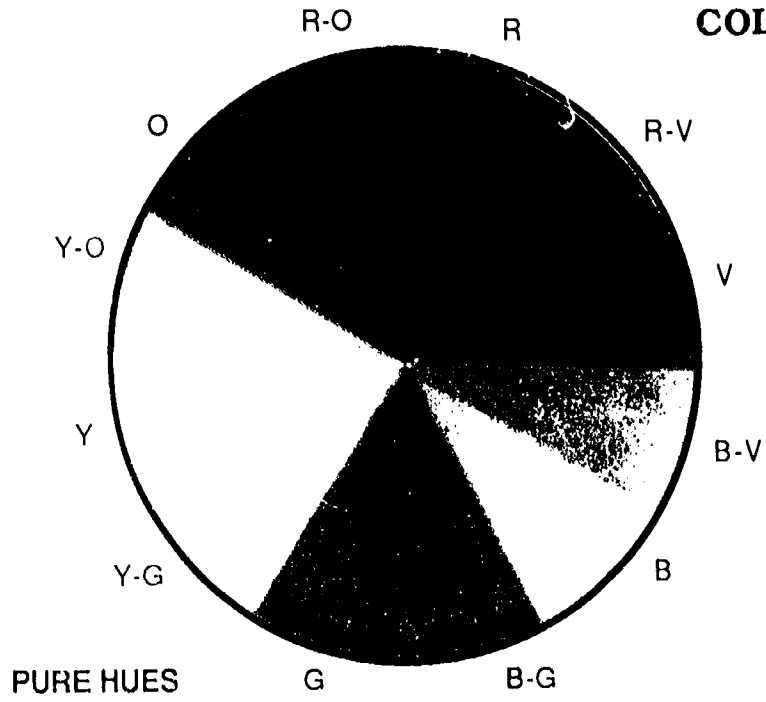
An interesting exercise that can be a useful educational tool later in the year is to photograph all the students with their first flower arrangements, preferably using print film. Have the film developed, but do not share the pictures until the end of the semester or school year.

After a skill is mastered, most people tend to forget the level at which they started. They believe they were always as skillful and knowledgeable at the beginning as they are later, so they may miss some of the benefits of recognizing that progress was made. Showing the students the pictures later on helps them see the progress that each made during the class. They feel rewarded for the effort they put into it.



Students proudly show their first arrangement of the class

COLOR WHEELS



TYPES OF ARRANGEMENTS



Line-Mass



Mass

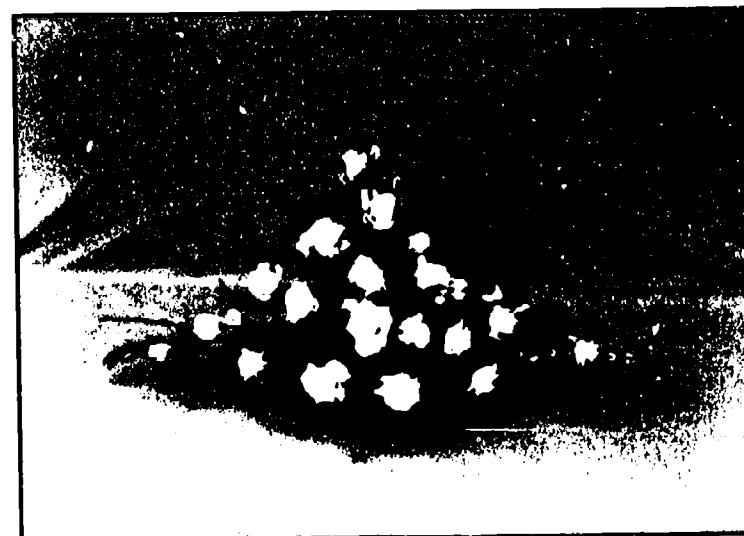


Line

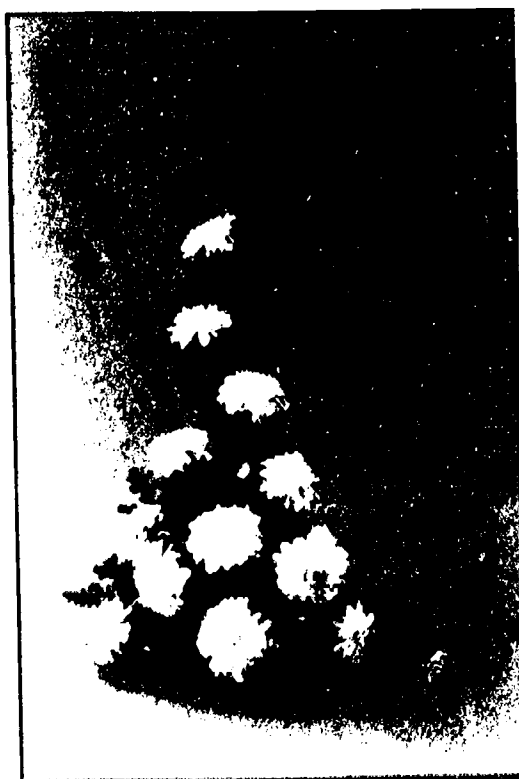


Equilateral

TRIANGLE VARIATIONS



Diamond



Right



Isosceles



Scalene

CIRCLE VARIATIONS



**Fan of roses, dendrobium orchids, freesia
and Dutch irises**



Oval of cherry blossoms



Open mound of spring flowers in a basket



Circular mound

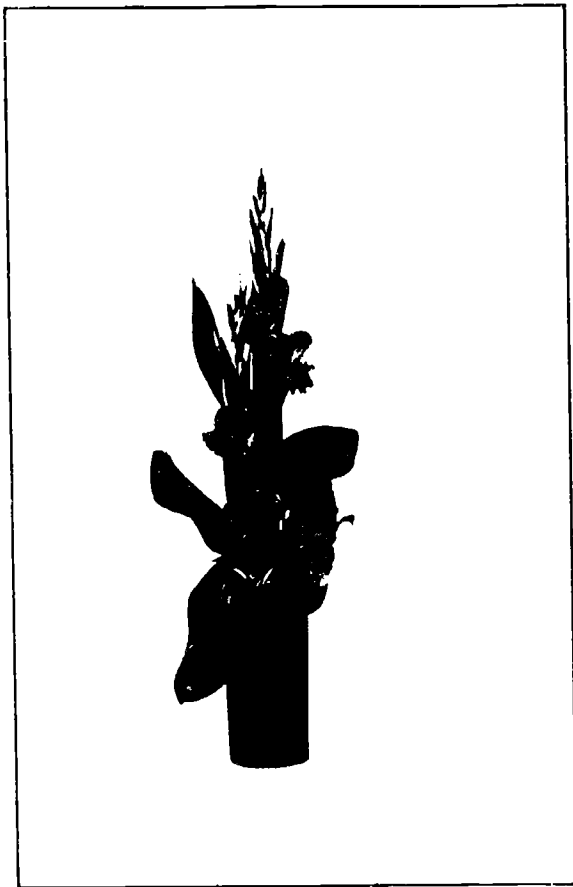


Diagonal line of bougainvillea

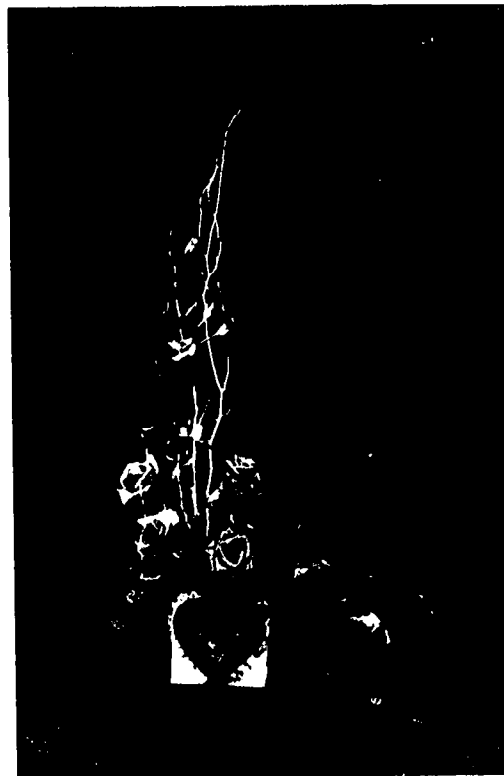


Horizontal line of lilies, carnations and kalanchoes

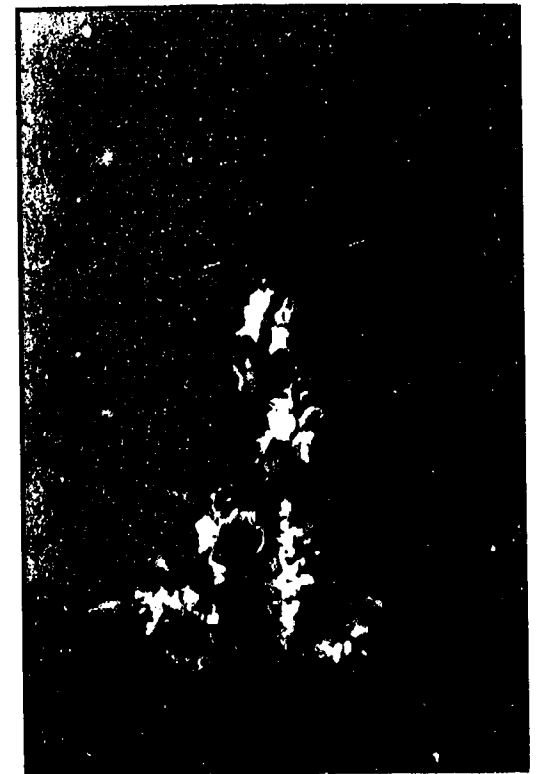
**STRAIGHT LINE
VARIATIONS**



Vertical line of gladioli and anthurium foliage



L-pattern of roses, freesia and
painted branches



Inverted-T of roses and snapdragons

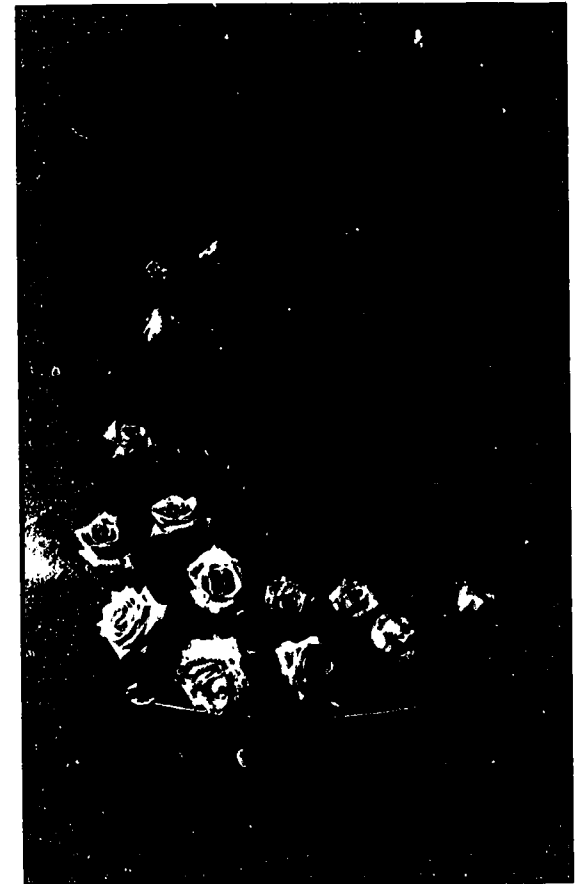
CURVED LINE VARIATIONS



Spiral of magnolia around a figurine



Hogarth curve of roses



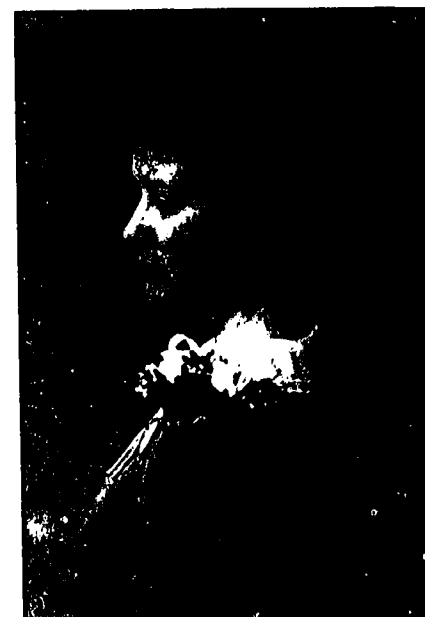
Crescent of roses



Shoulder corsage - Double spray



Hair flowers



Shoulder corsage - Single spray



Shoulder corsage - Potpourri

BODY FLOWERS



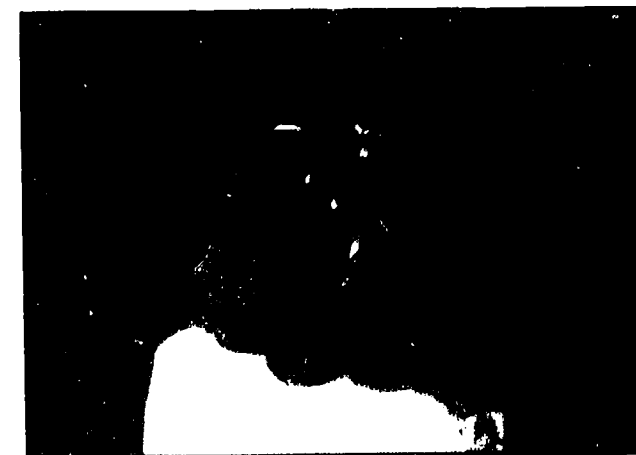
Waist flowers



Hair flowers - Stephanotis and dendrobium



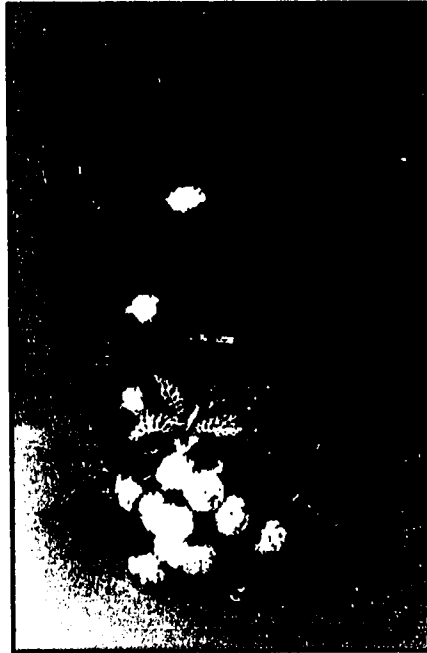
Ankle flowers



Hair flowers with ribbon



Bear



Baseball mitt



Rabbit



Bronze figurine

ACCESSORIES



Classical figurine



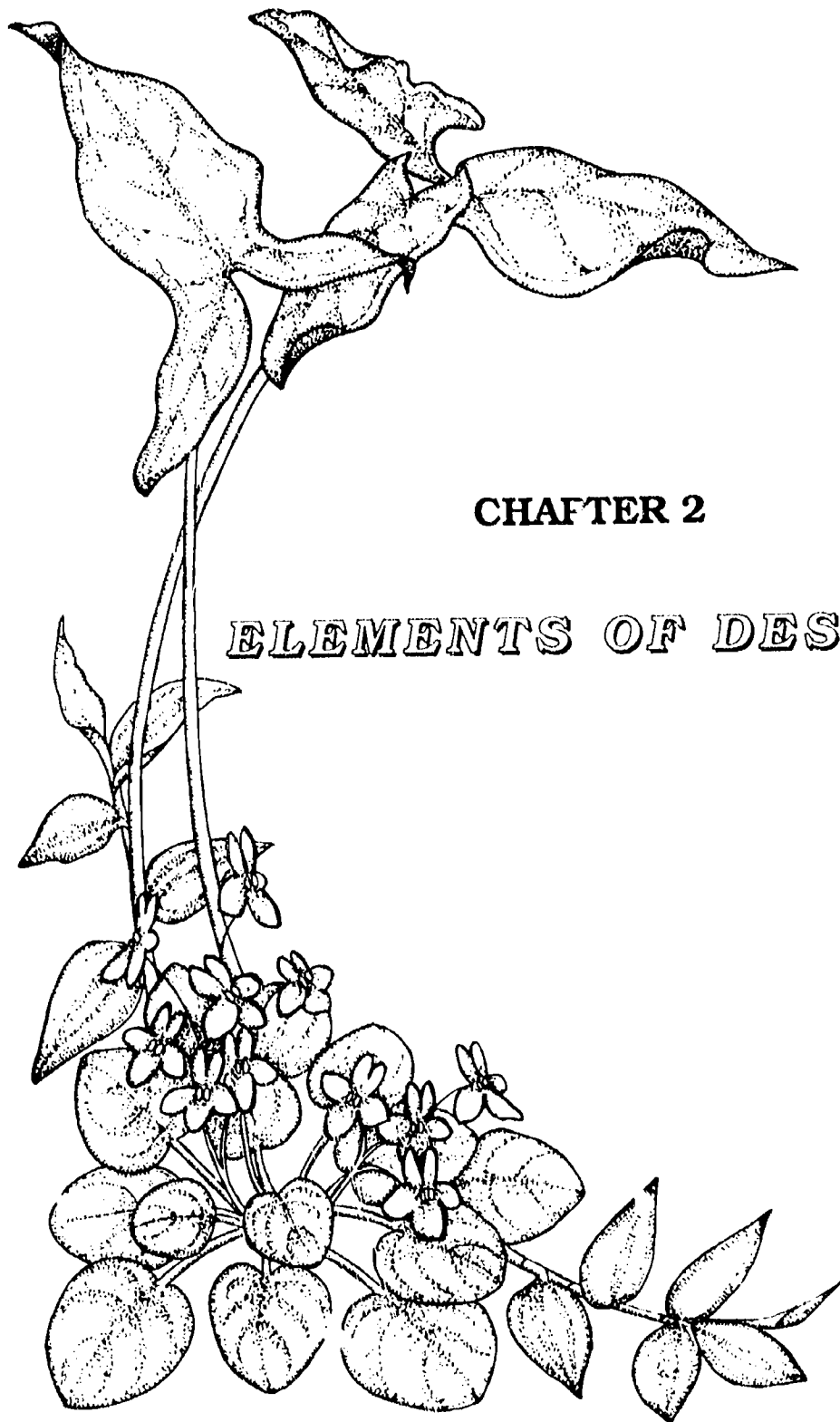
German statue



Madonna



Rabbit and nest



CHAPTER 2

ELEMENTS OF DESIGN



Diana Ferich, AIFD, consults AFS color wheel

INTRODUCTION

An arrangement of flowers makes an artistic statement to the viewer. It is assumed that the person arranging the flowers either had a plan in mind at the start of the arrangement or experimented as he or she went along until satisfied with the results. Although not all people react in the same way to a certain arrangement, there are standards of expectation that have developed over the years - standards by which arrangements are evaluated. Since flower arranging is an art form, many of these ideas have been taken from other media like painting and sculpture.

Persons not trained in floral design or other art principles are still influenced by them. They often form ideas about new designs they see based on comparison with traditional designs that have endured the test of time, or by comparison with modern designs that others have judged successful. The person who is aware of the parts of an arrangement and can analyze what makes it successful is better able to absorb new ideas from what he or she sees and eventually incorporate these ideas more effectively into his or her own work.

At times the number of terms used to identify various aspects of design seems unnecessarily large. Furthermore, these terms often overlap in meaning. Moving a flower an inch or two to the left in a design may affect several elements or principles of the design!

If you were to review several books and articles on floral design, you would find that the different authors use their own set of

terms and definitions. In spite of this the concepts are very similar. The following presentation is an attempt to combine and simplify these thoughts from the perspective of an observer of floral designs.

SHAPE

One of the first things you notice about a flower arrangement is its shape (Fig. 2-1). The outline of the design is called its **silhouette**. If you were to shine a bright light directly on an arrangement from the front, it would cast a shadow. This would be the silhouette. It might be in the shape of a triangle or a circle, or it might reveal a number of curving lines with blank space between.

This suggests that two very different types of arrangements exist. They originated in different parts of the world and very strongly influence design styles today. One type is the line arrangement (Fig. 2-2) and the other is the mass arrangement (Fig. 2-3). (See Color Plate 1-2.)



Figure 2-1 Line mass arrangement.
A Hogarth curve with
an S-shaped silhouette



Figure 2-2 Line arrangement
with interesting silhouette



Figure 2-3
Mass arrangement with oval silhouette

LINE ARRANGEMENTS

The line arrangement usually uses few flowers and foliage. There are also quite a few empty spaces, or **voids**, between the materials. Often the flowers have interesting shapes. Also, the branches or foliage that connects them attracts attention because of its unusual curves (Fig. 2-4) or dramatic straight lines (Fig. 2-2, 2-5). Because the eye of the viewer is led along these interesting lines, the arrangements are called *line arrangements*.

One usually thinks of Oriental style arrangements as a good example of line arrangements (Fig. 2-6). In Japanese flower arranging, which has been practiced for over 1500 years, the emphasis is on careful use of only a few flowers. Each flower in the design has a special meaning. A general term for Japanese flower arranging is **Ikebana**.

During the twentieth century, the oriental concepts of flower arranging began to influence design styles in the United States and other parts of the world. Many modern arrangements are line designs. Exotic or very special flowers are most effectively featured in a design with much open space. Birds of paradise, proteas and orchids are good examples of such flowers. This type of design directs more attention to the individual flowers. In addition to using few flowers, there is often less time involved in making this kind of design because there are fewer placements. However, since line arrangements often express a high degree of creativity, there may be more time involved in planning the design and more skill required to execute it successfully. (See Color Plate I-5.)

MASS ARRANGEMENTS

Mass arrangements contain many flowers and/or foliage. They may be one-sided or designed to be viewed from all sides. Very compact or very loose and open styles may be seen in this type of design. Many different kinds of flowers or perhaps just one kind of flower may be used (Fig. 2-7).

If you were to shine a light on a mass arrangement, you would expect to see a silhouette that resembles some geometric shape with few voids. These would be most commonly recognized as some variation of the triangle (Fig. 2-8) or the circle (Fig. 2-9). (See Color Plates I-3 and I-4.)



Figure 2-7
A large mass arrangement of ranunculus.

LINE ARRANGEMENTS



Figure 2-4
Curved lines of peeled root encircle hydrangea blossoms



Figure 2-5
Papyrus and lilies forming a strong vertical line



Figure 2-6
Fantail willows with daffodils in an Oriental design

MASS ARRANGEMENTS



Figure 2-9
Round mound bouquet of
mixed flowers



Figure 2-8
Mass scalene triangle of iris



Figure 2-12 Right triangle



Figure 2-13
Scalene triangle

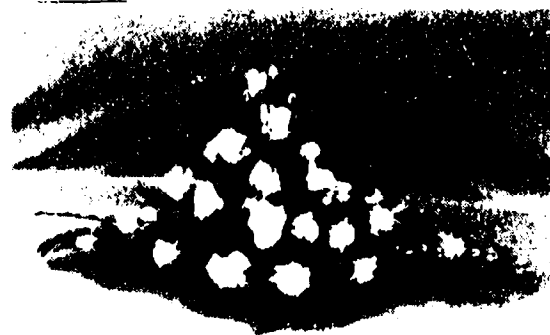


Figure 2-14 Diamond

TRIANGLE VARIATIONS



Figure 2-10
Equilateral triangle



Figure 2-11
Isosceles triangle

Triangle variations include the *equilateral triangle* (all sides equal - Fig. 2-10), the *isosceles triangle* (two sides equal but longer than the third side - Fig. 2-11), the *right triangle* (two sides forming a 90° angle - Fig. 2-12), the *scalene triangle* (each side of a different length - Fig. 2-8, 2-13), and the *diamond* (two triangles placed base to base - Fig. 2-14). The diamond is the silhouette created when you look directly down from above on a centerpiece suitable for use on a rectangular table. This is called the diamond centerpiece. In side view it looks like a low drawn-out triangle.

Circle variations include the *mound* (usually half or more of a globe form - Fig. 2-9, 2-15) and the *oval* (Fig. 2-16). The oval is often done in a raised container which suggests an elongation of the circle design into an oval shape. However, it may also be seen when looking directly down on a centerpiece designed for an oval table or looking down on an arrangement made in an oval basket.

Arrangements that were made in Europe over the past 500 or more years are now called **Period Arrangements** because they are typical of what was done with flowers in a certain period of history. Arrangements that suggest historical periods before 1900, whether done in Europe or the United States, were essentially all mass arrangements. Design styles such as Dutch, French, Georgian, Williamsburg and Victorian are often lumped together in a category called **Occidental (Western) Design** (Fig. 2-17). The counterpart of this is **Oriental Design** (Fig. 2-6, 2-18) that features a line style and originated in Japan and China. We will examine period designs of both Oriental and Occidental styles in Chapter 20.

CIRCLE VARIATIONS



Figure 2-15 Mound



Figure 2-16 Oval

OCCIDENTAL & ORIENTAL DESIGNS



Figure 2-17 Occidental



Figure 2-18 Oriental

LINE-MASS ARRANGEMENTS



Flowing line of spring blossoms



Roses enhance lines of the driftwood



Amaryllis at the base of the straight-line pussywillow

LINE-MASS VARIATIONS

Based on Straight Lines



Figure 2-19 Vertical



Figure 2-20 Diagonal



Figure 2-21 L-shaped

LINE-MASS ARRANGEMENTS

(See Color Plate I-2)

Another group of designs is known as line-mass arrangements. These have combined characteristics of the line and the mass styles. There is a definite line which is thickened or massed in with flowers and foliage. Few voids are found within the silhouette. The lines may gracefully taper off to a delicate point on each end. As in a mass arrangement, the flowers may be compactly or loosely spaced within the outline of the design.

Line-mass arrangements which are based on straight lines include the *vertical* (Fig. 2-19), the *diagonal* (Fig. 2-20), the *L-shaped* (Fig. 2-21), and the *inverted-T* (Fig. 2-22) arrangements. Line-mass arrangements based on curved lines are the *crescent* (Fig. 2-23) and the *S-curve* or *Hogarth curve* (Fig. 2-24). (See Color Plate I-6.)

The merging of line (Oriental) and mass (Occidental) design concepts occurred in the first part of the twentieth century. This happened primarily in the United States and resulted in the line-mass design style which is considered by many to be typically American. Since there are no definite boundaries between line, mass and line-mass design styles, it is possible to create or see designs which are difficult to put into one of these three categories. It is more important to evaluate these arrangements on their own merits than to be overly concerned about fitting them into arbitrary categories.



Figure 2-22 Inverted-T

Based on Curved Lines



Figure 2-23 Crescent

Figure 2-24 S-curve
(Hogarth curve)

COLOR

Almost everyone agrees that color is the single most important element in a flower arrangement. People react differently to color because of individual preferences and past experiences in seeing different color schemes. Their like or dislike for a particular arrangement is often based largely on color. All people do not see color in the same way. This may be due to actual physical differences in color perception between viewers. Also background colors near the arrangement may influence people in different ways. (See Color Plate II-8.)

Colors of flowers are related to their surface quality (texture). In addition, colors are affected by the lighting conditions under which the flowers are seen. Therefore, following this discussion of color will be a discussion of the effects of texture and light.

PSYCHOLOGY OF COLOR

Colors are symbolic because we associate them with objects and events with which we are familiar. Colors may appear warm or cold, exciting or restful, happy or somber. Colors may even appear to move toward you (advance), move away from you (recede), or stay put (stable). This may sound strange, but interior decorators have long recognized this in selecting colors for a room. A large cement block classroom on the north side of a school may be painted yellow to make it seem smaller, warmer and more cozy. A small bedroom on the southwest corner of a home is often painted light blue or green to make it appear more spacious. More conservative people are likely to select the safe,

stable colors of brown, beige and earth tones for much of their decor.

Color choices in clothing are another way we frequently express our feelings. Normally the colors we choose are dictated by fashion and our individual taste. However, special circumstances may alter these colors. Compare what you would choose to wear to a funeral with what you would wear to a Hawaiian luau. Also, contrast those people you know who tend to be daring in their choice of clothing colors with those who seldom deviate from traditional color combinations.

SUGGESTED ACTIVITY

Write down the feelings you have when you see each of the following colors. What things or occasions do you associate with each color? Do you think the color advances or recedes? Do you consider it a warm or a cool color?

RED	VIOLET
ORANGE	BLACK
YELLOW	WHITE
BLUE	GRAY
GREEN	BROWN

Share your ideas in a group discussion. Then read the following paragraphs to see if your conclusions agree with those usually associated with the color.

COLOR VARIATIONS

RED
 Brick
 Burgundy
 Cardinal
 Carmine
 Claret
 Maroon
 Pink
 Rose
 Scarlet
 Strawberry

ORANGE
 Apricot
 Bittersweet
 Cameo
 Coral
 Fawn
 Flesh
 Peach
 Salmon
 Shrimp
 Terra Cotta

YELLOW
 Amber
 Buff
 Buttercup
 Gold
 Lemon
 Maize
 Mustard
 Primrose
 Straw
 Sulphur

BLUE
 Aqua
 Azure
 Cobalt
 Cornflower
 Gentian
 Marine
 Navy
 Peacock
 Sky
 Turquoise

GREEN
 Avocado
 Emerald
 Forest
 Jade
 Lime
 Moss
 Olive
 Seafoam
 Shamrock
 Willow

Red***Advancing, Warm***

Examples of red objects are blood, the Valentine heart and the matador's cape. These all arouse strong emotions. Red is frequently used as a color choice in church carpeting because it is associated with the Holy Spirit and martyrs. However, it also helps to create a warmer feeling in an otherwise large and cold structure. Red is often used in restaurants because it is thought to stimulate the appetite. Red is used throughout the year in floral designs but is especially eye-catching in quantity at Christmas, Valentine's Day and the Fourth of July.

Orange***Advancing, Warm***

Orange is associated with the warmth of a crackling fire. It is most appreciated in nature in the brilliance of autumn foliage color. The Halloween pumpkin, clusters of bittersweet, and Thanksgiving squash and gourds all exhibit the color. Although orange is used most extensively in the autumn months, it is always a good companion color for the brownish earth-tone colors, which are brightened by the association.

Yellow***Advancing, Warm***

Yellow is a bright cheerful color associated with rays of sunlight. Yellow is the color of the spring daffodil and the newly hatched chick. It is widely used in spring arrangements and at Easter. Yellow is used as a wall color to make a large, stark room more hospitable since it "advances" toward the viewer. It is also a good choice for hospital arrangements intended to cheer the patient.

Blue***Receding, Cool***

Blue is the color of sky and water, both of which appear to go on endlessly. The tranquil quality of blue often makes it the choice for the interior color of churches, where it takes on a "heavenly" feeling. Blue is a color not heavily represented in common florist flowers available year round, though there are some good true blue flowers. Chrysanthemums, roses and snapdragons, for example, are not available in blue. Since blue is a widely selected clothing color, flowers are sometimes dyed or sprayed to produce the color. Blue can be used effectively with all other colors. Its use in a garden frequently gives unity to what would otherwise be a hodge-podge of colors.

Green***Receding, Cool***

Green is the color of trees, grass and rolling hills. These associations make it easy to understand why green is considered a receding color. Since foliage and stems are green, it is part of almost all arrangements. Usually green is not a strong color; it has the effect of tying the arrangement together. Green, a symbol of living things, is greatly appreciated during the drab months of winter in northern climates. It shows up in the Christmas tree and other holiday greens, where it is livened with red accents. One can hardly imagine interiors without the pleasing effect of green foliage plants. Green receives special attention on St. Patrick's Day, when an all-foliage arrangement can feature interesting variations of just this one color.

Violet***Receding, Cool***

Violet is usually thought of as a restful color because of its association with the last fading rays of light at dusk. It is often used in sympathy flowers. Violet also appears in many spring flowers like crocus. It also effectively combines with yellow in spring arrangements such as those made for Easter. Darker, more vibrant violet (purple) may be associated with elegance or royalty, especially when combined with gold.

Black***Stable, Neutral***

Black is associated with the darkness of night and the unknown. Black represents death and to many people is a funeral color. Halloween features black in cats, bats and witches. Nevertheless, black can be a very useful color in flower arranging. A black background, vase or accessory can often provide a striking contrast to a flower color. Black may be used for its heavy quality as a base to give stability in an arrangement. Black is often used in modern arrangements for its dramatic effect.

White***Stable, Cool***

White is usually associated with purity and innocence. It has many religious connotations and is widely used in weddings. Snow gives white its association with coolness. Although white can be used with all colors, it is a very strong color and must be given special attention. As lights dim in the evening and other colors fade, the last color to be seen is white.

Gray***Stable, Neutral***

Gray is a combination of white and black. The result is a very somber color. Gray is a widely used color choice in men's and women's clothing. There is considerable latitude in color choices to associate with gray. Gray is most frequently used in flower arranging to tone down the brilliance of other colors.

Brown***Stable, Warm***

Brown is an earthy color associated with soil and the somber November landscape. In flower arranging it is used widely in autumn arrangements. Many dried materials are available in browns and beiges. Brown is used throughout the year in interior decorating. It is a very "safe" color which can serve as a suitable background for many other colors. The heavier-appearing darker browns can be used in flower arrangements to give stability and depth to the design.

VIOLET
Amethyst
Grape
Lavender
Lilac
Magenta
Mauve
Mulberry
Plum
Purple
Wisteria

WHITE
Bone
Candlelight
Champagne
Cream
Ivory

BROWN
Chestnut
Cinnamon
Fawn
Mahogany
Russet

GRAY
Charcoal
Quaker
Silver
Slate
Steel

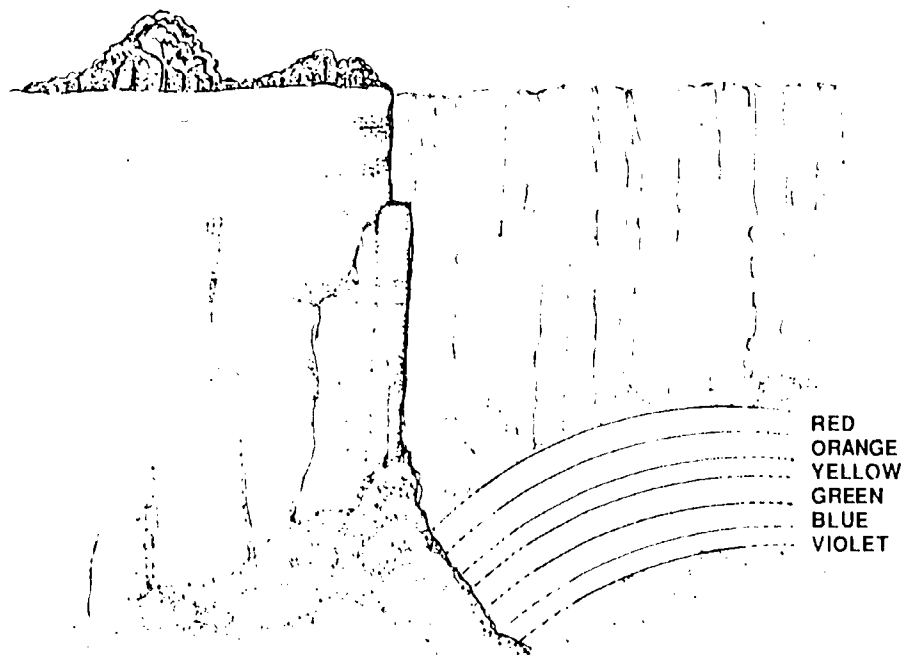


Figure 2-25 Rainbow

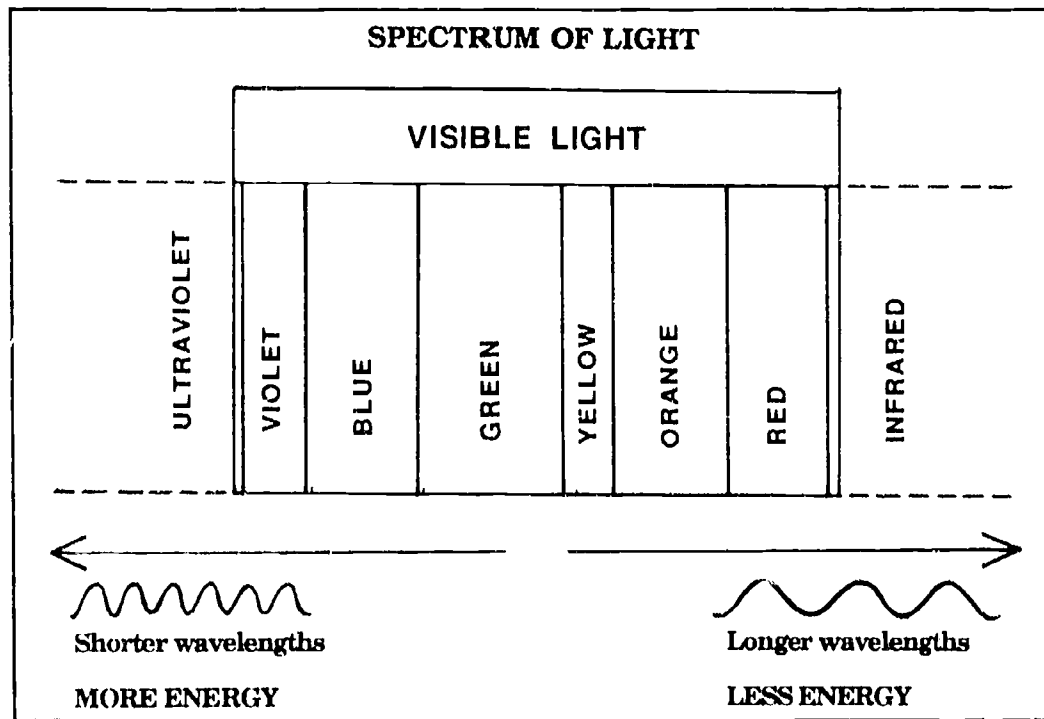


Figure 2-26 The visible light spectrum

SPECTRUM versus PIGMENT COLORS

If you hold a prism up to a window so that bright sunlight passes through it, a portion of a rainbow will appear. Just like a rainbow in the sky after a rain, the colors always appear in the following order: violet, blue, green, yellow, orange and red (Fig. 2-25). The reason for this phenomenon is that the clear light, sometimes called white light, coming from the sun (or even an artificial light source) is made up of wavelengths of light energy that include all these colors. See Figure 2-26. Clear light may also include other wavelengths of energy which the eye cannot see, like ultraviolet (which results in suntans) and infrared (associated with heat radiation). The wavelengths the eye can see make up the **visible light spectrum**. When clear light passes through the prism, the different wavelengths of light energy bend at different angles causing them to spread out into a rainbow (Fig. 2-27).

Knowledge of the visible light spectrum helps in understanding the color wheel as well as how flower arrangements look in different lighting situations. Both of these topics will be discussed later.

It is important in understanding color to learn about the **pigment theory** of color. Pigments are minerals or other chemicals that reflect light in specific ways to create a sensation of color. Pigments absorb certain parts of the visible spectrum and reflect others which the eye detects. A yellow flower like a daffodil contains naturally-occurring yellow pigments in the petals. As clear sunlight (composed of all the visible wavelengths of light) shines on the flower, all wavelengths are absorbed except yellow. Yellow light is

reflected back to the viewer's eye, so the flower is seen as yellow. The same reasoning applies to all other colors of objects we see: the color of the object is caused by the wavelengths that are being reflected from it. Spray paints contain pigments which are used to alter the natural color of the object being sprayed. Stem dyes, used mainly to color carnations, are taken up through the stem and deposited inside the flower petals. The eye perceives the wavelengths reflected by these artificial pigments as described, and the flower color is changed.

THE COLOR WHEEL (See Color Plate I-1)

A color wheel is a circle divided into pie-shaped wedges of various colors arranged in a specific order. You can make a simple color wheel using the colors of the rainbow by bending it into a circle. Having used the rainbow as an example, it is noteworthy that color wheels are actually based on pigment colors rather than spectrum wavelengths of colored light like those in a rainbow. Color wheels can be used to predict the outcome of mixing different pigment colors together. Some color wheels also show how the addition of white or black will alter a color. Floral designers, interior decorators and artists find color wheels useful in developing interesting color combinations in their work.

Red, yellow and blue are called **primary colors** because they are the three from which all other colors can be made by mixing. At first this statement may not seem possible. However, a little experimenting with red, yellow and blue paint will quickly show you that it is true. Orange, green and

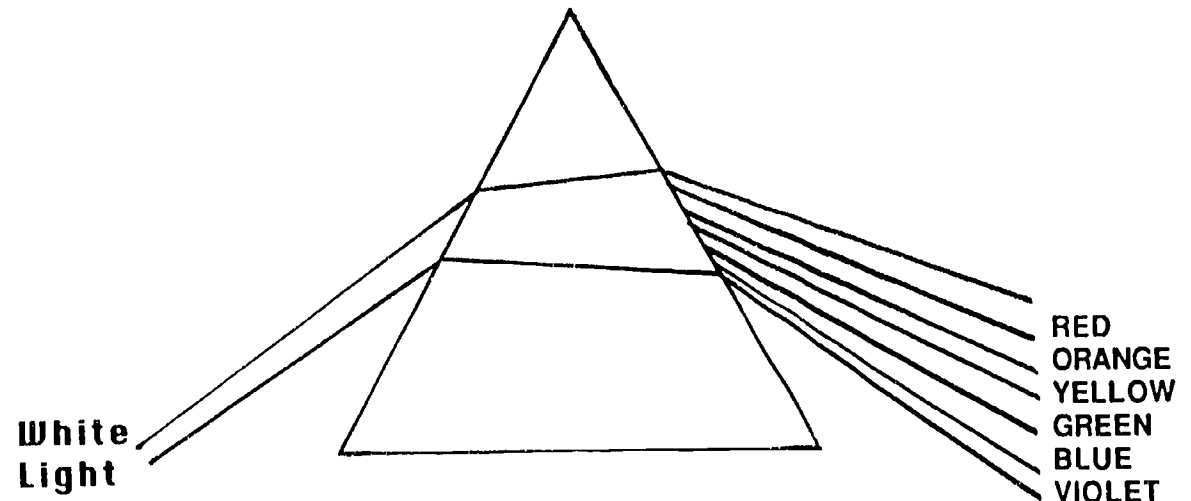


Figure 2-27 Light passing through a prism

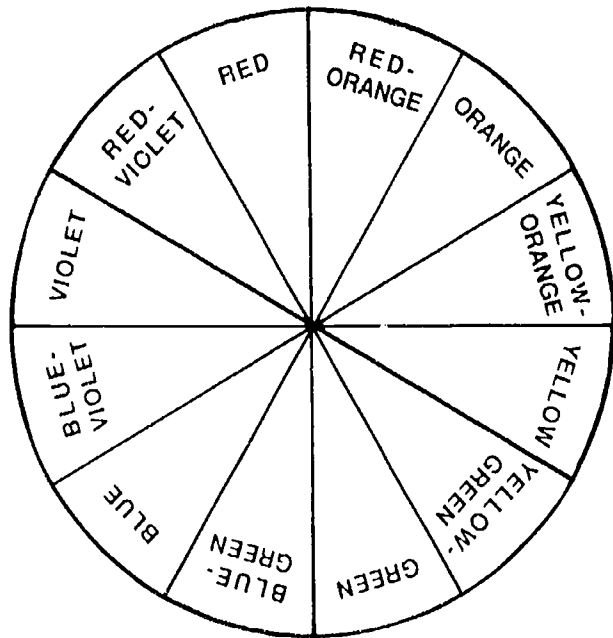
violet are called **secondary colors** (second order) because they can be made by mixing together two primary colors.

Primary Colors		Secondary Colors
red + yellow	=	orange
yellow + blue	=	green
blue + red	=	violet

Tertiary colors (third order) are created by mixing a primary color with a secondary color next to it on the color wheel. If the tertiary colors were added to the basic color wheel, it would be a twelve-spoke color wheel (see page 22).

Primary Color		Secondary Color		Tertiary Color
red	+	orange	=	red-orange
yellow	+	orange	=	yellow-orange
yellow	+	green	=	yellow-green
blue	+	green	=	blue-green
blue	+	violet	=	blue-violet
red	+	violet	=	red-violet

Color wheels can be made more complex by mixing secondary and tertiary colors into fourth-order colors or by showing light or dark versions of each color. If the latter is done, the darker color variations are placed toward the center of each pie-shaped wedge and the lighter color variations toward the outside of each wedge.



A twelve-spoke color wheel

An example of variation of the color RED

hue: red
 tint: pink
 shade: burgundy
 tone: dusty rose

variations in "value":
 pink vs. burgundy

variations in chroma:
 red velvet ribbon vs.
 red satin ribbon

SUGGESTED ACTIVITIES

1. Obtain an inexpensive set of paints. Mark first the primary colors and then the secondary colors. Use an artist's pallet or other suitable surface to create the secondary colors from the primary colors and the tertiary colors from the primary and secondary colors.
2. Use food coloring in jars or cylinders of water to show mixing of dyes to create secondary and tertiary colors. These could then be labeled and put on display.
3. Place a prism in a sunny window where sunlight can pass through the prism. It will bend the wavelengths of light at different angles, creating a rainbow on the wall, ceiling, floor or piece of white paper. Identify the spectrum colors and note their order of appearance.

(Note: The prism may not create a very bright rainbow on a cloudy day or with artificial light. You may have to turn and move the prism in many directions until you get a bright spectrum projected onto an area where all can view it. If the prism is propped up for a longer display, the rainbow will move or even disappear as the angle of the sun's rays changes during the day.)

COLOR TERMINOLOGY

The vocabulary used for various aspects of color is somewhat detailed and is often used incorrectly by those not trained in the subject. When used correctly, the terms can aid in recognizing and understanding the many subtle variations in color.

Hue

Hue is a general name for a spoke or pie-shaped wedge of color on the color wheel. Thinking in terms of a six-spoke color wheel, the basic hues or families of color are: red, orange, yellow, green, blue and violet. Each of these hues can have many variations. The lighter and darker color variations may have specific names but are still members of that hue. Colors that are muted with gray and those that are very bright and intense are also members of that hue. Here are some examples:

Hue	Some Color Members of the Hue
RED	pink, scarlet, burgundy
ORANGE	apricot, tangerine, rust
YELLOW	primrose, lemon, gold
GREEN	mint, kelly, emerald
BLUE	powder blue, azure, navy
VIOLET	heather, purple, grape

Variations of a Hue

1. Value

The lightness or darkness of a hue is called its value. If you think of colors as paints, a lighter color can be created by adding white to the pure hue and darker variations by adding black. The lighter values of a hue are called **tints**. The darker values are called **shades**. The pastel colors of pink, apricot, and mint are examples of tints of their respective hues. The dark, rich colors of burgundy and navy are shades.

2. Chroma

Chroma refers to the brightness or dullness of the color within a hue. It is affected by texture. Any color, including white, gray, and black, can have different chromas. Black patent leather, for example, has a hard, smooth, glossy chroma which may appear "more black" than black velvet with its softer, more dull chroma.

Plants often have many tiny hairs covering flower petals or leaves. These tiny hairs reduce the brilliance of the color and give them a soft, dull or velvety chroma. Contrast that with hard glossy surfaces like shiny ceramic containers. However, some leaves, like camellia leaves, are naturally smooth and glossy. Other leaves can sometimes be made glossy with plant shine. Both these kinds appear brighter green than do dull, rough-textured leaves.

The full impact of chroma cannot be shown on color wheels since they are printed in just one texture.

3. Tone

Tone is a color variation of the hue resulting from addition of gray to the pigment. The effect is a softer, dulled color. The toned color is more subtle and can usually be combined more safely with a wider range of other colors. Examples of tones are dusty rose, heather, sage green and colonial blue.

SUGGESTED ACTIVITY

Assemble a variety of objects from the classroom that are just one color. This might include bolts of ribbon, candles, pieces of fabric, or articles of clothing. What is the name of the hue that has been chosen? Attempt to select a specific name for the color of each object. Decide if it is a tint or a shade of the hue. How would you describe its texture (surface quality)? Does it have a bright or a dull chroma? Is there a hint of gray in the color? Would you call it a tone of the hue?

COMBINING COLORS

Because arrangements are seldom just one color, every floral designer is confronted with making color choices from the materials available to him or her. Color combinations may be dictated by the holiday or the occasion. You can't go wrong with the traditional combinations of red and green for Christmas, yellow and violet for Easter, and red, white and blue for the Fourth of July. A customer may have a specific color request, reflecting personal preference. This takes the decision out of your hands. However, you may be given only a description of the setting in which the arrangement will be used. This leaves the choice of colors up to your educated judgment. You now need a knowledge of the range of acceptable color combinations called **color schemes**.

The following color schemes are frequently used in flower arranging, interior decorating, and fashion design. Sometimes the only matter of concern is the color

Examples of Bright Chromas

- ★ shiny gold ornaments
- ★ mirrored surfaces
- ★ satin fabric
- ★ object sprayed with enamel paint
- ★ florists' foil

Examples of Dull Chromas

- ★ velvet fabric
- ★ moss
- ★ leaves with hairs
- ★ chenille stems
- ★ burlap

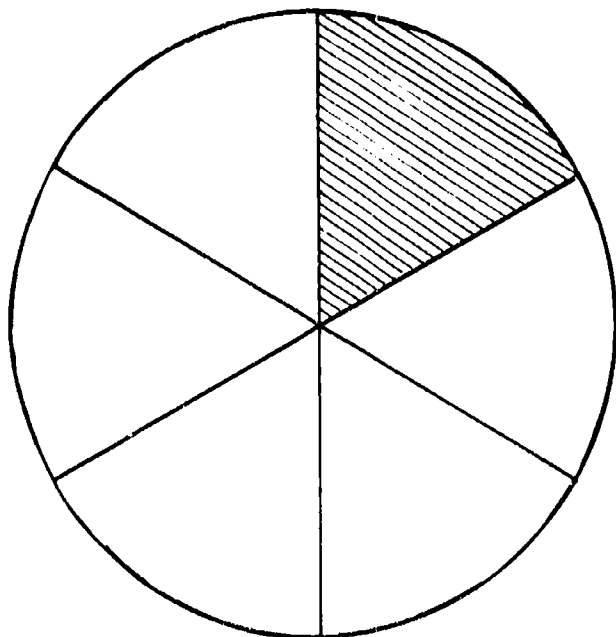


Figure 2-28 Monochromatic

relationships of the arrangement with its container and accessories. This would be the case when the designer is making an assortment of arrangements for sale in a shop. Other situations require color coordinating the designs with a larger setting. For example, in wedding work the bouquets, boutonnieres and corsages must harmonize with the clothing. In party work, the centerpiece must coordinate with the total table setting as well as the decor of the room. Custom designed silk or dried arrangements must effectively enhance the color scheme already existing in a room.

Following are different categories of color schemes designed to help increase your awareness of colors. No category is better or worse than the others. They are only suggestions to open up to you new possibilities for creative and pleasing color combinations.

Monochromatic Color Schemes

Mono means "one". In a monochromatic design only one hue is featured (Fig. 2-28). However, that hue may appear in different variations within the arrangement. Usually the more variation there is in value, chroma and tone of hue, the more interesting is the result.

An example of a monochromatic color scheme is an arrangement of pink snapdragons, rose colored annual statice, red roses and red huckleberry foliage. Rarely does the foliage fall into the hue being considered, but when it does, it can add a special touch and added dimension.

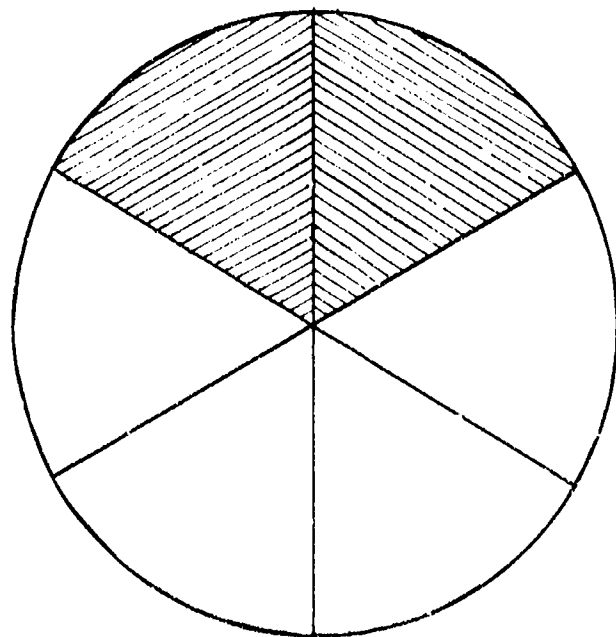


Figure 2-29 Analogous

Analogous Color Schemes

An analogous color scheme includes neighboring colors on the color wheel (Fig. 2-29). It is perhaps easiest to understand using a six-spoke color wheel. On such a wheel, analogous colors would be a primary and a secondary color positioned next to each other, such as yellow and orange, yellow and green, green and blue, blue and violet, violet and red, or red and orange. The scheme is never to be so large as to include two primary colors. However, it certainly can include the tertiary colors between the primary and secondary colors, as well as all the different tints, shades, chromas and tones of these colors. A mass planting of mixed marigolds with its cheerful combination of yellow, gold, orange and rust is a good example of such a color scheme.

Analogous color schemes are very safe in that they are usually pleasing to most people. An example of the use of yellow, yellow-green and green is yellow lilies, green gladiolus and dark green salal foliage. If foliage with yellow variegation could be obtained to add to the arrangement, it would add interest and also help carry out the analogous color scheme.

Complementary Color Scheme

A complementary (or **contrasting**) color scheme is made by selecting colors generally across from each other on the color wheel. There are two kinds of complementary color schemes: direct complementary and split complementary. The **direct complementary scheme** involves two hues that are directly across from each other on the color wheel

(Fig. 2-30), such as red and green, yellow and violet, or orange and blue. If a twelve-spoke color wheel is used, combinations like blue-green and red-orange, or yellow-green and red-violet are also seen to be complementary.

A twelve-spoke color wheel is essential to understand the second kind of complementary color scheme - the **split complementary scheme** (Fig. 2-31). This involves three colors: a hue and the two colors that appear in the pie-shaped wedges on either side of the color that is directly opposite on the color wheel. An example would be blue with orange-yellow and orange-red. Orange is directly opposite blue on the color wheel but would not be included in the color scheme.

A complementary color scheme emphasizes differences among colors rather than similarities. The floral designer may experiment with these contrasts to produce refreshing, bold and daring color combinations.

Although white does not appear as a hue on color wheels, a commonly used contrasting color scheme combines white with any of the colors on the wheel. The blending of white mums with red carnations or white gladioli with yellow roses is pleasing to most people.

A red and white combination creates a very strong contrast. However, white can also be used with pastel colors to achieve a more subtle contrast, as in the combination of pink carnations and white baby's breath. Because white has strong eye appeal, it can dominate the arrangement if large white flowers are used in equal quantity to flowers

of another color. Such domination can be avoided by the use of smaller white flowers such as baby's breath.

If white containers are used, a more harmonious arrangement can be achieved when some white flowers are included with the other colors that have been chosen. An even more subtle way to soften the contrast of white is to include some white variegated foliage along with the white flowers in such an arrangement.

The clean bright contrast of white with other colors is one more color idea that designers can add to their mental list of combinations to try.

Triad

The color scheme called the triad involves three hues that are equidistant from each other on the color wheel (Fig. 2-32). A bold combination of the three primary colors of red, yellow and blue is an example of a triad. Another triad scheme combines orange, violet and green. The three colors do not have to be used in equal amounts. In fact, the arrangement may be more effective if one color is used in greater amounts and allowed to dominate the other colors.

The concept of allowing one color to dominate can be applied to the other color schemes discussed as well as to the triad. Experience has also shown that using too few variations of a hue may be dull, while using too many may be confusing. The amount of each color used and the variability within each color, regardless of the color scheme chosen, is up to the

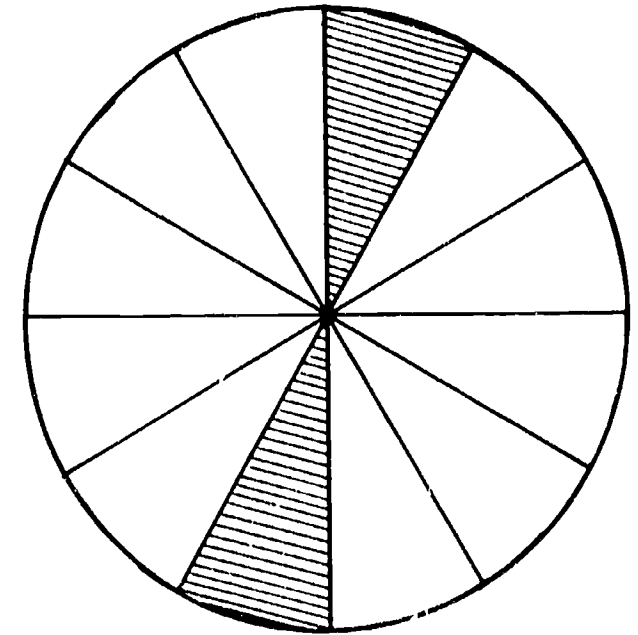


Figure 2-30 Direct complementary

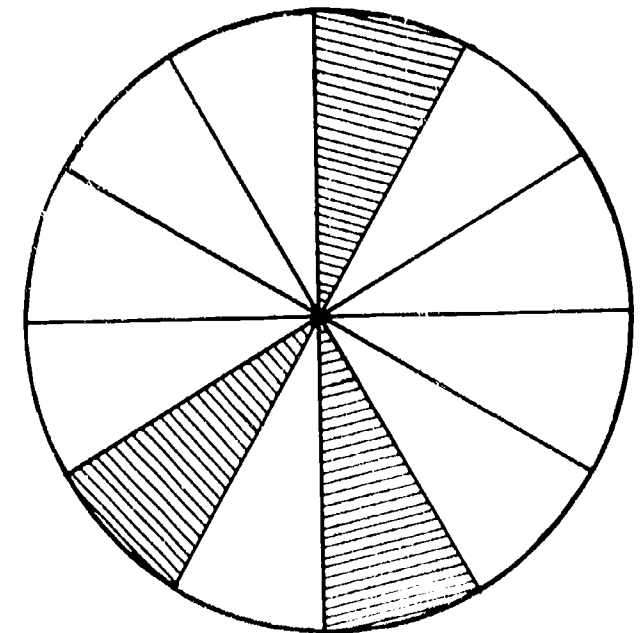


Figure 2-31 Split complementary

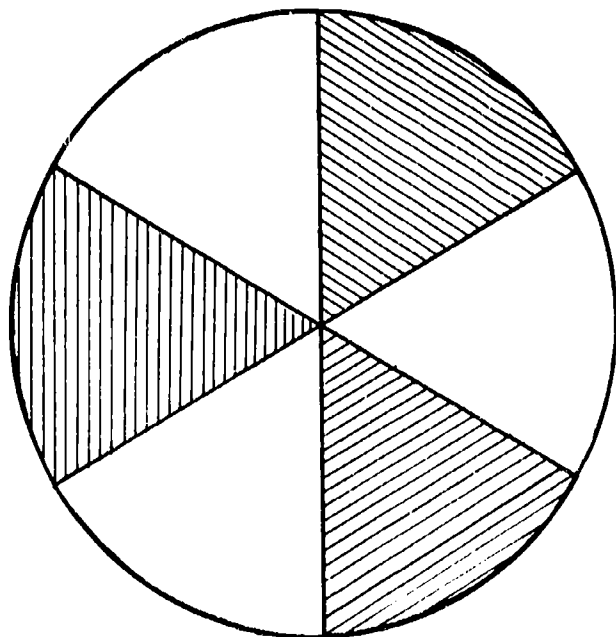


Figure 2-32 Triad

individual designer. Observation and experience will make these quantity decisions more obvious.

SUGGESTED ACTIVITIES

1. Collect an assortment of items (such as pieces of fabric, ribbons, candles, etc.), each of which is a single, solid color. Divide students into groups of two or three and have each group draw the name of a color scheme written on slips of paper placed in a basket. Each group will look over the items and select at least three of them to represent the color scheme that they have drawn.

Have each group explain their color scheme and why they made the choices they did. Colors can be pointed out on the color wheel as part of the discussion so that it is more clear how the choices were made.

What is the general class reaction to the representative examples of each color scheme?

2. Using the twelve-spoke color wheel, have each student list three colors that can be combined to represent a monochromatic, analogous, direct complementary, split complementary, and triad color scheme.

COLOR GUIDELINES

Color is important in helping attain most of the principles of design. It can influence balance, proportion, rhythm, dominance, contrast, harmony and establishment of the focal point. These will all be discussed in the next chapter entitled "Principles of Design."

These concepts will become even more clear to you when you begin to critique your own work. Nevertheless, there are some general color guidelines that can be understood without drawing heavily upon the principles of design. Here are some suggestions that may assist you in your initial attempts to use color.

1. Repeat colors in a design.

Avoid using a color only once in a design. If the container is white and your flowers are not, use a white filler flower or use foliage with white variegation. Flowers that are bicolored or have a different colored throat are useful in repeating a color. Don't ignore significant colors that show up in containers or figurines you may be using.

2. Don't use too many different colors.

Too many competing strong colors can lead to confusing results. Two colors can make a strong or a subtle contrast. Three well-chosen colors result in a slightly more complex color combination, but one which is usually safe. Larger numbers of colors should be used only when the colors are muted or toned down. For example, a dried arrangement made in the Williamsburg style can include many colors whose softened tones blend together in a pleasing overall effect.

3. Let one color dominate.

When using more than one color, allow one of the colors to dominate by using more of it. Equal amounts of color are difficult to work with. An example is a church arrangement in which there are one dozen white

carnations and one dozen red carnations of equal size. The results are often less than interesting.

4. Use darker colored flowers deeper and lower in the arrangement.

Darker colors usually appear heavier (with more visual weight) than do lighter colors. Inserting the colored flowers further into the arrangement than the lighter colored flowers will contribute to greater depth. Also, a lower placement of darker colored flowers in the arrangement will give it more stability. This general guideline does not apply if the chroma of the material is more significant than the value. For example, silver is a light color (it has a light value), but it can be very shiny (with a shiny chroma). The chroma gives it enough eye appeal that it may carry more visual weight than a darker color. This means that flowers or foliages with a dominant chroma may also have to be placed deeper or lower in the arrangement even if they are lighter in color.

5. Use sparingly colors with high eye appeal.

Flowers, accessories or containers which are very bright quickly attract the eye. They are most effectively used in small quantities and should be placed where they will attract attention to a key area in the arrangement (the focal point). A shiny brass container may be overly dominant, while an older one with an aged patina may be more effective. Flowers that are less bright can usually be used safely in larger quantities in arrangements than can very bright flowers.

6. Use larger flowers of a certain color to emphasize that color.

A larger flower has more density and more surface area than a smaller flower; therefore color appears stronger in the larger flower. One large white football mum has stronger eye appeal than several sprays of white statice or even a whole bunch of white baby's breath. Small flowers, like star flowers, may be clustered for more color impact.

7. Select either bold color contrasts or soft, subtle contrasts to suit the situation.

There is really no right or wrong when comparing these two alternatives. Color combinations that match the mood of an occasion will probably be more appreciated and longer remembered. A strong orange and black color contrast makes a definite statement in a Halloween arrangement. A bright arrangement of red, yellow and blue might be suitable for an informal daytime patio luncheon, but not for an elegant evening dinner. The gentle harmony of pink, lavender and pale blue may be most pleasing at a bridal shower or in a bouquet for a new baby.

Popular Color Combinations

- ★ Santa Fe colors of the Southwest desert - aqua, peach, adobe
- ★ Accented neutrals - earthtones, taupe, red
- ★ Contemporary contrast - black and white with any hue
- ★ Metallic - copper, silver, gold
- ★ Opalescent - pearlized effect, pink blush and lavender
- ★ Whitewashed effect - Wedgewood blue, mauve, pewter green and hyacinth

SUGGESTED ACTIVITIES

1. Based on the preceding discussion of color, examine several pictures of arrangements or slides of arrangements. Identify the color scheme that has been used. Critique the arrangement based on the color guidelines given.

Lighting surfaces with a high chroma can produce the following effects:

- ★ Glitzy
- ★ Sparkly
- ★ Shimmery
- ★ Shiny
- ★ Glittery

Another possibility is to have each student react to one picture or slide and present his or her observations to the class. It is helpful to be aware of how other people react to color.

2. Invite someone from outside the class who has not received any color instruction to react to the colors used in several arrangements. This may help you begin to understand customer reactions to different color schemes used in floral designs.

LIGHT

LIGHTING EFFECTS ON COLOR

It is sometimes surprising to see how different an arrangement looks at night on a dining table from what it did on the design bench, or how different an altar vase looks up in front of a church. Much of this can be explained by the change in lighting. Both light quality (color) and light intensity (brightness) affect color.

LIGHT QUALITY

You learned earlier that clear light from the sun is actually made up of many different wavelengths which include different colors of visible light. If the windows of a room were made of red colored glass, the light in the room would be red and the objects in the room would appear reddish. This is because the glass absorbed all the wavelengths except red. The red ones passed through and were subsequently reflected from the objects in the room. Colored spot-

lights have a similar effect when used to illuminate an arrangement. Those flowers that are the same color as the light falling on the arrangement appear intensified in color. Light colored and white flowers appear the color of the light. Other colors are distorted and may appear dark or even black.

Incandescent versus Fluorescent Lighting

Artificial light sources that are commonly used where arrangements are viewed include both incandescent and fluorescent lamps. Although the light they give off appears clear, it is actually different in the wavelengths of light it contains and therefore changes the way flowers and other objects look under it. **Incandescent lights**, the kind most often used in homes, give off large amounts of wavelengths in the red and orange end of the spectrum. These highlight the red and orange pigments in flowers, the warm colors. The result is a desired homey feeling. Clear crisp blues, on the other hand, are dulled under incandescent lighting.

Fluorescent light is widely used because of its higher efficiency especially in commercial settings. Fluorescent light is much higher in the amount of blue wavelengths it contains. Blue flowers and blue objects are highlighted, while the red and orange tones are subdued.

Candlelight is high in orange and red wavelengths and affects flower color much like incandescent light does. However it is usually much less bright.

LIGHT INTENSITY

Light intensity refers to the brightness of the light. In general, all colors can be seen more easily in brighter light than in dimmer light. Problems arise when light intensity is very low.

Some colors are very difficult to see when the light is dim. Those that have been described as receding colors (violet, blue and green) are most affected. Darker colors are affected more than lighter colors. Pale yellow, light pink and white are among the last colors to remain visible as light intensity decreases.

Certain flowers, like purple statice and dark red roses, should be avoided in low light situations. These flowers may appear to be black holes in the arrangement under these conditions.

SUGGESTED ACTIVITIES

1. Assemble spotlights that are red, blue and white and flowers that are red, blue and white (for example, a red rose, blue annual statice and a white carnation). Other flowers can also be used, including silk flowers. Place each flower individually in a bud vase.

Turning off lights, make the room dark enough so that most students are having difficulty seeing the flowers clearly. In the remaining light, which of the three flowers can you see best? Does this support the statement made earlier about which colors are most easily seen in dim light? Which colors are most difficult to see? Do you feel these colors should be used in arrange-

ments for evening events where light intensity is likely to be low?

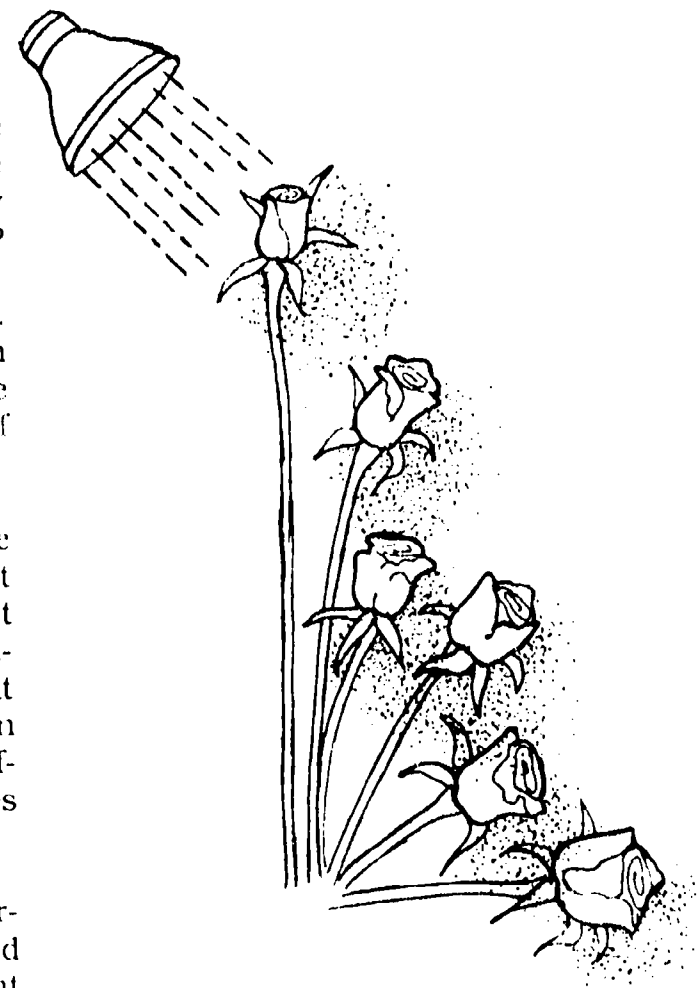
Shine the white spotlight on each of the three flowers. How much easier is it to see the flowers? What is the effect of light intensity on the ease with which flowers can be seen?

Shine the red light on the three flowers. What happens to the appearance of each flower? Shine the blue light on the three flowers. How does it affect the appearance of each flower?

What conclusion can you draw regarding the effect of light quality (color) on the objects it shines on? Remember that fluorescent light is higher in the blue wavelengths and incandescent is higher in the red. In view of what you just observed, can you explain why an arrangement of red roses might appear different under fluorescent lighting than it does under incandescent lighting?

Sometimes fluorescent lights are color-corrected to emit a higher amount of red light. These are sometimes used to light displays of African violets and also to light meat in grocery stores. How does this light change the appearance of the product? What effect does the lighting have on the marketing of the product?

2. Use one or two candles to light up the red, blue and white flowers. How is each flower affected? Can you explain the results in terms of light intensity and light quality?



Use spotlights of different colors and note the change in appearance of the flowers.

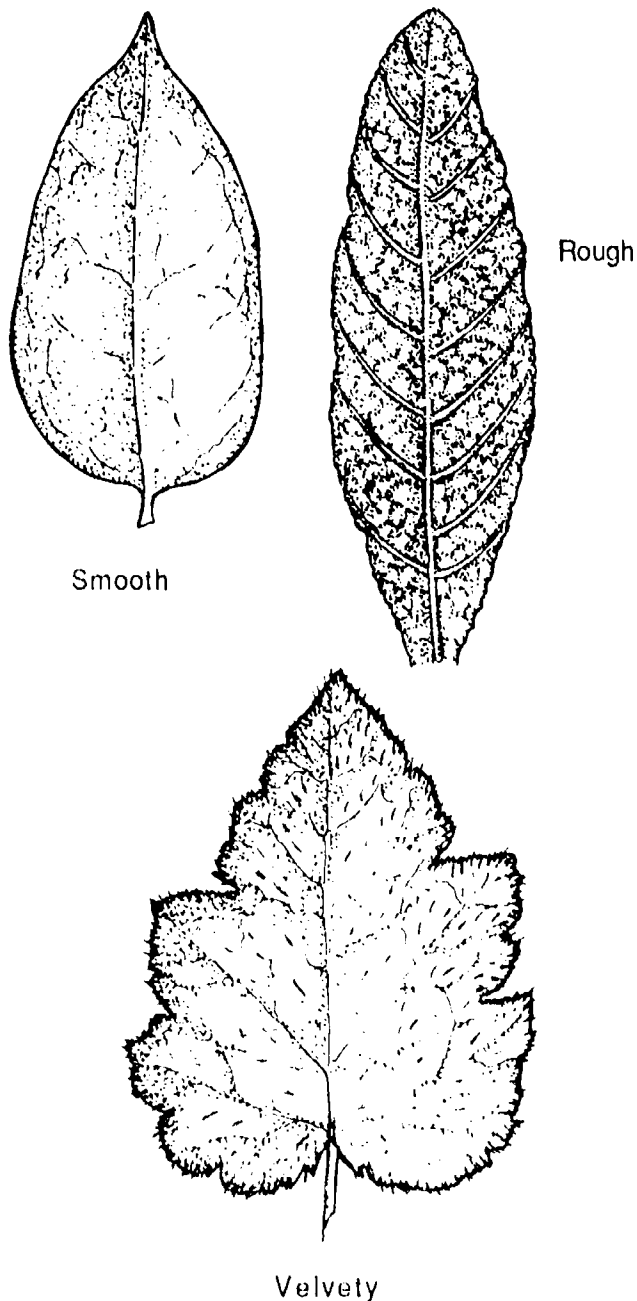


Figure 2-33 Textures

TEXTURE

Texture refers to the surface quality of any object. The major effect of texture on color through a change in the chroma has already been discussed. The impact of texture in a design goes beyond color and deserves some special attention. (See Figure 2-33.)

Some contrasting textures are suggested in the following list:

fine or coarse
smooth or rough
shiny or dull
satiny or velvety
downy or prickly
even or lumpy

These textural qualities can be used to provide interesting contrasts or subtle compatibility between the materials. The texture of an object can also be associated with the degree of formality that the object represents. For example, an arrangement in a Mexican theme might include coarse pottery, cacti and other succulents with prickly spines, coarse textured zinnias, and a loosely woven serape with a lumpy surface quality. Note that nothing has been mentioned about color. The texture alone creates a compatible grouping of items.

Velvety and satiny textures suggest a more formal situation. The soft, velvety texture of rose petals and shiny surface of camellia leaves are both associated with elegance. They are compatible when used together, but the contrast between the two textures adds interest to the arrangement.

Either bold or subtle textural contrasts are appropriate depending on the result the designer is trying to achieve. Textural contrasts can be achieved not only in the flowers and foliage, but also in the container, accessories and background chosen for the design. The velvety and shiny contrast between roses and camellia leaves could be further developed by placing them in a shiny silver container and displaying the arrangement on a piece of rich velvet.

SUGGESTED ACTIVITIES

1. Examine pieces of cloth that may be used as backgrounds for arrangements. Answer the following questions about each sample.

What word best describes the texture of each piece?

Does the texture suggest a formal or an informal feeling?

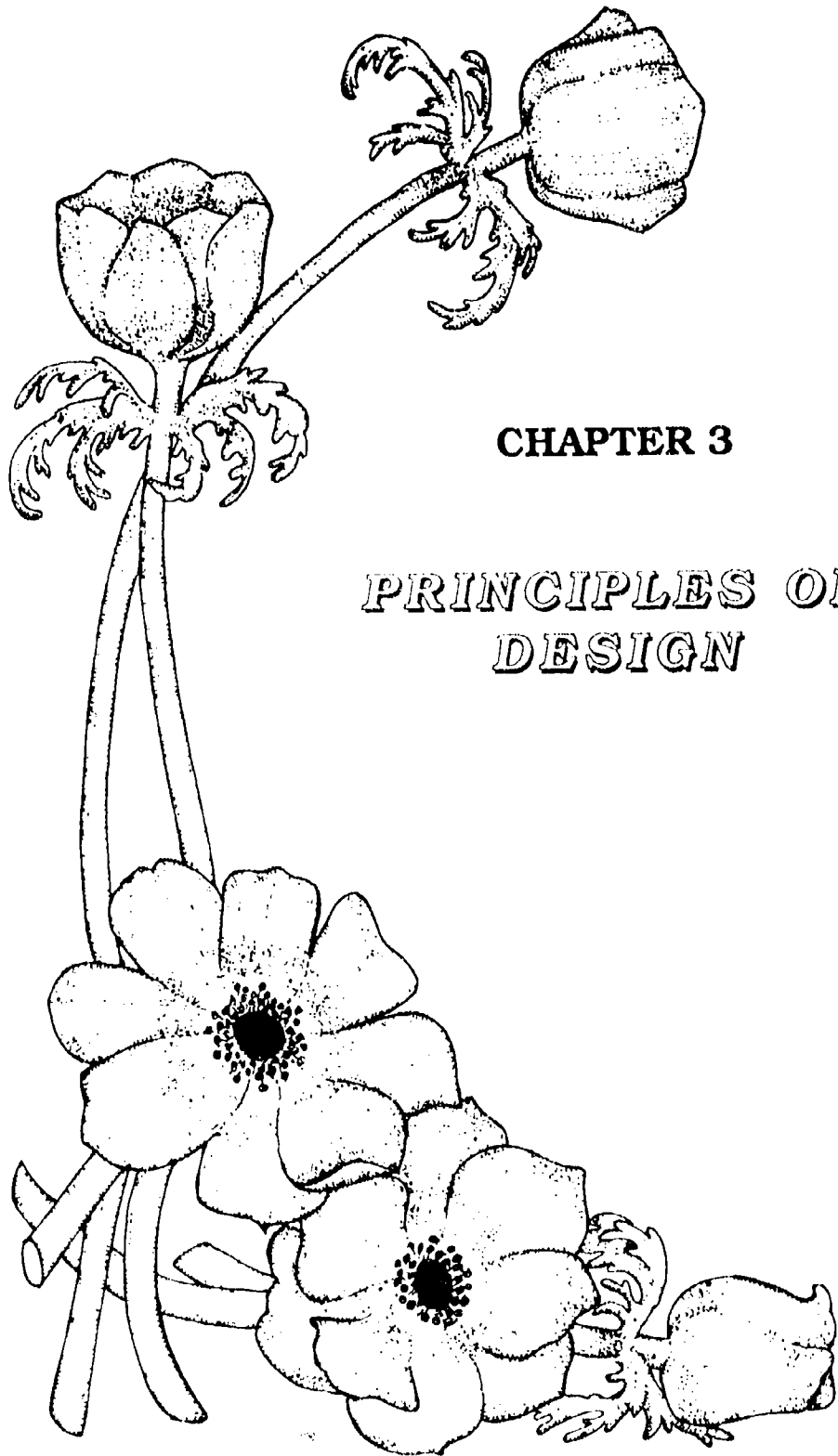
What flowers, foliages or accessories would be compatible with the cloth with regard to texture?

What flowers, foliages or accessories would provide a strong contrast to the cloth with regard to texture?

2. Answer the same questions listed above but in reference to articles of clothing worn by students in the class. Clothing texture is one factor to consider in selecting flowers, foliage and ribbon for corsages and wedding bouquets.

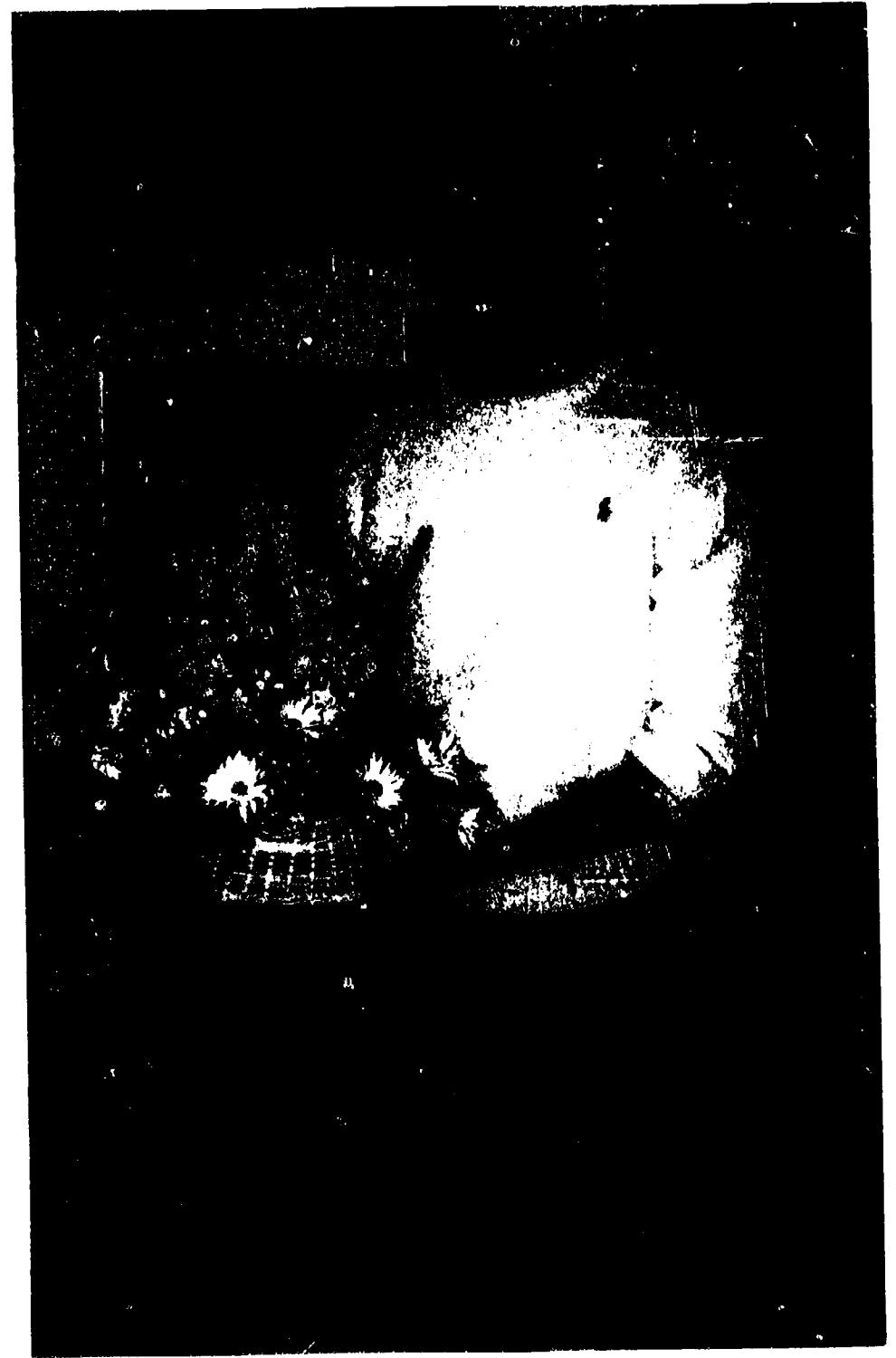
3. Assemble an assortment of pieces of cloth, fresh, dry and silk flowers, ribbon, and other available accessories. Group these into the following textural combinations:

- A. A strong textural contrast. (Name the two contrasting textures selected.)
 - B. A subtle compatible textural grouping. (What word best describes the texture that you have developed?)
 - C. A textural grouping that suggests formality. (Have you selected a contrasting or a compatible textural combination?)
 - D. A textural grouping that suggests informality. (Have you selected a contrasting or a compatible textural combination?)
-



CHAPTER 3

**PRINCIPLES OF
DESIGN**



Kiefer's Floral, Coshocton



INTRODUCTION

The principles of design are fundamental truths that have evolved over the centuries as the various art forms have developed. They are time-tested given statements that are universally accepted. Good art, whether it is painting, sculpture or flower arranging, is judged against these statements.

Although artists agree on the definition of the terms commonly used to identify principles of design, they do not agree on the exact listing of major art principles. Differences arise because these principles are so interrelated and must all function at one time for a successful product. Changing one flower placement in an arrangement can affect the way two or three principles are expressed in the arrangement.

Your understanding of the principles of design will grow as you continue to practice different kinds of designs and observe designs that others have made. An important long-range goal for you is to be able to use the principles of design to help you evaluate your own work as well as the work of others. You will become aware of the expression of these principles in arrangements you see in books, magazines and design shows. By seeing and understanding how skilled floral designers have been able to successfully apply the principles in their work, you can increase the number of valuable ideas you can extract from their examples and apply them in your own creative work.

The major principles of design are listed here. Within each major category are one or more minor principles of design. These are

not of lesser importance but are related to more specific aspects of design than are the major headings. It is unlikely that you will consciously consider every one of these principles when you make a design. However, if you are not satisfied with the result, it is likely that one or more of these principles have not been satisfied.

PRINCIPLES OF DESIGN

Balance

Symmetry
Stability
Depth

Scale

Proportion

Rhythm

Transition

Harmony

Repetition
Unity

Emphasis

Contrast
Dominance

BALANCE

A well balanced design is comfortable to look at. It does not look like it will tip forward or sideways. The materials selected, the amounts of each used, and their placement in the arrangement all affect balance. All materials used in floral designs have weight—real weight that can be measured by scales, and visual weight which is measured by the eye. In order to understand balance, you

Well balanced designs
by Hitomi Gilliam, AIFD



need to understand the concept of visual weight.

The visual weight of an object - whether it appears heavy or light to the eye - depends on its size, color, texture and what we associate the object with. An example of how visual weight and actual weight may differ is a dark gray fiberglass rock, which could be used at the base of an arrangement. Because of its dark color, rough texture, and our perception of rocks as heavy, the rock has high visual weight. If we actually picked it up, we would discover that it is not heavy. The larger the rock, the more visual weight it would have.

Flowers or leaves that have open forms have less visual weight than those which appear more solid with smooth outlines. Lilies and iris appear lighter and more airy than most chrysanthemums and carnations. A stem of camellia leaves appears heavier than an equal amount of leatherleaf or asparagus fern.

To better understand the effect of flower placement on balance, an understanding of two major categories of balance - symmetry and asymmetry - is important.

SYMMETRY

Symmetry is a design principle that deals with parts that correspond to each other on each side of an axis. Refer back to Chapter 2 where the various design shapes are listed. Within each design there can be identified a point or a line around which the flowers are placed in a predictable manner. In circular arrangements the point is in the center of the design. The flowers and foliage

appear to radiate out from this point (Fig. 3-1). As you look down on these arrangements, it would be possible to cut them in half in many different ways and still have the halves looking basically alike. This is an example of **radial symmetry** (sometimes called *equidimensional symmetry*). An example of this is the Williamsburg kissing ball in which stems of boxwood, all of approximately the same length, are placed in a styrofoam ball (Fig. 3-2). The boxwood appears to radiate out like rays of the sun.

In both equilateral (Fig. 3-3) and isosceles triangle arrangements, the design can be cut into two equal halves by a line running down the middle from top to bottom. This imaginary line is called the **axis**. These design shapes are examples of **bilateral symmetry**. Unlike radial symmetry, with bilateral symmetry there is only one way the design can be divided into two equal parts. The human body is an example of bilateral symmetry (Fig. 3-4).

BILATERAL SYMMETRY

Figure 3-3
Equilateral triangle

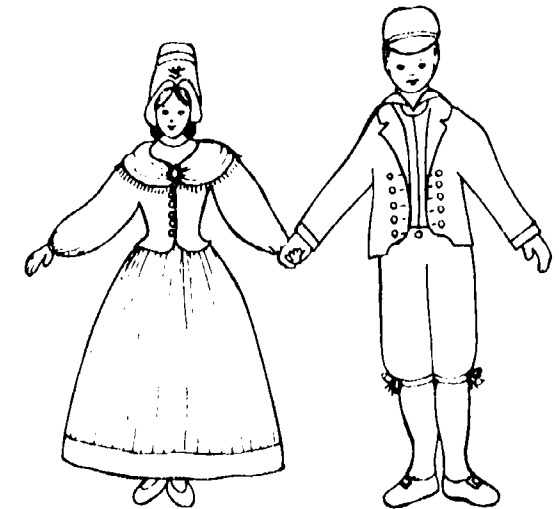
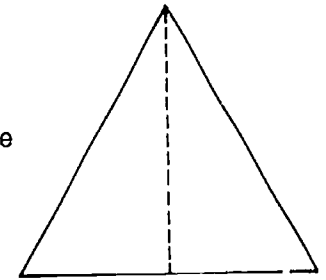


Figure 3-4
The human body

RADIAL SYMMETRY

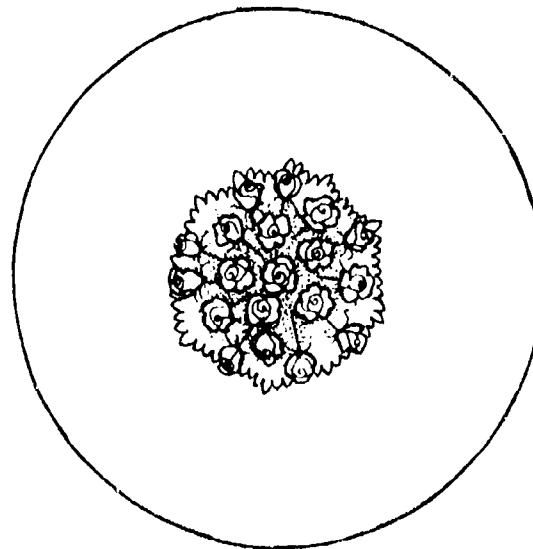


Figure 3-1 Round table centerpiece

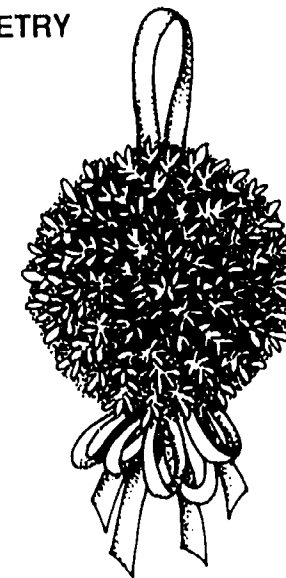


Figure 3-2 Boxwood kissing ball

Another type of symmetry is **spiral symmetry** - a concept in three dimensions. The axis is in the middle with the flowers or foliage spiraling around it in a predictable manner. Garlands of boxwood around a pillar in a church and Christmas greens around a porch railing are examples of spiral symmetry (Fig. 3-5).

Other examples of spiral symmetry are not as simple as the garland and pillar example. Some line-mass arrangements like the S-curve can be shown to have spiral symmetry. An arrangement called the *spiral* will be described for you to make in a later chapter. Ribbon spiraling around a wreath is an example of spiral symmetry (Fig. 3-6); the axis is a circle rather than a straight line.

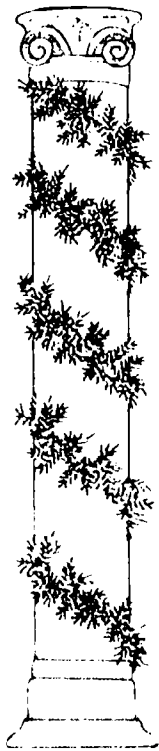


Figure 3-5 Pine roping around a porch support (axis is a straight line)

SPIRAL SYMMETRY

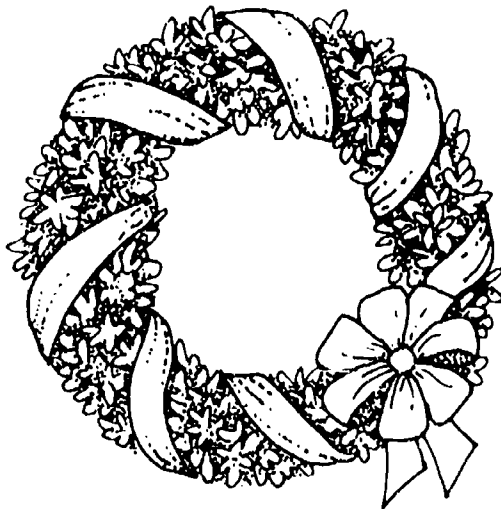
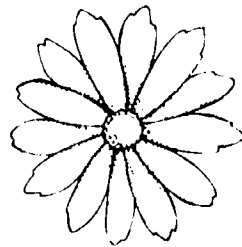


Figure 3-6 Ribbon spiraling around a wreath (axis is a circle)

SUGGESTED ACTIVITY

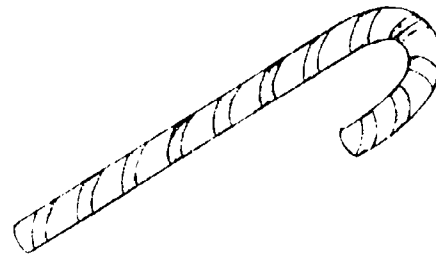
Consider the following objects. Identify them as examples of either **radial**, **bilateral** or **spiral** symmetry.

A. Daisy

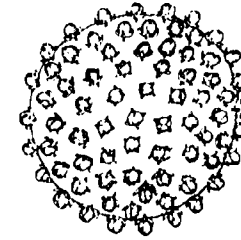


Type of Symmetry _____

B. Striped candy cane

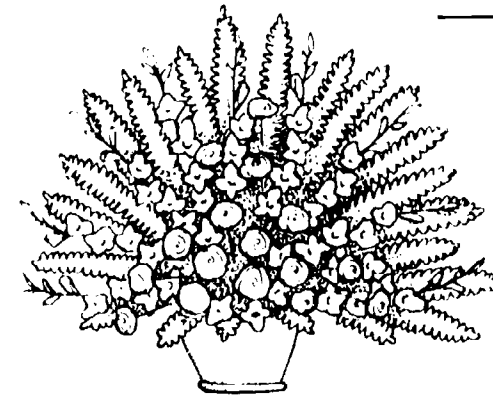


C. Orange stuck full of cloves

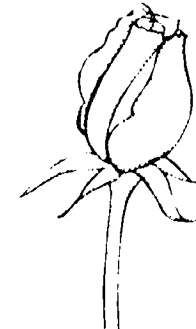


Type of Symmetry _____

D. Fan-shaped arrangement



E. Rose in side view



Asymmetry

Asymmetrical means NOT symmetrical, not divisible into equal parts. Asymmetrical arrangements are balanced in that they do not appear to lean in any direction. However, the balance is created by using placements of unequal visual weight at varying distances from the central axis.

A common example used to explain asymmetrical balance is the see-saw. The pivot point may be at the middle of the board, or the board may be moved so the pivot point is off-center. The balance depends on two things: (1) how much weight is placed on each side and (2) how far that weight is placed from the pivot point.

If the pivot point is in the middle and equal weight is placed on each side at an equal distance from the center, the see-saw will be balanced (Fig. 3-7). This is an example of **symmetrical balance**. If lighter weight is placed on one side, it must be farther from the pivot point than the heavier weight to result in balance (Fig. 3-8). This is **asymmetrical balance**. The board also could be moved so that the pivot point is not in the middle (Fig. 3-9). If equal weight is then placed on each end, the see-saw will tilt toward the longer end. To balance the see-saw, the weight nearest the pivot point must be greater to counter the greater force of the weight farther away.

Understanding balance is important in deciding where to place flowers in a design so that it does not appear to tip sideways, forward or back. In a flower arrangement the flowers with greatest visual weight are usually placed nearest the central axis, while the

smaller flowers are placed farther away. Since groupings of flowers have more visual weight than do single blossoms, groupings may be used to balance smaller flowers farther away from the focal area.

Symmetrical balance is sometimes called formal balance; asymmetrical balance is sometimes called informal balance. Large period arrangements of the Occidental style associated with formal, classical eras in history show symmetrical balance. Mass arrangements of oval and round shapes as well as many triangular arrangements (Fig. 3-10) and centerpieces are symmetrical.

Line arrangements in the Oriental style and many contemporary arrangements have asymmetrical balance (Fig. 3-11, 3-12). This gives either a modern or a naturalistic effect. Garden designs also have different feelings depending on whether they are symmetrically or asymmetrically balanced. Perhaps you can identify with the difference in feeling between a naturalistic landscape and a more formal symmetrical plan.

Symmetrical and Asymmetrical Balance

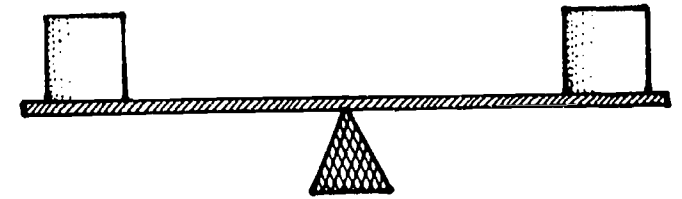


Figure 3-7 Symmetrical

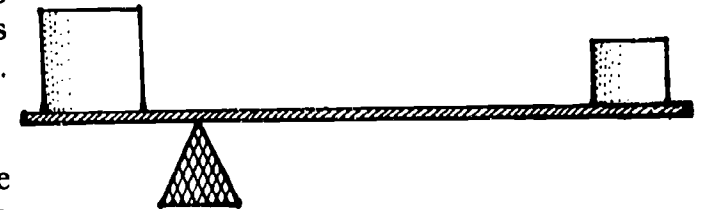


Figure 3-8 Asymmetrical

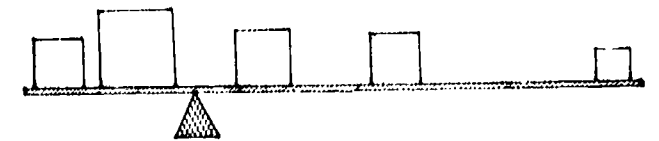


Figure 3-9 Asymmetrical

Symmetrical Balance



Equilateral triangle



Diamond centerpiece

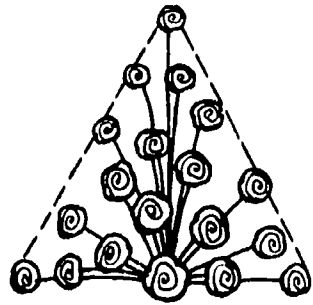


Figure 3-10
Symmetrical - Equilateral triangle

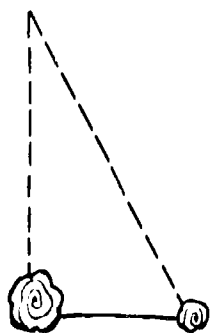


Figure 3-11
Asymmetrical
Right angle triangle
showing lower place-
ment of large and small
flowers

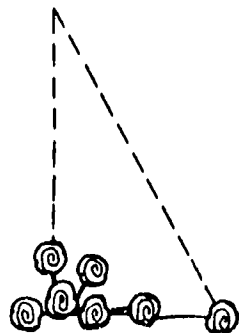
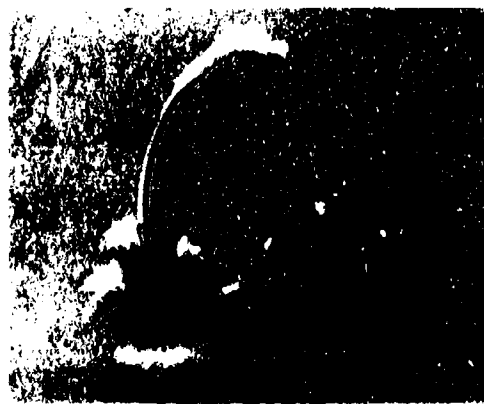


Figure 3-12
Asymmetrical
Right angle triangle
showing lower place-
ment of flowers of
similar size



Contemporary design - Asymmetrical

Symmetrical and asymmetrical balance can also be found in the setting for a flower arrangement or in the placement of an accessory that is an integral part of the total design. An arrangement placed at the center of a buffet table with a candle at either end is an example of symmetrical balance (Fig. 3-13). Formal fireplace mantels or church altars (Fig. 3-14) are often treated the same way. It is possible, however, to create an asymmetrical setting that is balanced. Using the buffet table again as an example, an asymmetrical arrangement and several candles grouped together could be placed off-center on the table. This grouping might then be balanced by a punch bowl at the opposite end of the table (Fig. 3-15).

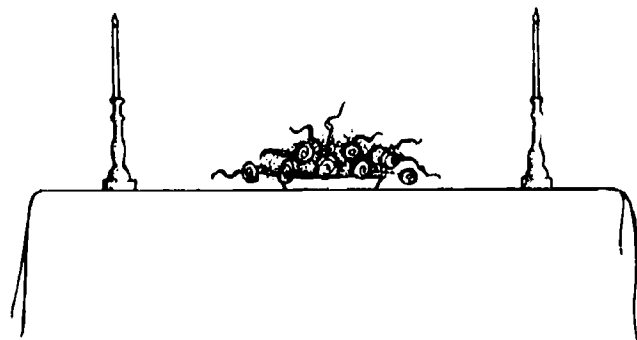


Figure 3-13 Symmetrical balance

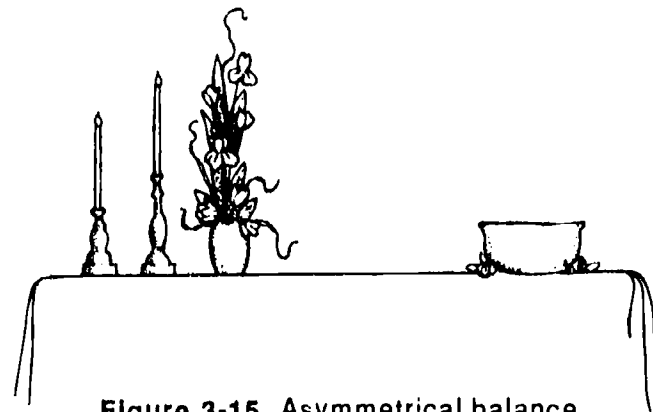


Figure 3-15 Asymmetrical balance

SUGGESTED ACTIVITIES

1. Make a see-saw small enough to set on a table and use it to illustrate how different weights and distances from the pivot point will change balance. For each example that is set up, relate the amount and positioning of physical weight to the positioning of similar visual weights in a flower arrangement.
2. You will be given a selection of flowers and foliage. Rank them in order from the greatest visual weight to the least visual weight. List your reasons for doing so. Remember to consider size, color, texture and form.

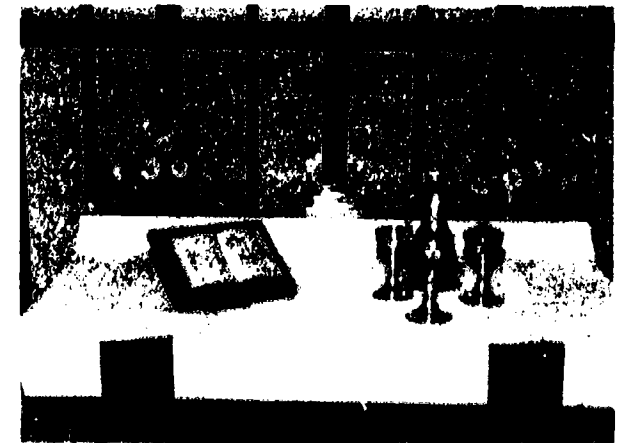


Figure 3-14
Symmetry of two right angle arrangements on either side of the cross on the altar

3. Look at pictures of several floral designs. Where is the imaginary axis or point around which the flower and foliage placements are arranged? Is the arrangement symmetrical or asymmetrical? Is the balance formal or informal?

4. Look at several pictures of floral designs that have accessories like birds, animals or figurines next to them. Cover up the accessory with a piece of paper. Does the remaining arrangement look balanced? How important is the accessory in establishing an overall balanced effect?

5. Look at several flowers of the same kind and size that are of different colors, for example, light, medium and dark pink carnations. Which color has the greatest visual weight? Which has the least? Where would you use the ones that have the greatest visual weight - closer or farther away from the central imaginary axis of a floral design?

In traditional arrangements, materials with higher visual weight are used lower in the arrangement to create a stable effect; they are sunken a little farther into the arrangement for depth. Both stability and depth are significant principles of design that are related to balance.

STABILITY

In simple terms, a stable arrangement is one that does not look top-heavy. Its visual weight is well distributed so that more of the heavier elements are placed lower in the arrangement (Fig. 3-16). Usually the base of an arrangement is the broadest part.

Stability may be lost if large, showy flowers are placed high in an arrangement with nothing to balance them lower down. Constricting the arrangement near the base will also lead to lack of stability.

DEPTH

Using flowers with greater visual weight to draw the eye into an arrangement, especially near the base, will produce depth. This also is likely to produce a better balanced arrangement. Depth is the third dimension of an arrangement. It involves leading the eye both **into** an arrangement and **around**-behind it.

A flat arrangement lacks interest. Designs should usually be broader at the base not only in silhouette but also in side view (Fig. 3-17). Flower placements should not appear to be pasted on a solid form. They should be spaced in a pleasingly in-and-out manner to lead the eye into the arrangement. This "in-out-ness" is one aspect of depth (Fig. 3-18). It takes advantage of all the three-dimensional space in an arrangement and allows the individual flowers to be displayed to a better advantage.

Changing the direction that flowers face can lead the eye across and around an arrangement. This must be done gradually (Fig. 3-19). Special attention should be given to the sides of the arrangement. Some flowers should face sideways and eventually a few should face backward. These changes in facing directions should never be abrupt. Arrangements in which the flowers all face the same way are flat. They also give you the uneasy feeling that your eye will "fall off the edge" when it reaches the sides of the design.



Oriental design - Asymmetrical



Figure 3-16
Good stability with smaller flowers at top
and a broad base

Aspects of Depth



Figure 3-17
Broad base in
side view

Figure 3-18
In-out-ness
of placement

Variations in color and texture in an arrangement will enhance the feeling of depth (Fig. 3-20). Coarser textures and darker, duller colors appear heavy. They should be used deeper in an arrangement to draw the eye into the arrangement. The cool receding colors of blue, violet and green draw the eye back, while the warm advancing colors of red, orange and yellow stand out. The result is depth.

The lighting on an arrangement can also affect depth. Lighting from behind will create maximum depth because shadows are produced which attract the eye and add interest (Fig. 3-21). Lighting from the front will direct shadows straight back where they usually are not seen. So, strong front lighting produces a flatter appearance with less depth. Candlelight is soft and often has the added intrigue of slight flickering of the flame. The resulting change of shadow patterns adds depth and interest to the design.



Figure 3-19
Gradual change in facing



Figure 3-20
Varying color and texture

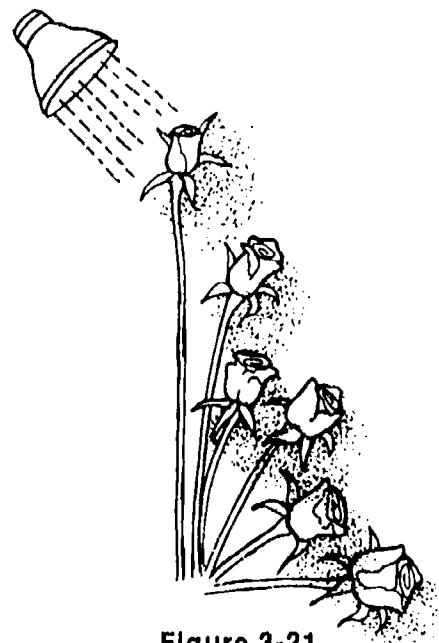


Figure 3-21
Back lighting to create shadows

SUGGESTED ACTIVITIES

1. The instructor will construct a symmetrical triangular arrangement that shows good depth. Each student should examine it for the following aspects of depth.

- A. Look for the broad base in side view. Does it gradually taper up to the tallest point?
- B. Are there spaces behind the flowers? Look to see if some flowers are sunken in.
- C. Looking from the front, examine the sides of the arrangement. Is there a gradual change in flower facing as you go toward the back? When you look at the arrangement in side view, do some flowers appear to be directly facing you?
- D. What different colors and textures are represented in the arrangement? Where are the receding colors placed? Where are the advancing colors placed?

2. Shine a spotlight directly on the arrangement from the front. Can you detect a change in the feeling of depth? Now direct the light from behind the arrangement. Do you see shadows? Under which lighting (front or back) does the arrangement seem to have more depth? Which lighting makes it appear flatter?

SCALE

Scale deals with the size relationship of an arrangement to its setting. Obviously, an arrangement for a large stage needs to be big, and an arrangement for a small coffee table needs to be petite. Flowers for a wedding held in a cathedral will be on a much grander scale than flowers for a wedding in a small country church. There is a logical and harmonious relationship between a design and its surroundings. If they have a correct size relationship, the arrangement is said to be *in scale* with its setting.

PROPORTION

The size relations between the different components **within** an arrangement are also important. The size of the container, the size of the bow or accessory, the number of flowers, and amount of foliage are all choices the floral designer has to make. The size and amount of each of these used is called proportion. If an arrangement is *scaled up* (made larger), the sizes of the components will all increase but the proportions between them will not. For example, the ratio of the flower surface area to the container surface area will remain the same even though more flowers and a larger container will be used in the scaled-up arrangement.

Picture a miniature arrangement (less than 4 inches in any direction) that is then enlarged twenty times. The size relationships within the enlarged design should still be as artistically pleasing to the eye as they were in the miniature arrangement. If this is not the case, the proportions in the miniature arrangement were not ideal. This example is mentioned to dispel the myth

that small arrangements can rely on their dainty charm to cover up violations of the principles of design. The truth is that a lot of skill is required to execute a good design in a very small space (Fig. 3-22).

Color and texture are important considerations in the decision of what amounts of each flower to use. The more any one color or texture is used, the more dominant that color or texture becomes and the greater importance it takes on.

Another important decision in creating an arrangement is the selection of the container. The size of the container sets certain limits on the size of the arrangement. A container that is taller than it is wide suggests an arrangement with some height. A common guideline in floral design is to make the height of the arrangement at least 1 1/2 times the height of the container (Fig. 3-23). When a container is low and wide but is being used for an arrangement with height, the rule is that the arrangement should be at least 1 1/2 times taller than the container is wide. This type of arrangement is frequently seen in the Oriental style (Fig. 3-24) with water showing in part of the container. Flower placements even taller than 1 1/2 times the container are often acceptable and usually result in a stately arrangement. Shorter heights are also possible if flowers and foliage are extended down below the rim of the container (Fig. 3-25).

How massive or delicate the container is also dictates the size limitations of the arrangement. A stoneware urn can be appropriately filled with a large, heavy line-mass arrangement (Fig. 3-26). By contrast, a crystal vase is more suitable for an airy display

Figure 3-22
Miniature
arrangements



Figure 3-24
Oriental
arrangement in
shallow,
rectangular
container

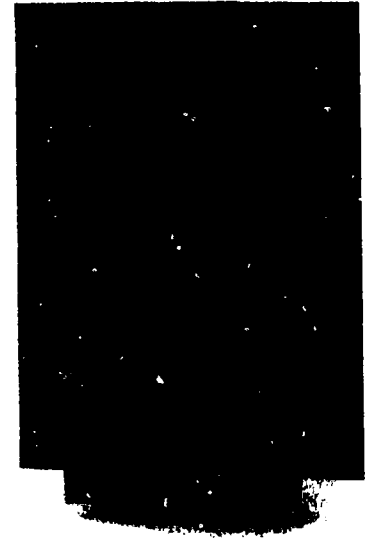


Figure 3-23 Using
a tall container



Figure 3-25 Arrange-
ment extending below
rim of container



Figure 3-26 Stoneware urn with heavy line-mass arrangement

of delicate flowers on long wispy stems (Fig. 3-27).

The container should not be so large and heavy in appearance that it overpowers the arrangement. On the other extreme, the arrangement should not overpower the container. This has happened if the container appears lost under a heavy load of flowers and foliage.

Another aspect of size relationship is that of flowers to foliage. In general, large flowers look best when combined with foliage that has larger leaves (Fig. 3-28). Small fine-leaved foliage is usually more effective with smaller, more delicate flowers (Fig. 3-29).

Size relationships also exist between the various flowers used in an arrangement. A very large flower next to a very small flower of the same type is usually not desirable. Even a very large flower next to a very small filler flower of a different type is often undesirable. If you must work with very small

filler flowers, like star-flowers, remember that they can be clustered together and used in loose bunches for a more pleasing size relationship with large flowers.

Open spaces or **voids** are as important as flower and foliage placements in determining the use of the area within an arrangement. Open spaces often give added interest to the flowers that are featured in or near them. Also, as discussed earlier, voids are an important element of depth.

Proportion and scale become critical if an arrangement is displayed in a well-defined unit like a niche or alcove. Similarly, proportion and scale are of primary concern when creating a design of pressed flowers in a picture frame (Fig. 3-30). The design must not be too large or too small; it must never crowd the frame or disappear under it. A helpful guideline for designing an arrangement in a well-defined space is this: the arrangement should occupy about two-thirds of the area, while the background should make up the remaining one-third.

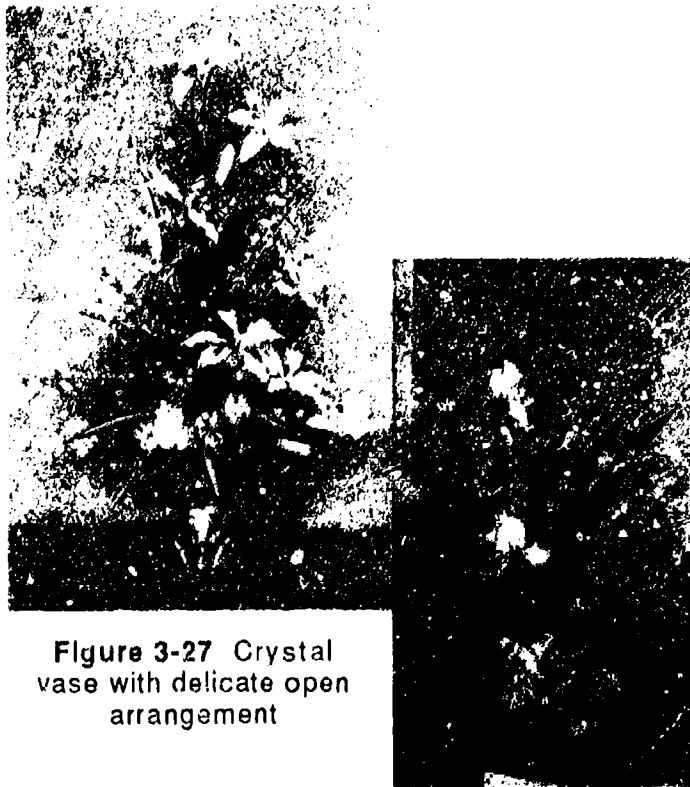


Figure 3-27 Crystal vase with delicate open arrangement

Figure 3-28 Large iris and lupine combined with bold linear foliage



Figure 3-29 Arrangement of delicate columbine with fine sprengeri foliage

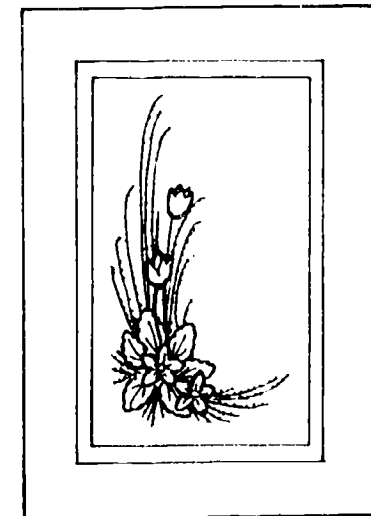


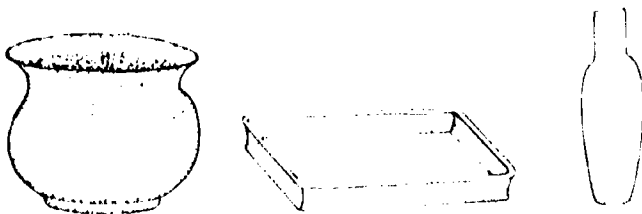
Figure 3-30 Floral picture showing good proportion and scale

SUGGESTED ACTIVITIES

1. Using small pieces of dried flowers, grape vine tendrils, small shells, buttons and other miniature objects, have each student create a small arrangement less than five inches in any direction. When the arrangements are finished, try to imagine each one five times larger than it is. (The proportions are the same but the scale has been increased five times.)

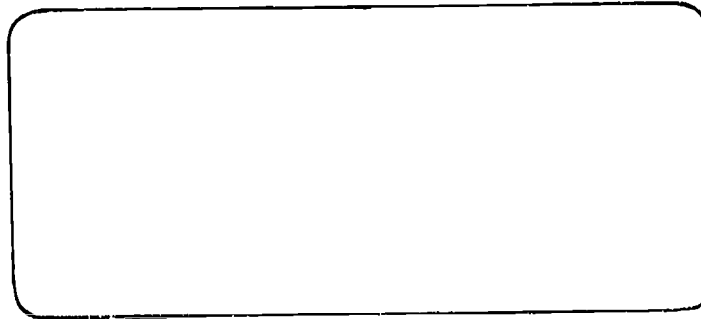
Is the arrangement still pleasing to you? If the answer is *yes*, your proportions were probably acceptable in the small arrangement. If the answer is *no*, the proportions were probably not ideal in the small arrangement.

2. Consider the following containers for arrangements. Using the guidelines established for height in relationship to container size, sketch in the appropriate height of an arrangement for each of the containers below.

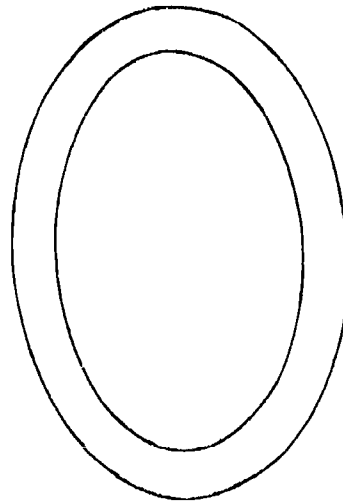


3. Consider the following settings for an arrangement. Sketch in the arrangement shape indicated. Give special attention to the scale of the arrangement (its size in relationship to the area where it is being displayed).

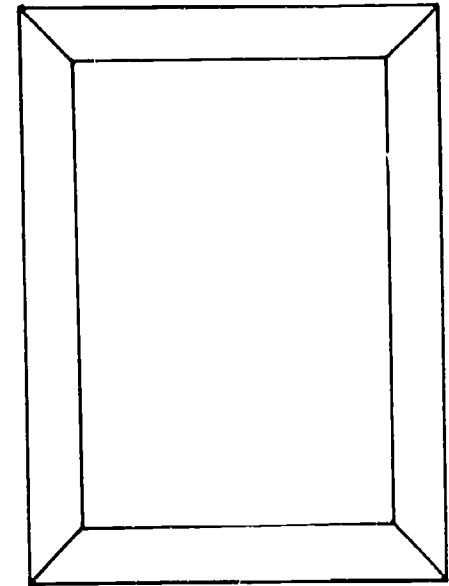
A. Diamond centerpiece on a rectangular dining room table



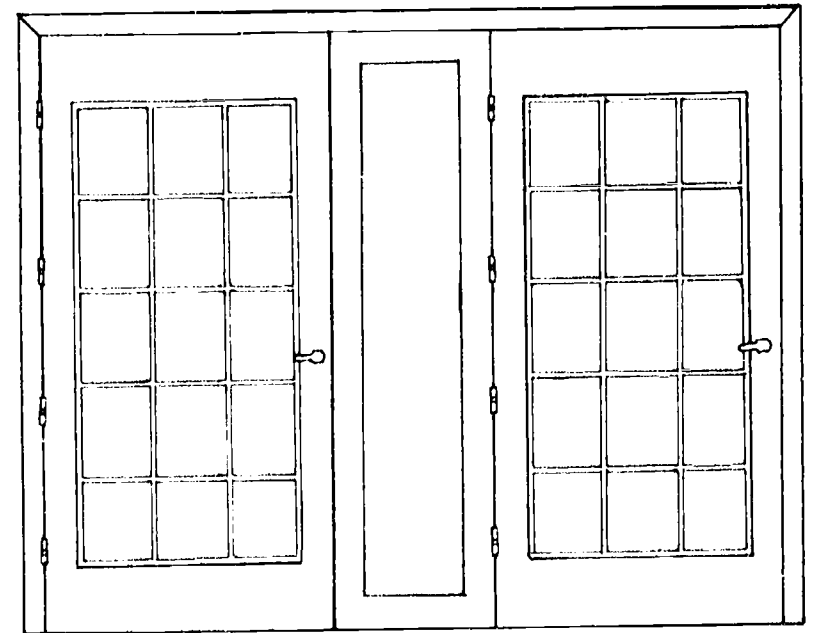
B. Crescent arrangement of pressed flowers in an oval picture frame



C. An isosceles triangle in a wall niche



D. A vertical arrangement to be placed on the floor between two doors



Arrangements Showing Rhythmic Flow

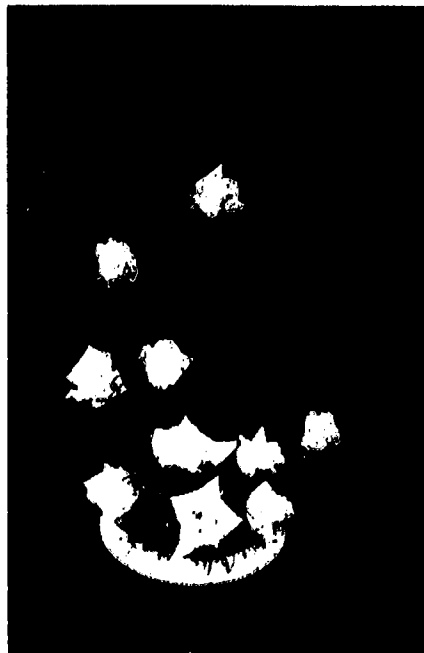
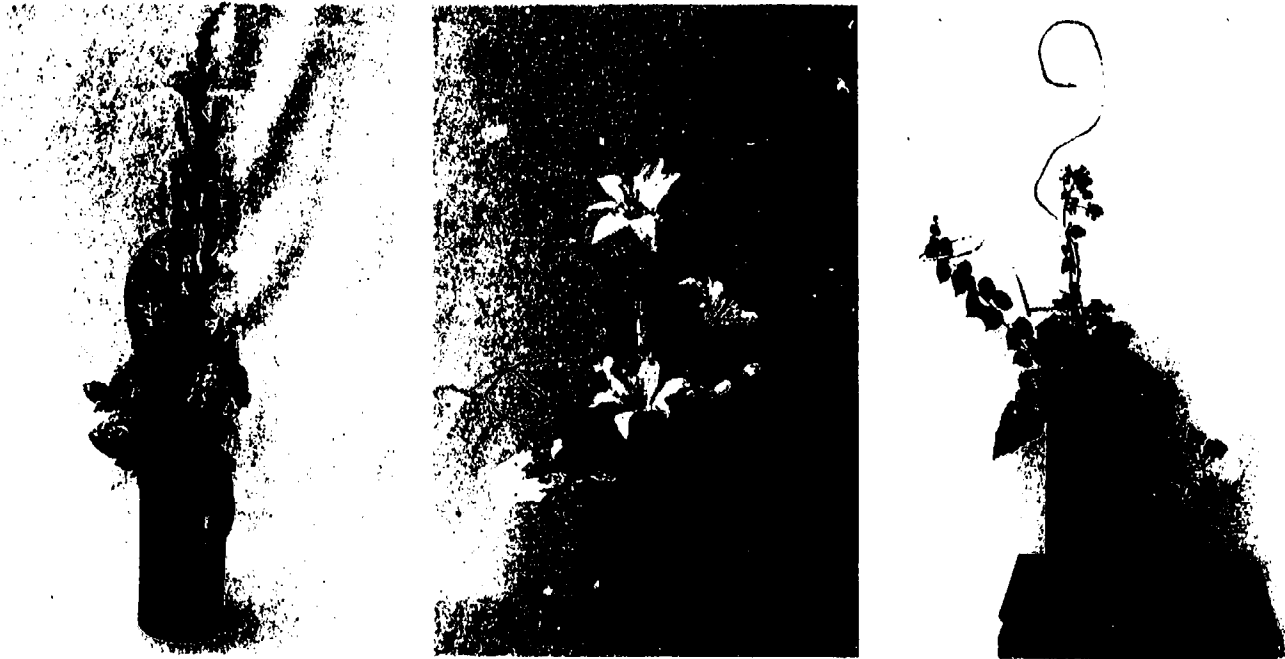


Figure 3-31 Crescent arrangement with a C-shaped trunk line; focal point just above rim of container

RHYTHM

A well-designed arrangement has the ability to lead the eye of the viewer around and through it by the careful selection of materials and their placement. This feeling of motion in the design is the principle of rhythm. Size, shape, color and texture of the materials, as well as spacing between materials and the way they are angled, are all factors in leading the eye in some direction. As in music, the pattern that is developed is usually regular and predictable.

In line arrangements the rhythmic flow is easy to see. The eye follows the straight or curved lines of branches, flowers or foliage. Willow branches, gladiolus and eucalyptus are examples of materials that naturally form lines. Round flower forms can also be used to form a line and therefore direct the eye along it. The repetition of the same flower will attract the eye and establish some type of movement, depending on the size, spacing and facing direction of the flowers.

Major lines in line-mass and even in mass arrangements are sometimes called **trunk lines**. They lead to or pass through the **focal point** (center of interest in an arrangement). They are usually established early in the construction of a design and are made using just one type of flower. Trunk lines are useful in studying how rhythm or visual flow is created. (See an example in Figure 3-31.)

Many different factors affect rhythm in a design. To discuss them more easily, we will look at an example of a specific arrangement:- a vertical arrangement of roses and assorted foliages in a tall container with the focal point at the rim. Some techniques for

achieving rhythm involve spacing, size, shape, facing, depth and color. These will be considered individually in the following sections.

Spacing Rhythm

The closer together flowers are spaced, the more visual attention they receive. Therefore, the closest spacing should be at the focal point with a gradual increase in spacing as the eye travels up the vertical line. Although flowers near the focal point ought to be close, they should never press on each other and give a crowded effect. Going outward from the focal point, the distances between flowers should gradually increase in a smooth and predictable manner in order to achieve rhythm (Fig. 3-32). Flowers that are evenly spaced result in a line that does not lead the eye because there is no rhythm (Fig. 3-33). Flower spacing that is irregular and unpredictable results in jerky rhythm (Fig. 3-34).

If you had to make an arrangement with flowers of all one size, like graded carnations, you would have to depend heavily on spacing rhythm to lead the eye along the line. Size variation used along with spacing variation is best to create a rhythmic effect.

Size Rhythm

Larger flowers have more visual weight and so are used closer to the focal point. Smaller flowers of the same kind are placed farther away. A gradual change in size from large to small should occur as the eye moves away from the focal area. In general, the farther from the focal point, the smaller the flowers of any one type become. For

example, rose buds are smaller than full-blown roses. A nice size rhythm along the line can be created with roses; buds should be placed at the top, then gradually more open blossoms in the middle, and finally fully opened flowers at the rim of the container.

If filler flowers are used, they are likely to be smaller than the principal flowers, but they are an entirely different element of the design. If you were to look at only the filler, it too should show size and space rhythm along the line. At times pieces of filler are bunched together near the focal point so that their size is larger than pieces used farther out in the design.

Shape Rhythm

Changes in shape can also be regular and predictable, and therefore rhythmic. Consider again the example of the roses. Buds gradually opening to full-blown roses, with their change in shape, can be used to achieve rhythm. The narrowest pointed buds can be used farthest away from the focal point. The more rounded forms are best used nearer the focal point. These can be made to look even larger and more round by tilting them so they are viewed head on. This is related to another aspect of rhythm- facing rhythm - that is discussed next.

Foliage shapes can be changed in a vertical arrangement to help develop shape rhythm (Fig. 3-35). Long narrow leaves, like those of snake plant (*Sansevieria*) are used to establish the tallest part of the line; oval shapes are gradually worked in; and finally round shapes are used near the focal point (Fig. 3-36). The predictable change in shape

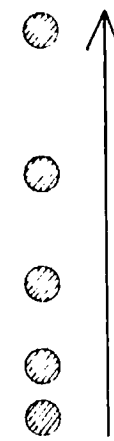


Figure 3-32
Gradual
increase in
spacing-
Good rhythm

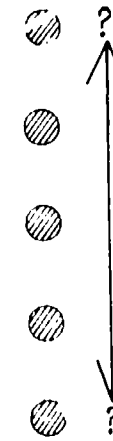


Figure 3-33
Even spacing-
No rhythm

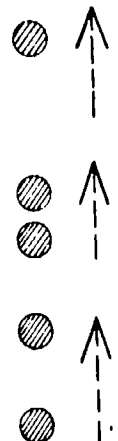


Figure 3-34
Irregular
spacing-
Jerky rhythm

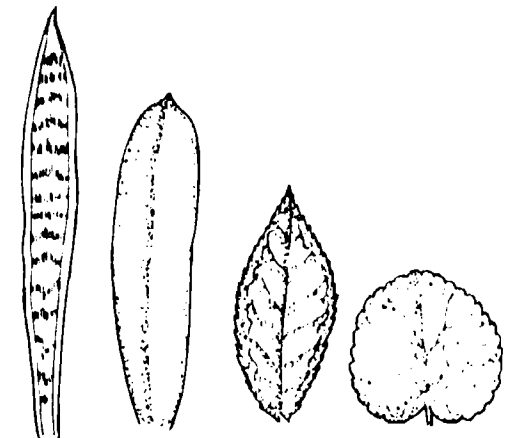


Figure 3-35
Rhythmic change in leaf shape
from linear to round

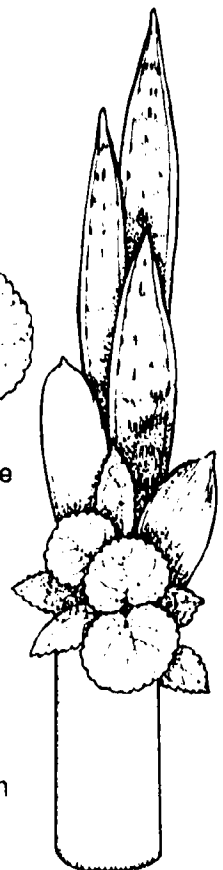


Figure 3-36
Use of shape rhythm
to lead the eye
to the focal point

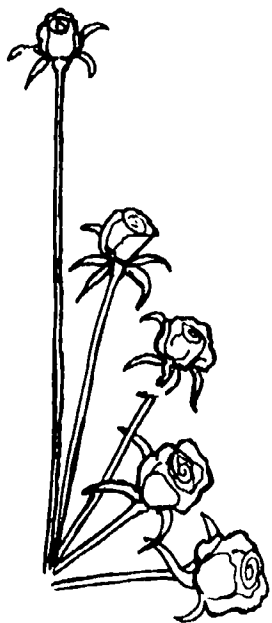


Figure 3-37
Side view of an
arrangement
showing good
facing rhythm

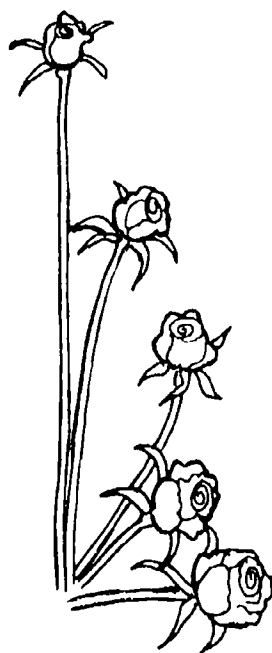


Figure 3-38
Jerky rhythm
resulting from
uneven facing

helps lead the eye to the focal point, while not distracting from the vertical line.

Facing Rhythm

The suggestion has already been made that tilting a rose to face forward in an arrangement is a way to increase its eye appeal. It is especially desirable for flowers near the focal point to face the viewer in order to gain maximum attention. As the eye travels up the vertical line, there should be a gradual and predictable change until the tallest flower is facing upright (Fig. 3-37). This facing change is most evident in side view. The stem angles make a 90° change in direction. If the facing changes are abrupt, the result is an uncomfortable feeling called jerky rhythm (Fig. 3-38).

Facing changes also occur as the eye travels to the sides of the arrangement. While the focal flower may face directly toward you, the side flowers will face sideways or even backwards. This change of facing leads the eye around the arrangement and creates depth. Again this facing change must be gradual or jerky rhythm will result.

Depth Rhythm

Depth in an arrangement can be achieved by an "in-and-out" placement of the flowers. Besides the effect on depth of the facing of the flowers, there is another aspect of depth that leads the eye in and out of an

arrangement. This is called depth rhythm and involves the arrangement of flowers in many designs to appear to radiate out from a common point. Depth rhythm gives unity as well as directional flow to the arrangement. In a mass arrangement like the mound, the eye is pulled inward to the focal area which exists in the heart of the design.

Color Rhythm

Color can be used very effectively to lead the eye from one part of a design to another. Usually colors with the greatest eye appeal are placed near the focal point, with a gradual change to less intense colors farther out in the design. Colors that appear heavier are used low in the design and sunken in for depth. Using too many colors can create a confusing effect where color rhythm is not obvious.

Color rhythm may be created by a change in value (such as pink to rose to dark wine) or a change in chroma (such as soft yellow to medium yellow to bright yellow). Color needs to be repeated predictably throughout a design so that it does not occur in a random or spotty fashion.

Rhythm is most effective when several or all of these aspects of rhythm work together. When the flowers to be used are all the same size and color, the designer must work harder on spacing and facing to ensure that the eye is led smoothly to the focal point.

SUGGESTED ACTIVITIES

1. Use seven carnations all of one color and one size and a low container filled with a piece of floral foam. Arrange the carnations in a vertical line so that they show spacing rhythm. Measure the distance between flowers, beginning at the bottom, and write them down in order. The figures should gradually become larger. If two numbers are the same or if a number suddenly shows up that is less than the one before it, you probably have jerky rhythm. If this happens, go back and alter the placements to correct the situation.
 2. Use the same flowers to check facing rhythm. Turn the container sideways. Do the stems gradually change in angle from straight up for the tallest flower to directly out sideways for the shortest? If not, change the angle of placement without changing the flower spacing. After you have done this, look at the arrangement from the front. The results should be pleasing. Can you relate all this to depth rhythm?
 3. Use seven flowers of various sizes in different degrees of openness. Arrange them in order from the smallest bud to the largest fully opened bloom. Do the stem lengths allow the smallest flower to have the tallest placement in an arrangement? This is a problem that frequently confronts floral designers. You may have to start your size progression with a slightly larger flower and eliminate the bud. Another option is to extend the stem length through the use of a water pick attached to a hyacinth stake.
 4. Look at a demonstration arrangement of a symmetrical triangle like the equilateral and analyze it for the various aspects of depth.
 - A. Identify the focal point. Is the tallest flower farther from the focal point than the side points of the triangle? In considering size rhythm should the tallest flower be larger or smaller than those at the side points?
 - B. Is there a gradual change in spacing as you move in toward the focal point in all directions? Is the focal area crowded? If flowers are touching, consider removing some or sinking some in for greater depth.
 - C. Do the flowers gradually change the direction they face as you go to the sides of the arrangement? Is the eye led behind or does it stop abruptly at the edge of the arrangement?
 - D. Turn the arrangement to a side view. Can you see a facing change from top to bottom? Is the lower focal area sticking out the farthest or is it overshadowed by placements above it? A pushed-in focal point usually is associated with facing changes that are not rhythmic.
 - E. If there is any color variation, has it been used to lead the eye to the focal point? Describe the qualities of the flower color nearest the focal point and those of the flowers farthest away. If there is a difference, are the intermediate values or chromas seen in between?
 - F. Analyze the arrangement for depth. Do the stems appear to radiate out from a common point? Are the flowers spaced so the eye can see into the arrangement?
-



Harmony in Tropical Arrangements
Allen Beck, AIFD



TRANSITION

Transition is a principle which is essential to rhythm, but it has a wider significance in floral design. Any change in size, shape, direction or color involves transition. A **smooth transition** is created by using intermediate sizes, shapes and colors. A sharp change (as in the direction of a line, for example) results in an **abrupt transition** which has been intentionally created for its dramatic effect.

Transition is also very closely tied to **repetition** and **unity**. In a case where the major flowers of an arrangement are of a different color from that of the container, repeating the color of the container in the foliage or filler flowers will create a smoother transition. For example, a yellow vase is holding bright orange flowers. Choice of a foliage with yellow variegation will make for a smoother transition. Transition is perceived as the eye moves from one part of an arrangement to another. The result should be a total unified statement.

HARMONY

Harmony is the principle of total compatibility of all parts of an arrangement with each other. It also relates to the appropriateness of the arrangement with regard to its surroundings and the occasion. Any jarring elements or disregard of any design principles will lead to lack of harmony.

Color harmony is often given special attention. Refer to the unit on color and color combinations to review color schemes generally regarded as pleasing. Using flowers

and foliages that repeat colors found in a vase or accessory will give a more unified and harmonious appearance to a floral design. Corsages which include colors that match or coordinate with the colors in the wearer's clothing will be harmonious. A silk arrangement to be used as part of the decor of a room is more likely to be harmonious with the setting if it contains some of the same colors that are found in the carpet, wallpaper or furnishings.

The style of an arrangement must also be appropriate for the setting and the occasion. Two major categories of design styles are **formal** and **informal**. A table centerpiece for a large wedding dinner would need to be formal, while a buffet piece for a back yard barbecue would most likely be informal. Design shapes and materials chosen for an arrangement influence how formal it appears.

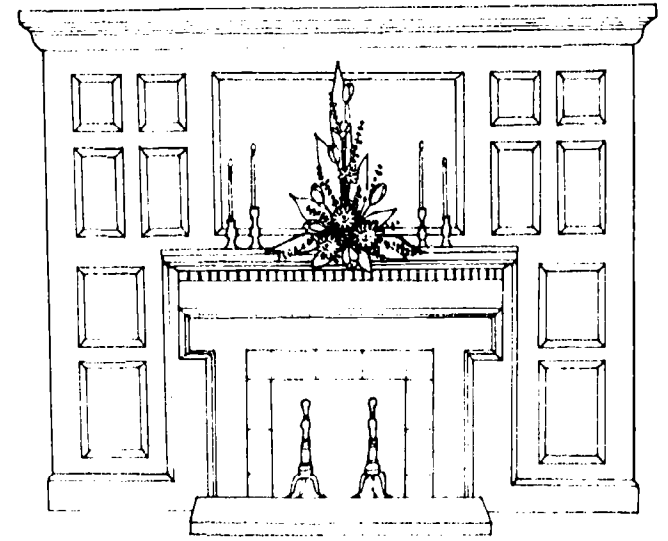
On the next page is a list of considerations that may help distinguish formal from informal settings.

Many flowers can be used in both formal and informal settings. A pompon chrysanthemum can appear totally appropriate in an informal, open arrangement for a picnic, placed on a red and white checked tablecloth. The same mum can be equally at home in a formal silver candelabra with roses and carnations, placed on a lace tablecloth. The selection of container, accessories, foliages and design style along with the flowers will determine which feeling is given. If the combination is pleasing to viewers, the result is harmony.

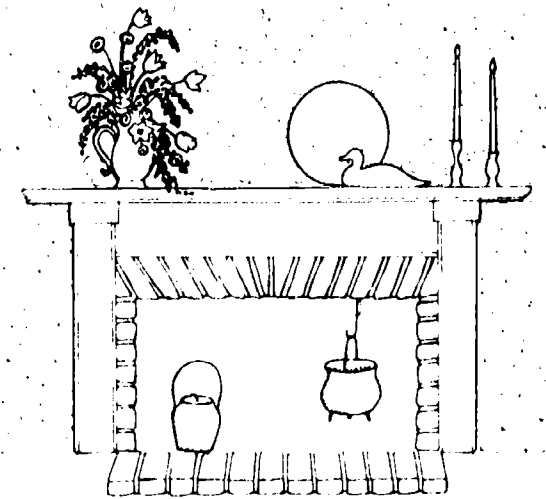
Combining contrasting textures in flowers, foliage and containers may be harmonious if the materials are compatible in formality. Velvety textured roses provide a nice contrast with the shiny silver of a formal container. In a corsage roses contrast appropriately with the smooth leaves of camellia or ivy. However, a coarse textured sunflower would be inappropriate in a smooth silver or delicate crystal container because the sunflower is informal and the containers are formal. The sunflower would be more suitably used in an earthenware pottery container.

Certain flowers and foliage are harmonious because of where they grow or when they bloom. Spring flowers like tulips, daffodils, irises and pussy willows combine

beautifully. It would be much less harmonious to combine these with geraniums, autumn colored chrysanthemums, or red poinsettias which represent other seasons of the year. Tropical plant materials from warm climates generally look inappropriate combined with plants from northern temperate climates. Tropical foliage like croton or philodendron harmonizes with birds of paradise, orchids and ginger, while native greens such as euonymus or juniper look best with the flowers of bulbs, perennials and annuals that grow in northern areas. Dry-climate plants like cacti and succulents look most harmonious with stoneware pottery, driftwood and other coarse textured, earthtone accessories that suggest their natural habitat.



Formal



Informal

	Formal	Informal
Design Shape	arrangement usually symmetrically balanced	arrangement often asymmetrically balanced
Placement of Design	arrangement usually placed symmetrically in center of the setting or in balanced pairs	arrangement may be placed off-center
Flowers Used	those associated with formal occasions - roses, orchids, carnations, lilies	those associated with informal occasions - daisies and garden flowers like marigolds, zinnias, geraniums, sunflowers
Textures	smooth, shiny, or velvety	coarse, rough

Harmonious Flower Combinations



Formal roses and
snapdragons



Summer
garden
flowers



Spring flowers

SUGGESTED ACTIVITIES

1. Have each person think of and then describe a situation that would require a formal floral arrangement and one that would require an informal floral arrangement. Tell for each what flowers and container you would use, what design shape you would select, and where you would put the design. Explain how each arrangement exhibits harmony with its setting and occasion. Did you remember to use color and texture to enhance harmony?

2. Describe the types of arrangements that would be suitable for the following occasions:

- A. New Year's Eve party
- B. opening of a new bank

- C. Sunday brunch for close friends
- D. Hawaiian luau
- E. pizza party
- F. National Honor Society tea

3. Describe the types of arrangements that would be suitable for the following settings:

- A. hospital room
- B. Williamsburg mantel
- C. principal's desk
- D. Easter dinner
- E. brunch for Ohio Conservation Club
- F. animal judging team banquet

4. From the list below of flowers, containers, design styles and accessories, pick one from each column to make a harmonious grouping. Try to find at least four groupings.

Flowers	Containers	Accessories	Design Styles
daisies	palm spathe	antique velvet-covered picture album	line
roses	Oriental urn	coconut	open line-mass
fuji mums	silver Victorian compote	paper-mache mushrooms	open mass
birds-of-paradise	hollowed-out log	long-legged bird figurines	compact mass

REPETITION

Repeating a color, texture or shape throughout an arrangement is desirable and necessary to give the arrangement a feeling that it is tied together. Using the same flower throughout the arrangement is one way to accomplish this. The flowers, however, must be placed rhythmically (with predictable differences in spacing) to avoid monotony.

More subtle repetition may be evident when different materials having the same qualities are used. The yellow color of a container may be repeated in a yellow foliage variegation, the coarse texture of a pottery container may be repeated in the roughness of a dried leaf, or the oval shape of a container may be repeated in an oval design shape selected for the arrangement.

Accessories and backgrounds present additional opportunities for clever repetition. Table settings have the possibility of repeating colors not only within the arrangement but also in the china, napkins, napkin holders, candles and other accessories. A dried or silk arrangement for a room should contain colors and textures that are found in the wallpaper, carpeting and furniture. Wedding flowers, including not only the larger arrangements for the sanctuary but also the flowers worn by the women and men attendants, are tied together as a total statement by repeating colors throughout. Repetition is a key factor in establishing unity.

UNITY

Unity is a statement of togetherness that results when all parts of the design are compatible with each other and with their

surroundings. Repetition is an essential element of unity. Harmony in style and suitability for the occasion as well as harmony in color and texture are necessary to create a feeling of oneness in a design.

The establishment of a focal point and the selection of one dominant flower in an arrangement will unify the design. Avoid using a flower in only one part of a design and do not layer colors. Try to achieve a rhythmic transition so that the viewer's eye is led throughout the design in a predetermined manner. As you can see, the goal of unity is achieved only if several other principles of design have been well carried out.

EMPHASIS

A well-planned arrangement will have one material that dominates over the others and one area that has the strongest eye appeal. Therefore, that area and that dominant material are emphasized. Other materials in the arrangement may provide contrast but take a second or third place in terms of attracting the eye.

The area of emphasis in an arrangement is called the **focal point** or center of interest. In traditional flower arranging it is usually located just above the rim of the container and is where the largest flowers are placed most closely without crowding. (See Figure 3-39.) The flowers in this area are usually placed facing directly outward and they stand out closer to the viewer than other flowers in the arrangement. A focal area that does not stand out like this, but instead is pushed in is called a **recessed focal point**. If flowers that are too small are used in this

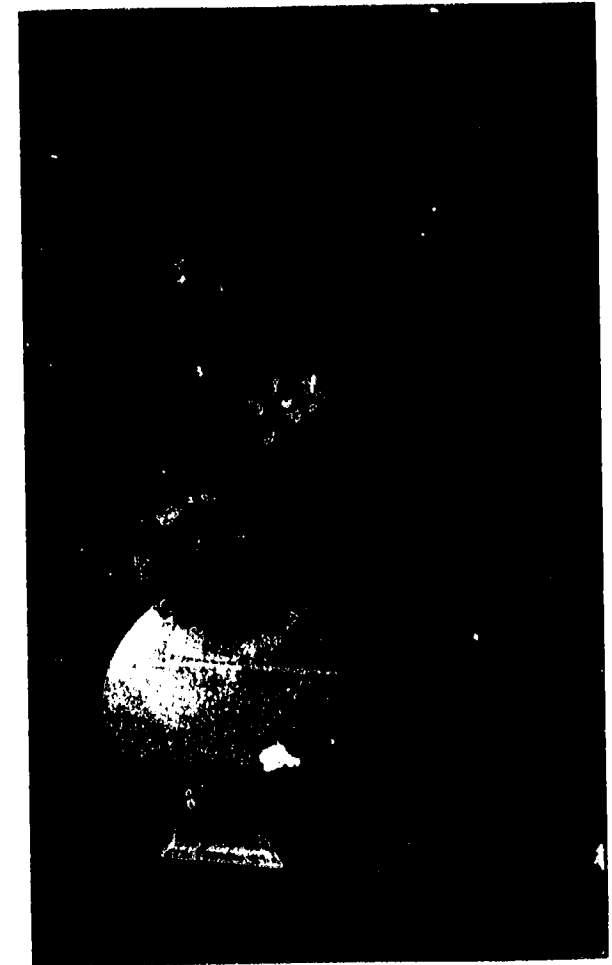


Figure 3-39
The largest rhododendron at the rim of the container is the focal flower

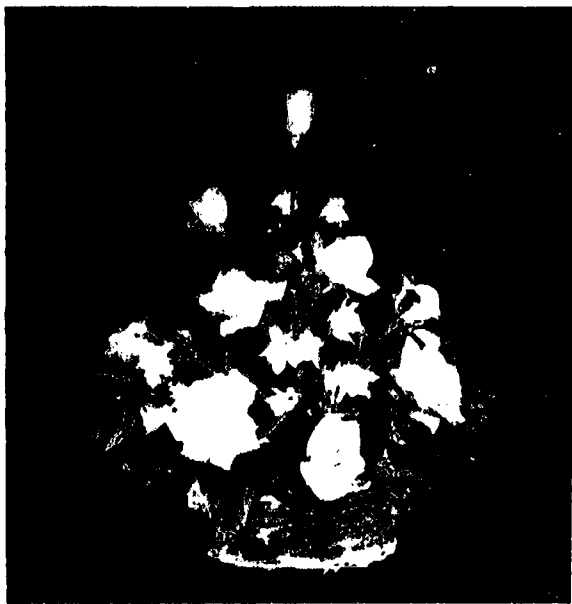


Figure 3-40

The focal point is deep in the design

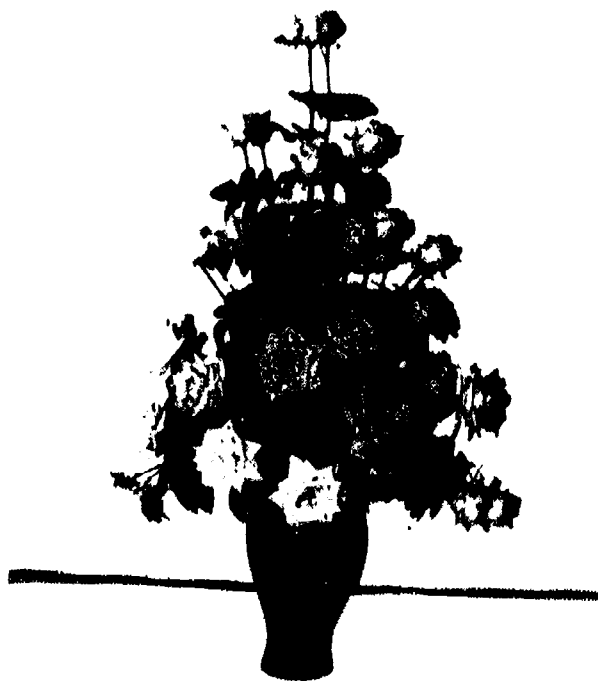


Figure 3-41

The focal area is low in the arrangement where the largest roses are facing the viewer

area, it is called a **weak focal point**. Recessed or weak focal points are undesirable and are considered to be serious flaws in a floral design.

Color can be used to give more emphasis to the focal point. If there is color variation in the design, the brighter colors with more eye appeal should be concentrated here. If flowers are at various stages of opening, the more fully opened blossoms should be used near the focal point.

Although the eye of the viewer is immediately attracted to the focal area, it should not stop there. A good design soon leads it through the arrangement in a rhythmic manner to the outermost points. Then a good design directs the eye of the viewer back to the focal area by a gradual increase in size and decrease in spacing of the flowers, and by predictable differences in facing, shape and color.

The focal point can be most easily identified in a line design that has few flowers. It is usually represented by the single largest flower. In Oriental and modern line designs the focal point is elevated well above the container and is surrounded by considerable space.

In an all-around mass arrangement the center of interest is represented by an imaginary point deep in the design from which all the flower placements appear to arise (Fig. 3-40). The actual spot may not be seen, but it is clear from the angle of stem placement that the design is unified by this point of radiation.

In one-sided mass arrangements the focal point is usually in the center just above the rim of the container. Symmetrical triangular arrangements and fans exhibit this very well (Fig. 3-41). In line-mass arrangements the focal area is also usually just above the rim of the container, but it may not be centered and there may be significant extensions of the arrangement both above and below the area. In crescent and Hogarth curve designs, approximately two-thirds of the arrangement is above the focal point and one-third is either to the side or below it.

A common flaw in establishing a focal area is to crowd the flowers together very closely. This is likely to happen if you have not left enough space between the flowers at the upper and outer extremities of the design. Crowding the point flowers at the start of design construction can result in a very crowded look by the time you work toward the focal point. A possible way to correct the flaw is simply to remove flowers from the crowded area. You could also pull some flowers out farther and sink others in deeper. (The pulled-out flowers should be completely removed and then reinserted in the floral foam so that an air pocket does not form right under the cut stem.) The latter solution will maintain the visual weight of the flowers while improving another important principle - depth.

Designers are sometimes faced with flowers which are relatively small and have little size variation to help establish a focal point. Such small flowers can be clustered into different sized bunches, with larger units used near the focal area.

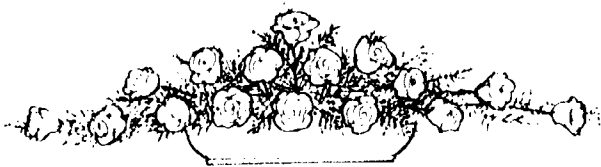
Color near the focal point is a little more complicated since eye appeal is determined by various aspects of the hue. Usually darker colors are thought to be the "heaviest" and therefore most suitable for using near the focal point. This is not always true, since the darker colors may be dull and often are hard to see in dim light. Dark flowers are usually good for sinking down into the arrangement for depth. Flowers that have a bright chroma would be natural choices for using near the focal point.

The designer must look at the materials available to work with, evaluate the lighting conditions under which the arrangement is to be viewed, and then decide which flowers will have the highest eye appeal. The designer will then use more of these flowers near the focal point.

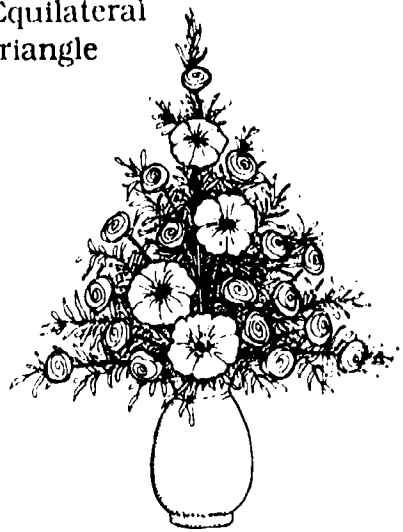
SUGGESTED ACTIVITIES

1. Draw a circle around the focal point (center of interest) in the following arrangements. If the focal point is not a flower or a group of flowers but is an imaginary point within the design, draw an arrow to where you think the focal point is in the arrangement.

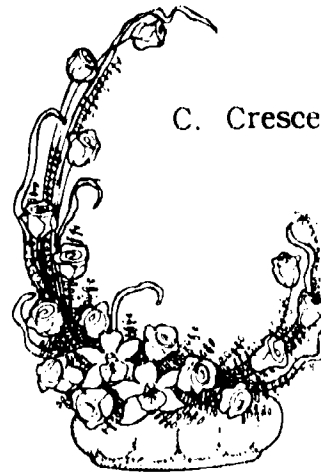
A. Diamond centerpiece



B. Equilateral triangle



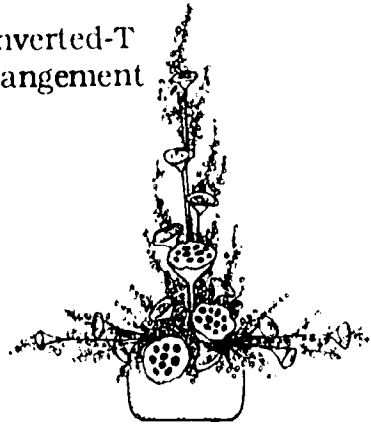
C. Crescent



D. Oriental arrangement



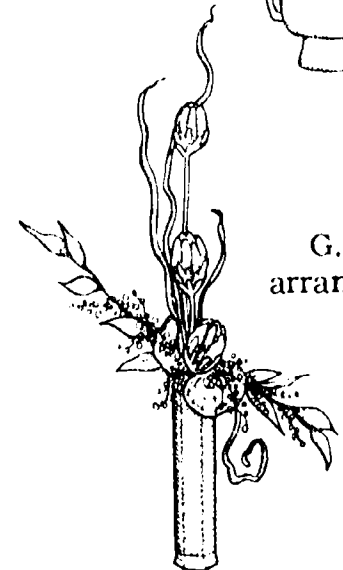
E. Inverted-T arrangement



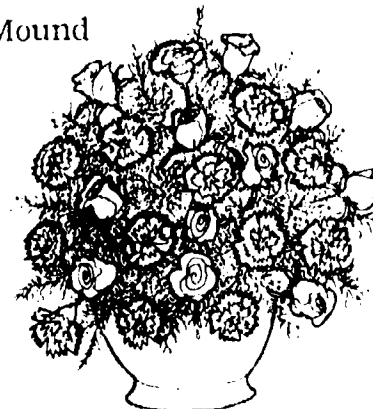
F. Modern arrangement



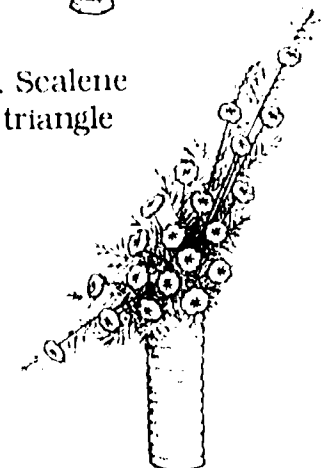
G. Line arrangement



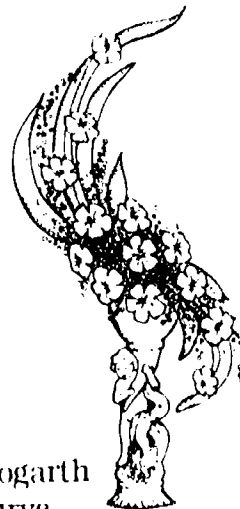
I. Mound



J. Scalene triangle



H. Hogarth curve



Examples of Dominance



Larger calla lilies dominate roses and orchids



Taller heliconia dominates shorter placements

2. Look at a demonstration arrangement which was well-planned and shows a lot of motion. Or find a large picture of such a design in a book or magazine. Concentrate on how your eye travels through this arrangement. Is your eye attracted first to the focal point? Does it then travel to the outermost points and then back again to the focal point? An interesting variation on this exercise is to have someone watch your eyes as you look at the arrangement for the first time. Your eye movements will confirm whether or not you have experienced the arrangement in the manner that is encouraged by the principles of design.

CONTRAST

Differences in color, texture and form are used in flower arrangements to introduce variation and interest. Often the difference will highlight the dominant material. The contrasting colors of red and green are an example. Red looks more intense next to green than it does in the absence of green.

Contrast can also add interest to materials that are not as dominant in the arrangement. For example, the linear form of yucca or snake plant leaves is emphasized by the presence of round galax leaves at their base. A rough-textured leaf looks coarser next to a smooth background than it does against a woven background. A curving branch of wisteria looks more interesting when it intersects a strong vertical line of iris leaves than it does by itself.

Contrast should be used somewhat sparingly to enhance the dominant form, color or texture in a design. When contrast is

used without restraint, it leads to confusion and busyness.

DOMINANCE

When several forms, colors or textures are used, one should be used in greater quantity than the others. Thus, one dominates while the other elements take a secondary position.

A classic example of lack of dominance can occur when an arrangement is to be made with equal numbers of red and white carnations. They are of equal size and when used in equal quantity, they compete with each other. While a skillful designer could manipulate the materials into a desirable product through placement, it would be much easier to have unequal quantities or two different types of flowers.

The flower used in largest quantity is the dominant flower and those used in lesser quantities are the secondary flowers or filler. The secondary flowers should, however, either follow the pattern of the arrangement or be introduced as a secondary line of color or form.

In line arrangements, because of their elevated position, taller flowers tend to dominate shorter flowers. If two flowers have the same stem length and are placed side by side, they will not lead the eye down the lines of the arrangement. Stem lengths should be gradually decreased as you near the focal point. This establishes dominance in height and helps create a clean-cut, distinctive pattern.

USING THE PRINCIPLES OF DESIGN

The principles of design are interwoven one with another. The designer, somewhat like a computer, is faced with hundreds of possible correct choices in the selection and placement of materials. If each member of the class made the same style arrangement, and if everyone correctly employed the principles of design, still no two would be exactly alike. There are many very good, but different, products that could be created, even if each student were given the same kinds of materials.

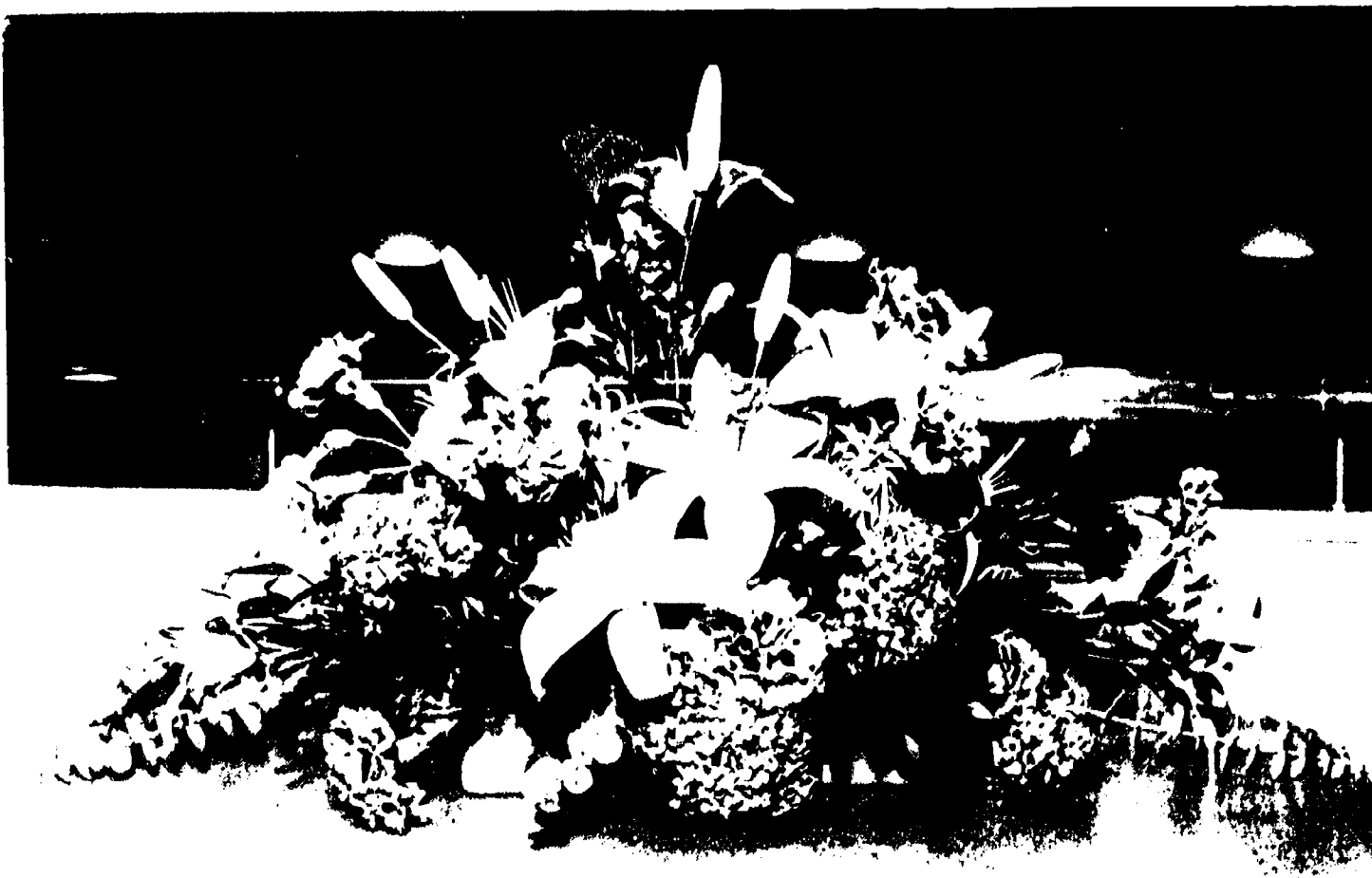
It is impossible to describe every possible way that the universal art principles can be expressed in flower arranging. Even so, every good design will adhere to the principles. It should be your goal to analyze your work and the work of others based on the principles of design. Practice using the terms so that you become comfortable with their meaning. Then you should be able to apply the principles creatively in your own original work.

Traditional Guidelines

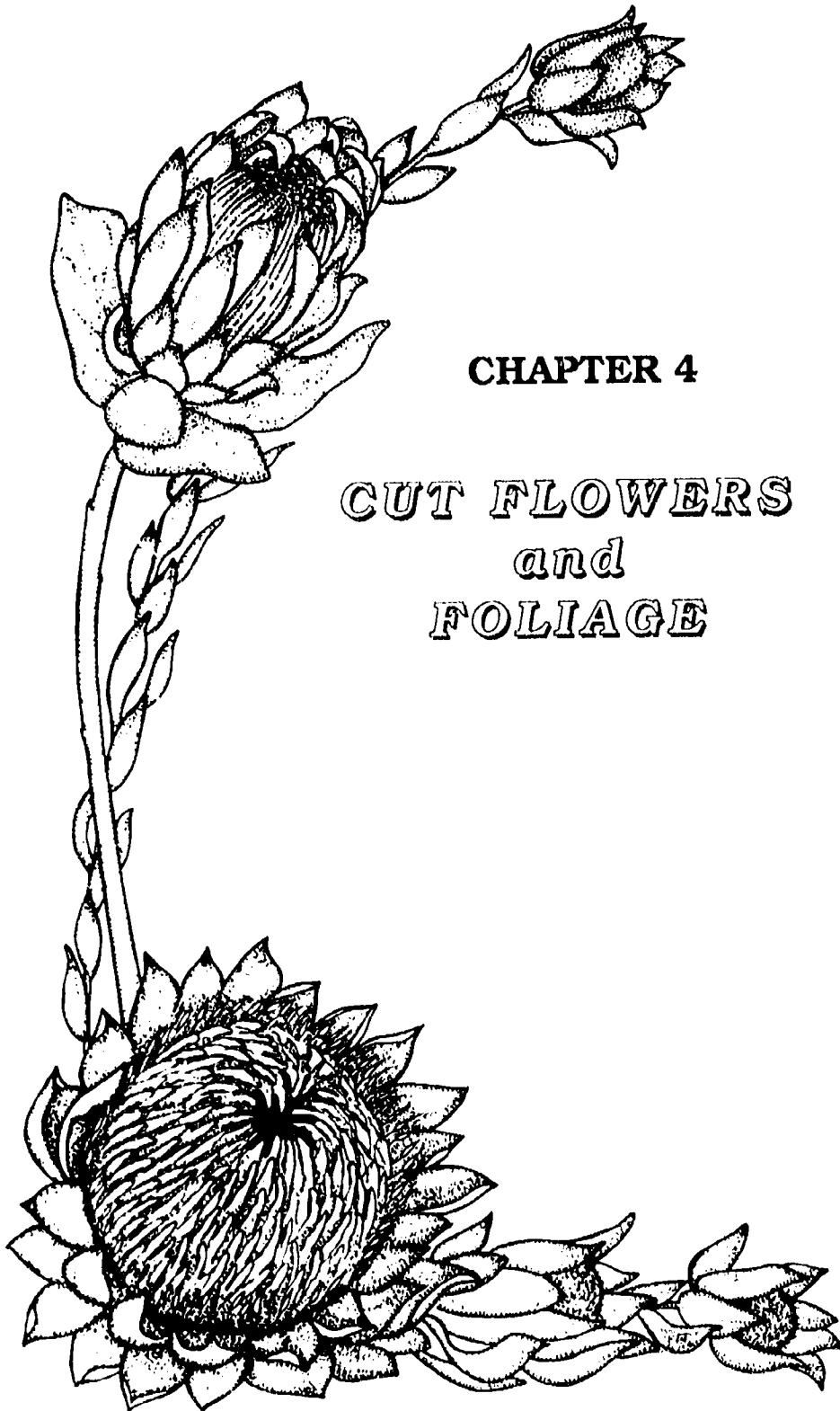
As the art of floral design has become more formalized through practice, teaching and writing, there has developed a group of traditional guidelines that are frequently cited by people involved in flower arranging. These guidelines may be especially beneficial to beginners in helping them avoid certain common mistakes. The advanced designer knows when and how to use exceptions to these guidelines in specialized design styles. These guidelines, listed in random order, are an important part of your floral design training.

Guidelines

1. An arrangement should be at least one and a half times the height of a tall container or one and a half times as tall as the width of a low elongated container.
2. Use odd numbers of flowers if you are using less than ten of one kind in an arrangement. This will avoid the lining up of flowers in awkward geometric shapes.
3. Avoid crossing lines and lines that abruptly change direction.
4. Use smaller flowers farthest from the focal area and gradually increase flower size as you move toward the focal area.
5. Flowers farthest from the focal area should be farthest apart, gradually getting closer together as you move toward the focal area. Avoid equal spacing of flowers.
6. Flowers should not crowd or touch each other. Sink some flowers in for depth. Leave space around the flowers.
7. The focal point should be prominent, standing out closest to the viewer. Don't push in the focal point by overshadowing it with other flowers.
8. Filler or secondary flowers should repeat the shape of the design in a rhythmic way. If you looked at just the filler, it should reveal the design shape with closer spacing near the focal area.
9. Keep flowers from lining up in distracting patterns.
10. Gradually face backward some of the flowers near the edge of the design to increase depth.
11. Don't use too many colors. (An assortment is permitted in historical period designs.)
12. Hide mechanics used to support the flowers.

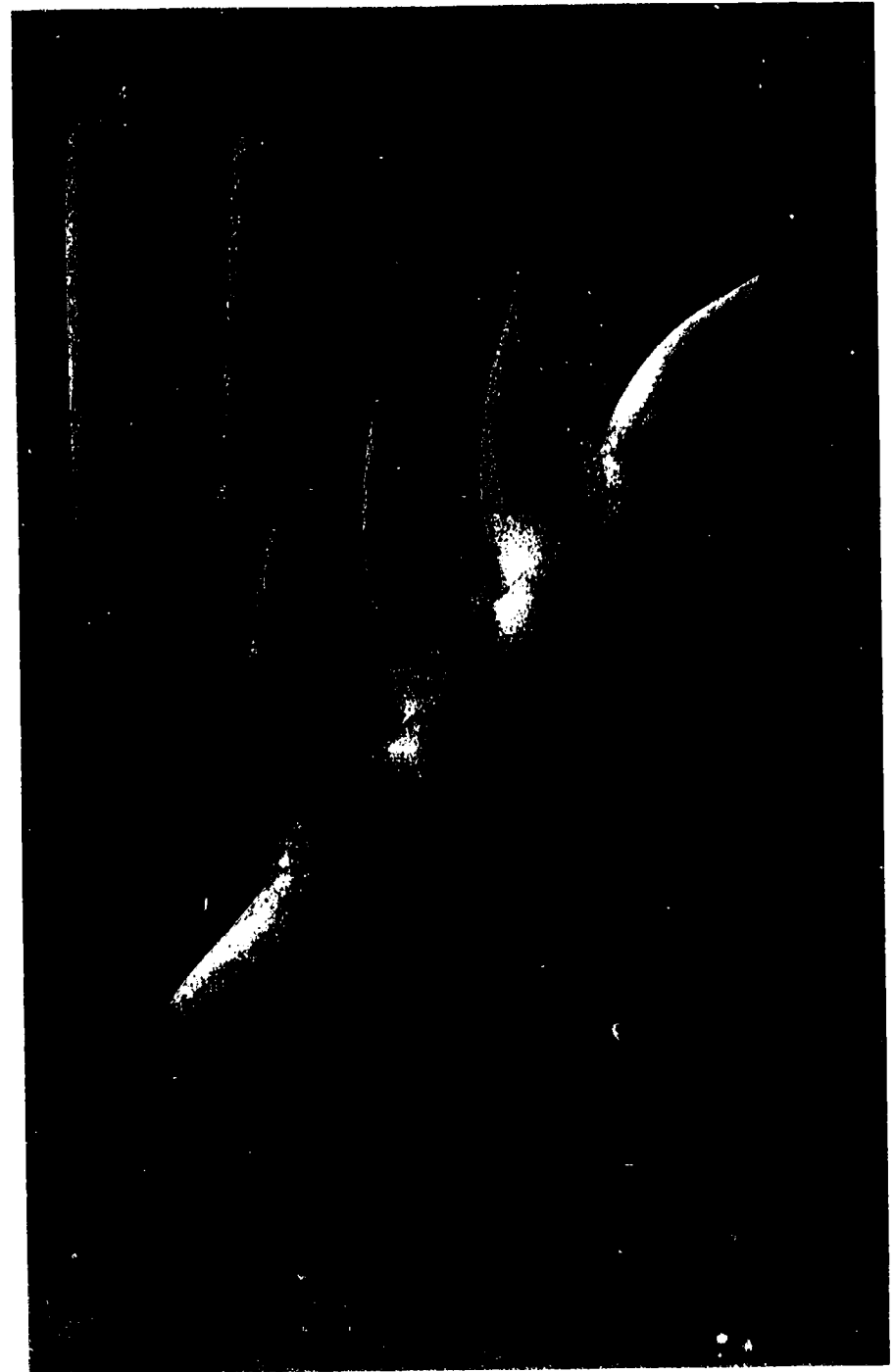


Form flowers like lilies dominate round filler flowers



CHAPTER 4

**CUT FLOWERS
and
FOLIAGE**



There is a vast array of cut flowers and foliage available to floral designers. Choices continue to multiply as marketing channels expand. Efficient transportation systems rapidly deliver plant materials from all parts of the world to local wholesalers.

Availability of some flowers varies with the time of year because of their natural blooming time or the production schedules that have been set based on demand for the product. For example, it is still easiest to obtain poinsettias and holly at Christmas, tulips and daffodils in winter and spring, and asters in summer and fall. Occasionally it is possible to get some flowers out of season, but there is usually an increase in price as availability becomes more limited. Other plant materials like leatherleaf fern, huckleberry, chrysanthemums and carnations are available year-round. When a flower is in high demand, like roses at Valentine's Day, the price is likely to increase substantially.

It is good to have a general knowledge of the flowers and foliages available at a given time of year, how they are bunched, and what colors they commonly come in. Then one must become familiar with the local wholesalers and learn what they can supply. The wholesalers' selection of material is based on the demand in the area they serve and the volume of business they do. Therefore, the selection and price in a wholesale house that serves a large metropolitan area may be quite different from those in a wholesale house that serves a number of smaller communities.

The following listing of cut plant materials available to florists is intended to be an introduction to some of the more common flowers and foliages used in arrangements. The list is divided into two parts: **Cut Flowers** and **Cut Foliage**. The plants are listed alphabetically by genus. For those unfamiliar with scientific names, each section includes an alphabetical listing (index) of common names with the corresponding scientific names (genus and species).

The picture of each flower is accompanied by information regarding the primary use of the flower (line, mass, filler or form), the common colors it comes in, its availability, the unit in which it is bunched, and in some cases special notes about the flower. The foliage pictures are accompanied by information on the bunching unit and availability.

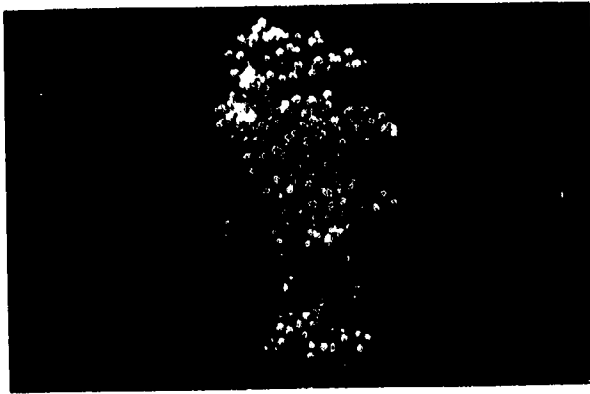
With experience, you will likely encounter exceptions to the listed information. There is much variation in many of the plant materials. New cultivars are frequently introduced, and new design styles sometimes create new uses for the materials. Also there is a general lack of universally accepted grading and packing standards. For example, many things are sold by the bunch. This unit may vary greatly between suppliers and with the time of year.

This list can be used as a reference in the identification of floral design materials. It can give you ideas of different alternatives to the basic materials you are used to working with. Additional cut material

may be found in the identification section at the end of Chapter 17, "Living Plant Groupings." Garden books listing annual and perennial plants are an additional source for the identification of flowers and foliage that can be incorporated into arrangements.

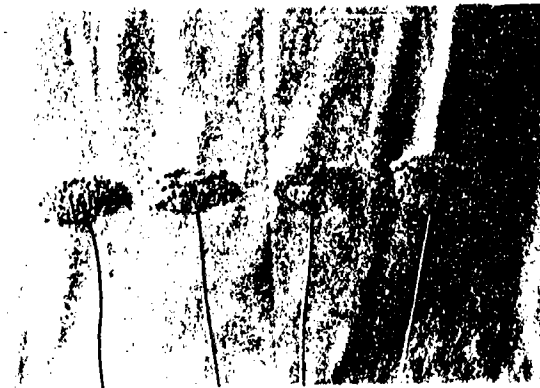
If you are cutting material from the garden or from greenhouse plants, be careful to condition it properly by placing it in water with added floral preservative for a few hours before using it. Any material that is to be stored overnight or longer should be placed in a cooler to prolong its life. For further information on this subject, refer to Chapter 28, "Conditioning and Storing Cut Flowers."

CUT FLOWERS

**Acacia dealbata****1**

ACACIA

Family: Leguminosae

Use: Filler*Color:* Yellow*Availability:* Late winter, spring*Unit:* Bunch*Note:* Sheds easily; store in plastic bag until used**Achillea filipendulina****2**

YARROW

Family: Compositae

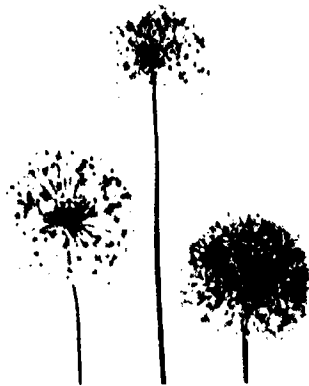
Use: Mass*Color:* Gold*Availability:* Fresh - summer, fall;

Dried - year-round

Unit: 10/bunch*Note:* Sturdy stems; long lasting; may be air dried**Agapanthus africanus****3**

LILY-OF-THE-NILE

Family: Amaryllidaceae

Use: Form*Color:* Blue, white*Availability:* Spring, summer*Unit:* 10/bunch*Note:* Thick sturdy stems, large flowers**Allium sp.****4**

FLOWERING ONION

Family: Amaryllidaceae

Use: Form*Color:* Lavender, White*Availability:* Spring, summer*Unit:* 10/bunch*Note:* Various sizes ranging from 1" to 8" across**Astroemeria sp.****5**

PERUVIAN LILY

Family: Astromeriaceae

Use: Form, filler*Color:* Yellow, pink, orange, white, lavender*Availability:* Year-round*Unit:* 10/bunch*Note:* Interesting delicate form; long-lasting; sturdy stems**Anemone coronaria****6**

ANEMONE

Family: Ranunculaceae

Use: Mass, form*Color:* Purple, red, pink, white*Availability:* Spring*Unit:* 10/bunch*Note:* Collar of leaves under flowers; petals easily reflex backward



Anthurium sp.
ANTHURIUM
Family: Araceae

7

Use: Form
Color: Red, pink, white
Availability: Year-round
Unit: 10/bunch or individually
Note: Stiff waxy spathe; long lasting; store above 55° F



Antirrhinum major
SNAPDRAGON
Family: Scrophulariaceae

8

Use: Line
Color: Yellow, orange, red, pink, white, lavender
Availability: Year-round
Unit: 10/bunch
Note: Tips bend upward (geotropic response)



Bouvardia sp.
BOUARDIA
Family: Rubiaceae

9

Use: Mass, filler
Color: Pink, white, rose
Availability: Spring
Unit: 10/bunch
Note: Delicate star-shaped flowers in clusters



Callistephus chinensis
ASTER
Family: Compositae

10

Use: Mass
Color: Pink, purple, white
Availability: Summer, autumn
Unit: 25/bunch
Note: Single, double and powderpuff types available



Centaurea cyanus
BACHELOR'S BUTTON or CORNFLOWER
Family: Compositae

11

Use: Mass
Color: Blue, pink, white
Availability: Spring, summer, autumn
Unit: Bunch
Note: Delicate, good source of true blue for corsages and wedding work



Chaenomeles speciosa
QUINCE
Family: Rosaceae

12

Use: Line
Color: Pink, peach, scarlet
Availability: Spring
Unit: Bunch
Note: Flowers clustered on the stem with much wood showing; can be forced in late winter

Cattleya sp. see Orchid
CATTLEYA ORCHID

140

SPRAY MUMS - Several small flowers on stiff stems branch off main stem (13-15)



SINGLE (DAISY) 13
One or more rows of petals around central disk



POMPON 14
Double, ball-shaped flower



ANEMONE 15
Like single, but central disk is a cushion of short tubular petals

Chrysanthemum frutescens- see next page

Chrysanthemum morifolium

CHRYSANTHEMUM, MUM

Family: Compositae

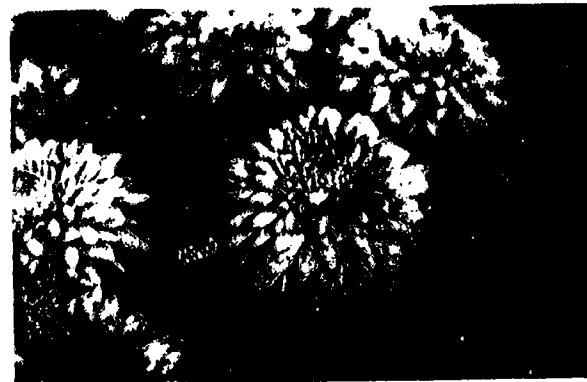
Use: Mass, filler

Color: White, yellow, lavender, bronze, orange

Availability: Year-round

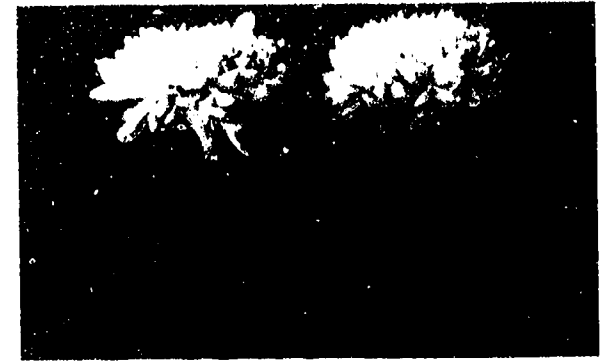
Unit: Bunch

Note: Long-lasting, always available, and relatively inexpensive

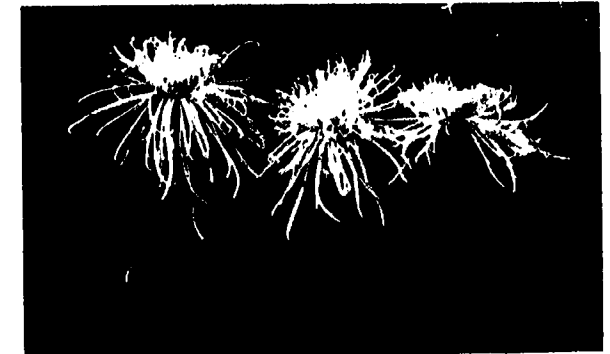


DECORATIVE 16
Double flowers with outer petals longer than inner ones

STANDARD MUMS- Large flowers usually over 3" across (16-19)



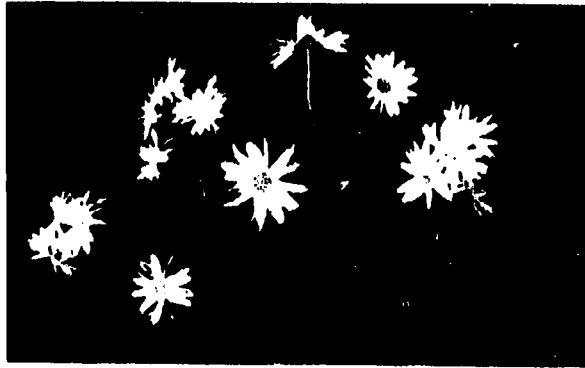
INCURVED (FOOTBALL) 17
Petals curve upward and inward forming a large globular flower



SPIDER 18
Long tubular petals with hooked ends, center petals shorter

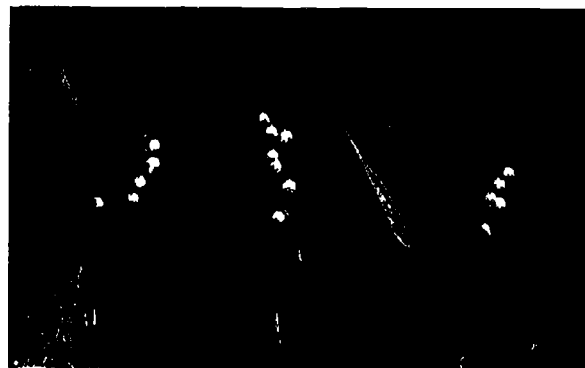


FUJI 19
Tubular petals with a brushlike appearance



Chrysanthemum frutescens 20
MARGUERITE DAISY
 Family: Compositae

Use: Mass
Color: White, yellow
Availability: Spring, summer
Unit: Bunch
Note: Delicate daisy flowers; do not last as long as single mums



Convallaria majalis 21
LILY-OF-THE-VALLEY
 Family: Liliaceae

Use: Filler, line
Color: White
Availability: Spring
Unit: Bunch
Note: Turns brown easily; dip in glue/water or spray with clear sealer to retard discoloring



Dahlia pinnata 22
DAHLIA
 Family: Compositae

Use: Mass
Color: Red, orange, pink, yellow, lavender, white, bi-colors
Availability: Summer, autumn
Unit: Bunch
Note: Flowers easily bruised and knocked from stems; large hollow stems; stem ends may be burned to seal; keep in deep water

***Cymbidium* sp. see Orchid**
CYMBIDIUM ORCHID



Delphinium elatum 23
DELPHINIUM
 Family: Ranunculaceae

Use: Line
Color: Blue, lavender, white
Availability: Spring, summer
Unit: 10/bunch



STANDARD CARNATION 24
Unit: 25/bunch (graded blue, red, green, white)
Note: Large single flowers; watch for split calyx; may be stem dyed

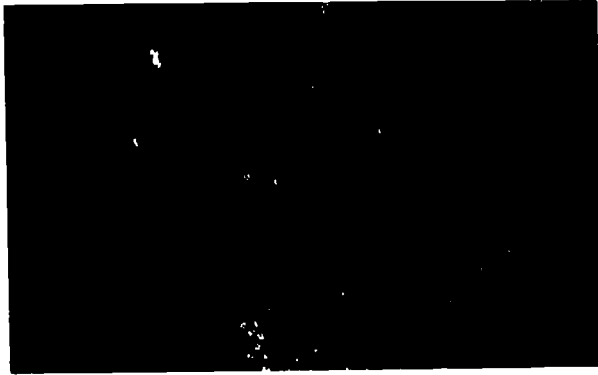


MINIATURE CARNATION (MINI-CARNATION) 25
Unit: Bunch
Note: Branched stems with small flowers in various stages of opening

***Dendrobium* sp. see Orchid**
DENDROBIUM ORCHID

Dianthus caryophyllus
CARNATION
 Family: Caryophyllaceae

Use: Mass, filler
Color: Pink, red, white, yellow, orange, lavender, bi-color



Diosma sp.
DIOSMA
Family: Rutaceae

26

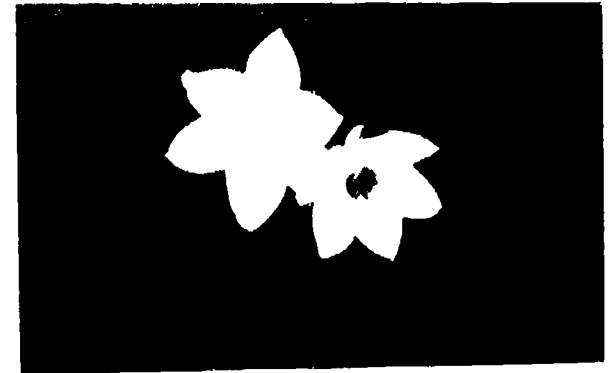
Use: Filler
Color: Pink, white
Availability: Winter, spring
Unit: Bunch



Erica sp.
HEATHER
Family: Ericaceae

27

Use: Line, filler
Color: Lavender, pink
Availability: Winter, spring
Unit: Bunch
Note: Florets shed easily



Eucharis grandiflora
AMAZON LILY
Family: Amaryllidaceae

28

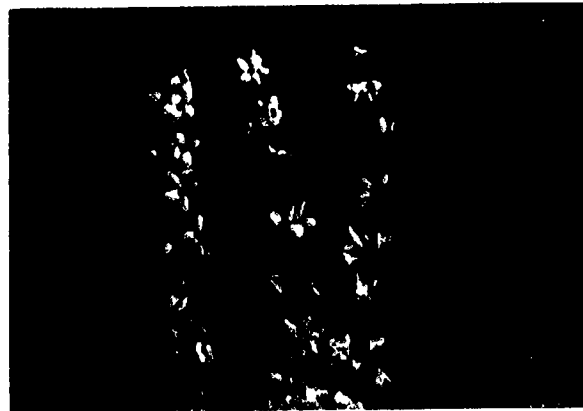
Use: Form
Color: White
Availability: Spring, summer
Unit: Individual
Note: Special flower for corsages or wedding work



Euphorbia fulgens
EUPHORBIA
Family: Euphorbiaceae

29

Use: Line
Color: White, orange, yellow
Availability: Winter, spring
Unit: 10/bunch
Note: Seal stems in hot water



Forsythia x intermedia
FORSYTHIA
Family: Oleaceae

30

Use: Line
Color: Yellow
Availability: Spring, winter
Unit: Bunch
Note: May be forced in winter



Freesia x hybrida
FREESIA
Family: Iridaceae

31

Use: Form
Color: Yellow, lavender, orange, white, rose
Availability: Winter, spring
Unit: 10/bunch
Note: Single or double with sweet fragrance



Gardenia grandiflora 32
GARDENIA
Family: Rubiaceae

Use: Form
Color: Creamy white
Availability: Year-round
Unit: Individual bloom or box of 3
Note: Sweet fragrance; easily bruised and turning brown



Genista fragrans 33
GENISTA
Family: Leguminosae

Use: Filler
Color: Pink, yellow
Availability: Winter, spring
Unit: bunch



Gerbera jamesonii 34
GERBERA DAISY
Family: Compositae

Use: Mass
Color: Red, yellow, salmon, pink, white
Availability: Year-round
Unit: Bunch or individually
Note: Store upright; protect flower with collar; dip stem in alcohol



Gladiolus x hortulanus 35
GLADIOLUS, GLAD
Family: Iridaceae

Use: Line
Color: Red, yellow, white, pink, salmon, orange, lavender, green
Availability: Year-round
Unit: 10/bunch
Note: Open at room temperature in warm water; will curve upward (geotropism)



Gloriosa rothschildiana 36
GLORIOSA LILY
Family: Liliaceae

Use: Form
Color: Red and yellow
Availability: Winter, spring, summer
Unit: Individual



Gypsophila paniculata 37
BABY'S BREATH
Family: Caryophyllaceae

Use: Filler
Color: White, pink
Availability: Year-round
Unit: Bunch



Heliconia sp.
HELICONIA
Family: Musaceae

Use: Form
Color: Yellow, red
Availability: Year-round
Unit: Individual

38



Hippeastrum x hybridum
AMARYLLIS
Family: Amaryllidaceae

Use: Form
Color: Red, pink, white, orange
Availability: Winter, spring
Unit: Individual or bunch

39



Hyacinthus orientalis
HYACINTH
Family: Liliaceae

Use: Form, mass
Color: Blue, pink, white, purple
Availability: Winter, spring
Unit: Pot or cut bunch
Note: Fragrant; individual florets used in corsage and wedding work

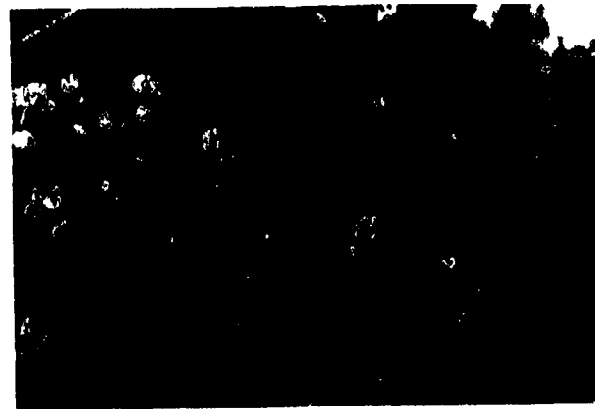
40



Iris hollandica
DUTCH IRIS
Family: Iridaceae

Use: Form, mass
Color: Blue, yellow, white
Availability: Winter, spring
Unit: 10/bunch

41



Lathyrus odoratus
SWEET PEA
Family: Leguminosae

Use: Filler
Color: Pink, white, lavender, red
Availability: Spring, summer
Unit: Bunch
Note: Fragrant and delicate

42



Leptospermum scoparium
LEPTOSPERMUM
Family: Myrtaceae

Use: Line, filler
Color: Pink, white, red
Availability: Winter, spring
Unit: Bunch

43

Liatris spicata - see next page



Lilium longiflorum
EASTER LILY

Color: White
Availability: Spring
Unit: Bunch or pot
Note: Fragrant; remove anthers to avoid staining

(44-46) *Lilium* sp.
LILY
Family: Liliaceae
Use: Form



Lilium sp.
ASIATIC LILY

Color: Yellow, orange, white, pink
Availability: Winter, spring, summer
Unit: 10/bunch
Note: Remove anthers



Lilium rubrum
RUBRUM LILY

Color: Pink
Availability: Spring, summer
Unit: Bunch
Note: Remove anthers



Liatris spicata
LIATRIS
Family: Compositae

Use: Line
Color: Lavender, white
Availability: Year-round
Unit: 10/bunch
Note: Stiff stems, long lasting



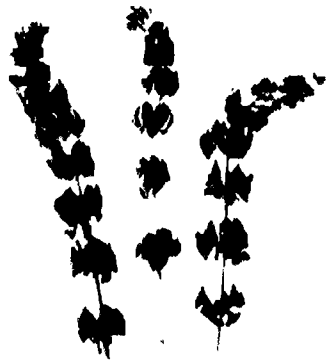
Limonlum sinuatum
ANNUAL STATICE
Family: Plumbaginaceae

Use: Filler
Color: Purple, yellow, rose, white
Availability: Year-round
Unit: Bunch
Note: Stiff, winged stems, long lasting; will keep color when dried



Matthiola incana
STOCK
Family: Cruciferae

Use: Line
Color: Purple, white, lavender
Availability: Winter, spring, summer
Unit: 10/bunch
Note: Fragrant



Molucella laevis
BELLS OF IRELAND
Family: Labiatae

Use: Line
Color: Green
Availability: Winter, spring, summer
Unit: 10/bunch
Note: Remove leaves to expose bells; pungent

50



Narcissus sp.
DAFFODIL
Family: Amaryllidaceae

Use: Form, mass
Color: Yellow, white, bi-color
Availability: Winter, spring
Unit: 10/bunch

51

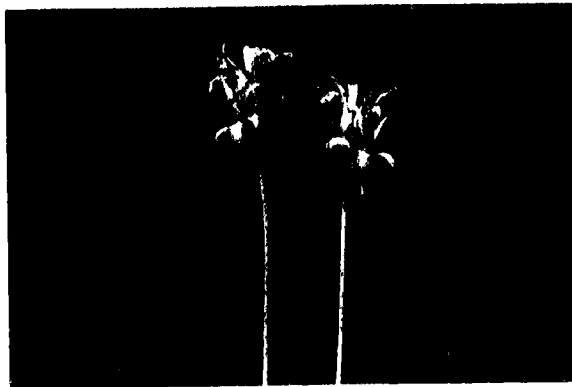


Narcissus tazetta
PAPER-WHITE NARCISSUS
Family: Amaryllidaceae

Use: Form, mass
Color: White
Unit: 25/bunch
Note: Fragrant

52

ORCHID (54-58)
Family: Orchidaceae



Nerine sp.
NERINE LILY
Family: Amaryllidaceae

Use: Form
Color: Pink
Availability: Winter, spring, summer
Unit: Bunch

53



Cattleya sp.
CATTLEYA ORCHID

Use: Form
Color: Lavender, white
Availability: Year-round
Unit: Individual

54



Cymbidium sp.
CYMBIDIUM ORCHID

Use: Form
Color: Pink, green, yellow
Availability: Year-round
Unit: Individual or spray

55

Oncidium sp. see Orchid
ONCIDIUM ORCHID



***Dendrobium* sp.**
DENDROBIUM ORCHID

56

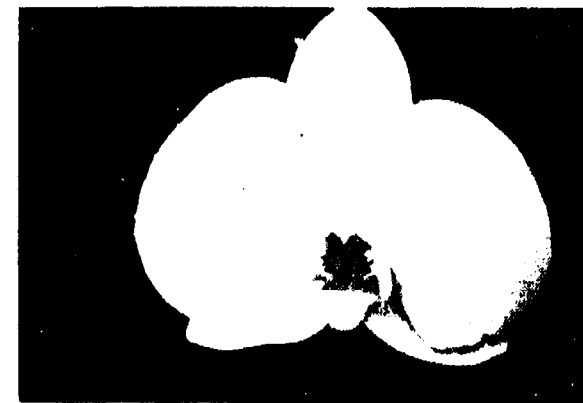
Use: Line, form
Color: White, pink, lavender
Availability: Year-round
Unit: Spray, bunch or individual



***Oncidium* sp.**
ONCIDIUM ORCHID

57

Use: Line, form
Color: Yellow
Availability: Year-round
Unit: Spray, bunch or individual



***Phalaenopsis* sp.**
PHALAENOPSIS ORCHID

58

Use: Form
Color: White, pink
Availability: Year-round
Unit: Individual



***Protea* sp.**
PROTEA
Family: Proteaceae

59

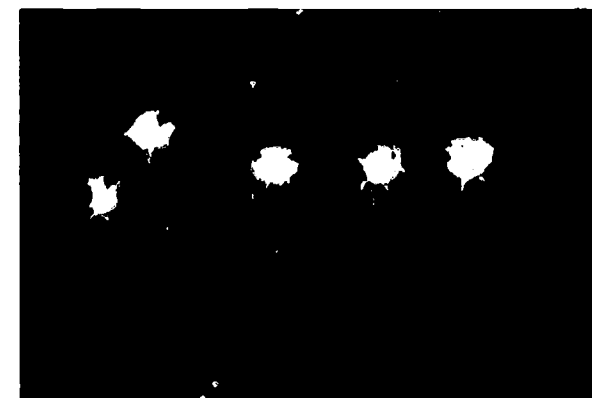
Use: Form
Color: Orange, pink, red, purple, white
Availability: Year-round
Unit: Individual
Note: Long-lasting



HYBRID TEA ROSE
Unit: 12 or 25/bunch

60

Note: Graded by stem length



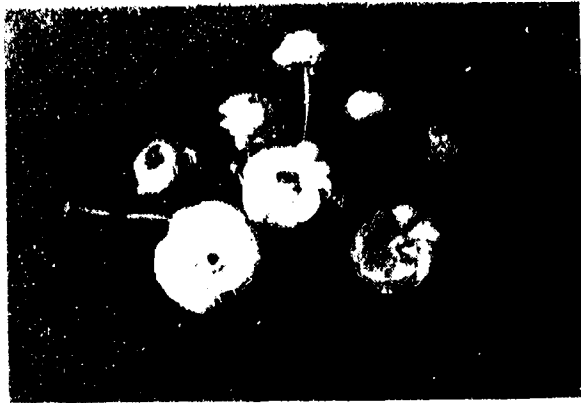
FLORIBUNDA ROSE (SWEETHEART)
Unit: 25/bunch

61

Ranunculus - see next page

Rosa hybrida
ROSE
Family: Rosaceae

Use: Mass, form
Color: Red, pink, yellow, white, orange
Availability: Year-round



Ranunculus aslaticus
 RANUNCULUS
 Family: Ranunculaceae

62

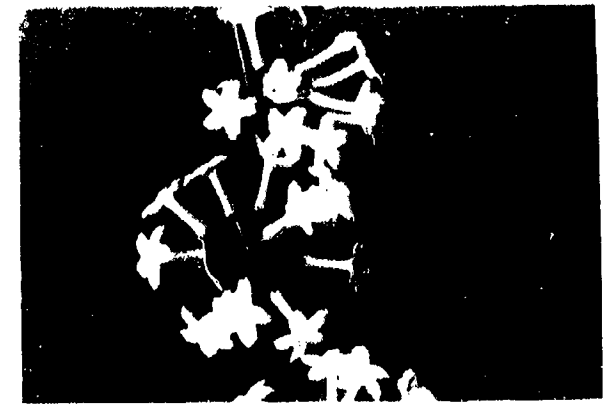
Use: Mass, filler
Color: Pink, yellow, orange, red, white
Availability: Spring
Unit: Bunch
Note: Delicate



***Salix* sp.**
 PUSSY WILLOW
 Family: Salicaceae

63

Use: Line
Color: Gray
Availability: Winter, spring
Unit: Bunch
Note: Will hold up well dry



Stephanotis floribunda
 STEPHANOTIS
 Family: Asclepiadaceae

64

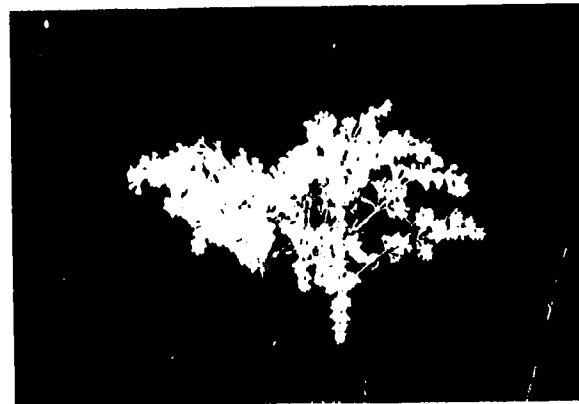
Use: Filler, form
Color: Creamy white
Availability: Year-round
Unit: 25/package
Note: Turns brown easily



Strelitzia reginae
 BIRD-OF-PARADISE
 Family: Strelitziaceae

65

Use: Form
Color: Orange
Availability: Year-round
Unit: Individual or bunch
Note: Long-lasting; may require manual opening



Syringa vulgaris
 LILAC
 Family: Oleaceae

66

Use: Mass, filler
Color: Purple, white
Availabilities: Spring, winter
Unit: 10/bunch



***Tulipa* sp.**
 TULIP
 Family: Liliaceae

67

Use: Mass, form
Color: Yellow, red, pink, lavender, white, orange
Availability: Winter, spring, fall
Unit: 10/bunch
Note: Problems: stem elongation and bending upward; keeps better if stored dry and wrapped at 32° F

**Zantedeschia aethiopica**

CALLA LILY

Family: Araceae

Use: Form

Color: White

Availability: Late winter, spring

Unit: Individual or 10/bunch

Note: Thick, fleshy stems; bruises easily; keep in deep water for longest life

68

**Zingiber sp.**

GINGER

Family: Zingiberaceae

Use: Form

Color: Red, pink, yellow

Availability: Year-round

Unit: Individual or bunch

69

Alphabetical Index of Cut Flowers - Common and Scientific Names

- 1 ACACIA - *Acacia dealbata*
 39 AMARYLLIS - *Hippeastrum x hybridum*
 28 AMAZON LILY - *Eucharis grandiflora*
 6 ANEMONE - *Anemone coronaria*
 48 ANNUAL STATICE - *Limonium sinuatum*
 7 ANTHURIUM - *Anthurium* sp.
 10 ASTER - *Callistephus chinensis*
 37 BABY'S BREATH - *Gypsophila paniculata*
 11 BACHELOR'S BUTTON - *Centaurea cyanus*
 50 BELLS OF IRELAND - *Molucella laevis*
 65 BIRD-OF-PARADISE - *Strelitzia reginae*
 9 BOUVARDIA - *Bouvardia* sp.
 68 CALLA LILY - *Zantedeschia aethiopica*
 24-25 CARNATION - *Dianthus caryophyllus*
 54 CATTLEYA ORCHID - *Cattleya* sp.
 13-19 CHRYSANTHEMUM - *Chrysanthemum morifolium*
 11 CORNFLOWER - *Centaurea cyanus*
 55 CYMBIDIUM ORCHID - *Cymbidium* sp.
 51 DAFFODIL - *Narcissus* sp.
 22 DAHLIA - *Dahlia pinnata*
 23 DELPHINIUM - *Delphinium elatum*
 56 DENDROBIUM ORCHID - *Dendrobium* sp.
 26 DIOSMA - *Diosma* sp.
 41 DUTCH IRIS - *Iris hollandica*
 29 EUPHORBIA - *Euphorbia fulgens*
 4 FLOWERING ONION - *Allium* sp.
 30 FORSYTHIA - *Forsythia x intermedia*
 31 FREESIA - *Freesia x hybrida*
 35 GLADIOLUS - *Gladiolus x hortulanus*
 32 GARDENIA - *Gardenia grandiflora*
 33 GENISTA - *Genista fragrans*
 34 GERBERA DAISY - *Gerbera jamesonii*
 69 GINGER - *Zingiber* sp.
 36 GLORIOSA LILY - *Gloriosa rothschildiana*
 27 HEATHER - *Erica* sp.
 38 HELICONIA - *Heliconia* sp.
 40 HYACINTH - *Hyacinthus orientalis*
 43 LEPTOSPERMUM - *Leptospermum scoparium*
 47 LIATRIS - *Liatris spicata*
 66 LILAC - *Syringa vulgaris*
 44-46 LILY - *Lilium* sp.
 3 LILY-OF-THE-NILE - *Agapanthus africanus*
 21 LILY-OF-THE-VALLEY - *Convallaria majalis*
 20 MARGUERITE DAISY - *Chrysanthemum frutescens*
 53 NERINE LILY - *Nerine* sp.
 57 ONCIDIUM ORCHID - *Oncidium* sp.
 52 PAPER-WHITE NARCISSUS - *Narcissus tazetta*
 5 PERUVIAN LILY - *Alstroemeria* sp.
 58 PHALAENOPSIS ORCHID - *Phalaenopsis* sp.
 59 PROTEA - *Protea* sp.
 63 PUSSY WILLOW - *Salix* sp.
 12 QUINCE - *Chaenomeles speciosa*
 62 RANUNCULUS - *Ranunculus asiaticus*
 60-61 ROSE - *Rosa hybrida*
 8 SNAPDRAGON - *Antirrhinum major*
 64 STEPHANOTIS - *Stephanotis floribunda*
 49 STOCK - *Matthiola incana*
 42 SWEET PEA - *Lathyrus odoratus*
 67 TULIP - *Tulipa* sp.
 2 YARROW - *Achillea filipendulina*

CUT FOLIAGE



Abies sp.
FIR (BALSAM, NOBEL, SILVER)
 Family: Pinaceae

Unit: Bunch or case
Availability: Winter/seasonal
Note: Soft, holds needles well

70



Asparagus asparagoides
SMILAX
 Family: Liliaceae

Unit: Bag or per yard
Availability: Year-round
Note: Keep in plastic bag; very perishable

71



Asparagus densiflorus 'Sprengeri'
SPRENGERI
 Family: Liliaceae

Unit: Bunch
Availability: Year-round

72



Asparagus macowanii
MING FERN
 Family: Liliaceae

Unit: Bunch
Availability: Year-round
Note: Watch for thorns

73



Asparagus setaceus
PLUMOSUS
 Family: Liliaceae

Unit: Bunch
Availability: Year-round

74



Asparagus virgatus
TREE FERN or TIKI
 Family: Liliaceae

Unit: Bunch
Availability: Year-round

75



Buxus sempervirens
BOXWOOD
Family: Buxaceae

Unit: Bunch or bale

Availability: Year-round

Note: Dries out easily if not in water; leaves remain on stem when dry

76



***Calathea* sp.**
CALATHEA
Family: Marantaceae

Unit: Bunch

Availability: Year-round

Note: Exotic markings on leaves

77



Camellia japonica
CAMELLIA
Family: Theaceae

Unit: Bunch

Availability: Year-round

Note: Dark green, shiny, long-lasting

78



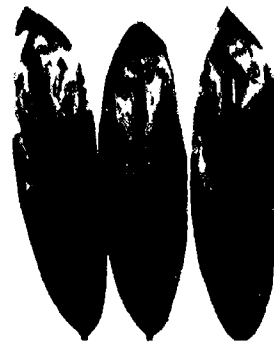
***Chamaedorea* sp.**
EMERALD, COMMODORE, JADE
Family: Palmae

Unit: 25/bunch

Availability: Year-round

Note: Store in moist boxes

79



Cordylina terminalis
TI
Family: Agavaceae

Unit: 10/bunch

Availability: Year-round

80



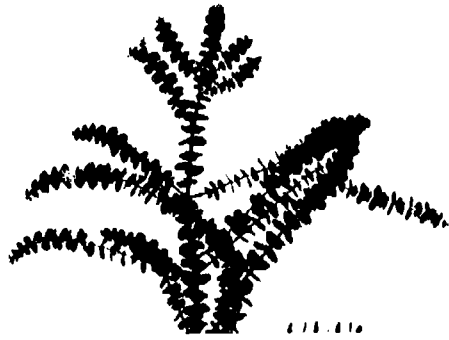
Cytisus scoparius
SCOTCH BROOM
Family: Leguminosae

Unit: Bunch

Availability: Year-round

Note: Can be bent into curved shapes

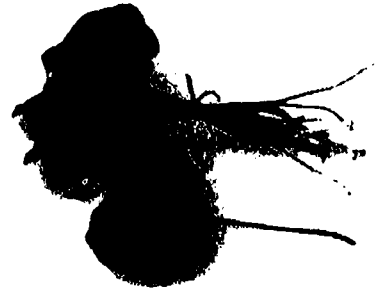
81



Eucalyptus sp.
EUCALYPTUS
Family: Myrtaceae

Unit: Bunch
Availability: Year-round

82



Galax urceolata
GALAX
Family: Diapensiaceae

Unit: 25/bunch
Availability: Year-round

83



Gaultheria shallon
SAILAL OR LEMON-LEAF
Family: Ericaceae

Unit: Bunch
Availability: Year-round

84



Hedera helix
ENGLISH IVY
Family: Araliaceae

Unit: Bunch or in pots
Availability: Year-round
Note: Spray with sealant or dip in glue/water mix to prevent drooping of young growth

85



Ilex aquifolium
ENGLISH HOLLY
Family: Aquifoliaceae

Unit: 5 or 10 lb. case
Availability: Winter/seasonal
Note: Store in plastic bags; dries out easily

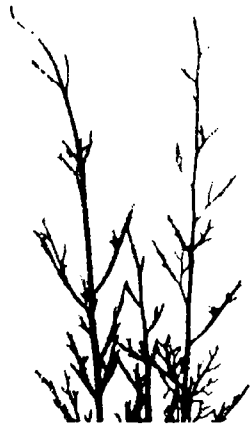
86



Juniperus sp.
JUNIPER
Family: Cupressaceae

Unit: Bunch
Availability: Winter/seasonal

87



Lycopodium sp.
LYCOPODIUM
Family: Lycopodiaceae

Unit: 10/bunch
Availability: Year-round

88



Magnolia grandiflora
MAGNOLIA
Family: Magnoliaceae

Unit: Bunch
Availability: Year-round

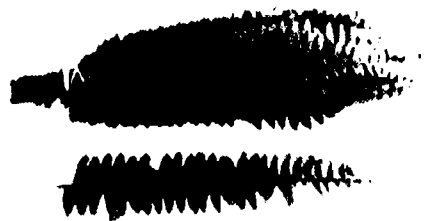
89



Myrtus communis
MYRTLE
Family: Myrtaceae

Unit: Bunch
Availability: Year-round

90



Nephrolepis sp.
BOSTON FERN, SWORD FERN, FLAT FERN
Family: Polypodiaceae

Unit: 25/bunch or in pots
Availability: Year-round
Note: Spray with sealant or dip in glue/water mix to prevent drooping of tips

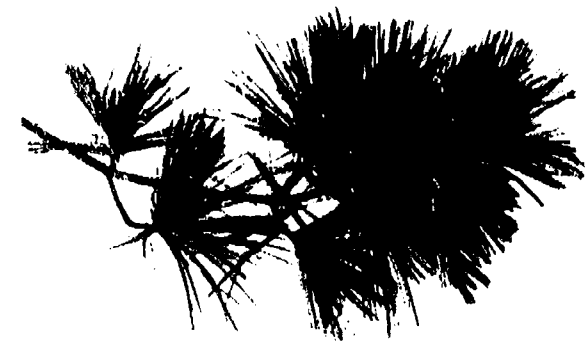
91



Picea sp.
SPRUCE (WHITE, BLUE)
Family: Pinaceae

Unit: Bundle or case
Availability: Winter/seasonal

92



Pinus sp.
PINE (SCOTCH, WHITE)
Family: Pinaceae

Unit: Bundle or case
Availability: Winter/seasonal

93



Pittosporum tobira
PITTOSPORUM
Family: Pittosporaceae

Unit: Bunch
Availability: Year-round



94

Rumohra adiantiformis
LEATHERLEAF, BAKER'S FERN
Family: Polypodiaceae

Unit: 25/bunch or case of 20 or 40 bunches
Availability: Year-round

95



Ruscus sp.
RUSCUS (Italian Ruscus pictured)
Family: Liliaceae

Unit: Bunch
Availability: Year-round

96



Salix matsudana 'Tortuosa'
CURLY WILLOW
Family: Salicaceae

Unit: Bunch
Availability: Winter/spring

97



Thuja occidentalis
CEDAR, ARBORVITAE
Family: Cupressaceae

Unit: Bundle
Availability: Year-round

98



Vaccinium ovatum
HUCKLEBERRY
Family: Ericaceae

Unit: Bunch
Availability: Year-round

99



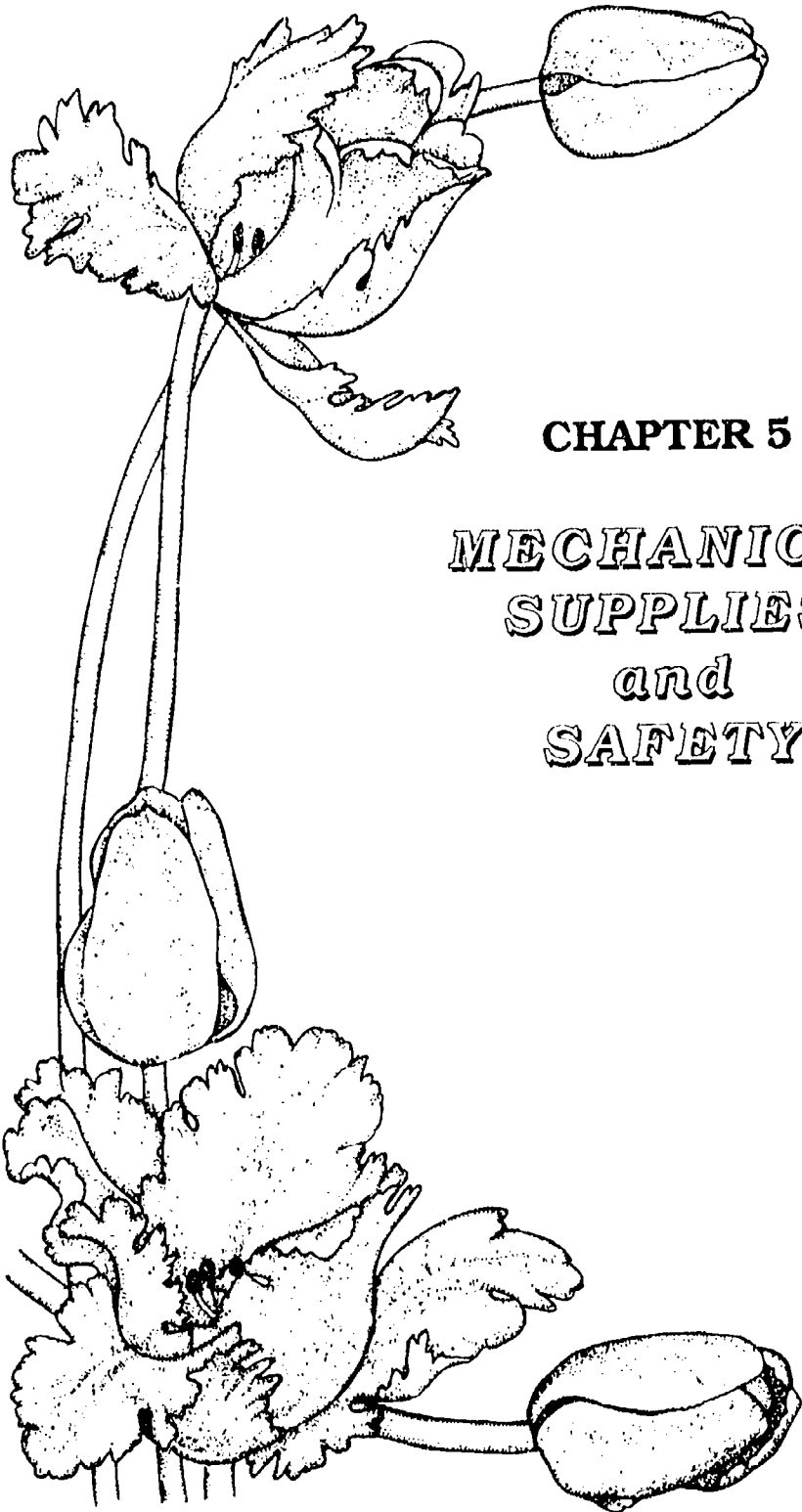
Xerophyllum tenax
BEARGRASS
Family: Liliaceae

Unit: Bunch
Availability: Year-round

100

Alphabetical Index of Cut Foliage - Common and Scientific Names

- | | |
|---|--|
| 98 ARBORVITAE - <i>Thuja occidentalis</i> | 95 LEATHERLEAF - <i>Rumohra adiantiformis</i> |
| 95 BAKER'S FERN - <i>Rumohra adiantiformis</i> | 84 LEMON-LEAF - <i>Gaultheria shallon</i> |
| 100 BEARGRASS - <i>Xerophyllum tenax</i> | 88 LYCOPODIUM - <i>Lycopodium</i> sp. |
| 91 BOSTON FERN - <i>Nephrolepis</i> sp. | 89 MAGNOLIA - <i>Magnolia grandiflora</i> |
| 76 BOXWOOD - <i>Buxus sempervirens</i> | 73 MING FERN - <i>Asparagus macowanii</i> |
| 77 CALATHEA - <i>Calathea</i> sp. | 90 MYRTLE - <i>Myrtus communis</i> |
| 78 CAMELLIA - <i>Camellia japonica</i> | 93 PINE - <i>Pinus</i> sp. |
| 98 CEDAR - <i>Thuja occidentalis</i> | 94 PITTOSPORUM - <i>Pittosporum tobira</i> |
| 79 COMMODORE - <i>Chamaedorea</i> sp. | 74 PLUMOSUS - <i>Asparagus setaceus</i> |
| 97 CURLY WILLOW - <i>Salix sachalinensis</i>
'Sekka' | 96 RUSCUS - <i>Ruscus</i> sp. |
| 79 EMERALD - <i>Chamaedorea</i> sp. | 84 SALAL - <i>Gaultheria shallon</i> |
| 86 ENGLISH HOLLY - <i>Ilex aquifolium</i> | 81 SCOTCH BROOM - <i>Cytisus scoparius</i> |
| 85 ENGLISH IVY - <i>Hedera helix</i> | 71 SMILAX - <i>Asparagus asparagoides</i> |
| 82 EUCALYPTUS - <i>Eucalyptus</i> sp. | 72 SPRÄNGER - <i>Asparagus densiflorus</i>
'Sprenger' |
| 70 FIR - <i>Abies</i> sp. | 92 SPRUCE - <i>Picea</i> sp. |
| 91 FLAT FERN - <i>Nephrolepis</i> sp. | 91 SWORD FERN - <i>Nephrolepis</i> sp. |
| 83 GALAX - <i>Galax urceolata</i> | 80 TI - <i>Cordyline terminalis</i> |
| 99 HUCKLEBERRY - <i>Vaccinium ovatum</i> | 75 TIKI - <i>Asparagus virgatus</i> |
| 79 JADE - <i>Chamaedorea</i> sp. | 75 TREE FERN - <i>Asparagus virgatus</i> |
| 87 JUNIPER - <i>Juniperus</i> sp. | |



CHAPTER 5

**MECHANICS,
SUPPLIES
and
SAFETY**



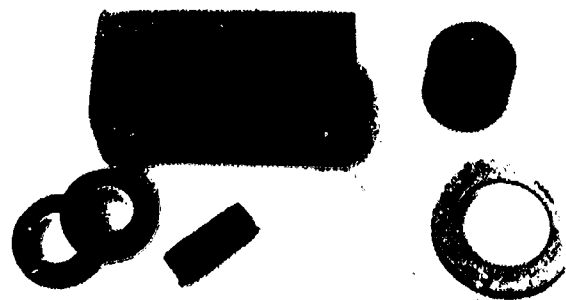


Figure 5-1
Various types of mechanics



Figure 5-2
Various shapes and sizes of floral foam

As a beginning designer, you need to become informed about basic techniques and tools used in commercial flower arranging. Specifically, you need to learn what supplies are available for positioning flowers in a design in a stable way so that they will not shift around. Also, you must learn how to handle tools and equipment not only efficiently but also safely so you do not injure yourself. Although arranging flowers is not a dangerous occupation, beginning designers can easily cut themselves with a knife or burn themselves on a hot glue gun. The techniques and precautions described in this chapter are intended to help you avoid these experiences.

There are many tools, pieces of equipment and supplies available to the floral designer, each with its specific use. To get started you will need only the basic supplies of a cutting tool for stems and something to hold the flowers firmly in place. Materials used to control the placement of flowers, foliage and accessories are collectively called *mechanics*. Floral foam, tape, wire and hot glue are examples (Fig. 5-1). In general, the mechanics should be inconspicuous or not visible in the finished arrangement.

MECHANICS

FLORAL FOAM

The most widely used mechanics item for supporting flowers in arrangements produced by retail flower shops is a material called floral foam. Floral foam is a lightweight material that is capable of absorbing quite a lot of water, which it can then supply to plant stems inserted into it. A large manufacturer of floral foam is the Smithers-

Oasis Company. Their products have such widespread use that the word "Oasis" is often used interchangeably with "floral foam."

Different kinds of floral foam are made to accommodate different types of plant materials. For example, Smithers-Oasis makes a product called *Springtime* for soft-stemmed bulb crops. They also make *Regular Oasis* and *Deluxe Oasis* for holding more sturdy stems and branches. For dried and silk flowers this company manufactures a product called *Sahara*. *Sahara II* is a stronger foam suitable for larger dried arrangements or heavier stems. Both *Saharas* are brown in color and are used dry.

Floral foam is available in various shapes and sizes (Fig. 5-2). The 9"x4"x4" block is most common. Cylinders are also made that will fit into standard containers without cutting. It is also possible to purchase foam that is already enclosed in plastic cages for the convenience of designers who are making certain special arrangements. The Smithers-Oasis Company produces a European Designer Collection (see listing of floral foam, page 85) which contains caged and plastic-supported floral foam in different shapes and sizes. Using these is simpler than preparing special mechanics from foam and chicken wire, and they are easier to attach to surfaces like walls, mirrors and candelabras.

To be effective, floral foam should be thoroughly soaked before fresh flowers are placed into it. A product known as "instant foam" absorbs water so quickly that it can first be placed dry in the container and is then ready for use as soon as water has been

poured over it. Other regular types of floral foam should be soaked using the free-float method (Fig. 5-3). This is done by placing the dry foam on the water surface in a sink or bucket. As the foam absorbs water it will gradually sink. The foam should not be forced under the water. Complete saturation is usually achieved in twenty minutes or less.

A floral preservative, which will get the arrangement off to a good start, may be added to the water in which the foam is soaked. Maximum flower life can be obtained if the arrangement is then periodically watered with preservative water. This is especially important if the arrangement is being displayed where environmental conditions like warm temperatures, low light, dry air and drafts are not good for promoting long flower life.

The soaked foam is soft and can easily be cut with a knife to fit the container being used. The foam should extend an inch or more above the rim of the container so that some stems can be angled downward. If the foam is wedged into the container, it will have more stability, but it should not totally fill the container (Fig. 5-4). A space should be left for adding water. This space is called a reservoir. If the container is very large, the bottom may be filled with foam scraps, styrofoam, perlite or gravel, with the floral foam then placed on top of the filler material. Sometimes the added weight in the lower part of the container is necessary to give the arrangement more stability.

After the foam has been placed in the container, its edges can be cut on an angle (beveled). This makes its shape conform

more closely to the intended shape of the design. It also helps the designer achieve a smoother transition in the placement angles of stems.

For certain arrangements, such as large designs or designs to be hung on candelabras, the floral foam may be covered with foil, chicken wire or both (Fig. 5-5). The foil slows evaporation of water from the surface of the foam and helps keep any attaching wires that may be used from cutting through the foam. The chicken wire will hold several blocks of foam together in a large design.

FLORAL TAPE AND CLAY

Waterproof tape is commonly used to hold floral foam in place. It is placed across the soaked foam and extended down over the sides of the container (Fig. 5-6). It is important to keep the container dry, since waterproof tape will not stick to a moist surface. The more contact the tape has with the surface, the more securely it will hold. However, running it too far down the sides of the container will make it difficult to hide the tape with flowers and foliage.

Waterproof tape is available in several widths and in the colors of green, white and clear. Although the wider half-inch width can be used in most cases, the narrower quarter-inch width has the advantage of covering less area on the foam. If only the wider tape is available, it can be split lengthwise into two narrow strips as it is pulled from the roll. It is best to use as little tape as possible to hold the foam, because it is frustrating and a hindrance to good design to keep running into tape when trying to insert stems in the foam.



Figure 5-3
Free-float method for soaking floral foam



Figure 5-4



Figure 5-5



Figure 5-6 Using waterproof tape to hold floral foam in container



Figure 5-7 O-Cage

Some containers do not need tape or other mechanics to hold the foam in place. Foam can often be securely wedged into small containers that have some depth. Other containers have prongs molded in the bottom upon which the foam can be secured. An example of a different style is the *O-Cage* made by Smithers-Oasis. It is a cage-like circle of molded plastic that will accommodate a #5 cylinder of *Oasis* (Fig. 5-7).



Figure 5-8 Materials that can be used to fasten anchor pins to a dry container

There are several other alternatives to waterproof tape for securing foam to a container. A shallow container can have one or more plastic four-pronged anchor pins fastened to the bottom with floral clay. One kind of clay is *Cling*, which is available as a flattened strip wound onto a spool (Fig. 5-8). It is kept from sticking to itself by a layer of waxed paper. *Oasis* double-faced tape can be used to get the same result (Fig. 5-8). Small pieces of clay or tape are placed on the bottom of the anchor pins, which are then firmly pressed onto the dry container. Floral clay will not stick to already-moist surfaces, but will hold if water is added after attachment. Soaked floral foam can then be pressed onto the anchor pins. These will hold the foam in place reasonably well, but not as securely as waterproof tape. Yet another method of binding floral foam to a container is hot melt glue (Fig. 5-9). Pieces of glue are melted in an electric frying pan. The soaked foam is dipped into the melted glue and then placed in the container.

Both waterproof tape and floral clay have the potential for fastening many things, but one should be aware that they often leave a sticky mark when removed. These products should be used with discretion when valuable surface areas are involved. Alcohol-

based compounds are useful in removing the residue if the surface can tolerate these substances without damage.

OTHER MECHANICS

Because of the widespread use of floral foam, it is easy to lose sight of other mechanics for holding flowers. In past eras arrangements were largely held in place by the criss-crossing stems of the materials themselves. Some containers were fashioned with narrow openings to make the task easier (Fig. 5-10). Early mechanics for some arrangements involved filling the container with sand, gravel, rolled cedar, layers of chicken wire, shredded styrofoam, or glass marbles to help keep the stems in position.

Some contemporary arrangements are made in clear glass vases with the stems showing as part of the beauty of the arrangement (Fig. 5-11). For these designs glass marbles may help give stability without being distracting. Another kind of arrangement that can be most effectively displayed



Figure 5-9 Hot melt glue



Figure 5-10 Williamsburg vase

in a clear glass container is the hand-tied bouquet. This is made by carefully binding the flower stems in position with a wire or cord so that the lower stems flare out in a sheaf-like manner. Hand-tied bouquets are often sold without the glass container (Fig. 5-12). The recipients may have to provide it themselves. Because the stems are held in place by the cord, this arrangement can simply be lowered into a clear vase that has a large enough opening. If this bouquet is well made, the flowers will not shift around.

Other stem-holding devices include pinpoint, frogs and small plastic or metal cages (Fig. 5-13). These can be fastened to the bottom of a dry container with floral clay. Pinpoints usually have a fairly heavy metal base with many sharp needle-like pins sticking up. They come in many shapes and sizes, and some are surrounded by a cup that can hold water. Pinpoints are good for using with figurines, for a larger holder could distract from the figurine.

Frogs are round holders made of heavy glass, flat on the bottom with a convex top. The top has a number of holes into which flower stems can be placed. Frogs are less secure than pinpoints and give less flexibility in the placement of stems. Both frogs and pinpoints are generally too expensive to use in arrangements sent out by retail flower shops. However, they are useful for making arrangements at home or for taking to flower shows because they can be reused.

SPECIAL TECHNIQUES for REGULATING PLACEMENTS

Some flower stems turn slightly in floral foam. This is sometimes a problem with very

long stems or those that have heavy flowers or leaves on relatively-small-diameter stems. These stems can be made more secure and their placement more carefully regulated if a wooden stake is attached to them before they are inserted in the floral foam (Fig. 5-14). The stake is attached to the lower stem with floral tape or waterproof tape (Fig. 5-15). The whole unit (stem with stake) is then placed firmly into the foam.



Figure 5-13 Metal pinpoints and glass frog



Figure 5-12 Hand-tied arrangement

Attaching wooden stakes to eucalyptus



Figure 5-14



Figure 5-15



Figure 5-11 Contemporary arrangement

Extending a rose stem



Figure 5-16

If a stem needs to be extended in length, a water tube (*pick*) may be placed on the cut end of the stem (Fig. 5-16). The flower with attached tube can then be taped with waterproof tape to one or more wooden stakes (Fig. 5-17). This procedure should be attempted only as a last resort because the limited water supply will shorten flower life.

In certain arrangements, the designer may want to change the curvature of a stem. This is especially important for the longest flower placements in a curved line arrangement like a crescent or Hogarth curve. Since most flowers seldom curve exactly as the designer wants, wire can be used to control the stems. Wire may also be needed to add support to long stems that are weak. In either case, the wire is inserted into the flower head (Fig. 5-18) and then spiraled down the stem (Fig. 5-19). Roses and carnations frequently have wires added to their stems. An additional benefit in the case of

roses is that the flower head is held up even if the neck becomes weak (bent neck), or if the flower head is bumped and breaks. Usually #20 or #18 gauge wire is required to hold the flower stem.

Wiring has several drawbacks. First, there is the likelihood that the wire will show. Second, the flower may not look natural after its stem has been bent into a curve. Finally, there may be damage to the flower, a likely happening if too heavy a wire has been used.

TOOLS

HOT GLUE GUN

The hot glue gun is a widely used tool in floral work (Fig. 5-20). Heated by electricity, it has a plug for inserting into an electrical outlet. Like all electrical equipment, it should never be used near water. Glue sticks



Figure 5-17

Attaching a wire to a carnation



Figure 5-18



Figure 5-19



Figure 5-20 A hot glue gun

are inserted into the gun, and melted glue oozes out of the point when the trigger is pressed.

Hot glue can be used to join many surfaces that are dry and not too porous or too smooth. The glue dries quickly and will hold indefinitely. The hot glue gun saves time and facilitates work with silk and dried materials. Attaching accessories such as ribbon, artificial birds and mosses is simple with hot glue. However, the high temperatures of the glue may cook fresh plant material. Floral adhesives like *Oasis* glue are better to use with fresh materials although they take longer to dry.

If melted glue comes in contact with your skin, you will be burned. **Extreme caution should be exercised to avoid touching the hot glue until it is completely dry.** If strands of glue form, allow them to dry before removing them.

CUTTING TOOLS

There are many specialized cutting tools for various purposes. If a person were limited to two tools, the most useful ones to have on hand would be a sharp knife and a pair of floral shears that will cut both ribbon and wire. Ribbon shears that cut wide ribbon and cloth evenly are also very useful (Fig. 5-21). More heavy duty cutting usually takes wire cutters (Fig. 5-22) and pruning shears (Fig. 5-23). Some shops have a counter-mounted cutter (see page 77) that is strong enough to cut through the handle of a wired and taped bridal bouquet.

A knife is the most important tool of the designer. Skilled designers have learned how to use the knife efficiently to cut stems

at a slight angle so they can be easily inserted into floral foam. If you watch skilled designers at work, you will notice their economy of motion; the knife is kept in one hand, as laying it down can mean wasting time.

Whether you are an expert or a beginner, learn to handle the knife carefully and properly to avoid cutting yourself. Obtain a good quality, sharp folding knife that is easy to carry around and convenient to use. A sharp knife will cut more easily and is probably less likely to slip and cut you than is a dull knife.

The knife should be held between your thumb and forefinger. Cut toward yourself at an angle (Fig. 5-24). Aim just below the thumb so you do not slice into your own skin. With time and practice, you will develop skill at handling a knife. If you have not had experience, proceed slowly until you gain confidence.

Tools, equipment and supplies that may be found in florist shops are listed in the following pages. Some items have specialized uses while others represent alternative ways to accomplish a certain task. This listing can be used as a shopping guide to help you decide what you need for your individual situation or project.



Figure 5-24 Making a correct cut



Figure 5-21 Ribbon shears



Figure 5-22 Wire cutters



Figure 5-23 Pruning shears

CANDLES



Candle holders

S-1

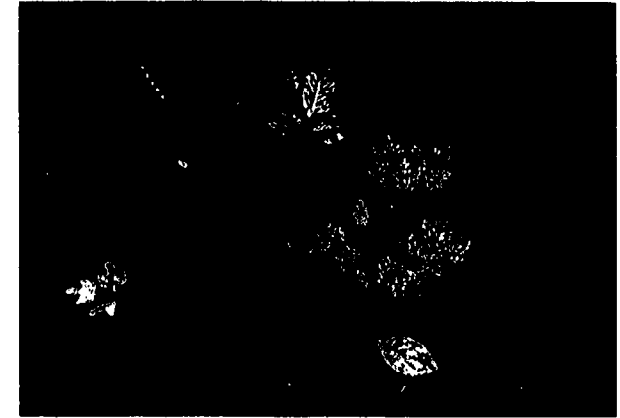
SUPPLIES
CHRISTMAS SUPPLIES



Greening pins

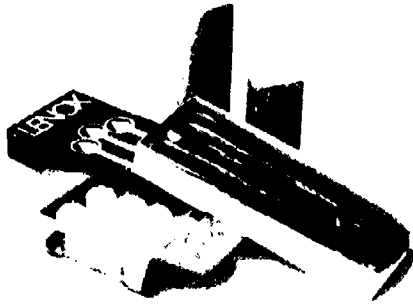
S-4

CORSAGE SUPPLIES



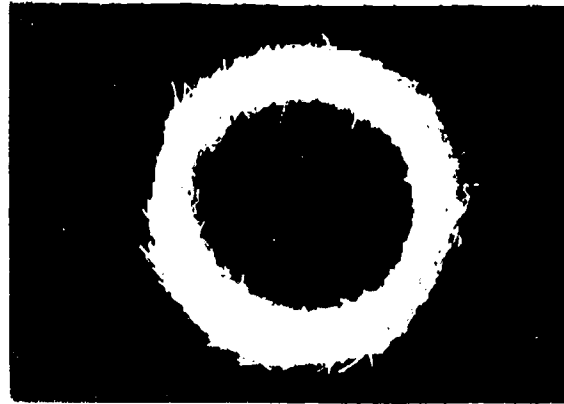
Artificial leaves and corsage accessories

S-7



Candles

S-2



Straw wreath ring

S-5



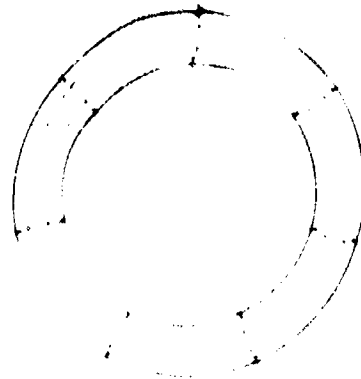
Corsage boxes and bags

S-8



Votive lights

S-3



Wire wreath ring

S-6



Corsage pins

S-9

CORSAGE SUPPLIES (cont.)



Floral tape

S-10

FLORAL FOAM (cont.)



Floral foam
for dried and silk flower arrangements

S-13

FLORAL FOAM (cont.)



Styrofoam
(sheets and shapes)

S-16

FUNERAL SUPPLIES



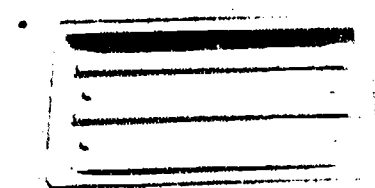
Wristlets

S-11



Floral preservative

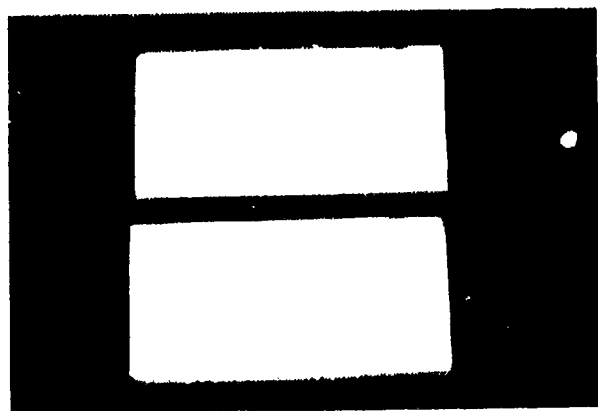
S-14



Casket saddle

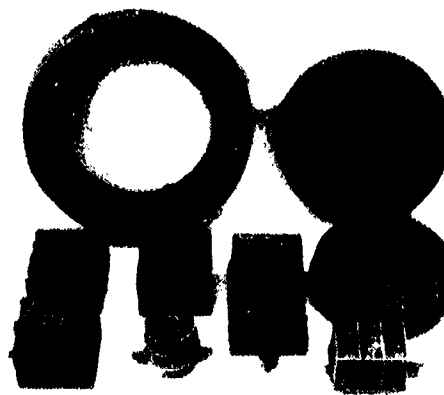
S-17

FLORAL FOAM



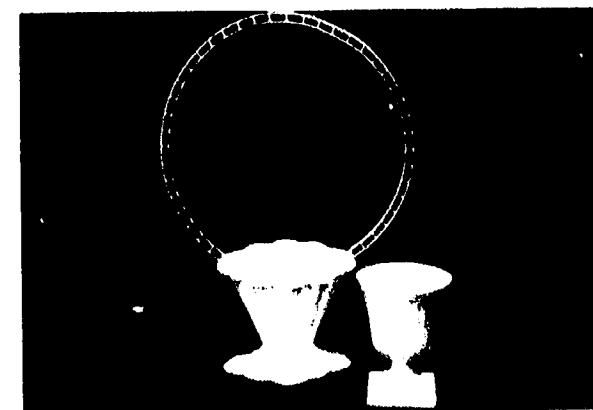
Floral foam
for fresh flower arrangements

S-12



Oasis European Designer Collection

S-15



Funeral baskets and vases

S-18

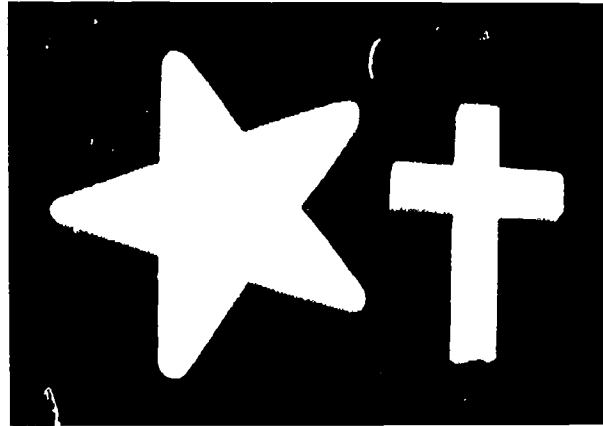
FUNERAL SUPPLIES (cont.)



Rosary

S-19

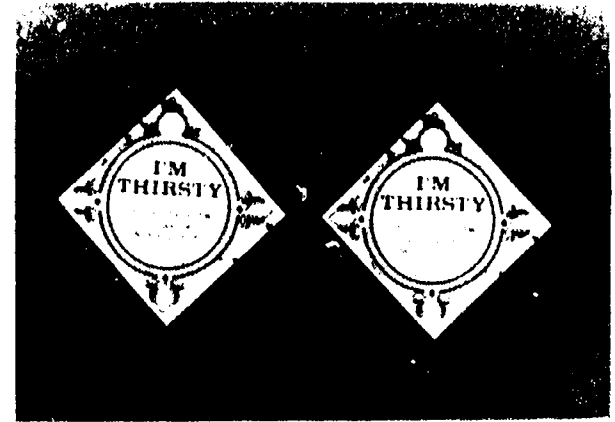
FUNERAL SUPPLIES (cont.)



Styrofoam symbols

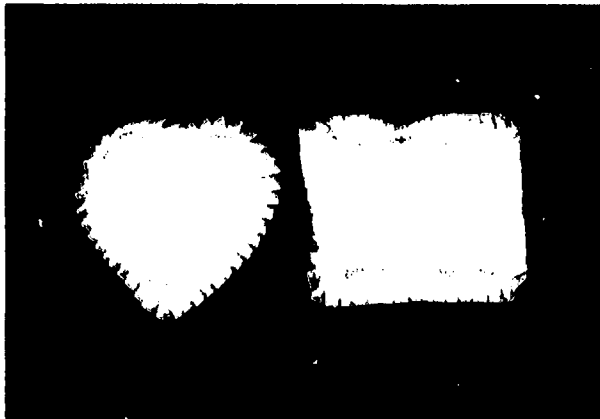
S-22

PACKAGING ITEMS (cont.)



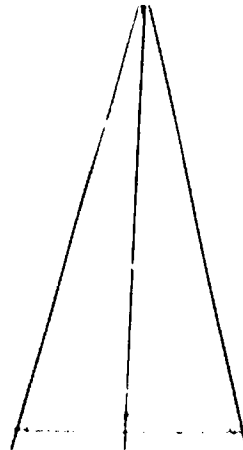
Care tags

S-25



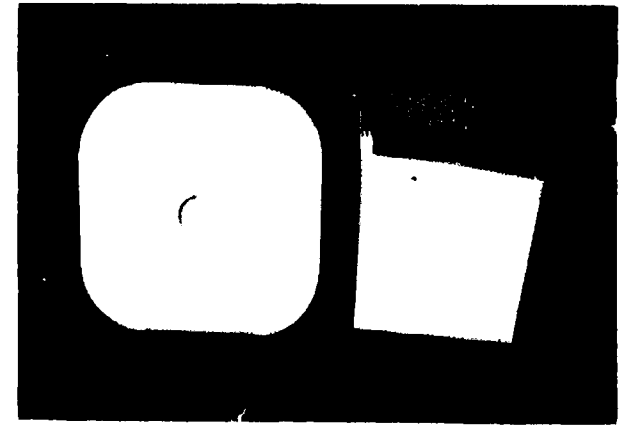
Satin pillows, hearts

S-20



Wire easels

S-23



Delivery boxes

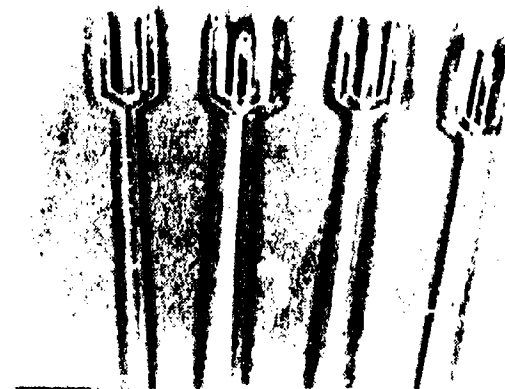
S-26

PACKAGING ITEMS



Script

S-21



Card holder

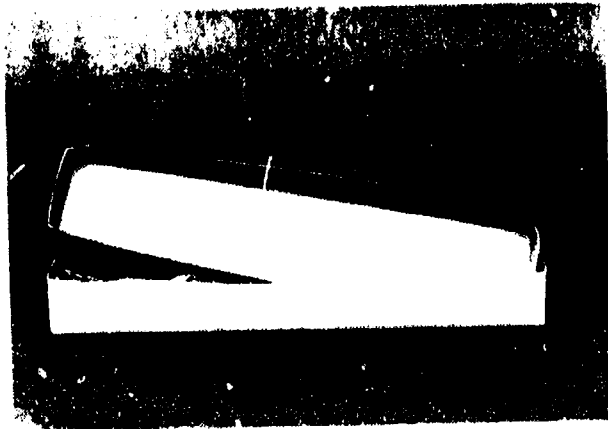
S-24



Enclosure cards

S-27

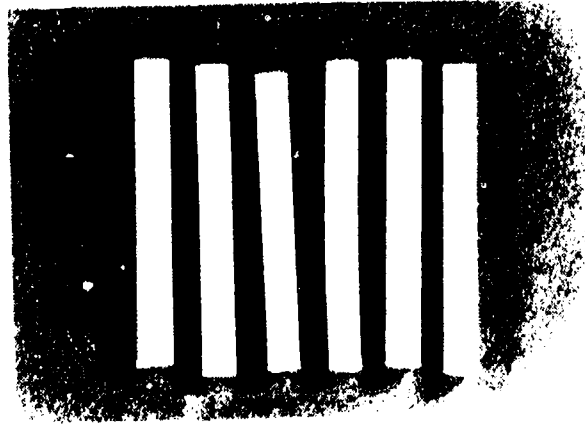
PACKAGING ITEMS (cont.)



Flower boxes

S-28

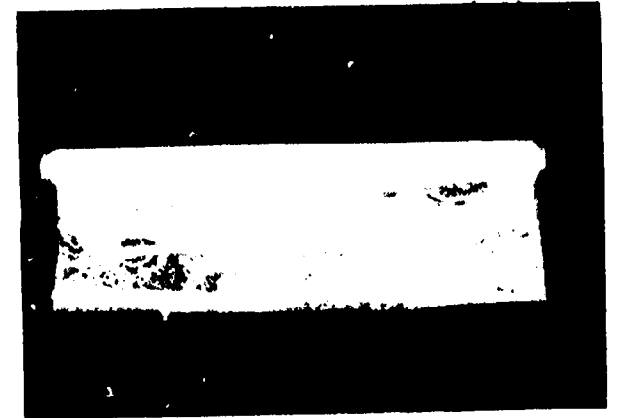
PAINT AND GLUE (cont.)



Glue sticks

S-31

PAPER AND FOIL



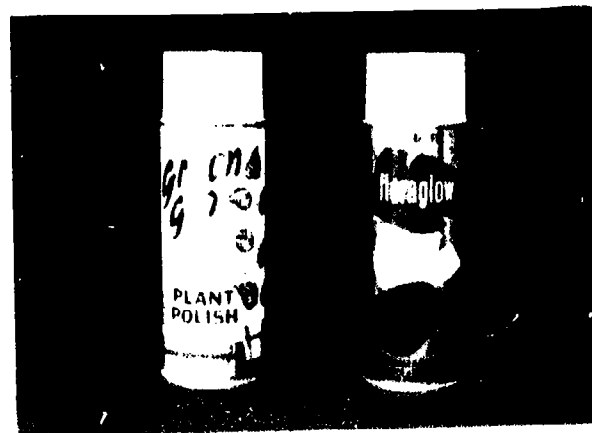
Cellophane

S-34



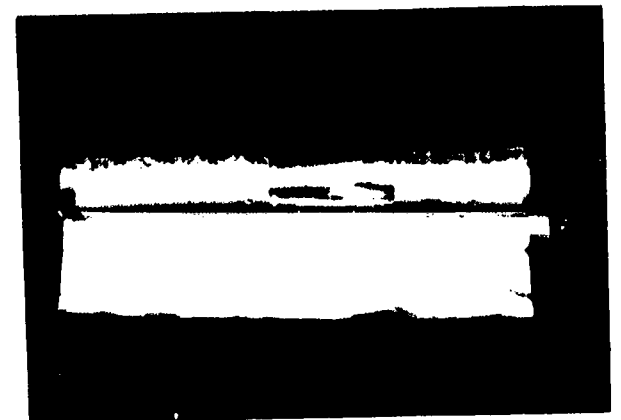
Plant sleeves

S-29



Plant polish

S-32



Foil

S-35

PAINT AND GLUE



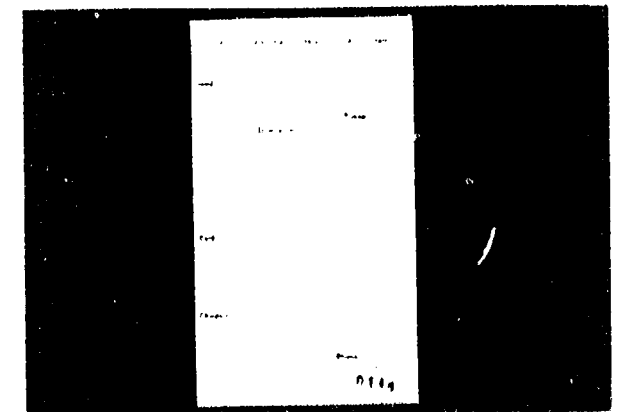
Floral adhesive

S-30



Spray paint

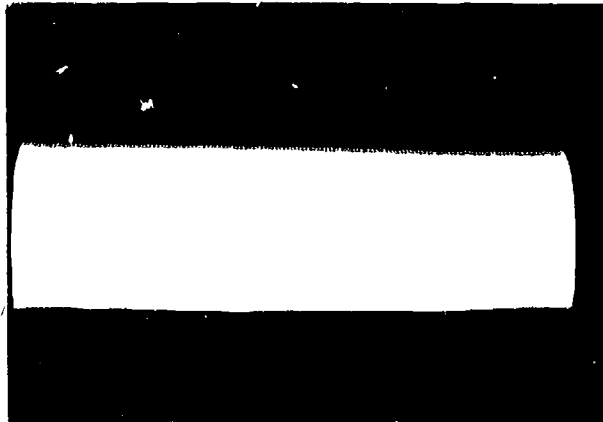
S-33



Order forms

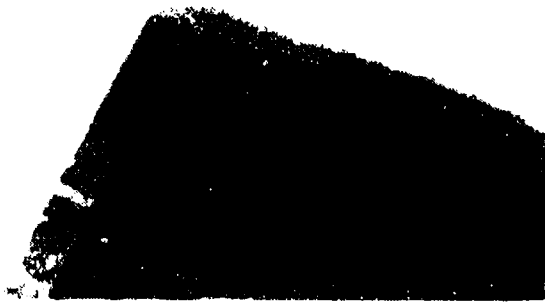
S-36

PAPER AND FOIL (cont.)



Paper on roll

S-37



Waxed paper

S-38

PERMANENT FLOWERS & ACCESSORIES

(cont.)



Birds

S-40



Feathers

S-41

PERMANENT FLOWERS & ACCESSORIES

(cont.)



Plastic flowers/follage

S-43



Silk flowers

S-44

PERMANENT FLOWERS & ACCESSORIES



Artificial fruit

S-39

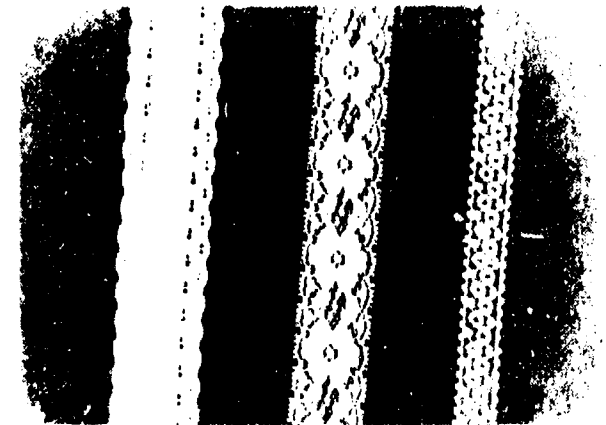


Picked novelties

S-42



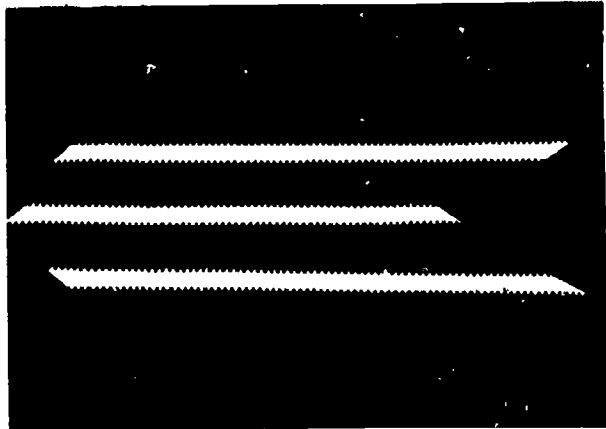
RIBBON



Lace ribbon

S-45

RIBBON (cont.)



Picot ribbon

S-46

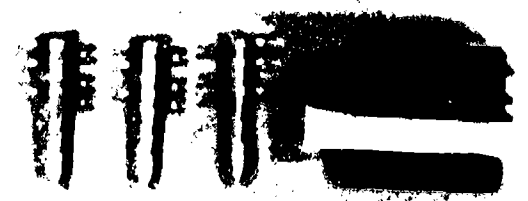
RIBBON (cont.)



Velvet ribbon

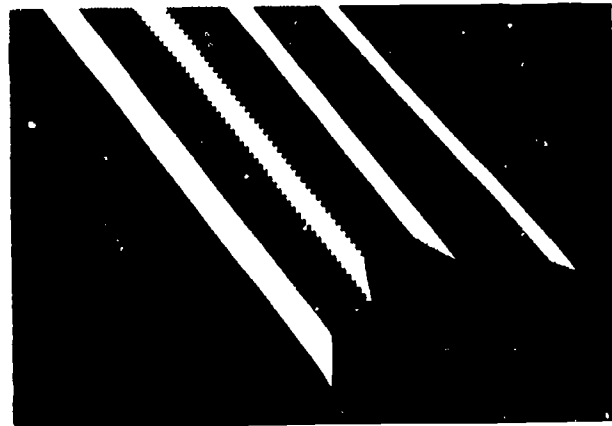
S-49

STAKES AND PICKS (cont.)



Steel picks

S-52



Satin ribbon

S-47



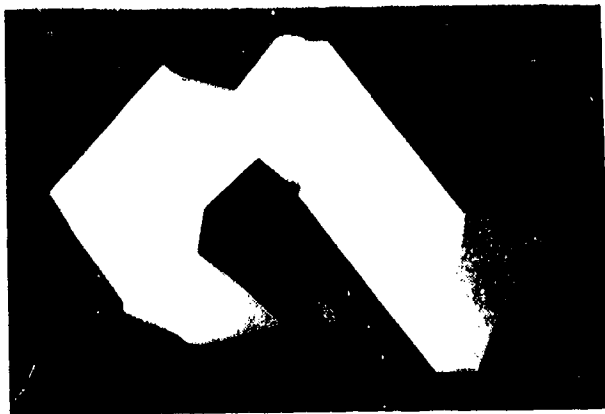
Velvet tubing

S-50



Water picks

S-53



Tulle

S-48

STAKES AND PICKS



Hyacinth stakes

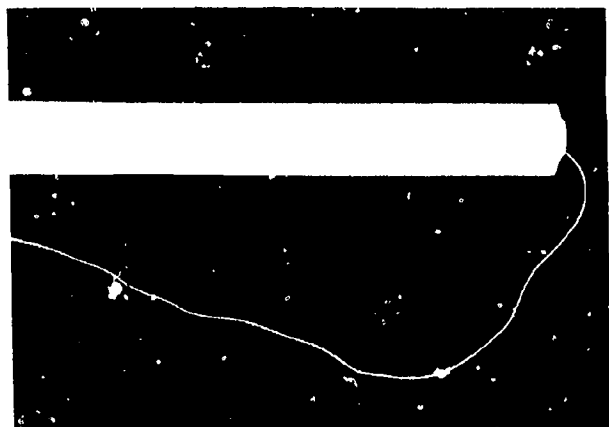
S-51



Wooden picks

S-54

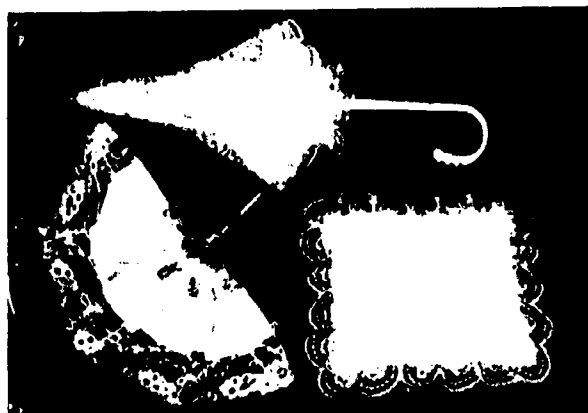
WEDDING SUPPLIES



Aisle runner

S-55

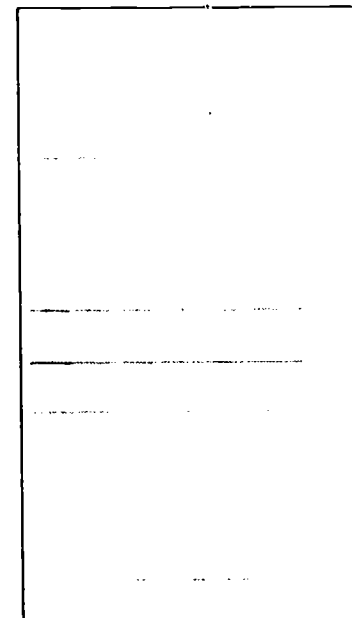
WEDDING SUPPLIES (cont.)



Lace fan, pillows, parasol

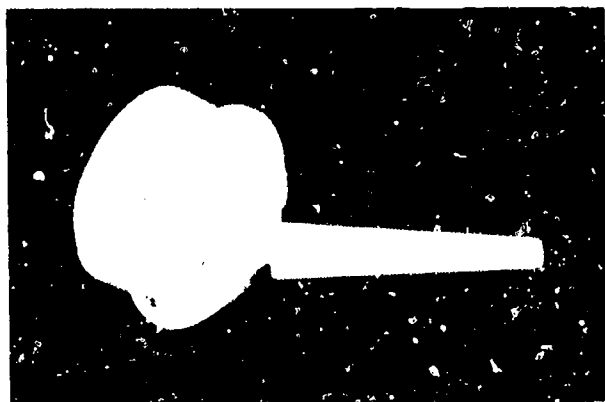
S-58

WEDDING SUPPLIES (cont.)



Wedding order forms

S-60



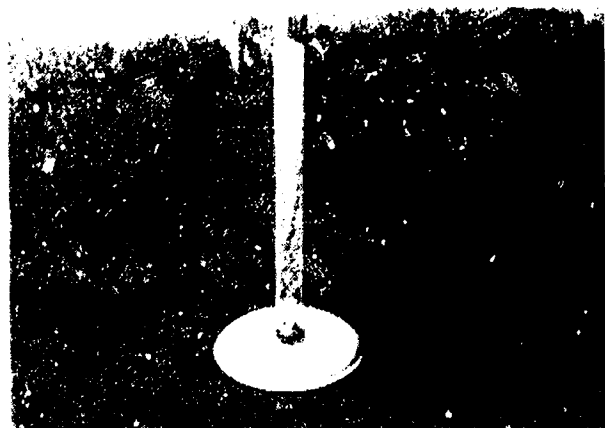
Bouquet holder

S-56



Palm buckets

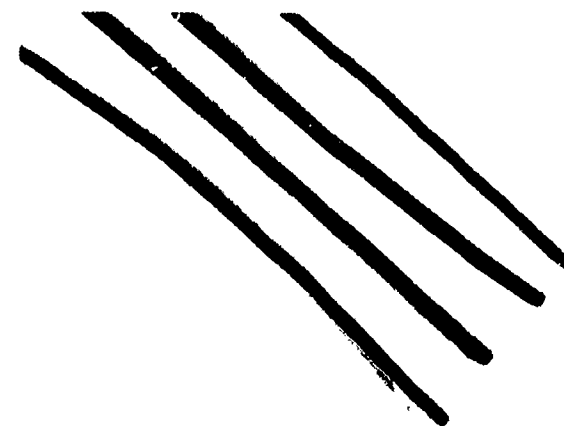
S-59



Designer bouquet stand

S-57

WIRE, CORD, TAPE



Chenille stems

S-61

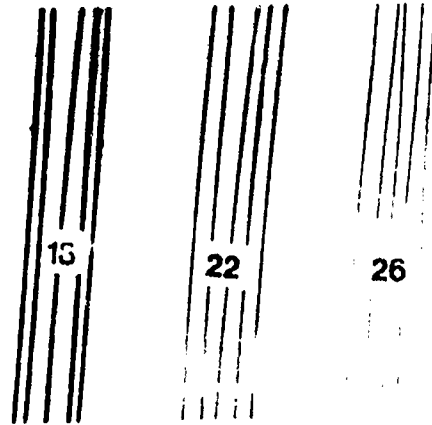
WIRE, CORD, TAPE (cont.)



Chicken wire

S-62

WIRE, CORD, TAPE (cont.)



Straight wire

S-65



Florist cord

S-63



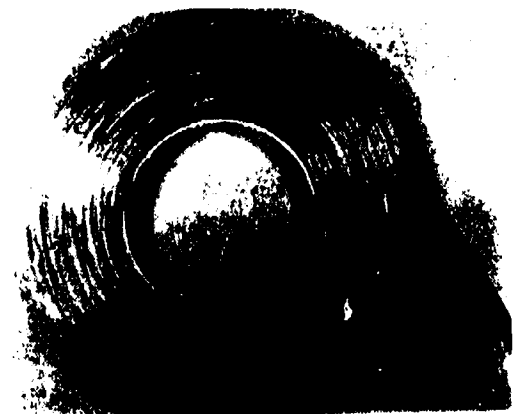
Twistems

S-66



Paddle wire

S-64



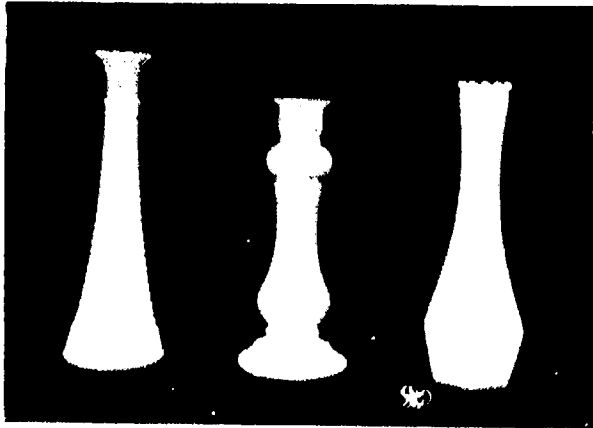
Waterproof tape

S-67

201

BEST COPY AVAILABLE

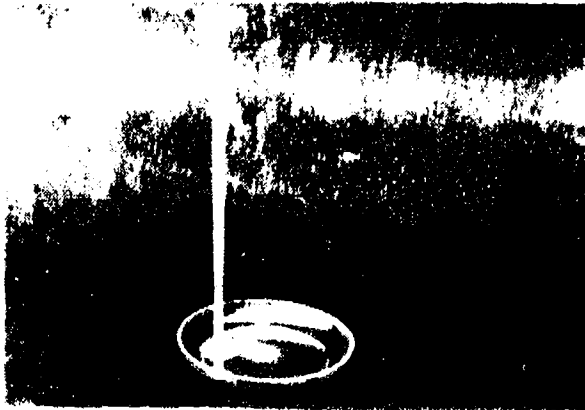
CONTAINERS



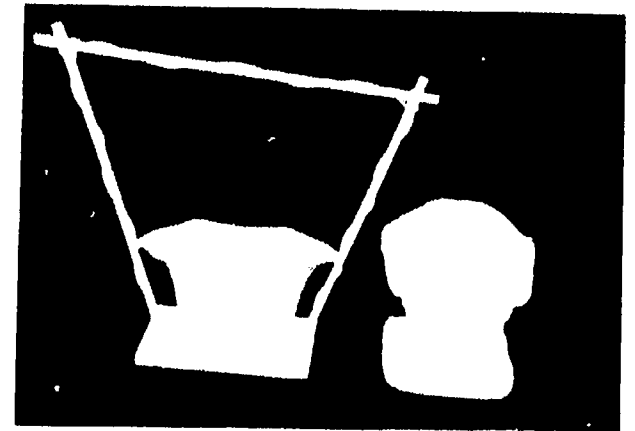
Bud vases

C-1

Fireside basket

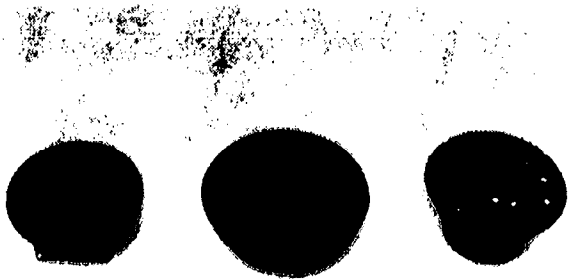


C-4



Papier mache baskets

C-7

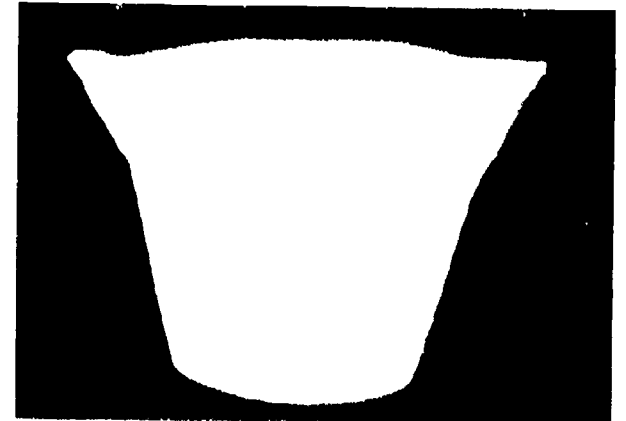


Centerpiece bowls

C-2

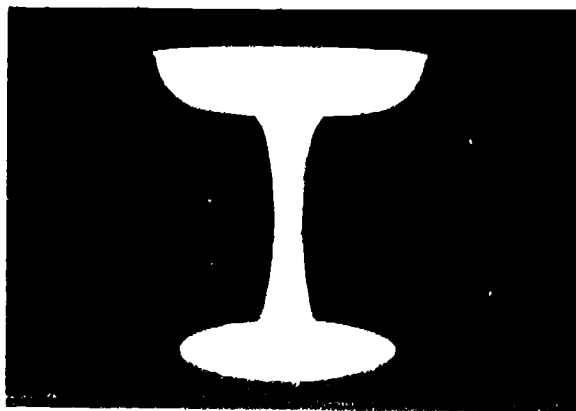
Lomey container

C-5



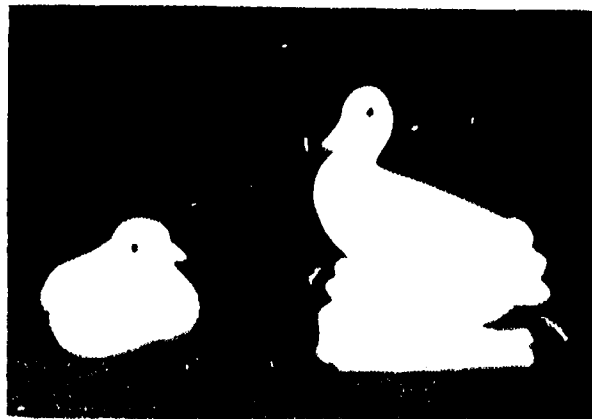
Pot cover

C-8



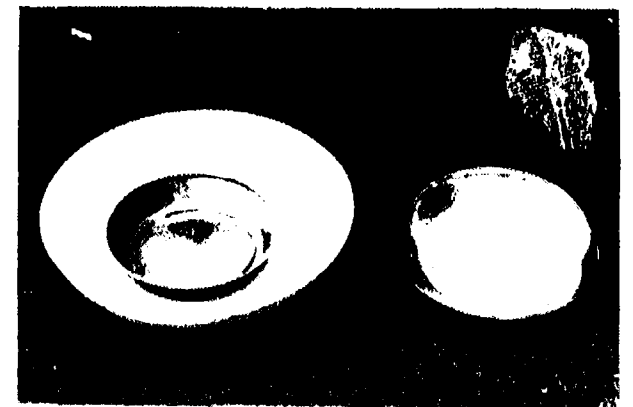
Compote

C-3



Novelty planters

C-6



Pot saucers

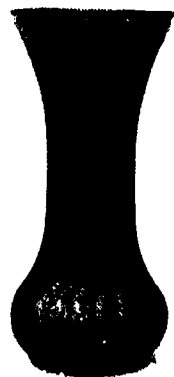
C-9

CONTAINERS (cont.)



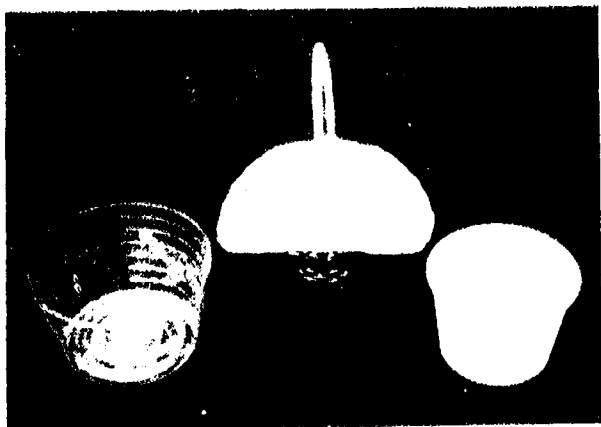
Planters

C-10



Rose vase

C-12



Plastic liners

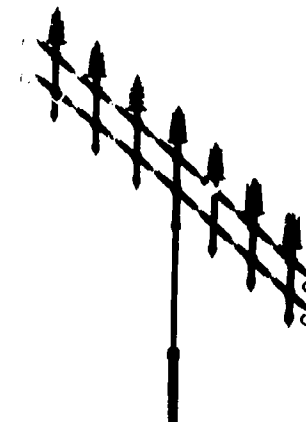
C-11



Vichek containers

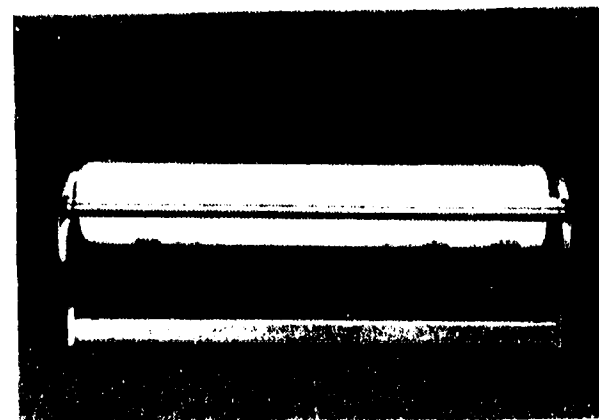
C-13

EQUIPMENT



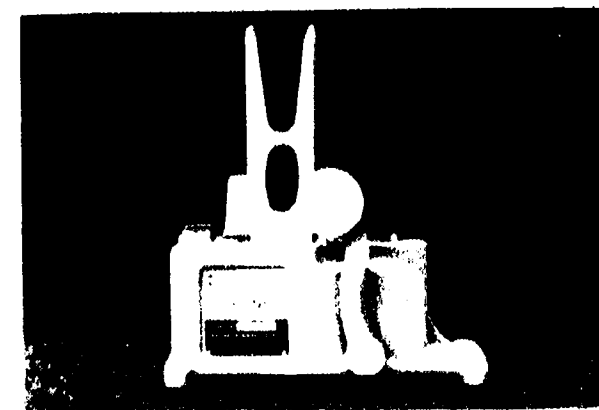
Candelabra

E-1



Paper cutter

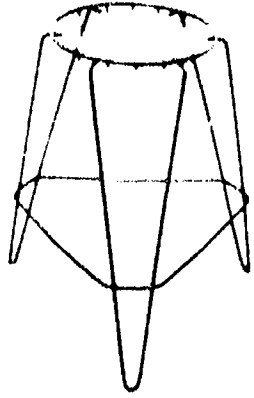
E-2



Pick machine

E-3

EQUIPMENT (cont.)



Plant stand

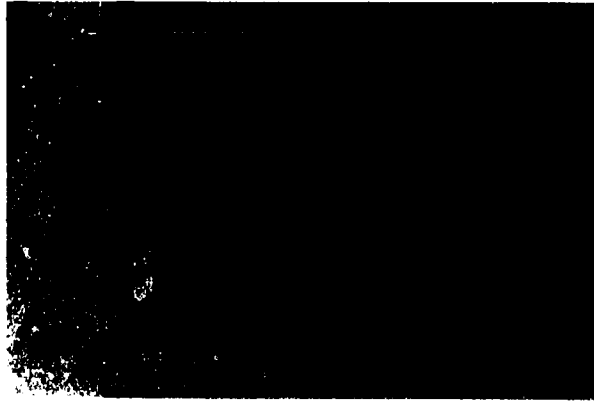
E-4



Storage buckets



E-6



Ribbon rack

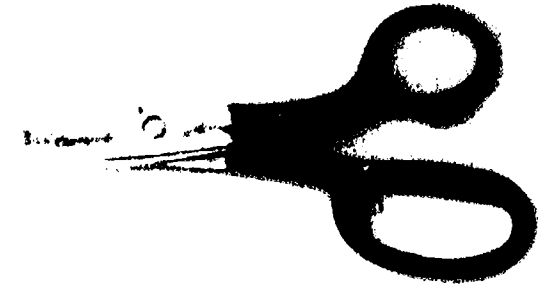
E-5



Wire holder

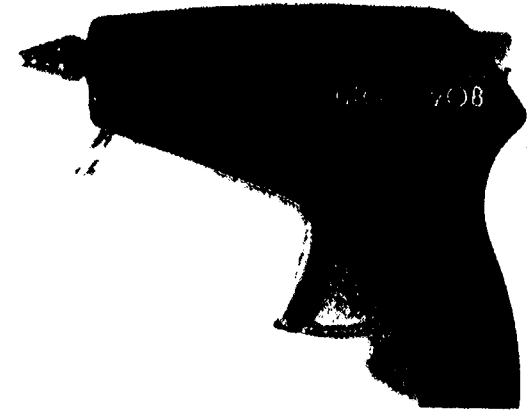
E-7

TOOLS



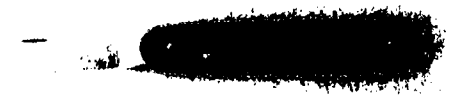
Floral shears

T-1



Hot glue gun

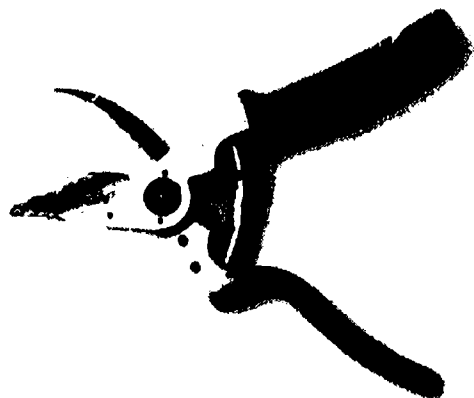
T-2



Knife

T-3

TOOLS (cont.)



Pruners

T-4



Stapler

T-7



Wire cutters

T-10



Ribbon shears

T-5



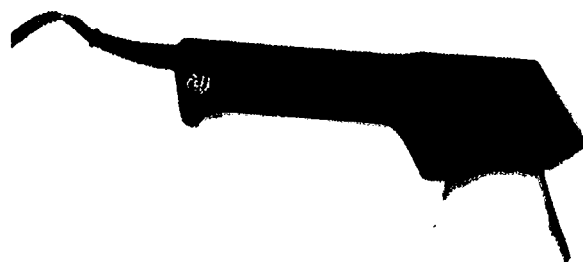
Stem stripper

T-8



Staple gun

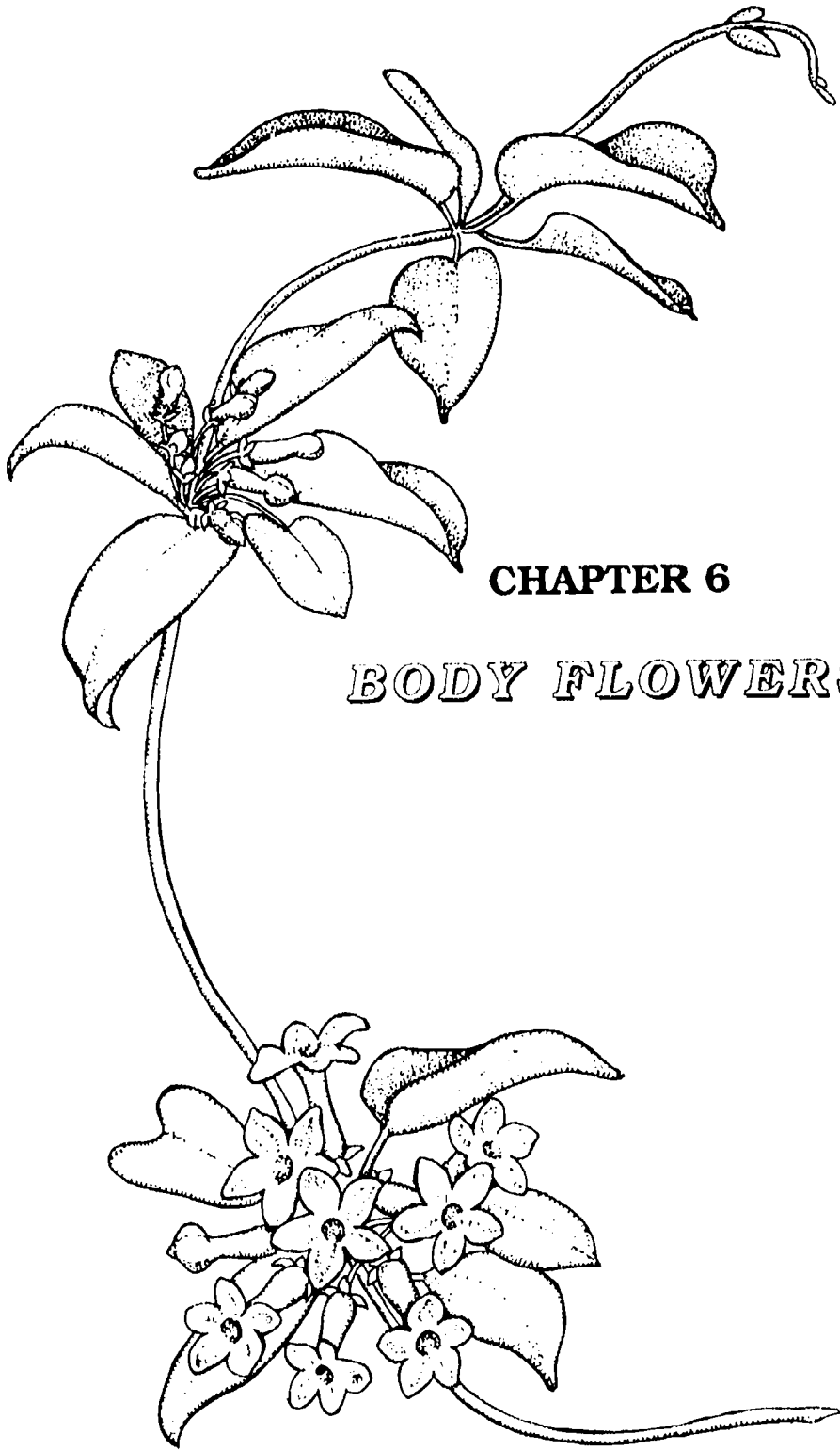
T-6



Styrofoam cutter

T-9

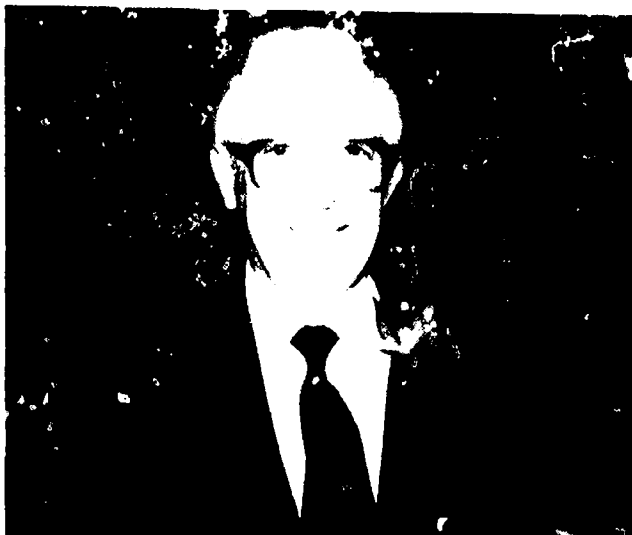
210



CHAPTER 6

BODY FLOWERS





Boutonniere pinned to a man's lapel



Corsage pinned to a woman's shoulder

INTRODUCTION

Flowers can be worn by either men or women. Such flowers worn on the person are collectively called body flowers. Those designed for women are referred to as **corsages**. Flowers worn by men, usually pinned on the lapels, are called **boutonnieres**.

Corsages are most commonly worn on the lady's left shoulder; however, they may be modified for attachment to the wrist (Fig. 6-1), hair (Fig. 6-2), waist (Fig. 6-3), neck or ankle (Fig. 6-4). Sometimes a woman prefers to carry the flowers in a small clutch bouquet or attach them to her purse (Fig. 6-5). She also may choose to wear coordinating flowers in two or more places (Fig. 6-6). For example, a wrist corsage of roses and baby's breath may be effectively complemented by a small cluster of baby's breath and a single rose in her hair. (See Color Plate I-7.)

When a woman has a dress style or type of fabric that will not support a shoulder corsage, the florist has the opportunity to suggest one or more creative alternatives. (See Figure 6-7.) Even with the shoulder corsage there are many choices of styles, ranging from the single flower backed by a few leaves to a multi-parted falcon shoulder piece that extends down the arm and back (Fig. 6-8). Different choices of ribbons and accessories can give the corsage a sweet romantic flavor or a sleek contemporary flair.

Individual preferences of the wearer, formality of the occasion, and clothing to be worn will all influence the style, size and materials chosen to make a corsage. The

present trend is toward smaller, more stylized corsages. Some women have been discouraged from wearing flowers after an experience with a heavy corsage that weighted down their clothing and interfered with their activities. Florists should make an effort to determine customer preferences in this matter. Then the florists can design corsages that women will enjoy wearing and will want to continue to order.

A corsage should never be heavy or bulky. Natural stems are removed from flowers or foliage pieces and replaced by wires that are as light as possible yet sturdy enough to control the position of the flower. Floratape, a stretchy, non-sticky tape, usually 1/4 inch in width, is used to bind the wire to flowers or foliage and also to bind taped materials together into a unit. Tape should completely cover the wires, but must be used sparingly so as not to add unnecessary bulk and weight.

WEARING A CORSAGE

Shoulder corsages are worn on the left shoulder. They should be pinned relatively high and may curve slightly over the shoulder (Fig. 6-9). This will allow them to show to maximum advantage and be partially visible from behind. Since the shoulder is curved, the back of the corsage should conform to this curve instead of being perfectly flat.

While the direction a corsage is worn is the wearer's choice, it is usually designed to be worn upright, so most of the flowers are in a position similar to that in which they grew. If the corsage is designed to have taped stems showing, the stems should be at the

FLOWERS WORN...



Figure 6-1 At the wrist



Figure 6-4 On the ankle

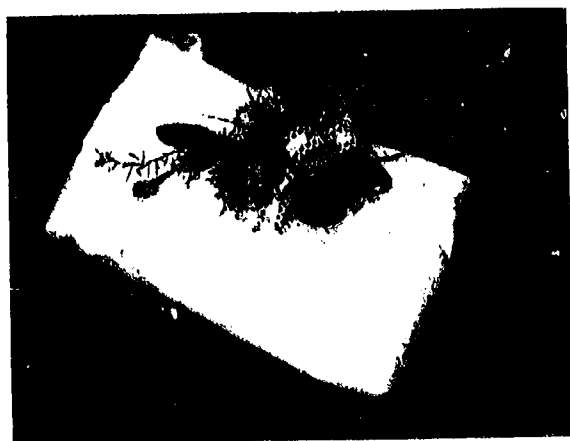


Figure 6-5 On the purse



Figure 6-2 in the hair



Figure 6-3 At the waist



Figure 6-8 A large falcon shoulder piece



Figure 6-6 Coordinating hair flowers and shoulder corsage



Figure 6-7 A single rubrum lily in the hair



Creative use of hair flowers



Figure 6-9 A shoulder corsage



The gathered-bouquet look of a spring flower corsage



Figure 6-10 Corsage placed in a cardboard box



Figure 6-11 Corsages cushioned by orchid grass in clear plastic boxes

bottom. At one time, wearing corsages upside down with the bow at the top was in vogue, but this is generally not done at present.

At least two corsage pins should be included with each corsage. If attached to the clothing at two points, the corsage will not rock or pivot. It is important to avoid a bulky knob of wires on the back of the corsage that will hold it out from the wearer or cause it to rotate. Corsage pins have white pearl heads to make them look attractive and keep them from slipping through the stems. Boutonniere pins are smaller and have black heads. Usually one pin will hold a normal-size boutonniere in place.

Corsages and boutonnieres can be packaged in lightweight cardboard boxes (Fig. 6-10), plastic boxes (Fig. 6-11), or cellophane bags. When cellophane bags are used, the pins may serve double duty. They seal the bag and then can be used to pin the flowers on the wearer. When boxes are used, the pins are placed directly on the back of the corsage or boutonniere so they are readily available.

THE WORK AREA for CORSAGE MAKING

It is important to have the materials used for corsage making well organized and within arm's reach. Since corsages are small and held in the hand when constructed, the designer should not have to stand while making them. A work area should be set up at a desk or table with a stool of suitable height. A swivel chair on rolling castors might be preferred to help the designer move easily to nearby supplies.

The work surface on which flowers and foliage are laid should be cushioned with several layers of moist newspaper covered by a layer of damp paper towels. These will protect the delicate plant materials from bruising and moisture loss. This area can be kept damp by misting the surface periodically. Care should be taken to work quickly and return flowers to the cooler as soon as possible. Misting flowers with a fine spray of water also helps keep them fresh and crisp.

As flowers are wired and taped they can be placed in narrow-necked containers like bud vases for storage in the cooler until the corsage is assembled. Each container should be loosely filled - not so full that flowers push on each other or become tangled. The vases of wired and taped flowers can then be misted (Fig. 6-12), covered with a light-weight plastic bag (Fig. 6-13), and returned to the cooler until they are needed. A stake that extends above the flowers in each container will keep the plastic from resting on delicate blossoms. A wire or twister can be used to secure the plastic around the neck of the container.

With these precautions and techniques, flowers can be wired and taped several hours or more in advance of making up corsages, and should remain in good condition. The often time-consuming job of wiring and taping can be started the day or night before a big design project, such as a wedding, is completed. In a classroom setting, the wiring and taping can be done in one lab in preparation for assembly of the corsage in another lab.

THE PARTS OF A CORSAGE

THE BOW

Corsages usually are accented with a bow. Depending on the style of corsage, the bow may be incorporated in the middle or it may be toward the bottom. The bow should always be integrated as part of the total corsage design, not appearing to be stuck on top as an afterthought. The bow color can either harmonize with the flower color or provide a striking contrast.

Number 3 satin ribbon, 5/8 inch wide, is frequently used, but narrower ribbon used alone or in combination with the wider ribbon can also give an interesting effect. Ribbon may be velvet, lace, cotton, burlap or metallic (lame). It is available printed with dots, plaid, stripes, gingham and hundreds of other patterns. The edges of some ribbons contain little loops called *picots*. Bows may also be made from satin or velvet tubing.

Some corsages do not have a bow at all; other materials may be used to give the effect of a bow. For example, a line of contrasting flowers may be used in the area where a bow might otherwise be found (Fig. 6-14), such as a grouping of purple statice in a corsage of pink roses. Interesting foliage may give a bow-like appearance, as when variegated spider plant leaves are looped to simulate ribbon (Fig. 6-15).

ACCESSORIES

Ribbon can be used in an expanded way so that it becomes more of an accessory. Examples include using separate loops of

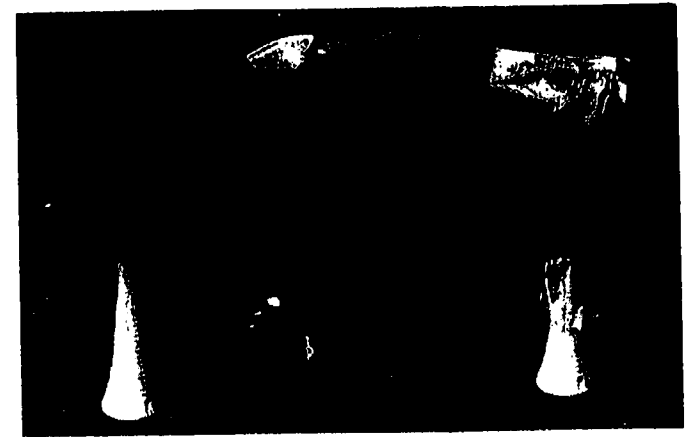


Figure 6-12 Misting wired and taped flowers

Figure 6-13



Figure 6-14 A tropical look with bird of paradise petals



Figure 6-15 A stylized corsage using spider plant leaves

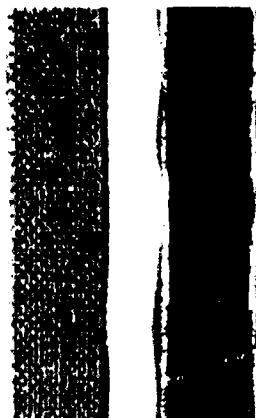
Different Types of Ribbon



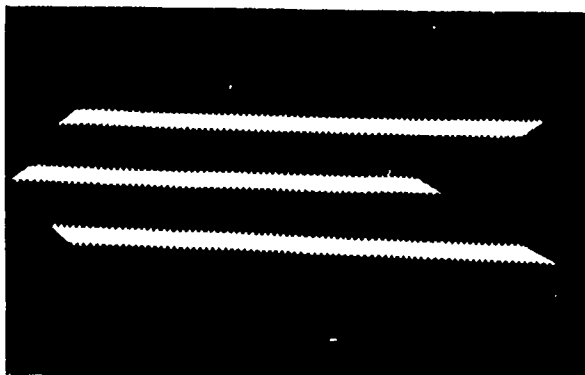
Satin and velvet ribbon



Patterned ribbon



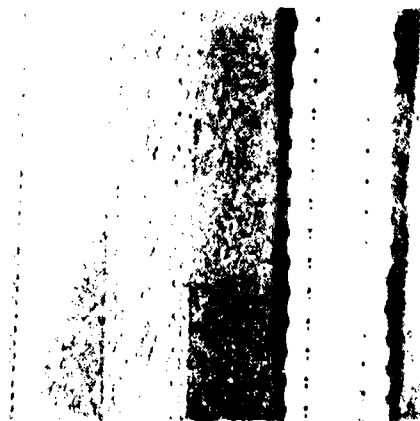
Burlap, lame', moire' and iridescent ribbon



Picot ribbon



Velvet tubing



Lace ribbon

ribbon or streamers throughout the corsage, combining two or more colors or widths of ribbon, or adding loops of braided ribbon.

A traditional addition to a corsage is tufts of nylon net (Fig. 6-16). Squares of net tulle are cut, gathered in the center, wrapped with a wire, and secured by floratape. Not only are the net tufts decorative, but they also perform a function in orchid corsages of helping support the delicate petals.

Many commercial accessories already on wires are available for corsage work. Examples include hearts, shamrocks, small animals, tiny cones and clusters of little pearls. Distinctive corsages with a contemporary feeling sometimes utilize small shiny ornaments made from bits of mirrors.

Dried materials such as pods, nuts and colored starflowers are interesting additions to corsages. Small bits of moss create a naturalistic feeling while tendrils extend the line in a graceful way. If a wire cannot be easily attached to these materials by a traditional method, they can be glued on with liquid or hot glue.

FOLIAGE

Foliage used in corsages must be of a type that does not wilt easily. It also must be of a relatively small size and with a shape that will work into most corsage designs.

Commonly used foliages include camellia, ivy, leatherleaf fern and huckleberry. Leaves may be sprayed or dipped into a plant shine product to make them look

polished and help them retain moisture. Ivy and some fern tips are known to wilt rather easily; after wiring, these may be dipped in a white glue and water mixture (equal parts of water and glue). After drying, the transparent barrier of glue will help reduce water loss and retard curling and wilting for a while.

Artificial leaves are often used to save time and eliminate any chance of wilting (Fig. 6-17). Some silk leaves are very realistic, closely resembling rose leaves and ivy. In addition to traditional green, artificial leaves come in many colors, with different shapes and textures. Silver, gold and pearlized versions are definitely for special effects. Artificial leaves may add to the cost of a corsage, but may be worth the convenience and labor saved.

FLOWERS

Flowers used in corsages should be able to hold up well out of water in the finished corsage. Favorite for their lasting quality are carnations, chrysanthemums and statice. Roses and orchids are also frequently used because of their widespread appeal. If properly handled, these and many other flowers can last reasonably well.

Proper conditioning, beginning after harvest and continued by wholesale and retail florists, is essential if the flowers are to hold well. (Refer to Chapter 28, "Conditioning and Storing Cut Flowers," for details.) Basically, flowers should be kept at least overnight in a cooler to harden off, and floral preservatives should be used.

Once a flower is wired and taped, it cannot take up additional water like flowers in floral foam or vases of water. The lasting quality of the flower therefore depends to a great extent on the storage conditions in addition to the freshness and inherent keeping qualities of the flower. Some corsage orchids are placed in small plastic water tubes containing sponges. These can be worked into corsages, but because of the added bulk, they are practical only for single-flower corsages in which one relatively large and special flower is used. Small moist pieces of cotton are sometimes placed at the base of the cut stem of a flower or in the throat of certain blossoms to prolong freshness.

Some flowers can be taken apart and reassembled into smaller, larger, or different-looking contrived flowers. Carnations are a good choice for this technique. They can be broken apart into smaller units of various sizes. Two large carnations used full-size in a corsage would be very chunky. Splitting them into units of various sizes gives the designer a chance to develop size rhythm and create a more pleasing design. Gladiolus florets can be wired or glued together to form a large double flower called a glamellia. Making these contrived floral novelties takes additional time but results in a different product that can be sized to the specific project.

WIRE

Green enamel-coated wire of various sizes is used for corsage work. It will not rust and is rather inconspicuous in most situations. This **florist wire** is commonly sold in

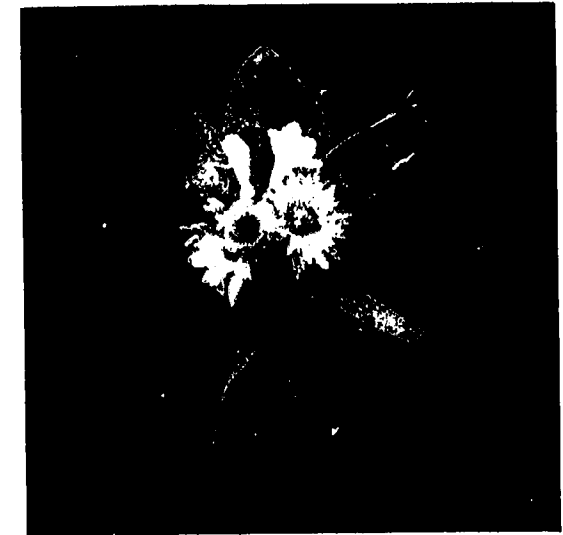
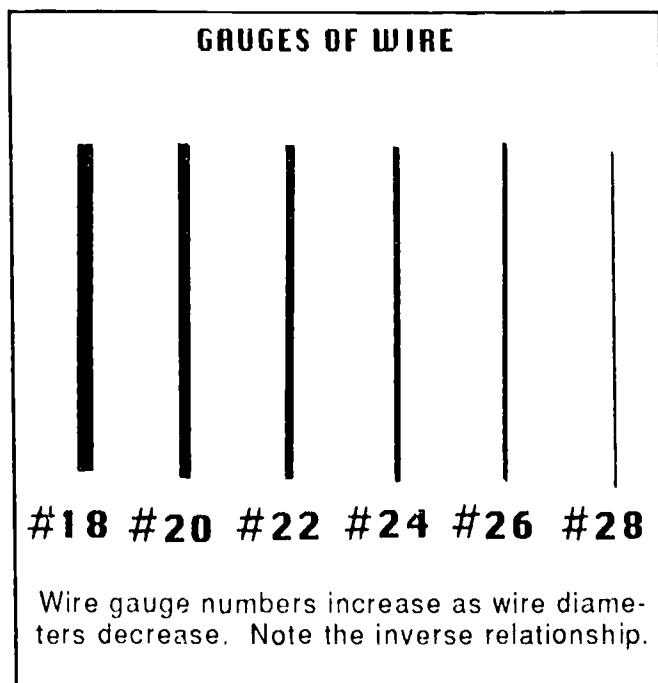


Figure 6-16 Hair piece with loops of net tulle



Figure 6-17 Artificial leaves used in corsages



boxes containing straight pieces 18 inches long. Wire on wooden paddles, called **paddle wire**, can be used, but since it comes off the paddle slightly wavy, it is not as easy to use in many situations.

Wire comes in different even-number diameters called **gauges**. Thin wires have higher gauge numbers and thick wires have lower gauge numbers. Florists commonly have on hand wire ranging from #18 to #28, specifically, #18, #20, #22, #24, #26 and #28 wire. Most corsage work requires only the thinner wires no larger than #22. A beginner or someone doing a small project could get by with #24 and #28. If you were limited to one gauge, #26 would be a good choice.

Less damage to flowers occurs when delicate flowers are wired with fine wire for the initial attachment. Then a heavier wire is usually added beside the fine wire for more support, but without piercing the flower. **The goal in corsage work is to use the lightest possible wire that will still give adequate support and control of the flowers and foliage.** Using a wire that is heavier than necessary will add undesirable weight and may damage the flower when attached. If a wire is not heavy enough, the flower will sag under its own weight and will not stay in position. A flower will also exert greater force on a long wire than on a short wire of the same gauge. For this reason, a carnation on a short wire in a corsage may be adequately supported by #26 wire, while the same flower in a bridal bouquet on an 8-inch wire of the same gauge will droop.

Wires 6 to 9 inches long are adequate for most corsage work. Using longer pieces is wasteful, since much of the length will be cut

off. The actual length of wire used will be determined by the wiring technique. With some techniques only a single length of wire is used, while with others the wire is doubled on itself, resulting in a wired stem length only half the length of the original wire.

To increase the efficiency of corsage making, 18-inch florist wires can be precut into thirds or halves and stored upright in vials or short bud vases that are clearly labeled with the gauge number of the wire. It is both convenient and efficient to pull from a marked upright container, a wire of known gauge and length. Keep the gauges separate and correctly labeled, since considerable time can be lost and wire wasted when wires of different gauges are mixed together.

TAPE

Floratape is a stretchy, non-sticky tape that is widely used for corsage work. The tape covers stems, binds wires to flower stems, and binds wired and taped flowers together when used in making a formal corsage. The tape must be stretched while it is being applied so that it adheres securely.

Floratape comes wound on plastic spools (Fig. 6-18). The most common width is 1/2 inch. Floratape 1 inch wide can also be purchased for use in larger projects such as bridal bouquets.

Green is the floratape color most frequently used, as it is least conspicuous among naturally green stems and leaves. There is a choice between foliage green and moss green. White tape can be used with white flowers, especially in wedding work.

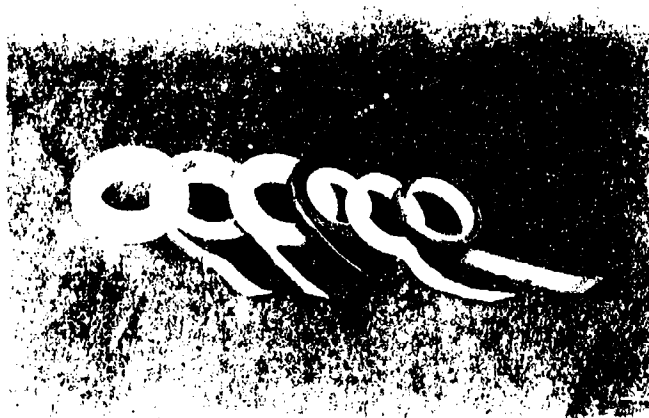


Figure 6-18 Spools of floratape

Lavender tape is sometimes used with orchids of that color. Brown tape is good to use with dried flowers. Many other colors are available for use in special effect arrangements.

A clear stretchy tape called parafilm accomplishes the same thing as floratape but is much less frequently used. It has a waxy consistency and seals cut stem surfaces when stretched over them.

RIBBON

Ribbon width is identified by number. Number 3 satin ribbon (5/8 inch wide) is often used for corsage bows. This is usually the widest ribbon used for corsages. Number 1 ribbon (1/4 inch wide) and #2 ribbon (7/16 inch wide) are also good possibilities. Even satin ribbon as narrow as 1/32 inch can make an interesting bow; however, many more loops are necessary when narrower ribbon is used. Bows of larger ribbon are used to decorate potted plants and in large arrangements such as those for weddings and funerals. Number 9 and #40 ribbon are widths that florists usually have. See the chart to the right for ribbon numbers of ribbon widths shown at one-half actual size.

Florist ribbon is made in many fabrics including satin, velvet, burlap and cotton. Most are single faced; that is, they have different front and back sides. The front side is usually considered the most desirable, and bows are made to feature this side. There are a few occasions where the dull textural quality of the "wrong side" of common satin florist ribbon may enhance certain flowers better than does the sath side.

Consider using the ribbon this way once in a while for a different effect.

Ribbon is wound on cardboard spools called **bolts**. Bolts of ribbon can be efficiently stored on ribbon racks that keep the bolts neat and afford a view of the entire ribbon selection at a glance. Adding or removing bolts of ribbon from such a rack is as easy as taking books off a library shelf. If large amounts of one kind of ribbon are frequently needed, however, it may be more efficient to put the bolt on a stationary bar or spindle. Then the ribbon can be reeled off as needed without having to remove the bolt from a rack, or wind it back up and return it.

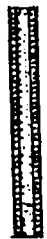

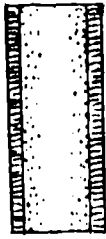
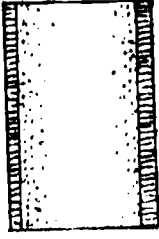
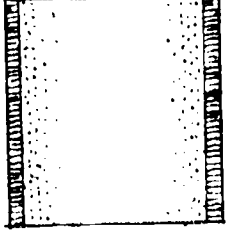
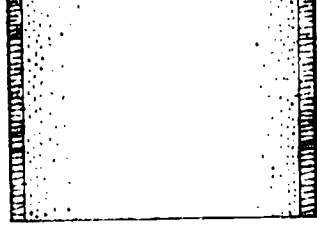
TOOLS

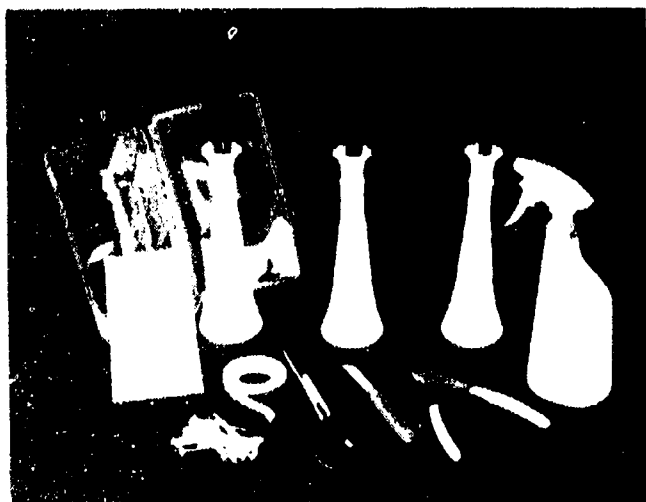
Scissors

Every floral designer needs a good pair of scissors that makes a clean cut. Scissors with long blades, called ribbon shears, are useful for making straight cuts on wider ribbons or for cutting fabric. Florist shears with serrate edges can cut ribbon as well as light-weight wires, but they are not as good



A convenient corsage-making area in a shop

NUMBERING SYSTEM FOR RIBBON WIDTHS						
Actual width in inches	1/4"	5/8"	7/8"	1 3/8"	2"	2 7/8"
						
Ribbon number	# 1	# 3	# 5	# 9	# 16	# 40



Corsage-making supplies

for making straight, clean cuts on ribbon wider than #3.

Wire Cutters

Hand-held wire cutters should be able to cut individual wires as fine as #28 as well as heavier wires and groups of wires. Sturdy counter-mounted wire cutters are best for cutting through large masses of wires like those encountered when making bridal bouquets or some styles of larger corsages.

Knife

Use a good quality, sharp florists' knife.

OTHER SUPPLIES

Corsage Pins

Long pins with white pearl heads are used for corsages. They are usually sold in boxes containing a gross (144 pins). A selection of different lengths and head sizes is available. Boutonniere pins are smaller and usually have a black head.

Mist Bottle

It is a good idea to mist plant materials periodically during wiring and taping. Also the completed corsage should be misted before it is placed in a bag or box. Use plastic bottles with a mist insert, filling them with water. Also use them to dampen the moist paper towels covering the work area.

Corsage Bags or Boxes

Cellophane bags are available in different sizes. They make inexpensive packages for one or more corsages. They should be opened fully and have the corners squared off before a corsage is placed inside, so that the cellophane does not press on the flowers.

The open end can also be squared off neatly and secured with two corsage pins.

Light-weight cardboard boxes made especially for corsages may be used instead. They can be lined with sheets of waxed paper to retain moisture, and shredded waxed paper to cushion the corsage.

TAPING

Taping flowers and wire with floratape requires skill that must be developed with practice. The key to good taping is learning to maintain proper tension on the tape while turning the wire or flower at the same time. You must also learn to overlap the tape just enough to catch the base of the previous turn, covering the wire and stem without developing an overlapping thickness of tape.

SUGGESTED ACTIVITY

Follow the steps listed here for taping down the length of a #18 florist wire. Read over the suggested procedure, then watch your teacher demonstrate the technique. Continue taping over the same wire until you acquire some confidence. You will have many opportunities to perfect this skill and develop more speed when you practice the different methods of wiring flowers and foliage.

Steps for taping a #18 florist wire (for a right-handed person)

1. Pick up the wire in your left hand.

2. Place a roll of floratape over two fingers farthest from the thumb on your right hand. Pull out enough tape to hold between your thumb and forefinger (Fig. 6-19).

3. Place the end of the tape under the wire at the top of the length.

4. Begin rotating the wire clockwise between thumb and forefinger of your left hand.

5. Pull firmly and uniformly downward and outward on the tape (at about a 45° angle) as it is taken up by the turning action of the wire.

NOTE these two points:

The **tension** you maintain on the tape is as important to the success of the taping job as the tension on a sewing machine is to producing quality sewing. Pulling too hard could break the tape, but pulling too lightly will result in loose tape that will not stay on the wire.

The **angle** at which you hold the tape determines the amount of overlap you will have. If you hold the tape straight out at a 90° angle to the wire, it will keep going over the previous turn, becoming very thick and requiring many turns to get down the wire. Try for the minimum amount of overlap that will hold securely, since this saves time as well as tape.

6. Let the spool turn freely on your two smallest fingers when the tape is pulled from it, just as the spool of thread turns on a sewing machine.

7. Keep turning the wire and maintaining tension on the tape until you have reached the bottom, ending by pulling sharply on the tape to break it.

8. Check results by rubbing your finger down the taped wire. A smooth, tight taping job is a sign of good work.

9. Repeat the process over the same wire several times until you feel comfortable with it.

PREPARING FLOWERS AND FOLIAGE FOR WIRING AND TAPING

Use conditioned flowers that have been hardened off in a cooler for several hours. Select quality flowers of the color and size appropriate for the corsage being made. Since corsages are viewed at close range, it is important that flowers be totally free from blemishes and spray residue. Using a sharp knife, cut the flower stem to within about a half inch of the flower. Leave the same amount of stem on the foliage if possible.

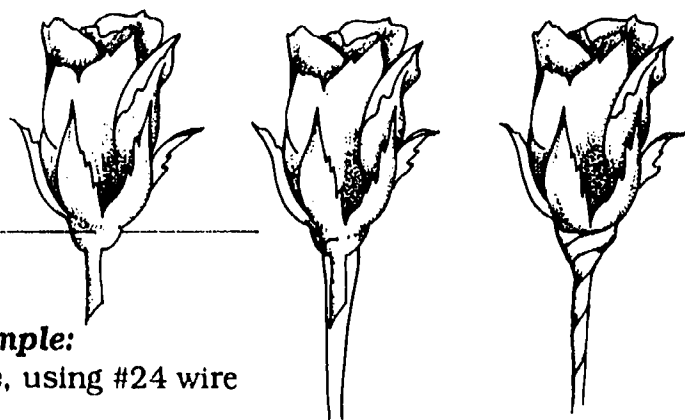
BASIC WIRING METHODS

PIERCE METHOD

Depending on the structure of the flower, a wire is inserted through the flower stem, calyx or ovary just below the petals at a 90° angle to the stem. The wire is pushed through to the midpoint of its length, then both ends are bent down parallel to the flower stem and taped. If additional support from a second wire is needed, the second wire can be pierced through just above or



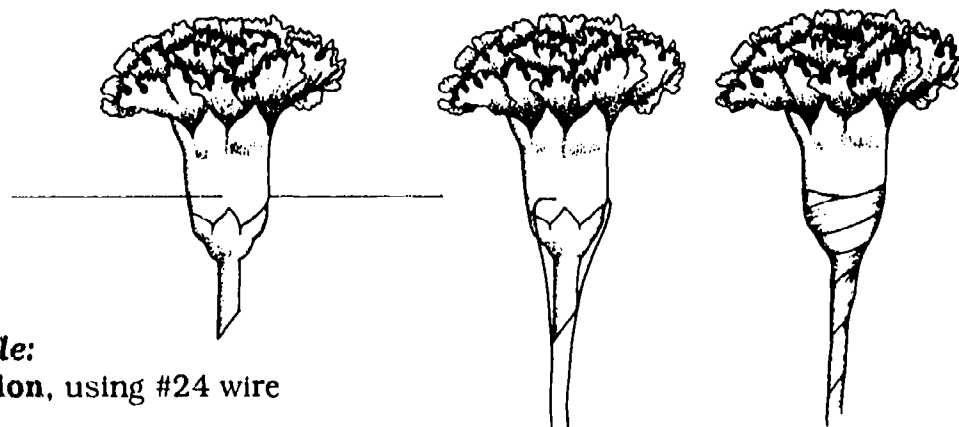
Figure 6-19 Taping a wire with floratape



PIERCE METHOD

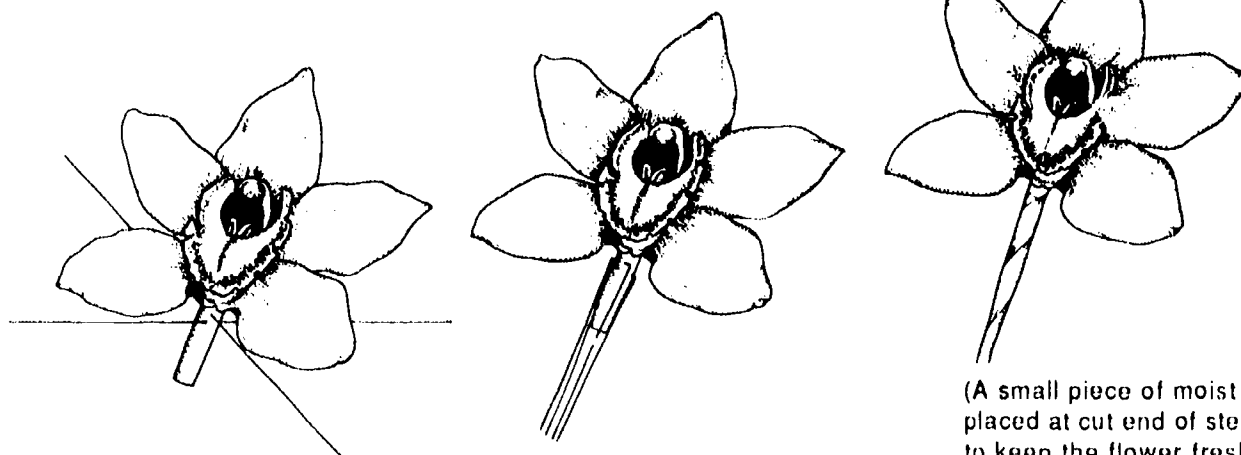
Example:
Rose, using #24 wire

Pierce ovary, bend wire down, and tape



Example:
Carnation, using #24 wire

Pierce calyx, bend wire down, and tape



Example:
Cymbidium orchid,
using two #26 wires

Pierce flower stem, bend wires down, and tape

below the first wire at a 90° angle to the first wire. Then all four wire segments are bent down parallel to the stem. (See the examples on this page.)

HOOK METHOD

Daisy-type flowers can be wired by pushing a wire up through the flower head near the flower stalk so that several inches of wire appear above the center of the flower. Then make a small hook in the end of the wire and pull gently downward on the other end of the wire until the hook just sinks into the disk florets. The hook will scarcely be noticed unless it was made too big. Tape the wire to the flower stalk and continue on down the wire.

Some people like to begin by pushing the wire up through the cut end of the stem instead of beside the stem. Although this method will also work, the first method described may allow for more secure taping of wire to stem. (See the daisy chrysanthemum example on the next page.)

(A small piece of moist cotton may be placed at cut end of stem before taping to keep the flower fresh.)

INSERT METHOD

Flowers with sturdy stems can be wired very simply by pushing a wire up the stem and into the flower. If the stem bends so that the flower faces outward, as is the case with daffodils, you may not be able to push the wire up as far without having it come out the top of the bend. Chenille pipe stems can be used instead of florist wire to insert into the calyx of carnations or into the ovary of a rose for a quick wiring method.

Inserting wires into or beside the stem without making a hook is not as secure as other methods. The flowers can pull loose if not tightly taped to the wire. (See the examples to the right.)

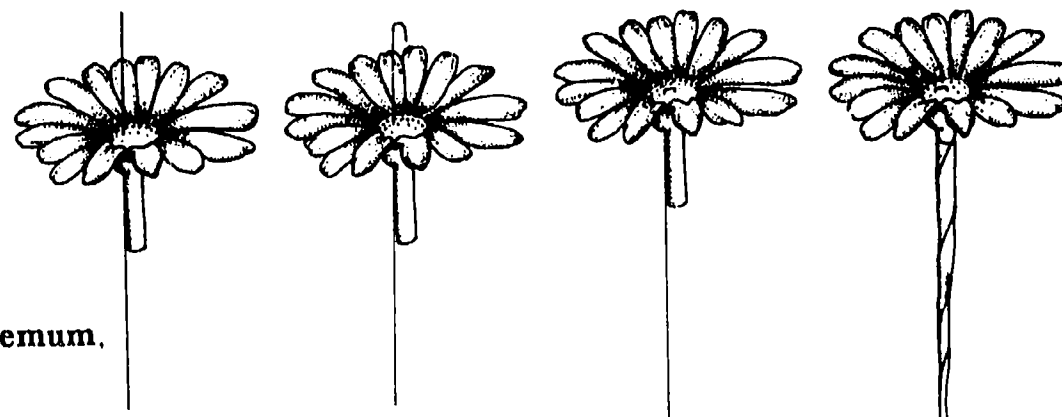
WRAP-AROUND METHOD

Small delicate flowers can be wired by wrapping a thin wire around the flower stem and blossom. Place the middle of the wire just under the flower, bring half the wire down parallel with the flower stem, and wrap the other half around the stem and wire with a few twists. Tape the two wires and stem together. This method is good for flowers that grow in a cluster (such as statice or baby's breath). It is also used to bunch several flowers together, wiring them as a group. (See the example of statice.)

Modified Wrap-Around Method

If the material is very delicate and likely to break when the wire is bent around it, the wire may be bent in half first. Then the hairpin-shaped wire can be passed through the lower leaflets or florets and wrapped around to secure the lower part of the stem.

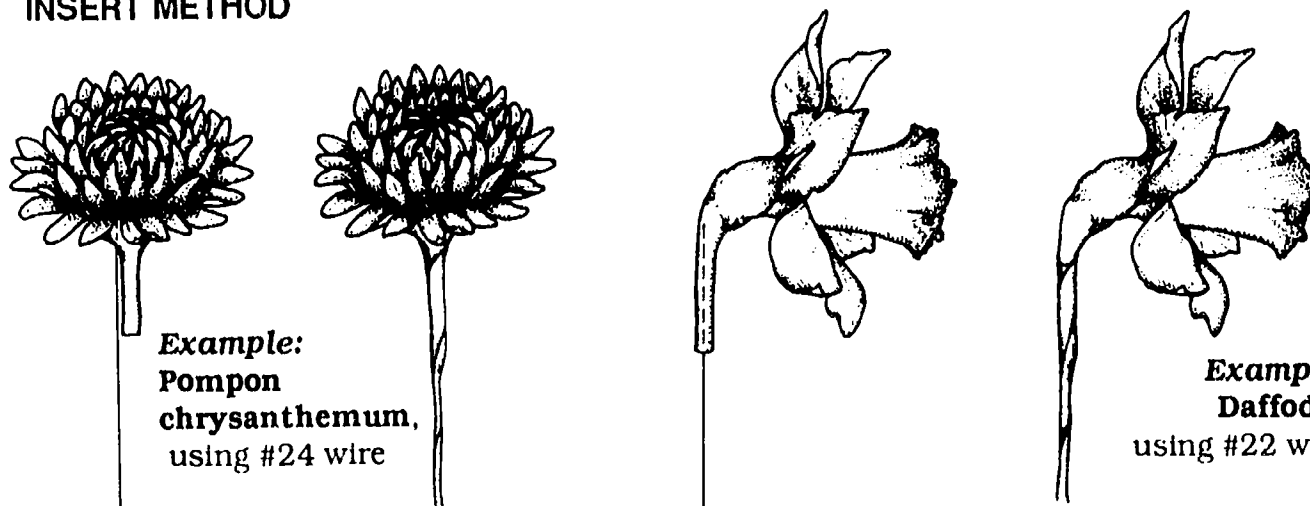
HOOK METHOD



Example:
Daisy chrysanthemum,
using #24 wire

Push wire up through flower center near stem, make a hook, gently pull hook down into center, and tape

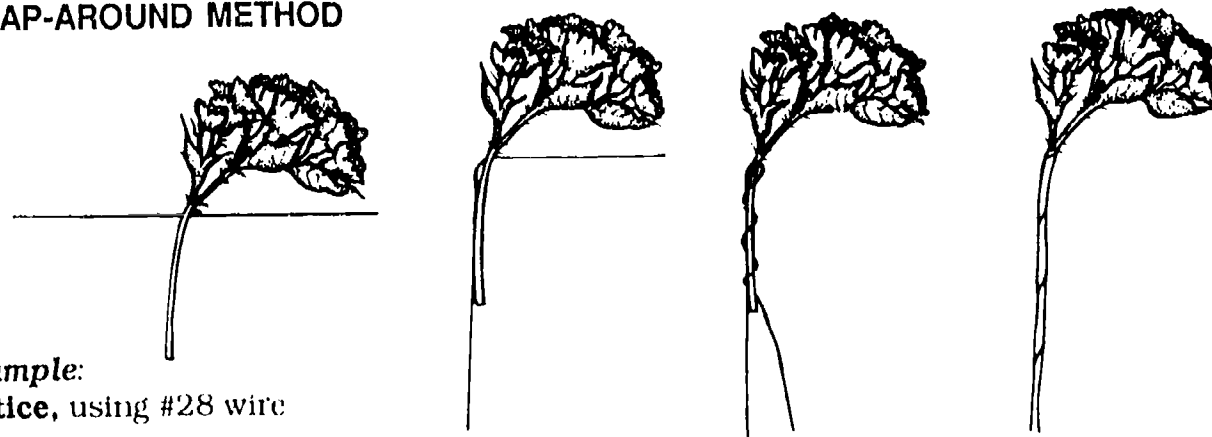
INSERT METHOD



Example:
Pompon chrysanthemum,
using #24 wire

Example:
Daffodil,
using #22 wire

WRAP-AROUND METHOD

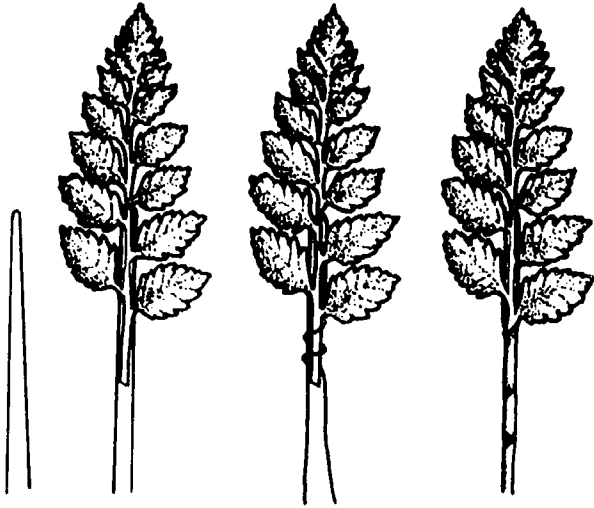


Example:
Statice, using #28 wire

MODIFIED WRAP-AROUND METHOD

Example:

Leatherleaf fern, using #28 wire



When wiring leatherleaf fern, it is often helpful to press firmly on the bend of wire against the foliage piece with one hand while wrapping one half of the wire around the remaining wire and stem with the other hand. The bottom two leaflets will keep the wire from slipping down. Finish by securely taping wires and stem together.

HAIRPIN METHOD WITH STITCH
(for Foliage)

Turn the leaf over to the underside. Using a thin wire like a sewing needle, take

a small stitch under the midrib about halfway up the leaf. Pull the wire through to its midpoint. Bend both halves of wire down parallel to the petiole. Wrap one half of the wire around the other half and the petiole with just a few twists to hold them together. Tape the wires and petiole and continue taping on down the wires.

If the petiole is about 1/4 to 1/2 inch long, there will be good attachment. If there is no petiole, the leaf may rock loosely on the wire. Some types of leaves can be cut away at the base, leaving a section of midrib showing that can be taped over to help attach the leaf to the wire.

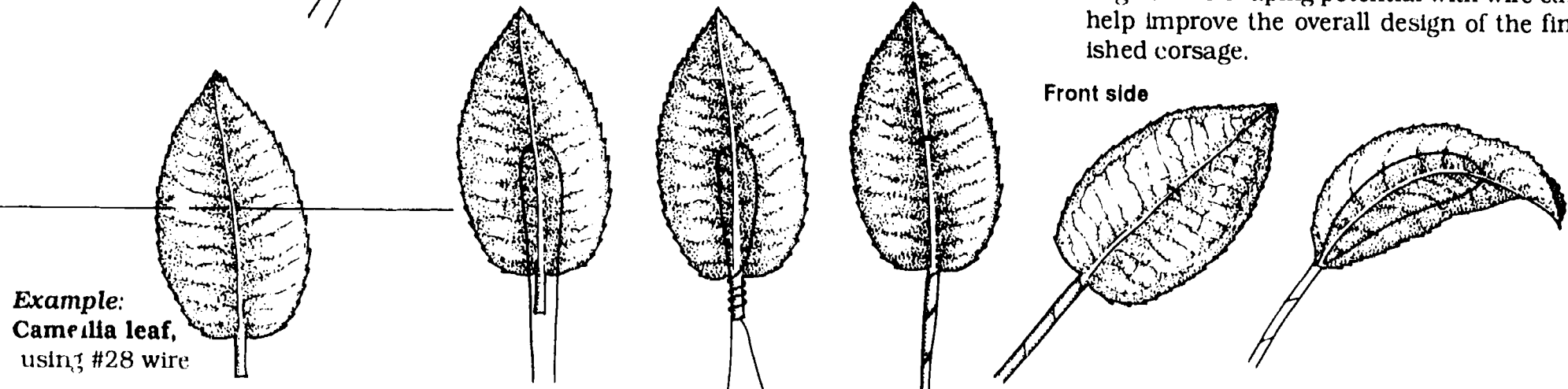
Example: Baby's breath, using #28 wire



This method works best on leaves that are somewhat leathery. If the leaf is too delicate, the wire may tear through. Using too heavy a wire may also cause this.

A nice feature of this method is that once wired, the position of the leaf can be controlled. Not only can the leaf be bent sideways at the base, but it can also be arched or curved backward by rolling the leaf over your finger. This shaping potential with wire can help improve the overall design of the finished corsage.

HAIRPIN METHOD WITH STITCH



Example:
Camellia leaf,
using #28 wire

Working on back side of the leaf, take a stitch under the midrib about halfway up. Bend the wires down. Wrap one wire around the other with a few twists. Tape. Only a small stitch should show on the front. The leaf can be curved and the wire will keep it in that position.

SUGGESTED ACTIVITY

Practice each of the wiring techniques that have been described and work on your taping skill by wiring and taping as many of the following flowers or foliages as are available. Have your instructor check each one and determine if you need more practice on that flower or leaf.

Flower or Foliage	Wiring Method	Wire Gauge
carnation	pierce	#24
daisy mum	hook	#24
pompon mum	insert	#24
statice	wrap-around	#28
baby's breath	modified wrap-around	#28
rose	pierce	#24
leatherleaf	modified wrap-around	#28
camellia	hairpin with stitch	#28
huckleberry	wrap-around	#28
ivy	hairpin with stitch	#28

SPECIALIZED WIRING TECHNIQUES

Some flowers require special wiring procedures because of their shape, size or fragile nature. Combinations of basic techniques and different wire sizes can be used to hold these unusual flowers in place.

Small pieces of moist cotton may be added to the base of the flower stalk or pushed down into the flower throat to prolong freshness. Spraying flowers with a clear spray like *John Henry Cherish* will also help keep flowers looking fresh longer.

Following are directions for wiring some of the special or delicate flowers that require additional wiring procedures.

Amazon Lily (*Eucharis Lily*)

The Amazon lily is a white flower about 3 inches across. It is related to the daffodil and has a similar short cup. The flower is relatively expensive and has been traditionally

prized for corsages or bouquets, especially at weddings.

Use a #26 wire and the hook method (Fig. 6-20). A small piece of moist cotton is usually inserted under the hook and pulled

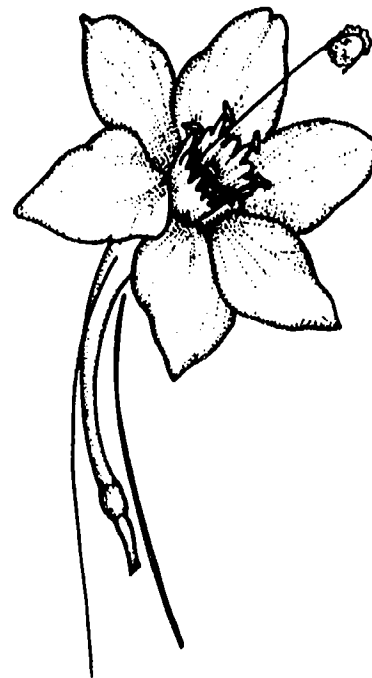
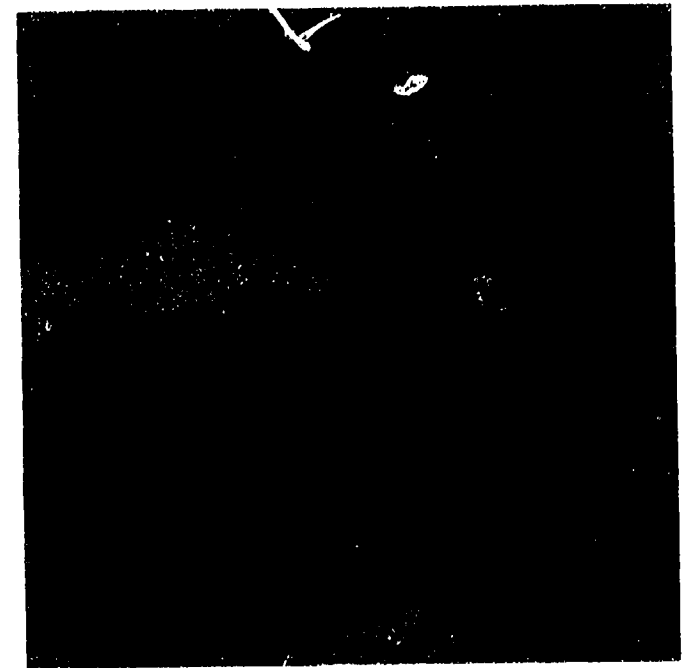


Figure 6-20 Wiring an Amazon lily



Taping a carnation that has been wired by the pierce method

Wiring stephanotis

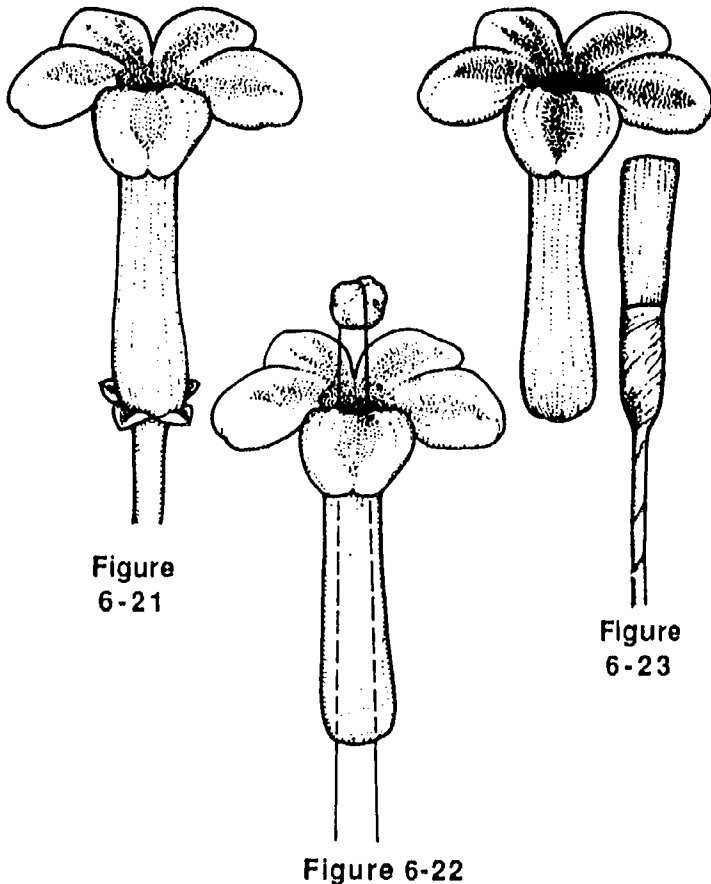


Figure 6-21

Figure 6-23

Figure 6-22



Figure 6-24 Hyacinth florets

gently down into the shallow cup of the flower. The moist cotton helps keep the flower fresh and cushions the wire so it will not pull through the flower. The white cotton is not conspicuous in the finished product.

After this initial wiring one or more heavier wires can be laid alongside the #26 wire and taped to it for added wire strength.

Stephanotis

The delicate flowers of stephanotis easily separate from the calyx and flower stalk (Fig. 6-21). So the first step is to gently break off the flower at the base of its tube. A wire will be attached directly to the flower tube. Bend a #26 wire like a hairpin and insert down through the tube from the top (Fig. 6-22). The wire ends are angled downward through the lower part of the tube.

Place a moist piece of cotton under the loop of the 'hairpin'. Gently pull the wire loop down into the flower tube until the cotton disappears. Tape over the wire and up slightly over the base of the flower tube.

A quicker method is to use stephanotis picks (Fig. 6-23). These are pretaped wires with a piece of cotton on the end. Soak the cotton ends in water. Separate the blossom from its calyx and insert the cotton from below through the hole at the bottom of the flower tube. This must be done gently, as the flower tubes split easily. Longer or heavier wires may be taped to the flower after the pick has been inserted.

Hyacinth Florets

Wire individual hyacinth florets as de-

scribed for stephanotis (Fig. 6-24). Stephanotis picks are too large for the hyacinth flower tube and will usually split it.

Chains of hyacinth florets may be made by using the hook method for wiring the first floret, then pushing more up the wire from the bottom. The chains may be bent into loops if desired for a different effect that simulates ribbon (Fig. 6-24).

Cattleya Orchid

The cattleya orchid is large, often measuring 4 or 5 inches across. Because of its large fragile petals, at least two wires should be attached (Fig. 6-25). A heavier wire (such as a #22), usually taped and bent into a hook or into several loops, is used for support. A finer wire is then used to attach the flower to the heavier wire without damage.

The heavier wire is usually wrapped with white, lavender, or another color of floratape to cushion it and make it less conspicuous. The floratape should be the same color as the orchid. If moderate support is wanted, a hook can be bent into the end of the taped wire and placed behind the uppermost petal (Fig. 6-26). A fine wire will then be used to attach the orchid to the heavier taped wire. Several additional loops of taped wire can be added to support the wing-like petals if they seem floppy or in danger of becoming limp.

An additional step that some florists take is to place a piece of moist cotton at the base of the flower stem. This provides a limited amount of water to prolong freshness. Small, soft plastic water tubes with sponge inserts can be used instead for a larger water supply. However, they are bulky

and are not usually necessary for the naturally long-lasting orchid.

An easy method of wiring a cattleya orchid with moderate support is to wrap a #22 wire with floratape. Then bend the end over to form a hook and place the hook behind the uppermost petal with the straight end of the wire coming down parallel with the flower stem. Pierce the flower stem just below the petals with a #26 wire just enough to secure the wire. Wrap this wire around the flower stem and larger taped wire.

A variation is to insert an untaped #24 wire up into the cut flower stem until it enters the flower. Then pierce a #24 wire to its midpoint through the flower stem, bending one side down and wrapping stem and wires together with the other side. This method really does not support the petals, however. They may need to be made more secure by backing them with tulle or with foliage worked into the corsage design.

If taped loops of wire are desired for additional support, they should be bent into loops a little smaller than the petals and then taped on to the wires that have already been attached by one of the previous methods. If a water tube is going to be used, various methods can be used to fasten the orchid to the tube. Because of the bulk and weight of the tube, it is unlikely that wire loops will be added. An unwrapped wire can simply be pierced through the upper stem to its midpoint. Then both halves can be bent down and taped to the tube.

Phalaenopsis Orchid

These delicate flowers require special care in the attachment of a wire so that it will not cut through the flower. Tape a #26 wire with white floratape and bend it into a hairpin shape (Fig. 6-27). Working from the front of the orchid, slip the ends of the 'hairpin' through the natural openings in the throat of the orchid. Then gently draw the hairpin down until the U-bend rests securely between the arched column and fringed lip petal. Finish by taping the wires and stem together.

Phalaenopsis petals easily become limp. A moist piece of cotton at the base of the flower stem may prolong freshness. Taped loops of #26 wire can also be added behind the two largest petals to provide additional support (Fig. 6-28).

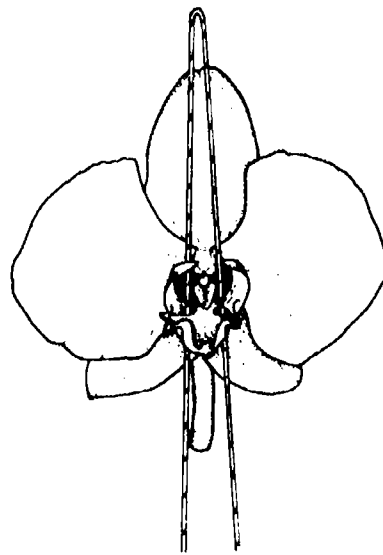


Figure 6-27 Wiring a phalaenopsis

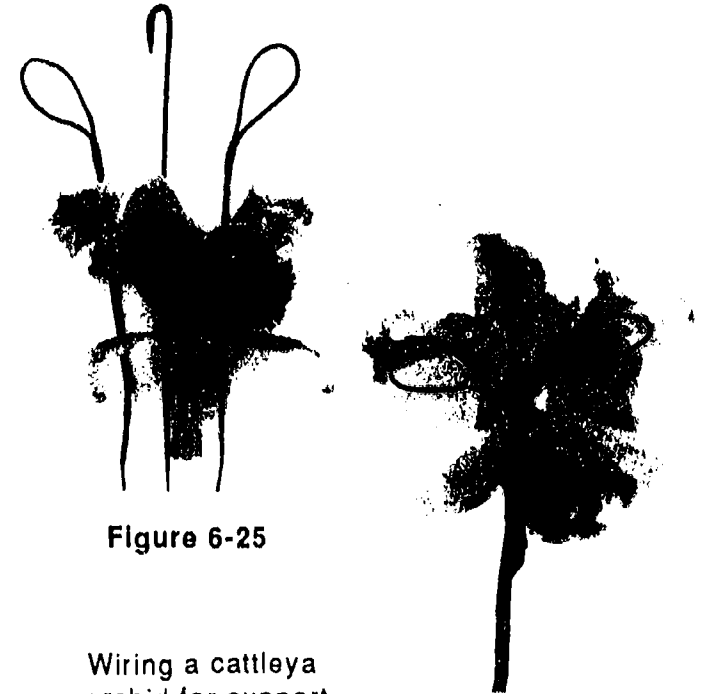


Figure 6-25

Wiring a cattleya orchid for support

Figure 6-26

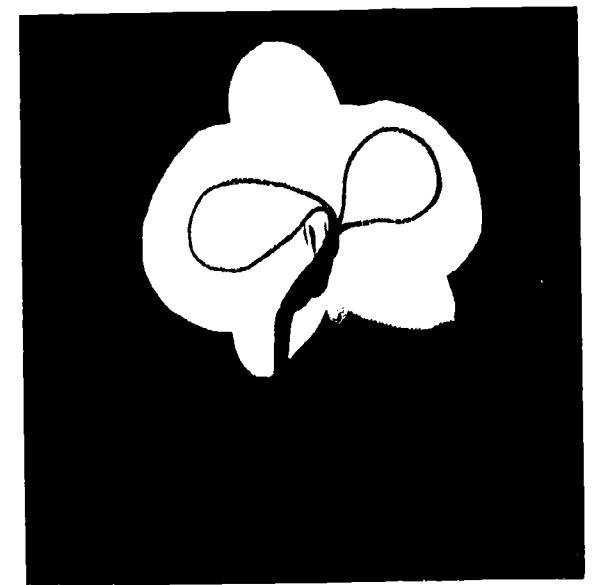


Figure 6-28 Back view of phalaenopsis

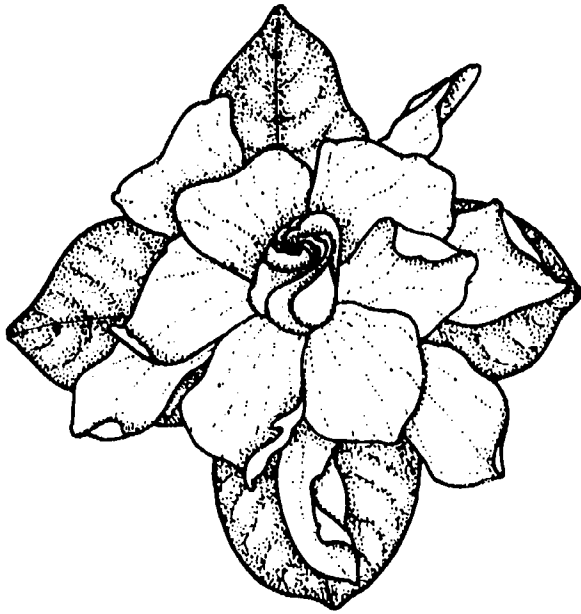


Figure 6-29

A gardenia backed by leaves for support

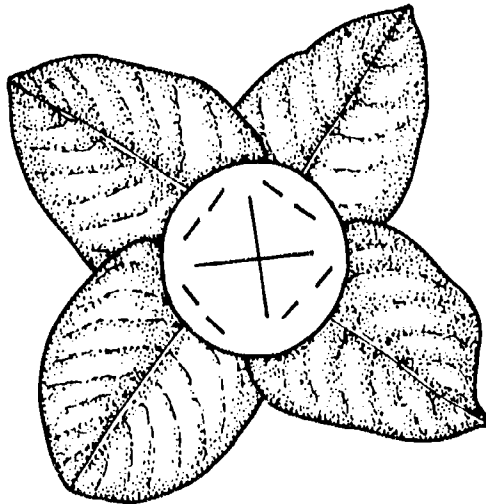


Figure 6-30

Back view of a cardboard collar

Gardenia

Gardenias are very fragile and easily turn yellowish. (See Figure 6-29.) Try to minimize this by keeping the work area and petal surface misted. Also work as quickly as possible so the flowers are not exposed to room temperature for a long period of time.

Gardenias are usually packaged and shipped with plastic or cardboard collars. These may be left on the finished corsage for continued support. A collar can also be made from a round piece of cardboard with criss-crossed slits in the center and several gardenia leaves stapled to the outside (Fig. 6-30).

If you are working with a gardenia that has no collar, first remove the bulky green calyx. Pierce two #26 wires through the flower tube at right angles to each other. Bend them down, wrapping one of the wires around the other three and the stem. Tape the stem and add a gardenia collar made as described above.

SPECIAL TREATMENTS for WIRED and TAPED FLOWERS

Various products are available for specialized care:- to prolong freshness, prevent petal shattering, add a glossy shine, or repair damage in flowers and foliage that have been wired and taped for corsages. Sometimes homemade preparations work just as well. No matter how careful you are, occasions will arise when you will need to apply one of these treatments to protect or repair the plant materials.

1. Glue/Water Dip

A mixture of half white glue and half water can be used as a dip for delicate flowers which turn yellow easily (lily of the valley) or foliage tips which wilt easily (ivy and leather-leaf). The mixture dries quickly to form a transparent barrier to water loss.

2. Aerosol and Pump Sprays

Commercially available sprays like *Stay Fresh* or *Chertish* form an invisible covering over the plant material which prevents contact with the air and retards water loss.

3. Plant Shine Products (Fig. 6-31)

Plant shine compounds like *Green-Glo* are available as dips, mists or aerosols. They can be applied to foliage to reduce water loss. This clear, shiny coating also makes the leaves glossy. This may enhance some plant material but may be undesirable in situations where a more textured look is wanted.

4. Water Mist

Clear water in a misting bottle may be sprayed on flowers and foliage while they are being worked on. The fine mist will reduce water loss and provide a slight cooling from the evaporation. Misting the finished corsage before it is bagged or boxed will help it remain fresh and crisp. Most corsage ribbons will not be damaged by a light mist.

5. Floral Adhesives

The petals of some flowers shatter easily. A floral adhesive like *Oasis Glue* may be brushed on the back of petals near their point of attachment to hold them on (Fig. 6-32). The glue can also be used to reattach a petal that has fallen off, as is often the case with lily petals.

Mum Mist and other spray adhesives (Fig. 6-33) can be applied to the back of mums and other flowers to help hold the petals on. Some people drip a little candle wax at the base of the petals to accomplish the same thing. In anemones the hardened wax will also retard the opening of the petals into a reflexed position.

6. Paints

A light coat of white floral spray paint over a slightly browned or yellowed gardenia or white orchid may restore a fresher look. Other colors of floral spray paint may be used on fresh materials to produce a color that is not available naturally or to slightly alter a flower color for a special effect.

BOWS

Many corsages include a bow. The bow should be blended into the design so that it enhances the flowers and does not stand out by itself. Thus a corsage bow is less full than a bow designed to be featured by itself, such as a bow on a package. The loops may vary in length but are generally about 2 inches long. The loops are held together by a fine wire which is often concealed by a small loop of the ribbon. Streamers may be made by leaving a length of ribbon at the beginning and end of the bow-making process, or by making one of the loops much larger and then cutting it to form two streamers.

Single-faced #3 satin ribbon is most commonly used for corsage bows. The shiny side is usually placed outward. This requires twisting the ribbon over after each loop is made. Bows made from narrower width ribbon are also very appropriate. Wider ribbon

can be cut lengthwise to produce ribbon of a more desirable width.

Corsage ribbon is available in a wide range of colors and fabrics, such as velvet, lace, burlap, cotton and metallic. The texture and character of the ribbon is also affected by the print (plaid, polka-dot, striped or figured) or plain surface of the ribbon.

SUGGESTED ACTIVITY

Make several bows according to the following directions until you feel reasonably confident and satisfied with the product.

To make a bow (directions for a right-handed person)

1. Cut a piece of #3 satin ribbon 1 1/2 yards long. Cut a 9-inch piece of #28 florist wire.
2. Wrap the end of the ribbon around your left thumb to form a loose loop over the thumb with the shiny side up (Fig. 6-34). The



Figure 6-34 Making a loose ribbon loop



Figure 6-31 Plant shine products



Figure 6-32 Oasis glue



Figure 6-33 Aerosol products - adhesives and surface sealers

remainder of the ribbon will be coming toward you with the dull side up. Hold loop between thumb and forefinger.

3. Pinch the ribbon together under your thumb using thumb and forefinger so that the length of ribbon coming toward you narrows into a crease where it comes off the loop.

4. Make a sharp twist in the ribbon so that the shiny side is up (Fig. 6-35). Use forefinger to hold ribbon in this position.



Figure 6-35

5. Form a 2-inch loop by bringing the ribbon back to and under the thumb (Fig. 6-36).

6. Lift your thumb enough to let the ribbon in under it. The ribbon length is now going away from you with the dull side up.

7. Again pinch the ribbon under your thumb and twist it so the shiny side is up. Make another 2-inch loop on the opposite side from the first loop (Fig. 6-37). Open

thumb and forefinger just enough to hold this loop as you did the first one.

8. Continue making loops on opposite sides by first twisting the ribbon so that the shiny side is up, holding all loops between thumb and forefinger. Loops can vary in size (the smaller ones should be made first), and



Figure 6-36



Figure 6-37

you can twist them as they are made so that they fan out slightly.

9. End with one large loop which you will later cut at a sharp diagonal to form two streamers.

10. Without letting go of any of the loops, slide the #28 wire under your thumb and over all the gathered bases of the loops (Fig. 6-38). Pull wire to its midpoint and then bend it so the two halves come together.

11. You may need to turn your left hand over for the next step so you can see what you are doing. Pinch the wires together tightly, close to the ribbon, and twist sharply several times so that the loops are firmly held. If the wire is not tight enough, the loops will come undone. A tight wire will cause the loops to stand up giving a fullness to the bow. About four loops on one side and five on the other will make a very good corsage bow.



Figure 6-38

To make streamers

1. Cut the large loop near the middle on a sharp angle to make two streamers. Bend into desired position.
2. If additional streamers are wanted, or if a bow was made without the large loop, streamers can be made and added separately (Fig. 6-39). Cut a piece of ribbon twice as long as the desired length of the streamers.
3. Bend and tuck the ribbon piece in the middle so that the two halves come down at a 45° angle to each other, with a triangular point at the tuck and the shiny side toward you on both halves.
4. Wrap a #28 wire tightly around the tuck about 1/4 inch from the point and twist the wire tightly.
5. Cut ends of streamers with ribbon shears at a sharp angle.



Figure 6-39 Adding streamers to the bow

6. The streamers can be added separately to the corsage by taping them in, or they can first be attached to the bow with floratape.

To make net tufts (Fig. 6-40)

1. Cut a 6-inch piece of waterproof netting (tulle). Waterproof netting comes on bolts and is 6 inches wide.
2. Gather the center of the net between your fingertips.
3. Twist a #28 wire around the gathered net about 1/2 inch up from the point. Tight wiring is necessary to hold the net and make it puff out.
4. Use floratape to tape the wire and the lowest point of the net.



Figure 6-40 Net tufts of waterproof tulle

BOUTONNIERES

Traditionally boutonnières have been single flowers worn in the buttonhole of a man's lapel. The simplest form of a boutonniere is a flower, such as a rose, carnation or orchid, broken off the flower stem and pinned on with a small black-headed pin.

Flowers for boutonnières may be wired and taped to provide a more finished look to the stem and to give some control over the position of the flower. One or more small pieces of foliage may be added for interest. If the foliage is wired, its position can be more carefully regulated.

Boutonnières may consist of more than one blossom, such as three stephanotis or



Single and multiple-flower boutonnieres

even a small collection of different flowers. There has been a recent trend toward more complex boutonnieres. Even though they are much smaller than a corsage, they still give a designer the opportunity to be more creative.

Flowers chosen for boutonnieres should coordinate with the color of the man's clothing and reflect the appropriate formality for the event. Wedding boutonnieres should be coordinated with the other flowers, usually by having the boutonnieres consist of one or more flowers used in the bouquets.

Boutonnieres are usually pinned on the *left* lapel of a man's jacket (to your right as you face the wearer).

SUGGESTED ACTIVITIES

A. Construct the five boutonnieres listed below. Practice pinning them on other people in the class.

B. Discuss your reaction to the following questions.

1. What jacket and what occasion would each boutonniere be suitable for?
2. Are any of the boutonnieres larger or smaller than you think appropriate?
3. There are different ways of finishing off the bottom of a boutonniere, some of which have probably been tried by your classmates. Consider the following possibilities. Which ones are the most appealing to you?

- * blunt or straight on the bottom
 - * individual taped wires showing, spread out as if they were stems
 - * single taped wire bent into a curl
 - * base of flower concealed by foliage
-

Style	Suggested Flowers	Suggested Follages
Single flower	standard carnation	none
Single flower with foliage	rose	ivy
Double flower	mini carnations	huckleberry
Mixed flowers	mum, rose, baby's breath	sprengerl
Creative	one or more unusual materials such as dendrobium orchids, small daffodils, freesias, alstroemeria, stephanotis, or hyacinth florets	one or more unusual materials such as small spider plant leaves, grape tendrils, or succulents

SINGLE FLOWER CORSAGES

Single flower corsages are designed to feature one special flower, such as an orchid or gardenia. If a standard carnation is chosen, the corsage will be relatively small, but if the featured flower is a cattleya orchid, the corsage will be quite large.

Single flower corsages can be enhanced by foliage, ribbon, tulle or other accessories. The ribbon is normally placed at the base of the flower and should not be out of scale by being overly dominant or too small. Tufts of netting (tulle) are sometimes used behind flowers to set them off with a delicate background. The tulle will also give some support to large petals, such as those found on orchids.

The bottom of the corsage should be wrapped with tape and cut off to a length that is relatively short and inconspicuous. Tape over the cut end so there are no exposed wires to snag clothing.

CORSAGE KIT (Fig. 6-41)

Supplies for making corsages should be assembled in one place so they are readily available while the corsages are being constructed. They consist of the following:

#24, #26, and #28 florist wire
 floratape
 corsage pins
 corsage bags or boxes
 mist bottle filled with water
 scissors
 wire cutters
 sharp knife

SUGGESTED ACTIVITIES

Single Flower Corsages

- A. Make a **single carnation corsage** using the following procedure.

Materials: (Fig. 6-42)

1 standard carnation
 3 small pieces of leatherleaf fern
 1 1/2 yards of #3 satin ribbon
 corsage kit

1. Wire and tape a standard carnation using #24 wire and the pierce method.
2. Wire three small pieces of leatherleaf using the modified wrap-around method.
3. Make one bow from the #3 satin ribbon. Loops should be about 2 inches long.
4. Place the smallest piece of leatherleaf behind the carnation so that it extends about 1 inch above the flower.
5. Use floratape to bind the foliage and flower together. Use only a couple of turns of the floratape as each new piece is added.
6. Add the bow in front of the flower and just underneath it, securing the wire to the other stems with a few turns of floratape.
7. Add the second piece of leatherleaf between the loops of the bow and off to one side of the flower.

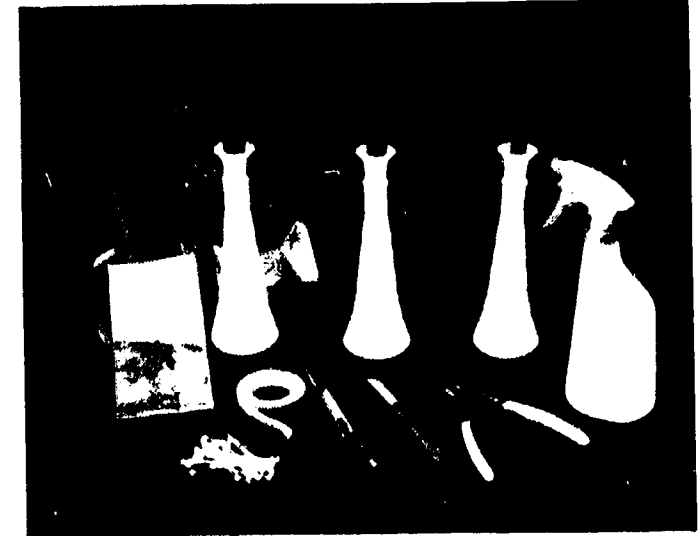


Figure 6-41 A corsage kit



Figure 6-42 Materials for a single carnation corsage



Figure 6-43 A finished single carnation corsage

8. Add the third piece of leatherleaf between the ribbon loops on the other side.
 9. Cut all the wires off about 1 1/2 inches below the flower and tape over the cut end.
 10. Bend ribbon loops and foliage pieces, arranging them into a pleasing design. (See Figure 6-43.)
 11. Mist the corsage lightly with water.
 12. Add two corsage pins, place in corsage bag or box, and store in cooler.
- B. Make a corsage containing a **single cymbidium orchid**, using the following directions.

Materials: (Fig. 6-44)

- 1 cymbidium orchid
- 5 pieces of sprengeri
- 1 1/2 yards of picot ribbon
- corsage kit

1. Wire and tape a cymbidium orchid using two #26 wires pierced through the flower stalk at right angles just below the flower. (If other flowers like cattleya orchids, phalaenopsis orchids, Amazon lilies or gardenias are used, select a wiring technique appropriate to those flowers. See the specialized wiring techniques described earlier in this chapter.)
2. Wire five pieces of sprengeri using #28 wire and the wrap-around method. These should be of various sizes that are in scale with the flower.

3. Make a bow with two streamers from 1 1/2 yards of picot ribbon.
4. Place one of the small pieces of sprengeri behind the orchid and tape. Add a second piece slightly below the first and a little to the right, then tape.
5. Add the bow by taping it below the flower.
6. Add the remaining three pieces of sprengeri below the flower, arching forward through the bow.
7. Adjust the flower and foliage pieces if necessary. (See Figure 6-45.)
8. Mist, add pins, and package.

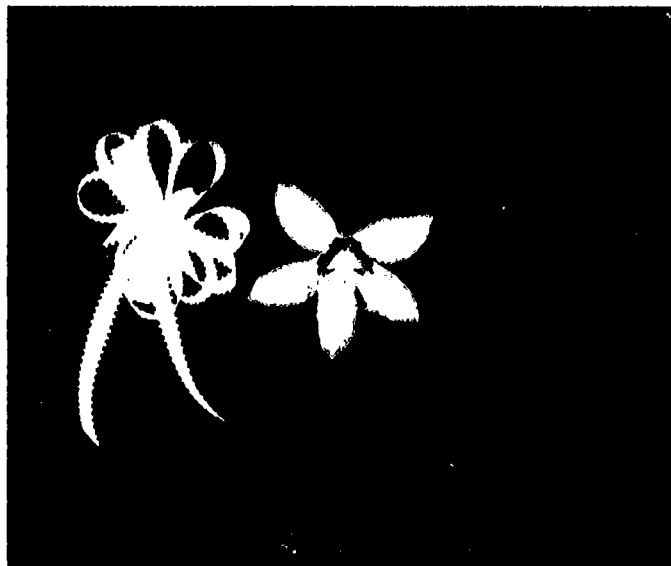


Figure 6-44 Materials for a single cymbidium corsage

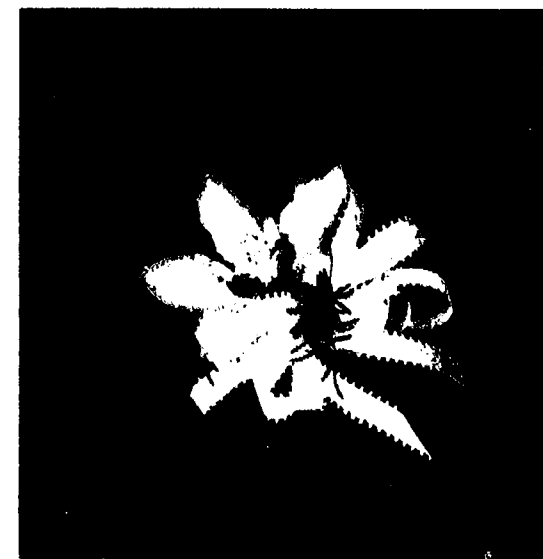


Figure 6-45 A finished single cymbidium corsage

SINGLE SPRAY CORSAGES

Single spray corsages contain more than one flower arranged in a triangular design with the bow incorporated into the lower area. There is a gradual progression in size from smaller flowers at the top to larger ones at the base.

The lower part of the corsage is considered to be the focal area. There should be closer spacing of materials in this area than higher up, but never let them appear crowded. The bow is also located here. While it enhances the focal area, it should not be the focal point. A larger flower placed over the bow is the center of interest.

The bottom area can be finished off with foliage that comes forward or arches slightly downward. The flowers gradually face sideways as you go to either side of the corsage. Leaves wired by the hairpin method can be rolled away from the focal area to cover mechanics and give a rhythmic feeling to the piece.

Depth is created in a single spray corsage by the gradual thickening of the corsage toward the focal area. Leaving some space around the flowers contributes to depth, as does the in-and-out placement of the filler flowers.

The corsage should be relatively flat on the back or arched slightly to conform to the shape of the shoulder. All wiring and taping must be securely done so the placements stay in position and give a well constructed look.

SUGGESTED ACTIVITY

Single Spray Corsage

Materials: (Fig. 6-46)

- 1 stem of pompon chrysanthemums
- 3 stems of annual static
- 7 camellia leaves of assorted sizes
(use smaller rather than very large leaves)
- 1 1/2 yards of #3 satin ribbon
- corsage kit

1. Wiring:
 - a) Wire five chrysanthemums of various sizes using the insert or hook method.
 - b) Wire seven pieces of annual static of different sizes using the wrap-around method.
 - c) Wire seven assorted camellia leaves by the hairpin method.
2. Make the bow.
3. Place one of the smaller static pieces in front of a small camellia leaf and tape. Add the smallest mum; tape (Fig. 6-47). Remember to leave the greatest distance between flowers at the top so there can be gradual and rhythmic progression toward closer spacing as you near the focal area. The corsage will also become wider and thicker as you go downward. Since this all occurs within about 5 inches, you must plan your first placements carefully.



Spring flowers grouped into a single spray, worn upright

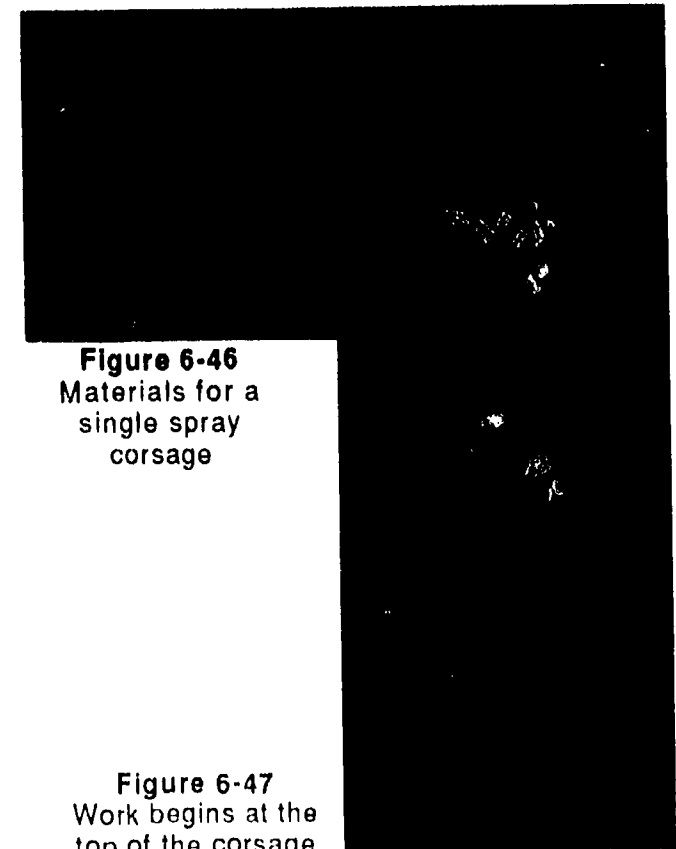


Figure 6-46
Materials for a
single spray
corsage

Figure 6-47
Work begins at the
top of the corsage



Figure 6-48
A finished single spray corsage



Figure 6-49
A double spray corsage worn on the wrist

4. Continue adding second and third leaves, mums and statice in an alternating manner. Also stagger the placements from right to left, gradually leaving more wire length free of the tape so there is a gradual widening and thickening of the corsage.
5. Add the bow below the third chrysanthemum flower and tape.
6. Place remaining flowers, foliage and filler over the bow to incorporate it into the design and create a triangular look. (See Figure 6-48.) Some leaves should have been added with the bow, arching out from the focal area between flowers or through the loops of the bow so that the leaves don't form a collar around the corsage.
7. Mist, add pins, and place corsage in a bag or box to be stored in the cooler.

DOUBLE SPRAY CORSAGES

A double spray corsage is slightly larger than a single spray corsage and consists of two parts with the focal area near the middle. (See Figure 6-49.) The final product may be bent into a crescent or S-curve if desired.

Special precautions must be taken to avoid making the corsage too large. Another potential problem is the development of a large stem of wires. This will hold the corsage away from the wearer, causing it to rock on the shoulder.

Since more placements are involved than in a single spray corsage, the designer

has more opportunity to develop a stylish piece with rhythmic flow. It is important to select relatively small materials which have good size variation.

In the following exercise a special technique will be introduced which allows the designer to create tailored size placements from ordinary larger materials. A standard carnation can be taken apart (shattered) into various sized segments for individual wiring and taping. Enough shattered carnation segments can be obtained from two standard carnations to make a double spray corsage.

SUGGESTED ACTIVITY

Double Spray Corsage Using Shattered Carnations

Materials: (Fig. 6-50)

- 2 standard carnations
- 1 stem of boxwood
- 1 stem of baby's breath
- 1 1/2 yards of #1 satin ribbon
- corsage kit



Figure 6-50

1. Divide one carnation in half, removing the seeds but keeping the calyx on the petals as much as possible (Fig. 6-51). Divide one of the halves into two equal parts. Try to keep the claw-shaped petals together and facing the same direction.



Figure 6-51 Two carnations shattered

2. Pick up one segment of petals and wrap a few turns of floratape around the narrow part near the base.
3. Wire the segment with #28 wire using the wrap-around method. Place wire over the tape so that it does not cut through the delicate petals. Tape.
4. Divide the second carnation into five different-sized pieces (Fig. 6-51). Wire and tape as described above.
5. Wire boxwood to produce nine sections in various sizes. It may be necessary to bunch two or three pieces together, wiring them as a unit to get a full enough section.
6. Wire nine pieces of baby's breath using the modified wrap-around method.

These should be small pieces that have three to seven flowers on each piece. They will be compatible in size with the small shattered carnations. Do not bunch the baby's breath tightly so that it looks unnatural and loses its light, airy effect.

7. Make the bow and streamers. (See Figure 6-52 for all the materials wired and ready for use.)

8. Alternate pieces of foliage, filler and flowers as you did for the beginning of the single spray corsage. Tape each piece in as you go with one or two turns of the tape. Set this top piece aside (Fig. 6-53).

9. Make a second piece that resembles the piece you made in step 8 (Fig. 6-53 also). This will be the bottom portion of the double spray. It will be attached upside down with the smallest flower toward the bottom.

10. Place the two sections together face to face with their wire bundles joined and parallel. Bend the bottom section down sharply over your thumb (Fig. 6-54). Then tape the wire bundles of the two sections together.



Figure 6-52 Materials assembled



Figure 6-53



Figure 6-54

11. Add the bow in the central area by taping it in.
12. Place the largest flower over the bow.
13. Add remaining foliage, flowers and filler to join together rhythmically the top and bottom sections. Create depth by leaving some space around the flowers and by gradually facing the flowers sideways as you go away from the focal area.
14. Bend corsage into a crescent or S-shaped curve if desired. Arrange individual placements to enhance the design. (See Figure 6-55.)
15. Mist, add pins, and place corsage in a bag or box. Store in a cooler.



Figure 6-55



Figure 6-56
A potpourri corsage

POTPOURRI CORSAGE

A potpourri corsage can be made from a few small blossoms and assorted foliages. They are arranged in a rounded shape with the taped wires spread out to simulate the natural stems of a mixed bouquet (Fig. 6-56). The overall size should be kept relatively small.

Baby's breath, small pieces of statice, chrysanthemum buds, shattered carnations and rolled rose petals are possible components of the potpourri. Small pieces of sprengeri or plumosus will contribute to the delicate, informal look.

In a corsage of this style, the wired flower and foliage stems radiate out from a common point like a miniature bouquet. Taping them together will be limited to a narrow area just under the point where the wires converge. This taped area will be concealed by the lower flowers in the corsage. Individual taped wires are allowed to fan out below the corsage as part of the design.

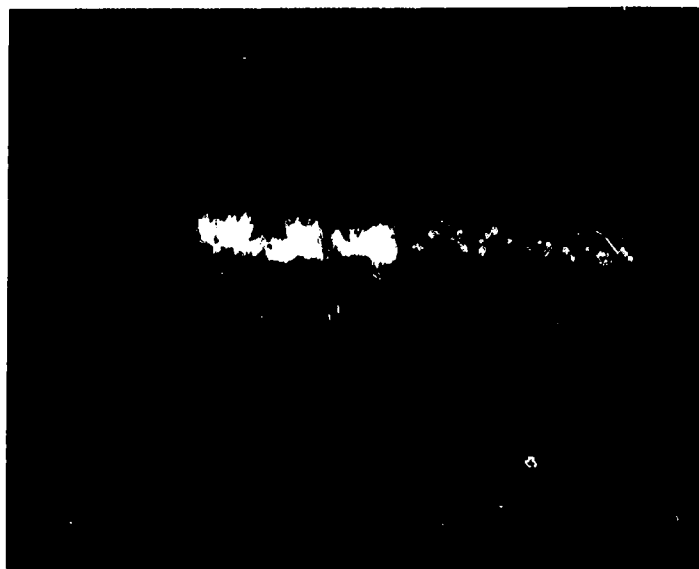


Figure 6-57
Materials ready for a
potpourri corsage

SUGGESTED ACTIVITY

Potpourri Corsage

Materials:

- 2 miniature carnations
- 1 full-blown rose
- 1 large piece of baby's breath
- 1 stem of statice
- 1 large piece of sprengeri
- corsage kit

1. Remove some petals from the rose. Roll them up, using two or three petals together to make a miniature rose bud. Wrap a #28 wire around the base of the petals (wrap-around method) and tape securely. Make five of these rose petal buds.
2. Wire and tape the following:
 - * three miniature carnations (pierce method)
 - * five small pieces of baby's breath (modified wrap-around method)
 - * five pieces of statice (wrap-around method)
 - * five pieces of sprengeri (wrap-around method)
 (See Figure 6-57.)
3. Gather the three carnations together, joining them at a common point so that they can be spread out equally from each other. Start taping the stems together just below where the wires are joined and stop one inch further down. This will leave the lower ends of the wires free so that they can be fanned out.

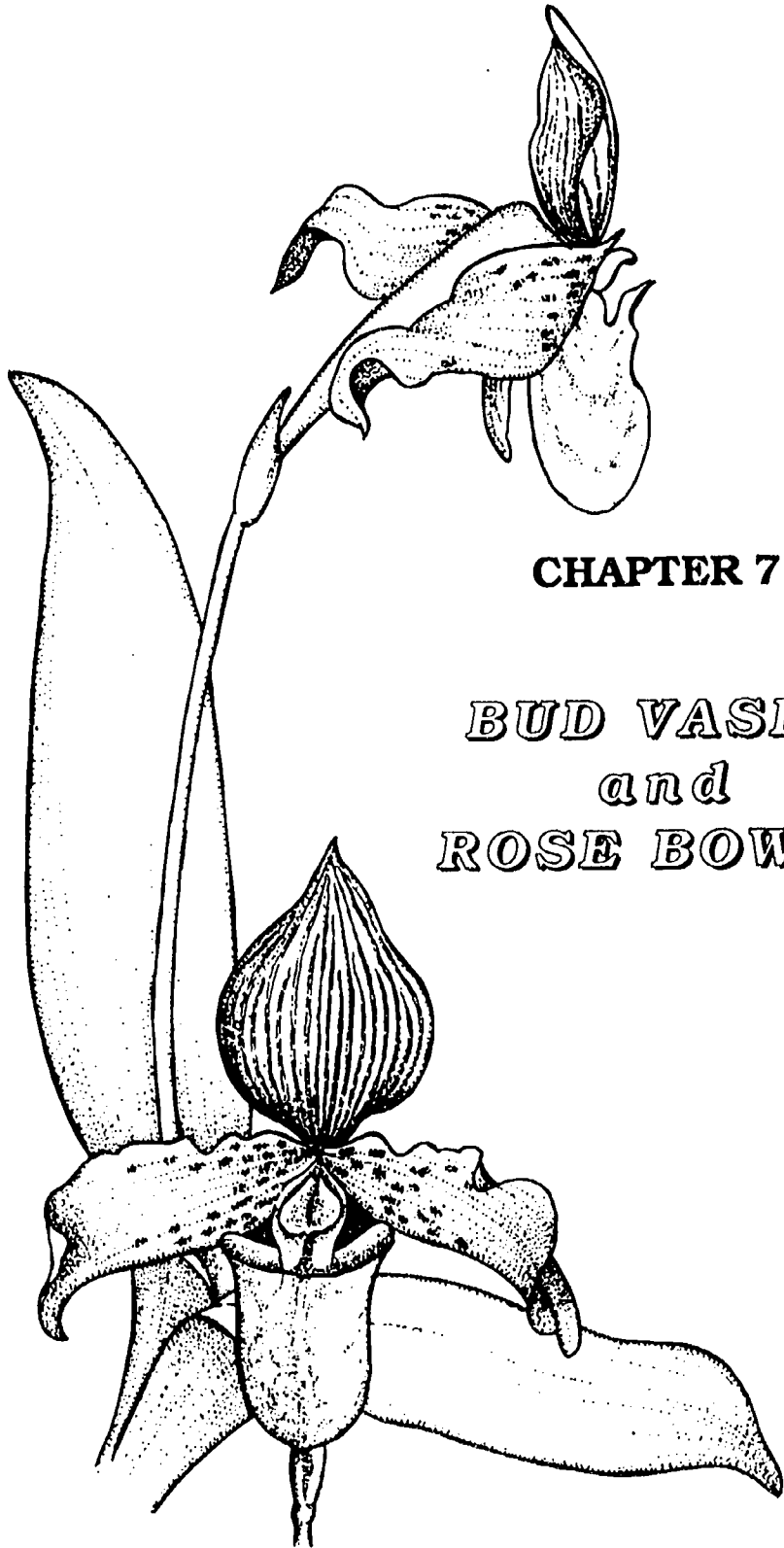
4. Add rolled rose buds, distributing them uniformly to create a generally rounded shape. Some placements should be bent down from the point of common attachment to create a full form and help hide the taped area.
 5. Add sprengeri, statice and baby's breath. Distribute each uniformly and tape them in at the same point as the other stems after each two or three placements are added.
 6. Adjust individual placements to create a one-sided bouquet that is somewhat flat on the back. This corsage will not have a bow. (See Figure 6-58.)
 7. Clip off the wires about 1 1/2 inches below the taped area and fan them out to look like the natural stems of the potpourri of flowers and foliage.
-



Figure 6-58
A potpourri corsage - top view

BEST COPY AVAILABLE

250



CHAPTER 7

BUD VASES
and
ROSE BOWLS



(De Santis Florists, Columbus)



Figure 7-1
Bud vase with
liatris and
marguerite daisies

Bud vases and rose bowls are used to display one or a few flowers in a simple but tasteful way. Customers looking for a relatively inexpensive floral piece that is in water and ready to display often select bud vases and rose bowls. They take up little space, making them suitable on office desks and in hospital rooms. They also can be used individually or in small groupings on food tables for a simple floral accent.

BUD VASES

A bud vase is a tall narrow container with a small neck which can hold one blossom or a small grouping of flowers and foliage (Fig. 7-1). A typical example is a single rose in a bud vase with a piece of sprenger and a bow. The plant material is held in place by the narrow neck of the container.

Bud vases are made of various materials, with clear glass and white milk glass being the most common (Fig. 7-2, 7-3). Clear glass bud vases may be plain or patterned. They allow the stems of the flower and foliage to show. An extension of the vertical line is thus established by the plant material. Bud vases may also be made of colored glass, plastic, or various kinds of pottery and china. The type of container chosen should be harmonious with the color and type of flowers used. Fine quality containers are nice, but add considerably to the price of the bud vase arrangement.

FLOWERS FOR BUD VASES

Many flowers are suitable for bud vases. They must be in good proportion to the size

of the vase. Also, the stem should be long enough to insert deeply into the vase while still holding the flower well above the rim of the container. Flowers with thick stems may not fit well into very narrow-necked bud vases, especially if several flowers are involved or foliage is added.

Flowers frequently used in bud vases include:

- Baby's breath
- Carnations
- Daffodils
- Dendrobium orchids
- Iris
- Pompon mums
- Roses
- Statice

FOLIAGE FOR BUD VASES

One or more pieces of foliage will complement the beauty of the flowers and help hold them in place. Foliage with small leaves in an alternating or spiral leaf attachment is preferable to foliage with a definite front and back like leatherleaf fern. Leaves should not be overly large or heavy in appearance.

The foliage choice can have a significant effect on the overall impact of a bud vase. For instance, adding an old or damaged piece of leatherleaf fern to a bud vase containing flowers that are fresh and nice will seriously detract from them.

Here are a few suggestions of the more interesting foliage and how to use some of them.



Figure 7-2 Crystal and milk glass bud vases



Figure 7-3 Assorted styles of bud vases

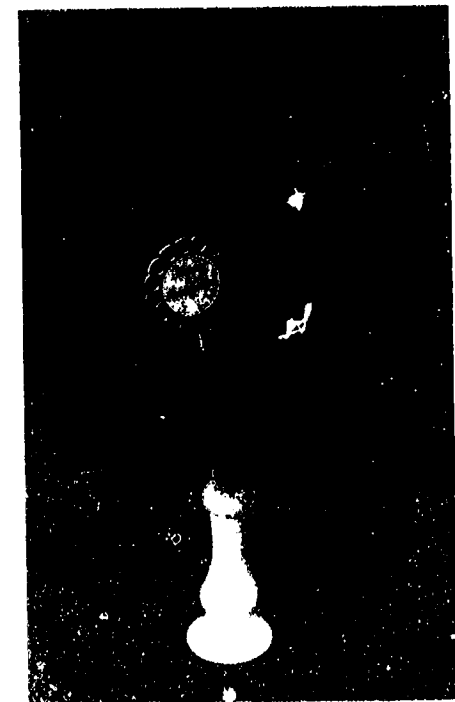
Boxwood
 Eucalyptus
 Galax
 Huckleberry
 Lycopodium
 Plumosus
 Ruscus
 Scotch broom
 Sprengeri

1. Trim a piece of huckleberry down to a narrow vertical section.
2. Use sprengeri or plumosus for a soft arching effect.
3. Place galax leaves near the rim of the vase, providing a horizontal line of opposition and adding depth to the design.

ACCESSORIES

Bows and other accessories are optional but are used often. Use a long piece of wire to fasten the bow when you make it. Do not twist the wire around the neck of the vase; instead, insert it into the bud vase with the flower stems. A bow may enhance the color scheme or may even help establish the theme for a particular occasion. The bow should be approximately the same size as a corsage bow. It should have at least two streamers 3 to 4 inches in length. Cut the ends of the streamers at a sharp angle for a more graceful look.

Accessories like glittered branches, artificial fruit, hearts, shamrocks and butterflies can be added. A heavy wire or wooden stake may be attached to the accessories if they are not on stems long enough to position them where they are wanted.



Bud vase with plastic-picked accessory

Small Groupings of Flowers In Bud Vases



Pussywillow, daffodils, pittosporum, spider plant



Dendrobium orchid spray, ruscus, galax, ivy



S-curve of oncidium orchids and acacia in classic vase



Figurines give balanced look to bud vase arrangement



Figure 7-4
Two examples of bud vases

SUGGESTED ACTIVITIES

1. Make a single flower bud vase using a rose and several pieces of sprengerii (Fig. 7-4, left). Cut the rose so that it is one-and-a-half times the height of the bud vase. Remove the thorns and the foliage on the lower half of the stem. Insert it in the bud vase. Cut three pieces of sprengerii to different lengths. Insert them so they arch out away from the rose.

2. Make a bud vase with a bow using two carnations, huckleberry and baby's breath (Fig. 7-4, right). Trim the huckleberry into two slender pieces, the taller one the same height as the container. Place the huckleberry upright in the vase. Place the carnations at different heights so that one is a few inches above the rim of the vase. Make the bow with #3 corsage ribbon. Use a full length of wire. Make 4-inch-long streamers. These may be wired separately from the bow. The wires should be inserted in the bud vase. Add two or three pieces of baby's breath as a filler. Keep a light airy feeling by using the baby's breath sparingly, not crowding it.

3. Make a creative bud vase for one or more of the following situations or occasions:

- * new baby
 - * modern office
 - * Mexican restaurant
 - * Secretary's Day
 - * Boss' Day
 - * Sweetest Day
-

ROSE BOWLS

Rose bowls are round clear glass bowls that can be used to feature a single rose blossom or other special flowers. A small amount of foliage may be used around the base of the flower. A ribbon may be tied around the neck of the container and fastened with a bow.

The blossom should not be submerged in or floating on water. The short stem of the flower can be inserted into a small piece of soaked floral foam with small pieces of foliage radiating out from it. This can be done outside the bowl; then the whole unit can be lowered into the container. A four-pronged anchor pin could first be fastened to the bottom of the container with floral clay. Double-faced mounting tape can provide even greater stability if desired. The floral foam is then pushed down onto the anchor pin. Glass marbles or small pebbles can be used instead of an anchor pin to help hold the foam in place. These would be added after the foam unit is inside the bowl. A small amount of water can then be added to the bowl to supplement what is in the floral foam and keep the flower fresh longer.

Another way to position the flower is to use glass marbles instead of floral foam. Put a shallow layer of glass marbles in the bottom of the rose bowl. Arrange small pieces of the foliage first. Then position the flower by pushing its stem down through the foliage and marbles. Lastly, add some water to keep the flower fresh, but not above the level of the marbles.

Some rose bowls have a neck with a slightly flared rim. This is a convenient place

to tie a #3 satin ribbon with an attached bow to give a finished look.

Other flowers that may be featured in a clear glass bowl include orchids, begonias, lilies and carnations.

SUGGESTED ACTIVITIES

1. Make up a rose bowl using a rose and leatherleaf (Fig. 7-5). Arrange a flat radiating circle of foliage in a small piece of floral foam. The overall size must be small enough to fit into the bowl without crowding. Cut the rose stem about 1 1/2 inches long and place it upright in the center of the floral foam. Place about 1/2 inch of water in the bottom of the rose bowl. Lower the foam with the flower and foliage into the bowl. (See Figure 7-6).



Figure 7-5
Materials for rose bowl - rose and leatherleaf

2. Make a rose bowl using a rose, huckleberry and baby's breath (Fig. 7-7). Select a rose bowl with a neck that will hold a ribbon. Use glass marbles for support.

Place glass marbles in the container to a depth of one inch. Arrange small pieces of huckleberry in a low flat plane so that the ends are anchored in the marbles and the tips radiate out from the center. Cut the rose stem to 1 1/2 inches and place in the middle with the stem pushed down in the marbles.

Add three pieces of baby's breath to create a cloud effect. It should not look crowded or hide the rose. Tie a piece of #3 satin ribbon around the rim of the container. Make a small bow from the same ribbon and fasten it with wire onto the ribbon that is tied around the rim of the bowl. (See Figure 7-8.) Short streamers may also be used.



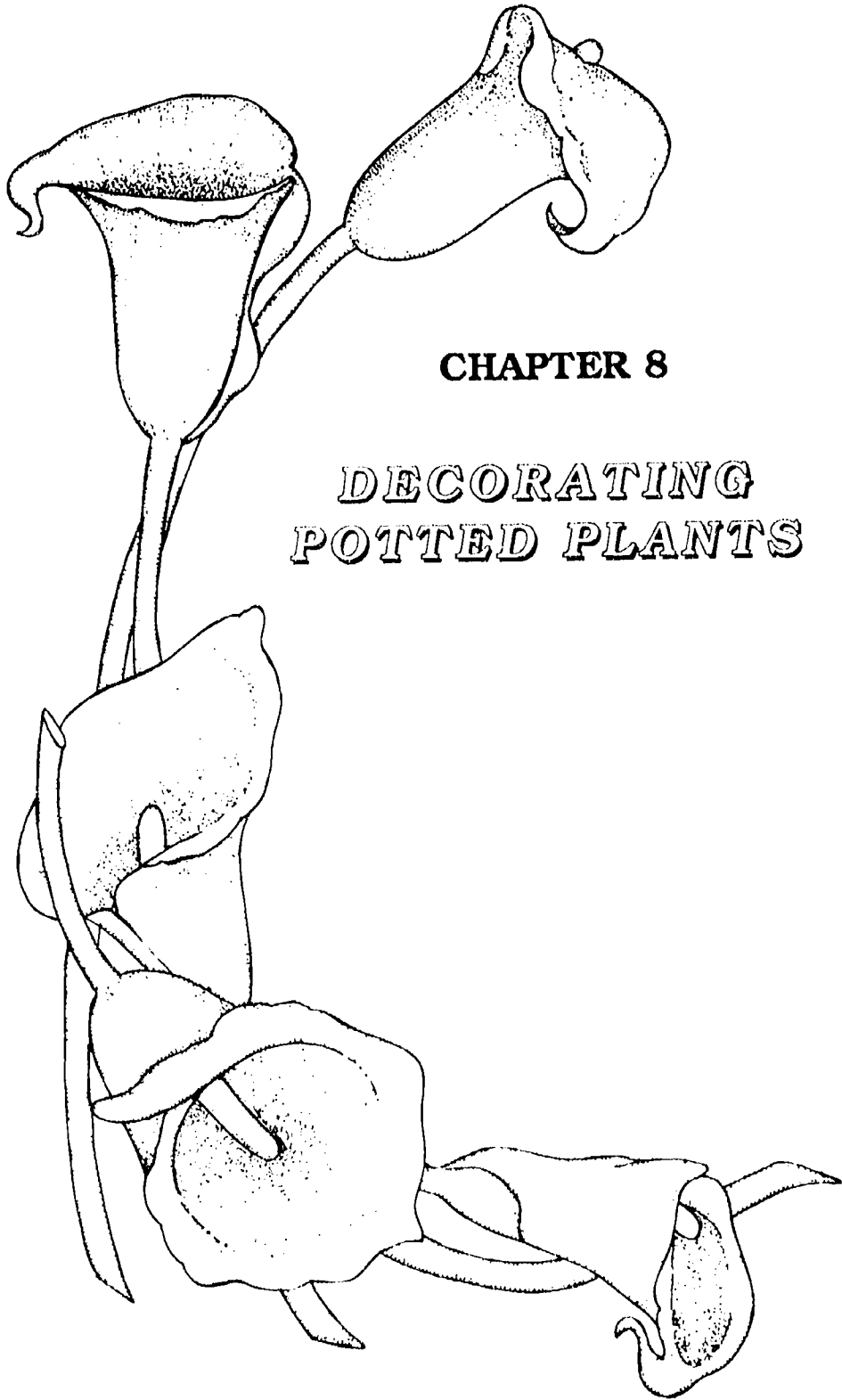
Figure 7-6
Completed rose bowl



Figure 7-7
Materials for a rose bowl including huckleberry and glass marbles



Figure 7-8
Completed rose bowl with a bow



CHAPTER 8

**DECORATING
POTTED PLANTS**





Grouping of kalanchoes and ivy
in a wicker suitcase



African violet set in a wooden rabbit planter



Bromeliads in a seashell

Flowering and foliage plants that are sold as gifts may be made more attractive by wrapping the pot with foil or setting the pot in a decorative container. A bow or various accessories may be added if desired. The wrap, ribbon and accessories can be very simple or elaborate to develop the theme of a special holiday or occasion.

Gift plants are usually produced in 4- or 6-inch plastic pots. However, these utilitarian containers do not provide the finished look that most people expect when buying or displaying one of these specimen plants. Without foil, clay pots are more acceptable for display, though less frequently used. They should be clean and in good condition.

It is a good idea to advise customers to place a saucer under the potted plant. A selection of saucers should be offered for sale. Most potted plants must be watered several times at least before being discarded. The decorative foil covering cannot always be relied upon to keep moisture from seeping through, damaging wood table tops. Clear or green plastic pot saucers are inexpensive and will not detract from the plant or its decorations.

Sometimes unglazed clay saucers are sold to match clay or terra-cotta containers. These are porous and will allow some moisture to seep through. In order to protect table surfaces, therefore, clay saucers must be set on some kind of waterproof mat. It is easier to use the non-porous plastic saucers that closely match real terra-cotta in color and texture.

FOILING POTS

The most common and economical method of covering a pot is to use aluminum florist foil. Foil is available in different thicknesses and a wide range of colors. Some foil is embossed with a textured design. Foils may be lined with plastic to make them more waterproof. Heavier foils are more expensive but are less likely to be punctured and to let water through.

Foil color should harmonize with the flower and foliage colors. The foil should not have a color or texture stronger than that of the flowers or it will command more attention than the plant.

Plants to be foiled should be well watered and allowed to drain, and should have their flowers and leaves groomed. Spent blooms and damaged leaves should be removed. Leaves should be wiped clean of dust and spray residue. Using plant shine products or oily compounds to make the leaves glossier is not recommended since these products clog stomates and may interfere with the long-term health and beauty of the plant.

Plants that will not stand upright can be staked with an inconspicuous wooden or metal stake and twistems. Bushy plants may require three or more short stakes around the outside connected by green string. Hyacinth stakes are good for this purpose. They are round wooden stakes, stained green and pointed at one end. Their name comes from their frequent use to support bulb crops like hyacinths, tulips and daffodils. Green colored bamboo stakes can be used for taller plants. Metal rods with

a hook at the end are good for supporting individual flower stalks, such as sprays of orchids. Wooden and fiber poles are sometimes used to support large climbing foliage plants.

After the plants are watered and groomed, they are ready to be foiled. To begin, cut a square of foil large enough to cover the pot being decorated. The foil should come up over the edge of the pot. Tall plants with less interesting lower stems, like Easter lilies and tulips, should have the foil extended higher up the stem than is done with shorter bushy plants.

Fold over all edges of the foil 1/2 inch for a finished look (Fig. 8-1). Press edges down neatly. Center the plant on the foil and bring corners up around the pot one at a time. Using both hands, one on either side of each point, take tucks in the foil as it is brought up around the pot. This will result in a neat pleated appearance around the pot (Fig. 8-2), rather than a rough, crumpled look. The four pointed corners can be flared out slightly, or two corners can be stapled together to form three points of foil (instead of four) around the plant.



Figure 8-1

THE BOW

A bow can be added at the rim of the pot to further dress up the potted plant (Fig. 8-3). Size #9 ribbon is commonly used for 6-inch pot bows. The bow must be in good proportion to the size of the pot and plant.

The bow and streamers are wired to a 4-inch wooden stake. The stake is then pushed into the soil on the best side of the potted plant. If you wish to encircle the pot with a separate piece of ribbon, do this before the bow is added. Cut a piece of ribbon a little longer than you need. Bring it loosely around the pot and tie it in a double knot. Secure the ribbon from slipping down by inserting the stake with its attached bow and streamers under the knot and into the soil.

Bows can be made from all kinds of ribbon including satin, cotton and burlap. Printed or patterned ribbon (Fig. 8-4) may suggest a particular theme or holiday. For variety, two ribbons of different colors or widths may be worked into a single bow.



Figure 8-2



Figure 8-4 A colorful bow decorating a gift basket of meat, cheese and a potted kalanchoe



Figure 8-3



A wooden troll used as an accessory to a basket of begonias and foliage plants



A jardiniere with begonia

ACCESSORIES

(See Color Plate I-8)

Various accessories such as artificial birds or fruit or dried materials can be added as an accent to the bow. A mini-sheaf of wheat or cattails placed diagonally across the bow will add an interesting line of opposition. Twisted branches, bamboo or driftwood inserted into the pot will lend more height to the plant or extend its boundaries in other interesting ways.

Accessories are usually attached to a wooden stake which is inserted into the soil. Bamboo and branches can also be inserted directly into the soil. Birds, butterflies and silk flowers may be hot-glued to the branches if desired.

Many plants have bushy lower leaves that cover up the soil in the pot. Plants without these may look more attractive if sheet moss, Spanish moss, lichens or wood chips are added to cover the soil and give a more finished look.

OTHER POT COVERINGS

Other materials besides foil can be used to wrap pots. Burlap, crepe paper and cellophane give different effects but do not cling to the pot as readily as foil. When a fabric like burlap is being used, the pot should first be covered by plastic or foil so that moisture will not dampen the cloth.

Several layers of newspaper or cardboard, cut the same size as the bottom of the pot, will serve as a blotter if placed directly under the pot. The paper will absorb excess

water and better keep it from running through the foil or plastic.

A *jardiniere* (jar-duh-neer') is a decorative container into which a potted plant can be set. Jardinieres may be made from pottery, china, metal or plastic. They do not have drainage holes so will retain any water that comes through the pot. Often fine gravel, perlite, shredded styrofoam, or simply an overturned saucer is put in the bottom of the jardiniere to keep the plant from sitting in drainage water and becoming waterlogged. Another advantage of adding these materials is that they raise the pot so that its rim is even with the rim of the jardiniere. However, the rim of the pot should not be raised so that it is visible above the rim of the jardiniere. The pot should be slightly smaller than the jardiniere so that there is no pressure put on it (especially if the jardiniere is an expensive ceramic container). Jardinieres are easy to use and save time, but add significantly to the cost of the plant.



A jardiniere with cyclamen

Wicker baskets are suitable containers for plants (Fig. 8-5) if they come with a plastic liner. Trying to line a basket yourself with layers of foil or plastic is time-consuming. It also may be somewhat questionable as an effective barrier to moisture.

Straw hats with plastic liners are available as a covering for various sized pots (Fig. 8-6). They fit snugly around the pot and may be decorated with ribbon and accessories just as with a foiled plant.

SUGGESTED ACTIVITIES

A. Decorate a potted plant that has been grown in a 6-inch plastic pot.

1. Clean the pot and groom the plant so that it is free of spent blooms, damaged leaves, and spray residue. Water the plant and let the excess water drain through.
2. Cut a square of foil that will extend up over the edge of the pot. Turn the edges in about 1/2 inch and press firmly down to form a smooth edge.
3. Cut a circle of cardboard or layers of newspaper the size of the bottom of the pot. Place the pot on the paper in the center of the foil.
4. Bring each corner of foil up to the side of the pot by taking a tuck in the foil on each side of the corner. Develop a pleated look around the pot. Flare the points out gently.

5. Make a bow from #9 satin ribbon. The bow should have loops 2 1/2 to 3 inches long so that the finished bow is a little less wide than the diameter of the pot. Make two 3-inch streamers. Attach the bow and streamers to a 4-inch wooden stake. Wrap a length of #9 satin ribbon around the pot and tie it off. Insert the stake with attached bow and streamers into the soil at the rim of the pot so that it holds up the ribbon that has been tied around the pot. The bow should be placed on the best side of the plant.

B. Decorate one or more potted plants to carry out one of the themes suggested below. Using bows and accessories, be as creative as possible.

- * autumn harvest buffet
 - * Easter breakfast
 - * contemporary office
 - * Mexican theme
 - * Oriental look
 - * young child's birthday
-

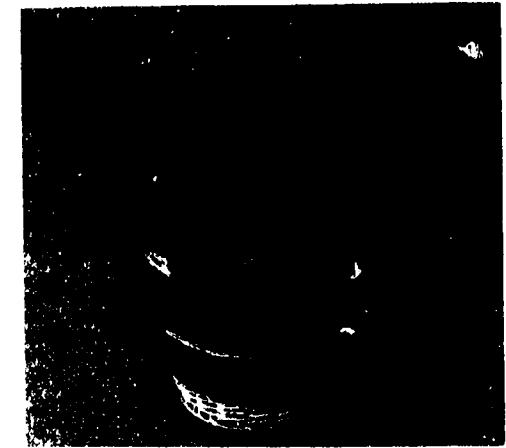


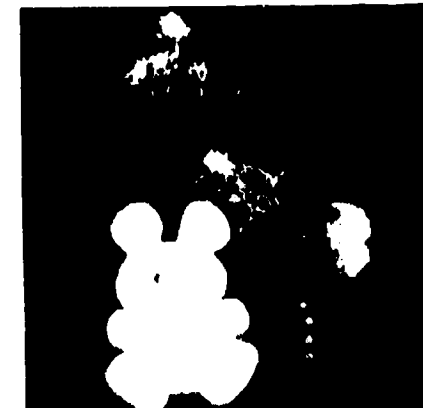
Figure 8-5 *Primula malacoides* in a wicker basket



Figure 8-6 Kalanchoe in a plastic-lined straw hat



Hyacinths with Spanish moss at the base, a satin bow and duck accessory



A rabbit sitting by a log basket of potted spring plants

ARRANGEMENTS IN SETTINGS



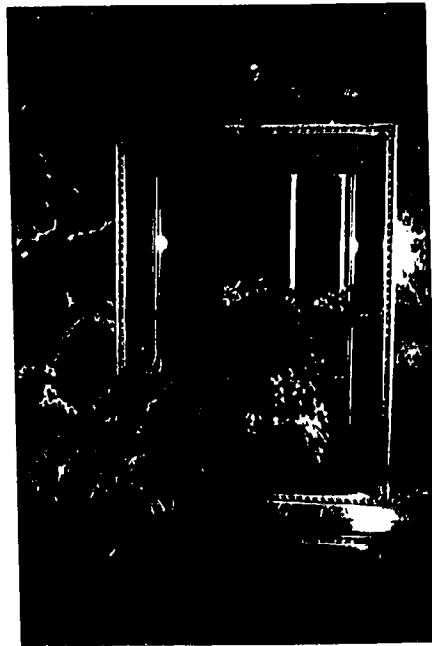
Lobby



Living room



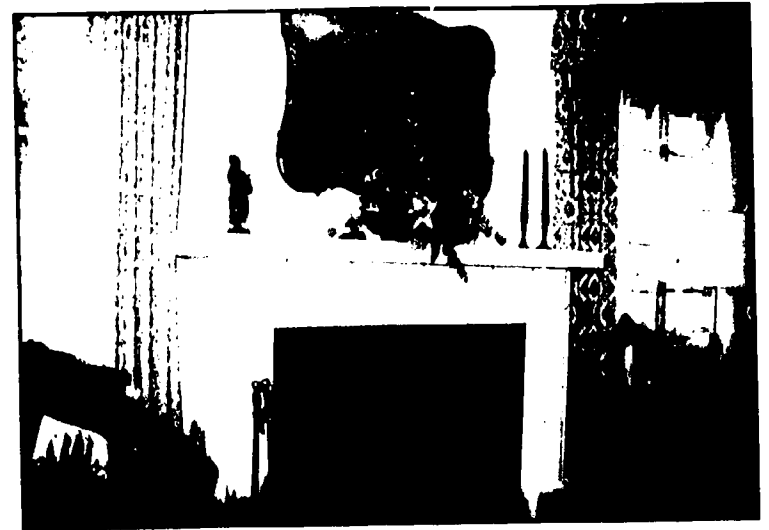
Writing area



Foyer



Hallway

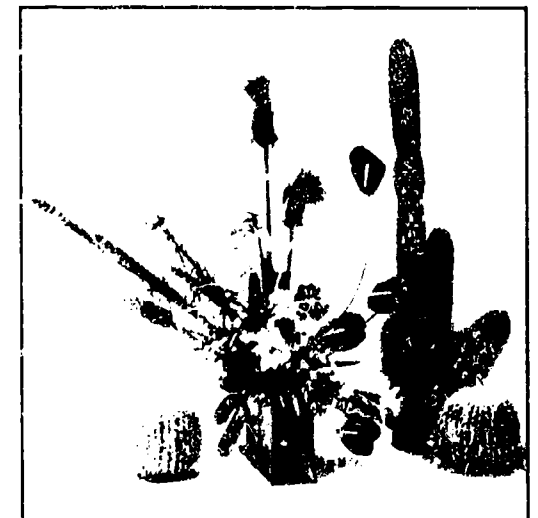


Living room



DESIGNS

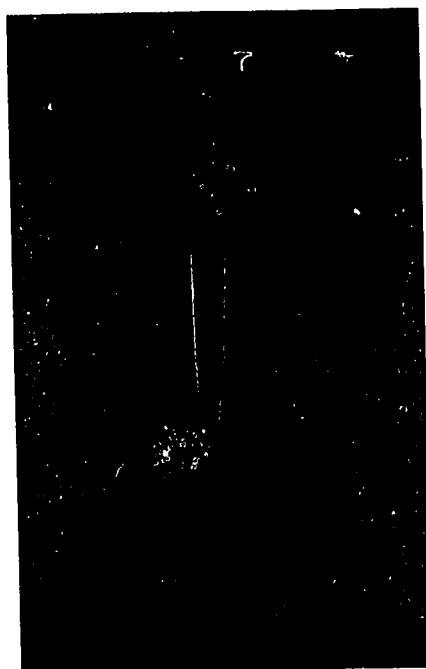
by Teresa Paniello
The Ohio State University
Agricultural Technical Institute

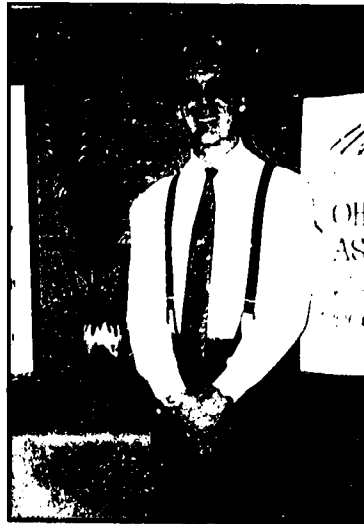
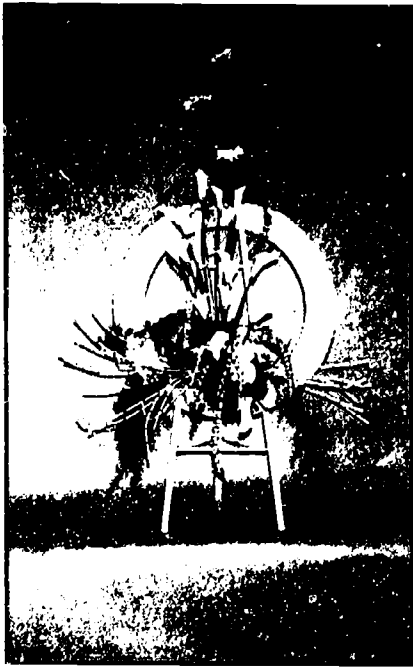




ARRANGEMENTS

by Hitomi Gilliam, AIFD
Ohio Florists' Association
Retail Discovery Series





ARRANGEMENTS

by Perry Walston, AIFD
Sympathy Symposium
Ohio Florists' Association
Retail Discovery Series



THE OHIO FLORIST SHORT COURSE DESIGN SCHOOL

(1987)



Richard Milteer - Commentator
American Floral Services, Inc.



Robert Wietholter - Designer
Country Squire Florists, Bluffton, Indiana



Rosemarie Schweltzer - Designer
Baker Florist and Greenhouse, Dover, Ohio



Eis Hazenberg - Designer
Flower Council of Holland

CONTEMPORARY DESIGN

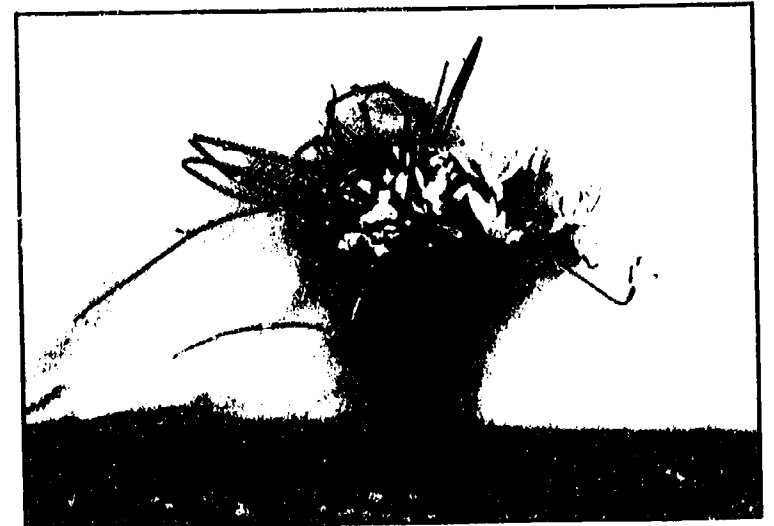




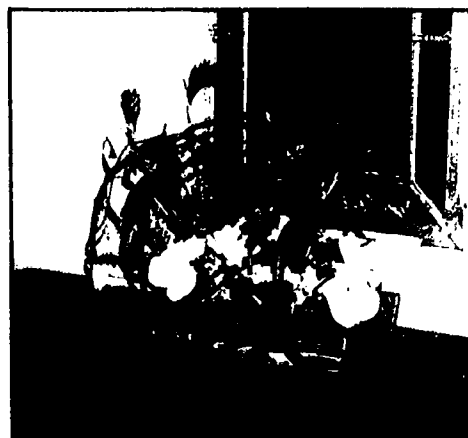
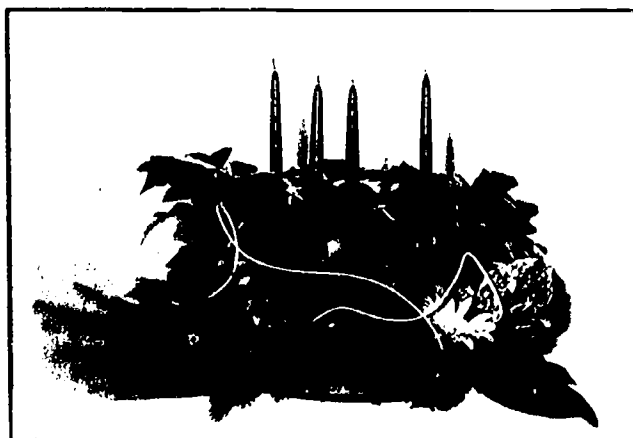
The Ohio Florist Short Course

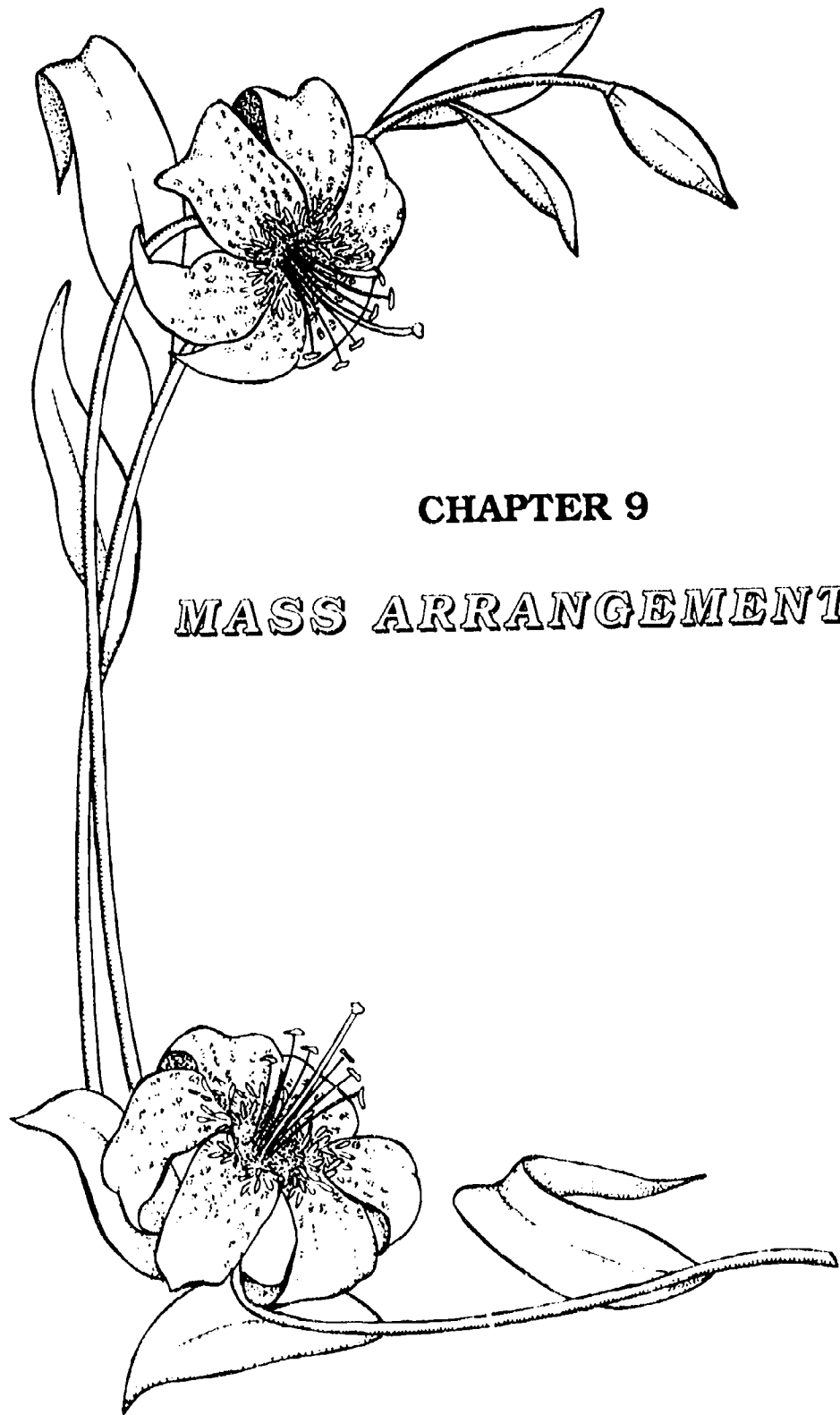


SIMPLICITY IN DESIGN



CREATIVE AND COLORFUL DESIGN





CHAPTER 9

MASS ARRANGEMENTS





One-sided triangular arrangement



All-around circular mass arrangement

A mass arrangement contains many flowers organized into a geometric form or shape. It may be one-sided or an all-around design. Different styles can be expressed depending on whether the mass arrangement is large or small; whether it has much depth or is very compact; and whether it consists of one type of flower or a mixture of flowers.

There are two groups of such arrangements: 1) those based on the triangle and 2) those based on the circle. The basic design shapes that fall under each category are listed below. (See examples in Chapter 2.)

Triangle Variations

- Equilateral triangle
- Isosceles triangle
- Right triangle
- Scalene triangle
- Diamond centerpiece

Circle Variations

- Mound
- Oval
- Fan

Containers such as low bowls, pedestal containers and baskets are used for mass arrangements. They come in different shapes, sizes and materials. The shape or form of the arrangement is modified to fit the chosen container. For example, the lower flower and foliage placements in a taller container will be brought down over the rim; flowers in a basket with a handle will be placed so they do not crowd the handle.

Although the mass arrangement had its origin centuries ago in early Western cultures, it still is the most commonly seen style

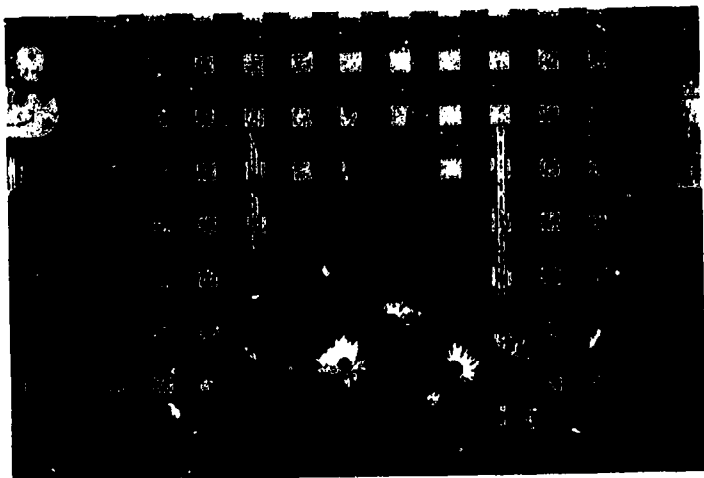
in traditional flower arranging. The round mound design is frequently created for table centerpieces, wire service specials, and wedding bouquets. In many areas triangles and fans remain traditional favorites for sympathy flowers and church decorations.

A contemporary trend in mass arrangements is to create very open designs with much depth. More open space means fewer flowers. But these flowers often have interesting forms which receive more attention because of the open space around them. Being "modern" sometimes involves going back to lesser-known antique styles. An example is the current interest renewed in the compact Old German style called the Biedermeir (Fig. 9-1).

Following is a discussion of the basic shapes of mass arrangements. A suggested activity accompanies each one as an introduction to the style and as a means to develop skill in flower arranging. The



Figure 9-1 The mass Biedermeir style



Triangular mass design in a basket



Tea centerpiece



Mantel arrangement



Open mass design of ranunculus on a pedestal



Delicate mass of baby's breath



Hand tied mass in crystal vase



FTD "Perfect Prescription" Bouquet

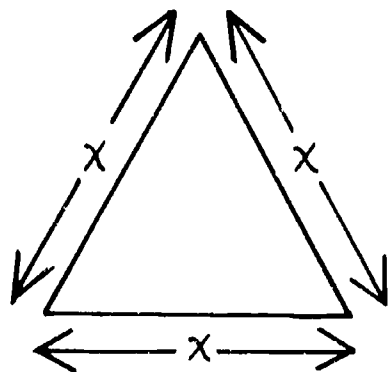


Figure 9-2 Equilateral triangle

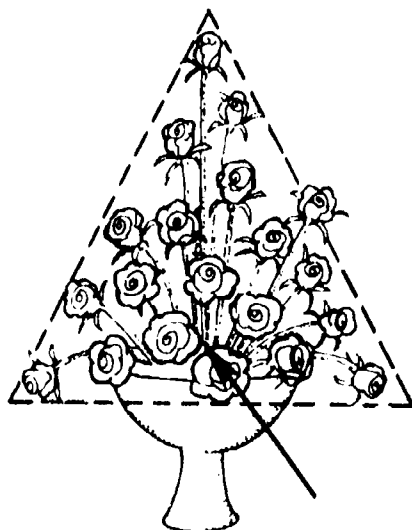


Figure 9-3 Focal area

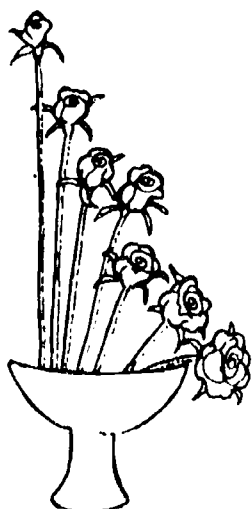


Figure 9-7 In-and-out placement for depth

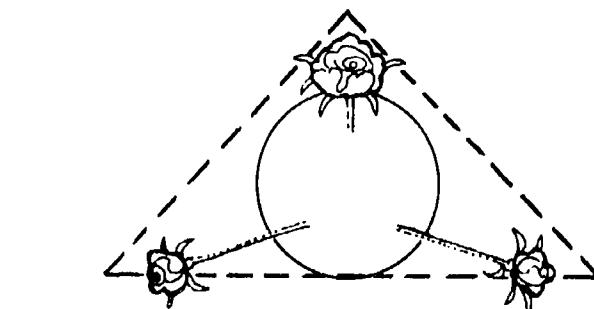


Figure 9-5 Overhead view

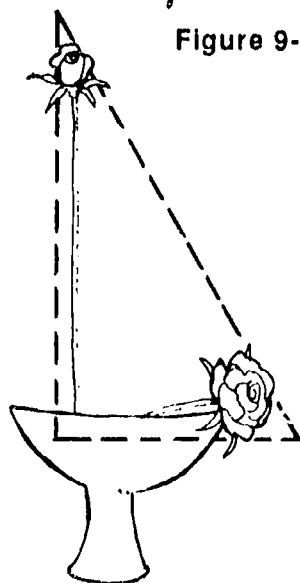


Figure 9-4 Side view

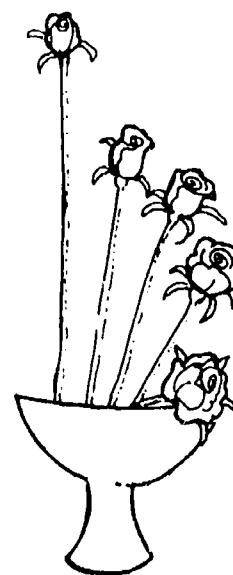
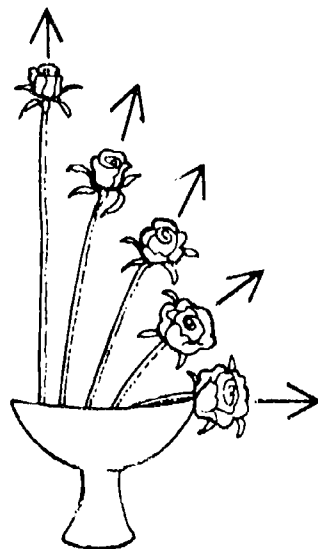
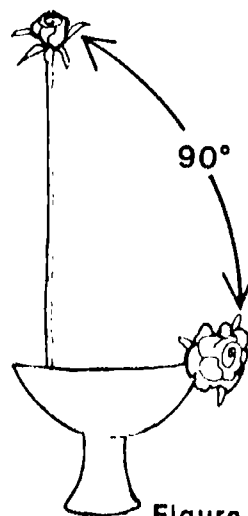
Figure 9-6 Flaw:
Recessed focal area

Figure 9-8 Gradual facing upward

Figure 9-9
Change in facing

arrangements can easily be varied by using different containers, flowers, foliages and accessories from those suggested in the exercise.

TRIANGLE VARIATIONS

EQUILATERAL TRIANGLE

The silhouette of an equilateral triangle design is a triangle with all sides equal (Fig. 9-2). It may be constructed in a low container or in one raised up on a pedestal. This symmetrical design has its center of interest (**focal area** - Fig. 9-3) low in the arrangement, directly under the tallest point and near the rim of the container. Larger flowers with closer spacing are used in this area. As you move up and away from the focal area, the flowers gradually become smaller with larger spaces between them.

An equilateral triangle should have depth, which is apparent when you look at the arrangement in side view (Fig. 9-4). You can see a right triangle with the focal area near its base where there is the greatest distance between front and back. Looking directly down on the arrangement from above (overhead view), the design shows yet another triangular pattern because of the forward placement of flowers in the focal area (Fig. 9-5). If the larger flowers near the focal area are pushed in, the arrangement lacks depth and is said to have a **recessed focal area** (Fig. 9-6).

Another way of creating depth in an arrangement is to leave some space around the individual flowers. Some flowers should be sunken in, while other flowers are

brought out. This must be done with care to keep the overall triangular pattern intact and avoid creating a shaggy look. Depth resulting from the in-and-out placement of flowers (Fig. 9-7) is much better than the flat rigid appearance of flowers placed all at the same level. The flowers should not look as if they were glued to a styrofoam form.

Gradual change in the facing of flowers is important in the creation of an interesting and rhythmic arrangement. Flowers in the focal area face directly forward. As the eye travels up the design, the flowers are gradually faced upward (Fig. 9-8). The tallest flower will face directly upward. This is a 90° angle change in facing between the larger flowers at the focal area and the tallest flower on top (Fig. 9-9).

As you move sideways away from the focal area, there is another gradual change in facing to the side and even to the back. The edges of the arrangement should not end abruptly with sideways placements. Some flowers should begin to angle backward for greater fullness and depth.

Flowers or foliage..... which should come first? The order in which materials are added depends on the type of flowers used, how open or tight the arrangement is, and whether the arrangement is being completed in one operation or at different times. During busy holidays or when working on large projects, it is possible to "green in" arrangements several days in advance of the final placement of flowers. By using well soaked foam, floral preservatives, plant shine on foliage, and proper refrigeration, greens can outlast most flowers.

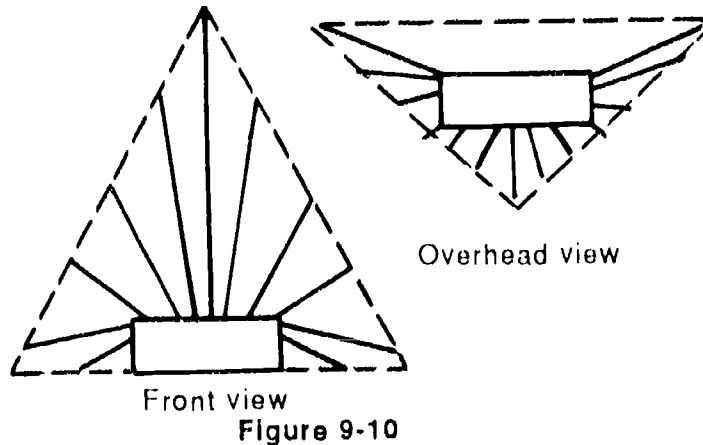
SUGGESTED ACTIVITIES

A. Equilateral Triangle - Sticks

For your first practice in making an equilateral design, use sticks to help you judge the precise length and angle of individual placements. Without foliage in the way, you will be able to see just where the placements are put into the foam and the angle at which they are inserted.

Stems should radiate out from the foam without crossing each other (Fig. 9-10). They should be inserted throughout the foam, utilizing the entire block, even in one-sided arrangements. If stems are placed in just the forward half of the foam, the arrangement will look as if it is perched at the front edge of the container. Another potential problem to avoid is placing too many stems in one part of the foam, causing it to split.

Use this exercise to visualize clearly the order, angle and length of placements as well as the size, silhouette and depth of the design. This skeleton arrangement will help you master some basic skills before you begin working with flowers and foliage.



Materials:

low pedestal container
floral foam or styrofoam
sticks or hyacinth stakes

1. Place a piece of foam or styrofoam in the low pedestal container so that the foam sticks up about one inch above the rim of the container (Fig. 9-11). Secure it with narrow waterproof tape attached to the rim and criss-crossed over the foam.

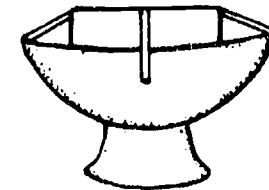


Figure 9-11

2. Establish the height (placement 1). (See Figure 9-12.) Cut one stick two times the height of the container plus about 2 inches. (The end of the stick will be pushed about 2 inches into the foam.) Place directly upright at the back of the foam and centered from where the edges of the triangle will be located.

(continued)

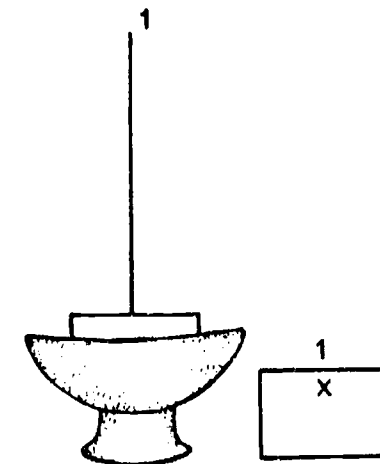
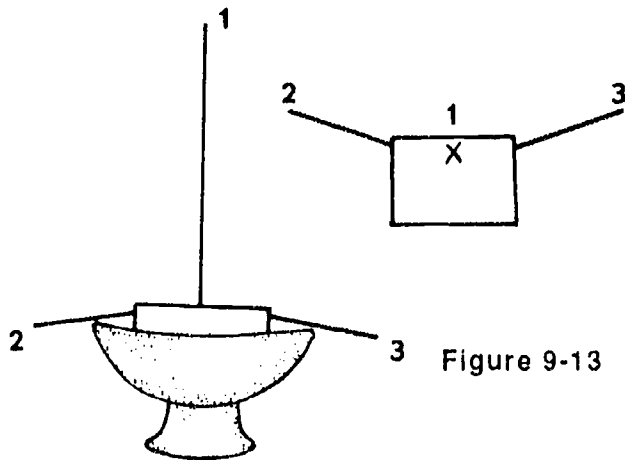


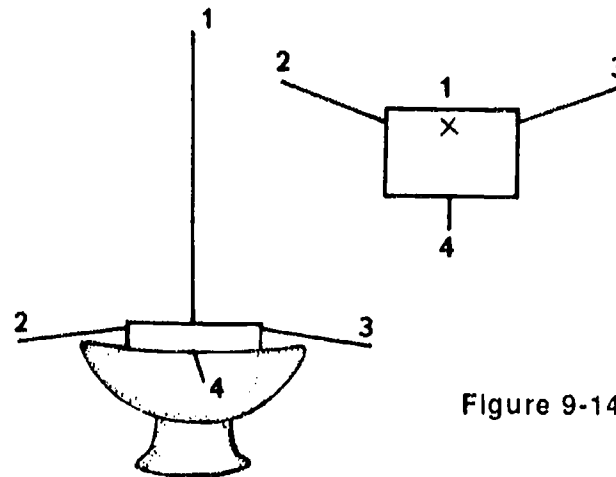
Figure 9-12

3. Establish the width (placements 2 and 3). (See Figure 9-13.) Cut two sticks of equal length that will form the lower points of the triangle. They will extend 2 to 3 inches beyond the rim of the container. The distance between the ends of these two sticks should be equal to the distance between the end of either of them and the highest point of the triangle. Thus all three sides of the equilateral triangle are of equal length. These sticks should be inserted into the side of the foam toward the back and should be angled slightly downward and backward.



angled slightly more forward. There will be a 90° change in angle of placement. The stick length also becomes shorter so that in side view a right triangle is formed. This line of placements down the vertical axis is called a **trunk line**.

6. Establish the silhouette. (See Figure 9-16.) Use three sticks on each side to connect the tallest point with the lower points of the triangle. It is important to sharply decrease the length of the side placements so that the triangular shape does not give way



4. Establish the depth (placement 4). (See Figure 9-14.) Cut another stick shorter than the previous two. Insert it in the front and center of the foam at the rim of the container. Bring it directly out toward you so that it is about 1 1/2 inches beyond the rim of the container.

5. Establish the main vertical line by staggering about five placements down the center of the triangle, connecting the tallest placement with the lowest forward-facing one (Figure 9-15). As you work down, alternate from left to right with each placement being shorter than the one above it and

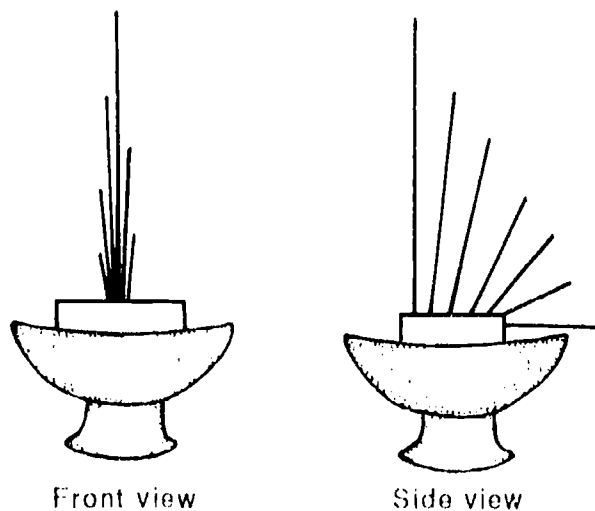


Figure 9-15 Trunk line

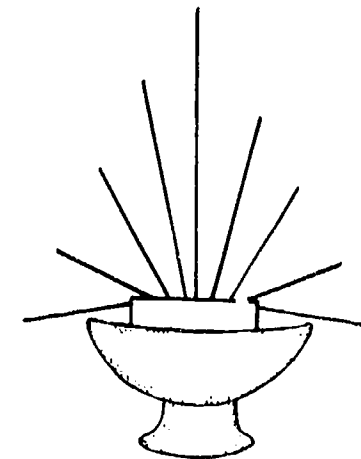


Figure 9-16 Silhouette

to a fan shape. In side view these placements should be staggered forward or backward, looking much like the trunk line did from the front. This gives depth to the arrangement and avoids the feeling of dropping off the edge of the arrangement when going beyond the placements forming the silhouette. Even though this arrangement has symmetrical balance, it is better not to identically match placements across from each other. The same number of placements on each side is not necessary as long as the basic triangular shape is evident.

7. Establish the base. (See Figure 9-17.) Use two or three short sticks to bridge the gap between the forward-facing focal stick and the lower points of the triangle. In overhead view these should form a triangular shape. They should not all be lined up in

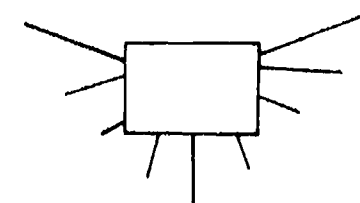


Figure 9-17 The base in overhead view

the same plane at the rim of the container. They should be alternated slightly up and down to achieve depth and to tie the arrangement to the container.

8. Fill in the design. On each side of the arrangement are two areas to be filled in. Gradual changes in spacing, facing and stem length should smoothly bridge the area between the trunk line and edges of the design.

9. Check the design.

- Are the three sides of the triangle equal in length?
- Is there an overall triangular appearance to the design?
- Are there any crossing lines?
- Do sticks appear to radiate out from a common point within the foam?
- Have you used the whole piece of foam for placements?
- Is the overall size of the arrangement in good relationship to the size of the container?

B. Equilateral Triangle - Flowers and Foliage

Use flowers and foliage to create an equilateral triangle. The order and positioning of placements will be similar to that outlined in detail for the sticks.

The foliage will be placed first because of its linear nature. Doing this also illustrates how

an arrangement can be greened in several days before finishing the design. Both foliage and flowers will exhibit a triangular design, with one superimposed on the other in the finished product.

Materials:

- low pedestal container
- floral foam
- waterproof tape
- carnations (12-14)
- huckleberry (1/8 bunch)

1. Place soaked foam in the container and tape with waterproof tape (Fig. 9-18).

2. Establish height of the arrangement with a fairly straight piece of huckleberry that has been selected and trimmed. Do not use bushy pieces or pieces that sharply angle in one direction. The height should be about one and one half to two times the height of the container.

3. Establish width with shorter pieces that are angled slightly downward and back.

4. Establish depth with a short piece coming straight out toward you just above the rim of the container.

5. Create a triangular shape with pieces of huckleberry radiating out as if from a central point (Fig. 9-19). There should be no crossing lines. Fill in so that the foam is not visible. Keep a light airy feeling. The foliage is only a background for the flowers. Sink some shorter pieces of huckleberry in deep to cover the foam without creating a bulky appearance.

6. Repeat the above steps using carnations (Fig. 9-20). Establish height, width, depth



Figure 9-18 Soaked foam in container



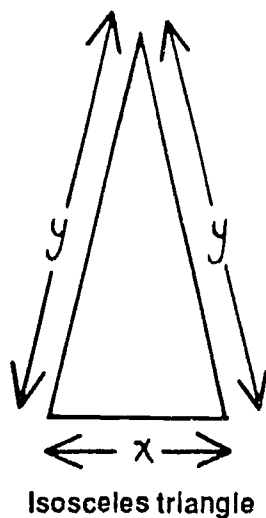
Figure 9-19 Triangle of foliage



Figure 9-20 Completed equilateral triangle



Figure 9-21 A completed isosceles triangle arrangement



317

and trunk line; then fill out the remaining area. The longer linear pieces of huckleberry will extend slightly beyond the flowers at the points. Most of the other huckleberry pieces should be behind the flower placements.

If the flowers are the same size, the focal area will be created by closer spacing and forward facing of flowers in that area. If the flowers vary in size, use smaller flowers toward the points of the triangle and gradually larger flowers toward the focal area.

Do not crowd the flowers. Sink some in for depth rather than having them all at the same level. Avoid both irregular groupings of flowers and the appearance of a line-up in the arrangement. Remember to change the facing from forward to sideways or upward as you move away from the focal area.

7. Check the arrangement, using the same guidelines as you did for the stick arrangement. (Apply the questions in Section A-9 on the previous page, to this activity.)

ISOSCELES TRIANGLE

An isosceles triangle has two sides of equal length and one side that is shorter. As an arrangement form it is a variation of the equilateral triangle. The highest point of this triangle is taller than in an equilateral triangle and the lower points are closer to the focal area.

This one-sided symmetrical arrangement emphasizes an upward vertical thrust and usually appears more stylized than does an equilateral design. The isosceles triangle may be constructed in a low container or in one that has a pedestal.

SUGGESTED ACTIVITY

Isosceles Triangle with Filler

You will be constructing an isosceles triangle design by placing the flowers in first, then the foliage, and finally the filler. Each material (flowers, foliage and filler) should individually form an isosceles triangle with a developed focal area. For example, a look at the filler by itself should give you this triangular shape with smaller pieces and greater spacing as your eye moves away from the focal area. Flowers should be placed at different depths so that even in the focal area, where there is the greatest concentration of flowers, there will not be crowding. Stems of flowers and foliage should appear to radiate out from a point within the design behind the focal area.

Materials:

pedestal container
floral foam
waterproof tape
pompon mums (1 bunch)
annual statice (1/6 bunch)
leatherleaf fern

1. Place soaked floral foam in the container so that it sticks up about an inch above the rim; secure it with crossed waterproof tape.
2. Begin the design with pompon chrysanthemums. First separate the stems in the bunch and examine them. You will need to break down the stems by cutting some flowers or flower clusters off, using a sharp knife. Leave smaller flowers on long stems to use in the outermost parts of the arrangement; reserve larger flowers on shorter stems for

318

use closer to the focal area. Remember as you cut that a stem that is too long can easily be cut shorter, but lengthening a stem that was cut too short is not so easy.

3. Establish the height of the arrangement (Fig. 9-22). Select a small mum on a long stem at least two and a half times the height of the pedestal container. Place this with the flower facing directly upward near the back of the foam where the center of the triangle will be.

4. Establish width (Fig. 9-22) by placing fairly small flowers into the side of the foam, angled down and back so that the lower points extend 1 1/2 inches beyond the rim of the container. At this point stand back and check your three placements. Make sure they establish an isosceles triangle. If the lower placements have been extended too far, the design will look more equilateral, and the resulting triangle may be too large for the container.

5. Establish depth and focal area (Fig. 9-22) by placing one of the larger flowers in the center of the arrangement just above the rim of the container. This flower should face directly forward or even very slightly downward and extend out 1 1/2 inches over the rim.

6. Establish the trunk line of the arrangement, staggering flowers downward from the highest flower to the focal flower (Fig. 9-23). Gradually increase flower size and decrease spacing as you progress downward. Also gradually tilt the stems so that there is a transition from upward facing flowers near the top to forward facing flowers in the focal area.

7. Establish the silhouette. Keep the outline sharp so that it is triangular, not fan-shaped. Alternate placements forward and backward to avoid a rigid appearance and to establish depth. As you work, always remember to continue size and space rhythm by using larger flowers and closer spacing near the focal area, and smaller flowers with farther spacing away from the focal area.

8. Establish the base by joining lower points to the front flower. Stems should not form a collar but should alternate slightly up and down. Viewed from overhead, they should form a triangular shape.

9. Fill in the remaining area (Fig. 9-24) so that the eye is rhythmically led to the focal area with no large gaps or irregular crowding of flowers.

10. Fill in with foliage so that mechanics are covered but flowers are not crowded. The foliage should appear to radiate out from a common point behind the focal area. Avoid using large pieces of leatherleaf that stick out beyond the flowers. Do not use more than you need to cover the foam.

11. Add static to enhance depth and bridge gaps between the mums. Remember to sink some static in deeper and bring some out farther for greatest depth. Make sure you have used some static throughout the arrangement, not just in one spot. This filler material should repeat the triangular design, exhibiting size and space rhythm similar to that established by the mums. (See Fig. 9-21 for completed arrangement.)

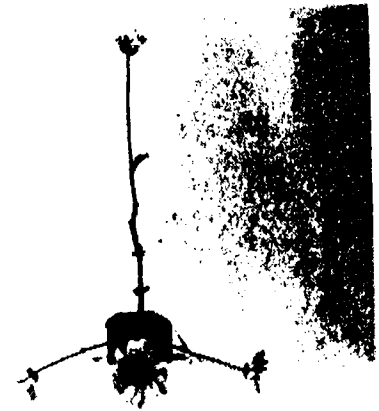


Figure 9-22 Establish height, width and depth

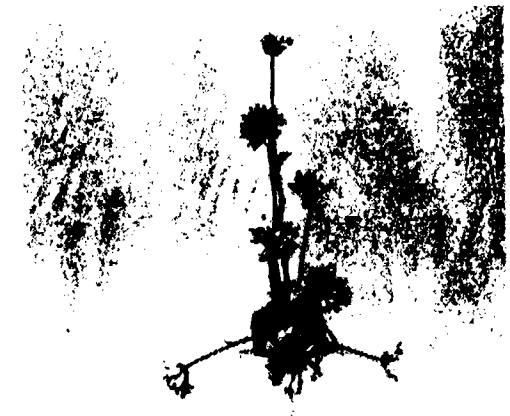


Figure 9-23 Establish the vertical trunk line



Figure 9-24 Flowers complete the isosceles triangle

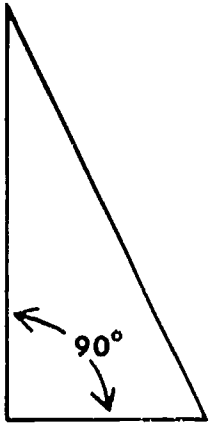


Figure 9-25
Right triangle

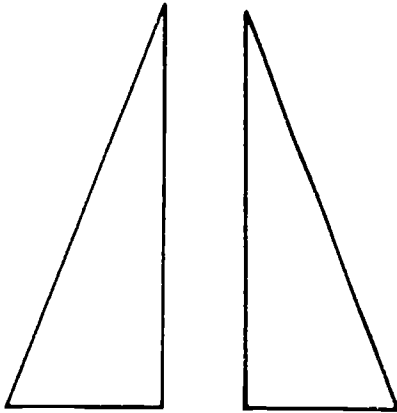


Figure 9-26 Complementary
pair of right triangles

RIGHT TRIANGLE

A right triangle arrangement is a one-sided mass arrangement that is basically one half of an equilateral or isosceles triangle. There is a 90° difference in angle between the vertical and horizontal sides of the arrangement (Fig. 9-25).

Right triangle arrangements can be designed either right or left sided (Fig. 9-26). Thus they can be used in complementary pairs, as on a mantel, stage or church altar. This design form may also be used beside a painting or some other object to help visually balance the total setting.

SUGGESTED ACTIVITY

Right Triangle in a Low Container

Materials:

low container
floral foam
waterproof tape
snapdragons (10-14 stems)
pompon mums (1/2 bunch or 14-16 flowers)
huckleberry

1. Place foam in the low container and tape.
2. Establish height by placing the tallest snapdragon (about 12 inches long) in the back left corner of the foam. (See Figure 9-27, placement 1.) It should point directly upward.
3. Establish the lower right point of the triangle with a snapdragon about 5 inches long (Fig. 9-27, placement 2). Place it toward

the back in the right side of the foam, angling it slightly downward and backward. The tip may be pinched out of the snapdragon to prevent its curling upward. This can be done to any of the stems that will be placed at an angle.

4. Most right triangle arrangements look more relaxed if the right angle is not rigidly established. Therefore some material will be brought out a little to the left of the tallest flower placement. Establish this lower left point with a snapdragon that is about 3 inches long (Fig. 9-27, placement 3). Place it toward the front of the foam and angle it slightly forward.

5. Establish the trunk line with snapdragons (Fig. 9-28). Alternate placements from left to right. Connect the tallest point with the lower left point by gradually spacing flowers closer together and angling them forward. Do not let the flowers extend too far out on the left or you will lose the neat triangular form. The focal area is at the base of this trunk line.

6. Establish the silhouette by joining the upper point with the lower right point (Fig. 9-29). Make sure the triangular outline is maintained.

7. Establish the base by connecting the two lower points of the triangle (Fig. 9-30). Keep this line fairly straight.

8. Fill in the arrangement lightly with snapdragons. Leave room for pompon mums and foliage.

9. Add foliage by sinking it down into the arrangement to cover the mechanics.

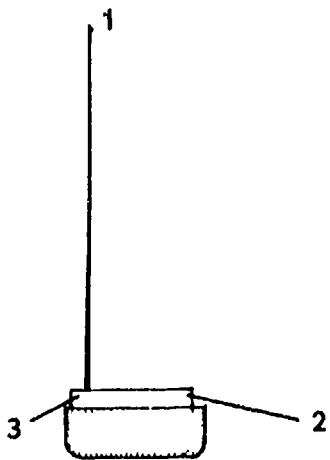


Figure 9-27
First 3 placements

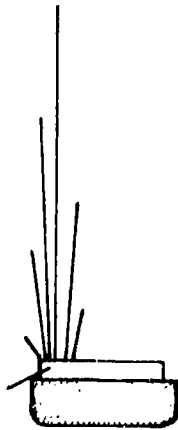


Figure 9-28
Establishing the
trunk line

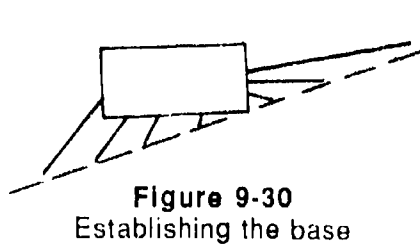


Figure 9-30
Establishing the base



Figure 9-29
Establishing the silhouette

10. Add chrysanthemums. Divide and cut the stems as you did before to get an assortment of stem lengths and flower sizes. Place mums first at the points of the triangle, then establish the trunk line, followed by the silhouette and base. Finally fill in the central area so that there is a rhythmic progression toward the focal area at the base of the trunk line. Place flowers in and out for depth. Use larger flowers or more flowers spaced closer together near the focal area. (See Figure 9-31.)

SCALENE TRIANGLE

A scalene triangle is composed of three sides of different lengths (Fig. 9-32). The design form is a one-sided mass arrangement with the tallest point off-center from the focal area.

The balance is asymmetrical and therefore more informal in appearance than the equilateral or isosceles triangle. The finished arrangement must not look as though it will tip sideways even though the tallest point is angled outward.

Scalene triangle arrangements are often done in raised containers, allowing a side of the design to be slanted downward. In the following exercise this design will be made in a fireside basket turned sideways. The design shape will allow the handle to show, since the upper edge of the triangle will cut down at a diagonal under the handle.

SUGGESTED ACTIVITY

Scalene Triangle with Bow in a Fireside Basket

Materials:

fireside basket
floral foam
waterproof tape
snapdragons (10-12)
carnations (10-14)
myrtle
#9 satin ribbon (3 yards)
#24 wire
3-inch wooden stake
low plastic container
chenille stems

1. Place soaked foam in a small plastic container and tape it in with waterproof tape. The foam should be about an inch higher than the rim.
2. Place container of foam in the center of a wicker fireside basket (Fig. 9-33). Run chenille stems (two twisted together if necessary) under the basket and thread through wicker on each side of the container. Bring ends up and twist together firmly on top of the foam. Repeat with a second chenille stem at right angles to the first so the container is firmly anchored.
3. Establish the upper left point (Fig. 9-33) by placing a snapdragon spike at a diagonal so that the tip is higher than the handle and just beyond the edge of the basket. Insert it toward the back of the foam and angle it slightly backward.

(continued)

Figure 9-31
Right triangle
arrangement

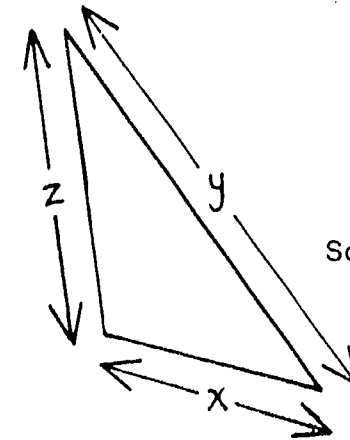


Figure 9-32
Scalene triangle



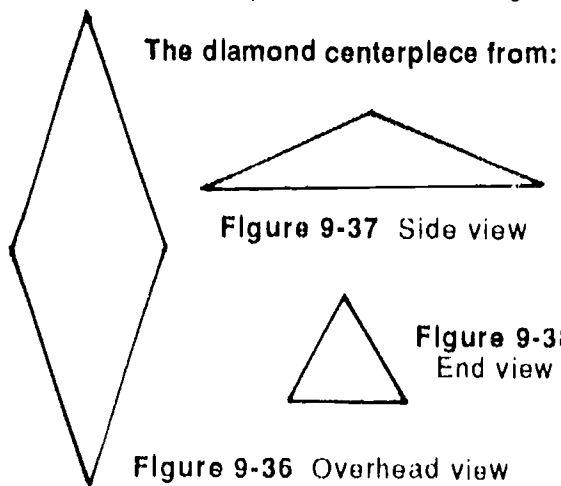
Figure 9-33 The first 3 placements establish the scalene triangle



Figure 9-34 Satin bow added to basic scalene shape



Figure 9-35 Completed scalene triangle



4. Establish the lower right point (Fig. 9-33) with a snapdragon spike about one-third the length of the first. Insert it in the foam so that the tip extends a couple of inches beyond the edge of the basket. Angle it slightly downward and backward but not enough to rest on the table.

5. Establish the lower left point (Fig. 9-33) with a snapdragon spike slightly shorter than the previous one. Place it in the left side of the foam toward the front. Angle it somewhat forward.

6. Establish the silhouette so that the upper edge of the triangle is a diagonal line connecting the upper left point with the lower right point. This line should come under the handle and not crowd it. Stems should appear to come from a common point and should not cross.

7. Make a bow from #9 satin ribbon. Make five or six loops on a side, each loop about 3 inches long (Fig. 9-34). Attach the bow to a 3-inch wooden stake using the wire that is holding the bow together.

8. Insert stake in foam just to the left of the handle near the edge of the basket.

9. Establish depth with a short section of snapdragon spike coming out toward you from the central area of the bow. This could be a section of the spike that does not include the tip (that might otherwise be discarded). When using these lower pieces, cut the stem at a sharp angle just above the upper floret to make the cut stem less conspicuous.

10. Fill in the design sparingly with a few more snapdragon spikes (tips or lower pieces).

11. Add foliage pieces between flower spikes to cover the mechanics. Use some longer pieces to emphasize the points of the triangle.

12. Repeat the scalene triangle with the carnations (Fig. 9-35). Use them to bridge the gaps between the snapdragon spikes. Place them at different depths to avoid a flat look. Space the larger flowers more closely near the bow since this is the center of interest. Incorporate the bow into the design by working flowers and foliages through it, but don't hide it. As in a corsage, the bow should enhance the focal area but should not be the focal point.

DIAMOND CENTERPIECE

The diamond centerpiece is a low elongated arrangement that emphasizes a horizontal line. It is considered a variation of the triangle; viewed from above the outline looks like two triangles, base to base (Fig. 9-36). In side view the diamond centerpiece looks like a short isosceles triangle with a very drawn-out base (Fig. 9-37). From either end this design looks like a small equilateral triangle (Fig. 9-38).

This design shape is low and thus well suited for use as a centerpiece on an oval or rectangular dining table. The arrangement, which is finished off on all sides, is made in a low container that often is largely concealed by the flowers and foliage. Even when the container is visible, some flowers or

foliage should be angled downward to soften the rim of the container and hide mechanics. Plant materials should be firmly anchored in the foam so that they do not rest on the table.

SUGGESTED ACTIVITY

Diamond Centerpiece

Materials:

low rectangular container
floral foam
waterproof tape
heather
roses
annual statice
huckleberry

1. Place foam in container and attach with waterproof tape. Foam should be about one inch above the rim of the container.
2. Establish the horizontal line (Fig. 9-39, placements 1 and 2). Select two pieces of huckleberry that are fairly straight. The total length of the arrangement will be the sum of the lengths of these two pieces of foliage plus the length of the foam. Overall length of the design can vary; for this exercise cut each piece 6 inches long. Insert one piece at each end of the foam, as low as possible. These pieces should come straight out or angle slightly downward without touching the table. The two pieces should form one elongated horizontal line with the foam between.
3. Establish the width (Fig. 9-39, placements 3 and 4). Cut two pieces of huckleberry about 3 inches long and insert in the wider sides of the foam opposite each other. Place them low and angled downward.

Together these placements determine the width of the arrangement. The four placements establish the four points of a diamond shape when viewed from the top (overhead view).

4. Establish the height (Fig. 9-39, placement 5). Select two pieces of huckleberry about 5 inches long. Place them back to back and insert them directly upward in the middle of the foam. The five placements now form the major points of the diamond centerpiece (Fig. 9-40). A low drawn-out triangle can be visualized in side view.

5. Lightly establish the diamond shape with huckleberry (Fig. 9-41). Keep the overall shape smaller than the size you plan for the final arrangement, since the flowers should eventually stand out above the foliage. Radiate lines of foliage outward in the foam without crossing stems.

6. Establish the diamond shape with heather (Fig. 9-42). The first five heather placements should repeat the first five foliage placements, establishing height, width and depth.

7. Join lower points to the tallest point by staggering about three placements from side to side much as you did when you established the trunk line in the previous triangular arrangements. Flowers should form the triangular silhouette with enough in-and-out variation in placements to establish depth and relieve stiffness.

8. Establish the base. Lower placements should join the four points and conform to a general diamond shape from an overhead view. Some of these flowers should be angled

Figure 9-39

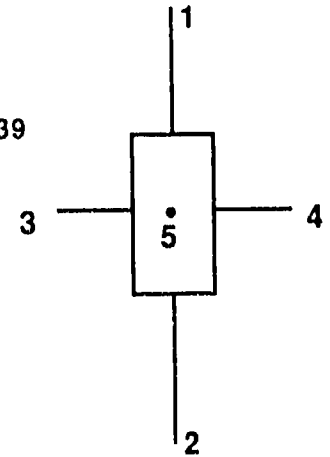


Figure 9-40 First 5 placements



Figure 9-41 Diamond shape established with greens



Figure 9-42 Heather added in diamond shape

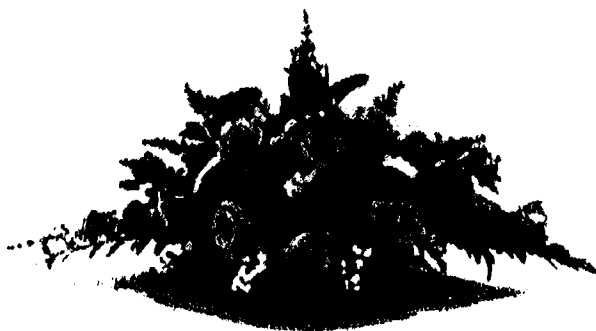


Figure 9-43 Completed diamond centerpiece with roses and statice

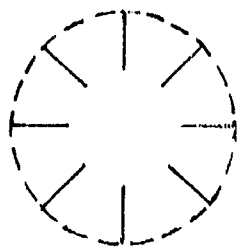


Figure 9-44
Overhead view

The circular mound arrangement

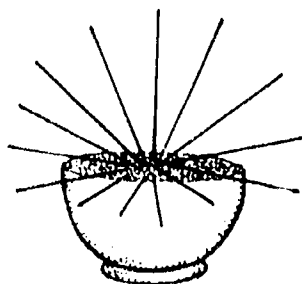


Figure 9-45
Side view

downward over the side of the container. Vary depth of placement slightly to create interest and to avoid forming a heavy collar of plant material around the rim of the container.

9. Lightly fill in the four quadrants so that there are no large gaps and the diamond form is evident. The center of interest is actually within the arrangement:- the area from which all stems appear to radiate. Flowers near this area should be the larger ones and have the closest spacing. Those flowers forming the width of the arrangement or those sunken in close to this area are closest to the center of interest.

10. Use roses to repeat the diamond shape (Fig. 9-43). Use the same order of placement suggested for the heather—length, width, height, trunk lines, base and fill-in. Use larger flowers near the heart of the design. Gradually create a transition to smaller flowers with greater spacing out on the points of the diamond. Insert roses at different depths, leaving space around each flower to show off its individual beauty.

11. Lightly fill the arrangement with statice (Fig. 9-43). Statice placements should also repeat the diamond shape. Use this filler to create depth and to fill conspicuous gaps. The statice should never crowd other flowers. Extend some pieces beyond the triangular silhouette and sink some in deeper than this imaginary line. Larger pieces or clusters of smaller pieces may be used near the center of interest.

12. Check the arrangement:

- Is the diamond shape evident? Did you avoid rounded outlines and an arrangement that appears oval?
- Have you created depth in the arrangement?
- Are the flowers too crowded?
- Are the larger flowers used near the center of interest?
- Are the mechanics covered?
- Are all placements firmly implanted in the foam?
- Are any pieces of plant material resting on the table?

CIRCLE VARIATIONS

CIRCULAR MOUND ARRANGEMENTS

The rounded circular arrangement known as a mound is based on the form of a sphere or globe. It is designed to be viewed from all sides (Fig. 9-44, 9-45). It may feature just one flower or several kinds of flowers. The design may be fairly compact (typical of Victorian arrangements) or light and airy with considerable depth.

The focal area is in the center (heart) of these designs. This is the spot from which the flower and foliage placements seem to arise. Since all the flowers are about the same distance from this focal area, their various sizes are somewhat evenly distributed throughout the arrangement. In other

words, size rhythm (placing larger flowers near the focal area and smaller flowers farther away from the focal area) is not a dominant feature of this type of flower arrangement.

When more than one kind of flower is used, each type should be evenly distributed over the circular form. This can best be accomplished by arranging all of one kind of flower at one time rather than switching back and forth between kinds of flowers. Start with the larger flowers and finish with the smaller filler flowers.

The globe shape should extend down over the rim of the container to avoid a sharp dividing line between arrangement and container. This is accomplished by angling some of the stems downward, a technique referred to as "breaking the rim of the container" or "softening the edge of the container."

Mass and filler flowers like mums, carnations, roses, statice and baby's breath are commonly used in a round mound bouquet. Avoid using large flowers in a small arrangement because of the difficulty in making a smooth transition from flower to flower while following the circular outline of the design. Flowers with interesting forms, like iris and daffodils, are appropriate if the arrangement is open enough to show off their individual shapes. Spike flowers are not recommended because they can create a porcupine effect.

Fine filler materials may be used in mound designs. Baby's breath creates a cloud effect over stronger placements, which may give the design a lighter appearance. German statice can be massed in a small

spherical form closer to the focal area with other flowers extending through and above it, thus repeating the circular pattern at two levels in the arrangement.

Circular mound arrangements are frequently made in flower shops (Fig. 9-46). They are offered by wire service organizations as relatively inexpensive standard bouquets that can be produced fairly consistently in flower shops throughout the country. The mound is also the basic form of many promotional arrangements for holidays and special occasions.

Circular mound designs may be arranged in low containers with or without a short pedestal. If the container is taller than it is wide, an oval arrangement would be more appropriate than a circular one. This style of arrangement best fits containers that are round in shape or that have a globe form.

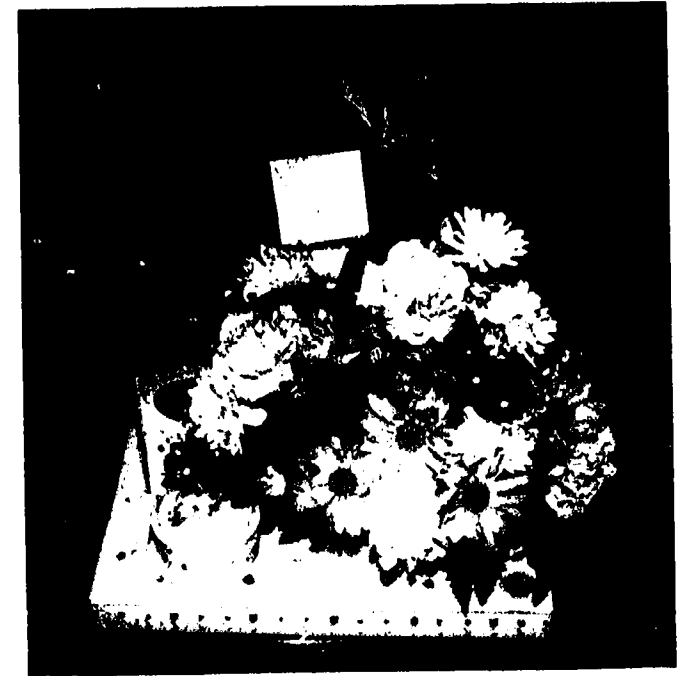


Figure 9-46 Circular mound arrangement in a flower shop

SUGGESTED ACTIVITY

Circular Mound Arrangement

Materials:

- low pedestal container
- floral foam
- waterproof tape
- pompon chrysanthemums
- carnations
- annual statice or baby's breath
- leatherleaf

1. Place foam in container with upper surface an inch above the rim. Tape with waterproof tape.

(continued)

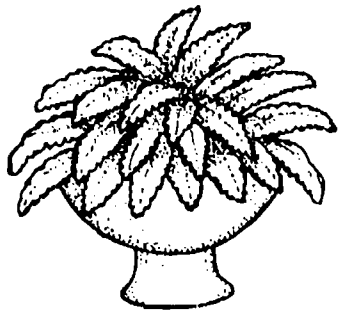


Figure 9-47 Side view

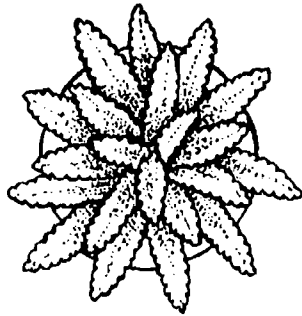
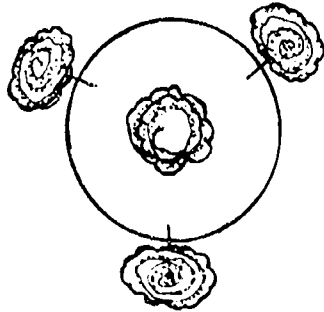
Figure 9-48
Overhead view

Figure 9-49 First three placements

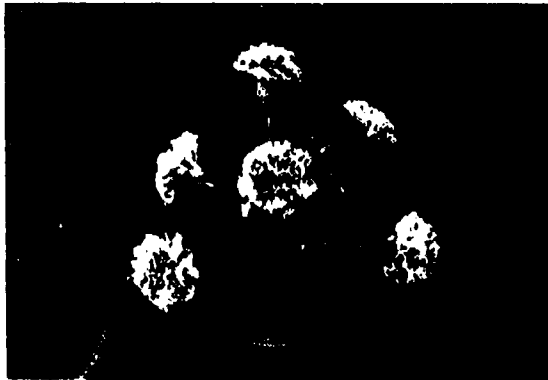


Figure 9-50 Carnations create rounded form



Figure 9-51 Finished circular mound arrangement

2. Use leatherleaf to establish the form of a globe (Fig. 9-47). This form should be smaller than the planned finished size of the arrangement since the foliage is meant to cover the mechanics and form a background to the flowers.

The leatherleaf should be placed so that it radiates out from the central area much as it would growing on a living plant (Fig. 9-48). Keep the top side of the frond up. These pieces should be slanted so they arch up and out, giving a layered appearance. Do not create a dense mound. Use the nicer end tips in more conspicuous places, but sink the remaining cut pieces in for depth. There is no reason to waste pieces of foliage as long as it is in good condition.

3. Use carnations to repeat the rounded form. These should stand out beyond the leatherleaf.

Begin by placing three carnations equidistant from each other so they are angled outward just above the rim of the container (Fig. 9-49).

Place a fourth carnation directly upward, centered in the foam to establish the height. Check these four points to see that they are equidistant from the heart of the design. They are the guide posts around which the rest of the bouquet will be built.

Place three more carnations, each at a point equidistant from the top flower and two of the bottom flowers (Fig. 9-50). Each placement must further establish the circular pattern.

The seven carnations should be adequate for this arrangement. If more are used, however, they should be distributed throughout the design but at different depths to avoid a rigid product that may resemble a styrofoam ball.

4. Use pompon mums to enhance the circular form. Distribute mums between carnations. Vary depth slightly to avoid crowding. If buds are used they should be evenly distributed, perhaps in clusters of three.

5. Use statice to further refine the globe form (Fig. 9-51). Create depth by sinking some in and extending some out beyond the mum and carnation placements. Usually the larger, heavier-looking pieces are sunken in, while smaller pieces are extended slightly beyond other flowers.

6. Check the design:

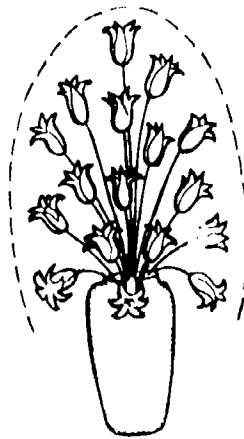
- Is there an overall form of a globe? Did you successfully avoid a flattened look on top or a bulge on one side?
- Is each kind of floral material evenly distributed?
- Does the arrangement have depth? Do any flowers appear crowded? Can you see down into the design?
- Are the mechanics covered?
- Does the design come down over the rim of the container?

OVAL ARRANGEMENTS

An oval arrangement is appropriate when a taller design with curving lines is desired. The additional height presents an opportunity to create an open arrangement which can feature a wide range of plant material with interesting forms. Arching branches and flower stems can complement the oval silhouette and lead the eye deep into the arrangement.

Some oval arrangements, especially those typical of historic periods, may be quite compact, just as the Victorian version of the circular mound is compact. If this is your goal, then many close placements such as the concentric rings of the Biedermeier style are appropriate. (Refer back to Figure 9-1.) However, a more popular trend is toward open styling (Fig. 9-52) which requires fewer flower placements.

Containers may be oval in shape or have pedestals that are tall enough to make the height of the container greater than its width. The higher the container, the taller the arrangement that is required to balance



Outline of an oval arrangement

it. A delicate container on a narrow pedestal would best be filled with a light, open arrangement. Large flowers are more suited to a sturdy container that is heavier in appearance.

SUGGESTED ACTIVITY

All-Around Open Oval

Materials:

- upright oval container or container with a pedestal
- floral foam
- waterproof tape
- mixture of flowers and foliage including some form flowers

1. Place foam in container and tape with waterproof tape.

2. Select interesting form flowers that have high eye appeal. Insert these in the foam in a position where they will show to maximum advantage. They must be within the oval shape you have envisioned for the container. Stems should not cross but instead radiate out from the center of the foam or from a central axis directly up from this point. Place all of one kind of flower before deciding on the positioning of the next kind.

3. Add arching branches or interesting foliage clusters (Fig. 9-53), positioning them as carefully as you would a flower placement. Do not crowd any of the materials. The space around the placements is as important as the flowers and foliages themselves. If they are not too rigid, spike flowers may be used to lead the eye down into the design.



Figure 9-52 Open oval arrangement of cherry blossoms



Figure 9-53 Open placement of foliage



Figure 9-54 Open oval arrangement of mixed flowers



Figure 9-55 Williamsburg fan in a five-fingered vase

4. Use filler flowers last to smooth out the design and refine the oval shape. (See Figure 9-54.) If any foam is still exposed, sink short foliage clusters deep into the arrangement to cover it.

5. Check the design:

- Is the oval shape evident?
- Is the arrangement balanced?
- Is the arrangement free of bulges or projections on any side?
- Does the arrangement have a light airy feeling?
- Is the eye led down into the design?
- Do flowers and foliage pieces appear to radiate out from a common point?

FAN ARRANGEMENTS

The fan is a one-sided mass arrangement based on a circular design shape. The construction of a fan arrangement is similar to that of an equilateral triangle. The major difference is the establishment of a rounded silhouette instead of the sharp linear connection of points that is characteristic of triangle designs.

Fan arrangements had their origin in European period designs. The Williamsburg style of fan arrangement, sometimes made in a five-fingered vase (Fig. 9-55), is known to those interested in that period. In more

recent times fan-shaped arrangements in papier-mache or metal baskets have been produced as traditional funeral tributes.

Spike flowers such as gladioli may be used to form the outline of a fan. Mass flowers like carnations and chrysanthemums are frequently used to complete the design. A bow may be used to strengthen the focal area. The focal area is low in the design and is the point from which the flowers appear to radiate.

Some fan arrangements appear very flat. They lack depth and would be improved by greater development of the focal area. Another common flaw is weakness of the silhouette part of the design. This may result if too few spike flowers are used, leaving large pie-shaped gaps in the outline. Another problem of the silhouette is having all the outline flowers in the same plane, once again resulting in a flat, rigid appearance.

There should be good integration of the spike flowers with the mass and filler flowers. If gladioli are used, shorter pieces of the spike can be inserted near the focal area and throughout other parts of the arrangement as well as the outline. This is especially important if the spike and mass flowers are of contrasting colors.

If a bow is used, it should be incorporated into the arrangement. The bow color may harmonize with the flowers or complement them. The entire arrangement should appear to fit down over the container. This is accomplished by angling flowers and foliage downward over the rim of the container.

SUGGESTED ACTIVITY

Fan Arrangement

Materials:

container to hold one block of foam
floral foam
waterproof tape
gladioli
pompon mums
salal
#9 satin ribbon
#28 wire
wooden pick

1. Place foam in container and fasten with waterproof tape (Fig. 9-56).



Figure 9-56

2. Use gladioli to create the fan silhouette (Fig. 9-57). Establish height and then width. The lower placements should be angled down over the side of the container and slightly backward.

3. Make a #9 satin bow with 3-inch loops and two streamers. Attach the bow to a wooden stake and insert into front center of the foam. Angle the bow slightly forward and a little over the rim of the container (Fig. 9-58).



Figure 9-57



Figure 9-58

4. Use a short piece of gladiolus spike to establish the depth. Bring it straight out toward you through loops of the bow. Use slightly longer gladiolus pieces to create the lower outline of the arrangement, consisting of placements projecting outward over the rim of the container. Tilt these pieces slightly up and down to avoid a rigid feeling, but conform to a curved outline in an overhead view.

5. Use gladiolus spikes of intermediate length as a bridge between the upper and

lower outline flowers (Fig. 9-59). Remember to change the facing from forward to upright gradually. These placements will establish a framework for the mums.

6. Add salal leaves to cover the foam (Fig. 9-59). Keep them sunken in. Avoid a heavy crowded look by using no more leaves than are necessary.

7. Repeat the fan shape with pompon mums (Fig. 9-60). Use clusters of pompons



Figure 9-59



Figure 9-60

at the end of a single stem as if they were one larger flower, giving each stem a single placement. This is necessary to get sufficient stem length and to have good size relation with the larger gladioli. Large stems of mums should probably have some of the flowers removed so that the overall size of the cluster is reduced. Sometimes the main stem can be cut, creating two usable clusters.

8. Check the arrangement:

- Is the overall fan shape evident?
- Is the outline tied together and not overly rigid?
- Have the spike flowers been integrated with the mass flowers?
- Does the arrangement have depth?
- Is the focal area well established?
- Is the bow coordinated with the arrangement? Is it tied in with the rest of the arrangement (not overly conspicuous)?

BASKET ARRANGEMENTS

A mass arrangement in a basket often follows an oval design shape; that is, an oval shape is apparent as you look down on it. Since many baskets have handles, this situation deserves special attention. A handle should not be crowded or buried by flowers. So, the arrangement in a container involving a handle may be shorter than if the container had no handle.

Many baskets come with plastic liners; these are handy if the arrangement is to be made of fresh flowers. If there is no liner, a small plastic container filled with foam can be attached to the basket with chenille stems or hot glue.

If the basket is to be viewed from one side, a wedge of styrofoam can be wired to the bottom of the basket to tilt it forward. This is sometimes done to large fireside baskets. An arrangement designed in an angled basket will show better if it is displayed on a stage or as a funeral tribute.

SUGGESTED ACTIVITY

Fireside Basket

Materials:

- fireside basket
- low plastic container
- chenille stems
- floral foam
- waterproof tape
- pompon mums
- leatherleaf
- glycerinized autumn leaves
- colored wheat

1. Place foam in plastic container and tape with waterproof tape. Anchor container to the basket with criss-crossed chenille stems worked through the wicker (Fig. 9-61).
2. Green in the arrangement creating a low oval mound of leatherleaf that conforms to the shape of the basket (Fig. 9-62). Maintain a light layered look to the greens. They

should radiate out from the center of the foam in a natural way.

3. Use mums to establish the lower horizontal line (Fig. 9-62). Extend these about 2 inches beyond the edge of the basket, angling them slightly downward over the rim.

4. Establish the width. Place mums at each side of the basket, extending them just beyond its rim near the point where the handle is attached. These flowers may be angled slightly upward since the edges of a fireside basket are rolled up.

5. Establish the height of the design with a mum placed directly in the center of the foam. The mum should be at least one inch below the handle of the basket.

6. Fill in with more mums at various depths (Fig. 9-63). The overall shape should appear oval from an overhead view. In side view you will see a low arching form under the handle. The shape should conform to that of the basket. The basket should not be hidden by

flowers even though some placements extend beyond its boundaries.

7. Add small clusters of autumn leaves to repeat the design shape (Fig. 9-63). These may be used at different depths but should not crowd or hide the mums.

8. Fill in all parts of the arrangement with pieces of colored wheat. These must be sunken in deep enough so that they do not give the design a bristling appearance. Wheat that has long awns provides an airy extension of the design.

9. Check the design:

- Is the basket featured well rather than buried?
- Is the handle clearly visible rather than crowded?
- Does the overall shape of the arrangement conform to the shape of the basket?

• Are materials uniformly distributed throughout the arrangement?

• Does the arrangement have good depth?

• Does the arrangement appear neat and well-ordered rather than shaggy?

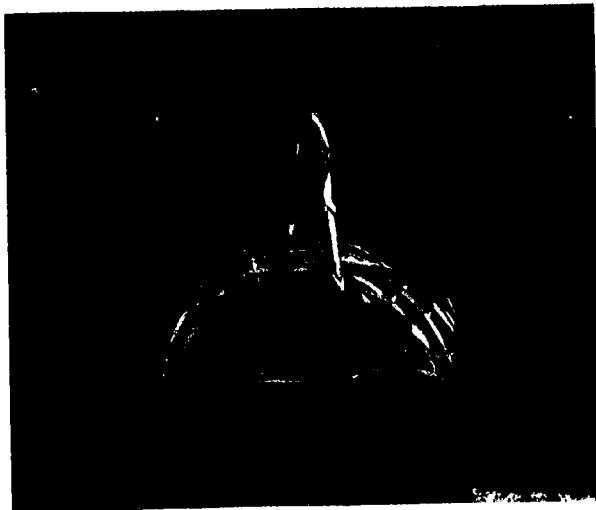


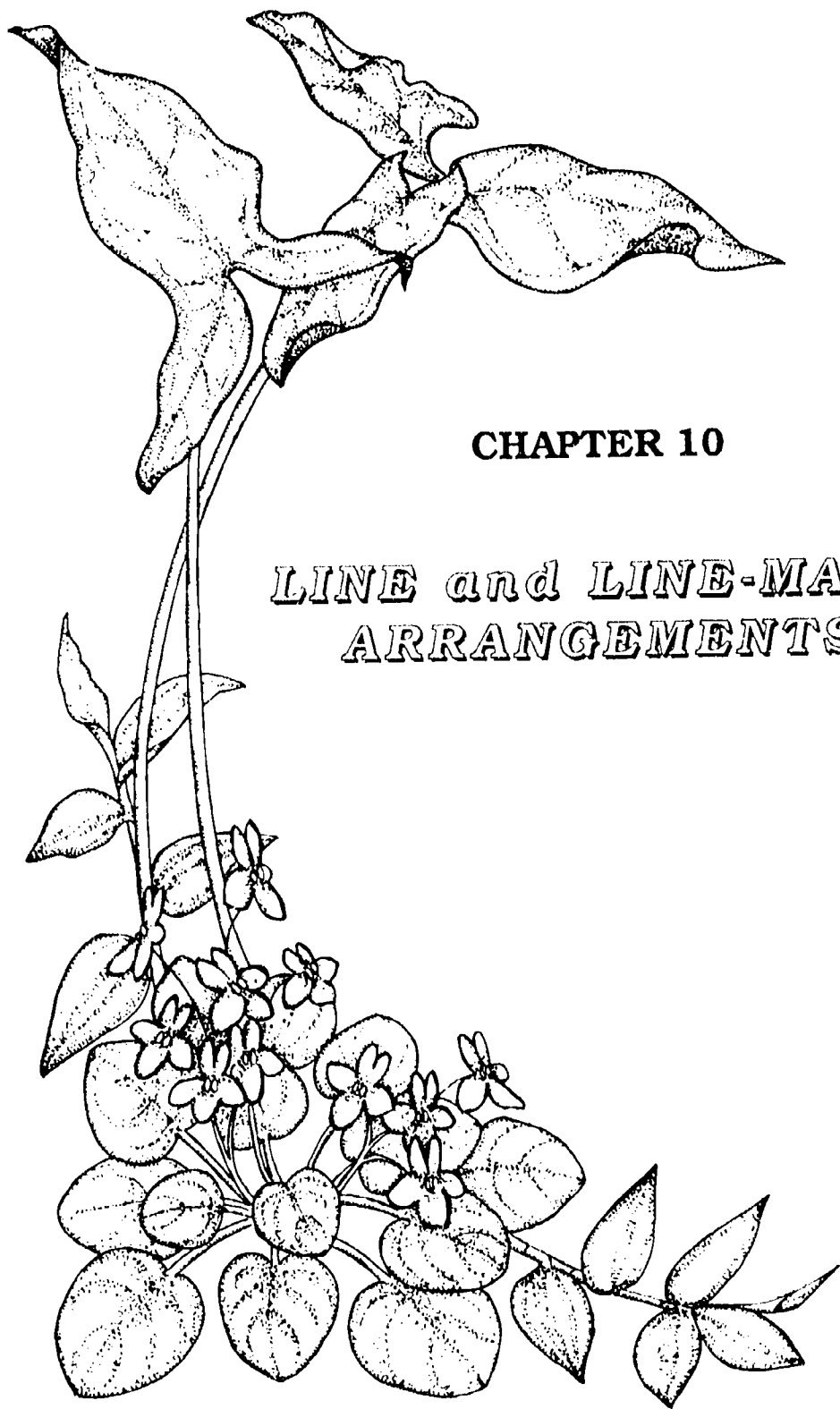
Figure 9-61



Figure 9-62



Figure 9-63



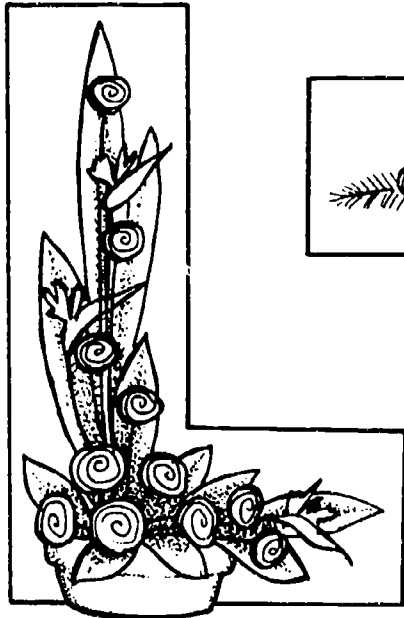
CHAPTER 10

LINE and LINE-MASS
ARRANGEMENTS

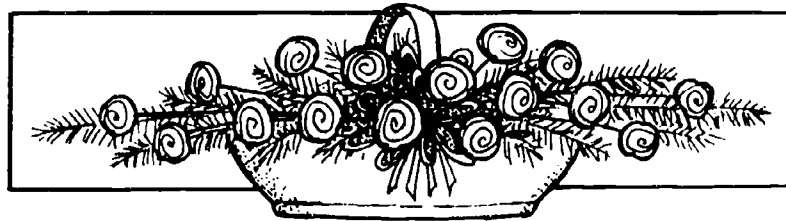


STRAIGHT LINE VARIATIONS

CURVED LINE VARIATIONS



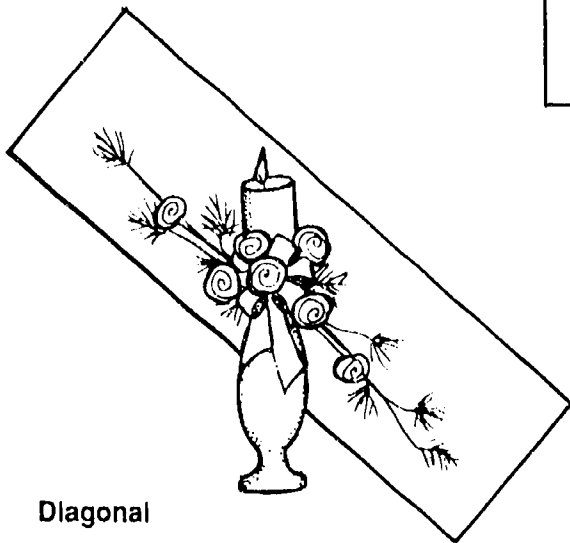
L-Pattern



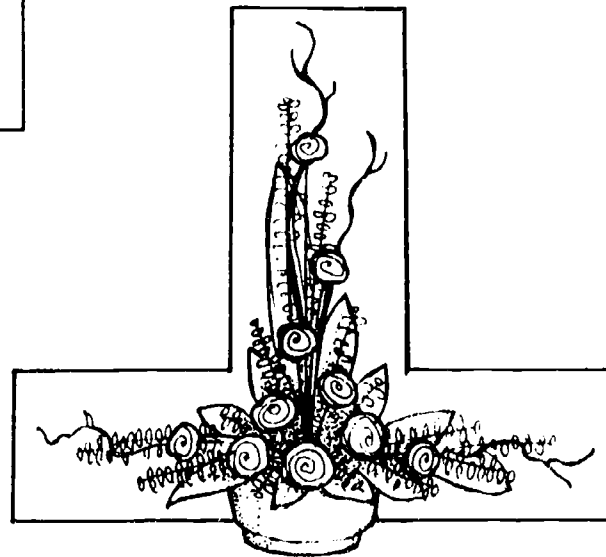
Horizontal



Vertical



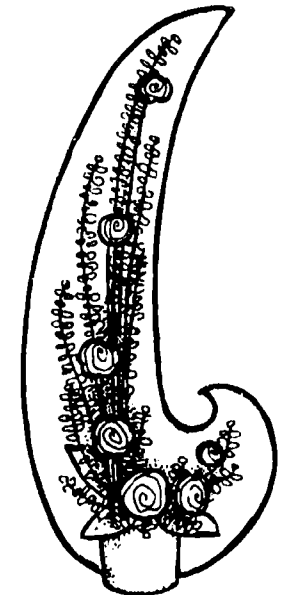
Diagonal



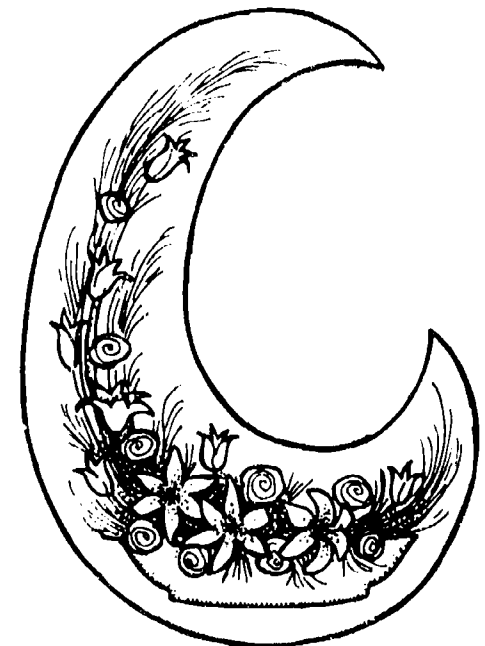
Inverted-T



Hogarth Curve



Spiral



Crescent

Basic designs that lead the eye of the viewer along an obvious trunk line are called line or line-mass arrangements. The major line may be straight or curved. Line-mass arrangements contain more flowers than do line arrangements, and the flowers are usually closer together. Some arrangements fall clearly into one category or the other, but other arrangements are intermediate between the two.

The basic design shapes of line or line-mass arrangements that fall under straight and curved line categories are as follows: (See illustrations on the opposite page.)

Straight Line Variations

Vertical
Horizontal
L-pattern
Inverted-T
Diagonal

Curved Line Variations

Spiral
Crescent
Hogarth Curve

The basic design shapes described in this unit are considered to be traditional American designs. Other styles of line and line-mass arrangements are found in Oriental (Fig. 10-1) and contemporary (Fig. 10-2) designs, some of which are discussed in Chapters 20 and 21 on period and contemporary arrangements.

A common horizontal arrangement is the diamond centerpiece, which was considered in Chapter 9, massed in, as a triangle

variation. If designed with a more open, contemporary feeling, the diamond centerpiece could be transformed into a horizontal line-mass arrangement.

An arrangement may consist of lines of flowers and foliage that meet or cross. A horizontal line and a vertical line are combined to form the L-pattern and inverted-T design. When a straight or curved diagonal line crosses a strong vertical line, the crossing line is called the **line of opposition**. An example (which you can try in one of the suggested activities) is a diagonal line of flowers and foliage arranged to cut across a candle on a pedestal (Fig. 10-3).

Curved lines are usually graceful and flowing (Fig. 10-4). The predictable curves of a spiral, crescent or Hogarth curve arrangement are pleasing to the eye. These designs may be produced as long, drawn-out line arrangements or as heavier line-mass designs with more flowers near the focal area.

STRAIGHT LINE VARIATIONS

VERTICAL ARRANGEMENTS

A vertical line emphasizes a straight upward thrust. These dynamic arrangements are usually designed in tall, narrow containers, which the design repeats - tall and thin (Fig. 10-5). The result is that the eye of the viewer is directed up and down the arrangement. Appropriate materials for establishing the vertical line include narrow straight pieces of foliage and flowers, such as gladioli, liatris, Scotch broom and eucalyptus. Mass flowers can be added, but they need to be stepped down rhythmically

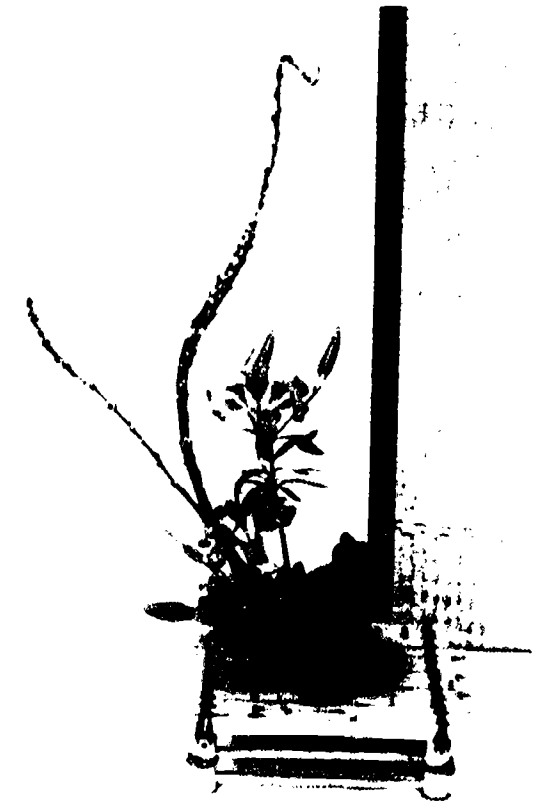


Figure 10-1 Oriental line arrangement



Figure 10-2 Contemporary line arrangement



Figure 10-3 Diagonal line of opposition

toward the focal area, which is normally at the rim of the container.

A common flaw in a vertical arrangement is to overdevelop the focal area. It should not extend significantly beyond the width of the container. Although the mechanics must be covered, this should be done with short tufts of foliage or moss to avoid excess visual weight in this area.

The rhythmic placement of flowers down the vertical line is very obvious and important (Fig. 10-6). Flowers near the top should be smaller and spaced farther apart; then as the eye approaches the focal area, the flowers should become larger and closer together. Since there may not be many flower placements, it is especially important to

create a smooth rhythmic progression. This line of flowers is similar to the trunk line of triangular arrangements, but the transition from upward- to forward-facing occurs over a much narrower depth from front to back. Flower stems must be carefully tilted, with upper placements facing mostly upward and lower placements making most of the facing transition to forward so the arrangement does not lose its slender profile in side view.

Vertical arrangements can become quite interesting when more exotic materials such as sansevieria leaves, bamboo sticks or horsetails are used to create the line. There is also an opportunity to develop shape rhythm if suitable materials are available from the greenhouse or garden. You may be able to find leaves that will gradually grade from linear to oval and eventually round shapes. If incorporated into the design, this gradual change in shape will help lead the eye to the focal area.

Vertical arrangements of suitable size may be used on church altars, in front of lecterns, or in front of narrow sections of wall. Since the base is narrow, little surface space is taken up. A small vertical design would be very appropriate for a hospital room with its limited surface space.



Figure 10-4 Curved lines of wisteria surround a vertical line of iris



Figure 10-5 Tall, thin, parallel lines in a contemporary arrangement



Figure 10-6 Rhythmic placement of allium down a strong vertical line

350

351

SUGGESTED ACTIVITY
Vertical Arrangement*Materials:*

tall narrow container
floral foam
waterproof tape
myrtle, huckleberry or Scotch broom
daisy mums
annual statice

1. Place foam in the container and secure with waterproof tape (Fig. 10-7). The foam should rise above rim of container, but not very much or it will be difficult to cover.



Figure 10-7

2. Establish a straight vertical line with a long, narrow piece of foliage that is two times the height of the container (Fig. 10-8). This should be inserted toward the back of the foam. Slightly off to the left, place a second piece of foliage about half the length of the first. Keep the vertical line straight and narrow.

3. Establish the trunk line by first placing a small flower in front of the foliage a few inches down from its tip. Then slightly stagger the remaining mums down the vertical

line (Fig. 10-9). Gradually increase the size of the flowers and place them closer together as you approach the rim of the container. There should be a transition in facing of the flowers from upright at the top to forward at the focal area. Do not extend flowers too far forward (especially the upper placements) so that the arrangement retains a slender profile in side view.

4. Use statice between mum placements as a filler to create additional depth. Some statice placements should be angled toward the back to help lead the eye around the arrangement. This will give it more depth and avoid a flat appearance. Be careful not to extend the width with these placements.

5. Add foliage pieces sparingly throughout the line and in small tufts near the focal area to cover the foam. (See Figure 10-10.) Avoid



Figure 10-8



Figure 10-9



Figure 10-10

extending the width of the arrangement and adding too much bulk at the focal area.

6. Check the arrangement.

- Is this a tall narrow arrangement with an upward thrust?
- Does the arrangement have enough height for the container?
- Is the arrangement too wide or bulky at the focal area?
- Do the placements form parallel lines rather than being united in one main axis?
- Is there a rhythmic transition down the line to the focal area?

- Is the arrangement also slender in side view without disturbing bulges?

- Does the arrangement have depth rather than appearing flat?
-

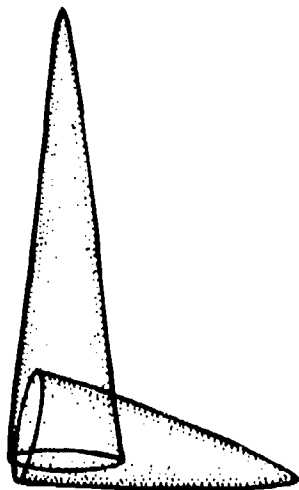


Figure 10-11 An L-pattern arrangement consists of 2 cone-shaped segments



Figure 10-12 L-pattern arrangement surrounding a praying cherub

L-PATTERN

The L-pattern is a line-mass arrangement that is very similar to a right triangle arrangement except that it is not filled in between the two major points. The result is a silhouette that resembles the letter L. The focal area is at the point where the vertical and horizontal lines meet.

The two lines increase in mass as they approach the focal area from the outer points. The vertical portion may be thought of as an elongated cone, while the horizontal section resembles a shorter, stouter cone (Fig. 10-11). The angle formed above the point where the two sections meet should be kept somewhat angular; it is important to preserve the void in this area. Do not fill it in like a right triangle arrangement.

The L-pattern has asymmetrical balance (Fig. 10-12). Larger flowers with closer spacing at the base of the arrangement in the focal area will have enough visual weight to balance the smaller extended placements of the horizontal line. This horizontal line may go off to the right or to the left forming a backwards L. Complementary pairs of L-pattern arrangements may be used on a church altar or mantel.

The L-pattern is lighter and more stylized in appearance than its right triangle counterpart. The arrangement may be very thin and delicate or it may be more massive. The same flowers must be used throughout the design in a similar way for a unified effect. In other words, the horizontal and vertical parts of the arrangement should have about the same degree of delicacy or massiveness. If more than one kind of flower

is used, both kinds should be found in both parts, not segregated into just one area.

A low rectangular container is appropriate for an L-pattern arrangement. The foam may be anchored off-center allowing a portion of the container to show. The mechanics can be a four-pronged plastic anchor pin stuck to the bottom of the container with floral clay. Soaked foam may then be pressed onto the prongs. Although this is not quite as secure as using waterproof tape, it does eliminate the problem of attaching tape in places where it may be hard to conceal.

SUGGESTED ACTIVITY

L-Pattern Arrangement

Materials:

- low rectangular container
- four-pronged anchor pin
- floral clay
- huckleberry, myrtle or Scotch broom
- pompon mums
- annual statice

1. Fasten four-pronged anchor pin to the container with floral clay, positioning it slightly off to the left.
2. Cut and soak a piece of foam. Press it down over the anchor pin (Fig. 10-13).



Figure 10-13

3. Establish height with a piece of foliage that is two times the width of the container (Fig. 10-14). Place this toward the back left corner of the foam.

4. Establish the horizontal line of the L with a piece of foliage about one-third the length of the tallest piece (Fig. 10-14). Stand back and check to see whether the two pieces form a shape that is in good proportion with the container.

5. Establish depth and balance by bringing a short piece of foliage out toward you from the lower left corner of the foam.

6. Insert several pieces of foliage of different lengths down the vertical axis and along the horizontal axis to establish the framework of the arrangement (Fig. 10-15). These placements illustrate a good rule to follow in traditional arranging: repeat materials throughout all parts of a design, not segregating any material into just one area.



Figure 10-14



Figure 10-15

7. Establish height with a small mum placed so that it is a couple of inches below the tip of the tallest foliage piece. Establish width with a medium-sized mum that has a stem a few inches shorter than the horizontal foliage placement. Establish depth with a large mum at the lower left corner. (See Figure 10-16.)

8. Develop a rhythmic trunk line of mums from the tallest placement to the focal area (Fig. 10-17). Then develop a shorter horizontal trunk line from the farthest mum to the focal area.



Figure 10-16



Figure 10-17

9. Position additional mums at the focal area to develop good balance and depth (Fig. 10-18). These should smoothly blend the two major trunk lines into one total design. However, make sure you leave a distinct void in the angle formed by the two trunk lines, developing a clean L shape.



Figure 10-18



Figure 10-19

10. Fill in the arrangement lightly with foliage and statice to cover mechanics and to create additional depth (Fig. 10-19).

11. Check the arrangement.

- Does the overall shape of the arrangement resemble the letter L?
- Is there good transition between the two sections?
- Does the arrangement have good depth?
- Is the arrangement in good size proportion to the container? Is its position well balanced with respect to the container?

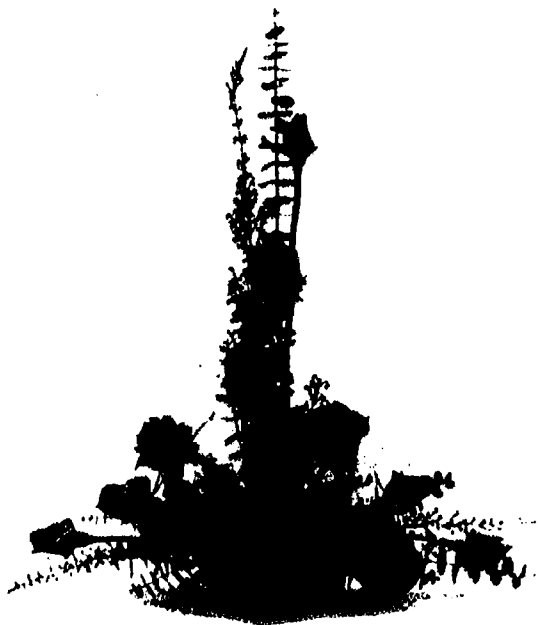


Figure 10-20 Inverted-T arrangement with roses, heather and eucalyptus

INVERTED-T

The inverted-T is a symmetrically balanced line-mass arrangement. It consists of a vertical axis arising from the middle of a horizontal axis. In construction it is very similar to the L-pattern except that it has a horizontal extension on both sides of the vertical axis. It looks like the letter T upside down.

The inverted-T arrangement (Fig. 10-20) is more stylized than a triangular mass arrangement and requires fewer flowers than a triangle of comparable size. This style can be adapted to a wide range of sizes. A low container with short sides will allow the horizontal placements to come straight out on each side.

Emphasis should be on straight angular placements rather than curves. Attention must be given to preserving the angular voids between the vertical and horizontal lines. It is important to tilt some flowers a little backward near the focal area to increase depth. However, if the focal area becomes too large or bulky, it can keep the eye from traveling freely throughout the T pattern.

SUGGESTED ACTIVITY

Inverted-T

Materials:

low O-cage
 small cylinder of foam
 eucalyptus, huckleberry or Scotch roses
 broom
 snapdragons



Figure 10-21

1. Place soaked foam in the O-cage (Fig. 10-21). There are cylinders of foam available that will just fit into the plastic O-cage, leaving a small shallow reservoir for water.

2. Establish the height, width and depth of the inverted-T pattern with foliage (Fig. 10-22). Develop the focal area so that it is a smooth blending of the three cones. Angle some foliage toward the back for depth. Maintain distinct angles and open voids between vertical and horizontal axes where they meet so that an upside-down T shape can be clearly distinguished.

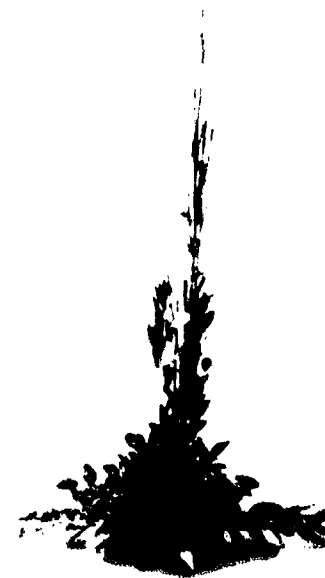


Figure 10-22

3. Establish the height, width and depth with snapdragons (Fig. 10-23). Gradually increase the thickness and depth of each cone-shaped segment as you get nearer to the focal area (where the vertical and horizontal lines intersect).

4. Fill toward the center of the arrangement with snapdragons (Fig. 10-24).

5. Repeat the inverted-T pattern with roses (Fig. 10-25). Use smaller flowers at the points and larger flowers near the focal area.

6. Check the arrangement.

- Does the overall shape of the arrangement resemble an inverted T?
- Is there good transition from one section to another?
- Does the arrangement have good depth?



Figure 10-23



Figure 10-24



Figure 10-25

DIAGONAL

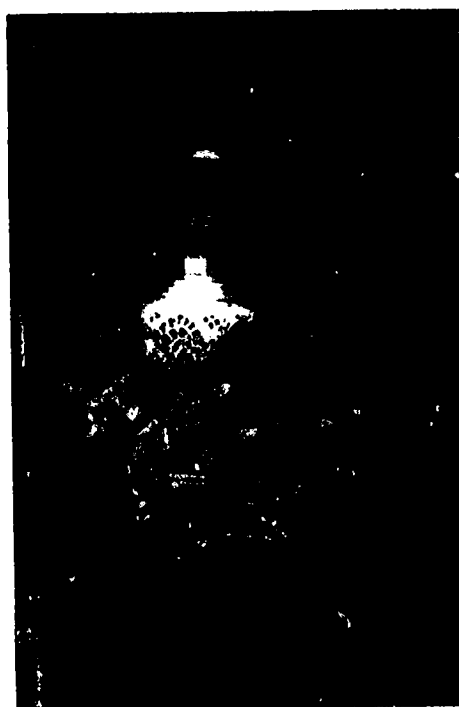
The diagonal line-mass arrangement is dynamic and interesting, but it is not frequently seen by itself. It is more commonly used in combination with a strong vertical line. When used this way the diagonal line forms a line of opposition across the vertical line. An example of this is a diagonal arrangement of flowers across a 9" X 2" candle in a pedestal candle holder.

SUGGESTED ACTIVITY

Diagonal Arrangement on a Candle

Materials:

9" x 2" candle	carnations
pedestal container	baby's breath
floral foam	#9 satin ribbon
waterproof tape	#28 wire
huckleberry or juniper	wooden picks
	(continued)



A diagonal line of bougainvillea extending from a brass mosque light



A diagonal line used in a modern stable featuring allium

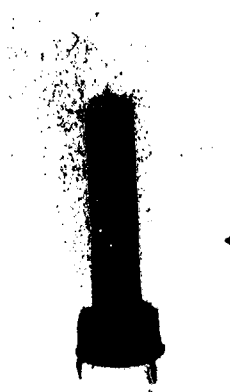


Figure 10-26

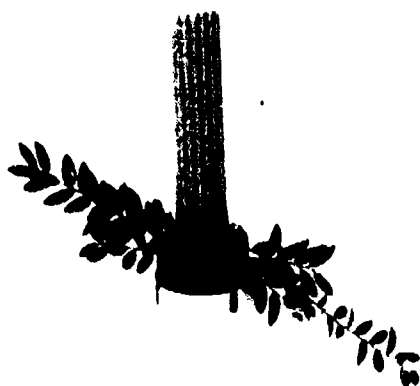


Figure 10-27

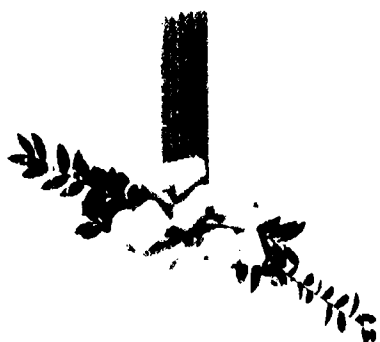


Figure 10-28

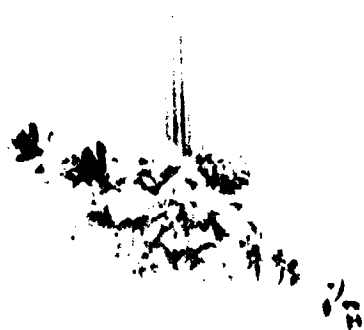


Figure 10-29

1. Attach foam to container with waterproof tape.

2. Attach four wooden picks to the bottom of the candle by overlapping them 1 1/2 inches around the outside of the base of the candle. Secure them with waterproof tape wrapped around the candle and the stakes.

3. Insert picks into the foam so that the base of the candle sits firmly on the foam (Fig. 10-26).

4. Establish a strong diagonal line of foliage cutting through the center of the foam (Fig. 10-27). The upper piece should be about 6 inches long and the lower piece about 3 inches long. Insert these near the back of the foam so that future placements will be in front of them.

5. Make a bow with 2 1/2-inch loops and streamers. Attach the bow to a wooden stake and insert it in the foam at the base of the candle (Fig. 10-28).

6. Place smaller carnations near the outer points of both upper and lower sections of the diagonal line. Place a third and larger carnation over the bow facing directly forward. The bow area will be the focal area of the finished arrangement.

7. Establish a trunk line of carnations from both points toward the focal area (Fig. 10-29). Spacing should become closer together near the focal area.

8. Fill in with baby's breath and foliage (Fig. 10-30). Bring these materials through loops of the ribbon and around the candle to conceal the foam. Avoid a heavy look around

the candle that will distract from the dynamic diagonal line.

9. Check the arrangement.

- Is the diagonal line clean-cut and obvious?
- Is the diagonal line of opposition well balanced and in good proportion to the candle and container?
- Are the stakes and tape at the base of the candle covered?
- Is the candle in good balance with the flowers, not buried in them?
- Is the bow worked into the design?
- Do the candles, flowers and ribbon coordinate with each other?

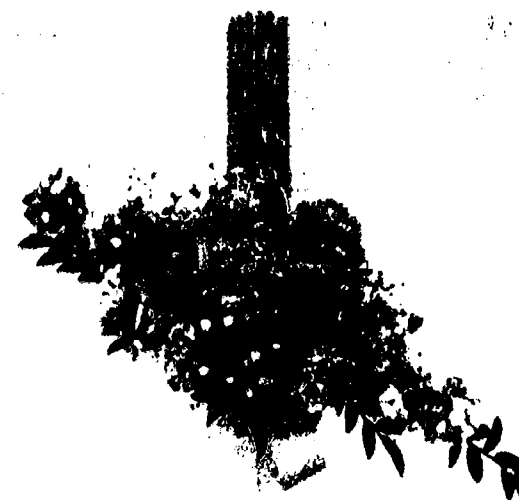


Figure 10-30

CURVED LINE VARIATIONS

SPIRAL ARRANGEMENTS

The spiral design shape is a simple line of flowers that curves downward and around like a drawn-out stripe on a barber's pole. With as few as five flowers the eye can be led along one spiral rotation around a central vertical axis. In a spiral arrangement the central column around which the flowers are placed is kept open and is therefore a void.

Flowers must be rhythmically placed with closer spacing of larger flowers at the base of the arrangement. The focal point is at the rim of the container where the largest flower should be faced directly forward. As the lower edge of the spiral begins to curve backward, the spacing of flowers should gradually increase and their size should gradually decrease.

Line material in spiral designs must be slender and must conform to the curvature of the spiral. Some branches curve naturally, while others (like eucalyptus and Scotch broom) can be made to curve by shaping them with your fingers (Fig. 10-31). Foliages and filler materials are used sparingly in spiral arrangements so that they do not detract from the slender curving line.

A simple spiral made with only five flowers is a good way to begin practicing curved line arrangements. Establishing a pleasantly curved trunk line is the first step in creating more complex curved line-mass arrangements like crescents and Hogarth

curves. The five-point spiral is also a good arrangement to demonstrate the ways of creating rhythmic visual flow in a design.

SUGGESTED ACTIVITY

Five-Point Spiral

Materials:

O-cage
floral foam cylinder
eucalyptus
5 daisy pompon mums
sheet moss
greening pins or #22 wire

1. Place foam cylinder into the plastic O-cage (Fig. 10-32).

2. Select a slender piece of eucalyptus about 10 inches long. Insert this piece into the foam toward the back in the "12-o'clock" position in the circle of foam (Fig. 10-33, #1).

3. Insert a very short curved piece of eucalyptus in the side of the foam at the "3-o'clock" position (Fig. 10-33, #2). Angle this curved piece toward the back. This piece and the taller placement establish the upper and lower extremities of the spiral.

Add two or three more pieces of eucalyptus between these two pieces to begin establishing a gently curving spiral (Fig. 10-34).

(continued)



Figure 10-31
Shaping Scotch broom into a flowing curve

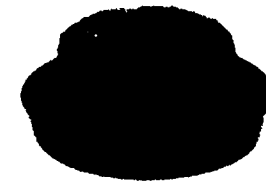


Figure 10-32

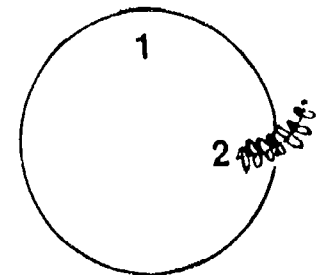


Figure 10-33



Figure 10-34

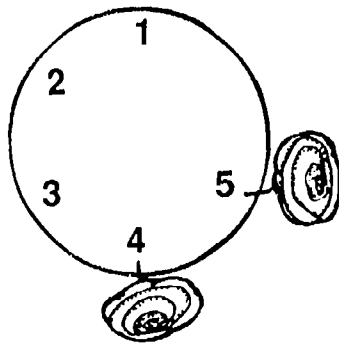
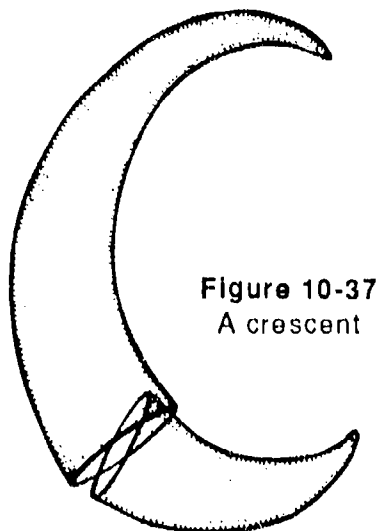


Figure 10-35



Figure 10-36

Figure 10-37
A crescent

4. Place the five chrysanthemums along the spiral line (Fig. 10-35). Use the smallest one at the top and work down to the larger ones at the base of the spiral. These placements should be positioned toward the edge of the foam at the positions of 12-, 10-, 8-, 6- and 4-o'clock. The central area is left open because the central axis around which the flowers are spiraling is a void. From the top to the base the flowers should gradually face more forward until the fourth flower faces directly toward you. The fifth flower should start to angle backward, following the lower piece of eucalyptus.

5. Use moist sheet moss to cover the foam. Either greening pins or 2-inch pieces of #22 wire bent into hairpin shapes can be used to anchor the moss to the foam. Moss is an alternative to short bushy pieces of foliage which might create a heavy look and overpower the beauty of the slender spiraling line. (See Figure 10-36.)

6. Check the arrangement.

- Do the flowers form a pleasantly curving line around an imaginary central axis?
- Is the arrangement free of all sharp angular sections to the curved line?
- Did you avoid having any materials appear to be shooting straight off from the basic line, forming distracting tangential lines?
- Is the base in good proportion to the rest of the arrangement, not appearing heavy and over-developed?

- Does the lower part of the arrangement lead the eye backward from the focal point along a line that appears to be a continuation of the upper part of the curve?

CRESCENT ARRANGEMENTS

A crescent arrangement is a curved line-mass arrangement which resembles the crescent moon in silhouette. From a design standpoint, the crescent resembles two animal horns fastened together base to base (Fig. 10-37). The upper part is twice as long as the lower part. The area where they meet is the focal area. Thus, two-thirds of the line is above the focal area and one-third below it.

The trunk line follows a circular or oval curve. If the upper and lower points of the trunk line were extended, they would meet. Neither the ends of the trunk line nor any sections of it should be straight. Straight sections would produce a rough feeling that could lead the eye along a disturbing tangential line away from the curve.

The horn analogy is useful because the arrangement also has mass, which gradually increases as you approach the focal area. Within this mass some of the flowers should face toward the back to keep the crescent from appearing flat.

The crescent should be built so that its curving line cuts diagonally across the foam. To achieve this, the taller placements of the upper curve will be in a back corner of the foam while the shorter placements of the

lower curve will arise from the opposite front corner. The entire block of foam will thus be used, and the arrangement is less likely to appear flat. The focal area should be cradled in the crescent directly over the center of the foam.

Both low and pedestal containers are suitable for crescent designs. The foam may be placed off-center if an oblong container is used. The foam should not be unnecessarily large or it may become too massive when it is greened in or covered with moss. Crescent arrangements may curve either to the right or to the left. Greater depth may be achieved if the design is slightly angled across the container when viewed from the front, so that one looks *into* the crescent instead of just at its side silhouette.



A crescent design of roses and eucalyptus

388

SUGGESTED ACTIVITY

Crescent Design

Materials:

low oblong container
four-pronged anchor pin
floral clay
floral foam
eucalyptus or Scotch broom
carnations or pompon mums
annual statice
huckleberry

1. Fasten the anchor pin left of center with floral clay. Place a medium-sized piece of foam over the anchor pin (Fig. 10-38).
2. Select a slender piece of eucalyptus about 12 inches long (Fig. 10-39). Work it between your fingers to produce a gentle curve. Insert it in the back left-hand corner of the foam so that even though the center part of the stem arches out away from the arrangement, its tip comes back in directly over the center of the foam. The curved portion of the stem should also be angled slightly toward the back, not straight out to the side, in order to begin building a crescent line that will cut diagonally across the foam.
3. Select another piece of eucalyptus and cut it to a length of about 5 inches. Shape into a curve and insert it at the front right corner of the foam (Fig. 10-39). This piece should be angled slightly forward. Its curvature should match that of the upper piece so that if both pieces were extended from the tips, they would meet.

These are the two most important placements because they establish the major line

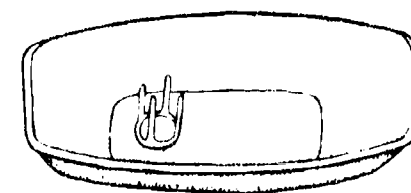


Figure 10-38 Anchor pin in container

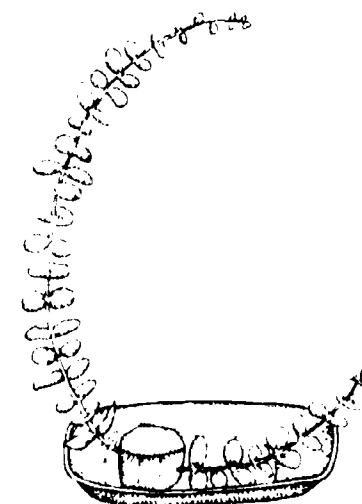


Figure 10-39 First two placements of eucalyptus establish the trunk line



A crescent design of Scotch broom and pompon mums

389



Figure 10-40



Figure 10-42

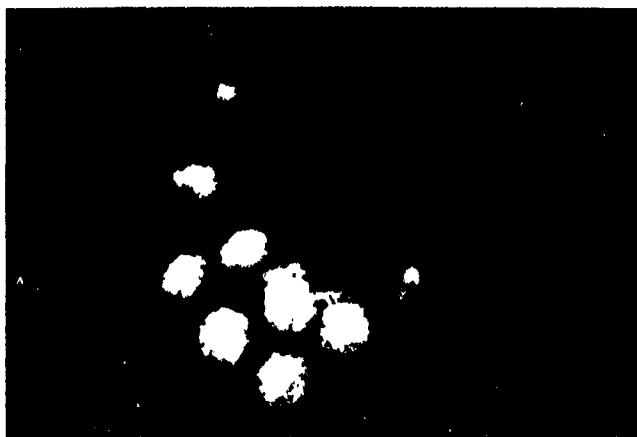


Figure 10-43

of the arrangement. Stand back and see if you have established a curve that resembles the crescent moon.

4. Add a few more pieces of Scotch broom between the first placements to further establish the crescent line (Fig. 10-40). These placements should come diagonally across the foam (Fig. 10-41).

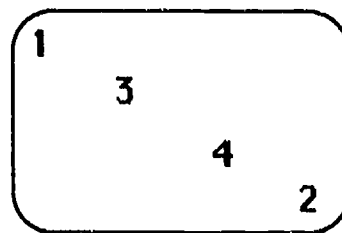


Figure 10-41

5. Establish a trunk line down the upper part of the crescent by starting with the smaller flowers and gradually increasing size and decreasing spacing as you come down the line to the focal area (Fig. 10-42). Face some flowers toward the back on both the inside and outside edges of the crescent to lead the eye around a three-dimensional horn shape. If all the flowers are in the same plane, the crescent will lack depth and appear flat.

Straight stems can be overcome by inserting a #20 wire up into the flower head and then spiraling it down the stem. This will allow you to bend the stem into a curve that will stay that way. No taping of the stems is necessary as the green wire is fairly inconspicuous.

6. Establish a trunk line from the lower point in toward the focal area. Blend the two

trunk lines together. The largest flowers should be placed where the two trunk lines meet right over the center of the foam in the focal area. The finished design should lead the eye into the arrangement, then up, over and back to the focal area.

7. Fill in the arrangement lightly with static (and huckleberry, if needed) (Fig. 10-43). Use these placements to smooth out the curve, develop depth, and cover the foam.

8. Check the arrangement.

- Is the eye led along a curved line that resembles a crescent moon?
- Did you avoid any obvious straight lines of material, either on the inside or the outside of the crescent?
- Are the line and focal area well developed so that the eye is led over and back to this area?
- Is the focal area "right" for the arrangement (not too heavy)?
- Has depth been developed so that the crescent does not appear flat?
- Does the main trunk line come diagonally across the foam so that the arrangement appears set well in the container?

HOGARTH CURVE ARRANGEMENTS

The Hogarth curve is a curved line-mass arrangement that resembles the letter S. It is quite similar to a crescent except that the lower trunk line is curved forward and down. Two-thirds of the total length of a Hogarth curve is above the focal area and one-third is below (Fig. 10-44).

A tall container is necessary for a Hogarth curve arrangement since the lower part of the design must be curved down. Containers with pedestals, cherub vases, cylindrical containers, and tall oval vases are all good choices if they have enough room to hold a piece of foam large enough for the many placements that are necessary.

Curved flowering shrub branches like forsythia and cherry are nice for establishing the line. Eucalyptus and Scotch broom work well and are available to the florist year-round. Taller flowers may require a wire so that they can be bent to conform to the required curves.

The Hogarth curve can be used by itself as an elegant design style or in combination with a vertical line to form a line of opposition. For example, a Hogarth curve could be substituted for the diagonal line used in combination with a 9" x 2" candle in a previous exercise (Fig. 10-45). The Hogarth curve may also be found as a visual pattern within a larger mass arrangement. For example, you might create an S-curve of yellow roses within a larger oval mass design of mixed flowers.

SUGGESTED ACTIVITY

Hogarth Curve Design

Materials:

tall pedestal container or
cherub vase
floral foam
waterproof tape
eucalyptus
roses
annual statice
pittosporum

1. Place foam in the container and tape with waterproof tape.

2. Select a piece of eucalyptus that is two times the height of the container. Cut off any side shoots. Work the piece between your fingers, especially at the lower end, so that a gentle curvature is evident. Place it in the back left corner of the foam so that the tip is directly over the center of the foam (Fig. 10-46).

If the thin stem of this tall foliage piece does not hold the branch securely in position, it can be more firmly anchored in the foam by using waterproof tape to attach two wooden stakes about 3 inches long to the bottom of the stem. Insert these stakes into the foam. Other flower or foliage stems may be substituted for the wooden stakes if they are not available.

3. Select a second piece of eucalyptus a little less than half the length of the first. Work a curve into the piece, insert it in the front right corner of the foam so it comes forward and down (Fig. 10-46). This lower



Figure 10-44
Hogarth curve

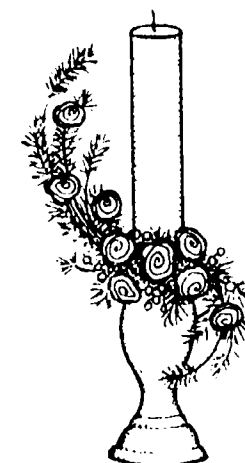


Figure 10-45

Hogarth curve of
eucalyptus and
daisy mums in a
design compote



Figure 10-46



Figure 10-47



Figure 10-48

foliage piece should curve enough to bring the tip in below the center of the foam, in line with the center of the foam and with the upper tip when looking at the arrangement from the front.

4. Add several other curved pieces of eucalyptus to establish the S line (Fig. 10-47). The line should swing diagonally across the piece of foam to ensure that the arrangement has depth and is well situated on the container.

5. Establish the upper trunk line with roses (Fig. 10-48) in the same way as with the upper part of the crescent.

6. Establish the lower portion of the trunk line, starting out near the tip and working back to the focal area (Fig. 10-48). The focal area should be over the center of the foam. It should have good depth without being unnecessarily heavy in appearance.

Remember to increase flower size and decrease spacing near the focal area. Also turn some flowers to the side and back on both edges of the curve to give the design shape a three-dimensional mass instead of a flat appearance.

7. Add statice and pittosporum to increase depth, smooth out the curve, and cover the foam (Fig. 10-49). Make sure you have concealed the waterproof tape used to attach foam to the container.

8. Check the arrangement.

- Does the major trunk line resemble the letter S?

- Is the arrangement free of any straight lines of material that distract from the flowing curve?

- Is there smooth transition between the upper and lower parts of the arrangement?

- Does the eye travel freely along the length of the curve, not stopped by an overly heavy focal area?

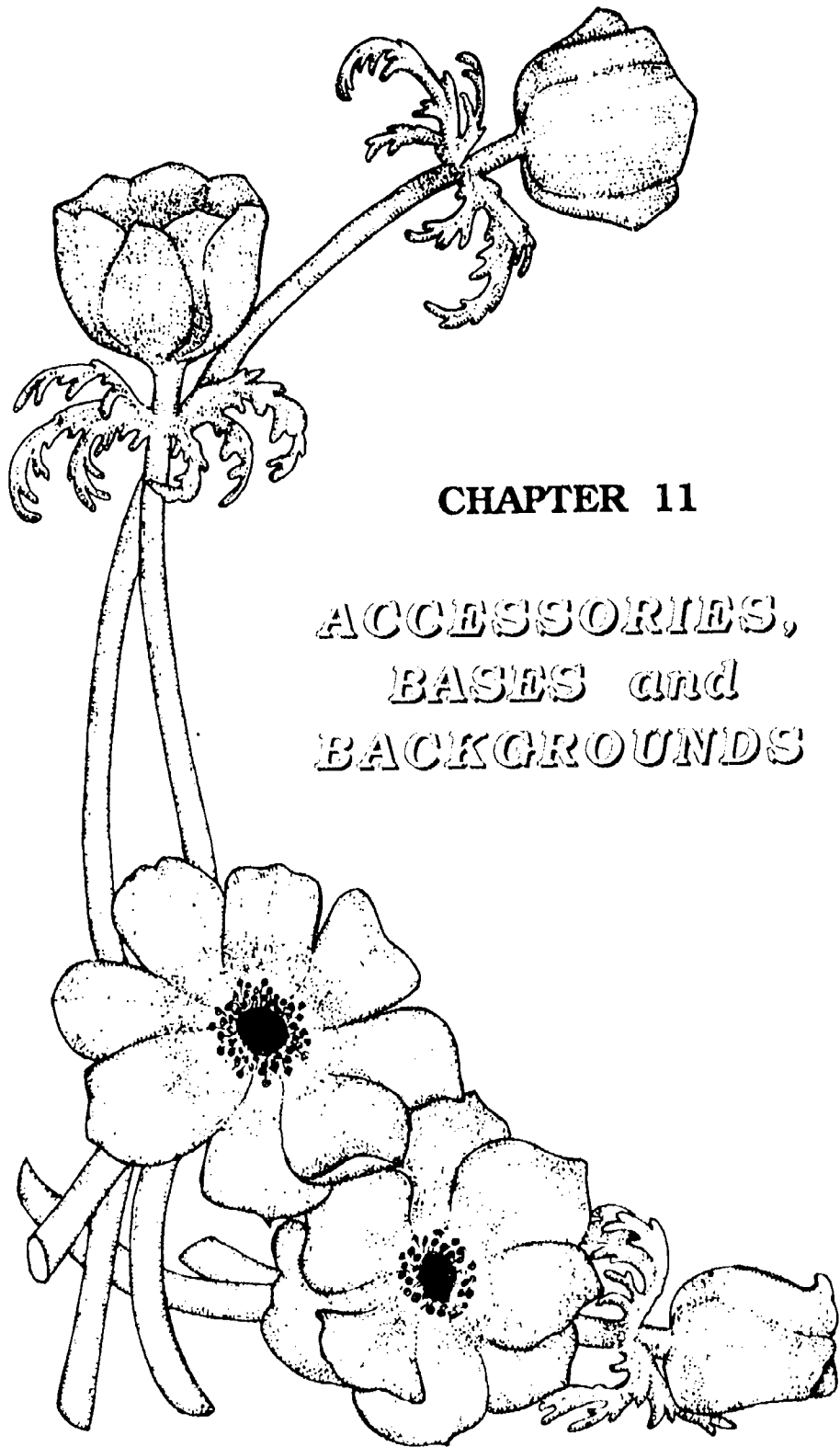
- Is the design well balanced, with upper and lower points in line with the focal area?

- Is there good depth rather than a flat look?

- Does the arrangement have an elegant appearance?



Figure 10-49



CHAPTER 11

ACCESSORIES,
BASES and
BACKGROUNDS

376



BEST COPY AVAILABLE

377

Flower Arrangements in Unusual Containers



By the sea
Lilies and maiden
grass in a seashell
with seagull
figurines



A touch of country
Geraniums, dusty
miller and snake plant
in a coffee grinder



Holland revisited
Tulips and
alstroemeria in a
pair of wooden
shoes

The character of an arrangement can be developed and often made more interesting by incorporating an accessory like a figurine, bow, candle or piece of driftwood into the design. Selecting from a vast choice of accessories, the floral designer is able to set a theme, create a mood, or suggest a holiday. The accessory may be a large dominant feature around which the arrangement is built, or it may be a subtle addition to the design. Examples of the latter might be a bow at the handle of a basket or artificial fruit clusters worked through the arrangement as additional placements.

Arrangements are sometimes set on bases. Oriental arrangements are often displayed on black lacquered bases. Wicker mats, wood or styrofoam, used as bases for a traditional design, also serve to anchor the container and accessories. The base may give stability to an arrangement and tie together the various units of a multi-parted arrangement.

The background against which an arrangement is seen is an important factor in the total impact of the arrangement on the viewer. A certain floral arrangement may have detail and beauty that can be appreciated when placed against a plain bone-colored wall. But the same arrangement may appear busy and unappealing in front of a heavily patterned wallpaper. If an arrangement is being made for a display, such as a shop window or flower show, the designer can select a background which shows the arrangement to its best advantage. In other cases where the background has been established first, the arrangement should be made with this in mind so that the design chosen will suit the background.

Accessories, bases and backgrounds should harmonize with the flowers, foliage and container in color, texture, size and degree of formality. A total impression should be created that can be visually communicated to anyone who views the arrangement. For example, an elegant formal feeling will be conveyed by a classical bronze statue, marble vase, and velvet background, while a cheerful, informal mood is created by a wicker picnic basket, loaf of French bread, and gingham table cloth.

The accessories, base and background should not overpower the rest of the arrangement in size. Neither should any one of the three be so small that they appear weak and insignificant. The use of small animal figurines dwarfed by large arrangements creates an unnatural picture because the proportions are so unbelievable.

A good test of the successful use of an accessory, base or background is to visualize the arrangement with that unit removed. If the arrangement appears lacking, that particular unit is probably an important part of the design. If the arrangement looks as good without it, or if a better alternative comes to mind, a change should be made.

ACCESSORIES

FIGURINES

A figurine is a molded or carved likeness of a person, bird or animal. Sometimes a figurine is merely placed next to an arrangement to complement the color and style of the design or to create a certain mood. Oriental, religious, brass, and fine porcelain

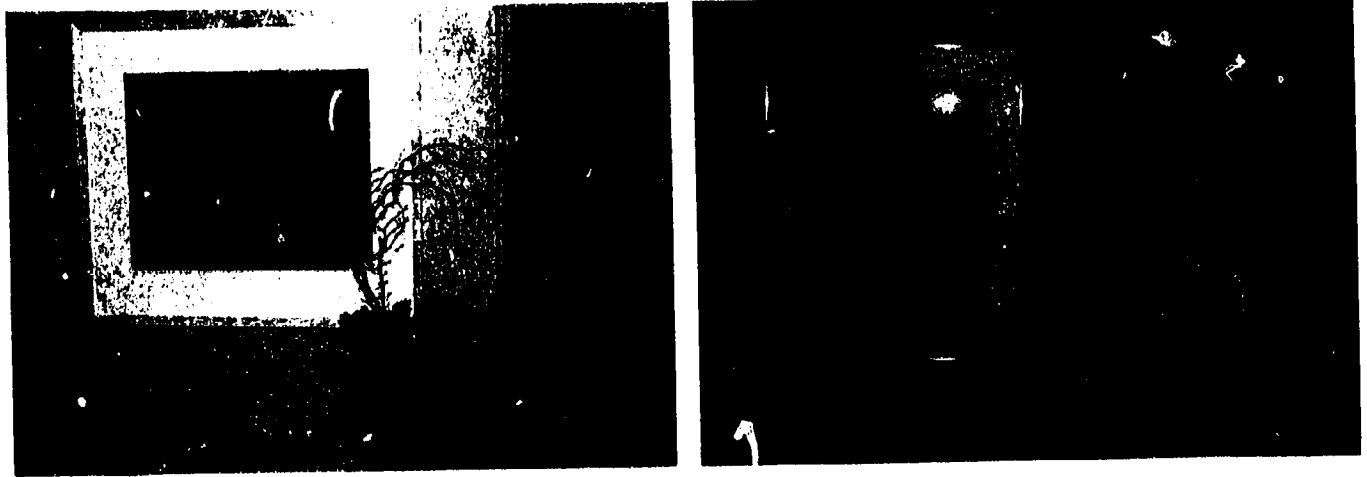
figures are often used this way. It is usually more successful to create the arrangement with the figurine in mind so that its overall size and style will appropriately feature the figure.

The base of a figurine is usually placed near the focal area of the design. The lines of the design should repeat any dominant lines of the figurine. A tall slender figurine could be complemented by a narrow vertical arrangement. A cherub figure posed in an S-shaped position could be enhanced by a Hogarth curve with the same degree of curvature.

Some figurines suggest motion. A running figure or a windswept girl holding on to her hat can be complemented by an arrangement which develops visual motion in the same direction. Possibilities include a creative crescent with sweeping lines or a dynamic diagonal line.

The arrangement must not overpower the figure by appearing to bury it. This can happen if the lines of the arrangement are too heavy or the figure appears crowded. If the figure appears to be getting buried, move it out slightly from the arrangement. Turn it to show its most interesting side so that its lines and the lines of the arrangement effectively complement each other.

In traditional arranging, religious figurines such as Madonnas are given special prominence (Fig. 11-1). Be careful never to rest flowers or foliage on the head. Also do not let any part of the design appear to crowd the figurine.



Art in the Garden Arrangements that complement an art piece
Garden Center of Greater Cleveland

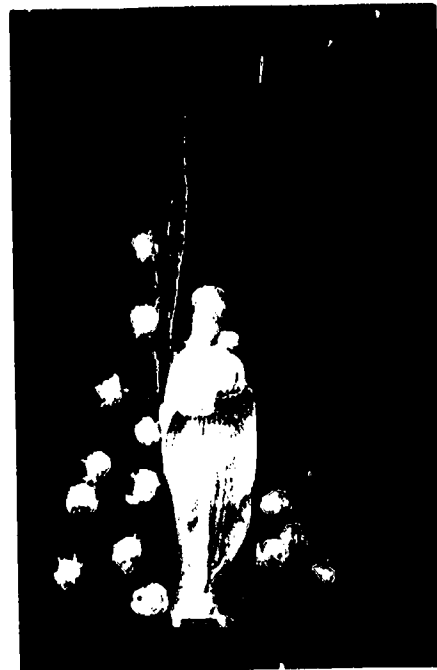


Figure 11-1 Madonna is prominent in an arrangement



An arrangement of magnolia around figure of a girl gathering flowers



Young horsechestnut leaves arranged sparingly around head of a horse

350

351

Holding a Figurine in Place

Figure 11-2
With wooden stakes

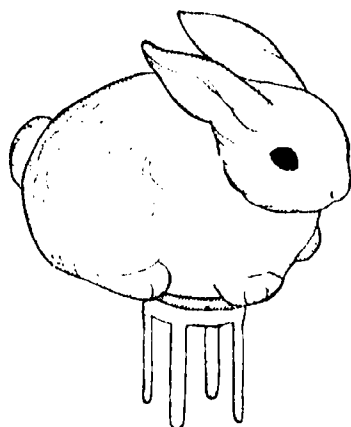
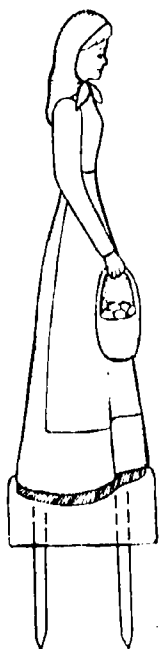


Figure 11-3 With four-pronged plastic anchor pins

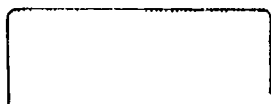


Figure 11-4 Ribbon loop attached to wooden stake



Figure 11-5 Wooden stakes attached to candle

ATTACHING ACCESSORIES

Figurines can be attached directly to a base or the bottom of a container with floral clay, floral adhesive or hot glue. Mechanics for the arrangement (usually a small container holding floral foam) can be attached to a base in the same way or wired on with chenille stems if the base is wicker or bamboo.

The mechanics for attaching figurines to floral foam involve first attaching a piece of styrofoam to the bottom of the figurine with floral clay, adhesive or hot glue. Insert wooden stakes into the bottom of the styrofoam, leaving two or three inches of the stake extending out from the bottom. Then push the figurine with its attached styrofoam and extended stakes down into the floral foam (Fig. 11-2). The height of the styrofoam can be adjusted to raise the figurine to whatever position is desired. The styrofoam will also protect the figurine from moisture that is in the floral foam. Four-pronged plastic anchor pins can be used for smaller figurines (Fig. 11-3). Attach them with floral clay and push the prongs into the foam.

Accessories that are intended to be used throughout an arrangement (like hearts, clusters of artificial candy or fruit, or shiny Christmas balls) may come on wire picks that can be inserted directly into floral foam or styrofoam. Often these accessories will need to be wired to wooden stakes or heavy wire to extend their length for some of the placements. Floratape can be used to cover the wire. Or the wire can be replaced with waterproof tape to attach the picks to wooden stakes.

Ribbon, ribbon loops (Fig. 11-4), and net tufts are usually secured by a wire. This wire can be inserted directly into floral foam or attached to a heavier wire or wooden stake if more strength and length are needed. When ribbon is used on a basket handle, it can be wired directly to the handle.

Driftwood requires more sturdy anchoring because of its weight. Heavier pieces need to be secured to bases large enough or heavy enough to support them by means of screws or dowel rods. Lighter branches may be inserted directly into floral foam. If added support is needed, use styrofoam in the bottom of the container and place soaked foam on top. Use waterproof tape to fasten two wooden stakes to the base of the branch. Then insert the branch down through the soaked foam until it is firmly anchored in the styrofoam.

Plastic candle holders with winged points are available for holding candles in floral foam. If these cannot be obtained, attach wooden stakes to the candle base with waterproof tape (Fig. 11-5). The stakes are necessary to anchor any tall candle firmly in foam. Even a regular 12-inch dinner taper should not be inserted directly into floral foam, since even slight movements will enlarge its hole, causing the candle to tip.

Two wooden stakes are sufficient for regular dinner tapers; for larger diameter candles, attach three or more wooden stakes with waterproof tape. Grooves can be cut with a knife in the candle base for the stakes to fit into. Both stakes and waterproof tape should not extend up the candle more than an inch. If they do, they will be difficult to conceal, and the candle will end up buried in

floral material. Push stakes down into the floral foam until the candle base rests firmly on the foam.

Votive lights containing candles can be attached in the same way as porcelain figurines. Stick a circular piece of styrofoam to the base of the votive with floral clay (Fig. 11-6). Insert wooden stakes in the styrofoam and push the whole unit into the floral foam. The candle can be raised higher by lengthening the stakes.

Plastic or glass rods are available to extend votives above the flowers in an arrangement. Bases made especially for these rods are glued to the bottom of the container for support. When using new votive cups, it is a good idea to spray the inside with a non-stick vegetable oil. This will keep candle wax from sticking to the glass, making removal of spent candles easier.

USING CANDLES IN ARRANGEMENTS

Candles add color and interest to a design even when they are not lighted. When lighted, they give a special charm and dimension to the design by creating shadows.

Candles must be in good proportion to the overall size of the arrangement. Both height and diameter of the candle should be great enough that it does not appear to be overpowered or buried by the flowers and foliage. While a single 9-inch taper may be appropriate for a small centerpiece, two or more candles would be better for a larger floral piece. When more than one candle is used, consider placing them at different heights for more interest. An alternative to

Using a Large Candle in a Centerpiece

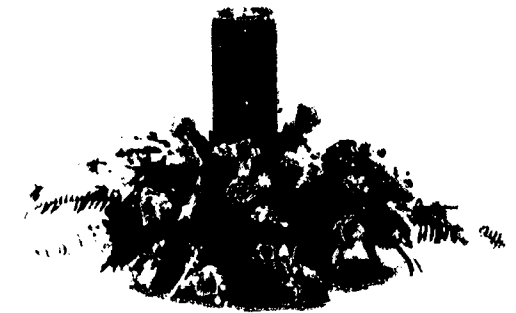
Wooden stakes are placed in grooves that have been carved at the base of the candles. They are held in place with waterproof tape.



The stakes are inserted into the floral foam until the bottom of the candle rests on the floral foam.



The diamond shape is created with greens



The centerpiece is completed with roses and alstroemeria placed around the candle

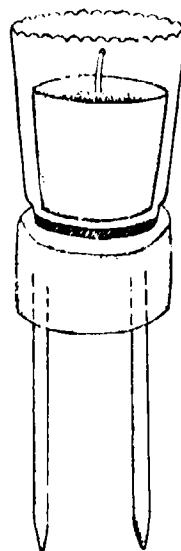
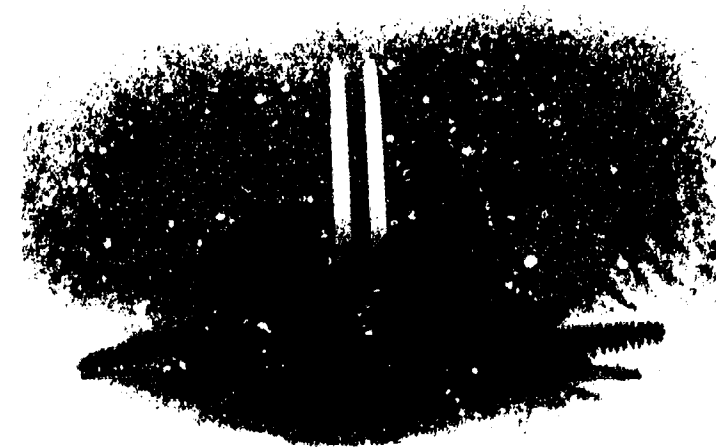
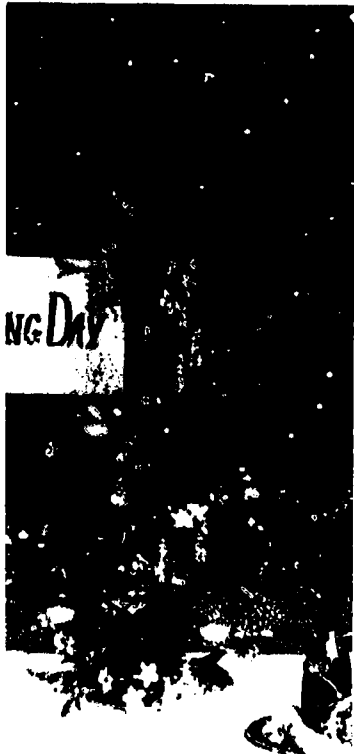


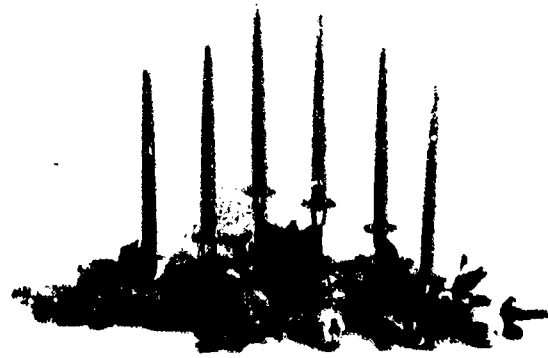
Figure 11-6
Staking a
votive light



A Christmas centerpiece with two candles



A centerpiece of greens and artificial fruit arranged around a brass candelabra

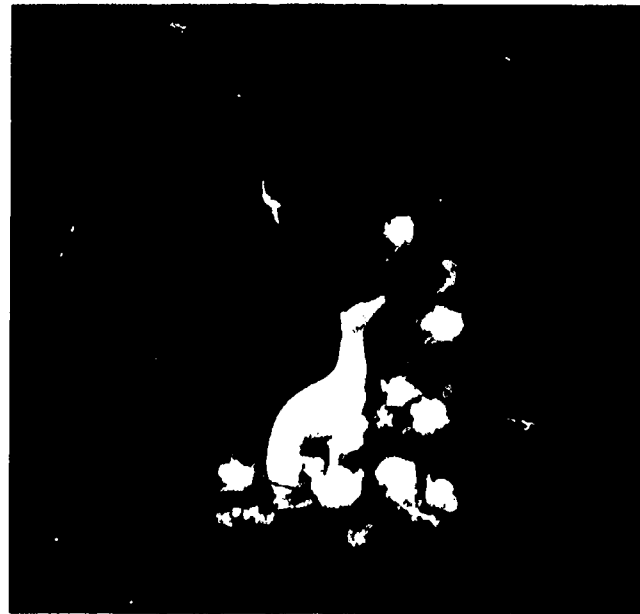


Centerpiece with picked accessories built around one large candle

Arrangement using Lomey container with plastic rods and votive lights



Candle arrangement with floral tapers and votive lights at its base; set on a mirror



Crescent arrangement featuring a figurine; placed on a black rectangular base

several narrow candles is to use a single larger one that is taller and larger in diameter.

For a special effect, very long, narrow floral tapers can be inserted at different angles in the foam. Because of their small diameter, these tapers burn completely and will not drip even if tilted. Wooden stakes taped to their bases make them more secure in the foam. Votive lights can be extended above the arrangement on rods and also scattered around it on the table top for a larger, more lavish effect. Adding mirrors or accessories that sparkle with reflected light creates a very festive mood. Always arrange the candles so that their flames do not endanger people, curtains or other furnishings, as well as the plant materials and accessories in the arrangement itself.

When candle holders or candelabras are used, the candles sometimes fit too loosely in the holders. Make them secure and straight by wrapping the candle base with floratape or waterproof tape. If neither is available, take the cellophane covering that new candles are usually wrapped in and twist it around the candle base so the candle will fit securely in the holder.

BASES

Sometimes arrangements are displayed on a special platform called a base. There is great variation among purchased or home-made bases. They can be many different shapes, colors, sizes, and textures. They can be constructed from many different materials. Whatever base is chosen, it should be harmonious with the overall theme or mood

of the arrangement. It should not be so large or heavy in appearance that it overpowers the flowers and foliage.

Bases may be round, rectangular, oval, triangular or free form. They may be raised on legs or stacked off-center. Bases are commercially available in various Oriental styles, usually painted black, as well as mirrored contemporary types or natural tree trunk cross sections. Any shape can be cut from styrofoam or plywood. It can be covered with moss or painted in any color that is desired. Creative bases have been fashioned from bamboo, cinnamon sticks, and dried shelf fungi.

Arrangements are often placed off-center on bases. The exposed base on one side may be an important element in the overall balance of the design. The base may be turned at an angle to create a different and perhaps more interesting effect.

Bases are often neutral colors like black, gray and brown. These colors do not compete with flower colors. Silver may be used for a hi-tech look. Other colors are possibilities if they coordinate with the arrangement and provide visual stability to the design.

BACKGROUNDS

Possible backgrounds for an arrangement include the wall behind a design, fabric hung behind a design in a display, the table covering under a centerpiece, or the clothing that a corsage is worn against. These backgrounds can vary in color, texture and pattern. The arrangement should harmonize

with the background or provide a pleasing contrast to it.

If the background is patterned, the arrangement should have bold outlines; also one of the background colors should be very dominant in the design. Backgrounds and arrangements coordinate best when they create the same mood or express the same degree of formality. Velvet and satin are formal; burlap and gingham are informal. A brightly colored serape would make a suitable background for a Mexican design. Soft chiffon would harmonize better with a spring arrangement and a woolen blanket with an arrangement in a football motif.

Mirrored backgrounds can add depth to a design and multiply the impact of the flowers. It is especially important for arrangements placed in front of mirrors to have the back well finished off with some flowers placed there to reflect in the mirror.

SUGGESTED ACTIVITIES

1. Choose a figurine 6 or more inches in height. Anchor the figurine to a base or directly to foam in a container. (See page 180 for the mechanics for anchoring figurines in foam.) Study the shape and feeling of the figurine and then create an arrangement that will feature the figurine.

Suggested figurines:

- | | |
|---------------------|--------------------|
| A. Madonna | D. rabbit |
| B. classical statue | E. clown |
| C. duck | F. Oriental figure |

(continued)



Mexican theme Bold forms of driftwood, snake plant and birds of paradise against a serape background



A cascading Oriental design displayed on a base



Use of a figurine



Figure 11-7 Use of a stuffed animal

Figure 11-8
Arrangement on a base*Indian theme* Large hibiscus in a brass container against a patterned background

An arrangement that blends in with its busy background

2. Use a stuffed animal (like a teddy bear) as a featured accessory in an arrangement (Fig. 11-7). Treat it just as you would a figurine. The stuffed animal may be wired to wooden stakes for support. Use styrofoam under it so that it will not rest on wet foam.

If the arms and legs of the stuffed animal are flexible, position them creatively to suggest animation, and try to complement these lines in your arrangement. Cover wire and other mechanics with flowers and foliage but don't let them crowd or bury the stuffed animal.

3. Make an arrangement that features ribbon. Use a bow near the focal area or on the handle of the basket in which the arrangement has been made. Make individual ribbon loops and use them as you would a filler flower throughout the arrangement.

4. Make an arrangement on a base (Fig. 11-8). The arrangement should be compatible in feeling with the base, and in good size relationship to it. Decide whether to center the arrangement on the base or perhaps to achieve an effect more creative and effective off-center. Try turning the base at different angles until you are most satisfied.

Some of the following bases you may have available or may wish to make:

- A. black Oriental base
- B. bamboo mat
- C. wicker mat
- D. wood slab, cross section
- E. styrofoam, cut and painted
- F. weathered barn siding

5. Make an arrangement featuring drift-wood (Fig. 11-9). Anchor an interesting piece of wood on a base or in a container of foam. (See page 180 for suggestions for securing the wood more firmly.) Repeat the lines of the wood in your design. The heavier the appearance of the wood, the larger your design must be.

6. Make an arrangement that suggests a holiday or special occasion by using accessories to accent the design. Fasten accessories on wires or wooden picks to extend them to the lengths you need.

Possible accessories include:

- A. candy canes (Christmas)
- B. noise makers (New Year's)
- C. hearts (Valentine's Day)
- D. shamrocks (St. Patrick's Day)
- E. baby chicks (Easter)
- F. pencils (Secretary's Day)
- G. stars (Fourth of July)

7. Make several arrangements featuring candles. One can be a small diamond centerpiece with one 12-inch taper (Fig. 11-10). Then make a larger centerpiece with three 12-inch tapers. Position the candles at different heights for interest.

In another design use a large candle, 2 or 3 inches in diameter, and construct a circular arrangement around the base to create a candle ring effect. Or try working with the candle on a pedestal container. Either a diagonal or an S-curve line of opposition is a possible design choice for this arrangement. Accent the design with a bow if you wish.

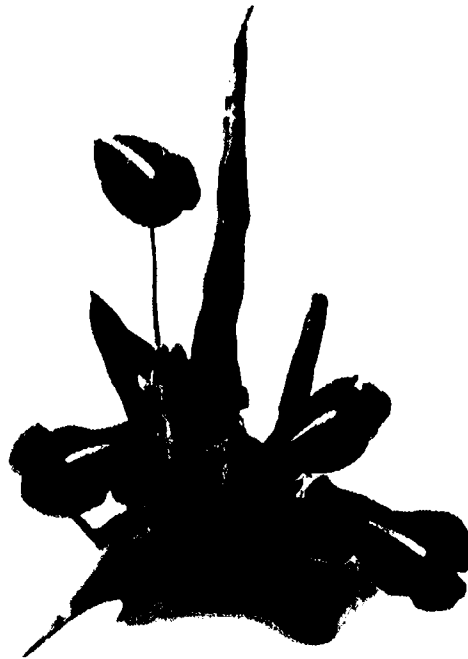


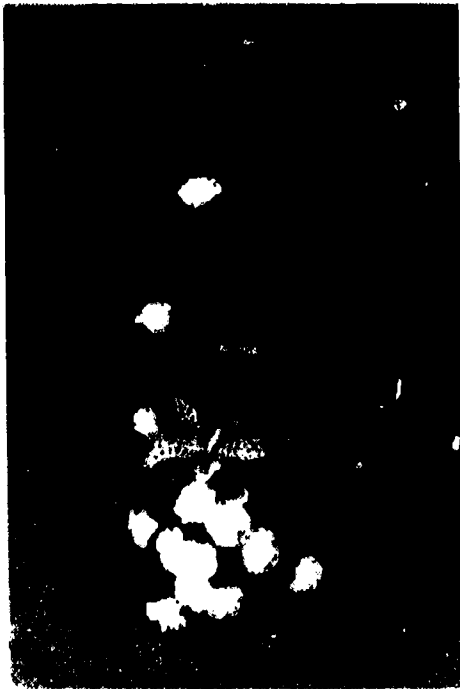
Figure 11-9



Figure 11-10



An arrangement featuring ribbon



Arrangement with "picked"
accessory

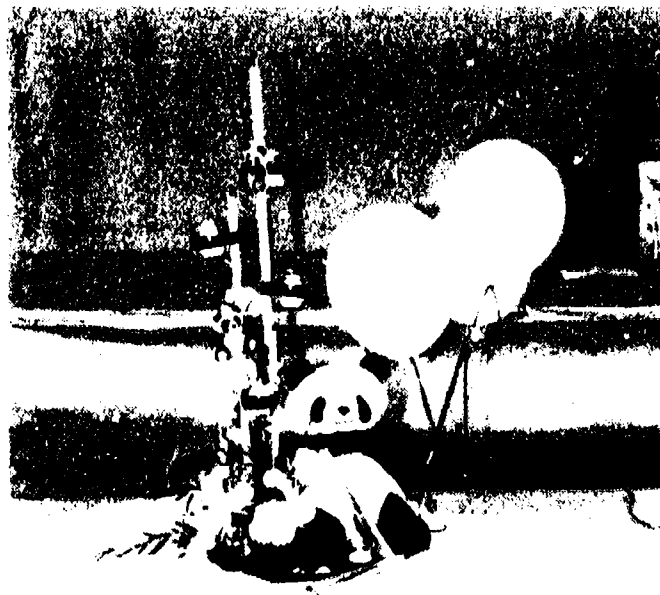


Figure 11-11 Using votive lights
with an arrangement

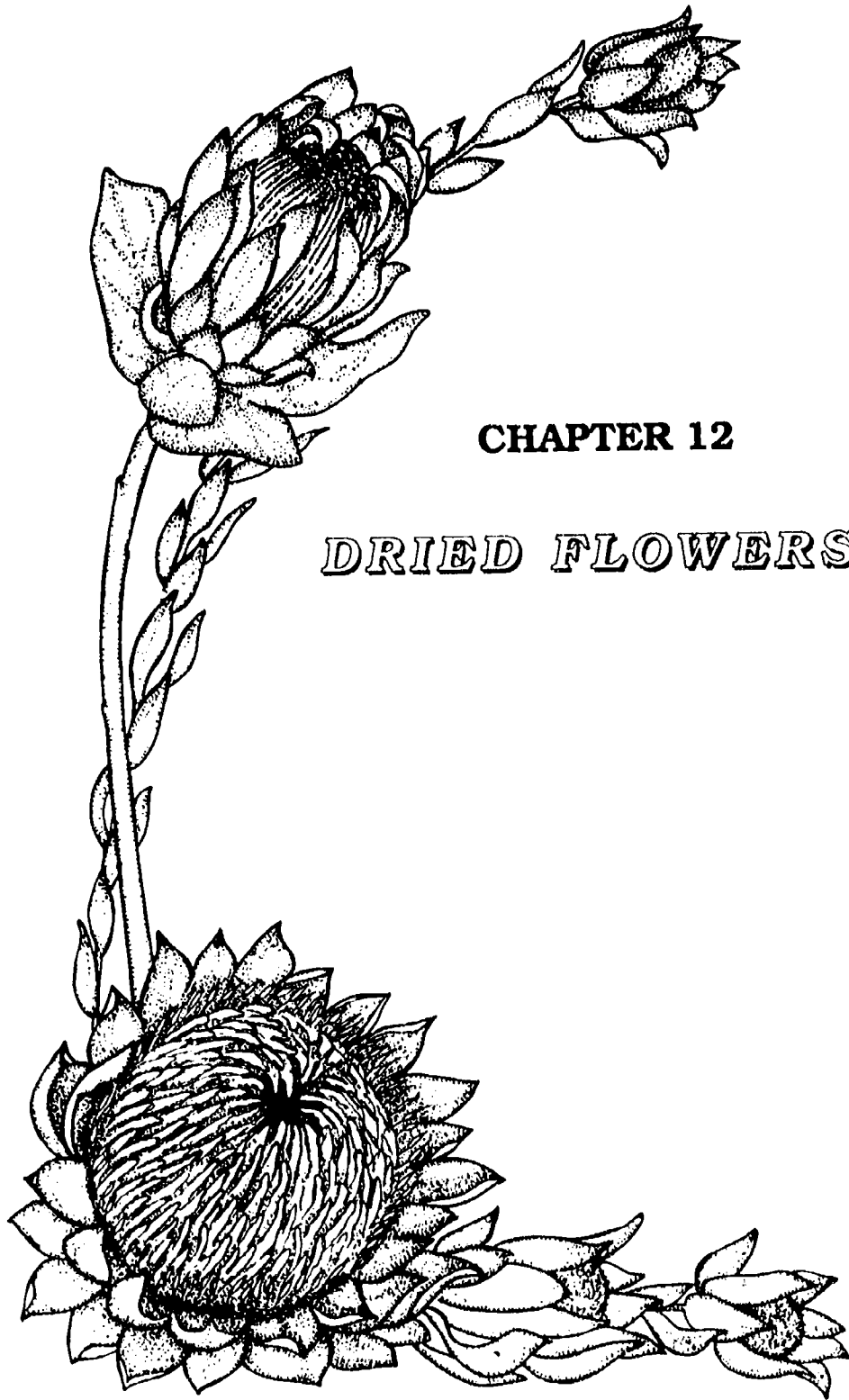


Designing against a challenging
background

Each student can make all these arrangements, or the different designs can be assigned so that each student will make only one. In either case, evaluate the designs upon their completion, paying special attention to the number and size of candles in relationship to the shape and size of the design.

8. Create an arrangement suitable for a festive buffet table and incorporate votive lights into the design (Fig. 11-11). Try raising some up at different heights within the arrangement. If you have Lomey extenders, this will be much easier. Scatter three or more votives around the base of the arrangement to extend the boundaries of the design.

9. Design an arrangement to be shown off against a specific background that you have chosen. Identify the theme or mood that you intend to develop. See if other viewers get the same feeling you have tried to create. If they do, you have been successful.



CHAPTER 12

DRIED FLOWERS



Dried Arrangements



Lavish Victorian wreath of dried materials



Vertical line of allium seed heads accented with the motion of curved day lily stems and a dried banana leaf

Beautiful long-lasting arrangements can be created from dried plant materials. Interest in dried flowers usually peaks during autumn and continues into the winter months. A vast array of dried flowers, foliages and pods is available commercially to satisfy every decorating need. Many are imported from various parts of the United States and from countries around the world. Some materials are natural, while others have been contorted, contrived and colored or glittered to give special effects.

Some materials, like ripened pods and cones, are naturally rigid and mostly free of moisture. They require merely gathering and storing until they are used. Other materials must be gathered at specific stages of development and require special treatment to produce satisfying results. The following sections will outline various methods for preserving plant material. If possible, try each of them. By experience you will better understand the techniques and you will accumulate a nice collection of dried materials. These can eventually be made into arrangements and floral pictures.

PRESSING

Sometimes when leafing through a book one finds flowers pressed between the pages where someone has tried to preserve the memory of a special event, person or place. To commemorate a wedding, flowers from the bouquet can be pressed, arranged around the wedding invitation, and then framed. A floral picture made from small pressed wildflowers seen on a vacation makes a pleasant remembrance of that experience. And of course those rare and

lucky four-leaf clovers need to be pressed as keepsakes.

In addition to their sentimental value, floral pictures make beautiful accents to the interior decoration of almost any style house. The interesting shapes and subtle colors of the plant material can be combined into designs that reflect either historic, traditional or contemporary design styles.

Pressed flowers have also been used to decorate stationery, placemats and lamp shades. These gifts show a very personal touch that is appreciated by those fortunate enough to receive them.

SELECTING FLOWERS FOR PRESSING

Flowers that press best are those that can be easily flattened and that do not have a great deal of bulk. They should not have thick, fleshy areas where the petals are attached, like a daffodil with its knobby ovary. Sometimes, however, good results can be obtained by cutting the entire flower in half right through the trumpet and ovary. It is best if the silhouette of the flower remains interesting when the flower is flattened. Flowers that contain considerable water in their petals often give disappointing results. Examples are the easily obtainable impatiens and wax begonia. Very bright or very dark colors may come out faded or almost black, and some white petals turn brown. An ideal flower for pressing is pansies, which are naturally thin and flat, with an interesting shape and markings.

Pieces of stems and leaves should also be pressed for use with the flowers. These must

be in good size relationship to the flowers. Thick woody stems are not desirable since they will prevent the uniform application of pressure on adjoining leaves during the pressing process. Leaves may be pressed separately from the stems and used either individually or matched up with lighter weight pressed stems in the final product.

Some materials suggested for pressing are:

African violets
 annual statice (small pieces)
 baby's breath
 celosia, plumed (pieces)
 daffodils (cut in half)
 dusty miller
 heather
 leatherleaf fern
 pansies
 Queen Anne's lace
 rose petals
 snapdragon florets
 violets

SUGGESTED ACTIVITY

Pressing Flowers and Foliage

Materials:

flowers and foliage
 newspaper
 corrugated cardboard
 blotter paper (optional)
 weights (books or blocks) or
 plant press

1. Take a piece of newspaper folded in half and open it up. On one side of the paper arrange flowers, foliage and stems in a single

layer so they do not overlap (Fig. 12-1). Lightly press flowers with your thumb so that they will not be crushed in an unnatural position when the paper is folded over them.

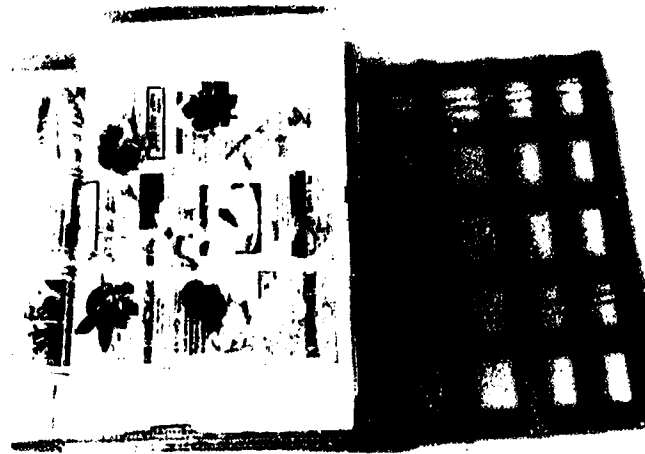


Figure 12-1 A single layer of flowers for pressing

2. Fold newspaper over the plant material. Place the newspaper with enclosed flowers between two layers of corrugated cardboard, with the corrugations facing inward. This "sandwich" makes up one unit. A number of additional units may be layered on top of the first.

The corrugated cardboard lets air penetrate to the flowers so they will dry more quickly. If you have blotting paper, this can be cut to the size of the newspaper and put on either side of it between the cardboard layers. It will give even better results but is not absolutely necessary.

3. Distribute the weight uniformly over the stacked layers. This can be done with heavy books or blocks. Or you can make and use a plant press instead. Plant presses consist of two pieces of wooden lattice work which are the same size as the cardboard pieces (Fig.

Dried Wall Pieces



Sea grape leaves and tropical pods arranged on weathered wood



Nature theme Moss covered wreath form entwined with grape vine and accented with mosses and lichens

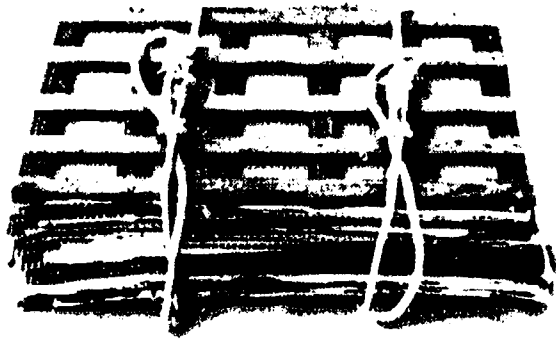


Figure 12-2 Plant press

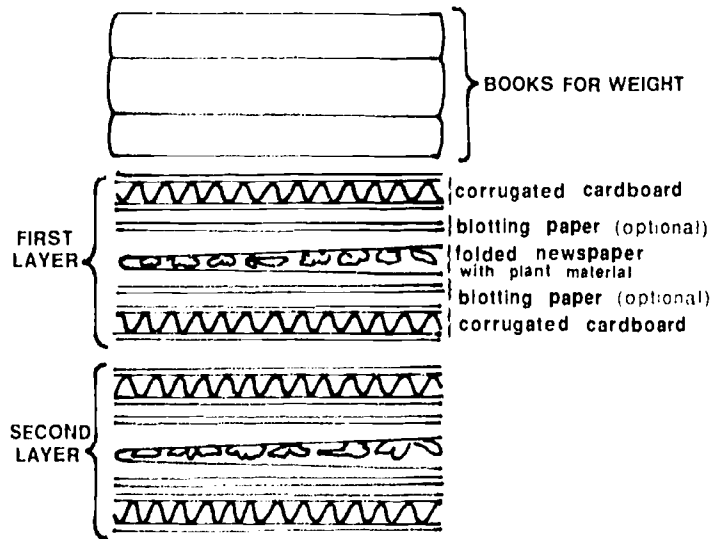


Figure 12-3 Cross section of layers in a plant press

12-2). These lattice pieces are placed on either side of the stacked cardboard "sandwiches" (Fig. 12-3). Pressure is then applied by kneeling on the press while it is tightly tied with several ropes or straps. This is another way to have uniform pressure on the plant material. An added benefit is ease of moving the pressed material from place to place.

4. The plant material under pressure should be kept in a warm, dry location with as much air movement as possible. Under these conditions moisture will be quickly absorbed from the flowers and evaporated, resulting in nice specimens with good color. (The press can also be stood on edge over a warm - not hot - register for fast drying.) The corrugated cardboard (and blotting paper, if used) speeds up this process and will give much better results than pressing the materials between pages in a book where no air can reach them.

5. Within a week the plant material should be dry. You may check drying progress at any time. You may even wish to create some interesting curves in stems by repositioning them a day or two after you have put them in the press. Flower shapes can also be improved at the same time by straightening out folded petals. The plant materials will be limp enough to do this early in the drying process and will continue to dry in the positions you have arranged.

6. Once materials are thoroughly dry, they may be removed from the press. They do not need to be kept under pressure. It is usually convenient to store them between the sheets of newspaper placed in a box or drawer. They must be stored in a fairly dry location or they

will reabsorb moisture and consequently lose color or even grow mold.

DRYING by HANGING UPSIDE DOWN

Certain plant materials can be preserved in their three-dimensional shape simply by hanging them upside down and allowing them to air dry. Hanging is also a convenient way to store the material without getting it tangled up. If the material should become limp during the drying process, it will develop a more natural shape if dried by hanging rather than in a vase or lying on a shelf.

Many essentially dry pods, seed heads and even leaves can be found in the garden and along roadsides, needing only to be gathered (Fig. 12-4). They are usually beige or brown in color, but may have interesting forms and textures. If stiff enough, they may be placed upright in containers, styrofoam or buckets of sand. Once completely dry they can be bunched and stored in boxes.

Examples of materials that require little treatment to preserve are:

cattails	pampas grass
dock	pine cones
lotus pods	teasel
milkweed pods	wheat

Cattails and dock are examples of plants that must be gathered at the correct time to prevent their shedding seeds. Cattails should be gathered in midsummer soon after they form. If collected later they will fuzz out as they dry. Dock that is gathered in late summer just as it is turning brown will

not drop its seed heads as much. Also it will turn a prettier shade of cinnamon brown.

Certain aerosol surface sealers can be used to help stick delicate seeds and other plant parts together (Fig. 12-5). When sprayed on dried materials, these sprays form an inconspicuous layer over the surface. Hair spray can be used for the same purpose, but neither product can resurrect a specimen that has already started to fall apart.

EVERLASTINGS

Some flowers are known to dry well and keep their color and shape when harvested at the proper time. These plants are often referred to as *everlastings*. Strawflowers are probably the best known example. Their stiff papery bracts, which contain little moisture, retain color very well when air dried.

Here are some common everlastings that can be grown in the garden. All are annuals unless otherwise indicated.

- annual statice
- baby's breath (perennial)
- bells of Ireland
- blue salvia
- Chinese lanterns (perennial)
- cockscomb (crested and plumed types)
- German statice (perennial)
- globe amaranth
- strawflowers
- yarrow (perennial)

Everlastings should be picked when they are reaching their peak of bloom. Strawflowers dry best if picked before they are fully



Figure 12-4 Plants found in the field and along roadsides



A wreath and decorated hat featuring everlastings



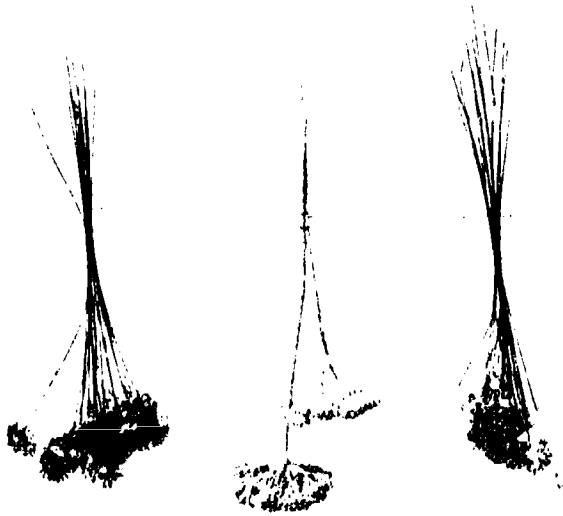
Figure 12-5 Aerosol surface sealers



A vertical arrangement of cattails, lotus pods and blackberry lily



A wreath of dried hydrangea and "flowers" made by gluing seeds to teasel heads



Everlastings air drying

open. If the flowers are too mature at harvest, the colored bracts may reflex backward and show too much of the yellow center. Some everlastings are dried on their own stems, while others are dried on a wire that is substituted for the natural stem. Strawflowers and globe amaranths are usually dried on wires. The insert method of wiring is usually adequate since the flower head shrinks upon drying and will cling to the wire. Wooden stakes or heavier wires can be attached later if longer or sturdier stems are needed.

Everlastings are usually bunched and hung upside down in a warm, dry place with good air circulation. Keep them out of strong light which fades their colors and very hot places which may cause the bloom to open too much.

AIR DRYING OTHER FLOWERS

Many flowers which are not considered everlastings may be air dried. The more delicate ones are likely to shrink and shrivel to some extent; however, the color and overall form may be retained. These dried materials can be used effectively in mass arrangements and wreaths. Some examples of non-everlastings that can be air dried by the hanging method include delphinium, larkspur, carnations and marigolds. Even air-dried roses with shriveled leaves still attached have received considerable acceptance and are commonly offered for sale by wholesale and retail florists.

Leftover scraps of foliage and flowers that have broken from their stems are common by-products in a flower shop. Instead of

throwing them away, they can be spread out and air dried on newspapers or trays for later use as background filler in dried wreaths or dried topiary forms. Even individual petals can be air dried for use in a potpourri. The petals will add color and interest, and the fragrance can be added in drops of scented oil that is sold to refresh commercially produced potpourri mixtures.

SUGGESTED ACTIVITIES

Air Drying

1. If everlastings are available from the garden, cut these, strip off foliage, and bunch them together with a twister or wire. Hang the bunches from a wire or clothesline installed in the classroom near the ceiling. If this is not possible, smaller amounts of bunched everlastings can be dried on a standing clothes-drying rack.

If strawflowers or globe amaranths are available, remove them from their natural stems. Insert a 9-inch piece of #22 wire in each flower head. As the flower dries, it will shrink firmly around the wire. Bunch the flowers loosely in groups of ten and either hang upside down or place in bud vases to dry.

If flowers are not available from the garden, use purchased annual statice. It can be rebunched into smaller bundles and hung to dry. The colors preserve very well and the natural stems are relatively strong.

2. Air dry pieces of foliage and flowers that might otherwise be discarded. Even blossoms that are too old to sell can be dried and put to good use. Spread them out on a

newspaper until they are dry. Then store them in a cardboard box until you are ready to glue them onto a wreath.

3. Air dry individual petals, like those from roses and carnations. Include small pieces of statice. After these small pieces are thoroughly dry, they can be put in a covered glass container and sprinkled with scented oil to make a charming potpourri.

BURYING FLOWERS in SILICA GEL

Most flowers can be preserved in their three-dimensional shape if they are buried carefully in a drying compound that will remove moisture from the petals (Fig. 12-6). Silica gel is the preferred choice for quality dried flowers. It is a white crystalline substance that is available under a number of trade names. Manufacturers of cameras and other equipment frequently include small packets of silica gel to absorb moisture and protect the equipment. It is also used in refrigeration units. Its absorbing and moisture-holding capabilities make silica gel an ideal flower desiccant. The fine crystals sift easily between the petals when flowers are being buried, and they do not leave a residue after the flowers are removed.

Silica gel sold as floral desiccant contains indicator crystals that are blue in color when the gel is dry. When these crystals turn pink, the silica gel should be placed in a 250°F oven for thirty minutes or up to an hour to dry it out. When the crystals turn blue again, the compound is dry. Repeated use of silica gel to dry flowers will dampen it, so the indicator crystals should be watched

carefully. The gel should be dried out occasionally to continue yielding good results. The cost of this product is great enough that drying it out rather than throwing it out is likely to be well worth the effort.

Containers for drying should be big enough to get a hand inside easily. They should have lids that seal tightly. Two-quart plastic freezer cartons or small round cookie tins work well.

Flowers may be buried side by side and in layers as long as they do not crowd each other. The flower will dry in the position in which it is buried. Better results are usually obtained if you face flowers upward, gently sifting the silica gel between petals and also around the outside so the flower is not flattened or bent into an unnatural shape. They cannot be reshaped after drying as they will be quite brittle. The container should be sealed during the drying process so that the silica gel does not draw moisture from the outside air. Drying usually takes from four to ten days.

Natural stems would be awkward in the small container. These are usually removed and replaced with a wire before the flower is buried. Wires are attached as you would wire flowers for a corsage. Then roll up the loose end of the wire and tuck it under the flower so that it takes up little space. It can be carefully unrolled after the flower is dry. Wire could also be glued on after the flower is dry, but that might be more difficult since the dried flowers are so fragile.

Flowers that have been dried in silica gel are often displayed in clear glass containers with lids. A small amount of silica gel can be



Figure 12-6 Silica gel used to preserve delicate flowers

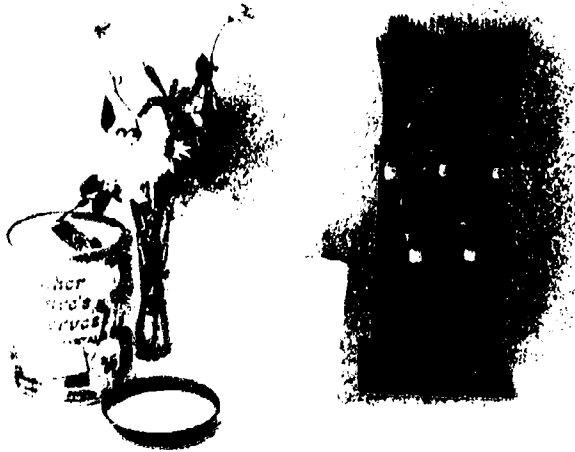


Figure 12-7 Materials for drying flowers in silica gel



Figure 12-8 Spooning silica gel between the petals



Figure 12-9 Storing silica gel dried flowers

added to the container to keep the air dry. It is a help in preserving the color and shape of the dried flowers. If used in open-air arrangements, the flowers usually reabsorb moisture, causing drooping and loss of color. Clear acrylic sprays may help seal the flowers from surrounding air so that they will last longer in the open air, but arranging in glass containers with lids will give the longest-lasting product.

Dried flowers usually change color to some extent when they are dried. Yellow, pink and white flowers usually retain their colors quite well. Dark colors like red and purple may become very dark when dried. Color changes that can be expected when flowers are dried are as follows:

Before Drying After Drying

yellow	gold
pink	rose
white	cream
green	olive
red	very dark red
purple	almost black

SUGGESTED ACTIVITY

Drying Flowers in Silica Gel

Materials: (Fig. 12-7)
2 two-quart freezer containers
2 quarts of silica gel
spoon
wire
flowers for drying

1. Select for drying five to seven small to medium size flowers from the following list:

roses, pompon mums, mini-carnations, snapdragon florets. Attach wires as you would if wiring the flowers for a corsage. Roll wire around your finger, then tuck the roll of wire up near the base of the flower.

2. Pour a half-inch layer of dry silica gel into the bottom of a freezer carton.

3. Place one to three flowers on the silica gel not touching each other.

4. Use the spoon to sift silica gel gently around and between the petals (Fig. 12-8). Try to preserve the flower's natural shape. Dumping the compound from the top may flatten flowers. Continue filling until the flowers are covered.

5. Add and cover more layers of flowers on top of the first one until you have buried all your flowers or until the container is full. Place lid on the container and set aside for drying.

6. After a week remove the lid and tilt container sideways as you gently tap it so that the silica gel falls away from the top layer of flowers. If the first flower exposed feels dry, continue uncovering. Allow flowers to gently flow out with the silica gel.

7. Store flowers in the second freezer carton with a little silica gel in the bottom (Fig. 12-9). Keep lid on so that moisture is not absorbed from the air. Clear plastic shoe boxes are even better for storage because the flowers can be spread out more and you can see what you have in the box without removing the lid.

GLYCERINIZING FOLIAGES

Foliages and even some flowers can be preserved in a leathery condition by treating them with glycerin. Eucalyptus, oak and magnolia leaves are the most commonly treated foliages, and baby's breath is the most commonly treated flower. The soft pliable condition of these preserved materials makes them easier to work with than other, more brittle dried materials.

Only certain plants have a structure that enables them to take up and support a glycerin solution. Even these plants must be in active growth and taking up water for the treatment to be successful. Oak and beech leaves can be glycerinized during the summer, but they will not take up the solution well in the fall when water is no longer moving up the stems in large amounts.

Glycerin is a clear viscous substance available in drug stores and chemical supply houses. The preserving solution is made from one part glycerin to two parts water. Place the lower 5 to 6 inches of the branches into the solution just as you would put them in a vase of water. The solution will gradually be taken up through the vascular system. As water evaporates from the leaves, glycerin will be drawn into the plant cells and will remain there.

Absorption of the glycerin may take two weeks or more. It is critical to a good product that the plant materials are not left in too long or too short a time. If the treatment is too long, glycerin may ooze out onto the leaf surface, making it sticky and more likely to catch and hold dust. If glycerin has not

penetrated all areas of the leaf, those areas not treated will shrivel up.

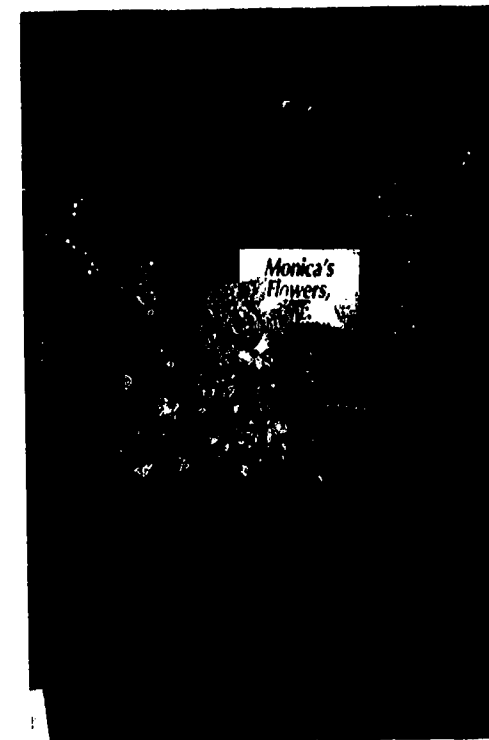
Glycerin-treated materials take on various colors including olive and bronze. Results vary depending on time of year and condition of the material. Dyes are sometimes used in the solution or as a dip to produce other colors.

SUGGESTED ACTIVITY

Glycerinizing Foliage (Fig. 12-10)

1. If trees in your area are in active growth, select some branches of oak or beech and cut them about 12 inches long. During other seasons use pine or purchased fresh eucalyptus or Scotch broom.
2. Mix one part of glycerin to two parts of warm water. Fill a vase with the solution to a depth of 6 inches.
3. Recut stems and crush ends with a hammer. Place cut ends of the branches in the solution.
4. Place the vase of branches in a place where there is good air circulation. Watch the level of solution in the vase and add more if the level declines.
5. Watch the movement of glycerin up through the leaves as indicated by a color change. The process will take about two weeks.
6. When most of the leaves appear to be fully penetrated by glycerin, remove

(continued)



Wreath of glycerinized baby's breath



Figure 12-10 Cut branches preserved in a glycerin solution



Arrangement of dried flowers
under a glass dome



Dried foliage and pods in Sahara
foam



Hand-tied bouquet of twigs
accented with oak leaves, etc.

Criss-crossed twigs decorated with pods,
mosses and a bird



Dried material arranged on
a grapevine wreath placed
on a table



Glycerinized ruscus and dried
flowers in a duck planter

branches from the solution. Hang branches upside down to encourage movement of glycerin out into the leaf tips. After a week or so the branches will be ready for immediate use, or they can be stored in boxes for future use.

ARRANGING DRIED FLOWERS

The mechanics for arranging dried flowers can be a dry material such as styrofoam, or a product called *Sahara* developed especially for this purpose. Styrofoam is very sturdy and will hold large stems. However, it is difficult to insert delicate stems directly into styrofoam. *Sahara* is a brown foam that is easily penetrated by fine stems; however, it does not hold large branches well. *Sahara II* is a similar foam that is stronger and made to hold sturdy stems.

If these foams are wedged into deep containers, usually no additional support is required. Foam can be secured in shallow glass or plastic containers by first sticking one or more four-pronged anchor picks to the bottom. The foam is then pushed down over the prongs. Another method is to criss-cross the dry foam with waterproof tape in the same way as you would fasten soaked foam. When using baskets, it is possible to run a chenille stem or taped wire through the wicker and over the foam to fasten them together. Dry foam can be more permanently fastened to containers with hot glue from a hot glue gun or by dipping the bottom of the piece in a pan of melted glue before joining it to the container.

The foam can be hidden with dry sheet moss, sphagnum moss or Spanish moss if it

will not be covered by flowers and foliage. Greening pins or "hairpins" of wire are good for holding the moss on the foam. An alternative is to use German statice massed over the foam to hide it. Statice is also a good filler material to serve as a background to the flowers.

The following activities will allow you to work with dried materials in several different situations. Pressed flowers require special handling and gluing techniques. Floral picture making is a good exercise in space relationships. Your goal is to try to create a feeling of depth while working in only two dimensions. Arranging flowers dried in silica gel in a glass apothecary jar will challenge you to create a good design with proper size relationships while working inside a small enclosed space.

SUGGESTED ACTIVITIES

A. Floral Picture

Materials: (Fig. 12-11)

- pressed flowers and foliage
- picture frame at least 5"x 7" with flat glass that lifts straight out (not inserted by sliding)
- piece of fabric a little larger than the picture frame
- cardboard or heavy poster board
- scissors
- white liquid glue that dries clear
- small paint brush
- wax paper
- knife or tweezers

1. Assemble all materials. Lay flowers out so you can see what you have to work with.

416



Diamond-shaped wall hanging featuring a pheasant pelt

Dried Wall Pieces

The natural look of a botanical wreath made from Sweet Annie, with a bird and nest



A contemporary wall piece with strong parallel lines

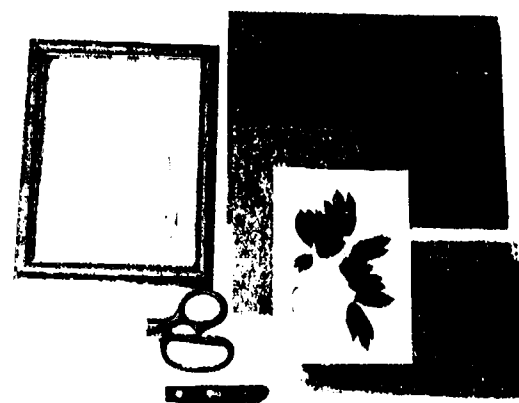
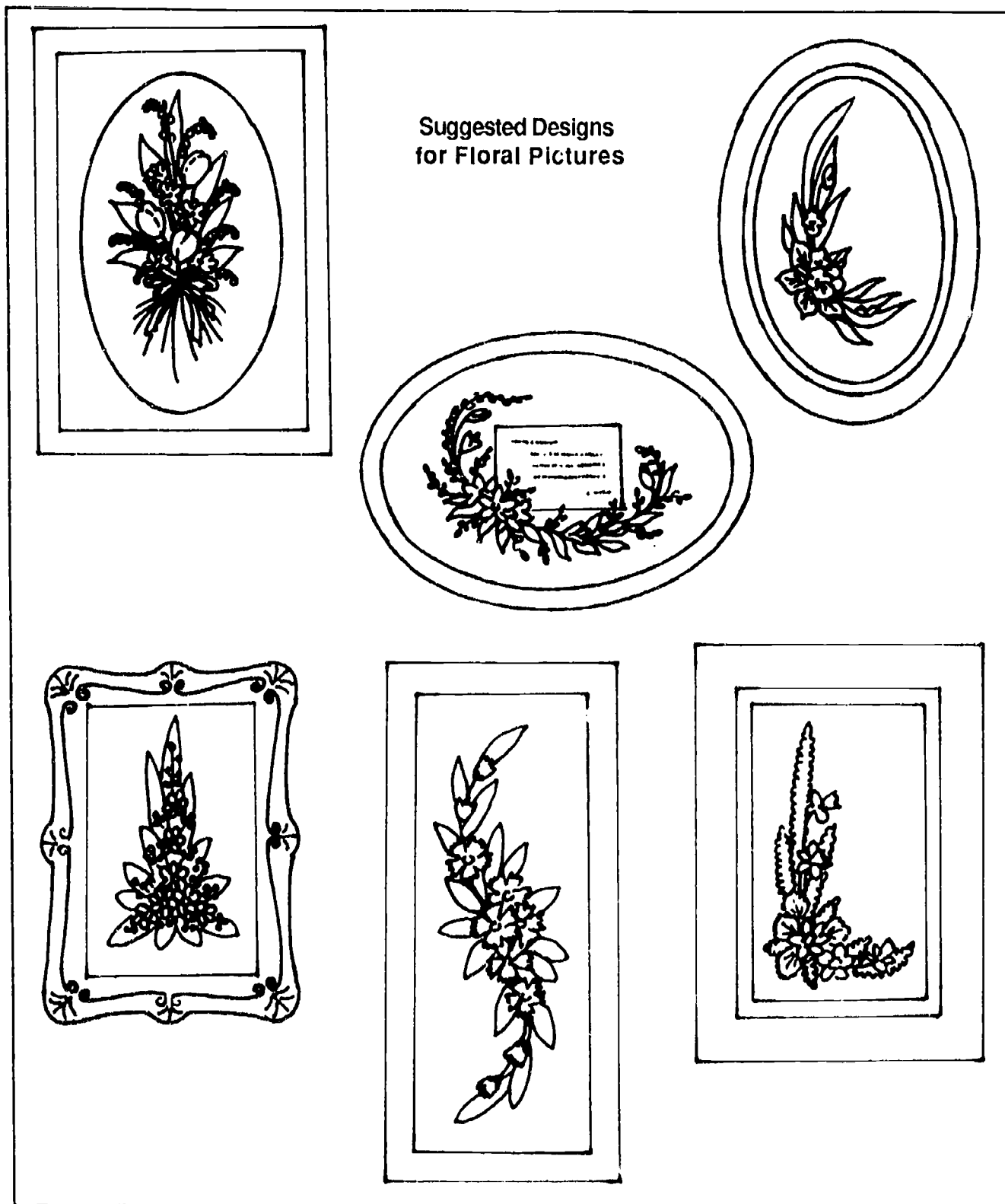


Figure 12-11 Materials for a floral picture



Grapevine wreath with a romantic look

417



Lift flowers gently with the tip of a knife or tweezers to avoid damaging them.

2. Select a background fabric that will harmonize with the flowers you intend to use. You may decide on a sharp contrast (like black or white) or you may choose a more subtle color scheme.

3. Cut a piece of cardboard or poster board the same size as the picture backing that comes with the picture frame. Cut a piece of fabric that is just a little larger than the cardboard (Fig. 12-12). Spread a thin layer of white glue over the cardboard and press it onto the fabric. Do not use too much glue or it will soak through the fabric.

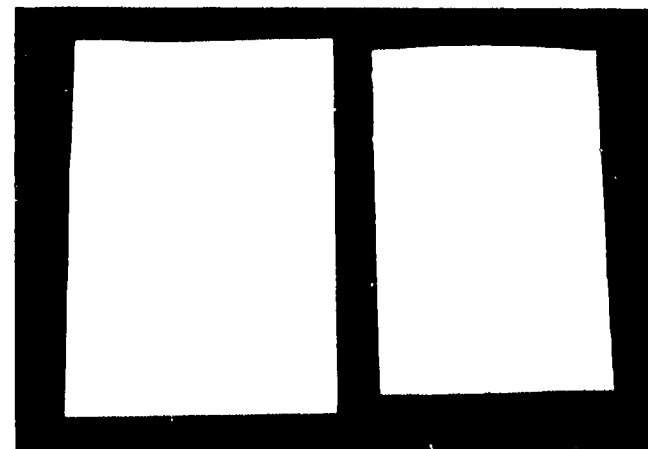


Figure 12-12

Trim off any fabric sticking out beyond the cardboard. Do not try to overlap it to the back as the additional thickness will make it hard to assemble the picture and frame. Place wax paper over the fabric; then, to prevent curling, weight it down with a book while it dries. The wax paper will not stick to the fabric if some glue should seep through.

4. On a piece of paper, trace the area that will show inside the picture frame. Use this

as a guideline of the space to be designed in. Practice arranging the pressed flowers on this paper to achieve a satisfactory design before you do any gluing. Select a design shape that fits the shape of the frame. Shapes of basic arrangements and corsages are possibilities. See the accompanying illustrations for suggestions.

5. Arrange flowers into the design you have chosen, which should fill about two-thirds of the area. NEVER crowd the edge of the frame or let the flowers disappear under it.

Try to create a feeling of depth by overlapping petals and foliage. Develop a focal area in the same way as in a flower arrangement: space larger flowers closer together near the center of interest. However, do not overlap so much that you make a thick layer of plant materials that will hold the glass away from the fabric. The floral picture will last longer in good condition if the glass presses evenly on the flowers in the completed picture.

6. After you are satisfied with your practice design, you will want to start transferring it to the cloth-covered cardboard. However, your first placements are now lying beneath all the other flowers. To get the materials in the order you need without totally destroying your tentative design, place a piece of paper or cardboard over the practice design and carefully flip it over. The flowers you need to glue on first should now be on top.

7. Apply a light layer of white glue on the back of each flower and foliage piece with a paint brush (Fig. 12-13). Place glued flowers on the background one by one. Avoid using excessive glue. Gradually recreate your planned design.

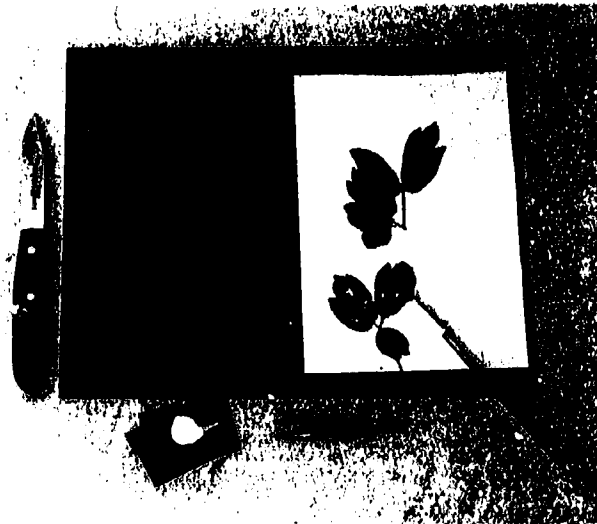
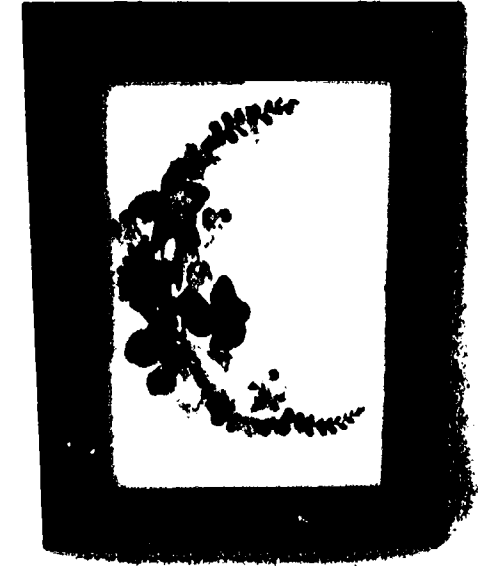


Figure 12-13

8. Place a piece of waxed paper over the finished product and weight it down until the glue dries. Drying overnight under pressure should be sufficient to keep flowers and cardboard from curling.

9. Place the floral picture in the frame behind the glass. Secure with picture backing or whatever mechanism is supplied with the frame.



Completed floral picture

B. Dried Arrangement Inside Clear Glass Jar

Materials:

flowers and foliage dried in silica gel
silica gel
clear glass jar with lid
Sahara
four-pronged anchor pin
floral clay
dried moss

1. Wash and thoroughly dry the glass container and lid.

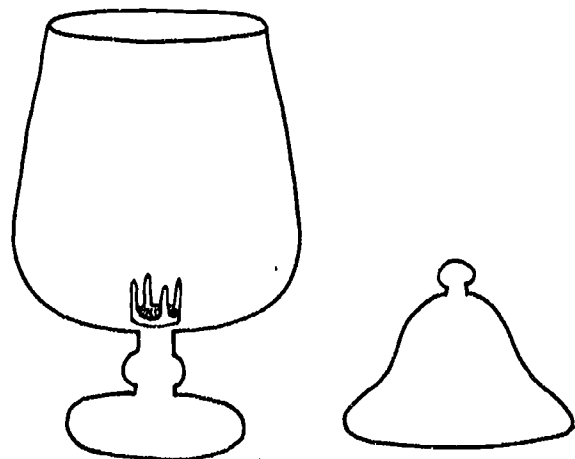


Figure 12-14



Figure 12-15

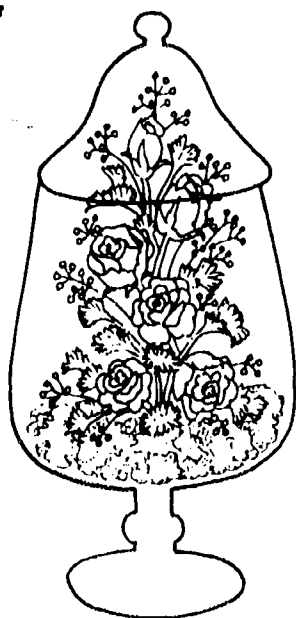


Figure 12-16

2. Assemble the flowers you have dried in silica gel. If you have wired the material it should be ready to use. If it needs a longer or heavier stem, attach it to another wire or thin wooden stake.

If the flowers are not wired, you can use white glue or floral adhesive to attach a wire to them. Make a small loop in one end of the wire and bend it at a 90° angle to the wire length. Glue the flower to this loop, which will provide more points of contact between flower and wire, thus making the attachment more secure.

3. Attach a four-pronged anchor pin with floral clay to the bottom of the dry container (Fig. 12-14). If anchor pins are not available, a small amount of hot glue can be placed on the bottom of the *Sahara* piece before it is lowered into the container.

4. Cut a piece of *Sahara* that will eventually be placed over the anchor pin.

5. Place the piece of *Sahara* on the table in front of you and create the arrangement (Fig. 12-15). The design should be made to be viewed from all sides. It is very important that the arrangement does not crowd the sides or top of the container. Check its sides by lowering the arrangement into the container after you have established the first few placements. Use a pencil stuck in the *Sahara* to lower it. After checking size, again place the arrangement in front of you on the table and finish it outside the jar.

6. Continue filling in the arrangement. The overall shape will conform to the shape of the container - basically oval or conical.

Work for in-and-out placing of materials to create depth. Keep it light and airy to harmonize with the delicate clear glass of the container.

7. Again using a pencil stuck into the *Sahara*, lift the completed arrangement off the table and lower it into the jar. Since materials are delicate and brittle, they must be handled gently as they are passed through the mouth of the container.

8. With the eraser end of the pencil, push the *Sahara* down over the anchor pin. Repair any damage that occurred during the move. Add more placements if necessary.

9. Use a funnel or rolled paper to direct a small amount of silica gel under the arrangement. The silica gel will help keep the inside air dry, extending the attractive life of the arrangement.

10. Place small pieces of moss around the base of the arrangement to conceal the *Sahara* and silica gel.

11. Place the lid on the container. Your finished product is ready to enjoy for months or even years (Fig. 12-16). Avoid placing the arrangement in bright light so that the flowers do not quickly lose their color.

C. Dried Flowers in a Cricket Box

Materials:

small brass cricket box

Sahara

small air dried flowers such as
strawflowers, statice, globe
amaranth, buttons, starflowers
dried moss

1. Cut and place a piece of *Sahara* in the bottom of the cricket box so that it is wedged firmly in place. Leave the lid open.
2. Cover the *Sahara* lightly with moss. A few wire hairpins may be used to anchor it; however, the flower stems will probably be sufficient to hold it in place.
3. Create a one-sided L-pattern arrangement using the materials you have available. Do not hide the open lid as this is part of the unique beauty of the container. The arrangement should flow from the inside of the box and not appear overly heavy.



Place amaranth and German statice in a brass cricket box

D. Dried Arrangement in a Basket

Materials:

small wicker basket with handle

Sahara

German statice

assorted small everlastings

1. Cut and wedge a piece of *Sahara* down into the basket.
2. Create a low bed of German statice over the *Sahara*. This will be an all-around mass arrangement that fits comfortably under the handle of the basket. German statice will form a background to the more brightly colored everlastings. Place this material so that it appears to radiate out from a common point inside the basket and arch gently over the side of the basket. The German statice should mostly conceal the *Sahara* without looking overly crowded.
3. Insert everlastings over the German statice in a uniform manner. They should be brought out from the statice, which forms a background to the flowers, rather than being embedded within the statice. Start with larger flowers and end with the smaller ones just as you did in the basic circular mound design.

Create a feeling of depth as you distribute each type of flower. The shape of the arrangement should conform to the shape of the basket without crowding the handle (Fig. 12-17).

E. Dried Arrangement on a Broom

Materials:

small straw broom

styrofoam

chenille stems

colored wheat

mini oak leaves

strawflowers or other dried flowers

burlap ribbon

wire

1. Cut a small piece of styrofoam and attach at the base of the broom handle with chenille stems.
 2. Make a bow with streamers from the burlap ribbon. Ribbon width and bow size should be appropriate for size of the broom. The ribbon can be cut lengthwise to make it narrower, if necessary. Wire bow and streamers to the middle of the piece of styrofoam.
- (continued)

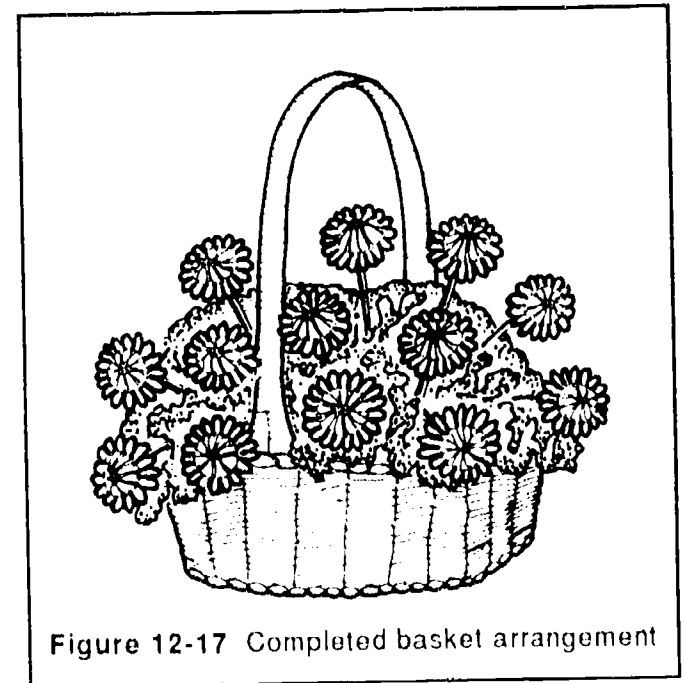


Figure 12-17 Completed basket arrangement

3. Establish a diagonal line with the wheat. This diagonal trunk line should cut through the center of the bow. A line of opposition is evident in this design, since the diagonal floral line cuts across the vertical line of the broom.

4. Fill and develop the diagonal line with mini oak leaves. Use the leaves to cover mechanics and establish depth.

5. Repeat the diagonal line with strawflowers or other dried flowers and pods. (See Figure 12-18.) Develop a focal area around the bow just as you do when making a corsage.



Figure 12-18

F. Dried Arrangement on a Hat

Materials:

small straw hat
ribbon (satin or cotton) in a width that is in good proportion to the hat size
dried flowers including baby's breath
hot glue gun

1. Run a piece of ribbon around the base of the crown of the hat. Tack it on using the hot glue gun.

2. Make a bow and a set of two or more streamers. Tack the streamers on first so that they flow from the back of the crown off the back of the brim. Glue the bow on over the place where the streamers were attached.

3. Use hot glue to attach pieces of dried baby's breath in a half crescent around the back half of the hat. Make the crescent symmetrical with its focal area developed around the bow.

4. Add other dried flowers to further develop the design. (See Figure 12-19.) Fasten each piece using a small amount of hot glue on the stem of each individual placement.



Figure 12-19

G. Dried Arrangement on a Wicker Mat

Materials:

small wicker mat
duck figurine about 4" long
small cattails
small yarrow or strawflowers
dock or other dried linear filler
Sahara II or styrofoam
hot glue gun

1. Attach the dry foam to the mat in the back left quadrant of the mat. Hot glue the duck to the foam near the front right corner. The head of the duck should be pointed toward the front right corner of the mat.

2. Establish an L-pattern arrangement around the duck. Use three cattails to establish the vertical axis. Use dock, glycerinized leatherleaf, or similar linear dried material to fill in the vertical line and establish the horizontal line. This lower line should come from behind the duck and extend to the edge of the mat to complete the L-pattern.

3. Repeat the L-pattern with yarrow or strawflowers. Since the arrangement features the duck, it should not be buried in flowers but blended into the arrangement by the flower placements. (See Figure 12-20.) Although this arrangement is designed to be viewed from the front, it should be finished to look attractive from all angles.



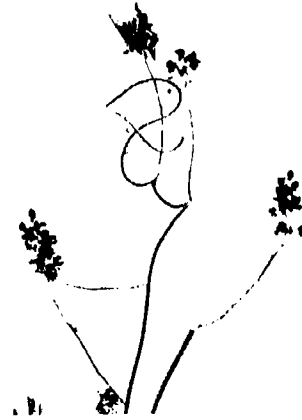
Figure 12-20

DRIED MATERIALS



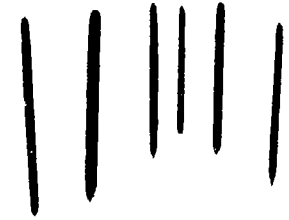
Annual Statice

1



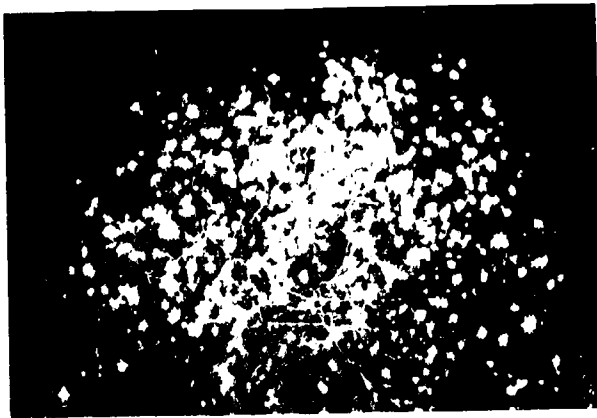
Bittersweet

4



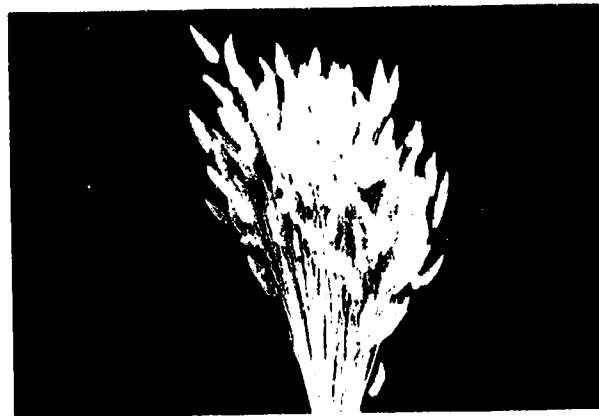
Cattails

7



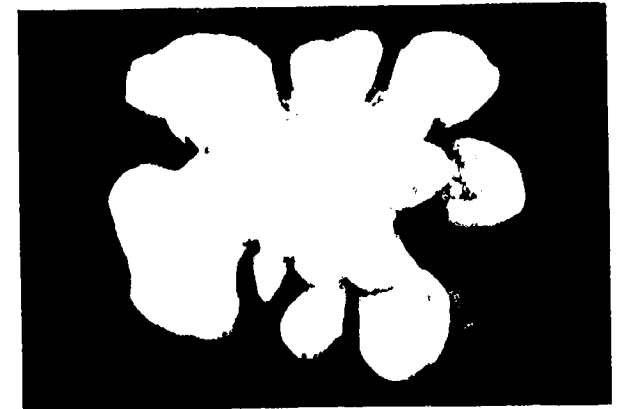
Baby's Breath (Gypsophila)

2



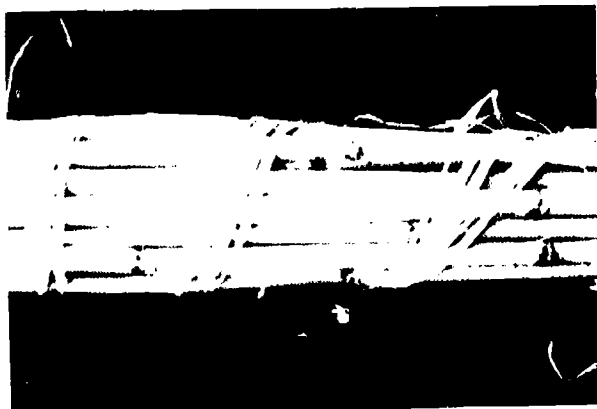
Bunnytails

5



Cedar - Cross Section

8



Bamboo

3



Cardone Puffs

6



Celosia

9



Chinese Lantern

10



Fantail Willow

13



Globe Amaranth

16



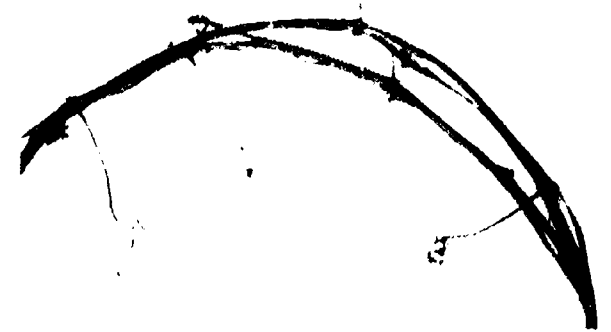
Dock

11



Fungi

14



Grape Vine

17



Eucalyptus

12



German Statice

15



Gypsy Bloom

18



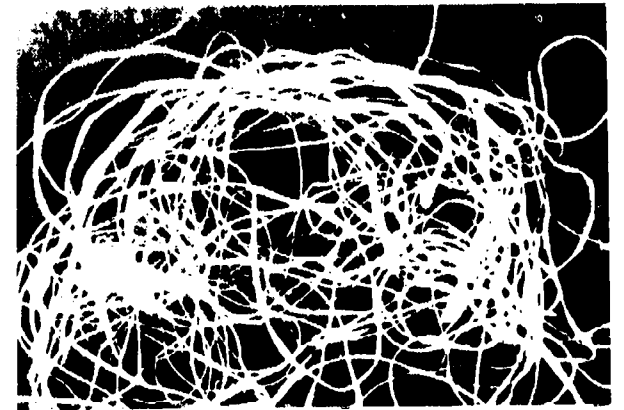
Lotus Pods

19



Oak Leaves

22



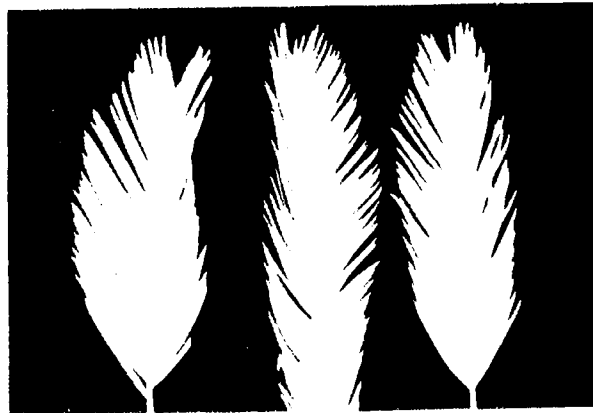
Raffia

25



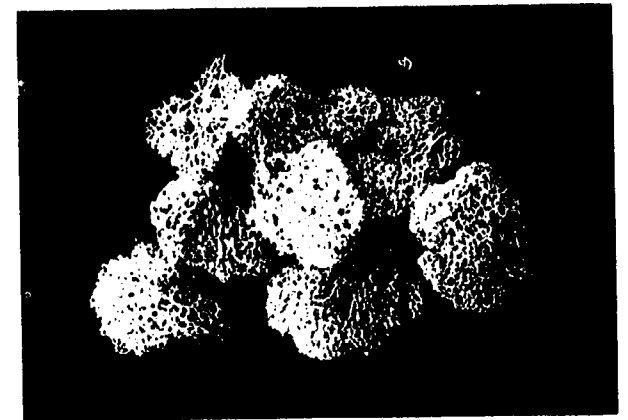
Manzanita

20



Palm

23



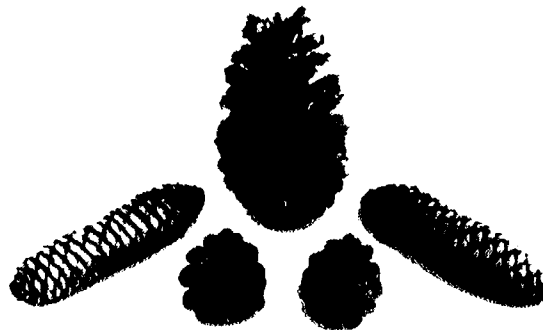
Reindeer Moss

26



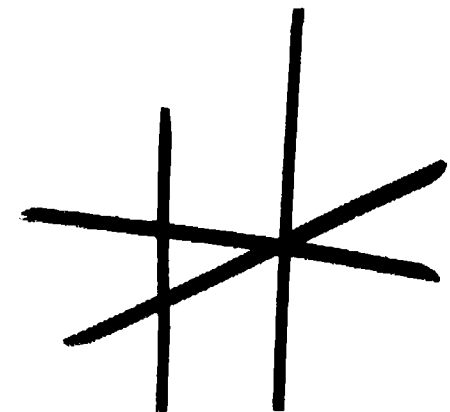
Money Plant

21



Pine Cones

24



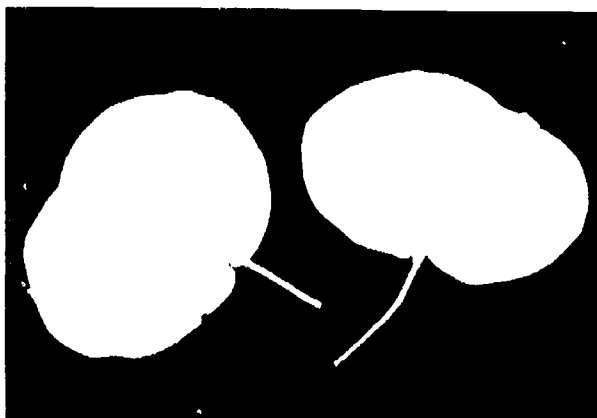
River Cane

27

430

BEST COPY AVAILABLE

430



Sea Grape

28



Starflowers

31



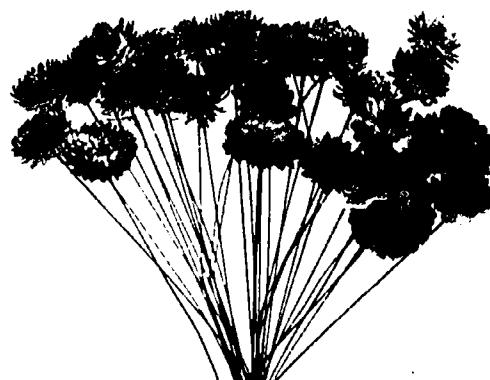
Teasel

34



Sheet Moss

29



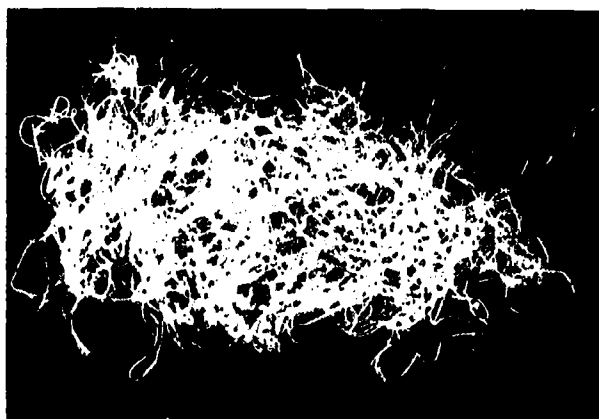
Strawflowers

32



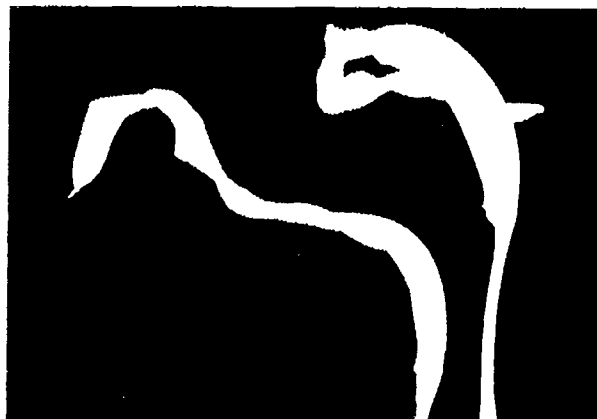
Ting-ting

35



Spanish Moss

30



Strelitzia

33



Yarrow

36



Weathered Wood

37



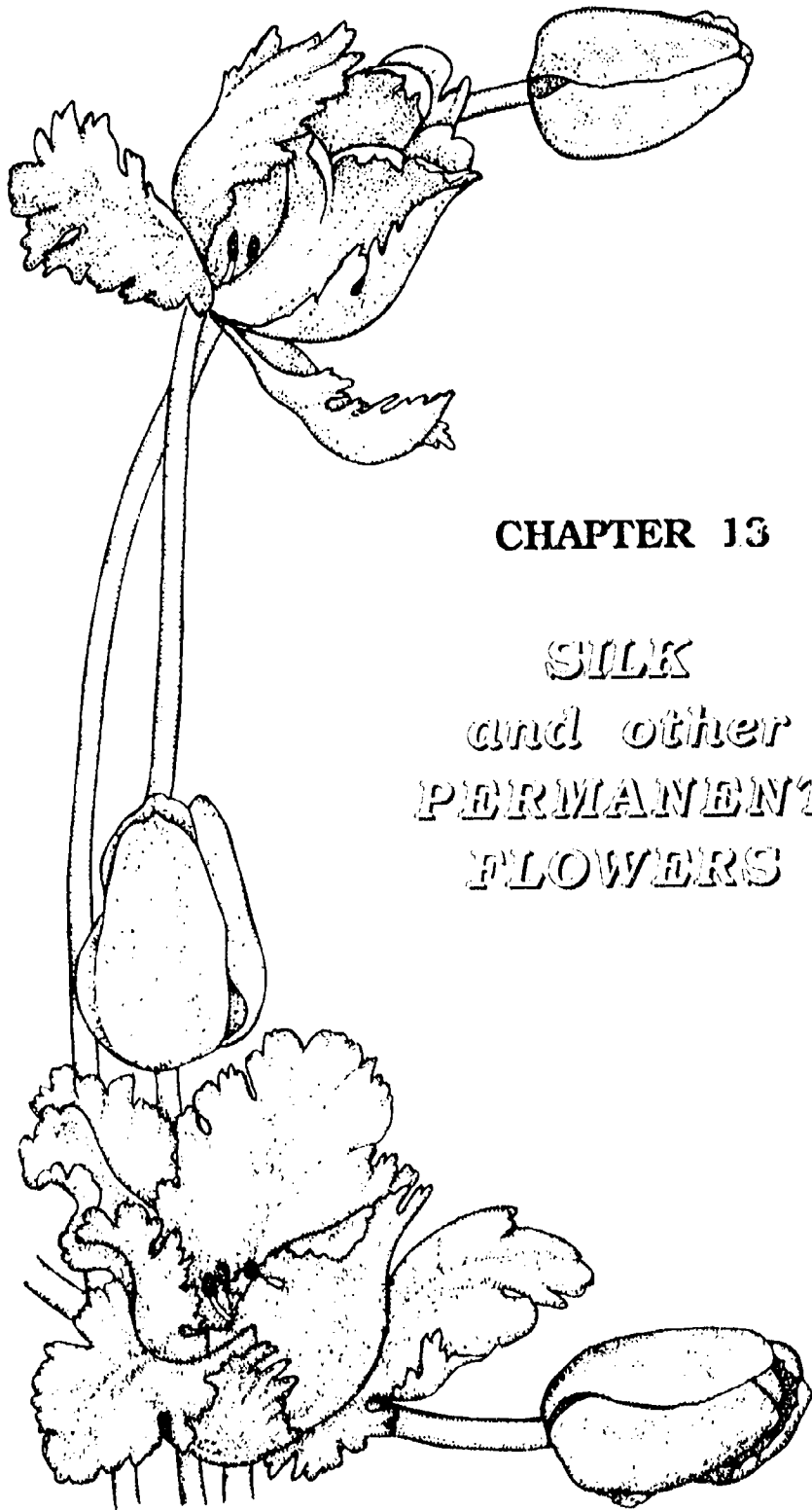
Wheat

38



Wisteria

39



CHAPTER 13

SILK
and other
PERMANENT
FLOWERS



Flowers by Davids Square, Columbus

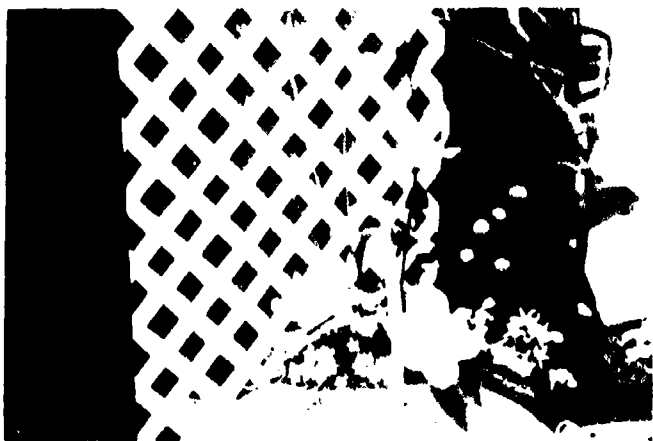
Silk Flowers with a Spring Theme



Cleveland Home and Flower Show



The Bouquet Shop, Wooster



The Bouquet Shop, Wooster

Silk Flowers

by Roger Swearingen,
The Flower Garden, New Boston



Artificial flowers and foliage are most commonly made from plastic or silk. They can be used to create any design that can be made with fresh flowers. Their advantages are that they last indefinitely even under harsh conditions and they do not require all the special care and handling that fresh plant material does. On the other hand, they cannot completely replace the special beauty of living plants and flowers.

Plastic flowers and foliage can be used outdoors during the winter months when weather conditions would be too harsh for fresh or silk materials. Cemetery wreaths, crosses and vases are often made of plastic. They do fade over time and can seldom be used outside more than one season. Plastic flowers, when they first appeared on the market, were popular for interior decoration. Now they are seldom used indoors, having lost their appeal to the more realistic and artistic permanent silk flowers.

The popularity of silk flowers has mushroomed as their quality has improved, along with an ever-greater selection of colors and



420



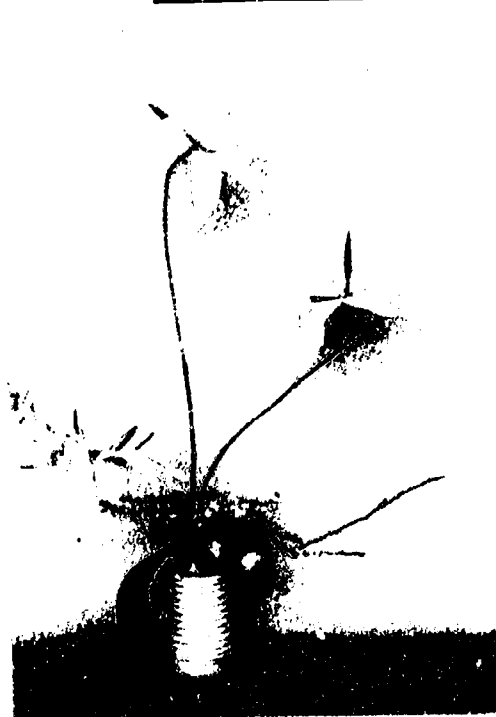
Mass Designs

Silk and Dried Combinations
from the Bouquet Shop,
Wooster



Line Designs

Contemporary Silk Design
by Hitomi Gilliam, AIFD
at Ohio Florists' Association
Retail Discovery Series
(See Color Plate 11-3)



441

BEST COPY AVAILABLE

442

Party Silk Designs



Don Johnson Floral, Lima



Alexander's Flowers, Cleveland

styles. The close-up beauty of silk flowers and their enormous range of decorator colors have found widespread appeal. There are silk flowers and foliages that simulate nearly every living flower, plus many additional specimens that have no counterpart in the real world.

Interior decorators like to use silk materials for residential and commercial customers. Long-lasting silk arrangements can be an important part of the total interior design and color scheme, making it much more effective. The only disadvantage of using silk flowers in this way is that the people who see these arrangements frequently may tire of them. Changing or replacing the arrangements periodically is the remedy. Silk flowers still can be used for longer periods of time than fresh flowers and will be easier and less expensive to replace than most other parts of the interior decoration. Occasional changes in the silk flowers can also give the opportunity to introduce welcome seasonal changes.



Hitomi Gilliam

Silk flowers are effective and practical for use in store window displays, in department stores, and on stages where relatively large displays are needed for a fairly long period of time. They also are useful in locations where conditions would be very harsh on fresh flowers or living plants, such as near heating units, near exterior doors, or in buildings that experience significant day/night or weekday/weekend fluctuations in temperature.

Artificial silk plants are being used to decorate offices, restaurants and other interiors instead of living foliage plants. While most people still prefer living plants to artificial, silk plants may be more practical where the light is too dim to maintain real plants. Silk plants do not need to be watered, fertilized or sprayed for insects, thus reducing maintenance costs. However, they do need to be dusted and replaced if their colors fade. An alternative to using all-silk or all-living foliage plants is using real plants where there is more light or where they will be seen more closely, and artificial plants in dimmer, more distant locations. If the artificial plants are of good quality, most people probably will not notice the difference. Costs may be reduced by having fewer living plants to maintain, rotate and replace as required. Silk plants are more desirable than plastic ones because they are more realistic.

Florists often use silk designs as a framework for their window and store displays. They also use silk bouquets and arrangements as samples when selling wedding work. Photographers have various styles of silk bridal bouquets for brides to pose with for pre-wedding pictures.

Christmas is a major holiday for which florists use large quantities of artificial plant materials. Customers are looking for decorative pieces that will last several weeks or more, maintaining good quality either in the warm dry air of a home or in below-freezing temperatures outdoors. Weeks in advance of the season, flower shops start creating artificial arrangements, wreaths and wall hangings for this busy time. This is one time of year when plastic is as popular as silk. There are fairly realistic plastic Christmas greens, fruits, cones and berries. Plastic items have the advantage of being able to withstand snow or rain and of crushing less during storage.

Silks are available to complement every season. Delicate pastels for spring and vibrant colors for summer are refreshing seasonal changes for interiors or door decorations. In the autumn artificial silk materials can be effectively combined with natural dried plant materials to expand the range of colors, shapes and textures available to the floral designer.

Silk flowers are sometimes used to give a color accent to living foliage plants either singly or grouped in planters. If the flowers are carefully chosen, they can appear quite natural. Corsages and hair pieces made of silk flowers can be useful accents to a wardrobe whenever a certain color or style is wanted. Since the flowers are permanent, they can be saved for future occasions.

There continues to be a steady demand for silk flowers and other permanent plant materials, giving floral designers yet another medium with which to express their creativity. Though permanent flowers will never

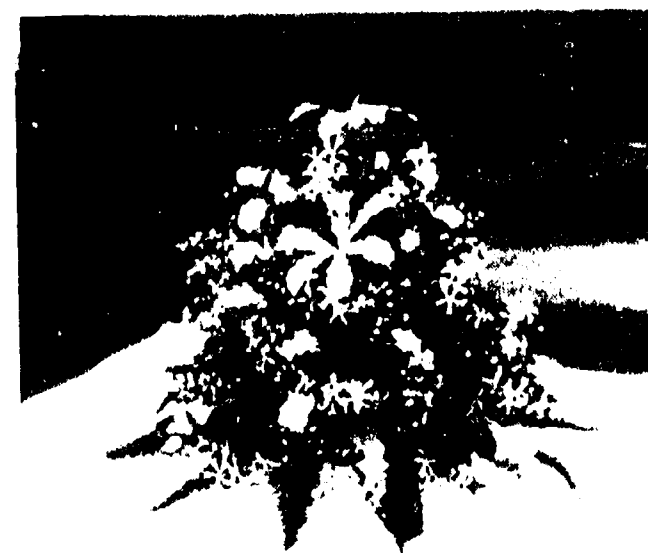
replace fresh flowers, the popularity of permanent flowers for certain settings and occasions is great enough that every designer should learn how to work with them. Artificial materials can be used effectively and tastefully in artistic arrangements that are useful and practical. The price may initially exceed that of a comparable fresh flower arrangement, but its value may be extended over a much longer period of time.

Artificial arrangements usually lose some of their appeal if they are seen too long by the same people. They become even less desirable if they become dusty or faded. Consider rotating artificial arrangements to other locations, putting them away for a while, or taking them apart and using the flowers in new creative designs.

SOME SUGGESTIONS for WORKING WITH SILK FLOWERS

1. Heavy-duty wire cutters may be needed to cut through sturdy wire-reinforced stems on silk flowers.
2. Cut multi-flowered stems apart to produce the size of flower clusters you need for the arrangement you are making.
3. Single silk blossoms can be glued onto natural bare branches with floral adhesive or hot glue to give the feeling of early spring.
4. Flowers that need longer or sturdier stems can be attached to a heavy wire or wooden stake. Floratape will hold small,

Silk Wedding Designs at the Ohio State Fair Professional Design Show



416



Wicker baskets decorated with silk flowers
Hitomi Gilliam, AIFD

light-weight flowers to wires, while waterproof tape will hold heavier flowers to stakes. If the wooden stakes already have wires attached to them, the flower stem and stake can be bound together by the wire.

5. Flowers with short stems that are going to be used in wreaths can be attached to a metal pick using a pick machine. Metal picks are good for inserting into straw or styrofoam forms.
6. Silk flowers used in corsages or bouquets should have a small length of the artificial stem left on. Then a fine wire can be attached by the wrap-around method. This wire will be more flexible than the stem of the flower itself and will give you more control in positioning the flower. If a sturdier stem is needed, start with the fine wire as described and then attach it to a heavier wire with floratape.
7. Silk flowers that need to be revitalized or altered in appearance can be tinted with spray paint. If edges are frayed, singe and remove the loose threads with a lighter.
8. In a flower shop where many silk arrangements are being made, hang one of each type of silk flower from a wire above the design table with a price tag in large numbers so the designers can more easily estimate the cost as they are working.
9. Display silk flowers upright in a display unit or flower cart in the shop. Many customers like to buy these individually to arrange themselves or for craft work.

SUGGESTED ACTIVITIES

1. All-around Mass Arrangement of Silk Flowers (Fig. 13-1)

Select an opaque pottery container that is cylindrical or oval. Fill the container with *Sahara* so that the foam sticks up about 2 inches above the rim of the container. Cover the *Sahara* with dry sheet moss.

Use a mixture of silk flowers to create a mass arrangement that can be viewed from all sides. Refer to Chapter 9 for information on mass arrangements.



Figure 13-1

2. Line-Mass Arrangement in a Wicker Basket (Fig. 13-2)

Using chenille stems, attach a piece of *Sahara* foam to a wicker basket. Create a line-mass design that is compatible with the basket in size and shape. If the basket has a handle, be sure to let it show in the finished arrangement. Refer to Chapter 10 for details on line-mass design.



Figure 13-2

3. Teacup Arrangement with Silk and Baby's Breath (Fig. 13-3)

Fill a china teacup with *Sahara*. Create a cloud of dried or glycerinized baby's breath over the cup to a height of 1 1/2 to 2 1/2 inches. Arrange seven to nine small silk flowers in a circular mound design so they stand out above the baby's breath.



Figure 13-3

4. Line Arrangement with Silk Flowers on Branches (Fig. 13-4)

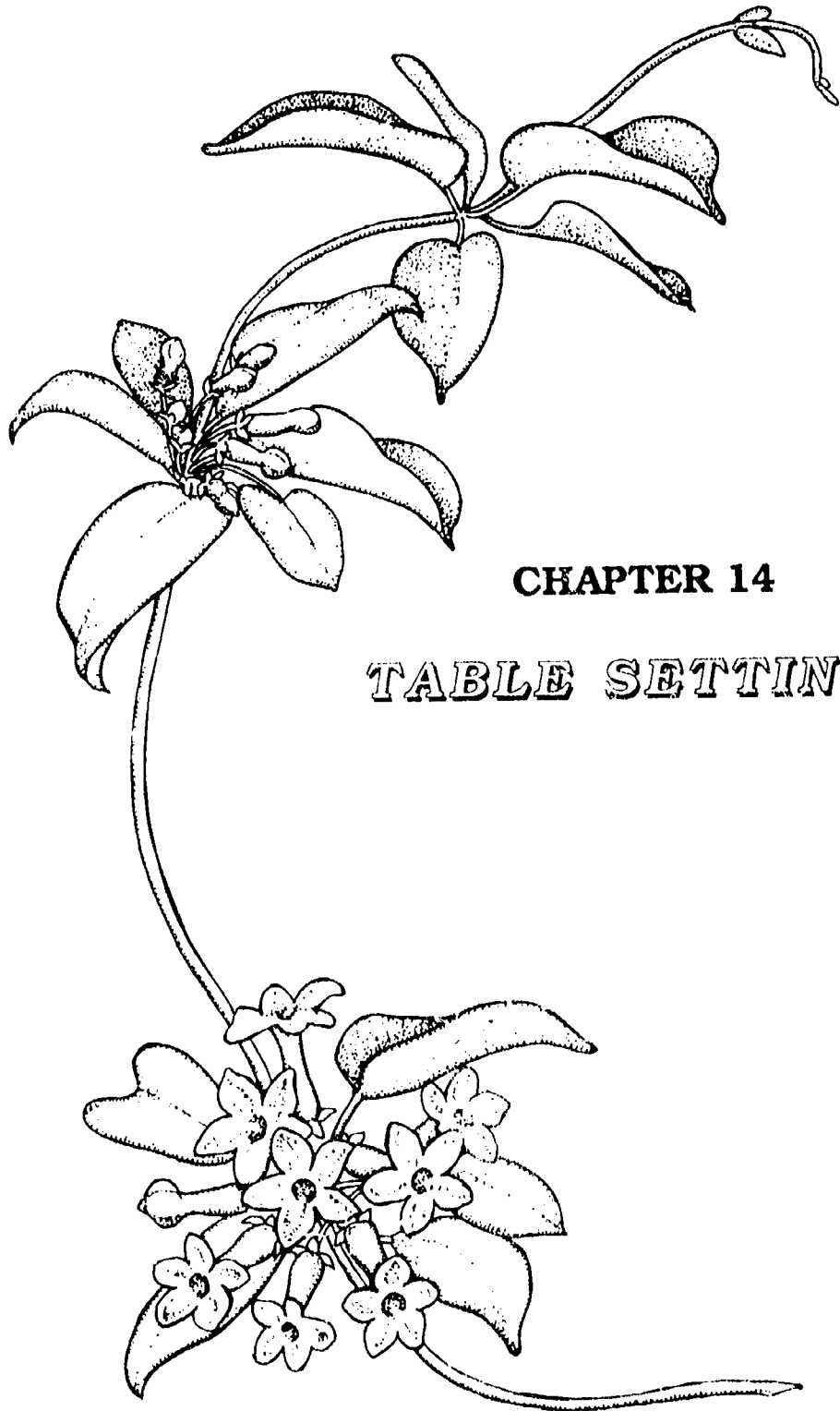
Select an interesting leafless branch that is 10 to 15 inches tall. Choose a base or a container that is in good proportion to the branch and capable of supporting it.

Attach styrofoam to the base (or fill the vase with it) and insert the branch firmly into the styrofoam. Cover the styrofoam with dry sheet moss.

Hot-glue silk flowers sparingly onto the branch to give it the look of a tree starting to bloom in spring. Arrange compatible silk flowers in the styrofoam to follow the line of the branch and give the total arrangement stability. Emphasize the line effect with considerable space around each flower.



Figure 13-4



CHAPTER 14

TABLE SETTINGS



INFORMAL

Brunch on the patio

FORMAL

Dinner with white linen cloth, crystal and silver

A well-appointed table includes a floral piece that coordinates with the dishes, tablecloth, flatware and napkins, creating a pleasant environment for dining. Harmony between the flowers and their setting is very important in creating a total unified look. Experimenting with different table settings is an excellent way to explore the importance of coordinating floral designs with the environment in which they will be used.

This exercise is designed to help you create a single place setting, complete with flowers, dishes, flatware, napkin and table covering, that artistically and creatively establishes a mood suitable for a specific occasion. Size relationships, color, texture, design pattern, and accessories are all elements that you should consider carefully for a successful result. The degree of formality, season of the year, time of day, and location of the table will affect the choices you make. (See Color Plate III-1.)

THE OCCASION

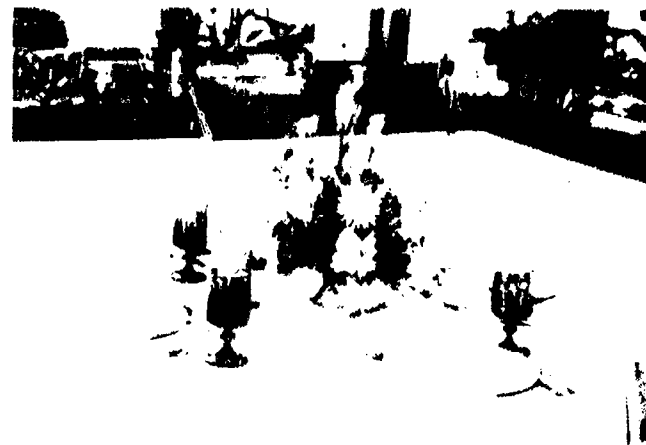
One must first identify whether the meal is a breakfast, brunch, lunch, afternoon tea, dinner, or evening meal. In most situations the evening meal is more formal than those earlier in the day, but this can vary, depending on the circumstances. For example, is this a quiet family gathering or is it a special event with invited guests? The number of people being served and their relationship to the host or hostess will also help establish the degree of formality of the table setting.

Determine the reason for the occasion. Is it centered around a special holiday or a particular theme? Is it a child's birthday, Easter brunch, graduation luncheon, or

retirement party? Have any of the participants expressed a preference for certain colors, accessories or flowers? All of this must be considered in determining possible choices of materials.

**SIZE and SHAPE
of the TABLE**

What are the dimensions of the table and how many people are going to be seated at it? For a sit-down meal at least two feet should be allowed for each guest. A buffet table, of course, would not involve seating people. The size of the table should be determined by the amount of food, floral pieces, dishes and other items it is to hold. This should be carefully planned in advance. A buffet table should not look crowded. Also at a buffet table the arrangement may be off-center and taller than it would be on a table where guests are seated, since at a buffet the arrangement will not interfere with conversation.



A round table with an open bouquet of spring flowers

A large table will require a larger centerpiece than a small table. If the table is longer than 8 feet, it may be best to use two or more arrangements. The arrangement (or sum of the arrangements) should not take up more than one-third the length of the table. The width of the arrangement should be such that it doesn't crowd the place settings.

A round table will generally call for an arrangement that is rounded or tri-symmetrical in overhead view (Fig. 14-1, 14-2). The diamond centerpiece works well on a rectangular table (Fig. 14-3) and an oval design on an oval table (Fig. 14-4).

CHINA AND FLATWARE

The choice of china and flatware is usually limited to what is available and therefore must be considered early in the decision-making process. High quality china like Wedgwood, Haviland, Limoge and Rosenthal is suitable for very formal occasions. White china with a simple gold band is versatile, easy to work with, and always in good taste. Interesting patterns in the china may impose some restrictions on the choice of floral materials and designs, but they can also be worked with in creative ways. Pattern, color and quality of the china must all be considered in order to make harmonious flower decisions.

Ironstone and stoneware are less formal, but they have a wide range of possible uses. Corningware and plastic are even more informal. A creative setting may be done even with paper plates. A table setting is not successful or unsuccessful because of its degree of formality. Each situation can be

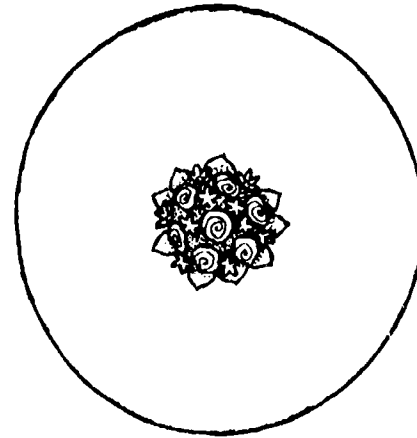


Figure 14-1
Round mound design

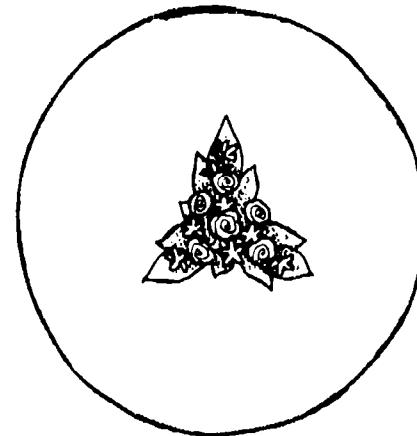


Figure 14-2
Tri-symmetrical arrangement

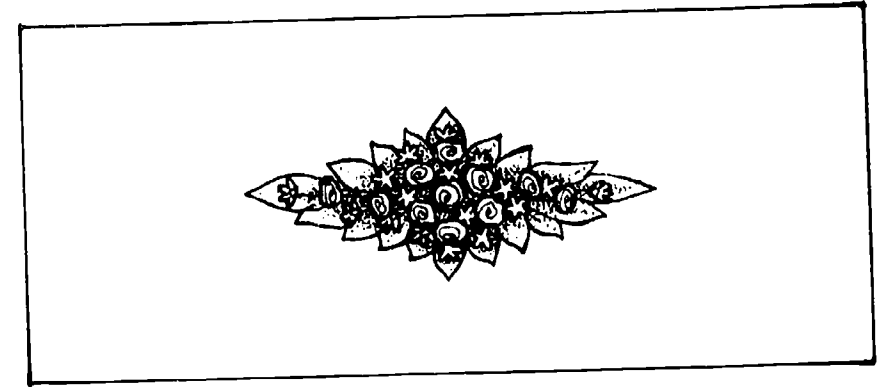


Figure 14-3 Diamond centerpiece

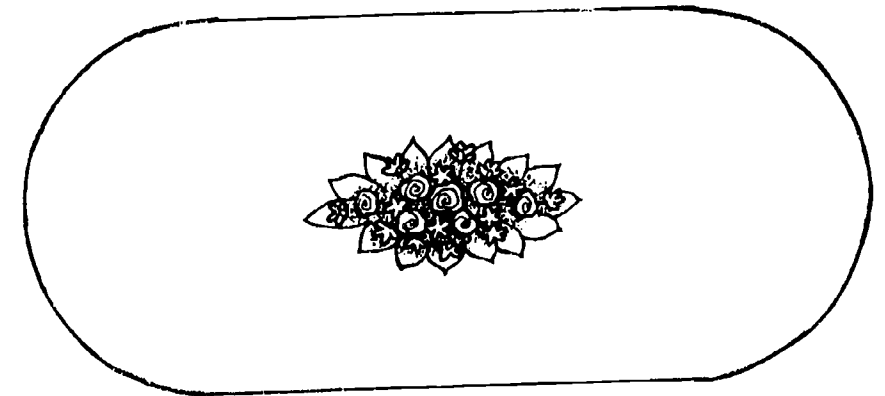
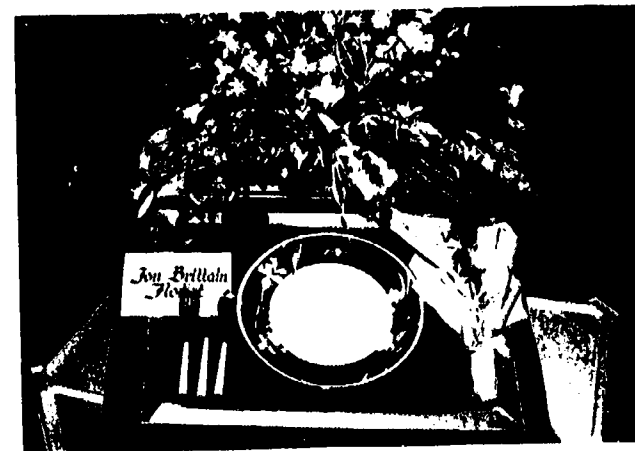
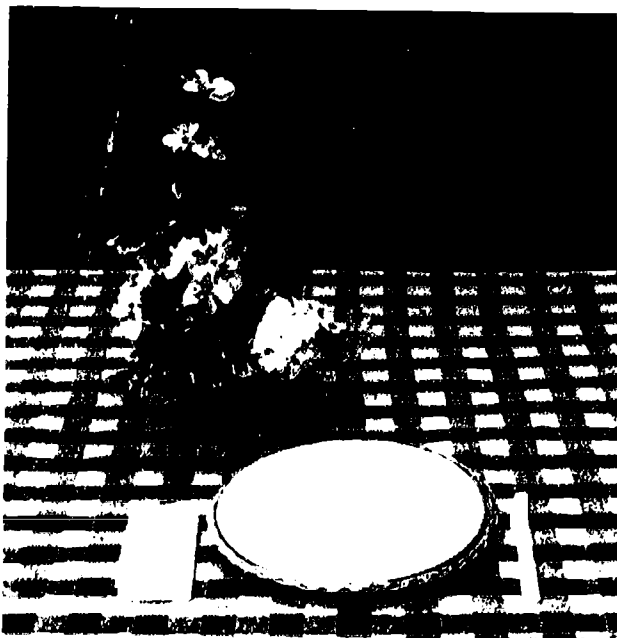


Figure 14-4 Oval centerpiece



Dramatic contemporary look - black placemat, colored handled flatware, and a creatively folded napkin



A plain white plastic plate, napkin and white geraniums stand out against the strong gingham check



An oblong diamond centerpiece of lilies, carnations and kalanchoe

artistically developed if all elements are well coordinated.

Flatware should be compatible with the china. Silver or goldware is appropriate for formal settings, stainless for less formal, and plastic for least formal occasions. Bone, wood or colored plastic handles are found in some flatware and are good for special effects when combined with appropriate dishes and flowers.

TABLE COVERING and NAPKINS

If a table covering is used, it should be a good background for the dishes. White linen and lace are formal. Colored cloths should repeat a color in the china or provide a pleasing contrast. Off-white china may appear discolored on a pure white cloth.

Napkins may match the cloth or be of another compatible color in the overall scheme. Changing the napkins is a relatively easy and inexpensive way to vary the color scheme or pick up a secondary color in the china or in the arrangement. Napkins are usually placed to the left of the fork with the folded side on the outside so they can be picked up and unfolded easily at the beginning of the meal. For special effects napkins can also be folded into many interesting shapes.

Place mats may be used at the individual place settings either with or without a tablecloth. The outside edge of the place mat should be one inch from the edge of the table. The guidelines previously described for selecting tablecloths also apply to place

mats. Those that are made of wicker or woven fiber have an interesting texture and can create a natural effect. Table runners or ribbons can be used instead of place mats to add a festive note, either with or without tablecloths. They can extend the length of the table or be criss-crossed to run under each place setting.

Occasionally napkin rings are used to add yet another dimension to the setting. A single blossom or small cluster of flowers may be attached to the napkin ring for a special occasion.

FLOWERS for the TABLE

The size and shape of the design will be largely determined by the size and shape of the table. This was discussed in a previous section, but some additional guidelines on the **height** of the arrangement will be given here. In general, the overall height of a table arrangement should be less than 12 inches so it does not interfere with conversation. An exception would be the use of very wispy materials that extend higher than 12 inches but can still be easily seen through. Other exceptions include two-parted arrangements where the top part is elevated above eye level on slender rods, tall-pedestaled candelabras, and hanging arrangements suspended from the ceiling. On buffet tables, of course, the height of the arrangement is not as important since people will not be seated.

A designer will also take into consideration the china, flatware, table covering, napkins, and reason for the occasion when deciding on the flowers, design style and

accessories. Containers may match or coordinate with the dishes. A very close match is achieved when a serving piece from the set of dishes is used to hold the flowers. Often very plain, inexpensive containers are sufficient, because many centerpiece designs have low flower placements that largely conceal the container. If the container shows and does not match the dishes, it should still be harmonious in color and formality.

Several historic styles of centerpieces for tables are of interest. One of these is the epergne (e-purn') (Fig. 14-5), an ornate silver, porcelain or glass container composed of a number of joined parts, each of which can hold flowers or fruit. Epergnes were popular during different eras, including Williamsburg and Victorian times. Another typically Williamsburg centerpiece can be constructed from a wooden cone from which nails project. Apples and other fruits are pushed onto the nails, and the area between the fruit is filled in with greens such as boxwood.

Flowers are selected on the basis of their color, texture, shape, degree of formality, and, of course, availability. Roses, orchids, lilies, carnations and snapdragons are suitable for formal settings, but can also be adapted to less formal situations. Daisy and pompon mums and garden flowers like zinnias or geraniums are good choices for the informal table. Actually, the degree of formality for most flowers is determined by the way they are used rather than any inherent quality.

The geometric design styles (diamond centerpiece, mound, tri-symmetrical and inverted-T) are most commonly used in the

floral piece for a table. However, a number of alternatives are available, some of which are discussed here.

1. Use a small collection of bud vases of different heights. Fill each with flowers. The collection could be "tied together" more by placing all of them on the same base like a mirror. Votive candles can be used between and around the vases if desired. This makes a quick and economical centerpiece.
2. For a casual centerpiece, use a collection of potted plants in a basket. Both blooming plants like African violets, and foliage plants like ivy are good choices. First line the basket with foil or plastic. Sheet moss can be used to hide the pots if necessary.
3. Lay greens down the middle of the table in a linear or serpentine pattern. Accent the greens with votive candles or candles in holders, fruit, nuts, and/or fresh flowers like chrysanthemums or carnations that hold up well out of water.

For a very personalized effect, include items of special significance to the person being honored:- items such as photocubes, awards and small figurines or toys that represent the person's interests. If the occasion is a birthday or anniversary party for which a special cake has been prepared, place the cake in the center of the greens and flowers so it can be enjoyed longer before being served.

4. Try a hanging arrangement for an unusual effect, if there is a way to suspend it. Keep it above eye level.

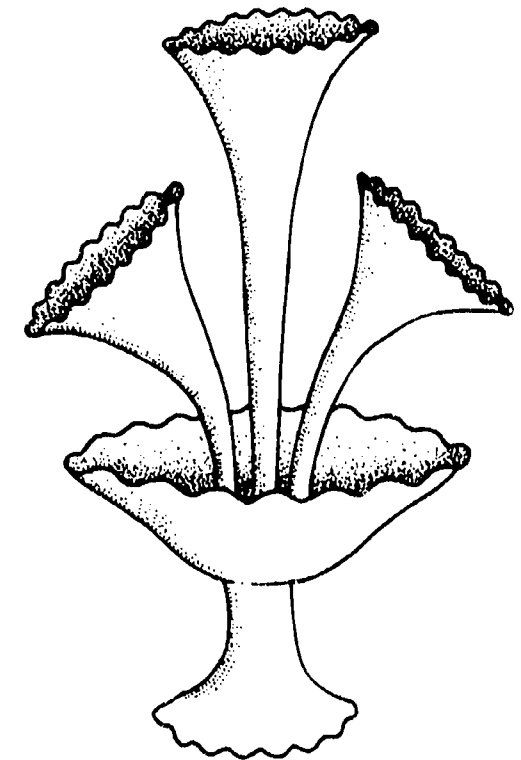
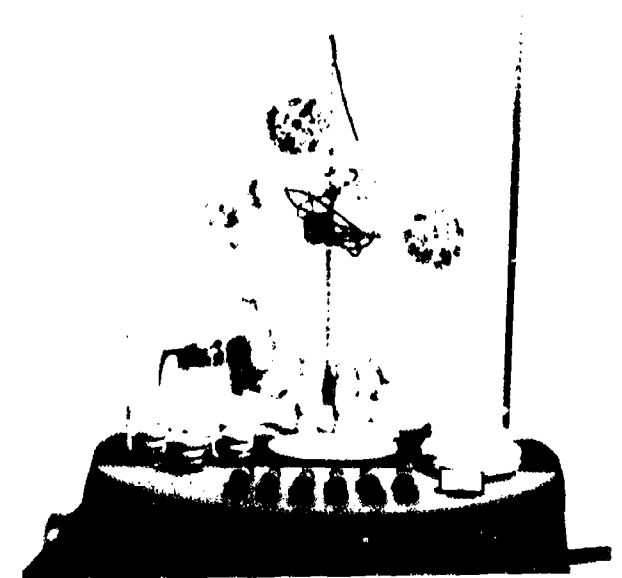


Figure 14-5 An epergne



A hanging arrangement suspended above a buffet table



Candles are a part of this arrangement. The container is a four-branched candelabra

CANDLES

(See Color Plate III-8)

Candles are appropriate any time the area is dark enough for them to be effective. Traditionally they were reserved for evening and more formal affairs. Candles create a soft glow and interesting shadows. Colors in the room as well as flower colors are subdued in candlelight. Dark flowers, especially purple and dark red, may appear black in dim light. Pastel colors and white are more easily seen under low light conditions.

Candles should be placed above or below eye level so the guests are not looking directly into the flame. When several candles are used, they may look more interesting if they are set at different heights. Votive lights can be placed down the table to extend the impact of a design. A different use of votive lights is to elevate them on glass, plastic or wooden rods above eye level.

The larger the table, the more candles should be used. A centerpiece built around a single taper may be adequate for a small table for two, but a table for twelve should have more candles - perhaps three on each side of the centerpiece. Votive lights can be used in combination with tapers to increase the overall effect of candlelight.

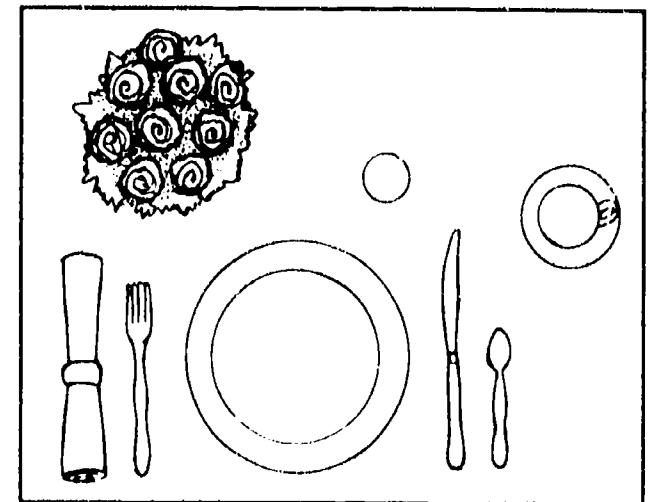
For safety, plant materials should be kept away from the flame. Candles should never be left unattended. When they burn low, they should be extinguished. Drafts on candles will cause them to burn rapidly and may result in wax dripped onto the tablecloth.

Another source of light is the so-called "uncandle." This is a clear glass container filled with water, on top of which is a layer of oil and a floating wick. The water may be colored with food coloring.

OTHER ACCESSORIES

Table arrangements can be accented with a wide variety of accessories including fruit, nuts, sea shells, decorative rocks and figurines. Decorative birds are a favorite of many people. Seasonal holidays like Christmas and Easter suggest a wealth of accessory materials. Whatever the occasion, it is considered inappropriate to use Madonna figurines or the American flag on food tables.

There are several different ways of setting a "correct" table. These will vary depending on the type of occasion, time of day of the meal, number of pieces of china and flatware to be used, and degree of formality. Here are some suggestions for meals served at different times of the day.



Breakfast

SUGGESTED ACTIVITY

Each student will create one place setting complete with a floral design that is in scale with the setting. Students should bring in the dishes, flatware, napkins and table covering (or place mat) that they will need for their single place setting.

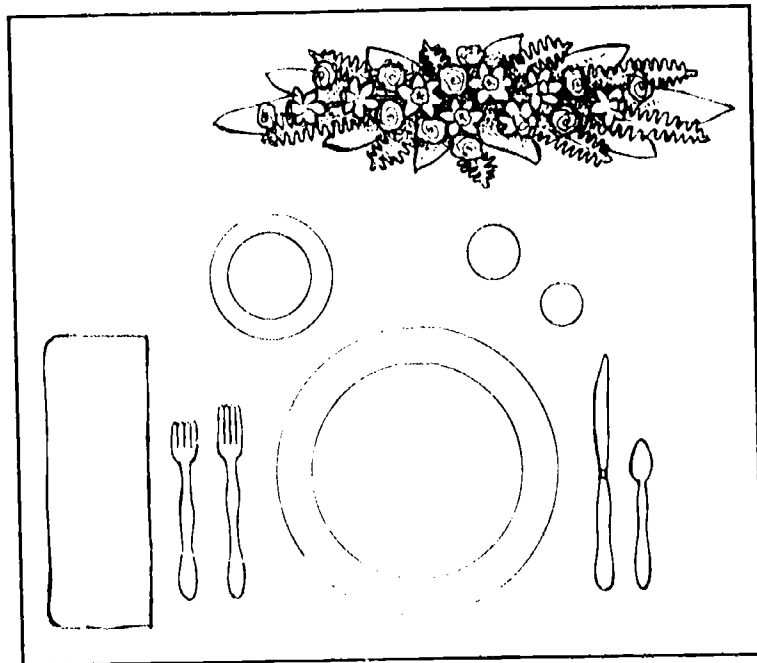
Identify the occasion the setting is for. Be rather specific. Design an arrangement that creates the mood you have envisioned. Use accessories if they will help establish the feeling without causing a cluttered look.

Be especially conscious of color, texture and pattern coordination. Repeat these wherever possible for a unified look. Use spray paint on flowers or dried materials if you cannot obtain the color you want in fresh flowers.

As part of evaluating the table settings, bring in some people who are not trained in floral design. Have them pick two or three favorites. Ask them to explain why they chose the ones they did. This will give you some insight into preferences of the general flower-buying public.



Father's Day Breakfast
Stoneware on a wicker mat. Duck motif repeated in napkin and accessory to arrangement. Teasel and kalanchoe



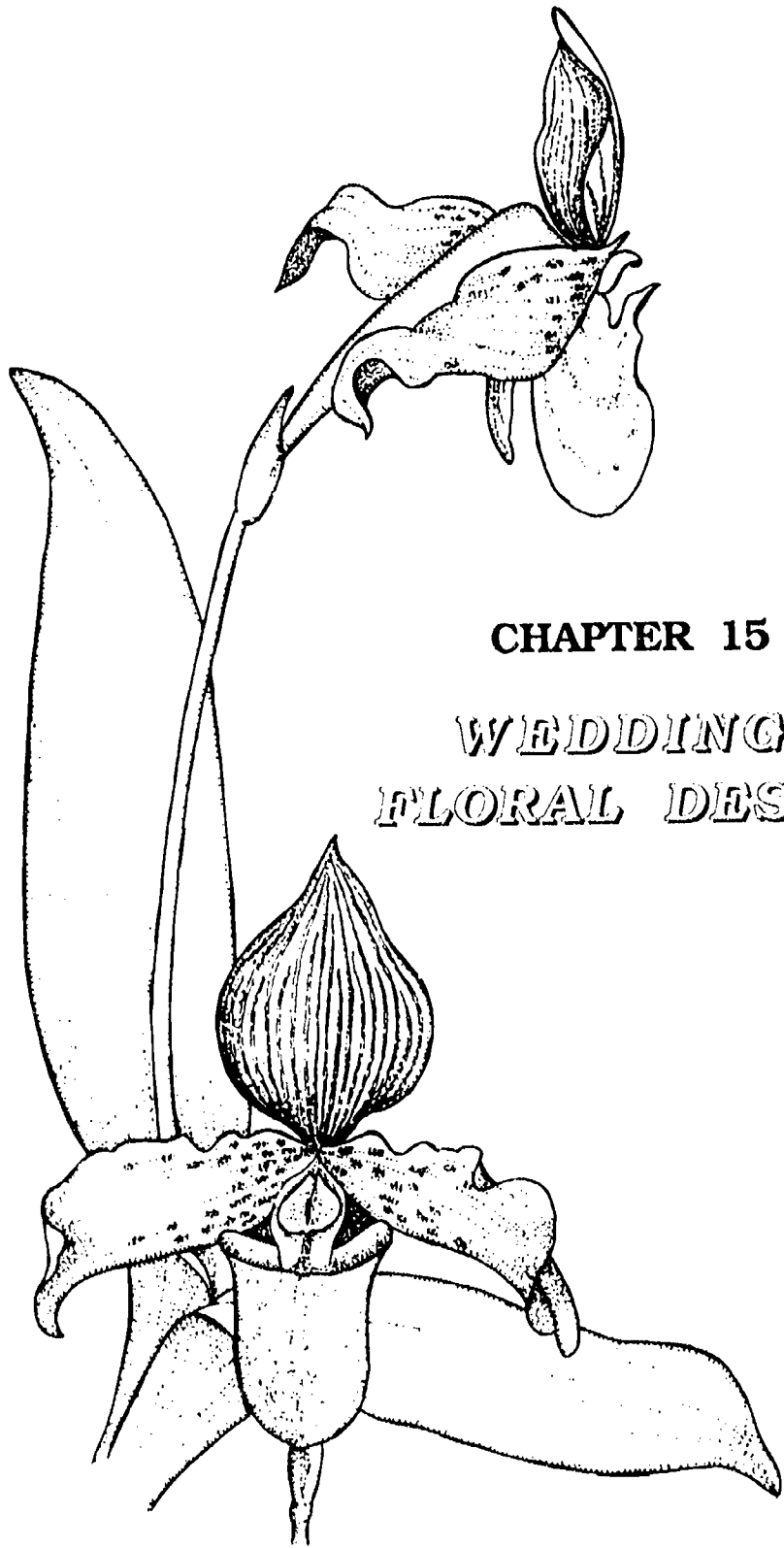
Dinner



Mother's Day Brunch
A delicate S-curve of spring blossoms in a pewter pitcher



Formal Dinner
A baroque feeling with Dresden china, goldware and arrangement of roses and carnations

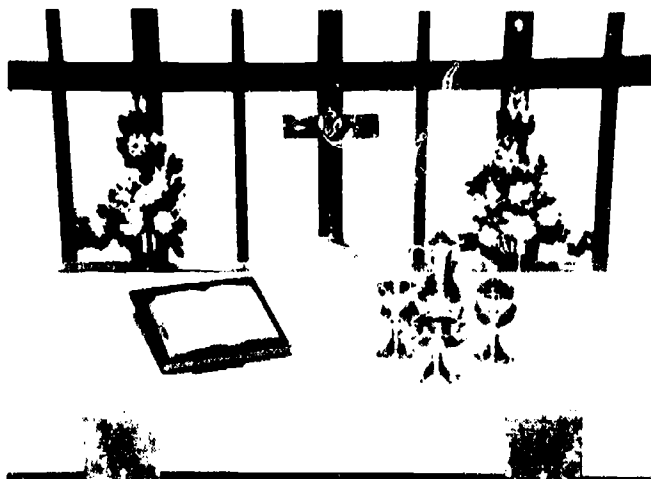


CHAPTER 15
WEDDING
FLORAL DESIGN

465



468



Traditional church wedding
(Concordia Lutheran Church, Wooster)

Brides-to-be want their wedding flowers to be special and to reflect their image of the perfect wedding. That image may be the most traditional round colonial bouquet, or it may be a unique hi-tech contemporary design. Successful florists need to be skilled in designing a wide range of styles, so that each individual wedding can be dealt with in a creative way appropriate to the situation, budget and preferences of the bride-to-be.

Wedding floral design involves arrangements, body flowers and bouquets. (See Color Plates III-2 through III-5.) Many arrangements are basic design shapes with variations in the types of flowers used, accessories chosen, and color scheme selected. Bouquets may be thought of either as corsages scaled up in size or arrangements modified so that they can be held comfortably.

The basic design principles apply to all wedding work. Likewise, all proper care and handling techniques should be carefully observed, since flowers must be in prime condition on this special day.

A florist must assess a number of factors concerning the wedding in order to assist the bride-to-be in the selection of suitable flowers that will enhance her wedding. Some of those considerations are listed below.

1. *Location of the wedding*

Is the wedding to be held in a church, synagogue, home or outdoors? What is the denomination of the church? Does it have any particular rules about the use or placement of flowers? What is the size, style and color scheme of the building or the character of the outdoor location?



A garden wedding setting at the Flower and Bridal Show at Agricultural Technical Institute, Wooster

2. Size of the wedding

Is this a small wedding with only the attendants and the immediate family, or is it a large one with 500 guests expected?

3. Formality of the wedding

Is it a formal church wedding with all the embellishments, or is it a small ceremony in a country church?

4. Time of year

Will the theme of the wedding be influenced by the season or nearby holidays, like Christmas, Valentine's Day or autumn? What flowers are available at a reasonable cost at this time of year?

5. Customs and traditions in the area

What has the bride seen at other recent weddings? Are there certain styles or customs that are currently popular in the area?

6. Budget range of the wedding

This is a sensitive subject that must be handled tactfully. The florist must assess the situation and sell within a price range that is reasonable for the individuals involved. It will also affect whether the wedding is serviced by the florist or the flowers are simply delivered.

SUGGESTED ACTIVITY

Whether the bride prefers a romantic look in soft pastels or selects a daring combination of bold colors, the goal should be to create a total image with every detail conforming to the overall style of the wedding. Some possible wedding styles are listed below as examples. Try to imagine what the other details might be and what types of flowers and arrangements would be appropriate for the setting.

- * A formal Catholic church wedding held during the Christmas season. 750 invited guests with a sit-down dinner to follow at the country club.
 - * A Protestant ceremony in the afternoon with family and friends in a medium-sized traditional church. Reception in the church basement.
 - * A Jewish wedding in June in the synagogue for 500 guests. Tent reception to follow on the lawn of the bride's parents.
 - * A September garden wedding in an arboretum. Reception in an enclosed picnic pavilion.
 - * An August wedding in the parents' home. Pool-side party to follow in the back yard.
-



Contrast the formal look (above) with the informal look (below)



Flowers for the Wedding of

The Bride _____ The Groom _____
 Address _____ Address _____
 Phones _____ of _____ Phones _____ of _____

Ceremony Location _____ Date _____ Time _____
 Reception Location _____ Date _____ Time _____
 Rehearsal _____
 Dinner Location _____ Date _____ Time _____

The Bride

	EXPENSES* of the	
	BRIDE	GROOM
Cost & state of gown _____		
Style of bouquet & flowers _____		
Floral hairpieces _____		\$

The Bridal Party

"Honor Attendant"
 Cost & state of gown _____
 Style of bouquet & flowers _____
 "Bridesmaids" Number _____
 Cost & state of gown _____
 Style of bouquet & flowers _____
"Flower Girl"
 Cost & state of gown _____
 Style of bouquet & flowers _____
 Floral headpieces _____

Boutonnieres

Groom _____
 Best Man _____
 Groomsmen Number _____ Groom's Father _____
 Ring Bearer _____

Corsages

Bride's mother _____
 Groom's mother _____
 Grandmother Number _____
 Other _____

Decorations for the Ceremony

Music Altar _____
 Vase & bouquet decorations _____
 Entrance (centerpiece, altar, aisle, arch, etc.) _____
 Flower girl basket _____
 Other _____

Reception

Cake & display table _____
 Centerpieces _____
 Other _____

Rehearsal Dinner

Cost of dinner _____
 Other _____

NOTE: add total of all items from previous sections of this form.

Subtotal	\$	\$
Tax	\$	\$
TOTAL	\$	\$
Deposit	\$	\$
Balance	\$	\$

Accepted by _____ Date _____

THE BRIDE

BRIDAL INTERVIEW

When the bride-to-be is ready to discuss her wedding flowers with the florist, she comes to the shop for a consultation. Ideally, the florist has a separate area in which to conduct the interview, with comfortable furniture and decorations in a bridal motif. This area should allow the florist to be free of interruptions while showing the bride-to-be pictures and sample silk designs as examples of what is available at that shop.

A **wedding order form**, such as the one shown on the opposite page, sold by the John Henry Company, is an efficient and organized way to determine the flower needs for the wedding. The more information the bride can supply regarding the wedding, the better the florist can serve her. Swatches of fabric taken from inside seams of the gowns should be brought to the florist and stapled to the wedding order form.

The discussion of flower needs should start with the bride's bouquet and progress in the following order:

- * bride's flowers
- * honor attendant's flowers
- * bridesmaids' flowers
- * flower girl and ring bearer's flowers
- * boutonnieres
- * corsages
- * decorations for the ceremony
- * reception flowers
- * rehearsal dinner flowers

EXPENSES

It is customary for the groom to pay for the bride's bouquet, the bride's going-away

corsage, corsages for the mothers and grandmothers, and all boutonnieres. The groom's parents sponsor the rehearsal dinner and pay for the flowers used at this event.

The bride's parents typically pay for all the other bouquets, corsages and flower arrangements at the church and reception.

FLOWERS for the WEDDING PARTY

THE BRIDE'S FLOWERS

(See Color Plate III-3)

The bride's flowers set the style for the other floral selections. Her bouquet should complement the style of the gown and figure of the bride. Bouquets which are commonly used can be placed in the following groups:

1. Colonial bouquets (page 230)
 - * round
 - * oval
2. Cascade bouquets (page 231)
 - * single slim cascade
 - * full cascade
3. Arm bouquets (page 232)
 - * diagonal
 - * crescent
 - * S-curve
4. Basket bouquets (page 233)
5. Arrangement on a prop, such as a Bible, fan, or parasol (page 234)
6. Composite flower (page 235)

(continued on page 236)



The bridal interview conducted in a separate room (De Santis, Columbus)



A formal theme is carried out in both the clothing and the flowers



Colonial with lace collar



Round mound bouquet

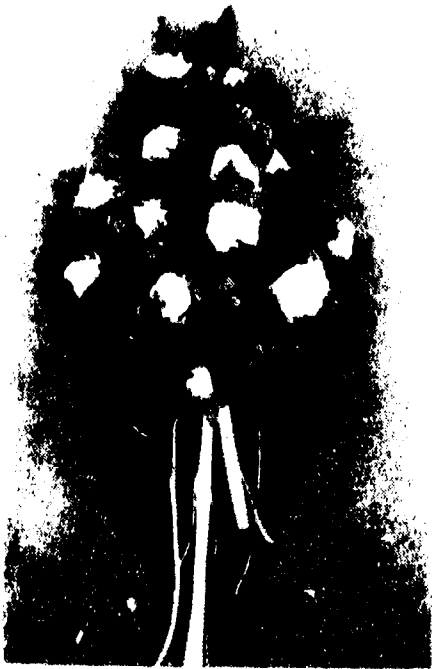


Cloud



Starburst

COLONIAL BOUQUET VARIATIONS



Oval



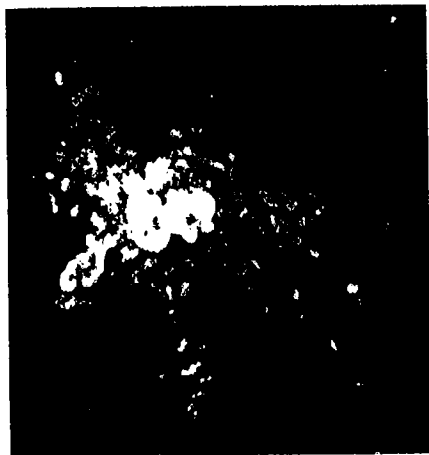
Hand-tied



Teardrop

474

475



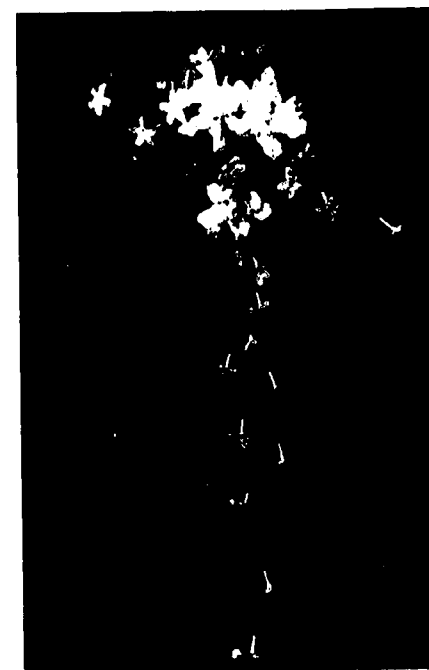
Spray cascade



Slim cascade



Full single cascade



T-cascade



Multiple cascade



Drop bouquet



Triple-drop bouquet

CASCADE BOUQUETS

478

477



Slim arm bouquet



Crescent
(See also page 250)



Diagonal



Arm bouquet
featuring feathers

ARM BOUQUETS



S-curve



Contemporary sheaf



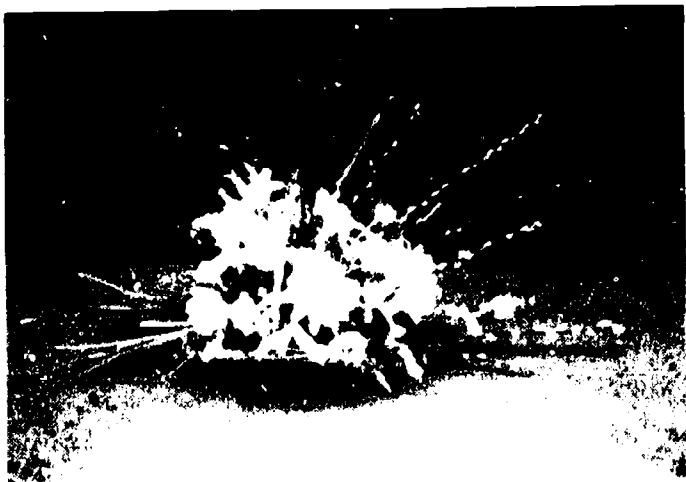
Vegetative arm bouquet

478

NOT AVAILABLE

479

Baskets



Basket of spring flowers with stems extending from one side; to be cradled in arm



Vertical basket with slim line of roses, ivy, baby's breath and ming fern

SPECIALTY BOUQUETS



Candle Bouquet
with a hurricane globe; ranunculus and cyrnbidium orchids surround the candle and continue down in a single cascade



Decorated basket and body flowers for a flower girl



Satin pillow for the ring bearer with an attached crescent of flowers

Children's Flowers

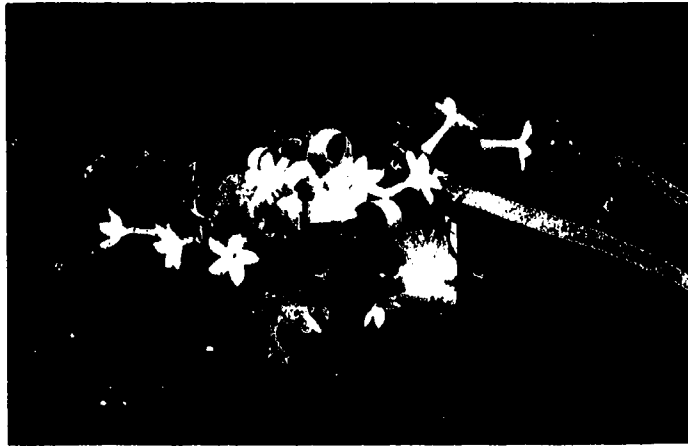
430

BEST COPY AVAILABLE

431



Slim cascade on a velvet muff



S-curve on a prayer book



Crescent of spring flowers on a purse

BOUQUETS ON A PROP



Cluster of flowers under the parasol extending outward with the spokes



Clustering flowers on top of a parasol



A closed parasol treated like a basket with roses spraying upward



Double ring of ivy with grouping and drop of spring flowers



A *basquet*, a bouquet with satin handle simulating a basket arrangement



Triple colonial drop of roses, hyacinth florets, and baby's breath

UNUSUAL BOUQUETS



Duchess rose made from rose petals; lycopodium foliage included



Composite flower made by gluing a rose petal to each camellia leaf



Figure 15-1



Figure 15-2

Some general suggestions for selecting the style of bouquet are as follows:

1. The bouquet should emphasize the best features of the dress and the bride, not stopping at a dominant place on either the dress or the figure.
2. The size of the bouquet should not overpower the bride or hide the features of the dress. (See Figure 15-1.)
3. The bouquet should not be stiff and rigid. It should flow visually and also have some physical motion when carried.
4. The bouquet should be comfortable to carry. (See Figure 15-2.) It should be light and should fit securely into the hand.
5. Graceful extensions of the line up the arm or downward in a cascade should be used, rather than tightly packed shapes that draw attention to one small area.



Bridal headpiece of silk flowers and tulle

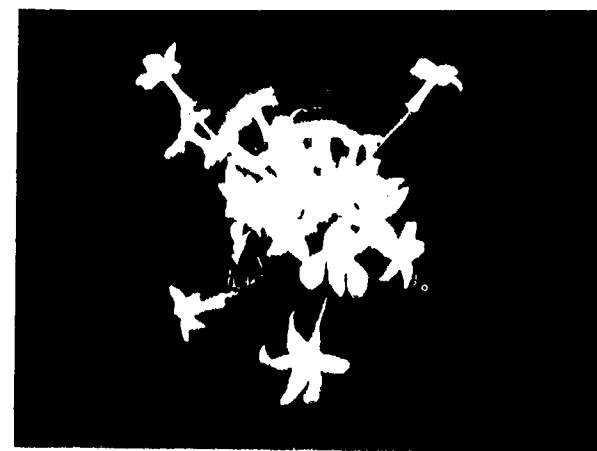
Additional Body Flowers for the Bride

The bride may elect to wear additional flowers that complement the bouquet and create a unified total look. Flowers attached to the hair or on headpieces, hats, or veils are the most common. Such flowers add visual interest during the ceremony when the bride has her back to the guests.

The going-away corsage should coordinate with the dress the bride will wear after the wedding. It can be made as a detachable part of the bridal bouquet.

ATTENDANTS' FLOWERS

The attendants' flowers should not compete with those of the bride. They should be harmonious with the style and formality of those selected for the bridal bouquet. The attendants' gowns and bouquets are usually the most colorful part of the wedding party; they carry out the color scheme that has been selected for the wedding.



Fresh hairpiece of dendrobium orchids and stephanotis

The attendants' flowers may include hairpieces and other body flowers. The flower girl will have a smaller bouquet - perhaps an arrangement in a basket. Each of the men in the wedding party will have a boutonniere and sometimes other "fashion flowers" that coordinate with the other wedding flowers. If there is a ring bearer, there may be flowers on the pillow he carries.

CORSAGES and BOUTONNIERES for SPECIAL GUESTS

Corsages are selected for mothers, grandmothers and other close female relatives and friends. Close male relatives and special guests are given boutonnieres. (See examples on the next page.) Those assisting with the ceremony or reception are also

given flowers. These may include the organist, soloist and hostesses. Flowers may coordinate with the colors of their dresses if they are known. If not, the corsage color should be neutral, like white or ivory, or it can include colors from the wedding color scheme.

FLOWERS for the CEREMONY

If the wedding is to be held in a church, the customs of the congregation and style of that particular church should be taken into consideration. The arrangements should not clash with the colors and architecture of the building, although there is a great deal of latitude in the simplicity or elaborateness that is possible within each setting.

Some churches have altar guilds that can assist florists in knowing what props are available at the church and whether the church has any special rules regarding the use of flowers. Candelabras, aisle posts and



Sporty attendants' flowers include arm bouquet and hair flowers for the bridesmaid, and full boutonniere and hat flowers for the groomsman.



Going-away corsage of roses, stephanotis and camellia leaves



Mother's corsage - a gardenia and rolled rose petals



A purse corsage of cymbidium orchids



Boutonniere of a cascading spray of oncidium orchids

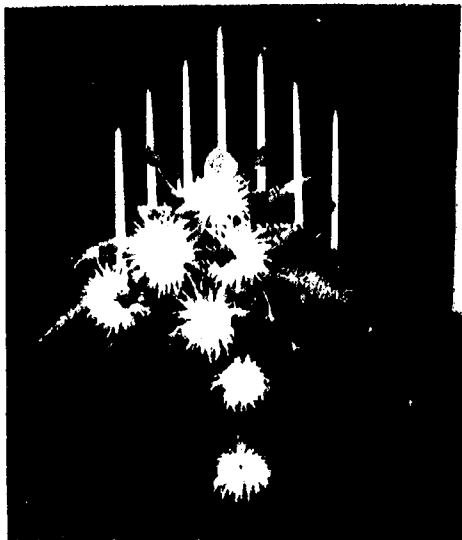


Figure 15-3

kneeling benches are props available at many churches. If these props are not available, most florists commonly have them for rent along with materials like palm buckets and foliage plants.

The following list identifies some of the props and floral decorations that might be used for a wedding ceremony.

1. Altar flowers

These can consist of one large arrangement or two smaller arrangements, either in concealed plastic containers or in altar vases that belong to the church.

2. Candelabra flowers (Fig. 15-3)

Branched candelabras are often decorated simply with bows, or bows combined with flowers and greens. Be very careful not to scratch or otherwise damage the metal of the candelabra.

3. Arrangements

Flower arrangements can be placed on pedestals, in front of lecterns, or in windows.

4. Foliage

Living potted foliage plants can be used, or cut greens can be placed in palm buckets or styrofoam. Palm buckets are designed to have emerald leaf inserted in the wire holders to simulate a living plant (Fig. 15-4). These are easier to transport than living plants and make a good show with height that can be seen from a distance.

5. Flowering potted plants

Foiled flowering plants decorated with bows are often used in various locations, either singly or grouped.

BOUTONNIERES



Single flower- ranunculus and maidenhair fern



Three flowers- rose and stephanotis with camellia leaves



Sweet peas and leatherleaf

6. *Pew bows* (Fig. 15-5)

Bows alone or with flowers and greens may be attached to the pews down the center aisle. Sometimes they are used only to mark the family pews.

7. *Aisle posts* (Fig. 15-6– 15-8)

Posts that clamp onto the pews and hold a candle at the top add a special touch to the church decorations. An arrangement of flowers and/or foliage may be attached to the base of the candle. Ribbon or greens may be spiraled down the post.

8. *Kneeling bench* (Fig. 15-9)

For some ceremonies a kneeling bench is used. It can be decorated with clusters of flowers and ribbons, with ribbons or greens swagged between the clusters.

9. *Flowers for the Blessed Virgin*

A single flower or a presentation arm bouquet may be placed at the feet of the Virgin Mary in a Roman Catholic ceremony.

10. *Canopy*

A wooden canopy called a *chuppah* is used for Jewish wedding ceremonies. The canopy can be decorated with greens and flowers.

11. *Aisle runner*

Florists often provide the aisle runner. They pin or tape it in place so it can be pulled easily at the proper time. Most aisle runners now used are plastic.

Figure 15-4
Emerald leaf for
a palm bucket



Figure 15-5
Pew bow

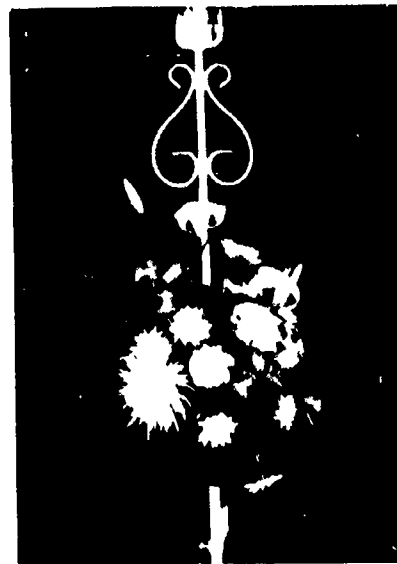


Figure 15-6

THREE AISLE POSTS



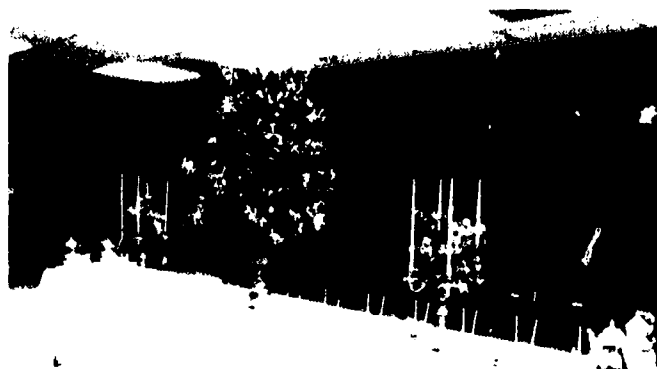
Figure 15-7



Figure 15-8



Figure 15-9
Kneeling bench



Reception table with large centerpiece and coordinating candelabra



Silver 4-branched candelabra with central grouping of flowers that flow out between the candles

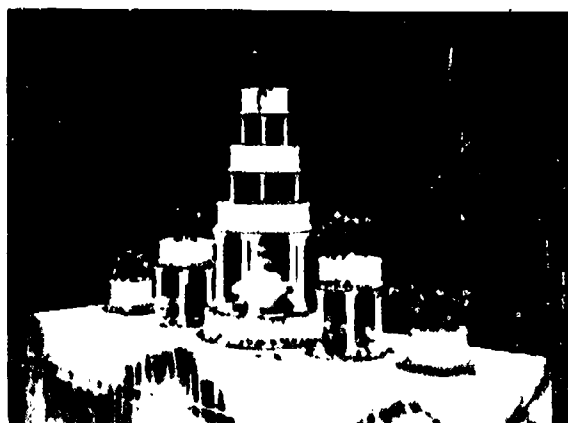


Figure 15-10 Cake table

FLOWERS for the RECEPTION

The nature and extent of the reception flowers will depend on the location of the reception, the theme of the wedding, and the degree to which the bride's family wishes to decorate. Obviously, the decorations for a country club dinner, a reception in the church basement, and a poolside party will differ. The object is to create a festive atmosphere for a joyous occasion.

Following is a listing of some possible uses for flowers at a reception.

1. Serving table

The buffet table may have one or more arrangements. Candles may be used in or with the designs, or the arrangements may be made in pedestaled candelabras so that they show well without taking up much table space.

2. Centerpieces

Individual table centerpieces where guests are to be seated are effective in repeating the color and romance of flowers throughout the room.

3. Cake table

Greens and flowers laid around the base of the cake help set it off. Use only unblemished materials whenever you are placing them near food. The cake table can also be decorated with festoons of ribbon, cloth or fresh green roping like smilax or sprengeri (Fig. 15-10). Fresh flowers for the top of the cake are an attractive alternative to the traditional plastic tops usually seen. A

cluster of fresh flowers may also be attached to the serving knife used by the bride and groom to cut the first slice of cake.

4. Guest book

The guest book is usually positioned by the entrance to the reception hall. A small arrangement of flowers may be placed near it, or a mini-corsage could be attached to a ribbon to use as a bookmark.

5. Punch table

Laying greens or flowers around the punch bowl is a simple way to extend floral decorations to this area. If there is room on the table, a flower arrangement can also be used there.

6. Room decorations

Additional flowers may be placed in windows or on walls, hung from the ceiling, or used to accent special features like balconies, staircases, pianos or stages.

7. Rehearsal dinner

Flowers for the rehearsal dinner usually consist of one or more centerpieces. There may be corsages and boutonnieres requested for the bride, groom and some family members. The groom's family typically hosts the rehearsal dinner and makes flower selections.

SUGGESTIONS FOR DOING WEDDING WORK

1. Mist flowers and keep them cool so they will remain fresh and in top condition.

Keep flowers in the cooler as much as possible. After they have been wired and taped, return them to the cooler.

Mist the flowers with water as you work with them. Use a mist bottle to spray a fine layer of water on the wired and taped flowers as well as the made-up bouquet.

Work over a layer of moist paper towels or newspapers. The paper will cushion flower petals, and the moisture evaporating from the paper will reduce water loss by the flowers.

2. Have all supplies and equipment in close proximity to the work area.

Wire holders are convenient for storing various gauges of wire in a vertical position. Shorter lengths of wire can be kept in bud vases that are labeled with the number gauge of the wire.

Scissors, wire cutters, floratape and corsage pins are frequently used and should be kept within reach.

A heavy-duty counter mounted wire cutter is useful for cutting the thick stem of a finished bouquet.

Ribbon should be displayed on a ribbon rack so that it can be easily seen and removed when needed.

3. Set up an assembly line procedure for efficiency.

Wire and tape all of one kind of flower or foliage at a time. Cut all the flowers from the stem at one time, wire them all, and then tape.

Place wired and taped flowers and foliage upright in the bud vases, mist the material, and cover with a plastic bag before returning them to the cooler. A hyacinth stake that is taller than the flowers may be placed in with them to keep the bag from resting on the flowers.

4. Use a bouquet stand to anchor bouquet holders while you are working on them.

A heavy pottery vase filled with styrofoam can accomplish the same purpose.

5. Use mists, dips and adhesives to make flowers look their best and preserve their quality.

Flowers that turn brown easily, like lily-of-the-valley, can be dipped in a half water-half white glue mixture to form a transparent barrier to air over the flower. Delicate foliage like ivy and fern tips can be dipped in the same solution to reduce water loss and slow wilting.

There are aerosol and mist products that form an invisible layer over flowers and help keep them fresh longer. *Green-Glo* and other plant shine compounds are suitable for use on foliage. They give foliage a glossy appearance and keep it fresh longer.

White spray paint can be used lightly over flowers like gardenias, stephanotis and orchids that may have a slightly browned area.

Adhesives can be used to repair broken petals or to keep petals from falling off or bending back. Lily petals often need the



A cake for the rehearsal dinner decorated with fresh flowers



An open arrangement of silk flowers with candles in bud vases—simple but elegant decoration for reception or rehearsal dinner
(Hitomi Gilliam)

extra support of an adhesive. *Mum Mist* prevents mum shattering. A couple of drops of candle wax low on the backs of the petals can be used to prevent the reflexed action of anemone flowers.

6. Store finished bouquets carefully in the cooler.

Cushion the bouquet on a layer of crumpled or shredded waxed tissue.

Cover the bouquet with a thin plastic bag. It is important not to crush the flowers with a heavy covering.

SUGGESTED ACTIVITIES

A. Colonial Bouquet (wired and taped)

Materials: (Fig. 15-11)
 15 daisy pompon mums
 12 carnations
 baby's breath
 leatherleaf fern
 huckleberry
 wire, sizes 20-28
 white floratape
 #3 and #5 satin ribbon
 corsage pins



Figure 15-11

1. Wire and tape each flower using hook method for the mums, pierce method for the carnations, and wrap-around method for the baby's breath and foliage. Use lengths of wire sufficient to give each flower at least a 9-inch wire stem when you are done. If attached wire bends under the weight of the flower or foliage, tape on an additional heavier wire.

2. Begin by arranging the carnations in a circular pattern. Hold one flower upright in your hand, then add another, bending it down to form the lower part of the round bouquet. Secure the stems with floratape by turning the bouquet two or three times after the addition of one or two placements. These first placements will establish the overall size of the finished bouquet. Be careful not to make it too large, but also avoid making it so small that the flowers appear to be crowded tightly together.

3. Continue adding carnations to form the circular framework of the design (Fig. 15-12). Sink some carnations in for depth.

4. Repeat the circular form with mums (Fig. 15-13). Do not crowd the flowers but place at different levels to lead the eye into the bouquet.

5. Add the greens (Fig. 15-14). They should be kept deep in the design and not be allowed to crowd the flowers or give an untidy look.

6. Add baby's breath (Fig. 15-15) just as you would add filler materials in an arrangement. Keep a light, airy, cloud-like feeling throughout the bouquet.

Figure 15-12



Figure 15-13

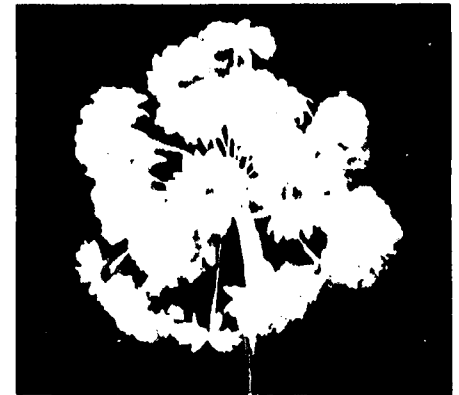


Figure 15-14



Figure 15-15



7. Make a bow of #3 satin ribbon with 3-inch loops. Also make a set of six streamers of different lengths ranging from 4 to 16 inches. Tape the bow and streamers into the bouquet (Fig. 15-16).

8. Cut the handle of bunched wires to a length of 5 inches. Wrap it with #9 satin ribbon, being careful to cover the rough cut ends of wire with the ribbon (Fig. 15-17). This can be most easily accomplished by starting right under the flowers and wrapping down the stem and then back up. Tuck the ribbon in neatly over the cut wires as you start back up the stem. To finish, tie a knot around the handle with the ribbon, trim the end, and fasten it with a corsage pin. Make sure that the pin is embedded in the handle, not sticking out anywhere.



Figure 15-16



Figure 15-17

B. Oval Clutch Bouquet (Bouquet Holder)

Materials: (Fig. 15-18)
 bouquet holder
 15 daisy pompon mums
 annual statice
 baby's breath
 pittosporum
 lace collar

1. Soak the bouquet holder. Place handle in styrofoam that has been firmly anchored in a heavy vase or in a commercial bouquet holder stand.

2. Green in the holder to loosely cover the foam and cage (Fig. 15-19).

3. Create an oval shape with the mums (Fig. 15-20). Remember to create depth by the in-and-out placement of flowers.

4. Fill in the design with statice and then baby's breath (Fig. 15-21).

(continued)



Figure 15-19



Figure 15-20



Figure 15-18



Figure 15-21

5. Place a lace collar under the bouquet by pushing the bouquet holder handle through the hole in the lace collar (Fig. 15-22).

6. Bend the plastic handle into a comfortable position for holding by running hot water over it before bending it.



Figure 15-22

C. Cascade Bouquet

Materials: (Fig. 15-23)

25 mini-carnations	10 pieces of ivy
12 roses	#9 satin ribbon
25 camellia leaves	corsage pins
25 annual statice pieces	



Figure 15-23

1. Wire the carnations and roses with #24 wire using the pierce method. Wire camellia leaves with #28 wire (hairpin method) and statice and ivy with #28 wire (wrap-around method). Add a #24 wire to the camellia, ivy and statice for added strength. Spray wired camellia leaves and ivy with plant shine.

2. Start the long cascading section (Fig. 15-24 bottom) in the same way as for a single spray corsage. Alternate the ivy, camellia leaves, statice pieces, carnations and roses, taping after each placement is added. Leave a greater distance between placements toward the end of the cascade.

As you approach the other end, gradually leave more of the individual placements free on longer stems from the main trunk, so that greater depth is created where the cascade will be joined to the main body of the bouquet. The total length of the cascading piece should be about 10 inches. Ideally the wiring and taping of this section should be light enough to allow graceful movement of the bouquet when it is carried.

3. Make a shorter cascading piece about 6 inches long (Fig. 15-24 top) with an alternating mix of ivy, camellia, statice, carnations and roses.

4. Join the two cascading pieces, leaving about an 8-inch gap between them to fill in the main body of the bouquet (Fig. 15-25). The longer cascade will flow down over the skirt of the gown, while the shorter cascade will arch up and over the hand.

5. Fill in the main body of the bouquet, first with carnations and then with roses and the other materials (Fig. 15-26). Blend the two



Figure 15-24



Figure 15-25

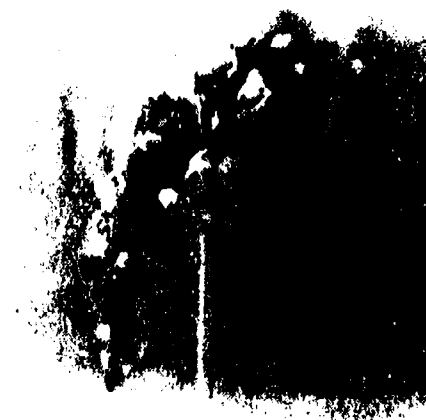


Figure 15-26

cascades together by developing a gently arching silhouette. Check the design to be sure you have created depth and fullness. Make sure the bouquet is well balanced and comfortable to hold.

6. Wrap the handle with #9 satin ribbon (Fig. 15-27) and secure with corsage pins.



Figure 15-27

D. Arm Bouquet

Materials: (Fig. 15-28)

3 liatris	#9 satin ribbon
5 tulips or daffodils	1-inch wide
3 stems of alstroemeria	floratape
6 pieces of sprengeri	



Figure 15-28

1. Gather the stems of liatris in your hand and bind them together about 6 inches from the cut ends with 1-inch-wide floratape (Fig. 15-29).

2. Add the alstroemeria and spring flowers. Fasten them in with floratape after each two or three additions. The bouquet is designed to be cradled in the arm with the natural stems extending beyond the hand as if freshly gathered.

3. Add arching pieces of sprengeri to soften the bouquet and give it some movement. Tape these on at the same place as the previous additions.

4. Make a #9 satin bow and attach it at the point of taping. (See Figure 15-30.) The bouquet should rest in the arm and be held just under the bow.



Figure 15-29



Figure 15-30

E. Basket Bouquet

Materials: (Fig. 15-31)

wicker basket with plastic liner
floral foam
daisy pompon mums
annual statice
baby's breath
ivy
pittosporum
#1 satin ribbon
chenille stems



Figure 15-31

(continued)

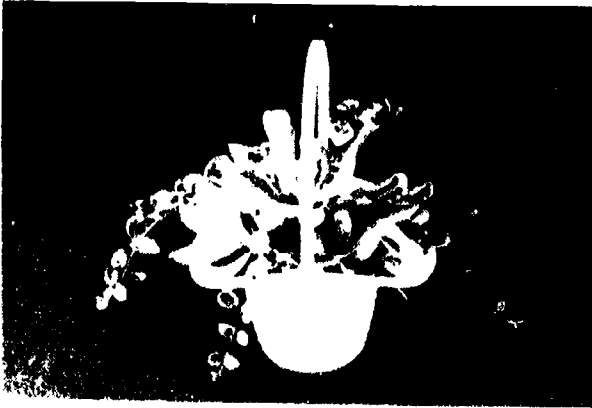


Figure 15-32

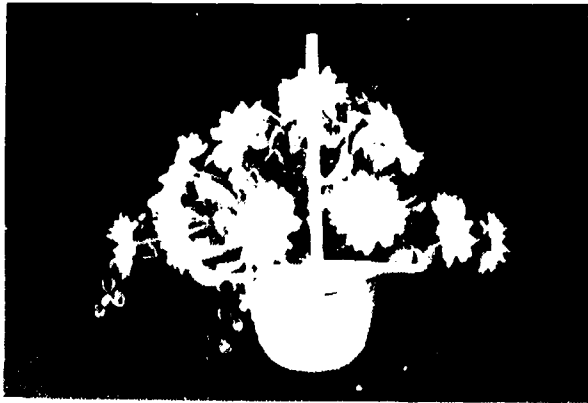


Figure 15-33



Figure 15-34

Basket Bouquet (continued)

1. Fill the plastic liner with soaked foam and secure it to the container with chenille stems that are fastened to the wicker.

2. Green in the bouquet with pittosporum. Create a low bed of foliage that arches through the basket well below the handle (Fig. 15-32).

3. Use the pompon mums to establish an arched trunk line through the handle of the basket with one side cascading down longer than the other (Fig. 15-33). The overall shape is a crescent.

4. Fill in the bouquet with statice and baby's breath (Fig. 15-34).

5. Spray the ivy with a plant shine compound. Position the strands of ivy to hang down over the side of the basket.

6. Make a bow with many loops (six to eight on each side) and several streamers. Attach these to the base of the handle on one side of the basket (Fig. 15-35).

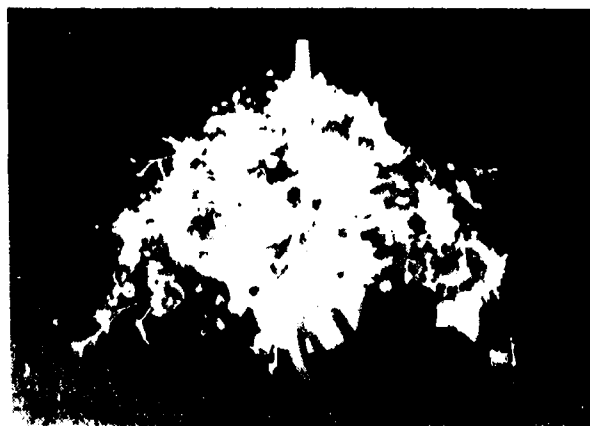


Figure 15-35

F. Bouquet on a Bible

Materials:

- white Bible
- 15 stephanotis (or hyacinth) florets
- 1 white cattleya orchid
- ivy
- 12 variegated pittosporum leaves
- #3 eggshell satin ribbon
- moist cotton
- floral adhesive

1. Wire and tape stephanotis, individual pittosporum leaves, and ivy branches. Use the following wiring techniques:

- * orchid - criss-cross #24 wire
- * stephanotis - form a hairpin of #28 wire and pull down into the throat of the flower over a moist piece of cotton
- * pittosporum leaves - hairpin method using #28 wire
- * ivy strands - use #28 wire and wrap-around method

Spray the foliages with a plant shine compound.

2. Make a bow and three streamers of varying lengths up to 10 inches long.

3. Tape two #18 wires with white floratape and fashion into a figure-eight larger than the Bible (Fig. 15-36).

4. Make an elongated double spray corsage that will fit on the cover of the Bible (Fig. 15-37). Bend the corsage into an S shape.

5. Fasten corsage to middle of the figure-eight with floratape.

6. Pin the corsage on cover of the Bible and bend ends of figure-eight over the cover.

7. Tie five loose knots (lovers' knots) in the ribbon streamers at different levels.

8. Use floral adhesive to attach an unwired stephanotis blossom and a small pitto-sporum leaf at each knot.

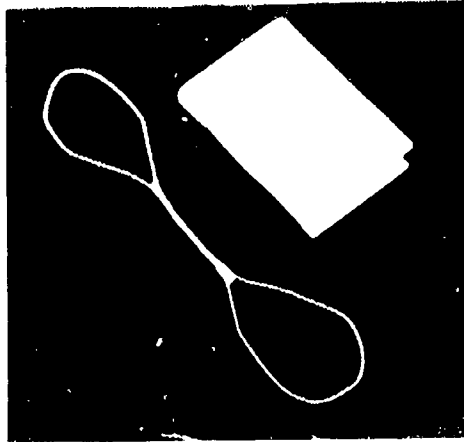


Figure 15-36



Figure 15-37

G. Composite Flower (Glamellia)

Materials: (Fig. 15-38)

gladiolus florets
camellia leaves
cardboard
floral adhesive
floratape
#18 and #28 wire

1. Pull off individual gladiolus florets and line up in order of size (Fig. 15-39). Begin by piercing with #28 wire a floret that is just starting to open. Bend the wires down. Open up additional florets and wrap them around the bud in concentric circles. Cross-pierce through the base of the flower to hold them in place, using #28 wires that are then bent downward. After several layers have been added, tape the base of the glamellia and continue taping on down the bunched wires (Fig. 15-40).

2. Cut a circle of cardboard 6 inches in diameter. Punch a hole in the center.

3. Spread floral adhesive around the outer edge of the cardboard circle and lay down a circle of petals.

4. Glue down three more rows of petals inside the first with each row covering the base of the petals on the previous row.

(continued)

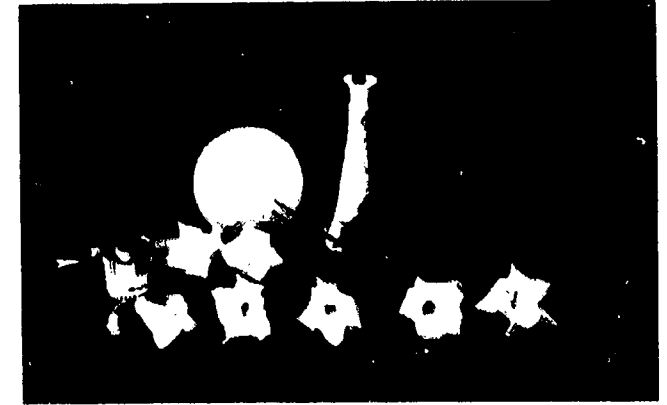


Figure 15-38



Figure 15-39



Figure 15-40



Figure 15-41



Figure 15-42



Figure 15-43



Figure 15-44

Composite Flower (continued)

5. Insert wired part made in Step 1 through the hole in the cardboard (Fig. 15-41). Continue adding petals outward, securing them with floral adhesive, until the composite flower is completed (Fig. 15-42).

6. Add two full-length #18 wires to the stem and tape. Cut to desired length.

7. Glue camellia leaves to the back of the cardboard so that they extend only slightly beyond the edge (Fig. 15-43). Wire and tape three leaves, then attach them by taping to the stem (Fig. 15-44). Bend the stem slightly for a natural appearance.



Figure 15-46

H. Pew Decoration

Materials:

- #40 white satin ribbon
- salal
- leatherleaf fern
- 2" x 4" piece of 2-inch-thick styrofoam
- #18 wire
- floratape

1. Tape two 9-inch lengths of #18 wire with floratape. Bend each piece into a U and insert into long sides of the styrofoam (Fig. 15-45). The styrofoam will sit on top of the pew with the taped wire loops bent down on either side to hold it in position. They can be taped to the pew for extra support.

2. Make a bow and two 12-inch streamers. Insert these into the styrofoam.

3. Insert salal leaves and leatherleaf around the bow to cover the styrofoam. Arch some greens over the wire loops to cover them and extend some branches downward to follow the streamers (Fig. 15-46).



Figure 15-45

I. Candelabra Decoration

Materials:

plastic floracage containing soaked foam
salal
huckleberry
5 gladioli
1 bunch of pompon mums
#40 satin ribbon
chenille stems
wooden pick

1. Use chenille stems to hang the floracage containing soaked foam on the candelabra where upright post and crossbar meet (Fig. 15-47).

2. Use salal to form a vertical line which extends about 6 inches above the cage and 12 inches below the cage (Fig. 15-48). Then establish a diagonal line of salal that cuts across the center of the foam and follows the line of the candle-holding crossbar. Repeat the shape with gladioli (Fig. 15-49).

3. Make a bow with #40 satin ribbon. Then make a pair of streamers that are 15 inches long. Attach the bow and streamers to wooden picks and insert in the middle of the foam (Fig. 15-50).

4. Work some of the gladioli through the bow. The spikes may be cut into sections to obtain shorter lengths.

5. Fill in the arrangement with salal, huckleberry and pompon mums (Fig. 15-51). Work the greens and flowers through the bow.

6. The streamers may be rolled up and pinned so that they will not wrinkle when the arrangement is transported.

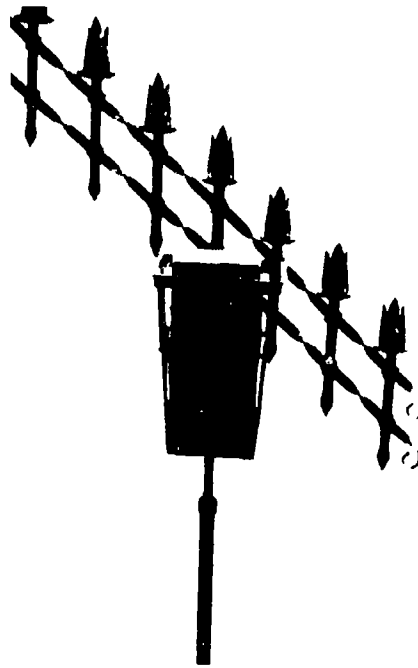


Figure 15-47



Figure 15-48



Figure 15-49



Figure 15-50



Figure 15-51



Amazon lilies and caladium leaves



Phalaenopsis orchids, roses and stephanotis

CRESCENT BOUQUETS



Gloriosa lilies, acacia and eucalyptus

514

515

TABLE SETTINGS



Diamond centerpiece



Informal luncheon



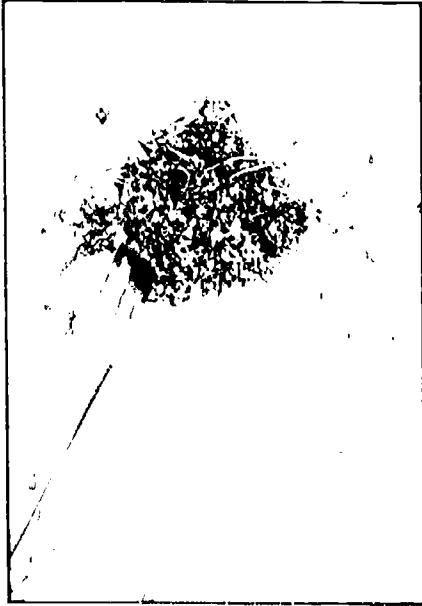
Victorian dinner



Family dinner



Single place setting with formal feeling



Starburst of violets

WEDDING FLORAL DESIGN

The Ohio State University
Agricultural Technical Institute



Flower and Bridal Show



Cascade of gardenias, stephanotis and roses



Arm bouquet of mixed flowers

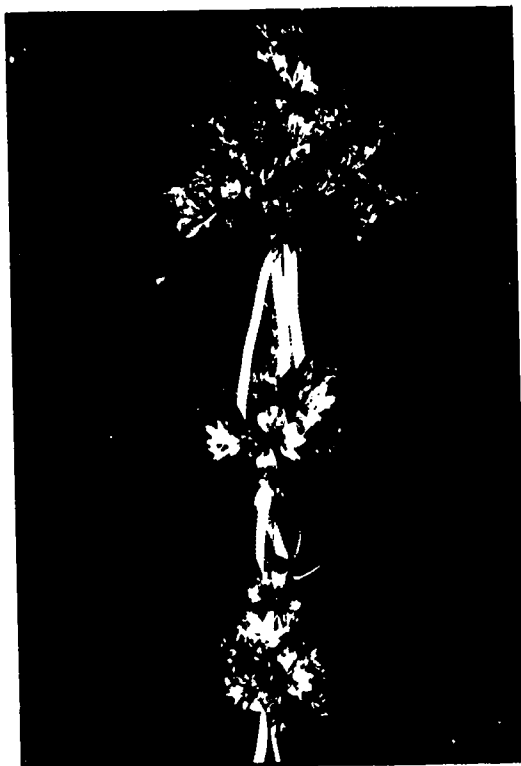


Corsage from rose petals



Fan arrangement on a palm leaf

BRIDAL BOUQUETS



Drop bouquet with small clusters suspended from the larger mass of flowers



Gathered with a fresh, gathered look



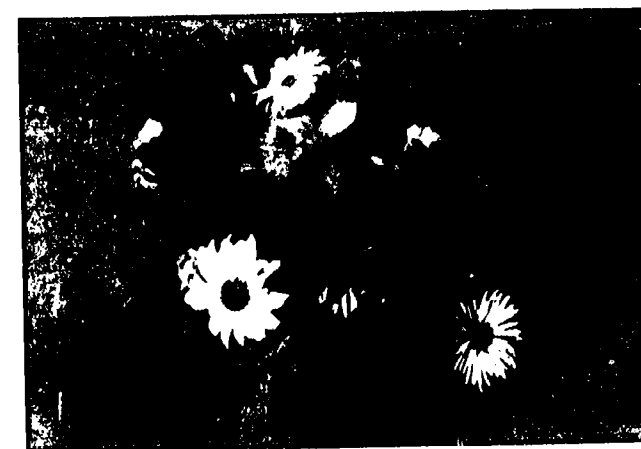
Arm bouquet featuring gerbera daisies



Basket with a shower cascade



Round basket of calendula and statice

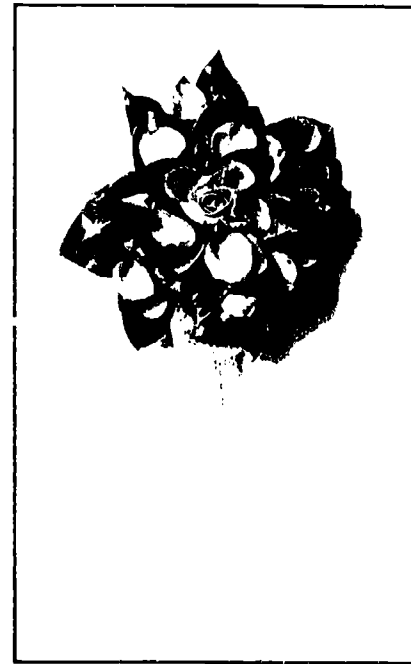


Basket with stems showing



Ring bearer's pillow

WEDDING FLOWERS



Composite flower of rose petals
on camellia leaves



Single cascade



Colonial bouquet



Arm bouquet of calla lilies



Wreath



Oval bouquet

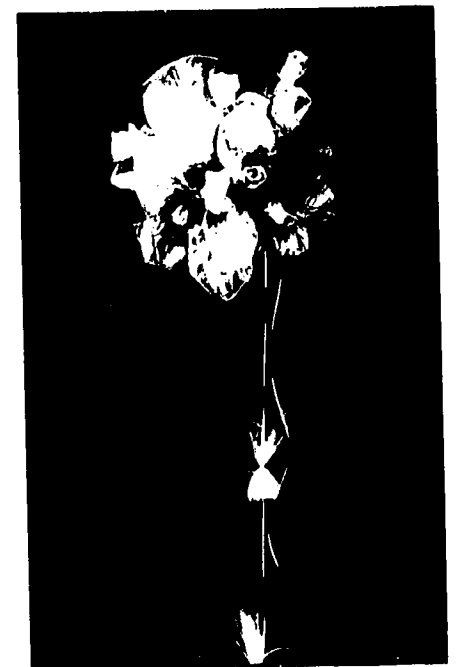


Slim cascade



WEDDING DESIGNS

by Julie Wilkinson, AIFD, PFCI
The Ohio Florists' Association
Retail Discovery Series



524

BEST COPY AVAILABLE

525



Office building

LIVING PLANT GROUPINGS



Hanging baskets



Church altar at Easter



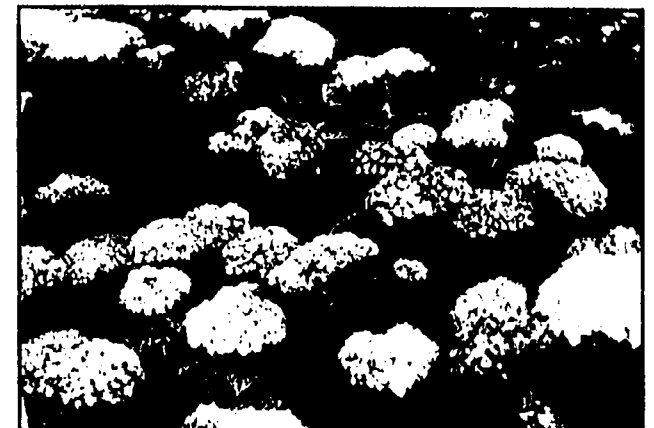
Library



Primroses



Primroses and ivy



Hydrangeas



Oriental

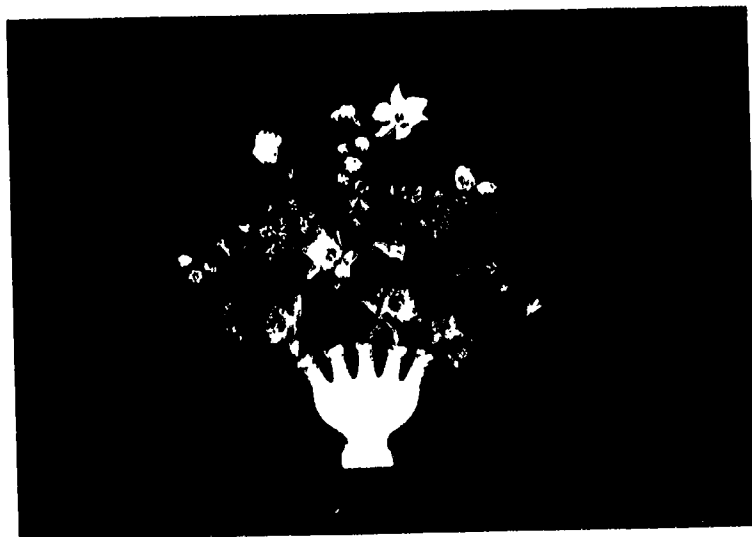


Classical



French

PERIOD ARRANGEMENTS

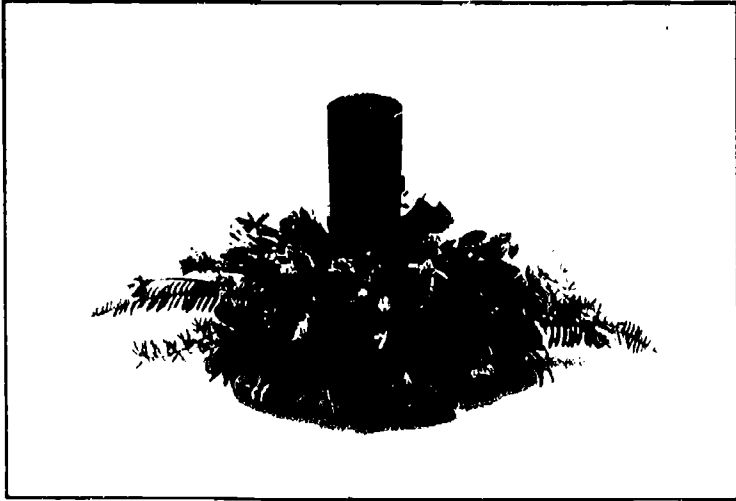


Williamsburg

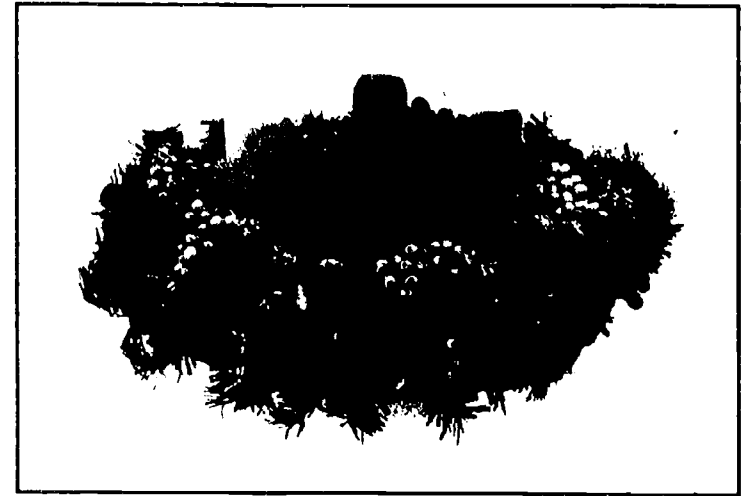


Dutch

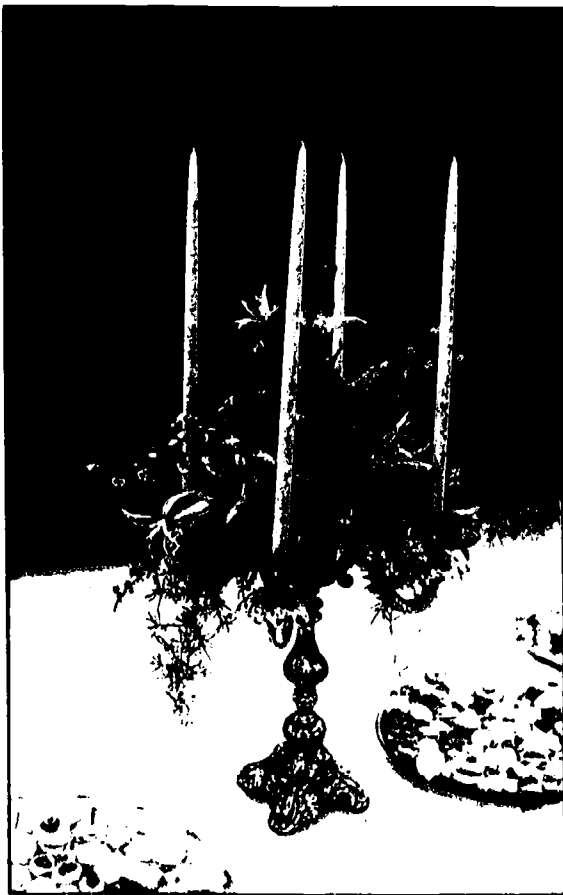
**ARRANGEMENTS
WITH CANDLES**



Diamond centerpiece with large candle



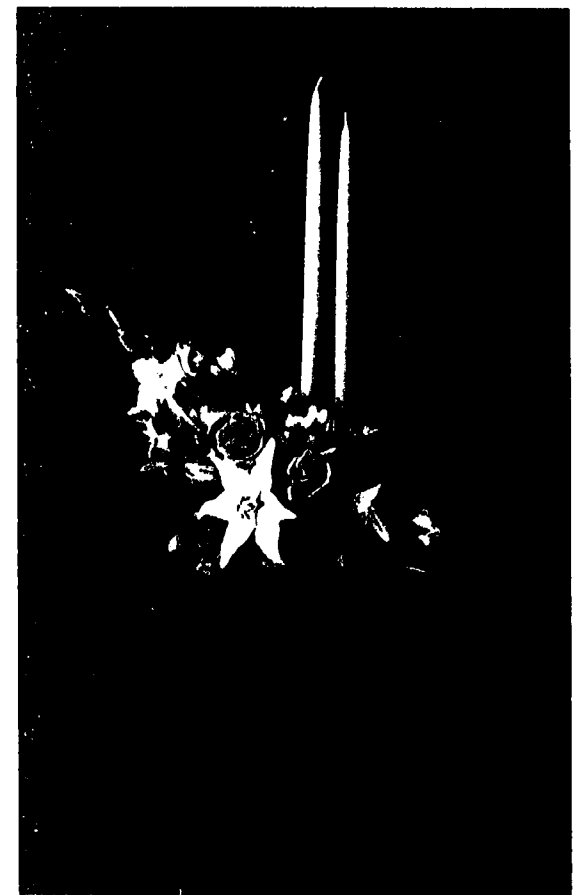
Advent wreath



Silver candelabra on tea table



Tropical arrangement with votive lights

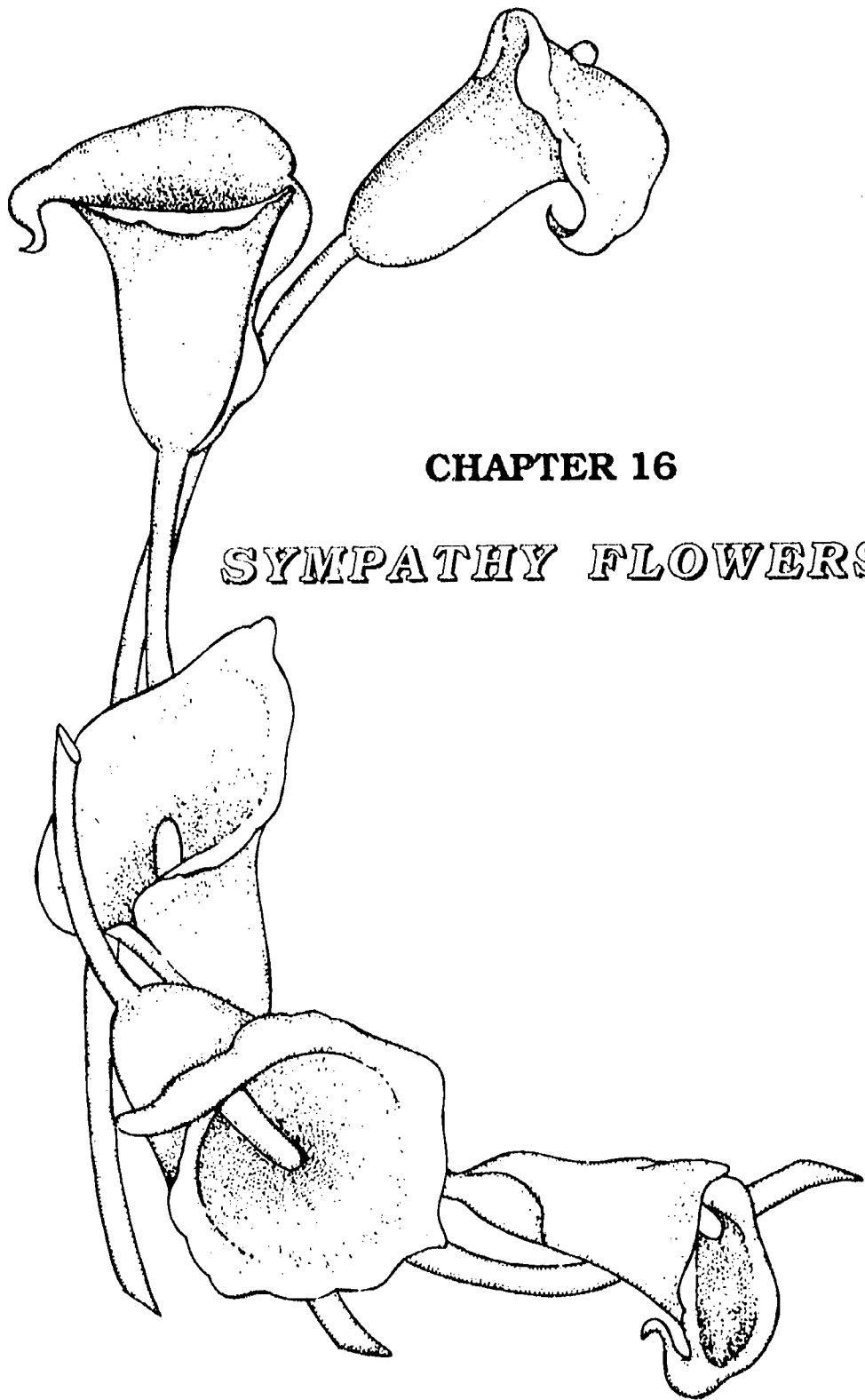


Flowers forming a diagonal line of opposition
across candles

500

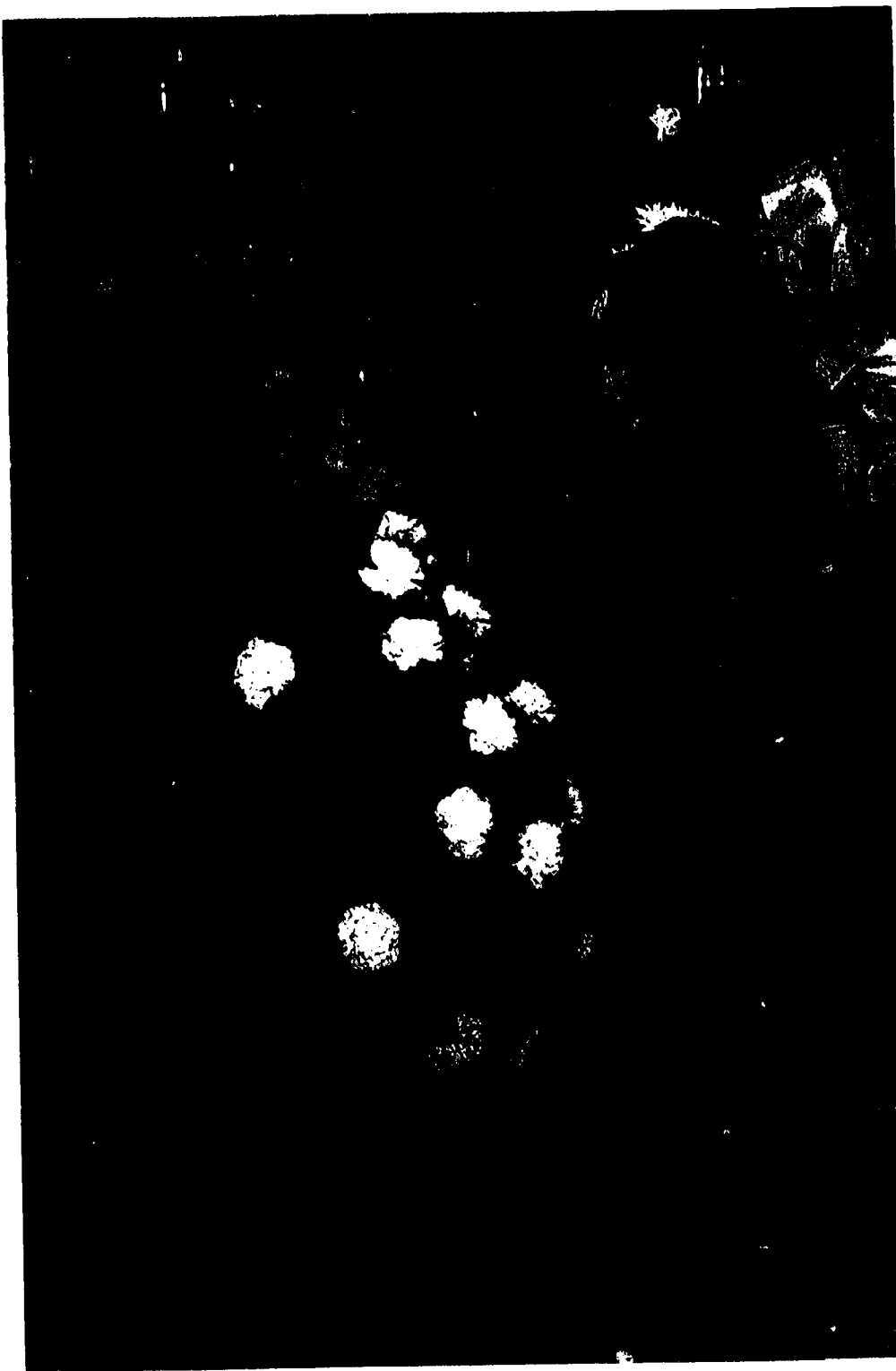
BEST COPY AVAILABLE

501



CHAPTER 16

SYMPATHY FLOWERS



(De Santis, Columbus)

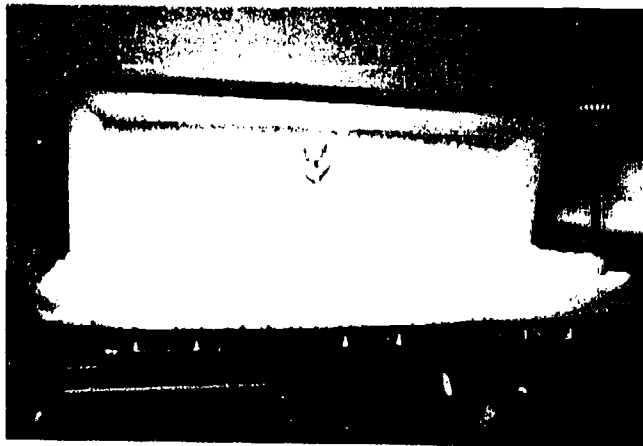


Figure 16-1
Casket with lid fully open

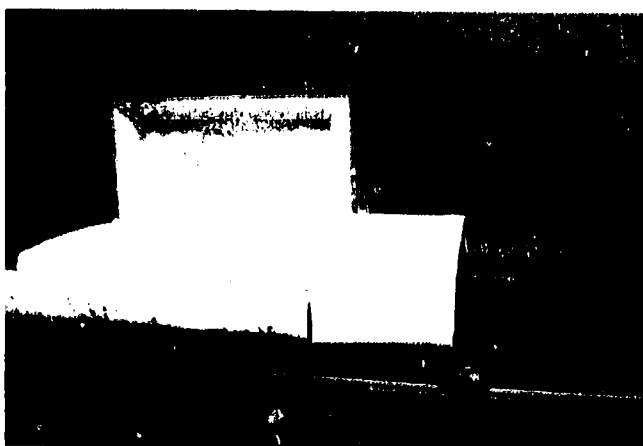


Figure 16-2
Casket with upper half of lid open



Casket spray of red roses and huckleberry

The sending of flowers when someone has died is not only a tradition, it is also a tangible way of showing respect for the deceased and expressing sympathy to the family. It is here that flowers can most powerfully display their ability to convey feelings that people are unable to say in other ways. Sympathy flowers fill a very real need for relatives and friends to express love and caring for the family. Also, through their selection of floral pieces for the casket, the family is better able to express their feelings for the one who has died.

The florists who prepare flowers for a funeral have as great an obligation to send out quality work for their customers on this sad occasion as they do for happy occasions like a wedding. Even though the flowers do not have to last a long time, they will be displayed next to the work of other florists, and are almost certain to be noticed by many people. (See Color Plate II-4.)

Sympathy flowers often comprise a significant part of the business of a flower shop. It is important for a new business to learn the traditions of the local area, which can vary significantly from region to region. These traditions may influence not only the style of the floral pieces but also the mechanics. Florists must cooperate with funeral directors to satisfy their preferences as well as the preferences of the customers.

A major variation in practice between regions involves the opening of the casket. In some areas the entire lid is typically open (Fig. 16-1). In others only the top half is open (Fig. 16-2) to show only the upper half of the body. In still other situations the lid is closed. An arrangement of flowers designed

for the top of a closed casket or to be hung above the lid of a fully open casket is called a **full couch spray**. Funeral homes provide a wire rack above the lid of a fully opened casket to which the spray can be attached. If only the upper half of the casket is to be opened, a smaller arrangement called a **half couch spray** can be designed for the closed end.

The casket spray is ordered by those closest in relationship to the deceased. They may also choose to order one or more companion pieces that coordinate with the casket spray. These may be standing sprays, symbols, or arrangements in vases or baskets.

Other relatives, friends and associates select floral tributes of their choice. These can be arrangements, baskets, vases, set pieces (flowers worked into different shapes, like a cross, supported by a wire strand), potted plants, dish gardens and terrariums. These are usually displayed on stands and pedestals on either side of the casket or on tables throughout the funeral home.

Here is a listing of the floral tributes that are frequently provided for funerals:

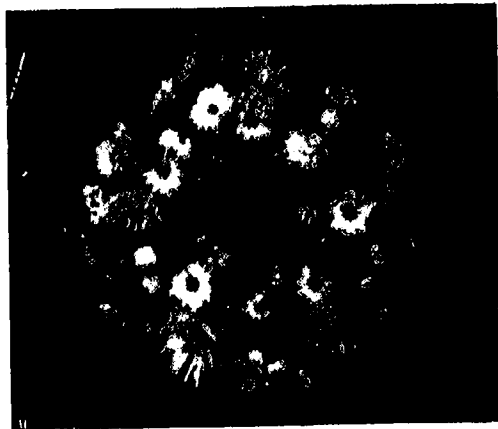
- * Casket sprays
- * Flowers for inside the casket (pillows, hearts, Bible, rosary, corsage, boutonniere)
- * Standing sprays
- * Baskets
- * Vases
- * Arrangements (which can include candles, driftwood or other meaningful accessories)

- * Set pieces (wreaths, pillows, crosses, hearts and emblems)
- * Decorated potted plants
- * Dish gardens and terrariums

Design principles and techniques for arranging funeral flowers are the same as for any other type of design. Florists should select their mechanics from the large assortment of modern and convenient devices that save time and allow for creativity in design.



Casket spray of carnations, roses and dendrobium orchids



Wreath of mixed spring blossoms on an Oasis ring



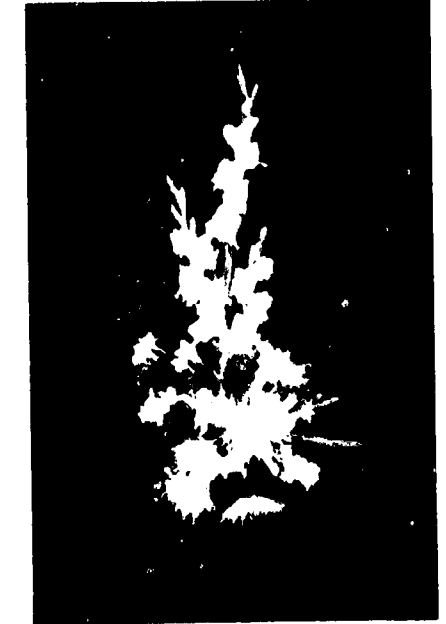
Satin-wrapped wreath with spray in Oasis Iglu



Spray of roses in Floracage holder



Standing spray of gladioli, carnations and clipped emerald



Grapevine wreath on easel; accents - gladioli, freesia and spider mums

Funeral Tributes

(James Bridenbaugh, AAF, PFCI; C. Michael Polychrones, AAF, AIFD, PFCI; Joseph Smith, AIFD)



Satin cross with diagonal line of carnations and Queen Anne's Lace



Line-mass arrangement of gladioli, carnations and pompon mums

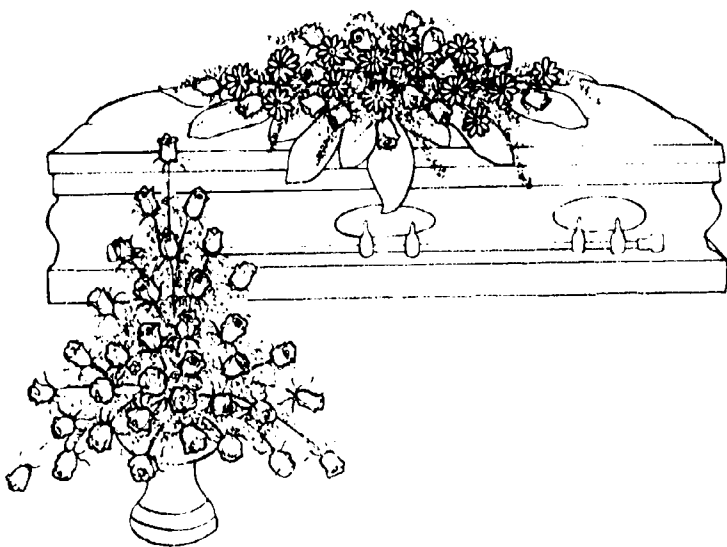


Figure 16-3

Full couch spray on a closed casket

Some special considerations related to funeral work include the following:

1. Casket sprays must be constructed on mechanics that will not scratch or otherwise damage the casket.
2. The floral foam must be well drained so that it has finished dripping before it is delivered to the funeral home.
3. Each funeral piece should be tagged with the name of the person it is for and the name of the sender. A card that also includes on it a brief description of the arrangement will help the family remember it when they send out acknowledgements. The card should be on a pick or cardholder so it can be easily removed from the arrangement. Two-parted cards are available in which the sender's name and a description of the arrangement can be separated from the name of

the deceased. These can be easily removed by the funeral director to give to the family before the floral pieces are dispersed after the funeral.

CASKET SPRAYS

FULL COUCH

Full couch casket sprays are usually oval or diamond-shaped. Though they should not exceed 8 or 9 inches in height, they can still exhibit depth within the design through skillful placement of flowers. When they are made to be placed on a closed casket, a gently arching silhouette from head to foot and side to side should be evident. The design may extend the length of the casket and arch down over the front side (Fig. 16-3). A bow may be used in the design but is not necessary.

The mechanics for a full couch casket spray commonly consist of a saddle that will hold two blocks of floral foam and which can be set without slipping on the arched lid of the casket. (See Figure 16-4.) These are available in plastic with a slight water reservoir to catch drips of water. Other casket saddles are made of wire with plastic protectors over the legs. Styrofoam, floral foam or soaked sphagnum moss can be wired to the saddle to serve as the foundation of the arrangement. Another technique is to carve a piece of styrofoam to fit the curvature of the casket. This will then serve as the base into which foliage and flowers in water picks can be inserted.

Placing water-picked flowers and foliage in styrofoam eliminates the danger of the

finished piece dripping. This is especially important when it is displayed above the lid of a fully opened casket (Fig. 16-5). Styrofoam is also lighter than soaked floral foam. Since the arrangement has to last only a few days, most of the foliage can be inserted directly into the styrofoam without

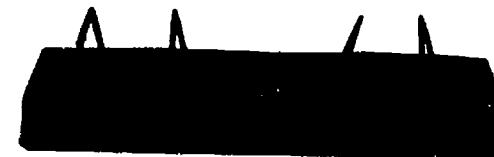


Figure 16-4

The John Henry casket saddle made of plastic

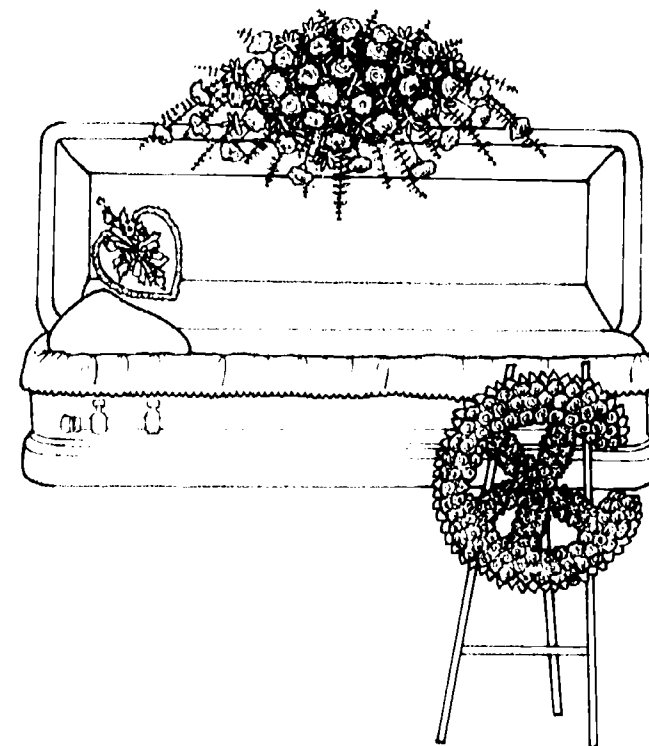


Figure 16-5

Full couch spray mounted above the lid of the casket

any serious decline in quality. Some disadvantages of using styrofoam are the added time and expense of placing flowers in water picks, and limitations on the ease with which placements can be made.

The suggested activities which follow include different combinations of mechanics so that you can gain some experience with each kind and evaluate their pros and cons for yourself. The goal is to be versatile and flexible enough so that you will be able to adapt to the expectations of the public, funeral directors and flower shop owners in whatever area you may work.

HALF COUCH (Fig. 16-6)

Half couch sprays are used when only the upper half of the casket is open. They rest on the lower, unopened part of the casket. Saddles for half couch sprays are therefore smaller than those used for full couch sprays, but they are made of the same kinds of materials. They usually hold only one block of floral foam instead of the two needed to make larger full couch sprays.

The design of half couch sprays is asymmetrical. Since they rest on the unopened part of the casket, their focal area is toward the opened side (usually toward the left), with a long arching line of flowers extending toward the foot of the casket. Another cascading section may extend forward from the focal area, draping down over the front of the casket. If a bow is used at the focal area, it may be enhanced by ribbon loops and streamers worked into the design, extending out from the bow.

The half couch spray, like the full couch spray, should not be over 8 or 9 inches tall and should consist of gracefully flowing lines. Stiff flowers either should be avoided or should be wired and bent to conform to the arching lines. Size and space rhythm within the design and good depth created by the in-and-out placement of flowers and foliage are distinguishing characteristics of a well-designed casket spray.

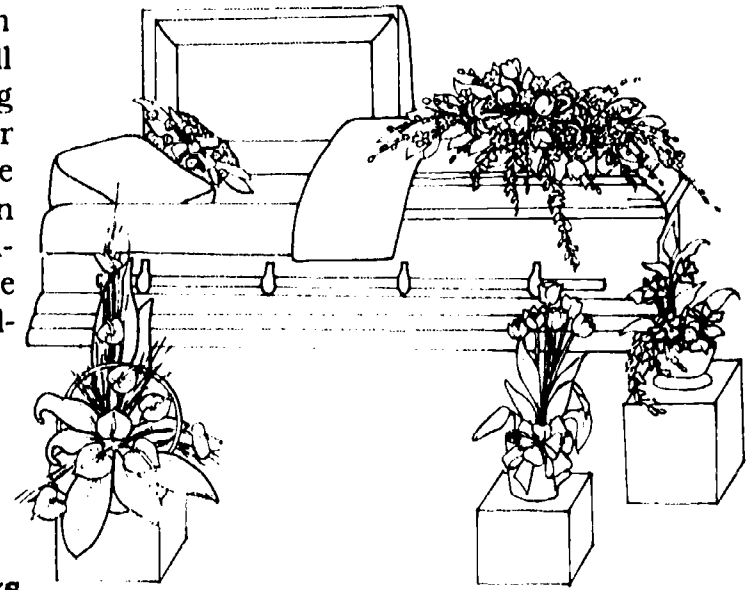


Figure 16-6
Half couch spray

Flowers and Foliage for Casket Sprays

A wide range of flowers and foliage is available for use in casket sprays, but some materials are used more frequently because of their availability, keeping quality, cost and preference by the customer. Chrysanthemums, carnations, roses, gladioli and baby's breath are often used. Commonly used foliages include emerald palm, salal, leatherleaf, huckleberry and sprengeri.

The foliage can be kept fresher by spraying it with *Green-Glo* or another plant shine product. This can be done after the foliage has been arranged but before flowers are added, since the initial framework of the design is usually first created with foliage.

Roses are usually wired by inserting a #18 wire into the ovary and spiraling it down the stem. This technique will hold the rose in position in the event that the stem becomes weak just below the flower. This situation, called **bent-neck**, is not uncommon if the water supply to the rose becomes limited.

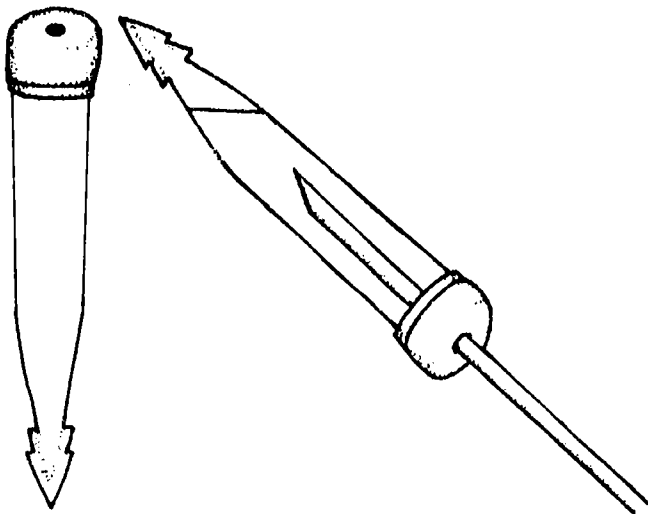


Figure 16-7

Figure 16-8

Plastic water pick



Figure 16-9

Gold script on a ribbon streamer

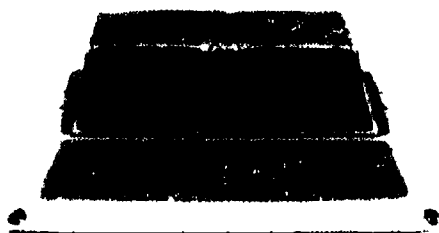


Figure 16-10

A foiled block of foam in a saddle

Roses and other flowers may be placed in **water picks** (Fig. 16-7). These are green plastic tubes that are pointed on the closed end and have a rubber cap on the open end. To use them, remove the cap, fill the tube with water, and replace the cap. Then insert the stem of the flower through the small hole in the cap. Do not push the stem end to the bottom of the water tube because that area will run out of water first if the tube is slanted downward. The rubber cap will cling to the stem and prevent water running down any stems that are angled downward (Fig. 16-8). Water picks are also useful for supplying water to flowers that must be extended farther than the length of their natural stems. The water picks can be fastened with waterproof tape to one or more hyacinth stakes.

Flowers should be in good condition and in general fully opened for funeral work. Because of the short viewing time, underdeveloped blossoms may never make their maximum show during the time when most people will see them.

Ribbon for Casket Sprays

A how of wide ribbon is often used at the focal area of a casket spray with two or more streamers radiating out from it. Number 40 satin or velvet ribbon is a popular choice for this purpose. Additional ribbon loops or streamers may be wired to wooden picks and used to extend the ribbon throughout the design.

Gold letters called **script** are sometimes applied to the ribbon streamers (Fig. 16-9) to indicate the relationship of the deceased to the person who has provided the flowers.

Script is available in individual letters or in complete names, like "Grandmother" or "Father." Some will stick to the ribbon when moistened, while others have a peel-off back which exposes a sticky surface when the back is removed. A glitter glue pen is another alternative for writing special words on ribbon.

SUGGESTED ACTIVITIES

A. Half Couch Casket Spray

Materials:

- plastic saddle frame
- 1 block of floral foam
- green florist foil
- #24 and #18 wire
- 1 bunch of salal
- 1 bunch of leatherleaf fern sprengeri
- 3 bunches of pompon mums
- #40 satin ribbon
- 4-inch wooden picks with wires
- Green-Glo

1. Soak and thoroughly drain the floral foam. Wrap it in a single layer of green florist foil. Tightly pinch shut the excess foil along the corner edges so it does not overlap on the flat sides. This is done to eliminate any double layers of foil that might make insertion of stems difficult.

2. Place the foiled block of foam in a plastic saddle (Fig. 16-10). Securely wire the two together by passing #24 wire through the holes of the saddle, wrapping the ends together on top of the block of foam. The wire

may first be wrapped with floral tape to help keep it from cutting through the foam.

3. Use salal to establish the foliage background. (See Figure 16-11.) First place the horizontal branches that will run parallel to the flat surface of the casket, from the open side to the foot end. One branch should extend about 6 inches to the left (placement 1) and another branch about 18 inches to the right (placement 2). Then establish an arching line that will follow the curvature of the casket by placing two curved branches into the foam, one extending toward the back and one cascading over the front (Fig. 16-12). The back curving branch (placement 3) should be about 6 inches long and the front cascading branch (placement 4) about 12 inches long.

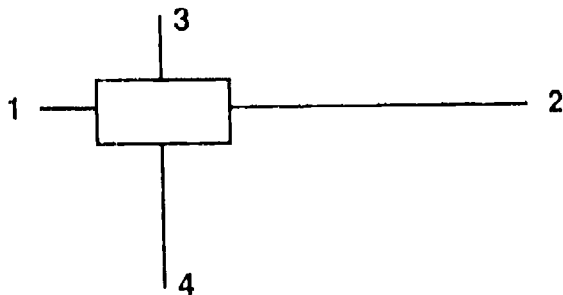


Figure 16-11 OVERHEAD VIEW
The first four placements of foliage

Next the height should be established by placing a 6-inch piece of salal (placement 5) upright in the foam, to the left of the center of the foam. All further placements should appear to radiate out from this point, which will be the focal area. (See Figure 16-13.)

4. Continue filling in the form with leather-leaf fern. Use leatherleaf to cover the foiled foam and create a layered look between the salal placements (Fig. 16-14). Avoid making a heavy solid block of greens. The greened-in form may then be sprayed with *Green-Glo* or a similar product so that it will last longer and look shiny.

(continued)

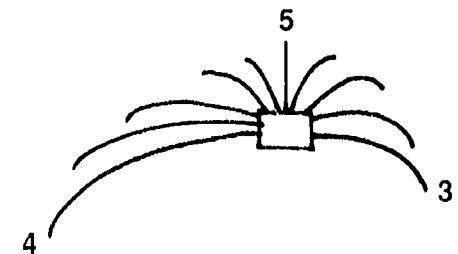


Figure 16-13 END VIEW
Fill loosely with salal

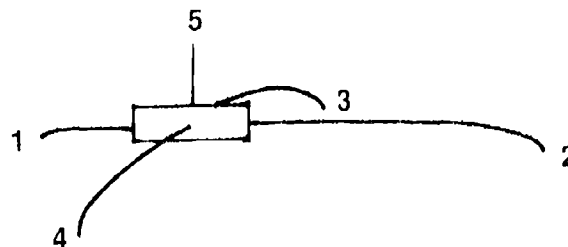


Figure 16-12 FRONT VIEW
Establish an arching silhouette with salal



Figure 16-14
A layered look



Figure 16-15 Add the bow



Figure 16-16
Complete the design with pompon mums



Figure 16-17 Fill with sprengeri

5. Make a full bow using #40 satin ribbon. (See Figure 16-15.) The longest loops should be from 4 to 5 inches long. Wire the bow to a 4-inch wooden pick. Make a set of 12-inch streamers from the ribbon and fasten them to a separate pick. If lettering (script) is to be used, it should be applied at this time.

Place the bow at the focal area (placement 5) angled slightly to the front. Insert the streamers so that they flow forward with the front cascading section of the spray (placement 4).

6. Establish the main lines (horizontal line and forward cascading line) with chrysanthemums. (See Figure 16-15.) First divide the pompon mums by stem length into units of one to three flowers. Those with longer stems can be used for the outermost placements in the design. Those with shorter stems can be saved for use near the focal point to create depth.

As you place the stems of mums, be very conscious of developing a **gently arching silhouette** in all directions. The longer stems of mums can be made to curve by

attaching a #18 wire near the end and spiraling it down the stem. When using roses or carnations, insert the wire into the ovary of the flower. This method of wiring has the added benefit of helping prevent the snapping off of flower heads when the piece is transported.

Stagger flower clusters in the main trunk lines with a gradual (rhythmic) increase in spacing as you approach the focal area. Placements at the focal area should extend up through and above the bow. Incorporate the bow into the design, just as you would in a well-constructed corsage.

Create depth by the in-and-out placement of flowers. (See Figure 16-16.) Avoid a flat or crowded look. The eye should be led down into the design.

7. Fill in the design with sprengeri. (See Figure 16-17.) Use long graceful pieces to enhance the forward cascade section and the longer horizontal section that extends toward the foot of the casket. Use shorter pieces to create depth, fill voids, and enhance the graceful arching lines of the silhouette.

B. Full Couch Casket Spray

Materials:

- wire saddle frame (for 2 blocks of foam) (Fig. 16-18)
- 2 blocks of floral foam
- styrofoam, 2-inch-thick sheet
- green florist foil
- newspaper
- green poultry netting (chicken wire)
- green florists' cord
- 1 bunch of emerald leaf
- 10 ti leaves
- 2 bunches of leatherleaf fern
- 50 carnations

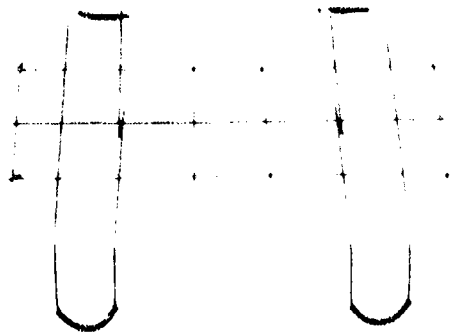


Figure 16-18

1. Cut a piece of styrofoam to fit on the platform of the wire saddle frame. Cut several thicknesses of newspaper the same size.

Foil each block of soaked, well-drained foam with a single layer of green florists' foil. Completely enclose each block and place the folded seam on the bottom of the block. Pinch the corners shut so that there are no double layers of foil on the flat faces of the block that might make insertion of stems more difficult.

2. Place styrofoam, newspapers and foiled foam on the wire saddle frame in that order.

3. Cut a piece of green poultry netting to cover the foiled foam and styrofoam. Cut out the corners of the netting so that it will fit smoothly over the rectangular block.

Place the poultry netting over the layers of foam, newspaper and styrofoam (Fig. 16-19). Tie the green florists' cord to the saddle frame and lace the cord back and forth over the chicken wire and alternately around the wire of the saddle. The goal is to have the foam that is covered with chicken wire securely bound to the saddle.

4. Establish a foliage background with emerald leaf that will result in a symmetrical oval form (Fig. 16-20). In this design the focal area is directly in the center of the foam; all stems radiate out from this point.

The overall length may be about 5 feet and the width about 3 feet. Emerald leaf is used primarily to form the basic shape. It gently arches downward enhancing the curved lines of the oval. Bring some shorter pieces inward to begin the arch to the focal area.

5. Use leatherleaf fern to establish more arching lines and to conceal foam and saddle. Work the leatherleaf between the emerald leaf pieces to increase interest and add depth. Create a layered look at the focal area but do not exceed a height of about 6 inches.

6. Use ti leaves to emphasize the long horizontal lines. Shorten some leaves for placement close to the focal point by trimming them at the base (Fig. 16-21). Roll some leaves over to form a loop by bringing the tip to the base. Fasten them together to a wooden stake with wire and waterproof tape. Insert the ti leaves between the other foliage

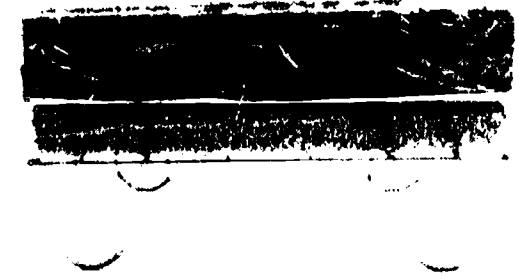


Figure 16-19

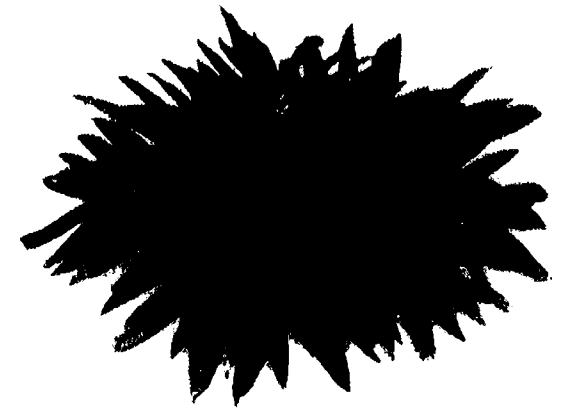


Figure 16-20



Figure 16-21



Figure 16-22



Figure 16-23



Figure 16-24

pieces to give a similar effect to that of ribbon (Fig. 16-22). This will serve to accent the focal area.

7. Use carnations to establish the basic oval shape (Fig. 16-23). Place the flowers as you would for an oval centerpiece. Be conscious of the gently arching silhouette. Create depth while rhythmically grouping flowers closer together at the focal area. See Figure 16-24 for the finished full couch casket spray.

8. Hang the spray to drip. Some water will run down the stems after they are pushed into the foam. Water should stop dripping after an hour or two.

STANDING SPRAYS

Standing sprays are sometimes called easel sprays because they are displayed on wire or wooden easels (Fig. 16-25). They are often placed alongside the casket and may coordinate with the casket spray. Diamond, oval and triangular outlines are most common, although many creative variations are possible.

Sprays can be hand tied with the natural stems showing. The same look can be created by placing both flowers and cut stems in floral foam, with the added benefit of staying fresh longer. The work can be made easier by using commercial products such as plastic *Oasis Floracage* holders or *John Henry* spray bars. These support the foam and can be easily attached to the easel with wire or chenille stems.



Figure 16-25
Standing spray of mixed spring
flowers in an *Oasis Floracage*

Another way to make an easel spray is to insert the greens and flowers directly into a piece of styrofoam. Water picks can be put on more sensitive flowers like roses before they are inserted into the styrofoam. You can also use soaked foam even if you do not have a *Floracage* or other commercially produced mechanics. Just wrap the soaked foam in foil and then in chicken wire for added support. Securely wire the chicken wire-enclosed foam to the easel.

Ribbons or other accessories may be added to the spray. An interesting example is the placement of a sheaf of grain or similarly bunched dried material across the spray in a diagonal line of opposition. If a bow is used, script may be added to the streamers just as it was on the casket spray.

2. Securely attach the *Floracage* to the easel using chenille stems (Fig. 16-26).

3. Use salal to establish the diamond shape of the design (Fig. 16-27).

4. Make a bow using #9 satin ribbon. The longest loops should be about 3 inches long. Wire the bow to a wooden pick. Make a pair of 15-inch streamers and wire them to a wooden pick. Insert the bow and streamers at the focal area of the spray (Fig. 16-28), which is at the intersection of the vertical and horizontal lines.

5. Establish the diamond shape with gladiolus spikes (Fig. 16-29). Break some gladioli into smaller sections to use closer to the focal area. The gladioli should be well opened. The design will not be attractive if long spikes of unopened buds are used.

(continued)

Figure 16-26

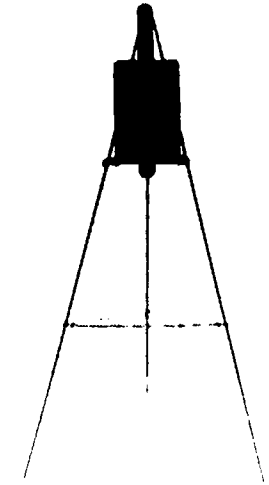


Figure 16-27



Figure 16-28



SUGGESTED ACTIVITY

Diamond Shape Standing Spray

Materials:

Oasis Floracage holder
 wire easel
 chenille stems
 salal
 huckleberry
 10 gladioli
 1 bunch of pompon mums
 #9 satin ribbon
 wooden picks

1. Thoroughly soak the *Floracage* with its enclosed foam and allow it to drain.

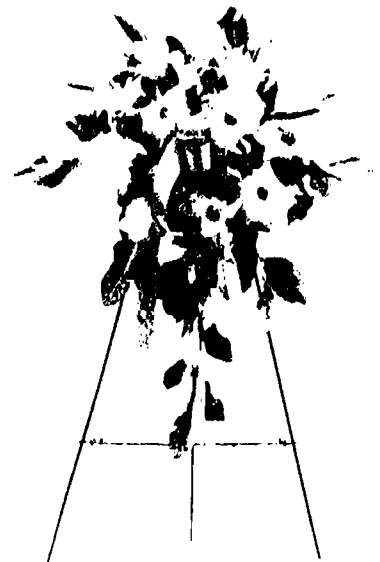


Figure 16-29

6. Fill in the design with huckleberry and then pompon mums. Bring some huckleberry and mums through the bow. The spray should display fullness and greatest depth at the focal area. Taper the outline gradually away from the focal area toward the extremities of the design. Also gradually change the facing by 90° as you move from the focal area to the outer points. See Figure 16-30 for the completed standing spray.

7. Arrange the ribbon streamers down the vertical line and cut their ends on a sharp diagonal. They usually look best if they are of slightly different lengths.



Figure 16-30
The completed standing spray

BASKETS

Flowers arranged in plastic, metal or papier-mache baskets are traditional sympathy tributes in many areas. They can

create a large, showy display using a moderate number of flowers. The design style is usually a fan or triangle. Baskets made of wicker, grapevines or twigs are alternative choices to the more traditional funeral basket.

Gladioli are often the line flowers with chrysanthemums used to enhance the focal area and fill in between the spikes (Fig. 16-31). A bow may be added at the focal area. Greens commonly used include salal, emerald palm, huckleberry and leatherleaf fern.

When a basket has a handle, it should be allowed to show and not be crowded or buried. An asymmetrical design like the scalene triangle is distinctive and allows the handle to be featured. In fan and triangular designs, the outermost placements extend up behind the handle, while the shorter placements near the focal area are in front of the handle (Fig. 16-32).

Traditional plastic, metal or papier-mache baskets come in a variety of sizes and styles. They are presumed to be waterproof. Non-traditional wicker, twig or vine baskets will need to be securely lined with plastic. The most convenient mechanics to use are one or more blocks of soaked floral foam. Whether one or two blocks are used and whether they are placed in the basket upright or sideways will depend on the size and shape of the basket. If the foam extends a little above the rim of the basket, the designer will have more freedom of placements since this will allow some stems to be angled downward. It is not necessary to fill the entire basket with foam. Shredded styrofoam or discarded pieces of foam can be



Figure 16-31
Triangular sympathy arrangement
(Kiefer's Floral, Coshocton)



Figure 16-32
Fan-shaped sympathy arrangement
(Maple Lee, Worthington)

used to fill the empty spaces and help stabilize the blocks that will hold the flower stems.

The floral foam can be further secured by criss-crossing waterproof tape over it. The tape will stick to the rim of a plastic or metal basket, but usually not to paper-mache. In this case the ends of the tape can be stapled to the basket. Or a sharp tool can be used to make small holes in the paper-mache, and through them wires can be inserted to cross over and secure the foam.

In the past other materials have been used to support stems in funeral baskets. These include rolled-up evergreens, crumpled chicken wire, sand, and shredded styrofoam.

When basket arrangements are constructed, every attempt should be made to create a good design with quality flowers. The current decrease in demand for funeral baskets may be linked to public reaction against the many baskets of less-than-top quality that have been sent to funeral homes.

SUGGESTED ACTIVITIES



Figure 16-33



Figure 16-35



Figure 16-36



Figure 16-37

A. Triangular Funeral Basket

Materials:

- plastic basket with handle
- 1 block of floral foam
- waterproof tape
- 10 gladioli
- 1 bunch of emerald palm
- 1/2 bunch of leatherleaf fern
- 1 bunch of pompon mums

1. Place soaked foam in the basket and secure it with waterproof tape (Fig. 16-33).

2. Use ribbon shears to cut the ends of the leaflets to form tailored pieces of foliage (Fig. 16-34). Establish the triangular form with the clipped emerald palm (Fig. 16-35).

3. Add gladiolus spikes to repeat the triangular shape (Fig. 16-36). Use sections of gladiolus spikes to develop the focal area and create depth.

4. Repeat the triangular form with leather-leaf fern and pompon mums (Fig. 16-37). Some mums may be left in larger clusters to give greater strength near the focal area. Develop the focal area without a bow in this arrangement.

5. Check to make sure the arrangement is not flat. Have you developed a smooth triangular outline without large gaps between spike flowers? Does the arrangement have good depth?

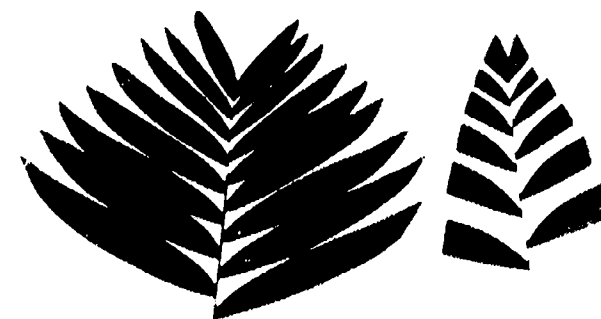


Figure 16-34



Figure 16-38

B. Fireside Basket with L-shaped Arrangement

Materials:

fireside basket
 Scotch broom
 huckleberry
 25 standard mums
 plastic liner
 floral foam
 chenille stems

1. Place soaked foam in a plastic liner and set it on the bottom of the fireside basket (Fig. 16-38).

2. Work chenille stems through the wicker and twist the ends firmly over the foam so the liner and foam are securely anchored to the basket.

3. Establish the L-pattern with Scotch broom (Fig. 16-39).

4. Lightly fill in the form with huckleberry (Fig. 16-40).

5. Repeat the L-pattern with mums (Fig. 16-41). Refer back to the discussion of the basic L-pattern design in Chapter 10. The scale is larger for this arrangement, but the order, spacing and facing of the placements is the same. Do not crowd the handle.



Figure 16-39



Figure 16-40



Figure 16-41

VASES and OTHER ARRANGEMENTS

Arrangements of flowers in a variety of design shapes are appropriate to send as sympathy flowers. They can be displayed on tables at the funeral home and taken home by members of the family after the funeral.

The traditional vase arrangement is usually a triangle (Fig. 16-42), fan or oval design. However, any of the basic design shapes could be used. Creative arrangements featuring special containers, accessories or seasonal flowers should be considered (Fig. 16-43). Driftwood makes a nice framework for an arrangement (Fig. 16-44). A candle is also an acceptable addition to a sympathy design.

Dried or silk arrangements are being selected by some people as a lasting piece that can be kept by the family. These are sometimes sent directly to the homes of the family members rather than to the funeral parlor.

Sympathy arrangements can be made in a wide range of styles and prices. To best meet the needs of the clients, the florist should be prepared to listen to their preferences, offer suggestions, and finally supply designs that are appropriate for each situation.

SUGGESTED ACTIVITY

Sympathy Arrangement

Have each student create a different arrangement suitable for sending to a funeral home. Specify the relationship of the sender to the deceased and the time of year.

Here are some suggestions:

- * arrangement with driftwood
- * arrangement with a candle
- * arrangement suggesting interest in nature or the outdoors
- * arrangement suggesting interest in a certain animal
- * arrangement in a contemporary style
- * arrangement for an antique collector
- * arrangement for an artist
- * arrangement for a politician
- * arrangement for a religious leader

PIECES for INSIDE the CASKET

(See illustrations on next page)

Close relatives or friends of the deceased may order a small floral piece to be displayed inside the casket. This may be a corsage, boutonniere or flower held in the hand. Decorated satin pillows or hearts are sometimes pinned inside the lid. Bibles or rosaries may also be included.

Satin pillows and hearts are most easily decorated by making a wired and taped corsage-style piece that can be pinned to the satin shape. This produces a relatively light-weight design that will not drip water. The piece can be designed so that it can be bent into a crescent or S-curve. Styrofoam Bible forms can be decorated with similar constructions or with flowers glued to a ribbon that is pinned on as a bookmark. Large rosaries are available with clamps for fastening on a single blossom at regular intervals along the chain. These can be pinned to the inside lid of the casket.

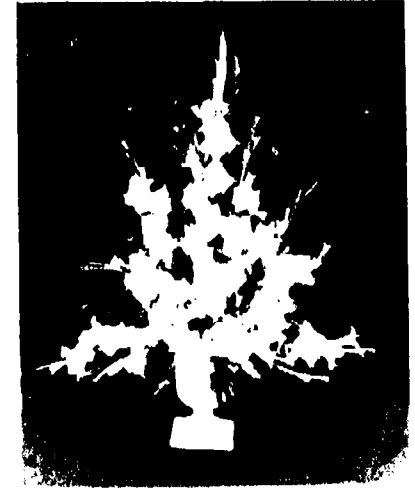


Figure 16-42
Gladioli in a
triangular
arrangement



Figure 16-43 Arrangement featuring a Madonna



Figure 16-44
Stylized
arrangement with
anthurium and
driftwood

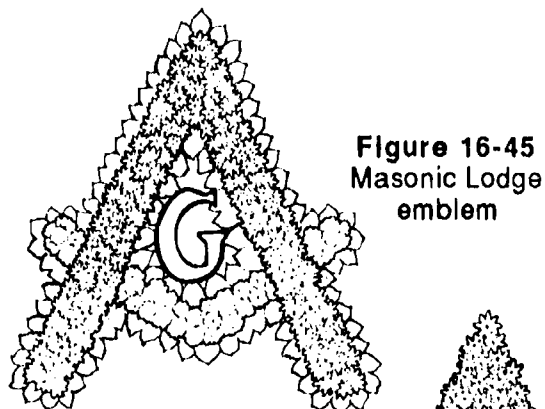


Figure 16-45
Masonic Lodge
emblem

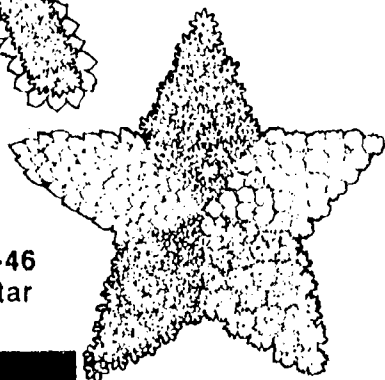


Figure 16-46
Eastern Star
emblem

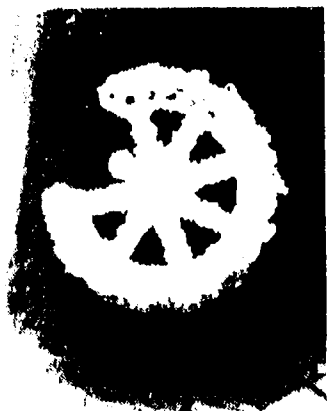


Figure 16-47 Broken wheel

SUGGESTED ACTIVITY

Each student will design one piece to be displayed inside the casket. Even if the same foundation is used, try to be creative in the way you treat it.

Some suggestions are:

- * corsage
- * boutonniere
- * flower-in-hand
- * pillow
- * heart
- * Bible
- * rosary

SET PIECES

There are a number of different symbols and emblems of special significance that can be rendered in flowers. Wreaths, crosses, hearts and stars are the most common. Fraternal emblems like those of the Masons, Odd Fellows and Elks are examples of pieces sometimes requested for members of these organizations (Fig. 16-45, 16-46). The

symbol of a broken wheel is sometimes used to represent the passing of one member of a group (Fig. 16-47). Some unusual symbols, less commonly seen today except in certain regions where they may be popular, include the "Gates Ajar" symbol that shows a partly open gate, "Jesus Calls"-a telephone with the receiver off the hook, and the "Vacant Chair."

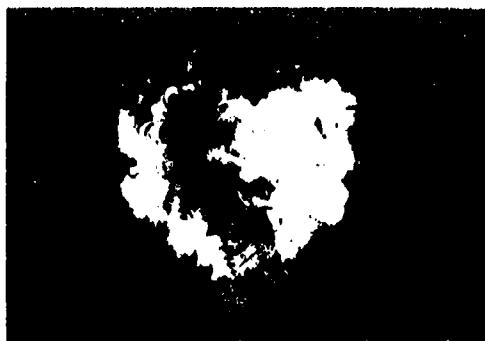
Styrofoam Forms and Mechanics

Some symbols can be purchased ready-made in styrofoam while others must be cut using an electric or battery-powered hot wire or a hand-held styrofoam cutter with a thin serrate blade. If the symbol is cut in several sections, the pieces can be joined using wooden stakes and glue.

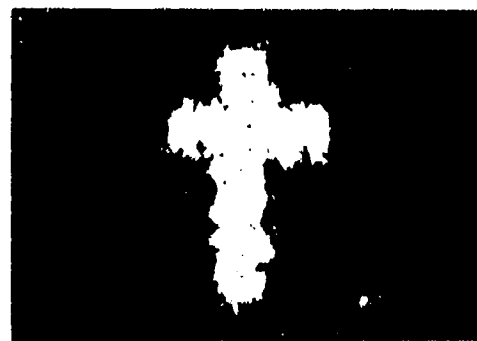
The styrofoam form may be covered entirely with flowers and foliage. Also it may be wrapped with ribbon or moss with one or more clusters of flowers attached. As an interesting variation, try using the back side of the ribbon to take advantage of the dull textural quality, which can enhance certain flowers. On wrapped wreaths, an *Oasis Iglu*



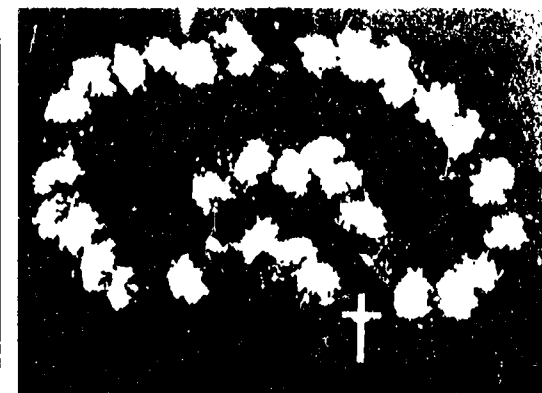
A crescent of roses, statice and
Scotch broom on styrofoam Bible



A styrofoam heart outlined with
leatherleaf, covered with carnations;
double-spray corsage of red roses



A cross covered with carnations,
outlined with pittosporum



A rosary of carnations,
baby's breath and leatherleaf

is easy to attach to serve as the mechanics for holding an arrangement of flowers (Fig. 16-48). A piece of floral foam, soaked and foiled, can be wired on to accomplish the same thing. If the piece of foam is large, it should be reinforced by wrapping with chicken wire before wiring it to the styrofoam form.

Oasis ring sets are convenient to use when a relatively small wreath of fresh material is needed. The ring is soaked and drained. The flowers and foliage are inserted directly into the *Oasis* foam and will stay fresh for several days.

Attaching Flowers and Foliage

An easy way to fasten flowers and foliage to a styrofoam form is to use floral glue. Glue such as *Oasis* floral adhesive can be brushed on the backs of flowers and will become tacky quite quickly. Another method to attach flowers is to insert a toothpick into the underside of the flower and push the other end of the toothpick into the styrofoam. This method works well on mums that have a flat bottom which makes them quite stable on the styrofoam. Flowers attached with either glue or toothpicks should be sprayed with a clear acrylic spray to increase their keeping quality. *Mum Mist* will also prevent shattering of petals.

Leaves can be added by using **greening pins** (Fig. 16-49). These U-shaped pins with S-shaped heads are very good for attaching leaves like salal, camellia and galax to forms. Overlap the leaves just enough to cover up the pin used to fasten on each preceding leaf (Fig. 16-50). In the finished product no pins

show. Greening pins also work well to attach materials to straw wreath forms.

A hot glue gun is useful for attaching accessories to styrofoam. It also works well when adding dried or silk flowers to wreaths made of twigs.

Completing the Set Piece

Finishing off the edges of the shape is important. This can be done with ribbon, used either straight or ruffled, or by pinning overlapped leaves around the edge. The edge can also be beveled and filled in completely with flowers.

Bows can be used as accents where desired. Wreaths give an especially good opportunity to be creative with the placement of bows and streamers. One suggestion is to make a larger and a smaller bow. These can be placed on opposite sides of the wreath and connected with several streamers of ribbon across the wreath (Fig. 16-51). Another variation is to use two different widths and colors of ribbon in a bow, with streamers of each color running to another part of the wreath.

It takes fewer flowers to place one or two flower clusters on a symbol than it does to cover the entire symbol with flowers. The flower groupings can resemble crescents, S-curves or diagonal lines. The shape chosen should complement the shape of the symbol and not be so large as to overpower it. Some suggested flower groupings on symbols are given on the next page.

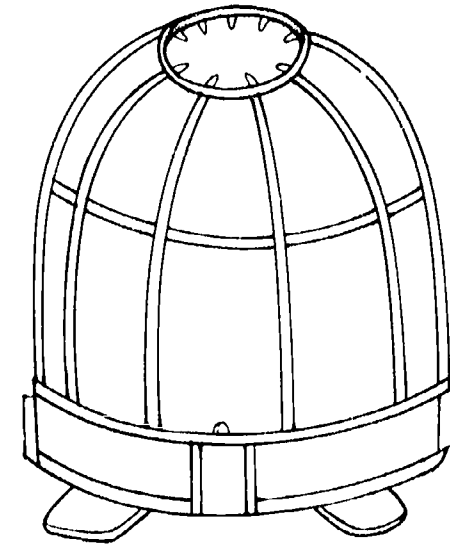


Figure 16-48

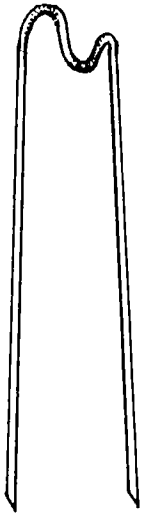


Figure 16-49

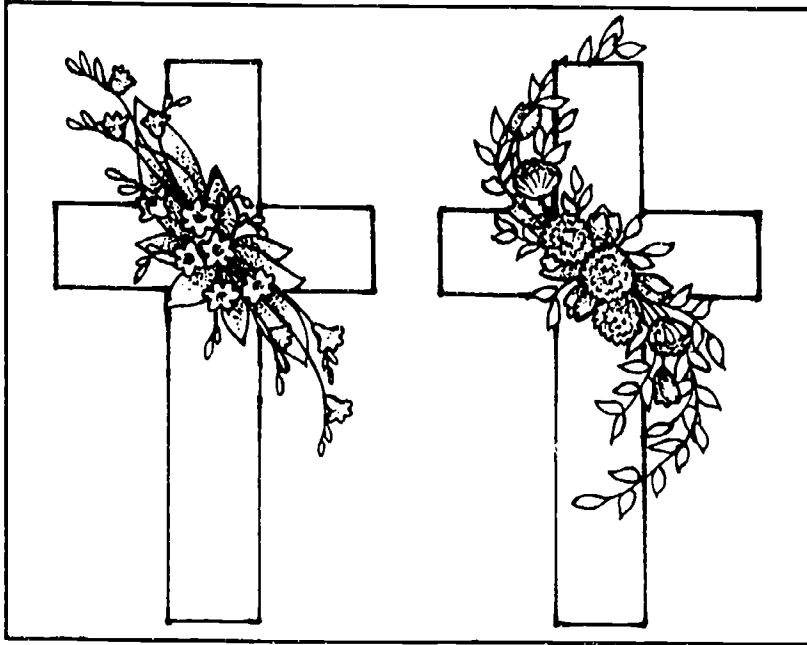


Figure 16-50 Plastic-covered straw wreath covered with salal leaves

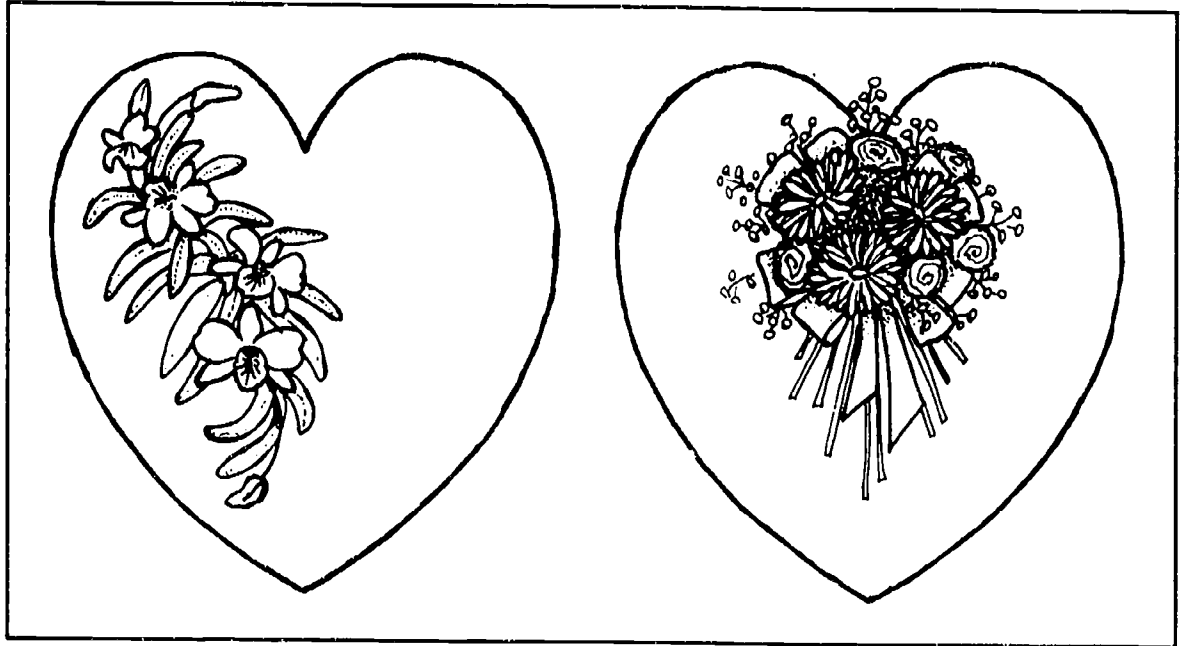


Figure 16-51 Satin-wrapped styrofoam wreath with ribbon streamers

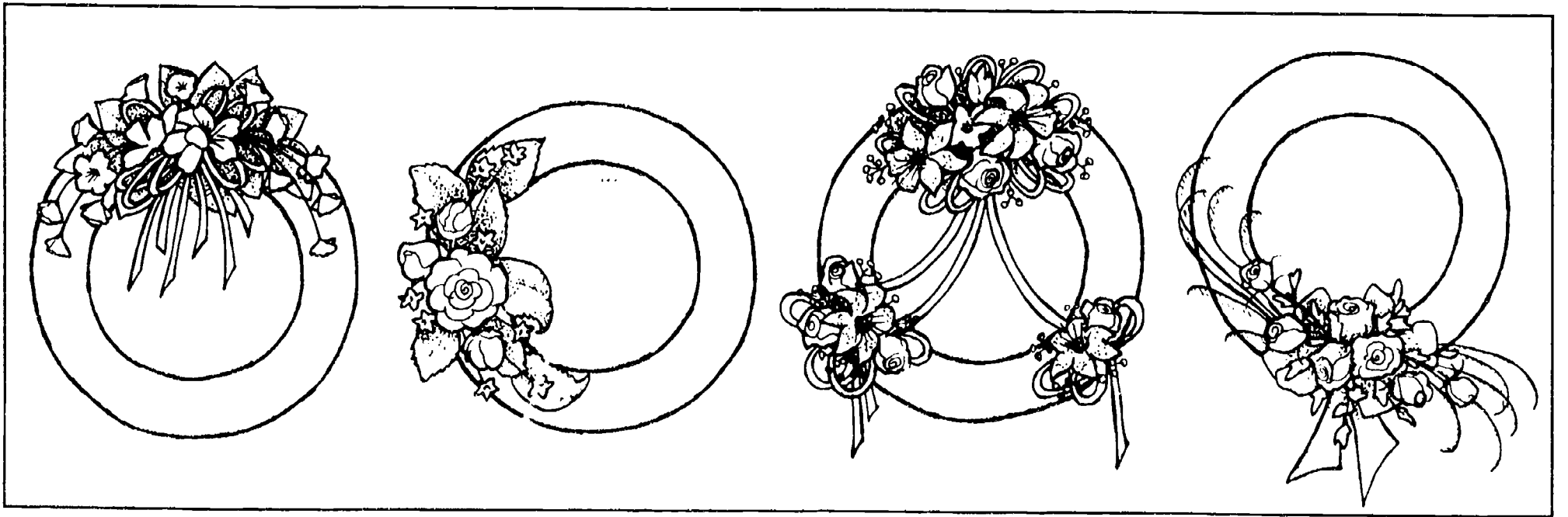
Suggested Floral Groupings on Symbols



Crosses



Hearts



Wreaths

550

557

SUGGESTED ACTIVITY

Each student will make one set piece. Use different methods of attaching the flowers including floral adhesive, toothpicks and hot glue. Cover some forms entirely with flowers, others with ribbon or moss accented with flowers. Be creative in the use of ribbon.

Some suggestions are:

- * mixed fresh flower wreath in an Oasis ring
 - * foliage (salal) covered wreath with floral accent
 - * moss covered cross with diagonal line of opposition
 - * flower (mums) covered heart with S-curve of roses
 - * fraternal symbol (Masonic)
 - * satin covered straw wreath with two floral accent pieces and connecting streamers
-



Dish Garden



Terrarium

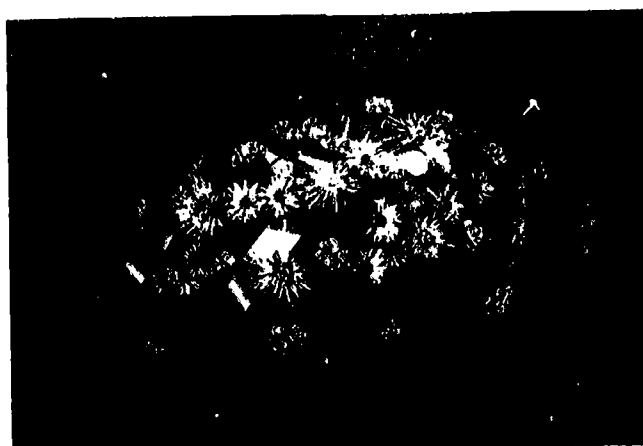
Living Plants



Potted Plant

POTTED PLANTS, DISH GARDENS and TERRARIUMS

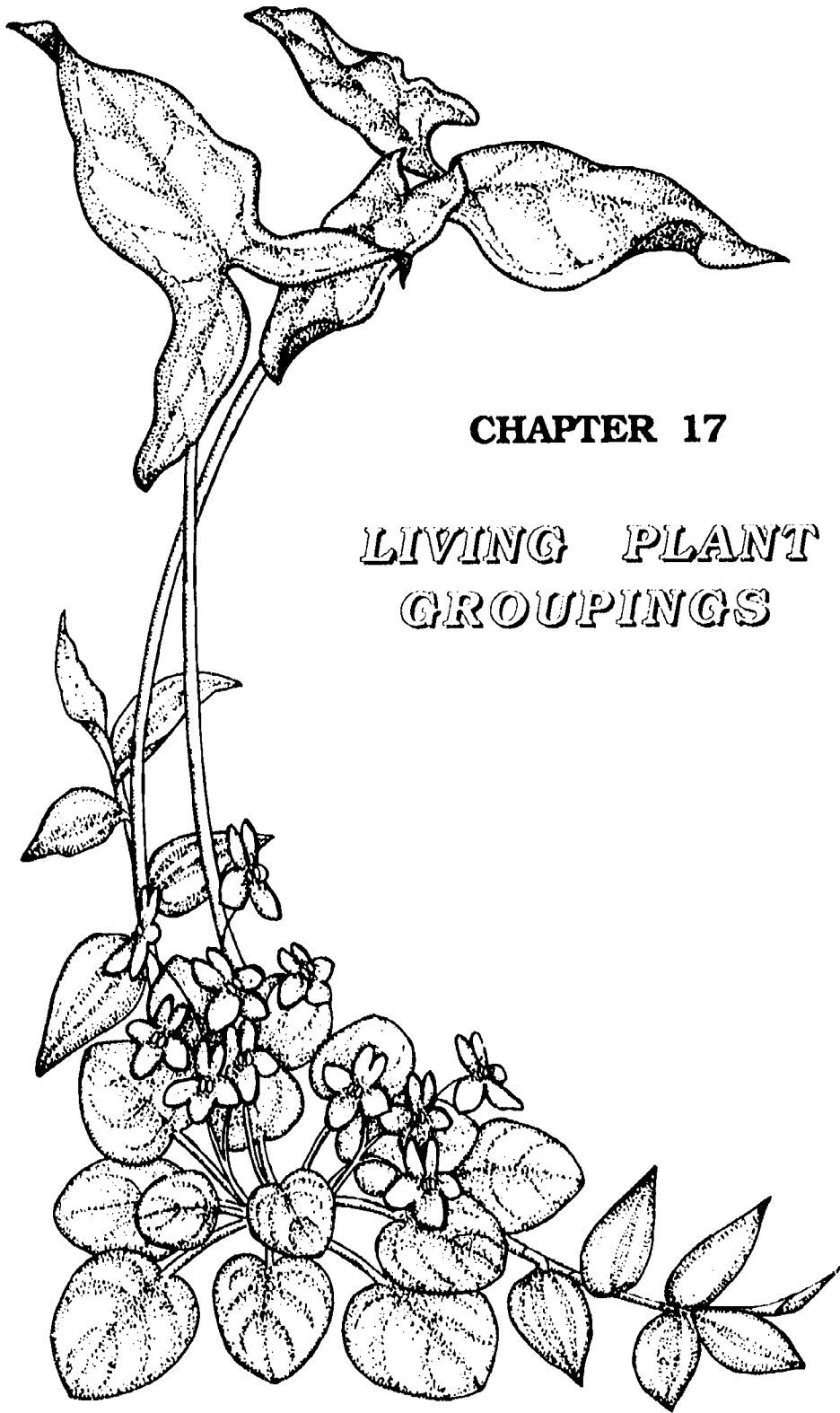
Living plants are appropriate and long-lasting sympathy tributes. The decoration of potted plants with foil and ribbon 's described in another unit of this book. Dish gardens and terrariums that are being sent to a funeral may be accented with religious figurines, silk flowers, or items of special significance. Guidelines for the construction of dish gardens and terrariums are given in the next chapter, *Living Plant Groupings*.



Casket spray ready to be delivered to the funeral home
(De Santis, Columbus)



Funeral directors transport flowers from funeral home to cemetery
(Murray Funeral Home, Creston)



CHAPTER 17

**LIVING PLANT
GROUPINGS**



Dish Gardens Express Themes



The figurine adds interest and motion.
Note the unity given by repetition of white.



Dish garden with a country look in a
spatterware crock

Small living plants can be combined artistically in dish gardens, terrariums and hanging baskets. They are popular gift items because of their decorative value and the fact that they can be expected to last several months or more. Dish gardens and terrariums make suitable sympathy tributes and are appreciated in offices, business establishments and homes. (See Color Plate III-6.)

DISH GARDENS

Dish gardens are shallow containers that hold two or more living plants. Sometimes they are referred to as planters, and although this is correct, the word "planter" is also used to describe much larger containers capable of holding plants as big as trees. The word "planter" will therefore be reserved for those larger containers that are used for interior plantscaping.

Dish garden containers are made from various materials including glazed and unglazed pottery, metal, glass, wood and plastic, but they all lack drainage holes. Wicker has become popular for dish gardens, but a plastic liner must be used inside it to keep moisture from seeping through. Unglazed clay or terra-cotta, which also may become damp on the bottom, should be set on a moisture-proof mat. Whatever the container, it should be at least 3 inches deep so that the plants' root balls can be accommodated without severely disturbing the roots.

Small flowering and foliage plants that are to be used in dish gardens should be grown, well rooted, in 2- or 3-inch pots. Plants are selected to give a full but not crowded look. There should be harmony



Dish garden with a tropical look



Dish garden with an Oriental theme

572

573

between the container and the plants. If figurines or other accessories like driftwood, branches or ribbon are used, they should complement the total look being created. Some possible themes that dish gardens might express are:

tropical
woodland
desert
Oriental
religious

Some dish gardens are merely a collection of plants of various forms, textures and colors, like a simple combination of variegated snake plant, green emerald ripple peperomia, and trailing ivy in a green ceramic container. Alternatively, dish gardens can be made to resemble miniature landscapes or scenes. When figurines are used, they must be in good proportion to the size of the plants. For example, a miniature frog may be dwarfed by too-large plants looming over it. Sheet moss or pebbles are frequently used to cover the soil surface for a special effect.

Fresh-cut flowers can be added to dish gardens by planting in the soil a piece of soaked floral foam into which flower stems are inserted. Flowers may also be placed in waterpicks that are pushed into the soil. Silk flowers and wired bows can be anchored directly in the soil.

Soil

Soil used in dish gardens should be a sterilized potting mix that is not excessively fertile. Bagged potting mixes can easily be purchased for small projects. If you make

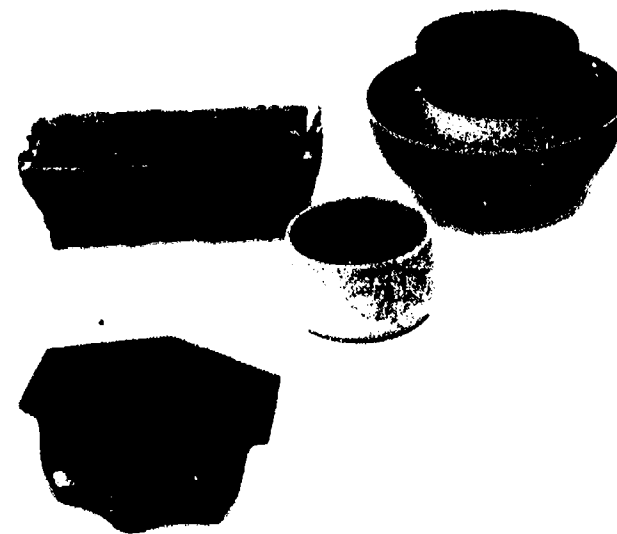
your own, a mixture of equal parts of soil, coarse sand and peat moss is one possibility. The amount of sand should be increased for cactus and succulent dish gardens. Since the root balls of the plants frequently take up most of the space in a dish garden, you actually may not need much additional soil. The soil mix should be moist but not overly wet at the time of planting.

Gravel or small pebbles may be used in a layer on the bottom of a dish garden if there is enough depth. Since overwatering is a common problem with dish gardens, a gravel layer provides a reservoir for some of the drainage water. If the container is very shallow, the gravel can be omitted since it would take up room needed for the soil balls of the plants.

Plants

Plants for dish gardens must be grown in small pots either 2 or 3 inches in diameter. Following are some good choices for dish gardens:

Aluminum Plant (*Pilea*)
Chinese Evergreen (*Aglaonema*)
Croton (*Codiaeum*)
Dracaena (*Dracaena*)
Dumbcane (*Dieffenbachia*)
English Ivy (*Hedera*)
Jade Plant (*Crassula*)
Neanthe Bella Palm (*Chamaedorea*)
Nephthytis (*Syngonium*)
Peperomia (*Peperomia*)
Philodendron (*Philodendron*)
Prayer Plant (*Maranta*)
Snake Plant (*Sansevieria*)
Ti Plant (*Cordylite*)
Wax Plant (*Hoya*)



A collection of dish garden containers



Figure 17-1

Cacti and succulents combined in a desert look



Figure 17-2

Snake plant creates a strong vertical line



Fantail willow branches create interest

Design

Here are some suggestions for combining plants in dish gardens:

1. Choose plants that are compatible with each other in cultural requirements, since the water, light, and temperature conditions will be the same for all. In general, do not mix cacti and succulents (Fig. 17-1) with tropical foliage plants. Use all low-light-tolerant plants for dish gardens that will be used on office desks.

2. Let one plant dominate over the others in height (Fig. 17-2). This taller plant may be placed in the middle for an all-around garden or to one side for an asymmetrical look.

3. Select plants that have enough difference in form, leaf shape, color and texture to produce an interesting mixture. However, do not select too many plants with very strong features (bright colors, dominant textures or variegation) or they will compete with each other. The result may be confusing and busy. One or two of the showier plants combined with plainer ones will give more pleasing results.

4. Use one or more trailing plants to soften the rim of the container.

5. Clean the leaves of the plants with a soft damp cloth. The use of plant shine products is not necessary since clean healthy plants are attractive without it.

6. Consider using driftwood or bare branches to add height and interest to dish gardens (Fig. 17-3). Vining plants can also be twined around the wood.

7. Figurines are optional; most dish gardens look attractive without them. However, if a figurine is needed to carry out a special theme, it should be used in such a way that it becomes an important part of the total design. It should be large enough so as not to be dwarfed by the plants, but not so large as to overpower them. A figurine, when used properly, is important enough that the design will appear lacking without it. (See Figure 17-4.)



Figure 17-3 Driftwood adding height to a cactus dish garden

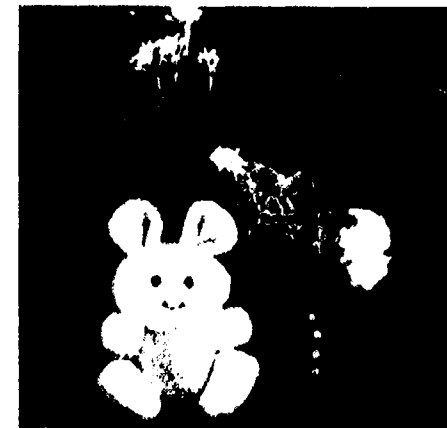


Figure 17-4 Dish garden in a log basket

SUGGESTED ACTIVITY

Planting a Dish Garden

Materials: (Fig. 17-5)
 shallow waterproof container
 sterilized potting soil
 gravel (disinfected) or perlite
 small potted foliage plants
 accessories of your choice



Figure 17-5

1. Assemble all materials.
2. Arrange potted plants in the empty container to get a general idea of their placement. The tallest plant can be in the center or off-center. The design can be one-sided or made to be viewed all around. However, even one-sided designs should be made interesting in the back. If they are placed near a window, they will have to be turned occasionally as the plants bend toward the light.
3. Place a thin layer of disinfected gravel or perlite in the bottom of the container. (Gravel can be disinfected by washing it in bleach water. Rinse well so that no bleach remains

in the gravel.) If the container is very shallow, omit the gravel layer.

4. Remove plants from their containers by turning them upside down, holding the stem between your fingers near the soil level, and rapping the edge of the pot on the counter edge to loosen the soil ball from the pot.

5. Place plants in the container so that their soil line is about 3/4 inch below the rim of the container. You may have to place some soil in the bottom or perhaps remove a little from the soil balls, depending on the depth of the container. Do not plant level with rim of container or the dish garden will be hard to water.

6. Fill in around the plants with sterilized potting soil. Press the soil lightly around the plants to anchor them, leaving the soil level at least 1/2 inch below the rim of the container.

7. Water the dish garden to settle the soil around the plants. Remember that there is no drainage, so avoid overwatering.

8. Wipe the container and foliage clean with a soft damp cloth.

9. Add accessories if you desire.



Completed dish garden showing variation in height, texture and plant form



The interesting duck basket is featured instead of covered with plants



An efficient work area for making dish gardens



European dish garden in a low twig basket



A colorful begonia with croton and velvet plant in a rectangular woven basket

EUROPEAN DISH GARDENS

A European dish garden is an interesting variation on the traditional dish garden. The difference is that the plants are left in their pots, wedged in with moss or styrofoam, and then covered with sheet moss to give a planted look. Flowering plants like African violets, small kalanchoes, poinsettias or chrysanthemums are frequently added to make a colorful combination. Cut flowers can also be added by wedging in a vase or piece of floral foam among the pots. When temporary splashes of color are used to accent a collection of foliage plants, the combination can also be called a *pot-et-fleur* arrangement. The addition of branches, birds, nests, and/or figurines makes the pot-et-fleur assemblage into a true floral arrangement.

European dish gardens are often done in baskets. A plastic liner is best in the bottom. However, several layers of heavy foil are good for short-term usage, such as a table centerpiece. The liner, foil, pots and styrofoam should be covered with sheet moss after the plants are arranged.

Colorful flowers have high eye appeal and usually become the focal point of the design. Therefore, their position is important enough to be given special thought. Trailing plants are effective in softening the rim of the container and leading the eye beyond its boundaries.

Accents can be used to develop certain themes or feelings. Holly berries and glittered branches suggest Christmas, birds holding strands of raffia represent nest building in the spring, and autumn leaves or

wheat are appropriate in the fall. Bows can be added for color and to help carry out the theme.

SUGGESTED ACTIVITY

Planting a Pot-et-Fleur Design

Materials:

- lined basket or shallow waterproof container
- assorted foliage plants in small containers
- one or more flowering plants in small containers
- soaked floral foam in a small container
- cut flowers (mums, carnations, etc.)
- styrofoam
- sheet moss
- #9 ribbon for a bow

1. Arrange plants in the basket. If the basket has a handle, do not bury it in plants. Place the flowering plants and bow at the focal point of the design, usually toward the



Pot-et-fleur design with a bow and spray of cut flowers at one side of the design

front of the basket. Use trailing plants over the edge of the basket.

2. Add a small container of soaked foam near the taller foliage plants. Wedge this container and the pots firmly into position with pieces of styrofoam.

3. Place cut flowers in the floral foam to develop a vertical line of color.

4. Cover the pots and styrofoam with sheet moss.

5. Wipe the foliage clean with a damp soft cloth.

TERRARIUMS

Terrariums are clear glass or plastic containers with plants inside them. They may have a lid or be open at the top. In either case the environment inside the container is protected and usually more humid than the surrounding air. Therefore, the terrarium is a good place to grow small plants that dry out easily or that require high humidity.

Terrariums may be made using bubble bowls, brandy snifters or rectangular aquariums. Specifically designed terrarium cases with hexagonal sides and domed tops are available. Bottles with narrow necks or small openings are a challenge to the designer, requiring special long-handled tools to carry out the planting.

If large enough, a terrarium can be designed as a miniature landscape. Very small terrariums may serve just to protect and

display a single special plant. The soil should be deep enough to hold the root system without coming too far up the side of the jar. Too much soil looks heavy and unattractive and may not leave enough room inside the jar for the tops of the plants. In general, the soil should not be deeper than one quarter the height of the container. A well-drained potting mixture that has been sterilized should be used, since diseases can spread rapidly in the moist environment of a terrarium. A layer of disinfected gravel can be used in the bottom for drainage. A thin layer of charcoal (the kind used in aquariums) could be spread on top of the gravel. It will help absorb odors that may develop in damp soil. Another optional material is sheet moss used to line the bottom of the terrarium so that the gravel, charcoal and soil do not show through the glass.

Plants

Terrarium plants are usually grown in small containers, often only 2 inches across. This results in little disturbance of the root system. Transplant shock is also reduced by the humid atmosphere inside the terrarium. Plants must be small when planted. They should also be rather slow-growing so they do not overrun the terrarium in a short time.

The plants that are chosen for terrariums should thrive in moist, humid conditions and moderate to low light. In fact, terrariums are ideal for growing plants that are otherwise difficult to grow in pots in the open air, such as small ferns, fittonia and baby's tears. Cacti and succulents are poor choices for terrariums; they will grow much better in an open dish garden. Terrariums are reserved mainly for two categories of

Types of Terrariums



Wardian case



Bubble bowl



Rectangular aquarium



Bottle garden

plants: 1) small tropical foliage plants and 2) native mosses, partridge berries and other plants that can be collected from the forest floor to make an attractive "winter garden."

The plants should have enough color and textural variation to be interesting. Baby's tears, selaginella and mosses can be used to simulate patches of turf. Small palms, ferns and other more upright plants serve as trees and shrubs in the mini-landscape. A few more colorful plants can be used as accents:- miniature flowering gesneriads in tropical terrariums or partridge berries and red-capped British soldier lichens in a woodland terrarium. Very special, more expensive, humidity-loving plants can be displayed individually in small terrariums. They can be left in their growing pots, which are hidden by sheet moss or Spanish moss. This will allow for easy removal from the terrarium for periodic cleaning and grooming. Miniature orchids, bromeliads or gesneriads are plants that can be grown this way.

Plants that are suitable for terrariums include:

Aluminum Plant (*Pilea*)
 Baby's Tears (*Soleirolia*)
 Creeping Fig (*Ficus*)
 Fittonia (*Fittonia*)
 Miniature African Violets and other small Gesneriads (*Saintpaulia*, *Sinningia*, *Eptiscia*, *Streptocarpus*, *Aeschynanthus*, etc.)
 Miniature Bromeliads (*Cryptanthus*, *Tillandsia*, etc.)
 Miniature Orchids (*Paphiopedilum*, *Ludisia*, *Rodriguezia*, etc.)
 Neanthe Bella Palm (*Chamaedorea*)

Needlepoint Ivy (*Hedera*)
 Selaginella (*Selaginella*)
 Small Ferns (*Pteris*, *Pellaea*, *Adiantum*, etc.)
 Small Peperomias (*Peperomia*)

Accessories

Special landscape features may be developed within the terrarium, such as buried containers for pools, stones to build ledges, caves or bridges, and pieces of branches, driftwood or bark to simulate fallen logs. Paths can be developed using fine gravel or small pebbles, but avoid gaudy, unnatural-looking colored gravel. The use of figurines is entirely optional. If used at all, they should be in scale with the surrounding plants, enhancing them rather than drawing attention away from them. Natural-looking ceramic or stoneware mushrooms, snails, frogs, rabbits, deer or other animals in earth-tone colors and non-glossy textures are examples of accessories in good taste. These can harmonize well with plants.

SUGGESTED ACTIVITY

Planting a Terrarium

Materials: (Fig. 17-6)
 glass terrarium
 gravel disinfected in bleach water
 aquarium charcoal
 potting soil
 small terrarium plants
 accessories of your choice (rocks, wood, figurines)
 watering can



Landscaped terrarium featuring a small pond with swans

1. Wash and thoroughly dry the terrarium.
2. In the bottom place a layer of gravel one inch thick and top it with a shallow layer of charcoal.
3. Add a layer of soil one inch thick. (See Figure 17-7.) Consider sloping the soil in one direction or terracing it with stones or pieces of bark.
4. Arrange the plants to form a miniature landscape. Fill in around the plants with soil.
5. Add the accessories if they are to be a part of the design.
6. If soil has fallen on foliage or on sides of the container during planting, rinse it off with a little water from a watering can.
7. Water the planted terrarium lightly so the plants are settled in. Do not overwater and make the soil muddy. (See Figure 17-8 for the finished terrarium.)

HANGING BASKETS

Plants that are suspended have a special charm. Vining plants are effectively displayed in containers that are hanging; however, other plants with a full cloud-like growth habit can also be used in the center of a hanging basket with vining plants around the edge.

The term "hanging basket" comes from an old method of lining a wire basket with moss to hold in the soil. Many plastic, pottery and wood versions of hanging containers are now on the market. These are collectively referred to as *hanging baskets*. The hanger can be rope, wire or chain. Macrame hangers made of cord knotted into patterns are often used to suspend decorative pots.

Containers that are to be hung indoors should be waterproof or should contain a waterproof liner so that there is no dripping. A well-drained sterile soil mix should be used for planting. Often more than one plant is placed in the container to make it look more full. The plants can be angled out over



A foliage hanging basket with spider plant (*Chlorophytum comosum*) which produces small plantlets at the ends of runners



Figure 17-6



Figure 17-7



Figure 17-8



Bolivian Jew (*Callisia repens*) showing teardrop silhouette



Figure 17-9 Moss-lined hanging baskets planted with a mixture of annuals in Victoria, British Columbia

Follage Hanging Baskets



String of Beads (*Senecio rowleyanus*) showing a column of soft stems falling straight down



Wandering Jew (*Zebrina pendula*) with bushy pendulous habit

the edge of the container to help them cascade more quickly.

Hanging baskets containing bedding plants are mainly used outdoors (Fig. 17-9). These may hold just one kind of plant (like cascading petunias or hanging-basket tuberous begonias) or a mixture of many different kinds. Since dripping is usually not a problem outdoors, these containers commonly have drainage holes. And a container with attached saucer frequently overflows. The old-fashioned wire hanging basket lined with sheet moss is still sometimes used. It has an advantage in that some of the specimens can be planted through the moss to cover and hide the bottom of the basket. This is the part people usually see, since hanging baskets are usually hung above eye level.

Plants that are suitable for **indoor** hanging baskets include:

- Asparagus Fern (*Asparagus*)
- Boston Fern (*Nephrolepis*)
- English Ivy (*Hedera*)
- Flame Violet (*Episcia*)
- German Ivy (*Senecio*)
- Inch Plant (*Tradescantia*)
- Philodendron (*Philodendron*)
- Piggyback Plant (*Tolmiea*)
- Pothos (*Epipremnum*)
- Spider Plant (*Chlorophytum*)
- Strawberry Begonia (*Saxifraga*)
- Velvet Plant (*Gynura*)
- Wandering Jew (*Zebrina*)

LARGE PLANT GROUPINGS

Larger plants can be displayed singly or in groupings as an important element in interior design. Planter sizes range from those suitable for small foliage plants to ones for large trees. These may be made from fiberglass, terra-cotta, plastic, lined wicker or wood. Plants may be planted directly in the planters, or the growing pot is simply set inside the decorative container. The latter method gives greater ease in replacing plants.

The same technique can be used for larger planters designed to hold more than one specimen. The plants are made to look direct-planted by filling in around the pots with styrofoam or wood chips, covering the top with bark mulch. This allows you to raise the plants first to the desired level by placing other pots or saucers under them. The result is less total weight and more flexibility. The planter may even have a way to remove excess drainage water, thus reducing the chances of overwatering and development of odors from stagnant water. Colorful plants like azaleas, poinsettias, spring bulbs and chrysanthemums can be added and removed from the display as the seasons change.

Wicker has become increasingly popular as an inexpensive but attractive container for larger plants. To prevent rotting of the wicker and damage to furnishings by moisture seeping through, such containers must be thoroughly lined with a commercial liner or layers of plastic and a plastic saucer in the bottom. Plastic saucers are preferable to unglazed clay since moisture can gradually work its way through the porous clay.

Medium-sized plants in 6-inch or 8-inch pots can be placed in *jardinieres*. These decorative ceramic or metal containers, which lack drainage holes, are designed to hold a single specimen plant left in its growing pot. They are safe to use on furniture and look attractive in the home or in the office.

Following are some general guidelines for creating plant groupings for interior environments.

1. Foliage plants soften harsh lines of modern interiors and bring a fresh, living look to the space (Fig. 17-10).



Figure 17-10

(Hyatt, Columbus)

2. Use plants with large leaves and bold forms to give a contemporary look or to hold attention when the background is patterned or "busy" (Fig. 17-11).

3. Carefully select a few choice foliage plants to decorate a room or office in preference to the "jungle look" with many plants of lesser quality (Fig. 17-12).

4. When three or more plants in separate containers are used in a group, create a



A decorative jardiniere with festoons of fruit holding a specimen of dumbcane



Figure 17-11

(Williamsburg, Virginia)



Figure 17-12 Three choice plants in wicker containers (ATI, Wooster)

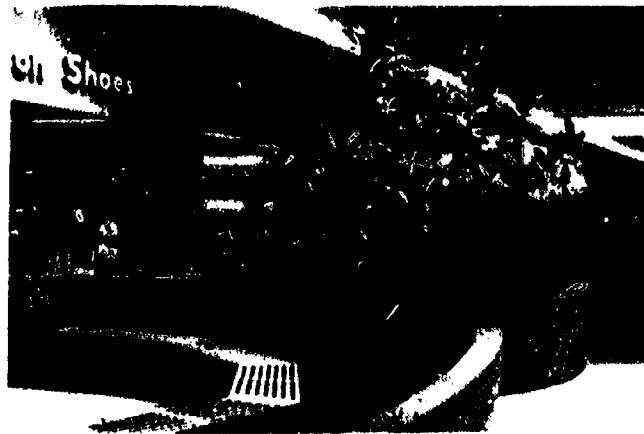


Figure 17-14 Plants dividing large open areas (Belder Village Mall, North Canton)



Figure 17-15 Plant groupings in a dining room window



Figure 17-13
(Garden Center of Greater Cleveland)



Figure 17-16 (Chi-Chi's, North Canton)

visual spiral from the tallest to the shortest (Fig. 17-13).

5. Use plants as room dividers or to direct foot traffic or to focus attention on a certain area (Fig. 17-14).

6. Use plants near windows to take advantage of the natural light and to carry the outdoors feeling inside (Fig. 17-15).

7. Suspend plants from the ceiling (Fig. 17-16) or mount them on walls (Fig. 17-17) when space is limited.

8. Do not attempt to introduce plants into areas that are too dark, cold or drafty, or they will go into rapid decline. Many tropical foliage plants need a *minimum* of 50 footcandles of light and temperatures in the 60-70°F range just to survive. Most will look much better if they receive more light and temperatures higher than this.



Figure 17-17 Plants attached to wrought iron wall sculpture
(Garden Center of Greater Cleveland)



Mexican
Plant grouping around a metal statue
(*Chi Chi's, North Canton*)

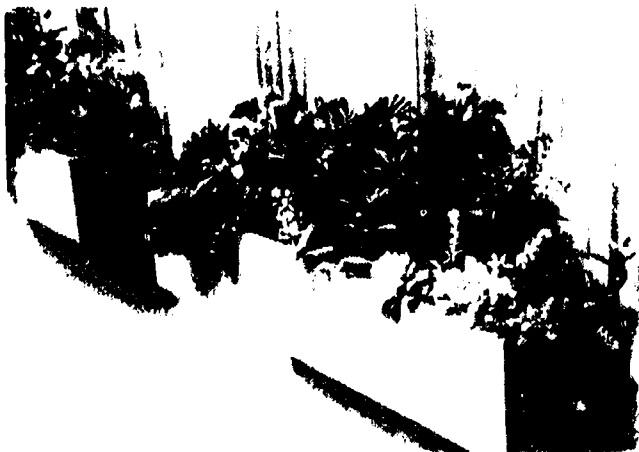
Plants Convey Themes



Oriental
Bonsai against bamboo screen
(*Longwood Gardens, Pennsylvania*)



Medieval
Statue of St. Francis surrounded by orchids
and caladiums
(*Garden Center of Greater Cleveland*)



Planter box of succulents
(*Longwood Gardens, Pennsylvania*)

Contemporary



Large Areca palm installed in a ground bed by
Architectural Greenery, Akron
(*Stark County Library, Canton*)



Foliage plants on cylinders of various heights
(*Garden Center of Greater Cleveland*)

Large Plant Groupings



Large weeping fig in a terra-cotta container (*Hyatt, Columbus*)



Copper container filled with foliage plants in a library (*Garden Center of Greater Cleveland*)

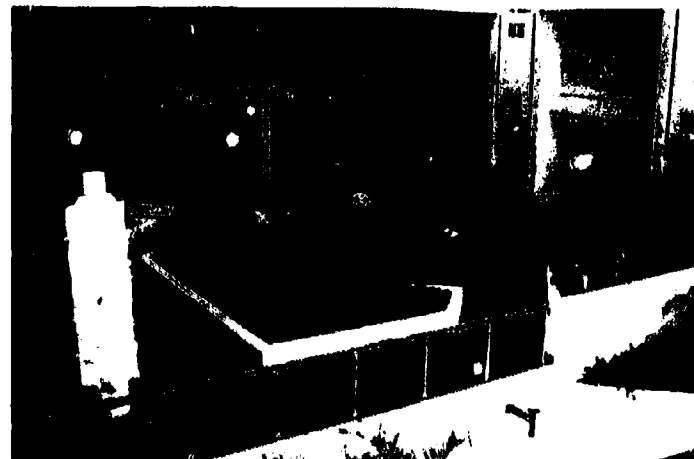


A fern displayed on a wooden pedestal

Plants in Large Buildings



Hotel
Balustrade planter of pothos (*Hyatt, Columbus*)



Library
Large foliage plants in built-in planters (*Stark County Library, Canton*)



Office Building
Planter boxes attached to railing at different levels (*State Office Building, Akron*)

INDOOR FLOWERING PLANTS



Aechmea fasciata
Family: Bromeliaceae

SILVER VASE
1



Cineraria cruentus
Family: Compositae

CINERARIA
4



Crossandra infundibuliformis CROSSANDRA
Family: Acanthaceae 7

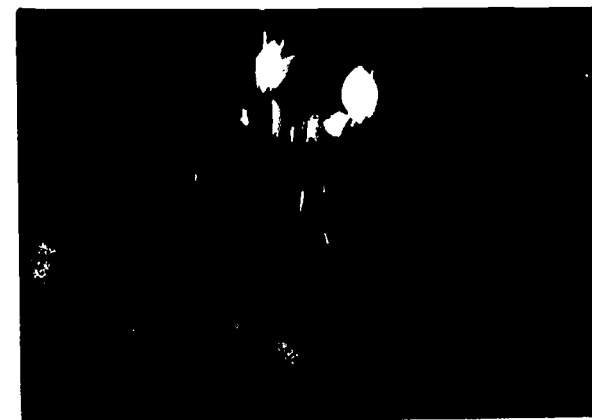


Calceolaria crenatiflora POCKETBOOK PLANT
Family: Scrophulariaceae 2



Citrus mitis
Family: Rutaceae

CITRUS
5



Cyclamen persicum CYCLAMEN
Family: Primulaceae 8



Chrysanthemum morifolium CHRYSANTHEMUM
Family: Compositae 3



Crocus sp.
Family: Iridaceae

GROCUS
6



Euphorbia pulcherrima
Family: Euphorbiaceae

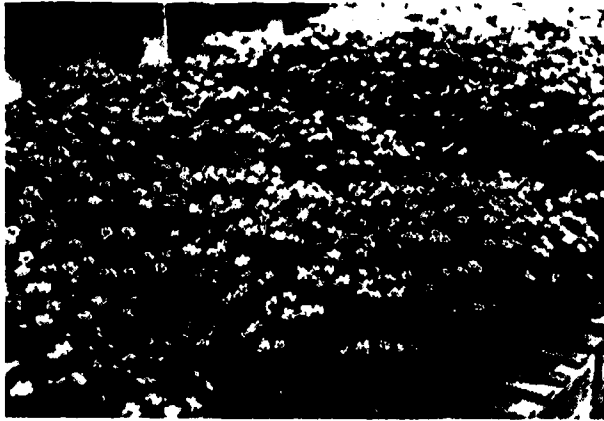
POINSETTIA
9

588

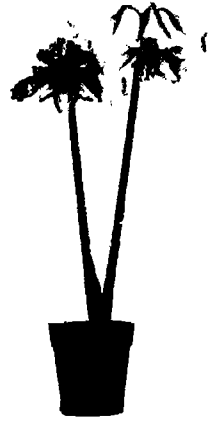
bl

588

599



Exacum affine PERSIAN VIOLET
Family: Solanaceae 10



Hippeastrum vittatum AMARYLLIS
Family: Amaryllidaceae 13



Kalanchoe blossfeldiana KALANCHOE
Family: Crassulaceae 16



Gardenia jasminoides GARDENIA
Family: Rubiaceae 11



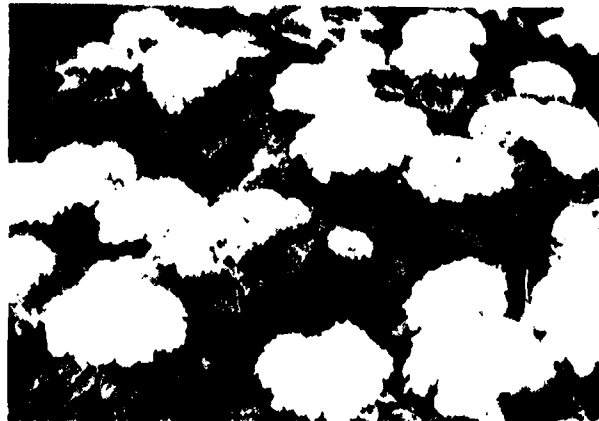
Hyacinthus orientalis HYACINTH
Family: Liliaceae 14



Lilium longiflorum EASTER LILY
Family: Liliaceae 17



Hibiscus rosa-sinensis HIBISCUS
Family: Malvaceae 12



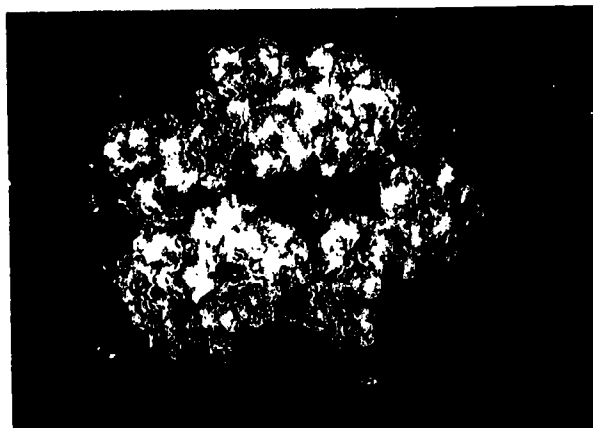
Hydrangea macrophylla HYDRANGEA
Family: Saxifragaceae 15



Narcissus pseudonarcissus DAFFODIL
Family: Amaryllidaceae 18



Narcissus tazetta PAPER-WHITE NARCISSUS
Family: Amaryllidaceae 19



Rhododendron sp. AZALEA
Family: Ericaceae 22



Sinningia speciosa GLOXINIA
Family: Gesneriaceae 25



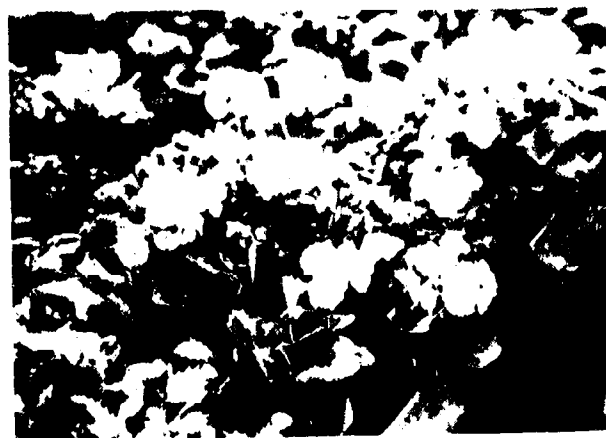
Pelargonium hortorum GERANIUM
Family: Geraniaceae 20



Saintpaulia ionantha AFRICAN VIOLET
Family: Gesneriaceae 23



Solanum pseudocapsicum JERUSALEM CHERRY
Family: Solanaceae 26



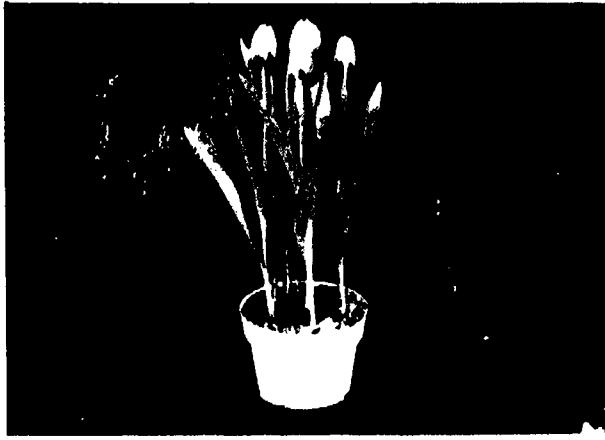
Primula malacoides PRIMROSE
Family: Primulaceae 21



Schlumbergera bridgesii CHRISTMAS CACTUS
Family: Cactaceae 24



Streptocarpus hybridus CAPE PRIMROSE
Family: Gesneriaceae 27



Tulipa sp.
Family: Liliaceae

TULIP
28

Indoor Flowering Plants

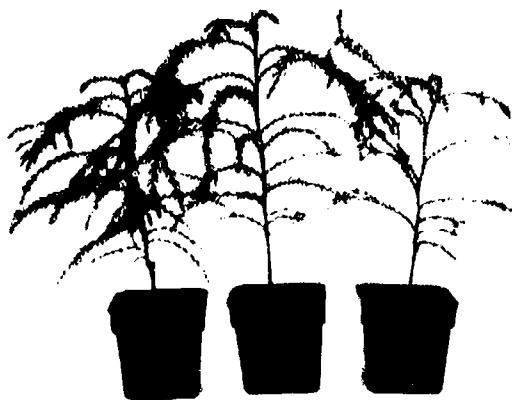
Listed Alphabetically by Common Name and including Scientific Name

- 23 AFRICAN VIOLET - *Saintpaulia ionantha*
- 13 AMARYLLIS - *Hippeastrum vittatum*
- 22 AZALEA - *Rhododendron* sp.
- 27 CAPE PRIMROSE - *Streptocarpus hybridus*
- 24 CHRISTMAS CACTUS - *Schlumbergera bridgesii*
- 3 CHRYSANTHEMUM - *Chrysanthemum morifolium*
- 4 CINERARIA - *Cineraria cruentus*
- 5 CITRUS - *Citrus mitis*
- 6 CROCUS - *Crocus* sp.
- 7 CROSSANDRA - *Crossandra infundibuliformis*
- 8 CYCLAMEN - *Cyclamen persicum*
- 18 DAFFODIL - *Narcissus pseudonarcissus*
- 17 EASTER LILY- *Lilium longiflorum*
- 11 GARDENIA - *Gardenia jasminoides*
- 20 GERANIUM - *Pelargonium hortorum*
- 25 GLOXINIA - *Sinningia speciosa*
- 12 HIBISCUS- *Hibiscus rosa-sinensis*
- 14 HYACINTH - *Hyacinthus orientalis*
- 15 HYDRANGEA- *Hydrangea macrophylla*
- 26 JERUSALEM CHERRY - *Solanum pseudocapsicum*
- 16 KALANCHOE - *Kalanchoe blossfeldiana*
- 19 PAPER-WHITE NARCISSUS- *Narcissus tazetta*
- 10 PERSIAN VIOLET - *Exacum affine*
- 2 POCKETBOOK PLANT - *Calceolaria crenatiflora*
- 9 POINSETTIA - *Euphorbia pulcherrima*
- 21 PRIMROSE - *Primula malacoides*
- 1 SILVER VASE - *Aechmea fasciata*
- 28 TULIP - *Tulipa* sp.

INDOOR FOLIAGE PLANTS



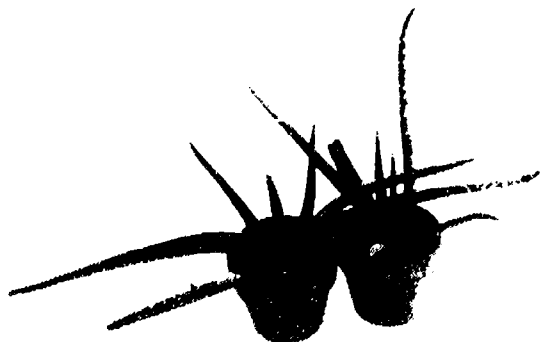
Aglaonema commutatum CHINESE EVERGREEN
Family: Araceae 29



Araucaria heterophylla NORFOLK ISLAND PINE
Family: Araucariaceae 32



Begonia masoniana IRON CROSS BEGONIA
Family: Begoniaceae 35



Aloe barbadensis ALOE, BURN PLANT
Family: Liliaceae 30



Aspidistra elatior CAST IRON PLANT
Family: Liliaceae 33



Brassia actinophylla SCHEFFLERA
Family: Araliaceae 36



Aphelandra squarrosa ZEBRA PLANT
Family: Acanthaceae 31



Asplenium nidus BIRDSNEST FERN
Family: Polypodiaceae 34



BROMELIADS 37



CACTI AND SUCCULENTS
38



Chlorophytum comosum
Family: Liliaceae
SPIDER PLANT
41



Cordylina terminalis
Family: Agavaceae
TI PLANT
44



Caladium hortulanum
Family: Araceae
CALADIUM
39



Cissus rhombifolia
Family: Vitaceae
GRAPE IVY
42



Crassula argentea
Family: Crassulaceae
JADE PLANT
45



Chamaedorea elegans
Family: Palmae
PARLOR PALM
40



Codiaeum variegatum
Family: Euphorbiaceae
CROTON
43



Cyperus alternifolius
Family: Cyperaceae
UMBRELLA PLANT
46



Dieffenbachia amoena
Family: Araceae

DUMBCANE
47



Dracaena fragrans
Family: Agavaceae

CORN PLANT
50



Dracaena surcolosa GOLD-DUST DRACAENA
Family: Agavaceae 53



Dizygotheca elegantissima
Family: Araliaceae

FALSE ARALIA
48



Dracaena marginata
Family: Agavaceae

MARGINATA
51



Epipremnum aureum
Family: Araceae

POTHOS
54



Dracaena deremensis 'Warneckei' WARNECKEII
Family: Agavaceae 49



Dracaena sanderana
Family: Agavaceae

RIBBON PLANT
52



Fatsia japonica
Family: Araliaceae

FATSIA
55



Ficus benjamina WEEPING FIG, BENJAMIN TREE
Family: Moraceae 56



Gynura aurantiaca VELVET PLANT
Family: Compositae 59



Maranta leuconeura PRAYER PLANT
Family: Marantaceae 62



Ficus elastica RUBBER PLANT
Family: Moraceae 57



Hedera helix ENGLISH IVY
Family: Araliaceae 60



Monstera deliciosa SPLIT-LEAF PHILODENDRON
Family: Araceae 63



Ficus lyrata FIDDLE-LEAF FIG
Family: Moraceae 58



Hoya carnosa WAX PLANT
Family: Asclepiadaceae 61



Nephrolepis exaltata BOSTON FERN
Family: Polypodiaceae 64



Peperomia caperata
EMERALD RIPPLE PEPEROMIA
Family: Piperaceae 65



Philodendron selloum TREE PHILODENDRON
Family: Araceae 68



Plectranthus australis SWEDISH IVY
Family: Labiatae 71



Peperomia obtusifolia VARIEGATED PEPEROMIA
Family: Piperaceae 66



Pilea cadleri ALUMINUM PLANT
Family: Urticaceae 69



Podocarpus macrophyllus BUDDHIST PINE
Family: Podocarpaceae 72



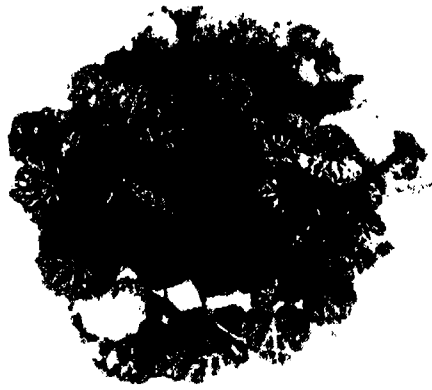
Philodendron oxycardium HEART LEAF PHILODENDRON
Family: Araceae 67



Platycerium bifurcatum STAGHORN FERN
Family: Polypodiaceae 70



Sansevieria trifasciata SNAKE PLANT
Family: Agavaceae 73



Saxifraga sarmentosa STRAWBERRY BEGONIA
Family: Saxifragaceae 74



Spathiphyllum patinii PEACE LILY
Family: Araceae 77



Tradescantia albiflora INCH PLANT
Family: Commelinaceae 80



Sedum morganianum BURRO'S TAIL
Family: Crassulaceae 75



Syngonium podophyllum NEPHTHYTIS
Family: Araceae 78



Zebraia pendula WANDERING JEW
Family: Commelinaceae 81



Soleirolia soleirolii BABY'S TEARS
Family: Urticaceae 76

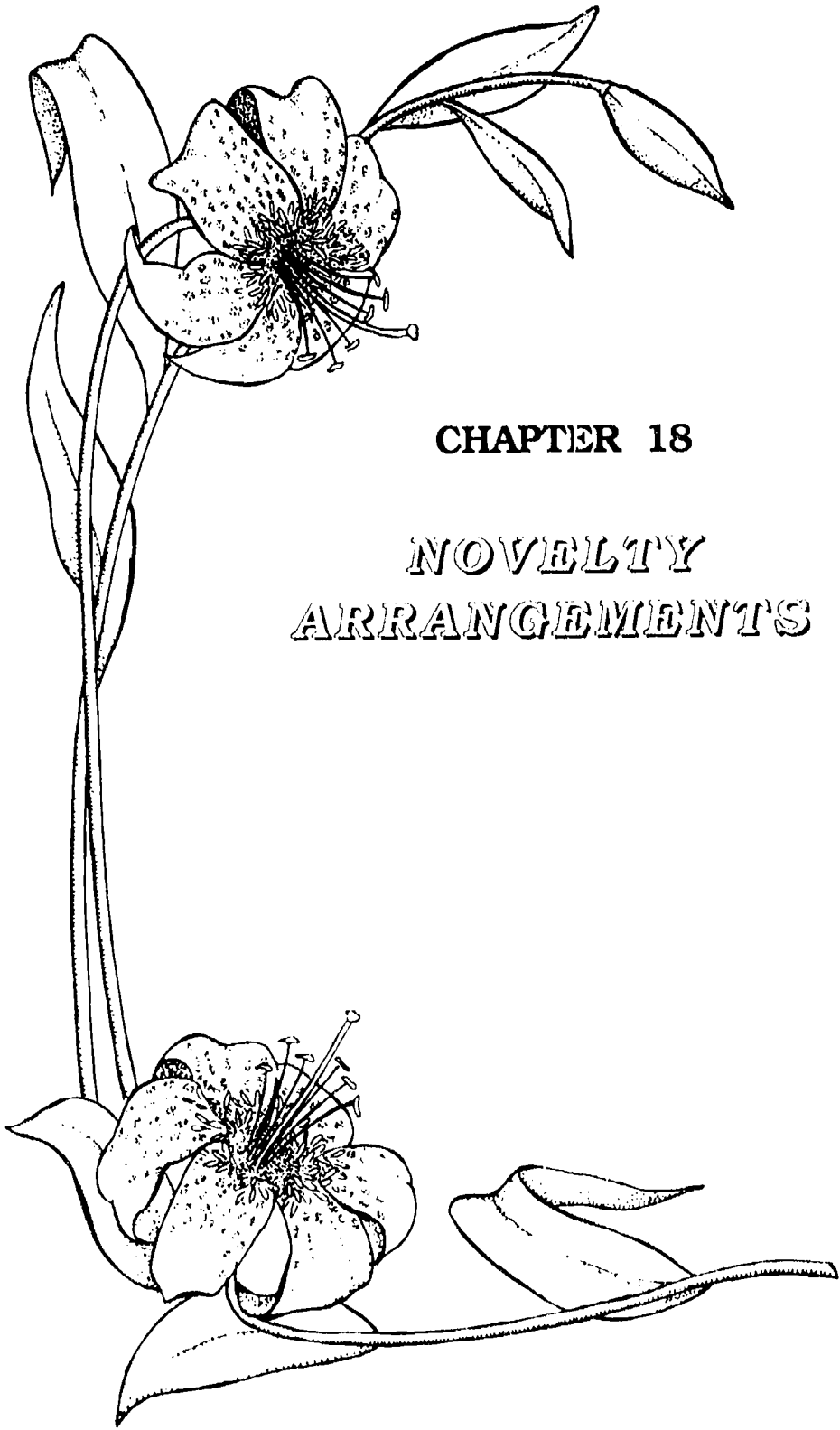


Tolmiea menziesii PIGGYBACK PLANT
Family: Saxifragaceae 79

Indoor Foliage Plants

Listed Alphabetically by Common Name and including Scientific Name

- 30 ALOE- *Aloe barbadensis*
69 ALUMINUM PLANT- *Pilea cadleroi*
76 BABY'S TEARS- *Soleirolia soleirolii*
56 BENJAMIN TREE- *Ficus benjamina*
34 BIRDSNEST FERN- *Asplenium nidus*
64 BOSTON FERN- *Nephrolepis exaltata*
37 BROMELIADS
72 BUDDHIST PINE- *Podocarpus macrophyllus*
30 BURN PLANT- *Aloe barbadensis*
75 BURRO'S TAIL- *Sedum morganianum*
38 CACTI AND SUCCULENTS
39 CALADIUM- *Caladium hortulanum*
33 CAST IRON PLANT- *Aspidistra elatior*
29 CHINESE EVERGREEN- *Aglaonema commutatum*
50 CORN PLANT- *Dracaena fragrans*
43 CROTON- *Codiaeum variegatum*
47 DUMBCANE- *Dieffenbachia amoena*
65 EMERALD RIPPLE PEPEROMIA- *Peperomia caperata*
60 ENGLISH IVY- *Hedera helix*
48 FALSE ARALIA- *Dizygotheca elegantissima*
55 FATSIA- *Fatsia japonica*
58 FIDDLE-LEAF FIG- *Ficus lyrata*
53 GOLD-DUST DRACAENA- *Dracaena surcolosa*
42 GRAPE IVY- *Cissus rhombifolia*
67 HEART LEAF PHILODENDRON- *Philodendron oxycardium*
80 INCH PLANT- *Tradescantia albiflora*
35 IRON CROSS BEGONIA- *Begonia masoniana*
45 JADE PLANT- *Crassula argentea*
51 MARGINATA- *Dracaena marginata*
78 NEPHTHYTIS- *Syngonium podophyllum*
32 NORFOLK ISLAND PINE- *Araucaria heterophylla*
40 PARLOR PALM- *Chamaedorea elegans*
77 PEACE LILY- *Spathiphyllum patinii*
79 PIGGYBACK PLANT- *Tolmiea menziesii*
54 POTHOS- *Epipremnum aureum*
62 PRAYER PLANT- *Maranta leuconeura*
52 RIBBON PLANT- *Dracaena sanderana*
57 RUBBER PLANT- *Ficus elastica*
36 SCHEFFLERA- *Brassia actinophylla*
73 SNAKE PLANT- *Sansevieria trifasciata*
41 SPIDER PLANT- *Chlorophytum comosum*
63 SPLIT-LEAF PHILODENDRON- *Monstera deliciosa*
70 STAGHORN FERN- *Platynerium bifurcatum*
74 STRAWBERRY BEGONIA- *Saxifraga sarmentosa*
71 SWEDISH IVY- *Plectranthus australis*
44 TI PLANT- *Cordyline terminalis*
68 TREE PHILODENDRON- *Philodendron selloum*
46 UMBRELLA PLANT- *Cyperus alternifolius*
66 VARIEGATED PEPEROMIA- *Peperomia obtusifolia*
59 VELVET PLANT- *Gynura aurantiaca*
81 WANDERING JEW- *Zebrina pendula*
49 WARNECKEI- *Dracaena deremensis* 'Warneckei'
61 WAX PLANT- *Hoya carnosa*
56 WEEPING FIG- *Ficus benjamina*
31 ZEBRA PLANT- *Aphelandra squarrosa*



CHAPTER 18

NOVELTY
ARRANGEMENTS





Bird and cat planters around a decorated rectangular planter



Figure 18-1
Assortment of novelty planters



Patriotic theme- red, white and blue arrangement in stars and stripes hat



A grouping of Raggedy Ann and Andy tied together by a connecting line-mass arrangement

Novelty arrangements can be created using unusual containers or planters which suggest a special theme. Another way to display flowers in a novel way is to use them to create animals, clowns, birds, snowmen, etc. There is a market for both kinds of these theme-oriented floral creations and they are fun to do.

NOVELTY PLANTERS

Small ceramic containers are available in an abundance of shapes, such as baby booties, Madonnas, cowboy hats, pipes, turkeys, pumpkins, rabbits and geese, to name a few (Fig. 18-1). These can be used as planters to hold living plants, but they also serve equally well for small arrangements that complement the container. The planter part easily holds floral foam for fresh arrangements or styrofoam for dry or silk designs.

Since the container is to be featured, the arrangement should not overpower it in size. A general rule of thumb is to make the arrangement less than one and a half times the height of the planter. The design will also be more effective if it allows the planter to show and does not cover up any prominent parts. If the shape and lines of the arrangement echo the dominant shape or lines of the planter, a more harmonious design will be created.

Another possibility is to plant one or more living plants in the container and then add an accent of fresh flowers in a water tube and possibly a bow. Or silk flowers could be used for a longer-lasting touch of color.

THEMES IN NOVELTY PLANTERS

SUGGESTED ACTIVITY

Novelty Planter Arrangement

Have each student design an arrangement in a different novelty planter. Fill the planter with soaked floral foam. Study the color, shape and lines of the container in order to select a harmonious design shape and appropriate materials. Pompon mums, statice, huckleberry and leatherleaf fern are versatile for planter arrangements.

FUN FLOWERS

Flowers can be assembled and decorated so that they resemble animals, birds and clowns. Your imagination is the only limit to what you can try in creativity. Shapes most often seen are poodles made from standard mums (Fig. 18-2) and turkeys, pheasants or clowns made from various floral materials. Since these designs are frequently given to children, your inventive abilities could also be used on figures like teddy bears, kittens, caterpillars, toys or cartoon characters.



Figure 18-2



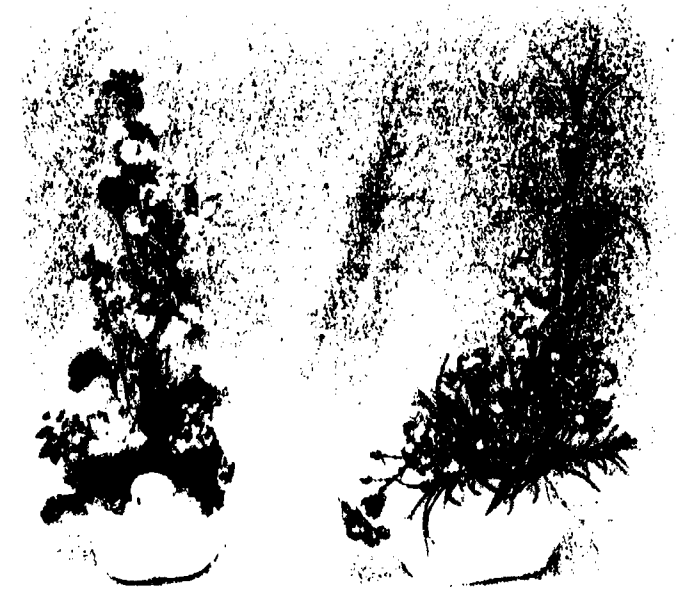
Thanksgiving Theme



Easter Theme



Religious Theme



Juvenile Theme

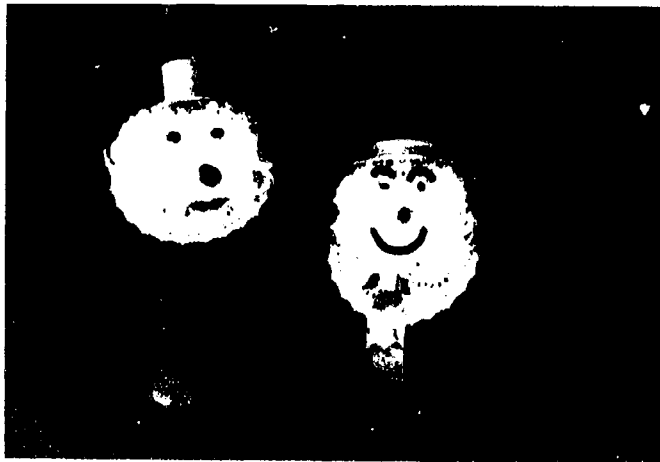


Figure 18-3

The simplest kind of fun flower project to make is a funny head out of a single standard mum in a bud vase (Fig. 18-3). You can decorate it with eyes, nose, mouth, hat, tie, etc. These items can be made from chenille stems, ribbon and construction paper. Eyes with movable pupils can be purchased in different sizes. Spanish moss and yarn can also be useful. All these decorations can be attached to the flower with hot glue or floral adhesive.

More complex designs can be made by using a larger number of flowers. The body of a dog, bear, or turkey can be created by inserting chrysanthemums in a block of floral foam. Special features are then glued on with hot glue or floral adhesive, just as with the single flower. Real feathers make realistic tails for bird figures (Fig. 18-4). If the flowers are fresh and the foam is kept moist, these creations can be expected to last as long as two weeks.

Fun flower creations like the ones just described are considered novelties rather than arrangements. They have special appeal to children and are appropriate when something very different and individualized is wanted.



Figure 18-4



A "soda" made with carnations

A fun flower with *personality*

SUGGESTED ACTIVITY

Fun Flowers

Materials:

- bud vase
- standard mum
- leatherleaf fern
- chenille stems
- ribbon
- plastic eyes
- construction paper
- hot glue gun or floral adhesive

1. Place the mum in a bud vase with water so that it is about 3 inches above the rim of the vase. Back it with a piece of leatherleaf.
 2. Create a creature of your choice using the materials available to you. Attach decorative items with hot glue or floral adhesive.
-

NOVELTY ARRANGEMENTS FEATURING ACCESSORIES



Easter Theme



Salute to Nature



Rural Theme



Mardi Gras Theme



Garfield on the Prowl

626

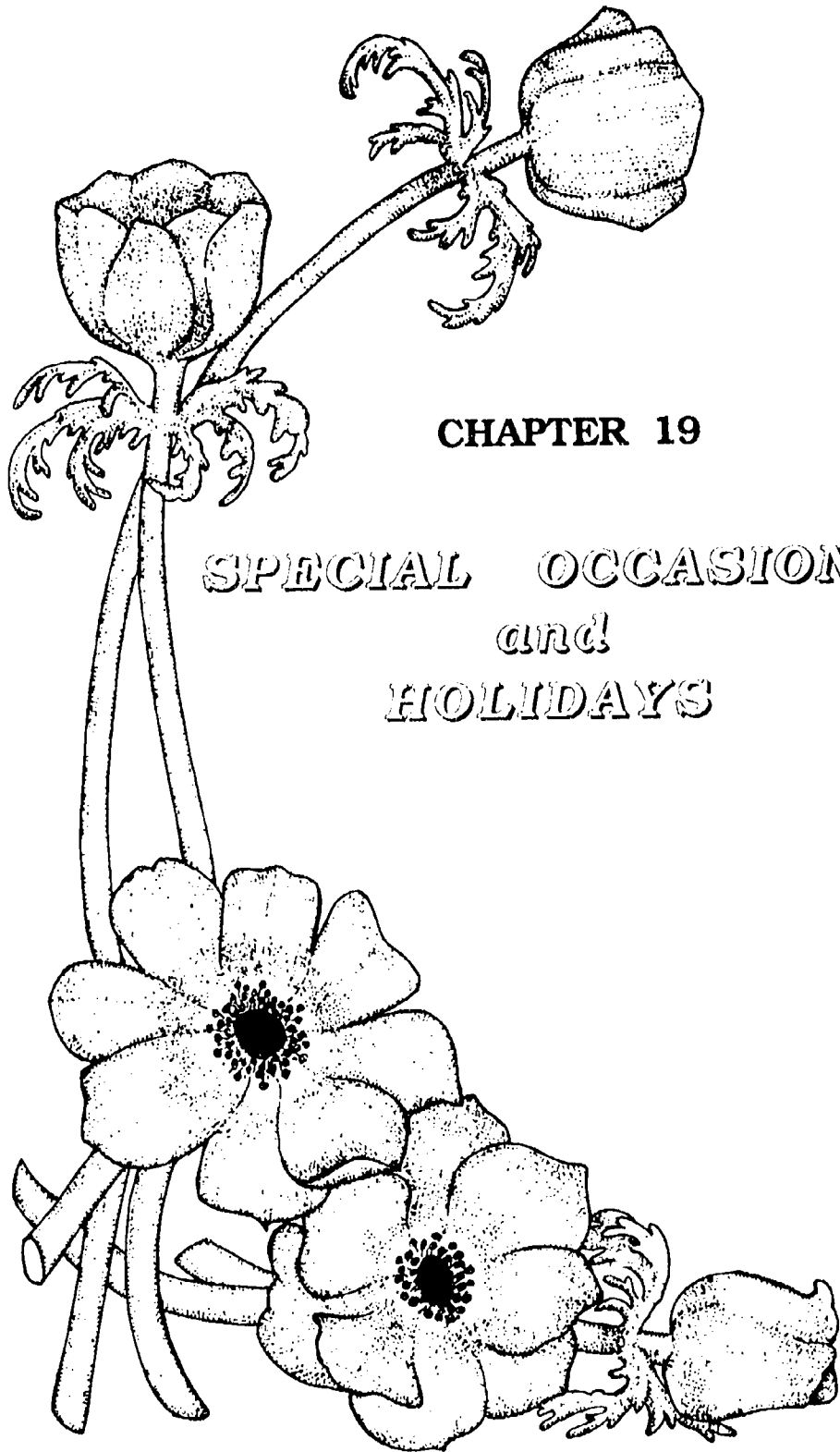
627



NOVELTY ARRANGEMENTS

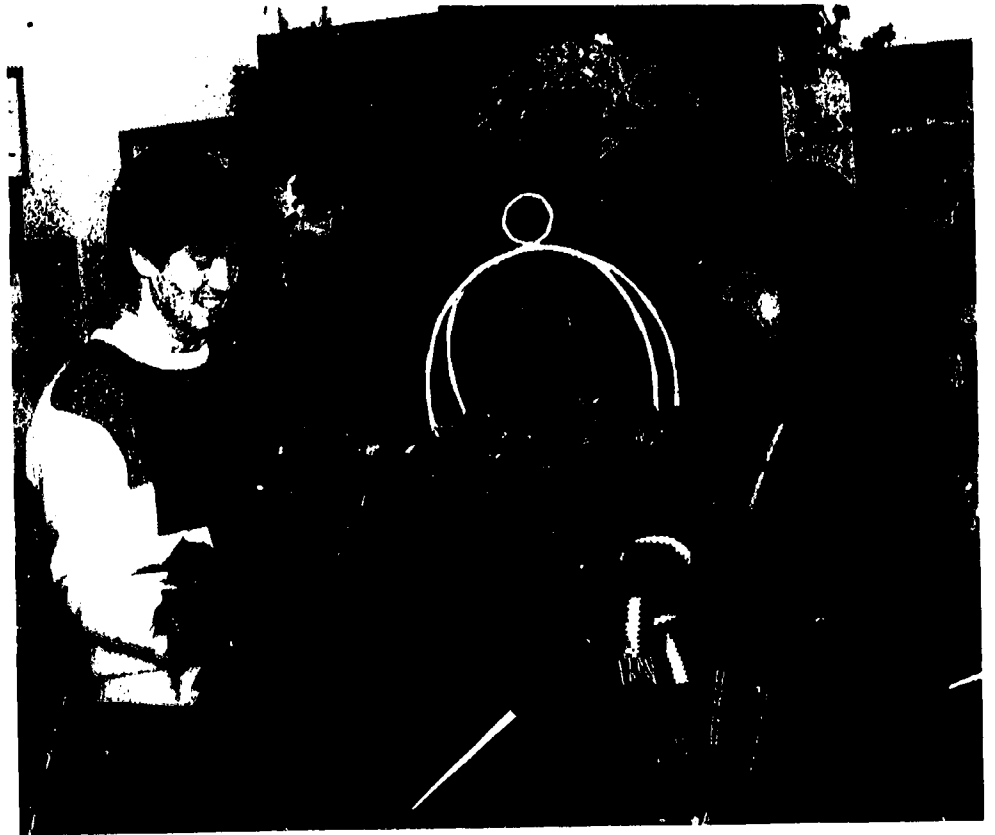
by Jerry Prokuski, OFA Short Course



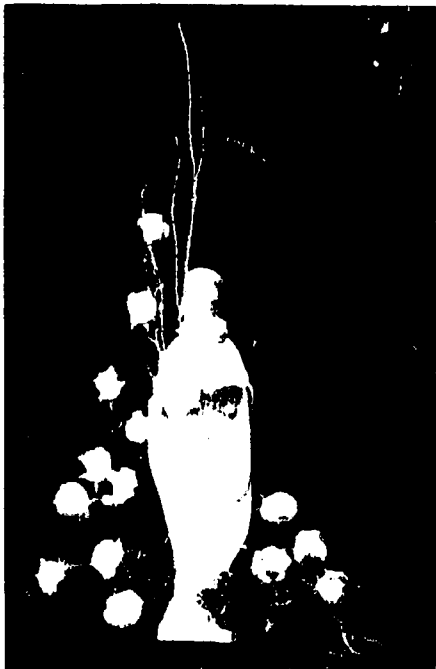


CHAPTER 19

SPECIAL OCCASIONS
and
HOLIDAYS



Theme Christmas Arrangements



Religious
Madonna and child



Country Victorian
Doll in a sleigh



Traditional
Mr. and Mrs. Santa



The Arts
Ballet slippers, musical scrolls, etc.

Theme Wreaths



Angelic
Ceramic angels, gold balls, strands of pearls

CHRISTMAS DESIGNING

Christmas is a long and important season for florists. Many start creating permanent arrangements in late summer so that a good selection is ready for early sales in late November. The month-long selling season often begins with an open house at the flower shop. This features an array of designs from which customers can select for their holiday decorating.

As December approaches there is a demand for door decorations, table centerpieces, and other designs which include fresh evergreens. Pine, spruce, boxwood, juniper, fir, cedar and holly are favorite Christmas greens. Candles and bows are used abundantly along with traditional accessories like pine cones, fruit, nuts, Santas, reindeer, shiny balls, wrapped packages, and glittered branches. Figurines of angels and the nativity, together with stars, bells and miniature churches, symbolize the religious significance of Christmas.

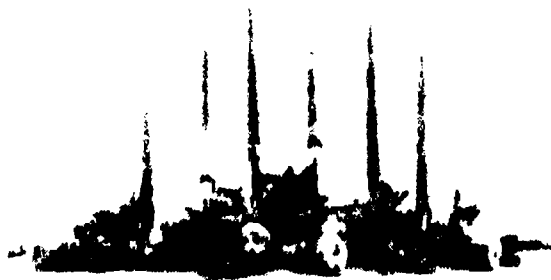
The Christmas season also brings a demand for decorated flowering plants, especially poinsettias. Another product that sells well is plain evergreen branches, sold in bunches or made into wreaths or roping. These can be offered by flower shops but are also easy to find for sale in other businesses related to the Christmas trade. Another need that can be supplied by florists often surfaces at Christmas. This is the demand for cemetery pieces including wreaths on easels, grave blankets, pillows, stone plaques and vases.

Christmas designing is merely a theme variation of basic floral design. The principles of design must be followed if a good product is to be achieved. Designers can also produce more original and distinctive work if they have interesting materials to work with. Many florists visit the wholesale houses when Christmas items are first put out so they can get the best selection. Each year brings new trends in Christmas decorations. The shops that take advantage of this can offer their customers an interesting selection of items that is different from the year before.

There is a wealth of materials that can be used to develop different Christmas themes. Some styles, like *Williamsburg Christmas*, have always been popular. Other themes such as *Victorian Christmas* or *Christmas in Foreign Lands* come and go in popularity. Often the decor of people's homes (which tends to follow cyclic national trends) will influence their choice of Christmas decorations.

Following is a list of some of the Christmas themes that have been popular over the years, along with the accessories that can be used to develop each theme.

Christmas Theme	Appropriate Accessories
Traditional	Santas, reindeer, bells, candles
Williamsburg	fruit, nuts, cones
Victorian	lace, velvet and satin ornaments; china dolls; ribbons; pearls
Country	baskets, animals (such as wooden geese, sheep, etc.), dried materials
Religious	angels, Madonnas, creche sets, Advent wreaths
International	straw ornaments, cookie molds, wooden accessories
Contemporary	mirrored or pearlized ornaments, lights in plastic tubes, stylized trees or other stylized figures
Natural	birds, branches, dried moss, berries



Long-lasting centerpiece with brass candelabra

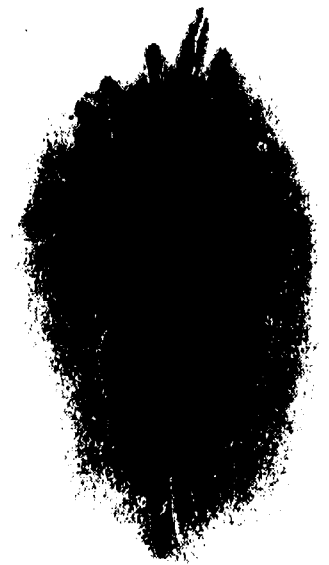
Williamsburg Christmas



An arrangement of fruit and magnolia leaves to be hung above the doorway



Candles in a fruit and nut centerpiece with leaves



Door swag with a French horn and bow

634

BES

635

A Williamsburg Style Centerpiece



Wooden cone with spikes;
magnolia leaves at base



Apples pushed onto spikes;
boxwood used as filler

Classical Christmas Styles



Della Robbia wreath with fruit



Victorian two-tiered compote



Topiary form accented with
velvet tubing

Color combinations are important in creating a pleasing arrangement in any style. Red and green is traditional, of course, and still is widely used. A touch of red ribbon, a red candle, or a red ornament adds a bright accent to an evergreen wreath or arrangement. Objects in shiny metallic colors such as gold, silver or brass are effective in reflecting light and producing a festive feeling. Blue, pink and white are also widely used at Christmas time. Purple is the liturgical color for Advent, the church season preceding Christmas. Advent wreaths contain purple candles (Fig. 19-1), and altar cloths are changed to purple for the season.

Some examples of colors appropriate for different Christmas themes are in the following list:

Christmas Theme	Possible Color Schemes
Traditional	red and green
Williamsburg	red, yellow and orange against a green background
Victorian	pink, rose and burgundy
Country	blue and rust
Religious	purple and gold
Foreign	beige and red
Contemporary	silver and white
Natural	beige and green

ASSEMBLING and STORING SUPPLIES

Christmas supplies become available at the wholesalers in the summer. Florists should make their selection of decorative items early so that they have the best choices and are aware of current trends. Supplies like wooden and metal picks, glue sticks, wire, tape and styrofoam are common items found year-round in the shop, but they are used in abundance at Christmas. Containers, ribbon, figurines and ornaments with a holiday motif, as well as glittered branches, artificial greens, flowers and fruits are more seasonal. Dried flowers such as baby's breath, German statice and starflowers are everyday items that can be combined with evergreens to carry out a Christmas theme. Flocked or glittered dried materials, however, will probably be available only for Christmas designs.

Following is a list of items that are useful for Christmas arranging. However, each person must decide individually what will be needed for his or her own project.

SHOPPING LIST FOR CHRISTMAS SUPPLIES

artificial greens and flowers (poinsettias)
candles (tapers of various lengths and diameters, votive lights, hurricane globes)
chenille stems
decorative branches and dried materials
decorative picks and ornaments (fruit clusters, holly berries, mistletoe, strings of beads)

figurines and stuffed animals (Santas, religious figures, deer, teddy bears, birds)
glitter
glue sticks
green florists' cord
metal picks
moss (sheet moss and Spanish moss)
paddle wire
raffia
ribbon (velvet, plastic waterproof, metallic, velvet tubing, ribbon with Christmas designs)
spray glue
styrofoam
wicker (baskets, mats, sleighs)
wooden picks
wreath forms (styrofoam, wire, straw, grapevine, Advent)

FRESH GREENS

Ideally fresh greens should be cut as close as possible to the time they are needed. If they are cut in advance, they should be stored in a cold place but **not** in a cooler with fresh flowers, as greens give off **ethylene gas** which causes flowers to age and die. If available, a separate cooler can be used exclusively for evergreens; if not, an unheated room should be satisfactory.

Wholesale florists have evergreens in stock starting in late November. These are sold by the bunch, bale or case. They may also be available already made into wreaths, roping or grave blankets.

Cut branches of evergreens that are about 20 to 30 inches long are called **boughs**. Shorter end pieces are called **tips**.



Figure 19-1 Advent wreath

Buying tips will result in less waste material, but they are more expensive than the larger boughs.

The smallest unit that evergreens are available in is **bunches**. These are usually determined by weight and may be as small as 2 pounds. A **bale** is a larger unit of boughs, often around 20 pounds, that is tied together with twine or wire. A **case** is a box, either cardboard or wooden, which weighs between 20 and 40 pounds. The contents may be in bunches or loose. Boxwood sometimes comes in a burlap bag with the contents determined by weight. Holly comes in 10-pound cases which are waxed and lined with plastic, since holly is very sensitive to drying out.

Many greens can be cut locally if a source is available. Wholesalers buy greens from suppliers in the northern states and the Pacific Northwest. Some of the more commonly used evergreens and their characteristics are as follows:

Selected Evergreens and Their Characteristics



Boxwood

- small, shiny, dark green leaves
- dries out easily, but leaves do not drop when dry
- makes a good filler



Cedar (Arborvitae)

- flat, scaly branches
- often yellowish green in color
- distinctive fragrance



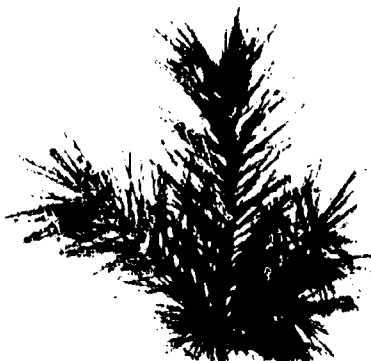
Hemlock

- soft, gracefully arching branches with short needles
- does not hold needles well indoors



Fir

- soft needles that hold well
- fragrant
- species used - *balsam, fraser, silver, noble and douglas*; balsam and fraser have the shortest needles; silver's needles are white underneath
- choice Christmas green that is easy to work with



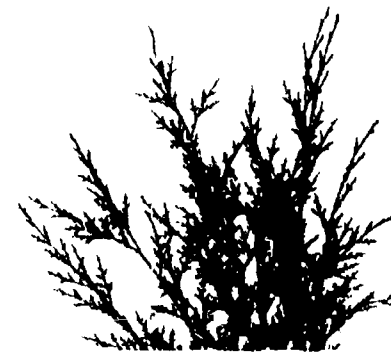
Pine

- holds needles well; *white pine* has long soft needles and is often used for roping and wreaths; *Scotch pine* has medium-length needles and may be somewhat yellowish; *red pine and Austrian pine* have long needles
- production of pitch can make it unpleasant to work with
- widely available and inexpensive



Holly

- green and variegated kinds available, both with spiny leaves
- shiny leaves turn dull indoors without a water supply
- some branches fruited with attractive red berries



Juniper

- prickly to work with
- sometimes has attractive blue berries attached
- good line material for Christmas designs because of long pieces with interesting curves



Spruce

- short stiff needles
- may be quite prickly
- needles hold reasonably well, but fall when dry
- *blue spruce* prized for its bluish color

WREATHS

A circle of plant material is an age-old favorite for decorating doors, walls and tables. The wreath as a design form dates from the Roman era or even earlier. Then wreaths were fashioned of leaves and flowers and given to special heroes.

At Christmas, an evergreen wreath with a big red bow is the most traditional interpretation of this ancient design form. There are endless variations in the construction of a basic wreath and the way it is decorated.

Wreaths have been made from many different materials, such as cones, straw, grapevines, corn husks, herbs, dried flowers, bread dough and fabric. Some of these materials must be attached to wreath forms, which are commercially available in wire, styrofoam or straw. If the wreath needs to be kept fresh longer, a wire form can be filled with moist sphagnum moss. One could also use the *O-Ring* by Smithers Oasis, a piece of wettable Oasis fused to a plastic ring and designed to keep flowers fresh.

The following summary lists several types of wreath mechanics and describes how to attach the evergreens.



Figure 19-2 Wire wreath form

Wreath Forms and Methods of Attachment

Metal contour (Fig. 19-2)

Weave greens between wire mesh and secure by wrapping with paddle wire, florists' cord or raffia.

To keep materials fresh longer, fill form with moist sphagnum moss; insert materials in the moss as you wrap them with raffia.

Metal with clamps

Bunch evergreens and push clamps down over them to hold.

Straw (Fig. 19-3)

Pin on evergreens with greening pins (Fig. 19-4) or attach wooden or metal picks to them and insert in straw.

Styrofoam (Fig. 19-5)

Pin on evergreens with greening pins or attach wooden or metal picks to them and insert in styrofoam. Styrofoam wreath forms are not strong enough for large projects.

Single hoop of wire or plastic tubing

Bunch greens and secure with paddle wire. Coat hangers can be used for small wreaths. Large plastic tubing has enough strength for larger wreaths.

Bows are common decorations for wreaths. They should be in good proportion to the overall size of the wreath. The larger the wreath, the wider the ribbon can be to make an appropriate-size bow. Number 9 ribbon is a good choice for medium-sized wreaths ranging from 12 to 16 inches in



Figure 19-3
Straw wreath form

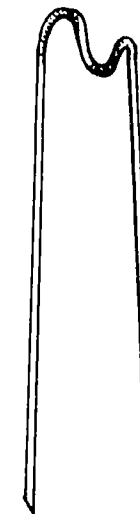


Figure 19-4
Greening pin

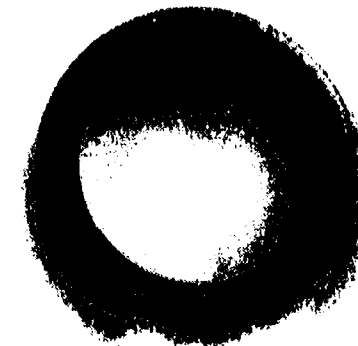


Figure 19-5
Styrofoam wreath form



Straw wreath with
velvet ribbon,
German statice,
boxwood and a bear

Bow Placement on Wreath



At the bottom



At the top



At the upper left



Figure 19-6
Satin ribbon-covered wreath with
connecting streamers



Figure 19-7
Large grouping of dried material at the bow

diameter. Number 5 ribbon should be considered for smaller wreaths and #40 for larger ones.

Ribbons may be chosen from the vast array of materials, colors and patterns that are available. Velvet ribbon is a Christmas favorite, and plastic waterproof ribbon has a special use on pieces that will be used outdoors. Other types of ribbon include satin, cotton, lace, metallic and b rlap. Special holiday patterns include plaid, dots and hundreds of prints.

The bow can be placed in any position around the circle. There may even be two or more bows, perhaps connected by several streamers of ribbon (Fig. 19-6). There may also be no bow; not every wreath requires one. If the design is effective without one, don't use a bow. Some suggestions for placement of bows are illustrated here.

Additional decorations, in the form of lights, ornaments, fruit, nuts, figurines, stuffed animals, birds, artificial flowers or dried materials, may be added to wreaths. Here are a few guidelines to consider when decorating a wreath.

GUIDELINES

1. Develop a focal point at the bow by clustering ornaments or plant materials in that area (Fig. 19-7). Work through the bow to develop depth and a feeling of unity. This is similar to working the bow into a corsage.
2. If using a large figurine or stuffed animal, position it at the focal area, most likely over the bow. Make sure the figure is not

buried and that it appears stable and well balanced. Some figures are more effective if they appear to look toward the viewer.

3. If you are extending smaller items around the wreath, consider clustering them rather than scattering them randomly.

4. Branches and twigs may be used to create a mini-arrangement attached to the wreath. These arrangements should not be so large that they overpower the wreath.

5. If no bow is used and decorations are placed all around the wreath, establish a predictable pattern of repetition. Let some materials dominate others in size and amount used. Develop a full look by placing decorations to the inside and outside edges of the wreath as well as in the middle.

6. Interest and motion can be introduced by spiraling materials around the wreath. Ribbon, strings of beads, grapevines or other flexible linear material can be used. Another variation is to spiral ribbon in both directions, resulting in a cross pattern on the front of the wreath.

7. Lights may be attached with greening pins to a styrofoam or straw wreath form before greens are added. Distribute lights evenly around the circle and from side to side. Use one greening pin for each light and leave enough cord free so the lights will not be buried by the greens.

When lights are used in a wreath covered with baby's breath or other dried materials, consider spray-painting the wreath form and light cord the same color as the dried materials in order to hide them. First cover

the lights with foil to protect them from the paint.

8. A wreath set on the table and used as a centerpiece is especially effective when candles are added. Advent wreaths have four candles which mark the weeks before Christmas. (See Figure 19-1.) It is traditional to light only one candle the first week and then to light an additional candle each week until all are lighted. Some people include a taller candle in the center to light on Christmas Eve. Advent wreaths can be used in homes. They are also found in most churches, displayed on pedestals or tables, or suspended from the ceiling by cords.

SUGGESTED ACTIVITIES

A. Christmas Wreath

Materials:

- 12" straw wreath form wrapped in green plastic
- greening pins
- assorted evergreen boughs
- artificial holly berries and flocked branches
- #9 red velvet ribbon
- one teddy bear ornament 3" to 4" long
- wooden picks

1. Place the wreath form on a table at a height that is comfortable for you. Do not unwrap the green plastic since it helps hide the straw.

2. Cut the evergreens into pieces about 3 inches long. Group two to four pieces and hold them together on the form while securing them with a greening pin. (See Figure

Special Ribbon Treatment



Spiral



Criss-crossed



Christmas swag

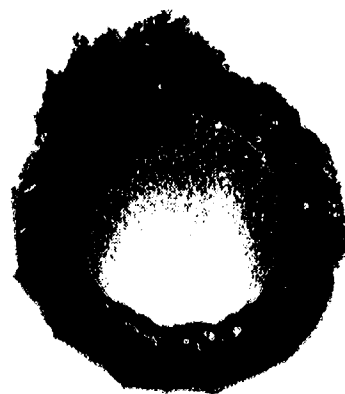


Figure 19-8



Figure 19-9



Figure 19-11



Figure 19-10

19-8). Continue with several more clusters in the same area. Place some to the inside edge and some to the outside edge so that the form is fully covered in that area.

3. Pin more clusters just below the first ones so that the second layer overlaps the first, hiding the greening pins. Remember to continue covering the inside and outside edges as well as the top. Continue around the wreath until it is full and round (Fig. 19-9). If any pieces stick out, pin them in or cut them off so the overall look is round and neat.

4. Make a bow with 3-inch loops from the velvet ribbon. (See Figure 19-10.) Make a pair of streamers about 12 inches long with sharply tapered points. Attach to wooden stakes and insert in the center at the bottom of the wreath.

5. Fasten the bear over the bow. If it is connected to a heavy wire, insert that into the straw wreath. If not, attach it to the bow with hot glue.

6. Develop a crescent of holly berries and flocked branches around the bow and bear (Fig. 19-11). Work some pieces through the bow and around the bear. Use greening pins or hot glue to attach the holly and branches.

B. Christmas Swag

A Christmas swag usually consists of an elongated grouping of evergreen boughs designed to be hung on a wall or door. It can be decorated with a bow and accessories much as a wreath can. Several evergreen boughs tied or wired together make a simple

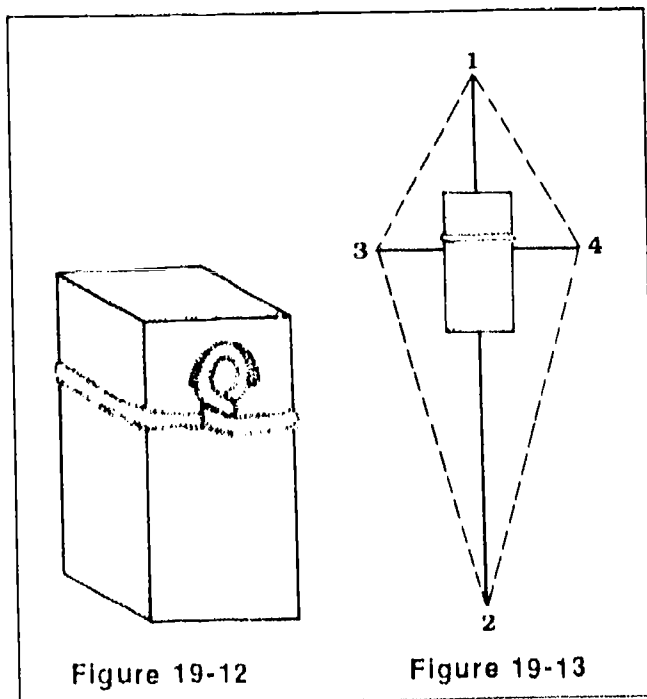
swag. In the following exercise a diamond-shaped swag will be made on a piece of styrofoam to give more control in placement of the materials.

Materials:

6" x 3" piece of 2"-thick styrofoam
 2 chenille stems
 evergreens (spruce or fir and boxwood)
 white glittered branches
 one dove (3"-5")
 #9 velvet ribbon
 wooden picks

1. Twist the chenille stems together; wrap around the piece of styrofoam about two-thirds up from the bottom and form a loop on the back (Fig. 19-12). The loop will be used to hang the completed swag.

2. Lay the styrofoam on the table and use spruce or fir to establish the outline of an elongated diamond pattern (Fig. 19-13).



Placement 1 should extend about 5 inches above the top of the styrofoam; placement 2 about 12 inches below the bottom of the styrofoam; and placements 3 and 4 about 3 inches beyond the edges of the styrofoam. Place the branches toward the back of the styrofoam so they will lie flat against the door or wall (Fig. 19-14).

3. Continue developing the diamond shape (Fig. 19-15). When you are finished, you should have a diamond of greens, one-third of which is above the center of the styrofoam and two-thirds below. Taper your filler branches in from the points of the diamond to avoid a rounded or bulgy look.

4. Make a bow and a pair of 12-inch streamers. Attach these to wooden picks and insert in the center of the styrofoam (Fig. 19-16).

5. Develop the center part of the swag (the focal area) with additional small pieces of spruce or fir so that the greatest fullness and depth are around the bow (Fig. 19-17). *(continued)*

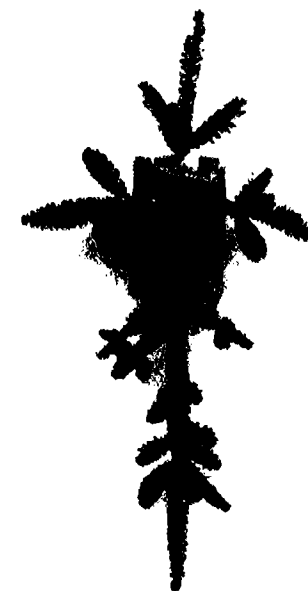


Figure 19-14



Figure 19-15



Figure 19-16



Figure 19-17



Figure 19-18



Centerpieces with candles are popular Christmas arrangements

6. Repeat the design with boxwood. Its small shiny leaves are a good contrast to the evergreen needles. Check to see that the styrofoam is covered on the sides and that the bow has been incorporated into the design by working some boxwood through it.

7. Repeat the design shape with the glittered branches.

8. Attach the dove to the bow using a hot glue gun. (See Figure 19-18.)

CHRISTMAS ARRANGEMENTS

Christmas designs are merely theme variations of basic designs. Centerpieces, basket arrangements, and mantel pieces can be adapted to the Christmas holiday by using evergreens and adding the appropriate candles, ribbon, ornaments, figurines or a touch of glitter. Permanent arrangements made from silk, plastic or dried material are popular with some people because of their lasting quality.

Candles, as a source of color in the design, add a festive touch to arrangements and create a special atmosphere when lighted. Candles come in many lengths and diameters. Votive lights are glass cups which hold small candles. Since the flame is within the glass cup, votive lights provide a safer source of candlelight.

Ribbon, velvet tubing, gold cord and glittered branches are important elements in creating a festive holiday feeling. Shiny balls, strings of beads, fruit clusters, holly berries, and numerous decorative ornaments can instantly give an arrangement a

Christmas look. The floral designer should be aware of new trends as well as old favorites and should always be ready to make new and creative combinations of materials.

SUGGESTED ACTIVITIES

A. Christmas Centerpiece

Materials:

- 6" rectangular plastic container
- floral foam
- one 12" red candle
- 6 wooden picks
- waterproof tape
- evergreens (fir and boxwood)
- #5 red velvet ribbon
- 3-5 wrapped package ornaments on picks
- 2 glittered white branches

1. Place soaked foam in the container and secure with waterproof tape.
2. Attach two wooden picks to the base of the candle with waterproof tape (Fig. 19-19).



Figure 19-19

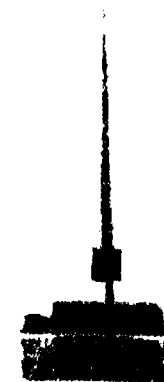


Figure 19-20

3. Insert picks and candle in middle of foam so the base of the candle rests on the surface of the foam (Fig. 19-20).

4. Use the first four placements of fir to create a diamond shape (Fig. 19-21).

5. Add more small pieces of fir to develop the diamond shape, but be careful not to crowd or bury the candle (Fig. 19-22). Create the "in-out-edness" necessary for depth.

6. Repeat the shape with boxwood or a second evergreen if available.

7. Make two bows from velvet ribbon and insert one on each side of the candle.

8. Repeat the diamond shape with pieces of glittered branches. Let them extend beyond the evergreens to give an airy look.

9. Insert the package ornaments on picks so that there is at least one on each of the four sides of the arrangement. (See Figure 19-23.) The ones on the short sides should come out through the bow. Do not sink them in too deep.

B. Christmas Basket Arrangement

Materials:

wicker basket with a handle and plastic liner
floral foam
juniper
#9 cotton print or burlap ribbon
3 medium-sized rounded pine cones
wooden picks with wires
German statice

1. Wedge foam in the plastic liner that is in the basket.

2. Establish a crescent line with juniper (Fig. 19-24). The crescent begins above and behind the handle, continues down under the handle and diagonally across the foam, and ends in front of the handle on the right side.

3. Make a bow and streamers from the ribbon. Attach these to wooden picks and insert them on the left side where the handle joins the basket.

4. Attach a wooden pick to each pine cone by wrapping the wire around the lower bracts of the pine cone. Insert cones so that they are grouped over the bow.

5. Use pieces of German statice as a filler to develop the crescent shape. This material harmonizes well with the basket and provides a good contrast to the juniper. The result is a simple but nicely designed Christmas basket that has a country feeling (Fig. 19-25).



Figure 19-24



Figure 19-25

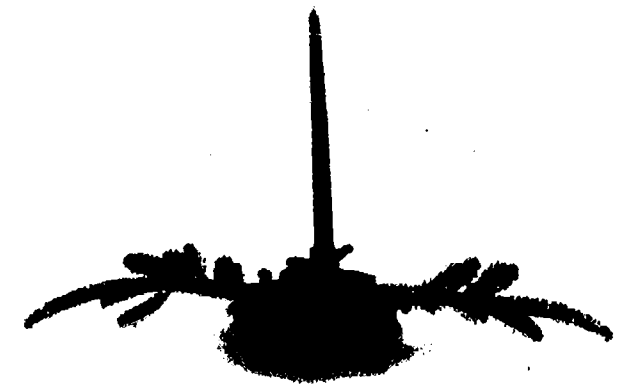


Figure 19-21



Figure 19-22



Figure 19-23



Figure 19-26
Permanent
Christmas
arrangement



Figure 19-27 Cinnamon stick cluster



Figure 19-28 Grapevine wreath ornament

C. Permanent Christmas Arrangement

Materials:

- low round container about 4" across
- styrofoam
- flocked branches
- silk evergreens
- small silk poinsettias

1. Fill the container with styrofoam.
2. Establish a vertical line using flocked branches toward the left side of the container.
3. Use silk evergreens to cover the styrofoam and extend up the vertical line.
4. Add silk poinsettias to follow the line, with closer spacing to develop a focal point at the base of the line. (See Figure 19-26.)

D. Cinnamon Stick Cluster

Materials:

- 6 cinnamon sticks, each 6" long
- 1 small bird
- #3 ribbon that harmonizes with the bird
- evergreens (fresh or permanent)
- glycerinized baby's breath
- hot glue gun

1. Criss-cross the cinnamon sticks and hot glue them together at the point of intersection.
2. Make a bow. Hot glue it to the cinnamon sticks at the point of intersection.

3. Add pieces of evergreen with hot glue so that they radiate out from the bow and from between the cinnamon sticks.

4. Secure bird on top of the bow with hot glue. (See Figure 19-27.)

5. Add pieces of baby's breath to extend out from the bow and cinnamon sticks.

E. Grapevine Wreath Ornament

Materials:

- one small wreath (4" diameter) from grapevine or another woody vine like Virginia creeper or honeysuckle
- #1 velvet or satin ribbon
- small dried flowers, artificial holly berries, and/or silk flowers
- hot glue gun

1. Make a small bow with streamers and attach it to the wreath with hot glue.

2. Develop a crescent-shaped cluster of dried or artificial flowers across the bow. Hot glue each piece under the loops of the bow. The overall design should be in good proportion to the size of the wreath. It should look somewhat like a designed crescent corsage mounted at the top of the wreath. (See Figure 19-28.)

656

BLS:

657

F. Boxwood Tree

Materials:

low round plastic container
floral foam
waterproof tape
boxwood
ornaments

1. Place the block of soaked foam on end in the dish. Tape foam to the bowl securely with waterproof tape (Fig. 19-29).
2. Establish a circle of boxwood at the base of the foam. The best way to insert the boxwood is to bunch several pieces together in your hand and push them into the foam as a unit.
3. Continue filling in, gradually tapering to a point so that an overall conical shape is formed (Fig. 19-30).
4. Decorate the tree with ornaments of an appropriate small size. If water is kept in the container, the boxwood will stay fresh for several weeks.

G. Kissing Ball

Materials:

styrofoam ball 4" in diameter
boxwood
chenille stem
wooden picks
velvet tubing
plastic mistletoe
plant shine spray

1. Make a hanger on top of the styrofoam ball by inserting the ends of a chenille stem

into the styrofoam and twisting the stem to form a loop.

2. Cover the ball uniformly with boxwood pieces cut about 2 1/2 inches in length. Cluster several pieces of boxwood together and insert them as a unit. After the ball is filled in, spray it thoroughly with plant shine to keep the boxwood fresh longer.

3. Make a bow from the velvet tubing with several streamers of different lengths. Attach to a wooden pick and insert into the bottom of the ball.

4. Attach a cluster of plastic mistletoe to a pick and insert over the bow. The kissing ball can be hung in a doorway or from a light fixture or other suitable location. (See Figure 19-31.)



Figure 19-31 Kissing ball

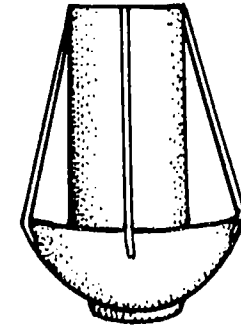


Figure 19-29 Foundation for a boxwood tree

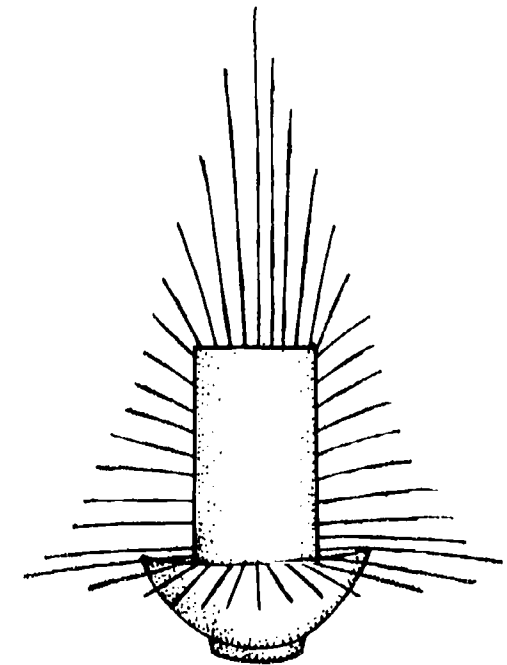


Figure 19-30 Conical shape of a boxwood tree

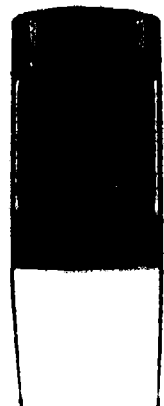


Figure 19-32

Figure 19-33
Cemetery arrangement

Styrofoam is scored with a knife and then broken on the edge of a table

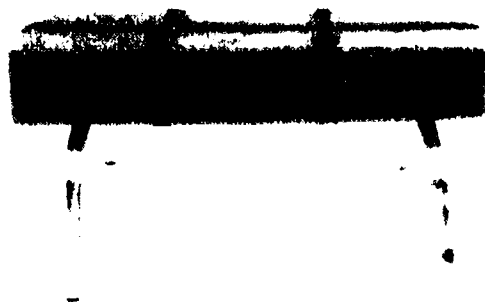


Figure 19-34

600



Figure 19-35 Headstone plaque

CHRISTMAS CEMETERY PIECES

A custom frequently observed at Christmas is decorating the cemetery in remembrance of those who have passed away. Often the cemetery piece is a wreath on an easel or an arrangement of greens in a metal cylinder anchored by prongs pushed into the ground (Fig. 19-32). Pine cones, red ruscus and red plastic bows are common accessories that withstand the weather (Fig. 19-33).

One type of decoration is made in styrofoam and attached to a metal plaque for a headstone (Fig. 19-34). This will fit over the flat top of upright stones (Fig. 19-35). Another piece is the grave pillow, a rectangular arrangement of greens that is supported by a wooden frame. It is placed on the ground but displayed at a 90° angle to the ground.

Another winter cemetery piece is the grave blanket (Fig. 19-38). It is larger than a pillow and is intended to lie flat on the ground. The greens may be attached directly to chicken wire that is stretched over a wooden frame. Or they may be inserted into styrofoam that has been attached to a plywood base. The blanket is usually decorated with a #40 plastic bow, pine cones and ruscus.

Some grave blankets are very large, measuring 8 feet by 4 feet. Because of the weight of the greens in such a large piece, a strong framework is needed. A smaller, lighter version can be made directly on poultry netting without a wooden frame.

601

SUGGESTED ACTIVITY
Grave Blanket**Materials:**

2' x 3' piece of 2" poultry netting
 evergreens
 #24 florist wire on a paddle
 #40 red plastic ribbon
 large pine cones
 red ruscus

1. Lay larger pieces of evergreen on the poultry netting with tips pointing outward along each edge (Fig. 19-36). Keep tips fairly even. Make sure at least half of each branch is lying on the poultry netting for support. Fasten each branch to the poultry netting with short lengths of paddle wire.
 2. Work inward by adding a second overlapping layer of evergreens to conceal the base of the outer layer. Continue until the wire is covered (Fig. 19-37).
 3. Make a large full bow from the #40 plastic ribbon. Make a set of streamers about 2 feet long. Wire the bow and streamers to the middle of the blanket.
 4. Wire the pine cones and insert them around the bow. Wire them to the blanket.
 5. Add the ruscus pieces around the bow and wire them in (Fig. 19-38).
 6. Wire in additional clusters of evergreens if they are needed to develop more fullness in the center.
-

DESIGNS for OTHER HOLIDAYS

There are a number of holidays throughout the year that florists are called upon to interpret with flowers. A feeling appropriate to the holiday can be attained through the designer's choice of flowers in season, colors, containers, accessories and ribbon.

On the next page is a listing of these annual holidays with suggestions for appropriate colors and accessories.

Grave Blanket**Figure 19-36****Figure 19-37****Figure 19-38**

Holiday Color Schemes and Accessories

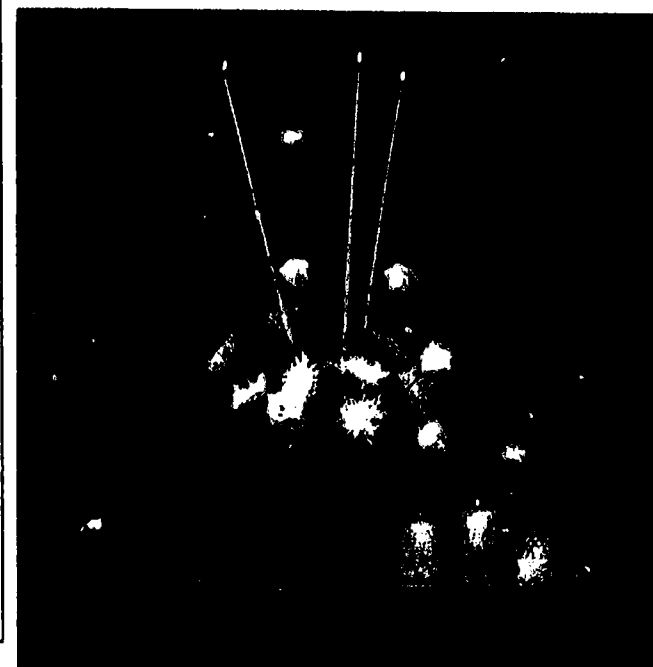
<u>Holiday</u>	<u>Color Scheme</u>	<u>Accessories</u>
New Year's Eve	black, white, silver, multicolor	balloons, noise makers, streamers, top hats, clock, Father Time, baby
Valentine's Day	red, white, pink	hearts, cupids, lace
Presidents' Day	red, white, blue	profiles of Washington & Lincoln, cherry tree & ax, American flag
St. Patrick's Day	green, white	shamrocks, leprechauns, pipes
Easter	yellow, purple, green, pink	Easter rabbits, chicks, ducks, baskets, colored eggs
Secretary's Day/ Boss's Day	all colors	office supplies and equipment
Mother's Day/ Father's Day/ Grandparents' Day	all colors	items that suggest the individual
Memorial Day/ Fourth of July/ Labor Day	red, white, blue	American flag, fireworks, stars
Sweetest Day	pastel colors	candy, ribbon, cards, hearts, balloons
Halloween	orange, black	black cats, witches, brooms, jack-o'lanterns, corn shocks
Thanksgiving	yellow, brown, orange	turkey, Pilgrims, cornucopia, Indian corn, pumpkins

A listing of many of the same holidays follows with a suggested arrangement for each.

Holidays and Suggested Arrangements

NEW YEAR'S EVE

A sophisticated party arrangement in a black top hat sets the mood for a New Year's Eve party. Use white snowflake mums or white roses and variegated pittosporum foliage. Add interest and zest with long white tapers and curled dried material painted white. Set the arrangement on a mirror and place three to five clear hobnail votive lights containing white candles around the arrangement. Reflection of candles in the mirror adds a festive note.



New Year's Eve

VALENTINE'S DAY

Decorate a grapevine heart with two white doves and red satin ribbon that has a white lace edge. Make two bows of the ribbon and wire them to the wreath. Connect the bows with a swag of ribbon consisting of three strands. Hot glue the birds over the bows. Accent the bow areas with silk leaves and small silk flowers.



Valentine's Day

ST. PATRICK'S DAY

Create an all-foliage arrangement in an L pattern. Use assorted greens with different values and textures. Consider using lycopodium for the line material. Use a green bow and a shamrock accessory if you wish.



St. Patrick's Day

EASTER

Design an arrangement of spring flowering bulbs like daffodils and tulips around a 6- to 10-inch-high rabbit. Use branches that have been forced into flower or leaf for the line material. Sheet moss can be used instead of filler to cover the foam for a natural, open look.



Easter

Mother's Day

MOTHER'S DAY

Design a mass arrangement of mixed flowers in a wicker basket for a sweet nostalgic look. Use delicate flowers with pastel colors. Make a bow from narrow satin ribbon of several pastel colors and attach it near the focal area.



Memorial Day

MEMORIAL DAY

Make a cemetery wreath using patriotic colors. Cover a straw or styrofoam wreath with salal leaves using greening pins. Attach soaked caged foam to the top of the wreath. Add a blue satin bow and design a crescent of red carnations, white statice and huckleberry foliage around the bow. Attach the wreath to a wire easel.



Father's Day



Fourth of July



Grandparents' Day



Sweetest Day



Halloween



Thanksgiving

FATHER'S DAY

Make an arrangement in a container shaped like a duck. Use a mixture of fresh and dried materials to create a masculine look. Do not overpower the duck or cover its head.

FOURTH OF JULY

Make an arrangement on a drum. Fill a plastic container with soaked foam and place it on the flat upper surface of the drum, off to one side. Use red, white and blue flowers to create an open L pattern arrangement.

GRANDPARENTS' DAY

Make an oval mass dried arrangement that will fit under a glass clock dome. Do not let the arrangement crowd the glass.

SWEETEST DAY

Arrange six roses in a crystal vase. Add huckleberry foliage and a lace bow.

HALLOWEEN

Make an arrangement of fresh and dried material in a real pumpkin. First cut an opening in the top about the size of your container and hollow out the pumpkin. Wedge the plastic container in the opening and fill it with floral foam. Create a design that has a good size relationship with the pumpkin.

THANKSGIVING

Make an arrangement of autumn-colored flowers in a cornucopia. Add fresh or artificial fruit and wheat as accessories. Create the feeling that the flowers and fruit are spilling from the cornucopia.

DESIGNS for OTHER OCCASIONS

During the year there are other events in people's lives for which flowers can be a symbol of happiness, sharing, love or concern. As requests for these kinds of arrangements come in, the style and flower choices will, of course, depend on preferences of the customer and also on what is available at that time of year. Flowers for parties and the office or hospital are examples. Here is a listing of some of the special occasions other than holidays for which flowers may be requested. As you read each suggested arrangement, try also to think of other possibilities for each event.

Special Occasions and Suggested Arrangements

ANNIVERSARY

For a fiftieth wedding anniversary, use yellow roses in a gold-colored container. A bow could be made from gold lame ribbon. A picked accessory with the number 50 could also be added with the bow.

BIRTHDAY

For a child's birthday consider a brightly colored arrangement with helium-filled balloons arising from the flowers. Favorite toys could be added to the arrangement or placed at the base of the design.

NEW BABY

Use one of the many baby novelty containers that are available for arrangements. Since the container is to be featured, make the arrangement only slightly higher than the height of the container. Use delicate flowers in pastel colors.

PARTIES

For a party with a Hawaiian theme, use a pineapple, birds-of-paradise, and assorted tropical foliage. Accent the arrangement with votive lights.

BUSINESS OPENING

Send an arrangement containing an interesting piece of driftwood. Use anthurium flowers and ti leaves for a bold distinctive look.

GET-WELL

Use cheerful colors like yellow and peach in a vertical arrangement that will not take up much space in a crowded hospital room. Avoid flowers with a strong fragrance. Daffodils and tulips are cheerful in season. The arrangement could be accented with a bow in pastel colors.



Business Opening



Anniversary



Birthday



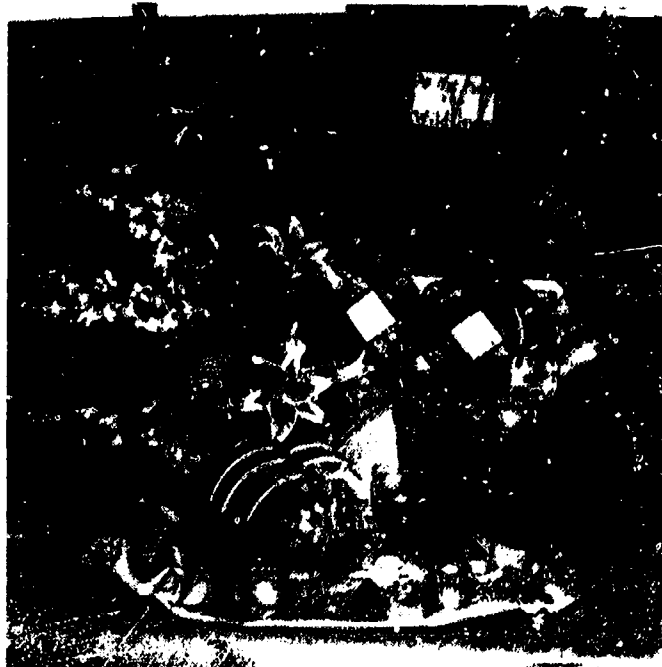
Parties

670

B.

671

SPECIAL OCCASION ARRANGEMENTS



Summer Picnic

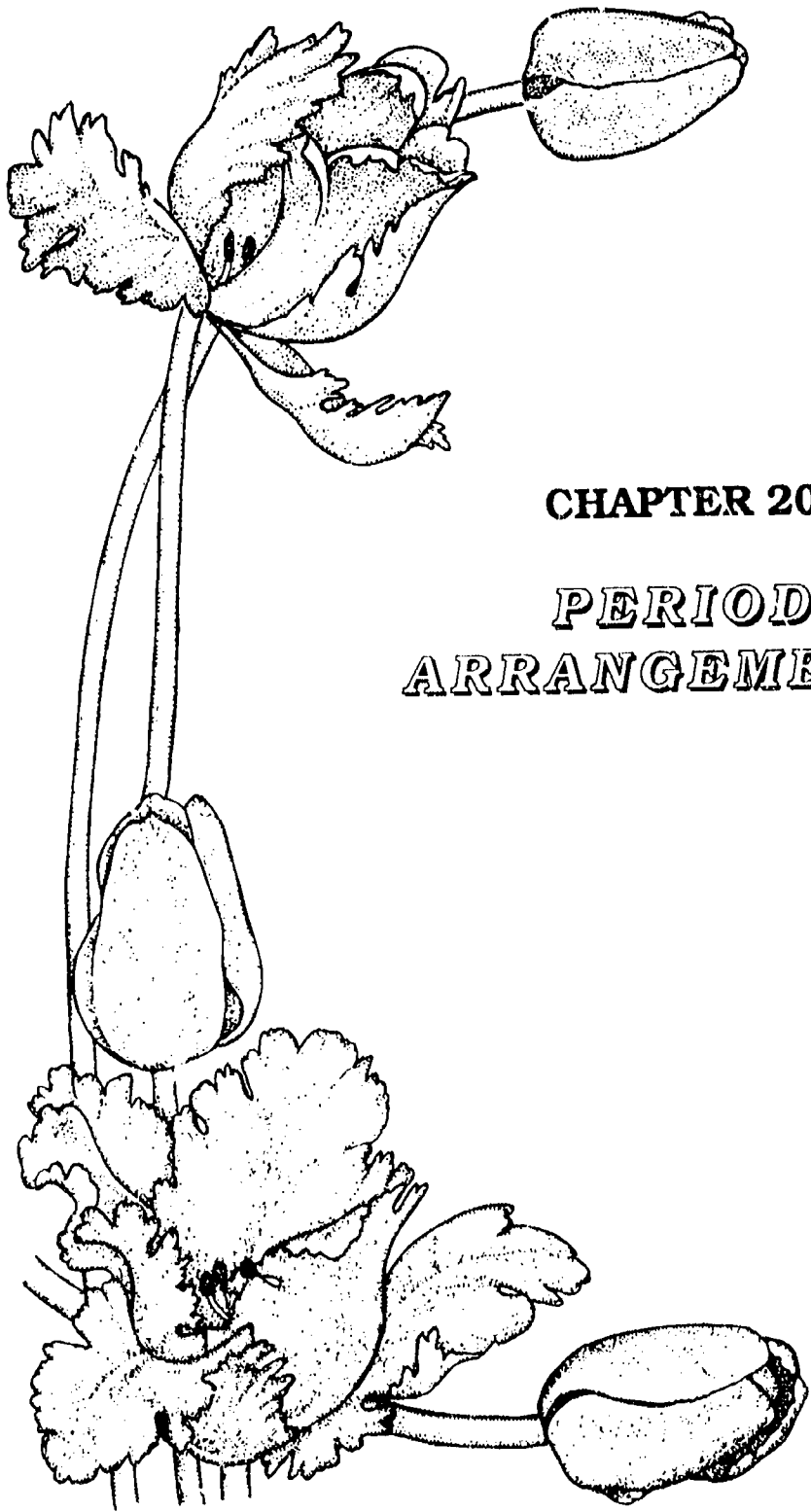
Ohio State Fair
Professional Design Show



Little Drummer Boy

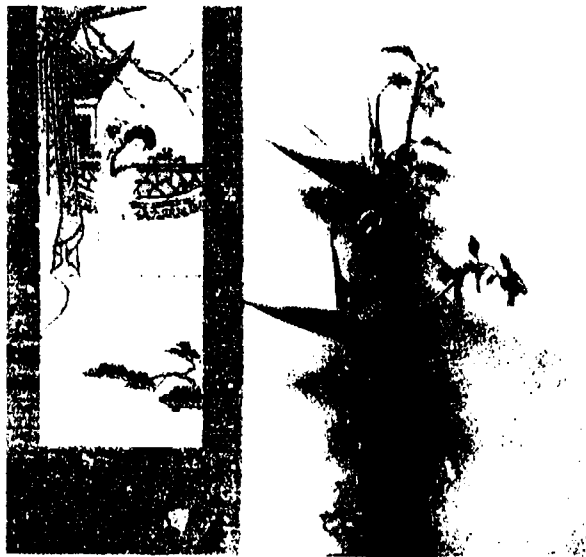


Birthday Magle

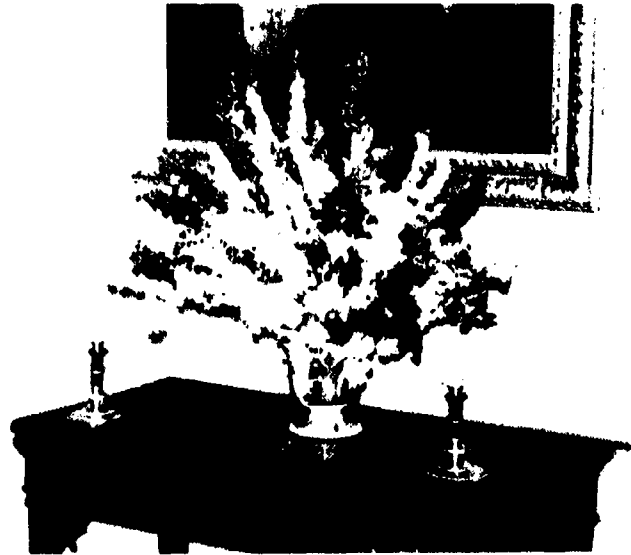


CHAPTER 20
PERIOD
ARRANGEMENTS





Oriental



Williamsburg

Arrangements in Period Settings



Victorian

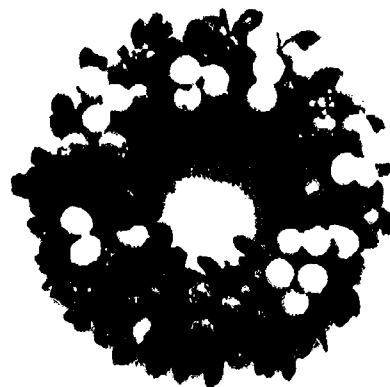


Figure 20-1
Della Robbia fruit wreath

Period flower arrangements are styles of floral design that were used during various periods in history by certain groups of people. (See Color Plate III-7.) Some styles, such as Oriental, Williamsburg and Victorian, have continued to be popular in interior decorating and design. Other styles are seldom seen except in pictures or paintings, or when the design style is intentionally recreated.

Two very different concepts of floral design developed independently of each other. The **Oriental style** is based mostly on carefully placed branches, flowers and small amounts of foliage. Each placement has meaning, as does the angle of placement. Usually materials are used very sparingly in an Oriental arrangement and there are many voids within the design.

In contrast, the **Occidental style** began to develop in early Egyptian and Middle Eastern cultures. Pyramids, sheaves of grain, lotus pods, and other natural symbols of abundance were constructed. Later the Romans and Greeks used wreaths and festoons of floral materials as decorations. During the Renaissance, large vases of loosely placed flowers were used, as shown in illustrated manuscripts and paintings from that era. Also at that time in Italy, the Della Robbia family developed a distinctive style that incorporated fruit and nuts into wreaths (Fig. 20-1), festoons and other decorative pieces. Ideas from each of these periods are still used today.

Starting with Dutch flower arrangements in the 1600's, definite period styles are recognized. More information is known about these later design styles because they

were painted by the artists of the time. The styles changed over the years as they were developed in different countries during different periods in history.

The most dramatic change in floral design was the combining of Oriental line concepts with Occidental mass concepts. The resulting line-mass design style began to evolve in the 1920's and was especially popular in the United States for many years. Many contemporary design styles are no longer line-mass, but instead exhibit concepts that have their origins in Oriental and Occidental period designs. Good design ideas are continually being recycled and combined in exciting new ways by creative floral designers.

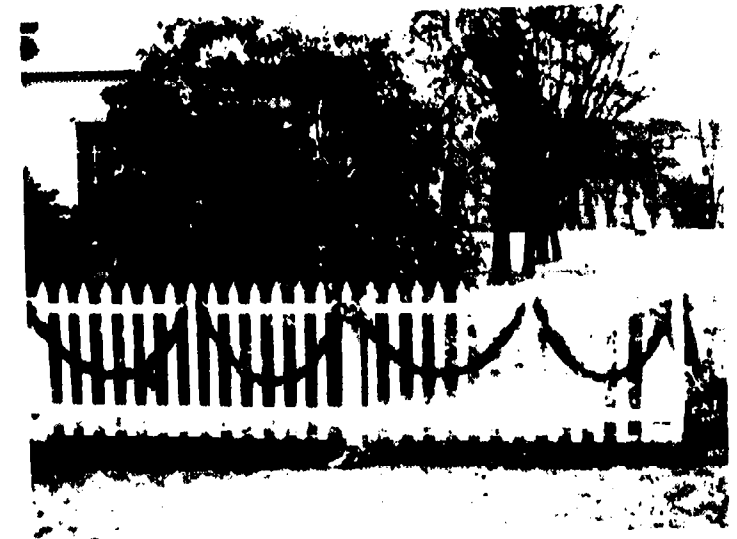
The major characteristics of some of the period styles are discussed in the following sections.

ORIENTAL

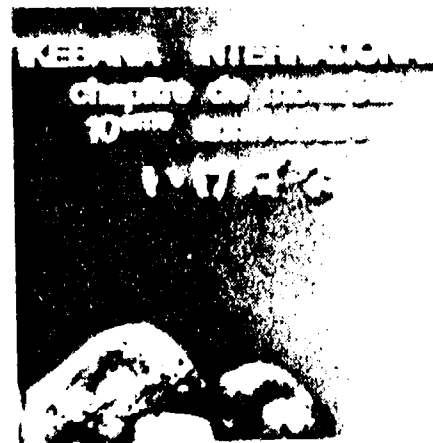
Japanese flower arranging, known in general as **Ikebana**, had its origin in China where Buddhist monks placed floral offerings on the altar. Over the years very strict rules developed regarding the placement and meaning of the flowers in arrangements. The different styles of Oriental design can be fully appreciated only by studying them in detail under a master teacher. The principles and guidelines taught for a particular style are referred to as a "school." **Ikenobo** is the school from which the others stemmed. Some other schools of Japanese design are **Nageire** (informal arrangements), **Moribana** (garden scenes), **Kabebana** (hanging designs), and **Morimono** (designs with fruit and vegetables).



Pyramids of flowers were constructed in early Egyptian and Middle Eastern cultures



Festoons of Christmas garland reflect a Roman design style



Ikebana organizations continue to teach various schools of Oriental design



Anthurium and quince arranged in Oriental manner

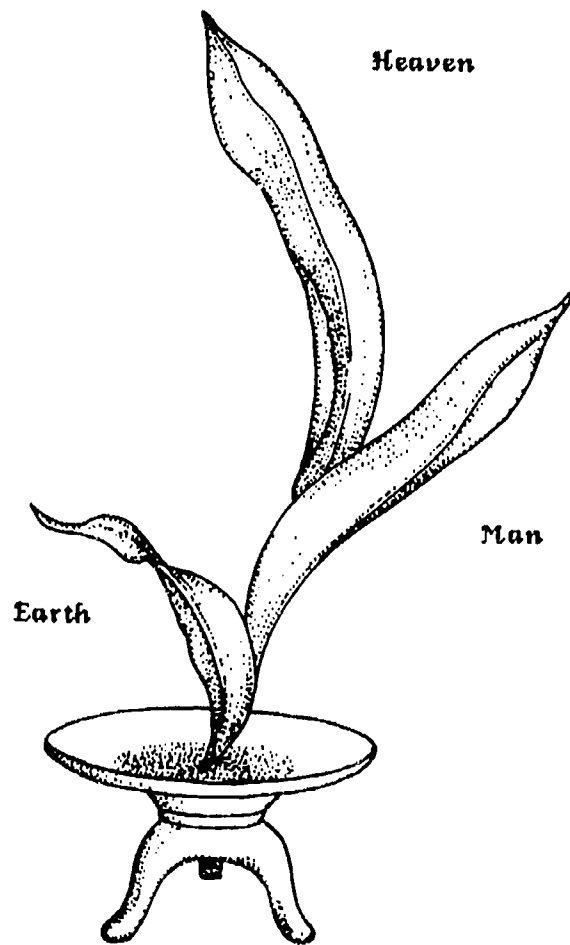


Figure 20-2
Main lines in classical Oriental style



Figure 20-3 Fuji mums in an usabata

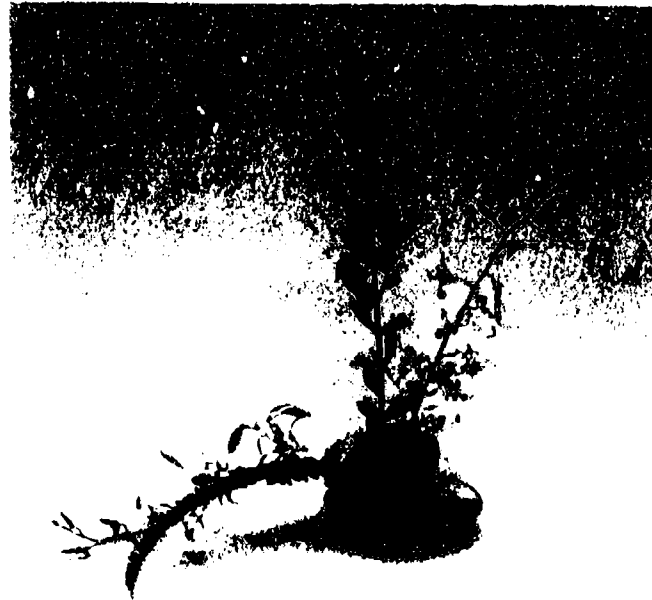


Figure 20-4 Simple line arrangement in a low container

Sho-ka is a classic design form which expresses the beauty of nature through three lines representing heaven (*shin*), man (*soe*) and earth (*ta*) (Fig. 20-2). These originate from a common trunk (*nemoto*). Other flowers or leaves called helpers may also be used in the design.

The container is an important part of an Oriental arrangement. The **usabata**, an urn-shaped container with a saucer-like top, is appropriate for Ikenobo arrangements (Fig. 20-3). Low flat containers with the water showing are used for certain other styles (Fig. 20-4). The container may be set on a base, often made of black lacquered wood or bamboo. Pebbles are sometimes used at the base of the flowers to hide the mechanics without adding visual weight to the design.

Some characteristics of Oriental arrangements are:

1. Restraint in the use of plant material
2. Line designs with considerable voids, which may necessitate extensive pruning of some branches
3. Emphasis on the form of the plant material
4. Creation of a natural feeling, but one that is also carefully controlled
5. Good development of the third dimension (depth)
6. Neat, well supported placements and clean-cut lines

DUTCH

The essence of Dutch and Flemish floral design was beautifully captured by the Dutch flower painters of the seventeenth century. They portrayed large lavish arrangements of mixed flowers in sturdy metal or alabaster containers. Rich colors and large amounts of varied and exotic materials were used in the designs. Examples include colorful striped Rembrandt tulips (Fig. 20-5) and the regal crown imperial (*Fritillaria*), which are frequently seen in many of the paintings. Accessories like bird nests (Fig. 20-6), butterflies, fruit and shells were often used at the base of the arrangement. Rich velvet or satin cloth sometimes formed a background for the arrangement or was draped at the base of the design.



Figure 20-5
Painting by a Dutch artist

Dutch Arrangements



Figure 20-6
Dutch arrangement
of summer flowers



Mass arrangement inspired
by the Dutch masters

FRENCH

The French developed a mass arrangement which was much lighter and more airy than that of the Dutch. They used delicate flowers in pastel colors and often with long, wispy stems (Fig. 20-7). The flowers were never crowded and the gently arching stems were allowed to show. The containers were delicate, either crystal (Fig. 20-8) or fine-painted porcelain. Figurines with intricate detail often accompanied the designs (Fig. 20-9).



Figure 20-7
Open mass arrangement of pastel
pink magnolia blossoms

French Arrangements

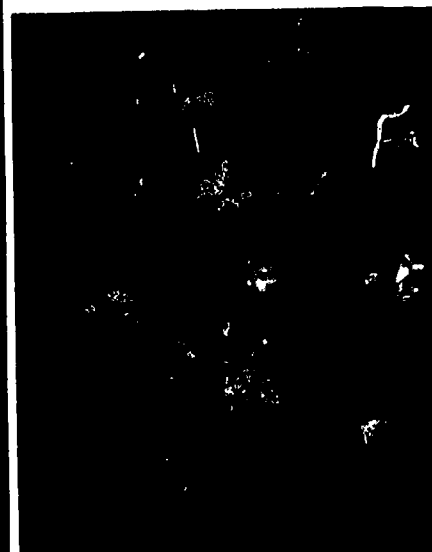


Figure 20-8
Lilac, stock, carnations and
freesia in a crystal vase



Figure 20-9
Motion expressed by figurine and
sweeping line of flowers

WILLIAMSBURG

The decorative arts in colonial America were heavily influenced by the English. Arrangements containing boxwood, magnolia and ivy combined with garden flowers were made in the summer. (See Figure 20-10.) At Christmastime native berries, pods, cones and greens were used with imported fruit to create a festive holiday mood. (See Figure 20-11.) Designs of dried flowers from gardens and fields added charm and a warm feeling to homes during the rest of the year.

Design forms popular during this period were the fan, triangles, cones and more casual mass groupings of materials. Containers included ornate silver and porcelain pieces as well as the more utilitarian pottery, pewter and baskets.

The five-fingered vase, a typical Williamsburg container, was used to create a fan-shaped arrangement by wedging materials in the fingers (Fig. 20-12). Imported Oriental porcelain and Dutch delftware in blue and white patterns were frequently used as containers to hold flowers. Wealthy homes sometimes had a beautiful silver epergne, a multi-branched composite container that could hold fruit or flowers and serve as the table centerpiece for elegant dinners.

Dried flower arrangements in the Williamsburg style are always in demand for homes that have a Williamsburg decorating scheme. At Christmas cones of apples and boxwood are appropriate table decorations for these homes. A fan featuring a pineapple, apples, magnolia and boxwood makes a

special over-the-door holiday welcoming piece in the Williamsburg style. This can be used in any home, but is especially effective in houses with an older style of architecture. (See Chapter 19.)

VICTORIAN

This English style of the 1800's developed a compact design form with a romantic feeling. Rich containers of silver and porcelain were filled abundantly with roses, carnations and lilies. Lace, velvet and satin often formed a base or background for the arrangements.

The Victorian design style is sometimes criticized as overdone and lacking in depth. Some regard it as a lavish style befitting only the era that produced it, - an era of elaborate ornamentation in clothing, household furnishings and architecture. Dried flowers under glass domes, cornucopias brimming with fruit and flowers, decorated lace fans on Christmas trees, and silver-trimmed mirrors used as bases for arrangements are examples that echo the era.



Figure 20-10

Fan shaped arrangement of summer flowers in Williamsburg setting



Figure 20-11

Cone shaped table centerpiece of apples and pineapple



Figure 20-12 Five-fingered vase

SUGGESTED ACTIVITIES

1. Investigate one of the period design styles that particularly interests you. Learn about the flowers that were used, the containers they were typically placed in, the mechanics available to support flowers, and traditional accessories often used. If appropriate materials can be obtained, make an arrangement that suggests the period style you have researched. Report back to the class on your findings so that other students can gain from your experience.

2. Invite to the class someone who has studied Japanese flower arranging. Ask that person to demonstrate the making of an Oriental arrangement and explain the meaning behind the placements.

3. Visit a museum to study decorative art that is typical of various periods in history. Discuss what kinds of flower arrangements you think would be harmonious with each style.



Arrangement in Victorian setting



Compact oval Victorian arrangement

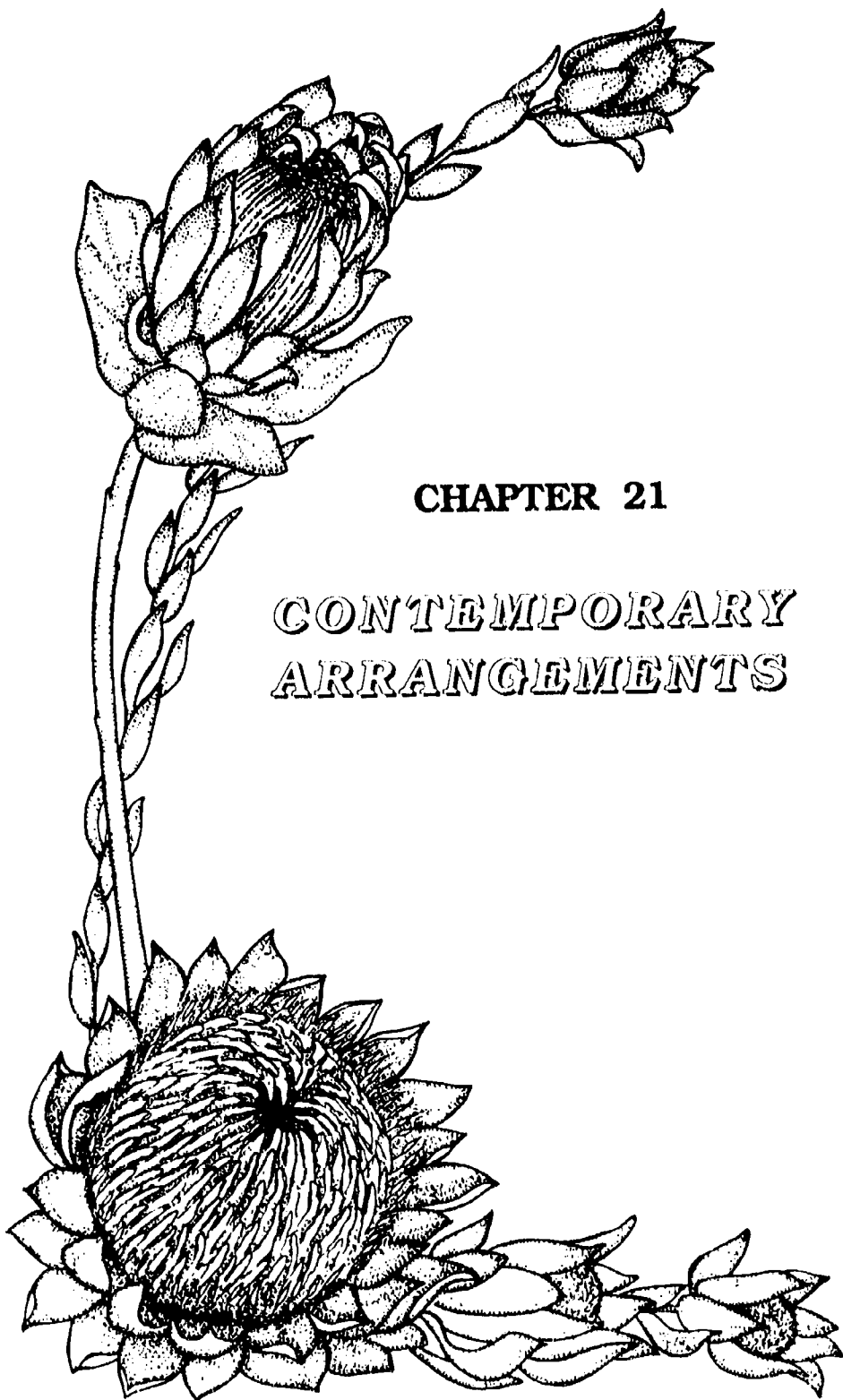


Dried Victorian arrangement

Period Arrangements

(Joe Smith, AIFD)





CHAPTER 21

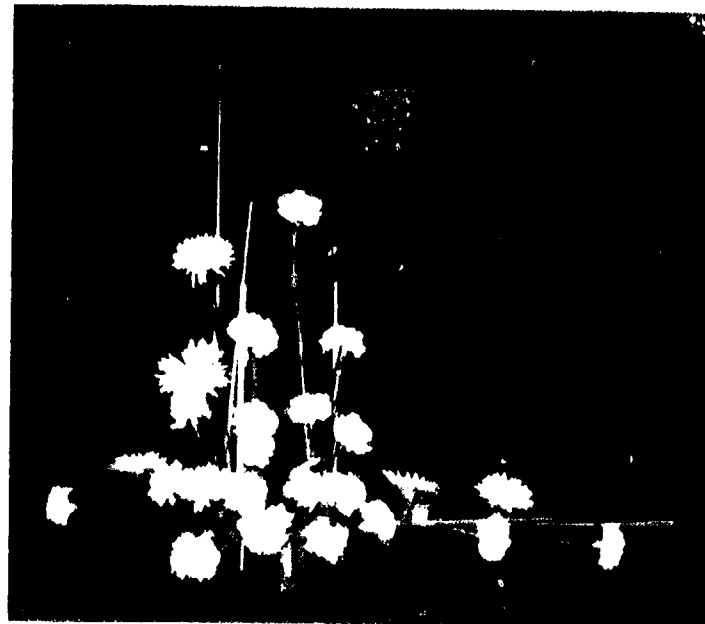
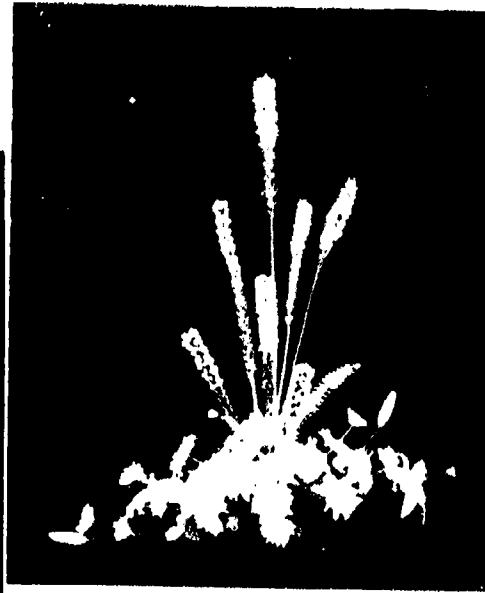
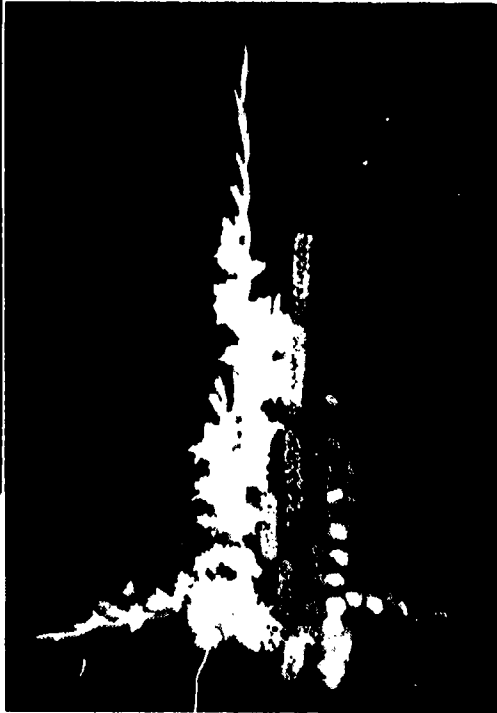
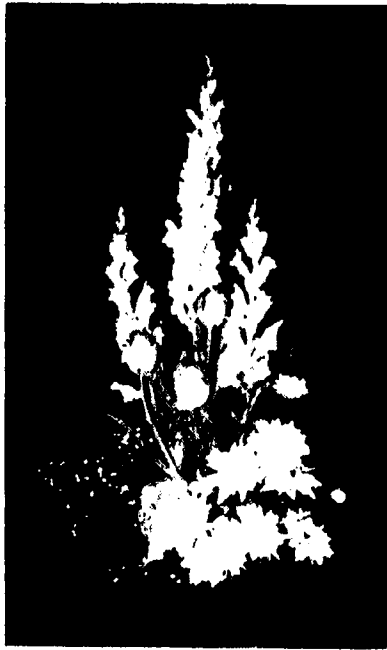
**CONTEMPORARY
ARRANGEMENTS**



New Convention by Connie Lyons, AIFD

Contemporary Arrangements

by Michael Polychrones, AAF, AIFD, PFC-I



The array of new design styles that have recently appeared in trade magazines and at special design shows has drawn mixed reactions from florists and customers alike. Regardless of personal preferences, designers who consider themselves floral artists must keep an open mind. They need first to develop an understanding of each new style and to evaluate it on its own merit, then carefully decide how it can be most appropriately used.

A good foundation in design principles and a mastery of basic design skills should be gained before attempting to construct or evaluate contemporary designs. There are good and bad contemporary arrangements, just as there are good and bad traditional arrangements. The principles of design must be considered when judging an arrangement, along with the perceived creativity, distinction and usage of the arrangement. (See Color Plates II-2, II-6 and IV-8.)

Some of the new design styles have originated in Europe and are collectively referred to as European design styles. A number of "contemporary" ideas represent recycling of old design themes. An example is the Biedermeier style, a cone consisting of concentric rings of different flowers tightly packed together. It was a popular old German style and, many centuries earlier, one used by the Egyptians. Other "new" styles are a creative blending of Oriental line concepts with traditional Western design. The results are unique, but the process is similar to what happened in the U.S.A. in the 1920's and '30's. Then American line-mass designs, such as the crescent and L-pattern, developed from a similar fusion of design ideas from two cultures.

Some of the new styles suggest nature; others reflect European period designs. Some reach into the world of bizarre abstraction, where flowers are regarded as solid and textural forms rather than according to their traditional values, and where non-floral items may also be used in design.

The following discussion deals with some of the contemporary styles that can be seen today.

BIEDERMEIR

This tight compact bouquet, usually conical in shape, consists of concentric layers of different flowers and foliage. Its appearance is that of a styrofoam form with flowers glued onto it, because of the lack of depth and the rigidity of the placements.

In ancient times the Egyptians created a forerunner of this design using lotus pods and grain. The modern version, however, is a recreation of an old German design. The old-fashioned colonial bouquet used for weddings in past decades reflected a similar feeling with its tightly packed rings of flowers. Some Biedermeir arrangements are modified into ovals. They are usually made in a piece of floral foam; however, hand-tied versions with the stems showing can be made as wedding bouquets or for placing in a vase.

CONTINENTAL BOUQUET

The continental bouquet is a collection of several flowers arranged at different levels. The design exhibits considerable depth, much as the early French arrangements did.

Interesting Containers with Modern Arrangements

by Julia Smetzer



Modernistic Arrangements Using Few Flowers



Continental Bouquet

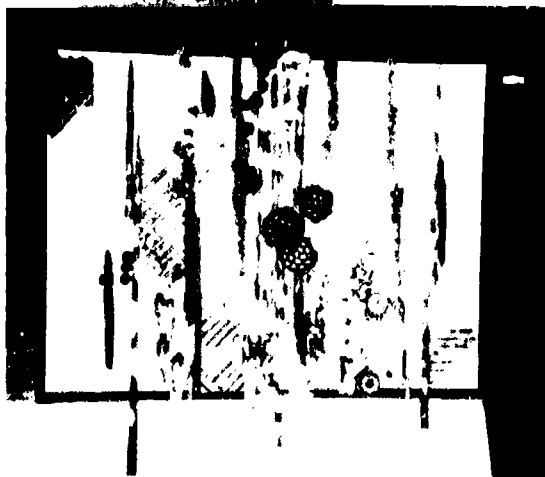


Biedermeir Bouquet



694

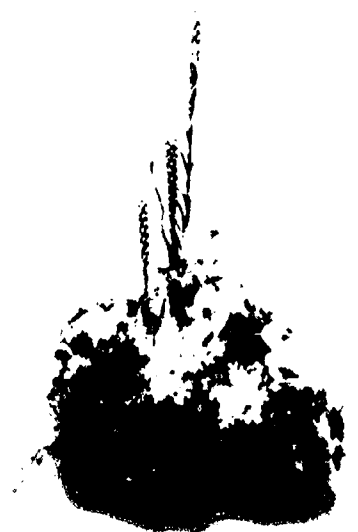
Contemporary Oriental Arrangements



Contemporary Wall Piece
Hitomi Gilliam, AIFD



Vegetative Arrangement



A Landscape Design

The flowers in a continental bouquet radiate out from a central axis. The arching lines of their stems and the flower shapes give an illusion of fullness. Each individual flower is surrounded by considerable space so it will show to advantage.

The designer who masters this style will find that it takes fewer flowers than a comparable size arrangement in a traditional style. Therefore, more unusual flowers can be used while remaining in the same price range for materials.

VEGETATIVE ARRANGEMENT

In a vegetative arrangement the flowers are placed in groupings or patches representative of the way they might grow naturally. Segments of color, sometimes in triangular wedges, make up the design. These segments may cross at certain points, but there is no total integration of contrasting colors as found in most traditional designs.

Flowers are featured in their natural growth forms. For example, tulips are allowed to stretch upward on their stems, and snapdragons may be shown as if bending toward the light. The vegetative bouquet is a good choice for casual settings and informal entertaining.

LANDSCAPE DESIGNS

A landscape design style arrangement has a natural "woody" feeling. Sometimes it is a small scene or collection of branches, fungi, bark and potted plants arranged as they might be found in nature. Moss may be

used to cover pots and mechanics, adding to the natural look. This style of arrangement sometimes utilizes a simulated country fence as a base or background. The fence could be made from twigs bound together with raffia or glue.

PARALLEL SYSTEMS

(See Color Plates IV-7 and IV-8)

In a parallel system arrangement, ninety percent of the material is parallel with respect to each other. The dominant line may be either vertical or horizontal. There is a sharp delineation between the parallel bands of materials. Liatris, gladioli, Scotch broom and other linear flowers and foliage are natural choices for parallel arrangements, but some other forms can also be lined up to create the desired effect.

Parallel arrangements are often designed in long low containers filled with floral foam. This style is suitable for any modern setting and is also equally appropriate for offices or sympathy flowers.

NEW CONVENTION

New convention is an extension of parallel design in which the vertical lines are combined with strong horizontal lines. The lines meet at a 90° angle. The horizontal lines often come forward off the base of the vertical lines.

New convention arrangements have an architectural quality because of the strong lines and sharp angles. They are suitable for the *hi-tech* look in a contemporary setting.

ABSTRACT

The goal of abstract art is to express a quality apart from any recognizable object. Abstract paintings and sculpture express various qualities but are dissociated from what is real and natural. As a result they are frequently subject to different interpretations, and most certainly they evoke different reactions in the viewers.

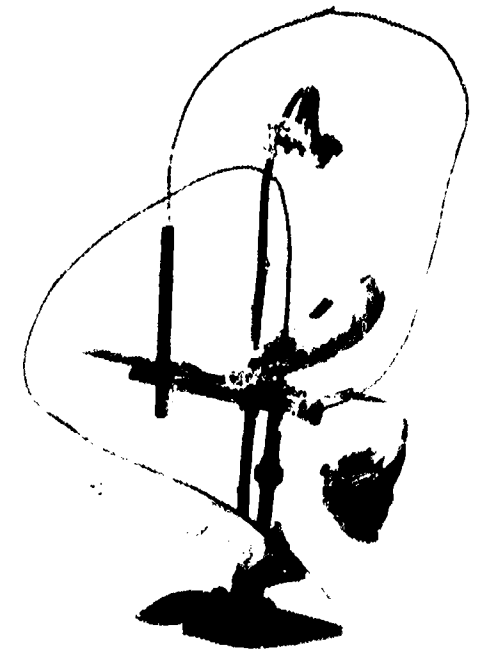
In floral art, abstract design has evolved as a new approach in both Oriental and Western floral design circles. In these designs plant materials are used strictly for their structural qualities and in whatever way necessary to best express the abstract quality being portrayed, without representing any real objects. As a result, the flowers and foliage are used in an unconventional manner, frequently appearing upside down, hanging from strings, glued together as part of a larger construction, or dismembered into unrecognizable pieces.



Parallel Systems

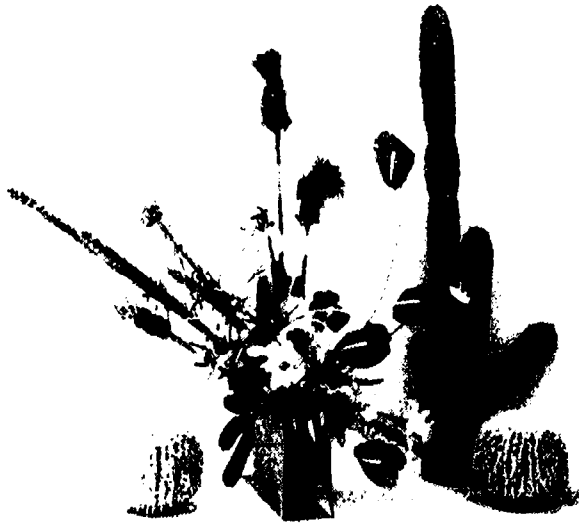


New Convention



Abstract

NEW WAVE



New Wave

New wave is a free-form style of design which enters into a creative and bizarre world. Flowers and follages may be painted, often with bright fluorescent colors. Items like plastic and copper tubing, carved styro-foam, and clear pieces of lucite often find their way into new wave designs. Lights may be incorporated into the arrangements or used to shine onto them for special effects.

New wave designs exhibit a lot of depth and are attractive from various angles. They require a great deal of creativity in addition to a mastery of basic design principles. Just being different is not enough to make an arrangement a good new wave design.

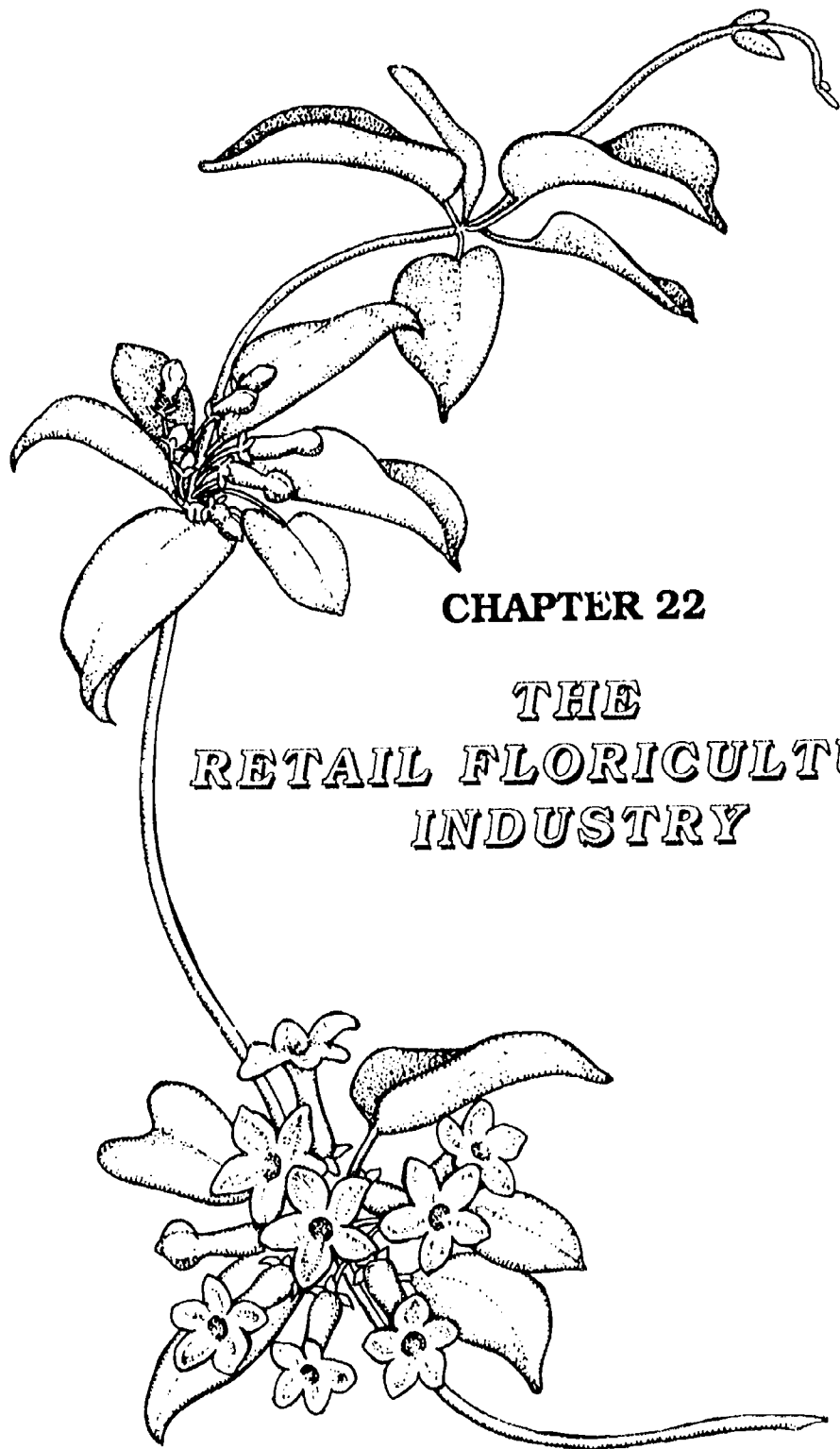
SUGGESTED ACTIVITIES

1. Choose one contemporary design style and investigate it in depth using back issues of trade magazines. Describe several arrangements that fall into the classification you have chosen. List the characteristics that you believe are typical of the specific style. Share your information with the class.
 2. What is your reaction to each of the contemporary design styles? Compare your reaction with that of other members of the class. Do you think these design styles would be accepted in your community? Have you seen any of these done by florists? Have you seen any at a flower show?
 3. Imagine different situations where these designs could be used. Consider weddings, hospitals, funerals and businesses.
 4. Construct a new wave design. Be as creative as possible. Use spray paint and non-floral items if they are available.
-

650

BES

700



CHAPTER 22

**THE
RETAIL FLORICULTURE
INDUSTRY**



The Bouquet Shop, Wooster

Wholesale Florist Business (United Floral, Canton)



Using the telephone and computers to communicate with suppliers and retail florists



Boxes of silk flowers on display



Glassware, plastic and baskets

The selling of flowers, living plants and related products is the heart of any retail floriculture business. These are aesthetic commodities that people traditionally seek to help them celebrate important events in their lives; to convey sympathy, appreciation or congratulations; and to add beauty to their environment. In many cases customers are willing to buy not only flower arrangements and plants, but also the services that go along with them. So, most retail florists offer consultation services, custom designing, delivery of floral products, and charge accounts. (See Color Plate IV-1.)

People buy flowers not only for themselves, but also to send to other people. In the past, sympathy flowers accounted for up to 80 percent of the retail florist trade. As other areas of the flower market expanded, this figure declined to the current average of about 30 percent. Here are some of the major reasons why people buy flowers:

- * for funerals (sympathy flowers)
- * for weddings
- * as gifts or to decorate for seasonal holidays (Christmas, Valentine's Day, Easter, Thanksgiving)
- * as gifts for special holidays (Secretary's Week, Sweetest Day, Mother-In-Law's Day)
- * as get-well floral gifts
- * as congratulatory gifts for new baby or other events
- * as birthday and anniversary gifts
- * to decorate for parties
- * as business gifts

DISTRIBUTION of FLOWERS and FLORAL PRODUCTS

Consumers of floral products may buy from either a typical retail florist, a garden center, or a mass marketing outlet like a discount store or grocery store. Retail florists, garden centers and mass marketers are collectively called **retailers** because they sell to the general public.

Retailers buy their flowers and supplies largely from wholesale florists (**wholesalers**). They may also buy directly from **manufacturers** of floral products and **growers** of plants and flowers. Foreign flowers enter the market through **importers** located in key entry points to the country like Miami, New York and Los Angeles.

See Figure 22-1 for a flow chart showing the chain of distribution of floral products.



Wholesale storage coolers for cut flowers

THE WORLD FLOWER MARKET

Flowers that are sold at flower shops come from many sources, including local growers as well as floral production centers in Florida, California and Colorado. However, about 40 percent of the flowers sold in the U.S. are imported from other countries. Some key exporters of flowers to the U.S.A. are Colombia, Netherlands (Holland), Mexico, Thailand, Israel, Costa Rica, Guatemala, Peru, Kenya, Dominican Republic, Ecuador, South Africa, Australia and New Zealand. (See Figure 22-2.)

The rapid transportation of a quality floral product to U.S. markets has resulted in an increasingly large assortment of flowers available to American consumers. Aggressive marketing campaigns and responsiveness to U.S. demand for flowers have resulted in foreign flowers accounting for an increasingly larger share of the market. The price, quality, availability and novelty of the product are factors that have caused Americans to buy more foreign flowers. Consequently, floral customers in the U.S. have become more dependent upon world markets. Therefore, a weather disturbance in Africa, political unrest in Central America, or an economic trade war with Southeast Asia may affect the price or availability of flowers in a local flower shop.

Floral products that are imported in large quantities include carnations, roses, chrysanthemums, statice, tulips, freesia, alstroemeria, gerbera daisies, gypsophila, orchids, lilies and chamaedorea. A list of the leading exporters of these flowers is included on page 343.

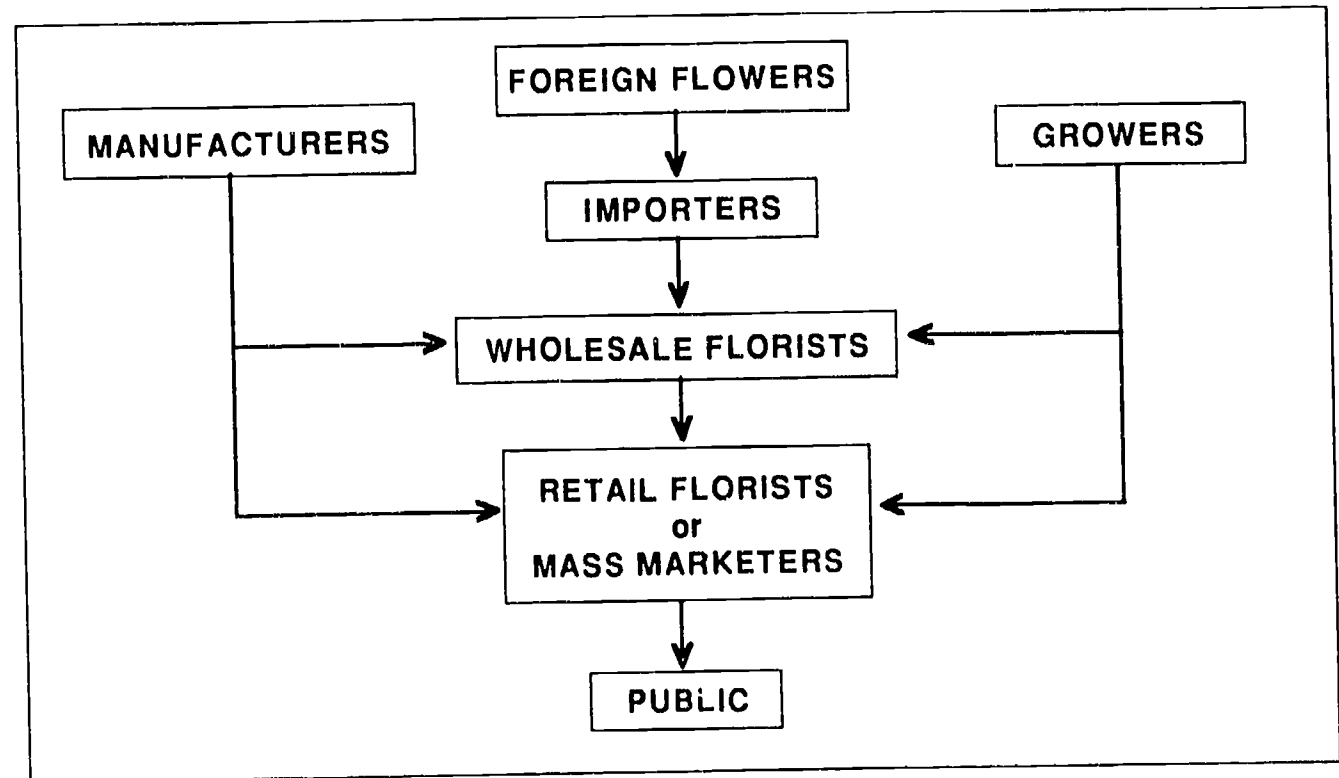


Figure 22-1 The chain of distribution of floral products



Figure 22-2 Map of major production sites of flowers imported into the United States

Floral Distribution Chain



1

Flowers are cut and packaged at the location where they are grown



2

U.S. wholesalers buy domestically grown and imported flowers



3

Flowers are stored temporarily in coolers at wholesale houses



4

Wholesalers deliver flowers to retailers in refrigerated trucks



5

Retailers arrange flowers



6

Retailers sell the arrangements to their customers

757

757

700

Exporters of Floral Crops

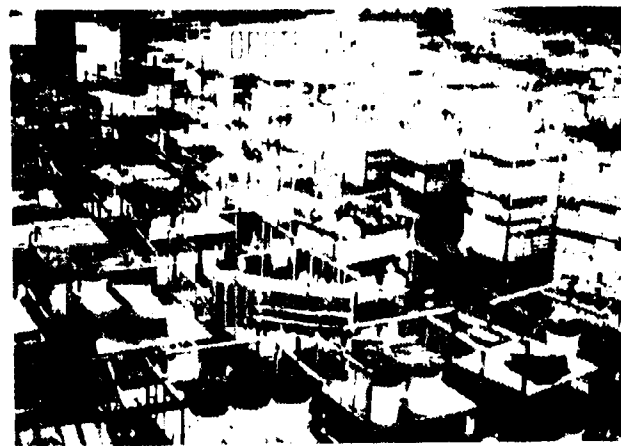
Holland is estimated to have 70 percent of the world market in flowers. Many flowers produced in the Netherlands and other parts of Europe pass through the large flower auction at Aalsmeer, Holland before coming to the U.S. Part of the profit at the flower auction is used to market flowers worldwide. The Flower Council of Holland is effective in promoting Dutch flowers in the U.S. through advertising. They distribute educational material and give informative programs to florists in this country.

Another large floral production center is in Colombia, South America. Over 90 percent of U.S.-imported carnations and pompon chrysanthemums and over 75 percent of the imported roses come from Colombia. Large production ranges are near major airport terminals for quick shipment. Low labor costs and little or no need for greenhouse heat are advantages that South American growers have over most U.S. growers. In addition, Colombian growers have a marketing organization that researches the preferences of customers in the U.S. The growers' production schedules are responsive to these preferences.

Floral Crop	Major Exporter
Standard Carnations	Colombia, Mexico, Netherlands, Peru
Mini Carnations	Colombia, Peru, Israel
Roses	Colombia, Netherlands, Guatemala
Standard Chrysanthemums	Colombia, Netherlands
Pompon Chrysanthemums	Colombia, Costa Rica, Peru
Statice	Colombia, Mexico, Peru
Tulips	Netherlands, France
Freesia	Netherlands, Colombia
Alstroemeria	Colombia, Netherlands
Gerbera Daisies	Netherlands, Colombia, South Africa
Gypsophila	Colombia, Peru
Cymbidium Orchids	Netherlands, New Zealand, Australia
Other Orchids	Thailand, Singapore
Lilies	Netherlands, Colombia, South Africa
Chamaedorea	Mexico, Guatemala, Costa Rica

CURRENT MARKETING TRENDS

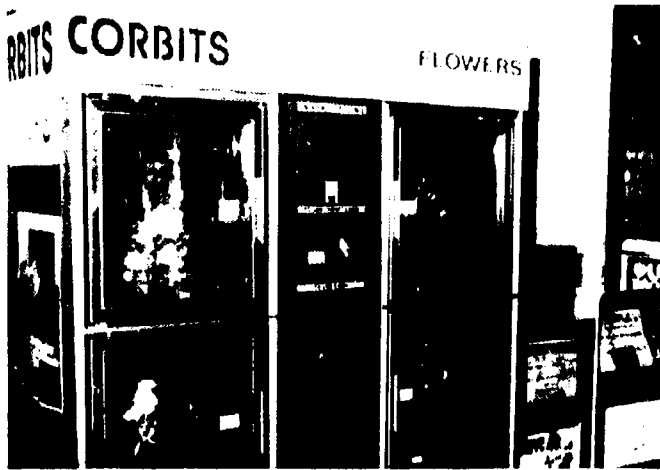
In a traditional flower shop a significant portion of the selling occurs over the telephone. Telephone sales account for as high as 75 percent of the sales, while in-store customers make up a relatively small percentage. This percentage is very different in the non-traditional mass marketing outlets such as discount stores and grocery stores. In the latter businesses much of the selling emphasis is on impulse sales generated by



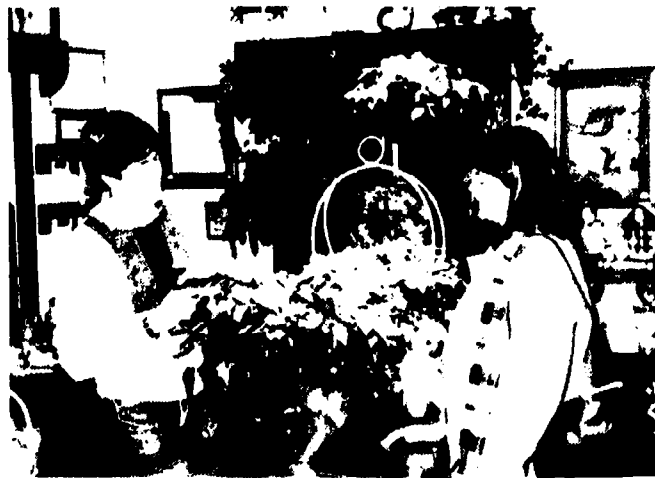
Thousands of flowers are sold daily at the Aalsmeer Flower Auction in Holland



Colombian worker packages cut flowers for air flight to U.S. markets



A flower vending machine appeals to the impulse buyer - *Corbits, Canton*



An average retail flower shop provides both product and service

the high customer traffic. In fact, much of the recent growth of the retail flower market has come from non-traditional sales like this; the product is located where many people can see it. Sales result from impulse buying simply because the product is attractive and fills a psychological need. Also, customers are attracted by the convenience factor - the opportunity to buy floral products at a store in which they frequently shop.

Because retail flower shops are so different in size, location, number of employees, and the way they are run, it is difficult to generalize about them. However, the statistics which follow will help give you an overview of today's retail floral industry.

- There are over 36,000 retail flower shops in the United States (as of 1987).
- The average gross yearly income for a flower shop is around \$200,000 (as of 1987).
- In a given area a population of at least 10,000 people is necessary to support an average flower shop.
- Only about 10% of retail flower shops have a paid manager.
- Over 85% of the retail shops belong to at least one wire service, like FTD, Teleflora or AFS.
- About 30% of the retail shops also do some growing of plants. This number has been declining.

TYPES of RETAIL FLORAL BUSINESSES

Though again broad generalizations are difficult, there are different categories of retail floral businesses that can be identified and recognized. These categories differ from one another not only in size and location, but also in their type of clientele, services available, merchandise offered for sale, and display techniques.

Following are brief sketches of the different kinds of retail flower shops that are commonly found.

Average Retail Flower Shop

The average retail flower shop is located in a suburban shopping district. It has four full-time employees and a yearly gross income of \$150,000 to \$200,000. Management of these shops is about equally divided between men and women. The shops provide a wide range of design prices and styles to meet the needs of the community. Services typically include delivery, credit and consultation.

High Style Flower Shop

These flower shops are located in the suburbs of large urban areas. In general they cater to higher-income customers who are willing to pay for exceptional and unique designs. Special attention is given to service and to custom designing for special occasions.

Shopping Center Shop

Small retail shops, often branches of larger area shops, are located in the high-traffic areas of a mall or shopping center. Because of the greater number of walk-in sales, more attention is given to giftware and small decorative items. Most of the sales are cash-and-carry, and services may be limited. This type of shop is not increasing in number at the present time.

Grocery Store Flower Shop

Flower shops in grocery stores have the advantage of a large number of walk-through customers. The focus is on impulse buying and small easy-to-carry items. Larger shops of this type may have a full range of services.

Garden Center

The retail flower shop section of a garden center often specializes in selling potted plants, planters and cemetery pieces. Other items that also may be featured are floral accessories, silk flowers, dried flowers and craft items. Services are usually limited.

Discount Store - Flower Department

The emphasis is on potted plants, silk flowers and pre-packaged floral items. Sales are cash-and-carry, with competitive lower prices depending on a higher volume of sales to generate income and offset the lack of services.

Specialized Location

Small flower shops may be located in

hospitals, hotels, department stores, college towns, apartment complexes, or even cruise ships. Their offerings vary according to the needs of their specialized clientele.

JOB RESPONSIBILITIES

Since most flower shops are quite small and do not have a large number of employees, each employee is often called upon to perform many different duties. Therefore, the more versatile and knowledgeable a person is, the more valuable an employee he or she will make. Only in very large shops is an employee allowed to be highly specialized; in smaller shops the employees usually have to share duties. Some of the duties that go with the specialized positions are as follows. (See Color Plates IV-2, IV-3 and IV-6.)

Manager

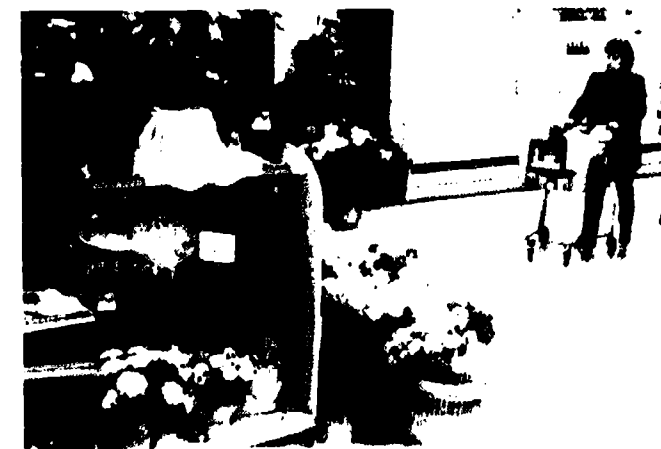
- organizes tasks and work schedules
- supervises other people
- does public relations work
- develops advertising strategies



Manager
Connells, Columbus



Kiosk flower shop in a shopping mall
Cowgill's, Canton



Grocery store flower shop
Buehler's, Wooster



Hospital flower shop
Aultman Hospital, Canton



Salesperson
The Flower Gazebo, Findlay

Salesperson

- answers telephone
- waits on customers
- operates cash register
- packages and wraps purchases
- stocks shelves
- prices merchandise
- creates displays

Office Worker

- does billing and bookkeeping
- operates computer
- keeps records of supplies, sales slips, purchases and expenses
- does payroll
- types letters and reports

Designer

- selects and handles flowers and supplies
- makes arrangements, corsages, bouquets, etc.
- prices designs
- may consult and service weddings and parties
- makes terrariums and dish gardens
- cleans up work area



Office Worker
Connells, Columbus



Designer
Maple Lee, Worthington



Delivery Person
Maple Lee, Worthington

Delivery Person

- loads and transports arrangements
- interacts with public
- maintains delivery vehicle
- performs custodial duties
- stocks supplies

JOB QUALIFICATIONS

The success of a retail flower shop employee in getting, keeping and advancing in a job depends on the individual's ability to do the work well. Education and experience are the two best ways to broaden horizons, learn skills, experience personal growth, and learn to accept more responsibility.

Training may begin during high school in a vocational program or in a part-time job in a flower shop. However, if you lack the initial work experience, a good way to gain entrance into the industry or to advance in a job already held is to attend a technical school offering a two-year associate degree program in floriculture on the college level. Not only will you receive specialized training in basic horticulture, floral design and retail marketing, but you will also develop necessary skills from general education courses in communications, math and business. Technical education at this level has the advantages of targeting skills needed for entry into the business and teaching them in two years. The internship requirement found in many technical programs will give you a chance to gain experience, find out what the job is really like, and meet people in the industry.

People who view their education as a life-long process, not completed with the first

degree they receive, are those who have a real opportunity to improve their skills, professional growth, and job satisfaction. Some may find themselves on a path that leads to higher education and a bachelor's, master's, or even a doctor's degree. Their goal may be to teach floriculture in high school or college or to become involved with research in one of the floral products industries. Others may simply want to keep current and sharpen skills by attending one or more design schools, short courses or workshops. They can also keep current by regular reading of trade magazines and literature produced by various floral organizations. In this industry many avenues lead to self-improvement, but the individual must take the initiative in seeking them out.

Some of the skills and attitudes important to employers in the retail floriculture industry are listed next. As you read them, decide which ones you are already strong in. If you have some weak areas, think of ways you might be able to improve.

A good employee:

- has a good knowledge of basic floriculture, including design, plant identification, care and handling of floral materials, and knowledge of plant culture.

- is able to communicate well with others.
- has good math skills and business sense.
- is reliable and steady.
- has good work speed; is efficient.
- strives to do quality work.
- cooperates and works well with other employees.
- dresses neatly and appropriately for the activities being performed.
- is creative, always looking for new ideas and better ways of doing things.
- is friendly and courteous.

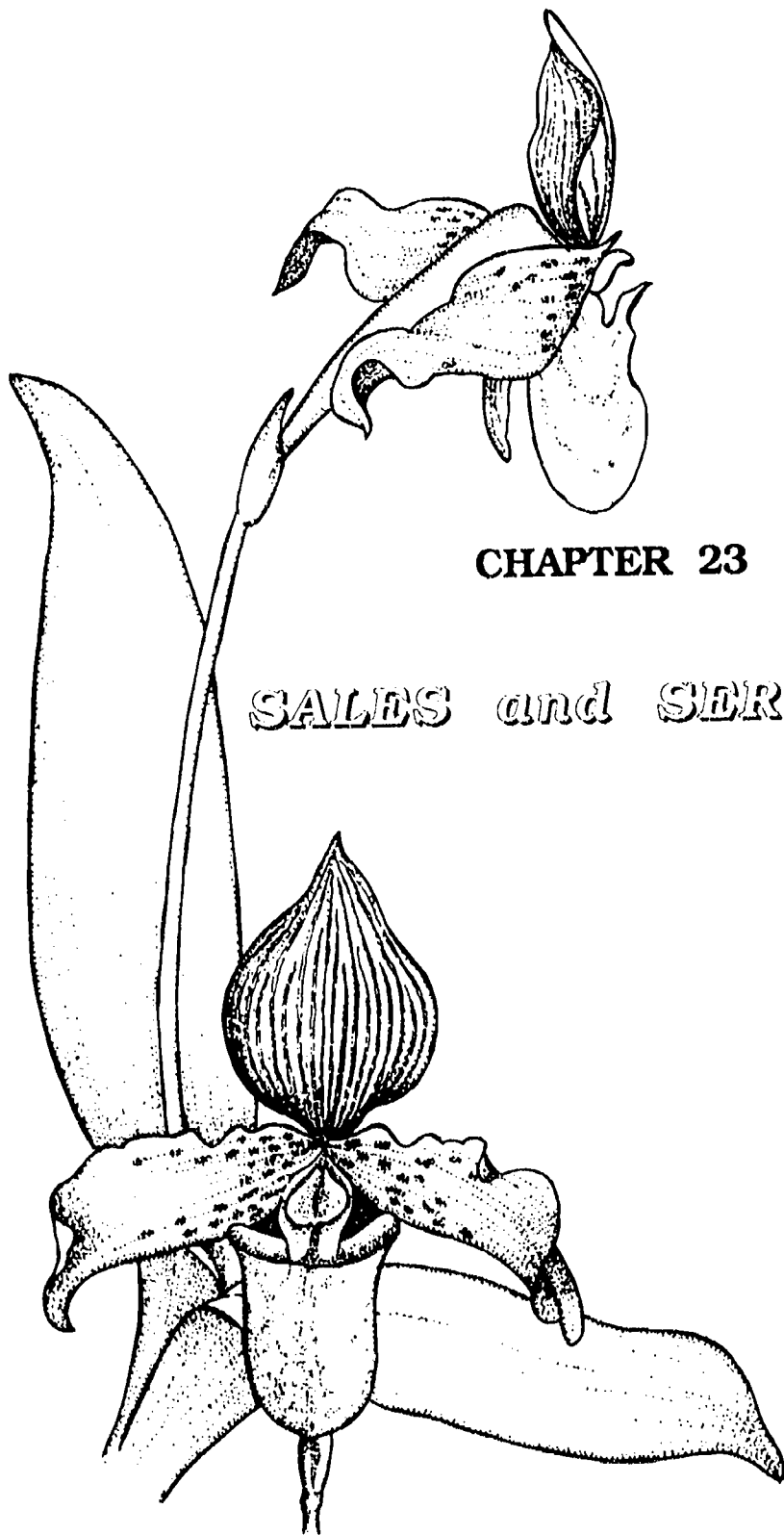
Working in a retail flower shop is an interesting job that can bring a great deal of personal satisfaction. The work changes with the seasons and holidays and offers opportunities to be creative both in floral design and in helping decorate windows or arrange displays. Employees have the satisfaction of working with a beautiful product that people are pleased to give and to receive.



The Ohio State University's Agricultural Technical Institute (ATI) offers technical training in retail floriculture



Experienced florists are looking for employees who work hard to improve their knowledge and skills - Don Johnson, Lima



CHAPTER 23

SALES and SERVICE



Sales Center, Maple Lee, Worthington



Customers must be shown new styles in attractive settings
Maple Lee, Worthington



Good cooler displays are valuable sales tools
Parkhurst's Flower Gallery, Medina

The existence of a retail flower shop depends on making a profit by selling to customers. In order to attract and keep customers the shop must:

1. offer a quality product
2. provide services that customers want
3. promote their products through advertising
4. charge fair prices
5. be accessible and responsive to customers

Each retail florist should try to understand the buying habits of customers in that particular area. Products and design styles that are popular in one area or neighborhood may be poorly received in another. Wedding traditions, funeral practices, and customs for decorating cemeteries vary from place to place. Florists need to understand these preferences and cater to them.

Even so, new and potentially profitable items and styles should be periodically introduced to give the shop a new look and combat the tiresome, old-fashioned look. New introductions may attract some new customers. They will also help project the image of a shop that keeps current with modern trends.

The florist business is typically seasonal because of the high volume of sales during holidays like Christmas, Easter, Valentine's Day and Mother's Day. The chart which follows indicates the percentage of yearly sales that might be expected each month in a shop. What holidays occur in the months with the higher sales volume?

Percentage of Yearly Sales Expected Each Month

January	6%	July	6%
February	9%	August	6%
March	7%	September	6%
April	11%	October	8%
May	12%	November	7%
June	8%	December	14%

Here are some additional thoughts about customers and trends in their buying habits.

- Over half of the people who buy flowers are women.
- Customers are increasingly more value-conscious. They are more willing to buy if convinced they are getting their money's worth. Product quality and keeping quality of the flowers are factors they seriously consider.
- Flowers are often purchased as gifts for sentimental reasons - to celebrate a special occasion or to express love and caring. Examples are wedding anniversaries and birthdays, Valentine's Day, Mother's Day.
- Flowers are an appropriate way to express sorrow and concern for the bereaved at the time of a death.
- Flowers create a beautiful setting for special occasions like weddings and parties. In many cases they are expected and even regarded as status symbols.
- Flowers are appropriate business gifts which can beautify the work place and project a positive image.

- People are increasingly buying flowers for themselves just for enjoyment, to enhance their living environment. Europeans have always led Americans in this trend of purchasing flowers for everyday use.

IN-STORE SALES

Customers entering a flower shop will form an impression of the business during their first moments inside. They will be influenced by the appearance of the shop and the displays as well as any sales personnel they encounter. Customers should be greeted in a friendly and courteous manner. Many customers do not visit flower shops often. They may be somewhat unfamiliar with where things are and the proper procedure for getting what they want. Their needs should be handled in a way that will make them feel comfortable.

There are several possible types of customers who may enter a flower shop. Here are some characteristics of each type and suggestions for how they may be most effectively served.

Decided Customer

The customer has come for a specific purpose. Usually this person has done business with the shop before and is familiar with the set-up and procedures. Deal with this customer as efficiently as possible, determining his or her needs, suggesting alternatives, if necessary, and closing the sale.

Undecided Customer

These customers have only a vague idea of what they want. They are not sure what

alternatives there are and how the shop might meet their needs. Sometimes they feel a bit uncomfortable in the shop. The salesperson needs to work with these customers, making each one feel that there is a personal interest in his or her situation and suggesting possible choices. Showing made-up arrangements, priced merchandise, and pictures in selection guides will help guide undecided customers toward a purchase.

Browser

This customer is "just looking around." A friendly greeting, with the assurance that the salesperson is available if needed, may be all that is required. Well displayed and priced merchandise will speak for itself. Even if the customer does not buy anything, a positive image can be created. Hopefully that will lead to a return visit and a sale in the future.

QUALITIES OF A GOOD SALESPERSON

The employee who deals with the public as a salesperson creates an image of the shop in the customer's mind. If it is a very negative image, sales can be adversely affected even if the merchandise is good. Instead, a salesperson should project a positive image - the personality and sales techniques for stimulating sales. Some salespersons have the ability to steer a customer tactfully to a higher dollar value sale. In any case, a good salesperson is one who knows how to treat customers respectfully so they will want to return often.

In a retail flower shop, a good salesperson:



First impressions of a flower shop are created by displays and the sales personnel
John Anderson Florist, Canton



A good salesperson shows a genuine interest in the customer's needs
Parkhurst's Flower Gallery, Medina



A salesperson should try to get the product into the hands of the customer

- is knowledgeable about the products and services offered by the shop.
- believes in the products and services being sold and projects a positive image of what will result from the purchase.
- knows prices of the products and is able to close the sale efficiently according to policies of the shop.
- shows a genuine interest in the customer's needs and helps the customer decide what products and services are best for the particular circumstances.
- shows enthusiasm about the merchandise that may stimulate customer interest and lead to more sales.
- is friendly and courteous and addresses the customer by name if possible.
- dresses neatly and in good taste.
- communicates effectively with the customer in a confident manner and maintains eye contact when speaking.

SELLING IN THE FLOWER SHOP

There are three basic "C" steps to selling in a flower shop:

- 1) *creating an interest* and desire for the product on the part of the customer;
- 2) *convincing the customer* that the product is just what he or she needs; and

- 3) *closing the sale* with the customer buying the product.

Some specific points that will help set the stage for a successful sale are as follows:

1. Have attractive displays showing made-up products.
2. Have prices on the made-up arrangements, flowers and supplies. Many customers want to get an idea of the prices so they can think over their options privately without having to ask the price of each item that interests them.
3. Create a good shop atmosphere. Avoid all inappropriate behavior on the part of the employees, like lounging, rowdiness or misuse of the telephone.
4. Use descriptive language to explain how a certain arrangement or flower choice will meet the customer's needs. Be enthusiastic! Help build a positive picture in the customer's mind about the effect of the floral gift on the one who is to receive it, or the impact of the flowers on the situation in which they are going to be used.
5. Get the product into the hands of the customer. For example, let the customer hold a rose rather than just look at a bucketful through the glass in a cooler.
6. If a customer likes a certain arrangement but seems doubtful about it, suggest alterations that you can make in the design or materials that will better suit the person's needs or preferences.

7. Offer three prices on a given arrangement to be made (such as \$15, \$20, and \$25), explaining (enthusiastically) the added attractive features of the higher priced designs. If the customer chooses the extras, you have made a larger sale. This is called *upselling*.
8. Sell related merchandise or extra services if the opportunity arises. For example, a customer may be choosing a flower arrangement for a party. If your shop also sells candles and napkins, ask the customer if he or she would like to purchase either of these items at the same time.
9. Be efficient in your use of time with a customer. Don't ignore one customer while working with another. If you are in the middle of a sale, reassure the waiting customer, "I'll be with you in a minute." The time you spend with one customer must be shortened when there are others waiting to be served.
10. Handle objections as they arise, but never argue with customers. Suggest other alternatives in products or prices to suit the specific need.
11. Use common sense and good judgment in all dealings with customers.

Writing Up the Order

After the customer decides to make a purchase, the salesperson completes the transaction by packaging the merchandise for immediate sale or by writing up an order for future delivery or pick-up. In the latter

case it is very important to write down all relevant information. There are different styles of order forms which will help standardize the collection of information. Figure 23-1 is an example of an order form.

Payment for the purchase may be made by cash, credit card or charge to the customer's account. Floral businesses differ in their credit policies, ranging from strictly cash-and-carry to "30 days same as cash." Traditionally florists have been quite liberal in extending credit to customers, billing them for later payment. Whatever the policy, it should be clearly communicated to customers to avoid misunderstanding. Other charges such as delivery fees or telephone calls should also be made known to customers.



The salesperson completes the transaction by writing up the order
Don Johnson Florist & Gifts, Lima

THE FLOWER GAZEBO	
1125 Tiffin Avenue FINDLAY, OHIO 45840 (419) 424-0681	
DELIVER TO	DELIVERY DATE
ADDRESS	S M T W T F S
 AM PM
WIRE IN OUT	ASSOCIATION CODE NUMBER CALL TAKEN BY
FLORIST	PHONE
ADDRESS	
<input type="checkbox"/> ARRANGEMENT	<input type="checkbox"/> SPRAY <input type="checkbox"/> CORSAGE <input type="checkbox"/> CUT FLOWERS <input type="checkbox"/> PLANT
	TAX
	TOTAL
11282	<i>Thank You</i>
CASH CHARGE	CASH NEW ACCOUNT
	MEMBER

Figure 23-1 Sample order form

FOR USE ON OR AFTER 11-25-81
OHIO'S BRACKETED TAX COLLECTION SCHEDULE
SALES & USE TAX FOR STATE, COUNTY AND OR
TRANSIT TAX - TOTAL [5 1/2%] TAX LEVY
SALES 15c AND UNDER - NO TAX

Each Sale	Tax	Each Sale	Tax
.16 to .18	.01	8.19 to 8.36	.46
.19 to .36	.02	8.37 to 8.54	.47
.37 to .54	.03	8.55 to 8.72	.48
.55 to .72	.04	8.73 to 8.90	.49
.73 to .90	.05	8.91 to 9.09	.50
.91 to 1.09	.06	9.10 to 9.27	.51
1.10 to 1.27	.07	9.28 to 9.46	.52
1.28 to 1.46	.08	9.47 to 9.64	.53
1.47 to 1.64	.09	9.65 to 9.82	.54
1.65 to 1.82	.10	9.83 to 10.00	.55
1.83 to 2.00	.11	10.01 to 10.18	.56
2.01 to 2.18	.12	10.19 to 10.36	.57
2.19 to 2.36	.13	10.37 to 10.54	.58
2.37 to 2.54	.14	10.55 to 10.72	.59
2.55 to 2.72	.15	10.73 to 10.90	.60
2.73 to 2.90	.16	10.91 to 11.09	.61
2.91 to 3.09	.17	11.10 to 11.27	.62
3.10 to 3.27	.18	11.28 to 11.46	.63
3.28 to 3.46	.19	11.47 to 11.64	.64
3.47 to 3.64	.20	11.65 to 11.82	.65
3.65 to 3.82	.21	11.83 to 12.00	.66
3.83 to 4.00	.22	12.01 to 12.18	.67
4.01 to 4.18	.23	12.19 to 12.36	.68
4.19 to 4.36	.24	12.37 to 12.54	.69
4.37 to 4.54	.25	12.55 to 12.72	.70
4.55 to 4.72	.26	12.73 to 12.90	.71
4.73 to 4.90	.27	12.91 to 13.07	.72
4.91 to 5.09	.28	13.10 to 13.27	.73
5.10 to 5.27	.29	13.28 to 13.46	.74
5.28 to 5.46	.30	13.47 to 13.64	.75
5.47 to 5.64	.31	13.65 to 13.82	.76
5.65 to 5.82	.32	13.83 to 14.00	.77
5.83 to 6.00	.33	14.01 to 14.18	.78
6.01 to 6.18	.34	14.19 to 14.36	.79
6.19 to 6.36	.35	14.37 to 14.54	.80
6.37 to 6.54	.36	14.55 to 14.72	.81
6.55 to 6.72	.37	14.73 to 14.90	.82
6.73 to 6.90	.38	14.91 to 15.07	.83
6.91 to 7.09	.39	15.10 to 15.27	.84
7.10 to 7.27	.40	15.28 to 15.46	.85
7.28 to 7.46	.41	15.47 to 15.64	.86
7.47 to 7.64	.42	15.65 to 15.82	.87
7.65 to 7.82	.43	15.83 to 16.00	.88
7.83 to 8.00	.44	16.01 to 16.18	.89
8.01 to 8.18	.45	16.19 to 16.36	.90

Continued on Reverse Side T-55

Each Sale	Tax	Each Sale	Tax	Each Sale	Tax
16.37 to 16.54	.91	27.47 to 27.64	1.63	42.55 to 42.72	2.35
16.55 to 16.72	.92	27.65 to 27.82	1.64	42.73 to 42.90	2.36
16.73 to 16.90	.93	27.83 to 28.00	1.65	42.91 to 43.09	2.37
16.91 to 17.09	.94	28.01 to 28.18	1.66	43.10 to 43.27	2.38
17.10 to 17.27	.95	28.19 to 28.36	1.67	43.28 to 43.46	2.39
17.28 to 17.46	.96	28.37 to 28.54	1.68	43.47 to 43.64	2.40
17.47 to 17.64	.97	28.55 to 28.72	1.69	43.65 to 43.82	2.41
17.65 to 17.82	.98	28.73 to 28.90	1.70	43.83 to 44.00	2.42
17.83 to 18.00	.99	28.91 to 29.09	1.71	44.01 to 44.18	2.43
18.01 to 18.18	1.00	29.10 to 29.27	1.72	44.19 to 44.36	2.44
18.19 to 18.36	1.01	29.28 to 29.46	1.73	44.37 to 44.54	2.45
18.37 to 18.54	1.02	29.47 to 29.64	1.74	44.55 to 44.72	2.46
18.55 to 18.72	1.03	29.65 to 29.82	1.75	44.73 to 44.90	2.47
18.73 to 18.90	1.04	29.83 to 30.00	1.76	44.91 to 45.09	2.48
18.91 to 19.09	1.05	30.01 to 30.18	1.77	45.10 to 45.27	2.49
19.10 to 19.27	1.06	30.19 to 30.36	1.78	45.28 to 45.46	2.50
19.28 to 19.46	1.07	30.37 to 30.54	1.79	45.47 to 45.64	2.51
19.47 to 19.64	1.08	30.55 to 30.72	1.80	45.65 to 45.82	2.52
19.65 to 19.82	1.09	30.73 to 30.90	1.81	45.83 to 46.00	2.53
19.83 to 20.00	1.10	30.91 to 31.09	1.82	46.01 to 46.18	2.54
20.01 to 20.18	1.11	31.10 to 31.27	1.83	46.19 to 46.36	2.55
20.19 to 20.36	1.12	31.28 to 31.46	1.84	46.37 to 46.54	2.56
20.37 to 20.54	1.13	31.47 to 31.64	1.85	46.55 to 46.72	2.57
20.55 to 20.72	1.14	31.65 to 31.82	1.86	46.73 to 46.90	2.58
20.73 to 20.90	1.15	31.83 to 32.00	1.87	46.91 to 47.09	2.59
20.91 to 21.09	1.16	32.01 to 32.18	1.88	47.10 to 47.27	2.60
21.10 to 21.27	1.17	32.19 to 32.36	1.89	47.28 to 47.46	2.61
21.28 to 21.46	1.18	32.37 to 32.54	1.90	47.47 to 47.64	2.62
21.47 to 21.64	1.19	32.55 to 32.72	1.91	47.65 to 47.82	2.63
21.65 to 21.82	1.20	32.73 to 32.90	1.92	47.83 to 48.00	2.64
21.83 to 22.00	1.21	32.91 to 33.09	1.93	48.01 to 48.18	2.65
22.01 to 22.18	1.22	33.10 to 33.27	1.94	48.19 to 48.36	2.66
22.19 to 22.36	1.23	33.28 to 33.46	1.95	48.37 to 48.54	2.67
22.37 to 22.54	1.24	33.47 to 33.64	1.96	48.55 to 48.72	2.68
22.55 to 22.72	1.25	33.65 to 33.82	1.97	48.73 to 48.90	2.69
22.73 to 22.90	1.26	33.83 to 34.00	1.98	48.91 to 49.09	2.70
22.91 to 23.09	1.27	34.01 to 34.18	1.99	49.10 to 49.27	2.71
23.10 to 23.27	1.28	34.19 to 34.36	2.00	49.28 to 49.46	2.72
23.28 to 23.46	1.29	34.37 to 34.54	2.01	49.47 to 49.64	2.73
23.47 to 23.64	1.30	34.55 to 34.72	2.02	49.65 to 49.82	2.74
23.65 to 23.82	1.31	34.73 to 34.90	2.03	49.83 to 50.00	2.75
23.83 to 24.00	1.32	34.91 to 35.09	2.04	50.01 to 50.18	2.76
24.01 to 24.18	1.33	35.10 to 35.27	2.05	50.19 to 50.36	2.77
24.19 to 24.36	1.34	35.28 to 35.46	2.06	50.37 to 50.54	2.78
24.37 to 24.54	1.35	35.47 to 35.64	2.07	50.55 to 50.72	2.79
24.55 to 24.72	1.36	35.65 to 35.82	2.08	50.73 to 50.90	2.80
24.73 to 24.90	1.37	35.83 to 36.00	2.09	50.91 to 51.09	2.81
24.91 to 25.09	1.38	36.01 to 36.18	2.10	51.10 to 51.27	2.82
25.10 to 25.27	1.39	36.19 to 36.36	2.11	51.28 to 51.46	2.83
25.28 to 25.46	1.40	36.37 to 36.54	2.12	51.47 to 51.64	2.84
25.47 to 25.64	1.41	36.55 to 36.72	2.13	51.65 to 51.82	2.85
25.65 to 25.82	1.42	36.73 to 36.90	2.14	51.83 to 52.00	2.86
25.83 to 26.00	1.43	36.91 to 37.09	2.15	52.01 to 52.18	2.87
26.01 to 26.18	1.44	37.10 to 37.27	2.16	52.19 to 52.36	2.88
26.19 to 26.36	1.45	37.28 to 37.46	2.17	52.37 to 52.54	2.89
26.37 to 26.54	1.46	37.47 to 37.64	2.18	52.55 to 52.72	2.90
26.55 to 26.72	1.47	37.65 to 37.82	2.19	52.73 to 52.90	2.91
26.73 to 26.90	1.48	37.83 to 38.00	2.20	52.91 to 53.09	2.92
26.91 to 27.09	1.49	38.01 to 38.18	2.21	53.10 to 53.27	2.93
27.10 to 27.27	1.50	38.19 to 38.36	2.22	53.28 to 53.46	2.94
27.28 to 27.46	1.51	38.37 to 38.54	2.23	53.47 to 53.64	2.95
27.47 to 27.64	1.52	38.55 to 38.72	2.24	53.65 to 53.82	2.96
27.65 to 27.82	1.53	38.73 to 38.90	2.25	53.83 to 54.00	2.97
27.83 to 28.00	1.54	38.91 to 39.09	2.26	54.01 to 54.18	2.98
28.01 to 28.18	1.55	39.10 to 39.27	2.27	54.19 to 54.36	2.99
28.19 to 28.36	1.56	39.28 to 39.46	2.28	54.37 to 54.54	3.00
28.37 to 28.54	1.57	39.47 to 39.64	2.29	54.55 to 54.72	3.01
28.55 to 28.72	1.58	39.65 to 39.82	2.30	54.73 to 54.90	3.02
28.73 to 28.90	1.59	39.83 to 40.00	2.31	54.91 to 55.09	3.03
28.91 to 29.09	1.60	40.01 to 40.18	2.32	55.10 to 55.27	3.04
29.10 to 29.27	1.61	40.19 to 40.36	2.33	55.28 to 55.46	3.05
29.28 to 29.46	1.62	40.37 to 40.54	2.34	55.47 to 55.64	3.06

Figure 23-2 Ohio Sales Tax Table

Sales Tax

Floral purchases are subject to sales tax. This must be added to the total amount of the bill. Some areas have local sales tax in addition to state sales tax. Although the tax can sometimes be calculated mentally, it is easier and more accurate to consult a table which gives the correct amount of tax for the amount of the purchase (Fig. 23-2). This table should be kept near or taped to the cash register so that it will not be mislaid. The sales tax is added to the amount of the purchase to determine the total amount that the customer owes.

Cash Register

The cash register not only holds money, but often keeps a record of transactions as well. All cash registers add up the customer's total of individual prices that were entered, but some machines have additional capabilities. They keep a record of amount of merchandise sold in various categories (such as arrangements, potted plants, giftware, etc.), automatically calculate sales tax, and show the salesperson the exact amount of change to give the customer.

Making Change

Often a customer pays in cash with a bill larger than the amount of purchase. That bill should be placed on the ledge above the cash drawer until the correct change has been made. Then if there is any disagreement over the amount, the original bill given by the customer is still in view. When making change, both the customer and the salesperson can understand one another

best if the salesperson counts **up** from the purchase amount to the payment amount given by the customer. For example, a customer pays for a \$3.56 purchase with a \$20 bill. When returning the change, the salesperson should count in the following order:

Salesperson gives:	Salesperson says:
-----	"3.56"
4 pennies	"3.60"
1 dime	"3.70"
1 nickel	"3.75"
1 quarter	"4.00"
1 dollar	"5.00"
1 five-dollar bill	"10.00"
1 ten-dollar bill	"20.00"

Checks and Credit Cards

Checks are usually accepted the same as cash from customers who are known in the shop. The manager will set a policy for approving checks. Often this includes asking for one or more pieces of identification (such as driver's license or credit card), or listing the customer's telephone number and address.

Credit cards like Visa or Master Card are accepted by many businesses. The appropriate form, along with the customer's card, is run through a machine that makes an imprint of the number on the card. The shop manager establishes the policy regarding what additional information should be requested from the customer. Some will require address or phone number on the form, while others call in for clearance or check published lists of card numbers that have been misused.



Cash registers are used to total individual orders and keep a record of sales



Symbols of credit cards and wire services used are posted on the flower shop door

5414938

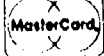

DO NOT CIRCLE EXPIRATION DATE — USE BOX BELOW

PRESS FIRMLY — USE BALL POINT PEN

EXPIRATION DATE <input checked="" type="checkbox"/> DATE CHECKED	QUAN	CLASS	DESCRIPTION	PRICE	AMOUNT
DATE			AUTHORIZATION	SERVER	SUB TOTAL
ID-CHECK NO -LIC NO STATE			REG/DEPT	CLERK	TAX
CUSTOMER SIGNATURE				TIPS	MISC
X				TOTAL	



SALES SLIP
THIS FORM TO BE USED WITH

SAFE/PERF U.S. Pat. 4,403,793

MERCHANT COPY

**SPLIT CARBONS
HELP PREVENT
FRAUD**

Credit card form



Selection guides are useful in showing customers sample arrangements that can be wired



The AFS selection guide is used as a colorful part of the store display
Flowers by Davids Square, Columbus

The salesperson should become familiar with the procedures for completing the sale with money, personal check or credit card, as well as the procedures for extending credit. Each transaction should be handled as smoothly and efficiently as possible.

TELEPHONE SELLING

Much of the selling in a traditional retail flower shop is done over the phone. The same principles of selling apply when dealing with customers over the phone as when dealing with them in person. The major difference is that on the phone, one is limited to word descriptions of the product being offered.

The people who answer the telephone should be thoroughly knowledgeable about products, prices and services offered by the shop. They should have a pleasant and confident telephone voice. They must be able to communicate verbally with the caller to determine the customer's needs, explain alternatives, and give assurance that the shop will be able to handle the order competently. If the salesperson has any doubt that the selection can be filled with the requested style or materials, the customer should be asked to give a second choice.

Information from a telephone order must be complete and legibly recorded. It should include:

- first choice of item to be ordered; (and second choice if necessary)
- message for the enclosure card

- name and address of the person or place receiving the flowers
- date and time the item should arrive at the destination
- name and address of the customer placing the order
- terms of the billing, including total cost and who will be responsible for the bill (name and address)

FLOWERS BY WIRE

Most full-service flower shops belong to one or more wire service organizations. Customers can place an order with a member flower shop in one city that will be filled and delivered in another city by another member florist. The wire service organization provides members with **selection guides** which show pictures of arrangements that can be ordered. Florists use the selection guide in selling, sending and filling orders.

The largest and best-known wire services in the U.S. are:

American Floral Services, Inc.
P.O. Box 12309
Oklahoma City, Oklahoma 73157-2309

afs

American Floral Services, Inc.

Carik Services, Inc.
P.O. Box 24286
Denver, Colorado 80224

Florafax International, Inc.
4175 South Memorial Drive
Tulsa, Oklahoma 74145

Florists' Transworld Delivery Association
(FTD)
29200 Northwestern Highway
P.O. Box 2227
Southfield, Michigan 48037

Redbook Floral Services
P.O. Box 258
Paragould, Arkansas 72451

Teleflora
2400 Compton Boulevard
Redondo Beach, California 90278

The New
FLORAFAX[™]
INTERNATIONAL



Carik
SOLUTIONS INC.

REDBOOK[®]
florist services

Teleflora



The Mercury console is used to send FTD orders
Maple Lee, Worthington

Some non-florist organizations also provide customers an opportunity to wire flowers to other cities. Examples include Flowers by Wire - Sears, Roebuck & Co., Flowers-By-Western Union, and 1-800-FLOWERS.

Wire services act as clearinghouses for orders sent by wire. Regular statements of incoming and outgoing orders are provided by their computer networks. Each member is identified by a code number. The code numbers of both sending and receiving florists are listed on all records of an order.

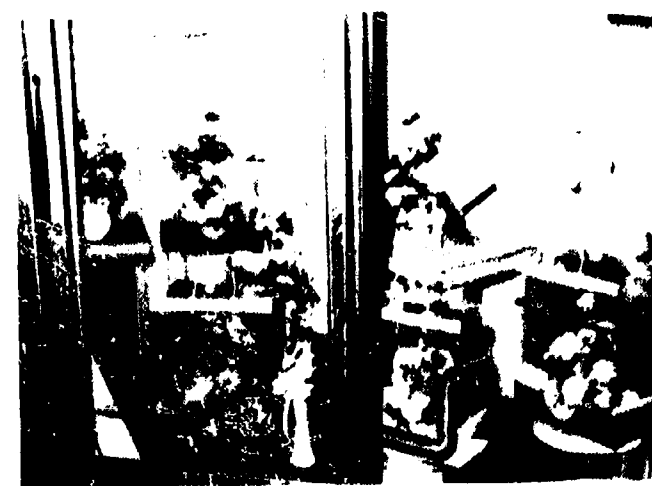
In the case of FTD, the organization has developed the Mercury Network which allows orders to be relayed efficiently to receiving florists through a central computer. Florists with a Mercury console type the information into the system. Both sending and receiving florists get a printed copy (hard copy) of the order. This is an

efficient and easy-to-use system that can be operated at a cost comparable to the telephone charges involved in calling member florists in the traditional way.

Wire organizations publish membership directories which list member florists. They look similar to big telephone books. If more than one florist is listed for a city, the names are rotated each time the list is printed so the same member is not always at the top of the list.

Wire service organizations have certain standards members must meet and rules they must follow. When florists apply for membership in the organization, they are not automatically guaranteed acceptance. Inspections of the shop are conducted and test orders sent to make sure that quality products of expected value are being produced.

In addition to the potential for increased sales, there are other advantages of belonging to a wire service organization. One is their extensive advertising program, including use of prime time television. The viewer frequently sees attractive FTD promotions of



Wire services promote special theme arrangements which are widely advertised



The arrangement created from a wired-in order should closely resemble the customer's choice at the local florist



European wire service organizations are linked to U.S. organizations so that flowers can be sent around the world by wire

their selection of everyday bouquets in addition to holiday and special occasion flowers. Wire services also wholesale merchandise used for their special bouquets as well as supplies, clothing (such as work smocks), signs and forms. They provide educational materials and programs for members to improve their design skills and business operations.

Magazines published by these organizations are yet another way to transfer information and stimulate florists to try new and better ways of doing things. Some of the more familiar trade magazines are:

Florist (FTD)
Flowers & (Teleflora)
Design for Profit (Florafax)
Professional Floral Designer (AFS)

Procedure for Handling Wire Orders

A customer can either telephone or visit a member shop in order to have flowers delivered in another city. A customer who comes to the shop in person can choose an arrangement from the selection guide. The one who calls will need a salesperson to suggest a selection that will be appropriate for the occasion and also will fall within the price range designated by the caller.

The salesperson should then take down the following information:

- description and price of the arrangement
- name and address of the customer

- name and address of the person who will be receiving the arrangement, including city or town and state
- when the arrangement is to be delivered
- what the enclosure card is to say

The florist then selects a receiving florist from the directory, writes down the shop code number, and places the order by telephone or enters it into the computer console (depending on the system being used). The customer's bill includes price of the arrangement plus telephone or transmittal charge.

The sending florist will receive between 10 and 20 percent of the value of the order. About 5 percent is retained by the wire service. The receiving florist must fill the order at its full value though receiving only about 75 percent of the value of the arrangement. A tally of incoming and outgoing orders for each member shop is kept by the wire service. At the end of the month the service sends the member florist either a check or a bill, depending on the transactions involved.

INTERNATIONAL FLOWERS BY WIRE

Flowers can be sent by wire to many parts of the world by the major wire service organizations. FTD's international organization is known as Interflora, Inc. Members from different countries use a common unit of value called a "fleurin" to avoid the confusion caused by the many different kinds and values of currency. Members also recognize certain standard

terms and definitions as established by the organization; examples are *arrangement*, *bouquet*, and *funeral sheaf*. This reduces misunderstanding over what is asked for and what is sent. Because of these international flowers-by-wire services, customers can send flowers to other parts of the world almost as easily as within the United States.

SUGGESTED ACTIVITIES

Selling and Taking Orders

A. Role-play situations in which one person acts as the salesperson and another person as the customer. The customer will present a certain need and the salesperson should react in an appropriate way.

Here are some suggestions:

1. A customer wants to wire flowers to an aunt's funeral in California.
2. A teenager wants to buy flowers for his girlfriend for the prom. He has never before been in the flower shop and does not know what he wants.
3. A middle-aged lady comes in to browse. She has a vague interest in some flowers for her home.
4. A garden club member comes into the store wanting supplies and some flowers for a club flower show.
5. A man comes in and wants to send a plant to a new business that is opening in town.

B. Prepare a short sales presentation to make to a customer who shows interest in a certain arrangement.

1. First make a list of descriptive words and phrases about the arrangement or flowers.
2. Think of different circumstances in which the arrangement might cheer someone up, delight someone, or make a situation more beautiful. Create word pictures to communicate these positive results.
3. Give your presentation to the class. Ask for reactions of your classmates to find out whether or not you have stimulated interest in buying the arrangement.

C. Practice answering the telephone with another student acting as the caller. Try handling some of the following situations that you might encounter.

1. A customer is ordering a centerpiece for a Saturday evening dinner he is hosting. He does not have a set price in mind.
2. A customer is complaining about an arrangement that was sent from your shop the week before. The flowers lasted only three days before they died.
3. A customer wants a dozen roses sent to his mother in New York City.
4. A lady wants to know what the store's credit policy is.

(continued)



Teleflora advertises worldwide delivery

DATE	A.M.	P.M.	CHARGE	C. O. D.	PAID				
Send to _____									
<table style="width: 100%; border: none;"> <tr> <td style="width: 60%; border: none; vertical-align: top;">Description</td> <td style="width: 40%; border: none; vertical-align: top;">Phone</td> </tr> <tr> <td style="border: 1px solid black; height: 200px;"></td> <td style="border: 1px solid black; height: 200px;"></td> </tr> </table>						Description	Phone		
Description	Phone								
Card									
Charge to _____									
<table style="width: 100%; border: none;"> <tr> <td style="width: 40%; border: none;">WIRE</td> <td style="width: 20%; border: none;">Phone</td> <td style="width: 40%; border: none;">Code No.</td> </tr> </table>						WIRE	Phone	Code No.	
WIRE	Phone	Code No.							
IN	OUT	FTD	TF	FX	AFS	Other			
Printed in USA THE JOHN HENRY CO. Lansing MI 48901 CA0151									

5. A man wants to have the FTD valentine special bouquet sent to his wife.

D. Practice writing up an order on the form provided on this page, using the following information.

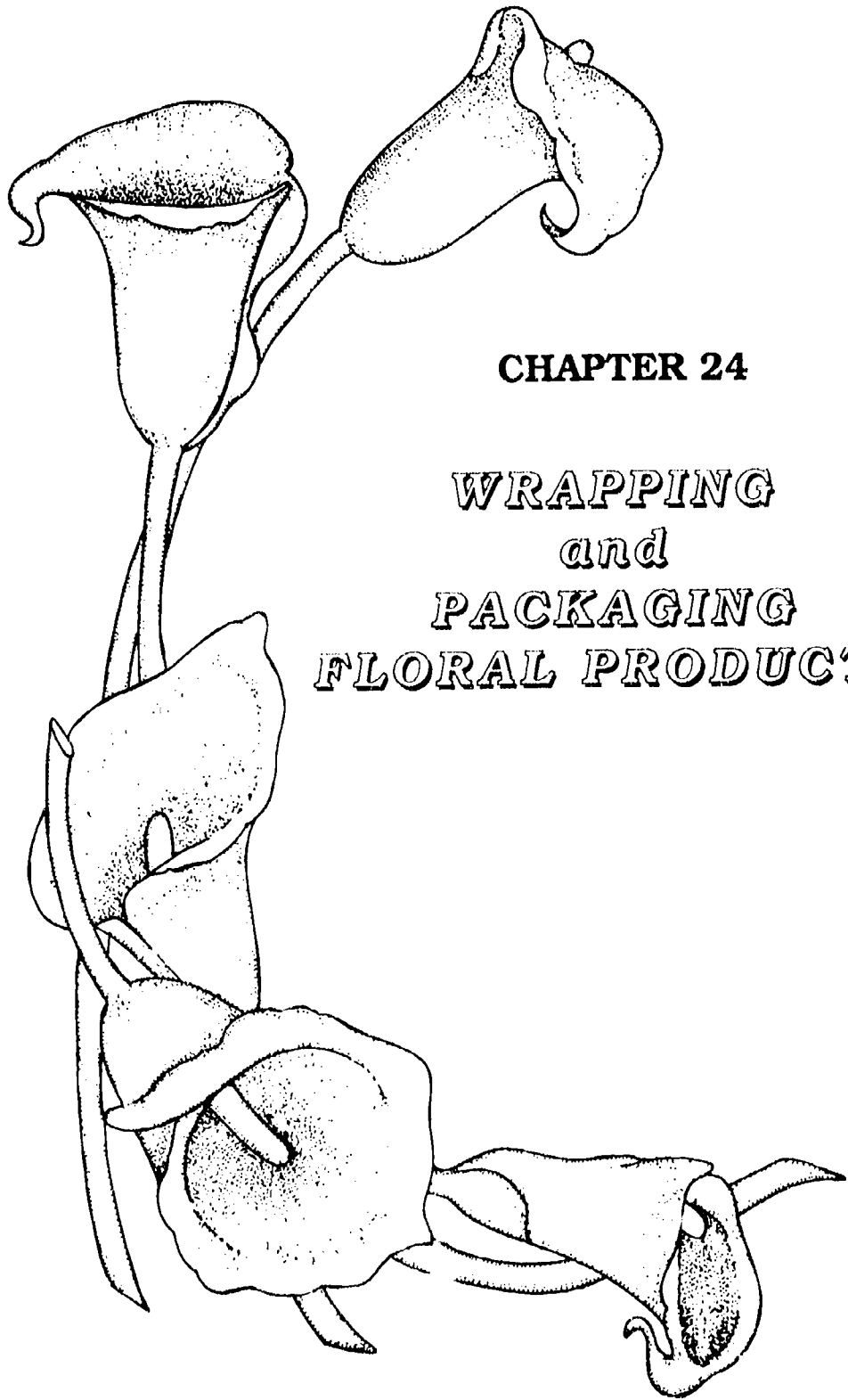
The order was called in by Mrs. Marjorie Harrington who lives at 310 North Rowe Street, West Salem, Ohio 44287. Her phone number is 843-8993. She has ordered a \$35 centerpiece arrangement of spring flowers to be sent to her sister, Mrs. Dorothy Arnold of Route 1, Wapwallopen, Pennsylvania. The arrangement is for her birthday and should be delivered on April 4. She wants the card to read, "To a dear sister on her birthday." The arrangement is to be charged to Mrs. Harrington's account at your shop. You send the order to Teleflora shop 907 in Pennsylvania. The phone call is \$1.80 and the tax on the order is \$1.58.

E. Practice making change for various sales. Obtain or make paper money but use real coins. Count out the change as you give it to the customer.

<i>Amount of sale</i>	<i>Amount given</i>
\$1.62	\$2.00
\$5.37	\$10.00
\$12.15	\$20.00
\$17.02	\$20.02
\$8.44	\$20.00
\$10.97	\$21.00

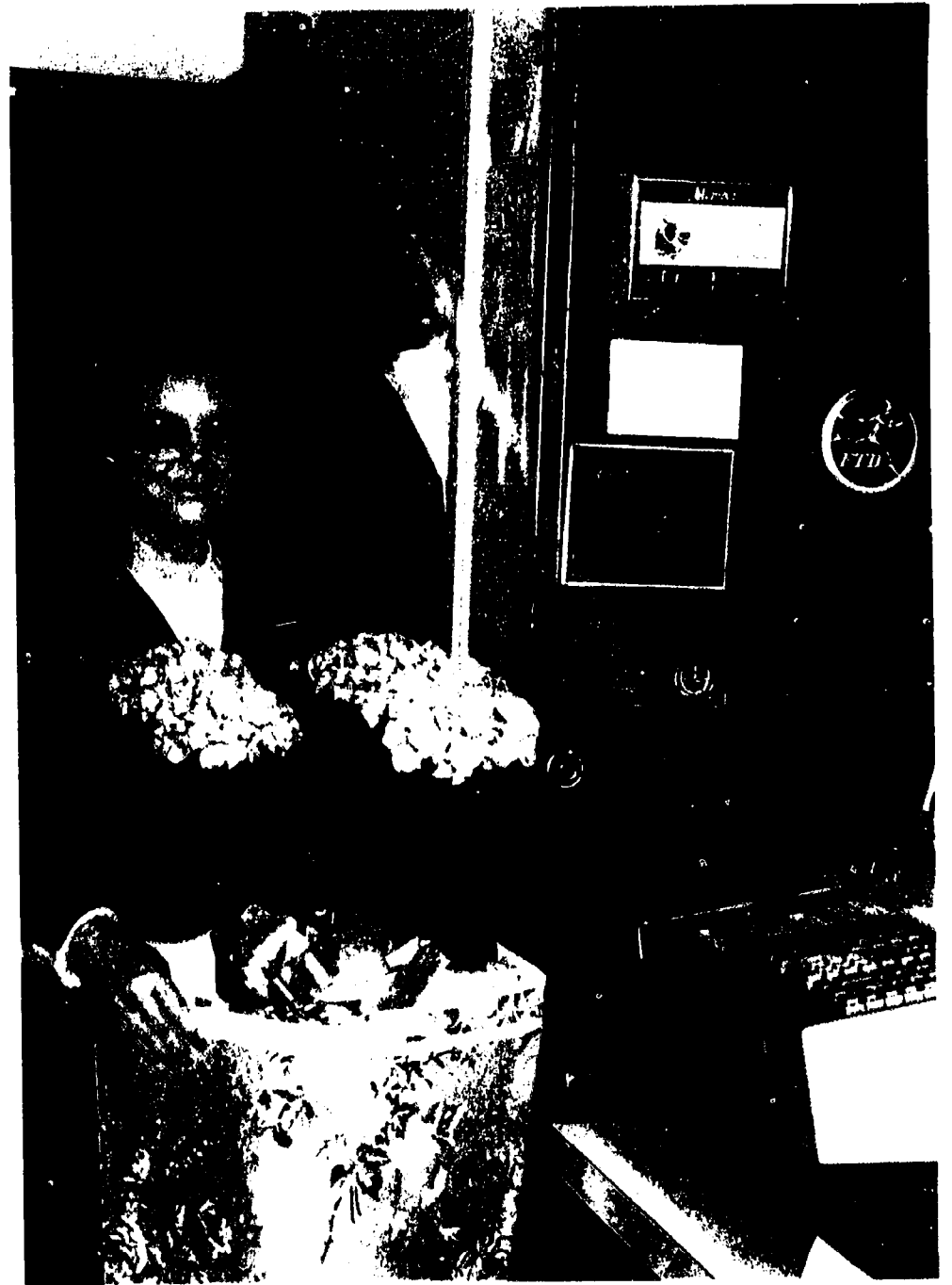
742

742



CHAPTER 24

**WRAPPING
and
PACKAGING
FLORAL PRODUCTS**



Hemmerly's, Marion

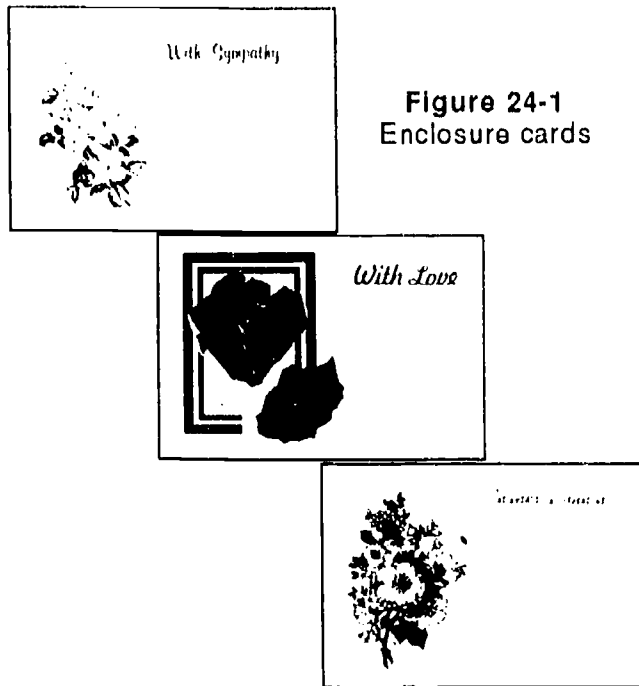


Figure 24-1
Enclosure cards

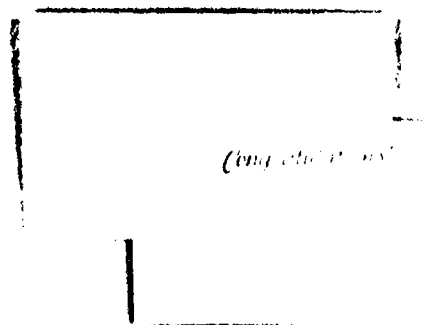


Figure 24-2 Enclosure card with envelope

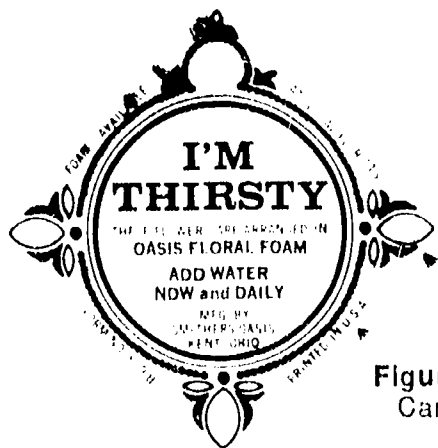


Figure 24-3
Care tag

Arrangements, bud vases, bunches of flowers, corsages and potted plants should all be wrapped neatly before they leave the shop. The wrapping will allow customers or delivery people to carry the purchases easily. It will also protect the flowers from cold temperatures, drying winds, and mechanical injury.

An enclosure card may be included if the purchase is a gift. (See Figures 24-1 and 24-2.) If it is to be delivered, the name and address of the recipient should be listed on the outside of the card. Care tags for arrangements, cut flowers or potted plants can be included with the packaging (Fig. 24-3). These tags will remind customers of things they can do to prolong flower life, thus lengthening the time they have to enjoy the purchase or gift.

Items commonly on hand in flower shops for wrapping and packaging are listed as follows:

Packaging Materials:

- green waxed tissue paper
- wrapping paper on a roll
- shredded waxed tissue paper
- rose boxes
- corsage boxes and/or corsage bags
- plastic bags in assorted sizes
- plastic boxes
- plant sleeves
- cardboard boxes and delivery bases

Other Supplies:

- cellophane tape
- staples
- enclosure cards
- care tags
- ribbon
- florist foil

Tools:

- ribbon scissors
- floral shears
- stapler
- knife
- plant sleeving stand

POTTED PLANTS

Prepare potted plants for sale by cleaning the pot and plant, wrapping the pot with decorative foil, adding a bow, and attaching a care tag to the stem of the plant. Usually this is done before the plants are placed on display in the shop.

Packaging foiled plants for removal from the shop is most easily done by using a **sleeve**, a cone-shaped piece of wrapping paper or plastic. An efficient and trouble-free way to slip on the sleeves is to use a **sleeving stand**, a vertical rod about 36 inches high with a small platform at the top (Fig. 24-4). Paper or plastic plant sleeves are put in place over the sleeving stand. Slip one sleeve on the stand at a time, or a large bunch if you will be doing a lot of sleeving. Place the potted plant on the small platform and pull a sleeve up around the plant. Then lift the sleeved plant off the stand by holding on to the sleeve. If the plant is not too heavy or fragile, it can even be carried by the sleeve. Or play it safe and carry the plant with one hand under the pot and the other holding on to the sleeve. Fold the top of the sleeve over and staple it shut. Then, if it is going to be delivered by the shop, tag the sleeved plant with gift tag and delivery instructions.

WRAPPING CUT FLOWERS

The following procedure is for packaging most kinds of cut flowers using paper. However, very special or expensive flowers, like long-stem roses, should be packaged in a box. (They will be discussed next.)

1. Tear a rather large piece of wrapping paper from the roll and lay it on the counter.
2. Lay a piece of waxed green tissue paper on the wrapping paper.
3. Lay a few pieces of foliage (such as leatherleaf or huckleberry) diagonally on the paper, pointed toward one corner.
4. Lay the flowers on top of the foliage (Fig. 24-5). Spread them out a little, if necessary, so they don't lie on top of each other.
5. Fold one corner of the paper over the stem ends. Then roll or wrap the rest of the paper around the flowers so they are rolled up inside (Fig. 24-6). The paper will be cone-shaped, tighter around the stem end and flared out where the flowers are.
6. Fold the open end of the paper over the flowers, and staple (Fig. 24-7).



Figure 24-5



Figure 24-6

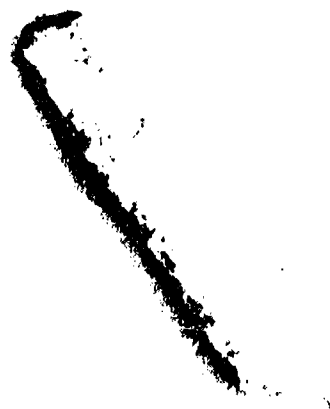


Figure 24-7



Figure 24-4
Sleeving stand
with plastic sleeves



Tag that indicates
the plant is sold



Wrapping cut flowers at the sales counter

ROSES IN A BOX

Rose boxes are long narrow boxes with lids that will hold a dozen roses. The boxes are sold flattened and must be bent into shape before use.

Rose thorns are usually removed with a metal stem stripper or by rubbing down the lower part of the stem with a soft cloth. Machines are available that mechanically remove the thorns without damaging the rose stem (Fig. 24-8).

Since roses are quite perishable, some florists choose to include a piece of soaked, foiled floral foam in one end of the box; the stems can be inserted into this foam. Also available are small water packs containing soaked foam which can be stapled in the end of a box. Or, roses can be and frequently are packaged without soaked foam, as in the following example.

1. Shape a rose box with its accompanying lid. (See Figure 24-9 for materials needed.)
2. Line the box with waxed green tissue paper, allowing ample paper to extend beyond the edges of the box (Fig. 24-10). This will later be folded over the flowers.
3. Place a layer of foliage (leatherleaf or huckleberry) in the bottom of the box.
4. Arrange the roses in neat rows with about three roses to a row (Fig. 24-11). Each row should be slightly below the previous one so that no flower heads are hidden.

5. Place a few pieces of foliage on top of the lower part of the stems. Some baby's breath may be placed on the foliage.
6. Fold the tissue paper neatly over the flowers.
7. Place the lid on the box.
8. Wrap #9 satin ribbon around the box and attach a bow (Fig. 24-12). A few pieces of leatherleaf and baby's breath may be hot glued between the ribbon loops for a special look.
9. Place the enclosure card in an envelope. Write on it the name and address of the person to whom the flowers are to be delivered and attach it to the rose box.



Figure 24-8 A mechanical rose stripper



Figure 24-9

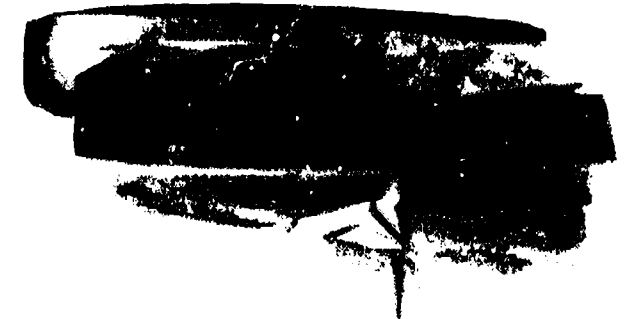


Figure 24-10



Figure 24-11



Figure 24-12

CORSAGES and BOUTONNIERES

Corsages can be packaged in cardboard or plastic boxes or placed in cellophane bags. Before they are inserted, the flowers should be misted lightly with a fine spray of water to help keep them fresh.

If a cardboard box is used, first open the box and place a layer of shredded waxed tissue paper on the bottom. Lay the corsage and/or boutonniere with attached pins on the shredded paper. If there is an enclosure card, it can be put inside the box. Close the lid and tag the box for delivery.

When using a cellophane bag, first insert your hand in the bag to open up the end folds, making the end of the bag somewhat square. Place a layer of shredded waxed paper in the bag and lay the misted corsage on the paper. Fold over the open end of the bag twice, but make sure the cellophane is not pressing on the flowers. Secure folds with two corsage pins, one at each side of the bag. (See Figure 24-13.)

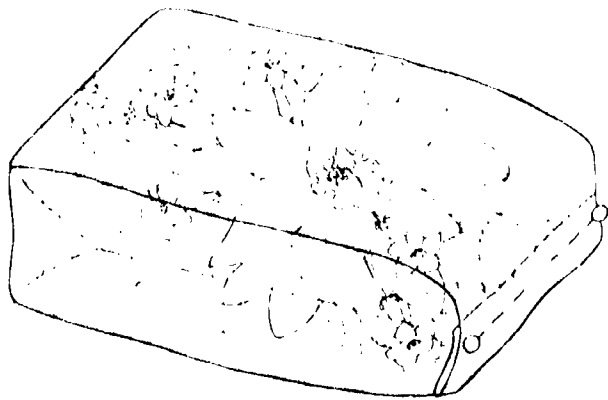


Figure 24-13 Cellophane corsage bag

A rigid plastic box may be used instead (Fig. 24-14). Like a cellophane bag, it will allow the corsage to be seen through the wrapping. Place a layer of shredded waxed paper in the bottom to cushion the flowers. With either rigid plastic or cardboard boxes there is less danger of the flowers being crushed, and the boxes can be stacked.

ARRANGEMENTS

A simple wrapping for arrangements that are in stable containers is to place them in the center of a large piece of tissue or wrapping paper. Bring the ends up, fold them over, and staple them (Fig. 24-15). Then fold and staple the larger pleats of paper so the wrap loosely conforms to the shape of the arrangement. Plastic sacks can be used instead, slipped over arrangements and stapled (Fig. 24-16).

When a pedestaled container needs to be packaged, a cardboard base can be stapled around it to give stability to the arrangement (Fig. 24-17). This will help keep the arrangement from tipping over when it is transported. Paper can then be wrapped around the arrangement as with any other design.

A small arrangement can be made stable by loosely wrapping its base with waxed tissue paper and placing it in a box that is slightly larger than the arrangement (Fig. 24-18). Extra tissue paper carefully crumpled in the corners of the box will help keep the arrangement from shifting. If the box is tall enough, it can be closed over the arrangement. If not, in cold weather a tent of waxed tissue paper can be taped over the top. In warm weather no covering may be required.



Figure 24-14 Rigid plastic corsage box



Wrapping paper on a roll in a metal holder



Figure 24-15
Tissue paper around an
arrangement



Figure 24-16
Plastic sack stapled around an
arrangement



Figure 24-17
Cardboard base stapled around
a pedestaled container

Care tags, enclosure cards and delivery instructions should be attached to the arrangement. A plastic card pick is often used (Fig. 24-19), inserted into the foam. Often a small packet of floral preservative is included for use when watering the arrangement.

DISH GARDENS

Living plant groupings should be sent out with clean containers and properly watered plants. As an extra touch, plant shine is sometimes applied to the leaves of foliage plants to make them glossy. However, if too heavily applied to both upper and lower leaf surfaces, plant shine will reduce the food-making ability of the plant.

Enclosure cards can be placed in plastic card picks and inserted into the soil. Packaging consists of wrapping the dish garden with waxed tissue paper and placing it in a cardboard box (Fig. 24-20).



Figure 24-18 Arrangement cushioned in a box
with tissue paper



Figure 24-20 Dish garden wrapped with
tissue and placed in a box

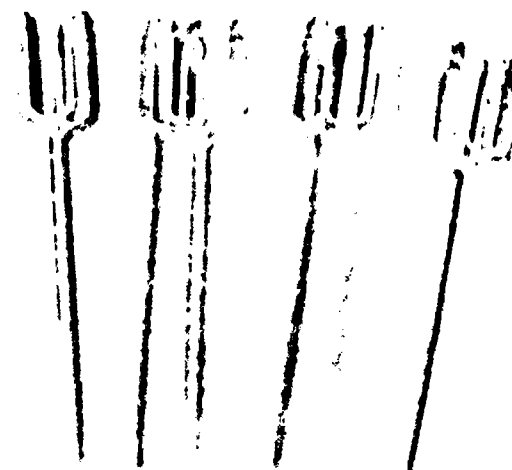


Figure 24-19 Plastic card picks

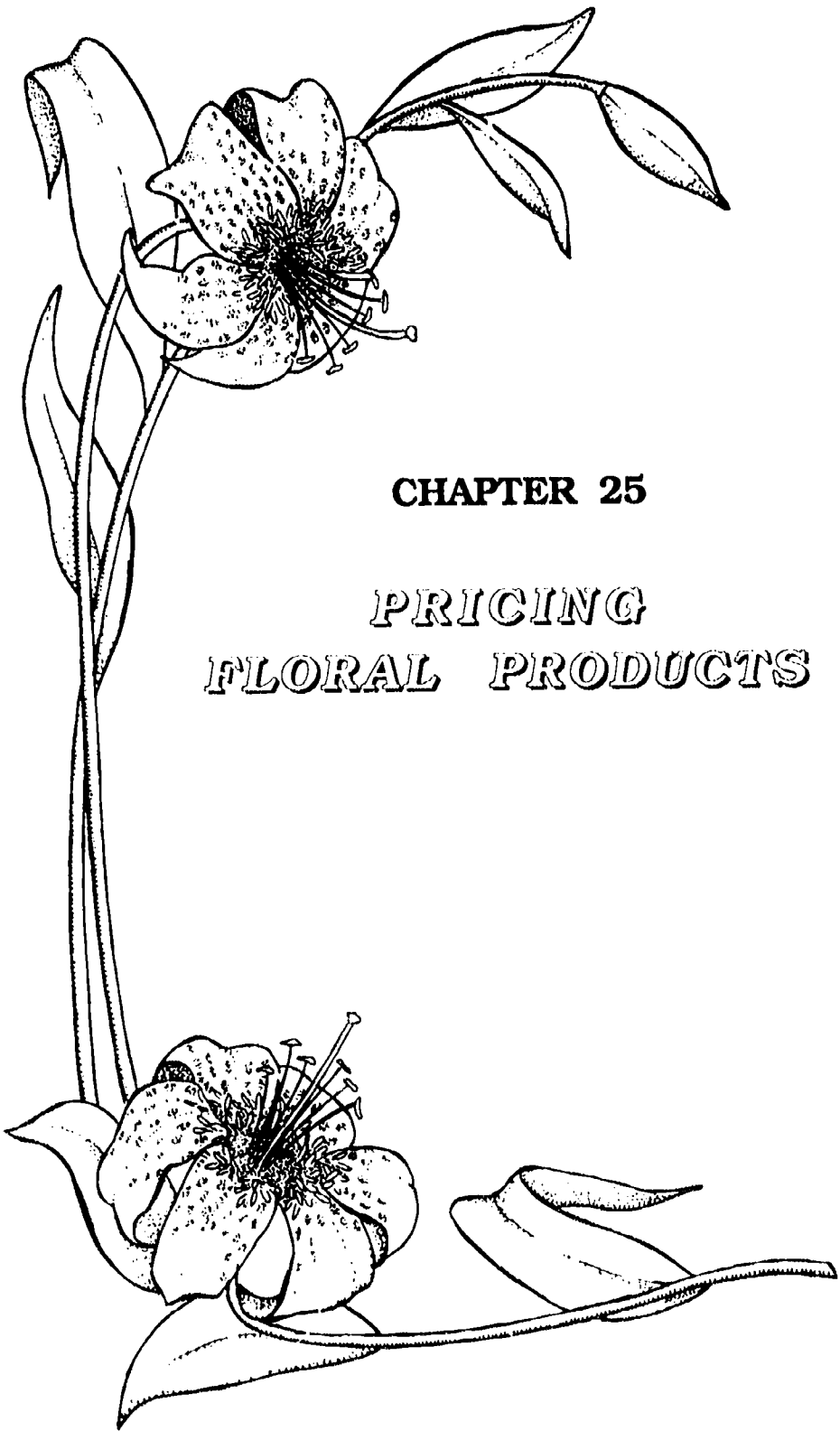
SUGGESTED ACTIVITY

Practice wrapping and preparing for delivery as many of the following products as are available to you. Include enclosure cards, care tags, and delivery instructions. Check for neatness and attractive presentation of the product.

1. 6-inch potted chrysanthemum
 2. bunch of mixed flowers and foliage
 3. one dozen roses and leatherleaf
 4. corsage and boutonniere
 5. triangular arrangement in a pedestal container
 6. small arrangement in a teacup
 7. dish garden
-



Arrangement in a cardboard delivery box



CHAPTER 25

**PRICING
FLORAL PRODUCTS**





Each business must determine a pricing system that will result in profit for the business - *Connell's, Columbus*

The manager of a flower shop must determine a pricing system that will result in a profit for the business. Because the cost of running each business is different, and sales volume varies from one business to another, the same pricing policy will not work for all shops. Pricing also depends on the demand that exists for a certain item and what the competition is charging. The type of community in which a shop is located will also influence prices. Roses may sell for \$100 a dozen in New York City for Valentine's Day, but that does not mean that a similar amount could be charged in Wooster, Ohio.

The wholesale cost of flowers and plants also changes with time. Flowers that are available at a reasonable cost during the season when they are most commonly produced, can be very costly out of season. Heavy demand for flowers for a holiday like Valentine's Day will also increase their wholesale cost. If a florist keeps a fairly steady price on a given arrangement, the profit will be higher at some times and lower at others.

Some arrangements can be made up quickly, while others are more time-consuming. Corsages and wedding flowers often involve a great deal of labor. Arrangements with many placements usually require more time than arrangements with fewer flowers. Gift items require only the time involved in handling them, but they may sit in the shop for a long time before being sold.

The manager must weigh all these considerations and then decide what system of pricing will work in different situations. The following sections discuss several methods that are used.

RATIO MARKUP METHOD

The easiest method of pricing is to figure the total wholesale value of the material in a product and multiply it by a certain number. Since some products require more labor than others and some items are more perishable than others, it is logical to expect the multiplying number to be different for different items.

When the value of the material is multiplied by two, the markup is said to be 2 to 1. When it is multiplied by three, it is 3 to 1, and so on. Below are possible categories of markups.

Markup	Types of Items
2 to 1	gift items, supplies, hard-goods, cash-and-carry cut flowers and plants
3 to 1	basic arrangements, bud vases, boxed flowers, decorated plants
4 to 1	creative designs, basic corsages
5 to 1	wedding flowers, party flowers, designs requiring a great deal of time and special attention

Example:

Cost of materials for a basic round centerpiece may add up to \$5.00. This would be the wholesale cost for the flowers, foliage and container.

1/2 bunch pompon mums	\$1.25
1/3 bunch leatherleaf	.50
1/6 bunch statice	.50
7 carnations	1.75
1/3 block floral foam	.25
container	.75
	<hr/>
Total wholesale cost of materials	\$5.00

Using a 3 to 1 markup, multiply \$5.00 by 3 to get a retail selling price of \$15.00.

$$\begin{array}{r} \$5.00 \text{ wholesale cost of materials} \\ \times 3 \\ \hline \$15.00 \text{ retail selling price} \end{array}$$

WHOLESALE PRICING METHOD (40% of Retail Selling Price)

Another pricing method is based on the concept that 40 percent of the retail selling price should be made up of the wholesale value of the materials used, while the remaining 60 percent should cover costs of running the business and should generate a profit. This relationship is shown by the following formula:

$$0.4 \times \text{retail selling price} = \text{wholesale cost of materials}$$

This formula can be used as a guideline for a florist in planning how much material can be put into an arrangement that is to sell for a set price. For example, an arrangement that retails for \$20 should have no more than \$8 worth (wholesale cost) of materials, as shown by the following calculation:

$$0.4 \times \$20 = \$8$$

or

$$\begin{array}{r} \text{retail selling price of arrangement} \quad \$20.00 \\ 40\% \quad \times \quad 0.4 \\ \hline 8.000 \\ \text{or } \$8.00 \end{array}$$

This formula can also be used in another way - to determine the price of an arrangement. If you have used \$10 worth of materials in an arrangement, you will find that you should charge \$25 for the arrangement.

$$0.4 \times \text{retail selling price} = \text{wholesale cost of materials}$$

or

$$\text{retail selling price} = \frac{\text{wholesale cost of materials}}{0.4}$$

$$\text{retail selling price} = \frac{\$10}{0.4}$$

$$\frac{25.00}{0.4} = \$25 \text{ retail selling price}$$

NESTING PRICING METHOD

At times a person buys wholesale for a single price a collection of items of various values. The price of each unit within the group must then be determined. Sometimes these individual items are packed or *nested* one inside the other. Therefore, this method of determining the price of each unit within the nest is called the **nesting pricing method**.



Wholesale prices marked on cooler door
Don Johnson Florist, Lima

Problem:

A nest of three baskets is purchased for a wholesale cost of \$6.50. Determine the wholesale value of the small basket, the medium basket, and the large basket.

Solution:

- Number each basket starting with 2 and add the numbers together.

small basket	2	
medium basket	3	
large basket	4	
	<u>9</u>	total number

- Divide the total number into the purchase price and round off to the next highest number.

$$\begin{array}{r} .72 \\ 9 \overline{) 6.50} \\ \underline{63} \\ 20 \\ \underline{18} \\ 2 \end{array} \quad \text{Round off to } \$.73$$

- Multiply the above value by the number assigned to the individual basket to get the wholesale value for that item.

$$\begin{array}{r} .73 \\ \times 2 \\ \hline \$1.46 \end{array} \quad \text{wholesale value for small basket}$$

$$\begin{array}{r} .73 \\ \times 3 \\ \hline \$2.19 \end{array} \quad \text{wholesale value for medium basket}$$

$$\begin{array}{r} .73 \\ \times 4 \\ \hline \$2.92 \end{array} \quad \text{wholesale value for large basket}$$

\$6.50 wholesale value for the collection

\$1.46	\$2.19	\$2.92	
small basket	medium basket	large basket	

- The markup is added on top of the wholesale price to determine the retail price charged to the customer.

Sample problem courtesy of Karen Wellbaum, Montgomery County Joint Vocational School

RETAIL COST OF GOODS METHOD

A fourth method of pricing involves figuring the retail value of each part of an arrangement using the ratio markup method and then adding a percent of profit that is wanted for the business. In the following example this percent of profit is 10%. The ratio markup that will be used is 2 to 1 for the container, mechanics, greens and accessories, and 3 to 1 for the flowers.

Example:

An arrangement includes the following materials at the prices indicated:

- 1/2 bunch pompon mums (\$2.50/bunch)
- 10 carnations (\$0.30 each)
- 1/3 bunch huckleberry (\$2.55/bunch)
- 1/3 block floral foam (\$0.75/block)
- 1 container (\$9.00/dozen)

First figure the wholesale cost for the exact amount of each material used. Then list the appropriate markup for the item (either 2 to 1 or 3 to 1). Calculate the retail cost of each item. Add the retail costs together to obtain the total retail cost of materials in the arrangement.

Wholesale Cost	Amount	Materials	Markup Ratio	Retail Cost
\$1.25	1/2 bunch	pompon mums	x 3	\$3.75
.85	1/3 bunch	huckleberry	x 2	1.70
3.00	10	carnations	x 3	9.00
.25	1/3 block	floral foam	x 2	.50
.75	1	container	x 2	1.50
Total retail cost of materials				\$16.45

Next calculate the 10% profit. Multiply the total retail cost of materials by 0.1. Then add this figure (profit) to the total retail cost of materials to get the retail selling price. The following calculations show that the retail selling price of this arrangement should be \$18.10.

Total retail cost of materials	\$16.45
10% Profit	<u>x 0.1</u> 1.645
	= \$1.65
Total retail cost of materials	\$16.45
Profit	<u>+ 1.65</u>
Retail selling price	\$18.10

RENTALS

Florists often have for rent items that are used by customers on a one-time basis. Items such as candelabras, kneeling benches, pedestals, aisle posts, fountains, large urns, and canopies may be used for weddings or parties. They enhance the over-

all floral decorations by serving as props to hold or display flowers. For a one-time event, renting these items is less expensive for the customer than buying them. Some florists also offer for rent large living plants or palm holders (metal tree forms) which they fill with fresh cut palm foliage.

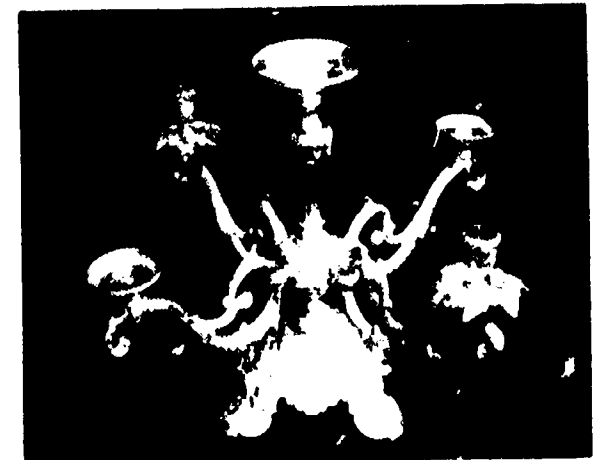
A price must be established for the rental of each item. This will depend on the initial cost of the item, its life expectancy, and the difficulty in storing the item. Living plants must be priced higher than other items because of the expense of maintaining them, the difficulty in moving them, and the rather high probability of damage or rapid decline while they are being rented.

One possible guideline for pricing supply-type rentals is 10% of the value of the item. In theory the initial cost would be recovered after ten rentals. However, in practice this is not the case, since an investment has also been made in upkeep and repair, transportation, set-up and take-down time, as well as storage of the item between rentals.

Rental Items



Urn



Candelabra



Kneeling bench

SUGGESTED ACTIVITIES

	Markup Ratio	Retail Selling Price
triangular arrangement (\$4.00)	_____	_____
Oriental vase (\$7.50)	_____	_____
single spray corsage (\$1.75)	_____	_____
wedding bouquet (\$6.50)	_____	_____
cash-and-carry foliage plant (\$0.75)	_____	_____

1. Use the ratio markup method to determine the retail selling price of the items listed to the left. Their wholesale value is included in parentheses.

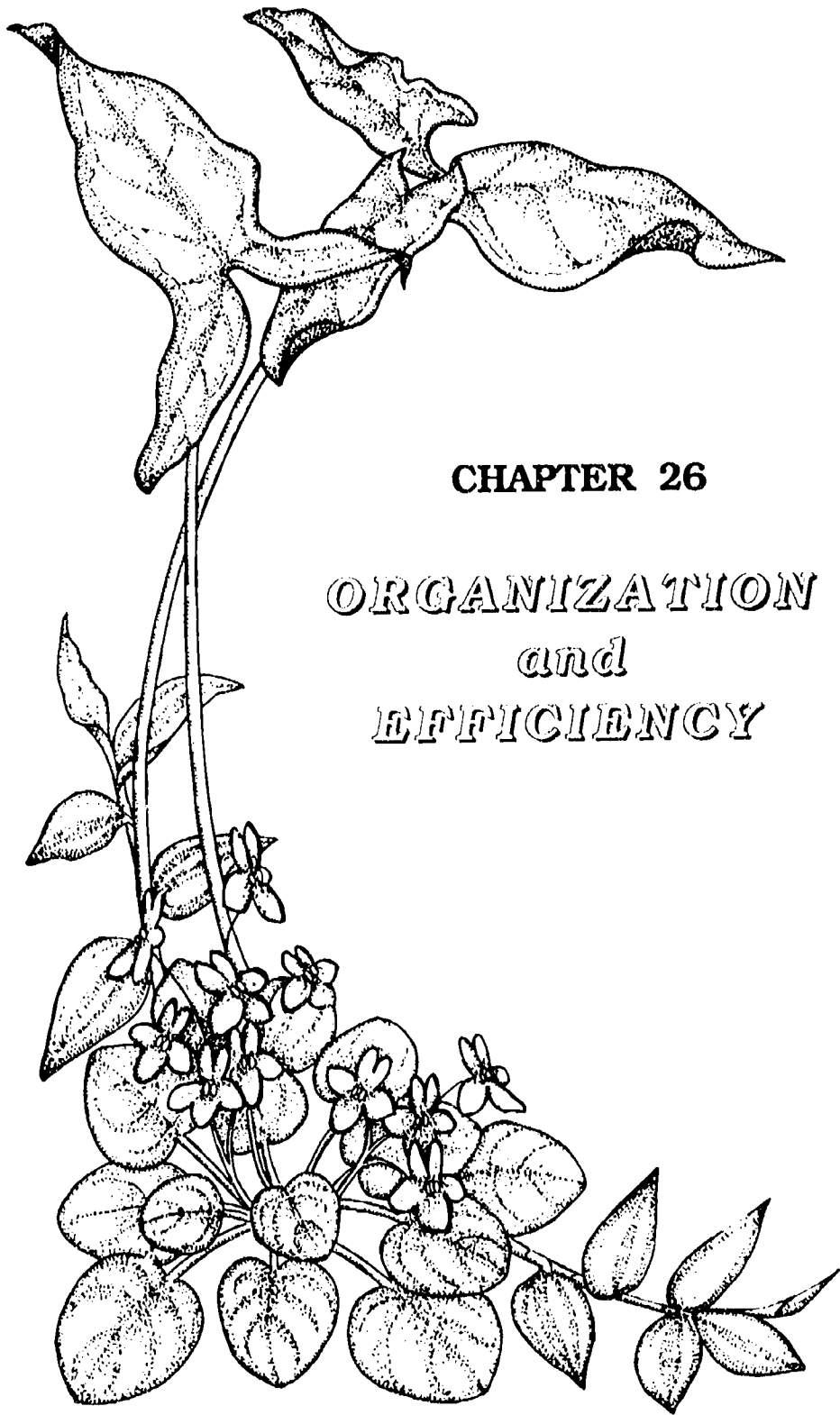
2. Use the wholesale pricing method (40% of retail selling price) to determine the following information.

A. If a customer orders a \$15 arrangement, what is the total wholesale value of the materials you can use in it?

B. If you use \$6.50 worth of materials in an arrangement, what should you sell the arrangement for?

3. Use the *retail cost of goods* pricing method to calculate how much you should sell an arrangement for if it contains the following materials. Wholesale prices have been listed in parentheses. Use the same markup ratios and profit percentage that were used in the example in this chapter.

- 12 snapdragons (\$5.00 for a bunch of 10)
 - 1/6 bunch baby's breath (\$6.00/bunch)
 - 7 carnations (\$0.30)
 - 1/2 bunch huckleberry (\$2.50/bunch)
 - 1/2 block floral foam (\$0.50/block)
 - 1 container (\$1.25 each)
-



CHAPTER 26

**ORGANIZATION
and
EFFICIENCY**



Don Johnson Florist, Lima



Figure 26-1 Hanging orders on a pegboard
Connell's Flowers, Columbus



Work area - *Connell's Flowers, Columbus*



Work area - *Maple Lee, Worthington*

Since a large part of the cost of operating a flower shop is in labor, everything possible should be done to maximize the efficiency with which the work can be accomplished. While some of the efficiency can be brought about by the shop layout, more can be obtained by organized methods of doing things. Keeping good records, organizing large projects, and maintaining a neat work area can all contribute to improved efficiency.

WORK AREA

Designers need a work table or bench that is conveniently located near the storage cooler, supplies and sink. It is helpful if there are shelves or drawers near the work bench for storing tools and supplies that are frequently used. An alternative is to use pegboards with hooks for hanging up tools, supplies and order forms (Fig. 26-1). Pegboards also offer the advantage of locating a particular item at a glance.

Design tables for making up arrangements should be at a convenient height for working while standing up. This is usually more efficient than sitting down, since the designer needs to walk around frequently to get supplies and also will be able to view the arrangement at a better angle. The design table, therefore, should be higher than a table one would sit at - usually about 40 to 42 inches high.

Corsage-making, however, involves a lot of wiring and taping that can be done just as well sitting down. A separate corsage-making center, where all the appropriate supplies are located, could be established at

a lower table. To be efficient the supplies should always be within reach of the designer even when sitting down.

Separate containers for trash and scraps of floral foam will be needed near the work area. Often foam and styrofoam scraps are saved to use as filler in certain kinds of containers. Different styles of brooms and dust pans for both floor and table tops are used to keep the area neat and tidy.

An area with a deep sink and water supply is needed for receiving and processing cut flowers. Efficiency is improved if a supply of clean storage containers is kept near this sink. Also, tools like counter-mounted stem cutters, machines to strip off thorns, and floral preservative dispensers should be kept nearby. Screens to prevent clogging of the sink and a drain in the floor near the sink will help avoid time-consuming unclogging operations or mopping up of spills.

A planned receiving and storage area for non-perishable supplies and merchandise should be set up. In large shops there may be less confusion if this area is separate from the flower-receiving area. It should be conveniently located and well organized so that both designers and salespeople can find the items they need.

SALES AREA

The sales area showroom is separate from the work area, but they often are connected by a large open window or door to make communication and movement of products easier between the two areas. The

sales area should be neat and appealing with adequate floor space for customers to move about. Features usually found in the sales area include:

1. wrapping/sales counter with cash register (Fig. 26-2)
2. display refrigerator holding made-up arrangements and cut flowers for sale
3. display shelving, tables or racks holding merchandise, arrangements and plants for sale
4. consultation area with table and chairs

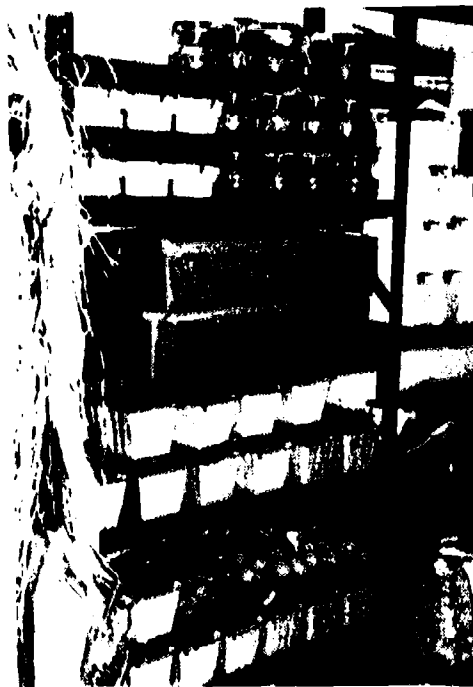
The arrangement of the sales area will depend on the size and configuration of each individual shop. However, a key point should be to provide a good traffic flow pattern within the area. The display cooler should be prominent, perhaps opposite the front door because of its potential value as a sales tool.

The wrapping and sales counter should be easy to access from any display area in the shop. It is usually near the back of the shop between display area and workroom. This will draw customers through the display area and give salespeople easy access to the design room and supplies. Located on or near the sales counter are items like cash register, telephone, sales tax and credit information, boxes, bags, wrapping paper, and all other tools and supplies needed to package up the merchandise. Selection guides from various wire organizations may also be placed here.

A consultation area for weddings, funerals and special events will ideally be a separate room if space permits. If this is not possible, a table and chairs for consulting can be placed in a more out-of-the-way corner of the store. Useful items to have on hand in this area are selection guides, albums of pictures showing other work done by the shop, perhaps sample bouquets made of silk flowers, and order forms.

STORAGE and INVENTORY

Containers, foam, accessories and supplies of all types must be unpacked and stored until they are used in arrangements or put on display in the sales area. The items that are used frequently must be stored in a convenient location. Supplies that are used less often or are seasonal may be put in a less accessible place.



Well organized storage area
The Flower Gazebo, Findlay



Figure 26-2 Wrapping/ sales counter
ATI, Wooster

Two Sales Areas - *Maple Lee, Worthington*





Sales area - Maple Lee, Worthington

All the supplies that are on hand in a shop collectively make up its **inventory**. The faster these items can be sold or "turned over," the more profit the shop can make. Sometimes supplies are bought in advance and stored for some time before being used because they are seasonal or unique. They may not be available year-round, so must be purchased when the opportunity arises. Another reason for buying in advance or buying in larger quantities is that often items are offered at a special reduced price, or substantial savings are realized when buying in larger amounts. These opportunities, plus the amount of storage space available, will influence the amount of early buying that is possible. In any case, the buyer should have a fairly clear idea of how the items are going to be used. Bargain merchandise that nobody wants to buy will sit unused on the shelves and represents wasted money.

The method chosen for keeping track of inventory is a management decision. The larger shops use computers as a valuable and time-saving way of knowing exactly what items are on hand and the price that was paid for them. In smaller operations purchase records should be kept systematically in notebooks. Another way to help keep inventory organized is to tag each in-coming item with a price and also a code indicating the supplier and the date received.

Some items are in the shop only a few days before they are sold, while other items sit on the shelf for several months. The number of times the same item could be sold in a year is called its **turnover rate**. A higher turnover rate is desirable because it means

more profit. Turnover rates in an average flower shop have been estimated as follows:

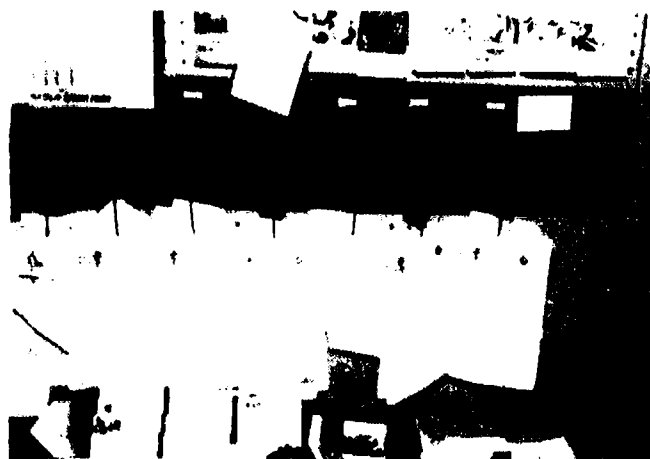
cut flowers	175
plants	90
gifts	3
other merchandise	6
<hr/>	
<i>total average</i>	23

A total accounting of inventory may be taken monthly, at the end of each season, or at the end of the year. It is important to know the total inventory for the year in figuring profit and for tax and insurance purposes. Salable items are divided into categories, listed and counted. The unit price of each item is multiplied by the number of those items in the inventory. These figures are then added together to give the total amount of money invested in the inventory.

PLANNING for HOLIDAYS and IMPORTANT EVENTS

Special holidays for which flowers are traditionally purchased, or weekends with large wedding or party orders are busy times for florists. If the work is to be handled efficiently, some thoughtful planning needs to be done. Of course, florists are sometimes pressed for time if they get an unexpected large funeral order or a rush of last-minute orders. Usually, however, florists can anticipate busy times, based on past experience, and plan ahead for them.

Here are some suggestions for handling busy times in the flower shop.



Orders organized by day on hooks near the telephone - Kiefer's Floral, Coshocton

- Have needed supplies on hand and organized in advance.
- Place the flower order with wholesalers at least a week in advance, and earlier if special items are requested.
- Prepare containers with soaked foam and green-in the basic shapes with foliage several days in advance of adding the flowers. (See Figure 2C-3.)
- Begin wiring long-lasting foliage for corsages or bouquets a couple of days in advance. Then wire the long-lasting flowers and leave only the very delicate ones for last.
- Even working alone, set up an assembly line procedure whenever you can. It is usually more efficient to perform the same step on all pieces before moving on to the next operation.
- If several people are working on a project, assign certain steps to each one rather than having each person do all the steps. People usually become more efficient when repeating the same task rather than switching from task to task.

TAKING A WEDDING ORDER

Once a prospective bride has chosen a color scheme, selected the dresses, and determined the size and location of the wedding, she is ready to visit a florist and place her wedding order. It works best if the bride makes an appointment with the florist for a time that is convenient for both parties.

The consultation should take place wherever there is the least chance of being interrupted. A separate consultation room, if available, is ideal because it also allows the florist to display pictures, books and sample bouquets. These items create a pleasant atmosphere and help sell the wedding flowers.

A wedding order usually involves several bouquets, corsages and arrangements. If a wedding order form is used, its format will suggest all possible needs in a logical sequence. The widely-used John Henry Wedding Order Form is one of these, with all the information assembled on one page. (See page 228.) Such forms make sure that nothing is left out in the discussion.

The florist now has an overview of the project which is useful in figuring flower orders and costs. A total cost should be figured and agreed upon. The bride's family is usually responsible for paying for most of the wedding flowers. Exceptions are the bride's bouquet and corsages for the mothers and grandmothers, which are typically paid for by the groom. Usually the total wedding is offered for a set price. The bride is often very firm about what she wants. But giving a skilled florist the opportunity to make substitutions and be more creative can often bring her even more satisfying and special results.

Terms of payment should be well understood by the customer. Usually an advance down payment is required with the balance due when the flowers are delivered.

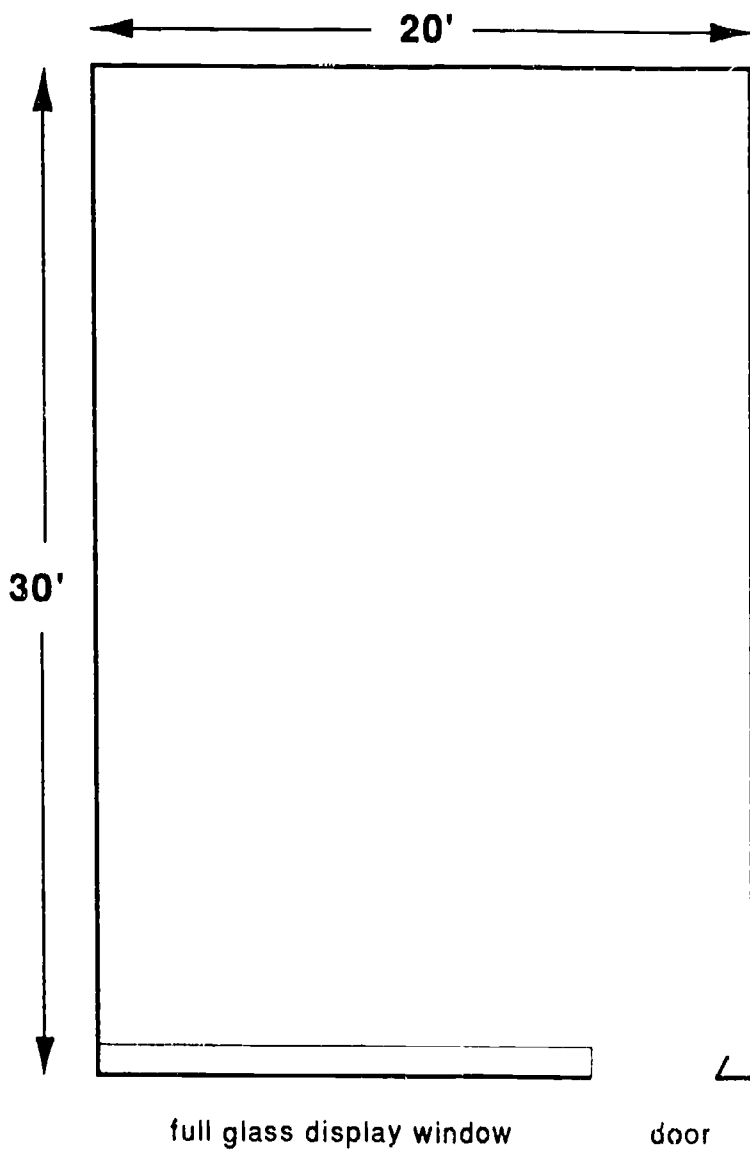


Figure 26-3 Arrangements greened in and stored in the cooler



A comfortable wedding consultation area
The Bouquet Shop, Wooster

SUGGESTED ACTIVITIES



1. Make a drawing of a work area that will include work table, storage cooler, sink and supply storage. First draw what you would consider an ideal situation. Then draw an actual situation where you have worked, either at school or on a job you had in a real flower shop. Compare the two drawings. Would it be possible to make any changes in the arrangement of the real work area to make it more efficient?

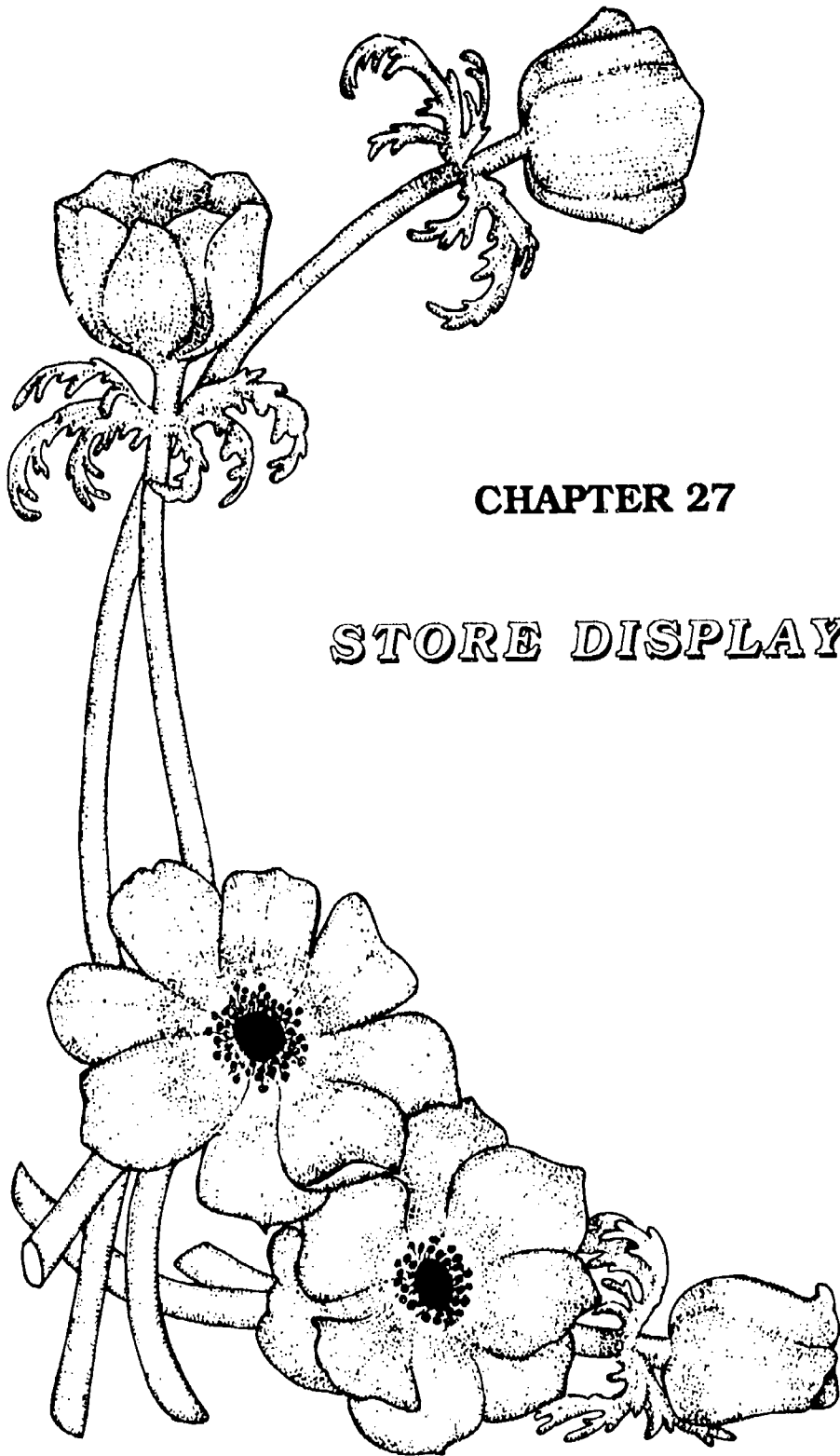
2. To the left is a sketch of a flower shop sales area that is 20 feet by 30 feet. Draw a possible layout which will include wrapping/sales counter, display refrigerator, display shelves or tables, and consultation area.

The counter, display units, refrigerator and table and chairs of the consultation area can be drawn to scale on a separate paper. Cut them out and move them around on the floor plan to visualize different possibilities.

3. Think of an important decorating event you have been involved in. Make a daily calendar for the week preceding the activity. List on it what you could do each day to get ready and how you could help eliminate the last minute rush.

4. Role-play taking a wedding order. One student will act the part of the prospective bride while another will be the florist. The florist should use a wedding order form and fill it out during the discussion. The florist may need to ask questions if the bride does not volunteer all the information.

???



CHAPTER 27

STORE DISPLAYS



Hemmerly's, Marion

Neat and Attractive Store Exteriors



Parkhurst's Flower Gallery, Medina



Boulevard Gardens, Portsmouth



Maple Lee, Worthington

Customers judge a floral business by the attractiveness and quality of its displays. The front window is seen by many more people than will ever enter the shop. Some viewers may be attracted into the store by an especially dynamic or appealing display. But most people form a quick impression based on what they see and go on their way. The florist hopes that when these people are in a situation where they need or want to buy flowers, they will remember the shop. If it made a favorable impression on them, a visit or telephone call to the establishment could then result.

STORE EXTERIOR

The exterior of a flower shop should be well maintained and have easy access from the parking area. An easy-to-read and attractive sign should be located where it can be seen easily from the street or road. This will help bring in business. If the situation permits, a well landscaped entrance with flower beds or containers of flowering plants during the growing season is desirable. Outdoor decorations can continue into the winter, especially in December when roping, lighted trees, and door decorations create a festive Christmas mood.

WINDOW DISPLAYS

The window is important whether or not it is complemented by a decorated exterior. Most windows are large and allow the customer to see into the shop. Window decorations that encourage this make use of displays that only partially block the view into the store. The other approach is to block the

view into the store with decorations used against a solid background. This usually is fabric or other backing material which enhances the display, helping carry out the theme or color scheme.

Effective window displays require thought, planning and a degree of creativity. They are set up from one side, but will mainly be viewed from the other side. Objects that are very pretty close-up may be "lost" at a distance. Insufficient materials may make the window look bare, while too many can result in a cluttered appearance. If you are working on a window display, take time to go outdoors and look at it from the sidewalk or road so you can determine what the impact will be on potential customers. Here are some additional suggestions for creating window displays.

- Select a theme for the display. The overall message of the display should be obvious to the person driving or walking by.
- Select an overall color scheme. Examples are red and white (Valentine's Day), white and silver (winter), or a triad of bright red, yellow and blue (summer).



Valentine's Day window - Maple Lee, Worthington

- Select a focal area and develop the display around it. The focal area should be relatively large and well lighted. Using animation, simulated or real, is a way to draw attention to this spot.
- Display items at various levels, using pedestals or other props to raise plants and flowers to different heights.
- Create a feeling of depth by placing items both to the front and to the back. Even if the window area is narrow, a feeling of perspective can still be established by using larger objects to appear close and smaller objects to appear farther away.
- Use oversized items when necessary so they show well from a distance. Generally, the use of fewer objects of a larger size is more distinctive and impressive than the use of many small items.
- Group arrangements and objects, leaving spaces or voids between the groupings.
- Frame the display on at least two sides with items like curtains, tree branches, corn shocks, etc.
- Use spot lights to feature key parts of the display. A window must be well lighted if it is to attract attention.
- Keep all cut flowers and plants watered and in good condition.

Window displays should be changed often to be current with the season and special holidays. Seasonal and holiday themes that might be considered for window displays are:

Special themes for each month

<i>January</i>	New Year's Day (1st) Winter
<i>February</i>	Valentine's Day (14th) Presidents' Day
<i>March</i>	St. Patrick's Day (17th) Spring
<i>April</i>	Easter (between March 22 and April 25) Passover Secretary's Week
<i>May</i>	Mother's Day (second Sunday) Memorial Day (last Monday)
<i>June</i>	Father's Day (third Sunday) Summer
<i>July</i>	Independence Day (4th)
<i>August</i>	Summer
<i>September</i>	Labor Day (first Monday) Autumn
<i>October</i>	Columbus Day Bosses' Day Sweetest Day Mother-in-Law's Day Halloween (31st)
<i>November</i>	Veteran's Day (11th) Thanksgiving (last Thursday)
<i>December</i>	Christmas (25th) Hanukkah

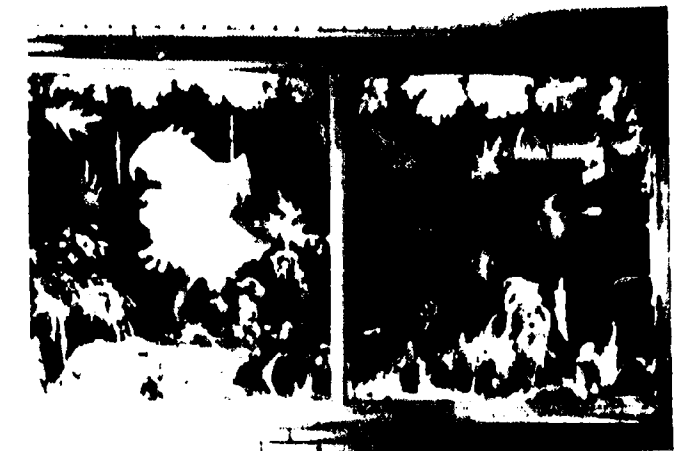
Seasonal Changes in Window Displays *The Bouquet Shop, Wooster*



Spring

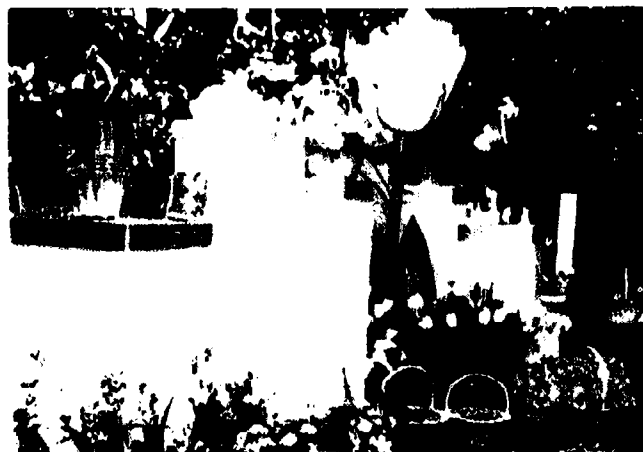


Summer



Autumn

Sales Area Displays



The Bouquet Shop, Wooster



Hemmerly's, Marion



Boulevard Gardens, Portsmouth



Permanent items used to create displays are called **props**. Examples include pedestals, urns, arches, benches, topiary forms and grass mats. Many of these items can be purchased from wholesale houses. Florists also usually collect and make props which suit their individual situation and style. Fireplace mantels, Oriental screens and flower carts are among the favorite props used by individual florists to develop particular themes or moods. These items are valuable, so they are usually stored in a basement or attic between seasons of use.

Other props can be created by cutting shapes from cardboard, styrofoam or other foam core. Fabric may be draped over boxes or other supports. Small trees and branches can be anchored upright and then decorated with silk flowers and leaves. Silk materials work well in window displays because they are not perishable.

Props can also be rented or borrowed if there is a convenient source. A greater variety of materials and themes can then be developed. Extra variation and creativity put into a display are more likely to attract attention to it. Besides that, it is more fun!

SALES AREA DISPLAYS

(See Color Plates IV-4 and IV-5)

Displays within the sales area should be as exciting and dynamic as the window display. Featured merchandise, flowers, plants and designs will sell better if they are changed to be in harmony with the changing seasons and holidays. New merchandise should be prominently displayed in coordinated groupings with appropriate backgrounds and accessories.

Frequent changes of the in-store displays not only create refreshing new combinations, but also result in clean, dusted merchandise. Items that have not sold well can be removed, redone or placed in new groupings where they may appear more attractive. Living plants will receive more attention. They may benefit from grooming or perhaps rotation to another area where they will get more light.

A variety of display units is preferable to just one type. A combination of shelves, round tables, flower carts, and recessed niches in the wall will add interest to a shop. Table coverings can be changed to complement the merchandise, carry out a color scheme, or reflect a particular theme. If space is limited, some items can be suspended from the ceiling or hung on walls or doors. Tiered shelving is another efficient way to display plants and other merchandise.

Information you want browsing customers to see should be placed on signs near the merchandise. These signs should be neat and easy to read. Larger signs look more professional if they are done with a lettering kit.

Take time occasionally to evaluate the shop's displays and traffic flow pattern. Walk through the door of the shop and view it from the customer's perspective. Does your overall impression include such thoughts as "clean", "neat", "interesting", "good smelling", and "pleasantly lighted"? Since flower shops market aesthetically pleasing products, the experience of visiting your shop should linger as a pleasant and positive memory in the minds of your customers.

Sales Area Displays (continued)



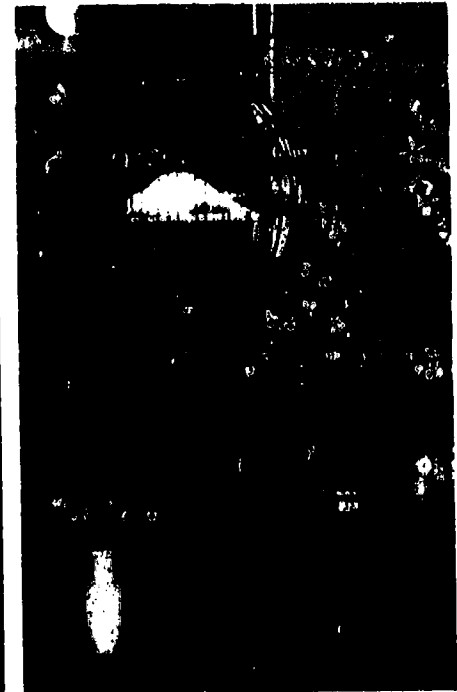
Parkhurst's Flower Gallery, Medina



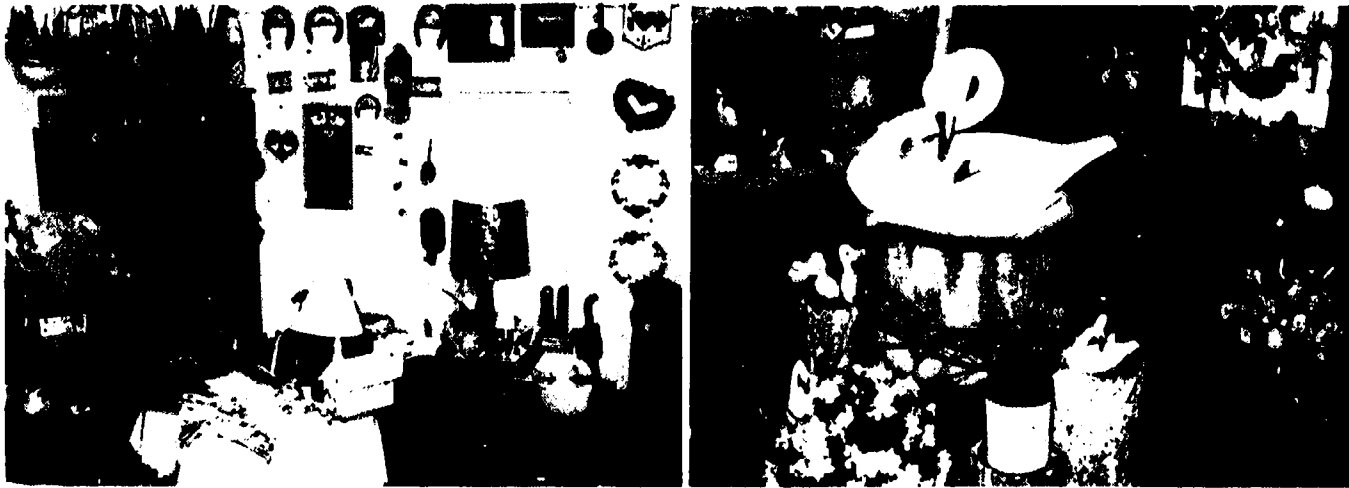
Hemmerly's, Marion



Don Johnson Florist, Lima



Sales Area Displays (continued)



Maple Lee, Worthington



Connell's, Columbus

SUGGESTED ACTIVITIES

1. Make out a monthly schedule for changing the window display of a flower shop. List the theme for each month's display. Also list the basic color scheme and major props you would use.
2. Sketch out a window display for one of the months. Indicate focal area and placement of the props. Make a list of all materials you would need to assemble before starting.
3. Describe the lighting of the window display you have created. What type of lights would you use? Where would they be placed, and how would you conceal them?
4. Create a shop or window display in a designated place at your school. Locate any props that are available, then decide if you need to borrow or make more. Draw up a plan for the fresh-cut flowers and potted plants you wish to use. Then assemble the display and maintain it for one week. Check with others who see your display and find out what their reactions are. Are they able to determine what the theme is? Are they interested enough to stop and examine the display in more detail?



United Floral, Canton



Maple Lee, Worthington



Engel's Wholesale Florist, Columbus

THE RETAIL FLORICULTURE INDUSTRY



Don Johnson Florist, Lima

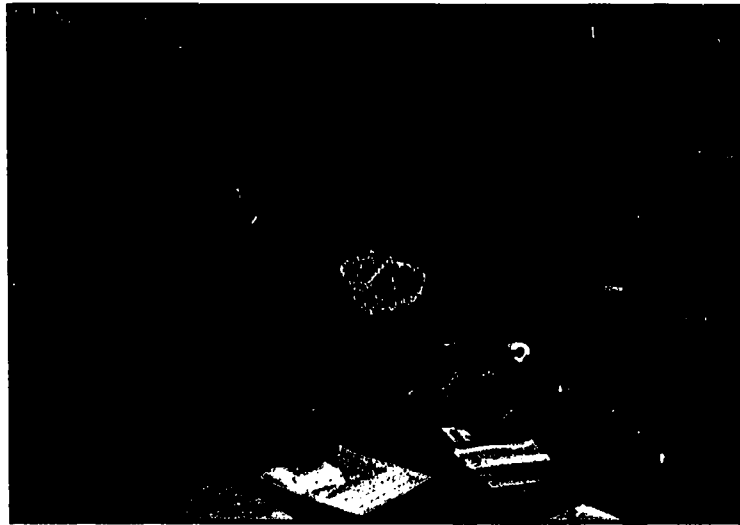


The Bouquet Shop, Wooster



De Santis, Columbus

**FLOWER SHOP
EMPLOYEES**



Manager



Salesperson



Office worker



Designer



Delivery person

752

753

CUSTOMER SERVICE



Advice on keeping quality
De Santis, Columbus



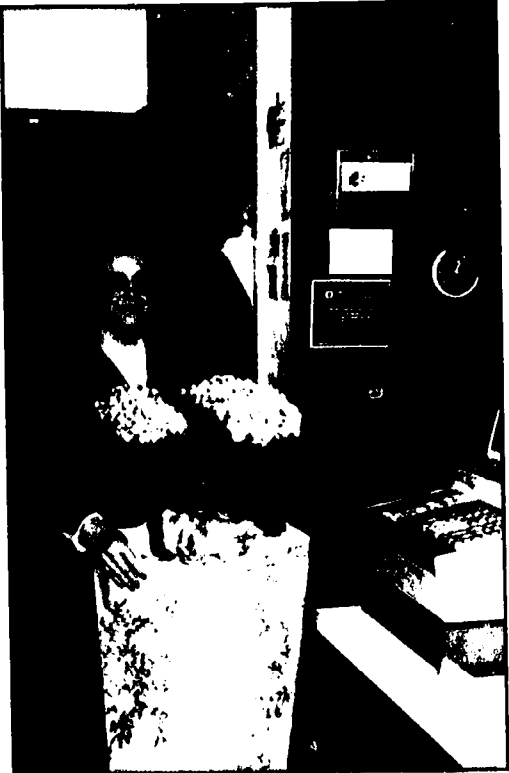
Taking a wedding order
De Santis, Columbus



Writing up an order
Maple Lee, Worthington



Selecting flowers to wire
Cornell's, Columbus



Wrapping plants
Hemmerly's, Marion

SHOP DISPLAYS



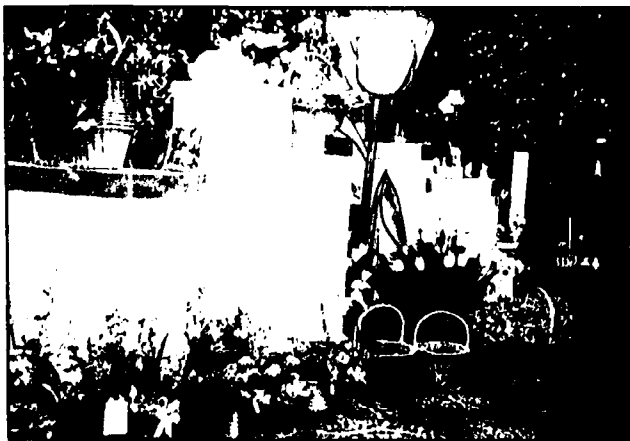
Maple Lee, Worthington



Flowers by Davids Square, Columbus



Hemmerly's, Marlon



The Bouquet Shop, Wooster



De Santis, Columbus



De Santis, Columbus

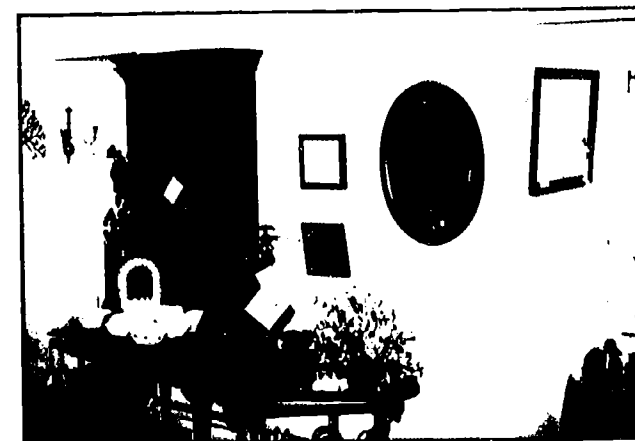
SHOP DISPLAYS
(continued)



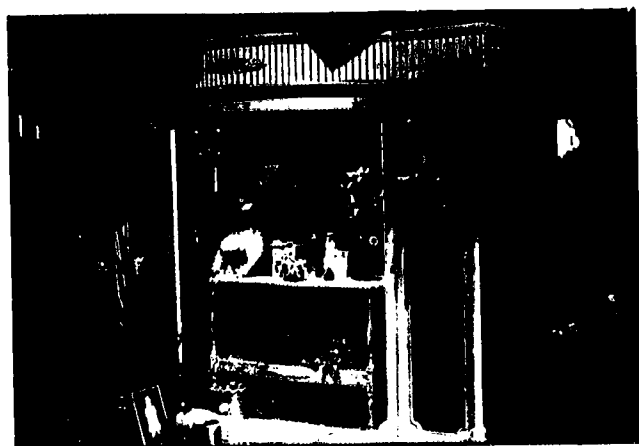
Parkhurst's Flower Gallery, Medina



Parkhurst's Flower Gallery, Medina



Maple Lee, Worthington



Boulevard Gardens, Portsmouth



Flowers by Davids Square, Columbus



Maple Lee, Worthington



Maple Lee, Worthington



John Anderson Florist, Canton



Flowers by Davids Square, Columbus

WORKING WITH FLOWERS



Aultman Hospital, Canton



The Flower Gazebo, Findlay

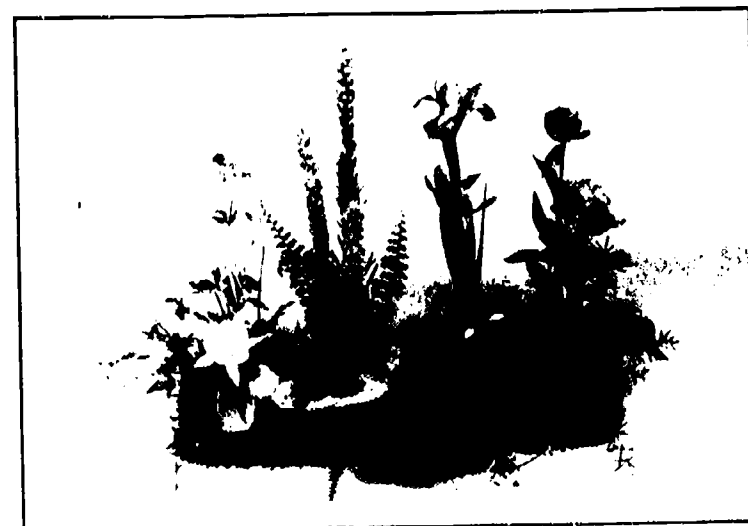


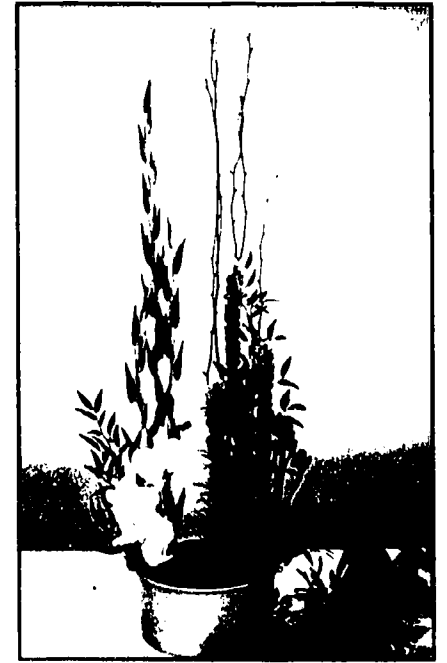
Toledo Florist Exchange, Toledo



CONSTRUCTING A PARALLEL DESIGN

Noreen Drake
De Santis, Columbus

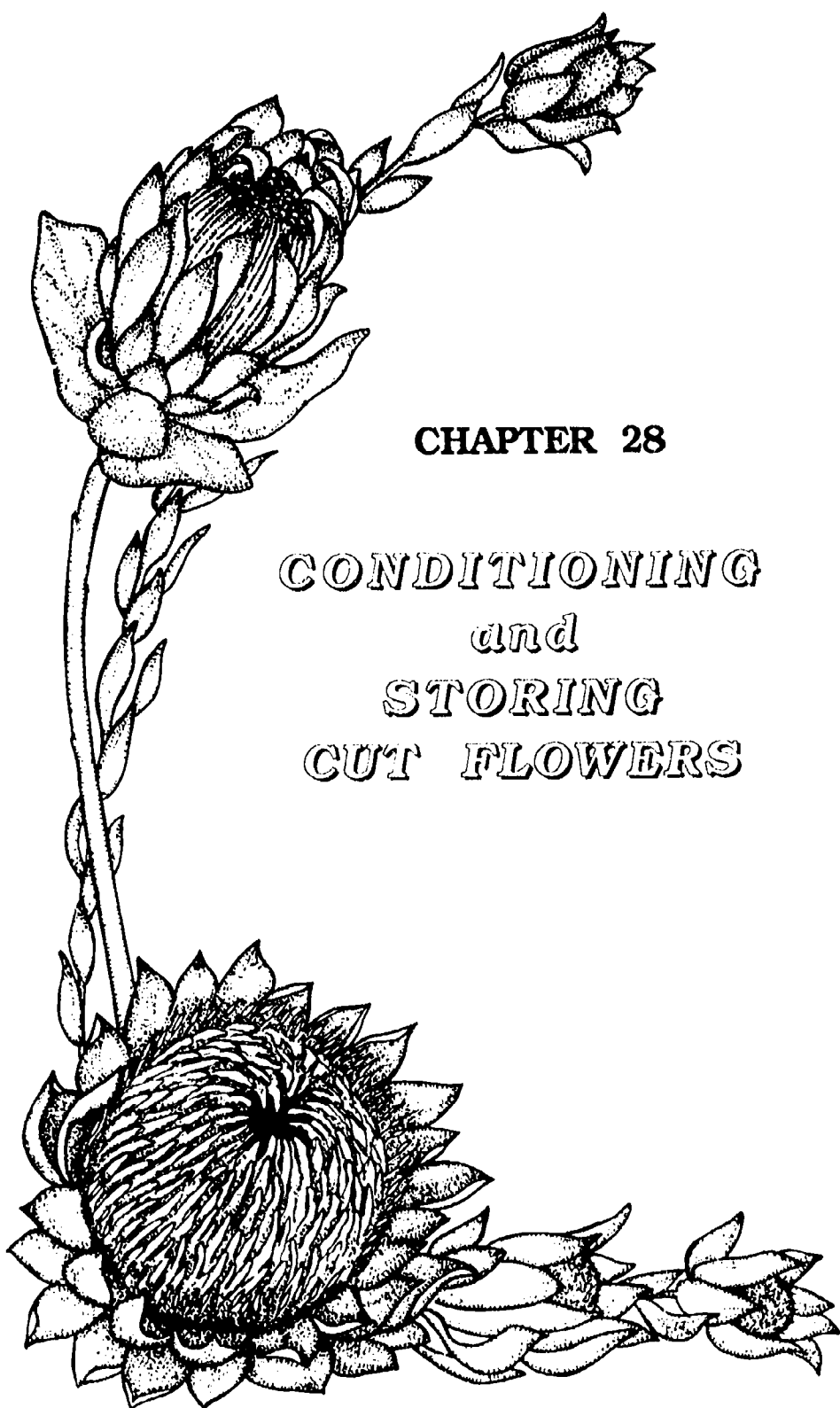




DESIGNING A CONTEMPORARY ARRANGEMENT

Roger Houseman
Connellsville, Columbus





CHAPTER 28

CONDITIONING
and
STORING
CUT FLOWERS



Underwater stem cutter- *Connell's, Columbus*

806

BEST COPY AVAILABLE

807



Figure 28-1



Flowers are brought to retail florists in refrigerated trucks - Toledo Florist Exchange

All cut flowers gradually wither and die, but their life can be extended with good handling and storage techniques. Florists have a responsibility to offer quality flowers that customers can enjoy for a reasonable length of time. Some flowers, like chrysanthemums, carnations and statice, naturally last longer than others, like roses and irises. However, all cut flowers can be enjoyed longer if proper attention is given to water supply, sanitation, refrigeration, and use of floral preservatives during their handling and storage.

To produce the highest quality cut flowers, proper care must be observed at all levels of the market chain - growers, wholesalers, retailers and customers. The Chain of Life program (Fig. 28-1) was developed by the Society of American Florists to make information available to all who handle cut flowers concerning lengthening the life of floral products. Their publications give accurate and extensive information on all aspects of care and handling.

FACTORS AFFECTING the LASTING QUALITY of CUT FLOWERS

What causes flowers to die prematurely? Here is a list of some of the more common reasons why flowers fail to last. As you read them, try to decide what role the grower, wholesaler, retailer and customer of cut flowers should play in overcoming each problem.

1. *The flowers run out of water.*

- The flowers are allowed to dehydrate during harvesting or shipping.
- The flowers are not unpacked promptly and put in water buckets when received by wholesaler or retailer.
- The designer lets the flowers dry out or does not soak the floral foam completely.
- Customers fail to add water to bud vases or arrangements.
- Designers do not leave room in the container where water can be added.

2. *Air temperatures are too warm.*

- The flowers are harvested in a hot greenhouse or allowed to heat up in shipping cartons while sitting too long on docks or in terminals.
- Refrigerated transit facilities or storage coolers are not used.
- The cooler breaks down and heats up.
- The design room is very warm.
- The customer places the arrangement near a hot-air register.

3. *Stems become blocked and can not take up water.*

- No one recuts the flower stems.
- Stems are cut with blunt scissors.
- The storage water is allowed to get slimy with bacteria, which clog the cut stems.

4. *The flowers use up their stored food.*

- Flowers are stored in the dark for a long time.
- No one adds a sugar-containing floral preservative to the water.

5. *Ethylene gas causes flowers to deteriorate rapidly.*

- Damaged flowers and foliage are not removed.
- Lower leaves on stems decay under water.
- Fruit or cut evergreens are stored near the flowers.
- Shipping cartons containing cut flowers are subjected to exhaust fumes from delivery trucks.

CONDITIONING CUT FLOWERS

Proper handling and storage of plant materials will keep them in good condition for a maximum length of time. Since cut flowers and foliages are perishable, they should be processed soon after arriving at the shop. Boxes left for periods of time on loading docks or even in the store are subject to temperature extremes and exposure to harmful exhaust fumes.

Flowers are usually shipped dry in cardboard boxes lined with newspaper. When they arrive they should be immediately unpacked. If there is a plastic sleeve around

the bunch, it should be removed or loosened. Flowers usually continue to open and they will need the space to do so in a natural way.

Immediately after they are unpacked, the flowers usually have their stems recut. They are then placed in warm water to which floral preservative has been added. They are allowed to stand at room temperature an hour or more before being placed in the cooler. These steps, aimed at making the flowers last longer, are called **conditioning**.

All damaged flowers and foliage should be removed. The damaged material is not usable and will give off **ethylene**, a gas which causes healthy flowers to age faster. The lower foliage should be stripped off the stems so none will be submerged below the water level in storage buckets. Again, foliage that is below the water will decay and give off ethylene. It will also promote the growth of bacteria which make the water slimy and block water uptake by the flower stems.

Use a sharp knife or sturdy counter-mounted stem cutter to cut an inch or two off the ends of the stems. Do not use dull equipment or blunt shears; they can do more harm than good by pinching shut the water-conducting tubes of the stem. There is no increase in water uptake through a slanted-cut stem. Underwater cutters that are now available seem to help extend flower life by minimizing the development of stem-blocking air bubbles. (See page 387 for the illustration of an underwater cutter.)

Flowers should be placed directly into plastic containers that have been filled a quarter to a half full of water to which a floral preservative has been added (Fig. 28-2).



Gerbera daisies carefully packed in cardboard shipping boxes



Figure 28-2 Flowers in plastic buckets



A fresh sharp cut should be made to maximize water uptake



Figure 28-3 Mixing floral preservatives

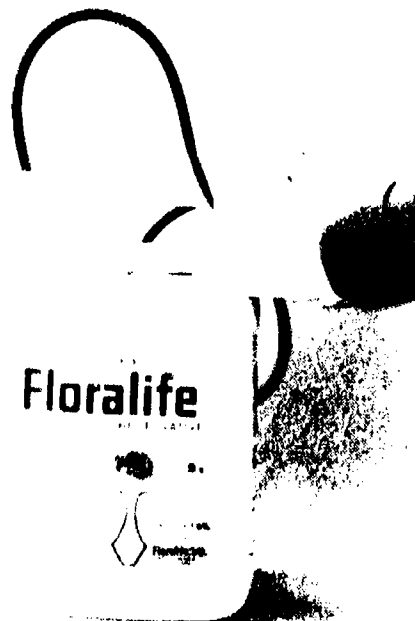


Figure 28-4 Liquid preservative used with a proportioner

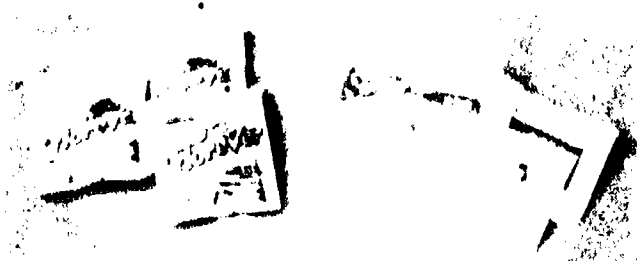


Figure 28-5 Floral preservative in packets

Directions for the correct amounts of water and preservative to use will be found on the preservative container. Metal containers may react with acidic preservative solutions and eventually rust. It is a good idea to have a selection of container sizes that can accommodate different stem lengths and different size bunches. Flowers that hang over the sides of a container can be easily damaged or broken off.

After the flowers have been in preservative water at room temperature from thirty minutes to an hour, the bucket with flowers should be transferred to the cooler. It will be stored there until the flowers are needed.

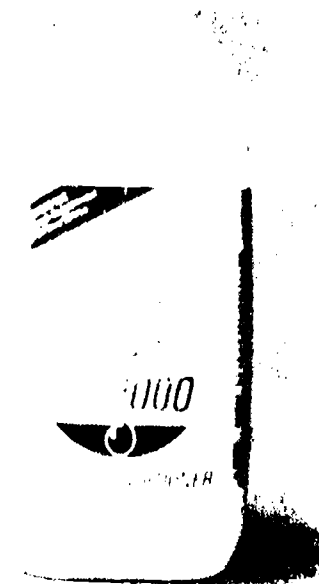
FLORAL PRESERVATIVES

Preservatives consist of two basic ingredients, a sugar and a bactericide. The sugar prolongs the life of flowers by supplying food that the living plant tissues need. The bactericide kills microorganisms that clog the vascular tubes of the stem and interfere with water uptake. Proper sanitation of the cooler and flower containers will also help keep bacterial growth to a minimum. Buckets should be washed out frequently with a disinfectant like bleach. The cooler walls and floors should also be frequently cleaned to eliminate sources of bacteria.

Floral preservatives are available as powders or liquids. They must be mixed with water according to directions given by the manufacturer (Fig. 28-3). Too small a concentration can be ineffective, while too much can damage flowers. *Floralife* and *Floever* are two major brand names.

Powders mix best with warm water. Liquids can be dispensed with a hand pump that fits on the jugs of concentrated preservative. Another mixing method is to use a proportioner that attaches to the water faucet (Fig. 28-4). The proportioner siphons out the proper amount of concentrate, mixing it with the water coming from the tap. The latter method is more efficient when many buckets are to be filled.

Preservatives are also available in small packets (Fig. 28-5) that can be included with arrangements or boxes of cut flowers. The customer can mix these with water according to the directions and use the solution to fill a bud vase or keep the foam moist in an arrangement. Making preservatives available to customers and informing them of the importance of preservatives is part of the general *Chain of Life* concept. Floral preservatives are recommended for use by all links in the market chain - grower, wholesaler, retailer and customer.



A flower conditioner that helps extend the life of cut flowers

STORAGE COOLERS

Large **walk-in coolers** are most commonly used for storage. They are lighted and some have humidity control. Cut flowers are still living plants which can be maintained in better condition under lights and with moist air. The air is usually circulated by a fan, but flowers should not be placed directly in front of one in blowing air. Buckets of flowers can be placed on the floor or on large storage shelves which are usually installed around the edge of the cooler for more efficient use of space.

Temperatures inside the cooler are usually maintained at between 35° and 40°F. Flowers can be stored even longer at temperatures approaching 32°F, but that can be dangerous. The temperature in the cooler could fluctuate right down to freezing, ruining the flowers.

Tropical flowers like birds-of-paradise, anthurium, ginger and orchids should be kept in a separate cooler set with warmer temperatures (45° to 50°F). Temperatures below 40°F often cause these flowers to become limp and show signs of browning. This is called **chilling injury**. If a second cooler is not available, these sensitive flowers could be kept in a part of the shop that is not too warm.

Coolers should be cleaned regularly. Buckets should be emptied promptly after flowers have been removed and washed out with a disinfectant. Decaying plant materials should be removed from the cooler. Every week or two the cooler should be emptied so that the floor and shelves can be washed down with a detergent solution.

DISPLAY COOLERS

Display coolers have large glass doors and shelves or pedestals for displaying arrangements and cut flowers. Some display coolers are large enough to walk into. In some shops the window display has been made into a large display cooler for holding fresh flowers.

Display coolers are usually brightly lighted with fluorescent lights to attract attention and show off the flowers. A well-earned nickname for a display cooler is "the silent salesperson" because made-up arrangements and well-priced merchandise in the cooler often create impulse buying. The designs are ready for immediate sale. They can also be shown as examples to customers who are uncertain as to what they want. Also, a good salesperson, by describing additional materials that could be added to the arrangement, can "upsell" a made-to-order arrangement that costs more.

Keeping clean and organized is very important in display coolers. The glass doors especially must be kept clean so customers can see the floral products to their best advantage. As soon as arrangements are sold, others should be put in their place, or the arrangements that are left should be rearranged.

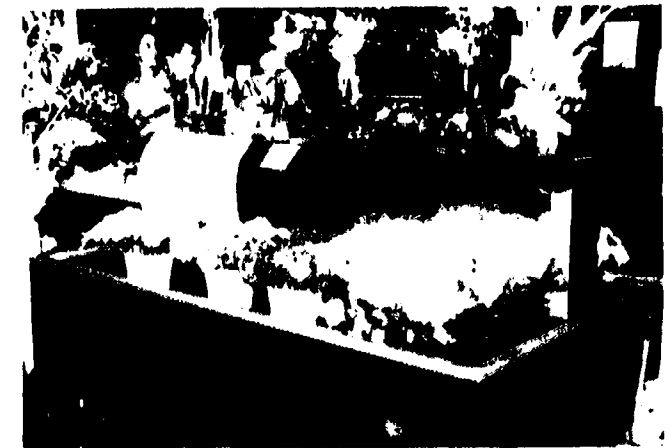
Cut flowers should be displayed in attractive containers that are in proportion to the size and stem length of the flowers. Mixed bunches of flowers, bud vases and novelty arrangements are good impulse items to include in display coolers.



Roses in a storage cooler



Well organized display cooler
Flowers by Davids Square, Columbus



Open display cooler for merchandising
cut flowers - Cowgill's, Canton



Bird-of-paradise

Tropical flowers that may be subject to chilling injury

More specific information on coolers can be obtained by writing to manufacturers and distributors of florist coolers. Their names and addresses can be found under "Refrigerators" and "Display Fixtures" in the Florists' Review Retail Buyers' Guide.

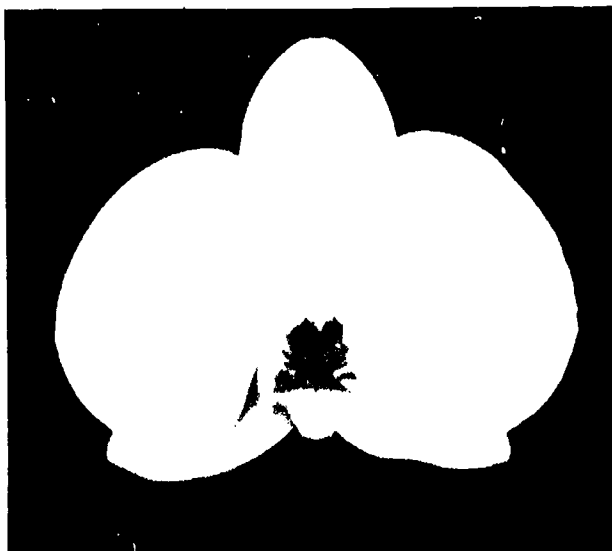
FORCING FLOWERS INTO BLOOM

The longer flowers are exposed to room temperatures (after their initial conditioning treatment) the faster they age and the shorter the time the customer has to enjoy them. Deliberate exposure to warm temperatures is sometimes used to hasten development of flowers that are in tight bud. These flowers need to show more color if they are to be used effectively in arrangements. Gladioli and lilies are often shipped in tight bud and then forced open by keeping them at room temperature after placement in warm water containing floral preservative. In general, the warmer the temperature, the faster the opening. Flowers which open readily (like daffodils and tulips) may be put into arrangements in the partially opened stage. This will allow customers to enjoy watching them over several days.



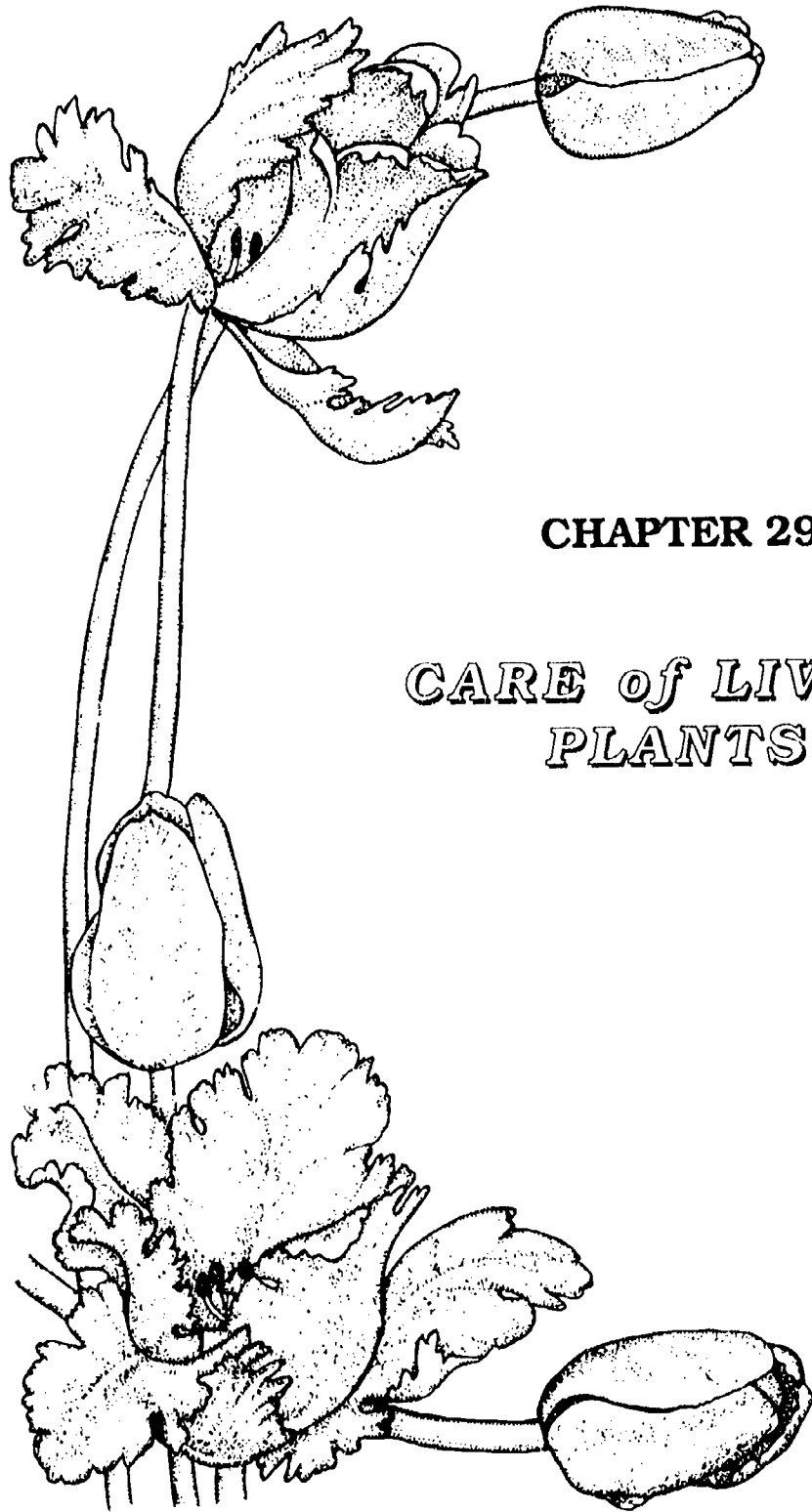
Heleconia

810



Phalaenopsis orchid

817



CHAPTER 29

CARE of LIVING
PLANTS



Flowers by Davids Square



Foliage plants in a retail display
Parkhurst's Flower Gallery, Medina



Grooming flowering plants
Connell's, Columbus

Living plants are not usually kept long in retail florist shops. While they are there, however, it is important to care for them properly. Furthermore, employees in a flower shop should know enough about living plants so they can give useful and correct information. Customers may want to know what conditions will be best for the plant and how long the plant can reasonably be expected to live.

FLOWERING PLANT CARE

Flowering plants should be at their peak of bloom or approaching it when purchased by a customer. If the plant is not far enough along in its development, the shopper may not find it attractive enough to buy. If the plant has been in flower for some time and is starting to decline, the customer will not be able to get many days of enjoyment out of the plant.

Before being put on display, plants should be cleaned up (**groomed**) by wiping off the leaves with a damp cloth. Also, any dead (spent) blooms or damaged foliage should be removed. The best flowering plants will be symmetrically shaped and full of flowers.

The following environmental conditions will prolong the life of most flowering plants.

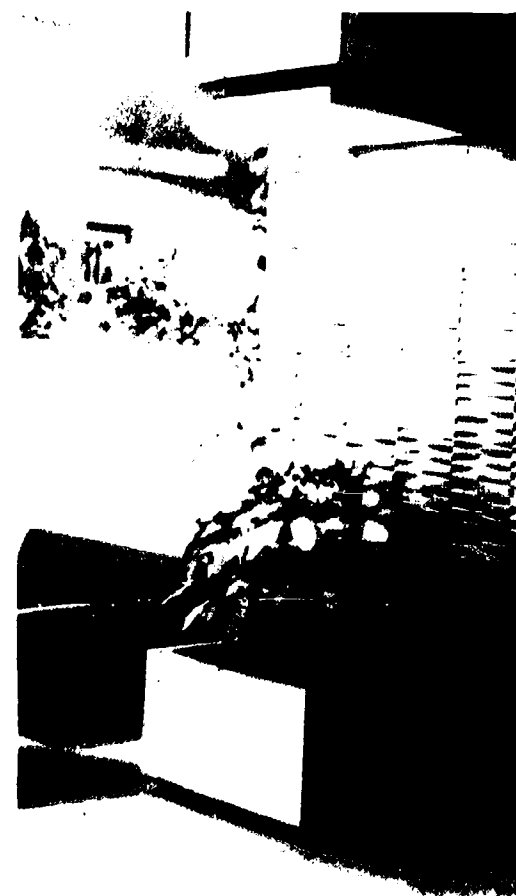
Cool Temperatures

Very warm temperatures cause the flowers to age more quickly. Cooler temperatures make them last longer. However, care must be taken not to chill sensitive plants like African violets, gloxinias and poinsettias.

Avoid placing plants near hot air registers where they will be exposed to currents of hot dry air, or near doors where they might receive blasts of cold air.

Adequate Light

Light in a retail store or home is often below the minimum levels required for good flowering plant maintenance. In low light plants will not be able to make enough food and they will eventually decline in quality. Supplemental lighting from lamps will help overcome this problem. If plants can be displayed near windows, they may get enough natural light to sustain them.



Supplemental light helps sustain plant quality

Adequate Water

Both overwatering and underwatering can be a problem in keeping plants looking good. Plants set in decorative containers are often overwatered because drainage water collects inside the container. The leaves then turn yellow and drop off. Plants that receive too little water may become light green or pale yellow and also lose leaves. If not watered, they will wilt and eventually die.

FOLIAGE PLANT CARE

Foliage plants can be expected to last indefinitely if provided with favorable conditions. Although their care requirements may vary, most foliage plants can adapt well to home conditions and remain popular with the buying public.

Unlike flowering plants, foliage plants may be kept by retail florists in the shop for at least several weeks before they are sold. When available, an attached greenhouse or conservatory is an excellent place to display and maintain foliage plants. For shops without such ideal facilities, the plants can be maintained best on a lighted cart, table or shelves. Plants that are set on waterproof trays filled with gravel will be easier to water properly. The plants also need adequate light, or they will gradually decline in quality. Fluorescent light is economical and also effective for maintaining foliage plants in a retail store.

Watering requirements vary depending on the type of plant, size of pot, and air temperature. Plants generally dry out faster in warm temperatures and will need more

water then. Small pots dry out faster than large pots, especially if they are made of clay or if they contain a fairly large, leafy plant. Tropical plants offered for sale to use in terrariums or dish gardens are often in small pots. They will require careful attention and frequent watering while they are in the shop.

Plants that are too large for a light cart should be set on large plant saucers or inside waterproof containers to catch the drainage water. Watering should be thorough, so that some water comes out of the drainage holes. Then the plant is allowed to dry out for a week or a little longer before its next thorough watering. Frequent watering with small quantities of water will not reach the entire root system. However, be careful not to let plants sit in large amounts of drainage water. This can be a problem when the pot is set inside a decorative container. If you hear water sloshing inside the container when you shake it, you should take the plant out and empty the container. Overwatering will waterlog the soil, causing roots to die, and result in wilting, yellowing and dropping of leaves.

Potted plants that are wrapped in decorative foil are difficult to water properly. The plants should be given enough water to moisten all the soil, but not so much that the soil becomes waterlogged. The foil will prevent the draining of excess water out of the drainage holes.

HANGING BASKETS

Hanging baskets are most effectively displayed at eye level so that one can see the plants rather than the bottom of the



Foliage planters on display
Maple Lee, Worthington



Watering large foliage plants
Connell's, Columbus



Hanging baskets in a retail display
Buehler's, Wooster



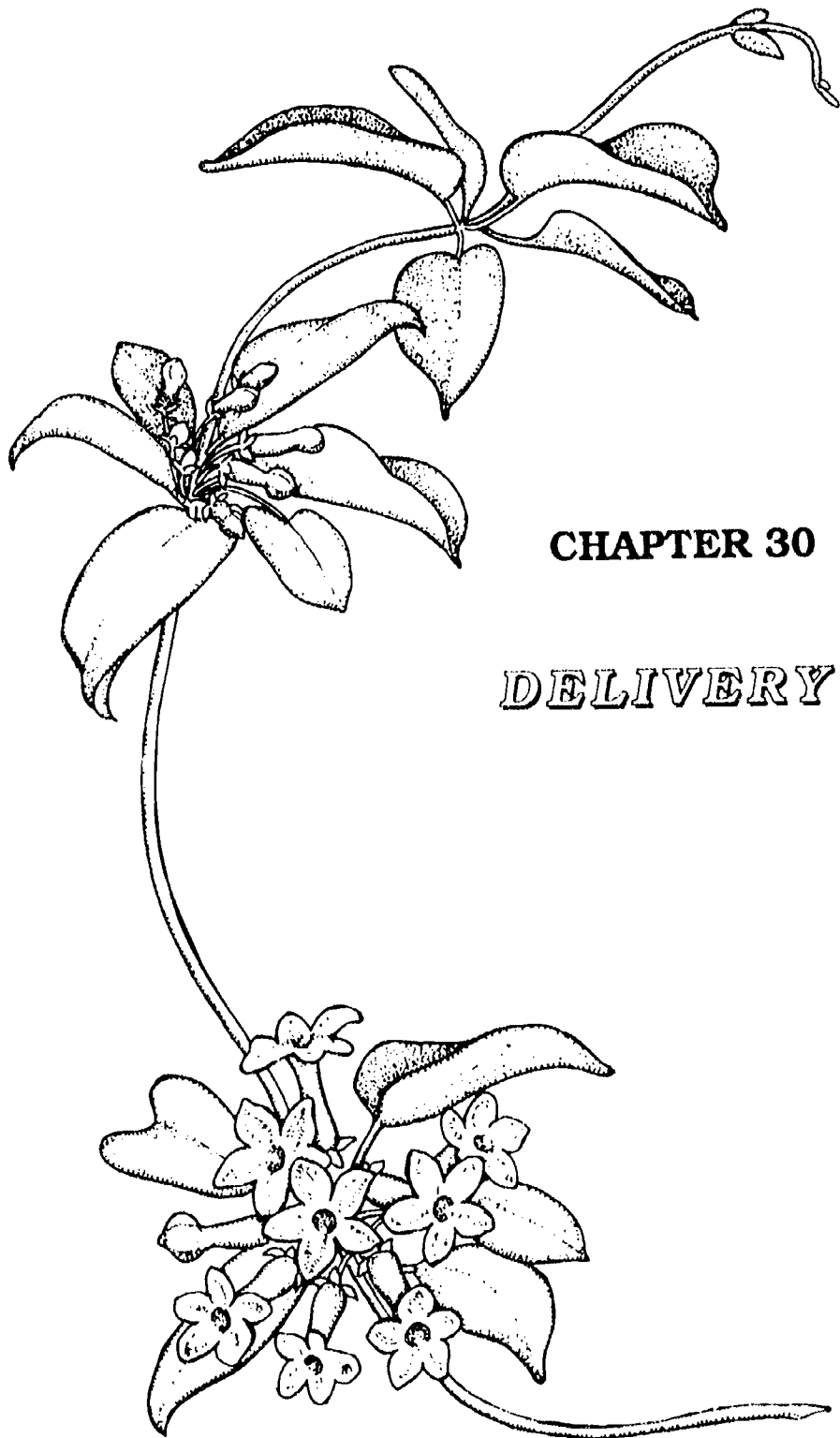
Hanging baskets in front of a retail establishment
Seattle

container. Hanging baskets can be surprisingly heavy, requiring sturdy suspension mechanics. If a hanging basket has an attached saucer to catch drainage water, it may be carefully watered in place. The saucers often are quite small and can easily overflow if the basket is watered too heavily. Baskets without saucers should be taken down, watered thoroughly where they can drain, and returned to their suspended position. The baskets may need to be turned if exposed to light coming from one direction, as through a window.

CAUSES of PLANT PROBLEMS

Similar symptoms can be caused by entirely different factors. When you are trying to analyze and correct problems, consider environmental conditions and watering practices in addition to looking at the symptoms.

<i>Problem</i>	<i>Possible Causes</i>
yellow leaves	overwatering, underwatering, chilling, low soil fertility
brown leaf tips	low humidity, fluorine in water
leaf drop	low light, overwatering, underwatering, chilling
leaf wilt	underwatering, overwatering, chilling
weak growth	low light, overwatering



CHAPTER 30

DELIVERY





Figure 30-1 Plotting the delivery route
Connell's, Columbus

Delivery is a service of convenience to customers that has traditionally been offered by most retail flower shops. It is especially helpful when orders are going to hospitals or funeral homes where there are special entrances and policies for flower deliveries. Also, on other occasions the customer sending a floral gift to someone may appreciate the opportunity to have it delivered by the florist.

Many mass market floral operations establish a business policy of cash-and-carry. Those operations that do not have the expense of hiring a delivery person or maintaining a delivery vehicle can offer the product for less money. There is a place in the market for both types of operations. Full-service flower shops are not likely to go out of business because people want service and are willing to pay for it. However, florists must recover the cost of delivery either in the price charged for flowers or by adding a delivery fee. More and more florists are establishing delivery fees.

THE DELIVERY PERSON

The people hired to deliver flowers are important representatives of the shop. They travel about the community and are likely to interact directly with more people than do those who work only at the shop.

It is important for delivery persons to be competent in the handling of flowers, capable of driving vehicles safely, and effective in communicating with people. They should be able to work efficiently without direct supervision. They should be well

groomed and appropriately dressed for the work they are doing.

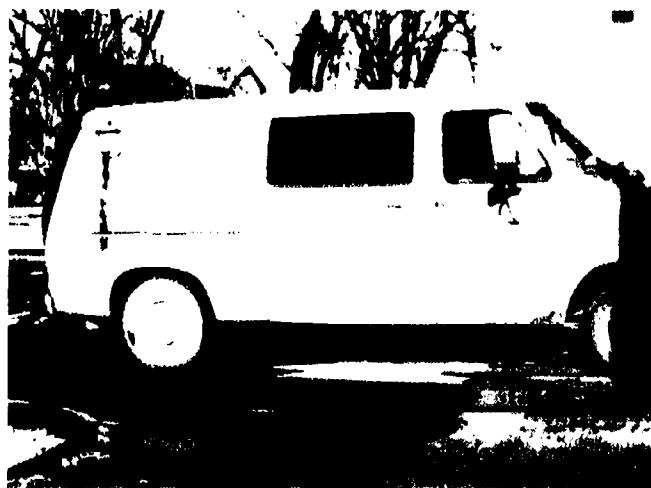
THE DELIVERY VEHICLE

The delivery vehicle needs to be kept clean and in good operating condition. There should be an attractive and easy-to-read logo on the vehicle indicating the name of the shop. Since this vehicle circulates widely throughout the community and is seen by many people, it helps create an image for the shop. It is a valuable advertising tool that cannot be ignored.

PLOTTING THE ROUTE

The delivery person should be familiar with the area being traveled. It is helpful to post a map to locate delivery sites (Fig. 30-1). If the map is mounted on a cork board, pins can be inserted into the locations to be visited so the most direct route can be visualized. Another technique is to put a piece of plexiglass over the map so that a non-permanent marker can be used to plot the route.

Orders should be sorted into morning and afternoon deliveries. Those that have special delivery times must be clearly marked and must have the delivery time posted. Once the route is determined, a list of stops in proper sequence can be made out and placed on a clipboard near the driver's seat.



Delivery vehicle - *Maple Lee, Worthington*

LOADING THE VEHICLE

The vehicle is loaded in reverse of the order that the flowers will be delivered. Those that go to the last stop are put in first, although the order may have to be altered somewhat for more efficient loading of items of different sizes. The vehicle may be equipped with rack and braces to hold baskets and sprays upright. A pole or bar may be used to suspend hanging baskets.

Cardboard delivery bases can be stapled around arrangements to give them more stability (Fig. 30-2). Arrangements can also be placed in open boxes with tissue paper wedged around their base to make them more stable and easier to handle. (For more discussion of wrapping and packaging, see Chapter 24.) Sand bags, pillows and rugs are used around arrangements and boxes to keep them from shifting during transport.

Easel and candelabra sprays can be laid flat on their backs on the floor of the vehicle, since the back is not designed to show and has no flowers. Ribbon streamers are often rolled up and pinned with a corsage pin so they do not become wrinkled or soiled.

The delivery address for each piece should be clearly stated on an attached tag. (See Figure 30-3.) The delivery person will need to have the tags attached in a spot where they are easy to see.

MAKING THE DELIVERY

The delivery should be made to the front door unless otherwise instructed. The delivery person rings the doorbell or knocks and

presents the flowers to the recipient. The delivery person should offer a friendly personal greeting and identify the name of the shop. For example: "Good afternoon, I'm Dan from the Bouquet Shop. I have a special delivery of flowers for you today."

If no one is home, the driver has three choices:

1. Leave the flowers with a neighbor. A note should be left telling the recipient where the delivery was made. Sometimes a small token floral gift like a single rose is given to the neighbor for his or her cooperation. It may spark some new business for the shop.
2. Leave the recipient a card saying you are returning the flowers to the shop and asking the person to call or stop by to pick them up. (See Figure 30-4.)
3. Leave the flowers on a porch or in a protected area. Follow up with a phone call to make sure they were received satisfactorily.

The delivery person should handle arrangements gently, keeping them upright to avoid damaging them. Good packing techniques and careful driving will reduce injuries during transport. Sometimes, even when good handling techniques are practiced, flowers become disarranged. The delivery person should carry a basic florist tool kit and supplies for making minor repairs. Ideally, the delivery person should know enough about flower arranging to make any repairs blend in with the rest of the design.

Figure 30-2
Bud vase in a
cardboard
delivery box



Don
Sylvester
Florist & Gifts
709-711 West Market St., Lima, Ohio 45801
Phone 224-6080

To _____

Figure 30-3
Delivery tag

DATE _____
TIME _____

IMPORTANT!

PLEASE NOTICE:
We called with a
delivery for you
and found you were out.

TO _____

KINDLY PHONE US
 PLEASE STOP BY AND PICK UP
 YOUR DELIVERY HAS BEEN LEFT AT:

Figure 30-4
Card to leave for
the recipient who
is not at home



Loading the delivery vehicle
Maple Lee, Worthington



Volunteers (candy strippers) distribute flowers
to patients in the hospital
Aultman Hospital Flower Shop, Canton

SPECIALIZED DELIVERIES

Funeral Home Deliveries

The delivery person should know the location and delivery policies of each funeral home. The delivery entrance must be located. A record should be made of the times of day that each funeral home prefers to have flowers delivered. The name of the deceased must be on the delivery tag.

Hospital Deliveries

It is important to know the delivery policies of the hospital(s). Often hospital volunteers receive the flowers and deliver them to patients' rooms. The patient's full name should be clearly marked on the delivery tag.

Wedding Deliveries

The flower shop should have a clear understanding with the bride as to when and where the flowers are to be delivered. If the wedding is not going to be serviced by the shop, the bouquets, corsages and boutonnieres may be left in the back of the church or in dressing rooms, or placed in refrigerators, according to instructions given in advance by the bride. Also, as prearranged, church and reception flowers may be put in place or left for others to take care of.

C.O.D. Deliveries

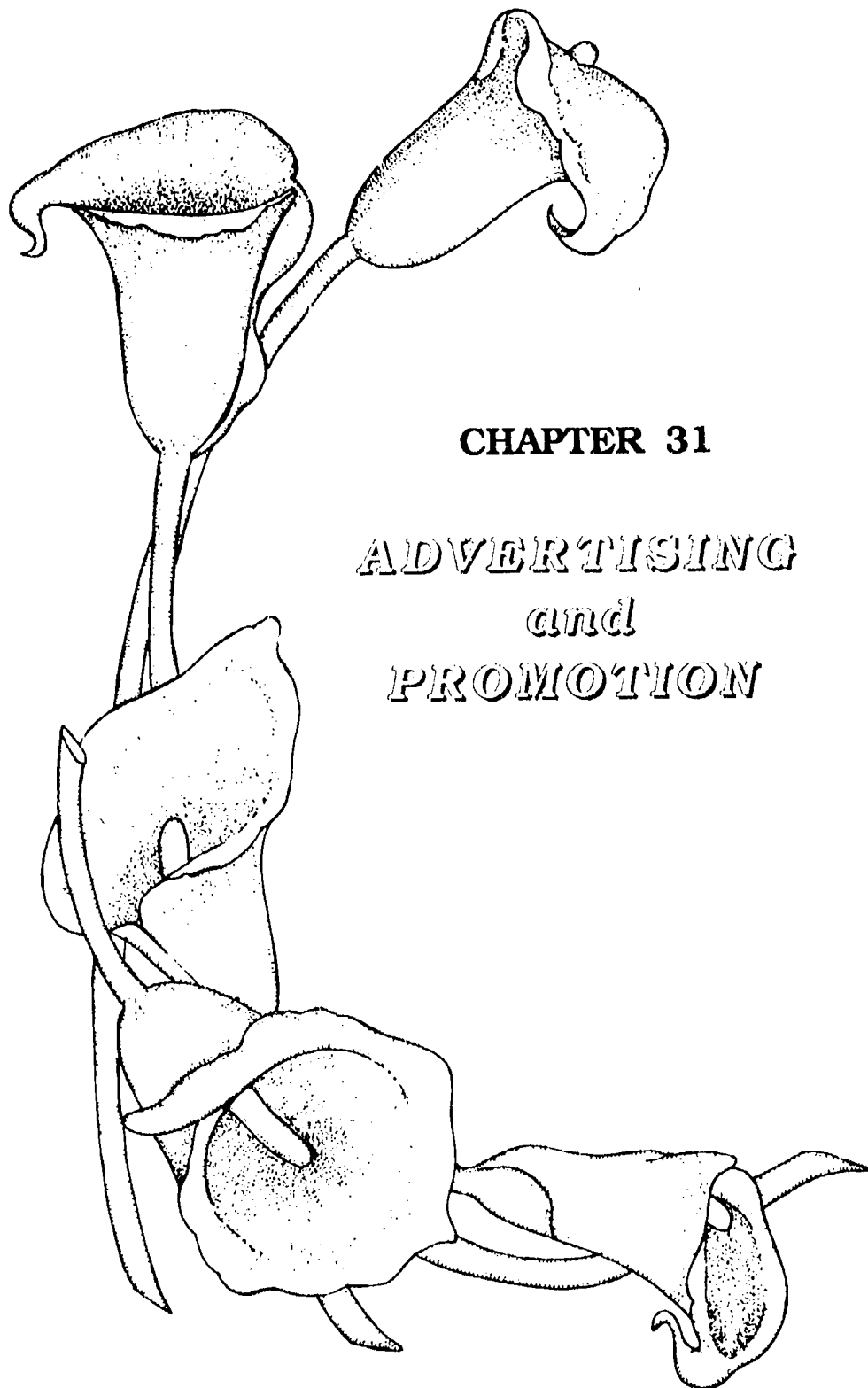
"C.O.D." means *cash on delivery*. The driver is to collect payment at the time of delivery. A receipt should be made out by the driver and given when the money is received. The shop manager must decide which orders can be shipped on this basis.

Cooperative Deliveries

The florists within a given locality sometimes go together to support a joint delivery service. This arrangement can save money and, under some circumstances, be more efficient. However, the implementation and success of this venture will depend on the degree of cooperation that can be achieved among the florists involved.

SUGGESTED ACTIVITIES

1. Obtain a county, town or city map of your local area. Pick six locations in various parts of the area and map out an efficient delivery route. Avoid backtracking when possible, but also consider driving time and condition of the roads.
 2. Practice loading a delivery vehicle with several arrangements. Label with delivery tags. Staple cardboard bases around pedestal containers and use sand bags or rugs to keep the items from shifting around.
 3. Role-play making a delivery to the door of a person receiving flowers. The person playing the recipient should be behind the closed door. That person may choose to cheerfully receive the flowers, complain about some damage in transport, or simply be "not at home." The delivery person should respond in an appropriate way.
-



CHAPTER 31

**ADVERTISING
and
PROMOTION**

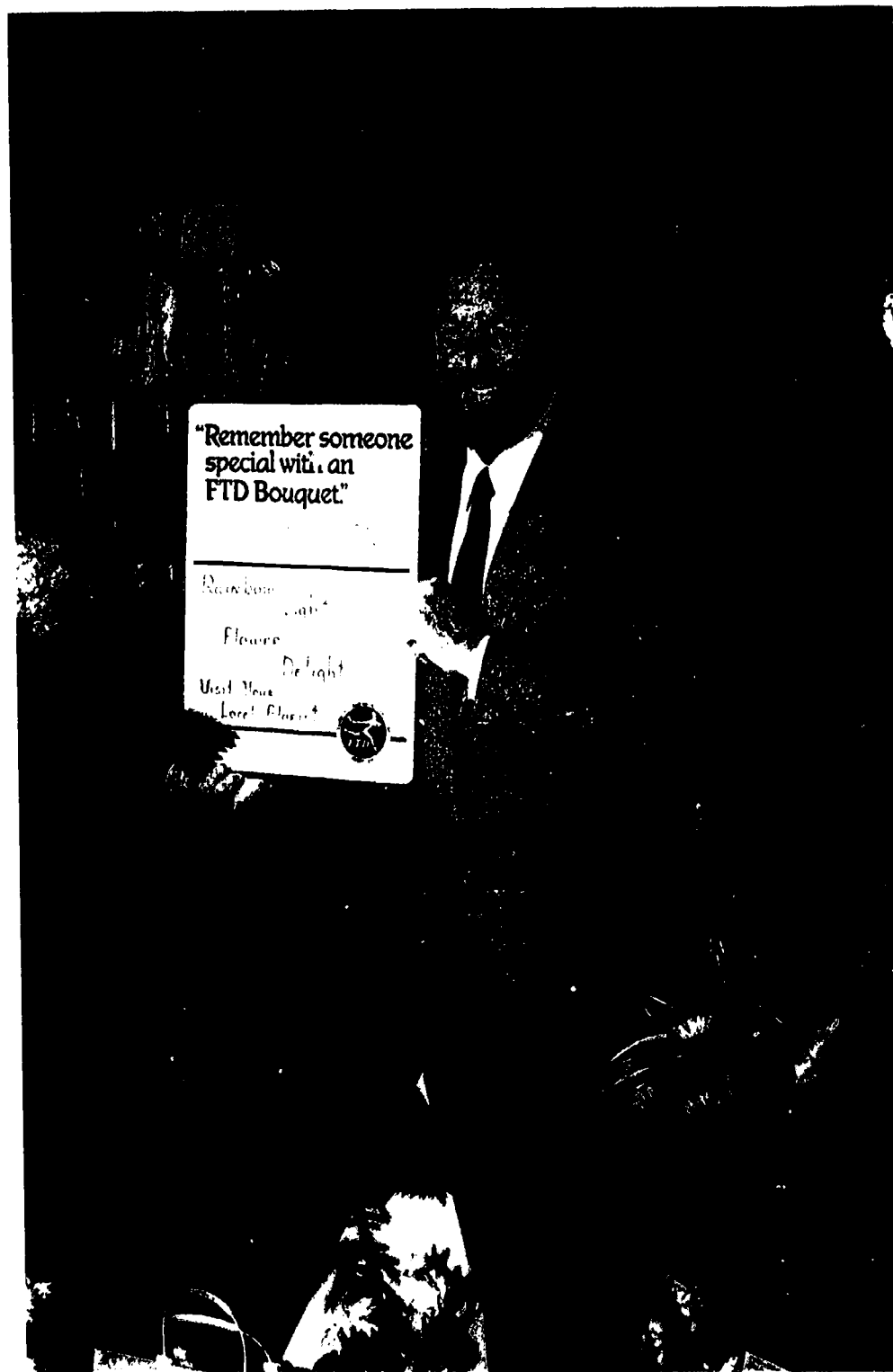




Figure 31-1 Shop window and sign

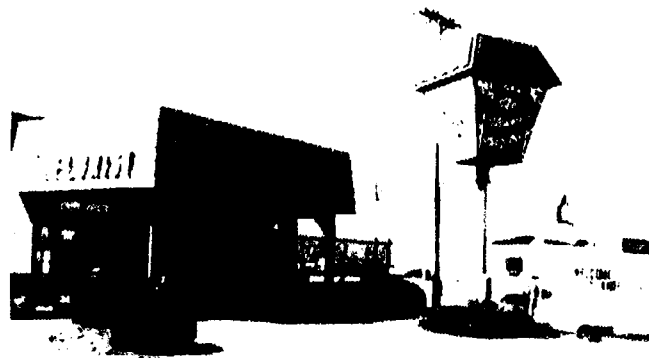
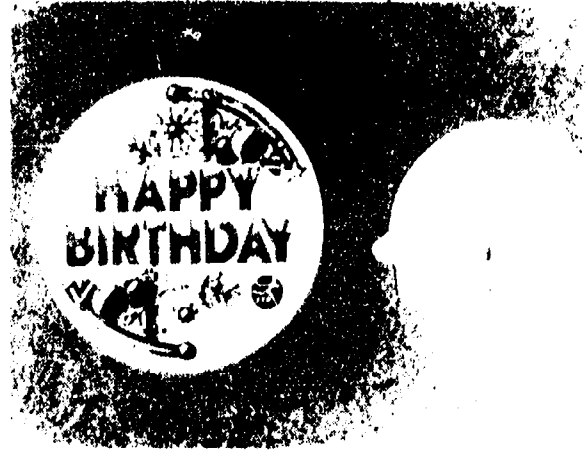


Figure 31-2 Exterior advertising



Figure 31-3 Delivery vehicle advertising the shop



Promotional materials from FTD

YOU'LL FIND US FAST
IN YOUR
YELLOW PAGES



Ohio
Bell
Yellow
Pages

Figure 31-4 Yellow pages ad

If a business is to grow and prosper, its products and services must be made known to potential customers. A favorable reputation can be built over time as a result of quality products and good service. New shops have a special challenge to win customers and gain a share of the potential market.

ADVERTISING OPTIONS

It has been recommended that florists spend about 3 to 5 percent of their gross sales on advertising. For businesses just getting started, this percentage may need to be even higher. Each florist must consider the different types of advertising available and decide how much and what kinds will be done. Developing ahead of time a well considered advertising plan is far better than randomly acting as various opportunities arise.

Some of the ways that florists advertise are as follows:

1. newspaper ads (Fig. 31-5)
2. radio ads
3. window displays (Fig. 31-1)
4. shop sign and store exterior (Fig. 31-2)
5. delivery vehicle (Fig. 31-3)
6. direct mailings
7. yellow pages ads (Fig. 31-4)
8. billboards
9. community involvement

Sometimes larger organizations provide general advertising of floral products that may benefit individual florists. Such larger groups include local allied florists, wire

service organizations, and national organizations such as the Society of American Florists (SAF) and American Floral Marketing Council (AFMC).

The easiest and least expensive advertising is the image projected by the store exterior, window display and delivery vehicle. All these may initially help attract customers. However, as business grows, it is the word-of-mouth reputation that is more likely to result in a valuable network that reaches more potential customers.

OPEN HOUSE

Another way to attract customers into the shop is to hold an open house. This is especially effective at the beginning of the Christmas season. By late November it is time to bring out new merchandise and redecorate the showroom in a Christmas motif. Customers are preparing to decorate for the holidays and are likely to be in a shopping mood.

Spring and fall are also possible times for an open house. With the seasonal change in decor, there is a reason to invite customers in to inspect the "latest look" for the season.

NEWSPAPER ADS

Newspaper ads reach large numbers of people. For most florists, ads are the most cost-effective form of advertising

Ads that are run regularly keep the name of the shop before the public, so that people are more likely to remember that name when

Mother's Day Is May 10th

OUR SPECIALS INCLUDE:

- TEA CUP ARRANGEMENT \$15.00*
- GERANIUM BASKET \$17.50*
- FTD SCENTED CANDLE BOUQUET \$30.00* and up
- FTD SPRING GARDEN BOUQUET \$22.50* and up
- TELEFLORA'S PICTURE FRAME BOUQUET \$25.00* and up
*DELIVERY EXTRA

WE ALSO HAVE:
BLOOMING PLANTS, HANGING FUCHSIA, GERANIUMS & ASSORTED FOLIAGE PLANTS & SILK FLORAL ARRANGEMENTS
ORDER EARLY!

The Bouquet Shop

2051 CLEVELAND RD. WOOSTER 345-6164
212 HOWARD ST. ORRVILLE 682-6856 or 682-6866
MON.-SAT. 8:30 - 5:30

Mother's Day

Figure 31-5
Newspaper Ads

TAKE NOTE!

SECRETARY'S WEEK
APRIL 20-25
SPECIALS...

ROSE BUD VASE \$5.00

TEA CUP BOUQUET
With Mini Carnations And A Couple Sweetheart Roses
\$12.50

The Bouquet Shop

WOOSTER 2051 Cleveland Rd 345-6164
ORRVILLE 212 Howard St 682-6856 or 682-6866

Secretary's Week

Valentine Specials

"LOVE IN A MUG"
6 RED ROSES and MICRO BALLOON
IN A HEART MUG \$17.50*

6 ROSES and 6 CARNATIONS
IN CELLOPHANE PACK \$22.50*

Teleflora BEAR BOUQUET \$25.00 and up*

FTD SWEETHEART BOUQUET \$23.00 and up*

The Bouquet Shop

WOOSTER 2051 Cleveland Rd 345-6164
ORRVILLE 212 Howard St 682-6856 or 682-6866
Both Shops open 8:30-5:30 Mon.-Sat.

Valentine's Day

Easter Specials

CORSAGES: CARNATION ... \$2.50
ORCHID \$4.50

WICKER RABBIT SPRING BOUQUET \$17.50

Easter Lilies, Potted Tulips,
Hyacinths & Bulb Gardens Available

FTD & TELEFLORA SPECIALS
ORDER EARLY!

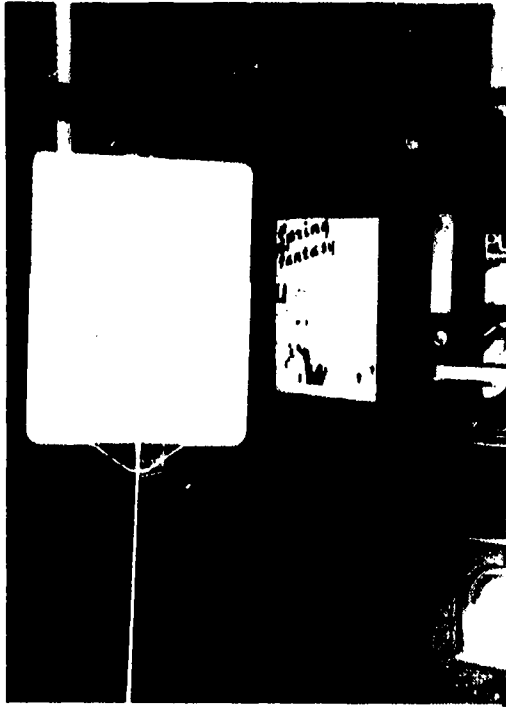
The Bouquet Shop

WOOSTER 2051 Cleveland Rd 345-6164
ORRVILLE 212 Howard St 682-6856 or 682-6866

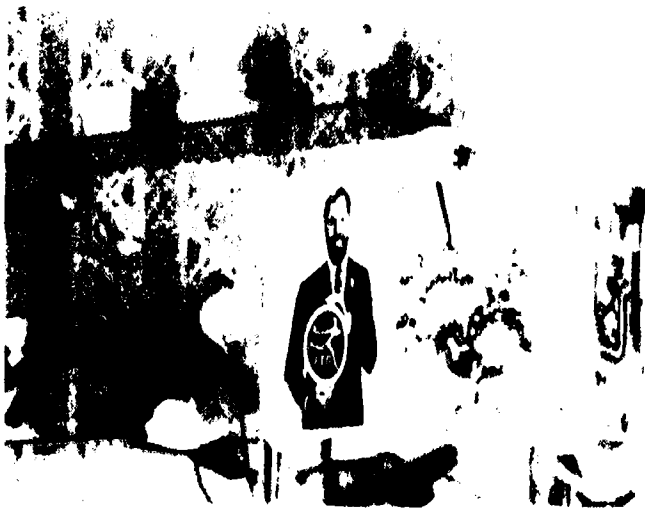
Easter



An open house shows customers what the shop has to offer



Weekly specials can attract customers



In-store display advertises wire service specials

they are ready to buy flowers. Holiday specials are logical subjects for a newspaper ad. Also, reminding the public of less common holidays like Secretary's Day, Grandparents' Day and Sweetest Day may create sales that would not otherwise have been made. Since flowers are especially appropriate for these and other holidays, the well-placed ad might convince customers to select flowers over other gifts like candy or perfume. Another advertising strategy is to suggest flowers as a good gift for the hard-to-please person who is thought to "have everything."

Ads should also promote everyday use of flowers. Wire service organizations offer good suggestions for both holiday specials and everyday bouquets. They help promote sales by preparing colorful posters for use in the shop and presenting attractive ads on television and in magazines.

Newspaper ads should be simple and to the point. Their wording, layout and artwork can help build the image you have chosen for your shop. Here are some additional suggestions for newspaper ads.

- Keep ads simple and easy to read. Stress one or two specials or ideas. Don't clutter the ad with too many thoughts.
- Use your logo with the shop's name clearly visible. This will establish an easy-to-identify format.
- Use good design principles just as you would in a window display. Remember that open spaces around the writing or illustrations are important in emphasizing or drawing attention to those features of the ad.

- Choose illustrations or pictures to help attract interest to the ad.
- Vary the size of the print for interest. Put main thoughts in bold print.

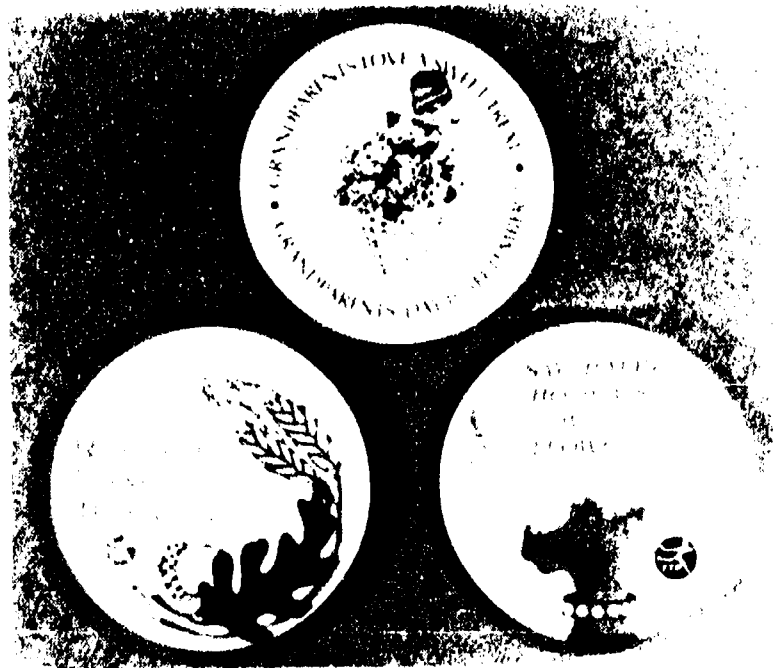
PUBLIC RELATIONS

Good public relations are essential if a business is to thrive. Public relations are important in creating an image, making people aware of your shop, and eventually drawing and keeping customers.

The relationship of the shop to the customers is one form of public relations. Guaranteeing flowers, educating customers about proper flower care, and employing pleasant salespeople who can effectively deal with people, along with every other service you provide, are all important forms of public relations. It can also be very valuable to reach out to the public through participation in local events, speaking engagements, and gifts of flowers, if such practices do not become too expensive or time-consuming.

SUGGESTED ACTIVITIES

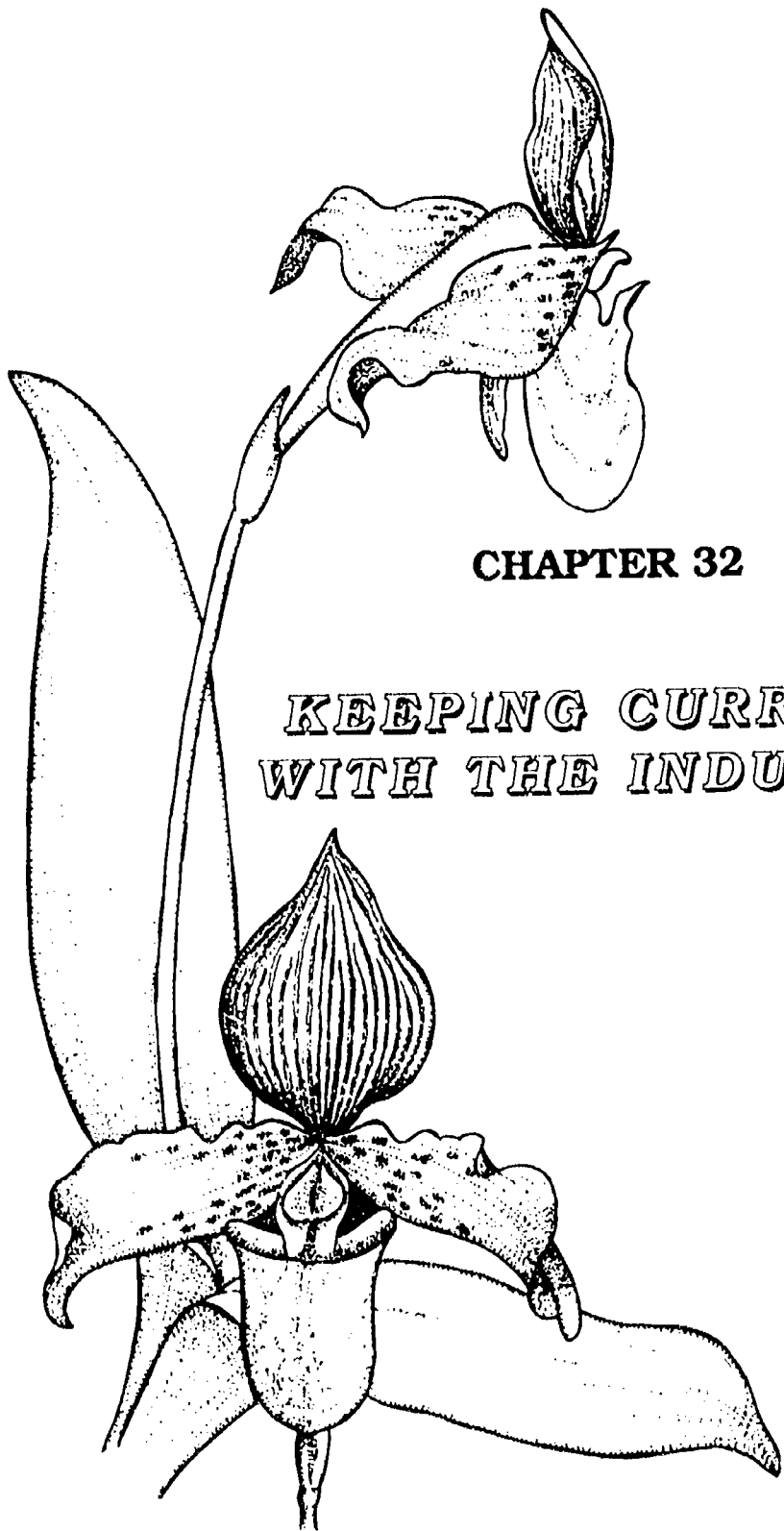
1. Select a week of the year. Design a 4- by 8-inch advertisement to be placed in the newspaper on Wednesday of that week to advertise your shop. Select whatever theme or specials you wish to promote.
 2. Prepare a one-minute radio advertisement that might be read over the air to promote your shop. Write out the message and read it to the class as if you were a radio announcer.
 3. Prepare an advertising strategy for a school project (such as Valentine flowers or flowers for a football game or prom). Decide what you will do and make a timetable for all the tasks that need to be done. Divide up responsibility among class members and carry out the project.
 4. Have each person make a poster to advertise an event that is happening at school. Use felt-tip markers and lettering sets if these are available. Discuss where the posters could be most effectively displayed.
-



Advertising buttons worn by shop employees

BEST COPY AVAILABLE

842



CHAPTER 32

**KEEPING CURRENT
WITH THE INDUSTRY**



The Flower Gazebo, Findlay



AIFD South Central Sym, oslum



A person embarking on a career in retail floriculture should be prepared to continue learning throughout life and be able to adjust to change. New design styles and business practices are constantly developing. Floriculture students who are aware of changes should be able to evaluate their merits. As they incorporate the best of the new ideas into their own situations, they are more likely to be rewarded with success.

A good education will lay a sound foundation for future learning. In high school and college a student will learn basic science, math and communications skills which can be applied in various aspects of everyday life. If enrolled in a horticulture program, the student will be introduced to the basics of plant growth, plant care, floral design, and business management, along with the related practical experience and skill development.

A student wishing to further his or her education by going on to college may begin with either a two- or a four-year program. In Ohio, The Ohio State University offers the two-year Associate of Applied Science Degree in Floral Design and Marketing at the Agricultural Technical Institute in Wooster. Also, there are the four-year Bachelor of Science Degree and graduate degrees offered by Ohio State University in Columbus.

For people who want to take a concentrated course in floral design, there are design schools that offer courses lasting a few weeks. Two well-known design schools are Hixon's in Lakewood, Ohio and the American Floral Art School in Chicago. Many others are advertised in florist magazines.

Keeping current while on the job can be accomplished by reading books and magazines and attending short courses and special programs sponsored by various organizations. In Ohio, the Ohio Florists' Association and The Ohio State University sponsor The Ohio Florist Short Course each July in Columbus. (See Color Plates II-5 and II-7.) This educational event offers special programs by outstanding people in floriculture. It also includes a large trade show where vendors present their latest products. This is an excellent opportunity to meet and exchange ideas with other people in the industry from Ohio and many other states and Canada.

Throughout the year local florist organizations (often called *allieds*) sponsor programs. Wire service organizations offer programs and workshops in addition to their regular publications. The prestigious American Institute of Floral Design (AIFD) has a selective membership of top designers who have gone through the stringent entry requirements. Their quality programs may be attended by non-members.

The Cooperative Extension Service of state land-grant institutions produces publications on a variety of topics and also hosts specialized programs. Garden clubs and horticulture centers often bring in guest designers or hold flower shows. By frequently viewing the work of other designers at these special events and shows, students can pick up new ideas and become motivated to try new approaches in their own work.

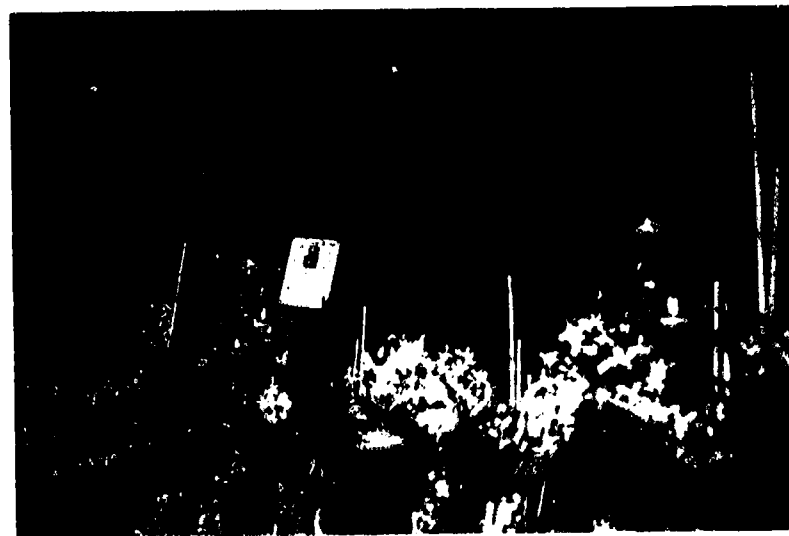
FTD has a student membership category and publishes the FTD Future Florists'

Newsletter. National Junior Horticulture Association (NJHA) has an organization in each state and a national convention with opportunities for displaying skills in identification, design and marketing. Future Farmers of America (FFA) also has a floriculture judging contest along with programs that encourage skill and leadership development. Pi Alpha Xi is a college-level organization which has flower judging competitions based on standards set by the organization.

The lists of periodicals and organizations on the next two pages are intended to be a guide to more information in the area of floral design and marketing. New sources continue to become available to those who keep current with the industry. Those involved in floriculture must evaluate for themselves which publications and activities best serve their needs and interests.



The Florists' Association of Greater Cleveland advertises at the Cleveland Home and Garden Show



The Ohio Florist Short Course in Columbus

Organizations Offering Information and Programs on Floral Design and Marketing

American Academy of Floriculture (AAF)

(same address as Society of American Florists)

American Floral Marketing Council (AFMC)

(same address as Society of American Florists)

American Institute of Floral Designers (AIFD)

113 W. Franklin Street
Baltimore, MD 21201

Associated Landscape Contractors of America

Interior Plantscape Division
405 N. Washington St., Suite 104
Falls Church, VA 22046

Cooperative Extension Service

at Land Grant Universities
(e. g., The Ohio State University)

Flower Council of Holland

250 West 57th Street
New York, NY 10019

Garden Clubs

- The Garden Clubs of Ohio
- Men's Garden Clubs of America
- The National Council of State Garden Clubs
- The Ohio Association of Garden Clubs
- The Women's National Farm and Garden

Local/Regional Florists' Organizations and Cooperatives

(examples in Ohio *besides* those associated with wire service organizations)

- Allied Florists' Association of Toledo, Toledo
- Allied Florists of Trumbull County, Warren
- Central Ohio Allied Florists' Association, Columbus
- Everyday Flowers, Inc., Dayton
- Florists' Association of Greater Cleveland, Inc., Cleveland
- Florists' Courtesy Service, Cleveland
- Lorain County Florists' Association, Elyria
- Metro Delivery Service, Cincinnati
- Southern Ohio Florists' Association, Portsmouth

Ohio Florists' Association (OFA)

700 Ackerman Road, Suite 230
Columbus, Ohio 43202

Professional Floral Commentators International (PFCI)

(same address as Society of American Florists)

Society of American Florists (SAF)

The Center for Commercial Floriculture
1601 Duke Street
Alexandria, VA 22314

Wholesale Florists and Florist Suppliers of America (WF & FSA)

P.O. Box 7308
Arlington, VA 22207

Wire Service Organizations

- American Floral Services, Inc. (AFS)
- Carik Services, Inc.
- Florafax International, Inc.
- Florists' Transworld Delivery Association (FTD)
- Redbook
- Teleflora, Inc.

Periodicals in the Area of Floral Design and Marketing

Design for Profit (quarterly)

Florafax International, Inc.
4175 South Memorial Drive
Tulsa, OK 74145

Floral Finance (monthly)

Financial Control Publishing, Inc.
1820 South Boulder Place
Tulsa, OK 74119

Floral & Nursery Times (semimonthly)

328 Linden Avenue
Wilmette, IL 60091

Floriculture Directions (monthly)

Herb Mitchell Associates, Inc.
234 East 17th Street, Suite 202
Costa Mesa, CA 92627

Florist (monthly)

Florists' Transworld Delivery Association
29200 Northwestern Highway
Southfield, MI 48037

Florists' Review (weekly)

Florists' Publishing Company
310 South Michigan Avenue
Chicago, IL 60604

Flower News (weekly)

Central Flower News, Inc.
549 West Randolph Street
Chicago, IL 60606

Flowers & (monthly)

Teleflora Inc.
2400 Compton Blvd.
Redondo Beach, CA 90278

FTD Future Florists' Newsletter

(3 times/year)
Florists' Transworld Delivery Association
29200 Northwestern Highway
Southfield, MI 48037

MarketLetter (weekly)

Florists' Publishing Company
111 North Canal Street, Suite 545
Chicago, IL 60606

Ohio Florists' Association Bulletin (monthly)

Ohio Florists' Association
700 Ackerman Road, Suite 230
Columbus, OH 43202

The Professional Floral Designer (bimonthly)

American Floral Services, Inc.
P.O. Box 12309
Oklahoma City, OK 73157

SAF - Business News for the Floral Industry (monthly)

Society of American Florists
The Center for Commercial Floriculture
1601 Duke Street
Alexandria, VA 22314

U.S. Government Publications

U.S. Government Printing Office
Superintendent of Documents
Washington, DC 20402

U.S. Department of Agriculture
(USDA Market News)

Department of the Treasury
Internal Revenue Service
(tax information)

U.S. Department of Commerce
The Bureau of the Census

Small Business Administration

World Flower Trade Magazine (bimonthly)

Global Marketing Associates, Inc.
P.O. Box 30185
6803 AD Arnhem
The Netherlands

REFERENCES

- Aaronson, Marian, *Flowers in the Modern Manner*, Grower Books, 1981
- The American Horticultural Society, *Houseplants*, The Franklin Library/Ortho Books for The American Horticultural Society, Mount Vernon, VA, 1980
- Ascher, Amalie, *The Complete Flower Arranger*, Simon and Schuster, New York, 1974
- Benz, Morris, *Flowers: Abstract Form*, San Jacinto Publishing Co., Houston, TX, 1976
- Benz, Morris, and Johnson, James, *Flowers: Geometric Form*, San Jacinto Publishing Co., Houston, TX, 1986
- Berrall, Julia, *A History of Flower Arrangement*, The Viking Press, New York, 1968
- Briggs, George, and Calvin, Clyde, *Indoor Plants*, John Wiley & Sons, New York, 1987
- Cavin, Bram, *How to Run a Successful Florist and Plant Store*, David McKay Company, Inc., New York, 1977
- Coe, Stella, *Ikebana*, The Overlook Press, New York, 1984
- Cook, Hal, *Arranging, The Basics of Contemporary Floral Design*, William Morrow & Company, New York, 1985
- Flesher, Irene, *Pressed Flower Art*, New Century Publishers, Inc., Piscataway, NJ, 1984
- Gaines, Richard, *Interior Landscaping*, Architectural Record Books, New York, 1977
- Goodrich, Dana, *Floral Marketing*, Lebharr-Friedman, New York, 1980
- Graf, Alfred, *Exotica Series 4, Volumes 1 and 2*, Roehrs Company, P.O. Box 125, East Rutherford, NJ 07073, 1985
- Guild, 'Tricia, *Designing with Flowers*, Mitchell Beazley Publishers, London, 1986
- Hamel, Esther, *The Encyclopedia of Judging and Exhibiting Floriculture and Flora-Artistry*, Ponderosa Publishers, St. Ignatius, MT 59865, 1976
- Healey, Deryck, *The New Art of Flower Design*, Villard Books, New York, 1986
- Hillier, Malcolm, and Hilton, Colin, *The Complete Book of Dried Flowers*, Dorling Kindersley, Simon and Schuster, New York, 1986
- Hixon, Bill, *Bouquets*, Toppan Printing Company, Ltd., Tokyo, Japan, 1979
- Hixon, Bill, *A Guide to Professional Floral Arrangements*, Printed in Japan for Hixon's Floral Design School, 14125 Detroit Ave., Lakewood, OH 44107, 1979
- Hixon, Bill, *A Treasury of Bridal Bouquets*, Kersen Engel Center, Tokyo, Japan, 1972
- Hunter, Margaret, and Hunter, Edgar, *The Indoor Garden: Design, Construction and Furnishing*, Wiley & Sons, New York, 1978
- Ingham, Stewart, and Martin, Sylvia, *Elegance in Flowers, Classic Arrangements for All Seasons*, Oxmoor House, Birmingham, AL, 1985
- Interior Plantscape Association, *Source Book*, Interior Plantscape Association, 1980

- The John Henry Company, 5800 W. Grand River, P.O. Box 17099,
Lansing, MI 48901
Christmas Around the World
The Christmas Idea Book
Corsages for All Occasions
Favorites Forever
Flower & Foliage Plant Book
Holland Flower Design Book
Prom and Party Floral Fashions
Reflections of Wedding Tradition
Remembrance
The Silk and Dried Arrangement Book, Vol. II
Tips 'n Techniques for Wedding Designs
Wedding Flowers
Your Wedding Planner
- Johnson, Marion, *Small and Beautiful Flower Arrangements*,
Clarkson N. Potter, Inc., New York, 1983
- Kong, Im Wha, *Oriental Flower Arrangement*, Shufunotomo Co.,
Ltd., Japan, 1982
- Kong, Im Wha, *Oriental Flower Arrangement II*, Shufunotomo Co.,
Ltd., Japan, 1984
- Larnie, Walter, *Flower Arranging, Basics to Advanced Design*,
Prentice-Hall, Inc., Englewood Cliffs, NJ, 1980
- Lewis, Taylor and Young, Joanne, *Christmas in Williamsburg*,
Williamsburg Foundation, Williamsburg, VA, 1976
- MacFarlane, Ruth, *Collecting and Preserving Plants for Science
and Pleasure*, Arco Publishing, Inc., New York, 1985
- Macqueen, Sheila, *Complete Flower Arranging*, Times Books,
1980
- Madderlake (Authors Pritchard, Tom; Jarecki, Billy; and
Boehmer, Alan), *Flowers Rediscovered, New Ideas for Using
and Enjoying Flowers*, Stewart, Tabori and Chang Publishers,
New York, 1985
- Manaker, George, *Interior Plantscapes: Installation, Maintenance
and Management*, Second Edition, Prentice-Hall, Inc.,
Englewood Cliffs, NJ, 1987
- Mann, Pauline, *Flowers That Last, Arranging Dried and Preserved
Plants and Flowers*, Batsford, Ltd., London, 1984
- McDaniel, Gary, *Floral Design and Arrangement*, Reston
Publishing Company, Reston, VA, 1981
- Miller, Marie, *New Dimensions in Floral Design*, Wegferd Publi-
cations, North Bend, OR, 1981
- Oliver, Libbey; Babb, Betty; Booth, Elizabeth; Kent, Betsy; and
Marquardt, Martha, *Colonial Williamsburg Decorates for
Christmas*, The Colonial Williamsburg Foundation,
Williamsburg, VA, 1981
- Ortho, *Complete Guide to Successful Houseplants*, Chevron
Chemical Company, San Francisco, CA, 1984
- Otis, Maia, and Beadle, Ernst, *Decorating With Flowers*, Harry N.
Abrams, Inc., New York, 1978
- Pfahl, Peter, and Kalin, Elwood, *American Style Flower Arranging*,
Prentice-Hall, Inc., Englewood Cliffs, NJ, 1982
- Pfahl, Peter, and Pfahl, P. Blair, *The Retail Florist Business*,
Fourth Edition, Interstate Printers and Publishers, Danville,
IL, 1983
- Pi Alpha Xi, *A Manual for Flower Judging*, Pi Alpha Xi National,
University of Wisconsin, River Falls, WI 54022, Revised 1983
- Poole, Hugh, and Pittenger, Dennis, *Care of Foliage and Flowering
Plants for Retail Outlets*, Cooperative Extension Service, Ohio
State University, Columbus, OH, 1978
- Reader's Digest, *Success with House Plants*, Reader's Digest,
Pleasantville, NY, 1979

- Rittner, Stephen, *Window Display for the Retail Florist*, Rittners Publishers, Boston, MA, 1981
- Rohman, Dale, *A Time for Flowers*, Patrice Press, St. Louis, MO, 1982
- Shinno, Tat, *Flower Arranging by Tat*, Lane Books, Menlo Park, CA, 1971
- Smithers Oasis, The Smithers Company, Box 118, Kent, OH 44240
European Designer Collection Holiday Ideas
European Designer Collection Spring Ideas
Smithers-Oasis Floral Products: Information and Demonstrations
- Society of American Florists, *Care and Handling of Flowers and Plants*, Society of American Florists, Alexandria, VA, 1987
- Sparnon, Norman, *Creative Japanese Flower Arrangement*, Shufunotomo Co., Ltd., Japan, 1984
- Staby, George; Robertson, Jerry; Kiplinger, D.C.; and Conover, Charles, *Chain of Life*, Ohio Florist Association, 1978
- Stewart, Martha, *Weddings*, Clarkson N. Potter, Inc., New York, 1987
- Sullivan, Glenn; Robertson, Jerry; and Staby, George, *Management for Retail Florists*, W.H. Freeman and Co., San Francisco, CA, 1980
- Taylor, J. Lee, *Growing Plants Indoors*, Burgess Publishing House, Minneapolis, MN, 1977
- Taylor, Jean, *Plants and Flowers for Lasting Decoration*, Larousse and Co., Inc., New York, 1981
- Teshigahara, Wafu, *Ikebana, A New Illustrated Guide to Mastery*, Kodansha International, Ltd., Japan, 1980
- Tharp, Leonard, and Ruffin, Lisa, *An American Style of Flower Arrangement*, Taylor Publishing Co., Bellingham, WA, 1986
- Time-Life Books, Alexandria, VA
Decorating With Plants, 1978
Flowering House Plants, 1972
Foliage House Plants, 1972
- Tolle, Leon, *Floral Art for Religious Events*, Hearthsides Press, New York, 1969
- Ullenbruch, Mrs. William, *Flower Arranging*, Cooperative Extension Service, Michigan State University, East Lansing, MI
- Vagg, Daphne, *Flowers for the Table*, The Anchor Press, Ltd., Batsford, England, 1983
- Webb, Iris, *The Complete Guide to Flower and Foliage Arrangement*, Doubleday and Company, Garden City, NY, 1979
- Wright, Michael, *The Complete Indoor Gardener*, Random House, New York, 1974