

DOCUMENT RESUME

ED 312 376

CE 053 420

TITLE Midwest Nuclear Training Association Annual Nuclear Instructors' Workshop (4th, Columbus, Ohio, October 16-18, 1989).

INSTITUTION Midwest Nuclear Training Association.; Ohio State Univ., Columbus. Center on Education and Training for Employment.

PUB DATE Oct 89

NOTE 167p.; Workshop conducted in cooperation with Ohio State University's Nuclear Engineering Program and the National Academy for Nuclear Training.

PUB TYPE Collected Works - Conference Proceedings (021) -- Reports - Research/Technical (143) -- Guides - Classroom Use - Guides (For Teachers) (052)

EDRS PRICE MF01/PC07 Plus Postage.

DESCRIPTORS Accreditation (Institutions); Computer Oriented Programs; Educational Improvement; Employee Attitudes; Energy Occupations; *Inservice Teacher Education; *Job Training; Mechanics (Process); Nuclear Physics; Nuclear Power Plants; *Nuclear Power Plant Technicians; *Nuclear Technology; Postsecondary Education; *Program Development; Program Evaluation; *Program Improvement; Teacher Certification; Teaching Methods; Utilities; Work Attitudes

ABSTRACT

This document reports the proceedings of a national workshop designed to provide nuclear trainers from the electric power industry with an opportunity to expand and improve their knowledge and skills in the development and implementation of effective training programs. The following papers are included: "Developing Positive Worker Behaviors: Techniques and Strategies that Work" (Robert E. Norton); "Root Cause Analysis Training, An Introduction" (Kenneth D. Crouch); "Using Computer Technology to Enhance Instruction" (Ronald C. Comer); "Using Evaluation Feedback for Instructional Improvement" (Michael Price); "Improving the Quality of Instruction: The First Step toward Excellence" (Thomas L. Fueston); "Certifying Simulator Instructors" (John Magennis and Jo Palchinsky); "Developing Training Program Steward Skills with Modularized Materials--Units 1-3" (San Onofre Nuclear Generation Site, Southern California Edison Company); and "Accreditation Renewal: An Overview" (Ronald L. Fritchley). An outline of the workshop sessions and a list of program participants is included in the report. (KC)

 * Reproductions supplied by EDRS are the best that can be made *
 * from the original document. *

ED312376

MNTA Fourth Annual Nuclear Instructors' Workshop

October 16-18, 1989 Columbus, Ohio



COSPONSORED BY



MIDWEST NUCLEAR TRAINING ASSOCIATION



NUCLEAR ENGINEERING PROGRAM



U.S. DEPARTMENT OF EDUCATION
Office of Educational Research and Improvement
EDUCATIONAL RESOURCES INFORMATION CENTER (ERIC)

- This document has been reproduced as received from the person or organization originating it
- Minor changes have been made to improve reproduction quality
- Points of view or opinions stated in this document do not necessarily represent official OERI position or policy

"PERMISSION TO REPRODUCE THIS MATERIAL HAS BEEN GRANTED BY

R. Norton

TO THE EDUCATIONAL RESOURCES INFORMATION CENTER (ERIC)."

CE 053420



October 17, 1989



1900 Kenny Road
Columbus, Ohio 43210-1090

Phone: 614-292-4353
Telex: 9102505950
Fax: 614-292-1260

Dear Colleague:

On behalf of the Program Planning Committee and workshop Co-Directors, Robert E. Norton and Brian K. Hajek, I want to WELCOME you to Columbus, Ohio and the Center on Education and Training for Employment. This national workshop is being conducted in cooperation with the Midwest Nuclear Training Association, the Nuclear Engineering Program at The Ohio State University, and the National Academy for Nuclear Training. This comprehensive, 2-day workshop is designed to provide training personnel from the electric power industry with an opportunity to expand and improve their knowledge and skills in the development and implementation of effective training programs.

Every effort has been made to make this an enjoyable and productive educational learning experience. You will have ample opportunity to share your ideas and concerns with fellow participants and presenters throughout the next two days. We hope upon conclusion of this program you will leave with new strategies, techniques, and resources for use in your company.

Sincerely,

Scot Krause
Program Coordinator
Center on Education and
Training for Employment

SK

WORKSHOP OBJECTIVES

You Will Learn How To--

- o Acquire some new instructional skills
- o Enhance instructional skills already possessed
- o Keep Abreast of changing industry standards and regulations
- o Keep Abreast of changing industry accreditation requirements and training guidelines

You Will Also Have The Opportunity To--

- o Network with recognized industry experts on selected topics and issues
- o Interact with other nuclear training professionals
- o Promote Professionalism, Safety, and Excellence within the electric utility industry

MNTA WORKSHOP PLANNING COMMITTEE

Ronald J. Bruno, Superintendent of Training, Wisconsin Electric Power Company

Brian K. Hajek, Research Scientist, Nuclear Engineering Program, The Ohio State University

Greg R. Hossbach, Program Development Administrator, Commonwealth Edison Company

Dave Igyarto, Training Manager, Cleveland Electric Illuminating

Robert E. Norton, Consortium Manager, Center on Education and Training for Employment, The Ohio State University

Rick A. Simpkins, Training Manager, Nuclear Operations, Toledo Edison

MNTA FOURTH ANNUAL
NUCLEAR INSTRUCTORS' WORKSHOP

October 16-18, 1989
Ohio Center-Holiday Inn
Columbus, Ohio

WORKSHOP PROGRAM

Monday, October 16, 1989

7:00-10:00 p.m. Get Acquainted Social
Ohio Center-Holiday Inn
Hosted by CORE--Pat Casey

Tuesday, October 17, 1989

7:30 a.m. Workshop Registration

8:30 a.m. OPENING GENERAL SESSION

Welcome, Introductions, and Orientation
to Workshop Program

Robert E. Norton
Consortium Director
Center on Education and Training
for Employment

Brian K. Hajek
Research Scientist
Nuclear Engineering Program
The Ohio State University

8:45 a.m. Opening Remarks

Dave Igyarto
MNTA Vice-Chairman and Training Manager
Cleveland Electric Illuminating

8:55 a.m. NRC Initiatives for FY1990

Tom Burdick
Chief of Operator Licensing
NRC, Region III

Tuesday, October 17, 1989 (Continued)

9:40 a.m. Preparing for Accreditation Renewal

 Ronald L. Fritchley
 Manager
 Training Systems Department
 Institute of Nuclear Power Operations

10:25 a.m. Refreshment Break

10:45 a.m. Panel Presentation: Developing
 Instructional Skills With Modularized
 Materials

 David Keck
 Instructional Trainer
 Duke Power and Light

 Jo Palchinsky
 Instructional Specialist
 Florida Power and Light

 Patrick Smith
 Training Systems Support Administrator
 Southern California Edison

 Dave Watson
 Nuclear Operations Training Academic
 Specialist
 Florida Power Corporation

12:15 p.m. Buffet Luncheon
 Ohio Center-Holiday Inn
 Prefunction Area

Tuesday, October 17, 1989 (Continued)

3:15-4:45 p.m. CONCURRENT WORKSHOP SESSIONS Select One

- (4) Evaluating Performance in Laboratory Training -- Riviera
Scott Stahler, Training Supervisor, Commonwealth Edison

By establishing a "working" lab quality control program, training laboratories can solve two recurring problems. Trainee performance can be objectively evaluated by monitoring the precision and accuracy of their analysis, and secondly, instructor qualifications can be evaluated, with their results forming the basis for instructor continuing education.

- (5) JPMs: Lessons Learned -- Kingsmill
Dave Dowker, Training Instructor, Toledo Edison Company

Job Performance Measures form an intergral part of the new requalification exams. Everyone has had an opportunity to test the effectiveness of these new JPMs. The question is, "How do the JPMs of today compare with those of just a year ago?" CIRCLE ONE: BETTER. SAME. WORSE.

- (6) Facilitating Effective Group Interaction -- Scioto
William P. Werner, Manager of Management/Educational
Development, GPU Nuclear Corporation

During this workshop, participants will receive a generic model of group development. Then they will be given proven facilitative, team building techniques that help a group become effective quickly. Therefore, anyone who works with groups--Managers, Supervisors, Instructors--would benefit.

4:45 p.m. Daily Feedback and Adjournment

5:30-7:30 p.m. Crackerbarrel and Networking
Ohio Center-Holiday Inn
Hosted by GE Nuclear Training Services--
Mike Price

Wednesday, October 18, 1989

8:00 a.m. Morning Refreshments and Conversation

8:15 a.m. SECOND GENERAL SESSION

Training Instructors: Keys To Nuclear Professionalism

Walt Coakley
Executive Director
National Academy of Nuclear Training

9:15 a.m. Professionalism, ASTD, and The Technical Trainer

Gloria Ann Regalbuto
National Board Member and President Elect
American Society of Training and Development

10:00 a.m. Refreshment Break

Wednesday, October 18, 1989 (Continued)

10:30-12:00 noon CONCURRENT WORKSHOP SESSIONS Select One

- (7) Maintaining a Requal Exam Bank -- Riviera
Mark L. Mervine, Training Coordinator, Wisconsin Electric
Power Company

The purpose of this presentation will be to make nuclear trainers aware of the NRC maintenance requirements for the NRC Requal Exam Bank and to review the different possible methods of maintaining and keeping the exam book up-to-date.

- (8) Critiquing Trainee Laboratory Performance -- Kingsmill
Greg Duncan, Senior Trainer, Toledo Edison Company

A participant-centered discussion of how laboratory trainers can use formative and summative critiques to increase student involvement in the learning process will be utilized in this workshop session. Through group interaction, the participants will generate a list of the five best tips for conducting critiques of laboratory performance.

- (9) Root Cause Analysis Training: An Introduction -- Scioto
Ken Crouch, Skills Training Coordinator, Cleveland
Electric Illuminating

This presentation will focus attention on the specific training needs for each work group. A gap exists between their unique needs and the generic training that many have received. You will learn how to bridge this gap by tailoring root cause analysis training to each work group.

12:00 noon Buffet Luncheon
 Ohio Center-Holiday Inn
 Prefunction Area

Wednesday, October 18, 1989 (Continued)

3:00-4:30 p.m. CONCURRENT WORKSHOP SESSIONS Select One

- (13) Closing The Feedback Loop -- Riviera
Michael G. Price, Lead Certification Examiner, General
Electric

Relating available methods of feedback to new technology will give the individual learner more specific help. This new technology will also aid in training program improvement as well as methods for documentation.

- (14) Motivating Your Students in Class by Establishing Yourself
in Their Presence -- Kingsmill
Brian K. Hajek, President/Research Scientist, Nuclear Educa-
tion and Training Services, Inc./The Ohio State University

This presentation will focus on methods to project yourself in front of a class. It will discuss and practice proven methods to establish your presence at the front of the class-room, commanding the area; methods to make contact with your students; to actually become part of the class; and methods for effectively using illustrations, visuals, and props.

- (15) Improving The Quality of Operations -- Scioto
Thomas L. Fueston, Senior Training Advisor, Westinghouse
Training and Operational Services

The basis for the "Quality" in your day-to-day operations is dependent upon the Quality Values of the individuals and teams that comprise your organization. But how do you teach values? Defining Quality, why it is important, as well as what focusing on Quality can do for both the individual and the organization are the first steps toward gaining individual and team commitment to "Quality of Operations".

4:30 p.m. Workshop Summary: Issues and
Challenges Ahead

Dave Igyarto
MNTA Vice-Chairman and Training Manager
Cleveland Electric Illuminating

4:45 p.m. Final Adjournment

MNTA Nuclear Instructors' Workshop
Columbus, Ohio
October 16 - 18, 1989

Roger Anderson
Program Administrator
Cook Indiana Michigan Power
1 Cook Place
Bridgman, MI 49106
(616)465-5901

Ronald Anfinson
Senior Specialist
Instructional Design
General Electric
7655 E. Collins Road
Morris, IL 60450
(815)942-5790

Norm Barnett
Area Manager
Training
Westinghouse Savannah River Co.
Savannah River Site
Aiken, SC 29808-0001
(803)557-9727

Dean Berardinelli
Product Applications Training
Westinghouse Electric
PO Box 598
Pittsburgh, PA 15230
(412)733-6542

Terry Breithaupt
Training Specialist
Westinghouse Savannah River Co.
Savannah River Site
Aiken, SC 29808
(803)557-9727

Tom Burdick
Chief of Operator Licensing
Section II, PWR
USNRC Region III
Building 4, 700 Roosevelt Rd
Glen Ellyn, IL 60137

Franklyn Cabanillas
Westinghouse Savannah River Co.
Savannah River Site.
Po Box 616
Aiken, SC 29802
(803)557-9727

Patrick Casey
President
CORE Corporation
6480 Dobbin Road
Columbia, MO 21045
(301)730-2673

Mike Chambers
Qualifications Instructor
Toledo Edison
300 Madison Avenue
Toledo, OH 43652
(419)321-7403

Walt Coakley
Vice President
Institute of Nuclear Power Operations
1100 Circle 75 Parkway
Atlanta, GA 30339

Ken Crouch
Skills Instructor
Perry Training Section
Cleveland Electric Illuminating Co.
Perry, OH 44081
(216)259-3737

Jim Dickson
Instructor
Indiana Michigan Power
1 Cook Place
Bridgman, MI 49106
(616)465-5901

Martin Dixon
Instructional Technologist
Indiana Michigan Power
1 Cook Place
Bridgman, MI 49106
(616)464-5901

Dave Dowker
Nuclear Training Specialist
CORE Corporation
6480 Dobbin Road
Columbia, MO 21045
(301)730-2673

E.R. Drenth
Senior Technical Instructor
Consumers Power Co.
10269 US 31 North
Charlevoix, MI 49720
(616)547-6537

Greg Duncan
Operations Training Manager
Toledo Edison
300 Madison Avenue
Toledo, OH 43652

Frank Fagan
Licensed Training Instructor
Perry Training Section
Cleveland Electric Illuminating Co.
10 Center Road
Perry, OH 44081
(216)259-3737

Mary F. Federspiel
Training Administrator
Consumers Power Co.
3249 E. Gordonville Road
Midland, MI 48640
(517)839-8078

Ronald Fritchley
Senior Project Manager
Institute of Nuclear Power Operations
1100 Circle 75 Parkway
Atlanta, GA 30339

Tom Fueston
Nuclear Training Center
Westinghouse Electric Corporation
505 Shiloh Blvd.
Zion, IL 60099

Gary Green
Technical Instructor
Westinghouse Hanford Company
PO Box 1970
Richland, WA 99352
(509)376-4861

Brian Hajek
Research Scientist
Engineering Experiment Station
The Ohio State University
206 W. 18th Avenue
Columbus, OH 43210
(614)292-5405

Lois Harrington
Program Associate
The Center on Education and Training
for Employment
1900 Kenny Road
Columbus, OH 43210
(800)848-4815

Darrel Hensley
Nuclear Instructor II
Consumers Power Co.
Palisades Power Plant
Covert, MI 49043-9530
(616)764-8913

Tom Hindes
Director
Instructional Materials Laboratory
The Ohio State University
1900 Kenny Road
Columbus, OH 43210
(614)292-4353

Marjorie Hobe
Emergency Planner/Nuclear Instructor
Consumers Power Company
10269 US-31 North
Charlevoix, MI 49720
(616)547-6537

Mark Hoffman
Supervisor
Technical Skills Training
Toledo Edison
300 Madison Avenue
Toledo, OH 43652
(419)321-7403

Greg R. Hossbach
Administrator
Commonwealth Edison Co.
36400 S. Essex Road
Wilmington, IL 60481
(815)458-3411

David Igyarto
Manager
Perry Training Section
Cleveland Electric Illuminating Co.
10 Center Road
Perry, OH 44081
(216)259-3737

Ronald Jacobs
Assistant Professor
The Ohio State University
160 Ramseyer
Columbus, OH 43210
(614)292-5037

Niles Johnson
Licensed Training Instructor
Perry Training Section
Cleveland Electric Illuminating Co.
10 Center Road
Perry, OH 44081
(216)259-3737

Tom Johnson
Simulator Instructor
Production Training Center
Commonwealth Edison
36400 South Essex Road
Wilmington, IL 60481
(815)458-3411

David Keck
Instructional Trainer
Production Training Services
Duke Power Company
Rt. 4, Box 531
Huntersville, SC 28078

Gerald F. Kenney
Instructional Technologist
Detroit Edison Co.
6400 N. Dixie Highway
Newport, MI 48161
(313)586-4114

Frank Keppel
Training Specialist
Duquene Lighting Co.
Beaver Valley Power Station
PO Box 4
Shippenport, PA 15077
(412)393-5771

Scot Krause
The Center on Education and Training
for Employment
1900 Kenny Road
Columbus, OH 43210
(800)848-485

Pat Leheney
Lead Instructor
Commonwealth Edison
RR1 Box 220
Marsailles, IL 61341
(815)357-6761

Steve Livingston
Qualification Instructor
Toledo Edison
300 Madison Avenue
Toledo, OH 43652
(419)321-7403

Richard Luse
Unit Supervisor
Nuclear Skills Unit
Perry Training Section
Cleveland Electric Illuminating Co.
10 Center Road
Perry, OH 44081
(216)259-3737

Michael Lyon
Supervisor
License Training
Illinois Power Co.
Clinton Power Station
V-922 PO Box 678
Clinton, IL 61727
(217)935-8881

Pat Martin
Sr. Training Specialist
Point Beach Nuclear Station
Wisconsin Electric
6610 Nuclear Road
Two Rivers, WI 54241
(414)755-2321

Don McAlhany
Instructor
Indiana Michigan Power
One Cook Place
Bridgman, MI 49106
(616)465-5901

Mark Mervine
Training Coordinator
Point Beach Nuclear Plant
Wisconsin Electric
6610 Nuclear Road
Two Rivers, WI 54241
(414)755-2321

John Miller
Supervisor of Training Support
New York Power Authority
Buchanan, NY 10511
(914)736-8926

Bill Myers
Pacific Gas & Electric Co.
PO Box 56
Avila Beach, CA 93432
(805)595-4218

Bob Norton
Senior Research Specialist
The Center on Education and Training
for Employment
1900 Keaney Road
Columbus, OH 43210
(800)848-4815

Patrick O'Brien
Coordinator
Nuclear Training Curriculum
Wisconsin Public Service Corp.
PO Box 196
Kewaunee, WI 54216
(414)388-3445

Blaine Olney
Senior Skills Instructor
Consumers Power Co.
Palisades Power Plant
27780 Blue Star Highway
Covert, MI 49043-9530
(616)764-8913

Mark Olson
Principal Instructor
Production Training Center
Commonwealth Edison
36400 S. Essex Road
Wilmington, IL 60181
(815)453-3411

Mark Onken
Instructor
Indiana Michigan Power
1 Cook Place
Bridgman, MI 49106
(616)465-5901

Jo Palchinsky
Nuclear Curriculum Specialist
Florida Power & Light
PO Box 1400
Juno Beach, FL 33477
(407)694-4236

Randy Patrick
Qualification Instructor
Toledo Edison
300 Madison Avenue
Toledo, OH 43652
(419)321-7403

Ferry A. Pease
General Program Developer
Production Training Center
Commonwealth Edison Co.
36400 S. Essex Road
Wilmington, IL 60481
(815)458-3411

Patrick Pitcher
Training Instructor
Technical Skills
Toledo Edison
300 Madison Avenue
Toledo, OH 43652
(419)321-7403

Mike Price
General Electric Nuclear Training Serv.
203 Earl Road, Suite C
Shorewood, IL 60436

Gloria Ann Regalbutto
ASTD National Board Member
3926 Charity Drive
Carroll, OH 43112

Randy Sargent
Training Instructor
Pacific Gas & Electric Co.
PO Box 56
Avila Beach, CA 93424
(805)595-4318

Eric Schatz
Skills Instructor
Perry Training Section
Cleveland Electric Illuminating Co.
10 Center Road
Perry, OH 44081
(216)259-3737

Dave Schavey
Simulator Instructor
Production Training
Commonwealth Edison
36400 S. Essex Road
Wilmington, IL 60481
(815)458-3411

Mike Schoener
Manager
Technical Training Services
Core Corporation
6480 Dobbin Road
Columbia, MO 21045
(301)730-2673

Dave Sheldon
Group Leader
Commonwealth Edison
RRI Box 220
Marseilles, IL 61341
(815)357-6761

Patrick Smith
Administrator
Training Systems Support
Southern California Edison
PO Box 128
San Clemente, CA 92672

Dale Spencer
Training Specialist
Indiana Michigan Electric
PO Box 458
Bridgman, MI 49106

Scott Stahler
Training Supervisor
Commonwealth Edison
36400 S. Essex Road
Wilmington, IL 60481
(815)458-3411

Tim Streeter
Computer Instructor
Niagara Mohawk Nuclear Training
Department 60
RRI Box 148
Oswego, NY 13126-9719
(315)349-2993

Don Sullivan
Instructor
Technical Skills Training
Toledo Edison
300 Madison Avenue
Toledo, OH 43652
(419)321-7403

Robert Svaleson
Operations Instructor
Quad Cities Nuclear Power Station
Commonwealth Edison
22710-206 Avenue North
Cordora, IL 61242
(309)654-2241

James H. Syrowski
Manager
Nuclear Training
Toledo Edison
300 Madison Avenue
Toledo, OH 43652
(419)321-7403

Paul Timmerman
Supervisor
Nuclear Operations Program
Toledo Edison
300 Madison Avenue
Toledo, OH 43652
(419)321-7403

Laura Travethar
Skills Instructor
Perry Training Section
Cleveland Electric Illuminating Co.
10 Center Road
Perry, OH 44081
(216)259-3737

Frank Van-Etten
Training Supervisor
Dwayne Arnold Energy Center
Iowa Electric Light & Power
33634 DAEC Road
Palo, IA 52324
(319)851-7569

Terry Vandenbosch
Sr. Training Specialist
Point Branch Nuclear Plant
Wisconsin Electric
6610 Nuclear Road
Two Rivers, WI 54241
(414)755-2321

S. Vanderheide
Nuclear Instructor II
Consumers Power Co.
10269 U.S. 31 North
Charlevoix, MI 49720
(616)547-6537

Dave Watson
Academic Specialist
Nuclear Operations Training
Crystal River Nuclear Plant
Florida Power Corp.
8200 West 7 Rivers Drive
Crystal River, FL 32629

Kathleen Wendell
Education Specialist
Pacific Gas & Electric Co.
PO Box 56
Avila Beach, CA 93424
(805)595-4318

William Werner
Manager
Management & Educational Development
General Public Utilities
1 Upper Pond Road
Parsippany, NJ 07054
(201)316-7376

Mike Wesley
Operator Training Unit Supervisor
Perry Training Section
Cleveland Electric Illuminating Co.
10 Center Road
Perry, OH 44081
(216)259-3737

Peggy Wickert
Skills Instructor
Perry Training Section
Cleveland Electric Illuminating Co.
10 Center Road
Perry, OH 44081
(216)259-3737

Tom Winfield
Training Specialist
Duquene Lighting Co.
Beaver Valley Power Station
PO Box 4
Shippenport, PA 5077
(412)393-5771

Scot Wise
Supervisor
Nuclear Operations Program
Toledo Edison
300 Madison Avenue
Toledo, OH 43652
(419)321-7403

Mike Wonacott
Program Associate
The Center on Education and Training
for Employment
1900 Kenny Road
Columbus, OH 43210
(800)848-4815

Developing Positive Worker Behaviors: Techniques and Strategies That Work¹

Robert E. Norton
Senior Research and Development Specialist
Center on Education and Training for Employment
The Ohio State University
Columbus, Ohio 43210

Worker attitudes and behaviors, like the weather, are things people talk about but (too often) don't do anything about. We, as instructors, however, can teach behaviors and try to cultivate the undergirding attitudes.

Worker attitudes and behaviors fall into the affective domain, as opposed to the cognitive or psychomotor domains. Educators have long been comfortable teaching cognitive knowledge (concepts, facts, principles, and generalizations) and psychomotor skills (performances that require the manipulation of objects, tools, supplies, and equipment). Some affective skills (attitudes and behaviors) have also been taught, albeit without the label (classroom/laboratory conduct).

What Are Attitudes and Behaviors?

... we believe that attitudes are internal states that influence behavior. We can infer these states from actions and words. (Martin and Briggs 1986, p. 101)

Behavior is the external reflection of internal attitudes. Attitudes, of themselves, are impossible to measure directly, but behaviors are not. Attitudes can be influenced by external as well as internal factors. The teacher's role, then, is to provide explicitly stated expectations of behavior (external factors) that the student can understand. The student may acquire the external behavior faster than the internal attitudes or may never really "buy into" the internal attitude. This does not constitute "failure" on the part of the teacher. If the student knows the behavior that is expected of him/her, then it is up to the student to internalize or not.

What, then, are the behaviors we should teach? The literature, unfortunately, is "...vast and diffuse, and the concept of attitude is confusing due to variations in both terminology and definitions" (Martin and Briggs 1986, p. 99). Chapter II will discuss the various ways people have grouped attitudes and behaviors. However, some of the behaviors that are frequently mentioned are--

- o punctuality,
- o cooperativeness,
- o reliability,
- o courteousness,
- o creativity,
- o loyalty,
- o adaptability,
- o initiative,
- o productivity,
- o honesty,
- o flexibility,
- o ability to follow directions
- o ability to accept criticism, and
- o attendance

¹Adapted from Norton, Robert E. and Kurth, Paula. *Developing Positive Worker Behaviors in Vocational and Technical Students*, Athens, GA: American Association for Vocational Instructional Materials, 1989.

Safety is also frequently listed as an attitude that is highly desirable in workers. A positive attitude toward implementing safe practices on the job is an aspect of worker preparation that must not be neglected. The above list is not, by any means, all-inclusive, but it does contain a representative sampling of behaviors.

To also add to the confusion, behaviors are referred to in the literature and resource materials for teaching behaviors as ethical behaviors, affective behaviors, attitudinal skills, ethical characteristics, work maturity skills, values, attitudes, habits, employee attributes, affective job skills, employability skills, and nontechnical skills. Unless quoting from a source, this document will use the term "behavior."

As instructors our job is to prepare trainees for their future roles. In industry, this means providing the worker with the skills necessary to succeed on the job. When we teach, we share knowledge and reinforce it through practice. We must teach not only the technical skills but also the behaviors that will make the workers more successful.

Why Are Attitudes and Behaviors Important?

When a supervisor describes a worker as having a "good attitude," it is not because that supervisor has read the worker's mind. It is probably because the supervisor has informally assessed the behaviors that have led him/her to that conclusion. If pressed for reasons why he/she holds that opinion, the supervisor will probably be able to respond with the criteria he/she used to measure the attitude. The criteria will be measures of behavior, such as attendance, assignments, and the enthusiasm the worker displays for tasks.

Just as a good attitude and positive behaviors are necessary for a student to succeed in school, a good attitude and positive behaviors are necessary for a worker to succeed in a job. Employers are unanimous in desiring workers with good attitudes. In a study of 60 businesses that was conducted to determine the ". . . qualities that employers consider important in beginning skilled or semi-skilled employees" (Stevenson 1986, p. 3), employers were asked to rate various worker qualities as being "essential," "advantageous," "company will train," or "not required on the job." Of the ten qualities measured, which included basic mathematics and reading, only "positive work attitude" was rated as essential (40 employers) or advantageous (20 employers) by all the employers interviewed.

Employers are very serious about desiring that their employees demonstrate positive attitudes. In a 1981 study, Beach found that 87 percent of terminations and refusals to promote employees were due to poor attitudes on the part of the worker as reflected in habits (behaviors). Oinonen (1984) also found that poor work attitudes and behaviors ". . . were unanimously identified by both employers and employees as the characteristics most frequently leading to recent graduates or dropouts losing their jobs" (p. 17). Lufts and Suzuki (1980) cite Klaurens' 1972 study, which also found that the principal reasons for job loss are not technical job skills, but, rather, the nontechnical skills. Lufts and Suzuki found that the four competencies most important to employers are promptness, honesty, use of time, and thoroughness. These competencies are behaviors that reflect attitudes. Crain's 1984 study of the quality of high school graduates as perceived by personnel officers indicates that dependability and proper attitudes of high school graduates are of greater concern to employers than grades or overall quality of the high school.

Positive work attitudes, then, are exhibited via behaviors in the context of performing a cognitive or psychomotor task. As Mongo (1978) states: "Values are qualities, principles, or things regarded as desirable and are reflected in specific human behaviors" (p. 9).

We, as instructors, may not be comfortable with changing values (attitudes) but we must teach our workers the behaviors that are valued and rewarded by employers, just as we would teach trainees the technical job skills valued and rewarded by employers. We may not be able to

directly modify and measure attitudes, but we can modify and measure behaviors, and we owe it to our trainees to do so.

Some Research Findings

Attitudes have been defined as ". . . internal states that influence behavior. We can infer these states from actions and words" (Martin and Briggs 1986, p. 101). Attitudes, then, are how we feel, and behaviors are the way we act on those feelings. Knowing what is appropriate and inappropriate behavior, however, can affect the display of an attitude, that is, result in a different behavior than that which one might prefer to display.

Both internal and external factors influence the development of attitudes. Internal factors include ". . . personality traits and structures, the brain, hormones and the nervous system, cognitive structures, mental states, types of attributions, undeveloped or underdeveloped moral systems or codes, and poor intellectual functioning" (Martin and Briggs 1986, p. 108). Some of these factors may be changed indirectly over time. As individual educators, we have neither the length of time with students nor, with regard to some of the factors, the specialized expertise or mission to enable us to directly influence or alter these factors. Thus, dealing with the internal factors that influence attitudes is not a productive nor sanctioned way for educators to proceed.

This leaves us the external factors with which to work. The external factors that influence attitudes and resulting behaviors are more within our control. External factors include environmental or social influences (parental expectations, peer pressure), reinforcement, and modeling. By dealing cognitively with behaviors, that is, explicitly stating what behaviors are expected in different situations or settings, we offer the student the opportunity to meet expectations. Setting a good example ourselves gives workers a positive role model. Positive reinforcement can provide incentives to workers to display positive behaviors.²

Given the realities of variances in worker backgrounds, susceptibility to peer pressure, and individual characteristics and ability to process and internalize, teaching positive work behaviors may not be easy. And, just as in teaching psychomotor skills, trainees will probably not master all the behaviors desired of a worker. The question, however, is not one of "Should we or shouldn't we?" but "How?" In the remainder of this paper we will discuss generalizable vs. occupation specific skills and instructional methods.

Findings from Studies on Generalizable Skills. Should appropriate work behaviors be taught as a general set of competencies that cut across all occupations or do different occupations require different behaviors? Valid arguments exist to support both points of view.

Kazanas (1978) reviewed, synthesized, and reported on what was known about the social and psychological aspects of work and identified and analyzed specific affective work competencies desirable and common for most vocational education programs. In the list below, numbers 1

²Martin and Briggs (1986) offer an excellent overview and critique of attitude change theories that is relevant but tangential to the purpose of this document.

through 31 were identified by both industry and educators, 32 through 41 were identified only by industry, and 42 through 63 were identified only by educators.

- | | | |
|------------------------|-----------------------------|------------------------|
| 1. punctuality | 23. cheerfulness | 44. consideration |
| 2. cooperativeness | 24. enthusiasm | 45. speed |
| 3. capability | 25. independence | 46. influence |
| 4. follows directions | 26. quantity of work | 47. orderliness |
| 5. responsibility | 27. intelligence | 48. patience |
| 6. emotional stability | 28. personal appearance | 49. poise |
| 7. initiative | 29. alertness | 50. interest |
| 8. dependability | 30. devotion | 51. curiosity |
| 10. helpfulness | 31. recognition | 52. forcefulness |
| 11. loyalty | 32. leadership potential | 53. activeness |
| 12. adaptability | 33. courtesy | 54. awareness |
| 13. efficiency | 34. pleasantness | 55. resourcefulness |
| 14. ambition | 35. responsiveness | 56. appreciativeness |
| 15. quality of work | 36. personality | 57. perceptivity |
| 16. dedication | 37. endurance | 58. achievement |
| 17. reliability | 38. tolerance | 59. compensation |
| 18. accuracy | 39. shyness | 60. variety |
| 19. perseverance | 40. tender-mindedness | 61. security |
| 20. judgment | 41. overall job performance | 62. working conditions |
| 21. concentration | 42. health | 63. friendliness |
| 22. carefulness | 43. creative | |

In a 1981 article, Beach and Kazanas published a refined list, omitting items 59 through 62, and grouped the remaining items into 15 clusters:

1. Ambitious
2. Cooperative/helpful
3. Adaptable/resourceful
4. Considerate/courteous
5. Independent/initiating
6. Accurate/quality of work
7. Careful/alert/perceptive
8. Pleasant/friendly/cheerful
9. Responsive/follows directions
10. Emotionally stable/judging/poised
11. Persevering/patient/enduring/tolerant
12. Neat/orderly/personal appearance/manner
13. Dependable/punctual/reliable/responsible
14. Efficient/quality of work/achieving/speedy
15. Dedicated/devoted/honest/loyal/conscientious

This list is generic rather than occupation specific. If one takes this list and combines them with attitudes and behaviors identified by Lankard (1987); Stevenson (1986); Wentling and Barnard (1984); Lane Community College (1979); Werner (1984); Shoff et al. (1983); and Miller, Rubin, and Glassford (1987), the following general list results:

- o Accurate/quality of work
 - works accurately regardless of importance of task
 - makes few errors
 - finishes work to a consistent, high standard

- o **Adaptable/resourceful**
 - adjusts readily to different conditions
 - adjusts to new or different time schedules, people, or responsibilities
 - learns quickly
 - is willing to try new procedures and ideas
 - willing to learn more
 - able to get along with a variety of people
 - seeks new ideas and ways of doing things
 - can devise a plan of action
 - uses what is already known to do a new or different job

- o **Ambitious**
 - improves abilities to do job
 - asks for additional assignments and tasks when time is available
 - does extra work when necessary
 - works extra time when necessary
 - makes an effort to learn more
 - maintains professional knowledge
 - anticipates responsibilities on the job
 - learns new job skills to get a different job or position

- o **Careful/alert/perceptive**
 - keeps work area orderly and safe from hazard
 - reviews work to check for its accuracy
 - writes neatly, legibly, and with correct spelling
 - asks for help when necessary
 - is particular about the finished product
 - perceives alternatives and chooses among them

- o **Considerate/courteous**
 - responds to the needs of others
 - makes a personal effort to improve conditions
 - praises others for their accomplishments
 - does something of value for others
 - empathizes with the point of view of others
 - uses good manners/is polite
 - shows thoughtfulness toward others
 - displays tact in dealing with difficult or delicate situations

- o **Cooperative/helpful**
 - works cooperatively with others
 - shares materials
 - shares information
 - shares ideas
 - asks if others need help
 - is helpful to others
 - does not criticize others unnecessarily
 - gets along with co-workers
 - cooperates with organization and union to resolve conflicts

- gets support from others to change things that need changing
- compromises when appropriate
- shares information and knowledge

o Dedicated/devoted/honest/loyal/conscientious

- tells the truth
- accepts responsibility for own actions
- faithful to obligations and commitments
- stays on task
- stands up for what is believed to be right
- provides an accurate account of how time is spent on the job
- does not steal from the company--even small things such as pencils, pads of paper, pens, etc.
- admits errors
- does own work
- works a full day
- doesn't speak negatively about company
- maintains confidentiality

o Dependable/punctual/reliable/responsible

- accepts responsibility for own actions
- is at work on time and doesn't leave early
- is at work every day
- takes responsibility for those things in one's power and control
- performs own share of the work
- uses time and supplies appropriately
- notifies supervisor if going to be late or absent
- is seldom absent
- completes required work on time
- carries through on promises
- is punctual in getting back to work after breaks
- is ready to begin work on time
- maintains confidentiality
- manages own time and activities

o Efficient/quality of work/achieving/speedy

- organizes work assignments
- produces goods or services to within required quality specifications
- completes required work on time
- is prepared with all materials necessary
- can immediately locate necessary materials
- plans ahead to avoid delays and wasting time
- is aware of what work is due when
- uses a minimum amount of time to do a task well
- makes efficient use of time and materials

o Emotionally stable/judging/poised

- sees the consequences of own actions
- makes decisions when there is no right answer
- suppresses annoyance with misfortune, delay, and other job frustrations
- is aware of and able to accept own strengths and weaknesses
- tolerates ambiguity

- values own accomplishments
- accepts correction and criticism without blaming others, offering excuses, or becoming angry
- learns from criticism
- learns from mistakes
- can analyze problems
- identifies and chooses among alternative solutions to problems
- does not permit personal life to interfere with performance of job duties
- deals with pressures in completing tasks
- knows when own work is being done well
- can appropriately assert own rights
- can discipline self to do undesirable parts of the job

o Independent/initiating

- organizes work assignments
- can make decisions when there is no right answer
- finds solutions to problems
- can devise and execute a plan of action
- works without supervision, if necessary
- deals with unexpected things that happen
- manages own time and activities
- figures out a better way to get things done

o Neat/orderly/personal appearance/manner

- is clean (clothes, body, hair, skin, teeth)
- wears pressed clothes
- practices good health habits
- dresses appropriately for the job
- behaves in a manner appropriate to the workplace

o Persevering/patient/enduring/tolerant

- continues on a task despite difficulty or obstacles
- displays a fair and objective attitude toward practices different from own
- respects the point of view of others
- follows through on tasks
- is patient when encountering difficulties
- accepts differences in the way of performing tasks
- is tolerant of individual differences (race, ethnicity, sex, handicap)

o Pleasant/friendly/cheerful

- responds positively to legitimate requests of others at work
- smiles frequently (and when appropriate)
- acknowledges others (verbally or non-verbally)
- uses a "warm" tone of voice
- participates in employee social activities that occur during working hours
- accepts assignments pleasantly
- exhibits an interest in others
- communicates freely with co-workers and supervisors

- o **Responsive/follows directions**
 - follows the rules
 - acknowledges legitimate authority
 - follows instructions as given
 - adheres to company policies, rules, and operating procedures
 - listens carefully to all instructions
 - accepts assignments pleasantly
 - works within the organizational structure

Greenan's study to identify generalizable skills in secondary vocational programs (1983) examined mathematics, communications, interpersonal relations (including behaviors), and reasoning skills in secondary agriculture; business, marketing, and management; health; home economics; and industrial occupations training programs. In the great majority of programs, the following work behaviors, which are considered in this study to fall under interpersonal relations skills, were found to have high generalizability:

- o Work effectively under different kinds of supervision
- o Work without the need for close supervision
- o Work cooperatively as a member of a team
- o Get along and work effectively with people of different personalities
- o Show up regularly and on time for activities and appointments
- o Work effectively when time, tension, or pressure are critical factors for successful performance
- o See things from another's point of view
- o Engage appropriately in social interaction and situations
- o Take responsibility and be accountable for the effects of one's own judgments, decisions, and actions
- o Plan, carry out, and complete activities at one's own initiation

Also under interpersonal skills, in addition to the work behaviors, are listed skills for instructional and supervisory conversations and skills in conversations. The skills in conversations are as follows:

- o Be able to handle criticism, disagreement, or disappointment during a conversation
- o Initiate and maintain task-focused or friendly conversations with another individual
- o Initiate, maintain, and draw others into task-focused or friendly group conversation
- o Join in task-focused or friendly group conversation

The studies of general skills are valuable for three reasons. First, they orient us to the concept. Second, they provide a structure for determining what the most basic positive work behaviors are. Third, they can be used to teach pre-vocational courses.

Findings from Studies on Occupationally Specific Skills. Some studies, such as that of Beach and Kazanas (1981) reveal that different occupations require or emphasize different behaviors. Therefore, to do the clearest and most thorough job of teaching positive work behaviors, the behaviors need to be tied to specific occupations or even to specific tasks.

According to Pucel (1987), while we still need to teach workers the cognitive information and the physical manipulative skills we have traditionally taught, that is no longer sufficient. Positive work behaviors are now as essential as the psychomotor skills and must be incorporated into instructional programs ". . . with the same level of planning, precision, and commitment as they have devoted to psychomotor skills" (p. 11).

The National Commission on Secondary Vocational Education (p. 26) clearly stated its position on the importance of teaching positive work behaviors when it stated--

In addition to developing occupational skills, secondary vocational courses must develop self-esteem, positive attitudes toward work, safe work habits, job-seeking skills, and other general employability skills.

This cannot be done by teaching behaviors separate from the rest of the curriculum.

Instructional Strategies/Techniques

Positive work behaviors can be taught in different ways and in various combinations of ways. No matter what technique or variety of techniques is chosen, one principle should not be violated: the trainee must be made aware of what behaviors are expected of him/her in various situations. The communication must be overt.

Non-integrative Strategies. Teaching positive work behaviors to all students is appropriate. No matter what students' plans for education, the vast majority will eventually enter the world of work. They need to be as well prepared for that eventuality as possible. In a recent (Winter 1987/88) article by Baumgart, he states:

New industry has made it very clear that . . . it does want the high school to give them employees with at least

- o basic communication and computation skills,
- o good attitudes and good attendance habits, and
- o a capacity to work closely with other people. (p. 18)

If high school graduates are expected to have these abilities, it follows that postsecondary graduates should, also, and, perhaps, to an even greater degree. It seems that most employers value positive work behaviors even more than technical skills (Beach and Kazanas 1981).

When taught in a special pre-vocational class, as part of a citizenship class, or as a special ethics class taught by guidance and counseling staff, positive work behaviors can be introduced to students. Teaching positive work behaviors in a non-integrative approach, however, is only the first step. Beach and Kazanas (1981) summarize the view of Kampsnider (1977) when they discuss a three-stage model for teaching these behaviors as being the most effective method. The three stages are: "(1) awareness, (2) modeling, and (3) implementation. Consequently, the initial step toward students' acquisition of affective work competencies (achievement) would be their increased awareness about which characteristics are desirable and why they are important" (Beach and Kazanas 1981, p. 55). But awareness is only the first step. The same is true of business and industry trainees.

Integrative Strategies. By integrating desirable behaviors into curriculum as specific competencies to be achieved, associating those behaviors with specific tasks, overtly informing trainees of what is expected, and providing a model of the behaviors, trainees stand the best chance of being successful.

Initially, this may require a great deal of preparation on the part of the instructor, especially if he/she must start from "scratch" by doing a job and task analysis. If the curriculum the instructor is using is current and performance-based, then only the positive work behaviors appropriate to each task must be determined. This can be done using a special committee of persons who are experienced in that occupation to provide input related to expected work behaviors. Or, when available, a task analysis or curriculum that has already been developed by someone else can be used.

One of three basic approaches may be used to identify positive work behaviors so they may be integrated into curriculum:

- o Ask a DACUM or other committee, as part of the job analysis, to identify positive work behaviors at the overall job level.
- o As part of the task analysis, identify the behaviors in relation to each specific task.
- o Use both of the above approaches.

Job and task analysis. The DACUM (Developing a Curriculum) approach to curriculum development can be used to determine what tasks are important, and then, what skills, knowledge, and behaviors are required for each task that must be performed. A good job and task analysis will result in a performance-based curriculum, which is clear and straight-forward.

How does the DACUM process work? Eight to 12 expert workers are carefully selected from the job or occupational area that is to be analyzed. This committee then works with a facilitator to identify and sequence the duties and tasks that are performed by successful workers on the job. In addition to the duties and tasks performed, ". . . lists of tools, equipment, supplies, and materials pertinent to the occupation; traits and attitudes important to workers in that occupation; and general knowledge and skill areas that are prerequisites to job performance" are also identified (Norton 1987, p. 15). For the job of graphic designer, for instance, a DACUM job analysis produced the following list of traits and attitudes:

- | | |
|-----------------|-----------------|
| o Resourceful | o Dedicated |
| o Cooperative | o Patient |
| o Persuasive | o Neat |
| o Understanding | o Proud of Work |
| o Flexible | o Conscientious |
| o Dependable | o Precise |
| o Curious | o Creative |
| o Good memory | o Imaginative |
| o Analytical | o Adaptable |

Pucel (1987), also advocates conducting a job analysis to determine behaviors appropriate to a job.

Just as we identify job-related psychomotor behaviors by conducting a job analysis to determine what behaviors [skills] a qualified person in an occupation needs to be able to perform, it is also possible to identify job-related affective [positive work] behaviors that are required in order for a person to succeed in an occupation through a job analysis. The resulting job-related affective behaviors are the legitimate content to be taught by vocational educators and industrial trainers as they prepare people for careers and occupations. They warrant the same quality of instructional planning and delivery as are afforded psychomotor behaviors [skills]. The test of whether an affective behavior is job-related is if its absence inhibits a person from being employed in the job or from maintaining employment in the job. If an affective behavior can pass this test and is verified by a qualified advisory committee, it should be treated as legitimate content for the instructional program along with the psychomotor tasks which have also been verified. (pp. 13-14)

Once the tasks have been identified, whether through DACUM or another procedure, the tasks should be verified. This is generally done by requesting workers who perform the tasks or the immediate supervisors of such workers to review the tasks and rate them as to their importance. One way to accomplish this is to mail a task inventory to these two groups and request their response. The tasks that are verified as important are then organized into a DACUM chart or verified task list.

Exhibit 1 shows an example of a form that can be used for task analysis and a sample analysis that has been developed for the task: prepare a business letter. When using a task analysis form such as this, each step of the task being analyzed should be carefully considered to determine what, if any, behavior is important as the worker performs that step. It should be noted that there will not always be an important behavior associated with each step.

Summary

Positive work behaviors can be taught as separate units or integrated into many units. These approaches, although having value, do not allow the trainees to observe modeling or to implement (perform) behaviors as they relate to occupations. The use of simulations, on-the-job training, and role modeling, for example, provide excellent opportunities for trainees to perform behaviors they have been made aware of and seen modeled.

Awareness, modeling, and implementation, then, are the three steps in acquiring a behavior. To encompass all three steps, an integrated, performance-based curriculum should be developed for each curriculum area being taught. Performance-based training can and should provide trainees the opportunity to move through all three steps to acquire the appropriate positive work behaviors.

EXHIBIT 1

SECRETARY

Task Analysis Form

DUTY: _____ PREPARE WRITTEN DOCUMENTS _____
 TASK: _____ PREPARE A BUSINESS LETTER _____

Steps	(How Well)	Materials	Safety	Related Knowledge			Attitudes (Behaviors)
				Science	Mathematics	Language	
1. Decide on letter format	business letter format used					understand business letter format	follows instructions as given
2. Select materials	appropriate letterhead appropriate type style	stationery typheads	avoid paper cuts			type styles	can make decisions when there is no right or wrong answer
3. Check draft for spelling, punctuation, and editing	error free					editing skills, grammar, spelling, and punctuation	produces goods or services to within required quality specifications reviews work to check for its accuracy
4. Edit letter as needed		pencil/pen				editing skills, grammar, spelling, and punctuation	produce goods or services to within required quality specifications
5. Type letter		typewriter or word processor					
6. Proofread letter						grammar, spelling, and punctuation	knows when own work is being done well
7. Make corrections or retype	error free	typewriter or word processor					is particular about the finished product
8. Make final check	error free neat					proofreading skills	reviews work to check for its accuracy
9. Submit to writer	within reasonable time						uses a minimum amount of time to do a job well is aware of what work is due when

BIBLIOGRAPHY

- Baumgart, Donald. "Secondary Voc Ed: An Alternative View. *Wisconsin Vocational Educator* 12, no. 1 (Winter 1987/88): 7 and 18.
- Beach, D. P. *Preliminary Development of an Affective Work Competencies Testing Program*. Paper presented at the Fourth Annual Meeting of the Eastern Educational Research Association, Philadelphia, PA, March 1981. (ERIC No. ED 205 532)
- Beach, David P., and Kazanas, H. C. "Development of an Affective Competencies Testing Program." *The Journal of Vocational Education Research* VI, no. 4 (Fall 1981): 49-64.
- Crain, Robert L. *The Quality of American High School Graduates: What Personnel Offices Say and Do About It*. Baltimore, MD: Center for Social Organization of Schools, The Johns Hopkins University, May 1984.
- Greenan, James P. *Identification of Generalizable Skills in Secondary Vocational Programs*. Springfield: Research and Development Section, Department of Adult, Vocational, and Technical Education, Illinois State Board of Education, June 1983.
- Kampsnider, J. J. "Affective Teacher Education in Competency Based Programs." In *Competency Based Industrial Arts Teacher Education*. Twenty-Sixth Yearbook of the American Council on Industrial Arts Educators, 1977.
- Kazanas, H. C. *Affective Work Competencies for Vocational Education*. Columbus: The ERIC Clearinghouse on Adult, Career, and Vocational Education, National Center for Research in Vocational Education, The Ohio State University, 1978.
- Lufts, Roger L., and Suzuki, Warren N. "Nontechnical Employment Competencies for Secondary Cooperative Work Experience Students." *The Journal of Vocational Education Research* V, no. 1 (Winter 1980): 71-80.
- Martin, Barbara L., and Briggs, Leslie J. *The Affective and Cognitive Domains: Integration for Instruction and Research*. Englewood Cliffs, NJ: Educational Technology Publications, 1986.
- Miller, Pamela Fine; Rubin, Nancy M.; and Glassford, F. E. (Joe). "Vocational Educators' Rankings of Ethical Characteristics of Workers Using a Q-Sort Survey." *Journal of Industrial Teacher Education* 24, no. 3 (Spring 1987): 67-73.
- Mongo, Celestine. "Work Values and Career Education." *Business Education Forum* 33, no. 1 (October 1978): 9-11.
- The National Commission on Secondary Vocational Education. *The Unfinished Agenda. The Role of Vocational Education in the High School*. Columbus: The National Center for Research in Vocational Education, The Ohio State University, 1984.

- Norton, Robert E. "A Tool for Developing Curricula." *Vocational Education Journal* 62, no. 3 (April 1987): 15.
- Norton, Robert E. and Kurth, Paula. "Developing Positive Worker Behaviors in Vocational and Technical Students," Athens, GA: American Association for Vocational Instructional Materials, 1989.
- Oinonen, Charlotte M. *Business and Education Survey: Employer and Employee Perceptions of School to Work Preparation*. Parker Project Number 3. Bulletin No. 4372. Wisconsin: Parker Pen Co., May 1984. (ERIC No. ED 244 122)
- Pucel, David J. "Incorporating Affective Skills Into Performance-Based Vocational Education and Industrial Training." Paper presented at the Mid-America Conference for Vocational-Technical Education, St. Paul, MN, May 31, 1987.
- Shoff, Phil et al. *Work Attitudes Handbook. A Unit of Study to Teach Students Positive Work Attitudes*. Redwood City, CA: San Mateo County Office of Education, September 1983. (ERIC No. ED 237 787)
- Stevenson, William. *Qualities Employers Seek in Employees*. Westerville: Ohio Council on Vocational Education, 1986.
- Wentling, Tim L., and Barnard, Wynette S. "A Study of State-Wide Perceptions of Vocational Educational Outcomes. Identification and Assessment of Vocational Education Outcomes." Urbana: Department of Vocational and Technical Education, Illinois University, June 1984.
- Werner, Claire. *Pre-Employment and Work Maturity Competencies for JTPA Youth*. Los Angeles: Los Angeles Unified School District, June 30, 1984. (ERIC No. ED 250 555)

Root Cause Analysis Training,
an Introduction

A paper presented to the
Midwest Nuclear Training Association
Nuclear Instructors' Workshop
October 17, 1989

by

Kenneth D. Crouch
Perry Training Section
B.S., University of the State of New York
M.S., University of Cincinnati

Introduction

1. A technician was assigned to test instrument channel A, but mistakenly connected the test equipment to channel B, resulting in a reactor scram.
2. A reactor operator mispositioned control rods during a reactor startup.
3. A reactor scram occurred during the performance of a reactor level detector calibration due to pressure perturbations caused by isolating the detector.
4. Two maintenance workers received significantly high dose rates when the control room failed to notify Health Physics of a resin transfer.

Although these situations appear to be a rather diverse collection of events, they share many common threads. In all cases, the identified cause was *inattention to detail*. The corrective actions for each situation were identical — "the individuals involved were counseled and training was conducted." Finally, in all cases there was a repeat event within 6 months!

The real common thread between these four events was that they were all improperly analyzed and canned solutions were used to address plant problems. The recurrence of each event clearly demonstrates the inadequacy of the event analysis performed and the corrective actions adopted.

Purpose of Root Cause Analysis

Equipment failures and plant trips costing millions of dollars can be avoided when the root causes of plant events are determined. The primary purpose of a root cause analysis, or event investigation, is to prevent similar occurrences and thus improve operational safety. Properly applied analytical techniques will help appropriately focus corrective actions on these problems and avoid the shallow approach of treating the symptoms. Recurrence of an event can only be prevented when all the root causes have been determined.

Root cause is defined as: "the most basic cause(s) of an event that, when eliminated or compensated for, will prevent recurrence."

Root causes are those that we have the ability to take some action to prevent. Prevention may be from a management, engineering, or operational perspective.

The intent of a root cause analysis is not to place blame but to determine how to clarify responsibilities and reduce errors. Collateral purposes of an investigation are to determine the nature and extent of the event and its overall impact; to assist in the improvement of policies, standards, and regulations; and to improve plant performance and reliability. These purposes and benefits are summarized on the following page.

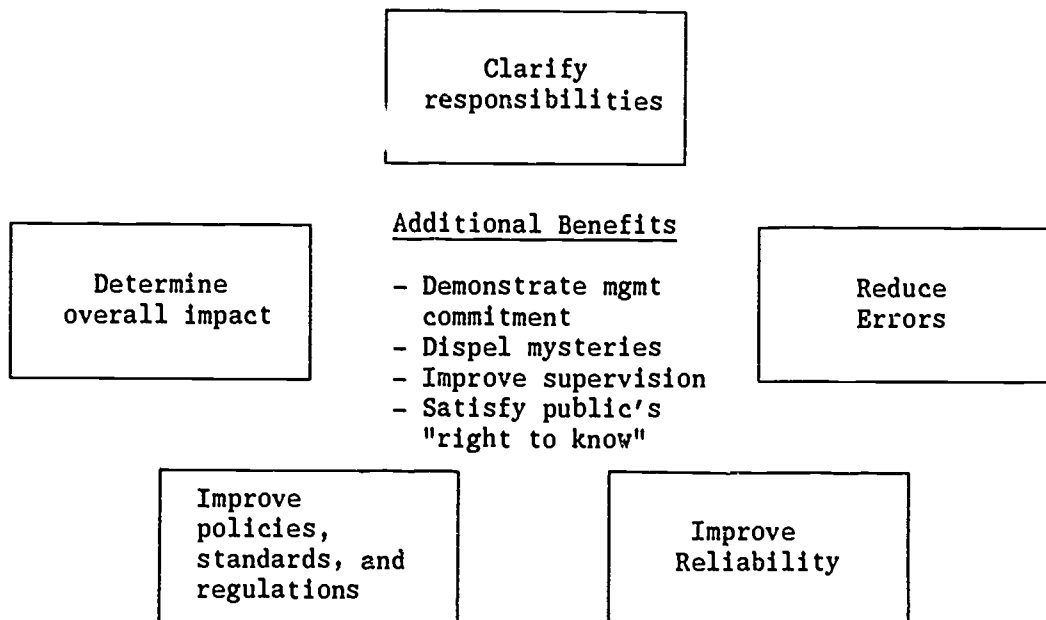

Purposes of Root Cause Analysis

Root Cause Analysis Programs

There are several programs being used by industry to aid them in performing root cause analysis. Four such programs are the Management Oversight and Risk Tree, Human Performance Evaluation System, Kepner-Tregoe Problem Solving and Decision Making, and the Savannah River Cause Coding Tree programs.

Management Oversight and Risk Tree

Management Oversight and Risk Tree (MORT) was developed by the National Safety Council for the Energy Research and Development Administration (now the DOE). It is a combination of the best safety practices and "system safety" concepts from the military and aerospace industry. This systemic approach to the management of risks incorporates ways to increase reliability, assess risks, control losses, and allocate resources effectively.

The acronym MORT carries two primary meanings to most people: (1) the MORT tree, which organizes risk, loss, and safety program elements and is used as a master worksheet for event investigations and program evaluations; and (2) the total safety program. The MORT process includes four main analytical tools. These are: *Change Analysis*, *Energy Trace and Barrier Analysis*, *MORT Tree Analysis*, and *Positive (Success) Tree Design*.

MORT is now used internationally by many organizations, including DOE contractors, the Nuclear Regulatory Commission, the aviation industry, chemical plants, and utilities. MORT is used in all major DOE accident/event investigations.

Human Performance Evaluation System (HPES)

The Institute of Nuclear Power Operations (INPO), working with several member and participant utilities in an extended pilot program, developed a non-punitive program designed to identify, evaluate, and correct situations that involve human performance errors. HPES has been revised and improved based on the operational experience of participating utilities. Today many domestic and international utilities are participating in the program.

The objective of the Human Performance Evaluation System is to improve plant operations by reducing human error through correction of the conditions that caused the error.

The program is founded on the following premises:

- **Human error can be reduced and minimized.**
By studying an event, the basic causes of human error can be determined. This information is used to modify training, procedures, or hardware to prevent recurrence of the error.
- **The causes of minor events are often the same as those of major events.**
The careful study of a minor event can often correct a problem that could have caused a major event.
- **The management environment is of key importance.**
People want to perform well and will try harder if they feel that management is helping them improve their performance. Punitive action usually does not correct underlying event causes and it discourages workers from reporting mistakes.
- **Accurate identification of causes can preclude repeat events.**
When the causes of an event are accurately identified and effective corrective actions are placed in effect, the chances for similar occurrences will be greatly diminished.
- **Lessons learned from human error events must be shared.**
Sharing lessons learned throughout the industry promotes better plant and industry-wide understanding and correction of human error causes.

A summary of the HPES program is illustrated on the following page.

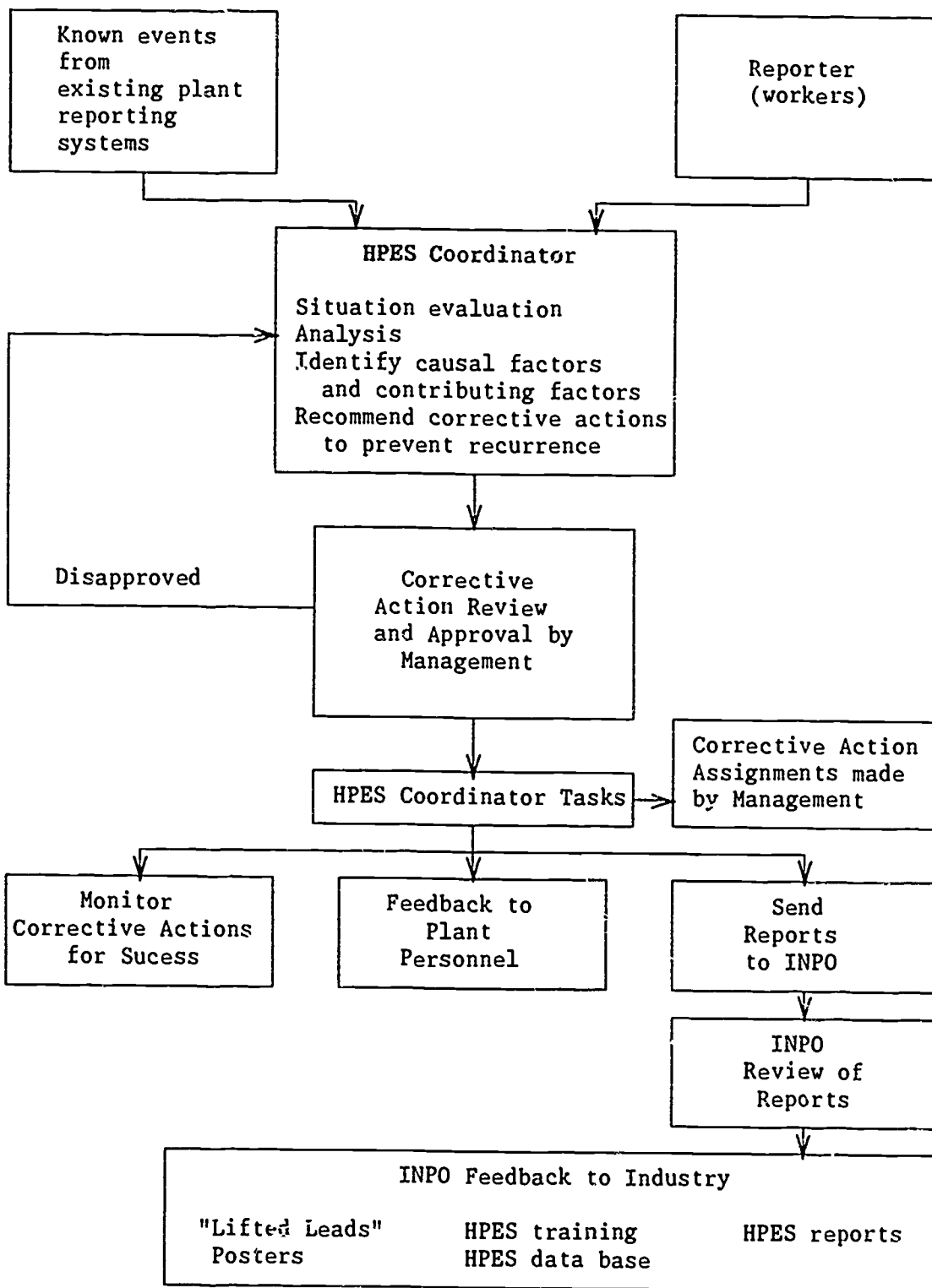

Human Performance Evaluation System

Kepner-Tregoe Problem Solving and Decision Making

The Kepner-Tregoe program is widely used by business and industry to improve individual, group, and organizational effectiveness. Many utilities offer Kepner-Tregoe training to their supervisors and managers. The KT program includes four systematic approaches to strategic operational decision making:

Situation Appraisal is a technique used as a starting point for approaching problems.

Decision Analysis helps managers shift focus from alternatives to objectives, encouraging careful definition of the decision to be made before drawing conclusions.

Potential Problem Analysis is used to identify possible actions to prevent problems from interfering with the successful implementation of a plan.

Problem Analysis is an efficient way to find the true cause of a problem before committing to a solution.

Each process fulfills a clearly identified purpose. The choice of which to use will depend on the question at hand. Therefore, each takes a different approach to solving concerns.

Savannah River Plant Cause Coding Tree

This system was designed to help identify root causes of plant events. The use of a cause coding tree allows the data to be used for tracking and trending. This program was developed in 1985 by the Reactor Safety Evaluation Division in response to the need for a "nuclear specific" root cause analysis program.

Elements from several existing programs were studied & used including INPO's HPES program, INPO's Significant Event Report identification system, MORT, current methods already in use at SRP, and specific analytical techniques.

The premise of the program is that 80% of events in complex systems are caused by problems over which operators have no control, but management can fix. The other 20% are human failures, some of which can be corrected and others that cannot. The SRP Cause Coding Tree targets causes that fall into the 80% category.

The coding starts with the event or causal factor at the top of the coding tree. The analysis proceeds down as far as possible toward the root causes. If information is insufficient to reach the root causes, the analysis stops at the lowest level of the tree that was reached.

A strong selling point for the SRP approach is its simplicity. Only five top level categories are used to describe the problem. After the problem has been isolated to a responsible department, seven basic root cause categories are used to further categorize the problem.

Steps In a Root Cause Analysis

A root cause analysis can be broken down into five major steps, as seen below.

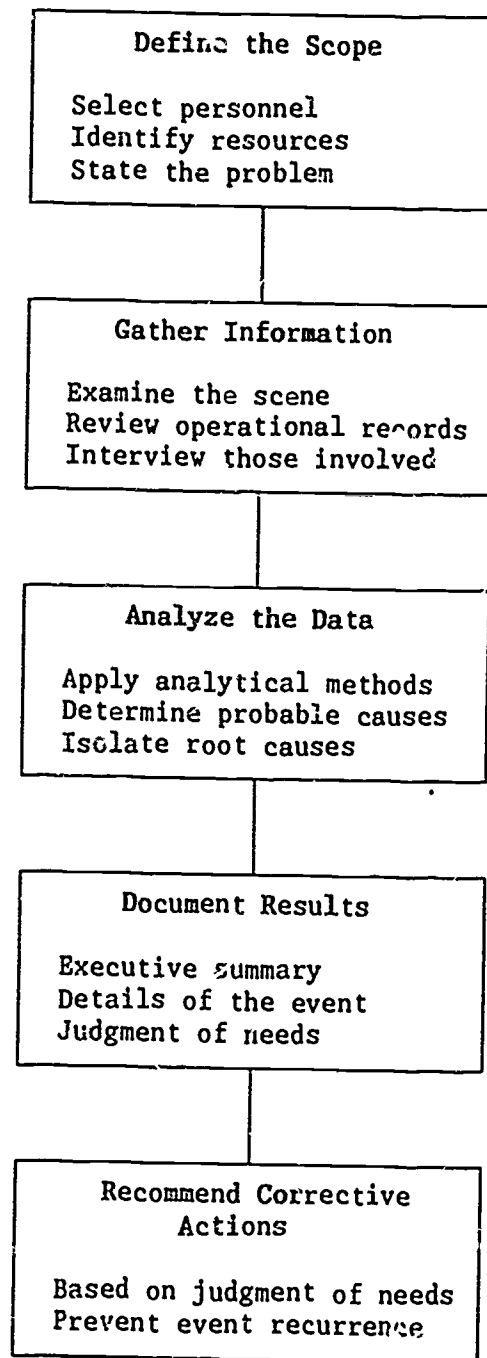

Steps in a Root Cause Analysis

Defining the Scope

The first step in any root cause analysis involves defining the scope of the investigation and selecting the personnel who will perform the analysis. Consideration must be also be given to resources needed, authority of the investigating team, and time constraints that must be adhered to.

Gathering Information

The accuracy of data gathered in an investigation largely depends on the time period between the event and the initial investigation. It is important to physically examine the scene of the event as soon as possible, then supplement this evidence with interviews and research.

Analyzing the Data

In this step the analytical methods are applied to the problem to determine probable causes. Each probable cause is analyzed for its causal or contributing relationship to the event. These root causes and contributing factors, identified in the analysis, will be used to determine corrective actions to be taken to prevent recurrence. Some techniques applied are:

- *Change Analysis*
- *Event and Causal Factors Charting*
- *Hazard-Barrier-Target*
- *Fault Tree Analysis*
- *Problem Analysis*
- *Task Analysis*
- *Technique of Operations Review*
- *Surveys and Questionnaires*

Documenting Results

The purpose of the investigation report is to convey in clear and concise language the results of the investigation, including the facts surrounding the occurrence, the analysis of these facts, and the conclusions drawn. The report constitutes a record of the occurrence and measures the thoroughness, accuracy, and objectivity of the investigation. In addition, any corrective actions directed by plant management will be based largely on the contents of the report.

Recommending Corrective Actions

The final step in a root cause analysis is to ensure the event does not happen again. This can only be assured if focused, corrective actions are enacted to remedy the problems found in the people-plant-procedure relationships.

Who should be trained?

Root Cause Analysis becomes a way of thinking -- it pervades your thoughts and teaches you a new way to look at situations. It is difficult to instill this heightened awareness in all plant personnel, but the more training we provide, the better our plants will run. An excellent vehicle for our task is the continuing training programs for the various work groups. Include some amount of RCA training in these continuing training sessions. Walk through case studies of operating experiences. Demonstrate how problems can be solved without blaming anyone. I strongly endorse some RCA training for *all* operating personnel. The level of training and the emphasis will change from group to group, but strong opportunities to improve plant operations exist with all groups.

Maintenance - These workers are frequently the first to discover a problem. They perform the calibrations, repair, and troubleshooting of our most complex plant systems. They must be made aware of the importance of preserving evidence and failed parts. They must understand the importance of properly documenting both routine maintenance as well as troubleshooting and repair activities. Valuable data should be retained for future use.

Planners - Often these individuals are responsible for allowing repeat failures to go unnoticed and merely "write up another work package." In plants without extensive tracking mechanisms in place, the planner's memory is the tracking mechanism. Sadly, at many plants planners get little if any training.

Engineering - These professionals are the individuals responsible for the performance of our complex systems. Many responsible engineers lack basic troubleshooting skills and rely heavily on experienced technicians to lead the way. They would like to learn the techniques necessary to allow them to troubleshoot their systems. They also need to be able to recognize mechanisms and modes of equipment failure. Teaching them the details of fractography may not be the answer, but explaining what resources are available inside and outside the company to help them study failed parts would be very valuable.

Operations - These people run our power plant systems, participate in incident response teams, and prepare event reports. They certainly need training to identify the root causes of problems and prevent their recurrence.

In summary...

We need to change attitudes if we are going to improve reliability and reduce errors. The benefits of reducing scrams and errors are too great to be ignored. The cornerstone of a strong root cause analysis program is the commitment to solving problems, not affixing blame. That message must be loud and clear to all, from the president down to the troops.

Using Computer Technology to Enhance Instruction

Ronald C. Comer, Ph.D.
Ohio State University
College of Medicine
Columbus, Ohio
(614) 292-6192

Computer controlled interactive video is used by Ohio State University College of Medicine students to study and learn topics in ophthalmology, cardiology, parasitology, and anatomy. The College has produced two videodiscs containing faculty collections of video and audio materials. Computer-based education programs have been locally developed to interface with these and other generic videodisc materials. Other discs and program materials have been obtained from the National Library of Medicine.

The use of advanced technology for instruction has become increasingly effective over the past ten years. Computer-Assisted Instruction has offered great potential since the late 1960's. For many years, however, successful projects were not plentiful. Offsetting the advantages of computer-assisted instruction were major disadvantages that included a large investment in hardware, lengthy time-lines for development, and lack of available computer-assisted instruction programs that could be acquired on the open market. Where projects were successful, centralized organizations were established providing experts in instructional design and programming to work closely with faculty in the development, implementation, and maintenance of the computer-based materials.

With the advent of the microcomputer, the role of computer-based education began to change rather significantly. Inexpensive computing was immediately available to both faculty and students; so the problem of access, at least in formal education settings, was largely resolved. Interest increased rapidly during the early 80's as the use of graphics and color increased motivation as well as effectiveness of teaching materials.

The education and training community became even more enthusiastic about the use of advanced technology for direct instruction when interactive videodisc was introduced. With immediate access of up to 54,000 still frames of visual materials, 30 minutes of full-color video, and two sound tracks of audio all functioning under computer control, the use of interactive video has brought a new sense of realism and drama into the instructional environment.

At the Ohio State University College of Medicine, program participants are enthusiastic about the future of interactive video technology for instruction. The systems are well received by medical students who use the materials on a voluntary basis and by faculty who are involved in the production of the programs.

The instructional strategies used in the design of the College's learning materials are equally effective in other education and training environments. Benefits are particularly significant when providing instruction to employees or students who are dispersed geographically. In business, industry, government, and the military, technology-based education offers cost effective solutions to educational problems.

Using Evaluation Feedback
For Instructional Improvement

Michael Price
Lead Certification Examiner
Project Manager Innovative Technologies
GE BWR Operations Training

Training's target is improved job performance of the individual.

The first step is defining desired job performance. This definition, referred to as the objective, is used to generate evaluations. Evaluations will determine the gap between what job performance should be and what it is.

Only with objectives and evaluation can we begin to design training programs to meet the specific needs of each student.

Evaluation becomes the key word here. Following the TSD model for training we improve our programs as feedback is received.

The evaluation and feedback phases of TSD are what make TSD a dynamic rather than a static model. Using the TSD model has allowed for ongoing program improvements.

The continual improvement of programs and emphasis on program achievement has been acceptable only because there were no cost effective alternatives. Tracking individual students and generating training to meet their individual deficiencies could not be done economically.

Using the TSD model, we have improved programs based on overall measurements. Our next step is to tap into a model for training to meet individual needs.

In the 70's and 80's we had the option of only dealing with students that fit the program. There were plenty of students with the skills and background for the technical positions. This is no longer true. By 1992 new skilled positions will out pace new entries into the skilled workforce. We can no longer afford to only look at program improvements.

Using an expanded training model that provides feedback at every phase allows us to train to the individual's needs. This offers a far more efficient and effective training program. Why train them in what they don't need?

The question becomes "How can we be cost effective and look at each individual in hundreds of proficiencies?"

General education tried this and, although providing individualized instruction works well, the time and talents of those doing the tracking were stretched.

We now have the missing pieces. The mechanisms exist to match our training to the individual's needs without jeopardizing the integrity of the overall program objectives.

Using the computer to track, report, and prescribe training for the individual is both efficient and effective.

Looking at feedback as a useful tool throughout the model allows us to look beyond the past formal use of feedback and forward to its use as an instrument to continually adjust training to the individual. With tracking and adjustment in place, the feedback becomes the compass for the training path.

1988

1998

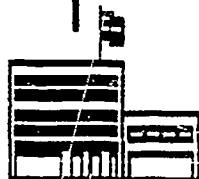

UNIVERSITIES

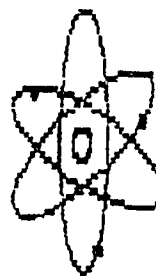

US NAVY

PERSONNEL

TRAINING

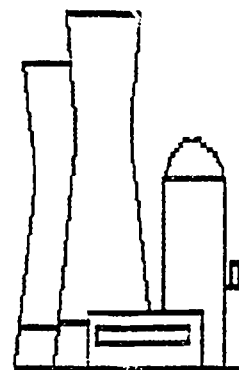

GE BWR Operations Training
Copyright 1989

NRC

INFO

UTILITY

Job Performance

Objectives

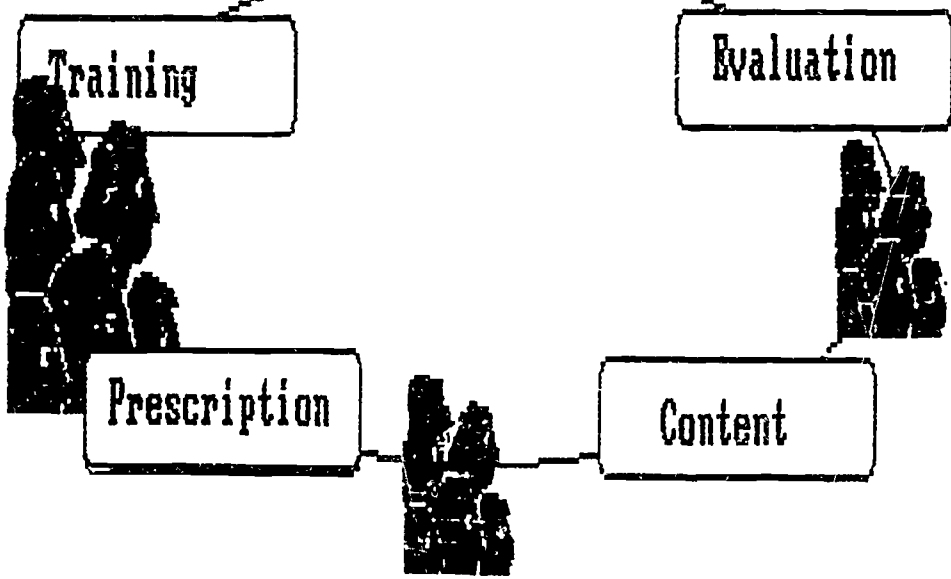

Training from
Feedback

- * Exam Banks
- * CBT
- * CEI

Computerized Exam Banks

Assure

- A. Items
- B. Scoring
- C. Record
Keeping

Midwest Nuclear Training Association
Fourth Annual Nuclear Instructor's Workshop
October 16 - 18, 1989

IMPROVING THE QUALITY OF INSTRUCTION
THE FIRST STEP TOWARD EXCELLENCE

Thomas L. Fueston
Senior Training Advisor
Westinghouse Nuclear Training Center
Westinghouse Electric Corporation
505 Shiloh Blvd.
Zion, Illinois
60099

IMPROVING THE QUALITY OF INSTRUCTION THE FIRST STEP TOWARD EXCELLENCE

Introduction

As instructors / trainers in the nuclear industry, each of us over the past ten years have been asked to 'rethink' what our roles in developing and delivering instruction in our industry should be. In some cases, we have said ..."It's about time we did this!", but at other times its been ..."Why are we doing this? Training as we all know, has been in the spotlight ever since the accident at Three Mile Island occurred in March of 1979. Today, even after ten years of concentrated efforts to improve training techniques in the nuclear industry, the focus is still on the importance of training personnel for safe plant operations. Dr. Forrest Remick, the soon to be appointed NRC commissioner, stated at INPO's 1989 Training Managers' Workshop, that several challenges still remain in the training of nuclear plant personnel if excellence is to be achieved.

During Dr. Remick's talk, one of the areas he focused upon was the knowledge and skills of the instructor. Not the instructor's technical knowledge and skills, but the teaching abilities of the instructor were his concern. He stated "...very few instructor delivery weaknesses were identified by the (evaluation) teams during initial accreditation. It is my understanding that increased emphasis is being placed in this area during accreditation renewal visits." He supported his concern in this area by sharing the comments he has received. These included:

"Interviews with operators indicated that the quality of training was poor."

"The quality of the classroom material leaves much to be desired. It remains vintage 1950 and is superficial in coverage."

"A reactor operator said, 'reactor theory isn't important because we don't see it in the control room. It is certainly obvious why the operators don't see it in the control room, it isn't in the classroom to begin with.'"

For Dr. Remick, this raised the question of whether adequate evaluation of instructor skills and knowledge is occurring. This is an interesting question. What is the "Quality" of OUR Instruction?

WHAT IS QUALITY?

Often when we look around us, we find many different definitions of quality. For example, in one of AT&T's television commercials they state that the important aspect of the telephone is its dependability. Where as one of their competitors, Sprint, believes that the clarity of transmission is the most important aspect of telephone service. Each is betting that their interpretation of what the customer wants is correct. We see these definitions almost everywhere, advertisements for cars, boats, lawn mowers, hamburgers, services, paper, etc.; the list goes on and on. If you put all these definitions together, you find that quality is being defined as :

- Meeting or exceeding customer expectations,
- What the customer says it is,
- Dependability,
- Products backed by a guarantee,
- The very best products or services,
- Products or services that leave a special impression,
- Products with many standard features, and
- Committed dealer service.

As you can see, this is a fairly diverse list, and it would be difficult to sum up into a simple statement. Even the experts can't agree on the definition of quality. Phillip Crosby, a renown quality consultant has defined quality as: "Conformance to requirements, where the standard is zero defects." In other words, companies must set performance standards for products or services and then adhere to those standards with no exceptions. This was probably best expressed by Sydney Harris, columnist for the Detroit Free Press in an article entitled "We must hope for the best in order to come close to it". Basically he said that we must always look for the highest quality. Once we settle for less, then our standard gets lower and lower until finally we will be measuring quality as we do quantity, by the smallest unit that is convenient, rather than by the largest. If this occurs, we find ourselves choosing between the lesser of two evils rather than choosing the best for the situation. Mr. Harris summed it up this way; "...The archer always aims at the center of the target, though he knows he may not hit it. To aim elsewhere is literally to 'lower one's sights.' It may be idealistic to hope for the bull's-eye, but it is the most realistic way to get close to it." Thus we must set high standards, and then continuously aim for the "bull's-eye."

Another renown quality expert, John Guaspari, who has written several books on quality, said, "Quality? I know it when I see it." Here he is saying that our customers know what quality is, therefore, to produce quality products or services you must talk to them and find out what they want.

Can it then be said that "quality is in the eye of the beholder?" But, who is OUR beholder (customer)? Is it the NRC; INPO; Plant Management; Training Management; our Students; the Public; or all of the above. For many of us, this is our first major hurdle we need to cross; we must decide who our true customers are.

Unfortunately where quality is concerned, you hear the statement that something is a "...quality product or service." There are no nice units for quality, is there? For example, this course or lesson plan has 10 widgets of quality. All we can do is compare the quality of products or services; e.g. this product has a higher quality than that product. But with what do we compare our instruction? We compare it to our customer's expectations or needs. If it meets their expectations, it has good quality. If it exceeds their expectations, it has high quality. This is why I would like to think of quality as "...performance against expectations." But these expectations are not just any expectations, they are the highest expectations. To have a high quality product, we must compare it against the best, not the worst.

ACHIEVING QUALITY

How do we achieve quality? This is the crux of the issue. Another writer who has addressed quality, Willa Foster, said, "Quality also marks the search for an ideal after necessity is satisfied and mere usefulness achieved." She also stated, "Quality is never an accident. It is the result of:

- High Intentions,
- Sincere Effort,
- Intelligent Direction, and
- Skillful Execution.

Quality represents the wise choices from many alternatives as well as the cumulative experience of many masters of craftsmanship."

A simpler way of saying the same thing is that "...you achieve quality by doing the right things right the first time." The "right things" are the attributes of the product or service that meet and exceed your customer's expectations, the things that define the "target." Doing it "right the first time" is related to the quality in the workplace. It has to do with "personal attitude and job environment." The attitude is to do the best possible job that can be done. The environment is one where the organization and the people support each other by providing the tools, the time, and the trust necessary to complete the jobs correctly. In other words...Aiming for the Bull's eye.

But who's expectations are we to focus on?

HAVING A QUALITY ATTITUDE

As Instructors / Trainers, each of us should share a common responsibility that can be expressed simply as: teach our students. Our product in this case is an "educated individual." But isn't our product at times, also our customer?

If our attitude is not the best, or if we don't care about our product, does that mean then we don't care about our customers? Our product, whether it be a system description, an instructor lesson plan, a test, or a presentation, will reflect our attitude toward quality. If our attitude is poor, then our product will be poor.

But how do you improve one's attitude toward quality?

Having ownership in the product is probably the most direct link to developing a quality attitude. When you "own" a project or product, your work with that product will reflect your ideals, and your commitment because you feel that you are contributing to the success of the product, and it, in turn, is a reflection on you and your capabilities. Everyone wants to do a good job.

However, to gain ownership of a product or project, the environment must be conducive for individual contributions. People need to feel that they are a valuable asset, that their work is important for the safe operation of the plant, and ultimately for the protection of the public health and welfare.

Next, we must understand the goals and objective of the organization and how we as individuals, fit into the plan that will be used to accomplish these goals. Once this has been established, then an open, honest atmosphere for communications of individual concerns must exist. When people feel that their inputs are being heard by someone who can do something about it, and they see some kind of proactive response, they are encouraged and more willing to listen, as well as feedback, to their customers and supervisors. All of this is well and good for establishing the proper environment for "quality of instruction," but it is still up to the individual to take that first step.

In our industry today, it is easy to sit back and be "perscribed to." We are told how to develop our materials, what format to use, how to write and administer our exams, even what to teach and at what level. But even with the best training program ever developed, it is still the instructor that is needed to make it a high quality presentation. The demeanor of the instructor is as important to the quality of the lesson as is the lesson content and materials. In fact, in the past it was probably more important because the material quality was not as high then as it is today. The instructor therefore, has the pivotal role in quality instruction.

CONCLUSION

So, what is the first step in improving the quality of instruction? Maybe it is each instructor accepting their role as educators and realizing the impact they can have in the lives of their students (successes and failures), and on the safety of the general public at large. This role is more than just regurgitating mere facts and figures. It means taking an active part in each student's education. Being a coach, counselor, helper, cheerleader, sounding board are just a few of the parts the interactive instructor undertakes.

Then once this is realized, becoming proactive in their profession by learning how to perform their job in a manner that exceeds the highest expectations of all of their customers (including the students). Knowing the lesson content, how it is applied in the plant, knowing how to present it to the students so that each one "learns with understanding," and doing all of this in a manner that conveys a positive demeanor that is indicative of high quality, is the challenge of the instructor in the nuclear industry today.

BIOGRAPHY

THOMAS L. FUESTON, Senior Training Advisor, has been with Westinghouse since 1974. As the Westinghouse Nuclear Training Center Curriculum Material Specialist, he ensured the technical and educational accuracy in the development of training materials, conducted audits for various plant operator classes, developed and taught the Simulator Instructor Skills and Methods Program, and served on the Illinois Department of Adult Vocational and Technical Education Evaluation Team. While a Senior SNUPPS Simulator Instructor and Manager of Facilities and Administration, Mr. Fueston developed, supervised, and acted as Quality Control for the development of the SNUPPS Nuclear Plant Systems Training programs and materials as well as coordinated the Administration for the Westinghouse Nuclear Training Center. In 1987, Mr. Fueston was instrumental in the development of a course entitled "Conduct of Operations," which focused on professionalism and how to make individuals more aware of their roles as a professional. In addition to extensive training with the U.S. Navy, he holds M.S. and B.S. degrees in Occupational Education, as well as degrees in Technical Communications and Nuclear Technology and also serves on the College of Lake County Technical Communication Curriculum and Zion Benton High School Vocational Education Department Advisory Committees. Mr. Fueston is licensed on the Zion Nuclear Station at the SRO level in 1976.



**Sydney
Harris**

We must hope for the best in order to come close to it

Over the years, three or four maxims of judgment have helped me in evaluating ideas and attitudes. One of the most valuable is from "Meditations on Quixote," an early book by Cervantes y Casset, the Spanish philosopher whose centenary we will be observing next year.

"The minimum is the measuring unit in the realm of quantity," he wrote, "but in the realm of values, the highest values are the measuring unit."

These brief two dozen words, so profoundly true, call for a little meditation.

IN MEASURING distance, we begin with the inch, not the yard or the mile. In measuring time, we begin with the second, not the hour or the day.

Quantities are compared in relation to their smallest unit, to determine what small really be called large or long or heavy or fast or rich, or anything measured, weighed or counted.

But when we are dealing with values, we use the highest value as the measuring unit. All diamonds are judged by what a perfect stone would be; heroism is compared with the most heroic act we have known; an actor's ability is gauged in comparison with the greatest actor we have seen.

Now what is the practical importance of this distinction between ways of measuring quantities and values?

It is this: In the realm of values, if the really topmost values are ignored or suppressed in our scale, then those next in line assume the highest rank.

"THE HEART OF MAN does not tolerate an absence of the excellent and supreme," Ortega explains, "and so the ranks are filled by objects and persons less and less fit for them."

And this is why what is called Utopianism and Idealism by most people is actually the most practical and necessary perspective to maintain in all such matters. Otherwise our standards become lower and lower, and we are soon measuring values as we do quantity, by the smallest unit that is convenient, rather than by the largest.

Once we surrender the ideal of the first-rate man in public life, for instance, we accept the second-rate as the standard; then it is easy to go to the third- and fourth-rate until, finally, we have utterly lost sight of the ideal of the public man and are merely choosing between lesser evils, as we do in so many elections.

The archer always aims at the center of the target, though he knows he may not hit it. To aim elsewhere is literally to "lower one's sights." It may be idealistic to hope for the bull's-eye, but it is the most realistic way to get close to it.

CERTIFYING SIMULATOR INSTRUCTORS

Prepared by

John Magennis
Licensed Operator Training
St. Lucie Nuclear Plant

and

Jo Palchinsky
Nuclear Training Staff
Juno Beach Office

Nuclear Energy Department
Florida Power & Light Company

Prepared for

MNTA FOURTH ANNUAL
NUCLEAR INSTRUCTORS' WORKSHOP

October 17, 1989

Columbus, Ohio

TABLE OF CONTENTS

PREFACE.....	ii
WORKSHOP OUTLINE.....	iii
SIMULATOR INSTRUCTOR TRAINING PROGRAM DEVELOPMENT	
Needs Analysis.....	1
Job Analysis.....	2
Task Analysis.....	3
Program Design.....	4
Materials Development.....	5
Training Implementation.....	6
Evaluation: Lessons Learned.....	6
ATTACHMENTS:	
A - Simulator Instructor Job.....	9
B - SQIOC Model.....	10
C - Simulator Exercise Types.....	11
D - Simulator Instructor Skills Matrix.....	12
E - "Perform SQIOC" Task Analysis.....	13
F - Simulator Instructor Qualification Flowchart.....	39
G - SIT Terminal Objectives.....	40
H - Human Information Processing (HIP) Model.....	41
I - HIP/SQIOC Interface.....	42
J - Procedural and Diagnostic Problem Solving.....	43
K - A Structured Approach to Simulator Instructor-Student Interactions (An article).....	44
L - How to Prepare for Exercise & Conduct Pre-exercise Brief.....	50
M - One Method of Conducting a Critique Covering All Elements.....	51
N - Simulator Training Development Process.....	52
O - Simulator Training Development Products Relationship.....	53
P - SIT Program Map.....	54

PREFACE

My colleague and friend John Magennis, who helped me prepare this presentation, was the lead subject matter expert on our Simulator Instructor Training (SIT) development project. I served as the project analyst and curriculum development specialist. When we implemented our first seminar back in 1987, he kicked it off with a few words that reflected back on his own development as a simulator instructor--which didn't benefit from a structured simulator instructor training program.

He said that when he first qualified as a simulator instructor at Combustion Engineering (CE) and started to conduct simulator training, he first focused on mastering the machine--the simulator facility--how it worked, so that customers would not lose training time due to any facility operator mistakes. Once its operation was mastered, then he focused on observing and instructing the operators who came to the CE facility to train in a simulated environment--to practice the technical manipulation of equipment--to exercise the control manipulations and use their plant procedures. Then when he was challenged to develop operators diagnostic and team skills, he entered a whole new phase in his development as a simulator instructor--how to develop operators critical thinking skills. Past observations of operator error that could not be explained technically, could be explained using the principles of human information processing. This revelation caused him to critically analyze how his performance as a simulator instructor impacted the operators thinking during simulator scenarios--and what are the critical skills of an effective simulator instructor.

His experience was built into and shared throughout our simulator instructor training program, one that I hope you find interesting and challenging after reviewing this presentation and experiencing the MNTA workshop for which it was prepared.

Jo Palchinsky

WORKSHOP OUTLINE

- INTRODUCTION:** Welcome
SME Perspective
- PRESENTATION:** Needs Analysis/SIT Charter
- ACTIVITY:** Activity #1 - Building a Scenario
- Equipment used
 - Instruments used
 - Procedures used
 - Related Industry Events
- Activity #2 - Uncovering the SQIOC skills
- What would you observe?
 - What questions would you ask?
 - How would you coach?
 - How would you intervene?
 - Individual and Team Skills?
- DISCUSSION:** Exercise Guide Instructor Cues
- Five types of cues
 - Excerpt of Exercise Guide
- PRESENTATION:** Summarizing the SQIOC Model
- Target Population Frame of Reference
 - Observation Skills
 - Questioning Skills
 - Coaching Skills
 - Intervention Skills
- DISCUSSION:** Using the SQIOC Model
- SQIOC: Adaptation Over Time
- ACTIVITY:** Activity #3 - Applying SQIOC
- Initial License candidates
 - Requal Training
- Activity #4 - Relating Cues to SQIOC
- Activity #5 - Relating Cues to Exercise Types
- Types of Simulator Exercises
- PRESENTATION:** Job/Task Analysis
- Methodology
 - Creating the SQIOC Model
 - Task Hierarchy
 - Pilot testing the ideas
 - Simulator Instructor Skills Matrix
 - "Perform SQIOC" Task Analysis
- Program Design/Development
- Program Map (Certification Requirements)
 - Program Outline
- Implementation/Lessons Learned
- Simulator Practice
 - Feedback Tools
 - Simulator Instructor Development
 - SRO Supervisory Skills
 - Intercompany Transfer of Knowledge
- CLOSING:** Questions & Answers
Learning Points

CERTIFYING SIMULATOR INSTRUCTORS

Simulator Instructor Training Program Development

Needs Analysis

Florida Power and Light Company (FPL) working with CAE, a Canadian company, developed two high-fidelity plant-referenced control room simulators for use in training at the St. Lucie and Turkey Point nuclear plants. The simulators, because of their consoles, displays, and computer systems, can simulate many of the conditions an operator may encounter in the actual plant control room. Therefore, we consider simulator training to be vital to the safe, efficient operation of FPL's nuclear power plants.

However, we recognize that the most effective simulators can only contribute partially to the total training experience. The position of "simulator instructor" is responsible for shaping this experience to achieve the total training expected in the nuclear power industry.

We made two assumptions. First, that training individuals and teams in a control room simulator environment is different than training in a classroom environment. Thus, specialized instructional skills are needed by technical instructors who must train in a simulator environment.

Second, since simulators play a prominent role in operator training, the quality of operator training has become directly proportional to the preparation of simulator instructors. Consequently, it was essential that we define the job of the simulator instructor position and train and certify our simulator instructors.

Mark Shepherd, the Operations Training Supervisor at St. Lucie, noted that the experienced simulator instructors who were developing our Licensed Operator simulator training materials were incorporating simulator instructional skills into the materials. This observation culminated in a series of work sessions designed to identify these specialized skills. The list of specialized skills was compared to the simulator instructor competency inventory developed by Dr. Janice Reitmeyer as a result of her national study. [Janice was working at the Susquehanna nuclear plant at the time she conducted the study.] So we used her list of 80 competencies as a basis for the systematic development of our training.

CERTIFYING SIMULATOR INSTRUCTORS

Job Analysis

However, we recognized that our simulator training had some unique features, and decided to engage in a rigorous verification process to ensure that our resulting profile of the simulator instructor job at FPL included all required and expected duties and tasks. We added, deleted, and modified the original inventory using a strict set of decision criteria. We compared the results to three additional simulator instructor task lists compiled by: 1) the Institute of Nuclear Power Operations, 2) the Electric Utility Instructor Development Consortium, and 3) the Mid-Atlantic Nuclear Training Group.

We drafted, piloted and administered a job survey to our FPL population that consisted of supervision, subject matter experts (SMEs) and future simulator instructors, and compared their ratings. The 24 survey respondents consisted of thirteen FPL and eleven full-time contracted employees. The respondents represented 51 combined years of "simulator" instructor, developer and supervisory experience in initial licensed, requalification, and Shift Technical Advisor simulator training, as well as for a variety of target populations including NRC Resident Inspectors, USN Officers, Nuclear Utility management, engineers and Health Physics Technicians. Also, eight respondents had past experience participating in the Acceptance Testing of a simulator.

Our survey data analysis, including the very valuable write-in comments, indicated that the verified inventory actually reflected a hierarchy of Simulator Instructor competencies. Using the definitions of job components in NUREG 1750, we constructed a hierarchy of Simulator Instructor duty areas, task areas, task elements, and supporting skills, and identified additional elements, skills and knowledge. This became our preliminary task analysis information.

The synergy of this process stimulated our in-depth analysis of how the successful Simulator Instructor performs on the simulator floor during the actual simulator exercise. We focused on the simulator instructor-student interface and constructed a preliminary model. The model represented the dynamic student-instructor interaction whereby the instructor integrates observation, questioning, coaching and intervention skills in order to facilitate student learning to higher cognitive levels of thinking. The "integration" of the four key elements was deemed critical to the success of the instructor when working to facilitate learning in the simulator environment.

CERTIFYING SIMULATOR INSTRUCTORS

We could not correlate this "integration" process with any single competency/task on the FPL Job Survey, nor any other industry task list. In order to proceed with the Job Analysis process, and a further in-depth analysis of this old but unnamed task, it was titled "Perform SQIOC" (pronounced sky-ock.) SQIOC stands for:

SQIOC

S = The Integral Sign = Integration
Q = Questioning Skills
I = Intervention Skills
O = Observation Skills
C = Coaching Skills

Our final Task Inventory resulted in three duty areas and thirteen tasks (see Attachment A.)

Task Analysis

We analyzed the nine tasks in duty area A-- Implementing Training, and duty area B--Developing Training. To complete the task analysis, we refined and tested the SQIOC model (see Attachment B for final SQIOC Model). Based on the instructor cues being built into the simulator exercise guides (see Attachment C), we drafted a Simulator Instructor Skills Matrix to reflect unacceptable, acceptable, and excellent behaviors in the important skill areas (see Attachment D.) To validate the model, we prepared materials and instruments and used them to pilot and further develop the forming concepts, principles, criteria and job aids. The evaluation was conducted on three levels. The pilot evaluation instruments were used to collect feedback from students (operator, STA, and Tech Staff trainees) of a group of future simulator instructors, the instructors themselves, and observers of the instructors' performance. At the Combustion Engineering simulator facility, the future instructors were oriented to the concepts and skill behaviors, were videotaped during several practice sessions, and viewed and discussed the videos using the feedback, self-assessment, and observation data. This pilot provided extensive analysis data that was recorded and validated by the Task Analysis Team (see Attachment E for sample task analysis.)

CERTIFYING SIMULATOR INSTRUCTORS

Program Design

We constructed a Simulator Instructor Career Path which consisted of four certification levels (see Attachment F.) The thirteen tasks were assigned to the appropriate levels and job functions as outlined below.

SIMULATOR INSTRUCTOR CERTIFICATION LEVELS

FUNCTION	CERTIFIED TO	TASKS
1. Simulator Operator	Operate simulator facility	A-1
2. Simulator Training Developer	Develop simulator training	B-1,2,3
3. Simulator Training Facilitator	Facilitate simulator training	A-2,3,4 5,6 C-1,2
Simulator Instructor	All above	All above
4. Sr. Simulator Instructor	Evaluate simulator training effectiveness & regulatory compliance	C-1,2,3,4

Dr. "Dan" Pond, an industrial psychology & ergonomics professor at the Florida Institute of Technology, joined the Design Team. Using the task analysis data, we prepared terminal and enabling objectives for the initial Simulator Instructor Training Program (see Attachment G.) The following briefly describes the instructional and evaluation strategies of the program design.

Training Settings:

Classroom, Simulation, OJT

Training Methods:

Seminar with interactive presentations, discussions, exercises and a written exam
Demonstration and practice exercises on the simulator using skill behavior modeling
Self study OJT modules providing the opportunity for further practice and feedback prior to formal performance evaluation

CERTIFYING SIMULATOR INSTRUCTORS

Instructional Media:

Print media including a pre-seminar reading packet, a notebook including seminar handouts, job aids, OJT guides, supplemental references, and a SQIOC Tips list, and simulator instruction procedures and forms, example exercise guides, and instructor facility operator instructions

Non-print media including wall charts, flipcharts, overhead transparencies, and the use of a whiteboard

Interactive media - The full-scope FPL simulators and their associated on-the-job resources

Materials Development

Based on the analysis data, we further refined the SQIOC model and designed several graphic depictions to clarify the integration of its components (see Attachment B.) We designed and described a human information processing (HIP) model, and its relationship to SQIOC (see Attachments H & I.) We depicted the problem-solving process to show the procedural and diagnostic HIP flow path (see Attachment J.) We refined the Simulator Instructor Skills Matrix and used it to develop task performance checklists that reflect expected standards. Supplemental reading references were carefully selected and copyright permission or printed copies were obtained.

The pre-reading text materials that described HIP and SQIOC were written in a simple to read form, from a nuclear operations point of view (see Attachment K for article adapted from the pre-reading text.) A flow diagram was prepared to illustrate the elements of preparing for an exercise and conducting a pre-exercise brief with students (see Attachment L.) A flow chart was prepared to depict one method of conducting a post-exercise critique covering all elements of the scenario (see Attachment M.) Visual aids were prepared to illustrate how the development of simulator training fit within the bigger context of the Systems Approach to Training process, and the relationship between the various products of each simulator training development activity (see Attachments N & O.) Evaluation instruments and tests were prepared to assess student achievement of the objectives and provide documentation of certification. Lesson plans and OJT guides were developed to guide instruction through the components of the program.

CERTIFYING SIMULATOR INSTRUCTORS

A program map was prepared to illustrate how the simulator instructor flows through the program and completes the certification requirements (see Attachment P.) Prerequisite requirements for entry into the program include an SRO license or certification and licensed operator instructor qualification. Students first complete the pre-seminar reading. Then they attend a classroom seminar and simulator practice sessions before completing a written exam. Finally, they complete the appropriate OJT guides and when ready, their performance is evaluated. Upon completion of all the requirements, the graduate is a qualified simulator instructor.

Training Implementation

Thirty-four FPL permanent and contracted instructors attended the four offerings of the seminar and simulator sessions, and many have completed all the OJT requirements. The experienced contracted simulator instructors attested to the skills and techniques taught. Many indicated that, while they had not had names for the skills and techniques they found to be critical to their effectiveness, they surely recognized them as presented in FPL's simulator instructor training.

Evaluation: Lessons Learned

Since 1987, when we first began the development of the SIT program, and throughout its implementation, we have received invaluable feedback and have learned a lot. The following are five of the lessons learned.

Simulator Practice

Lesson Learned: The simulator practice component the training is critical to instructor skill development, and scenarios used during the practice sessions can not be too technically complex.

When we implemented the first seminar at St. Lucie, the simulators were not yet functional, so we could not provide the students with an opportunity to practice the new skills on the simulator. This section of the training is critical to providing a link between the conceptual models and techniques discussed during the classroom seminar and doing the OJT activities. So, once the simulators were functional, we implemented the training again for the first group of instructors including the seminar and simulator practice sessions. This second round at St. Lucie,

CERTIFYING SIMULATOR INSTRUCTORS

which also had Dr. Dan Pond present to respond to any questions regarding HIP, was much more successful.

After implementing the training the second time at Turkey Point, we received useful feedback from the instructors on the simulator practice section of the training that in the future will help to make the practice sessions run more smoothly. For example, it's important that the scenarios used during the practice are not technically complex that they interfere with applying the instructor skills. If the instructors get hung up on the technical aspects of the scenario, then they're not able to effectively question and coach during the exercise.

Feedback Tools

Lesson Learned: The three instruments that were used to validate the SQIOC model during the analysis phase of the project would be useful to use during the simulator practice component of the training.

After implementing the training at Turkey Point, the three instruments were shared with one of the experienced contractor simulator instructors. During the simulator practice sessions, he SQIOC'd and evaluated the instructor's application of the skills presented during the seminar. He indicated that the instruments would be useful tools to use during the practice sessions since they are designed to rate the instructor's skills from three perspectives: those who are role playing operators, the instructors themselves, and the observers.

Simulator Instructor Development

Lesson Learned: It takes a lot of practice and time to fully develop the skills of an effective simulator instructor (SI), so you can not expect instructors to master these skills before being certified.

As with any interpersonal skill, simulator instructor-student interaction skills take time to master. This fact has been recognized by many experienced supervisors of simulator instructors. We found this to be true during our certification process. During initial training and certification, it's important that instructors: 1) learn what skills they're expected to perform, and identify the specific behaviors related to each skill, 2) demonstrate a satisfactory behavior in each skill area, and 3) make a commitment to continually practice the skills during simulator training. Over time, with reinforcement and feedback, simulator instructors will continue to develop their skills to a mastery level.

CERTIFYING SIMULATOR INSTRUCTORS

SRO Supervisory Skills

Lesson Learned: The skills of an effective simulator instructor are also used by senior reactor operators who supervise control room crews, and they too can benefit from similar training.

One of the simulator instructors who completed the training was an ex-shift supervisor. He recognized that what was presented applied to effective control room supervision. His insight was further explored at St. Lucie, resulting in the development of SRO supervisory skills training that included the HIP and SQIOC concepts and skills. A videotape was produced and used in a pilot session to give shift supervisors an opportunity to identify when to use the SQIOC skills before they practiced applying them in the simulator. Their feedback was very positive, and the piloted materials are being refined and incorporated in the SRO Training Program.

Intercompany Transfer of Knowledge

Lesson Learned: The SQIOC skills are also relevant to the success of maintenance crew supervisors and trainers who instruct in other than the simulator setting.

The instructional approach used to develop FPL's simulator instructors and SRO supervisory skills at St. Lucie has not only proven successful but has gained the interest of others. Individuals from several nuclear plants, including Diablo Canyon, Indian Point, McGuire, North Anna, and Seabrook, have contacted St. Lucie in response to a brief article that was in the Nuclear Professional.

In addition, within FPL, we recognize that the video-based approach used in the SRO supervisory skills training can also be effective in the training of other nuclear personnel. The training uses videotaped re-enactments of situations based on past License Event Reports to stimulate discussion of the specific supervisory skills (i.e. SQIOC) which are then applied during practice sessions. The approach is not only applicable to the Turkey Point SRO Training Program, but also to Maintenance Crew Supervisor training and the basic instructor skills course, both currently being developed for implementation at both FPL nuclear sites. To facilitate the evaluation of the already proven approach, information is being transferred to the applicable persons who are developing the maintenance and instructor training.

ATTACHMENT A

Job: SIMULATOR INSTRUCTOR

Duty Area A: IMPLEMENTING TRAINING

- Task A-1: Operate the simulator
A-2: Prepare for exercise
A-3: Conduct pre-exercise brief
A-4: Perform SQIOC
A-5: Conduct critique
A-6: Conduct student evaluations

Duty Area B: DEVELOPING TRAINING

- Task B-1: Analyze requirements
B-2: Design exercise
B-3: Develop exercise

Duty Area C: PERFORMING ADMINISTRATIVE
FUNCTIONS

- Task C-1: Maintain proficiency
C-2: Perform support activities
C-3: Interact with regulators
C-4: Evaluate programs
-

SOIOC

OBSERVATION

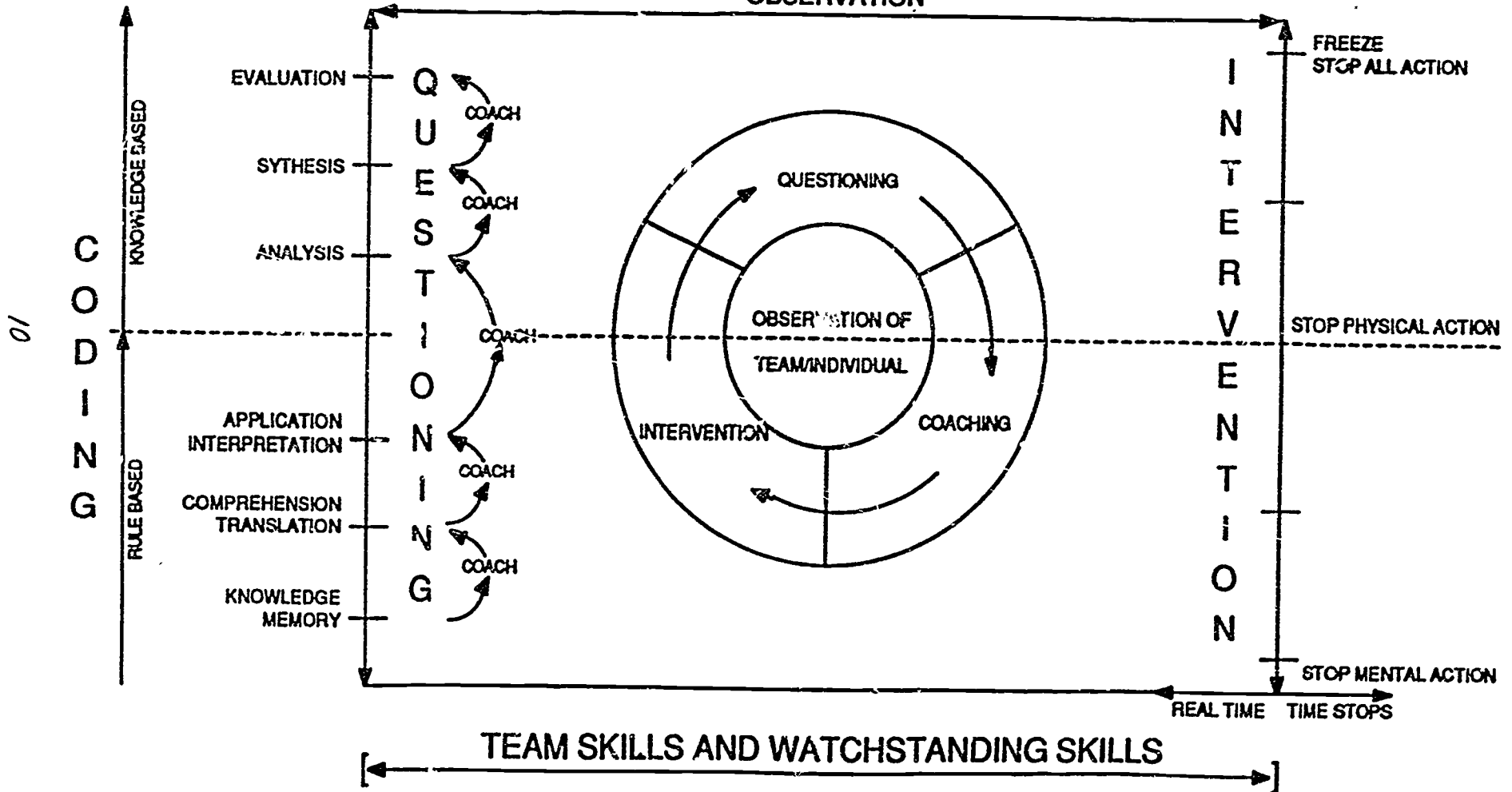

ATTACHMENT B

10

72

73

SIMULATOR EXERCISES

Exercise - The implementation of an approval lesson plan on the simulator floor

TYPES	DESCRIPTION
Laboratory Exercise	A session that addresses a specific portion of plant operation in a theoretical and/or non-integrated context.
Demonstration Exercise	A session that transmits information on the knowledge and procedural techniques of plant operation by direct example.
Practice Exercise	A session that allows students the opportunity to practice the use of knowledge and skills under direct supervision.
Evaluation Exercise	A session that measures student mastery of specified skills in accordance with objectives.

ATTACHMENT D

SIMULATOR INSTRUCTOR SKILLS MATRIX

Observation (Cued)

- becomes sidetracked in peripheral duties
- does not position self to monitor operator actions
- allows operators to perform actions without assessment
- doesn't implement observes required by E.G or W.S.M

- usually positions self strategically to assess most actions
- implements only observes required by E.G and most of W.S.M

- always strategically positioned to assess operator actions
- implements all E.G and W.S.M observes
- SKY-OCR applied throughout

Questioning Techniques (Non-cued)

- fails to address target population
- does not follow hierarchy of questioning
 - o pre-cueing
- misses some E.G questions

- directs questions at target population
- achieves minimal level of questioning hierarchy
- some pre-cueing
- asks E.G. questions only

- effectively uses probing questions
- fully implements SKY-OCR model

Coaching (Non-cued)

- no coaching
- procedural compliance without guidance
- unable to respond to student problems

- instructs the operator prior to performance
- teaches the concept of think, act, see and do
- coaches on request or only when directed by E.G

- coaches effectively at all levels
- fully implements SKY-OCR model

Intervention (Cued)

- allows operator to perform actions incorrectly
- intervenes when unnecessary
- can't intervene when directed by E.G.

- intervenes prior to incorrect action
- can discuss in real time environment
- intervenes when directed by E.G.

- intervenes effectively at all times
- SKY-OCR model applied to all intervention situations

Stress/Resource Management (Non-cued)

- sets unrealistic goals
- places excessive expectations on operators
- provides unrealistic settings/scenarios

- sets goals specified in E.G. overview and objectives
- provides realistic control room setting
- role models ANPS/other staff as directed by E.G.

- allows individual operators to express E.G. goals/objectives when appropriate
- role models confidence and competence in all positions
- always reinforces coding and diagnostics during stressful situations

Constructive feedback (Non-cued)

- fails to provide feedback
- gives inappropriate praise or criticism

- provides feedback appropriate to most real time situations
- provides feedback as necessary during critique session

- always uses praise/criticism effectively
- encourages individual initiative
- criticism is always constructive

Critiques (Cued)

- does not cover E.G. critique topics
- criticism is negative, demeaning
- does not promote self analysis/peer analysis
- critiques on unannounced goals or expectations

- covers all E.G. critique topics
- critiques based on E.G. objectives, goals, performance indicators
- critique comments are generally positive and constructive
- allows self analysis/peer analysis

- establishes rapport for effective feedback on group/individual performance
- always provides methods or techniques for improving/honing skills
- achieves closure for all questions
- encourages self analysis and peer analysis using T.S.M. and W.S.M.

Pre-shift Brief (Cued)

- does not cover pre-shift brief topics in E.G.
- cannot clarify/explain objectives
- does not try to establish rapport with operators

- covers all pre-shift brief topics in E.G.
- attempts to establish good rapport/communication
- objectives and expectations are stated

- establishes a realistic setting for exercise
- relates objectives and goals to operators job
- promotes interest, enthusiasm in the exercise

Evaluation (Cued)

- unable to perform all evaluations required by E.G.
- interferes/intervenes when unnecessary
- unable to record pertinent comments

- evaluates and records all observations required by the E.G.
- uses objectives and performance indicators as evaluation criteria
- occasional questions to clarify actions, understanding, judgement

- observes, questions, evaluates without interference
- maintains proper distance and position for optimal observation
- fully documents all observations related to performance, attitude, knowledge

ATTACHMENT E

SIMULATOR INSTRUCTOR

TASK ANALYSIS

TRACKING NO. A-4

Florida Power & Light Company, Copyright, 1987

SIMULATOR INSTRUCTOR TRAINING PROGRAM

TASK ANALYSIS

Task Worksheet (Part I)

TASK TITLE: Perform SQIOC

NOTE A: SQIOC is pronounced "sky-ock"

NOTE B: SQIOC stands for

S - The "Integration" Sign
Q - Questioning skills
I - Intervention skills
O - Observation skills
C - Coaching skills

NOTE C: SQIOC is the student-instructor interaction process whereby the instructor integrates observation, questioning, coaching and intervention skills in order to facilitate student learning to achieve higher cognitive levels of thinking.

TRACKING NUMBER: A-4

DUTY AREA: Implementing Simulator Training

JOB TITLE: Simulator Instructor

ANALYST/DATE: Jo Palchinsky, 8/26/87

ORIGINATING SME/DATE: John Magennis, 9/25/87

VALIDATING SME/DATE: John Dedon,, 10/3/87

SUPERVISOR REVIEW/DATE: Mark Shepherd, 9/25/87

TERMINAL PERFORMANCE OBJECTIVE:

TASK CONDITIONS: Given any student target population and an approved exercise guide, the simulator instructor will

ACTION STATEMENT: perform SQIOC

TASK STANDARDS: integrating the four elements and including appropriate skills listed on the Simulator Instructor Skills Matrix, as the exercise permits and the students progress.

INITIATING CUE:

The simulator instructor has completed the pre-exercise briefing.

TERMINATING CUE:

The students have achieved the exercise guide objectives and the simulator is frozen.

OUTPUT/OUTCOME OF TASK:

The student team members have achieved the exercise guide performance objectives and improved their watchstanding skills.

NOTE: SEE SQIOC MODEL ATTACHED

PERFORMANCE CHECKLIST:

1. Observe students.
2. Question students.
3. Coach students.
4. Intervene to correct.

CONSEQUENCES OF INADEQUATE PERFORMANCE:

The simulator instructor facilitates negative training.
The students' transfer negative learning to the plant control room that results in a performance error.

SAFETY CONSIDERATIONS: Negative training that results in a performance error on-the-job can jeopardize the safe and stable status of the plant.

AFFECTIVE INDICATORS: The simulator instructor:
role models confidence and competence in all positions.
complies with company policies and procedures.
encourages individual operators to think and operate at a level above that expected.
discourages and debates irrational operator actions.
resolves conflicts, between student team members, that are negatively impacting team performance.
resists conflict with students that may have a negative impact on learning.
coach in the use of coding and diagnostics to reduce unwarranted levels of stress.
encourages individual initiative.
uses praise and criticism that is always constructive (focuses on performance related to the objectives, not the person.)
implements all instructor cues in exercise guide.
fully and consistently implements SQIOC process.
self-evaluates SQIOC behavior/performance and strives to improve.

77

HUMAN INTERFACES: The simulator instructor, as a facilitator of training, interfaces with diverse target populations of simulator training, including:

- Hot license candidates
- Licensed operators (RO and SRO)
- Shift Technical Advisors
- Technical Staff
- Managers
- Other simulator instructors
- Other Operator Training instructors

REQUIRED TOOLS/EQUIPMENT/MATERIALS:

Approved exercise guide and any required supplementary references (e.g. Watchstanding Skills Matrices, evaluation forms.)

GENERAL REFERENCES:

AUTHORITY REFERENCES:

INPO 86-026, Guidelines for Simulator Training

SELECTED REFERENCES:

Allen, D.W. "Micro-teaching: A new framework for in-service education." In Cooperative Curriculum Center, Synopsis of the taxonomy of questions, Title III ESEA III Project of CESA #10, Washington, D.C.: Office of Education, Department of Health, Education and Welfare, [n.d.]

Allen, D.W., Ryan, K.A., Bush, R.N. & Cooper, J.M. "Proposed clusters of technical skill." In Cooperative Curriculum Center. Synopsis of taxonomy of questions, Title III ESEA Project of CESA #10, Washington, D.C.: Office of Education, Department of Health, Education and Welfare, [n.d.]

Cooper, J.M. "Developing specific teaching skills through micro-teaching." In Cooperative Curriculum Center, Synopsis of taxonomy of questions, Title III ESEA Project of CESA #10, Washington, D.C.: Office of Education, Department of Health, Education and Welfare, [n.d.]

Cooperative Curriculum Center. Synopsis of the taxonomy of questions, Title III ESEA Project of CESA #10, Washington, D.C.: Office of Education, Department of Health, Education and Welfare, [n.d.]

Davis, L.T., Gaddy, C.D., Turney, J.R., & Koontz, J.L. "Team skills training," Performance and Instruction Journal, October 1986, 25 (8), 12-17.

Eyseuck, M. Handbook of cognitive psychology, Hillsdale, New Jersey: L. Erlbaum and Associated, 1984.

Hedegard, J. Training of control room crews in plant disturbance diagnosis - a methodological framework, Stockholm, Sweden: Swedish Nuclear Power Inspectorate, February, 1987.

Krahenbuhl, G.S., Darst, P.W., Maret, J.R., Reuther, L.C., Constable, S.H. Swinford, M.E. & Reid, G.B. "Instructor pilot teaching training," Aviation, Space and Environmental Medicine, October 1981, 594-597.

Rasmussen, J. On information processing and man-made interaction, Riso: Riso National Lab., 1984.

Sanders, N.M. Classroom questions: What kinds? New York: Harper & Row, 1966.

Spettell, C.M. & Liebert, R.M. "Training for safety in automated person - machine systems," American Psychologist, May 1986, 41 (5), 545-550.

Welford, A. T. Skilled performance: Perceptual and motor skills, Glenview, Ill.: Scott, Foresman and Company, 1976.

JOB ANALYSIS DATA:

FPL STUDY:

ID#	TASK/ELEMENT/SKILL DIFFICULTY	YES/NO
E-3	(S) Perform instructor role play	No
E-4	(S) Execute demonstration exercise guide	No
E-5	(S) Modify exercises based on student feedback	No
E-6	(S) Modify exercises when recognize simulator conditions approach ATP boundaries	Yes
E-7	(S) Determine data for feedback on operator performance	No
E-8	(E) Question students as necessary	Yes
E-9	(E) Coach students as appropriate	Yes
E-10	(S) Reinforce team skills	Yes
E-11	(E) Intervene to foster team interaction	Yes
E-12	(S) Intervene to assess cognitive skills	Yes
E-13	(S) Develop student diagnostic abilities	Yes
E-14	(S) Develop student perceptual coding skills	Yes
E-15	(S) Develop stress management skills	Yes
E-16	(S) Execute lab exercise guide	No
E-17	(S) Execute practice exercise guide	No

- E-18 (S) Determine data for feedback on operator perceptual coding Yes
- E-19 (S) Recognize/act on simulator conditions which diverge from expected responses Yes

CAPABILITY LEVEL (expected result of initial training)

- 1 = Prerequisite to initial training
 2 = Knowledge only
 3 = Skilled execution with assistance
 4 = Skilled execution, independently
 5 = Mastery required

	LEVEL
E-3 (S) Perform instructor role play	4
E-4 (S) Execute demonstration exercise guide	4
E-5 (S) Modify exercises based on student feedback	3
E-6 (S) Modify exercises when recognize simulator conditions approach ATP boundaries	3
E-7 (S) Determine data for feedback on operator performance	4
E-8 (E) Question students as necessary	4
E-9 (E) Coach students as appropriate	4
E-10 (S) Reinforce team skills	4
E-11 (E) Intervene to foster team interaction	4
E-12 (S) Intervene to assess cognitive skills	4
E-13 (S) Develop student diagnostic abilities	4
E-14 (S) Develop student perceptual coding skills	4
E-15 (S) Develop stress management skills	4
E-16 (S) Execute lab exercise guide	4
E-17 (S) Execute practice exercise guide	4
E-18 (S) Determine data for feedback on operator perceptual coding	4
E-19 (S) Recognize/act on simulator conditions which diverge from expected responses	4
Write-in: (E) Observe students	

REITMEYER STUDY:

ID#	TASK/ELEMENT/SKILL	SUPV	SME	COMB
IMPORTANCE (to success of simulator instructor)				
E-3	(S) Act as fill-in during trng. or testing	2.16	2.27	2.24
E-4	(S) Execute lesson plans/scenarios	3.49	3.37	3.40
E-5	(S) Adapt scenario based on stud. response	3.54	3.44	3.46
E-6	(S) Adapt to simulator anomalies	3.45	3.28	3.32
E-7	(S) Collect data for evaluation/critique	3.08	2.97	3.00
E-8	(E) Question individuals as appropriate	3.47	3.00	3.35
E-9	(E) Tutor individuals as appropriate	3.46	3.48	3.47
E-10	(S) Reinforce team skills	3.29	3.33	3.32
E-11	(E) Limit intervention to foster team interaction	3.19	3.08	3.11

IMPACT ON LEARNER

E-3	(S) Act as fill-in during trng or testing	2.18	2.29	2.26
E-4	(S) Execute lesson plans/scenarios	3.47	3.35	3.38
E-5	(S) Adapt scenario based on stud. response	3.56	3.36	3.41
E-6	(S) Adapt to simulator anomalies	3.40	3.25	3.29
E-7	(S) Collect data for evaluation/critique	3.10	2.82	2.89
E-8	(E) Question individuals as appropriate	3.42	3.36	3.38
E-9	(E) Tutor individuals as appropriate	3.58	3.57	3.57
E-10	(S) Reinforce team skills	3.37	3.34	3.35
E-11	(E) Limit intervention to foster team interaction	3.17	3.07	3.10

DIFFICULTY

E-3	(S) Act as fill-in during trng or testing	1.82	1.98	1.94
E-4	(S) Execute lesson plans/scenarios	2.59	2.60	2.60
E-5	(S) Adapt scenario based on stud. response	3.24	3.12	3.15
E-6	(S) Adapt to simulator anomalies	3.19	3.13	3.14
E-7	(S) Collect data for evaluation/critique	2.71	2.59	2.62
E-8	(E) Question individuals as appropriate	2.66	2.71	2.70
E-9	(E) Tutor individuals as appropriate	2.75	2.83	2.81
E-10	(S) Reinforce team skills	3.00	2.83	2.87
E-11	(E) Limit intervention to foster team interaction	2.66	2.66	2.66

RECOMMENDED INSTRUCTIONAL SETTING: Combination Classroom & Simulator

RECOMMENDED PERFORMANCE EVALUATION MODE:

(X) Perform (X) Simulate () Discuss

Task Worksheet (Part II)**TASK ELEMENTS/STANDARDS/PROBLEM ASSESSMENT/PROBLEM RESOLUTION:****1. Observe students.**Standards:

- positioned self strategically to visually assess student actions.
- used Observe cues required in the exercise guide.
- critically listened.

Problem Assessment:

- a. What would you do if your strategic positioning was interfering with student performance?
- b. What would you do if you missed an Observe cue required in the exercise guide?
- c. What would you do if during the exercise you are not sure why a student has taken a particular action that seems to be negatively affecting individual or team performance?
- d. What would you do if it became difficult to determine the appropriate amount of notes to record?
- e. What would you do in the event that both individual and team performance during a practice exercise is effectively achieving the objectives (i.e. no performance errors)?
- f. What if you must observe two or more students in different roles who are performing different tasks, and you find it difficult to observe all required behaviors?

Problem Resolution:

- a. Move out of the way, and observe the student to determine if your interference was detrimental to the achievement of the exercise objectives. If so, question and coach the student in order to facilitate student success and defer/eliminate unnecessary stress.
- b. Question other simulator instructors (if present) or the student to determine if the required behavior specified in the Observe cue had actually occurred.
- c. Question the student to determine "why" without interfering/detracting the student. In some cases, it is important that you know the reason why a student has taken certain actions in order for you to fully determine proper coding.
- d. Focus your note-taking on the objectives and the items included in the Watchstanding Skills Matrices.
- e. Maintain correct strategic positioning that does not interfere or distract the high quality of this effective team performance.

- f. Plan your observation strategy using the sequence of events, cues, and expected student actions that are listed in the exercise guide; then position yourself appropriately in order to observe the student(s) actions taken in response to critical incidents as specified in the guide.

2. Question students.

Standards:

- used low- and high-ordered probing.
- practiced pre-cueing.
- asked questions included in the exercise guide.

Problem Assessment:

- a. What if a student jumped to a conclusion/solution to a problem without fully diagnosing the root cause or assessing the impact from an integrated systems perspective?
- b. What if the student cannot relate the existing data and information to his existing schema of the situation?
- c. Why, at appropriate times during an exercise, is it important that you assess at which specific cognitive level a student is thinking?
- d. What if you asked a question that could not be readily answered, and you noticed that the student's stress level was rising (i.e. you were distracting the student's concentration during real time - mental intervention)?
- e. What if you noticed that you were questioning too much on the same parameter/indicator/topic?
- f. How can you determine at which cognitive level you should begin your questioning routine with a particular student?

Problem Resolution:

- a. Question the student to check/assess what schema he is using, what data he has collected and is using, and why he has converged on a particular solution?
- b. Question to assess the existing schema being used by the student and coach in order to correct any misunderstanding of normal and the current situation.
- c.
 - 1) so you can develop the student's thinking skills;
 - 2) so you are cognizant of the student's current level of thinking, and can contrive situations in the "knowledge-base" dimension for the student to experience during training;
 - 3) so you can help to reduce any unnecessary high stress levels of student's during training; and more importantly, reduce the likelihood of negative stress

on-the-job by providing opportunities to experience situations in the "knowledge-based" dimension that can occur on-the-job.

- d. Use the pre-cueing technique, that is, inform the student that you will expect the answer later. Be certain that you follow through; ask the question again at a more appropriate time.
- e. Stop questioning, reflect back on what you just accomplished, develop a strategy and begin again, being certain that you follow through to achieve the purpose of your questioning routine.
- f. Consider the Frame of Reference of the particular target population. Use the top-down approach by starting at an appropriate higher level and moving down until you locate the student's current level of thinking; or, use the bottom-up approach by starting with questions at the Knowledge Level and moving up.

3. Coach students.

Standards:

- hinted facts.
- prompted strategies.
- used Coding cues in the exercise guide.
- used Socratic Method.
- achieved student closure.

Problem Assessment:

- a. What if the student does not practice good communication skills while currently involved in an in-depth diagnostic routine?
- b. What if you recognize that your coaching is moving in the direction toward a mental intervention?
- c. What if a student asks you a question that you cannot immediately answer?

Problem Resolution:

- a. Provide little coaching on the expected communication behavior at that time, then when the student has completed the diagnostic routine, discuss the incident of poor communication in order to correct performance.
- b. Use the pre-cueing technique, stop the discussion and inform the student that you expect the answer later. Be certain to follow-through; at a more appropriate time restart the discussion.
- c. Tell the student that you do not know the answer at that time and (if possible) that you will locate the answer and get back to him before the exercise is over or during the critique, or make a note and follow-up after the exercise.

4. Intervene to correct.Standard.

- performed prior to the student's incorrect action. (verbal)
- performed during real time, (physical) unless appropriate to freeze simulator. (Big picture)
- based on cues in the exercise guide.

Problem Assessment:

- a. What if during your coaching routine you notice that the student is mentally blocked?
- b. What if the student is about to operate equipment that could result in damage or personnel injury?
- c. What if the team is not performing in accordance with the expected behavior as defined in the Watchstanding Skills Matrix?
- d. What if the team is implementing a solution to a mis-diagnosed problem?

Problem Resolution:

- a. Mentally intervene. Explain to the student the correct information and why it is correct. Discuss and ask questions in order to achieve closure. Be certain to facilitate a smooth transition back to real time.
- b. Prevent the operation by physically intervening, tell the student what he was about to do wrong and why it is wrong, then tell the student how to do it correctly. Demonstrate if necessary. Be certain to question the student in order to assess if closure is achieved, then transition smoothly back to real time.
- c. Overall poor team performance may be corrected by using a physical intervention. Get the attention of all team members, then explain what is expected that is not occurring and why it is important. Refer to the Watchstanding Skills Matrix, describe your observations, be specific, site consequences of inadequate performance on-the-job, emphasize expectations, answer any questions, then transition smoothly back to real time.
- d. Depending on the seriousness of the implementation, and the degree of action required to recover from the situation and lead the team back toward the exercise objectives, a freeze intervention may be required. If so, freeze the simulator and get the attention of all team members. Assess why the team mis-diagnosed the problem through questioning and discussion. Clearly explain what they did wrong and why. Coach them back to the proper direction, achieve closure and transition smoothly back to real time.

SKILLS AND KNOWLEDGE WORKSHEET

TASK ELEMENTS:

GENERAL SKILLS AND KNOWLEDGE

- (K) Explain what elements of a shift turnover must be included at the beginning of exercises.
Identify the instructor's Shift Turnover activities in an exercise guide.
Explain how a shift turnover during a simulator exercise is conducted.
Discuss the nature of the information processing model.
Define the meaning of "coding".
Discuss the role of "selection" and "integration" in the coding process.
Define the meaning of "schema".
Discuss three types of schema traps.
Discuss how "bias" affects coding.
Explain the advantages and disadvantages of schema.
Site examples of the use of coding during a simulator exercise.
Explain how proper coding can reduce stress and improve an operator's performance.
List behavior cues which indicate a student may have a coding problem.
Define the meaning of "programming of action".
Explain why it is important to utilize "programming of action" during a simulator exercise.
Distinguish between rule-based and knowledge-based data management.
Identify four sources of data input to a human's coding process.
Construct a diagram of the human information processing model.
Explain the two different diagnostic search routines.
Distinguish between "algorithmic" and "heuristic" diagnostic rules.
Describe the meaning of "negative training".
Explain when "negative training" could occur and who will prevent it.
Identify examples of operational team skills.
Explain when stress occurs.
Identify instructor behaviors that positively and negatively affect student stress (i.e. commands, instructional cues, questions, acceptance, praise-general/specific, correction, scold-general/specific modeling-positive/negative.)
Identify instructor cues in exercise guide (i.e. Action, Observe, Role Play, Coding.)

- (S) Model positive operator behavior.
 Execute Demonstration, Lab, and Practice exercise guides.
 Modify exercises based on student feedback.
 Modify exercises when recognize simulator conditions approach Acceptance Testing Program (ATP) boundaries.
 Use Watchstanding Skills Matrices.
 Use Team Skills Matrix.
 Investigate root cause of performance problem.
 Use SQIOC to develop correct strategies.
 Execute a strategy to correct cognitive errors.
 Use micro-teaching to develop/improve SQIOC skills and technique.
 Provide positive feedback to reduce stress.
 Maintains realistic control room setting to manage stress/resources.
 Role model ANPS/other staff as Role Play cues specify in exercise guide.
 Use Action cues in exercise guide to achieve sequence of events.
 Locate, interpret and use "Optional instructor activity/- student activity" cues supplemental to basic simulator exercise.
 Not taking

1. Observe students.

SKILLS AND KNOWLEDGE:

- (V) Define the purpose of instructor "observation" during the performance of SQIOC.
 List observation techniques that the simulator instructor utilizes during an exercise and explain how each can be applied to various situations.
 Explain how proper observation skills can contribute to team building during a simulator exercise.
 Explain the importance of instructor strategic positioning
 Identify student cues which indicate:
 -confusion;
 -apprehension;
 -lack of confidence;
 -performance resulting from poorly coded framework;
 -performance resulting from properly coded framework.
 Recognize Normal Operations.
 Recognize Off-Normal/Emergency Operations.
- (S) Locate self in a strategic position at the proper time.
 Use critical and active listening skills.
 Determine data for feedback on operator performance.
 Determine data for feedback on operator's coding ability.

Develop students' diagnostic abilities.
Develop students' coding ability.
Develop stress management skills.
Recognize students' eye movement, visual cues, non-verbal cues, professionalism.
Monitor technical performance using Watchstanding Skills Matrices.
Monitor communications using Watchstanding Skills Matrix.
Use Observe cues in exercise guide.

2. Question students.

SKILLS AND KNOWLEDGE:

- (K) Define the purpose of instructor "questioning" during the performance of SQIOC.
List and distinguish between the levels of the questioning hierarchy.
Site an identifying characteristic and example of each level of the questioning hierarchy.
Define the meaning of "achieving closure".
Explain how the questioning hierarchy can be used effectively to achieve closure during an exercise.
Define the meaning of "pre-cueing".
Discuss the advantages of using pre-cueing as a questioning technique.
Explain how "pre-cueing" can contribute to the development of team building during an simulator exercise.
Define what is meant by "probing questions".
List methods of probing questioning.
List the elements of the "inquiry development" technique.
- (S) Use SQIOC process to determine appropriate level of questioning.
Use the pre-cueing technique.
Use probing questioning techniques.
Construct questions consistent with the exercise objectives.
Construct questions consistent with intended level of questioning.
Ask questions at the proper time without interfering with student operations.
Ask questions to assess student's current level of thinking.
Use the inquiry development technique.
Use the planned repetition technique.
Reinforce team skills.
Develop students' diagnostic abilities.
Develop students' coding ability.
Develop stress management skills.

Use Coding cues in an exercise guide to formulate questions.
 Assess achievement of closure through questioning.
 Directs questions at target population.

3. Coach students.

SKILLS AND KNOWLEDGE:

- (K) Define the purpose of instructor "coaching" during the performance of SQIOC.
 Distinguish between the different levels of coaching involvement.
 Explain how the instructor can generate "student-initiated questioning" and why this is advantageous.
 Explain how proper coaching will prevent operator (target population) apprehension and build confidence in actions.
 Explain how the instructor can minimize stress and maximize operator (target population) performance during a simulator exercise.
 Explain what is meant by the term "synergy" and "group think".
 List what diagnostic schemes can be utilized to solve plant problems during a simulator exercises.
 Given a plant problem, explain which diagnostic scheme should be used and justify you choice.
- (S) Use SQIOC process to determine level of coaching.
 Coach at the proper time without impeding flow of exercise or interfering with student operations.
 Reinforce team skills.
 Develop students' diagnostic abilities.
 Develop students' coding ability.
 Develop stress management skills.
 Use inductive and deductive uses of examples.
 Facilitate achieving closure for students.
 Use instructional cues.
 Provide positive, constructive feedback.
 Use Role Play cues in exercise guide to coach students.
 Develop individual efforts into a synergistic effort.
 Coaches both prior to and during evolution, as appropriate
 Coaches within target population's Frame of Reference
 Does not interfere with student when student has situation under control.

4. Intervene to correct.

SKILLS AND KNOWLEDGE:

- (K) Define the purpose of instructor "intervention" during the performance of SQIOC.
Distinguish between the three types of intervention methods (i.e. mental, physical, freeze.)
Discuss the meaning of the concept "operator as a manager of systems."
Explain how proper instructor intervention can be performed during a simulator exercise to promote the idea of an operator as a "manager of systems".
Explain why intervention should be used judiciously during a simulator exercise.
Explain how excessive intervention may result in a negative learning experience.
Recognize performance that indicates a coding or cognitive error that requires intervention.
- (S) Use SQIOC process to determine appropriate intervention.
Reinforce team skills.
Foster team interaction using intervention techniques.
Assess cognitive skills using intervention techniques.
Develop students' diagnostic abilities.
Develop students' coding ability.
Develop stress management skills.
Recognize/act on simulator conditions which diverge from expected responses.
Establish conditions at end of intervention routine and continue exercise.
Recognize negative training occurring.
Prevent/recover from negative learning experience.

RESOURCE WORKSHEET

RESOURCES FOR DEVELOPMENT:

OWN RESOURCES:

1. SQIOC Model
2. Questioning Exercises
3. Watchstanding Skills Matrices

OTHER RESOURCES: (If used, copyright permission may be required)

TASK ANALYSIS K&A REFERENCES

GENERAL SKILLS AND KNOWLEDGE

EXPLAIN WHAT ELEMENTS OF A SHIFT TURNOVER MUST BE INCLUDED IN THE BEGINNING OF EXERCISES. ELEMENTS ARE IN EACH EXERCISE GUIDE FOR PRESENTATION: REF. SIMULATOR EXERCISE GUIDE.

IDENTIFY THE INSTRUCTOR'S SHIFT TURNOVER ACTIVITIES IN AN EXERCISE GUIDE. ELEMENTS ARE IN EACH EXERCISE GUIDE FOR PRESENTATION: REF. SIMULATOR EXERCISE GUIDE.

EXPLAIN HOW A SHIFT TURNOVER DURING A SIMULATOR EXERCISE GUIDE IS CONDUCTED. ELEMENTS ARE IN EACH EXERCISE GUIDE FOR PRESENTATION: REF. SIMULATOR EXERCISE GUIDE

DISCUSS THE NATURE OF A INFORMATION PROCESSING MODEL. REF.#1 SKILLED PERFORMANCE: PERCEPTUAL AND MOTOR SKILLS PG.'S 1-35.

DEFINE THE MEANING OF "SCHEMA". REF.#1 SKILLED PERFORMANCE: PERCEPTUAL AND MOTOR SKILLS PG.'S 19-32.

DISCUSS THE ROLE OF "SELECTION" AND "INTEGRATION" IN THE CODING PROCESS. REF.#1 SKILLED PERFORMANCE: PERCEPTUAL AND MOTOR SKILLS PG.'S 2-28.

DISCUSS THREE TYPES OF SCHEMA TRAPS. REF.#1 SKILLED PERFORMANCE: PERCEPTUAL AND MOTOR SKILLS PG.'S 10-16, 30-32.

DISCUSS HOW BIAS AFFECTS SCHEMA. REF.#1 SKILLED PERFORMANCE: PERCEPTUAL AND MOTOR SKILLS PG.'S 30-32, REF.#2 NATURE AND STRUCTURE OF KNOWLEDGE PG.'S 9-14.

EXPLAIN THE ADVANTAGES AND DISADVANTAGES OF SCHEMA. REF.#1 SKILLED PERFORMANCE: PERCEPTUAL AND MOTOR SKILLS PG.'S 10-16, 30-32, REF.#2 NATURE AND STRUCTURE OF KNOWLEDGE PG.'S 9-14.

SITE EXAMPLES OF THE USE OF CODING (SCHEMA) DURING A SIMULATOR EXERCISE. REF. SIMULATOR PRACTICE EXERCISE GUIDE HAS CODING AS AN INSTRUCTIONAL CUE.

EXPLAIN HOW PROPER CODING CAN REDUCE STRESS AND IMPROVE AN OPERATORS PERFORMANCE. REF. #1 SKILLED PERFORMANCE: PERCEPTUAL AND MOTOR SKILLS PG.'S 30-32, REF. #2 THE NATURE AND STRUCTURE OF KNOWLEDGE PG.'S 18,19, REF. #6 TRAINING FOR SAFETY IN AUTOMATED PERSON-MACHINE SYSTEMS. (ALL).

LIST BEHAVIORAL CUES WHICH INDICATE A STUDENT MAY HAVE A CODING PROBLEM. REF. #4 EXCERPTS FROM SYNOPSIS OF THE TAXONOMY OF QUESTIONS PG.'S 1,3,4,6.

DEFINE THE MEANING OF THE TERM "PROGRAMMING OF ACTION". REF. SUMMARY PG.3.

EXPLAIN WHY IT IS IMPORTANT TO UTILIZE "PROGRAMMING OF ACTION" DURING AN SIMULATOR EXERCISE. REF. SUMMARY PG.3.

DISTINGUISH BETWEEN RULE-BASED AND KNOWLEDGE BASED DATA MANAGEMENT. REF. NO REFERENCE IN READING MATERIALS.

IDENTIFY FOUR SOURCES OF DATA INPUT TO A HUMAN'S CODING PROCESS. REF. #1 SKILLED PERFORMANCE: PERCEPTUAL AND MOTOR SKILLS PG.'S 1-6, (ADDITIONAL INFORMATION NECESSARY, THE MODEL WHICH WAS GENERATED DURING SEMINAR, ADEQUATE).

CONSTRUCT A DIAGRAM OF THE HUMAN INFORMATION PROCESSING MODEL. REF. #5 TRAINING OF CONTROL ROOM CREWS IN PLANT DISTURBANCE DIAGNOSIS- A METHODOLOGICAL FRAMEWORK PG.'S 4-11 (NEED TO USE MODEL GENERATED DURING SEMINAR).

EXPLAIN THE TWO DIFFERENT DIAGNOSTIC SEARCH ROUTINES. REF. #5 TRAINING OF CONTROL ROOM CREWS IN PLANT DISTURBANCE DIAGNOSIS- A METHODOLOGICAL FRAMEWORK PG.'S 11-15.

DISTINGUISH BETWEEN "ALGORITHMIC AND HEURISTIC" DIAGNOSTIC RULES. REF. #5 TRAINING OF CONTROL ROOM CREWS IN PLANT DISTURBANCE DIAGNOSIS- A METHODOLOGICAL FRAMEWORK PG.'S 11-15.

DESCRIBE THE MEANING OF "NEGATIVE TRAINING". REF. SUMMARY PG.'S 1-8.

EXPLAIN WHEN " NEGATIVE TRAINING" COULD OCCUR AND WHO WILL PREVENT IT. REF. SUMMARY PG.'S 1-8.

IDENTIFY EXAMPLES OF OPERATIONAL TEAM SKILLS. REF. #8 PG. 13.

EXPLAIN WHEN STRESS OCCURS. REF. #6 TRAINING FOR SAFETY IN AUTOMATED PERSON-MACHINE SYSTEMS PG.'S 547,548 REF.#7 INSTRUCTOR PILOT TEACHING BEHAVIOR AND STUDENT PILOT STRESS IN FLIGHT TRAINING ALL.

IDENTIFY INSTRUCTOR BEHAVIORS THAT POSITIVELY AND NEGATIVELY AFFECT STUDENT STRESS. REF.#7 INSTRUCTOR PILOT TEACHING BEHAVIOR AND STUDENT PILOT STRESS IN FLIGHT TRAINING. PG. 595.

IDENTIFY INSTRUCTIONAL CUES IN AN EXERCISE GUIDE. REF. SIMULATOR EXERCISE GUIDE.

MODEL POSITIVE OPERATOR BEHAVIOR. REF.#7 INSTRUCTOR PILOT TEACHING BEHAVIOR AND STUDENT PILOT STRESS IN FLIGHT TRAINING. PG. 595; REF.4 EXCERPTS FROM SYNOPSIS OF THE TAXONOMY OF QUESTIONS PG.'S 1-4.

EXECUTE DEMONSTRATION, LAB AND PRACTICE EXERCISE GUIDES. REF. SIMULATOR EXERCISE GUIDE.

MODIFY EXERCISES BASED ON STUDENT FEEDBACK. REF. NO REFERENCE READING.

MODIFY EXERCISES WHEN RECOGNIZED SIMULATOR CONDITIONS APPROACH ACCEPTANCE TESTING PROGRAM BOUNDARIES. REF. NO REFERENCE READING.

USE WATCHSTANDING SKILLS MATRIX. REF. WATCHSTANDING SKILLS MATRIX; REF.#8 TEAM SKILLS TRAINING ALL.

INVESTIGATE ROOT CAUSE OF PERFORMANCE PROBLEM. REF.#4 EXCERPTS FROM THE SYNOPSIS OF THE TAXONOMY OF QUESTIONS PG.'S 3-9; SQIOC MODEL.

USE SQIOC TO DEVELOP CORRECT STRATEGIES. REF. SQIOC MODEL IN CONJUNCTION WITH SEMINAR; REF. #3 EXCERPTS FROM A SYNOPSIS OF THE TAXONOMY OF QUESTIONS ALL.

EXECUTE A STRATEGY TO CORRECT COGNITIVE ERRORS. REF. SQIOC MODEL IN CONJUNCTION WITH SEMINAR; REF.#3 EXCERPTS FROM A SYNOPSIS OF THE TAXONOMY OF QUESTIONS ALL.

USE MICRO-TEACHING TO DEVELOP/IMPROVE SQIOC SKILLS AND TECHNIQUE. REF.#4 EXCERPTS FROM SYNOPSIS OF THE TAXONOMY OF QUESTIONS PG.'S 16-19; SQIOC MODEL IN CONJUNCTION WITH SEMINAR.

PROVIDE POSITIVE FEEDBACK TO REDUCE STRESS. REF. #7 INSTRUCTOR PILOT TEACHING BEHAVIOR AND STUDENT PILOT STRESS IN FLIGHT TRAINING. ALL.

MAINTAINS REALISTIC CONTROL ROOM SETTING TO MANAGE STRESS/RESOURCES. REF. NO READING MATERIAL REFERENCES.

ROLE MODELS ANPS/OTHER STAFF AS ROLE PLAY CUES SPECIFY IN EXERCISE GUIDES. REF. SIMULATOR EXERCISE GUIDE; REF. #8 TEAM SKILLS TRAINING PG. 'S 15-16.

USE ACTION CUES IN EXERCISE GUIDE TO ACHIEVE SEQUENCE OF EVENTS. REF. SIMULATOR EXERCISE GUIDE; REF. #8 TEAM SKILLS TRAINING PG. 'S 15-16.

LOCATE, INTERPRET AND USE "OPTIONAL INSTRUCTOR ACTIVITY/STUDENT ACTIVITY" CUES SUPPLEMENTAL TO THE BASIC SIMULATOR EXERCISE GUIDE. REF. SIMULATOR EXERCISE GUIDE.

1. OBSERVE STUDENTS

DEFINE THE PURPOSE OF INSTRUCTOR OBSERVATION DURING THE PERFORMANCE OF SQIOC. REF. SQIOC MODEL IN CONJUNCTION WITH SEMINAR; REF. #4 EXCERPTS FROM SYNOPSIS OF THE TAXONOMY OF QUESTIONS PG. 'S 1-4.

LIST THE OBSERVATION TECHNIQUES THAT THE SIMULATOR INSTRUCTOR UTILIZES DURING AN EXERCISE AND EXPLAIN HOW EACH CAN BE APPLIED TO VARIOUS SITUATIONS. REF. SQIOC MODEL IN CONJUNCTION WITH A SEMINAR; REF. #4 EXCERPTS FROM SYNOPSIS OF THE TAXONOMY OF QUESTIONS ALL.

EXPLAIN HOW PROPER OBSERVATION SKILLS CAN CONTRIBUTE TO TEAM BUILDING DURING AN EXERCISE GUIDE. REF. #4 EXCERPTS FROM SYNOPSIS OF THE TAXONOMY OF QUESTIONS PG. 4.

EXPLAIN THE IMPORTANCE OF INSTRUCTOR STRATEGIC POSITIONING. REF. #4 EXCERPTS FROM SYNOPSIS OF THE TAXONOMY OF QUESTIONS PG. 1; IN CONJUNCTION WITH SQIOC MODEL.

IDENTIFY STUDENT CUES THAT INDICATE; CONFUSION, APPREHENSION OR LACK OF CONFIDENCE; POOR CODED FRAMEWORK/ PROPER CODED FRAMEWORK. REF. #4 EXCERPTS FROM THE SYNOPSIS OF THE TAXONOMY OF QUESTIONS PG. 1; SUMMARY PG. 1.

RECOGNIZE NORMAL OPERATIONS. REF. #2 NATURE AND STRUCTURE OF KNOWLEDGE PG. 'S 14-19.

RECOGNIZE OFF-NORMAL/EMERGENCY OPERATIONS. REF. #2 NATURE AND STRUCTURE OF KNOWLEDGE PG.'S 14-19.

LOCATES SELF IN A STRATEGIC POSITION AT THE PROPER TIME. REF. #4 EXCERPTS FROM SYNOPSIS OF THE TAXONOMY OF QUESTIONS PG.'S 1-4; IN CONJUNCTION WITH SOIOC MODEL AND SEMINAR.

USES ACTIVE LISTENING. REF. NO REFERENCE READING.

DETERMINE DATA FOR FEEDBACK ON OPERATOR PERFORMANCE. REF. SIMULATOR PRACTICE EXERCISE GUIDE.

DETERMINE DATA FOR FEEDBACK ON OPERATORS CODING ABILITY. REF. SIMULATOR PRACTICE EXERCISE GUIDE.

DEVELOP STUDENT'S DIAGNOSTIC ABILITIES. REF. #5 TRAINING OF CONTROL ROOM CREWS IN PLANT DIAGNOSIS- A METHODOLOGICAL FRAMEWORK PG.'S ALL.

DEVELOP STUDENTS CODING ABILITY. REF. #1 SKILLED PERFORMANCE: PERCEPTUAL AND MOTOR SKILLS PG.'S ALL.

DEVELOP STRESS MANAGEMENT SKILLS. REF. #6 TRAINING FOR SAFETY IN AUTOMATED PERSON-MACHINE SYSTEMS PG. 548; REF. #7 INSTRUCTOR PILOT BEHAVIOR AND STUDENT PILOT STRESS IN FLIGHT TRAINING. PG.'S ALL.

RECOGNIZE STUDENT'S EYE MOVEMENT, VISUAL CUES, NON-VERBAL CUES AND PROFESSIONALISM. REF. #4 EXCERPTS FROM SYNOPSIS OF THE TAXONOMY OF QUESTIONS PG.'S 1-4.

MONITOR TECHNICAL PERFORMANCE USING WATCHSTANDING SKILLS MATRIX. REF. WATCHSTANDING SKILLS MATRIX AND SIMULATOR EXERCISE GUIDE.

MONITOR COMMUNICATIONS USING WATCHSTANDING SKILLS MATRIX. REF. WATCHSTANDING SKILLS MATRIX.

USE OBSERVE CUES IN THE EXERCISE GUIDE. REF. SIMULATOR EXERCISE GUIDE.

2. QUESTION STUDENT'S

DEFINE THE PURPOSE OF INSTRUCTOR "QUESTIONING" DURING THE PERFORMANCE OF SOIOC. REF. #3 EXCERPTS FROM THE SYNOPSIS OF TAXONOMY OF QUESTIONS PG.'S 1-18; SOIOC IN CONJUNCTION WITH SEMINAR.

LIST AND DISTINGUISH BETWEEN THE LEVELS OF THE QUESTIONING HIERARCHY. REF.#3 EXCERPTS FROM THE SYNOPSIS OF THE TAXONOMY OF QUESTIONS PG.'S 1-18

SITE AN IDENTIFYING CHARACTERISTIC AND EXAMPLE OF EACH LEVEL OF QUESTIONING HIERARCHY. REF.#3 EXCERPTS FROM THE SYNOPSIS OF TAXONOMY OF QUESTIONS PG.'S 1-18.

DEFINE THE MEANING OF "ACHIEVING CLOSURE". REF.#4 EXCERPTS FROM THE SYNOPSIS OF THE TAXONOMY OF QUESTIONS PG. 6.

EXPLAIN HOW THE QUESTIONING HIERARCHY CAN BE USED EFFECTIVELY TO ACHIEVE CLOSURE DURING AN EXERCISE. REF.#4 EXCERPTS FROM THE TAXONOMY OF QUESTIONING PG. 6; IN CONJUNCTION WITH A SIMULATOR EXERCISE GUIDE.

USE THE PRE-CUEING TECHNIQUE. REF.#4 EXCERPTS FROM THE SYNOPSIS OF TAXONOMY OF QUESTIONS PG.'S 2,3.

DISCUSS THE ADVANTAGES OF USING PRE-CUEING AS A QUESTIONING TECHNIQUE. REF.#4 EXCERPTS FROM SYNOPSIS OF THE TAXONOMY OF QUESTIONS

EXPLAIN HOW "PRE-CUEING" CAN CONTRIBUTE TO THE DEVELOPMENT OF TEAM BUILDING DURING AN EXERCISE SESSION. REF. NO REFERENCE IN THE READING MATERIALS.

DEFINE WHAT IS MEANT BY "PROBING QUESTIONS". REF.#4 EXCERPTS FROM SYNOPSIS OF THE TAXONOMY OF QUESTIONS PG. 4.

LIST METHODS OF "PROBING QUESTIONS". REF.#4 EXCERPTS FROM SYNOPSIS OF THE TAXONOMY OF QUESTIONS PG. 4.

LIST THE ELEMENTS OF THE "INQUIRY TECHNIQUE" METHOD. REF. NO REFERENCE IN READING. (NEED THE PAGE USED IN SEMINAR)

USE THE SQICC PROCESS TO DETERMINE THE APPROPRIATE LEVEL OF QUESTIONING. REF.#3 EXCERPTS FROM SYNOPSIS OF THE TAXONOMY OF QUESTIONS. ALL; ALSO NEED THE SQIOC MODEL IN CONJUNCTION WITH SEMINAR.

USE THE PRE-CUEING TECHNIQUE. REF.#4 EXCERPTS FROM SYNOPSIS OF THE TAXONOMY OF QUESTIONS PG. 2.

CONSTRUCT QUESTIONS CONSISTENT WITH EXERCISE OBJECTIVES. REF.#3 EXCERPTS FROM THE TAXONOMY OF QUESTIONS ALL; SIMULATOR EXERCISE GUIDE.

CONSTRUCT QUESTIONS CONSISTENT WITH THE LEVEL OF

QUESTIONING. REF. #3,4 EXCERPTS FROM SYNOPSIS OF TAXONOMY OF QUESTIONS ALL.

ASK QUESTIONS AT THE PROPER TIME WITHOUT INTERFERING WITH STUDENT OPERATIONS. REF. SIMULATOR EXERCISE GUIDE, SQIOC MODEL IN CONJUNCTION WITH SEMINAR.

ASK QUESTIONS TO ASSESS STUDENT'S CURRENT LEVEL OF THINKING. REF. #3 EXCERPTS FROM SYNOPSIS OF THE TAXONOMY OF QUESTIONS ALL; SQIOC MODEL IN CONJUNCTION WITH SEMINAR.

USE THE INQUIRY DEVELOPMENT TECHNIQUE REF. NO REFERENCE READING.

USE THE PLANNED REPETITION TECHNIQUE. REF. #4 EXCERPTS FROM SYNOPSIS OF THE TAXONOMY OF QUESTIONS PG. 5.

REINFORCE TEAM SKILLS. REF. #5 TRAINING OF CONTROL ROOM CREWS IN PLANT DISTURBANCE DIAGNOSIS-A METHODOLOGICAL FRAMEWORK PG.'S 15-20; REF #7 TEAM SKILLS TRAINING ALL.

DEVELOP STUDENT DIAGNOSTIC ABILITIES. REF. #5 TRAINING OF CONTROL CREWS IN PLANT DISTURBANCE DIAGNOSIS-A METHODOLOGICAL FRAMEWORK PG.'S 15-20.

DEVELOP STUDENT'S CODING ABILITY. REF. #2 THE NATURE AND STRUCTURE OF KNOWLEDGE PG.'S 9-14.

DEVELOP STRESS MANAGEMENT SKILLS. REF. #7 INSTRUCTOR PILOT TEACHING BEHAVIOR AND THE STUDENT PILOT STRESS IN FLIGHT TRAINING. ALL.

USE CODING CUES IN AN EXERCISE GUIDE TO FORMULATE QUESTIONS. REF. #3 EXCERPTS FROM SYNOPSIS OF TAXONOMY OF QUESTIONS ALL; SIMULATOR EXERCISE GUIDE; SQIOC IN CONJUNCTION WITH SEMINAR.

ASSESS ACHIEVEMENT OF CLOSURE THROUGH QUESTIONING. REF. #4 EXCERPTS FROM SYNOPSIS OF THE TAXONOMY OF QUESTIONS PG. 6; REF. #3 EXCERPTS FROM SYNOPSIS OF THE TAXONOMY OF QUESTIONS ALL.

3. COACH STUDENTS

DEFINE THE PURPOSE OF INSTRUCTOR COACHING DURING THE PERFORMANCE OF SQIOC. REF. NO REFERENCE IN READING; SQIOC MODEL IN CONJUNCTION WITH SEMINAR.

DISTINGUISH BETWEEN THE DIFFERENT LEVELS OF COACHING INVOLVEMENT. REF. NO REFERENCE IN READING; SQIOC MODEL IN CONJUNCTION WITH SEMINAR.

EXPLAIN HOW AN INSTRUCTOR CAN GENERATE A "STUDENT-INITIATED QUESTIONING" AND WHY THIS IS ADVANTAGEOUS. REF.#4 EXCERPTS FROM SYNOPSIS OF THE TAXONOMY OF QUESTIONS PG. 4.

EXPLAIN HOW PROPER COACHING WILL PREVENT OPERATOR (TARGET POPULATION) APPREHENSION AND BUILD CONFIDENCE IN ACTIONS. REF. SUMMARY PG. 5.

EXPLAIN HOW THE INSTRUCTOR CAN MINIMIZE STRESS AND MAXIMIZE OPERATOR (TARGET POPULATION) PERFORMANCE DURING A SIMULATOR EXERCISE. REF.#6 TRAINING FOR SAFETY IN AUTOMATED PERSON-MACHINE SYSTEMS PG. 547

EXPLAIN WHAT IS MEANT BY THE TERM "SYNERGY" AND "GROUP THINK". REF.#5 TRAINING OF CONTROL ROOM CREWS IN PLANT DISTURBANCE DIAGNOSIS-A METHODOLOGICAL FRAMEWORK PG. 17,18. NEED READING REFERENCE FOR SYNERGY.

LIST WHAT DIAGNOSTIC SCHEMES CAN BE UTILIZED TO SOLVE PLANT PROBLEMS DURING A SIMULATOR EXERCISE. REF.#5 TRAINING OF CONTROL ROOM CREWS IN PLANT DISTURBANCE DIAGNOSIS- A METHODOLOGICAL FRAMEWORK ALL

GIVEN A PLANT PROBLEM EXPLAIN WHAT DIAGNOSTIC SCHEME WOULD BE USED AND JUSTIFY YOUR ANSWER. REF.#5 TRAINING OF CONTROL ROOM CREWS IN PLANT DISTURBANCE DIAGNOSIS-A METHODOLOGICAL FRAMEWORK. ALL

USE SQIOC PROCESS TO DETERMINE THE LEVEL OF COACHING. REF. NO READING REFERENCE; SQIOC MODEL IN CONJUNCTION WITH SEMINAR.

COACH AT THE PROPER TIME WITHOUT IMPEDING FLOW OF EXERCISE OR INTERFERING WITH STUDENT OPERATIONS. REF. NO REFERENCE READING; EXERCISE GUIDE IN CONJUNCTION WITH SQIOC DURING SEMINAR.

REINFORCE TEAM SKILLS. REF.#5 TRAINING OF CONTROL ROOM CREWS IN PLANT DISTURBANCE DIAGNOSIS-A METHODOLOGICAL FRAMEWORK PG.'S 15-20; REF.#6 TRAINING FOR SAFETY IN AUTOMATED PERSON-MACHINE SYSTEMS ALL

DEVELOP STUDENT DIAGNOSTIC ABILITIES. REF.#5 TRAINING OF CONTROL ROOM CREWS IN PLANT DISTURBANCE DIAGNOSIS- A METHODOLOGICAL FRAMEWORK PG.'S 15-20.

DEVELOP STUDENT CODING ABILITY. REF. #2 THE NATURE AND STRUCTURE OF KNOWLEDGE PG.'S 9-14.

DEVELOP STRESS MANAGEMENT SKILLS. REF. #6 TRAINING FOR SAFETY IN AUTOMATED PERSON-MACHINE SYSTEMS ALL; REF. #7 INSTRUCTOR PILOT TEACHING BEHAVIOR AND STUDENT PILOT STRESS IN FLIGHT TRAINING ALL.

USE INDUCTIVE/ DEDUCTIVE USES OF EXAMPLES. REF. #4 EXCERPTS FROM SYNOPSIS OF THE TAXONOMY OF QUESTIONS PG.'S 6,7. NEED MORE REFERENCE MATERIAL.

FACILITATE ACHIEVING CLOSURE FOR STUDENTS. REF. #4 EXCERPTS FROM SYNOPSIS OF THE TAXONOMY OF QUESTIONS PG. 6.

USE INSTRUCTIONAL CUES. REF. SIMULATOR EXERCISE GUIDE.

PROVIDE POSITIVE AND CONSTRUCTIVE FEEDBACK. REF. #7 INSTRUCTOR PILOT TEACHING BEHAVIOR AND STUDENT PILOT STRESS IN FLIGHT TRAINING PG. 595

USE ROLE PLAY CUES IN EXERCISE GUIDE TO COACH STUDENTS. REF. SIMULATOR EXERCISE GUIDE; SQIOC MODEL IN CONJUNCTION WITH SEMINAR.

DEVELOP INDIVIDUAL EFFORTS INTO A SYNERGISTIC EFFORT. REF. NO REFERENCE IN READING MATERIAL.

4. INTERVENE TO CORRECT

DEFINE THE PURPOSE OF INSTRUCTOR "INTERVENTION" DURING THE PERFORMANCE OF SQIOC. REF. NO REFERENCE READING MATERIAL, SQIOC MODEL IN CONJUNCTION WITH SEMINAR.

DISTINGUISH BETWEEN THE THREE TYPES OF INTERVENTION METHODS. REF. NO REFERENCE READING; SQIOC MODEL IN CONJUNCTION WITH SEMINAR.

DISCUSS THE MEANING OF THE TERM THE OPERATOR IS A "MANAGER OF SYSTEMS". REF. NO REFERENCE READING, DISCUSSED IN SEMINAR.

EXPLAIN HOW PROPER INSTRUCTOR INTERVENTION CAN BE PERFORMED DURING A SIMULATOR EXERCISE TO PROMOTE THE IDEA AN OPERATOR IS A "MANAGER OF SYSTEMS". REF. NO REFERENCE READING, DISCUSSED IN SEMINAR.

EXPLAIN WHY INTERVENTION SHOULD BE USED JUDICIOUSLY DURING A SIMULATOR EXERCISE.REF. SUMMARY PG. 4

EXPLAIN HOW EXCESSIVE INTERVENTION MAY RESULT IN A NEGATIVE TRAINING" EXPERIENCE.REF. SUMMARY PG. 5

RECOGNIZE PERFORMANCE THAT INDICATES A CODING OR COGNITIVE ERROR THAT REQUIRES INTERVENTION.REF.NO REFERENCE READING;SQIOC MODEL DURING SEMINAR.

USE SQIOC PROCESS TO DETERMINE APPROPRIATE INTERVENTION.REF. NO REFERENCE READING;DISCUSSED DURING SEMINAR WITH SQIOC MODEL.

FOSTER TEAM INTERACTION USING INTERVENTION TECHNIQUES.REF.NO REFERENCE READING; DISCUSSED DURING SEMINAR,SQIOC MODEL.

REINFORCE TEAM SKILLS.REF.#5 TRAINING OF CONTROL ROOM CREWS IN PLANT DISTURBANCE DIAGNOSIS-A METHODOLOGICAL FRAMEWORK PG.'S 15-20; REF.#6 TRAINING FOR SAFETY IN AUTOMATED PERSON-MACHINE SYSTEMS ALL.

ASSESS COGNITIVE SKILLS USING INTERVENTION TECHNIQUE.REF.NO REFERENCE READING; DISCUSSED DURING SQIOC MODEL DURING SEMINAR.

DEVELOP STUDENTS DIAGNOSTIC ABILITIES.REF.#5 TRAINING OF CONTROL ROOM CREWS IN PLANT DISTURBANCE DIAGNOSIS- A METHODOLOGICAL FRAMEWORK PG.'S 15-20.

DEVELOP STUDENTS CODING ABILITIES.REF.#2 THE NATURE AND STRUCTURE OF KNOWLEDGE PG.'S 9-14.

DEVELOP STRESS MANAGEMENT SKILLS.REF.#6 TRAINING FOR SAFETY IN AUTOMATED PERSON-MACHINE SYSTEMS ALL;REF.#7 INSTRUCTOR PILOT TEACHING BEHAVIOR AND STUDENT PILOT STRESS IN FLIGHT TRAINING ALL.

RECOGNIZE/ ACT ON SIMULATOR CONDITIONS WHICH DIVERGE FROM EXPECTED RESPONSE.REF.NO REFERENCE READING; DISCUSSED DURING SEMINAR DURING SEMINAR.

ESTABLISH CONDITIONS AT THE END OF INTERVENTION ROUTINE AND CONTINUE EXERCISE. REF.NO REFERENCE READING; DISCUSSED DURING SEMINAR, SQIOC MODEL.

RECOGNIZE NEGATIVE TRAINING OCCURRING.REF. SUMMARY PG.'S 4,5

PREVENT/ RECOVER FROM A NEGATIVE TRAINING EXPERIENCE. REF. SUMMARY PG.'S 4,5.

NEED TO DEVELOP: (Potential Ideas)

SIMULATOR INSTRUCTOR PROGRAM MATERIALS TO BE DEVELOPED

1. ACTIVE LISTENING- READING MATERIALS, INCLUDE IN LESSON PLAN.
2. PEER & SELF ANALYSIS- NEED READING MATERIAL DEVELOPED, ALREADY INCLUDED IN LESSON PLAN.
3. HEURISTIC & ALGORITHMIC PROBLEM SOLVING, SOME MATERIAL IN READING (SWEDISH PAPER) NEED MORE INFO.
4. RULE & KNOWLEDGED BASED THOUGHT- NEED SOME SUPPLEMENTAL READING, DISCUSSED IN LESSON PLAN.
5. INQUIRY DEVELOPMENT- NEED ADDITIONAL INFORMATION, 1 PAGE SUMMARY IN READING MATERIALS NOT SUFFICIENT; A VIDEO WOULD BE USEFUL.
6. EXERCISE- NEED TO DEVELOP A EXERCISE FOR THE STUDENTS TO ASK YES/NO QUESTIONS TO STIMULATE DIAGNOSTIC SEARCH ROUTINES.
7. PRE-EXERCISE FLOWCHART- NEEDS TO BE DEVELOPED FOR SEMINAR.
8. EXERCISE GUIDES- NEED TO DEVELOP MATERIALS TO SHOW STRUCTURE OF SDDMS IN CONJUNCTION WITH EXERCISE GUIDE. (DOUG)
9. VIDEO- SHOWING SQIOC & QUESTIONING TECHNIQUES.
10. EVALUATIONS- IN PROGRESS DALE IS PUTTING INTO FORMAT.

ATTACHMENT F

SIMULATOR INSTRUCTOR QUALIFICATION FLOWCHART

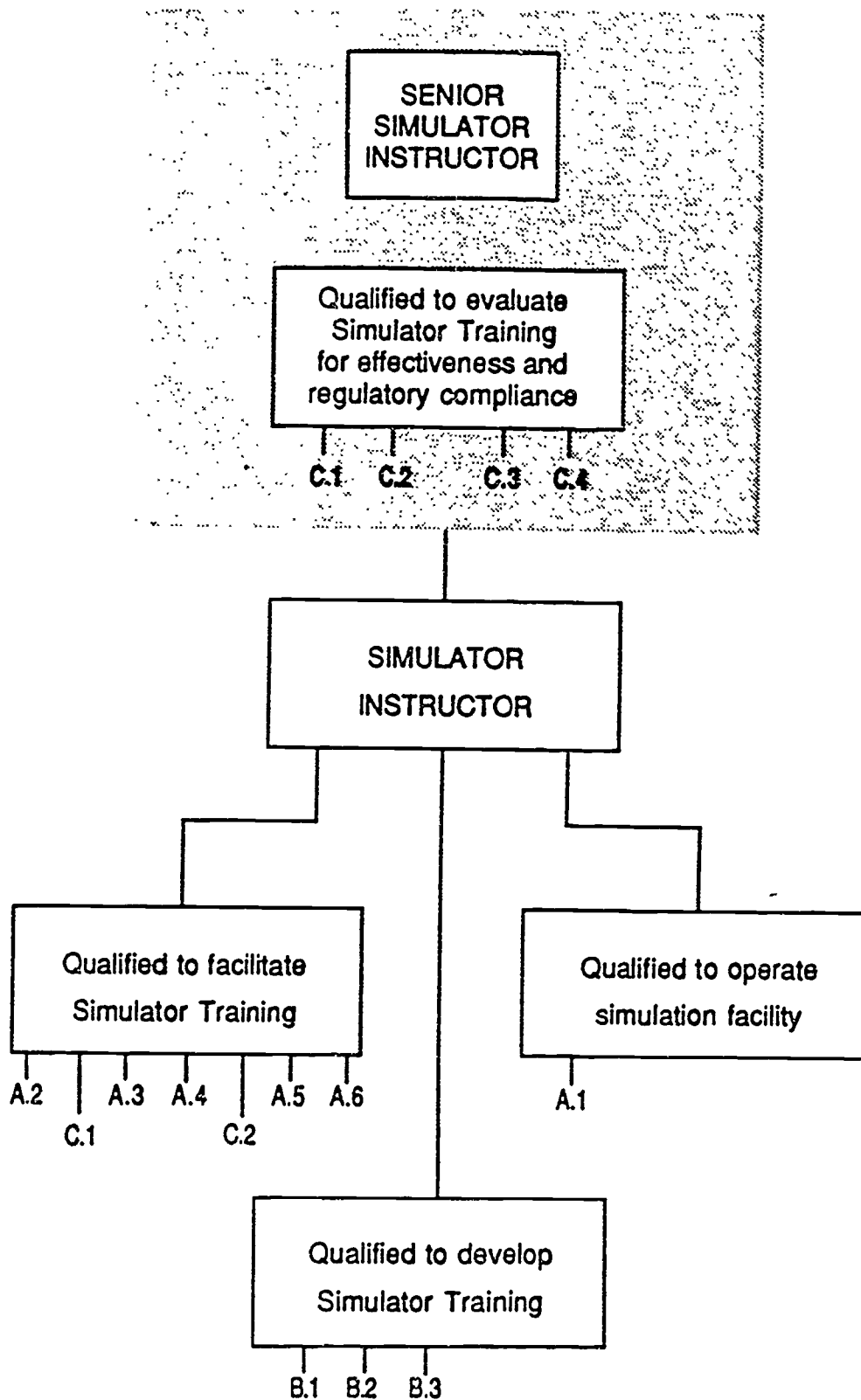

39102

ATTACHMENT G

SIMULATOR INSTRUCTOR TRAINING PROGRAM INITIAL TRAINING

TERMINAL OBJECTIVES

- A-1. Given a simulator, instructor facility (IF), and simulator operator instructions, the simulator instructor will operate the simulator executing an exercise guide sequence or running a test.
- A-2. Given an exercise guide, the Simulator Development Database Management System (SDDMS), and required paperwork, the simulator instructor will prepare for the exercise; exercise materials are reviewed and the simulator set-up.
- A-3. Given any exercise guide, the simulator instructor will conduct a pre-exercise brief that includes all prescribed elements outlined in the exercise guide.
- A-4. Given any student target population and an approved exercise guide, the simulator instructor will perform SQIOC integrating the four elements, as the exercise permits and the students progress.
- A-5. At the conclusion of any lab, demonstration or practice exercise, the simulator instructor will conduct a critique covering all exercise guide critique topics, and focusing on exercise objectives and performance indicators.
- A-6. Given a specific target population, an approved simulator evaluation exercise guide, and Watchstanding Skills Matrices, the simulator instructor will conduct a student evaluation that focuses on the exercise objectives.
- B-1 Given a request for simulator training, a personal computer (PC) workstation, and the SDDMS, the simulator instructor will analyze the training requirements, producing or modifying an Identification Block Diagram (IBD).
- B-2 Given a request for simulator training, a PC workstation and appropriate references, the simulator instructor will design a training exercise; the exercise guide outline (EGO) is in the approved format and meets the scope of the request.
- B-3 Given an EGO, the simulator instructor will develop a training exercise; the exercise guide (EG) is in the approved format, meets the Review Criteria, and is within the scope of the EGO.

THE HUMAN INFORMATION
PROCESSING MODEL
(ADAPTED FROM WICKENS, 1984)

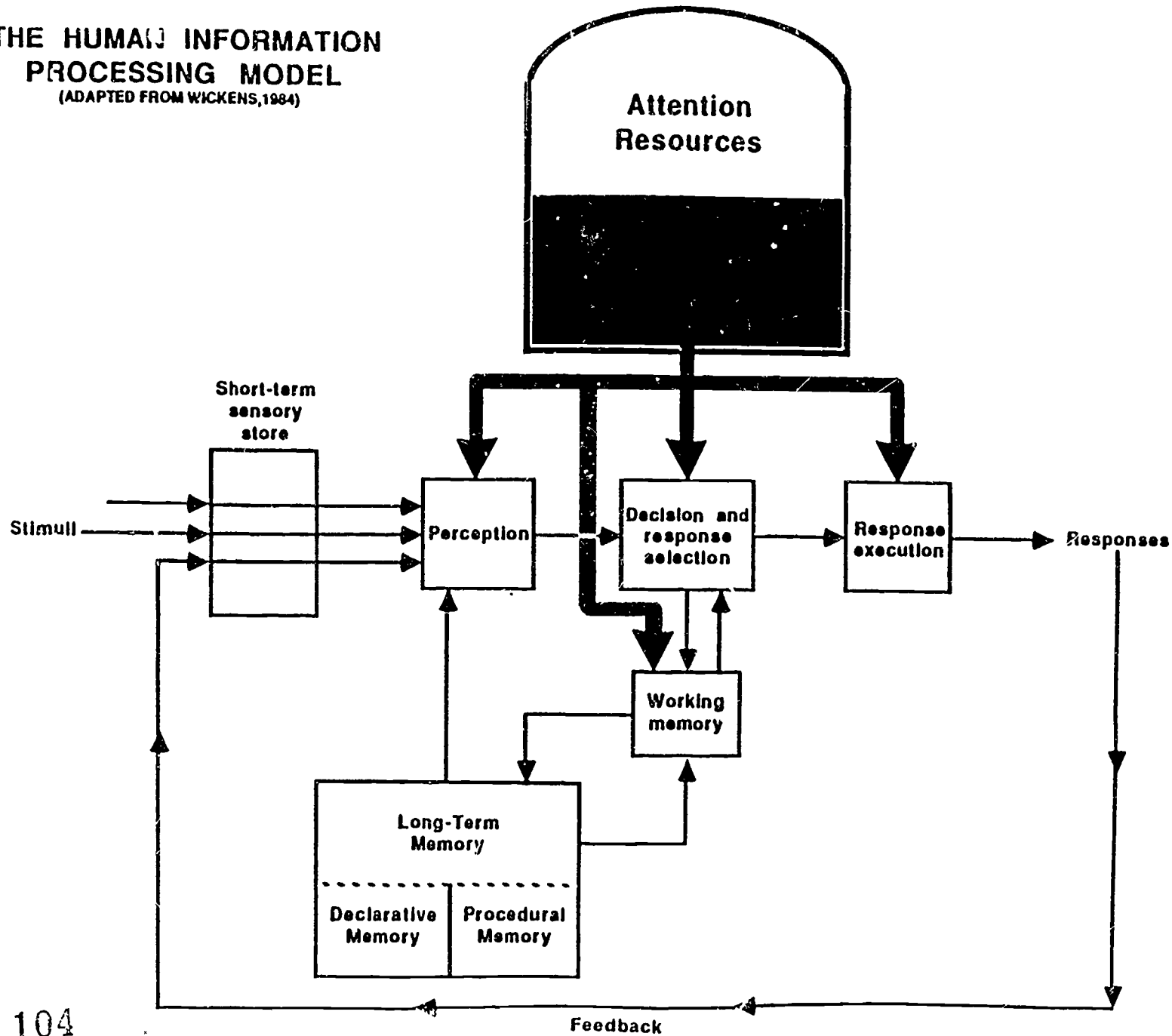

41

ATTACHMENT H

JQIOC INFORMATION PROCESSING RELATIONSHIP

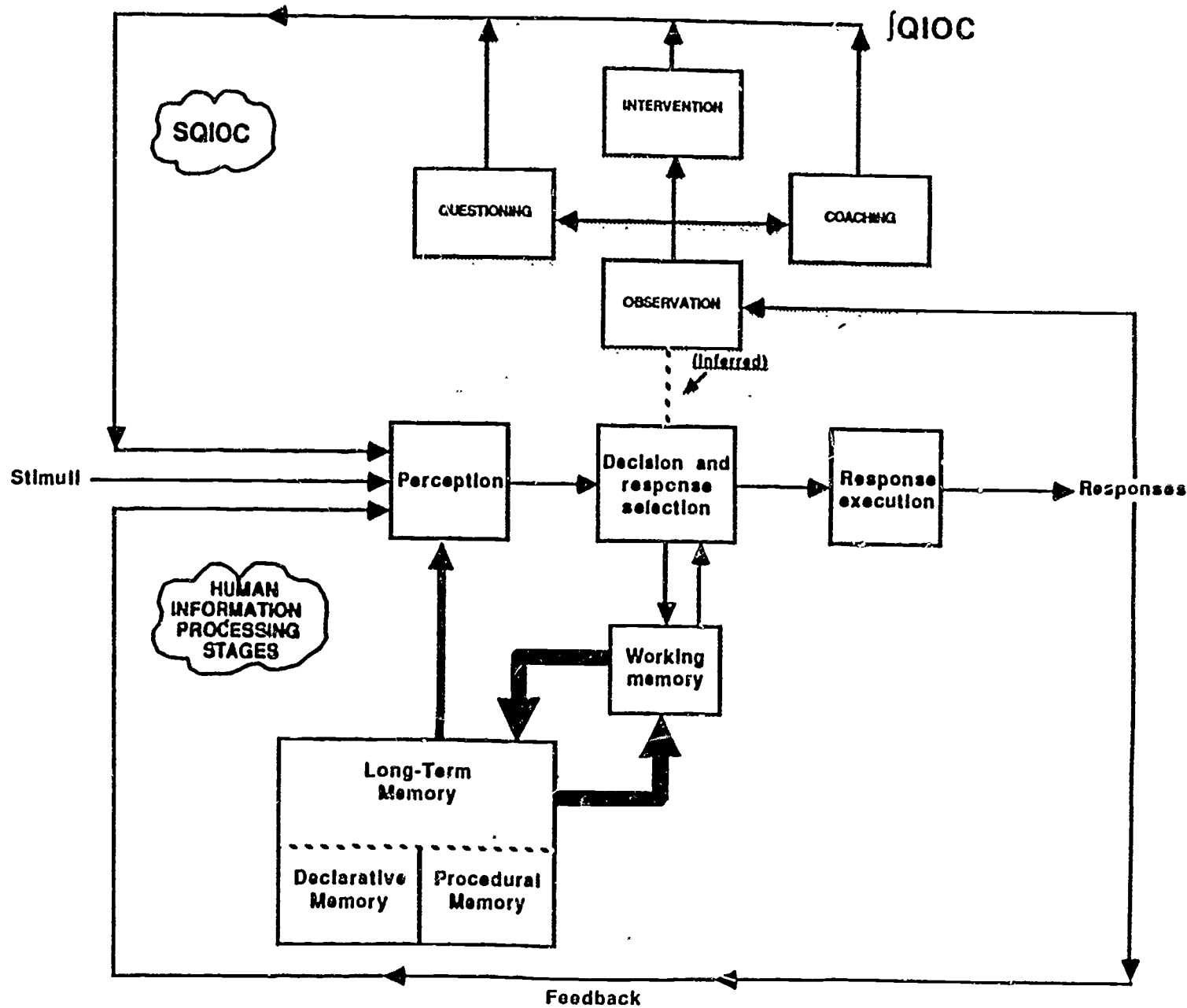

42

ATTACHMENT I

106

107

PROCEDURAL AND DIAGNOSTIC PROBLEM SOLVING

ATTACHMENT J

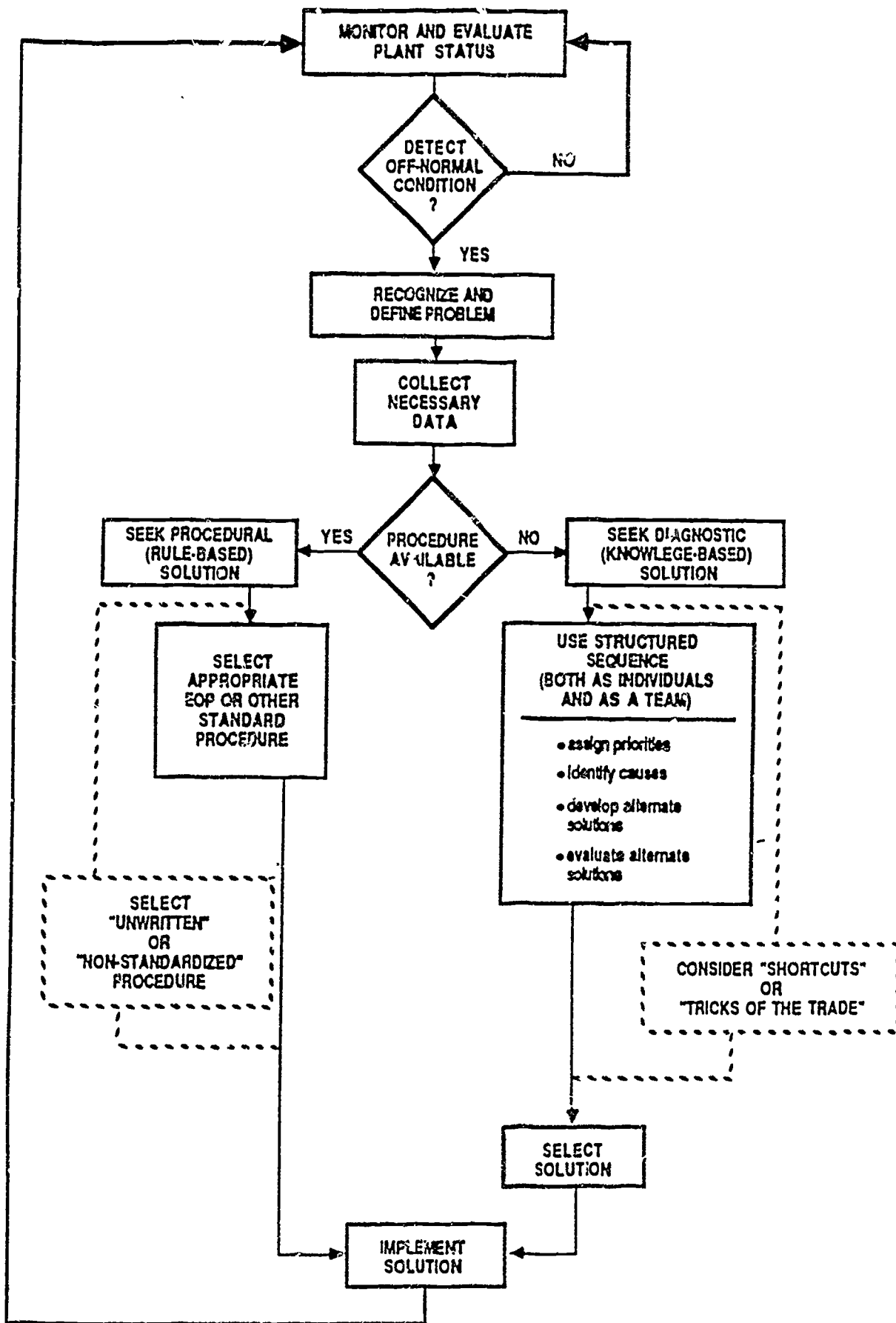

Human Information Processing

Consideration of human cognitive functioning in the development of JQIOC was predicated on the belief that if SIs are to enhance CRO training effectiveness, they must not only be well versed in course content, but must also be knowledgeable about their intended "audience". These audience characteristics include specific information about a student's incoming level of knowledge (e.g., engineering technician versus senior reactor operator) as well as some general information regarding the ways in which humans acquire, retain, and use knowledge.

Our discussion is generally based on a recent model of information processing developed by Wickens [4], but the descriptions and graphic representations have been tailored in some cases to be more specifically applicable to JQIOC implementation at FPL (additional details of this implementation may be found in Pond, Magennis, and Dedon, [5]). The stages of human information processing postulated by Wickens are represented in the lower, unshaded portion of Figure 1 and the elements of JQIOC depicted in the upper, shaded area.

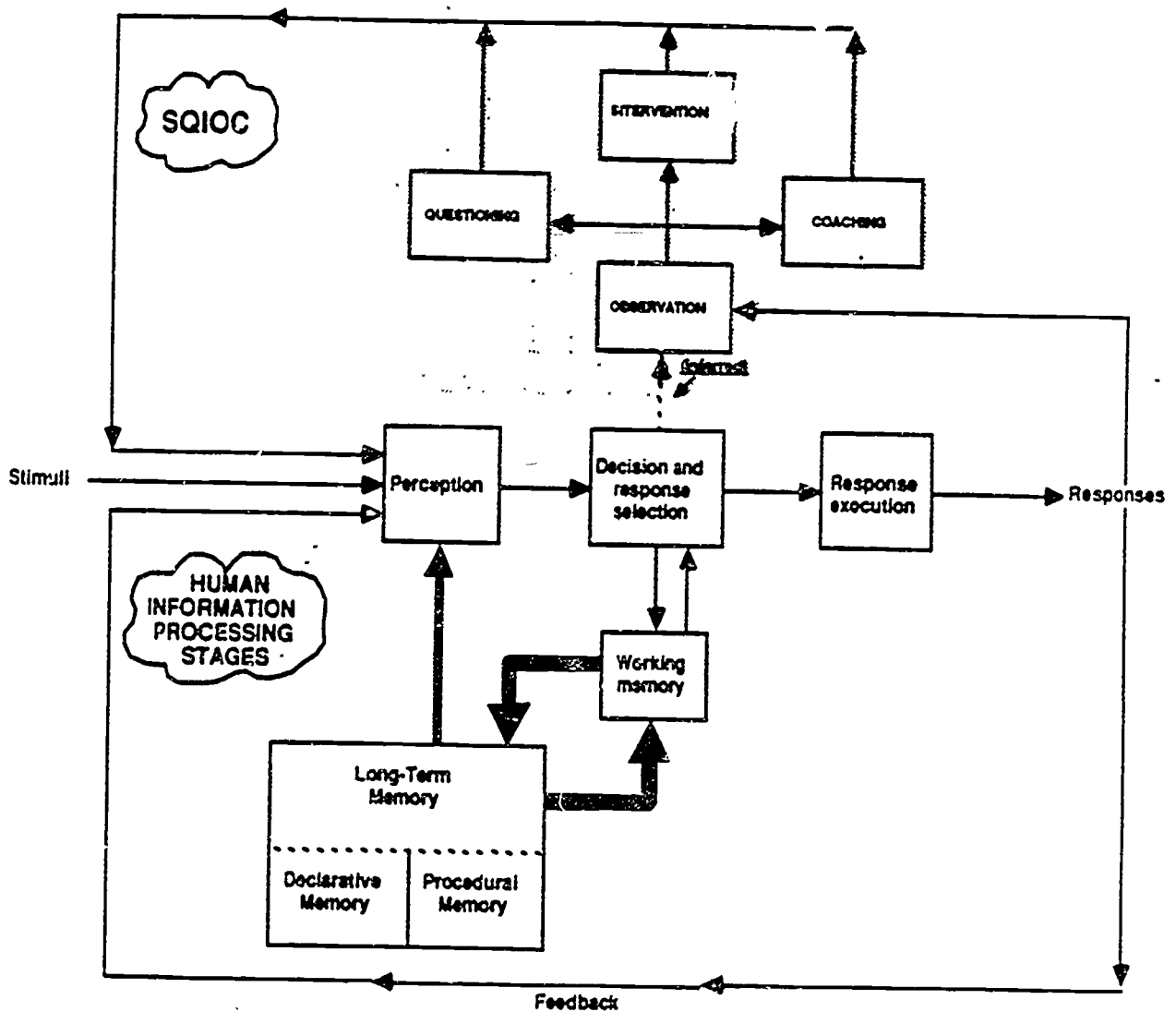

FIGURE 1: SQIOC - INFORMATION PROCESSING RELATIONSHIP

For present purposes, the following details should provide sufficient background to demonstrate the importance of these data for NPP training and to appreciate the role of JQIOC in increasing training effectiveness. *Stimuli* (that is, the information received by our senses) may be transmitted to the *Perception* stage, where our first awareness of this information occurs. The input channel from *Long Term Memory*, which is our permanent storehouse of knowledge, into the *Perception* stage enables what we have learned in the past to influence what we perceive in the present. Additionally, perceptions may be influenced by our expectations (which are also stored in *Long Term Memory*) of which inputs we believe to be most likely to occur. Perception may be described as the process of associating incoming data with a *template* from *Long Term Memory*. Our existing templates are modified or new templates created to account for new information acquired (that is, "learned").

Decisions are then made regarding which information may be transmitted to *Working Memory* for additional processing. Generally speaking, placing something in *Working Memory* is akin to "thinking about" it. *Working Memory* capacity is limited and only those data in active use—that is, those to which we are "paying attention"—are retained on the desk top. Others are either forgotten or sent to/returned to *Long Term Memory* for storage. As shown in Figure 1, *Working Memory* acts as the waystation through which the primary conduits to and from *Long Term Memory* must pass. These conduits are magnified in Figure 1 to indicate the importance to training of the processes represented. Simply stated, the primary goal of training is to aid the acquisition/retention/recollection of information and, therefore, the information flow through these conduits.

One view of *Long Term Memory* is that it can be divided into two storehouses of permanent memory. *Procedural memory* is organized into a series of "If-Then" statements such as "If a reactor trip has occurred, then follow Emergency Operating Procedure 1". *Declarative memory*, is organized into a network of fact nodes which are connected by relational links. Each of these nodes also connects to and is therefore associated with other nodes. The "free association" game in which one person says a word and a second person says the first thing that comes to mind is a technique for determining an individual's node-link connections, and thus provides a map of the *Declarative memory* component of LTM. As will be discussed, a SI uses JQIOCing to build such a map in order to properly diagnose the source of a trainee's difficulty in responding to some simulated event and to modify existing, unsuitable links/nodes or to create appropriate new links/nodes.

Based on the information processing activities in *Working memory*, the *Decision and Response selection* of the actions deemed appropriate are transmitted to *Response execution* for enactment. Knowledge gained through this process may be retained in *Procedural memory*. It may also be used to build fact nodes and create or strengthen connecting links in *Declarative memory*, and to modify or create templates which will be available for later use in *Perception* as well as *Working Memory*.

NPP Operation

At Florida Power & Light the design of all simulator exercise material is based on *Identification Block Diagrams* (IDBDs). All events/conditions selected for simulator training are charted by identifying the major steps or milestones comprising each "evolution". A sequence of these milestones beginning with a specific initial set of conditions and ending with a desired terminating condition is called an IDBD. Each milestone block of the IDBD is examined to determine or define the relevant information for a number of areas:

- industry events
- procedures
- technical specifications
- CRO tasks
- knowledge and ability requirements
- student activities

As a result of this process, every milestone of every evolution may contain reference data of value to the SI.

This information is used to construct an *Exercise Guide Outline* which details the milestones and specifies the goals to be achieved by students. Upon approval of the Outline, the above data are then used to develop the *Exercise Guides* which SIs employ in orchestrating simulator sessions. These Guides contain *terminal* (i.e., product) as well as *enabling* (i.e., process) objectives for each evolution. Further, the detailed *Exercise Guides* provide behavioral and simulator status indicators which serve as cues for the SI to implement the various JQIOC techniques.

As shown in Figure 1, and as further detailed in the following discussion, there are three interfaces between JQIOC and the cognitive processing stages: First, SI gather most of their information regarding performance by visual and auditory observation of the student's overt responses. Second, additional information may be inferred from student behaviors exhibited prior to or in the absence of overt responses. Finally, all SI inputs—in the form of questioning, coaching, or process intervention—are provided to the student through *Perceptual stage* processing.

JQIOC

As indicated, NPP operation typically levies relatively light physical/motor demands on CROs. Frequently, however, considerable information processing—and the attendant workload—precedes such simple motor responses as turning a key-activated switch. For effective training, a SI must be able to distinguish between situations in which a proper response (product) was based on correct knowledge and sound logic (process) from that in which this response was the serendipitous result of incorrect or incomplete knowledge and/or faulty logic. While the terminal objective may be attained in each case, if faulty templates/nodes/links are reinforced because only product criteria are used, subsequent plant operations may be jeopardized through enactment of deficient or defective process behaviors.

FPL's simulator instructors, therefore, are trained to be keen observers and to strategically position themselves during evolutions to gather the requisite process indicators. If it appears through visual and auditory observation that the student and/or the team is not properly handling the simulated event, a questioning routine is begun. The [QIIOC questioning procedure is based on Bloom's *Taxonomy of Educational Objectives in the Cognitive Domain* [6] which distinguishes six levels of cognitive functioning. The SI generates questions at the lower-order, *knowledge, comprehension, and application* levels to test a student's memory for facts and rules. Higher order questions involving *analysis, synthesis, and evaluation* are used to assess an individual's analytical/relational level of functioning. Broadly speaking, these low- and high-order questions may be related to the information represented by the Long Term Memory nodes and links, respectively.

In many cases, this questioning process serves as a hint or a guide to proper CRO operation. Failing this, however, the SI uses the student's responses to diagnose the source of the problem—faulty or missing fact nodes or relational links—and attempts through coaching to lead the operator/team towards the proper solution path. Such coaching may entail prompting with specific information, hinting at associations, or use of the Socratic Method through which students are led towards discovery of solutions by a series of questions from the SI.

If, despite coaching, the CRO/team is still unable to effectively deal with the evolution, the SI will elect to intervene. In [QIIOC there are three levels of intervention based on the degree to which the individual or team is removed from the real-time simulated event. As indicated in Figure 2, the least invasive level is termed a *Mental* intervention and it represents a student's brief cognitive departure from the evolution to, for example, contemplate and respond to a SI's questioning or coaching.

More severe is a *Physical* intervention in which a SI enters the simulation scenario and prohibits a student from taking a particular action. There is a school of thought that would, for example, allow a student to violate an interlock in order to teach him a lesson through the consequences suffered. At St. Lucie, however, the student would be stopped from taking this action in order to reinforce the FPL policy of never intentionally challenging interlocks on operational equipment. In information processing terms, we prevent the building of improper links. Finally, *Big Picture* interventions are aborted evolutions in which the simulation is frozen. This may be called for if a team has mis-diagnosed an event or if the "big picture" plant status is lost by the team as they attempt to remedy smaller, localized faults; and, of course, if questioning and coaching have failed to get the evolution back on track.

[QIIOC is a dynamic, interactive technique which adapts to the needs of each individual/team. In Figure 2, the lower right hand corner—or bottom rung of the ladder—represents an individual with the plant experience of, say, an initial license operator. For someone at this relatively low level of operational sophistication, the SI should utilize a *micro* level

of observation in which each specific behavior is scrutinized. The questioning should be characterized by low-order (knowledge) questions, and may require a significant amount of coaching. Frequent simulation freezes may be necessary to assure that students maintain awareness of the big picture event.

Figure 2 also depicts the relative frequency of the various [QIIOC elements appropriate for sessions with more highly skilled operators such as those upgrading to senior reactor operator. At the upper end of this experience ladder (as, for example, with requalifying senior reactor operators), [QIIOCing is more typically characterized by *macro* (i.e., broad perspective) observations, high-order questions, minimal coaching, and brief, *Mental* interventions. Finally, this same progression "up the ladder" with increased experience/skill is evident as well within training modules.

The anchor or focus for the SI is the FPL *Watchstanding Skills Matrix*. This document details the critical watchstanding process behaviors which have been grouped and labeled as:

- control board awareness
- control board manipulations
- use of procedures
- use of technical specifications
- use of reference data
- communications
- team skills
- event diagnosis

Each critical behavior is supported by a number of observable, supporting actions, the absence or presence of which enable categorization of CRO/team performance as *Unsatisfactory, Satisfactory, or Expert* in nature.

Concisely stated, the *Exercise Guide* alerts the SI to approaching behavioral/performance milestones during each evolution. The SI implements and adjusts his [QIIOCing techniques to aid/guide the control room crew through these milestones, and he then assesses individual and team performance in light of the criteria specified in the *Watchstanding Skills Matrix*.

[QIIOC Status

To date, 19 SIs in 2 classes have been trained in the [QIIOC techniques. Their response has been very favorable and SI comments have been incorporated into successive revisions of the program. Considerable team spirit and enthusiasm are seen in SIs who have completed [QIIOC training. Being a "[QIIOCer" is viewed as a badge of honor and "[QIIOCing" is often used as a pre-simulation session rallying cry among SIs.

Control Room Supervisors and Shift Supervisors were able to easily identify with the [QIIOC process because many were already employing these techniques with their operating

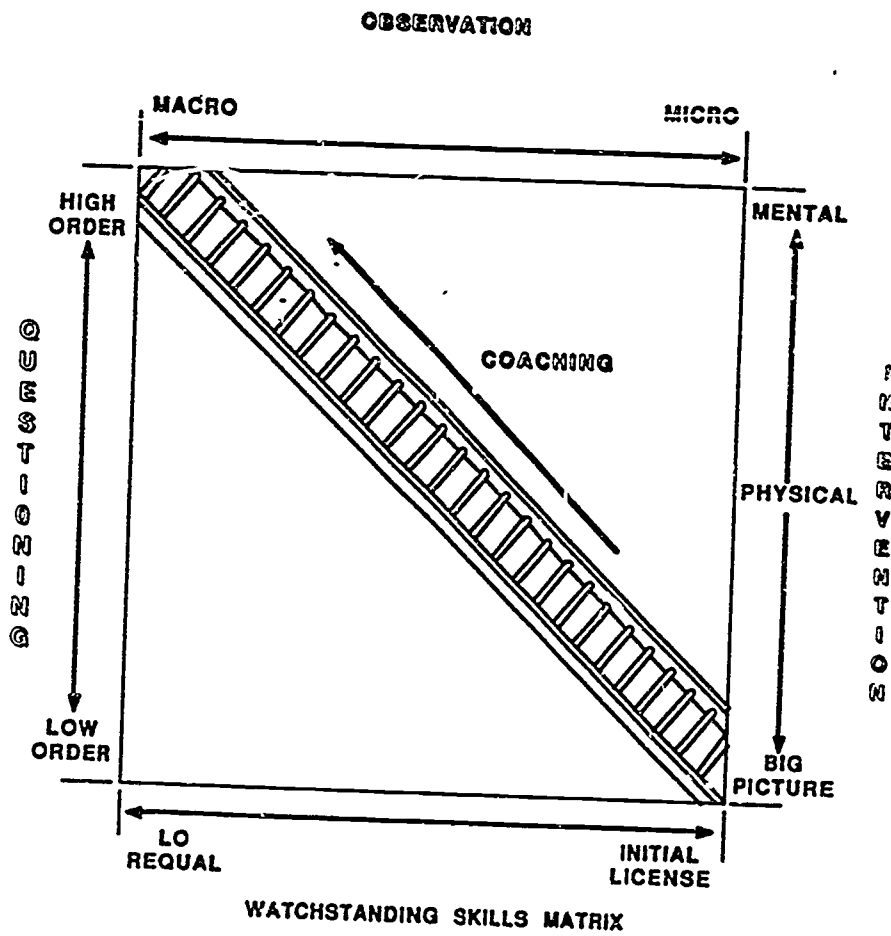

FIGURE 2: SQIOC - ADAPTATIONS OVER TIME

crews— albeit in a less structured and effective manner than is possible with JQIOC. Future plans include developing JQIOC as a Senior Reactor Operator skill and, therefore, to incorporate these techniques into operational as well as simulated environments.

The training activities at Florida Power & Light's St. Lucie facility are increasingly being focused on the range of team skills needed for safe, efficient NPP operation. In particular, team decision making techniques and effectiveness are areas of continuing effort. For example, work is in progress to define the relevant behaviors associated with CRO leadership and "followership" styles. These behaviors will then be incorporated into the appropriate Exercise Guides—probably as Enabling Objectives—and, given these data and the structure of the JQIOC process, SIs can devote special attention to proper development of these skills. Finally, in addition to the above stylistic issues, consideration is being given to the significance of simulator instructor, operator/student, and team *individual differences* in personality, experience, etc. for training and operations effectiveness.

Through this combination of research, selection, classroom education and simulator practice (including JQIOCing), FPL hopes to assemble, mold, and train teams of operators who will perform effectively under the demanding conditions inherent in NPP operation.

References

- [1] T.B. Sheridan, "Understanding human error and aiding human diagnostic behavior in nuclear power plants," In: J. Rasmussen & W.B. Rouse, Human detection and diagnosis of system failures. New York: Plenum, 1981, pp.19-35.
- [2] R.L. Henneman & W.B. Rouse, "Measures of human problem solving performance in fault diagnosis tasks," IEEE Transactions on systems, man, and cybernetics, vol. SMC- 14, No. 1, January/February 1984.
- [3] K.D. Duncan, "Training for fault diagnosis in industrial process plant," In: J. Rasmussen & W.B. Rouse, Human detection and diagnosis of system failures. New York: Plenum, 1981, pp. 553-573.
- [4] C.D. Wickens, Engineering psychology and human performance. Columbus, OH, 1984, ch. 1, pp. 1-18.
- [5] D.J. Pond, J.A. Magennis, & J.M. Dedon, Simulator instructor training program: Pre-seminar reading materials. Ft. Pierce, FL: Florida Power & Light Company, 1988.
- [6] B.S. Bloom, Taxonomy of Educational Objectives, Handbook I: Cognitive Domain. New York: David McKay Co., pp. 201-207.

PREPARE FOR EXERCISE AND CONDUCT PRE-EXERCISE BRIEF

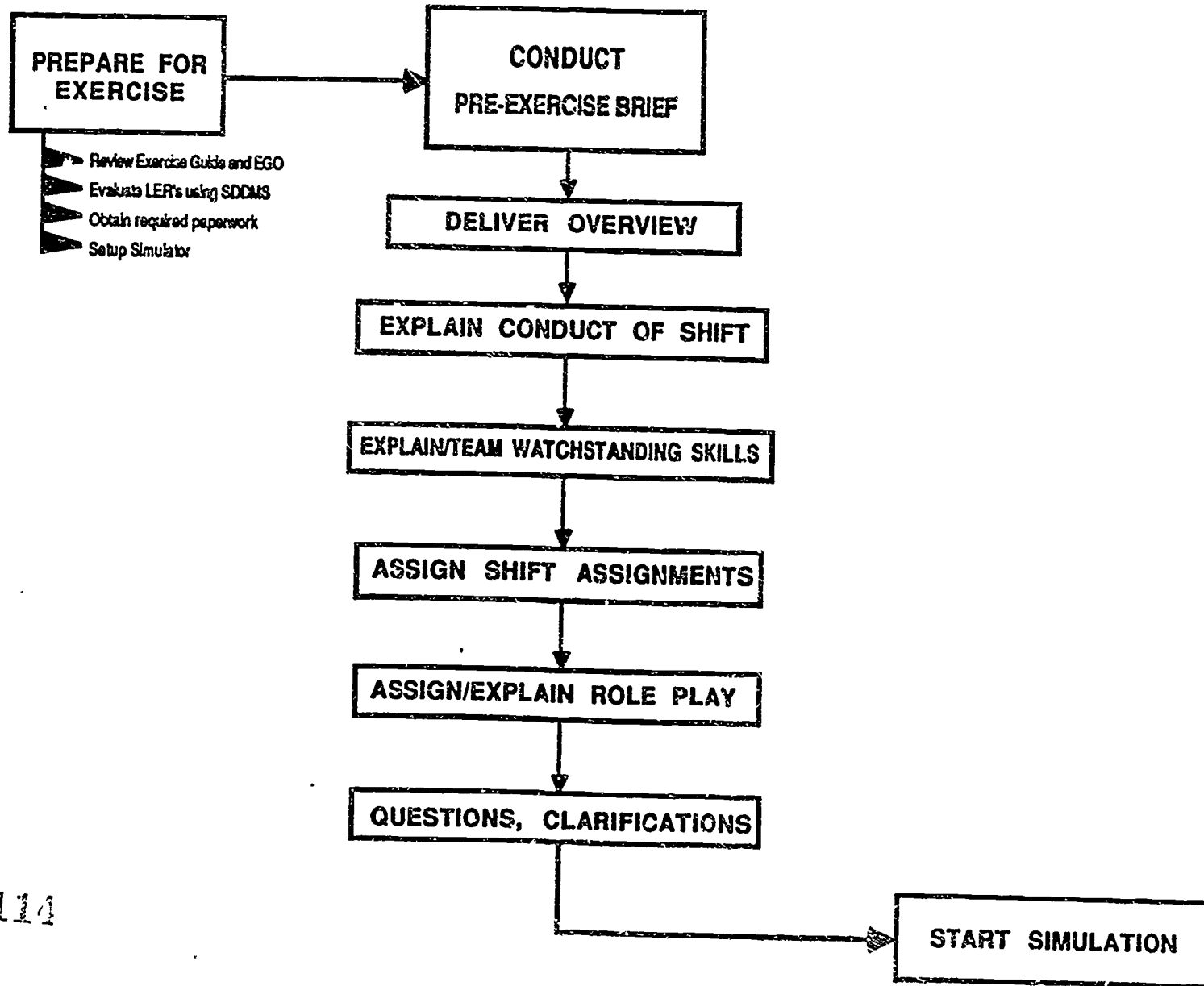

50

ATTACHMENT 2

114

115

ONE METHOD OF CONDUCTING A CRITIQUE COVERING ALL ELEMENTS

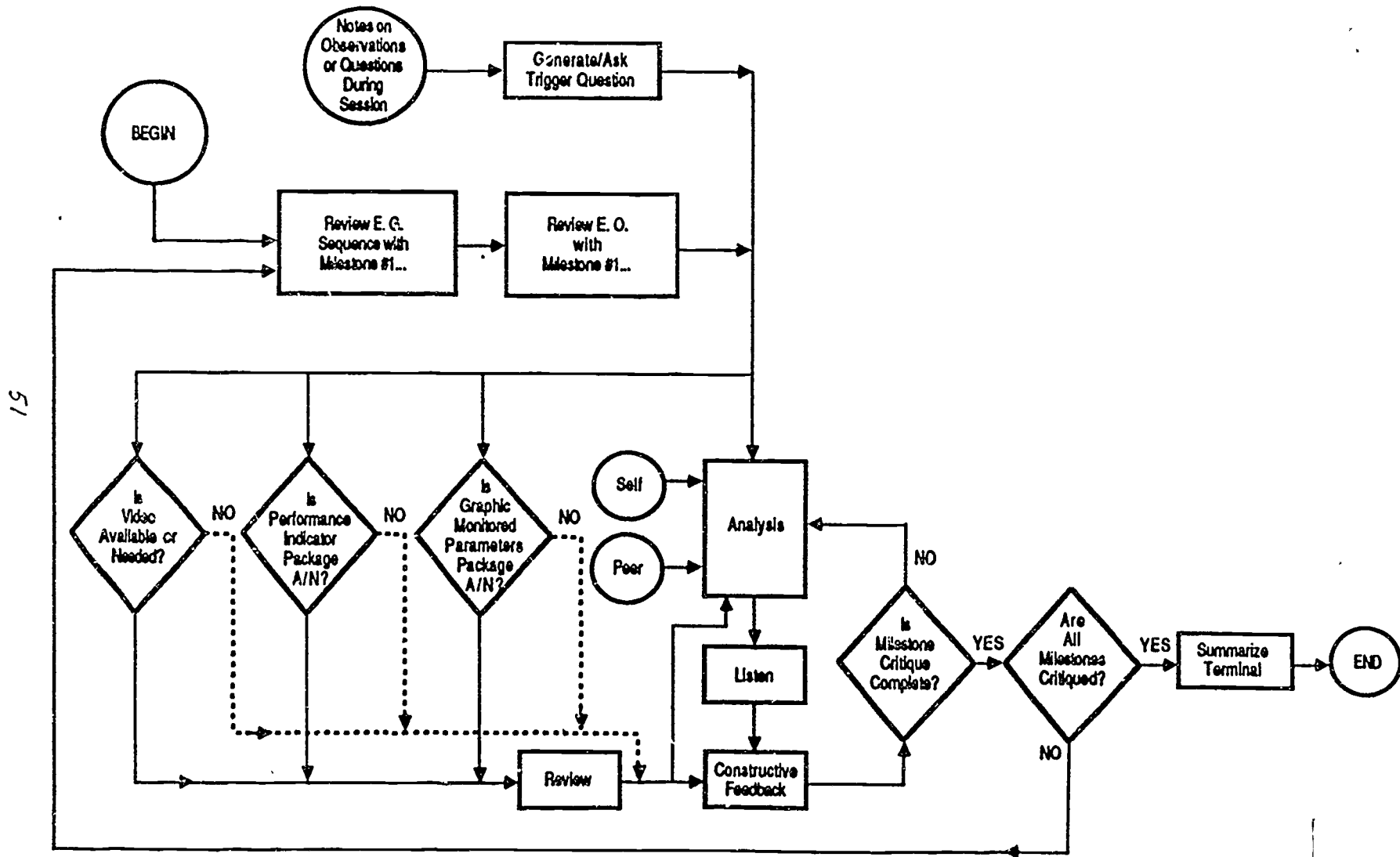

ATTACHMENT M

SIMULATOR TRAINING DEVELOPMENT PRODUCTS RELATIONSHIP

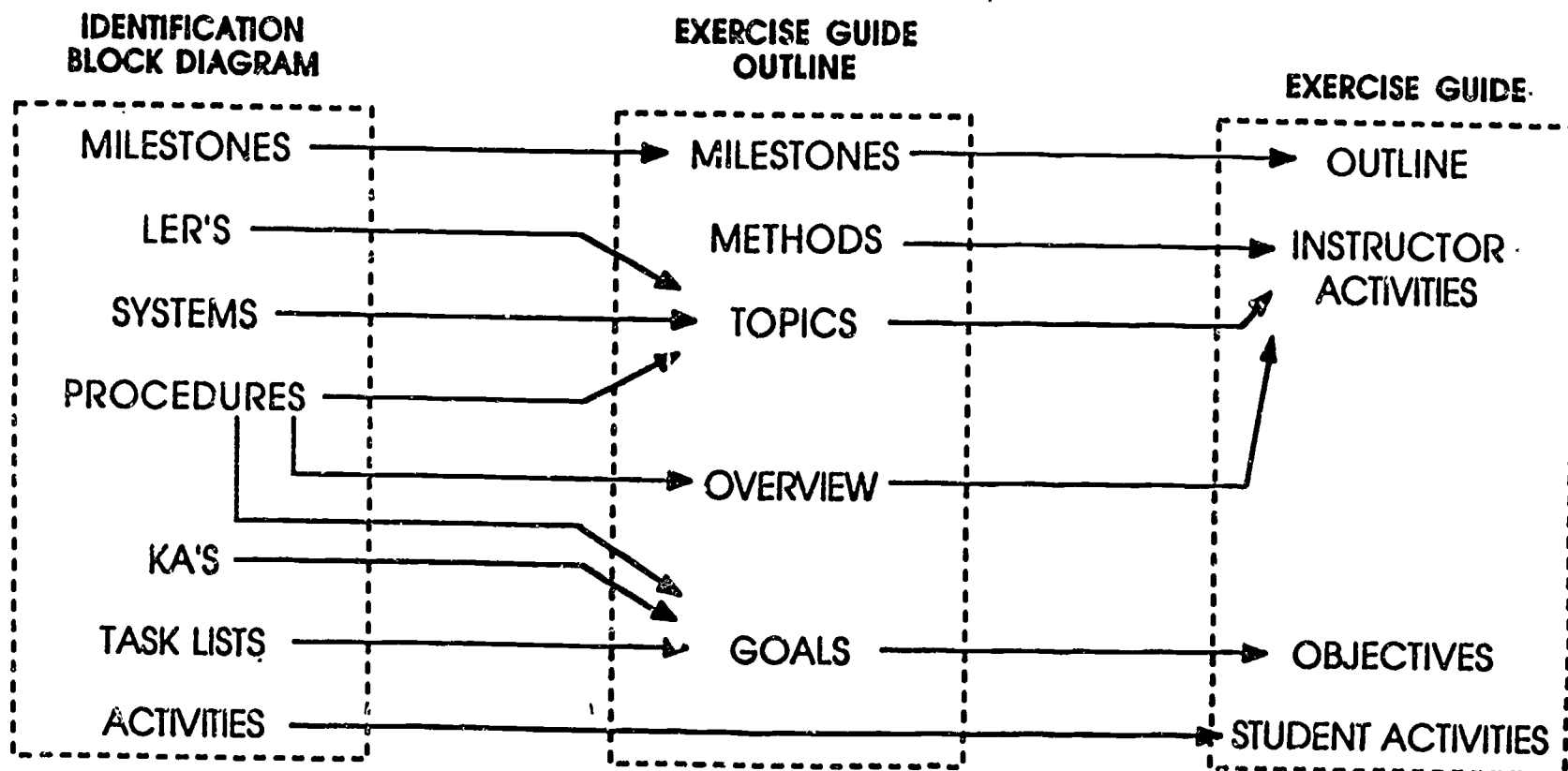

53

ATTACHMENT D

ATTACHMENT P

SIMULATOR INSTRUCTOR TRAINING
PROGRAM MAP

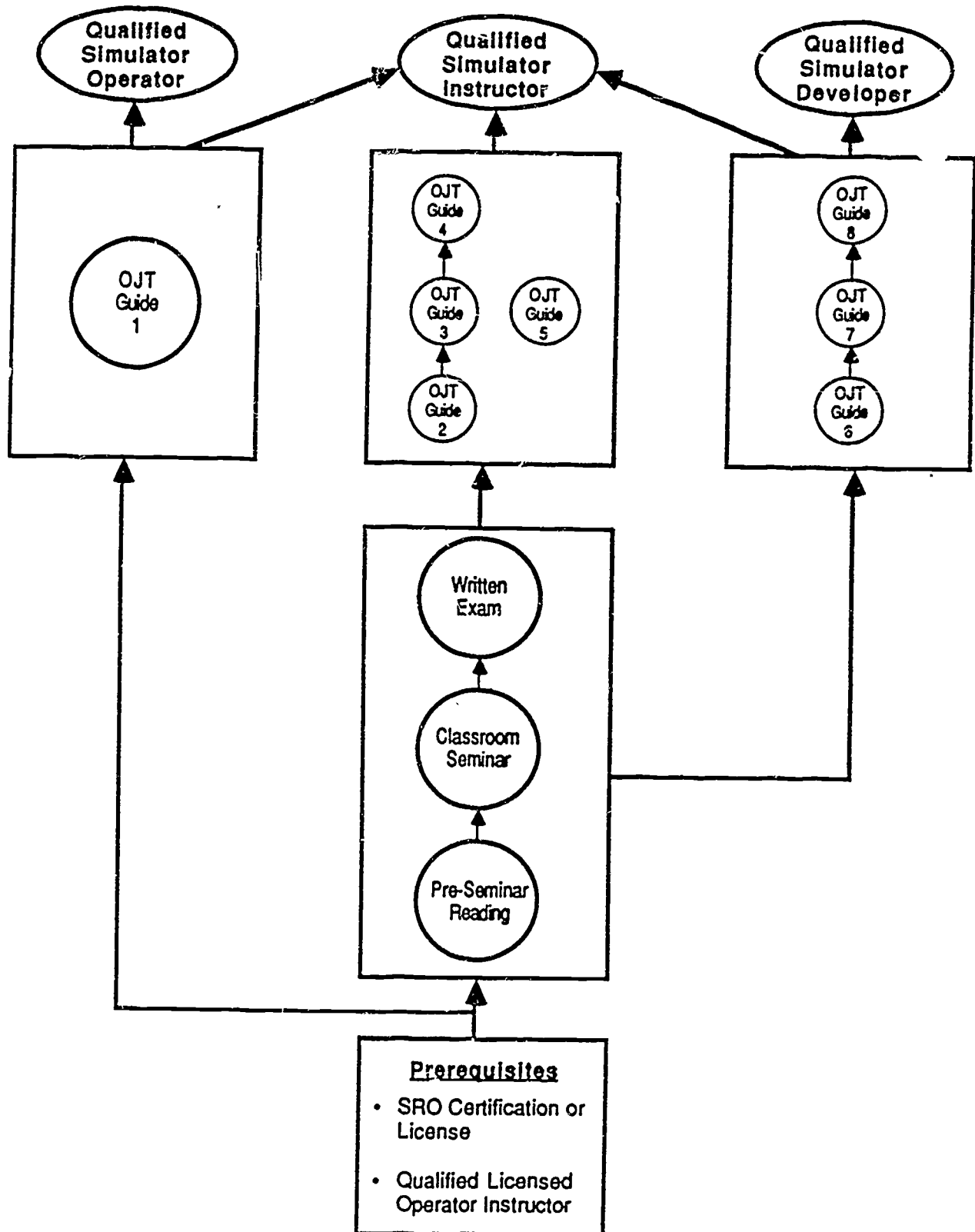

DEVELOPING TRAINING PROGRAM STEWARD SKILLS WITH MODULARIZED MATERIALS

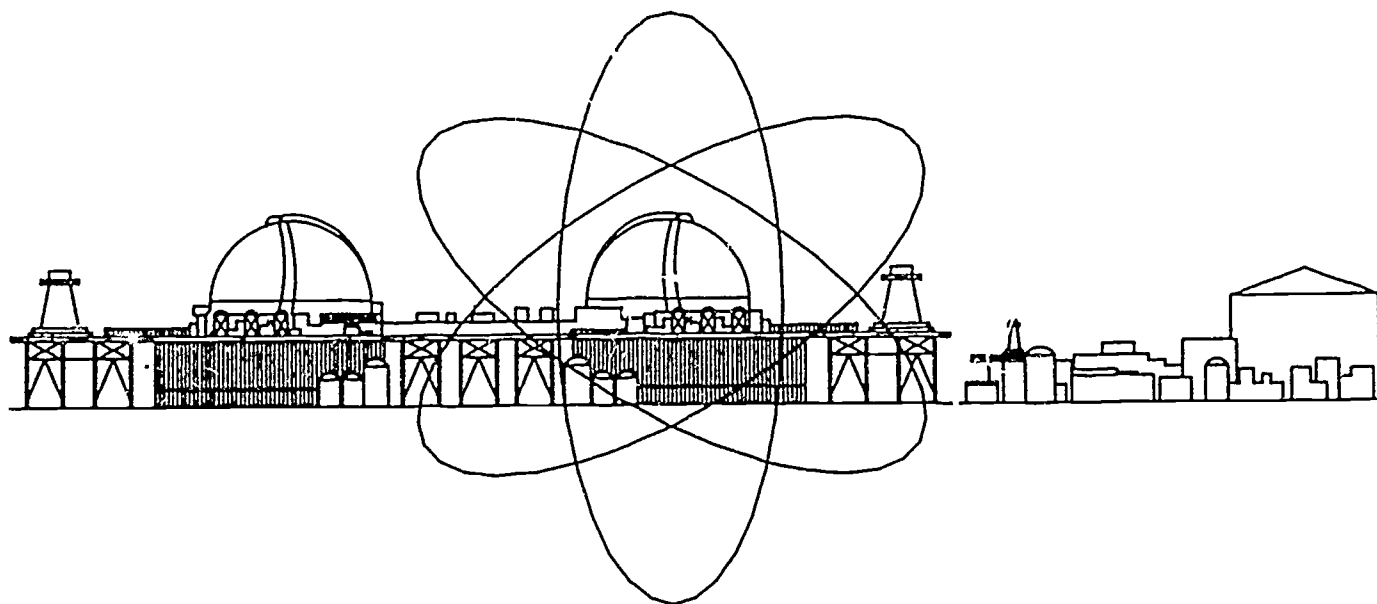

SAN ONOFRE NUCLEAR GENERATION SITE
UNITS 1, 2 & 3

Southern California Edison Company

TRAINING PROGRAM STEWARDSHIP

Identified Problem

- ATV Identified Program Concerns
 - Routine Review and Maintenance of Training Program Components Lacking
 - . Task Lists
 - . Task to Training Materials Matrix
 - . Training Program Outline
 - . Qualification Guides for OJT
- Found Quality In Training Materials
 - Lesson Plans Technically Accurate
 - Maintained Current With Industry and Plant Operating Experience
- Conclusion: Program Design-Basis Documentation Lacked "Stewardship."

TRAINING PROGRAM STEWARDSHIP

Proposed Solution

- Revise Nuclear Training Division Procedures
 - Identify and Fill Gaps In Business Practices Implementation
 - Tighten Administrative Controls To Clarify Responsibilities and Accountability
- Identify, Train And Assign New Roles To Selected Instructors
 - Monitor The Material Condition Of Program Components
 - Apply Principles Of SAT Processes
 - Assess Program Status Using Industry Criteria For Maintaining Accreditation
 - Document Results

TRAINING PROGRAM STEWARDSHIP

Training Development Process

- Prepare Job Description
 - Define Roles and Responsibilities
 - QAT Review and Approval

- Conduct Job Analysis
 - Develop Task List
 - Select Tasks for Training

- Conduct Task Analysis
 - Identify Knowledge, Skills, and Practical Factors

TRAINING PROGRAM STEWARDSHIP

Training Development Process

- Design Training Program
 - Establish Training Prerequisites
 - Develop Learning Objectives

- Develop Training Program/Materials
 - Classroom Lesson Plans (12 hrs)
 - Guided Self-Study-E.U.I.T.C. (32 hrs)
 - Qualification Guide (60 hrs)

- Implement Training Program
 - Identify Program Stewards
 - Establish Training Schedule

TRAINING PROGRAM STEWARDSHIP

Training Program Components

- Classroom Training - 12 Hours
 - Roles & Responsibilities of Stewards
 - Overview of SAT Principles (B-1)
 - INPO Accreditation Criteria

- Guided Self-Study (E.U.I.T.C.) - 32 Hours
 - Conduct Job & Task Analysis (A-2)
 - Design Instruction (B-1)
 - Develop Learning Objectives (B-2)
 - Develop Lesson Plans (C-1)
 - Evaluate Trainee Performance (E-2)

- Qualification Guide - 60 Hours

TRAINING PROGRAM STEWARDSHIP

Training Program Status

- Program Implementation
 - R&R Overview Lesson Presented 4 Xs
 - 46 Instructors (75%) Completed
 - 25 TPS Designated Instructors
 - Training Scheduled for 1990
- Training Materials Development
 - Lesson Plans: Status 2
 - Self-Study: E.U.I.T.C. Mat'l Available
 - Qual Guide: Approved

SONGS INSTRUCTOR TRAINING PROGRAM

Program Implementation

- 3 Modes of Program Delivery
 - Classroom Training
 - Guided Self-Study (E.U.I.T.C.)
 - On-The-Job Training/Qualification
- All Modes Used In 8 Areas of Certification
 - Classroom/Laboratory Instr Training
 - Training Materials Development
 - Training Program Development (SAT)
 - Computer-Based Training Development
 - Simulator Instructor Training
 - In-Plant Training/Evaluation
 - Instructional Television Development
 - Training Program Stewardship

SONGS INSTRUCTOR TRAINING PROGRAM

Training Outline

- 3 Phase Training Program
 - Initial Instructor Certification
 - . New Instructor Orientation
 - . Classroom/Laboratory Instr Training
 - . Training Materials Development
 - Continuing Instructor Certifications
 - . Training Program Development
 - . Computer-Based Training
 - . Simulator Instructor Training
 - . In-Plant Training/Evaluation
 - . Instructional Television Development
 - . Training Program Stewardship
 - Annual Continuing Instructor Trng
 - . Instructional Skills Development

Training Program Stewardship Certification

Problem

During a recent INPO I -Accreditation Team Visit at San Onofre Nuclear Generation Site (SONGS), INPO peer evaluators identified deficiencies in key components of some of the Site's performance-based training programs. Task lists and task to training matrix had not been routinely reviewed and maintained current with plant and procedure changes, industry operating experience, and job scope changes. Consequently, job requirements and OJT qualification guidelines were incomplete and contained some inaccuracies. These problems were characterized by the ATV Manager as a "training program stewardship" concern.

Solution

Identify, train and assign instructors to monitor the material condition of training programs components in their discipline using defined criteria for maintaining performance-based training programs and the application of the Systems Approach to Training (SAT) processes; document the results of these program stewardship activities in the Annual Program Record Book.

Training Program Steward Functions

- A. Verify the status of the assigned Training Program by tracking the following functions required by Nuclear Training Division (NTD) procedures and SAT activities:
- Program design integrity through routine updates and annual validation of the site-specific Task List, Task to Training Materials Cross-Reference Matrix, OJT Qualification Guide(s), and Training Program Description (including the training program curriculum).
 - Program training material effectiveness through reviews and revisions being performed prior to the next time taught.
 - Program training evaluations conducted at the specified intervals.
 - Program lessons scheduled and conducted in accordance with the content of the Training Program Description.
- B. Maintain the Annual Program Record Book containing a comprehensive file of correspondence, schedules, audits, and reports for the assigned Training Program. These records shall provide documentation of continuing satisfactory stewardship of both accredited and non-accredited training programs.

- C. Advise the Cognizant Training Administrator of the program status and identified problems. The Training Program Steward shall be the program advocate and lobby for the support and assets necessary for the program to meet NTD requirements.

Organizational Relationships

- A. When possible, attend meetings held with the Plant OJT Coordinator and Line management associated with their assigned Training Program.
- B. Monitor the activities of instructors and support personnel in the scheduling and implementation of classroom, laboratory, and simulator training for their assigned Training Program.
- C. Monitor the activities of Line personnel, instructors and TSSG to ensure the performance basis and technical integrity of their assigned Training Program.
- D. Report directly to their Cognizant Training Administrator any stewardship concerns associated with their assigned Training Program.

Definitions

Program Steward: An instructor/SME who has been assigned the responsibility to routinely monitor identified components and processes associated with specific SONGS training programs. The Program Steward is the responsible NTD program expert and point of contact for identifying specific SAT and procedural/administrative program needs.

Annual Program Record Book: A chronological record which contains the necessary format elements needed to document the material condition of a performance-based training program in accordance with INPO accreditation criteria, SAT standards and NTD procedures.

PROGRAM STEWARD
TRAINING PLAN

INSTRUCTIONAL SETTING	TRAINING MATERIAL	HOURS	DEVELOPMENT STATUS
Classroom	LP-Roles and Responsibilities	4	0
	LP-SAT Overivew	4	1
	LP-INPO Accred Overview	4	2
	Totals:	12	
Self Study	Electric Industry Instructor Training Series		
	* SAT Review (Module B1, pgs 7-12)	1	2
	* Job Analysis (Module A2, pgs 1-48)	2	2
	* Selection of Tasks for Training - Training Level and Training Setting (Module B1, pgs 36-47)	1	2
	* Task Analysis (Module A2, pgs 49-86)	4	2
	* Writing Terminal and Enabling Objectives Objectives (Module B2, pgs 1-66)	4	2
	* Writing Test Items (Module E1)	4	2
	* Writing JPM's (Module E2)	4	2
	* Course Map-Sequencing Objectives (Mcdule B2, pgs 67-78)	1	2
	* Course Map-Unit Plan (Module B2, pgs 47-68)	2	2

PROGRAM STEWARD
TRAINING PLAN

INSTRUCTIONAL SETTING	TRAINING MATERIAL	HOURS	DEVELOPMENT STATUS
*	Lesson Plan (Module C1)	4	2
	Totals:	30	
Qualification Guide	Application of above materials to NTD procedures	120	0
	Totals:	120	
	GRAND TOTAL:	162	

* Module A2 = "Conduct Job and Task Analyses: -
 Module B1 = "Design Instruction"
 Module B2 = "Develop Learning Objectives"
 Module C1 = "Develop Lesson Plans"
 Module E1 = "Evaluate Trainee Performance - Knowledge"
 Module E2 = "Evaluate Trainee Performance - Using JPM's"

NUCLEAR TRAINING DIVISION ROLES AND RESPONSIBILITIES

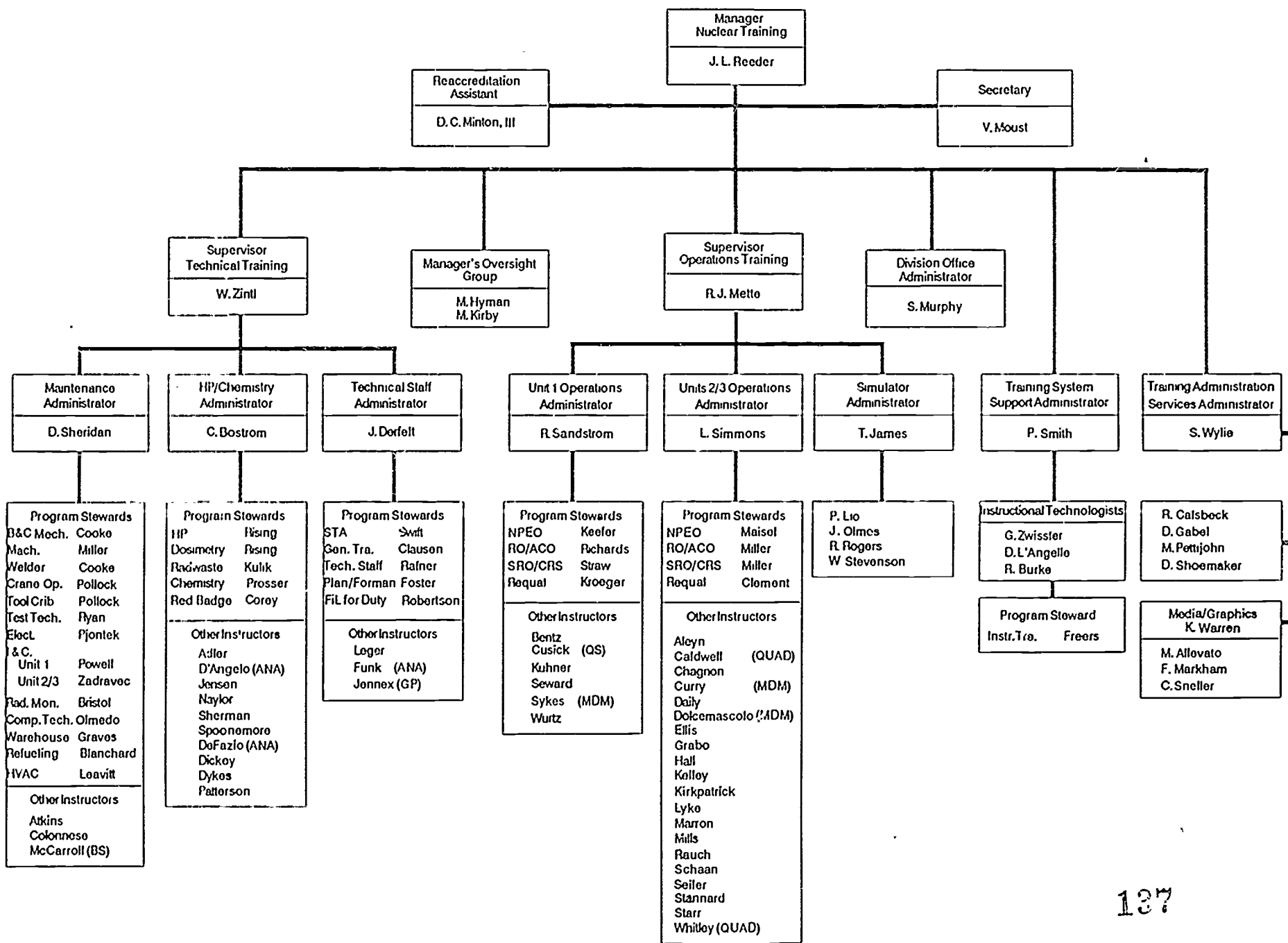

5/11/89

Program Stewards
Activities to Track

1. Annual and monthly Training Program schedule including (INPO 1.7.1 and SO123-XXI-3.200)
 - o Student attending
 - o Lesson plans used
 - o Exams given and keys
 - o (Ops Requal Steward only) Annual Requal Schedule Plan (SO123-XXI-1.303)

2. Evaluations by:
 - o Management direct involvement in training and qualification (INPO 1.1.3)
 - o Line management providing feedback to enhance training (INPO 1.2.1)
 - o Training managers and supervisors observing and evaluating training (INPO 4,3.1)

3. Training Material Changes resulting from:
 - o In-training evaluations (INPO 4.3.3 and SO123-XXI-3.900)
 - o Trainee feedback (INPO 4.4.2 and SO123-XXI-3.900)
 - o Former trainee feedback (INPO 4.5.4 and SO123-XXI-3.900)
 - o Change actions (regulatory, external evaluations/inspections, INPO guidelines/ good practices, plant procedures and system/equipment modifications) (INPO 4.6.6 and SO123-XXI-3.900)
 - o Industry operating experience (SOERs, owner groups, NRC notification, etc.) (INPO 4.7.1 and SO123-XXI-2.150)
 - o Plant experience and performance trends (INPO 4.8.2 and SO123-XXI-2.150)

4. Process
 - a. Annual Task List reviews (SO123-XXI-5.200)
 - b. Task List Changes resulting from: (INPO 5.1.2)
 - o Job scope changes
 - o Plant changes
 - o Procedure changes
 - o Industry operating experience
 - o Plant operating experience
5. Task List to Training Materials Matrix Changes resulting from: (INPO 5.2.2)
 - o Changes in the structure of the training program (phases, courses, lesson plans) setting (classroom, laboratory, simulator, or OJT) and frequency (Initial, Continuing, or Requal) (INPO 9.1.2)
 - o Terminal Learning objectives
6. OJT Qualification Manual Annual Audit (SO123-XXI-2.160)
7. Training Program Descriptions Review (SO123-XXI-2.100)
8. Student Performance measurements:
 - o Examination results measuring trainee performance or behavior as required by the learning objectives. (INPO 6.5.4)
 - o Trainee remedial training or tutoring (INPO 8.6.7)
 - o Re-examination of trainee requiring remedial training (INPO 8.6.8)
9. Attend all CRC Meetings applicable to the assigned program (SO123-XXI-5.200)
10. Special:
 - o (Ops Requal Steward Only) Audit of Requal Training (SO123-XXI-1.303)

Annual Training Program Record Book

- I. Table of Contents
- II. Oversight Audit Comments Comments/observations made by the Oversight Group during routine review
- III. Chronological Record Narrative list of activities/observations entered by the Program Steward
- IV. Program Course Schedules
 - A. Annual Scheduled
 - B. Monthly Actual as taught, including lesson plan numbers and instructors (for periods that training is in progress)
 - C. Student rosters List of students for each time taught
- V. Program Audit Schedule Schedule of Annual Task List, Matrix, OJT Guide and TPD audits
- VI. Process
 - A. Changes made to: Correspondence/report/records documenting changes as they occur during the year
 - o Task List
 - o Matrix
 - o TPD - Curriculum Outline
 - o OJT Qualification Manual
 - B. Annual Task List Review Report of completion
 - C. Annual OJT Manual Audit Report of completion
 - D. TPD Review Report of completion

VII. Content

- A. Training Material Changes resulting from:
 - o In-training evaluations
 - o Trainee feedback
 - o Former trainee feedback
 - o Change actions
 - o Industry operating experience
 - o Post training feedback from Line supervisors and managers
 - o Line review of training programs and materials (CRCs and TICs)
 - o Instructor feedback (IPDEs)

- B. Student Performance measurements
 - o Examination results
 - o Trainee remedial training
 - o Post remedial training re-examination

VIII. Meeting Minutes

Only those minutes, or sections of minutes, effecting the applicable Training Program should be retained.

- A. CRC
- B. TIC

IX. Evaluations (copies)

- A. Management direct involvement
- B. Line management feedback
- C. Training managers and supervisors feedback
- D. Program Evaluation Report (six months after program completion)

X. Other

- A. AIMS Detailed Status All open and closed Action Items related to the program for the year
- B. Audit of Requal Training (Ops Requal only)

NOTES

1. Only copies of reports/records/correspondence should be filed in this Record Book. The original documents shall be stored as directed by procedure (Masterfile, CDM, etc.).
2. Program Stewards are encouraged to use copies of existing documents to meet the needs of this Record Book or to recover the required information from common data bases, such as TRIMS.

NTD INSTRUCTOR

- = INSTRUCTIONAL S TING
- ▭ = CLASSROOM LESSON PLAN
- ◡ = SELF-STUDY MODULES
- ◩ = DATABASES
- ◪ = FILE

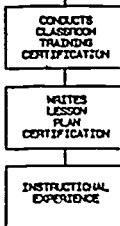

SELECTED TO BE PROGRAM STEWARD

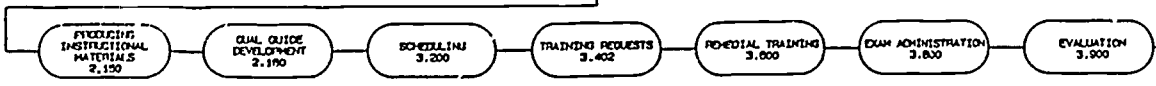
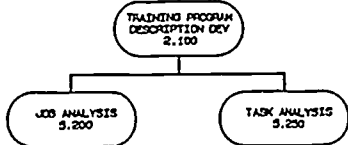
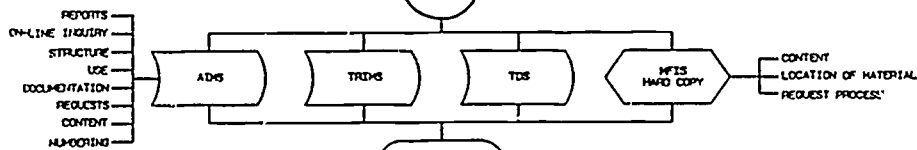
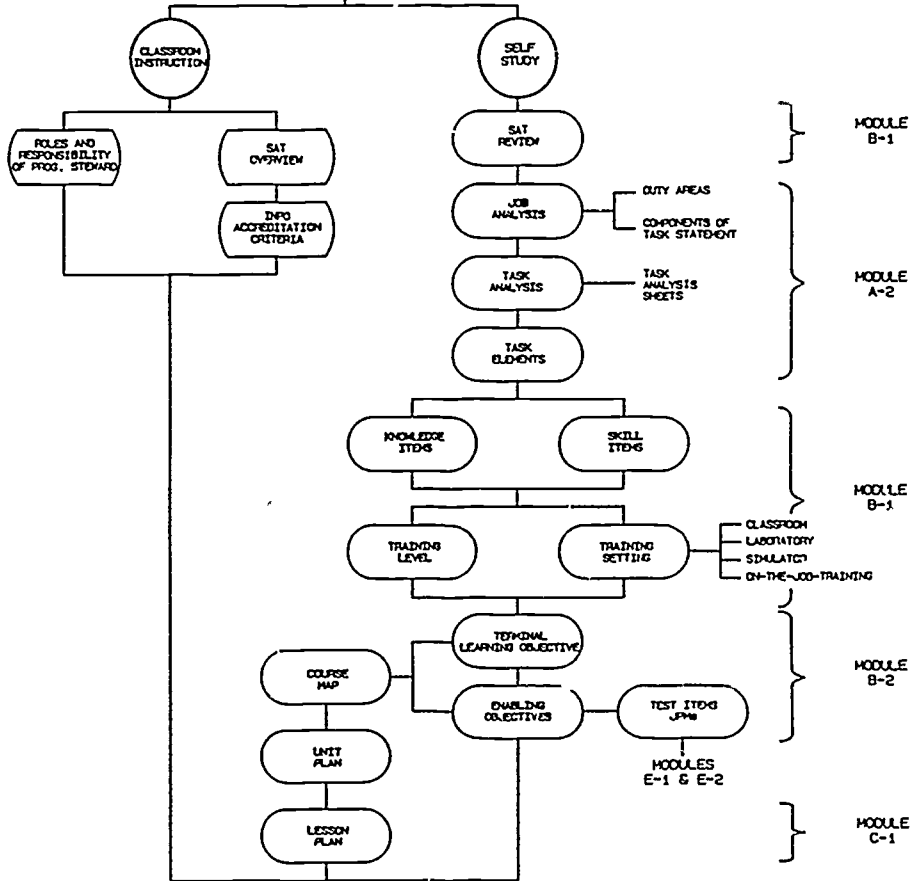

CERTIFIED TRAINING PROGRAM STEWARD

62508

ACCREDITATION RENEWAL: AN OVERVIEW

by

Ronald L. Fritchley

Manager

Accreditation Systems

National Academy for Nuclear Training

Mid-West Nuclear Training Association

Instructor Workshop

Columbus, Ohio

October 16-18, 1989

ACCREDITATION
RENEWAL: AN OVERVIEW
by

Ronald L. Fritchley

(Slide 1 - Title Slide)

- o Good morning! It is a pleasure to be here this morning to address this very distinguished group
- o My remarks this morning will focus on the following areas:
 - Historical background of Academy accreditation process
 - Benefits to utility training programs as a result of accreditation
 - Principal differences between initial and renewal accreditation
 - Recurring training problems

(Slide 2 - Accreditation Background)

- o Initiated in 1982 as part of INPO's responsibility to promote training excellence
- o Purpose - assist INPO member training programs to produce and maintain well-qualified and competent work force
- o Operated under auspices of National Academy for Nuclear Training - Academy established in 1985
- o Academy accreditation formally recognizes utility training as meeting the industry's accreditation objectives and criteria - initial and continuing training for operations, maintenance, and technical personnel

(Slide 3 - Benefits to Training)

- o Industrywide standards (accreditation objectives and criteria) established by the National Academy - significant input and review from the industry
- o Standards based on principles of performance-based training and are applied to training programs and not to individuals
- o Accreditation ensures the process is in place to prepare the individual to independently perform the duties and tasks of the job for which he/she is being prepared - the utility certifies that individuals are ready to perform work independently
- o Systematic evaluation and feedback - self-evaluations, program evaluations, plant feedback, accreditation team visits, and other evaluative inputs - provide systematic means for maintaining and improving the various training programs
- o Use of INPO and industry peer evaluators during accreditation team visits provides high quality expertise in nuclear power plant operations, nuclear utility training, training program development and evaluation, and instructional processes

- o Use of industry peer evaluators on accreditation teams has been highly successful in improving training - has led to networking, enhancement of community of training professionals, and providing each peer with personal knowledge and experience on which to draw

- o Assurance of quality training is important to a variety of audiences such as plant and line management, Nuclear Regulatory Commission, nuclear insurance groups, nuclear power plant workers, and the general public to name a few

NOTE: Today there are over eight times as many individuals working in the area of nuclear utility training as in 1979 (about 4500).

(Slide 4 - Initial and Renewal Differences)

- o Process for initial accreditation consists of self-evaluation (and self-evaluation report preparation); team visit (team report preparation, utility actions and utility responses); and review and accreditation decision by the independent National Nuclear Accrediting Board.
- o Accreditation renewal repeats much of the initial accreditation process. However, assumptions include the accredited training programs being maintained at a high level and being used to deliver high quality training
- o Renewal objectives and criteria reflect increased emphasis on quality day-to-day plant line management involvement with training
- o Emphasis is also placed on program maintenance through incorporation of feedback from various sources such as: program use; job incumbents and their supervisors; observed performance deficiencies; plant and procedure changes; pertinent plant and industry operating experience; and program effectiveness evaluations
- o Licensed operator continuing training has been added as an eleventh accredited program

(Slide 5 - Recurring Training Problems)

- o Although the INPO accreditation program and the nuclear utility industry have enjoyed numerous successes, several recurring training problems have been identified during accreditation team visits and plant evaluations that detract from high quality training
- o Significant objective or criteria deficiencies or an accredited program not being used prompts INPO to initiate a review appropriate to the magnitude of the problem
- o The utility may be asked to demonstrate to the National Nuclear Accrediting Board why accreditation should continue - continue, probation for up to 180 days (although cases to date have been for only 120 days), or withdraw

(Slide 6 - Examples of Recurring Problems)

- o Training and line management monitoring and evaluation of training activities do not ensure that key training functions are performed and training is conducted effectively
- o Maintenance supervisors are assigning personnel to perform maintenance tasks independently, without reference to their formal qualification status
- o Some licensed operator continuing training programs have not been revised to a performance-based training and evaluation format
- o Several problems with instructor training and evaluations have been noted - evaluations of technical and instructional skills, continuing development of technical and instructional skills, and using instructor evaluation results as a basis for continuing instructor development
- o The process for obtaining post-training feedback from former trainees and their supervisors has not been effectively implemented, and as a result, objective or task-based feedback has not been collected to improve training effectiveness

- o Some training programs -- in particular, maintenance and technical staff/technical staff managers programs -- have not been fully implement (attendance and continuting training being two prominent deficiencies)

(Slide 7 - The Bottom Line)

- o Ultimate objectives of accreditation are to maintain high quality training and enhance the professionalism and performance of personnel who operate nuclear power plants
- o The nuclear power industry has accepted the responsibility to strive for excellence in training its personnel to safely operate the power plants - the full use of accreditation and the accrediting process by all nuclear utilities. An important means to fulfilling this responsibility



Accreditation Renewal:

An Overview

Ronald L. Fritchley

Manager, Accreditation Systems

National Academy for Nuclear Training

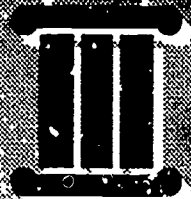

Accreditation Background

- Initiated in 1982
- Assist in improving industry training
- Part of National Academy for Nuclear Training
- Training for operations, maintenance, and technical personnel



Benefits to Training

- Industrywide standards
- Training and qualification process
- Systematic evaluation and feedback
- Evaluation by industry peer evaluators
- Assurance of quality training



Initial and Renewal Differences

- Initial process
- Renewal assumptions
- Renewal emphasis
- Additional programs



Recurring Training Problems

- Objective or criteria deficiencies
- Non-use of accredited program
- INPO review and follow-up
- Accrediting Board options

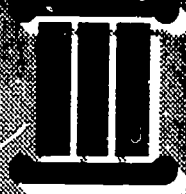

Examples of Recurring Problems

- Training and line management involvement
- Maintenance work assignments
- Continuing training for licensed operators
- Instructor training and evaluation
- Post-training feedback



The Bottom Line

- ❑ Maintain high quality training
- ❑ Enhance professionalism and performance
- ❑ Strive for excellence in training plant personnel