

ED 308 074

SE 050 659

TITLE A Manual on Conservation of Soil and Water.
Appropriate Technologies for Development. R-58.

INSTITUTION Peace Corps, Washington, DC. Information Collection and Exchange Div.

PUB DATE Jun 85

NOTE 219p.; Photographs and drawings may not reproduce well.

PUB TYPE Reports - Descriptive (141) -- Guides - Classroom Use - Guides (For Teachers) (052)

EDRS PRICE MF01/PC09 Plus Postage.

DESCRIPTORS *Agronomy; *Conservation (Environment); Depleted Resources; *Environmental Education; Forestry; Land Use; Sciences; *Soil Conservation; Water; *Water Resources; *World Problems

ABSTRACT

In order to keep the land productive, a good conservation program is imperative. The primary purpose of soil and water conservation is to prevent soil erosion and heal its scars. This handbook explains the causes, processes, and consequences of soil erosion and depletion, and describes major soil- and water-conservation measures. This book was prepared for the use of officials, technicians, and agriculturists interested in controlling wind and water erosion and making better use of rainfall available and irrigation water throughout the world. Main topics included are: (1) "What is Soil Erosion"; (2) "Classifying Land Capability"; (3) "Preventing and Controlling Gullies"; (4) "Woodland Improvement"; (5) "Terracing"; (6) "Stripcropping"; (7) "Cover Crops"; (8) "Soil-depleting, Soil-conserving, and Soil-building Crops"; (9) "Pasture Improvement"; (10) "Rangeland Improvement"; (11) "Conservation Irrigation"; (12) "Farm Drainage"; and (13) "Conservation Nurseries." (YP)

* Reproductions supplied by EDRS are the best that can be made *
* from the original document. *

ED308074

APPROPRIATE TECHNOLOGIES FOR DEVELOPMENT

PERMISSION TO REPRODUCE THIS MATERIAL HAS BEEN GRANTED BY

P. Heady

TO THE EDUCATIONAL RESOURCES INFORMATION CENTER (ERIC)

U.S. DEPARTMENT OF EDUCATION
EDUCATIONAL RESOURCES INFORMATION CENTER

PERMISSION TO REPRODUCE THIS MATERIAL HAS BEEN GRANTED BY P. HEADY

TO THE EDUCATIONAL RESOURCES INFORMATION CENTER (ERIC)

A Manual on Conservation of Soil and Water

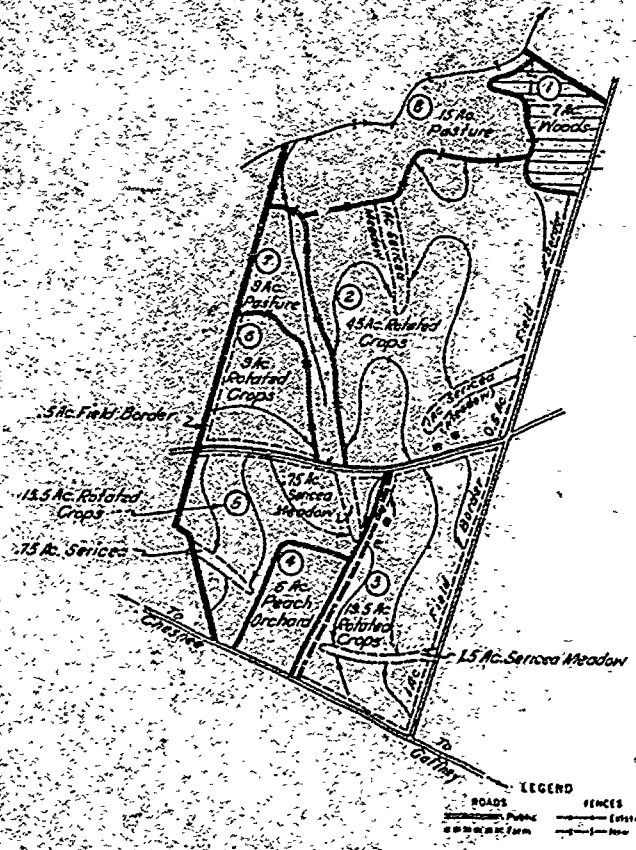

Principal features of the conservation farm plan.

Peace Corps

INFORMATION COLLECTION & EXCHANGE

REPRINT R-38

56 050 659

INFORMATION COLLECTION & EXCHANGE

Peace Corps' Information Collection & Exchange (ICE) was established so that the strategies and technologies developed by Peace Corps Volunteers, their co-workers, and their counterparts could be made available to the wide range of development organizations and individual workers who might find them useful. Training guides, curricula, lesson plans, project reports, manuals and other Peace Corps-generated materials developed in the field are collected and reviewed. Some are reprinted "as is"; others provide a source of field based information for the production of manuals or for research in particular program areas. Materials that you submit to the Information Collection & Exchange thus become part of the Peace Corps' larger contribution to development.

Information about ICE publications and services is available through:

Peace Corps
Information Collection & Exchange
Office of Training and Program Support
806 Connecticut Avenue, N.W.
Washington, D.C. 20526



Add your experience to the ICE Resource Center. Send materials that you've prepared so that we can share them with others working in the development field. Your technical insights serve as the basis for the generation of ICE manuals, reprints and resource packets, and also ensure that ICE is providing the most updated, innovative problem-solving techniques and information available to you and your fellow development workers.

A MANUAL ON CONSERVATION OF
SOIL AND WATER

Reprinted With Permission
For Peace Corps Use
By:
United States Department of Agriculture

PEACE CORPS
Information Collection and Exchange
Reprint R-38
September 1982
June 1985

Preface

All over the world people are becoming more and more aware of the importance of keeping their agricultural land permanently productive. They are coming to realize that productive land is the source of human sustenance and security—that it is basic to the welfare of people everywhere at all times.

Essential foods, vegetable oils and fats, leather, fibers required for clothing and cordage, forage for livestock—these are indispensable products, and for our supply of them we are dependent entirely or largely on the soil. Wood products, tobacco, and various other agricultural products come also from the soil.

In order to keep the land productive, a good conservation program is imperative. Soil and water conservation is the basis of such a program, and also helps improve land impoverished by erosion and overuse—makes it more productive so that it can support more people.

For effective conservation of soil and water, we must treat and use the various kinds of land according to their capability and need. To do this it is necessary to study the land carefully, so as to be able to fit conservation practices and structures to the various kinds of land.

These measures can be used singly on some of the more stable land, but more often than not they must be used in combinations that will mutually support one another and thereby give greater strength, durability, and productiveness to the land. Moreover they must be used within the economic limitations and in accordance with the facilities of farmers.

Soil conservation stores more of the runoff from excess rainfall in the reservoir of the soil for subsequent crop use; and this much water is kept out of streams, thereby contributing to flood reduction.

Today these techniques of soil and water conservation are being practiced in many countries with much benefit to great numbers of people. Agriculturists throughout the world now generally agree that a change-over from wasteful to protective and fruitful land use and farming methods should be brought about as quickly as possible. It must be brought about, that is, if individual nations and the world as a whole are to build a healthy economy, with agricultural production wherever possible adequate to feed, clothe, and shelter the people and to supply materials required in time of emergency.

Soil erosion is the most serious and prevalent disease of the land. Vast areas have been so damaged that they no longer can be used to grow anything of value to human beings. Much of the good land that remains is in danger, from overuse and improper use. Populations are expanding nearly everywhere, and pressure on the land is heavier than ever before.

The primary purpose of soil and water conservation is to prevent soil erosion and heal its scars where it has not advanced too far to respond to curative methods. This involves, in many instances, changing the uses to which land is put. It has been found, in fact, as stated previously, that the first requisite to conservation of land is to fit the crop—whether cultivated crops, trees, or grazing plants—to the capabilities of the soils and the water available. Equally important is the use of engineering and agronomic practices which, conjointly, will control and conserve water and counteract the erosive action of both water and wind on the soil.

In conjunction with these two basic principles, there must be put back into the soil what is taken out—organic matter, nitrogen, the mineral plant foods. And proper amounts of moisture for plant growth must be maintained through sound conservation measures, including irrigation

where it is needed and is feasible. Also, the many machines and tools now coming into use over the world must be used according to the capability and need of the land, otherwise both the machines and the land are likely to suffer.

It is on these premises that modern soil conservation has been planned and developed. Its ultimate objective is to achieve a sustained-yield type of agriculture based on principles and practices that will protect and improve land while it is being used, rather than one that will further deplete or destroy its productive capacity.

This handbook explains the causes, processes, and consequences of soil erosion and depletion, and describes the major soil- and water-conservation measures which, when applied to the land in correct combinations, will greatly reduce or prevent soil erosion, improve fertility, and increase yields.

Soil conservation is an international concern. Eroded and impoverished land that was formerly productive is now scattered throughout nearly all countries. Responsibility for care of the productive land rests on all the people of a country.

This handbook was prepared for the use of officials, technicians, and agriculturists interested in controlling wind and water erosion and making better use of rainfall available and irrigation water throughout the world. The practices and recommendations are based very largely on the experience and technical publications of the Soil Conservation Service of the United States Department of Agriculture and other agencies in this and other Departments.

Further details can be had by consulting technical publications issued in the United States and other countries.

CONTENTS

	Page
What is soil erosion	1
Erosion by rainfall and running water.....	7
Erosion by wind	17
Erosion—past, present, and future.....	21
Classifying land capability	23
Facts obtained in the field	24
Significant variations in land features	24
The classification scheme	26
Land-capability classes	26
Subclasses and units	28
Land suited for cultivation.....	29
Land not suited for cultivation.....	38
Land not suited for cultivation, grazing, or woodland.....	43
Using the physical inventory	45
Choosing practices to fit the land	45
A conservation farm plan	46
Preventing and controlling gullies	49
Woodland improvement.....	60
Tree planting	60
Woodland management.....	69
Terracing.....	79
Terracing and agronomic control measures	80
Hydraulics of terrace design.....	81
Velocities in terrace channels.....	82
Types of terraces	83
Planning the terrace system.....	89
Terrace specifications	96
Terrace staking, realignment, and marking.....	98
Terrace construction.....	100
Farming terraced land.....	102
Stripcropping.....	108
Rotations.....	110
Contour tillage and terraces.....	111
Liming, fertilizing, and manuring.....	112
Stubble-mulch farming.....	112
Width of strips.....	112
Grass waterways.....	113
Managing stripcropped fields.....	114
Cover crops.....	117
Soil-depleting, soil-conserving, and soil-building crops.....	121
Soil-depleting crops	121
Soil-conserving crops	122
Soil-building crops.....	123
Pasture improvement.....	126
Selecting land for pasture.....	127
Pasture on land suited for cultivation.....	127
Land that should be put in pasture.....	128
Seedbed preparation and seeding.....	129
Treatment of newly seeded pastures.....	130
Cultivating and reseeding	130
Liming and fertilizing.....	130
Controlling weeds and brush.....	131
Effect on methods and intensity of grazing.....	132
Effect of burning pastures.....	133
Drainage of pastureland.....	133
Pastures compared with harvested crops.....	133
Grazing practices and livestock management.....	135
	III

Rangeland improvement.....	137
The grazing load.....	137
Time for grazing.....	139
Rotation grazing.....	139
Grazing distribution.....	139
Reservoirs or ponds.....	141
Spring development.....	143
Wells.....	143
Reseeding.....	144
Noxious plants.....	145
Water conservation.....	147
Contour furrows.....	147
Pitting.....	148
Water spreading.....	150
Reserve feed supplies.....	151
Conservation irrigation.....	153
Wasted water, damaged land.....	154
Problems can be solved.....	155
Conservation irrigation on the farm.....	156
Irrigation methods to fit the land, crops, and water supply.....	156
Preparing land for conservation irrigation.....	163
Irrigation-distribution system on the farm.....	163
Improving the water supply.....	164
Farm drainage.....	166
How drainage helps.....	166
How land is drained.....	167
Planning a drainage system.....	168
The outlet.....	168
Surface drainage.....	169
Structures used with open ditches.....	174
Underground drainage.....	177
Constructing tile drains.....	182
Maintenance of farm drains.....	193
Conservation nurseries.....	195
Selecting nursery site.....	195
Maintaining soil fertility.....	196
Selecting suitable conservation plants.....	197
Production procedures.....	198
Winter storage of nursery stock.....	205
Grass and legume seed production.....	206

Issued June 1954

What Is Soil Erosion?

Of all the gifts of nature, none is more indispensable to man than soil. Lying over the rocky core of the earth at different depths, this complex mixture of animal, vegetable, and mineral matter is one of the four prime requisites for life. Along with sunlight, air, and water, soil nourishes all plantlife and supports human life and most animal life. Without it, this planet of ours would be as barren as the moon.

Since the dawn of time, soil has been on the move. Rain and wind have scoured away almost constantly at the earth's surface and transported soil particles from place to place. In this way stream channels have been carved out, river deltas have been built up, and whole landscapes have gradually been transformed. But under a protective cover of grass, trees, or other thick-growing vegetation, the rate of soil removal has always been exceedingly slow—no faster, generally, than the normal rate of soil creation.

This favorable soil balance prevailing under natural conditions was disturbed almost from the moment when man first started to till the earth for food. Clearing away the wild growth and breaking the ground surface with crude implements, the primitive farmer and his successors unwittingly speeded up the rate of soil removal. But farming probably went on for centuries before soil erosion became a recognizable human problem. It was only when population pressures forced the cultivation of steep slopes or unstable soils that people began to realize dimly that the earth can rapidly waste away under the impact of rain and wind.

From the vantage point of today, it seems as if the farmers of the world have done everything possible to speed the impoverishment of their productive lands. Steep hillsides have been plowed—usually straight up and down the slope. Ranges and pastures have been overburdened with great



Figure 1.—Cropland ruined by gullies. No place is left for cultivation.

herds of cattle and flocks of sheep. Fields have been planted to the same crop year after year, without protection, without replenishment. Grasslands have been ripped open and exposed to the sweep of the wind. And canals for irrigation and drainage have filled with the products of erosion—transported soil.

If we are to check this destructive use of the land we must take stock of the situation. Each field must be examined and its troubles analyzed. If the condition is serious, the assistance of specialists may be needed—agronomists and land experts to advise on the care of the land and cropping systems, geologists to help interpret the erosion conditions, and engineers to aid in planning and applying cures. The cause of the present condition of the lands, the best methods of improving them, and the outlook for the future must all be investigated. Then, having determined what is wrong, a course of treatment must be planned which will arrest the destructive erosion and bring the lands back to the most productive condition possible. Erosion-resisting or soil-building crops may be needed. It may be necessary to divert water from gullies and construct new systems of terraces and outlet ditches to take care of the runoff. On steeper slopes or seriously eroded fields a long period of rest or complete retirement from cultivation to woodland may be indicated.

Signs of soil erosion are visible to everyone, but recognition of the present and future implications is less easy. To learn what is happening to our agricultural lands we must look at erosion critically. We must differentiate between normal and accelerated erosion and must know the significance of each. Continuity of slopes on the land surface, streams with normal open channels and well adjusted to the valleys in which they flow, slow uniform downhill creep of the soil mantle, and streams and rivers flowing clear except when in flood are all signs of natural erosion—indications of a perfectly normal condition of the landscape. Quickening of the pace of erosion, owing to changes wrought by man, has produced erosion land forms and other conditions which are definitely abnormal—gullies,

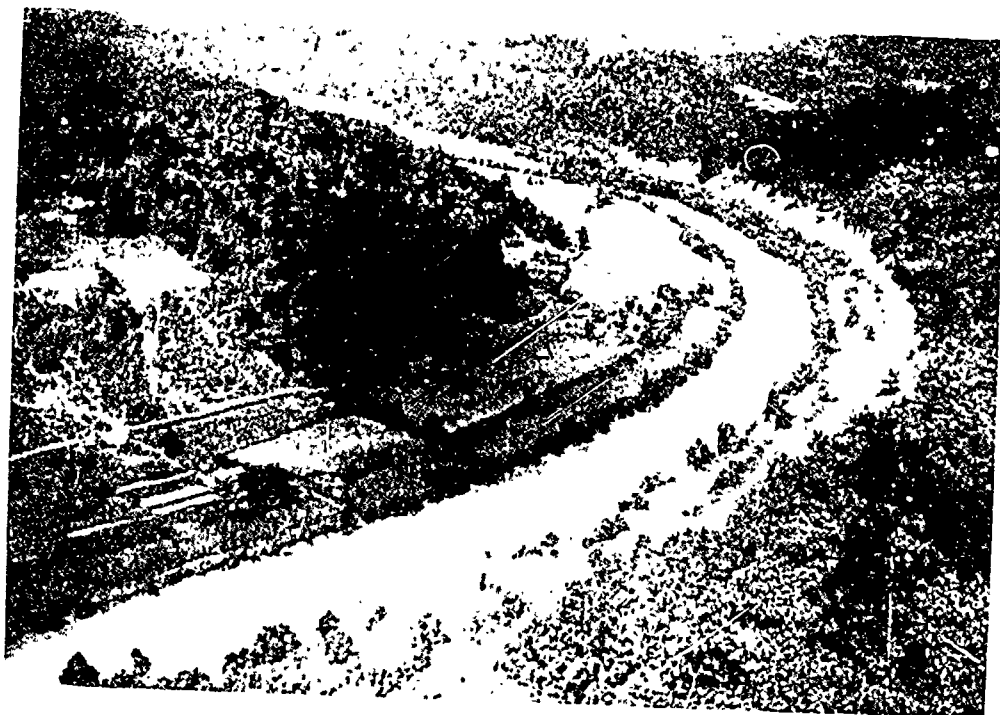

Figure 2.—Forest-clothed hills.



Figure 3.—Rolling grassy prairie.

subsoil exposed by sheet erosion, landslides, undercut highways, and reservoirs and river channels filled with silt. They are evidence of soil wastage which has already done great damage and which, unless checked, threatens to destroy our agricultural lands and means of livelihood (fig. 1).

Although the process may go on so slowly that it can scarcely be detected, soil erosion is sapping the vitality of farms everywhere, and over periods of time the loss is very great. Gullies are the most spectacular symptoms of this destruction. Starting as small rills, gullies may grow to terrifying size. Gullies even a few feet in depth interfere with cultivation and make the land less suited for pasture. Unless prompt action is taken to check growing gullies they get out of hand. Fields, farms, or whole townships may have to be abandoned.

Less obvious but no less important is sheet erosion. This form of soil erosion is particularly detrimental because it attacks the relatively rich topsoil first. Removal of a cubic yard of soil each week from an acre of land would scarcely be noticed, but if continued for 30 years, or one generation, the loss would amount to about 11 inches from the entire surface. In many parts of the world only this surface soil is suited for cultivation and when it has been lost farming can scarcely provide subsistence. Wind erosion also attacks the surface soil, blowing it away as so much dust.

Just as climate is important in determining the natural vegetation and kind of soil of any region, so climatic elements influence the rate of natural erosion. The decay and disintegration of rocks are controlled by the action of frost, heating and cooling, wetting and drying, and other conditions dependent on weather and climate. Soil and broken rock formed by weathering are carried away by the action of running water from rain and melting snow and the finer soil particles by wind. Downhill gravitational creeping and sliding movement of masses of soil and rock also occur. By these means the great constructional land forms are gradually worn down. Plateaus and mountains become so dissected by streams that their appearance is entirely changed. Erosion of soil and rock produces the destructional land forms of the earth's surface. Valleys carved by streams, rock surfaces scoured and polished by windblown sand, cliffs cut by waves, valleys deepened by moving glaciers, channels carved by underground

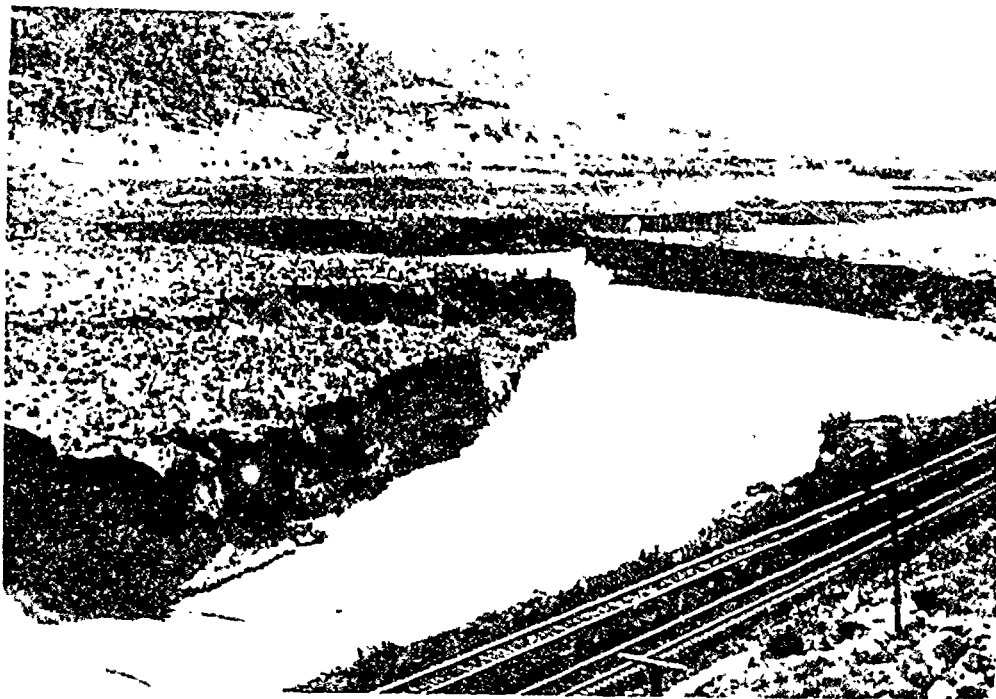

Figure 4.—Cliffs and flat-topped upland of the arroyo.

water, and depressions or scars left by landslides are a few of the common or normal erosional land forms.

Erosion has carved great canyons and broad river valleys. Mountains have been worn away by the continual wash of water. Material removed from the lands and carried by swollen rivers has filled lakes, formed broad flats along low-lying river channels, and built great deltas into the sea. Geologists have read the story of the rocks and have found that the land surface today is very different from what it was thousands of years ago. It is constantly changing.

The major elevations and depressions of the earth's surface are effects of earth disturbances on rocks of the earth's crust. Rock lies beneath us everywhere. It may outcrop at the surface as in rugged mountain areas. It may be covered by a layer of soil a few inches to many feet in thickness, or it may be concealed by a great body of water. Nonetheless the land surface is underlain everywhere at no great distance by some form of bedrock, usually consolidated.

Parts of the earth's surface have in times past been slowly uplifted from the sea and other parts gradually submerged. Parts of the continents have been pushed up to form great mountain chains and plateaus, others have been depressed to form broad valleys. Volcanoes have poured out molten lava onto the lands. Transportation of soil material by normal erosion has built up, mainly through deposition and uplift, great areas of sedimentary materials. These processes are still going on today. Earthquakes give evidence of the unrest of the earth's crust. These major movements of the earth build the great land masses. They are the constructional processes of the landscape.

The forest-clothed hills (fig. 2) and the rolling grassy prairies (fig. 3) are typical of the natural landscape of humid and subhumid regions where rainfall is adequate. Slopes are gracefully curved except in rare places where rock outcrops project through the soil cover. Valley walls slope evenly. Hilltops are rounded. Sharp angles and straight lines are unusual.

In the arid or semiarid regions the natural landscape tends to be angular. The flat floor and vertical banks of the arroyos, and steep cliffs and flat-topped uplands (fig. 4) are typical of regions deficient in precipitation. Owing to the character of the rocks and erosion processes in large areas of the world, broad flat-topped mesas or smaller buttes (fig. 5) are common land forms.

These differences between the characteristic landscapes of arid and humid regions are due in part to the protection offered by vegetation. In humid climates where a luxuriant forest or grassland normally covers the surface, soil erosion can have little effect. Much of the rainfall is absorbed, and vegetation binds the soil and protects it against the action of running water or wind.

Plowing up the natural sod and cutting or burning down the forests expose the soil to the destructive processes (fig. 6).

The Badlands are typical of land forms produced, under certain geologic conditions, in semiarid and arid climates where millions of gullies eat their way headward immediately after rains (fig. 7).

The farmland in figure 8 shows badland topography developed by accelerated erosion in a humid region having an annual rainfall of 35 to 50 inches. The hillside in the background is in the early stages of destruction. The sod cover has been broken. Sheet wash and rilling have removed the fertile topsoil, and gullies are now developing. In the flatter area at the base of the hill, sod-capped remnants of the old surface are still present but are steadily being undermined by gulying. The subsoil and parent material exposed within the gully are of low fertility. Slopes of the walls are so steep that vegetation would have difficulty gaining a foothold. Erosion is progressing so rapidly that few plants can maintain themselves on the gully floor. Soil and rock washed from this area have covered fields lower on the slope to a depth of 3 to 4 feet.

Unless precautionary measures are taken, hillsides like this one may develop into badlands.

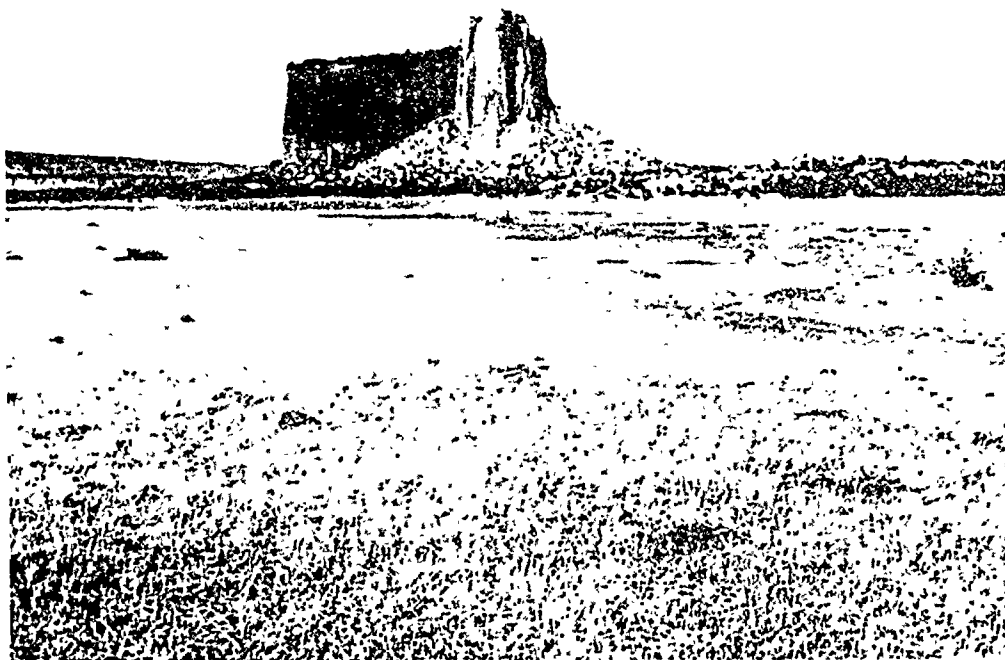

Figure 5.—A view of a butte caused by the erosion processes.



Figure 6.—This recently cutover hillside will become severely eroded unless care is given the land.

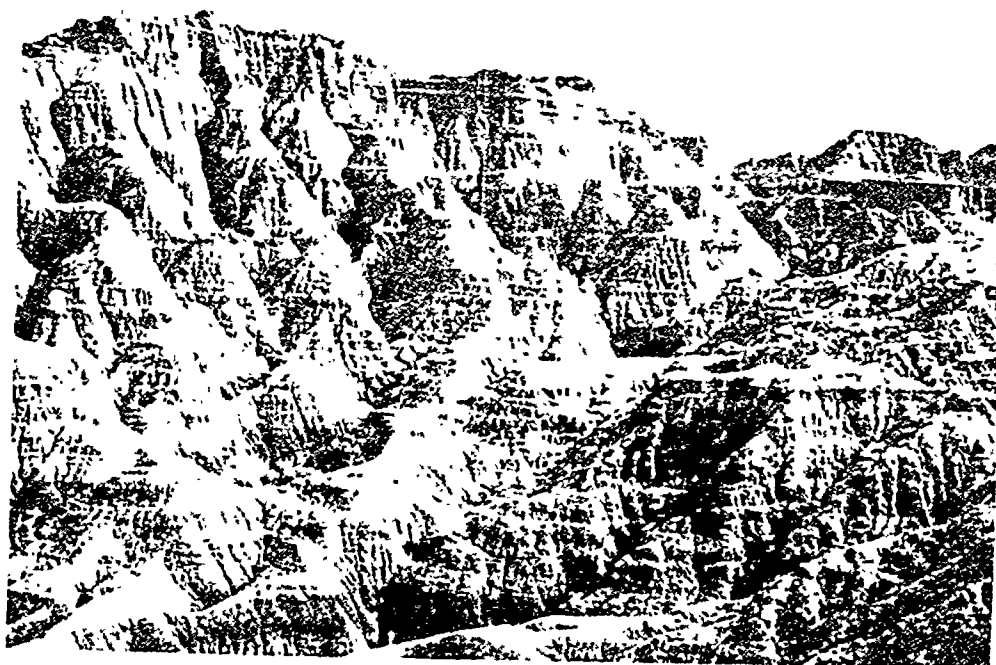

Figure 7.—The Badlands are typical of land forms produced under certain conditions of geology.

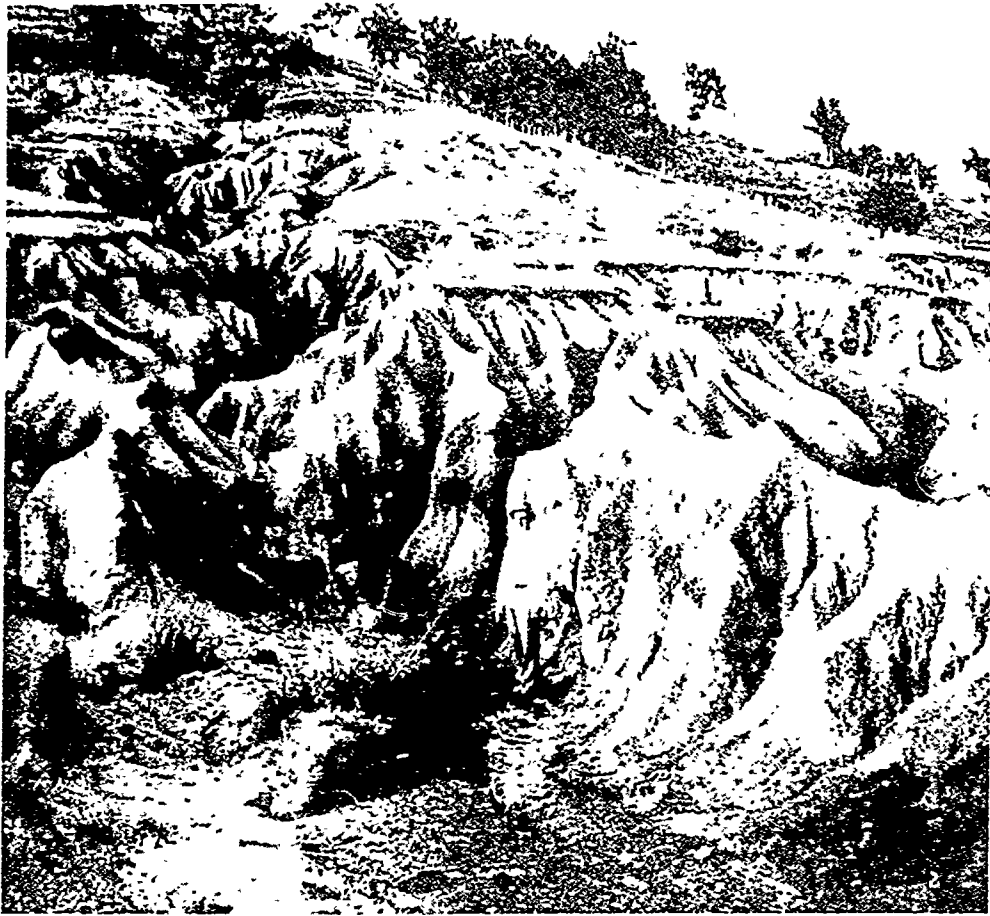

Figure 8.—This farmland shows badland topography developed by accelerated erosion in the humid region.

Erosion by Rainfall and Running Water

Where heavy rain falls on thick sod or on the plant litter of a forest floor the force of the fall is broken by the vegetative cover. Part of the water is absorbed by the vegetation, part evaporates, and part soaks into the ground where it is available for future use by plants. There is little or no surface runoff, and washing or erosion of the soil is almost negligible.

Rain falling on clean-cultivated fields or on bare spots in hillside pastures stirs up the unprotected soil. During heavy showers thin sheets of water muddied by suspended earthy material flow across these unprotected surfaces. On slopes, clay and silt transported by this sheet wash tend to seal the pores of the soil and the openings into the soil made by plant roots and insects to form a crust. Little water soaks into the ground.

True sheet wash follows no definite channels. Water tends to concentrate its flow, however, and small drainageways soon develop. Unless the area is soon protected by vegetation or is smoothed over by cultivation the channels continue to grow with each successive rain. They may increase in size and form gullies too large to be smoothed over by normal tillage.

The large volume of material which can be removed from a field by sheet wash and cutting is also shown by the amount of sand and silt that often accumulates at the lower side of sloping fields after a hard rain.

Gullies may develop from rills in cultivated fields, ruts in roadways, cattle trails, ditches, improperly constructed terrace outlets, or other



Figure 9.—In this hardwood forest there is little underbrush, but dead leaves form a thick covering over the ground.

depressions along which running water is concentrated. Recurring flows of water remove from the floor the material washed or fallen into the gully, and thus gradually deepen the channel. Caving and slumping of the gully walls increase the width, and flow of water from tributaries helps develop side channels which eat into adjoining areas.

Starting as a small channel across which a man can step, a gully may rapidly increase in size until it is large enough to hide a cow, a horse, or even houses. Their depth and the rate of cutting are determined in large part by geologic conditions, particularly the thickness of the soil profile or depth to hard bedrock, the softness of the subsurface materials, the gradient of the gully floor, and the amount of material transported by the stream in the gully. Gullies in some areas can cut downward only a few feet before encountering firm, resistant rock.

If the flow of water through a gully is large and the debris load small, the water can cut into the floor and pick up additional material. If the water is heavily loaded with solid matter, it may actually deposit and raise the level of the gully floor. Deposition is encouraged by vegetation, dams, or other obstructions which help check the velocity of the water.

Streams have always been active agents of erosion but have become still more violent owing to changes which man has brought about. Removal of natural vegetation has increased the proportion of the water which runs off during or immediately after a rain.

Streams in mountainous or hilly areas ordinarily flow at a high gradient in narrow steep-sided valleys. They are vigorous and actively erode the bottoms of their channels. In less rugged areas where the lands have been worn down through the ages the streams and rivers flow in flat-bottomed valleys with broad flood plains. Here cutting is largely sideward and the

streams swing or meander from one side of the valley to the other, broadening the flood plain and eroding away the banks. Undercutting by streams causes caving and slumping from the banks, and lands adjoining the stream are gradually eroded away. Cutting out of brush or other vegetation along the banks of a stream increases the danger by removing this protection from the stream's banks.

Part of the rainfall enters the ground and percolates through pores in the soil and crevices in the rocks. It carries downward the finer soil particles and dissolves soluble materials such as limestone. Water entering the ground through cracks which open parallel to a gully margin and through holes made by burrowing animals or decayed plant roots sometimes causes the collapse of large blocks of the gully wall.

The type of soil erosion in any region and the differences in erosion at different seasons of the year depend in part on the character of the rainfall. Intense rains give a larger proportion of immediate surface runoff than do slow drizzles. Although the intense rains usually last but a short time and cover only small areas, it is these rains that cause the greatest amount of sheet erosion and gullyng.

Rain falling in a forest has the force of the fall broken by the leaves of the trees, and the rain dripping from the trees falls on the vegetative litter formed by dead leaves and is absorbed. In normal rains there would be little or no surface runoff from forests such as that in figure 9. Thanks to the abundant vegetative mold the soil is open and porous. Water enters the ground easily and is stored for use in drought. Even in the heaviest downpours, water flows over the surface slowly. It is clear because it carries little or no sediment. Under natural forest conditions soil is not only held in place but is usually well supplied with organic matter.

The woodlot in figure 10 shows a markedly different condition. The amount of vegetative litter is small because of heavy overgrazing, and



Figure 10.—Lack of humus protection in this woodlot has allowed all the topsoil and several feet of the subsoil to wash away and expose the roots of the trees.

the animals have kept the underbrush cropped or trampled down. Lack of humus protection has allowed the topsoil and several feet of subsoil to wash away leaving the roots of the trees exposed. Runoff is rapid; water has little opportunity to soak into the ground because there is no longer an absorbent and protective cover of leaf litter. The loose-textured topsoil has been completely removed, and the subsoil which is now exposed absorbs water slowly and washes away easily. Streams of water flowing from this woodlot are discolored with eroded soil. Water runs off the surface rapidly, and little is stored in the soil for the use of the trees during drought periods.

Rain falling on a tight sod cover is absorbed rapidly and very little is lost as surface runoff. On the left side of the fence in the pasture in figure 11 there is a good grass cover due to wise range management. The pasture at the right has been overgrazed by sheep or cattle. Growth is sparse and the vegetation is inferior. Many bare spots are visible.

Everything favors the land at the left. More water is retained owing to slower runoff; therefore better growth of grass is made possible. There is little chance for water to concentrate in channels and cut rills or gullies; there are no bare spots where the wind can blow the soil away.

The hog lot and its surroundings in figure 12 show extreme differences in erosion due to different land use. Trampling and rooting in the area at the left have completely denuded the soil. Sheet erosion and rill cutting have carried away the more productive upper layer, and a gully is now dissecting the land still further. During dry periods wind erosion takes its toll. Grass and weeds provide good protection for the soil to the right of the fence. When such protection is removed, whether by hogs or goats, cattle or horses, the wasting effects are the same.

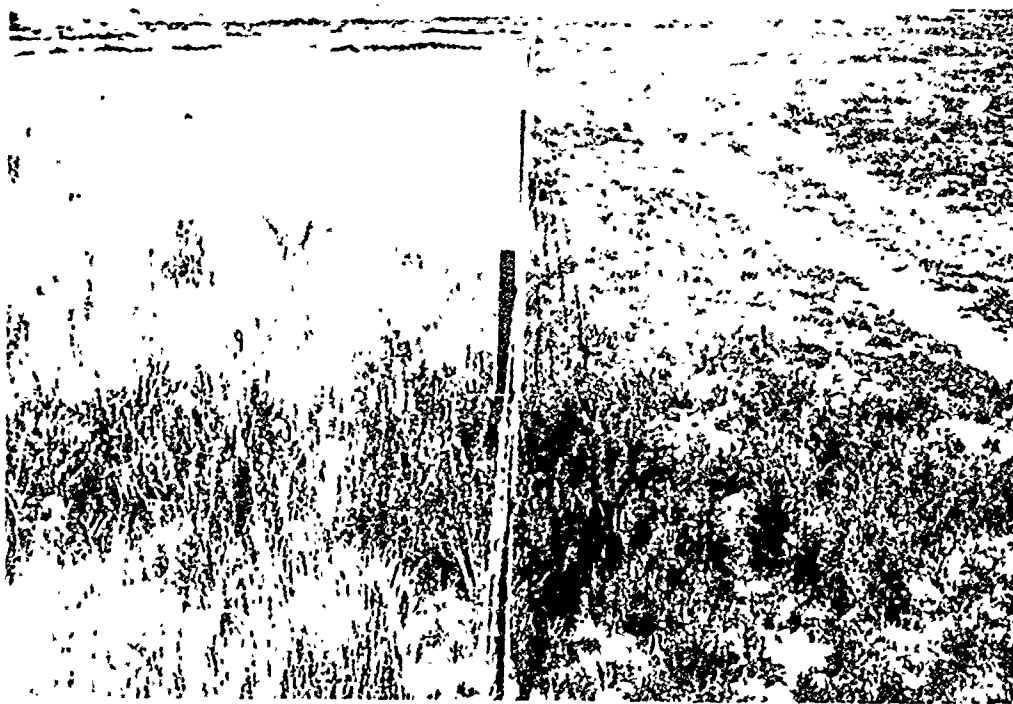

Figure 11.—On the left side of the fence the pasture has a good grass cover and will lose little rainfall as runoff; on the right, the pasture has been overgrazed.



Figure 12.—Trampling and rooting in the area at the left completely denuded the soil; at the right of the fence, the soil is protected by grass and weeds.

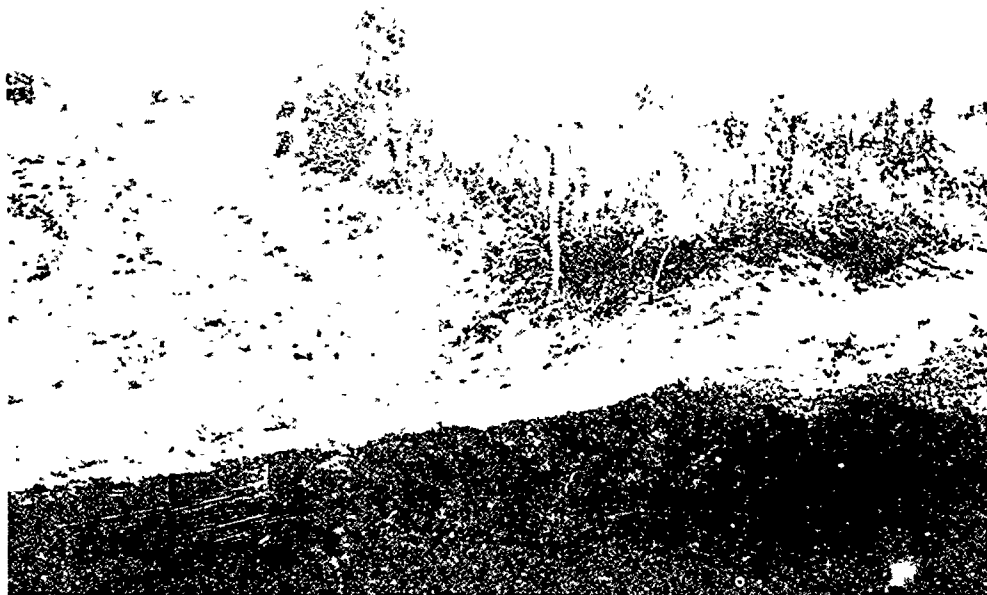

Figure 13.—A scarp almost $1\frac{1}{2}$ feet high divides the cottonfield at the left from the strip of sod along the road. Field study shows that beneath the sod the soil has been protected, and there is still a layer of topsoil (or A horizon) several inches thick. Although the cottonfield is contour tilled and contains old terraces, the topsoil has been removed and erosion has cut far down into the subsoil (B horizon). In the foreground is a wall of a gully 20 feet deep, tributaries of which are gradually eating back into the field.

Where there is an abrupt change in land use and erosion along a property line, cooperation between farmers is needed to check the destruction. Unless preventive measures are taken on the barren land in figure 12, the gully and rills will eat headward onto the higher plot at the right. Under other circumstances water concentrated on one property may cause gullying in adjoining lands further downhill. Study of the work of running water and the development of gullies shows that neighborly cooperation over a wide area is essential for the success of soil-conserving measures.

Rapid sheet erosion due to human use often results in marked wearing down of the land (figs. 13 and 14). In this way a single field, or a whole farm or ranch, may be eroded to a level several feet below its surroundings.

Figure 15 makes apparent that even a short stubble gives some protection from wind erosion. The wind has carried all the loose soil off the unprotected sandy cropland to the right. Sorghum stubble though too short to prevent blowing has given some protection to the field to the left.

Where running water concentrates in furrows or minor channels, the scouring action of the water is accentuated and rills tend to form. Prominent rills may develop in one season or even in a single rain (fig. 16). Rills form also in smooth surfaces, by some such accidental cause as deflection of the runoff, by a clod or rock or piece of stubble, and this deflected current develops enough turbulence to start soil cutting. Unless preventive measures are taken rills enlarge into gullies (figs. 17-19). The size to which these will grow depends on many factors.

The development of a valley within a valley is recognized by geologists as an indication of an increased rate of erosion (fig. 20).

Increase in the rate of runoff of rainwater and melted snow due to man's unwise use of the land has resulted in greater floods and increased deposition of sediment on bottom lands. Soil removed by sheet erosion and gully

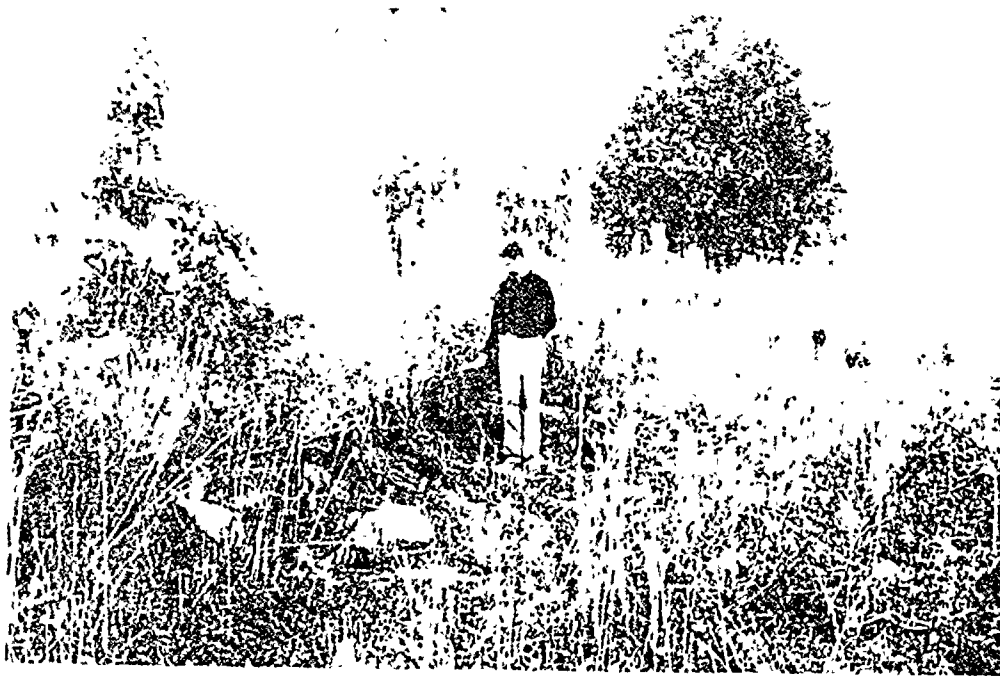

Figure 14.—This shows a property-line fence. The farmer owning the land at the left has practiced soil-conserving measures and has retained most of the original soil. Water erosion has removed 2½ feet of soil from the land at the right.



Figure 15.—Wind erosion carried away the soil on the right and piled drifts 3 to 5 feet deep in the road. Sorghum stubble gave some protection to field on the left.



Figure 16.—This area shows the effects of one 40-minute rain. The land has been plowed for summer fallow and tilled once. Note that the minor rills are roughly parallel to the direction of cultivation. Part of the eroded material was deposited in the major channel in the left foreground. Even on this gentle slope, contour tillage would have helped to prevent erosion.



Figure 17.—These gullies are about 3 feet deep but are not likely to enlarge rapidly. Because of loose rock in the soil and outcrops of bedrock at several places in the bottom of these gullies, downcutting will be slow, but the channels may broaden. Even if gully erosion never cuts deep into the hillside, serious damage will result because removal of the shallow soil leaves only useless bedrock.



Figure 18.—The pattern of rills and gullies on this hillside is typical of the rapidly eroding Palouse silt loam and other similar types of land.



Figure 19.—Under natural conditions this rangeland would support a good growth of bunchgrass. The area has been seriously overgrazed, however, and now little cover is left. The resulting accelerated runoff has cut a large gully in the valley floor.



Figure 20.—In the bottom of an old valley a narrow gully 15 feet deep has developed. Almost 6 feet of the gully depth was cut out in a single winter.



Figure 21.—Sand and silt are piled over the fertile soils in this valley.



Figure 22.—The farmer has already started clearing the sand and silt out of his house. He can dig out his damaged farm machinery, but the deposited material destroys his crop and is an irreparable loss to the land from which it came.

cutting is carried downstream by the heavily loaded floodwaters and dropped wherever the current slackens. Much sand and silt are piled over fertile soils of river flood plains (fig. 21). Thin layers of silt are sometimes of benefit, but thick deposits of sand practically ruin much agricultural land (fig. 22).

Erosion by Wind

Wind erosion is serious in areas where there is not enough vegetation to cover and protect the soil. This is the natural condition in arid lands and along the sand shores of lakes, oceans, and rivers. It is also a common feature on cultivated loose sands anywhere. Sand dunes are common landforms in such places, and storms of blowing sand have long been a danger to caravans and inhabitants of desert regions.

Protection against such damage is best accomplished by the maintenance of a good vegetative cover on the soil. Wind erosion, like sheet erosion, acts over a broad area and cannot operate where there is thick sod or natural forest cover or a cover of vegetative litter. Once sand accumulates into shifting dunes, means must be used to check the movement so that vegetation can gain a foothold. Selected grasses and trees can then be planted to provide permanent anchorage for the loose material. Sometimes it will be necessary to drive stakes into the ground or to pile vegetative litter over the ground to permit the delicate seedlings to get a start against the wind. In some places it has even been necessary to sow weeds in order to help get the desired plants started.

Sandhills, or sand dunes, are common features of the landscape on ocean fronts and along many lakes and rivers. Dunes which are bare of vegetation are active and free to move with the shifting winds. Sand is blown up one side then spills over the crest, where there usually is a steep slope. In this way, a dune may move many feet in a single severe windstorm.

Large dunes are very destructive when they invade areas of valuable land, buildings, crops, or forests (fig. 23). Sand dunes in the past have buried forests, houses, churches, and whole villages, some of which have been uncovered many years later when a shift in the wind during a few storms has caused the sand to blow in another direction. Planting suitable grasses or other drought-resisting vegetation on dunes will often prevent



Figure 23.—This dune is moving toward the trees at the left. If it continues, the sand may completely cover the forest.



Figure 24.—The boards of these portable sand fences can be raised as the sand accumulates on coastal dunes.



Figure 25 —Use of brush barriers to control the movement of sand dunes along a lakeshore. In the background is an old stabilized area on which vegetation is well established.



Figure 26.—The sand dunes lie on a broad flat along the side of a river. Before 1890 there was no extensive sand plain there. Now, owing to overgrazing, the sand piles high and blowing such as that in the background occurs frequently.

shifting. Lines of stakes, brush, and other obstructions are sometimes used to cause deposition of the sand in drifts, thus preventing it from blowing onto valuable property (figs. 24 and 25).

It has already been shown how overgrazing and devegetation increase erosion. Sand and silt thus produced wash into the rivers, and increase their load. In arid and semiarid regions there is seldom enough water to handle the added burden. Sand flats are formed along the river and the bare sand is readily moved by the winds (fig. 26).

Where there is no covering vegetation and but little moisture in the ground, the bare soil is at the mercy of the winds. Unprotected fine-grained topsoil blows easily when loose and dry and can be carried greater distances. It fills the air, clouding the sun for days, giving a weird character to the light. In heavy blows, or "dusters," the fine soil gets into everything. Tightly closed houses are not adequate protection. The blowing sand is choking and blinding to animal and human alike.

The Plains in the United States have suffered heavily in severe drought years. In the areas from which the loose material, as plowed land, is blown there may be nothing left but hard subsoil (fig. 27).

Congregation of livestock causes excessive grazing and trampling of the vegetation. In years of normal precipitation grass protects the soil. In periods of drought the resistance of the grass is lowered, and the trampling and grazing of animals collecting around the available water cause much of the grass to die (fig. 28). The bare soil is then exposed to the action of the wind. Once started, erosion goes faster as vegetation is cut away or buried by the shifting sands. The grass-covered mounds in figure 28 are remnants of the original surface and show the thickness of topsoil and subsoil which have been eroded.

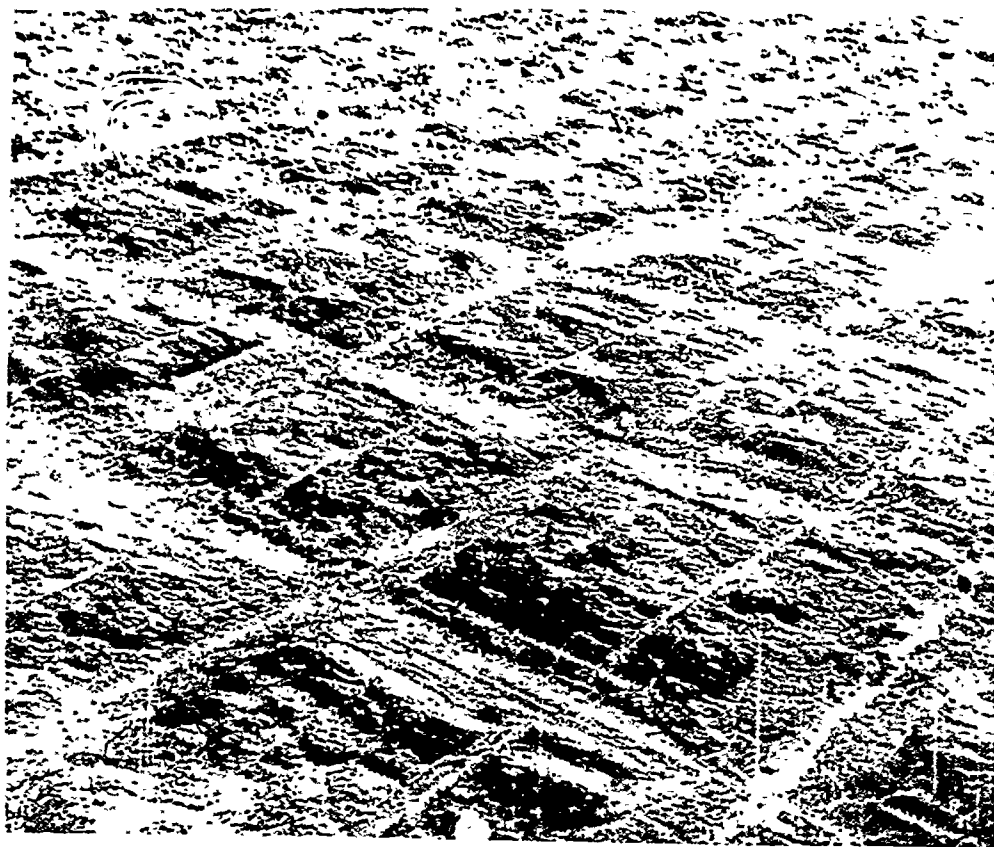

Figure 27.—This field was stripped down to the depth of cultivation as is shown by the intersecting pattern of plow marks.



Figure 28.—Concentration of livestock around the watering places kills the vegetation. Hollows are blown out by wind erosion. Areas where the vegetation holds in time stand out as hummocks.

Wind erosion lowers the productive value of land from which the soil is removed and, if the blowing material is sandy, its accumulation on farmlands elsewhere is usually detrimental. Neither the place of origin nor of deposition benefits by wind erosion.

Erosion—Past, Present, and Future

Looking into the past we see the continuous working of geologic erosion. It has worn away and sculptured the surface of the earth since time immemorial and is a process of nature which has formed the landscape as we know it today. Natural erosion is a sign of a normal condition of the landscape. The process acts steadily but so slowly that ages are required for it to make any marked alterations in the major features of the earth's surface. And during the ages there doubtless were differing climatic conditions affecting rates of erosion.

The great canyon known as the Grand Canyon of the Colorado is so beautiful that it has been set aside for public enjoyment (fig. 29). Early in its history it probably was little different from hundreds of other small valleys in the same region. Age-long erosion has carved this tremendous gorge by abrading out each day and each year a little more rock and soil from the area, which once was a continuous level plateau.

And yet the Grand Canyon is still growing. The chasm is deep and the sides slope steeply. Rock and soil are constantly falling and washing from the walls down into the canyon and being carried downstream. The river is always heavily loaded with sediment.

As these same processes of erosion are continued on into the future the canyon will steadily become broader. Tributaries will cut farther back into the level upland. The valley walls will become less steep and the erosive processes will gradually become slower. In distant ages to come the canyon will widen probably to 2, 5, or 10 or more times its present width. Instead of a deep narrow trench across a level plateau there will be a broad open valley and the distance from the river to the rim of the upland may be farther than the eye can see.

Natural or geologic erosion is a continuing process and will go on into the future regardless of anything man may do. Soil erosion that we are so seriously concerned with is an abnormal and undesirable process started by man's activities and subject to his control. Whether this soil wastage is to be allowed to continue rests with the landowners and producers and consumers of foodstuffs, and with the soil conservationists, agronomists, geologists, foresters, engineers, and others who may be called in to help prescribe a cure and carry on the treatment. Unchecked erosion produces poverty and undermines the strength of nations. Land must be conserved, while being used, not depleted—the soil saved by holding it in the fields. To accomplish this we must work hand in hand with nature, and use strategy based on knowledge of the natural processes rather than waste our efforts on needless procedures.

It has become clear enough that soil erosion is one of the world's most pressing problems. Already it has ruined millions of acres of formerly cultivated land and reduced other millions to a definitely submarginal condition. As matters now stand, we no longer have too much good land left. Some countries do not have enough. Furthermore, the greater part of our good-quality cropland is continually losing soil under prevailing methods of use. In short, unless we adequately safeguard our area of good land we may eventually face a serious shortage.



Figure 29.—The Grand Canyon of the Colorado River in Arizona—an awe-inspiring example of the work of natural erosion on the landscape.

On any given farm the effects of erosion are sometimes slow in appearing, depending on the physical characteristics of the land and the way the land is used. But sooner or later, crop yields begin to decline as the more productive top layers of soil are removed. At the same time, plowing frequently becomes a more difficult and more expensive job owing to the formation of gullies or the exposure of heavy subsoil resistant to tillage. Such soil-stripped land requires more fertilizer or manure and more rainfall in order to produce rewardingly. In short, as erosion advances, the whole job of farming becomes at once more difficult, more costly, and less profitable, and eventually it becomes impracticable or impossible.

In terms of the individual farmer alone, this situation is bad enough. But when it is multiplied thousands of times across a country, a problem develops which adversely affects the entire structure of a nation's social and economic life. Almost without exception, farm people on severely eroded lands are "ill-fed, ill-clad, and ill-housed;" they make poor risks for banks and lending companies, are poor customers for industry and business.

The chief objective of soil conservation is to promote control of soil erosion and better use of farm and range lands over the widest possible area. Accomplishments to date show clearly that farmers can make their fields permanent and their lives and occupations more secure if they have the will, the energy, and the necessary technical assistance.

Since all people, whether farmers or residents of cities, are utterly dependent on the continuing productivity of the land for the substance of life, soil conservation is the concern and responsibility of all people everywhere.

Classifying Land Capability

To make a sound and complete farm-conservation plan, two sets of facts are needed. One is an inventory of the land, which is most conveniently recorded on a map. The other has to do with facts about the farm business—available facilities, etc. On rangelands it is necessary to know the carrying capacity of each acre.

Soil conservation technicians have discovered that the land inventory, in order to meet the needs for planning conservation farming, must be more than a soil map, erosion map, or a slope map; and yet it must be simple. It must show clearly the adjustments that are needed. It must be sufficiently detailed to allow separate treatments field by field or acre by acre if necessary. It was in response to these needs that the method of classifying land capability was developed.

Land capability has to do with the suitability of land for specified uses. Farmland as a rule is used either for the production of crops requiring tillage or for some form of permanent vegetation (usually grass, other forage plants, or timber) requiring little or no tillage. In classifying land capability, answers to these questions are first sought: Is the land suited for the production of crops? Can it be cultivated without soil erosion? Is its safe and permanent use limited to the production of perennial vegetation?

Probably most farmers have made at one time or another in their own minds some kind of classification of the capability of their land. They know that some fields can be used for cultivated crops and that others are too steep, too stony, too thin, or too wet, for cropping. They know that some of their fields which are unsuited to cultivation make good pasture, and that still others are most productive if planted to trees. In a general way they know these outstanding facts about their land although probably they have never made a map of their farms nor even expressed all of these ideas in words.

Many farmers, however, have failed to realize fully that steeply sloping land cannot be farmed safely with level-land methods. They have plowed straight furrows and planted straight rows rather than change their farming to fit the land. This makes some of the rows run uphill and downhill, and every rain falling on an unprotected slope removes part of the soil. A few farmers, watching muddy water flow from their fields, have appreciated how valuable and how irreplaceable their thin layer of topsoil really is and have taken steps to check this kind of waste. But losses of soil for the most part come about so gradually that they are not fully realized. Farming habits, like any others, are difficult to change; moreover, precise recommendations for soil-saving measures have not been generally available to farmers. Therefore, it is not surprising that in the past farmers in classifying their land for use more often than not have neglected to consider the full significance of soil erosion.

Use and conservation of land are influenced by the nature of the soil, the degree to which it has been affected by erosion, the slope, the wetness of the soil or its droughtiness, and the climate. The climate must be considered because it affects the crops that can be grown and the density of vegetation, both of which help to determine the need for and the possibility of erosion control and water conservation.

Any one of these factors, or several of them together, may limit the possible use of land. The rate of soil erosion depends on several properties,

as soil, vegetative cover, climate, and steepness of slope. On some soils erodibility on critical slopes is the deciding factor in setting up classes of land suited for cultivation. On others, the combined influence of a high water table and low fertility may be dominant.

Facts Obtained in the Field

The only dependable way of determining the capability of land is to make a careful examination of it in the field. This is done by soil scientists who walk over the ground, bore or dig holes in the soil, and determine its depth, texture, permeability, available moisture capacity, inherent fertility, organic-matter content, and other characteristics that affect the use, management, and treatment of the land (fig. 30). They measure the slope, determine the degree of soil loss by erosion, the overflow hazards, the wetness of the land, and other significant characteristics. They note also the present use of the land. These facts are recorded on aerial photographs for later use by farmers and others.

Significant Variations in Land Features

The factors used in mapping land are characterized by differences that significantly affect conservation practices, use suitability, crop yields, and management requirements. In interpreting what the land can do and what it needs, each of these land characteristics is considered in relation to all others.

The land characteristics and those significant ranges of each that have been found most generally to be meaningful are given below:

Effective depth of soil (as depth over rock, tough clay, or hardpan):
Very deep, 60 inches or more; deep, 36-60; moderately deep, 20-36; shallow, 10-20; very shallow, 0-10.

Texture of surface soil (fineness of constituent particles): Very heavy (heavy clay; 60 percent or more 2-micron clay particles); heavy (clay, silty clay, sandy clay); moderately heavy (silty clay loam, clay loam, sandy clay loam); medium (silt loam, loam, very fine sandy loam); moderately light (sandy loam, fine sandy loam); light (loamy fine sand, loamy sand); very light (sand, coarse sand).

Permeability of subsoil: Very slow (less than 0.05 inch of water percolation per hour); slow (0.05-0.20); moderately slow (0.20-0.80); moderate (0.80-2.50); moderately rapid (2.50-5.00); rapid (5.00-10.00); very rapid (10.00 or more).

Permeability of substratum: Very slow (less than 0.05 inch of water percolation per hour); slow (0.05-0.20); moderately slow (0.20-0.80); moderate (0.80-2.50); moderately rapid (2.50-5.00); rapid (5.00-10.00); very rapid (10.00 or more).

Thickness of surface soil: Thin (0-6 inches); moderately thick (6-12); thick (12-24); very thick (24-36).

Available moisture capacity (inches of absorbed water per 60 inches of soil depth): Very high (12 inches or more); high (9-12); moderate (6-9); low (3-6); very low (less than 3).

Reaction: Acid (6.5 pH or less); neutral (6.6-7.3 pH); alkaline (7.4 pH or more).

Natural soil drainage: Well drained (well oxidized and free from mottling of colors in surface and subsoil); moderately well drained



Figure 30.—A soil surveyor studying the soil brought up on an auger to determine the color and texture of the subsoil. He also studies soil layers in road cuts and excavations. He records his findings on an aerial photograph of the land.

(well oxidized and free from mottling except in lower part of subsoil); imperfectly drained or somewhat poorly drained (well oxidized surface, subsoil mottled); poor; drained (gray color, mottling in surface and subsoil); very poorly drained (dark surface soil and gray or mottled subsoil).

Inherent fertility: High; moderate; low; very low.

Organic content: High; medium; low.

Slope: Nearly level; gently sloping; moderately sloping; strongly sloping; steep; very steep.

Erosion: No apparent or slight; moderate; severe; very severe; very severely gullied land.

Wetness: Slightly wet (growth of crops slightly affected or planting dates delayed for brief periods, as less than a week); moderately wet (growth of crops moderately affected or planting dates delayed by a week or so); very wet (growth of crops seriously affected, or planting delayed as much as a month or more); extremely wet (swamp, marsh, too wet for cultivated crops or improved pastures).

Salinity: Slight (crop yields slightly affected or range of crops slightly limited); moderate (crop yields moderately affected, or range of crops moderately limited); severe (crop yields seriously affected, or range of crops severely restricted); very severe (growth of useful vegetation prohibited except some salt-tolerant forms).

Frequency of overflow: Occasional overflows, or overflows of short duration (crops occasionally damaged, or planting dates delayed); frequent damaging overflows, or overflows of long duration (crops

frequently damaged, or range of crops limited); very frequent overflows, or overflows of very long duration (not feasible for cultivated crops).

With these facts and a knowledge of the climate of the area, the land can be classified according to its capability—its ability to produce permanently under specified uses and treatments.

For each area, one or more soil conservationists, combining the techniques of soil science, plant technology, engineering, and biology, and working with local farmers together determine how the land should be used and the practices needed for each kind of land. The facts recorded on the land map, research findings, and all technical information are joined with practical farm experience in classifying the land and in working out the right combination of practices to make full use, without waste, of the land resources.

The Classification Scheme

The land-capability classification is a systematic arrangement of different kinds of land according to those properties that determine the ability of the land to produce on a virtually permanent basis. Suitability for cultivation is assumed to include the use of machinery—at least of plows, tillage implements, and harvesting equipment—and the capacity for at least a moderate yield of one or more crops with suitable treatment and protective measures. The restrictions imposed by natural land characteristics necessarily affects (a) the number and complexity of the corrective practices to be used; (b) the productivity of the land; and (c) the intensity and manner of land use—for example, the choice of crops on cropland or the amount and season of use on grazing land.

The classification is made and used for practical purposes, which is the selection and application of land uses and treatments that will, while using the land, keep it in condition for longtime production. The latter will involve control of erosion, conservation of rainfall, and maintenance.

The classification is arranged according to a number of categories.

The first category covers land suited for cultivation and land not suited for cultivation.

The second category covers the eight land-capability classes. Four are suited for cultivation and four are not. The classes under this category are differentiated according to the degree of limitations in land use imposed by the nature of the land itself.

Land-Capability Classes

The eight land-capability classes range from the best and most easily farmed land (class I) to land which has no value for cultivation, grazing, or forestry, but may be suited for wildlife, recreation, or for watershed protection (class VIII). They all fall into the two broad groups of land, one suited for cultivation, the other not suited for cultivation.

Classes I, II, and III include land suited for regular cultivation. Class I land is very good nearly level land, with deep, easily worked soils that can be cultivated safely with ordinary good farming methods. Class II land is good but it has some limitations. It needs moderately intensive treatment if it is to be cultivated safely. Such treatment, for example, may be contouring and cover cropping to control erosion, or simple water-management operations to conserve rainfall. Class III land is moderately good

Table 1.—Outline of the land-capability classification

Land use suitability (broad grouping)	Land-capability class (degree of limitations for use)	Land-capability subclass (grouped according to kind of limitation, shows examples only)	Land-capability unit (land-management groups based on physical characteristics, shows examples only)
Suited for cultivation	I Few limitations. Wide latitude for use. Very good land. (Green on colored map). II Moderate limitations in use. Good land (Yellow). III Severe limitations in use. Regular cultivation possible if hazards are provided against. Moderately good land. (Red). IV Very severe limitations in use. Suited for occasional cultivation or for some kind of limited cultivation. (Blue).	c Use is limited by moderate hazards of water or wind erosion. c Climate. w Use is limited by excess water; drainage needed for cultivation. s Use is limited by low water-holding capacity or by low plant-nutrient content.	Moderately sloping, slightly acid soils on limestone. Moderately sloping, highly acid soils on sandstone or shale. Imperfectly drained acid soils. Poorly drained neutral soils. Sandy, rapidly permeable soils.
Not suited for cultivation	V Not suited for cultivation because of wetness, stoniness, overflows, etc. Few limitations on use for grazing or forestry. (Dark green). VI Too steep, stony, dry, wet, etc., for cultivation. Moderate limitations on use for grazing or forestry. (Orange). VII Very steep, rough, dry, wet, etc. Severe limitations on use for grazing or forestry. (Brown). VIII Extremely rough, dry, swampy, etc. Not suited for cultivation, grazing, or forestry. Suited for wildlife, watershed protection, or recreation. (Purple).	Grouping of sites according to kind of limitation.	Sites significant in management of ranges, pastures, forests, etc.

and can be used for cultivated crops regularly in a good rotation, if plowed on the contour on sloping fields. It has limitations of such degree that intensive treatment is necessary. The treatment may be terracing or strip-cropping to control erosion, or intensive water management on flat, wet areas.

Class IV is fairly good land, but its safe cropping use is very limited by natural features such as slope, erosion, adverse soil characteristics, or adverse climate. As a rule its best use is for pasture or hay, but some of it may be cultivated occasionally with proper safeguards.

Classes V, VI, and VII are not suited for any cultivation but may be used for grazing or forestry, according to adaptability. Class V land has few natural limitations for such uses, and needs only good management. Class VI needs protective measures, usually because of slope or shallow soil. Class VII needs extreme care to overcome or cope with its major limitations, which usually are steep slope, very shallow soil, or other very unfavorable features.

Class VIII land is suited for wildlife, recreation, or watershed protection. It is usually characterized by such features as extreme steepness, roughness, stoniness, wetness, sandiness, or erodibility. These characteristics make it unfit for any safe or economical cultivation, grazing, or forestry.

An outline of the land-capability classification is shown in table 1.

Subclasses and Units

The eight land-capability classes cover a simple land classification useful for many purposes. They are not detailed enough, however, for many specific recommendations about management and treatment of land. These eight classes are distinguished from each other by inherent, durable land characteristics. Each of the eight classes is determined by the degree to which the land characteristics represent longtime limitations on land use. Each land-capability class includes a specified range in degree of its natural limitations with respect to use.

The subclasses represent convenient groupings of subordinate characteristics. A land-capability class is determined by the degree of limitations in land use, together with the hazards involved. Within a given land-capability class the subclasses are determined by the kind of limitation. For example, within class III land, suited for cultivation but subject to severe hazards, most frequently we have sloping land subject to water erosion, but we also have smooth land subject to wind erosion and wet land that produces crops only if drains are installed and maintained.

Within each subclass the land that is suited for essentially the same kind of management and the same kind of conservation treatment is designated as a land-capability unit. A land-capability unit is essentially uniform in all major characteristics that affect its management and conservation. It is the smallest unit recognized in the land-capability classification, although greater detail may be recognized for some local purposes in mapping.

Table 1 shows the relation of the different categories to each other. It gives the eight land-capability classes and examples of the subclasses and units.

The eight land-capability classes are indicated on maps by Roman numerals I to VIII, or by standard colors, or by both. The Roman numerals and the standard colors are uniform on a nationwide basis. Subclasses are designated by lowercase letters, and land-capability units by ordinary numerals, as IIc1 and IIc2.

The eight land classes express degree of usefulness. The subclasses express kinds of limitations within each class; and the units, divisions of the subclasses, are practical groupings for use and treatment of the land.

The four subclasses, which may be recognized in most of the land-capability classes, except class I, are:

- e. Land dominantly subject to wind or water erosion, or both.
- w. Land subject to presence of excess wetness or to overflow.
- s. Land limited chiefly by soil conditions, such as excessive sandy texture, excess of gravel or stones, or shallow depth.
- c. Land limited chiefly by climate, either inadequate precipitation or low temperature.

Land Suited for Cultivation

Class I land

Class I is very good land that can be cultivated safely with ordinary good farming methods (fig. 31). It is nearly level land, has deep, productive, easily worked soils, and is not subject to more than slight water or wind erosion. It is well drained and is not subject to damaging overflows. It is suited for intensive cropping, such as production of corn and other intertilled crops.

Class I land may be recognized under irrigation where under natural conditions it was essentially valueless for crop production (fig. 32). Class I irrigated land ordinarily has a slope of less than 1 percent and a deep, medium-textured moderately permeable soil of good water-holding capacity. Some class I irrigated land requires initial conditioning, such as leveling to the desired grade, leaching to remove salts, or the lowering of a seasonal water table. If limitations are likely to recur and require



Figure 31.—This highly productive well-drained nearly level class I land can be cultivated safely on a longtime basis without special practices.



Figure 32.—Class I land in an irrigated area. It can be cultivated safely and will produce on a longtime basis moderate to high yields of sugar beets, corn, beans, and other adapted farm crops. It is assumed that the commonly recognized good farming and irrigation practices will be used.

periodic attention, however, the land is subject to continuing limitations in use, and is not class I. Class I land may also be recognized in artificially drained areas where the soil is moderately to rapidly permeable. On certain lands that meet the ordinary requirements for class I, drainage is sometimes worthwhile as a practical method for greater production or ease of operation.

Class I land for crop use may, in some places, require the use of fertilizers and lime, cover and green-manure crops, crop residues, and crop rotations.

Class II land

Class II is good land that can be cultivated with easily applied special practices (figs. 33-37). Some of its variations are: gentle slopes, moderate susceptibility to erosion, soils of only moderate depth, occasional moderate overflow, and moderate wetness easily correctible. These are examples—the list is not complete. Each of these limitations requires attention on the part of the land operator. The limitation sometimes gives the farmer less latitude in choice of crops or of management methods or requires special practices such as soil-conserving rotations, water-control devices, and tillage methods, to name only a few.

Generally its safe use calls for a combination of mutually supporting practices. For example, the class II gently sloping land having deep soils subject to moderate erosion needs several of the following practices: Terracing, stripcropping, contour tillage, crop rotations that include grasses or legumes, vegetated water-disposal areas, cover or green-manure crops, stubble mulching, fertilizers, manure, and lime. The exact combination of measures will differ from place to place. It depends on the characteristics of the land, including climate, and the system of farming the farmer wants to follow.



Figure 33.—This class II land (subclass e) is suited for cropping if simple practices are used, including contour tillage, protection with a covering of vegetative litter (stubble mulching), rough open tillage, and a rotation of wheat-summer fallow or spring wheat and peas. This field is a moderately eroded fine sandy loam on 8-percent slope.



Figure 34.—Contour stripping, calcareous clay on class II land (subclass e).



Figure 35.—Class II land (subclass w) in an irrigated valley. A simple drainage system must be maintained on this level soil to protect the land from a high water table.



Figure 36.—Class II land (subclass e) on a 5-percent slope. The soil is a silt loam that has lost nearly half of its topsoil because of former improper farming methods. This land is now being farmed safely by the use of stripcropping and cultivating on the contour, practices that will control erosion on this kind of land.



Figure 37.—This Class II land, in the Plains region, has soil and slope conditions that are responsive to simple conservation treatments, such as terracing and farming on the contour. To stop surface runoff and make more moisture available for crops, water is backed up from one level terrace (closed at the ends) to the other.

Class III land

Class III is moderately good land that can be used regularly for crops in a good rotation, with intensive treatment (figs. 38-42). Some of the characteristics of this kind of land are: Moderately steep slope, high susceptibility to erosion, moderate overflow, slow or very slow subsoil permeability, excessive wetness, shallow depth to bedrock, hardpan, or claypan, sandy, very sandy, or gravelly soil with low moisture capacity, and low inherent fertility.

Class III land is more limited in use by its natural characteristics than class II land. Limitations of some class III land restrict the choice of crops or the timing of such operations as planting and tillage. An adequate soil-conserving rotation includes enough ground cover to reduce losses of soil through erosion, minimize losses of plant nutrients through leaching, maintain good soil structure so that it will absorb water readily, increase and maintain organic matter and nitrogen supply of the soil, and promote high yields of cultivated crops grown in the rotation. On moderately steep slopes of some class III land, the rotations should be longer than on level land and must include more years of hay or other sod crops to prevent excessive soil losses.

On much of the nearly level wet land of this class, having heavy, slowly permeable soil, a drainage system along with a cropping plan including deep-rooted legumes grown in rotation is needed. To maintain good soil



Figure 38.—Erosion in a soybean field on class III land (subclass e). Special practices such as contour farming, stripcropping, crop rotations, and terracing must be applied to protect this land.

structure and prevent puddling and resultant reduced permeability on such soils, it usually is necessary, also, to supply organic matter and to be careful not to work the soil when it is too wet or too dry. Class III land in some irrigated areas is limited in use by a high water table, slow permeability, and danger of salt accumulations.

On class III land that is subject to wind erosion, the practices for controlling this type of erosion are the same as those recommended for class II land—contour farming, stripcropping, stubble mulching, rough tillage, and terracing where it can be used effectively.



Figure 39.—Class III (subclass e) irrigated land on a moderately eroded 12-percent slope. This irrigated orchard should be protected from future damage by annual cover crops along with contour cultivation, wheel grade ditches, and buffer strips. Proper irrigation practices and application of nitrogenous fertilizer are also essential.



Figure 40.—Class III land (subclass e) on a slope of nearly 10 percent. This land requires intensive use of erosion-control measures, including terraces and vegetated outlets for water disposal. A meadow strip has been established in a natural drainageway to be used as an outlet for terraces and for drainage from crop rows. Such areas can produce good hay.



Figure 41.—Class III land (subclass e) on a 4-percent slope of heavy clay. The conservation practices protecting this land are contour cultivation, stripcropping, terracing with protected outlets, green manuring, and a crop rotation that includes close-growing crops, as grass and legumes.

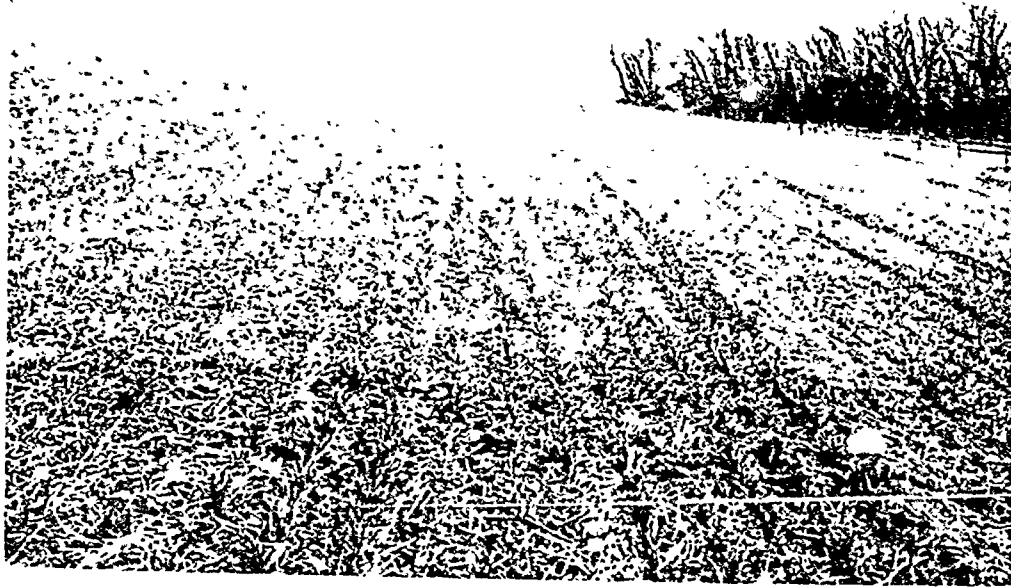

Figure 42.—Class III (subclass e) land on a moderately eroded 12-percent slope of silt loam. To cultivate this land with safety, intensive erosion-control measures must be used. The practices needed are: Maintenance of vegetative litter on the surface, contour cultivation and seeding, strip-cropping, field-diversion ditches seeded to perennial grass, and a rotation of legumes and grasses for 3 or more years, such as peas and spring wheat or surface protection with vegetative litter 1 year and wheat several years.

Class IV land

Class IV is fairly good land that is best maintained in perennial vegetation but can be cultivated occasionally or in a limited way if handled with great care (figs. 43 and 44). Its cropping use is restricted by natural features, such as slope, erosion, unfavorable soil characteristics, or adverse climate. Much class IV land in the humid regions is suited for occasional cultivation. On it the farmer can safely use a long rotation such as a grain crop every 5 or 6 years, followed by several years of hay or pasture. Some of the nearly level imperfectly drained land classified as IV is not subject to erosion but is unsuited for intertilled crops because of the time required for the soil to dry out in the spring and because of its low productivity when in these crops. Also choice of crops is often limited. Some class IV land is suited only for certain specialized crops.

In subhumid regions some of the land classified as IV is shallow or only moderately deep, moderately or strongly sloping, low in fertility, extremely sandy, or sometimes moderately saline. Longtime rotations including soil-building legumes and grasses are in some places difficult to follow in a semiarid climate. Periods of weather suitable for getting a stand of grasses or legumes occur at irregular intervals. Whenever a stand is obtained the land should remain in these protective crops at least long enough to restore soil structure and fertility.

In some semiarid regions, on the other hand, the best land is in class IV. All cultivation is subject to very severe limitations because of wind erosion.



Figure 43.—Class IV land (subclass e) in the humid region on a 10-percent slope, which on this soil is too steep for safe cultivation. This 3-acre pasture was seeded to a mixture of White Dutch, Hop, Persian, and black medic clovers, and bermudagrass. A cultivated crop may be grown occasionally as a step toward the renewal of a stand of grass and legumes for permanent pasture.



Figure 44.—Class I land (subclass e) in the humid region. Severely eroded slope planted to kudzu for permanent hay.

Special and intensively applied cropping systems and practices are needed during the time of cultivation to conserve soil moisture and reduce erosion.

Class IV semiarid land often produces high yields of adaptable crops during years of above-average rainfall. But during years of average or below average rainfall it produces low yields. During bad years the land must be protected from blowing. It needs special treatments, special cropping systems, or special practices to protect it against erosion and to conserve moisture. These treatments must be applied with greater regularity in dry years. Sometimes protective crops must be planted primarily to hold the soil. Perennial vegetation is needed to protect the land during severe drought and to rebuild soil structure and fertility.

Most of the class IV land in humid regions is well suited for woodland. Unless needed for pasture, it is not as a rule desirable to clear areas now covered with trees.

Land Not Suited for Cultivation

Class V land

Class V is land not suited for cultivation but is suited for perennial vegetation (grazing and forestry) with few or no limitations (figs. 45-47). Cultivation is not feasible because of one or more factors, such as wetness, stoniness, or some other limitation. The land is nearly level and not subject to more than slight wind or water erosion. Grazing use or forestry use is governed by the requirements for a good cover of vegetation. Certain range-management or woodland-management practices, such as stocking within the range's carrying capacity and the control of burning, are always needed for satisfactory production. Class V land on which vegetation has become temporarily depleted through misuse may require moderate or even severe restrictions in grazing or woodland use for a period, in order to improve the vegetation. The land, however, is not damaged easily.

Class V also occurs in many of the swampy areas that cannot be drained feasibly.

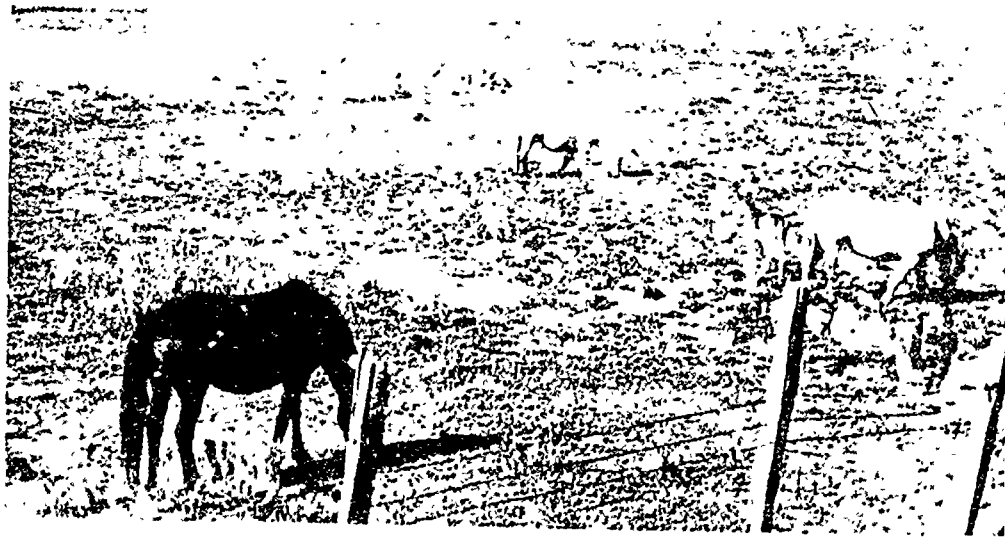

Figure 45.—Class V land (subclass s). Nearly level shallow soil, too stony for cultivation except in spots generally too small for successful use. Best use of this land is for pasture under irrigation with waste water from neighboring irrigated fields.



Figure 46.—This land is class II and because the rock outcrops make it unsuited for any cultivation.

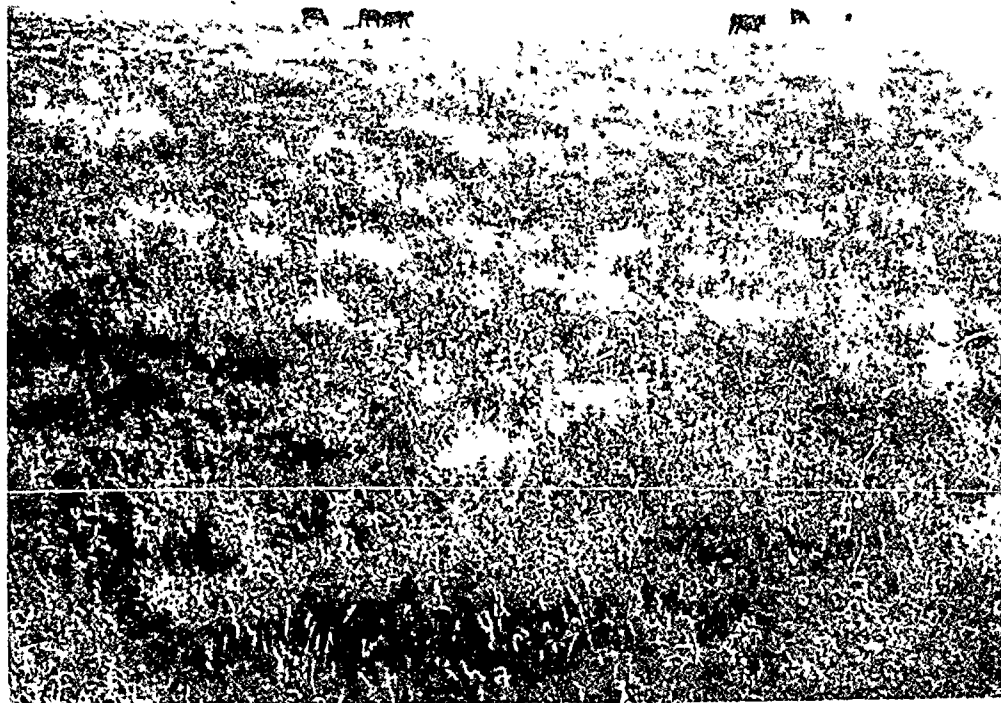

Figure 47.—This class V land (subclass c) is nearly level, and is deep and fertile and in no appreciable danger of erosion. The rainfall is too low for successful production of cultivated crops but is adequate for production of grass vegetation.



Figure 48.—This class VI land has a shallow soil on a 20-percent slope. The practices needed for good range management on this land include utilization of the forage according to grazing capacity; seasonal use; rotational grazing; open herding; development of springs; location of saltboxes at strategic places; fences for better distribution of stock; contour furrows; and diversion ditches.

Class VI land

Class VI is land subject to moderate limitations under grazing or forestry use (figs. 48-50). It is too steep, subject to erosion, shallow, wet, dry, or otherwise not suited to cultivation, but with careful management is suited to either grazing or forestry. Some class VI land can be tilled just enough to establish pastures; some can be used safely for tree crops. The restrictions commonly needed on class VI rangeland are chiefly adjustment of grazing to the carrying capacity, deferred grazing to permit growth of grass in the spring, and rotation of grazing to permit the grass to recover enough to form seed. Fencing, careful location of watering places, salting, and herding are some of the practices necessary to use the land prop-



Figure 49.—Class VI land (subclass e) too steep for safe cultivation but suited for permanent pasture with fertilization and proper adjustment of grazing to carrying capacity.

erly. Gullies should be controlled by diversion of water, planting, or other adaptable measures. Contour furrows, ridges, diversions, or water spreaders are useful on some sites to store in the soil more of the runoff by checking or diverting the water.

Land of class VI is capable of producing forage or woodland products under moderate restrictions. If the vegetation has been depleted by mismanagement, severe restrictions in use for a few years probably are needed to permit recovery of vegetation. An example of such temporary severe restrictions would be exclusion of livestock from overgrazed class VI rangeland until desirable vegetation is restored.

Pastures in humid regions on class VI land generally need liberal fertilization and careful adjusting of grazing. Many of them need liming and reseeding.

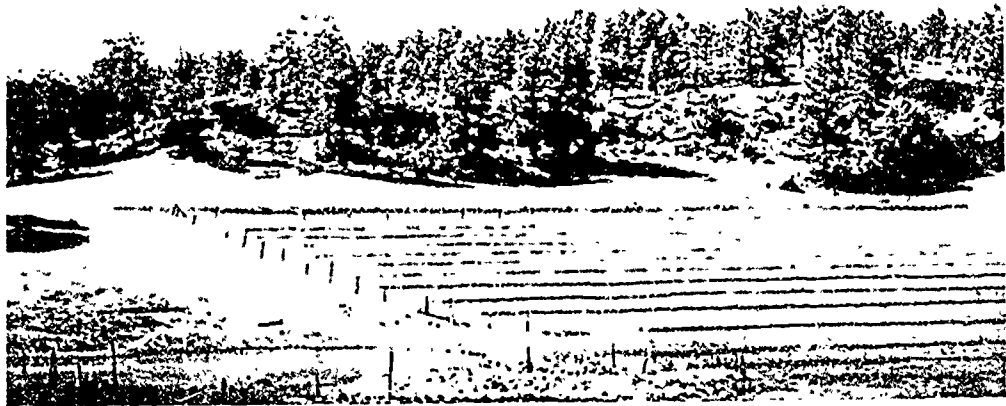

Figure 50.—Rainfall is barely adequate here to maintain good grass. (Top), Class VI land (subclass c) in the foreground, class VII (subclass c) on the steeper slope; (bottom), land of classes VI and VII. The slope in the foreground is class VI (subclass c); the rough land is class VII (subclass c). The class VII land in both pictures is steeper, has shallower soil, and should be grazed only under very careful management.

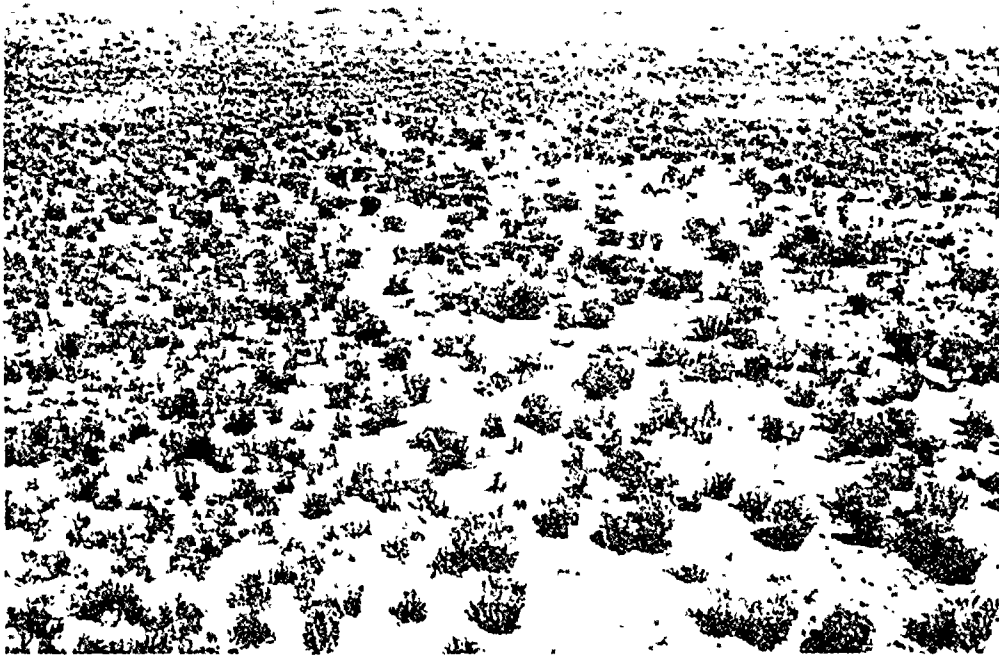

Figure 51.—Class VII land (subclass c) is extremely susceptible to wind erosion because the soil is sandy, the rainfall low, and the vegetation sparse. Grazing should be carefully managed.

Class VII land

Class VII is land that is subject to severe limitations or severe hazards under either grazing or forestry use; it is not suited for cultivation (figs. 51-53). It is very steep, eroded, stony, rough, shallow, dry, swampy, or



Figure 52.—Class VII land (subclass e) on a 25-percent slope severely damaged by erosion. Trees are being planted with the view of establishing permanent cover to protect the soil.



Figure 53.—Woods on very steep, stony class VII land (subclass s).
Such land should be kept in forest.

otherwise unfavorable, but can be used for grazing or forestry if carefully handled. Owing to these adverse land characteristics that severely limit the growth or utilization of vegetation, the land is generally only fair or poor for grazing or forestry. Depletion of cover on rough, erodible class VII land leads to more rapid damage than on class VI land that has similar but less extreme limitations. Structures such as contour furrows, ridges, and water spreaders for the most part cannot be used on class VII rangeland because of steep slopes, shallow soils, or other unfavorable factors.

Most class VII land in humid regions is recommended for woodland rather than for pasture. Practices recommended for woodland usually include exclusion of livestock, prevention of fire, selection of trees for cutting, and careful harvesting methods. Most of the severely gullied land in humid areas consists of class VII that should be planted to trees.

Land Not Suited for Cultivation, Grazing, or Woodland

Class VIII land

Class VIII is land of such unfavorable characteristics as to be unsuited for cultivation, grazing, or forestry (figs. 54 and 55). It is suited for wildlife, recreation, or watershed-protection uses. It includes such areas as marshes, deserts, badlands, deep gullies of the caving type, high mountain land, and very steep, rough, stony, barren land. Class VIII land often occurs in small areas, such as roadsides or ditchbanks, that cannot be shown on the maps made for farm-conservation planning. Protection is necessary even for some of these areas.



Figure 54.—This class VIII land (subclass e) in a sand-dune area that is not only wasteland in itself but is also a menace to adjoining land.

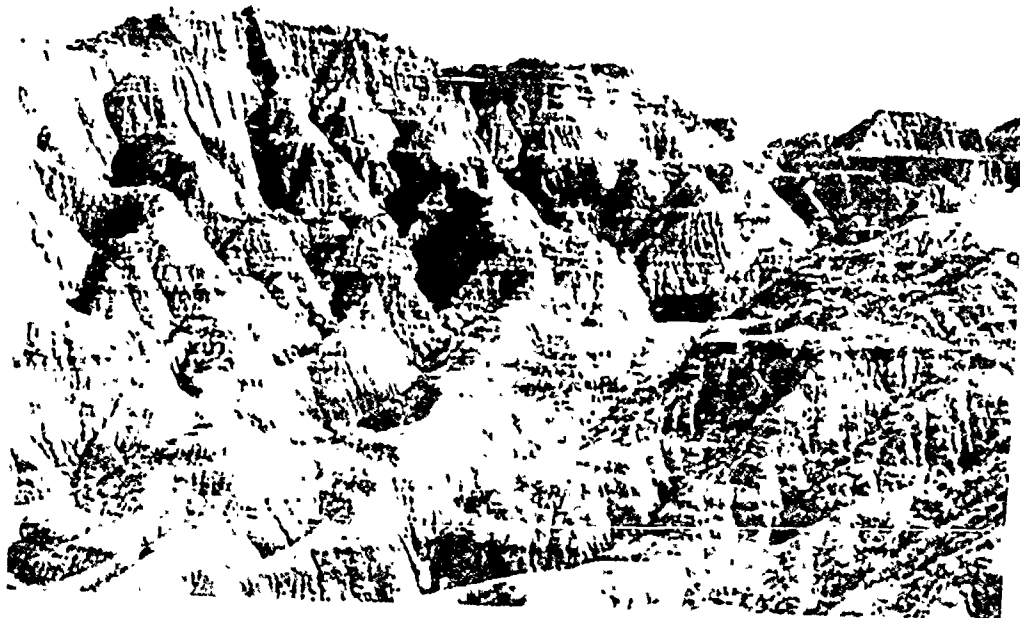

Figure 55.—These badlands are class VIII land (subclass e), unsuited for cultivation or grazing.

Using the Physical Inventory

In the foregoing discussion of the eight land-capability classes no attempt has been made to list or to show by photographs all of the possible conditions or sets of conditions involved with each class. The lists of practices, likewise, while representative, are not complete. The classification that is finally made must be one that will be useful in bringing about better land use, more conservation farming, and more production. Decisions about how to properly use these classifications should include due consideration by a local committee of practical farmers. And it is well also for these farmers to have a part in setting up the final capability classes.

Many of the factors that affect land capability, such as natural drainage, supply of plant nutrients, and the climate, influence also the productiveness of the land. Others, such as slope and erodibility, have little direct effect on productivity. The relationship between land-capability classes and a productivity grouping may be fairly close, or there may be little relationship, depending on which factors are dominant. A dark-colored prairie soil on a slope steep enough to be classified as class IV land may be decidedly more productive temporarily—as long as the surface soil lasts—than a light-colored soil on a gentle slope or in class II land. All land in classes I, II, and III, however, must be at least productive enough to give moderate to high yields of some crops without unusual or extreme fertilizing or management practices. To be in one of these three classes, land must be productive enough to make regular cultivation practical.

The land-capability classification, once made, is fairly permanent, but changes either in the land or in the methods by which it can be used or protected may make reclassification necessary. Soil erosion unattended, for example, changes the capability of the land almost without exception to a class less suited for cultivation. Wind erosion can ruin a cultivated field in a single season or even in a few weeks, and water erosion in extreme cases can in a few hours carve gullies which are impassible to farm machinery. A possible need for reclassification might arise where certain slopes formerly believed to be too erodible for cultivation have been adequately controlled. Still other causes for reclassification might be the development of new sources of water for irrigation of arid land, new outlets for draining wet land formerly considered not drainable, extensive new levees to protect bottom land from overflows that formerly made cultivation impossible, or the use of pumping for drainage.

Choosing Practices To Fit the Land

While the members of a committee of farmers and agricultural workers are summarizing the many uses that can be made of the various combinations of different soils, slopes, and erosion classes into land-capability classes, they should also study and discuss the various practices and measures that are adaptable for the particular location. They talk over and write down the most suitable crops and combinations of these for different kinds of land, the various crop rotations that can be used, the need for fertilizers, lime, manure, green manure, or other soil-improving measures, along with the many soil-saving and water-saving practices that must be used to protect the cropland. In a similar way they should consider the different methods of handling pasture, woodland, and rangeland.

A land-capability map and a set of recommendations for the use and conservation of the different kinds of land furnish a simple guide for conser-

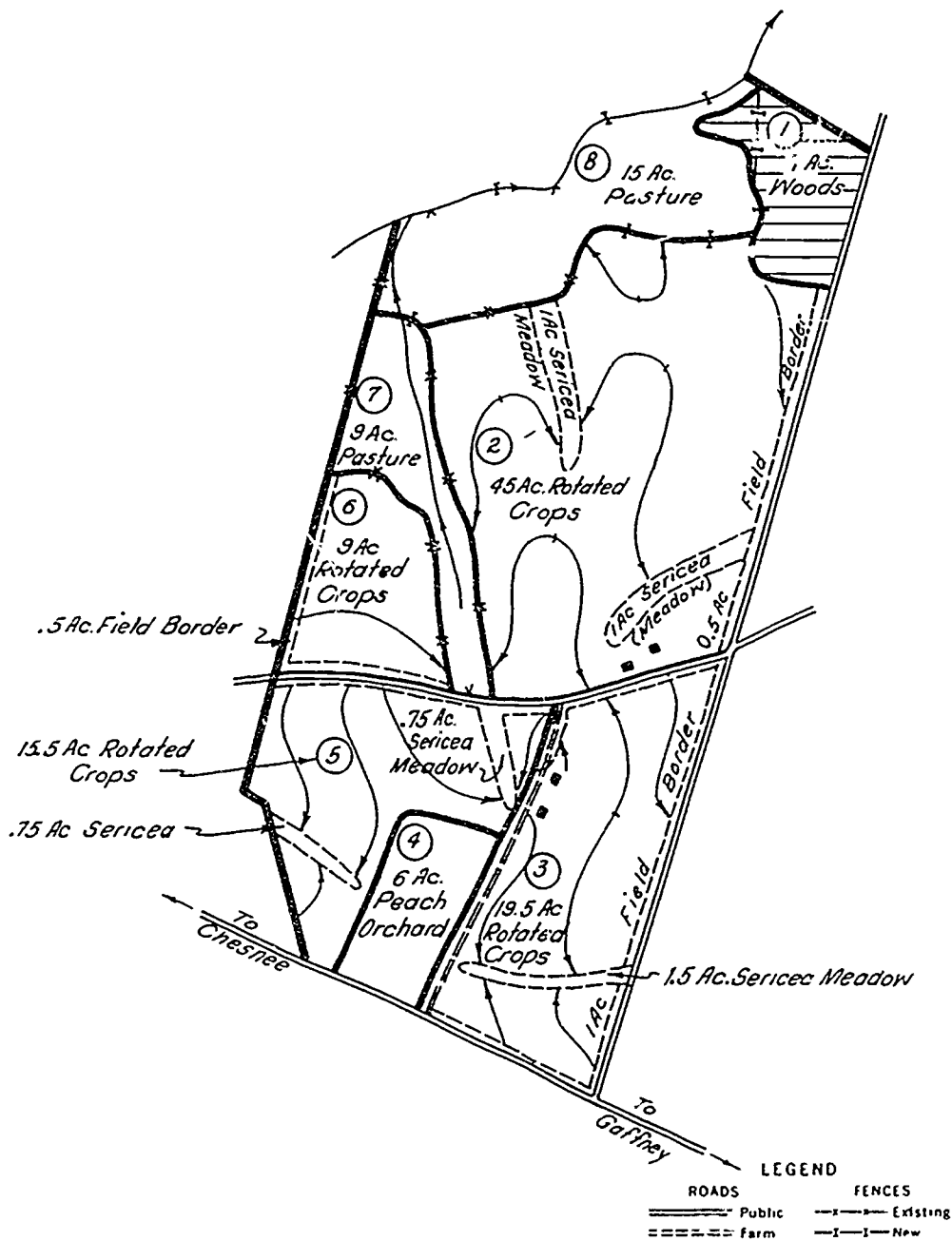

Figure 57.—Principal features of the conservation farm plan.

than the general descriptions of land-capability classes. The locally adapted descriptions should be consistent with the general concepts of land-capability classes, subclasses, and units.

Principal features of the conservation farm plan for this same farm are shown in figure 57.

This cotton farm of 124 acres (fig. 56) is located in the Piedmont Plateau, latitude 35 degrees north, in South Carolina. The annual precipitation is about 48 inches. The outline of the farm, the roads, and the streams have been marked in black to make their locations clear. The two dwelling houses on the farm have been outlined in black also. Locations of other buildings can be seen on the photograph. Areas of woodland are clearly visible, and outlines of old terraces in some of the cultivated fields can be seen.

Land-capability classes are shown by Roman numerals. The small area of class I land along the stream would be excellent land for crops. An adjoining area, however, is land too wet for cultivation but good for pasture. In the farm-conservation plan one pasture of 9 acres includes this small area of class I land, the adjoining wet land of class V, subclass V-w and the strip of poorly drained land shown as subclass III-w, running up as far as the road. Another 15-acre pasture includes the flat, wet land shown as V-w farther down the stream and the adjoining class VI land that is too steep for cultivation.

This farm has a large acreage of class II and class III land. Most of the class II land is gray sandy land that has a gentle slope, between 3 and 5 percent. One area, used for a peach orchard in the new plan, is brownish-red sandy clay land on 3-percent slope. Most of the class III land is brownish-red sandy clay land, on slopes of from 4 to 7 percent, more subject to erosion and already damaged by erosion more than the class II land. This land is farmed in a good crop rotation for soil protection and for soil building. Terraces lead excess runoff gradually into safe outlets. All waterways are protected by perennial cover of sericea lespedeza. This perennial legume protects the outlets, and also furnishes several cuttings of good hay every year.

The land in subclass III-w drains slowly during wet spells because of its heavy, slowly permeable subsoil. It could be used for crops after drainage, but on this farm its best use is for pasture and for the location of one of the waterways.

The farm contains three areas of class IV land, too steep to be cultivated safely in a regular rotation unless extreme care is taken. One of these areas remains in woodland. One makes up part of the new pasture. The third, located along the road, is included with the terraced cropland field. A long rotation that includes several years of legume crops will be needed to control erosion on this slope of 11 percent.

On millions of farms all over the world there are land problems to be solved—problems of good land use, of soil conservation, of soil-erosion control. No two farms and no two farmers are exactly alike. For most farms the operator and a farm planner can together devise a system of safe and permanent use of the land. Everywhere they will need a land inventory, together with an awareness of the farmer's own resources, his system of farming, and his likes and dislikes; and a sound, practical knowledge of the practices and skills that he can use to hold his soil in place and to use it for a good job of farming. The land inventory will show that many of these farms have enough good land for their needs.

On a few farms the inventory shows that there is not enough land of classes I, II, and III to grow the crops necessary for a profitable, balanced farm business. Planning for conservation farming on these farms is difficult. On some such farms no lasting solution can be found unless additional land can be leased or purchased or a supplementary source of income for the farmer can be established. Here the physical inventory furnishes the facts about the land and enables the farmer to attack his problems with full understanding of the difficulties involved.

Preventing and Controlling Gullies

Gullies are a symptom of a functional disorder of the land: improper land use. But gullies are not the first symptom of land misuse. Before gullies appear, water flowing across sloping, unprotected land removes thin layers of fertile topsoil. Gullies are generally a secondary symptom, indicating misuse of the land over a long period of time.

As in human disease, we can relieve the symptoms by various kinds of local treatment. But we can effect a permanent cure only by directing our primary treatment at the source of the disorder—in the case of land, the entire watershed or area from which water flows into the gully.

Under natural, healthy conditions in humid areas, the land is clothed with grass, shrubs, trees, or other vegetation. This vegetative cover protects the land against erosion. It slows up runoff water and causes much of it to sink into the ground. The water that is absorbed into the ground promotes more vegetative growth. This is a beneficial cycle.

When we disturb this natural, healthy condition by cutting down the trees and shrubs and plowing the grass, we expose the land to erosion. As the topsoil is washed away, water will concentrate more rapidly in the natural waterways and form gullies. Less water soaks into the soil for plants to use. Unless we devise other methods of protecting the land, we may thus set up a vicious cycle.

While gullies are developing, fertile topsoil is picked up and carried off in the runoff. Both productive topsoil and relatively unproductive subsoil may be deposited over rich bottom lands. In addition to ruining good agricultural land, gullies also encroach on and sometimes undermine public highways, fills, bridges, and culverts. This increases maintenance costs and makes travel unsafe.

One of the most frequent kinds of land misuse is the cultivation of steep slopes. But there are other kinds too, such as overgrazing and trampling by livestock (fig. 58), which may destroy vegetative cover and cause gullies. The steeper the slope, the greater the danger of land damage. Steep slopes cleared for cultivation (fig. 58) will soon be badly gullied.

Gullies often start in the banks of natural watercourses that have been eroded to great depth. They extend back into the drainage area and grow deeper as they advance up the slope. As they extend backward and cross lateral drainageways or natural depressions, waterfalls are sometimes formed in the sides of these depressions, and branch gullies develop. This branching may continue until a network of gullies covers an entire area.

The first step in preventing the formation of gullies is to plan the farm so as to make the best possible use of all the land. This should include converting to permanent cover such areas as are definitely too steep or too eroded to cultivate, the use of level or moderately sloping land for cultivated crops, and the planting of natural depressions or waterways to close-growing perennial vegetation.

The best known methods of controlling or preventing erosion are the vegetative controls, such as grass, mixtures of grass and legumes, and combinations of vegetative and engineering controls. These controls can be supported by engineering controls, such as contour cultivation, cover crops and crop rotations, and contour stripcropping, used alone or in combination with terracing where it is required, and the use of meadow outlets for terrace-water disposal.

Although severely gullied land may have little immediate value, control measures are usually warranted on such areas if only to protect adjacent

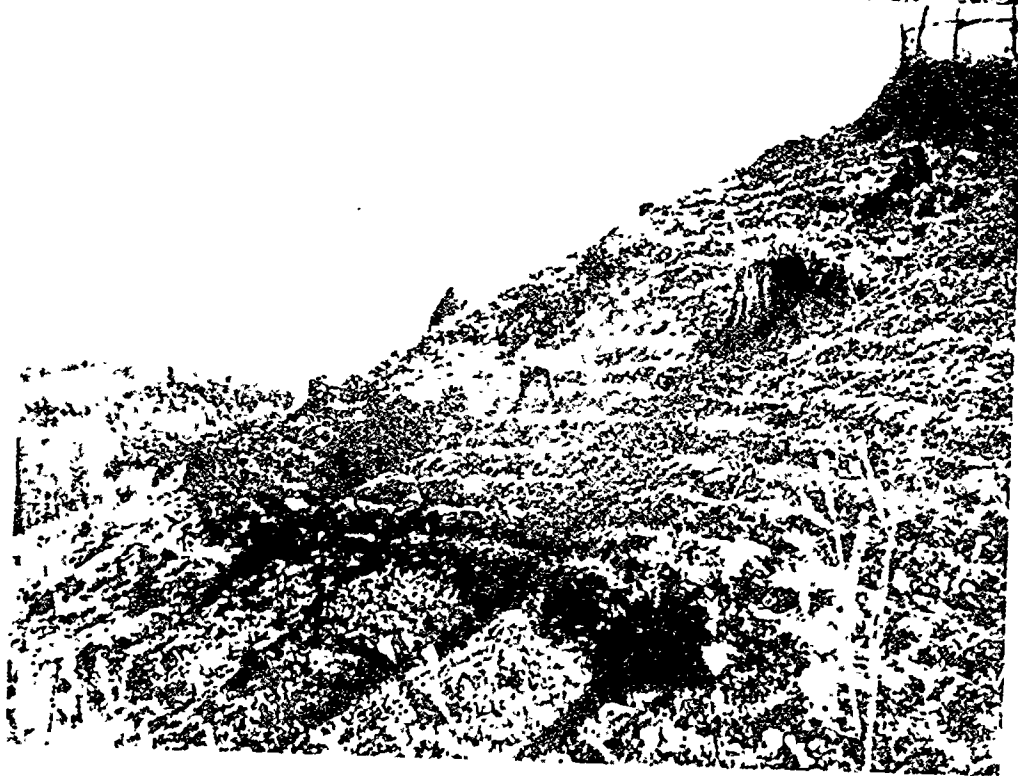
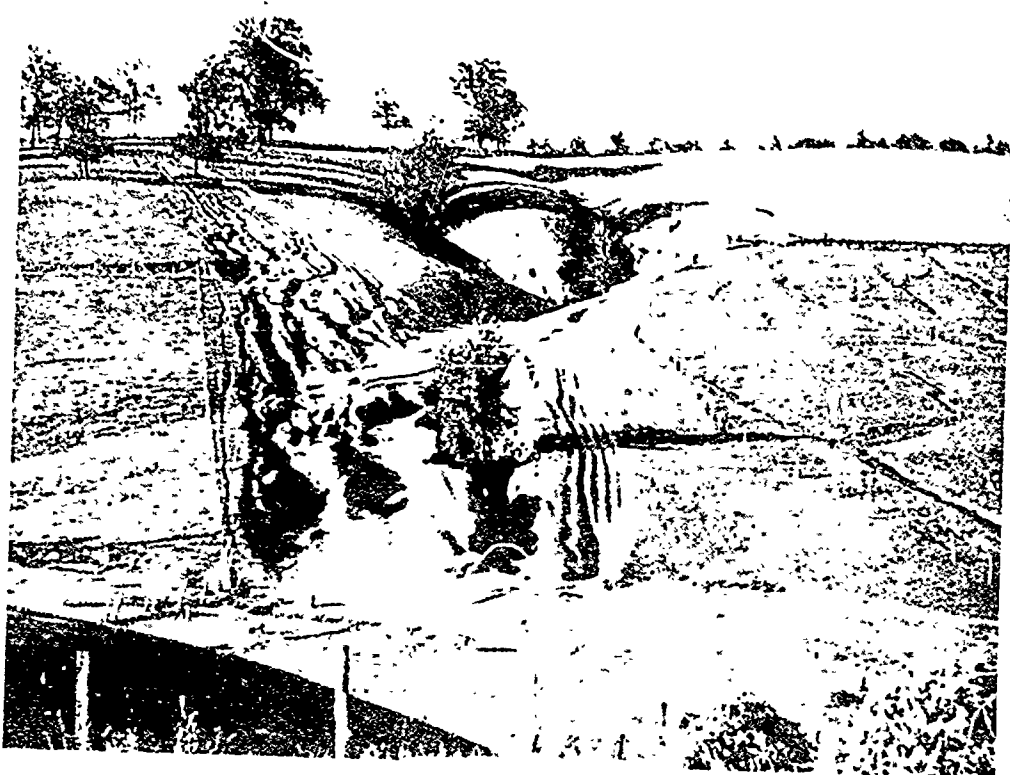

Figure 58.—(Top), Sheep traveling up and down the slope made the paths that gradually developed into these gullies. Shifting or rearranging pasture lanes would have prevented this. (Bottom), Continued cultivation of this hillside will cause gullies to develop down the slope. Land as steep as this should be left in permanent cover.

lands. But it is well to determine what is the most economical and suitable protection for each gullied area. The cost of controlling a gully and the type of protection should always be considered in relation to the use that can be made of the gullied land as well as the protection that such control will afford to adjacent areas.

On cultivated areas with absorptive soils, small- or medium-sized gullies with small watersheds can sometimes be filled in by plow, shovel, or drag pan. These small areas can, in some places, be mulched and brought back into cultivation, although it is generally best to use them for grass.

The most economical and effective control of gullies and gullied areas where the climate permits can often be attained by planting kudzu in good soil near the borders of the gullies so the vines will gradually encroach on the gullied area. Kudzu (*Pueraria thunbergiana*) or tropical kudzu (*Pueraria phaseoloides*) provides excellent control of gullies (fig. 59).

Extensive areas of gullied land, when covered with kudzu, can be used for supplemental grazing. If the land is not too rough, the kudzu may be cut for hay. Kudzu provides high-quality food for livestock, either as grazing or hay, and therefore represents excellent land use for gullied areas. Small areas, however, should be protected from livestock, and grazing should be strictly limited even on larger areas, as kudzu can easily be ruined either by overgrazing or too frequent mowing.

Where necessary and practical, runoff should be diverted from a gully head before control measures are attempted within the gully. In using either terraces or diversion ditches to divert water from a gully, careful



Figure 59.—Water from two adjacent farms emptied into this property-line gully, which extended back 500 yards from the road ditch seen in the foreground. Kudzu and pine trees were planted along the left edge of the gully only. Within 6 years the kudzu extended across the gully, completely stabilizing it.

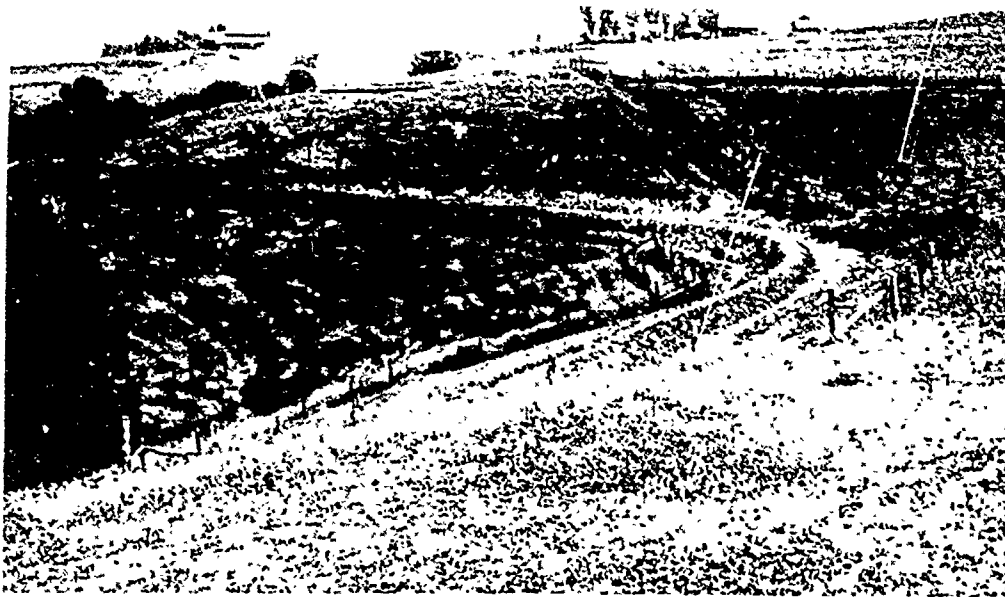

Figure 60.—Water is intercepted by a diversion ditch above the gully and carried to a disposal point so slowly that little erosion occurs. The fence keeps out livestock.

consideration should be given to the disposal of the diverted water. Unless a safe disposal area can be provided, no attempt should be made to divert the water. The disposal of concentrated runoff over unprotected areas may cause serious additional gulying.

Terraces are effective in the control of small gullies in cultivated fields. Terraces placed above a gully too deep to be terraced across will divert headwaters from the gully, which may then be treated further if necessary. If the slopes above a gully are too steep to terrace or if the drainage area is pasture or woodland, diversion ditches (fig. 60) may be used to keep runoff out of the gully. Diversion ditches are particularly adapted to areas lying below trees or grass, because the ditches are not so likely to fill with eroded material from above.

Any gully, no matter how large and regardless of its condition, will eventually be reclothed with vegetation, provided it is properly protected and is in a locality where vegetation will grow. If the water that caused the gully is diverted and livestock and fire are kept out, plants eventually will come in. At first the recovery may be slow because of the difficulty of getting a foothold. Later, when the pioneer plants have improved the soil somewhat, other plants will come in to help. The whole natural process may take many years in dry areas; where there is moisture, revegetation will be more rapid.

Even though plants will usually come in naturally on protected areas of gullied land, there are several factors that slow down the final healing of the erosion scar. One is continued loss of soil by thawing and freezing. This can usually be reduced by a mulch of boughs, straw, or leaves, which also serves to catch and hold plant seeds. Another factor is the steep sides of some gully banks. Until the sides cave in and reach a gentler slope (about a 1 to 1 slope), it is difficult for the unassisted plants to take root. If it is economically feasible, steep banks may be plowed in, pushed in with a bulldozer or by hand labor, or dynamited into an improved condition for vegetative growth (fig. 61). Kudzu planted along the edges of such gullies, however, will generally extend down into the gullies and



Figure 61.—(Top), This picture was taken soon after the gullied area had been fenced and planted to trees. Very little bank sloping was done preparatory to planting. (Bottom), The same area 2 years later. The raw gully banks have been almost completely covered with vegetation.

establish root systems in the banks of even very steep-sided gullies (fig. 59).

In spite of adverse conditions, hardy, thrifty plants capable of surviving in gullied areas will generally appear naturally. Weeds will usually come first. They prepare the way for other plants, which always follow them in a year or two. Given sufficient time, this natural process will eventually reclothe the gully with the predominant vegetation of the region, whether that be trees, brush, or grass. Frequently this opportunity to obtain a cheap protective covering is overlooked, and unnecessary expenditures are made for structures or plantings.

Where natural growth does not appear to be able to cope with existing erosion or where certain plant species of economic value are desired, it may be necessary to consider means of establishing vegetation artificially. So far as erosion control alone is concerned, it makes little difference whether trees, shrubs, vines, or grasses are used. Any of these, when well established, provides good protection for soil. Consequently, the kind of vegetation to use is best chosen on a basis of what the planted area will be used for when it is established.

A good grass sod will carry more water safely and at higher speeds than where woody plants are used. A sodded drainageway can sometimes be crossed with farm machinery, whereas one with a woody cover cannot. Grass- or vine-covered drainageways produce good yields of hay in some sections. If they are utilized as pasture, grazing should not be overdone. It should not be forgotten, however, that good grass growth demands a well-prepared seedbed and reasonably fertile soil, a condition rarely present in gullies.

Before gullied areas are planted, they should be fenced from livestock, unless they are in a field in which livestock do not run. Trampling and grazing by domestic animals in these critically eroding areas will prevent vegetation from forming a good cover, which is essential in preventing washing.

The area to be fenced or otherwise protected should be larger than the width of the gully. For example, if a gully is about 10 feet deep, the distance from the fence to the nearest edge of the gully should be 20 to 25 feet. It is better to allow an even greater distance at the gully head because at the head the erosion hazard is greatest.

The first choice of trees, shrubs, and vines for gullies should be plants that are native to the locality and which grow on similar sites. These plants are already acclimated and thus have the best chance of survival under the harsh growing conditions often existing in gullies. If useful native plants are unsatisfactory, second choice would fall on the more promising plants introduced from other areas or countries.

In small- or medium-sized gullies with small drainage areas it is frequently possible to construct checks consisting of shrubs placed across the flow line of the gully (figs. 62 and 63). The shrubs are placed 4 to 5 inches apart in shallow trenches and are sometimes protected by rows of stakes. The stakes are placed about 1 foot down the channel from the shrubs so that the plants will benefit from silt collected by the stakes. The shrub checks reduce water velocities in the gully channel and induce silting, which gives other vegetation a chance to become established. Shrub checks should be closely spaced if they are to be effective. They should be used only in gullies that have a mild grade.

If an immediate grass cover is required, it may be necessary to transplant sod. Sodding is generally too costly for extensive use over large gullied areas. Sod may be required, however, on critical sections at the



Figure 62.—Shrub checks in a small gully. Note the close spacing of the checks.

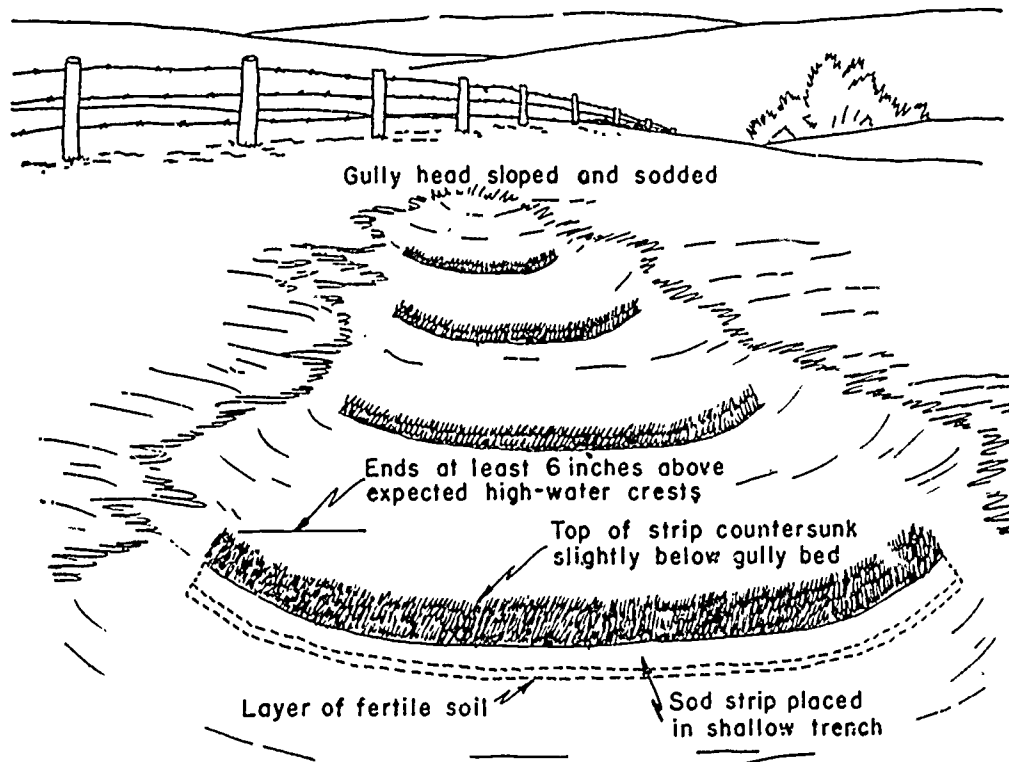

Figure 63.—A series of sod-strip checks in a small gully. These checks cannot be used in gullies with very steep grades.

gully head or at points along the bank or bottom where protection against waterfall erosion is necessary. It is also frequently used in connection with engineering structures, such as the lower sides of earthen gullies. Grass covers can usually be established by sodding on areas so exposed to runoff that it would be impractical to provide a secure cover by seeding. Where the amount of runoff is not too large, and good sod is available, it can be used as a substitute for the more costly masonry and concrete materials. Sod flumes, sod-check dams, and sod spillways have all functioned satisfactorily when properly constructed and applied. Their installation, however, is generally cheaper, more effective, and more lasting than engineering works.

Mechanical structures are used in gullies to facilitate the establishment of vegetation or to provide protection at points that cannot be adequately protected in any other way. They are usually used only in gullies through which runoff must be conveyed. If the runoff that must be conveyed through gullies is not in excess of the amount that can be handled by well-established vegetation, temporary mechanical structures may be used in the gullies until the vegetation becomes established. Such materials as brush, poles, wire, and loose rock are usually used for constructing temporary check dams (fig. 64). If the runoff is of sufficient volume to make control by vegetation impracticable, mechanical control measures will have to be resorted to. Structures, built to give reinforcement to vegetation, should be made of durable materials—reinforced concrete, masonry, metal, or earth. They should be used only where less expensive means are impracticable and should be supplemented by vegetation wherever possible.

The proper use of structures in gullies requires good judgment in determining the need for them and the extent of their use. It may be just as great a mistake to attempt to control a gully without structural assistance as it would be to use structures in gullies that could be stabilized more economically and just as effectively with vegetation alone. Temporary structures do not require such good materials as structures built for permanency, nor is so much precision in construction necessary. A permanent structure usually costs more than a temporary structure, and its failure is therefore a greater loss.

Temporary check dams are used to collect and hold soil and moisture in the bottom of sterile gullies so that vegetation can be established. They may also be used to check temporarily erosion in the gully head or in the channel of a gully until a protective cover of vegetation can be produced.

Piles of closely compacted rock and brush are all that is necessary across the bottom of the gully if runoff is negligible.

Where temporary structures have been used to control gullies, it has been found that several low check dams are more desirable than one large dam. Low dams are less likely to fail, and after they silt up and rot away, the vegetation can protect low overfalls at these sites much easier than high ones. A temporary dam should seldom exceed 15 inches in overfall height, and an average effective height of about 10 to 12 inches will be better. By effective height is meant the vertical distance from the original gully bed to the spillway crest of the structure.

Temporary check dams may be located at definite intervals and spacings, but usually they are constructed at strategic locations so as to protect and facilitate plant growth at critical points. In this way effective results can be produced with fewer dams.

Temporary dams are used most successfully in gullies that have small drainage areas. The total amount of soil collected by these dams is rela-

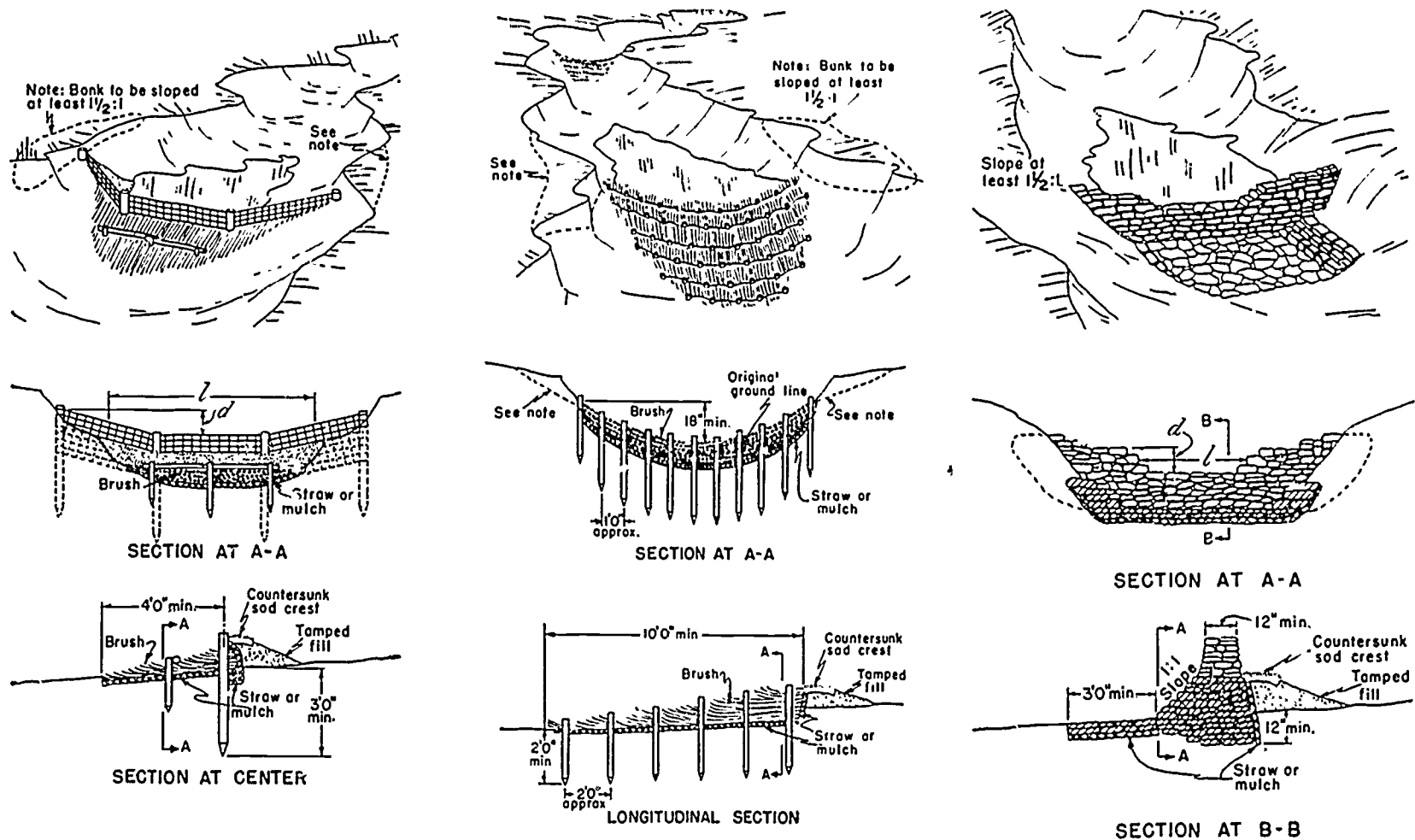

57

Figure 64.—(Left), a woven-wire dam; (center), a brush dam in common use; (right), a loose-rock dam.

tively small, but they hold enough to promote the growth of some vegetation, which in turn forms a barrier that collects more soil. The dams should be constructed far enough into the bottom and sides of the gully to prevent washouts underneath or around the ends of the dams. They should also have sufficient spillway capacity to convey runoff at the maximum rate that can be expected during the life of the structure. An apron will generally be necessary to protect the structure from the undermining action of the runoff as it is discharged from the spillway.

Brush dams are best suited for gullies having small drainage areas and with soil conditions that permit the driving of necessary anchoring stakes. These dams are cheap and easy to build. Many kinds of brush dams are in use; the kind chosen for a particular site will depend on the amount of brush available and the size of the gully to be controlled (fig. 65). Whatever type is used, it is important that the center of the dam be kept lower than the ends to allow the water to flow over the dam itself rather than around the ends.

Loose-rock dams are desirable where plenty of suitable rock is readily available. They are used in gullies of moderate slope having small- to medium-sized drainage areas. A well-constructed loose-rock dam can be made more durable than the other types of temporary dams because rock will outlast brush, wire, or slabs. It also has an advantage because its flexibility and weight constantly hold it in contact with the bottom of the gully. The best structures can be built from flat stones, which are commonly known as flagstone. With practice these can be so laid that the entire structure will be keyed together. If round or irregularly shaped rocks must be used, the structure is usually encased in woven wire, so as to prevent the outside rocks from being washed away. Irregularly shaped rocks should preferably be placed in such a way that voids will be reduced to a minimum. If considerable time must be spent to fit the rocks in laying

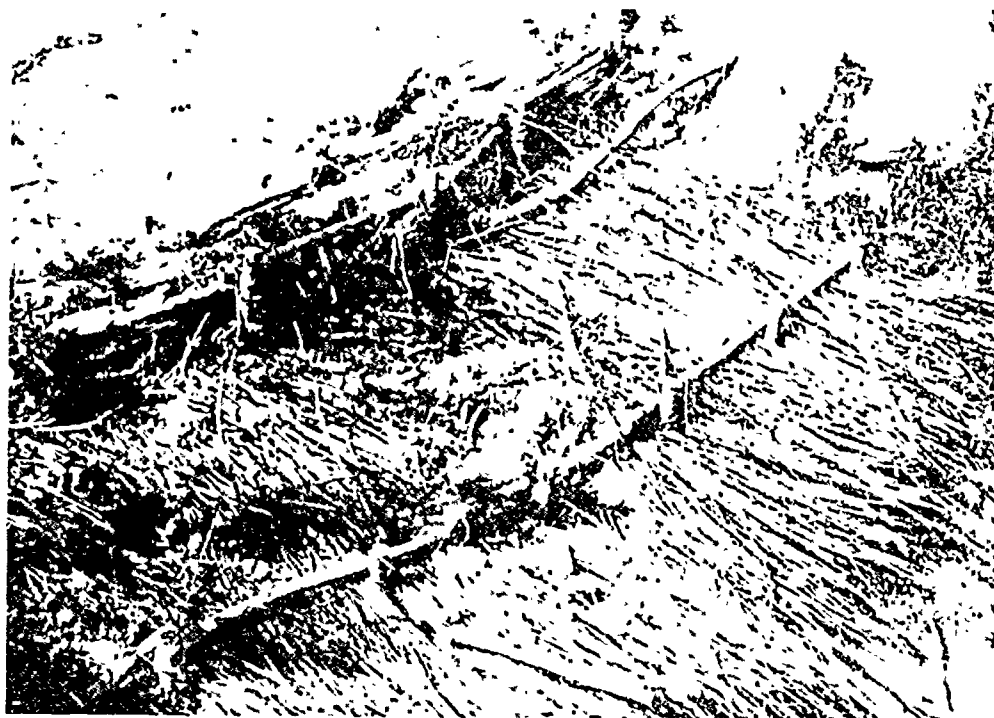

Figure 65.—A dam built of branches in a small gully. Note the sediment deposited above the dam.



Figure 66.—A fence around this gully would have kept the cow out; building a fence is usually less trouble than continually repairing check dams.

up the dam, it may be cheaper and more effective to construct a rubble masonry dam or a concrete dam.

The choice of the type of structure to be used for any particular job is largely a problem of determining the type that will provide the necessary capacity and meet other requirements and yet give the most economical construction costs. Large dams represent a sufficient investment to warrant special precaution. Considerable skill is required to build permanent structures.

Too often erosion controls are installed and then neglected until they become so badly damaged that they are no longer effective. They should be inspected periodically, especially after heavy rains, to determine whether they need minor repairs. This is particularly true of vegetative controls when the vegetation is becoming established. Mechanical structures are also more subject to failure when first installed because they do not become thoroughly settled, compacted, or sealed for some time.

All types of erosion controls should be protected from livestock (fig. 66). Hogs particularly should be excluded, for they root up vegetation and damage structures. Vegetation or structures of combustible materials should also be protected from fires. Burrowing rodents occasionally cause failure of structures by digging through or around them.

Woodland Improvement

In humid regions, a good forest cover is the most effective means for soil and moisture conservation. The development of complex civilizations in such regions makes it necessary, however, to use much of the land for other purposes than growing trees. Of the land originally forested, some areas are much better suited physically to cultivated crops than others.

The best use of land normally would coincide with its maximum safe use. The physical capabilities of any piece of land constitute a use ceiling above which it is not safe to go. But a second group of factors, primarily economic in nature, determines the best use of a piece of land somewhere along a scale, but not above the physical capability ceiling (fig. 67). These factors are more or less temporary in nature, and changes in them may change the best use for a given piece of land. These factors are distinctive for the particular land-operating unit involved and are therefore not subject to determination on an extensive survey basis.

Tree Planting

It may be necessary to plant trees on some forest land not now adequately forested, if stand is too thin for good forest production. Local observation, supplemented by ecological understanding, will usually serve to indicate the species, density, and rate of natural reproduction that may be depended on. Planting should be done in those cases where the natural reproduction reasonably to be expected will not meet the objectives expected from the land under consideration.

Selection of species

The first step in planting trees is the selection of species that will thrive well enough on a given site. This is an especially critical decision in the case of much of the tree planting needed for soil and water conservation where much of the land is in impaired condition. The most severely eroded and the most impoverished sites are generally designated for reforestation. Topsoil is important in growth of trees, as with field crops. Yet tree-planting sites frequently have little or no remaining topsoil. Erosion generally is still active. Relicts of the original forest cover may be very misleading as to the species that the site will now support. It is usually necessary to move down the ecological scale to the more primitive species, and, gradually build the site back toward its virgin condition. Obviously, the initial production from reforesting such a site is likely to be much inferior to its original capacity or to its potential capacity. The economic returns obtainable from such plantings should not be considered a measure of the economic possibilities of forestry as an enterprise.

The purpose of planting should be to establish a protective cover that will accelerate the vegetative improvement of the site and at the same time go as far as possible toward paying its own way in the production of useful materials.

Plant associations developing naturally on the sites to be reforested, or nearby under similar conditions, may serve as excellent indicators of the tree species likely to prosper. Every locality has in its flora one or more species suited to the formation of temporary or preliminary vegetative

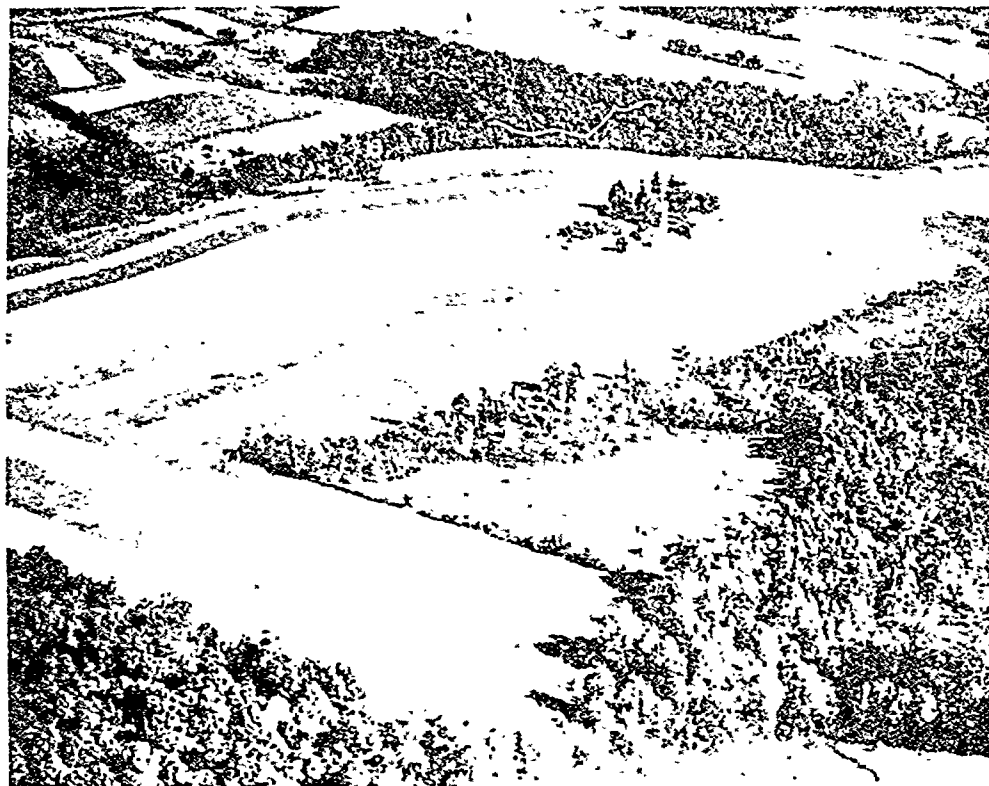

Figure 67.—Land use based on the physical capabilities of the land and the economic needs of the individual operating unit.

cover on the poorest soils. Some of them are trees, more are shrubs or herbs. Often the most suitable local species has little commercial value.

Native species are to be preferred, but it is sometimes desirable to use exotic species. Advantage should be taken of all local experience with the exotic species.

It is generally advisable to use more than one species if compatible combinations are available. Pure stands of any species are generally more vulnerable to insects and diseases. This is especially true of exotic species. On the other hand, combinations must be carefully chosen for their compatibility. Rate of growth and vigor of branching should be approximately equal, for example, or one species will tend to dominate the site. Some control can be exerted by planting component species in pure groups, but this arrangement is generally inferior to mixed stands of more compatible species.

Windbreaks are planted to reduce wind velocity near the surface of the ground as a partial control of wind erosion and to protect crops against hot winds. Different species are used in a special pattern with one species to a row. The number of rows is usually 3, 5, 7, or 9, with experience favoring 5-row belts. The outside row on the windward side is planted to closely spaced adaptable shrubs or conifers. The next row would be a taller conifer, forming with the outer row a fairly tight barrier against the wind. The next row or two is a hardy, intermediate tree, then a tall-growing hardy species. A medium-height fast-growing species comes next, with the outside of leeward border having a close-growing berry or fruit-producing shrub. Figure 68 shows arrangement of the wider belt to illustrate different spacing in rows for different species and the cross-sectional appearance of the mature belt. The planting arrangement assures a gable-

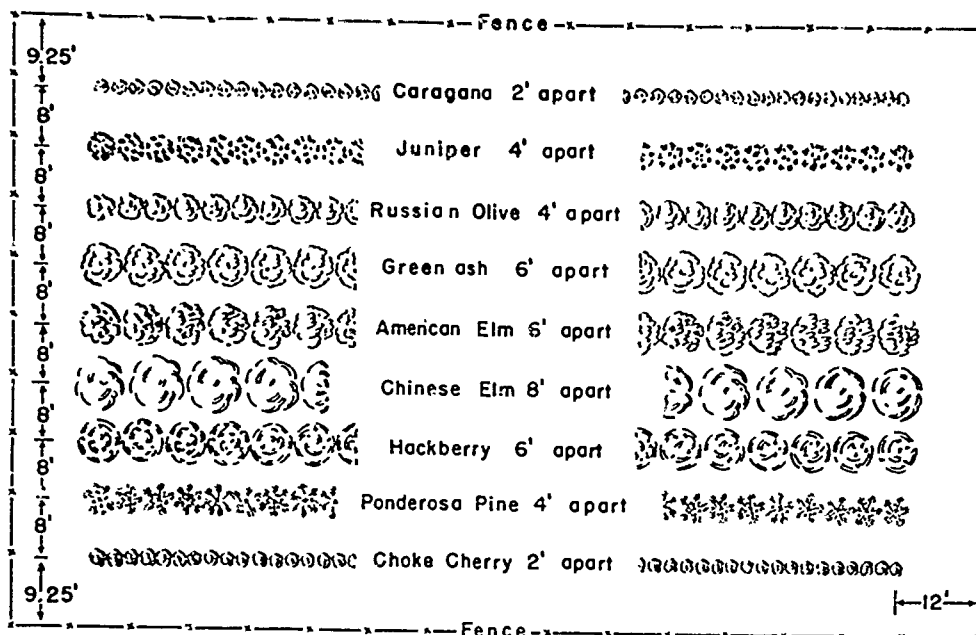

This arrangement of species and spacing will require 6,313 trees for a 1/2 mile wind break, an average of 1,263 plants per acre.

Ground Plan

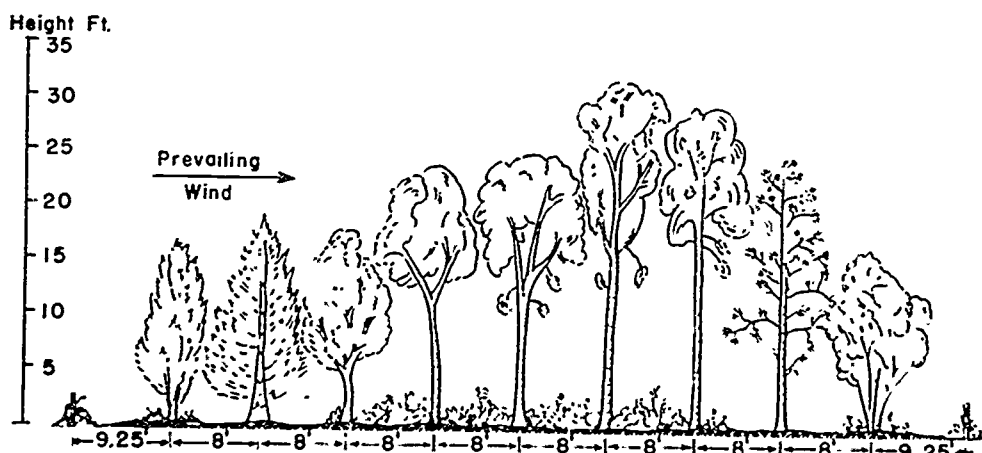

A cross section of the wind break shown above.

Figure 68.—Design of a representative windbreak utilizing a strip 5 rods (82½ feet) in width.

roof contour of foliage exposed to the wind, for the purpose of lifting it well above the ground level and dropping it gradually downward on the lee side of the planting. Tests have shown that material reduction in wind velocity near the ground on the lee side may be expected out to distances sometimes equal to 10 to 20 times the height of the tree barrier.

Planting-stock specifications

Plant material that will result in satisfactory establishment at lowest cost include seeds for direct sowing; cuttings, either rooted, calloused, or freshly gathered before planting; wildlings, or naturally sown plants dug up for replanting; and nursery grown seedlings or transplants.

Nursery-grown seedlings or transplants are generally the most satisfactory

plant materials for establishing tree cover in soil conservation work. Direct seeding of trees, such as in seed spots spaced 6 by 6 feet apart, has limited application. It is used for some of the large-seeded hardwoods such as walnuts and oaks on sites where damage to the seed from rodents will be low or can be prevented economically by protective measures such as wire caps. The mortality of tree seedlings during their establishment from seed planted on very poor sites is generally high—much higher than of seedlings grown from the same seed in nurseries under superior conditions of soil treatment and protection. Since tree seed are generally expensive, the production of seedlings or transplants in nurseries and subsequent transplanting in fields is less costly than enough direct field seeding to assure a corresponding number of surviving plants.

For certain species and certain sites, cuttings, either rooted, calloused, or freshly cut, may be satisfactorily used, generally at a saving in cost. Cottonwoods (*Populus*) and willows (*Salix*), for example, are the principal trees to which this applies. Unrooted cuttings generally require a better site than calloused or rooted cuttings. All are more demanding with respect to site conditions, especially in degree and constancy of moisture, than nursery-grown seedlings or transplants.

Wild seedlings have been used but sparingly because of the difficulties involved. Vigorous and easily dug native seedlings of the right size do not often occur in sufficient concentrations close enough to the planting site to justify their use over nursery-grown stock. Digging and transporting costs seldom favor the use of wildings over efficiently produced high-quality nursery stock.

Nursery stock itself is produced in several classes. Hardwood species are generally planted as seedlings, grown 1 or 2 years in the nursery seedbeds, depending on the time required to get them to the size desired.

While most species can be used as bare-root stock, other species are grown in the nursery in pots, especially small paper pots or tubes, and are planted in these containers in their permanent field locations. Conifers are planted either as seedlings or as transplants. Coniferous seedlings are grown one or more years in the nursery seedbeds. Transplants are seedlings that have been grown an additional year or two in nursery-transplant rows in order to develop better root systems.

Instead of transplanting them, seedlings are sometimes root-pruned in place in the seedbeds a year or two before they are lifted for planting, in order to encourage more compact fibrous root growth. A low ratio of top to roots is generally desirable.

The source of the seed used is important to successful tree planting. It should come from the best strains of the species, and from a climate comparable to that of the planting site.

Site preparation

It is often possible to ameliorate adverse site conditions by good soil preparation and subsequent care of the site. In subhumid areas the amount of available soil moisture may be increased to favor tree survival by summer-fallowing the site the year before planting. In humid regions, the effectiveness of rainfall is increased, and sheet and rill erosion reduced, by contour furrowing of the site. The contour furrow is thrown downhill to increase the retaining capacity of the furrow plus the ridge. The furrow may be blocked every few feet by earthen dams to prevent major concentrations of surface runoff. The furrows are spaced 6 to 8 feet apart, and the trees planted either in the furrow, on the downhill edge, or on the furrow blocks

which are sometimes put in as part of the planting operation. Subsoiling, especially on the contour, is advantageous in places as a means of increasing soil moisture in preparing sites for planting. On gentle slopes, basin listing is sometimes used.

In areas of low rainfall, excess surface water from adjoining lands or roadside ditches is sometimes diverted to the tree-planting site by dikes and there distributed by ridges to the individual tree rows. Where some of the precipitation falls in the form of snow, additional soil moisture can be stored during the winter before planting by placing snow fences so that drifts will accumulate on the planting sites. In some areas, provision may be made for irrigating especially useful tree plantings.

Mulching of small areas with straw, boughs of conifers, brush, leaf litter, or other vegetative matter is frequently useful in retaining or increasing soil moisture, particularly on badly eroded spots where the subsoil is exposed. Even in areas of considerable rainfall, the soil moisture of such spots will approach that of subarid regions, and without special treatment the spots are likely to remain bare of vegetation for considerable periods. Mulching is also applied immediately around individual trees at the time of or soon after planting, where the sites are subject to severe drought or excessive soil-surface temperatures. This is particularly important on loose sandy soils low in organic matter, where a fertilizing effect is also one of the benefits. Mycorrhizal growth beneficial to the success of pines also is encouraged by such applications.

Generally speaking, hardwood or broadleaf trees require either a better site or a greater degree of soil preparation and subsequent care than do coniferous trees. Especially on fields where the structure of the soil and its organic content have been destroyed by cultivation, it is frequently desirable to plow the planting site and even apply commercial fertilizers.

Where conditions permit, the planting and plowing under of a green-manure crop is an excellent method of site preparation for tree planting. Sometimes the first tree rotation is given over to site improvement through the planting of inferior pines that are especially suited to extremely deteriorated site conditions and will, through their leaf fall and root action, pave the way for their replacement, often natural, by more valuable but more demanding species.

In gullies, site preparation often means building temporary dams across the water channels to check soil movement and accumulate silt beds which will serve as planting spots. Gully banks may be sloped to more stable grades by plowing or bulldozing them in, or through the use of explosives. The resulting loose soils are more favorable to survival and growth of planted trees. Water may need to be diverted away from gully heads to permit temporary stabilization of the soil so that the planted trees will not be washed out or covered up (fig. 69).

Many of these site treatments also help to reduce plant competition and to increase ease and quality of actual planting. Some site-preparation practices are aimed directly at these objectives. Even on sites and in regions where detention of runoff and erosion prevention are not especially important, tree-planting sites are sometimes furrowed, but not necessarily on the contour, in order to reduce competition and increase the speed of planting. The latter objective is especially favored by adding a subsoiling attachment to the plow, so that the soil at the bottom of the furrow is more deeply loosened.

On sites not otherwise prepared, vegetation that may compete with the planted tree is scalped from the surface of the soil in the spots where the trees will be planted. Depending on the character of the vegetation, these



Figure 69.—A gully completely stabilized by a young planting of black locust, *Robinia pseudoacacia* L.

scalped spots may range from $1\frac{1}{2}$ to 3 feet in diameter. On erodible slopes, these spots should be staggered to avoid rows in the direction of the slope. The scalping process may be performed ahead of the planting or as part of that operation.

On planting sites where the competing vegetation is brush or undesirable trees, preparation sites may involve clearing of the entire area, or of the spots or rows where the trees will be planted. As a general rule, it is safer to get the planted trees established in any openings in the existing vegetation and perform only enough release cutting later to free the planted trees from damaging competition.

Care of planting stock

Every time young trees are taken from the soil, sorted, graded, tied in bundles, packed, shipped, unpacked, heeled in, or transferred to their final location in the soil, there is danger of loss. Losses may be due to the drying out of the roots (or of the aerial portion, if exposed to drying winds at a time when roots cannot replenish the lost moisture), overheating, freezing, mechanical injury, the starting of annual growth, and the increase of diseases. Foresters agree that better results are obtained by securing planting stock as near the planting site as practicable, and by eliminating all unnecessary handling and delays between nursery lifting and field planting. During these operations, tree-planting stock must receive the best of care to avoid losses. The roots must be kept moist and should be shielded from the direct rays of the sun.

Planting stock must sometimes be "heeled in" for several days or even weeks in order to protect it until it can be planted. The location, construction, and care of heel-in beds are important to the vitality of the stock. The site chosen for heeling-in should be protected from extreme climatic conditions and have a light, well-drained soil. All the roots and part of the stems, but not the foliage of conifers, should be covered with

soil in trenches. The stock should be placed in the trenches at an angle from vertical in thin layers between layers of soil and not in bunches as often received from the nursery, so that all of the roots will be in contact with moist soil. The beds should be protected from drying winds by barriers, shaded from excessive sunlight, mulched if in danger of heavy frosts, and watered occasionally to maintain soil moisture. Only sufficient trees for the day's planting should be removed from the heel-in beds. The stock removed for planting should be promptly transferred to the planting site in wet burlap, in planting buckets with a few inches of water in their bottoms, or otherwise assured of constant moisture.

Time of planting

Tree planting is generally done when the plants are dormant just before the growing season starts, in moist, unfrozen soil. Some planting is done earlier in the dormant season, but in regions where alternate freezing and thawing occurs in winter, fall planting involves the dangers of frost heaving, especially on the heavier soils. Where potted plants are used, it is possible to perform the planting at any time, even during the growing season, when moisture conditions are favorable, since the burying of the pot involves no disturbance of the roots and the minimum shock to the plant.

Spacing

Trees may be spaced all the way from 1 foot or so apart where willow cuttings are planted along eroding streambanks to as much as 10 to 12 feet or more apart. Usually about 6 by 6 feet is considered the standard spacing, as a compromise usually promising reasonable results at a moderate cost. Some species that are inclined to diffusive branching (such as some strains of black locust, *Robinia pseudoacacia* L.) or to heavy lateral branch growth (such as eastern white pine, *Pinus strobus* L.) can profitably be planted slightly closer to encourage development of better stems. Where a quick cover is needed, a spacing of 4 by 4 feet, or, in the case of shrubs, even 2 by 2 feet is sometimes used. Closer spacing, naturally, increases the cost of planting. Wider spacing than 6 by 6 is used under several conditions. Turpentine pines are often planted at a greater spacing, such as 8 by 8 feet. Trees planted for nut or other wild-fruit production may be spaced still farther apart.

In case of plantations that have to be kept clean cultivated, such as windbreaks in subhumid areas, the spacing is often adjusted to permit passage of the cultivating equipment locally available, and may be as wide as 10, 12, or more feet in one or both directions. Spacing of tree belts in windbreak plantings should be arranged in a pattern so that the individual belts separately spaced give effective protection to the surface area. One primary belt designed to protect a wide field often needs secondary 3-row belts at intervals of one-fourth mile to keep the winds above the field surface. Figure 70 shows a typical primary belt planted along a field border. All belts are planted across the direction of prevailing winds.

Planting tools

The selection of planting tools is also important, both to assure that the planting is properly done and to make the operation as economical as possible. Planting tools range from a simple planting bar or dibble, used for small trees on sites with loose soils, to heavy mattocks for use in heavy sod



Figure 70.—Wider spacing of trees in windbreaks encourages maintenance of crowns that are more effective as wind barriers.

or on rocky or rooty ground. Grub hoes, spades, and various kinds of shovels are other tools used, particularly under conditions intermediate between these two extremes.

For planting sites relatively free of stumps, roots, and large stones, planting machines are sometimes used. These are generally drawn by tractors and may be of one-row or two-row types. Plows, disks, and wheels are so arranged on a frame that when the machine moves forward a furrow is opened just ahead of the planter seated on the frame, who inserts trees at the proper interval in the furrow just ahead of disks and wheels that close the furrow on the tree roots and pack the soil around the plant. A two-row machine seats a planter for each row.

Planting operations

Using handtools, planting crews can plant on the average from 500 to about 1,000 trees per 8-hour man-day, depending on the difficulty of the site (topography, density of ground cover, nature of the soil, type of site preparation, etc.).

In some crews, the planters work in pairs, one man digging the holes, followed closely by his partner who carries the trees in a bucket, tray, bag, or basket (fitted to keep the roots moist at all times) and actually sets the tree in the hole and completes the planting. In other crews, each planter performs the whole task. In either case, the planting crew moves forward approximately abreast or at a slight angle (with the guiding end of the crew line slightly in front), with the individual planters or planting pairs maintaining their spacing from the adjoining individual or pair on the leading side unless the row locations have been previously marked in site preparation. Other crew members keep the planters supplied with trees, care for the stock, and perform other necessary work.

All the root must be gotten into the hole, spread naturally rather than curved upwards or doubled up, and completely covered. The tree should be planted to the same depth at which it stood in the nursery, with the

root collar at or slightly below the ground surface. Both deep planting and shallow planting are causes of plantation failure, and planters should be taught to grasp the tree by the root collar during the planting operation as a specific guide to the depth of setting. The best soil available should be carefully packed about the roots and the fill firmed when about half in, and again with the heel or planting tool when completed, in order to eliminate any air pockets in the vicinity of the roots. The planted tree should be upright, and sufficiently firmed so that it will resist withdrawal when the top is grasped and tested by the foreman or inspector. A good proportion of the trees planted by each man should be tested by the foreman walking back of the crew line.

Care of plantations

The minimum of maintenance consists of protection from fire and from grazing animals. Fire protection may require the construction of firebreaks, actual patrol to detect fires during dry seasons, and prompt suppression of fires that endanger the plantation. Firebreaks (fig. 71) are generally constructed with plows or disks by removing or burying all inflammable material and exposing the mineral soil over a strip 6 or more feet wide between the plantation and areas of high fire hazard. Firebreaks must be so constructed as not to induce erosion and have to be maintained annually or oftener. Protection from stock may be accomplished by herding, but usually by constructing a stockproof fence around the plantation.

Plantation maintenance involves the performance of any necessary replanting the year after planting or at least during the second year. A survival check should be made of each planting. Generally, a survival of 70 or 75 percent of the trees is considered sufficient, if the failures are not bunched so that they will leave major openings in the ultimate canopy of the plantation, or permit excessive lateral branch growth of the living trees.

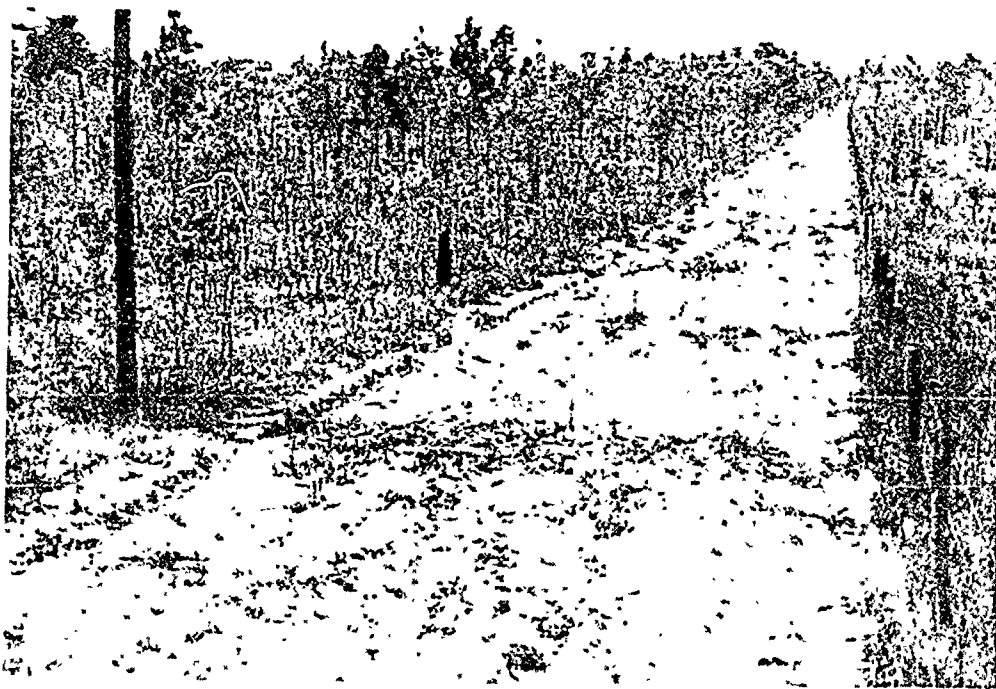

Figure 71.—This firebreak, exposing mineral soil over its 16-foot width, is helpful in the control of fire.

In the case of shelterbelts, where the wind-barrier effect of the crowns is important, and in other critical situations, a higher percentage of surviving trees may be essential.

In subhumid climates, a most important maintenance step is periodic cultivation to control competing weeds. Windbreaks for the control of wind erosion and the protection of crops and homesteads usually need to be cultivated 2 or 3 times a year to reduce competing vegetation. Cultivation has to be kept up until the tree crowns begin to mesh and by themselves shade out competition. Even in the more humid regions, when using hardwoods that are more demanding of site quality than the particular site affords, cultivation the year of planting and sometimes the year following helps the trees to weather the inferior conditions and promotes more rapid growth. If cultivation is foreseen as a need on sloping lands, it is advisable to lay out the original planting so that the rows will be approximately on the contour. Then, subsequent cultivation will aid in moisture retention and at the same time reduce the hazard of water erosion.

Woodland Management

The difficulty, time, and cost involved in artificially reestablishing forest cover on denuded sites for soil and moisture conservation should lead us to appreciate the value of existing natural forest cover and the need for its proper care and management, so that it will attain and permanently maintain its maximum protective influences on the site and on lower lying lands in the watershed. The task of reestablishing trees on bare, severely eroded areas is generally long, difficult, and costly. Every year that passes makes it more so.

The aim of forest management should generally be to get the maximum economic benefits from the forest consistent with the maximum, continuous effectiveness of the forest cover in protecting the forest site and its environs (including property below it in the watershed) from soil erosion and excessive runoff.

Usually, when we speak of a forest, we mean a dense growth of trees and shrubs so completely covering an area that the tree crowns touch each other, forming a closed canopy. In such a forest, the leaves, twigs, branches, and stems of trees, shrubs, and other plants expose innumerable little surfaces aggregating an area several times greater than that of the ground beneath. This loosely thatched roof, often 50 to 100 feet or more in thickness, is the first line of protection against runoff and the soil erosion it causes (fig. 72). Raindrops beating on this roof are shattered into droplets or what sometimes amounts to mist reaching the ground where a further protection of the soil against raindrop splash occurs from a layer of forest litter. As much as half an inch of rainfall may be completely intercepted by this intervening thatch.

The main forest bulwarks against erosion, however, are just on top of the ground. Uppermost on the ground is a blanket of litter and humus, a layer of organic material composed of leaves and twigs in various stages of decomposition. The blanket acts like a sieve, and the water slowly filters downward through it to the soil beneath. This all important organic blanket also influences the soil in several ways, making it more permeable to water. The surface of the soil is kept moist and absorbent, even in winter when exposed soil is deeply frozen. Organic material from this surface litter makes the soil more porous, giving it what is known as tilth. In addition, the litter and the humus derived from it form the principal habitat



Figure 72.—The loosely thatched roof of a virgin forest, extending from near the ground to the tips of the tallest trees, is the forest's first line of protection against surface runoff and soil erosion.

for a vast population of organisms important to soil building, soil holding, and water storage.

There is little or no runoff from an unburned woodland area, and, of course, no soil erosion. Water not evaporated or utilized by the vegetation moves slowly through the soil to feed springs and streams or to replenish deeper stores. With this perfect association of vegetation, soil, and water, functioning in the presence of abundant air and sunlight, each associate is preserved and renewed to perpetuity.

Intensive forest management goes beyond the attainment and maintenance of favorable foliage density and forest-floor conditions. It includes cultural operations designed to increase the quality (and hence value) of the wood produced, and to regulate the production in order to permit orderly cropping at desired intervals. Usually both cultural operations and the periodic harvesting of forest crops may be performed without adversely affecting the soil- and moisture-protective influences of the forest cover. Therefore, there need be no conflict between the protective and the economic production objectives of forest management; on the contrary, these objectives are mutually beneficial. Most of the steps or practices making up what is herein termed "forest management" have bearing on both.

Fire protection

The most important step in forest management is to assure the protection of the forest from fire. The effects of this greatest enemy of the forest may range, depending on the nature of the forest cover and the intensity of the burn, from minor damage to the complete destruction of both the protective and economic benefits of the forest, not merely currently, but in some measure for generations in the future (fig. 73).

Fire destroys the organic mantle on the forest floor, so important to soil



Figure 73.—Severe fires may convert highly protective and productive forests to eroding barrens, also burdening lands below with excessive runoff, silt, and boulders.

and moisture conservation and to the health and growth of the trees. Fire destroys the young trees and saplings, and their shrub and herb associates largely useful in developing and maintaining site quality and protection. Even the larger trees may be killed by fire, soon rendering them useless for products or for protection, sometimes preventing their reproduction, and often leading to their replacement by species more resistant to fire but having much lower economic possibilities. Even if the larger trees are not killed, their growth rate is retarded and they are scarred and weakened, becoming prey to insects and fungi which impair or destroy their utility for marketable products.

Even repeated superficial fires reduce forest stands and have caused loss of as much as half the value or volume of the forest over extensive areas. Repeated fires have converted forests of valuable species into brush fields, or into ragged stands of unmerchantable trees. Frequently, the problem of protection against future fires is intensified by the effects of past fires.

Controlled burning

Under specific conditions fire can be a useful tool in handling forests. Controlled or prescribed burning is being used in some localities to reduce hazards of wildfires and prepare the forest floor for establishment of desirable species. If an accumulation of inflammable litter is removed by controlled burning, the risk of severe damage to the stand by wildfire is reduced. Most seed of desirable conifer species need contact with the mineral soil to

assure survival. Many of the undesirable hardwood species can take root and survive where a deep forest litter covers the soil. If the forest is to be managed for conifer production, surface conditions should be made favorable for growth, either by burning off the litter or disturbing it with cultivating equipment.

When controlled burning is used, special care must be taken to burn at the time of day and under such atmospheric conditions that the fire does not become too hot or spread beyond the area treated. This burning is done only when desirable reproduction is either not going on or is so far advanced as not to be seriously damaged by the fire. Light burning, well controlled, at intervals of a few years can be valuable in both protecting and improving the forest stand but should be used restrictedly and intelligently, never carelessly.

Protection from grazing

The grazing of domestic animals reduces both forest production and the protection afforded by forest cover. Its influence is least important in certain coniferous types where the trees are naturally wide spaced, crowns do not form a complete canopy, and the normal vegetation between the trees is made up mainly of grasses, herbs, and shrubs. These coniferous types occur on soils that are relatively young geologically, where the climate is subhumid or, if humid, deficient in rainfall during certain seasons. Much of this type is on sloping land, and the herbaceous cover is frequently light as compared to that in a lowland meadow, and its effectiveness in soil and moisture conservation is quickly impaired by overgrazing. Carrying capacities are relatively low, and with proper management, trampling by livestock will ordinarily not result in damaging compaction of the soil. Reproduction of the forest may be affected to some degree, but not prevented if proper grazing management is practiced.

In all other types of forest, intensive management should preclude use of



Figure 74.—The grazing of hardwood stands adversely affects their productive and protective values.

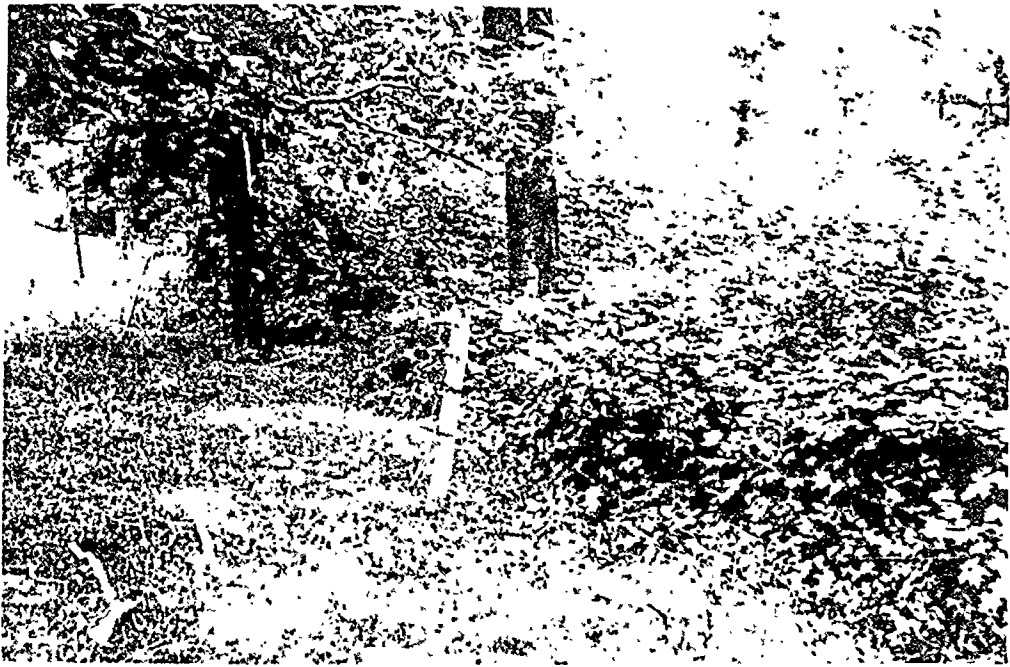

Figure 75.—The effect of grazing in preventing hardwood reproduction is clearly revealed along a fence line between grazed and ungrazed forest properties.

the forest for grazing. In coniferous stands on relatively level, sandy soil, dual use for timber production and cattle grazing may be justifiable under an extensive form of management. Even here, the two uses are essentially competitive. Coniferous reproduction and brush tend to invade the areas of palatable herbs between the older trees. Controlled burning to reduce this invasion has a depressing effect on growth of the older trees and materially reduces desirable reproduction also where there is no forage. The advisability of nongrazing of forest is particularly applicable to other coniferous types on erodible slopes, to forests in which hardwood species are valuable components (fig. 74), and to intensively managed forests generally.

Grazing may have several harmful effects. Trampling of the forest floor reduces the effectiveness of the organic layers in protecting the soil, conserving moisture, and nourishing the vegetation. The organic layers in a hardwood forest especially, may be essentially destroyed by trampling, giving way to a herbaceous cover not ecologically associated with the forest trees under healthful normal conditions, or may leave the soil relatively bare of protection (fig. 75). The soil of a grazed forest is measurably more compact than that of a corresponding ungrazed forest. This reduces the infiltration capacity of the soil and the beneficial effects of the forest on watershed lands below, as well as adversely affecting the water regimen of the site itself. Browsing and mechanical injury may eliminate all reproduction of desirable tree species.

The herbaceous cover often resulting from grazing may form a sod that will prevent even the starting of new tree reproduction. Tree saplings do not escape mechanical injury, and gradually even the older trees become affected; their growth slows down and they become more susceptible to drought and various pests. Inferior tree species, less affected by the grazing or better suited to the deteriorating site conditions, may invade the forest area.

Improvement cutting

The first type of cutting generally needed when second growth or partly harvested virgin forests are placed under management is rather broadly termed improvement cutting. All forests contain individual trees that are not paying their way in the stand and offer little promise of doing so. These include large-crowned and coarsely branched trees utilizing more than their fair share of forest space and hindering the development of promising smaller trees; trees of such poor form, slow growth, undesirable species, or so damaged or diseased that they will not rapidly improve in volume and value if given additional time or opportunity to grow; suppressed trees not likely to live until the next cut is made; trees so crowding their associates that the growth of all of them is reduced; relatively poor trees that are suppressing the development of better trees; and overmature trees that are declining rather than increasing in value, and are not needed as seed trees. Such trees should be removed in improvement cutting, to the extent that this can be done economically and without creating large holes in the forest canopy. It may pay to kill undesirable hardwoods by girdling or poisoning rather than to cut them. This is especially true in trees of low or no market value, or where the falling of such trees will seriously damage valuable young growth. The girdling or poisoning of undesirable conifers may create severe fire hazards and is generally not recommended.

Usually, the trees to be cut or girdled should be marked in advance either by a trained man or under his supervision. Improvement cuttings generally produce sufficient products, mostly of low quality, to pay for themselves, making the resulting benefit to future production entirely a net gain. After a stand, either natural, or through improvement cutting, reaches good growing condition and includes mature crop trees, improvement cutting should be combined with the periodic harvesting of crop trees.

Removing weed trees

Weeding is a specialized kind of improvement cutting designed to increase the most desirable trees in dense young stands. The most desirable seedlings are frequently in the minority and subject to suppression by faster growing but less desirable associates. The freeing of individuals of the better species from this competition is termed weeding. The work may be done with axes, brushhooks, machetes, or merely with the hands, since the trees so treated are generally small. This operation does not yield marketable products and must, therefore, be justified on the basis of improved future production.

Thinning

Forest stands, especially when even-aged, frequently get so dense that the growth of even the most desirable individual trees is materially reduced. Such conditions require a particular kind of improvement cutting known as thinning (fig. 76).

Naturally reproduced forest stands frequently start with many thousand seedlings per acre, yet at maturity, support only 50 to 250 grown trees. This great reduction is accomplished naturally through the survival of the fittest. The competition throughout the life of such a stand is beneficial up to a certain point, encouraging the development of good form and the



Figure 76.—Thinning and pruning operations are frequently combined in order to encourage maximum growth of valuable wood on the cleared stems.

natural pruning of side branches, but it also reduces the growth of even the successful competitors. Furthermore, the trees destined to become the successful competitors in this natural process are not necessarily those that can yield the most profit of all the trees that start on the acre.

Thinning aims to retain the advantages of density while reducing the disadvantages. Generally, thinning is begun, if needed, as soon as the material removed will pay for the cost of the operation and is repeated as needed. Sometimes the thinning of trees while still below useful size is advisable as an investment in future production.

The trees to be removed in a thinning should be selected and marked in advance by a competent person. The aim is to maintain the maximum number of trees so as to use all the productive capacity of the soil. A simple rule for thinning and one easily learned and applied is the D rule. For example, in thinning fast-growing pine, the formula $D6$ can be used. D represents the average diameter of any 2 trees and 6 the factor for this pine. Hence, in the case of an 8-inch and a 12-inch tree, the space in feet between the trees should be the average diameter, 10, plus 6, or a 16-foot spacing. This rule provides for the removal of 1 crop tree per acre per year and crown closing in 5 years, when another thinning should be made. The factor is reduced to 4 or even 2 for slower growing trees.

Pruning

The lower branches of a tree tend to die and drop off naturally, especially in dense stands. This natural tendency differs widely among species. The wood formed on stems retaining branches or stubs will produce mainly knotty lumber when the log is sawed. With species tending to have persistent branches, or in case of trees growing in understocked stands, where the final product will be more valuable if free of knots, it may pay to

remove the lower branches from the stem by artificial methods. This is generally done on trees 4 to 10 inches in diameter, carefully selected as the individuals most likely to be grown to final crop size. The work is done preferably with hand or pole saws, from the ground or from ladders. Branches are cleanly severed as close to the stem as possible without injuring the bark on the latter.

The trees selected for pruning should have small branches, since cuts over 2 or 3 inches in diameter may expose heartwood more vulnerable to rots, or delay the callousing of the wound, perhaps seriously deforming the subsequent growth. All the dead branches on the lower part of the stem may be pruned, plus some of the lower living branches. Generally, rate of growth will not be materially affected if the lower 40 to 60 percent of the stem is cleared of branches, depending on the species and the proportion of the stem having living branches. The pruning may be done in some cases in one operation. In others, two or more operations a few years apart, during which the tree gains more height, are needed to extend the work to the desired height. The pruning should be planned to clear entirely one or two standard log lengths, otherwise much of the benefit will not materialize.

Harvesting

The ideal form of harvesting, where the forest type and silvicultural conditions permit, is a selective cutting that involves the removal at frequent, regular intervals of scattered trees selected as having reached their economic maturity, along with trees that should be cut for stand improvement, thinning, or salvage purposes.

In comparing selective cutting and clear cutting on the basis of economic returns, the former is generally more profitable to the forest owner. Only about half the total volume of wood produced by a stand of trees during its lifetime is present at maturity. The other half has been lost through suppression, diseases, insects, and other causes. By selective cutting at intervals, this volume, although often of inferior quality, is utilized and the quality and total remaining volume increased. Also selective cutting provides income and products at frequent intervals. This is often of advantage to the owner and is also important in providing stability to local wood-using industries.

Selective cutting also has some practical disadvantages, especially over modified forms of clear cutting. It cannot be successfully used for species readily windthrown, species requiring complete sunlight for reproduction, or inferior species with greater capacity to reproduce than the desirable species. Furthermore, since smaller volumes of products are removed in the individual selection cuts, the forest harvested by this method must have somewhat greater accessibility, and the value of the products must be relatively higher. Usually these economic disadvantages are substantially outweighed by the economic advantages of selective cutting.

The protective advantages of selective cutting over clear cutting are less measurable and generally less direct. In selective cutting, the forest canopy is not seriously broken, and little disintegration of the organic layer of the forest floor results. These bulwarks of protection against soil erosion and runoff remain fully effective. If complete reproduction immediately follows clear cutting, these protective influences will likewise be maintained. Unfortunately, complete reproduction is frequently delayed, sometimes for very long periods, following clear cutting.

One of the worst effects of clear cutting is in the attitude of the owner, local people, and others toward devastated forest land. The owner, who

himself will not reap another forest crop from the area, is relatively unconcerned about its future. Clear-cut areas are frequently subject to disastrous burns, excessive grazing, severe erosion, and other forms or results of mistreatment or carelessness. A selectively cut forest, on the other hand, represents obvious value to the owner and to others, and is therefore more apt to receive some protection and care.

Restriction of the volume of each harvest cut to the equivalent of the volume growth added by the crop trees since the last harvest cut would be helpful toward maintaining a continuing good forest. If the forest stand is understocked, the density could be increased by cutting less than the periodic growth. On the other hand, if the stand is overstocked, at first somewhat more than the periodic growth may be cut.

The amount of any harvest cut being limited by growth, the maximum frequency of such cuts is determined by economic factors, especially the lowest volume per acre that may profitably be removed. From a silvicultural standpoint, maximum frequency is generally desirable. Very often, the interval between cuts on the same acre, the "cutting cycle" in other words, may be as low as 3 or 5 years. Ten years is considered about as long as a cutting cycle can be and still attain maximum silvicultural benefits. If harvest cuts are desired every year to provide stability of employment and of income, the forest may be divided into as many parts as there are years in the cutting cycle to be followed. Then, one part may be cut over each year, continuously. When a forest attains the most desirable distribution of trees by size classes, even the volume of the annual yield can be approximately stabilized.

The crop trees harvested in a selective cut are generally among the larger size classes. The trees selected should be the slower growing, or least promising of future gain, among the crop trees. Rigid application of diameter limits fails to take advantage of difference in growth rate between individual trees of the same size, even of the same species.

The trees to be removed should be marked in advance under competent direction. Unless the owner personally is going to supervise the cutting, two marks should be used, one about head high and uniformly on one side of the stem to permit quick location by the loggers of the trees to be cut, and a second mark, distinctive in character, at the base of the tree below stump height, which will permit a check subsequent to cutting on the loggers' adherence to the marking.

Plans

A forest crop requires 30 to 150 years or more to grow from seed to forest. Treatment as early as the beginning of this crop period may affect the amount and quality of the harvest. During such long periods, owners change, and the well-laid plans of a previous manager may be obscured if not recorded in a written plan of management. Even during one manager's tenure, his plans will be more useful guides if written.

Management plans generally include maps and descriptions of property; the location, age, and character of individual stand; and other historical and descriptive information pertaining to the forest. They should outline also the objectives of management and the procedures or methods that will be followed to obtain those objectives. The types of cutting and current information on volumes may be included. Also important are the plans that will be followed in protecting the forest, in maintaining roads, trails, fences, and buildings, and in accomplishing any supplemental tree planting that may be desirable. Information on markets and marketable products

may be included. Inventories of specific stands are particularly important to forest managers who wish to take advantage of occasional opportunities to market special products at premium prices.

Forest appreciation

Perhaps the most difficult part of a public forester's job in relation to soil and moisture conservation, is educational in nature. It is necessary that forest owners, operators, and the public in general attain full appreciation of forest values and benefits, both economic and protective. Generally, in the case of forest owners or operators, economic benefits have the greatest appeal, and the soil- and moisture-conserving objectives must be attained through securing acceptance of a form of forest management that will bring them about incidentally in obtaining greater forest income. A considerable number of farm owners and operators, however, readily see the protective advantages of planting steep erodible slopes to trees, and some like to see trees growing on land that has shown marked deterioration as a result of unwise land use and cultivation.

Two principal steps may be considered in public effort to bring about better forest management. General educational work coupled with demonstration of the benefits of better management on representative properties, usually in cooperation with private owners and operators, will reach a few forest owners, cause some improvement in practice, develop local techniques, provide experience, and tend to create desire. The second step provides technical forestry assistance to all forest owners and operators who can be interested in improving the management of their forest properties.

Terracing

As a means of controlling erosion and conserving rainfall on sloping land, farmers long ago introduced the use of hillside ditches. The ditches themselves proved inadequate, but the principle of controlling erosion by systematically intercepting surface runoff on sloping lands has led to the use of farm terracing. The development of terracing as recommended today has required years of use, extensive field observations and experimentation, and many modifications from time to time in construction procedure. When terraces are properly used and constructed and adequately supported by approved cropping and tillage practices they provide one of the most effective erosion-control measures applicable to cultivated lands. When improperly constructed or not coordinated with good land use and soil-conserving practices, they often accelerate rather than retard soil losses.

This section gives up-to-date information on terrace construction and maintenance in coordination with other recommended soil conservation practices. The information it contains is based on the terracing work of the Soil Conservation Service in every important agricultural region of the United States.

The basic factor that must be recognized in the application of erosion-control measures is the proper utilization of the land. The use of land in accordance with its capabilities is a guide in considering what areas or fields are to be terraced and what areas need a combination of terracing and other supporting measures. Land used for cultivated crops should be terraced where runoff and erosion cannot be controlled by use of vegetation or tillage practices in the proposed cropping rotation or with contour stripcropping.

Land unsuited for cultivated crops should not be terraced except in special cases. For instance, where land has been severely impoverished, terraces may be desirable to assist in the establishment of a permanent stand of grass. In such places terraces are used as a temporary measure and may be constructed according to standards somewhat below those required for a permanent system. Experience indicates that terracing on land not suited to cultivation usually results in expensive failures. The original cost and subsequent maintenance are high, owing to steep slopes, erosion, or unsatisfactory working conditions of the soil. The high cost of construction and maintenance coupled with the unusually low yields in cultivated crops would indicate that a less intensive use, such as for pasture, meadow, or woods, would result in greater net income.

The success of terracing depends primarily on maintenance and management. Neglect of the terrace system will destroy the terraces and cause serious erosion in the field. In keeping terraces in repair, the most important operation is proper plowing.

Plowing should be parallel to the terraces. Plowing across terraces, up and down the slope, fills the channels and destroys the ridges. Plowing parallel to the terrace, so that a dead furrow falls in the channel and a backfurrow on the ridge, keeps the channel open and builds up the ridge. In this way, well-built terraces can be kept to proper size, and terraces slightly undersize can gradually be built up.

If terraced fields are plowed as they should be, terrace maintenance becomes a part of the regular tillage operations and not a special maintenance job.

Old terraces that have been well maintained seldom need repair, but new ones may require some attention during the first few years. Fresh fills in



Figure 77.—When terraces are properly constructed and supplemented with suitable tillage and crop-rotation practices, good farm crops can be produced without excessive soil loss.

the ridge may have settled unevenly, and the low spots thus formed should be built up. This work can best be done before plowing so that the repaired spot will be smoothed up in plowing and harrowing.

Terracing and Agronomic Control Measures

Terracing cannot be economically justified on cropland that can be protected by less expensive conservation measures. Agronomic measures, such as contour tillage, crop rotations, and stripcropping, are all that is needed on many sloping areas. These agronomic measures alone may furnish enough protection where rainfall intensities are low and the soil absorbs the rainfall rapidly, where the soils are erosion resistant and the slopes gentle, and where profitable rotations can be introduced that will provide an erosion-resistant cover during a large part of the rotation cycle, particularly during the rainy seasons. But where erodible soil, long slopes, and high rainfall intensities prevail and where short rotations must be followed to provide a profitable farm income, the agronomic control measures may give only partial control. They can then be reinforced with terracing.

Terraces should always be supplemented with the best possible cropping practices because terraces in themselves do not improve soil fertility and used alone they fail to hold the soil adequately. These facts justify the expectation that terraced fields properly supplemented with other practices will produce better crop yields over several years than unterraced fields (fig. 77).

Hydraulics of Terrace Design

Rainfall coming at a high rate is likely to induce considerable surface runoff, which will cause erosion down the slopes. When runoff attains a velocity of about 2 to 3 or more feet per second it is usually capable of loosening and transporting topsoil from unprotected fields, especially where raindrop splash has aided in throwing soil particles into suspension. Velocities of even less than this frequently cause erosion on some of the finer clays and sands. At the top of a slope the quantity of runoff is usually small and the movement slow—without power to do much damage. But as the water flows down the slope its volume and velocity tend to increase, and it gains increasing momentum and power to tear away soil particles.

Terraces must intercept the surface runoff before it attains sufficient velocity to severely erode the soil. They must carry the surplus rainfall from the field at nonerosive velocities and deliver it to stabilized waterways where gullies are not likely to be formed by the discharge water. This is accomplished by placing a series of terraces across the slope, the first one being located near enough to the drainage divide to intercept all the runoff from that part of the contributing areas above before it attains excessive erosive power or a volume that will exceed the capacity of the terrace channel. Each succeeding terrace downslope is located in a similar manner. The surface slope, the rate of velocity of runoff, and the amount of rainfall within a given period are therefore the first factors to be considered in the design of a terrace system.

Ordinarily a terrace is designed to take care of runoff from rains of the maximum intensity that is likely to occur during a 5- to 10-year period.



Figure 78.—Overtopping, caused by improper design, construction, or maintenance of terraces, damages both field and terrace.

Designing for runoff from rains of the maximum intensity likely to occur during a shorter period would result in frequent overtopping and consequent heavy repair costs, and designing for runoff from rains of an intensity that is not likely to occur more frequently than once in 15 or 25 years might involve excessive construction costs. It is conceded that during parts of the year when rates of runoff from fields are below average the full capacity of terraces designed for storm recurrence intervals of 5 to 10 years will not be utilized. But terraces that cannot carry the higher rates of runoff will fail at the very time when they are most needed to retard soil loss (fig. 78).

Velocities in Terrace Channels

Terrace channels of ample capacity must be constructed so as to transport water at nonerosive velocities, otherwise much soil may be carried from the channel with the runoff and serious gulying may develop. The velocity in a terrace channel increases not only as the slope of the channel increases, but as the average water depth (approximately the hydraulic radius) increases and as the surface resistance (coefficient of roughness) decreases.

Under field conditions, the roughness of the channel surface is established by soil, tillage, and crop conditions and cannot be changed to control velocity. The velocity, therefore, can be controlled by adjusting only the gradient and the average depth of water in the channel.

The maximum channel gradient that can be satisfactorily used must be less than the minimum slope that produces sufficient channel scouring to injure the terrace. The average depth of flow can be adjusted and the capacity maintained by changing the shape of the cross section of the channel. If other factors remain constant, a narrow, deep channel will produce a higher velocity with greater erosive power than a wide, shallow channel because the average depth of flow is less in the shallow channel. A channel cross section that is wide in proportion to its depth not only retards velocities but also facilitates tillage operations over terraced fields.

In terrace construction, a channel of uniform cross section is desirable. In order that such a channel may take care of the increasing amounts of water being intercepted the gradient is increased along successive segments of the channel. Such a channel gradient also gives more desirable flow characteristics because the flatter grade in the upper reaches of the terrace tends to retard channel flow and so reduces the tendency for water to pile up in the lower part of the channel. The final gradient will be limited by the maximum permissible velocity above which scouring will result. Thus, by proportioning the channel area, shape, and slope the necessary channel velocity and capacity can be obtained.

The recommended terrace specifications given under Planning the Terrace System have been developed from experimental and exploratory data collected under actual field conditions. They will ordinarily be found to suffice if applied under conditions for which they are recommended. For the man inexperienced in engineering they form a safe basis for terrace design and can generally be used without further computation. The exceptional conditions for which these specifications are not entirely adequate may require the computation of runoff from agricultural areas and the determination of theoretical channel velocities and capacities. Where there are problems of this type a competent engineer should be consulted.

Types of Terraces

The ultimate objective of all terraces is soil conservation. This objective is achieved by terraces that provide for the interception and diversion of runoff or the impounding of surface runoff for increased absorption. From a functional aspect, terraces are classified as (1) interception and diversion types and (2) absorption types.

When the construction characteristics are considered, it is found that a well-constructed channel somewhat below the original ground surface is the most dependable structure for intercepting and diverting runoff, whereas a ridge constructed well above the original ground surface, with as little channel as possible, is the best structure for impounding runoff for increased absorption over a wide area above the ridge. Generally terraces are classified as (1) the broad-channel type; (2) the ridge type; and (3) the bench terrace, which is sometimes used on steeper slopes.

In some sections both absorption and diversion are important objectives of terracing, but there are large areas where diversion is of first importance and other areas where absorption is.

Regions of moderate rainfall and favorable soil conditions will have intermediate terrace requirements, and a dual-purpose terrace combining the desired features of both types can be used. Cross-sectional dimensions of all terrace types will differ throughout the country according to the soil, terrain, rainfall characteristics, and types of machinery to be worked over them. But the fact that dimensions must be adjusted to meet local conditions does not invalidate the classification of all terraces according to function.

Figure 79 shows the cross-sectional difference between the broad-channel terrace and the ridge terrace. Both types are shown singly to assist in visualizing the finished cross sections desired for each, and one is superimposed on the other to bring out more clearly the variation between the two terraces.

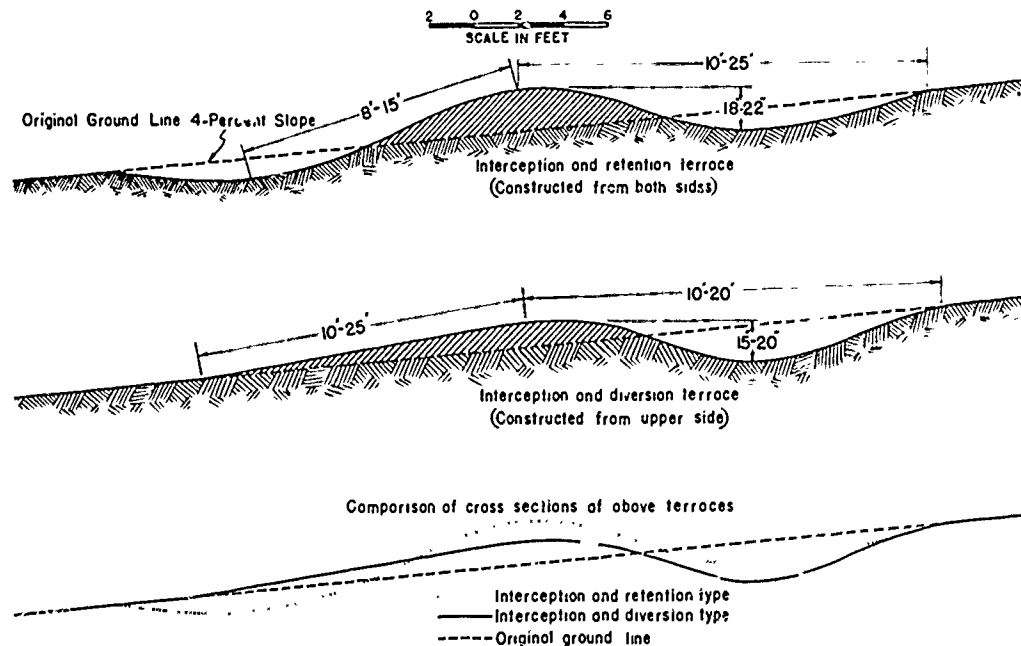

Figure 79.—Terrace cross sections after settlement and cultivation.

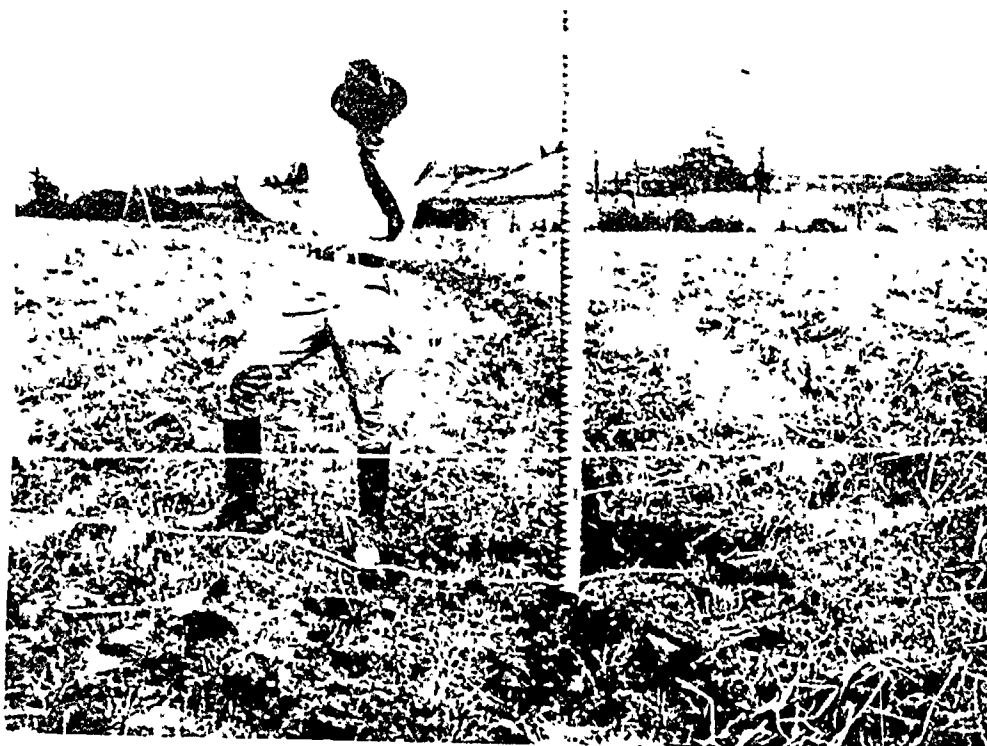

Figure 80.—A broad-channel terrace in the Piedmont area. To be effective, the channel must have ample capacity.

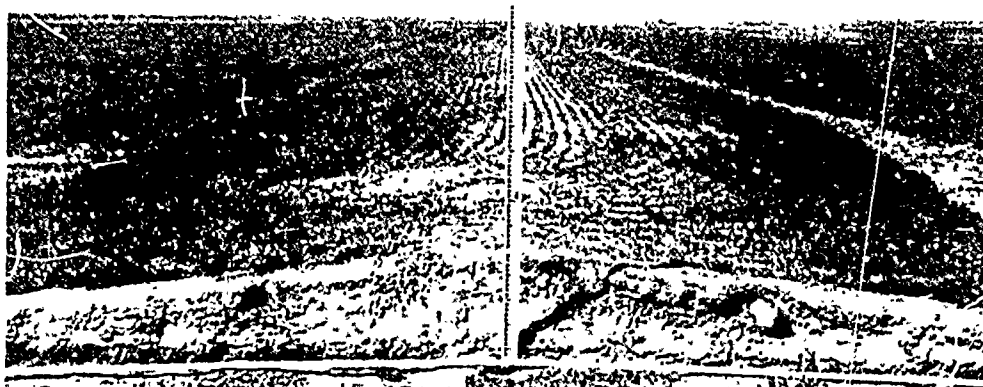

Figure 81.—The ridge terrace is used in the Great Plains for erosion control and moisture conservation. To be effective the ridge must be high enough to spread the collected runoff over a wide area and wide enough to allow satisfactory operation of tillage equipment.

Broad-channel terraces

The broad-channel terrace acts primarily to conduct excess rainfall from the fields at nonerosive velocities. Since low-velocity surface removal of excess rainfall is required, the channel and not the ridge is of primary importance. A wide, relatively shallow channel of low gradient that has gentle side slopes and ample water capacity will give the most desirable results (fig. 80).

The excavated earth is used to bring the lower side of the channel to a height sufficient to provide necessary capacity. A high ridge is not desirable since it seriously interferes with tillage operations, increases construction costs, and frequently requires for its formation a large part of the topsoil scraped from the field. In the broad-channel terrace the ridge should be considered as supplemental to the channel and should blend gradually into the surface slopes to afford a minimum of interference with machinery operations. Moreover, the low gradient of the downslope side of the ridge, which is the critical part of ridge terraces, so nearly conforms with the natural slope of the land that there is much less danger of erosion at this point.

Ridge terraces

Erosion control by the ridge terrace is accomplished indirectly by water conservation. In order to increase absorption the terrace is constructed so as to flood collected runoff over as wide an area as possible. If this is to be done most effectively the surface slopes on which the terraces are built should be fairly flat, the ridge should be of sufficient height to pond water over a relatively large surface, and the earth required for the ridge so excavated as to avoid concentration of runoff on a small area (fig. 81).



Figure 82.—Runoff impounded by level terraces is needed for increased production in the Great Plains during normally dry seasons.

The degree to which these conditions can be attained is limited by necessary construction methods and the slope of the land. In this type of terrace the ridge is of greater importance than the excavated channel, which is more or less incidental to the construction of the ridge. When maximum absorption is desired, the terraces must be designed for ample storage capacity and placed on level grades with closed ends. As a factor of safety the ends are often left open so that excess rainfall can escape before the terrace overtops. In some areas the ends of the terraces are partly blocked depending on the necessity of safety outlets for excessive rains not included in the design frequency. If the impounded water from level terraces would result in excessive crop damage, a slight channel grade, particularly near the outlet, may be necessary.

The ridge terraces are adapted to low rainfall areas and to soils that will absorb the accumulated runoff fast enough to prevent damage to growing crops (fig. 82). These areas are largely confined to absorptive soils and gentle slopes in wind-erosion areas. The ridge terrace may also be used with considerable success on certain areas of sandy soils and gentle slopes where the rainfall is heavier, such as sandy coastal plains. Thorough examination of the soil absorption and rainfall rates should always be made before this type of terrace is used.

Bench terraces

Bench terracing is one of the oldest mechanical methods of erosion control, having been used for many centuries in thickly populated countries where economic conditions necessitated the cultivation of steep slopes. Bench terracing was highly developed by the Inca civilization centuries ago in the Andes Mountains of Peru, in parts of China, the Mediterranean countries, and in other places. It consists principally in transforming relatively steep land—20- to 50-percent slopes—into a series of level or nearly level strips, or steps, running across the slope. The strips are separated by



Figure 83.—True bench terraces consist of a flat step or bench for cultivation—notice the furrows—and a slope covered with grass.

Sketch showing bench terrace constructed on a 45 percent slope, using a vertical interval of 6 feet, and having a back slope of $\frac{1}{2}$ on the riser

The bench is approximately 10.5 feet wide with an *m* slope of 1 inch per foot of width.

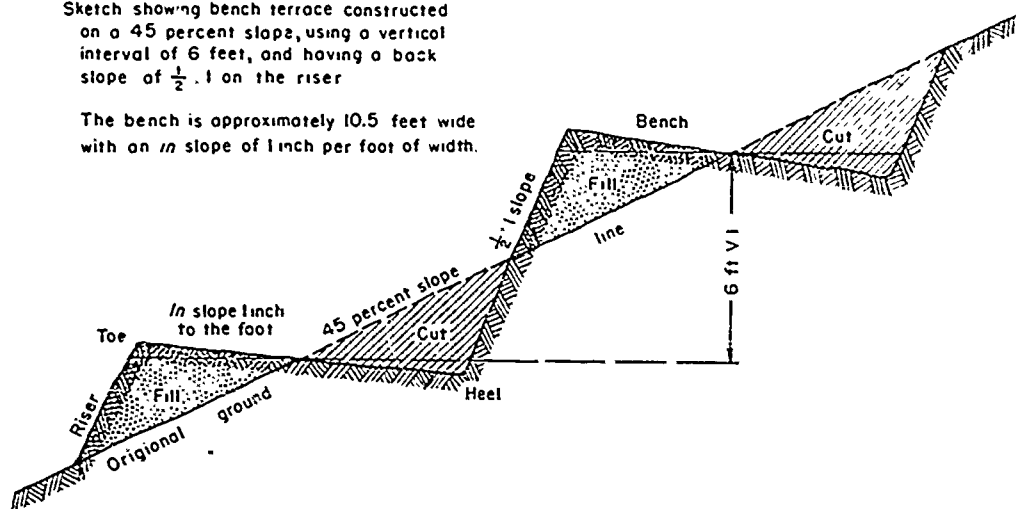

Figure 84.—Cross section of an excavated bench terrace.

almost vertical risers, which are of rock or earth protected by a heavy growth of vegetation. This type of terrace exemplifies the original meaning of the word terrace (fig. 83).

The use of bench terraces on steep slopes not only retards erosion losses but it also makes cropping operations on these slopes possible and safe. Whenever the absence of adequate flatlands, or the special adaptability of particular slopes to high income crops necessitates the cultivation of steep slopes, the bench terrace will probably continue to be used.

When a bench terrace is constructed (by excavation) the tendency is to remove the fertile topsoil from the bench leaving subsoil exposed for the planting of crops. It usually takes 2 or 3 years to put the bench into shape for cultivation by the heavy use of commercial fertilizers, farm manure, and green-manure crops. On deep soils, grass crops may be grown as soon as the benches are completed by using plenty of fertilizer or compost material. Many of the bench terraces of the Mediterranean countries are made of soil carried in from other places with human labor.

Excavated bench terraces should usually have a vertical interval between benches such that the area to be excavated will equal the area to be filled (fig. 84). If the slope or riser is of earth construction, it should be as steep as possible, $\frac{1}{2}$ foot horizontal to 1 foot vertical or steeper. If the riser is of rock it is built nearly vertical. The slope or riser, if not of masonry, should be planted to deep-rooted grass so as to hold it in place and prevent erosion. The bench or floor of the terrace should slope inwards from the toe to the heel about 1 inch per foot so that excess rainfall will flow towards the heel and be carried off in a small ditch. This small ditch should follow the heel to a grassed or forested area or to a protected ditch for safe disposal. These excavated terraces should be laid out and built so as to have a slight grade ($\frac{1}{4}$ of 1 percent, longitudinally) so that the water carried across the bench of the heel will be carried away to the disposal ditch or area.

These water-disposal outlets may be constructed of masonry, wood, or some such material, if additional protection is needed due to the high velocity of the water. If the slope is not too steep, and the disposal ditch can be widened, the area can be stabilized by the planting of certain grasses, legumes, or certain types of vines (fig. 85).

Excavated bench terraces may be built with handtools or, if the slope is not too steep, with power equipment. Bench terraces are not recommended



Figure 85.—Grass-covered outlet ditch.

on slopes below 15 percent. The cost of constructing bench terraces is excessive. As a general rule their use is not recommended.

A much more satisfactory procedure is to develop bench terraces rather than to "excavate" them. In bench formation, the land is used for normal hillside farming while the benches are forming. The method found most satisfactory is to plow the land on the contour and allow the soil to move downhill against a barrier of stiff-stemmed grasses until the slope has been reduced to a nonerosive grade.

A barrier of stiff-stemmed grass, such as Merker (*Pennisetum purpureum var. merkeri*), is first planted on the contour at vertical intervals recommended for the various slopes (fig. 86). Then the land between the grass barriers is used in the normal manner, but care is taken to plow towards the barrier line each time the land is plowed in the preparation of a seedbed for a new planting. The slope of the bench will change with each plowing and after



Figure 86.— The first step in developing bench terraces is the planting of stiff-stemmed grasses on the contour.

about seven or eight plowings a very satisfactory bench will usually be formed. The land would not be out of use at any time as it would be where terraces are constructed outright. Also, soil loss will be reduced by the use of the barriers and contour cultivation. This is sometimes referred to as the California or Puerto Rico terrace. In using this method the objective is to allow normal movement of soil, by erosion and gravity, between the vegetative barriers, but to stop and hold this soil at the barrier lines.

Benches can be developed on slopes up to about 45 percent where the soil is fairly deep. A vertical interval of 6 feet is considered satisfactory. This interval may be somewhat increased if the soil does not wash badly during the earlier stages of bench formation and will stand a riser of more than 6 feet high with a back slope of $\frac{1}{2}$ to 1 or 1 to 1. A flatter back slope can only be used at the expense of the bench.

No provision is made for carrying off water along the heel of the developed terrace as a continuous grade cannot be maintained longitudinally along the terrace by plowing under normal farming operations. In some places the plow will dig deep on account of a soft spot while in others the plow will ride over obstructions such as rocks, roots, and hard spots. Unless the slope is extremely long the water is allowed to move down the slope through the barrier grass. Intercepting ditches draining to protected dispersal ditches or areas should be used below the barriers where the length of slope might cause a concentration of water that could damage the barriers or cause serious erosion.

Merker grass seems to be the best grass to use for the barriers; however, any stiff-stemmed grass may be used provided it does not seed in such a manner as to become a pest on the bench devoted to clean-tilled crops. A mixture of Melao (*Melinis Minutiflora*), or of Jaragua, and Tropical Kudzu (*Pueraria Phaseoloides*) has been highly successful in Puerto Rico. When this mixture is used as a barrier it also covers the riser. It is an excellent feed for farm animals.

During the development of terraces the barrier grasses should be kept harvested, especially if Merker is used. It makes good fodder for cattle and under normal conditions of rainfall it can be harvested every 3 months. Merker grass in a barrier should not be cut lower than 10 inches to 18 inches from the ground. By cutting it at that height a better barrier is formed and there is no tendency for the grass to spread out over the bench. The banks or risers of the formed terraces are protected by the barrier grass or by allowing native vegetation to come in naturally.

Before the use of bench terraces in any area is considered, a thorough study should be made to determine whether there is justification for cropping the steep slopes that require this type of protection. If suitable lands with flatter slopes are available or if a profitable return cannot be expected, cropping of the steeper slopes by the use of bench terraces should be discouraged. The construction of bench terraces on flatter slopes that are suitable for the ridge or channel terrace should also be discouraged.

Planning the Terrace System

Certain fundamental engineering principles are involved in designing and constructing terraces, but a high degree of theoretical training is not so important as the faculty of good judgment, combined with an agricultural background and a general understanding of the various phases and measures of erosion control. It will usually be well for farmers who have not had training in the use of surveying equipment and in the planning of

a terracing system to have the surveying and planning done by an agricultural engineer or someone who has had the necessary training and experience.

In the preliminary planning, all necessary terracing for the entire farm should be considered in order that terracing on any part of the farm may be fitted into the complete terrace system without difficulty or unnecessary expense. The possibility of rearrangement of fields, fences, and roads to conform to good land-utilization and farm-management policies should be kept in mind. Terracing is usually planned according to drainage units, that is, areas that can be satisfactorily handled through one outlet or system of outlets. Such factors as ridges, drains, roads, large gullies, abrupt changes in slopes, property or field lines, and terrace lengths are some of the main determinants of boundary or division lines between terracing units.

Terrace outlets

The first step in planning the terrace system is to select the locations for the outlet or disposal area. If protected areas or stabilized channels are not available, they must be provided before the terraces are constructed. Adequate outlets can usually be provided by protecting natural depressions with a cover of vegetation that will withstand the force of water moving down them (fig. 87). In some cases constructed channels will be necessary because of the absence of natural outlets or because gullying or other erosion damage has made the use of natural locations impracticable. Constructed channels may be protected with vegetation if suitable varieties can be established. If adaptable vegetation is not sufficient for protection,

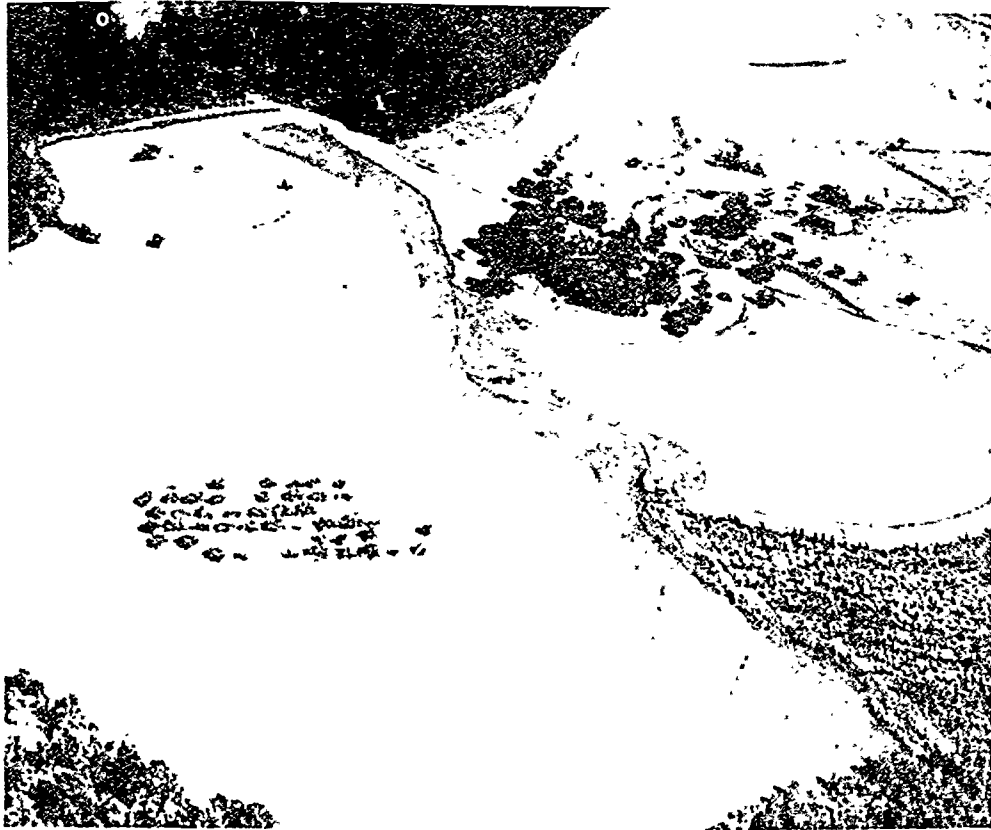

Figure 87.—A complete system of terrace discharging into a meadow-strip outlet.



Figure 88.—Ridges along the sides protect this newly seeded meadow-strip outlet. Terraces will be constructed when the sod is well established.



Figure 89.—A terrace discharge on pasture sod. The water spreads as it leaves the terrace channel. Much of it will be absorbed and stored in the soil.

mechanical structures will be necessary as a safeguard against erosion in the channel.

Owing to the hydraulic problems involved in estimating the amount of runoff, in designing the channels, and in determining the ability of various types of vegetation to withstand expected velocity, assistance should be secured from an engineer trained in the solution of such problems before constructing channels for outlets.

Vegetated outlets should be prepared one or two seasons in advance of terrace construction, depending on the length of time required to establish the necessary cover (fig. 88). Terraces should not be constructed before stabilized outlets are available to receive the discharge of excess runoff.

A meadow-strip outlet is a relatively flat swale that can be protected with adaptable grasses or legumes in an area large enough to form an economical pasture or hay unit stable enough to take care of excess runoff (fig. 89). The shape of the cross section must be such as to insure a wide shallow flow rather than a deep narrow stream whose velocities would be destructive. To prevent overflow and gulying along the edges, the vegetation should extend several feet beyond the edge of any expected flow of water. In order to maintain nonerosive velocities low gradients are required. Grades of less than 6 percent have usually proved satisfactory. On erosive soils, however, a 6-percent grade may be too steep for safety. Although a shallow, wide cross section is desirable, there must be sufficient fall from the terrace ends to the flow line of the outlet to prevent silting, either in the channel or in the ends of the terrace. About 1-foot minimum fall is usually adequate for the narrower outlets, and a 1-foot fall in 50 feet of horizontal distance should be enough for wider outlets.

Constructed or artificial channels may be protected with vegetation if the expected water velocity is sufficiently low. The ability of different types of vegetation to withstand water velocity varies widely. A dense turf of bermudagrass has in numerous locations carried velocities of 8 to 10 feet per second without noticeable damage (fig. 90), and a well-rooted mat of kudzu vines will stand even higher velocities. Experience shows

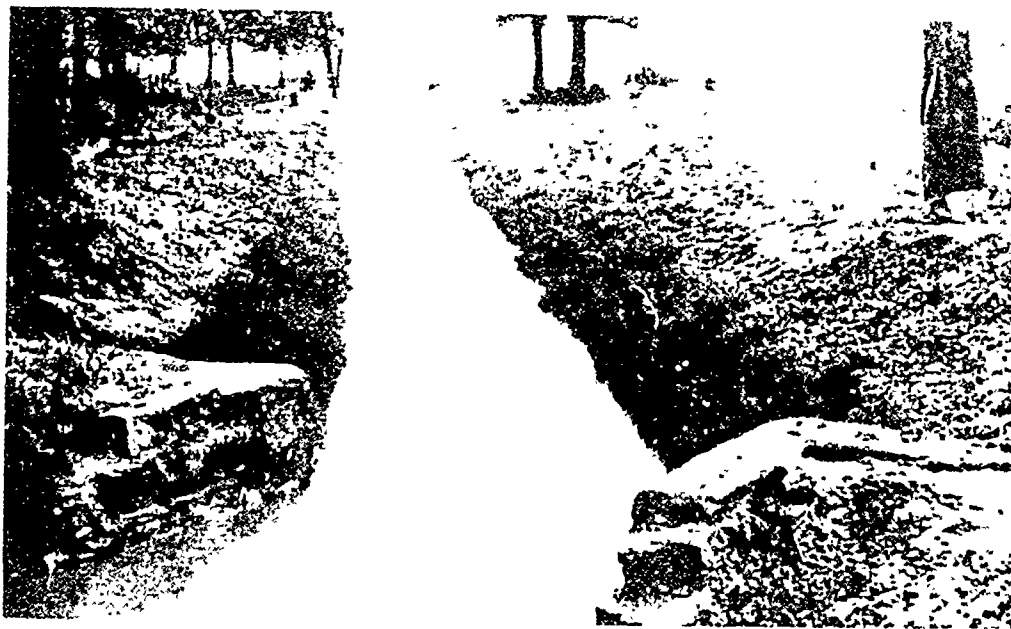

Figure 90.—Constructed terrace outlet stabilized with bermudagrass. Velocity of the water is $7\frac{1}{2}$ cubic feet per second.

that bluegrass sod is limited to velocities of 5 to 7 feet, and most other adaptable grasses to somewhat smaller velocities. Annual and perennial lespedezas have a relatively low value for channel protection, being limited to velocities of 3 or 4 feet per second.

Locating the broad-channel terraces

The individual terraces on a field must be located so as to provide the necessary control of surface water, make farming operations as easy as possible, and perform satisfactorily with minimum maintenance requirements. There are a few general principles applicable to most conditions that will assist in attaining these objectives. Experience in locating terraces will be required, however, if the best job is to be done.

The capacity of the top terrace must not be overtaxed by runoff or the whole system will be endangered. This means that the top terrace must be placed at a point near the top of the slope where the drainage area above is no greater than the drainage area above any other terrace of equal length. A trial location of the top terrace should first be made and location then moved uphill if it is necessary to intercept surface flow above critical areas or to place the terrace in better position with respect to the configuration of the field surface.

If short abrupt changes in slope occur, terraces should be just above rather than on or at the foot of them. Evidence of excessive erosion near the top of the field indicates that surface runoff has attained critical erosive velocities at that point and that the terrace should be moved higher up the slope. Minor adjustments should be made in the location of successive terraces in the field in accordance with these principles. Such adjustments should not exceed 15 to 20 percent of the vertical interval of the terraces.

Sharp bends in the terrace retard the flow and cause silt deposits that may block the channel or interfere with cultivation of the field. Many bends may be smoothed out by adjusting the terrace location slightly. Occasionally a critical place in a field below the top terrace will necessitate locating a terrace at that point first. The terraces above should be located according to the determined spacing, but the last terrace must be sufficiently near the upper limits of the slope to be safe from overtopping.

A short terrace is much easier to maintain than a long one and requires less channel capacity. In order to decrease the length of drainage in one direction the terraces may be crested at points about midway between the outlets. The point of a ridge is an ideal location for the terrace crest and assures flow in both directions to the low points where outlets should be located. If possible, terraces should not be extended around the points of sharp ridges. If this must be done, the terraces should be strengthened at those points by increasing the height of the ridge and enlarging the channel.

Likewise, terraces should not be carried across depressions that collect considerable amounts of surface water, particularly if the terrace makes a sharp bend at this point. Although it is possible to enlarge the terrace sufficiently to carry the water that drains to such depressions safely, often the cost and labor involved will be excessive. Such places in a terrace require inspection and maintenance after each period of runoff owing to silt blocking the channel or excess water damaging the ridge.

In planning terraces it should be kept in mind that farm roads must be provided for access to all parts of the farm. Roads through a field should be located as nearly as practicable on the contour just below a terrace or on the crest of the terrace ridges. Vegetated outlets should not be used for

farm roads, since farm vehicles would seriously damage the stabilizing turf in the channel bottom or create ruts that would be quickly enlarged by erosion unless expensive repair measures were undertaken promptly.

Locating the ridge terrace

Since level, ridge terraces are used to conserve moisture by impounding the water for increased absorption, there usually is limited need for outlets and in most instances they can be disregarded. On some of the steeper slopes, however, ridge terraces are used for the dual purpose of conserving water and controlling water erosion. Under these conditions outlets may be required and the entire problem of locating the individual terraces, determining the spacing, and controlling the discharge into outlets is handled in a manner similar to that described for the broad-channel terrace.

On more nearly level slopes under proper soil and climatic conditions these level terraces will not require outlets, although there may be occasional brief periods when discharge will occur. On slopes of less than 3 percent with smooth uniform surfaces, the terrace spacing should be regulated so as to impound all the runoff for the required rainfall intensity recurrence interval (usually the maximum rainfall intensity to be expected once in 10 years) and, to provide for coverage by impounding water over as much of the field as practicable, with least interference of tillage operations (fig. 91). In deciding on the best spacing to use it is necessary first to determine the effective height to which the terraces will be constructed. The effective height will be the elevation of the blocks in the ends of the terraces above the natural ground level, usually the height of the blocks is from one-half to three-fourths the height of the terrace ridge. The capacity of the terrace will determine the maximum spacing.

To make farming operations easier on relatively flat uniform slopes, adjustments usually can be made in the terrace locations so that sets of two or more terraces will be exactly parallel. This eliminates the necessity for point rows except between sets of parallel terraces. Flat field surfaces

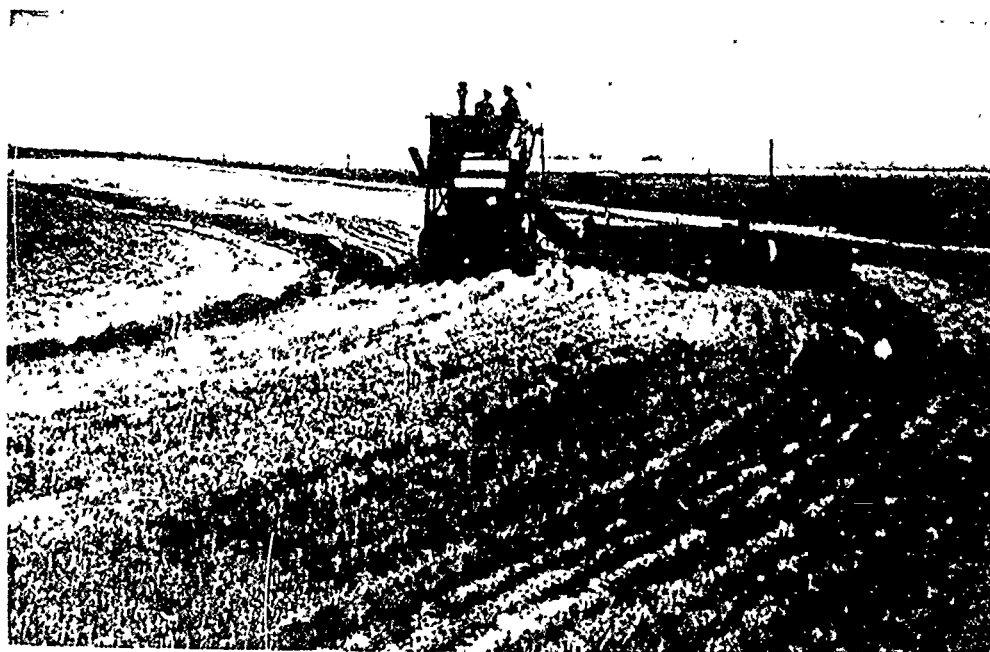

Figure 91.—Harvesting grain on a terrace, using a large combine.

lend themselves to considerable horizontal adjustment in terrace locations without significant changes in the amount of cut or fill required to build the ridges. In making such adjustments it is usually economical to prepare a topographical map of the field and make trial locations of the terraces on the map before staking them out on the ground.

Excess water from above must be diverted by enlarging the top terrace or by other means to prevent damage to the terraces or the field below. Where additional water is needed for crop growth, a regulated quantity is sometimes directed into a terraced field and allowed to flow from one terrace interval to the next by openings in alternate ends of the terraces. Part of the water is utilized by absorption in each terrace interval, and in many dry-farmed areas this will insure substantial increases in crop yields. This practice requires specially designed terraces and controls in order to regulate the flow from above and should be done under the supervision of someone familiar with the principles of hydraulics and experienced in calculating rates of runoff in the locality.

Terracing and soils

Both terrace design and construction may be influenced to a considerable degree by the characteristics of the soils. For example, the erodibility or permeability of a particular soil may modify the selection of the terrace spacing, grade, and cross-sectional dimensions. Soil structure has a marked effect on construction features, such as size and type of equipment, difficulty of construction, season of construction, and time and power required, and the ease with which terraces can be constructed will be directly affected by soil characteristics. On some soils terrace construction may even be impracticable owing to the unstable nature of the soil or the presence of rock or hardpan near the surface.

Knowledge of differences in erodibility and permeability of the various soils tends to encourage, on first thought, material changes in terrace specifications to compensate for such differences. A closer examination of the factors involved, however, indicates that any changes made must be held within close limits, or the safety of the entire terrace system may be endangered. Rainfall intensities are frequently so great that even the most pervious soils cannot absorb all the rain that falls. Storms of long duration usually produce a saturated soil condition. This materially reduces infiltration rates and thus contributes a relatively high rate of runoff from a soil that under ordinary conditions would be very pervious. Once runoff is underway, some of the more permeable soils are very erodible.

Since terraces must be built to withstand the unusual storms that may occur during the design period, it is not well to deviate from standard terrace specifications because of ordinary variations in soil. Where there is a combination of favorable conditions, some variation from standard specifications may be made without endangering the safety of the terrace system.

Terracing and cultural practices

Tillage equipment and terrace design.—In the development of terracing specifications, consideration must be given to necessary tillage-machinery operations. If the terrace spacing is too close or the terrace slopes too steep, the proper operation of tillage machinery becomes impracticable. The minimum terrace spacing and side slopes that permit machinery operation on a terraced field will differ in different regions according to the size of machinery customarily used for field work.

Major adjustments in standard terrace designs to allow for better operation of tillage machinery cannot be justified because many of the initial difficulties in operating machinery on terraced land can be overcome or greatly diminished by proper operation of the equipment. The operation of tillage equipment on the contour or approximately parallel to the terraces not only reduces soil movement between terraces but also aids materially to terrace maintenance and eliminates many of the difficulties in operating tillage machinery. Regulating the position at which the various implements operate over the terraces also eliminates certain of these difficulties.

Cropping practices and terrace design.—In order to determine what alternation a particular cropping practice will permit in terrace-design specifications it is necessary to consider the protection it will afford during a complete rotation and rainfall cycle. The degree to which the crop protects the soil during adverse seasons and the stage of crop growth during seasons of intense rainfall are of particular importance. A certain cropping system may materially reduce annual or average runoff and soil loss, but if reductions cannot be assured during the rains of higher intensities, which are used as a basis in establishing terrace specifications, it would be unsafe to make material changes in the terrace design to allow for this reduction.

Runoff data from the soil and water conservation experiment stations indicate that fields with clean-cultivated crops experience moderately high runoff rates more frequently than do fields with close-growing crops and that the average annual soil loss from the former is usually much higher than from the latter. A study of these records, however, indicates that rates of runoff from close-growing crops are not of like degree during all storms that produce the higher rates of runoff. If these storms occur at a critical crop period the rate of runoff and soil movement may be high.

The primary purpose of using good cropping practices on terraced land is to improve the soil fertility, reduce the annual soil movements between terraces, and minimize terrace maintenance, rather than to permit major adjustments in terrace specifications.

Terrace Specifications

The previous discussion of slopes, rainfall and runoff rates, soil characteristics, vegetative cover, tillage, and cropping practices as related to terrace design gives some appreciation of the many factors involved in establishing terracing specifications. It has not been found practicable to assign definite values to each of these variables and to treat each as a separate item in determining final terrace specifications. For such a procedure the problem is too complex and the variables too indefinite. Standard specifications can be established by using actual field and experimental data on terracing in a certain area as a guide for terrace design in similar areas.

Limiting land slopes

On slopes above 10 to 12 percent, it is difficult to build and maintain terraces having adequate capacity that can be farmed with modern machinery. These steeper slopes are ordinarily not recommended for production of the more common clean-cultivated crops. In most agricultural areas the broad-channel terrace is applicable to the slopes, which under a good land use program, are generally suited for the production of cultivated crops.

The upper limit of land slopes on which the ridge terrace can be used most effectively for water conservation is, in general, about 3 percent. Where this terrace is used on lands having greater slopes the actual area ponded is too small to conserve much moisture unless the terrace ridge is built unreasonably high. If it is impracticable to obtain the desired storage capacity, a modified form of the ridge terrace may sometimes be used.

Where it is necessary to use slopes above 12 percent for orchards and the production of farm crops, the bench terrace may be applied on slopes to around 25 percent or a little more.

Spacings

A convenient rule that gives the approximate vertical interval (in feet) for average conditions can be determined by dividing the slope (in percent) by 4 and adding 2 to the resulting quotient, $VI = (2 + S/4)$. To convert the result to metric units multiply by 0.0305, that is $VI = (2 + S/4) 0.0305$ which gives the vertical interval in meters.

The minimum and maximum values differ from the average by 15 percent. If exceptionally good cropping practices, erosion-resistant soil, and low rainfall intensities are characteristic of the area to be terraced, the terrace spacing might be increased as much as 15 percent with reasonable safety. But if the rotations include a relatively high percentage of clean-tilled or row crops, if the soils are highly erodible, and if the rainfall intensities are high, terrace spacing should probably be decreased as much as 15 percent.

It will often be found that a favorable factor is offset by an unfavorable one, and in such instances any deviation from recommended average spacings cannot be justified. For example, the value of a good erosion-resistant rotation may be offset by a very erodible soil or by high rainfall intensities so that the combined results are about the same as if all factors were average.

The ideal spacing for the ridge terrace would seem to be that which would give the most uniform moisture distribution and minimum soil movement between terraces as well as the least interference with tillage practices and a low construction cost. The water-storage capacity of a level terrace with closed ends is an important and often a limiting factor in determining spacings. It should be sufficient to take care of the maximum runoff accumulation that can be expected from the contributing drainage area during the design period. This runoff may be as high as 4 or 5 inches in the semiarid regions and 7 or 8 inches in the more humid areas.

On fairly uniform slopes the average slope of the area can be used in computing the vertical interval for the terraces. If the slopes vary considerably the weighted average of all the slopes that a terrace is to cross should be used in computing the vertical terrace interval for each terrace.

Grades

Since experimental results show that both the rate of surface runoff and the soil loss in runoff increases with steeper terrace grades, the minimum grade that will provide satisfactory water discharge is desirable for the channel terrace. As a variable grade retards the rate of runoff in a more satisfactory manner than the uniform grade, its use is generally preferable for terraces more than 300 feet in length.

In determining the final grade, the total length of the terrace should

be estimated and a variable grade established that increases toward the outlet by regular increments. The grade is commonly changed every 300 to 500 feet. Wherever convenient, it is usually desirable to break grades at critical points such as gullies, fills, or low spots. Maximum grades of over 4 inches per 100 feet of length are seldom advisable since steeper channel grades usually allow excessive amounts of soil to be washed from the terrace channel. A possible exception may be found in areas with heavy clay soils or where runoff rates are relatively high. Under either of these conditions, a fall of as much as 5 inches per 100 feet of length for the last segment of a 1,600- or 1,800-foot terrace may be advisable.

The ridge terrace is built with a level grade. Wherever it is desirable to discharge some of the runoff either one or both ends of the terrace can be left open.

Lengths

In general, 1,200 to 1,600 feet is the maximum distance that a terrace should carry water in one direction. Shorter terraces are desirable and should be used if convenient.

The maximum length of the ridge or level terrace, particularly when both ends are left open or when a slight grade is used toward the outlet, should not exceed that recommended for the broad-channel type. This would mean that a maximum total length of 2,400 to 3,200 feet might be used for a level terrace if necessary. If closed ends are used, occasional blocking of the terrace channel provides a margin of safety against excessive water concentration should breaks occur at any point, and if this practice is followed there appears to be no need for restrictions in permissible terrace lengths.

Cross sections

The three main requirements of satisfactory terrace cross sections are: (1) Ample channel capacity, (2) channel and ridge side slopes flat enough to permit the operation of farm machinery along the terrace without undue breaking down of the terrace or hindrance to tillage operations, and (3) economical cost of terrace construction.

The broad-channel terrace provides channel capacity primarily by means of a graded, excavated waterway; the ridge terrace derives its capacity from a ridge that holds back the water in a way so as to flood a wide area. The water depth of a settled terrace of either type should be from 12 to 17 inches, and the minimum water cross-sectional area of the channel should seldom be less than 8 to 10 square feet. Larger cross-sectional water areas are usually necessary for the ridge terrace. Long terraces should have a larger cross-sectional area.

The side slopes of the channel or ridge should seldom be steeper than 4 to 1, and 5 to 1 is preferable. Steeper side slopes may be permissible where small equipment is generally used, but the flatter side slopes are necessary for larger machinery. The total width of terraces may range from 15 to 40 feet, depending on the land slopes and the type of machinery to be provided for.

Terrace Staking, Realignment, and Marking

The upper terrace is staked first, the drainage divide being used as a starting point from which to measure the vertical interval for the first

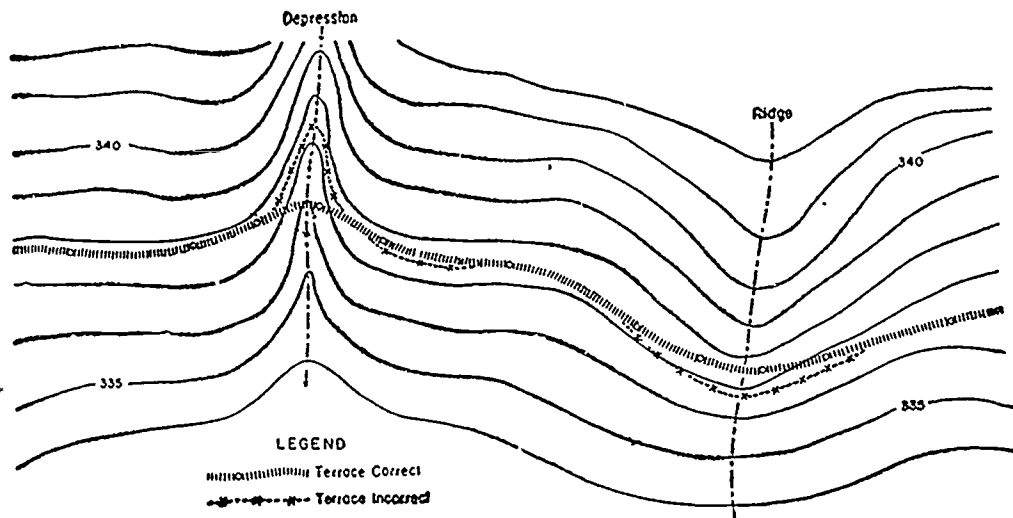

Figure 92.—Realining the terrace line by straightening sharp curves facilitates both terrace construction and tillage operations.

terrace. An exception to this rule may be made if it is desired to have a definite location for some particular terrace in the system. This terrace would then be located first. After the upper terrace is staked, each of the succeeding terraces is staked in turn.

In order to get proper alinement of terraces at the outlet ditch it will usually be found most convenient to start staking at the outlet end of the terrace. The selected terrace-channel grades can then be used to locate all other stakes from there to the other end of the terrace. If the outlet ditch has terraces emptying into it from one side only, there is no particular advantage in starting to stake a terrace from the outlet end. Stakes should be set at 50-foot intervals except on curves and through draws, where a 25-foot spacing should be used. It is customary and usually most convenient to have the stakes indicate the location of the centerline of the ultimate terrace ridge.

Realinement of terrace lines

After the terrace lines have been staked some realinement is usually necessary on each proposed terrace in order to eliminate sharp curves, to obtain greater ease of construction, and to secure a finished terrace that will offer a minimum of inconvenience in later tillage operations.

The realinement needed will vary with the relief of the field but will usually consist of moving certain stakes up or down the slope where there are sharp curves in terrace lines until the most desirable terrace line is secured (fig. 92). Good field judgment must be exercised in order to secure the most satisfactory realinement of terraces.

Marking terrace lines

If a final check of the terrace and outlet locations shows that the entire layout will be satisfactory, the terrace lines should be marked with a plow furrow since stakes are easily lost and more difficult to follow with the larger terracing equipment.



Figure 93.—Terrace construction with a plow and V-drag. It requires considerable work to construct satisfactory terraces with this type of equipment.

Terrace Construction

Terraces may be constructed with light equipment adapted to the power available on the farm whether it be horses or mules or tractors or they may be built with heavier, more expensive equipment especially designed for terracing (figs. 93 and 94). The cost on the one hand will be labor and time with little cash outlay, and on the other the cash outlay will be greater with a corresponding saving in time and labor. A terrace not properly finished may do more harm than good; insufficient channel capacity will invite overtopping and failure; a narrow ridge will prevent the best use of tillage equipment and may contribute to inefficient use of the field.



Figure 94.—Building a channel terrace with a slip scraper.

Construction procedure

In terracing a field the uppermost terrace should be constructed first, and after it, in turn, each succeeding terrace down the slope. If the lower terraces are constructed first they are likely to be badly damaged should a rain occur before the upper ones are completed.

Supplemental work

Where terraces cross gullies or even slight depressions it is necessary to do some extra fill work in order to maintain the proper terrace locations and ridge elevation. A slip scraper, fresno, or rotary scraper is usually used for this work. Failure to build fills properly is a common cause of trouble in terracing.

A terrace cannot be considered completed until it has been carefully checked for correct grade and height. To assure proper channel capacity and the flow of water in the direction desired, low places on the ridge and high spots in the terrace channel should be marked and corrected before the equipment leaves the field. On the level terrace it is usually necessary to determine only the low points in the ridge. The level and rod are used in checking, and enough readings are taken to determine where corrections are necessary. Elevations and grades should be checked very carefully around bends and across gullies and at terrace outlets. A common fault in terrace construction is to provide too much grade near the terrace outlet. If much correctional work is required, it can usually be done most satisfactorily by using regular terracing equipment.



Figure 95.—Contour plowing the interval between terraces aids in moisture conservation and erosion control and facilitates proper terrace maintenance.

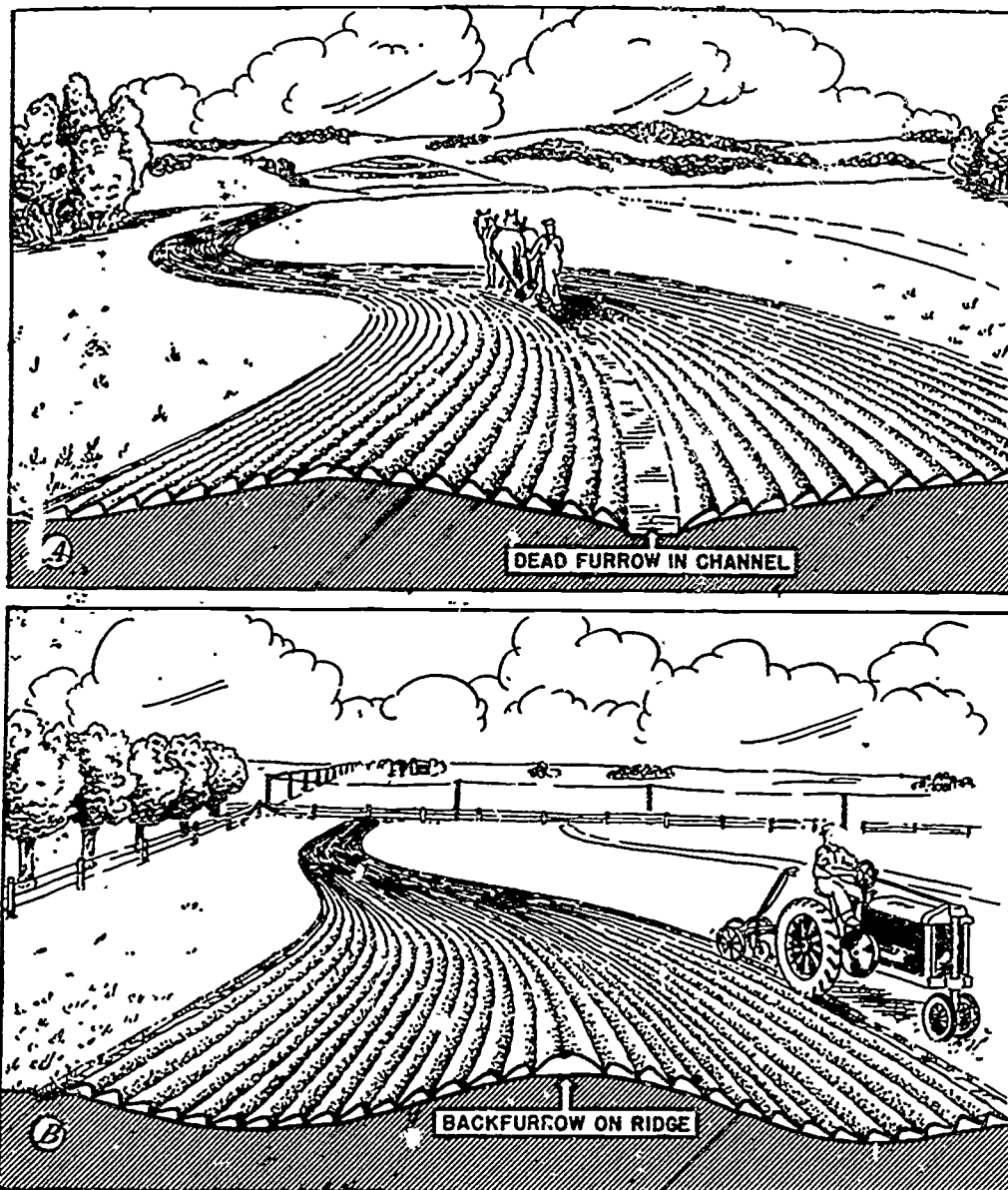

Figure 96.—Maintaining terraces by plowing: A, The channel of the channel terrace can be enlarged by plowing it out. Between channels turn as many of the furrows uphill as possible to offset the natural soil movement down the slope. B, The ridge of the ridge terrace can be enlarged by backfurfrowing to it. The location of the dead furrow should be changed from year to year to avoid excessive depression at any one point.

Farming Terraced Land

The construction of a well-designed system of terraces does not in itself stop erosion. Construction is only the beginning. The success of the terraces depends on whether they are properly maintained and farmed after construction. Too often erosion-control efforts cease with the construction of the terrace, and construction cost is wasted because of faulty cropping and tillage practices. A surprisingly large number of terraces that have been in use for 5 years or more are no longer effective because the continued practice of one-crop farming and tillage up and down the slopes have

reduced the capacity of the terrace channels to such an extent that frequent overtopping has resulted.

One of the most desirable tillage practices for terraced land is contour farming—the plowing and planting of crops parallel to the terraces. This produces a series of miniature depressions and ridges between terraces, and these aid in moisture conservation and erosion control. Operating tillage equipment parallel to the terraces, particularly equipment that penetrates the soil, also results in minimum damage to the terrace ridge and channel (fig. 95). By plowing parallel to the terrace and regulating the location of dead furrows and backfurrows, terraces can be maintained and their cross sections changed so as to provide the most desirable slopes for any particular field. The method of locating dead furrows and backfurrows to enlarge or maintain the channel or the broad-channel terrace and the ridge of the ridge terrace is illustrated in figure 96. The location of the other backfurrows and dead furrows may be varied from year to year according to the surface condition of the field and the most convenient manner of finishing irregular strips or short rows.

Good terrace sections can usually be maintained with little additional maintenance work if contour tillage and proper method of plowing are practiced. Under exceptional conditions, where it may not be possible to maintain proper cross sections by the regular plowing operations, it will be necessary to use the blade or scraper on the terraces at regular intervals. The lighter terracing machines or homemade V-shaped drags with ordinary farm power units can ordinarily be used satisfactorily.

In some areas stripcropping is combined with terracing to control erosion more completely (fig. 97). There are several methods of arranging the alternate strips of close-growing and row crops on a terraced field. The type of rotations, the crops, and the proportions of each crop to be produced will determine in part the arrangement and width of strips. In combining the two control measures (1) use strips as nearly uniform in width as



Figure 97.—Stripcropping combined with terracing. Adjacent strips are centered on consecutive terraces.

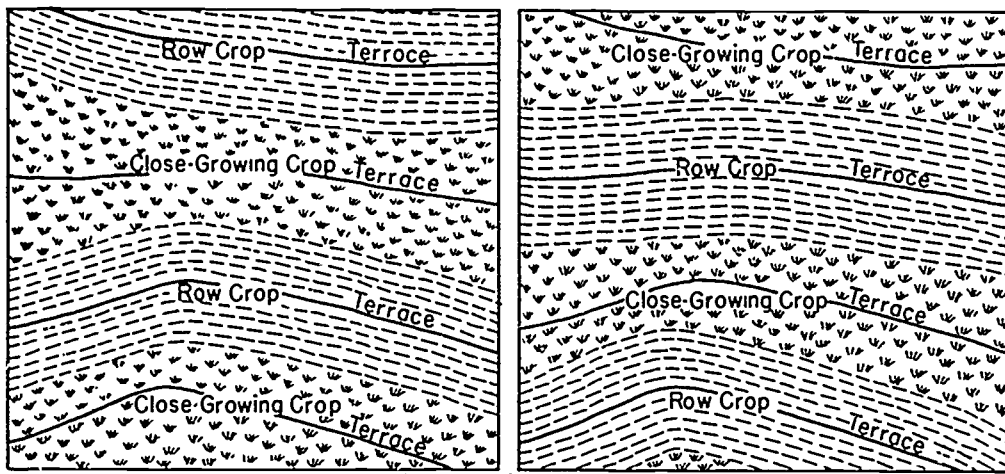

Erosion-Resistant Strip on Alternate Terraces

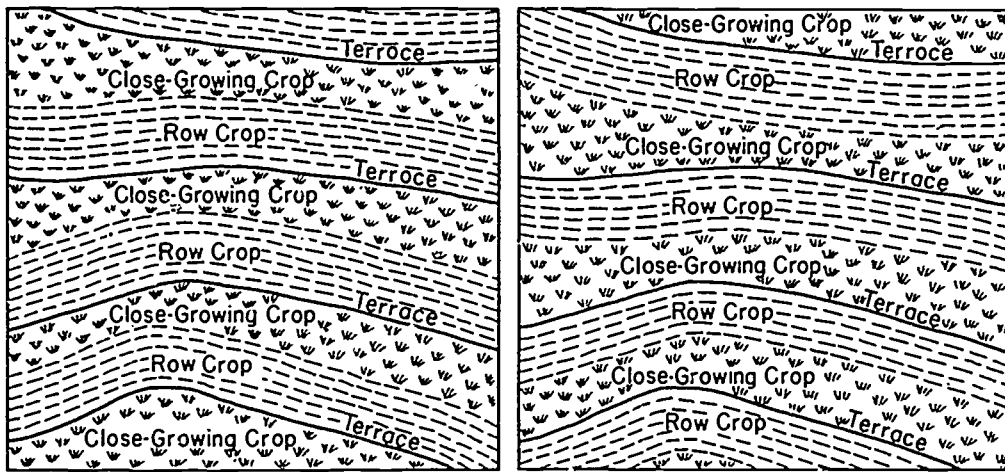

Erosion-Resistant Strip Directly Below or Above Each Terrace

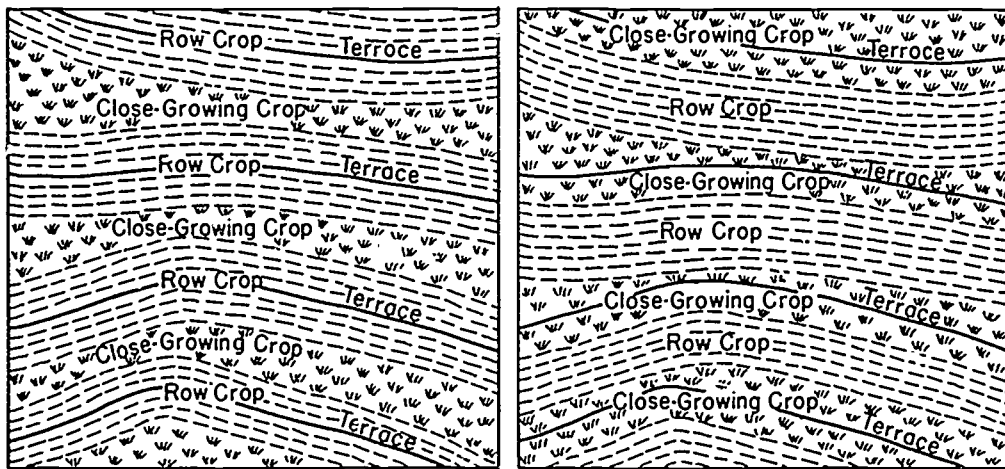

Erosion-Resistant Strip Between or On Consecutive Terraces

Figure 98.—Three suggested methods of combining stripcropping and terracing.

possible in order that rotation of crops may be practical, (2) have at least one boundary line of each strip fall between adjacent terraces so that a portion of each terrace interval will be protected by a close-growing crop, (3) eliminate point rows insofar as possible by absorbing irregular areas in strips of close-growing crops, and (4) use the minimum number of strips

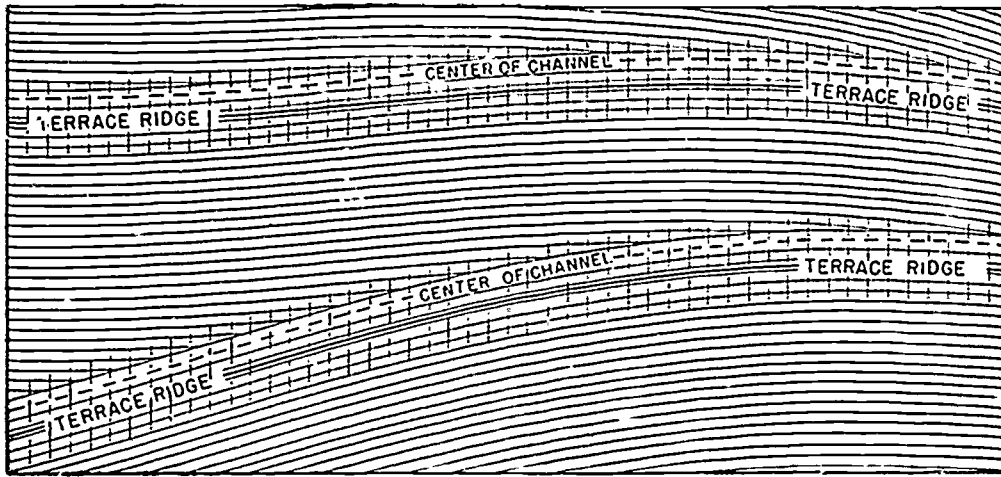

Point Rows in Terrace Channel

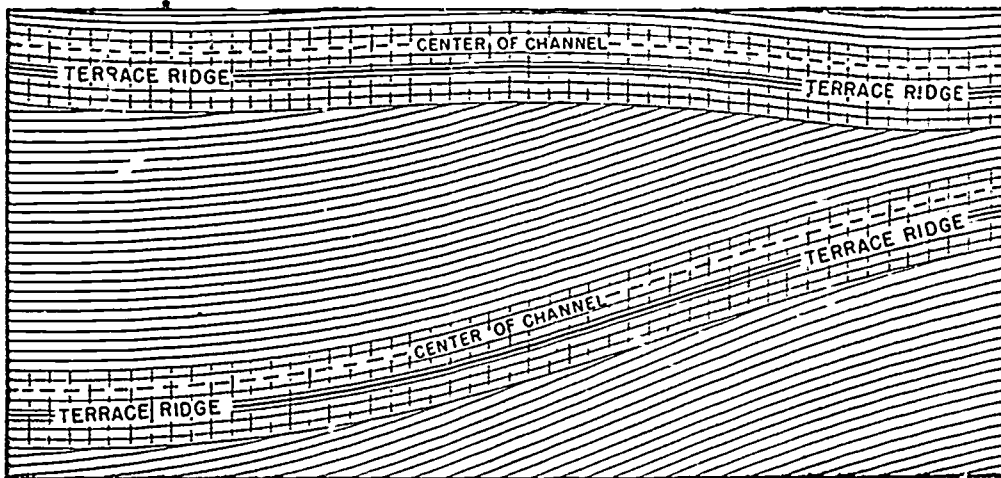

Point Rows at Base of Terrace Ridge

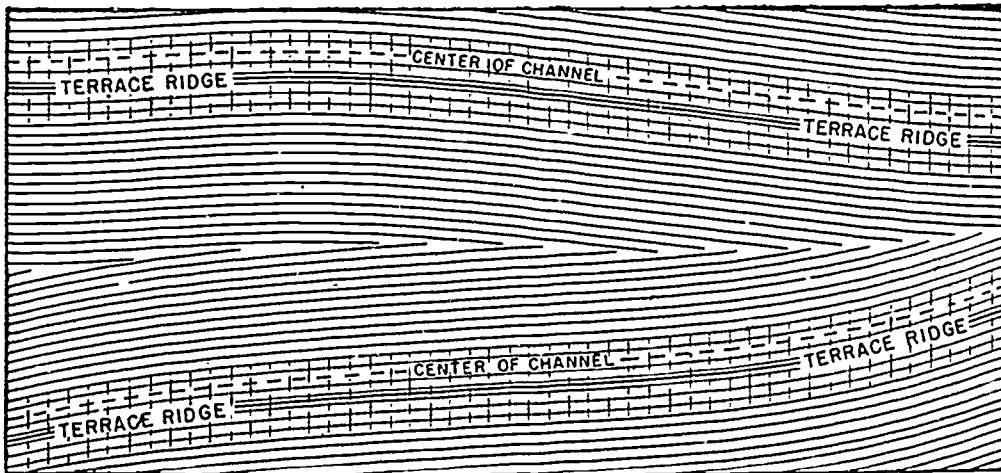

Point Rows Between Terraces

Figure 99.—Three suggested arrangements of point rows in relation to terraces.

that will provide effective erosion control in order that the necessary tillage operations may not become unduly complicated.

A combination of stripcropping and terracing that provides for close-growing crops on alternate terrace intervals and for row crops on the intervening one merely complicates the tillage and harvesting operations

and does not provide any better erosion control than would be effected by terracing and by rotating the same crops in the usual method. The most effective methods of combining terracing and stripcropping are given in figure 98.

When a field is in contoured row crops it is impossible to avoid short or point rows unless the land slope happens to be very uniform. These point rows may be arranged in many different ways, and the arrangement selected depends largely on the preference of the land operator. His choice may be influenced by such factors as past practice or the type of tillage equipment he uses. Figure 99 indicates three of the more common row arrangements, showing point rows in the terrace channel, at the base of the terrace ridge, and between terraces.

Many combinations of these arrangements are possible. The relative merits of each will depend largely upon local conditions and individual choice. A combination that appears to have some merit is to run the long rows parallel along alternate terraces and allow the short or point rows to terminate along the intervening terrace. By this method only every other terrace will receive point rows, and these will terminate both in the channel and against the ridge. It is contended by some that terminating point rows on the terraces is conducive to erosion because these rows are slightly off the contour, and they also tend to concentrate the turning of cultivating machinery on the terraces. This objection can be offset to some extent by always using parallel rows on the area occupied by the terrace and by ending the point rows just above or below this area. The third arrangement suggested in figure 99 throws point rows between terraces and more nearly equalizes the digression of the point rows from the contour.

The row arrangement shown in figure 100 reduces even more the variation of the point rows from the true contour. One or more master rows are equally spaced between terraces, and the point rows are allowed to fall between the master rows or between the master row and the terrace, according to the row arrangement used. This arrangement of rows requires more field work than any other discussed in this section.

Some farmers object to terracing because they believe that it will interfere with their regular farming operations. At the same time they usually fail

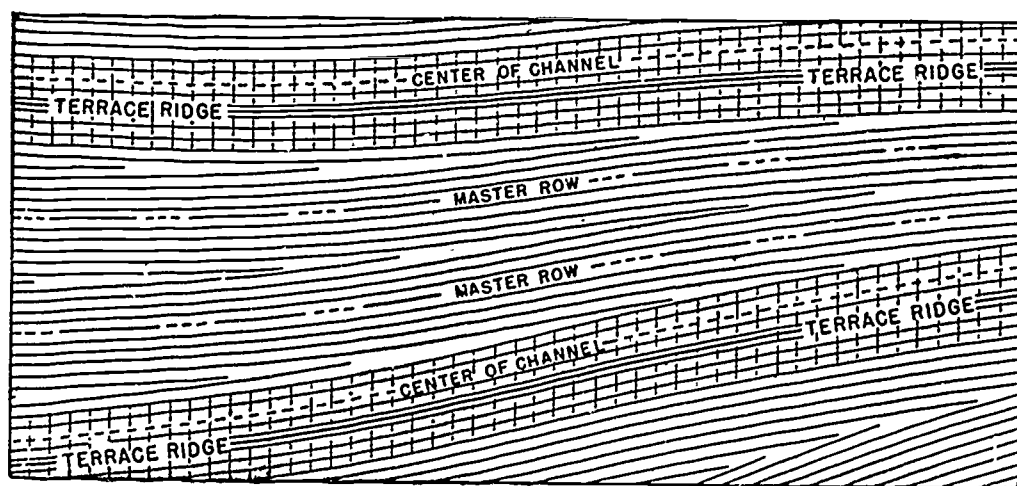

Figure 100.—Arranging point rows between master rows on terraced land places all the rows more nearly on the contour than does any of the methods shown in figure 99. This is the most intricate of the four suggested arrangements.



Figure 101.—Farm machinery can be satisfactorily operated over terraces if they are properly constructed and if contour tillage is practical.

to appreciate the fact that gullies that are gradually developing on their farms will eventually cause more serious interference with their farming operations than terracing possibly could and that the continual loss of topsoil will eventually make their entire farming operations futile. Farming terraced land is not unduly difficult if the farmer is willing to give up straight rows and try contour farming (fig. 101). Although contour farming introduces minor inconveniences it is usually found that the advantages far outweigh the disadvantages. Farmers have found that even the turning of equipment necessitated by short rows is not nearly as difficult as was anticipated. After the operator becomes accustomed to point rows he can carry on his regular farming operations with very little damage to crops. It has also been found much easier to operate machinery on the contour than up and down hill.

Stripcropping

There are four general types of stripcropping recognized: (1) Contour stripcropping, (2) field stripcropping, (3) wind stripcropping, and (4) buffer stripcropping.

In contour stripcropping, the crops are arranged in strips or bands on the contour at right angles to the natural slope of the land. Usually the strips are cropped in a definite rotational sequence. This type of stripcropping is used for the control of water erosion. It is also used effectively sometimes on sloping land in areas where wind erosion may be as serious as water erosion (fig. 102).

In field stripcropping, the strips are of uniform width and are placed across the general slope, but they do not curve to conform to the contour in crossing drainageway depressions, for example. It is recommended only for those areas where the topography is too irregular to make contour stripcropping practical (fig. 103).

In wind stripcropping, the strips are uniform in width, usually straight and laid out as nearly as possible at right angles to the prevailing winds. It is recommended on level or nearly level land where erosion by water is unimportant (fig. 104).

In buffer stripcropping, strips of grass or a legume or mixture of grass and legumes are laid out between strips of crops grown in regular rotations. The buffer strips may be wide or narrow and of even or variable widths. They may be placed only on the steep, badly eroded parts of a slope or they may be at more or less regular intervals on the slope. The buffer strips are used to give more protection from erosion than is afforded by a solid planting



Figure 102.—Contour stripcropping.

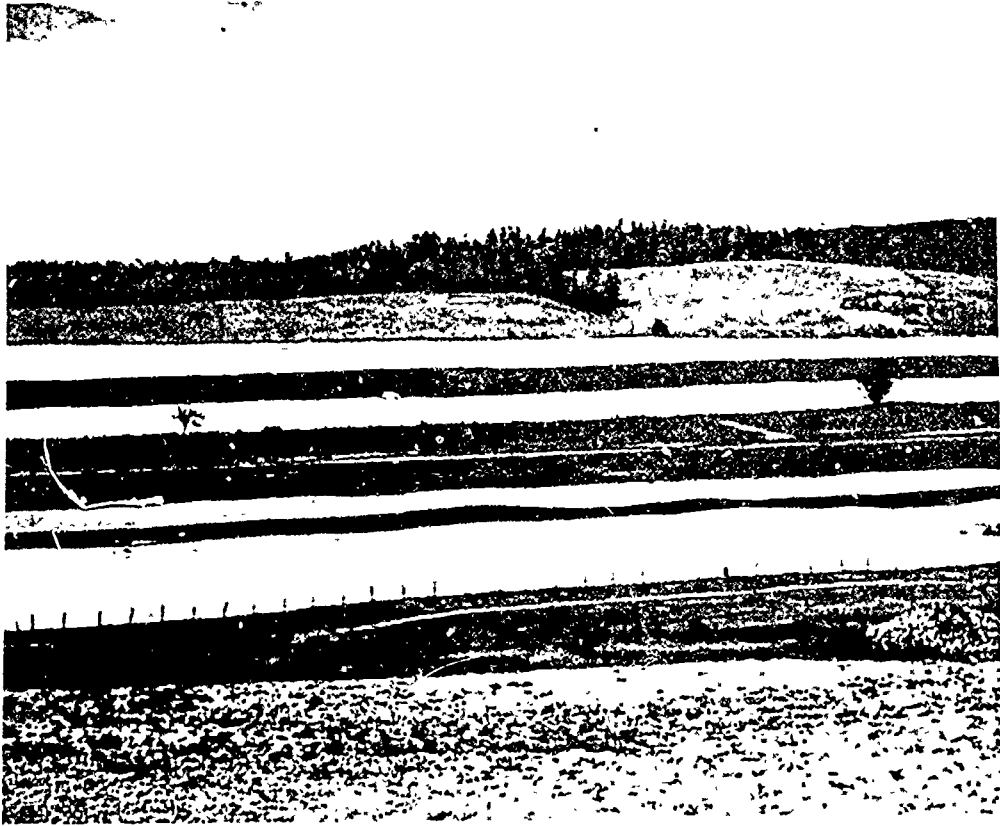

Figure 103.—Field stripcropping.

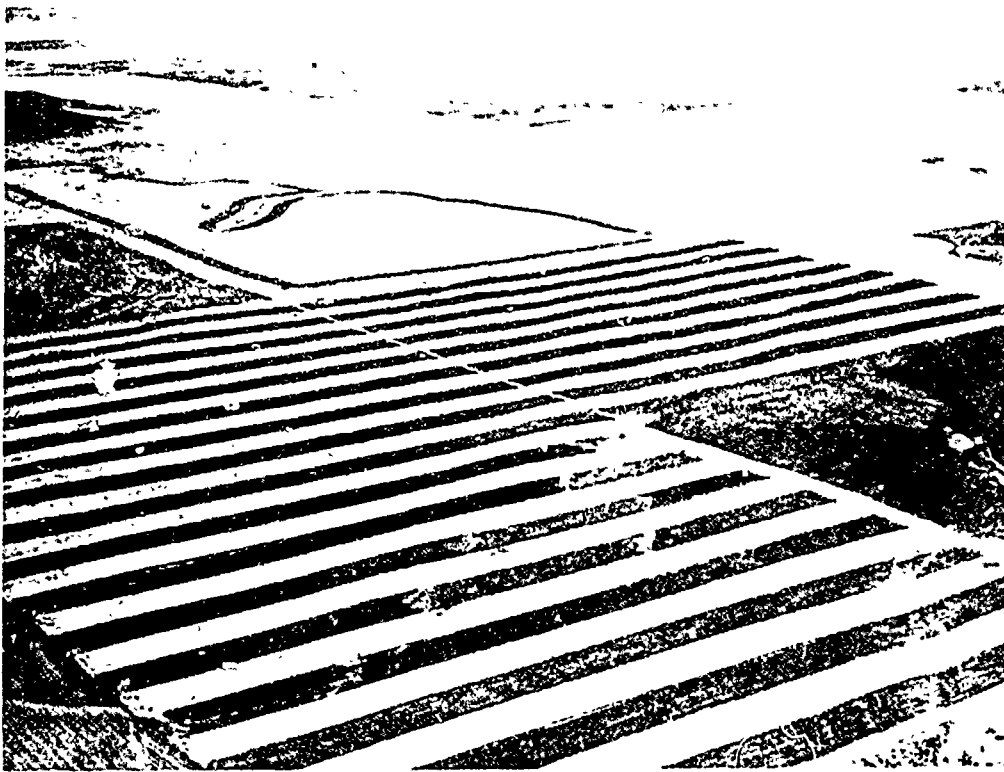

Figure 104.—Wind stripcropping. Strips are even width, parallel, and crosswise to prevailing winds.

of grain or intertilled crops. Where the buffer strips are on the contour, they facilitate contour tillage. For wind erosion, some annual crop may be used in the buffer strip (figs. 105 and 106).

Farmers should become familiar with the capability of their land. Level land needs little protection from erosion unless it is subject to wind erosion. Slightly to moderately sloping land is subject to erosion and here strip-cropping materially assists in the control of erosion and in increasing crop yields. Slopes may be steep and badly eroded, yields may be low owing to low fertility and lack of organic matter or to low rainfall, and the land may be subject to both wind and water erosion. On such land, all the adaptable soil-building measures and soil conservation practices should be used as needed. Where applicable, strip-cropping on this type of land is one of the most effective conservation practices.

Land that has shallow soil, slopes too steep, rainfall too low, or other factors making it unsuited for use as cultivated land, should be put in permanent vegetation as pasture or hayfields. Under some conditions, to maintain productive pasture or hay stands, however, an occasional plowing and reseeding may be necessary. Sometimes when renewing or improving stands in this manner, it is necessary to crop the land for a year to a row crop or small grain. It is always advisable that plowing and cropping land of this kind be done in strips to avoid exposing the entire slope or area to erosion at one time.

Rotations

Rotations which provide strips of close-growing perennial grasses and legumes alternating with a row crop or a grain crop are the most effective arrangement of crops for the reduction of erosion on cropland. Such an arrangement of crops can be obtained by using a 4-year rotation of row crop,



Figure 105.—A buffer strip of bluegrass and timothy between tobacco and corn.



Figure 106 —A buffer strip of corn in a potato field for protection against wind erosion.

grain, and 2 years of meadow; a 5-year rotation of row crop, grain, and 3 years of meadow; and a 6-year rotation of a row crop, grain, and 4 years of meadow. To get the proper crop arrangement in the field, two field units are necessary for the 4-year rotation and three field units for the 5- and 6-year rotations. In any of these three rotations one field unit will have alternating strips of grain and meadow, and the second unit will have alternating strips of row crop and meadow, and the third unit, in the 5- and 6-year rotations, will all be in meadow. The crop arrangement will change from year to year as the rotation progresses.

In sections where perennial grasses and legumes are not widely adaptable, a rotation of row crop, small grain, and annual legume crop can be arranged in strips. The sequence of crops should be arranged so that maximum use can be made of winter and summer cover crops, green-manure crops, and crop residues to protect and improve the land. In dry-farming areas, the sequence of row and small-grain crops, and fallow if used, should provide for efficient use of moisture and for adequate crop residues

Contour Tillage and Terraces

Tillage operations, such as plowing, disking, harrowing, planting, cultivating, and others, can be done on the contour without stripcropping, but it is usually more difficult because there are no permanent markings to follow. A stripcropping system provides definite contour guidelines for each farming operation. Additional protection against water erosion can be obtained by the use of terraces. Terraces are especially needed with stripcropping on fields having numerous small depressions, or gullies, where runoff concentrates. Diversion terraces may frequently be used to advantage in place of regularly spaced terraces, both in the stripcropped fields and above the stripcropped fields to protect against runoff from higher lying lands. Level, closed-end terraces are needed with stripcropping in

many dry-farming areas to prevent runoff and increase moisture absorption by the soil. Where terraces are used with stripcropping to prevent runoff and erosion, more row crops may be grown in the rotation and the strips may be wider.

Liming, Fertilizing, and Manuring

The effectiveness of stripcropping in humid regions depends much on the quality of the meadow strips. Vigorous, dense stands of perennial meadow grasses and legumes are the most effective for control of erosion. They also improve the soil and result in increased yields. In order to get the rotation started to promote vigorous, dense stands of the perennial grasses and legumes, and to increase yields, lime and fertilizer should be applied where needed. Stripcropping provides an orderly plan whereby each strip can be limed or fertilized in regular order and the expense can thus be budgeted evenly over a period of years.

Stripcropping facilitates the use of practices that increase the organic-matter content of the soil. Rotations selected include a combination of deep-rooted and fibrous-rooted crops a large proportion of the time. Crop residues are left on the ground or returned in the form of manure in regular order because of the systematic rotation used in stripcropping. Green-manure or cover crops are often grown between or in combination with the regular crops in the rotation.

Stubble-Mulch Farming

Tillage that leaves the surface of the soil cloddy and mulched with crop residues is an effective accompanying measure with stripcropping to minimize soil erosion and to conserve moisture. It is one of the most effective measures to conserve soil and moisture on land that is in fallow and to protect small-grain and row cropland during periods of seedbed preparation for a succeeding crop. A combination of these two practices will provide greater protection against erosion than either practice alone. In the control of wind erosion, stripcropping aids by reducing the expense of individual clean-tilled areas and by reducing the velocity of the wind at the surface of the ground, whereas cloddy tillage, with mulching by proper use of crop residues, lessens the tendency of the soil to drift or wash and conserves moisture. Frequently soil will start drifting from an exposed knoll, sandy spot, or bare area in a field. Stripcropping confines the drifting to one strip where it may be brought under control by tillage or other means more easily than had it spread to the entire field.

Width of Strips

There is no fixed rule for determining the width of strips in a stripcropping system that will apply under all conditions. In humid regions, strips from 60 to 150 feet in width are in common use. The degree and length of slope, the permeability of the soil, the susceptibility to erosion, the amount and intensity of rainfall, kinds and arrangement of crops in the rotation, and farm equipment are some of the factors that influence the width of strips. In dry-farming regions, strips of peanuts as narrow as 12 feet and strips of small grain as wide as 320 feet can be used effectively

for wind-erosion control. Under different soil-drifting conditions, the width of the strips may differ, depending on the soil, cropping and tillage system, and wind velocities. Where protection is needed from both wind and water erosion, the maximum width of strip should not exceed the safe limits of width for either type. Actual field trials will provide the most accurate information.

Terraces have the effect of shortening the slope; that is, the length of slope is the distance between the terraces rather than the entire distance up and down the field. For this reason, terraces, when used with a strip-cropping system, influence the width of strips (p. 103).

In general, strips should be made a width most convenient to farm yet not so wide as to permit concentration of runoff and excessive soil losses. It has been found that more soil and water losses may occur by having the strips too far off the contour than by having the strips of intertilled crop too wide. On uneven slopes where the strips do not follow the contour closely, they may need to be narrower to prevent erosion than strips on uniform slopes with only slight variations from the contour.

Where water erosion predominates, the strips should generally be narrower as the slopes become steeper or the soil shallower.

Grass Waterways

Waterways are definitely a part of the stripcropping system and should be protected by a grass or legume sod or other suitable close-growing vegetation. When the field is laid out for stripcropping, definite plans should be made for planting all major waterways. If the field is in meadow when stripcropping is started, the waterways should be left in sod.

It is usually best to seed or sod the waterways at the same time meadow seedings are made in the field, but they can be prepared and seeded separately. When the waterway is badly eroded or gullied, it may be necessary



Figure 107.—Broad grassed waterway.

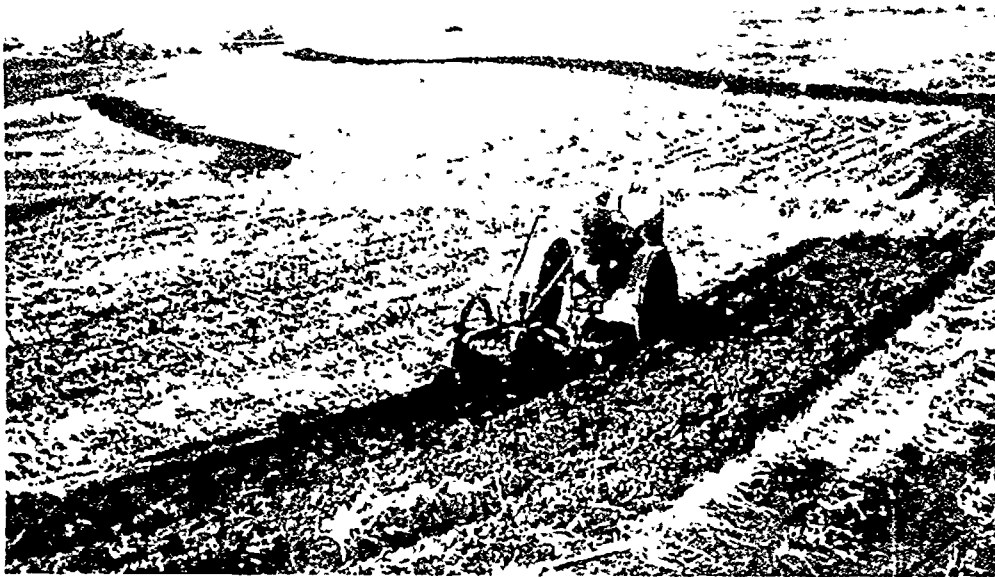

Figure 108.—Plow should be lifted in crossing the waterways.

to level it somewhat before preparing the seedbed. A hay or straw mulch will protect the seeding until the grass is established. Later it may be necessary to place pieces of sod in spots where the new seeding or sodding has been washed out.

It is a common mistake to make grass waterways too narrow. They should be made wide enough to mow and should be clipped at the time meadow strips are cut for hay (fig. 107).

Grass waterways should be protected from all tillage operations. Plows should be raised out of the ground, disk harrows should be straightened, and cultivators should be lifted before crossing a grass waterway.

Grass waterways have a tendency to build up with sediment. In extreme cases, the location of the waterway may be shifted to such an extent that the water flows along the edges, often starting new gullies. For this reason, the edges of a grass waterway should be left irregular. A little care in crossing waterways with tillage implements, avoiding plowing furrows parallel to the waterway, allowing the grass waterway to widen as the need demands, mowing to prevent excess accumulation of forage, and protection from trampling by livestock when the ground is wet and soft will assure a permanent waterway for the removal of runoff from rains of high intensity (fig. 108).

Managing Stripcropped Fields

When the stripcropping system has been carefully planned and accurately laid out in the field, it can be readily maintained permanently. In general, farming operations are no different for farming strips than for farming whole fields, yet some extra precautions are necessary.

The crop rotation should be maintained. Meadows should be plowed and planted to the proper crops according to plan. If meadow seedings fail on one series of strips, they should be reseeded so as not to interfere with the sequence of crops in the stripcropping system.



Figure 109.—Planting from the outside edges toward the middle puts all point rows in the center of the contour strip.

The plowing of strips should be varied so as not to build up high ridges on the edges and deep dead furrows in the centers. The equipment used, the shape, and the location of the strips may determine how the strips should be plowed. If a two-way turning plow is used, land can all be turned up the slope so that water can seep under the furrow slice. After a little experience, strips can be plowed as easily as ordinary plowlands.

Where the strips are irregular in width and both sides are on the contour, most farmers prefer to plant from both sides toward the center. This places the greatest number of rows on the contour with the point rows all in the center of the strip and is the most effective row arrangement to conserve moisture. Also, such a planting arrangement (1) saves time by eliminating long deadhead trips in cultivating and harvesting long and short rows together, (2) is more convenient, especially when harvesting row crops (corn can be cut for silage or husked, by hand or with machinery, by starting on the long outside rows, leaving the short point rows to be harvested last), and (3) eliminates the need of turning on the crops of adjoining strips (fig. 109).

In many places short rows can be eliminated by varying the width of the thick-crop strips.

Water or soil losses are less from meadow strips than from either grain or row crops. Also, losses are much less from rotations than from continuous cropping. The denser a crop grows and the longer it occupies the ground, the lower the water and soil losses. Row crops do not provide a dense cover nor a root system to give much protection to the soil. Such crops as corn and sorghum, however, may provide good protection against wind erosion. Small grains may occupy the land an even shorter time. But they provide a denser ground cover, a greater total root system, and more dense residues than row crops, and therefore provide more erosion protection. Perennial grasses and legumes occupy the land the entire year, have a very dense top growth during summer months, and have a deep

fibrous root system, producing a dense sod, which provides the greatest erosion protection.

Strips of perennial grasses and legumes between strips of row crops and of small-grain crops provide the most effective crop arrangement. In areas where the percentage of grasses and legumes in the rotation is not sufficient for this arrangement of crops, meadow strips of perennial grasses and legumes not included in the regular rotation may often be used.

There is often greater runoff from small-grain strips than from row-crop strips during the period of seedbed preparation and stand establishment because of the ridging effect of tillage and seeding implements used in planting the row crops. For this reason, in humid regions, if the rotation necessitates small grain and row crops to be adjacent to one another, the small-grain strips should be placed below the row-crop strip for best results. Where strips of small-grain and row crops must alternate for lack of suitable perennial grasses and legumes for use in the rotation, terraces are usually needed to support stripcropping.

With the lighter rainfall of dry-farming areas, alternate strips of small-grain and row crops, small-grain and summer fallow, or two row crops, one providing more cover and residue than the other, such as cotton and sorghum, or beans and sorghum, are effective stripcropping arrangements to conserve soil and moisture. Where grasses and legumes can be grown, a meadow strip between the cultivated strips will provide greater protection. In many dryland areas where the slopes are long and gentle, level terraces with stripcropping will conserve moisture, increase yields, and provide greater amounts of crop residues to prevent soil washing and drifting than stripcropping alone.

In humid regions, lime is often applied to get legumes started in the rotation, and fertilizers are used on the small-grain and meadow seedings; and in both humid and dry-farming regions all field operations are changed from uphill and downhill to the contour.

Cover Crops

Actual measurements show that soil is most susceptible to erosion when fields are bare of vegetation. They also show that soils low in organic-matter content are more easily eroded than those with high organic-matter content. Further, the evidence shows that except on very gentle slopes soil losses by rains are certain to occur where the soil is bare. This is especially serious, since about three-fourths of all farm crops are produced on land with sufficient slope to induce erosion if not protected with adequate vegetative cover or by other control measures.

The continuous loss of soil from the cultivated lands of the world means reduced fertility and consequent increased expense, if crop production is to be maintained. As the fertile topsoil is washed away and the plow turns up less productive subsoil, crop yields diminish, tillage operations become more difficult, and farm profits dwindle, unless the soundest possible conservation measures, including the use of organic matter and commercial fertilizers are employed.

The stupendous task of improving and reclaiming these wasted acres emphasizes the importance of conserving the remaining productive areas of the world. But we must not avoid this task simply because it is a difficult one.

Any crop while serving as a solid ground cover, whether or not specifically planted for that purpose, is a cover crop. Thus a growing grain crop, grasses in pastures, and crops planted for turning under as green manure are cover crops. General usage, however, perhaps restricts the term more definitely to crops that are planted especially for the purpose of checking soil erosion, adding organic matter to the soil, and improving soil productivity. It is for lands under cultivation that cover crops need most consideration, although the vegetative cover in any situation is of first importance in soil conservation.

The principal advantages of a cover crop may be summarized as follows:

1. Reduces runoff of rain and thus conserves rainfall, like a rug.
2. Prevents excessive erosion of the land.
3. Improves soil tilth by the addition of organic matter to the soil and by loosening up the subsurface of the soil with deep-growing roots.
4. Diminishes leaching of available plant food, especially of nitrates.
5. Aids, when turned under, in the liberation of mineral plant food and makes the soil easier to plow.
6. May provide late fall, winter, and early spring pasture.
7. Protects newly constructed terraces and other mechanical erosion-control devices.
8. Increases yield of corn, cotton, and other regular farm crops.
9. Increases the water-absorbing capacity and the infiltration of water into the soil.
10. Furnishes winter pasture.

The advantages of cover crops ordinarily outweigh any reasonable objections which can be made to them. Nevertheless, for practical information, the principal features which might be disadvantageous in the use of a cover crop are listed as follows:

1. The cost of seed.
2. Cost of labor in the preparation of the seedbed and seeding.
3. Uncertainty of getting a stand.
4. A possible refuge for insect pests, such as cutworms, that later attack corn or other crops.



Figure 110.—Redclover seeded in wheat. Redclover, other legumes, and grass seeded in small grain prevent erosion after the grain is harvested.

Cover cropping is not a cure-all. It represents only one of the recommended practices of a well-rounded soil conservation program.

Crops grown in wide rows with cultivation, like cotton, corn, potatoes, and tobacco, are highly conducive to soil loss. All of these crops should be grown in systematic rotations and the rotations supplemented with cover crops if soil loss is to be reduced to a minimum and crop yields maintained. Wheat and other small-grain crops, when grown on steep slopes, especially under a summer-fallow system, also need to be given special consideration if extreme soil loss and reduced yields are to be avoided.

Summer cover crops likewise are often of vital importance. In regions of sandy soil and where rainfall in summer may be heavy or wind velocity excessive a cover crop is essential unless the soil organic matter is unusually high.

The annual lespedezas following winter-grain cash crops make an efficient and economical ground cover and soil-improving crop. Legume cash crops that are grown in thick stands reduce erosion to a minimum during the period they occupy the land and increase the yield of any crop with which they may be grown in rotation. Most close-drilled or broadcast summer crops used in rotations contribute in some degree to control of erosion and help maintain soil fertility. The annual lespedezas and soybeans are generally considered as not good controllers of erosion.

Growing special winter or summer cover crops in conjunction with rotated cash crops is for the purpose of preventing leaching and erosion, and not primarily for harvest. Ordinarily they should not require fertilization or special soil treatment; their plant-food requirements should be taken care of in the fertilizer application made to the cash crops in the rotation.

Many permanent cover crops, such as kudzu, perennial lespedezas, grass, various shrubs, and vines which are not commonly grown with cultivated crops and which occupy the land for a long time often can be grown on poor, eroded soil not under cultivation.

The seeding and growing of cover crops are an imitation of nature's method of holding the soil. Under natural conditions some type of vegetation oc-

cupies the soil throughout the growing season and leaves an organic residue to cover the ground during the winter. If agriculture is to be permanent, the soil must be managed so as to maintain productivity not altogether by temporarily supplying plant food but by conserving the soil itself by using cover crops in rotation or association with row crops (fig. 110), orchard (fig. 111), and other crops that occupy the land for only a part of the growing season or form a partial soil cover.

The practice of using cover crops for green manure, or turning them into the soil while yet green, is common in certain parts of the United States. When used in this way, these crops improve the soil by adding organic matter and supply plant food for succeeding crops. A green-manure crop thus provides a ground cover and checks erosion during its growing period and subsequently adds fertility to the soil.

Cover crops used for green manure should generally be turned under in the spring while there is ample moisture and before the growth reaches the point of maturity, such as would resist decay. Usually 2 weeks before corn planting or 3 weeks before cotton planting will be safe. For early truck crops it is advisable to select a type of cover that will rapidly form a dense growth early in the fall and serve as a winter mulch that can be turned under or cut before spring growth starts.

The kind of cover crops to use must be determined by local conditions and needs and the special purpose for which they are desired.

On land not producing cash crops and where erosion is severe, it may be advisable to use a mixture of locally adaptable herbaceous perennial crops and allow the most aggressive plants to form a permanent cover, which in time may naturally or artificially be displaced by a forest cover.



Figure 111.—Blue lupine cover crop in bloom in a pecan grove.

Roadbanks and similar sites can often be planted advantageously to perennial plants to prevent erosion and also to improve appearance.

On cultivated lands, however, ordinary field crops such as sweetclover, alfalfa, redclover, crimson clover, vetch, field peas, rye, lespedeza, ryegrass, orchardgrass, redtop, timothy, smooth brome, wheat, and oats that are known to be locally adaptable can be depended on to furnish the most economical and effective cover. Mixtures of legumes and grasses are particularly desirable for erosion control and soil improvement. When used for soil-erosion control and soil improvement, these crops should be seeded and cultivated in the manner recommended locally when they are grown as forage.

So far as possible seed of cover crops should be grown on the farm where it is to be used. This will tend to reduce the cost of such seed, help insure an adequate supply, and provide greater assurance that the crop will be locally adaptable.

Soil-Depleting, Soil-Conserving, and Soil-Building Crops

Some crops are said to be "soil-depleting," some "soil-conserving," and others "soil building." These crops differ in their effect on the land and on the conservation of soil and water.

The terms "soil-depleting," "soil-conserving," and "soil-building crops" must not be confused with soil-depleting, soil-conserving, and soil-building practices. A soil may be depleted by a bad practice although no crops are grown. Soil-conserving and soil-building practices involve the application of lime and fertilizers, the practice of rotations, and the use of other measures that go beyond the mere use of certain crops.

Plants need a variety of minerals for good nutrition, but the ones most commonly needed in general agriculture are lime, phosphorus, potash, and occasionally magnesium. Under certain conditions elements such as manganese, boron, copper, iron, sulphur, and zinc may be added to soils to advantage, and in some cases, some of the less-common minerals. Plants also need nitrogen, but that does not come from the decomposed rock. A soil may be depleted with respect to its mineral plant food or with respect to its organic-matter content or both.

Soil-Depleting Crops

A soil-depleting crop may be defined as one that causes rapid using-up of the organic matter and essential mineral constituents. The organic matter may be lost because the crop requires excessive cultivation. Minerals may be lost because the crop-leaves the soil exposed to erosion. The term is a relative one; some crops are more soil-depleting than others. Small-grain crops allow some erosion and, whether harvested or not, are never true soil-conserving crops. There is, however, less soil depletion than where corn or cotton is grown.

If a small-grain crop is interplanted with clover or lespedeza and the legume covers the ground by the time the grain is harvested, probably as much organic matter will be left in the soil as is lost. There will be even more left in the soil if the grain is pastured down. A combination of a small-grain crop and clover or lespedeza pastured or left on the land tends to conserve the soil.

When all the lime, phosphorus, and potash has been taken from the soil in which plants grow, there is no other place the plant can get it. If these plants are grazed or otherwise removed from the soil on which they grow, just so much lime, phosphorus, potash, and other minerals as they contain are removed from the soil. If the plants are left to decay in place or are turned under, the minerals they contain are returned to the soil. The mineral content of soils may be depleted by cropping, by leaching, or by erosion; it may be conserved by proper farming practices that reduce leaching and erosion, but it cannot be increased by any form of cropping. When minerals are needed they must be added. All harvested crops remove something from the soil and insofar as this is done the soil is depleted. Cotton and corn are classed as soil-depleting crops; most hay crops as soil-conserving. A 4-ton per acre yield of alfalfa removes more nutrients than a 50-bushel per acre yield of corn, and a 100-bushel per acre corn crop removes more nutrients than a 50-bushel per acre corn crop.

Cotton and corn are considered soil depleting because of the chance they give for erosion. If they could be grown under conditions that eliminate erosion, they would be no more soil depleting than hay.

The quantities of minerals removed by plants are small in comparison with those lost by erosion, but on the soils less well supplied with minerals the steady withdrawal of plant food through the years has a great effect and cannot be ignored. Old grass pastures become poorer with the lapse of time because the constant removal of herbage as milk and meat means the slow depletion of the soil. In addition to the nitrogen removed, with every 1,000 pounds of milk produced by cows on pasture, about 1.6 pounds of lime and 2 pounds of phosphoric acid are carried away. With every ton of alfalfa hay around 39 pounds of lime, 10.8 pounds of phosphoric acid, and 44.6 pounds of potash are removed; and the soil is depleted to that extent.

This depletion of the soil of minerals simply cannot be avoided if the crop is to be taken off the land. In the course of time these minerals will have to be replaced. If they are not replaced, a gradual decline in productivity may occur even without erosion. Fortunately, replacement of minerals is not very expensive and usually pays.

Soil-Conserving Crops

Organic matter is essential to soil, and nitrogen, an important food element, is present in it. Soil-conserving and soil-building crops must be considered chiefly in terms of the effect these crops have on the organic matter in soils.

The destruction of organic matter is brought about by a process of oxi-



Figure 112.—Kudzu protects this slope and conserves organic matter and minerals.

dation through the action of micro-organisms, aided by aeration of the soil following cultivation. The more intensive the cultivation, therefore, especially in warm sections, the greater the destruction of organic matter. Here soil erosion also plays a great part. The organic matter is mainly in the surface soil. It is this surface soil that is washed away, and the organic matter goes with it. Erosion too is facilitated by the stirring of the soil.

Crops that can be grown with a minimum of stirring the soil are in varying degrees soil-conserving crops. Noncultivated crops, such as alfalfa, clover, lespedezas, kudzu, grass hay, and pasture, conserve the organic matter in the soil (figs. 112 and 113). The growing of these crops, therefore, tends to conserve the soil even if some minerals are carried away in the crops removed.

These close-growing crops prevent erosion with its attendant loss of organic matter and minerals. The annual stirring of the soil necessary to the culture of a small-grain crop occasions some loss of organic matter and allows more erosion than is permitted by meadow or pasture. A small-grain crop can be called a soil-conserving crop, therefore, only by comparison with a crop that is more soil depleting, such as corn or cotton. In comparison with meadow, small grain is a soil-depleting crop.

Soil-Building Crops

Soil-building crops must not only conserve the soil, but build it up—make the soil better. Plants cannot build up the minerals, all they contain comes from the soil. If plants are turned under, just so much goes back into the soil. If the soil needs more lime, phosphorus, or potash it must be added.

Plants can, however, build up the organic matter and with it the nitrogen content of the soil. Legumes, of course, work best as nitrogen gatherers. They get a large part of their nitrogen from the air, and if they are turned under, the soil will have that much more nitrogen.

The kind of legume used and the way it is used must be considered. Soybeans cultivated in rows and harvested as hay are about as competent soil robbers as corn. Even when the soybeans have been well inoculated there is more nitrogen in the soybean hay than the plant took from the air. Since the root system is relatively small, little nitrogen is returned to the soil. The same is true of other annual legumes, such as cowpeas and velvetbeans, if they are removed from the ground.

When these crops are broadcast or planted in close drills they help somewhat to stop erosion, but if harvested they do not build soil. That is possible only when they are turned under. Even when they are turned under, little benefit may be derived from the nitrogen unless another crop is ready to use it. Turning under a summer legume in the fall and leaving the ground bare is a wasteful practice. Most of the nitrogen derived from the legume is lost during winter by erosion or leaching. This is not the fault of the crop but of the practice.

All annual legumes have relatively poor root systems, usually not exceeding 10 to 12 percent of the total weight of the plant. In redclover, on the other hand, about one-third of the total plant weight is underground. Even when a redclover crop is removed, organic matter and nitrogen remain to maintain soil productivity.

When soil-building crops are discussed, therefore, it is not enough to suggest the use of legumes. It is necessary to specify not only the kind of legume, but also how it must be used to help in soil building (fig. 113).

Soil building is an extremely slow process. The reference here is not to



Figure 113.—Sericea is a hardy, deep-rooted, perennial summer legume that grows on sites which are not best for many of the other legumes and grasses. In addition to its soil-holding and soil-improving abilities, sericea is a good forage crop valuable for both hay and pasture.

the geological soil building, which is a process going on from below. The term is used in its agricultural meaning of permanently raising the productive capacity of a soil. If the organic-matter content of the soil can be increased, other effects, physical and chemical, will follow. The mineral content of a soil, to be sure, will not be increased by cropping, although it may be conserved by preventing wastage.

It has been shown that in a sandy soil in a hot climate a lasting increase in organic matter is an extremely slow process. A heavy crop of legumes plowed under on such a soil may be burned up by cultivation in one season. On heavier soils and in cooler climates there is some increase in organic matter when plants are turned under, but it is very slow. If a crop of vetch that would cut a ton of hay per acre is turned under, one-half or more is quickly lost by decay, mostly as carbon dioxide. Of the remainder, some is later lost, and only a small part is added to the organic matter of the soil.

Allowing for loss of organic matter in the cultivation of the summer crop, it might be 100 years before the organic matter in a soil containing 2 percent of organic matter could be doubled by the practice of turning under a good green-manure crop every year. It is more nearly correct, therefore, to speak of green manuring as a soil-conserving rather than as a soil-building practice. The best that can be hoped for is to maintain the organic matter at a level satisfactory for crop production.

The soil building commonly referred to in agricultural practice is a temporary process. It is quite true that when a green-manure crop is turned under, the soil is temporarily more productive than it would have been if that crop had not been turned under. This is due in part to the

additional nitrogen supplied when a legume is turned under and in part to an increase in organic matter. If this organic matter were not later removed by cultivation the soil might be built up, but it is removed, at least in great part. The organic matter must be constantly renewed if the productivity of the soil is to be maintained. This is soil conserving rather than soil building.

For real soil building it is necessary to turn to permanent sod. A permanent sod will increase the organic matter in the soil, chiefly by its root growth. A healthy grass sod produces new roots every year, and the decay of the old roots adds to the organic matter, most of which is retained because the soil is undisturbed. These roots die and are renewed constantly and in a comparatively short time really build up the organic-matter content of the soil.

In a forested area, however, where the organic matter has been derived from fallen leaves and the decaying roots of trees and other vegetation, it takes a long time to build up the organic-matter content of the soil. Trees may build soil too slowly for man's immediate use.

A grass sod, if not utilized, is therefore probably the only practical 100-percent soil-building cover. If it is grazed or if hay is taken off, it may be necessary to add plant food, but even then the protection from erosion that such a cover offers, together with the increase in organic matter by root growth, makes such a crop the ideal for soil conservation. Of course all land cannot be treated in this way, and, in the main, crops should be called soil-conserving rather than soil-building.

Pasture Improvement

Pastures afford one of the most effective and economical means of holding and enriching the soil, provided they are properly developed and managed. Two outstanding requirements of good management in humid sections where rainfall is usually adequate for abundant plant growth are (1) a sufficient supply of mineral plant foods such as lime, phosphorus, and potash for desirable pasture plants to make enough growth to cover and protect the soil and to provide forage for livestock, and (2) regulation of the number and kinds of livestock and the periods of grazing so that the pasture plants can make a vigorous growth during the grazing season.

When sloping land is kept in good pasture the wastage of soil is stopped. In addition, the soil under a good pasture sod actually becomes more productive when supplied with needed mineral plant food. About three-fourths of the mineral matter in the forage consumed by the grazing livestock is returned directly to the soil if the animals are kept on pasture continuously. The decaying grass roots add humus to the soil, and the humus in turn aids in converting the raw minerals of the soil into forms that can be used by plants. In addition, grass has a beneficial mechanical effect on the soil, tending to develop a favorable granular structure (fig. 114).

A large part of the badly eroded pastureland in most countries is the result of soil having been washed away while the land was being cropped. When the soil became too poor to pay the costs of putting in a crop, it was abandoned by the plowman, and livestock were turned in to eat whatever would grow there. Such land, if it is to be devoted to pasture, should not be used without proper development and grazing control. Otherwise, erosion goes from bad to worse. Rather, it must be built up by the use of lime, fertilizer,



Figure 114.—Beef cows grazing on second-year sweetclover, a legume which helps to improve the soil. As a supplemental or temporary pasture, sweetclover rates very high, often carrying 1 to 2 head of mature cattle per acre for 3 months.

and seed. That takes work and money, but it pays on most soils of fair fertility and is a necessary investment if such land is to be used for any other purpose than forest or wildlife production.

Selecting Land for Pasture

Despite all the advantages of a pasture sod, it is not always possible to use all the land on a farm for pasture. It may be advisable to retain certain lands permanently in pasture, convert other lands from cropland to pasture, and build up abandoned croplands so that they will produce pasture. The extent to which pastures should be used in rotation with cultivated crops should be determined. The solution of these problems involving land use and conservation practices is made easier if the land is classified according to its capability, which depends on physical properties of the soil, the prevailing climate, and other factors (see pp. 23-59).

Pasture on Land Suited for Cultivation

Lands classed as suited for cultivation are usually well adapted to the production of pasture. The levels of fertility necessary to produce moderate to high yields of cultivated crops on such lands are sufficient to produce profitable yields of forage for grazing and a vegetative cover for protection against rain or wind. Sometimes on farms where all of the land is suited for cultivation a part is used permanently for pasture. However, it is generally much better to use all of the land in a rotation of cultivated crops, grain, and meadow or hay, pasturing the hay lands as needed. Such rotation pastures usually yield more than pastures that are kept permanently on the same land. This is partly because they are on land of somewhat higher productivity, partly because the tall-growing grasses and legumes commonly used yield more than those in permanent pasture. Plowing up pastures regularly and rotating them with cultivated field crops also helps to increase yields by reducing infestations of animal parasites.

The minimum period that the land should be in grass will depend on the class of land and the extent to which erosion-resistant vegetation, such as perennial grass and legume mixtures, is needed to protect the soil from erosion. Because of the cost of legume and grass seeds and the benefit to soil tilth when the land is in grass at least 2 years, crop rotations should be no less than 4 or 5 years in length.

It is a common practice to use the grass grown in the first year or two of the rotation for hay and then graze it with livestock until it is again plowed for grain crops, but there is no hard and fast rule. When cropland in grass is used for hay, the aftermath or stubble may be used as a reserve or supplemental pasture in the late summer, fall, or winter. The most important thing is to provide plenty of high-quality forage for the maximum grazing season, and hay or silage for barn feeding the rest of the year. Among satisfactory rotations when other appropriate conservation measures are used, are the following:

Class I. 3 years of row crops, 1 year of small grain, and 2 years of legumes or grasses and legumes or continuous row crops where good winter cover crops are grown.

Class II. 1 year of row crops, 1 year of small grain, and 2 years of grasses and legumes.

Class III. 1 year of row crops, 1 year of small grain, and 3 years of grasses and legumes.

Class IV. Not more than 1 year of row crops, 1 year of small grain, and 4 to 6 years of grasses and legumes.

Land That Should Be Put in Pasture

Upland not suited for cultivation may include (1) land that has either never been broken by the plow or was in cultivation such a short time that little or no damage has been done, and (2) land that has been cultivated until it is no longer fit for crop production and must be converted to pasture or planted to trees if any economic returns are to be obtained (fig. 115).

On uplands that have been cropped until all of the surface soil has been washed away, the remaining subsoil is not nearly as effective generally as the original surface soil in absorbing the rainfall and holding it for plant growth. It often is in such poor condition that the expenditures necessary to produce a protective cover of pasture plants will not always pay quick returns for the necessary investment in fertilizer, seed, and the labor required.

Poorly drained wasteland, not suited for crops, may often be cleared and made to give profitable response to an expenditure for fertilizer, seed, and labor (fig. 116); but many areas of infertile, eroded upland can be used more profitably for woodland than for pasture.

Much land has been cleared which either never has been cultivated or was cultivated only long enough to get a stand of grass established. Such land is usually so low in fertility and so steep and erodible that it has been difficult to maintain a sufficiently good sod to protect the soil from erosion. Much of this land on the more clayey types of soil can be restored or maintained by applying necessary fertilizers, carefully regulating grazing, and following other good management practices such as weed and brush control and protection from fire. Disking or plowing may be neces-



Figure 115.—Such old fields as this may be made into a good pasture. Gully treatment, seedbed preparation, fertilizing, and seeding will be necessary.



Figure 116.—Mowing poorly drained bottom-land pasture for weed and brush control after it has been fertilized and seeded.

sary to establish or renew a stand of desirable plants, provided the land is not too steep, rough, or rocky.

Seedbed Preparation and Seeding

The seed of most of the plants recommended for permanent pastures are small, and the young seedlings are weak. It is necessary, therefore, to prepare a good, firm seedbed and to cover the seed lightly. In humid areas, many farmers have followed the practice of seeding the grasses and legumes in small grain, considered a 'nurse' crop. It is claimed that a light seeding of wheat, oats, rye, or barley takes the place of weeds and is less harmful to the pasture plants than are weeds. In addition there is a crop of grain or hay which pays for the labor expended. However, numerous experiments have shown that pasture mixtures, if sown in the fall or early spring without a companion crop, will be highly productive the first year, and if grazed properly will provide a larger net return than the grain crop.

The land to be seeded should be plowed and firmly settled. Just before seeding it is usually profitable, except on especially productive soil, to apply some 400 to 600 pounds per acre of a complete fertilizer known to be successful on small-grain crops in the vicinity. Fertilizers having approximately a 5-10-10 formula are generally effective. A light disking after the fertilizer application will put the soil in condition for seeding. Running a cultipacker over the land after broadcast seeding is one of the best methods for covering the seed. If no cultipacker is available, an ordinary spike-tooth or drag harrow with the teeth sloping slightly backward can be used. Usually a better, more uniform stand results if the seed are sown in lightly than when broadcast, and where the seed are such as wheat through a drill the seeding and covering may be accomplished in one operation.

Clovers and other legumes should be seeded in late winter or very early spring. This is particularly desirable on stiff clay soils, as generally the loss of fall-seeded legumes on such soils from heaving is much more severe than that of the grasses.

The amount and distribution of rainfall are often limiting factors in the establishment and maintenance of pastures. Before a good sod is formed, the loss of rainfall by runoff may be so great that the soil moisture becomes deficient for growth during periods of drought. Even on old pastures the effects of drought are first apparent on the slopes where much of the rainfall is lost as runoff. Small contour furrows help to reduce the runoff and thus conserve the rainfall and provide better conditions for seed germination and subsequent plant growth. Mulches and surface residues may also be used for this purpose.

Treatment of Newly Seeded Pastures

Care should be exercised in grazing newly seeded pastures. The young seedlings must have time to develop good root systems in order to withstand drought, freezing weather, and the strain of being cropped by livestock. If many weeds appear in spring seedlings, it may be necessary to clip the weeds 4 to 6 inches high before grazing is begun. In any event the grazing should be rather light the first year. On clay soils, rolling early in the spring compacts the ground and helps to reset any plants that may have been heaved by frost. Moderate grazing is usually beneficial after the grass is well started.

Cultivating and Reseeding

Cultivation is of no value for the purpose of improving old pastures unless it is accompanied by reseeding or the application of fertilizer or both. Lack of desirable grazing plants in a mixture that formerly produced well is due generally either to a decrease in soil fertility or improper grazing. Cultivation alone cannot overcome either of these conditions; but cultivation in connection with fertilizing and reseeding has given excellent results by eliminating weeds, covering the seed, and mixing the fertilizer with the soil. Quick-growing grasses and clovers seeded on old-pasture sod that has been well disked and fertilized will give grazing in a surprisingly short time, and will continue to produce forage while the slower growing; more permanent grasses are becoming established.

Reseeding of old pastures alone may be desirable, but it is not often a complete remedy. If legumes are scarce in the stand of grass, broadcasting seed on the surface in late winter or early spring is advisable. Such seeding cannot be expected to succeed, however, until fertilizers have been applied.

Liming and Fertilizing

Most pasture soils in humid areas are deficient in calcium, phosphorus, and nitrogen, and many are deficient in potassium. All these elements are valuable in increasing the stand and production of desirable grazing plants and should be added when not present in the soil in sufficient quantity.

It is folly to expect fertilizers to produce a good growth of grass on inherently poor soils. Such land should be used for timber or wildlife

production. On soils of fair natural fertility much can be expected from fertilization, particularly where the land has never been fertilized or has been neglected for several years.

If a fair stand of desirable pasture plants is present, fertilizer treatment is sure to result not only in a larger growth of the plants but also in an improvement of the stand, especially of stoloniferous plants, thereby enabling them better to compete with weeds.

Soils suspected of calcium deficiency should be tested to determine their needs for lime. In sections where lespedezas thrive, these legumes, which are not sensitive to acid soils, may well replace the clovers and make the application of lime unnecessary. Both lime and phosphate are believed to be more effective when they are worked into the soil than when they are applied on the surface.

Barnyard manure will furnish considerable nitrogen if applied at the rate of 5 to 10 tons per acre. The effect of such an application continues for several years. The effect of applications of commercial nitrogen is soon exhausted. Many dairy farmers use commercial nitrogen, applying small quantities from 1 to 3 times a season. Some prefer, however, to make one heavy application of nitrogen in the spring and rely on supplementary grazing crops for midsummer.

The mineral fertilizers, limestone, and barnyard manure can be applied in the fall, winter, or very early spring. Commercial nitrogen should be applied about 2 weeks before increased growth is desired, as it results in a quick stimulation of the growth. Early applications may make it possible to begin grazing about 2 weeks earlier than could be done on unfertilized pastures. Applications of nitrogen are rarely effective in the absence of adequate soil moisture. Hence the returns from midsummer applications are often unsatisfactory.

Barnyard manure should be spread lightly and uniformly on the whole pasture, preferably in the fall. Spreading some phosphatic fertilizer with each load of manure is good practice.

Shade trees and shelters should be set on the higher parts of the field, and not along the banks of running streams. Thus, a larger part of the manure produced while the animals are not grazing will be voided on the land that produces the grass. Manure deposited on the upper slopes and hilltops has beneficial effects on the grass for some distance down the hillsides.

On old pastures where there are relatively few desirable pasture plants it is often better to plow, fertilize, and reseed the land than to attempt to renovate the pastures by applying fertilizers alone.

Controlling Weeds and Brush

Increasing soil fertility is one of the best means of weed control, as generally grasses will dominate when they have favorable soil conditions. Mowing weeds at the proper time is another good means of control. In general, weeds should be mowed before the seed have formed. It is necessary to mow twice during the year to eradicate some weeds.

Sheep and goats are very efficient in keeping down many troublesome weeds, and many farmers have found it profitable to keep a few sheep in their cattle pastures because of their tendency to eat weeds.

Shrubs and tree sprouts can best be controlled by cutting them at the proper time. Apparently the best time to cut brush is when the roots contain the smallest amount of starch. Generally, this is at time of blooming.

The eradication of sprouts and shrubs is generally more difficult in the warm countries than in the cold. Grubbing them out or treating them with chemicals has so far seemed the only sure way to eradicate them.

Effect of Methods and Intensity of Grazing.

The good plants must have an opportunity to produce leaves and strengthen their root systems in the spring and throughout the growing season. Overgrazing in these periods will cause a reduction in their subsequent growth. Grazing pastures closely in the late fall, before the plants enter their dormant period, is likewise harmful because the plants are prevented from building up a reserve food supply in the roots and a fair cover of foliage to protect them from injury when their vitality is low and conditions are unfavorable.

In the humid areas, forests are the usual climax type of vegetation, and trees will dominate over grass if man does not interfere. In such regions fairly close grazing is helpful in maintaining a grass cover. Browsing by goats helps to prevent brush and trees from occupying grazing lands. In general, reasonably heavy grazing favors plants that require light for their best growth.

On the other hand, in arid and semiarid regions, where grasses are the climax form of vegetation and may even conquer hardy shrubs, continuous heavy grazing is destructive rather than helpful. The plants have a short period of growth because of the scarcity of soil moisture during a large part of the year. They cannot maintain their vitality, and therefore cannot perpetuate themselves by seeding or storing plant food in their subterranean parts, if they are closely cropped throughout their growing period each year.

Cattle alone graze more uniformly and will keep a pasture in better condition than horses or sheep alone, but mixed grazing generally results in the most uniform utilization of the forage. Regardless of the class of livestock grazed, the presence of good pasturage and poor pasturage within the same boundary usually results in poor utilization because the stock will overgraze the good pasture areas and undergraze the poor ones. Consequently, improving some parts of a pasture and neglecting the others may eventually result in reduced rather than increased carrying capacity.

Understocking may have adverse effects on a pasture. This may occur when animals are fed heavily with supplemental feeds and hence do not have to depend greatly on the pasture for feed. As a result, the animals graze selectively, avoiding the plants that have become too mature. This allows the less desirable plants to grow and crowd out the more palatable and closely grazed plants. In such instances, young stock and breeding animals that are not receiving supplemental feed should be placed in the pasture to graze the unused forage.

The selective grazing that results when the use of a pasture is limited to one kind of animal is likely to affect the quality of the pasture adversely. Horses are likely to graze local areas very closely and to leave other areas wholly untouched. On the other hand, they may be used to graze down a pasture that has largely or completely grown up to coarse herbage. Any rough herbage left uneaten can be removed by mowing late in the summer. Sheep are much inclined to eat the more tender grass and the tender tips of weeds and bushy plants. One of the rules for maintaining a uniform grass-legume mixture in humid regions is to graze it all down close at least once a year.

Effect of Burning Pastures

No general statement can be made regarding the advisability of burning pastures or ranges, except that indiscriminate, uncontrolled burning is usually harmful. Much depends on the kind of vegetation, the time of year, and the soil and weather conditions when burning takes place. Pastures and ranges are burned over for various reasons—to destroy dead herbage which was unconsumed the previous season and remains to interfere with the grazing of new growth; to control weeds and brush which otherwise might replace the desirable pasture plants; or to destroy pine needles and other forest litter which tend to smother out the forage plants on cut-over timberland. When fire is so used, care should be exercised to prevent its spread to adjacent fields, forests, and farmsteads.

Drainage of Pastureland

Land can be brought into productive pasture use, or improved for pasture, by drainage through the use of open waterways or tiling. Unless pastureland is exceptionally productive, the expense of tile drainage is seldom warranted. There are, however, many small, fertile, low-lying areas, occupied by undesirable plants, which have been rendered unproductive by seepage from higher lands. Short lines of tile laid above such wet spots and opening into a waterway below may be justified by the increased productivity that results. Often open ditches, if properly designed and located, may be constructed to remove surplus water.

Pastures Compared With Harvested Crops

The labor needed to maintain permanent pastures after they have been established is relatively small. In a number of typical cases the labor required for fence repair and replacement has ranged from 1 to 3 hours or man labor and less than 1 hour of horse labor per acre per year. The principal other labor requirements have been for occasional jobs such as the application of fertilizer and weed and brush cutting. The charges for interest and taxes were fully as low as for other similar acres of the farm. Even annual and other temporary pastures, although costing as much as grain crops to produce, are harvested cheaply by livestock with practically no labor cost.

Studies which have been made of the effect on meat quality of using grass in the ration of grazing animals show that the meat of suckling lambs produced on good pasture is as satisfactory both as to fatness and palatability as that from suckling lambs which received a supplement of grain on pasture (fig. 117). The results of these studies also indicate that production costs can be lowered by making greater use of pastures in the fattening of livestock.

Fresh green pasturage grown on fertile soil provides, in a palatable form, most of the substances required for perfect animal nutrition. Pasturage, which is rich in protein, minerals, and vitamins, maintains the health and productivity of livestock. It permits the animals to replace the stores of minerals or vitamins which have been used up during the winter and enables them to lay up a supply for use during a period of inadequate nutrition. Good pasturage appears to be a perfect feed for all herbivorous animals except those doing hard work, those giving large quantities of



Figure 117.—Good pasture of grasses and legumes. This type of pasture reduces or eliminates the need for supplemental feed.

milk, or animals that are being fattened rapidly. On the other hand, long-continued feeding of herbivorous animals on poorly cured roughages is detrimental to both production and reproduction.

Although certain types of injury to animals caused by parasites and diseases may be largely avoided by keeping livestock in dry lots or barns, animals generally are better off on pastures. A clean pasture not only provides natural conditions for the livestock but also reduces the labor of caring for the animals and minimizes the danger of mineral and vitamin deficiencies.

Pastures provide breeding animals a means of obtaining the exercise needed for healthy development and full production and give work animals an opportunity to obtain the exercise they need to maintain themselves in good condition when not actively at work.

Immature pasturage consisting of both grasses and legumes has feeding properties similar to those of high-protein concentrates, such as the oil-mill byproducts. It is especially well supplied with protein, minerals, and vitamins, and is richer in protein and more digestible than the best mature hay. The protein in good pasture plants is high in quality as well as in quantity. The protein in the leaves is particularly valuable for supplementing the protein deficiencies of the cereal grains.

Several methods have been developed to preserve immature forages for use in winter and other periods of shortage. In one method the grass is dried by artificial heat and either stored as hay or pressed into small cakes to facilitate handling and shipment. In either form the dried herbage usually maintains its green color and agreeable odor. When used in the rations of cattle and sheep, it has proved to be a satisfactory substitute for oil-mill byproducts.

Green, immature grass is a much better source of minerals than hay or mature plants from the same land. It is generally about twice as rich in phosphates as mature freshly cured grass, and may be from 4 to 5 times as

rich in phosphates as mature grass which has been exposed to the weather for several months. The dry matter of immature grass contains practically 4 times as much mineral as the average cereal grain, and as much as the average legume hay. Furthermore, pasturage produced on fertile land probably contains considerably more of the important minerals than that produced on poor soil.

An adequate supply of vitamins is necessary for proper growth and reproduction in livestock and to keep them thrifty and resistant to diseases. Vitamin A, for example, promotes growth and increases resistance to disease. When animals are grazing on green, immature pasturage they appear to be better supplied with vitamins than by any other practical method. Such feed is especially rich in carotene (from which Vitamin A is made in the animal body), and contains other less well-known vitamins of importance to animals.

The palatability of pasturage depends on the kind of plants, their tenderness, stage of maturity, density of stand, and climatic and soil conditions. In addition, livestock tend to select plants which contain relatively high percentage of minerals in preference to those having a low percentage of the same minerals. The palatability of most grasses is greatly reduced by seed-head formation. Hence, mowing or close grazing at heading time helps to keep the forage palatable.

Grazing Practices and Livestock Management

On small farms and where livestock produces a minor part of the farm income, a common farm practice is to use whatever pasture is available or can be most readily supplied for the kind of livestock to be kept. Usually the pasture supplements other feed. But where grazing is the chief source of feed for livestock or where the bulk of the farm or ranch area is in pasture, the problem is to choose the kind or kinds of livestock best suited to the pasture. On most farms, greatest returns will be obtained from the forage available and the pasture will be kept most productive if two or more kinds of livestock are grazed, either at the same time or at different times during the season. Where large areas of several kinds of pasturage are available, or where so few animals are kept that it does not pay to provide separate pasture, all kinds may be turned on the same area.

As farm animals may suffer from the heat of summer days, some sort of shade should be provided. If there are not sufficient trees or brush, sheds or other shelters should be built. If they are for summer use only, all sides should be left open. The roof may be of poles, brush, or straw. About 15 square feet of roof surface are required per head of mature cattle. For protection against cold, rains, and sleet the more exposed sides of the shelters should be walled. Where there is little rainfall but much cold wind, windbreaks like tight fences, rows of trees, or bluffs can be used for protection.

Rotation grazing is the grazing of two or more pastures in regular order with definite rest periods for each pasture. When only two pastures are involved this type of grazing is sometimes known as alternate grazing. Under certain conditions, rotation grazing of permanent pastures may increase the production from 10 to 15 percent over continuous grazing.

Although pastures are conducive to the general health and vigor of livestock, precautions should be taken against certain diseases and parasites. Tuberculosis, for instance, though much less common among cattle on ranges than in those confined much of the time in barns, may be spread by

such means as infected watering holes and ponds. It is apparent that the droppings of tuberculous animals in the water supply may pollute it sufficiently to infect other cattle that drink the water.

At the beginning of the plant-growing period the moisture content of young grass is high and the crude-fiber content is low. It is often well to give cattle and sheep some supplementary feed at this early period to counteract, in some measure, the laxative effect of the succulent grass. The best supplement is some nonlaxative roughage, such as timothy hay or grain straw, which gives bulk to the ration. This helps to slow up the passage of the contents through the digestive system and thereby allows time for the absorption of nutrients. The transition to succulent pasture should be gradual, beginning with an hour or two of pasture each day, depending largely on supplementary feeds.

During periods of drought when the grass is brown and dry, or in the fall or winter when the forage is mature and leached out, the forage consists largely of crude fiber with relatively little protein. Under such conditions it is desirable to feed some laxative supplement such as linseed or soybean meal or green leafy alfalfa hay.

Since a pasture on which cattle are kept only during the time they are grazing receives only a small quantity of manure, it loses its fertility faster than a pasture on which cattle remain the full 24 hours of each day. On many dairy farms the portion of the pasture easily accessible from the farmstead is likely to reach a very low state of fertility. This is due in large part to the custom of keeping the cows at or near the farmstead during the night, and applying the manure thus saved to other parts of the farm instead of to the pasture.

Rangeland Improvement

The most useful practices for the conservation and improvement of rangelands depend on the land, the rainfall, the growing season, the vegetation, and other factors. Of these, the type and condition of the vegetation is usually the most varied. Thus, the first factor to be considered is usually adjustment of grazing to bring about a proper balance between the amount of vegetation the livestock eat and that left to protect the soil. Water-conservation practices weaken the effects of drought and promote recovery of the range following extended droughts. Reseeding of depleted grasslands is frequently necessary. Fencing, water developments, and other facilities for handling livestock are particularly important in getting proper use of the range. Supplementary pastures and stockpiles of home-grown feeds, where available, relieve pressure on the range itself.

A range-conservation program should utilize all types of conservation measures adapted to the range involved. The use of only part of them falls short of doing the best possible job. Wherever possible, the various conservation practices and treatments applied to any rangeland should be so correlated that each practice used will supplement all the others.

The Grazing Load

Range-forage plants should be considered as a crop that must not only produce the forage used during the current season but also must be left in condition to produce a good crop the following season. Continued heavy grazing cannot be expected to produce the maximum amount of either forage or animal products. In planning a grazing program, it is necessary to consider not only the needs of the livestock using the area but also the needs of the grass and other forage plants (fig. 118).



Figure 118.—Proper stocking provides ample forage for the animals at all times, builds up depleted ranges, and increases livestock gains and total livestock production.

Grass plants do not manufacture food in the roots. The roots take moisture and plant nutrients from the soil and transport them to the leaves where they are manufactured into plant materials. Consequently, development of the roots is dependent on growth of that part of the grass plant above the ground. Overgrazing of the plants during the growing season usually results in a decrease in the size and vigor of the root systems. This, in turn, makes the plant less able to use the moisture and plant food in the soil.

If livestock are held on a pasture until they begin to lose weight, the forage plants will usually be so damaged that they cannot produce a satisfactory crop the next season. Also many weakened grass plants die during moisture shortages.

Plant growth also helps maintain soil fertility and prevent erosion. Both runoff and soil loss are much less, and may be negligible, under a heavy growth of grass. Grass also provides shade that reduces surface evaporation and protects young plants.

A grazing load that is suitable when rainfall is average usually is too heavy for the same pasture during drought. Overgrazing during drought may so damage a range that it will be less productive when the drought ends.

A heavier than normal rate of grazing may be used without detriment to a range in good condition when rainfall is above average. Often it is not possible for the ranch operator to adjust his herd to all variations in growing conditions, but he should reduce the grazing load when production is below average. During severe droughts the number of animals must be reduced to the extent that they will not graze the range beyond a point where rapid recovery can be expected when conditions again become average. Moreover, this reduction should not be postponed until loss of livestock and extreme depletion of the range occur.

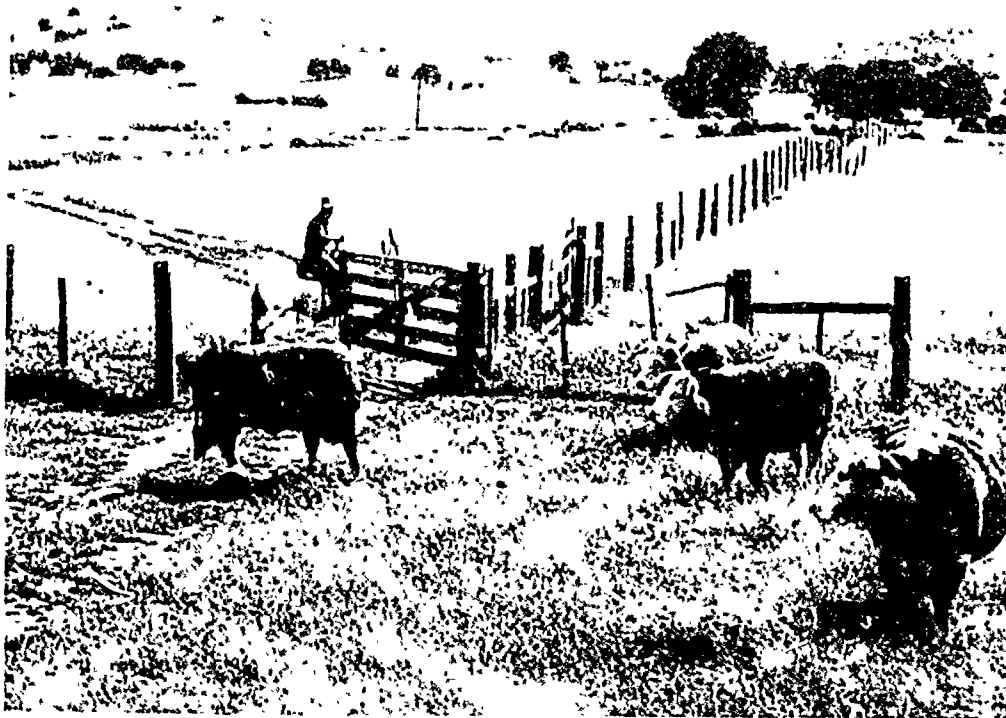

Figure 119.—Rotation grazing of two or more pastures in systematic order with definite rest periods aids in better use of the vegetative cover, increases the grazing capacity, and induces greater livestock gains during the growing season.

Experimental study supported by careful observations by ranchmen and rangeworkers indicates that over a period of years a greater profit can be expected from grazing fewer well-fed animals, than from more animals that do not get enough forage for normal gains. One authority defines proper stocking as the least number of animals which will produce the greatest total gain in weight from a given range.

Time for Grazing

Since the most critical time in the life of any plant—either perennial or annual—is at the beginning of growth, grazing should be light during the early spring on most ranges. The right time to graze depends not only on the kind of range but on its condition. Badly depleted range is usually improved fastest by deferring grazing during the early part of the growing season because at this time the forage plants must not only maintain themselves but should also develop additional vitality and reserve.

Some grasses, however, grow more following summer rains than early spring rains. Where such grasses predominate it sometimes is advisable to restrict grazing during the summer rather than in the early spring. Also, certain grasses should be grazed while green and growing because they become harsh, woody, and unpalatable after they reach maturity.

Rotation Grazing

Good results may be expected from rotation grazing that allows every part of the range to grow to maturity at least once every 3 or 4 years (fig. 119). On many types of range more total forage will be produced under a proper system of rotational grazing than where the range is grazed continuously. It is possible on some ranches to establish a satisfactory grazing rotation by simply closing the waterholes on the range to be protected.

Rotation grazing is almost essential on severely depleted ranges or where erosion and soil losses have been serious. If the more desirable forage plants are to compete with undesirable species, rest periods are essential.

Alternate use of different parts of the range during the growing season may not be practicable on ranches that have land more suited for use during one season than another. If topography is such that certain areas afford protection during winter months, or if the forage produced can be utilized to advantage only during certain seasons, it may be necessary to use the same ranges more or less continuously during the same season year after year. On ranges grazed continuously during the growing season, it is imperative that grazing be light enough to permit accumulation of reserves.

Grazing Distribution

One of the most important features of range conservation is to maintain proper distribution of the grazing animals so that localized areas are not overgrazed while others are undergrazed. Overgrazing of local areas may occur even on ranges that are not overstocked if there is poor distribution of watering places, or if fences are not well located. Excessive trampling of livestock around waterholes, salt licks, windbreaks, or other concentration areas may result in wind or water erosion that eventually spreads to other parts of the range.



Figure 120. --Salting improves the health and growth of the animals and properly distributed will help prevent localized overgrazing and insure more even utilization of the forage.

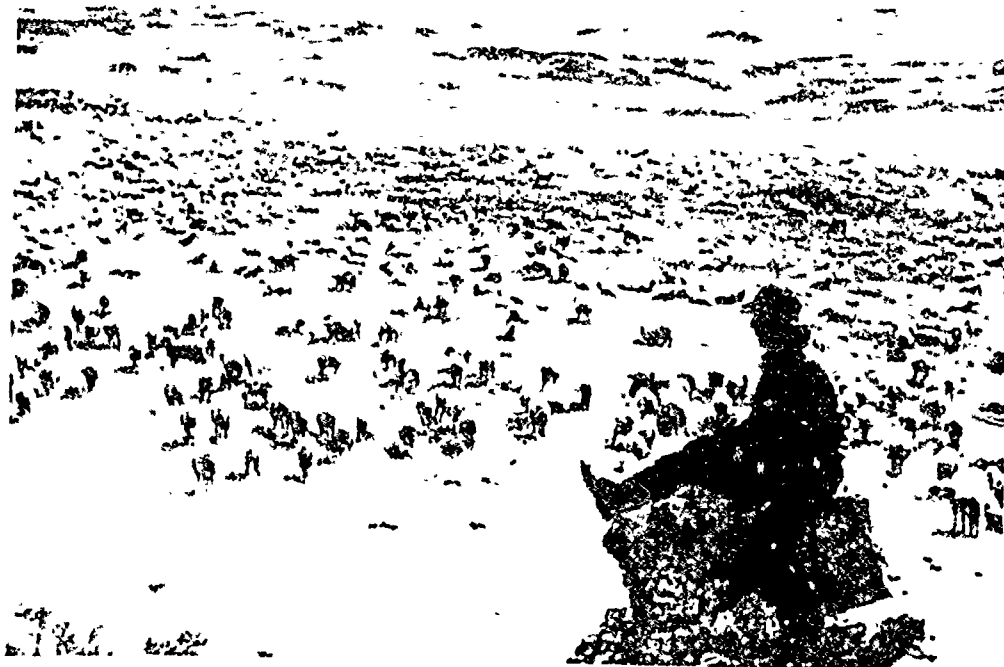

Figure 121. —To avoid damage from trampling, sheep should be allowed to graze in open bands and to bed-down where night overtakes them.

Good distribution of stock-watering places is an effective means of spreading the grazing load over all parts of a pasture. Watering places should be spaced close enough so that livestock will travel to the area farthest from water without being forced to do so from feed shortage. The distance cattle will travel for water varies greatly according to topography, temperature, and other factors. It is desirable in most places to have watering places not more than a mile apart, but spacing at such close intervals is not always practical because of the cost, or of lack of suitable sites for development. In some sections cattle may travel 2 miles or even more under favorable weather conditions and on relatively smooth terrain without severely overgrazing areas near the water.

Enough fences in the right places will also aid greatly in distributing livestock over the range. Fences should be so placed that animals will not have to cross deep ravines, high ridges, or other natural obstructions in traveling to water and feed.

Placing salt on parts of the range that might not otherwise be grazed will bring about better distribution (fig. 120). Rotation grazing may relieve trampling and overgrazing on many areas that are subject to concentration. It may be practical to fence off small areas that are being grazed or trampled too heavily. Occasionally shifting cattle by driving may be necessary if distribution is not secured otherwise.

Where sheep are under herd, the herder can see that all parts of the range are uniformly grazed (fig. 121). To avoid excessive trampling, sheep should be held in open and well spreadout bands and not be driven over the same trails day after day to water or bad grounds. Frequent moving of bad grounds also is desirable. Some sheepmen fence their lands into paddocks, thereby eliminating herding and the concentration of animals that occurs with herding even under the most careful management.

Reservoirs or Ponds

The construction of reservoirs, ponds, or storage tanks for use as watering places affords a practical method of supplying water in many dry locations (fig. 122). In arid country this type of development may provide water only part of the year unless large ponds are built. If the ponds are properly located, however, ordinarily the range adjacent to a pond can be used when there is water in the pond, and in this way supplement permanent water supplies. In many places, ponds can be built where adequate water supplies cannot be obtained from underground sources.

Pond sites

Satisfactory pond sites usually can be found on all ranges except those with very sandy or shallow soils. Factors to be considered in selecting a pond site are its location with respect to good grazing lands, the distance from other sources of water, the type and size of the drainage area, and the probable cost of the dam and spillway.

Where the drainage area above a pond is too large, runoff from heavy rains may overtop and destroy the dam. On the other hand, if the drainage area is too small, the pond probably will be dry when it is needed most. Sheet or gully erosion in the drainage area may cause the pond to fill with silt and become useless.

The dam site should be such that the dam can be constructed at a minimum cost and still have enough depth. A minimum depth of 10 feet is

recommended where surface evaporation is 5 feet or more a year. A pond that has a potential water supply of less than 5 feet below the spillway level will normally lose most of its water through evaporation during the summer months of dry years, especially in a dry, hot climate.

The site should be carefully explored to determine whether there is danger of excessive seepage. Ponds should not be installed on porous rock or dry gravel beds. An engineer's help in selecting the site and designing the pond may save needless expense.

Dams and spillways

A suitable site must be available for a wide, stable spillway of sufficient capacity to carry safely the runoff from the heaviest rains. The spillway also must have a suitable place to empty. Turning water loose from a spillway near rough, broken areas may cause serious gulying.

Use and care of ponds

Larger ponds not only serve as stock-watering places but also may be used to irrigate small tracts of feed crops, gardens, or other crops. If properly developed for fish, waterfowl, and other types of wildlife, they make good recreational areas. Small ponds often can be constructed across eroded areas and serve to check further gulying. A fenced area immediately above the pond, supplemented by dikes to check the flow of water and aid in holding up silt, helps materially to lengthen the effective life of a pond. A heavy cover of grass or other vegetation in the water-course at the head of a pond will cause floodwaters to drop much of their silt load, thus affording protection to the pond. It may be desirable to fence most ponds and water the livestock from a tank placed below the dam and fed by a pipe from the pond.



Figure 122 Well-constructed ponds often may serve to supply livestock or where other watering places are not available.

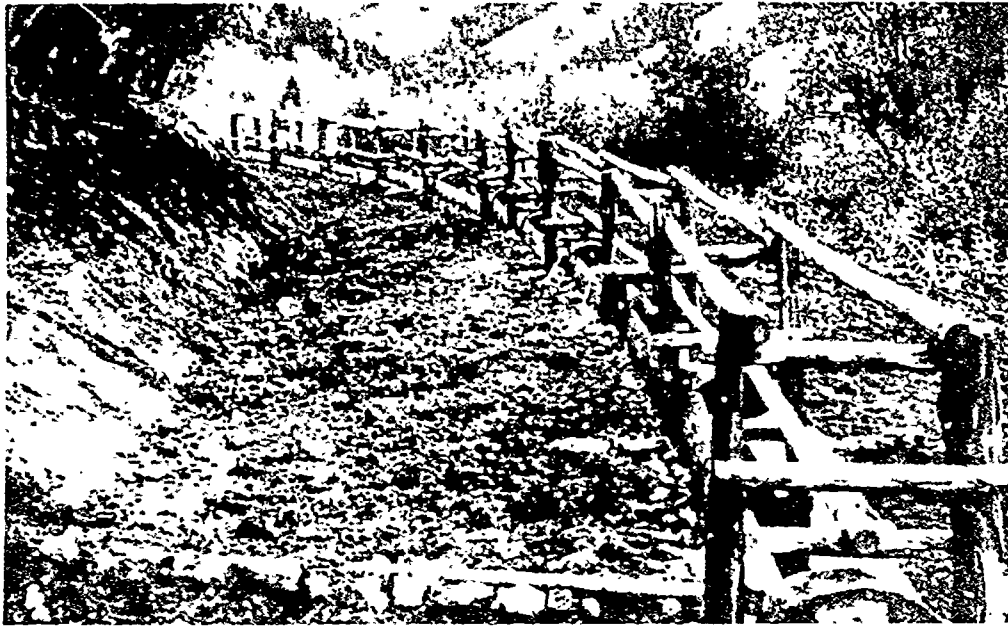

Figure 123.—This series of log troughs has a capacity of 1,200 gallons. A few feet of pipe and native materials, where available, are practical ways to convert a mudhole to a permanent supply of fresh water.

Spring Development

Both intermittent and ever-flowing springs provide good sources of water for livestock, particularly in rough, broken areas adjacent to higher lands (fig. 123).

To develop a spring, it is necessary to clean out the opening, locate the true water-bearing outcrop, and provide means for collecting and utilizing the outflow. The spring should be protected from erosion damage and suitable cribbing, and collecting facilities should be provided to keep the collecting sump and inflow channels open.

All springs should be protected from surface runoff, and, except for the open-type development, be enclosed by a substantial fence to exclude livestock. A suitable intercepting ditch is desirable to divert surface runoff around the spring. A dense cover of vegetation around the spring will retard erosion damage. The drinking trough should be placed outside the fenced enclosure, where animals will have ready access to it from as many directions as the natural terrain will permit. Rock or gravel should be placed around the trough to prevent the formation of mudholes.

Wells

In regions not watered by springs and streams, wells may be used to supply water for livestock. Ordinarily, wells are more dependable than ponds and, where water is present at a reasonable depth, they may be less expensive. Windmills usually can be depended on for pumping power in most sections (fig. 124).

Wells ordinarily are dug, driven, or drilled. Dug wells are usually considered only where adequate water can be obtained within 30 to 40 feet and where the excavating can be done with handtools. The large storage space provided by dug wells is advantageous in a water-bearing stratum that is slow to deliver water.

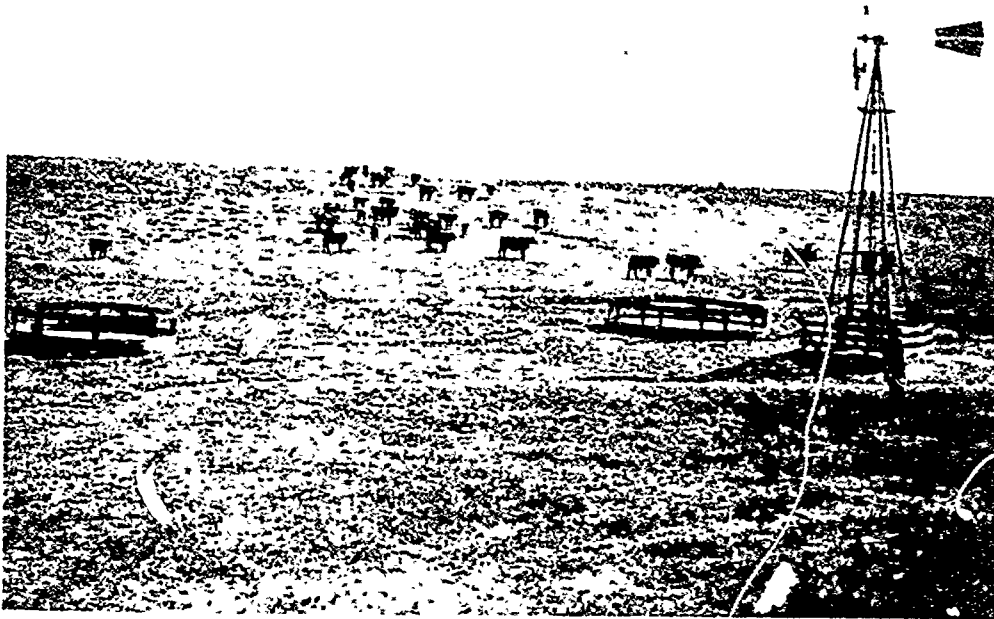

Figure 124.—Wells often are the most dependable source of stock water if underground supplies are not too far below the surface. Windmills usually can be depended on for pumping power.

Driven wells are used where a water-bearing stratum can be penetrated at a shallow depth. They are generally cheaper to install than dug wells of the same depth. A well cannot be driven, however, where there is rock or other formation difficult to penetrate.

Where the ground formation is difficult to penetrate or the water-bearing stratum is far below the surface, a drilled well is usually the most economical and satisfactory. Usually the deeper water-bearing strata that supply drilled wells are the most satisfactory source of stock water. The water is less likely to fluctuate with changes in climatic conditions and is more easily protected from surface contamination.

Provision should be made for storing a reserve supply of water to serve when the well is being repaired or when there is not enough wind to supply pumping power.

Reseeding

On some rangeland practically all the vegetation has been destroyed by overgrazing, drought, wind erosion, or other causes. On still more the grass stands have but little value for grazing. If these are to attain their highest economic usefulness within a reasonable period, they must be re-vegetated.

On land where the grass is not destroyed, natural processes may bring about recovery if grazing is restricted. If misuse has proceeded to the point that the grass cover is completely destroyed, reseeding will be necessary (fig. 125).

On land that has been cultivated and is being converted to grass, or on native pastures completely denuded of grass cover, the first step is to stop soil blowing. Eroding heavy soils and moderately sandy soils can usually be temporarily stabilized by contour listing or chiseling. On some bare

land it is necessary to plant erosion-resistant forage crops, such as sudan-grass, broomcorn, sorgo, or grain sorghums for immediate stabilization and to enable the planted grasses to become established.

Grasses should be planted when soil-moisture conditions are favorable and preferably free of growing weeds or volunteer crops, which compete with small grass plants for moisture. If weeds come up thickly after grasses are planted, they should be mowed. Cover crops on land to be planted to grass should be close-drilled, with rows 12 to 20 inches apart. The cover crop should be mowed high before it produces seed, and all the crop left on the ground as an added protection for the soil.

Loose, sandy soils are difficult to revegetate, especially if they have lost most of the plant cover and have a tendency to form dunes. Wind and moving sand on such land usually kill young plants before they have a chance to form a ground cover that will hold the soil in place. Revegetation by nature of loose, sandy soils is usually slow. Great pains should be taken to stabilize them before the plantings are made.

Noxious Plants

The control of noxious plants is coming to be one of the most needed practices for the improvement of rangeland in many areas. Literally millions of acres throughout the world are infested with such noxious shrubs as



Figure 125.—Reseeding depleted ranges to perennial grasses reduces runoff and erosion and increases forage and livestock production.

oak, mesquite, cedar, and sagebrush. Such invasions are frequently the result of many years of overuse by livestock. As the forage grasses are weakened and reduced, the shrubs have also increased in density. Fire has also been a factor in the spread of such shrubs. Where there are root-sprouting species, ill-advised burning has helped to increase the invasion since the plants merely send up additional shoots after the parts above the ground are killed. In some places, failure to make judicious use of fire as a control measure has permitted the spread of aggressive shrubby species.

Knowledge of why the species have invaded his range may help a landowner select the right method for control, or determine whether any attempt will be effective. If shrubs constitute the climax vegetation for his range, the effect of control measures will be of short duration and reinvasion is probable. If overuse has been responsible, the landowner needs to satisfy himself that management following control will be such as to prevent reinvasion. Otherwise his investment of money and labor for control measures may be wasted or of only temporary benefit.

One of the most effective methods for the control is hand-grubbing. But because of high labor costs, this method is seldom economical except when the shrubby plants are few in number.

Fire is the most ancient of all methods for land clearing. But because haphazard burning has had harmful, or even disastrous results, burning is frequently condemned. Recent research studies show that under carefully controlled conditions fire can be an effective means of controlling some woody species and of increasing forage production. The fire must be kept within the area planned for burning, and the area burned should be protected from grazing the first year and properly managed thereafter.

Recently power equipment has been developed that is able to cover large areas rapidly and thereby reduce the cost of removing shrubby growth. These machines include specially adapted bulldozers, rolling brush cutters,

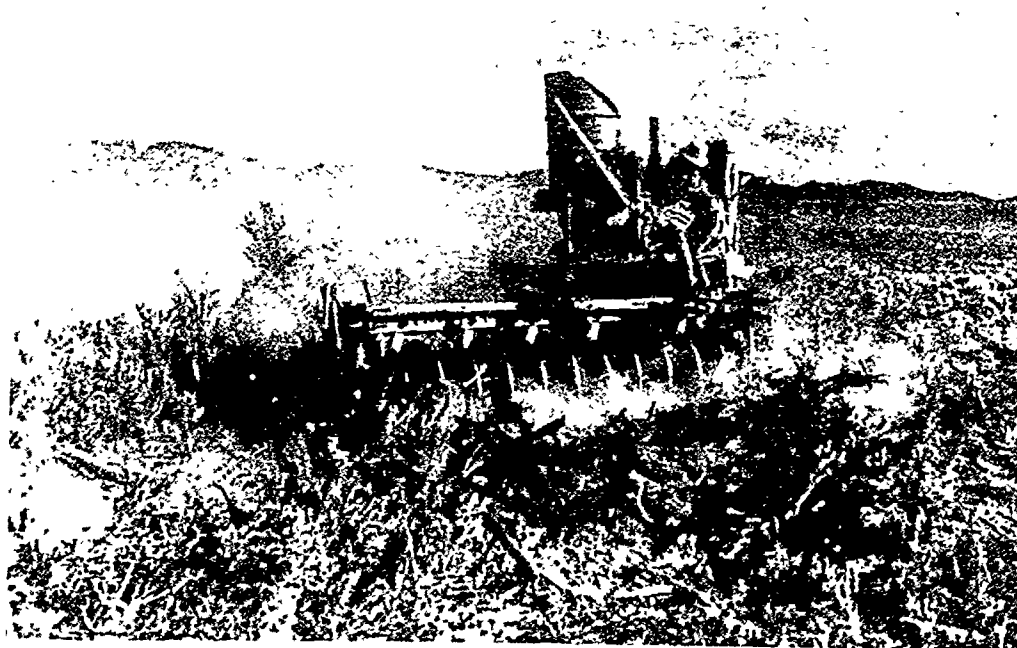

Figure 126.—Heavy disk plows are a practical means of removing low-value sagebrush from some rangeland. Disking followed by reseeding reduces erosion and runoff and replaces the shrubs with productive forage grasses.

power saws, heavy-duty mowers, and large disk plows (fig. 126). Such equipment is expensive, however, and operating costs are high. Consequently, careful consideration needs to be given to such costs in relation to probable benefits before large-scale control operations are undertaken with power equipment.

Chemicals offer the greatest promise for effective control of noxious shrubs and, for those that can be applied by airplane, the cheapest available method. Sodium arsenite and acid arsenic pentoxide have been used successfully for mesquite and prickly pear. These compounds are hazardous to grazing animals, as well as workers, however. Ordinary kerosene is also effective in the control of many noxious shrubs. For mesquite, the usual method is to pour a quart of kerosene on the ground at the base of the tree. The liquid penetrates the soil and saturates and kills the underground buds at the junction of the trunk and roots. If resprouting is to be prevented, all the buds must be killed.

2,4-D and related compounds show great promise as effective herbicides for many of the noxious broad-leafed shrubs, including sandsage, skunkbush, sand plum, and mesquite. Where applied from the air, care must be used to avoid releasing the spray on areas not intended to be treated, as these compounds are fatal to many cultivated crops.

Both costs and benefits from the removal of noxious shrubs from rangeland vary tremendously, depending upon density and kind of shrubs, roughness of the terrain, equipment used, productiveness of the site, amount of good forage grasses left, and other factors. On many ranges, improvement will be rapid and the benefits more than repay the costs. On others, and with other kinds of brush, results may be less favorable. High costs may be justified, however, where failure to control the invading shrubs will result in further reduction in the productivity of the land, or even in complete loss of its grazing value.

Water Conservation

On many ranges, all of the rain is needed for the production of grass and should be held on the land and at the point where it falls. Water that runs off is not only lost to use by the plants but may cause destructive erosion.

A cover of grass is the best means of preventing water loss through runoff, and under most conditions an adequate plant cover will reduce runoff to a minimum. Under some conditions, however, water-conservation structures are beneficial as supplements. Since structures are costly, before construction on a large scale is started, two important questions should be answered: (1) Can the forage be increased and runoff halted by more conservative management, making the structures unnecessary; and (2) will the benefits to be derived at least equal the cost of the proposed structures?

Contour Furrows

Contour furrows are effective on ranges supporting sod-forming grasses where the slopes are gentle to moderate, and where the soil is productive enough to support the additional grass growth that the increased moisture encourages (fig. 127). Contour furrows are not satisfactory on loose soils where they will accumulate silt or sand, on rough broken lands, or on steep slopes. Nor can satisfactory response from contour furrowing be expected on shallow, unproductive soils.



Figure 127.—During periods of excessive drought, contour furrows hold the little moisture that falls, enabling the vegetation close to the furrows to regain its vigor and produce seed, thus speeding its recovery.

Small furrows from 4 to 6 inches in cross section and spaced not to exceed 5 feet apart are more effective than larger furrows or those spaced more widely. The small furrows regrass more rapidly and hold the water where it is of most benefit. Widely spaced, larger furrows, on the other hand, regrass slowly if at all, and hold more water than can be used at one point, while areas between the furrows suffer from lack of water. Moreover, large furrows cannot be readily constructed with ordinary farm implements.

Pitting

Pitting rangeland with an eccentric disk is particularly effective in improving the forage growth on shortgrass ranges. The instrument used is a heavy 18-inch one-way disk plow with the alternate disks 20 inches in diameter and mounted 2 inches off center. In operation, the equipment scoops out shallow, discontinuous pits about 16 inches apart (fig. 128). The capacity of the pits on an acre thus treated is roughly 1,000 cubic feet, and they will hold an additional 0.3 inch of rainfall. This is a tremendous advantage in sections where the moisture from the sporadic rainfall is usually almost entirely lost through runoff. Pitting is particularly adapted to ranges which, under excessive use, have reverted to a shortgrass cover with a high density but with low volume production of forage. The pitting thins out this cover and makes more moisture and plant food available to the remaining plants. It also stimulates the return of the earlier growing taller grasses, increasing the feed available in the critical spring period as well as the total forage production. The increased moisture retained in the "wafflized" surface, the longer grazing season, and the greater supply of better forage, combine to increase the grazing capacity. Sheep ranges where this treatment has been applied have carried 33 percent more animals over a 5-year period.



Figure 128.—A pitted range with moisture that would ordinarily run off held to increase forage growth.

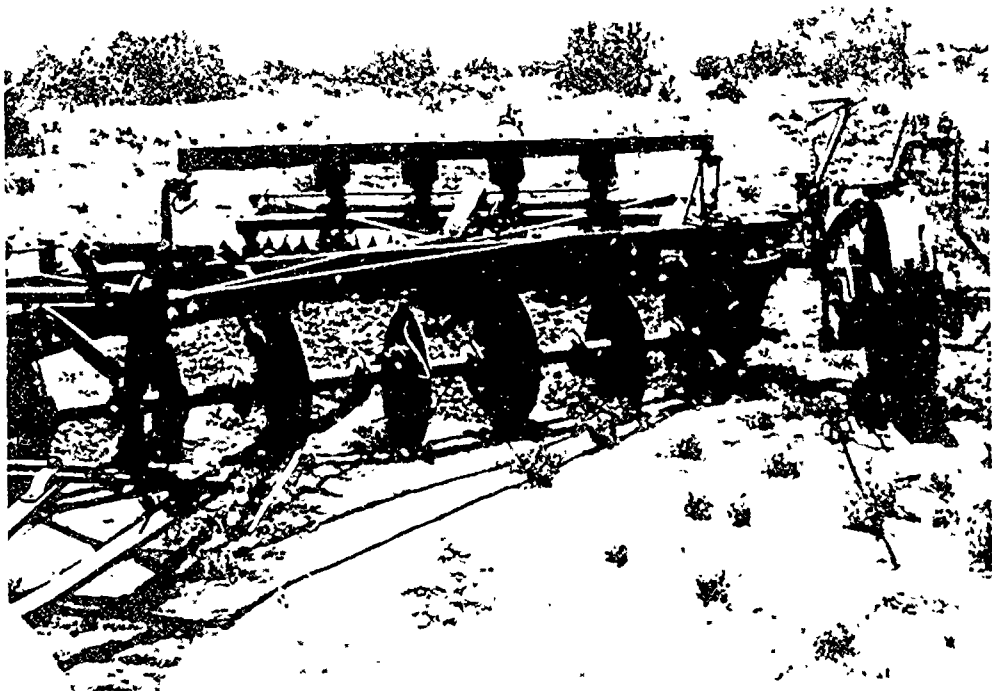

Figure 129.—A range-pitting machine. The alternate disks are mounted 2 inches off center and, in operation, scoop out shallow pits that catch the rainfall and stimulate grass production. This machine has been equipped with cultipacker and seedboxes to permit pitting and seeding in one operation.

In addition to its use on shortgrass ranges, pitting may mean the difference between success and failure in reseeding ranges in extremely arid regions. On such ranges the rainfall is normally insufficient to permit seedling establishment. If the range is pitted before seeding, enough moisture may be retained from the little rain that falls to enable the young plants to live through the critical spring period (fig. 129).

To the range stockman, one of the principal values of both contour furrows and pitting is that they enable the maximum use to be made of the little rain that falls during very dry seasons when the natural grass cover is sparse and when complete utilization of moisture is vital. Conservation of water by mechanical structures of this kind will not assist materially in conserving the range, however, if overgrazing and other management practices that destroy the grass are permitted.

Water Spreading

The diversion of water from natural watercourses to adjacent slopes where it can be spread over productive grassland may be highly profitable if the right sites are available (figs. 130 and 131). This not only reduces flood hazards and erosion losses, but also increases forage production on the spreading grounds. The most common type of spreader is a small dam placed in a watercourse, with gradient ditches or terraces leading the water out to gentle slopes where it is released. Often such diversion structures may be effective in controlling gully heads if placed immediately above the gullies.

Where terraces or ridges are used for diversion, frequently openings at several places will let a limited amount of water through in order to secure effective spreading. Water spreading should be attempted only on gentle

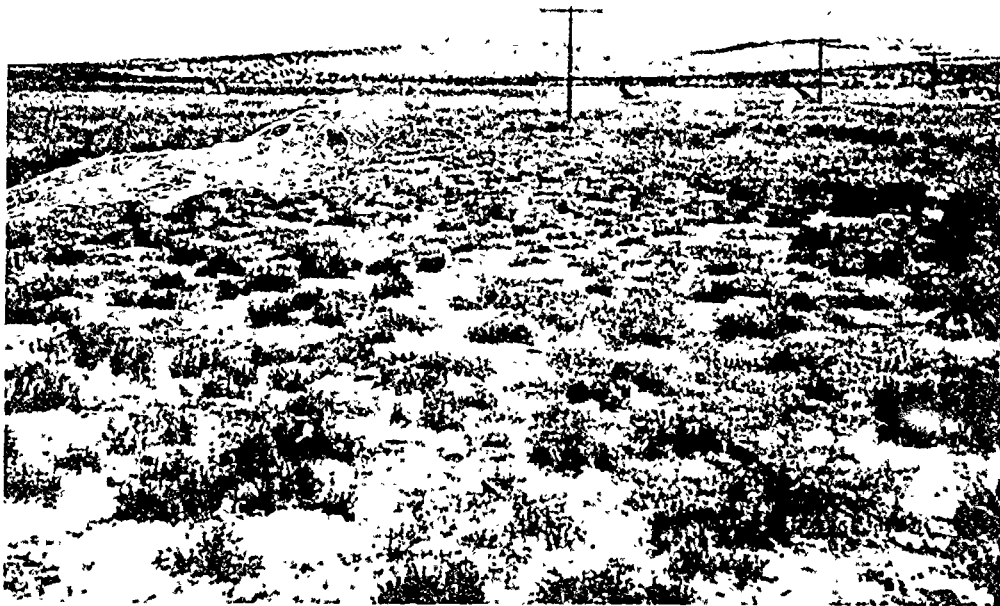

Figure 130.—A water-spreading system consisting of a dike and diversion structures designed to catch the storm waters from the distant slopes and spread them over the depleted but potentially productive flat in the foreground.



Figure 131.—The same area 3 years later. Runoff waters have been completely controlled and the depleted vegetation increased many times to produce a highly productive forage crop.

and uniform slopes, and the water should be released only at points where it will spread on the land and not tend to concentrate in draws or low places and cause gulying. Ordinarily water should not be spread except where there is a good cover of grass on the spreading grounds, because it is difficult to control a large amount of water on sparsely covered areas and erosion is likely to result. Water spreading usually is not practical on loose, sandy soils or rough, broken land. Seldom will very thin shallow soils give satisfactory response. Water-diversion structures, however, may be highly practical where the normal runoff from shallow land and rough, broken land can be spread over adjacent valley slopes and flats with productive soil. Heavy clays may be satisfactory as spreading grounds if the water can be retained on the land long enough to permit its penetration.

Reserve Feed Supplies

Many ranch units have some cultivated land. Ranches which have suitable cropland should make use of such land to produce feeds that can be used during winter, drought periods, or whenever needed in ranch operations. Many ranchers use supplemental feeds of some type, and wherever it is possible to produce the feed on the ranch, the cash outlay for purchased feeds may be greatly reduced. Where possible, it is well to store a supply of feed that can be carried over from year to year as a reserve against drought or other emergency (fig. 132).

Reserve feed supplies in dry climate can ordinarily be stored in stacks, trench silos, or otherwise. Properly stacked feeds and forage usually will remain useful for several years.

Purchased feeds usually consist largely of concentrates which may be fed on the pastures. The small amounts ordinarily fed do not relieve the range to any extent, but they may assist in maintaining the livestock.



Figure 132.—Reserve feed supplies for winter use and for drought years are a highly essential feature of good ranch management.

It is an asset to any ranch to be able to supply roughage for feed during the winter, especially when the range is covered with snow. While crop production and supplemental feeding may not be essential to ranch operation in some places, it is a practice which may be of great value in stabilizing the ranch operations and in improving the condition of the range livestock. When feed production can be developed to establish a reserve supply, the risk in operation is greatly reduced and sale on unfavorable markets may be avoided. Production and use of supplemental feeds may also result in improvement of the range by relieving the grazing load at critical periods.

The use of supplementary pastures on land suited for cropping often is a desirable practice to permit rest for the native pastures. Cereal grain species for use before and after the main grazing season, and drought-resistant crops for summer use may also serve as supplementary pastures. Many ranches have areas of native meadow which may be used advantageously for the production of hay. Some small irrigated tracts may be developed to help augment the feed supply.

Conservation Irrigation

The term "conservation irrigation" is relatively new. Only in recent years has it become part of the terminology of irrigated agriculture. "Conservation irrigation" is simply using irrigated soils and irrigation water in a way that will insure high production without the waste of either water or soil. It means using cropping, irrigation, and cultural practices that will maintain the land in permanent agriculture.

To the farmer, conservation irrigation can mean savings in water, control of erosion, better crop yields, lower production costs, and assurance of continued productivity from his irrigated land. For many farmers, it can mean a start toward the final solution of alkali problems, waterlogging, and numerous other evils now prevalent over large sections of the country.

In these sections, the need for conservation irrigation is urgent. Until recently, more water has been their chief concern. Little attention has been paid to the conservation of soil or, for that matter, of water. Ironically, the careless handling and unwitting waste of this irrigation water is responsible for many grave difficulties which now confront irrigated agriculture. For waste water can lead to wasted land.

Throughout the development of irrigated agriculture, the major concern has been water (fig. 133). Much progress has been made in the harnessing of rivers and the construction of vast canal systems for distributing water to the land but too little attention has been given to the land itself. Particularly, proper care has not been taken to insure wise and efficient use of either the land or the water used in irrigation farming.



Figure 133.—Water brings life to the land.

Wasted Water, Damaged Land

Many land and water problems of grave importance confront irrigation agriculture today. In many areas there is more land suitable for irrigation than can be irrigated with the amount of water available. Yet over wide-spread sections less than half of the water applied to the land actually benefits growing crops. This waste of irrigation water usually causes land damage by erosion, alkali accumulations, leaching, or waterlogging. It often increases irrigation-water and farming costs.

Soil erosion is as great a menace to irrigated land in arid regions as it is to land in humid regions. Moreover, in arid regions, soils are generally shallow and light in texture. Also, they are low in organic matter, which leaves them highly subject to both wind and water erosion.

Erosion is threatening the continued productivity of more than half of all the irrigated land. A quarter of a million acres are losing topsoil at the rate of an inch every 3 years, according to our best estimates. Another half million acres are losing soil at the rate of an inch every 5 years. This loss represents a permanent land-investment loss to the farmer. Attempts to grow crops on land not suited for them contribute to the damage. But most of this damage results from misuse of irrigation water.

Besides the erosion damage, uncontrolled irrigation water also causes serious drainage problems and salt accumulations on many irrigated bottom lands. Or, if the surplus water passes through the root zone, it leaches out plant foods. Where the water collects to form wet spots, alkali salts may concentrate. Some of this alkali land is still being farmed, but with reduced yields and less profitable crops.

Moreover, every gallon of water that is either pumped or purchased is money wasted out of the farmer's pocket when the water is wasted. This waste increases the cost of producing crops, in addition to the damages the land and crop may suffer.

Soil structure has broken down in fields where row crops have been grown too long. The combined effects of this broken-down soil structure, erosion, and depleted organic matter have made these fields less and less able to take water. Their productiveness is on the downgrade.

Much of the damage to irrigated land is due to irrigation runs that are too long. These are the cause of the severe erosion in many areas. Long runs also contribute to water waste and leaching. To get water to the lower ends, the upper ends must be overirrigated.

Delivery of irrigation water in open ditches contributes heavily to water loss. This loss may be as much as 70 percent. The average in the western part of the United States is about one-fourth of the volume of water carried. Most of it is due to seepage. If seepage water is not recovered by return flow, it is lost to agricultural use. In any case, it is lost to the farmer who purchased or developed it. Heavy weed growth in canals slows down the flow of water—besides reducing the capacity. And this reduced velocity increases canal losses from both evaporation and seepage.

Improper methods of logging and heavy grazing on the watersheds that produce the irrigation water have created other problems. They have changed the flow characteristics of the streams in many irrigated areas. Streams and rivers which once gave a steady water supply throughout the growing season now flood more often in the spring and deliver less water during the rest of the year. In places, additional storage has had to be built. Silt carried down from these unprotected watersheds is filling in many reservoirs. It has also added to the debris that must be removed from irrigation and drainage canals.

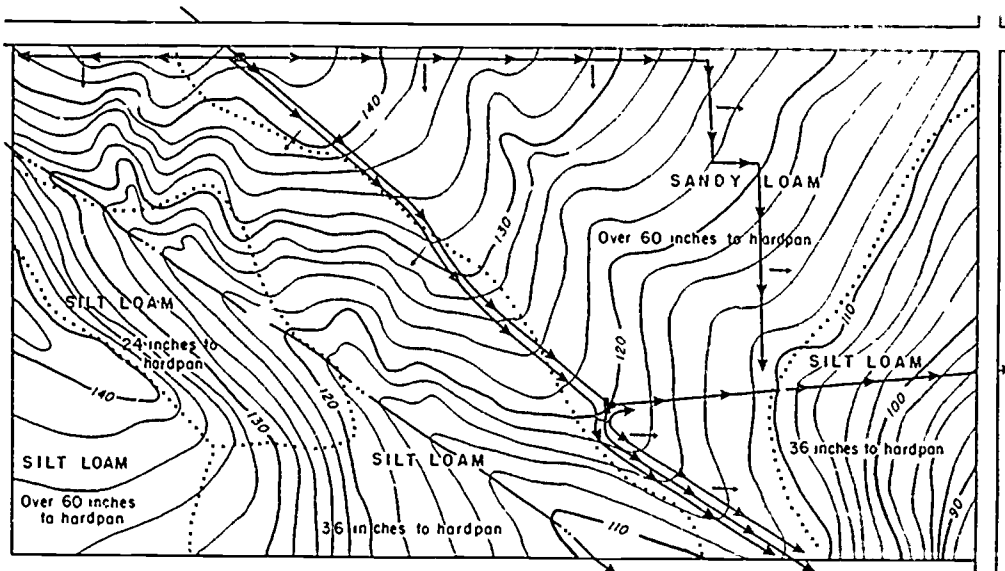

SOIL CONSERVATION SURVEY AND CONTOUR MAP
(Showing original irrigation system)

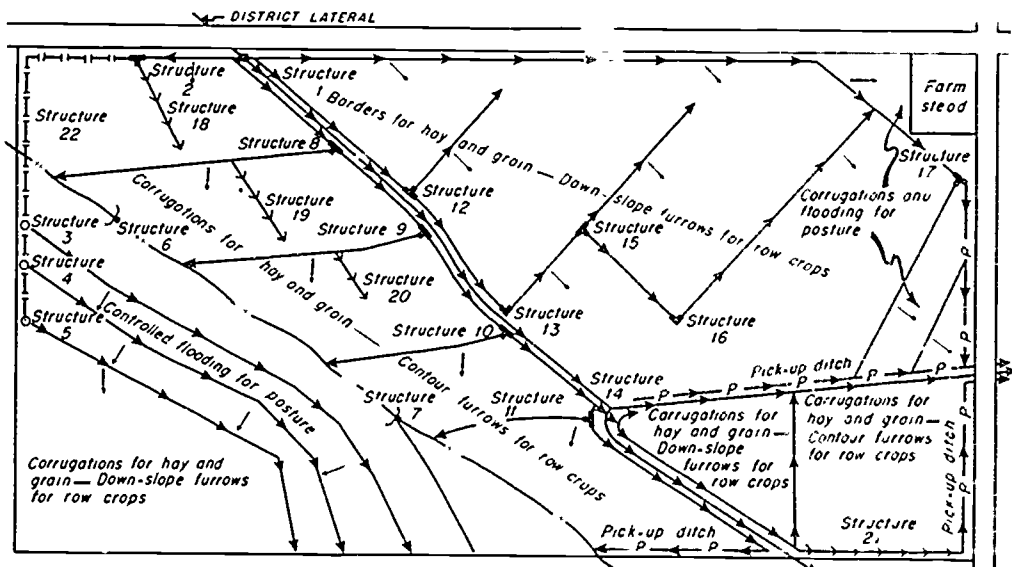

LAY-OUT OF IMPROVED FARM IRRIGATION SYSTEM AFTER LAND GRADING

- | | |
|--|---|
| Structure 1: District head gate and weir | Structure 7: Drop and turn-out |
| 2: Check turn-out and pipe intake | 8, 9, 10, 11, 12, 13, 15, 16, 17: 2-way take-outs |
| 3 and 4: Riser and Valve | 14: Flume over district lateral |
| 5: Riser | 18, 19, 20, 21: Temporary feeder flumes |
| 6: Drop | 22: 8-inch concrete pipe line |

Figure 134.—A farm-irrigation plan to fit the land.

Problems Can Be Solved

There are practical ways to solve most of these problems in irrigated areas. They involve basic principles of soil and water conservation, and they require an accurate knowledge of soil, topography, water needs, and the capability of the land to be irrigated.

An irrigator practicing conservation irrigation has control over his

irrigation water from the time it enters the ditches and on down until a small part leaves as waste water. He is able to apply the water in such a way that it wets the root zones of his plants with the least practicable loss from runoff or from percolation.

On many farms a different method of irrigating is needed. Some also need drainage, supplemental water supplies, or land leveling.

Irrigation systems carrying water to the farms need to be studied to find out what can be done about improving water delivery and cutting down seepage losses. Often better delivery schedules and improved management will stretch the available water supply.

Soil-building crops in rotation with cash crops need to be grown more extensively to add organic matter to the soil.

Reforestation and better range management are needed for some watersheds. Measurement of both water and snow accumulations will aid in better planning for the seasonal use of the available water.

Conservation Irrigation on the Farm

Conservation irrigation on the farm is simply the use of the irrigation and cropping methods that best fit the particular soil, slope, crop, and water supply. It makes possible irrigation without erosion damage, alkali accumulation, waterlogging, or undue water loss.

Conservation irrigation can be established on the farm by the following steps:

Get an inventory of the soil and water resources—The soil on the farm needs to be examined for depth, texture, structure, permeability, available water capacity, and productivity. A soil conservation survey map showing these and other factors, such as slope, past erosion, and seep spots, will provide the required detail (fig. 134). The amount of water available on the farm must be determined as well as how the water is made available through the irrigation season. If the water supply is not adequate, possibilities for improving it should be studied before plans are made for the farm.

Decide how to apply the water—The methods used to apply water must fit the land. Also, they must fit the crops needing irrigation. Finally, they must fit the water supply available.

Plan the distribution system—The farm irrigation-distribution system must be designed to get enough water to all parts of the farm when needed. It should also provide for the safe disposal of any waste water.

Prepare the land—All fields must be prepared so the water can be applied with maximum efficiency. To accomplish this some land may need to be "leveled."

Make efficient use of the irrigation water—Adjust the size of water streams so that they will not cause erosion but will apply just enough water to satisfy crop demands. Where there is alkali in the water, special methods may be needed to prevent its concentration in the plant root zone.

Irrigation Methods To Fit the Land, Crops, and Water Supply

The water supply, the soil, the topography, and the crops to be irrigated determine the correct methods for applying irrigation water. Irrigation requires careful attention to all these factors.

The ability of different soils to take in and hold water differs greatly. Some soils absorb and hold large quantities. Others take water very slowly

SOME TYPICAL IRRIGATED SOIL PROFILES

Indicating effective depth and relative dangers of poor drainage, low intake, alkali, and erosion

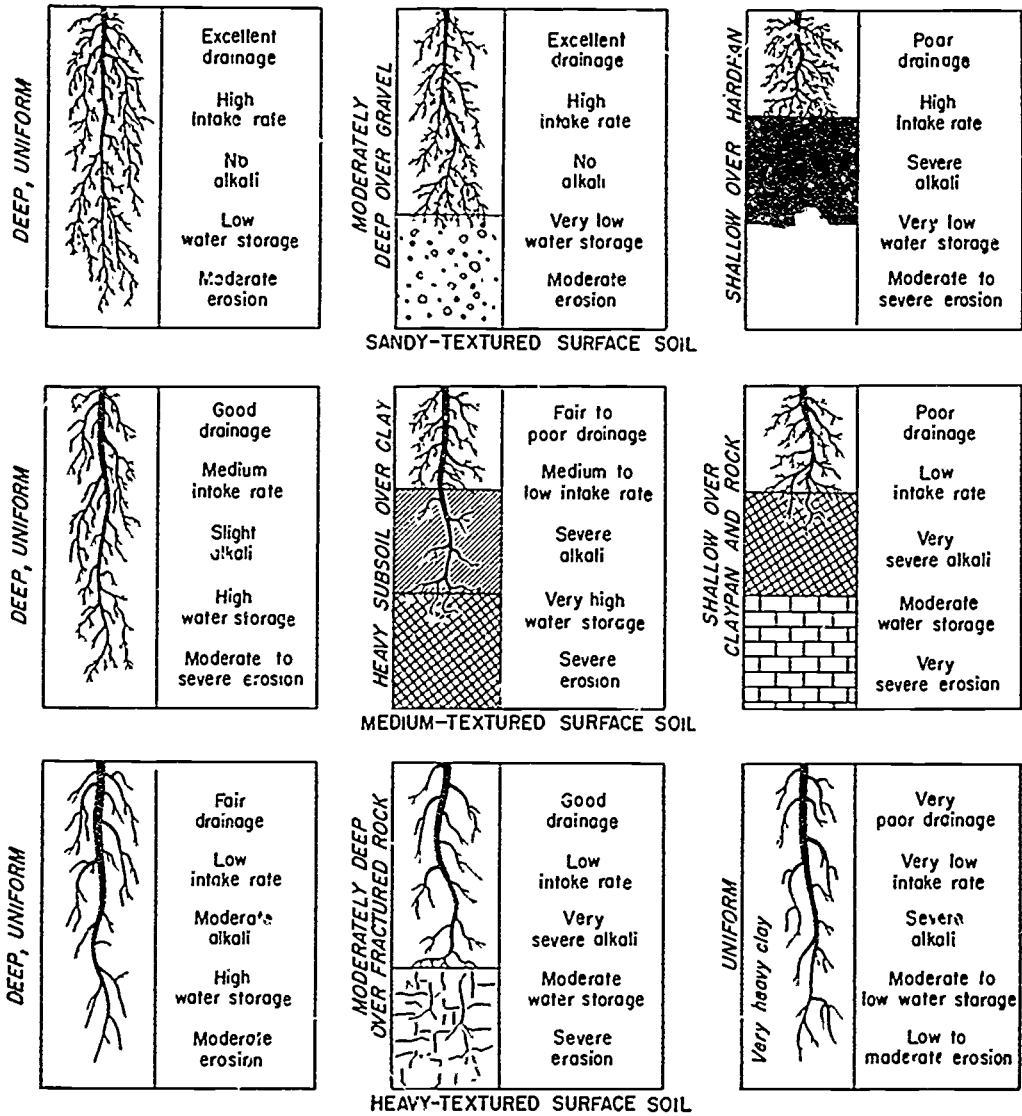

Figure 135.—Some typical irrigated soil profiles indicating effective depth and relative dangers of poor drainage, low intake, alkali, and erosion.

or have little holding capacity. Some of the more common variations are shown in figure 135.

A thorough knowledge of the way the soils absorb water and the capacity of the different soils on the farm to store water is vital to conservation irrigation. If more water is applied to a particular field than it can readily absorb, both expensive water waste and erosion occur. Knowledge of the water-holding capacity of the soil makes it possible to apply just enough water to satisfy the needs of growing crops but not enough to cause waste and damage.

Once the water-intake rates and the storage capacity of the soil are known as well as the amount of irrigation water available and the method of delivery, the cropping program can be adjusted to these conditions.

Some of the more common methods of irrigating and their use in conservation irrigation are described and illustrated on the pages that follow.

Specifications for each method have to be worked out to fit the soil, climate, and water supply of each area. The Soil Conservation Service has prepared specifications for nearly all irrigated areas of western United States. These specifications are based on scientific research, field tests, and local irrigation experiences.

Where some common irrigation methods fit in conservation irrigation

Method	Adapted to—	Conservation features
Basins.....	Close-growing crops and rice on flatland with sandy soil.	Provides good control of water applied. Good for alkali control.
Borders.....	Hay or grain on uniform slopes up to 3 percent; established pasture on uniform slope up to 6 percent.	Provides uniform wetting and efficient water use. Utilizes large water streams safely and thus less time is required to cover area.
Corrugations.....	Close-growing crops on sloping land with soil slow to take water. Extreme care is needed in applying water to slopes of more than 2 percent.	Provides uniform wetting and prevents erosive water accumulation on land too rolling or steep for borders or basins. Makes use of small streams.
Furrows.....	Row crops, truck crops, orchards, vineyards, and berries on gentle slopes with all but coarse-textured soils.	Provides no conservation features unless furrows laid on nearly level land on the contour and water applied with extreme care.
Sprinklers.....	Nearly all crops on any irrigable soil except in very windy, hot climates.	Provides uniform wetting, eliminates erosion, and gives high water use in most places.
Controlled flooding.....	Close-growing crops on rolling land; pasture sod established by corrugations or sprinklers.	Provides water control and fairly uniform wetting where land cannot be used for other methods.

Basin irrigation

The purpose of this method is to fill a diked area of land with water to the desired depth quickly and allow the water to go into the soil. When basins are properly graded and built to the right dimensions for the kind of soil and the water supply, water can be applied efficiently.

Border irrigation

This is a controlled way of flooding the surface of a field (fig. 136). The idea is to advance a sheet of water down a narrow strip between low ridges or borders and to get the water into the soil as the sheet advances. It requires that the strip be well leveled between the border ridges, and the grade down the strip be fairly uniform to avoid ponding. The ridges should be low and rounded so they can be plowed with the strips. Then no land is taken out of production.

Contour- or bench-border irrigation

This method is adapted to fairly uniform moderate slopes with deep soils. The strips are laid out across the slope on a controlled grade, and the ridges are constructed parallel to each other.

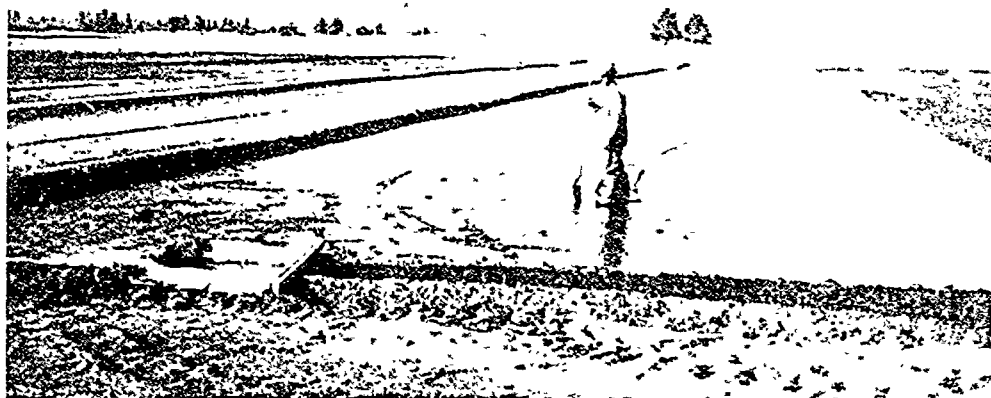

Figure 136.—Border irrigation.



Figure 137.—Corrugation irrigation.



Figure 138.—Furrow irrigation.

Corrugation irrigation

In this method the water is applied in small furrows. It then moves laterally through the soil between the furrows to wet the entire area (fig. 137). The method is designed for heavy soils that take water slowly and that seal over and bake when flooded. It is recommended also for close-growing crops on steep or rolling land.

Furrow irrigation

Furrow irrigation is the most common method of irrigating row crops (fig. 138). The water is applied in the furrows between the plant rows. Many of the present furrows are too steep for safe irrigation. This fact has been the greatest single cause of erosion by irrigation water. Because cultivation to control weeds keeps the soil in the furrows loose, it is easily eroded.

Contour-furrow irrigation

This is the method of applying water in furrows across rather than down sloping land (fig. 139). The furrows are given just enough grade for water to flow, but not enough to cause soil washing. Deep-furrow row crops can be irrigated safely by the contour-furrow method on cross slopes up to about 8 percent

Broad-furrow irrigation

On slopes not exceeding 3 percent for most soils, the use of broad-bottom furrows in place of the usual narrow V-type furrow will increase the rate of water intake and reduce furrow erosion (fig. 140). This method is recommended for orchards planted on contour benches, as a means of eliminating erosion resulting from grade variation along the benches.

Sprinkler irrigation

Where it is adapted and where crop returns can support the cost, sprinkler irrigation provides excellent control of the water applied to the soil (fig. 141). Water may be applied with sprinklers at a rate that the soil will absorb without runoff. Sprinklers can be turned off when the soil has absorbed the right amount of water. Because the water can be so carefully controlled, sprinklers have special uses in conservation irrigation. For example, they can be used to establish pastures on steep slopes. Sprinklers, however, cannot be used universally. In hot windy climates, much water is lost through evaporation and wind drift causes uneven water application. On very heavy soils, because of the low intake ability the rate of applying water may have to be so low that much of it is evaporated before it enters the soil.

Controlled flooding

In this method water is flooded downslope between closely spaced field ditches which keep the water from concentrating and causing erosion (fig. 142). Frequent openings in the ditches allow a uniform distribution of water over the field.



Figure 139.—Contour-furrow irrigation, stubble mulch.



Figure 140.—Broad-furrow irrigation in an orchard.



Figure 141.—Sprinkler irrigation.



Figure 142.—Controlled flooding rather than wild flooding.

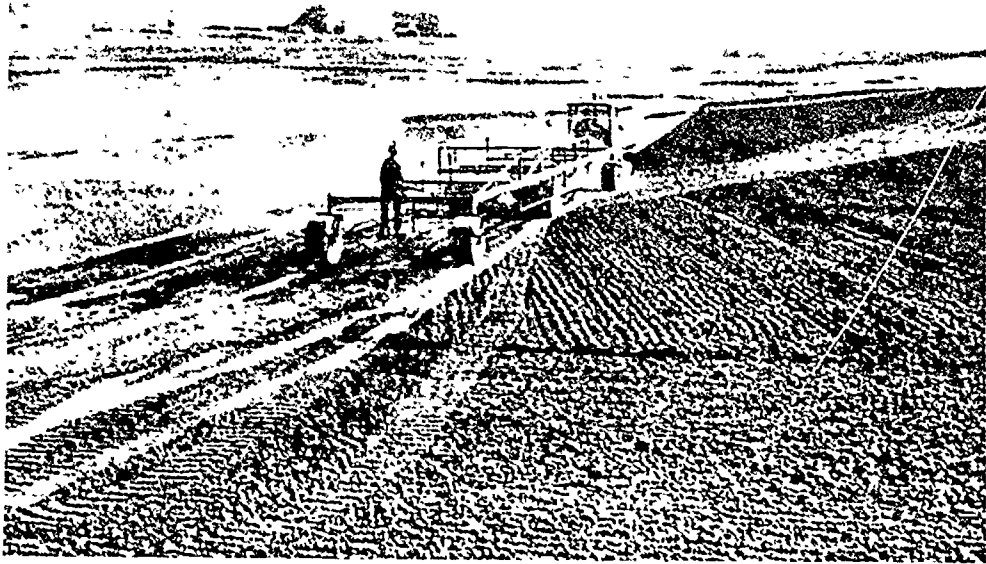

Figure 143.—Smoothing out the land surface with a landplane.

Preparing Land for Conservation Irrigation

Few operations are of greater importance to conservation irrigation than the proper preparation of land by grading and leveling (fig. 143). Low spots, which allow concentration of water, may cause waterlogging or may bring harmful salt deposits to the surface. High spots, which do not receive enough moisture, result in reduced yields. Irregularities in slope make it very difficult to control water velocities, a frequent cause of erosion.

The extent to which land should be graded and leveled is governed largely by the depth of soil. Care must be taken not to make leveling cuts that would leave the root zone too shallow for the crops that are to be grown.

The method of water application to be used influences the degree to which land should be leveled. With sprinkler irrigation, little leveling is necessary. For furrow irrigation, land must be brought to a nearly uniform slope if soil and water losses are to be avoided. Border irrigation requires careful leveling within the borders for proper distribution of water along the strip. The specific requirements for grading and leveling for each method have been worked out through research and practical experience. They differ with the locality, depending on the soil and other physical conditions and on the crops to be grown.

Irrigation-Distribution System on the Farm

The system for distributing irrigation water over the farm must serve the method of water application selected to fit the land, crops, and water supply (fig. 144). All requirements for conservation irrigation need careful study before it is laid out. A farm-irrigation system should be designed so that water can be delivered (1) to all parts of the farm when needed, and (2) in quantities sufficient to meet crop demand during peak-use periods.



Figure 144.—Controlling water applied for safe and efficient irrigation.

If the water is delivered on a rotation or turn basis, the system should be large enough to allow the delivery of sufficient water in the time allotted.

Some means of measuring the flow of water is needed where the water enters the farm system. Where water is delivered to several fields at one time, fairly accurate division structures should also be installed.

The ditches, pipelines, and flumes that make up the farm system should be laid out to provide the right length of irrigation run for the different soils and slopes and crops. Also, the layout should provide for sufficient water within each field where balanced crop rotations are followed as part of the soil conservation program. Head ditches should be located to avoid major slope or irrigation grade changes within irrigation runs.

Provision must be made for checks to raise the water level in ditches or flumes for takeouts. On pipelines, check gates and risers are required for proper water control. The farm system should be designed for a minimum fluctuation in the size of streams used in the field. Some means of picking up and disposing of waste water and storm water safely is also required.

Open ditches should be constructed with enough grade for water to flow but not enough to cause soil erosion. Chutes, pipelines, or linings may be needed to prevent the erosion. Pipelines should be designed so they will not be damaged by high water pressure, and trash and debris should be kept out of them to prevent clogging.

The farm system should deliver water to the fields with a minimum loss by seepage. Pipelines, flumes, or ditch linings may be required in open sandy soils.

Improving the Water Supply

On irrigated farms where there is not enough water or where the supply is uncertain, it is often difficult to establish all the soil- and water-con-

ervation measures needed (fig. 145). The only answer may be to find some way to improve the water supply. Some solution to the problem should be found before even an attempt is made to establish the soil- and water-conservation measures.

In some areas irrigation-water supplies can be both increased and stabilized by improving the condition of the watershed that produces the irrigation water. In some, supplemental water supplies can be developed. In others, putting the diversion, storage, or delivery systems into good operating condition will increase the effective water supply on the farm. For example, conveyance losses can be reduced by lining canals, using closed conduits, and controlling weeds in the canals and ditches.

On some farms, better distribution and more efficient application of the present water supply would mean that no additional water was needed.

If no way to improve the water supply can be found, the only thing left to do is to choose crops that fit the supply at hand. This may mean growing crops that require less water, or it may mean confining the use of the water to the best land.



Figure 145.—Snow surveys aid in planning better use of available water supplies.

Farm Drainage

Draining fertile, wet cropland is one of the important practices of conservation farming. It fits into conservation farming in that land is treated according to what it needs to produce the kind of crop it is best fitted to produce.

On many farms, the bottoms have the most fertile soil. But because they are wet part of the year they produce only part of the yield they could produce. Once drained, they will produce bumper row crops. Draining this flatland takes the pressure off steeper, poorer land that erodes easily when forced to produce such crops as corn, cotton, potatoes, and tobacco. The drained flatland can produce the row crops needed, and the slopes can be planted to close-growing crops or to grass (fig. 146).

How Drainage Helps

A wet soil is a cold soil. This is because it takes much more heat to warm water than to warm soil. When soil is drained, air replaces the water that is drained away. It takes relatively little heat to warm this air. To grow well, plants, of course, need warmth and air in the root zone. The bacteria that change organic matter and fertilizer into something the plants can use require both air and warmth.

A wet soil is likely to be tight—or compact or dense. Plant roots cannot spread easily through such soil. Sweetclover and other soil-building crops will not grow, so a balanced crop rotation cannot be followed. Liming, also, is often useless in a soggy soil.



Figure 146.—Bottom land being tile-drained as part of a conservation plan for a farm. When the conservation treatment is complete on this farm, all the row crops will be raised on bottom land and the rolling land will be kept in grass or some other close-growing crop.

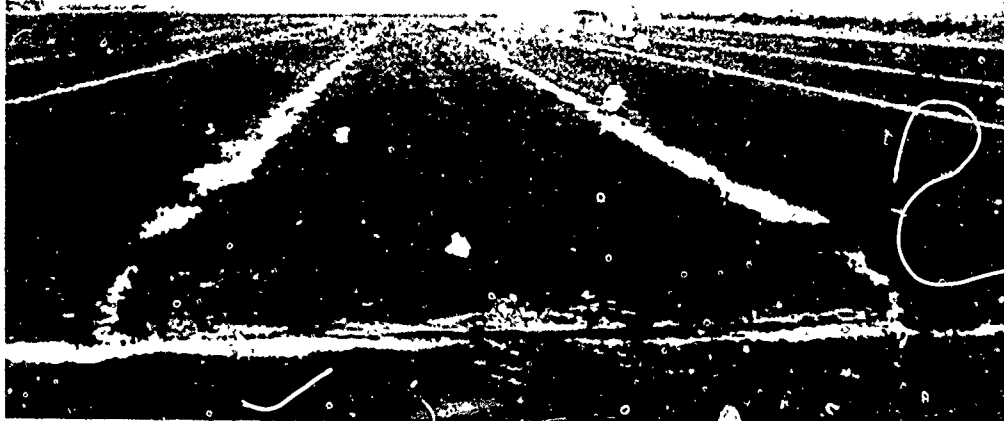

Figure 147.—Open bedding ditches for draining land. Heavy, impermeable clay subsoil makes tiling impractical.

After a wet soil is drained, it can be worked earlier in the spring. Seeds germinate faster and a better stand is obtained. Moreover, plants do not drown out after a rain.

Sun and wind start drying a drained soil almost as soon as rain stops falling. Thus a field can be cultivated sooner after a rain. And the crop is not lost at harvesttime because of wet ground.

A properly drained field will not have wet spots, so it can be farmed more efficiently, and the whole field can be plowed, planted, and cultivated at the same time. Usually a bigger yield not only is obtained, but a more even yield is obtained also.

Crops planted on land that needs drainage often "burn out." In a soil that is saturated nearly to the surface in spring and early summer, the plant roots spread out near the surface. Later, when summer droughts come, the water table falls below this root zone and the crop gets little moisture. In well-drained land, the roots go down deeper. Thus they can draw on deeper moisture, and the plants are better able to withstand summer droughts.

How Land Is Drained

Excess water can be drained from land either by open surface drains or by underdrains, usually tile.

Each method has advantages and disadvantages.

Open ditches occupy land. They are usually hard to cross with farm machinery. They choke up with weeds and silt and have to be cleaned. Unless they are deep they drain only the surface, not the soil. But their first cost is less than tile drainage. And for tight soils in humid areas surface drainage is usually necessary (fig. 147).

Tile drains, on the other hand, waste no land and do not interfere with farm operations. They need little care once they are installed. Since they drain the pores of the soil, roots of crops can spread. But usually tile drains require more cash outlay in the beginning. And they are not effective in some soils.

Planning a Drainage System

Only conditions in the area involved can determine the kind of drainage needed and the method of doing the work. What is good in one place may not be good in another. The soil, the ground slope, the crops raised, and the value of the land must all be considered. An adequate drainage system often involves a number of farms, sometimes a whole watershed. In such cases it is better to plan on a district basis rather than farm by farm.

The first thing to determine is whether the land can produce enough to make it worthwhile to install a drainage system—for drainage is expensive.

Plans for successful farm drainage include plans for controlling erosion on the land, on ditches and spoil banks, and at outlets. They include plans for farming the drained land in crop rotations that will bring about good soil tilth, or structure. They also include plans for keeping the drains working.

Some simple drains can be located by inspection. And if there is ample fall, a workable grade can be determined with a carpenter's level. But engineering instruments and techniques should be used for large areas. They should also be used wherever it is not certain that enough fall is available for all the drains.

Except for simple drains, a map should be drawn to show:

Boundaries and slopes of the areas needing drainage.

Existing drains.

Location and elevation of all swales and watercourses, knolls and ridges.

Location and elevation of possible outlets.

Area that will drain into each part of the system.

The drainage system can be laid out readily on the map; grades and sizes of the drains can be determined; and costs estimated.

After the drains have been laid out on the map, they can be staked out in the field. This is the time to make any minor changes needed. The next step is to run levels along the lines of each of the proposed drains to determine accurately the grade or fall available for each, and next to establish the grade to which the ditches or trenches must be dug. The most practical way to do this is to plot a profile of each drain and then determine the most economical adjustment that will give good drainage.

It is also practical to make soil borings to find out what kind of material must be dug through. If rock, hardpan, or quicksand are found, further explorations are necessary. The location of the drain may need to be changed. Or, if it is an open ditch, a change in size may be sufficient.

The Outlet

A great many farm-drainage systems have failed because of poor outlets. Ordinarily water is discharged by gravity into a natural watercourse or into a public ditch, such as one constructed by a county or a drainage district.

The outlet must be large enough. It must carry away the water brought to it promptly enough to drain the land, and it must prevent injury to any neighboring lands. Its size depends on a combination of many factors—the rainfall, the area of the watershed, the slope, the soil, the vegetation.

Every outlet must be deep enough to permit inflow from the tributary drains. Where the land is to be tile drained, the outlet should be at least 5 feet, preferably 6, below ground surface. The water, except for short periods after storms, should be at least 4 feet below ground surface.

Water can be discharged by pumping instead of by gravity. It often proves profitable, for undertakings such as an organized community enterprise, or for a farm growing high-value crops. In any case, pumping for drainage is costly. It should be planned only with competent engineering direction.

Surface Drainage

With surface drainage, water on the fields is removed through open ditches (fig. 148).

These field ditches empty into larger and larger ditches (fig. 149) until they reach some natural or artificial watercourse that carries the water away without any damage to the land.

Where the land is somewhat rolling, surface drainage may be obtained by shallow field ditches that follow the depressions. The locations can easily be determined by observing where water is standing on the ground after a heavy rain. Then the ditches can be dug or plowed at a later time—when men and equipment are not doing other work. In this way the low spots of the field can gradually be brought into cultivation. Shallow ditches, however, merely remove surface water. If the land also needs soil drainage, numerous and comparatively deep ditches must be dug, or underdrains constructed.

Ditches that follow the lowland may be very crooked. Often it is better to cut the ditch through a low ridge or knoll and so avoid a sharp bend. Changes in direction should be made by easy curves in order to prevent erosion of the ditchbanks. These curves can be laid out "by eye."

Field ditches

Field ditches may be either narrow with nearly vertical sides or V-shaped with flat side slopes. V-shaped ditches have the advantage of being easy to cross with large machinery. Narrow ditches are most common where large farming machinery is not used much.

Land occupied by the narrow, steep-sided ditches cannot be cultivated. Where many of them are required, a considerable area is lost to cultivation.

Neither can large V-shaped ditches be cultivated, but many can be planted to grass and mowed for hay. Where very closely spaced field drains are needed, V-shaped ditches can be made very shallow and broad and then cultivated with the rest of the field.

In level areas a collecting ditch may need to be installed along one side of the field and shallow V-shaped ditches constructed to discharge into the collecting ditch. The field ditches should be laid out parallel and spaced 50 to 150 feet or more apart as required by the soil, surface conditions, and crops to be grown. They should be 12 to 24 inches deep, depending upon the depth of the collecting ditch.

Farming operations should be parallel to the field ditches. In plowing, back furrows should be established midway between the ditches and all furrows turned toward the middle. This will give each land a slight crown and will keep the ditches open (figs. 147 and 150).

If this practice is followed several years, the land acquires a considerable crown. Therefore, it is best not to use it where land should be kept as level as possible. This is especially true where field drains supplement tile drains.



Figure 148.—Sodded field ditch, in class II land, very good level land that needs drainage to produce good crops.



Figure 149.—V-shaped collecting ditch with the banks seeded to lovegrass.

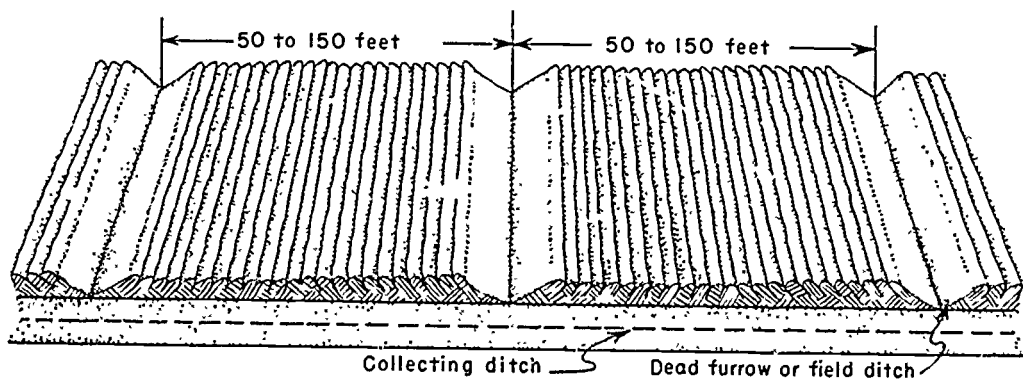
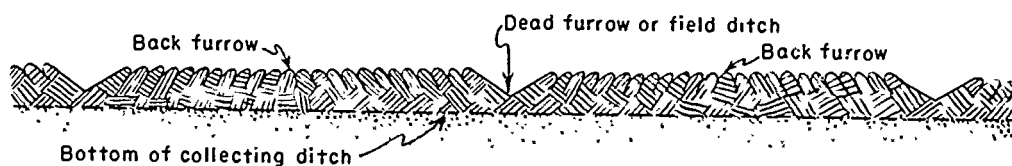

Figure 150.—How to plow a field divided by field ditches.

Size of ditches

The area that a ditch will drain satisfactorily depends on how quickly water runs into it, its size, its grade (precisely, the slope or rate of fall of the water surface), and its irregularity. This irregularity is affected by both the roughness of the ditch section and the debris and growing vegetation in the ditch. How quickly water runs into it depends on how much rain falls, and when, and on the land slope and the condition of the soil and the plan-cover.

Field ditches and outlet ditches to drain up to 600 acres of level to gently sloping land should be large enough to remove at least 2 inches of water from the area in 24 hours.

Flowing water has power to erode channels as well as land surfaces. This power increases with the velocity of flow, but very much faster.

In many cases it is practicable to keep a low velocity by constructing the ditch in sections having less fall than the natural slope and connecting those sections with drop spillways. Drop spillways are recommended wherever the average velocity of the flow will exceed $2\frac{1}{2}$ feet per second in sand or sandy loam, 3 feet per second in silt loam, $3\frac{1}{2}$ feet per second in sandy clay loam, 4 feet per second in clay loam, and 5 feet per second in stiff clay or fine gravel.

Side slopes

Field ditches of the V-shape designed to be crossed by farm machinery should have side slopes of 3 to 1 (horizontal to vertical) or flatter. Narrow field ditches may have sides as nearly vertical as will resist frost action and erosion by water running down the sides.

For outlet and collecting ditches in clay and clay loam soils, 2-to-1 side slopes are best. In some areas $1\frac{1}{2}$ -to-1 slopes have been satisfactory and in many even 1-to-1 slopes have stood up well.

Vertical slopes can be used in rock. In hardpan and loose rock $\frac{1}{2}$ -to-1 slopes generally are satisfactory. In peat and muck soils, ditchbanks nearly vertical have stood better in many places than flatter slopes.

Berms

The berm is the strip of ground between the edge of the ditch and the nearer edge of the waste or spoil bank. One of its purposes is to avoid adding the weight of excavated earth at the edge of the ditch. Too much weight would be likely to cause caving of the bank. Another is to give room for men and machinery to work when clearing the channel of sediment, debris, or growing plants.

A clear width of at least 10 feet is needed where spoil banks are not leveled. On large outlet ditches the berms should be wider, usually 15 to 20 feet. How wide depends on the side slopes of the ditch and the equipment to be used for maintenance work.

Staking out ditches

Staking out is the first step in constructing an open ditch. To do a good job and get the most effective drainage, several stakes for different purposes are needed. Some will be used to establish the grade; others to mark the centerline of the ditch. "Slope stakes" will mark the top width of the ditch. "Berm stakes" will mark the toe of the spoil bank. All of these

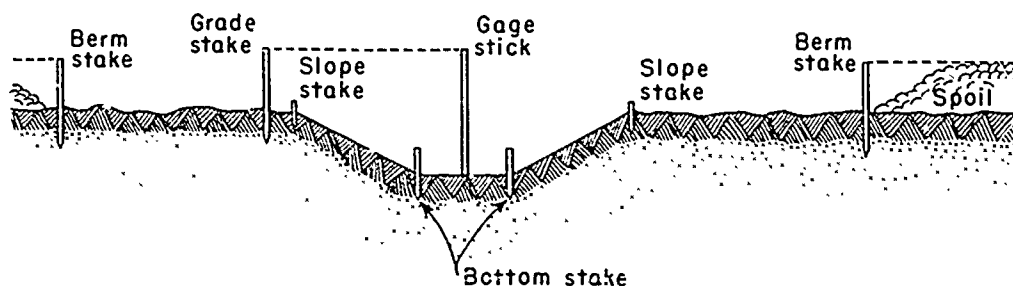

Figure 151.—Cross section of ditch showing the location of the different kinds of construction stakes.

stakes are included under the general term "construction stakes." These stakes, their uses, and the names they are commonly called are shown in figure 151.

The first step is to set stakes along the centerline every 100 feet where the ditch is straight and every 50 to 25 feet on curves, then to set grade stakes to one side of the ditch at 100-foot or shorter intervals with their tops at a uniform height, usually 5 feet, above the grade of the ditch bottom. These grade stakes should be checked by sighting to be sure that their tops line up properly.

To be sure the ditch is excavated to grade as construction work progresses, the depth of the ditch can be checked by sighting over the top of a gage stick held in the bottom of the ditch. The gage stick should have a length equal to the distance the tops of the grade stakes are set above the established grade of the ditch. When the ditch is excavated to grade, the top of the gage stick will be in line with the tops of the grade stakes.

On ditches to be constructed by dragline excavators, slope stakes can be set on each side of the centerline stakes to mark the top of the ditch. Berm stakes show the toe of the spoil bank. The tops of the berm stakes could be at the maximum height at which the earth may be deposited in the spoil bank. Bottom stakes should be set between each pair of slope stakes just as soon as the excavating machine has passed. They will guide the machine operator in working ahead. A good job of staking out is necessary to get a uniform ditch with even banks.

Spoil banks

The "spoil" excavated in making the ditch should be placed back of the berm stakes. The banks should not be so steep that rains will wash the material back on the berm. And there should be openings through the spoil banks to let surface water into the ditch. Work can be saved by staking out the openings before the ditch is constructed and thus avoid putting the spoil where it will have to be rehandled.

Where the land is to be cultivated, pastured, or used as meadow, the spoil banks should be "leveled." This can be done with a tractor equipped with a bulldozer, or with a tractor and road grader, or with a carryall scraper. At the same time the field can be smoothed up, using the spoil to fill in slight depressions. The resulting side slopes should never be steeper than 4 to 1. More nearly flat slopes are desirable, but they increase the amount of earth to be moved. If the ditch is excavated with a dragline, the leveling work can be reduced by requiring that the machine spread the spoil so that a tractor can operate on the top.

Spoil banks with 4-to-1 side slopes can be cultivated readily, or moved for hay, or fenced and pastured. But stock should be kept off ditchbanks and berms when the ground is wet.

W-Ditches

The W-ditch is used on gently sloping land where it is advantageous to dispose of the excavated material between two parallel ditches, one on each side of the spoil bank. This allows the water to enter the ditches freely because no excavated material is piled up along side the ditches to keep the water out. One ditch takes the water from one side of the spoil bank, and the other handles the water on the other side of the spoil bank. Farmers frequently use the spoil bank for a farm roadway.

Ditching with machinery

Where the ground is relatively free of stumps and large stones and is dry enough to afford good traction, V-shaped ditches can be constructed economically with a tractor and grader, with a plow and V-drag, or with tractor and a small ditching plow. These machines are drawn back and forth until the ditch is as large as desired or as large as the machine can dig.

The narrow type ditches, usually $1\frac{1}{2}$ to $2\frac{1}{2}$ feet deep, are usually dug with handtools. An ordinary turning plow is helpful in loosening the topsoil, or in cutting the edge of the ditch where there is heavy sod.

Under most conditions a small dragline excavator is the best machine for digging ditches deeper than 3 feet.

Ditching with dynamite

Ditching with dynamite is possible under almost any condition. But, usually, it is economical only for making small ditches or cutoffs in stream channels, in soils other than gravel and dry sand. Dynamite is best suited for ditching in soft ground where heavy machinery would bog down, and on jobs where the amount of earth to be moved is not enough to pay for a power-excavating machine. Ideal for dynamite ditching is a saturated sedimentary soil that is firm, but not stiff, and is free from stumps and large roots. Many excellent ditches have been blasted under conditions different from these, but at greater cost.

Dynamite can be used to advantage on a ditch about 3 feet in depth and 8 feet in top width. But on larger ditches the cost per cubic yard of earth moved increases rapidly with the size. Where conditions permit the use of ditching machines, the cost is usually less than if dynamite were used. It is, however, usually cheaper to dig ditches with dynamite than with hand labor.

Charges are exploded by one of two methods:

1. The propagation method (used in saturated soils). Charges are so closely spaced that the detonation of one explodes the next, and so on through the series. The starting charge is primed with a blasting cap and fuse, or with an electric blasting cap connected to an electric blasting machine.

2. The electric method. Each charge is primed with an electric blasting cap connected by wires that lead to an electric blasting machine. This method is more expensive.

Straight or nitroglycerin dynamite is usually used for ditching. It is made in several strengths designated by percentages. For explosion by the propagation method, 50-percent strength is usually satisfactory.

The size of the charges, the depth, and the distance apart depend on the conditions in each case. For each size of charge there is a definite depth which will give a broad, clean-cut, U-shaped ditch and also the maximum

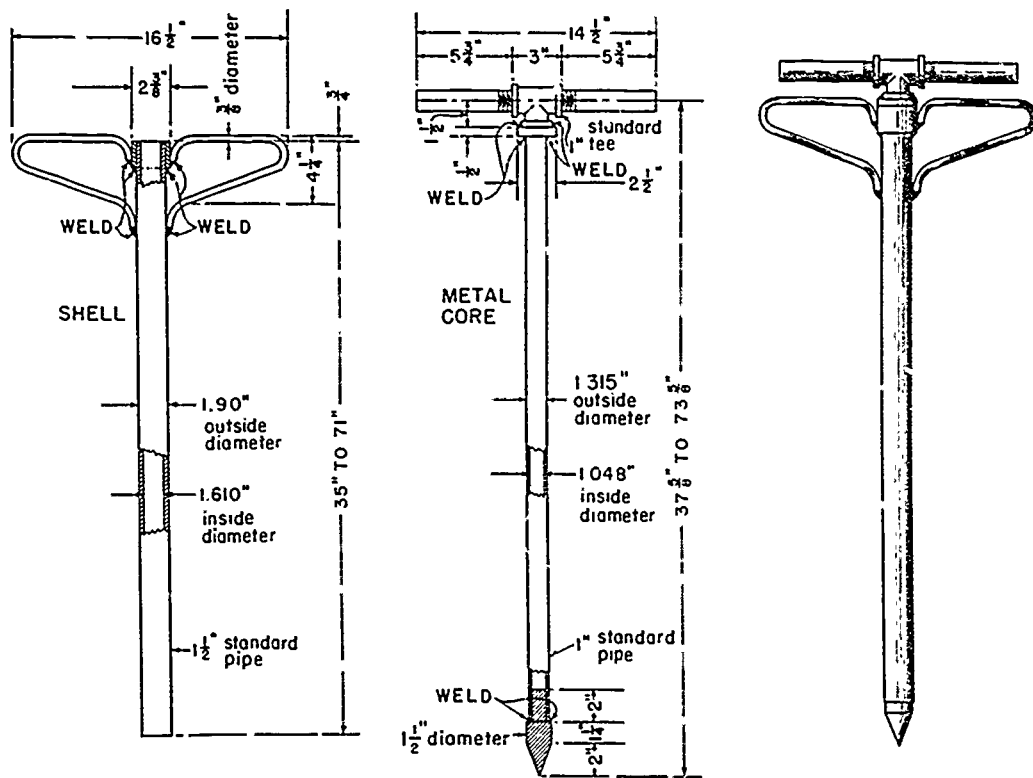

Figure 152.—The Ashley core punch, a useful tool for getting dynamite into wet soils that tend to cave or for getting it under stumps and boulders.

of excavation per pound of explosive. If a charge is placed too deep for its strength, loose dirt will be left on the sides of the ditch. If it is put too shallow, full power of the dynamite is not used.

The effective size of charge and the spacing must be determined by trial for each set of conditions. For a ditch 3 feet deep and 8 feet wide on top, in a saturated soil, the propagation method usually requires charges of one stick of 50-percent straight dynamite each, in holes 30 inches deep and 18 to 24 inches apart.

The Ashley core punch is a useful tool for getting dynamite into soft ground, and it may be made by a blacksmith (fig. 152). It operates on the principle of a pile driver. A metal core with a pointed end is worked up and down inside a shell to make a hole for the dynamite. The metal core is then withdrawn and the dynamite is pushed in place with a wooden stick. The metal core, or any iron bar, should never be used to push dynamite. Fatal accidents have been caused by attempting this. Wood should always be used for tamping sticks of dynamite.

Any of the manufacturers of explosives can furnish detailed directions for loading and firing explosives in ditching and for handling and storing dynamite. No one should undertake dynamiting until trained by a competent blaster.

Structures Used With Open Ditches

Water flowing into field ditches and from field ditches into collecting ditches or main ditches is apt to erode the banks. In fact, wherever a ditch

joins a deeper ditch there is apt to be erosion unless the water surface in the deeper ditch is always as high as in the tributary. Erosion once started is likely to continue, and to start gullies in the field. The eroded material will be dropped in lower parts of the drainage system, obstructing the flow. Removing this material is costly. Fortunately, there are fairly easy and inexpensive ways to protect the fields and ditches against erosion. The cheapest and easiest way is to make a short grassed waterway or flume.

Flumes

The grassed flume provides an economical means of safely admitting water from a field ditch into a lateral or an outlet ditch. It is a broad channel lined with grass or other vegetation, sloping gently from the field to the ditch bottom. The bottom slope should not be greater than 6 to 1; 10 to 1 is better if the soil erodes easily or cannot readily maintain a dense cover.

The same kind of flume can be used where a shallow field ditch joins a main or outlet channel, provided a dense enough grass cover can be obtained. The bottom of the field ditch should be the same height as the bottom of the outlet for 5 to 15 feet back from the junction, before beginning the upward slope.

Occasionally, natural growth of vegetation will be sufficient to prevent serious erosion. But most flume channels must be seeded, sodded, or planted.

Where grassed flumes will not prevent erosion, a paved flume should be used. Concrete and stones are the most common paving materials. It is advisable to place the toe of the slope of a paved flume 10 to 15 feet back from the bottom of the larger ditch. This will decrease the danger of silting the main ditch.

Headwalls or drop spillways

In some places a flume between ditches might extend back into cultivated land. It may be preferable to make such a drop by a headwall at the bank of the larger ditch, even at a greater cost. A headwall of reinforced concrete is shown in figure 153. Brick or stone masonry sometimes is used. Headwalls can be used anywhere in a ditch to drop the flow from one level to another. A headwall, or drop spillway, should extend well into the sides of the ditch in which it is built, and below the bottom of the outlet ditch, to prevent erosion around or under the structure. For the same reason, the ends must be built up above the highest flow.

To prevent undercutting, the structure usually must have an "apron" or floor for the water to fall on. The apron usually should have side walls (called wing walls) and a cutoff wall at the outer edge. In some cases, an opening can be left through the spoil bank of the outlet ditch at some distance above or below the headwall to serve as an auxiliary spillway. During extreme floods some of the water can then overflow into the outlet channel. By this arrangement, a smaller structure can be used than would otherwise be safe.

Pipe outlets

In some places a spoil bank, or perhaps a roadway prevents surface water from an adjacent field from reaching a drainage ditch. Here a small pipe outlet can be used under the spoil bank or roadway (fig. 154). A concrete surface inlet at the low point of the field admits the water to a metal pipe, which carries the water to the drainage ditch.

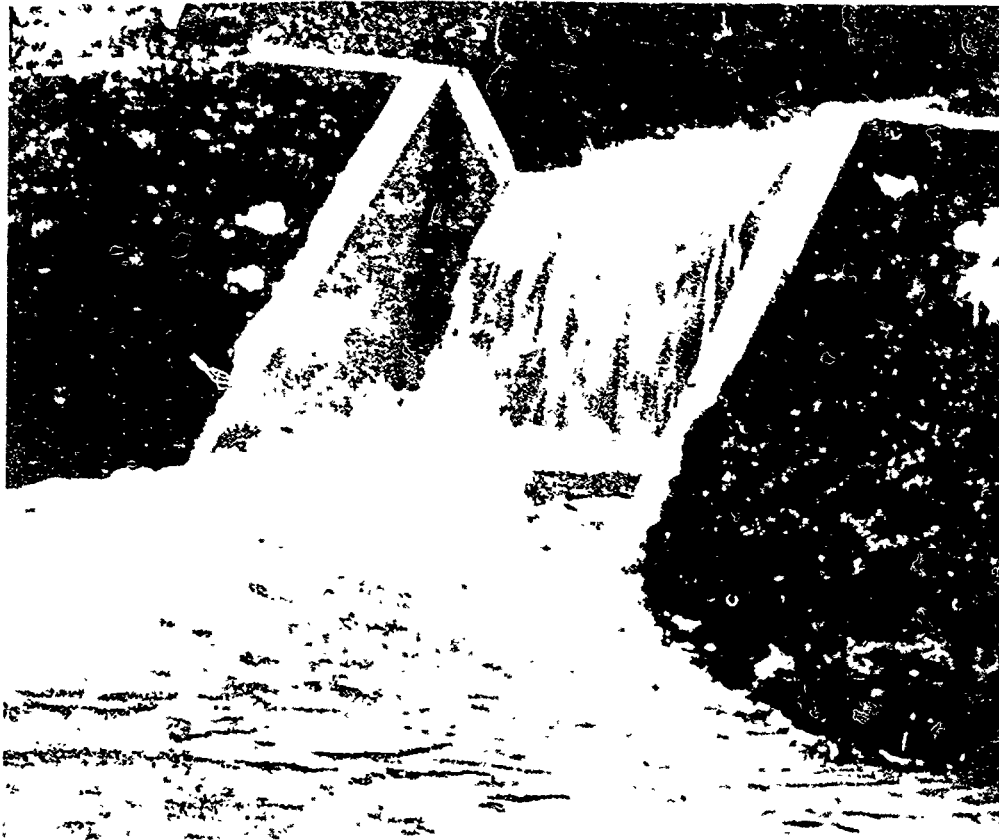

Figure 153.—Reinforced concrete headwall, or drop spillway, where flow from a field ditch drops into an outlet ditch. The apron between the wing walls is below low water in the outlet.

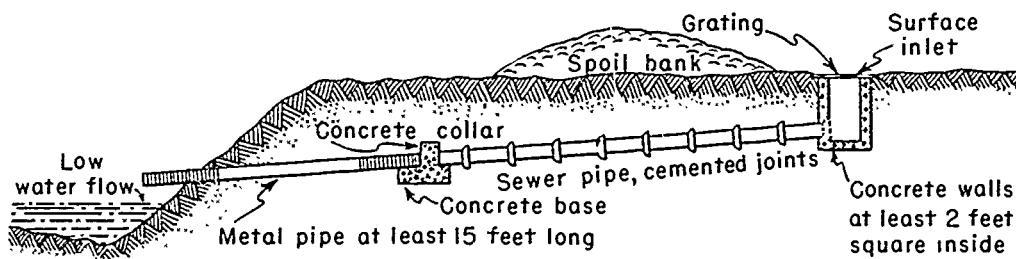

Figure 154.—Pipe outlet under spoil bank to carry surface flow from low ground to drainage ditch. The water enters through a concrete inlet back of the spoil bank.

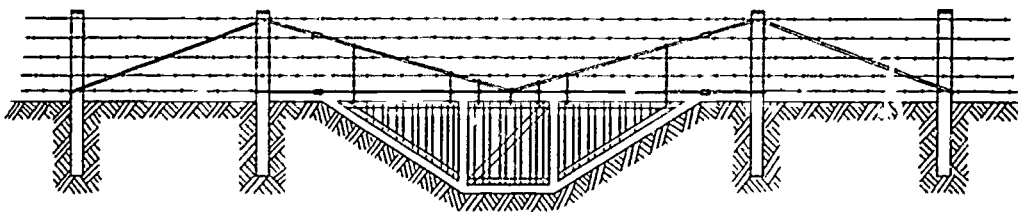

Figure 155.—A three-section watergate, swinging from a cable that can be tightened if it sags. The gate is designed to confine livestock but pass floating debris.

A shallow V-shaped channel parallel to the ditch and above the spoil bank may be needed to collect the water from the field and carry it to the concrete inlet.

Watergates

Wherever fences must cross an open ditch, usually a "watergate" or floodgate is needed. This gate should keep livestock from passing under the fence and at the same time not catch any floating plants or trash that would choke up the ditch or cause cross currents that would damage ditchbanks.

A swinging gate, hung in sections from a cable or beam, answers both needs (fig. 155). When high water flows in the ditch, the gate swings forward and lets trash and floodwaters through. It closes when the water stops running.

To help keep a cable from sagging, the posts should be well anchored. Usually a turnbuckle or some other device is also needed to tighten the cable if it does sag.

Underground Drainage

Underdrains drain the soil rather than the surface. They take out only excess water, not water that plants can use. That water is held in the soil by capillarity. The excess water flows by gravity into the drains and is carried through them to the outlet. Underdrains have definite advantages over surface drains. They occupy no land surface. And they do not harbor weeds or interfere with farming operations.

Tile is the common material used for underdrainage. Poles, brush, stones, and lumber have also been used. Where properly installed, they provide fair drainage for a time. But usually they work well for only a few years because they become obstructed by sediment or by decaying wood.

Another kind of underdrain that has been satisfactory in some localities is the mole drain. Mole drains are unlined channels through the ground that operate similarly to tile drains. They are made with a special moling machine. This type of drain is most often used in clay, clay loam, or organic soils. It is not feasible in loam or sandy soils, or in rocky soils, or where there are stumps and other obstructions. Before constructing mole drains, advice should be obtained from an experienced drainage engineer.

Tile drains

The tile drain is undoubtedly the best underdrain. When properly selected and installed, it becomes a permanent improvement which needs only slight care afterward.

Water moves into tile drains by gravity. It enters through the joints between the tiles, not through the walls as many people suppose. The walls of most porous tile absorb water rapidly until saturated, but little water passes through them. Thus, porous tile gives no better drainage than impervious tile. Moreover, porous tile is likely to be soft and easily broken or crushed.

Locating tile drains

The lay of the land and the location of the outlet largely control the placing of tile drains. If the land is rolling, it may be possible to drain it by lines of tile laid in the natural watercourses, with extra branch lines as needed in wide wet areas. Such an arrangement of drains is known as a random system (fig. 156).

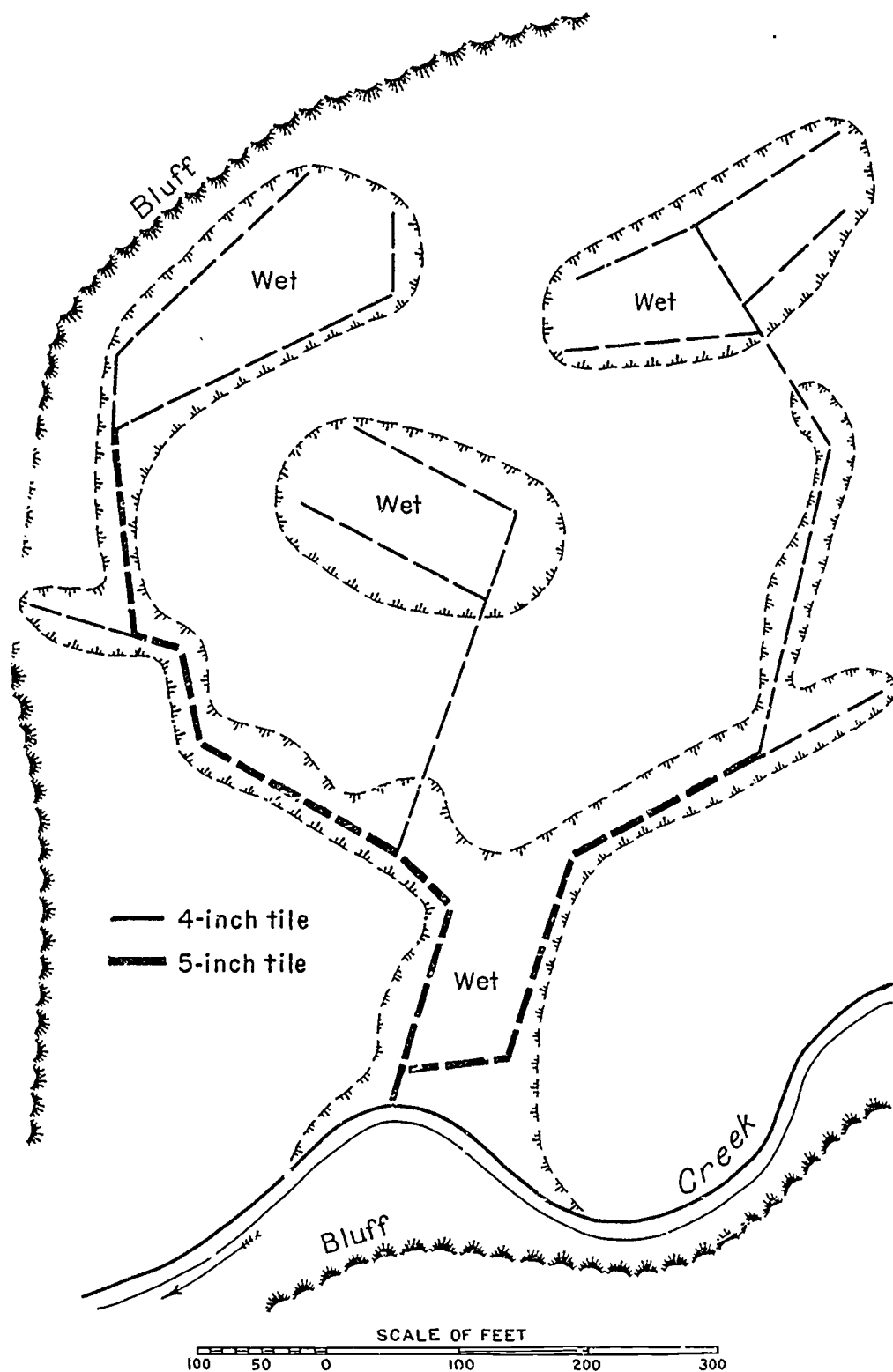

Figure 156.—Plan for a random system of tile drainage. Main drains are to be laid in the natural waterways and smaller branch lines in large wet areas.

If the land is uniformly too wet for cultivation it is better to construct a so-called complete system of tile drainage (fig. 157). The main drains follow generally the natural watercourses of surface flow, the laterals are laid in parallel lines or groups of parallel lines under the whole area. The

laterals should be straight and run in the general direction of greatest slope. They should be laid at such intervals and at such depths as the soil requires.

A system of short mains with long laterals is most economical. The mains drain the land for a distance on each side, across this drained belt the laterals serve only to carry their water to the main. Each main should serve as large a portion of the area as possible, to keep the number of outlets at a minimum, for outlets always require more or less attention if the drains are to operate satisfactorily.

If a whole field would be benefited by tile drainage but there is not enough money to construct a complete system, drain the parts that need it most and leave the remainder of the work until later. Study the results obtained from the first drains installed. Then determine more surely where to lay additional drains. When a drainage system is planned in this manner, keep in mind the requirements of the complete system so that the random lines will be large enough and deep enough to take the flow from future laterals. In this way the best results will be obtained from the money expended, and the increased returns from the drained land can be used for completing the improvement.

When the area to be drained is large and nearly level, a drainage engineer should be obtained to survey the area, design the improvements, stake out the drains, and check on their construction. Where the land has plenty of fall and the tracts to be drained are small, locate the drains during wet periods and construct them whenever the general farm work and the weather permit.

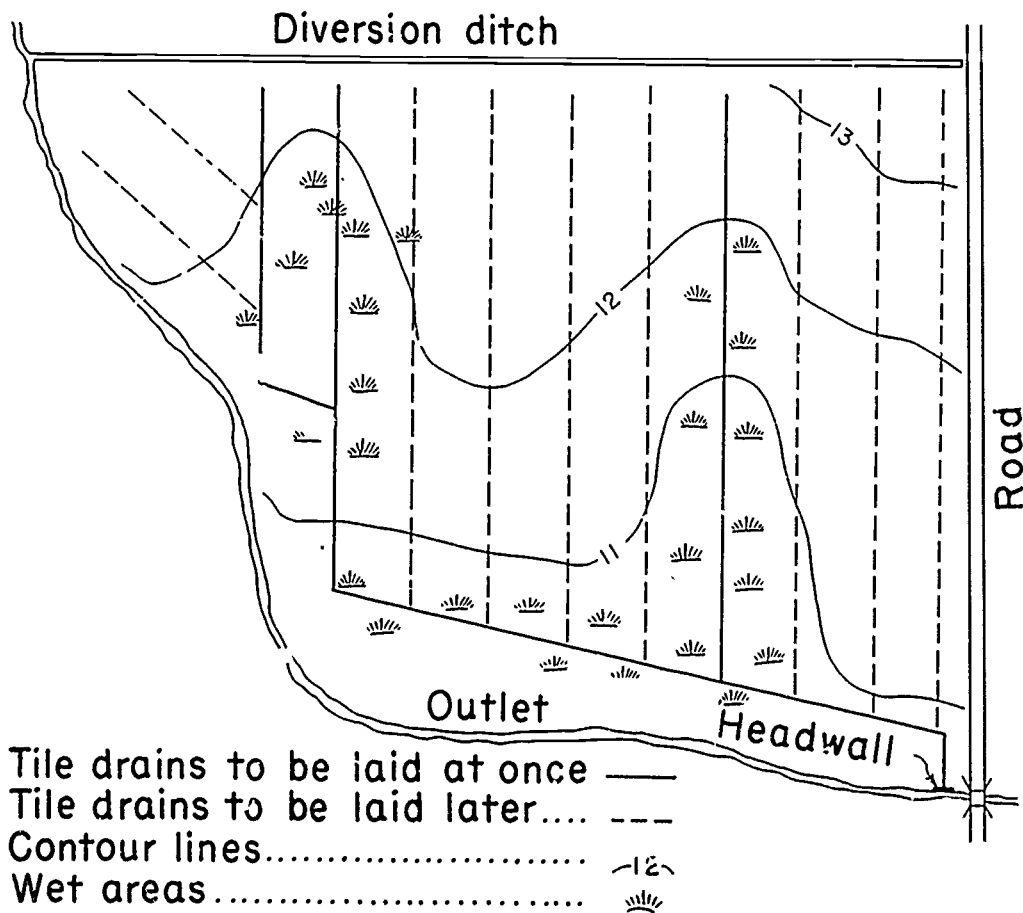

Figure 157.—Plan for a complete system of tile drainage. Random drains are to be installed at once in wettest parts of field and parallel lateral drains to be installed later.

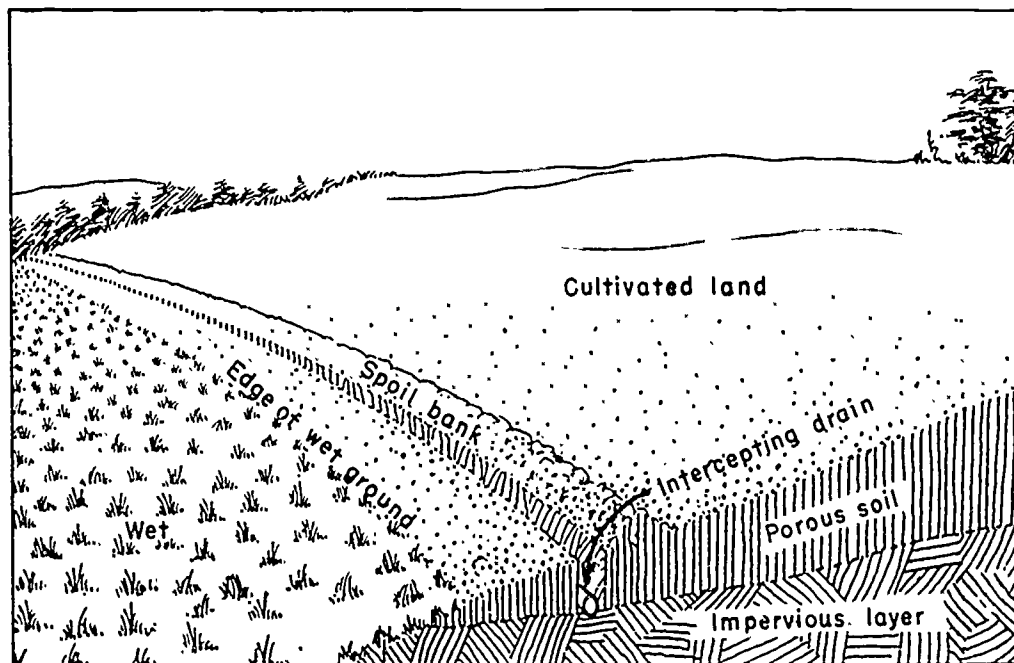

Figure 158.—Proper location for an intercepting drain.

Draining seepy hillsides

Wet areas along hillsides usually are caused by an impervious layer of soil that stops the downward flow of the water and forces it above ground. This keeps the soil too wet for cultivation. This condition can be corrected by laying a tile drain above the line where the ground becomes wet. Place it deep enough to intercept the water flowing along the top of the impervious layer (fig. 158). Set the tile a few inches into the impervious layer and backfill with gravel. The drain should run across the slope as nearly parallel to the seepy place as possible, with a continuous slight fall toward its outlet.

Depth and spacing of tile

Tile drains should be spaced so as to lower the ground water enough for good plant growth within 24 hours after a rain. They lower the ground-water surface in a curve that is lowest at the drains and ordinarily highest midway between them (fig. 159).

The rapidity with which drains lower the water depends on how easily water moves through the soil. The soil's texture and structure affect this rate.

In sandy land the drains can be placed deeper and therefore farther apart than in clay land.

Some clay soils have a tendency to crack, and this greatly helps under-drainage. Water flows more readily through the cracks.

In tight clay soil the movement of water is very slow, and tiles must be placed at less depth and closer together than in soil with more open texture.

In clay and clay loam soils tile may have to be placed 40 to 70 feet apart and 2½ to 3 feet deep. No tile should be laid less than 2½ feet deep; that is, the bottom of the trench should be at least 2½ feet below the ground surface. Large tile should be laid deeper. Cover the tile with at least 24 inches of earth to prevent breakage by heavy machinery.

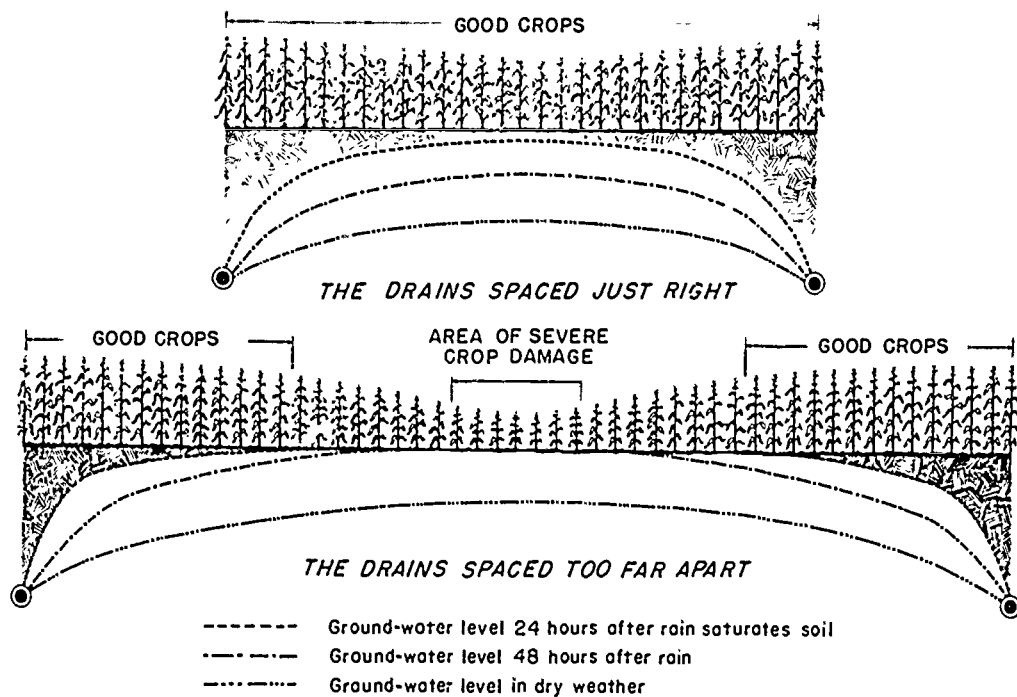

Figure 159.—How spacing of tile drains affects ground-water level and crop damage.

In silt loams tile can often be placed 60 to 100 feet apart and 3 to 4 feet deep. In sandy loams, tile spaced 100 to 300 feet apart and $3\frac{1}{2}$ to $4\frac{1}{2}$ feet deep may give good results. A spacing closer than 50 feet usually makes drainage too costly unless the land is used for truck or other high-value crops.

All tile should be laid deep enough to be free from frost damage.

Size of tile

The proper sizes of tile for the mains and submains of a system depend on many things. In the first place, where surface channels carry off a large part of the water during a storm, tile drains have to provide for only the part that seeps into the soil.

Also, because water passes through open soil more rapidly than through tight soil, it reaches drains faster through open or more permeable soil.

Then, too, the less the grade or fall, the larger must be the size of tile. The capacity of a tile line is twice as great at 4 inches fall in 100 feet as at 1 inch.

And finally, the needed size depends on the size of the drained area. Other conditions being the same, the required capacity of a drain is nearly proportional to the acreage from which the water comes.

Four-inch tile is the smallest that should be used in land drainage. Five-inch tile will serve better and should be used if it will not cost much more than the other. The 5-inch tile has nearly twice the capacity of the 4-inch and is less likely to become clogged by sediment getting into the line.

Where no surface water will get into the tiles, tile systems in ordinary loamy soils should be able to remove $\frac{3}{8}$ inch of water over the drained area in 24 hours. If the field has one of the more permeable soils through which water passes rapidly, such as a very loose sandy loam, the main tile drains should remove $\frac{1}{2}$ inch in 24 hours. Where much surface water will

be admitted, these drains should be large enough to carry a runoff of 1 inch in 24 hours.

Grades for tile drains

Experience shows that there are minimum grades at which drains of small-size tile give satisfactory service, and also limits to the lengths that will be satisfactory at those grades.

The minimum grade per 100 feet and maximum length recommended for 4-inch tile is 0.10 foot and 1,300 feet, respectively; for 5-inch tile, 0.07 foot and 2,000 feet, respectively; and for 6-inch tile, 0.05 foot and 3,000 feet, respectively. With any size of tile, avoid flatter grades than 0.05 foot per 100 feet, if possible.

The steepest grade for tile mains constructed with farm draintile should not exceed 2 feet per 100 feet. On steeper grades, bell-type tile (sewer pipe) with sealed joints should be used. If the grade of a tile main is greatly reduced at any point the drain will need to be protected by a pressure-relief well.

Selecting tile

Draintile should be circular in cross section and approximately straight. The inside should be smooth, and the ends should be regular and smooth enough to permit making close joints with spaces of not more than $\frac{1}{8}$ inch between tiles. Tile smaller than 10 inches in diameter are commonly 12 inches long; larger tile may be up to 30 inches long, according to the diameter.

Good tile should be free from visible grains or masses of lime or minerals that cause slaking or breaking down. A broken surface should show a uniform structure throughout. A tile should be free from chips or cracks that would decrease its strength, and when dry it should give a clear ring when stood on end and tapped with a light hammer.

Tile used in underdrains must be strong enough to withstand the pressure that will be put on it. Locating and replacing broken tile in a drain is difficult and costly. The tile should also be resistant to the action of any chemical in the soil and in the water that flows through it. Breaking down by chemical action may even require replacing the whole drain with new and better materials.

Clay draintile is classified as either common or vitrified. Common tile is made from common brick clay, the kind that when well burned makes a good-quality building brick.

To make good concrete tile takes the right equipment and careful supervision by experienced men. For this reason the making of tile on the farm is not recommended.

Constructing Tile Drains

Staking out tile drains

Stake out the drains by setting stakes at 50-foot intervals. At each 50-foot station should be two stakes—a hub or grade stake with its top about at ground level and a guard stake standing a foot or more above ground (fig. 162).

The grade hub is a marker from the top of which all measurements are made. The grade hub, therefore, should be set firmly. The hub elevations should be determined accurately.

The guard stake locates and gives the number of the hub, and on it may be marked the required depth of cut below the top of the hub. This depth is determined by subtracting the elevation of the designed trench bottom from the elevation of the hub.

It is imperative that there be no sags in the completed tile line. Silt is likely to settle in any depression and cause partial or even total clogging of the drain. Therefore, the leveling must be very accurate. The less the fall allowed for the drain, the greater is the necessity for accurate work.

Tile trenching with machinery

Shortage of labor skilled in laying tile has led to the use of power-operated machines, under contract with a man or company in that business.

Power-operated trenching machines are of two types, wheel excavators and endless-chain excavators. The wheel excavator, shown in figure 160, is more common in farm-drainage construction. It has, just behind the excavating wheel, a shoe for giving the trench a smooth, firm, rounded bottom upon which to lay the tile. The machine also has a shield to keep loose dirt from falling into the trench until the tile can be placed, and a chute that lays the tile at the end of the smoothing shoe.

Proper depth to give the drain a uniform grade is obtained by raising and lowering the excavating wheel as the machine travels along the line of the



Figure 160.—Wheel-trenching machine in operation. The man at the wheel is controlling the depth of the trench by sighting over the target. The man in the trench is putting the tile in place.

drain. The machine operator moves levers to keep the sight bar in line with targets set ahead. These targets are long stakes or rods driven vertically near the grade hubs. Each has a level crossbar at a height above the grade line equal to that of the sight bar on the machine.

There are several special trenching plows that may be helpful in tile-drain construction if a power-operated machine is not available.

Hand trenching

The tools most commonly used in trenching and laying tile by hand are tile spades, shovels, drain scoops, tile hooks, and gage sticks (fig. 161).

The tile spades are of two kinds—solid and open—with blades 16 to 22 inches long. The 18-inch and 20-inch sizes are most used. The open spade is used in mucky or sticky soils.

The shovel is of the ordinary long-handled, round-nosed type.

The drain scoop is semicylindrical in shape and is fitted with a long handle. It is made in sizes to fit 4-inch to 8-inch tile.

The tile hook is made of $\frac{1}{2}$ -inch round iron—one side 9 inches and the other 4 inches long—fastened to an ordinary rake handle.

The gage stick is a straight stick 1 by 2 inches in cross section and 5 or 6 feet long to suit the method of establishing grade. A braced T-piece on the bottom aid in setting the gage vertical.

Some factories now are making tile so uniform in cross section and with ends so regular that the tile can be fitted very closely together and there is little space for the water to enter the drain. Where such tiles are used in heavy soils, they should be spaced about $\frac{1}{16}$ to $\frac{1}{8}$ inch apart. But where fine sand is likely to be washed into the drain, the tile should be fitted closely.

Tile up to 6 inches in diameter can be placed with a tile hook by a man on the trench bank. Or it can be placed by hand by the man who is finishing the trench with the tile scoop. Results are usually best if the man using the tile scoop, working backward up the trench, lays the tile as fast as he finishes the grade.

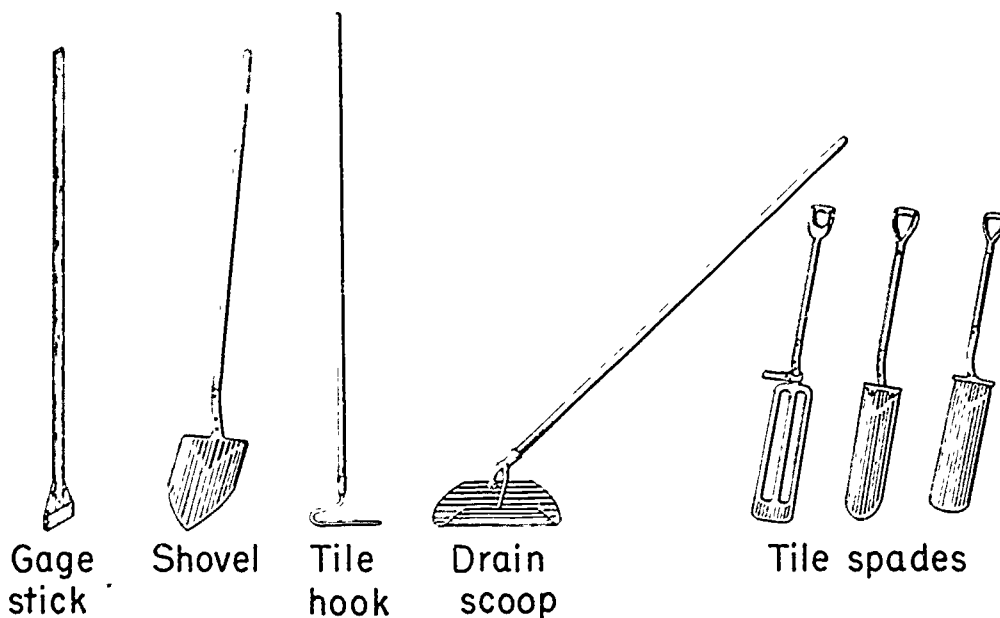

Figure 161.—Handtools for tile-drain construction.

In a wet, soft trench it may be advisable to lay the tile on plank bedded at grade. Through saturated fine sand or sandy loam it may be necessary to wrap the joints with cloth or roofing paper to prevent soil from washing into the drain. In laying tile through quicksand you need the help of a man experienced in such work.

All tile that are cracked, soft, or poorly shaped should be laid aside. Unless there is an excessive number they will not be wasted, because broken tile is needed to patch junctions and wide joints.

It is very important that the tile be laid and blinded as soon as the trench is completed to grade. Otherwise, banks may cave and the bottom may soften. To prevent dirt getting in, the upper end of the tile line should be closed whenever workmen leave the job. When a line is completed its upper end should be closed with a brick or stone or pieces of broken tile.

To finish grade, the workman stands in the trench ahead of the tile and draws the scoop toward him, leaving the trench bottom smooth and rounded to fit the lower part of the tile.

Take great care to cut the bottom of the trench accurately to grade. If the trench is cut below grade at any place, the low spot should be filled with well-pulverized soil and thoroughly tamped, and the scoop used again.

Be sure that the tile scoop used is of suitable size for the tile being laid. The 5-inch size meets most of the requirements for ordinary farmwork. The round-nosed shovel is commonly used for finishing grades for tile larger than 8-inch. Where it is used, the bottom of the trench should be finished to fit the bottom eighth of the tile.

Laying the tile

Like trenching, laying the tile should begin at the lower end or outlet and progress up grade, following closely the excavation of the trench. In placing tiles, turn them until they fit closely together. If a tile is crooked or the ends are irregular, turn it until it fits tightly at the top and the open space is left at the bottom. Where a crack or opening of as much as one-fourth inch must be left at the top or sides, cover it with pieces of broken tile, a strip of roofing paper, or, in some sandy soils, cement mortar.

The drain must be laid in straight lines and smooth curves if it is to be most effective and least likely to become obstructed. To do this, a guide must be used in the trenching. A guide line or rope is stretched along the ground about a foot to one side of the grade hubs, making smooth curves at all bends. Then the edge of the trench is marked off along this line with a spade. If the top spading is done to imperfect line, it is practically impossible to smooth up the line on later spadings.

For small tile, trenches 12 to 15 inches wide, with the sides practically vertical are usually dug. Dig them with tile spades to within 1 or 2 inches of grade, then clean out the bottom to the correct grade with a tile scoop. Most tile trenches are 2 or 3 spade blades deep.

The tile spade is somewhat different from the ordinary spade or shovel used in farmwork. In digging with it, do not attempt to take a thick bite for the spading cannot be loosened readily from the side of the trench. Moreover, the earth on the spade will shatter and too much of it will crumble into the trench.

The correct method of using the tile spade is to drive the blade obliquely for three-fourths its length, then push the handle forward and drive the blade vertically to its full length, and finally, pull the handle back and lift loosened spade load from trench. When the trench has been dug to

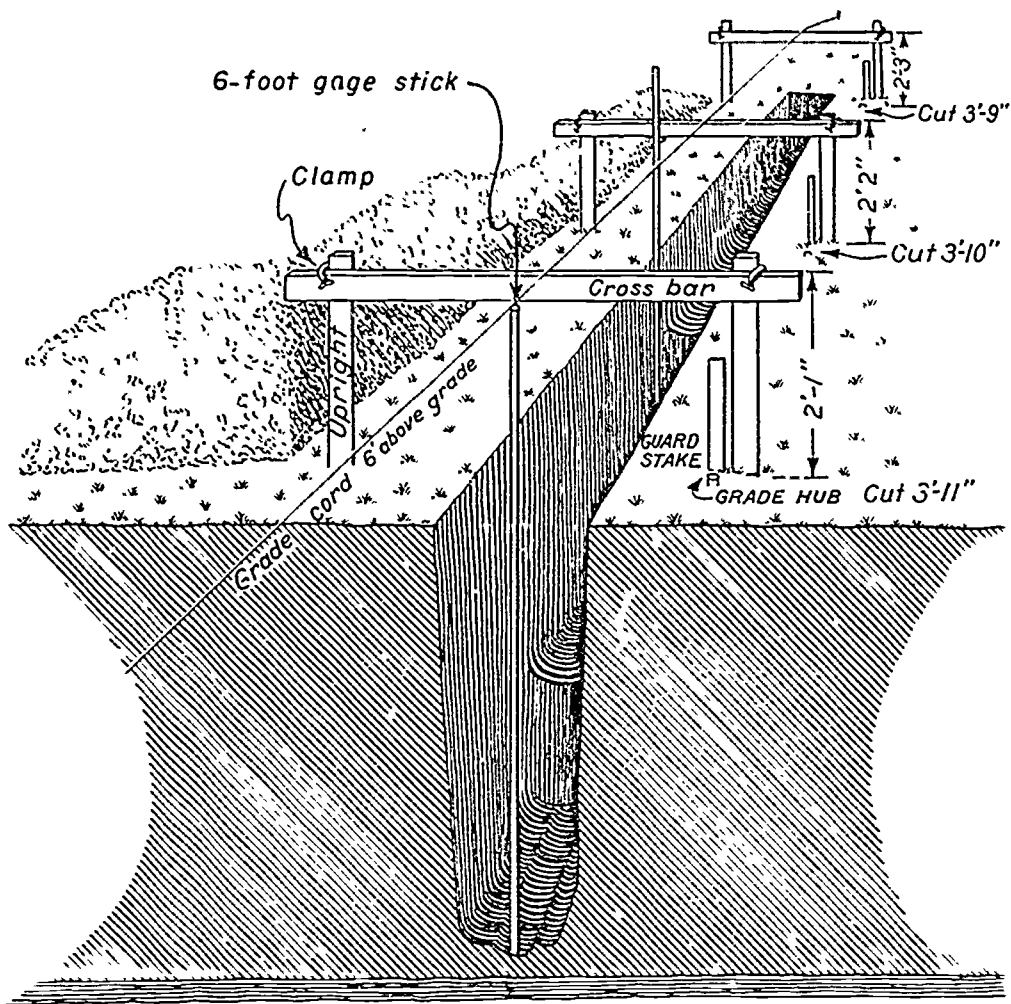

Figure 162.—Gage-and-line method of establishing grade for a tile drain. A cut of 3 feet 11 inches is indicated at the hub in the first station. Subtracting this cut from the length of the gage stick (6 feet), the difference of 2 feet 1 inch is the height for setting the top of the crossbar above the hub. The gage stick at the first station shows that the trench has been dug to the correct grade elevation at that point. The gage stick at the second station shows that more digging is required for the needed cut of 3 feet 10 inches.

within an inch or two of grade elevation, the loose crumbs of soil left by the tile spade must be taken out.

A convenient way to fasten the crossbar to the uprights is by clamps. Similar crossbars should be set at three or more consecutive stations. If the fall of the drain is uniform, any error can be detected in setting the crossbars by sighting over them.

Next, across the tops of the bars, over the centerline of the trench, stretch a light strong cord (preferably fishline). This grade cord must be kept taut. Otherwise there will be sags in the tile line that will very likely cause trouble later.

The trench bottom is at correct grade when the gage stick is upright in the trench and its top just touches the grade cord. The bottom of the gage stick must be kept clean, any adhering dirt will result in incorrect grade.

Since trench diggers work backward up the drain line, it is more convenient for them to sight down rather than up the completed trench. So,

where it can be done, in starting from the outlet or from a point where the grade changes: it is well to set extra targets down the grade, lined in with those above. The same procedure will often help where the drain makes long curves.

Digging the trench

Trench digging should begin at the outlet and proceed up grade. This permits any water that gets into the trench to flow away instead of collecting to make the trench bottom soft.

Establishing grade

The best method of establishing grade for hand trenching when the workmen are inexperienced is probably that of gage and line (fig. 162). This consists of stretching a cord at a uniform height above the bottom of the trench to be dug and measuring down from it with a gage stick. The cord should be placed high enough so that it will not interfere with the men working in the trench.

To get the grade cord at the right elevation, at each station two strong stakes should be set upright near each grade hub, one on each side of the drain-line. To these uprights a crossbar should be fastened at a height above the hub equal to the difference between the length of the gage stick and the depth of cut at that station. A carpenter's level is used to set the crossbar level.

Making junctions and curves

Junctions between laterals and main tile drains should be made with Y's (fig. 163), not with T's or elbows. Practically all tile factories make junction tile. If Y's cannot be obtained, junctions can be made by cutting



Figure 163.—A well-made junction of small lateral with larger main tile drain.

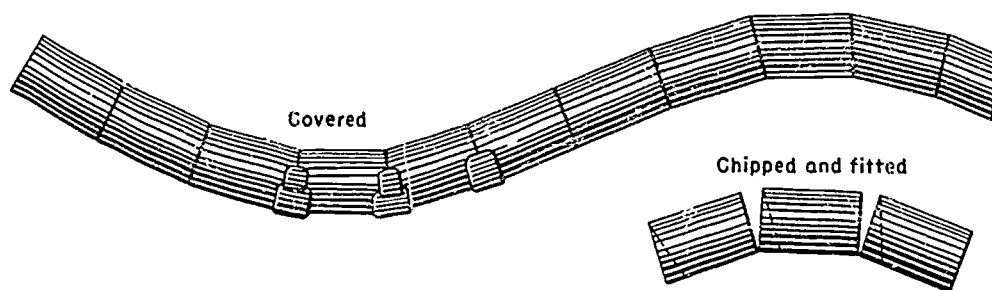

Figure 164—Curves in tile lines.

and fitting straight tile. When this is done, care must be taken to prevent the branch tile from projecting into the main. Unless lack of fall prevents, there should be a drop from the branch into the main. This drop can be assured by turning the Y slightly in its bed so as to elevate the branch.

Changes in direction should be made by curves and not by sharp angles. The curves should be regular, with the outer side of the joints covered with pieces of broken tile (fig. 164).

Blinding the tile

On the day that the tile are laid they should be covered with loose earth to a depth of 4 to 6 inches, to hold them in position. This work is called blinding the tile. A workman stands astride the trench and shaves earth from the sides with a tiling spade.

The earth should be worked under the sides of the tile to give them support and prevent displacement when the trench is backfilled. But it should not be compacted about the joints, for that would be likely to keep water from getting into the drain.

In tight soils better results are often obtained by taking earth from the upper edges of the trench. Topsoil usually is looser and contains organic matter and therefore helps percolation into the tile drain. Putting topsoil around the joints may prevent the soil's cementing the tile joints, which would keep water out of the drain. If they can be obtained at a reasonable cost, organic materials such as straw or pine needles are good in both tight and sandy soils.

In tight soils, gravel is good if it can be obtained at reasonable cost. It is also good for filling the trenches to within about a foot of ground surface. The upper foot should be filled with soil.

Backfilling the trenches

Trenches should be filled soon after the tile are blinded. This can be done readily with a farm tractor and a homemade bulldozer. If horses are used, a scoop or V-drag can do the job. Usually two rounds are enough to backfill the trench. A scraper made from a 2- by 12-inch plank about 4 feet long can be used to advantage for many trenches. With this, the horses work at right angles to the trench, scraping in the earth piled on the farther side. If a scraper, a tractor and bulldozer, or a road grader is used, it will save work in backfilling if all the earth thrown out in digging the trench is on one side, rather than part on each side.

Protecting the outlet

Failure to protect the outlet end is one of the most common causes of tile drains failing to work well. The outlet should be protected against washing or eroding of the ditchbank. Also, trampling livestock can force tile out of position; or animals may nest or become lodged in the tile and block the flow of water.

Good protection can be obtained for a tile outlet with a reinforced concrete headwall or bulkhead (fig. 165). In front it should extend from the ground surface to at least $1\frac{1}{2}$ feet below the bottom of the ditch. A solid foundation is necessary to prevent undermining of the structure and heaving from frost action. The headwall should be set in line with the top of the ditchbank. Wing walls should be constructed at right angles to the headwall with their tops about level with the slope of the ditchbank. An apron or floor should be constructed between the wing walls to prevent the water from the tile undermining the headwall. For 10 to 15 feet from the headwall, the drain should be either vitrified bell-type tile (sewer pipe) with firmly cemented joints or a length of metal pipe. Ordinarily, surface water which follows the depression over the tile line should be diverted so as not to discharge over or near the headwall.

In many places the tile outlet can be protected merely by using a 15- to 20-foot length of strong metal pipe for the end section of the line. If not likely to be displaced by ice or floating debris, it should stick out through the bank of the outlet ditch (fig. 165) far enough so that the flow from it will fall beyond the slope of the ditchbank. Otherwise it should not stick out,

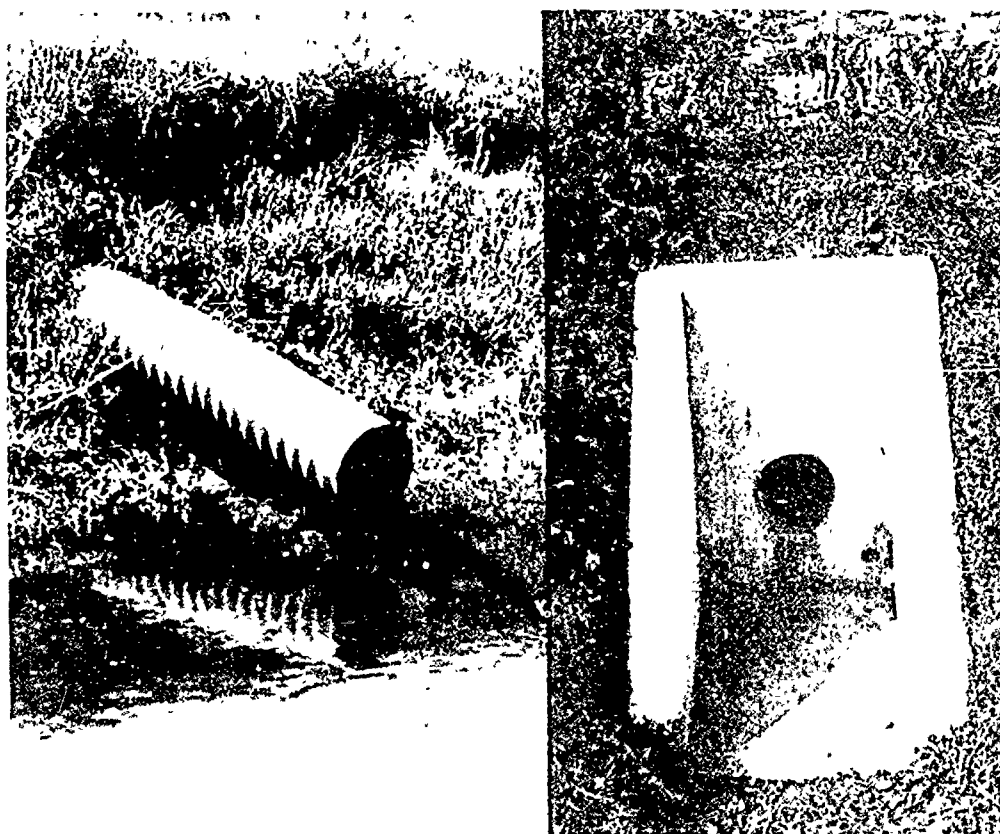

Figure 165.—Outlet protection for tile drains: (Left), Corrugated metal pipe that will empty into the drainage ditch without eroding the ditchbank; (right), reinforced concrete headwall, with wing walls and apron.

and the bank slope should be protected under it against erosion by making a substantial pavement.

If the pipe sticks out, it should be pointed to angle downstream, to reduce interference with the flow in the ditch.

The pipe should be about 2 inches larger than the tile discharging through it, so it can be slipped over the last tile for about 6 inches. This joint should be cemented tight, to prevent any earth from being washed into the drain.

To prevent burrowing animals such as muskrats and rabbits from entering the tile, hang a screen or gate over the end of the drain. Use the swinging type, because one rigidly fixed will catch trash washed down the drain and obstruct the outflow.

The gate should extend well beyond the sides of the drain opening,

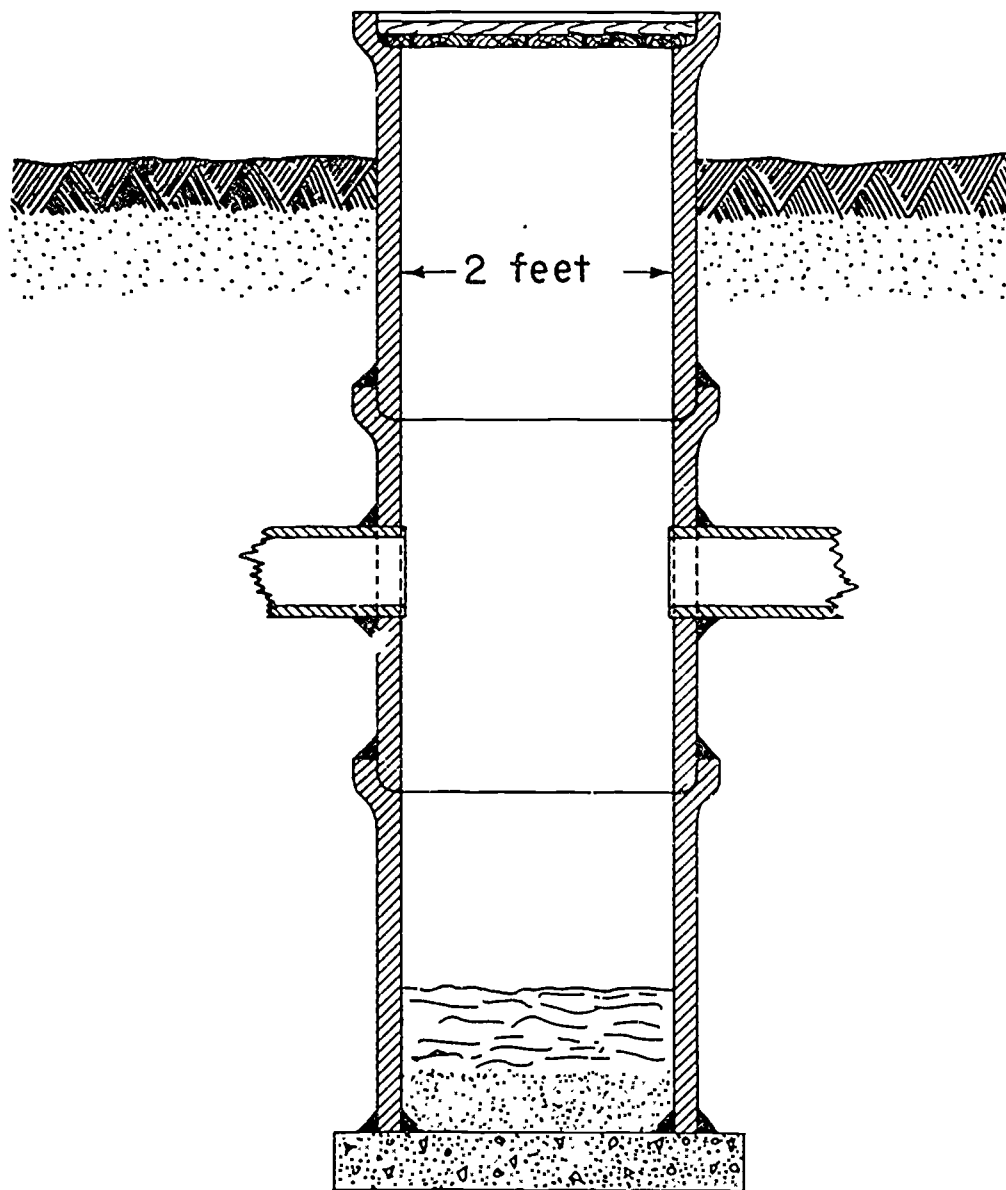

Figure 166.—A silt well made with sewer pipe. Since it has an open top, it also serves as a “relief well.” Like the concrete silt well in figure 167, it can serve also as a junction box where two or more tile lines come together.

except that when fastened to the end of a pipe the top of the sheet should be trimmed to permit easy opening. Folding back the edges will make the sheet more rigid. The wire links supporting the gate should be large and loose, for freedom of movement. Heavy wires fastened to the end of the pipe about $1\frac{1}{2}$ inches apart, also make an effective screen. Such screens must be cleaned annually.

Surface inlets and silt wells

In some tight soils surface water collects in low spots and stands until it "scalds" the crop. Here a surface inlet may be needed to let the standing

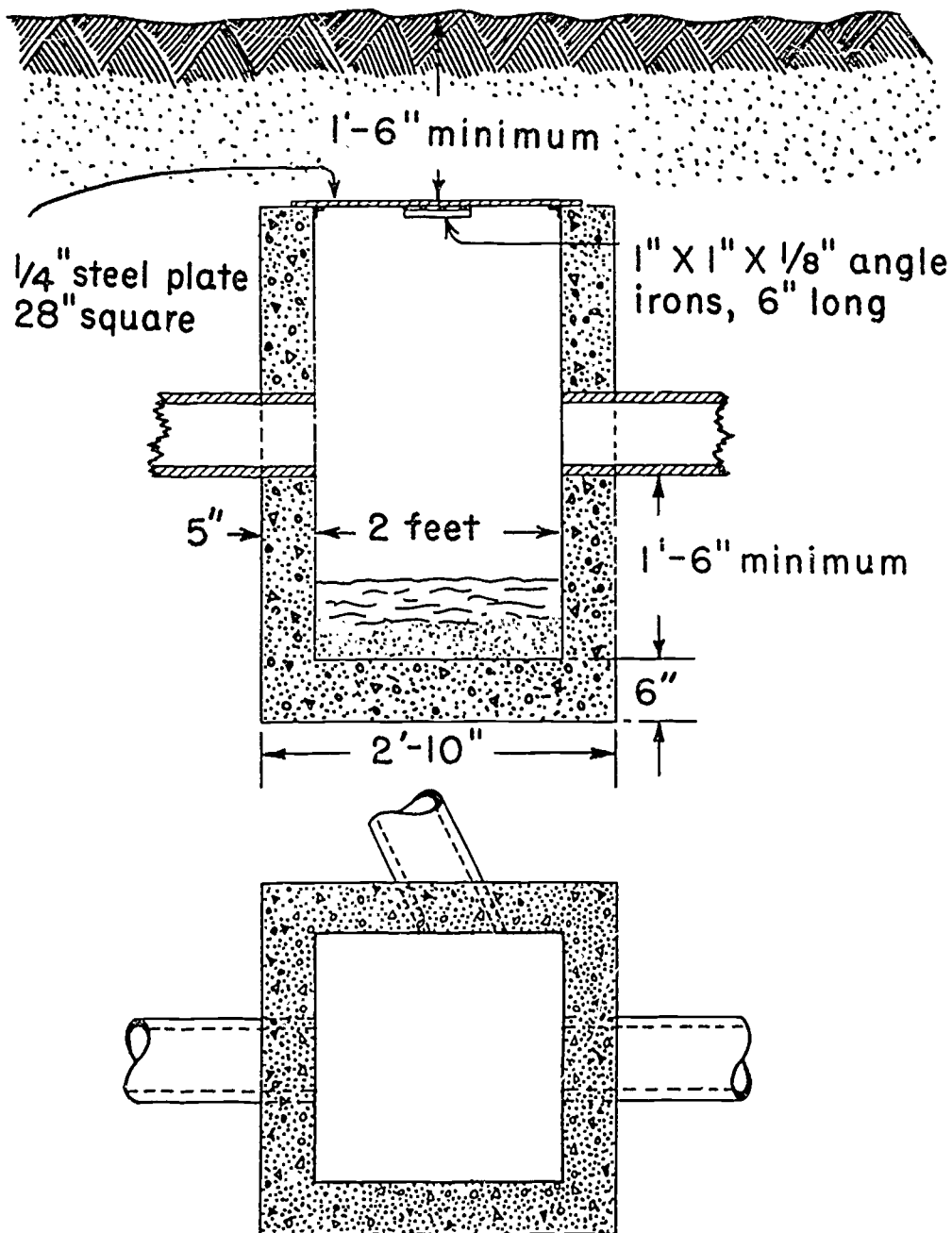

Figure 167.—A silt well made of concrete and sunk below plow depth so as not to interfere with cultivation. Silt wells can also serve as junction boxes, as shown in the cross section that is the lower part of the drawing.

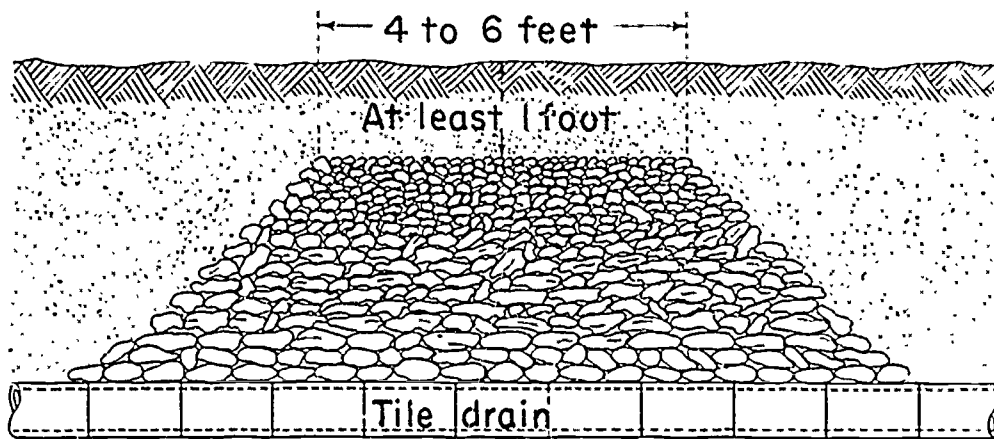

Figure 168.—A blind inlet made by digging out a wet spot over tile and filling it with cobbles, broken tile, and gravel graded upward from coarse to fine. In cropland the top 12 inches should be porous soil.

water directly into the tile drain. Surface water usually carries a good deal of fine sand and trash. For this reason a good surface inlet should include some means of trapping this solid material before it gets into the tile.

If tile drains are carefully constructed, silt wells are seldom necessary except where there is a surface inlet. But, a silt well may be needed where the grade of a tile line changes abruptly. When the grade decreases, the speed of the water decreases. And when the speed of water decreases, its capacity for carrying suspended soil also decreases. In other words, where tile flattens out suddenly there is danger it will clog up. This danger is especially great if the soil contains much fine sand and silt—the kind of silt in a silty clay loam soil.

Two or more lengths of sewer pipe set on a concrete base make a satisfactory silt well (fig. 166). Or one can be built of concrete (fig. 167). Where the silt well would interfere with cultivation, sink the top a foot and a half or so below the ground surface and cover it with soil. In this case, make a record of the location so it can be found easily later. Also, a buried well should have a solid cover that can be removed without too much trouble when the well needs cleaning (fig. 167).

Silt wells can also serve as junction boxes where two or more tile lines come together (fig. 167).

Where there is only a little surface water, it can usually be handled satisfactorily through a "blind inlet" (fig. 168). One can be made by filling a small section of a trench with stones, broken brick or tile, or gravel. The filler should be graded upward from coarse to fine, with still finer material for the top 12 to 18 inches. In cultivated fields, the upper layer should be porous soil. Elsewhere pea gravel or coarse sand is satisfactory.

The inlet should be checked frequently. Whenever enough trash or sediment collects to keep the water from draining through quickly, the top layer should be shoveled out and new put in.

Relief wells

Silt wells with open tops also serve as "relief wells" (fig. 166). A relief well is needed wherever a tile main flattens out and the tile in the flatter part is not large enough to take care of the resulting pressure. If the water pressure in the tile is greater than that in the soil, it forces water

Heavy wire screen

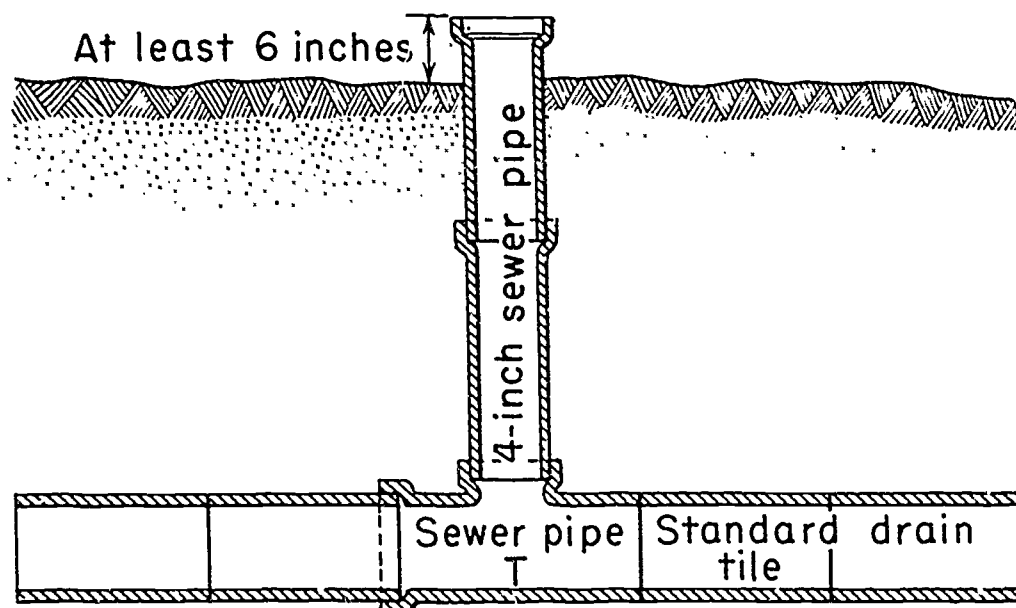

Figure 169.—A pressure relief well made of sewer pipe.

out through the joints. This washes soil from around the drain and permits the tile to get out of place.

Usually a relief well is needed if the grade flattens by more than 1 percent. Figure 169 shows one made of sewer pipe. For added protection, a section of sewer pipe with closed joints may be needed in the tile line.

A relief well should be supported by a base of concrete if the soil on which it is built is soft when saturated.

Relief wells are best located at fence lines and field borders. There they interfere least with farming and are in least danger from farm machinery.

Drains obstructed by tree roots

Roots of trees growing near tile drains may enter them and obstruct flow. This is most apt to happen where drains are fed by springs and carry water in dry seasons. The roots enter the drains to get moisture. Masses of roots sometimes grow until they completely fill the tile. Where there is reason to expect this difficulty, cement the joints of sewer pipe or bell-and-spigot tile. As a general practice, all willows and other water-loving trees growing within 50 feet of the tile drain should be destroyed.

Maintenance of Farm Drains

Here are a few of the things that should be kept in mind to keep the farm drains working efficiently.

First of all, any drain that is to work efficiently must be kept clean.

Open ditches and outlet channels should be inspected frequently and all weeds, briars, willows, silt, trash, or refuse of any kind that obstructs the flow of water removed. Frequent inspection keeps maintenance costs comparatively small. But if ditches are allowed to deteriorate, the cost of repairing or redigging them may equal the original cost.

On outlet ditches, a good grass sod will reduce maintenance problems. Pasturing such ditches, where practicable, is an effective and economical way of controlling growth, but stock should not be allowed on the ditches when the banks are saturated. In many places it will be found practical to mow the ditches, or to cut and burn the weed growth.

The important thing is to keep the ditch free of anything that will obstruct the flow of water in the channel. Silt bars that form in an outlet ditch can often be removed with dynamite or with slip scrapers.

Small V-shaped field ditches can usually be maintained in satisfactory shape by plowing. If such ditches are planted to grass, keep them mowed, and use the grass for hay.

Tile drains with good outlets, if properly constructed, seldom become clogged. Nevertheless, it is advisable to inspect the tile system at least once or twice a year by walking along the tile lines. The condition of the soil along a drain a few days after a heavy rain indicates how the drain is working. Wet spots show that water is not being carried off. A hole or cave-in above a tile line indicates that a tile has been either broken or displaced. When this occurs, immediate steps should be taken to repair the line. Otherwise the whole drain above the break may become filled with silt, which makes it necessary to replace that part of the line.

Crop rotations and methods of cultivation that maintain a good soil structure help keep tile drains working. This is especially true with heavy soils. The continued growing of clean-tilled crops breaks down the soil structure until water cannot percolate to the drains rapidly enough.

Conservation Nurseries

In soil- and water-conservation operations the variability of soil, degree of erosion, and the practices involved are such as to require the use of a wide range of planting materials. For that reason conservation nurseries must not only grow tree and shrub stock but must produce seed of grasses and herbaceous legumes.

Selecting Nursery Site

The proper selection of a nursery site is a prime essential in successful nursery stock and seed production. The topography, location, fertility, and texture of the soil and the quality and accessibility of irrigation water will markedly affect the cost of operation. Closeness to the planting operation is an additional point to consider.

Topography and location

The ideal nursery site is most likely to be a smooth, flat, stone-free, and moderately sandy soil (fig. 170). It is highly desirable that the site have a uniform slope, preferably in one direction, in order to facilitate furrow irrigation. Acceptable gradient varies with soil texture, ranging from a minimum of 0.25 percent on the fine-textured soils having a slow infiltration rate up to a maximum of 2.0 percent on the sandy soils that permit rapid infiltration. A hilly or choppy surface adds so tremendously to the cost of the nursery operation that it is poor economy to begin nursery production on anything but the best available site even though the initial cash outlay may seem high.

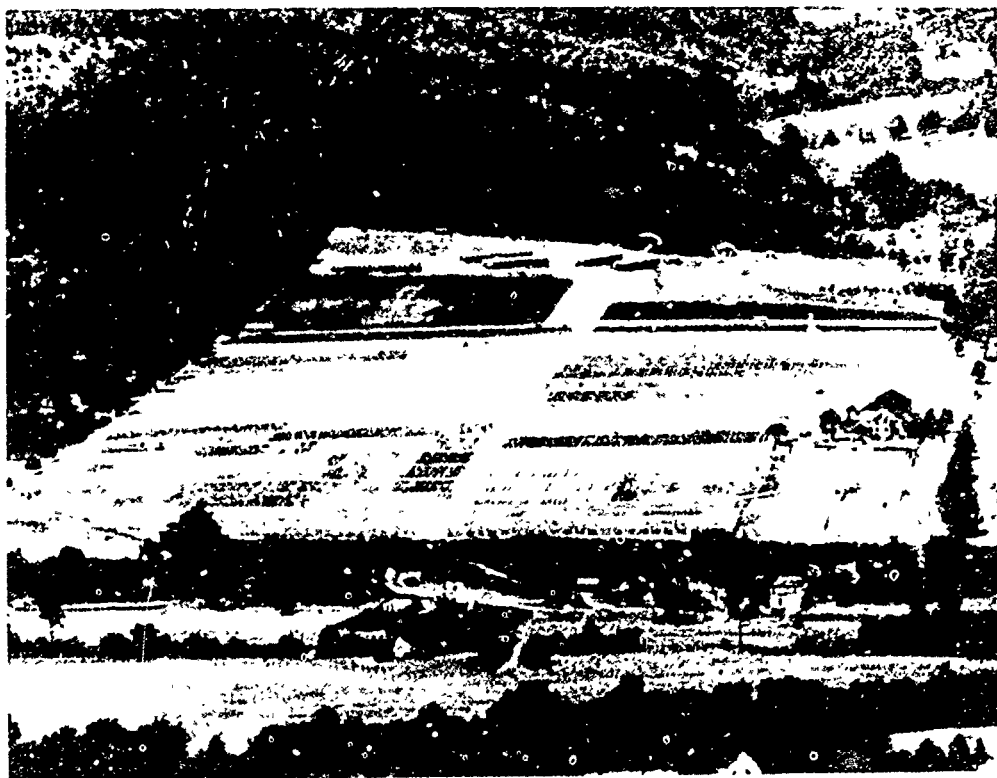

Figure 170 —Deciduous-tree nursery.

It is a well-known fact that local terrain has a marked effect on the severity and occurrence of late spring and early fall frosts. Danger areas generally lie in basins where there is a lack of adequate air movement—commonly referred to as air drainage—and should be avoided in selection of a nursery site.

Soils

Experience has shown that moderately sandy soils are most desirable for nurseries. The top 18 to 24 inches of the soil should range from a sandy loam to a loam, although the lighter silt loams are fairly satisfactory. Heavier soils are recommended only if the class of stock produced is to be balled and burlapped. Too much clay (over 20 percent) in the topsoil causes undesirable baking and cracking. A sandy clay topsoil would not be considered ideal because of its tendency to form crusts, which seriously hinder seedling emergence.

The substratum must be reasonably retentive of moisture. Sites with open and porous coarse sand or gravel substrata should be avoided, unless an overhead irrigation system is available, because of the frequent irrigation necessary on such soils. It is desirable, where furrow irrigation is used, to have a somewhat heavier subsoil below the 2-foot depth in order to retain moisture within reach of the tree roots. Its texture can range from a sandy clay to a loam, silt loam, or clay loam.

The soil of the nursery site should be of high fertility and reasonably free from harmful alkalis. Inadequate soil fertility and a poor balance of nutrients result in a relatively large proportion of cull stock and high production costs. Expressed in a general way, any moderately sandy soil that is producing good yields of agricultural crops such as wheat, corn, sorghum, or cotton will produce satisfactory planting stock. Deciduous seedlings require more fertile and somewhat heavier soils than do most of the conifers.

Maintaining Soil Fertility

Although a tract of good fertile soil may be selected as a nursery site, it cannot be expected to be cropped repeatedly without the necessity of taking some measures to maintain its productivity. Moreover, the area selected for a nursery site will in most cases be land that has been used in the past for production of farm crops, and may need attention at the outset if the highest quality of nursery stock is to be produced.

Animal manures

Although animal manures do not run as high as commercial fertilizers in percent of different plant nutrients, they may have a higher value in soil building, in maintaining the soils in good tilth, and in increasing their ability to absorb and retain moisture. In the process of decomposition in which phosphorus and other elements are dissolved and converted into available plant nutrients, the bacteria present not only aid in the decomposition of the manure itself, but also attack the soil material. If added in liberal amounts the manure often takes care of most soil-nutrient deficiency.

It is advisable to allow animal manures to be rotted thoroughly before applying them to the soil. Fresh manure, especially that which contains a high percentage of horse excrement, has an injurious effect on many plants, commonly known as burning. Moreover, it has a higher percentage

of viable weed seeds than well-rotted material. To some extent, the burning effect can be controlled by maintaining soil moisture at a fairly high level by means of irrigation.

Soil crops and other fertilizers

It may be necessary, in addition to the use of farm manure, to sow a green-manuring crop every third or fourth year. This crop can be either a legume or a grain or a combination of the two and should be plowed under while it is still succulent and immature. Mature crops do not decompose rapidly and may produce a seed crop that will germinate the following year and add to weeding costs. One of the best ways of using animal manures most effectively is to apply them before sowing the green-manure crop. A good crop cannot be produced if soil fertility is low, and this makes an application of some fertilizer before sowing, especially animal manure, most advisable.

In the use of legumes, warm-season crops such as the cowpea, soybean, and crotalaria are sown in the spring and turned under in late summer. Cool-season legumes such as vetch and field peas are sown in late summer and turned under the following spring. Grain crops such as rye, wheat, and oats are seeded in late summer and turned under the succeeding spring. The grain crop may then be followed by a summer legume.

If a very heavy crop is produced, it can be disked before plowing to aid in getting it turned under. The plowing should be done at least 4 to 6 weeks before nursery sowing in order that the green-manure crop may decompose sufficiently and not interfere with seeding or cultivation.

Where it is not feasible to use animal manures, the nurseryman can resort to such commercial fertilizers as bonemeal, dried blood, tankage, cottonseed meal, ammonium sulfate, superphosphate, and muriate of potash. Complete fertilizers, consisting of an 8-12-4 combination of ammonium sulfate, superphosphate, and muriate of potash, have given good results when worked into the soil before seeding in amounts ranging from 600 to 1,000 pounds per acre.

Selecting Suitable Conservation Plants

Success in the application of vegetation to conservation practices depends on the kind and character of planting materials used. An essential part of nursery activities, therefore, is to find out by careful testing the most suitable plants for specific conservation jobs. This is accomplished by assembling promising species, strains, and varieties from all available sources and growing them under comparative observation.

The plants are first grown in the nursery in such manner that their characteristics and performance can best be observed. Usually cultivated rows are most satisfactory for this purpose with the various species and strains grouped according to similarity of composition, season of growth, or probable conservation use (fig. 171).

After observing the behavior of the plants for one to several growing seasons they are preliminarily evaluated. The most promising varieties are selected out and subjected to appropriate conservation-use trials such as waterway protection, general ground cover, and soil building. Finally, those proving most satisfactory are placed under actual field trial with farmers in representative conservation-problem areas. Designed to further



Figure 171.—Section of nursery showing observational method of testing grasses for conservation uses.

determine environmental limitations, erosion-control efficiency, and crop values, such trials are simple and practical and conform to the prevailing local cropping system. Thus the farmer himself participates in the final evaluation.

Production Procedures

Ground preparation

A well-prepared seedbed is the nurseryman's first consideration in planning his season's operations. Since the production of nursery stock and seed represents an intensive form of crop culture, it is essential that the preparation of the soil be given much closer attention than would ordinarily be necessary in the production of most farm crops. Good tilth is highly important in nursery work, since the soil must be in a finely pulverized condition to assure close contact with the seed before germination, to facilitate emergence during germination, and to permit easy cultivation during the growing season.

Planting

Distance between rows is governed by the spacing which will give maximum production of usable seedlings per acre at the lowest cost per thousand. A row spacing of 21 to 27 inches usually will produce the maximum amount of usable stock of most species, at the lowest cost per thousand.

In general, the nature of the seed dormancy determines for all species the optimum time of sowing. Species having embryo dormancy, or a combination of embryo dormancy and impermeable seedcoat, respond either to fall sowing, which is sometimes preferable, or to stratification

followed by spring sowing. Species possessing only an impermeable seedcoat are preferably spring sown, following the prescribed pretreatment of rendering the seedcoat permeable. Species possessing no dormancy are preferably spring sown.

Small seed should be sown at less depth than large seed. Other important factors that enter into the depth of sowing are the texture of the soil and season of sowing. It is safe to sow at a greater depth in sandy than in fine-textured heavy soils, because of the comparative ease of seedling emergence. Fall-sown seed should be sown at twice the depth of spring-sown seed of the same species. The following rule has been used as a guide in gaging the depth to sow the seed: Sow all seed to a depth of three times the average diameter of the clean seed kernel but in no case less than one-fourth inch. This rule applies to all spring-sown seed in fine- to medium-textured soils regardless of whether ridging is practiced, and results in 0.5 inch or thereabouts as the sowing depth of a great many of the deciduous species.

Large-seeded species such as plum, apricot, honeylocust, and many others, which produce a sturdy vigorous growth immediately on germination, can normally be expected to show lower mortality during and immediately following germination than small-seeded species such as elm and mulberry. Seedlings from small-seeded species are normally very delicate during early life and heavy losses can occur quickly from soil crusting, heat, windburn, drought, and other causes.

One should first determine the germination percentage and the ultimate stand desired per lineal foot for each species. It is then possible to compute the number of seed to sow per lineal foot by the following formula:

$$N = \frac{100SR}{P}$$

wherein N =number of seed to sow per lineal foot;
 S =ultimate stand desired;
 P =germination percent of the seed; and
 R =sowing ratio.

For example, if a stand of 6 seedlings per lineal foot is selected as the optimum density for a particular species, and if the seed has a germination of 50 percent and the sowing ratio of 4 to 1, the formula then becomes

$$N = \frac{100 \times 6 \times 4}{50} = 48,$$

the number of seed to sow per lineal foot of drill. Given the number of seed per pound and the lineal feet of row per acre, a supplementary formula of value for expressing the number of seeds sown per foot of drill in pounds of seed needed per acre is

$$A = \frac{NF}{M}$$

wherein A =pounds of seed needed per acre;
 N =number of seed sown per foot of drill;
 M =number of thousands of seed per pound; and
 F =number of thousands of lineal feet of row per acre.

For example, if 48 seed are to be sown per lineal foot and the rows are to be 2 feet apart (21,780 lineal feet of row per acre) and there are 26,000 seed per pound, the formula becomes

$$A = \frac{48 \times 21.78}{26} = 40.2$$

pounds of seed needed per acre

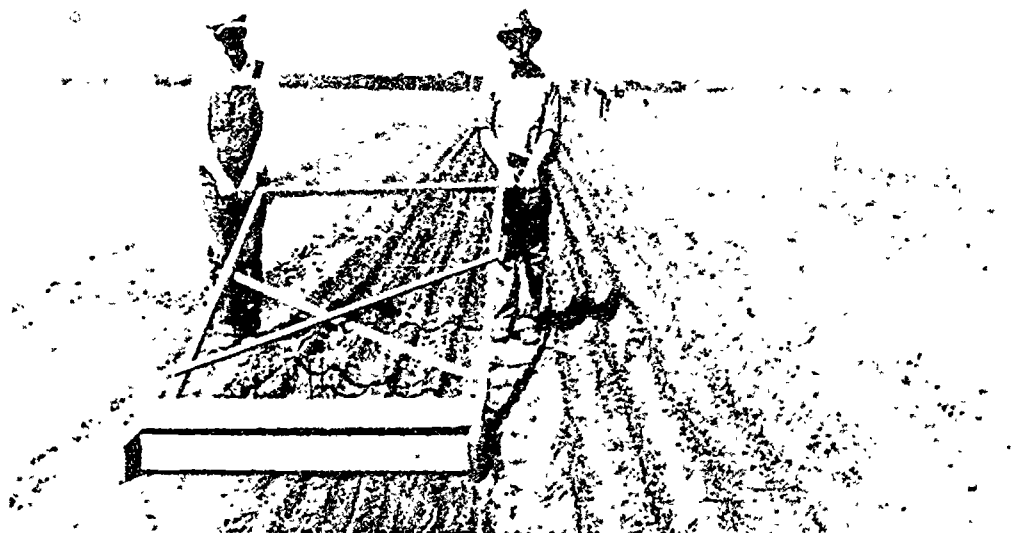
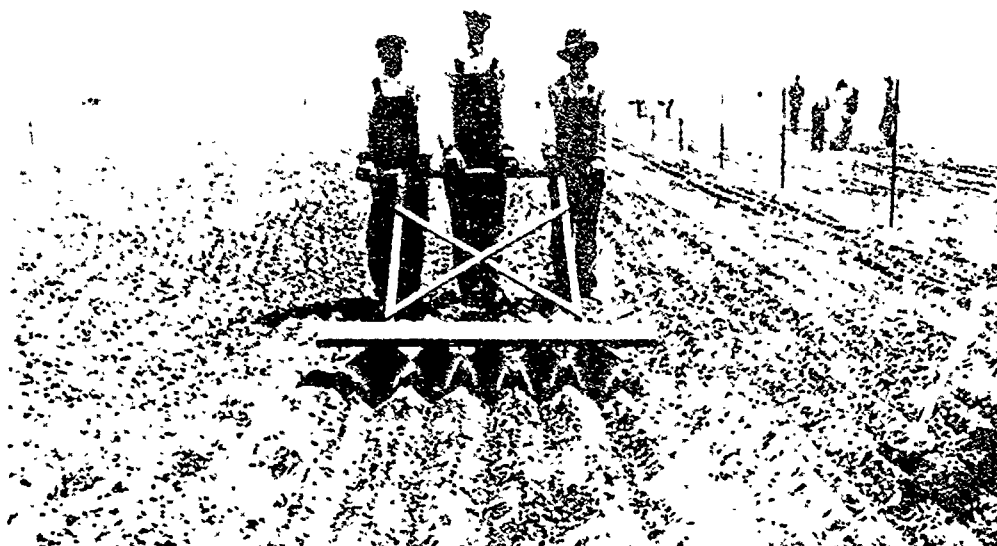

Figure 172.—Hand sowing green ash seed in narrow bands in rows spaced 10 inches apart. Top, Opening the furrows; center, sowing seed; bottom, covering seed.

If adequate seed supplies are available, the safest procedure is to sow heavily enough to obtain stands slightly in excess of optimum density and after the seedlings are well established to thin down to the desired final stand. This is especially desirable for certain species which are difficult to establish. Costs per thousand of growing seedlings are virtually in an inverse proportion to the percent of stand, that is, a 50-percent stocking will practically double the cost per thousand of that in a 100-percent stand. Therefore, the cost of the seed used in oversowing and of the labor involved in thinning is well justified within reasonable limits.

The method of sowing seed is secondary in importance to the factors of season, density, and depth of sowing. Emphasis should be placed on obtaining even distribution of seed and uniform depth of cover. With hard, dry seed of spherical or ovoid shape, uniform distribution can easily be assured by mechanical drill sowing. Not all species, however, lend themselves readily to machine sowing because of shape and size of seed, or pretreatment.

Because of the lack of a suitable mechanical sower, nurserymen have relied on hand sowing of some seed to get even distribution in the bands. This method (fig. 172) necessitates several operations, namely: opening the band or furrow, distributing the seed, covering, firming, and, in some cases, ridging the rows. In small nurseries, this hand method is fairly satisfactory, but it is obvious that in larger nurseries any mechanical method that will do all these operations at once will reduce sowing costs materially.

A number of seeding devices have been used with success in sowing hardwoods. For seed that can be sown mechanically, the best device is of a series of seed drills mounted on a frame and pulled by a tractor (fig. 173).

Regardless of method followed, careful sowing should be the objective rather than low initial costs, since in the final analysis sowing costs are a relatively small part of the cost per thousand of producing seedlings. A cheap job of sowing may be quite expensive in the long run if it results in low production.

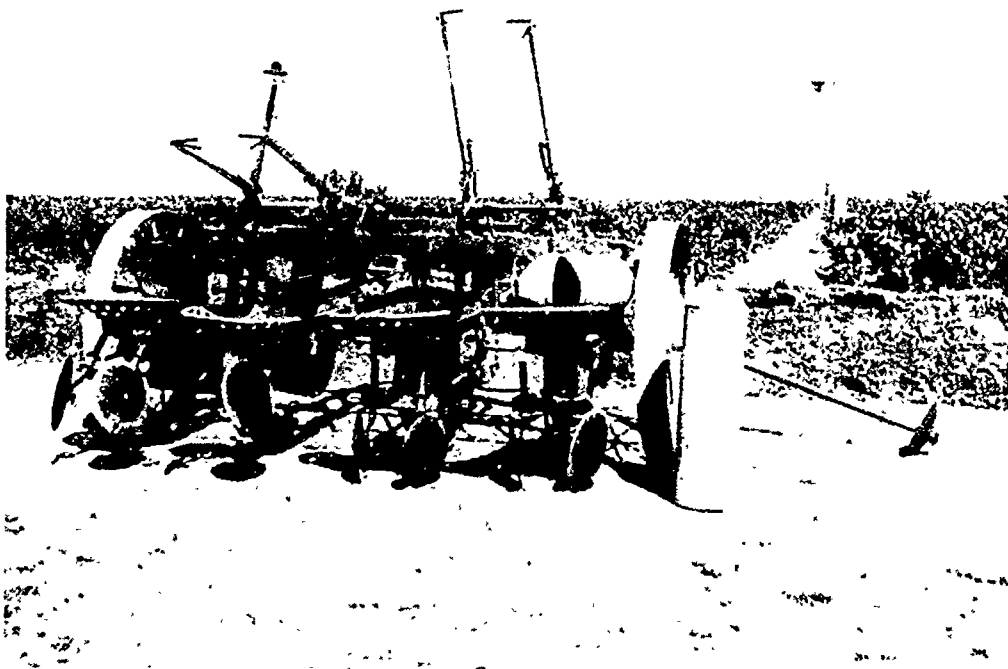

Figure 173.—Rear view of four-row mechanical seeder.

Care during germination

If the nursery soil is quite dry, it should be irrigated before rather than after sowing, in order to store up moisture in the soil for the germination period. Irrigation will ordinarily not be necessary during the germinating period if sufficient soil moisture is available at the time the seed are sown if proper cultural practices to conserve this moisture are followed, and provided prescribed practices are followed with respect to seed treatments to hasten germination. With overhead sprinklers the problem is simplified, but in heavy soils crusting and baking will occur following application of water. Furrow irrigation presents a greater problem, since an average of 2 to 3 inches is usually the minimum that can effectively be applied under this system in the best type of nursery soils. It is desirable, therefore, to follow practices that will insure successful germination of the seed without irrigation, especially where furrow irrigation is practiced later on.

Should it become necessary to irrigate during germination, the minimum amount of water needed to soak up the seed area should be applied. To avoid washing out the seed, the water should be applied immediately adjacent to the rows rather than flooded over them. The formation of pools and standing water in slight depressions should be avoided. It is helpful to have the rows ridged to mark their location and to prevent washing out of the seed.

Thinning

If the stand following germination and early establishment is overdense, it is good practice to remove the surplus seedlings. This will insure optimum development of the remaining seedlings and will in the end result in a higher total production of better quality stock.

Thinning should logically be done during one of the early weedings, or as soon as the seedlings have started to develop a woody stem. Prior to becoming woody, the seedlings are still susceptible to heavy losses from diseases and insects.

Insofar as possible, the smaller, weaker understory seedlings should be removed. The common method of reducing the stand density consists in pulling out the surplus seedlings by hand or cutting them out with knives or weeders. It is desirable to leave the remaining seedlings uniformly distributed over the entire seedling band.

Controlling size and quality of seedlings

After the seedling stand is established, the nurseryman's task is to focus his cultural activities on obtaining a large percentage of seedlings of optimum size and quality for field planting. In all cases, it is best to encourage full, unretarded growth during the first half of the season and to reserve the control measures for the latter half of the season. Otherwise the nurseryman may be faced with the necessity of forcing the seedlings in the latter part of the growing season, and so cause them to remain soft and succulent late in the fall and difficult to harden off properly. Such seedlings are more subject to injury from occasional early frosts, are more difficult to handle in storage, and are more subject to desiccation in drought periods, with consequent great reductions in survival.

Moisture regulation

With optimum stand density and soil fertility, control of growth becomes largely a matter of moisture regulation. If an abundant supply of soil moisture is well distributed throughout the season, growth will be fairly consistent and, barring early frosts, will continue until late in the fall. Under such circumstances, the top growth rate of the seedlings may materially decrease during the heat of the summer but it will increase again during the cooler early fall months. Therefore, for species that need to be retarded, irrigation may be discontinued.

Root pruning

Root pruning may be practiced to some extent on taprooted plants to hold back top development or change rooting habits. Summer root pruning is commonly practiced on walnut to force lateral root development. A cool, cloudy day is best for this operation. It should be followed immediately by irrigation. Eight to ten inches are the customary depth for this type of root pruning. The usual tool is a sharp U-blade tree digger with the lifter removed to prevent unnecessary disturbance of the seedlings.

Cultivation

Nursery stock requires intensive cultivation. This is done first to remove weed growth and to keep the soil in good physical condition, thus permitting aeration, normal bacterial action, and absorption of rainfall, and secondly to hold crusting and baking of the surface soil to a minimum.

Cultivating tools should not go deeper than 2 to 3 inches. Continuous deep cultivation, especially close to the rows, will sever the shallow spreading roots.

Timeliness in cultivation is important. Competing weed growth must be destroyed while it is in the seedling stage, preferably when it is less than 3 inches high. Excessive weed growth invariably makes cultivation more difficult and expensive and less effective, and will cause an unnecessary drain on soil moisture. Timeliness is also of major importance in improving the physical condition of the soil. To keep crusting, baking, or clodding at a minimum, the soil must be cultivated after each heavy rain or following every irrigation, as soon as it is dry enough so that the upper 1 or 2 inches can be brought into a fine, mealy, or crumb condition.

Irrigation

The frequency of irrigation and amount of water needed depends on available rainfall, soil type, growth habits of the species concerned, stand density, and size of stock desired. Climatic factors such as temperature, wind velocity, and humidity are also important. Without exception, irrigation should be tapered off in late summer and early fall to the minimum quantity needed to keep the trees from actual drought injury.

Hardening off

When fall rains are not too heavy, moisture control, in the form of holding off all irrigation, is the common method of hardening off nursery

stock. All cultivation and irrigation should generally be tapered off after midsummer and usually should cease entirely from a month to 6 weeks in advance of the average killing frost, the time depending somewhat on the water-retaining capacity of the soil and on the size of the stock. A gradual depletion of the soil moisture will bring about the hardening of the seedling tissues and cause cessation of growth. In this condition seedlings can withstand fairly severe frosts without having the tops killed back.

Propagation in beds

The nursery methods detailed on the preceding pages, involving propagation from seed, without shade, in rows from 18 to 40 inches apart, will serve for most deciduous species. There are many species, however, which require shade. A number of species, particularly conifers, make very slow growth the first year, and because of their small size require rather careful handling during the entire first season. These are grown in beds 1 to 3 years prior to field plantings.

Beds may be of any convenient length, but a width of 4 feet is recommended as facilitating shading and weeding. Drilled rows or narrow bands spaced 6 to 12 inches apart and running lengthwise of the bed are preferred. Broadcast sowing is an alternative method.

The desired practice is to so regulate seeding, thinning, and other cultural operations as to produce strong, stocky plants. Grown in this manner, the plants are allowed to remain in the bed until planted to a permanent site. In the case of overcrowding in the seedbed, however, the seedlings should be transplanted 2 to 3 inches apart in field rows and grown for 1 to 3 years previous to utilization.

Digging and grading

If the soil is quite dry, it is considered good practice to irrigate the trees from 1 to 3 days in advance to put the soil in best condition for digging and to prevent the stripping of roots. Such irrigation is especially necessary on heavy soils.

Digging practice and equipment.—Dormant seedlings may be dug with safety at any time during the fall or spring. If lifting is delayed until just before planting, the seedling is exposed to less danger than if it is dug earlier and held in storage during the winter months; but on the other hand, digging delayed until spring demands quick work, since seedlings do not long remain dormant after warm weather sets in. In practice, most nursery stock is dug during the fall months after the stock has become dormant.

Fall digging is preferable because it allows the seedlings to be graded, counted, and assembled ready for delivery as soon as weather conditions permit planting. In addition, it clears the land for the next crop, thus permitting ground preparation and fall sowing of certain species.

The most desirable mechanical digger for row-grown stock is the 18-inch tree-type digger on a wheel chassis. The wheel-chassis type has proved more satisfactory than the straight-beam type since the proper depth of undercutting can be more uniformly maintained. For bed-digging, a tractor-drawn, 5-foot blade, cutting to an 8-inch depth, is most satisfactory.

Grading technique.—Grading the stock in the field and selecting only the usable seedlings greatly simplifies and speeds up the entire operation and dispenses with double handling of the stock. Another practice is

to place the seedlings in a storage building immediately after pulling, and to perform all subsequent operations under cover with a few specially trained men when time is available.

A relatively low top-to-root ratio has long been regarded as a very important criterion in selecting conifer-planting stock. Top-to-root ratio, as used by nurserymen, indicates the "balance" of a seedling, the relation of the weight of the entire top including foliage to the roots.

The best conifer-planting stock usually has ratios of 1 to 1 up to 3 to 1. Stock with higher values than 3 to 1 does not usually survive so well in the field, although this figure will differ somewhat by species and depends on the total weight and caliper of the plant. Poorer survival in stock with a high top-root ratio is partially attributed to the relatively large transpiration area in proportion to the absorbing area of the roots and the consequent difficulty in supplying adequate moisture for the plant under stress.

Because caliper of stem is considered the best and most practical basis of grading deciduous nursery stock, the nurseryman should instruct and train his field graders as to the caliper specifications for each species. In case only one plantable grade (includes premium and marginal sizes) is considered for field planting, the process is very simple, and the men can easily learn to estimate the desired caliper.

In summary, it might be said that stocky, sturdy seedlings of good caliper are much preferred to tall spindling stock of poor caliper.

Winter Storage of Nursery Stock

Fall-dug nursery stock which is not immediately planted must be stored over winter to hold it in readiness for spring planting. The two methods of storage commonly used are inside storage and heel-in or outside storage.

Inside storage

Inside storage is of chief advantage to nurseries which use the winter months for grading and assembling orders, since it affords ready access to the stock at any time during the storage season. The essentials of a nursery-stock storage building are adequate rack and working space and proper insulation and construction for the control of temperature, humidity, and aeration.

Temperatures in the storage building should be near freezing to hold the seedlings dormant for many months. A temperature range from 34° to 38° F. is most satisfactory, and even 30° may be permitted if the stock is well covered with packing material. In addition to holding the stock dormant, low temperatures reduce the rate of respiration and keep fungi inactive. In a well-insulated building desired temperatures are readily maintained by correct ventilation techniques. During spring and fall months the temperatures in the storage sheds may be reduced by opening ventilators at night, or whenever outside temperatures are below those inside, and closing them when the opposite condition exists. In milder winter days when it may be necessary to raise the temperatures occasionally, the ventilators should be opened during the day when outside temperature is above freezing, and closed at night.

The best humidity for stock storage is 85 to 90 percent. If lower than 85 is permitted, the stock may shrivel, and if above 90, molds and other storage diseases may spread. Proper moisture content is best maintained



Figure 174.—Outside storage in heel-in beds.

by relative humidity of the air rather than by contact with moist packing material. Humidity can be reduced by opening of ventilators or increased by sprinkling the walls and floors with water.

Although it is not necessary to pack the roots where the storage humidity is properly maintained, they should be protected with a light covering of shingletow or sphagnum moss as a safeguard against fluctuation of temperature and, to some extent, variation in humidity. If the packing material is soaked in water and then allowed to drain before using, it will retain sufficient moisture to make frequent sprinkling unnecessary in a storage shed where a proper range of humidity is maintained.

Outside storage

Outside heel-in conditions vary widely as between warm and cold climates. In the warmer sections, the ground seldom remains frozen for any great length of time and heel-in beds may be opened and stock heeled in or removed as needed, with very little delay because of frozen ground. In the colder locations, where the ground remains frozen over winter, the stock must be heeled in before the ground freezes and remain in beds until the spring thaw.

The essentials of a satisfactory heel-in site are (1) sandy soil, (2) adequate drainage, (3) ready accessibility to an all-weather road, (4) convenience to a warehouse suitable for assembling orders and packing out stock for planting (fig. 174).

Where freezing and thawing alternate and drying winds commonly occur during the winter months, the beds can be covered with straw in late fall to protect the ground from freezing and will give access to the stock at all times.

Grass and Legume Seed Production

The production of grass and legume seed for conservation plantings requires the same degree of skill and cultural technique as the growing

of woody stock. The first requisite is pure, high quality seed of adapted varieties, obtained through observational studies previously described. Seed supplies should be free of all weed seeds especially noxious species.

Good, well-drained soil and a well-prepared seedbed also are essential preplanting requisites. Where furrow irrigation is practiced, the land must be carefully leveled so as to properly control the water and lessen the expense of application. The more easily the soil washes, the more necessary it is to restrict the grade and the head of water. To insure even water distribution and adequate moisture penetration, a slope of less than 0.40 percent is advisable. Where practical, preplanting cultural treatment that assists in the elimination of weeds also is desirable.

The method of planting depends greatly on the species. For grasses, row planting with a spacing of 24 to 42 inches between rows has been found most generally satisfactory. This gives more room for normal vegetative growth and facilitates cultivation.

The rate of seeding differs with the variety, germination percentage, and seed purity as well as with the method of planting. The row method requires less seed than the broadcast method. All of these factors should be taken into consideration in deciding upon the quantity of seed to sow per acre. In general, enough seed should be used to obtain a good stand without undue crowding.

Warm-season grasses and legumes usually are planted in the spring after danger of frost is over and the ground is thoroughly warmed up. If the plantings are made too early emergence during cool weather will be slow. The planting of cool-season species is delayed until late summer to fall.

Plantings can be made by using a grain drill with a sufficient number of the seed holes plugged to give adequate row spacing. However, a tractor-mounted disk-opener type of planter is desirable if the seed is to be placed in moist soil at sufficient depth to emerge with preirrigation moisture only. The Planet Junior or similar garden-type seeder also is satisfactory especially with small-seeded species, since it can be regulated to accommodate the size of the seed and depth of planting.

Adequate water at the time it is needed is a prime consideration in production. It is important not only to have a good, deep, moisture supply when growth starts but to maintain good soil moisture throughout the growing season. Therefore, where rainfall is not sufficient, irrigation must be practiced preceding and after planting. The frequency of irrigation and the amount of water applied vary with the soil, species, and season of planting. The critical period is during seedling establishment when it may be necessary to irrigate at 1- to 3-day intervals. Afterward the intervals between irrigations are lengthened in accordance with local soil and weather conditions and the demand of the species. It is important to continue irrigation until the plants have finished blooming and set the seed crop.

Cultivation must be often and thorough enough to completely control weed growth. This is particularly necessary with summer-growing species. Every field contains seeds of annual weeds. Unless carefully watched, they grow rapidly enough to smother out perennials and contaminate the seed crop. To insure clean seeds, cultivation must be continued after the summer seed harvest and as often as needed during succeeding years to prevent weeds growing to maturity. Where grasses have underground creeping root stalks, cultivation is further necessary to prevent formation of solid stands.

Associated with cultivation is the application of fertilizer. Few soils are sufficiently fertile to produce satisfactory seed yields without fertiliza-

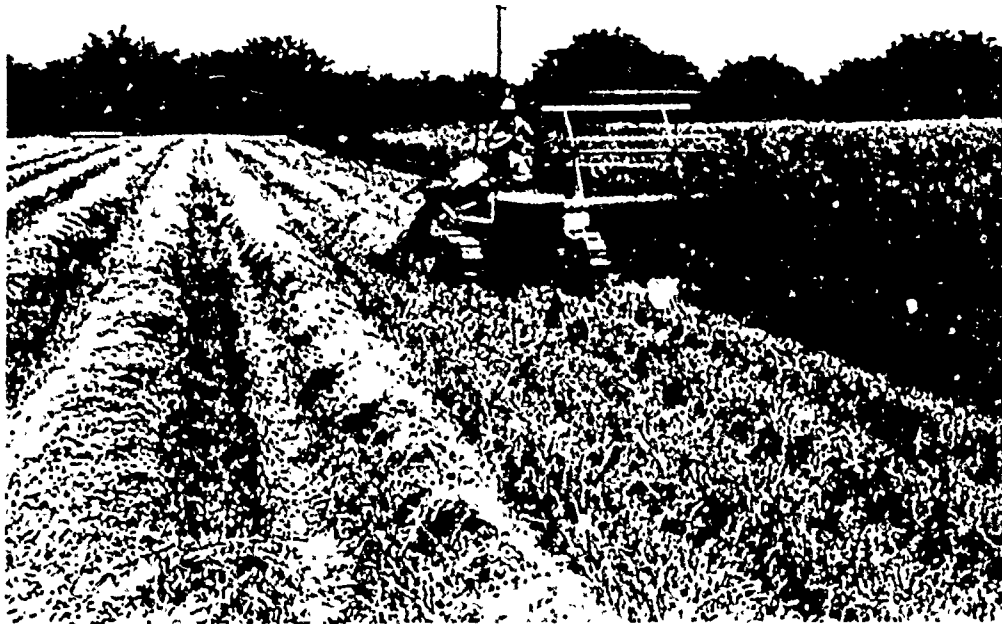

Figure 175.—Nursery field of Harding grass for seed production. Grass is swathed by use of grain binder with binding attachment removed. After drying, the seed is threshed.

tion. It has been found generally that grasses respond best to fertilizers high in nitrogen and legumes to fertilizers high in phosphates. The quantities applied depend upon local soil conditions. Legumes often require inoculation as well.

To prevent undue shattering, the seed crop should be watched carefully and harvested as soon as it matures. There is a period of a week to 10 days during which the seed of most species is in best condition to be harvested. Depending on the species, combines or binders are largely used as harvesting machinery (fig. 175). The threshed material from the combine usually must be spread out and kept stirred two or three times a day until it is dry throughout. Heating and spoilage will occur if the seed is not well aerated. When it has been thoroughly dried, it is cleaned in a fanning mill and then placed in dry storage.

Since 1961 when the Peace Corps was created, more than 80,000 U.S. citizens have served as Volunteers in developing countries, living and working among the people of the Third World as colleagues and co-workers. Today 6000 PCVs are involved in programs designed to help strengthen local capacity to address such fundamental concerns as food production, water supply, energy development, nutrition and health education and reforestation.

Peace Corps overseas offices:

<u>BELIZE</u> P.O. Box 487 Belize City	<u>ECUADOR</u> Casilla 635-A Quito	<u>MALI</u> BP 85 Box 564	<u>SOLOMON ISLANDS</u> P.O. Box 547 Honiara
<u>BENIN</u> BP 971 Cotonou	<u>FIJI</u> P.O. Box 1094 Suva	<u>MAURITANIA</u> BP 222 Mouakchott	<u>SRI LANKA</u> 50/5 Siripa Road Colombo 5, Sri Lanka
<u>BOTSWANA</u> P.O. Box 93 Gaborone	<u>GABON</u> BP 2098 Libreville	<u>MICRONESIA</u> P.O. Box 9 Kolonja, Ponape F.S.M. 96941	<u>SUDAN</u> Djodi Deutsch Administrator/PCV's c/o American Embassy Khartoum
<u>BURKINA FASO</u> BP 537-Samandin Ouagadougou	<u>GAMBIA, The</u> P.O. Box 582 Banjul	<u>MOROCCO</u> 1, Zanquat Benzerte Rabat	<u>SWAZILAND</u> P.O. Box 362 Mbabane
<u>BURUNDI</u> c/o American Embassy Bujumbura	<u>GHANA</u> P.O. Box 5796 Accra (North)	<u>NEPAL</u> P.O. Box 613 Kathmandu	<u>TANZANIA</u> Box 9123 Dar es Salaam
<u>CAMEROON</u> BP 817 Yaounde	<u>GUATEMALA</u> 6a Avenida 1-46 Zona 2 Guatemala	<u>NIGER</u> BP 10537 Niamey	<u>THAILAND</u> 42 Soi Somprasong 2 Petchauri Road Bangkok 4
<u>CENTRAL AFRICAN REPUBLIC</u> BP 1080 Bangui	<u>HAITI</u> c/o American Embassy Port-au-Prince	<u>PAPUA NEW GUINEA</u> P.O. Box 1790 Boroko Port Moresby	<u>TOGO</u> BP 3194 Lome
<u>COSTA RICA</u> Apartado Postal 1266 San Jose	<u>HONDURAS</u> Apartado Postal C-51 Tegucigalpa	<u>PARAGUAY</u> c/o American Embassy Asuncion	<u>TONGA</u> BP 147 Nuku'alofa
<u>DOMINICAN REPUBLIC</u> Apartado Postal 1412 Santo Domingo	<u>JAMAICA</u> Musgrove Avenue Kingston 10	<u>PHILIPPINES</u> P.O. Box 7013 Manila	<u>TUNISIA</u> BP 96 1002 Tunis- Belvedere Tunis
<u>EASTERN CARIBBEAN</u> Including: Antigua, Barbados, Grenada, Montserrat, St. Kitts-Nevis, St. Lucia, St. Vincent, Dominica "Erin Court" Bishops Court Hill P.O. Box 696-C Bridgetown, Barbados	<u>KENYA</u> P.O. Box 30518 Nairobi	<u>RWANDA</u> c/o American Embassy Kigali	<u>WESTERN SAMOA</u> Private Mail Bag Apia
	<u>LESOTHO</u> P.O. Box 554 Maseru	<u>SENEGAL</u> BP 254 Dakar	<u>YEMEN</u> P.O. Box 1151 Sana'a
	<u>LIBERIA</u> Box 707 Monrovia	<u>SEYCHELLES</u> BP 697 Victoria	<u>ZAIRE</u> BP 697 Kinshasa
	<u>MALAWI</u> Box 208 Lilongwe	<u>SIERRA LEONE</u> Private Mail Bag Freetown	