

DOCUMENT RESUME

ED 307 482

CE 052 609

AUTHOR Mahaffey, George; And Others  
 TITLE Forestry Training Manual for Africa Region U.S. Peace Corps. Training for Development. Peace Corps Information Collection & Exchange Training Manual No. T-14.  
 INSTITUTION Peace Corps, Washington, DC. Information Collection and Exchange Div.  
 PUB DATE Jan 84  
 NOTE 401p.  
 PUB TYPE Guides - Classroom Use - Guides (For Teachers) (052)

EDRS PRICE MF01/PC17 Plus Postage.  
 DESCRIPTORS Community Education; Competence; Competency Based Education; Course Content; Course Organization; \*Developing Nations; Foreign Countries; Forestry Aides; \*Forestry Occupations; Horticulture; Lesson Plans; Natural Resources; Postsecondary Education; Soil Conservation; Soil Science; Teaching Methods; Trees; Visual Aids; Volunteers; \*Volunteer Training  
 IDENTIFIERS \*Africa; Peace Corps

ABSTRACT

This manual is a state-side forestry teaching guide, complete with exercises, for the training of prospective Peace Corps volunteers who will serve in various African countries. The modular format lends itself to both single-country and multicountry forestry training. The first part of the guide contains instructions to the trainer on conducting the program, based on a field test conducted in Arizona in 1982. Included in this section are an overview of the training program, tips on conducting the program, and ideas on presenting the sessions, as well as information on how the sessions fit together. The second part of the guide contains the 50 sessions of the training program. Sessions cover both the technical content of forestry and information on group processes and teaching methods for the volunteers to use in teaching forestry to persons in their host countries. The format of each session includes time allotment, goals, overview, exercise(s), list of materials needed, procedures and activities, and trainer's notes. (KC)

\*\*\*\*\*  
 \* Reproductions supplied by EDRS are the best that can be made \*  
 \* from the original document. \*  
 \*\*\*\*\*

## INFORMATION COLLECTION & EXCHANGE

Peace Corps' Information Collection & Exchange (ICE) was established so that the strategies and technologies developed by Peace Corps Volunteers, their co-workers, and their counterparts could be made available to the wide range of development organizations and individual workers who might find them useful. Training guides, curricula, lesson plans, project reports, manuals and other Peace Corps-generated materials developed in the field are collected and reviewed. Some are reprinted "as is"; others provide a source of field based information for the production of manuals or for research in particular program areas. Materials that you submit to the Information Collection & Exchange thus become part of the Peace Corps' larger contribution to development.

Information about ICE publications and services is available through:

Peace Corps  
Information Collection & Exchange  
Office of Program Development  
806 Connecticut Avenue, N.W.  
Washington, D.C. 20526



Add your experience to the ICE Resource Center. Send materials that you've prepared so that we can share them with others working in the development field. Your technical insights serve as the basis for the generation of ICE manuals, reprints and resource packets, and also ensure that ICE is providing the most updated, innovative problem-solving techniques and information available to you and your fellow development workers.

# Peace Corps

FORESTRY TRAINING MANUAL FOR  
AFRICA REGION  
U.S. PEACE CORPS

Prepared by  
George Mahaffey, Jacob Fillon & Julius Weeks

of the

FORESTRY/NATURAL RESOURCE CONSERVATION SECTOR  
OFFICE OF TRAINING & PROGRAM SUPPORT

P E A C E C O R P S

through the

PEACE CORPS/USAID FORESTRY INITIATIVE  
PARTICIPATING AGENCY SERVICE AGREEMENT

January 1984

Printed By:  
PEACE CORPS  
Information Collection and Exchange  
September 1985

## ACKNOWLEDGEMENTS

We wish to acknowledge the contributions of many people to the development of this Africa Region Forestry Training Manual. The initial research for this manual began May of 1982, with a meeting between Bruce Burwell, Technical Forester, Reginald Petty, Peace Corps/Kenya Country Director, and Ken Barber, Associate Peace Corps Director for Forestry in Senegal. At this meeting, the needs assessments and task analysis were reviewed. In addition, Bruce interviewed Forestry Volunteers in the field in both Senegal and Kenya, as well as Peace Corps staff members and ministry officials of each country concerned with their national forestry programs.

The initial design for this manual was field tested in July/August 1982, at the University of Arizona Conference Center in Oracle, Arizona with Peace Corps Forestry Trainees for Kenya and Senegal. Our special thanks to Dr. Zube and his staff of the University's Department of Renewable Resources, particularly Carol Wakely, for all their help and guidance. We also want to thank Beth Suit, Director of the University of Arizona Conference Center, and her staff, especially Georgia McKay, for their cooperation and concern.

We appreciate the support of Wayne White and Deborah Huerta, U.S. Forest Service, Rocky Mountain Station, for all their help in arranging the interagency agreement connected with this project. Special thanks to Val Mezainis, former Deputy Director, OPTC, Peace Corps and Diane Hedgecock for their time and support of the program. We would also like to acknowledge Dr. David Cleveland for arranging access to the University of Arizona resources and for his continued interest and support of the training program.

Very special thanks are due to the Papago Tribe for their cooperation in making the field trip a success. We would like to thank Max Norris, the Tribal Chairman, for his assistance. Many thanks to David Muturi of Kenya for spending a great deal of time with us in Arizona and sharing his knowledge and expertise.

Last, but not least, we acknowledge the trainees who were the participants in the field testing of this design at Oracle, Arizona.

This Africa Region Pre-service Training Manual was developed by Joan Bordman, Training Design Consultant, Bruce Burwell, Technical Forester, and Steven Joyce, Training Administrator. Substantial review and revision input came from George Mahaffey, Peace Corps Forestry Program Manager on detail from the National Park Service, Pat Riley, Mary Risser and Jacob Fillion who reviewed and edited the manual and Julius Weeks who was responsible for the production of the manual.

## TABLE OF CONTENTS

ACKNOWLEDGEMENTS	i
TABLE OF CONTENTS	iii
TRAINEE GUIDELINES	xi
TRAINING PROGRAM OVERVIEW	1
Training Program Goals	3
Advance Information	4
Library Reference Materials	4
List of Reference Materials	5
Training Site	8
Planning the Field Trip	9
Tree Planting Site	10
Soil Erosion Site	11
Transportation	11
Materials	11
Medical	12
Unexpected Resources	12
CONDUCTING THE TRAINING PROGRAM	13
Timing	13
Location	13
Group Size	13
Trainers/Facilitators	13
Sessions	14
Materials	14
Journals	14
Sharing	15
Staff Meetings	15
PRESENTING THE SESSIONS	15
Format	15
Review/Study the Training Program Guidelines	16
Adding to the Given Design	17
Sequence for Session/Exercise	17
WORDS ABOUT TRANSITION	17

### SESSIONS

Session 1	Welcome, Expectations, and Evaluation Criteria	19
Session 2	Special Projects	30
Session 3	The Forests of the World, Peace Corps' Forestry Goals, the Individual Volunteer's Role	39
Session 4	Record Keeping - Group Process	46
Session 5	Video Tapes	51

Session 6	Agro-Forestry Collection Data	53
Session 7	Feedback	57
Session 8	Flowers, Seeds, the Beginnings	62
Session 9	Nutrition	70
Session 10	Non-Verbal Communication	75
Session 11	Germination	80
Session 12	Coping Skills	83
Session 13	Basic Site Selection, Planning and Layout of a Nursery	87
Session 14	Review of Trainees' Nursery Plan	93
Session 15	Communication Through Illustrations	103
Session 16	Soil Preparation, Seedbed Sowing	107
Session 17	Individual Interviews	112
Session 18	Reproduction by Clippings and Nursery Review	114
Session 19	Introduction to Extension	121
Session 20	Protection and Record Keeping (Insect Collection)	127
Session 20A	Chicken Preparation	137
Session 21	The Volunteer's Role as an Extensionist	140
Session 22	Tropical Horticulture: Care, Tending and Disease Control	147
Session 23	Women in Development - Part I	148
Session 24	Team Building	150
Session 25	Building and Using a Rustic Transit	153
Session 26	Women in Development - Part II	161
Session 27	Working with Groups as an Extension Worker	166
Session 28	Trees: Identification and Planting	173

Session 29	Lesson Plans and Use of Visual Aids in Teaching	183
Session 30	The Ugly American	197
Session 31	Catchments - Sowing of Seedlings into Catchments	216
Session 32	Weekly Interview	220
Session 33	Agro-forestry	221
Session 34	Community Analysis Introduction	232
Session 35	Soils	232
Session 36	Community Analysis	250
Session 37	Irrigation	252
Session 38	Review of Expectations - Mid-Way	259
Session 39	Problem Analysis	261
Session 40	Soil Erosion	265
Session 41	Species Report - Research Demonstration	274
Session 42	Cultural Values	289
Session 43	Wellbeing	293
Session 44	Field Trip Overview	297
Session 45	Agro-forestry	302
Session 46	Weekly Interview	321
Session 47	Field Trip	322
Session 48	Pesticides	323
Session 49	Review of Field Trip	325
Session 50	Resources	328
Session 51	Area Measurement, Pacing, Compass Use	336
Session 52	Compost Heap - Greenhouse Construction - Germination Percentage	351
Session 53	Culture Shock	364

Session 54	Range Management	369
Session 55	Grafting and Fruit Trees	370
Session 56	Professional Approaches to Interaction with Host Country Officials	374
Session 57	Project Planning: Goal Setting	377
Session 58	Final Interviews	380
Session 59	Ecology Teams Presentations	381
Session 60	Graduation	382



ARTICLES, CLIPPINGS, VOLUNTEERS' PROJECTS/REPORTS

Sample Special Report	37
PCV Nursery Report	97
Power In The Willow	116
Rustic Transit	155
Why Organize Groups	168
Variables to Risk Taking	170
Tree Identification	182
Lesson Plan	187
Innovative Ways of Learning	187
Conservation Education	190
Guide for Making a Slide Show	193
The Ugly American	200
The Bent Backs of Chang'Dong	211
Agro-forestry	223
Soils: Principles and Definitions	234
Physical and Chemical Factors Influencing Plant Growth	240
Things to Know when Watering	254
Irrigation Systems	255
Possible Problems for Analysis	264
Erosion Control	267
Watershed Management	270
Species Reports	
<u>Acacia mearnsii</u> De Wild	276
<u>Acacia albida</u>	277
<u>Acacia radiana</u>	278
<u>Acacia scorpioides</u>	281
<u>Pinus radiata</u> D. Don	283
Research Demonstration	286
Handling Stress	295
GOAGOA-Agro-forestry Development Project Proposal	305
Agri-Silva Culture Project Proposal	309
Multi-Purpose Agro-forestry System	318
Development	331
The 30 Day "Hot" Compost System	353
Determining Percent Germination	360
Fruit Trees and Forestry (Grafting/Pruning)	372
Role Plays	376

ILLUSTRATIONS/CHARTS/TABLES/GRAPHS

Flowering Cycle/Seed Maturity (Fig. 1)	64
Nursery Layout (Fig. 2)	99
Nursery Fact Sheet (Tables 1, 2, 3)	100,101,102
Sample Illustration (Fig. 3)	105
Insect Collection (Fig. 4, 5, 6, 7)	133
Rustic Transit Measurements (Fig. 8, 9, 10 11, 12, 13, 14)	156,157,158, 159,160
Tree Planting (Fig. 15, 16, 17, 18, 19, 20)	176 - 181
Catchment Types (Fig. 21, 22, 23)	218
Chart: Irrigation (Table 4)	242
Chart: Crop Tolerance of Soil Salinity (Table 5)	244
Chart: Crop Tolerance of Exchangable Sodium Percentage Table 6)	247
Chart: Crop Reduction in Relation to Exchangable Sodium Percentage (Table 7)	247
Flood Irrigation (Figure 23)	255
Furrow Irrigation (Figure 24)	256
Surface Irrigation (Fig. 25)	256
Water Catchments (Fig. 26)	256,257
Pitcher Irrigation (Fig. 27)	258
Gradonis (Fig. 28)	271
Intermittent Terraces (Fig. 29)	271
Intermittent Bench Terraces (Fig. 30)	272
Parabolic Shaped Bow (Fig. 31)	272
Agro-forestry Plot Layout I (Fig. 32)	304
Agro-forestry Plot Layout II (Fig. 33)	315
Pacing Illustrations (Fig. 34, 35, 36, 37)	338,339
Compass Types (Fig. 38, 39, 40, 41, 42)	342 - 344
Area Traverse (Fig. 43)	346
Area Calculation (Fig. 44, 45, 46)	348,349
Graph: Turning the Compost Heap (Fig. 47)	354
Blueprint for Greenhouse Construction (Fig.48,48,50)	356,358
Chart: Percent Germination (Table 51,52)	361,362
Culture Shock Flow Chart (Fig. 53)	367

# FORESTRY TRAINING MANUAL FOR AFRICA REGION

## TRAINER GUIDELINES

This manual has been developed as a state-side forestry training guide, complete with exercises, for the training of prospective Peace Corps Volunteers who will serve in various African countries. This module or design lends itself to both single-country and multi-country forestry training.

Two methods were used to collect information for the Africa-specific content of the training program. Peace Corps staff in Senegal (West Africa) and Kenya (East Africa) provided the design team with needs assessments for forestry training in their respective countries. In addition, the technical trainer visited both countries and did active research on the various tasks involved in Forestry Volunteers' extensionist roles. He also did extensive videotaping of Volunteers, their sites, trees, forest nurseries and community settings.

Combining information from the two countries' needs assessments, the trainer's active research, including videotapes, and the body of data about technical forestry skills and practices, a task analysis for the training program was developed. A list of objectives for training was derived from this task analysis, and a six-week training model designed to meet the objectives. The format and many of the exercises used in this model are patterned after the Forestry Training Manual for the Inter-America Region, which in turn drew from materials developed for other training manuals produced by the Office of Program Development, with special attention to integrating the Core Curriculum Materials.

Each session of this training program builds from the one(s) preceding it, and toward the one(s) which follow, making for smooth linkages between sessions. With minor modifications, however, sessions may be used independently, or in some cases deleted from the design.

Suggestions for location, timing and administration of the training program are drawn from experience gained during a pilot program conducted in July and August of 1982, in Oracle, Arizona. While the constraints of your setting and the availability of resources may require some modifications of these guidelines, we suggest that special consideration be given to each of the above categories, so that the training program may offer the greatest benefit to potential Forestry Volunteers.

An effort has been made to purge the instructions and materials of excessive training jargon; some, however, remains. Trainers may want to further modify the training language if it gets in the way of communicating with participants. It is hoped that the language, the instructions and the trainer's notes provided in this manual will facilitate both the trainers' presentations and the trainees' learnings in a forestry training program.

## TRAINING PROGRAM OVERVIEW

The general purpose of this training program is to prepare potential Peace Corps Forestry Volunteers for service in Africa. It includes cross cultural as well as technical training to insure that trainees will not only be competent in their technical abilities but have confidence in their ability to transfer skills after placement in country. The training is experiential and gives practice time for skill building. Because of the fact that most Forestry Volunteers will be doing extension work after placement, we recognized the need to train in areas of communication, cultural awareness, and community development as part of the Volunteer role.

The participants do not always see the value of the communications, cultural awareness and community analysis (which they perceive as sociology) exercises. We went through difficult times in the pilot training program getting the trainees to understand the concept of extension work and the skills necessary to be effective extension Volunteers. To have technical skills alone is unsatisfactory; the ability to transfer these skills is a necessary prerequisite for the extension Volunteer. Discomfort with exploring feelings associated with human interaction and resistance to learning interaction skills are, for the most part, due to a lack of awareness rather than insensitivity to the needs of the prospective host country on the part of the trainees.

The introduction to practical forestry technology starts with the establishment of a nursery that the trainees complete on the training site. Practice in tree handling, transporting and planting are part of the technical training. The trainees learn how to pace, make catchments and transplant trees. They are responsible for special projects such as, rustic transit assembling, planning and implementing irrigation systems, compost heap start-up and vegetable gardening. They then pass along the skill they have learned to the other trainees. In the technical aspects of training, the participants conduct research and prepare reports on agro-forestry and ecology concerns. They conduct interviews with local people and practice extension techniques. At the end of the training all reports and write-ups are made into a forestry handbook called the "Trainees' Manual" for use by participants during their Peace Corps service.

Starting almost immediately, and throughout the period of training, the participants conduct some sessions or parts of sessions and are responsible for content and delivery of certain exercises, i.e., making a diameter tape, lesson plans, insect collection, etc. This provides the trainees with experience in making presentations, skill transference and assuming responsibility as extensionists.

A week long field trip is conducted during the fifth week of training. The purpose of this field trip is to give the trainees practice in forestry extension using techniques discussed in the training exercises. In our pilot training program, this was accomplished by visiting the Papago Indian Reservation for several days. While on the reservation, the trainees talked with the Indians, helped plant trees, taught children to plant trees and told people where trees were available should they want to plan more. During the field trip they also went to a citrus nursery for instruction in budding and grafting. In addition, the trainees visited a desert museum to see the ecological displays and were given a tour of the Arboretum in Superior, Arizona. During and after field exercises, the trainees discussed their observations and tried to anticipate conditions at their Peace Corps sites in Africa.

During week six, emphasis is placed upon the technical planning which will be undertaken by the Volunteer at his/her work site. Attention is also focused on culture shock and communicating with counterparts and host country officials through the use of role plays, simulations, skits and report writing.

In implementing the sequences of technical and interaction training, it is important that the participants understand that the initial review of the technical aspects of forestry will be new to some of the trainees. For those who are knowledgeable in the technical components of forestry, the program provides an opportunity to help others understand and practice transferring skills.

The identification and development of technical and interreaction skills and areas of personal growth will be useful in the participants' role as Peace Corps Volunteers. The identification of areas of accomplishments are also used in the process. Consideration of topics such as the "Role of the Peace Corps Volunteer in Forestry Extension Work" and "The Role of the Volunteer in Development" stimulates thoughts that could find practical application in the Volunteers' work.

As a special project, one of the trainees conducts a language lesson every day. These lessons are not intended to make trainees proficient in a language but rather to alleviate some of the anxieties that many trainees have about learning a language. Additionally, the trainees practice traditional greetings both upon meeting someone and at departure. The training staff models this behavior from the first day of training.

Finally, the participants are made aware from the first session that they are responsible for their own learnings. What we have done in this training program is to provide the opportunity for their educational enhancement. It is not possible to develop a training program specific to every site where Volunteers will be placed in Africa, and it is therefore up to

the trainee to gather as much data as possible about his/her prospective host country and work site. It is hoped that this will help make each participant's learning specific for his/her own use.

### TRAINING PROGRAM GOALS

The design of the state-side training program for the Africa Region is such that upon completion, the Peace Corps Trainee will have been provided technical information, knowledge and skills development which will facilitate productive and satisfying Peace Corps Volunteer service. Specific training program goals are:

1. To enable the trainees to recognize their skills and feel competent in the use of these skills,
2. To enable the trainees to know how to transfer the technical skills that they have,
3. To identify areas for skill building and to improve those skills,
4. To enable the trainees to understand their role in host country and as Peace Corps Volunteers,
5. To help the trainees identify resources available to them and know how to find resources in their community sites and host country agencies,
6. To allow the trainees to research species of trees and know where to find the information to identify species both indigenous and exotic,
7. To enable the trainees to start small research projects, investigations, etc., related to forestry in host country,
8. To allow the trainees to experience the implementation and up-keep of a tree nursery,
9. To enable the trainees to apply practical forestry techniques in tree planting, pruning, pacing, measuring, grafting and other techniques necessary to forestry,
10. To enable the trainees to analyze communities' social systems, identify problems and help communities seek solutions,
11. To acquaint the trainees with women in development (WID) issues related to forestry,
12. To introduce the trainees to the basic theories of extension work,

13. To allow the trainees an opportunity to test the extension theory,
14. To allow the trainees to practice their interaction skills,
15. To ensure that the trainees have an understanding of agro-forestry issues,
16. To provide the trainees with a concept of ecology issues as related to their future jobs.

Objectives and activities for each session are described at the beginning of each session.

#### ADVANCE INFORMATION

It is assumed that trainees will have an orientation to Peace Corps service during or before the first week of training. We recommend the orientation model developed by Marine Fisheries Training Program, Puerto Rico, October, 1982, (see Joyce - Martinson report, Marine Fisheries Training, October, 1982). In addition to this orientation, two days of country specific information should be added. It is also possible that trainees will have gone through a CAST or CREST. Whatever event trainees attend for orientation, the training director should make clear to trainees that the technical training program will:

1. Be intense (little free time),
2. Entail a great deal of study, research and writing,
3. Continue to build cross-cultural skills,
4. Teach technical skills,
5. Be experiential, "hands on" training,
6. Highlight and improve their inter-personal skills,
7. Enforce a dress code of forestry professionals.

#### LIBRARY REFERENCE MATERIALS

Several technical forestry books and sets of reference materials are needed as library stock. Every effort should be made to select materials which will aid trainees in research paper development, agro-forestry planning, and species identification. In addition, the training staff should incorporate manuals (PC/ICE is a good source) and research papers that will be of general interest. Putting together the library is perhaps the most difficult of all preliminary tasks. You will find that you have few friends and fewer resources when it comes to borrowing books, papers and manuals.

5/

You will want to make a list of all library materials and from whom you have borrowed them. At the beginning of technical training, the managing of the library is assigned to one of the trainees as a special project. We suggest that a 3" x 5" card with title and author's name be prepared for each item. The appropriate card is then attached with a paper clip to each piece of reference material. As the materials are checked out, the cards are placed in a box. Having a trainee in charge of materials encourages equal distribution and relieves the staff from monitoring the distribution of material.

Below is a partial list of the materials with which we started in Arizona. Trainees who had brought their own materials also lent them to the library and a few guest speakers lent books. This list is not exhaustive by any means.

#### List of Reference Material

- \* 1. An Assessment of the Potential for Peace Corps/USAID/Host Country Cooperation in Social Forestry Projects. Frederick J. Conway & James L. Fickes. Peace Corps.
- 2. A Visual Geography of Africa. CT Quinn - Young.
- 3. Agri-silviculture in Tropical America. Peter Weaver.
- 4. Agro-forestry Species for Kenya. Amare Getahun.
- \* 5. A Glossary of Agricultural Terms. Peace Corps.
- \* 6. Appropriate Technology Sourcebook, Volume II. Ken Darrow, Kent Keller, Rick Pam.
- \* 7. Audiovisual Communication Handbook. Peace Corps.
- 8. Agro-forestry Species. A Crop Sheets Manual. P.K.R. Nair. ICRAF.
- 9. Afforestation Species for the Savannah. G. Mensbruge.
- 10. A Tourist Guide to Simple Swahili. Ines May & Alfred Banner.
- 11. Builders Vest Pocket Reference Book. William J. Hornung.
- 12. Collecting Forest Trees Seeds & Growing Your Own Seedlings. USDA Forest Service.
- 13. Cassava Cultural Practices. Edward J. Weber (Editor).
- \* 14. Crop Production Handbook. Peace Corps.
- \* 15. Conservation in Arid and Semi-arid Zones. FAO Conservation.
- 16. Community Forestry (Report).
- 17. Countries of the Tropics & Subtropics. Howard B. Sprague.
- 18. Deserts of the World. William G. McGinnies, Bram J. Goldman, Patricia Pagh.
- 19. Eucalyptus for Planting. FAO Draft, Volume I.
- 20. Eucalyptus for Planting. FAO Draft, Volume II.
- 21. Forest Resources Management. Project Paper, Volume II. Dan Dealy. USAID.
- 22. Forest Ecology. Stephen H. Spur.
- 23. Forest Products in Terms of Metric Units. A. Binek.
- \* 24. Forestry Case Studies. Craig Storti.
- \* 25. Forest Tree Planting in Arid Zones. A.U. Goor & C.W. Barney.
- \* 26. Firewood in the Less Developed Countries. Dale Avery (report).



- \* 27. Fuel Consumption among Rural Families in Upper Volta, W. Africa. Elizabeth Ernst.
- 28. Forestry for Local Community Development. FAO.
- 29. Forestry Nursery Practice in the Lake States. J.H. Stoeckeler & C.W. Jones.
- 30. Geographic Distribution of the Pines of the World. William Critchfield.
- 31. Guidelines for Watershed Management. FAO Conservation Guide.
- \* 32. Handbook of Tropical and Sub-tropical Horticulture. Washington, D.C.
- \* 33. Intensive Vegetable Gardening. Peace Corps.
- 34. International Cooperation in Agro-forestry. International Conference.
- 35. ICRAF's Programme of Work for 1982 with Projections for 1985 & 1986.
- 36. Jojoba in a Nutshell. P. Lynn Scarlett.
- 37. Kenyatta Succession. Joseph Karimi & Philip Muriuki.
- 38. Kenya's People: People Around Mt. Kenya. G. Muriuki.
- 39. Kenya's People: People of the Coast. Al Salim.
- 40. Kenya's People: People of the Rift Valley. B. Kipkorir.
- 41. Kenya's People: People Around the Lake. W. R. Ochieng.
- 42. La Desertification Au Sud du Sahara. Colloque de Nouakchott.
- 43. Le Role des Arbes au Sahel. (Dakar, Senegal).
- 44. Leucaena. Promising Forage and Tree Crop for the Tropics. National Academy of Science.
- 45. Les Atlas Afrique. Senegal.
- 46. Literature Review of Common Tropical Trees. Jacob L. Whitmore.
- \* 47. Lorena Stoves. Ianto Evans and Michael Boutette.
- \* 48. Memento du Forestier. Republique Francais.
- 49. Management of Southwestern Desert Soils. Wallace H. Fuller.
- \* 50. Niger Forestry Conference 1978. Peace Corps.
- 51. Natural Durability and Preservation of One Hundred Tropical African Woods. Ives Fortin and Jean Poliquin.
- 52. Nursery Management Manual. Valerie Mailler.
- 53. North American Forest Tree Nursery Soils Workshop. USFS.
- 54. Noxious Bush and Weed Control. Range & Wildlife Management. University of Texas.
- 55. Orchard Management. Peace Corps.
- \* 56. Pinus Patula. T.J. Wormald.
- 57. Planting Southern Pines. Philip C. Wakeley.
- 58. Papers for Conference on Improved Utilization of Tropical Forests.
- 59. Proceedings: Research on Coniferous Forest Ecosystems.
- 60. Pesticide Safety. Guidelines for Personal Protection. USDA.
- \* 61. Profiles of Selected Senegal Villages. Patricia Riley. Peace Corps.
- \* 62. Peace Corps Rural Energy Survey: Senegal. Peace Corps.
- \* 63. Reforestation in Arid Lands. Fred Weber. Peace Corps.
- 64. Republique du Senegal. Strategy and Planning.

65. Sorghum and Millet. Sally Vogel (Editor).
66. Soils of the Desert Southwest. Wallace H. Fuller.
67. Soils Research in Agro-forestry. ICRAF.
- \* 68. Selection of Species for Fuelwood Plantations. Jeffrey Burley.
- \* 69. Soils, Crops, and Fertilizer Use. Peace Corps.
- \* 70. The Role of Shrubs and Trees in the Management of Natural Grazing Lands with Particular Reference to Protein Production. H.N. Le Houerou.
- \* 71. The Role of Wild Animals in Human Nutrition in the Developing World. Antoun de Vos (Report).
72. The Coast Agro-forestry Centre. Implementation Plan 1982.
- \* 73. The Status and Challenge of Dryland Agriculture in Developing Countries of the Tropics & Subtropics. February, 1981. Howard B. Sprague.
74. Trees for People. IDRC.
75. The Farmers Guide. Jamaican Agricultural Society.
76. Trees Yearbook of Agriculture. USDA 1949.
77. The Need for Agro-forestry and Special Considerations Regarding Field Research. P.A. Huxley.
- \* 78. Using Firewood More Efficiently. Ianto Evans report.
79. The Genus Pinus. N.T. Miror.
- \* 80. Teaching Conservation in Developing Countries. Peace Corps.
- \* 81. Traditional Field Crops. Peace Corps.
- \* 82. Techniques de Reboisement dans les Zones....d'Afrique.
83. Understanding the Game of the Environment. David Houston.
84. Tropical Forest Ecosystems. UNESCO.
85. Vegetation & Flora of the Sonoran Desert. Forest Shreve & Ira Wiggins.
- \* 86. Wood Energy & Rural Communities. J. & M. Arnold (Report).
87. Workshop: Agro-forestry Systems in Latin America. CATIE.
88. Weekly Review. May 28, 1982. (Periodical).
- \* 89. Worlds Tropical Forests: Policy, Strategy & Program.
- \* 90. Well Construction. Peace Corps.
- \* 91. World Watch Paper 13. Spreading Deserts. Erick Eckholm & Lester Brown.
- \* 92. World Watch Paper 15: Energy. Dennis Hayes.
- \* 93. World Watch Paper 26: Planting. Erick Eckholm.
- \* 94. World Watch Paper 44: Hydropower. Daniel Deudney.
- \* 95. World Watch Paper 45: Wind Power. Christopher Favin.
96. Zoonoz: West Africa's Wildlife Crisis. Periodical. San Diego Zoo.
97. Rattan: A Report of a Workshop Held in Singapore. 1979.
98. Removing Constraints for Small Farm Production. Caqueza Project.
99. Materials Needed for Village Woodlot Project (Report). (Caudeau).
100. Species List for Senegal (Posted on wall).
101. Map of Senegal (Posted on wall).
102. Map of Kenya (Posted on wall).

\*These articles and publications are available at ICE/Peace Corps Headquarters.

8/

### Reference Additions

1. Trees of Puerto Rico & the Virgin Islands. 2 Volumes. Little, Woodbury, & Wadworth.
2. Taxonomy of Prosopis in Mexico and Latin America. Peter F. Folliot.
3. Introductory Plant Science. Henry T. Northern.
4. The Plant Kingdom. Harold C. Bold.

### TRAINING SITE

We were fortunate to have been able to use the University of Arizona Conference Center, Oracle, Arizona for the State-side Training. This location was chosen over many potential sites because the desert conditions closely match the arid region of the Sahel in Senegal and the Eastern Region of Kenya. Other considerations taken into account include the presence of the following:

1. Land for establishing a nursery,
2. Availability of water,
3. Availability of materials which could be used by the participants such as old fence posts, chicken wire, old lumber, a chicken coop, etc.,
4. Land to plant a vegetable garden,
5. Other land areas for planting,
6. Classrooms,
7. Housing and meals,
8. Resource availability for research projects that could be set up by the trainees,
9. Remote area with few distractions,
10. Recreational facilities, e.g., basketball court, swimming pool, pool table, ping pong, etc.,
11. Neighboring small community where the trainees could interview residents as part of agro-forestry planning,
12. Site where ecological problems are evident,
13. Site where erosion prevention could be practiced,
14. Proximity to the University of Arizona so that resources of the University could be utilized.

In choosing the training site, it is important to remember that the focus of the training program is participant learning. The trainees should not have to cope with a physical environment that needs a great deal of managing during the training cycle. A certain amount of privacy and a living and recreation area where the trainees can get away is desirable. We also found that the trainees needed to adjust to the climate in the Tucson area. We had them turn off air-conditioners in their sleeping quarters after two weeks, but continued to use air-conditioners in the classrooms. All of these considerations are important when determining a new training site.

The University of Arizona also issued a certificate, complete with seal, to each trainee stating that he/she had completed an intensive agro-forestry course. We felt that it would be beneficial for the participants to be able to exhibit their certificates at their work sites as it might enhance their credibility and acceptance as professionals by their community.

#### PLANNING THE FIELD TRIP

In order to plan field trips for the trainees which will expose them to forestry projects in which they could be involved and allow them to utilize skills that they will need overseas, you must fully investigate the resources available in the area. We used the field trip to give trainees first hand experience with extension work and at the same time reinforce learnings from early sessions about cross-cultural communication. In Arizona, we considered numerous options that were available and chose the following:

1. Visit to Sonora Desert Museum - ecology,
2. Visit to Sonoita, Mexico - data collection,
3. Visit to Argona Pipe National Monument Palanetiem Exhibits,
4. Several trips to the nearby Papago Indian Reservation - extension practice, tree planting, cross cultural communication,
5. Arizona State University experimental citrus farm - grafting and budding practice,
6. Boyce Thompson Institute Arboretum - seed collection, gathering and storage,
7. Fashion Center Shopping Mall - last minute shopping prior to departure.

After brainstorming your options, pick out the one(s) that will benefit the trainees the most. The field trip provides a good chance to introduce the trainees to a number of people

working in forestry and forestry-related fields and to practice being extension workers. If you are going to have the participants practice extension work, it is imperative that you investigate the site and then work closely with the trainees during the field trip. We found that pre-training visits to the field trip sites, thorough explanations of what we wanted to do, and then follow-up phone calls or letters ensured that we were not expecting unavailable opportunities. In the case of the Papago Reservation, we met with the Tribal Chairman, explained our plans, asked permission of the Tribal Council, worked through the local agricultural extension agent, and still found when we arrived that we also needed to contact the individual chairmen of each village even though they had been at the tribal council meeting.

Develop a list of field trip objectives with expected outcomes after you have decided where you want to go and for what purpose. The list should be given to the trainees prior to the field trip.

When you have determined your field trip schedule, it will help to send a copy of the schedule as a reminder of your arrival to the people with whom you plan to see and work.

Prepare and provide a daily schedule of events for each participant. You will need to make arrangements for food and lodging while on the field trip. This should also be done by visiting prospective sites well in advance and making reservations. An additional thirty people for lunch in a small rural cafe on an impromptu basis creates havoc for the cafe owner and his help. However, if they know you are coming, they will generally be most accommodating and can enrich the field trip experience.

Finally, arrange transportation well in advance with confirmed reservations, especially if you are renting vehicles. Be careful in planning your trip so that you do not spend 75% of your time riding the bus. It is also important to remember that you are not only providing transportation for staff and trainees and their luggage, but will also have to take a certain amount of equipment, i.e., shovels, trees for outplanting etc., with you.

#### TREE PLANTING SITE

During the course of training, the participants will plant trees. We chose to plant 1,000 trees in the Papago Reservation. This site was ideal for our purposes as it not only provided the participants an opportunity to practice extension techniques, work with local children and have a cross cultural encounter with Indians, but also gave everyone a sense of doing something that would have lasting results. The stock from the nursery started by the trainees will not be ready to outplant during the field trip and large quantities of trees for outplanting are not always available locally. We not only had to have trees shipped from a neighboring state, but also had to arrange storage for several

days. We also learned about citrus trees we could have had for free; however, the information came too late for us to transport the trees in time for our tree planting exercises.

For the seedlings that will be planted by the trainees at their nursery, we used cat litter boxes as seed beds. The forestry technical trainer can plant seeds upon arrival at the training site for pre-training preparation.

### SOIL EROSION SITE

An example of soil erosion should be found in the immediate area of the training site. You should look for gullies formed as a result of water erosion that can accommodate gully plugs. The trainees will need to install gully plugs and examine indigenous vegetation in the area to see if plants, shrubs, etc., have established themselves naturally and could be used as a deterrent of further erosion. Remember to contact the land owner for permission to install gully plugs.

### TRANSPORTATION

You will need transportation for setting up training, getting materials and responding to emergencies. Additionally, you will need transportation for the trainees for short visits to nearby sites, a medical facility to get shots for going overseas, the airport, and the field trip.

### MATERIALS

The following is a minimal list of materials you will need during this training program.

- Diameter tapes (tailor tapes work well)\*
- Hats\*
- Vegetable seeds
- Rain guage/outdoor thermometer
- Insect netting/straight pins
- Film
- Plastic water containers
- Ball point pens\*
- Notebooks\*
- Rustic transit materials:
  - nuts/bolts (1/4"x2" and 2 1/2")/wing nuts
  - twine
  - washers
  - boards
    - 1"x4"x8'
    - 1"x2"x4'
- Poly bags (2x8 or 3x8)
- Charcoal/planter mix
- Watering can
- Screening
- Poly film (black for compost)

File, mill bastard  
 Gloves\*  
 Emery paper  
 Tracing paper  
 Labels (self-adhesive)  
 Pesticide spray  
 Clipboards  
 Live chickens  
 Rake, pick, axe  
 Chemical thermometer  
 Bottles (insect collection)  
 Alcohol, ethyl  
 Cat litter boxes  
 Shovels  
 Cassette tapes  
 Shears  
 Hammer  
 Pliers  
 Stanley bit brace 10"  
 Saw  
 Index cards  
 Staplers  
 Plastic coated red cloth tape  
 Markers  
 Masking tape  
 Newsprint

\*Indicates at least one for each participant.

#### MEDICAL

At some point during training, the participants will need shots in preparation for going overseas. You will need to make arrangements well in advance with a hospital (if one is available in your area), particularly if yellow fever shots are needed. You may also need to start the trainees on prophylaxis for malaria. Make arrangements with a medical facility to which you can take trainees in the event of accident or illness.

#### UNEXPECTED RESOURCES

There may be resources that materialize unexpectedly. We thought we should mention a few of which we took advantage just so you could be on the lookout for them.

1. A group of African students who were on a field trip from the University of New Mexico were invited by us to have dinner with the trainees. For many of the trainees, this was their first encounter with Africans.
2. Returned Volunteers visited us on a Saturday evening and brought slides of Africa.

3. A former Peace Corps staff member with experience in Africa joined us for an evening session.
4. A British visitor came to see a staff member and graciously taught a Swahili class.

### CONDUCTING THE TRAINING PROGRAM

#### TIMING

This program immediately follows an orientation program by the Peace Corps Office of Staging and Orientation. It is the trainees first real introduction to cross cultural and technical training, as well as to considering the role of the Volunteer in development work. The program is meant to make the participant a well rounded Peace Corps Trainee who is technically and personally competent and confident when he/she arrives in their country of service for further country-specific training. The trainees leave the SST fully aware that they are expected to complete two full years of productive Peace Corps service.

#### LOCATION

As stated in a previous section, when planning ahead the setting for training is important. A site located in an isolated area is helpful not only because that is where forestry techniques are best practiced, but because it reduces the trainees' desire to do other things, i.e., going to the movies, dancing, etc. The countryside has fewer distractions than a more populated area.

Available time is limited during the training. In selecting a site consider as critical the "time loss factor" in taking care of activities such as getting food, bathing and sleeping. The atmosphere of the training site directly affects participants' attitudes. If they have to spend time coping with the facilities, they are less likely to spend time productively during training.

#### GROUP SIZE

The program is designed for 20 to 30 people who may be in training to go to two or more different countries. The design can be adjusted to accommodate more participants by adding trainers. If the group size is too large, the facilitators will not have enough time during a session to offer individual assistance, especially for the sessions about identifying communication skills, technical skills and "hands on" activities.

#### TRAINERS/FACILITATORS

This program requires one well rounded experienced forestry technical trainer, one human interaction/process trainer and one administrative/technical trainer. If more than one country is involved an additional co-trainer is desirable.



Sometimes during the small group activities, several of the small groups will need the assistance of facilitators, especially if the group is having difficulty. During small group activities, trainers also gather assessment data. Once an activity is explained and the exercise started, the facilitators "float" from group to group to assure that the activity is moving smoothly and to see if help is necessary. One person cannot cover all the groups effectively. It is essential to have the support of another facilitator for handling problem situations.

The trainers are the key to the training program. They create the atmosphere, set the tone and help participants achieve maximum benefit from the activities. However, in the introductory session, the trainers should make it clear to the participants that each person will get out of the training program whatever he/she puts into it.

### SESSIONS

As part of the "tone", it is important to give a clear but concise overview of the training program - what we are doing, where we are going and why. At the first session, trainees are introduced to the schedule of training events but told that from time to time the sequence of the sessions will be changed due to weather, etc. At the beginning of each day, the goals for the day are introduced, any changes in schedule announced, and the goals from the previous days are reviewed. Our experience from all previous forestry programs is that forestry trainees need daily, as well as, session goals and should be reminded of what goals they met the previous training day.

While conducting a session, take a few minutes to explain an exercise, the direction of the exercise and how the trainees will benefit from it. We reviewed goals of each session when possible.

### MATERIALS

In the previous session on "Library Reference Materials", we have included a long list of materials for the six-week long training program. At the beginning of each session there is a list of materials which you should have ready before the session begins. As there are a great number of materials and tools, we suggest that one trainer be in charge of all materials and responsible for ordering supplies. In addition, that same trainer is the one to whom the participants go when the need arises for supplies or materials for specific projects.

### JOURNALS

The trainees are given spiral notebooks to be used for personal journals. These journals offer the participants a chance to record their thoughts, insights, learnings, technical data, and note what he/she finds relevant and useful. The participants should be provided an opportunity at the end of each day to write in their journals.

## SHARING

Many of the activities involve sharing with a partner or a small group. We use this technique in order to help the trainee get a different perspective about an idea or thought when verbalizing it or hearing it repeated from other people. The purpose of the sharing technique is to add dimensions - trying to help people "stretch" and get help and suggestions from one another.

It is the trainers/facilitators' responsibility to create an atmosphere of trust and non-judgement that will encourage people to feel free to express themselves. Early in the training process, the facilitator encourages people to share with each other. The facilitators talk about taking risks and explain new communication techniques of getting and giving feedback to each other - all ways of sharing.

## STAFF MEETINGS

It is important for the trainers to meet daily. We found that the time immediately following morning sessions was the best. We frequently met after evening sessions, however, if the day's activities prevented all of us from being available in the morning. The following is a suggested agenda:

1. How have sessions gone since we last met?
2. Are we ready for the next sessions? (We try to prepare one to two sessions ahead of ourselves.)
3. What kind of help do we need?
4. Assessment data to report;
  - a. data is recorded,
  - b. lack of data is noted and the trainers discuss strategies for collection.
5. Overall, how are we doing? Changes? Additions?

The day before ind. dual interviews, staff meetings run longer as the staff decides upon feedback for each trainee/participant. It is important that the staff reach consensus on the feedback they are providing to each trainee.

## PRESENTING THE SESSIONS

### FORMAT

Each session design includes one or more exercises directed at meeting the goals of the session. The information provided in the design includes:

1. Session/exercise title,
2. Total time required to complete session/exercise,
3. Overview statement describing the purpose of the exercise/session,
4. Procedures and activities - sequenced and timed steps which describe what the trainer and participants are required to do at a particular point in the session,
5. Materials required,
6. Trainer's Notes: Special instructions relevant to a particular session or exercise.

#### REVIEW/STUDY THE TRAINING PROGRAM GUIDELINES

Even though each session is described in detail, it will be necessary for you and any co-staff to review carefully the entire design to assure that there is an understanding of the overall sequence of activities and of specific trainer activities/responsibilities for each session. In reviewing the design for each session, you should do the following:

1. Review the trainer and participant materials,
2. Review the goals of each session and determine the relationship of the session to the previous and subsequent sessions to the total program,
3. Prepare sessions/exercise, goals/objectives on flip chart (write these in your own words rather than copying them verbatim from the guidelines),
4. Be sure all the materials are prepared, equipment is working, and the space needed is properly set up for training,
  - Prepare flip charts before the session - if an easel is not available, paper may be tacked or taped to the wall;
  - Prepare any lecture notes required - keep these to a minimum,
  - Gather copies of all handouts and worksheets.
5. Review the sequence of activities, the points to be discussed, and materials several times before the session to become thoroughly familiar with the session and its content,
6. Assign shared responsibilities of co-trainers,

7. During the presentations, keep in mind the structure of the session, i.e., introduction, major points, summary.

If you are not confident of your own knowledge as to the content of one of the sessions, you may want to look for an outside resource person to cover that session. We had a specialist in tropical horticulture give two presentations: one on fruit trees and another on jojoba as a cash crop. A soil specialist covered the sessions on soils.

#### Adding to the Given Design

It has been our experience that outside speakers do not necessarily add to the design. In fact, we had to redo several sessions when the speakers did not cover the requested material. Be sure experts are expert and that they focus their talks on the required topic area.

#### Sequence for Session/Exercise

For each session/exercise the trainer should:

1. Explain the purpose of the session/exercise,
2. Review specific goals and objectives,
3. Summarize major activities contained in session/exercise,
4. Provide time for the participants to make journal entries.

Remember the time allotted for each activity is approximate. More or less time may be required or desired depending upon the group size and needs. While some flexibility is "built-in", scheduling should allow for adequate coverage of all activities in each session.

#### WORDS ABOUT TRANSITION

One key to any training program "hanging together" is the participants understanding of how the pieces (i.e., sessions and exercises) fit together.

It is important to bridge each exercise and/or session with the one(s) that precede and follow it. These transitions are done simply by summarizing what has already happened/been accomplished:

Thus far we have had a chance to get to know each other, review the goals of the training program, and reach agreement upon what we might expect from this training ...

Then link it to what is going to happen;

In addition to being helpful in "hands on" nursery management, this session will also generate useful data for conducting small research projects.

Each session/exercise needs to be explained with these linkages in mind. As you prepare to introduce individual activities, take a few moments to determine what these transitions are and which ones you need to highlight as you explain the goals of each activity.

WELCOME, EXPECTATIONS, AND EVALUATION CRITERIA

Total time      2 hours 45 minutes

Goals

- o To introduce the staff and define staff roles,
- o To provide an overview of the training program goals,
- o To introduce experiential training method and explain the adult learning theory,
- o To review the schedule for the next five weeks,
- o To share expectations,
- o To provide evaluation criteria,
- o To provide an opportunity to become better acquainted.

Overview

The beginning session is critical to establishing the climate for the entire training program and assuring that everyone understands the intended outcomes, methods of training and ground rules for the conduct of the program. It is also the time for people to get acquainted. Even if they have met before, it is helpful to have participants re-introduce themselves in some way that is relevant to the training program.

Exercises

1. Training Program Overview/Goals
2. Who Are We?
3. Expectations
4. Working Together

Materials

Flip chart, marker pens, tape, pencils pens.

Handouts: Weekly schedule, training program schedule, loose leaf binders, 5 X 7 index cards, pins, evaluation criteria.

## SESSION 1

Exercise 1      Training Program Overview/GoalsTotal time      25 minutesOverview

The purpose of this exercise is to introduce the trainers and other staff and to provide a brief review of the purpose and goals of the training.

ProceduresTimeActivities

5 minutes

1. Introduce yourself and welcome participants to the workshop. Introduce everyone responsible for training and provide an opportunity for them to welcome participants.

10 minutes

2. In the description of the training program the following points may be made (Show flip chart with the following):

The Adult Learning Theory

- Adults learn through experience,
- Adults learn when they have a need to know,
- Adults learn when they can apply their learning,
- Adults have a lifetime of experience from which to draw,
- Adults need to have life experiences validated.

Lecture should make the following points:

- A. To the extent possible, the trainees will be experiencing training,

There will be very little directive training as the idea is for the trainees to solve problems through experience.

- B. The very fact trainees are here for this program tells us that they have a need to know.
- C. In some cases, such as with graduate foresters, there will already be knowledge and skill. This training program is designed for them to apply their learnings.
- D. The trainees have a lifetime (short though it may be) of education, technical skills, job related skills, work experience, and social skills that they will bring into focus in the next five weeks.
- E. Finally, as adults, we expect the trainees to take responsibility for their own learning. We will provide many opportunities and experiences, simulations, and insights for them, but they must understand that they alone are responsible for what they get out of this program.
- F. The skills on which we will focus are those that will give them technical competence and interaction skills to enable them to do their jobs. It is important that they are not only prepared technically and feel competent about their skills, but also that they become confident in their own abilities over the next six weeks.

10 minutes

- 3. Briefly review the goals of the training program and explain the sequence of the sessions. The training goals and the titles and sequence of sessions should be displayed on flip chart for this presentation.



On the flip chart put the following (use your own words):

Goals

1. To enable the trainees to recognize their skills and feel competent in the use of these skills,
2. To enable the trainees to know how to transfer the technical skills that they have,
3. To identify areas for skill building and to improve those skills,
4. To enable the trainees to understand their role in host country and as Peace Corps Volunteers,
5. To help the trainees identify resources available to them and know how to find resources in their community sites and host country agencies,
6. To allow the trainees to research species of trees and know where to find the information to identify species both indigenous and exotic,
7. To enable the trainees to start small research projects, investigations, etc., related to forestry in host country,
8. To allow the trainees to experience the implementation and up-keep of a tree nursery,
9. To enable the trainees to apply practical forestry techniques in tree planting, pruning, pacing, measuring, grafting and other techniques necessary to forestry,
10. To enable the trainees to analyze communities' social systems, identify problems and help communities seek solutions,
11. To acquaint the trainees with women in development (WID) issues related to forestry,
12. To introduce the trainees to the basic theories of extension work,
13. To allow the trainees an opportunity to test the extension theory,
14. To allow the trainees to practice their interaction skills,
15. To ensure that the trainees have an understanding of agro-forestry issues,
16. To provide the trainees with a concept of ecology issues as related to their future jobs.

## SESSION 1

Exercise 2      Who Are We?Total time      35 minutesObjectives

- o To allow the participants to get acquainted,
- o To get people talking,
- o To begin building a sharing atmosphere.

Overview

This exercise gives the participants an opportunity to get to know each other. Even if they have met in training before, this activity allows them to see each other in a different way and to begin talking and interacting.

This exercise is the first in which the participants share something about themselves. This design is therefore fairly simple and does involve some risk-taking.

ProceduresTimeActivities

10 minutes

1. Introduction: Introduce the exercise by stating the purpose and asking participants to get an index card and a pin.

20 minutes

2. Mingling: After everyone has a card, show the following on newsprint;

ON YOUR CARD, WRITE OR PRINT WHETHER YOU ARE A FORESTER OR A GENERALIST. NEXT LIST ANY SPECIALIST CLASSIFICATION YOU MAY HAVE. NEXT LIST SPECIAL INTERESTS YOU HAVE (PHOTOGRAPHY, MUSICAL INSTRUMENT, ART....) AND FINALLY, TWO HUMAN INTERACTION SKILLS THAT YOU HAVE (GOOD LISTENER, ABLE TO MIX WELL IN NEW GROUP....)

When you have completed your card, please pin it on yourself and mingle with the other participants and discuss each others' card. Attempt to meet with as many people as possible.

The trainers should join the group as participants after you have set up the exercise and are sure people are mingling.

Time check

Let the participants know when they have five minutes left so they can be sure that they have talked with as many people as possible.

5 minutes

3. Summary: Ask individuals to share some of the interesting "things" they have discussed about each other.

**Trainer's Note:** Listed below are five possible introduction exercises that can be used. You may prefer to use another exercise to accomplish the same purpose.

1. Dyad-Quartet

Each person meets and gets to know one another; he/she in turn introduces his/her partner to another dyad.

2. Depth Unfolding Process

Because it takes five minutes per person, this exercise should be done in small groups. The leader should disclose first to make trainees more comfortable.

In the first three minutes, tell what has brought you to this point in your life. Use one minute to describe your decision to join Peace Corps. Use the last minute to answer questions from others.

3. Structured Introductions

In dyads, small groups or a large one, participants can tell why they joined Peace Corps, or write a letter to a friend about their decision.

4. Life Map

Each person draws on newsprint with crayons or magic marker using stick figures and symbols, a picture of their vision of their Peace Corps service.

5. Sentence Completion

The trainer presents a series of unfinished sentences and asks each group member in turn to complete the statement.

Example:

One of the things I anticipate about my Peace Corps service is \_\_\_\_\_.

The thing I will miss about home is \_\_\_\_\_.

Exercise 3      ExpectationsTotal time      1 hour 15 minutesOverview

The purpose of this exercise is to provide each participant with an opportunity to identify and classify his/her own goals and interests in this training program. It also provides an opportunity to match the participants' goals with the content of the training program and to either reassure participants that goals are possible, state reasons why goals may not be met and perhaps negotiate any inconsistencies which may exist.

ProceduresTimeActivities

5. minutes

1. Divide into small groups. Explain the purpose of the exercise. Ask the participants to write on newsprint the expectations they have for this training program.

Expectations may include things they want:

- o To know,
- o To have given to them,
- o To have happen/not happen,
- o The facilitator to do/be,
- o The other participants to do/be,
- o To be able to do.

15 minutes

2. Encourage the group to record as many items as possible in a short time. (Put items on flip chart)

10 minutes

3. Now ask each group to prioritize the top five expectations that they all share.
4. Ask the groups to share their expectations with the large group.
5. Explain that there will be quiet time every evening for a half hour of journal writing.

Exercise 4      Working TogetherTotal time      30 minutesObjectives

- o To present and discuss administrative business, i.e., time breaks, housekeeping issues, travel, per diem, etc.,
- o To reach an agreement regarding ground rules about attendance, participation,
- o To explain evaluation criteria,
- o To clarify the role of the participants and staff.

Overview

This exercise focuses upon reaching an agreement on ground rules for how program participants and staff will work together. The evaluation criteria are also discussed and questions answered. This is also an opportunity for the participants to clarify their roles and expectations.

ProceduresTimeActivities

- |           |   |
|-----------|---|
| 5 minutes | <ol style="list-style-type: none"> <li>1. The trainer reviews the purpose and objectives of the exercise.</li> </ol>  |
| 5 minutes | <ol style="list-style-type: none"> <li>2. He/she presents and discusses appropriate points regarding the mechanics of program including:           <ul style="list-style-type: none"> <li>o Starting times/stopping times,</li> <li>o Break/meal times,</li> <li>o Procedure for meals,</li> <li>o Facilities,</li> <li>o Restrooms, offices, recreation, etc.</li> </ul> </li> </ol> |
| 5 minutes | <ol style="list-style-type: none"> <li>3. The trainer gives some general rules about the program and sessions:           <ul style="list-style-type: none"> <li>o Attendance; no coming and going - arrive on time,</li> <li>o Participation; i.e., the more you give, the more you get,</li> </ul> </li> </ol>   |

- o Listening - allow and encourage each person to speak fully before the next person begins talking,
  - o The importance of keeping on schedule.
- 5 minutes
4. The trainer discusses the group norms which will help the workshop be a success.
- o The need to trust the process and the trainers,
  - o Push yourself; stretch even though it may be uncomfortable - that is a part of the learning experience,
  - o Avoid being judgemental with other's contribution - remember that you are responsible for your own learnings.
- 10 minutes
5. Evaluation criteria: The trainer now produces on newsprint the evaluation criteria. He/she explains that at the end of each week the trainees will be interviewed individually and given feedback based on this criteria.

### EVALUATION CRITERIA

Productive Competence - The trainees will be able to:

- o Transfer information and skills to others,
- o Maintain an energy level necessary to accomplish tasks, solve problems,
- o Acquire information and skills necessary to establish professional credibility in program areas,
- o Become familiar with forestry terms in the host country language,
- o Formulate three-month work plan.

Social Sensitivity - The trainees should:

- o Show respect and empathy,
- o Demonstrate cultural awareness,
- o Develop interaction skills,
- o Adjust.

Emotional Maturity - The trainees will:

- o Have a strong attitude about self in order to deal effectively with their new environment,
- o Recognize own strengths/weaknesses,
- o Give and receive feedback,
- o Modify behavior appropriately,
- o Balance pessimism and optimism,
- o Demonstrate self-confidence and self-reliance.

Motivation - The trainees shall:

- o Balance enlightened self-interest and altruistic-humanitarian value system,
- o Maintain a sense of responsibility and accountability to self, Peace Corps and the host country forestry service,
- o Participate actively in training activities,
- o Take an active role with group work.

Technical Skills - The trainees will be able to:

- o Grasp the basic concepts of forestry techniques,
- o Use tools,
- o Show the ability to do simple forestry mechanics and to demonstrate these mechanics to others.

5 minutes

6. The trainer outlines the expectations as a trainer as well as the roles you wish to assume. Responsibilities may include:
  - o Providing structure/instructions,
  - o Introducing each activity and assisting in its completion,
  - o Monitoring group energy,
  - o Managing how the group works,
  - o Probing/pushing/facilitating the process of "looking within",
  - o Drinking, having fun, generally enjoying the experience.
  
7. The trainer summarizes the activity by emphasizing that this training program is really directed at helping the participants realize that they have many of the skills and information needed to meet the challenge of their role as a Peace Corps Volunteer. We will be adding to that information and introducing new tools for them to use in forestry. They will develop a new awareness of the cross-cultural dimensions of their Volunteer experience and skills necessary to communicate, analyze and work with groups in host country.



SPECIAL PROJECTS

Total time      1 hour 45 minutes

Goals

- o To begin the process of transferring skills and experience to others,
- o To assume the responsibility for teaching others,
- o To assume the responsibility for completing task assignments,
- o To produce a manual for use in the field to which all participants have contributed,
- o To meet the dates given for each project's presentation,
- o To measure the trainees' ability to be resourceful by the amount of explanation and assistance they ask from trainers.

Overview

The purpose of this exercise is to begin to identify those participants with special skills and have them assume responsibility of transferring those skills during the training. The trainees will have to look for resources and decide what materials, if any, they need to complete their projects. They will also discuss the need for research.

Exercise

## 1. Introduction of Individual Projects

Materials needed for special projects

Flip charts, marker pens, tape, schedule of special projects due dates, \*board ( 1 meter long by 1 meter wide), graph paper, common pins, rubber bands, \*protractors, plumb line, weight, survey flags, stakes, \*measuring tapes ( 3 meter long), pole ( 2 meters long - bamboo is good), small piece of wood (2 centimeters high X 4 centimeters wide X 40 centimeters long), nails, wing nut (6 centimeter long), \*thermometer/rain gauge

\* Indicates one for each Volunteer.

**Trainer's Note:** These materials will definitely be needed. The trainees will determine what used materials are available and what are needed.

Exercise 1      Introduction of Individual Projects

Total time      1 hour 45 minutes

Objectives

- o To introduce special projects for each individual to manage,
- o To give a brief explanation of each,
- o To have the trainees volunteer for a project they want to do,
- o To give time lines and due dates,
- o To make project assignments.

Procedures

Time

1. hour 45 minutes

Activities

1. The trainers introduce a list of projects for which individual trainees are asked to volunteer; it is explained that these projects are part of the design and are specific in nature. The forester trainer will need to demonstrate or explain in detail. Many projects will require the help of other trainees and the management of that help. There are enough projects so that each trainee gets a different one.

**Trainer's Note:** It is vital that each trainee have a project: Listed below are the 20 or so we have found to be most effective. Some are intrinsic to a particular session; all are meant to be challenging.

- A. Species Identification Manual:  
The trainee will assign two species per participant to be identified, re-researched and written-up. The species to be used in the manual will be decided by the trainee and final approval will be given by the technical trainer.

(The following outline is given to the trainee to transmit to other trainees so that all species reports have similar content and format.)

Outline for Species Reports

**SPECIES:**

**SCIENTIFIC NAME:**

**COMMON NAME:**

**FLOWER: TYPE, FLOWERING CYCLE SKETCH**

**FRUIT: TYPE, COLOR**

**SEED: GERMINATION, WHEN SEEDS MATURES, HOW TO COLLECT, METHOD OF STORAGE, TREATMENT, SKETCH**

**LEAVES: TYPE, ALTERNATE - OPPOSITE, MARGINS, SHAPE, COLOR**

**BARK: GENERAL CHARACTERISTICS**

**SHAPE: YOUNG TREE, MATURE TREE**

**HABITAT: WHERE TREE GROWS, SOIL, WATER**

**USE: LOCAL, INDUSTRIAL, COMMERCIAL**

**RANGE: N-S-E-W**

**DISEASE/INSECTS: TYPES, CONTROLS**

**NURSERY MANAGEMENT NEEDS: HOW TO TREAT IN NURSERY**

**NURSERY REQUIREMENTS:**

**NATURAL REGENERATION:**

**MAIN IDENTIFICATION CHARACTERISTICS**

- 1.
- 2.
- 3.
- 4.

**REFERENCES:**

- B. Agro-forestry Site Plan: The trainer should explain that this is a new sub-discipline of forestry - about ten years old - although it has been practiced for hundreds of years by farmers to some degree. Since it is a new discipline, there is very little written on agroforestry and nothing which is site specific. The trainer should state that it is quite possible that this generation of participants are the ones who will write the books and become the authorities. Based upon their own observations and knowledge, we want them to work up a plan for their site area. It should be as extensive as possible. The trainee will be managing a moving presentation, and all the trainees will participate in this activity. There are three stages - researching, planning and presenting.
- C. Ecology Teams: Based upon country an geographical similarities, groups will be formed to report on the ecology of a particular area. These reports will be given in the same way one would present this concept to a group at a future site. The trainee for whom this is a special project is responsible for calling meetings and managing presentations.

**Trainer's Note:** The training staff makes the team assignments for the project and they are posted on day three.

- D. Making a Diameter Tape: This project involves a forester participant assembling materials (which are available) and determining the best way for each trainee to make his/her own diameter tape. Forester trainee demonstrates the use of the diameter tape and has the other trainees practice using it.

- E. Rustic Transit: A forester trainee assembles a Rustic Transit from available material and shows the other trainees how to use it. He/she records the directions for construction.
- F. Greenhouse: A trainee builds a greenhouse with help from trainees using the local material. He/she is responsible for drawing up plans to be put in the trainees' manual.
- G. Slide Show Presentation: A forester trainee prepares a slide show on a forestry related topic. This slide presentation is to be used later by Peace Corps in the host country. If slides are not available, the forester trainee writes the directions for preparing a presentation.
- H. Compost Heap: At the onset of training, a forester trainee prepares a compost heap near the nursery site. He/she explains the steps to the other trainees, keeps a graph of temperature and the times that the compost is turned. The compost will be available for use during the last week of training if done correctly.
- I. Lesson Plan: The trainee prepares a lecture on the preparation of lesson plans. The trainee who has the special project writes directions and presents a lecture to the group. Have each trainee prepare a simple lesson plan and demonstrate it to the group.
- J. Manual: A trainee manages the trainee manual, keeps track of the contents and prepares it for publication.
- K. Plan Soil Erosion Walk Tour: The trainee finds gullies for plugging and demonstrates the gully plug technique.

- L. Gathering Climatic Data: The trainee selects volunteers to collect the daily weather conditions (including wind, temperature and humidity) and posts this information daily.
- M. Insect Collection & Identification: The trainee prepares a lecture and gives a demonstration.
- N. Methods of Research: A research demonstration is done by the trainees and instructions are given to the other trainees. The trainee for whom this is a special project writes the guidelines for the manual.
- O. Irrigation Project: The trainee prepares a presentation on watering nursery and garden sites. He/she is responsible for drawing irrigation plans to be included in the manual.
- P. Vegetable Gardening: A trainee prepares a presentation which will be included in the manual on how to plan and start a vegetable garden.
- Q. Library: The trainee catalogues all materials and oversees the distribution of materials. At the end of training, he/she sees that all materials are returned to those institutions or individuals from whom they were borrowed.
- R. Germination Site: The trainee records all germination experiments, gathers other trainees' records and reports his/her findings. The trainee is responsible for watering the seed beds which were started prior to the trainees' arrival.
- S. French Vocabulary: The trainee is responsible for conducting a mini-French lesson of forestry terms at the start of each day.

**Trainer's Note:** You may want to delete some projects and add others that are more specific to the host country. Since these projects are built into the design, however, they will have to be covered by trainers if not done by trainees. (The trainees may also add a few on their own).

20 minutes

2. The trainees are now invited to ask questions and to sign up for their special projects.

10 minutes

3. The summary by the trainers should state that we are aware that actual training has not yet begun but you can already see that we are going to be very busy. We are sure that no one will be bored.

SAMPLE SPECIAL PROJECTClimatic Data Gathering MethodsPurpose

To establish some methods of collecting simple climatic information about an area. To chart the information about a specific area as an indicator of general weather conditions of that area over a period of time.

Procedure

An ambient temperature thermometer was attached to the southern side of a tree located in a grassy area. This site was chosen for its provision of shade, a nonreflective ground surface, and shelter from the ground surface to avoid the influence of any ground heat. Accurate ambient temperature readings require sheltering of the thermometer from the sun, wind and reflected heat.

Temperature readings recorded at 6:00 AM and varying afternoon times were taken as the approximate low and high temperatures of the day.

Rainfall was determined by setting up a rainguage in an open area unobstructed by trees, buildings, or other factors that might lead to erroneous readings.

Wind direction was determined simply by throwing a little leaf matter into the air and noting the direction it was carried by the wind. This was done several times at each reading to assure accuracy.

In determining relative humidity, a crude psychrometer was designed and used. A small piece of cotton shoelace was slipped over the bulb of the thermometer. The thermometer was then waved through the air for about two minutes to determine a "wet-bulb" thermometer reading. The relative humidity could then be determined by comparing this "wet-bulb" temperature to the dry bulb or normal ambient temperature reading on a psychrometric table.

This method of determining relative humidity is based on the facts that:

1. The rate of water evaporation from the "wet-bulb" is positively correlated to the dryness of the air.
2. As the water evaporates from the "wet-bulb" when it is waved in the air, the thermometer is cooled and the temperature drops.



3. The amount of cooling is positively correlated to the rate of water evaporation.
4. Thus, the amount of cooling is positively correlated to the dryness of the air. The more the cooling, the lower the humidity. The less the cooling, the greater the humidity.

Useful Formulae

$$F = 9/5C + 32$$

$$C = 5/9(F - 32)$$

Conclusion: The results given on the foregoing pages show that the various weather parameters during a particular time of year remain fairly constant and can be used to determine the type of climate to expect in an area at a certain time of year.

THE FORESTS OF THE WORLD, PEACE CORPS' FORESTRY GOALS,THE INDIVIDUAL VOLUNTEER'S ROLE

Total time      2 hours 30 minutes

Goals

- o To have the participants brainstorm key problems and possible solutions concerning forestry, reforestation and afforestation,
- o To provide a global view of forestry today and in the future,
- o To provide information on Peace Corps' forestry goals,
- o To have the participants commence journal keeping.

Overview

This session focuses on the global view of the world's disappearing forests. The discussion moves to Peace Corps' goals in forestry and finally brings into perspective what an individual Volunteer can do. The trainees search for possible problems and solutions based upon their own knowledge.

Exercises

1. Problems and Solutions in Forestry
2. Forestry: Global Perspective, Peace Corps' Goals, Volunteer's Role
3. Journal Keeping

Materials

Flip charts, marker pens, tape notebooks with tabs.

Exercise 1      Problems and Solutions in ForestryTotal Time      30 minutesOverview

The participants will brainstorm and record forestry problems and possible solutions.

Procedures

<u>Time</u>	<u>Activities</u>
15 minutes	1. The trainer asks the participants to form small groups of both foresters and generalists. The groups are asked to brainstorm and list on newsprint all the forestry problems about which they are familiar and any possible solutions.
10 minutes	2. The lists are presented to the large group.
5 minutes	3. The trainer summarizes the activity and illustrates similarities and differences.

**Trainer's Note:** These lists should also be saved because they will be used again a part of a later exercise. It is advisable to keep them posted if possible.

Exercise 2      Forestry: Global Perspective, Peace Corps' Goals, Volunteer's Role

Total time      1 hour 30 minutes

Overview

This exercise provides information on the world problems in forestry. Peace Corps' goals are explained and the trainees are encouraged to realize that as individual Volunteers they can play a part in changing the grim prediction for the world's forests.

Procedures

<u>Time</u>	<u>Activities</u>
20 minutes	1. The trainer or visiting authority on forestry lectures on the global picture. The lecture follows.
20 minutes	2. The trainer or Program Manager from Peace Corps lectures about Peace Corps' goals for forestry. The outline follows.
20 minutes	3. The trainer lectures about what the individual can do.
15 minutes	4. The trainer and/or speakers ask for questions from the participants. He/she summarizes and illustrates that Volunteers are a part of a large picture and have a valuable job to do. We are going to spend the next five weeks getting ready to do that job.
15 minutes	5. At this time, the director of the conference/training center may want to say a few words of welcome and give a tour of the training facilities.

**Trainer's Note:** Sample lectures are provided as guidelines. You will want to put these views in your own words. Depending upon the resource people available at the time of the training, however, you may not need to worry about lecture preparation.

GLOBAL DEFORESTATION

- I. Causes of Deforestation
  - A. Clearcutting for agriculture
    - 1. Shifting agriculture
    - 2. Colonization
    - 3. Unemployment
    - 4. Land tenure
    - 5. Cattle raising
  - B. Firewood gathering
    - 1. 4/5 of volume removed from tropical forests is for firewood
    - 2. Charcoal production
  - C. Logging
    - 1. Clearcutting
    - 2. Damage to standing timber left 50% of stand
    - 3. Little reforestation
- II. Success of reforestation will include
  - A. Technical proficiency
  - B. Personal fulfillment
  - C. Agency accomplishment
  - D. Community involvement
- III. Selection of areas of action out of awareness of total picture
  - A. Result of deforestation
    - 1. Erosion
    - 2. Loss of raw material
    - 3. Siltation
    - 4. Soil infertility
    - 5. Economic loss
    - 6. Extinction of flora and fauna
    - 7. Lack and/or reduction of water
    - 8. Lack of toilet paper

PEACE CORPS' FORESTRY GOALS

- I. Ideal: Educate people in:
  - A. Conservation
  - B. Rational utilization of resources
  
- II. Practical: Plant as many trees as possible.
  
- III. What to do:
  - A. Agency Problems
    1. Political
    2. Emphasis of technical
    3. Lack of interest
    4. Efforts to not address problems
    5. Lack of resources
    6. Laws
    7. No cooperation with other agencies; no cooperation among field of specialization
  
  - B. Farmer/Community Problems
    1. Have other problems to solve
    2. Getting people together is difficult
    3. Level of education is usually low
    4. Cultural habits
  
- IV. The Answer?
  - A. Forestry Measures
    1. Agroforestry systems
    2. Village woodlots
    3. Intensive plantations
    4. Better management - reserves
    5. Regulation of logging practices
    6. Application of known technology
    7. Research
  
  - B. Enabling Actions
    1. National development patterns
    2. Alternatives - food supply
    3. Increase crop yields
    4. Land tenure
    5. Effective attention to energy
    6. Conservation of forest products
    7. Better stoves - recycling
    8. Reduce waste
    9. Population

Exercise 3      Journal KeepingTotal time      45 minutesOverview

As scientists, it is important for participants to collect data daily and keep a journal as part of their profession. It is a key to recording information and provides a tool for trainees to use once they have left the security of the training program. The journal can be used for project management and continued learning, as well as goal setting, planning and personal reflection.

ProceduresTime

2 minutes

10 minutes

Activities

1. Introduce the purpose of the session.
2. Explain to the group (with the use of a flip chart) the following format for journal use (provide notebooks with tabs). Divide the journal into the following sections:
  - A. Weekly goals (for learning during training, then for tasks during volunteer service),
  - B. Daily activity log,
  - C. Community analysis questions and data,
  - D. Community problem analysis,
  - E. Personal reflections, personal learnings,
  - F. Scientific, climatic data,
  - G. Language words I hear and want to look up.

30 minutes

3. Ask the group to begin making their first journal entries by writing their personal learning goals for the week. Under each goal, try to write as many objectives as possible. Relate this back to "responsibility for one's own learning."

3 minutes

4. Explain that there will be quiet time every evening for a half hour of journal writing.



RECORD KEEPING - GROUP PROCESS

Total time      2 hours 15 minutes

Goals

- o To establish the importance of record keeping as scientists and as responsible Peace Corps Volunteers,
- o To observe group process.

Overview

This session is devoted to the importance of accurate record keeping not only during training but also as a professional habit during Peace Corps service. The group will also look at its own group process.

Exercises

1. Record Keeping
2. Group Process

Materials

Flip charts, marker pens, tape.

Exercise 1      Record KeepingTotal time      1 hour 30 minutesOverview

This exercise provides the trainees with an opportunity to realize the importance of record keeping as essential during training and Peace Corps service.

ProcedureTime:Activities

- |            |   |
|------------|---|
| 20 minutes | <ol style="list-style-type: none"> <li>1. The trainer asks that the trainees get together with four other people with whom they have not worked.</li> <li>2. The trainer gives the group the following problem which is posted on newsprint:<br/><br/>What information would you need to know if you arrived three weeks after an experiment in germination was begun in a nursery and you were expected to take over the experiment?<br/><br/>Trainer asks the groups to make a list of all data they would need.</li> </ol> |
| 10 minutes | <ol style="list-style-type: none"> <li>3. Have two groups meet together and combine their lists.</li> </ol>   |
| 10 minutes | <ol style="list-style-type: none"> <li>4. The combined groups present their data sheet to large group.</li> </ol>   |
| 30 minutes | <ol style="list-style-type: none"> <li>5. The combined groups are given the task of designing a record keeping form. They must determine how they can best do the task with such a large group. The form developed is put on newsprint.</li> </ol>  |

**Trainer's Note:** The purpose of combining groups (making them large) is to have groups experience having people with the same information but articulating it in a different way.

10 minutes

6. The groups make presentations and critique the other forms.

10 minutes

7. Using newsprint, the trainer summarizes as follows:

Data Sheet

- A. Careful layout,
  - B. Easy to read,
  - C. Easy to use,
  - D. All on one sheet if possible,
  - E. All data can be important.
8. The trainer stresses once again the importance of keeping records during training.
  9. Move from this exercise directly into the "Group Process" exercise.

**Exercise 2      Group Process****Total time      45 minutes****Goals**

- o To explore the group process,
- o To understand collaboration.

**Overview**

Experiential learnings and group collaboration are emphasized in this exercise.

**Procedure****Time****15 minutes****Activities**

1. Each group is instructed to discuss observations of the group process on a technical and interpersonal level. Some questions that may stimulate discussion are:
  - A. What were the reactions of group members regarding various individual technical skill levels in the group?
  - B. Did people find it a help or a hinderance to work with people of different skill levels?
  - C. How were decisions made during the data/form making process?
  - D. What factors contributed to or impeded mutually shared decision-making?

**15 minutes**

2. The trainer presents a summary of various styles in group decision-making, including:
  - o The "pulp",
  - o Self authorization,
  - o Handclasp,

- o Baiting,
- o Authority rule,
- o Majority vote,
- o Unanimous consent,
- o Consensus.

A short discussion concerning the potentially positive (satisfying) or negative (frustrating) consequences of each type of decision-making technique follows. The trainer should point out that all the styles, with the exception of consensus, often preclude the full involvement and commitment of some group members, or ignore important issues that should be raised. Mutually shared decision-making, termed consensus, is a positive alternative to other styles; although it may require more time and increased sensitivity to the individual group member, it provides for the commitment necessary for group cohesiveness and cooperation.

10 minutes

3. Each group meets to discuss the styles of decision-making that characterized their group during the record keeping exercise.

5 minutes

4. The trainer guides a summary of group conclusions concerning decision-making styles and group cooperation. Some points for discussion are:
  - A. The perceived value of different styles to facilitate accomplishing a group task,
  - B. The reaction of group members to various styles,
  - C. Observations of ways to improve group dynamics during training,
  - D. The application of such experience to the role of the volunteer in forestry extension work.

VIDEO TAPES

Total time      3 hours

Goals

- o For trainees to view forestry specific tapes of Senegal and Kenya.

Overview

During the initial research for the project, the technical forester trainer made several video tapes of forestry projects in Senegal and Kenya. These tapes included Volunteers' sites, ministry officials at government sites and general country information.

Exercise

1. Video Tapes

Materials

Equipment for showing video tapes.

Exercise 1      Video TapesTotal Time      3 hours 5 minutesOverview

The technical forester trainer shows several video tapes of forestry projects in Senegal and Kenya. These tapes include Volunteers' sites, ministry officials at government sites and general country information.

ProceduresTimeActivities

3 hours

1. Videotapes are shown to the trainees. Tapes are stopped to make points or to question the trainees about what they think they are seeing. The technical trainer is careful to call attention to specific areas that will be discussed later in training program.

5 minutes

2. The trainees are asked to write their thoughts of the tapes in their journals.

**Trainer's Note:** The tapes should be reviewed before the session and decisions made about where and when to stop the tapes, what questions to ask the trainees and which references to make to future training programs.

AGRO-FORESTRY DATA COLLECTION

Total time      4 hours

Goals

- o To collect data to be used in agro-forestry projects,
- o To interview people in the neighboring community.

Overview

This session introduces the trainees to the collection of data which can be found in the community using a list of questions. The trainees experience for the first time talking with strangers about forestry issues and community attitudes. This session also gives the neighboring community an opportunity to meet potential Peace Corps Volunteers.

Exercise

1. Community Interviews

Materials

Flip chart with interview questions.



Exercise 1      Community InterviewsTotal time      4 hoursObjectives

- o To interview community members using a set of questions,
- o To obtain data for an agro-forestry project.

Overview

During this session, the trainees are asked to go into a local community to interview residents using a set format to collect forestry data for use in later sessions. The trainees also test interviewing skills and serve as representatives of Peace Corps in the community; as such, they are encouraged to dress and comport themselves in a professional manner.

ProceduresTime

10 minutes

Activities

1. The trainer gives the trainees the following list of questions to ask in the community:
  - A. Climatic data (local beliefs and official information);
    - o rainfall,
    - o temperature,
    - o problems; beliefs; frequency and seriousness, frost? hail? drought? storms?
  - B. Uses of forest products;
    - o local uses - prices,
    - o commercial uses - prices.
  - C. Forest problems.
  - D. Local attitudes and/or traditions related to trees or forests.

- E. The ten most common trees - local and scientific names.
- F. Agricultural crops that are grown that might have agro-forestry potential.
- G. Fruit trees.
- H. Soil;
  - o general soil types,
  - o erosion problems,
  - o attempts at erosion control.
- I. Land tenure;
  - o ownership patterns,
  - o size of holdings.
- J. Animals (wild and domestic) and their influence on forestry.
- K. Measurements and equivalents;
  - o local land measurements,
  - o local distance measurements,
  - o forest product measurements.

5 minutes

2. The trainer gives the trainees a schedule for being dropped and picked up and assigned areas for the interviews. He/she also mentions that they are Peace Corps Trainees and are representing Peace Corps to fellow Americans - many of whom are unaware of Peace Corps' activities in recent years. They must also be prepared to be interviewed by community members.

**Trainer's Note:** We checked with the vice mayor about having the trainees interview people. He thought that the people of Oracle would be very receptive. The trainees collected a great deal more data than we expected and did an excellent public relations service for Peace Corps.

3 hours

3. The trainees are transported to sites for data collection and returned.

30 - 40 minutes

4. The trainers ask groups to report on the events of the last three hours but not to report the data. Each group shares events and outcome of activity.

5. The trainer wraps-up the session by asking if trainees think that they might have similar experiences in Africa? He/she reminds the trainees that the data will be used later for agro-forestry projects. Some of the interaction skills that they used will be sharpened during the next few weeks.

FEEDBACK

Total time     1 hour

Goals

- To review how to give and receive feedback,
- To learn more about ourselves,
- To become more skillful in obtaining and understanding information about the effectiveness of our behavior,
- To become more sensitive to our reactions to others and the consequences of these reactions.

Overview

In this session, the trainees are given exposure to established methods of sending and receiving feedback. The positive and negative impact feedback can have on a Volunteers' service is covered during this session.

Exercise

1. Feedback

Materials

Flip charts, marker pens, tape.

Exercise 1      FeedbackTotal time      1 hourOverview

The purpose of this exercise is to remind the participants that although they may have had lectures and some practice in feedback, skillful feedback needs to be practiced.

ProceduresTimeActivities

5 minutes

1. The trainer should acknowledge that all of the trainees have been through feedback practice at the CAST, CREST, or Staging and that many may have had an earlier introduction to feedback.

5 minutes

2. He/she asks the individuals to jot down as many feedback rules as they can remember.

15 minutes

3. The trainer produces a newsprint with the following rules:

### FEEDBACK RULES

- A. It is honest and frank rather than diplomatic or subtle. It is true reporting of your real feelings and reactions to the behavior of another person. This implies that you are aware of your reactions and are willing to run the risk of possible rejection by sharing them with the other person.
- B. It is specific rather than general. To be told that one is dominating will probably not be as useful as to be told that: "Just now you were not listening to what the others said, but I felt I had to agree with your arguments or face attack from you."
- C. It is focused on behavior rather than on the person. It is important that we refer to what a person does rather than to what we think or imagine he is. Thus we might say that a person "talked more than anyone else in this meeting" rather than that he is a "loudmouth". The former allows for the possibility of change; the latter implies a fixed personality trait.
- D. It takes into account the needs of the receiver of feedback. Feedback can be destructive when it serves only our own needs and fails to consider the needs of the person on the receiving end. It should be given to help, not hurt. We too often give feedback because it makes us feel better or gives us a psychological advantage.
- E. It is directed toward behavior about which the receiver can do something. Frustration is only increased when a person is reminded of some shortcomings over which he has no control or a physical characteristic about which he can do nothing.
- F. It is solicited, rather than imposed. Feedback is most useful when the receiver himself has formulated the kind of question which one can answer either by observing him or through actively seeking (soliciting) feedback.
- G. It involves sharing of information rather than giving advice. By sharing information, we leave a person free to decide for himself, in accordance with his own goals, needs, etc. When we give advice we tell him what to do, and to some degree take away his freedom to decide for himself.
- H. It is well-timed. In general, immediate feedback is most useful (depending of course, upon the person's readiness to hear it, support available from others, etc.). The reception and use of feedback involves many possible emotional reactions. Excellent feedback presented at an inappropriate time may do more harm than good.
- I. It involves the amount of information that receiver can use rather than the amount we would like to give. To overload a person with feedback is to reduce the possibility that he may be able to use what he receives effectively. When we give more than can be used, we are more often than not satisfying some need of our own rather than helping the other person.

- J. It concerns what is said or done, or how, not why. The "why" takes us from the observable to the inferred and involves assumptions regarding motive or intent. Telling a person what his motivations or intentions are more often than not tends to alienate the person, and contributes to a climate of resentment, suspicion, and distrust; it does not contribute to learning or development. It is dangerous to assume that we know why a person says or does something, or what he "really" means, or what he is "really" trying to accomplish. If we are uncertain of his motives or intent, this uncertainty in itself is feedback and should be revealed.
- K. It is checked to insure clear communication. One way of doing this is to have the receiver try to rephrase the feedback he has received to see if it corresponds to what the sender had in mind. No matter what the intent, feedback is often threatening and thus subject to considerable distortion or misinterpretation.

5 minutes

4. The trainer gives the following reasons why we want to practice and become more skillful at giving and receiving feedback.
- A. By learning to give and receive feedback skillfully, we help ourselves and others become more effective Volunteers.
- B. The more we learn about ourselves in this training and how effective our behavior is, the more we will be prepared for our two years as Volunteers.
- C. We will also become more sensitive to our reactions to others and the consequences of these reactions in our interpersonal relationships.

15 minutes

5. The trainer asks the group to break into groups of five and brainstorm ways in which we can become more skillful at giving and receiving feedback and list ideas on newsprint.

15 minutes

6. The trainer asks the groups to present their list to the entire group.
7. By way of summarizing, two trainer models for giving and receiving feedback through short role plays are used. The feedback should be real, perhaps based

upon the record keeping exercise in which the trainees took part. This would help set a climate of openness. It is also important to model positive feedback.



FLOWERS, SEEDS, THE BEGINNING

Total time    2 hours

Goals

- o To refresh the memories of the trainees about flowering cycles, pollination, seeds, seed germination, seed dispersal, basic seed storage and point out our lack of knowledge about seed germination and dispersal among many tropical species,
- o To gather seeds,
- o To instruct the trainees on setting up seed collection records,
- o To instruct the trainees in basic seed storage.

Overview

This session reviews the flowering cycle and seeds from pollination to germination. It is necessary to start at the beginning as most trainees will have studied these cycles in North America and need to recognize the differences in tropical species. The trainees will also gather seeds and record data.

Exercises

1. Flowers & Seeds
2. Seed Collection

Materials

Flip charts, marker pens, tape.

Exercise 1      Flowers & Seeds

Total time      1 hour

Overview

Many of the participants will have learned in North American schools the cycles of flowering and seed development. This lecture refreshes their memories and has them relate the cycles to African trees.

Procedures

Time

1 hour

Activities

1. The technical trainer states that this morning is a quick refresher for everyone and invites a botanist in the group to add his/her comments throughout the lecture.

It is recommended that the following outline be put on newsprint and the trainees follow it as lecture is given.

## FLOWERS

- I. FLOWERS: Many different colors, shapes and sizes
- II. FLOWER TYPES:
  - A. Male flower
  - B. Female flower
  - C. Complete flowers - bisexual
- III. TYPES OF TREES:
  - A. Monoecious - staminate (male) flowers and pistillate (female) flowers on same tree, (pine; Douglas fir).
  - B. Dioecious - staminate and pistillate flowers occurring on separate trees (willow; poplar).
  - C. Polygamo - monoecious - complete flower plus staminate and pistillate flowers on same tree (Buckeye).
  - D. Polygamo - Dioecious - perfect flower plus either staminate or pistillate flowers (Buckthorn).

NOTE: All of the above types of trees can bear seeds except the dioecious tree that produces staminate flowers.

### FLOWERING CYCLE/SEED MATURITY

#### POLLINATION

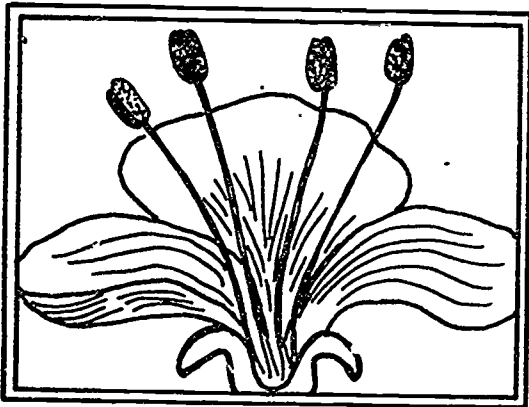

Staminate Flower

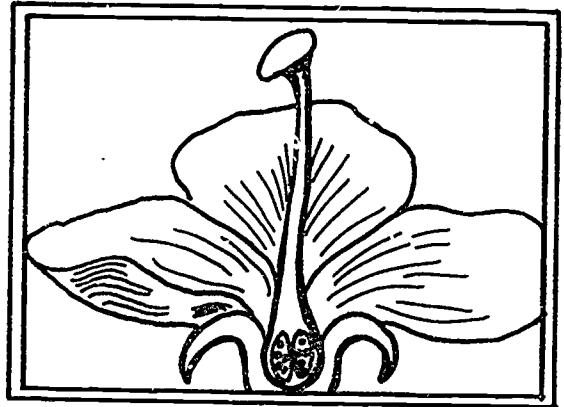

Pistillate Flower

(Fig. 1)

#### IV. POLLINATORS

- A. Wind
- B. Insects
- C. Birds
- D. Others - mice, bats

Two nuclei penetrate the ovule and double fertilization occurs.

1. One fertilization unites egg to form embryo.
2. Other fertilization unites with two polar nuclei to form endosperm.

SEEDS

- I. Mature Seed
  - A. Three - six months after fertilization
  - B. One year after fertilization - pine
  - C. Some take more time
- II. Formation
  - A. Mature embryo embedded in endosperm (endosperm can be small or absent)
  - B. Seed coat (integument) forms around the ovule
- III. Embryo = Germ
  - A. Composed of:
    - 1. Seed leaves - Cotyledon - mostly two (palms one, pines four plus)
      - a. manufacture food
      - b. have stored food
    - 2. Bud - Plumule
    - 3. Stem - Hypocotyl
    - 4. Rudimentary root - radicle
    - 5. Seed Coats
      - a. hard (pines)
      - b. soft
      - c. leathery (cypress)
- IV. Types of Seeds
  - A. True seeds (from pine)
  - B. Dry fruits; fruit is small (oak)
  - C. Fleshy fruit (apple)
- V. Ripening
  - A. Chemical change
  - B. Hardening
  - C. Dry
  - D. Color change
- VI. Seed Dispersal
  - A. Wind
    - 1. Light seeds
    - 2. Seeds with wings
  - B. Mammals
    - 1. Rodents
    - 2. Animals
  - C. Water
  - D. Fish
  - E. Man

## VII. Seed Collection - Records

- A. Seed Maturity
- B. Ripeness
- C. When to collect
  - 1. Early collection - not ripe
  - 2. Late collection - few viable seeds left
- D. Methods
  - 1. Climbing
  - 2. Clippers
  - 3. Cutters
  - 4. Shaking
  - 5. Logging
  - 6. Bamboo poles
  - 7. Collect off ground
  - 8. Spread sheet below tree
- E. Seed Extraction
  - 1. Air dry\*
  - 2. Oven kiln
  - 3. Depulping
  - 4. Dewinging
  - 5. Floating
  - 6. Winnowing

\*Note: It is important in air drying that birds do not eat the seeds. Air drying is also the most used and practical method of seed extraction.

- F. Dormancy
  - 1. Internal dormancy (triggering internal chemical reactions)
  - 2. External dormancy (seed coat permeability)
- G. Seed Treatment
  - 1. Burning
  - 2. Soaking
  - 3. Boiling
  - 4. Filing - soaking
  - 5. Cutting
  - 6. Tumbling - (with grit)
  - 7. Others
- H. For Germination to Occur
  - 1. Internal factors - ripe
  - 2. External factors
    - a. moisture
    - b. temperature
  - 3. Dormancy
  - 4. Oxygen
  - 5. Light
- I. Seed Storage
  - 1. Dry - cold: in sealed containers; pine, cypress
  - 2. Moist - cold: oak, maple

3. Room temperature: Acacia, eucalyptus
4. Other possibilities
  - a. partial vacuum
  - b. dry freeze
  - c. hole in ground - bury in sealed plastic bags
5. How does nature do it? peat moss (turba)
6. Small containers

Exercise 2      Seed CollectionTotal time      45 minutesOverview

The trainees collect as many varieties of seeds as possible. They try to identify seed species. The trainees begin to look at vegetation in the environment from a reproductive point of view.

Procedure

<u>Time</u>	<u>Activities</u>
15 minutes	1. This exercise is done immediately after the lecture in Exercise 1. The technical trainer asks the trainees to collect individually as many seeds from different sources as they can in the next 15 minutes.
15 minutes	2. After 15 minutes, the trainees are asked to place the seeds on newsprint on the floor for display. They are to write under each species whether or not seed is mature and how the trainee thinks it is dispersed.
10 minutes	3. The technical trainer makes a few remarks about the displays and points out the accuracy of identification, dispersal methods, etc.
5 minutes	4. The technical trainer reviews the goals of this session and asks that the trainees save the mature seeds they have collected until tomorrow.



NUTRITION

Total time      1 hour

Goals

- o To introduce the concept of "good nutrition",
- o To explore the basic nutritional needs of people,
- o To identify the nutritive value of categories of food,
- o To identify and research the uses and nutritive value of locally available foods at the training site and in the host country.

Overview

This session focuses upon basic nutrition concepts, classification of nutrients, and the characteristics of a nutritional diet. The trainees will examine their personal eating habits and daily diets in relation to nutritional needs, and discuss how their eating habits have changed during training and how it may change while living overseas.

Exercises

1. Nutrition

Materials

Flip charts, markers, tape.

Exercise 1      NutritionTotal Time      1 hourOverview

This session focuses upon basic nutrition concepts, classification of nutrients and the characteristics of a nutritional diet. The trainees will examine their personal eating habits and daily diets in relation to nutritional needs and discuss how their eating habits have changed during training and how they may change while living overseas.

ProceduresTime

5 minutes

Activities

1. The trainer introduces the session by remarking that: for the most of us "good nutrition" is not a new concept. We hear about the use of chemical additives in food; the dangers of junk and fast foods; and our mother's concerns for "cleaning up plates" and "eating green vegetables" that are good for us. Despite the concern about "good nutrition" to which we have been exposed, how many of us actually pay close attention to what we eat? For many of us, our food habits have changed at the training site and are sure to change even more radically once we are overseas. "We are what we eat." The quality of what we eat determines to a great extent the quality of life we have.

This session examines the area of "food and nutrition" so that we can maximize our nutritional intake as trainees and in the future as Peace Corps Volunteers.

5 minutes

2. The trainer summarizes the goals of the session which are listed on newsprint.

10 minutes

3. The trainer begins the next segment of the exercise with the following introduction, "In order to better understand the concept of 'good nutrition' and how it relates to us personally, we are going to take a close look at our personal eating habits and daily diets. First, however, let's take a look at food in general." The trainer facilitates discussion around the following questions: (answers are written on newsprint)
  - A. What are nutrients? What are the major nutrients found in foods?
  - B. What are the important functions of these nutrients?

The trainer asks about the functions of the nutrients in various foods. The trainer shows the following chart which has been put on newsprint.

3/

### Three Main Food Groups

Group I  
(Protective Foods)

Fruits & Vegetables

Provide water, minerals and vitamins

Group II  
(Energy Foods)

Cereals, grains, starchy roots, extracted oil, beer and wine

Contains high amounts of carbohydrates and/or fats

Group III  
(Body Bldg./Repair Foods)

Meat, fish, poultry, eggs, milk, cheese, yogurt

Contains a high percentage of protein

The trainer continues, "As you can see, foods fall into one of three groups depending upon the major nutrient they contain."

10 minutes

4. The trainer asks each trainee to record what they have eaten and drank in the last 24 hours and place each of these foods in the appropriate nutrient group. The trainees complete the 24 hour diet recall.

25 minutes

5. The training group is then divided into small groups and encouraged to discuss their individual findings. Possible questions to facilitate the small group discussion might include:
  - A. In which food group did most of what you ate and drank yesterday fall?
  - B. Was yesterday a normal day for you in terms of what you ate? Were you tired, sluggish, energetic?
  - C. Were there any surprises in what you found to be the major nutrients that you got yesterday?
  - D. Where were you deficient? Where were you in surplus?

The trainer asks the group to develop strategies to correct deficiencies and surpluses. The small groups report to the large group. Strategies are discussed and those that are feasible are encouraged by the trainer.

6. The trainer asks the small groups of trainees going to the same country to list what they know about foods and diets in their prospective host country. What dietary habits will they have to modify?

5 minutes

7. The trainer discusses the changes upon which they have agreed for their diet while in training and how this is a good place to start practicing "good nutrition" by monitoring each other. He/she points out that good nutrition will help them stay energized throughout the training.

**Trainer's Note:** We had several people who were vegetarians who complained about the food at the center. We used this exercise to focus on nutrition and the center's staff did present alternative foods, i.e., peanut butter, cheese, etc. However, many people took the opportunity to reintroduce meat into their diets as they realized that they may not have choices when eating from a common bowl in Africa.

NON-VERBAL COMMUNICATION

Total time 1 hour 30 minutes

Goals

- To identify ways we communicate verbally and non-verbally,
- To identify patterns of non-verbal communication,
- To look at perceptions about one's non-verbal message,
- To identify some implications of non-verbal communication for cross cultural effectiveness,
- To develop non-verbal communication skills.

Overview

This session explores communication as a process. The trainees will have previously received some non-verbal communications training. This session will reinforce those learnings and concentrate on building non-verbal skills.

Exercises

1. Messages
2. Reflections on Non-Verbal Communications and Observations of Another

Materials

Flip chart, markers.

Exercise 1      MessagesTotal time      45 minutesOverview

Non-verbal communication is practiced in this exercise. Because we tend to communicate our likes and dislikes in our day-to-day relationships in a non-verbal way, special attention is given to this method of communication in this session.

ProceduresTimeActivities

5 minutes

1. The trainer announces that "we are going to try a game; the meaning of which we will discover later, trust me." The game is structured rather like charades except that one may not use charade-like signals (such as spelling with the fingers or using word conventions). Even if you have played this game before, it is fun to see if you are becoming skillful at it.

10 minutes

2. In pairs, give each person a message on a piece of paper (see list below); then tell the group that they have three minutes to try to get the message across without using words. They cannot write, spell or talk. The trainer keeps track of time. After the first three minutes, switch so that the other person can try it also. A sample list of messages follows (you may add your own but the message should include either an emotion or communicate something about a relationship). Messages (have them written out on slips of paper):
  - A. "I'm angry because the goats ate my seedlings."
  - B. "I'm happy because your crew arrived for work today."

- C. "I'm frustrated because you never listen to me."
  - D. "You can't understand me and this frightens me."
  - E. "I'm surprised at your youthful appearance."
  - F. "I like you and want to be your friend."
  - G. "I'm weak (and submissive) and you are strong (and dominant)."
  - H. "I don't like not being able to talk."
3. After the non-verbal experience, gather group reactions:
- o. What was that like for you?
  - o. What was easy about it (i.e., what part of the message could you get)?
  - o. What was difficult (i.e., what part of the message couldn't you get)?

30 minutes

4. Build a lecture out of group experience:
- o. How many of you know about non-verbal communication?
  - o. What is it? Give some examples.
  - o. What does non-verbal communication communicate?
  - o. How aware are you of your own non-verbal message?

As the trainees answer these questions, write down the answers on a flip chart and examine them with the group. At the end, the group and the trainer should arrive at a working definition of non-verbal communication which they can test during the next week with each other.



Exercise 2      Reflections on Non-Verbal Communications  
and Observations of Another

Total time      45 minutes

Overview

This exercise gives individuals time to think about how they communicate non-verbally. They can then decide if there is perhaps some new or different non-verbal behavior that they would like to try during training.

Procedure

Time

Activities

20 minutes

1. Trainer lists on newsprint the following:

- o Body bearing
- o Appearance
- o Tone of voice
- o Use of space
- o Content of language
- o Gestures
- o Ornaments
- o Touching
- o Facial expressions
- o Smells
- o Colors
- o Signs
- o Other

Ask the participants to take a few minutes to write how and what they think they communicate non-verbally in each one of these categories.

5 minutes

2. Ask the participants to look over responses to the non-verbal categories. Determine if there is some area of non-verbal communications that they want to strengthen or perhaps change.

15 minutes

3. Ask the trainees to choose partners which will be for the purpose of "observing each other" for a one week period in order to learn more about

non-verbal communication and the way we are perceived by another. The task is to "watch each other" during the week whenever possible and notice how the other person uses non-verbal communication.

At this point they may want to share with each other their responses to the non-verbal categories and have partners determine their perceptions of how and what is communicated non-verbally.

5 minutes.

4. Trainer says next week, the same pairs will meet to provide feedback on how they communicated non-verbally and to draw some generalizations from the experience about how people from our culture communicate non-verbally. Also, participants will be able to check their own non-verbal images with their partners.

GERMINATION

Total time      2 hours 45 minutes

Goals

- o For trainees to conduct their own germination experiments,
- o To establish record keeping systems for experiments,
- o For trainees to look at their own group process.

Overview

The trainees will apply learnings from previous sessions on seeds. They conduct germination experiments with several different varieties of seeds including the mature seeds that they have collected the previous day. The trainees will also develop a record keeping system for their experiments which will reinforce learnings from the record keeping exercise done two days prior to this session.

Exercises

1. Germination Experiments & Record Keeping
2. Small Group Process

Materials

Several varieties of seeds, plastic bags (zip lock), sand paper, and paper toweling.

Exercise 1      Germination Experiment & Record KeepingTotal time      2 hoursOverview

This exercise gives the trainees "hands-on" experience to apply their learnings from previous exercises. The trainees will also develop a record keeping system for their experiments which will reinforce learning from the record keeping exercise of the previous day.

ProceduresTimeActivities

- |            |   |
|------------|---|
| 15 minutes | 1. The trainees are asked to form groups of three. Groups are given a variety of seeds.   |
| 45 minutes | 2. The groups are told that they are to determine the best way to treat the seeds (scarify and/or stratify). They must decide upon three different methods with at least two varieties of seeds. They are told the species. |
| 45 minutes | 3. Trainees are told to determine a record keeping system for the germination experiment.   |
| 15 minutes | 4. The trainee/manager is identified; the groups are to report their data on the progress of germination experiments to the manager every three days.   |

**Trainer's Note:** The purpose of this exercise is not to furnish all the materials the trainees need, but to have them find their own boiling water, sand paper, finger nail files etc., at the training site. Plastic bags, seeds and blotter paper are provided.

**Trainer's Note:** The trainer or expert in seed management should present the most applicable procedures and record keeping system used for the germination test. He/she should obtain feedback on the students' efforts.

Exercise 2      Small Group ProcessTotal time      45 minutesOverview

This exercise examines the small group process as compared to the large group process which was discussed in an earlier session. This session also utilizes feedback skills.

Procedures

30 minutes

Activities

1. The trainers look at the process of their groups. They are told to give each other feedback on the following:
  - A. Leadership qualities,
  - B. Participation,
  - C. What helped/hindered getting the task done?

Everyone must get/give feedback. While one is giving feedback to another, the third trainee observes the feedback and gives feedback on the quality and skill used with which the feedback was given.

5 minutes

2. The trainees are asked to compare working in a small group to working in a larger group.

5 minutes

3. The trainer lists the findings of the various groups as to...
  - o Things that are harder,
  - o Things that are easier,
  - o Impact on individuals.

5 minutes

4. The trainer points out the greater responsibility of human interaction as the trainees work together and become more skillful.

COPING SKILLS

Total time      2 hours

Goals

- o For the trainees to understand the necessity of possessing coping skills as a Peace Corps Volunteer,
- o To discuss with the trainees openly and frankly, the differences in the cultures in which they will be and the possible effects these differences may have upon their personal lives.

Overview

This session enables the trainers to introduce sensitive subject matter concerning the possible effects that living in a new culture may have upon the trainees. The mores of the host country are openly discussed so the trainees will understand how to conduct themselves as Peace Corps Volunteers to be effective in their roles. The trainers invite questions and encourage open discussion between themselves and the trainees.

Exercise

1. Coping Skills

Materials

Flip chart, markers.

**Trainer's Note:** This session requires the trainer to have researched the attitudes, values, mores, and cultural norms of the host country if he/she does not have first hand knowledge of same.

## SESSION 12

Exercise 1      Coping SkillsTotal time      2 hoursOverview

The trainers introduce sensitive subject matter concerning the possible effects that living in a new culture may have upon the trainee. The mores of the host country are openly discussed so the trainees will understand how to conduct themselves as Peace Corps Volunteers to be effective in their roles.

ProceduresTimeActivities

1. The trainer lists on newsprint, the following items:
  - A. Mores of host country,
  - B. Corruption,
  - C. Sexuality,
  - D. Drinking/drugs,
  - E. How children are treated,
  - F. How animals are treated,
  - G. Women's roles/rights,
  - H. Hospitality,
  - I. Privacy,
  - J. Personal safety.
  
2. Men and women are asked to meet with a trainer in separate groups. After presenting the newsprint with the above items, the trainer gives a brief definition/explanation of each as follows.
  - A. Social customs, eating with hands, special greetings, etc.;
  - B. Corruption that may be evident in host country; the importance of not handling other people's money;
  - C. Sexuality, the openness in some cultures and the strictness in others; ways of coping with

suggestiveness from members of the opposite sex in host country;

- D. The drinking practices in host country; ways to cope with not wanting to drink, the appropriateness of women drinking or not drinking; drugs; reinforcing Peace Corps' policy of "no drugs" even if they are available;
- E. How children are treated; in some countries, child beating is practiced (but only by the child's parents); how to deal with telling parents that a child is misbehaving if you know that a beating will ensue;
- F. How animals are treated; the sometimes rough treatment of animals and the advisability of keeping pets;
- G. Women's role; long hours of work; how to manage your feelings about women's acceptance of their roles;
- H. Hospitality in the host country; why your denial of food or drink would be considered rude;
- I. Privacy, or lack of privacy;
- J. Personal safety; not inviting aggressive behavior through your own rudeness (or what could be perceived as rudeness).

It is usually advisable to go down the list one item at a time. Ask the trainees to feel free to ask questions in the areas of concern. The trainer should state that no question is unimportant if it is of concern to the trainee. The trainer should emphasize that these areas will probably be brought up again during in-country training.

**Trainer's Note:** We have found that trainees have concerns in these areas and are reluctant to ask questions. By having this session early in training, you are



able to dispel myths and clear up misinformation that the trainees have either gotten from outside sources or faulty assumptions on their parts that have created concerns.

BASIC SITE SELECTION, PLANNING & LAYOUT OF A NURSERY

Total time      4 hours

Goals

- o To introduce nursery teams and explain how and why they were chosen,
- o To explore knowledge within the group about nursery site selection,
- o To explore group experience in planning and layout of a nursery,
- o To explore group process in an unstructured situation.

Overview

In this session, the trainees will be asked to plan a nursery. They will be divided into teams which have been chosen by the trainers and given the task without further instructions. It is during this session that the trainees' ingenuity and ability to organize is pushed.

Exercises

1. Factors to be Considered in Nursery Sites
2. Location of Site and Planning of Nursery

Materials

Flip charts, marker pens, tape.

Exercise 1      Factors to be Considered in Nursery SitesTotal time      2 hoursOverview

Building upon the groups' knowledge, the trainers will attempt to determine factors to be considered in planning a possible nursery site.

ProceduresTimeActivities

10 minutes

1. The nursery teams are introduced. The trainer explains that teams have been chosen as a result of staff observations of how they have worked individually over the last three days. They are unchangeable and non-negotiable. Strengths have been taken into consideration as well as weaknesses. Lastly, role models from which others could benefit through observation of their working styles were considered. If anyone is curious as to why they are in specific groups, they can ask privately and will be given the information.

45 minutes

2. The trainer instructs the nursery teams to get together and list on newsprint those factors that they feel are important in choosing a site for establishing a forest nursery.

30 minutes

3. The teams make presentations to the large group. Each presentation is questioned and discussed by the forester/trainer and other group members.

15 minutes

4. The forester/trainer presents a summary lecture. He/she then puts the following on newsprint:

### Nursery Site Selection

#### Points to consider:

1. Moderate slope
  - a. drainage
  - b. watering
2. Good soil (A soil sample should be taken)
3. Frost-free site
4. Protection from winds
5. No large trees nearby
6. Near water
7. Good labor supply
8. Close to transportation
9. Written permission of owner
10. Caretaker
11. Fencing
12. Not used recently as nursery
13. Sufficient size for anticipated seedling demand - expansion
14. No weeds

5. The technical trainer explains that you will not always, if ever, find everything on site.

### Nursery Site Trade-offs

1. What is really important?
2. What can you live with?

15 minutes

6. The forester/trainer explains planning the layout of a nursery.
  - o Layout of nursery
 

Contiguous group of seed beds to facilitate ease of working and irrigating.
  - o Seed beds
    - a. Built-up 15 - 20 centimeters,
    - b. 1 - 1.3 meters wide.

- o Walkways

40 - 80 centimeters for ease of access.

5 minutes

7. The trainer instructs the trainees to draw up plans for Session 14.

Exercise 2      Location of Nursery Site and PlanningTotal time      2 hoursOverview

Leadership ability to organize and the ingenuity of group members are highlighted. The trainees are given an approximate idea of possible site locations. The trainers leave the area and are not available to the group as they decide upon a site and draw up their plans. The trainers return and review the site plan and help the group examine their own process.

ProceduresTimeActivities

1 hour 30 minutes

1. The trainer identifies an area near the training center, shows sketch map of area, and tells the trainees that they are to plan a nursery in that area. Written instructions are:
  - o Each row will be four meters long. Each nursery group will be responsible for one row.
  - o Plan the layout; when the trainees have the nursery area planned, bring it to the trainer to be evaluated. All the trainers leave without answering any further questions.

30 minutes

2. The trainers return to the center and ask about the group's process. Some possible questions are:
  - A. Who took charge of the overall project? How did they do it?
  - B. What problems did they have or are still having?
  - C. Is everyone satisfied with the plan?
  - D. How did the nursery groups communicate and interact with each other?

E. How were decisions made?

3. The trainer summarizes the morning activities.

**Trainer's Note:** A great deal of frustration and hard feelings on the part of the trainees are to be expected. They will expect more structure, resist making decisions, and be angry when they are not met with total approval for their plans. In fact, we have never been able to accept the first site chosen by trainees.

REVIEW OF TRAINEES' NURSERY PLAN

Total time      2 hours 30 minutes

Goals

- o For the trainees to experience summarizing events,
- o For the trainees to present their plans for a nursery,
- o For the technical trainer to review plans and approve start of the nursery layout.

Overview

In this session the trainees start with a communication exercise. This exercise helps the trainees begin the process of summarizing events. The technical trainer reviews nursery plans, makes suggestions/corrections and may approve the start of work on the nursery layout.

**Trainer's Note:** The frustrations of the previous exercise are very evident in this session. The summarizing exercise helps the trainees to articulate pent-up feelings.

Exercises

1. Summarizing
2. Review of Nursery Plans

Material

Flip chart paper, markers, tape.



Exercise 1      SummarizingTotal time      30 minutesOverview

This exercise is designed as a short, quick energizer/change of pace and is used in conjunction with the technical training session. It is done by the technical trainer as a way of integrating a skill which can be used for technical learning. This is the first introduction of this exercise and it will be used later in the program.

ProceduresTimeActivities

- |            |  |
|------------|--|
| 2 minutes  | 1. The technical trainer asks the participants to examine the technical training of the past three days and prepare an explanation of what has happened and what they have learned so that they can inform someone else about it.  |
| 10 minutes | 2. The technical trainer asks the participants to form pairs, preferably with someone who has a different technical training experience (i.e., generalist with forester). One person explains his technical training experience of the past three days while the other person listens and then summarizes his/her partner's presentation. Then the trainees switch roles and repeat the process.           |
| 15 minutes | 3. Bring the group together and discuss the experience by asking: <ul style="list-style-type: none"> <li>o What, if anything, caused difficulty?</li> <li>o How did it feel to hear the other person try to summarize your content?</li> <li>o Upon what do you have to concentrate to become a better summarizer?</li> <li>o What are some of the advantages and disadvantages of summarizing?</li> </ul> |

3 minutes

4. The technical trainer asks the group:
  - o What can we say about summarizing as a communication skill?
5. Close by stating that we will return to practice summarizing as a skill from time to time throughout the training.

Exercise 2      Review of Trainee Nursery Plan and Layout of NurseryTotal time      2 hoursOverview

In this exercise the technical trainer reviews the trainees' nursery plan and provides comments about the process of arriving at that plan. The trainees will then proceed to the nursery site and begin to lay out their nursery.

ProcedureTimeActivities

10 minutes

1. The technical trainer reviews the nursery plan, makes recommendations, and points out work that is excellent and that which is not. He/she discusses with the group that this nursery will be their responsibility during the rest of training. They will lay out, prepare the soil, sow seeds and keep the nursery watered. No one will remind them, but the trainers will check progress from time to time.

1 hour 45 minutes

2. The trainees are now instructed to layout the nursery. They know where the tools are kept. No further instructions are given. Once again, the trainers become unavailable.

**Trainer's Note:** There will be more trainees than work space and tools. The groups will have to negotiate the use of tools and space with each other.

5 minutes

3. The trainers arrive and check the nursery layout. Observations are made on the group work at the site. Nothing is said about the group process at this point. The trainers collect data.

**Trainer's Note:** On the following pages is the nursery report that we requested along with the nursery plan that was submitted for approval.

## Peace Corps Volunteer Nursery (Pepiniere) Report

The PCV nursery was begun on 7/17/82 after the plan was approved by the technical trainer. Beds were constructed, fencing was made, and the first seeds were planted on 7/23/82. The soil mixture was made using one part sand, two parts organic matter (saw dust), and three parts soil. The following is a report of the results of this nursery.

### Nursery Description

The Nursery (la pepiniere) is located at the University of Arizona Conference Center, just outside of Oracle, Arizona. To reach the nursery, drive out past The Suffolk House to the conference building. Outside the door at the bottom level, there is a sign directing you to the nursery. If you follow the signs, you will find the nursery in the lee of a large tan water tank.

The nursery is surrounded by a fence constructed of recycled sheep fencing, plywood, and tin roofing. The fence was dug into the ground approximately six inches to discourage rabbits. Strips of lathing were woven into the bottom foot of sheep fencing to further discourage rabbits.

As one enters by the main gate next to the water tank, there are two long seedbeds on the right (see nursery layout plan). These were raised 15 - 20 cm. above the ground and held in place with white cement pipes. Suspended over the seedbeds are several different types of shading; we used palm fronds, lathes and empty boxing crates. In the southern corner of the nursery, we placed a compost bin and piles of organic matter, soil and sand.

Straight ahead as one enters are the sunken and raised seed beds (beds 1 - 8). Beds 5 - 8 are raised. They are surrounded with rows of single bricks and are shaded with palm fronds and wooden frames. Only beds 6, 7 and 8 actually contain seedlings in bags. Beds 1 - 4 are sunken into the ground 20 cm. In these beds are groups of seed bags containing seeds and some seedlings. Each group is a different species. All the tools and records of the nursery are kept in the shed.

### Discussion of Results

All beds were checked twice daily and watered if necessary. Checks were made also for possible problems. The problems that were encountered included pest damage (mice), plastic bags folding over, puddling in seed beds, algae in plastic bags and crusting of the soil. All of these problems affected the germination of our seeds as well as the survival rate of the seedlings.

The direct seedbeds experienced mainly puddling and crusting of the soil due to an insufficient amount of organic matter and mice damage. There was not enough time to conduct proper germination tests, so the viability of the seeds used was uncertain. This may account for the low germination rate.

In addition to the problems encountered in the direct seed beds, the bagged seed beds also experienced difficulty with bag tops folding over because of soil levels and algae in the bags because of poor drainage due to too few holes in the bags. The Eucalyptus camaldurensis was too small when it was transplanted which accounts for its low survival rate.

The species which exhibited good germination and growth (greater than 40%) were: Foothill Paloverde, Mexican Paloverde, Blue Paloverde, Desert Broom, Red Bird of Paradise and Desert Willow. Of the transplanted seedlings, Acacia holosecia and Chilean mesquite both showed good survival rates.

(Fig. 2)

26.25 m.

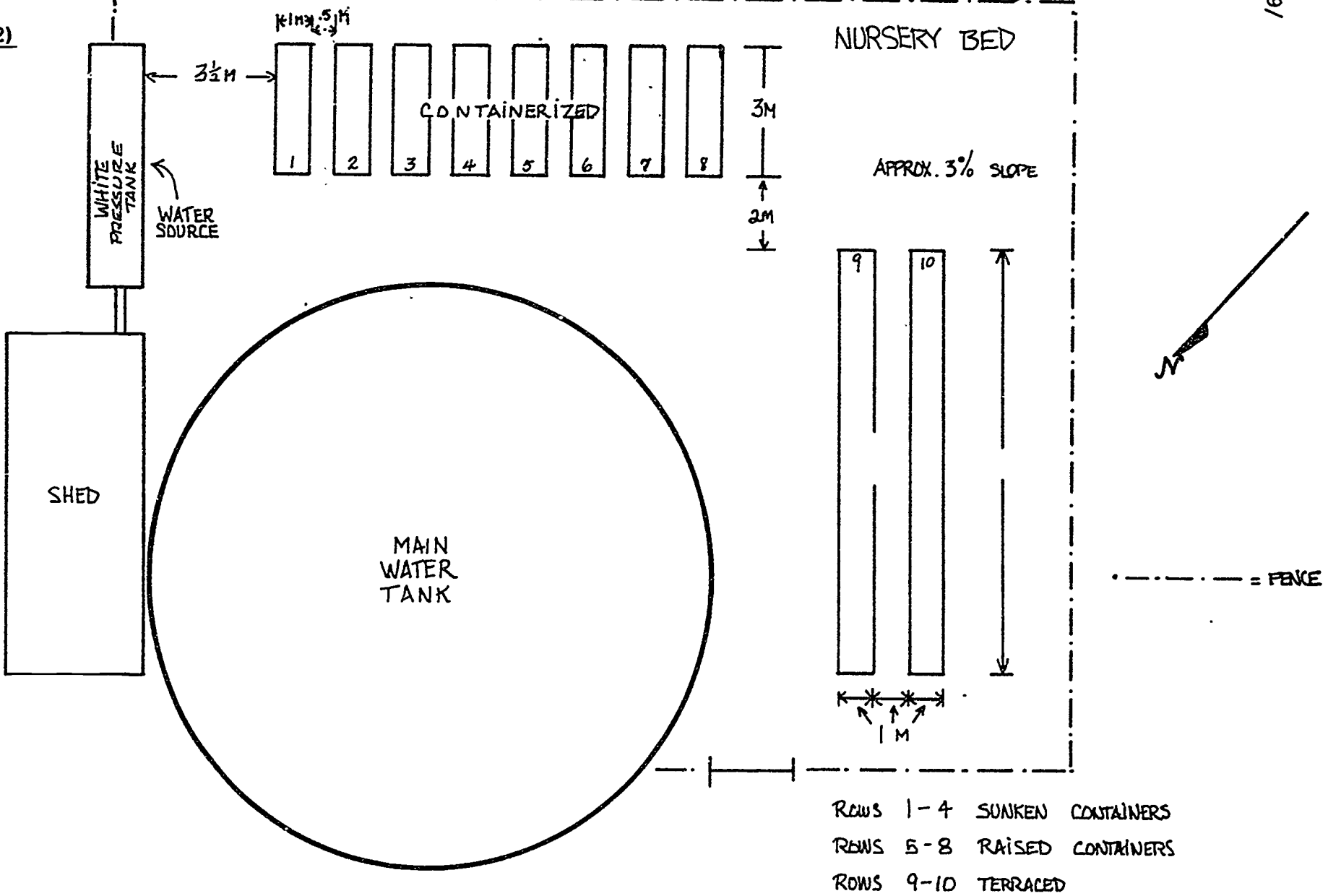

- ROWS 1-4 SUNKEN CONTAINERS
- ROWS 5-8 RAISED CONTAINERS
- ROWS 9-10 TERRACED

CONFERENCE CENTER ←

DIRT ROAD

Transplanted (orphan) Seedling Data  
(Table 1)

Species	Container Type	Date Planted	# Planted	# Alive 8/11/82	Bed Number	Percent Survived
<u>Acacia holoserica</u>	Paper bags	7/23	154	150	8	98
"	Plastic bags	7/23	60	54	8	90
"	Plastic bags	7/24	118	86	8	73
"	Plastic bags	7/23	75	5	7	7
"	Plastic bags	7/23	75	70	7	93
Chilean Mesquite	Plastic bags	7/24	60	45	7	75
<u>Eucalyptus camladulns.</u>	Plastic bags		1000	50	6	5
TOTAL			1,542	460		

BAG SEEDING Planted (7/30/82)

(Table 2)

Bed #	Species	Number Planted	# Alive 8/11/82	Percent Survival	Number of Bags	Depth (Plant)
1	Desert Marigold	660	7	1	33	.25
2	Bursage	56	0	0	28	1.00
3	Primrose	82	3	4	41	.50
4	Paper Flower	100	6	6	25	.50
5	<u>Atriplex leutiforms</u>	56	0	-	28	1.00
6	Desert Broom	210	30	15	42	2.00
7	<u>Dadensa viscosa</u>	192	3	2	64	.75
8	Desert Broom	210	30	15	42	2.00
9	Desert Willow	90	43	48	64	.50
10	<u>Atriplex leutiforms</u>	90	3	3	45	.50

PCV Nursery Fact Sheet

Construction dates: 7/17/82 - 7/22/82

	<u>Per bed</u>	<u>Total</u>
Square meters direct seeding:	11m <sup>2</sup>	22m <sup>2</sup>
Square meters bagged seeding:		
Sunken beds	3m <sup>2</sup>	12m <sup>2</sup>
Raised beds	3m <sup>2</sup>	12m <sup>2</sup>
	Total m <sup>2</sup>	46m <sup>2</sup>

Total number seeds planted:

Direct seeding	11,448
Bag seeding	2,197
TOTAL	13,645

Number germinated\* as of 8/11/82:

Direct seeding	872
Bag seeding	174
TOTAL	1,046

Total number of seedlings transplanted:

Number planted	1,542
Number survived	460

Grand total of seedlings in nursery:	1,506
Total number of species planted	24

\* Does not include those sacrificed to herbivores.



Direct Seed Beds  
(2 species for each bed)

(Table 3)

BED #	SPECIES	DATE PLANTED	DEPTH (cm)	# PLANTED	# GERM	% GERM	AVG. HT. (cm)	# ROWS
1	Mesquite	7/23	1	180	0	0	-	5
	Foothill Palvd.	7/24	2	40	11	28	10	5
2	Mesquite	7/23	1	180	0	0	-	5
	Mex Paloverde	7/24	1	96	46	47	10	6
3	Mesquite	7/23	1	180	1	0.6	2.5	5
	Blue Paloverde	7/24	1	75	48	64	9	5
4	Mesquite	7/23	1	140	0	0	-	4
	Mtn. Mahogany	7/24	1.5	240	25	11	1	8
5	Mesquite	7/23	1	180	3	2	1.5	5
	Brittlebrush	7/24	1	200	14	7	2	5

Numbering for seeds planted in bags

9            14    19  
 1   15       12    18  
 3            6/8   11    4        2\*  
 11520                    16        5\*  
 10/17       13    7

1.0

\*Orphan seedlings

COMMUNICATION THROUGH ILLUSTRATION

Total time      2 hours

Goals

- o To show the trainees simple drawing techniques,
- o To have the trainees understand the importance of illustrating what they are verbalizing;
- o To have the trainees practice simple poster drawing techniques and the use of other materials for making posters - illustrated by the trainer, posters are then made by trainees.

Overview

This session introduces the importance of illustration as a communication technique. In future sessions the trainees will be expected to use illustrations as part of the presentations. The importance of using visual aids while talking to a group is also emphasized.

Exercise

1. Communication Through Illustration

Materials

Flip charts, marker pens, tape, crayons, glue, old magazines, scraps of material, felt pieces, candy bars for prizes.

Exercise 1      Communication Through IllustrationTotal time      2 hoursOverview

This exercise is a lot of fun and the trainers have to keep a focus on communication aspects of the exercise. The Volunteers frequently have to give talks to school children, groups, and at community events. It is important that the participants see the value of holding a group's attention through the use of illustrations.

ProceduresTimeActivities

10 minutes

1. The trainer introduces the session with a short lecture about using visual aids. He/she explains that in rural areas, the more sophisticated forms of visual aids are not available and the trainees must rely upon their own ability to make these aids. The trainer should point out that the use of newsprint during the program is employing a visual aid (implicit group memory).

15 minutes

2. The trainer draws a series of stick figures on newsprint (may want to have light pencil outlines to go over). The trainer asks the trainees to draw a set of stick figures of their own for practice.

1 hour

3. SAMPLE ILLUSTRATION - Keeping cows out of field by fencing.

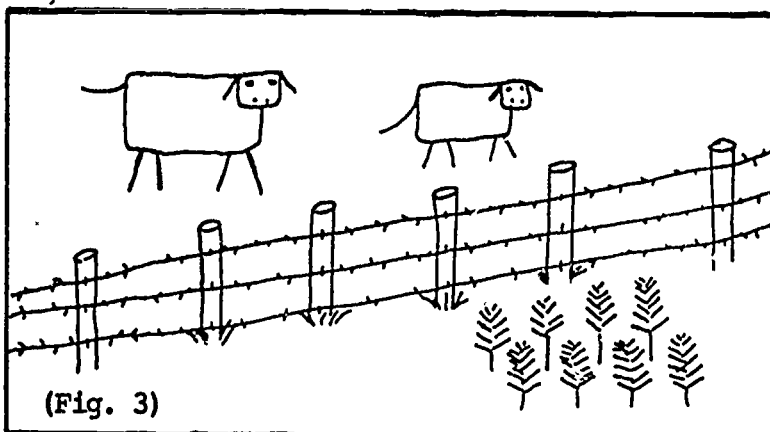

(Fig. 3)

The trainer explains that it is alright to make people laugh by your drawings as long as they understand your message. Getting people to laugh helps them to remember. The trainer explains that we are now going to draw a poster with a message about planting trees. The trainees are instructed to put time and thought into this project as they will have to do this many times during their volunteer service. The trainer tells the trainees that there is a table of different materials that may be used for this project. Each trainee makes a poster. When they are done, the posters are to be hung on the walls. This is a contest and there will be prizes awarded. Awards will be given on:

- o Best presentation of message,
- o Most creative use of materials,
- o Best effort by non-artistic person,
- o Honorable mention in the above categories.

30 minutes

4. The participants are asked to describe their posters if the message is not clear. Suggestions are given by both trainers and trainees. The trainer discusses the various design possibilities exhibited. The trainer states that all of the presentations during the remainder of the training program are expected to be accompanied by

visual presentations. Therefore materials will remain where the trainees can have access to them.

5 minutes

5. The trainers and any guests decide upon the awards. Candy bars are presented.

SOIL PREPARATION, SEEDBED SOWING

Total time      Approximately 4 hours

Goals

- o To give information about soil preparation, and seed bed sowing,
- o To prepare soil in nursery and get seed beds ready for sowing.

Overview

Information about soils is given as a refresher for some and new information for others in this session. The trainees prepare the soil and get the seed beds ready for sowing.

Exercises

1. Soil Preparation and Seedbed Sowing
2. Soil Preparation and Seedbed Sowing

Materials

Flip charts, marker pens, tape, string, shovels, rakes.

Exercise 1      Soil Preparation and Seed Bed SowingTotal time      1 hour 30 minutesOverview

The technical trainer gives a lecture on soil preparation and seedbed sowing. For many participants this will be a refresher session and the technical trainer should ask people to make comments about their experiences.

ProceduresTimeActivity

1 hour 30 minutes

1. The technical trainer gives a lecture using the following outline. It is recommended that the outline be placed on newsprint and displayed as the technical trainer teaches various stages during the lecture. A newsprint outline helps to hold attention.

SOIL PREPARATION

1. If a danger of disease exists, the soil might be sterilized by:
  - a. Boiling water,
  - b. Acid treatment,
  - c. Heating soil on steel plate..
2. Might be better to move site.
3. Chemical sterilization.
4. Fertilization medium to be mixed with soil according to need.
5. Organic material might have to be added to help retain soil moisture and/or improve texture. The following are possibilities:
  - a. Compost,
  - b. Straw,
  - c. Chopped pine needles (dry),
  - d. Sawdust (aged).
  - 1) Toxic effect?
  - 2) Nutrient loss?

(Organic material could contain weed seeds and/or fungi or insects).

6. Mycorrhiza.
7. pH 6.5 (slightly acid).

SOWING

1. Across the bed - facilitates weeding.
2. Make your own seed "trench":
  - a. Board,
  - b. Depth of trench (see drawing on following page).
3. Sow sand in seed trench (optional).
4. Sprinkle seed in trench.
5. Number of seeds/meter:
  - a. Size of seedling,
  - b. Plant species,
  - c. Germination prospects,
  - d. 1 viable seed/cm.



6. Cover with sand or dirt.
7. Water heavily after sowing.
8. You may put straw over beds - for protection against birds and moisture retention.

Exercise 2      Soil Preparation & Seedbed SowingTotal time      2 hours 30 minutesOverview

This exercise is the last formal time allotted for work on the trainees' nursery. However, the weather and their own group process may not allow for the final seedbed sowing. It is possible to finish on the next day.

Procedures

<u>Time</u>	<u>Activities</u>
5 minutes	1. The trainer starts with observations made by staff members as to how the nursery groups have worked together. He/she asks the trainees to verify these observations. The observations are listed on newsprint.
30 minutes	2. The trainer asks the nursery groups to give each other feedback about: <ul style="list-style-type: none"> <li>o How they worked together,</li> <li>o How they feel about the amount of work,</li> <li>o How they feel about the leadership in the group,</li> <li>o How they feel they have worked with other nursery groups,</li> <li>o How they now feel about themselves as a group.</li> </ul>
10 minutes	3. The trainer asks the group to call out adjectives that describe themselves and records them on newsprint. He/she talks about the importance of feedback in the group process.
1 hour 45 minutes	4. The groups are given instructions to finish their nursery. The trainer asks who is keeping records. Make no comment on answer. The trainers once again leave the nursery area.

INDIVIDUAL INTERVIEWS

Total time      Approximately 20 minutes per interview

Goals

- o To give each trainee time with a trainer to review the week's learnings,
- o To give the trainee collective feedback from training staff,
- o To receive feedback from the trainee on the training program and its effectiveness.

Overview

This session gives each trainee individual time with a trainer to review their learnings and experiences of the week. The staff will give each trainee feedback based upon the assessment criteria given to the trainees in Session 1.

Exercise

1. Individual Interviews

Exercise 1 Individual InterviewsTotal Time Approximately 20 minutes per interviewOverview

This session gives each trainee individual time with a trainer to review their learnings and experiences of the week. The staff will give each trainee feedback based upon the assessment criteria given to the trainees in Session 1.

ProceduresTimeActivities

1. The trainers divide the group by the number of trainers and assign trainees to each trainer for interview. The list should be divided so that each trainee will be interviewed at least once by each trainer during the training program.
2. The interview schedule is posted in the training room.
3. The trainer interviews each trainee asking the following questions:
  - A. On a scale of 1 to 10 how would you rate your learnings of the week?
  - B. Overall, how has the training been for you?
  - C. Would you like feedback from staff? We have some for you.....
  - D. Is there any feedback you want to give to the staff?
4. Immediately after last interview, the trainers meet and discuss the interviews, highlighting potential problem areas. The trainers should report on each trainee. Feedback to the staff should be recorded and processed and, if possible, responded to and acknowledged.

REPRODUCTION BY CLIPPINGS AND NURSERY REVIEW

Total time      Approximately 4 hours

Goals

- o To give information pertinent to reproduction by clippings,
- o To review the trainees' plan for the nursery and to check the progress to date,
- o To introduce a problem to be solved by the trainees' resourcefulness.

Overview

Information about reproduction by clipping is given in this session. The participants' nursery plan is reviewed and progress is checked. A problem of missing seedling containers is introduced.

Exercises

1. Reproduction by Clippings
2. Review of Trainee's Nursery Plan and Progress of Nursery
3. Plastic Bag Caper

Materials

Flip charts, marker pens, tape, string, shovels, rakes, newspapers, staples.

Exercise 1      Reproduction by ClippingsTotal time      1 hour 30 minutesOverview

In this exercise, the technical trainer gives a lecture on reproduction by clippings. For many participants this will be a refresher session and the technical trainer should ask people to make comments about their experiences.

ProceduresTimeActivities

1 hour 30 minutes

1. The technical trainer gives a lecture using the following outline. It is recommended that the outline be placed on newsprint and displayed as the technical trainer shows the various stages of the outline during the lecture. The newsprint outline below helps hold the attention of trainees.

REPRODUCTION BY CLIPPINGS

1. Sprouts cut and stuck in ground.
2. More experimentation needed in hardwoods.
3. Rooting medium.
4. Other:
  - a. Layering,
  - b. Moss-soil around sprout.
5. Horticulture:
  - a. Roots,
  - b. Fertilizer.

### POWER IN THE WILLOW

The common willow evidently contains a substance, which you can extract and use at home, that far surpasses synthetic plant hormones in its ability to stimulate almost any plant into rooting. That means hard-to-root trees like beech, cherry, pine and oak - to say nothing of vegetable cuttings, flower slips and woody ornamental bushes - now may be routinely turned out from our potting sheds and window sills.

The discovery of the "willow rooting substance", as Dr. Makota Kawase, professor of horticulture at the agricultural research center in Wooster, Ohio, calls his finding, was an accident. (Ever notice how many scientific breakthroughs are the result of accidents? I finally know why: If scientists could define what it is they're looking for, they'd have already found it. It's when they're looking for something else that they find what they seek.)

An experimental team was using water from a basin where willow twigs were soaking to moisten softwood cuttings in a centrifuge. The softwood cuttings sent out extraordinary numbers of roots. In tracing why, the scientists found the willow rooting substance - which may turn out to be "rhizocaline" (literally "root-stimulator"), a hypothetical substance that scientists long felt must exist, even though they'd never found it.

Is willow rooting substance the long-sought rhizocaline?

"They share many characteristics," says Dr. Kawase. Willow rooting substance is a "remarkably strong root-promoting agent. A crude extract from only a third of an ounce of willow twig stimulated production of 12 times as many roots per mung bean cutting as controls in plain water. At the highest concentration tested, the willow rooting substance could easily produce more than 100 roots in the two-inch stem of mung bean cuttings, while control sections produced only four or five roots. Alone, it seems to have the ability to stimulate rooting unmatched by any previously known rooting substance, including plant hormones." Commercially available rooting preparations are usually synthetic plant hormones.

"the newly discovered willow rooting substance is not a plant hormone, its root-promoting effect increases sharply when it is applied to cuttings along with plant hormones, however, and this is another important link to the true rhizocaline."

How strong is willow rooting substance?

Yellow birch cuttings are known to be almost impossible to root. In one study, yellow birch cuttings treated with plant hormones produced no roots at all. When the hormones were com-

bined with a water solution of willow twigs and applied to the cuttings, 100 per cent of them rooted. These tests also showed significant results with bittersweet, forstia, peach and spirea.

Dr. Kawase says use of willow rooting substance could mean an end to the time-consuming bedding and transplanting now needed for propagation of woody plants. Using it during routine transplanting of potted plants could ease shock and reduce plant loss by stimulating new root growth. He even suggests we try it on seeds before planting.

To make an extract of the willow rooting substance at home, gather current-year willow shoots, remove the leaves, and cut the shoots into short pieces - an inch or less. Pack as many as you can into a container such as a cup or mason jar. Cover with water and use a lid or plastic bag to prevent evaporation. Let it sit for about 24 hours, then drain off the liquid for use.

For softwood or herbaceous plants, place the cuttings upright in a container with willow extract in the bottom. Allow them to absorb the extract, adding more if needed, until about 24 hours have passed. Then root them normally in soil. As usual, a plastic tent over the potted cuttings will prevent them from drying out. If you're dealing with a plant that ordinarily roots well in water, try rooting it in willow water.

Now that I think of it, willows always were the easiest plants to root - just stick slips in the ground, keep them moist, and they take hold. Maybe now we can transfer something of the willow's rooting power to our other plants.

\*This article reprinted from Organic Gardening. September 1981. Jeff Cox's Organic Discoveries.



Exercise 2 Review of Trainees' Nursery Plans and Progress of NurseryTotal time 1 hourOverview

In this exercise, the technical trainer reviews the trainees' nursery plan and comments on the process of arriving at the plan. The trainees then proceed to the nursery site with the technical trainer. The technical trainer makes suggestions, points out possible pitfalls, etc.

ProcedureTime

1 hour

Activities

1. The technical trainer reviews the nursery plan and then goes to the nursery with the trainees and points out the quality of the work. He/she discusses with group that this nursery will be their responsibility during the rest of the training. No one will remind them, but trainers will check progress from time to time.
2. The technical trainer moves to Exercise 3 while at the nursery site.

**Trainer's Note:** There will be more trainees than space with which to work. The groups will have to negotiate the use of tools and space with each other.

Exercise 3      Plastic Bag CaperTotal time      20 minutesOverview

The trainees are aware that there are several seedlings which were started by the technical trainer weeks before the training program commenced. The technical trainer announces that the plastic bags ordered for transplanting are unavailable and that the trainees will have to make containers for the seedlings.

ProceduresTime

20 minutes

Activity

1. The technical trainer tells the trainees that the seedlings are ready to be transplanted and the plastic bags that were ordered have not arrived and may not for some time. The trainees will have to figure out how to get 1,500 to 2,000 seedlings transplanted into containers in the next week.

**Trainer's Note:** We called this the plastic bag caper. It comes after the trainees are aware that the trainers expect them to use available materials whenever possible. This exercise is processed all week long. We had stacks of newspapers from the first day we arrived. Having asked the trainees to stack their newspapers, we eventually wanted them to make paper tube containers from newspaper. In the pilot training program, the trainees eventually had to be instructed to do this. Instructions for paper tubes are shown below in case you also have to demonstrate the use of newspaper to construct seedling containers.

1. Take a standard size sheet of newspaper, fold in half, then fold in half again.
2. Roll folded paper around fingers to give cylindrical shape.
3. Staple top and bottom.

4. Pack bottom tightly with potting soil using tamping stick.
5. Transplant seedling packing soil tightly around roots, pack up to collar of seedling.

INTRODUCTION TO EXTENSION

Total time      2 hours

Goals

- o To introduce extension work,
- o To give historical overview,
- o To examine specific goals of extension,
- o To begin the process of developing an extension agent.

Overview

Each trainee, regardless of their job assignment, will eventually become involved in forestry extension work. This session begins by giving the historical overview of extension work in North America and then discusses the "Six Axioms of Forestry Extension".

Exercises

1. Extension: Historical Overview and Some Techniques Used in the Past
2. Six Axioms for Forestry Extension

Materials

Flip charts, marker pens, tape.

Exercise 1      Extension: Historical Overview and Some  
Techniques Used in the Past

Total Time      40 minutes

Overview

During the introduction to extension, it is important for the trainees to understand that the extension movement has one hundred years of history. Although it may be a new concept in developing countries, it comes as a tried and true system for helping farmers. Experiences are shared to help the trainees understand that the extension worker is one who must interact on a one to one basis in order to help a community develop.

Procedures

Time

Activities

40 minutes

1. Lecture on the history of extension outline:
  - o 1862 Morrill Act - Land Grant Colleges,
  - o 1887 Research - Experimentation
  - o 1914 Extension,
  - o 1940 - 1950 - Good Neighbor Policy of Harry S. Truman, "Partners in Progress".

For extension to be most effective, it must achieve:

General:

1. National concern to improve agrarian structures,
2. Rural population with high level of self-esteem,
3. Active participation in significant development programs, i.e. agrarian.

**Specific Goals of Extension:**

1. Significant objectives - precise, measurable, realistic,
2. Appropriate image,
3. Power - legal, money, political,
4. Institutional mystique,
5. Internal efficiency,
6. Effective communication with public,
7. Coordination with other agencies,
8. Democratic procedures.

Exercise 2      Six Axioms of Forestry ExtensionTotal time      1 hour 30 minutesOverview

Participants become familiar with the basic rules of extension work. Since extension work is such an unstructured activity, the extensionist will find that there are long periods of time when he/she feels as if he/she is not doing anything and is tempted to do more; he/she may also wonder, from time to time, if what he/she is doing is actually advancing or retarding extension work in the community. In extension work, the temperament and sensitivity of the extensionist influences to a large degree how effective the work will be.

ProceduresTimeActivities

30 minutes

1. The trainer posts on newsprint the following axioms and speaks about each one.
  - o The forestry extensionist should never do anything for people that they are able to do for themselves.
  - o The forestry extensionist should never encourage the use of resources from outside the community until all the resources within the community have been exhausted.
  - o The forestry extensionist should never try to organize people to deal with a need they do not recognize themselves (may have to educate them).
  - o The forestry extensionist's most important dedication must be to the sound local progress of his/her community.

- o Forestry extension must be carried out from an understanding of the host culture and in terms of that culture.
- o The forestry extensionist role in his/her community is transitory.

**Trainer's Note:** It is tempting to add a seventh axiom, which says that the above six should not be taken too seriously. If there is one single encompassing rule in extension work, it is that given the basic goals, the means ultimately are flexible and subject to variations according to specific conditions. The extensionist should understand the axioms of forestry extension well enough to follow them when possible and break them if necessary.

- 20 minutes-small group    2. The trainer now asks the participants to break into groups of five and discuss ways in which they can be successful extensionists. The ideas are recorded on newsprint and presented to the entire group. The following are some examples that came out of our groups.
- 30 minutes-large group

### Ways to Be Successful Extensionists

We are not alone  
 Communication - contacts  
 Know when to compromise  
 Positive attitudes  
 Diplomacy  
 Know where to start  
 Cultural sensitivity  
 Technical competence  
 Be objective  
 Be aware of problems  
 Don't push own ideas  
 Keep it simple  
 Be a Mr. Tree  
 Work with counterpart  
 Be a resource  
 Be a good example  
 Get along with officials  
 Impart knowledge  
 Follow up on what you do  
 Do not spread yourself too thin  
 Follow the six points of extension  
 Be aware of external and internal resources  
 Transfer a system  
 Work with people



Have a good reputation  
Help others make decisions; do not do it for them  
Build extension bridges  
Action speaks louder than words  
Maintain a sense of humor  
Quality vs. quantity (do a few things well)  
Be aware of group dynamics

30 minutes

3. The trainer summarizes the session, and emphasizes that the trainees are becoming members of a historical tradition - extension.

PROTECTION AND RECORD KEEPING

Total time 4 hours 15 minutes

Goals

- o To give information about the protection of a nursery from animals, disease, weeds and insects,
- o To review record keeping practices,
- o To have the trainees decide upon a standard record keeping format,
- o Special project: Insect collection.

Overview

This session completes the technical presentations in establishing a nursery. The trainees will have the satisfaction of having planned, laid out, prepared soil and finally sowed the seeds in their own nursery. Also, record keeping is reviewed and trainees decide upon a standard format for keeping nursery records. Protection of a nursery is discussed in depth. The special project on insect collection is introduced in this session.

Exercises

1. Protection and Summary of Week's Nursery Activity
2. Insect Collection
3. Record Keeping Practices - Decision Making

Materials

Flip chart paper, markers, tape, pins, insect collection bottles, cardboard.

Exercise 1      Protection of the Nursery and Summary  
Weeks' Activities

Total time      30 minutes

Overview

This is the final exercise focusing on establishing a nursery. The trainer will give a lecture on protection and summarize steps taken in the establishment of a nursery (there is additional time allotted in this session if nursery beds are not yet sown).

Procedures

Time

30 minutes

Activities

1. The technical trainer gives a lecture on protection from the outline posted on newsprint. The outline follows.
2. The technical trainer now reviews steps that have been taken so far and links them to the next exercise.

Protection

1. Small animals
  - a. mice/rats
    - rat poison
  - b. rabbits, sling shots
  - c. chickens
2. Large animals
  - a. goats/sheep
  - b. pigs
  - c. horses, cattle
  - d. dogs, etc.
3. Birds
  - a. sowed seed
  - b. new seedling
  - c. as control - insects
  - d. bird control
    - 1) chemicals
    - 2) screens
    - 3) sling shots
    - 4) tin cans
4. Disease - damping off
  - a. pre-emergence
    - 1) sterile soil
    - 2) sun and sterile sand
    - 3) keep pH moderately acid
    - 4) boiling water
  - b. in roots: upper part of roots infected, plants fall over, stems turn watery inside.
    - 1) watering schedule
      - i. less often
      - ii. time of day
      - iii. chemicals
5. Weed control
  - a. herbicides
  - b. other
    - 1) boards
    - 2) burlap
    - 3) straw

c. weeding

- 1) weed early - late weeding is very costly
- 2) use in compost

6. Insects

- a. grub worms (eats roots)
- b. cut worms
- c. aphids
- d. nematodes
- e. spiders, mites, thrips

Exercise 2      Insect CollectionTotal time      1 hourOverview

The trainee for whom this is a special project introduces insect collection and has the participants collect insects. As volunteers, they will have to collect insects for identification in the field.

ProceduresTimeActivities

1. The trainee for whom this is a special project demonstrates several ways to collect insects; he also should speak about the purpose of insect collection.
2. The participants collect insects.
3. The special project person does exercise wrap-up.

**Trainer's Note:** The following is a newsprint lecture outline for insect collection.

INSECT COLLECTION

Look for:

1. Holes in leaves
  - o caterpillars, beetles, crickets
2. Wilting
  - o soil insects - white grubs, wireworms
  - o stem borers
3. Leaf curling, wrinkling, yellowing
  - o sucking insects - aphids, leaf hoppers
4. Leaf speckling, spots of white
  - o mites
5. Black, sooty mold on leaves
  - o scale, aphids
6. Pitted, cupped leaves
  - o psyllids
7. Plant disappears at ground level
  - o cut worms, grazing animals
8. Holes in stem
  - o stem borers

Bug like invertebrates

1. Class Arachnida
  - o spiders, ticks, mites  
(2 body parts, 4 pairs of legs, no wings/antennae)
2. Class Crustacea
  - o sowbugs, pill bugs  
(2 pairs of antennae, 5 or more pairs of legs)

3. Class Chilopoda

- o centipedes  
(one pair of legs per body segment)

4. Class Diplopoda

- o millipedes  
(2 pairs of legs per body segment)

Preserving your bugs

- o Hard bodied: Use alcohol killing jar; wrap jar with tape.

- o Soft bodied: Boil in water for 30 seconds; preserve in alcohol

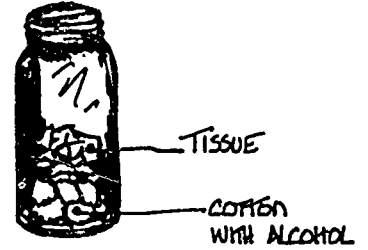

(Fig. 4)

- o Verlese sampler: Soil insects

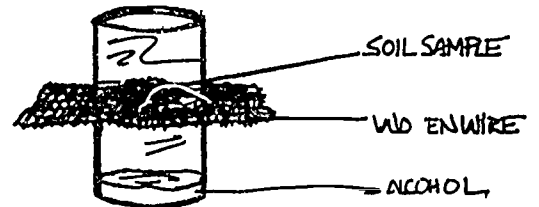

(Fig. 5)

Pinning

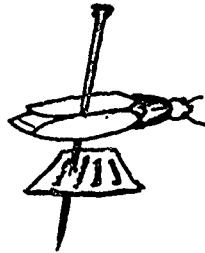

(Fig. 6)

hard bodied insects

- o Use points (actual size) for small insects
- o Attach with clear glue or nail polish



(Fig. 7)



Labelling

Date:  
Place:  
Your name:

Scientific Name:  
Species found at:

Damage also goes  
on here

- Use pencil or India ink
- Put label in jar if insect preserved in alcohol
- Store insects in closed box or container
- Moth flakes keep pests away

Shipping

- Pack in hard sided container
- Pack with nylons, tissue or cotton
- Include sample or description of damage

Exercise 3      Record KeepingTotal time      1 hour 45 minutesOverview

This exercise stresses the importance of record keeping; ask what data the trainees have and how they are going to record it. Finally, the trainees will go through a decision-making process about standardizing a record-keeping method and preparing a form.

Procedures

<u>Time</u>	<u>Activities</u>
10 minutes	1. The technical trainer starts this session by saying, "Remember yesterday when I asked you who was keeping records for the nursery?" The technical trainer then remarks about the first exercise on record keeping and its importance. The trainer has two choices; he/she can (1) congratulate the participant(s) that have taken responsibility for keeping records or (2) make the point that the participants must take responsibility for keeping records, realizing that all parts of training build one upon the other.
10 minutes	2. The trainer asks the group what data they need to record for the nursery that they have just established. The trainer records data titles on newsprint.
1 hour	3. The trainer says, "I feel you are ready to decide upon a standard format for recording nursery data. Please do so."

**Trainer's Note:** No directions are given about the procedure or how to break into group(s). The trainers remain in the room and observe trainees organizing the project.

15 minutes

4. The trainer comments on the organization process which he and the other trainers have just observed. He/she asks for comments from the trainees about their own feelings over the last hour.

10 minutes

5. The trainer remarks about the data recording form, additions and/or deletions.

CHICKEN PREPARATION

Total time      2 hours 30 minutes

Goals

- o For the trainees to learn how to slaughter and clean a chicken.

Overview

Most of our trainees have never lived on a farm or been involved in the preparation of live food for human consumption. They will see animals being sold live in the markets and have no idea about the preparation. In this exercise they kill, pluck and gut a live chicken which is prepared for eating. In our case the cook allowed us to keep our live chickens in his coop, furnished the equipment for preparation, watched the process but drew the line at letting the trainees into his kitchen to cook the chickens; that he did himself.

Exercise

1. Chicken Preparation

Materials

One live chicken per two trainees, large pot of boiling water for dipping chicken; one knife for each pair of trainees.

Exercise 1      Chicken PreparationTotal Time      2 hours 30 minutesOverview

In this exercise the trainees kill, pluck and gut a live chicken which is then prepared for eating.

ProceduresTimeActivities

3 to 4 days

1. The trainee for whom this is a special project takes care of the chickens upon their arrival. He is responsible for feeding and providing water for them.

2. The trainee consults with other trainees who have lived on farms and gets procedure posted on newsprint.

2 hours

3. The trainees are assigned to pairs and each pair is given a live chicken to process as follows:

A. Tie the feet together,

B. Slit the throat,

C. Hang upside down and desanguinate (drain out blood),

D. Dip chicken in boiling water to loosen the feathers,

E. Make incision at base of tail to bring forward along grain area to just under breast plate,

F. Remove entrails (gut),

G. Wash chicken under cold water, cut off head and feet.

30 minutes

4. Chicken is prepared for eating and consumed at dinner that evening.

**Trainer's Note:** The cook prepared the chicken by cooking it in a vegetable-rice dish much as it would have been served in Africa.

This exercise needs a great deal of space outdoors and careful monitoring.

THE VOLUNTEERS' ROLE AS AN EXTENSIONIST

Total time      2 hours 30 minutes

Goals

- o Examination of the roles of an extensionist,
- o Exploration of ways in which to introduce innovations to communities,
- o Practice in communicating with community people regarding an innovation,
- o To examine communication skills, verbal and non-verbal once more.

Overview

Seven roles are isolated in the process by which a Volunteer in the role of an extensionist introduces the concept of tree planting to his/her community. The area of communication is reviewed again and focus is placed upon skills that the Volunteers will need. The non-verbal observation assignment from the previous week is discussed and the trainees share with their partner their observations over the past week.

Exercises

1. Extensionist's Roles
2. Communication Skills, Verbal and Non-Verbal, of an Extensionist

Materials

Flip charts, marker pens, tape.

Exercise 1      Extensionist's RolesTotal time      1 hour 20 minutesOverview

We examine the seven roles of an extensionist. The trainees discuss ways in which they can adopt these roles as Volunteers doing extension work in their communities.

ProceduresTime

20 minutes

Activities

1. The trainer introduces the following seven roles and explains each:
  - A. Develops need for change,
  - B. Establishes a change relationship,
  - C. Diagnoses the problem,
  - D. Creates intent to change in community members,
  - E. Translates intent into action,
  - F. Stabilizes change and prevents discontinuances,
  - G. Achieves a terminal relationship.

**Trainer's Note:** Use local examples to illustrate each role.

- A. Develops need for change - A Volunteer is often initially required to help his/her community become aware of the need to alter their behavior. The behavior in this case is either planting trees or the preservation of trees. This is especially true among rural farmers whose potentials have not been realized and workers who resist change. The unwillingness to accept change readily and other institutionalized behavioral patterns often result in the Volunteer serving as a catalyst in the community. In order to do forestry extension, the



Volunteer illustrates new alternatives to existing forestry problems, dramatizes these problems and convinces the farmers that they are capable of confronting forestry problems. The Volunteer, acting as an extensionist, not only assesses the community at this stage but also helps to create these needs in a consultative and persuasive manner.

- B. Establish a change relationship - Once the need for change is created, the Volunteer must develop a rapport with the community. He/she enhances his/her relationship with the community by creating an impression of credibility, trustworthiness, and empathy toward their needs and problems. Communities must trust the Volunteer before they will accept the innovations he/she proposes.
- C. Diagnosis of the problem - The extensionist is responsible for analyzing his community's problems/situation in order to determine why existing alternatives do not meet the community's needs. In arriving at his/her diagnostic conclusions, the extensionist must view the situation empathetically from the community's point of view and not his/her own. The Volunteer extensionist must psychologically place him/herself in their situations. This empathy transferral is difficult.
- D. Creates intent to change in community members - After the Volunteer explores various avenues of action that his/her community might take to achieve their goals, he should encourage an intent to change. The change must be community-centered rather than for the sake of change. Here the Volunteer's role is to motivate.

- E. Translates intent into action - The Volunteer seeks to influence his/her community's behavior in accordance with his recommendations which are based upon the community's needs. In essence, the Volunteer promotes compliance with the program he/she advocates. This means more than simple agreement on intent. It means action or behavioral change.
- F. Stabilizes change and prevents discontinuances - The Volunteers may effectively stabilize new behavior by directly reinforcing messages to those community members who have adapted, thus "freezing" the new behavior. This assistance frequently is given when the rural farmer is at the trial-decision or confirmation function in the innovation-decision process.
- G. Achieves a terminal relationship - The end goal for the Volunteer extensionist is development of self-renewing behavior on the part of his/her community. The Volunteer should put him/herself out of business by developing his/her community's ability to be their own change agent. The Volunteer must seek to shift the community from a position of reliance on the Volunteer to self-reliance.

(The above seven roles have been adapted from: Communication of Innovations by Rogers & Shoemaker)

40 minutes

2. The trainer asks the group to form small groups and envision the seven roles of an extensionist as objectives they have set for themselves and develop action steps to achieve these objectives. Make a list of these steps on newsprint.

15 - 20 minutes

3. Small groups now share with the large group their action steps.
4. The trainer summarizes the presentations and introduces the next exercise.

Exercise 2      Communication Skills, Verbal and Non-verbal of an Extensionist

Total time      1 hour 15 minutes

Overview

In the preceding exercise we have examined the seven roles of an extensionist. Now we want to look at the kind of communication skills a Volunteer will need to carry out extension work. In this exercise, we also process the session of the previous week by discussing, generalizing and applying the experience accumulated by the trainees in one week of observing non-verbal behavior with each other. The participants give each other feedback on what they observed, discuss their observations and arrive at some working assumptions/generalizations about how non-verbal communications may be the most important part of their communications system in the early days of their volunteer work.

Procedures

Time

Activities

5 minutes

1. The trainer asks the participants to list various kinds of communication skills that they will need to carry out their role as extensionists.

5 minutes

2. The trainer asks the participants to call out skills and lists them on newsprint.

5 minutes

3. The trainer comments about skills the trainees have not identified. If non-verbal skills have not been listed, the trainer adds three minutes and makes the point that in the early days of volunteer service the participants will send out many non-verbal messages that will be his/her first impact upon the communities.

10 minutes

4. The trainer asks the group to form the same pairs that have been observing each other for the past week and spend a few minutes telling each other what they observed each other doing in terms of non-verbal communication during that time.

Individuals should gain insight on how they use non-verbal processes.

5 minutes

5. Bring the group together and draw some generalizations from the experience of observing each other.

30 minutes

6. Ask each pair to get with another pair and discuss the following questions. Discussion questions should be posted on flip chart.

- o Did any of you learn anything new about yourselves? What?

- o Is there anything about non-verbal communication in general that you have learned from the experience?

- o Have you any ideas how you can use non-verbal communication as an extensionist? What are they?

15 minutes

7. The trainer asks for comments from the participants on communication skills. He/she summarizes the verbal and non-verbal skills that an extensionist needs.

TROPICAL HORTICULTURE: CARE, TENDING AND DISEASE CONTROL

Total time      3 hours

Goals

- o To acquaint the trainees with tropical horticulture,
- o To acquaint the trainees to a variety of trees they will be introducing,
- o To acquaint the trainees with the proper care of a variety of tropical fruit trees they will be handling,
- o To acquaint the trainees with a variety of diseases they might encounter and ways to prevent and treat these diseases in trees.

Overview

This session is done by an outside expert in tropical horticulture. We were very fortunate to have Le Mayne Hogan, Ph.D., Head, Department of Plant Sciences, College of Agriculture, University of Arizona, available for this session. Dr. Hogan used slides for visual effects during his presentation. The trainees were able to see those trees, plants, methods, etc.. that were being described.

WOMEN IN DEVELOPMENT - PART I

Total time      2 hours 30 minutes

Goals

- o To acquaint the trainees with Women in Development issues,
- o To heighten the trainees' awareness of the significant role women play in the development process,
- o For the trainees to examine their work as forestry extensionists and the role that women will play in the success of their program.

Overview

Several WID readings are distributed to the trainees four days prior to the WID sessions. Specific reading assignments are given to country groups of three. Each group is told to prepare a presentation to the large group at this session. Reading assignments are given to each group by topic, i.e., women in health, Peace Corps and WID, etc.

The trainers have the opportunity to relate personal experiences from their own work in developing countries. It should also be stressed during the discussions that PCV men as well as women need to see themselves as role models in their countries of assignment - for how women should be treated and what women are capable of achieving.

Exercise

1. Women in Development - Part I

Materials

1. Peace Corps' Programming and Training Journal, Volume IV, No. 6. 1977.
2. Programming for Women and Health. Africa Report: Special Issues on Women in Africa. March - April 1981.
3. Fairy Tales and Facts: Economy, Family, Fertility and the Female.
4. Counting in the Women. Women in Development: Peace Corps Policy.
5. Life in the Global Assembly Line. Integrating Women in Development.
6. The NFF Exchange: Women in Development.

## SESSION 23

Exercise 1      Women in Development - Part I

Total Time      2 hours 30 minutes

Overview

The trainees will become acquainted with Women in Development issues and recognize the significant role which women play in the development process.

Procedures

Time

2 hours 15 minutes

Activities

1. Each country group presents at least six to nine points from the readings which could affect their programs. Each presentation should not take more than 30 to 40 minutes, including group discussion.

15 minutes

2. Trainer draws closure to the session by emphasizing the predominant role that women play in forestry related industries in most developing countries. Linkage is made to WID - Part II with mention that strategies for assuring the involvement of women in small-scale development programs will be examined.



TEAM BUILDING

Total time      2 hours

Goal

- o To improve communication and the relationship between the trainees who will be stationed in the same Peace Corps country.

Overview

The trainees use feedback skills in this session. This exercise requires some degree of personal risk taking. At the end of the session, the trainees feel closer to each other and are eager to become a team.

Exercise

1. Team Building

**Trainer's Note:** At the end of this session, people will still be engaged in dialogue. Your role is to be sure that everyone shares with everyone else.

Exercise 1      Team BuildingTotal Time      2 hoursOverview

The trainees use feedback skills in this session. This exercise requires some degree of personal risk taking. At the end of the session, the trainees feel closer to each other and are eager to become a team.

ProceduresTime

2 hours

Activities

1. The trainer states that during this exercise the participants themselves will conduct the activity and the time frame, etc. The trainers will be available only if they are asked to facilitate one of the dyads' interactions.
2. The participants make a list, being as specific as possible, for everyone in their group, of;
  - A. "Things you do or say which make me feel good."
  - B. "Things you do or say which make me feel bad."
  - C. "Things I do toward you which make me feel good."
  - D. "Things I do which I regret or make me feel bad."
  - E. "Things of which I would like us to do more."
  - F. "Help I think you can give me."
  - G. "Differences and disagreements between you and me?"

- H. "The source of our disagreement seems to be....."
  - I. "I handle these disagreements by....."
  - J. "You handle these disagreements by....."
3. Each trainee explores the questions with all the other trainees. In cases where there is a problem or difference the following is put in writing by the two parties.
- A. Situation, problem or difference.
  - B. What I intend to do about it.
  - C. What I might do in spite of myself.
  - D. How I would like you to help me.

Adapted from Cross Cultural Trade-off, by Paul Pedersen.

BUILDING AND USING A RUSTIC TRANSITTotal time 3 to 4 hoursGoals

- o To have a forester trainee teach the other trainees how to build a rustic transit,
- o To have the trainees build rustic transits,
- o For the trainees practice use of transit by laying out the area in which to plant trees during Session 28.

Overview

The trainee for whom this is a special project instructs the other trainees in building a rustic transit. The trainees practice using the rustic transit for contouring by laying out an area to be used the following day. It is necessary for the trainees to learn how to construct and use these practical measuring devices, as in many cases more sophisticated equipment will not be available.

Exercise

1. Building a Rustic Transit

Materials:

Board 2 m (h) X 3 cm (w) X 2 cm (l)  
 Pole 2 m long (bamboo is good for this)  
 Small piece of wood 2 cm (h) X 4 cm (w) X 40 cm (l)  
 1 wing nut, 6 cm long  
 Nails  
 1 protractor  
 1 plumb line  
 1 weight (bowling ball is too big)  
 A piece of cloth - marker  
 Bottle cap - sight  
 Stakes for surveying

Exercise 1      Building a Rustic TransitTotal time      3 to 4 hoursOverview

The trainee for whom this is a special project shows how to build and use a rustic transit and lay out the area.

Procedures

<u>Time</u>	<u>Activities</u>
1 hour	1. The trainee presents a lecture about rustic transits. (example of lecture follows)
30 minutes	2. Using newsprint and a completed transit, the trainee shows the others how to construct transits.
1 hour	3. The trainees construct a transit either individually or in groups of three depending upon the method used.
30 minutes	4. The trainees practice using a transit.
1 hour	5. In the area designated by the technical trainer, the trainee lay out the area to be used for tree planting the following day.

**Trainer's Note:** The technical trainer should monitor this session very closely. It will be necessary to work with trainees from the time they get the assignment to be sure the proper materials are available and being used.

## RUSTIC TRANSIT

Plowing along the contour is an agricultural practice to aid in erosion control. By plowing with the contour, soil erosion can be reduced by as much as 50%. Contour lines are generally incorporated with other erosion control measures such as strip cropping, crop rotation, agroforestry, diversion ditches and diversion terracing.

Diversion terraces are widely used in Africa to catch surface run-off and allow its safe exit from the field. The terraces are constructed along the contour at intervals down the slope. The distance between terraces varies depending upon the slope of the land. The terrace is raised to a height of 50 - 70 cm with a width of 1 meter. The up slope side of the terrace has a channel 50cm wide and 30cm deep which catches surface run-off. This channel has a gradual slope of 0.25 - 0.50 percent off to one side of the field. The channel should be covered with a low growing grass to reduce erosion in the channel itself. The terraces should be vegetated with bunch grass, trees or naturally covered by weeds.

Contours can be laid out using rustic or modern instruments. Rustic instruments can be constructed easily and cheaply. Three people are generally needed to lay out the contour lines. Using rustic methods, about 4 - 6 ha/day can be marked as opposed to 15 - 20 ha/day with a tripod surveyor's level. These figures vary depending on the uniformity and slope of the land.

### Laying out the Contours

The first step is to measure the slope of the field in degrees or percent. The steepness of the slope will determine the distance between terraces. The steeper the slope, the closer the terraces; the less the gradient, the farther apart the terraces. Slope can be measured using a protractor, abney level or surveyor's level. The protractor will give degree slope while the latter will be percent slope. Tables are available in most areas which indicate terrace spacing in relation to slope and soil type.

After determining the slope and the terrace spacing, the marking can be started. Start from the highest point in the field and measure down the slope your calculated terrace interval to your first point. It is important to always measure this distance directly down the slope. This direction may not coincide down the border of the field. If this distance is not measured directly down the slope, the terraces will not have uniform distances between them. This may mean starting from the middle of the field (fig. 8) from point "A" and measuring down slope towards point "B".

Point "B" is the starting point. From here you mark the contour towards the borders of the field.

When you arrive at point "C", you measure to your next terrace to point "D", directly down slope.

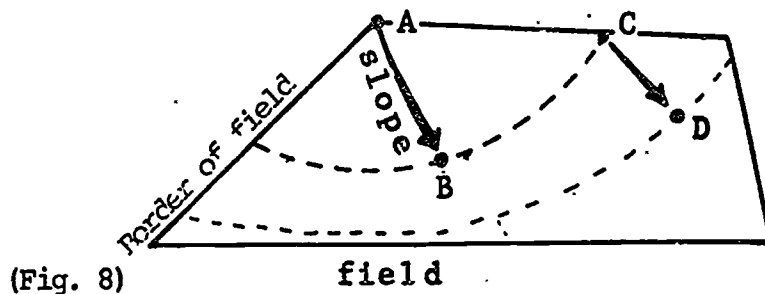

(Fig. 8)

field

Using the rustic instruments, points can be marked every 10 or 15 meters. The points are marked by driving a stake into the ground. Using a surveyor's level, points can be placed every 20 - 25 meters. A helpful way to measure these distances is to tie a light weight rope between the sighting instrument and the sight rod.

Once all the contours are marked, you will see that some stakes may not be in line. It will be necessary to adjust some points in order to have a smooth plow line. For example, a sharp "V" in the contour will cause water to collect and leak through the terrace. It will also be harder for the farmer to plow his field.

The terraces can be constructed with a tractor, horse, oxen or by hand. The tractor is most efficient because it can throw more soil. When using animals, it is necessary to follow up with hoes to raise the terrace and also deepen the channel in front.

The actual plowing is done by throwing soil toward the stakes on both the uphill and downhill side. Two passes with a tractor on each side are usually sufficient. Three or four passes with animals on each side are recommended. The last pass with either method should be on the uphill side to clean out the diversion channel.

Vegetation should be established as soon as possible. Bunch grasses can be planted from cuttings or by seed. The grass in the diversion channel can be seeded or left to natural weed growth. Trees can also be planted on the terraces in conjunction with the bunch grasses.

SOME WAYS TO USE YOUR RUSTIC TRANSIT

You will be using this level to aid you in making contour level terraces. These are for the protection of soil in crop fields. This method is not recommended for over 13% slope.

Example: This is a Contour line.

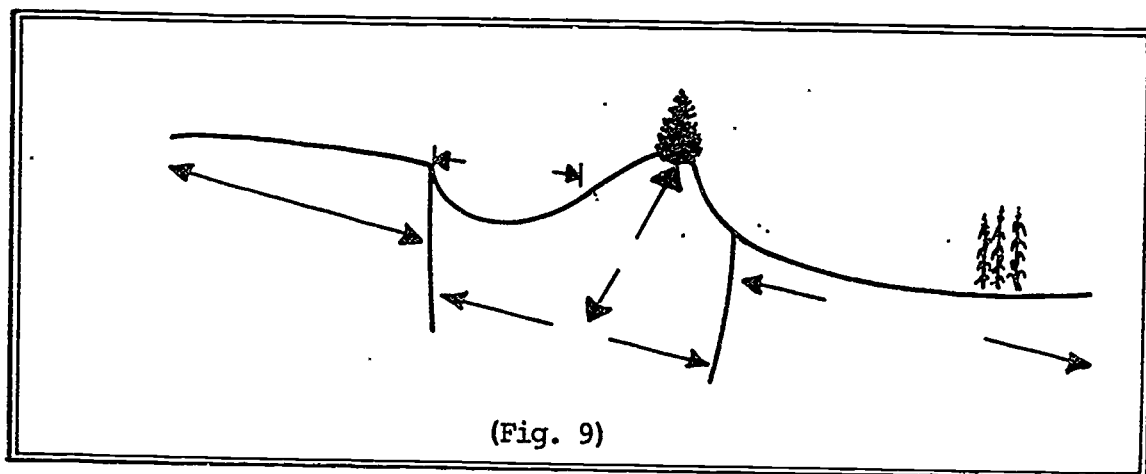

You take the rustic transit and sight over the sight arm to the mark on the sight pole (which is ten meters away in this example).

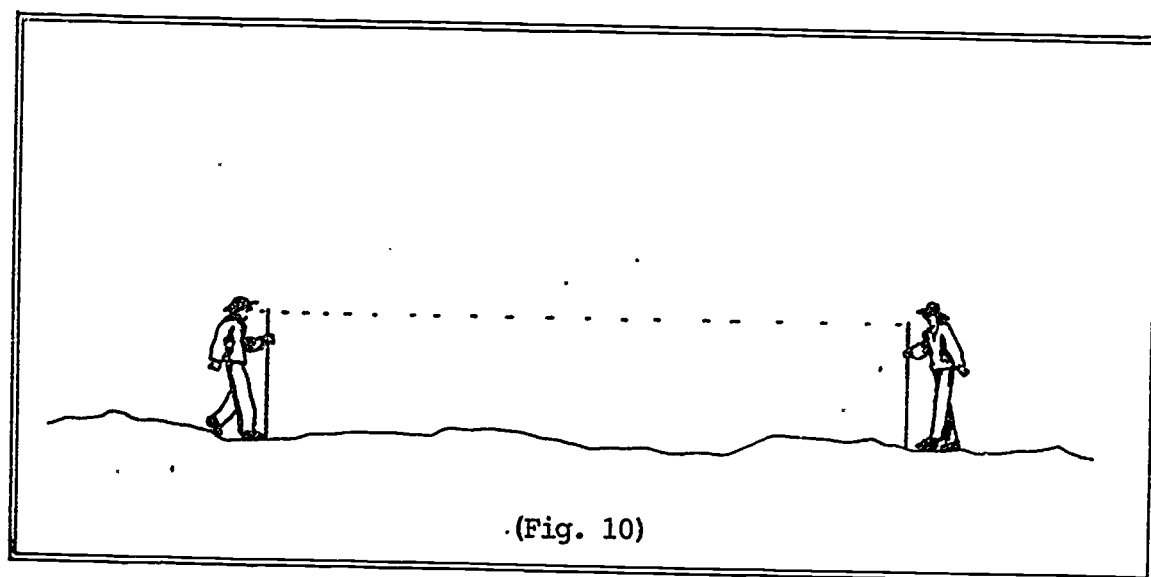



Some ways to use the rustic transit

You can also incorporate a drainage slope into the contour terraces. This would be to disperse water caught in the ditches of the contour terraces. For example, you decide on .5% slope for drainage. For every 1% slope at 10 meters distance from sight pole to rustic level, you move the mark on the sight pole up or down (depending which way the slope runs). In this case, with .5% slope drainage at 10 meters distance, you would move mark up or down 5 cm.

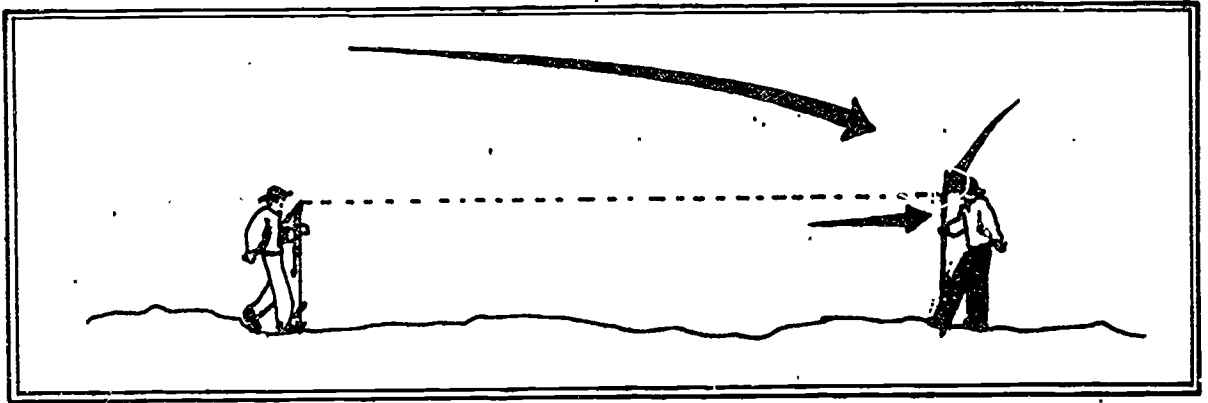

Fig. 11

For .5% slope, drain off channel, move sight line 5 cm every 10 meters between the two men (up or down depending on which way you want the water to run).

You can control 50% of your erosion by running your rows of crops along the contour line. The contour line does not need to be long.

SIGHT POLE

(Fig. 12)

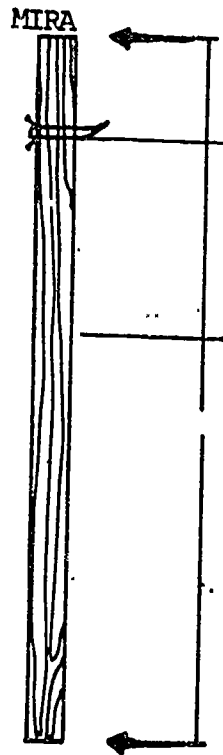

RUSTIC LEVEL

(Fig. 13)

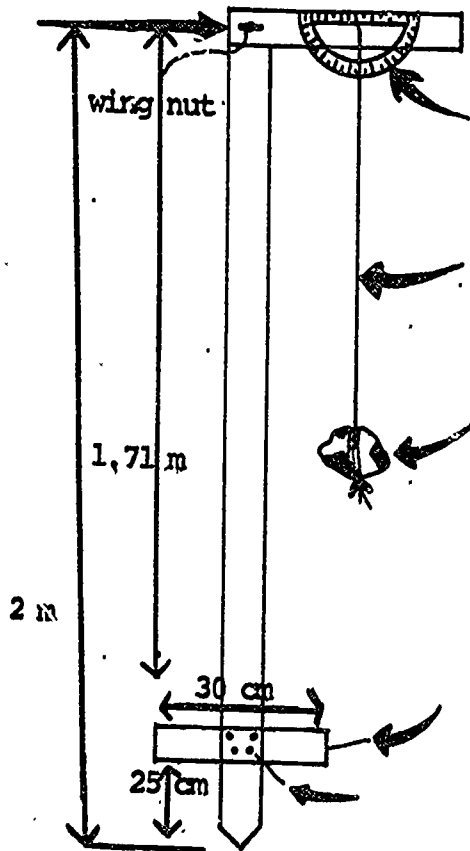

Another Rustic Level that could be built.

Rustic Level: A-Frame

A rustic level is a tool that can be made of simple materials, easy to use and simple to construct. The materials can be anything that is readily available, such as lumber (1 X 2's or 2 X 2's) or poles cut from local vegetation.

The dimensions do not have to be exact. The cross arm should be placed about half-way up. The string with the end weight should be hung from a nail placed in the juncture where the two legs meet. Consideration should be given to bolting together all pieces to facilitate easy transportation.

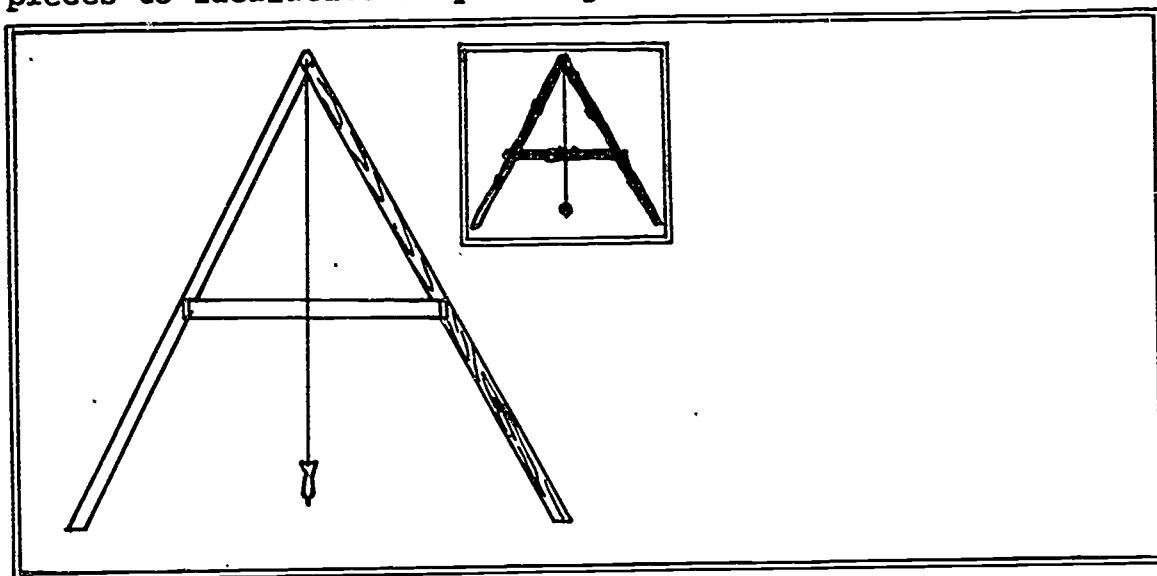

DIAGRAM OF RUSTIC LEVEL (Fig. 14)

To calibrate the level, choose a semi-level spot of ground and pound a couple of 6" - 8" stakes halfway into the soil at a distance equal to the spread of the level's legs. Place the level on the stakes and make a pencil mark where the plumb line comes to rest. Then reverse the level and make a second mark. The level mark is halfway between these marks.

To make contours along a hillside, simply put a stake at the starting point. Then place one of the legs of the level on the stake and the other in the direction you wish to travel. Then move the latter leg up or down hill until the plumb line comes to rest on the level line. Mark that spot and move on. Put one of the legs on the stake you just placed.

Some information contained here is extracted from Soils, Crops, and Fertilizer Use by David Leonard, Peace Corps Reprint R-8.

## SESSION 26

Women in Development - Part II

Total time      2 hours 30 minutes

Goals

- o To develop strategies for involving women in small-scale development programs.

Overview

The role of women in small-scale forestry development efforts should be reflected in the project design and supported by project documentation throughout the life of the project. In this session, the trainees develop possible strategies for accomplishing this objective.

Exercise

1. Women in Development - Part II

Materials

AID Program Guidelines: WID. This session was developed by Bordman, Joyce, 1982.

Exercise 1 Women in Development - Part IITotal time 2 hours 30 minutesOverview

The role of women in small-scale forestry development efforts should be reflected in the project design and supported by project documentation throughout the life of the project. The trainees develop possible strategies for accomplishing this objective.

Procedures

<u>Time</u>	<u>Activities</u>
30 minutes	<p>1. Trainer gives the following lecture:</p> <p>A. Information gathering</p> <ol style="list-style-type: none"> <li>1. The division of labor by sex is task related to the scope of the project.</li> <li>2. The role of women in decisions and their likeliness to affect the success of the project.</li> <li>3. The extent to which existing extension services reach women.</li> <li>4. The existance of grassroots level women's groups which might serve as vehicles for project activities.</li> <li>5. The social services available in the project area, including water supply, health facilities, schools, housing - how do these particularly affect women? (day care centers?)</li> <li>6. The anticipated impact of the project on women's tasks (i.e., housing, farming, forestry, income generation) and possible conflicting demands on women's time, especially during peak seasons.</li> <li>7. The percentage of income (household) contributed by women and its source.</li> </ol>

8. The education level and functional literacy of women, men and children.
9. Opportunities which exist for women in community level adult education programs.

B. Project Documentation

1. Should describe the situation before project implementation and the changes during implementation, and give indications of the future situation.

C. Project Design

1. Training

- a. Does the project contain a training component; if so, are women benefiting from the program, particularly where the training relates to tasks traditionally performed by women?
- b. Do training programs for women reflect the actual roles of women in forestry related projects?
- c. Do training programs for women take into account the potential roles of women in management, etc?

2. Monitoring & Evaluation

a. Monitoring project operations

- Have village women been consulted in the project identification, formation, decision making, implementation, monitoring and evaluation?
- Is the implementation of the women's component on schedule relative to the rest of the project?
- What percentage of project funds are earmarked for women?

b. Monitoring Project Performance

- What is the percentage of women among participants in project activities by type?
- What is the rating of female participants to total potential female participants? (females of eligible age within the project area?)

- What is the socio-economic group of female participants?
- What is the percentage of women among persons trained?
- What is the percentage of women among persons for whom jobs are created?
- What is the percentage of women among persons receiving credit?
- What is the percentage of women among members and leaders of groups organized?

### 3. Monitoring Project Impact

#### a. Economic

- Does the percentage increase in income from women's productive activities?
- Does the percentage increase in individual income of female participants?
- What is the net change in female employment (type, increase/decrease)?

#### b. Social

- What are the changes in the division of labor by sex (including workload)?
- What are the changes in the distribution of production resources (credit, inputs, technology)?
- What are the changes in the distribution of knowledge and skills?
- What are the changes in women's community participation?
- What are the apparent stresses within intra-familial roles?

1 hour 45 minutes

2. The trainer divides the group into trios by country to develop a list of strategies for their own programs for integrating women into the design and implementation. The group reports with strategies listed on newsprint.

15 minutes

3. The trainer draws closure to the session and links it to the sessions on extension and social cybernetics.

**Trainer's Note:** Since the reference for this session is the AID guidelines for involving women in AID projects, it is important that the trainer draw from past Peace Corps experience and/or experience from small-scale development projects sufficiently during the lecture so that the trainees have enough of a framework for Activity 2.



WORKING WITH GROUPS AS AN EXTENSION WORKER

Total time      1 hour 45 minutes

Goals

- o For the trainees to understand the benefits of doing extension work with groups,
- o For the trainees to understand group dynamics,
- o For the trainees to understand the variables to risk taking.

Overview

This session focuses on extension work. Working with groups is stressed as a method of extension work.

Exercise

1. Working with Group as an Extension Worker

Materials

Sample lecture.

Exercise 1 Working with Groups as an Extension WorkerTotal time 1 hour 45 minutesOverview

This session focuses on extension work. Working with groups is stressed as a method of extension work.

ProceduresTime

30 minutes

Activities

1. The trainer lectures on the benefits of doing extension work with groups of people rather than individuals. The trainer discusses group dynamics and stresses risk taking. (Sample lecture follows)

**Trainer's Note:** The lecture should be in your own words. Use situations with which you are familiar to stress points.

Sample Lecture

AWARENESS



INTEREST



EVALUATION



A propensity to take risk supported by rational decision making processes in the evaluation stage, or promoted through behavioral techniques utilized by extension agents.



TRIAL

ADAPTATION

### Why Organize Groups

Both subsistence farmers and large land holders are less disposed to take risks on an individual basis. The behavioral tool, however, or the risk-shift phenomenon largely used in a business-making atmosphere, can be used more effectively to promote risk taking by small groups of people involved in collective decision making.

Small groups of people concerned with decisions that involve some element of risk, unlike large group members, will, after engaging in various modes of group discussion, make a collective decision that is far more risky than would be their individual decision on the same matter. That group discussion on a matter of importance must take place to the point of group consensus on that particular matter before the shift occurs is a key element.

In the case of subsistence farmers, much depends upon the extension agent's ability to explain the risk involved to group members, and consequently show how the new technology substantially exceeds, in cost/benefit advantages, the farmer's present traditional technology.

For example, if an extension agent suggests to a group of farmers that a particular technology or agricultural technique could improve productivity, but is unable to explain how much the technology would cost, where it could be obtained, how to use it and what benefits could be expected from its use, one can rightly predict that conservative influences will prevail and a risk decision will not be taken to adapt the technology.

There are four major hypotheses that support the process of group acceptance of risky technical innovations. The four are leadership, familiarization, diffusion of responsibility and risk as cultural value hypothesis. In order for risk-shift to occur, regardless of the particular hypothesis, a group discussion to the point of group consensus on the issue must take place beforehand. Without discussion and consensus, the shift will not occur.

#### Leadership

In the leadership hypothesis, it is believed that certain group members are viewed as both natural risk takers and group leaders who have an above average influence on the rest of the group membership. The risk-shift condition is believed to occur because these people are inclined to be more dominant and/or influential in the group discussions and consequently influence the group in the direction of accepting risk. A behavioral problem with the leadership approach, however, is that leaders can be either conservative influencers or risk takers under certain circumstances. This brings us back to the extension agent's ability to explain adequately the nature of the risk involved. Once convinced that a suggested program is adequately organized and supported, leaders become effective promoters.

Extension agents should be made aware of the potential effect, negative and/or positive, opinion leaders in village societies can have upon the transference of new technology to group members.

### Familiarization

Group discussion allows persons to become more familiar with the issue being discussed. Because they know the other group member's attitudes towards risk, members will be more willing to take a risk. (Rogers: "There appears to be a pooling effect in media forums (groups) by which those members who begin at lower levels of knowledge, persuasion, or adoption gain more in these respects than do forum group members who begin at higher levels. Knowledge reduces risk.")

A group of farmers who have attained the minimum capacity to function as a cohesive decision-making unit should test a technology by discussing and becoming familiar with its objective before making any decision. A wrong decision could result in the loss of crops.

### Diffusion of Responsibility

It is felt that group discussion and cohesion develop emotional bonds between members and free individuals from full responsibility for a risky decision. An individual feels that his/her decision has been shaped by the group and if it fails, he/she is no worse than the others since they will fail together. It is difficult for subsistence farmers particularly in the Latin American countries to establish strong emotional bonds with each other when they are related. In Latin America there appears to be a great deal of factionalism. Short term groups will probably not develop strong emotional ties.

This hypothesis cannot account for cautious shifts. It does not specify how the creation of emotional bonds among subjects makes them less concerned about the negative consequences of risky decisions.

Developing the emotional bonds which are necessary for risk shift is more important than simply exchanging information.

### Risk as Cultural Value

This hypothesis maintains that moderate risk has a cultural value which develops during the life span of a group and causes individuals to view themselves as being as willing as the other group members to take risks. Peer pressure is the major mode to conform those not reflecting the views of the majority of the group.

All of the hypotheses interact in varying degrees to produce the shift in small group decision-making.

Let's go back to familiarization and talk about that process, information exchange, feedback and group discussion.

Variables to Risk TakingNot Known or UnderstoodNot Within Farmer's Managerial Competence

Farmers may have heard about a new technology but the comprehension of its purpose or effective utilization may require additional knowledge and skills.

Not Socially, Culturally or Psychologically Acceptable

Development literature gives many examples of a new practice or a new technique not being adapted because it would severely upset the established patterns of social, economic or political organizations.

Not Technically Viable or Adequately Adapted

Often the new recommended technology has not been locally adapted or tested under conditions which closely resemble those faced by the farmer. Subsistence farmers are shrewd and can discern whether the new variety or practice has had enough adaptive research and local testing to meet their unique needs.

Not Economically Feasible

Probably the biggest cause of resistance to change is the unprofitability of the new technology as seen by the farmer. Often the new technology requires the purchase of additional inputs to achieve the higher productivity. When the farmer compares the expected output plus its associated income with the additional costs of the input, the balance sheet employing the new technology is found wanting.

Not Available

Often the new technology is embedded in a physical item such as seeds, pesticides, fertilizer or equipment. Unless the new item is readily available to the farmer in quantities at the time he needs it, knowledge of its potential contribution to his agricultural production will not result in its adaptation.

30 minutes

2. Divide into small groups and give each group a different problem (see examples). The trainees are to search their own experience for specific examples of situations in which they encountered a similar problem and the solutions used in that group situation. Would it work in the host country?

15 minutes

3. The groups give their presentations to the large group on problems, similar experiences, and possible solutions:

Problem Examples

- o Problems that ensure that effort is maintained when extensionist is gone,
- o To get outside organizations (including local governments, voluntary organizations and technical departments) to cooperate in forestry extension work,
- o To get local leaders to cooperate,
- o To work in a community divided by racial or religious factions or by other factional rivalries,
- o To regain the confidence of a community once it has been lost.

5 minutes

4. The trainer draws ideas from presentations that apply to extension work and asks for generalizations about groups from the participants.

25 minutes

5. The trainer summarizes the three sessions on extension work. He/she concludes with the following:

- A. Relative advantage is the degree to which an innovation is perceived as better than the idea it supersedes. The relative advantage of a new idea, as perceived by members of a social system, is positively related to its rate of adoption.
- B. Compatibility is the degree to which an innovation is perceived as consistent with the existing values, past experience, and needs of the receivers. The compatibility of a new idea, as perceived by members of a social system, is positively related to its rate of adoption.
- C. Complexity is the degree to which an innovation is perceived as relatively difficult to understand and use. The complexity of an innovation, as perceived by members of a social system, is negatively related to its rate of adoption.
- D. Trialability is the degree to which an innovation may be experimented on a limited basis. The trialability of an innovation, as perceived by members of a social system, is positively related to its rate of adoption.

- E. Observability is the degree to which the results of an innovation are visible to others. The observability of an innovation, as perceived by members of a social system, is positively related to its rate of adoption.

(Communication of Innovation by Rogers & Shoemaker)

After studying more than 1500 publications on the diffusion of ideas and the change process, Rogers and Shoemaker found that extensionists were more successful when they:

1. Expand more effort in change activities with communities;
2. Are community oriented rather than change agency oriented;
3. Propose programs compatible with community needs;
4. Have empathy with their communities and community members;
5. Are similar to their community members;
6. Work through opinion leaders;
7. Have credibility in the eyes of their community;
8. Increase their community's ability to evaluate innovations.

Reference: "Training for the Cross-cultural Mind," The Society for International Education, Training and Research, Washington, D.C., 1980.

Communication of Innovations: A Cross-Cultural Approach. Everett Rogers and Floyd Shoemaker, New York Free Press, 1971.

Organization for Rural Development. Allen D. Jedicka, Praeger Publications, 200 Park Avenue, New York, NY 10017, 1977.

TREES: IDENTIFICATION & PLANTING

Total time      2 hours 30 minutes

Goals

- o For the trainee's special project to be presented,
- o To explore tree identification,
- o To plant trees.

Overview

In this session the trainees learn about tree identification and are instructed in tree planting. They also plant trees in the area which they laid out and contoured in Session 25.

Exercises

1. Tree Identification
2. Tree Planting

Materials

Shovels, seedlings, watering cans.

**Trainer's Note:** This session is a follow-up to Session 25 in which the trainees use rustic transits to contour and lay out a site for tree planting on a hillside or sloped area.



Exercise 1      Tree Ident' ficationTotal time      1 hourOverview

This exercise is a special project given to one of the participants at the beginning of training.

ProceduresTime

45 minutes

Activities

1. The trainee introduces the session using newsprint and states his/her goals for session.
2. The trainee then proceeds with the following lecture.

**Trainer's Note:** This lecture was done by a trainee now serving in Kenya as a Peace Corps Volunteer. The trainee who accepts this as a special project will not do his/her project exactly as this one was done. We have included this lecture in the event that the technical trainer should decide not to use this as a special project.

3. The technical trainer comments and links this exercise to the exercise which follows.

**Exercise 2      Tree Planting****Total time      1 hour 30 minutes****Overview**

In this session, the trainees receive instruction on proper tree planting. The trainees then plant in the area which they have prepared in Session 25.

**Procedure**

<b><u>Time</u></b>	<b><u>Activities</u></b>
20 minutes	1. Using a series of flip chart drawings, the trainer gives instructions in proper tree planting.
1 hour	2. The trainees go back to the contoured site and plant trees. The technical trainers inspect the trees as planted.
10 minutes	3. The trainer does session wrap-up and links to catchments in Session 31.

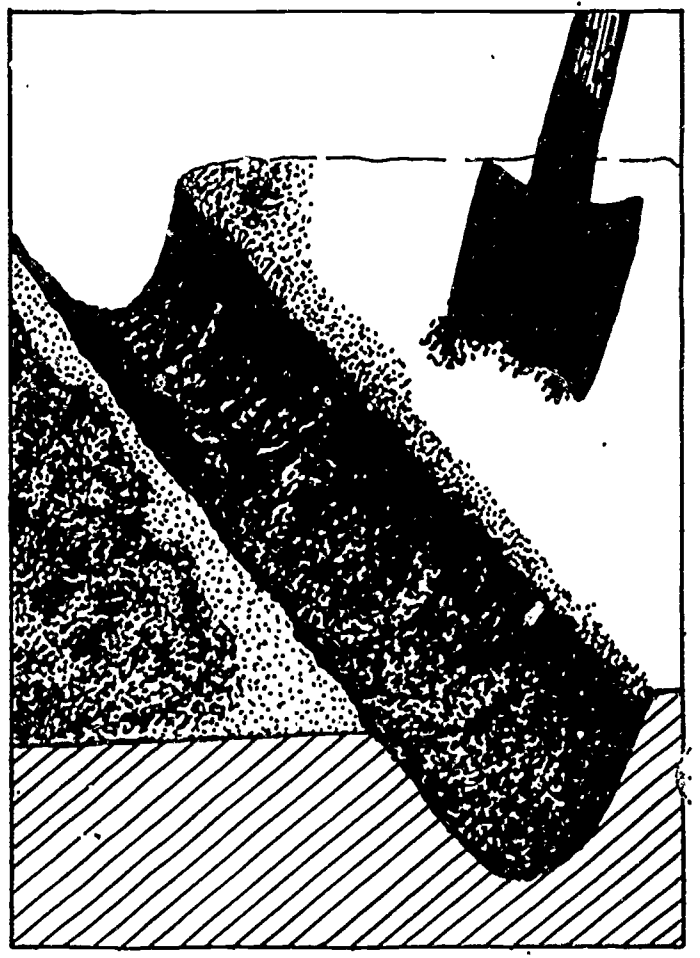
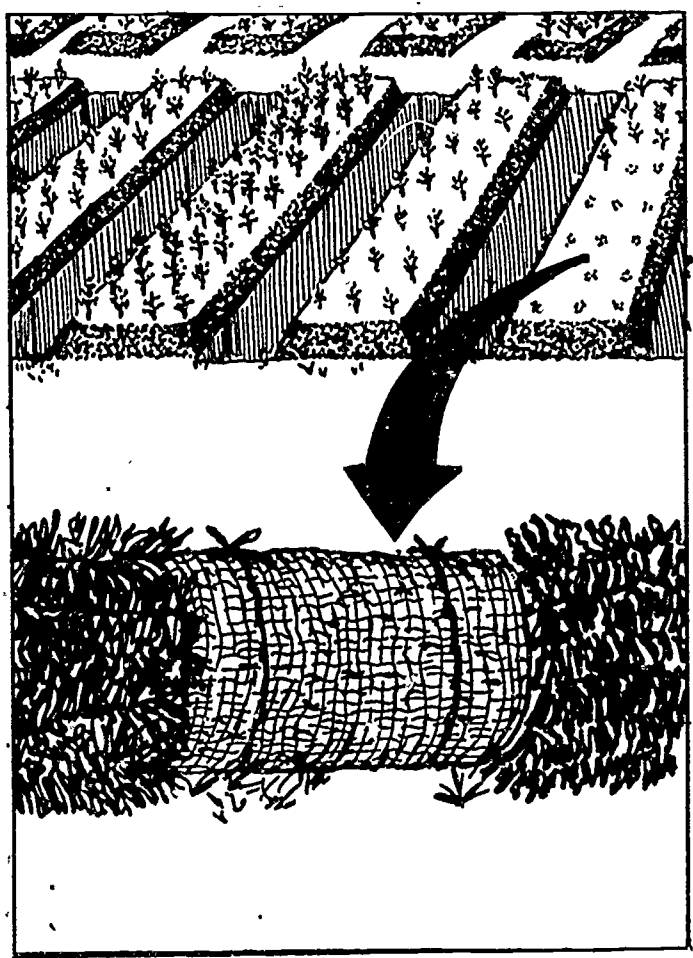
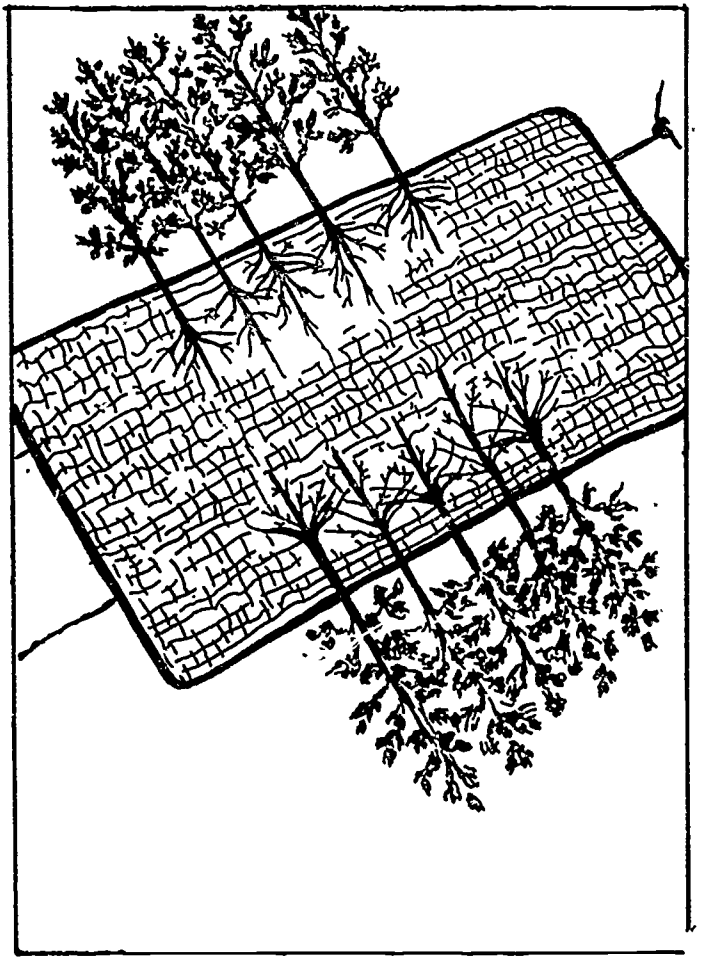

190 (Fig. 15)

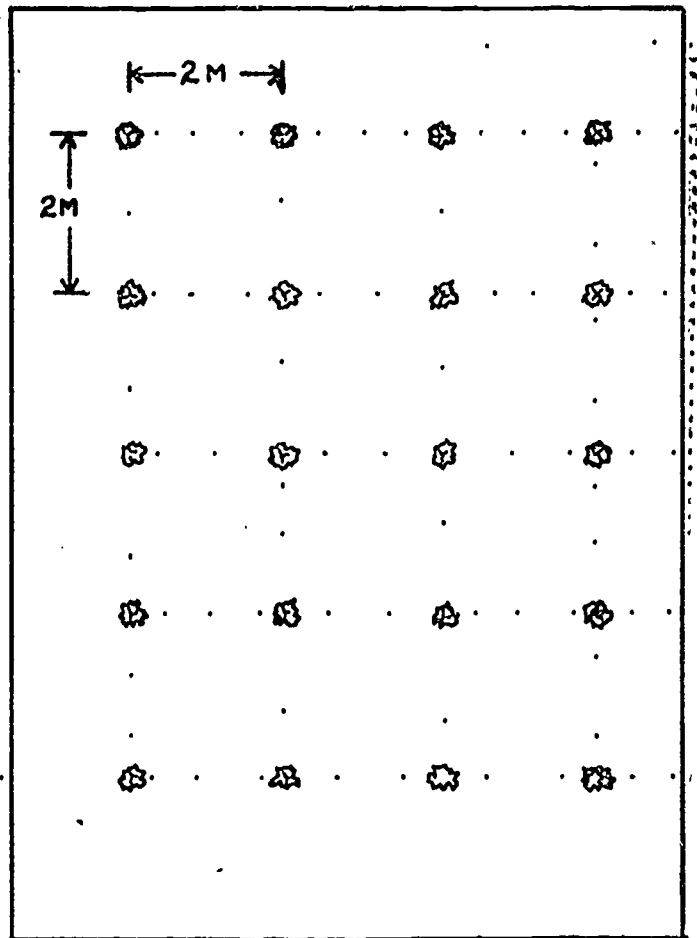
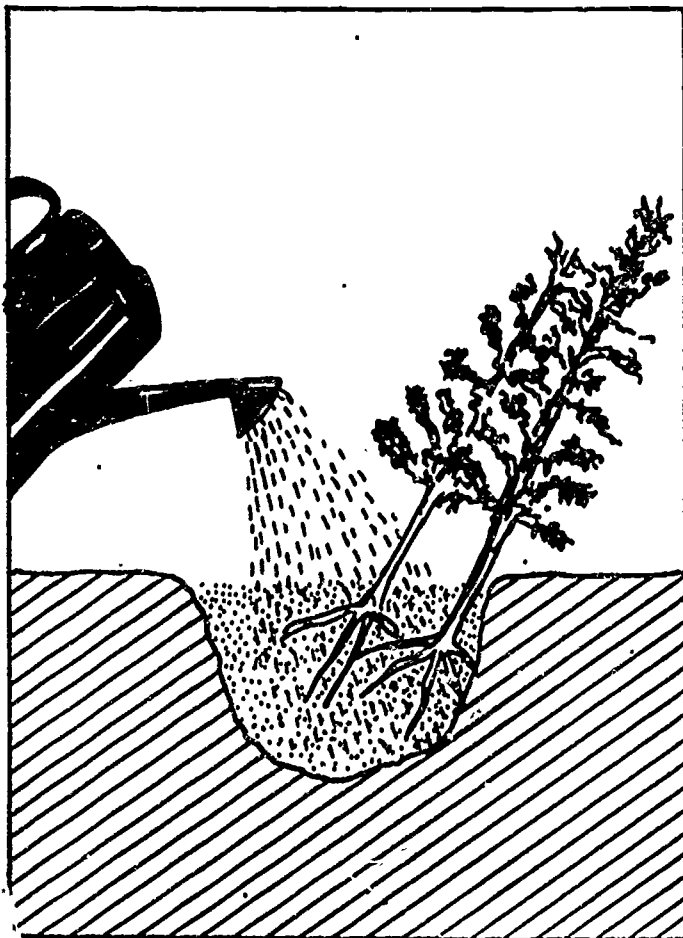
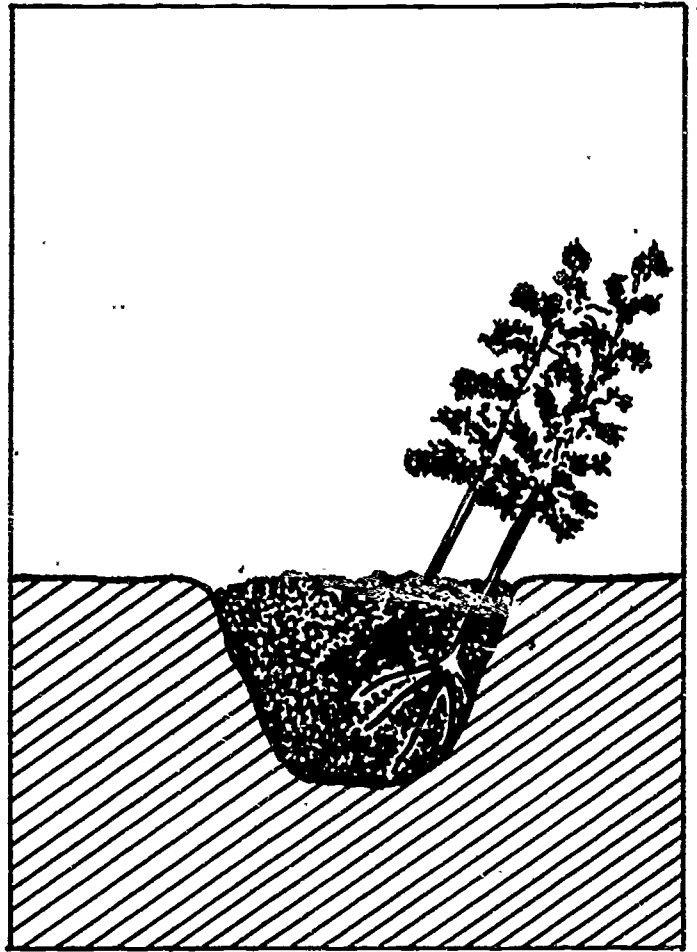
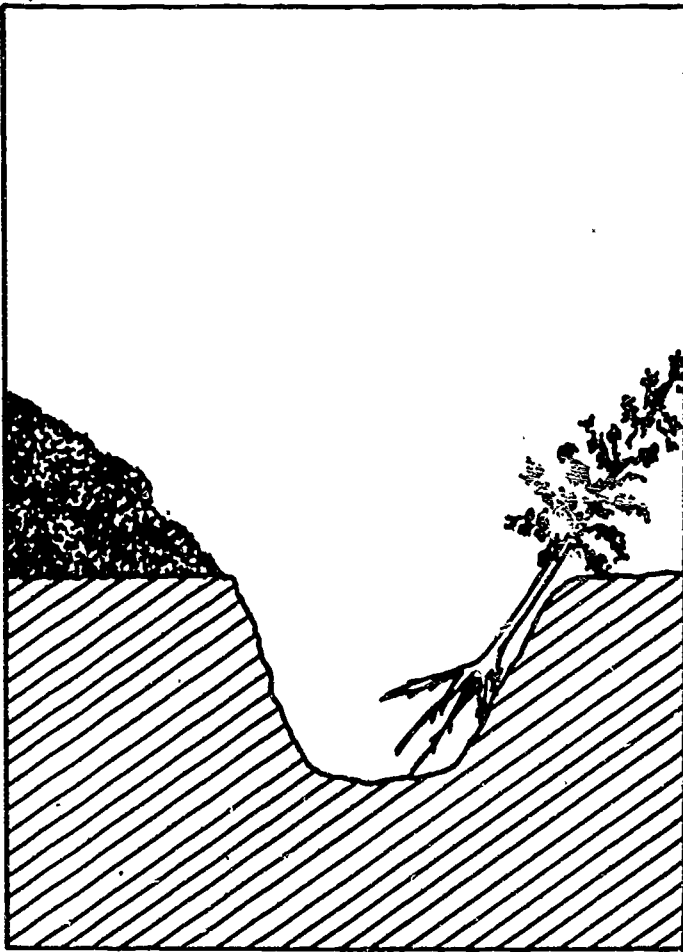

(Fig. 16, 191)

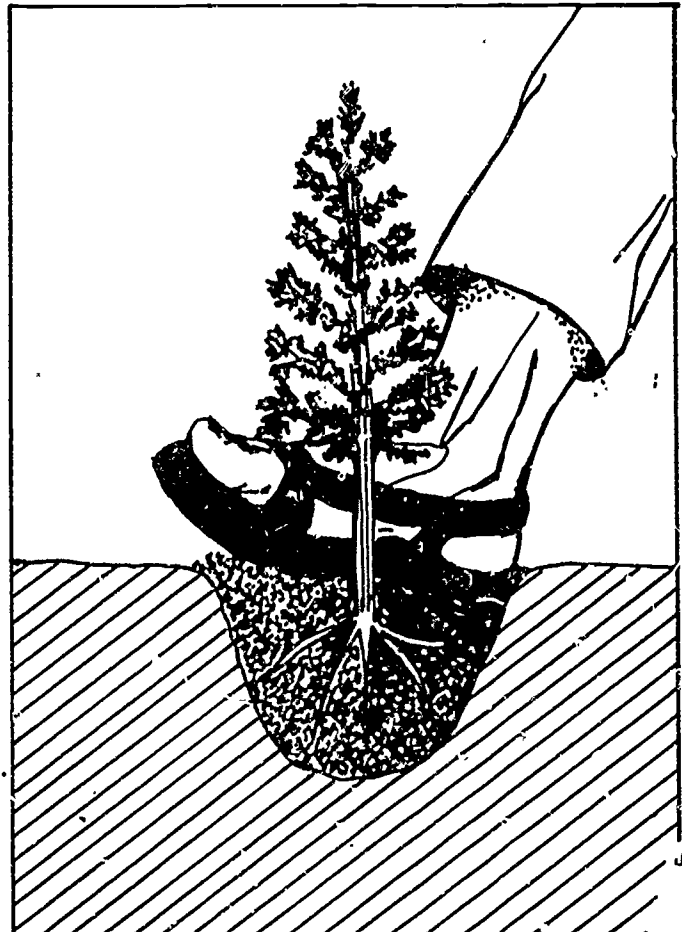
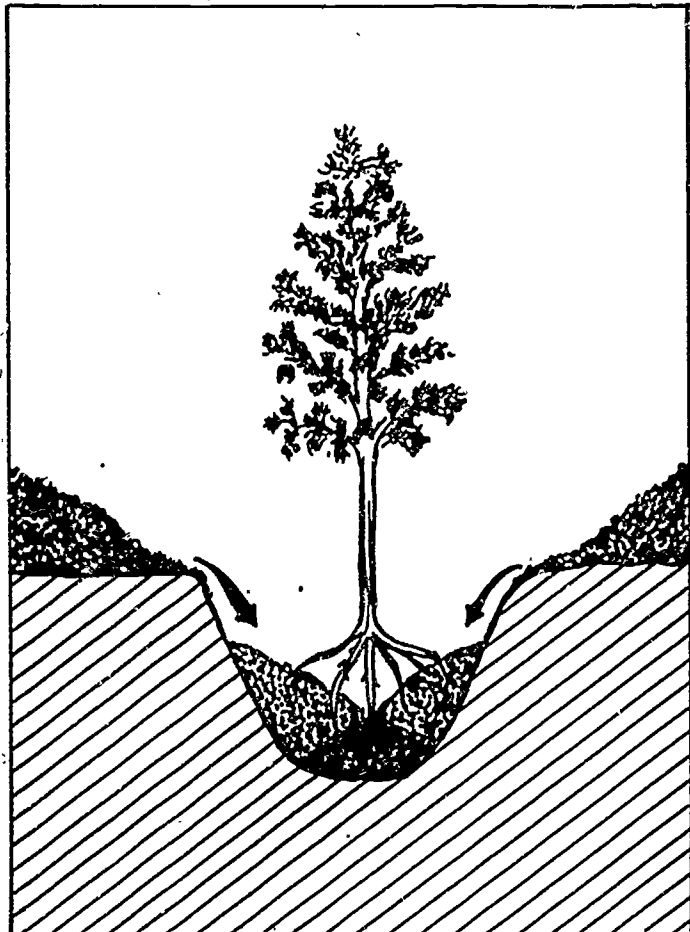
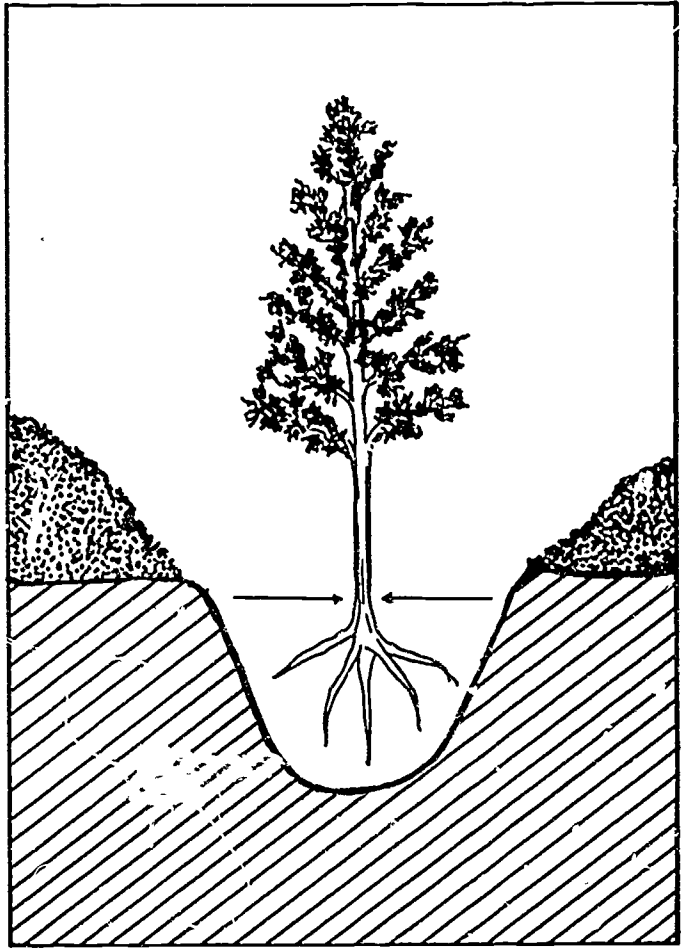
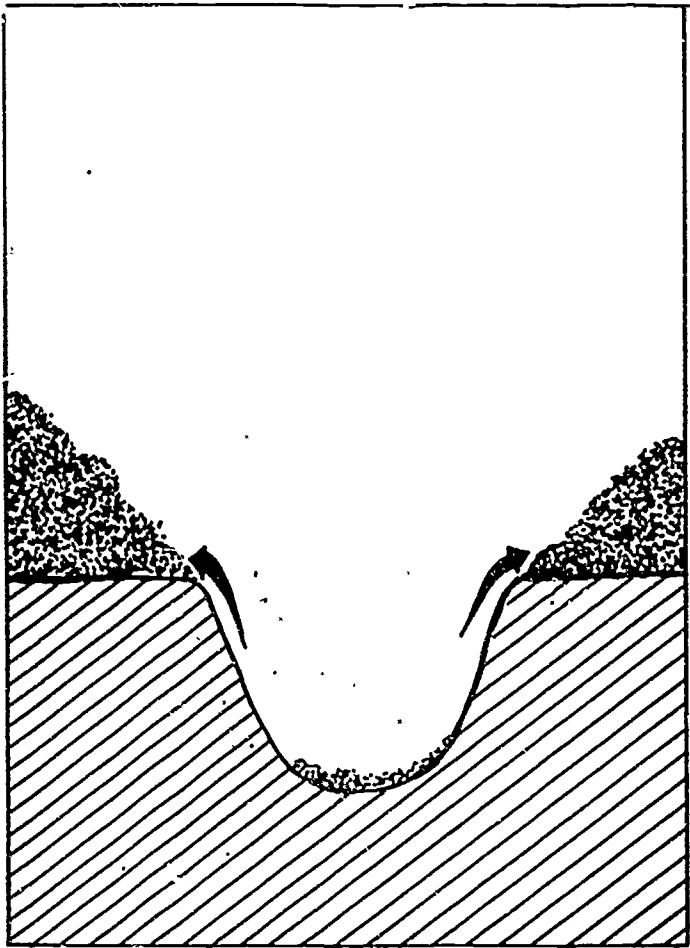

192 (Fig. 17)

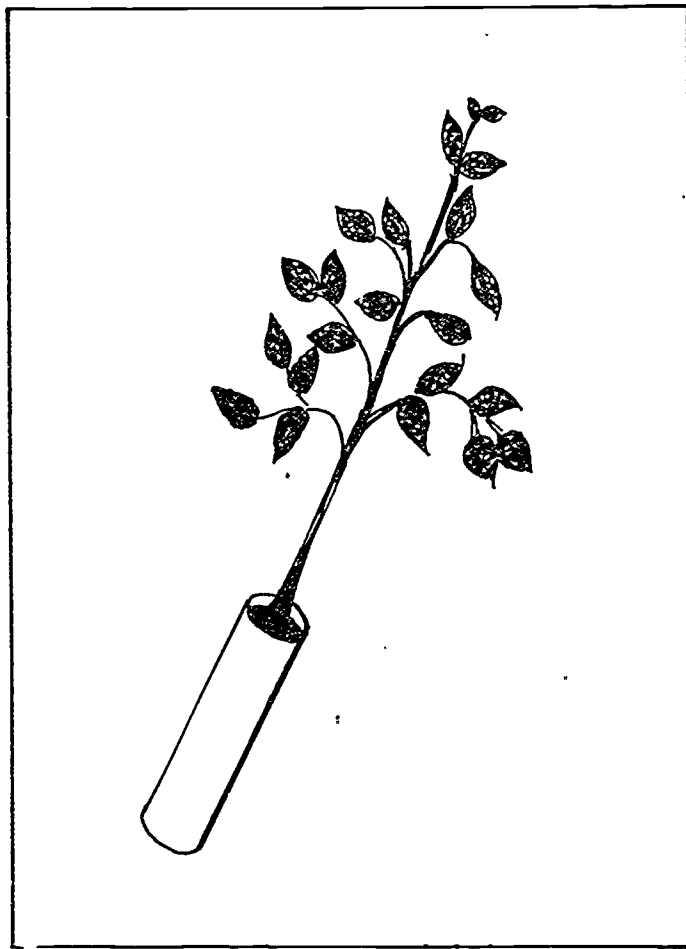
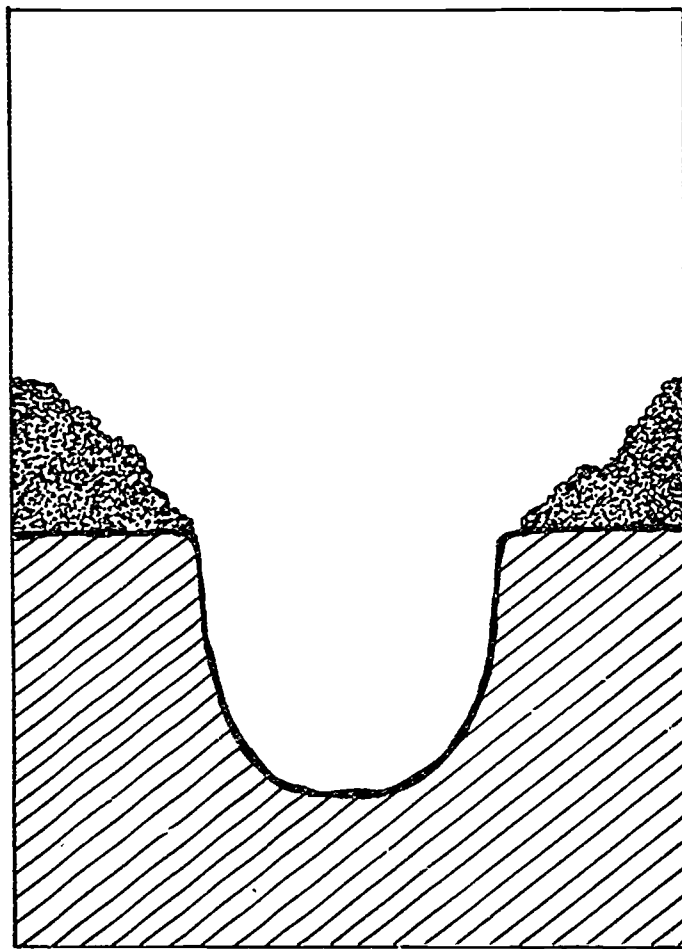
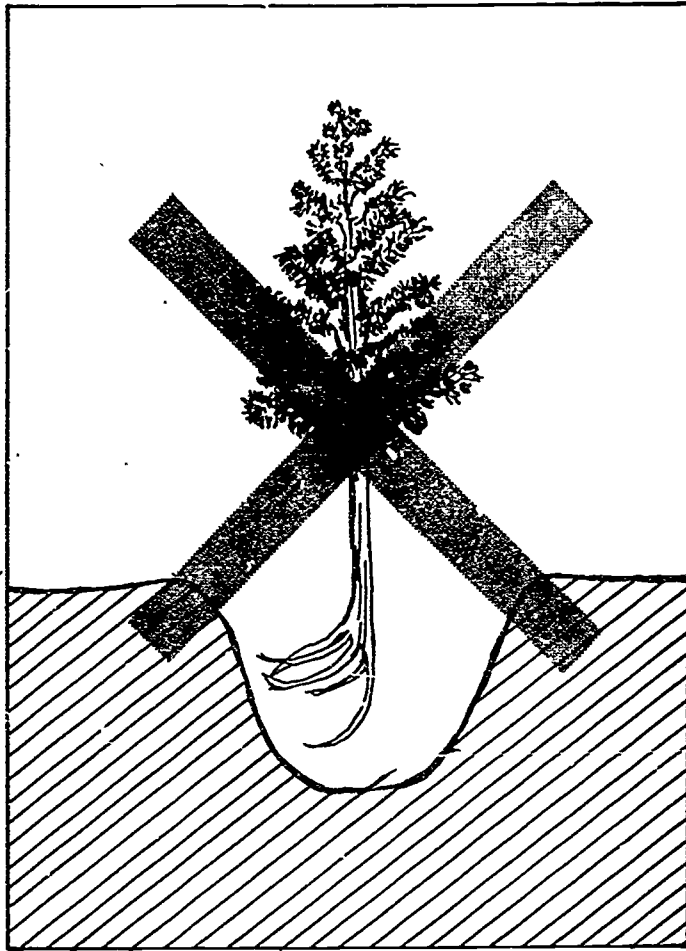
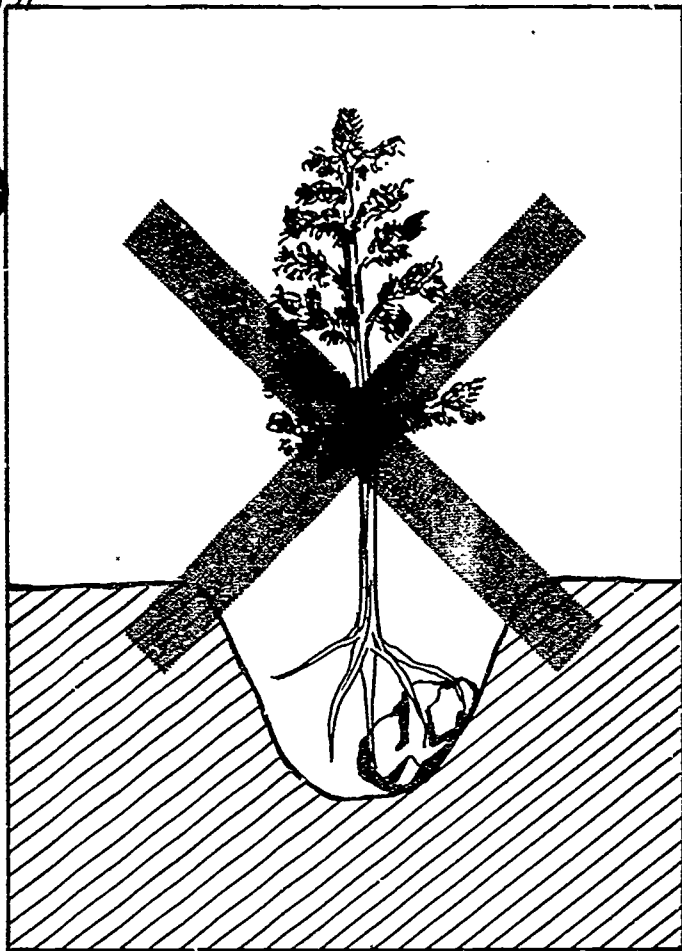

(Fig. 19) . . . 193

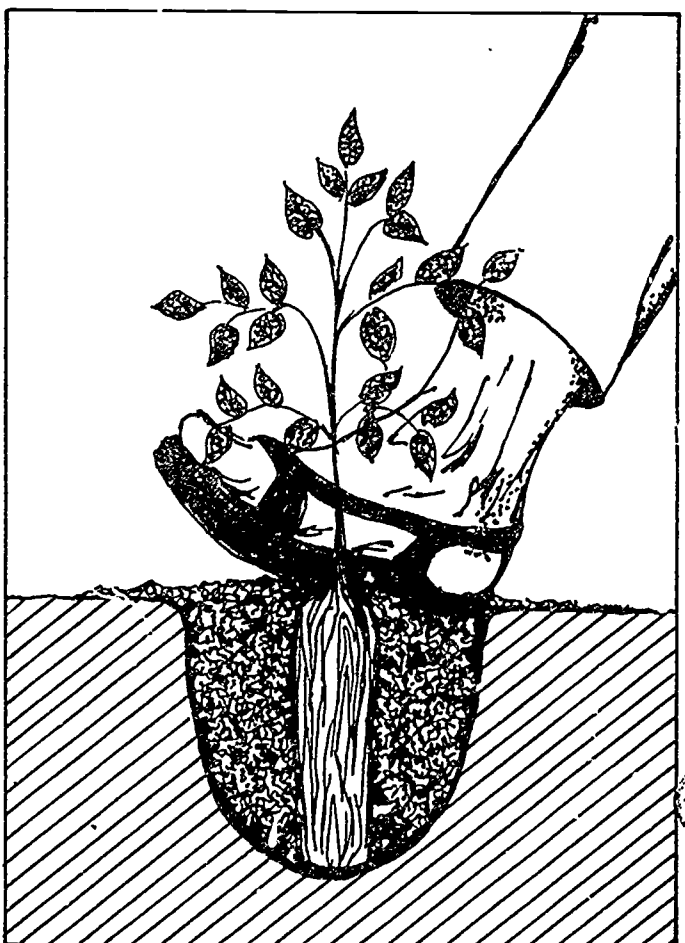
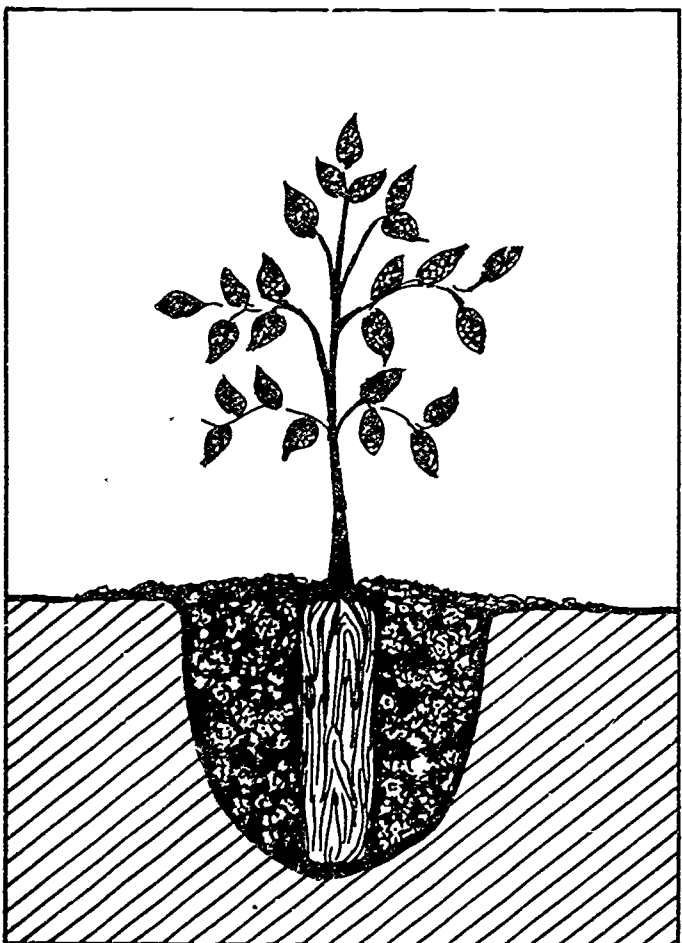
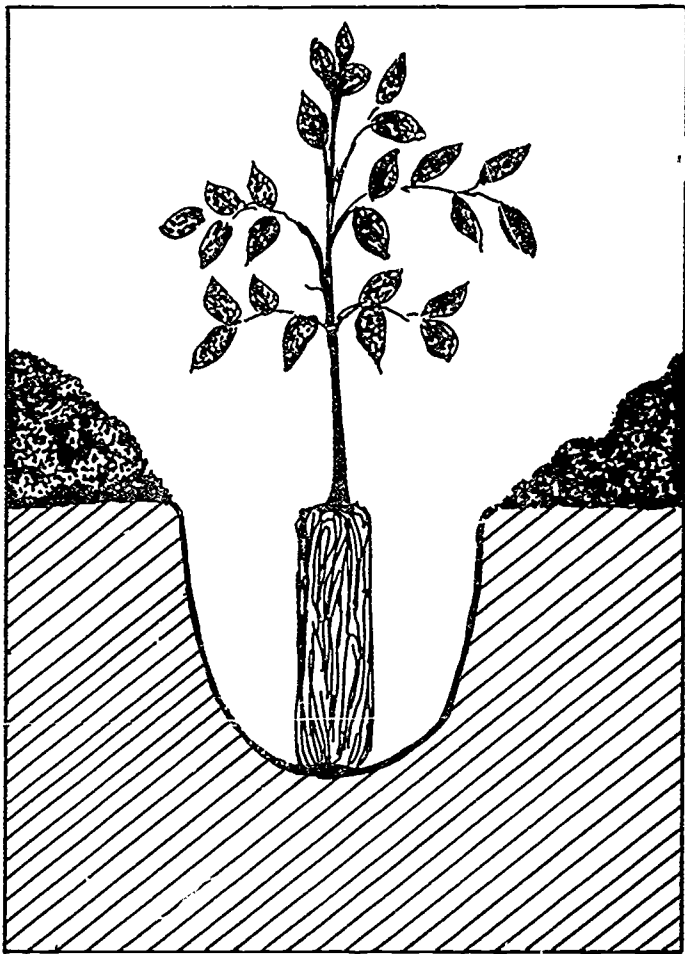
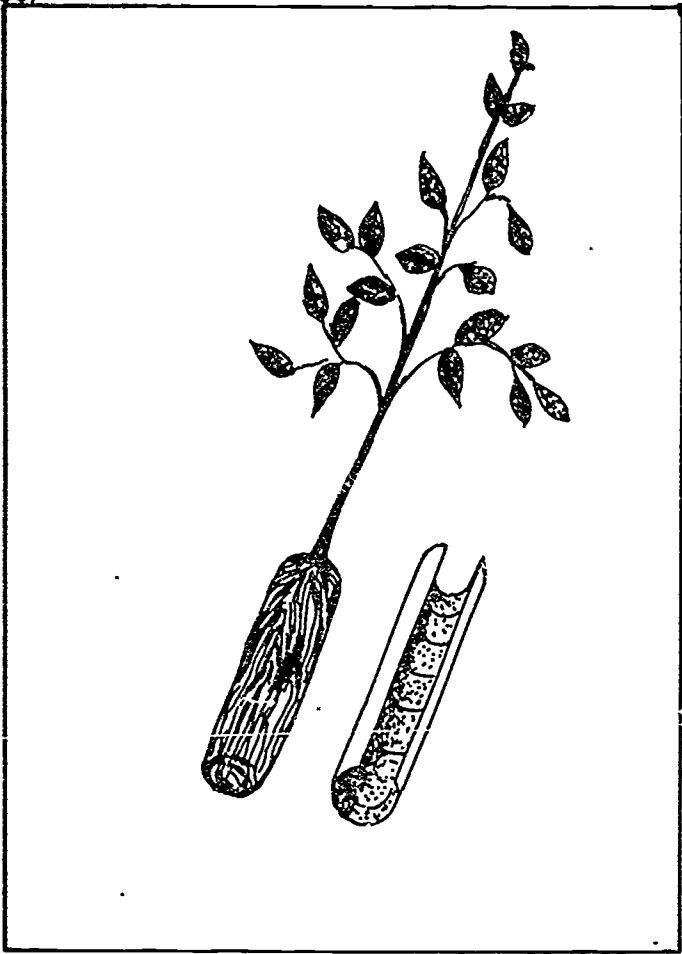

194 (Fig. 19)

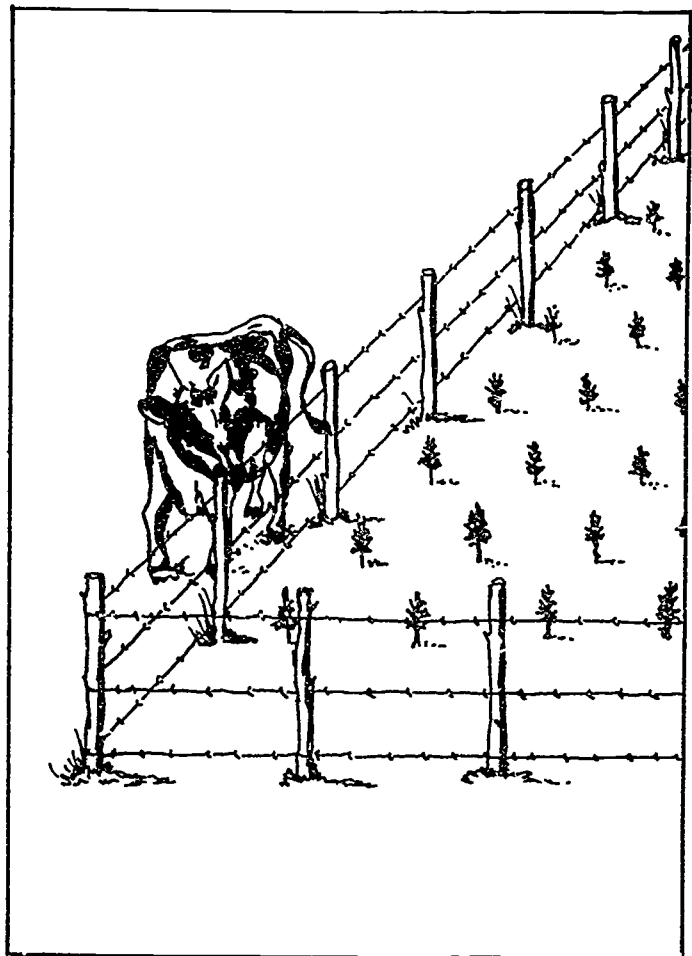
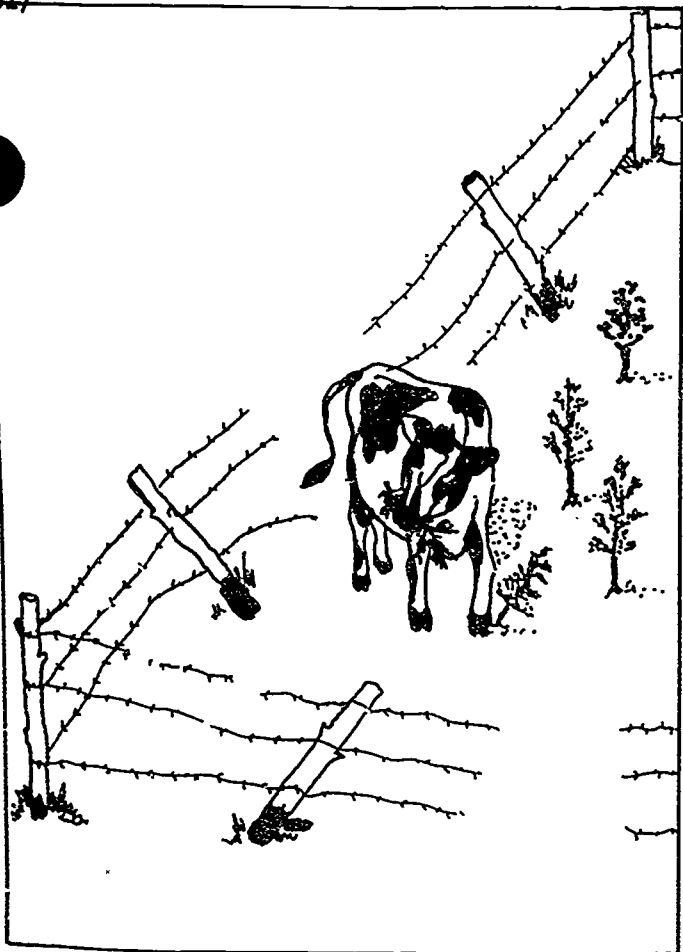

(Fig. 20)



## TREE IDENTIFICATION

The following will be a brief review of concepts and terminology which are important in tree identification. No attempt will be made to make a comprehensive review because such information is readily available in most plant keys or botany texts.

Tree identification can be approached in several ways. The most common and popular method is the use of general tree identification manuals such as Peterson's Guide, The Golden Guide and other such "picture books". These books are excellent for learning common trees, amateur identification and general field reference. For professional purposes, however, more technical, precise sources must be consulted. Two such sources are the consultation of an expert in the discipline or comparison of the unknown to herbarium specimens. These two approaches, though quite acceptable, are generally not convenient. The most accepted method of proper identification is the use of technical keys. Though such keys are often quite extensive and detailed, they are also "state of the art" (unless you are consulting an outdated source) and therefore reliable. In addition, the use of such keys makes one aware of many aspects of the tree's biology that might otherwise have gone unnoticed.

Plants are classified in a hierarchical fashion based upon the presence of shared characteristics. Such classification is thought to reflect actual evolutionary relationships between plants. The basic taxa are: Kingdom, division, class, order, family, genus and species. Only the last three are useful for practical purposes. It is often helpful to know plant families and common genera because species within the same genus often require the same or similar nursery management.

The concept of a species is actually a much more nebulous concept than most people realize. More often than not the variation within a taxa is so great that subdivisions of the taxa (say species) are often delimited quite subjectively or even arbitrarily. The general biological definition of a species is that group of individuals which is capable of interbreeding; any two individuals could mate and produce viable offspring. The use of such a definition is very difficult (delimiting species would require a tremendous series of "orgies") and a much more practical definition is that group of individuals which share common traits.

Species nomenclatures are of two types; there are common names and there are scientific names. Common names are not considered reliable. They are usually fine for local use, but are misleading otherwise. For example many species have different common names in different parts of their range. Also, common names often are used for individuals that a scientist would recognize as different species.

LESSON PLAN AND USE OF VISUAL AIDS IN TEACHING

Total time      2 hours

Goals

- o To instruct the trainees in procedures for presenting lesson,
- o For the trainees to practice setting up simple lesson plans to demonstrate to the group,
- o To discuss a method for making and presenting a slide show.

Overview

During this session, the trainees present special projects on lesson plans and slide presentations. This is a fun time and the trainees enjoy making up lesson plans. A short slide show is also presented (if slides are available).

Exercises

1. How to Make a Lesson Plan
2. How to Make a Slide Show

Materials

Flip chart, marker pens, tape, crayons, old magazines, scissors, paste, material scraps and slide projector.

Exercise 1      How to Make a Lesson PlanTotal time      1 hour 30 minutesOverview

In this exercise the trainee for whom lesson plans has been a special project gives a lecture on preparing lesson plans by demonstrating one he/she has made using "Teaching Conservation in Developing Nations" as a guide. The trainees then design a simple lesson plan and give a one minute demonstration on lesson plans either by actually presenting a lesson or describing a lesson plan they have developed.

ProceduresTimeActivities

30 minutes

1. The trainee responsible for lesson plans as a special project gives lecture covering:

- A. Stated objectives
- B. Present information
- C. Activity
- D. Summary
- E. Follow-up

(Samples of trainees' lectures follows)

30 minutes

2. The trainer now assigns (or can have the trainee assign) everyone to give a one minute lesson to the group. They have 30 minutes to do an outline and prepare a lesson plan.

30 minutes

3. The trainees give either a short lesson or have option of describing a lesson plan they might use in the field. List of lessons given are included for reference.

List of Lessons

- o Proper way to use a knife
- o How to tie a figure 8 knot
- o Teaching children to draw leaves
- o Proper way to mulch
- o Proper way to prepare an environmental collection
- o Proper way to do a drum roll
- o How soil erosion works
- o Earthworms
- o The flower cycle
- o The five senses in the environment
- o Proper way to cut a tree

LESSON PLAN

## I. MOTIVATION FOR LEARNING

- A. Why do the people you are instructing want to learn?
- B. Address the reasons that make them willing to learn.
- C. Adults are motivated to learn necessary things (Adults Learning Theory).

## II. AUDIENCE

- A. The kind of audience you are instructing dictates the manner in which you present the material (i.e., children, adults). Keep in mind the degree of literacy of your children.

## III. DISCUSSION

- A. Incorporate and encourage discussion before, during and after your presentation. The discussion may be formal or spontaneous.

## IV. PLANNING

- A. State objectives. What?
  - 1. Be specific - identify the needs of those you are teaching.
    - o attitude - change needs
    - o knowledge needs
    - o skill needs

2. Identify objectives to your audience
3. Stick to your stated objectives
  - a) Presentation strategy - How?
  - b) Information selection - content of presentation?
    - (1) Refer to objectives - stated objectives are the basis for selection your strategy.
    - (2) Objectives may relate to one or more than one presentation (some may require more re-enforcement).
  - c) Organization of information - sequence of content?
  - d) Evaluation - before, during and after.

INNOVATIVE WAYS OF LEARNING

- I. PRESENTATION STRATEGY - How am I going to do this?
- A. What are your objectives?
  - B. When is the best time to make your presentation?
  - C. Should it be in one, two or more parts (attitude changes are slow and need reinforcement; certain skills take practice)?
  - D. How are skill/information/attitudes transferred in your villages?
  - E. What does the audience already know (feel) about the subject; little to no knowledge... hands on presentation; moderate knowledge of subject...more technical?
  - F. Logistics - are materials available, does everyone know when and where the presentation is, have you reconfirmed guest speaker?

II. ORGANIZATION OF INFORMATION (S-E-Q-U-E-N-C-E)

- A. What are the key points?
- B. Is information relevant to your stated objectives?

Now prepare a content outline.

1. Is it logical? - sequential?
2. Do you have all the points you want to cover?...or too many?
3. Decide which points should be visual and which can be verbal.

III. EVALUATION - before, during and after

- A. Idea - is useful, valid - what new behavior is desired of the audience?
- B. Receiver - did (does) he/she understand the message; does he/she consider it relevant; can he/she do what the message asks?
- C. Message Material - is the material accurate; does it offend; will it be passed on accurately to others?

D. Presentation - was it timely, clear? Did it permit audience feedback? Try it on a small sample audience first to eliminate the wrinkles. You can determine if the presentation has been understood by asking non yes/no questions.

NON-FORMAL EDUCATION

- I. MUTUAL LEARNING RATHER THAN TEACHING
  - A. Involve free flow of facts and ideas among participants.
  - B. Share leadership.
  - C. Use group discussion, demonstrations, role-playing, interviewing.
  - D. Visualize ideas.
- II. STRATEGY FOR EDUCATIONAL SELF-RELIANCE
  - A. People are usually their own best resource.
    - 1. Source of background and insight on own problems.
    - 2. Have locally relevant skills and experience for tackling problems.
  - B. Mobilize skills and resources to pursue educational goals.
- III. IMPORTANCE OF EXTENSION WORK
  - A. Utilize village resources.
  - B. Work yourself out of a job.
  - C. Work within cultural parameters.
  - D. Help people to recognize their own skills.
  - E. Do not do anything people are able to do for themselves.



## CONSERVATION EDUCATION

**INTRODUCTION** - You do not have to be a school teacher to teach basic conservation education. While the school system is the most centralized and organized medium for reaching communities, conservation education should not end there. Simple projects around your home in the backyard are just as effective and serve as an important educational tool when shared with neighbors.

**Resources:** The background you already have based on your education, readings and experiences should be taken seriously as resource materials. Of special importance is the manual "Teaching Conservation in Developing Nations" which can be ordered from Peace Corps at the following address:

Peace Corps Information, Collection &  
Exchange  
M-701  
806 Connecticut Avenue, NW  
Washington, D.C. 20526

Other resources include:

Basic Educational Outline - a syllabus outline of basic goals and topics in a logical progression.

### I. Looking at the environment

#### A. Objectives

1. To develop an awareness of the environment,
2. To understand some interrelationships,
3. To learn how people use and abuse their environment.

#### B. Topics

1. Rocks and soils,
2. Plant communities,
3. Animal Communities,
4. Relationships and man in the environment.

#### C. Projects

1. Slides shows,
2. Posters,
3. Soil examinations,
4. Identification,
5. Terrariums,
6. Planting trees and gardens.

## II. Changes in the natural world

### A. Objectives

1. To understand the life of plants and animals,
2. To develop an awareness of one's impact, etc.

### B. Topics

1. Products from plants and animals,
2. Everyday activities and how they affect the environment,
3. Soil building,
4. What plants need to survive and produce.

### C. Projects

1. Diary of changes in environment,
2. Erosion control project - i.e., contour lines,
3. Water collection and conservation,
4. Fertilizer experiments,
5. Evaluation.

## III. Responsibility for environment conservation

### A. Objectives

1. To understand responsibilities for use and management of natural resources,
2. To learn conservation practices,
3. To learn what local government and national programs are doing.

### B. Topics

1. Conservation practices and alternatives,
2. Sewage and solid waste disposal,
3. Chemicals in everyday life.

### C. Projects

1. Plots,
2. Presentation (store windows),
3. Contact and work with local agencies,
4. Map community,
5. Develop a park with teaching signs.

### Lesson Plans

1. State Objectives,
2. Present information using visual aids - pictures, slides, etc.,
3. Activity - demonstrate,  
construct examples,  
organize presentation.
4. Summary - repeat main points,
5. Follow-up and evaluation.

Exercise 2      Slide Show PresentationTotal time      30 minutesOverview

The trainee(s) who has(have) taken the slide presentation as special project present(s) a lecture on the steps involved. Possibly the(se) trainee(s) could present a short slide show.

ProceduresTimeActivities

20 minutes

1. The trainee(s) for whom slide show presentation is a special project give(s) a lecture including the following steps:
  - A. Before you take pictures,
  - B. Taking pictures,
  - C. Organizing the presentation,
  - D. Equipment,
  - E. Slide show topics,
  - F. Photo reproduction stand.

(Sample follows)

10 minutes

2. The trainee(s) give(s) a short slide presentation to demonstrate the lecture.

## GUIDE FOR MAKING A SLIDE SHOW

For a presentation on almost any subject, a slide show with pictures of good quality is an excellent medium. The following was written as a guide for producing a slide show.

### I. BEFORE YOU TAKE PICTURES

- A. Planning is very important. State the objectives of the presentation. Keep it as specific as possible. Make a list of what you want to show. Research your subject and define specific scenes needed.
- B. Complete the charts, posters and book materials to use in the program.
- C. Buy quality film from a reputable dealer.
- D. Know your camera and be sure to clean lenses, etc. before beginning.

### II. TAKING PICTURES

- A. Action shots showing specific activities involving local people are ideal. Be sure the subjects are willing and explain why you are taking the shots.
- B. Watch the background. Keep the focus of the shot on your specific subject.
- C. Lifting graphs and charts from books can be very useful. Also, original drawings can be changed to slides simply. Excellent title slides and conclusions with written summaries can be made by taking a photo of the written text. A simple stand can be made to hold your camera above the page or book (see figure #1). Close up tubes (automatic extension tubes) can be used to lift photographs for slide production. The slides can be made to look as if they were taken on location. For copying slides, attachments are available which mount onto a 35mm camera. This process reduces the need to rely upon costly slide reproduction processes. In essence, you are taking a slide of a slide.

### III. ORGANIZING THE PRESENTATION

- A. Written script - Scripts should be direct and concise. The presenter should take the time to review the presentation several times prior to the show (practice makes perfect!) Either an entire script can be written or note cards utilized.

- B. Tape recording accompaniment - There are both pros and cons to a slide show including a tape recorded script and/or music. On the positive side is the ease of presentation. A taped script with music background may be more interesting to the viewers and appear more professional. A recording made by a local speaker may also alleviate language difficulties.

A few problems could arise due to:

1. Difficulty in stopping to answer questions,
2. Possible difficulty in coordination of tape with slides.
3. Costs,
4. More equipment and electrical outlets needed.

If you decide to use a tape system, make sure that the speaker has good diction and uses the language indigenous to the area (In Senegal, the urban French is distinct from the French spoken in regional townships.)

#### IV. EQUIPMENT

The list of equipment needed can vary with the needs and resources available for slide show production.

Equipment to consider include:

- A. Reliable 35mm camera - Although not necessary, many options are available to a user of a SLR 35mm camera such as:
1. Telephoto lenses,
  2. Macro lenses,
  3. Automatic extension tube sets,
  4. Slide copiers,
  5. Light filters - from skylight to polarized to infrared,
  6. Wide angle and fish-eye lenses.
- B. Slide projector - A carousel type with a remote slide advancer is best. It would be easier to have enough carousels to enable you to store the slide show directly in the carousel.
- C. Tape recorder - If you prefer "canned" slide shows, a tape recorder which is easy to transport and use is needed.
- D. Quality film and tapes - If the project is a large one, you may want to consider buying in bulk from a photo outlet. This would be cheaper in the long run and the majority of times results in the best quality (fresh) film available.

5. Extension cords - Many slide presentations have been inconvenienced or even ruined due to the lack or nonexistence of electrical outlets and extension cords.

#### V. SLIDE SHOW TOPICS

Following is a list of slide show topics which we feel would be useful to Peace Corps foresters.

- A. Starting a nursery - The following factors could be used as individual slide shows or incorporated into a single presentation.
  1. Site selection,
  2. Seedbed preparation,
  3. Seeds,
  4. Planting,
  5. Maintenance,
  6. Costs.
- B. Agro-silvicultural systems - Specific systems could be handled as individual shows or could be used to present an overview of agro-forestry for any given area of the world.
- C. Planting and transplanting a tree.
- D. Types and uses of various tree species - Trees provide not only wood but also oils, resins, wildlife, food and cover. This show could cover specific species or present an overview.
- E. Pest control - Forest pests throughout the world cost millions of dollars annually in terms of the associated costs of their suppression and lost wood products. This presentation could deal with identifying a problem, the causative agent and possible remedies.
- F. Exotic tree species - In some areas of the world, exotic trees are a necessity in reforestation projects. A show could help promote the tree's usage and deal with any special management problems.
- G. Compost - Its benefits and usage. A presentation could be extremely helpful for areas where the use of inorganic fertilizers cannot be afforded. The show could demonstrate how to start, maintain, and use a compost pile for fertilization.
- H. Erosion and its control - This could deal with the alarming rate of land lost due to erosion by water and wind and ways to deal with the problem.

- I. Land management - The aspect of total land management of agriculture crops, animals, forest, and pasture could be presented to the people to demonstrate better use of the land.
- J. Chainsaw use and safety - Modern harvesting methods are on the increase in developing nations. With the increase in the use of machinery comes the increased risk of accidents and injuries. This show would cover the safe use and operation of the basic "mechanized" tree harvesting tool.

These are some of our suggestions. Many possibilities exist for quality shows which can aid our work in the developing countries. It is up to us, as Volunteers, to recognize the need and act accordingly.

GOOD LUCK

THE UGLY AMERICAN

Total time     1 hour 30 minutes

Goals

- o To acquaint the trainees with the elements of effective development work,
- o To have the trainees explore why effective development work is time consuming and requires considerable patience,
- o To have the trainees understand the importance of community involvement in development projects.

Overview

The trainees are given chapter 18 of The Ugly American, entitled, "The Ugly American and the Ugly Sarkhanese". This particular reading demonstrates the importance of careful consideration of one's project as a development worker. It illustrates the absolute necessity for community involvement in a project, and emphasizes the need for ownership of project by community members.

Exercise

1. The Ugly American

Materials

Flip chart paper, markers, copies of article "The Ugly American and the Ugly Sarkhanese" and copies of "The Bent Backs of Chang 'Dong" for each trainee.

References: Joyce and Martinson, Marine Fisheries Training, October 1982.



Exercise 1      The Ugly AmericanTotal time      1 hour 30 minutesOverview

The trainees are given Chapter 18 of The Ugly American, entitled, "The Ugly American and the Ugly Sarkhanese". This particular reading demonstrates the importance of careful consideration of one's project as a development worker. It illustrates the absolute necessity for community involvement in a project, and emphasizes the need for ownership of the project by community members.

ProceduresTime

20 minutes

Activities

1. The trainer distributes reading material and asks the trainees to spend next 20 minutes reading and underlining the elements they see as important in development work.

15 minutes

2. The trainees are asked to form small groups of five or six and to list on newsprint the most important elements to them as Peace Corps Volunteers. They briefly share their lists with the large group. The trainer should add any elements which may have been missed.

3. The trainees are asked to return to the small groups and list traits the "Ugly American" exhibited which they would wish to emulate. Once again they share lists with the large group.

20 minutes

4. The trainees are given copies of chapter 19, "The Bent Backs of Chang 'Dong." They are asked to read the material and observe Emma's behavior that could apply to their own Peace Corps Service.

The trainer suggests that the trainees may want to record these observations in their own journals.

10 minutes

5. The trainer asks for observations that anyone may want to share at this time. The trainer gives a short talk on the learnings of the past two weeks and summarizes the role of the extensionist, the need for community analysis and the necessity for setting realistic goals for one's self as a Peace Corps Volunteer.

THE UGLY AMERICAN

Two weeks later, Atkins and his wife left by plane for Sarkhan. Emma, a stout woman with freckles across her nose, in her way, quite as ugly as her husband was hopelessly in love with Atkins, but had never been able to tell him why adequately.

She did not blink when Atkins told her they were going to Sarkhan. She told Homer that she'd be pleased to move into a smaller house where she could manage things with her own hands, and where she wouldn't need servants.

Two weeks later the Atkins were living in a small cottage in a suburb of Haidho. They were the only Caucasians in the community. Their house had pressed earth floors, one spigot of cold water, a charcoal fire, two very comfortable hammocks, a horde of small harmless insects, and a small, dark-eyed Sarkhanese boy about nine years old who apparently came with the house. The boy's name was Ong. He appeared promptly at six each morning and spent the entire day following Emma around.

Emma Atkins enjoyed herself in Sarkhan. She learned enough of the language so that she could discuss with her neighbors the best places to buy chickens, ducks, and fresh vegetables. She learned how to prepare beautifully fluffy rice seasoned with saffron. She liked working in her house, and it was a matter of some pride to her that she was as good a housekeeper as most of her neighbors.

Homer Atkins kept busy with his man-powered water pump. The idea had developed very slowly in his mind. What was needed was some kind of efficient pump to raise the water from one terraced paddy to another. Lifting water in the hilly sections consumed enormous amounts of energy. It was usually done by a pail, or by a cloth sack, attached to the end of a long pole. One man would lower the pail and swing it up to the next terrace where another man would empty it. It was a slow and cumbersome method, but the Sarkhanese had been doing it for generations and saw no sense in trying to talk them out of an obviously inefficient method unless he could offer them a more efficient method to replace it.

He solved two-thirds of his problem. A simple pump needed three things. First, it needed cheap and readily available piping. He had decided that the pipes could be made out of bamboo, which was abundant. Second, the pump needed a cheap and efficient pump mechanism. This had taken longer to find, but in the end Atkins had succeeded. Outside many Sarkhanese villages were piled the remains of jeeps which had been discarded by the military authorities. Atkins had taken pistons from one of these jeeps and had replaced the rings with bands of cheap felt to make a piston for his pump. He then cut the block of the jeep in two; he use one of the cylinders as a suction chamber, and the other cylinder as a discharge chamber. With a simple mecha-

nical linkage the piston could be agitated up and down, and would suck water as high a thirty feet. The third problem, which Atkins had not yet solved, was the question of what power could be applied to the linkage.

In the end Emma give him the answer.

"Why don't you just send off to the States for a lot of hand pumps like they use on those little cars men run up and down the railroads?" she asked one day.

"Now, look, dammit, I've explained to you before," Atkins said. "Its got to be something they can use out here. It's no good if I go spending a hundred thousand dollars bringing in something. It has got to be something right here, something the natives understand."

"Why, Homer," Emma said, "with all that money you've got in the bank back in Pittsburgh, why don't you give some of it to these nice Sarkhanese?"

Atkins looked up sharply, but saw at once that she was teasing him. He grunted.

"You know why. Whenever you give a man something for nothing the first person he comes to dislike is you. If the pump is going to work at all, it has to be their pump, not mine."

Emma smiled fondly at Homer Atkins. She turned and looked out the window. A

group of Sarkhanese on bicycles, as usual, were moving in toward the market places at Haidho. She watched them for a few moments, and then spun around, excitement in her eyes.

"Why don't you use bicycles? There are millions of them in this country and they must wear out. Maybe you could use the drive mechanism of an old bicylce to move the pump."

Atkins look at Emma and slowly sat up straight. He slapped hs hand against his knee.

"By God, I think you've got it, girl," he said softly. "We could take the wheels off an old bike, link the chains of the bike to one large reduction gear, and then drive the piston up and down with an eccentric."

Atkins began to walk around the room. Emma a slight grin on her face, returned to her charcoal fire over which she had a fragrant pot of chicken cooking. In a few moments she heard the rustle of paper and knew that Atkins was bent over his drawing board. Two hours later he was still drawing furiously. An hour after that he went to a footlocker, took out a half-dozen bottles of beer, and brought them back to his work table. By dinner time he had drunk them all and was whistling under his breath. When Emma tapped him on the shoulder and told him that dinner was ready, he swung around excitedly.

"Look, baby, I think I've got it," he said, and began to explain to her rapidly, interrupting himself to make quick calculations on a piece of paper. When she finally got him to sit down, he ate so fast that the chicken gravy ran down his chin. He wiped his chin with his shirt sleeve and made sure none of the gravy got on his precious drawings. Emma Atkins watched her husband fondly. She was proud of him, and she was happy when he was happy. Today, she felt very happy, indeed.

"Stop drinking beer, Homer Atkins," Emma said, grinning. "You'll get drunk. And then you'll forget that it was my idea about the bicycle."

"your idea?" he yelled astonishment. "Woman you're crazy. I was thinking about that all along. You just reminded me of it."

But then he went back to the locker, brought back two bottles of beer, and blew suds at her when he filled her glass.

Two days later Atkins had a working model. Not a single item in the crude pump would have to be imported. He had calculated that there was probably enough scrap around the countryside to make a couple of thousand pumps. What he had to do now was to get a couple of pumps actually in operation, to see how they worked. At this point Emma Atkins demonstrated her diplomatic skills.

"Now look, Homer, don't go running off like a wild man," Emma said softly. "You've got a good machine there. I'm proud of you. But don't think that just because it's good the Sarkhanese are going to start using it right away. Remember the awful time that you had getting trade unions in America to accept earth-moving equipment. These people here are no different. You have to let them use the machine themselves and in their own way. if you try to jam it down their throats, they'll never use it."

"All right, Mrs. Foster Dulles, you tell me what to do," Atkins said. He knew she was right, and he was grateful to her. "You tell me how I ought to approach the Sarkhanese."

Emma calmly explained her plan to Homer. He realized that she had been thinking of this for some time. It was an intricate, beautiful plan, and he wished that some of the stuffed-shirts in the American Embassy could hear his wife talking.

The next day he put into operation Emma Atkins' grand strategy.

He drove in his jeep to the tiny village of Chang 'Dong, a community of one hundred souls, living in fifteen or twenty houses. The village was set precariously on a steep hill sixty miles outside of Haidho. The soil there was rich; but the backbreaking, time-consuming process of lifting water up seven or eight levels - even

though the differentials were small - had always made Chang 'Dong a poor village.

Atkins politely asked the first person he met in Chang 'Dong where the home of the headman was. He talked to the headman, a venerable man of seventy-five, without an interpreter. It was not easy, but he could tell that the headman was pleased that Atkins was making the effort to talk his language. With infinite courtesy the old man sensed what words Atkins was searching for, and politely supplied them. The conversation moved along more rapidly than Homer had expected it would.

Atkins explained that he was an American and that he was an inventor. He, Atkins, wanted to develop and patent this pump and sell it at a profit. What Atkins wanted the headman to find was a Sarkhanese worker with mechanical skill. Atkins said he would pay well for the man's time and skill; if he was able to help with the pump, he would become half-owner of the patent. The old man nodded gravely. They then began a long, complicated and delicate negotiation over the matter of how much the native mechanic should be paid. Atkins understood all of this quite well - it was just like negotiating with a trade union organizer in the States. Each man knew that he would eventually have to compromise; and each took pleasure in talking the whole thing out. In the end Atkins got the services of a mechanic for a price which he knew was just slightly higher than the going rate.

Both the headman and Atkins were satisfied. They shook hands, and the headman left to bring in the mechanic. Atkins reached in his shirt pocket, took out a cigar, and lit it with pleasure. This would, he thought, be fun.

When the head man returned he brought with him a small, stocky, heavily-muscled man whom he introduced as Jeepo. The headman explained that the name was not a native name. He was called Jeepo because of his reputation as a famous mechanic in the maintenance and repair of jeeps. Atkins didn't listen too closely to what the headman was saying. He was studying Jeepo, and he liked what he saw.

Jeepo looked like a craftsman. His fingernails were as dirty as Atkins', and his hands were also covered with dozen of little scars. Jeepo looked back steadily at Atkins without humility or apology, and Atkins felt that in the mechanic's world of bolts and nuts, pistons and leathers, and good black grease he and Jeepo would understand one another.

And Jeepo was ugly. He was ugly in a rowdy, bruised, carefree way that pleased Atkins. The two men smiled at one another.

"The headman says you are a good mechanic," Atkins said. "He says that you're an expert on repairing jeeps. But I must have a man who is expert at other things as well. Have you ever worked on anything besides jeeps?"

Jeepo smiled.

"I've worked on winches, pumps, Citroens, American and French tanks, windmills, bicycles, the toilets of wealthy white people, and a few airplanes."

"Did you understand everything that you were working on?" Asked Atkins.

"Who understand everything that he works on?" Jeepo said. "I feel that I can work with anything that is mechanical. But that is only my opinion. Try me."

"We'll start this afternoon," Atkins said. "In my jeep outside is a heap of equipment. You and I will unload it and we'll start once."

By the middle of the afternoon they had assembled most of Atkins' equipment on the edge of a paddy on the second level of the village of Chang'Dong. Twenty five feet of bamboo pipe had been fastened together; the bottom of the pipe was put into a backwater of the river that flowed by the village. The top piece of the pipe was fitted by a rubber gasket to the crude pump which Atkins had designed. Above the pump was the frame of a used bicycle with both of its wheels removed. Jeepo had done the assembly entirely by himself. Atkins had made one attempt to help, but Jeepo had gone ahead on his own, and Atkins realized that he wanted to demonstrate his virtuosity. By late afternoon the assembly was ready.

Atkins squatted calmly in the mud waiting for Jeepo to finish. The headman and two of three of the elders of the village were squatting beside him. Although they were externally as passive as Atkins, he was aware that they were very excited. They understood perfectly what the machine was intended for; they were not sure it would work.

"Sir, the mechanism is ready to operate," Jeepo finally said quietly. "I'm not sure we can get suction at so great a height; but I'd be pleased to turn the bicycle pedals for the first few minutes to test it."

Atkins nodded. Jeepo climbed aboard the bicycle and began to pump slowly. The chain-drive of the bicycle turned with increasing speed. The crude pipes made a sucking noise. For several seconds there was no other sound except this gurgle. Then, suddenly, from the outflow end of the pump, a jet of dirty brown water gushed forth. Jeepo did not stop pedaling nor did he smile; but the headman and the other elders could not restrain their excitement about the size of the jet of water that was being lifted to the second rice terrace.

"This is a very clever machine," the headman said to Atkins. "In a few minutes you have lifted more water than we could lift by our old method in five hours of work."

Atkins did not respond to the man's delight. He was waiting to see how Jeepo

reacted. He sensed that Jeepo was not entirely happy or convinced.

Jeepo continued to pump at the machine. He looked down at the machinery, noted some tiny adjustments that had to be made, and called them out to Atkins. When the small paddy was full of water he stopped, and swung down out of the bicycle seat.

"It is a very clever machine, Mr. Atkins," Jeepo said quietly. "But it will not be a sensible machine for this country."

Atkins looked steadily at Jeepo for a long moment, and then nodded.

"Why not?" he asked.

Jeepo did not respond at once. He moved silently around the mechanism, twisting a bolt here, adjusting a lever there; then he stood up and faced Atkins.

"The machine works very, very well," Jeepo said. "But to make it work a person would have to have a second bicycle. In this country, Mr. Atkins, very few people have enough money to afford two bicycles. Unless you can find another way to drive the pump, or unless your government is prepared to give us thousands of bicycles, your very clever device is a waste of time."

For a moment Atkins felt a flush of anger. It was a hard thing to be criticised so bluntly. For a hot, short moment, Atkins calculated how many bicycles his three

million dollars would buy; then, with the memory of Emma's tact in his mind, he put the thought aside. He turned back to Jeepo.

"What happens to old bicycles in this country?" asked. "Aren't there enough of them to serve as power machines for the pumps?"

"There are no old or discarded bicycles in this country," Jeepo said. "We ride bicycles until they are no good. When a man throws his bicycle away, it's too old to be used for one of these pumps."

For a moment the ugly American faced the ugly Sarkhanese. When he was younger, Atkins would have turned on his heel and walked away. Now he grinned at Jeepo.

"All right, Jeepo, you say you're an expert mechanic. What would you do? Am I simply to give up my idea - or can we find some other way to give power to the pump?"

Jeepo did not answer at once. He squatted in the shallow rice-field, his khaki shorts resting in three inches of mud. He stared fixedly at the improbable machine. For ten minutes he said nothing. Then he stood up and walked slowly to the machine. He turned the pedal and held his finger over the rear-drive sprocket of the wheel as if to test its strength. Then he walked back and squatted again.

The headman looked at



Atkins and then talked in a sharp voice to the elders. The headman was embarrassed at Jeepo's arrogance, and he was saying that the entire village of Chang 'Dong would lose face. Jeepo's ears became slightly red at the criticism, but he did not turn his head or acknowledge that he heard the headman's words.

Atkins felt like laughing. The headman and the elders reminded him very much of the diplomats to whom he talked for so many months in Phnom Penh. He was quite sure that Jeepo had an answer for these comments, and he was quite sure that it was not a political or personal answer, but technical. Atkins squatted down beside Jeepo, and for fifteen minutes the two men sat quietly on their heels studying the machine. Atkins was the first to speak.

"Perhaps we could make the frame of the bicycle out of wood and then we'd only have to buy the sprocket mechanism," Atkins said in a tentative voice.

"But that's the part of the bicycle which is most expensive," Jeepo said.

For perhaps another ten minutes they squatted motionless. Behind him Atkins could hear the shrill voices of the headman and the elders. Although they were attempting to maintain their dignity and manners, it was clear to Atkins that they were trying to find a way to apologize to him and to smooth the whole thing over. It never occurred to Atkins to talk to them. He

and Jeepo were hard at work.

Once Atkins walked to the mechanism, turned the pedals rapidly, held his finger to the sprocket gear, and looked at Jeepo. Jeepo shook his head. He understood the mechanical questions that Atkins had asked and was giving his answer. Without exchanging a word they demonstrated six or eight alternative ways of making the pump work, and discarded them all. Each shake of the head upset the headman and elders profoundly.

It was dusk before they solved the problem, and it was Jeepo who came up with the solution. He suddenly stood bolt upright, walked over the bicycle, remounted, and began to pedal furiously. Water gushed out of the outflow of the pump. Jeepo looked back over his shoulder at the lower level of the pump, then started to shout at Atkins in a loud and highly disrespectful voice in which there was the sound of discovery. It took Atkins another five minutes to understand fully what Jeepo was proposing.

It was the height of simplicity. What he proposed was that a treadmill be built which could be turned by the rear wheel of an ordinary bicycle fitted into a light bamboo frame. What this meant was that a family with a single bicycle could put the bicycle in the bamboo rack, mount it, and pedal. The rear wheel would drive the treadmill which in turn the pump with an efficiency almost as

great as Atkin's original model. When anyone needed to use the bike, he could simply pick it up from the rack and ride away.

"This man has made a very great discovery," Atkins said solemnly to the headman and the elders. "He has developed a way in which a bicycle can be used to drive the pump and still be used for transportation. Without Jeepo's help my idea would have been useless. What I propose is that we draw up a document giving Jeepo on-half of the profits which might come from this invention."

The headman looked at Jeepo and then at the elders. He commenced talking to the elders in a solemn voice. Atkins grasped that the headman had never heard of binding legal documents between a white man and a Sarkhanese. It became clear to him, also that the headman was determine to drive a hard bargain. After several minutes of consultation he turned to Atkins.

"Do you propose that you and Jeepo will begin to build such pumps?" the headman asked.

"Yes, I would like to enter into business with Jeepo. We will open a shop to build this kind of pump, and we will sell it to whoever will but. If the customer does not have the money, we will agree that he can pay of the cost of the pump over a three-year period. But don't get the idea that Jeepo will be paid by me for doing

nothing. He must work as the foreman of the shop, and he will have to work hard. Not any harder than I work, but as hard as I do."

One of the elders broke in excitedly. He pointed out that it was very unlikely that a white man would work as hard as Jeepo. He had never seen a white man work with his hands before, and what guarantee could they have that Atkins would work as hard. Another of the elders agreed, pointing out that this looked like the trick of a white man to get cheap labor from a Sarkhanese artisan. Both of the elders were firmly opposed to Jeepo entering into the partnership.

During all of this discussion, Jeepo did not speak. He tinkered with the pump and bicycle mechanism, tightening gears, checking valves, and tightening the bicycle chain. When the two elders had finished talking, he turned around and came through the mud of the rice paddy to where the group was talking.

"I have listened without speaking to what you foolish old men have been saying," Jeepo said, his voice harsh with anger. "This American is different from other white men. He knows how to work with his hands. He built this machine with his own fingers and his own brain. You people do not understand such things. But men that work with their hands and muscles understand one another. Regardless of what you say, I will enter into business with this man if

he will have me."

There was a quick flush of shame on the headman's face. "I think that Jeepo is correct," he said. This man can be trusted. I will now write up the document which will ensure that he and Jeepo share the profits and the work equally."

"And the document should say that neither I nor the American shall license or patent the idea of the pump," Jeepo said. "We will make the idea available to anyone else who can make it. But on the ones we make, we deserve the profit. That is the way of working men."

Jeepo looked at Atkins. Atkins was pleased and he nodded.

"Also, when we have made some pumps and sold them we will print little books and it will show others how to do it," Atkins said. "We will send it around the whole of Sarkhan, and the village of Chang 'Dong will become famous for its mechanical skills."

Jeepo and Atkins did not wait for the headman to complete their contract before beginning work. Two days later they had rented a large old rice warehouse on the edge of Chang 'Dong. In another day they had hired twelve workers. Jeepo and Atkins drove into Haidho, bought used tools and supplies, and carted them to the warehouse. In a week, the plant was in full operation. Over the entrance to the warehouse a small sign written in Sarkhanese said:

The Jeepo-Atkins Company Limited." Inside the warehouse was a scene of incredible and frantic effort. Jeepo and Atkins worked eighteen to twenty hours a day. They trained the Sarkhanese; they installed a small forge which glowed red-hot most of the day. They tested materials; they hammered; they swore; and several times a day they lost their tempers and ranted at one another. Their arguments, for some reason, caused the Sarkhanese workmen a great deal of pleasure, and it was not until several months had passed that Atkins realized why - they were the only times that the Sarkhanese had ever seen one of their own kind arguing fairly and honestly, and with a chance of success, against a white man.

Emma Atkins did not stay long in the suburb outside of Haidho. Within a week she had moved their belongings to a small house in Chang 'Dong. She bustled about her home and through the village, buying chickens and vegetables, and making huge casseroles of rice and chicken. Every day at noon, she and several of the village women brought two of the casseroles to the warehouse and all of the men ate from them. Emma seemed to find it not at all unusual that her husband should be in a tiny hillside village constructing something as outlandish as bicycle water pumps.

Once a technical advisor from the American Embassy called at the warehouse and watched quietly for several

hours. The next day the Counselor of the Embassy called. Taking Atkins to one side, he pointed out to him that for a white man to work with their hands, and especially in the countryside, lowered the reputation of all white men. he appealed to Atkins' pride to give up this project. Moreover, he pointed that the French, most experienced of colonizers, had never allowed natives to handle machinery. Atkins' reply was brief, but it was pointed, and the counsellor drove away in anger. Atkins returned joyfully to his work in the warehouse.

At the end of six weeks they had manufacture twenty three pumps. When the twenty-fourth pump was finished, Atkins called all of the men together. He and Jeepo then faced the group and between them outlined what now had to be done. Jeepo did most of the talking.

"This is the difficult part," Jeepo started quietly, "You have worked hard and well to build these pumps - now you must sell them. Our friend Atkins here says that in America one of the best things that can happen to engineers like yourself is to be allowed to sell what they make. So each of will now take two of these pumps as samples, and go out and take orders for more. For each pump that you sell you will get a ten per cent commission."

One of the men interrupted. He did not understand what a commission was. There was a confused

five minutes while Atkins and Jeepo explained, and when they were finished the prospective engineer-salesmen were smiling cheerfully. They had never heard of such a proposal before, but it struck them as both attractive and ingenious. When the discussion was over, twelve contracts were laid on a table; and each Sarkhanese signed a contract between himself and The Jeepo-Atkins Company, Limited.

The next morning twelve oxcarts were lined up outside the warehouse. Two of the pumps were carefully laid out on beds of straw on each of these carts. By noon the twelve salesmen had left for all parts of the province.

Now the waiting began. Jeepo, the headman, the elders, and everyone else in the village realized that everything rested on the persuasiveness of the engineer-salesmen and the performance of the bicycle-powered pump. If no orders were placed, Atkins would have to leave, and the excitement of the factory would disappear. In only a few weeks all of this activity had become very important to the people of Chang'Dong. The people drifted into the warehouse, and watched Jeepo and Atkins at work, and many of them began to help. The tension grew steadily; and when four days had passed and not one of the salesmen had returned, a blanket of gloom as thick as a morning mist settled over the village.

Then on the morning of the fifth day one of the salesmen returned. He drove

at a speed which, for an oxcart, is rare. The oxcart stumbled and splashed mud in the air, and the salesman beat the animal with gusto and enthusiasm. As the ox labored up the hill, everyone in the village came to the warehouse to learn what would happen. When the cart, covered with mud, drew to a halt, there was a low murmur. They could all see that the cart was empty. The driver got down from the cart slowly, fully aware of his importance. He walked over calmly and stood before his two employers.

"I have the pleasure to inform you, sirs, that I have done wrong," he began, a grin on his face. "You told me that I should bring back the two samples, but I was unable to do it. I have taken orders for eight pumps. But two of my customers insisted that I deliver the pumps at once. Because their paddies were in desperate need of water and the crops might have been ruined, I reluctantly gave them the pumps. I hope I have not made a mistake.

There was a deep sigh from the crowd and everyone turned and looked at Jeepo and Atkins. These two squat, ugly, grease-splattered men stared at one another for a moment, and then let out shouts of joy. Jeepo hugged Atkins. Atkins hugged Jeepo, and then Jeepo hugged Mrs. Atkins. Then everyone in the village hugged everyone else. For several hours an improvised party involved the entire village.

The next morning the village was up early, but not as early as Atkins and Jeepo. As the people went down to the warehouse, they heard the clank of hammers and wrenches. They peered into the dim interior of the warehouse and smiled at one another. Atkins and Jeepo were in the midst of a terrible argument over a modification of the pump. Emma Atkins was laying out a huge breakfast in front of the two men, and they were ignoring it as they continued their argument.

THE BENT BACKS OF CHANG'DONG

Emma Atkins was a simple and straightforward person. She was not a busybody; but she had learned that when she wanted to know something the best way to find out was to ask a direct question. She had been in Chang'Dong only two weeks when she asked an unanswerable question.

She was working in her kitchen with two of the Sarkhanese neighbors, trying to make a small guava which grew in the jungle into a jam. The glowing charcoal stove and the sweet aroma of the bubbling fruit gave the kitchen a cozy and homey atmosphere. Emma felt good. She had just finished telling her neighbors about how a kitchen was equipped in America; then through the open window, she saw an old lady of Chang'Dong hobble by, and the question flashed across her mind. She turned to the two women and spoke slowly, for the Sarkhanese language was new to her.

"Why is it that all the old people of Chang'Dong are bent over?" Emma asked. "Every older person I have seen is bent over and walks as if his back is hurting."

The two neighbor women shrugged.

"It is just that old people become bent," one of them answered. "That's the natural thing which happens to older people."

Emma was not satisfied, but she did not pursue the problem any further then. Instead, she kept her eyes open. By the time the rainy

season was over, she had observed that every person over sixty in the village walked with a perpetual stoop. And from the way they grimaced when they had to hurry, she realized that the stoop was extremely painful. The older people accepted their backaches as their fate, and when Emma asked them why they walked bent over, they only smiled.

Three weeks after the monsoon ended, the older people in the village began to sweep out their homes, the paths leading from their houses to the road, and finally the road itself. This sweeping was inevitably done by the older people. They used a broom made of palm fronds. It had a short handle, maybe two feet long, and naturally they bent over as they swept.

One day as Emmas was watching the wrinkled and stooped woman from the next house sweep the road, things fell into place. She went out to talk to the women.

"Grandmother, I know why your back is twisted forward," she said. "It's because you do so much sweeping bent over that short broom. Sweeping in that position several hours a day gradually moulds you into a bent position. When people become old their muscles and bones are not as flexible as when they were young."

"Wife of the engineer, I do not think so," the old woman answered softly. "The old people of Southern Sarkhan have always had bent backs."

"Yes and I'll bet that they got them from sweeping several hours a day with a

short-handled broom," Emma said. "Why don't you put a long handle on the broom and see how it works?"

The old woman looked puzzled. Emma realized that in her excitement she had spoken English. She put the question to the woman in Sarkhanese.

"Brooms are not meant to have long handles," the old lady said matter-of-factly. "It has never been that way. I have never seen a broom with a long handle, and even if the wood were available, I do not think we would waste it on long handles for brooms. Wood is a very scarce thing in Chang'Dong.

Emma knew when to drop a conversation. She had long ago discovered that people don't stop doing traditional things merely because they're irrational. She also knew that when people are criticised for an action, they stubbornly persist in continuing it. That evening, Emma had a talk with Homer.

"Home, have you noticed the bent backs of the old people in this village?" Emma asked.

"Nope, I haven't, Homer said, washing down a bowl of rice with a bottle of beer. "But if you say they're bent, I'll believe it. What about it?"

"Well, just don't say what about it," Emma said angrily. "I'm getting to the age where when my bones get stiff, it hurts. Imagine the agony those old people go through with their back perpetually

bent. It's worse than lumbago. I've asked them, and they tell me it's excruciating."

"All right, all right, Emma," Atkins said. "What are we going to do about it?"

"Well, the first thing we're going to do is get longer broom handles," Emma said with heat.

However, Emma found that it was difficult to get longer handles. Wood of any kind was scarce in that area, and expensive. The handles the Sarkhanese used for their brooms came from a reed with a short strong stem about two feet long. For centuries this reed had been used; and, centuries ago people had given up looking for anything better. It was traditional for brooms to have short handles, and for the broom to be used exclusively by people too old to work in the rice fields. But Emma wasn't bound by centuries of tradition, and she began to look for a substitute for the short broom handle.

It would have been simple, of course to have imported wooden poles, but long ago, Homer had taught her that only things that people did for themselves would really change their behaviour. With the mid-western practicality, Emma set about researching her problem. It was a frustrating task. She tried to join several of the short reeds together to make a long broomstick. This failed. Every kind of local material she used to try to lengthen the broomstick handles failed.

Emma refused to be defeated. She widened the scope of her search, until one

day she found what she was after. She was driving the jeep down a steep mountain road about forty miles from Chang'Dong. Suddenly she jammed on the brakes. Lining one side of the road for perhaps twenty feet was a reed very similar to the short reed that grew in Chang'Dong - Except that this reed had a strong stalk that rose five feet into the air before it thinned out.

"Homer," she ordered her husband, "climb out and dig me up a half-dozen of those reeds. But don't disturb the roots."

When she got back to Chang'Dong, she planted the reeds beside her house and tended them carefully. Then, one day, when several of her neighbors were in her house she casually cut a tall reed, bound the usual coconut fronds to it, and began to sweep. The women were aware that something was unusual, but for several minutes they could not figure out what was wrong. Then one of the women spoke.

"She sweeps with her back straight," the woman said in surprise. "I have never seen such a thing."

Emma did not say a word. She continued to sweep right past them, out on the front porch, and then down the walk. The dust and debris flew in clouds; and everyone watching was aware of the greater efficiency of being able to sweep while standing up.

Emma, having finished her sweeping, returned to her house and began to prepare tea for her guests. She did not speak to them about the broom,

but when they left, it was on the front porch, and all of her guest eyed it carefully as they departed.

The next day when Emma swept off her porch, there were three old grandmothers who watched from a distance. When she was finished Emma leaned her long-handled broom against the clump of reeds which she had brought from the hills. The lesson was clear.

The next day, perhaps ten older people, including a number of men, watched Emma as she swept. This time when she finished, an old man, his back bent so that he scurried with a crab-like motion, came over to Emma.

"Wife of the engineer, I would like to know where I might get a broom handle like the one you have," the man said. "I am not sure that our short-handled brooms have bent our backs like this but I am sure that your way of sweeping is a more poserful way."

Emma told him to help himself to one of the reeds growing beside the house. The old man hesitated.

"I will take one and thank you; but if I take one, others may also ask, and soon your reeds will be gone."

"It is nothing to worry about, old man," Emma said. "There are many such reeds in the hills. I found these by the stream at Nanghsa. Your people could walk up there and bring back as many as the village could use in a year on the back of one water buffalo."



The old man did not cut one of Emma's reeds. Instead he turned and hurried back to the group of older people. They talked rapidly, and several hours later Emma saw them heading for the hills with a water buffalo in front of them.

Soon after, Homer completed his work in Chang'Dong, and they moved to Rhotok, a small village about seventy miles to the east. And it was not until four years later, when Emma was back in Pittsburgh, that she learned the final results of her broomhandle project. One day she got a letter in a large handsome yellow-bamboo paper envelope. Inside, written in an exquisite script, was a letter from the headman of Chang'Dong.

Wife of the Engineer:

I am writing you to thank you for a thing that you did for the old people of Chang'Dong. For many centuries, longer than any man can remember, we have always had old people with bent backs in our village. And in every village that we know of the old people have always had bent backs.

We had always thought this was a part of growing old, and it was one of the reasons that we dreaded old age. But, wife of the engineer, you have changed all that. By the lucky accident of your long-handled broom you showed us a new way to sweep. It is a small thing, but it has changed the lives of our old people. For four

years, ever since you have left, we have been using the long reeds for broom handles. You will be happy to know that today there are no bent backs in the village of Chang'Dong. Today the backs of our old firm. No longer are their bodies painful during the months of the monsoon.

This is a small thing, I know, but for our people it is an important thing.

I know you are not of our religion, wife of the engineer, but perhaps you will be pleased to know that on the outskirts of the village we have constructed a small shrine in your memory. It is a simple affair; at the foot of the altar are these words: "In memory of the woman who unbent the backs of our people." And in front of the shrine there is a stack of the old short reeds which we used to use.

Again, wife of the engineer, we thank you and we think of you.

"What does he mean, 'lucky accident'?" Emma said to Homer. "Why I looked all over for three months before I found those long reeds. That was no accident."

Homer did not look up at her from the letter. He knew that the indignation in her voice was false. He knew that if he looked now he would see tears glittering in the corners of her eyes. He waited a decent amount of time; when he raised his head she was just

pushing her handkerchief back  
into the pocket of her apron.

CATCHMENTS - SOWING OF SEEDLINGS INTO CATCHMENTS

Total time        3 hours

Goals

- o To introduce water catchments and their purposes,
- o For the trainees to make catchments,
- o To begin sowing seedlings into containers,
- o To use feedback skills.

Overview

The use of water catchments is introduced. The trainees are divided into teams to build catchments and plant more trees. The Plastic Bag Caper (Session 18) comes to an end in this session and the trainees continue to work on the nursery.

Exercises

1. Catchments
2. Plastic Bag Caper, Part II

Materials

Shovels, trees for out planting, seedlings for planting in containers.

Exercise 1      CatchmentsTotal time      2 hours 15 minutesOverview

The technical trainer briefly explains water catchments. The trainees build catchments and plant trees. Feedback skills are used at the end of the exercise.

ProceduresTimeActivities

15 minutes

1. The technical trainer lectures on the use of catchments and describes three types.

2 hours

2. The trainer explains that in this next exercise the trainees will once again use their transits. The trainees lay out an area on a hillside, build "v" catchments and plant ten trees.

**Trainer's Note:** The trainees are divided into small groups. Each group has a group leader. These leaders are chosen by the training staff from trainees who have not assumed leadership roles previously. The trainers observe while the groups work.

3. The trainer processes the activity by asking the trainees to give each other feedback in their small groups based upon the following questions:
  - o What style of leadership did the group leader use?
  - o How did the group leader feel about the response of the group?
  - o What was easy for leader? Group members?
  - o What was hard for leader? Group members?
4. The trainer summarizes, shares his observations and asks for remarks from the small groups.

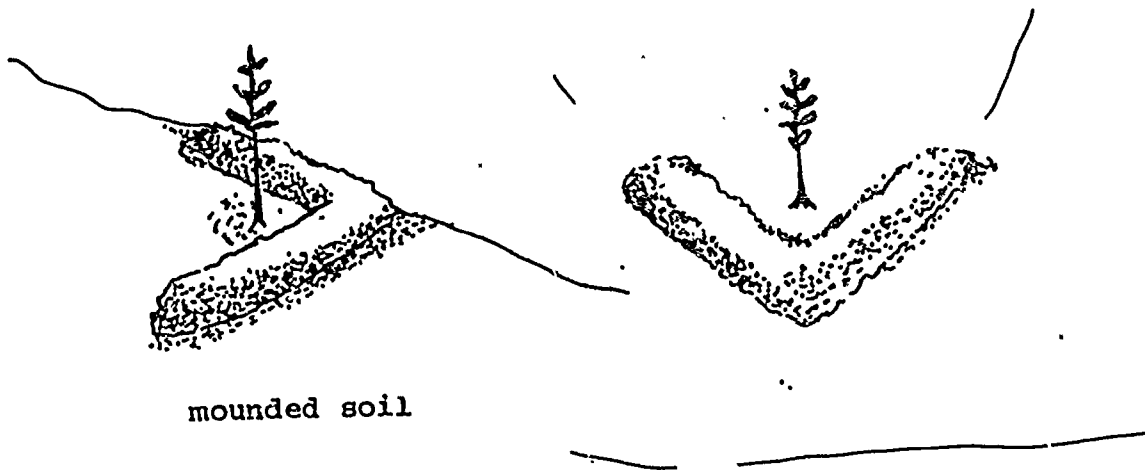

mounded soil

(Fig. 21) "V" Shaped Catchment

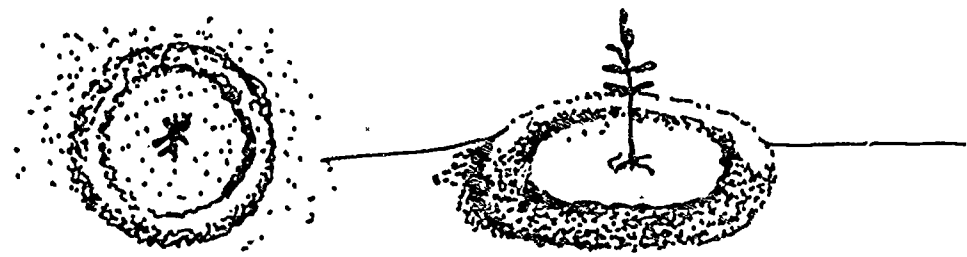

(Fig. 22) Circle Catchment

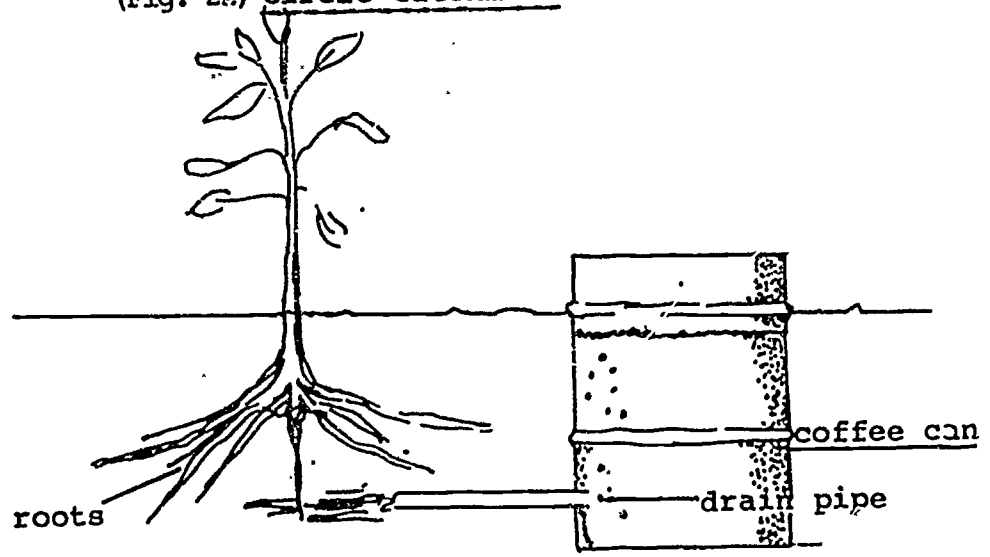

(Fig. 23) Can Collection

Exercise 2      Plastic Bag Caper - Part IITotal time      45 minutesOverview

The trainees will have made seedling containers for the better part of a week. In their spare time, they have been planting seedlings in a variety of containers. The trainer now produces plastic bags for them to use.

ProceduresTime

45 minutes

Activities

1. At this point, the trainer reviews the weeks' activities around the making of containers. He then makes the following points:
  - A. Peace Corps Volunteers must be resourceful,
  - B. Peace Corps Volunteers will frequently have to make do with local resources.
  - C. Trainees have not used human resources available to them (give examples).
2. Finally, the trainer gives the trainees plastic bags to finish the seedling transplanting.

WEEKLY INTERVIEW

Total time 15 - 20 minutes/interview

Goals

- o To give each trainee time with a trainer to review the weeks' learnings,
- o For the training staff to give collective feedback to the trainees based upon assessment dimensions given on the first day of training,
- o To get feedback from the trainees on their own progress.

Overview

The purpose of this session is to give each trainee individual time with a trainer to review their learnings of the week. The staff gives each trainee feedback based upon assessment criteria given to the trainees in Session 1. They also receive feedback from the trainees on their own progress.

The following are suggested questions to be asked at the end of the second week of training.

Technical Self-Assessment (For questions 1 - 4 use a scale of 1 - 5 with 5 being the high)

1. How do you rate yourself on the use of tools this last week?
2. How conscientious have you been this week about safety precautions? Hat? Gloves? Looking under rocks?
3. How would you rate your ability to go into a village and completely set-up a nursery?
4. How do you rate your skills to cope with differences?
5. How many hours would you say you have worked?  
In the nursery? \_\_\_\_\_  
In the garden? \_\_\_\_\_  
In relaxation? \_\_\_\_\_
6. Why do you believe you are capable of being a forestry Volunteer in Africa?
7. Do you believe you will be able to learn to speak the local language?
8. Are you leaving anyone behind? What will happen if they do not wait?

AGRO-FORESTRY

Total time      4 hours

Goals

- o To introduce agro-forestry,
- o To explore the concept of forestry in combination with agriculture or livestock,
- o To explore the reason why agro-forestry is a good concept,
- o To explore agro-forestry as an extension technique,
- o To look at elements necessary in planning an agro-forestry project.

Overview

Agro-forestry, as a sub-discipline of forestry, has been recognized for the last ten years; however, it should be emphasized that farmers have been practicing agro-forestry for hundreds of years. As a new discipline, there is not yet a great deal written about the subject. Currently, there are thousands of projects being researched and investigated throughout the world.

In this session we explore the concepts of agro-forestry and examine the extension work. Each participant's agro-forestry plan is evaluated to date and questions answered. It should be pointed out that the participants in this training program are undoubtedly the pioneers in this discipline who will write the books on agro-forestry.

Exercise

1. Agro-Forestry

Materials

Flip charts, marker pens, tape, article "Can Farming and Forestry Coexist in the Tropics?" (Optional).



Exercise 1     Lecture on Agro-ForestryTotal time 1 hourOverview

This new discipline in forestry is introduced and the concepts of agro-forestry as related to the Peace Corps Volunteer are presented. It is pointed out that this field, although not entirely new, is new in academic instruction of forestry and, as such, there has not been many books written on the subject to date. Perhaps the future authors are present here as participants in this session.

ProceduresTime

1 hour

Activity

1. Two sample lectures follow. The first was written by Bruce Burwell and the second by William E. Prentice.
2. Following the lecture, the trainees are given the next two hours to work on their own agro-forestry projects which will be presented in later sessions:

Things to consider are:

- A. Make a list of possible crops from which to choose and learn about each one,
- B. Seek out local expertise and experience,
- C. Do not jump to conclusions,
- D. If the crop needs pampering in your area, leave it alone,
- E. Shade tolerance is related to soil fertility,
- F. Grow what you like to grow.

**Trainer's Note:** If a local expert is available, a presentation from that expert can be substituted for this session.

AGRO-FORESTRY

The agro-forestry approach to land management and use is not a new one; in fact it is used in many countries around the world and has been used for hundreds of years. In the United States, "progress" in crop production has led us to the growing of large areas of single crops. Recently, however, there has been renewed interest in the agro-forestry approach, especially in those areas where the monocultures have proven difficult to manage or on sites that do not lend themselves easily to single cropping.

Underlying the agro-forestry approach is the concept that the production of crops, fruits, animals and forest products can be compatible if the right mix of species is chosen and production carefully monitored. This mix could essentially be any two or more of the above. An example would be the pasturing of sheep in an orchard: animal and fruit production. Another example could be apple trees bordering a field of mint where geese are used to weed the mint: fruit, crops and animals. The actual mix could be essentially anything that is compatible.

This compatibility of production also implies another facet of the agro-forestry approach. Wherever possible, the plant and animal association is natural and mutually beneficial. Some shrubs can provide forage to animals, fix nitrogen naturally in the soil (fertilize), and offer a cover crop for the establishment of natural grasses. Sheep can provide fertilizer to the vegetation. Trees can provide shade to the animals, cover for the lower vegetation, and fruit or forest products. Thus, each segment is not only considered from the standpoint of its own production, but also in what way it can be beneficial in the production of another segment.

Although the agro-forestry approach to land use can be applied to most areas, it has generally not been accepted in the United States. There are two main reasons for this; first, the people giving technical advice have been divided in their approach. Those involved in animal production tend to be concerned with only animals. Fruit tree specialists have no interest in forest trees, animals or shrubs, and foresters have no interest in anything outside the area of forest products. This disinterest has been strengthened by the creation of separate areas of study: agriculture, horticulture, animal husbandry and forestry. There is a certain amount of possessiveness by each of their specific area of specialization. None wants an "outsider" to encroach on their field and will not enter the area of another specialist.

The second reason for the non-acceptance of the agro-forestry approach has been the trend towards farming larger areas using more mechanized and specialized equipment to handle a specific crop. The introduction of several crops or types of production tends to complicate the system by requiring specialized equipment for each product.

## The Possibilities for Agro-forestry in the Southwest

What can the agro-forestry approach do with the arid conditions of the Southwest? First, it can look at the whole picture; it can take into consideration the multiple interrelated possibilities of production. For example, a combination of several of the following might be tried:

Pinon pine: For the production of fuelwood and nuts.

Sheep: For the production of meat and wool.

Native grasses: For range use and soil protection.

Shrubs: For animal forage.

Junipers: For berries and wood.

Bees: For honey and pollination.

These are just examples. There are many other species that could be combined; for example, the jojoba has a nut that produces an oil that is in high demand.

An agro-forestry project should first be done on a sample area basis such that the best possible combination can be determined through measuring and monitoring. This can be done by setting out replicated areas and observing the resulting production on each area. For example, trees can be measured for height and later volume, growth and/or fruit production; grasses can be measured on a ground cover basis; and sheep on a meat and wool production basis. The monitoring of these sample areas should be carefully done to observe any incompatibility, especially as related to any species that are introduced into the area. Once the best productive combination is determined, the area can be expanded.

An attempt should be made to work with nature as much as possible. The mixing of species is much the way nature itself handles the vegetation on a specific site. By artificially creating a "balance", however, it is almost certain that the balance will be different than the one that nature would have planned. The point is to try and make it as close as possible, yet productive, such that nature is helping instead of trying to destroy the artificially made balance. It is much easier and more productive to have nature helping.

Lecture 2      Agro-Forestry - By William E. Prentice

We believe that it is right for a man to strive to better the world in which he lives.

How?

Each tree you plant makes the world a better place.

As a PCV, you can have a great multiplier effect by teaching others to plant and care for trees.

I. Combining "forestry" with agriculture and livestock.

- o Possible combinations,
- o Why do it?
- o Overcoming resistance.

II. Selecting the crops, horticultural trees and animals.

- o Animals,
- o Fruit and nut trees,
- o The birds and the bees,
- o Fowl play.

III. Land usage: Production techniques.

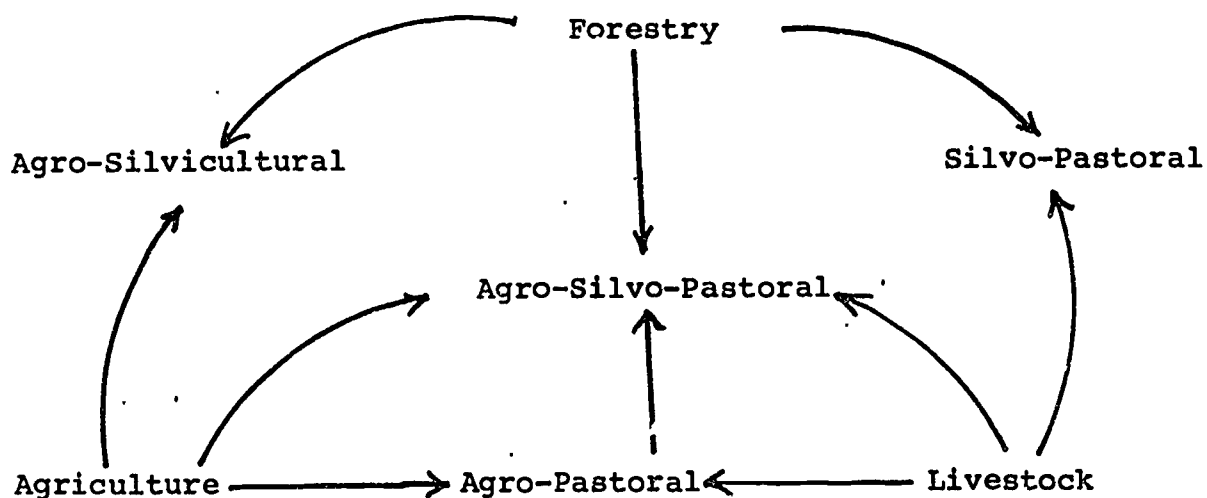

Land Usage - Various PossibilitiesAgricultural - Field Crop Monoculture

- o Orchard monoculture
- o Mixed cropping
- o Polycultures

Forestry

- o Reservations
- o Conservation
- o Plantation - single species
- o Plantation - mixed species

Livestock

- o Ranging
- o Pasturage of paddocking
- o Confinement
- o Forage and feed storage

Agro-Silvicultural

- o Animal under trees; regular distribution,
  - In relay sequence
  - Permanent association
- o Animal under trees; irregular distribution,
- o Horticultural tree with forest trees.

Agro-Pastoral

- o Grazing under trees (fruit and nuts)
- o Grazing plant residues
- o Fowl with resistant crops
- o Pigs and fowl (self-harvesting)

Silvo-Pastoral

- o Grazing under trees
- o Planted forage for weed control

Agro-Silvo-Pastoral

- o Annuals, trees and animals
- o Perennials, trees and animals
- o Annuals, perennials, trees and animals

COMMUNITY ANALYSIS INTRODUCTION

Total time      2 hours 30 minutes

Goals

- For the trainees to receive feedback from non-verbal exercise,
- The trainees should learn the names of the 14 sub-systems in the social cybernetics framework,
- The trainees should define each system and its elements,
- The trainees should develop a series of questions for inquiry which fit into the categories.

Overview

Community analysis is introduced in this session. Building upon the extension workers' role, the social cybernetics sub-systems are used in this session because they were developed in Latin America and are widely used for analysis by many institutions in the Inter-American region.

Exercises

1. Feedback on Non-verbal Observations
2. Introduction to Social Cybernetics Sub-systems

Materials

Flip charts, marker pens, tape.

Exercise 1      Feedback on Non-verbal Observations

Total time      30 minutes

Overview

Trainees started observing each other's non-verbal behavior in Session 10. They will now give their partner feedback on non-verbal behavior.

Procedures

Time

30 minutes

Activities

1. The trainees will have selected partners in Session 10 and will now exchange information on their observations of non-verbal behavior.
2. At the end of one-half hour, the trainer starts on next exercise.

Exercise 2      Introduction to Social Cybernetics Sub-SystemsTotal time      2 hoursOverview

Social Cybernetics Methodology was developed in South America and has been applied in Central and South America particularly among tribal people for the last 15 years. In this session, the 14 sub-systems are introduced and defined. Trainees then develop a list of questions for each sub-system that will generate data necessary for analysis of their communities.

ProceduresTime

15 minutes

Activities

1. The trainer introduces sub-systems and gives a brief lecture including:
  - A. The community analysis model with which you will be working assumes that you can break down a community into a series of segments or sub-systems for purposes of analysis.
  - B. Each segment, in the real world, interacts with the other to produce a continual movement and balance which keeps the community active. Change in one segment can affect the other and vice versa. Intervention will do the same, e.g., if you introduce improved piggery techniques by penning up pigs and feeding them rather than letting them forage for food (an economic intervention), you affect community health by reducing swine-borne diseases.
  - C. Cutting across all segments of the community, you will find that there are common elements. These common elements are defined as:



- o Resources (both human, natural and manmade);
- o Problems possibly exist - problems are defined as the gap between what is and what should be (what "should be" is often defined culturally);
- o Patterns exist which give you clues about what is there, and how persons perceive them (these patterns of behavior often include cultural habits, as well as biological necessities); and,
- o Among the human resources you will probably find that leadership exists in many of the sub-areas of the community.

The following model describes this approach to the community.

#### SUB-SYSTEMS

Kinship	Birth, sex, marital status, ethnic groups, habitation, migration, family, relatives, demography, population.
Health	Hygiene, infirmity, hospitals, campaigns, nursing, pharmacy, medicine, dentistry, sanitation, public health, mortality.
Maintenance	Consumers, bars, stores, hotels, diets, food/drink, clothing, warehouse, malnutrition.
Affinity	Friendship, love, hate, association, clubs, unions, co-ops, federations, societies, solidarity, integration.
Leisure	Tourism, holidays, games, free time, music/songs, diversions, sports, hobbies, exhaustion, relaxation.
Communications	Trips, transportation, accidents, languages, newspapers, broadcast stations, telecommunications, networks.
Education	Culture, teachers, didactics, research, study, school, library, education, academics, teaching.

Owner- ship	Public/private property, possessions, assets, wealth/salaries, rich/poor, distribution of wealth, stock market, GNP.
Extra- Ag-Ind- Art	Manufacture, enterprises, firms, specialists, departments, arts, technologies, farming, energy, extractive industry.
Reli- gious	Creeds, beliefs, participation, churches, ministers, rites, congregations.
Secur- ity	Police power, combativity, defense, attacks, crimes, violence/war, armed forces, military operations, fear.
Adminis- trative	Public power, planning, political parties, bureaucracy, regime, public administration, government.
Judicial	Laws, justice, rights, duties, courts, codes, legal process, jurists.
Status	Prestige, respect, merit, competition, privilege, titles, excellence, elites, "who's who", nobel prize, monuments.

**Trainer's Note:** We have used this model because it is all inclusive of social sub-systems used in social planning in the Americas. You may wish to use a shorter version called KEEPRAH, Holistic Model, developed by Phil Donohue and used in the early 1960's at Peace Corps Training Center, Escondido, California.

1 hour 30 minutes

2. The trainees are instructed to write their autobiography using the 14 sub-systems.

15 minutes

3. The trainees meet with their non-verbal partner and share the learnings they have derived from seeing themselves through the 14 sub-systems.

4. The trainer links the exercise to Session 36 on the following night.

SOILS

Total time      2 hours

Goals

- o To introduce varieties of soils found in Africa,
- o To explain soil fertility,
- o To discuss fertilization of soils,
- o To explain the steps for taking soil samples,
- o To explore the techniques to be used in soil conservation extension.

Overview

The technical trainer introduces the subject of soil in the host country(ies). He/she talks about different types, fertility, and fertilization as a means of improving soil quality. The trainer explains the steps for taking soil samples and discusses the techniques to be used in soil conservation extension work.

Trainer's Note: It may be possible to get a local soil expert to give a presentation during this session.

Exercise

## 1. Soils

Materials

Flip charts, magic marker, tape, movies, soil testing kit.

Exercise 1      Soil LectureTotal time      2 hoursOverview

The technical trainer introduces the soil section of training and discusses the varieties of soil found in host country(ies), the fertility of the soils, and the use of fertilizers on the soil. He/she explains the steps for taking soil samples and gives examples of techniques to be used in soil conservation extension work.

ProceduresTime

2 hours

Activities

1. The technical trainer lectures on soils. This lecture must be country specific, and, if not, the trainees must know how to find specifics on the host country.
2. Slide show.
3. Field trips - visit to poor and good soil management and the affects on crops.

## Soils: Principles and Definitions

Prepared by:  
Oliver A. Chadwick  
Dept. of Soils, Water and Engineering  
University of Arizona

During plant and bacterial growth phosphorus, sulfur, calcium, iron and other minerals are removed from the soil and nitrogen fixation takes place. Nutrient cycles consist of the incorporation of chemical elements during the process of growth followed by their release during respiration, excretion, and decay. These processes are carried out by plants, the herbivorous animals that eat them, the carnivores, and lastly countless microorganisms which return a portion of the minerals to the soil for reuse (Morowitz, 1983). Plant nutrients come from either the atmosphere or the lithosphere and their release in usable form is critically important for man's agricultural efforts. Where minerals are missing from the geologic substrate or atmospheric inputs are insufficient, minerals must be added. In other cases, physical characteristics may restrict air or water movement thus inhibiting root growth. Man has developed remedies for many of these agricultural problems.

This discussion introduces the complex interactions between biological, chemical and physical processes in soil and their relevance to agriculture. Specific management procedures are not recommended because it takes a detailed series of laboratory and field trials before relevant crop-soil management procedures can be developed. These recommendations must be developed by country or regional agricultural specialists. It will be your responsibility as volunteers to find these experts and interpret their recommendations. Therefore, I will introduce you to some of the important definitions and principles of soil science.

### BASIC DEFINITIONS

Cation Exchange Capacity (CEC) - Nearly all soils have a net negative charge and are able to retain positively charged ions on clay and organic matter surfaces. These ions can also be exchanged with ions in the soil solution and thus are available for plant uptake. Most plant nutrients are cations. CEC is an important soil parameter because it indicates how many nutrients can be retained by the soil and readily lost by leaching. Clay content and mineralogy is the primary determinant of the CEC level. In general, the greater the clay content the greater the CEC, but it varies from 10 meq/100g to nearly 180 meq/100g for kaolinite and montmorillonite respectively. These variations in mineralogy are primarily due to surface area characteristics, with montmorillonite having a much higher surface area than kaolinite. Two main factors control which cations will be preferentially held on the negatively charged surface; one is the valence charge on the cation and the other is mass action. Mass action simply means

that if there are enough certain cations they will be absorbed on the exchange complex regardless of their valence compared to other cations. Based on valence, aluminum ( $\text{Al}^{3+}$ ) is held preferentially to calcium ( $\text{Ca}^{2+}$ ) and magnesium ( $\text{Mg}^{2+}$ ), while sodium ( $\text{Na}^{+}$ ) and potassium ( $\text{K}^{+}$ ) are held least strongly. Many factors influence cation availability for mass action exchange. The amount of water leaching through the soil is a primary factor. High leaching conditions favor aluminum over the monovalent ions because the latter are held less strongly. Cations are available for plant uptake when they are in the soil solution (i.e. dissolved in water held loosely in soil pores). When a plant takes up a cation from the soil solution, there are less of that species to hold their own in the mass action process and therefore more of the cation will be released to the soil solution and to plants.

Base saturation - The primary plant nutrient cations are ammonium ( $\text{NH}_4^+$ ), calcium, potassium, and to a lesser extent magnesium and sodium. They are called bases and their total percentage on the cation exchange complex is base saturation. This is an important measure of soil fertility status because these bases can be released to soil solutions for plant uptake as described above.

Exchange acidity - In addition to the bases mentioned above, the exchange complex contains hydrogen ( $\text{H}^+$ ) and aluminum, primarily the latter. These elements are not plant nutrients and aluminum can be toxic in high concentrations. Their total percentage on the exchange is termed exchange acidity. It is an important measure because it indicates potential aluminum toxicity and indirectly the nutrient status of the soil.

pH - pH is the negative logarithm of hydrogen ion activity in the soil solution. This means that a pH of 8 indicates less hydrogen activity than one of 6. The primary importance of soil pH measurements is to indicate which of several chemical reactions are dominant. The chemical reactions in turn control plant nutrient availability. At pH values below 5.5, the soil is primarily controlled by chemical reactions associated with aluminum. The exchange is dominated by aluminum and most of the nutrient bases have been leached from the soil. Phosphate, calcium, and molybdenum are held in insoluble compounds limiting their availability. Aluminum, zinc and manganese are soluble and may cause plant toxicities. At pH 5.5 - 7.5, most of the necessary nutrient elements are available for plant uptake. Because the exchange complex and soil solution contain moderate amounts of many different nutrients, there are few toxicities and deficiencies. At pH values from 7.5 - 8.5 calcium is the dominant cation on the exchange complex. High calcium levels cause insoluble precipitates with phosphate. Iron, manganese and zinc may also be deficient at these pH levels. At pH values above 8.5, the exchange complex is dominated by sodium. Nutrient deficiencies occur because of insoluble compound formation but the primary concern is a physical effect on soil clays. The clays are dispersed into very fine particles which plug pores and lower soil permeability causing poor soil-water relationships.

It is the aim of soil management to attempt to keep soil pH within the range of 6 - 7.5. The pH is usually lowered using gypsum ( $\text{CaSO}_4 \cdot 2\text{H}_2\text{O}$ ) or sulfuric acid ( $\text{H}_2\text{SO}_4$ ). It is usually raised using lime ( $\text{CaCO}_3$ ). Information on specific amounts and methods of application are available from local agricultural research centers.

### SOIL FERTILITY MANAGEMENT\*

Nitrogen - In most cases nitrogen is the limiting nutrient for plant growth. This is partly because it is required to a greater extent than any other soil supplied element and partly because there are limited inputs of nitrogen to soil. Most nitrogen in soil is in organic form which may be released as ammonium by microbial respiration. Under favorable conditions ammonium may be oxidized to nitrate ( $\text{NO}_3^-$ ). Most plants can utilize both ammonium and nitrate.

The amount of nitrogen in the form of soluble ammonium and nitrate is seldom more than 1-2 percent of the total nitrogen present, except where large applications of inorganic fertilizers have been made. This is fortunate because inorganic nitrogen is subject to loss from soils by leaching and volatilization. Only enough is needed to supply the daily requirements of growing plants.

In the course of a year nitrogen undergoes many complex transformations, some of which may be partly controlled by man while others are beyond his command. This succession of largely biochemical reactions is known as the nitrogen cycle.

External inputs of nitrogen are from commercial fertilizers, crop residues, green and farm manures, and ammonium and nitrate salts brought down by precipitation. There is also fixation of atmospheric nitrogen accomplished by certain microorganisms. Nitrogen depletion is primarily due to crop removal, leaching, erosion and denitrification (i.e. loss in gaseous form).

The process of incorporating inorganic nitrogen into organic form is called immobilization while its release is called mineralization. Immobilization can be accomplished by plants or microorganisms. Mineralization occurs when microorganisms break down nitrogen rich organic compounds releasing ammonium.

One of the most important factors in practical soil management is the maintenance of a proper balance between the soil's

---

\* Based on reviews by Brady, 1974 and Black, 1968.

71

organic matter content and nitrogen immobilization and mineralization processes. Ample amounts of organic matter are needed in soils to maintain favorable physical properties such as aeration and permeability. If, however, organic matter is added which has very little nitrogen (e.g. straw or sawdust), microorganisms will immobilize much of the available inorganic nitrogen as they break down the carbon rich organic additions. If, on the other hand, succulent green plant materials (green manure) are incorporated into the soil, microorganisms will release excess nitrogen as they break down the nitrogen rich plant material. Addition of low nitrogen organic materials to improve soil physical characteristics must be accompanied by inorganic nitrogen fertilizers to stimulate microbial activity and provide enough nitrogen for plant growth as well.

Phosphorus - Phosphorus is critically important to plant growth. It is needed for cell division, flowering, seed production, and root development. Legumes cannot fix nitrogen without adequate amounts of phosphorus. Therefore low phosphorus levels impinge on nitrogen availability as well.

Phosphorus may be unavailable because of a small total amount available in soils, the unavailability of this native phosphorus, or a marked precipitation of added soluble phosphates. Since crops remove relatively small amounts of phosphorus and world supplies are large, supplying sufficient total phosphorus is not difficult. Increasing the availability of the native soil phosphorus and retarding precipitation of added phosphates are important problems.

Phosphorus occurs in soil in inorganic and organic forms and both are nutrient sources for plants. The inorganic compounds fall into two groups: those containing calcium and those containing iron and aluminum. The simpler calcium compounds are relatively soluble while the more complex ones are insoluble especially at high pH values. Iron and aluminum phosphate compounds are least soluble at low pH values.

Other than pH, phosphorus availability is influenced by the amount and decomposition state of organic matter as well as microbial activity. As with nitrogen, the rapid decomposition of organic matter and consequent high microbial populations result in temporarily tying up of inorganic phosphates in microbial tissue. As organic matter is decomposed by microorganisms, phytin and nucleic acids are produced. These are sources of phosphorus. Phytin is absorbed directly by plants while nucleic acids are broken down by enzymes at the root surfaces and the phosphorus is then absorbed in either organic or inorganic form. Plants commonly suffer from phosphorus deficiency even in the presence of large quantities of organic forms of the nutrient. Just as with inorganic phosphates, the problem is one of availability.

Phytin is similar to inorganic phosphates, forming iron and aluminum phytates and calcium phytates at low and high pH values



respectively. Under acid conditions nucleic acids are strongly absorbed by clays, especially montmorillonite.

In practical phosphorus management, the small amount of control that can be exerted over phosphate availability seems to be associated with pH control, fertilizer placement, and organic matter maintenance. Phosphate precipitation is kept to a minimum if soil pH is kept between 6 and 7. Phosphate fertilizers are applied in concentrated bands to prevent rapid precipitation reactions. They may be pelleted to retard soil contact and slow phosphate diffusion.

A major portion of added phosphates will be precipitated regardless of what precautions are followed. These precipitated forms are not totally lost since they are slightly soluble and release small amounts of phosphates. This may be significant in areas with high amounts of precipitated phosphorus compounds. In summary, maintaining sufficient phosphorus in a soil requires the addition of phosphorus containing fertilizer and the partial regulation of phosphate precipitation.

Potassium - Potassium is needed by plants for photosynthesis, starch formation, and translocation of sugars. It encourages strong root systems and is necessary for tuber development. All root crops respond to liberal applications of potassium.

In contrast to phosphorus, most mineral soils, except sandy ones, are relatively high in total potassium. The amount held in easily exchangeable form is, however, usually very small. Most potassium is part of the primary soil minerals especially mica and feldspar. It must be released by geologic weathering processes which are very slow compared to crop growth cycles. A smaller but significant portion is held in slowly soluble form in the crystal lattice of minerals. Soluble potassium is in the soil solution and on the exchange complex. It is not held tightly on the exchange complex and is readily susceptible to leaching losses. Potassium supplying power is the term used to describe the supply of potassium being released from the slowly available forms. Soluble potassium comes from the inherent potassium supplying power, organic matter decomposition, and added fertilizer. Competition by microorganisms contributes to its unavailability to growing plants. Thus, potassium is similar to both phosphorus and nitrogen because a large proportion of all three is insoluble and unavailable to growing plants.

Potassium management has three complications: a very large proportion is relatively unavailable to higher plants; because its available forms are soluble and not strongly held on the exchange complex, they are easily leached; and, the removal of potassium by crops is sometimes excessive because of luxury consumption.

Practical fertility management should take full advantage of the potassium supplying power of the soil (it is difficult to measure and not known in most places) in calculating fertilizer

needs. Fertilizer applications should be light and frequent to minimize leaching and luxury consumption losses.

Fertilizers - A fertilizer is any substance which is added to soil to supply plant nutrient elements. It can be an organic material which releases inorganic elements when broken down by microorganisms, or it can already be in inorganic form.

Organic materials are usually produced locally by green manuring, return of plant residues, or use of animal manures. They are bulky, difficult to ship, and have a lower nutrient supplying power compared to inorganic fertilizers. Their varied carbon compounds have beneficial physical and chemical effects on the soil. Organic materials should be used to supply part of the necessary plant nutrients. Animal manures must always be composted before use to avoid plant damage.

Inorganic fertilizers are fairly concentrated and easy to ship and apply. Because the nutrient elements are usually rapidly available for plant uptake, it is important not to over fertilize and burn plants. Immediate availability also implies a potential for large nutrient losses through leaching. Inorganic fertilizers are the simplest way to add plant nutrients. Continual reliance upon them with no organic additions, however, will lead to degradation of soil porosity and aeration.

A complete fertilizer is one which supplies the three major plant nutrients. Nitrogen fertilizer carriers are usually one or several of the following: sodium nitrate ( $\text{NaNO}_3$ ), ammonium sulfate ( $(\text{NH}_4)_2\text{SO}_4$ ), ammonium nitrate ( $\text{NH}_4\text{NO}_3$ ), or diammonium phosphate ( $(\text{NH}_4)_2\text{HPO}_4$ ). The primary sources of phosphorus in inorganic fertilizers are superphosphates ( $\text{CaHPO}_4$  and  $\text{Ca}(\text{H}_2\text{PO}_4)$ ) which have higher phosphate availability than rock phosphate. Potassium is usually supplied by one of the following salts: potassium chloride ( $\text{KCl}$ ), potassium sulfate ( $\text{K}_2\text{SO}_4$ ), or potassium nitrate ( $\text{KNO}_3$ ).

Fertilizer grade refers to the minimum guarantee of the plant nutrient content in terms of total N, available  $\text{P}_2\text{O}_5$ , and water soluble  $\text{K}_2\text{O}$  in a complete fertilizer (e.g. 5-10-10). Fertilizer ratio refers to the relative percentages of N,  $\text{P}_2\text{O}_5$ , and  $\text{K}_2\text{O}$  in a complete fertilizer. For instance, a 5-10-10, and 8-16-16, a 10-20-20 and a 15-30-30 all have a 1-2-2 ration. These fertilizers should give essentially the same results when applied in equivalent amounts. Thus, 1,000 pounds of 10-20-20 provides the same amounts of nitrogen, phosphorus, and potassium as does a ton of 5-10-10.

It is best to fertilize using many light applications rather than one heavy application. This ideal is seldom possible because the specific site conditions and economics usually dictate procedures. Slow release fertilizers are available to mitigate these problems but they are more expensive.

## PHYSICAL AND CHEMICAL FACTORS INFLUENCING PLANT GROWTH \*

Particle Size Distribution - Texture influences infiltration, permeability, moisture and nutrient retention, and susceptibility to erosion. Its effect on these qualities may be modified by soil structure, nature of the clay minerals, organic matter, and calcium carbonate content. Soils of all textural classes, except perhaps coarse sand, are arable by an appropriate method. In arid regions fine textured soils may be high in soluble salts, while in humid regions they may be water-logged during part of the year. Coarse textured soils are subject to rapid permeability, low water-holding capacity, and low nutrient holding and supplying capacity. Thus, medium textured soils are generally favored for agriculture.

Available Water Capacity - Readily available water is that portion of the water in the soil that can be readily absorbed by plant roots (about 50-75 percent of the total available moisture). The "total available moisture" is usually defined as the difference between the soil moisture content at "field capacity" and "wilting point". The capacity of a soil to retain water available to plants has a direct bearing on required rooting depth and frequency of precipitation or irrigation. It is important, therefore, in judging the suitability of a soil for agriculture.

Permeability - The permeability of a soil profile is used to determine subsurface drainage and to evaluate the possibility of perched water table conditions developing, which may injure crop roots. Soil morphological features that influence or reflect permeability include texture, structure and structure stability, color and mottling, visible pores, and depth to impermeable strata such as bedrock or hardpan. A moderate to rapid permeability allows the greatest flexibility on water, fertility and salinity management.

Effective Rooting Depth - Root penetration is inhibited by physical factors such as bedrock or cemented pans, by chemical factors such as high calcium carbonate or gypsum concentrations, or by poor drainage. Effective rooting depth greater than 90 cm is considered optimal.

Restricted rooting inhibits proper root formation, decreases plant stability, and limits the amount of soil that the plant can utilize thus restricting its intake of nutrients and moisture.

Water Table - Perched or regional high water tables can act as root inhibiting layers by restricting aeration. In arid areas soils having high water tables should not be developed for irrigation because the groundwater will be degraded by leaching of natural salts and fertilizer salts. The concentrated salts can then rise into the root zone by capillary action. This will lower the agricultural productivity of the soil (see salinity section below).

\* Sources include FAO, 1979; FAO, 1975; FAO, 1976; and Black, 1968.

For irrigated agriculture, good quality water should not be higher than about 90 cm for any 24-hour period after irrigation has begun. Pre-irrigation water tables must be lower than that. Saline water tables should never be higher than three meters below the surface (FAO, 1979).

Topography - Slope and local relief influences the type and scale of agriculture which can be developed. Level to nearly level land can be utilized for large scale monoculture cropping while steep dissected terrain is more suited to intensive agroforestry techniques. Table 1 presents some choices of irrigation methods and crops for different topographical conditions. For extensive tree planting, small rainfall runoff catchments can be designed for each tree. In arid regions, upper slopes may be left bare as a collection area for tree belts lower on the slope.

Salinity - An excess of soluble salts is probably the most widespread soil quality adverse to crop growth in arid irrigated areas. It is fortunate that, owing to their solubility, such salts are mobile and can be removed by leaching where drainage conditions are satisfactory.

The primary deleterious effect of excessive salinity is to raise the concentration of the soil solution. The flow of water into the plant by osmosis is reduced or reversed and the plant is starved of water even though the soil is moist. Some ions, particularly sodium, chloride, and sulfate, have specific toxicity for certain crops. The variation among plants in their tolerance to salinity (Table 2) affects the choice of cropping pattern when evaluating the possible effects of salinity.

Inadequate drainage and a rising water table after a few years of irrigation may lead to the entry of saline water into the root zone. The salinity level and sodic conditions at the time of sampling are not stable characteristics of the soils, and both can be changed with irrigation, salinity being the easiest and cheapest to correct. Important considerations in the evaluation of saline or sodic soils include: water quality to be used for irrigation, infiltration and permeability rate of the soil; leveling required to provide a suitable surface for leaching; ability of substrata to transmit the necessary leaching water; the level of salinity or sodic conditions; and availability or absence of gypsum to replace sodium in sodic soils.

Exchangeable Sodium Percentage (ESP) - The exchangeable sodium percentage is the degree of saturation of the soil exchange complex with sodium. ESP is usually a good indication of the structural stability of a soil and of its physical response to irrigation water. Most soil containing expanding type clay minerals exhibit unfavorable physical properties at ESP greater than 15 percent. In general, physical properties become increasingly unfavorable with increasing ESP. Expanding 2:1 clay minerals are more strongly affected than non-expanding clays. In sandy soils, sodium-induced clay dispersion may favorably increase water-holding capacity.

Table 3

## GUIDE FOR SELECTING A METHOD OF IRRIGATION

Irrigation method	Topography	Crops	Remarks
Widely spaced borders	Land slopes capable of being graded to less than 1% slope and preferably 0.2%	Alfalfa and other deep rooted close-growing crops and orchards	The most desirable surface method for irrigating close-growing crops where topographical conditions are favourable. Even grade in the direction of irrigation is required on flat land and is desirable but not essential on slopes of more than 0.5%. Grade changes should be slight and reverse grades must be avoided. Cross slope is permissible when confined to differences in elevation between border strips of 6-9 cm.
Closely spaced borders	Land slopes capable of being graded to 4% slope or less and preferably less than 1%	Pastures	Especially adapted to shallow soils underlain by clay pan or soils that have a low water intake rate. Even grade in the direction of irrigation is desirable but not essential. Sharp grade changes and reverse grades should be smoothed out. Cross slope is permissible when confined to differences in elevation between borders of 6-9 cm. Since the border strips may have less width, a greater total cross slope is permissible than for border irrigated alfalfa.
Check back and cross furrows	Land slopes capable of being graded to 0.2% slope or less	Fruit	This method is especially designed to obtain adequate distribution and penetration of moisture in soils with low water intake rates.
Corrugations	Land slopes capable of being graded to slopes between 0.5% and 12%	Alfalfa pasture and grain	This method is especially adapted to steep land and small irrigation streams. An even grade in the direction of irrigation is desirable but not essential. Sharp grade changes and reverse grades should at least be smoothed out. Due to the tendency of corrugations to clog and overflow and cause serious erosion, cross slopes should be avoided as much as possible.
Graded contour furrows	Variable land slopes of 2-25% but preferably less	Row crops and fruit	Especially adapted to row crops on steep land, though hazardous due to possible erosion from heavy rainfall. Unsuitable for rodent-infested fields or soils that crack excessively. Actual grade in the direction of irrigation 0.5-1.5%. No grading required beyond filling gullies and removal of abrupt ridges.

Table 3 (continued)\*

Rectangular checks	Land slopes capable of being graded so single or multiple tree basins will be level within 6 cm	Orchards	Especially adapted to soils that have either a relatively high or low water intake rate. May require considerably grading.
Contour checks	Slightly irregular land slopes of less than 1%	Fruit, rice, grain and forage crops	Reduces the need to grade land. Frequently employed to avoid altogether the necessity of grading. Adapted best to soils that have either a high or low water intake rate.
Contour ditches	Irregular slopes up to 12%	Hay, pasture and grain	Especially adapted to foothill conditions. Requires little or no surface grading.
Portable pipes	Irregular land surface	Hay, pasture on small scale	Minimum preparation of land surface required.
Subirrigation	Smooth-flat	Shallow rooted crops such as potatoes or grass	Requires a water table, very permeable subsoil conditions and precise levelling. Very few areas adapted to this method.
Sprinkler	Undulating 1- > 35% slope	All crops	High operation and maintenance costs. Good for rough or very sandy lands in areas of high production and good markets. Good method where power costs are low. May be the only practical method in areas of steep or rough topography. Good for high rainfall areas where only a small supplemental water supply is needed.
Contour bench terraces	Sloping land - best for slopes under 3% but useful to 6%	Any crop, but particularly well suited to cultivated crops	Considerable loss of productive land due to berms. Require expensive drop structures for water erosion control.
Subirrigation (installed pipes)	Flat to uniform slopes up to 1% surface should be smooth	Any crop, row crops or high value crops usually used	Requires installation of perforated plastic pipe in root zone at narrow spacings. Some difficulties in roots plugging the perforations. Also a problem as to correct spacing. Field trials on different soils are needed. This is still in the development stage.
Drip	Any topographic condition suitable for row crop farming	Row crops or fruit	Perforated pipe on the soil surface drips water at base of individual vegetable plants or around fruit trees. Has been successfully used in Israel with irrigation water. Still in a development stage.

\*Source: FAO (1979), from Richards et al. (1954).

Table 4 RELATIVE TOLERANCE OF VARIOUS CROPS TO SOIL SALINITY

Fruit Crops		
High salt tolerance	Medium salt tolerance	Low salt tolerance
<p>Date Palm</p> <p><math>EC_e \times 10^3 = 8</math></p>	<p><math>EC_e \times 10^3 = 8</math></p> <p>Pomegranate Fig Olive Grape Cantaloup</p> <p><math>EC_e \times 10^3 = 4</math></p>	<p><math>EC_e \times 10^3 = 4</math></p> <p>Pear Apple Orange Grapefruit Prune Plum Almond Apricot Peach Strawberry Lemon Avocado</p> <p><math>EC_e \times 10^3 = 2</math></p>
Vegetable Crops		
<p><math>EC_e \times 10^3 = 12</math></p> <p>Garden beets Kale Asparagus Spinach</p> <p><math>EC_e \times 10^3 = 10</math></p>	<p><math>EC_e \times 10^3 = 10</math></p> <p>Tomato Broccoli Cabbage Bell pepper Cauliflower Lettuce Sweet corn (maize) Potatoes Carrot Onion Peas Squash Cucumber</p> <p><math>EC_e \times 10^3 = 4</math></p>	<p><math>EC_e \times 10^3 = 4</math></p> <p>Radish Celery Green beans</p> <p><math>EC_e \times 10^3 = 3</math></p>
Field Crops		
<p><math>EC_e \times 10^3 = 16</math></p> <p>Barley (grain) Sugar beet Rape Cotton</p> <p><math>EC_e \times 10^3 = 10</math></p>	<p><math>EC_e \times 10^3 = 10</math></p> <p>Rye (grain) Wheat (grain) Oats (grain) Rice Sorghum (grain) Maize Flax Sunflower Castorbeans Soybeans</p> <p><math>EC_e \times 10^3 = 6</math></p>	<p><math>EC_e \times 10^3 = 4</math></p> <p>Field beans Sugar cane Cassava</p>

Table 4 (continued)\*

Forage Crops		
$EC_e \times 10^3 = 18$ Alkali sacaton Saltgrass Nuttall alkali grass Bermuda grass Rhodes grass Fescue grass Canada wildrye Western wheatgrass Barley (hay) Birdsfoot trefoil	$EC_e \times 10^3 = 12$ White sweetclover Yellow sweetclover Perennial ryegrass Mountain brome Strawberry clover Dallis grass Sudan grass Hubam clover Alfalfa (Calif.common) Tall fescue Rye (hay) Wheat (hay) Oats (hay) Orchardgrass Blue grama Meadow fescue Reed canary Big trefoil Smooth brome Tall meadow oatgrass Cicer Milkvetch Sourclover Sickle milkvetch.	$EC_e \times 10^3 = 4$ White Dutch clover Meadow foxtail Alsike clover Red clover Ladino clover Burnet
$EC_e \times 10^3 = 12$	$EC_e \times 10^3 = 4$	$EC_e \times 10^3 = 2$

\*Source: FAO (1979) from Richards et al. (1954).



In addition to the possible deleterious effects that ESP levels may have on physical properties of a soil, some crops have a low tolerance for exchangeable sodium. Tolerance of various crops to ESP is presented in Table 3 and ESP crop reduction is shown in Table 4.

Calcium Carbonate - Calcium carbonate commonly accumulates in soils developed under arid and semiarid climates. It may be diffused throughout the soil profile, or may take the form of soft concretions, or nodules, or may be concentrated in a continuous horizon of varying hardness and at varying depths below the surface. The amount of carbonate present, the form of its distribution in the profile, and the depth to the carbonate-rich horizons are all important factors in judging the suitability of a calcareous soil for irrigated agriculture.

The presence of calcium carbonate affects both physical and chemical characteristics of a soil. Continuous horizons of carbonate accumulations may not restrict water movement, but may prevent root penetration. The presence of carbonates reduces the ability of calcareous soils to retain moisture, especially at high tensions (FAO, 1979).

Up to 10-15 percent calcium carbonate may assist formation of stable aggregates associated with relatively large pores and rapid water movement. With an increased content of 20 or 25 percent, precipitation of carbonate within capillary tubes tends to increase the proportion of very small pores and reduce diffusivity.

Surface crusting can be a serious problem in newly irrigated calcareous soils, especially those of low organic matter content. Crusts not only affect infiltration and soil aeration, but also impede or prevent the emergence of seedlings. Heavy applications of water on soils with a high content of fine-grained carbonate encourages the formation of thick crusts on drying. Therefore, soils which have a tendency to crust will require a frequency of irrigation sufficient to prevent drying and hardening of the surface.

The physical characteristics of calcareous soils often change when they are irrigated. From a favorable virgin condition the soils become more coherent and resistant to root penetration, especially in the part of the profile subjected to wetting and drying. The effect is likely to be more marked if organic matter content is low. Careful timing of tillage operations and careful seedbed preparation must be foreseen. The optimum moisture range for plowing calcareous soils is very narrow and occurs within four to five days after irrigation, whereas seven to eight days after irrigation the plowing operation is often rather difficult.

Nutrient deficiencies of phosphorus, iron, and micro-nutrients are common in plants grown on calcareous soils. High lime content usually results in a need for later inputs of fertilizers and is a dilutant factor for roots seeking nutrition.

Table 5 \*

## TOLERANCE OF VARIOUS CROPS TO ESP

Tolerance to ESP and range at which affected	Crop	Growth responses under field conditions
Extremely sensitive (ESP = 2 - 10)	Deciduous fruit Nuts, avocado, cassava	Sodium toxicity symptoms even at low ESP values
Sensitive (ESP = 10 - 20)	Beans	Stunted growth at low ESP values even though the physical condition of the soil may be good
Moderately tolerant (ESP = 20 - 40)	Clover, oats, tall fescue, rice, dallis grass	Stunted growth due to both nutritional factors and adverse soil conditions
Tolerant (ESP = 40 - 60)	Wheat, cotton, alfalfa, barley, tomatoes, beets	Stunted growth usually due to adverse physical conditions of soil
Most tolerant (ESP more than 60)	Crested and fairway wheatgrass, tall wheatgrass, rhodes grass	Stunted growth usually due to adverse physical conditions of soil

\*Source: FAO (1979) from Bower (1959).

Table 6 \*

## INFLUENCE OF ESP ON CROP REDUCTION

50% Crop reduction at ESP of 15 or less	50% Crop reduction at ESP of 15-25	50% Crop reduction at ESP 35
(Sensitive)	(Intermediate)	(Tolerant)
Avocado	Dwarf kidney bean	Alfalfa
Green beans	Red clover	Barley
Corn	Cotton	Beets
Tall fescue	Lemon	Carrots
Peach	Lettuce	Dallis grass
Sweet orange	Oats	Onion

\*Source: FAO (1979) from Lunt (1963).

Accordingly, a highly calcareous soil can be expected to be less productive than slightly calcareous soils if all other factors are equal.

Gypsum - Soils containing gypsum ( $\text{CaSO}_4 \cdot 2\text{H}_2\text{O}$ ) are widespread in arid and semiarid areas. A small amount of gypsum is favorable to crop growth in that it serves as a relatively soluble source of calcium to replace sodium on the exchange complex and thus acts to preserve soil structure. Sodic soils containing gypsum are relatively easy and inexpensive to reclaim. High percentages of gypsum in the soil, however, can cause serious problems especially in irrigated agriculture and, in some areas, the content of gypsum must be regarded as an important criterion in judging the suitability of soils for irrigation.

### CONCLUSION

Agriculture is applied ecological management. It is human intervention in natural ecological cycles to maximize our harvest at the expense of other herbivores and carnivores. Some of the controlling mechanisms for these cycles are easily manipulated while others such as weather are beyond our influence.

Soil is one of the major substrates from which plant nutrients are derived. Soil supplied nutrient availability is controlled by biogeochemical cycles. Agricultural science attempts to understand and manipulate these cycles. This understanding becomes critical when applied to extremely dry or wet geographic regions. In the former, there is little or no leaching and soluble salts may accumulate while in the latter almost all nutrients are rapidly leached from plant root zones.

Agricultural researchers are solving management problems at local and regional levels. This basic introduction to soils will allow you to interact with these researchers and utilize their localized information. It will become second nature as it is applied in the field.

Your own powers of observation will help you to become familiar with new geographic areas. Notice the distribution of cultivated fields in relation to topography and to native vegetation. These relationships usually indicate water collection areas and good agricultural soils; while certain plants will indicate abnormal soil conditions.

The books listed as references should be consulted for further information on specific problems. N. C. Brady's book is an excellent introduction to all aspects of soil science. The United Nations Food and Agriculture Organization (FAO) has published a number of Soils Bulletins which are expressly concerned with agricultural and land management problems in developing countries. These can be very useful when specific problems have been identified.

References

- Black, C. A. 1968. Soil-Plant Relationships. John Wiley and Sons, Inc. New York.
- Bohn, H. L., B. L. McNeal, and G. A. O'Connor. 1979. Soil Chemistry. John Wiley and Sons, Inc., New York.
- Bower, C. A. 1959. Chemical Amendments for Improving Sodium Soils. Agriculture Information Bulletin 195, United States Department of Agriculture, Washington, D.C.
- Brady, N. C. 1974. The Nature and Properties of Soils. 8th edition. MacMillan Publishing Co., Inc. New York.
- Food and Agriculture Organization (FAO). 1973. Sandy Soils. Soils Bulletin 25. Food and Agriculture Organization of the United Nations. Rome.
- Food and Agriculture Organization (FOA). 1976. Prognosis of Salinity and Alkalinity. Soils Bulletin 31. Food and Agriculture Organization of the United Nations. Rome.
- Food and Agriculture Organization (FAO). 1977. Organic Materials and Soils Productivity. Soils Bulletin 35. Food and Agriculture Organization of the United Nations. Rome.
- Food and Agriculture Organization (FAO). 1979. Soil Survey Investigations for Irrigation. Soils Bulletin 42. Food and Agriculture Organization of the United Nations. Rome.
- Lovelock, J. E. 1979. GAIA - A New Look at Life on Earth. Oxford University Press. Oxford.
- Lunt, O. R. 1963. Sensitivity of Plants to Exchangeable Sodium Percentage. University of California Report No. 5, Agricultural Water Quality Research Conference, Appendix B.
- Morrowitz, H. 1983. Two Views of Life. Science 83. Volume 4, No. 1.
- Richards, L. A. et. al. 1954. Diagnosis and Improvement of Saline and Alkali Soils. Agriculture Handbook 60. United States Department of Agriculture Salinity Laboratory, Riverside, California.

COMMUNITY ANALYSIS

total time      2 hours

Goals

- o To apply the 14 sub-systems to those communities where the trainees have previously collected data for agro-forestry.

Overview

The trainees will equate the direct relationship of agro-forestry data to the social sub-systems and determine what additional data is needed to do a complete community analysis.

Exercise

1. Community Analysis

Materials

Magic markers, flip chart paper, tape.

Exercise 1      Community AnalysisTotal time      2 hoursOverview

For the trainees to equate the direct relationship of the agro-forestry data and the social sub-systems and for the trainees to determine what additional data is needed to do a complete community analysis.

ProceduresTimeActivities

- |            |  |
|------------|--|
| 15 minutes | 1. The trainer asks the teams which collected data Session 6 to get together, review the data and place it under the 14 sub-systems.                 |
| 30 minutes | 2. The trainees should determine other data they would need for a complete community analysis. A list is made on newsprint.                          |
| 15 minutes | 3. The teams report the data they would need for complete community analysis.  |
| 30 minutes | 4. The teams determine how many sub-systems would be affected by an agro-forestry project and how they would be affected.                            |
| 15 minutes | 5. The teams report to the large group.  |
| 15 minutes | 6. The trainer's summary covers: <ul style="list-style-type: none"> <li>A. The person as a system,</li> <li>B. The community as a system.</li> </ul> |
|            | 7. The trainer links this session to Session 39 where they will use the 14 sub-systems as a problem solving tool.                                    |

IRRIGATION

Total time      2 hours

Goals

- o For the trainees to understand the principles of irrigation,
- o For the trainee who has irrigation as a special project to explain the project,
- o For the technical trainer to review work done in the nursery.

Overview

In this session, the trainees look at their own irrigation systems in the nursery and garden. The trainee for whom this is a special project explains the steps for installation. The technical trainer formally reviews work to date in the nursery.

Exercise

1. Nursery Irrigation

Materials

Flip chart paper, tape, markers, irrigation report, nursery plans.

Exercise 1      Nursery IrrigationTotal time      2 hoursOverview

The trainees look at their own irrigation systems in the nursery and garden. The trainee for whom this is a special project explains the steps for installation. The technical trainer formally reviews the work done to date in the nursery.

ProceduresTimeActivities

1 hour 15 minutes

1. The trainee for whom this is a special project gives a presentation. (example follows)

45 minutes

2. The technical trainer reviews the progress at the nursery, assesses each trainee's area in the nursery and gives direct feedback on the technical excellence of the trainees' area.



THINGS TO KNOW WHEN WATERING

- A. The frequency and amount of irrigation depends upon the rate at which water is absorbed by the roots and the water capacity of the soil in the root zone (water capacity should never be below 65%).
- B. The rate at which nursery stock absorbs water is determined by the character of stock (species, stage of growth, size, density and whether it is bare rooted or balled stock in containers), weather conditions (temperature, wind and air humidity), and soil (depth, texture, structure and organic matter). For container stock, the characteristics of the potting soil must be considered. More water is needed for containers with porous walls than non-porous walls. Good drainage and wet soil in the base of the containers are important.
- C. Older, well established plants should be watered after the hottest part of the day.
- D. Seeds and young transplants may need to be watered two or three times per day.
- E. Young seedlings and plants are very sensitive to dry soils.
- F. Irrigate before planting.
- G. The morning after watering, the first two inches of soil should be moist.
  - 1. If dry, irrigate longer.
  - 2. If wet, shorten the irrigation time.
- H. Too much water causes leaching, washing away of topsoil and nutrients and can result in root rot (due to a lack of oxygen).
- I. If pools of water form in an irrigated area, it is a sign that water is being applied faster than can be absorbed by the soil.
- J. Deep watering and soaking make roots go deep and vice versa. Shallow roots damage easier in dry conditions.
- K. When irrigating raised beds, use sprinklers or water by hand.

## IRRIGATION SYSTEMS

### A. Surface

#### 1. Flooding

- a. Area must be level,
- b. Land to be watered is divided into strips by borders,
- c. Border strips are leveled from side to side and made to slope slightly (1 to 2%) from the head ditch to the far end,
- d. The lower end may or may not be terminated in a waste ditch (water not used could be used in irrigating another bed),
- e. This method is very useful for irrigating sunken seed beds and small beds of transport.
- f. Seedlings may be damaged if waterlogged or silt accumulates on their foliage,
- g. Surface soil pores can become clogged with sediments and crust can develop on the soil surface.

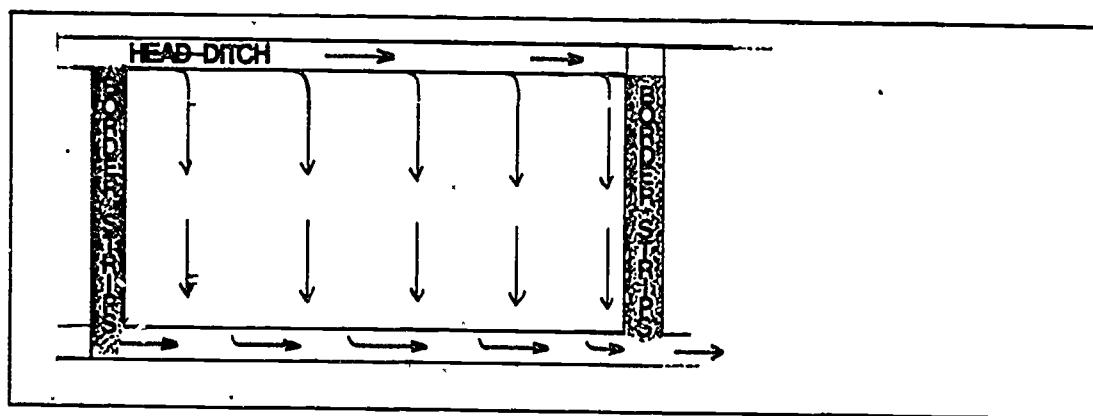

(Fig. 23) FLOOD IRRIGATION

#### 2. Furrow

- a. From the head ditch, water is diverted first into lateral ditches and then into the furrows adjacent to the rows of trees,
- b. The head ditch and the furrows must have sufficient slope for the flow of water. The laterals follow the contour of the land,
- c. For most nurseries, row spacing is between 50 and 70 centimeters. Length of the furrows should be about 10 meters,

- d. There is less evaporation with furrows than with flooding.
- e. Furrows are used where naked root stock is grown in rows

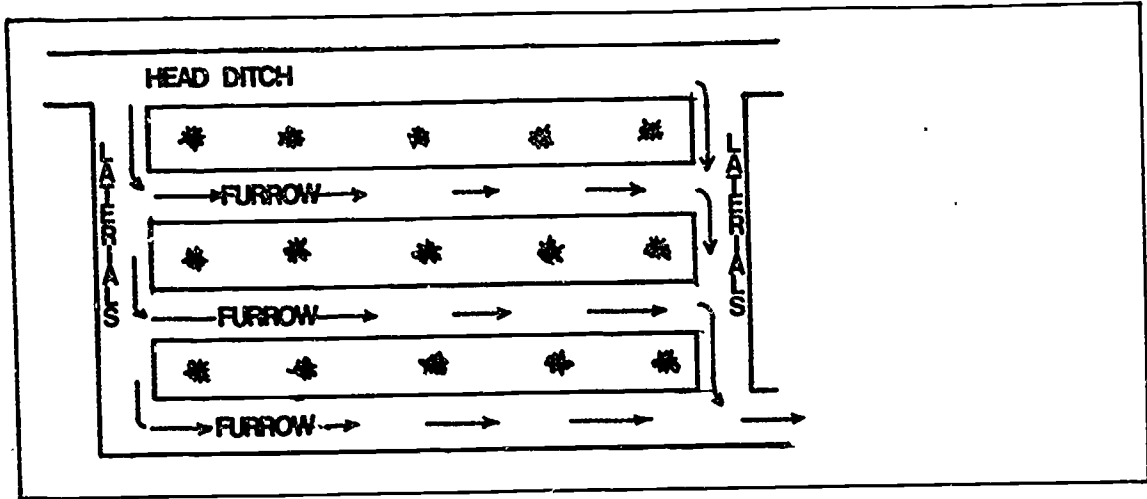

(Fig.24) FURROW IRRIGATION

B. SUBSURFACE

- 1. Underground pipes or tiles are laid,
- 2. Water is applied directly to the roots through a means of seepage from the pipes and tiles.

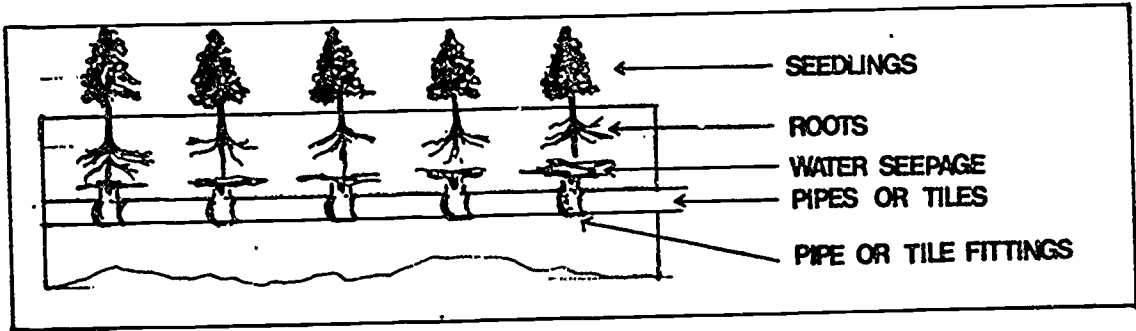

(Fig. 25) SUBSURFACE IRRIGATION

C. WATER CATCHMENT (Uses Rain)

- 1. Terrace,
- 2. Contour, catchment,

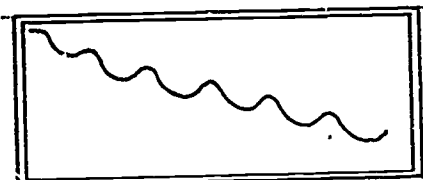
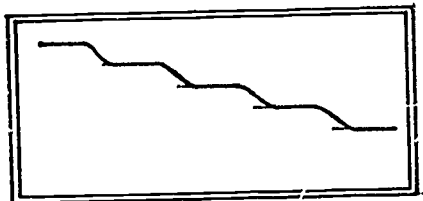

(Fig. 26)

3. Hill & dale catchment,

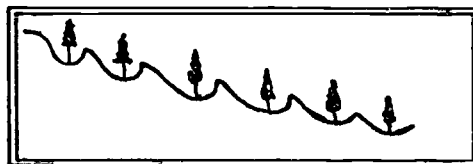

4. Roof catchment,



5. Can,

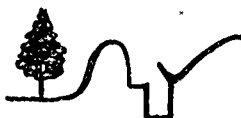

6. Barrel



D. WATERING CAN

1. Direct hand irrigation,
2. Uses the correct amount of water.



E. HOSE

1. Direct hand irrigation,
2. Uses the correct amount of water.

F. SPRINKLER

1. Sprinklers could cause a great waste of water.

G. SHADE, SOIL TEXTURE AND WATER CONSERVATION

1. Shade, soil texture and water conservation are important adjuncts to irrigation which can and should be used with most irrigation systems,
2. These conditions should be exploited when no irrigation facilities are available,
3. This system is used to increase the water holding capacity of the soil
  - a. Soil Structure and Texture
    - o Soil can be improved by adding compost, manure and decaying organic matter. You do this to build up the sponge structure of the soil.
    - o The soil can be covered with a mulch.
  - b. Windbreaks
    - o Windbreaks are used to stop the sun and wind from depleting soil moisture.

- o Trees and nurseries could be surrounded by tall crops, hedges or small walls.
- c. Shade
  - o Shade protects seedlings and soil from the sun.

#### H. TRICKLE OR DRIP

1. This method requires a minimum amount of water,
2. It is very efficient in water use.
  - a. A hose is hooked up to a water system. Small holes are cut into the hose at the base of each seedling. This enables you to have direct irrigation to each seedling. A variation of this method is to run smaller hoses from the main hose directly to the seedlings. For these systems, no pump is needed because water is moved by gravity. Small mounds could be built around the seedling as a water catchment devise.

#### I. PITCHER

1. Pitchers filled with water are placed underground with only the mouth of the pitcher on the surface. Condensation builds on the pitcher's surface. This condensation is then absorbed by the roots.

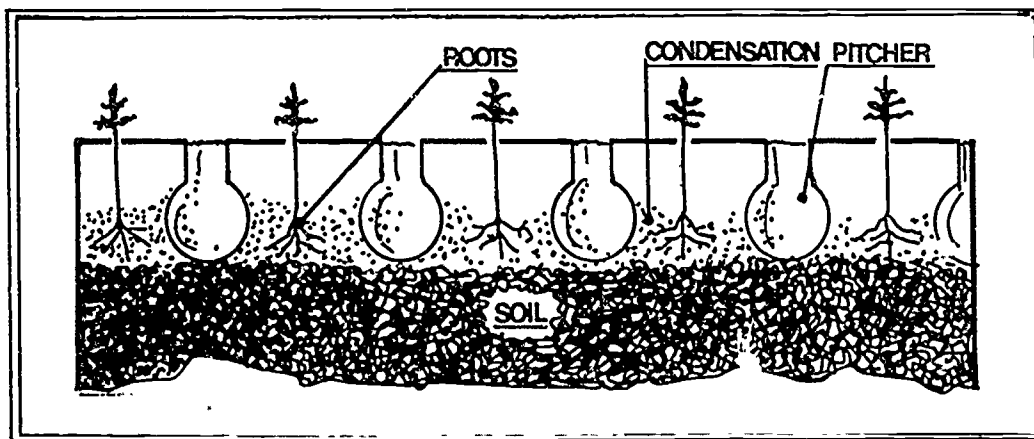

(Fig. 27) PITCHER IRRIGATION

\* Pitchers must have a cover firmly fitted on top.

#### J. PLASTIC OR METAL PIPES

1. Metal or plastic pipes are laid underground as with the pitcher system. Condensation builds on the pipes and is absorbed by the roots. The water is recirculated by means of a pump. This system could be expensive.

REVIEW OF EXPECTATIONS - MID-WAY

Guest Speaker (to be announced)

Total time 45 minutes

Goals

- o To review the trainees' expectations from Session 1 and assess objectives, directions.

Overview

At this point, roughly mid-way through the training, the trainees' expectations are reviewed to determine if they are being met. Given the scope of training, are the designated goals realistic? Will they be met under this program?

Exercise

1. Trainees' Expectations

Materials

Trainees' expectation list from Session 1.

Exercise 1      Trainees' ExpectationsTotal time      45 minutesOverview

At this mid-point, we review the trainees' expectations. We examine whether the expectations are realistic and will be met later in the program. This is a good time for trainees to realize how much progress they have made.

ProceduresTime

5 minutes

Activities

1. The trainer asks groups to form as they did the first day and look at their expectations. The trainees ask themselves the following questions (posted on newsprint).
  - A. How many expectations have been met?
  - B. Of those not met, are they realistic of this program?
  - C. Which ones are not yet met?
2. The groups assess expectations and discuss them using questions posed by the trainer.
3. The groups report their findings to the entire group.
4. The trainer responds and points out expectations that could possibly be met in future sessions. He/she reminds the trainees of their responsibility for their own learnings.

20 minutes

15 minutes

5 minutes

PROBLEM ANALYSIS

Total time     2 hours

Goals

- o Using the same cybernetic social sub-system as used in Session 36, the trainees do problem analysis,
- o Explore each possible solution's impact on the fourteen social sub-systems.

Overview

Building upon the community analysis from Session 36, the trainees should analyze a problem using the fourteen social sub-systems to discover resources, patterns, and see how possible solutions affect other segments in the community. They may also discover possible support for solutions.

Exercise

1. Problem Solving

Materials

Flip charts showing fourteen sub-systems.



Exercise 1      Problem SolvingTotal time      2 hoursOverview

In this session the trainees work with the fourteen social cybernetic sub-systems to examine how each problem and solution impacts the other sub-systems.

ProceduresTime

1 hour 30 minutes

Activities

1. The trainer describes the following problem solving system to the group (place on newsprint).

- A. Problem identification,
- B. Information gathering,
- C. Pre-conclusion (hypothesis),
- D. Diagnosis,
- E. Brainstorming,
- F. Decision making,
- G. Planning,
- H. Implementation stages.

The trainer gives the following directions:

We are going to give you some problems we have identified as step A. You will check the fourteen sub-systems to determine how many are affected by the problem. This is step B. Step C will be your pre-conclusions and will include some assumptions on your part. Step D will be your diagnosis of the problem. In step E you will brainstorm for possible solutions. In Step F you will decide upon one solution and once again see how solutions will affect other sub-systems. You will decide how your solution could be implemented in step G. In step H try to look at what steps would have to be taken in implementation and what other sub-systems might be involved.

You will list all steps taken on newsprint. At the end of this exercise you will describe to the group your eight step process. Each group will have a different problem on which to work.

**Trainer's Note:** A list of several problems that Volunteers have faced during their service follows. You may wish to add others.

25 minutes

2. The groups describe the problems and process they used as a group on newsprint.

5 minutes

3. The trainer summarizes by emphasizing that there is no way to effect just one sub-system with a solution and that no problem effects just one sub-system.

Possible Problems for Analysis

1. In a small community, a neighboring large land owner has offered a piece of land for a forestry project. The PCV has organized the group and since everything except the final arrangements for purchase of the land was ready, the group decided to proceed with planting one hectare of trees.

But after a year, permission to purchase the land had not been arranged. The landowner decided to sell his land and move to the city. The new owner refuses to recognize the value of the trees planted and the group is angry with the PCV.

2. A PCV organized a tree planting project on the land of the local school and with the students planted seedlings.

The teacher gave permission to the president of the "PTA" to graze his cows in the woodlot and many small trees were killed.

3. In a small community a PCV has established a forestry nursery with good results - largely due to the help of the president of the Town Council who got fencing, water and wages for the laborers from the town budget.

When the trees are ready for outplanting the president comes to the PCV and asks for 2000 free trees for planting on his own farm.

4. After six months of hard work in developing an interest in forest management and success in establishing a nursery, your project is going full speed. Seeing this success your counterpart is getting nervous and realizes he is going to have to spend more time on the project than he anticipated or else look very bad. He is planning a trip to headquarters to complain about you and to suggest that you be changed to another site.

5. In your community there is a high interest in tree planting and available land. A meeting was called to discuss the project and Ahmed Bah was named project chairman.

After the meeting you learn that Ahmed Bah has very few friends. In fact as a store owner who sells on credit, almost everyone owes him money and is intimidated by him. It is clear that the forestry project will not prosper under Ahmed's leadership.

**Trainer's Note:** These are sample problems. It would be best to write problems that are specific to the area in which the trainees will be working.

SOIL EROSION

Total time      5 hours

Goals

- o To acquaint the trainees with local soil erosion problems,
- o To have the trainees build gully plugs for erosion control,
- o The trainee who has taken this as a special project gives a brief lecture and describes activities,
- o To investigate vegetation at erosion site.

Overview

In this session, the trainee who has taken soil erosion as a special project gives a brief lecture and describes the day's activities. The trainees go to the field and install gully plug(s) and investigate plant life on and near the erosion site for possible planting.

Exercises

1. Practical Erosion Control
2. Watershed Management

Materials

Shovels, local brush, paste for weaving brush (possible to use trees that were thinned in earlier session).

Exercise 1      Practical Erosion ControlTotal time      4 hoursOverview

The trainee who has previously taken soil erosion as a special project and who has field experience will give a short lecture and explain the activity before going into the field. Then the trainees will investigate vegetation and build gully plugs at the erosion site.

Procedures

<u>Time</u>	<u>Activities</u>
20 minutes	1. The trainee lectures on the site visit and describes the activity. The trainees break into groups with a forester in each group.
20 minutes	2. In groups, the trainees move to the erosion site; investigate and record the vegetation around the site. Each group records their observations.
3 hours	3. Each group builds a gully plug as described earlier at the place designated by the special project trainee.
20 minutes	4. The technical trainer supervises the construction of the gully plugs. When the plugs are completed, he/she calls the groups together to discuss vegetation in the area and to explore methods to be applied in erosion control.

## EROSION CONTROL

The following concentrates upon water erosion. This is not to belittle the power of wind as an eroder - and in flat lands with sporadic vegetation, wind has tremendous impact - but rather to keep the contents to a manageable size. Some of the controls outlined below affect both wind and water erosion.

Two aspects of water erosion will be dealt with: First, why erosion is occurring; and second, some control methods.

### Why Erosion is Occuring

The first consideration in approaching an erosion problem is the determination of the cause of erosion. Before implementing any specific controls, one should look at as many variables as possible. The conditions at the head of the drainage, the type and amount of vegetation in the drainage, slope, etc., in each situation is different. The best tools in determining the whys of erosion are basic knowledge of erosion and a pair of eyes that work.

Erosion begins with rain falling on land with incomplete cover of the soil (here, "cover" can be rock as well as vegetation). A falling drop has enough power to knock many soil particles to pieces, sometimes clogging surface pores. When it rains too fast for soil to absorb the water, overland erosion will occur, carrying off sediment. The finest particles, clays, are removed first, followed by coarser particles (silts and sand). The faster the water moves, the more sediment drops out. The larger particles drop first and the clays last. Almost any type of land manipulation in which humans engage will increase erosion; road-building has, by far, the greatest impact.

### Some Methods of Control

First, decide what type of control is needed. Controls can protect the soil from raindrops and slow rampaging water and can divert water or catch water for plant growth.

Often, any one of these types can be used in a situation; the decision as to which one is best depends on funds, time, manpower and importance of the problem. By the time erosion has produced large gullies, however, substantial work is usually required.

- o Soil Protection - Methods of soil protection include rock coverings and the planting of grasses, shrubs, and trees. These methods can treat the problem at the root by keeping water in the soil and preventing it from running on the surface (a covering of organic matter serves the same purpose). In arid regions this is often not possible. Overall, protective vegetation is the best method.

- o Slowing Water - Anything that stands in the way of water slows it; gully plugs or scattered rock will allow ruts and gullies to fill. These erosion controls show relatively quick results, but unless they are coupled with methods of treating the cause of the problem, gully plugs, etc., are mainly stop-gap measures which only delay the problem. They are quick and inexpensive to install.
- o Diversions - Water bars in roads and trails, diversion dams, channelling of streams are considered to be diversions. These can be used to collect water or to divert it to flat land where it can infiltrate the soil or redirect it away from a critical area without diminishing its force. This method can easily cause as much damage somewhere downstream as it prevents at the present critical area.
- o Catchments - Catchments are usually built on a slope. They include V-catchments, terraces, honeycomb type catchments, and trenches of various designs. They serve the dual purpose of erosion control and enhanced tree growth and can be used at the head of drainages.

It is important to consider the consequences of any kind of control. As already mentioned, a diversion may serve mainly to anger your neighbors. What good has a gully plug served when after the gully has filled, water runs elsewhere to form another gully?

Finally, the very best way to control erosion is through practices that do not promote excessive erosion. The material in this section can be applied in the alleviation of existing problems as well as to the prevention of future difficulties.

Exercise 2      Watershed ManagementTotal time      1 hourOverview

Soil erosion control, high quality water and control flooding, are the topics of this lecture on watershed management.

ProceduresTimeActivities

1 hour

1. The technical trainer lectures as follows:

**Trainer's Note:** You may want to have an expert deliver this lecture if the technical trainers do not feel competent to cover this material. If the technical trainer does cover this lecture, you may want to use slides or movies to illustrate points.



## Watershed Management

### Objective

Watershed management produces high quality water and controls flooding. This requires integrated management of cropland, rangeland, pasture land, forest land and urban development. This objective for forest land often differs from that of timber management. Timber management is producing the most commercial wood that can be grown on a watershed, managed on a sustained yield basis, and harvested at regular intervals. In contrast, watershed management could be total protection with no timber harvesting or other disturbances. Generally, however, good timber management is compatible with watershed management.

### Aspects

Two aspects of watershed management are watershed protection and flood prevention.

Watershed Protection is accomplished by applying land treatment measures such as tree planting, contour farming, pasture planting, dam control, debris basins, streambank stabilization, etc.

Flood Prevention is accomplished with flood water retarding structures and stream channelizations. PCVs will be involved in diagramming and applying forest land treatment measures for watershed protection. They normally are not involved in flood prevention so this will not be discussed further. Since a large proportion of the Volunteers' tree planting will be done on steep, badly eroded hillsides, the following two supporting conservation measures are valuable to know:

1. Gradonis (mine bench terraces) and,
2. Bench terraces..

Gradonis are small terraces that run level or nearly level across the slope. Trees are planted in the gradonis (see Fig. \_\_\_). They can be built and maintained by hand, constructed by animal drawn implements or by machines. The purpose of gradonis is to change a steep slope to many continuous flat slopes and long slopes to a series of short slopes. This traps run-off, filters it into the soil and aids in seedling survival and growth. It also reduces erosion and sedimentation. (see fig. \_\_\_).

Gradonis are needed at, but not limited to, planting sites that receive less than 800mm (32 inches) of rainfall per year. They can be built on slopes up to 35° (70%) but are better suited to slopes of less than 30° (58%).

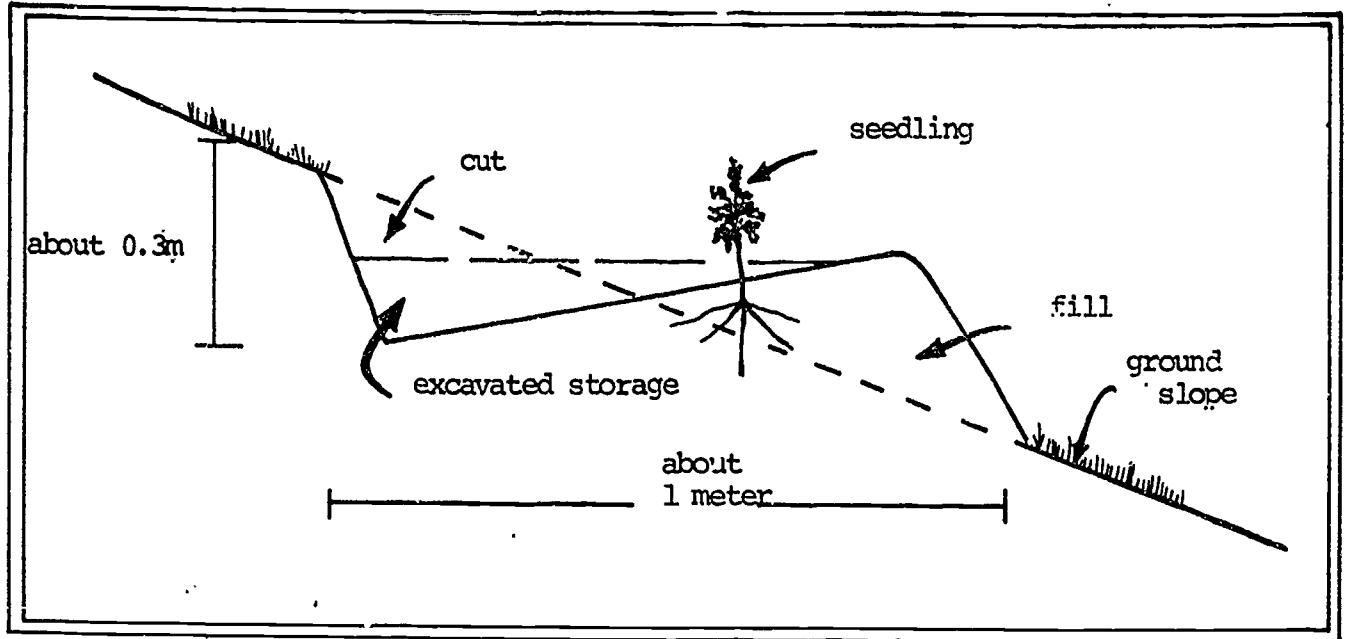

Figure 28. Cross-sectional View of Gradonis

Gradonis spacing is determined by the desired tree spacing - usually 2 x 2 or 3 x 3 meters. The closer spacing is recommended on the critical eroding areas to obtain a quicker crown closure and litter (mulch deposit on the forest floor). The trees can be thinned as needed to maintain plant vigor. The thinnings can be utilized for fuel or other uses.

Due to slope conditions, the gradonis are often wider than the desired spacing. To have complete land utilization or a fully stocked stand, a better or substitute gradonis should be used as illustrated below.

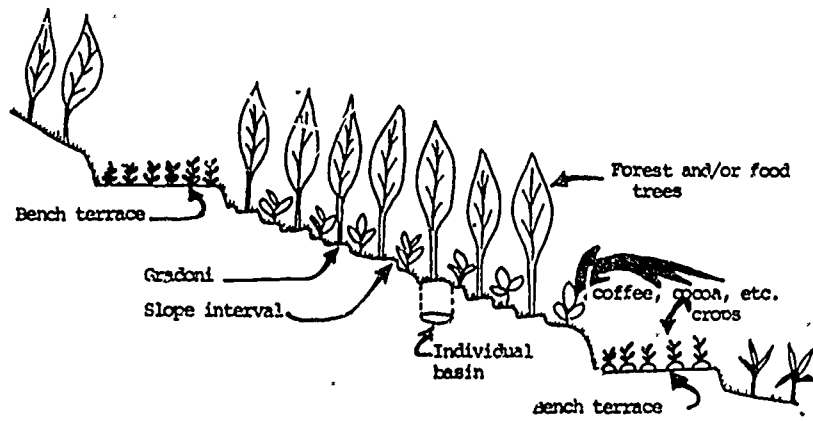

Figure 29. Cross-sectional view of intermittent terraces.

Individual basins can be substituted for the gradonis. The basins are round (about 1 meter in diameter) with a 10% back slope. The trees are planted in the center of the basin.

Bench Terraces can be constructed by hand, thus providing additional employment for local inhabitants. Figure \_\_\_ shows the cross sectional view of a bench terrace.

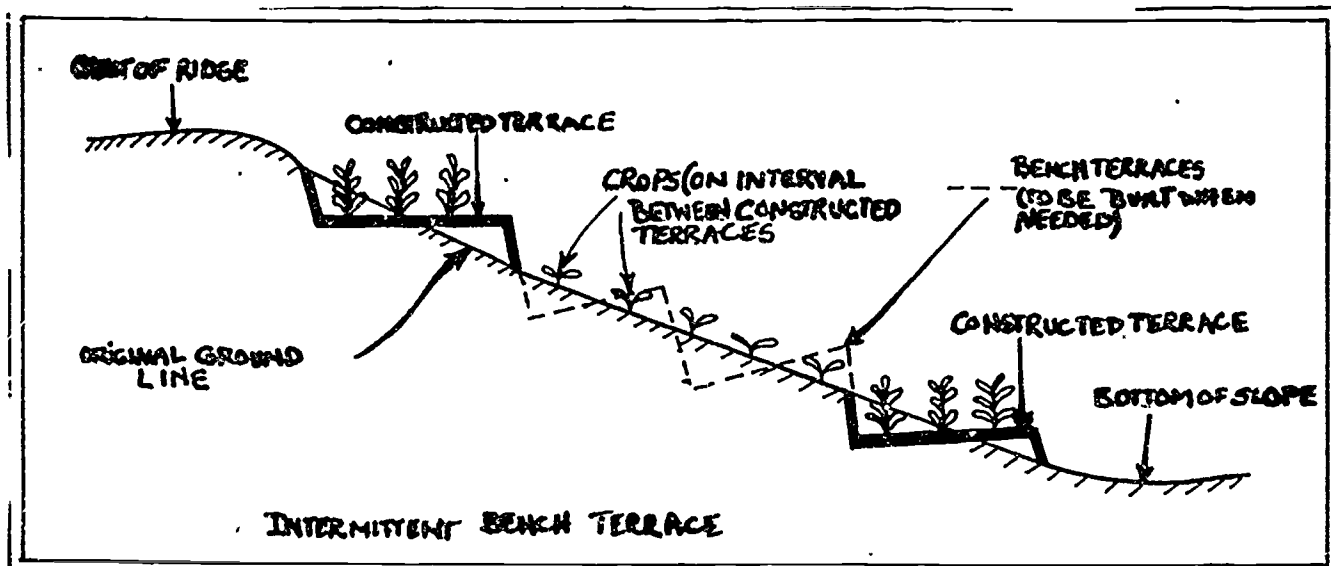

Figure 30. Cross-sectional view of bench terrace.

Bench Terraces should be no longer than 10 meters because runoff from longer terraces is difficult to manage. The horizontal grade of toe-drain is 1 percent to safe outlet (waterway).

If topsoil is available, it should be moved away and put to one side and then spread back on the finished terrace.

The top (first) terrace is built just below the ridge. Downhill spacings of the other terraces is three times the width of the previous bench terrace.

Run-off Disposal - Excess run-off is inevitable and a protected waterway is needed to drain it safely. A natural depression - not a large gully - can be used. It must be reshaped into a parabolic shape and sprigged with a soil binding grass (i.e., kukuyu grass). The sprigs should be about 15 cm apart. A light mulch and fertilizer will help to establish the grass.

A parabolic shaped bow (illustrated below) - used in shaping the waterway can be made from bamboo or other similar materials.

PARABOLIC SHAPED BOW USED IN SHAPING WATERWAYS  
WIDTH (w) 2 m.

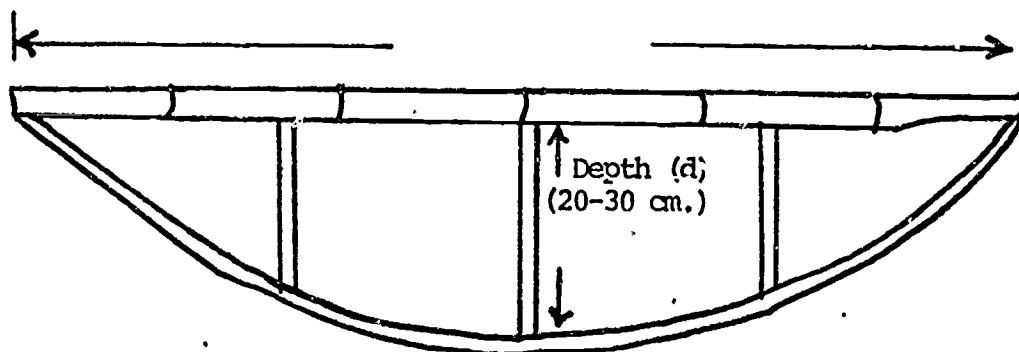

Fig.31) PARABOLIC SHAPED BOW ILLUSTRATION

The rear part of the terrace, called the toe-drain, functions as a drainage ditch toward the waterway. In order to avoid overbuilding and excessive expenses, the following principles should be observed:

1. Divide rather than concentrate runoff, if possible,
2. Use adjacent, well protected grassland or forest land to diffuse run-off,
3. Use locally available materials, if possible,
4. Select suitable waterway sites carefully to reduce construction cost.

Structural measures may be needed on slopes over 20% or where flow velocity exceeds one meter/second.

Cost depends upon slope, soil, type and width of the terrace, presence of rocks, etc., and the necessary tools. Intermittent bench terraces, including waterways, are estimated to cost about \$250 per hectare (125 man-days). Gradonis cost about \$180 per hectare (about 90 man-days). A man with hand tools can move, on the average of four cubic meters of soil in eight hours. Actual records, however, are needed before detailed costs can be estimated.

SPECIES REPORT - RESEARCH DEMONSTRATION

Total time      2 hours

Goals

- o To receive each participants' species report,
- o To have reports presented in a creative and interesting manner,
- o To review research demonstration project.

Overview

In this session, individual species reports are received by the group. A trainer who has taken this as a special project is in charge of the session. The special project and research demonstration are presented in this session.

Exercises

1. Species Reports
2. Research Demonstration

Materials

Individual species reports.

Exercise 1      Species ReportsTotal time      1 hour 30 minutesOverview

The trainee for whom this session is a special project introduces species reports. The trainee gives a brief overview of the guidelines. The trainees are asked to present their reports in an interesting and creative manner.

Procedures

<u>Time</u>	<u>Activities</u>
5 minutes	1. The trainee reviews the task and details the guidelines used.
1 hour 25 minutes	2. The reports are introduced.

**Trainer's Note:** It is hoped that you will not have to sit through 30 or 40 species presentations; keep a list of pertinent points since everyone needs to practice making presentations. There is some risk in doing this but the creativity of the trainees in a pilot program convinced us that as long as species reports were acknowledged, presentations were effective. Included at the end of this session are a few samples of the submitted species reports.

SPECIES REPORTSAcacia mearnsii De Wild

Common Name: Black or tan wattle  
 Flower:  
 Fruit: Seed in pod  
 Seed: Dormancy broken by immersing in boiling water  
 Leaves: Dark green, feathery.  
 Bark: Black appearance  
 Shape: Solitary trees with spreading crowns; in crowded plantations, erect, slender; can grow to 25 meters

Habitat: Native to New South Wales, Queensland, South Australia, Tasmania, Victoria. Cultivated in New Zealand, South, Central and East Africa, India, Sri Lanka, Central America and Indonesia. Cannot tolerate calcereous soils, yet can grow on poor soils. In native range, requires 500 - 700 mm of rainfall. Higher temperatures where introduced require more rainfall. Native to areas with cool winters. Growth slows with high temperatures. Moderately frost tolerant.

Uses: In native areas, grows to 1,100 meter altitude. Used as firewood and charcoal (often grown in small woodlots and by individual farmers). Foliage for green manure, bark for tannin extraction, pulp for wrapping paper. Also grown in dense stands to improve nitrogen levels of soil.

Disease/ Insects: Not a serious problem unless rainfall is greater than 3,000 mm when tree is susceptible to fungal diseases and insect attacks.

Nursery Management/  
 Nursery Requirements:

Main Identification Characteristics:  
 Natural regeneration. Direct seed growth, coppices poorly.

References

Firewood Crops: Shrubs and Tree Species for Energy Production. National Academy of Sciences, Washington, D.C., 1980. pp. 72 - 73.

Acacia albida

- Common Names:** English - Gao  
Arabic - Herraz  
Wolof - Cad  
French - Gao
- Flower:** Creamy white blossoms
- Seed:** Yellow pods 8 - 15 cm long, 2 - 5 cm wide. Seeds dark brown, convex on one side concave on the other. Seeds ripen January - February (Upper Volta). Collect pods off the ground; will remain viable for a long time if kept in a dry place. Pretreatment: Soak in hot water or scarify hull.
- Leaves:** Grey-green, 3 - 10 pairs pinnules and 6 - 23 pairs of leaflets. Appear at start of rainy season and persist during all of the dry season.
- Bark:** Dull gray, fissured and scaly. Branchlets white, spines thick, white straight and points downward.
- Description:** Large thorny tree (10 - 20 meters) with large spreading crown. Timber rotation 30 - 40 years. Deep roots, flowers at 7 years, pods after 8 years.
- Habitat:** Dry savannahs throughout Western and Northern Africa to Egypt and East Africa. Annual rainfall 300-500mm. Generally below 1,200 m elevation. Grows on deep, sandy soils (similar to that in which millet grows). Will withstand heavier soils and occasional flooding.
- Diseases:** Seeds sometimes heavily infested with bruchid beetles. Watch for caterpillar and locust attacks which destroy young leaves. The seedlings are especially susceptible to insect damage. When collecting seeds, watch for small worm holes. Some pods may taint milk if fed to dairy cows.
- Nursery Management:** Direct seeding can be tried under good conditions. However, potting is recommended due to long tap root. Frequent root pruning is necessary. Seedlings reach heights of 10 - 15 cm in 14 - 16 weeks. Outplanting spacing is 10 X 10.
- Uses:** Good forage for areas with prolonged dry season. Good soil conservation tree (enriches soil).



Acacia raddiana

**Common Names:** Chad Arabic - Saiade  
 Bambara - Sayele  
 Djerma - Bissau  
 Fulani - Chillukl  
 Hausa - Kandill  
 Kunouri - Kandil

**Synonyms:** Acacia tortillis Hayne  
 Acacia Fascientata Guill. and Perr.

**General Description:**

Medium tree 4 - 15 meters tall, sometimes with several trunks that spray upwards and outwards fountain-like, that support a flat-topped umbrella of feather foliage. Under extreme aridity, it becomes a small shrub, often barely one meter tall. Under heavy grazing it is frequently reduced to a number of trailing, seemingly unconnected branches radiating from a low sand mound. Its thorns are a distinguishing feature; there are two kinds, long, straight and white, and small brownish and hooked. The fragrant white flowers are borne singly or in clusters. Pods are controlled or spiraled like a coil spring.

**Uses:** As firewood, the dense, red heartwood of this species has high calorific value and makes superior firewood (and charcoal). The plant coppices well, so there is no need to replant trees after every harvest. Other uses include fence posts and for manufacturing small implements and articles. Fodder - Pods are produced prodifecially. They fall to the ground and are eaten by goats, sheep, wild herbivores and other domestic livestock. The thorny branches are used to pen cattle, goats, and sheep. Sand stabilization.

**Habitat:** Temperature; grows well in hot, arid climates with maximum temperature as high as 50°C; grows where minimum temperatures are close to 0°C. Plants less than 2 years old are easily damaged by frost and require protection. Altitude; best adapted to the lowlands. Rainfall; it is extremely drought resistant and can survive in climates with less than 100mm of rainfall and long, erratic dry seasons.

Acacia raddiana

**Common Names:** Chad Arabic - Salade  
 Bambara - Sayele  
 Djerma - Bissau  
 Fulani - Chilluki  
 Hausa - Kandil  
 Kunouri - Kandil

**Synonyms:** *Acacia tortillis* Hayne  
*Acacia Fascientata* Guill. and Perr.

**General**

**Description:** Medium tree 4 - 15 meters tall, sometimes with several trunks that spray upwards and outwards fountain-like, that support a flat-topped umbrella of feather foliage. Under extreme aridity, it becomes a small shrub, often barely one meter tall. Under heavy grazing it is frequently reduced to a number of trailing, seemingly unconnected branches radiating from a low sand mound. Its thorns are a distinguishing feature; there are two kinds, long, straight and white, and small brownish and hooked. The fragrant white flowers are borne singly or in clusters. Pods are controlled or spiraled like a coil spring.

**Uses:** As firewood, the dense, red heartwood of this species has high calorific value and makes superior firewood (and charcoal). The plant coppices well, so there is no need to replant trees after every harvest. Other uses include fence posts and for manufacturing small implements and articles. As fodder pods are produced prodifecially. They fall to the ground and are eaten by goats, sheep, wild herbivores and other domestic livestock. The thorny branches are used to pen cattle, goats, and sheep. Sand stabilization.

**Habitat:** Temperature; grows well in hot, arid climates with maximum temperature as high as 50°C; grows where minimum temperatures are close to 0°C. Plants less than 2 years old are easily damaged by frost and require protection. Altitude; best adapted to the lowlands. Rainfall; it is extremely drought resistant and can survive in climates with less than 100mm of rainfall and long, erratic dry seasons.

- Soil:** The tree favors alkaline soils. It grows fairly well in shallow soils, less than 0.25 meters deep, though it develops long lateral roots that become a nuisance in nearby fields, paths and roadways. In shallow soil, the plant remains shrubby.
- Establishment:** Easily raised from seed and the seedlings can be established in plantations with less loss.
- Seed Treatment:** Seeds are dipped in hot water and soaked overnight to ensure quick uniform germination. Seed can also be treated to facilitate faster growth.
- Pests and Diseases:** Seed production is often severely reduced by insects (bruchids). Trees are susceptible to attacks by caterpillars, beetles, and blight diseases that infest other Mimosoideae in an area. Wild herbivores graze new shoots and young seedlings.

#### References

Firewood Crops: Shrubs and Tree Species for Energy Production. National Academy of Science, Washington, D.C. 1980.

Action/Peace Corps Program and Training Journal. Manual Series Number 5.

Reforestation in Arid Lands. Appropriate Technologies for Development.

Acacia scorpioides

- Other Names: Acacia adansonii; A. arabica var. nilotica; A. nilotica; A. scorpioides var. adstringens; A. scorpioides var. nilotica; Mimosa nilotica.
- Common Names: Gonakier (F), Egyptian thorn, Red-heat, Kudupod.
- Flower: Sweet-scented balls of yellow flowers 5/8" diameter, on stalks 1/2 - 1" long.
- Seed: Sweet-smelling, grey-black, round but flattened. Ripen November - January. Pre-treatment; a) fresh seeds plant right away; b) older seeds - soak overnight or feed pods to goats; seed is scarified and either collected from dung or goats are confined to an area.
- Leaves: Alternate or opposite, bi-pinnate, 2 - 6" long, 3 - 8 pairs of side axes, 10 - 30 pairs narrow oblong leaflets 1/8 - 1/4" long. Paired whitish spines at leaf base 1/2 - 1 1/2" long.
- Bark: Very dark, almost black, fissured, with long white or grey spines.
- Shape: Height determined by site - may be 3 - 20 meters tall. Umbrella shaped crown or flattish.
- Habitat: 500 meters altitude. May be found near water or moist soils, in areas of periodic flooding (Acacia scorpioides var. nilotica) or in drier highlands (Acacia scorpioides var. adstringens). Soils may be poor to alluvium.
- Use: Live fences, windbreaks, fodder (leaves and pods), tanning material (pod & bark), honey, carving, gum arabic.
- Disease/  
Insects: Wood borers, bruchid beetles attack seeds in pods, pathogenic fungi.
- Nursery Management  
Needs: Rarely use seedlings. Direct seed in pots ready in 14 - 18 weeks. Direct seeding common but have poor results due to browsing, low soil moisture, weeds.
- Nursery Requirements: Heavy soil, lots of water.
- Natural  
Regeneration: Seeds, sprouting.

**Four Identifying Characteristics:**

1. Spines at leaf base,
2. Bipinnate feathery leaves,
3. Balls of yellow flowers,
4. Narrow whitish grey pods.

**References**

Firewood Crops: Shrubs and Tree Species for Energy Production. National Academy of Sciences. Washington, D.C. 1980.

Reforestation in Arid Lands. Fred Weber. Action/Peace Corps Programming & Training Journal Manual. Series 5.

Trees of Puerto Rico and the Virgin Islands. Elbert L. Little, Jr., Roy O. Woodbury, Frank H. Wadsworth. 2<sup>nd</sup> Volume. Forest Service - United States Department of Agriculture Handbook No. 449. 1974.

Pinus radiata D. Don

- Common Names:** Monterey Pine  
Insignis Pine
- Flower:** Flowers in late winter or early spring, monoecious  
-- male and female strobili borne separately.
- Fruiting Body:** Cones mature in autumn of second season; 3 - 7 cones on main stem or branches; size varies -- young trees bear larger cones than older trees; brown color.
- Seeds:** One cone produces 120 to 200 seeds; viability between 70 and 80% - regardless of size; pretreatment by cold stratification increases rate and amount of germination (33 - 41°F for 35 - 40 days); temperature of 86°F during the day and 68°F at night best for germination; seeds often released from cone after fire or when exposed to hot, dry winds sooner than the average dispersal which may take between 2 and 6 years.
- Leaves:** Two-needled
- Bark:** Fissured
- Shape:** In natural stands, reaches height of 70 to 110 feet, 2 - 3 feet in diameter; often taller in introduced areas; roots shallow (not deeper than 2 feet) and wide spreading. Not self-pruning.
- Habitat:** Three native stands along California coast and one native stand on Guadaloupe Island off the coast of California. Introduced to Australia, New Zealand, and South Africa. Soils are coarse, deep sandy loams, acidic, permeable and well drained. Rainfall required varies with elevation, minimum of 5.68 inches to a maximum of 50.41 inches; most moisture should occur between December and March or the coolest months with humid, foggy summers. Temperature range is 48° - 52°F in January, 60°-64°F in July. Gentle moderate slopes at an altitude from 0 to 1,000 feet (500 feet is best); hot and dry exposures not favorable.
- Uses:** Used for timber, shelterbelts, and environmental forestry.

Disease/  
Insects: Seventy different pathogens found on North American stands; 86 pathogens on exotics -- 44% are saprophytes, 31% wound parasites, 10% obligate parasites, 15% not classified; diseases affects stem, root, foliage.

Nursery  
Management

Requirements: Season for sowing is spring at a depth of 1/8 - 3/4"; peat moss 1/2 - 1/4" deep often used; outplanting after a year.

Main Identifi-  
cation  
Characteris-  
tic:

Similar to Knobcone pine (Pinus attenuata)

Natural Re-  
generation:

No sprouting in native stands; easily established after fire or clear-cut.

References

Silvics of Forest Trees in the United States. Fowells, H.A., US Department of Agriculture. Washington, D.C. 1965. pp. 390 - 397.

Seeds of Woody Plants in the United States. Schopmeyer, C.S., US Department of Agriculture. Washington, D.C. 1974. pp. 598 - 563.

Exercise 2      Research DemonstrationTotal time      30 minutesOverview

The trainee for whom this session is a special project introduces the research demonstration. The trainee gives a brief overview of the guidelines which were used and proceeds in his/her demonstration.

ProceduresTimeActivities

30 minutes

1. The trainee reviews the task and guidelines used. He/she proceeds to explain the demonstration.

**Trainer's Note:** The following is a basic outline prepared by the trainees during the pilot test. It is included in this manual as an example of what the Volunteer should expect.



RESEARCH DEMONSTRATION

[Project supplement to Peace Corps Volunteer Training Manual]

The purpose of this supplement is to illustrate benefits to be derived from the use of a specific research project in a Volunteer's work. More specifically, how can the Volunteer use a particular experiment designed by him/her to solve some of the problems they may face in the technical aspect of their work as foresters.

Much of our work as Peace Corps Foresters will involve the implementation of a particular system (village tree nursery, vegetable garden, community agro-forestry project, etc.) in our community. Whatever it may be, the Volunteer will be confronted by any number of unforeseen technical pitfalls in his/her work. By performing a simple, yet basic experiment to try to solve a particular problem or to test a particular component of the system, certain questions may be answered that were otherwise unanswerable.

How can the Peace Corps Volunteer set-up an experiment to solve a technical problem? Our first step is basically to define the problem and then develop a coherent hypothesis to enable us to start solving it. One of your best tools for coming up with a clear hypothesis is a complete definition of the technical problem. How do we test this hypothesis once it is made? Design an experiment or test to determine the validity of your hypothesis. This test may include a control to test experimental components against natural conditions or parallel comparisons of different effects. Remember, as a PCV researcher, resources are limited so keep your experimental design simple and basic.

Once the experiment is designed and then set-up, your next step is to implement it. Carrying out the experiment may involve actual implementation within your work. A good example might be a test of soil sterility in your area by testing the soil within the community tree nursery in which you are working. Another example would be to test for insect damage in your vegetable garden using different plant seedlings from your cold-frame surplus. The possibilities are only limited by the available resources and the feasibility of the experiment within the context of your project.

The experiment/test can be done outside the context of your work, but having it integrated within your own project can aid you greatly in relating the specific problem to your work. An important point to keep in mind is retesting. If time is not a crucial factor in solving your problem, carrying out the experiment/test more than once can help to establish the validity of your experimental results. If a number of trials are performed and consistent results obtained, you know that a specific component you are testing actually acts in that particular manner

when subjected to standards within your test.

After the experimental results are obtained and verified through retesting, you can then draw preliminary conclusions based upon your results. These conclusions may or may not answer your original hypothesis, and in some cases may even ask more questions than they answer. In this case you may want to perform another experiment/test of a similar but slightly different nature. Your options at this point are experiment specific and depend upon the particular situation. Was the experiment able to confirm the hypothesis or reject it? Did the experiment confirm or deny already established information? What new questions did the experimental results raise?

If the experiment was able to solve your original problem, you have accomplished your objective. If it did not, do not get discouraged. Possibly an improvement in your experimental design can act to more clearly incorporate a test of the hypothesis. Retesting or performing the experiment again may be another option to consider at this point. Further research is more than likely the path one will take at this point. Perform another experiment to test other hypotheses you may have related to the problem.

I have designed and carried out a very simple experiment to give you an idea of the option of implementing an experiment/test to help answer technical problems you may face in your work.

### Problem

In setting up the community tree nursery, no one in your area is sure what soil type to use for growing a tree species that is similar yet slightly different from the indigenous species. (The people of the community wish to plant this species since it is resistant to a fungal disease that has wiped out the indigenous tree species.)

### Step 1 - Define the Problem

What soil type do you use in the nursery that best works for the plant? In this case the plant needs a soil that has a strong water holding capacity.

### Step 2 - Develop a Hypothesis

A well mixed soil containing mineral matter, organic matter, and good aeration will give the best water holding capacity. (Elements: clay, organic matter, sand.)

### Step 3 Design an Experiment to Test the Hypothesis

In this case, soil water holding capacity was tested through a rather simple procedure for testing water retention in a variety of soils.

#### Step 4 - Implement the Experiment

Different soil types were each placed in a similar size container (46 fl. oz. cans) and weighed. Prior to filling with soil, holes were punched in the bottom of the soil cans for water drainage. Different soil types were then placed in each can and the soil was saturated with water. Time for water drainage through each can was measured and the weight of each can was taken again after saturation with water. The percent of water retained by each soil type was calculated in contrast to the original weight of the soil sample. Five different soil types were tested including: sand, loam, garden mixture (containing organic matter), clay, and a mixture of clay, sand, organic matter and dirt. Without detailing the individual results for each sample, the mixture sample (clay, sand, organic matter and dirt) turned out to be the best for water retention. While the clay had a great water holding capacity, it presented inherent drawbacks (infiltration into clay was very slow). The sand mixture turned out to be the poorest for water retention.

#### Step 5 - Draw Conclusions Based on Results Obtained

In this case, we can conclude that the evenly mixed soil sample is best for planting tree seedlings requiring good water retention properties in your nursery.

Not all of your problems will be as simple and the experiment you design to test a particular hypothesis may be more complex with multiple components, a control, and other factors. The point to keep in mind is that experimentation is a definite tool one can use to solve technical problems in your work. One point not mentioned previously is the importance of keeping accurate records of experimental data and observations made during the five research steps.

In conclusion, one may consider their entire work as a PCV as a sort of experiment in itself. The work may not seem experimental but the results can be thought of in the light of ongoing research in the country of PCV service.

CULTURAL VALUES

Total time      2 hours

Goals

- o To recognize our own value system,
- o To determine what we have learned about the host country cultural values,
- o To explore commonalities and differences,
- o To find ways of accepting cultural differences.

Overview

In this session, the trainees will be asked to list their own cultural values. The purpose is to determine how many of their own values can be identified and to examine host country cultural values. The trainees begin to recognize commonalities and differences between the two cultures. Finally, the trainees will try to begin accepting the differences.

Exercise

1. Cultural Values: An Exploration - Mine, Ours, Theirs, Acceptance

Materials

Flip charts, marker pens, tape.

Exercise 1      Cultural Values: An Exploration - Mine, Ours, Theirs, Acceptance

Total time      2 hours

Overview

In this session the trainees will explore different cultural systems and find ways to accept the differences discovered.

Procedures

Time

Activities

10 minutes

1. The trainer posts on newsprint the following diagram:

BELIEFS

CULTURE

VALUES

BEHAVIOR

The trainer briefly lectures that values are not good or bad; they just are. The unique lifestyles of a particular group of people is a learned behavior that is communicable. We are able to see two very key concepts of culture. Since cultural values are communicable, you can learn something about it. If it were not communicable, you would have nothing to do today or for the rest of your Volunteer service. To learn about the behavior of others is also very meaningful, not only in a social sense, but in a management sense. It is important for people to understand the influence that the environment has upon you and that culture. Understand that you are not "born" with a

culture; you can be born into a culture but you are not born cultured. Another positive aspect of learned behavior is that not only can we broaden our appreciation of other cultures but also broaden our ability to participate in other cultures.

Prior to integration into a new culture, one should reflect upon his/her cultural background and then move forward in the process of understanding that new culture.

15 minutes

2. The trainer asks the trainees to list their own cultural values. You may have done this before so it will be easy.

30 minutes

3. The trainer asks the participants to form groups of four, share their lists of cultural values and look for similarities and differences in their lists.

15 minutes

4. The trainer asks the groups to share their differences and write them on newsprint. He/she asks for ways in which we accept differences in our own culture.

20 minutes

5. The trainer asks the groups to list as many cultural values of the host country as they can. He/she asks that after they have completed this list, they once again check for commonalities and differences.

15 minutes

6. The trainer asks the groups to make a list on newsprint of ideas they may have for accepting these differences.

**Trainer's Note:** The list generated from the pilot program is included as a guide.

15 minutes

7. The trainer requests that the small groups share with the large group their ideas. The trainer leads a discussion of how these ideas can be used in the volunteer experience.

List of Ways of Accepting Differences

- o Adjust to the environment,
- o Have respect for the culture and customs,
- o Be cultural sensitive,
- o Have patience,
- o Be outgoing,
- o Display empathy,
- o Be introspective,
- o Be flexible enough to (tolerate, accept) values different from our own,
- o Educate ourselves to explain the motives for cultural values,
- o Realize our values are as different to them as theirs are to us,
- o Be willing to conform/compromise,
- o Understand that the differences are deep-rooted and cultural,
- o Be able to modify our behavior without modifying inner values,
- o Keep an open mind, culturally and personally,
- o Maintain a good sense of humor (be able to laugh at self).

WELLBEING

Total time      50 minutes

Goals

- o To enable the trainees to realize that they are responsible for their wellbeing as Volunteers,
- o To introduce the topic of stress and its effects on our wellbeing,
- o To have the trainees identify ways how they can alleviate/eliminate stress.

Overview

In this session the trainees are asked to read the article "Plain Talk about Handling Stress", by the National Institute of Mental Health. They are then asked to list some concrete ways that they could handle stress as a Volunteer.

Exercise

1. Living with Stress

Materials

Article "Plain Talk About Handling Stress."



Exercise 1      Living with Stress

Procedures

Time

Activities

- |            |  |
|------------|--|
| 15 minutes | 1. The trainer distributes the article "Plain Talk About Handling Stress" and asks the trainees to read the article.   |
| 5 minutes  | 2. The trainer asks the participants what one thing impressed them about the article and records their statements on newsprint. The trainer emphasizes that stress is one of the major contributing factors to illness and that awareness leads to prevention.   |
| 20 minutes | 3. The trainer asks the small groups to take the "ten points for living with stress" and plan a strategy for using each point to their advantage as a Volunteer. He/she lists the strategies on newsprint. If the trainees can think of other points, they should also list them.                                      |
| 5 minutes  | 4. The small groups report back to the large group.  |
| 5 minutes  | 5. The trainer points out the importance of recording these strategies in their journals and referring to them from time to time. Living and working in a new cultural environment will be stressful but by dealing with the stress they will be able to turn stress into a positive force in their Volunteer service. |

# plain talk about... handling stress

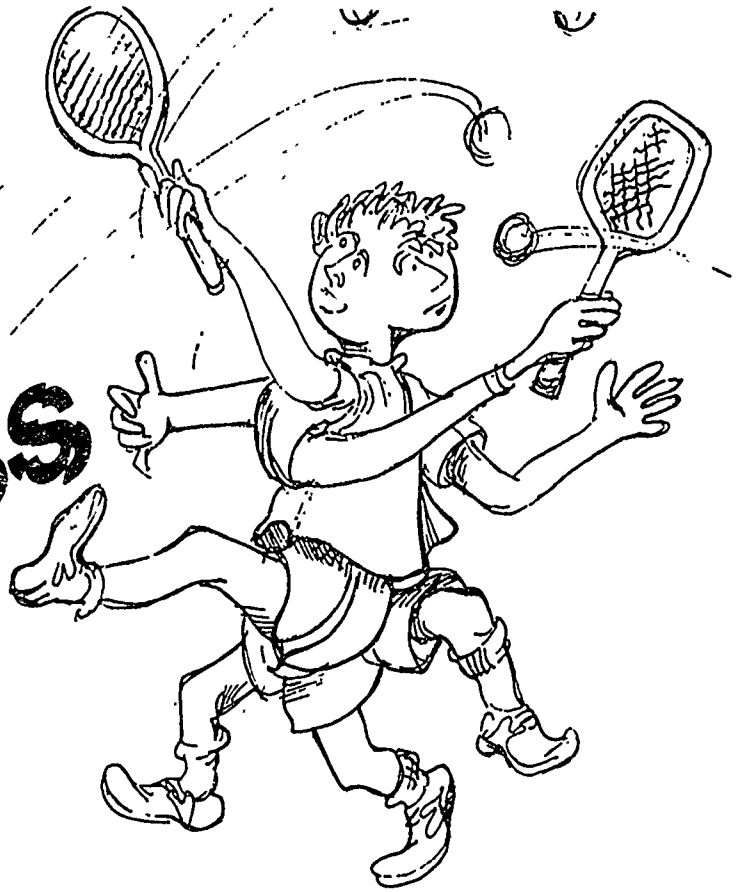

## REACTING TO STRESS

To use stress in a positive way and prevent it from becoming distress, you should become aware of your own reactions to stressful events. The body responds to stress by going through three stages: (1) alarm, (2) resistance, and (3) exhaustion.

Let's take the example of a typical commuter in rush-hour traffic. If a car suddenly pulls out in front of him, his initial alarm reaction may include fear of an accident, anger at the driver who committed the action, and general frustration. His body may respond in the alarm stage by releasing hormones into the bloodstream which cause his face to flush, perspiration to form, his stomach to have a sinking feeling, and his arms and legs to tighten. The next stage is resistance, in which the body repairs damage caused by the stress. If the stress of driving continues with repeated close calls or traffic jams, however, his body will not have time to make repairs. He may become so conditioned to expect potential problems when he drives that he tightens up at the beginning of each commuting day. Eventually, he may even develop one of the diseases of stress, such as migraine headaches, high blood pressure, backaches, or insomnia. While it is impossible to live completely free of stress and distress, it is possible to prevent some distress as well as to minimize its impact when it can't be avoided.

You *need* stress in your life! Does that surprise you? Perhaps so, but it is quite true. Without stress, life would be dull and unexciting. Stress adds flavor, challenge, and opportunity to life. Too much stress, however, can seriously affect your physical and mental well-being. A major challenge in this stress-filled world of today is to make the stress in your life work *for* you instead of against you.

Stress is with us all the time. It comes from mental or emotional activity and physical activity. It is unique and personal to each of us. So personal, in fact, that what may be relaxing to one person may be stressful to another. For example, if you're a busy executive who likes to keep busy all the time, "taking it easy" at the beach on a beautiful day may feel extremely frustrating, nonproductive, and upsetting. You may be emotionally distressed from "doing nothing." Too much emotional stress can cause physical illness such as high blood pressure, ulcers, or even heart disease; physical stress from work or exercise is not likely to cause such ailments. The truth is that physical exercise can help you to relax and to handle your mental or emotional stress.

Hans Selye, M.D., a recognized expert in the field, has defined stress as a "non-specific response of the body to a demand." The important issue is learning how our bodies respond to these demands. When stress becomes prolonged or particularly frustrating, it can become harmful—causing *distress* or "bad stress." Recognizing the early signs of distress and then doing something about them can make an important difference in the quality of your life, and may actually influence your survival.

NATIONAL INSTITUTE OF MENTAL HEALTH -  
Division of Scientific and Public Information - Plain Talk Series - Ruth Kay, Editor

U.S. DEPARTMENT OF HEALTH AND HUMAN SERVICES -  
Public Health Service - Alcohol, Drug Abuse, and Mental Health Administration  
5600 Fishers Lane, Rockville, Maryland 20857

## HELPING YOURSELF

When stress does occur, it is important to recognize and deal with it. Here are some suggestions for ways to handle stress. As you begin to understand more about how stress affects you as an individual, you will come up with your own ideas of helping to ease the tensions.

- **Try physical activity.** When you are nervous, angry, or upset, release the pressures through exercise or physical activity. Running, walking, playing tennis, or working in your garden are just some of the activities you might try. Physical exercise will relieve that "up tight" feeling, relax you, and turn the frowns into smiles. Remember, your body and your mind work together.
- **Share your stress.** It helps to talk to someone about your concerns and worries. Perhaps a friend, family member, teacher, or counselor can help you see your problem in a different light. If you feel your problem is serious, you might seek professional help from a psychologist, psychiatrist, or social worker. Knowing when to ask for help may avoid more serious problems later.
- **Know your limits.** If a problem is beyond your control and cannot be changed at the moment, don't fight the situation. Learn to accept what is—for now—until such time when you can change it.
- **Take care of yourself.** You are special. Get enough rest and eat well. If you are irritable and tense from lack of sleep or if you are not eating correctly, you will have less ability to deal with stressful situations. If stress repeatedly keeps you from sleeping, you should ask your doctor for help.
- **Make time for fun.** Schedule time for both work and recreation. Play can be just as important to your well-being as work; you need a break from your daily routine to just relax and have fun.
- **Be a participant.** One way to keep from getting bored, sad, and lonely is to go where it's all happening. Sitting alone can make you feel frustrated. Instead of feeling sorry for yourself, get involved and become a participant. Offer your services in neighborhood or volunteer organizations. Help yourself by helping other people. Get involved in the world and the people around you, and you'll find they will be attracted to you. You're on your way to making new friends and enjoying new activities.

- **Check off your tasks.** Trying to take care of everything at once can seem overwhelming, and, as a result, you may not accomplish anything. Instead, make a list of what tasks you have to do, then do one at a time, checking them off as they're completed. Give priority to the most important ones and do those first.
- **Must you always be right?** Do other people upset you—particularly when they don't do things your way? Try cooperation instead of confrontation; it's better than fighting and always being "right." A little give and take on both sides will reduce the strain and make you both feel more comfortable.
- **It's o.k. to cry.** A good cry can be a healthy way to bring relief to your anxiety, and it might even prevent a headache or other physical consequence. Take some deep breaths; they also release tension.
- **Create a quiet scene.** You can't always run away, but you can "dream the impossible dream." A quiet country scene painted mentally, or on canvas, can take you out of the turmoil of a stressful situation. Change the scene by reading a good book or playing beautiful music to create a sense of peace and tranquility.
- **Avoid self-medication.** Although you can use drugs to relieve stress temporarily, drugs do not remove the conditions that caused the stress in the first place. Drugs, in fact, may be habit-forming and create more stress than they take away. They should be taken only on the advice of your doctor.

## THE ART OF RELAXATION

The best strategy for avoiding stress is to learn how to relax. Unfortunately, many people try to relax at the same pace that they lead the rest of their lives. For a while, tune out your worries about time, productivity, and "doing right." You will find satisfaction in just *being*, without striving. Find activities that give you pleasure and that are good for your mental and physical well-being. Forget about always winning. Focus on relaxation, enjoyment, and health. *Be good to yourself.*

Written by Louis E. Kopolow, M.D.

YOU MAY REPRODUCE THIS DOCUMENT FREELY, IN ANY QUANTITY YOU WISH.

FIELD TRIP OVERVIEW

Total time      1 hour

Goals

- To review the objectives of the field trip,
- To review the schedule for the field trip,
- For the trainees to set personal learning goals for the field trip,

Overview

The objectives for the field trip are presented in this session and schedule are carefully reviewed. All questions should be answered concerning the objectives, schedule, meals and lodging. The trainees set personal learning goals for the field trip.

Exercise

1. Overview of Field Trip/Set Personal Learning Goals

Materials

Schedule for field trip, flip charts, markers.

Exercise 1      Overview of Field Trip/Set Personal Learning Goals

Total time      1 hour

Overview

The trainees are given an overview of the following week's schedule, objectives and details concerning housing and meals. Appropriate clothing is also discussed. The trainees then set personal learning goals.

Procedure

<u>Time</u>	<u>Activities</u>
30 minutes	1. The trainer gives an overview of the field trip and a brief lecture on realistic goals.
10 minutes	2. The trainees individually set personal learning goals.
15 minutes	3. In small groups, the trainees discuss their learning goals and make contracts with each other for reaching their goals during field trip.
5 minutes	4. The trainer wraps up the session. He reminds the trainees again that they are responsible for their own learnings.

**Trainer's Note:** The list of objectives and schedule used during the pilot training program are included on the following pages.

Objectives of the Field Trip

1. To practice forestry extension techniques discussed in the previous sessions by visiting Indian villages on the Papago Reservation,
2. To explore two cultures which are different from our own,
3. To see a cooperative agricultural development project,
4. To plant trees with people of a different culture,
5. To visit a seed research center,
6. To practice budding techniques at a citrus orchard,
7. To allow the trainees time to shop for needed items,
8. To process each day's learnings and to relate experiences of the field trip to those that the trainees will have as Peace Corps Volunteers.

Field Trip ScheduleSUNDAY

AM Sonora Desert Living Museum,  
Desert Ecology,  
Lunch at Museum.

PM Travel to Ajo,  
The trainer points out terrain that is similar to African  
countries: housing, mud stoves, results of overgrazing,  
erosion.

## Evening

Arrive Ajo - Cornelia Hotel,  
Dinner at China Cafe,  
Process Meeting.

MONDAY

AM Sonora, Mexico, Trainees explore community; their  
assignment is to find out what kind of agricultural crops  
are grown in the area.

PM Lunch, Sonora restaurants,  
Argan Pine National Mt.,  
Seed dispersal on the desert,  
Ecology exhibits,  
Film about Argan Pipe area.

## Evening

Return to Ajo - Dinner at Pizza Hut.

TUESDAY

AM Sells, Arizona, capitol of Papago Nation,  
Native foods seed collection research station,  
Tribal offices, and points of interest,  
Agricultural extensionist.

PM Lunch, Sells Cafe,  
Group divided into small groups assigned village in which  
they will work for 2 days;  
Groups go to villages and call on village chairman,  
Start extension practice.

## Evening

Return to Ajo - dinner at Mexican Restaurant,  
Process meeting of the day.

WEDNESDAY

AM Return to villages for extension work.

PM Lunch picnic style,  
Extension work/tree planting.

## Evening

Return to Ajo - Dinner at Wagon Wheel.  
Process meeting of the day.

THURSDAY

AM Pack-up,  
Return to village for extension.

PM Extension wrap up,  
Leave for Phoenix.

## Evening

Arrive Lodging, Scottsdale, Arizona,  
Process meeting of the day,  
Trainees are on their own for dinner.

FRIDAY

AM Citrus orchard for budding practice at University of  
Arizona Experimental Station, Tempe.

PM Free time; trainees are on their own for lunch.

## Evening

Free time: Trainees are on their own for dinner.

SATURDAY

AM Free time,

PM 1:00 PM Trainees should have eaten lunch - depart for  
Arboretum.

## Evening

Arrive Oracle in time for dinner.

Breakfast every morning in Ajo will be at the Wagon Wheel.  
Once we are in Scottsdale, you are on your own and go wherever  
you would like.



AGRO-FORESTRY REPORTS

Total time      3 to 4 hours

Goals

- o For the trainees to present the agro-forestry programs on which they have worked in small groups,
- o Through the utilization of data collected, extension skills required and knowledge of community, the trainees make recommendations for agro-forestry programs.

Overview

This session helps the trainees exhibit new learnings, skills, and techniques. The trainees use creativity and organizational skills.

Exercise

1. Trainees' Presentations

Materials

Trainees' projects

Exercise 1      Trainees' PresentationsTotal time      3 - 4 hoursProceduresTimeActivities

1. The trainee for whom this session is a special project introduces the session, gives an overview of the projects and introduces the groups.

Examples of agro-forestry reports are on the following pages.

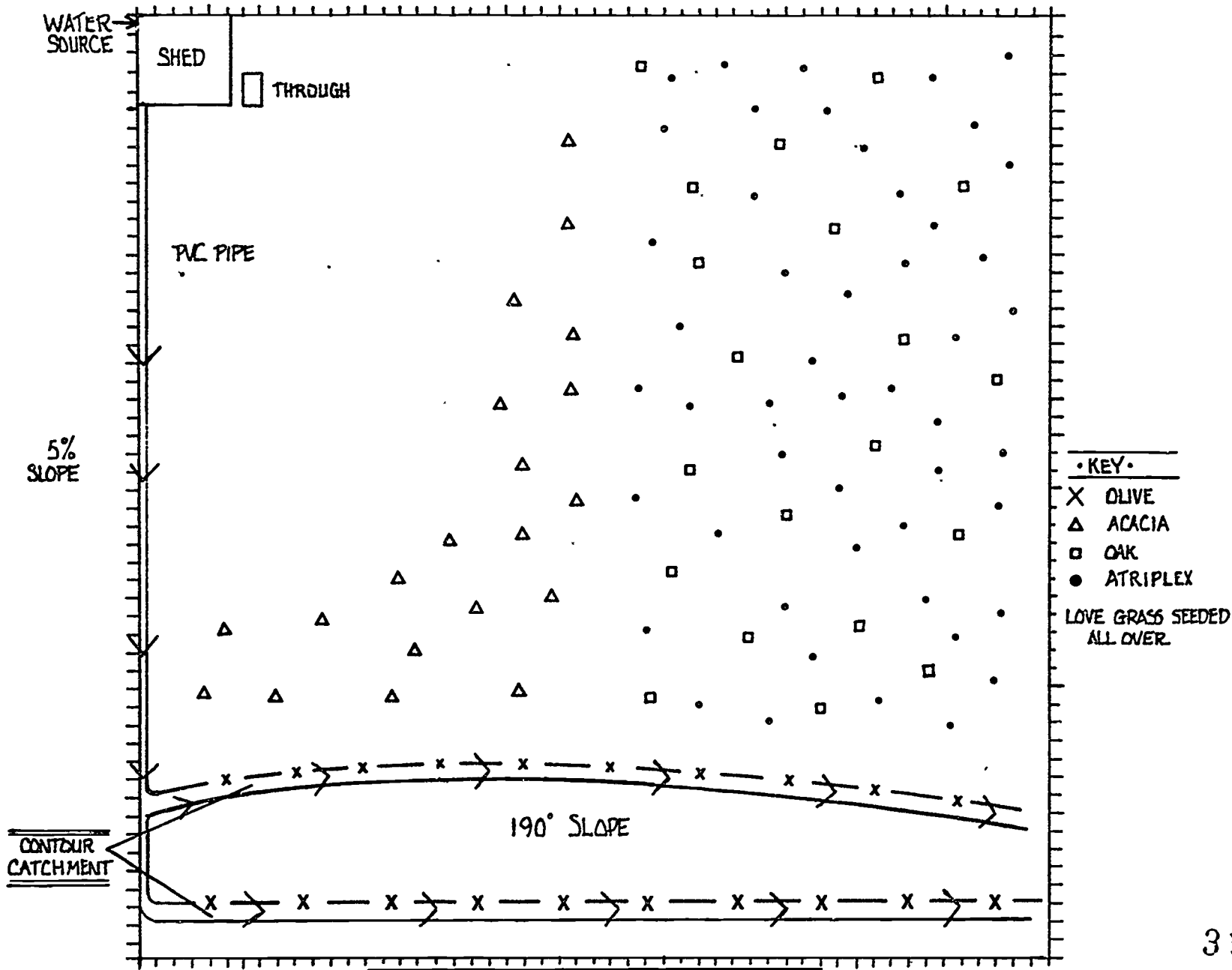

• KEY •

- X OLIVE
- △ ACACIA
- OAK
- ATRIPLEX

LOVE GRASS SEEDED ALL OVER

318

319

(Fig. 32)

EXAMPLE: 1 ACRE PLOT 1 SQ = 4 FT

GOAGOADevelopment Project for Oracle, Arizona

Agro-forestry is a land management system that aims to optimize available resources for a higher total, more diversified, sustainable production than is possible with other forms of land use. In a silvo-pastoral system, land is managed for the production of wood as well as for the rearing of domesticated animals. Other applicable agro-forestry systems include agri-silviculture, agro-silvo-pastoral, and the multi-purpose system, all of which may possibly be applied to the Oracle area.

The ecological environment of the Oracle, Arizona area includes many limiting factors which may inhibit the selection of species possibilities for agro-forestry. The soil type is shale to bedrock. The bedrock consists mainly of granite. The soils are shallow and rocky. North of Oracle the soils are deeper due to the alluvial fan created by the river. Precipitation falls predominantly in the form of short, violent rainstorms, called monsoons which occur from July - September. Average rainfall is 18" - 19" per year. Soft gentle rain falls from March to May. Occasional winter storms which include snow and sleet fall in January and February. The temperature range is from 34°F in the winter to 91°F in the summer. Slope is variable, from nearly level (0-1%) to very steep (80-90%) and varies locally. Elevation is from 3,500 to 4,500 feet.

Current agricultural practices in the Oracle area are limited to cattle grazing and small home gardens. Because the climate and soil cannot support much vegetation, 80 - 120 acres of range land per year are required to support one cow/calf unit.

Water supply, although available, is quite expensive. Therefore, home gardens are often uneconomical, yet rather common in Oracle. The warm temperatures and well-drained soil contribute to high yields and fast growth of vegetables and other garden crops.

Factors affecting the socio-economic environment of the Oracle area i.e., increasing unemployment due to mining layoffs, limited agricultural potential, and the relatively high cost of living, make Oracle a desirable place for implementation of land intensive agro-forestry. The Goagoo silvo-pastoral system of incorporating the existing range resources and the slow development of an intensive land-use technique of fodder with livestock is basically geared toward the industrious type of individual with diverse side interest. The lack of many rich landowners and the economic unfeasibility of large scale beef grazing has geared the goals of Goagoo to fit the needs of the community.

Specifically, the silvo-pastoral system outlined includes the following species (see table 7). These are distributed

according to the outlined plan (see fig.32). Water is directed to the olive trees through a water catchment system which also includes a supplementary irrigation system. Contour catchment is the type of catchment, and polyvinyl chloride pipes with holes at each tree site is the method of irrigation. If additional watering of Oak, Acacia or grass is indicated, a sprinkler system may be added. To keep costs low, use of grey water is suggested. Goat grazing is permitted in all areas once the trees and browse have reached correct maturity. Tethering is the type of goat restraint recommended since it is the least costly and most effective for controlled browsing and rotation.

Several extension practices will be available. The Goagoa project will be presented, and alternatives will be suggested. The goal of this project is to adapt it to the people of Oracle. The extension agents from the University of Arizona will continue to work as a consulting team in establishing flexible silvo-pastoral systems. A quarterly newsletter will be available to those interested. Information concerning the Oracle Goagoa project as well as current news in the agro-forestry world will be presented in this free periodical. Also, the University of Arizona's extensionists encourage participation in county and state fairs. Booths will display the latest innovations and be manned by a well-informed staff who will answer any questions pertaining to Goagoa or agro-forestry.

#### FODDER AND BROWSE SPECIES

Acacia greggii, catclaw, is a palatable browse and fodder plant for goats. Like most legumes A. greggii will enrich the soil with nitrogen. In native stands it usually grows as a rounded shrub. When isolated, however, it is a low branching tree five - eight meters tall. This species is indigenous to the Oracle area, found mainly in washes and on rocky hillsides. The foliage withstands all but the severest winters. Leaves will remain on the plant for several weeks after a severe frost, or even until the commencement of spring growth.

Atriplex canescens, four-winged saltbush, is a perennial, green shrub about two and a half meters tall at maturity. A native North American species, it survives in saline, heavily textured soils. Spring and fall rains and temperatures as low as  $-10^{\circ}\text{C}$  to  $-12^{\circ}\text{C}$  are common climatic factors to which A. canescens is adapted. Palatable to livestock, it is browsed most in summer and fall when no other green vegetation remains. Twelve percent of the dry matter is digestible protein, making this species a favorable fodder crop.

Quercus turbinella, scrub oak, is an excellent fuelwood species native to the southern Arizona region. The plant grows as a branching shrub or small tree one to five meters tall. Livestock often browse on Q. turbinella, and acorns serve as good fodder. Another advantage is the high natural regeneration rate.

## GRASS, FODDER AND HOBBY SPECIES

Eragrostis lehmanniana, Nees., Lehmann lovegrass, Perennial; culms finally prostrate, 30 - 80 cm. It was introduced from Africa, is drought-resistant and proving effective in erosion control. It is well established in Arizona with local distributors and is relatively cheap with good germination and establishment percentages. Irrigation is not necessarily needed and therefore it provides the cheapest feed for livestock. It is a principal means of restoring soils worn out by cropping along with its characteristic to maintain or increase nutrient levels.

Olea Europaea L., olive tree. The broad-leaved evergreen tree reaches a height of 10 - 60 feet. It is drought resistant and tolerant of poorly aerated soils. It is a well balanced, nutritional feed which can be browsed at two years of age, but it is better to wait four to five years. It produces an annual crop of olives which are harvested during October to December. Hundreds of varieties are known and are mainly cultivated for the production of commercial olives and olive oil. An enjoyable hobby is to can olives to one's own taste. This tree species lives to a ripe old age.

## SMALL LIVESTOCK

Goats: The history of goat raising in the Oracle area dates back to World War II and earlier. At that time there were two or three large bands of goats on the open range which was owned by large landowners. As the climate became hotter and drier, the large land masses were broken down and cattle grazing took over. We feel that small landowners can effectively and economically raise a few goats on one or two acres of land with little initial investment. This representative acre plot, which does not necessarily have to be exactly the same as ours, can support two to three goats year round.

Since goats will eat almost anything, but prefer forbs to grass, this area provides a wide variety of species for forage. As previously mentioned, five new species are being introduced for feed. Goats will also feed on existing species such as mesquite and prickly pear cactus. A daily supply of good water is needed. This will be provided by means of a trough at the top of our plot (see diagram on following page).

Fencing can be used to keep goats contained, but to keep costs down, tethers can be used. Each tether should allow the goat 20 yards of freedom. Tethering helps to control the area of browsing which is especially important at the initial stages of plant establishment.

The gestation period of a goat is five months. Two kids are normally born but a nanny can have up to four. The kids can be sold for added revenue.

Mohair goats are highly prized for their wool which can be sold to speciality shops that spin their own yarn or market the wool. Various methods of dyeing wool naturally can be implemented. Goat meat can be eaten also.

The price range for purebred mohair goat is \$60 - \$75 per goat. A cross between a Spanish goat and a purebred is hardier and costs between \$10 - \$15 per goat. The wool, however, is less valuable. It is recommended that there be one billy and two nannies per acre of land.

Since this plan is flexible to the needs of the landowner, many different small livestock can be introduced. Horses can browse as a diet supplement but cannot be sustained on one acre. Chickens and/or exotic bird species, sheep and llamas are alternative small livestock. The list can be expanded to include species desired by the landowner.

#### BENEFITS OF GOAGOA

- o Low initial investment
- o Income through fuel/wood production
- o Small scale olive production
- o Income from livestock products
- o Protection from soil erosion
- o Nutrient enrichment of soil
- o Optimal water use and conservation
- o Recreation and hobby activities

#### SUMMARY

Goagoo is a silvo-pastoral program involving Goats, Olives, Acacia, Grass, Oak and Atriplex. Agro-forestry is a land management system that aims to optimize available resources for a higher total, more diversified, more sustainable production than is possible with other forms of land use. In a silvo-pastoral system, land is managed for the production of wood as well as for the rearing of domesticated animals.

## AGRI-SILVA CULTURE PROPOSALS

### For Oracle, Arizona

#### I. INTRODUCTION

Due to the increasing problem of water availability and cost, the raising of home gardens and backyard orchards in Oracle, Arizona has become less feasible. Produce of these types is important to the economy of many households in Oracle. This research presents a possible program for backyard family gardens as well as an alternative to this type of conventional gardening system.

Practices of agro-forestry are believed to be a possible solution to this problem. Agro-forestry is not a new concept, it has been practiced for centuries by various peoples. Due to contemporary population explosions, and reduced availability of arable land, however, the practice has recently become more accepted as a management practice.

Agro-forestry can be defined as the practice of integrated land use and is particularly suited for fragile environments or degraded environmental situations where imports are restricted by economic necessity. It is a system that combines practices of agriculture and forest products and at the same time improves the specific environmental area. By employing the major concepts of consistent ground cover for soil stability, water retention, and high organic matter, the agro-forestry system helps alleviate degradation of delicate ecosystems.

The agro-forestry practices discussed here deal with the concurrent production of agriculture crops (including tree crops) with forest crops for the town of Oracle, Arizona. When considering the types of crops to be employed in this system, emphasis should be directed at the following aspects of the study site: ecological environment, present and potential agriculture practices and the socio-economic environment. After analysis of these factors, major considerations major consideration should be given to the availability and cost of water and climatic conditions.

Oracle's amenities are threefold: it offers a rural lifestyle, easy access to the mountains, and a more temperate climate than Tucson. People, however, are not drawn here by employment; services are minimal or non-existent, and there are living inconveniences (lack of zoning, distance from Tucson).

The greatest factor which restricts Oracle's growth is water. During the past fifteen years the water table has dropped approximately one foot per year. Private wells do exist, however in dry periods, these must be supplemented by the Arizona Water Company. Since water is pumped from Oracle Junction, ten miles east of



Oracle, its cost is prohibitive and is expected to keep rising.

Due to this situation, a community park/garden system is proposed. Involved in the project is the establishment of a park in a centrally located area of town. Agro-forestry techniques will be used in the planting of family gardens, fruit and nut trees, and vine fruits. Establishment of a well and a water holding tank at the site are essential parts of the project. Also present at the park will be a hot house, picnic tables and barbecue pits.

A possible program for backyard family gardens is also presented in this paper. This program outlines agro-forestry practices and water conservation measures which may be incorporated in residential situations.

## II. SOCIO-ECONOMIC FACTORS

Oracle's population is varied. It is a mixture of miners, ranch workers, business and service employees, retirees, people who work in Tuscon, artisans, and other self-employed workers. There have been no accurate demographic statistics taken. In 1980, however, its population was believed to be between four and five thousand people.

Population statistics have not been kept in Oracle due to its status as an unincorporated community. Residents have strongly resisted incorporation each time the issue has been raised. The people believe that incorporation would mean higher taxes, regulations, another level of government, and more red tape. The people also reject incorporation because they want their autonomy and less government interference. Oracle is administered by the county which provides police and fire protection and any needed social services.

Residents believe that Oracle will grow in the future, but that growth will be slow due to the interest rates for home loans and the scarcity of water. Because the town is unincorporated and no large industries exist other than nearby mining, people hope that the economy of the overall county will help maintain Oracle as a small, rural community.

## III. ECOLOGICAL ENVIRONMENT

Oracle is on the edge of two distinct ecosystems. To the north, east and west, there are desert grasslands; oak woodlands dominate southward. Throughout the general area, overgrazing and the lowering of the water table has brought in mesquite and other xerophytic vegetation.

The desert grasslands of north Oracle is different in soil, topography and plant species than other nearby areas. Dissected alluvium is abundant through the terrain with the soil much deeper than that of the adjacent foothills. Soils along the washes are deep, sandy to gravelly, unconsolidated material.

One type of ecosystem that extends across all environmental zones is the vipersian. Plants here are of the winter deciduous type and are restricted to drainage ways. These plants were once abundant but the lowering of the water table has caused them to die out.

Soils in the foothills around Oracle have evolved from granite bedrock. Topsoil is often thin due to steep slopes and the close proximity of the bedrock. Due to this, once vegetation is eliminated, any unconsolidated material is quickly washed away. It may be years before plants can be re-established. The bedrock is often fractured with many of the cracks and fissures holding small amounts of water. This has allowed evergreen oaks to become dominant climax species of the area.

These aspects of shallow soils and slope have a bearing on how, where and what kind of development can occur in the area. Most soils are not conducive to septic tanks, excavations, basements, sanitary landfills and irrigation.

The area averages 10" - 20" of annual precipitation. The majority occurs as intense thunderstorms from July to October and lighter rains of longer duration from December to April. It is not uncommon to see snow, sleet or hail during the winter. Temperature range is from an average high of 90°F in July to an average low of 34°F in January.

Wildlife in the area is limited to small species such as jack rabbits, squirrels, and kangaroo rats. The bird population is more diverse, ranging from wrens to hawks. In the mountains and foothills south of Oracle the wildlife has more variety.

#### IV. COMMUNITY PARK/GARDEN

The main proposal for Oracle is for a community park and garden. It would be developed with the concept of agri-silvicultural systems in mind. We believe that our plan is workable and profitable for the inhabitants of Oracle.

In order for the project to succeed, several stumbling blocks will have to be resolved. The first of these is funding. This we hope could be solved with a community development grant from either the state or federal level. The other problem's solution hinges on the solution of the first one. This funding is necessary to initiate the project. It should cover the irrigation system, fencing costs, and layout and planting of the trees.

A reliable water source is necessary for the project to succeed. Few people in town can presently afford the watering costs for a large garden of their own. Our watering system will rely upon a well or holding tank system. Up to 35 gallons per minute can be pumped from the well legally. A 100,000 gallon

holding tank will hold the water after it is pumped and before it is used. Our generous estimate calculated that 50,000 gallons of water each day is needed. This includes the plots, the grassy areas, and the fruit trees. Distribution of the water will be from a faucet at each set of plots.

Another problem is the location of a suitable piece of land that is easily accessible from town. Not only will it have to be quite large (3.9 acres) but the soil should also be tillable.

A map of the plan itself is attached. We designed a dual purpose park. Not only will people be able to come here for picnics and to relax in the shade, but they would also be able to come here after work and on weekends to care for their own gardens. Presently, many people cannot afford gardens due to the high cost of watering.

The plan itself incorporates agri-silvicultural practices. There are 104 plots. Fruit and nut trees will be scattered throughout and between the plots and completely encircle the whole area. These will provide fruits and nuts at first, and later firewood when they grow old. The trees will also provide shade, prevent erosion, act as windbreaks, and slow evaporation rates from the garden. Trees native to the area or ones that are known to do well were chosen for the project.

In order to fund the project after the initial costs, a fee of \$10/season, per plot will be charged. This money will go toward maintenance and a part-time groundskeeper/caretaker. This person will receive a fee-free plot. They will assign plots, trees (and the produce from them) and see that the grounds are maintained.

A source of possible organic matter to improve the soil is the sewage treatment plant in town. There is a large stockpile of waste that could be used if it tests clean.

#### V. PRIVATE/RESIDENTIAL GARDENS

A secondary proposal for Oracle concerns information regarding backyard family gardens. This practice is not new to the community, but due to water availability, its practice has been on the decline. It is believed that a review of the present and potential crops grown in the area would be an aid to families interested in backyard gardening. Also, various methods of water conservation are outlined.

Plants reported to be grown locally include: (Table 7)

Almonds	Fig	Pecan
Apples	Grapefruit	Pepper plant
Apricots	Lettuce	Pepper tree
Beans	Manzanita	Pinon nut
Black walnuts	Mulberry	Pomegranate
Boysenberry	Oak	Potatoe
Canteloupe	Okra	Squash
Cherry	Olive	Strawberry
Corn	Orange	Tangerine
Cucumbers	Peaches	Tomato
Eggplant	Peanuts	Watermelons
	Pears	

Plants that would be most successful in individual gardens include:

Beans	Okra	Tomato
Canteloupe	Pepper plant	
Grapefruit	Squash	

Plants chosen as the most successful were considered adaptable to the local:

1. Climatic conditions of water and temperature,
2. Edaphic factors of soil texture and nutrient composition,
3. Need for production of a popular product at a fairly low investment.

Some plants were not as desirable as others due to the following requirements:

1. Lower temperatures - apricots, lettuce, potato, strawberries.
2. Light soil - cucumbers, oranges, peanuts, peaches, watermelons.
3. No frost - almonds, apricots, cucumbers, fig, grapefruits, peaches.
4. Heavy fertilizing - cherry, corn, olive, oranges, strawberries.
5. Heavy watering - corn, cucumber, potatoes, peaches, strawberries, watermelon.
6. Tender care - apricots, boysenberry, corn.
7. Unpopular fruit - manzanita, olive, pinon, acorns.
8. Long-term investment - almonds, boysenberry, figs, pears, apples and other fruit trees.
9. Insect problems - corn, eggplant.

Of these less hardy plants, most could probably be grown without financial loss if given proper care. Ways of successfully growing these may include;

1. Growing cool climate plants only during fall and winter months,
2. Providing sufficient water/irrigation when necessary,

3. Providing sufficient fertilizers,
4. Controlling insects.

Several tree species can be grown well in the Oracle climate if a person is willing to make a long-term investment and wait for a return.

In general, plants can be raised more successfully and economically by implementing progressive growing techniques. These include:

1. Intercropping of nitrogen-fixers with plants requiring higher nitrogen levels,
2. Using strong-stemmed plants as physical support for climbing vine plants,
3. Using crop rotation to avoid soil nutrient depletion,
4. Creating a compost heap for the provision of cheap and effective fertilizer,
5. Growing plants which are subject to desiccation under shade trees that can tolerate long hours of sunlight,
6. Using water catchment techniques and grey-water to save on water costs.

Grey-water is water that has been used for household needs such as washing. It may be then employed on gardens and is an inexpensive water source. The city of Oracle utilizes grey-water from the sewage treatment plant to water the local football field (the sludge removed is sold for compost after two to three year). Residents who are not connected to the sewage system may therefore use grey-water from their homes in their gardens. When such water is employed, biodegradable detergents should be used for washing so that the garden is not contaminated. This source of water is in common use in Oracle presently.

Another inexpensive source of water is through water-catchment systems. These are fairly easy to construct.

Examples of some types of water-catchment systems are:

1. Harnessing water run-off from household roofs,
2. Using "V"-catchment resevoirs around trees on slopes,
3. Contour type catchment systems can be employed on slopes where crops or trees are planted.

Implementing one or more of these systems could provide substantial savings on irrigation costs.

# ORACLE COMMUNITY GARDENS AND FRUIT TREES

3.9 ACRES

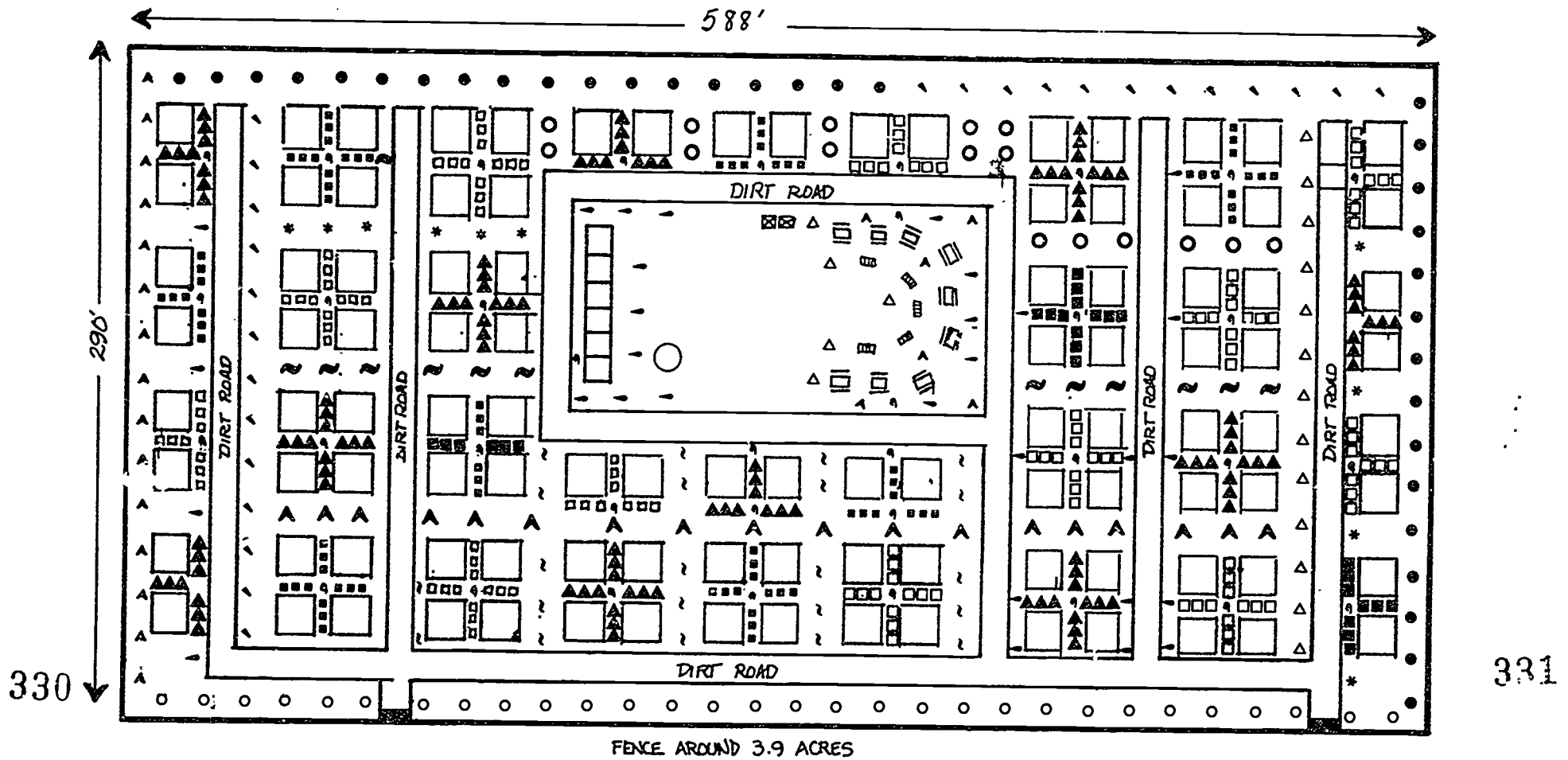

331

(Fig. 33)

LEGEND:

TREES

WINES

- BLACKBERRIES
- RASPBERRIES
- GRAPES

104-GARDEN PLOTS

WATER SPIGNET

GATES

PICNIC TABLES

BAR-B-Q GRILLS

DUT HOUSES

WATER

● ▲ ~ ~ ~ ○ \* ○

## VI. EXTENSION WORK

The roles of an extensionist in these proposals are two-fold: first, to promote the implementation of the community park/garden system and second, to play an advisory role, acting as an information center for families planning gardens. Key to the success of such a program in Oracle is the extensionist's understanding of the cultural systems inherent to the community.

In order to initiate the community park/garden, the extensionist should be fully aware of potential leaders and groups within the community who might support the project. Meetings should be arranged with such clubs, societies and community leaders and the idea for the park/garden system should be presented and discussed. At these meetings, the extensionist must identify those willing to pursue the proposal further and arrange a second meeting with those leaders.

At the second meeting the extensionist should allow these local people to take the leadership and organizational roles; he/she takes the role of an advisor. The extensionist should urge further discussion of the plan and the incorporation of any desired alterations.

From this point, the extensionist's main duties would be to monitor the progress of the project, provide motivation when it is necessary, and make the leaders aware of what they have accomplished. The extensionist must insure that the project is kept in proper perspective. If things go well, the leaders will establish appropriate contacts with state officials, apply for and receive a community development grant, arrange for the purchase of necessary materials and the manpower needed for the construction of the project (possibly employing the youth of the community through established programs run by the tri-community behavioral health center).

The extensionist should then meet once a year with the leaders to evaluate the success of the community garden/park.

In order to provide information on improved technologies for family gardens, the extensionist would want to make his/her expertise as readily available as possible. There are two approaches that the extensionist should take: have public meetings and make visits to individual households. Such work needs to be done once a year. The best time to do this extension work is in the early spring before the planting season begins.

In order for the extension meetings to be successful, they need to be extensively publicized. Announcements should be placed in local newspapers, on local radio stations and posters should be placed in highly visible locations around Oracle. At the meeting, appropriate technologies for lowering the cost of home gardening, while increasing benefits, should be discussed.

In addition to a meeting, the extensionist should set aside one month during the pre-planting season when he can visit households for evaluating individual home sites for appropriate garden technologies. The extensionist's availability for this work should also be well publicized. Visits should be made by request with appointments arranged over the telephone.

#### VII. CONCLUSIONS

Good extension work is paramount to the success of the projects outlined in this proposal. The extensionist must particularly insure that the people are involved and that a strong community development grant proposal is written.

These proposals have the potential for enhancing the feasibility of family gardens in Oracle. Households in the community could profit from their implementation. In addition, the community park/garden has the potential to increase community interaction - to "bring the people together".



### MULTI-PURPOSE AGRO-FORESTRY SYSTEMS

In most marginal and fragile ecosystems around the world, many agricultural land-use systems have been deemed inappropriate or implemented in such a way that it results in the degradation of the ecosystem. Where these systems of land-use are not accepted, the decision is made because inputs, such as water, are often limited due to economic restraints. Agro-forestry is one system of land-use that combines the practices of agriculture and forestry. This system can provide food and water without causing deterioration of the ecosystem or without requiring excessive inputs such as machinery, pesticides, and fertilizers. Multi-purpose agro-forestry systems have the advantage of being low input systems, providing multiple products, preventing soil and water loss, providing supplementary income and recycling nutrients. These specific advantages are closely related to the surroundings in which a system is incorporated.

An agro-forestry land system is very dependent upon the ecological environment of the area of consideration. Factors that need to be addressed are the climate, general geography and elements of limitation of the region. The climatic conditions in the Oracle area include rainfall of roughly 10 - 20 inches annually. This precipitation is mainly concentrated during two periods of the year. April and May are the months in which the first rains of the season occur, while July through September comprise the second period of heavy rainfall. Available water in the form of snowfall is minimal, since little snow falls in that area. Frost can occur in Oracle around January, but usually only annual plants are damaged. Temperatures can vary greatly in the desert ecosystem. High temperatures average 90°F and low temperatures average 34°F. Some days in the summer months the temperature can reach as high as 120°F, while in the winter, lows of 15°F are recorded.

Oracle is located at an elevation of approximately 3,900 feet above sea level. The geography of this desert region is such that vegetation needs to be drought resistant. Soils in the area are underdeveloped granitic, sandstone, and caliche type formations. The parent material is close to the surface. The bedrock slopes from the mountains into Oracle. Therefore, the topsoils are very thin and soils along the washes are unconsolidated. A multi-purpose agro-forestry system must consider the limiting factors apparent to the area. Water availability, make-up of soils, and temperature fluctuations will disallow certain tree species or crops to be incorporated into the management system. Local agricultural techniques and community practices need to be observed.

Successful agro-forestry systems must recognize the current agricultural practices and realize the potential possibilities. Several large old family ranches exist in Oracle in which cattle, horses, and chickens are raised. Many people have either attempted or maintained a garden around their home. Some Oraclites have planted native ornamental tree species or have

introduced species into the area. The commercial potential for intensive agricultural practices is extremely low, due to limiting factors. Residential areas or small landowners can be self-sustained by using the proper agro-forestry system. The system can help to remedy certain community inconveniences such as higher food costs and outside firewood collection. These factors and other relevant criteria are involved in the Oracle economic dilemma.

Socio-economic conditions, relating to the area in which Oracle is located, significantly reduce the alternatives for improvements. The fact that most of the town relies upon the mining industry creates a substantial problem. Lack of a cost effective market has caused the industry to start a shutdown of production. Therefore, Oraclites have reduced work hours and less of an annual income. Another major factor resulting in less useable income is availability of water. Outside distributors and privately owned wells provide the only source of water in the area. Most residents in Oracle have either bought their existing land area or are in the process of doing so. An interest in agro-forestry could propose a viable alternative to harsh economic woes. With low input, the amount of time people spend to establish a multi-purpose system would be offset by future gains. By integrating the most efficient system of agro-forestry, the local economy could receive an essential uplift.

An agro-forestry system best suited for the Oracle area is a multipurpose forest tree production system. The benefits of this system include the following:

- o fruit and nuts
- o shade
- o mulch
- o firewood
- o ornamentals
- o Christmas trees
- o windbreaks
- o erosion control
- o supplemental income

Components of this system are suited to an average residential lot of one-fifth acre. The suitable species to be incorporated fall into several categories: large long-lived trees (pecans, mulberry), small short-lived trees (fruit species), annual crops to protect seedlings (corn, beans), shade and ornamental trees (green ash, Douglas fir), Christmas and windbreak species (Colorado blue and Engelman spruce), and firewood trees (fruit species). Although water presents a limitation due to its high cost and scarcity, solutions are attainable. Drip irrigation, catchments, and grey-water provide efficient alternatives to the problem.

The system itself consists of three major processes: the initial planting, middle, and final stages. In the initial planting, trees are laid out in an appropriate network with a drip irrigation system. Establishment of annual crops for a few years will provide shading for seedlings. First harvesting of Christmas trees and productive fruit trees distinguish the middle stage. In this six to nine year old stage, some nut trees have reached production, but not maturity and the canopy is too closed for annual crops. Mature trees continue to close the canopy at 25 - 30 years; fruit trees have been removed due to exhausted production; and continued planting and growth of Christmas and windbreak trees occurs at this period of the final stage. Further involvement of this multi-purpose tree production system can be enhanced by existing resource potential.

Efforts to establish a proper agro-forestry system should be done in conjunction with knowledgeable extensionists. The University of Arizona and county officials are available for conducting seminars to inform the interested public. Certain people in the area with previous experience, notably Mr. Reynolds and Mr. McKinley, could provide an excellent opportunity to initiate ideas and influence a successful program. All in all, a continued effort on the part of the citizenry of Oracle could ease the economic burden that has been handed down to them. By using an agro-forestry system, the people would provide for themselves and protect the fragile ecosystem in which they live.

WEEKLY INTERVIEW

Same as SESSION 32

LEAVE ON WEEK-LONG FIELD TRIP

PESTICIDESGoals

- o To acquaint the trainees with the use, application and safety precautions of pesticides, fungicides and herbicides.

Overview

In this session an outside expert lectured on the ramifications of pesticides and their safe and judicious use.

Exercise

1. Pesticides

Exercise 1      Pesticides .

Total Time      2 hours

Overview

In this session the trainees will learn the ramifications of pesticides and their safe and judicious use.

Procedures

2 hours

Activities

1. An outside expert should be invited to lecture on pesticides.

REVIEW OF FIELD TRIPS

Total time      1 hour 30 minutes

Goals

- o For the trainees to examine the objectives of the field trip and determine if they have been met,
- o For the trainees to give an overview of their experiences while on the field trip,
- o To be given the assignment "The Role of the Forestry Volunteer...A Transition to Peace Corps Service".

Overview

In this session the trainees examine their field trip(s) experience(s) and the objectives of the field trip and post their findings on newsprint. The field trip groups report their findings to the large group. They receive their final assignment to write an essay about the role of the Forestry Volunteer, a Transition to Peace Corps Service.

Exercise

1. Checking Objectives of Field Trip

Materials

Objectives of field trip(s), flip charts, marker pens, tape.



Exercise 1      Checking Objectives of Field TripTotal time      1 hour 30 minutesOverview

The trainees have completed one week of field work and observations. They take time to review how well they reached the objectives of the field trip and share the experience with the others who did not accompany them.

Procedures

<u>Time</u>	<u>Activities</u>
45 minutes	1. The trainees review the objectives of the field trip to determine how well they were met. Findings are posted on newsprint.
30 minutes	2. The trainees select members of their group to present their findings. Presentations are made.
10 minutes	3. The trainer summarizes the findings of all of the groups.
5 minutes	4. The trainer then gives the assignment "The Role of the Forestry Volunteer - A Transition to Peace Corps Service".

THE ROLE OF THE FORESTRY VOLUNTEER  
A TRANSITION TO PEACE CORPS SERVICE

Please present a clear, thoughtful, and concise description of your perception of your role as a Peace Corps Volunteer. Include the following points for consideration:

- o Your definition of forestry service in Peace Corps,
- o Your understanding of the job or project to which you have been assigned,
- o The manner in which you have been prepared by this training program,
- o Your honest appraisals of your skills in physical, cognitive and social areas,
- o The limitations you perceive in your abilities and in the potential job situation,
- o Methods you will consider to encourage the active participation and inclusion of all community members affected by your project,
- o How your job or project may contribute to improving the quality of life of people affected,
- o Methods you plan to use for effective community involvement in the application of forestry technologies and extension techniques.

The description should be prepared carefully and should reflect your current philosophical perspective on Peace Corps training and service. A copy of your paper will be returned to you. It will be interesting to review and compare it with the realities of your job situation a year from now.

RESOURCES

Total time      Open

Goals

- o Restate the importance of local resources so the trainees can again register this statement,
- o Identify local resources, where to find them, how to approach them,
- o National and international resource identification.

Overview

What happens when a Volunteer really needs outside help? Have they looked at all the alternatives? Human? Monetary? In this session we once again dwell on finding local resources and outside help. The implications of bringing in outside help are explored. The where, who, and how to locate funds is explained in detail.

Exercise

1. Resources

Materials

Flip chart, marker pens, tape

- Optional:
1. Article by E.F. Schumacher
  2. Catalogs, guidelines, newsletters from funding sources for display and perusal by the trainees.

Exercise 1      ResourcesTotal time      OpenOverview

This exercise re-emphasizes the importance of first looking within your own community. After having exhausted all community resources, what do Volunteers do next; to whom do they go and how do they ask for resource assistance?

ProceduresTimeActivities

1. The trainer lectures on resources using the following outline posted on newsprint.
  - A. Do you really need outside help?
    1. Have you exhausted local solutions?
    2. What are the implications of outside help?
      - a. Dependency,
      - b. Non-support of local potential,
      - c. Creativity.
    3. Schumacher - Development depends upon people not resources.
  - B. If you really need help:
    1. What sources are available?
      - a. \$ \$ \$ \$ \$,
      - b. In kind: material, equipment, supplies,
      - c. Information/technical assistance.

## 2. What sources?

a. LOCAL

Private: clubs, service organizations, professional associations, churches,

Government: local, national.

b. INTERNATIONAL

Private: Development groups, universities,

Government: UNDP-FAO, AID, Peace Corps ICE, British, Swiss, USDA Experimental Station, Puerto Rico.

## C. How does one find out about them?

1. Curiosity, creativity,
2. Clearinghouse - TAICH, Catalogs-FAO, USDA, Newsletters,
3. Write - Wait.

## D. How to get the most?

1. Be aware of their
  - a. speciality,
  - b. interest.
2. Follow their system or format.
3. Advance by stages.

2. If available, newsletters, catalogs and funding guidelines should be displayed through which the participants can browse.

**Trainer's Note:** If no one on the training staff feels comfortable with this lecture, you could probably convince the PTO from Peace Corps to do this one.

## D E V E L O P M E N T

by

E. F. Schumacher  
(from: Small is Beautiful)

A British Government White Paper on Overseas Development some years ago stated the aims of foreign aid as follows:

To do what lies within our power to help the developing countries to provide their people with the material opportunities for using their talents, of living a full and happy life and steadily improving their lot.

It may be doubtful whether equally optimistic language would be used today, but the basic philosophy remains the same. There is, perhaps, some disillusionment: the task turns out to be much harder than may have been thought--and the newly independent countries are finding the same. Two phenomena, in particular, are giving rise to world-wide concern--mass unemployment and mass migration into cities. For two-thirds of mankind, the aim of a "full and happy life" with steady improvements of their lot, if not actually receding, seems to be as far away as ever. So we had better have a new look at the whole problem.

Many people are having a new look and some say the trouble is that there is too little aid. They admit that there are many unhealthy and disrupting tendencies but suggest that with more massive aid one ought to be able to overcome them. If the available aid cannot be massive enough for everybody, they suggest that it should be concentrated on the countries where the promise of success seems most credible. Not surprisingly, this proposal has failed to win general acceptance.

One of the unhealthy and disruptive tendencies in virtually all developing countries is the emergence, in an ever more accentuated form, of the "dual economy" in which there are two different patterns of living as widely separated from each other as two different worlds. It is not a matter of some people being rich and others being poor, both being united by a common way of life: it is a matter of two ways of life existing side by side in such a manner that even the humblest member of the one disposes of a daily income which is a high multiple of the income accruing to even the hardest working member of the other. The social and political tensions arising from the dual economy are too obvious to require description.

In the dual economy of a typical developing country, we may find fifteen per cent of the population in the modern sector, mainly confined to one or two big cities. The other eighty-five per cent exists in the rural areas and the small towns. For reasons which will be discussed, most of the development efforts goes into the big cities, which means that eighty-five per cent of the population is largely bypassed. What is to become of them? Simply to assume that the modern sector in the big cities will grow until

it has absorbed almost the entire population--which, is of course, what has happened in many of the highly developed countries--is utterly unrealistic. Even the richest countries are groaning under the burden which such a maldistribution of population inevitably imposes.

In every branch of modern thought, the concept of "evolution" plays a central role. Not so in development economies, although the words "development" and "evolution" would seem to be virtually synonymous. Whatever may be the merit of the theory of evolution in specific cases, it certainly reflects our experience of economics and technical development. Let us imagine a visit to a modern industrial establishment, say a great refinery. As we walk around in its vastness, through all its fantastic complexity, we might well wonder how it was possible for the human mind to conceive such a thing. What an immensity of knowledge, ingenuity, and experience is here incarnated in equipment. How is it possible? The answer is that it did not spring ready-made out of any persons' mind--it came by a process of evolution. It started quite simply, then this was added and that was modified, and so the whole thing became more and more complex. But even what we actually see in this refinery is only, as we might say, the tip of the iceberg.

What we cannot see on our visit is far greater than what we can see: the immensity and complexity of the arrangements that allow crude oil to flow into the refinery and ensure that a multitude of consignments of refined products, properly prepared, packed and labelled, reaches innumerable consumers through a most elaborate distribution system. All this we cannot see. Nor can we see the intellectual achievements behind the planning, the organizing, the financing and marketing. Least of all can we see the great educational background which is the precondition of all extending from primary school to university and specialized research establishments, and without which nothing of what we actually see would be there. As I said, the visitor sees only the tip of the iceberg; there is ten times as much somewhere else, which he cannot see, and without the "ten", the "one" is worthless. And if the "ten" is not supplied by the country or society in which the refinery has been erected, either the refinery simply does not work or it is, in fact, a foreign body depending for most of its life on some other society. Now, all this is easily forgotten, because the modern tendency is to see and become conscious of only the visible and to forget the invisible things that are making the visible possible and keep it going.

Could it be that the relative failure of aid, or at least our disappointment with the effectiveness of aid, has something to do with our materialist philosophy which makes us liable to overlook the most important precondition of success, which are generally invisible? Or if we do not entirely overlook them, we tend to treat them just as we treat material things--things that can be planned and scheduled and purchased with money according to some all-comprehensive development plan. In other words, we tend to think of development, not in terms of evolution, but in terms of creation.

Our scientists incessantly tell us with the utmost assurance that everything around us has evolved by small mutations sieved out through natural selection. Even the Almighty is not credited with having been able to create anything complex. Every complexity, we are told, is the result of evolution. Yet our development planners seem to think that they can do better than the Almighty, that they can create the most complex things at one throw by a process called planning, letting Athene spring, not out of the head of Zeus, but out of nothingness, fully armed, resplendent, and viable.

Now, of course, extraordinary and unfitting things can occasionally be done. One can successfully carry out a project here or there. It is always possible to create small ultra-modern islands in a pre-industrial society. But such islands will then have to be defended, like fortresses, and provisioned, as it were by helicopter from far away, or they will be flooded by the surrounding sea. Whatever happens, whether they do well or badly, they produce the "dual economy" of which I have spoken. They cannot be integrated into the surrounding society, and tend to destroy its cohesion.

We may observe in passing that similar tendencies are at work even in some of the richest countries, where they manifest as a trend toward excessive urbanization, toward "megalopolis", and leave, in the midst of affluence, large pockets of poverty-stricken people, "drop-outs", unemployed and unemployables.

Until recently, the development experts rarely referred to the dual economy and its twin evils of mass unemployment and mass migration into cities. When they did so, they merely deplored them and treated them as transitional. Meanwhile, it has become widely recognized that time alone will not be the healer. On the contrary, the dual economy, unless consciously counteracted, produces what I have called a "process of mutual poisoning", whereby successful industrial development in the cities destroys the economic structure of the hinterland, and the hinterland takes its revenge by mass migration into the cities, poisoning them and making them utterly unmanageable. Forward estimates made by the World Health Organization and by experts like Kingsley Davies predict cities of twenty, forty and sixty million inhabitants, a prospect of "immiseration" for multitudes of people that staggers the imagination.

Is there an alternative? That the developing countries cannot do without a modern sector, particularly where they are in direct contact with the rich countries, is hardly open to doubt. What needs to be questioned is the implicit assumption that the modern sector can be expanded to absorb virtually the entire population and that this can be done fairly quickly. The ruling philosophy of development over the last twenty years has been: "What is best for the rich must be best for the poor." This belief has been carried to truly astonishing lengths, as can be seen by inspecting the list of developing countries in which the Americans and their allies and in some cases also the Russians have found it necessary and wait to establish "peaceful" nuclear reactors--Taiwan, South



Korea, Philippines, Vietnam, Thailand, Indonesia, Iran, Turkey, Portugal, Venezuela--all of them countries whose overwhelming problems are agriculture and the rejuvenation of rural life, since the great majority of their poverty-stricken peoples live in rural areas.

The starting point of all our considerations is poverty, or rather, a degree of poverty which means misery, and degrades and stultifies the human person; and our first task is to recognize and understand the boundaries and limitations which this degree of poverty imposes. Again, our credulously materialistic philosophy makes us liable to see only "the material opportunities" (to use the words of the White Paper which I have already quoted) and to overlook the immaterial factors. Among the causes of poverty, I am sure, the material factors are entirely secondary--such things as a lack of infrastructure. The primary causes of extreme poverty are immaterial, they lie in certain deficiencies in education, organization, and discipline.

Development does not start with goods; it starts with people and their education, organization and discipline. Without these three, all resources remain latent, untapped, potential. There are prosperous societies with but the scantiest basis of natural wealth, and we have had plenty of opportunity to observe the primacy of the invisible factors after the war. Every country, no matter how devastated, which had a high level of education, organization, and discipline, produced an "economic miracle". In fact, these were miracles only for people whose attention is focused on the tip of the iceberg. The tip had been smashed to pieces, but the base, which is education, organization and discipline was still there.

Here, then, lies the central problem of development. If the primary causes of poverty are deficiencies in these three respects, then the alleviation of poverty depends primarily on the removal of these deficiencies. Here lies the reason why development cannot be an act of creation, why it cannot be ordered, bought, comprehensively planned, why it requires a process of evolution. Education does not "jump"; it is a gradual process of great subtlety. Organization does not "jump"; it must gradually evolve to fit changing circumstances. And much the same goes for discipline. All three must evolve step by step, and the foremost task of development policy must be to speed this evolution. All three must become the property not merely of a tiny minority, but of the whole society.

If aid is given to introduce certain new economic activities, these will be beneficial and viable only if they can be sustained by the already existing educational level of fairly broad groups of people, and they will be truly valuable only if they promote and spread advances in education, organization, and discipline. There can be a process of stretching--never a process of jumping.

If new economic activities are introduced which depend on special education, special organization, and special discipline, such as

are in no way inherent in the recipient society, the activity will not promote healthy development but will be more likely to hinder it. It will remain a foreign body that cannot be integrated and will further exacerbate the problem of the dual economy.

It follows from this that development is not primarily a problem of economists, least of all for economists whose expertise is found on a crudely material philosophy. No doubt, economists of whatever philosophical persuasion have their usefulness at certain stages of development and for strictly circumscribed technical jobs, but only if the general guidelines of a development policy to involve the entire population are already firmly established.

The new thinking that is required for aid and development will be different from the old because it will take poverty seriously. It will not go on mechanically, saying: "What is good for the rich must also be good for the poor." It will care for people--from a severely practical point of view. Why care for people? Because people are the primary and ultimate source of any wealth whatsoever. If they are left out, if they are pushed around by self-styled experts and high handed planners, then nothing can ever yield real fruit.

AREA MEASUREMENT, PACING, COMPASS USE

Total time      3 hours

Goals

- o For the trainees to learn how to measure an area,
- o For the trainees to learn how to pace,
- o For the trainees to learn how to use a compass,
- o For the trainees to calculate an area's dimensions.

Overview

In this session, the trainees learn about land measurements, methods of measuring, instruments to use in measuring and how to calculate the area measured.

Exercises

1. Pacing
2. Compass
3. Simple Traverse
4. Simple Calculations

Exercise 1      PacingTotal time      30 minutesObjective

- o To teach the trainees how to measure distance by pacing.

Overview

Pacing, if done correctly, can be used to get good distance measurements. The technical trainer instructs the trainees in the method of pacing and how to measure distance by pacing.

ProceduresTime

15 minutes

Activities

1. The technical trainer lectures on pacing and gives instructions in the use of a pacing stick (lecture follows, post on newsprint).

15 minutes

2. The trainees determine their pace and make a pacing stick for themselves.

## Pacing

Pacing, if done correctly, can be used to get good distance measurements.

Methods for developing pacing skills:

1. Lay out a base line 20 meters long,
2. Walk naturally along base line to determine how many paces you take for 20 meters (1 pace = 2 steps),



(Fig. 34)

3. Cut a stick the length of your pace,
4. On flat ground you can pace naturally keeping track of every 20 meter interval,
5. On slopes you can use your stick to measure your horizontal pace.

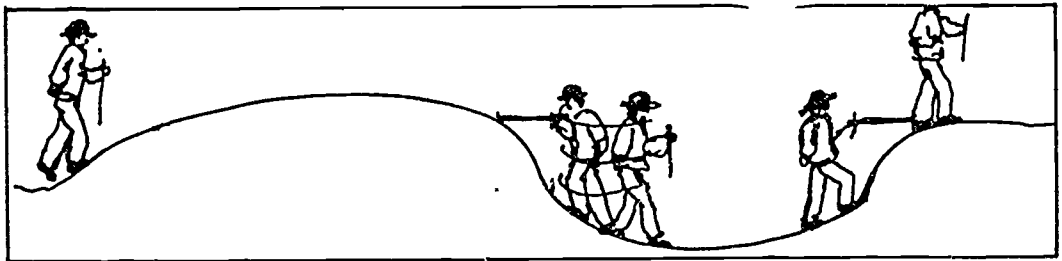

(Fig. 35)

### Pacing Examples

1. My pace: 2 steps = 1.6 meters,  
(My stick is 1.6 meters long),

My pace for the 20 meter baseline = 12.5 paces,

62.5 paces = 100 meters.

2. When actually pacing an unknown distance, put out a finger, or pick up a stone or stick to keep track of every 20 meter segment. Total distance can easily be calculated in your head.

You have the man move up or down the slope until you see the mark through the sight. He puts a stake in that spot, and then moves to the next mark. Fairly soon, you will have stakes all along the contour of the slope for that particular terrace.

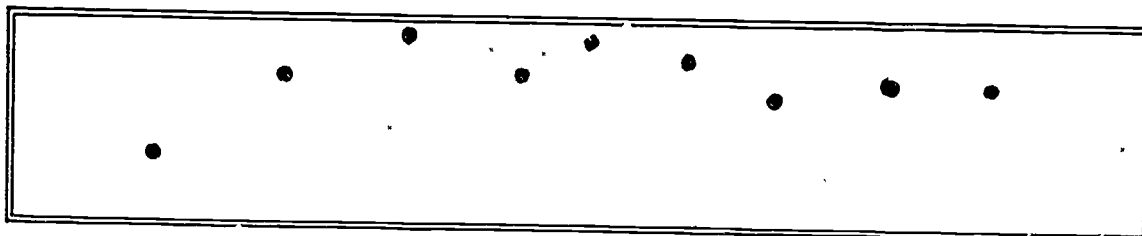

(Fig. 36)

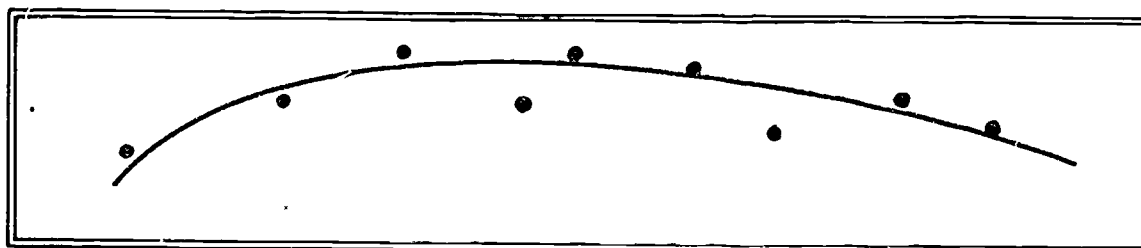

(Fig. 37)

All of these points are ten meters apart. You want to make an average line from these points (stake markers) since a jagged line would be difficult with which to work. Further, puddles of water would gather in the pockets.

**Example:** At the end of an unknown segment, I have 3 stones in my hand and 4 paces more.

3 X 20 meters = 60 meters

4 X 1.6 approx. equals 4 X 1.5 = 6 meters

Total Distance = 66 meters

**Trainer's Note:** Although pacing is not widely used in the U.S., it is desirable for PCVs to know this method for use in developing countries and to be able to teach the same.

Exercise 2      CompassTotal time      30 minutesOverview

Some of the participants will not have been instructed in the use of a compass. Those who know how to use a compass will assist other trainees in learning to use it.

ProceduresTime

15 minutes

15 minutes

Activities

1. The trainer lectures on the use of a compass. On newsprint, show the Azimuth compass, Quadrant compass and the European compass and their use.
2. The trainees who do not know how to use compasses practice aided by the trainees who know how to use them.



EUROPEAN COMPASS - Circle divided into 400 grads  
Special tables are needed for computations

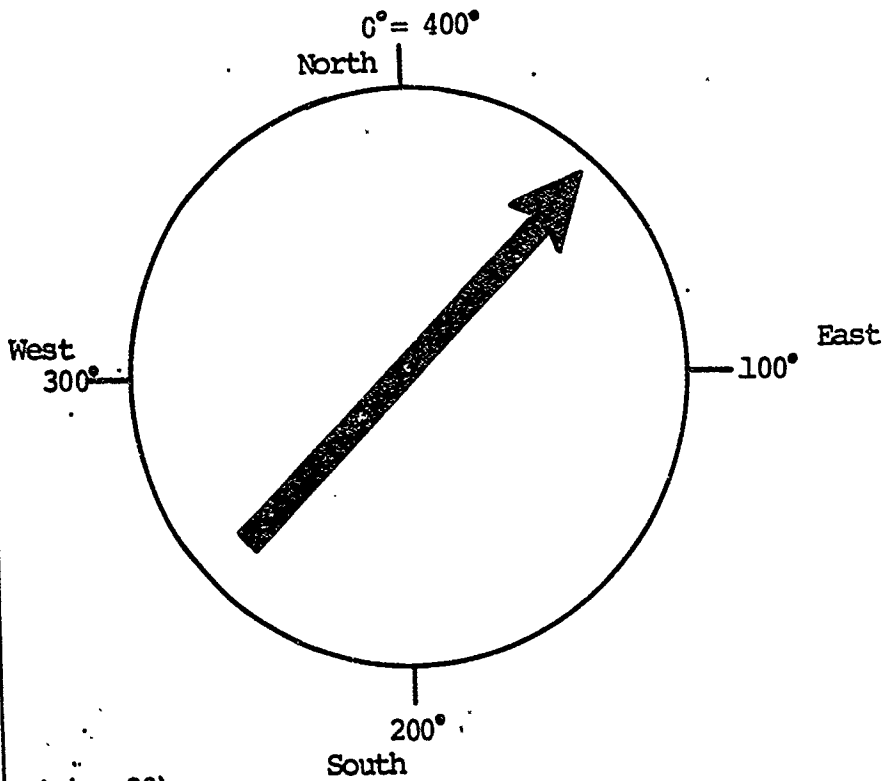

(Fig. 38)

Using the Compass (SILVA TYPE)

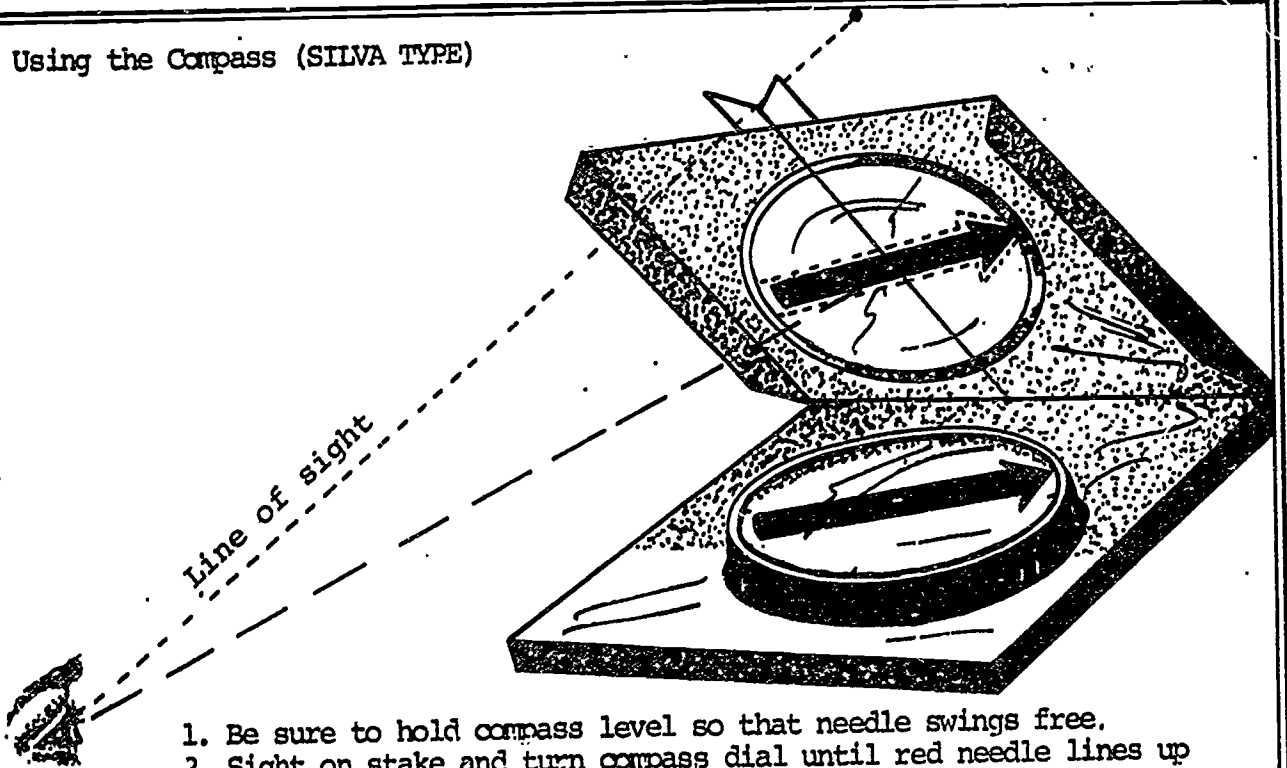

1. Be sure to hold compass level so that needle swings free.
2. Sight on stake and turn compass dial until red needle lines up parallel to black arrow.
3. Read bearing on dial.

(Fig. 39)

**COMPASS**

(Compass - Instrument for drawing circles.)

AZIMUTH COMPASS

Compass circle is graduated from  $0^{\circ}$  to  $360^{\circ}$ , reading clockwise.

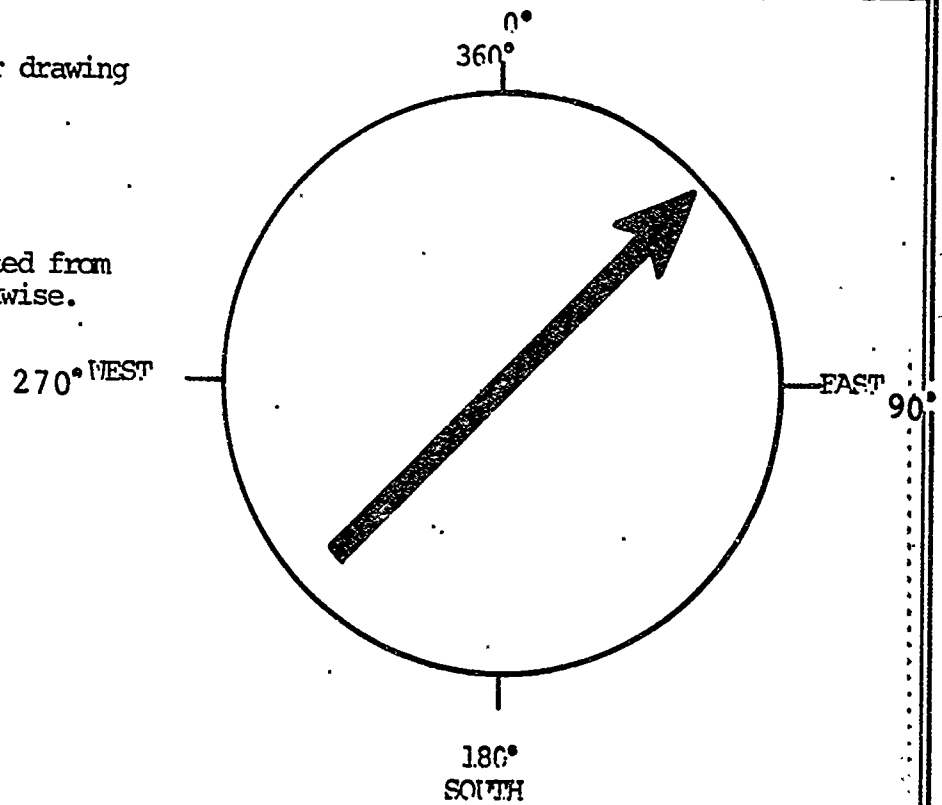

(Fig. 40)

QUADRANT COMPASS - Compass circle broken into four  $90^{\circ}$  quadrants reading from north to east or west, and from south to east or west.

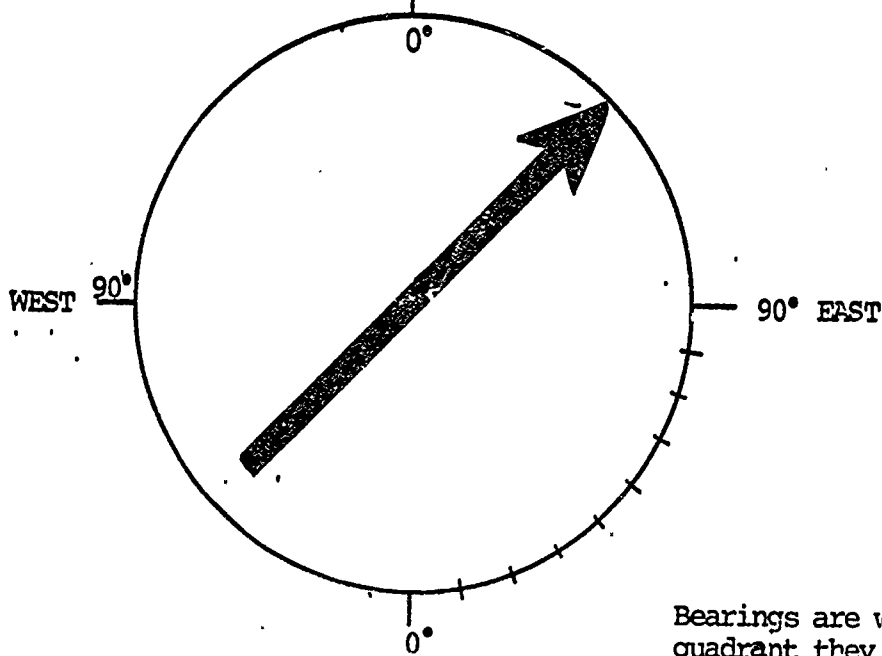

Bearings are written according to which quadrant they fall into:

e.g., S- $20^{\circ}$  E, N- $35^{\circ}$  W, N- $50^{\circ}$  E, S- $10^{\circ}$  W

DISADVANTAGES: Quadrants can be confused.

(Fig. 41)

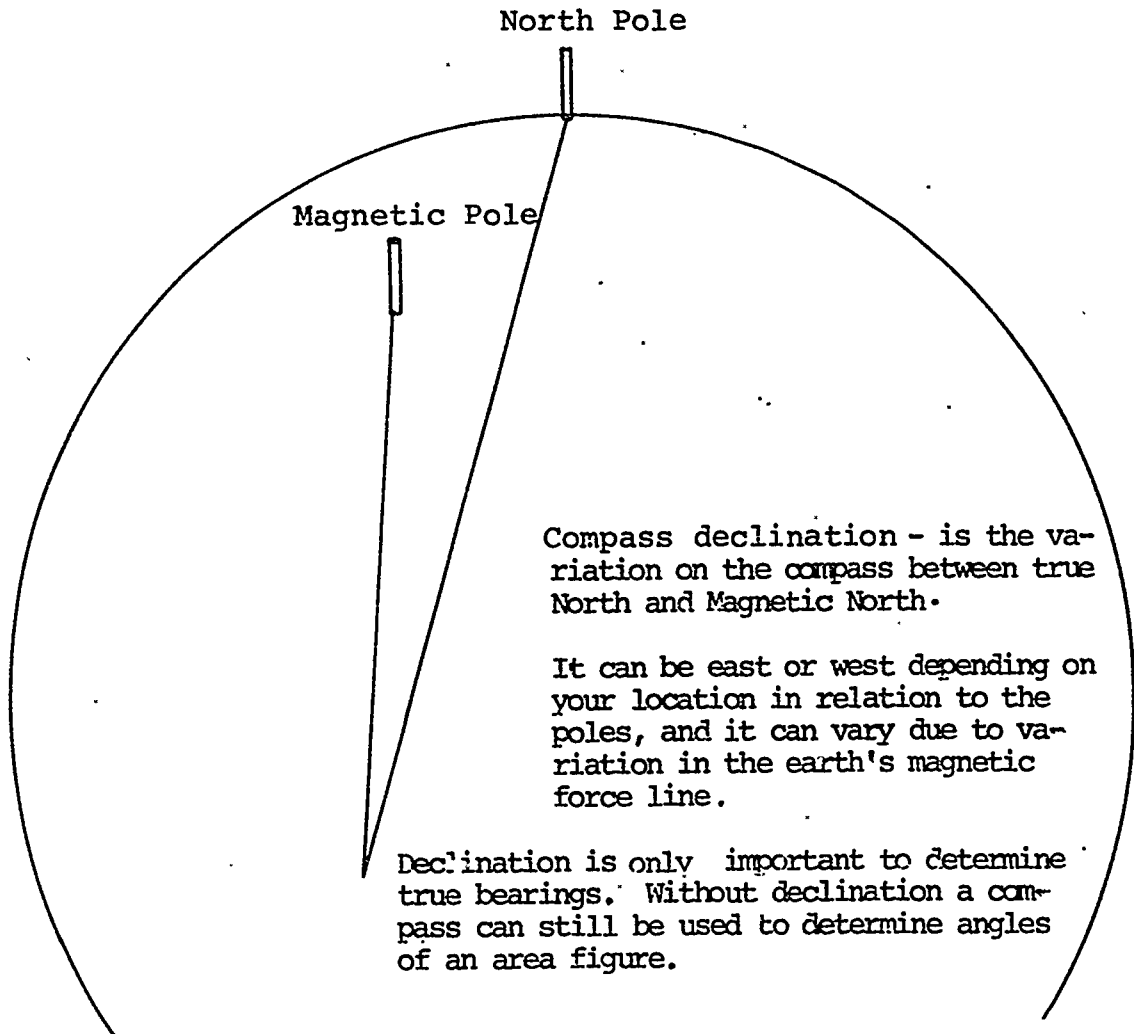
COMPASS DECLINATION

(Fig. 42)

Exercise 3      Simple TraverseTotal time      1 hourOverview

This exercise gives the trainees a chance to use pacing skills and a compass to run a simple traverse.

ProceduresTimeActivities

30 minutes

1. Prior to this session, the technical trainer stakes an area on which the trainees practice. The technical trainer uses flags to mark points. The area selected should have some steep slopes.
2. The trainees are divided into groups with at least one forester trainee in each group.

30 minutes

3. The trainees run a traverse using a hand compass and pacing.
4. Upon completion of traverse, the trainees plot the area on graph paper and calculate the area.

Area to be traversed with hand compass and pacing. Information to be used to calculate area in hectares.

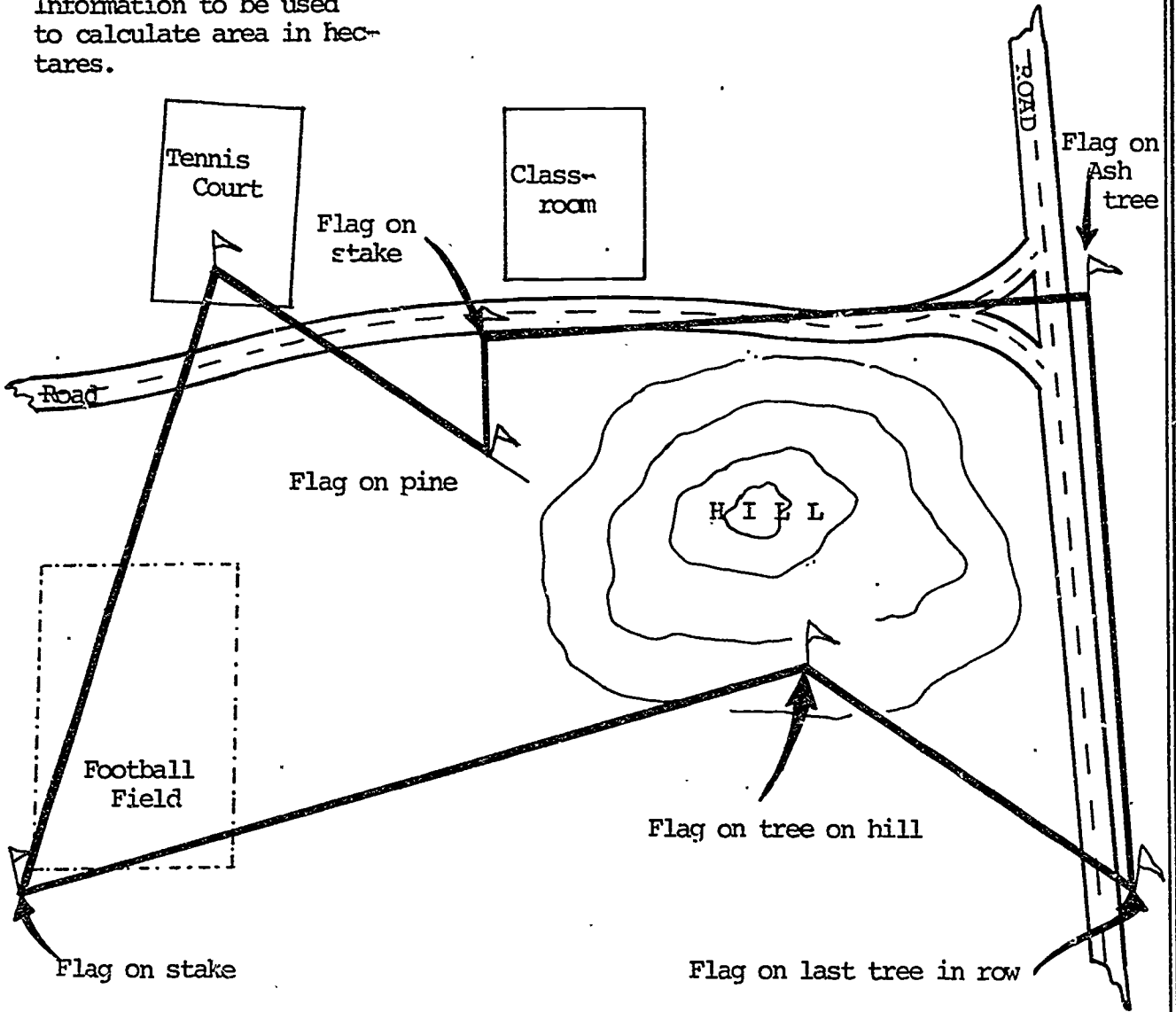

(Fig. 43)

Exercise 4      Simple CalculationsTotal time      1 hourOverview

In this session, the trainees learn a simple method of determining approximate land areas.

ProceduresTimeActivities

1. The technical trainer lectures on area calculations and posts the following on newsprint.
  - A. Plot a traverse to scale on sheet,
  - B. Break down the traversed figure into right triangles and/or rectangles,
  - C. Calculate each area in right triangle and/or rectangle,
  - D. Divide by 10,000 to get hectares,

Area Formulae

Area of right triangle =  $\frac{1}{2}(\text{base})(\text{height})$   
 Area of rectangle =  $(\text{base})(\text{height})$

(can check by counting squares on graph paper).

2. The technical trainer continues with lecture on area traverse record keeping. Displays the following example.

EXAMPLE OF CALCULATING AREA BY BREAKING AREA FIGURE  
INTO RIGHT TRIANGLES

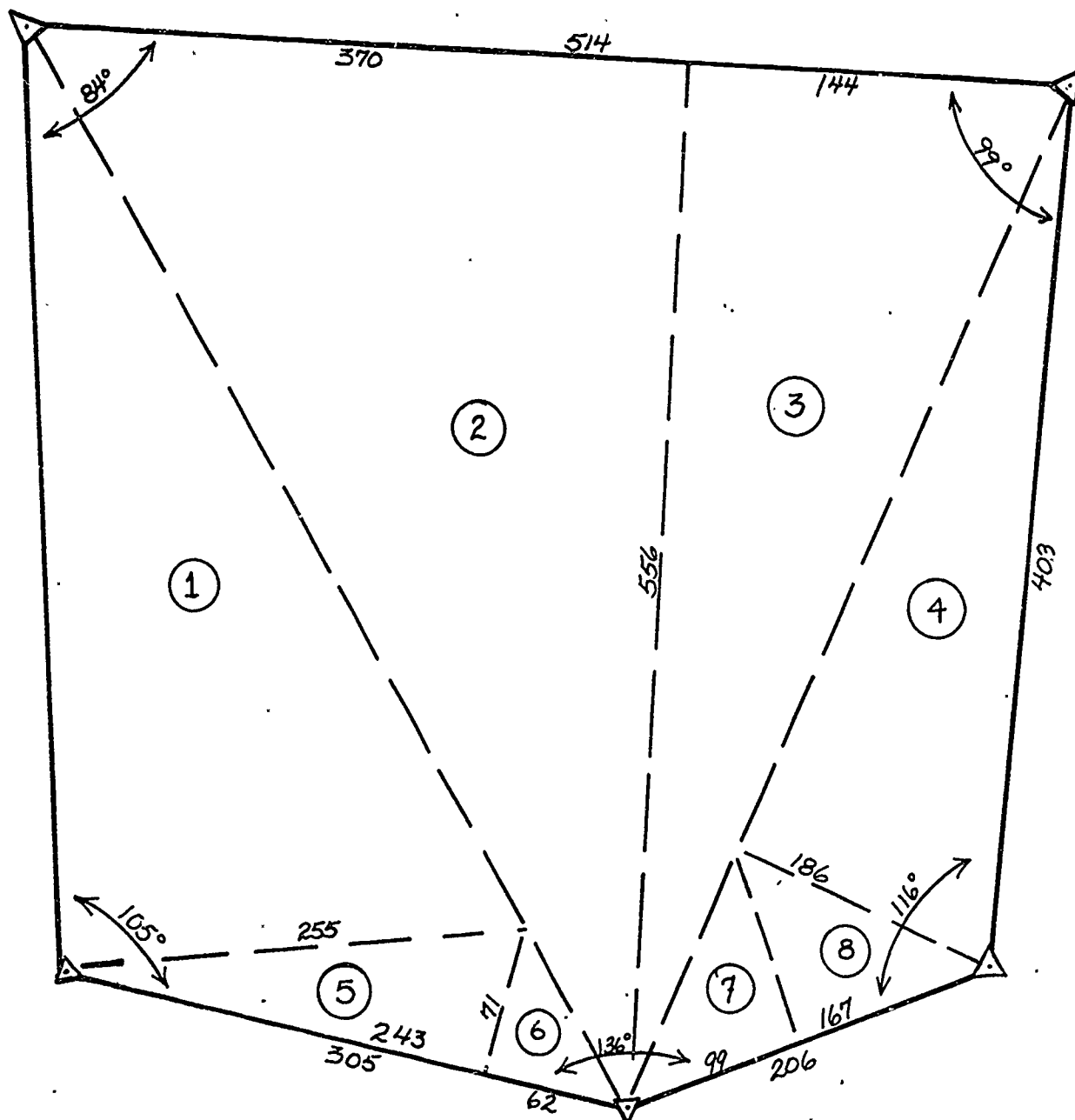

Draw traversed figure to scale on graph paper. Break into triangles and scale off distances.

$$\begin{aligned}
 1. & \frac{1}{2} (512) (255) = 65,280 \text{ m}^2 \\
 2. & \frac{1}{2} (310) (556) = 86,180 \\
 3. & \frac{1}{2} (144) (556) = 40,032 \\
 4. & \frac{1}{2} (186) (408) = 37,944 \\
 \text{TOTAL AREA} & = 251,314 \text{ m}^2
 \end{aligned}$$

$$\begin{aligned}
 5. & \frac{1}{2} (71) (243) = 8,505 \text{ m}^2 \\
 6. & \frac{1}{2} (62) (71) = 2,201 \\
 7. & \frac{1}{2} (99) (84) = 4,158 \\
 8. & \frac{1}{2} (84) (167) = 7,014
 \end{aligned}$$

$$\frac{251,314 \text{ m}^2}{10,000 \text{ m}^2/\text{ha}} = 25.13 \text{ hectares}$$

(Fig. 44)

Area Traverse

Keeping records - what, again?  
Field book traverse records

Sta	Dist	Bearing
1	401	580°E (100°) B.S. N80° (265°)
2		585°W B.S. N86°E (265°)
3	326	N 10°E B.S. S11°W (10°)
1	189	

(Fig. 45)

Field Sketch

Hypothetical Data Sheet

Date: November 18, 1981

Weather: Clear

Crew: Mohammed Bah  
Peter, PCV  
Flomo Garteh

Tools: Hand Compass &amp; Pacing Stick

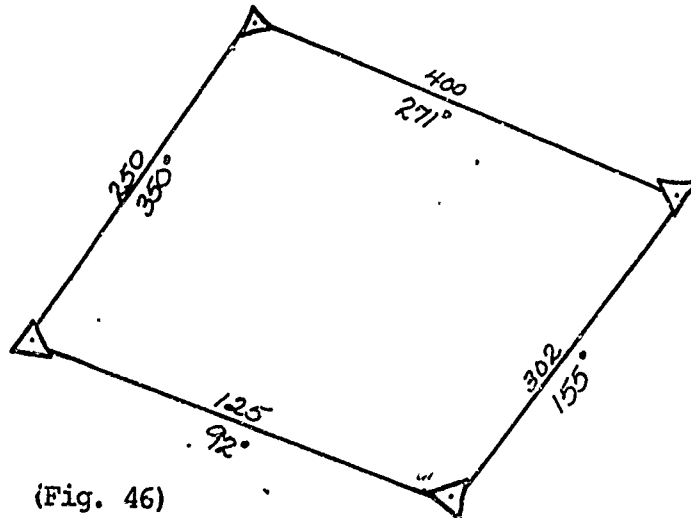

(Fig. 46)



3. The technical trainer checks each group's area map, calculations and traverse.

**Trainer's Note:** While the technical trainer works with one group at a time the other groups use a rustic transit. This gives everyone time to practice. This is also a time to observe how well forester trainees are able to transfer skills, explain, have patience, etc., with generalist trainees. Record these observations because you will want to give forester trainees feedback during the interview on their performance.

COMPOST HEAP - GREENHOUSE CONSTRUCTION - GERMINATION PERCENTAGE

Total time      2 hours

Goals

- o To observe the results of the compost heap prepared the first week,
- o To use compost as top dressing (mulch in nursery),
- o To learn how a greenhouse is constructed and used,
- o Presentation of the results of the germination project.

Overview

During this session, two unrelated technical forestry exercises are undertaken; the compost heap started in week one is now ready for use and the greenhouse constructed during the first week of training is explained.

Exercises

1. The Compost Heap
2. Greenhouse Construction
3. Determining Percent Germination

Materials

Flip charts, marker pens, tape, compost heap (four weeks +), clear glass bottles (four ounces and under), alcohol, plastic bags (hand size), one greenhouse.

Exercise 1      Compost HeapTotal time      1 hourOverview

Composting is any process which facilitates or increases the speed of the natural break-down process of decomposition. One of the trainees who has started a compost heap in the first days of training presents a lecture. The trainees go to the compost heap. Using compost as mulch for the seedlings, the trainees spread it on seed beds.

ProceduresTimeActivities

30 minutes

1. The trainee who has started the compost heap as a special project gives a lecture on starting compost heap. He/she answers questions from other trainees (See "The 30 Day Hot Compost System").

30 minutes

2. The trainees go to the compost heap and, if ready, use it as mulch for the seedlings that were planted during the first week.

### THE 30 DAY "HOT" COMPOST SYSTEM

Composting is any process which facilitates or speeds up the natural breakdown process of decomposition. There are many forms of composting; some involve combining many types of materials that require long periods of time to break down. Times vary from three weeks to several years. The method that will be covered here is a 30 day or "Hot Compost" method. This is a system using high temperatures (up to 170°F) and frequent turnings to achieve a fast, usable compost in 30 days. Several advantages to using Hot Compost include:

1. High temperatures eliminate weed seeds, disease and insect eggs,
2. Quick usable compost is available in just 30 days.

Many believe that composting is a complicated and time-consuming process. This belief can be overcome if a couple of basic principles are understood.

1. A hot compost has to be properly mixed with the correctly matched materials. While putting together a compost pile, a helpful guideline to remember is the "Carbon:Nitrogen" ratios. The Carbon:Nitrogen ratio is the amount of brown or dried stalky materials (carbon source) that are mixed to the amount of green leafy or fresh materials (nitrogen source). A well balanced compost pile usually has a Carbon:Nitrogen ratio of 1:12 (1 part carbon to 12 parts nitrogen). It is important to maintain this ratio because a pile with too much carbon containing materials and not enough nitrogen will not achieve the 170°F temperature necessary for the compost. A pile with too large or a disproportionate amount of nitrogen means nitrogen lost needlessly to the atmosphere in the form of NO<sub>2</sub> gas (ammonia). Organic materials high in nitrogen are any type of fresh green material (i.e., fresh grass clippings, fresh young weed cuttings, etc.) or any type of animal manure; the best or "hottest" is chicken manure. Another source is kitchen scraps: coffee grounds or waste seeds (i.e., grape seed are especially hot). Materials high in carbon are usually brown dried plant materials (i.e., leaves, dried grass or straw, dried weeds, saw dust or wood shavings, etc.).
2. Watch compost pile temperatures. Get a good soil thermometer to measure temperatures. One with a long stem is the most useful. A good pile will heat up to 110°F within 24 hours of being mixed. Within three days it should be 125°F. If it does not heat within the first three days, take it apart and start over. Each time the pile temperature begins to drop (every four to five days), it will be time to turn and mix the pile again. After a while the pile will not heat more than 100-110°F no matter how much you mix it. At this point the compost can be used as is or may be left until it achieves a fine and easily crumbled texture.

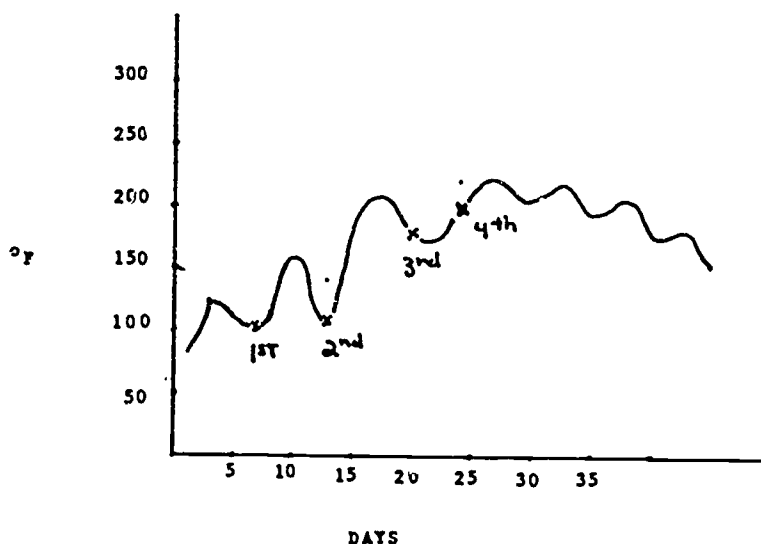

(Fig. 47)  
TURNING THE COMPOST HEAP

3. TURNING THE PILE. The first turning is the heaviest and most time-consuming. If it is done correctly, the rest will be easy. Once the pile is put together and has heated correctly to 120°F or so, it might maintain this temperature until day five or six then begin to drop. At this point, take a pitch fork and move the pile. While rebuilding it, mix all the materials that were on the outside into the center of the pile, so that they will heat. Also break large pieces of organic material with a machete so that they will be broken down quickly. After this first turning, the mixing should not involve anything more than half an hour of tossing the pile from one spot to another with a pitch fork and shovel.
4. Think about the amount of moisture percentage in the pile while you are putting it together. Sometimes a pile will not need any water other than the natural moisture contained in the compost material. Fresh green materials (grass clippings) are an example. A good rule of thumb for determining the correct moisture content in the pile is that the material should feel like a squeezed out sponge. It should not, however, release water if squeezed very tightly. If water is required, it should be judiciously applied to each layer as the pile is being built, rather than watering it from the top after the pile is put together. Remember: too much water can drown a pile and not enough water can retard bacterial growth so the pile will not heat.
5. AIR. Composting is an aerobic process. Soil microbes need oxygen to develop. Try to avoid building the pile higher than four feet, otherwise poles layered horizontally in the pile will be required to aid air circulation. Care should also be

taken while building the pile to ensure that fine materials (i.e., grass clippings) are not layered too thickly, to prevent matting which will form a barrier to air circulation.

6. PUTTING IT ALL TOGETHER. Start the pile with a five inch thick layer of leaves to provide good drainage. The next layer should be two inches of grass clippings, loosening it to keep it from matting. On top of this sprinkle a mixture of topsoil and organic material. This will increase the nitrogen content and inoculate the pile with soil microbes (the power house of the compost pile). If kitchen scraps are available, they can also be added here. Water each layer lightly - if needed. Now repeat the whole process until all your materials are used.

Composting is the backbone of my nursery and home garden. Once you begin to use it, it becomes invaluable. Be patient. I have yet to meet the person whose first pile heated properly. With time and practice, you can expect much in return for a small investment.

Exercise 2      GreenhouseTotal time      30 minutesOverview

The trainee for whom this is a special project, shows the other trainees how a greenhouse is constructed and its use.

ProcedureTimeActivity

1. The trainee explains greenhouse construction and use.

GREENHOUSE INSTRUCTIONS

Cold frame/hot house

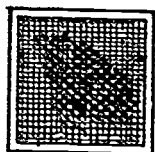

Screens to add more shade and protection from birds.

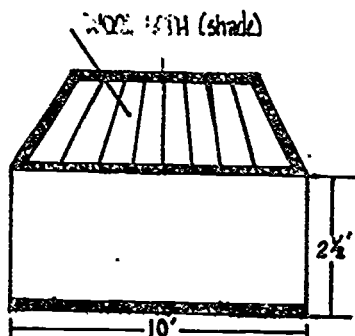
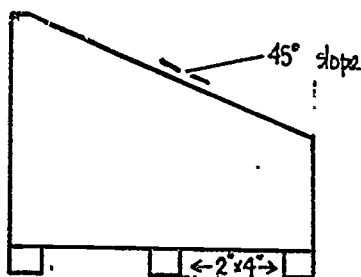
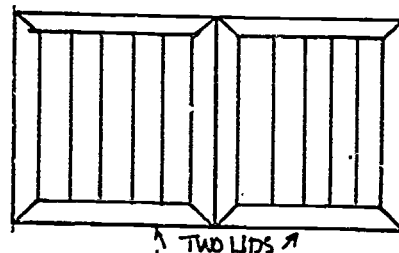
Front viewside viewtop view

(Fig. 48)

This type of greenhouse has many advantages; it is portable, retains heat during cold periods (only when lids are covered with clear plastic), and provides protection from animals.

Materials

Plywood or any scrap wood for sides and bottom will work, 2" X 4"(s) for frame, 1" X 2" for lids, and wood lath to add shade. Screens may also be used for more shade and protection from birds.

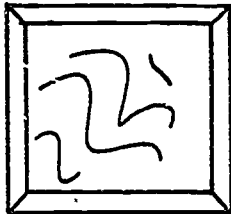

Other Easier DesignsEarth greenhouse (Fig. 49)Top view

← PLASTIC WINDOW

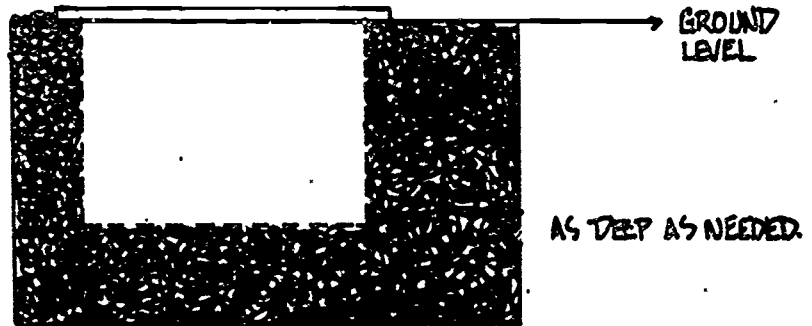
side view

This type of greenhouse is easy to install. It is usually cooler in the summer. During the summer months if there is wood lath or screen, it will allow heat to escape and add more shade. During the cold seasons, plastic retains the heat.

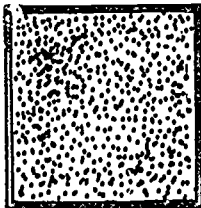
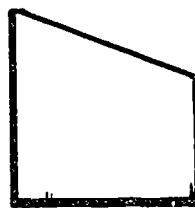
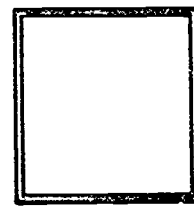
Five sided greenhouse (Fig. 50)Top viewfront viewside viewbottom view

As large as you want...

This type is very simple - make a frame then put plastic on all sides and top leaving bottom open; place over pots, seed beds or wherever you want to grow plant(s).

Exercise 3      Determining Percent Germination

Total time      30 minutes

Overview

The trainee for whom this is a special project shows the other trainees the results of the trainees' germination projects from week one.

## DETERMINING PERCENT GERMINATION

When working with seeds from an unknown or little known source, a germination test is often a helpful guide in determining planting techniques and pretreatment methods. The percentage of germination will provide information for planning on the amount of seed needed to establish a particular species.

### Procedure

Two seed species were studied. Since this experiment was a general study of germination, scientific names were not necessary to differentiate between the two seed species. The "Big Seeds" were wrinkled, whitish and hard-coated. The "Little Seeds" were smooth, black and had a thin shell-like seed coat. Because the seed types were so varied, a variety of pretreatments were used to find a most effective means of germination.

After pretreatment, the seeds were placed on moist paper towels in plastic bags for approximately five days. Average high temperature was about 90°F during the day and average low temperature about 75°F at night. Approximately 14 hours of indirect light were provided. Seeds were observed daily until no new germination occurred.

### Data Calculations

Germination percentage was calculated as follows:

$$\% \text{ germination} = \frac{\# \text{ of seeds germinated}}{\# \text{ of seeds treated}}$$

Percent germination was determined for each particular pretreatment used. Results were then graphically displayed. (See following page)

### Analysis and Conclusions

From the graph, Percent Germination for "Big Seeds" the pretreatment or scarification with two hour soaking appeared to be the most effective. Without scarification, soaking alone reduced percent germination lower than that of control (untreated) seeds. Scarification increased percent germination even without soaking. Clipped seed coats and scarified seeds with a relatively short cold treatment also had a higher germination than untreated seeds.

Clipped seed coats treatment was also quite effective in increasing percent germination for the "little seeds". Unlike the "big seeds", fewer generalizations were possible in analyzing the results displayed on the graph, Percent Germination for "Little

PERCENT GERMINATION FOR "BIG SEEDS"

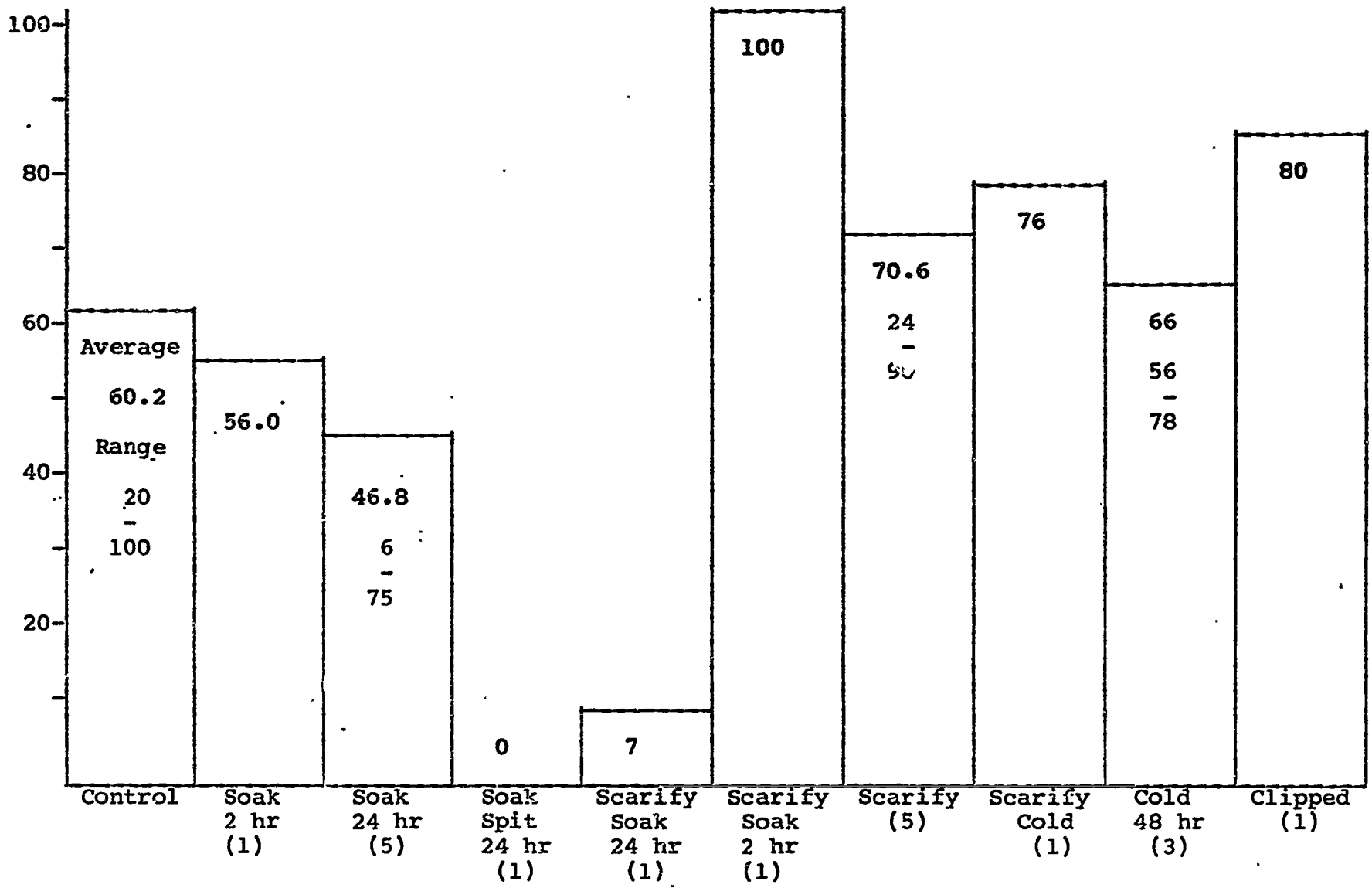

(Fig. 51)

PRETREATMENT

PERCENT GERMINATION FOR "LITTLE SEEDS"

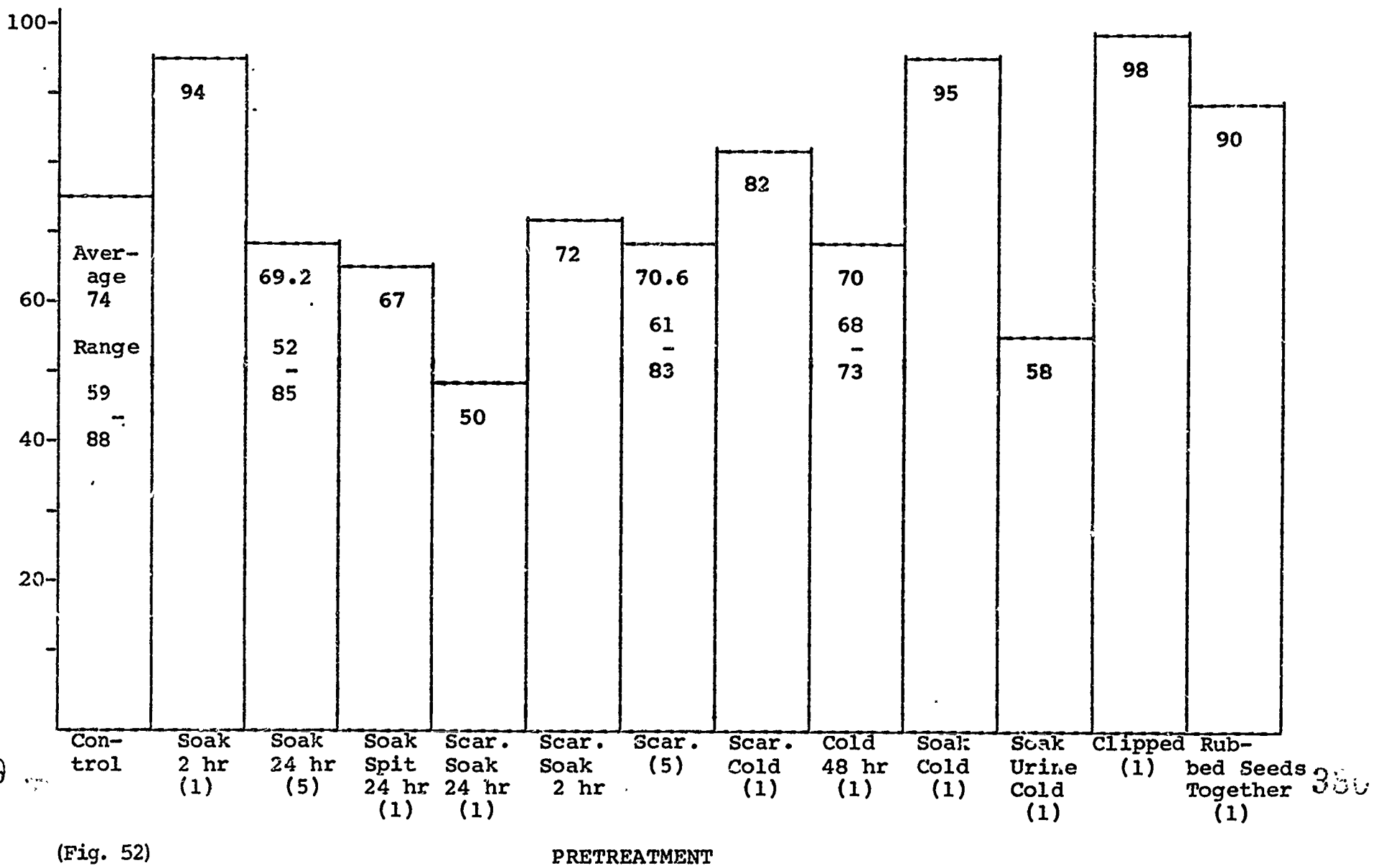

379

380

(Fig. 52)

PRETREATMENT

seeds". A two hour soaking and a soaking with short cold treatment increased percent germination over that of the control group. However, longer soakings and soakings with scarification reduced germination. Since clipped seed coats and seed coats rubbed together increased germination more than seeds scarified with emery paper, the exact method of scarification was detrimental in percent germination.

Although a study such as this one can provide the "researcher" with information on how to pretreat seeds and how many to plant, there are many other factors which must be considered before actual planting takes place. More specifically, in this particular study seven separate groups were conducting individual germination tests. As shown on the graphs, ranges of results for the same treatment were often quite great. An example is the control group of "big seeds" where percent germination ranged for 20 to 100%. Many variables could have caused such differences in germination: moistness of paper towelling, sealing or not sealing bags, duration of study, methods of counting, and definition of "a germinated seed". There were most likely other factors within a group which affected the outcome.

Improvements in the consistency of this study would aid application in the field. If conducted by a single person, methods can be pretty uniform. Ground rules as to counting, maintenance, pretreatment, duration, etc. must be made, however, regardless of the number of "researchers". Also, important to remember, actual environmental conditions in the field can vary; germination test results might disagree significantly with field results.

CULTURE SHOCK

Total time      2 hours

Goals

- o To help prepare the trainees for the usually difficult adjustment to another culture.

Overview

In the process of getting the trainees ready for volunteer service and with the realization that many of the participants will in a few weeks be alone for the first time in their project sites, we once again review the process of culture shock.

Exercise

1. Culture Shock - Are We Ready for It?

Materials

"The Culture Shock Process" flow chart.

Exercise 1      Culture Shock - Are We Ready For It?Total time      2 hoursProcedure

<u>Time</u>	<u>Activities</u>
10 minutes	1. The trainer gives a brief introduction and reviews the goals. He/she reminds the trainees that this subject has been covered before but now they are almost ready to go to their sites for two years of volunteer service. We should then review the following stages.
10 minutes	2. The trainer, using the following diagram posted on newsprint, asks the trainees to break into groups of five or six and discuss each stage. They should discuss the following:
10 minutes	A. Ways to cope with the problems in stage two,
10 minutes	B. Feelings that will be generated during stage three,
10 minutes	C. The inevitable reactions in stage four.
20 minutes	3. The trainer distributes to the group the fears and hopes form, and they make a list of fears and hopes.
20 minutes	4. The trainer distributes a "check list" for fears and hopes. The trainees discuss their lists using the check list.
15 minutes/group	5. Each group is asked to prepare a statement to give to the large group. This presentation should include highlights of the small group discussion and points they would like to stress.



15 minutes

6. The trainer summarizes the exercise. He/she picks up points that have been raised during the presentation and may add some of his/her own experiences which are appropriate to alleviate fears that have been raised.

THE CULTURE SHOCK PROCESS

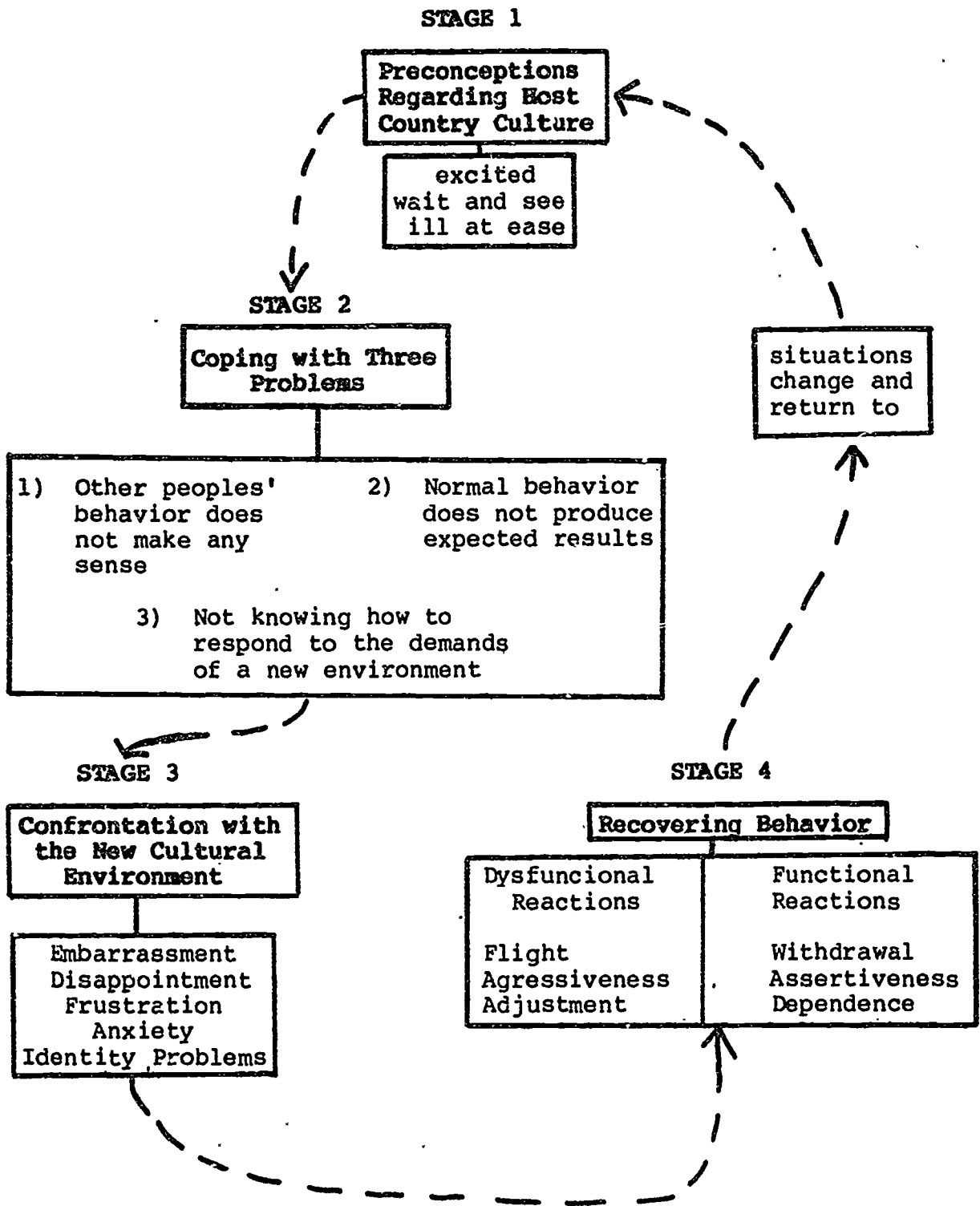

((Fig. 53)

CHECK LIST FOR FEARS AND HOPES

1. Are the fears and hopes realistic or not? (Let's find out through concrete examples.)
2. What are the cultural dimensions of each fear and hope? (From where are those fears and hopes coming?)
3. What can be done to overcome the fears if necessary and build upon the hopes?
  - a. The anticipated negative responses from others: are they real or imaginary?
  - b. The obstacles which prevent the implementation of what people wish to do but do not do.
  - c. The required modifications for making the ideas acceptable?

FEARS

1. To fail
2. To be misunderstood
3. To hurt people
4. To lose face
5. To be rejected

Others

HOPES

1. To learn something
2. To grow from the experience
3. To adjust
4. To help others
5. To be successful

Others

RANGE MANAGEMENT

Total time      2 hours

Goals

- o To introduce the trainees to the concepts of range management.

Overview

In this session the trainees are introduced to the concepts of range management. An outside speaker covered this area in the pilot project.

GRAFTING AND FRUIT TREES

Total time      3 hours 30 minutes

Goals

- o To acquaint the trainees with fruit tree care and grafting techniques.

Overview

Foresters are often expected to be experts in all trees including fruit trees. As it is important to be knowledgeable on fruit tree culture, this session is devoted to grafting and fruit trees.

Exercise

1. Fruit Trees and Grafting Practice

Materials

Fruit trees for pruning, grafting, sharp knife, sharpening stone, plastic tape (grafting tape), bees wax.

Exercise 1      Fruit Trees and Grafting PracticeTotal time      3 hours 30 minutesOverview

In this exercise the trainees learn about fruit trees and fruit tree reproduction.

ProceduresTime

3 hours 30 minutes

Activities

1. The trainer gives the following lecture on fruit trees.

## FRUIT TREES AND FORESTRY

### Grafting and Fruit Trees

Foresters are often expected to be experts in all kinds of trees including fruit trees - so it is important to be aware of some of the basics of fruit tree culture.

- I. Differences between forestry for wood products and for fruit:
  - A. Fruit trees are short term, usually with an annual production cycle;
  - B. They require intensive cultural practices; fertilization, pruning, grafting, disease and pest control,
  - C. In summary, fruit trees are domesticated trees needing a series of special treatments.
- II. Critical cultural practices in detail
  - A. Pruning
    1. Specific systems vary according to the crop,
    2. Some basic rules are generally valid:
      - a. There should be a space for every branch and a branch for every space.
      - b. Watch the timing - Prune generally during the lowest growth period (dormancy) of the tree.
      - c. Prune with clean cuts so that the tree can heal with no projecting stumps so that rain will collect in the cut.
  - B. Grafting
    1. What is grafting?
      - a. Grafting is the union of the cambium layers of a parent tree (stock) and a desired variety (scion) in such a way that the two form a solid, growing unit.
      - b. The continued growth from the scion is true to the scion's characteristics and is not a combination of stock and scion.
      - c. It is essential to protect grafts of all types with wax and/or by wrapping to prevent drying or mechanical damage.

2. Why graft?
  - A. Graft to achieve the desired variety of fruit with root stock adapted to local conditions,
  - B. Graft to gain time by multiplying a desired variety faster than plants from seeds,
  - C. Graft to assure genetic purity,
  - D. Graft to have several varieties on one tree for pollination purposes,
  - E. Graft for repair purposes; it renews an old tree or repairs girdled trunks from rodents or mechanical damage.
3. When to graft? - Beginning of the growth period.
4. What are the types of grafting?
  - a. Top working - renewing of a tree
    - o Cleft graft,
    - o Whip graft,
    - o Bark graft.
  - b. Repair
    - o Bridge graft.
  - c. Budding
    - o Most practical and reliable,
    - o Demonstrations and practice of cutting bud shields,
    - o T-cuts, inserting, and wrapping.

3 hours

2. The trainer demonstrates grafting techniques and the trainees practice techniques.

**Trainer's Note:** During the pilot we were able to arrange for some of the trainees to observe beekeeping during this same time. We gave the trainees the choice between fruit tree grafting and beekeeping.



PROFESSIONAL APPROACHES TO INTERACTION WITH HOST COUNTRY OFFICIALS

Total time 1 hour 30 minutes

Goal

- o To help the trainees assume a professional demeanor when interacting with host country officials.

Overview

In this session the trainees will practice interacting with host country officials in a professional manner.

Exercise

1. Role Play

Materials

Flip chart, marker pens, tape, newsprint.

"When you cross the Atlantic or Pacific or even our southern border, you undergo a transformation. You become a foreigner. It is imperative to display your best manners and make a favorable impression on those you meet, because you have also gained new importance. You are now an ambassador of the United States and it is not inconceivable that your personal conduct may influence international understanding."

Eleanor Roosevelt

Exercise 1      Role PlayTotal time      1 hour 30 minutesOverview

Through a series of role plays and the processing of those role plays, the trainees will come to understand the importance of interacting professionally with host country officials.

ProcedureTime

1 hour 30 minutes

Activities

1. The trainer introduces a series of role plays and the trainees take the roles of Volunteers to practice professional interactions.
2. The important part of this exercise is the processing.

**Trainer's Note:** Role plays that follow are samples. You may want to write your own based upon actual people.

Role Plays

1. Trainer - Official is pro-United States, and anti-communist. He is in favor of the United States invading Cuba, Nicaragua etc., to stop the spread of communism. He sees PCVs as anti-communist and criticizes the United States for its weak foreign policy (does not bomb Cuba, etc.).

PCV Volunteer - this is your first visit to the forestry official who will be your contact for your job.

2. Trainer - Official is leftist. The United States is inflicting misery and capitalism on poor people in Third World countries. The United States is sending PCVs to Third World countries as spies to influence public opinion in those countries. (Peace Corps and the CIA are part of the State Department).

3. PCV & 2 Trainers The counterpart and PCV arrive at the Forestry Office. The counterpart and forestry official are old friends with family ties, etc. The PCV is completely ignored.

4. 2 Trainers An established PCV arrives at the forestry office. He has been working for two years with the Forestry official and is good friends with him. The Forestry official lets it be known that he is worried about the new PCV who is quiet, immature, and speaks little French or local dialect.

5. Trainer & PCV - A female PCV visits the forestry official. He makes pass at PCV trying to get her to meet him later, going to dance or dinner together.

6. Trainer & PCV - The PCV visits forestry official for the first time. The forestry official is nice, very helpful and interested in the work plan of the PCV. He offers assistance and help in getting the PCV to work on the project.

7. Trainer & PCV - The PCV visits the forestry office for the first time. The forestry official is interested in agricultural crops and tries to exclude any reference to planting forest trees. He/she tries to get the PCV to help in planting potatoes and onions for forestry official's personal use.

PROJECT PLANNING: GOAL SETTING

Total time      4 hours

Goals

- To integrate the technical material, problems identified and personal learnings into a clarified set of personal and project goals and objectives,
- To write immediate and three month project goals,
- To identify and list the resources needed to accomplish goals,
- To identify personal learning goals for the next three months,
- To review learnings of and accomplishments in the last five weeks of training.

Exercise

1. Project Planning

Material

Flip charts, marker pens, tape.

**Trainer's Note:** You may want to suggest that the participants bring their journals to this exercise.

Exercise 1      Project PlanningTotal time      4 hoursOverview

In this session the trainees take the time to plan their projects and set their own goals. They integrate the training they have received, problems that have been identified and personal learnings. They will also examine the accomplishments they have made since the beginning of training.

ProceduresTimeActivities

- |            |   |
|------------|---|
| 15 minutes | 1. The trainer opens the session by explaining the goals of the session; making linkages to the prior sessions and stresses the role as a Volunteer. All the information they have gathered over the past five weeks is to be incorporated into a series of plans for the future.   |
| 15 minutes | 2. The trainer asks each person to review and list their major learnings during the training.   |
| 15 minutes | 3. He/she asks each person to review the learning goals they have set for themselves in Session 5 and record if they have reached these goals.  |
| 1 hour     | 4. He/she asks each person to then fill out the following matrix. He/she explains that the exercise has two parts. The first considers the specific Volunteer project assignment and the second asks people to set goals for personal learning or development. <ul style="list-style-type: none"> <li>A. Where would I like to be on my project in three months?</li> </ul> |

<u>Goals</u>	<u>To Do's</u>	<u>By When</u>	<u>Resources Needed</u>
--------------	----------------	----------------	-----------------------------

- B. Benchmarks (or milestones) - To reach my next three month goals, I plan to have accomplished the following in six weeks.

Objectives                      To Do's                      Resources Needed

- C. When I reach my site, I plan to do the following things first.

Goals                      To do's                      By when                      Resources Needed

1 hour

5. After the exercise is completed, the trainer asks the group to review the "goals", "to do's" and "resources needed" in pairs. He/she reminds the group that this is another opportunity to use their planning skills and apply them to this situation. Use the following questions.

- o Is the Plan realistic, feasible?
- o What will I do to measure success?

15 minutes

B R E A K

15 minutes

6. Personal learning/action goals: Ask each person to look over their journal entries and chart they made earlier and consider what they want to set as personal learning or action goals for the next three months.

30 minutes

7. When the list is completed, ask the group to return to the same pairs and review each person's plan. The group should be instructed to share only what they feel comfortable sharing. Some areas may be private.

15 minutes

8. Close the session by asking:
- o What have you learned from this process?
  - o Is there any unfinished business?
  - o Will you be able to apply these goals in your work with the community?

FINAL INTERVIEWS

Total time      2 hours

Goal

- o To conduct final interviews with the trainees.

Overview

This is the final interview with the trainees and the last chance for coaching. The trainees will definitely be praised for good work and positive skills.

ProceduresTime

2 hours

Activity

1. Same as the other interviews except the trainers may choose which trainees to interview. It is suggested that those trainers with whom the trainees identify most closely interview those trainees.

ECOLOGY TEAMS PRESENTATIONS

Total time      4 hours

Goals

- o For each team to give the presentations which they have prepared for use in their geographic area,
- o The trainers summarize ecological issues and discuss trade offs.

Overview

The objective of this session is to have trainees give a presentation concerning ecology that they would possibly give at their site. The trainer gives some of his/her own insights concerning ecology.

Exercise

1. Ecology Team Presentations; Trainer Responses

Materials

Trainees' previously-prepared ecology presentations.



GRADUATION

Total time      2 hours

Overview

During the pilot program, a Certificate of Completion of Training was awarded to the trainees by the University of Arizona.

ProceduresTimeActivity

1. To be arranged

**Trainer's Note:** We allowed the trainees to design their own graduation exercise.

Since 1961 when the Peace Corps was created, more than 80,000 U.S. citizens have served as Volunteers in developing countries, living and working among the people of the Third World as colleagues and co-workers. Today 6000 PCVs are involved in programs designed to help strengthen local capacity to address such fundamental concerns as food production, water supply, energy development, nutrition and health education and reforestation.

Peace Corps overseas offices:

<u>BELIZE</u> P.O. Box 487 Belize City	<u>FIJI</u> P.O. Box 1094 Suva	<u>MALI</u> B.P. 85 Bamako	<u>SOLOMON ISLANDS</u> P.O. Box 547 Honiara
<u>BENIN</u> BP 971 Cotonou	<u>GABON</u> BP 2098 Libreville	<u>MAURITANIA</u> BP 222 Nouakchott	<u>SRI LANKA</u> 50/5 Siripa Road Colombo 5
<u>BOTSWANA</u> P.O. Box 93 Gaborone	<u>GAMBIA, The</u> P.O. Box 582 Banjul	<u>MICRONESIA</u> P.O. Box 9 Kolonja, Ponape 96941	<u>SWAZILAND</u> P.O. Box 362 Mbabane
<u>BURUNDI</u> c/o American Embassy Bujumbura	<u>GHANA</u> P.O. Box 5796 Accra (North)	<u>MOROCCO</u> I, Zanquat Benzerte Rabat	<u>TANZANIA</u> Box 9123 Dar es Salaam
<u>CAMEROON</u> BP 817 Yaounde	<u>GUATEMALA</u> 6a Avenida 1-46 Zona 2 Guatemala	<u>NEPAL</u> P.O. Box 613 Kathmandu	<u>THAILAND</u> 242 Rajvithi Rd. Amphur Dusit Bangkok 10300
<u>CENTRAL AFRICAN REPUBLIC</u> BP 1080 Bangui	<u>HAITI</u> c/o American Embassy Port-au-Prince	<u>NIGER</u> BP 10537 Niamey	<u>TOGO</u> BP 3194 Lome
<u>COSTA RICA</u> Apartado Postal 1266 San Jose	<u>HONDURAS</u> Apartado Postal C-51 Tegucigalpa	<u>PAPUA NEW GUINEA</u> P.O. Box 1790 Boroko	<u>TONGA</u> BP 217 Nuku'Alofa
<u>DOMINICAN REPUBLIC</u> Apartado Postal 1412 Santo Domingo	<u>JAMAICA</u> 9 Musgrave Avenue Kingston 10	<u>PARAGUAY</u> Brasil 293 (Esq. Mariscal Estigarribia) Asuncion	<u>TUNISIA</u> BP 96 1002 Tunis- Belvedere
<u>EASTERN CARRIBBEAN</u> Including: Antigua, Barbados, Grenada, Montserrat, St. Kitts-Nevis, St. Lucia, St. Vincent, Dominica "Erin Court" Bishops Court Hill P.O. Box 696-C Bridgetown, Barbados West Indies	<u>KENYA</u> P.O. Box 30518 Nairobi	<u>PHILIPPINES</u> P.O. Box 7013 Manila 3129	<u>UPPER VOLTA</u> BP 537-Samand in Ouagadougou
<u>ECUADOR</u> Casilla 635-A Quito	<u>LESOTHO</u> P.O. Box 554 Maseru	<u>RWANDA</u> c/o American Embassy Kigali	<u>WESTERN SAMOA</u> P.O. Box 880 Apia
	<u>LIBERIA</u> Box 707 Monrovia	<u>SENEGAL</u> BP 254 Dakar	<u>YEMEN</u> P.O. Box 1151 Sana'a, Yemen Arab Republic
	<u>MALAWI</u> P.O. Box 208 Lilongwe	<u>SEYCHELLES</u> BP 697 Victoria	<u>ZAIRE</u> BP 597 Kinshasa
	<u>MALAYSIA</u> 177 Jalan Raja Muda Kuala Lumpur	<u>SIERRA LEONE</u> Private Mail Bag 401	