

DOCUMENT RESUME

ED 298 339

CE 050 928

TITLE Irrigation Systems. Instructor's Guide.  
 INSTITUTION Amarillo Coll., Tex.  
 SPONS AGENCY Texas Higher Education Coordinating Board, Austin.  
 PUB DATE Jun 88  
 NOTE 472p.; For a related student's guide, see CE 050 929.  
 PUB TYPE Guides - Classroom Use - Guides (For Teachers) (052)  
 -- Tests/Evaluation Instruments (160).

EDRS PRICE MF01/PC19 Plus Postage.  
 DESCRIPTORS \*Agricultural Education; Design; Equipment Utilization; Fluid Mechanics; Hydraulics; Landscaping; \*Ornamental Horticulture Occupations; Postsecondary Education; \*Site Development; \*Turf Management; Vocational Education; \*Water  
 IDENTIFIERS \*Irrigation; \*Irrigation Systems; Texas

ABSTRACT

This guide is intended for use by licensed irrigators who wish to teach others how to design and install residential and commercial irrigation systems. The materials included in the guide have been developed under the assumption that the instructors who use it have little or no formal training as teachers. The first section presents detailed instructions for using the guide and for setting up a classroom and instructional laboratory. Lesson plans covering the following topics are provided: irrigation then and now; procedures for controlling water flow (water meters and cross connections, valves, controllers and electrical wiring); methods of controlling water placement (piping and sprinkler types and nozzles); layout and design (design basics, basics of hydraulics, and procedures for developing a design and checking it mathematically); drip irrigation; and irrigation considerations. Each lesson plan includes lists of required materials and related assignments, steps to complete before teaching the lesson; instructional text, and a subject review exercise. Drawing and laboratory exercises are also provided. Appendixes contain the text of Texas's Licensed Irrigators Act and Permanent Rules for Irrigators, examples of local codes, tips on preparing for the licensing exam, common terminology of the turf irrigation industry, an index, and a pretest and posttest. (MN)

\*\*\*\*\*  
 \* Reproductions supplied by EDRS are the best that can be made \*  
 \* from the original document. \*  
 \*\*\*\*\*

ED 298339

# IRRIGATION SYSTEMS

## Instructor's Guide

U.S. DEPARTMENT OF EDUCATION  
Office of Educational Research and Improvement  
EDUCATIONAL RESOURCES INFORMATION  
CENTER (ERIC)

This document has been reproduced as received from the person or organization originating it.  
 Minor changes have been made to improve reproduction quality.

• Points of view or opinions stated in this document do not necessarily represent official OERI position or policy.

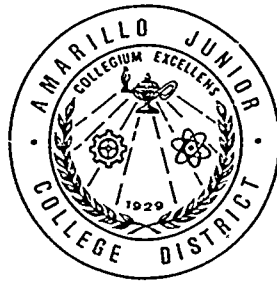

"PERMISSION TO REPRODUCE THIS MATERIAL HAS BEEN GRANTED BY

TO THE EDUCATIONAL RESOURCES INFORMATION CENTER (ERIC)."

### AMARILLO COLLEGE

Amarillo, Texas

THIS PROJECT WAS FUNDED BY THE TEXAS HIGHER EDUCATION COORDINATING BOARD THROUGH A GRANT UTILIZING FUNDS FROM THE CARL D. PERKINS VOCATIONAL EDUCATION ACT.

Project Number 88103014  
Project Year 1988

This material is public domain and may be reproduced for educational purposes.

BEST COPY AVAILABLE

826 250-270

**June 1988**

**Printed in the United States of America**

# Read This First!

Please complete the following steps prior to the course:

1. Make sure that all of the curriculum materials are present:

- 1 copy of the Instructor's Guide
- 1 set of do-it-yourself tabs for the Instructor's Guide
- 1 master of the Student's Guide
- 1 master set of do-it-yourself tabs for the Student's Guide
- 1 master for each pretest
- 1 master for each of the design drawings
- 1 master for each of the written sections of the final exam
- 1 master of the answer key for each of the written exams
- 1 master of the final design problem

If anything is missing, contact Dr. Wallace Johnston at Amarillo College at (806) 371-5211.

2. Contact the college administrator with whom you are working and obtain the items required for the course:

- Textbooks
- Photocopies of the Student's Guide
- Photocopies of the do-it-yourself tabs for the Student's Guide
- Supplemental publications for the appendix of both Guides
- Laboratory materials
- VHS Videotape: The T.B.I. - Historical Perspective (optional)

Note that Section 1, Using This Guide, in the Instructor's Guide explains where and how to obtain these items.

Also note that Dr. Wallace Johnston can put the administrator in touch with suppliers of all of the materials required for the course. The suppliers will give the college a discount on the materials commensurate with those offered to educational institutions.

3. Completely read Section 1, Using This Guide, in the Instructor's Guide. Among other things, it explains how the course is structured, what materials are required to present the course, and specific steps to take before, during, and after the course.

# Irrigation Systems

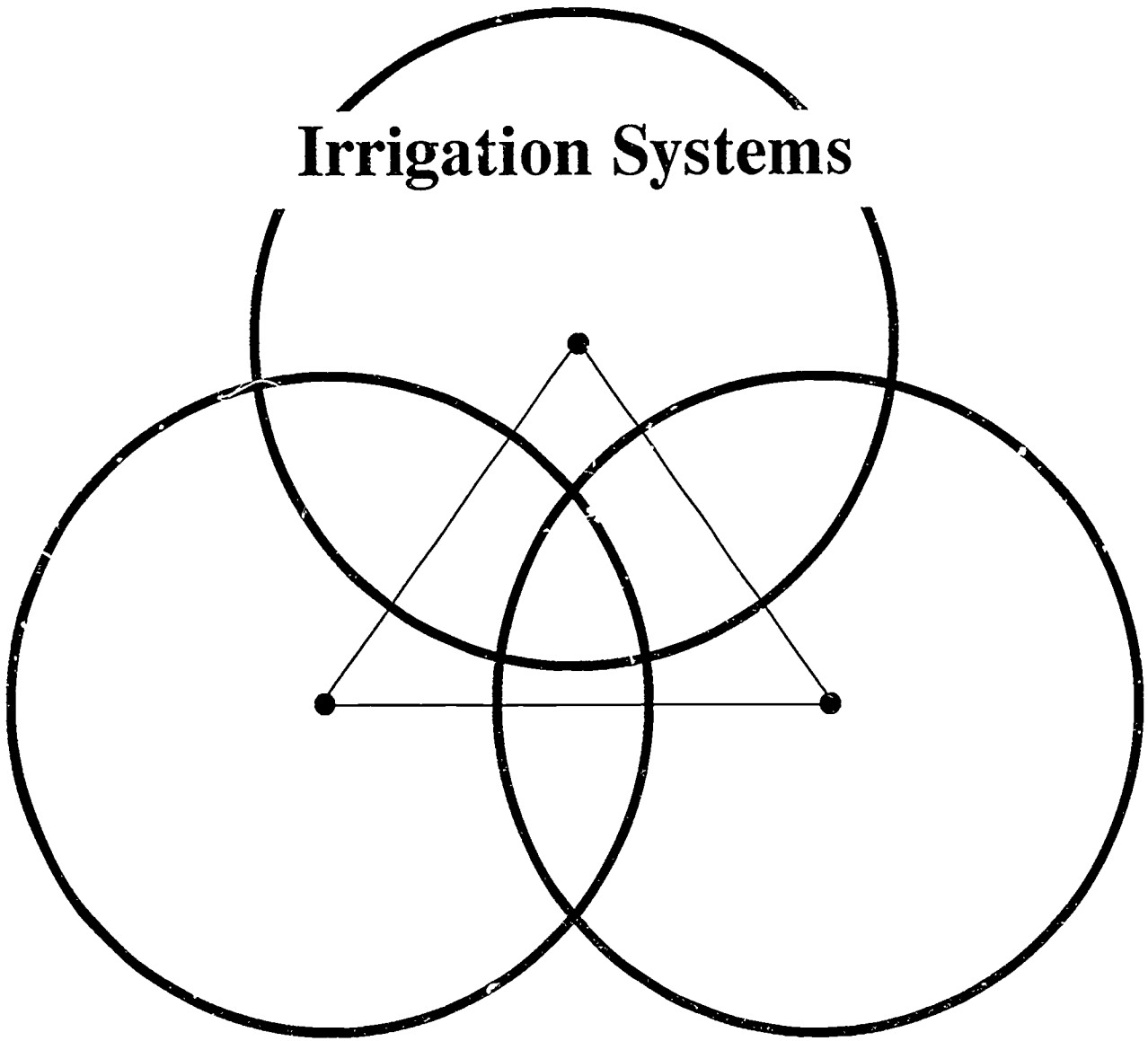

**Design and Installation**

## **Instructor's Guide**

## Acknowledgements

Amarillo College expresses deep gratitude to the following individuals and companies for contributing to the development of the Irrigation Systems curriculum. The project would not have been possible without their donations of time and knowledge.

Special thanks go to the manufacturers and suppliers who furnished products and technical literature for the testing phase of the curriculum.

### Coordinators

Mr. Mike Roark, Program Consultant Texas Higher Education Coordinating Board	
Dr. Wallace Johnston, Project Coordinator	Licensed Irrigator 3488
Mr. Glenn Branch, Project Coordinator	Licensed Irrigator 3582
Mr. Tim Meiers, Documentation Specialist	Licensed Installer 379

### Content Reviewers

Mr. Tom Gandy, President	Watersmith, Inc.	L.I. 3020
Mr. Gerald Giese, Vice President	Watersmith, Inc.	L.I. 3021
Mr. Keagan Giese, Area Manager	Watersmith, Inc.	L.I. 3188
Mr. Kurt Hall, President	DnK Enterprises, Inc.	L.I. 3191
Mr. Scott Jordan, Area Manager	Watersmith, Inc.	L.I. 3563
Mr. Autie McVicker, Treasurer	Watersmith, Inc.	L.I. 3039
Mr. Leon Orick, Grounds Supervisor Member of Board of Directors, Region I, Texas Turf Grass Association	High Plains Baptist Hospital	L.I. 2191
Mr. Ted Seyfert, General Manager	Waterscape, Inc.	L.I. 3306

## Manufacturers/Suppliers Who Furnished Items for the Testing Phase

### Febco

Crawford Terry, Inc.  
Manufacturers Representative  
10574 King William Drive  
Dallas, TX 75220  
Thanks to Mr. Gary High

### GardenAmerica Corporation (Richdel/irri-Trol)

4757 West Park Blvd. Suite 106 #404  
Plano, TX 75075  
Thanks to Mr. Claude Whitehead

### Hardie Irrigation

Watersmith, Inc.  
10909 Sanden #700  
Dallas, TX 75238  
Thanks to Mr. Autie McVicker

### Hunter Industries

1940 Diamond St.  
San Marcos, CA 92069  
Thanks to the Customer Services Department

### I.P.S. Industrial Polychemical Service

17109 S. h Main  
P.O. Box 379  
Gardena, CA 90248  
Thanks to Mr. Bill Godwin

### Pepco

4055 West Shaw Avenue Suite 104  
Fresno, CA 93722  
Thanks to Mr. Charles Shaheen

### Rain Bird

145 North Grand Avenue  
Glendora, CA 91740  
Thanks to Mr. Dan Pope

### RainJet

Watersmith, Inc.  
10909 Sanden #700  
Dallas, TX 75238  
Thanks to Mr. Tom Gandy

Texas Agricultural Extension Service  
Texas A&M University System  
College Station, TX  
Thanks to Mr. Stacy Reese

Texas Water Development Board  
P.O. Box 13231  
Capitol Station  
Austin, TX 78711-3231  
Thanks to Mr. Jim Fries

Toro  
Goldwaith's  
Master Distributor  
1501 Foch  
Fort Worth, TX 76107  
Thanks to Mr. David Pitts

Watts Regulator Company  
P.O. Box 628  
Lawrence, MA 01842  
Thanks to the Customer Services Department

Weather-matic (Telsco Industries)  
P.O. Box 18205  
Dallas, TX 75218  
Thanks to Mr. Steve McCarter



## Colleges Participating in the Testing Phase

### Amarillo College

P.O. Box 447  
Amarillo, TX 79178

Dean: Dr. Wallace Johnston  
Instructor: Mr. Leon Orick

### Austin Community College

P.O. Box 2285  
Austin, TX 78768

Dean: Ms. Ruth Ann Wilson  
Instructor: Mr. Reagan Giese

### Eastfield College (DCCCD)

3737 Motley Drive  
Mesquite, TX 75150

Dean: Dr. Lu McClellen  
Ms. Carolyn Stock, Director,  
Adult Vocational Education  
Instructor: Mr. Tom Gandy

### Kilgore College

Kilgore, TX 75662

Dean: Dr. Gerald Pinson  
Instructor: Mr. Gerald Giese

### North Harris Community College

233 Benmar Drive  
Houston, TX 77060

Dean: Dr. Kenne Turner  
Instructor: Mr. Kurt Hall

## Videotape Interview: Texas Board of Irrigators - Historical Perspective

Mr. Henry V. Alford, former Board Member, T.B.I.

Mr. S. Dale Ousley, Board Chairman, T.B.I.

Mr. William C. Kleine, past President, Texas Turf Irrigation Association

Mr. Art Young, Interviewer

## Steering Committee

Mr. John Baker  
Executive Director  
Texas Association of Private Industry Councils

Mr. Glenn Branch  
Director of Center for Business and Industry  
Amarillo College

Mr. Howard Coulter  
past President  
Texas Turf Irrigation Association

Mr. John A. Heidman  
Board Member  
Texas Board of Irrigators

Mr. H. Ray Johnson, Jr.  
Chairman of Education Committee  
Texas Turf Irrigation Association

Dr. Wallace Johnston  
Dean of Continuing Education  
Amarillo College

Dr. Lu McClellen  
Dean of Career and Continuing Education  
Eastfield College (DCCCD)

Mr. Autie McVicker  
Adviser to the Technical Evaluation and Assistance Center  
Amarillo College

Dr. Fay Murphy  
Assistant Director of Program Development  
Tarrant County Junior College

Mr. Mike Roark  
Program Consultant  
Texas Higher Education Coordinating Board

Dr. Kenne Turner  
Dean of Occupational Technical Education  
North Harris Community College

# Contents

<u>Topic</u>	<u>Section</u>
Using This Guide.....	1
Lesson Plans .....	2
Irrigation - Then and Now.....	3
Controlling Water Flow .....	4
Water Meters and Cross Connection .....	4 - 1
Valves.....	4 - 11
Controllers and Electrical Wiring.....	4 - 25
Controlling Water Placement.....	5
Piping.....	5 - 1
Sprinkler Types and Nozzles.....	5 - 25
Layout and Design .....	6
Design Basics .....	6 - 1
Basics of Hydraulics.....	6 - 7
Design Phase 1: Drawing a Plot Plan .....	6 - 17
Design Phase 2: Laying Out the Heads.....	6 - 25
Design Phase 3: Sectioning the Heads .....	6 - 37
Design Phase 4: Checking Your Design Mathematically.....	6 - 41
Drip Irrigation.....	7
Irrigation Considerations.....	8

<u>Topic</u>	<u>Section</u>
<b>Labs and Exercises .....</b>	<b>9</b>
Laboratory Exercise 1.....	LE1 - 1
Laboratory Exercise 2.....	LE2 - 1
Laboratory Exercise 3.....	LE3 - 1
Laboratory Exercise 4.....	LE4 - 1
Drawing Exercise 1 .....	DE1 - 1
Drawing Exercise 2 .....	DE2 - 1
Drawing Exercise 3 .....	DE3 - 1
Drawing Exercise 4 .....	DE4 - 1
 <b>Appendix .....</b>	 <b>10</b>
Appendix A TBI Act.....	A - 1
Appendix B TBI Rules .....	B - 1
Appendix C Examples of Local Codes .....	C - 1
Appendix D Preparing for the LI Exam.....	D - 1
 <b>Glossary .....</b>	 <b>11</b>
 <b>Index.....</b>	 <b>12</b>

# 1. Using This Guide

---

## Overview

This section provides orientation information, such as how the course is structured, what materials you need, and how to prepare for the classroom.

*Read this section completely before attempting to use the rest of this Guide.*

## Panic button

A situation may arise for which you need help and do not know where to turn. If so, contact Dr. Wallace Johnston at Amarillo College. His phone number is (806) 371-5211.

Dr. Johnston will be able to help you resolve your problem.

## Purpose of the Irrigation Systems course

This course helps prepare a student for a career in commercial and residential irrigation. In the process, the course helps prepare a student to take the licensing examinations given by the Texas Board of Irrigators.

## Purpose of this guide and intended audience

This guide contains a structured method for presenting the design and installation of irrigation sprinkler systems. *This guide is not a textbook on irrigation systems.* Rather, it allows an instructor to present irrigation technology, in a systematic manner, in classroom and laboratory settings.

This guide is intended for the Licensed Irrigator who wishes to teach others about the design and installation of irrigation sprinkler systems. This guide assumes that the Licensed Irrigator has little or no formal training as a teacher.

## How the course is structured

The Irrigation Systems course is a 60 clock hour course that includes 4 laboratory exercises and 4 drawing exercises.

## Determining your own structure

To simplify explanations, this guide discusses the course as if you will teach it in 10, six-hour sessions. The sessions will meet once a week.

You may choose to teach the course within a different time frame (for example, 12 five-hour sessions, or 7 eight-hour sessions plus 1 four-hour session). You may want to meet twice a week.

The time frame within which you teach the course is up to you, provided you adequately cover the subject matter and meet any scheduling requirements of the college.

The next tabbed section, Lesson Plans, contains guidelines on how to structure the time for each subject.

At the end of the course, you will administer a 100 question examination and a design problem, both of which will be graded. The questions and the design are similar to what the student will encounter on state examinations.

## Number of students

The minimum number of students required for a course to be offered is usually up to the college. Check with your college administrator to find out this minimum number.

The number of students to which a class is limited is usually up to the instructor. Twenty students is a good number to set as the maximum class size.

## Room requirements

You need 2 different areas in which to conduct the course. One of the areas needs to be a place where the students can get dirty and physically create a mess. This area is where you will conduct the labs. Shop classrooms work well for this area because they usually are spacious and have a cement floor that is easily swept and cleaned.

## 1. Using This Guide

### **Arrangement of furnishings**

An ordinary classroom can serve as the other teaching area. Be sure to obtain a classroom large enough to accommodate the number of students in the class.

Arrange the chairs and tables or desks in the room so that the students can see each other. Arranging the furnishings in a "U" shape works well. Be sure to leave the furnishings as you found them before you adjourn for the day.

If at all possible, avoid an arrangement of seating where each row faces the front of the room. This isolates the students and is less conducive to learning.



**Textbook for the course**

The textbook for the course is the *The ABC's of Lawn Sprinkler Systems* prepared by the staff of Irrigation Technical Services under the direction of A. C. Sarsfield.

Both the instructor and each student must have a copy of the *ABC's*.

In addition to the *ABC's*, the instructor must have a copy of the *Turf Irrigation Manual, The Complete Guide to Turf and Landscape Sprinkler Systems*, by James A. Watkins.

Only the instructor needs a copy of the *Turf Irrigation Manual*.

Also valuable for the instructor to have, but not required, is a copy of *Residential Irrigation - Design and Installation* by Warren Johnson.

**Where to obtain textbooks for the course**

You may obtain textbooks for the course by contacting the college representative for whom you have agreed to teach the course (this may be the dean). That person can assist you in obtaining the textbooks.

The textbooks may be obtained either of 2 ways:

1. Contact the supplier of the books directly and place your order:

*ABC's of Sprinkler Systems*  
Irrigation Technical Services  
P. O. Box 268  
Lafayette, CA 94549

*Turf Irrigation Manual*  
Telsco Industries  
P. O. Box 18205  
Dallas, TX 75218

## 1. Using This Guide

### *Residential Irrigation*

Warren Johnson  
13777 N. Central Expressway  
Dallas, TX 75243

2.

Contact Dr. Wallace Johnsten at Amarillo College (806/371-5211). He will put you in touch with an irrigation supply company that has all of the items already assembled into a package called the **Textbook Kit**.

The **Textbook Kit** contains:

*ABC's of Lawn Sprinkler Systems* (the company will supply as many of the books as required for your class)

*Turf Irrigation Manual* (1 each)

*Residential Irrigation - Design and Installation* (1 each)

The T. B. I. - Historical Perspective (VHS video tape)

The college sponsoring the course will receive a discount on the **Textbook Kit** commensurate with those offered to educational institutions.

**Supplemental publications for the appendix**

In addition to the textbook, three publications are required for the appendices in the Instructor's Guide and in the Student's Guide. **These publications are required and must be obtained--this is vitally important!**

The three publications are the *Febco Cross Connection Control Handbook*, *The Watts 50 Cross Connection Questions, Answers, and Illustrations*, and *Drip Irrigation*.

**Where to obtain the supplemental publications**

You may obtain the supplemental publications by contacting the college representative for whom you have agreed to teach the course (this may be the dean). That person can assist you in obtaining the publications.

The publications may be obtained either of 2 ways:

1. Contact the suppliers of the publications directly and place your order:

*Febco Cross Connection Control Handbook*

Febco  
Crawford Terry, Inc.  
Manufacturers Representative  
10574 King William Drive  
Dallas, TX 75220

*50 Cross Connection Questions, Answers & Illustrations*

Watts Regulator Company  
P.O. Box 628  
Lawrence, MA 01842

## 1. Using This Guide

### *Drip Irrigation*

Texas Water Development Board  
P.O. Box 13231  
Capitol Station  
Austin, TX 78711-3231

2. Contact Dr. Wallace Johnston at Amarillo College (806/371-5211). He will put you in touch with an irrigation supply company that has these publications grouped as a package called the **Appendix Kit**.

The **Appendix Kit** will contain as many of each publication that you need for your class.

The college sponsoring the class will receive a discount on the **Appendix Kit** commensurate with those offered to educational institutions.

20

**Teaching materials supplied to you**

The following is a list of the items that you will receive from the Texas Higher Education Coordinating Board, Community College and Technical Institute Division.

- 1 copy of the Instructor's Guide
- 1 set of do-it-yourself tabs for the Instructor's Guide
- 1 master of the Student's Guide
- 1 master set of do-it-yourself tabs for the Student's Guide
- 1 master for each pretest
- 1 master for each of the design drawings
- 1 master for each of the written sections of the final exam
- 1 master of the answer key for each of the written exams
- 1 master of the final design problem

**Administrative items you need to teach the course (paperwork)**

A certain amount of paperwork is required for you to administer the course. The college sponsoring the course will supply you with the following items:

- Class roster
- Class attendance record (form on which to keep roll)
- Applicable forms for late registrations, student withdrawals, etc.
- Requisition form to request supplies for the course
- Forms for requesting audio-visual equipment and classroom support

## 1. Using This Guide

### **Classroom materials you need to teach the course**

You will need the following classroom materials to present the course:

Blank transparencies  
Calculator (hand-held or desktop)  
Drafting board, at least 18" X 24"  
Drafting compass  
Drafting triangles  
Eraser  
Erasing shield  
Graph paper, 10 squares per inch  
Overhead projector  
Paper towels or shop rags  
Paper, ruled  
Pencils, #2 with erasers  
Photocopies of various items (that is, you need access to a photocopier)  
Projection screen (or a suitable surface such as a blank portion of a wall)  
Ruler, 10 scale  
T-Square to fit size of drafting board  
Transparency markers  
VHS video tape player  
Video tape monitor  
Watch or clock

### **Additional classroom materials you may wish to have**

Flip chart and easel  
Flip chart pad  
Markers for flip chart  
Cassette tape recorder to record lectures  
Cassette tapes  
Extension cord  
35mm slide projector  
Slide tray(s) for 35mm slides  
Reference books and magazines  
35mm slides (your own)  
Examples of interesting irrigation products (very old or very new items, oddball items, self-made items, etc.)

**Where to obtain the  
classroom materials**

You may obtain most of the audio-visual materials from the college where the course will be held. Contact the college representative for whom you have agreed to teach the course (this may be the dean). That person can assist you in obtaining the materials (which often means completing the appropriate form).

Give the representative at least 1 week prior to the start of the course.

## 1. Using This Guide

### Laboratory products required for the course

Four laboratories allow the students to physically participate in the learning process, such as dismantling components and practicing solvent welding.

The following products are required for use in the labs.

#### Pipe

- 5 each 1 foot of 1" copper, type L
- 1 each 1 foot of 1" copper, type M
- 5 each 1 foot of 1" PVC, schedule 40
- 1 each 1 foot of 1" PVC, class 200
- 4 each 1 foot of 7/8" PE

#### Fittings

- 1 each 1" compression tee CTS (PVC)
- 1 each 1" compression tee IPS (PVC)
- 4 each 1" copper tee
- 4 each 1" copper ell
- 4 each 1" copper coupler
- 4 each Compression tee for PE, 7/8" to 1/2" NPT
- 4 each Compression coupler for PE, 7/8" to 7/8"

#### Welding/Soldering Supplies

- 1 each Soldering flux
- 1 each Roll of solder
- 1 each 1/2 pint PVC solvent
- 1 each 1/2 pint PVC primer

#### Controllers

- 1 each 4 station solid state, push pad type
- 1 each 6 station solid state, dial type
- 1 each 4 station electro-mechanical, pin type
- 1 each 12 station electro-mechanical, switch type
- 1 each 2 or 4 station battery powered



Sensors

1 each Rain sensor

Heads

2 each Spray head, large circular pattern  
2 each Spray head, small circular pattern  
2 each Spray head, stream rotor  
2 each Spray head, tall (12") pop-up  
2 each Impact head, bucket type  
2 each Shrub head  
2 each Rotary head, gear drive  
2 each Rotary head, ball drive  
2 each Hybrid head, large square pattern

Sprinkler stands/nipples

2 each Sprinkler stand  
2 each 1/2" X 1/2" nipple  
2 each 3/4" X 1/2" nipple

Valves and valve accessories

1 each 3/4" gate  
1 each 3/4" ball  
1 each 3/4" straight-through electric  
1 each 3/4" manual angle  
1 each 1" electric globe  
1 each 1" electric anti-siphon  
1 each 1" electric globe with flow control  
1 each Hose bibb  
1 each Quick connect  
1 each Valve handle

Backflow prevention devices

1 each Dual check  
1 each Atmospheric vacuum breaker

## 1. Using This Guide

- 1 each Pressure vacuum breaker
- 1 each Double check
- 1 each Reduced pressure principle
- 1 each Hose bibb vacuum breaker

### Drip irrigation products

- 1 each 10 feet of 1/4" PE tubing
- 1 each 10 feet of 1/2" PE tubing
- 1 each 10 feet of double chamber PE tubing
- 5 each Emitters, pressure balanced
- 5 each Emitters, non-pressure balanced
- 5 each 1/4" coupler
- 5 each 1/4" tee
- 5 each 1/4" ell
- 5 each 1/2" coupler
- 5 each 1/2" tee
- 5 each 1/2" ell
- 5 each double chamber coupler
- 5 each double chamber tee
- 5 each double chamber ell
- 1 each Filter
- 1 each Hole punch
- 1 each Fogger
- 1 each Micro sprinkler
- 1 each Pressure regulator
- 1 each Dual chamber self-flushing ends
- 1 each Fertilizer injector
- 1 each Anti-siphon device
- 1 each Drip kit for patios
- 1 each Drip kit for vegetables
- 1 each Coring tool
- 1 each Moisture sensor
- 1 each Drip manual (vendor product literature)

**Where to obtain the lab products**

You may obtain the products in either of 2 ways:

1. Visit irrigation/plumbing supply houses and request the items on the list. Be aware that any single supply house may not stock all of the items.
2. Contact Dr. Wallace Johnston at Amarillo College (806/371-5211). He will put you in touch with an irrigation supply company that has all of the items already assembled into a package called the **Lab Kit**.

The college sponsoring the course will receive a discount on the **Lab Kit** commensurate with those offered to educational institutions.

**Additional items required for the labs**

In addition to lab products listed above, you need the following items for the labs:

Assorted hand tools (open end wrenches, pliers, screwdrivers, hacksaw, propane torch, plumbing solder, and goggles)

Additional types of solvents and cleaners to practice solvent welding.

Additional samples of tubular goods (PVC, PE, ABS, copper, etc.)

These items are available from different sources. You can probably obtain the tubular goods and solvents from your students. Ask your students to bring any scrap pieces of pipe, fittings, and solvents/primers. The scraps can be short, 12 inches or less, and still be adequate for purposes of the course.

The hand tools can either be your own or those of the students.

27

## 1. Using This Guide

### **Instructor's Guide and Student's Guide**

The Instructor's Guide and the Student's Guide supplement the course textbook and help round out the explanations of certain subjects.

Both the Instructor's Guide and the Student's Guide use a two column format. The left hand column contains descriptive information about the paragraphs in the right hand column. The descriptive information helps the reader move quickly through the pages and pick out key ideas.

The lines of descriptive information are called callouts.

### **Annotations in the Instructor's Guide**

The Instructor's Guide also contains annotations in the left hand column. The annotations provide additional information to the instructor.

In order for the instructor to tell an annotation from a callout, all annotations are labelled "Annotation." Following the word "annotation" is a description of the type of annotation. For example, an annotation that lists a discussion question for the students would appear in the left column as follows:

Annotation:  
(Discussion Question)

### **Sections in the Guides**

Both Guides are divided into 12 sections. Except for Section 2, the names of the 12 sections are the same in both Guides.

Section 2 in the Student's Guide is titled "Preparing for the LI Exam." That same information is located in the appendix of the Instructor's Guide.

All of the sections dealing with irrigation systems are similarly organized. They present the material in narrative form and usually conclude with a subject review.

The subject reviews usually contain 24 questions: 8 fill in the blank, 8 true or false, and 8 multiple choice.

The Instructor's Guide contains answers to the review questions. In addition, each answer lists the page number where that answer can be verified.

## Pretests

Sections 3 through 6 have an accompanying pretest.

The purpose of a pretest is to determine how much of the subject matter the students already know. This allows you to adjust your level and speed of teaching to suit the majority of students. In addition, a pretest allows the students to participate in an activity at the start of the sections.

All pretests are located in the 9x12 envelope labelled "Tests."

## Posttests

The purpose of a posttest is to determine how much of the subject matter the students have learned. The teaching materials for this course contain no posttests as such. The subject reviews serve as posttests.

That is, if you go over the subject review questions, you will cover most of the information on the pretests. You will cover the remaining questions on the pretests during the discussion of the information in the sections.

## Overview of the sections

The first 2 sections contain information to help you get oriented and organized.

Section 3 is a general introduction to irrigation.

Sections 4 through 8 contain the heart of the subject matter. The subjects are generally organized in a

## 1. Using This Guide

from-the-meter-to-the-house approach. That is, the discussion of irrigation systems begins at the water meter and works its way toward the dwelling.

Section 8 is designed to be taught by persons other than the instructor, such as local code inspectors, local landscapers, etc.

The last 3 sections contain reference materials to supplement the course.

### Overview of the sections by weeks

The following graphic representation shows what material you will cover during which week.

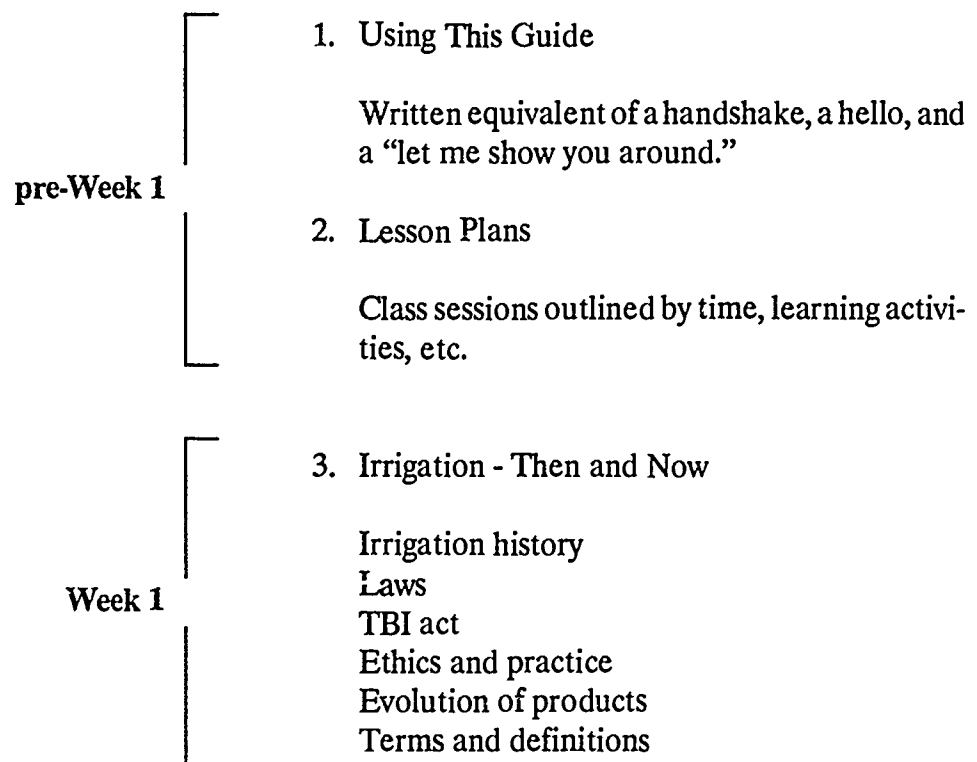

33

<b>Week 2 (plus Lab 1)</b>	<b>4. Controlling Water Flow</b> Water meters Cross connection Backflow prevention
<b>Week 3</b>	Valves Types, uses, etc.  Controllers and electrical wiring
<b>Week 4 (plus Lab 2)</b>	<b>5. Controlling Water Placement</b> Piping Types, uses, schedules, etc. Connecting pipe Solvent welding and soldering  Sprinkler types and nozzles Precipitation and application rates
	<b>6. Layout and Design</b>  Basics of hydraulics Drawing exercise 1

## 1. Using This Guide

Week 5	Design and plot plans Design hydraulics Drawing exercise 2
Week 6 (plus Lab 3)	7. Drip Irrigation  Drip and micro irrigation Percolation Drawing exercise 3
Week 7	8. Irrigation Considerations  Codes and ordinances Application enforcement Landscape design Beautification Efficiency of water use
	9. Labs and Exercises
Week 2	Lab #1 Show and tell of backflow prevention devices
Week 4	Lab #2 Show and tell of solvent welding, soldering, types of pipe Drawing Exercise #1
Week 5	Drawing Exercise #2
Week 6	Lab #3 Show and tell of drip irrigation products Begin Drawing Exercise #3



## 1. Using This Guide

- Week 7  Complete Drawing Exercise #3
- Week 8  Lab #4 Show and tell of irrigation equipment  
(trenchers, etc.)  
 Drawing Exercise #4
- Week 9  Practice test, LI Exam design part
- Week 10  Practice test, LI Exam written part

## 1. Using This Guide

### **Teaching tips**

Your greatest resource as an instructor is your students. Let them share what they know and everyone benefits. The more that you involve your students in classroom discussions and activities, the more that they will learn.

### **Involve your students**

That is the first teaching tip: involve your students in classroom discussions and activities. The “learning activities” included with the lesson plans are specifically designed for this. In addition, when a student asks you a question, give the other students the chance to answer it first. Ask the students, “What do you think?”

### **Do not feel obligated to know it all**

The second teaching tip concerns your knowledge of the irrigation business: no one knows everything about a subject. Do not feel that you must know everything about irrigation. Your job is to facilitate learning, not to be a walking encyclopedia.

Help the students share with each other what they know. Correct any erroneous information that they may impart.

It is perfectly acceptable for you, as an instructor, to respond to a question with, “I don’t know, but why don’t we both try to find out.” If such a situation occurs, request that the students research an answer. Follow up on your promise and also research an answer. Next time that the class meets, ask the students to share what they discovered before you provide an answer.

### **Ask open ended questions**

A third teaching tip is to ask open ended questions. That is, ask questions that cannot be answered with a simple “yes” or “no.” Open ended questions will encourage your students to communicate.

**Be enthusiastic**

A fourth teaching tip involves your enthusiasm. Be enthusiastic about what you are doing and put some life into the course. If you enjoy the learning process, your students will enjoy it too.

Mingle with the students when they do written work. Peek over shoulders and give praise and encouragement where it is genuinely due. Offer advice and suggestions for improvement in a nonthreatening way. Treat your students as adults, and they usually respond as adults.

**Give frequent, but short, breaks**

A fifth teaching tip concerns breaks. Frequent, but short, breaks are more conducive to learning than infrequent, long breaks. If convenient, break about every hour for five minutes.

Be punctual on the time and show the students that a five minute break means five minutes, not seven, not ten. Resume your teaching after five minutes whether or not all of the students have returned from the break.

## 1. Using This Guide

### Steps to complete prior to the course

Make sure that you complete the following activities before the course begins:

1. Assist the college is advertising the course and obtaining students. Notify likely candidates about the course.
2. Tell the college dean or administrator your room requirements. This will allow that person to arrange a suitable classroom and laboratory area.
3. Locate the classrooms and familiarize yourself with the area.
4. Give the dean or administrator your requirements for audio-visual equipment.
5. Work with the dean or administrator to complete the administrative tasks involved with presenting the class.
6. Once you know the number of students enrolled for your class, order that number of *ABC's*. The dean or administrator can assist you with the ordering. (Refer to the information above, "Where To Obtain Textbooks For The Course.")
7. Give the master of the Student's Guide to the dean or administrator and inform that person how many photocopies of it you need for the students. Note that the Guide is duplexed (copied on both sides).
8. Review all of the reference materials that you have for the course and become familiar with them.

9. *Enlist the support of local code inspectors, landscapers, irrigation equipment suppliers, and agricultural extension office agents. These are the type of speakers that you need for class session 7 of the course.*

Determine when session 7 will occur and decide on which speakers that you want. Contact the speakers and give them very specific topics on which to speak. In other words, do not request that a landscaper come and talk about landscaping. Be specific and state what you want: you want the landscaper to talk for an hour on the problems of integrating landscape design and irrigation, for example.

10. Begin gathering the materials that the college cannot supply, such as tubular goods.
11. Prepare open ended questions that you can use to invite student participation.
12. Prepare your lesson plan for class session 1 if you choose not to follow the one provided.

**Steps to complete for each class session**

Make sure that you complete the following activities for each class session:

1. Check the roll.
2. Review all assignments and student contributions.
3. Ensure that the students understand the material by asking open ended questions.
4. Assign reading and out-of-class activities.
5. Prepare your lesson plan for each class session if you choose not to follow the ones provided.

## 2. Lesson Plans

### Lesson Plan Class Session 1

#### Irrigation - Then and Now

<u>When</u>	<u>What</u>	<u>How</u>
<b>Morning</b>		
7:45 - 8:00	Greet students as they arrive	Walk around the room and mingle
8:00 - 8:15	Distribute pretest	Written activity Ask the students to answer as many of the questions as they can on their own, then discuss the answers with the other students
8:15 - 10:00	Introduce yourself and welcome the students Check roll and add names to the class attendance record Hand out receipt of payment to the students who mailed in their tuition Register any walk-ins Ask students to introduce themselves Distribute printed materials (ABC's and Student Workbooks) Explain the course and how you plan to present it Give an overview of the subject for today	Lecture
10:00 - 10:15	Break	

Lesson Plan: Class Session 1

When	What	How
10:15 - 10:40	Discuss what irrigation means, how long it has existed, the types of irrigation, and early examples of irrigation such as Euphrates Wheel, aqueducts, windmills. (Pages 1 - 3)	Lecture and student participation (discuss questions)
10:40 - 12:00	Discuss irrigation in Texas: the history of it, methods used such as windmills and reservoirs, irrigation and beautification, irrigation as big business, and the TBI Act. (Pages 4 - 7 and Appendices A and B)	Lecture and student participation (read and discuss parts of the TBI Act)
Noon		
12:00 - 1:00	Lunch	
Afternoon		
1:00 - 1:30	Discuss ethics in irrigation: what it means to be a profession irrigator and ways in which irrigators can improve public opinion. (Pages 8 and 9)	Lecture and student participation (discuss questions)
1:30 - 2:00	Discuss how methods of watering have changed over the years, how products have improved and why, and what some of the common terms are in the irrigation business. (Pages 9 - 12 and glossary)	Lecture and student participation (read and discuss terms in the glossary)
2:00 - 2:05	Break	
2:05 - 2:35	Complete Learning Activity 2 (See Activity 2 at the end of this lesson plan)	Class activity
2:35 - 2:50	Complete subject review Discuss it and the pretest (Pages 13 and 14 and pretest)	Writing activity and class discussion of answers

30

When	What	How
2:50 - 3:00	Wrap up: answer questions, announce reading assignment for next class, and thank the students for their participation (Listed in the Orientation for Section 1)	Open forum:
3:00	Dismiss class.	

### Learning Activities

1. Instruct the students to form groups of three or four persons. Ask each group to agree on three ways for irrigators to exhibit professional behavior. Allow the groups about five to ten minutes to prepare. Ask each group to share with the class its ideas.
2. Divide the students into two groups, Sprinkler Company A and Sprinkler Company B. Each group is to choose a spokesperson.

Describe this scenario to them:

Mr. and Mrs. Smith purchased a residential sprinkler system from your company. The Smiths agreed to pay for the system in three payments over three months. At the insistence of the Smiths, your workers have made five trips to the residence to adjust and fine tune the system. From your standpoint, the system appears to work perfectly. The Smiths still contend that the system does not work as promised and they refuse to pay the final two-thirds until you satisfy them.

How does your company resolve this?

Allow the students about ten to fifteen minutes to prepare, then ask each group to explain its resolution.



This page included for duplexing.

**Lesson Plan**  
**Class Session 2 (includes Lab 1)**

**Water Meters, Cross Connection, and Backflow Prevention**

<u>When</u>	<u>What</u>	<u>How</u>
<b>Morning</b>		
7:45 - 8:00	Greet students as they arrive	Walk around the room and mingle
8:00 - 8:15	Distribute pretest	Written activity Ask students to answer as many of the questions as they can on their own, then discuss the answers with the other students
8:15 - 8:30	Check roll and add names to the class attendance record Register any walk-ins Give an overview of the subject and lab for today	Lecture
8:30 - 9:10	Discuss water meters and cross connection Define backflow prevention and explain why it is important to the irrigator Go over the information in the Febco handbook and the Watts publication. (Pages 1 - 4, and the appendix)	Lecture and student participation (discuss questions)
9:10 - 9:20	Break	
9:20 - 9:45	Answer any questions that may have originated during the break Discuss the subject review for this section (Pages 5 - 10)	Writing activity

Lesson Plan: Class Session 2

When	What	How
9:45 - 10:00	Instruct the students to read the explanation for Lab 1 in Section 9 Verify that the students understand the purpose of the lab and what they are supposed to do	Class activity
10:00 - 10:10	Break	
10:10 - 12:00	Begin the procedure steps for Lab 1	Class activity
Noon		
12:00 - 1:00	Lunch	
Afternoon		
1:00 - 2:25	Continue with the procedure steps for Lab 1	Class activity
2:25 - 2:30	Break	
2:30 - 2:55	Continue with the procedure steps for Lab 1 but begin to conclude the activities Request that the students not begin a task that will take more than 30 minutes to complete (unless you and the students are willing to extend the lab time) Begin to re-box the backflow prevention devices as the students complete the lab	Class activity
2:55 - 3:00	Announce reading assignment for next class (Listed in the Orientation for Section 4)	Open forum
3:00	Dismiss class (unless you and the students are willing to extend the lab time)	

## Learning Activities

1. Divide the students into two groups (or let them determine the two groups).

Each group has two tasks to accomplish:

To list all of the different types of backflow prevention devices that the group members have used in irrigation. To list the good and bad points about each type based on their experience with the devices in actual irrigation situations.

Allow the groups about fifteen minutes to prepare, then ask each group to present its information. As a class, discuss the information from both groups.

2. Divide the students into two groups, Sprinkler Company A and Sprinkler Company B (or let them determine the two groups). Each group is to choose a spokesperson to explain the decision of the group.

Describe this scenario to them:

The ChemPest Company has contacted you about installing a residential sprinkler system. ChemPest manufactures liquid pesticides at their plant. The office area is a separate building from the chemical plant. Separate water meters serve the plant and the office building. ChemPest wants all of their turf areas irrigated.

What type of backflow prevention devices will your sprinkler company install and why?

Allow the groups about fifteen minutes to prepare, then ask each group to present its information. As a class, discuss the information from both groups.

This page included for duplexing

## Lesson Plan Class Session 3

### Valves, Controllers, and Electrical Wiring

When	What	How
<b>Morning</b>		
7:45 - 8:00	Greet students as they arrive	Walk around the room and mingle
8:00 - 8:15	Distribute pretest	Written activity Ask the students to answer as many of the questions as they can on their own, then discuss the answers with the other students
8:20 - 8:30	Check roll and add names to the class attendance record Give an overview of the subjects for today	Lecture
8:30 - 9:10	Discuss the concept of valves, why they are used in irrigation, the types of manual valves and the types of electric valves (Pages 11 - 13)	Lecture and student participation (discuss questions)
9:10 - 9:25	Break	
9:25 - 10:00	Discuss hydraulic valves, additional types of valves common in irrigation, where to place valves, and the importance of drain valves (Pages 14 - 18)	Student participation
10:00 - 10:30	Guide a learning activity Choose either Learning Activity 1 or 2, which are listed at the end of this lesson plan	Student participation

Lesson Plan: Class Session 3

When	What	How
10:30 - 10:40	Break	
10:40 - 11:00	Answer any questions that may have originated during the break Discuss the answers to the subject review for valves (Pages 19 - 24)	Writing activity
11:00 - 12:00	Discuss the different types of controllers and review the advantages and disadvantages for each type Discuss the power requirements of controllers and their common features (Pages 25 - 30)	Lecture and student participation (discuss questions)
Noon		
12:00 - 1:00	Lunch	
Afternoon		
1:00 - 1:35	Discuss wiring: how it relates to controllers, size, how to splice, and how to install (Pages 31 - 33)	Lecture and student participation (discuss questions)
1:35 - 1:45	Break	
1:45 - 2:25	Complete Learning Activity 3, which is explained at the end of this lesson plan	Student participation
2:25 - 2:30	Break	
2:35 - 2:55	Discuss the answers to the subject review for controllers and to the pretest (Pages 35 - 41)	Writing activity

41

When	What	How
2:55 - 3:00	Announce reading assignment for next class (Listed in the Orientation for Section 4)	Open forum
3:00	Dismiss class	

### Learning Activities

1. Divide the students into two groups (or let them determine the two groups).

Each group has three tasks to accomplish:

To list all of the different brands of valves that the group members have used in irrigation.

To categorize the brands of valves as many ways as they can think of: by type of operation, by configuration, by purpose, and so forth.

To list the good and bad points about each brand based on their experience with the valves in actual irrigation situations.

Allow the groups about fifteen minutes to prepare, then ask each group to present its information. As a class, discuss the information from both groups.

2. Divide the students into two groups (or let them determine the two groups). Each group is to choose a spokesperson to explain the findings of the group.

The task for each group is to explain the procedure for installing valve boxes. Assume that the explanation is for someone who has never worked in the irrigation business and is not familiar with the methods or products.

Both groups should consider factors such as the following:

Potential problems when installing boxes

Types of soils and how to deal with them

How the depth of the boxes affects the installation, if at all



How the shape of the boxes affects the installation, if at all  
How the material of the boxes (plastic, etc.) affects the installation, if at all.

Allow each group about 15 minutes to prepare what they want to say. Each group should then spend about 10 minutes explaining the procedure.

**Note:** After the groups have finished explaining their procedures, refer the students to page 122 in the ABC's. That page lists some information concerning how to set valve boxes.

3. This activity is for the discussion of controllers. Among the irrigation products supplied for the course are some controllers. You will need those controllers for this activity.

Divide the students into as many groups as you have different controllers. For example, if you have two types (or brands) of controllers, form two groups; if you have three types of controllers, form three groups, etc.

Give each group a controller and the operating instructions that accompany it.

Each group has two tasks to accomplish:

Learn how to operate the controller to establish the watering times, days, and lengths for a sprinkler system.

Explain to the rest of the class how to operate the group's particular type or brand of controller.

Allow each group about 15 minutes to prepare what they want to say. Each group should then spend about 5 minutes explaining how to operate the controller.

**Lesson Plan**  
**Class Session 4 (includes Lab 2)**

**Piping, Connecting Pipe, Sprinkler Heads and Nozzles**

When	What	How
<b>Morning</b>		
7:45 - 8:00	Greet students as they arrive	Walk around the room and mingle
8:00 - 3:10	Distribute pretest	Written activity Ask students to answer as many of the questions as they can on their own, then discuss the answers with the other students
8:10 - 8:20	Check roll and add names to the class attendance record Give an overview of the subject and lab for today	Lecture
8:20 - 9:00	Discuss the various types of pipe common in the irrigation business and the different ways of connecting pipe (Pages 1 - 18)	Lecture and student participation (discuss questions)
9:00 - 9:20	Discuss the subject review on piping and connecting pipe (Pages 19 - 23)	Written activity
9:20 - 9:55	Discuss sprinkler heads and nozzles. (Pages 25 -34)	Lecture and student participation (discuss questions)
9:55 - 10:10	Discuss the answers to the subject review on sprinkler heads and nozzles and to the pretest (Pages 35 - 41)	Writing activity

When	What	How
10:10 - 10:20	Break	
10:15 - 12:00	Verify that the students understand the purpose of Lab 2 and what they are supposed to do Begin the procedure steps for Lab 2	Class activity
Noon		
12:00 - 1:00	Lunch	
Afternoon		
1:00 - 2:30	Continue with the procedure steps for Lab 2 (The students should take breaks on their own, not formally as a class)	Class activity
2:30 - 2:55	Continue with the procedure steps for Lab 2 but begin to conclude the activities Request that the students not begin a task that will take more than 30 minutes to complete (unless you and the students are willing to extend the lab time)	Class activity
2:55 - 3:00	Announce reading assignment and homework for next class (Listed in the Orientation for Section 5)	Open forum
3:00	Dismiss class (unless you and the students are willing to extend the lab time)	

### Learning Activity

Laboratory 2 serves as the learning activity for this class session.

**Lesson Plan  
Class Session 5**

**Layout and Design**

<u>When</u>	<u>What</u>	<u>How</u>
<b>Morning</b>		
7:45 - 8:00	Greet students as they arrive	Walk around the room and mingle
8:00 - 8:10	Distribute pretest	Written activity Ask the students to answer as many of the questions as they can on their own, then discuss the answers with the other students
8:10 - 8:15	Check roll and add names to the class attendance record Give an overview of the subjects for today	Lecture
8:15 - 8:35	Discuss the basics of design, such as efficient/effective systems, precipitation rate, and problems such as low pressure and high pressure (Pages 1 - 6)	Lecture and student participation (discuss questions)
8:35 - 9:30	Discuss the basics of hydraulics, such as static pressure and working pressure, friction, friction loss, and velocity Discuss the subject review on the basics of design and hydraulics (Pages 7 - 15)	Lecture and student participation (discuss questions)
9:30 - 9:35	Break	

When	What	How
9:35 - 10:30	<p>Discuss the first 2 phases of layout and design: plot plans and how to lay out sprinkler heads on a plot plan (triangulation)</p> <p>Discuss the subject review on design phases 1 and 2</p> <p>Ask if any student had difficulty using a compass or ruler for the homework (if so, offer suggestions on ways to improve, etc.)</p> <p>(Pages 17 - 35)</p>	Lecture and student participation
10:30 - 10:35	Break	
10:35 - 12:00	<p>Discuss phases 3 and 4 of layout and design: adding the plumbing, sizing pipe, and checking the design mathematically</p> <p>Explain the math for each drawing on the following pages in the ABC's: 99, 100, 101, 106, 107, and 108</p> <p>Discuss the subject review for design phases 3 and 4</p> <p>(Pages 37 - 49)</p>	Lecture and student participation
Noon	Lunch	
12:00 - 1:00		
Afternoon		
1:00 - 1:55	<p>Begin Drawing Exercise 1</p> <p>Have the students work individually to place the heads and decide what patterns to use</p>	Student participation
1:55 - 2:00	Break	

When	What	How
2:00 - 2:15	Divide the students into two equal groups Have each group look at the layouts of its members and discuss the different ways of laying out the heads	Student participation
2:15 - 2:55	Complete Learning Activity 1. Work both problems on the blackboard as a group activity (that is, ask the students to explain how to solve the problems while you write on the blackboard) Only offer advice if the students are stumped or do not know how to proceed Complete both problems	Class activity
2:55 - 3:00	Announce reading assignment and drawing homework for next class (Listed in the Orientation for Section 6)	Open forum
3:00	Dismiss class	

### Learning Activities

- This activity allows the students to practice sizing pipe. This information is not included in the Student's Guide. Instruct your students to take notes.

Drawing:

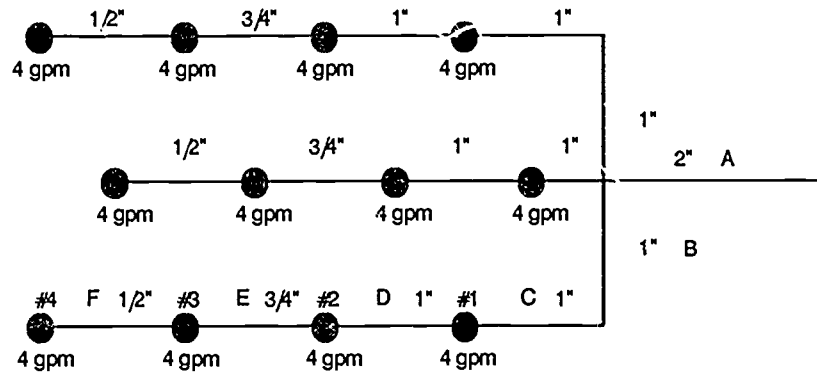

**Information Known:**

- 48 gpm total flow
- SDR 21 PVC pipe is used for the entire section
- Each head requires 4 gpm
- Minimum operating pressure at the head is 20 psi
- Velocity not to exceed 5 fps

**Information Required:**

Size the pipe accordingly (and do not exceed 5 fps velocity)

**Answer:**

Section A has a flow rate of 48 gpm.  
Refer to Table 5a (p. 317) in the *Turf Irrigation Manual*.  
2" SDR 21 PVC will flow 55.5 gpm at 5 fps.  
1-1/2" SDR 21 PVC will flow 35.4 gpm at 5 fps.

Therefore, use 2" SDR 21 PVC for Section A.

Section B flows 16 gpm (4 heads X 4 gpm/head)  
Refer to Table 5a (p. 317) in the *Turf Irrigation Manual*.  
1" SDR 21 PVC will flow 16.7 gpm at 5 fps.

Therefore, use 1" SDR 21 PVC for Section B.

Section C flows 16 gpm (4 heads X 4 gpm/head)  
Refer to Table 5a (p. 317) in the *Turf Irrigation Manual*.  
1" SDR 21 PVC will flow 16.7 gpm at 5 fps.

Therefore, use 1" SDR 21 PVC for Section C.

Section D flows 12 gpm (3 heads X 4 gpm/head)  
Refer to Table 5a (p. 317) in the *Turf Irrigation Manual*.  
1" SDR 21 PVC will flow 16.7 gpm at 5 fps.  
3/4" SDR 21 PVC will flow 10.1 gpm at 5 fps.

Therefore, use 1" SDR 21 PVC for Section D.

Section E flows 8 gpm (2 heads X 4 gpm/head)  
Refer to Table 5a (p. 317) in the *Turf Irrigation Manual*.  
3/4" SDR 21 PVC will flow 10.1 gpm at 5 fps.

Therefore, use 3/4" SDR 21 PVC for Section E.

Section F flows 4 gpm (1 head X 4 gpm/head)  
Refer to Table 5a (p. 317) in the *Turf Irrigation Manual*.  
1/2" SDR 21 PVC will flow 5.9 gpm at 5 fps.

Therefore, use 1/2" SDR 21 PVC for Section F.



- This activity allows the students to practice sizing pipe and to calculate pressure loss. This information is not included in the Student's Guide. Instruct your students to take notes.

Drawing:

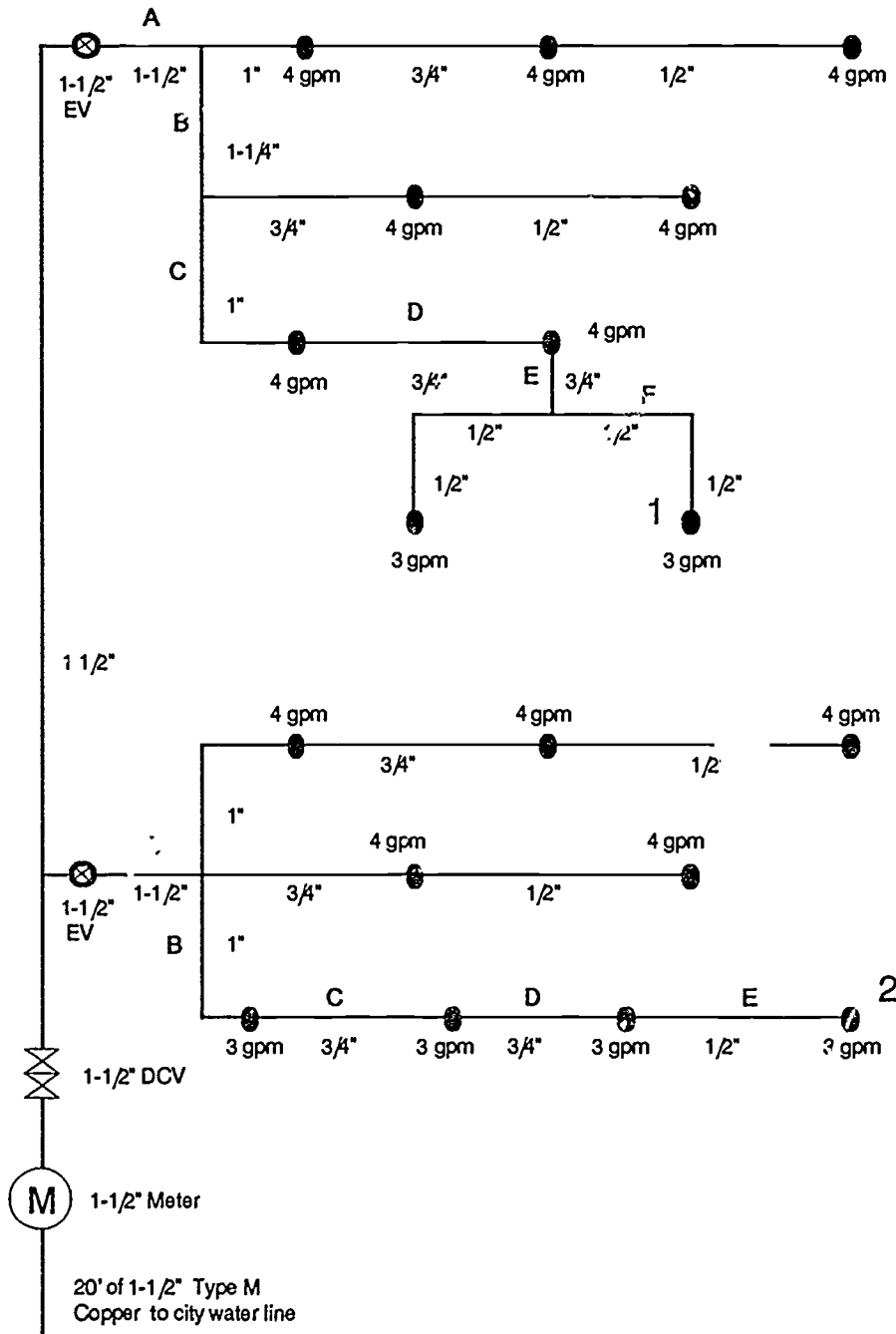

**Information Known:**

1-1/2" water meter  
 1-1/2" double check valve  
 20' of 1-1/2" Type M copper pipe runs from the city supply line to the water meter  
 6' of pipe runs between the water meter and the double check valve  
 Minimum operating pressure at the head is 20 psi  
 Static pressure is 65 psi  
 Keep the velocity around 5 fps  
 SDR 13.5 PVC pipe is used for the main supply line  
 SDR 21 PVC pipe is used for the the laterals

**Information Required:**

Size the pipe and valves accordingly and calculate the pressure loss to Points 1 and 2.

**Answer:****SIZING THE MAIN SUPPLY LINE:**

Section 1 flows 34 gpm (7 heads X 4 gpm/hd + 2 heads X 3 gpm/hd).  
 Refer to Table 4a (p. 315) in the *Turf Irrigation Manual*.  
 2" SDR 13.5 PVC will flow 49.1 gpm at 5 fps.  
 1-1/2" SDR 13.5 PVC will flow 31.3 gpm at 5 fps.  
 1-1/2" SDR 13.5 PVC will flow 37.5 gpm at 6 fps.

Section 2 flows 32 gpm (5 heads X 4 gpm/hd + 4 heads X 3 gpm/hd).  
 Refer to Table 4a (p. 315) in the *Turf Irrigation Manual*.  
 2" SDR 13.5 PVC will flow 49.1 gpm at 5 fps.  
 1-1/2" SDR 13.5 PVC will flow 31.3 gpm at 5 fps.  
 1-1/2" SDR 13.5 PVC will flow 37.5 gpm at 6 fps.

Therefore, use 1-1/2" SDR 13.5 PVC for the main supply line. It is large enough to supply both Sections 1 and 2.

Reasoning: SDR 13.5 PVC is a relatively strong pipe and will carry 34 gpm at a velocity between 5 and 6 fps. The slight increase in velocity over 5 fps will not cause any problems for the system.

### SIZING THE LATERAL LINES IN SECTION 1

Section A has a flow rate of 34 gpm (7 heads X 4 gpm/hd + 2 heads X 3 gpm/hd).

Refer to Table 5a (p. 317) in the *Turf Irrigation Manual*.

1-1/2" SDR 21 PVC will flow 35.4 gpm at 5 fps.

Therefore, use 1-1/2" SDR 21 PVC for Section A.

Section B flows 22 gpm (4 heads X 4 gpm/hd + 2 heads X 3 gpm/hd).

Refer to Table 5a (p. 317) in the *Turf Irrigation Manual*.

1-1/4" SDR 21 PVC will flow 26.9 gpm at 5 fps.

Therefore, use 1-1/4" SDR 21 PVC for Section B.

Section C flows 14 gpm (4 heads X 2 gpm/hd + 2 heads X 3 gpm/hd).

Refer to Table 5a (p. 317) in the *Turf Irrigation Manual*.

1" SDR 21 PVC will flow 16.7 gpm at 5 fps.

Therefore, use 1" SDR 21 PVC for Section C.

Section D flows 10 gpm (1 head X 4 gpm/hd + 2 heads X 3 gpm/hd).

Refer to Table 5a (p. 317) in the *Turf Irrigation Manual*.

3/4" SDR 21 PVC will flow 10.1 gpm at 5 fps.

Therefore, use 3/4" SDR 21 PVC for Section D.

Section E flows 6 gpm (2 heads X 3 gpm/hd).

Refer to Table 5a (p. 317) in the *Turf Irrigation Manual*.

3/4" SDR 21 PVC will flow 10.1 gpm at 5 fps.

1/2" SDR 21 PVC will flow 5.9 gpm at 5 fps.

Therefore, use 3/4" SDR 21 PVC for Section E.

Section F flows 3 gpm (1 head X 3 gpm/hd)

Refer to Table 5a (p. 317) in the *Turf Irrigation Manual*.

1/2" SDR 21 PVC will flow 5.9 gpm at 5 fps.

Therefore, use 1/2" SDR 21 PVC for Section F.

### SIZING THE LATERAL LINES IN SECTION 2

Section A has a flow rate of 32 gpm (5 heads X 4 gpm/hd + 4 heads X 3 gpm/hd).

Refer to Table 5a (p. 317) in the *Turf Irrigation Manual*.  
1-1/2" SDR 21 PVC will flow 35.4 gpm at 5 fps.

Therefore, use 1-1/2" SDR 21 PVC for Section A.

Section B flows 12 gpm (4 heads X 3 gpm/hd).

Refer to Table 5a (p. 317) in the *Turf Irrigation Manual*.  
1" SDR 21 PVC will flow 16.7 gpm at 5 fps.

Therefore, use 1" SDR 21 PVC for Section B.

Section C flows 9 gpm (3 X 3 gpm/hd).

Refer to Table 5a (p. 317) in the *Turf Irrigation Manual*.  
3/4" SDR 21 PVC will flow 10.1 gpm at 5 fps.

Therefore, use 3/4" SDR 21 PVC for Section C.

Section D flows 6 gpm (2 heads X 3 gpm/hd).

Refer to Table 5a (p. 317) in the *Turf Irrigation Manual*.  
3/4" SDR 21 PVC will flow 10.1 gpm at 5 fps.  
1/2" SDR 21 PVC will flow 5.9 gpm at 5 fps.

Therefore, use 3/4" SDR 21 PVC for Section E.

Section E flows 3 gpm (1 head X 3 gpm/hd).

Refer to Table 5a (p. 317) in the *Turf Irrigation Manual*.  
1/2" SDR 21 PVC will flow 5.9 gpm at 5 fps.

Therefore, use 1/2" SDR 21 PVC for Section F.

### SELECTING VALVES

1-1/2" electric valves are selected as a reasonable practice. 1-1/4" valves are too uncommon; 1" valves have considerably more pressure loss.

## PRESSURE LOSS TO POINT 1

The table and page references in the following chart cite the *Turf Irrigation Manual*. For purposes of discussion, assume that the PSI loss for the double check valve and the electric valve came from the product literature for those products.

Desc. of Item	Size Inches	Len. Feet	PSI/100'	PSI Loss
Copper pipe, Type M, city main to meter	1-1/2	20	4.41 (Tab. 11, p. 328)	.882
Water meter	1-1/2	--	--	6.9 (p. 345)
SDR 13.5, meter to BP	1-1/2	6	2.97 (Tab. 4, p. 314)	.1782
Double check valve	1-1/2	--	--	5.9
SDR 13.5, BP to section valve	1-1/2	81	2.97 (Tab. 4, p. 314)	2.406
Electric valve	1-1/2	--	--	2.4
SDR 21 lateral line A	1-1/2	4	2.20 (Tab. 5, p. 316)	.088
SDR 21 lateral line B	1-1/4	8	1.91 (Tab. 5, p. 316)	.155
SDR 21 lateral line C	1	10	2.63 (Tab. 5, p. 316)	.263
SDR 21 lateral line D	3/4	15	4.77 (Tab. 5, p. 316)	.716
SDR 21 lateral line E	3/4	4	1.86 (Tab. 5, p. 316)	.074
SDR 21 lateral line F	1/2	10	1.90 (Tab. 5, p. 316)	.19
Total Pressure Loss		61		20.15

Static Pressure	65 psi
Minimum Sprinkler Operating Pressure	20 psi
Design Pressure (pressure loss + min. sprinkler op. pres.)	40.15 psi
Actual Head Operating Pressure (static pressure - pressure loss)	44.85 psi

**PRESSURE LOSS TO POINT 2**

The table and page references in the following chart cite the *Turf Irrigation Manual*. For purposes of discussion, assume that the PSI loss for the double check valve and the electric valve came from the product literature for those products.

Desc. of Item	Size Inches	Len. Feet	PSI/100'	PSI Loss
Copper pipe, Type M, city main to meter	1-1/2	20	3.95 (Tab. 11, p. 328)	.79
Water meter	1-1/2	--	--	6.1 (p. 345)
SDR 13.5, meter to BP	1-1/2	6	2.65 (Tab. 4, p. 314)	.159
Double check valve	1-1/2	--	--	5.9
SDR 13.5, BP to section valve	1-1/2	25	2.65 (Tab. 4, p. 314)	.6625
Electric valve	1-1/2	--	--	2.2
SDR 21 lateral line A	1-1/2	4	1.96 (Tab 5, p. 316)	.0784
SDR 21 lateral line B	1-1/4	11	1.98 (Tab 5, p. 316)	.2178
SDR 21 lateral line C	1	10	3.93 (Tab 5, p. 316)	.393
SDR 21 lateral line D	3/4	10	1.86 (Tab 5, p. 316)	.186
SDR 21 lateral line E	3/4	10	1.90 (Tab 5, p. 316)	.190
Total Pressure Loss				16.98

60

Static Pressure	65 psi
Minimum Sprinkler Operating Pressure	20 psi
Design Pressure (pressure loss + min. sprinkler op. pres.)	39.98 psi
Actual Head Operating Pressure (static pressure - pressure loss)	48.02 psi



This page included for duplexing

**Lesson Plan**  
**Class Session 6 (includes Lab 3 and Drawing 2)**

**Drip Irrigation**

<u>When</u>	<u>What</u>	<u>How</u>
<b>Morning</b>		
7:45 - 8:00	Greet students as they arrive	Walk around the room and mingle
8:00 - 8:10	Distribute pretest	Written activity Ask students to answer as many of the questions as they can on their own, then discuss the answers with the other students
8:10 - 8:20	Check roll and add names to the class attendance record Give an overview of the subject and lab for today	Lecture
8:20 - 9:00	Discuss the various ways that water, soils, and plants interact, especially evapotranspiration Discuss the formula for determining the gallons per day watering requirement for a plant (Pages 1 -8)	Lecture and student participation (discuss questions)
9:00 - 9:05	Break	
9:05 - 9:40	Discuss drip irrigation, what it is and why it works, and the advantages and disadvantages (Pages 9 - 16)	Lecture and student participation (discuss questions)
9:40 - 9:55	Discuss answers to the subject review and to the pretest (Pages 17 - 23)	Class discussion

When	What	How
9:55 - 10:00	Break	
10:00 - 12:00	Verify that the students understand the purpose of Lab 3 and what they are supposed to do Begin the procedure steps for Lab 3	Class activity
Noon		
12:00 - 1:00	Lunch	
Afternoon		
1:00 - 2:00	Continue with the procedure steps for Lab 3 (The students should take breaks on their own, not formally as a class)	Class activity
2:00 - 2:55	Discuss Drawing Exercise 2 Answer any questions the students have about how to proceed with the drawing, or questions remaining about Drawing Exercise 1 If time allows, let the students get started on Drawing Exercise 2	Class activity
2:55 - 3:00	Announce reading assignment and homework for next class (Listed in the Orientation for Section 7)	Open forum
3:00	Dismiss class	

### Learning Activity

Laboratory 3 and Drawing Exercise 2 serve as the learning activities for this class session.

## Lesson Plan Class Session 7

### Irrigation Considerations

When	What	How
<b>Morning</b>		
7:45 - 8:00	Greet students as they arrive	Walk around the room and mingle
8:00 - 8:10	Check roll and add names to the class attendance record Give an overview of the subjects for today	Lecture
8:10 - 8:30	Discuss codes and ordinances, landscape design and irrigation, beautification, and the efficiency of water use. (Pages 1 - 6)	Lecture and student participation (discuss questions)
8:30 - 9:00	Complete Learning Activity 1	Student participation
9:00 - 9:05	Break	
9:05 - 10:30	Introduce your first guest speaker Allow the speaker about one hour to talk, followed by 15 minutes for a question and answer session	Lecture and student participation (question and answer session)
10:30 - 10:45	Break	
10:45 - 12:00	Introduce your second guest speaker Allow the speaker about one hour to talk, followed by 15 minutes for a question and answer session	Lecture and student participation (question and answer session)
<b>Noon</b>		
12:00 - 1:00	Lunch	

When	What	How
<b>Afternoon</b>		
1:00 - 2:20	<p>If you have a third guest speaker, introduce that person                      Allow the speaker about one hour to talk, followed by 15 minutes for a question and answer session                      If you do not have a third guest speaker, discuss Drawing Exercise 2                      Answer any questions the students have about how to proceed with the drawing, or questions remaining about Drawing Exercise 1                      Let the students get started on Drawing Exercise 3</p>	Lecture and student participation (question and answer session)
2:20 - 2:30	Break	
2:30 - 2:55	<p>Discuss Drawing Exercise 2                      Answer any questions the students have about how to proceed with the drawing, or questions remaining about Drawing Exercise 1                      If time allows, let the students get started on Drawing Exercise 3</p>	Class activity
2:55 - 3:00	<p>Announce drawing homework for next class                      (Listed in the Orientation for Section 7)</p>	Open forum
3:00	Dismiss class	

## Learning Activity

1. Divide the students into two groups, Sprinkler Company A and Sprinkler Company B. Each group is to choose a spokesperson.

Describe this scenario to them:

Mr. and Mrs. Tovar intend to purchase a residential sprinkler system from your company. The Tovar residence is a new one in a very affluent part of town, and no landscaping has yet been added.

Their lot is 85' by 140'. Most of the backyard slopes gently toward an alley. The last 15 feet of the backyard drop off in a very steep slope toward the alley. The Tovars plan to fence the backyard.

The Tovars are considering large areas of turf grass and very few shrub beds. They are also considering exotic shrubs that are not native to the locale.

The Tovars have asked for your advice about landscaping and irrigating.

What advice does your company give them about landscaping? About irrigating the plants? How do you support your advice? What types of sprinkler heads/drip irrigation do you recommend? What about the steep slope in the backyard?

Allow the students about 10 minutes to prepare, then ask each group to explain its advice.

This page included for duplexing.

## Lesson Plan Class Session 8

### Laboratory 4 and Drawing Exercise 3

When	What	How
<b>Morning</b>		
7:45 - 8:00	Greet students as they arrive	Walk around the room and mingle
8:00 - 8:10	Check roll and add names to the class attendance record Give an overview of the subjects for today	Lecture
8:10 - 12:00	Visit various vendors of irrigation equipment, such as trencher manufacturers, vibraplow manufacturers, and plumbing supply houses Try to see demonstrations of at least two different pieces of equipment If supervised by and acceptable to the vendor, allow the students to operate the equipment If possible, tour at least one plumbing/irrigation supply house If possible, visit at least one job site where a sprinkler system is currently being installed. The system can be residential or commercial If any of the students are employed in the irrigation business, try to visit one of the systems being installed by the student's company	Class activity
<b>Noon</b>		
12:00 - 1:00	Lunch	



Lesson Plan: Class Session 8

<u>When</u>	<u>What</u>	<u>How</u>
<b>Afternoon</b>		
1:00 - 2:55	Continue working on Drawing Exercise 3 Answer any questions the students have about how to proceed with the drawing, or questions remaining about Drawing Exercises 1 and 2	Class activity
2:55 - 3:00	Announce drawing homework for next class: Drawing Exercise 4	Open forum
3:00	Dismiss class	

70

**Lesson Plan  
Class Session 9**

**LI Exam Practice Test - Design**

<u>When</u>	<u>What</u>	<u>How</u>
<b>Morning</b>		
7:45 - 8:00	Station yourself outside of the classroom and greet students as they arrive Have the students sign in on a sign-in log and assign them a number based on the log	Act as a proctor
8:00 - 8:10	Explain what is required of the students for the practice design Mention that the design test has a time limit of 4 hours	Lecture
8:10 - 12:00	Have the students complete the practice design drawing Do not allow the students to converse with one another during the 4 hours Have the students turn in their drawings as soon as they complete them Ask the students to leave the room after turning in their drawings (and meet back at 1:00 pm)	Student participation
8:10 - 12:00	Grade the exams as they are turned in Use the evaluation sheet provided with the drawings as a guideline for grading the drawings	Instructor's activity
<b>Noon</b>		
12:00 - 1:00	Lunch	

When	What	How
1:00 - 2:55	Critique the designs Have the students exchange designs with one another and critique them based on the evaluation sheet Spend a few minutes looking at each student's design and offer suggestions, answer any questions, and assign a grade based on your opinion and on the evaluation sheet	Class activity
2:55 - 3:00	Announce drawing homework for next class: Drawing Exercise 4	Open forum
3:00	Dismiss class	

70

**Lesson Plan**  
**Class Session 10**

**LI Exam Practice Test - Written Part**

<u>When</u>	<u>What</u>	<u>How</u>
<b>Morning</b>		
7:45 - 8:00	Station yourself outside of the classroom and greet students as they arrive Have the students sign in on a sign-in log and assign them a number based on the log	Act as a proctor
8:00 - 8:10	Explain what is required of the students for the practice exam Mention that the design test has a time limit of four hours	Lecture
8:10 - 12:00	Have the students complete the practice exam Do not allow the students to converse with one another during the 4 hours Have the students turn in their exam sections as soon as they complete them Ask the students to leave the room after turning in all of the exam sections (and meet back at 1:00 pm)	Student participation
<b>Noon</b>		
12:00 - 1:00	Lunch	

When	What	How
<b>Afternoon</b>		
1:00 - 2:30	Distribute the exam sections to the students Verify that no student has his/her own exam Grade all sections of the written exam: a grade of 70 or more is required on each Discuss the answers to the written sections	Class activity
2:30 - 3:00	Answer any remaining questions about Drawing Exercise 4 Thank the class and wish them success as professional irrigators	Open forum
3:00	Dismiss class	

## Orientation

### Irrigation - Then and Now

#### Class Session 1

**Audio-visual aids that you need to present this section**

None.

**Labs or drawing exercises associated with this section**

None.

**Steps to complete before teaching this section**

Complete the following steps before you teach this section:

1. Read pages one through eight in the ABC's of Lawn Sprinkler Systems.
2. Read this section completely. Familiarize yourself with the contents, including the subject review, but do not try to memorize the information.
3. Study the lesson plan for class session 1. Remember that the times allotted are guidelines, not hard and fast requirements.

Note: The first class session, this one, involves some administrative activities that the other sessions do not. You may wish to review the information in the "Using This Guide" section about administering classes.

4. Determine which of the learning activities that you want to include during the class.

5. For you and your students, photocopy the pretest for the subject "Irrigation - Then and Now." All pretests are located in the 9x12 envelope. Be sure to return the master to the envelope.
6. Sit or lie in a quiet place where you will not be disturbed. Close your eyes and relax your entire body. Breathe deeply several times, using your diaphragm to inhale and exhale. Mentally picture yourself with your students, discussing irrigation. "See" the situation as a sharing of information that unfolds pleasantly. Imagine the learning process as being a pleasant and beneficial experience. Hold that thought for a few minutes, then open your eyes and resume your daily activities.

**Reading assignment for  
class session 2**

At the end of class 1, give the reading assignment for class session 2:

In the ABC's:  
Pages 1 through 8

In the Student's Guide:  
All of Section 1 and the information on  
Water meters and Cross Connection in  
Section 4

### 3. Irrigation - Then and Now

---

#### Overview

This section introduces the subject of irrigation and relates how it has evolved as an integral part of human existence. Specific to Texas is a discussion of the Texas Board of Irrigators Act. This section also discusses irrigation as a profession, the improvements in irrigation products, and the vocabulary common to the irrigation business.

#### Irrigation defined

We humans have actively changed our surroundings since the very beginning. And, since most of this planet is water, it stands to reason that we have spent much time moving water from one location to another. In fact, the definition of irrigation is "to supply with water."

Irrigation dates back as far as we have recorded history. People from all ages and in all parts of the world have always manipulated water to keep themselves, livestock, and vegetation alive.

#### Diversion as an early form of irrigation

One of the earliest forms of irrigation was diversion. Humans would sometimes want to change the direction of a natural source of running water, such as a river or stream. They may have wanted to bring water closer to their habitat, or to get the water away from something that they wanted to protect. In either case, they needed to divert the water.

#### Annotation:

#### (Discussion Question)

What are some of the modern day uses of diverted water?

(To generate electricity, to power machines such as mills, to create water recreation areas)

Today, we are surrounded by many types of water diversion. Canals, levies, and dams are obvious ones. But even the curb on a street serves to divert water. Diverting water is so commonplace that we seldom stop to consider the places where irrigation got started.



## Early examples of irrigation

One very early example of irrigation comes from the area that we now call the Middle East, in a region low along the borders between Iraq and Iran. That area was once referred to largely as Persia. It is there that the Tigris and Euphrates Rivers merge to form the Shatt al-Arab, a place that some believe to be the location of the Garden of Eden.

Because the Shatt al-Arab runs through low marshlands, inhabitants in that area had to change the level, the vertical height, of the water to reach their crops. They needed to irrigate date groves.

## Euphrates Wheel

Over time, the inhabitants created something called the Euphrates Wheel. It was a mechanical device powered by an ox, donkey, or even a person. The muscle power would turn a wheel which had a series of buckets on it. The buckets would fill with water and, as the wheel rotated and the buckets were turned upside down, would empty into a canal. The canal was slightly higher than the level of the river and would carry the water to the date groves.

The Euphrates Wheel operates basically like a booster pump to lift water from one level to another. It offers a cheap, fairly efficient way to provide irrigation water and is still used today.

## Roman aqueducts

Several thousand miles northwest of the Shatt al-Arab lived another ancient people who devoted much effort to diverting water. The Romans built a lavish network of aqueducts, sections of which still remain.

Some of the aqueducts had rock walls that contained fluid chambers. The chambers had a measurable drop so that water would flow through them

gradually under its own hydrostatic pressure. The ancient Roman architects were ingenious enough to build some of the walls without mortar, yet the chambers have survived for thousands of years.

## Windmills

### Annotation: (Discussion Question)

What material do you think that the Netherlanders used for the windmill bellows and diaphragms?  
(Leather)

In an area of Europe still further northwest, the inhabitants wanted to divert water for a different reason. The Netherlands had long been plagued with tidal influxes that would flood much of their land. Their need was to remove water to make arable fields.

The Netherlanders created wind driven pumps in the form of windmills. They used the windmills to drain the land, and built earthen dikes to keep the water from flowing in again. The combination of windmills and dikes worked successfully and much of the Netherlands is now arable. You have probably seen photographs of the beautiful tulip fields in the Netherlands. Tidal waters once flooded most of those fields.

## Irrigation in Texas

Let us move into more recent times. In Texas, for example, the practice of irrigation is fairly recent, at least historically speaking. Around 1890 and early 1900, it became important for us to use some of our water resources on vegetation. Prior to that, any farming was done in locations with ample rainfall or in alluvial soils near waterways.

### An old friend revisited

**Annotation:**  
(Humorous Anecdote)

A couple traveling across the country stopped for gas at a remote service station in west Texas.

They noticed three windmill derricks clustered beside the station. One still functioned as a wind-mill; nothing remained of the other two except the derrick.

When they inquired about this to the old-timer who ran the station, he replied, "Yep, we used to have three windmills, but we had to take two of 'em down. There was only enough wind for one."

But we began to populate the state and push out into areas where water was not so easily had for raising vegetation or for drinking. Once again, humans had the need to divert water. We adapted an idea that was already being used in Europe, in places like the Netherlands--using the wind to divert water.

Daniel Halladay introduced the wind pump to the United States in 1854. And even though the device pumped water, it came to be known as the windmill. In 1883, Stewart Perry started building windmills out of steel. They were not very efficient, but they were durable, reliable, and inexpensive to operate. The windmill helped wet the West.

But even as the popularity of the windmill reached its peak across Texas, another device in New York City was capturing the imagination of the country. The first public power station went into operation in September of 1882, producing direct current electricity. Within a few years, scientists were demonstrating the usefulness of alternating current. Trouble was, they needed some way to generate it on a large scale. They needed something like . . . like water falling from a reservoir.

### 3. Irrigation - Then and Now

#### Power to make power

And so it was that once again humans diverted water for their needs. People quickly realized that reservoirs could provide more than just a means to generate electricity. They could also provide irrigation water. The race to build reservoirs was on, and Texas was among the racers.

#### Buchanan Dam

Texas, like most states, has an extensive system of dams that was begun years ago. For instance, early in the 1930's, during the Great Depression, Buchanan Dam was built on the Colorado River. The Colorado would fluctuate from flood to drought, either ruining crop land or failing to supply sufficient water.

Since 1930, there have been over eight major dammings on the Colorado River alone (and the creation of eight major lakes). Not all of the dams in the state are for irrigation. But many, particularly the smaller dams, do provide water for irrigation.

#### From crops to lawns

For many years, irrigation in Texas was used strictly for agriculture. We developed various ways during those years to irrigate crops, such as center pivot irrigation, furrow irrigation, and surge irrigation.

During the years 1935 to 1950, Texans did very little watering of plants for beautification. Residential irrigation was a practice for only the very wealthy. Think how times have changed!

We have developed here in Texas a love for the growing of plants. We spend millions of dollars to develop programs for irrigating crops. Many of the crops are cash crops, not food crops. In addition, we spend tremendous sums on irrigation just for beautification, which has nothing to do with the food chain at all.

82

Currently, 10% to 15% of all the buildings built in Texas provide for the watering of turf grasses and bedding plants for beautification. The percentages refer to residential and light commercial irrigation.

This involves a tremendous amount of money. The total do-it-yourself sprinkler business in Texas-- everything from hose bibs to garden hoses to complete sprinkler systems -- is in the millions of dollars in annual sales.

Irrigation has become a big industry that impacts many people. And, as is usually the case under such situations, a regulatory body arises to address the situation. And so it was for Texas.

### **TBI Act and other laws**

The Texas legislature passed the Texas Board of Irrigators (TBI) Act in 1979 and created the Texas Board of Irrigators. The express purpose of the Board is to bring some accountability to the installers of sprinkler systems. The TBI Act addresses only residential and light commercial sprinkler systems, not agricultural irrigation.

The legislators saw a rapidly evolving industry that needed regulatory control. The consuming public needed some assurance that the installers of sprinkler systems had certain knowledge before tampering with potable water supplies.

The TBI Act is included as Appendix A of this book. Appendix B contains the TBI permanent rules.

### **Sunset Law**

In Texas, legislative acts that create commissions, committees, or any other bureaucratic entity have to be reviewed from time to time to determine the validity of the act. The law that requires this is the Sunset Law. The TBI Act, for example, is scheduled for its review in 1991.

## **How the TBI Act affects you**

**Annotation:  
(Reading, Discussion,  
Reminder)**

**Turn to Appendices A and B and discuss the TBI Act as a group activity.**

**Be sure to point out the following information:**

**Provision 427.1**

**Local regulation**

**Provision 431.4**

**Advertisement**

**Section 12**

**Penalty: injunction**

**Section 13**

**Enforcement of act**

**Section 16**

**Sunset provision**

The Texas Board of Irrigators is a funded operation and charges a fee for licensure as well as an annual renewal fee. Over 4,000 persons have taken the licensure examination.

The TBI Act directly affects you. The Act requires that anyone who "sells, designs, consults, installs, maintains, alters, repairs, or services" an irrigation system must be a Licensed Irrigator, or must work under the direct supervision of a person who meets those qualifications.

The Texas Board of Irrigators, however, does not have infinite control over the irrigation business. A number of installers practice illegally in our state. You may wonder, "What does it matter whether or not I'm licensed?" To answer that, let us first talk about laws in general.

The reason we have laws is to protect the community at large. For example, we have laws governing fair trade practices so that you are legally obligated to tell the truth if you are trying to sell something. In addition, we have truth in lending laws so that if you borrow money and pay interest on it, the lender must tell you what the total financial burden of the loan will be.

So it is with the TBI Act: we must protect the potable water supply, the drinking water, for the community at large. The simple fact is that we cannot live without water.

## Ethics and irrigation

Complying with the law is one reason for becoming a Licensed Irrigator. But there are other reasons, ethical reasons, that perhaps are equally as important. As a professional irrigator, you are responsible for protecting our potable water supply and for treating the consumer fairly.

### Annotation: (Discussion Question)

What does ethics mean to you?

In order for us to have any longevity of our industry and to increase the popularity of irrigation, we must do business with this sort of responsibility in mind. It seems that few groups in the business world have a worse reputation than installers of sprinkler systems. One example may be the used car salesperson in a bright plaid jacket. And in some cases, even that person appears more trustworthy than an irrigator.

As irrigators, we must realize that much of the public views us as irresponsible liars, without professionalism, and ignorant of the technologies involved in our own business. We often appear to be just as likely to sell them a system that will not work and will violate a law, as we are to sell them a system that will be effective, efficient, and serve their needs. And all too often, the public is right!

## Improving public opinion

### Annotation: (Discussion Question)

What are some other ways in which irrigators can improve public opinion?

How can you help improve the public's opinion of irrigators? First of all, consider yourself a professional irrigator, not just "some person who installs sprinkler systems." Consider yourself belonging to a profession that demonstrates responsible, ethical practices.

As a united group, we must comply with local ordinances and regulations as well as with the TBI Act. Further, we must support efforts to conserve water, efforts aimed at preventing the predicted four-fold increase in the cost of water by the year

## Watering - Then and Now

### Annotation: (Discussion Question)

**When is your earliest remembrance of an underground sprinkler system? Where was it?**

2000. Our compliance and conservation efforts will help show that we are a profession to be trusted rather than doubted.

Residential Irrigation systems have become more and more commonplace over the years. But it was not always so. For example, if you wanted to water your lawn during the 1930's, you probably had a fairly archaic variety of hose and some sort of sprinkler attached to the end of it. During the 1940's--if you were wealthy--you may have had an underground sprinkler system made of galvanized pipe and copper tubing. Such systems were not highly efficient and required somebody to manually open and close valves.

By the 1950's, the push was on in California, Florida, and even parts of Texas, for the luxury of an automatic sprinkler system. Automatic timers were available, as well as materials that made such systems fairly efficient. Not just the wealthy wanted sprinkler systems, but the middle class began to see them as valuable additions to a property.

The 1960's brought many changes to our country, including an increase in residential irrigation and beautification. Sprinkler systems became increasingly common, particularly along the West Coast. Sprinkler systems continued their popularity throughout the 1970's as well.

By now, the late 1980's, many homeowners are familiar with sprinkler systems as a necessary part of a residential property. The concept of how to water a lawn has evolved from hoses and hose-end products, to underground, automatic sprinkler systems.



## **Underground sprinkler systems**

Underground sprinklers began with fixed orifice nozzles buried in the ground. The nozzles were usually heavy brass and very expensive. Today, underground sprinklers have evolved from being made of brass, bronze, and copper, to thermoplastics such as PVC, ABS, and polyethylene (PE). These synthetic materials are less expensive than metal, easier to work with, less corrosive, and more durable.

Sprinkler systems have progressed from having spray heads with a fixed nozzle orifice to spray heads with an adjustable nozzle orifice to various types of sprinklers that throw a long stream. Some heads are gear driven; others even make a square pattern. The principles of mechanical engineering are very much a part of modern irrigation products.

## **Sprinkler products and methods improve**

### **Annotation: (Discussion Question)**

**What is the most unusual hose-end sprinkler that you have ever seen?**

The evolution of the products themselves is also interesting. Hose-end products began as fixed nozzle, or fixed orifice, attachments that scattered water from the end of a hose. You had to manually open a valve at the house to get water to the hose-end attachment, and you had to move the attachment to distribute water over a large area.

People got tired moving the attachments, which opened the door to another product: the walking sprinkler. This mechanism is a moving sprinkler, usually shaped like a tractor, that drags the hose with it. Arms on top of the tractor rotate and distribute water. Water-powered gears propel the sprinkler.

Other products that evolved were mechanical valves designed to operate with moving sprinklers and shut off the water to the sprinkler. Spring powered timers used to control watering intervals also appeared on the market.

**Demand for better products**

The products have evolved because of a demand for better products. The consumer of the '80's, for example, spends a great deal of money and research on anything concerning home improvement.

For example, central air conditioning, insulation, and carpeting were luxury items in the '50's. Such items began to be a fashion in the '60's, and a requirement in the '70's. They have become commonplace in the '80's. The point of all this is that most consumers with whom you will deal understand much about the technologies available today.

**Learning aids:**

Consumers have read enough, and seen enough, to be knowledgeable about many subjects. Not just products evolve, so does the knowledge level of the public. One of your challenges as a professional irrigator is to be knowledgeable about irrigation products and practices. A good place to begin your understanding is with the glossary at the back of this book.

**Glossary**

**Subject review**

After you explore the glossary, complete the subject review for this section.

**Annotation:**

**(Reading, Discussion,  
Reminder)**

**Turn to the glossary at  
the back of the book.**

**Be sure to discuss the  
following terms:**

**Anti-siphon device**

**Backflow prevention  
device**

**Distribution rate**

**Double check valve**

**Percolation**

**Precipitation rate**

## Subject Review

### Irrigation - Then and Now

#### True or False

In the answer column, mark the following statements "T" for true or "F" for false. The whole statement is false if any part of it is false.

Then, after the questions are discussed in class, place an "X" through an incorrect answer and write the correct answer in the answer column. That way, you will know the correct answers if you later review this information.

Statement	Answer
1. Many methods of irrigation have been employed in Texas since 1860.	False. (page 4)
2. The process of product evolution has had little effect on consumers of sprinkler materials.	False. (page 11)
3. Less than 25% of the homes and buildings in Texas have sprinklers.	True. (page 6)
4. In areas where no local regulations are in force, the irrigator may use his or her favorite method to prevent backflow.	False. (Appendix A, provision 427.4)
5. Water costs are predicted to decrease by the year 2000 because of continued efforts in education and conservation.	False. (page 8)
6. "T.B.I." stands for Texas Board of Irrigators.	True. (page 6)

Statement

Answer

- 
7. An anti-siphon device is also called a vacuum breaker.
8. Diversion was one of the earliest forms of irrigation, but is no longer used today.

- 
- True. (Glossary, anti-siphon device)**
- False. (page 1)**

9.

# Orientation

## Controlling Water Flow

**Section 4 covers two class sessions**

Two class sessions are required to cover the information in Section 4:

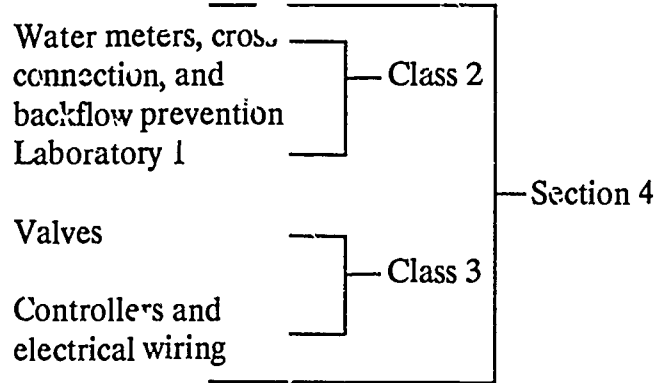

This orientation discusses each class session separately, beginning on the next page.

## Class Session 2

**Audio-visual aids that you need to present class session 2**

None.

**Labs or drawing exercises associated with class session 2**

Laboratory 1

**Steps to complete before teaching class session 2**

Complete the following steps before you teach class session 2:

1. Read the part of this section that deals with water meters and cross connection. Notice that two publications in the appendix are required reading to supplement the information.
2. Read the description for Laboratory 1. It is in the tabbed section "Labs and Exercises."
3. Determine exactly what Laboratory 1 involves. For example, you may plan to hold the lab in a different location than the regular class. If so, you may need to contact your college representative and verify that the different location is available.  
  
Make sure that you have all of the required materials prior to the lab. Again, you may need to contact your college representative to verify the location of the materials.
4. Study the lesson plan for class session 2. Remember that the times allotted are guidelines only.

5. Determine which of the learning activities that you want to include during the class.
6. For you and your students, photocopy the pretest for the subject "Water Meters, Cross Connection, and Backflow Prevention." All pretests are located in the 9x12 envelope. Be sure to return the master to the envelope.
7. Sit or lie in a quiet place where you will not be disturbed. Close your eyes and relax your entire body. Breathe deeply several times, using your diaphragm to inhale and exhale. Mentally picture yourself with your students, discussing irrigation. "See" the situation as a sharing of information that unfolds pleasantly. Imagine the learning process as being a pleasant and beneficial experience. Hold that thought for a few minutes, then open your eyes and resume your daily activities.

**Reading assignment for  
class session 3**

At the end of Lab 1, give the reading assignment for class session 3:

In the SC's:  
Pages 29 through 59.

In the Student's Guide:  
The information on valves and  
controllers in Section 4



**Class Session 3**

**Audio-visual aids that you need to present class session 3**

Sample controllers.

**Labs or drawing exercises associated with class session 3**

None.

**Steps to complete before teaching class session 3**

Complete the following steps before you teach class session 3:

1. Read pages 29 through 59 in the ABC's of Lawn Sprinkler Systems.
2. Read the part of this section that deals with valves and controllers.
3. Study the lesson plan for class session 3. Remember that the times allotted are guidelines only.
4. Determine which of the learning activities that you want to include during the class.
5. For you and your students, photocopy the pretest for the subject "Valves, Controllers, and Electrical Wiring." All pretests are located in the 9x12 envelope. Be sure to return the master to the envelope.

6. Sit or lie in a quiet place where you will not be disturbed. Close your eyes and relax your entire body. Breathe deeply several times, using your diaphragm to inhale and exhale. Mentally picture yourself with your students, discussing irrigation. Imagine the learning process as being a pleasant and beneficial experience. Hold that thought for a few minutes, then open your eyes and resume your daily activities.

### Reading assignment for class session 4

At the end of the class, give the reading assignment for class session 4:

In the ABC's:

Pages 10 through 28

Pages 60 through 74.

Pages 124 through 129

In the Student's Guide:

All of Section 5

The information on the basics of hydraulics in Section 6

The discussion for Laboratory 2.

Notes:

90

## 4. Controlling Water Flow

---

### Section overview

This section discusses the common ways in which the flow of water is controlled to and through sprinkler systems. The first area of discussion involves water meters, cross connection, and the importance of backflow prevention. Also presented in this section is an explanation of valves and controllers.

### Water Meters and Cross Connection

#### Water meter defined

A water meter is a device that registers the amount of water, typically in gallons, used by a residence or business. Municipalities install and own the meters. A property can have more than one meter if the property owner so desires. This allows a sprinkler system to be on its own meter, for instance.

Water meters are measured in inches. This is the size of the orifice through which the water passes. The most common meter sizes are  $\frac{5}{8}$ ,  $\frac{3}{4}$ , 1,  $1\frac{1}{2}$ , 2, and 3. Although water meters come in different sizes, you will often find the same size within a neighborhood or locale. For instance, the meters in one neighborhood may all be  $\frac{5}{8}$  inch. In another neighborhood they may all be  $\frac{3}{4}$  inch.

#### Annotation: (Discussion Question)

How many different sizes of water meters have you seen in this locale?

### Pressure loss and flow rate

You will need to know the size of the water meter to install a sprinkler system because of two reasons: pressure loss and flow rate.

The meter reduces the pressure of the water. This reduction, caused by friction, is called pressure loss or pressure drop. The subject of pressure loss is explained later in the course. For now, just remember that the smaller the size of the meter, the greater the amount of pressure loss.

The pressure loss, in turn, affects the flow rate of the water. The flow rate is measured in gallons per minute. Water meters are rated as to their flow capacity. That is, the rating tells how many gallons of water can pass through the meter in 1 minute at a given water pressure. For example, with a water pressure of 60 pounds per square inch (psi), a 1 inch water meter is rated at 30 gallons per minute. At the same water pressure, a 3/4 inch meter is rated at 22 gallons per minute.

### Static pressure and working pressure

When discussing water pressure, irrigators distinguish between static pressure and working pressure. The pressure of water when it is not moving is called static pressure. The pressure of water when it is moving is called working pressure. Static pressure and working pressure are also discussed later in the course.

If the working pressure is too low for a sprinkler system to operate correctly, the only solution may be a larger water meter. The property owner would have to contact the city water department to have a larger meter installed.

**Locations of meters**

Water meters are not located in any one specific place. They may be on the front side of a property, on the backside, or even in a basement. Usually, they are located fairly close to the main water line. The ones that are buried are protected by some sort of box that commonly has a lid.

**Annotation:  
(Discussion Question)**

**Where are water meters usually located in this locale?**

A sprinkler system is connected to the water supply at some point between the meter and the house or business. This point is often at the water meter because the supply line is most easily found there. The water supplied to houses and businesses is potable, meaning that it is suitable to drink. When you install a sprinkler system, you connect it to the potable water supply. Any connection made to a potable water supply is called a cross connection.

**Cross connection defined**

In Texas, cross connection is closely regulated by city ordinances and even by state law. To legally make a cross connection in Texas, you must be a licensed professional engineer, a licensed plumber, a licensed irrigator, or a licensed installer of irrigation systems. A homeowner also may legally make a cross connection on his or her own property. However, the homeowner must obtain a permit to make the cross connection.

Why all the fuss over cross connection? Without proper safeguards, a cross connection could allow hazardous materials to enter the supply of drinking water. A condition such as that, fluids flowing backward, is called backflow.

**Backflow**

In the appendix of this book is a publication from the Febco Company titled Cross Connection Handbook, and one from the Watts Regulator Company titled 50 Cross Connection Questions, Answers, and Illustrations. Please turn to the appendix and entirely read both of those publications. They will greatly help your understanding of cross connection and backflow.

**Annotation:  
(Discussion Question)**

**How many different types of backflow prevention devices have you seen? What are some of the problems you have encountered with the different types?**

After you finish reading the publications, return to this section and continue with the subject review on water meters, cross connection, and backflow prevention.

100

## Subject Review

### Water Meters, Cross Connection, and Backflow Prevention

#### Fill In The Blank

Supply the word or words in the answer column to complete the following statements.

Then, after the questions are discussed in class, place an "X" through each incorrect answer and write the correct answer in the answer column. That way, you will know the correct answers if you later review this information.

Statement	Answer
1. Any connection made to a potable water supply is called a _____.	Cross connection. (Febco, page 2)
2. Backpressure occurs if the _____ pressure in a line exceeds the pressure in the supply line.	Downstream. (Febco, page 2)
3. A device that can be attached to a hose bibb to prevent backflow is called a hose bibb _____.	Vacuum breaker. (Watts, page 3)
4. An atmospheric type vacuum breaker _____ be used under continuous pressure.	Cannot. (Febco, page 7)
5. _____ space can be used to separate a potable water supply from a nonpotable water supply.	Air. (Febco, page 7)
6. A pressure type vacuum breaker must be installed _____ the usage point.	Above. (Watts, page 8)



Statement

---

Answer

---

7. Impaired water that is not an actual hazard to the public health is said to be \_\_\_\_\_.

Polluted. (Febco, page 7)

8. Water that is an actual hazard to the public health is said to be \_\_\_\_\_.

Contaminated. (Febco, page 7)

## True or False

In the answer column, mark the following statements "T" for true or "F" for false. The whole statement is false if any part of it is false.

Then, after the questions are discussed in class, place an "X" through an incorrect answer and write the correct answer in the answer column. That way, you will know the correct answers if you later review this information.

Statement	Answer
1. The main supply line from a residential water meter to the house is usually a 1" diameter pipe.	False. (Page 1)
2. The two forms of backflow are backsiphonage and backpressure.	True. (Febco, page 2)
3. The most common form of cross connection is the ordinary water hose.	True. (Watts, page 2)
4. An anti-siphon vacuum breaker protects against backpressure backflow.	False. (Watts, page 4)
5. In residential areas that have alleys, the water meters are always located beside the alleys.	False. (Page 3)
6. Depending on local codes, an atmospheric type vacuum breaker can be used on lawn sprinkler systems.	True. (Watts, page 4)
7. A strainer or filter will help protect a backflow preventer from clogging.	True. Watts, page 10.
8. The "size" of a water meter refers to the volume of water that can pass through it.	False. (Page 1)

## Multiple Choice

Circle the letter of the choice that best completes the statement.

Then, after the questions are discussed in class, write the letter of the correct answer in the answer column. That way, you will know the correct answers if you later review this information.

Statement	Answer
<p>1. A common example of backsiphonage is</p> <p>A. Draining water from an ice chest through the drain cock</p> <p>B. Forcing pressurized water through a sprinkler head</p> <p>D. The way in which a drip coffee maker discharges water</p> <p>E. The way in which a gasoline pump discharges gasoline</p> <p>F. None of the above</p>	<p><b>C. Drinking a liquid through a straw. (Fehco, page 2)</b></p>
<p>2. One way to help protect a backflow preventer from leaking is</p> <p>A. To reduce the water pressure to the system</p> <p>B. To reduce the number of heads in the system</p> <p>C. To install the backflow preventer higher than the supply line</p> <p>E. Both A and B</p> <p>F. Both C and D</p>	<p><b>D. To install a strainer or filter on the upstream side of the preventer. (Watts, page 11)</b></p>

101

Statement	Answer
<p>3. Leakage from a backflow preventer is normally caused by</p> <ul style="list-style-type: none"> <li>A. Too much water pressure</li> <li>B. Too many heads for the backflow preventer</li> <li>C. The "O'Hearn effect" of siphonage combined with reverse osmosis</li> <li>E. Both A and B</li> <li>F. Both C and D</li> </ul>	<p>D. Foreign matter lodged on the seating area of the valve(s). (Watts, page 11)</p>
<p>4. The ways to protect potable water from a cross connection include</p> <ul style="list-style-type: none"> <li>A. Fluid gaps, osmosis flow preventers, uni-flow valves</li> <li>B. Air gaps, double chamber guards, siphon modulators</li> <li>C. Double check valves, reduced pressure backflow preventers</li> <li>D. Air gaps, atmospheric vacuum breakers, pressure type vacuum breakers</li> <li>E. Both A and B</li> </ul>	<p>F. Both C and D. (Febco, page 7)</p>
<p>5. A pressure vacuum breaker must be installed</p> <ul style="list-style-type: none"> <li>A. 4 inches above the highest outlet</li> <li>B. 6 inches above the highest outlet</li> <li>C. 8 inches above the highest outlet</li> <li>D. 10 inches above the highest outlet</li> <li>F. None of the above</li> </ul>	<p>E. 12 inches above the highest outlet. (Febco, page 10)</p>

Statement	Answer
<p>6. Some states require that</p> <ul style="list-style-type: none"> <li>B. Only atmospheric vacuum breakers be tested once a year</li> <li>C. Only pressure vacuum breakers be tested once a year</li> <li>D. Only reduced pressure principle devices be tested once a year</li> <li>E. Both B and C</li> <li>F. None of the above</li> </ul>	<p><b>A. All types of backflow prevention devices be tested once a year. (Febco, page 7)</b></p>
<p>7. Continuous pressure means that pressure is being supplied to a backflow prevention device</p> <ul style="list-style-type: none"> <li>A. All of the time</li> <li>B. For more than 50 minutes each hour</li> <li>C. For periods over 18 hours at a time</li> <li>D. For periods over 15 hours at a time</li> <li>F. None of the above</li> </ul>	<p><b>E. For periods over 12 hours at a time. (Watts, page 4)</b></p>
<p>8. If you install an atmospheric type vacuum breaker, it must go on the _____ side of the last control valve.</p> <ul style="list-style-type: none"> <li>A. Supply</li> <li>C. Left</li> <li>D. Right</li> <li>E. Water meter</li> <li>F. None of the above</li> </ul>	<p><b>B. Discharge. (Watts, page 8)</b></p>

## Valves

### Valve defined

#### Annotation: (Discussion Question)

**What is the most unusual type of valve that you have every seen?**

In irrigation, a valve is a device that controls the flow of water. Valves are manufactured today in a variety of plastics and metals. Valves, just like pipe, need to be correctly sized because a certain amount of pressure loss occurs at each valve. You will learn more about this in Section 6, Layout and Design.

Aside from their material, valves may be discussed several ways: by how they operate, such as manual or automatic; by their configuration, such as ball or gate; or by their purpose, such as drain or anti-siphon.

A “manual” valve is one that requires a human to manually open or close the valve. An “automatic” valve is one that can open or close without human interaction. Automatic valves operate by either electricity or hydraulics, or a combination of the two.

### Valve operation

Actually, some valves also use gravity to help them operate, such as the gravity ball-type drain valve or the gravity-type check valve. But to keep from over complicating the discussion, we will classify automatic operation as either electric or hydraulic. Figure 4-1 classifies valves by how they operation.

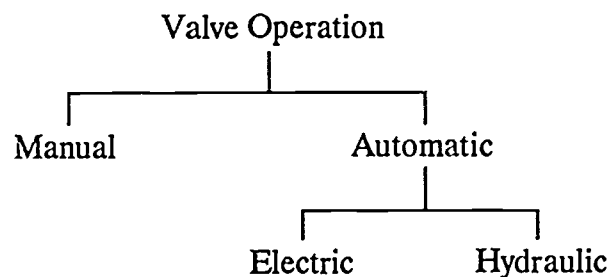

Figure 4-1. Valves Classified By How They Operate

### Manual valves

The types of valves vary depending on whether or not they are manual or automatic. Let us look first at the types of manual valves, as shown in Figure 4-2.

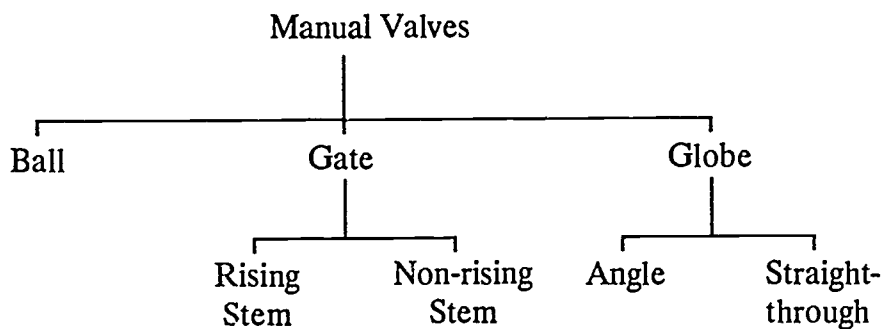

Figure 4-2. Types of Manually Operated Valves

Gate valves and globe valves are discussed in the ABC's of Sprinkler Systems.

A manual ball valve contains a ball on the inside that is connected to a handle on the outside. The ball contains a hole through its center. When you turn the handle to align it with the direction of water flow, water passes through the hole in the ball. When you turn the handle at a right angle to the flow, water cannot pass.

**Electric valves**

Figure 4-3 show the types of electrically operated automatic valves.

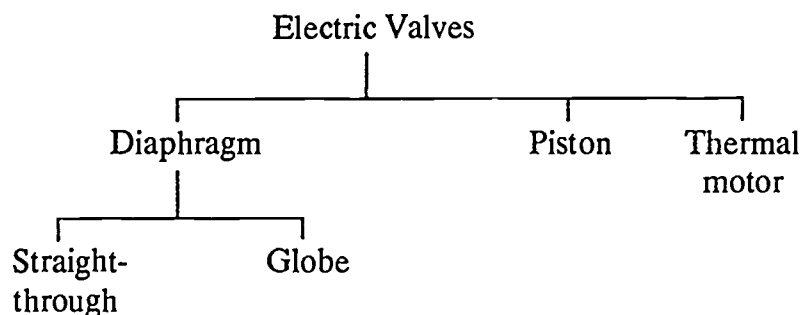

Figure 4-3. Types of Electrically Operated Valves

Diaphragm globe valves, piston valves, and thermal motor valves are discussed in the ABC's of Sprinkler Systems.

The straight-through diaphragm valve functions much the same as the globe-type diaphragm valve. In the straight-through valve, however, the diaphragm raises out of the flow passage and allows the water to flow straight through. With the valve open, you can look through the flow passage. With a globe-type valve, even with it open, you cannot see through it because of a baffle in the flow passage.

**Operating current**

Most electric valves today operate on 24 volt AC current. In the past, valves requiring 110 volt AC current were used, but such valves are not commonly used any more.

**Annotation:**  
**(Discussion Question)**

Have any of you every dealt with 110 volt AC valves? Where and how so?



**Hydraulic valves****Annotation:**  
**(Discussion Question)**

Have any of you every dealt with hydraulic valves? Where and how so?

Hydraulically operated valves were once quite common. Today, electrically operated valves have superseded them as the most commonly used valve. Figure 4-4 shows the types of hydraulically operated valves.

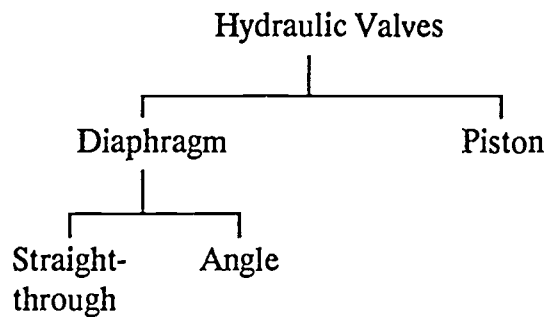

Figure 4-4. Types of Hydraulically Operated Valves

### Additional types of valves

In addition to the types of valves already discussed, you will also deal with other types that are often used in the irrigation business. Figure 4-5 lists the most common of these.

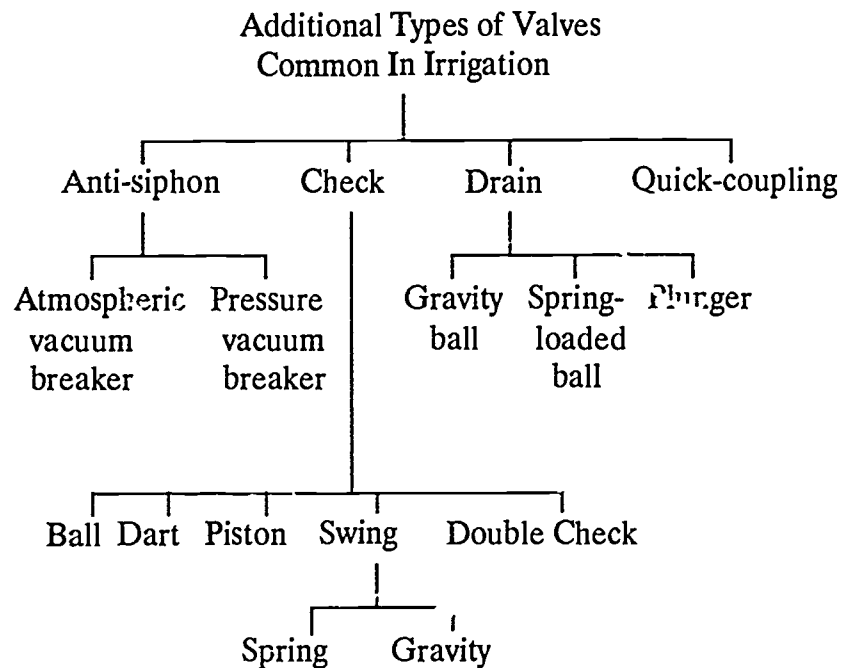

Figure 4-5. Additional Types of Valves Common In Irrigation

Notice that anti-siphon valves and drain valves indicate the function they perform. That is, anti-siphon valves prevent backflow and drain valves allow the water to drain from a sprinkler system.

Most of the valves listed in Figure 4-5 are explained in the ABC's of Sprinkler Systems. Discussed below are the ones that are not.

The five types of check valves all work similarly to the swing check valve, which is explained in the ABC's. The name of the valve indicates the type of "clapper" used: a ball, a dart, a piston, or a swinging disk. The purpose of the clapper is to prevent water from flowing backward into the supply line.

The double check valve is discussed in the *Cross Connection Control Handbook* in the appendix of this book

The gravity ball drain valve functions much the same as the spring-loaded ball type. Instead of using a spring, however, the ball is moved away from the drain port by gravity. When the valve fills with water, the flow out of the drain port causes the ball to seat itself on the port and to shut off the flow.

### **Referring to a valve by its purpose**

#### **Annotation: (Discussion Question)**

**How many valves does a typical residential system need?**

**(Impossible to tell--each system is unique and must be design accordingly)**

The purpose that a valve serves in a sprinkler system is often how you will refer to them. For example, we commonly talk about master valves, circuit valves, flow control valves, drain valves, and backflow prevention valves.

You already know about the purpose of drain valves and backflow prevention valves. The purpose of a master valve is just what you would expect--it controls water flow to the entire sprinkler system. A master valve is usually operated automatically.

Circuit valves are the valves that control individual circuits, or groups, of sprinkler heads. The most common circuit valve used today is the electrically operated diaphragm globe valve. Flow control valves can be pre-set at a given rate of flow to regulate flow.

### **Placing valves**

#### **Advantages of a manifold**

#### **Annotation: (Discussion Question)**

**How many of you have ever used a manifold to centrally locate valves? What were the advantages and disadvantages from an installation standpoint?**

You should always place the master valve at the point where you make the cross connection. This point is most often at the water meter.

You may place circuit valves in the turf area or connect them to a manifold at a central location. The manifold approach offers a couple of advantages over burying the circuit valves in the turf area. First, all of the circuit valves are easy to find, repair, or replace. Second, you avoid damage, and unsightliness, to the turf area.

## Drain valves

### Annotation: (Discussion Question)

How many of you routinely use drain valves on your systems?

Automatic drain valves are an important part of any sprinkler system. You should place them at all low points in the system. Install them at an angle of 30° to 45° below horizontal. If you put them straight down, the valve may clog from debris. If you put them straight across, not enough water can drain from the pipe.

Never install an automatic drain valve at the end of a pipe. Debris can be flushed to the end of the pipe and clog the drain. Move back from the end of the pipe about 12 inches and install the drain valve there.

Always include a sump pit for each drain valve. The size of the sump will vary depending on the type of soil; heavy clay soils require larger sumps. As a general rule, a sump about the size of a one pound coffee can works well. Fill the sump with gravel to ensure good drainage.

## Backflow prevention valves

The Febco *Cross Connection Control Handbook* in the appendix of this book discusses where to install the various backflow prevention valves. You may wish to re-read portions of that handbook to review the information.

## Opening and closing valves

Automatic valves, whether electric or hydraulic, need some device to open and close them. That device is called a controller and is the subject of our next discussion.

Before you learn about controllers, however, complete the subject review on valves.

## Subject Review

### Valves

#### Fill In The Blank

Supply the word or words in the answer column to complete the following statements.

Then, after the questions are discussed in class, place an "X" through each incorrect answer and write the correct answer in the answer column. That way, you will know the correct answers if you later review this information.

Statement	Answer
1. The more valves used in a system, the fewer _____ per circuit.	Heads. (Common sense)
2. Valves bodies today are available in two types of material, both _____ and _____.	Plastic, metal. (Page 11)
3. A system with manual valves buried at 29" requires a _____ for the property owner to open and close the valves.	Key. (ABC's, page 46)
4. Three common ways to operate section valves are _____, _____, and _____.	Manually, hydraulically, and electrically. (Page 11, and ABC's, pages 32 and 36)
5. Valves that _____ and _____ ly are less likely to cause fatigue in sprinkler components.	Open and close. (Glossary, water hammer)
6. Water running through an angle valve always exits at a _____ angle from the direction of entry.	90° or right. (ABC's, page 32)

Statement

Answer

- 
7. Most electric valves require sustained electric current for the valve to remain \_\_\_\_\_.
8. A \_\_\_\_\_ is really any device that can control fluid flow.

- Open. (ABC's, page 36)
- Valve. (ABC's, page 29)

## True or False

In the answer column, mark the following statements "T" for true or "F" for false. The whole statement is false if any part of it is false.

Then, after the questions are discussed in class, place an "X" through an incorrect answer and write the correct answer in the answer column. That way, you will know the correct answers if you later review this information.

Statement	Answer
1. All electric valves are globe type.	False. (Figure 4-3)
2. Master valves are used to prevent velocities above 7 ft/sec.	False. (Glossary, Flow Control Valve)
3. Solenoids often use 24 V AC electrical current to close.	False. (ABC's, page 36)
4. The water from the sprinkler system must never be allowed to pass into the cavity above the diaphragm in an electric valve.	False. (ABC's, page 36)
5. Valves need not be sized because they seldom create friction loss.	False. (Page 11)
6. Anti-siphon valves can be used to regulate flow by partially closing their poppet.	False. (ABC's, page 34)
7. Common backflow prevention devices last many years and do not need to be tested regularly.	False. (Febco, page 10)
8. Codes usually require that circuit valves be several inches above the highest head in a circuit.	False. (Common sense)



Multiple Choice

Circle the letter of the choice that best completes the statement.

Then, after the questions are discussed in class, write the letter of the correct answer in the answer column. That way, you will know the correct answers if you later review this information.

Statement	Answer
<p>1. Most residential sprinkler systems need</p> <p>A. Only two valves for the front yard and two valves for the back yard</p> <p>B. One master valve, no drain valves, and four circuit valves</p> <p>C. An atmospheric vacuum breaker connected to a master valve</p> <p>D. As many valves as the water pressure will allow</p> <p>E. Both C and D</p>	<p><b>F. None of the above. (Class discussion)</b></p>
<p>2. You should always place a master valve</p> <p>A. Next to a building for protection</p> <p>B. Higher than the water meter</p> <p>D. On the circuit that has the most sprinkler heads</p> <p>E. Both A and B</p> <p>F. Both C and D</p>	<p><b>C. At the point where you make the cross connection. (Page 17)</b></p>

Statement	Answer
<p>3. With a straight-through diaphragm valve open, you</p> <ul style="list-style-type: none"> <li>A. Cannot see through the flow passage because of the baffle plate</li> <li>B. Can see through the flow passage</li> <li>C. Cannot tell from the outside of the valve if it is open or not</li> <li>D. Can tell from the outside of the valve if it is open or not</li> <li>E. Both A and C</li> </ul>	F. Both B and D. (Page 13)
<p>4. A gate valve with a non-rising stem means that</p> <ul style="list-style-type: none"> <li>A. The valve will not open as fully as a rising stem gate valve</li> <li>B. The valve will always wear out faster than a rising stem gate valve</li> <li>C. The valve body cannot be removed</li> <li>E. The stem can be turned only with a valve key</li> <li>F. None of the above</li> </ul>	D. The stem swivels in the valve body at a fixed height. (ABC's, page 30)
<p>5. Drain valves</p> <ul style="list-style-type: none"> <li>A. Are closed when the valve fills with water</li> <li>B. Should be placed at an angle of 30° to 45° below horizontal</li> <li>C. Should never be installed at the end of a pipe.</li> <li>D. Should always drain into a sump pit</li> <li>F. None of the above</li> </ul>	E. All of the above. (Page 18)

112

Statement	Answer
6. Circuit valves A. Must be placed in the turf area C. Must be electric valves D. Must be a piston type valve E. Must be a globe type valve F. None of the above	<b>B. May be connected to a manifold at a central location. (Page 17)</b>
7. Swing check valves B. Are all spring actuated C. Cannot be disassembled for maintenance D. Never require maintenance E. Both A and B F. Both C and D	<b>A. Allow water to flow in only one direction. (ABC's, page 31)</b>
8. Hose bibbs A. Always have an outlet that is 90° to the inlet B. Cannot be buried in a valve box D. Always have an outlet smaller than the inlet E. Always have a permanent hand wheel for operating the valve F. None of the above	<b>C. Are often called hydrants or faucets. (ABC's, page 35)</b>

## Controllers and Electrical Wiring

### Controller defined

Within the irrigation business, controllers are often referred to as clocks or timers. But by whatever name, an automatic controller is a device that actuates remote control valves. We refer to a valve and its group of sprinklers as a circuit. Controllers vary widely in the number of circuits they can control, from a single circuit to at least 30.

### Types of controllers

The three types of automatic controllers are hydraulic, electro-mechanical, and solid state.

Actually, there is a fourth way to control sprinkler systems: manually. With manual control, of course, a person must physically turn on and off the system. A manually controlled system typically cost less than an automatically controlled one. The inconvenience, however, is a definite drawback.

### Hydraulic

Hydraulic controllers are seldom used anymore. Their disadvantages outweigh their advantages. As much as anything, they are victims of the advance of technology. Hydraulic controllers are discussed in the ABC's.

### Electro-mechanical

#### Annotation: (Discussion Question)

**How many of you have ever taken apart an electro-mechanical controller? Describe what you did and how.**

Electro-mechanical controllers use a combination of electronic parts and mechanical parts (such as gears). Watering cycles are turned on and off by means of tripping pins located on a wheel or dial. Such controllers typically have a day wheel and an hour wheel. The pins trip, or turn on, switches as the wheels rotate. This starts the watering cycle, which stays on until the controller timer shuts it off. The cycle then remains off until the wheels rotate around again and the pins once more trip the switches.

For several years, electro-mechanical controllers have been the most widely used. The use of solid state controllers is quickly gaining on them, however.

### Solid state

Solid state controllers will undoubtedly become more common than electro-mechanical ones during the next decade. They offer the advantage of being completely electronic. This allows them to have more features than electro-mechanical controllers, as well as to avoid mechanical breakdown.

120

Table 4-1 summarizes the advantages and disadvantages of the different types of controllers.

**Table 4-1. Advantages and Disadvantages of Controllers**

Controller Type	Advantages	Disadvantages
Hydraulic	<ul style="list-style-type: none"> <li>Provided a way to actuate remote control valves before the invention of valves with electric solenoids</li> <li>Not sensitive to surges in electrical power</li> </ul>	<ul style="list-style-type: none"> <li>Can freeze</li> <li>Requires normally open valves</li> <li>Requires clean water to function correctly</li> <li>Leaks in tubing can cause malfunctions</li> <li>Few options and features available</li> </ul>
Electro-mechanical	<ul style="list-style-type: none"> <li>Simple to operate</li> <li>Proven to be reliable</li> <li>Powered by electricity instead of water</li> </ul>	<ul style="list-style-type: none"> <li>Physically large</li> <li>Subject to mechanical breakage</li> <li>Limited programming</li> </ul>
Solid State	<ul style="list-style-type: none"> <li>Powered by electricity instead of water</li> <li>Physically small</li> <li>Flexible programming</li> <li>Several options available</li> <li>Reliable</li> </ul>	<ul style="list-style-type: none"> <li>Sensitive to electrical surges</li> <li>Cost (sometimes)</li> </ul>
Manual	<ul style="list-style-type: none"> <li>Less expensive</li> <li>Can be installed in remote locations where no electrical power is available</li> <li>Allows a visual verification that the system is operating correctly</li> </ul>	<ul style="list-style-type: none"> <li>Inconvenient</li> <li>Not conducive to water conservation (wasteful if operator forgets to shut off system or cannot get to the system for an extended period)</li> </ul>

**Power requirements**

Normally, all three types of controllers require 115 volts AC current for their power. Some controllers operate on the 115 volts. Other controllers change the 115 volts AC to 24 volts AC and operate on 24 volts. In either case, a common wall socket can supply the power.

The power output from most controllers is 24 volts AC. The output power is used to actuate the valves.

**Use an unswitched circuit**

Controllers that require 115 volts AC current can be plugged into a wall socket or wired directly. In either case, the current needs to be supplied by an unswitched circuit. This prevents accidentally turning off the controller when a switch is turned off. If you wire a controller directly, always turn off the circuit breaker to that direct line. Remember: you must be a licensed electrician to legally tie into the electrical system and run a direct line.

**Annotation:  
(Discussion Question)**

**What are some of the problems you may face if you install an outlet instead of a licensed electrician installing it?**

As a point of caution, remember that the 115 volt input power is polarized. That is, the positive, "hot" wire must be connected to positive and the negative wire must be connected to ground. Polarity is especially important if more than one controller needs to operate from a single power supply.

**Electricity and the law**

Input power may not always be available at the exact location where you need to mount a controller. A wall of a garage may not contain an electric outlet, for example. In such cases, you must explain the situation to the property owner and request that he or she contact a licensed electrician. Unless you are a licensed electrician, you cannot legally tie into the electrical system to add an outlet or to run a direct line.

181

### Controller features

Automatic controllers are capable of more than just opening and closing valves. The features vary widely with the different types and brands of controllers. Features that are standard on one brand may be optional on another.

### Common features

Standard features frequently include an override switch, master valve operation, and pump start. An override switch lets you manually turn off the sprinkler system when watering is not needed, like when it is raining. In fact, some controllers label the switch as a rain switch. The override switch also allows you to start the system manually.

The ability to operate a master valve is an important feature. If a sprinkler system uses an atmospheric vacuum breaker, a master valve is required upstream from the breaker. Also, a master valve is often used to relieve pressure from the manifold and the supply line when the system is not operating.

The ability for the controller to start a pump is another common feature. The water for some sprinkler systems comes from a well or a lake and must be pumped to the system. The pump start feature allows the controller to start the pump at the beginning of the watering cycle and to shut off the pump at the end of the cycle.

### Programming

Solid state controllers often have features that are seldom found on the other two types. The most common of these is multiple programming, or the ability to have more multiple watering cycles. This feature is very important because of the increased use of drip irrigation and the fact that different types of plants have different water requirements.



**Power backup**

Also common on solid state controllers is a battery that provides backup power for the program in the controller's memory. If the electricity is cut off, the battery retains the program until the electricity comes back on. If the electricity were to stay off long enough, the battery would eventually go dead and the program would be erased from memory.

In such situations, many solid state controllers have a built-in program that automatically turns on the system each day, for a brief period, to ensure watering. The built-in program is powered by electricity and will not activate until the electricity is restored.

**Surge protection**

Because power surges can damage electronic components, surge protection is another feature often found on solid state controllers.

**Actuating the valves**

Controllers must have some way to actuate the valves. Hydraulic controllers use water pressure. Electro-mechanical and solid state controllers use an electric charge. The charge is transmitted to the valves through wires.

Fortunately, valves that operate on 24 volt AC current are not polarized. All they require is a "hot" wire and a common wire. You do not have to worry about which wire goes where. You can use the same common wire for all of the valves that the controller actuates. If a system has more than one controller, use separate common wires for each controller.

120

### Electrical wiring

Two types of wire are approved by the National Electrical Code for direct burial: UF and TW. Both types are approved for circuits that operate on less than 30 volts. Type UF contains a heavier insulation than type TW and for that reason is used more often. Check local codes to be certain that the wire you use complies.

### Wire gauge

The gauge of a wire refers to its size. Most wire used for sprinkler systems is copper wire of 18, 16, or 14 AWG (American Wire Gauge). The smaller the gauge number, the larger the wire. For example, 14 AWG wire is larger than 18 AWG wire.

The gauge is important because the longer the wire and the higher the amperage requirement, the larger the wire size needed. Most controllers and valves come with documentation that explains their wire requirements, such as the amperage, gauge, and how far you can run the wire. Normally, you can run 18 gauge wire 2000 feet. That distance is the complete circuit, so you could locate a valve 1000 feet from a controller.

### Conductor wires

Wire used for sprinkler systems usually contains numerous individual wires within a jacket or sheath. Wire such as this is described by two numbers separated by a slash: 18/8, 16/6, and so forth. The number on the left of the slash indicates the gauge of the wire. The number on the right indicates how many conductors (individual wires) are within the jacket. For example, 18/8 is 18 gauge wire with 8 conductors, and 16/6 is 16 gauge wire with 6 conductors.

Each conductor within the jacket is usually a different color from the other conductors. The white colored conductor is usually used as the common, or ground, wire.

**Splicing wire**

**Annotation:**  
**(Discussion Question)**

**What type of problems have you had with bad wiring connections?**

Try to wire your sprinkler systems without splicing the wire. Run a single piece of wire from the controller to each valve. The reason for this is simple: most electrical problems are caused by bad connections.

When you connect wires, make sure that the ends are clean and secure. Use crimp connectors if the wires will be buried. Taping the wires together or connecting them with wire nuts is not recommended for wires that will be buried.

Always seal a connection regardless of how you make the connection (crimp, taping, or wire nut). A common sealant used in the irrigation business is an epoxy resin type. The resin forms a waterproof seal to protect the connection from moisture.

**Installing wire**

Leave plenty of slack in the wire throughout the system. Put a loop in the wire at every 90° turn. "Snake" the wire from side to side in the ditch to ensure that the wire has enough slack. At each valve, create a "pig tail" by wrapping about 18 inches of wire around a piece of pipe to curl the wire like a cord on a telephone receiver. Leave additional slack at each connection.

Remember: compared to troubleshooting electrical problems, wire is cheap.

A good place to run the wire as much as possible is under the pipe. The pipe will help protect the wire when you fill in the trench. Handle the wire carefully during the entire installation so that you do not skin off the insulation. A skinned place can allow moisture to enter and can cause grounding problems.

**Check the solenoids**

Verify that the valve solenoids operate before you bury the wire. Sometimes you can check the operation just with an ohm meter.

Use conduit for any wire that is above ground, even UF and TW wire.

(This page included for duplexing.)

## Subject Review

### Controllers and Wiring

#### Fill In The Blank

Supply the word or words in the answer column to complete the following statements.

Then, after the questions are discussed in class, place an "X" through each incorrect answer and write the correct answer in the answer column. That way, you will know the correct answers if you later review this information.

Statement	Answer
1. The three types of irrigation controllers are electro-mechanical, hydraulic, and _____.	Solid state or electronic. (Page 25)
2. Control valves used with hydraulic controllers may be normally _____ or normally _____.	Open, closed. (ABC's, page 52)
3. List three disadvantages of a hydraulic controller _____, _____, _____.	Plugging of supply line (needs clean water), freezing, uses normally open valves, requires tubing to each valve, few options and features. (Table 4-1)
4. List three functions that you can normally perform with any controller _____, _____, _____.	Open and close a valve, manually turn off the controller (rain switch), set specific start times, set specific start days, time specific stations. (ABC's, page 49)

Statement	Answer
5. List three functions that are considered extra options on a controller _____, _____, _____.	Pump start, master valve control, multiple programs, weather tight housing, moisture sensor circuitry, surge protection. (Pages 29-30)
6. In the irrigation industry, a controller is usually called a _____.	Clock or timer. (Page 25)
7. The two types of wire that can be used under ground are _____ and _____.	UF and TW. (ABC's, page 51)
8. If wires will be buried in the ditch, make sure that any splices are _____.	Sealed against moisture, water tight. (Page 32)

## True or False

In the answer column, mark the following statements "T" for true or "F" for false. The whole statement is false if any part of it is false.

Then, after the questions are discussed in class, place an "X" through an incorrect answer and write the correct answer in the answer column. That way, you will know the correct answers if you later review this information.

Statement	Answer
1. At most, the number of valves that a single controller can operate is 25.	False. ( <u>ABC's</u> , page 49)
2. All controller housings are weather tight.	False. ( <u>ABC's</u> , page 53)
3. A totally electronic controller is more versatile than an electro-mechanical controller.	True. (Table 4-1)
4. Not all controllers have protective circuit breakers.	True. ( <u>ABC's</u> , page 53)
5. The wire to a valve should be pulled fairly tight to prevent the wire from moving in the ditch.	False. (Page 32)
6. You can use 18 AWG wire on all sprinkler systems.	False. (Page 31)
7. Wire listed as 18/8 contains 8 circuit wires and 1 ground wire.	False. (Page 31)
8. Wire that is approved for burial should be enclosed by conduit if the wire is above ground.	True. (Page 33, and <u>ABC's</u> , page 130)



Multiple Choice

Circle the letter of the choice that best completes the statement.

Then, after the questions are discussed in class, write the letter of the correct answer in the answer column. That way, you will know the correct answers if you later review this information.

Statement	Answer
<p>1. The pressure required to operate a hydraulic controller is</p> <p>A. 75 psi or greater                      B. The number of valves multiplied by .87 psi                      C. Less than 45 psi                      E. The number of heads multiplied by .87 psi                      F. None of the above</p>	<p><b>D. Equal to or greater than the water pressure in the system. (ABC's, page 52)</b></p>
<p>2. The output voltage from most controllers is</p> <p>A. 24 Volts DC                      C. 115 Volts DC                      D. 115 Volts AC                      E. 220 Volts AC                      F. None of the above</p>	<p><b>B. 24 Volts AC. (ABC's, pages 50, 52, 58, 59)</b></p>

1.3;

Statement	Answer
<p>3. Although it may vary with different brands of controllers, the number of valves that a single station normally operates at one time is</p> <p>B. Two C. Three D. Four E. Six F. None of the above</p>	<p>A. One. (<u>ABC's</u>, page 55 )</p>
<p>4. If electric power is not available at any of the reasonable locations for a controller, you should</p> <p>A. Install an electric outlet in a suitable place, such as a garage, and put the controller there B. Run a weather-proof extension cord from an outside outlet to where you want to put the controller C. Install a manual-start system D. Call a licensed electrician to install an electric outlet F. None of the above</p>	<p>E. Inform the customer that a licensed electrician must install an electric outlet. (Page 28)</p>

Statement	Answer
<p>5. Make certain that a controller is connected to</p> <ul style="list-style-type: none"> <li>A. An outlet that is used only for the controller</li> <li>B. An outlet that has its own circuit breaker</li> <li>C. An outlet that is can be turned on and off by a wall switch</li> <li>E. An outlet on an outside wall so that you can get to the wiring if necessary</li> <li>F. None of the above</li> </ul>	<p><b>D. An outlet that cannot be turned on and off by a wall switch (an unswitched circuit). (Page 28)</b></p>
<p>6. Regardless of the type of controller used, make certain that you</p> <ul style="list-style-type: none"> <li>A. Sell the controller under a separate maintenance contract</li> <li>B. Mount the controller where young children cannot easily reach it</li> <li>C. Explain to the customer how to operate the controller</li> <li>D. Both A and B</li> <li>F. None of the above</li> </ul>	<p><b>E. Both B and C. (Common sense )</b></p>
<p>7. The common, or ground, wire is usually</p> <ul style="list-style-type: none"> <li>A. Red</li> <li>B. Black</li> <li>D. Orange</li> <li>E. The wire largest in diameter</li> <li>F. None of the above</li> </ul>	<p><b>C. White. (Page 31 )</b></p>

Statement	Answer
8. A single ground wire can be used as the common wire for a maximum of  A. Four valves B. Four valves if the controller is electro-mechanical C. Twelve valves D. Twelve valves if the controller is programmable E. One to six valves	F. None of the above. (Page 30)

(This page included for duplexing.)

141

## Orientation

### Controlling Water Placement

#### Class Session 4

**Audio-visual aids that you need to present class session 4**

None.

**Labs or drawing exercises associated with class session 4**

Laboratory 2

**Steps to complete before teaching class session 4**

Complete the following steps before you teach class session 4:

1. Read this entire section and the following pages in the ABC's: 77 through 108.
2. Read the description for Laboratory 2. It is in the tabbed section "Labs and Exercises."
3. Determine exactly what Laboratory 2 involves. For example, you may plan to hold the lab in a different location than the regular class. If so, you may need to contact your college representative and verify that the different location is available.

Make sure that you have all of the required materials prior to the lab. Again, you may need to contact your college representative to verify the location of the materials supplied by the vendors..

4. Study the lesson plan for class session 4. Remember that the times allotted are guidelines only.

142

5. Determine which of the learning activities that you want to include during the class.
6. For you and your students, photocopy the pretest for the subject "Water Meters, Cross Connection, and Backflow Prevention." All pretests are located in the 9x12 envelope. Be sure to return the master to the envelope.
7. Sit or lie in a quiet place where you will not be disturbed. Close your eyes and relax your entire body. Breathe deeply several times, using your diaphragm to inhale and exhale. Mentally picture yourself with your students, discussing irrigation. "See" the situation as a sharing of information that unfolds pleasantly. Imagine the learning process as being a pleasant and beneficial experience. Hold that thought for a few minutes, then open your eyes and resume your daily activities.

#### Reading and homework assignments for class session 4

At the end of Lab 2, give the reading assignment and the homework for class session 4.

**Very Important:** In many respects, layout and design is central to the irrigation business. The time has now arrived for some commitment on the part of the students.

Point out that the amount of reading is very lengthy. Advise the students to read a few pages every day and not try to read it all the day before the next class.

Also emphasize that the homework assignment is very serious and not just "busy work." Each student must feel completely comfortable handling a compass and ruler. Tell the students to bring the homework with them to the next class.

Reading assignment:

In the ABC's:

Pages 76 through 108.

In the Student's Guide:

All of Section 6.

Homework:

Draw at least 60 circles, to scale, with a compass:

12 circles with a 3 foot radius

12 circles with a 6 foot radius

12 circles with a 9 foot radius

12 circles with a 12 foot radius

12 circles with a 15 foot radius.

The students may use 10-squares-per-inch graph paper if they choose. Otherwise, they must use a 10 scale ruler and set their compass to the correct radius. On a scale of 10 squares per inch, each square equals one foot.

142



Notes:

## 5. Controlling Water Placement

---

### Section overview

This section discusses the main ways in which water reaches, or is placed at, the locations where watering occurs. First of all, some sort of pipe must convey the water to a location. Once at a location, the water must be dispersed through sprinkler heads and nozzles. Allied with a discussion of sprinkler heads and nozzles is an explanation of precipitation and application rates.

### P i p i n g

#### Pipe defined

Pipe is any hollow tubular material used to convey a fluid. In sprinkler systems, of course, the fluid is water.

The ABC's of Lawn Sprinkler Systems covers the subject of pipe fairly thoroughly. Therefore, this Guide will not dwell on the subject. A few points, however, are worthy of further discussion.

#### Older pipes may restrict flow

In houses built during the 1930's, '40's, and '50's, most of the supply lines from the water meters into the houses were galvanized steel pipe. Over the years, a certain amount of corrosion can build up on the interior of such pipe and restrict the flow passage.

One form of corrosion can be electrolytic corrosion, or corrosion caused by electrolysis. In simple terms, electrolysis is a chemical change in an object caused by the flow of electrons. A car battery is a good example of electrolysis occurring between different metals and solutions to produce direct current electricity.

Connecting two dissimilar metals together may also cause electrolysis depending on the types of metal. For example, connecting copper pipe to

steel or iron pipe can cause electrolytic corrosion of the steel or iron. The way to prevent this is to use a dielectric fitting or other insulation type fitting.

**Annotation:**

**(Discussion Question)**

**What are some of the ways that you can think of to check flow rate without using a flow meter? (One way is the "bucket test." Use a hose bibb or a water hose to fill a container of a known size, one gallon or five gallon, for example. Time how long it takes. If it takes one minute to fill a five gallon bucket, then the flow rate is five gallons per minute.)**

Be aware that if you connect a sprinkler system to an old supply system, you will probably have to deal with restricted flow rates. This make it doubly important for you to check the available flow rate coming from the meter. The most accurate way to do this is with a flow meter, although other methods are available.

## Standards

A standard is a comparison against which the quantity, quality, or extent of other items may be measured. For example, the standard measure of a yard is 36 inches. A yardstick 35 inches long would be nonstandard. As you can see, standards allows us to have consistency. Standards also exist for pipe, particularly regarding the size of pipe.

Private industry often originates standards. This can lead to the existence of many different standards and can create a confusing situation. To remedy such confusion, the official representative of the United States for defining standards is the American National Standards Institute, or ANSI.

ANSI was formerly known as the American Standards Association, or ASA. So, when dealing with pipe, you may run across a standards number with a prefix of ASA. (In fact, depending on the time period when the standard was approved, you may also encounter prefixes of NCANSI, USAA, and USAS.)

## Effects of temperature on pipe

Temperature affects pipe a couple of ways. First, the temperature of the water affects the pipe. For most sprinkler systems, the working temperature of the water does not vary enough to be a major concern. You will need to use a larger class of pipe if the water temperature in the system is consistently hot (90° or above). The hotter the water, the larger the class number of pipe you should use.

A second way that temperature affects pipe is called thermal expansion. Pipe, particularly all types of plastic pipe, expands when it gets hot and contracts when it get cold. The amount of expansion and contraction can be several inches per hundred feet depending on the type of plastic and the amount of temperature change.

For example, suppose that you installed a 100 foot section of PVC on a July day when the temperature was 100°. After burying the pipe and running cool water through it, suppose that the temperature of the pipe dropped to 50°. The pipe will contract about three inches. If you have not left sufficient slack, the force of the contraction could pull apart fittings.

### Water hammer

Impact strength, or the ability to withstand the shock of a blow, is another important characteristic of pipe. Think about the effect of a valve that quickly shuts off the flow of water in a sprinkler system. The water is moving, so it has momentum; the water is also heavy, so it has weight.

The effect of abruptly stopping that water causes a shock called water hammer. Water hammer can actually fatigue pipe and cause it to expand beyond its normal shape. In some cases, the expansion can cause the pipe to rupture.

Make sure that the class of pipe in your sprinkler systems can withstand the surge pressure of water hammer. A rule of thumb is to use the 50% rule. In other words, if the maximum amount of pressure that you expected to encounter is 100 psi, you would want to use at least a class 200 pipe in order to safely allow for surges (50% of 200 is 100).

Another form of water hammer occurs when water that is flowing straight makes a turn. For example, water reaching an elbow fitting actually pushes against the fitting. In some cases, the force is great enough to dislocate the fitting from the pipe. One safeguard against this is a thrustblock, which is some kind of hard material such as a brick, rock, or piece of wood. The thrustblock is placed against the elbow and provides resistance against water hammer.

**Effects of sunlight on pipe**

Sunlight can deteriorate PVC pipe over a period of time and cause it to weaken. You should store PVC where it is covered and not expose it to direct sunlight for long periods.

Conversely, advances in polymer chemistry have given us polyethylene pipe that can be exposed to sunlight for long periods without harmful effect. In fact, polyethylene pipe is often used for drip irrigation and is made to lay directly on top of the ground. You will learn more about drip irrigation in Section 7.

**Connecting pipe**

Pipe is connected in various ways depending on the type of pipe. Metal pipe such as galvanized steel is connected with threaded fittings. Connections to copper pipe are usually soldered, or sweated. PVC and ABS connections are solvent welded. Polyethylene pipe cannot be solvent welded. You must use clamp-type fittings instead.

Solvent welding and soldering are so common in the irrigation business that each merits further discussion.

**Solvent welding**

PVC pipe is connected by a process called solvent welding. The process is called welding rather than gluing because an actual fusing of materials occurs. The solvent softens the pipe and the fitting so that they fuse together when they touch. This is different from a glued connection, which would leave a layer of glue between the pipe and the fitting.

(ABS pipe is also connected by solvent welding. But to simplify discussion, this Guide will refer only to PVC. Keep in mind that the same information applies to ABS pipe.)

Before you solvent weld plastic pipe you must cut it to the proper length. A hack saw cuts PVC very well, or you may choose to use one of the cutting tools especially made for cutting PVC. In either case, make sure that all cuts are square and that the ends of the pipe are free from rough edges.

**Remove the gloss**

The inside of the fitting and the outside of the pipe must be clean and dry. PVC has a glossy coating that you must remove or the weld may not occur properly. You can remove the gloss with sandpaper, but a better method is to use a chemical cleaner or primer.

The cleaner slightly softens the PVC so be careful not to put the pipe and fitting together after you have chemically cleaned them. They will bond enough so that you cannot get them apart, yet they will not be strong enough to withstand water pressure.

### Apply the solvent

After you have cleaned the PVC, apply a generous coat of solvent, but not an excessive amount. Apply the solvent to the outside of the pipe and to the inside of the fitting. The distance from the end of the pipe to where you stop applying solvent depends on how far the pipe will fit into the fitting. For example, if the pipe will fit two inches into the fitting, start two inches from the end of the pipe and apply the solvent from there to the end.

After you coat the pipe and fitting with the solvent, push them together and turn one or the other about a quarter of a turn. This evenly distributes the solvent. Hold the pipe and fitting together for 10 to 15 seconds, just long enough for them to make the initial bond, before you proceed to the next connection.

### Watch the excess

Be careful not to use too much solvent. Excessive solvent can form a ring on the inside of the pipe and fitting when you push the two together. Since you have no way to get inside and clean off the ring, the solvent will keep softening the PVC and weaken the plastic.

Wipe off any excess solvent from around the fitting. If you do not, the solvent develops a film over itself and will not evaporate. The solvent will then keep softening the pipe at that point and, over time, weaken the pipe.



Use enough solvent to form a good bond, but not so much that you do more harm than good. Keep from dripping solvent on other connections that you are not gluing. Normally, you should wait about 24 hours after solvent welding PVC pipe before you put full pressure on the piping.

### Types of solvents

There are several types of welding solvents. Solvents that are referred to as "hot" mean that they soften the pipe quicker and evaporate faster. Take care if you use hotter solvents. Once you apply the solvent, you will need to make the connection rather quickly before the solvent evaporates.

Most welding solvents are flammable and toxic. Use them in well ventilated areas and be careful with open flames around them.

Most of the solvents come in a can with the brush built into the lid of the can. A good practice is to put the lid back on the can every time that you use the solvent. This keeps the solvent from evaporating.

You also need to consider the size of the brush in relation to the size of fitting. Use a brush that is approximately one-third the inside diameter of the fitting. The brush will hold enough solvent to evenly coat the inside the fitting, but not so much that you end up with excess solvent. If you use a brush too small, it may not hold enough solvent to completely coat the fitting. If you use a brush too big, you will not be able to fit it into the fitting.

### **Soldering defined**

Connections to copper pipe are made by using a combination of heat and a fusible metal alloy. This process is called soldering or, more commonly, "sweating." The heat is usually supplied by a propane torch. The metal alloy is called solder and usually comes on a spool.

Soldering often scares people because they feel it is harder to get a good connection than with solvent welding. But soldering is actually fairly simple provided you use the right materials, follow a few simple guidelines, and do not hurry the process.

About the only time that you will need to solder in the irrigation business is when you connect to a water supply. Some city codes require that a permanent tee fitting be sweated into the line if the building has a copper supply line coming into it. The only way to do this is to solder the tee into place.

We will first discuss soldering and then describe how to fit a tee into an existing water line.

### **Start with flux and solder**

To make soldered connections, you need flux and solder. Flux is an agent that cleans the tarnish off of the pipe and the fitting so that the solder and the copper can bond properly. Use a flux that is referred to as a non-acid or self-cleaning flux. The label on the container will identify the flux as being of this type or not.

The flux removes any chemical barrier that may prohibit a good bond and allows the solder to flow more smoothly. The solder is the actual agent that does the bonding.

## Types of solder

When you select a solder, avoid the acid core and flux core solders. Some solders come with a core that has flux or acid in it to clean the pipe. But by the time such solder gets hot enough to actually release the flux or acid, the solder has already melted and is on the pipe. Therefore the flux does not really clean well.

The best type of solder for copper sweating is not available any more, a 50/50 wire solder. The 50/50 refers to the percentage of lead and zinc in the solder, 50% each in this case. The EPA has banned products that contain lead if the products come into contact with potable water supplies. (You may still find 50/50 solder, but eventually it will be removed from the market.)

An acceptable alternative on the market today is referred to as a 95/5. Such solder is 95% tin and 5% antimony. This is a harder solder and is a little more difficult to work with. Nevertheless, it is the best available at this time.

Not all of today's solders are 95/5. Most of them contain a large percentage of tin, but the other 5 or 10% may be antimony, silver, copper, or zinc. Some of these are still fairly easy to work with; any of them will make an acceptable bond.

## Add a heat source

The heat required to melt the solder is usually supplied by a small propane torch or an acetylene torch. Use the soldering tip for sweating.

Along with flux, solder, and torch, you need certain safety equipment.

**Remember your safety equipment**

A pair of gloves is necessary to protect your hands and wrists. The pipe and fittings get very hot when sweated. You also need a pair of goggles to protect your eyes in case the flux or solder pops. Another good idea is to wear a long-sleeved shirt to protect the lower arms. Remember: safety first. Always.

**How the bond forms**

How is the bond actually made between the fitting and the pipe? When you sweat a fitting, the solder is actually drawn into the void between the pipe and the fitting by capillary action. This is why it is important that they both be really clean and not scratched. You need a smooth, clean surface so that the solder can be drawn in consistently around the joint.

**Guidelines for soldering**

You will have more success with soldering if you follow a few simple guidelines. These guidelines are presented below. Remember not to rush the soldering process.

**Make sure that the pipe and fitting are dry**

The pipe and fitting must be totally dry before you solder. Otherwise, the water will keep part of the pipe or fitting from heating. The solder will not stick to that area, and a leak will occur there.

Because you will usually be sweating a water line, some amount of water will be in the line. Even after you drain the line, a small amount of water may still be in the bottom of it and come trickling out for a long time.

The pipe and fitting must be dry, yet water is always present. What do you do? Break. Take a slice of bread, remove the crust, and form the slice into a ball or oval. Push the bread up the pipe about 2 or 3 inches back from where you will solder.

The wad of bread will temporarily stop the flow of water. You can then make your solder connection. The bread breaks down completely and will not plug up the line. When you turn the water back on, open a hose bibb to flush out what is left of the bread. Remember to open a hose bibb and flush out the remnants of the bread. Let the water flow out of the bibb for 2 or 3 minutes to thoroughly flush the line.

**Clean the pipe and fitting**

Always work with a clean pipe and fitting. You need to remove any dirt and grime, as well as any filings that may be left from when you cut the pipe. You can clean the pipe after a cut with fine emery cloth or sandpaper.

Be careful not to use an emery cloth or sandpaper that is course enough to roughen the surface. The surface must be kept smooth. Any scratches or grooves on the surface can hinder the actual bond.

### Use flux

Before you solder, coat the fitting and the pipe with flux. The flux cleans the copper and helps the solder to flow smoothly and evenly. Flux is usually applied with a brush. Apply an even coating, but not excessive, to the inside of the fitting and the outside of the pipe.

Slide the connection together and rotate it to make sure that you spread the flux evenly. Once the fitting is together and rotated, turn the fitting to the correct position and you can start the soldering.

### Apply the heat to the fitting

Always heat the fitting, not the pipe. The fittings are normally of a heavier construction than the pipe. If you heat the pipe, it may get too hot before the fitting has a chance to heat thoroughly. This situation can cause inconsistent heat around the connection and create a bad solder connection. Heat just one side of the fitting; do not try to move the torch around and heat the entire fitting.

Normally, you can heat a fitting in 7 to 10 seconds. You will be able to tell when the fitting is hot enough because the flux will start to bubble and pop as it melts. You can scorch a fitting if you heat it too long. A fitting usually turns a blue color if it is overheated. If the fitting stays blue after it has cooled off, you should replace the fitting. Solder will not stick well to a scorched fitting.

Once you see the flux starting to bubble, apply the solder to the opposite side of the connection. If the solder sticks and does not melt immediately, pull it away and heat the fitting for another 2 or 3 seconds.

Just as soon as the connection is hot enough to melt the solder, remove the heat from the fitting. Apply the solder right at the joint where the pipe and the fitting come together.

The solder will spread naturally around the joint and be drawn into the void between the pipe and the fitting.

### **Apply solder opposite the heat**

Always apply the solder to the side of the connection opposite the heat. That makes sense when you think about it: if the side opposite the flame is hot enough to melt solder, the side toward the flame certain is. The reverse may not be true.

A good practice is to heat the upper part of the fitting on one side and apply the solder on the lower side across from the heat. You can be fairly certain of a good solder joint if you can draw the solder up and around the fitting. Regardless of where you apply the heat, however, make sure that the solder draws completely around the fitting.

### **Tips on handling the solder**

Normally, you need about the same amount of solder wire to make a connection as the size of the pipe's outside diameter. That is, a 1/2 inch pipe normally requires about 1/2 inch of solder wire; a 3/4 inch pipe normally requires about 3/4 inch of solder, and so forth.

Just after you apply the solder, wipe off the joint with a soft cloth. This removes any excess solder and smooths out the sweated joint. Any solder left on the outside has nothing to do with the actual solder connection. It is just extra and should be removed (for looks more than anything).

A good way to handle the solder is to take about 18 to 24 inches off of the roll. Do not try to work with the entire roll. Wrap about half the length around your hand to make sort of a coil.

This gives you something easy to hold, yet it is a small enough piece that you can easily work with it.

### **Tips on soldering several fittings**

When soldering several fittings, you need to start with the lowest one and work your way up. That way, any excess solder from a fitting will not drip on one that you are getting ready to solder. Also, if you have several fittings to put together, go ahead and clean them, put the flux on, and assemble the whole thing before you start soldering. Then you can come back and solder all of the fittings.

Soldering all of the fittings at one time can speed up the job. A certain amount of the heat applied for the first fitting heats the next fitting, and so on.

### **Resoldering a fitting**

If you need to resolder a fitting, heat it and remove it from the pipe. Remove any solder that is on the pipe or fitting and reflux them both. You must reflux if you resolder, or the connection will probably be faulty.



**Watch out for flammable backgrounds**

If you are sweating a fitting against a wooden wall or something that is flammable, you need to slide a piece of tin or some protective barrier between the fitting and the flammable substance. Remember that the heat from the end of the torch extends quite a bit farther than the actual flame. Be careful not to burn yourself or ignite something.

The hottest part of the flame is at the end of the blue part of the flame. Normally, on a well adjusted torch, the blue part is about a quarter of an inch long.

**Connecting plastic to copper**

In some cases you may need to connect plastic to copper, such as coming off of a copper tee with a PVC line. The PVC connection needs to be a threaded fitting. Special adaptors are available that have a sweat fitting on one end and threads on the other end. Be sure to solder the adaptor in place before you connect the PVC to it. Otherwise, the heat from the soldering may damage the threads on the PVC. Wait until the adaptor has cooled completely before connecting the PVC.

### Connecting a tee to an existing water line

The types of copper pipe commonly used for water lines are fairly soft. When you dig a hole to reach the water line, be careful not to hit the pipe with the shovel--you may scar or flatten the pipe. The pipe needs to be round and unmarked to help ensure a leakproof connection.

Select an area of pipe that is round and unmarked about 8 to 10 inches long. This is where you will connect the tee.

Use a tubing cutter or hack saw and remove about a 6 to 8 inch section of the pipe. Remove any burrs from the ends of the pipe.

### Using a no-stop coupling

Because the copper pipe is fairly rigid, you will not be able to simply replace the cut-out section with a tee fitting the same length. Instead, you need three pieces to install a tee: the tee fitting itself, a short piece of copper pipe the same outside diameter as the water line, and a no-stop coupling.

A no-stop coupling does not have a ridge on the inside for the pipe to butt against. The coupling can slide completely on the pipe.

Clean and flux the fittings and pipe. Slide the no-stop coupling onto the existing water line, flush with the end of the line. Push the tee onto the other exposed end of the water line. Add the small piece of pipe to the other end of the tee. Now slide the no-stop coupling onto the short piece of pipe until the coupling overlaps the short piece and the water line about the same amount.

This arrangement leaves you 4 joints to solder: 1 on each side of the tee, and 1 on each side of the coupling. You can then sweat all 4 joints in sequence and complete the water connection.

**Intermission to change  
the pacc**

Before you read about the next subject, sprinkler heads and nozzles, complete the subject review on piping and connecting pipe.

160

## Subject Review

### Piping and Connecting Pipe

#### Fill In The Blank

Supply the word or words in the answer column to complete the following statements.

Then, after the questions are discussed in class, place an "X" through each incorrect answer and write the correct answer in the answer column. That way, you will know the correct answers if you later review this information.

Statement	Answer
1. Three main types of thermoplastic pipes are _____, _____, and _____.	PVC, ABS, PE. (ABC's, page 64)
2. With PVC 1120 pipe, the first "1" refers to the _____, the second "1" refers to the _____, and the "20" refers to the _____.	Type (material type), Grade, Design tensile strength. (ABC's, page 64)
3. The stretching of plastic pipe by over-pressuring is called _____.	Creep. (ABC's, page 66)
4. A type of pipe that is flexible, comes in rolls, and is resistant to freezing is _____ pipe.	Polyethylene. (ABC's, page 69)
5. The term used for the comparative reference of different sizes of pipe is the _____ pipe size.	Nominal. (ABC's, page 61)
6. 50/50 wire solder is no longer available because it contains _____.	Lead. (Page 10)
7. Solder is drawn into the joint because of _____.	Capillary action. (Page 11)
8. The two materials needed to sweat a joint are solder and _____.	Flux. (Page 9)

## True or False

In the answer column, mark the following statements "T" for true or "F" for false. The whole statement is false if any part of it is false.

Then, after the questions are discussed in class, place an "X" through an incorrect answer and write the correct answer in the answer column. That way, you will know the correct answers if you later review this information.

Statement	Answer
1. Electrolysis may occur when two dissimilar metals are joined.	True. (Page 1)
2. I.F.S. refers only to metal pipe.	False. (ABC's, page 61)
3. An installation process that allows for the pipe to expand and contract is called "snaking."	True. (ABC's, page 65)
4. The force that develops when valves quickly close is called water hammer.	True. (ABC's, page 66)
5. An installation device that helps cushion pipe elbows against water hammer is called a thrust block.	True. (Page 4)
6. PVC 2210 pipe has a design tensile strength of 2000 psi.	False. (ABC's, page 64)
7. All PVC solvents are the same.	False. (Page 8)
8. PVC solvent can also be used to weld polyethylene pipe.	False. (Page 6)

160

## Multiple Choice

Circle the letter of the choice that best completes the statement.

Then, after the questions are discussed in class, write the letter of the correct answer in the answer column. That way, you will know the correct answers if you later review this information.

Statement	Answer
<p>1. The official representative of the U.S. in the field of international standards is</p> <p style="margin-left: 20px;">A. ASTM (American Society of Testing and Materials)</p> <p style="margin-left: 20px;">B. AWWA (American Water Works Association)</p> <p style="margin-left: 20px;">D. AAIS (American Association for International Standards)</p> <p style="margin-left: 20px;">E. USSA (United States Standards Association)</p> <p style="margin-left: 20px;">F. None of the above</p>	<p><b>C. ANSI (American National Standards Institute).</b></p> <p><b>(Page 3)</b></p>
<p>2. The term "schedule" refers to</p> <p style="margin-left: 20px;">A. The wall thickness of iron pipe only</p> <p style="margin-left: 20px;">B. The wall thickness of PVC pipe only</p> <p style="margin-left: 20px;">D. The I.D. and tensile strength of all pipe materials</p> <p style="margin-left: 20px;">E. The O.D. minus the I.D.</p> <p style="margin-left: 20px;">F. None of the above</p>	<p><b>C. The O.D. and wall thickness of all pipe materials, based on the O.D. and wall thickness used in steel pipe.</b></p> <p><b>(ABC's, page 66)</b></p>

Statement	Answer
<p>3. The wall thickness of a pipe may be determined by</p> <p>A. O.D. - I.D.            B. (I.D. + diameter)/2            C. (I.D. + radius)/2            D. (I.D. x 2) - O.D.            E. Both C and D</p>	<p><b>F. None of the above. (ABC's, page 61. O.D - I.D. / 2)</b></p>
<p>4. The letters which designate copper tube size are</p> <p>A. A, B, S            B. P, V, C            C. J, K, L            E. S, M, L            F. L, S, M, F, T</p>	<p><b>D. K, L, M. (ABC's, page 63)</b></p>
<p>5. Continuous water hammer and surges can cause:</p> <p>A. Hydrostatic design stress            B. Hydrostatic pressure vacuum            D. Pipe electrolysis            E. Both A and B            F. None of the above</p>	<p><b>C. Pipe fatigue. (Page 4)</b></p>

157

Statement	Answer
6. The term "class" refers to the A. Design tensile strength of pipe B. Design tensile strength of fittings D. Design process of pipe extrusion E. Impact strength of pipe F. None of the above	<b>C. Design working pressure of pipe. (ABC's, page 65)</b>
7. A good sign that the fitting is ready to take solder is A. The fitting will turn a bluish color B. The fitting will turn a reddish-orange color C. The fitting is hot to the touch E. The solder sticks to the fitting F. None of the above.	<b>D. The flux bubbles and pops. (Page 13)</b>
8. To solder a 1/2 inch fitting should take approximately A. 4 inches of solder B. 2 inches of solder C. 1 inch of solder D. 1-1/2 inches of solder F. None of the above	<b>E. 1/2 inch of solder. (Page 15)</b>



(This page included for duplexing.)

165

## Sprinkler Types and Nozzles

### Sprinkler head defined

So far in this Guide, you have learned about connecting to the water supply and conveying the water through pipes to various locations. Once you get the water distributed, you need some way to disperse it. This is the purpose of the sprinkler head. A sprinkler head is a device that connects to the piping for the purpose of dispersing water.

Actually, the sprinkler head itself is usually a housing, or container, for a nozzle. The nozzle is the component that dispenses the water in a specific pattern and distance. Two terms that you will see associated with nozzles are trajectory and arc. Trajectory is the angle from horizontal at which the water stream or spray or flow leaves the nozzle. Arc is the portion of a circle that the water covers. For example, a half-circle arc is 180°.

### Annotation: (Discussion Question)

**Are impact heads available as either a pop-up or an above-ground type? If so, describe what you think a pop-up type looks like.**

**(Yes. The pop-up type are housed in a bucket or canister with a cap that is attached to the top of the impact head itself. In some cases, the cap can hold a plug of turf.)**

In common terms, the two basic categories of sprinkler heads are rotary heads and spray heads.

A rotary head disperses water while rotating. A mechanism--usually a water-driven mechanism--rotates a nozzle over a given arc. The three most common types on the market are the impact head, also called impulse head, the gear drive head, and the ball drive head.

Because the ABC's of Lawn Sprinkler Systems discusses the types of rotary heads quite thoroughly, this Guide will not dwell on them. A few points about rotary heads do merit further discussion.

### Application of rotary heads

Rotary heads are usually used to water large turf areas, which most commonly means commercial applications. The heads may be placed in the turf area itself, or along the edge and throw water into or across the area. In either application, one advantage of rotary heads is their large radius of throw to cover such areas. Another advantage is that a system with rotary heads usually costs less than a comparable system with spray heads. The rotary heads cost more per head, but it takes fewer of them to cover an area.

### Some drawbacks

The disadvantages of rotary heads is that they are sloppy and wasteful. To cover such long distances, rotary heads throw water high into the air. The water has more contact time in the air and is more susceptible to wind deflection and evaporation. In short, rotary heads are not efficient in conserving water.

Another disadvantage of rotary heads is the limited amount of adjustment to reduce their radius of throw. This, combined with the fact that rotary heads throw only circular patterns, limits their usefulness almost entirely to large, open areas. Trying to use rotary heads in areas with obstructions such as buildings, walls, streets, sidewalks and parking lots, will invariably mean that you throw water into places that may prove objectionable.

### Operating pressures

Rotary heads, just like spray heads, have a minimum operating pressure, and usually a maximum operating pressure. The heads operate most effectively in the range between the minimum and the maximum pressure. Pay very close attention to the manufacturer's specifications on heads. Rotary heads have vastly differing operating ranges depending on the type of head. Some may require 60 or 70 psi, or more, to work properly; others may operate just fine at 20 or 25 psi.

171

### Water distribution with impact heads

Impact heads distribute water unevenly because the nozzle assembly “jumps” with each impact. The “jumping” results in a jerky movement so the water is not applied evenly.

Also with most impact heads, the precipitation rate changes as you adjust the arc down (from 180° to 90° for example). The discharge rate remains the same, however. The discharge rate is how much water per minute exits the nozzle or the head. (Some type of rotary heads do allow you to decrease the discharge rate as you decrease the arc.)

Precipitation rates and discharge rates are discussed further at the end of this section.

Interestingly, ball drive heads are actually impact heads--the spinning ball impacts an “anvil” and thus rotates the nozzle assembly. A ball drive nozzle typically rotates more smoothly than an impulse nozzle and therefore distributes water more evenly.

### Gear drive heads

From the name, the gear drive head is somewhat misleading. The head is driven by a turbine or water wheel. The spinning action of the turbine is then reduced through a series of gears (much like a transmission in a car). The gear mechanism rotates the nozzle very smoothly. The smoothness of rotation allows the gear drive head to distribute water more evenly than other types of rotary heads.

## Spray heads

Spray heads are the other common type of sprinkler heads. Spray heads typically have a nozzle with a fixed orifice that is machined or milled. The size of the orifice, as well as how it is machined or the angle at which it is cut, determines the arc of the throw, the trajectory of the throw, and the discharge rate of the head.

The discharge rate is how much water per minute exits the nozzle or the head. Some spray heads have a flow adjustment, usually a valve, that you can adjust with a screwdriver. The adjustment is commonly located at the nozzle and allows you to vary the radius of throw.

Spray heads vary in their trajectories and arcs of throw and their discharge rates. Most spray nozzles are available in trajectories from 0° to about 40°. The arcs vary from the most common, 360° or a full circle, down to about 20°. The various arcs, or spray patterns, help you to irrigate oddly shaped areas.

Discharge rates vary greatly among spray heads, just as they do among rotary heads. Always check the manufacturer's specifications when determining discharge rates.

## Shrub heads

One common application of spray heads is for watering shrubs and flower beds. Obviously, to disperse the water past obstructions, shrub heads need to be higher than the shrubs. This is accomplished by raising the shrub head above the ground on what is called a riser (typically a piece of PVC or copper).

Risers have a couple of disadvantages. First, they are a hazard if anyone should trip on one or fall on one. For this reason, you should always place them against a fixed wall or structure. Second, they need

170

to be higher than the shrubs. But shrubs may easily grow above the height of the risers. Fortunately, an extremely effective and efficient alternative to risers exists. Section 7, Drip Irrigation, discusses it.

### **Disadvantages of spray heads**

The main disadvantage to spray type nozzles is just that--they spray. This usually limits the useful radius of throw to about 15 feet. Also, many spray heads distribute water in a doughnut shaped pattern. This means that they leave a dry area near the head itself. The patterns of spray heads must be overlapped to correct the problem.

Another disadvantage of spray heads, which is actually a problem of incorrect design, is that they are often easy to over-pressurize. This condition causes a very distinct atomizing effect on the water leaving the nozzle and produces a fog or fine mist.

In fact, the main design factor that affects sprinkler operation is pressure. Too much pressure not only causes a head to perform poorly, it can actually shorten the operating life of the head.

If you do operate a spray nozzle at an ideal pressure, the nozzle will produce droplets of water. But the droplets are so small that they still susceptible to wind deflection and evaporation.

### **Controlling water placement with spray heads**

It may seem economical to use heads that cover a large radius and therefore use less heads. In actuality, such a decision may be false economy. The loss in water will probably, in the long run, exceed the cost of the additional heads.

Using more spray heads also gives you more control of water placement. Typically, the shorter the distribution radius of the head, the more control you have of where the water lands. Some spray nozzles have an adjustment on them that is usually located right at the nozzle. The adjustment allows you to decrease or increase the radius of the throw by regulating the amount of water through the nozzle. But when you adjust the water at the place where it exits, what you actually do is distort the pattern of the head itself. This is a distinct disadvantage.

170

### Hybrid spray heads: stream rotor and wob- bling nozzle

Two types of spray heads could be classified as hybrids. One type is the stream rotor, which ejects water in a number of small streams from a pop-up nozzle. These heads have an internal mechanism that gives you some of the effects of a rotary head and some of the effects of a spray head. Often the mechanism is a turbine type gear drive that rotates an internal nozzle.

These heads were developed for use in places where runoff is a major problem. For example, areas that have steep slopes and very nonporous soil would cause run off. If you use this type of head, remember to put them on their own circuit, separate from other heads. The reason is that they have a low precipitation rate, much lower than regular spray heads. You should also overlap stream rotors head-to-head.

### Wobbling nozzle

The other type of hybrid is really not a spray head at all even though it is commonly listed as such. This type of head has a pop-up piston with a nozzle in it. The nozzle itself moves--it both spins and pendulates, or wobbles. The moving nozzle is similar to a rotary head, yet the water going in all directions at once is similar to a fixed orifice spray head.

The main advantage of this type of head is that the wobbling action distributes water better than from a spray or a rotary head. In addition, the wobbling action and internal nozzle design breaks up the water into droplets which are less susceptible to wind deflection and evaporation. This type of head is mentioned on page 15 in the ABC's.



## Precipitation

Precipitation and precipitation rate are of utmost importance to an irrigator. Precipitation is the amount of water applied over a given area. The amount of water is measured in inches (or some unit of depth such as millimeters). For example, suppose that you have a flat, waterproof box 20 feet square. If it rained  $1/2$  inch and you took a ruler and measured the depth of the water anywhere in that box, it be  $1/2$  inch. (The box could be any size and this would still be true.) Your box received  $1/2$  inch of precipitation.

Precipitation as applied by an irrigation system should be looked at in exactly the same terms. In other words, you can easily calculate precipitation if you know the volume of water used and the area over which you applied it.

## Precipitation rate

Precipitation rate is a measurement of how rapidly a sprinkler head or a sprinkler system applies water. The rate is defined as depth of water per some unit of time. Usually, it is expressed in inches per hour.

## Discharge rate and precipitation rate

Discharge rate is how much water per minute exits the nozzle or the head. You cannot simply relate precipitation rate to the manufacturer's discharge rate of the head. The discharge rate is usually calculated within the range of proper operating pressures.

Operating pressures outside of the proper range will change the discharge rate (the greater the pressure, the greater the discharge rate). Also, the discharge rates change over time. Older heads may have a certain amount of washout; the orifices may have grown larger from water erosion. The piping may develop constrictions or corrosion, or may become partially clogged by solids in the water.

In addition, the discharge rate does not take into account overlapping. In general, circular pattern heads, spray or rotary, are overlapped 50% of the diameter. Said another way, that amount of overlap is radius-to-radius or head-to-head.

With such overlap, some areas will be covered by 1 head, other areas by 2 heads, and still other areas by 3 heads. The amount of precipitation varies depending on the amount of overlap.

### Figuring precipitation rate

One inch per hour is a number often claimed to be a normal precipitation rate for most conventional, fixed orifice spray heads. For the reasons just discussed, you can see that such a number is essentially useless except for initial design estimates.

The only reasonable way to calculate precipitation is to compare the total volume of water applied to the actual area of landscape or turf watered.

The most accurate way to measure the amount of water applied is to install a flow meter in the system. Sometimes you can use the water meter for this if it is legible and operates properly. Formulas also exist for calculating precipitation rate, but they tend to be approximations. If you are interested in such formulas, consult product documentation from various head manufacturers or reference books such as the Turf Irrigation Manual.

### Plants and precipitation

Why fuss with precipitation and precipitation rates anyway? Because different types of plants have different watering needs. You need to apply the proper amount of water for the type of plant life being irrigated. Otherwise, your system is less efficient and you waste water and the customer's money.

Determining the correct precipitation for different plant types takes some research on your part. A variety of sources exist where you can get information: county extension agents, the National Weather Bureau, nurseries, garden clubs, and books (bookstores and public libraries), for example.

The research is worth the effort, however. Remember the discussion in Section 1 about your becoming a professional irrigator and not just "someone who installs sprinkler systems." Part of being a professional irrigator is to know about the watering requirements of the plants common to your locale. With modern irrigation products and technology available to you, guessing about the amount of precipitation being applied is unacceptable.

### **Precipitation rate and heads on a circuit**

Precipitation is also important because you need to put heads with similar precipitation rates on the same circuit. This allows the circuit to cover a given area with a consistent amount of precipitation.

Rotary heads typically have a much lower precipitation rate than spray heads because at the same discharge rate they cover a much larger area. For that reason, you normally do not want to put rotary heads on the same circuit with spray heads. Precipitation rates over a given circuit should be the same unless you are tailoring certain parts of that circuit to apply less water to certain areas. This would make the design process very complicated, however, and usually less accurate.

### **Onward and upward**

Now that we have discussed sprinkler heads and nozzles, complete the subject review on the next few pages.

## Subject Review

### Sprinkler Heads and Nozzles

#### Fill in The Blank

Supply the word or words in the answer column to complete the following statement:

Then, after the questions are discussed in class, place an "X" through each incorrect answer and write the correct answer in the answer column. That way, you will know the correct answers if you later review this information.

Statement	Answer
1. The main design factor that affects sprinkler operation is _____.	<b>Pressure. (Page 26)</b>
2. In common terms, the two major categories of sprinkler heads are _____ and _____.	<b>Spray, Rotary. (Page 25)</b>
3. The most common types of drive mechanisms for rotary heads are _____, _____, and _____.	<b>Impact, Gear, Ball. (ABC's, pages 23-25)</b>
4. The drive mechanism for so-called "gear-drive" heads is actually a _____.	<b>Turbine. (ABC's, page 24)</b>
5. When you design a system that has different types of heads, with various shapes and sizes of spray patterns, always take into account the _____ rate of the heads.	<b>Precipitation. (ABC's, page 91)</b>

Statement

Answer

- 
6. Conventional spray heads discharge a flat pattern of spray that is usually \_\_\_\_\_ in shape.
  7. Some sprinklers distribute water more efficiently by means of a moving nozzle which creates a \_\_\_\_\_ action.
  8. A system with rotary heads is generally less \_\_\_\_\_ than a system with lawn or spray heads.

---

Circular. (Page 28)

Wobbling, Pulsating, Pendulating. (ABC's, page 15)

Expensive, Costly. (Page 26)

181

## True or False

In the answer column, mark the following statements "T" for true or "F" for false. The whole statement is false if any part of it is false.

Then, after the questions are discussed in class, place an "X" through an incorrect answer and write the correct answer in the answer column. That way, you will know the correct answers if you later review this information.

Statement	Answer
1. Generally, the greater the distance water is thrown, the more it is affected by wind.	True. (Page 26)
2. If a turf area is quite large and you have enough water supply, you should use the largest radius rotary heads available.	False. (Page 26)
3. Ball and cam drive heads are, in effect, impact heads.	True. (ABC's, page 24)
4. All fixed orifice spray heads distribute water very evenly within the pattern.	False. (Page 29)
5. For the same area, a well designed system with rotary heads can be just as water efficient as a well designed system with spray or sprinkler heads.	False. (Page 26)
6. With most impact heads, as you adjust the arc down (for instance, from 360° to 180°), the precipitation rate remains the same.	False. (Page 27)
7. With most impact heads, as you adjust the arc down, the discharge rate remains the same.	True. (Page 27)
8. Some lawn sprinkler heads have nozzles that pendulate or wobble to improve water distribution within the pattern.	True. (ABC's, page 15)

## Multiple Choice

Circle the letter of the choice that best completes the statement.

Then, after the questions are discussed in class, write the letter of the correct answer in the answer column. That way, you will know the correct answers if you later review this information.

Statement	Answer
<p>1. The application for rotary heads is</p> <p>A. For the cheapest system possible            B. For small, mostly square yards            C. For mostly square yards with no trees            D. For flower beds            E. For none of the above</p>	<p>B. For large turf areas.            (ABC's, page 25)</p>
<p>2. Lawn heads are more efficient than rotary heads because</p> <p>A. They are usually less affected by wind            B. They waste less water            C. You can fit them into odd shaped areas more efficiently            D. They cost less            E. A, B, and D</p>	<p>E. A, B, and C. (Page 28)</p>

Statement	Answer
<p>3. Shrub heads on risers</p> <ul style="list-style-type: none"> <li>A. Should be on both sides of a flower bed to distribute water evenly</li> <li>B. Must be made of copper or brass because the riser is above ground</li> <li>C. Can be a hazard and should always be placed against a fixed wall or structure</li> <li>D. Should be higher than the height of the shrubs</li> <li>E. Both A and B</li> </ul>	F. Both C and D. (Page 28)
<p>4. Water pressure that is too high for a sprinkler system</p> <ul style="list-style-type: none"> <li>A. Is a major cause of water waste because the heads perform poorly</li> <li>B. Can shorten the operating life of the heads</li> <li>C. Gives a little extra distance of throw and thus improves water distribution</li> <li>D. Is generally okay because the heads pop up to their full height</li> <li>F. Both C and E</li> </ul>	E. Both A and B. (Page 29)



Statement	Answer
<p>5. Never include rotary heads and sprinkler or spray heads on the same circuit because</p> <p>A. They look unsightly together when they operate</p> <p>B. Determining the spacing for good overlap is very difficult</p> <p>D. The discharge rates are greatly different</p> <p>E. Both A and B</p> <p>F. Both C and D</p>	<p><b>C. The precipitation rates are greatly different. (ABC's, page 91)</b></p>
<p>6. The reasonable way to calculate precipitation is</p> <p>A. To know the discharge rates of the heads</p> <p>B. To know how long the system has been running</p> <p>C. To know the distribution profile of the heads</p> <p>E. Both A and B</p> <p>F. Both C and D</p>	<p><b>D. To know the actual volume of water applied and the actual size of the area to which it was applied. (Page 33 )</b></p>

Statement	Answer
7. Trajectory is important to the irrigator because  A. Generally, the higher the throw, the greater the radius B. The higher the throw, the better the water distribution C. The higher the throw, the more water lost to wind D. The higher the throw, the more water evaporation E. Both A and B	F. Both C and D. (Page 26)
8. All conventional circular pattern spray heads  A. Throw large drops of water B. Have the same operating pressure range D. Have a constant discharge rate regardless of water pressure E. All of the above F. None of the above	C. Must be properly overlapped to improve water distribution. (ABC's, page 82)

(This page included for duplexing.)

1.87

## Orientation

### Layout and Design

#### Class Session 5

**Audio-visual aids that you need to present class session 5**

Overhead projector  
Transparency marking pens

**Labs or drawing exercises associated with class session 5**

Drawing Exercise 1

**Steps to complete before teaching class session 5**

Complete the following steps before you teach class session 5:

1. Locate the packet of sample plot plans. The plot plan masters are inked drawings on tracing paper and measure approximately 17" x 22".
2. Use the pressure loss charts in the ABC's and the *Turf Irrigation Manual*. Photocopy as many of the sample charts as you have students enrolled in your class.
3. Locate sample plot plan 1 (it may be labelled 1-3). This copy will serve as a master.  
  
Photocopy as many of plot plan 1 as you have students enrolled in your class.
4. Read this entire section and the following pages in the ABC's: 77 through 108.
5. Read the description for Drawing Exercise 1. It is in the tabbed section "Labs and Exercises."

6. Determine exactly what Drawing Exercise 1 involves.

Make sure that you have all of the required materials prior to the class.

7. Study the lesson plan for class session 5. Remember that the times allotted are guidelines only.

8. For you and your students, photocopy the pretest for the subject "Layout and Design." All pretests are located in the 9x12 envelope. Be sure to return the master to the envelope.

9. Sit or lie in a quiet place where you will not be disturbed. Close your eyes and relax your entire body. Breathe deeply several times, using your diaphragm to inhale and exhale. Mentally picture yourself with your students, discussing irrigation. "See" the situation as a sharing of information that unfolds pleasantly. Imagine the learning process as being a pleasant and beneficial experience. Hold that thought for a few minutes, then open your eyes and resume your daily activities.

At the end of class session 5, give the reading assignment and the homework for class session 6.

### Reading and homework assignments for class session 6

Reading assignment:

In the ABC's:

Pages 110 through 118.

In the Student's Guide:

All of Section 7.

Homework:

Complete Drawing Exercise 1

## 6. Layout and Design

---

### Section overview

Layout and design involves much information that is central to the irrigation business. This section is fairly lengthy and at first may seem overwhelming. Remember, however, that you are building your understanding one piece at a time. As you progress through the areas in this section, the entire subject of layout and design will make more sense.

The layout and design of sprinkler systems can be looked at as involving 4 main phases:

1. Drawing an accurate plot plan.
2. Laying out the sprinkler heads on the plot plan.
3. Sectioning the sprinkler heads (adding the plumbing).
4. Checking your design mathematically.

Before discussing each phase, however, we need to cover some general information about layout and design. This information discusses the basics of design and of hydraulics. Following that, the 4 main phases are then explained.

### Design Basis

**When a customer wants the least expensive system**

Your goal is to design a system properly and according to good irrigation practices. But you also have to comply with what the property owner wants.

Many times you will encounter a property owner who wants the least expensive system. The least expensive system is seldom, if ever, the most effective and efficient system. The customer needs to know this.

For example, a system that throws water across sidewalks and driveways will probably be less ex-

expensive than one that does not. But over the years, the customer may actually spend more on water than on the cost of a more efficient system. In addition, watering sidewalks and driveways does not promote water conservation.

A better approach to serving the customer's needs is to offer a choice. Design the most efficient and effective system based on the requirements of the customer and on good irrigation practices. Be prepared to support your design when you present it to the customer. Always explain to the customer the design and how the system will operate.

Remember that as a professional irrigator, you promote good irrigation practices. Wasting water is not one of them. Design your systems with good irrigation practices in mind. Most customers will recognize that your design is professional and is not priced merely for more money.

If necessary, but only if necessary, you can adjust the design to lower the total cost of the system. You need to find that balance between the best possible system and one that the customer can afford. Ideally, they are the same.

## Installation and Design

The installation of the system may not exactly match the design. Sometimes you must make on-the-job alterations. Try to keep the installation and the design as identical as possible, however. Note any alterations on the design.

Always leave a copy of the design with the customer. He or she needs to know where the system components are located. The design is also helpful if another irrigator needs to perform maintenance on the system at a later date.

## Precipitation rate revisited

### Annotation: (Reference)

Formulas for calculating precipitation rate are listed on pages 138 and 139 in the *Turf Irrigation Manual*.

You learned about precipitation rate in the last section. But a discussion about design basics is another good place to mention it. Remember that precipitation rate measures how much water is applied to an area and how rapidly.

The precipitation rate for each circuit can be calculated. One way to do this is listed on page 91 in the *ABC's*. You will understand each part of the formula more fully by the time you finish this section.

The formula calculates the rate for triangular spaced spray heads. Other formulas exist; some even take into account full-circle sprinklers and part-circle sprinklers on the same circuit.

Calculating the precipitation rate of individual sprinklers, or circuits, is a way to know how quickly water will be applied to the landscape. For instance, suppose that you calculated the precipitation rate on a circuit to be 1/2 inch per hour. If you ran that circuit for an hour, the amount of precipitation would be the same as if it had rained 1/2 inch in an hour's time.

## Precipitation rate and controllers

### Annotation: (Discussion Question)

For those of you in the irrigation business, what have you been telling customers when you explain how long to run each circuit?

You need to know the precipitation rates of the various circuits to determine how long each circuit should water. You can then apply the rates when you explain to the property owner how to set the length of watering times on the controller.

Knowing the rates is your basis for knowing how long to set the watering times. The property owner can then understand each circuit in terms of "so many minutes" equals "so many inches of rain"









Other factors, such as the type of soil and slope of the land, also affect watering times. Consider such factors when you determine watering times; do not rely totally on the calculation of precipitation rate.

### Drawing practices

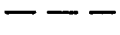
Use common sense in the drawing practices for your designs. For example, use a half circle to show one pipe crossing another. Use short lines at intersections to show the fittings. Elbows should have two short lines; tees should have three.

The following symbols are commonly used in the irrigation business:

	=	Water meter
	=	Backflow prevention device
	=	Section valve
	=	Main line piping
	=	Section piping
	=	Grass head
	=	Shrub head

Your drawings should always be drawn well enough to prevent confusion about the layout and design.

### Problem: low static pressure

If the static water pressure is 30 psi or less, you may not have enough pressure to operate a sprinkler system. Let us look at why.

Many types of spray heads have a minimum operating pressure of about 20 psi. This means that all of the spray heads--even the last head on the farthest circuit--must get 20 psi to operate correctly. If you have only 30 psi to start with, you can afford to lose only 10 psi before water reaches that furthest head. Depending on the route, the water may lose more than 10 psi before it reaches the last heads.

**Use a larger supply line**

A reasonable and economical way to reduce the amount of pressure drop is to use a larger size pipe for the supply line.

Tie into the water line with a tee fitting as close to the water meter as possible. This helps prevent any further pressure loss by running unnecessary pipe. From the tee, you use a larger supply line. A good irrigation practice that is commonly followed is to upsize the pipe at least one size from the size of the meter.

For example, if you connected your tee to a 3/4 inch line, you would use a 1 inch supply line. In some cases, you may even need a 1-1/4 inch supply line depending on the water pressure and the amount of pressure loss.

A larger supply line is a good way to improve the flow and decrease the pressure loss.

**Problem: static pressure too high**

A static pressure that is too high can also cause problems with a sprinkler system. Possibly the most prevalent mistake that irrigators make is to install systems that are over pressurized. The reason that many spray heads mist and fog is because of too much pressure at the head.

**Annotation:  
(Discussion Question)**

**For those of you working in the irrigation business, how many of you have used pressure regulators or pressure-regulating valves? Explain where and how.**

Sprinkler heads have an ideal operating range of pressure (often from 20 to 35 psi). If the pressure exceeds that range, the operation and the longevity of the heads suffer. Over pressurizing occurs all too commonly. As irrigators, we tend to look at having high pressure as a good thing for a variety of reasons. (You need fewer sections, valves, pipes, etc.) But keep in mind that too much pressure can reduce the effectiveness of a system.

**Use a pressure regulator**

A common remedy for high pressure are pressure regulators. A variety of types exist, including pressure-regulating valves. The regulators are fairly expensive, but they greatly prolong the life of a system.

## Basics of Hydraulics

### Hydraulics defined

In irrigation, hydraulics is the study of the motion of water. You need to have a working knowledge of hydraulics in order to correctly design irrigation systems. Fortunately, much of the information concerning hydraulics exists in charts and tables. Most of your calculations require only simple math.

### Moving water

For all practical purposes, water cannot be compressed. Therefore, a mechanical force -- pressure-- is required to move the water. The pressure may come from a pump or from the weight of the water itself.

In the irrigation business, pumps are most commonly used on large commercial installations. The pumps are usually the centrifugal type.

Regardless of the type, however, no pump can draw water upwards more than 33.94 feet. You would typically want to install a pump no more than 15 or 20 feet above a water source.

Many areas get their water from elevated storage tanks (water towers). The weight of the water produces the water pressure. Water weighs 8.34 pounds per gallon. One cubic foot of water weighs 62.37 pounds. The higher the tank, the more water pressure at ground level.

Water pressure is something that irrigators are concerned with in the design of systems. The different parts of a system have different pressure requirements.

## Measuring pressure

Pressure is measured in pounds per square inch (psi), or in feet of head. Pounds per square inch is the force that is produced by the weight of the water on 1 square inch of area. For example, the weight of 1 foot of water acting on 1 square inch is .433 pounds. Therefore, 1 foot of head (height) equals .433 pounds per square inch.

If you increase the height of the water to 2.3 feet, the weight acting on 1 square inch is 1 pound. ( $2.3 \text{ feet} \times .433 \text{ psi/foot} = 1 \text{ psi}$ ). Therefore, 1 psi equals 2.3 feet of head. Feet of head is further explained in the ABC's.

## Static pressure and working pressure

The amount of water pressure when the water is not moving is called static pressure. You design a sprinkler system initially based on the static water pressure. As you progress further with the design, you must deal with what is called working pressure. Working pressure involves water that is moving.

The working pressure will always be lower than the static pressure. Just as soon as water starts moving, it loses pressure. You have only so much static pressure to work with. Once the pressure is lost, you cannot regain it. (Remember, water pressure may come only from a pump or from the weight of the water itself.)

Friction is the reason that moving water loses pressure.

## Friction

Friction occurs when two objects rub against each other. Water flowing through a pipe, for instance, rubs against the walls of the pipe. Friction exists between the walls of the pipe and the water.

Friction also occurs when the water changes directions. For example, friction occurs when water

passes through a meter, a backflow prevention device, or even a valve.

The ABC's explains friction quite well on pages 95 through 98, and introduces the term "friction loss."

### Friction loss

The effect of friction is to slow down the water. This is the same result as if you were to decrease the pressure on the water. Therefore, friction loss is also called pressure loss. The two terms are used interchangeably.

Every type of sprinkler head has a minimum operating pressure. It is the least amount of water pressure required for the head to operate correctly. Any amount less, and the head may work incorrectly or not at all. So you can see why working pressure is so important to a design. You will learn about calculating working pressure later in this section.

An important thing to remember about irrigation hydraulics is that there is a difference between static pressure and working pressure.

### Velocity

Velocity is often confused with pressure. Velocity is the speed at which the water is moving in a system. Pressure is the amount of force moving the water.

Velocity is important to your design because of a condition called water hammer. Think about water flowing quickly through a pipe. If you were to quickly close a valve and shut off the flow, what would happen? It would be like you running face first into a brick wall.

The force that develops from such sudden halts of water flow is called water hammer. The force is a temporary increase in water pressure near the point of stoppage. If the velocity, speed, of the water is too great, the force of the water hammer can rupture the pipe, fittings, or valves.

**Annotation:  
(Reference)**

**Table 16, on page 339 in the *Turf Irrigation Manual*, shows an example of the multiplying factors. Page 338 explains the formulas used to determine velocity.**

Therefore, a safe range to keep the speed of the water moving through a sprinkler system is 5 feet per second. The range may vary slightly depending on the size, type, and strength of the pipe material.

Velocity is usually calculated by multiplying the flow rate in gallons per minute times a factor. The factor is based on the size and type of pipe. The multiplying factors are usually listed on the manufacturer's specifications for the pipe or the sprinkler component.

Now that you have covered the basics of design and hydraulics, try your hand at the subject review on the next few pages. After completing the review, continue reading the rest of this section.

## Subject Review

### Basics of Design and of Hydraulics

#### Fill In The Blank

Supply the word or words in the answer column to complete the following statements.

Then, after the questions are discussed in class, place an "X" through each incorrect answer and write the correct answer in the answer column. That way, you will know the correct answers if you later review this information.

Statement	Answer
1. A good business practice is to design for the property owner the most _____ and _____ system and not just the least expensive system possible.	Efficient, effective. (Page 2)
2. PSI stands for _____.	Pounds per square inch. (ABC's, page 92)
3. One gallon of water weighs _____ pounds.	8.43. (Page 7)
4. The pressure of water when it is not moving is called _____.	Static pressure. (Page 8)
5. One way to reduce the amount of pressure drop is to use a _____ size pipe for the supply line.	Larger. (Page 5)
6. The weight of a column of water 1 inch square and 1 foot high is _____ pounds.	.433. (Page 8)
7. Calculating the _____ for each circuit gives you some basis for setting the controller.	Precipitation rate. (Page 3)
8. The reason that many spray heads fog or mist is because of too much _____ at the head.	Pressure. (Page 5)

200



## True or False

In the answer column, mark the following statements "T" for true or "F" for false. The whole statement is false if any part of it is false.

Then, after the questions are discussed in class, place an "X" through an incorrect answer and write the correct answer in the answer column. That way, you will know the correct answers if you later review this information.

Statement	Answer
1. When you design an irrigation system, you can consider the working pressure and the static pressure as the same.	False. (Page 9)
2. The installation of a system may not exactly match the design.	True. (Page 2)
3. Elevation has nothing to do with the working pressure in an irrigation system.	False. ( <u>ABC's</u> , page 93)
4. Generally speaking, water is not compressible.	True. (Page 7)
5. Always leave a copy of the design with the property owner.	True. (Page 2)
6. One foot of head equals one psi.	False. (Page 8)
7. As a professional irrigator you recognize that throwing water on streets and sidewalks is unavoidable, and should therefore be of little concern to you or to the property owner.	False. (Page 2)
8. Always draw your designs such that only you know what they mean.	False. (Page 2)

201

## Multiple Choice

Indicate the letter of the choice that best completes the statement.

Then, after the questions are discussed in class, write the letter of the correct answer in the answer column. That way, you will know the correct answers if you later review this information.

Statement	Answer
<p>1. If the water level in a water tower is 110 ft above ground level, the static pressure at ground level is</p> <p>A. 253 feet of head            C. 38.8 psi            D. 63.6 psi            E. 65.7 psi            F. B and C</p>	<p>B. 110 feet of head (110 ft x 1 ft of head/ft = 110 ft of head)</p>
<p>2. Two gallons of water weighs</p> <p>A. .433 lbs            B. 2.31 lbs            C. 8.34 lbs            D. 10.45 lbs            F. 18.23 lbs</p>	<p>E. 16.68 lbs (8.34 lbs/gal x 2 gal = 16.68 lbs)</p>

210

Statement

---

Answer

---

3. Water pressure can be increased only by
- A. Using a larger water meter
  - B. Using a smaller pipe size
  - C. Raising the elevation of the water source
  - D. Pumping the water
  - E. Both A and B
4. The friction loss of water flowing through pipe is affected by
- A. The material the pipe is made of
  - B. The size of the pipe
  - C. The roughness of the inside surface of the pipe
  - D. The I.D. of the pipe
  - E. The flow rate and the velocity of the water

- F. Both C and D (Page 7)
- F. All of the above (ABC's, pages 95-97)

200

## Statement

## Answer

5. Calculate the static pressure at points 1, 2, 3, and 4.

- A. 30.5 psi  
 B. 32.5 psi  
 C. 42.4 psi  
 D. 46.2 psi  
 E. 55.4 psi  
 F. 59.1 psi

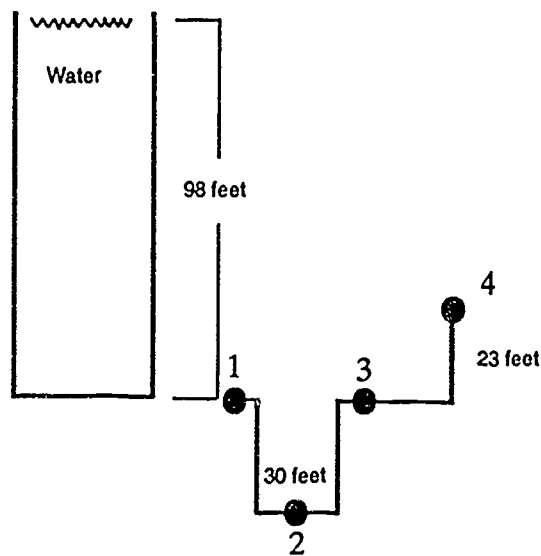

1.        C (98 ft x .433 psi/ft = 42.4 psi)  
 2.        E (128 ft x .433 psi/ft = 55.4 psi)  
 3.        C (98 ft x .433 psi/ft = 42.4 psi)  
 4.        B (75 ft x .433 psi/ft = 32.5 psi)

2012

(This page included for duplexing.)

## Design Phase 1: Drawing A Plot Plan

### Plot plan defined

In the irrigation business, a plot plan is a scale drawing of the property to be irrigated. A plot plan shows the dimensions of the property, the landscaping, and all structures, as well as indicates the presence of any items on the property such as utility poles. From a practical standpoint, the definition should also include the notes that you record about the property. As you will see, the notes can be as important as the measurements themselves.

### Annotation: (Discussion Question)

**How many of you have ever drawn a plot plan?  
What did you find to be the easiest part about it?  
The most difficult?**

### Producing a plot plan

A good way to produce a plot plan is to make a freehand sketch of the property. You need a pencil, drawing paper, compass, and a scaled ruler. You may also wish to have a T-square, triangle, protractor, French curves, calculator, and templates.

The drawing paper can be blank, but graph paper is much easier to use when drawing to scale. The ruler can be either in 8ths of an inch or 10ths of an inch. The choice is yours--but be consistent. Do not switch back and forth or you will very likely get confused and produce inaccurate drawings.

### Determine the property boundary lines

Once you have your drawing materials, you need to determine the property boundary lines. This is usually fairly easy, but not always. Property lots may be irregularly shaped and structures such as fences may not follow the property lines. An architect's plot plan or a survey plot can help you determine the boundary lines. Homeowners sometimes have a copy of the architect's plot plan or the survey plot.

You want to determine the boundary line for a couple of reasons. First, you need to avoid putting any part of a customer's sprinkler system on someone else's property. Second, you want to throw as little water as possible on adjacent properties.

### Measuring the property

A plot plan must be accurately drawn to scale. This means, of course, that you must accurately measure the property. "Stepping off" the distance is totally unacceptable. Even if you have an architect's plot plan, you should re-measure the property and double check the accuracy of the architect's plan. You may find that dimensions were changed from the architect's plan, or that items were added or deleted.

You will need an accurate measuring device. Two commonly used ones are a measuring tape and a measuring wheel. The measuring wheel is basically a counter attached to a wheel. The rotation of the wheel is shown as a distance on a display. Remember to keep your lines of measurement straight regardless of which measuring device you use.

Measure as accurately as you can. Generally, it is easier if you round off to the nearest half foot. Whether you round up or down is up to you, but be consistent. Decide on your rules for rounding and stick with them.

Be sure to take enough measurements to adequately design the system. It is better to have too many measurements than not enough. You will waste time and money if you have to return to a property to get additional measurements.

207

### Indicating landscaping and other items

Your plot plan should also include the locations of landscaping items such as trees, bushes, shrub beds, flower beds, garden beds, and so forth. You should also include the locations of any items that may obstruct the water from a sprinkler systems. These include objects such as cooling/heating compressors, fire hydrants, mailboxes, utility poles, utility buildings, retaining walls, fences, and so forth.

### Drawing an arc

Properties sometimes include arcs such as a curved street or a circle driveway. You need to draw such arcs as accurately as possible. Various methods exist for doing this. The method explained next is but one way.

Most curved curbs or circle driveways contain expansion joints. These are usually wood pieces placed into the curb or driveway at the point where the arc actually starts. Measure from a fixed point, such as the corner of a house, to each expansion joint.

Pick 2 points on the arc that divide the arc into thirds. For ease of discussion, we will call them Points A and B (you will have to estimate where the points are). From Point A, measure to 2 fixed points, such as the corner of a house and a corner of a sidewalk, etc.

On the plot plan, draw in the distances from the 2 fixed points. The place where the 2 lines cross is Point A.

Repeat the same procedure for Point B: measure to 2 fixed points and draw the distances on the plot plan. The place where the 2 lines cross is Point B.



You have now identified 4 points on the arc: the end points (the expansion joints), and Points A and B. Use a French curve and draw the arc from one expansion joint to the other. The arc must pass through Points A and B.

You now have an accurate drawing of the arc.

### Plot plan notes

After you have drawn a plot plan that includes everything discussed so far, your next step is to take some written notes. Do not try to remember the information--write it down. Be as thorough as you can with the notes. You may sometimes need to take a photograph of a property as a further reminder. An instant picture camera works well for this (such as a Polaroid).

The following questions are included to help you with your note taking. Make sure that you answer each of the questions in your notes. If you do, your plot plan and notes will be invaluable when you design the system.

All of the questions are based on one rule: talk to the property owner. This is very important. You must find out what the property owner wants. The following questions help illustrate why.

1. Does the property owner plan to add items to the property or remove them?

For example, you need to know if the property owner plans to add a swimming pool, spa, utility shed, garden area, and so forth. Conversely, what if the owner plans to quit using a garden area (remove it) and cover it with turf? You need to know this type of information before you design the system.

2. Does the property owner object to water on any certain areas?

For example, the owner may not want water thrown on the driveway, sidewalks, fence, or even the dwelling itself. (The water in some locations contains minerals that can stain brick, wood, and other building materials.)

3. Does the property owner have any special watering requirements?  
(This may also include areas of the property that the owner does not want irrigated.)

You already know from previous discussions that different types of plants require different amounts of water. As a professional irrigator, you should be familiar with the watering requirements for the types of plants common to your locale. Even so, check with the property owner about special watering requirements.

4. Does the property owner want a manually operated system?

If so, you need to find out if the owner wants the valves located in a specific place. The advantages and disadvantages of a manually operated system were discussed in Section 4. Some property owners want a manually operated system despite the disadvantages.

5. Where does the property owner prefer to have the controller located? Does the proposed location have electricity?

Section 4 discussed controllers, where to locate them, and how to deal with the situation of no available electricity. You may wish to review that information at this time.

6. Does the property have sufficient hose bibbs?

Sometimes property owners would like to have additional hose bibbs around the property. Some residential customers prefer to have a hose bibb near the driveway to make washing their vehicles more convenient.

Also ask any other questions that may occur to you about the particular situation.

**Observe the surroundings**

Your plot plan notes should also include information based on your observations. The following items are reminders of the type of information to write down.

1. Note the direction of north in relation to the property.

2. Note any rises or falls in elevation.

Changes in elevation, depending on the type of changes, can affect your design.

3. Note any underground utility boxes or lines.

Utility companies will often post signs warning about the location of buried utility lines. As a general rule, contact the utility companies before you trench or dig.

4. Note the types of borders around the property.

The borders may include curbs, gravel shoulders, drainage ditches, other properties, and so forth.

5. Note the direction of the prevailing winds.

Wind is the nemesis of sprinkler heads. You need to consider the direction of the prevailing winds when you plan your system. Dry spots can develop where you least expect them because of wind deflecting the water. You may need to add an extra head at a certain spot, for example, to allow for wind deflection.

Remember that the higher and the farther the water is thrown, the more susceptible it is to wind deflection.

Never depend on the wind to water an area for you. In other words, do not design a system such that it depends on wind-blown water to adequately cover the irrigated area.

6. Note if the property is using a water source other than city water.

If the property is using a water well, you need to determine the rating of the pump in gallons per minute and the size of the discharge pipe.

You may need to filter the water if it is from a source other than city water.

7. Note the items listed on page 79 in the ABC's.

Once you have an adequate plot plan, you are ready to enter phase 2 of layout and design.

(This page included for duplexing.)

213

## Design Phase 2: Laying Out The Heads

### Layout

After you have drawn an accurate plot plan, taken notes, and talked with the property owner, you are ready to layout the sprinkler heads. This involves deciding on which types of heads and patterns, the size of the patterns, and how to arrange the patterns.

### Heads and patterns

Sprinkler heads and nozzles were discussed in Section 4 of your Guide and on pages 10 through 28 in the ABC's. Remember that spray, rotary, and hybrid type heads exist, as well as both circular and square patterns.

Once you decide on the type of heads to use, you can look at the patterns available within that type (full circle, part circle, large square, small square, etc.). After you determine the types of heads and patterns, you will need to space the heads correctly within the property.

### Spacing patterns

The two types of spacing patterns are triangular and square. Since the ABC's explains them, this Guide will not discuss them in depth.

### Annotation: (Quick drawing activity)

Ask the students to look at the top drawing on page 82 in the ABC's. Instruct them to adjust their compasses to the distance between the heads in the first row.

In triangular spacing, each row is offset from the row next to it (thus forming triangular patterns in relation to the heads). The distance between each head is the same. The distance between each row of heads, however, is about about 87% of the distance between each head. It is fairly easy to complete a triangular design with a compass. The intersection of the compass arcs from any two heads is the point where you need a head.

Square pattern spacing is typically used in larger lawn areas. The distance between each head is the same as the distance between each row of heads.

Set the compass on the location of the first head and draw an arc across the second row of heads, at about the four o'clock position. Set the compass on the location of the second head and draw an arc that intersects the first arc. The arcs will intersect at the location of the second head in the second row.

### Inconsistency in spacing

Unfortunately, not all property is square or rectangular. Sometimes you will have to adjust the head spacings based on the shape of the area being irrigated. Triangular and square spacing help to get you started. But arranging the spacings and patterns relies less on a scientific method and more on an artistic method. It is often learned by trial and error.

You want to ensure that the system fully covers the area being irrigated. This may require that you alter the spacing between heads, or add an additional head at certain locations. In other words, do not be afraid of inconsistency in your spacing if it ensures complete coverage.

With either triangular or square spacing, consistent or not, you must consider the overlap of the patterns.

## Overlap

Overlap is usually expressed as a percentage of the diameter of the pattern. You may find it more convenient to discuss the size of patterns in terms of radius. Just remember that the diameter is twice the radius.

Opinions on the correct amount of overlap vary. For example, the ABC's mentions that the overlap of circular pattern spray heads should not exceed 80% of the diameter. For example, if a head throws a pattern with a 20' diameter, the spacing between heads would be 16' (80% of 20 is 16).

A more effective overlap, perhaps, is to stay in the range of 50% to 65% of the diameter. That is, never exceed 65%. In this range, the patterns should reach from head to head, or close to it.

Square pattern spray heads typically require less overlap than circular pattern spray heads. An overlap of 18" to 24" is usually sufficient.

## Why have overlap?

The reason for a head-to-head overlap is that spray and rotary heads typically do not water close to the head itself. You have to throw water into the circular pattern to avoid dry spots. Dry spots are never acceptable in a design. Therefore, if you must change the spacing between heads, decrease it rather than increase it.

A well-designed sprinkler system with properly spaced circular pattern spray heads provides complete coverage because of the overlap. The same system, however, distributes water very unevenly. That may come as a surprise, but think about it. Some areas get watered from three different directions; they get triple watered. Other areas get double watered. And still other areas get watered only once.



Remember that complete coverage does not necessarily mean even distribution.

### Where to begin a layout

There is no one specific way to layout the sprinkler heads. You may find it helpful to start with the corner areas. Determine the most effective and efficient way to irrigate the corner areas and work out from there. (You may place a head to throw out from a corner or into a corner depending on the circumstances.)

You can space the other heads based on the positions of the corner heads. A convenient step to do next is to place the heads in the areas that have special watering requirements. For example, the property owner may not want the fence, driveway, and sidewalks to get wet. Go ahead and place the heads such that these conditions are met.

Remember that shrubs and flower beds typically require less water than turf does. Rather than watering them along with the turf, a more efficient way is to use drip irrigation. Drip irrigation is discussed in Section 7. For now, just keep in mind that shrubs and flower beds can be watered other than from the turf heads.

Narrow strips of turf, such as parkways, are usually challenging to water. The ABC's, on page 88, discusses several of the methods used to water them.

After you layout the heads, you are ready to enter phase 3 of layout and design. Before you read about phase 3, however, complete the subject review on phases 1 and 2.

## Subject Review

### Layout and Design: Phases 1 and 2

#### Fill In The Blank

Supply the word or words in the answer column to complete the following statements.

Then, after the questions are discussed in class, place an "X" through each incorrect answer and write the correct answer in the answer column. That way, you will know the correct answers if you later review this information.

Statement	Answer
1. The two most common methods of placing sprinkler heads are by _____ and _____ spacing.	Triangular, square. ( <u>ABC's</u> , pages 82-83)
2. The two types of patterns from spray heads are _____ and _____.	Circular, square. ( <u>ABC's</u> , pages 17-19)
3. The _____ pattern requires the least amount of overlap.	Square. (Page 27)
4. It is almost always better to _____ the spacing between heads to achieve a better fit than to _____ the spacing.	Compress, stretch; Decrease, increase, etc. ( <u>ABC's</u> , page 84)
5. _____ paper is usually helpful in designing a sprinkler system.	Graph. (Page 17)
6. With true triangular head placement, the distance between rows is _____ percent of the spacing between the heads.	87 ( <u>ABC's</u> , page 82)

Statement

Answer

- 
7. Always check the water pressure at a location with a \_\_\_\_\_.
8. \_\_\_\_\_ strips of turf are challenging to water efficiently and effectively.

---

**Pressure gauge, or just gauge. (ABC's, page 79)**

**Narrow. (Page 28)**

## True or False

In the answer column, mark the following statements "T" for true or "F" for false. The whole statement is false if any part of it is false.

Then, after the questions are discussed in class, place an "X" through an incorrect answer and write the correct answer in the answer column. That way, you will know the correct answers if you later review this information.

Statement	Answer
1. You should always verify the dimensions of property with an accurate measuring tool.	True. (ABC's, page 78)
2. With triangular head placement, the spacing from head to head and from row to row is the same.	False. (ABC's, page 83)
3. On plot plans, you should include the locations of shrub and flower beds only because they may create an obstruction.	False. (Page 19 and 28)
4. On plot plans, you should always include the locations of trees, utility poles, and any other structures such as a storage building.	True. (ABC's, page 79)
5. Overlap circular pattern sprinklers as little as possible.	False. (Page 27)
6. Always irrigate any lawn areas with as few heads as possible to achieve full coverage.	False. (ABC's, page 91)
7. It is always preferable to water shrubs, flowers, and lawn at the same time if possible.	False. (Page 28)
8. For certain slopes, you may have to use sprinklers with a low precipitation rate.	True. (ABC's, page 90)

## Multiple Choice

Circle the letter of the choice that best completes the statement.

Then, after the questions are discussed in class, write the letter of the correct answer in the answer column. That way, you will know the correct answers if you later review this information.

Statement	Answer
<p>1. Some of the items that you must know to design an efficient sprinkler system include</p> <p>A. Desires of the property owner            B. Size and location of the city water meter            C. Size, shape, and location of flower beds            D. Location of trees and utility poles            E. A and B only</p>	<p>F. A, B, C, and D (<u>ABC's</u>, page 79)</p>
<p>2. Sprinkler head spacing should be based on</p> <p>A. Types of heads and sizes of patterns            B. Slope of property and location of trees            C. Water pressure            E. Both A and C            F. A, B, and C</p>	<p>D. Both A and B (<u>ABC's</u>, pages 84-90)</p>

221

Statement	Answer
<p>3. When you need to find out the size of a property, it is sufficient to</p> <ul style="list-style-type: none"> <li>A. Use the measurements from an architect's plan of the property</li> <li>B. "Step off" the distance, which will measure close enough for irrigation systems</li> <li>C. Use a measuring tape to measure</li> <li>D. Use a wheel-type measuring device to measure</li> <li>E. Both A and B</li> </ul>	<p><b>F. Both C and D (ABC's, pages 78-80)</b></p>
<p>4. A few dry spots in a design are</p> <ul style="list-style-type: none"> <li>A. Acceptable if the spots are at the bottom of an incline where run-off water will reach them</li> <li>B. Acceptable because wind and run-off will usually get water to the spots</li> <li>C. Acceptable if the design has no more than three such spots</li> <li>D. Acceptable if the design has no more than three such spots and at least two of the three appear side by side</li> <li>E. Both A and B</li> </ul>	<p><b>F. Never acceptable (Page 27)</b></p>

270

Statement	Answer
<p>5. A well-designed sprinkler system with properly spaced circular pattern spray heads</p> <p>A. Distributes water very evenly</p> <p>B. Distributes water very evenly unless the ground is hilly</p> <p>C. Distributes water very evenly if the correct wind loss factor has been figured into the design</p> <p>E. Distributes water very unevenly unless a filter keeps the water clean</p> <p>F. Distributes water very unevenly only if the water is blocked by obstructions such as trees</p>	<p><b>D. Distributes water very unevenly (Page 27)</b></p>
<p>6. An effective spacing for circular pattern spray heads is</p> <p>A. 10-20 percent of the diameter of the spray pattern</p> <p>B. 30-40 percent of the diameter of the spray pattern</p> <p>C. 40-50 percent of the diameter of the spray pattern</p> <p>E. 65-85 percent of the diameter of the spray pattern</p> <p>F. None of the above</p>	<p><b>D. 50-65 percent of the diameter of the spray pattern (Page 27)</b></p>

223

Statement	Answer
<p>7. Determining where to begin the placement of the heads on a layout</p> <ul style="list-style-type: none"><li>A. Can be done scientifically if you use Davidson's Placement Formula</li><li>B. Can be done scientifically if you use the Bourge scaling method</li><li>C. Relies less on a scientific method and more on an artistic method</li><li>D. Is often learned by trial and error</li><li>E. Both A and B</li></ul>	<b>F. Both C and D (Page 26)</b>
<p>8. Overlapping the patterns of circular spray heads</p> <ul style="list-style-type: none"><li>B. Is necessary because water pressure will always decrease in the summer season</li><li>C. Is necessary because most lawns are rectangular and the only way to reach the corners is by overlapping</li><li>D. Both A and B</li><li>E. Both B and C</li><li>F. None of the above</li></ul>	<b>A. Is necessary to avoid dry spots between patterns (Page 27)</b>



(This page included for duplexing.)

210

### Design Phase 3: Sectioning The Heads (adding the plumbing)

#### Sectioning as a series of steps

Pages 99 through 106 in the ABC's discuss dividing the heads into groups (called sectioning). The information may seem intimidating at first. But sectioning the heads is really just a series of steps within itself. If you follow the steps one at a time, the whole process is easier to understand.

For example, the following list summarizes the main points from pages 99 through 106, and also includes supplementary information. The list is to help you get an overview of the steps involved in sectioning the heads.

*The list is not a substitute for thoroughly understanding the information on the pages.*

1. Determine the static pressure and the size and flow rate of the water meter. Apply the 75% rule to the supply volume.

The rating in gallons per minute is imprinted on some types of meters. Check the meter to see. If not, you can find out the rating from the meter manufacturer or from various tables that list how much water can pass through a given size meter at a given pressure.

Always test the flow rate of the water. At least turn on a hose bibb and see if you get a trickle or a full stream of water. Do not base your design strictly on static pressure because conditions may exist of which you are not aware. For example, suppose that the supply line from the water main to the meter has a crimp in it. Your static pressure will still read the same. But, instead of getting 16 gallons per minute through the meter, you may get only 6.

223

2. List the types of sprinklers that you are using, their discharge rates, and their minimum and maximum operating pressures.
3. Divide the sprinklers into sections, starting at the source of the water supply.

A good practice, if you have triangular placement of the heads, is to section the heads by rows. This also often adds to the consistency in the overall aesthetic appeal of the system and usually reduces the amount of pipe required.

The amount of water available at a given time determines how many heads that you can put in a given section. The amount of water used by all of the heads in a section must be less than the total amount of water available. Otherwise, you have too many heads in the section.

4. Estimate where the main supply line will run (you can change it later if necessary).
5. Calculate the friction loss for the farthest section and for the largest section by using the "quick check" method.

You will need to refer to pressure loss tables such as those in the back of the ABC's.

Pressure loss charts are usually calibrated in psi per 100 feet. Remember to divide the pressure loss number from the chart by 100, then multiply that answer by the number of feet.

Apply the 90% rule to the static pressure.

If either the farthest or the largest circuit requires a pressure greater than the design static pressure, resection the heads and repeat this step.

277

6. Add the piping (after you have successfully sectioned the heads).

Do not size the pipe yet.

7. Add the valves.

A reasonable practice is to put the remote control valve somewhere close to the middle of its circuit. This gives you a consistent pressure drop from the center to either end. In all cases, you cannot locate it near the center. One reason, of course, is that the locations of the valves determine where the supply line will run.

8. Route the main supply line.

For some installations, looping the supply line around the property and back to itself can be advantageous. Looping the line gives the effect of having 2 supply lines to each section--1 line from each direction. You may be able to reduce the size of the supply line 1 size as well as reduce the total amount of pressure loss.

Sometimes the looping requires only a small amount of extra pipe (an extra 20 feet of pipe to go underneath a driveway, perhaps). Keep in mind the economic and design benefits of looping the supply line. If it improves the installation, use it.

9. Size the pipe and valves.

When sizing pipe, use the smallest pipe that can safely carry the amount of water that has to pass through it. How much water has to pass through a section of pipe? Let us look at an example.

END

Suppose that you have the following arrangement of pipe and sprinkler heads. Each head discharges 4 gallons per minute.

meter	A	B	C	D
Pipe Section From	Carries The Water For			Section Must Carry
meter to head A	Heads A, B, C, and D			16 gpm
head A to head B	Heads B, C, and D			12 gpm
head B to head C	Heads C and D			8 gpm
head C to head D	Head D			4 gpm

Decreasing the pipe size causes the water velocity to increase (there are hydraulic limits to this rule, of course).

Remember to keep the velocity about 5 feet per second. You must also check the pressure drop for each section of pipe to make sure that you have enough pressure to operate the head. (The discussion about Design Phase 4 explains that more fully.)

Fortunately, some pressure loss charts list all this information: the pressure loss factors, and the velocity (feet/second) of a given rate (gpm) through a given size pipe.

Now that you have an overview of sectioning, re-read pages 99 through 106 in the ABC's until you have a thorough understanding of the information. Pay close attention to the drawings and the mathematics that accompany them.

After you feel comfortable with the information, return to this Guide and read about Design Phase 4.

220

## Design Phase 4: Check Your Design Mathematically

After you complete a design, you need to check it mathematically. This check ensures that all of your calculations are correct and that the system will function as designed.

Pages 107 and 108 in the ABC's discuss the final check. Reread those pages until you are thoroughly familiar with the information.

Notice that you calculate the minimum required operating pressure for the circuit farthest from the meter and for the largest circuit. If those two circuits will operate, you can usually assume that all other circuits will operate. But check each circuit if you have any doubt about whether or not it will operate.

### Follow the bouncing bubble

Imagine that you are going to follow a bubble from the water meter to the farthest head in a system. You will need to keep track of everything along the route that causes the water pressure to drop. Do not include any lines that branch off from the route because that bubble does not branch off--it bounces along directly to the head.

The following list summarizes what to keep track of:

- The water meter itself
- Any backflow prevention devices
- Any valves
- The total length of the pipe
- Any change in elevation of 10 feet or more
- Any component in the system that causes turbulence in the water
- The minimum required pressure for the head

Pressure loss also occurs through certain types of fittings. For practical purposes, the loss is typically very small and usually can be ignored. If you have a very large system that is operating very close to the maximum, you may need to include the fittings. But usually the accumulative affect of all of the fittings is negligible.

Add all of the pressure loss numbers together. The result, plus the minimum head operating pressure, is the minimum pressure required to operate the farthest circuit.

This number must be less than your design static pressure. (Remember, design static pressure is 90% of the static pressure.) If the number is larger, you need to adjust your design and recalculate.

After calculating the pressure loss for the farthest circuit, repeat the process for the largest circuit.

The mathematics involved for the final check is not difficult, but you do need to be careful during the process. Make sure that you have included a pressure loss for everything in the system that causes pressure loss. Verify that you are using the correct table or chart before using a pressure loss number from it.

## Subject Review

### Layout and Design: Phases 3 and 4

#### Fill In The Blank

Supply the word or words in the answer column to complete the following statements.

Then, after the questions are discussed in class, place an "X" through each incorrect answer and write the correct answer in the answer column. That way, you will know the correct answers if you later review this information.

Statement	Answer
1. When you size pipe, make sure that the size is not too _____.	Small. ( <u>ABC's</u> , pages 95-98)
2. When you use PVC pipe, a safe critical velocity for the water is _____.	5 ft./sec. (Page40)
3. Water flowing from a sprinkler nozzle may travel a greater distance than it would from an open ended water hose because the nozzle increases the _____ of the water.	Velocity. ( <u>ABC's</u> , page 99)
4. Any reduction in the size of pipe through which water flows, or any abrupt change in the direction of the flow, causes a _____ in the water _____.	Drop, Pressure. ( <u>ABC's</u> , page 95-98)
5. A reasonable way to check if a sprinkler system will work correctly is to calculate the pressure & (loss) in the _____ circuit and in the _____ circuit.	Largest, Longest (farthest). ( <u>ABC's</u> , page 107)

2.32



Statement

Answer

- 
6. Choose the size of pipe and the placement of the valves so that you reduce the total \_\_\_\_\_ of pipe needed and reduce the pressure \_\_\_\_\_.
  7. Place manual control valves so that the operator does not get \_\_\_\_\_ when turning the valves on or off.
  8. Pressure losses are cumulative only in a direct \_\_\_\_\_ from the farthest point to the water source.

---

**Amount, Loss (drop).  
(ABC's, page 103-106)**

**Wet. (ABC's, page 105)**

**Line or route.(Page 41)**

2.55

## True or False

In the answer column, mark the following statements "T" for true or "F" for false. The whole statement is false if any part of it is false.

Then, after the questions are discussed in class, place an "X" through an incorrect answer and write the correct answer in the answer column. That way, you will know the correct answers if you later review this information.

Statement	Answer
1. Pipe in a sprinkler system is sized to maintain velocity.	False. (ABC's, page 98)
2. Pipe in a sprinkler system is sized efficiently to save the buyer money.	True. (ABC's, page 98)
3. When you want to estimate how much water is available for a sprinkler circuit, all you need to know is the static pressure, meter size, and service line size (main to meter).	True. (ABC's, page 99)
4. Friction loss tables are usually listed in PSI per 100 feet.	True. (ABC's, page 101)
5. Heads with greatly different precipitation rates should never be operated on the same circuit.	True. (ABC's, page 91)
6. All plants require roughly the same amount of water, and can be watered at the same time and with the same amount of water.	False. (Page 28)
7. Plant types and requirements are of no interest to the professional irrigator.	False. (Page 28)
8. The actual operating pressure at a head does not matter as long as it is more than the minimum operating pressure needed for the head.	False. (Page 42)

Multiple Choice

Circle the letter of the choice that best completes the statement.

Then, after the questions are discussed in class, write the letter of the correct answer in the answer column. That way, you will know the correct answers if you later review this information.

Statement	Answer
<p>1. Pipe is progressively sized down in a sprinkler system</p> <p>A. To maintain water pressure                      B. To maintain water velocity                      D. Because the number of circuits keeps increasing                      E. Both A and B                      F. None of the above</p>	<p><b>C. Because small pipe costs less than large pipe (ABC's, page 98)</b></p>
<p>2. Looping a main supply line in a sprinkler system can</p> <p>A. Lower the pressure loss to the circuits                      B. Allow you to use smaller pipe for the main supply line                      C. Increase the water pressure to the system                      D. Allow you to adjust the heads easier because of better water pressure                      F. Both C and D</p>	<p><b>E. Both A and B (Page 39)</b></p>

Statement	Answer
<p>3. Water hammer</p> <p>A. Can be removed if you size the pipe correctly</p> <p>B. Can be removed if you use a larger water meter</p> <p>C. Is only a problem with PVC pipe</p> <p>E. Both A and B</p> <p>F. None of the above</p>	<p><b>D. Should be kept at a safe level (Page 10)</b></p>
<p>4. For all practical purposes, static pressure</p> <p>A. Is the same throughout a piping system</p> <p>B. Is the same throughout a piping system if the water is flowing</p> <p>D. Differs at each valve in a sprinkler system</p> <p>E. Is lower in small diameter pipe than in large diameter pipe</p> <p>F. Is greater in long sections of pipe than in short sections of pipe</p>	<p><b>C. Is the same throughout a system if the water is not flowing (ABC's, pages 95-97)</b></p>
<p>5. The number of heads in a single section depends on</p> <p>A. The total gallons of water available</p> <p>B. The total gallons of water required by the heads</p> <p>C. The size of the pipe</p> <p>D. The number of valves</p> <p>F. Both C and D</p>	<p><b>E. Both A and B (ABC's, page 9)</b></p>

Statement	Answer
<p>6. Generally, the total pressure loss through a circuit plus the minimum operating pressure of the sprinkler heads in the circuit should be no more than</p> <p>A. 50% of the static pressure            B. 60% of the static pressure            C. 70% of the static pressure            D. 80% of the static pressure            F. None of the above</p>	<p><b>E. 90% of the static pressure            (ABC's, page 191)</b></p>
<p>7. The fittings in a system</p> <p>A. Do not cause any pressure loss            C. Cause a great deal of pressure loss            D. Cause a pressure loss only if the fittings are thermoplastic            E. Cause a pressure loss only if they reduce the size of the orifice through which the water passes            F. None of the above</p>	<p><b>B. Cause such a small amount of pressure loss that usually you can ignore it            (Page 42)</b></p>

2.5'

Statement	Answer
<p>8. You have a section of 3/4" PVC pipe 72' long. On a chart, you find the friction loss factor is 2.87 psi / 100' at a water velocity of 5 ft/sec. The friction loss through that section of pipe is</p> <p>A. 206.6 psi B. 25.08 psi D. 1.89 psi E. 0.92 psi F. None of the above</p>	<p>C. 2.06 psi (72' x 2.87 psi / 100' = 2.06 psi)</p>

(This page included for duplexing.)

2.30

## Orientation

### Drip Irrigation

#### Class Session 6

**Audio-visual aids that you need to present class session 6**

None.

**Labs or drawing exercises associated with class session 6**

Laboratory 3  
Drawing Exercise 2

**Reminder about class session 7**

Remember that the next class session is structured to allow outside speakers. If you have not arranged for outside speakers, make arrangements now. If you have arranged for outside speakers, contact them and remind them of their commitment to speak.

**Steps to complete before teaching class session 6**

Complete the following steps before you teach class session 6:

1. Read this entire section.
2. Read the descriptions for Laboratory 3 and for Drawing Exercise 2. They are in the tabbed section "Labs and Exercises."
3. Determine exactly what Laboratory 3 and Drawing Exercise 2 involve.  
  
Make sure that you have all of the required materials prior to the class.
4. Study the lesson plan for class session 6. Remember that the times allotted are guidelines only.

210



5. For you and your students, photocopy the pretest for the subject "Drip Irrigation." All pretests are located in the 9x12 envelope. Be sure to return the master to the envelope.
6. Sit or lie in a quiet place where you will not be disturbed. Close your eyes and relax your entire body. Breathe deeply several times, using your diaphragm to inhale and exhale. Mentally picture yourself with your students, discussing irrigation. "See" the situation as a sharing of information that unfolds pleasantly. Imagine the learning process as being a pleasant and beneficial experience. Hold that thought for a few minutes, then open your eyes and resume your daily activities.

**Reading and homework assignments for class session 7**

At the end of class session 6, give the reading assignment and the homework for class session 7.

Reading assignment:

In the ABC's:  
Pages 118 through 137.

In the Student's Guide:  
All of Section 7.

Homework:

Complete Drawing Exercise 2

## 7. Drip Irrigation

---

### Section overview

In the appendix of your Guide is a publication from the Texas Water Development Board titled "Drip Irrigation." If you have not already read it, please read it before continuing in this section.

This section discusses drip irrigation, how it originated and why it works successfully. In addition, this section offers the professional irrigator much information about the watering requirements of plants. In fact, even before getting to drip irrigation, you need to know something about the relationship of water, soils, and plants.

### When water meets the soil

Soil is typically in layers that range from greater compaction to lighter compaction. The layers may or may not be well defined, but to some extent the layers exist in all soils.

Water penetrates the soil one layer at a time. Another term for penetration is percolation. The leading edge of the water as it moves down is called the wetting front. Each layer fills up until it reaches a point that is called its field capacity. The field capacity is how much water the layer will hold before the water continues to move on down.

Field capacity is not necessarily the same thing as saturation point. Saturation occurs when the soil is incapable of holding any more water.

### Speed of percolation

The speed at which water can move through soil depends directly on the size of the particles in the soil. Small particles are usually referred to as "fine"; large particles are referred to as "coarse."

As a general rule, the finer the particles, the slower that water moves through the soil. Clay soils, for example, have the finest particle size of all. This is the reason clay soils get gummy and thick when wet. Water moves slowly through clay soils.

Sandy soils, on the other hand, have coarse particles. Water moves quickly through sandy soils.

It is important for you to know how deeply into the soil water penetrates and how rapidly.

**One of nature's cycles:  
evapotranspiration**

What happens to the water when you irrigate? Some of it reaches the plant roots and some of it does not. The water that reaches the roots is absorbed and passes up through the plant. The water carries nutrients throughout the plant. Eventually, the water travels out to the leaves of the plant and is discharged as vapor. This process of absorbing and losing water is called transpiration.

Evaporation also claims a portion of the water applied. Some of the water evaporates from the soil before it ever reaches the plant roots.

These two processes, transpiration and evaporation, are called evapotranspiration. Together, they make up the actual water requirement of a particular plant.

Ideally, you want to maintain a moisture level in the soil at the point where the water is replenished at exactly the same rate as the plants use it and as it evaporates.

Plants require oxygen to live, which they take in through their roots. If you saturate the soil, you wash out all of the oxygen. Plants cannot take in oxygen from the water. So, in effect, they suffocate from lack of oxygen.

Incidentally, many plants appear the same when suffering from over watering as from under watering. They begin to wilt and turn yellow. Many people assume that yellowing leaves indicates lack

## 7. Drip Irrigation

of water, so they water the plant more. The plant, however, may be drowning, not suffering from thirst. Do not assume: always check the moisture level of soil with a moisture meter. More about that later.

### ET rates

Evapotranspiration is often abbreviated as ET, and is usually referred to in terms of rate. The rate is commonly measured in inches of water per day. The ET rate tells you how many inches of waters per day needs to be replenished for a certain type of plant.

Calculating ET rates is a detailed process because so many things affect the rate. Almost everything that the plant is exposed to has an influence: the temperature, cloud cover, wind, humidity, mulching, the number of plants, and so forth.

You can usually get a list of ET rates from your local county extension agent. Product literature for certain brands of irrigation equipment sometimes lists ET rates also.

### Annotation: (Discussion Question)

**How many of you have had customers ask about watering requirements for plants? What have you told them?**

Some charts of ET rates list what is called a potential evapotranspiration rate, or PET. A PET is like an average for a particular time of year, usually mid summer, and for different climates.

How much water does a plant need?

What you want to do as an irrigator is to tell a customer about how much water a plant can be expected to use. A formula exists to help you:

$$\frac{.623 \times \text{canopy size} \times \text{PET} \times \text{plant factor}}{\text{Irrigation efficiency}} = \text{Gallons per day for plant}$$

Irrigation efficiency

Where:

.623 = Conversion factor to convert inches of water per square foot of area to gallons. It takes .623 gallons of water to cover a square foot to a depth of one inch.

canopy size = Plant area in square feet (the area under the canopy of the tree, for instance). If you draw a circle around the drip line on the ground, the area of that circle is the canopy size. Remember the formula for figuring the area of a circle: Square the diameter of the circle and then multiply by 0.7854.

PET = Potential evapotranspiration rate.

plant factor = A number that varies with the type of plant. Plant factor numbers are sometimes available from nurseries or in product literature for certain brands of irrigation equipment.

## 7. Drip Irrigation

**Irrigation efficiency** = The efficiency of the irrigation in applying the water. Irrigation is never 100% efficient; some loss always occurs. You strive to keep that loss to a minimum, but you always have some. Drip irrigation is very efficient: 85% in hot, dry climates; 90% in moderately hot climates; and 95% in cool or humid climates. Sprinkler irrigation efficiency is normally less, and depends on sprinkler type, climate, wind, etc.

The formula gives you the gallons of water per day that need to be applied to a particular plant to replenish the water used through evapotranspiration.

For example, a shrub with a 3 foot diameter would require 1.22 gallons per day in a moderate climate if you used drip irrigation:

$$\frac{.623 \times ((3 \times 3) \times .7854) \times .25 \times 1.0}{.90} = 1.22 \text{ gpd}$$

### Root depth and irrigation

Plants need to grow their roots to a depth that most benefits the plant. For turf grasses, the depth is about 6 inches in clay soils, and deeper in sandy soils, down to about 12 inches in some cases. Watering should encourage proper root growth—which brings us right back to proper irrigation.

## 7. Drip Irrigation

Let us look at clay soils as an example. If you water in only very small amounts, the water penetrates the soil only to a very shallow level. If you do this over a long period, you encourage the plant roots to become shallow. The roots grow to where the water is.

Do not assume that the water just keeps running down through the soil. It does not. In fact, if applied in very small quantities, the water may soak into just the top inch or so. It remains there until either the plants absorb it or it evaporates.

What you want to do is apply enough water to soak down to the bottom of the root zone, but no deeper. Water that goes below the root zone is basically wasted because the plants make no use of it.

### 1 inch per week

As it turns out, applying one inch of water per week to clay soils typically gives about 5 to 6 inches of penetration. It gives about 8 inches of penetration in a loam, and about 12 inches of penetration in sand. This is why you hear that number, 1 inch per week, so often in the irrigation business.

Obviously, depending on the type of soil, you cannot apply the water too rapidly. The finer the soil particles, the less rapidly the soil absorbs water. Try to apply too much too quickly and you cause runoff.

All this points to an efficient way to water--a slow, frequent application of water over a long period. And that is what drip irrigation is all about. That is why drip irrigation is embraced by one of the 7 Xeriscape principles.

241

## 7. Drip Irrigation

### Xeriscape

Xeriscape means conserving water through creative landscaping. Or, said another way, water-efficient landscaping. The term was coined during a water conservation project in Denver, Colorado in 1978.

Xeriscape incorporates 7 principles that lead to saving water:

**1. Planning and design of the landscape**

Creating a well-thought-out landscape design is where saving water begins. Plan a landscape instead of adding one haphazardly.

**2. Limited turf areas**

Limiting the amount of turf area is a very effective way to save water. Turf grasses almost always require more water than other landscaping plants.

**3. Thorough soil preparation**

Adding organic matter to soil helps to increase plant health and conserve water.

**4. Efficient and effective irrigation**

The goal of any irrigation system is to supply plants with enough water without waste. Drip irrigation is ideally suited for this.

**5. Mulching**

The benefits of mulching are discussed later in this section.

243



6. Adapted, lower water-demand plants

Select trees, shrubs, and ground covers based on their adaptability to your region's soil and climate.

7. Proper landscape maintenance

Maintaining a landscape, such as mowing grass to the proper height, also helps conserve water.

As a professional irrigator, you should also support water conservation. The principles of Xeriscape are excellent practices to follow and promote.

If you are interested in learning more about Xeriscape, check with your local Extension agent. In addition, you may want to become a member of the National Xeriscape Council (which, incidentally, is headquartered in Texas). Their address is:

National Xeriscape Council, Inc.  
940 E. Fifty-first St.  
Austin, Texas 78751-2241

## 7. Drip Irrigation

### The roots of drip

Drip irrigation came into being during the late 1960's and has become prevalent only in the last several years. Historically, drip irrigation had its greatest development in the Middle East, particularly in Israel. A number of Israeli drip irrigation manufacturers sell products in the United States.

Climatically, the Middle East has some very harsh areas in which to grow crops. Drip irrigation allows crop growth in such arid regions.

### Fill 'er up: car

Is it possible to water just as efficiently with a sprinkler system as with a drip system? No. Let us look at an analogy between gasoline in your car and water in soil to explain this.

Suppose that the tank on your car held only 6 gallons and that you could drive for 1 week on that amount. You put in 6 gallons, drive your car until the tank is almost empty, then put in about 6 more gallons. You have to stop every week to put in 6 gallons.

You could refill the tank when it is only half empty--after half a week--but you would still have to stop. Imagine how convenient it would be if your tank were refilled at the same rate that you burned the gasoline. You would always have 6 gallons of gasoline and would never have to stop for more.

### Fill 'er up: soil

Now consider a situation where the bottom root zone of a plant is 6 inches down. Starting with completely dry soil, you need to "fill'er up" to get the water down 6 inches. Assume that you accomplish this by running a sprinkler system for 1 hour to apply 1 inch. That amount of water soaks down 6 inches, which is exactly what you want. Apply more than that and you just waste water.

Assume further that the soil will dry out completely again in 1 week. Now what do you do? You could wait 1 week, let the soil dry out completely, and then apply another 1 inch of water. (That, by the way, is what turf grass authorities suggest for turf--soak it deeply, let it dry out almost to the point of wilting, then soak it again.)

Or, you could wait half a week and apply 1/2 inch of water. But 1/2 inch of water soaks down only 3 inches, not 6 inches. And you want the roots to stay 6 inches deep, not come up to 3 inches looking for water.

Imagine how convenient it would be for the plant if the water in the soil was replaced at the same rate as it was lost. Drip irrigation can accomplish this. Sprinklers cannot. As we just pointed out about sprinklers, watering 1/2 inch every half week does not produce the same results as watering 1 inch every week.

(Incidentally, the feeder roots of most plants, even shrubs and trees, are in the top six inches of soil. This is one reason why you want to remove grass from beneath trees--it competes for the water.)

### Stable soil moisture

Drip irrigation can maintain a stable content of soil moisture. This causes much less stress on plants than a "feast or famine" way of watering. You can keep plants in a situation of always having water available. They never have too much or too little. Drip irrigation applies water under low pressure, at low flow rates, at frequent intervals, and usually at specific points (directly at the plant).

Drip irrigation is practical for fairly long distances because it operates at low pressures--usually between 10 and 40 psi. Because the water moves very

## 7. Drip Irrigation

slowly, it produces very little pressure loss. This allows you to distribute water to plants scattered over a large area and still have enough pressure to operate. That operating pressure is the pressure required to operate an emitter.

### Emitters

The outlet which dispenses water from a drip line to the plants is called an emitter. Strictly speaking, a hole in a drip line is an emitter, although emitters are usually thought of as devices. Several types of device emitters are available. The Drip Irrigation publication in your Guide shows 2 types.

Some emitters compensate for differences in pressure to achieve a given flow. This type is useful if you have vast changes in elevation to allow for. Other types of emitters are rated to disperse a given amount of water over a certain period of time. Most emitters, and irrigation products in general, are rated in gallons per hour instead of gallons per minute. Still other types of emitters have multiple outlets.

Any emitter creates a flow restriction, which causes a pressure drop at that particular point. The pressure drop is created by one of two methods. One method, of course, is the hole itself--a very tiny orifice through which the water escapes. The other method is by channeling the water through a tortuous path or maze. The more complicated the maze, the greater the pressure drop. This is how emitters can be constructed to deliver a certain amount of water within a certain amount of time.

### Supply lines and laterals

Like emitters, the other components of drip irrigation systems are basically very simple. A drip system needs a supply line just as does a sprinkler system. Supply lines are usually made of flexible, 1/2 inch polyethylene pipe. They are usually con-

230

nected with a quick-connect fitting such as a press-lock or barbed type.

From the supply line, you build a pipe line, or lateral line, to each particular plant. The lateral lines can be tubing, such as double-walled, or very small, flexible polyethylene tubing, sometimes called micro tubing.

Double-walled tubing has a small tube attached piggyback to a bigger tube. The Drip Irrigation publication in your Guide illustrates this type. Notice that the bigger tube must fill with water before the smaller tube can. This helps equalize the pressure and distributes the water more evenly. The holes in double-walled tubing are often cut by a laser.

### **Spacing intervals**

Space the emitters or double-walled tubing at fairly frequent intervals. The spacings of the plants will often dictate the spacings of the emitters. For double-walled tubing, the distance between laterals depends on the type of soil. The finer the soil, the broader the wetting pattern is going to be. You can space the intervals further apart in clay soil than you can in sandy soil. Double-walled tubing is generally spaced 12 to 18 inches.

### **Above or below ground**

The double-walled tubing and micro tubing can be placed above or below ground. Burying them below mulch is particularly effective. (Incidentally, mulch offers a variety of benefits: it insulates the soil, moderates the soil temperature, reduces evaporation, reduces erosion, and helps reduce the amount of weeds. Encourage property owners to use it where applicable.)

253

## 7. Drip Irrigation

Using the tubing above ground has several advantages. The tubing can be easily moved. For instance, you could pull it off a garden when you needed to till and plant, then replace it. Most drip products are polyethylene and relatively immune to freeze damage. Most of the products also drain naturally (walled tubing tends to flatten and squeeze out the water).

If you bury the tubing, keep it between 3 and 6 inches deep. Be careful not to go below the root zone of the plants being irrigated. Also remember that the pear-shaped wetting profile expands out to the sides. It gets fatter as the water gets deeper. As you bury the drip strip, you are also lowering the level at which you get the fattest point of that wetting pattern.

### Pressure regulators

A pressure regulating device is often a necessary component of a drip system. The 2 types are fixed and adjustable. Fixed regulators limit the output pressure to a preset rate (usually about 15 psi). The output pressure can vary, however, if the input pressure is too great (usually above 70 psi). Adjustable regulators allow you to set the output pressure within a specified range.

### Injectors

Another useful component in drip systems are chemical and fertilizer injectors. A variety are on the market and are commonly used in agricultural applications. They allow you to apply pesticides or fertilizers through the drip system.

A fertilizer injector is very useful for adding chlorine to a drip system. A major cause of emitter plugging in double-walled tubing is bacteria growing around the openings, around the orifices. Chlorine will eliminate the bacteria. If you use chlorine tablets, make certain that they dissolve

**Compatibility with existing systems**

completely into very small particles. Otherwise, you may clog the emitters with pieces of tablet.

Drip irrigation is very compatible with sprinkler systems. The drip system can be on one circuit, controlled by the controller just as the other circuits. The main problem is whether or not the controller allows sufficient watering time per cycle. Drip irrigation requires fairly long watering times, particularly during the summer.

You can use the same type of solenoid valve that you use for the rest of your sprinkler system. Most manufacturers have connectors that allow you to connect the drip tubing to PVC or polyethylene.

**Advantages and disadvantages of drip**

The Drip Irrigation publication in your Guide lists the major advantages and disadvantages of drip irrigation. Notice that the advantages outnumber the disadvantages.

Drip irrigation systems are fairly quick and easy to put together. The products themselves typically have a very low cost per component. But you must have a product for every plant. If you have a lot of plants, you can need a lot of products, and that can run into a high cost.

On the other hand, drip irrigation products are perfect for the do-it-yourself person because they are so easy to put together. Be aware that drip equipment from different manufacturers may not be compatible. Generally, it is advisable to use the same brand of product throughout a drip system.

As a general rule, you cannot use drip irrigation to water turf. It is impractical from a maintenance standpoint and often from an installation standpoint.

## 7. Drip Irrigation

### **Annotation: (Discussion Question)**

**How many of you have used a coring tool or moisture meter in your irrigation work?**

### **Coring tool and moisture sensor**

As the "Drip Irrigation" publication points out, salt buildup may be a problem with drip irrigation in some locations. The salts in the water and soil tend to precipitate at the edges of moist areas. If you anticipate problems with salt accumulation, locate emitters so that the wetting patterns overlap.

Two pieces of equipment that you should be familiar with as a professional irrigator are a coring tool and a moisture sensor. They are not actually part of a drip system, but they are useful when determining the efficiency of a drip system.

A coring tool allows you to take a plug sample of soil and plant material and visually determine root depths. A moisture sensor indicates the relative wetness of soil. You can check the moisture at various depths depending on how deeply you insert the sensor probe.

Both a coring tool and a moisture sensor make it easier to determine the moisture content at a given depth.

### **Practice makes perfect**

Now that you have learned about drip irrigation, complete the subject review on the next few pages. Also note that Laboratory Exercise 3 is on drip irrigation.

213



(This page including for duplexing.)

## Subject Review

### Drip Irrigation

#### Fill In The Blank

Supply the word or words to complete the following statements.

Then, after the questions are discussed in class, place an "X" through each incorrect answer and write the correct answer in the answer column. That way, you will know the correct answers if you later review this information.

Statement	Answer
1. Drip irrigation, properly operated, allows for very successful plant growth because plants have less _____ because of variations in soil _____.	Stress, moisture. (Page 10)
2. It is generally not possible to achieve the same growing efficiency with sprinklers as with drip irrigation because sprinklers apply water much too _____.	Rapidly. (Page 10)
3. Drip irrigation allows the ability to accurately adjust _____ rates to individual plant _____.	Application or watering, requirements. (Page 10)
4. When using drip irrigation in some areas, it is necessary to be aware of possible _____ build-up around the wetting pattern of an emitter.	Salt. (Page 15)
5. Drip emitters restrict and control water flow by means of a small _____ or by a water channel that takes a _____ path.	Orifice, hole, or opening; circuitous, tortuous, twisted. (Page 11)

Statement

Answer

- 
6. Water containing any solid particles requires the use of a \_\_\_\_\_ on a drip system.
  7. Emitter plugging is frequently caused by the growth of \_\_\_\_\_ in the orifice.
  8. In drip tubing, such as double-walled, the small laser-drilled orifices serve the same function as \_\_\_\_\_.

---

**Filter. (Drip Irrigation Publication)**

**Bacteria. (Page 13)**

**Emitters. (Page 11)**

## True or False

In the answer column, mark the following statements "T" for true or "F" for false. The whole statement is false if any part of it is false.

Then, after the questions are discussed in class, place an "X" through an incorrect answer and write the correct answer in the answer column. That way, you will know the correct answers if you later review this information.

Statement	Answer
1. Modern drip systems are usually very dependable if designed, installed and operated properly.	True. (Pages 9 - 11)
2. The penetration of soil by water as it saturates the soil and moves downward is referred to as percolation.	True. (Page 1)
3. Water penetration is fastest through fine soils, like clay.	False. (Page 2)
4. Water retention is greatest in coarse, sandy soils.	False. (Page 2)
5. Evapotranspiration rates depend, to some degree, on whether or not mulch is used.	True. (Page 3)
6. Drip irrigation allows for better growth with less water use than conventional methods.	True. (Page 9)
7. Mulches should only be used around shrubs and trees, and never around flowers.	False. (Page 12)
8. Tree growth is unaffected by grass growing beneath it.	False. (Page 10)

## Multiple Choice

Indicate the letter of the choice that best completes the statement.

Then, after the questions are discussed in class, write the letter of the correct answer in the answer column. That way, you will know the correct answers if you later review this information.

Statement	Answer
<p>1. Drip irrigation is characterized by which features:</p> <p>A. Low flow rate and low pressure            B. Long watering periods            C. Frequent watering intervals            D. Selective areas of application            E. Only A and B</p>	<p><b>F. A, B, C, and D</b>  <b>(Pages 9 - 14)</b></p>
<p>2. Drip irrigation is very suitable to water plants that are spread out over a large area because</p> <p>A. It is very inexpensive            B. It requires no maintenance            D. A and B            E. B and C            F. None of the above</p>	<p><b>C. It uses low flow rates and has low pressure losses</b>  <b>(Page 11)</b></p>

Statement	Answer
<p>3. Water penetrates faster through</p> <ul style="list-style-type: none"> <li>B. Fine-textured soils like clay</li> <li>C. The wetting front</li> <li>D. The root zones of plants</li> <li>E. Soil covered by tree foliage</li> <li>F. None of the above</li> </ul>	<p><b>A. Coarse, sandy soil (Page 2)</b></p>
<p>4. The water requirement of a given plant in a given climatic condition in a given planting situation can be defined as</p> <ul style="list-style-type: none"> <li>A. Wetting front</li> <li>C. Precipitation rate</li> <li>D. Field capacity</li> <li>E. .623 X gallons per day</li> <li>F. Root zone reservoir capacity</li> </ul>	<p><b>B. Evapotranspiration (Page 2)</b></p>
<p>5. Drip irrigation is impractical for use in</p> <ul style="list-style-type: none"> <li>A. Orange groves</li> <li>B. Pecan groves</li> <li>C. Ground cover</li> <li>D. Chinese tomatoes</li> <li>F. Hothouses</li> </ul>	<p><b>E. Turf (Page 14)</b></p>

Statement	Answer
<p>6. The daily water requirement in gallons for a given plant can be determined by:</p> <ul style="list-style-type: none"> <li>A. Bernoulli's equation</li> <li>B. (Irrigation + rain) - evaporation</li> <li>D. Potential evapotranspiration rate</li> <li>E. Potential evapotranspiration rate - evaporation / (irrigation efficiency factor + canopy type)</li> <li>F. None of the above</li> </ul>	<p><b>C. <math>.623 \times \text{canopy area} \times \text{potential evapotranspiration} \times \text{plant factor} / \text{irrigation efficiency factor}</math></b> (Page 4)</p>
<p>7. The basic reason why drip irrigation is very successful for watering plants is that</p> <ul style="list-style-type: none"> <li>A. It is very inexpensive</li> <li>B. It is suitable for use with dirty water</li> <li>C. It allows chemical injection pumps to be used for fertilizer distribution</li> <li>E. It reduces weed growth</li> <li>F. Both A and B</li> </ul>	<p><b>D. Soil moisture content can be kept at a relatively constant and proper level</b> (Page 10)</p>

255

Statement	Answer
8. The reasons why drip irrigation is considered very water efficient are	<b>F. A, B, C, and D</b> (Pages 7 - 10)
A. Precise water placement and control B. Less water lost to wind and evaporation and reduced weed growth C. Saturation is avoided because water is applied slowly D. Energy savings because of lower power requirements E. Both A and B	

2812



(This page included for duplexing.)

255

## Orientation

### Irrigation Considerations

#### Class Session 7

**Audio-visual aids that you need to present class session 7**

None.

**Labs or drawing exercises associated with class session 7**

None.

**Guest speakers for class session 7**

The intent of class session 7 is to allow guest speakers to address your class. You will probably want to have more than one speaker during the session.

Good candidates from which to attain speakers include county extension agents, municipal code inspectors, municipal permitting agents, professional landscapers, nursery owners, professional irrigators, local garden club representatives, Xeriscape representatives, and so forth.

Be specific when you contact the candidates and give them very specific topics on which to speak and a recommended length of the talk. In other words, do not request that a landscaper come and talk about landscaping. Be specific and state what you want: you want the landscaper to talk for an hour on the problems of integrating landscape design and irrigation, for exampl

263

**Steps to complete before teaching class session 7**

Complete the following steps before you teach class session 5:

1. Read this entire section. Notice that this section contains no subject review and no pretest.
2. Contact your guest speakers and arrange for them to address your class.
3. Have a contingency plan ready in case some, or all, of your guest speakers cancel at the last minute. A good substitute for such a situation is to continue working on the design drawings.
4. Study the lesson plan for class session 7. Remember that the times allotted are guidelines only.
5. Sit or lie in a quiet place where you will not be disturbed. Close your eyes and relax your entire body. Breathe deeply several times, using your diaphragm to inhale and exhale. Mentally picture yourself with your students, discussing irrigation. "See" the situation as a sharing of information that unfolds pleasantly. Imagine the learning process as being a pleasant and beneficial experience. Hold that thought for a few minutes, then open your eyes and resume your daily activities.

**Homework assignments for class session 8**

At the end of class session 7, give the homework assignment for class session 8.

Homework:

Complete Drawing Exercise 3  
Begin on Drawing Exercise 4

## 8. Irrigation Considerations

---

### Section overview

This section discusses subjects with which a professional irrigator needs to be familiar. The subjects include codes and ordinances, landscape design and irrigation, beautification, and the efficiency of water use.

### Codes and Ordinances

Most cities in Texas have structured codes governing plumbing, particularly the way in which cross connections may be made to the potable water supply. The rules and regulations are usually very specific, and frequently cover such areas as the types of backflow prevention devices that are acceptable and the burial depth of service lines.

Irrigation is relatively new in terms of being controlled by laws. Because of this, irrigation in many cities falls under the code administration of the plumbing group.

Often, however, plumbing codes have little relation to modern technology. The codes have a tendency to be a decade or more behind. This is somewhat normal: technology changes much more rapidly than the legislative processes to create and change laws. Technology evolves and challenges the laws to catch up.

Municipal utility districts, often referred to as "MUDs", have rules governing plumbing and irrigation that are frequently outdated. So codes and ordinances become restrictions that may or may not be realistic. Remember that the underlying reason for most of the codes, however, is to deter the irrigator from doing something irresponsible.

Most cities that have laws also have employees whose job it is to determine whether or not these laws are being complied with. In the case of irrigation systems, this person is the code inspector.

The code inspector ensures that the irrigator and the consumer comply with city codes, even if those codes are outdated. The code inspector does not interpret the code, but rather enforces those interpretations which have been made.

The situation is similar to that of a judge and a police officer. A judge interprets the meanings of law and makes some judgment on right and wrong. The police officer does not create laws nor interpret them, but rather enforces the law against the masses. That is exactly what enforcement of codes and ordinances is about.

The code inspector is not your enemy. At times, that may be difficult to accept. Bureaucracies, and their representatives, sometimes exhibit an attitude of confrontation instead of cooperation.

It is your responsibility to understand and comply with the codes and ordinances of your community. If the codes are outdated, then you need to use the slow, but always successful, process of educating your community about the new technologies. Visit with your plumbing commission and your plumbing code group. Visit with your city council. Talk with the people involved: do it in the sense of professionalism rather than just violating the law and going about your business.

Get the codes and ordinances revised. Demonstrate your willingness to comply with the law, but also show your determination to require laws as current as possible.

## Landscape design and irrigation

All of the plants in a landscape have to be watered. That is where we, as irrigators, come in. Irrigation serves the landscape.

Interestingly, professional irrigators and professional landscapers seldom, if ever, design a landscape together. More often than not, the irrigator is concerned that the landscaper has laid out designs that are difficult, if not impossible, to irrigate, and for no better reason than the landscaper has no understanding of irrigation technology.

The landscaper, on the other hand, is often upset at the irrigator for tearing up the landscape while installing an irrigation system. Landscapers also feel sometimes that irrigation products, such as risers, are unsightly intrusions into the landscape design.

So we are often at odds with one another, irrigators and landscapers.

Remember the discussion about Xeriscape in Section 7? Xeriscape is the meeting ground of irrigation and landscaping. Customers are demanding effective, efficient, and economical designs of landscape and irrigation. Landscape preferences are changing rapidly to include efficiency and effectiveness, not just beauty at any cost. Fortunately, irrigation technology is on the zoom and able to keep pace.

It is very important for an irrigator to understand some things about plants, particularly about plant watering requirements. You have to determine the nutrient and water needs of plants and design your irrigation and fertilization system around that, rather than give some blanket coverage and expect high levels of growth.

Learn about landscape design. Talk with landscapers and offer to cooperate with them. Share what you know about irrigation. Together, irrigators and landscapers can produce landscapes that offer the best of both worlds.

## Beautification

It is important for the irrigator and the landscaper to understand that beautification is not something that we now do just as a commercial practice. Humans need green things around them for a number of reasons.

Not the least of which is that it is soothing to be in a garden atmosphere. When the wealthy folks of many years past wanted to contemplate how they were going to change the world, they sometimes strolled through hedge mazes in manicured gardens in the countryside.

When you and I think about a pastoral setting, a place where we can get back to nature, so to speak, we think of a garden or a golf course or a park or a woodland setting. We never think about standing on squares of concrete as a soothing place of contemplation. Humans have always leaned toward having green areas around them. This is not all psychological.

We have always tried to culture plants because we need plants as food. Plants freshen our air and dampen sound. The plants around us provide a myriad of benefits, and we are wise enough to recognize that.

So beautification becomes more than an effort in commerce. You beautify real estate not only to make it more valuable, but because it enhances the enjoyment of the property. The beautification is pleasant to look at, has a soothing effect on passers

271

## 8. Irrigation Considerations

by, and certainly serves the residence better to be in good condition rather than bad.

Where we start getting into some problems is with grandiose designs and landscaping with plant materials that are not indigenous or even well suited to an area. It costs a lot of money and wastes a lot of water. Beautification needs to use water efficiently.

### Efficient water use

There are a number of practices that can reduce the amount of water we use to sustain landscape and beautification. First, use automatic controllers and moisture sensors to determine when it is time to water. There is no point in watering to the point of run-off or to apply more inches of water than you would wish for in terms of rain.

Second, use equipment that is designed to conserve water. The Texas Water Development Board helps folks understand that water waste is easily turned into water conservation. They say that sprinklers should be designed to have a low angle of throw, should throw a raindrop-like drop rather than a spray mist or fog, and should be designed to have uniform coverage and predictable precipitation rates.

Third, administer the sprinkler equipment so that you avoid under watering and over watering, particularly over watering because it is a terrible waste of a valuable resource.

Design and install your sprinkler systems in such a way that the moisture gets on plant material, not on paving or other areas where run-off occurs. Water during times when there is low wind and low evaporation rates. Early in the morning is generally the best time to water.



## 8. Irrigation Considerations

Fourth, take responsibility for instructing the user or the consumer on how best to use water. Sprinklers are a great asset and a great labor saving device, but they can also be a terrible source of waterwaste. As a professional irrigator, you should be interested in protecting the potable water and in conserving water by using it efficiently.

270

## Orientation

### Laboratory 4 and Drawing Exercise 4

#### Class Session 8

**Audio-visual aids that you need to present class session 8**

None.

**Labs or drawing exercises associated with class session 8**

Laboratory 4  
Drawing Exercise 4

**Steps to complete before teaching class session 8**

Complete the following steps before you teach class session 8:

1. Read the descriptions for Laboratory 4 and for Drawing Exercise 4. They are in the tabbed section "Labs and Exercises."
2. Determine exactly what Laboratory 4 and Drawing Exercise 4 involve.

Make sure that you have all of the required materials prior to the class.

**Reading and homework assignments for class session 9**

At the end of class session 8, have the students concentrate on drawing practices for the next class session. Class session 9 is the practice exam on design.

Notes:

270

## Orientation

### Practice LI Exam - Design

#### Class Session 9

**Audio-visual aids that you need to present class session 9**

None.

**Labs or drawing exercises associated with class session 9**

LI Exam practice drawing on design.

**Simulating test conditions in Austin**

To the extent possible, simulate the conditions under which the students will take the LI Exam when they travel to Austin. For example, hold class session 9 in a different room than where you ordinarily meet. The unfamiliar surroundings will help to simulate the Austin environment.

Set up a table or desk outside of the room and ask to see some sort of identification for each student before allowing the students to enter. Have the students sign in on a sign-in log. Assign a number to each student based on their relative position in the sign-in log.

Allow the students to use only the sample charts and tables that you provide.

Do not allow the students to converse with each other during the Design test.

**Steps to complete before teaching class session 9**

Complete the following steps before you teach class session 9:

1. Arrange to meet in a different room than where you ordinarily meet. This may require you to contact the college representative for whom you have agreed to teach the course (which may be the dean).
2. Set up a table or desk outside of the new meeting room. Prepare a sign-in log and have it ready.
3. Read the description for the practice design drawing.
4. Study the lesson plan for class session 9. Remember that the times allotted are guidelines only.

**Homework assignment for class session 10**

At the end of class session 9, give the homework assignment for class session 10.

Homework:

Complete Drawing Exercise 4

## Orientation

### Practice LI Exam - Written Part

#### Class Session 10

**Audio-visual aids that you need to present class session 10**

None.

**Labs or drawing exercises associated with class session 10**

None.

**Simulating test conditions in Austin**

To the extent possible, simulate the conditions under which the students will take the LI Exam when they travel to Austin. For example, hold class session 10 in a different room than where you ordinarily meet. The unfamiliar surroundings will help to simulate the Austin environment.

Set up a table or desk outside of the room and ask to see some sort of identification for each student before allowing the students to enter. Have the students sign in on a sign-in log. Assign a number to each student based on their relative position in the sign-in log.

Do not allow the students to converse with each other during the Written portion of the LI test.

**Steps to complete before teaching class session 10**

Complete the following steps before you teach class session 10:

1. Arrange to meet in a different room than where you ordinarily meet. This may require you to contact the college representative for whom you have agreed to teach the course (which may be the dean).
2. Set up a table or desk outside of the new meeting room. Prepare a sign-in log and have it ready.
3. Prepare copies of the practice exam, sections 1 through 4.
4. Study the lesson plan for class session 10. Remember that the times allotted are guidelines only.

273

## Drawing Exercise 1

### Laying Out Heads

<b>Purpose</b>	This drawing exercise allows students to become familiar with their drawing instruments and to practice triangulation and head placement.
<b>Plot plan used for this exercise</b>	Plot Plan 1 (the instructor will distribute it during class)
<b>Approximate time to complete drawing</b>	Four hours.
<b>Materials required</b>	Drawing compass Engineer scale (10 scale ruler) Eraser Template (optional) Triangle (optional)
<b>Conditions affecting the design</b>	The property owner does not want water thrown on the house, driveway, sidewalk, patio, or fence.  The valves may be located throughout the yard.



## Procedure

Complete the following steps for this drawing exercise:

1. Determine the type of heads and the size and shape of patterns that you will use for the plot plan.
2. Lay out the heads based on the conditions affecting the design.
3. Use triangulation to correctly space the heads and rows.
4. Answer the review question.

**Review questions**

Answer the following questions based on class discussion and "hands on" work with the drawing.

1. What was the most difficult part about this drawing exercise?
  
2. What did you learn about layout from looking at the layouts of the other students?
  
3. Think about your layout in terms of square and round patterns. How would the layout differ if you used square patterns (if you did not use any)? How would it differ if you used round patterns (if you did not use any)?
  
4. What did you learn from this drawing exercise that you did not already know? Be specific.

**Notes:**

285

## Drawing Exercise 2

### Sectioning the System

<b>Purpose</b>	This drawing exercise allows students to layout the main line and lateral lines, size the piping, and calculate the pressure loss for the sprinkler system.
<b>Plot plan used for this exercise</b>	Plot Plan 1 (same plot plan as used for Drawing Exercise 1)
<b>Approximate time to complete drawing</b>	Four hours.
<b>Materials required</b>	Drawing compass Engineer scale (10 scale ruler) Eraser Template (optional) Triangle (optional) Calculator
<b>Conditions affecting the design</b>	The property owner does not want water thrown on the house, driveway, sidewalk, patio, or fence.  The valves may be located throughout the yard.

**Procedure**

Complete the following steps for this drawing exercise:

Note: You may need to review Section 6 in your Guide, and pages 99 through 108 in the ABC's before starting this exercise.

1. Determine the static pressure and the size and flow rate of the water meter. Apply the 75% rule to the supply volume.
2. List the types of sprinklers that you are using, their discharge rates, and their minimum and maximum operating pressures.
3. Divide the sprinklers into sections, starting at the source of the water supply.
4. Estimate where the main supply line will run (you can change it later if necessary).
5. Calculate the friction loss for the farthest section and for the largest section by using the "quick check" method.

You will need to refer to pressure loss tables such as those distributed by the instructor for Drawing Exercise 1.

6. Add the piping (after you have successfully sectioned the heads).

Do not size the pipe yet.

7. Add the valves

A reasonable practice is to put the remote control valve somewhere close to the middle of its circuit. This gives you have a consistent pressure drop from the center to either end. In all cases, you cannot locate it near the center.

8. Route the main supply line.

9. Size the pipe and valves.

When sizing pipe, use the smallest pipe that can safely carry the amount of water that has to pass through it.

10. Answer the review questions.

203

**Review questions**

Answer the following questions based on class discussion and “hands on” work with the drawing.

1. What was the most difficult part about this drawing exercise?
  
  
  
  
  
  
  
  
  
  
2. Did you find that you needed to change the layout of the sprinkler heads when you began to section the system? If so, explain.
  
  
  
  
  
  
  
  
  
  
3. Think about your drawing in terms of square and round patterns. How would the piping differ if you used square patterns (if you did not use any)? How would it differ if you used round patterns (if you did not use any)?
  
  
  
  
  
  
  
  
  
  
4. What did you learn from this drawing exercise that you did not already know? Be specific.

287

## Drawing Exercise 3

### Pricing the Components

<b>Purpose</b>	This drawing exercise allows students to route the wire for a sprinkler system and to locate the controller. In addition, the students will price the various components used in the sprinkler system.
<b>Plot plan used for this exercise</b>	Plot Plan 1 (same plot plan as used for Drawing Exercises 1 and 2)
<b>Approximate time to complete drawing</b>	Four hours.
<b>Materials required</b>	Pencil Drawing compass Engineer scale (10 scale ruler) Eraser Template (optional) Triangle (optional) Calculator Price information
<b>Conditions affecting the design</b>	The property owner does not want water thrown on the house, driveway, sidewalk, patio, or fence.  The valves may be located throughout the yard.



**Procedure**

Complete the following steps for this drawing exercise.

Note: You may need to review pages 110 through 114 in the ABC's before starting this exercise.

1. Make sure that you have completed Drawing Exercises 1 and 2 before continuing with this exercise.
2. Determine where you will locate the controller for the irrigation system.
3. Route the wire from all of the valves to the controller.
4. List the types of irrigation components used in your system design, including backflow prevention device(s), valves, heads, pipe, fittings, controller, and miscellaneous parts.
5. Determine the total cost of the components in the system. If necessary, contact a plumbing/irrigation supply house and get price information.
6. Determine how much labor you would charge for the system. Remember to consider such things as how the system was installed, by hand, trencher, vibraplow, etc.
7. Determine a total cost of the system that you would present to the property owner.
8. Answer the review questions.

200

**Review questions**

Answer the following questions based on class discussion and "hands on" work with the drawing.

1. What was the most difficult part about this drawing exercise?
  
  
  
  
  
  
  
  
  
  
2. Did you find that you needed to change the layout when you located the controller and ran wire? If so, explain.
  
  
  
  
  
  
  
  
  
  
3. What was the most difficult part about pricing the system? The easiest? Be specific.
  
  
  
  
  
  
  
  
  
  
4. What did you learn from this drawing exercise that you did not already know? Be specific.

200

Notes:

## Drawing Exercise 4

### Designing a Complete System

<b>Purpose</b>	<p>This drawing exercise allows students to design a complete system from beginning to end. It is the equivalent of Drawing Exercises 1, 2, and 3.</p> <p>The students will practice triangulation and head placement, layout the main line and lateral lines, size the piping, calculate the pressure loss for the sprinkler system, route the wire, locate the controller, and price the various components used in the sprinkler system.</p>
<b>Plot plan used for this exercise</b>	Plot Plan 2 (the instructor will provide copies to the students)
<b>Approximate time to complete drawing</b>	Eight hours.
<b>Materials required</b>	<p>Pencils Drawing compass Engineer scale (10 scale ruler) Eraser Template (optional) Triangle (optional) Calculator Price information</p>
<b>Conditions affecting the design</b>	<p>The property owner does not want water thrown on the house, driveway, sidewalk, patio, or fence.</p> <p>The valves must be located at a central manifold near the house.</p> <p>The property owner wants drip irrigation used where applicable.</p>

240

**Procedure**

Complete the following steps for this drawing exercise:

Note: You may need to review Section 6 in your Guide, and pages 99 through 114 in the ABC's before starting this exercise.

1. Determine the type of heads and the size and shape of patterns that you will use for the plot plan.
2. Lay out the heads based on the conditions affecting the design.
3. Use triangulation to correctly space the heads and rows.
4. Determine the static pressure and the size and flow rate of the water meter. Apply the 75% rule to the supply volume.
5. List the types of sprinklers that you are using, their discharge rates, and their minimum and maximum operating pressures.
6. Divide the sprinklers into sections, starting at the source of the water supply.
7. Estimate where the main supply line will run (you can change it later if necessary).
8. Calculate the friction loss for the farthest section and for the largest section by using the "quick check" method.

You will need to refer to pressure loss tables such as those distributed by the instructor for Drawing Exercise 1.

210

9. Add the piping (after you have successfully sectioned the heads).

Do not size the pipe yet.

10. Add the valves

A reasonable practice is to put the remote control valve somewhere close to the middle of its circuit. This gives you have a consistent pressure drop from the center to either end. In all cases, you cannot locate it near the center.

11. Route the main supply line.

12. Size the pipe and valves.

When sizing pipe, use the smallest pipe that can safely carry the amount of water that has to pass through it.

13. Determine where you will locate the controller for the irrigation system.

14. Route the wire from all of the valves to the controller.

15. List the types of irrigation components used in your system design, including backflow prevention device(s), valves, heads, pipe, fittings, controller, drip irrigation parts, and miscellaneous parts.

16. Determine the total cost of the components in the system. If necessary, contact a plumbing/irrigation supply house and get price information.

17. Determine how much labor you would charge for the system. Remember to consider such things as how the system was installed, by hand, trencher, vibraplow, etc.
18. Determine a total cost of the system that you would present to the property owner.
19. Answer the review questions.

245

**Review questions**

Answer the following questions based on class discussion and “hands on” work with the drawing.

1. What was the most difficult part about this drawing exercise?
  
2. Did you find that you needed to change the layout for any reason? If so, explain.
  
3. Think about your drawing in terms of square and round patterns. How would the piping differ if you used square patterns (if you did not use any)? How would it differ if you used round patterns (if you did not use any)?
  
4. What did you learn from this drawing exercise that you did not already know? Be specific.



Notes:

# Laboratory 1

## Backflow Prevention Devices

<b>Purpose</b>	This lab allows students to disassemble and reassemble various backflow prevention devices. The students can examine the insides of the devices and get a better understanding of how the devices operate and how to service them.
<b>Approximate time to complete lab</b>	Four hours.
<b>Work area required</b>	Fairly large counter tops are best suited for this lab. Individual desks will suffice, but are much less desirable.
<b>Materials required</b>	Backflow prevention devices Protective covering for counter tops, such as news papers, plastic drop cloths, or cloth rags. The covering is optional if the lab is being held in a shop or other suitable area.
<b>Annotation: (Reminder)</b>	Paper towels or rags Wrenches Open end Adjustable Socket (optional) Screwdrivers slotted phillips Pliers Adjustable-jaw Needle nose Lock-jaw (optional) Hammer Flashlight (optional)
<b>Except for the backflow prevention devices, both you and the students should supply the required materials.</b>	

**Procedure****Annotation:  
(Suggested Method)**

**Have one student disassemble a device while the partner observes, then have the partner reassemble it.**

Ideally, each student should disassemble and reassemble each type of device. The number of students, the number of devices, and the amount of lab time may prevent this. If so, have the students choose a partner and work in pairs.

Each pair should disassemble and reassemble at least two types of devices. (If there are still more students than devices, have the students form groups of three, and so on.)

Complete the following steps for this lab. Remember to answer the review questions during the course of the lab.

1. Identify the boxes that contain the backflow prevention devices. Make sure that you return each device to its box at the end of the lab.
2. Unpack all of the devices and lay them out in one location.
3. Identify the different types of devices. Discuss some of the advantages and disadvantages of each. Refer to the *Febco* handbook in the appendix if necessary.
4. Distribute the manufacturer's specifications that accompany each device. Ask the students to spend about 10 minutes reading through the specifications to get a feel for the types of information in them. Stress the importance of always reading the specifications for any product.

5. Discuss the direction of water flow through each of the devices. Point out the directional arrows on the outside of the devices and explain how the devices prevent flow in the opposite direction.
6. Let the students choose which devices to work with and have them get started disassembling the devices
7. Mingle with the students, observe, ask them questions, remind them to complete the review questions for the lab.
8. Stay aware of the time so that all devices can be reassembled by the end of the class session. If you and your students want to extend the lab time, let that be an option.
9. As a group activity, discuss the answers to the lab review questions.

000

**Review questions**

Answer the following questions based on the discussion and "hands on" work in the lab.

1. How many different types of backflow prevention devices were with the sample goods?
  
2. How can you recognize the different types? (For each type, list the identifying characteristics. Write across the full width of the page.)
  
3. How easy or difficult are the devices to disassemble and reassemble? (For each type listed under Question 2, mention whether it was easy or difficult.)
  
4. What tools were required for each device? Some devices may require only wrenches and screwdrivers; others may require wrenches, screwdrivers, and pliers, etc. (For each type listed under Question 2, mention the tools required.)

5. What did you learn from this lab that you did not already know?

**Tips**

Sketch any details that you wish to remember about the inside construction of the devices. Be sure to label your drawings as to the type of device.

302

Notes:

303

## Laboratory 2

### Solvent Welding, Soldering, Types of Pipe

#### Purpose

This lab allows students to practice connecting different types of pipe. They will have hands on experience with compression fittings, solvent welding and soldering. In conjunction, various types of pipe will be discussed.

#### Approximate time to complete lab

Four hours.

#### Work area required

A large, open area with few flammable materials is best suited for this lab. The area must be well ventilated--this is vitally important! An exposed cement floor is much preferred over other flooring. If you must work on tile, linoleum, wood, or carpeting, be certain to cover the flooring with a drop cloth or rags.

#### Safety precautions

Locate the fire extinguisher that is closest to the lab area. Know exactly where it is--in a crisis situation you will not have time to look for it. If necessary, bring your own extinguisher.

The student doing the soldering must wear goggles and gloves. No exceptions. For example, if you have only one pair of goggles, the whole class must share them, one student at a time. If this is the situation, the students may have to work in groups instead of individually.

Remind the students about the safe handling of a propane torch. Do not point the flame at another person or bring it near any flammable material. Remember that the heat of a torch extends much further than the visible part of the flame.



**Materials required****Annotation:  
(Reminder)**

**Both you and the students should supply the required materials. You can often get free pieces of scrap plastic and copper pipe from plumbing supply houses and irrigation supply houses. In addition, such supply houses often have free samples of solvents and primers.**

Polyethylene pipe and fittings  
 Various lengths and diameters of PVC and ABS pipe  
 Various PVC and ABS fittings to fit the pipe  
 Various lengths of copper pipe  
 Various copper fittings to fit the pipe  
 Protective covering for the floor if it is tile, linoleum, wood, or carpeting. Plastic drop cloths or cloth rags work well.  
 Heavy work gloves (very important for each student to have for this lab)  
 Goggles (very important for each student to have for this lab)  
 Paper towels or rags  
 Various solvents for thermoplastic pipe  
 Various cleaners or primers for thermoplastic pipe  
 Hacksaw  
 Propane torch  
 Soldering tip for torch  
 Matches or cigarette lighter  
 Solder  
 Flux  
 Utility knife or pocket knife  
 Pliers  
     Adjustable jaw  
     Lock jaw (optional)  
 Wire cutters  
 Portable vise (optional, but strongly suggested)  
 C-clamps (optional, but strongly suggested)  
 Two foot length of 2X4 or 2X2 (optional, but strongly suggested)

**Procedure**

Complete the following steps for this lab.

1. Unpack the samples of polyethylene pipe and compression fittings from the boxes of irrigation products supplied by the vendors.
2. For each student, cut two pieces of PE pipe about six inches long per piece. For yourself, cut two pieces about 18 inches long per piece.

Note: If you have enough utility knives or pocket knives, ask the students to cut the pieces of PE pipe.

3. Give two pieces and a compression fitting to each student.
4. Instruct the students to attach the two pieces of PE pipe with the compression fitting. Ask them to try to pull the two pieces apart by hand after they finish the connection.

While they are attaching their pieces, attach the two 18 inch pieces with a compression fitting.

5. Ask for two volunteers to try and pull apart the pieces of 18 inch PE pipe. They should stand opposite of each other and each should use both hands to tug on the pipe. Spend a couple of minutes to see if the volunteers can pull apart the fitting.

Answer and discuss Review Question 1 before proceeding with Step 6.

6. Gather the pieces of thermoplastic pipe and fittings, and the solvents and primers. In the process, ask the students to identify the different types of thermoplastic pipe.
7. Ask the students to select at least three pieces of pipe and three fittings. The pieces can be short, four to six inches. If the amount of pipe is limited or the pieces are long, you may have to cut short pieces with a hacksaw.
8. The students are to practice solvent welding the pipe and fittings. Make sure that the students are in a ventilated area. If necessary, they may need to review the information on solvent welding in Section 4.

Instruct each student to accomplish at least three solvent welds:

1. Try to weld the pipe and fitting correctly. Set this aside to cure.
2. Purposely weld the pipe and fitting incorrectly.

Here are some ways to do it incorrectly: apply an excessive amount of solvent; apply too little solvent; apply solvent without first using primer, and so forth.

Set the connection aside to cure.

3. Try once again to weld the pipe and fitting correctly. Set this aside to cure.

307



9. If you have enough hacksaws to go around, have the students form groups, each group with a hacksaw.

For each of the three welded samples, instruct the students to cut in half the pipe and fitting. Cut through both the fitting and pipe. (It is sufficient for each group to cut apart five or six samples. The group does not need to cut apart all three samples for each member.)

One student may need to hold the pipe and fitting with pliers while another student cuts. Optionally, clamp the pipe and fitting to a 2X4 or 2X2 and rest the board across something (like a desk or counter). One student can hold the board steady while another student cuts.

Answer and discuss Review Questions 2 and 3 before proceeding with Step 10.

10. Ask the students to select at least three pieces of copper pipe and three copper fittings. The pieces should be at least six inches long. If the amount of pipe is limited or the pieces are long, you may have to cut short pieces with a hacksaw.

Important: Because of using short pieces, one student will need to hold the pipe with pliers while another student practices soldering. Caution the student holding the pipe to stand to the side of the flame, not directly in front of it.

One student may need to hold the pipe and fitting with pliers while another student cuts. Optionally, clamp the pipe and fitting to a 2X4 or 2X2 and rest the board across something (like a desk or counter). One student can hold the board steady while another student cuts.

11. The students are to practice soldering the pipe and fittings. If necessary, they may need to review the information on soldering in Section 4.

Instruct each student to solder at least three connections:

1. Try to solder the pipe and fitting correctly. Set this aside to cool.
2. Purposely solder the pipe and fitting incorrectly.

Here are some ways to do it incorrectly: overheat the fitting ("cook" it until it turns blue); apply the solder to the same side of the fitting as the torch (before the side opposite the torch has had a chance to heat); apply the solder with using flux; rough up the end of the pipe with sandpaper or a file before soldering it to the fitting, and so forth.

Set the connection aside to cool.

3. Try once again to weld the pipe and fitting correctly. Set this aside to cool.

12. If you have enough hacksaws to go around, have the students form groups, each group with a hacksaw.

For each of the three soldered samples, instruct the students to cut in half the pipe and fitting. Cut through both the fitting and pipe, very near the actual solder connection itself.

(It is sufficient for each group to cut apart five or six samples. The group does not need to cut apart all three samples for each member.)

One student may need to hold the pipe and fitting with pliers while another student cuts. Optionally, clamp the pipe and fitting to a 2X4 or 2X2 and rest the board across something (like a desk or counter). One student can hold the board steady while another student cuts.

Answer and discuss Review Questions 4 and 5 before proceeding with Step 13.

13. If time permits, allow the students to practice some more on solvent welding or soldering. Each student should choose the activity that he or she feels least comfortable doing. (Most will choose soldering because it generally takes more practice than solvent welding.)
14. Clean the lab. If you rearranged furniture or equipment, place it back as you found it.
15. Answer Review Question 6. If the students have questions or comments about any of the review questions, discuss them as a group.

Be sure to announce the reading and homework assignments for next class session. This information is in the Orientation for Section 5.

**Review questions**

Answer the following questions based on the discussion and "hands on" work in the lab.

1. Was anyone in class able to pull apart the PE pipe and compression fitting? If so, describe where the separation occurred (did the pipe pull loose from the fitting or did the fitting itself separate, etc.)
  
2. What is your reaction to solvent welding? Is it easier than you expected? Why? More difficult? Why? Do you feel comfortable with solvent welding, or do you need more practice?
  
3. What did the solvent welded bond look like after you cut in half the pipe and fitting? Describe the differences between the correctly welded connection and the incorrectly welded one.
  
4. What is your reaction to soldering? Is it easier than you expected? Why? More difficult? Why? Do you feel comfortable with soldering, or do you need more practice?

5. What did the soldered bonds look like after you cut in half the pipe and fitting? Describe the differences between the correctly soldered connection and the incorrectly soldered one.
6. What did you learn from this lab that you did not already know? Be specific.



Notes:

## Laboratory 3

### Drip Irrigation

<b>Purpose</b>	This lab allows students to assemble and disassemble various drip irrigation components. The students can examine the components and get a better understanding of how they operate and how to service them.
<b>Approximate time to complete lab</b>	Three hours.
<b>Work area required</b>	An outside area with access to a hose bibb is required for this lab. In addition, an inside area with fairly large counter tops is strongly recommended.
<b>Materials required</b>	Drip irrigation products Paper towels or rags Screwdrivers slotted Pliers Adjustable-jaw Hammer Utility knife

**Procedure**

Complete the following steps for this lab.

1. Identify the boxes that contain the drip irrigation products. Make sure that you return each device to its box at the end of the lab.
2. Unpack all of the products and lay them out in one location.
3. Identify the different types of products.
4. Distribute the manufacturer's specifications that accompany the products. Ask the students to spend about 10 minutes reading through the specifications to get a feel for the types of information in them. Stress the importance of always reading the specifications for any product.
5. Ask the students to disassemble some of the emitters. This may require cracking the emitters with a hammer. Look at the path of water flow through the emitters and discuss how the emitter achieves pressure loss.
6. Ask the students to cut open some the double-walled tubing and inspect the 2 chambers.
7. Instruct the students to assemble 1 on the drip kits. Attach the kit to a hose bibb and run water through the system.

If time allows, and a suitable area is available, bury 1 strip of the double-walled tubing and run water through it for a short while. Dig down into the soil and observe the type of watering pattern produced.

8. Determine how well the pressure regulators work. For example, attach 2 or more regulators together and see if the pressure is reduced proportionately.
9. Answer the lab review questions.

**Review questions**

Answer the following questions based on the discussion and “hands on” work in the lab.

1. How many different types of drip irrigation products were with the sample goods? Describe them.
  
2. Describe the different types of emitters. How do they achieve pressure loss to regulate flow?
  
3. How easy or difficult was the drip kit to assemble? Describe the water flow and pattern(s) from the kit.
  
4. Were the pressure regulators effective? Describe the effects of using 2 or more regulators together.
  
5. What did you learn from this lab that you did not already know?

**Tips**

Sketch any details that you wish to remember about drip products. Be sure to label your drawings.

## Laboratory 4

### Irrigation Equipment

<b>Purpose</b>	This lab allows students to become familiar with various equipment used in the irrigation business. The students can see demonstrations of the equipment and ask questions about how to operate and service the equipment.
<b>Approximate time to complete lab</b>	Four hours.
<b>Lab area required</b>	An outside area where the irrigation equipment can be demonstrated.
<b>Materials required</b>	Vehicles to transport the students to various vendor locations (See Step 1 below)

**Procedure**

Complete the following steps for this lab.

1. Contact various vendors of irrigation equipment, such as trencher manufacturers, vibraplow manufacturers, and plumbing supply houses. Explain that you are teaching a class on irrigation systems and request that the vendors demonstrate their equipment. Offer to meet at the vendor's location if necessary.
2. If necessary, travel to the vendor's location for a demonstration of the equipment. Try to see demonstrations of at least two different pieces of equipment. If supervised by and acceptable to the vendor, allow the students to operate the equipment.
3. If possible, tour at least one plumbing/irrigation supply house (more if available). Contact the supply house(s) ahead of time and arrange the tour(s).

Visit with the owner/manager(s) of the supply house(s) and find out what products the vendor(s) stocks.

4. If possible, visit at least one job site where a sprinkler system is currently being installed. The system can be residential or commercial. If any of the students are employed in the irrigation business, try to visit one of the systems being installed by the student's company.
5. Answer the lab review questions.

**Review questions**

Answer the following questions based on the discussion and "hands on" work in the lab.

1. How many different types of irrigation equipment did you see demonstrated? Describe them.
  
2. If you were allowed to operate any of the equipment, what was the easiest part about the operation? The most difficult?
  
3. What types of irrigation products did the plumbing/irrigation supply house(s) carry? Did the owner/manager(s) seem knowledgeable about the irrigation business? Why or why not.
  
4. What did you learn from this lab that you did not already know?



Notes:

321

TEXAS BOARD OF IRRIGATORS

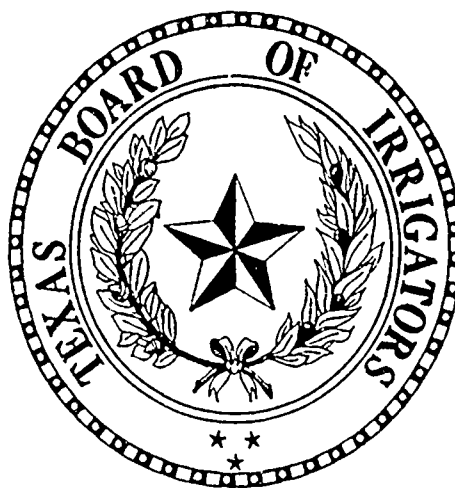

PERMANENT RULES  
AND  
LICENSED IRRIGATORS ACT

P.O. Box 12337  
Capitol Station  
Austin, Texas 78711

**THE  
TEXAS BOARD OF  
IRRIGATORS**

presents

**THE BOARD'S  
PERMANENT RULES  
AND  
LICENSED IRRIGATORS ACT**

**Office of the Board**

Stephen F. Austin Building, Room 647  
1700 North Congress Avenue, Austin, Texas

**Official Mailing Address:**  
Post Office Box 12337  
Austin, Texas 78711  
(512) 463-7990

**BOARD MEMBERS**

S. Dale Ousley, Chairman  
Herman R. Johnson, Sr., Vice-Chairman  
Hugh Rushing, Jr., Member  
Douglas D. Hawthorne, Member  
John A. Heidman, Member  
William C. Lucas, Member

Fort Worth  
Corpus Christi  
Austin  
Dallas  
Dallas  
Garland

**PAST BOARD MEMBERS**

Henry V. Alford  
Robert I. Goehrs  
Weldon Pool

Dallas  
Houston  
Tyler

**LICENSED IRRIGATORS ACT**  
**Article 8751, V.T.C.S.,**  
**as Amended by**  
**S.B. 249**

**SECTION 1. DEFINITIONS.**

In this Act:

- (1) "Person" means a natural person.
- (2) "Board" means the Texas Board of Irrigators.
- (3) "Executive director" means the executive director of the Texas Water Commission.
- (4) "Executive secretary" means the executive secretary of the board.
- (5) "Commission" means the Texas Water Commission
- (6) "Irrigation system" means an assembly of component parts permanently installed with and for the controlled distribution and conservation of water for the purpose of irrigating any type of landscape vegetation in any location or for the purpose of dust reduction or erosion control.
- (7) "Irrigator" means a person who sells, designs, consults, installs, maintains, alters, repairs, or services an irrigation system including the connection of such system in and to a private or public, raw or potable water supply system or any water supply. The term does not include (a) a person who assists in the installation, maintenance, alteration, repair, or service of an irrigation system under the direct supervision of a licensed irrigator, and (b) an owner of a business that regularly employs a licensed irrigator who directly supervises the business's sale, design, consultation, installation, maintenance, alteration, repair, and service of irrigation systems.
- (8) "Licensed irrigator" means an irrigator who is licensed under this Act.
- (9) "Installer" means a person who actually connects an irrigation system to a private or public, raw or potable water supply system or any water supply.
- (10) "Licensed installer" means an installer who is licensed under this Act.

## **SECTION 2. EXEMPTIONS.**

This Act does not apply to:

- (1) any person licensed by the Texas State Board of Plumbing Examiners;
- (2) a registered professional engineer or architect or landscape architect if his or her acts are incidental to the pursuit of his or her profession;
- (3) irrigation or yard sprinkler work done by a property owner in a building or on premises owned or occupied by him or her as his or her home;
- (4) irrigation or yard sprinkler work done by a maintenance person incidental to and on premises owned by the business in which he or she is regularly employed or engaged and who does not engage in the occupation of licensed irrigator or in yard sprinkler construction or maintenance for the general public;
- (5) irrigation or yard sprinkler work done on the premises or equipment of a railroad by a regular employee of the railroad who does not engage in the occupation of licensed irrigator or in yard sprinkler construction or maintenance for the general public;
- (6) irrigation and yard sprinkler work done by a person who is regularly employed by a county, city, town, special district, or political subdivision of the state on public property;
- (7) a temporary or portable water device such as a garden hose, hose sprinkler, soaker hose, or agricultural irrigation system;
- (8) a portable or solid set or other type of commercial agricultural irrigation system;  
or
- (9) irrigation or yard sprinkler work done by an agriculturist, agronomist, horticulturist, forester, gardener, contract gardener, garden or lawn caretaker, nurseryman, or grader or cultivator of land on land owned by himself or herself.

## **SECTION 3. TEXAS BOARD OF IRRIGATORS.**

(a) There is created a Texas Board of Irrigators composed of six members, each of whom shall be a citizen of the United States and a resident of this state.

(b) Each member of the board and his or her successor shall be appointed by the governor with the advice and consent of the senate. Two members shall be members of the public not licensed under this Act, and four members shall be licensed irrigators who have been actively engaged in the practice of irrigation of the type licensed under this Act for a period of at least five years. Appointments to the board shall be made without regard to the race, creed, sex, religion, or national origin of the appointees.

(c) Except for the initial appointees to the board, the members of the board hold office for terms of six years, with the terms of two members expiring on January 31 of each odd-numbered year. In making initial appointments, the governor shall designate two members to serve terms expiring January 1, 1981, two members to serve terms expiring January 31, 1983, and two members to serve terms expiring January 31, 1985.

(d) The board shall select one of its members as chairman. The Chairman shall serve for the term provided by the rules of the board and may be removed for cause, but his or her removal does not disqualify him or her from continuing as a member of the board.

(e) Four members of the board constitute a quorum for transaction of business.

(f) The initial board shall hold its first meeting within 30 days after all members have qualified, and the board shall hold at least two regular meetings each year at a time and place designated by the chairman. The board may hold special meetings at times and places considered necessary by a majority of the members of the board.

(g) Each member shall receive as compensation for his or her services an amount provided by the General Appropriations Act for each day he or she is actively engaged in official duties in addition to actual travel expenses.

(h) It is a ground for removal of a member from the board that the member does not attend at least one-half of the regularly scheduled meetings held by the board in a calendar year.

#### SECTION 4. CONFLICT OF INTEREST.

A member of the board may not be an officer, employee, or paid consultant of a trade association in the field of landscape irrigation. No board member may be related within the second degree by affinity or within the second degree by consanguinity to a person who is an officer, employee, or paid consultant of a trade association in the irrigation industry.

#### SECTION 5. EXECUTIVE SECRETARY; EMPLOYEES.

(a) The board may employ an executive secretary to perform the duties and functions provided by this Act and as directed by the board.

(a) The executive director shall provide necessary services to assist the executive secretary and the board in performing their duties and functions under this Act.

(c) The commission shall hear all contested cases as defined in the Administrative Procedure and Texas Register Act, as amended (Article 6252-13a, Vernon's Texas Civil Statutes), arising under this Act. The board is subject to the open meetings law, Chapter 271, Acts of the 60th Legislature, Regular Session, 1967, as amended (Article 6252-17,

Vernon's Texas Civil Statutes), and the Administrative Procedure and Texas Register Act, as amended (Article 6252-13a, Vernon's Texas Civil Statutes).

(d) A person who is required to register as a lobbyist under Chapter 422, Acts of the 63rd Legislature, Regular Session, 1973, as amended (Article 6252-9c, Vernon's Texas Civil Statutes), may not act as the general counsel to the board.

#### **SECTION 6. BOARD FINANCES.**

(a) Money paid to the board under this Act shall be deposited in the State Treasury in a special fund known as the Texas Board of Irrigator's Fund.

(b) The Texas Board of Irrigators Fund shall be used to pay expenses under this Act.

(c) Before September 1 of each year, the board shall make a written report to the governor accounting for all receipts and disbursements under this Act.

#### **SECTION 7. RULES.**

(a) The board shall adopt only those rules consistent with this Act to govern the conduct of its business and proceedings and shall adopt standards governing revocation of certificates of registration and connections to public or private water supplies by a licensed irrigator or a licensed installer.

(b) The board does not have authority to amend or enlarge by rule on any provision of this Act, to change the meaning of this Act by rule in any manner, to adopt a rule that is contrary to the underlying and fundamental purposes of this Act, or to make a rule that is unreasonable, arbitrary, capricious, illegal, or unnecessary.

(c) The board shall adopt no rules which would preclude advertising or competitive bidding.

(d) If the appropriate standing committee of either house of the legislature acting under Subsection (g), Section 5, Administrative Procedure and Texas Register Act, as added (Article 6252-13a, Vernon's Texas Civil Statutes), transmits to the board statements opposing adoption of a rule under that section, the rule may not take effect, or if the rule has already taken effect, the rule is repealed effective on the date the board receives the committee's statements.

#### **SECTION 8. REGISTRATION REQUIREMENT.**

(a) No person may act as an irrigator or installer unless he or she has a valid certificate of registration under this Act.

(b) The board shall issue certificates of registration to persons of good moral character who have shown themselves fit, competent, and qualified to act as licensed

irrigators or licensed installers by passing a uniform, reasonable examination which will include the principles of cross connections and safety devices to prevent contamination of potable water supplies.

(c) The board shall provide in its rules for the preparation, administration, and grading of examinations to acquire certificates of registration under this Act. The fee for taking the examination shall be set by the Board not to exceed \$100 for the irrigator certificate of registration and not to exceed \$75 for the installer certificate of registration.

(d) A person holding a certificate of registration under this Act shall not be required to comply with any other licensing requirements of other state agencies to perform connections to private or public raw or potable water supply systems.

(e) Not later than the 30th day after the day on which a person completes an examination administered by the board, the board shall send to the person his or her examination results. If requested in writing by a person who fails the examination, the board shall send to the person not later than the 30th day after the day on which the request is received by the board an analysis of the person's performance on the examination.

#### SECTION 9. RECIPROCITY.

(a) The board may certify for registration without examination an applicant who is registered as a licensed irrigator or licensed installer in another state or country that has requirements for registration that are at least substantially equivalent to the requirements of this state and that extends the same privilege of reciprocity to licensed irrigators or licensed installers registered in this state.

(b) The application for registration under this section shall be accompanied by a fee of not to exceed \$100 for a licensed irrigator or \$75 for a licensed installer as determined by the board.

#### SECTION 10. RENEWAL.

(a) Certificates of registration expire on August 31 of each year.

(b) The board or the executive secretary shall notify every person registered under this Act of the date of expiration of his or her certificate and the amount of the fee that is required for renewal for one year. The notice shall be mailed at least two months in advance of the date of expiration of the certificate.

(c) A person may renew his or her certificate at any time during the months of July and August of each year by payment of the fee adopted by the board in an amount of not more than \$150 for a licensed irrigator or \$100 for a licensed installer.



(d) Failure of a registrant to renew his or her certificate by August 31 does not deprive the registrant of the right to renewal, but the fee paid for renewal of a certificate after the August 31 expiration date shall be increased 10 percent for each month or part of a month that renewal payment is delayed. If the registrant fails to renew within 90 days after the date of expiration of the registration certificate, the registrant must reapply for registration and must qualify under Section 8 of this Act to act as a licensed irrigator or licensed installer.

(e) Renewal certificates carry the same registration number as the original certificates.

(f) By rule, the board may adopt a system under which certificates of registration may expire on various dates during the year. Renewals may be made at any time during the two-month period before the designated expiration date, and renewal fees paid after the expiration date shall be increased 10 percent for each month or part of a month that renewal payment is delayed. If a registrant fails to renew within 90 days after the expiration date of the registration, the registrant must reapply for registration and must qualify under Section 8 of this Act to act as a licensed irrigator or a licensed installer. For the year in which the expiration date is changed, registration fees payable on August 31 shall be prorated on a monthly basis so that each registrant will pay only that portion of the registration fee that is allocable to the number of months during which the registration is valid, and on renewal of the registration on the new expiration date, the total of the registration fee is payable.

#### SECTION 11. REVOCATION.

(a) The commission may revoke a certificate of registration of any registrant whom it finds guilty of:

- (1) violations of this Act or rules adopted under this Act;
- (2) fraud or deceit in obtaining a certificate of registration; or
- (3) gross negligence, incompetency, or misconduct while acting as a licensed irrigator or licensed installer.

(b) The commission shall hear complaints under Subsection (a) of this section subject to standards adopted by the board in its rules.

(c) Any person may file a complaint with the board. The complaint shall be in writing, shall be notarized, and shall set forth the facts alleged. Three copies of the written allegations shall be filed with the executive director. One copy shall be sent by certified mail to the alleged violator.

(d) On receipt of written allegations, the board, if it considers the information sufficient to support further action, shall issue an order referring the complaint to the commission for setting a hearing.

(e) If the executive director determines through investigation that evidence exists of a violation, he may refer such evidence to the board or may proceed directly to the commission to request setting of a hearing.

(f) The commission may compel the attendance of a witness before it in civil cases in the district court by issuance of a subpoena.

#### **SECTION 12. PENALTY; INJUNCTION.**

(a) A person who represents himself or herself as a licensed irrigator or licensed installer in this state without being licensed or exempted under this Act, who presents or attempts to use as his or her own the certificate of registration or the seal of another person who is a licensed irrigator or licensed installer, who gives false or forged evidence of any kind to the board or to any member of the board in obtaining or assisting in obtaining for another a certificate of registration, shall be guilty of a Class C misdemeanor. Each day a violation of this subsection occurs constitutes a separate offense.

(b) A person who violates this Act or a rule or order of the commission adopted under this Act is subject to a civil penalty of not to exceed \$1,000 for each offense. Each day a violation is committed is a separate offense.

(c) An action to recover the penalty under Subsection (b) of this section may be brought by the board in any court of competent jurisdiction in the county in which the offending activity occurred, in which the defendant resides, or in Travis County.

(d) The board may enforce this Act or a valid rule or order of the commission by injunction or other appropriate remedy. The action may be brought by the board in a court of competent jurisdiction in the county in which the offending activity occurred, in which the defendant resides, or in Travis County.

(e) At the request of the board, the attorney general shall institute and conduct a suit in the name of the state to recover the civil penalty as provided under Subsection (b) of this section or for injunctive relief or other appropriate remedy, or for both.

#### **SECTION 13. ENFORCEMENT OF ACT.**

The executive director with the assistance of the attorney general shall enforce this Act and the rules adopted by the board.

#### **SECTION 14. LOCAL RULES AND REGULATIONS.**

The regulatory authority of any city, town, county, special purpose district, or other political subdivision of the state may require licensed irrigators or licensed installers to comply with any reasonable inspection requirements or ordinances and regulations

designed to protect the public water supply and pay any reasonable fees imposed by that local entity relating to work performed by licensed irrigators within its jurisdiction.

**SECTION 15. CERTIFICATION OF CERTAIN PERSONS.**

A person who holds a license as a landscape irrigator under Chapter 457, Acts of the 61st Legislature, Regular Session, 1969, as amended (Article 249c, Vernon's Texas Civil Statutes), on the effective date of this Act is entitled to be certified as a licensed irrigator without meeting the requirements of Section 8 of this Act; however, persons seeking to become licensed installers must comply with Section 8 of this Act.

**SECTION 16. SUNSET PROVISION.**

The board is subject to the Texas Sunset Act, and unless continued in existence as provided by that Act, the board is abolished and this Act expires effective September 1, 1991.

# Appendix B - Permanent Rules

## TABLE OF CONTENTS

	Page
<b>CHAPTER 421. INTRODUCTORY PROVISIONS</b> .....	<b>421-1</b>
General Provisions .....	421-1
Definitions .....	421.1
Purpose .....	421-2
General Provisions Affecting Board .....	421-3
Office; Mailing Address .....	421-3
Person for Service of Process .....	421-3
Official Seal .....	421-3
Meetings and Notices Thereof .....	421-3
Quorum .....	421-4
Officers and Employees .....	421-4
Official Records .....	421-4
Signing Certificates .....	421-5
Liaison with Secretary of State .....	421-5
Irrigation Standards and Testing Procedures .....	421-5
<b>CHAPTER 423. REGISTRATION OF IRRIGATORS AND INSTALLERS</b> ...	<b>423-1</b>
Application for Registration .....	423-1
Eligibility for Certificates of Registration .....	423-1
Applications for Certificates of Registration .....	423-1
Application or Examination Fees; Form of Payment .....	423-2
Application Processing .....	423-2
Determination of Application for Registration under Reciprocity ...	423-3
Incomplete Application Returned .....	423-3
Rejection of Application .....	423-3
Hearing on Rejected Application .....	423-3
Examinations .....	423-5
Eligibility for Written Examinations .....	423-5
Notification of Examination, Date, Time and Place .....	423-5
Study Materials .....	423-5
Appearance for Examination; Failure to Appear .....	423-5
Examination Conditions .....	423-5
Grading; Minimum Passing Score .....	423-6

Notification of Examination Results and Performance . . . . .	423-6
Reexamination; Fee . . . . .	423-6
<b>CHAPTER 425. CERTIFICATE OF REGISTRATION AND SEAL . . . . .</b>	<b>425-1</b>
Certificate of Registration . . . . .	425-1
Issuance of Certificate; Registration Fee . . . . .	425-1
Description of Certificate . . . . .	425-1
Display of Certificate . . . . .	425-1
Replacement of Certificate . . . . .	425-2
Expiration of Certificate . . . . .	425-2
Notice of Certificate Expiration; Change of Address . . . . .	425-2
Renewal of Certificate; Same Registration Number . . . . .	425-2
Failure to Renew Certificate of Registration; Notice; Penalty . . . . .	425-3
Unauthorized Use of Certificate . . . . .	425-3
Seal . . . . .	425-5
Seal Required . . . . .	425-5
Seal and Rubber Stamp Facsimile Design . . . . .	425-5
Authorized Use of Seal and Rubber Stamp Facsimile . . . . .	425-6
Unauthorized Use of Seal or Rubber Stamp . . . . .	425-6
Required Use of Seal . . . . .	425-6
<b>CHAPTER 427. WATER SUPPLY CONNECTIONS . . . . .</b>	<b>427-1</b>
Standards for Connections to Potable Water Supplies . . . . .	427-1
Local Regulation . . . . .	427-1
Absence of Local Regulation—Backflow Prevention Devices . . . . .	427-1
Connections to Alternate Water Supplies . . . . .	427-2
<b>CHAPTER 429. VIOLATION OF STATUTE OR BOARD RULES . . . . .</b>	<b>429-1</b>
Complaint Process . . . . .	429-1
Complaint . . . . .	429-1
Board's Receipt of Complaint . . . . .	429-1
Investigation of Complaint . . . . .	429-1
Informal Resolution of Complaint . . . . .	429-2
Setting Complaint on Board Agenda; Notice . . . . .	429-2
Board Consideration of Complaint; Board Action on Complaint . . . . .	429-3
Copies of Board Order . . . . .	429-3
Probable Violation Report of Board Member . . . . .	429-3
Revocation of Registration . . . . .	429-5
Grounds for Revocation of Registration . . . . .	429-5
Surrender of Certificate and Identification Card; Seal . . . . .	429-5

Appendix B - Permanent Rules

Enforcement .....	429.5
Civil Penalty .....	429.5
Injunctions .....	429.5
Action by Attorney General.....	429.5
<b>CHAPTER 431. LICENSED IRRIGATOR STANDARDS.....</b>	<b>431-1</b>
Licensed Irrigator Standards .....	431.1
Purpose of Standards .....	431-1
Intent .....	431-1
Proficiency in Field of Irrigation; Representation of Qualifications ..	431-1
Advertisement .....	431-2
Contracts .....	431-2
Design .....	431-2
Warranties .....	431-3
<b>LICENSED IRRIGATORS ACT .....</b>	<b>1-8</b>

**NOTICE:** These rules are current as of the final publishing date of April, 1984, but are subject to change pursuant to the procedures established in the Texas Administrative Procedure and Texas Register Act.

Texas Board of Irrigators  
Introductory Provisions

**GENERAL PROVISIONS**  
**§§421.1-421.4**

The following rules are adopted under the authority of Article 8751, Section 7, Vernon's Texas Civil Statutes.

**§421.1. DEFINITIONS.**

The following words and terms, when used in this Part XIV, shall have the following meanings, unless the context clearly indicates otherwise:

- (1) "Board" means the Texas Board of Irrigators.
- (2) "Commission" means the Texas Water Commission.
- (3) "Complainant" means anyone who has filed with the Board a notarized complaint which states matters within the board's jurisdiction.
- (4) "Executive director" means the executive director of the Texas Water Commission.
- (5) "Executive secretary" means the executive secretary of the board.
- (6) "Installer" means a person who actually connects an irrigation system to a private or public, raw or potable water supply system or any water supply.
- (7) "Irrigation system" means an assembly of component parts permanently installed with and for the controlled distribution and conservation of water for the purpose of irrigating any type of landscape vegetation in any location or for the purpose of dust reduction or erosion control.
- (8) "Irrigator" means a person who sells, designs, consults, installs, maintains, alters, repairs, or services an irrigation system including the connection of such system in and to a private or public, raw or potable water supply system or any water supply. The term does not include (a) a person who assists in the installation, maintenance, alteration, repair, or service of an irrigation system under the direct supervision of a licensed irrigator, and (b) an owner of a business that regularly employs a licensed irrigator who

**Texas Board of Irrigators  
Introductory Provisions**

directly supervises the business's sale, design, consultation, installation, maintenance, alteration, repair, and service of irrigation systems.

(9) "Licensed installer" means an installer registered under Texas Civil Statutes, Article 8751, pursuant to these sections.

(10) "Licensed irrigator" means an irrigator registered under Texas Civil Statutes, Article 8751, pursuant to these sections.

(11) "Person" means a natural person.

(12) "Respondent" means anyone against whom a notarized complaint, which states matters within the board's jurisdiction, has been filed with the board.

**§421.4. PURPOSE.**

The purposes of the provisions of this Part XIV are to implement the powers and duties assigned to the Texas Board of Irrigators, and its executive secretary by Texas Civil Statutes, Article 8751 and other laws of this state, and to establish the general policies which are specifically applicable to the board. The provisions of this Part XIV shall be given a reasonable, fair, and impartial interpretation.

421-2

336



Texas Board of Irrigators  
Introductory Provisions

**GENERAL PROVISIONS AFFECTING BOARD**  
**§§421.21-421.48**

The following rules are adopted under the authority of Article 8, Section 7, Vernon's Texas Civil Statutes.

**§421.21. OFFICE; MAILING ADDRESS.**

The official place of business of the board shall be the office of its executive secretary in the Stephen F. Austin State Office Building in Austin, Texas. The official mailing address of the board shall be P.O. Box 12337, Austin, Texas 78711.

**§421.24. PERSON FOR SERVICE OF PROCESS.**

The executive secretary, at the address of the board's official place of business, shall be the person upon whom service of process may be served in judicial proceedings against the board.

**§421.27. OFFICIAL SEAL.**

The official seal of the board will bear the words "Texas Board of Irrigators" encircling the oak and olive branches common to other official seals.

**§421.30. MEETINGS AND NOTICES THEREOF.**

(a) The board shall hold at least two regular meetings each year at times and places designated by its chairman.

(b) The board may hold other meetings at times and places considered necessary by a majority of the members of the board or the chairman of the board.

(c) The board shall give notice of its meetings and shall hold its meetings in accordance with the open meetings law, Texas Civil Statutes, Article 6252-17.

Texas Board of Irrigators  
Introductory Provisions

**§421.33. QUORUM.**

Four members of the board shall constitute a quorum for the transaction of business. The chairman of the board is a voting member.

**§421.36. OFFICERS AND EMPLOYEES.**

(a) The board shall elect a chairman who shall hold office for two years and thereafter until his successor has been elected. The chairman may be removed by the board for cause, but his removal does not disqualify him from continuing as a member of the board. When present, the chairman shall preside at all meetings, sign all certificates of registration issued, and perform all other duties pertaining to the office.

(b) The board shall elect a vice-chairman who shall hold office for two years and thereafter until his successor has been elected. In the absence of the chairman, the vice chairman shall fulfill all responsibilities of the chairman.

(c) Where there is a vacancy in the office of the chairman or vice-chairman, the board shall elect a member to fill the vacancy for the remainder of the unexpired term.

(d) The board may employ an executive secretary to serve at the will of the board. The executive secretary shall perform the duties and functions provided by Texas Civil Statutes, Article 3751 and as directed by the board. The board shall arrange for necessary office space with the executive director to house the staff and records.

(e) The executive secretary is authorized to request necessary services from the executive director.

**§421.39. OFFICIAL RECORDS.**

(a) Among other official records required by law, or by rules of other agencies, there shall be kept in the office of the executive secretary accurate and current records including but not limited to:

(1) Minutes: A record containing, in chronological order, minutes of all the meetings of the board.

**Texas Board of Irrigators  
Introductory Provisions**

(2) **List of registrants:** A list containing the name, last known address and registration number of all persons who hold certificates of registration which are currently renewed.

(3) **Registrant records:** An individual record for each registrant containing the original application, relevant verification and evaluation data, examination and grade records, the date of registration, and a record of annual renewals and fees received after registration, and when applicable, a record of alleged violations, suspensions, and revocations.

(4) **Budget Records:** Records showing funds budgeted, committed, spent, and remaining, and projects of appropriate requests for consideration in budget development, as well as financial records required by various state agencies.

(b) Subject to the limitations and exceptions provided under the Open Records Act, Texas Civil Statutes, Article 6252-17a, information collected, assembled, or maintained by the board or its executive secretary is public information open to inspection and copying during regular business hours.

**§421.42. SIGNING CERTIFICATES.**

Each certificate of registration shall be signed by the chairman and vice-chairman of the board and shall bear the seal of the Texas Board of Irrigators.

**§421.45. LIAISON WITH SECRETARY OF STATE.**

The executive secretary shall be the liaison through whom all required documents may be submitted on behalf of the board to the secretary of state for filing and publication. The executive secretary may designate one or more persons to act as liaison in the executive secretary's absence.

**§421.48. IRRIGATION STANDARDS AND TESTING PROCEDURES.**

The board shall remain current on national irrigation testing procedures as well as national and local requirements governing irrigation systems.

Texas Board of Irrigators  
Registration of Irrigators and Installers

APPLICATION FOR REGISTRATION  
§§423.1-423.22

The following rules are adopted under the authority of Article 8751, Section 7, Vernon's Texas Civil Statutes.

**§423.1. ELIGIBILITY FOR CERTIFICATES OF REGISTRATION.**

(a) The board may issue certificates of registration only to individuals who are eligible for registration as licensed irrigators or licensed installers under Texas Civil Statutes, Article 8751 and these sections. No certificate of registration may be issued to any firm, partnership, corporation, or other group of persons.

(b) No individual is eligible to receive a licensed irrigator's or licensed installer's certificate of registration unless he has applied for it pursuant to these sections and:

(1) the board has determined that he is a person of good moral character who has passed a uniform, reasonable examination for irrigators or installers, as applicable, administered by the board in accordance with these sections; or

(2) the board has determined that he is a person registered as the equivalent of a licensed irrigator or licensed installer in another state or country that has requirements for registration that are substantially equivalent to the requirements of Texas and that extends the same privilege of reciprocity to licensed irrigators or licensed installers registered in Texas.

**§423.4. APPLICATIONS FOR CERTIFICATES OF REGISTRATION.**

(a) Every person applying for a licensed irrigator's or licensed installer's certificate of registration shall complete a required application form and submit it to the executive secretary with the required application or examination fee.

(b) In addition to submitting his completed application form and application fee, an irrigator or installer holding a certificate of registration in another state or country who wishes to be considered for registration in Texas under reciprocity, shall submit to

423-1

310

**Texas Board of Irrigators  
Registration of Irrigators and Installers**

the executive secretary his certification record from the state or country in which he is registered.

(c) Upon request, the executive secretary shall furnish the required application form and instructions for obtaining a licensed irrigator's or licensed installer's certificate of registration.

**§423.7. APPLICATION AND EXAMINATION FEES; FORM OF PAYMENT.**

Persons applying for an irrigator's certificate of registration shall remit an application and examination fee of \$75. Persons applying for an installer's certificate of registration shall remit an application and examination fee of \$35. Payments shall be made by personal check, money order, or cashier's check made payable to the Texas Board of Irrigators. These fees shall not be refundable.

**§423.10. APPLICATION PROCESSING.**

(a) Applications for registration shall be submitted to the board in a complete form and accompanied by the required application or examination fee, as applicable.

(b) Applications for registration by examination may be made at any time but must be accompanied by the examination fee and received by the executive secretary at least 30 days prior to the applicant's examination date. Applicants shall be responsible for fulfilling application requirements by the deadline.

(c) The board shall verify and evaluate each submitted application, and if the board or the executive secretary should require additional relevant information, the applicant shall submit such information within the time and form requested.

(d) Rejection of an application for registration shall be by letter sent by certified mail to the applicant explaining the board's reasons for rejection, outlining the procedures under which reconsideration may be possible, and explaining the applicant's right to a hearing.

Texas Board of Irrigators  
Registration of Irrigators and Installers

**§423.13. DETERMINATION OF APPLICATION FOR  
REGISTRATION UNDER RECIPROCITY.**

The board's approval of an application for registration under reciprocity shall be given by letter which assigns the applicant a registration number. A certificate of registration and identification card shall be issued upon the applicant's compliance with § 425.41 of this title (relating to Seal Required) and § 5.44 of this title (relating to Seal and Rubber Stamp Facsimile Design) as applicable.

**§423.16. INCOMPLETE APPLICATION RETURNED.**

If an applicant resubmits an incomplete application after the executive secretary has returned the application to the applicant with written instructions to completely answer all or particular parts of the application, the executive secretary may return the application to the applicant again without any further action or explanation.

**§423.19. REJECTION OF APPLICATION.**

(a) The board, or the executive secretary on behalf of the board, may reject an application if:

(1) the applicant has not completely filled in the required application form and submitted it to the executive secretary in accordance with these sections; or

(2) the applicant has failed to remit the required application or examination fee in accordance with these sections.

(b) The board may reject an application if the board finds that the applicant is not of good moral character.

**§423.22. HEARING ON REJECTED APPLICATION.**

(a) If the board rejects an application for a certificate of registration, the affected applicant may request a hearing by the board on the board's reasons for rejection as stated in the letter of rejection.

(b) The applicant must request a hearing in writing within 10 days after the applicant receives his letter of rejection.

423-3

**Texas Board of Irrigators  
Registration of Irrigators and Installers**

(c) The board shall hold its hearing on the reasons for rejection after it receives the written request for the hearing.

(d) During the hearing, the board shall consider any relevant evidence and argument presented by the applicant in support of his application.

(e) The board shall inform the applicant of its final decision on his application by certified mail. If the final decision is to uphold its rejection of the application, the board shall state in its final decision the reasons and relevant facts for rejection.

423-4

Texas Board of Irrigators  
Registration of Irrigators and Installers

**EXAMINATIONS**  
**§ §423.41-423.62**

The following rules are adopted under the authority of Article 8751, Section 7, Vernon's Texas Civil Statutes.

**§423.41. ELIGIBILITY FOR WRITTEN EXAMINATIONS.**

The board, or any board members, or the executive secretary on behalf of the board shall administer written examinations only to persons who the board has determined to be of good moral character and who have completed the required application form and have submitted it and the required examination fee to the executive secretary in accordance with these sections.

**§423.44. NOTIFICATION OF EXAMINATION DATE, TIME, AND PLACE.**

The executive secretary shall notify each person eligible to take the written examination of his examination date, time, and place by first-class mail.

**§423.47. STUDY MATERIALS.**

Upon request, the executive secretary shall furnish information regarding study materials to persons eligible to take the written examination.

**§423.50. APPEARANCE FOR EXAMINATION; FAILURE TO APPEAR.**

Applicants shall personally appear for the written examination at the designated date, time, and place and be prepared to present sufficient identification. An applicant who fails to appear for an examination shall forfeit the required examination fee except upon written request showing good cause why the applicant failed to appear, as determined by the board.

**§423.53. EXAMINATION CONDITIONS.**

Examinations shall be conducted under conditions assuring honest results. The executive secretary, individual board members, or their designees shall monitor all tests.

423-5



**Texas Board of Irrigators  
Registration of Irrigators and Installers**

Examinees shall not be permitted to communicate with anyone except a board member during the examination period.

**§423.56. GRADING; MINIMUM PASSING SCORE.**

A score of 70% or more on each and every section of the applicable examination is required for registration as a licensed irrigator or licensed installer.

**§423.59. NOTIFICATION OF EXAMINATION RESULTS AND PERFORMANCE.**

Within 30 days after the day on which an applicant completed an examination, the executive secretary on behalf of the board shall send the applicant his examination results by first-class mail. If requested in writing by an applicant who fails the examination, the executive secretary on behalf of the board shall send to the applicant, within 30 days after the day on which the request is received by the board, an analysis of the applicant's performance on the examination.

**§423.62. REEXAMINATION; FEE.**

An applicant who fails the written examination must repeat the entire examination and make full payment of the applicable examination fee.

423-6

Texas Board of Irrigators  
Certificate of Registration and Seal

**CERTIFICATE OF REGISTRATION**  
**§ §425.1-425.25**

The following rules are adopted under the authority of Article 8751, Section 7, Vernon's Texas Civil Statutes.

**§425.1. ISSUANCE OF CERTIFICATE; REGISTRATION FEE.**

(a) Once the board has determined that an applicant has passed the board's written examination, and the applicant has paid to the executive secretary the registration fee in accordance with subsection (b) of this section and has complied with §425.41 of this title (relating to Seal Required) and §425.44 of this title (relating to Seal and Rubber Stamp Facsimile Design) as applicable, the executive secretary shall issue a certificate of registration and identification card to the applicant.

(b) The registration fee shall be the applicable amount specified in §425.19 of this title (relating to Renewal of Certificate; Same Registration Number) prorated on a monthly basis beginning with the month during which the board informed the applicant that he passed the examination through the following August. Payment of the fee shall be made within 60 days after the date of the letter sent by the executive secretary to the applicant, notifying him of the amount of the fee. Payment shall be made by personal check, money order, or cashier's check made payable to the Texas Board of Irrigators.

**§425.4. DESCRIPTION OF CERTIFICATE.**

Certificates of registration shall identify the registrant by name and registration number, show effective date and year, confirm the registrant's qualifications, and acknowledge the registrant as a licensed irrigator or licensed installer.

**§425.7. DISPLAY OF CERTIFICATE.**

Every person holding a certificate of registration shall display it at his place of business or employment and be prepared to substantiate his annual renewal for the current year.

425-1

346

Texas Board of Irrigators  
Certificate of Registration and Seal

**§425.10. REPLACEMENT OF CERTIFICATE.**

A certificate of registration or identification card may be issued to a registrant to replace a lost or destroyed certificate or card provided that:

- (1) his current annual renewal is effective;
- (2) the registrant makes proper request for such replacement certificate or card and submits a notarized affidavit containing an acceptable explanation of the loss or destruction of the original certificate or card; and
- (3) the registrant pays the \$10 replacement fee for each certificate or card.

**§425.13. EXPIRATION OF CERTIFICATE.**

Certificates of registration shall expire on August 31 of each year unless renewed in accordance with §425.19(a) of this title (relating to Renewal of Certificate; Same Registration Number).

**§425.16. NOTICE OF CERTIFICATE EXPIRATION; CHANGE OF ADDRESS.**

(a) The executive secretary shall notify each licensed irrigator and licensed installer of the date of expiration of his certificate and the amount of the fee that is required for the annual renewal of registration. Such notice shall be sent by first-class mail by June 30 of each year to each licensed irrigator's or licensed installer's last known address.

(b) Licensed irrigators and licensed installers shall immediately notify the executive secretary in writing of any change in mailing address.

**§425.19. RENEWAL OF CERTIFICATE; SAME REGISTRATION NUMBER.**

(a) A licensed irrigator or a licensed installer may renew his certificate of registration at any time during the months of July and August of each year by payment of a renewal fee in the amount of \$75 for a licensed irrigator or \$50 for a licensed installer. Payment shall be made by personal check, money order, or cashier's check made payable to the Texas Board of Irrigators.

Texas Board of Irrigators  
Certificate of Registration and Seal

(b) Renewal of a certificate of registration shall be effected by issuance of a current identification card. Each identification card shall show the name of the registrant, the card's expiration date and the number of the certificate of registration which it renews.

**§425.22. FAILURE TO RENEW CERTIFICATE  
OF REGISTRATION; NOTICE; PENALTY.**

(a) Failure of a licensed irrigator or a licensed installer to renew his certificate of registration by August 31 of each year does not deprive him of the right to renewal, but his registration shall be automatically suspended and the fee paid for renewal of a certificate of registration after the August 31 deadline shall be increased 10% for each month or part of a month that the renewal payment is delayed. If the licensed irrigator or licensed installer fails to pay his renewal fee within 90 days after the August 31 deadline, his registration shall automatically expire and he must requalify under Texas Civil Statutes, Article 8751, §8, and must comply with Chapter 423 of this title (relating to Registration of Irrigators and Installers) to obtain a licensed irrigator or licensed installer certificate of registration.

(b) The executive secretary shall immediately notify each licensed irrigator and licensed installer who has failed to renew his certificate of registration by August 31 of such failure by certified mail sent to his last known address.

(c) Any irrigator or installer who acts as a licensed irrigator or licensed installer when his registration has been automatically suspended or has automatically expired pursuant to these sections is in violation of Texas Civil Statutes, Article 8751 and is subject to the penalties provided in section 12 thereof.

**§425.25. UNAUTHORIZED USE OF CERTIFICATE.**

(a) Only a licensed irrigator or licensed installer may use or attempt to use his certificate of registration.

(b) Anyone who uses or attempts to use as his own the certificate of registration of someone else who is a licensed irrigator or licensed installer violates Texas Civil Statutes, Article 8751 and this section.

425-3

3-18

**Texas Board of Irrigators  
Certificate of Registration and Seal**

(c) Any licensed irrigator or licensed installer who authorizes anyone else to use his certificate of registration to act as a licensed irrigator or licensed installer violates this section.

425-4

313

Texas Board of Irrigators  
Certificate of Registration and Seal

SEAL  
§§425.41-425.53

The following rules are adopted under the authority of Article 8751, Section 7, Vernon's Texas Civil Statutes.

**§425.41. SEAL REQUIRED.**

(a) Each licensed irrigator, upon registration and before issuance of his certificate of registration, shall obtain a seal, or a rubber stamp in lieu thereof, of the design authorized by the board. The seal shall be placed on all professional documents, including contracts, maps, plans, designs, drawings, specifications, estimates, and reports issued by a registrant for use in this state.

(b) Each licensed irrigator shall file with the board in duplicate a sample impression of his seal or rubber stamp facsimile on letterhead or other business stationery which he proposes to use. A licensed irrigator shall notify the board of any changes in his seal or rubber stamp facsimile.

(c) Each licensed irrigator who, on August 28, 1979, held a valid license as a landscape irrigator under Texas Laws 1973, chapter 629, as amended, and therefore is registered pursuant to Texas Civil Statutes, Article 8751, § 15 shall file with the Board before January 1, 1981, in duplicate, a sample impression of his seal or rubber stamp facsimile of the design required by §425.44 of this subchapter (relating to Seal and Rubber Stamp Facsimile Design) on letterhead or other business stationery which he uses.

**§425.44. SEAL AND RUBBER STAMP FACSIMILE DESIGN.**

The required seal and rubber stamp impressions shall be circular and not less than one and one-half inches in diameter. The words "State of Texas" shall be at the top between the two knurled circles and the words "Licensed Irrigator" shall be in a like position at the bottom. The licensed irrigator's name shall be placed horizontally in the circular field accompanied by this certificate number. Letters and figures shall be as bold as possible to insure legibility and durability.

425-5

350

Texas Board of Irrigators  
Certificate of Registration and Seal

**§425.47. AUTHORIZED USE OF SEAL AND RUBBER STAMP FACSIMILE.**

(a) The licensed irrigator shall sign his legal name on each professional document and shall affix the imprint of his seal or rubber stamp facsimile of the seal over that signature. Use of a rubber stamp facsimile is encouraged for application on all tracings to produce legible reproduction of all copies or prints made from such tracings. If a rubber stamp facsimile of the seal is used, the licensed irrigator shall affix his signature to the documents and shall stamp the documents with the rubber seal over the signature.

(b) The presence of the licensed irrigator's seal imprint over his signature on any document constitutes his acceptance of all professional responsibility for the document and the work done pursuant to and in accordance with the document.

(c) The licensed irrigator is responsible for the security of his seal and rubber stamp.

**§425.50. UNAUTHORIZED USE OF SEAL OR RUBBER STAMP.**

(a) Only a licensed irrigator or a person acting under his direction and on his behalf may use or attempt to use his seal or rubber stamp.

(b) Anyone who uses or attempts to use as his own the seal or rubber stamp of someone else who is a licensed irrigator violates Texas Civil Statutes, Article 8751 and this section.

(c) Any licensed irrigator who authorizes anyone else to use his seal or rubber stamp except on his behalf and under his direction violates this section.

**§425.53. REQUIRED USE OF SEAL.**

Each licensed irrigator must affix his seal, or rubber stamp impression in lieu thereof, to the original index page identifying all drawings covered, to the original cover and index page identifying all specification pages covered, and to other documents of service as well, which are developed and issued under the direction or authorship of the licensed irrigator. In the absence of index pages or covers identifying all pages bound, each page of all original contract documents of service, including drawings, must have the seal, or rubber stamp impression in lieu thereof, of the responsible licensed irrigator affixed

425-6

**Appendix B - Permanent Rules**

**Texas Board of Irrigators  
Certificate of Registration and Seal**

thereto. The absence of a seal or rubber stamp impression affixed to any contract documents or plans is a violation of this section.

425-7



Texas Board of Irrigators  
Water Supply Connections

**STANDARDS FOR CONNECTIONS  
TO POTABLE WATER SUPPLIES  
§§427.1-427.10**

The following rules are adopted under the authority of Article 8751, Section 7, Vernon's Texas Civil Statutes.

**§427.1. LOCAL REGULATION.**

Where any city, town, county, special purpose district, or other political subdivision of the state requires licensed irrigators or licensed installers to comply with reasonable inspection requirements or ordinances or regulations designed to protect the public water supply, any of which relates to work performed or to be performed within such political subdivision's territory by licensed irrigators or licensed installers, a licensed irrigator or licensed installer shall comply with such requirements, ordinances, and regulations.

**§427.4. ABSENCE OF LOCAL REGULATION—BACKFLOW PREVENTION DEVICES.**

Where a licensed irrigator's or a licensed installer's connection of an irrigation system or yard sprinkler system to a public or a private potable water supply is not subject to any inspection requirement, ordinance, or regulation of any city, town, county, special purpose district, or other political subdivision of the state, the licensed irrigator or licensed installer making such connection shall install one of the following devices:

(1) Vacuum breakers. Vacuum breakers are designed to prevent only back-siphonage. Therefore, vacuum breakers shall not be used in systems where back-pressure may occur. In this subchapter, back-pressure means any pressure, regardless of its source, against the outlet side of the backflow prevention device, which exceeds the supply pressure against the inlet side of the device. Where vacuum breakers may be used, they shall be installed at least 12 inches above the surrounding ground.

(2) Atmospheric vacuum breakers. In addition to the prohibition and installation requirement of subsection (a) of this section, continuous pressure on the supply side of an atmospheric vacuum breaker is prohibited. Therefore, atmospheric vacuum breakers shall be installed in either of the two following ways:

427-1

353

Texas Board of Irrigators  
Water Supply Connections

(a) A separate atmospheric vacuum breaker shall be installed on the discharge side of each water control valve, between the valve and all of the sprinkler heads such valve controls.

(b) A single atmospheric vacuum breaker may be installed in the pressure main only if there is a single, automatic master water control valve in the pressure main. The automatic master water control valve shall be installed between the water supply and the atmospheric vacuum breaker.

(3) Pressure-type vacuum breaker. Subject to the prohibition and installation requirements of subsection (a) of this section, a single pressure-type vacuum breaker may be used in systems where the sprinkler main may be pressurized at all times.

(4) Double check assembly backflow preventor. A double check assembly (DCA) backflow preventor may be used where water supply pressure and back pressure on the device may continuously exist.

(5) Reduced pressure principle device. A reduced pressure principle device shall be installed above ground in a location so as to insure that the device will not be submerged during operation. In addition, adequate provisions shall be made for any water which may be discharged through the device's release valve. A licensed irrigator may not incorporate this device in an irrigation system design without first obtaining informed approval to do so from the party for whom he is designing the system.

**§427.10. CONNECTIONS TO ALTERNATIVE WATER SUPPLIES.**

(a) Because of the danger of contaminating potable water supplies, the design and installation of irrigation systems and yard sprinkler systems which incorporate connections to alternate potable and nonpotable water supplies are not recommended and are discouraged unless absolutely necessary.

(b) Where an irrigation system or yard sprinkler system is designed to have alternate water supplies, one being a potable water supply and the other a nonpotable water supply, a licensed irrigator or licensed installer shall not install any connection for alternate potable and nonpotable water supplies except one which:

(1) provides for a complete absence of pipe between the two water supplies (i.e., air gap);

427-2

**Texas Board of Irrigators  
Water Supply Connections**

(2) makes impossible the connection of the two water supplies to each other; and

(3) makes impossible the simultaneous connection of both water supplies to the irrigation system or yard sprinkler system.

(c) The installation of any mechanical connection device as a substitute for or equivalent of the connection required by subsection (b) of this section is prohibited and is a violation of this section.

427-3

355

Texas Board of Irrigators  
Violation of Statute or Board Rules

**COMPLAINT PROCESS**  
**§§429.1-429.22**

The following rules are adopted under the authority of Article 8751, Section 7, Vernon's Texas Civil Statutes.

**§429.1. COMPLAINT.**

(a) Any person knowledgeable of any probable violation of Texas Civil Statutes, Article 8751 or of these sections may file a written complaint with the board.

(b) Any person knowledgeable of any probable act of a licensed irrigator or licensed installer which may constitute gross negligence, incompetency, or misconduct while he is acting as a licensed irrigator or licensed installer may file a written complaint with the board.

(c) A written complaint shall include the name and address of the person against whom the complaint is filed and the alleged facts and shall be notarized.

**§429.4. BOARD'S RECEIPT OF COMPLAINT.**

Upon the board's receipt of a complaint, the executive secretary shall :

- (1) send three copies of the complaint to the executive director;
- (2) send one copy of the complaint by certified mail to the respondent; and
- (3) send a copy of the complaint to the chairman of the board.

**§429.7. INVESTIGATION OF COMPLAINT.**

(a) The chairman of the board may appoint not more than three members of the board to investigate a complaint. The chairman may appoint one or more licensed irrigators to assist board members in the investigation of a complaint.

(b) The executive secretary shall furnish each appointed board member with a copy of the complaint file.

429-1

Texas Board of Irrigators  
Violation of Statute or Board Rules

(c) Appointed members shall investigate the matters complained of and may take steps to secure the respondent's voluntary compliance with Texas Civil Statutes, Article 8751 and these sections, or otherwise informally resolve the matter.

(d) Upon completion of the investigation, the investigating board members shall file with the executive secretary a written report, including a detailed description of the investigation and any informal resolution, and any recommendations to the board. The report shall be signed by at least one of the board members investigating the complaint.

(e) Upon receipt of the investigation report, the executive secretary shall send, by first-class mail, copies of the report to the complainant and respondent, notifying them of the deadline for filing written responses to the report. The executive secretary shall also send a copy of the report to the chairman of the board.

(f) Any response of the complainant or respondent to the investigation report must be in writing and filed with the executive secretary within 14 days after the executive secretary mailed copies of the report to the complainant and respondent.

(g) Upon receipt of a response to an investigation report, the executive secretary shall send copies of the response to the chairman of the board and the board members investigating the complaint.

**§429.10. INFORMAL RESOLUTION OF COMPLAINT.**

Where the chairman of the board determines that a complaint is informally resolved:

(1) The executive secretary shall so inform the complainant and respondent in writing, notifying them that the board will take no further action on the complaint unless requested to do so by the complainant; and

(2) The board members investigating the complaint shall brief the board, at its next meeting, on the complaint, investigation and resolution.

**§429.13. SETTING COMPLAINT ON BOARD AGENDA; NOTICE.**

Where the chairman of the board determines that a complaint is not informally resolved, he may place consideration of the complaint on the agenda for a board meeting.

Texas Board of Irrigators  
Violation of Statute or Board Rules

The executive secretary shall send notice of the meeting to the complainant and respondent by first-class mail, and to the executive director.

**§429.16. BOARD CONSIDERATION OF COMPLAINT;  
BOARD ACTION ON COMPLAINT.**

(a) During its consideration of a complaint, the board shall hear any relevant evidence and argument presented on behalf of the complainant and the respondent.

(b) After hearing relevant evidence and argument the board may consider whether the information presented in the complaint and at its meeting is sufficient to warrant further action by the commission, the executive director, or the attorney general. If the board considers such information sufficient, it shall issue an order referring the complaint to the commission, or request the executive director or the attorney general, or both, to take appropriate measures to enforce Texas Civil Statutes, Article 8751 and the board's rules. If the board considers the information insufficient to warrant further action by the commission, executive director or attorney general, it may take any action it deems appropriate.

(c) The executive secretary shall notify the complainant and respondent of any decision or action of the board by letter sent by first-class mail.

**§429.19. COPIES OF BOARD ORDER.**

Where the board enters an order referring a complaint to the commission, the executive secretary shall issue the order by filing copies with the commission and the executive director and sending copies by certified mail to the complainant and the respondent.

**§429.22. PROBABLE VIOLATION REPORT OF BOARD MEMBER.**

(a) Where a member of the board becomes aware of a probable violation of Texas Civil Statutes, Article 8751 or of these sections, such member may file a written report with the board, setting forth the name of the person about whom the report is filed and the facts pertaining to the probable violation.

Texas Board of Irrigators  
Violation of Statute or Board Rules

(b) A board member's report of a probable violation shall be processed by the board pursuant to §§429.1, 429.4, 429.7, 429.10, 429.13, 429.16, and 429.19 of this title (relating to Complaint Process) and this section.

429-4

**Texas Board of Irrigators  
Certificate of Registration and Seal**

**ENFORCEMENT  
§§429.51-429.55**

The following rules are adopted under the authority of Article 8751, Section 7, Vernon's Texas Civil Statutes.

**§429.51. Civil Penalty.**

- (a) A person who violates Texas Civil Statutes, Article 8751; a rule adopted by the board pursuant to Article 8751; or an order of the commission issued after a hearing, pursuant to Article 8751, §5(c); and/or an order revoking a certificate of registration under Article 8751, § 1, is subject to a civil penalty of not to exceed \$1,000.00 for each offense. Each day a violation is committed is a separate offense.
- (b) An action to recover the penalty under subsection (a) of this section may be brought by the board in any court of competent jurisdiction in the county in which the offending activity occurred, in which the defendant resides, or in Travis County.

**§429.53. Injunctions.**

The board may enforce Texas Civil Statutes, Article 8751, a board rule, or commission order by injunctions or other appropriate remedy. The action may be brought by the board in a court of competent jurisdiction in the county in which the offending activity occurred, in which the defendant resides, or in Travis County.

**§429.55. Action By Attorney General.**

At the request of the board, the attorney general shall institute and conduct a suit in the name of the state to recover the civil penalty as provided under §429.51 of this title (relating to Civil Penalty) or for injunctive relief or other appropriate remedy or for both.



Texas Board of Irrigators  
Licensed Irrigator Standards

**LICENSED IRRIGATOR STANDARDS**  
**§§431.1-431.7**

The new sections are adopted under Texas Civil Statutes, Article 8751, Section 7, which provides the Texas Board of Irrigators with the authority to adopt rules consistent with the Act.

**§431.1. PURPOSE OF STANDARDS.**

(a) The correct practice of irrigation as a profession is essential for the protection and conservation of the water resources of the state. The installation of irrigation systems should be conducted by individuals with high ethical standards. The Legislature has vested in the Texas Board of Irrigators the authority and duty to establish and enforce standards of professional conduct and ethics for practitioners of the irrigation industry. These standards of conduct have been adopted by the Texas Board of Irrigators to ensure compliance with and enforcement of the statutory charge to the board.

(b) Every applicant for registration as a licensed irrigator shall become fully informed of the obligations and responsibilities inherent in the practice of irrigation as outlined by these Standards of Conduct. Each licensed irrigator shall be deemed to have notice of these Standards of Conduct, and shall be required to abide by the standards.

**§431.2. INTENT.**

(a) These Standards of Conduct are established to prescribe responsibility and knowledge on the part of the irrigator and to aid in governing the irrigation industry.

(b) The board shall determine what actions constitute violations of the Standards and institute appropriate disciplinary action which may lead to the suspension or revocation of a license in accordance with the applicable state statutes.

**§431.3. PROFICIENCY IN FIELD OF IRRIGATION;  
REPRESENTATION OF QUALIFICATIONS.**

(a) Competence in the performance of services of a licensed irrigator requires that the licensee's knowledge and skill encompass the currently accepted practice and

431-1

**Texas Board of Irrigato.  
Licensed Irrigator Standards**

knowledge of selling, designing, consulting, installing, maintaining, altering, repairing, or servicing an irrigation system including the connection of such system in and to a private or public, raw or potable water supply system or any water supply. Licensed irrigators must therefore maintain proficiency in the field of irrigation.

(b) A licensed irrigator shall accurately and truthfully represent to a prospective client his qualifications and capabilities, resources to perform the services requested and shall not perform services for which he is not qualified by experience or knowledge in the technical field involved.

**§431.4. ADVERTISEMENT.**

(a) A licensed irrigator shall display his registration number in the form of "LI \_\_\_\_" in block letters at least two inches high, on both sides of all vehicles used by him or by his employees for installation, service or repair of irrigation systems.

(b) All advertisements, including business cards, of a licensed irrigator shall display his registration number in the form of "LI \_\_\_\_\_".

**§431.5. CONTRACTS.**

(a) A licensed irrigator's agreement to install an irrigation system, if in writing, shall specify his name, business address and telephone number, date that the agreement was signed by each party thereto, total agreed price, and the design number or a copy of the design. If there is no written design, the agreement shall contain a brief description of the major components of the system to be installed.

(b) All written contracts to install irrigation systems shall include the statement: "Irrigation in Texas is regulated by the Texas Board of Irrigators, P.O. Box 12337, Austin, Texas 78711, (512) 463-7961."

**§431.6. DESIGN.**

(a) No licensed irrigator may design an irrigation system, or a portion thereof, so as to require the use of any component part in a way which exceeds the manufacturer's performance limitations for the part, unless the use is necessary to accommodate special site conditions. Special site conditions shall be noted on the design or in the written agreement if there is no written design.

431-2

**Texas Board of Irrigators  
Licensed Irrigator Standards**

(b) Adequate design and specifications of an irrigation system to be installed are the responsibility of the licensed irrigator who designs or supervises the designing of the system regardless of whether a fee is collected for the design work.

(c) The design shall include a statement of area coverage of the irrigation system, and any system which does not provide 100% coverage shall be so noted on the design or in the agreement if there is no written design.

**§431.7. WARRANTIES.**

On all installations of new irrigation systems (i.e., excluding remodeling and renovation) a licensed irrigator shall present the customer a written statement of his guarantees for materials and labor furnished in the installation of the irrigation system.

431-3

363

## Appendix C - Examples of Local Codes

The following examples show how greatly local irrigation/plumbing codes can vary from city to city across Texas.

City	Backflow Device Req.	Location of Device	Type of Box	Tie in Req.
Amarillo	DCA (must be 24" below ground)	Between water meter and sprinkler system	Not specified	Schedule 40 or better PVC
Canyon	Atmospheric vacuum breaker A DCA may be substituted	Not specified	Not specified	Galvanized steel, Type K copper, or Schedule 40 PVC
Dallas	AVB or PVB (if a DCA is used, it must be 12" deep with 12" gravel below)	Any place in yard	Large concrete or Turf area plastic	Match existing service
Eules	DCA	Out of city easement	Standard	Copper
Houston	Pressure vacuum breaker	At cress connection point	Not applicable	Match existing service (cannot increase pipe size without a plumbing permit)
Richardson	DCA	On private property	Plastic or concrete	No compression fittings permitted

(This page included for duplexing.)

## Appendix D - Preparing For The LI Exam

---

### Overview

This section discusses the Licensed Irrigator's Examination administered by the Texas Board of Irrigators (TBI). This section tells you how to apply for and prepare for the exam, and shows you examples of various correspondence that you will receive from the TBI.

### The LI Exam defined

Texas state law requires that irrigators be licensed by the state to legally install and maintain sprinkler systems. The licensing is to protect our potable water supplies. The Licensed Irrigator's Examination is a method of determining who gets licensed. The exam is a five-part test given several times a year in Austin. The purpose of the exam is to ensure that only those irrigators with a certain level of knowledge and competency obtain licensure.

To pass the exam, you must score at least a 70 on each of the five sections.

### Applying for the LI Exam

You must submit an application to become a licensed irrigator. It is strongly suggested that you request the application at least two months prior to the test day. You must return the completed application at least one month prior to the test day.

To request the application, contact the Texas Board of Irrigators and ask for the "Application For Registration As A Licensed Irrigator." You may write or telephone:

Texas Board of Irrigators  
P.O. Box 12337  
Austin, Texas 78711  
(512) 463-7990

The Texas Board of Irrigators will send you some general information about the exam and the application. The next six pages show examples of what you will receive.

2. Preparing For The LI Exam



**APPLICATION  
FOR REGISTRATION AS A LICENSED IRRIGATOR**

For examination under Section 8 of Chapter 197, Acts of the 66th Legislature, Regular Session, 1979 (codified as Article 8751, Vernon's Texas Civil Statutes).

**I. PERSONAL RECORD**

DOB      /      /       
Mo. Day Yr.

SSN#      /      /     

Full Name of Applicant \_\_\_\_\_  
Last First Middle

Home Address \_\_\_\_\_  
Street

\_\_\_\_\_ / \_\_\_\_\_ / \_\_\_\_\_  
City County State Zip A.C. Phone #  
County name must be present!

Company Name \_\_\_\_\_ Position \_\_\_\_\_

Office Address \_\_\_\_\_  
Street

\_\_\_\_\_ / \_\_\_\_\_ / \_\_\_\_\_  
City County State Zip A.C. Phone #

Place of Birth \_\_\_\_\_  
City County State

U.S. Citizen?  Yes  No

Have you ever been convicted of a felony in Texas or elsewhere?  Yes  No

If yes, explain briefly \_\_\_\_\_  
\_\_\_\_\_

**FOR BOARD USE ONLY**

Rect. #:						
City Cd:						
Recv'd:						
CK #:						
SP:	1-21-88					
EXAM DATE:						

367

2. Preparing For The LI Exam

II. SCHOLASTIC RECORD

Name and location of high school attended \_\_\_\_\_

Date of graduation from high school \_\_\_\_\_

If you are not a high school graduate, state in detail what equivalent education you have had \_\_\_\_\_

College or University (in chronological order):

Name	City & State	Major	Dates From-To	Degrees Title-Date	Semester Credit Hrs. (if no degree listed)

List any technical irrigation training \_\_\_\_\_

III. PROFESSIONAL SOCIETIES, ASSOCIATIONS OR ORGANIZATIONS

List membership in professional societies, associations, or organizations:

Organization	City & State	Type Membership	Date Joined

**AFFIX RECENT PHOTOGRAPH OF APPLICANT**  
 (PHOTOGRAPH MUST ACCOMPANY APPLICATION, AND SHOULD BE AFFIXED WITH TAPE OR GLUE. PHOTO DOES NOT HAVE TO BE THIS EXACT SIZE, BUT MUST BE EASILY IDENTIFIABLE AS THE PERSON MAKING APPLICATION.)





**IV. EXPERIENCE**

Start with your present position and work back in time for the last ten years. Provide complete information of work done, including any in the area of Landscape Irrigation specifically. (If additional space is needed, use extra sheets.)

Date	State nature, location and magnitude of work; name and title of supervisor; your duties	Work:Hrs. Av./Wk.	Employer Name and Address

36J

2. Preparing For The LI Exam

V. CERTIFICATE OF MORAL CHARACTER

List four (4) citizens as general and character references. (Must not be your relatives or members of the Board)

Name	Address	Phone	Occupation
Name	Address	Phone	Occupation
Name	Address	Phone	Occupation
Name	Address	Phone	Occupation

I hereby certify that I have familiarized myself with the provisions of Chapter 197, Acts of the 66th Legislature, Regular Session, 1979 (codified as Article 8751, Vernon's Texas Civil Statutes), as outlined by the Texas Board of Irrigators and that the statements made in the above application are true.  
**THIS APPLICATION MUST BE NOTARIZED.**

\_\_\_\_\_  
 Signature of Applicant (in presence of a Notary Public)

Subscribed and sworn to before me this \_\_\_\_\_ day of \_\_\_\_\_, 19\_\_\_\_.  
 County of \_\_\_\_\_, State of \_\_\_\_\_.

(Seal)

\_\_\_\_\_  
 Notary Public

My commission expires \_\_\_\_\_, 19\_\_\_\_.

Note 1: The <sup>75.00</sup> \$50.00 examination fee must accompany this application. Upon successful completion of this examination, an initial registration fee, which is a prorated amount of the <sup>75.00</sup> \$75.00 annual registration renewal fee, will be required.

Note 2: At the Board's request, you may be required to personally appear for an interview to submit additional proof of your qualifications.

Be sure that all questions are answered in full where applicable. Send this application, examination fee, and photograph of applicant affixed inside, to:

TEXAS BOARD OF IRRIGATORS  
 Post Office Box 12337  
 Austin, Texas 78711  
 Phone (512) 463-7990

NOTE: Prior to the examination you have made application for, please keep the Board office informed in writing of any address or phone number changes.

370

## Texas Board of Irrigators

Stephen F. Austin Building, Room 647 1700 North Congress Avenue  
Austin, Texas 78701

S. Dale Ousley  
Chairman

Herman R. Johnson, Sr.  
Vice Chairman



Hugh Rushing, Jr.  
Douglas Hawthorne  
John A. Heidman  
William C. Lucas

Joyce Watson  
Executive Secretary

### GENERAL INFORMATION LICENSED IRRIGATOR'S EXAMINATION

The irrigation industry, like many other industries, has enjoyed tremendous growth in the last two decades. Technological improvements in design, technique and equipment within the industry, coupled with advancements from other industries, have increased the size of the marketplace a hundredfold.

Developers have become extremely conscious of a need for pleasant surroundings near office buildings, shopping centers, municipal buildings and schools. These areas would go undeveloped were it not for the irrigation industry. Ecology is our business!

Thousands of irrigation systems requiring billions of gallons of water are already in operation in this state. And thousands of new systems are installed every year. The irrigation industry represents one of the largest water consumers in the state, and therefore plays an important role in water conservation.

If the irrigation industry has become highly specialized, so must the people within the industry. If equipment and materials have become highly technical, we must be technically inclined. If the limited water supply requires conservation, then we must know how to conserve.

These are some of the reasons why regulation of the irrigation industry is necessary and also why an irrigator's examination is required. To become a licensed irrigator, it is not necessary to attend school or serve an apprenticeship. Qualification by examination is all that is necessary. This pamphlet has been prepared to familiarize you with the subject matter of the licensing exam. We have highlighted areas of importance. A word of caution: Do not underestimate the amount of preparation required to successfully complete the examination. It is a t. rough review of what a prospective irrigator should know. Hopefully, you will be one of the many who find the irrigation industry a rewarding occupation.

Provisions for the certification of irrigators were created by the passage of Senate Bill 259 during the 66th Legislature. Governor Clements signed the act into l. in May, 1979.

#### EXAMINATION DAY

From 200 to 300 applicants take the exam which is given several times a year. Information on where and when it will be given will

Mailing address: P.O. Box 12337 • Austin, Texas 78711 • (512)463-7990

371

## 2. Preparing For The LI Exam

be sent to each applicant. The exam is given by the Board members and other licensed persons in the irrigation industry who act as proctors. The test begins at 8:00 a.m. and ends at 3:00 p.m.

Drawing boards and T-squares, and all charts and tables will be provided, however applicants must bring their own drawing instruments and hand calculators. No other material will be allowed in the room during the test.

The exam is given in sections and you will not be permitted to leave the room except between sections. You will be allowed to ask questions of Board members only during the test.

The time required to take the exam varies. Some persons complete it in four or five hours, however the majority of applicants finish in seven or eight hours. An incomplete examination almost always results in failure.

While taking the test, applicants should conduct themselves so that they will not cast suspicion on themselves or others. Anyone caught cheating will be asked to leave without certification. You will be notified of your test results within 30 days with instructions on how to secure a license if you passed.

Comments from individuals who have taken the test have revealed that those who successfully complete the exam generally register early, read the material in the publications listed on the Recommended Study Material sheet, attend a design school or seminar and arrive in Austin the day before the exam.

Should you have any questions about the study information feel free to call our office in Austin, (512) 463-7990.

### STUDY RECOMMENDATION

There are sections on the test with true/false, multiple choice, and fill-in-the-blank questions. The questions in these sections are of a general nature and deal with industry history, construction, usage, design and drafting, hydraulics, friction loss and head selection. This information can generally be found in the manuals listed on the study material sheet; however, not all the information in the exam can be found in any one manual. Therefore, we recommend that you read everything suggested by the Board. Questions concerning the Licensed Irrigators Act will also be included on the examination.

### YOU MUST HAVE A MINIMUM GRADE OF 70 ON EACH SECTION.

SECTION 1 True-False - Spacing, nozzles, patterns, GPM, pressure, velocity, pipe, cement, heads, wire, valves, precipitation, percolation, design, drip irrigation, automation, rules, act, laws.

SECTION 2 Multiple Choice - Wire, valves, sprinklers, pipe, definitions, precipitation, pressure, design, rules, act, laws.

SECTION 3 Backflow Types, uses.

SECTION 4 Hydraulics Velocity of flow, pressure loss.

SECTION 5 Design Complete design of irrigation system, heads, piping, pressure loss.

### SUMMARY

The Texas Board of Irrigators has attempted to give you information that will help you successfully complete the licensing examination. It is up to you to demonstrate that you have the knowledge to practice irrigation in Texas.

Certification places a responsibility on the licensee to protect the domestic water supply. The integrity of your license is affected by your actions and those of other licensed irrigators. All of us have a responsibility to enforce the provisions of this law and ensure conformance to it. We sincerely hope that, if you are certified, you will continue to expand your expertise in the irrigation field.

As you enter into your new occupation as an irrigator, we encourage you to establish a high standard of business ethics.

*GOOD LUCK!*

372

## 2. Preparing For The LI Exam

**Submit the application early**

You must return the completed application, with your fee, at least one month prior to the test day.

**Instructions for the exam and study materials**

After you submit your application, the Texas Board of Irrigators will send you information about the exam and suggested study materials. The next two pages show examples of what you will receive.

373

## 2. Preparing For The LI Exam

### INSTRUCTIONS FOR THE LICENSED IRRIGATOR EXAMINATION

It is the responsibility of each candidate to seek out additional information regarding landscape irrigation and its application as each candidate feels is necessary.

The basic categories of the exam encompass Design, Hydraulics, Terminology, the Licensed Irrigators Act (copy of Act is furnished with the application packet), and Material Take-Off. The written portion requires approximately four (4) hours followed with a practical design problem.

Since the privileges of this license are recognized statewide, it is necessary that you have a basic understanding of the various types of backflow devices used in this state, even though they may not be required in your locality.

It is the recommendation of this Board that you be completely familiar with the subject of design and hydraulics so you can design an irrigation system under test conditions. You may secure assistance in developing a practice design.

PLEASE BE REMINDED THAT A SCORE OF 70 OR MORE MUST BE MADE ON EACH SECTION OF THE EXAMINATION IN ORDER FOR YOU TO BECOME ELIGIBLE FOR CERTIFICATION AS A LICENSED IRRIGATOR.

You will need to bring the following instruments and equipment to the exam:

- |                      |                            |
|----------------------|----------------------------|
| A. Engineer Scale    | F. Pocket Calculator       |
| B. Triangle          | (permissible, but quiet)   |
| C. Compass           | G. Template                |
| D. Pencils - #2 only | (permissible if you desire |
| E. Erasers           | to use one)                |

YOU WILL BE NOTIFIED APPROXIMATELY TWO TO THREE WEEKS PRIOR TO THE EXAM AS TO WHAT DAY YOU WILL SIT FOR THE EXAMINATION.

**NOTE:** Approved candidates **MUST APPEAR** for the examination at the designated date, time and place, arriving **NO LESS** than ten (10) minutes prior to the announced starting hour of 8:00 a.m. If you sign up for the exam you must take it on the assigned date or forfeit the examination fee. **THE EXAMINATION FEE IS NOT REFUNDABLE.**

For those of you who wish to travel together, an attempt by the staff will be made to schedule your group for examination on the same date. Please notify this office immediately, or include a written request with your application and fee, requesting a specific exam date to be assigned, allowing the staff to consider as many requests as possible.

Certification places a responsibility on the licensee to protect the domestic water supply. All of us have a responsibility to enforce the provisions of this law and ensure conformance to it. We sincerely hope that, if you are certified, you will continue to expand your expertise in the irrigation field.

G O O D L U C K !!

## 2. Preparing For The EI Exam

### STUDY MATERIAL

Following is a suggested list of publications that may aid you in preparing for the examination.

- THE ABC'S OF LAWN SPRINKLER SYSTEMS (\$6.95) - plus  
(1.25 packaging and shipping)  
Irrigation Technical Service  
Post Office Box 268  
Lafayette, California 94549  
(415) 284-5881
- IRRIGATION SYSTEMS DESIGN MANUAL (\$11.00)  
RESIDENTIAL DESIGN GUIDE (.50¢)  
BACKFLOW PREVENTION HANDBOOK (.50¢)  
Rain Bird Sales, Inc. - Turf Division  
145 North Grand Avenue  
Glendora, California 91740  
(818) 963-9311
- TURF IRRIGATION MANUAL (\$23.95) - plus  
(1.95 shipping, plus Texas residents sales tax)  
Weather-Matic Division  
Telsco Industries  
Post Office Box 18205  
Dallas, Texas 75218  
(214)-278-6131
- RESIDENTIAL DESIGN MANUAL Form #490-1663 (\$8.00) - plus  
(1.50 shipping)  
Toro Company Irrigation Division  
Post Office Box 489  
Riverside, California 92502  
(714) 688-9221 or 688-9224
- CROSS CONNECTION CONTROL (Backflow Prevention Devices) No Charge  
Febco  
Post Office Box 8070  
Fresno, California 93747  
(209) 252-0791
- #F50-50 CROSS CONNECTIONS, QUESTIONS, ANSWERS, AND ILLUSTRATIONS No Charge  
Watts Regulator Company  
Post Office Box 628  
Lawrence, Massachusetts 01842  
(617) 688-1811

NOTE: The Board does not require you to purchase these publications. It is intended that the candidate be aware that these irrigation publications are available.

375

## 2. Preparing For The LI Exam

### Failing the LI Exam

If you fail the LI Exam, the TBI will notify you by letter. The following page shows an example of that letter. Notice that you have the opportunity to review your examination with a Board member if you so choose.

There is no limit on the number of times you may re-take the examination. It is not necessary to submit an additional application form. However, each re-take requires prepayment of the entire examination fee and a commitment to travel to Austin.



## Texas Board of Irrigators

Stephen F. Austin Building, Room 647    1700 North Congress Avenue  
Austin, Texas 78701

S. Dale Ousley  
Chairman

Herman P. Johnson, Sr.  
Vice Chairman



Hugh Rushing, Jr.  
Douglas Hawthorne  
John A. Heidman  
William C. Lucas

Joyce Watson  
Executive Secretary

October 8, 1937

This is to inform you that you were unsuccessful on the Licensed irrigator examination that you took in Austin on September 28, 1987. Listed below are your scores concerning the examination:

<u>SUBJECT</u>	<u>MINIMUM PASSING SCORE</u>	<u>YOUR SCORE</u>
Section 1 - True/False	70	86
Section 2 - Composite	70	80
Section 3 - Backflow	70	82
Section 4 - Hydraulics	70	50
Section 5 - Design	70	85

UPON WRITTEN REQUEST to this office, we will furnish you with an analysis of your examination. Upon receipt of your written request by this office, you will be provided the name and phone number of the Board member of your choice. You may, at that time, contact the Board member to establish a time and date for review of your examination results. If you wish to discuss your examination with a Board member, in lieu of a written evaluation, we will forward your exam papers to that member.

Your name will be maintained in our file for a period of six months and you will receive notification when the examination will be offered again.

Sincerely,

Joyce Watson  
Executive Secretary

JW/cs

Mailing address: P.O. Box 12337 • Austin, Texas 78711 • (512)463-7990

377

## 2. Preparing For The LI Exam

### Passing the LI Exam

If you pass the LI Exam, the TBI will notify you by letter. The following page shows an example of that letter. Notice that you must submit a registration fee, after which you will receive further instructions about completing your registration.

## Texas Board of Irrigators

Stephen F. Austin Building, Room 647 1700 North Congress Avenue  
Austin, Texas 78701

S. Dale Ousley  
Chairman

Herman R. Johnson, Sr.  
Vice Chairman



John A. Heidman  
William C. Lucas  
William E. Petty, Sr.  
Frederick T. Abt

Joyce Watson  
Executive Secretary

January 11, 1988

I am pleased to inform you that you have passed the January 4, 1988, Licensed Irrigator examination and the Board has certified your eligibility to register as a Licensed Irrigator. Please remit your initial registration fee of \$56.72 to this office as soon as possible, but not later than 60 days after the date of this letter. Upon receipt of the initial fee, I will proceed with your formal registration and give you further instructions on how you can complete your registration. Please be reminded that you are not authorized to act as a Licensed Irrigator until you obtain your certificate of registration and identification card upon completion of your registration.

Licenses are renewed annually. A Licensed Irrigator may renew his certificate of registration during the months of July and August of each year by payment of a renewal fee in the amount of \$85.00. You will be notified by first-class mail by June 30 of each year of the expiration of your certificate of registration. Such notice will be sent to your last known preferred mailing address. If you fail to pay your renewal fee, your certificate of registration shall automatically expire and you must requalify under Texas Civil Statutes, Article 8751, Section 8.

Please notify our office in writing of any changes in mailing addresses and/or telephone numbers.

Sincerely,

A handwritten signature in cursive script, appearing to read "Joyce Watson".

Joyce Watson  
Executive Secretary

JW,

Mailing address: P.O. Box 12337 • Austin, Texas 78711 • (512)463-7990

373

## 2. Preparing For The LI Exam

### Completing your registration

After you have passed the LI Exam and sent in your registration fee, you will receive a letter explaining how to obtain a personal seal or rubber stamp. The following two pages show an example of that letter. Follow the instructions included with the letter to obtain your personal seal or rubber stamp.

## Texas Board of Irrigators

Stephen F. Austin Building, Room 647 1700 North Congress Avenue  
Austin, Texas 78701

S. Dale Ousley  
Chairman

Herman R. Johnson, Sr.  
Vice Chairman



Hugh Rushing, Jr.  
Douglas Hawthorne  
John A. Heidman  
William C. Lucas

Joyce Watson  
Executive Secretary

January 19, 1988

Re: Completion of Your Licensed Irrigator Registration  
YOUR REGISTRATION NUMBER \_\_\_\_\_

Dear Mr. \_\_\_\_\_ :

I am writing to inform you that I have received your initial registration fee and to furnish instructions on how you can complete your registration as a Licensed Irrigator.

The Board's rules require each Licensed Irrigator to have a personal seal or rubber stamp facsimile of the seal. The seal imprint is to be placed on all professional documents issued by the Licensed Irrigator. In order to complete your registration, you must obtain a personal seal or rubber stamp facsimile of the design prescribed in the Board's rules and file with the Board, in duplicate, a sample impression of your seal on letterhead or other business stationery which you propose to use. Seals can be purchased from commercial sources listed in the Yellow Pages of telephone books under "Seals". Upon receipt of your sample impressions, your registration will be complete and I will forward your certificate of registration and identification card.

Enclosed is a copy of the Board's rules which pertain to the Licensed Irrigator seal and sample illustrations of the seal. Your name and registration number shown above must be placed in the center of the seal, as illustrated. Also, enclosed is that portion of the Board's rules which pertain to Standards of Conduct for licensed irrigators. You should read these rules carefully and become familiar with them, as violations thereof are subject to Board action.

Please be reminded that you are not authorized to act as a Licensed Irrigator until you obtain your certificate of registration and identification card.

Mailing address: P.O. Box 12337 • Austin, Texas 78711 • (512)463-7990

381

## 2. Preparing For The LI Exam

TEXAS BOARD OF IRRIGATORS  
COMPLETION OF REGISTRATION  
PAGE TWO

---

In addition, all correspondence you send this office should include your registration number shown above. You must notify this office if and when you have any change of address or telephone number.

If you have any questions regarding the registration, please feel free to contact this office.

Sincerely,

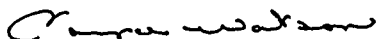

Joyce Watson  
Executive Secretary

JW/cs

Enclosures

## Studying for the exam

One of the best ways to prepare for the exam is exactly what you are doing--taking a study course through a community college.

You may wish to supplement your learning. If so, you have at least of couple of options:

Take a study course offered by various suppliers of irrigation products. Use your own discretion in choosing one of these. Some of them are abbreviated in content and may tend to show case only the products offered by the vendor.

Obtain and read all of the study materials suggested by the TBI.

Regardless of how you choose to study for the exam, do so over a reasonable time period. Do not try to cram for the exam at the last minute.

## Accommodations in Austin

Arrive in Austin the day before your scheduled test day. Otherwise, you run the risk of delay unless you live within easy driving time. Do what is necessary to be fresh and un-hassled.

The LI Exam has been given in several different locations over the years. Presently it is conducted at the Howard Johnson Plaza-Hotel South, 3401 I-35 South, Austin, Texas, (512) 448-2444. Take the I-35 S. and Woodward St. exit.

The hotel has airport shuttle service, a restaurant, lounge, ample parking and quiet, comfortable rooms. It also provides the "call for scores" and courtesy service to persons taking the examination.

## Pluses and Minuses

It is convenient, but may be somewhat more costly to stay at the Plaza-Hotel South where the examination is offered. There are some disadvantages, however, of which you should be aware. The dining room opens at 6:30 AM and your line up time is at 7:00 AM. Because of the number of persons present for breakfast, the food service may take longer than the amount of time you have to spare. The luncheon is similarly crowded and may also require lengthy waiting on the food service.

One solution is to eat the buffet, which does not require kitchen preparation time that cuts into your limited examination time.

Although there are a number of dining establishments in various locations in Austin, none are within easy walking distance of the Howard Johnson, Plaza-Hotel South. Between Woodward exit and Oltorf--one mile to the north--are a Denny's and a Kettle restaurants and a Lubys cafeteria.



All of them are a one-to-two mile round trip. They are options if you have transportation and wish to arise early, go out, and eat away from the crowd.

## Check-in Procedure

At approximately 7:00 AM on the day you are scheduled to take the examination, an identification and check-in procedure will begin at a table near the main testing room. Usually a TBI staff member, a Board member, and possibly others will begin the check-in process for that day's testing.

You must have your permit to take the test (a colored cardboard ticket which was sent to you upon submission of the exam fee a minimum of 30 days prior to the exam day) and your Texas Drivers License or other ID that has a photograph affixed.

The permit and the photograph ID will be checked against your personal file folder, which contains the completed application and any correspondence from you.

If all matches, your card and ID will be returned and you will sign-in on a numbered line in a sign-in log. Record the number on your permit in the space provided. You will use that number--NOT YOUR NAME--on every answer sheet, drawing, or calculation sheet you turn in for grading the rest of the day! You will then proceed to the main examination room.

All persons are usually logged-in by shortly after 8:00 AM and are ready for the examination. A member of the Board will welcome the group, introduce the other Board members and TBI staff present, and give some details of test procedure.

## 2. Preparing For The LI Exam

### Layout of the examination room

The hotel ballroom will be set up with conference tables and chairs, arranged in rows facing one wall. Tables will usually be arranged in groups of two to four, end-to-end depending on whether they are along the wall or in the center of the room. All tables will have table cloths and four testing locations per block of two tables. Center sections may have eight or more testing stations set up on a long run of tables. Adequate aisles between rows and columns of tables are provided because participants will be moving about the room to log-in and log-out for various sections of the test, sharpen pencils, request assistance, etc.

For those of you who smoke or who wish to avoid smoke from others, the back few rows are usually reserved for smokers during the examination. No cigars or tobacco chewing in any form is permitted.

A typical table arrangement with four seats includes a "drawing pad" station, a written exam station, another "drawing pad" station, and another written exam station.

You may not have briefcases, etc., at your table during the examination. They will have to be placed in the back of the room.

### Recognizing the materials

Rather than drafting boards and T-squares being provided as in the past, large cardboard "pads" (about 18" x 22" in size) with a length of masking tape are provided. Your drawing for the design portion of the test will be placed on this cardboard pad. This eliminates the need for a T-square. This also allows those who take the written portion first to immediately proceed to the drawing portion since extra "pads" are available at the front of the room.

## 2. Preparing For The LI Exam

All written examinations are bound in a three ring notebook. Do not write in the notebook. Record your answers on the Scantron answer sheets, which will be read and graded electronically.

A set of official TBI Charts and Tables is provided in the back of the test notebook. They are the only charts and tables you may use on the test.

As you log in and are ready to walk into the test room, you are handed the TBI Test Booklet. Take the notebook along with your own drawing and calculating equipment and locate a testing area you can be comfortable with. If you wish to start the examination with the drawing, select a chair in front of a "drawing pad." If you wish to start with the written portion, select a chair in front of a space without a "drawing pad." You may not open the notebook until told to do so. As soon as you are able, though, turn to the Official Charts and Tables in the back section of the notebook and familiarize yourself with them. The arrangement of the tabular material and charts may be different from anything you are used to using. Therefore, a few minutes at the beginning of the entire test may save you much frustration later when time is of the essence.

One to two hundred persons may be taking the exam on any given day. Concentrate on your own work. Give yourself every advantage for success.

### Materials you may use

The TBI supplies the examination notebook with the official tables and charts, cardboard "drawing pads," machine graded Scantron answer sheets (100 response and 50 response depending on the section), #2 soft lead pencils, and scratch paper.

## 2. Preparing For The LI Exam

The personal materials permitted are drafting instruments (triangles, engineers scale, erasers, templates), and a calculator. No “singin’ or musical” calculators please, unless you can turn them off to avoid distracting other participants.

The templates may be shape or symbol aids. Specific shapes and symbols are required for a good score on the design. Also allowed are commercial or self-prepared spacing templates for triangulated head layout. Caution: the head sizes specified in the Official Charts are the only ones you may use on the exam. (Do not bring too many personal materials that you cannot use.)

All answer sheets and design problems are provided for you. You may find it useful to get scratch paper from the front of the room.

Also, you may want to bring several sheets of tracing paper or onion skin for trial placement of heads and adjustment of zones prior to drawing in the final design. It is far easier, quicker, and neater to make mistakes on expendable tracing paper than to erase completely and re-draw several times on the design test itself. Keep your drawings clean and neat. Another helpful item is stick-on notes on which you can jot reminders and write down starting times and quick calculations.

### Examination sections

The exam comprises five section tests, which you must complete within the eight hour day (8:00 AM to 5:00 PM). The sections are untimed. You may spend as much time as you wish on a section; however, you must complete all five within the eight hours. You do not have to go to lunch, if you do not want to.

## 2. Preparing For The LI Exam

After you complete each section, you return that answer sheet to the check-in/out station outside the conference room. You will initial a designated area on a control sheet showing you completed and handed in that score sheet. You may now take any length of break you wish or you may immediately check out the answer sheet for the next section.

You may begin with either the Design Drawing or with Section 1 of the written portion. Some participants prefer to do the drawing first because of the time involved (usually 3 to 5 hours). If you wish to do the design first, be in line early. Log-in, get your assigned number and Exam Notebook, then quickly select a drawing station in the testing room. At the proper time, you will be handed your design drawing and a Scantron answer sheet for Section 5. If you choose the written portion first (by selecting a "non-drawing station"), you will be handed a Scantron answer sheet for Section 1.

The sections of the LI Exam contain three types of questions: true/false, multiple choice, and fill-in-the-blank, all answered on the Scantron electronically graded score sheet. The questions are of a general nature and deal with industry history, construction, usage, design and drafting, hydraulics, friction loss, head selection, and the Lacey and Irrigators Act. This information can generally be found in the manuals listed on the study material sheet. Not all the information on the exam, however, can be found in any one manual. Therefore, if at all possible, read everything suggested by the Board.

383

## 2. Preparing For The Ll Exam

The following summary lists the topics covered by the various sections:

Section 1: Spacing, nozzles, patterns, GPM, pressure, velocity, pipe, cement, heads, wire, valves, precipitation, percolation, design, drip irrigation, automation, rules, act, laws.

Section 2: Wire, valves, sprinklers, pipe, definitions, precipitation, pressure, design, rules, act, laws.

Section 3: Backflow prevention devices, uses.

Section 4: Hydraulics, velocity of flow, pressure loss.

Section 5: Design, complete design of irrigation system, heads, piping, pressure loss.

### **Pacing and efficient time management**

No matter which part of the exam you start on, you must keep track of the time remaining for other phases of the examination. A rough rule of thumb is that the drafting design takes about half or more of the eight hours. The first three sections usually take about 2 to 3 hours. Respectively, they involve 100 true/false questions, 50 multiple choice questions, and 50 true/false questions.

The hydraulics section, which involves calculations and reference to charts and tables, takes about an hour. Care should be taken that you do not get mixed up when recording your answers. You may be consulting particular places on as many as four pieces of paper and calculations on a calculator in getting any one answer.

The written portions take from 3 to 4 hours out of a total of 8 (9 hours if you do not eat lunch). You then have 4 to 5 hours remaining to do the design section.

If you do the design section first and finish everything in 3 to 4 hours, then you can do the written sections (in order, no skipping around) in the time remaining.

## Grading

The written sections and drawings are graded as soon as they are returned to avoid a log jam at the end of the day. Naturally, the written sections, which require less time to complete than the drawing, will begin to be turned in within the first hour or so. Therefore, people will be moving around as they leave the room to check in a finished section, check out a new answer sheet or take a break between sections. There is an orderly process of sign-in and sign-out for the various sections. Be prepared to wait in line when you go to the examination table (same table as used for the log-in).

Once you return your answer sheet you may not get it back. You must move on to the next section.

## Posting of scores

An announcement will be made as to the anticipated time the notification of pass/fail will be posted on the door of the grading room. A sequential list of numbers will be posted with a pass/fail. The numbers include the number that you placed on all answer sheets and designs. The score reflects the overall score for the entire examination. The grades on individual sections will not be posted.

Remember, you must make 70 points or more on each of the five sections, or you must retake the entire examination.

## 2. Preparing For The LI Exam

### Unofficial reporting

The desk clerk at the hotel will have a copy of the same pass/fail list that is posted on the door. If you have to leave Austin before the scores are posted, you may call the desk clerk to get an unofficial notification of your score. Remember, this is a courtesy of the hotel, not an official action of the TBI staff.

Official notification of your score will come by mail, usually within two weeks, to the address on your application. Do NOT call the Board office for grades. In some instances, several examination days may be required to accommodate all applicants and the staff will be involved in conducting examinations over several days.



(This page included for duplexing.)

## COMMON TERMINOLOGY OF THE TURF IRRIGATION INDUSTRY

As semantics is always a problem when dealing with areas all over this and other nations, the use of the following list of terms is explained as the terms are used in this manual. These terms and meanings are generally accepted as standards within the irrigation industry.

- ABS** Acrylonitrile butadiene styrene.
- ABS pipe** Black, semi-rigid plastic pipe; limited in irrigation usage. Utilizes solvent welded fittings.
- Absorption rate** The rate at which a soil will absorb water. It is not a static rate as it incorporates the infiltration rate and the infiltration capacity of the soil.
- Angle valve** A valve from which water flows out at a 90 degree plane from the plane at which it enters.
- Anti-siphon device** A device to protect domestic water from possibly contaminated water in sprinkler system lines. Also called a vacuum breaker.
- Application rate** The rate at which water is applied to the turf by the sprinklers in pattern.
- Arc** The degrees of coverage of a sprinkler from one side of throw to the other. A 90 degree arc would be a quarter circle sprinkler.
- Architect scale** A device that expresses foot measurements in parts of an inch. Ex: 1/4" = 1'0". A measuring scale.
- As-built-plan** A finished plan of an installed irrigation system designating valve, sprinkler and controller locations, routing of pipe and control lines and all other pertinent information.
- Atmospheric vacuum breaker** An anti-siphon device which uses a floating seat to direct water flow. Water draining back from irrigation lines is directed to the atmosphere to protect domestic water supply.
- Automatic control valve** A valve in a sprinkler system which is activated by an automatic controller by way of control lines.
- Automatic drain valve** A valve that opens automatically when pressure drops within a sprinkler line so that water remaining in the line will drain.
- Automatic system** An irrigation system which will water in accordance to a pre-set program decided upon, and programmed, into the automatic controllers.

<b>Available pressure</b>	Pressure of water in a pipe measured when there is a flow condition.
<b>AWWA</b>	Abbreviation for American Water Works Association.
<b>Backflow</b>	Water which drains back, or is sucked back, from irrigation lines. Contamination of this water by insecticides, herbicides, fungicides, fertilizers, and bacteria is possible.
<b>Backflow prevention device</b>	A device which prevents backflowing water from irrigation lines, possibly contaminated, from mixing with domestic water supplies.
<b>Bellied pipe</b>	Pipe enlarged at one end to accept the spigot end of another piece of pipe.
<b>Block (of heads)</b>	A section of sprinklers controlled by one valve.
<b>Block system</b>	An irrigation system in which several groups of sprinklers are controlled by one valve for each group.
<b>Body (of head)</b>	The exterior case or shell of the sprinkler.
<b>Booster pump</b>	A pump which has a pressurized suction and is designed to raise the existing pressure of the water in the irrigation main.
<b>Bubbler head</b>	A sprinkler head that sprinkles water rather than spraying it. Bubblers are normally used in very small planting areas, or to water the root system of a tree.
<b>Bushing</b>	The method of adapting a fitting to either a larger or smaller size.
<b>Bush down</b>	To use a bushing to go from a large pipe to a smaller one.
<b>Bush up</b>	To use a bushing to go from a small pipe to a larger one.
<b>By-pass-valve</b>	A pressure relief valve in a pumping station which opens when pumping pressures rise, dumping excess water back into the reservoir, eliminating repetitive on-off cycles of the pumps.
<b>CI</b>	Universal abbreviation for cast iron pipe.
<b>CTS</b>	Universal abbreviation for copper tube size.
<b>CU</b>	Universal abbreviation for copper.
<b>Cam drive</b>	A method of rotating a sprinkler stream by the collision of two solid pieces of material.

<b>Cancel switch</b>	Also called a rain switch. A means of overriding the watering cycle of a controller without interrupting future watering programs.
<b>Cap</b>	A fitting that either threads or is solvent welded onto a pipe to prevent flow.
<b>Channel locks</b>	A type of plier. Also called a slip-joint plier. Used because of its ability to grasp pipe tightly.
<b>Check valve</b>	A valve which permits water to flow in one direction only.
<b>Class (of pipe)</b>	A method by which pipe is grouped according to the working pressure at which it can be used. Class 160 pipe can be used where pressures don't exceed 160 P.S.I., etc.
<b>Compression fitting</b>	A fitting that is secured by the compression of a rubber ring caused by the snug threading of its end caps.
<b>Control lines</b>	Lines which transmit information from the controller to the valves.
<b>Control wires</b>	The wires which transmit the signals to open and close from the automatic controller to the automatic valves.
<b>Controller</b>	The timing mechanism and its mounting box. The controller signals the automatic valves to open and close on a pre-set program.
<b>Coupling</b>	A fitting used to join two pieces of pipe together.
<b>Coupler key</b>	A hollow shaft to which a sprinkler or hose can be attached and which is inserted into a quick coupling valve, causing the valve to open and provide water.
<b>Coverage</b>	Coverage can relate the actual throw of water from a head to the recommended throw, or the efficiency of water application to an irrigated area.
<b>Cross</b>	A four-way fitting.
<b>Cross connection</b>	Any connection made between a domestic or potable water supply and a potential source of contamination or pollution.
<b>Cycle</b>	Refers to one complete run of a controller through all programmed controller stations.
<b>Design</b>	To recommend the use of sprinkler system components which make up the total system. A design can be an informal field plot location or a formal hydraulically engineered drawing.

<b>Diaphragm</b>	The portion of an automatic valve which regulates the passage of water through the valve.
<b>Direct burial wire</b>	Plastic coated single strand copper wire for use as a control line for electric valves.
<b>Distribution</b>	The manner in which a sprinkler applies water to the irrigated area.
<b>Distribution curve (of sprinkler head)</b>	A curve showing the rate of water application by a sprinkler at various points along the radius.
<b>Distribution pattern</b>	The pattern of water application by a sprinkler over the area the sprinkler covers. Usually applied to sprinklers in pattern.
<b>Domestic water</b>	Water meant for human consumption. Potable, or drinking water.
<b>Double check valve</b>	A backflow prevention device employed in irrigation systems.
<b>Drain valve</b>	A valve used to drain water from a line. It can be a manual drain valve in mains or laterals or an automatic drain valve in nonpressurized lines.
<b>DRI splice</b>	Trade name for a waterproof splicing device
<b>Dual programming</b>	The feature on some automatic controllers which allows two diverse watering schedules.
<b>Dump valve</b>	A valve pre-set to open at a certain pressure to prevent damage to a sprinkler system caused from excess pumping pressure.
<b>Electronic valve</b>	Automatic valves usually controlled by a 24-30 volt current carried in direct burial ground wire between the controller and valves.
<b>Electrolysis</b>	A chemical reaction caused by the joining of two dissimilar metals.
<b>Engineers' scale</b>	A device that expresses foot measurements as a certain number of feet per inch. Ex: 1" = 10'0".
<b>Elevation gain</b>	Pressure gained as water is used downhill from its source. It is figured at the rate of .433 pounds per square inch for each foot of elevation.
<b>Elevation loss</b>	Pressure lost as water is used uphill from its source.
<b>Evapotranspiration</b>	The rate at which water is evaporated into the air and absorbed into the soil

<b>FIP</b>	Abbreviation for threads. Female Iron Pipe.
<b>Female adapter</b>	A fitting with a slip socket on one end and a female threaded socket on the other.
<b>Field capacity</b>	The amount of water a layer of soil will hold before the water continues to move down.
<b>Flow</b>	The movement of water.
<b>Flow control valve</b>	A valve which is pre-set and remains constant.
<b>Flow restriction</b>	Physical restriction in the lines of water flow.
<b>Flux</b>	A chemical oxidizer used in soldering a connection in copper.
<b>Foot-head</b>	A measurement of pressure. Equivalent to .433 pounds per square inch and equal to one foot of elevation.
<b>Friction loss</b>	That loss incurred when water is moving through an enclosure.
<b>GPH</b>	The universal abbreviation for gallons per hour. The standard for flow measurement of water in drip irrigation.
<b>GPM</b>	Abbreviation for gallons per minute.
<b>Gate valve</b>	A valve utilizing a rising and descending gate to control the flow of water. Gate valves are normally used as a mainline shut-off valve rather than as a sprinkler section or zone valve because they wear quickly with heavy use.
<b>Gauge (wire)</b>	A standard used in wire sizing. The larger the gauge number, the smaller the wire in diameter.
<b>Gear driven</b>	A method of rotating a sprinkler stream utilizing a series of reduction gears to facilitate smooth rotation.
<b>Glove valve</b>	A valve through which water flows in the inlet, up through the sealing and flow control opening and out the outlet.
<b>Grid</b>	A cross-hatched pattern printed on some drafting paper that disappears when reproduced. Usually printed in standard scales.
<b>Head</b>	A sprinkler head.
<b>Head to head spacing</b>	Spacing of sprinklers so that the radius of the sprinklers match the spacing of them.

<b>Hose bibb</b>	The valve to which a garden hose attaches. Also called a hose faucet. Hose threads are spaced further apart than standard IPS threads.
<b>Hose thread</b>	The type of thread used on garden noses. It is a different thread than the standard iron pipe size threads so that it can be quickly attached to an outlet.
<b>Hydraulics</b>	The study of liquid movement and its dynamics.
<b>Hydraulic ram</b>	The shock wave caused by filling a pipe with water at a faster rate than air can escape.
<b>Hydraulic system</b>	A sprinkler system that utilizes water as a replacement for electric current to open and close valves.
<b>Hydraulically controlled</b>	An automatic valve which is controlled by the controller supplying and releasing water under pressure to the diaphragm or piston of the valve through use of control tubing.
<b>ID</b>	Universal abbreviation for inside or interior diameter of pipe.
<b>IPS</b>	Universal abbreviation for iron pipe size.
<b>Impact or impulse drive</b>	The method of providing rotational movement to a sprinkler head by utilizing a weighted or spring loaded arm that is repulsed by the water stream, and upon returning, collides with the head, forcing movement.
<b>In-pattern</b>	Refers to the precipitation rates of sprinklers when their throws overlap.
<b>Insert fittings</b>	Fittings designed to be pushed inside of a pipe. Usually barbed and secured with stainless steel clamps. Normally used on polyethylene pipe.
<b>Isolate</b>	A method of rendering a portion of a looped sprinkler mainline inoperative so that repairs can be made without rendering the system useless.
<b>Lateral</b>	A field or section pipe line other than the main pressure line. This line is pressurized when the controller actuates the section valve.
<b>Loop</b>	A piping method which allows water to circulate without end.
<b>Main</b>	A pipe sized to carry the water for the irrigation system from source to section valve. This line may stand under constant pressure when the system is inoperative.

<b>Male adapter</b>	A fitting with a slip socket at one end and a male threaded end on the other.
<b>Manual drain valve</b>	A manual valve, usually a boiler drain, used to drain the water from a main line prior to a freeze or for repairs.
<b>Manual system</b>	A system in which control valves are opened manually.
<b>Master valve</b>	A valve installed at the supply point of the main which controls water flow into the system.
<b>MIP</b>	Abbreviation for Male Iron Pipe threads.
<b>Moisture control</b>	An automatic feature on some controllers that allows the system to come on only if the moisture content of the soil is correct.
<b>Multi-cycling</b>	Many short watering cycles rather than one long cycle. Helps to eliminate run-off and flooding.
<b>Non-pressure lines</b>	See lateral.
<b>Normally closed valve</b>	An automatic valve through which no water will flow unless external influences are applied to cause the valve to open.
<b>Normally open valve</b>	An automatic valve through which water will flow unless external influences are applied to close the valve.
<b>NSF</b>	Abbreviation for National Sanitation Foundation.
<b>Nozzle</b>	A device through which sprinkler system water is channeled to form the desired pattern and radius.
<b>OD</b>	The universal abbreviation for outside diameter or dimension in pipe.
<b>Operating cycle</b>	One complete run by a controller through all of its active stations.
<b>Operating pressure</b>	The pressure at which a system or sprinkler operates.
<b>Orifice</b>	The opening in a nozzle through which water is forced. Its size determines radius and pattern.
<b>Overlap</b>	The amount one sprinkler pattern overlaps another.
<b>Over watering</b>	Applying more water than necessary to turf or plantings.
<b>PE</b>	Universal abbreviation for Polyethylene.
<b>P.S.I.</b>	Abbreviation for pounds per square inch.



<b>P.V.C. Pipe</b>	Unplasticized polyvinyl chloride pipe.
<b>PE pipe</b>	Black, flexible plastic pipe.
<b>Pen-tite connectors</b>	Trade name for a waterproof wire splicing device.
<b>Percolation</b>	The penetration of soil by water. The rate of percolation is affected by the type of soil, slope of terrain, run-off, etc.
<b>Pipe wrench</b>	A tool expressly designed for holding pipe.
<b>Piston</b>	(1) The portion of an automatic valve which regulates the passage of water through the valve. (2) The portion of a pop-up sprinkler head that is pushed up when water pressure is applied.
<b>Plug</b>	A fitting that goes into pipe or fittings to stop the flow of water.
<b>Potable water</b>	Water which is meant for human consumption. It can be used for irrigation systems as long as protection is provided to prevent contamination to the domestic supply.
<b>Pressure</b>	The force of water, measured in PSI or foot-head.
<b>Pressure loss</b>	The loss of pressure under flow conditions caused by friction of water passing through a closure.
<b>Pressure rating</b>	A rating of pipe for given pressures.
<b>Pressure regulator</b>	A device which regulates available pressure to a pre-set maximum under static or flow condition.
<b>Pressure relief valve</b>	A valve which will open when the pressure exceeds a preset point.
<b>Pressure vacuum breaker</b>	A backflow prevention device which incorporates the use of a spring loaded seat for positive sealing to protect domestic water from possibly contaminated irrigation water.
<b>Program</b>	The watering schedule of an automatic sprinkler.
<b>Programming</b>	The act of planning and entering the watering program into the automatic controller.
<b>Pump circuit</b>	The feature on some automatic controllers which allows a connection to be made with the pump starter of the pump so that the starter will be energized when the watering cycle begins. May also activate a master valve.

<b>Quick coupling system</b>	A sprinkler system which uses quick coupling valves, keys and impact heads. The valves are permanently installed with the keys and sprinklers manually moved from valve to valve.
<b>Quick coupling valve</b>	The valve used in a quick coupling system which is activated by a coupling key.
<b>Rain switch</b>	(1) A feature on many controllers which lets the owner stop watering during rainy periods without interrupting the program. (2) A device which will automatically cancel watering when a pre-set amount of rain occurs.
<b>Remote control valve</b>	An automatic valve which opens or closes when energized by a controller.
<b>Riser</b>	(1) A threaded nipple to which a sprinkler is attached. (2) A tall nipple used to water over shrubs or ground cover.
<b>Run-off</b>	Water which is not absorbed by the ground to which it is applied. Caused by water being applied at too rapid a rate, watering for too long a period of time, or by a slope.
<b>SDR</b>	Abbreviation for Standard Dimension Ratio. The SDR is a nominal or approximately equal measurement of pipe.
<b>Saddle</b>	A type of fitting which goes over the pipe. A hole is drilled through the pipe to furnish water to the outlet of the saddle.
<b>Scale</b>	A device that converts feet to fractions of an inch for reduction purposes in designing. Ex: Architects scale, engineers scale.
<b>Scale drawing</b>	A miniature drawing of a large object.
<b>Section (noun)</b>	A group of sprinkler heads which operate from one valve.
<b>Section (verb)</b>	The act of placing certain sprinkler heads within a section in the design phase.
<b>Sleeve (conduit)</b>	A pipe placed under a sidewalk or driveway that is large enough to permit the passage of active sprinkler pipes or wiring.
<b>Sleeve (valve)</b>	Any protective device that allows access to a section valve. A sleeve can be a short length of large diameter pipe, with or without cap, or a manufactured valve box.
<b>Slip fitting</b>	A type of fitting that is solvent welded on PVC or ABS pipe.

<b>Snaking pipe</b>	The practice of undulating pipe from side to side in the bottom of a trench to counteract expansion and contraction breakages.
<b>Socket</b>	The belled end of a piece of pipe or the slip end of a PVC or ABS fitting.
<b>Solder</b>	An alloy of lead and tin that melts at a relatively low temperature and sets as soon as it cools. Solder is used to join copper fittings in a sprinkler system.
<b>Solenoid</b>	The solenoid is the device on an automatic electric valve that permits the flow of water into the upper chamber of a valve, permitting it to open or close. It is a simple electromagnet.
<b>Solvent</b>	A material which causes a partial dissolving of PVC or ABS pipe and fittings so that a chemical fusion can be accomplished between the pipe and fitting.
<b>Solvent welding</b>	The act of chemically fusing pipe and fittings together using solvent.
<b>Spacing</b>	The distance between sprinkler heads.
<b>Spigot</b>	The end of a piece of pipe; not the bellied end.
<b>Spring check valve</b>	A valve that utilizes a spring loaded seat to permit water to flow in one direction only.
<b>Sprinkler</b>	The sprinkler head.
<b>Static pressure</b>	The pressure of water when it is not moving.
<b>Station</b>	(1) A position on the controller that is responsible for a particular valve or section. (2) A group of sprinkler heads, a section or zone.
<b>Stop and waste valve</b>	A valve required by most cities so that property owners can shut off all water to the house. They are usually located near the house or, in cold climates, may be inside.
<b>Strap wrench</b>	A wrench used in piping that utilizes a canvas trap to grip the pipe.
<b>Supply (water)</b>	The origin of water used in a sprinkler system.
<b>Surge</b>	An energy wave in pipe lines caused by sudden opening or closing of valves.
<b>Sweated fittings</b>	A fitting that has been connected utilizing a soldered joint.

<b>Swing check valve</b>	A valve which allows water to flow in only one direction, using a flexible hinge and the weight of water to seat.
<b>Swing joint</b>	A threaded connection between the pipe and sprinkler which allows movement to be taken up in the threads rather than as a sheer force on the pipe. Also used to raise or lower sprinklers to final grade.
<b>Tee</b>	A fitting that permits pipe to be connected at a 90 degree angle from itself on one side only. It is shaped like the letter "T".
<b>Thermal expansion</b>	The expansion or contraction of pipe due to differences in temperature.
<b>Threaded fitting</b>	A fitting which has threads to receive the standard pipe thread.
<b>Torch</b>	A device used to heat copper prior to the application of solder on a sweated joint, usually utilizing either propane or acetylene as a fuel source.
<b>Underspaced</b>	Heads spaced too close together, resulting in over watering and wet spots.
<b>Uniformity of application</b>	A general term designating how uniform the application of the sprinkler is over the area it is covering while in pattern.
<b>Vacuum breaker</b>	See atmospheric or pressure vacuum breaker.
<b>Valve</b>	A device that controls the flow of water.
<b>Valve-in-head</b>	Indicates that the automatic control valve is part of the sprinkler.
<b>Velocity (of water)</b>	The speed at which water travels. Usually expressed in FPS (feet per second).
<b>Water demand</b>	The amount of water, measured in GPMs, that is expended through the sprinkler heads when operating.
<b>Water hammer</b>	A shock wave created by a fast closing valve.
<b>Water pressure</b>	Pressure which water exerts, measured in pounds per square inch or in foot-head.
<b>Water ram</b>	A shock wave that occurs when water at high pressure is introduced into an air filled pipe. Since the air cannot escape, a pulsating wave is created which exceeds the pressure of the water entering the pipe.

<b>Watering requirements</b>	The irrigation or water requirements of the area to be covered, based on variables of season, types of plantings, and available demand.
<b>Watering time</b>	The length of time a station or section of heads remains on.
<b>Wetting front</b>	The leading edge of water as it moves down.
<b>Wire nut</b>	A device that insulates a wire splice by threading onto two twisted wires.
<b>Working pressure</b>	Actual pressure taken at any given point when a sprinkler system is operating. Usually taken at the base of a sprinkler head.
<b>Wye strainer</b>	A strainer that resembles the letter "Y" in its configuration. It utilizes a wire or nylon mesh strainer to strain foreign particles out of water.
<b>Xeriscape</b>	Optimized vegetation, water use, and landscape arrangement.

**STANDARD "DESIGNATION CODES" FOR PRESSURE RATED PLASTIC PIPES:**

- 1120—PVC pipe, Type one, Grade one, 2000 psi hydrostatic design stress.
- 1220—PVC pipe, Type one, Grade two, 2000 psi hydrostatic design stress.
- 2110—PVC pipe, Type two, Grade one, 1000 psi hydrostatic design stress.
- 2306—Polyethylene pipe, Type two, Grade three, 600 psi design stress.

## - A -

Advantages of controllers .....	4 - 27
Agriculture .....	3 - 5
American National Standards Institute .....	5 - 3
ANSI.....	5 - 3
Aqueducts.....	3 - 2
Arc, drawing an.....	6 - 17

## - B -

Backflow .....	4 - 4
Backflow prevention valves .....	4 - 18
Basics of design.....	6 - 1
Beginning a layout.....	6 - 25

## - C -

Calculating precipitation rate.....	5 - 33, 6 - 3
Canopy size .....	7 - 4
Charts, pressure loss .....	6 - 36
Checking solenoids .....	4 - 33
Common features of controllers.....	4 - 29
Conductor wires.....	4 - 31
Connecting a tee to an existing water line .....	5 - 17
Connecting pipe.....	5 - 6
Connecting plastic to copper .....	5 - 16
Controller, defined.....	4 - 25
Controllers	
advantages of .....	4 - 27
common features of .....	4 - 29
disadvantages of .....	4 - 27
power requirements.....	4 - 28
types of .....	4 - 25
use on unswitched circuits.....	4 - 28
Coring tool.....	7 - 15
Couplings, no-stop.....	5 - 17
Cross connection, defined.....	4 - 4

- D -

Dams ..... 3 - 5

Demand for better products ..... 3 - 11

Design basics ..... 6 - 1

Design symbols ..... 6 - 4

Disadvantages of controllers ..... 4 - 27

Discharge rate ..... 5 - 32

Diversion ..... 3 - 1

Drafting symbols ..... 6 - 4

Drain valves ..... 4 - 18

Drawing a plot plan ..... 6 - 15

Drawing an arc ..... 6 - 17

Drip irrigation

    advantages of ..... 7 - 14

    defined ..... 7 - 9

    disadvantages of ..... 7 - 14

Drip supply lines ..... 7 - 11

Drip supply lines, how to install ..... 7 - 12

- E -

Early forms of irrigation ..... 3 - 1

Effects of sunlight on pipe ..... 5 - 5

Effects of temperature on pipe ..... 5 - 3

Electric circuit, adding one legally ..... 4 - 28

Electric valves, types of ..... 4 - 13

Electrical wiring ..... 4 - 31

Electro-mechanical controllers ..... 4 - 25

Emitters ..... 7 - 11

ET rates, calculating ..... 7 - 3

Ethics and irrigation ..... 3 - 8

Euphrates wheel ..... 3 - 2

Evaporation ..... 7 - 2

Evapotranspiration (ET) ..... 7 - 2

Evapotranspiration rates, calculating ..... 7 - 3

## - F -

Fertilizer injectors .....	7 - 13
Field capacity .....	7 - 1
Fittings, how to resolder.....	5 - 15
Fittings, how to solder .....	5 - 15
Flow rate.....	4 - 2
Flux.....	5 - 9
Friction.....	6 - 8
Friction loss.....	6 - 9

## - G -

Gear drive heads .....	5 - 27
Guidelines for soldering.....	5 - 12

## - H -

Heads and patterns .....	6 - 23
Heads	
gear drive.....	5 - 27
hybrid .....	5 - 31
operating pressures of .....	5 - 26
shrub .....	5 - 28
spray .....	5 - 28
stream rotor.....	5 - 31
wobbling nozzle .....	5 - 31
High static pressure ... ..	6 - 5
Hybrid spray heads.....	5 - 31
Hydraulic controllers.....	4 - 25
Hydraulic valves .....	4 - 14
Hydraulics, defined .....	6 - 7



Index

- I -

Impact heads, water distribution with..... 5 - 27  
Injectors, fertilizer..... 7 - 13  
Installation and design..... 6 - 2  
Installing wire..... 4 - 32  
Irrigation efficiency factor ..... 7 - 4  
Irrigation in Texas..... 3 - 4  
Irrigation Systems course, purpose of..... 1 - 1  
Irrigation systems, residential..... 3 - 9  
Irrigation, defined ..... 3 - 1

- L -

Lateral supply lines..... 7 - 11  
Laws  
    electricity, installing circuits legally..... 4 - 28  
    Sunset Law ..... 3 - 6  
    TBI Act ..... 3 - 6  
Layout, defined..... 6 - 23  
Layout, where to begin a..... 6 - 25  
Least expensive system..... 6 - 1  
Locations of water meters..... 4 - 3  
Low static pressure..... 6 - 4

- M -

Manifold ..... 4 - 17  
Manual valves, types of ..... 4 - 12  
Measuring property..... 6 - 16  
Measuring water pressure..... 6 - 8  
Moisture sensor ..... 7 - 15

- N -

No-stop coupling ..... 5 - 17  
Notes, plot plan ..... 6 - 18  
Nozzles, wobbling..... 5 - 31

## - O -

Opening and closing valves.....	4 - 18
Operating pressures of heads.....	5 - 26
Overlap.....	6 - 24

## - P -

Percolation.....	7 - 1
Pipe fatigue.....	5 - 4
Pipe	
defined.....	5 - 1
effects of sunlight on.....	5 - 5
effects of temperature on.....	5 - 3
how to connect.....	5 - 6
how to section.....	6 - 33
restricted flow in.....	5 - 1
Placing valves.....	4 - 17
Plant factor.....	7 - 4
Plants, precipitation needs of.....	5 - 33
Plot plan notes.....	6 - 18
Plot plan, defined.....	6 - 15
Plot plan, drawing a.....	6 - 15
Potential evapotranspiration rate (PET).....	7 - 3
Potential evapotranspiration rate, calculating.....	7 - 3
Power backup for controllers.....	4 - 30
Power requirements of controllers.....	4 - 28
Precipitation.....	5 - 32
Precipitation needs of plants.....	5 - 33
Precipitation rate.....	5 - 32, 6 - 3
Precipitation rate and circuit heads.....	5 - 34
Precipitation rate and controllers.....	6 - 3
Precipitation rate, calculating.....	5 - 33, 6 - 3
Pressure loss.....	4 - 2
Pressure loss charts.....	6 - 36
Pressure regulator.....	6 - 6, 7 - 13
Principles of Xeriscape.....	7 - 7
Producing a plot plan.....	6 - 15
Programming controllers.....	4 - 29
Property boundaries.....	6 - 15
Property, how to measure.....	6 - 16
Public opinion.....	3 - 8
Pumps.....	6 - 7

- R -

Reservoirs..... 3 - 5  
 Residential irrigation systems ..... 3 - 9  
 Resoldering a fitting ..... 5 - 15  
 Restricted flow in pipes..... 5 - 1  
 Root depth..... 7 - 5  
 Rotary heads, application of..... 5 - 26

- S -

Safety equipment..... 5 - 11  
 Saturation ..... 7 - 1  
 Sectioning pipe ..... 6 - 33  
 Shrub heads..... 5 - 28  
 Soil moisture ..... 7 - 9, 10  
 Soil moisture, measuring..... 7 - 15  
 Soil particles..... 7 - 1  
 Solder, tips on handling..... 5 - 15  
 Solder, types of ..... 5 - 10  
 Soldering fittings..... 5 - 15  
 Soldering  
     defined ..... 5 - 9  
     guidelines for..... 5 - 12  
     how the bond forms ..... 5 - 11  
 Solenoids, how to check ..... 4 - 33  
 Solid state controllers ..... 4 - 26  
 Solvent welding..... 5 - 6  
 Solvents, types of ..... 5 - 8  
 Spacing intervals for supply lines..... 7 - 12  
 Spacing patterns, types of..... 6 - 23  
 Spacing, inconsistency in ..... 6 - 24  
 Splicing wire ..... 4 - 32  
 Spray heads ..... 5 - 28  
 Spray heads, controlling water placement..... 5 - 29  
 Spray heads, disadvantages of..... 5 - 29  
 Spray heads, hybrid ..... 5 - 31  
 Sprinkler head, defined ..... 5 - 25  
 Square spacing ..... 6 - 23  
 Standards ..... 5 - 3  
 Static pressure..... 4 - 2, 6 - 8  
 Static pressure, too high ..... 6 - 5  
 Static pressure, too low ..... 6 - 4

Stream rotor heads.....	5 - 31
Sunset law.....	3 - 6
Supply lines .....	6 - 5
Supply lines, spacing intervals for.....	7 - 12
Surge protection for controllers.....	4 - 30
Symbols, design.....	6 - 4

## - T -

TBI Act .....	3 - 6
Tee fitting, connecting.....	5 - 17
Texas Board of Irrigators.....	3 - 6
Tips on handling solder.....	5 - 15
Tips on soldering several fittings .....	5 - 15
Transpiration .....	7 - 2
Triangular spacing.....	6 - 23
Types of controllers .....	4 - 25
Types of solder.....	5 - 10
Types of solvents .....	5 - 8

## - U -

Underground sprinkler systems .....	3 - 10
Unswitched circuits and controllers .....	4 - 28

## - V -

Valve manifold .....	4 - 17
Valve operating current .....	4 - 13
Valve operation.....	4 - 11
Valves	
actuating by controller.....	4 - 30
backflow prevention .....	4 - 18
defined .....	4 - 11
drain .....	4 - 18
electric.....	4 - 13
hydraulic .....	4 - 14
manual.....	4 - 12
opening and closing .....	4 - 18
referring to by purpose .....	4 - 17
types common in irrigation.....	4 - 15
Velocity.....	6 - 9, 6 - 36

- W -

Water distribution..... 5 - 27  
Water distribution with impact heads..... 5 - 27  
Water hammer..... 5 - 4, 6 - 10  
Water meter, defined..... 4 - 1  
Water meters ..... 4 - 1  
Water pressure, measuring..... 6 - 8  
Water, weight of..... 6 - 7  
Weight of water ..... 6 - 7  
Wetting front..... 7 - 1  
Windmills..... 3 - 3,4  
Wire gauge ..... 4 - 31  
Wire, how to install..... 4 - 32  
Wire, how to splice ..... 4 - 32  
Wiring, electrical ..... 4 - 31  
    locations of ..... 4 - 3  
Wobbling nozzle heads..... 5 - 31  
Working pressure..... 4 - 2, 6 - 8

- X -

Xeriscape ..... 7 - 7

## NOTES TO THE USERS OF THESE MATERIALS

The Irrigation Technology Instructor's Guide, The Student Workbook, and the associated drawings, practice tests and other third party referenced materials are provided as an assist to instruction in water use, conservation, sprinkler system design, installation and use. These materials are designed for use with the technical literature available from manufacturers, standard publications, texts and reference materials which are common and accepted by the industry, and the suggested self study procedures suggested by the Texas Board of Irrigators to applicants seeking licensure in this state.

The writer has attempted to organize materials from a variety of sources into a sequential study course which may be used at the community college level. The instructor should be a licensed, experienced irrigator, approved to teach at the local level by the institution offering the course and which provides the facilities, materials, instructional environment and support required for such a course.

The Coordinating Board for Texas Colleges and Universities, Community Colleges and Technical Institutes Division has approved two courses in which these materials may be utilized:

The first, a 128 clock hour introductory class to prepare an irrigation installer assistant to work under the direct supervision of a licensed irrigator. Persons completing this course should be able to successfully sit for the State Licensure Examination for a Licensed Installer certificate.

The second course is a 60 clock hour class to assist the more experienced person to develop a broad understanding of the irrigation industry as a career field and to explore the contemporary applications of emerging technology in the industry. This course may be helpful to persons preparing for the Licensed Irrigator's Examination.

These classes may be taught as individual, stand-alone offerings or incorporated with others as a part of a larger program of study now offered or developed by the institution.

**NOTE: These materials ARE NOT intended to be used as a "TBI Examination Cram Course".** They are supplementary to other references and materials which **MAY ASSIST** the student prepare for a state licensure examination by systematically directing the study of a broad, generic (Non Product or Manufacturer specific) body of knowledge related to the Irrigation Profession. The final authority for content, questions and correctness of answers for the mandatory state TBI Licensure Examination is vested solely with the Board which administers that Examination.

The sample tests, drawings and other study aids are in the public domain and may be reproduced by the user to, meet the needs of the students. Every attempt has been made to insure accuracy, consistency and compliance commonly accepted practice, **HOWEVER**, the writer did encounter obvious differences or even contradictions between various manufacturers recommendations, the published works of other writers and currently accepted authorities. We have attempted to resolve these differences equitably as reflected in the study guides sample tests and drawings. Adaptation to meet local requirements is encouraged.

## Pretest

### Irrigation - Then and Now

Define the following terms:

1. T.B.I.
2. Anti-siphon Device
3. Distribution Rate
4. Precipitation Rate
5. Euphrates Wheel

Mark the following questions True or False. If any part of the question is false, the entire question is false.

1. Less than 25% of the homes and buildings in Texas have an underground sprinkler system.
2. In areas where no local regulation are in force, the irrigator may use his or her favorite method to prevent backflow.
3. Diversion was one of the earliest forms of irrigation.
4. The Texas Sunset Law has nothing to do with irrigation in Texas.
5. Over the years, consumers have demanded better products, including better irrigation products.

## Pretest

### Water Meters, Cross Connection, and Backflow Prevention

Fill in the missing word or words:

1. Any connection made to a potable water supply is called a \_\_\_\_\_ .
2. An atmospheric type vacuum breaker cannot be used under continuous \_\_\_\_\_ .
3. Water that is an actual hazard to the public health is said to be \_\_\_\_\_ .

Mark the following statements True or False. If any part of the statement is false, the entire statement is false.

1. In residential areas that have alleys, the water meters are always located beside the alleys.
2. A swing-type check valve works in any position and whether it is buried or exposed.
3. The two forms of backflow are backsiphonage and backpressure.

Define the following terms:

1. Frost depth
2. Pig tail
3. Reduced pressure principle
4. Master valve



# Pretest

## Valves, Controllers, and Electrical Wiring

Mark the following statements True or False. If any part of the statement is false, the entire statement is false.

1. Always use teflon tape when attaching valves to a main supply line.
2. You can use 18 AWG wire on all sprinkler systems.
3. No more than three valves can be run on the same circuit wire of a controller.
4. The two types of wire that can be used underground are UF and TW.
5. When you connect section valves to a manifold, it is wise to stack the valves to allow for several in a valve box.
6. Water hammer only occurs at fluid velocities below 25 ft/sec.
7. The three types of irrigation controllers are electro-mechanical, hydraulic, and solid state.
8. Most valve manufacturers recommend using PVC cement to attach valves to pipe.
9. 110 V AC solenoid valves are illegal.

Define the following terms:

1. Water hammer
2. Flow control valve
3. Controller
4. "Snaking"

# Pretest

## Piping and Sprinkler Heads

Mark the following statements True or False. If any part of the statement is false, the entire statement is false.

1. I.P.S. refers only to metal pipe.
2. The force that develops when valves quickly close is called water hammer.
3. 50/50 wire solder has been banned by the EPA because it contains lead.
4. The two materials needed to sweat a joint are solder and flux.
5. PVC solvent can be used to weld polyethelene pipe also.
6. The main design factor that affects sprinkler operation is pressure.
7. Generally, the greater the distance water is thrown, the more it is affected by wind.
8. Some lawn sprinkler heads have nozzles that pendulate or wobble to improve water distribution within the pattern.

Define the following terms:

1. Nominal pipe size
2. Creep
3. Ball drive head
4. Capillary action
5. Nozzle

# Pretest

## Layout and Design

Mark the following statements True or False. If any part of the statement is false, the entire statement is false.

1. The pressure of water when it is not moving is called static pressure.
2. Calculating the precipitation rate for each circuit gives you some basis for setting the controller.
3. The reason that many spray heads mist is because of too much pressure at the head.
4. Elevation has nothing to do with the working pressure in an irrigation system.
5. Generally speaking, water is not compressible.
6. The two most common methods of placing sprinkler heads are by triangular and square spacing.
7. With true triangular head placement, the distance between rows is 87% of the spacing between the heads.
8. With triangular head placement, the spacing from head to head and from row to row is the same.
9. An effective spacing for circular pattern spray heads is 50-65% of the diameter of the spray pattern.

Define the following terms:

1. Working pressure
2. Hydraulics
3. Friction loss
4. Velocity

# Pretest

## Drip Irrigation

Mark the following statements True or False. If any part of the statement is false, the entire statement is false.

1. Modern drip systems are usually very dependable if designed, installed and operated properly.
2. Water penetration is fastest through fine soils, like clay.
3. Water containing any solid particles requires the use of a filter on a drip system.
4. Emitter plugging is frequently caused by the growth of bacteria in the orifice.
5. Drip irrigation is impractical for use in turf.

Define the following terms:

1. Wetting front
2. Percolation
3. PET
4. Evapotranspiration
5. Emitter

Answer sheet for use with the Irrigation Technology PRACTICE EXAMINATION.  
 Fill in the ( ) of your choice. Your Examination Number \_\_\_\_\_ (NOT NAME)

Section 1 True/False					Section 2 Multiple Choice					Section 3 True/False			
1	(T)	(F)	51	(T)	(F)	1	(A)	(B)	(C)	(D)	1	(T)	(F)
2	(T)	(F)	52	(T)	(F)	2	(A)	(B)	(C)	(D)	2	(T)	(F)
3	(T)	(F)	53	(T)	(F)	3	(A)	(B)	(C)	(D)	3	(T)	(F)
4	(T)	(F)	54	(T)	(F)	4	(A)	(B)	(C)	(D)	4	(T)	(F)
5	(T)	(F)	55	(T)	(F)	5	(A)	(B)	(C)	(D)	5	(T)	(F)
6	(T)	(F)	56	(T)	(F)	6	(A)	(B)	(C)	(D)	6	(T)	(F)
7	(T)	(F)	57	(T)	(F)	7	(A)	(B)	(C)	(D)	7	(T)	(F)
8	(T)	(F)	58	(T)	(F)	8	(A)	(B)	(C)	(D)	8	(T)	(F)
9	(T)	(F)	59	(T)	(F)	9	(A)	(B)	(C)	(D)	9	(T)	(F)
10	(T)	(F)	60	(T)	(F)	10	(A)	(B)	(C)	(D)	10	(T)	(F)
11	(T)	(F)	61	(T)	(F)	11	(A)	(B)	(C)	(D)	11	(T)	(F)
12	(T)	(F)	62	(T)	(F)	12	(A)	(B)	(C)	(D)	12	(T)	(F)
13	(T)	(F)	63	(T)	(F)	13	(A)	(B)	(C)	(D)	13	(T)	(F)
14	(T)	(F)	64	(T)	(F)	14	(A)	(B)	(C)	(D)	14	(T)	(F)
15	(T)	(F)	65	(T)	(F)	15	(A)	(B)	(C)	(D)	15	(T)	(F)
16	(T)	(F)	66	(T)	(F)	16	(A)	(B)	(C)	(D)	16	(T)	(F)
17	(T)	(F)	67	(T)	(F)	17	(A)	(B)	(C)	(D)	17	(T)	(F)
18	(T)	(F)	68	(T)	(F)	18	(A)	(B)	(C)	(D)	18	(T)	(F)
19	(T)	(F)	69	(T)	(F)	19	(A)	(B)	(C)	(D)	19	(T)	(F)
20	(T)	(F)	70	(T)	(F)	20	(A)	(B)	(C)	(D)	20	(T)	(F)
21	(T)	(F)	71	(T)	(F)	21	(A)	(B)	(C)	(D)	21	(T)	(F)
22	(T)	(F)	72	(T)	(F)	22	(A)	(B)	(C)	(D)	22	(T)	(F)
23	(T)	(F)	73	(T)	(F)	23	(A)	(B)	(C)	(D)	23	(T)	(F)
24	(T)	(F)	74	(T)	(F)	24	(A)	(B)	(C)	(D)	24	(T)	(F)
25	(T)	(F)	75	(T)	(F)	25	(A)	(B)	(C)	(D)	25	(T)	(F)
26	(T)	(F)	76	(T)	(F)	26	(A)	(B)	(C)	(D)	26	(T)	(F)
27	(T)	(F)	77	(T)	(F)	27	(A)	(B)	(C)	(D)	27	(T)	(F)
28	(T)	(F)	78	(T)	(F)	28	(A)	(B)	(C)	(D)	28	(T)	(F)
29	(T)	(F)	79	(T)	(F)	29	(A)	(B)	(C)	(D)	29	(T)	(F)
30	(T)	(F)	80	(T)	(F)	30	(A)	(B)	(C)	(D)	30	(T)	(F)
31	(T)	(F)	81	(T)	(F)	31	(A)	(B)	(C)	(D)	31	(T)	(F)
32	(T)	(F)	82	(T)	(F)	32	(A)	(B)	(C)	(D)	32	(T)	(F)
33	(T)	(F)	83	(T)	(F)	33	(A)	(B)	(C)	(D)	33	(T)	(F)
34	(T)	(F)	84	(T)	(F)	34	(A)	(B)	(C)	(D)	34	(T)	(F)
35	(T)	(F)	85	(T)	(F)	35	(A)	(B)	(C)	(D)	35	(T)	(F)
36	(T)	(F)	86	(T)	(F)	36	(A)	(B)	(C)	(D)	36	(T)	(F)
37	(T)	(F)	87	(T)	(F)	37	(A)	(B)	(C)	(D)	37	(T)	(F)
38	(T)	(F)	88	(T)	(F)	38	(A)	(B)	(C)	(D)	38	(T)	(F)
39	(T)	(F)	89	(T)	(F)	39	(A)	(B)	(C)	(D)	39	(T)	(F)
40	(T)	(F)	90	(T)	(F)	40	(A)	(B)	(C)	(D)	40	(T)	(F)
41	(T)	(F)	91	(T)	(F)	41	(A)	(B)	(C)	(D)	41	(T)	(F)
42	(T)	(F)	92	(T)	(F)	42	(A)	(B)	(C)	(D)	42	(T)	(F)
43	(T)	(F)	93	(T)	(F)	43	(A)	(B)	(C)	(D)	43	(T)	(F)
44	(T)	(F)	94	(T)	(F)	44	(A)	(B)	(C)	(D)	44	(T)	(F)
45	(T)	(F)	95	(T)	(F)	45	(A)	(B)	(C)	(D)	45	(T)	(F)
46	(T)	(F)	96	(T)	(F)	46	(A)	(B)	(C)	(D)	46	(T)	(F)
47	(T)	(F)	97	(T)	(F)	47	(A)	(B)	(C)	(D)	47	(T)	(F)
48	(T)	(F)	98	(T)	(F)	48	(A)	(B)	(C)	(D)	48	(T)	(F)
49	(T)	(F)	99	(T)	(F)	49	(A)	(B)	(C)	(D)	49	(T)	(F)
50	(T)	(F)	100	(T)	(F)	50	(A)	(B)	(C)	(D)	50	(T)	(F)

Answer sheet for use with the Irrigation Technology PRACTICE EXAMINATION.  
 Fill in the ( ) of your choice. Your Examination Number KEY (NOT NAME)

Section 1 True/False				Section 2 Multiple Choice				Section 3 True/False					
1	(T)	(●)	51	(T)	(●)	1	(A)	(●)	(C)	(D)	1	(T)	(●)
2	(●)	(F)	52	(T)	(●)	2	(●)	(B)	(C)	(D)	2	(●)	(F)
3	(T)	(●)	53	(●)	(F)	3	(A)	(B)	(C)	(●)	3	(●)	(F)
4	(●)	(F)	54	(T)	(●)	4	(●)	(B)	(C)	(D)	4	(●)	(F)
5	(●)	(F)	55	(T)	(●)	5	(A)	(B)	(C)	(●)	5	(●)	(F)
6	(T)	(●)	56	(●)	(F)	6	(A)	(B)	(●)	(D)	6	(T)	(●)
7	(T)	(●)	57	(T)	(●)	7	(A)	(B)	(C)	(●)	7	(●)	(F)
8	(T)	(●)	58	(T)	(●)	8	(A)	(B)	(●)	(D)	8	(●)	(F)
9	(●)	(F)	59	(●)	(F)	9	(A)	(B)	(C)	(●)	9	(●)	(F)
10	(T)	(●)	60	(●)	(F)	10	(A)	(B)	(C)	(●)	10	(●)	(F)
11	(T)	(●)	61	(●)	(F)	11	(A)	(B)	(●)	(D)	11	(T)	(●)
12	(●)	(F)	62	(●)	(F)	12	(A)	(B)	(●)	(D)	12	(●)	(F)
13	(T)	(●)	63	(●)	(F)	13	(A)	(B)	(C)	(●)	13	(●)	(F)
14	(●)	(F)	64	(T)	(●)	14	(A)	(B)	(●)	(D)	14	(●)	(F)
15	(●)	(F)	65	(●)	(F)	15	(●)	(B)	(C)	(D)	15	(T)	(●)
16	(T)	(●)	66	(T)	(●)	16	(●)	(B)	(C)	(D)	16	(T)	(●)
17	(●)	(F)	67	(T)	(●)	17	(A)	(●)	(C)	(D)	17	(●)	(F)
18	(●)	(F)	68	(●)	(F)	18	(A)	(B)	(C)	(●)	18	(●)	(F)
19	(T)	(●)	69	(●)	(F)	19	(●)	(B)	(C)	(D)	19	(●)	(F)
20	(●)	(F)	70	(●)	(F)	20	(A)	(B)	(C)	(●)	20	(●)	(F)
21	(●)	(F)	71	(●)	(F)	21	(A)	(●)	(C)	(D)	21	(T)	(●)
22	(T)	(●)	72	(T)	(●)	22	(A)	(B)	(C)	(●)	22	(●)	(F)
23	(T)	(●)	73	(●)	(F)	23	(A)	(B)	(C)	(●)	23	(T)	(●)
24	(T)	(●)	74	(●)	(F)	24	(●)	(B)	(C)	(D)	24	(●)	(F)
25	(●)	(F)	75	(T)	(●)	25	(A)	(●)	(C)	(D)	25	(T)	(●)
26	(●)	(F)	76	(T)	(●)	26	(A)	(B)	(●)	(D)	26	(●)	(F)
27	(T)	(●)	77	(●)	(F)	27	(A)	(B)	(●)	(D)	27	(T)	(●)
28	(●)	(F)	78	(T)	(●)	28	(A)	(●)	(C)	(D)	28	(●)	(F)
29	(●)	(F)	79	(●)	(F)	29	(A)	(B)	(●)	(D)	29	(T)	(●)
30	(●)	(F)	80	(T)	(●)	30	(A)	(B)	(●)	(D)	30	(●)	(F)
31	(●)	(F)	81	(●)	(F)	31	(●)	(B)	(C)	(D)	31	(●)	(F)
32	(T)	(●)	82	(T)	(●)	32	(●)	(B)	(C)	(D)	32	(T)	(●)
33	(●)	(F)	83	(T)	(●)	33	(A)	(B)	(C)	(●)	33	(●)	(F)
34	(T)	(●)	84	(T)	(●)	34	(A)	(B)	(C)	(●)	34	(T)	(●)
35	(●)	(F)	85	(●)	(F)	35	(A)	(B)	(●)	(D)	35	(●)	(F)
36	(T)	(●)	86	(●)	(F)	36	(A)	(●)	(C)	(D)	36	(●)	(F)
37	(T)	(●)	87	(●)	(F)	37	(A)	(B)	(C)	(●)	37	(●)	(F)
38	(T)	(●)	88	(T)	(●)	38	(●)	(B)	(C)	(D)	38	(T)	(●)
39	(●)	(F)	89	(●)	(F)	39	(A)	(B)	(●)	(D)	39	(●)	(F)
40	(●)	(F)	90	(●)	(F)	40	(A)	(B)	(●)	(D)	40	(●)	(F)
41	(●)	(F)	91	(●)	(F)	41	(A)	(B)	(C)	(●)	41	(T)	(●)
42	(●)	(F)	92	(●)	(F)	42	(A)	(B)	(●)	(D)	42	(●)	(F)
43	(T)	(●)	93	(●)	(F)	43	(A)	(B)	(C)	(●)	43	(●)	(F)
44	(T)	(●)	94	(T)	(●)	44	(A)	(B)	(●)	(D)	44	(●)	(F)
45	(●)	(F)	95	(T)	(●)	45	(A)	(B)	(C)	(●)	45	(●)	(F)
46	(●)	(F)	96	(●)	(F)	46	(A)	(B)	(●)	(D)	46	(T)	(●)
47	(T)	(●)	97	(●)	(F)	47	(●)	(B)	(C)	(D)	47	(T)	(●)
48	(T)	(●)	98	(●)	(F)	48	(A)	(●)	(C)	(D)	48	(T)	(●)
49	(●)	(F)	99	(●)	(F)	49	(●)	(B)	(C)	(D)	49	(T)	(●)
50	(●)	(F)	100	(●)	(F)	50	(●)	(B)	(C)	(D)	50	(●)	(F)

## SECTION 1

True-False: 100 questions covering Spacing, Nozzles, Patterns, Pressure, Velocity, Pipe, Cement, Heads, Wire, Valves, Precipitation, Percolation, Design, Drip Irrigation, Automation, Rules, Act and Laws.

**DO NOT WRITE OR MARK ON THIS TEST MATERIAL**

**USE THE MACHINE SCORED ANSWER SHEET PROVIDED**

Use a soft, #2 black lead pencil to indicate your answer on the Scantron sheet. Do not write your name on the answer sheet - Use your Examination Number assigned to you at the time you signed in for the test.

On True or False questions, use the "A" block for True and the "B" block for False. If you make a mistake or wish to change a response erase completely and blacken in your new answer carefully. Incomplete erasures or two responses for the same question will be graded as wrong.

Be sure you are recording your answers on the properly numbered blocks. Check at the end of every page (more often is recommended) to be sure that you are answering the questions in the proper column and beside the corresponding item number.

**REMEMBER:** If you are off by only one number, you may be placing what you know to be a correct answer in an out of sequence location and be marked down as a result. The grading machine cannot tell that you put the "right" answers in the "wrong" spaces.

When finished with item 100, check to see that you have not skipped any items.

1. Velocity is the only reason that pipe is sized in a sprinkler system.
2. Pipe in a sprinkler system is sized efficiently to save the buyer money.
3. When you want to find out how much water is available for a sprinkler circuit, all you need to know is the static pressure, meter size, and supply line size (main to meter).
4. Friction loss tables are usually listed in PSI loss/100 ft.
5. Heads with greatly different precipitation rates should never be operated on the same circuit.
6. All plants require roughly the same amount of water and can be watered at the same time and with the same amount.
7. Plant types and requirements are of no interest to the professional irrigator.
8. Sloping lots and changes in elevation have nothing to do with the working pressure in an irrigation system.
9. You should always verify the dimensions of property with an accurate measuring tool.
10. With triangular head placement, the spacing from head to head and from row to row is the same.
11. You should include the locations of shrub and flower beds on plot plans, only because they may create an obstruction.
12. On plot plans, you should always include the locations of trees, utility poles, and any other structures such as a storage building.
13. The main supply line from a residential water meter to the house is usually a one-inch diameter pipe.
14. Always use as many heads as necessary to achieve full coverage.
15. The water from the sprinkler system must never be allowed to pass into the cavity above the diaphragm in an electric valve.
16. As a professional irrigator, you recognize that throwing water on streets and sidewalks is unavoidable, and should therefore be of little concern to you as to the property owner.
17. Overlapping the patterns of circular spray heads is necessary to avoid dry spots between patterns.
18. It is always preferable to water shrubs, flowers, and lawn at different times due to their varying moisture requirements.



19. With true triangular head placement, the distance between rows is 97 percent of the spacing between the heads.
20. It is almost always better to compress the spacing between heads to achieve a better fit than to stretch the spacing.
21. The two most common methods of placing sprinkler heads are triangular and square spacing.
22. In order to be appointed to the Texas Board of Irrigators one must be a licenced irrigator.
23. Most city codes are similar, particularly if the cities are neighbors.
24. The actual operating pressure at a head does not matter as long as it is more than the minimum operating pressure needed for the head.
25. Diversion was one of the earliest forms of irrigation.
26. Electrolysis may occur when two dissimilar metals are joined.
27. I.P.S. refers only to metal pipe.
28. The stretching of plastic pipe by over-pressuring is called creep.
29. An installation process that allows the pipe to expand and contract is called "snaking."
30. The force that develops when valves quickly close is called water hammer.
31. An installation device that helps cushion pipe elbows against water hammer is called a thrust block.
32. PVC 2210 pipe has a design tensile strength of 2000 psi.
33. Generally, the greater the distance water is thrown, the more affected it is by wind.
34. If a turf area is quite large and you have enough water supply, you should use the rotary heads with the largest radius available.
35. Ball and cam drive heads are, in effect, impact heads.
36. All fixed orifice spray heads distribute water very evenly within the pattern.
37. For a given area, a well designed system with rotary heads can be just as water efficient as a well designed system with spray or sprinkler heads.
38. With most impact heads, as you adjust the arc down (for instance, from 360 to 180 degrees), the precipitation rate remains the same.

39. With most impact heads, as you adjust the arc down, the discharge rate remains the same.
40. Some lawn sprinkler heads have nozzles that pendulate or wobble to improve water distribution within the pattern.
41. Modern drip systems are usually very dependable if designed, installed and operated properly.
42. The penetration of soil by water as it saturates the soil and moves downward is referred to as a percolation.
43. Water penetration is fastest through fine soils, like clay.
44. Water retention is greatest in coarse, sandy soils.
45. Evapotranspiration rates depend, to some degree, on whether or not mulch is used.
46. Drip irrigation, in its present state of development is less economical than conventional irrigation methods.
47. Mulches should only be used around shrubs and trees and never around flowers.
48. Tree growth is unaffected by grass growing beneath it.
49. 50/50 wire solder is no longer available because it contains lead.
50. With a straight-through diaphragm valve open, you can see through the flow passage.
51. All PVC solvents are the same.
52. PVC solvent can be used to weld polyethylene pipe also.
53. When designing a sprinkler system, you can consider working pressure and design pressure as the same.
54. When you design an irrigation system, you can consider the working pressure and the static pressure as the same.
55. Elevation has no effect on the working pressure in an irrigation system.
56. For all practical purposes, water is not compressible.
57. One foot of head equals one psi.
58. Regardless of the manufacturer of the nozzles, all heads have the same radius of throw and have identical distribution patterns.

59. The minimum operating pressures published by manufacturers indicate the lowest pressure at which the nozzle will perform properly.
60. Excessively high pressures at the head will cause the water pattern to mist or drift resulting in uneven distribution.
61. Different brands of spray heads which have a 15-foot radius and the same GPM and pressure ratio can generally be spaced the same distance apart.
62. Triangular spacing is recommended for all types of sprinkler designs whenever possible.
63. With a given radius and arc of coverage, brass nozzles and plastic nozzles perform the same.
64. The GPM discharge of a specified nozzle will always be the same, even if pressure changes.
65. If the volume of liquid flow in a given pipe is doubled, the pressure loss in the pipe will be approximately four times greater than the pressure loss from the original flow.
66. One pound per square inch (PSI) of water equals one foot of head.
67. Static water pressure on a two-inch line will read higher on a pressure gauge than it will on a half-inch line.
68. The velocity of water flowing through pipes is measured in feet per second.
69. The same thickness PVC pipe can withstand greater pressures than polyethylene pipe.
70. Of the three types of copper supply pipe, Type K has the thickest wall.
71. The coefficient of friction, or "C factor," refers to the interior surface smoothness of pipe.
72. Set up and cure times are the same for all brands of PVC cement.
73. When solvent welding, you should remove excessive solvent from the joints.
74. Plastic pipe should not be stored in direct sunlight.
75. Measures to ensure waterproof connection of buried underground wire splices is not necessary.
76. In order to increase the radius of throw for a rotary sprinkler head, the rotational speed should be increased.
77. Systems using direct burial electric valves use solenoids which require less than 30 volts DC.

78. It is permissible for atmospheric type vacuum breakers to operate under conditions of continuous back pressure.
79. The use of 115 volt AC electric solenoid valves is not recommended for underground direct burial.
80. Electric control valves are designed to be covered by a valve box and therefore are never to be directly buried in the soil.
81. If the head spacing is not uniform within a section, precipitation rates will vary radically.
82. The percolation rate is greater in clay or clay-type soils and less in compact, sandy soils.
83. Because rotary heads and spray heads have the same precipitation rate, they can be installed on the same section and valved together.
84. Household water which has been processed through sodium type water softener is good for lawn irrigation.
85. In irrigation systems which are connected to city water supply mains, it is possible for contaminated water to be drawn into the city water supply unless proper back flow prevention is used.
86. Local plumbing and electrical codes take precedence over manufacturer's recommendations.
87. Drip irrigation basically refers to the slow, measured application of irrigation water over a long period of time.
88. In its present form, drip and/or trickle irrigation will water plants, ground cover, and turf grass, better than conventional spray or rotary heads.
89. Drip irrigation systems should usually be equipped with a filter.
90. Subsurface irrigation systems depend upon water saturation of the subsoil, which causes water to travel in all directions.
91. Automated sprinkler systems are generally more efficient than manually operated systems due to the human element.
92. Clock controllers for automatic systems should be programmed to start the watering cycle early in the evening.
93. The best time to water with automatic sprinkler systems is to finish the watering cycle near dawn.
94. Frequent watering will cause roots of plants to grow deeper in the soil.

95. Registered professional engineers, architects, landscape architects and plumbers are not required to be licensed as irrigators and therefore may advertise to design and sell, install and repair irrigation systems.
96. The Licensed Irrigators Act does not apply to irrigation done by a homeowner.
97. The Texas Board of Irrigators is composed of six members, all of whom must be residents of the state.
98. Under the Licensed Irrigators Act, a licensed irrigator must renew his or her certification every year.
99. Under the Licensed Irrigators Act, a Licensed Irrigators Certificate can be revoked for negligence, incompetency or misconduct.
100. An irrigator who fails to renew his or her license by the renewal date can renew within 90 days by paying a fee plus a prorated penalty. If he or she fails to renew by the end of the 90-day period, the license will expire and can only be reissued by re-examination.

## SECTION 2

Composite Multiple Choice: 50 questions covering Wire, Valves, Sprinklers, Pipe, Definitions, Precipitation rates, Pressure, Design, Rules, Act, Laws.

**DO NOT WRITE OR MARK ON THIS TEST MATERIAL  
USE THE MACHINE SCORED ANSWER SHEET PROVIDED**

Use a soft, #2 black lead pencil to indicate your answer on the Scantron sheet. **Do not write your name on the answer sheet - Use your Examination Number assigned to you at the time you signed in for the test.**

On Multiple Choice questions, blacken in the appropriate response in the spaces provided on the answer sheet. If you make a mistake or wish to change a response **erase completely and blacken in your new answer carefully.** Incomplete erasures or two responses for the same question will be graded as wrong.

Be sure you are recording your answers on the properly numbered blocks. Check at the end of every page (more often is recommended) to be sure that you are answering the questions in the proper column and beside the corresponding item number.

**REMEMBER: If you are off by only one number,** you may be placing what you know to be a correct answer in an out of sequence location and be marked down as a result. The grading machine cannot tell that you put the "right" answers in the "wrong" spaces.

When finished with item 50, check to see that you have not skipped any items.

1. The most appropriate irrigation application for rotary heads is
  - A. For the cheapest system possible
  - B. For large turf areas
  - C. For small, mostly square yards
  - D. For flower beds
  
2. Water pressure which is too high for a sprinkler system
  - A. Is a major cause of water waste because the heads perform poorly
  - B. Gives a little extra distance of throw and improves water distribution
  - C. Is generally okay because the heads pop up to their full height
  - D. None of the above
  
3. The pressure required to operate a hydraulic controller is
  - A. 75 psi or greater
  - B. The number of valves multiplied by .87 psi
  - C. Less than 45 psi
  - D. Equal to or greater than the water pressure in the system
  
4. The output voltage from most controllers is
 

A. 24 Volts DC	C. 115 Volts DC
B. 24 Volts AC	D. 115 Volts AC
  
5. The occurrence of water hammer in a piping system
  - A. Can be removed if you use larger valves
  - B. Can be removed if you use a larger water meter
  - C. Is only a problem with PVC pipe
  - D. Should be kept at a safe level
  
6. The pressure of water when it is not moving is
  - A. Lower in small diameter pipe than in large diameter pipe
  - B. Lower in PVC pipe than in PE pipe
  - C. Called static pressure
  - D. Called non-gradient pressure
  
7. The number of heads in a single section depends on
  - A. The total gallons of water available
  - B. The total gallons of water required by the heads
  - C. The size of the pipe and the number of valves
  - D. Both A and B
  
8. Generally, total pressure loss through a circuit plus the minimum operating pressure of the sprinkler heads in the circuit should be no more than
 

A. 70% of the static pressure	C. 90% of the static pressure
B. 80% of the static pressure	D. None of the above

9. Some facts needed in order to design an efficient sprinkler system include
- Desires of the property owner
  - Size and location of the city water meter
  - Size, shape, and location of flower beds
  - All of the above
10. Sprinkler head spacing should be based on
- Type and size of heads
  - Slope of property and location of trees
  - Water pressure
  - Both A and B
11. To find out the size of a property, it is usually sufficient to
- Use the measurements from an architect's plan of the property
  - "Step off" the distance, which will measure close enough for irrigation systems
  - Use a measuring tape or a wheel-type measuring device to measure
  - None of the above
12. A few dry spots in an irrigation design are
- Acceptable if the spots are at the bottom of an incline where run-off water will reach them
  - Acceptable because wind and run-off normally get water to the spots
  - Never acceptable
  - None of the above
13. Drain valves
- Are closed when the valve fills with water
  - Should be placed at an angle of 30° to 45° below horizontal
  - Should never be installed at the end of a pipe
  - All of the above
14. An acceptable rule-of-thumb for determining the amount of overlap for circular pattern spray heads is
- 40 - 50 percent of the diameter of the spray pattern
  - 50 - 65 percent of the diameter of the spray pattern
  - 65 - 85 percent of the diameter of the spray pattern
  - None of the above
15. Determining where to begin the placement of heads on a layout
- Can be done scientifically if you use Davidson's Placement Formula or the Bourge scaling method
  - Relies less on a scientific method and more on an artistic method and is often learned by trial and error
  - Doesn't matter if you start at the street and work toward the dwelling
  - None of the above



16. Overlapping the patterns of circular spray heads
- Is necessary to avoid dry spots between patterns
  - Is necessary because water pressure decreases in the summer season
  - Is necessary because most lawns are rectangular and the only way to reach the corners is by overlapping
  - None of the above
17. Pipe is progressively sized down in a sprinkler system
- To maintain water pressure
  - Because small pipe costs less than large pipe
  - Because the number of circuits keeps increasing
  - Because of hydrostatic turbulence
18. The friction loss of water flowing through pipe is influenced by
- The material the pipe is made of
  - The I.D. of the pipe
  - The flow rate and the velocity of the water
  - All of the above
19. Water pressure can be increased only by
- Raising the source of the water or pumping the water
  - Using a larger water meter
  - Using a smaller pipe size
  - Both A and B
20. Looping a main supply line in a sprinkler system can
- Lower the pressure loss to the circuits
  - Allow you to use smaller pipe for the main supply line
  - Allow you to adjust the heads easier because of better water pressure
  - Both A and B
21. The official U.S. representative in the area of international standards is
- ASTM (American Society of Testing and Materials)
  - ANSI (American National Standards Institute)
  - AWWA (American Water Works Association)
  - AAIS (American Association for International Standards)
22. The types of pipes that may be used for sprinkler systems include
- |                          |                     |
|--------------------------|---------------------|
| A. Metal (steel, copper) | C. Thermoplastic    |
| B. Asbestos cement       | D. All of the above |
23. The term "schedule" refers to
- The O.D. and wall thickness for all pipe materials, based on the O.D. and wall thickness used in steel pipe
  - The I.D. and tensile strength of all pipe materials
  - The wall thickness of iron pipe only
  - The wall thickness of PVC pipe only

24. The wall thickness of a pipe may be determined by
- |                          |                        |
|--------------------------|------------------------|
| A. O.D. - I.D.           | C. (I.D. + radius) / 2 |
| B. (I.D. + diameter) / 2 | D. None of the above   |
25. The letters which designate the types of copper tubing are
- |            |                  |
|------------|------------------|
| A. J, K, L | C. S, M, L       |
| B. K, L, M | D. L, S, M, F, T |
26. The ratio of wall thickness to pipe diameter
- |           |           |
|-----------|-----------|
| A. P.S.R. | C. S.D.R. |
| B. S.R.F. | D. T.S.R. |
27. Continuous water hammer and surges can cause
- |                                |                      |
|--------------------------------|----------------------|
| A. Hydrostatic design stress   | C. Pipe fatigue      |
| B. Hydrostatic pressure vacuum | D. Pipe electrolysis |
28. The term "class" refers to the
- Design tensile strength of pipe
  - Design working pressure of pipe
  - Design process of pipe extrusion
  - Impact strength of pipe
29. The common, or ground, wire is usually
- |          |                                 |
|----------|---------------------------------|
| A. Red   | C. White                        |
| B. Black | D. The wire largest in diameter |
30. Lawn heads are more efficient than rotary heads because
- They are usually less affected by wind
  - You can fit them into odd shaped areas more efficiently
  - All of the above
  - None of the above
31. Shrub heads on risers
- Can be a hazard and should always be placed against a fixed wall or structure
  - Should be on both sides of a flower bed to distribute water evenly
  - Must be made of copper or brass because the riser is above ground
  - None of the above
32. Although it may vary with different brands of controllers, the number of valves that a single station normally operates at one time is
- |        |          |
|--------|----------|
| A. One | C. Three |
| B. Two | D. Four  |

33. Never include rotary heads on the same circuit with sprinkler or spray heads because
- Determining the spacing for good overlap is very difficult
  - The precipitation rates are greatly different
  - The discharge rates are greatly different
  - All of the above
34. The reasonable way to calculate precipitation is
- To know the discharge rate of the heads
  - To know how long the system has been running
  - To know the distribution profile of the heads
  - To know the actual volume of water applied and the actual size of the area to which it was applied
35. Trajectory is important to the irrigator because
- Generally, the higher the throw, the greater the radius
  - The higher the throw, the better the water distribution
  - The higher the throw, the more water evaporation
  - All of the above
36. All conventional circular pattern heads
- Have the same operating pressure range
  - Must be properly overlapped to improve water distribution
  - Have a constant discharge rate regardless of water pressure
  - None of the above
37. Drip irrigation is very suitable to water plants that are spread out over a large area because
- Water can be applied with little loss to evaporation
  - It uses low flow rates and has low pressure losses
  - All of the above
  - None of the above
38. Water penetrates faster through
- Coarse, sandy soil
  - Fine-textured soils like clay
  - The wetting front
  - The root zones of plants
39. The water requirement of a plant, considering the climate and the planting situation, can be defined as
- Wetting front
  - Precipitation rate
  - Evapotranspiration
  - Root zone reservoir capacity
40. Drip irrigation is impractical for use in
- Orange groves
  - Ground cover
  - Turf
  - Hothouses

41. Daily water requirement in gallons for a given plant ca.. be determined by:
- Bernoulli's theorem
  - (Irrigation + rain) - evaporation
  - Potential evapotranspiration rate - evaporation / (irrigation efficiency factor + canopy type)
  - .623 X canopy area X plant type factor X potential
42. The basic reason why drip irrigation is very successful for watering plants is that
- It is suitable for use with dirty water
  - It allows chemical injection pumps to be used for fertilizer distribution
  - Soil moisture content can be kept at a relatively constant and proper level
  - None of the above
43. Drip irrigation is considered very water efficient because of
- Precise water placement and control
  - Less water lost to wind and evaporation and reduced weed growth
  - No saturation since water is applied slowly
  - All of the above
44. If the water level in a water tower is 110 feet above ground level, the static pressure at ground level is
- |                     |             |
|---------------------|-------------|
| A. 254 psi          | C. 47.6 psi |
| B. 110 feet of head | D. 58.2 psi |
45. Two gallons of water weigh
- |               |               |
|---------------|---------------|
| A. 8.34 lbs.  | C. 14.50 lbs. |
| B. 10.45 lbs. | D. 16.68 lbs. |
46. A good sign that the fitting is ready to take solder is
- The fitting will turn a bluish color
  - The fitting is hot to the touch
  - The flux bubbles and pops
  - The solder sticks to the fitting
47. One advantage of a "manual" controller (a valve) is that
- The valve can be installed in locations where no electricity is available
  - The valve will never leak
  - The valve will never freeze
  - None of the above

48. Turning the adjusting screw on a spray head to reduce the radius causes
- A. The nozzle orifice to decrease
  - B. The volume and radius to decrease
  - C. All of the above
  - D. None of the above
49. Gate valves are not recommended for use as manual section valves on a sprinkler system because
- A. They are too expensive
  - B. They cause too much pressure loss
  - C. Under frequent use the seats will wear and leak
  - D. All of the above
50. The flow capacity of a two-inch pipe compared to a one-inch pipe of the same kind of pipe would be
- A. Four times as much
  - B. Six times as much
  - C. Eight times as much
  - D. None of the above

### SECTION 3

True-False: 50 questions covering Backflow Prevention Devices, Rules, Act and Laws.

DO NOT WRITE OR MARK ON THIS TEST MATERIAL  
USE THE MACHINE SCORED ANSWER SHEET PROVIDED

Use a soft, #2 black lead pencil to indicate your answer on the Scantron sheet. Do not write your name on the answer sheet - Use your Examination Number assigned to you at the time you signed in for the test.

On True or False questions, use the "A" block for True and the "B" block for False. If you make a mistake or wish to change a response erase completely and blacken in your new answer carefully. Incomplete erasures or two responses for the same question will be graded as wrong.

Be sure you are recording your answers on the properly numbered blocks. Check at the end of every page (more often is recommended, to be sure that you are answering the questions in the proper column and beside the corresponding item number.

**REMEMBER:** If you are off by only one number, you may be placing what you know to be a correct answer in an out of sequence location and be marked down as a result. The grading machine cannot tell that you put the "right" answers in the "wrong" spaces.

When finished with item 50, check to see that you have not skipped any items.

1. Pressure type vacuum breakers and atmospheric vacuum breakers will operate satisfactorily under backpressure conditions.
2. A pressure type vacuum breaker generally has check valves which are spring loaded to insure correct operation.
3. Cross connection is defined as any point in a plumbing system where potable water supply may come in contact with a potential source of contamination.
4. The surest means for preventing contamination is the air gap.
5. A garden hose may allow the back syphoning of material from the end of the hose if the bibb is open.
6. An irrigator may legally simultaneously connect an irrigation system to both the domestic water supply and a lake.
7. Four types of backflow preventers are: atmospheric vacuum breakers, pressure type vacuum breakers, double checks, and reduced pressure principle devices.
8. Toxic substances include any liquid, solid or gas that may cause a danger to health and well being.
9. Back pressure is the reversal of normal flow in the system due to increased downstream pressure.
10. A vacuum breaker is in effect a mechanical means of introducing air into a system.
11. Pressure regulators will not freeze even if the unit contains water.
12. Depending on local codes, atmospheric vacuum breakers can be used on lawn sprinkler systems.
13. Atmospheric vacuum breakers are also known as anti-syphons.
14. An example of back-siphonage is drinking a liquid through a straw.
15. An atmospheric vacuum breaker may be used as protection against cross connection when the vacuum breaker is subjected to back pressure.
16. Reduced pressure back flow preventers are usually used where there is no high hazard from substances that are hazards to health.
17. The actual or potential connection between a potable water system and any other source or system through which it is possible to introduce into the potable system any hazardous substance other than the intended potable water is called cross connection.

18. Basic differences between atmospheric vacuum breakers and pressure type vacuum type breakers is that the pressure type vacuum is designed to operate under constant pressure for long periods of time without becoming inoperative.
19. Toxic substances are those which may create a moderate hazard, nuisance, or aesthetically objectionable appearance.
20. Back-siphonage is a reversal of normal flow caused by a negative pressure.
21. In areas where occasional freezing occurs it is necessary to provide proper drainage only on the discharge leg of vacuum breakers.
22. It would be advisable to mount a vacuum breaker in an area where it is not likely to be damaged by people or equipment.
23. All anti-syphon devices and vacuum breakers have built-in screens around the air gap to prevent the intrusion of grass, vines and other plant material.
24. A double gate check valve assembly is designed so it may be installed below ground level.
25. The double gate check valve is so manufactured that it can be installed with water flowing either direction.
26. In double gate check valve assemblies, check valves are usually spring loaded.
27. The reason for having two check valves in double gate check assemblies is to allow water to flow in either direction depending on which end of the system is connected to the supply line.
28. Most cities and municipalities have a local code requirement covering installation.
29. If there is no local code requirement, landscape irrigators are under no obligation to install any type of backflow device.
30. There exists some type of conventional backflow and cross connection practice to protect the domestic water supply, which will prevail in the absence of local code.
31. Local codes enforcement practices in effect across the state may give the irrigation contractor a choice as to the type of unit which will be installed.
32. The State of Texas has uniform irrigation codes covering installation of irrigation systems.
33. Violations of the TBI Permanent Rules can jeopardize an irrigator's license.



34. An irrigation system does not really make a cross connection.
35. An irrigation system that has a fertilizer injector may be more likely to contaminate the potable water than a system without a fertilizer injector.
36. Material caught in the valves may cause leaking double check assemblies.
37. Cross connection refers to any point in a system where potable water can come into contact with contamination.
38. The basic function of an atmospheric vacuum breaker is to seal off flow using a spring loaded valve.
39. The atmospheric vacuum breaker should not be subjected to constant pressure.
40. The basic function of atmospheric vacuum breakers is to introduce air into the lines when back siphonage occurs.
41. Backflow prevention devices should be installed according to your own judgement.
42. Backflow is the flow of water or other materials into the pipes containing potable water from any source.
43. A vacuum breaker should be installed 6 to 12 inches higher than the highest head, depending on manufacturer's recommendations.
44. Water that is an actual hazard to the public health is said to be contaminated.
45. A booster pump which has been designed without back flow prevention devices can cause back flow.
46. A broken sprinkler head may cause back siphonage.
47. Booster pumps operate at the same efficiency regardless of input pressure.
48. In normal operation, the pressure in the zone between the two check valves of a reduced pressure backflow preventer is lower than the supply pressure.
49. Atmospheric vacuum breakers provide protection against back pressure.
50. Hose bibb vacuum breakers should be used to prevent contamination through a garden hose.

YOUR EXAMINATION NUMBER \_\_\_\_\_

SECTION 4

Design Hydraulics - Five problems dealing with sizing of pipe and other system components to maintain specified water velocity; Pressure loss calculations for designated zones or sections of the sprinkler field; and the accurate use of charts, graphs and tables customarily used in the irrigation industry. Skillful and accurate use of applicable formulas and a hand held calculator will be required to complete this section

Use the information given for each of the problems in this section AND the appropriate charts, tables and graphs provided for your use.

**READ CAREFULLY AND CHECK YOUR WORK**

**ALL ANSWERS ARE TO BE WRITTEN ON THESE PAGES. THERE IS NO SEPARATE ANSWER SHEET**

DRAWING #1

Legend:

● - Full 4.0 GPM

○ - Half 2.0 GPM

32 PSI Static

Scale 1" = 20 Feet

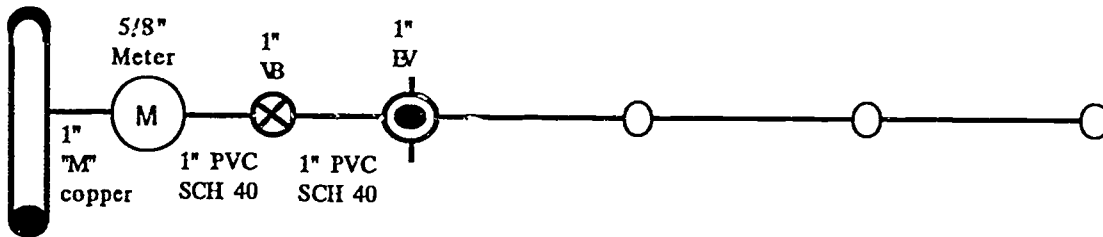

USING THE CHARTS AND TABLES PROVIDED, YOU ARE TO:

1. Size the pipe
2. Calculate the pressure loss through the system

Use SDR 13 on Supply Lines  
Use SDR 21 on Section Pipe

DRAWING #2

Legend:

● - FULL 5.0 GPM

○ - HALF 3.0 GPM

55 PSI Static

Scale 1" = 20 Feet

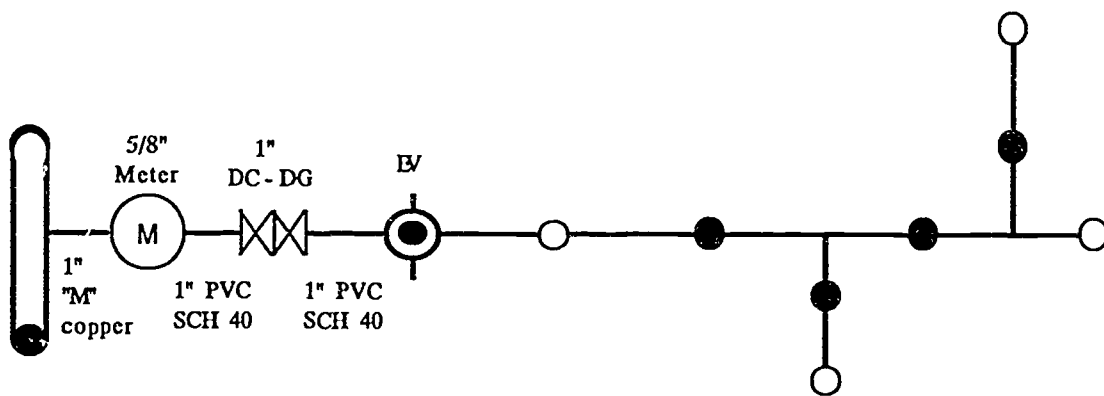

USING THE CHARTS AND TABLES PROVIDED, YOU ARE TO:

1. Size the pipe
2. Calculate the pressure loss through the system

Use SDR 13.5 on Supply Lines  
Use SDR 21 on Section Pipe

DRAWING #3

Legend:

- - FULL 4.0 GPM
- - HALF 3.0 GPM

75 PSI Static  
Scale 1" = 20 Feet

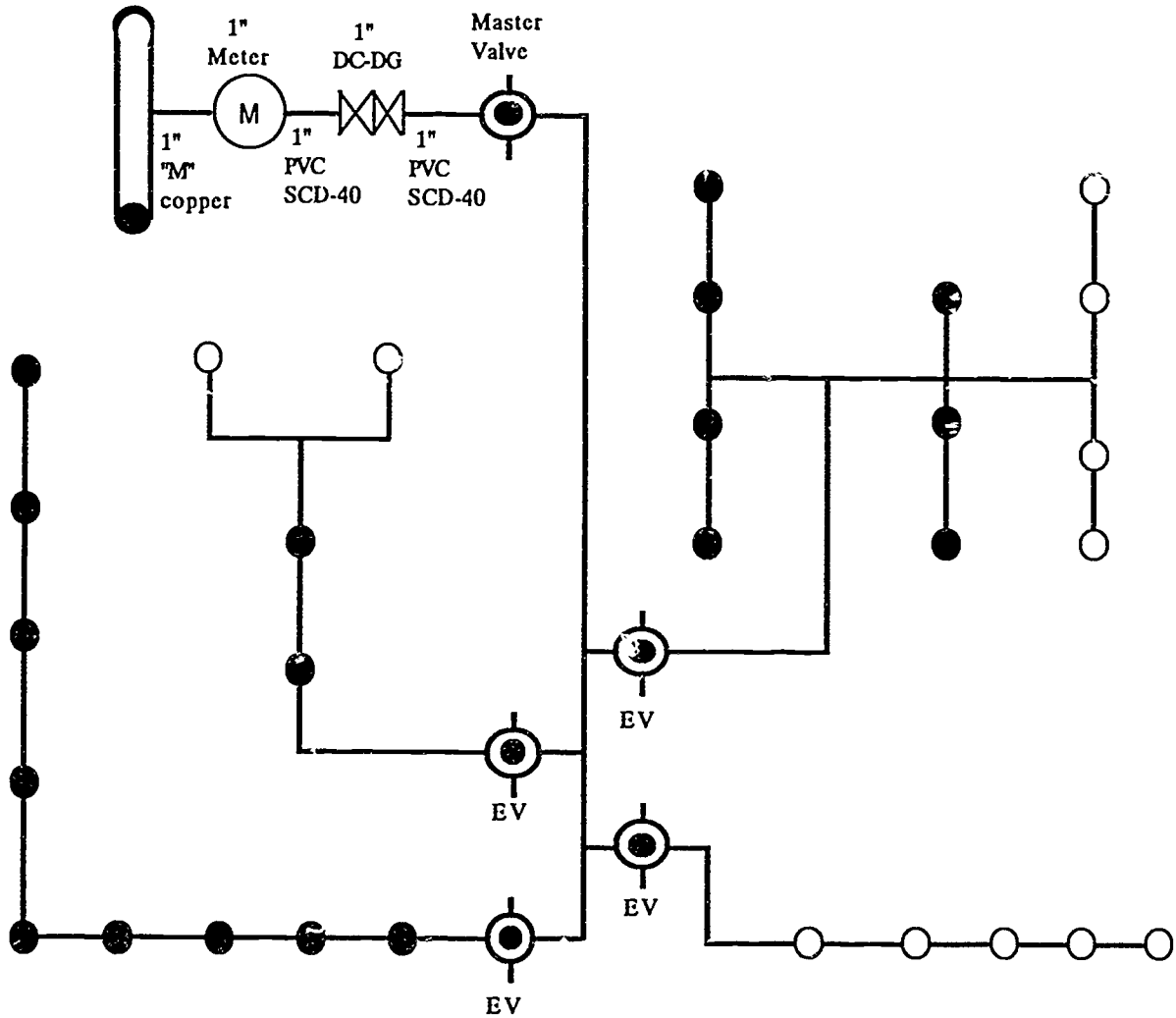

USING THE CHARTS AND TABLES PROVIDED, YOU ARE TO:

1. Size the pipe and other components in the system
2. Calculate the pressure at the farthest head

Use SDR 13.5 on Supply Lines  
Use SDR 21 on Section Pipe

DRAWING #4

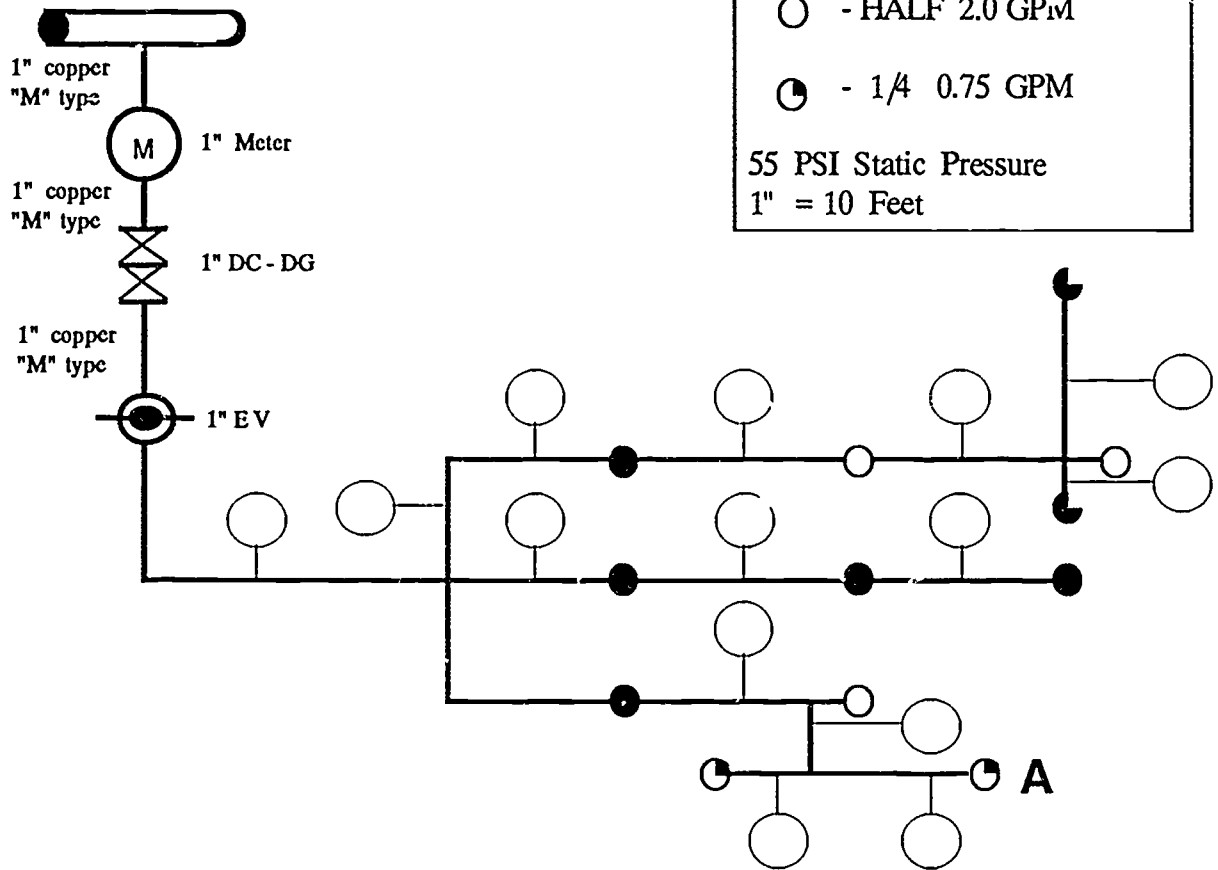

Legend:

- - FULL 4.0 GPM
- ◐ - 3/4 3.0 GPM
- - HALF 2.0 GPM
- ◑ - 1/4 0.75 GPM

55 PSI Static Pressure  
1" = 10 Feet

Use SDR 13.5 on supply line.  
Use SDR 21 on section piping.  
Minimum operating pressure is 22 PSI.

USING THE CHARTS AND TABLES PROVIDED, YOU ARE TO:

1. Size all pipe
2. Show sizes in the circled spaces provided

SAMPLE WORKING COPY FOR PRACTICE USE IN CLASS

DESIGN HYDRAULICS - HEAD "A"	SIZE	LENGTH	G.P.M.	LOSS/100	ACTUAL LOSS
SECTION PIPING					
SECTION PIPING					
SECTION PIPING					
SECTION PIPING					
SECTION PIPING					
SECTION PIPING					
SECTION PIPING					
SECTION VALVE					
MAIN LINE PIPING					
DC-DG (Backflow)					
COPPER LINE					
WATER METER					
TOTAL PRESSURE LOSS					

DESIGN HYDRAULICS - HEAD "B"	SIZE	LENGTH	G.P.M.	LOSS/100	ACTUAL LOSS
SECTION PIPING					
SECTION PIPING					
SECTION PIPING					
SECTION PIPING					
SECTION PIPING					
SECTION VALVE					
MAIN LINE PIPING					
DC-DG (Backflow)					
COPPER LINE					
WATER METER					
TOTAL PRESSURE LOSS					

Legend:

- - FULL 4.0 GPM
- ◐ - 3/4 3.0 GPM
- - HALF 2.0 GPM
- ◑ - 1/4 0.75 GPM

75 PSI Static Pressure  
1" = 10 Feet

DRAWING #5

Use SDR 13.5 on supply line.  
Use SDR 21 on section piping.  
Minimum operating pressure is 22 PSI.

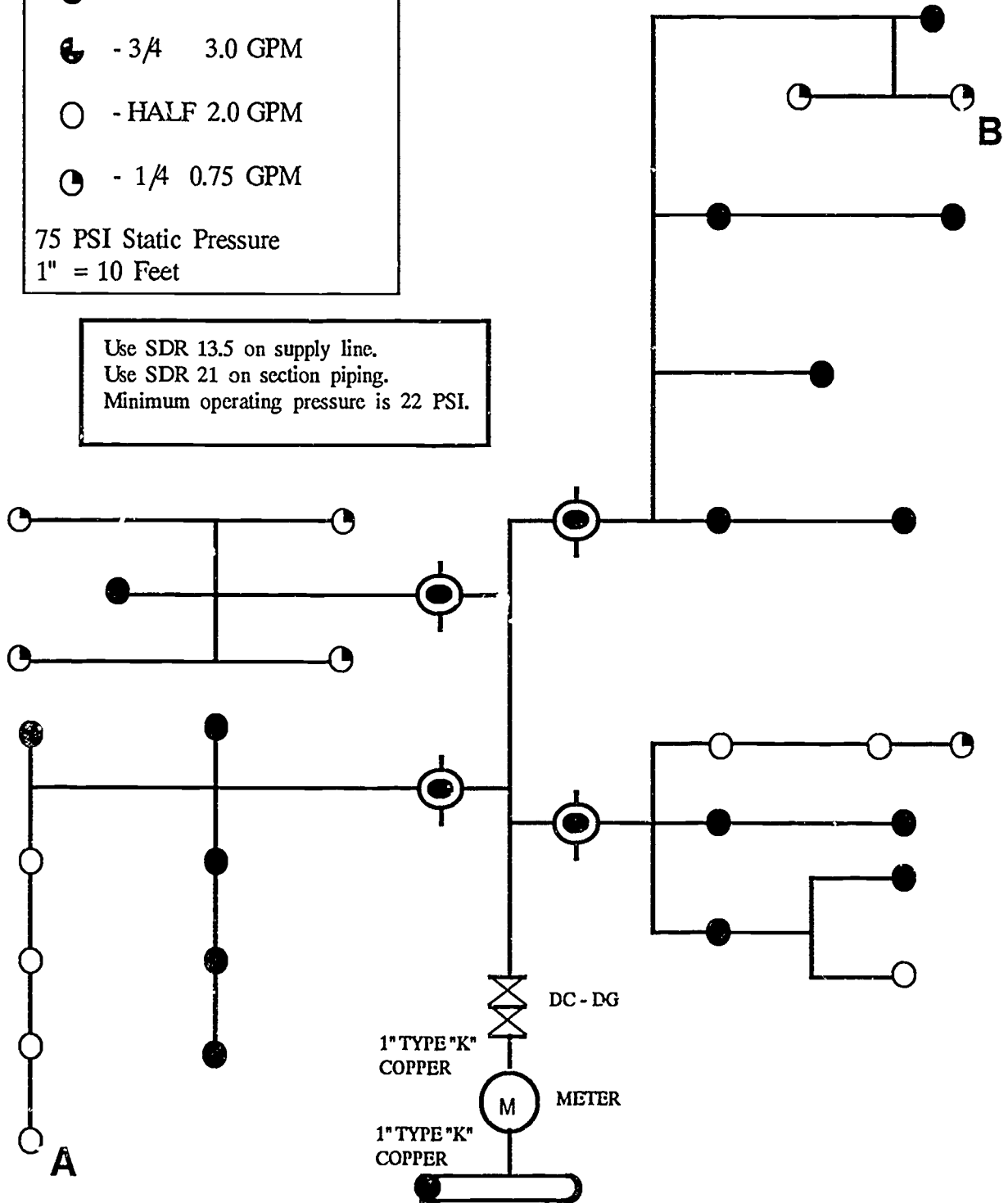

USING THE CHARTS AND TABLES PROVIDED, YOU ARE TO:

1. Size all pipe and components
2. Show all calculations on the worksheet provided for Section "A" and Section "B"



## Design Drawing - Final Examination      Part A

Using the drawing of the residence provided, calculate the actual pressure loss from the water meter to the largest section and for the farthest section. If the largest section is also the farthest section, select another and show calculations for it. You must show calculations for two sections. The design must be efficient and economical. Do not exceed maximum spacing and do not place heads too close together. Make no extra allowances for wind conditions or humidity. Do not calculate pressure loss in fittings. Static water pressure is 65 PSI.

Use only the specified heads. Use class 200 PVC pressure loss tables for all pipe except 1/2" which is 315. Round all answers to 1/10 pound. Scale is 1" = 10'. Label section valves with GPM flow. Example: Valve "A" = 26 GPM.

Do not throw water on the house, street or driveway. You may throw water across the sidewalk and on the air conditioner. Throw minimal water on the patio and on the wooden fence. If you size all pipe for water velocities of less than 5 fps, you may use a pressure loss factor of 5 PSI for each section.

Scoring:	Possible	Earned
Head Layout	20	_____
Logic of Sectioning	15	_____
Logic of Piping	10	_____
Appearance	10	_____
Calculations	15	_____
Sizing of components	10	_____

### PRESSURE LOSS CALCULATIONS FOR THE DESIGN PROBLEM DO THE FARTHEST SECTION AND THEN, THE LARGEST SECTION

ITEMS OF PRESSURE LOSS <sup>s</sup>	FARTHEST	LARGEST
SERVICE LINE	:	:
WATERMETER	:	:
BACKFLOW DEVICE	:	:
MAIN LINE PLUMBING	:	:
SECTION VALVE	:	:
SECTION PIPING	:	:
TOTAL LOSS	:	:

MINIMUM SPRINKLER OPERATING PRESSURE \_\_\_\_\_  
THIS SHOULD BE THE MFG'S SPEC

DESIGN PRESSURE \_\_\_\_\_  
THIS SHOULD BE THE MFG'S SPEC PLUS THE PSI LOSSES

ACTUAL SPRINKLER HEAD OPERATING PRESSURE \_\_\_\_\_  
SHOULD BE THE STATIC PRESSURE MINUS THE PSI LOSSES

NUMBER OF SECTIONS \_\_\_\_\_

NUMBER OF GRASS HEADS \_\_\_\_\_

NUMBER OF SHRUB HEADS \_\_\_\_\_

APPROXIMATE COST \_\_\_\_\_

### Part B

Draw a figure on the reverse side of your design problem (Part A) which is described as follows:

A north property line of 45 feet,  
An east property line of 73 feet,  
A south property line of 83 feet.

Connect the ends of the north and south lines to complete the figure. Calculate the total square footage in the area. Show your work and all calculations on the back side of your plot plan drawing.

### Scoring:

Correctness of drawing	10	_____
Calculations	10	_____

IRRIGATION DESIGN DRAWING EVALUATION

ID# \_\_\_\_\_

1. Layout (20 points possible)

Evidence of Triangulation in head layout? \_\_\_\_\_  
Maximum row spacing not exceeded on triangulation \_\_\_\_\_  
Maximum head spacing not exceeded on triangulation \_\_\_\_\_

Efficient total coverage (No Dry Spots) \_\_\_\_\_  
Logic of piping, fittings, component layout \_\_\_\_\_  
No Water Thrown on "NO WATER AREAS" \_\_\_\_\_

Proper symbols used & drawn with templates, instruments \_\_\_\_\_

- Lawn Heads ( )
- Shrub Heads ( )
- Backflow Device ( )
- Electric Valves ( )
- Flow for each valve noted ( )
- Main Line ( )
- Section Line ( )
- Fittings ( )
- Non-Intersections ( )
- Arcs of Coverage Shown ( )

Proper labeling and sizing of components:

- Meter sized ( )
- Backflow Device Sized ( )
- Main Supply Line sized ( )
- Two Section Lines sized ( )
- Overall neatness and appearance ( )

HEAD LAYOUT	20	_____
CALCULATION	15	_____
SIZING	10	_____
LOGIC	15	_____
PIPING	10	_____
APPEARANCE	10	_____

Suggestions to the Examinees for future designs : \_\_\_\_\_

-----  
-----

Note to the Instructor: Have the class break into groups of 3 or 4 and "grade" the exam drawings. BE SURE THAT NO NAMES ARE ON THE DRAWINGS - ONLY EXAM NUMBERS. It is suggested that YOU do a drawing which can be used as a "sacrificial goat" to show the class what is correct and what to mark down on prior to giving them the opportunity to evaluate the work of others.



# Final Design Drawing

M 3/4" WATER METER 1 1/4" SERVICE  
LINE 65 PSI

NOTE: BACKYARD IS FENCED IN

10'x15'  
GARDEN  
PLOT

PATIO

HOUSE

AD

DRIVEWAY

SIDEWALK

SIDEWALK

GRASS

GRASS

GRASS

SIDEWALK

GRASS

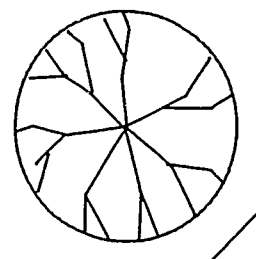
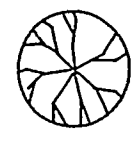
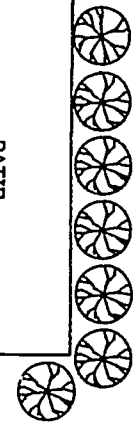
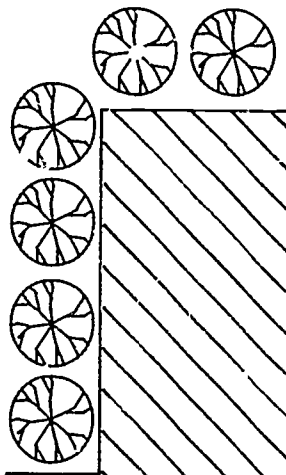
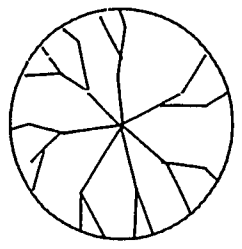
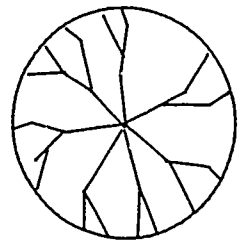

## Drawing Exercises

Through the use of a series of progressively more complex drawing exercises, the student will be taught the principles and practice of irrigation system design.

Design drawings, prepared at a scale of 1"= 10' which is common in the industry, are included in the Instructor's teaching materials. There are both un-dimensioned student work sheets as well as complete, dimensioned, zoned, and annotated teacher's copies of the same designs. Additional sample drawings are included from a variety of sources to be used as examples of various design approaches used by professional irrigators.

Proper drawing techniques, accurate symbol use and placement, neatness and professional appearance of drawings, and the proper use of required tables, charts and graphs will be stressed.

This activity is conducted as "open book" in nature. Any questions, assistance, or time required to do the complete drawing will be permitted (within reason). Following the completion of the exercise, the students will participate in a critique of their work to gain immediate feedback.

**Drawing Exercise #1** Using the Conventional Irrigation design (the G. Giese residence - 55 heads) the class will practice triangulation, sectioning and general drawing, instrument familiarization and use. At the end of the period the student will be able to correctly calculate head spacing, determine triangulation positioning, calculate altitude for subsequent rows of heads, size, select and properly place fill-in heads and approximate sections or zones given the operating characteristics of the nozzles specified and the limits and pressures of the water supply.

**Drawing Exercise #2** Using the sectioned property plan from Drawing #1, the student will size the pipe, BFPD, manual or electric valves and calculate the pressure losses in the system. Students will understand and use properly the terms: Minimum operating pressure, Manufacturers design specifications, Design Pressure, Pressure loss (in pipe, valves, meters, Backflow devices, fittings, filters, etc), Loss per 100', Total pressure Loss.

### Drawing Exercises (Cont.)

Using this knowledge, the student will be able to design, adjust, balance and predict the operating characteristics of the system in question. Care will be exercised in neatly, accurately and consistently measuring, recording and calculating the necessary factors required for a comprehensive system design.

**Drawing Exercise #3** The final phase will deal with routing the wiring for the low voltage clock/controller, completing a parts take-off and estimating costs for the system components, labor, and miscellaneous expenses.

**Drawing Exercise #4** Using a different plot plan which is somewhat similar to the first, but, with sufficient changes in features to present a challenge to the student, a comprehensive drawing will be undertaken which encompasses all elements of the first three exercises. The student will triangulate, section, size components and pipe, calculate pressure losses, use proper symbols, charts, tables and recording procedures.

**Final Drawing Exercise #5** A "mock drafting examination" under conditions which closely approximate the actual conditions in Austin will be given. There will be restrictions on talking, leaving the room, etc., and the drawing problem will be completely new to the students.

While the time permitted in Austin will be somewhat flexible for those who elect to begin the examination with the design portion, our examination drawing #5 will be limited to five hours so as to subject the student to the necessity to pace themselves during the test. Following the completion of the exercise, the students will participate in a critique of their work to gain immediate feedback.

## Design Drawings - Notes to the Instructor

There are five (5) design drawings to be used with the Irrigation Curriculum

Drawing Exercises 1 - 3 use the same basic plan, a small house with a front driveway and a meter location at the southwest corner of the lot. This drawing is furnished with Inked, tracing paper masters for reproduction by your school or a blueprint firm using a BlueRay (Ozalid, ammonia developed process) or an electrostatic copier. The actual drawing is drawn at 1" = 10' scale and will fit on a 8.5" x 14" - legal size sheet of paper without reduction. This same drawing is used for the first three labs for the purposes listed. To aid you in the head placement phase, we have included a conventional piping layout which has 55 sprayheads AND a second drawing which uses "RainJet, LOW TRAUMA installation techniques" for the same property. While it is understood that each designer may use slightly different heads, and patterns of placement, this suggested design will give a basis for comparison. The conventional TRIANGULATED SPRAYHEAD LAYOUT is the method which must be used on the current state examination.

There are other drawings which can be used for Exercise #4. It consists of doing a complete design all in one sitting, rather than over several sessions as in designs 1 - 3. The drawing sample included in these materials is slightly different - however, it is larger than a legal sized piece of paper and must be either reduced to fit (which makes the scale be "off") or copied with a process that will produce a "right sized" final drawing.

The Final Drawing #5 is the simulated State Examination. It too must be reproduced on a larger than standard sized paper. The accompanying Instructions and background materials are to be reproduced and given to the student to record answers on. The sample included is all on one sheet which is the way the State Exam is given, You probably will want to reproduce the Instructions on regular handouts sheets and do the drawing on another sheet.

NOTE: The student will have to have access to the Charts and Tables provided with the flow charts and head sizes allowable for use on the design test and the Hydraulics test (Section 4). Not all materials is specified on either the Design test or the Charts and Tables - they must have both. (This is the way it is done on the "Real Test" and the student will have to learn to read carefully to find the information needed to do the problems.) A Rule of Thumb - If it is not in the Instructions, Read the Charts and Tables. If it is not there, re-read the Instructions. If it is not there either - ASK THE TEST PROCTOR.... do not assume anything and do not make up any values or use charts and tables not provided for you.

The G. Giese Residence  
Drawings 1, 2, & 3

Conventional  
Triangulated Pattern

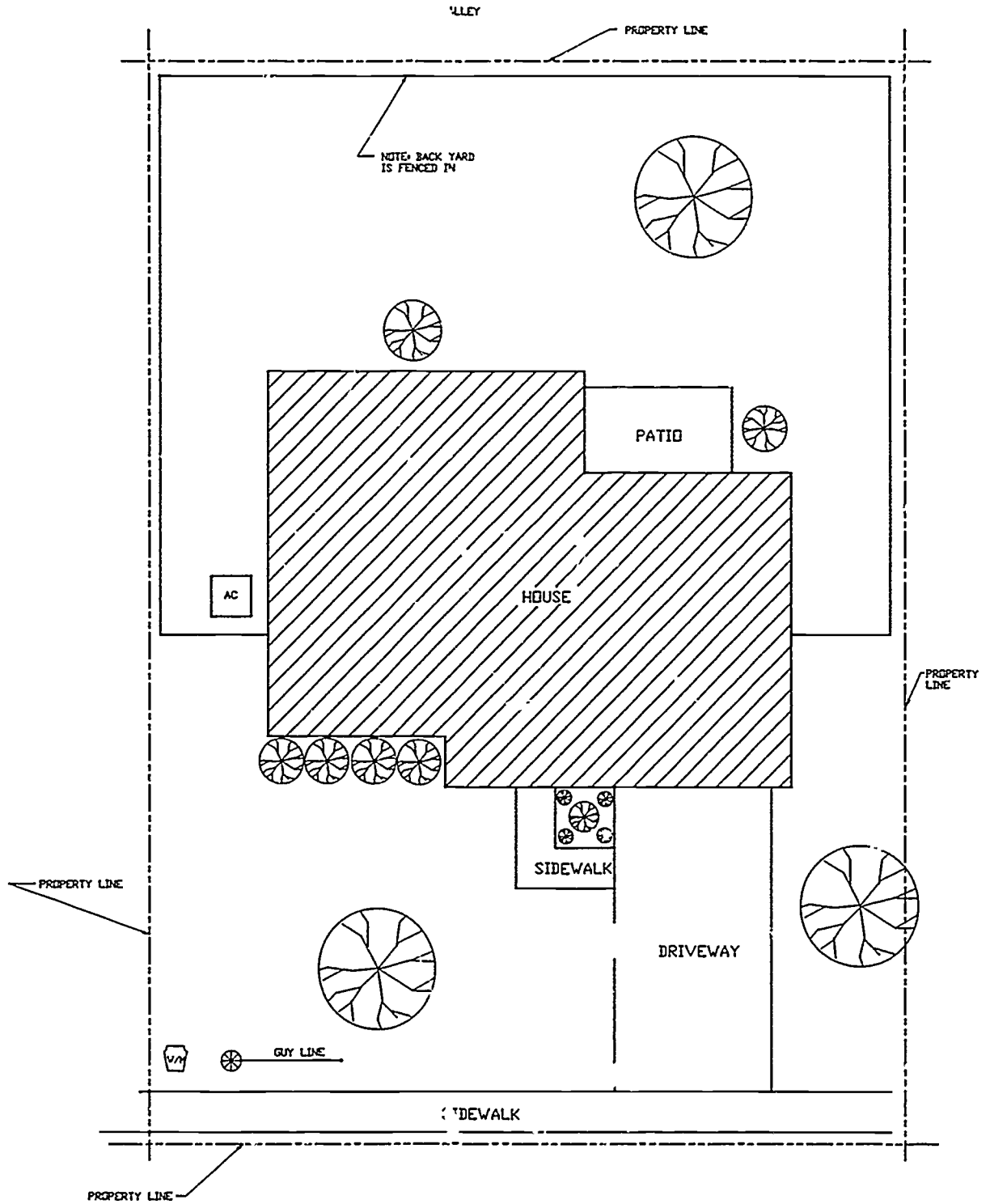



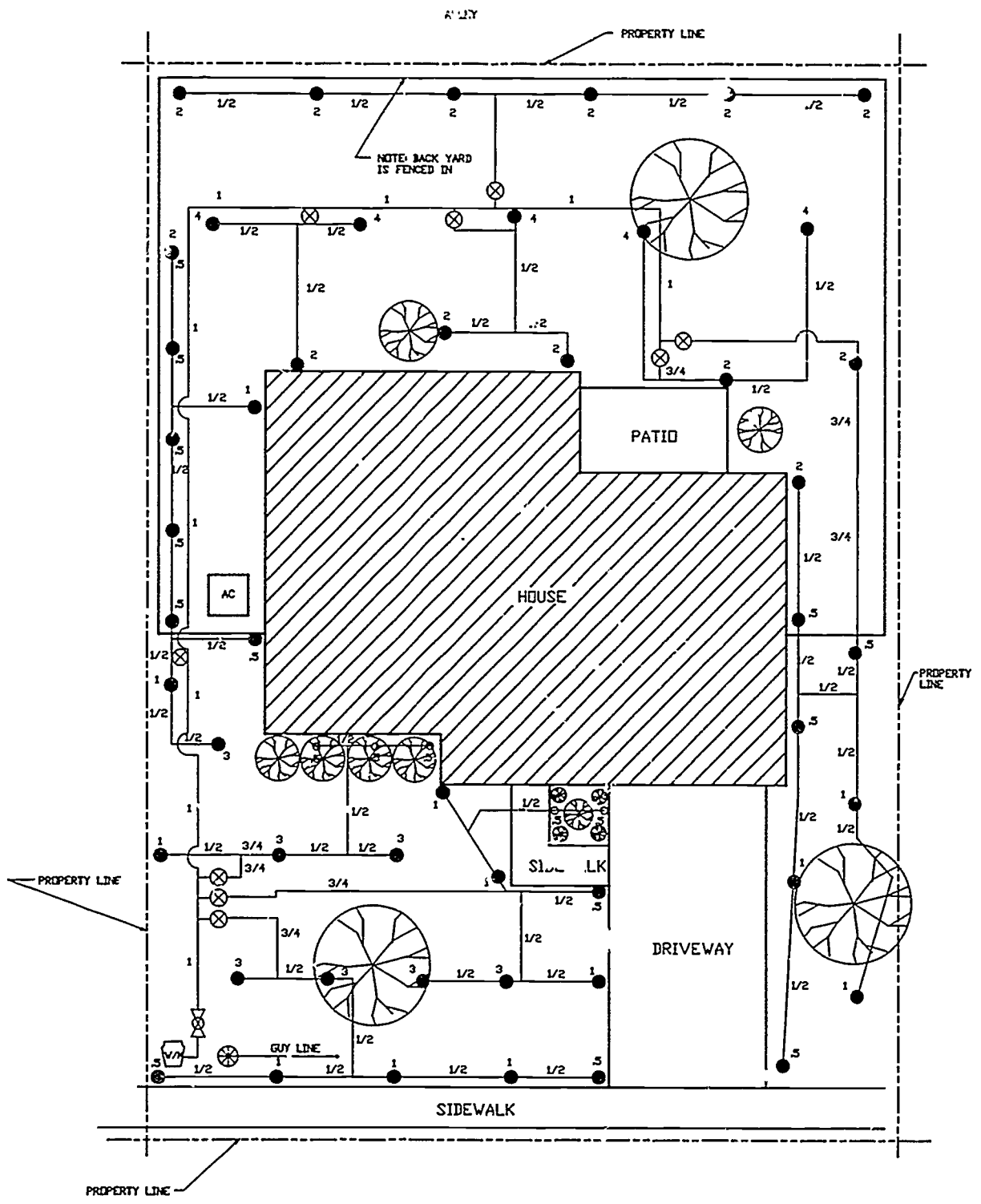

5/8" WATER METER 65 PSI STATIC WATER PRESSURE

CONVENTIONAL SPRAY SYSTEM  
55 LAWN AND SHRUB HEADS

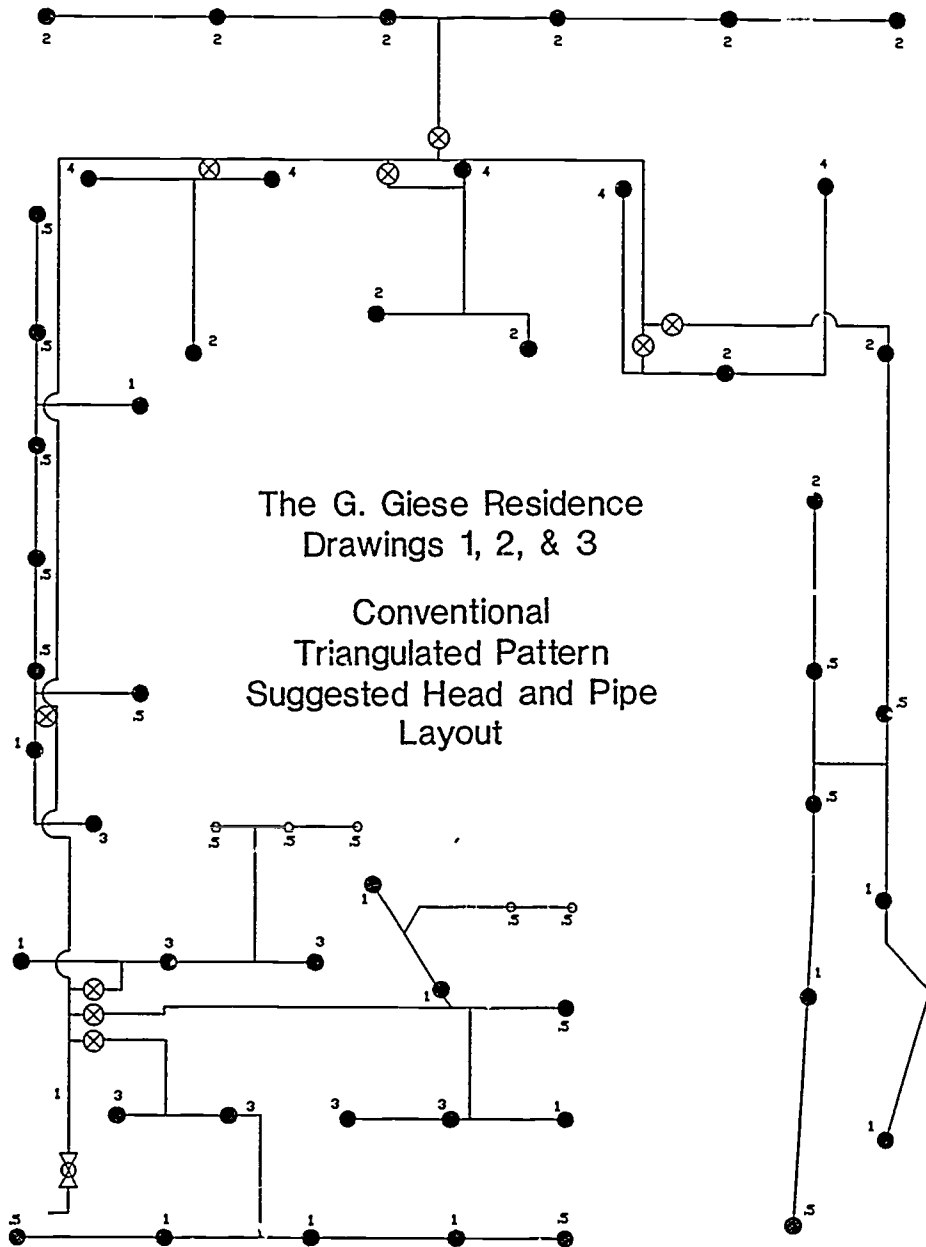

The G. Giese Residence  
Drawings 1, 2, & 3

Conventional  
Triangulated Pattern  
Suggested Head and Pipe  
Layout

5/8" WATER METER 65 PSI STATIC WATER PRESSURE

CONVENTIONAL SPRAY SYSTEM  
55 LAWN AND SHRUB HEADS

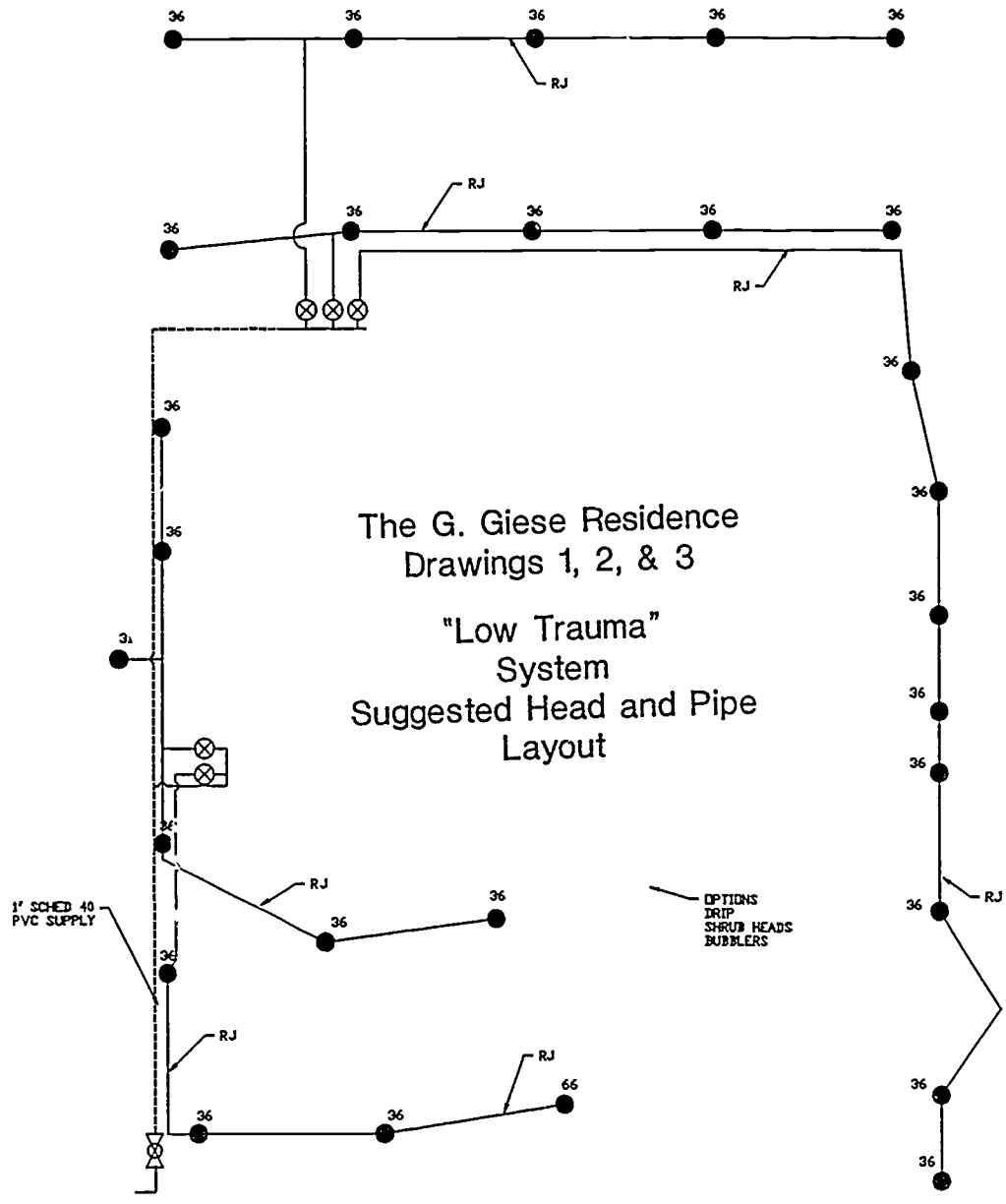

The G. Giese Residence  
Drawings 1, 2, & 3

"Low Trauma"  
System  
Suggested Head and Pipe  
Layout

5/8" WATER METER 65 PSI STATIC WATER PRESSURE

RADJET SYSTEM  
29 LAVN HEADS

# DESIGN COMPARISON BY PRICE

## CONVENTIONAL SYSTEM

Qty	Description	Unit Price	Total
50	3" pop-up spray head	\$ 3.00	\$150.00
5	Shrub spray head	1.25	6.25
55	1/2" cut-off riser	.35	19.25
9	3/4" valve	16.90	152.10
3	24" shrub riser	1.75	5.25
2	12" shrub riser	.95	1.90
1	10-station timer	160.00	160.00
9	3/4" nipple	.69	6.21
9	Auto drain valve	1.99	17.91
160'	1" Sch40 PVC	.34/ft	54.40
150'	3/4" PVC-200	.14/ft	21.00
560'	1/2" PVC-315	.11/ft	61.60
1	1" Febco DCV	130.00	130.00
2	Med. valve box	18.00	36.00
6	Single valve box	5.50	33.00
	18ga. wire	26.50	26.50
	PVC fittings	48.18	48.18
	Valves & connections	9.98	9.98

## "LOW TRAUMA" SYSTEM

Qty	Description	Unit Price	Total
4	EHD-822 RJ Pipe	\$ 18.50	\$ 74.00
27	8836 Sm. Square	9.49	256.23
1	8866 Lg. Square	11.99	11.99
1	8831 Qtr. Circle	8.49	8.49
29	9NR850 Riser Nipple	.49	14.21
9	9L50 Riser Ell	1.89	17.01
25	9T50 Riser Tee	2.39	59.75
5	PDV-50 Auto Drain	1.99	9.95
4	9T90 RJ Tee	2.79	11.16
1	RJC-6 Controller	79.95	79.95
5	RJV-75 3/4" Valve	16.90	84.50
5	9NR4150 3/4" Nipple	.69	3.45
1	7023W 1/2" Wrench	2.99	2.99
100'	1" Sch40 PVC	.34/ft	34.00
1	1" Febco DCV	130.00	130.00
3	Med. Valve Box	18.00	54.00
150'	18/7 18ga. wire	19.50	19.50
	PVC fittings	4.80	4.80
	Valves & Connections	10.00	10.00
	Drip for flower beds	40.00	40.00

	CONVENTIONAL	*LOW TRAUMA*
Total Cost of Parts	\$ 939.53	\$ 925.98
Estimated Cost of System (installed by contractor)	\$1840.00	\$1740.00

#### System Efficiency

Amount of Trench Required	800 ft.	400 ft.
Number of Glue Connections (approximately)	354	25
Total Number of Connections (approximately)	354	111
Drip Irrigation	May not be compatible	Completely compatible
Number of Sprinkler Heads To Level and Adjust	55	29
Overlap of Spray Patterns	Over 100%	< 5%
Water Distribution	Very Uneven	Very Even
Wind Resistance	Poor	Very Good
Evaporation Resistance	Fair	Very Good
Freeze Resistance	Safe if buried below frostline or if autodrains work perfectly	Safe Regardless

# Sample Drawing #4

Drawing Exercise #4 Using a different plot plan which is somewhat similar to the first, but, with sufficient changes in features to present a challenge to the student, a comprehensive drawing will be undertaken which encompasses all elements of the first three exercises. The student will triangulate, section, size components and pipe, calculate pressure losses, use proper symbols, charts, tables and recording procedures.

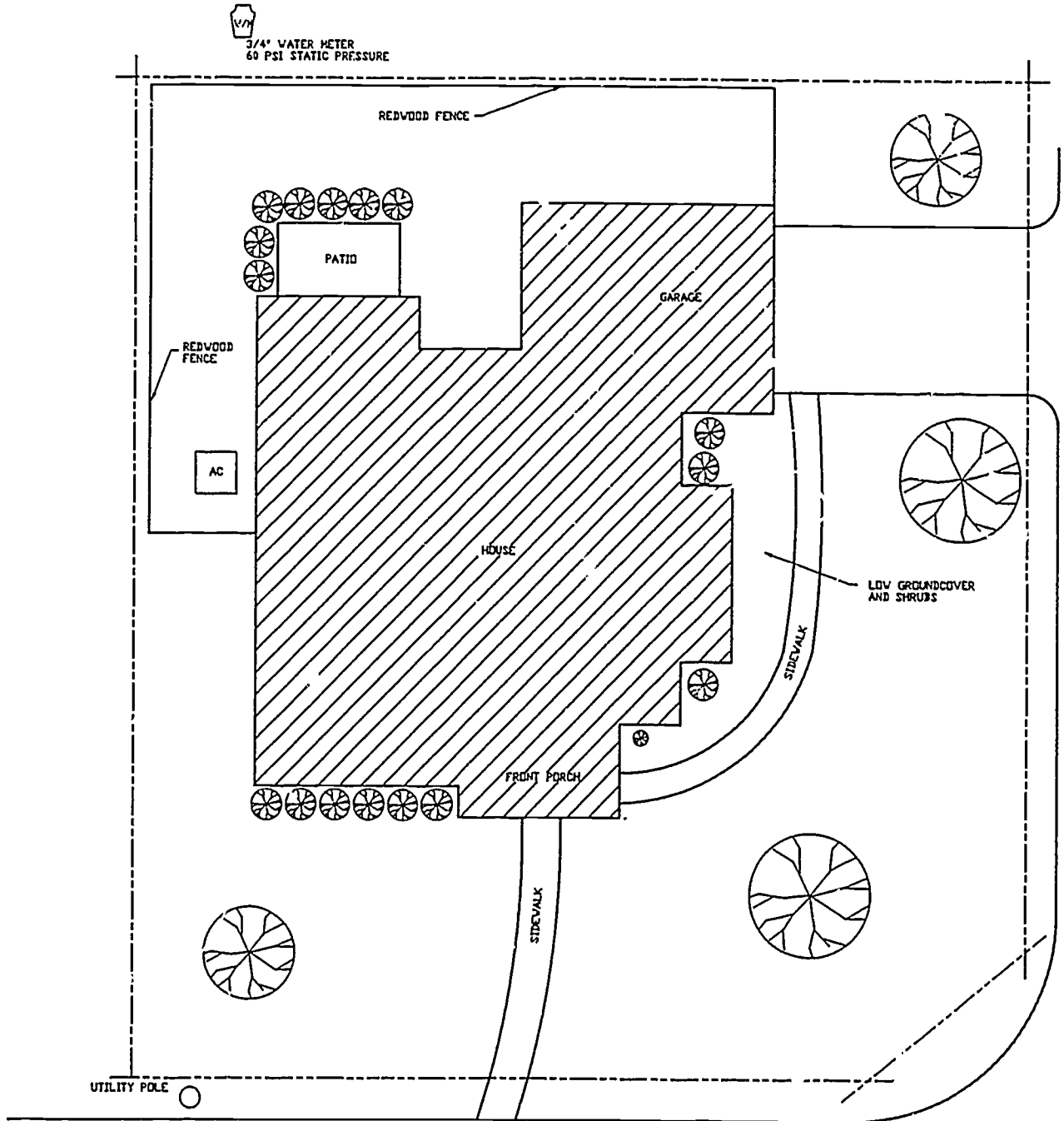

# Sample Drawing #5

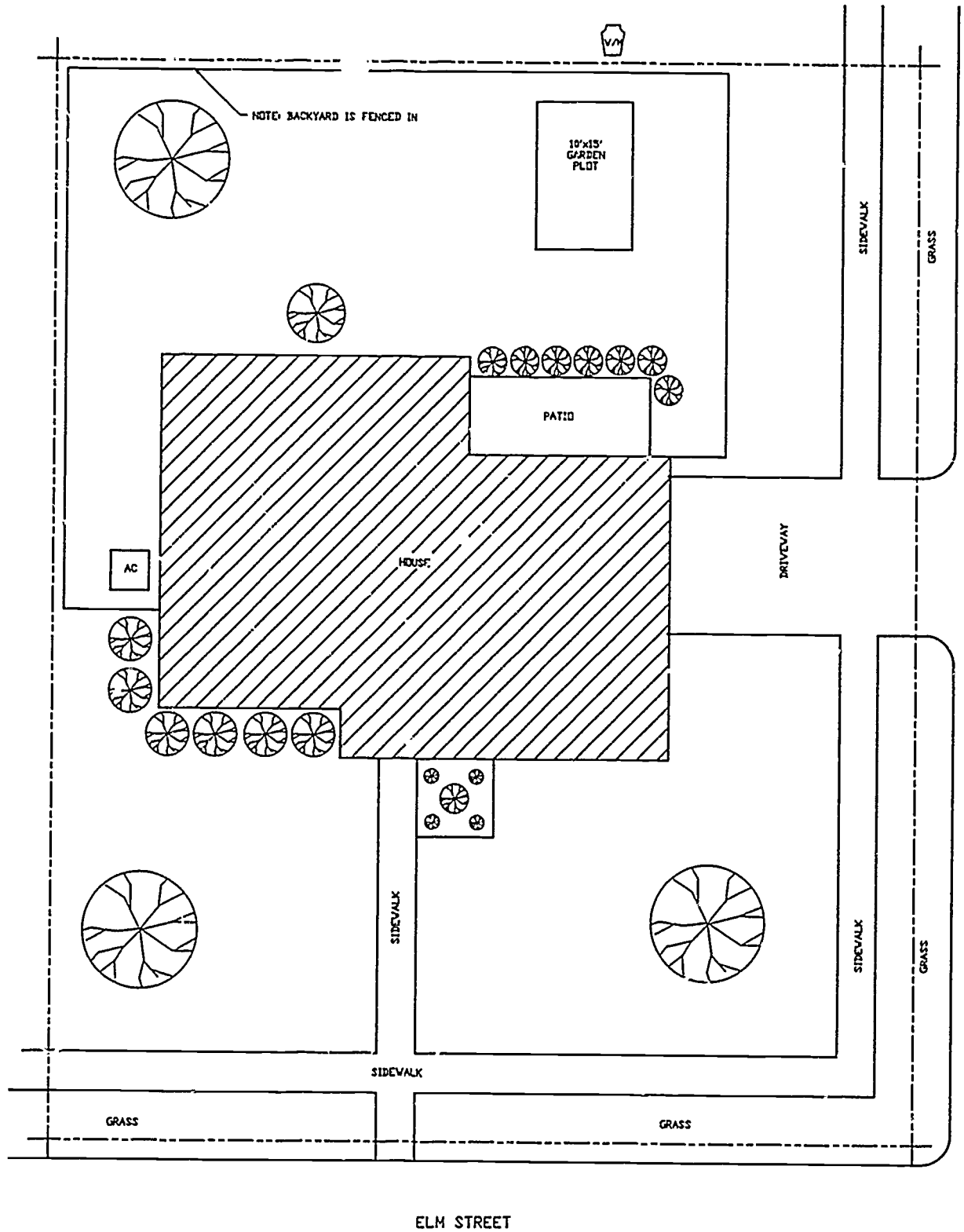

PLEASE POST, SHARE WITH FRIENDS, WORK ASSOCIATES, CUSTOMERS, ETC.

AMARILLO COLLEGE  
CONTINUING EDUCATION PROGRAMS  
and the  
TEXAS HIGHER EDUCATION COORDINATING BOARD

A N N O U N C E

IRRIGATION SYSTEMS: DESIGN AND INSTALLATION

---

Irrigation Systems: Design and Installation I.D.2408 1124-299  
60 Clock Hours (6.0 CEU) 10 Weeks  
Beginning: December 5, 1987 Ending: February 20, 1988  
Meets: Saturday 8:00AM-2:00PM Cost: \$68.00  
Location: Hallmark Builders, 8222 "A" Canyon Drive

---

**COURSE DESCRIPTION:** To prepare individuals for careers in Commercial and residential irrigation. Persons successfully completing the course will be prepared to sit for the State licensure examination of the Texas Board of Irrigators. (Licensed Irrigators Act, Article 8751, V.T.C.S. as amended by S.B. 249)

Instructor for the course is Mr. Autie McVicker (Texas Licensed Irrigator #3039)

**TARGET POPULATION:** Persons with some practical experience in the irrigation industry. Employees of public or private grounds maintenance departments, nurseries, landscape design and installation companies.

**COURSE OBJECTIVES:** A comprehensive study of applicable codes, laws, regulations, terminology, components, installation methods, design principles, hydraulics, control systems, and related information necessary for licensure and successful practice. Classroom instruction, laboratory exercises and practical field experiences leading to employment as an agricultural, commercial or residential irrigation specialist. Career opportunities include the sale, installation, repair and design of sprinkler and irrigation systems.

**REGISTRATION:** Registration for these courses may be accomplished by coming to the Registrar's Office in the Administration Building on the Washington Street Campus, or to the Administration Building at the West Campus (6222 W.9th), or you may register by mail by completing the Enrollment Coupon below and mailing it, along with your check to Amarillo College, Adult Vocational Education, Box 447, Amarillo, TX 79178. Please make your check payable to Amarillo College. Amarillo College now accepts Master Card, Visa and American Express. Upon satisfactory completion of a course, Amarillo College will present a certificate of completion awarding Continuing Education Units (CEU's). REGISTRATION WILL BEGIN NOVEMBER 30, 1987.

FOR ADDITIONAL INFORMATION CALL (806) 371-5200

-----ENROLLMENT COUPON-----

No acknowledgement of mailed fees will be made. Receipts will be issued at the first class meeting.

COURSE TITLE & NO. IRRIGATION SYSTEMS: DESIGN AND INSTALLATION ID 2408 #1124-299

NAME \_\_\_\_\_

SS # \_\_\_\_\_

(Last)

(First)

(Middle)

ADDRESS \_\_\_\_\_

(Street)

(City)

(State) (Zip)

HOME PHONE \_\_\_\_\_

BUSINESS PHONE \_\_\_\_\_

**PLEASE CIRCLE ONE:** Requested by the U.S. Department of H.E.W.

Caucasian

American Indian

Negro

Spanish Surnamed American

Asian

Other

Master Card  Visa  American Express  Card Number \_\_\_\_\_

Authorized Signature \_\_\_\_\_ Expiration Date \_\_\_\_\_



AMARILLO COLLEGE  
CONTINUING EDUCATION PROGRAMS  
ADULT VOCATIONAL EDUCATION

COURSE OUTLINE

COURSE TITLE: Irrigation Systems, Design and Installation - #1124

COURSE LENGTH: 60 Clock Hours

COURSE OBJECTIVES: To prepare individuals for careers in commercial and residential irrigation. Persons successfully completing the course will be prepared to sit for the state licensure examination given by the State Board of Irrigators. Career opportunities include the sale, installation, repair, and design of sprinkler and irrigation systems.

TARGET POPULATION: Persons with some practical experience in the irrigation industry who require a comprehensive study of the applicable codes, laws, regulations, terminology, components, installation methods, design principles, hydraulics, control systems, and related information necessary for licensure and successful practice.

MAJOR TOPICS	NO. OF HOURS
I. Introduction - Irrigation History	5
A. T.B.I. Act	
B. Laws, ethics, and practice	
C. Evolution of products	
D. Terms and definitions	
II. Water Supply Sources	5
A. Meters, backflow prevention	
B. Cross connection control	
C. Static and working pressures	
D. Pumps, wells, water filtering, storage	
III. Valves	5
A. Types, applications, use, considerations	
B. Controllers, electrical wiring	
C. Terms and definitions	
IV. Hydraulics	5
A. Nature of liquids	
B. Design basics	
C. Pipe and hose. VC, ABS, PE, copper, steel. Sizes, grades, schedules, strength.	
D. Solvent welding and soldering	

COURSE OUTLINE - Irrigation Systems, Design and Installation - #1124  
Page 2

V.	Sprinkler Equipment	5
	A. Types, performance, head layout, and related considerations	
	B. Hydraulics, head positioning and pattern of distribution, design pressure	
	C. Flow, pressure velocity	
VI.	System Performance Criteria	5
	A. Effects of wind, plant requirements, soil characteristics, precipitation, and percolation rates	
	B. Drip and micro irrigation introduction	
	C. Application rates, conservation by irrigation design	
VII.	Codes, Ordinances, and Regulations	5
	A. Content, application, enforcement	
	B. Landscape design, beautification, variations in planting	
	C. Methods of irrigation and zoning	
VIII.	Comprehensive Design	10
	A. Drafting practice, symbols, templates, conventional layout and design	
	B. Calculations of pressure, flow, size	
	C. Use of tables, distribution profiles, special layout methods	
IX.	Laboratory - Field Experiences	15
	A. Trenching, vibra-plowing, hand installation of backflow prevention devices, manifold boxes, supply and field lines, heads, valves, drains	
	B. Measuring, cutting, solvent welding, soldering, pipe and hose	
	C. Selection, installation, programming automatic controllers	
	D. Seasonal maintenance and adjustments of automatic sprinkler systems	
	TOTAL	60

AMARILLO COLLEGE  
CONTINUING EDUCATION  
ADULT VOCATIONAL COURSE

COURSE OUTLINE

COURSE TITLE: Irrigation Installer Aide

COURSE LENGTH: 128 clock hours

OCCUPATIONAL TRAINING OUTCOMES: Upon successful completion of the course, students will be able to prepare basic site drawings, read irrigation blueprints, understand and conform to manufacturers specifications, local codes, properly trench, ditch and backfill excavations, identify, install and adjust system components, use appropriate hand and power tools, safely and efficiently operate equipment used in the irrigation industry.

Course completers will be prepared to sit for the Licensed Irrigation Installers examination mandated by the state of Texas and administered by the Texas Board of Irrigators. LICENSED IRRIGATORS ACT Article 8751, V.T.C.S, as Amended by S.B. 249. SECTION 1., (7), (a) "a person who assists in the installation, maintenance, alteration, repair, or service of an irrigation system under the direct supervision of a licensed irrigator.."

TARGET POPULATION: Individuals with interest in employment in some phase of the irrigation industry who require a comprehensive knowledge of applicable codes, laws, regulations, terminology, backflow prevention, trenching, ditching and excavation, pipe, hose, heads, nozzles, fittings and related components to be gainfully employed. Includes displaced workers, hard to serve youth.

MAJOR TOPICS:	NO. OF HOURS
I. Introduction	4
A. T.B.I. Act	
B. Codes, Regulations	
C. Evolution of products	
D. Terms and definitions	
II. Water Supply Sources	6
A. Public reservoirs, lakes, wells	
B. Meters, pumps, filtering and storage	
C. Cross connection control	
D. Backflow prevention devices	
E. Static and working pressures	
III. Basic Properties of Liquids	4
A. Force, pressure, velocity	

IV. Site Inspection, Measurement and Recording	6
A. Proper measuring and recording of boundaries, structures, utilities locations	
B. Location and flow determination of water supply	
C. Preparation of working sketch of property	
D. Blueprint reading	
E. Planning for excavation, trenching	
V. Excavation Procedures	4
A. Hand	
B. Equipment assisted	
C. Backfill	
VI. Component Assembly	8
A. Pipe, hose and fittings metallic and synthetic	
1. Characteristics	
2. Welding, soldering, compression connection	
B. Valves, Pressure Regulators and controllers	
C. Heads and nozzles	
E. Micro and drip	
VII. Installation Techniques	16
A. Containment Boxes	
B. Backflow Prevention Devices	
C. Main Line	
D. Manual and Automatic Section Valves, Manifolds	
E. Section Lines, fittings, drains	
F. Control wiring	
G. Trench backfill	
VIII. Related Study	16
A. Laws, Acts, Codes, Local and state regulations affecting job performance	
B. Expectations for professional practice Working with other tradesmen/crafts	
C. Applied mathematics, hydraulics, sanitation	
D. Necessity for backflow prevention devices to protect the public water supply	
E. Water management and conservation methods	
F. Terminology, identification and use of components, tools	
G. Basic drawing - Recording of measurements and information	
H. Basics of machine operation, maintenance	
I. Job Seeking and Retaining skills	

IX. Laboratory and Field Experiences	64
A. Trenching, vibra-plowing, hand installation of backflow prevention devices, manifold boxes, supply and field lines, heads, valves, drains	
B. Measuring, cutting, solvent welding, soldering, pipe and h...	
C. Selection, installation, programming automatic controllers	
D. Seasonal maintenance and adjustments of automatic sprinkler systems	
TOTAL	<u>128</u>

STUDENT EVALUATION: Successful progress and evidence of satisfactory completion will be based on the following:

1. Written examinations (4) on which a score of 70 or better will be required.
2. Oral examinations as appropriate to cover concepts and performance not appropriate for written examination.
3. Competency attainment in manipulative activities judged at an acceptable job entry level by a T.B.I. Licensed Irrigator.

---

Upon successful completion to the program, the Installers Aide will receive a certificate containing an itemized and detailed record of significant competencies attained. This certificate will be signed by a Licensed Texas Irrigator who will attest to the achievement of the entry level competencies listed thereon.

---

## "PASSPORT" OF SKILLS ATTAINED

IRRIGATION INSTALLER COMPETENCIES    S - Satisfactory    W - With Supervision    N - Needs Improvement

	S	W	N		S	W	N
<b>I. CUSTOMER RELATIONS</b>				<b>VI. PARTS IDENTIFICATION</b>			
A. Businesslike Attitude	( )	( )	( )	A. Assembly	( )	( )	( )
B. Businesslike Appearance	( )	( )	( )	B. Take-Off	( )	( )	( )
C. Businesslike Communication	( )	( )	( )	<b>VII. TUBULAR GOODS</b>			
<b>II. WORK FROM PLANS</b>				PVC, PE, Copper			
A. Measured and Flagged	( )	( )	( )	A. Solvent Welding	( )	( )	( )
B. As-Built	( )	( )	( )	B. Soldering	( )	( )	( )
C. Code and Permit Requirements	( )	( )	( )	C. Compression Fitting	( )	( )	( )
<b>III. EQUIPMENT PREPARATION, OPERATION AND REPAIR</b>				<b>VIII. SET HEADS, NOZZLES, TEST SYSTEM</b>			
A. Excavation and Trenching	( )	( )	( )	A. Low Voltage Wiring	( )	( )	( )
<b>IV. WATER TIE-IN</b>				B. Controllers	( )	( )	( )
A. Tap Connection	( )	( )	( )	C. Check Setting	( )	( )	( )
B. Backflow Preventer	( )	( )	( )	<b>IX. TRENCH BACKFILL</b>	( )	( )	( )
C. Box burial	( )	( )	( )	<b>X. LOCATION CLEANUP</b>	( )	( )	( )
D. Backfill Excavation	( )	( )	( )	<b>XI. FINAL CUSTOMER RELATIONS</b>	( )	( )	( )
E. Inspection by Code Office	( )	( )	( )	<b>XII. PAPERWORK</b>	( )	( )	( )
<b>V. LOW-TRAUMA INSTALLATION</b>				<b>XIII. SPECIFIC TROUBLESHOOTING AND REPAIR TECHNIQUES</b>	( )	( )	( )
A. Vibratory Plow	( )	( )	( )				
B. Hand Dug	( )	( )	( )				

Instructor \_\_\_\_\_  
Date of Review \_\_\_\_\_